

**EATON Emergency Lighting**

Self-contained emergency lighting global catalogue - Ed.3



# Emergency Lighting Self-contained luminaires

**EATON**

*Powering Business Worldwide*



A long history of expertise in the life safety industry with a commitment to deliver market-leading solutions that protect people and property.

Heritage of innovation.

CEAG  
Cooper  
Menvier  
JSB  
Luminox  
Crompton  
Blessing  
Univel



Emergency lighting design guide	0
Safety luminaires - Indoor	1
Safety luminaires - High degree of protection	2
Safety & exit signs - Indoor	3
Safety & exit signs - High degree of protection	4
Exit signs - Indoor	5
Exit signs - High degree of protection	6
Beam lights	7
Portable lamps & converters	8
Customization	9
Monitoring systems	10
Increased Affordance	11
Adaptive Evacuation	12

# When it comes to protecting life and property, there's no room to compromise.

In a constantly changing world, owners and operators of commercial and industrial buildings must keep up-to-date with the changing nature of risk. Safe evacuation is becoming more challenging due to a number of external influences.

## What are the risks businesses face today ?

### The ongoing risk of fire

Over a third of businesses never resume operations after a major fire - losing orders, contracts, and key employees. This results in lost jobs and services to the community.

### Non-traditional threats

Power outages, terrorism and domestic extremism are a rising cause for evacuation. These risks demand a different approach when planning for safe evacuation. High-profile terrorist attacks can shape regulation.

## Each emergency lighting system is important, it protects life and health.

- Escape route marking during regular power supply: Evacuation of a building due to an accident, a bomb threat etc.
- During blackout: Light supply
  - Showing the directions out of the building
  - Illumination of the escape route to guarantee a safe evacuation



## Our products meet your challenges

### Innovation, tests and compliance for more reliability

- We constantly innovate for contemporary design and technologies
- Customers light engineering requirements are fully tested at an in-house lighting laboratory. We also expose newly developed products to extreme conditions and life cycle testing
- As a commitment to deliver high quality for all products and employees, Eaton's emergency lighting manufacturing facilities are certified ISO 9001
- Most of our products and complete systems are 3rd party certified

### Different technologies to meet the requirements of your building and activity

- "Unmonitored" luminaires: only the battery charge circuit is tested, manual tests and inspection book management
- Luminaire Automatic Test (AT): battery and light source circuit is continuously monitored and the status is displayed via LED. Specified tests (Weekly function test, annual duration test) are automatically started.
- Addressable luminaires: luminaires monitored and automatic tests, central display of system status, automatic inspection book management with digital memory, web access and visualisation possible.

### Eco-friendly luminaires all along their life cycle

Our manufacturing plants are ISO14001 & ISO 9001 certified. We are committed to favour the choice of recycled materials and reduce weight and volume of products and packaging. Our LED luminaires are low consumption, prevent from relamping operations as their life time goes up to 60.000 hours.

### A large portfolio for a wide range of applications

- Exit sign, escape route, anti-panic luminaires
- Indoor or with high degree of protection
- Aesthetic solutions
- High output luminaires and beam light projectors for large premises



# Look to the future, trust our past

The projects listed below are only a selection of the locations and applications where EATON emergency lighting solutions are installed.



## Hospitality & leisure

- New Modern Art Museum, Italy
- Ritz-Carlton Hotel, Germany
- Marriot Opera Ambassador, France
- Ramada Resort Hotel, Hungary
- Atlantis the Palm Hotel, Dubai



## Schools and universities

- Technical University Berlin, Germany
- University Hamburg, Germany
- Normale University, Italy
- University Zurich, Switzerland
- University of Dubai, U.A.E.



## Airports

- Frankfurt, Germany
- Athens, Greece
- Schiphol, Netherlands
- Bangkok, Thailand
- Dubai, United Arab Emirates



## Sport venues

- Emirates Stadium, UK
- Stadium Borussia-Park, Germany
- Stade des Lumières Lyon, France
- Karaiskakis Stadium, Greece
- National Aquatics Center, China



## High-rise buildings

- Tower 115, Slovakia
- Etisalat Tower, U.A.E.
- Capital Gate Tower, U.A.E.
- Burj Khalifa Tower, U.A.E.
- Burj Al Arab, U.A.E.



## Commercial centres / retail

- Centro, Germany
- Carrefour Supermakets, Belgium
- Arena Plaza Budapest, Hungary
- Montedoro Freetime, Italy
- Mazaya Centre, U.A.E.



## Industry

- Microsoft, Italy
- EADS Airbus, Germany & France
- Bayer, Germany
- BP, Norway
- Dubai Cable Company, Abu Dhabi



## Assembly halls / rooms

- German Bundestag, Germany
- National Theatre Budapest, Hungary
- National Library Leipzig, Germany
- Town Hall Sydney, Australia
- National Convention Center, Qatar



# Eaton answers any specific application requirements



This catalogue shows the core range of Eaton Emergency Lighting (Self-contained) portfolio which covers a wide range of applications.

Besides this portfolio, Eaton works very closely with its customers in order to develop and manufacture products which meet Industries' very specific requirements.

For example, Eaton provides luminaires with minimal glare effect for train conductor specifically developed for tunnel applications, ATEX (explosion proof) products for harsh environments.

Several Eaton luminaire's specifications also meet food industry specific health and safety requirements (HACCP or IFS), like iP-65+, Atlantic LED or 46811 LED CGLine+.



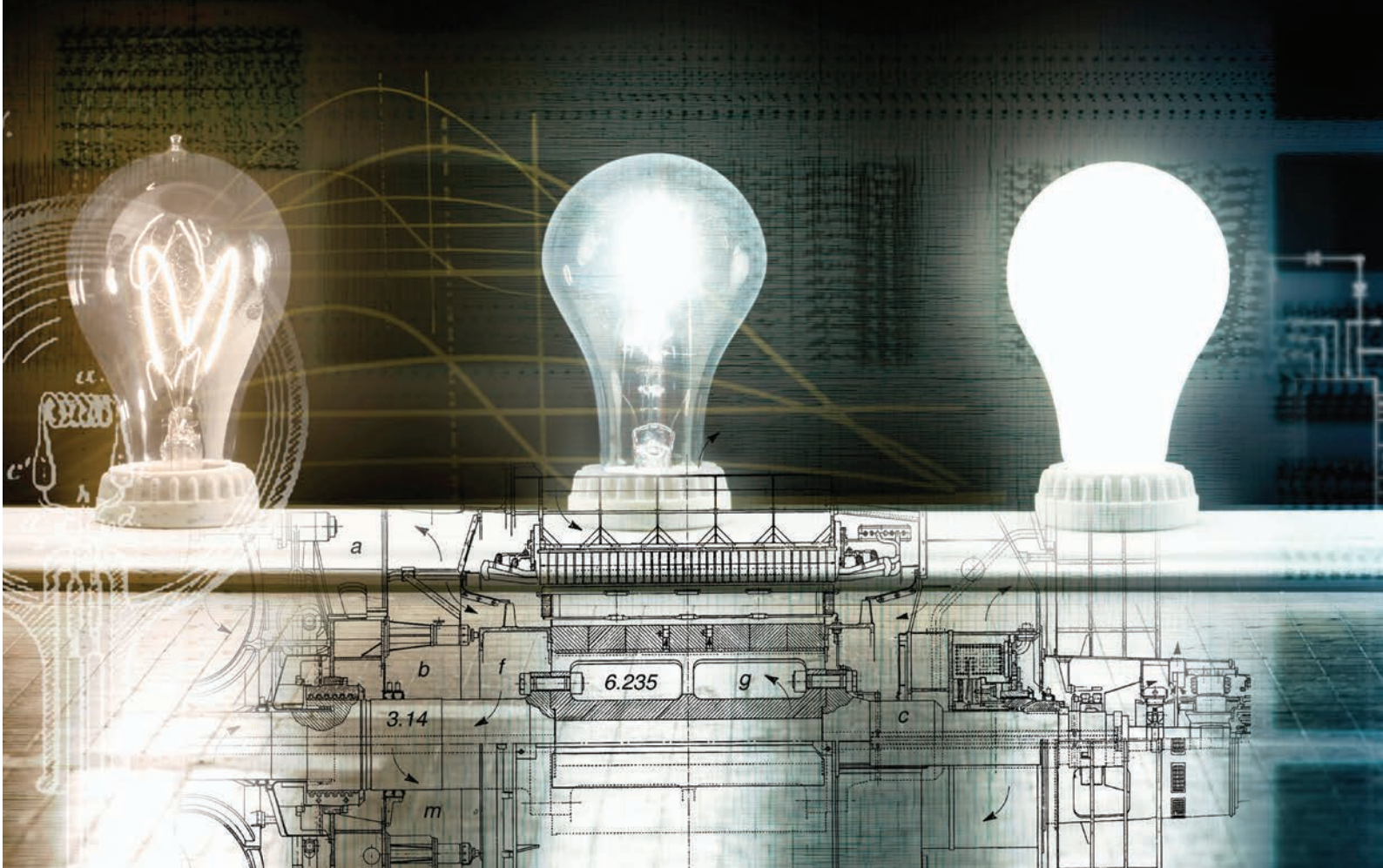

## From Static to Adaptive Evacuation, Eaton innovates to light the way to safety

### Static Emergency Lighting

Eaton's quality above standards

### Increased Affordance (IA)

For better visibility of escape routes  
Learn more about IA on pages 8

### Adaptive Evacuation (AE)

To show the safest way to exit  
Learn more about AE on pages 10

Innovation is key at Eaton. We own more than **30 patents** linked to emergency lighting.

- 2000: First to market with LED Emergency Lighting luminaires
- 2001: First addressable central power system
- 2003: First eco-friendly range of luminaires
- 2005: First monitoring panel for self-contained luminaires with web server integrated
- 2012: First graphic webserver
- 2015: Launch of CrystalWay luminaires, the new aesthetic reference
- 2017: Increased Affordance capability for better visibility of escape routes
- 2018: Adaptive Evacuation systems for safer evacuation





# Increased Affordance

Eaton innovates for better recognition of escape routes

0

## Better recognition of escape routes

The evacuation of commercial buildings can be inhibited by people's failure to recognise standard emergency exit signs.

Research has shown that only 38% of people see conventional exit signs during an evacuation from an unfamiliar environment. Much of this is down to the proliferation of branding, advertising and informational signage in buildings such as shopping centers and airports which can distract attention away from exit signs.

Eaton has developed a new system to increase the visibility of exit signs, whereby the emergency luminaire that illuminates the sign can flash on and off or pulse more softly.



Bearing in mind the two-sense principle for emergency notification, the challenge of recognising exit signs is exacerbated for people with hearing disabilities who may not hear any accompanying vocal instructions or alarms. In their normal mode, the luminaires offer excellent visibility thanks to a high level of luminance that exceeds the minimum requirement in most countries.

When activated, Increased Affordance enables even better recognition by flashing or pulsing but never dipping below the minimum level of luminance that is established in industry standards, thus achieving full compliance.



### CrystalWay IA

The CrystalWay design combines LED Lightguide technology with a highly transparent frame. Also thanks to optimal illumination, this achieves excellent recognition of the escape sign and a concise, discreet appearance. The standard scope of supply for CrystalWay already contains all accessories for mounting to walls or ceilings and a pictogram set.



### NexiTech IA

NexiTech LED™ was created with the aim of simplifying the work of the installer. No tools are needed to open or close the product and installation is further simplified by the presence of a quick plug-in screwless terminal block.



### FlexiTech ED

FlexiTech ED is a double-sided exit sign that can be mounted on either the wall or the ceiling. The edge panel is equipped with a LED strip and lightguide for a perfect and homogenized illumination of the exit legends. The new Increased Affordance functionality is available on CGLine+ variants.





## How to improve the recognition of escape routes for faster evacuation ?

### Traditional evacuation

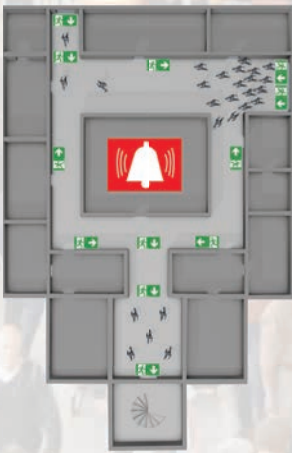

- Occupants may go to the exit they came in
- Crowding and congestion may slow evacuation
- Occupants may spend time trying to locate an exit
- Evacuation takes longer

### Increased Affordance



- Provides a catalyst for less congested exit routes
- Aids people with hearing difficulties
- Ensures that users understand the importance of the emergency
- Compliant with emergency lighting standards

## How does it work ?



In mains operation, **uniform illumination** of the pictogram facilitates the identification of emergency exits.



An evacuation order (fire, danger or climatic risk) triggers the **Increased Affordance** function which enables better recognition of the escape route through blinking or pulsing.

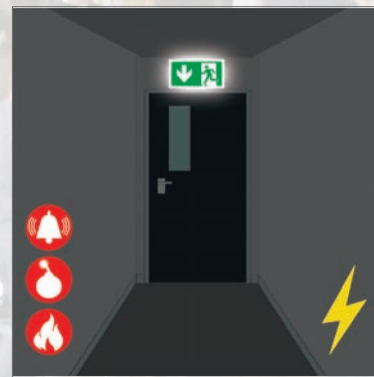

In case of power failure, the pictogram is perfectly legible **without risk of glare** for users.

*For more information, refer to page 174*



# Adaptive Evacuation

Eaton innovates for safer evacuation

## Improving escape route guidance

An increasingly urbanised and complex environment, combined with a rising diversity of safety threats, means the owners and managers of buildings need to re-evaluate the way they protect people and property as well as ensure business continuity that may be at risk in an emergency.

Building evacuation can prove increasingly challenging when a proportion of visitors are not familiar with layout and procedures, and particularly if they are in large, highly-populated, high-risk or complex premises such as railway stations, shopping centres, airports, stadia, government buildings or leisure facilities.

Research into crowd behaviour and advances in scenario-modelling technology have highlighted the need for evacuation strategies that are more adaptable to differing circumstances.

Building upon decades of expertise in the delivery of life safety systems, Eaton has developed a highly innovative Adaptive Evacuation System.

Adaptive signage enables building owners to direct people out of the building in the safest way as and when the nature of the threat changes. The danger posed by fires, acts of terrorism and natural disasters will change as the event unfolds; Eaton's Adaptive Evacuation signage allows building occupants to be redirected to the safest exit route available should such an event occur.

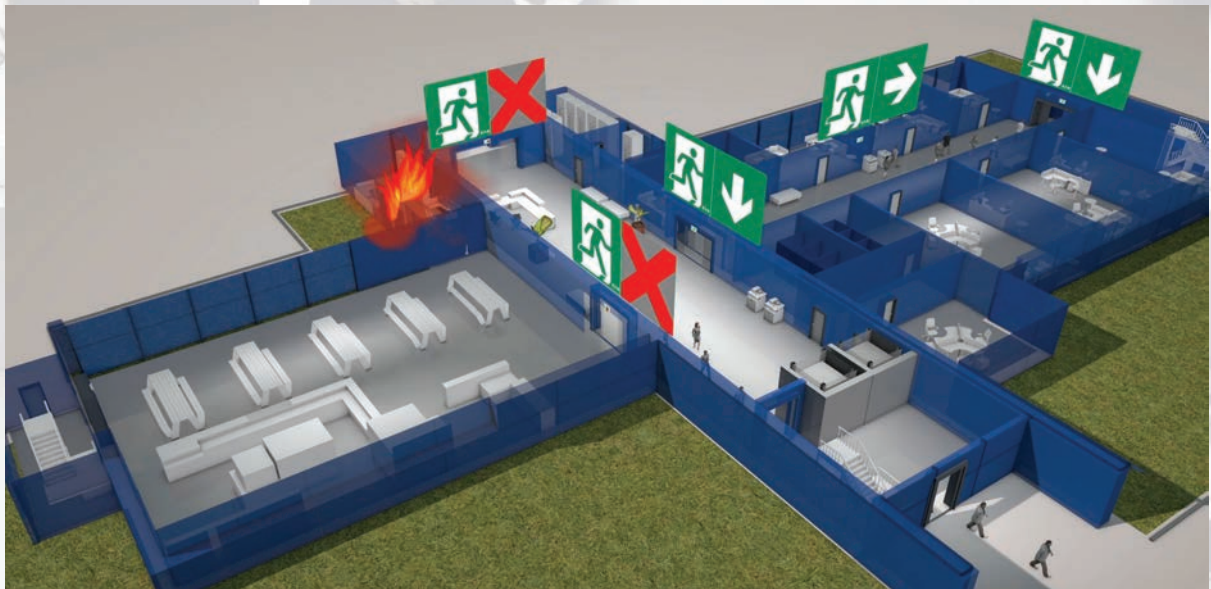

For more information, refer to page 180



## Meet the innovative self-contained Matrix CGLine+ luminaire



Matrix CGLine+ can adjust the direction of the arrow it displays, with the aim of improving the speed and safety of emergency evacuations in commercial buildings.

The self-contained Matrix escape sign luminaire displays an arrow that can point in any one of four different directions. The additional ability to scroll the arrow from one side to the other increases its visual impact among the general population and helps to alert people with hearing impairments. It can also display a red cross to indicate that a particular exit route has become closed, blocked or dangerous. Making it a powerful tool when containment measures are the safest option. In such an emergency, it will not only lead occupants to but also keep them in a safe place.

### How is the Matrix CGLine+ luminaire activated to adapt to the safest escape route?

In normal mode, the Matrix exit sign works exactly as a standard exit sign luminaire would, with all the necessary regulatory compliance.

In adaptive mode, they are able to indicate one of a number of different directions, based on a series of pre-programmed scenarios. This functionality can be activated manually from a central control room, based on CCTV footage, for example, or can be triggered automatically by specific local devices such as smoke alarms or panic buttons.

### How is the self-contained adaptive-enabled CGLine+ system installed and maintained?

Ease of installation is always a key consideration during the design process and Eaton's self contained Adaptive Evacuation System is no exception. The adaptive-enabled CGLine+ is installed in the same way as its predecessor, but with additional inputs and back-up power supply. Operation of the system is reliant upon sophisticated cause-and-effect programming which should only be carried out by an appropriately trained specialist.

Ongoing maintenance of the system is aided by an automatic testing function, which runs continuous checks and issues alerts when any fault is identified. This enables remedial work to commence immediately and overcomes the time, cost and inconvenience associated with carrying out manual checks on a regular basis.

## Flexible and easy Emergency Lighting New FlexiTech range

### FlexiTech makes emergency lighting unmissable

In an emergency, exit signage and safety lighting is vital to guide a building's occupants to safety.

Yet a project may have different requirements for signage and safety lighting. It will need both wall and ceiling mounted options with different lighting levels and exit legends to suit various applications.

Whatever the project, FlexiTech can offer multiple options. FlexiTech SE is all you need for safety lighting. FlexiTech ED meets your exit signage requirements, all from one box.

CGLine+ variants brings you even more peace of mind, making monitoring and visualisation of the system easier and evacuation safer thanks to new Increased Affordance functionality.







FlexiTech ED  
(see more page 88)



FlexiTech SE  
(see more page 44)

FlexiTech facilitates your day to day jobs and projects thanks to an easy to manage and consistent range

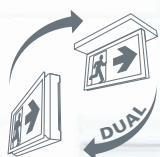

**Exit sign - FlexiTech ED**  
(Exit Sign **D**ual position)

FlexiTech ED is a double-sided exit sign (IP43) that can be mounted on either the wall or the ceiling. The edge panel is equipped with a LED strip and lightguide for a perfect and homogenized illumination of the exit legends. Slide the edge panel on the electronic casing and connect the LED strip to configure the luminaire in the ceiling position. The new Increased Affordance functionality is available on CGLine+ variants.

**Safety lighting - FlexiTech SE**  
(Safety light for **E**scape route illumination)

The safety light, FlexiTech SE (IP43 and IP65), is optimized for escape route illumination offering efficient spacing between luminaires and adapts to most applications. For other use, the optical lens could be easily replaced by optional one providing a different light distribution.



## FlexiTech ED - Exit Sign



- Multiple configurations in one box
- DUAL : Wall or ceiling mounted
- Homogenized illumination
- High luminance of white contrast colour >500 Cd/m<sup>2</sup>
- Increased Affordance for safer evacuation
- Selectable level of light in mains mode



## FlexiTech SE - Safety light for Escape route illumination

- Up to 600 lm in emergency mode
- Efficient lighting performance
- Distribution optimized for escape route illumination
- Optional lens to provide different light distribution
- Selectable level of light in mains mode



## Easy to install

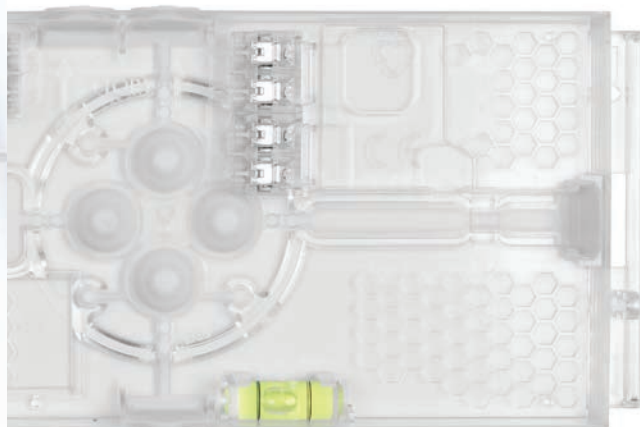

### Set...

- Slotted holes for quick fixing and easy adjustment
- Transparent baseplate
- Large working space
- Spirit level for perfect alignment

### Wire...

- 9 cables entries in rubber
- Screwless terminal blocks
- Possibility of direct mounting on electrical boxes

### Configure...

- Mounting position
- Direction of the arrow



## Technologies and features that make FlexiTech a friend for life



**AT**

### Automatic Test

- Reduced efforts for inspection
- Result of test is displayed on LED visible in all mounting positions

**CG+**  
Line

### Monitoring for projects and long use

- Automatic Tests and individual monitoring
- Compatible with CGLine+ systems



- 0 replacement of spare parts for 10 years

## Eco-design preserving your product and the environment



- Reduced impact on the environment throughout its life cycle (manufacture, use, recycling)
- Conform to REACH and ROHS
- Batteries without Cadmium
- Latest generation of high performance LEDs

- Low consumption
- Brightness in mains mode could be also adjusted (30, 70, 100%)
- Luminaires could be used in Maintained & Non-Maintained mode

## Go further with additional integration



### Recess Kit for Ceiling

- One kit compatible with FlexiTech SE and ED
- Low profile for full recessed ability
- Cutting template included for quick implementation

### Customization

- Frames and accessories in a variety of colours
- Custom designed pictograms



For more information, refer to page 44, 88 and 142









0.1	How to read ? .....	18
0.2	8 steps to compliance .....	20
0.3	Emergency lighting design guide .....	22

# 0.1 Emergency lighting design guide

How to read ?

## Emergency lighting design guide

The opening pages of this catalogue have been developed to share our expertise regarding the main standards, regulations, and technologies related to emergency lighting. They will support you in choosing the most appropriate solutions to meet your project requirements.

8 steps to Compliance

8 steps to Com

1. Carry out a risk assessment

Light levels to ensure compliance with emergency lighting regulations

Emergency lighting can be a lifeline for people trying to find their way out of a building in an emergency. This is particularly important in the event of a fire. It is therefore essential to ensure that emergency lighting is fit for purpose. European standards and regulations set the minimum requirements for emergency lighting. To ensure the quality, reliability and conformity of your installation we recommend that all emergency lighting units be covered by a third party certification. So how can you use your emergency lighting to comply?

2. Look for third party certification

The most reliable way to ensure your emergency lighting is fit for purpose is to ensure it is covered by a third party certification scheme such as ENEC approved testing laboratories.

ENEC is the high quality European mark for product protection that demonstrates compliance with European standards (EN). The ENEC approval marking guarantees the representation of an independent European committee on the design and manufacture of emergency luminaires under regulation including EN1838:2011 and EN1838:2011:2012.

ENEC approved luminaires are installed, maintained and used according to the manufacturer's instructions, installation conditions and good engineering practice (such as correct location, spacing, etc.), the emergency lighting system will meet the intention of emergency lighting (to be the safety of people).

However, the way used enhancement of specific risks are identified during the assessment. Under normal conditions, the installation would not be considered sufficiently safe to prevent users of the building without the facilities of any legal action relating to non-compliance with regulations.

3. Positioning, location, location

The positioning of emergency lighting is crucial. Some of the key factors when emergency luminaires should be located are along escape routes in every change of direction, adjacent to any step or trip hazard, every flight of stairs as that which will receive direct light, close to firefighting equipment, call points and fire alarm control panels, every exit door to a safety of any area.

Please refer to your local regulations to check the recommended locations for emergency lighting products at the right location.

4. Consider the long term costs

As emergency lighting is a safety product, emergency lighting may initially seem more costly, but consider the longer term costs. For example, good quality products may have a higher output and better performance meaning fewer units are needed to achieve the required level of illuminance, which may not only reduce the initial purchase cost but also the installation cost. LED based emergency luminaires, low consumption, long life components, automatic testing and monitoring devices (CGLine) significantly reduce the operating and maintenance costs of the installation. LED based emergency luminaires have a working life span of up to 100,000 hours, which is up to 10 times longer than conventional fluorescent lamps and 3 to 5 times longer energy consuming.

5. Emergency lighting shall be chosen in accordance with the applicable national conditions to ensure a safe way. Extra design emergency lighting with waterproof, high bay, inductive, and other other solutions.

6. Emergency lighting shall be chosen in accordance with the applicable national conditions to ensure a safe way. Extra design emergency lighting with waterproof, high bay, inductive, and other other solutions.

7. Think about maintenance and servicing

A Murray online testing checklist are one of the most important conditions to ensure a safe way. Extra design emergency lighting with waterproof, high bay, inductive, and other other solutions.

Another tip is to consider self-testing systems, which reduce the expense. Some products and structures equipped with manual testing devices (CGLine) also have an automatic test system (CGLine) - results from a built-in network are collected and fed back to a control panel where the exact location of the fault can be pinpointed. The system will also identify the cause of the fault which helps to repair or replace, as the necessary spare part can be ordered and taken to the location to speed up the repair process.

8. Don't forget the sign

When selecting a product, be aware that the visible distance for a luminaire, luminaire and sign will be affected by the height of the illuminated element's size. The illuminator will remain the same for manufacturers. For severely illuminated signs, the factor is only 100, but must be at least 1.5 m for sign-in emergency luminaires.

Additionally, EN1838 covers the other emergency conditions the sign shall be sufficiently illuminated clearly visible. The visible clear must remain given specified in EN1838:2011.

9. Think about maintenance and servicing

A Murray online testing checklist are one of the most important conditions to ensure a safe way. Extra design emergency lighting with waterproof, high bay, inductive, and other other solutions.

10. Think about maintenance and servicing

A Murray online testing checklist are one of the most important conditions to ensure a safe way. Extra design emergency lighting with waterproof, high bay, inductive, and other other solutions.

11. Think about maintenance and servicing

A Murray online testing checklist are one of the most important conditions to ensure a safe way. Extra design emergency lighting with waterproof, high bay, inductive, and other other solutions.

## Selection guides

These double pages introducing some catalogue sections provide a quick overview of our product portfolio and enable simple product selection. You can base your choice on multiple criteria, including technology type, product features or applications.

	Page	Performance	Aesthetics	Global Features	Operation	Technology	Battery	Installation	Applications	Best use
crystalWay	82	★★★★	One box solution* Non-maintenance parts for 10 years Low consumption / Economy Protection Degree Viewing distance	42	20	Li-Ion	•	•	•	Aesthetic range for easy integration in differently sized environments. Accessories and pictograms included for a wall & ceiling surface mounting.
sideLed	84	★★★★		20	20	Li-Ion	•	•	•	Versatile mounting options enable the use in many applications and the design can be the same in the whole building.
lexiTech ED	88	★★★★		43	20	LiFePO4	•	•	•	
1811/1822LED	90	★★		41	32	Li-Ion	•	•	•	Robust solution made from extruded and anodised aluminium for public areas.
plus	92	★★		20	30	Ni-Cd	•	•	•	
tile 8011/28021	96	★★		41	32	Li-Ion	•	•	•	
xit cube	98	★★		40	20	Li-Ion	•	•	•	3-sided exit signage for large areas like warehouses or supermarkets.
uro X LED	100	★★		54	20	Li-Ion	•	•	•	

## Product pages

For better readability and understanding, our product pages are all built using the same model, making it easy to find the information you are looking for (dimensional drawings, order codes, etc.). If you require any further technical information, feel free to contact us.

**Product category (function)**

**Product name** 3.1 Safety & exit signs - Indoor NextTech LED

**Main features**  
See next page for product features icons definition

**Product picture**

**Technical specifications**  
(Light source, material, installation, operation mode, etc.)

**Dimensional drawings**



**Light Source:** LED strip

**Material:** Base and reflector white polycarbonate  
Diffuser clear polycarbonate  
Protection degree IP40 and IP65 with the accessory kit  
Ni-Cd battery

**Installation options:** Wall and ceiling mounting  
Surface or recessed installation in false ceiling and bricks wall  
Single side glueless ISO7019 programs with 20m viewing distance  
Double side ISO7010 panels with 20 or 30m of viewing distance

**Operation:** Maintained and Non-Maintained mode on all versions  
Fixed 60lm output in Maintained mode for all variants for high energy saving  
1h, 1.5h and 2h duration  
Rest Mode and Tests via remote command  
12h recharge period (24h for 3h versions)

**Applications:** Schools, universities, commercial, malls, stores, offices, public administration and all indoor generic environments  
Safety antiscaling lighting and escape route lighting

**Top level signification**  
The pictograms, optional and available upon request, conform to the international standard ISO7010, have no glue and can be repositioned at will and with ease, without a complex installation. They are placed between the diffuser and reflector creating a translucency which finds its maximum aesthetic applications when recessed into the wall.

**Lighting data** (distribution curves, lighting tables) may also be displayed. Please consult page 20 (EL Lighting guide) for more information.

**Accessories & other installation options**

**Order code table**





In order to help you to find solutions you need, we created a set of icons presented on each product page of this catalogue. This way, you will be able to identify the main characteristics of the product in one quick look.

This catalogue doesn't show the exhaustive list of emergency lighting self-contained luminaires developed by Eaton but a selection of them.

**Please note that most of our emergency lighting luminaires are also available for central power systems.**

Please, contact us for further information.

## Definitions of key feature icons

Icon	Definition	Icon	Definition	Icon	Definition
	Viewing distance, here: 20 m		CE certified		Customization available for better integration in the building <b>see page 134</b>
	Light output, here: single-sided		According to EN60598-2-22		0 replacement of spare parts for 10 years
	LED light source		According to EN 1838		With Lithium-ion battery
	Protection class 1		ENEC certified		Rest mode
	Protection class 2		Suitable for use in food processing industry e.g. acc. HACCP or IFS		Auto test
	Degree of protection, here: IP20		Suitable for outdoor use		CGLine+ technology
	Degree of mechanical impact resistance, here: IK10		Luminaire with limited surface temperature		Increased Affordance for better recognition of escape route <b>see page 174</b>

### Eight ways to ensure compliance with emergency lighting regulations

Emergency lighting can be a lifeline for people trying to find their way out of a building if main lighting fails. This is particularly important in the event of a fire, earthquake, flood, etc.

To ensure that emergency lighting is fit for purpose, European standards and local regulations bring all aspects of safety to save people. To ensure the quality, reliability and conformity of your installation we recommend that the emergency lighting used is covered by a third part certification. So how can you be sure your emergency lighting is compliant?



#### 1. Carry out a risk assessment

If you have employees, workers or any public visitors in your building you may be required by law, under the European and local regulations, to carry out a safety risk assessment (including information on those persons with disabilities) and keep a written record of the assessment. This legislation exists to ensure that the correct emergency lighting for the safety of people is installed to cover any identifiable risks and that it will correctly operate in the event of a failure of the main lighting supply. These regulations provide specifiers with information regarding areas that need emergency lighting such as: the minimum levels of illumination, duration, maximum brightness to prevent glare, and any points of emphasis which require particular consideration. Failure to comply with these stipulations not only puts lives at risk and raises the possibility of prosecution, but could also invalidate insurance policies.

#### 2. Know what you are buying

Given that emergency lighting will never be used on an everyday basis, it can be tempting to opt for cheaper luminaires. These are often supplied from distant sources and will pass through numerous intermediaries before installation. This can lead to confusion over the precise specifications and the claims made by manufacturers and sellers, which may not be independently verified. Buying cheaply may also turn out to be a false economy since lower-quality components can shorten the lifespan of batteries and lamps; they may also have inferior optics, resulting in an increased number of fittings being required to meet the minimum emergency lighting levels. As this is a life safety product you do need to consider whether a cheaper option might be more vulnerable to failure.

#### 3. Look for third-party certification

The most reliable way to ensure your emergency lighting is fit for purpose is to buy products approved by third-party certification schemes such as ENEC approved testing laboratories. ENEC is the high quality European mark for electrical products that demonstrates compliance with European standards (EN). The ENEC approved testing laboratory governs the implementation of strict European standards on the design and manufacture of emergency luminaires under regulations including EN60598-1 and EN60598-2-22. If ENEC approved luminaires are installed, maintained and used according to the manufacturer's instructions, installation standards and good engineering practice such as the correct location, spacing data, etc, the emergency lighting system will meet the minimum emergency lighting levels for the safety of people.

However, this may need enhancement if specific risks are identified during the risk assessment. Upon meeting these conditions, the installation would then be considered sufficiently safe to protect users of the building and reduce the likelihood of any legal action relating to non-compliance with regulations.

#### Consider the long-term costs

4. Buying high-quality and industry approved emergency lighting may initially seem more costly, but consider the bigger picture. For example, good quality products may have a higher output and better spacing performance meaning fewer units are needed to achieve the required level of illumination, which may not only reduce the outlay on products but also the installation cost.

LED based emergency luminaires, low consumption, long life components, automatic testing and monitoring devices (CGLine+) significantly reduce the operating and maintenance costs of the installation to optimise the total cost of ownership (TCO).

For example, LED-based emergency luminaires have a working life often greater than 50,000 hours, which is up to 10 times longer than a conventional fluorescent lamp and 3 to 8 times lower energy consuming.

Using 10 years life time batteries will also significantly reduce maintenance costs in the long term.

#### Low voltage directive

All emergency lighting shall be compliant with the low voltage directive (2014/35/EU) who is referring to product standard such as EN60598-1 and EN60598-2-22. For a better and global understanding of the signage, Pictogram is normalised by the ISO7010.

These regulations apply to all safety signs including those which provide directional signage for escape routes.

#### Other regulations

Please refer to your local regulation because some places like theatres, cinema, stadiums, nursing houses, schools, hospitals, car parks, etc may required specific equipment and installation rules.



### 5. Location, location, location

The positioning of emergency lighting is crucial. Some of the key locations where emergency luminaires should be installed are: along escape routes, at every change in direction, adjacent to any step or trip hazard, over every flight of stairs so that each tread receives direct light, close to firefighting equipment, call points and first aid points, outside every final exit to a place of safety or any other location identified by the risk assessment. Please refer to your local regulation to choose the recommended Eaton emergency lighting product at the right location.

### 6. Pay attention to the exit

Emergency lighting shall be chosen in accordance with the application and environmental conditions to ensure a safe exit way. Eaton designs emergency lighting with waterproof, high bay, industrial, and various other solutions.

### 7. Think about maintenance and servicing

Minimum routine testing schedules are one of the requirements of the regulations and standards. The time this takes can become a significant demand on facilities managers and maintenance teams. One way to avoid the ongoing costs associated with maintenance, servicing, repairs and replacements is to specify quality emergency luminaires in the first place.

Another tip is to consider self-testing systems, which reduce the expense, time demands and disruption associated with manual testing regimes upon individual luminaires. With automatic test systems like CGLine+, results from an entire network are collected and fed back to a central point where the exact location of the fault can be pinpointed. The system will also identify the cause of the fault which might be a failed lamp or module, so that the necessary spare part can be selected and taken to the location to speed up the repair process.

Using long life time LEDs & batteries will significantly reduce maintenance costs.

### 8. Don't ignore the signs

In addition to the emergency lighting, it's important to consider signage at the earliest stage. The obligation is to ensure that escape routes are clearly defined and identified with the correct exit signage.

When selecting a product, be aware that the viewing distance for an internally illuminated exit sign is calculated by multiplying the height of the illuminated element by a factor of 200. This information will normally be available from reputable manufacturers. For externally illuminated signs, the multiplication factor is only 100, but it must have at least 5 lux at any point of the sign in emergency conditions.

Additionally, EN1838 states that under emergency lighting conditions the sign shall be sufficiently illuminated so that it is clearly visible. The safety colour must remain green and the contrast colour must remain white within the colour boundaries specified in ISO3864-4.

Also, pictogram are normalized by ISO7010 with the arrow and the running man.



### Emergency lighting lifecycle costs

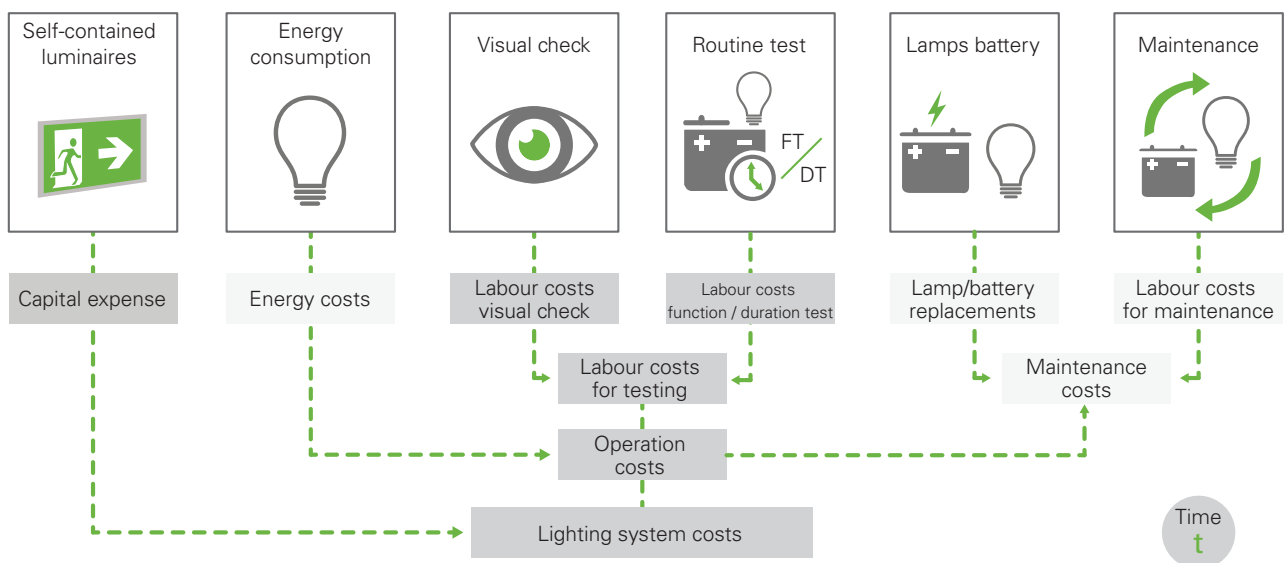

# 0.3 Emergency lighting design guide

0

## Locate luminaires at mandatory "Points of Emphasis"

Initial design is conducted by situating luminaires to reveal specific hazards and highlight safety equipment and signs, care should be taken to ensure the correct illumination level is achieved, in addition to providing illumination to assist safe travel along the escape route. This should be performed regardless of whether it is an emergency escape route or an open (anti-panic) area. Only when this is accomplished should the type of luminaire or its light output be considered. EN 1838: 2013 requires that the luminaires sited at points of emphasis must comply with EN 60598-2-22.

Specific locations where a luminaire must be provided are:



At each exit door



All safety exit signs



Outside the final exits and to a place of safety

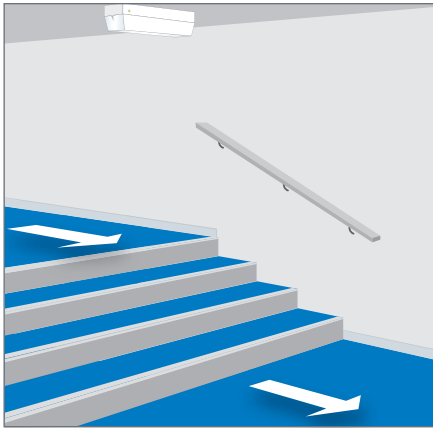

Near stairs so that each tread receives direct light



At each change of direction

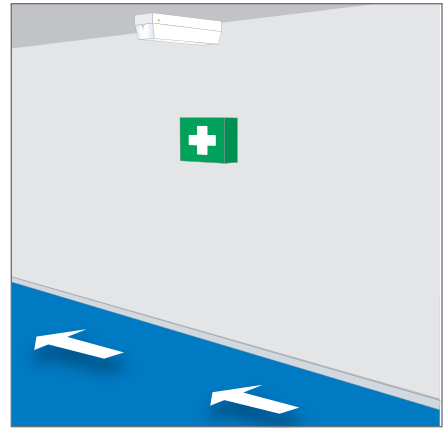

Near each first aid post

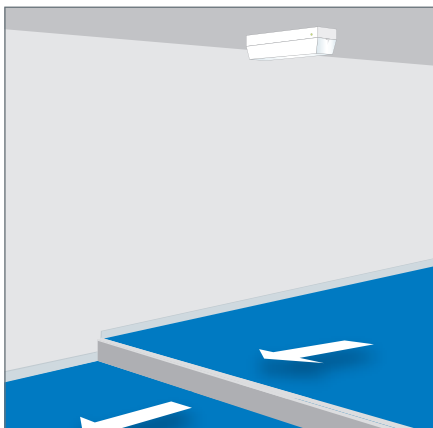

Near any other change of floor level

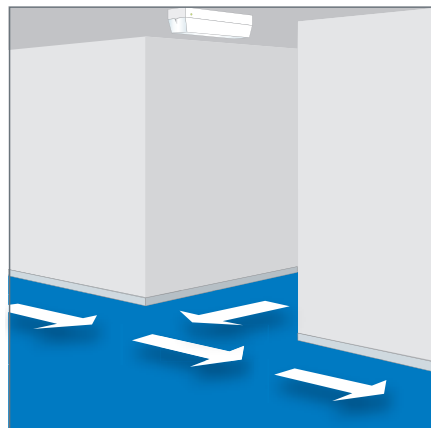

At each intersection of corridors

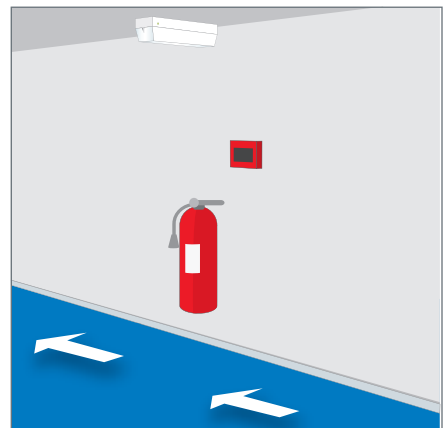

Near each piece of fire fighting equipment and call point



## Ensure the exit signs are of correct format and size

Section 4.1 of EN 1838: 2013 states that "Signs which are provided at all exits intended to be used in an emergency and along escape routes shall be illuminated to indicate unambiguously the route of escape to a point of safety". Where direct sight of an emergency exit is not possible, an illuminated directional sign (or series of signs) shall be provided to assist progression towards the emergency exit.

### Sign formats should not be mixed

#### Example of old-style signs now obsolete:

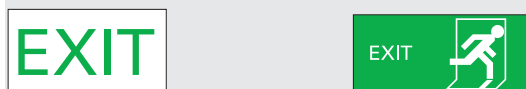

European signs directive format



#### ISO 7010

In 2011, it was decided by many of the National Standards bodies to consider adoption of a single pictogram format as detailed in ISO 7010.

### Illumination Requirements

The sign must conform to the colours of ISO 3864, which defines that exit and first aid signs must be white with green as the contrast colour. The ratio of luminance of the white colour to the green colour must be between 5:1 and 15:1. The minimum luminance of any 10mm patch area on the sign must be greater than 2cd/m<sup>2</sup> and the ratio of maximum to minimum luminance shall be less than 10:1 for either colour.

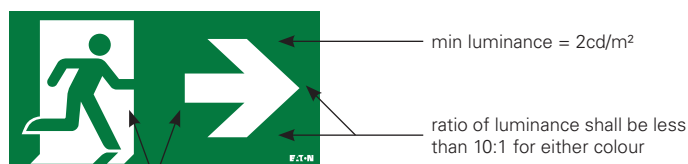

Contrast of the colours must be between 5:1 and 15:1

**Note:** Internally illuminated exit signs are pre-tested to ensure they meet these requirements, provided that they comply with EN 60598-2-22. If the sign is designed to be externally illuminated, considerable care must be taken by the system designer to see that these conditions are met. Even though an emergency luminaire must be sited within 2 metres from the sign (see stage 1) calculations should still be made to check that the sign is illuminated to 5 lux on any part of the face in emergency conditions.

### Maximum viewing distances

For all formats of safety signs, the maximum viewing distances and luminance conditions are given in EN 1838: 2013. Signs can be either internally illuminated, such as exit boxes or edge lit emergency luminaires with a screened sign that have a controlled illuminance, or painted signs.

#### Maximum viewing distances are:

Internally illuminated signs - 200 x the panel height

Externally illuminated signs - 100 x the panel height

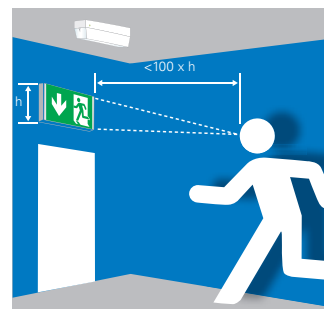
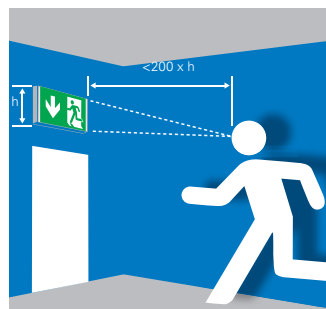

### Escape Route Lighting

When the points of emphasis have been covered, it is essential to provide any additional luminaires to ensure that minimum illuminance levels are met to enable the routes to be used safely. In addition, every compartment on the escape route must have at least two luminaires, to provide some light in the event of luminaire failure.

#### Lighting Level Requirements

EN 1838: 2013 4.2 calls for a minimum of 1 lux anywhere on the centre line of the escape route for normal risks. A uniformity ratio of 40:1 maximum to minimum must not be exceeded. This illuminance must be provided for the full duration and life of the system. 50% of the illuminance must be available within 5 seconds and the full value within 60 seconds of supply failure.

#### Photometric Design

Emergency Escape Routes  
The use of authenticated spacing tables or a suitable computer program provides the information to determine whether luminaires are needed in addition to those for the points of emphasis (see data section), to provide the minimum required level of illumination on the escape routes. To ensure that the design will meet the required levels at all times the data is de-rated, as required by the standard, to cover the following factors:

- i. Reduction in light as the battery voltage reduces during discharge
- ii. Ageing of lamps in maintained circuits
- iii. The effects of dirt

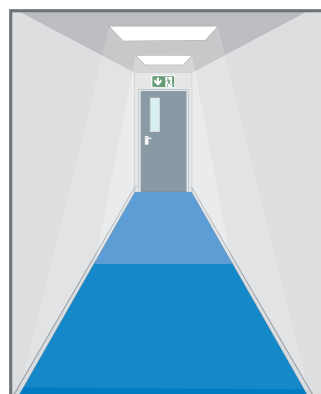

# 0.3 Emergency lighting design guide

0

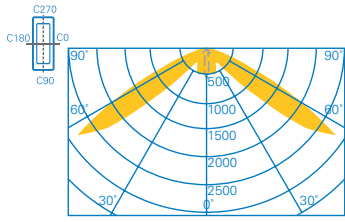

## Escape optic (Asymmetric)

Mode	Mount height (m)	Lux level directly under	Escape route 2m wide, 1 Lux min			
Self contained	2.5	3.28	3.9	11.3	4.0	2.0
	4.0	1.28	2.1	9.6	5.6	1.2
	6.0	0.57	-	-	-	-

Example - luminaire spacing along escape route

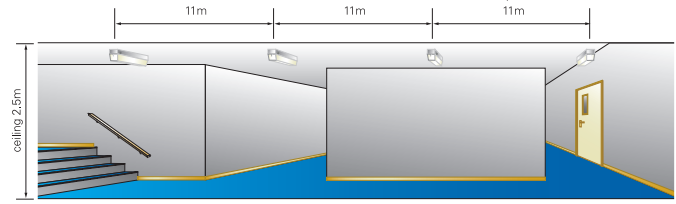
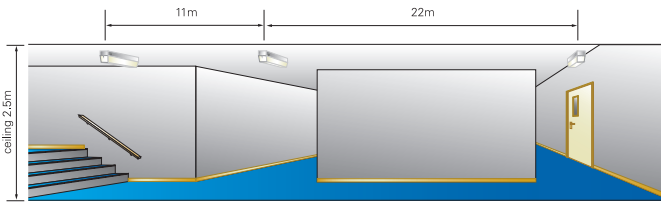

Locate luminaires at mandatory "Points of emphasis"

Add additional luminaire to achieve 1 lux minimum

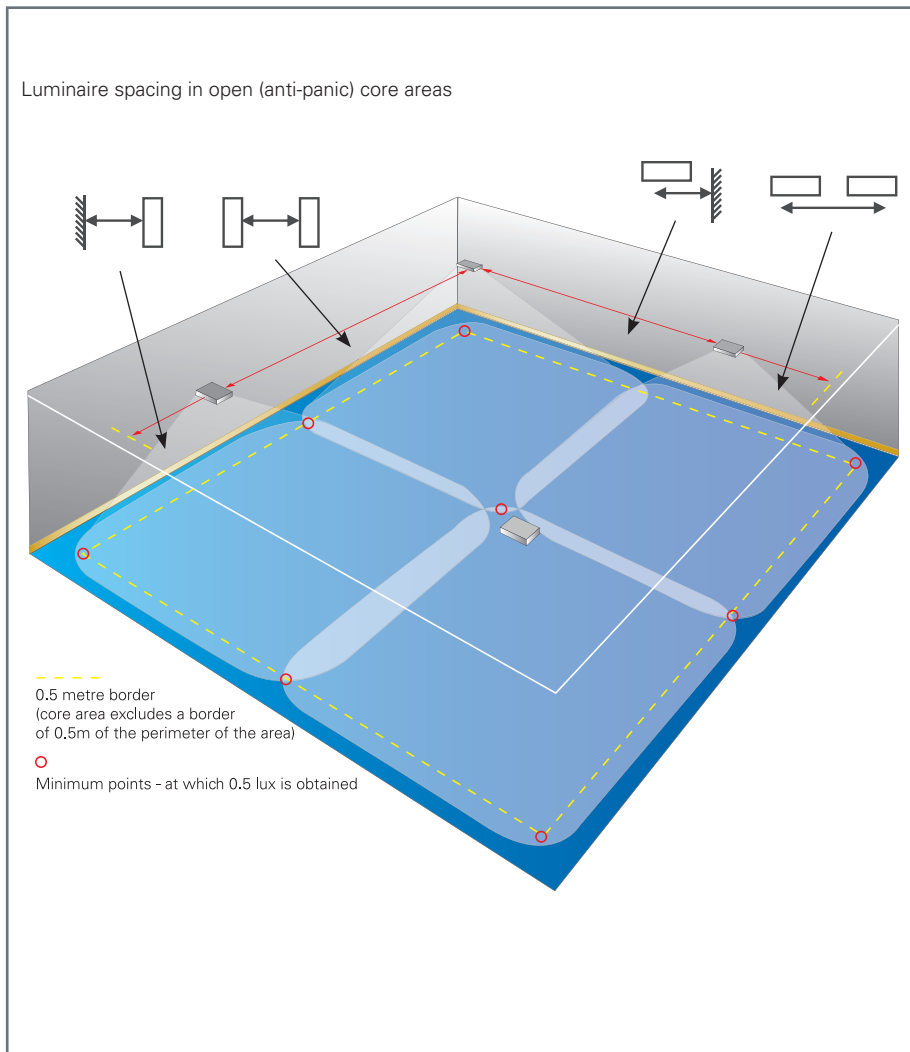

## Open (anti-panic) core areas

Open areas with an escape route passing through them, or **hazards identified by the building risk assessment** all require emergency lighting. The current standard is easy to design for and to verify, promoting systems that provide good uniformity rather than ones that use a few large output luminaires.

### Light level requirements

EN 1838:2013 - 4.3 calls for 0.5 lux minimum of the empty core area, which excludes a border of 0.5m of the perimeter of the area. Spacing tables or a suitable computer program provide simple and accurate data that can easily be used. The spacing tables for 0.5 lux are de-rated on the same basis as those for escape routes. They can also be used as a guide for initial selection of the location of luminaires when using a computer program.

### Spacing data

Specific data is available for self-contained dedicated emergency luminaires. This can be found on each of the individual product entries in this catalogue.

If using standard mains luminaires fitted with an emergency conversion kit, you should use one of the available computer programs to calculate the layout of converted luminaires. Using the actual distribution of the luminaire ensures that the correct emergency lumen value is used with the relevant depreciation factors.



### High risk task area Lighting

The risk assessment carried out will have identified a number of locations needing special consideration. These may be areas in which plant and production lines are deemed to have a high risk or control rooms managing dangerous processes.

EN 1838: 2013 defines that in areas of high risk the maintained illuminance on the reference plane shall not be less than 10% of the required maintained illuminance for that task, however it shall not be less than 15 lux.

### Design procedures

In order to reach this enhanced level of emergency illumination it is important to consider all options, which may include converted luminaires, either operated from integral batteries or the use of luminaires supplied from a central emergency unit. These versions in most instances would have higher Ballast Lumen Factors (BLF). It is also important to consider the emergency response time which may require that the emergency luminaires are operated in maintained mode, or possibly require the use of tungsten projector units. If these are used it is important to maintain a reasonable level of uniformity.

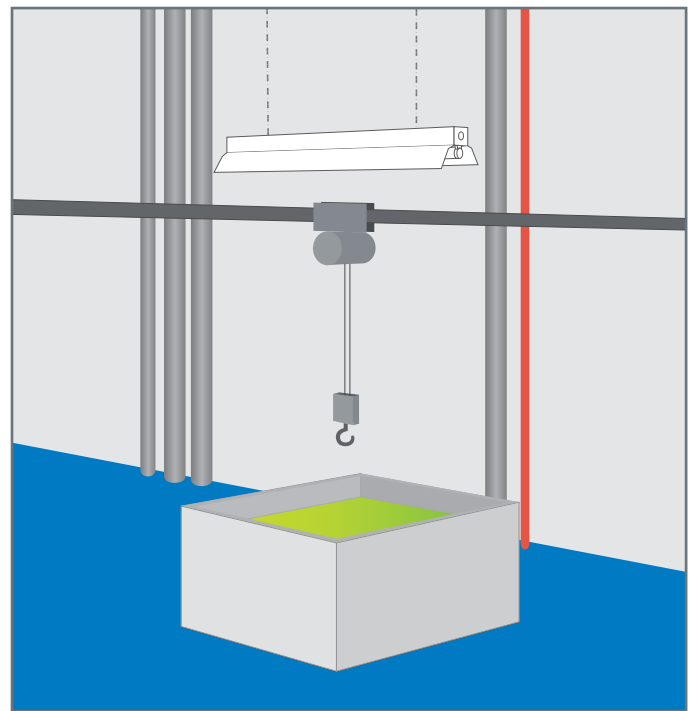

# 0.3 Emergency lighting design guide

0

## Control

Non-maintained luminaires must be activated by failure of supply to the normal lighting. They must therefore be connected to an un-switched live taken from the local normal lighting final circuit.

It is important at this stage to ensure that the luminaires used in the design process are not changed without a full assessment of the lumen output and distribution of any alternative proposal. Failure to validate the performance could lead to a non-compliant installation.

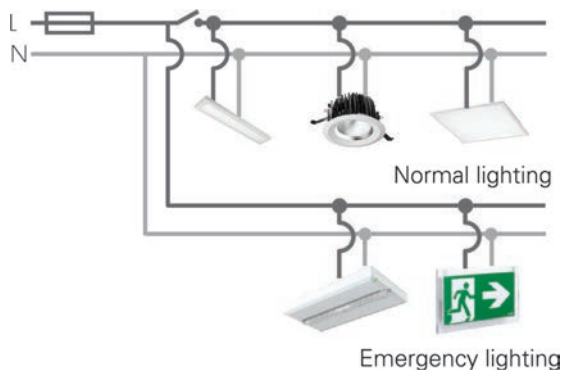

## Testing and log book

Local regulation requires that appropriate testing is performed to maintain compliance of the system. The system should include adequate facilities for testing and recording the system condition. These need to be appropriate for the specific site and should be considered as part of the system design. Discussions with the user or system designer should identify:

- The calibre and reliability of staff available to do the testing
- The level of difficulty in performing the test
- If discharge tests need to be done outside normal working hours, or phased so only alternate luminaires are tested in buildings that are permanently occupied

The testing requirements in the code of practice are:

### • Function Test

All emergency luminaires should be tested by breaking the supply to them and checking that they operate satisfactorily. The supply must then be restored and the charging indicators must be seen to be operating correctly. This test must be performed at least once per month and the results logged.

### • Discharge Test

The luminaires must be tested for their full rated duration period and checked for satisfactory operation. The supply must then be restored and the charging indicators rechecked. This test must be performed at least once annually and the results logged.

If manual testing is utilised, the following points should be considered:

- Is a single switch to be used? Unless the whole building is to be switched off, a separate switch should be used for each final circuit. As the feed to non-maintained circuits must be taken from the switch, this will probably mean that the building will have to be walked around twice, once to check the luminaires and once to check that they are recharging.
- With manual testing it is difficult to correctly validate that the emergency luminaires illuminated within the specified time and at the correct level. Validation is also required that all emergency luminaires meet the minimum duration. Again, this would be difficult to validate for all locations.
- Are luminaires to be individually switched? In practice, only a single walk around the building will be needed. However, the test switches could spoil the décor of the building and they must be of a type that is tamper proof.
- After the tests, the performance of the luminaires must be logged.

## Commissioning certificate

European Standard requires written declarations of compliance to be available on site for inspection. These consist of:

### 1. Installation quality

IEE regulations must have been conformed with and non-maintained fittings fed from the final circuit of the normal lighting in each.

### 2. Photometric performance

Evidence of compliance with light levels has to be supplied by the system designer. Therefore copies of the spacing data in this catalogue provides the verification required.

### 3. Declaration of a satisfactory test of operation

A log of all system tests and results must be maintained. System log books, with commissioning forms, testing forms and instructions are available from Eaton.

## Maintenance

Finally, to ensure that the system remains at full operational status, essential servicing should be defined. This normally would be performed as part of the testing routine, but in the case of consumable items such as replacement lamps, spares should be provided for immediate use.



### Automatic test systems

Legislation demands that emergency lighting systems are regularly tested and maintained in full working order. To avoid the cost and disruption of manual testing, automatic test systems should be considered. Eaton offer alternative testing systems, each optimised for different building types:

#### • Autotest

Designed for use with self-contained emergency luminaires, Autotest is a stand alone self-test system for small installations. The testing module self calibrates and carries out testing at predetermined intervals. Faults are precisely reported by the flashing sequence of the LED indicator.

#### • CGLine+



CGLine+ is an automatic testing and monitoring device for up to 800 self-contained luminaires, giving information regarding their functionality and status. There are many ways in which you can monitor the status and event information of the system.

Each CGLine+ controller has an inbuilt web browser which can be accessed to view the status of the luminaires and system events, there are a number of LEDs used to signal system status and multiple controllers can be connected in a network allowing the ability to monitor up to 25,600 emergency luminaires on one system. If site IT infrastructure allows, the system can be accessed remotely and can be configured to distribute email alerts from selectable alarm conditions. Alternatively a USB stick can be used to upload the event log and luminaires configuration and status.

CGLine+, simply the most flexible single screen system, offers enhanced safety by providing reliable efficient monitoring of your emergency evacuation lighting.

In order to support facility managers in their effort of monitoring and targeting energy consumption, improve life safety, save time and money during maintenance, Eaton enables its CGLine+ systems to communicate with their BMS through an OPC server. (See more page 170)

### Key regulations

#### IEC 60364-5-56 (2009-07) Ed. 2

Low-voltage electrical installations - Part 5-56: Selection and erection of electrical equipment - Safety services

560.5: General

560.5.4: Regarding control and bus systems, a failure in the control or bus system of a normal installation shall not adversely affect the function of safety services.

560.7 Circuits of safety services

560.7.1 Circuits of safety services shall be independent of other circuits.

*NOTE This means that an electrical fault or any intervention or modification in one system must not affect the correct functioning of the other. This may necessitate separation by fire-resistant materials or different routes or enclosures.*

560.9 Emergency escape lighting applications

560.9.8 Control and bus systems for safety illumination shall be independent of control and bus systems for general illumination; coupling of both systems is permitted only with interfaces that ensure a decoupling/ isolation of both busses from each other. A failure in the control and bus system of the general illumination shall not influence the proper function of the safety illumination.

#### IEC 62034 (2012-02) Ed. 2

Automatic test systems (ATS) for battery powered emergency escape lighting

4.4.5 Systems parts compatibility

It shall be the responsibility of the system designer to ensure ATS component and procedure compatibility. The manufacturer of ATS components/ system shall provide details of compatible system components (...)

The manufacturer shall declare: (...) the justification of compatibility between any part within the ATS

4.4.6 Electromagnetic immunity of the ATS

Compliance is checked by the tests of IEC 61547 applying the requirements and compliance criteria for emergency lighting luminaires.

*NOTE* :Some requirements are specific to emergency lighting luminaires.

#### IEC62386-202 (2009-06) Ed 1.0

Digital Addressable Lighting Interface

Part 202: Particular requirements for control gear - Self-contained emergency lighting













- Overview ..... 30
- 1.1 GuideLed ..... 32
- 1.2 Planete 400 Disc..... 36
- 1.3 Micropoint 2 ..... 38
- 1.4 Micropoint 2 High Output ..... 42
- 1.5 FlexiTech SE ..... 44
- 1.6 3583 LED ..... 46
- 1.7 Halo-pack 2 ..... 47

# Safety - Indoor

## Overview

			Aesthetic	No replacement parts for 10 years	Low consumption / Eco-friendly	Protection Degree	Maintained	Non-Maintained	Stand alone	Auto-test	Monitored (CGLine+)	
	Page	Performance	General features			Operation		Technology			Battery	
<b>1.1</b> GuideLed SL 	32	★ ★ ★	●	●	20 41	●	●		●	●	Li-Ion	
<b>1.2</b> Planete 400 Disc 	36	★ ★ ★	●	●	41	●			●	●	Ni-Cd 10 years	
<b>1.3</b> Micropoint 2 	38	★ ★ ★	●		44	●	●	●	●	●	Ni-Cd	
<b>1.4</b> Micropoint 2 High Output 	42	★ ★ ★	●		20		●	●	●	●	Ni-Cd	
<b>1.5</b> FlexiTech SE 	44	★ ★		●	43 65	●	●		●	●	Li-Ion	
<b>1.6</b> 3583 LED 	46	★ ★ ★	●		20	●	●		●	●	Li-Ion	
<b>1.7</b> Halo-pack 2 	47	★			20		●	●			Ni-Mh	



Wall	Ceiling surface	Ceiling recessed	Healthcare	Hotels	Cinemas / Theaters	Commercial centers	Stadia / Arenas	Offices	Service room	Warehouse	
Installation			Applications							Best use	
	●	●	●	●	●	●	●	●			With different light distributions and variants for surface and recessed installation, this range fits many applications and heights up to 8m. Special version for 5 lx vertically acc. to EN 1838 available.
●	●	●	●	●	●	●		●			The diffuse and symmetric light distribution enables universal use on both ceiling and wall. Reduced glare effect thanks to light guide technology.
	●	●	●	●	●	●		●			With asymmetric and symmetric optics especially designed for typical mounting heights between 2.5 and 3.5m, Micropoint 2 shows excellent spacing values of more than 19m.
		●	●	●	●	●	●			●	The high output version of Micropoint 2 was designed for higher illuminance requirements e.g. 10.8 lx acc. to NFPA standard. It can also be used for areas with high ceiling of up to 15m.
●	●	●	●	●	●	●	●	●			FlexiTech facilitates your day to day jobs and projects thanks to an easy to manage and consistent range.
		●	●	●	●	●		●			This luminaire has a universal wide beam optic and a high lumen output and can therefore be used in several installations with up to 9 m height.
		●							●		

The information given in this brochure is accurate at the time of compilation (errors and omissions excepted), however due to Eaton philosophy of constant product development we reserve the right to change specifications without prior notice.

1

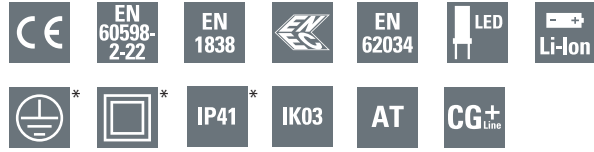

- Surface and recessed variants available
- Two different optics: for escape route or room illumination
- Universal use for maintained or non-maintained solutions and free configurable for 1 h, 3 h or 8 h operation
- With environmental-friendly Li-Ion battery technology
- CGLine+ as standard

#### Light Source:

2 × 1.6 W LED

#### Materials:

White polycarbonate

Aluminium reflector (heat sink)

Module housing with steel sheet

Lithium ion battery

#### Operation:

For maintained and non-maintained operations

CGLine+ (Without bus working in AT mode)

Selectable emergency duration of 1h, 3h, 8h

#### Installation:

Surface and recessed variants available

#### Applications:

Healthcare, Hotels, offices, cinemas, theaters, museums, commercial centers

GuideLed SL is a range of self-contained safety luminaire with a unique and innovative design using LED technology. The sophisticated electronics and long life Li-Ion batteries allow a considerable autonomy in emergency for up to 8 hours.

This range is proposed with optimal symmetric uniform illumination for open anti-panic spaces, and asymmetric light distribution for escape routes. Surface and recessed variants are available to meet your needs.

The use of LEDs, automatic testing and monitoring devices (CGLine+) significantly reduce the operating and maintenance costs of the installation.

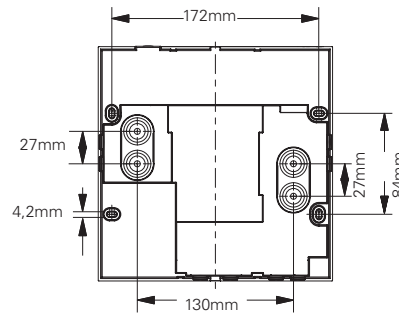
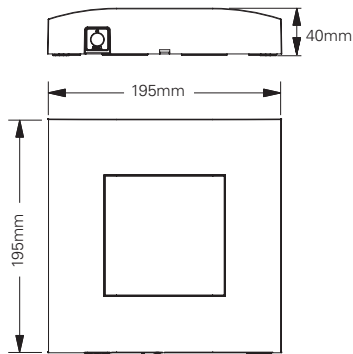

\* Recessed mounting:  
Protection class II  
IP41 for the luminaire  
IP20 for the module housing  
Surface mounting:  
Protection class I - IP41

### Lithium ion battery technology

Lithium ion batteries require much less space than Ni-Cd or NiMh cells of equal capacity, allowing more space in a compact design for cable routing. The Lithium ion batteries also don't suffer from the so-called memory effect associated with Ni-Cd and NiMh cells.

### Permanent safety

Capacity losses from ageing have been considered by corresponding dimensioning of the cells.

A multiple protective circuit, integrated in the batteries ensures safe operation and high reliability. Ni-Cd and NiMh batteries have a significantly higher self-discharge and are therefore permanently charged. This is no longer necessary with the new GuideLed luminaires, saving additional energy costs.

**Powered by Lilon**

- Low spacial requirement
- No memory effect
- Environmentally friendly

### Equipped for all situations

With all GuideLed luminaires, selection can be made between Maintained and Non-Maintained mode of operation as well as 1h, 3h and 8h emergency light duration as standard. As such, all accommodation establishments and homes can be equipped with self contained luminaires.

**Rated duration of emergency operation and its application**

**1h** e.g. escape routes in places of work

**3h** e.g. escape of assembly, sales areas, restaurants, schools, exhibition halls

**8h** e.g. hotels, sleeping areas

### GuideLed SL recessed

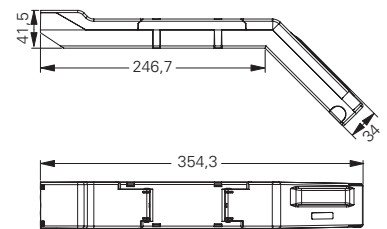
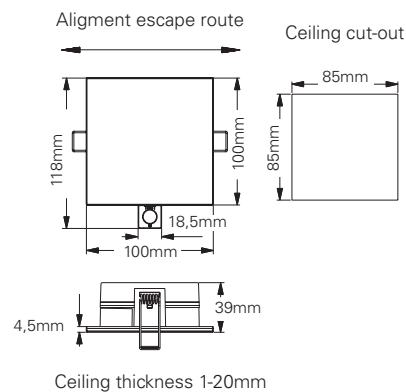

Required height in cavity ceiling for recessing through ceiling cut-out: 150 mm

Order code	Description					
40071353275	GuideLed SL 13811 recessed asym. CGLine+	6.9VA / 6.7W	210 Lm	1h, 3h, 8h	LiNiMnCoO <sub>2</sub> 3.7V 4Ah	Maintained / Non-Maintained
40071353274	GuideLed SL 13821 recessed sym. CGLine+	6.9VA / 6.7W	204 Lm	1h, 3h, 8h	LiNiMnCoO <sub>2</sub> 3.7V 4Ah	Maintained / Non-Maintained
40071353279	GuideLed SL 13812 surface asym. CGLine+	6.9VA / 6.7W	210 Lm	1h, 3h, 8h	LiNiMnCoO <sub>2</sub> 3.7V 4Ah	Maintained / Non-Maintained
40071353278	GuideLed SL 13822 surface sym. CGLine+	6.9VA / 6.7W	204 Lm	1h, 3h, 8h	LiNiMnCoO <sub>2</sub> 3.7V 4Ah	Maintained / Non-Maintained
40071353280	GuideLed SL 13851 recessed asym. 5 lx CGLine+	6.9VA / 6.7W	310 Lm	1h, 3h, 8h	LiNiMnCoO <sub>2</sub> 3.7V 4Ah	Maintained / Non-Maintained
40071353282	GuideLed SL 13852 surface asym. 5 lx CGLine+	6.9VA / 6.7W	310 Lm	1h, 3h, 8h	LiNiMnCoO <sub>2</sub> 3.7V 4Ah	Maintained / Non-Maintained



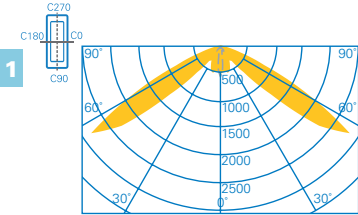

Escape route illumination with asymmetric optics

#### Planning help for GuideLed SL CGLine+ with asymmetric optics for E = 1.0 lx (0.5 lx)

Measurement level 0.02 m, maintenance factor MF = 80 %, battery operation, distances in m

Emergency light operating duration	Mounting height in metres	Mounting types	Mounting types			
			L1	L2	L3	L4
1 h	2.5	Ceiling mounting	1.6 (2.9)	5.8 (7.4)	5.9 ( 6.6)	13.2 (14.7)
	3.0	Escape route centre	1.3 (3.0)	5.8 (7.9)	6.6 ( 7.5)	15.0 (16.6)
	3.5		1.1 (2.2)	4.5 (8.2)	7.3 ( 8.3)	16.6 (18.5)
	4.0		1.1 (1.9)	3.9 (8.4)	8.1 ( 9.0)	18.0 (20.3)
	5.0		1.1 (1.6)	3.2 (6.3)	9.4 (10.4)	20.9 (23.6)
	6.0		1.0 (1.5)	3.0 (5.1)	10.5 (11.9)	23.8 (26.4)
	7.0		1.0 (1.5)	3.0 (4.6)	3.5 (13.2)	19.0 (29.3)
	8.0		0.9 (1.4)	2.9 (4.2)	3.3 (14.4)	19.6 (32.3)
3 h	2.5	Ceiling mounting	1.0 (2.3)	4.5 (6.4)	5.4 ( 6.2)	12.3 (13.7)
	3.0	Escape route centre	0.9 (1.7)	3.4 (6.7)	6.2 ( 6.9)	13.9 (15.6)
	3.5		0.9 (1.4)	2.9 (6.5)	6.9 ( 7.6)	15.3 (17.3)
	4.0		0.9 (1.3)	2.6 (5.1)	7.5 ( 8.4)	16.7 (18.9)
	5.0		0.8 (1.2)	2.5 (4.0)	8.7 ( 9.8)	19.6 (21.7)
	6.0		0.8 (1.2)	2.4 (3.5)	2.7 (11.1)	15.5 (24.7)
	7.0		0.5 (1.1)	2.3 (3.5)	2.4 (12.2)	16.3 (27.5)

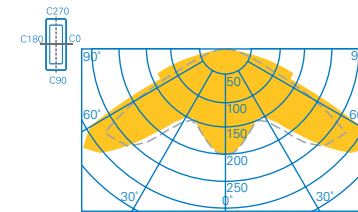

Escape route illumination with symmetric optics

#### Planning help for GuideLed SL CGLine+ with symmetric optics for E = 1.0 lx (0.5 lx)

Measurement level 0.02 m, maintenance factor MF = 80 %, battery operation, distances in m

Emergency light operating duration	Mounting height in metres	Mounting types	Mounting types			
			L1	L2	L3	L4
1 h	2.5	Ceiling mounting	3.8 (4.5)	9.0 (10.2)	4.2 (4.9)	9.7 (11.4)
	3.0	Escape route centre	4.1 (5.0)	10.0 (11.5)	4.4 (5.4)	10.9 (12.4)
	3.5		4.0 (5.4)	10.8 (12.7)	4.4 (5.9)	11.8 (13.7)
	4.0		3.4 (5.8)	11.5 (13.7)	2.4 (6.2)	12.3 (14.9)
	5.0		1.3 (5.6)	11.0 (15.4)	1.3 (6.2)	10.3 (16.7)
3 h	2.5	Ceiling mounting	3.3 (4.1)	8.2 (9.5)	3.6 (4.5)	8.9 (10.2)
	3.0	Escape route centre	3.1 (4.5)	9.0 (10.6)	3.4 (4.9)	9.7 (11.5)
	3.5		1.5 (4.7)	9.4 (11.5)	1.5 (5.1)	9.0 (12.6)
	4.0		1.0 (4.6)	8.9 (12.4)	1.1 (5.0)	8.3 (13.5)

Emergency light operating duration	Mounting height in metres	Mounting types	Mounting types			
			L1	L2	L3	L4
1 h	2.5	Ceiling mounting	3.4 (4.3)	8.8 (10.2)	3.2 (3.9)	8.1 ( 9.0)
	3.0	Room illumination	3.4 (4.5)	9.4 (11.3)	3.5 (4.2)	9.4 (10.3)
	3.5		3.4 (4.4)	10.3 (12.5)	3.5 (4.2)	10.2 (11.3)
	4.0		3.4 (4.4)	11.0 (13.5)	3.4 (4.2)	10.9 (12.3)
	5.0		0.6 (5.0)	10.5 (14.7)	1.1 (4.7)	11.4 (14.5)
	6.0		0.7 (2.4)	10.8 (15.9)	0.5 (2.5)	10.0 (15.9)
	7.0		0.5 (0.7)	9.1 (14.9)	0.5 (1.6)	9.9 (16.1)
3 h	2.5	Ceiling mounting	2.9 (3.4)	7.7 ( 9.5)	2.9 (3.3)	7.7 ( 8.3)
	3.0	Room illumination	3.0 (4.0)	8.5 (10.4)	2.9 (3.5)	8.5 ( 9.5)
	3.5		1.4 (4.0)	9.2 (11.0)	2.0 (3.8)	9.1 (10.8)
	4.0		0.5 (4.1)	8.5 (11.7)	1.1 (4.0)	9.2 (11.7)
	5.0		0.7 (1.4)	8.3 (13.0)	0.5 (1.9)	8.3 (13.0)

Data for 8h emergency light operation upon request

# Requirements of EN 1838: illuminance of 5 lx for safety equipment

The aim of emergency lighting is to enable people to exit a room or building safely. It must also ensure that fire fighting and safety equipment can be easily found and operated when needed. This equipment includes (but not exclusively):

- First aid stations
- All fire fighting equipment and all alarm devices

Lighting is required near each first aid kit, near each alarm and piece of fire fighting equipment, as well as each sign indicating a fire alarm system. In accordance with EN 1838, „near“ generally means a distance of no greater than 2 metres, measured horizontally (this corresponds with distance a in the diagram below).

The required level of illuminance on the equipment is 5 lx measured vertically - i.e. perpendicular to the usual horizontal illuminance measurements on one level.

In comparison to the escape route requirement for 1 lx horizontally, different requirements apply in this situation for the light distribution from the safety luminaires, due to the flatter light angle of incidence.

## GuideLed SL 13851 and 13852 CGLine+ meet the specific requirements of EN 1838

In order to meet the requirements of EN 1838, the new GuideLed SL 13851 and 13852 CGLine+ have special optics to guarantee the required illuminance of 5 lx vertically over a wide area. Hence mounting at heights of up to 5.6 m, and a breadth of illumination of up to 2.8 metres, are possible.



### Engineering help, GuideLed SL 13851 and 13852 CGLine+

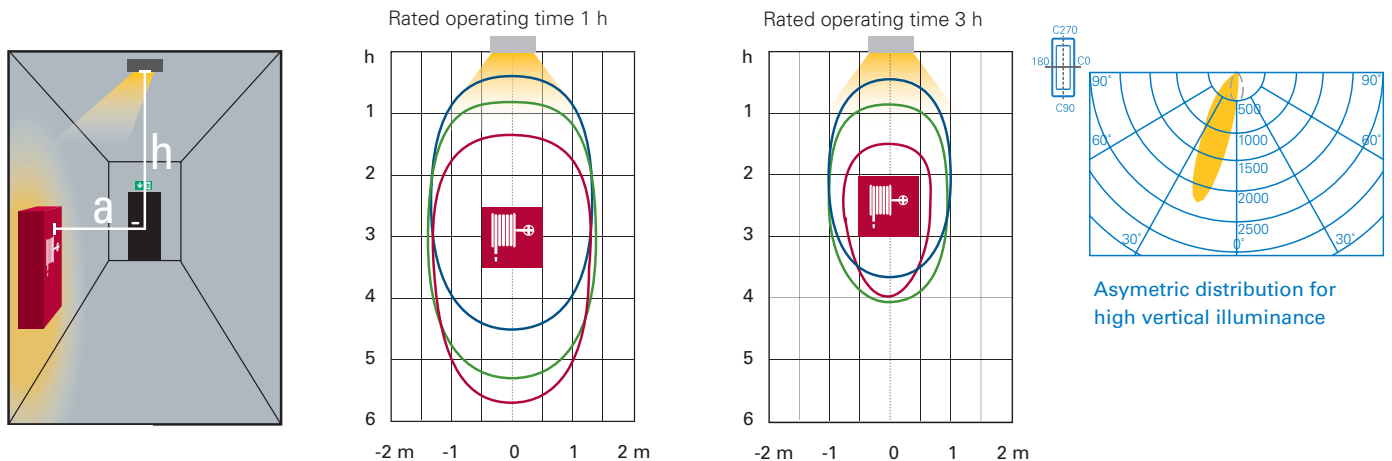

Area in which a minimum illuminance of 5 lx (maintenance factor 0.8) is achieved, depending on distance a and the rated operating time:

a = 1.0 m

a = 1.5 m

a = 2.0 m

# 1.2

## Safety luminaires - Indoor

### Planete 400 Disc

1



- Seamlessly integrated with the pure architectural lines of the building.
- Fits into the all-round light-theme concept.
- Shares the same standard diameter as most popular downlights.
- The standby-mode LED lighting (when mains-connected) is soft with a minimal glare.
- Recessed-mounting integration (close-fit mounting < 2mm thick, colors on request).

#### Light Source:

Flexible LED strip

#### Materials:

- Body: white polycarbonate
- Aluminium rim (heat sink)
- High-performance micro-lens light diffuser
- Ni-Cd battery (10 years)

#### Installation:

- Screwless terminal strips: automatic connectors.
- Built-in housing for quick and easy mounting of the safety baffle hanger (metal cable thread)
- Recessed-mounting trim options for structural or dropped ceilings:
  - diameter 200 mm
  - down light hole saw
  - Shallow 65 mm recess

The Planete 400 Disc enables especially efficient escape route lighting. The uniform illumination of the light guide provides a non-glare lighting output.

We have created a slender design with only 25mm depth and high uniformity of the light output area. A special snapping mechanism allows the luminaire to be opened or closed easily and safely. The diffuse and symmetric light distribution enables universal use on both ceiling and wall.

This 10 years lifetime range has benefited from an eco-design in order to meet the latest environmental standards. The use of LEDs, long life components, automatic testing and monitoring devices (CGLine+) significantly reduce the operating and maintenance costs of the installation.

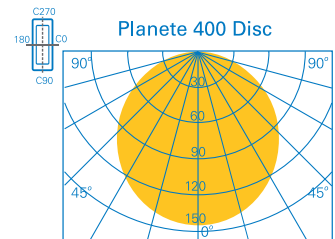
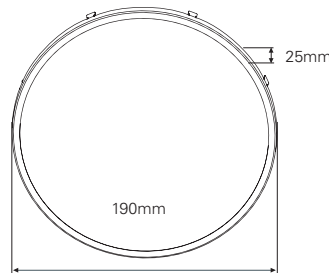

#### Operation:

- Maintained operation with 360 lumen output in emergency operation
- CGLine+ (Without bus working in AT mode)
- Disk delivers uniform down lighting: Homogeneous illumination for optimal visual comfort ( $L_{max}/L_{min} < 1,5$ )
- Maintenance costs reduced, no replacement of spareparts needed for 10 years

#### Applications:

Healthcare, Hotels, offices, cinemas, theaters, museums, commercial centers

Model	Height (m)	Escape route ceiling mounting 2m wide, 1 Lux				Open area ceiling mounting 2m wide, 1 Lux			
LUM17144	02.50	04.40	10.80	04.40	10.80	03.50	08.30	03.50	08.30
	02.80	04.60	11.30	04.60	11.30	03.60	08.80	03.60	08.80
	03.00	04.70	11.60	04.70	11.60	03.70	09.00	03.70	09.00
	03.50	04.90	12.40	04.90	12.40	03.80	09.70	03.80	09.70
	04.00	05.00	13.00	05.00	13.00	03.90	10.10	03.90	10.10
	05.00	04.60	12.40	04.60	12.40	04.10	11.00	04.10	11.00
	06.00	04.60	12.90	04.60	12.90	04.10	11.70	04.10	11.70
	07.00	04.30	13.10	04.30	13.10	04.00	12.10	04.00	12.10





LUM10541





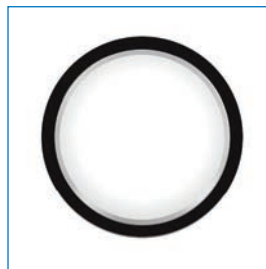

Recessed-mounting trim

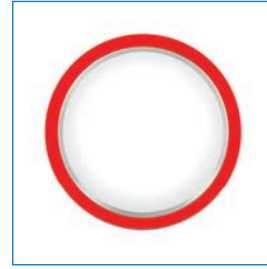

Other recessed mounting trim colors on demand



Other recessed mounting trim colors on demand

Order code	Description					
LUM17144	Planete 400 Disc CGLine+	1.5W	360 Lm	1h	10 x 1.2 V/0.6 Ah - Ni-Cd 10 years	Maintained (10 lm)
<b>Accessories</b>						
LUM10541	Recessed-mounting trim					
On demand	Recessed-mounting trim in colour					

# 1.3

## Safety luminaires - Indoor

### Micropoint 2 Surface

1



- Versatile multi functional use (escape and open area anti-panic)
- IP44 ingress protection suitable for bathrooms and wet environment
- First fix base for ease of installation
- 60,000 hour life LED for reduced maintenance

#### Light Source:

1 x 1 W LED

Micropoint 2 Surface is a high performance surface mounted emergency luminaire utilising the latest LED and optic technology to provide an unobtrusive, high quality and high performance luminaire for indoor use.

#### Materials:

Luminaire Enclosure  
Polycarbonate  
Battery - Ni-Cd

The innovative optic design used in the Micropoint 2 utilises light efficiently from the LED to provide a uniform distribution in either an escape route or open area anti-panic emergency lighting. Preset light levels can be adjusted in maintained mode to operate as a security light, adjustable using a touch sensitive button on the luminaire fascia.

#### Installation:

Flush & Surface mount  
20mm Conduit entry on all four sides  
BESA box entry on base

The use of LEDs, automatic testing and monitoring devices (CGLine+) significantly reduce the operating and maintenance costs of the installation.

#### Operation:

Self-contained Maintained luminaire can be operated in Non-Maintained mode  
Can be used as security light with 4 pre-set light levels

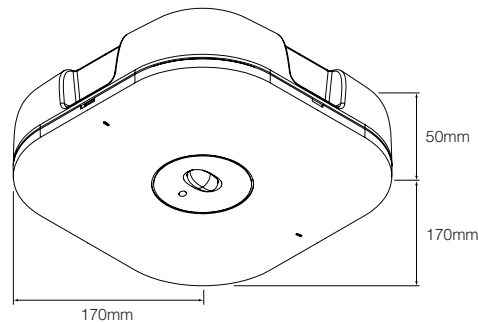

#### Applications:

Healthcare, Hotels, offices, cinemas, theaters, museums, commercial centers

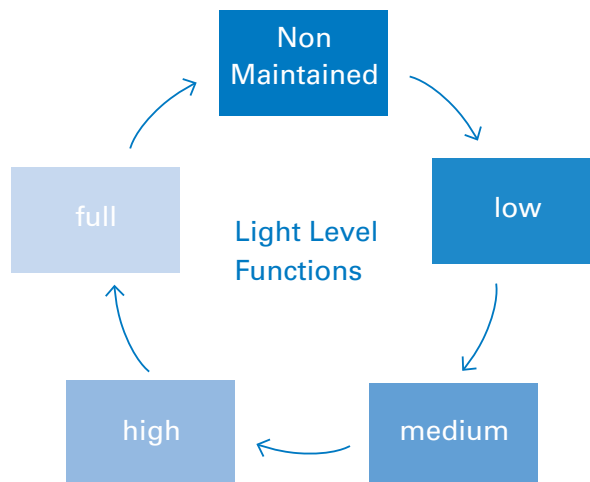

Preset light levels can be adjusted in Maintained mode to operate as security light, adjustable using touch sensitive button on luminaire fascia.



Open area anti-panic

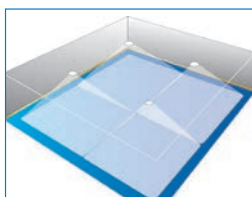
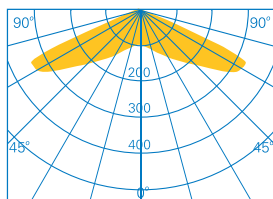

Open area (Symmetric)

Mode	Mount height (m)	Lux level directly under	Open area 1 Lux min			
Self contained						
	02.50	01.70	04.30	09.40	04.30	09.40
	02.80	01.40	03.30	09.30	03.30	09.30
	03.00	01.20	03.20	09.20	03.20	09.20

Open (anti-panic) area 0.5 Lux min

Mode	Mount height (m)	Lux level directly under	Open (anti-panic) area 0.5 Lux min			
Self contained						
	02.50	01.70	05.30	10.50	05.30	10.50
	02.80	01.40	05.70	11.50	05.70	11.50
	03.00	01.20	05.90	12.20	05.90	12.20
	04.00	00.67	04.90	12.50	04.90	12.50

Escape route

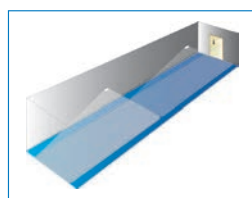
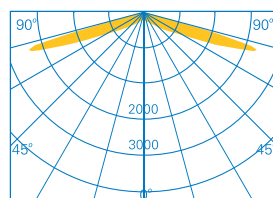

Escape optic (Asymmetric)

Mode	Mount height (m)	Lux level directly under	Escape route 2m wide, 1 Lux min			
Self contained						
	02.50	02.70	-	-	07.50	16.60
	02.80	02.20	-	-	08.10	18.10
	03.00	01.90	-	-	08.30	19.10

Order code Description



MP2SO3H	Micropoint2 Surface Open Area	3.6VA/2.5W-6.9VA/5W	144 Lm	3h	4.8V - 2Ah Ni-Cd	Maintained / Non-Maintained
MP2SE3H	Micropoint2 Surface Escape Route	3.6VA/2.5W-6.9VA/5W	145 Lm	3h	4.8V - 2Ah Ni-Cd	Maintained / Non-Maintained
MP2SO3HIS	Micropoint2 Surface Open Area Auto-Test	3.6VA/2.5W-6.9VA/5W	144 Lm	3h	4.8V - 2Ah Ni-Cd	Maintained / Non-Maintained
MP2SE3HIS	Micropoint2 Surface Escape Route Auto-Test	3.6VA/2.5W-6.9VA/5W	145 Lm	3h	4.8V - 2Ah Ni-Cd	Maintained / Non-Maintained
MP2SO3HCGL	Micropoint2 Surface Open Area CGLine+	3.6VA/2.5W-6.9VA/5W	144 Lm	3h	4.8V - 2Ah Ni-Cd	Maintained / Non-Maintained
MP2SE3HCGL	Micropoint2 Surface Escape Route CGLine+	3.6VA/2.5W-6.9VA/5W	145 Lm	3h	4.8V - 2Ah Ni-Cd	Maintained / Non-Maintained



# 1.3

## Safety luminaires - Indoor

### Micropoint 2

1



- Versatile multi functional use (escape and open area anti-panic)
- Low power consumption reducing cost of ownership
- Excellent spacing reducing the quantity of fittings required
- 60.000 hour life LED for reduced maintenance

#### Light Source:

1 x 1W LED

Micropoint 2 is a high performance recessed mounted emergency luminaire utilising the latest LED and optic technology to provide an unobtrusive, high quality and high performance luminaire for indoor use.

#### Materials:

Luminaire body:  
Aluminium, luminaire Head:  
Polycarbonate, remote gear  
pod: flame retardant ABS  
Battery - Ni-Cd

The innovative optic design used in the Micropoint 2 utilises light efficiently from the LED to provide a uniform distribution in either an escape route or open area anti-panic emergency lighting, improving the performance and reducing the electrical power consumption. Preset light levels can be adjusted in maintained mode to operate as a security light, adjustable using a touch sensitive button on the luminaire fascia.

#### Installation:

Flush mounting  
Spring retaining clips for  
surface installation (install  
from below ceiling)  
Plug and play socket  
for mains supply  
No disassembly required  
during installation

The use of LEDs, automatic testing and monitoring devices (CGLine+) significantly reduce the operating and maintenance costs of the installation.

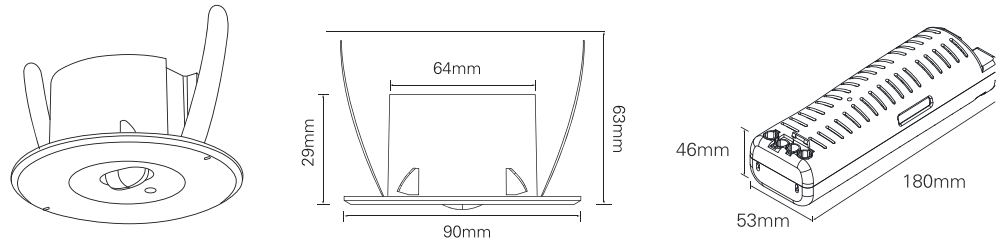

#### Operation:

Maintained luminaire  
can be operated in Non-  
Maintained mode  
Can be used as security light  
with 4 preset light levels

#### Applications:

Healthcare, Hotels, offices,  
cinemas, theaters, museums,  
commercial centers

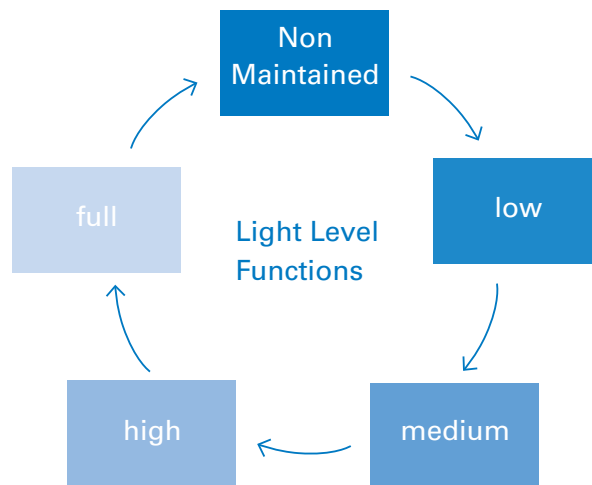

Preset light levels can be adjusted in Maintained mode to operate as security light, adjustable using touch sensitive button on luminaire fascia.

The high power, high efficiency LED light source provides uniform illumination with asymmetric and symmetric light patterns for escape or open area use.

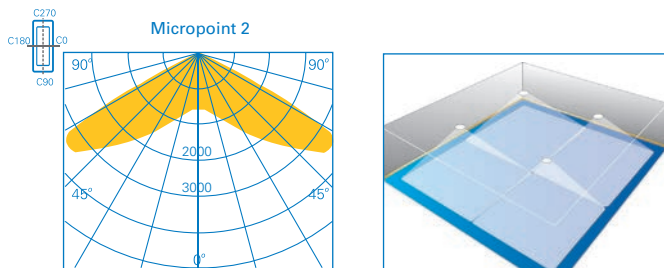

Open Area (Symmetric 0.5 Lux)

Model	Height (m)	Distance for 1 Lux			
<b>MP2O3H</b> (Open Area Anti-Panic)					
	02.50	04.30	09.40	01.70	09.40
	02.80	03.30	09.30	01.40	09.30
	03.00	03.20	09.20	01.20	09.20

Model	Height (m)	Distance for 0.5 Lux			
<b>MP2O3H</b> (Open Area Anti-Panic)					
	02.50	05.30	10.50	05.30	10.50
	02.80	05.70	11.50	05.70	11.50
	03.00	05.90	12.20	05.90	12.20
	04.00	04.90	12.50	04.90	12.50

Micropoint 2 advanced optics with rectangular distribution  
Luminaire with 'no' optics require overlap to eliminate dark spots

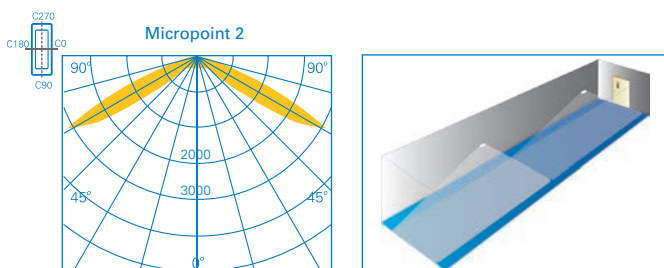

Escape Route (Asymmetric 1 Lux)

Model	Height (m)	Distance for 1 Lux (escape route 2m wide)			
<b>MP2E3H</b> (Escape Route)					
	02.50	-	-	07.80	17.10
	02.80	-	-	08.40	18.60
	03.00	-	-	08.60	19.60



Order code	Description					
MP2O3H	Micropoint2 Open Area	3.6VA/2.5W-6.9VA/5W	153 Lm	3h	4.8V - 2Ah Ni-Cd	Maintained / Non-Maintained
MP2E3H	Micropoint2 Escape Route	3.6VA/2.5W-6.9VA/5W	148 Lm	3h	4.8V - 2Ah Ni-Cd	Maintained / Non-Maintained
MP2O3HIS	Micropoint2 Open Area AT	3.6VA/2.5W-6.9VA/5W	153 Lm	3h	4.8V - 2Ah Ni-Cd	Maintained / Non-Maintained
MP2E3HIS	Micropoint2 Escape Route AT	3.6VA/2.5W-6.9VA/5W	148 Lm	3h	4.8V - 2Ah Ni-Cd	Maintained / Non-Maintained
MP2O3HCGL	Micropoint2 Open Area CGLine+	3.6VA/2.5W-6.9VA/5W	153 Lm	3h	4.8V - 2Ah Ni-Cd	Maintained / Non-Maintained
MP2E3HCGL	Micropoint2 Escape Route CGLine+	3.6VA/2.5W-6.9VA/5W	148 Lm	3h	4.8V - 2Ah Ni-Cd	Maintained / Non-Maintained

\*Non-maintained - Maintained

# 1.4

## Safety luminaires - Indoor

### Micropoint 2 High Output

1

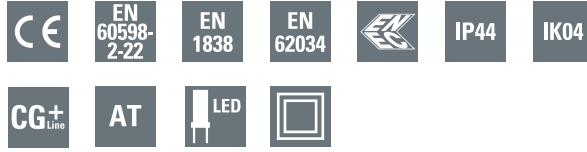

- Versatile multi-functional use (high ceiling, NFPA 101 escape route and specific locations as stated within BS 5266-1:2011)
- Low power consumption reducing cost of ownership
- Excellent spacing reducing the quantity of fittings required
- 60,000 hour life LED for reduced maintenance

#### Light Source:

1 x 2,5W LED

Consumption 7.2VA/3,9W

#### Materials:

Luminaire body: polycarbonate

Remote gear pod - flame retardant ABS

Battery box- steel powder coated in RAL9016

Battery - Ni-Cd

Micropoint 2 High Output remains a high specification LED emergency down light designed for use as both escape route and anti-panic emergency lighting in high ceiling applications. It meets the requirements for the specific high-risk locations such as disabled refuge areas, plant rooms, kitchens, first aid rooms, treatment rooms and reception areas and meets the requirements to reach 10.8 lux average light output in an escape route application.

As with the rest of the Micropoint 2 range, ease of installation, reduced energy consumption and minimal maintenance reduce the total cost of ownership without compromising on performance or aesthetics.

The use of LEDs, automatic testing and monitoring devices (CGLine+) significantly reduce the operating and maintenance costs of the installation.

#### Installation:

Flush mount

Spring retaining clips for surface installation (install from below ceiling)

#### Operation:

Non-Maintained luminaire

#### Applications:

All recessed high risk indoor applications

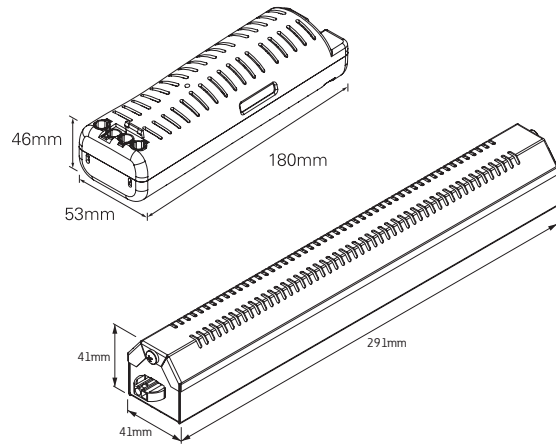
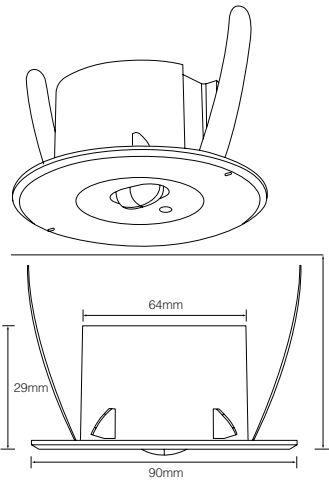

Model	Height (m)	Lux level directly under	Escape route 2m wide, 1 Lux min	
<b>Self contained</b>				
	15.50	01.00	04.10	22.70
	14.00	01.30	06.40	22.70
	12.00	01.70	07.90	22.10
	10.00	02.50	08.00	21.00
	8.00	04.40	07.70	19.70
	6.00	07.00	07.00	18.00

Self contained



Order code

Description



Order code	Description	Power	Light Output	Battery Life	Battery	Maintenance
MP2HI3H	Non-maintained 3 Hour self-contained	7.2VA/3,9W	298 Lm	3h	4.8V - 4Ah Ni-Cd	Non-Maintained
MP2HI3HIS	Non-maintained 3 Hour self-contained AT	7.2VA/3,9W	298 Lm	3h	4.8V - 4Ah Ni-Cd	Non-Maintained
MP2HI3HCGL	Non-maintained 3 Hour self-contained CGLine+	7.2VA/3,9W	298 Lm	3h	4.8V - 4Ah Ni-Cd	Non-Maintained



Corridor and refuge area

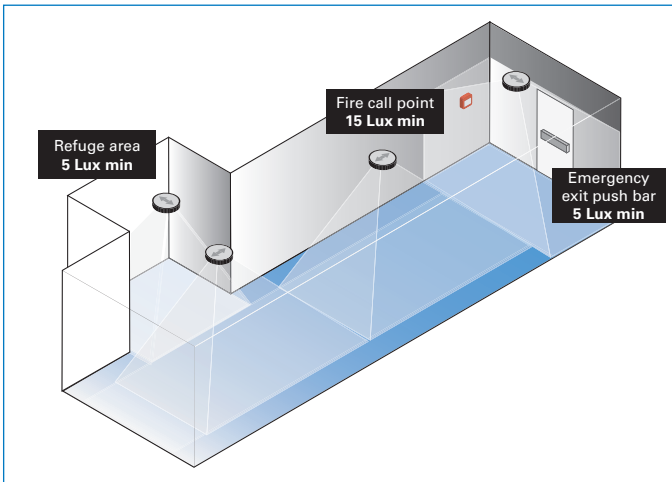

Plant room

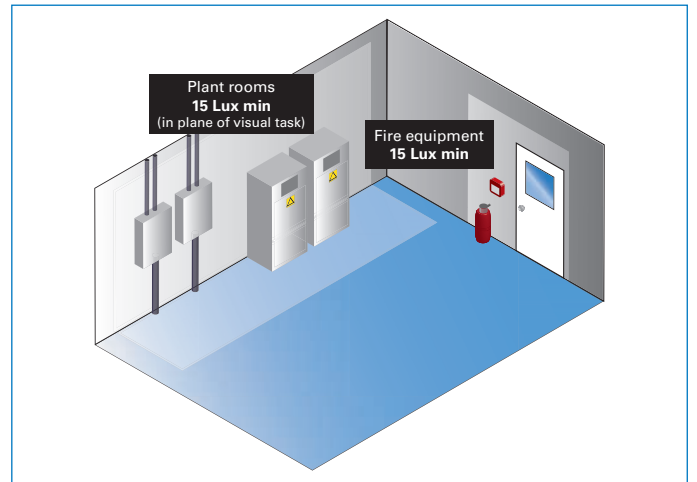

Kitchen

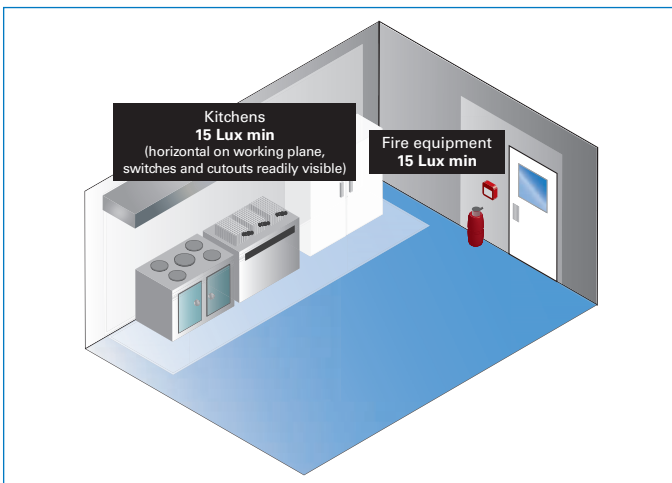

Reception areas

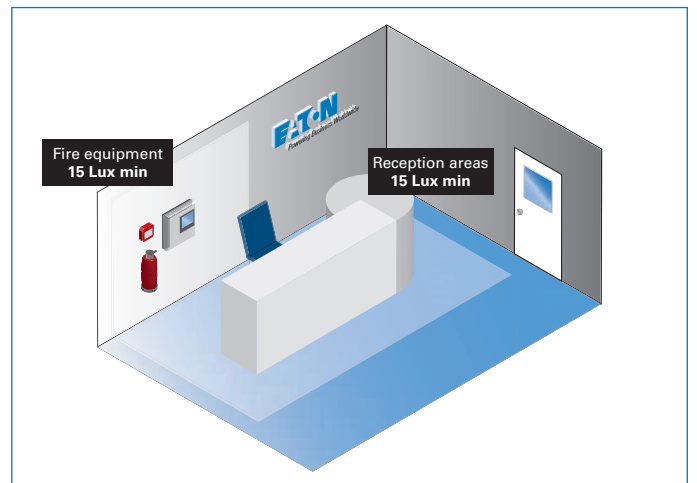

First aid rooms



Treatment rooms

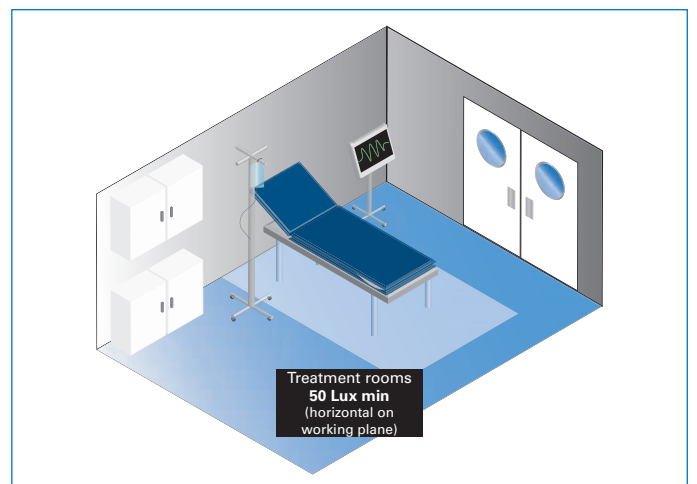

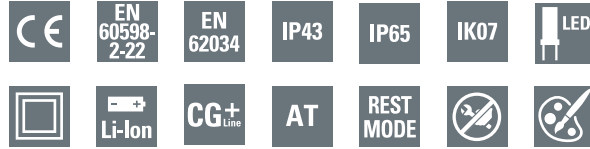

- One product for multiple durations
- Efficient lighting performance
- Identical aesthetic in waterproof version
- Fast installation
- Customization for improved integration
- Reduced maintenance effort, energy savings and respectful to the environment

#### Light Source:

LED strip

#### Materials:

Polycarbonate

Lithium ion battery

#### Operation:

Maintained (M) / Non Maintained (NM)

Configurable level of light in mains mode via magnet (30%, 70%, 100%) on CGLine+ versions

Duration selectable 1h, 1,5h, 2h and 3h

Installation possibilities: Wall, ceiling, recessed

Maintenance costs reduced, no replacement of spareparts needed for 10 years (CGLine+ version)

#### Applications:

Hotels, restaurants, meeting rooms, offices, shops, cinemas, theaters, museums

FlexiTech facilitates your day to day jobs and projects thanks to an easy to manage and consistent range. FlexiTech SE is a modern and flexible safety luminaire that offers efficient lighting performance and adapts to most applications. Its transparent baseplate is a host of several clever features that ensures easy installation.

FlexiTech SE is optimized for escape route illumination offering good spacing between luminaires. For other use, optional lens provides different light distribution. Waterproof version is also available with identical aesthetic.

The use of LEDs, long life components, automatic testing and monitoring devices (CGLine+) significantly reduce the operating and maintenance costs of the installation.

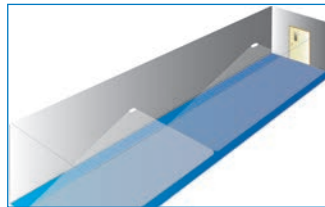
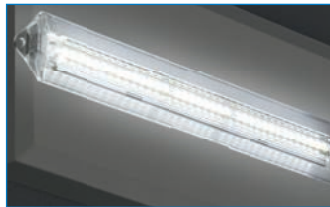

#### Escape route illumination

Delivered lens offers efficient spacing between lights and meets most of the applications.

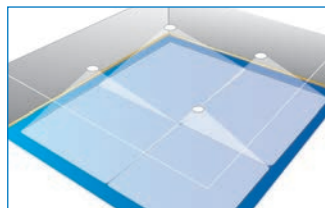

#### Open area illumination and more

This optional lens provides a symmetric light distribution for more flexibility.

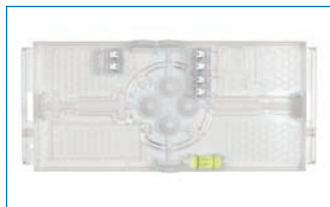

#### 6 innovations that make FlexiTech easier to install

- Slotted holes for quick fixing and easy adjustment
- Screwless terminal blocks with double connection
- Transparent baseplate with a large working space for ease of installation and replacement of existing products
- Spirit level, for perfect horizontal alignment
- Possibility of direct mounting on electrical boxes
- 9 cables entries in rubber (4 backs, 2 at the top, 1 at the bottom and 2 at the side)  
Cables sizes : 2,5<math>\lt; \varnothing </math>13,5mm  
No plastic parts to break when access from the back

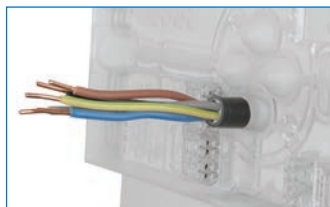



Ceiling-surface mounting



Wall-surface mounting



Recessed mounting option

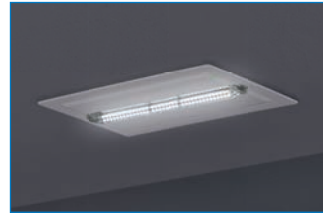

Optional lens



Order code	Description	lm in emergency				lm in mains		⚡	🕒	🔋	⚙️
		1h	1.5h	2h	3h						
FT2SE150CGL13	FlexiTech SE CGLine+, 150lm, IP43	150	100	75	60	10 or 100	5 VA / 2 W	1-1,5-2-3h	FT-BATLL2	MNM	
FT2SE150CGL13IP	FlexiTech SE CGLine+, 150lm, IP65	150	100	75	60	10 or 100	5 VA / 2 W	1-1,5-2-3h	FT-BATLL2	MNM	
FT2SE300CGL13	FlexiTech SE CGLine+, 300lm, IP43	300	200	150	125	10 or 100	5 VA / 2 W	1-1,5-2-3h	FT-BATLL3	MNM	
FT2SE300CGL13IP	FlexiTech SE CGLine+, 300lm, IP65	300	200	150	125	10 or 100	5 VA / 2 W	1-1,5-2-3h	FT-BATLL3	MNM	
FT2SE600CGL13	FlexiTech SE CGLine+, 600lm, IP43	600	400	300	200	10 or 100	5 VA / 2 W	1-1,5-2-3h	FT-BATLL3	MNM	
FT2SE600CGL13IP	FlexiTech SE CGLine+, 600lm, IP65	600	400	300	200	10 or 100	5 VA / 2 W	1-1,5-2-3h	FT-BATLL3	MNM	
FT2SE150ATT13	FlexiTech SE AT, 150lm, IP43	150	100	75	60	100	5 VA / 2 W	1-1,5-2-3h	FT-BAT2	MNM*	
FT2SE150ATT13IP	FlexiTech SE AT, 150lm, IP65	150	100	75	60	100	5 VA / 2 W	1-1,5-2-3h	FT-BAT2	MNM*	
FT2SE300ATT13	FlexiTech SE AT, 300lm, IP43	300	200	150	125	100	5 VA / 2 W	1-1,5-2-3h	FT-BAT2	MNM*	
FT2SE300ATT13IP	FlexiTech SE AT, 300lm, IP65	300	200	150	125	100	5 VA / 2 W	1-1,5-2-3h	FT-BAT2	MNM*	
FT2SE600ATT13	FlexiTech SE AT, 600lm, IP43	600	400	300	200	100	5 VA / 2 W	1-1,5-2-3h	FT-BAT3	MNM*	
FT2SE600ATT13IP	FlexiTech SE AT, 600lm, IP65	600	400	300	200	100	5 VA / 2 W	1-1,5-2-3h	FT-BAT3	MNM*	

\*via Jumper

## Accessories

Order code	Description
FT2-RKC	Recess Kit for Ceiling, compatible with FlexiTech SE and FlexiTech ED (ceiling position)
FT2-WG	Wire Guard, compatible with FlexiTech SE and FlexiTech ED
FT2SE-RB	Recessed Box for plaster and brick compatible with FlexiTech SE
FT2SE-LO	Lens with light distribution optimized for Open area, compatible with FlexiTech SE
40071352379	Eaton Magnet for lighting configuration and manual tests
FT-BAT2	Battery Pack, LiFePO <sub>4</sub> 3,2V / 1,5Ah
FT-BAT3	Battery Pack, LiFePO <sub>4</sub> 3,2V / 3Ah
FT-BATLL2	Battery Pack, LiFePO <sub>4</sub> long life 3,2V / 1,5Ah
FT-BATLL3	Battery Pack, LiFePO <sub>4</sub> long life 3,2V / 3Ah

## FlexiTech Wall-surface mounting

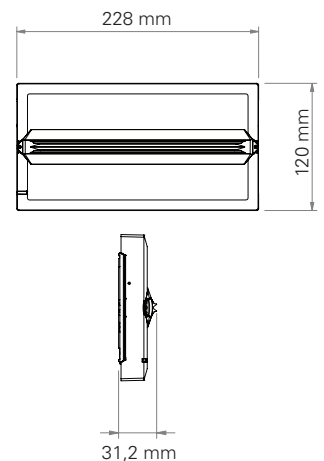



# 1.6

## Safety luminaires - Indoor

3583 LED

1

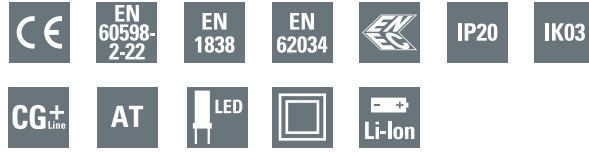

- Recessed luminaire with up to 385 lm in battery mode for high spacing and mounting heights up to 9 m
- Common ceiling cut-out diameter of 68 mm
- With CGLine+ technology

### Light Source:

3 x 1W LED  
Lithium ion battery

The 3583 LED is a recessed safety luminaire which provides a lumen output of 385lm with a wide beam distribution. Thus, it can be used for various applications, also for areas with high mounting heights up to 9m.

### Materials:

Bezel: sheet steel  
Module: Polycarbonate

One, three or eight hours rated operating duration can be freely specified according to application (luminous flux at the end of rated operating time 100% at 1h; 70% at 3h; 25% at 8h). 3583 LED is equipped with an environmental-friendly Li-Ion battery technology.

### Installation:

Recessed ceiling mounting

The use of LEDs, automatic testing and monitoring devices (CGLine+) significantly reduce the operating and maintenance costs of the installation.

### Operation:

For maintained and non-maintained operations  
CGLine+ (Without bus working in AT mode)  
Selectable emergency duration of 1 h, 3 h, 8 h

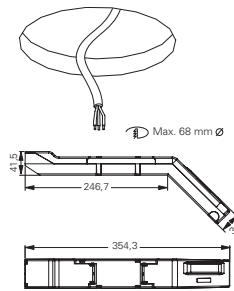
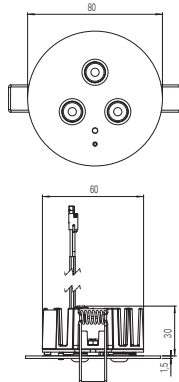

### Applications:

Hotels, offices, cinemas, theaters, museums and hospitals

### Guided SL CGLine+ with asymmetric optics for E=1.0lx

Measurement level 0.02m, maintenance factor MF = 80%, battery operation

Mounting height in metres	Types of mounting	Mounting Types of mounting			
		L1	L2	L3	L4
1 h	2.5 Ceiling mounting	4.3	10.0	4.3	10.0
	3.0 Escape route centre	4.7	11.2	4.8	11.2
	3.5	5.1	12.2	5.1	12.2
	4.0	5.3	13.0	5.3	13.1
	5.0	5.6	14.4	5.6	14.5
	6.0	5.6	15.3	5.6	15.3
	7.0	5.3	15.7	5.3	15.8
	8.0	4.6	15.8	4.6	15.9
	9.0	2.2	15.6	2.2	15.6
3 h	2.5 Ceiling mounting	3.9	9.2	3.9	9.2
	3.0 Escape route centre	4.2	10.1	4.2	10.2
	3.5	4.4	10.9	4.4	11.0
	4.0	4.5	11.6	4.5	11.6
	5.0	4.5	12.4	4.5	12.5
	6.0	4.0	12.7	4.1	12.8
	7.0	2.7	12.6	2.8	12.6

Order code Description

40071353365 3583 1-8h/D LED CGLine+



7VA / 6.6W



385 Lm



1h, 3h, 8h



LiNiMnCo<sub>2</sub>  
3.7V / 4Ah



Maintained & Non-Maintained



- Suitable for both solid and exposed grid ceilings as the gear pod fits through the head unit installation aperture
- Adapter plate for retrofit and shallow ceiling applications
- Up to 50.000 hour life LED for reduced maintenance
- Low power consumption reducing cost of ownership
- Environmentally friendly NiMH battery

### Light Source:

1 x 3W LED

Halo-Pack 2 combines the latest in LED technology with an ultra-low profile, providing emergency lighting where aesthetics and reliability are of prime importance. Installation into an existing ceiling is fast and simple to complete.

### Materials:

Luminaire head, remote gear and adaptor plate - polycarbonate and ABS blend  
Battery - NiMH

### Installation:

Flush mounting  
Spring retaining clips for surface installation (install from below ceiling)  
Plug and play socket for mains supply  
No disassembly required during installation

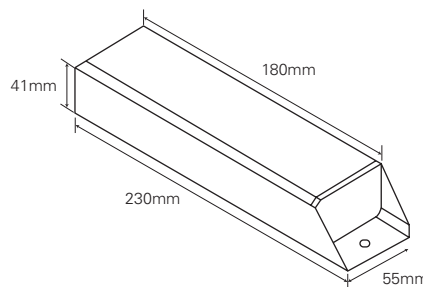
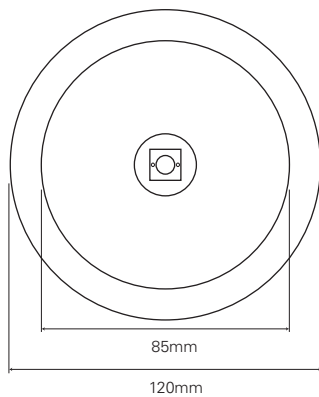

### Operation:

Non-Maintained operation

### Applications:

All recessed indoor applications



For retrofit and/or shallow ceiling applications an optional adapter plate is provided as standard

Model	Height (m)	Lux level directly under	Escape route 2m wide, 1 Lux min				Open (anti-panic) area 0,5 Lux min			
<b>HPLED3H</b>										
	2.50		3.20	8.90	3.20	8.90	3.60	9.60	3.60	9.60
	2.80		3.30	9.10	3.30	9.10	3.70	9.90	3.70	9.90
	3.00		3.30	9.20	3.30	9.20	3.70	10.20	3.70	10.20
	4.00		3.10	9.60	3.10	9.60	3.80	11.30	3.80	11.30
	5.00		2.50	9.40	2.50	9.40	3.80	11.80	3.80	11.80

Order code	Description					
HPLED3H	Halo Pack 2	4 W	170 Lm	3h	6x1.5Ah AA NiMH	Non-Maintained









- Overview ..... 50
- 2.1 i-P65+ ..... 52
- 2.2 Outdoor Wall ..... 54
- 2.3 Planète 400Tube CGLine+ ..... 55

# Safety - High degree of protection

## Overview

			Aesthetic	No replacement parts for 10 years	Low consumption / Eco-friendly	Protection Degree	Maintained	Non-Maintained	Stand alone	Autotest	Monitored (CGLine+)	
	Page	Performance	General features			Operation		Technology			Battery	
<b>2.1</b> i-P65+ 	52	★ ★ ★				65	●	●		●	●	Ni-Cd
<b>2.2</b> Outdoor Wall 	54	★ ★ ★			●	65	●	●		●	●	Li-Ion
<b>2.3</b> Planete 400 Tube 	55	★ ★	●	●	●	68 66	●			●	●	Ni-Cd 10 years

Installation	Applications									Best use	
Wall	Ceiling surface	Ceiling recessed	Healthcare	Hotels	Cinemas /Theaters	Commercial centers	Stadia / Arenas	Offices	Industrial	Warehouse	
●									●	●	High lumen output combined with special optics for highest spacing for large areas and high ceilings. Can be used at 40°C permanent ambient temperature.
●			●	●	●	●	●	●	●	●	Especially made for outdoors above the exit door and escape routes alongside the building. With battery heater suitable for down to -20°C.
●	●			●	●	●	●	●	●	●	

The information given in this brochure is accurate at the time of compilation (errors and omissions excepted), however due to Eaton philosophy of constant product development we reserve the right to change specifications without prior notice.



# 2.1

## Safety luminaires - High degree of protection

i-P65+

2



- Robust design with IK08
- i-P65+ L: with wide-beam symmetrical lens
- i-P65+ H: with narrow-beam reflector
- High lumen output for high spacing and high ceilings
- Minimum maintenance effort and increased safety via use of LEDs with high service life (up to 60,000 hours)

### Light Source :

COB LED 6.5W

### Materials:

Impact-resistant polycarbonate

Die-Cast aluminium optional

Ni-Cd battery

### Operation:

Maintained / Non-maintained

1h or 3h duration

### Applications:

Factories, warehouses

i-P65+ was developed specifically for requirements in industrial environments. With a combination of high-efficiency LEDs and special optics, it provides optimum performance for a variety of applications. The housing construction features an IP65 protection rating and IK08 impact resistance, making it ideal for ambient conditions in the industrial sector.

The photometric and electronic components including batteries are designed for reliable functionality with continuous ambient temperatures up to 40°C. The luminaires can therefore be reliably used in halls where machines or processes cause increased temperatures. Because of the high light output - also with battery operation - the i-P65+ is also suitable for applications in which more than 1lx is required e.g. high-risk areas.

The use of LEDs, automatic testing and monitoring devices (CGLine+) significantly reduce the operating and maintenance costs of the installation

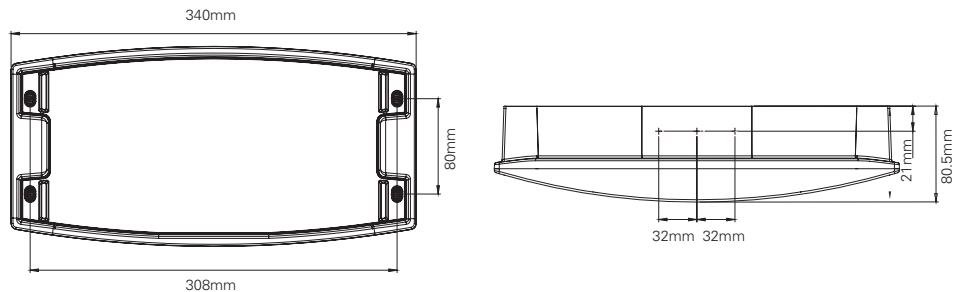

Order code	Description	⚡	☀️	🕒	📦	⚙️
<b>Polycarbonate enclosure</b>						
iP65PLP1H	i-P65 Plus L 1H	21.9 VA/10.1 W	740 Lm	1h	7.2V-1.6Ah Ni-Cd	Maintained / Non Maintained
iP65PHP1H	i-P65 Plus H 1H	21.9 VA/10.1 W	560 Lm	1h	7.2V-1.6Ah Ni-Cd	Maintained / Non Maintained
iP65PLP3H	i-P65 Plus L 3H	21.7 VA/10.7 W	510 Lm	3h	4.8V-4Ah Ni-Cd	Maintained / Non Maintained
iP65PHP3H	i-P65 Plus H 3H	21.7 VA/10.7 W	380 Lm	3h	4.8V-4Ah Ni-Cd	Maintained / Non Maintained
iP65PLP1HIS	i-P65 Plus L 1H, Auto-Test	21.9 VA/10.1 W	740 Lm	1h	7.2V-1.6Ah Ni-Cd	Maintained / Non Maintained
iP65PHP1HIS	i-P65 Plus H 1H, Auto-Test	21.9 VA/10.1 W	560 Lm	1h	7.2V-1.6Ah Ni-Cd	Maintained / Non Maintained
iP65PLP3HIS	i-P65 Plus L 3H, Auto-Test	21.7 VA/10.7 W	510 Lm	3h	4.8V-4Ah Ni-Cd	Maintained / Non Maintained
iP65PHP3HIS	i-P65 Plus H 3H, Auto-Test	21.7 VA/10.7 W	380 Lm	3h	4.8V-4Ah Ni-Cd	Maintained / Non Maintained
iP65PLP1HCGL	i-P65 Plus L 1H, CGLine+	21.9 VA/10.1 W	740 Lm	1h	7.2V-1.6Ah Ni-Cd	Maintained / Non Maintained
iP65PHP1HCGL	i-P65 Plus H 1H, CGLine+	21.9 VA/10.1 W	560 Lm	1h	7.2V-1.6Ah Ni-Cd	Maintained / Non Maintained
iP65PLP3HCGL	i-P65 Plus L 3H, CGLine+	21.7 VA/10.7 W	510 Lm	3h	4.8V-4Ah Ni-Cd	Maintained / Non Maintained
iP65PHP3HCGL	i-P65 Plus H 3H, CGLine+	21.7 VA/10.7 W	380 Lm	3h	4.8V-4Ah Ni-Cd	Maintained / Non Maintained
<b>Aluminium enclosure</b>						
iP65PLA3HCGL	i-P65 Plus L 3H, CGLine+	21.7 VA/10.7 W	510 Lm	3h	4.8V-4Ah Ni-Cd	Maintained / Non Maintained
iP65PHA3HCGL	i-P65 Plus H 3H, CGLine+	21.7 VA/10.7 W	380 Lm	3h	4.8V-4Ah Ni-Cd	Maintained / Non Maintained
<b>Accessories</b>						
iP65PSUSPB	Mounting bracket for chain suspension or for mounting at trunking systems or similar					

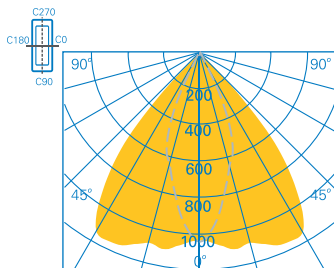

**i-P65+ H**  
Asymmetric reflector  
Narrow-beam  
reflector technology

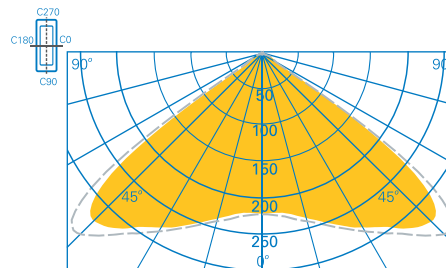

**i-P65+ L**  
Wide-beam  
Symmetrical lens

Luminaire type	Height (m)	Distance for 1 Lux				
		↔	↔	↔	↔	
1 h	Ceiling mounting	03.00	03.20	07.00	02.30	05.70
	Escape route centre	04.00	04.20	08.70	02.50	06.40
		05.00	05.10	10.60	03.00	06.80
		06.00	05.90	12.40	03.40	07.50
		07.00	06.70	14.20	03.80	08.30
		08.00	07.50	16.00	04.20	09.20
		09.00	08.20	17.60	04.50	10.00
		10.00	08.80	19.20	04.80	10.80
		15.00	10.70	25.90	05.00	13.80
		16.00	10.80	27.00	04.40	14.20
	18.00	10.70	28.60	03.50	14.20	
3 h	Ceiling mounting	03.00	03.10	06.60	02.00	05.10
	Escape route centre	04.00	04.10	08.50	02.40	05.60
		05.00	04.90	10.30	02.80	06.20
		06.00	05.70	12.10	03.20	07.10
		07.00	06.40	13.80	03.60	07.90
		08.00	07.10	15.50	03.90	08.70
		09.00	07.70	17.00	04.10	09.50
		10.00	08.20	18.40	04.20	10.20
		15.00	08.80	23.70	02.80	11.70
		16.00	08.00	24.30	02.20	11.60

**The reflector solution** was specifically developed for extreme mounting heights in combination with tight escape routes, e.g. with highbay racking applications, where in the case of wrong light distribution more light is distributed into the shelving than for safety along the escape routes. Here mounting heights to 28 m and luminaire spacing to 30 m are possible. This reduction in the quantity of luminaires needed leads to reduced installation- and operating costs.

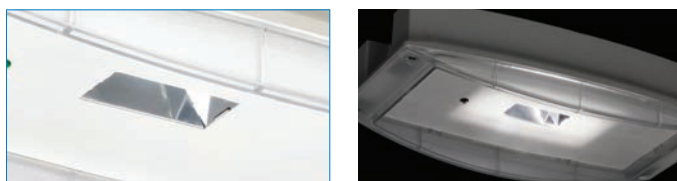

Luminaire type	Height (m)	Distance for 1 Lux					
		↔	↔	↔	↔		
1 h	Ceiling mounting	03.00	04.50	09.40	04.50	09.50	
	Escape route centre	04.00	05.80	12.10	05.80	12.20	
		05.00	07.00	14.70	06.90	14.70	
		06.00	07.90	17.20	07.80	17.10	
		07.00	08.60	19.50	08.30	19.20	
		08.00	08.90	21.60	08.50	21.10	
		09.00	08.40	23.10	08.00	22.40	
		10.00	07.10	23.40	06.80	22.90	
		11.00	04.90	23.30	04.70	22.60	
		Ceiling mounting	03.00	04.40	09.20	04.40	09.30
	Escape route centre	04.00	05.60	11.80	05.50	11.80	
3 h		05.00	06.60	14.30	06.50	14.20	
		06.00	07.20	16.60	07.00	16.40	
		07.00	07.40	18.50	07.00	18.10	
		08.00	06.40	19.50	06.10	19.00	
		09.00	04.60	19.50	04.50	18.90	
		10.00	-	15.50	-	15.00	
		Ceiling mounting	03.00	04.30	08.40	04.20	08.30
		Room illumination	04.00	05.40	10.80	05.30	10.70
			05.00	06.20	13.10	06.30	13.10
			06.00	07.10	15.40	06.90	15.30
1 h		07.00	07.50	17.50	07.50	17.50	
		08.00	08.00	19.50	07.90	19.50	
		09.00	08.30	21.40	08.00	21.30	
		10.00	05.50	22.00	05.80	22.00	
		15.00	00.50	19.10	00.50	19.10	
		18.00	00.50	18.80	00.50	18.80	
		Ceiling mounting	03.00	04.20	08.20	04.10	08.10
		Room illumination	04.00	05.20	10.50	05.20	10.50
			05.00	05.90	12.80	05.90	12.80
			06.00	06.30	14.90	06.40	15.00
3 h		07.00	06.80	16.90	06.80	16.90	
		08.00	05.00	18.50	05.40	18.40	
		09.00	03.60	18.20	03.70	18.20	
		10.00	00.50	16.00	00.50	16.00	
		15.00	00.50	15.70	00.50	15.60	
		18.00	00.50	09.40	00.50	09.40	

**The lens optic** emits almost square light distribution over a very large area. This makes it especially suitable for large halls where no fixed escape route can be defined due to changing uses, meaning the complete area must be illuminated. A maximum spacing of up to 23 m between luminaires reduces the number of required light points. An application range up to 17 m enables mounting at the normally occurring heights.

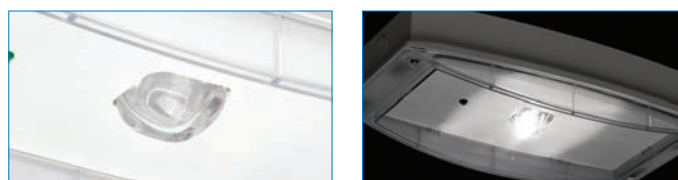

# 2.2

## Safety luminaires - High degree of protection

Outdoor Wall

2



- For indoor and Outdoor use
- Robust construction from aluminium diecast and high impact resistant cover made of polycarbonate
- Optional with self-regulating battery heater for use at low temperature down to -20°C

### Light Source:

2 x 1.6 W LED

### Materials:

Diecast aluminum housing

Polycarbonate lens

Lithium ion battery

### Installation:

Wall mounting above exit door or along escape routes

### Operation:

For maintained and non-maintained operations CGLine+ (Withoutworking in AT mode)

Manual test with magnet

### Applications:

Factories, warehouses, underground car parks, workshops, tunnel

Installation on emergency exits inside and outside buildings

The durable cast aluminum along with the high degree of protection (IP65) makes the Outdoor Wall safety luminaire particularly suitable for industrial areas, underground car parks and tunnels. The range has been developed to be mounted on the wall above the safety exits of a building both inside and outside.

For application with low ambient temperature down to -20°C, e.g. outdoors, this luminaire is also available with a self-regulating battery heater.

The use of LEDs, automatic testing and monitoring devices (CGLine+) significantly reduce the operating and maintenance costs of the installation.

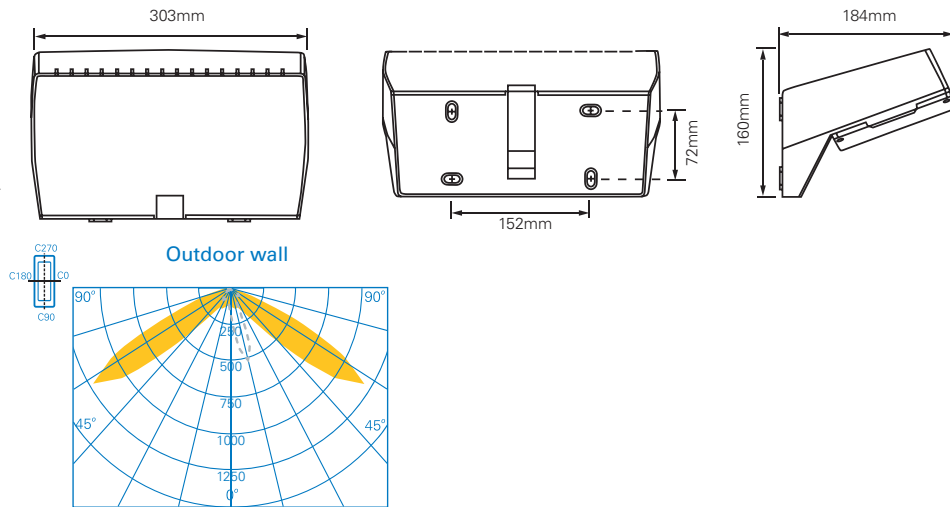

Outdoor Wall light coverage

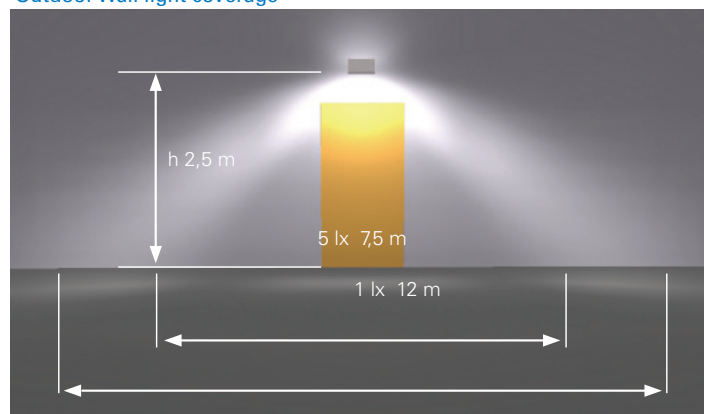

Order code	Description					
40071354874	Outdoor Wall 1-8h CGLine+	7.2 VA/7.0 W	225lm	1 - 3 - 8 h	LiNiMnCoO <sub>2</sub> 3.7V / 4Ah	Maintained / Non-Maintained
40071354879	Outdoor Wall 1-8h CGLine+ H (with battery heater)	9.2 VA/9.3 W	225lm	1 - 3 - 8 h	LiNiMnCoO <sub>2</sub> 3.7V / 4Ah	Maintained / Non-Maintained

# Safety luminaires - High degree of protection

Planete 400 Tube CGLine+

# 2.3

2

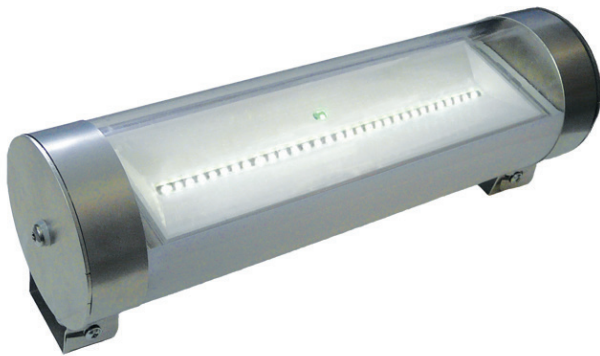

- Suitable of architectural or industrial environments
- Pure design - no technical details visible
- Opaque back face : invisible electronics and connections
- Eco-friendly, low consumption

### Light Source:

LED strip

The Planete 400 Tube is a maintained safety luminaire designed on a tubular housing concept. It fits with mains lighting design tendencies and is well appreciated for its robustness and sealing.

### Materials:

Polycarbonate tube body,  
stainless steel hubcap, fixing  
brackets and screws

This polycarbonate and stainless steel housing offers an IP66/68 and a shock protection.

Ni-Cd battery (10 years)

This 10 years lifetime range has benefited from an eco-design in order to meet the latest environmental standards. The use of LEDs, long life components, automatic testing and monitoring devices (CGLine+) significantly reduce the operating and maintenance costs of the installation.

### Installation:

- Wall & ceiling surface mounting
- Quick installation
- Necklaces with open holes for fast tightening
- 360° orientation
- Screw less connectors
- Metal cable gland included

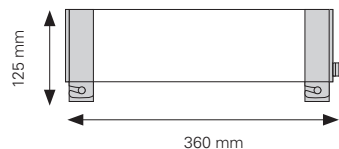



### Operation:

- Maintained (10 lm in mains)
- Maintenance costs reduced, no replacement of spareparts needed for 10 years

### Applications:

- Factories, warehouses, underground car parks, workshops, tunnel
- Buildings with industrial design (restaurants, offices, etc.)
- Escape routes, corridors



Order code	Description					
LUM17151	Planete 400 Tube CGLine+	1.1W	400 lm	1h	6V / 1.5Ah - Ni-Cd 10 years	Maintained (10lm)













- Overview ..... 58
- Indoor**
- 3.1 NexiTech LED ..... 60
- 3.2 NexiLite ..... 66
- 3.3 SafeLite..... 68
- High degree of protection**
- 4.1 Atlantic LED..... 74
- 4.2 i-P65 .....76

# Safety & Exit signs

## Overview

	Page	Performance	Aesthetic	One box solution *	No replacement parts for 10 years	Low consumption / Eco-friendly	Protection Degree	Viewing distance	Maintained	Non-Maintained	Stand alone	Autotest	Monitored (CGLine+)	Battery
<b>3.1</b> NexiTech LED 	60	★ ★	●			●	40 65	20 30*	●	●		●	●	Ni-Cd
<b>3.2</b> NexiLite 	66	★					40 65	20 30*	●	●	●			Ni-Cd
<b>3.3</b> SafeLite 	68	★					42 65	20 30	●	●	●			Ni-Cd
<b>4.1</b> ATLANTIC LED 	74	★ ★ ★				●	65	24	●	●		●	●	Li-Ion
<b>4.2</b> i-P65 	76	★ ★					65	20	●	●	●	●	●	Ni-Cd

\*double side panels available for 30m viewing distance

Wall	Ceiling	Recessed	Suspended*	Healthcare	Hotels	Cinemas / Theaters	Commercial centers	Stadia / Arenas	Offices	Industrial	Warehouse	
Installation				Applications								Best use
●	●	●		●	●	●	●	●	●		●	
●	●	●		●	●	●	●		●			
●	●	●		●	●	●	●		●			
	●							●		●	●	Very robust solution with IK10 for industrial and public buildings like car parks . With battery heater suitable for down to -20°C.
	●									●	●	Versatile multi-functional use and designed to support aggressive environment

\* See pure exit sign section for suspended luminaires



# 3.1

## Safety & exit signs - Indoor

NexiTech LED

3

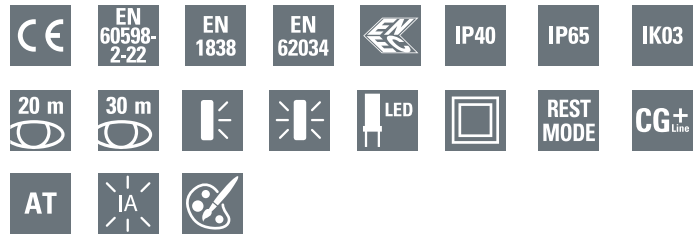

- From 100 to 800lm output flux
- Comparable to 8, 11 and 24W fluorescent lamp
- Ni-Cd HT high quality batteries

### Light Source:

LED strip

The modern style, the simplicity of the shapes and the high quality surfaces make NexiTech LED ideal for any architectural context, while the precision of the mechanics and the sophisticated electronics guarantee a full unmatched reliability. The latest generation of LED light source provides a good and uniform light distribution.

### Material:

- Base and reflector white polycarbonate
- Diffuser clear polycarbonate
- Protection degree IP40 and IP65 with the accessory kit
- Ni-Cd battery

The wide range of accessories allows installation on a wall or ceiling, surface or recessed in indoor and harsh environments, thanks to the IP65 protection kit. It is also possible to use it as single or double-sided exit sign and to combine exit and safety lighting functions in one product.

This range is composed of maintained and non-maintained variants, 1/1.5/3h duration versions, from 100lm up to 800lm light output. The use of LEDs, automatic testing and monitoring devices (CGLine+) significantly reduce the operating and maintenance costs of the installation.

### Installation options:

- Wall and ceiling mounting
- Surface or recessed installation in false ceiling and bricks wall
- Single side glue-less ISO7010 pictograms with 20m viewing distance
- Double side ISO7010 panels with 20 or 30m of viewing distance

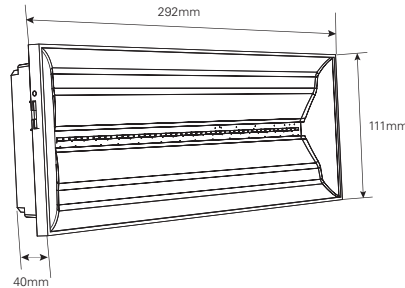

### Operation:

- Maintained and Non-Maintained mode on all version
- Fixed 60lm output in Maintained mode for all variants for high energy saving
- 1h, 1.5h and 3h duration
- Rest Mode and Tests via remote command
- 12h recharge period (24h for 3h versions)

### Autotest is now for all

The reliability and the guarantee of operation are now within everyone's reach. We chose to design NexiTech LED starting directly from models with built-in diagnostic functions, all the self-contained versions (with battery on board) are equipped with a self-test system that performs automatic tests in accordance with standard EN62034 and EN50172.

### Top level signalization

The pictograms, optional and available upon request, conform to the international standard ISO7010, have no glue and can be repositioned at will and with ease, without a complex installation. They are placed between the diffuser and reflector creating a translucency which finds its maximum aesthetic applications when recessed into the wall.

### Applications:

- Schools, universities, commercial malls, stores, offices, public administration and all indoor generic environments
- Safety antipanic lighting and escape route lighting
- Hi-bay environments



NexiTech LED with IP65 protection kit

The IP65 kit is compatible with all the variants. Only surface mounting. Dimension 308x125x53 mm



NexiTech LED in the combined version "Door" allows for 2 functions in one device: safety light, with viewing distance of 20m and emergency lighting with 5lx on the floor.



With double-side pictograms



Viewing distance: 20 or 30m

With single-side pictograms



Nexi pictograms don't stick, but are placed behind transparent diffuser.

Viewing distance: 20m

45° Wall Bracket (IP40/IP65)

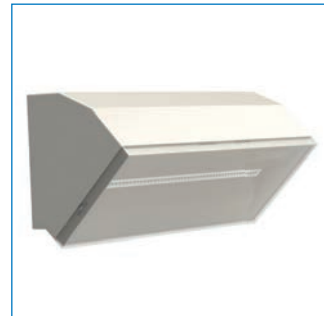

Light the floor from the wall







NexiTech LED frame



Order code	Description					
NEXI100-AT	NexiTech LED 100 1.5h Auto Test	0.65 W - 2.4 W	100 Lm	1.5h	3.6V - 0.8Ah Ni-Cd	Non-Maintained
NEXI100-3H-AT	NexiTech LED 100 3h Auto Test	1.3 W - 3.1 W	100 Lm	3h	3.6V - 2.0Ah Ni-Cd	Non-Maintained
NEXI100-AT-IP	NexiTech LED 100 1.5h IP65 Auto Test	0.65 W - 2.4 W	100 Lm	1.5h	3.6V - 0.8Ah Ni-Cd	Non-Maintained
NEXI150-AT	NexiTech LED 150 1h Auto Test	0.65 W - 2.4 W	150 Lm	1h	3.6V - 0.8Ah Ni-Cd	Maintained / Non-Maintained
NEXI150-3H-AT	NexiTech LED 150 3h Auto Test	1.3 W - 3.1 W	150 Lm	3h	3.6V - 2.0Ah Ni-Cd	Maintained / Non-Maintained
NEXI150-AT-IP	NexiTech LED 150 1h IP65 Auto Test	0.65 W - 2.4 W	150 Lm	1h	3.6V - 0.8Ah Ni-Cd	Maintained / Non-Maintained
NEXI250-AT	NexiTech LED 250 1.5h Auto Test	2.25 W - 3.6 W	250 Lm	1.5h	7.2V - 1.7Ah Ni-Cd	Maintained / Non-Maintained
NEXI250-3H-AT	NexiTech LED 250 3h Auto Test	2.25 W - 3.6 W	250 Lm	3h	7.2V - 1.7Ah Ni-Cd	Maintained / Non-Maintained
NEXI250-AT-IP	NexiTech LED 250 1.5h IP65 Auto Test	2.25 W - 3.6 W	250 Lm	1.5h	7.2V - 1.7Ah Ni-Cd	Maintained / Non-Maintained
NEXI400-AT	NexiTech LED 400 1.5h Auto Test	2.25 W - 3.6 W	400 Lm	1.5h	7.2V - 1.7Ah Ni-Cd	Maintained / Non-Maintained
NEXI400-AT-IP	NexiTech LED 400 1.5h IP65 Auto Test	2.25 W - 3.6 W	400 Lm	1.5h	7.2V - 1.7Ah Ni-Cd	Maintained / Non-Maintained
NEXI600-AT	NexiTech LED 600 1.5h Auto Test	2.25 W - 3.6 W	600 Lm	1.5h	7.2V - 1.7Ah Ni-Cd	Maintained / Non-Maintained
NEXI600-AT-IP	NexiTech LED 600 1.5h IP65 Auto Test	2.25 W - 3.6 W	600 Lm	1.5h	7.2V - 1.7Ah Ni-Cd	Maintained / Non-Maintained
NEXI1000-AT	NexiTech LED 1000/1h 800/1.5h Auto Test	2.25 W - 3.6 W	800 Lm	1h	7.2V - 2.0Ah Ni-Cd	Maintained / Non-Maintained
NEXI1000-AT-IP	NexiTech LED 1000/1h 800/1.5h IP65 Auto Test	2.25 W - 3.6 W	800 Lm	1h	7.2V - 2.0Ah Ni-Cd	Maintained / Non-Maintained
NEXI-D-AT	NexiTech LED Door 1.5h Auto Test	2.25 W - 3.6 W	250 Lm	1.5h	7.2V - 1.7Ah Ni-Cd	Maintained / Non-Maintained
NEXI150-CGL	NexiTech LED 150 1.5h CGLLine+	0.65 W - 2.4 W	150 Lm	1.5h	7.2V - 1.7Ah Ni-Cd	Maintained / Non-Maintained
NEXI150-CGL-IP	NexiTech LED 150 1.5h IP65 CGLLine+	0.65 W - 2.4 W	150 Lm	1.5h	7.2V - 1.7Ah Ni-Cd	Maintained / Non-Maintained
NEXI150-3H-CGL	NexiTech LED 150 3h CGLLine+	1.3 W - 3.1 W	150 Lm	3h	7.2V - 1.7Ah Ni-Cd	Maintained / Non-Maintained
NEXI150-3H-CGL-IP	NexiTech LED 150 3h IP65 CGLLine+	1.3 W - 3.1 W	150 Lm	3h	7.2V - 1.7Ah Ni-Cd	Maintained / Non-Maintained
NEXI300-3H-CGL	NexiTech LED 300 3h CGLLine+	2 W - 3.2 W	300 Lm	3h	7.2V - 1.7Ah Ni-Cd	Maintained / Non-Maintained
NEXI300-3H-CGL-IP	NexiTech LED 300 3h IP65 CGLLine+	2 W - 3.2 W	300 Lm	3h	7.2V - 1.7Ah Ni-Cd	Maintained / Non-Maintained
NEXI400-CGL	NexiTech LED 400 1.5h CGLLine+	2 W - 3.2 W	400 Lm	1.5h	7.2V - 1.7Ah Ni-Cd	Maintained / Non-Maintained
NEXI400-CGL-IP	NexiTech LED 400 1.5h IP65 CGLLine+	2 W - 3.2 W	400 Lm	1.5h	7.2V - 1.7Ah Ni-Cd	Maintained / Non-Maintained
NEXI1000-CGL	NexiTech LED 1000/1h 800/1.5h CGLLine+	2.25 W - 3.6 W	800 Lm	1h	7.2V - 2.0 Ah Ni-Cd	Maintained / Non-Maintained
NEXI1000-CGL-IP	NexiTech LED 1000/1h 800/1.5h IP65 CGLLine+	2.25 W - 3.6 W	800 Lm	1h	7.2V - 2.0 Ah Ni-Cd	Maintained / Non-Maintained

\*Non maintained - Maintained

### Increased Affordance versions

Order code	Description						
NEXI1HIA-CGL	NexiTech LED 1h IA CGLLine+ IP40	✓	2.5W - 4W	>500cd	1h	7.2V - 1.7Ah Ni-Cd	Maintained / Non-Maintained
NEXI3HIA-CGL-IP	NexiTech LED 3h IA CGLLine+ IP40	✓	2.5W - 4W	>500cd	3h	7.2V - 1.7Ah Ni-Cd	Maintained / Non-Maintained
NEXI1HIA-CGL-IP	NexiTech LED 1h IA CGLLine+ IP65	✓	2.5W - 4W	>500cd	1h	7.2V - 1.7Ah Ni-Cd	Maintained / Non-Maintained
NEXI3HIA-CGL-IP	NexiTech LED 3h IA CGLLine+ IP65	✓	2.5W - 4W	>500cd	3h	7.2V - 1.7Ah Ni-Cd	Maintained / Non-Maintained

\*\*50cd - 500cd

# 3.1

## Safety & exit signs - Indoor

NexiTech LED

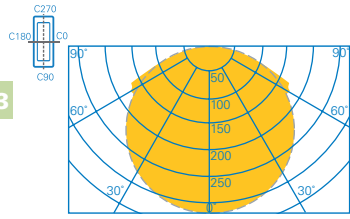

### NexiTech, 100 lm

#### Escape route 2m wide 1 lux min

Mounting height [m]	Lux level directly under				
2,5	4,4	2,7	7,2	7,2	2,7
2,8	3,6	2,7	7,4	7,4	2,7
3,0	3,2	2,7	7,5	7,5	2,7
4,0	1,8	2,5	7,8	7,8	2,5

#### Open (anti-panic) area 0.5 lux min

Mounting height [m]	Lux level directly under				
2,5	4,4	3,1	7,5	7,5	3,1
2,8	3,6	3,2	7,9	7,9	3,2
3,0	3,2	3,3	8,1	8,1	3,3
4,0	1,8	3,4	9,1	9,1	3,4
5,0	1,1	3,1	9,6	9,6	3,1
6,0	0,8	2,7	10,2	10,2	2,7

#### Mounting height for 5 lux below 2 meters

### NexiTech, 250 lm

#### Escape route 2m wide 1 lux min

Mounting height [m]	Lux level directly under				
2,5	10,1	3,9	10,0	10,0	3,9
2,8	8,4	4,0	10,6	10,6	4,0
3,0	7,4	4,1	10,8	10,8	4,1
4,0	4,5	4,3	10,8	10,8	4,3
5,0	2,8	4,0	11,3	11,3	4,0
6,0	1,9	3,7	11,4	11,4	3,7
7,0	1,4	2,9	11,2	11,2	2,9





#### Open (anti-panic) area 0.5 lux min

Mounting height [m]	Lux level directly under				
2,5	10,1	4,0	9,4	9,4	4,0
2,8	8,4	4,2	9,9	9,9	4,2
3,0	7,4	4,3	10,3	10,3	4,3
4,0	4,5	4,7	11,8	11,8	4,7
5,0	2,8	4,8	12,7	12,7	4,8
6,0	1,9	4,9	13,6	13,6	4,9
7,0	1,4	4,9	14,4	14,4	4,9



#### Mounting height for 5 lux below 3.9 meters

## NexiTech, 400 lm

### Escape route 2m wide 1 lux min

Mounting height [m]	Lux level directly under				
2,5	8,3	4,8	11,1	11,1	4,8
2,8	7,6	4,9	11,8	11,8	4,9
3,0	7,2	5,0	12,4	12,4	5,0
4,0	5,2	5,3	13,8	13,8	5,3
5,0	3,8	5,5	14,3	14,3	5,5
6,0	2,8	5,5	14,9	14,9	5,5





### Open (anti-panic) area 0.5 lux min

Mounting height [m]	Lux level directly under				
2,5	8,3	4,6	10,6	10,6	4,6
2,8	7,6	4,7	11,2	11,2	4,7
3,0	7,2	4,9	11,6	11,6	4,9
4,0	5,2	5,4	14,3	14,3	5,4
5,0	3,8	5,8	15,1	15,1	5,8
6,0	2,8	6,1	16,1	16,1	6,1
7,0	2,1	6,2	17,2	17,2	6,2





### Mounting height for 5 lux below 4 meters

## NexiTech, 1000 lm

### Escape route 2m wide 1 lux min

Mounting height [m]	Lux level directly under				
2,6	45,9	5,4	13,4	13,4	5,4
2,8	39,6	5,9	13,9	13,9	5,9
3,0	34,4	6,1	14,4	14,4	6,1
3,5	25,3	6,5	15,5	15,5	6,5
4,0	19,3	6,9	16,5	16,5	6,9
4,5	15,2	7,2	17,4	17,4	7,2
5,0	12,3	7,4	18,2	18,2	7,4
6,0	8,5	7,9	18,2	18,2	7,9

### Open (anti-panic) area 0.5 lux min

Mounting height [m]	Lux level directly under				
2,6	45,9	4,5	10,4	10,4	4,5
2,8	39,6	4,9	11,5	11,5	4,9
3,0	34,4	5,2	12,4	12,4	5,2
3,5	25,3	5,9	14,5	14,5	5,9
4,0	19,3	6,5	16,1	16,1	6,5
4,5	15,2	6,8	17,1	17,1	6,8
5,0	12,3	7,1	18,0	10,0	7,1
6,0	8,5	7,6	19,6	19,6	7,6
7,0	6,3	8,0	21,2	21,2	8,0
8,0	4,8	8,3	22,5	22,5	8,3

### Mounting height for 5 lux below 7.5 meters



# 3.1

## Safety & exit signs - Indoor

NexiTech LED - Edge Light Panel with opal diffuser

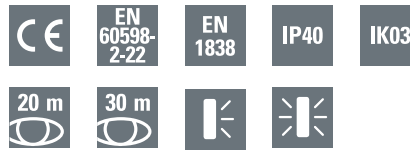

- Combined Exit Sign and Safety Lighting functions in one product
- Good light distribution performance
- No glare effect thanks to the opal diffuser
- Suitable for (IP40 luminaires), Self Contained and Central Power System versions
- Suitable for all light output variants (100lm to 1000lm)

**Light Source:**  
LED strip

**Material:**  
Diffuser polycarbonate  
Edge Light Panel polycarbonate and PMMA  
Protection degree IP40

**Installation options:**  
Compatible with false ceiling adaptor and finishing frame  
20m and 30m viewing distance  
4 mm thickness panel  
Single and double sided edge panel for ceiling mounting

**Applications:**  
Schools, universities, commercial malls, stores, offices, public administration and all indoor generic environments  
Safety antipanic lighting and escape route lighting

This new range of accessories makes NexiTech LED luminaires a solution for Exit Sign and Safety Lighting functions in one product.

The additional light provided by the luminaire through the opal diffuser contributes to the escape route lighting (possible spacing up to 12m with NexiTech LED 500, 14.9m with NexiTech LED 1000).

The standard edge light panel with opaque cover make NexiTech LED luminaires a solution for pure Exit Sign. All new Edge Light Panel are available in two versions: 20 and 30m viewing distance. The illumination of the ISO format pictogram is homogenous and complies with EN1838.

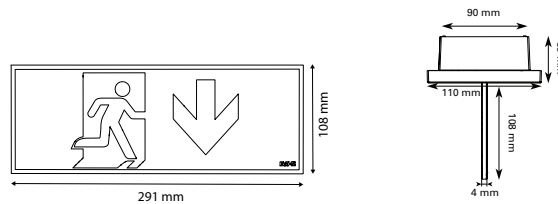

NexiTech LED 20m viewing distance

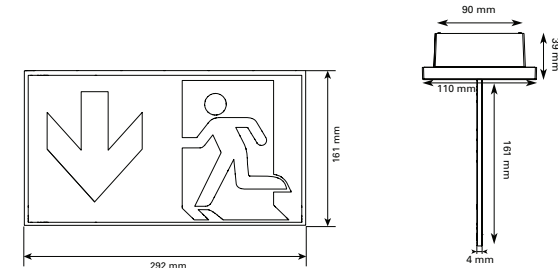

NexiTech LED 30m viewing distance

### Ordering details - Opal diffuser for Exit Sign and Safety Lighting functions

High Uniformity, complying with EN1838, suitable for NexiTech LED IP40 versions

Order code	Description	Pictogram
NEXI-PLEXO-DB	NEXI PANEL OPAL 30 D-B ISO High Unifor.	30m, Down/Blank
NEXI-PLEXO-DD	NEXI PANEL OPAL 30 D-D ISO High Unifor.	30m, Down/Down
NEXI-PLEXO-LR	NEXI PANEL OPAL 30 L-R ISO High Unifor.	30m, Left/Right
NEXI-PLEXO-UB	NEXI PANEL OPAL 30 U-B ISO High Unifor.	30m, Up/Blank
NEXI-PLEXO-UU	NEXI PANEL OPAL 30 U-U ISO High Unifor.	30m, Up/Up
NEXI-PLEXO-20-DB	NEXI PANEL OPAL 20 D-B ISO High Unifor.	20m, Down/Blank
NEXI-PLEXO-20-DD	NEXI PANEL OPAL 20 D-D ISO High Unifor.	20m, Down/Down
NEXI-PLEXO-20-LR	NEXI PANEL OPAL 20 L-R ISO High Unifor.	20m, Left/Right
NEXI-PLEXO-20-UB	NEXI PANEL OPAL 20 U-B ISO High Unifor.	20m, Up/Blank
NEXI-PLEXO-20-UU	NEXI PANEL OPAL 20 U-U ISO High Unifor.	20m, Up/Up



NexiTech LED recessed using false ceiling adapter + Edge light panel

### High Uniformity, complying with EN1838, suitable for NexiTech LED IP40 versions

Order code	Description	Pictogram
NEXI-PLEX-20-DB	NEXI PANEL 20 D-B ISO High Unifor.	20m, Down/Blank
NEXI-PLEX-20-DD	NEXI PANEL 20 D-D ISO High Unifor.	20m, Down/Down
NEXI-PLEX-20-LR	NEXI PANEL 20 LR ISO High Unifor.	20m, Left/Right
NEXI-PLEX-20-UB	NEXI PANEL 20 U-B ISO High Unifor.	20m, Up/Blank
NEXI-PLEX-20-UU	NEXI PANEL 20 U-U ISO High Unifor.	20m, Up/Up
NEXI-PLEX-30-DB	NEXI PANEL 30 D-B ISO High Unifor.	30m, Down/Blank
NEXI-PLEX-30-DD	NEXI PANEL 30 D-D ISO High Unifor.	30m, Down/Down
NEXI-PLEX-30-LR	NEXI PANEL 30 LR ISO High Unifor.	30m, Left/Right
NEXI-PLEX-30-UB	NEXI PANEL 30 U-B ISO High Unifor.	30m, Up/Blank
NEXI-PLEX-30-UU	NEXI PANEL 30 U-U ISO High Unifor.	30m, Up/Up



NexiTech LED + Edge light panel

### Standard uniformity, suitable for NexiTech LED IP40 versions

NEXI-PLEXL-DB	NEXI PANEL 30 D-B ISO Lite Unifor.	30m, Down/Blank
NEXI-PLEXL-DD	NEXI PANEL 30 D-D ISO Lite Unifor.	30m, Down/Down
NEXI-PLEXL-LR	NEXI PANEL 30 LR ISO Lite Unifor.	30m, Left/Right

### Standard uniformity, suitable for NexiTech LED IP65 versions

NEXI-PLEX-IP	NEXI PANEL 30 ISO Lite Unifor. Delivered with 7 stickers	
--------------	--	--



NexiTech LED + finishing frame + Edge light panel

### Single-side pictograms

NEXI-PICTO-D	Pictogram Down ISO single-side 20m	
NEXI-PICTO-L	Pictogram Left ISO single-side 20m	
NEXI-PICTO-R	Pictogram Right ISO single-side 20m	
NEXI-PICTO-U	Pictogram Up ISO single-side 20m	

### Accessories

NEXI-IP	IP65 protection kit
NEXI-WB45	45° Wall Bracket (IP40/IP65)*
ELBR1	90° Wall Bracket (IP40/IP65)*
NEXI-RB	Bricks wall recessed base (cut-out 277x100mm)
NEXI-FC	False ceiling adapter (cut-out 272x95mm)
NEXI-FR	Finishing frame NexiTech LED
LUM10312	Rest-Mode and Test telecommand

\* available in 2019

# 3.2

## Safety & exit signs - Indoor

NexiLite



- Latest generation LED light source
- 100, 150 and 250lm output flux
- 1h and 3h duration
- Complete recharge in 12h for 1h models
- Compact dimensions: 290x110x40mm

### Light Source:

LED strip

### Material:

Base and reflector white polycarbonate

Diffuser clear polycarbonate

Protection degree IP40 and

IP65 with the accessory kit

Ni-Cd battery

### Operation:

Maintained and Non-Maintained mode

Fixed 60lm output in Maintained mode for all variants for high energy saving

1h and 3h duration

Rest Mode and Tests via remote command

12h recharge period (24h for 3h versions)

### Applications:

Schools, universities, commercial centers, stores, offices, public administration and all indoor generic environments

Safety antipanic lighting and escape route lighting

Exit sign with single and double side signalization

NexiLite is a range of anti-panic and escape route luminaires that can also be used as an exit sign by purchasing optional sets of pictograms (Conforms to ISO7010). The low profile housings are available in two IP rating options (IP40 & IP65) making NexiLite luminaires suitable for indoor or more industrial applications.

With its compact and modern design, NexiLite can be used in any architectural context. The wide range of accessories allows installation on a wall or ceiling, surface or recessed.

This range of LED stand-alone self-contained luminaires is composed of maintained and non-maintained variants, 1h and 3h duration versions, from 100lm up to 250lm light output.

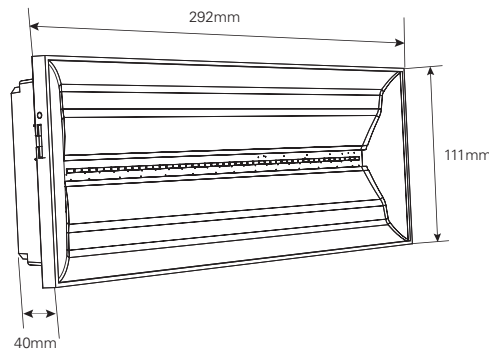

### The right accessory at the right time

NexiLite is equipped with a wide range of accessories to meet any installation requirement.

The standard versions, with degree of protection IP40 are suitable to be installed indoors, but thanks to the IP65 kit are transformed into outdoor luminaires for use in wet and dusty environments.

For escape sign lighting, NexiLite is equipped with a series of single side pictograms and double side panels in accordance with International Standard ISO7010 with visibility distance of 20 and 30m (EN1838).

NexiLite's single side pictograms are different from those adhesives commonly used since are positioned between the reflector and the diffuser, are free of glue and can be repositioned as desired without the formation of unsightly defects.



NexiLite LED with IP65 protection kit

The IP65 kit is compatible with all the variants.  
Only surface mounting. Dimension 308x125x53 mm



With double-side pictograms



Viewing distance: 20 or 30m

With single-side pictograms

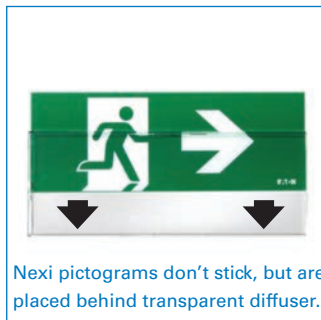

Nexi pictograms don't stick, but are placed behind transparent diffuser.

Viewing distance: 20m

45° Wall Bracket (IP40/IP65)







Light the floor from the wall

NexiTech LED frame



All NexiTech LED accessories are usable with NexiLite luminaires

Order code	Description					
NXL100	NexiLite 100Lm 1h NM	1.5 W	100 Lm	1h	3.6V - 0.8Ah Ni-Cd	Non-Maintained
NXL150	NexiLite 150Lm 1h NM	1.5 W	150 Lm	1h	3.6V - 0.8Ah Ni-Cd	Non-Maintained
NXL250	NexiLite 250Lm 1h NM	1.8 W	250 Lm	1h	3.6V - 1.7Ah Ni-Cd	Non-Maintained
NXL150-3H	NexiLite 150Lm 3h M	3.1 W	150 Lm	3h	3.6V - 2.0Ah Ni-Cd	Maintained / Non-Maintained
NXL250-3H	NexiLite 250Lm 3h M	3.6 W	250 Lm	3h	7.2V - 1.7Ah Ni-Cd	Maintained / Non-Maintained
NXL100-IP	NexiLite 100Lm 1h IP65	1.5 W	100 Lm	1h	3.6V - 0.8Ah Ni-Cd	Non-Maintained
NXL150-IP	NexiLite 150Lm 1h IP65	1.5 W	150 Lm	1h	3.6V - 0.8Ah Ni-Cd	Non-Maintained
NXL250-IP	NexiLite 250Lm 1h IP65	1.8 W	250 Lm	1h	3.6V - 1.7Ah Ni-Cd	Non-Maintained



# 3.3

## Safety & exit signs - Indoor

SafeLite

3

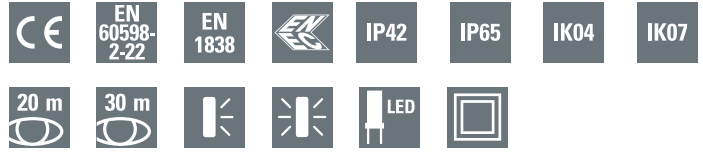

- All applications covered (Escape route, Anti-panic, Exit sign)
- One product throughout installation for same look and feel across the building
- Accessories available for a better integration in all buildings
- Easily installed as retro fit due to good performance ensuring scheme compliance
- 1h, 2h & 3h Duration
- Latest generation LEDs with high lumen/watt ratio

### Light Source:

LED strip

### Materials:

Base and reflector white polycarbonate

Diffuser clear polycarbonate

Protection degree IP42 and IP65 housings

One product, several applications. SafeLite is a range of anti-panic and escape route luminaires that can also be used as an exit-sign by purchasing optional sets of pictograms (Conform to ISO7010). The housings are available in two IP rating options (IP42 & IP65) making SafeLite luminaires suitable for indoor or more industrial applications.

A wide range of accessories (recessed box, recessed base, double-sided diffuser and wire guard) will provide more flexibility and ease of integration within the building.

This range of LED stand-alone self-contained luminaires is composed of maintained and non-maintained variants, 1/2/3h duration versions, from 60lm up to 300lm light output.

### Installation:

Surface

Options: Recessed box for plaster or brick, recessed base for ceiling, double sided diffuser, set of adhesive exit legends

### Operation:

Non Maintained or Maintained & Non Maintained mode selectable

Safety antipanic lighting and escape route lighting  
Exit sign with single and double side signalization

### Applications:

Schools, universities, commercial malls, stores, offices, public administration and all indoor generic environments

#### SafeLite 20m

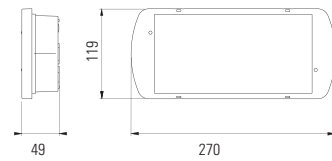

#### Recessed Base 20m

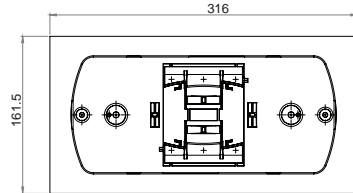

#### Cone Diffuser 20m

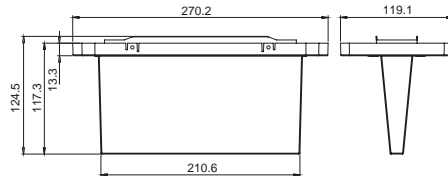

#### SafeLite 20m Exit Sign Plexiglass

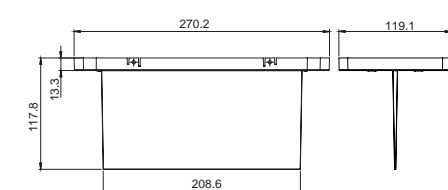

#### SafeLite 20m Recessed box for concrete

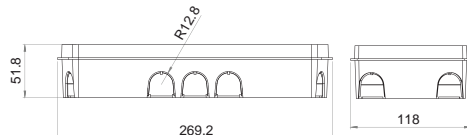

#### SafeLite 30m

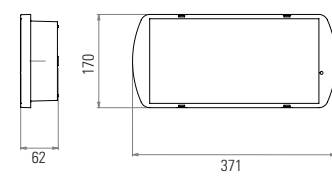

#### Recessed Base 30m

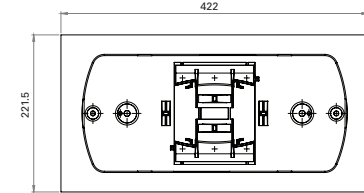

#### Cone Diffuser 30m

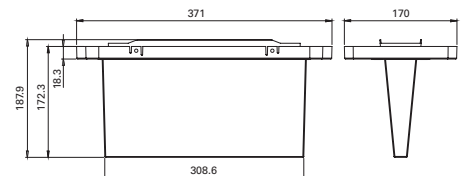

#### SafeLite 30m Exit Sign Plexiglass

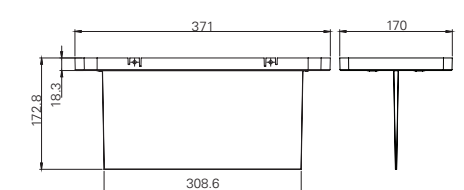



**Double side cone diffuser:**

Used to do ceiling signage, double or single side (blind picto inside).  
In accordance with EN1838 standard.  
Exit pictograms comply with ISO7010. Compatible with IP42 and IP65 luminaire versions.  
Could be associated with recessed base. Adhesives pictograms have to be ordered separately (or re use ones delivered with luminaires).



**Double side plexi diffuser:**

Used to do ceiling signage, double or single side.  
Exit pictograms comply with ISO7010.  
Select order code according to signage configuration requested.  
Compatible with IP42 and IP 65 luminaire versions.  
Could be associated with recessed base.



**Recessed base:**

Option used for full recessed mounting in false ceiling.  
Compatible with IP42 and IP65 luminaire versions.  
Could be associated with double side diffuser and panel signage.

# 3.3

## Safety & exit signs - Indoor

SafeLite



Consumption



3

Order code	Viewing distance (m)	IP	IK	Duration (h)	Lum in emergency	Lum in mains	Operation	NM VA	NM W	M VA	M W	Battery	Weight (kg)	Adhesive Exit Legend included	
SL2MNM42C1C3A	20	42	04	1	60	60	MNM	2.7	2.6	2.8	2.7	3.6V	0.8 Ah	0.5	ISO (L, R, D)
SL2MNM42D1C3A	20	42	04	1	100	60	MNM	2.5	2.4	2.6	2.5	3.6V	0.8 Ah	0.5	ISO (L, R, D)
SL2MNM65C1C3A	20	65	07	1	60	60	MNM	2.7	2.6	2.8	2.7	3.6V	0.8 Ah	0.5	ISO (L, R, D)
SL2MNM65D1C3A	20	65	07	1	100	60	MNM	2.5	2.4	2.6	2.5	3.6V	0.8 Ah	0.5	ISO (L, R, D)
SL2NM42C1	20	42	04	1	60	-	NM	1.4	0.9	-	-	3.6V	0.8 Ah	0.5	
SL2NM42D1	20	42	04	1	100	-	NM	1.4	0.9	-	-	3.6V	0.8 Ah	0.5	
SL2NM42E1	20	42	04	1	150	-	NM	1.4	0.9	-	-	3.6V	0.8 Ah	0.5	
SL2NM42F1	20	42	04	1	200	-	NM	1.4	0.9	-	-	3.6V	0.8 Ah	0.5	
SL2MNM42E1C3A	20	42	04	1	150	60	MNM	2.7	2.6	2.8	2.7	3.6V	0.8 Ah	0.5	ISO (L, R, D)
SL2MNM42F1C3A	20	42	04	1	200	60	MNM	2.5	2.4	2.6	2.5	3.6V	0.8 Ah	0.5	ISO (L, R, D)
SL2MNM65E1C3A	20	65	07	1	150	60	MNM	2.7	2.6	2.8	2.7	3.6V	0.8 Ah	0.5	ISO (L, R, D)
SL2MNM65F1C3A	20	65	07	1	200	60	MNM	2.5	2.4	2.6	2.5	3.6V	0.8 Ah	0.5	ISO (L, R, D)
SL2MNM42H1C	20	42	04	1	300	60	MNM	3.2	2.5	3.8	3.2	3.6V	1.7 Ah	0.7	
SL2MNM65H1C	20	65	07	1	300	60	MNM	3.2	2.5	3.8	3.2	3.6V	1.7 Ah	0.7	
SL2MNM42C2C3A	20	42	04	2	60	60	MNM	2.7	2.6	2.8	2.7	3.6V	0.8 Ah	0.5	ISO (L, R, D)
SL2MNM42D2C3A	20	42	04	2	100	60	MNM	2.5	2.4	2.6	2.5	3.6V	0.8 Ah	0.5	ISO (L, R, D)
SL2MNM65C2C3A	20	65	07	2	60	60	MNM	2.7	2.6	2.8	2.7	3.6V	0.8 Ah	0.5	ISO (L, R, D)
SL2MNM65D2C3A	20	65	07	2	100	60	MNM	2.5	2.4	2.6	2.5	3.6V	0.8 Ah	0.5	ISO (L, R, D)
SL2MNM42D2D3A	20	42	04	2	100	100	MNM	2.5	2.4	2.6	2.5	3.6V	0.8 Ah	0.6	ISO (L, R, D)
SL2MNM42D2C	20	42	04	2	100	60	MNM	2.5	2.4	2.6	2.5	3.6V	0.8 Ah	0.5	
SL2MNM42F2C	20	42	04	2	200	60	MNM	3.2	2.5	3.8	3.2	3.6V	1.7 Ah	0.6	
SL2MNM65D2C	20	65	07	2	100	60	MNM	2.5	2.4	2.6	2.5	3.6V	0.8 Ah	0.5	
SL2MNM65F2C	20	65	07	2	200	60	MNM	3.2	2.5	3.8	3.2	3.6V	1.7 Ah	0.6	
SL2MNM42C3C3A	20	42	04	3	60	60	MNM	2.7	2.6	2.8	2.7	3.6V	0.8 Ah	0.5	ISO (L, R, D)
SL2MNM42D3C3A	20	42	04	3	100	60	MNM	3.2	2.5	3.8	3.2	3.6V	1.7 Ah	0.6	ISO (L, R, D)
SL2MNM65C3C3A	20	65	07	3	60	60	MNM	2.7	2.6	2.8	2.7	3.6V	0.8 Ah	0.5	ISO (L, R, D)
SL2MNM65D3C3A	20	65	07	3	100	60	MNM	3.2	2.5	3.8	3.2	3.6V	1.7 Ah	0.7	ISO (L, R, D)
SL2NM42C3	20	42	04	3	60	-	NM	1.7	1.4	-	-	3.6V	0.8 Ah	0.5	
SL2NM42D3	20	42	04	3	100	-	NM	1.7	1.4	-	-	3.6V	1.7 Ah	0.5	
SL2NM42E3	20	42	04	3	150	-	NM	1.7	1.4	-	-	3.6V	1.7 Ah	0.5	
SL2NM42F3	20	42	04	3	200	-	NM	1.8	1.5	-	-	3.6V	2 Ah	0.5	
SL2MNM42E3C3A	20	42	04	3	150	60	MNM	3.2	2.5	3.8	3.2	3.6V	1.7 Ah	0.6	ISO (L, R, D)
SL2MNM42F3C3A	20	42	04	3	200	60	MNM	3.2	2.5	3.8	3.2	3.6V	2 Ah	0.6	ISO (L, R, D)
SL2MNM65E3C3A	20	65	07	3	150	60	MNM	3.2	2.5	3.8	3.2	3.6V	1.7 Ah	0.7	ISO (L, R, D)
SL2MNM65F3C3A	20	65	07	3	200	60	MNM	3.2	2.5	3.8	3.2	3.6V	2 Ah	0.7	ISO (L, R, D)
SL2MNM42C3C	20	42	04	3	60	60	MNM	2.7	2.6	2.8	2.7	3.6V	0.8 Ah	0.5	
SL2MNM42D3C	20	42	04	3	100	60	MNM	3.2	2.5	3.8	3.2	3.6V	1.7 Ah	0.7	
SL2MNM65C3C	20	65	07	3	60	60	MNM	2.7	2.6	2.8	2.7	3.6V	0.8 Ah	0.5	
SL2MNM65D3C	20	65	07	3	100	60	MNM	3.2	2.5	3.8	3.2	3.6V	1.7 Ah	0.7	
SL2MNM65D3D	20	65	07	3	100	100	MNM	5.5	4.3	6.5	5.5	3.6V	1.7 Ah	0.7	
SL2MNM42D3D	20	42	04	3	100	100	MNM	5.5	4.3	6.5	5.5	3.6V	1.7 Ah	0.7	
SL3MNM42E1C3A	30	42	04	1	150	60	MNM	2.7	2.6	2.8	2.7	3.6V	0.8 Ah	0.7	ISO (L, R, D)
SL3MNM42F1C3A	30	42	04	1	200	60	MNM	2.5	2.4	2.6	2.5	3.6V	0.8 Ah	0.7	ISO (L, R, D)
SL3MNM65E1C3A	30	65	07	1	150	60	MNM	2.7	2.6	2.8	2.7	3.6V	0.8 Ah	0.7	ISO (L, R, D)
SL3MNM65F1C3A	30	65	07	1	200	60	MNM	2.5	2.4	2.6	2.5	3.6V	0.8 Ah	0.7	ISO (L, R, D)
SL3MNM42E2C3A	30	42	04	2	150	60	MNM	3.2	2.5	3.8	3.2	3.6V	1.7 Ah	0.9	ISO (L, R, D)
SL3MNM42F2C3A	30	42	04	2	200	60	MNM	3.2	2.5	3.8	3.2	3.6V	1.7 Ah	0.9	ISO (L, R, D)
SL3MNM65E2C3A	30	65	07	2	150	60	MNM	3.2	2.5	3.8	3.2	3.6V	1.7 Ah	0.9	ISO (L, R, D)
SL3MNM65F2C3A	30	65	07	2	200	60	MNM	3.2	2.5	3.8	3.2	3.6V	1.7 Ah	0.9	ISO (L, R, D)
SL3MNM42E3C3A	30	42	04	3	150	60	MNM	3.2	2.5	3.8	3.2	3.6V	1.7 Ah	0.9	ISO (L, R, D)
SL3MNM42F3C3A	30	42	04	3	200	60	MNM	3.2	2.5	3.8	3.2	3.6V	2 Ah	0.9	ISO (L, R, D)
SL3MNM65E3C3A	30	65	07	3	150	60	MNM	3.2	2.5	3.8	3.2	3.6V	1.7 Ah	0.9	ISO (L, R, D)
SL3MNM65F3C3A	30	65	07	3	200	60	MNM	3.2	2.5	3.8	3.2	3.6V	2 Ah	0.9	ISO (L, R, D)
SL3MNM42E3C	30	42	04	3	150	60	MNM	3.2	2.5	3.8	3.2	3.6V	1.7 Ah	0.9	
SL3MNM42F3C	30	42	04	3	200	60	MNM	3.2	2.5	3.8	3.2	3.6V	2 Ah	0.9	
SL3MNM65E3C	30	65	07	3	150	60	MNM	3.2	2.5	3.8	3.2	3.6V	1.7 Ah	0.9	
SL3MNM65F3C	30	65	07	3	200	60	MNM	3.2	2.5	3.8	3.2	3.6V	2 Ah	0.9	

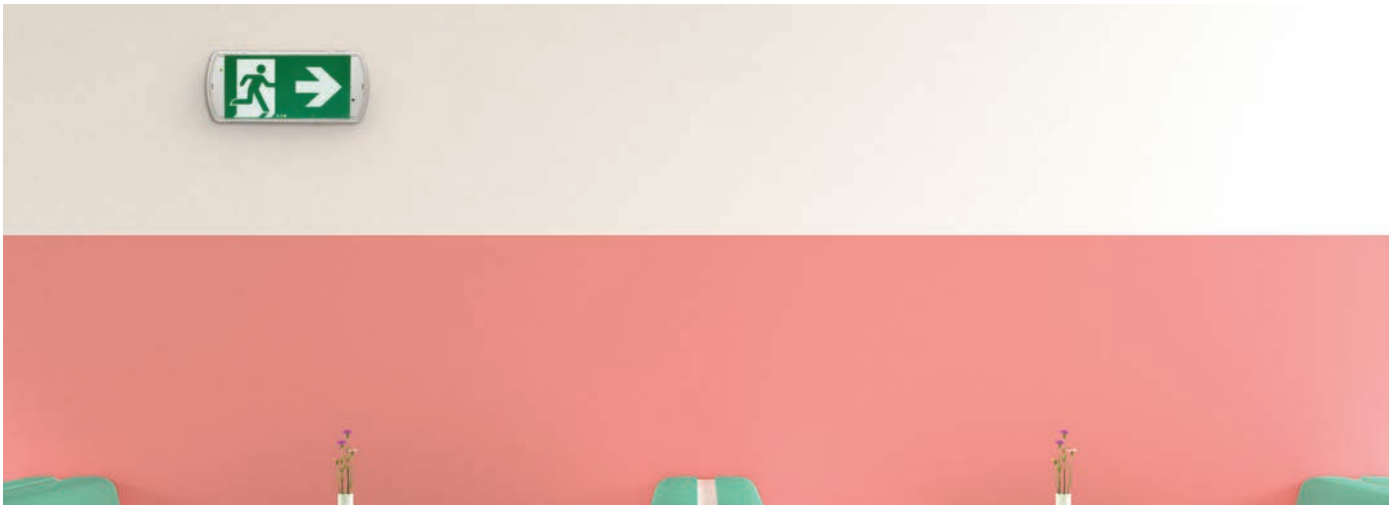

**Accessories**

**Wire guard - ensures high degree of protection**

SL2PG	SafeLite 20m, Wire guard
O-ELGRID	SafeLite 30m, Wire guard



**Recessed base - For full recessed mounting, compatible IP42 & IP65 variants, can be associated to double side diffusers**

SL2RB	SafeLite 20m, RecesBase
SL3RB	SafeLite 30m, RecesBase



**Recessed box**

SL2WB	SafeLite 20m, Wall Base
-------	-------------------------



**Opal diffuser**

SL2OP	SafeLite Opal Diffuser**
-------	--------------------------

\*\* Light decrease around 5%, mesured values upon request



**Wall bracket**

EL-BR1	SafeLite 20m, 90° Wall Bracket
--------	--------------------------------

\*Pictograms have to be ordered separately (or re use ones delivered with luminaires)



**Double side cone diffuser - compliant with EN1838**

SL2CD	SafeLite 20m, Cone Diffuser*
SL3CD	SafeLite 30m, Cone Diffuser*



**Double side plexi diffuser**

SL2PPD	SafeLite 20m, Plexi Plate, one side, Down
SL2PPDD	SafeLite 20m, Plexi Plate, double side, Down
SL2PPLR	SafeLite 20m, Plexi Plate, double side, Left & Right
SL3PPD	SafeLite 30m, Plexi Plate, one side, Down
SL3PPDD	SafeLite 30m, Plexi Plate, double side, Down
SL3PPLR	SafeLite 30m, Plexi Plate, double side, Left & Right



**Set of adhesive exit legends**

ISO7010 format

SL23A	SafeLite ISO 20m, 3x Adh (Left, Right, Down)
SL33A	SafeLite ISO 30m, 3x Adh (Left, Right, Down)
SL24A	SafeLite ISO 20m, 4x Adh (Left, Right, Down, Up)
SL34A	SafeLite ISO 30m, 4x Adh (Left, Right, Down, Up)





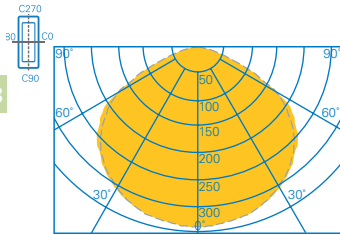

Light distribution curve

#### SafeLite 20m version, 60 lm

##### Escape route 2m wide 1 lux min

Mounting height [m]	Lux level directly under				
2,5	3,4	2,5	6,6	6,4	2,4
2,8	2,7	2,4	6,7	6,6	2,4
3,0	2,3	2,3	6,8	6,7	2,3
3,5	1,7	2,1	6,8	6,7	2,1
4,0	1,3	1,7	6,6	6,5	1,7
4,5	1,0	0,8	6,3	6,2	0,8

##### Open (anti-panic) area 0.5 lux min

Mounting height [m]				
2,5	2,9	7,2	6,9	2,8
2,8	3,0	7,5	7,2	2,9
3,0	3,0	7,7	7,4	2,9
3,5	3,0	7,9	7,8	2,9
4,0	2,9	8,3	8,2	2,8
4,5	2,8	8,5	8,5	2,7

#### SafeLite 20m version, 200lm

##### Escape route 2m wide 1 lux min

Mounting height [m]	Lux level directly under				
2,5	10,0	3,9	8,7	9,2	3,7
2,8	8,0	4,0	9,4	9,7	3,9
3,0	7,0	4,0	9,8	9,9	3,9
3,5	5,1	4,1	10,8	10,5	4,1
4,0	3,9	4,2	11,2	11,0	4,0
4,5	3,1	4,2	11,5	11,2	4,1
5,0	2,5	4,1	11,7	11,4	4,0
5,5	2,0	3,9	11,8	11,6	3,8
6,0	1,7	3,7	11,8	11,6	3,6
6,5	1,5	3,3	11,6	11,5	3,3
7,0	1,3	2,8	11,4	11,3	2,7

##### Mounting height for 5 lux below 3.7 meters

##### Open (anti-panic) area 0.5 lux min

Mounting height [m]				
2,5	3,9	9,1	9,5	3,7
2,8	4,1	9,4	9,8	3,9
3,0	4,1	9,7	10,1	4,0
3,5	4,3	11,0	10,9	4,2
4,0	4,5	11,8	11,6	4,4
4,5	4,6	12,6	12,4	4,5
5,0	4,7	13,0	12,8	4,6
5,5	4,7	13,4	13,1	4,6
6,0	4,7	13,7	13,5	4,6
6,5	4,6	14,1	13,9	4,6
7,0	4,5	14,6	14,3	4,4

**SafeLite - 30m version, 100lm**

**Escape route 2m wide 1 lux min**

Mounting height [m]	Lux level directly under				
2,5	5,2	3,0	7,5	7,5	2,9
2,8	4,2	3,0	8,0	7,8	3,0
3,0	3,6	3,1	8,3	8,0	3,0
3,5	2,7	3,0	8,5	8,2	2,9
4,0	2,1	2,8	8,6	8,4	2,8
4,5	1,6	2,6	8,5	8,4	2,5
5,0	1,3	2,1	8,3	8,2	2,0

**Mounting height for 5 lux below 2.6 meters**

**Open (anti-panic) area 0.5 lux min**

Mounting height [m]				
2,5	3,4	7,4	7,3	3,4
2,8	3,5	7,9	7,8	3,4
3,0	3,5	8,3	8,2	3,4
3,5	3,5	9,2	9,1	3,4
4,0	3,6	9,9	9,6	3,5
4,5	3,6	10,5	9,9	3,5
5,0	3,5	10,8	10,3	3,5
5,5	3,4	10,8	10,5	3,4
6,0	3,3	10,8	10,6	3,3
6,5	3,0	10,9	10,8	3,0
7,0	2,7	10,9	10,8	2,7

**SafeLite - 30m version, 200lm**

**Escape route 2m wide 1 lux min**

Mounting height [m]	Lux level directly under				
2,5	10,6	3,8	8,3	9,1	3,8
2,8	8,5	4,1	9,2	9,6	4,0
3,0	7,4	4,2	9,6	9,9	4,0
3,5	5,5	4,3	10,6	10,6	4,2
4,0	4,2	4,4	11,5	11,2	4,2
4,5	3,3	4,4	11,9	11,5	4,2
5,0	2,7	4,2	12,1	11,8	4,1
5,5	2,2	4,1	12,2	11,9	4,1
6,0	1,8	3,8	12,2	11,9	3,8
6,5	1,5	3,5	12,1	11,9	3,5
7,0	1,3	3,1	11,9	11,7	3,0

**Mounting height for 5 lux below 3.65 meters**

**Open (anti-panic) area 0.5 lux min**

Mounting height [m]				
2,5	3,9	7,7	8,5	3,8
2,8	4,3	8,6	8,7	3,9
3,0	4,4	9,2	9,1	4,1
3,5	4,5	10,1	10,1	4,3
4,0	4,6	11,2	11,3	4,5
4,5	4,7	12,3	12,1	4,7
5,0	4,7	13,1	12,9	4,7
5,5	4,8	13,7	13,4	4,7
6,0	4,8	14,2	13,8	4,7
6,5	4,8	14,5	14,1	4,7
7,0	4,8	14,8	14,4	4,7

\*Further data available upon request.

# 4.1

## Safety & exit signs - High degree of protection

Atlantic LED

4

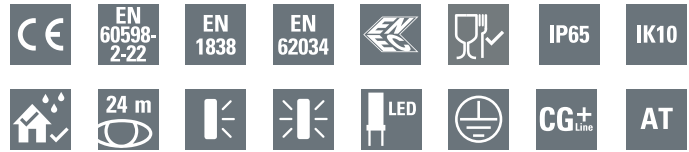

- For Indoor and Outdoor use
- Robust construction from aluminium diecast and high impact resistant cover made of polycarbonate
- Optional with self-regulating battery heater for use at low temperature down to -20°C

### Light Source:

2 x 1.6W LED

### Materials:

Aluminium die-cast housing  
 White polycarbonate reflector  
 Clear polycarbonate diffuser  
 Lithium ion battery

### Operation:

For maintained and non-maintained operations  
 CGLite+ (Without bus working in AT mode)  
 For 1h, 3h or 8h operation

### Installation:

Wall and ceiling installations

### Applications:

Factories, warehouses, underground car parks, workshops, tunnel  
 Escape routes, corridors

The Atlantic LED luminaire series fulfills protection rating IP65 with UV-resistant materials and an especially tough construction. It is ideal for use in outdoor areas or in industrial applications. Optional versions with a self-regulating battery heater allow ambient temperature down to -20°C.

The range includes safety luminaires with different optics for escape route or anti-panic illumination and single or double-sided exit signs with an optimal perceptibility of the exit sign is achieved by the high luminance of the white contrasting colour (>500 cd/m²). Atlantic LED is also suitable for use in the food processing industry in accordance with Standards IFS and HACCP

The use of LEDs, automatic testing and monitoring devices (CGLite+) significantly reduce the operating and maintenance costs of the installation.

### Drawings for Atlantic LED R, O and S

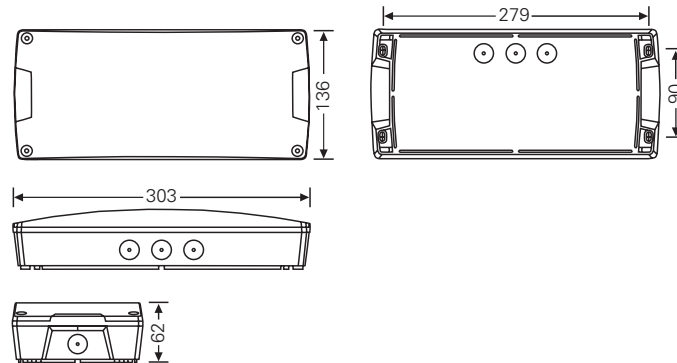

Atlantic LED S - Single sided exit sign

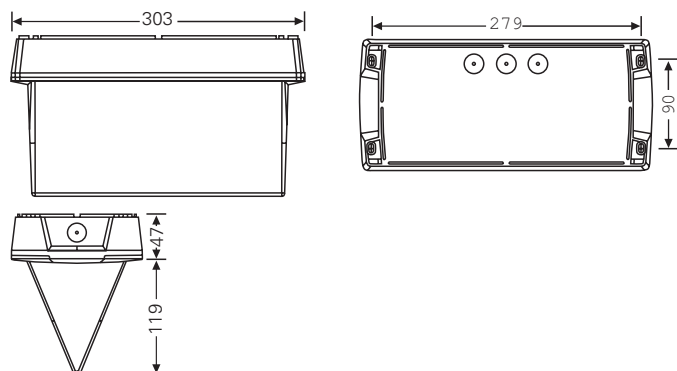

Atlantic LED D - Double sided exit sign

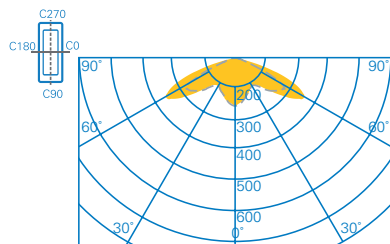

Atlantic O CGLine+ with symmetric optics

**Planning help for Atlantic LED O – symmetric optics for E = 1.0 lx**  
 Measurement level: 0.02 m, maintenance factor MF = 80 %, battery operation

Duration of emergency operation	Mounting height in metres	Mounting types	Mounting types				Mounting types				
			L1	L2	L3	L4	L1	L2	L3	L4	
1 h	2.5	Ceiling mounting	4.5	10.7	3.8	8.9	Ceiling mounting	3.9	9.6	2.9	7.2
	3.0	Escape route centre	4.7	11.7	4.1	9.9	Room illumination	3.4	10.6	3.1	8.1
	3.5		4.9	12.5	4.1	10.8		3.4	11.6	3.1	8.8
	4.0		4.3	13.2	4.1	11.4		3.4	12.5	2.8	9.4
	5.0		1.9	13.1	1.9	10.4		1.9	12.1	0.8	11.1
	6.0		1.1	7.0	1.1	7.3		1.2	11.8	0.5	10.5
3 h	2.5	Ceiling mounting	3.8	9.6	3.3	8.1	Ceiling mounting	3.4	8.9	2.4	6.5
	3.0	Escape route centre	3.8	10.4	3.3	8.9	Room illumination	3.4	9.7	2.5	7.3
	3.5		1.9	10.8	1.9	9.4		2.0	10.5	2.0	7.9
	4.0		1.6	10.6	1.5	8.4		1.4	9.7	0.9	9.0
	4.5		1.2	10.0	1.2	7.6		1.0	9.4	0.6	8.8

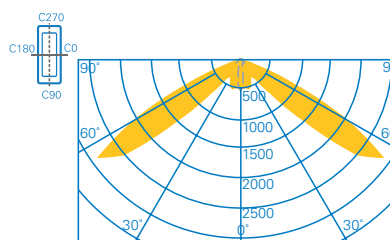

Atlantic R CGLine+ with asymmetric optics

**Planning help for Atlantic LED R – asymmetric optics for E = 1.0 lx**  
 Measurement plane: 0.02 m, maintenance factor MF = 80 %, battery operation

Duration of emergency operation	Mounting height in metres	Mounting types	Mounting types			
			L1	L2	L3	L4
1 h	2.5	Ceiling mounting	6.0	13.0	2.0	6.1
	3.0	Escape route, centre	6.8	15.0	1.7	6.1
	3.5		7.5	16.8	1.4	5.6
	4.0		8.3	18.5	1.2	5.0
	5.0		9.6	21.5	1.1	3.9
	6.0		10.8	24.4	1.0	3.3
	7.0		3.5	21.9	1.0	3.3
	8.0		3.3	22.0	0.9	3.1
3 h	2.5	Ceiling mounting	5.6	12.4	1.3	4.9
	3.0	Escape route, centre	6.3	14.2	1.0	4.2
	3.5		7.1	15.8	0.9	3.7
	4.0		7.7	17.2	0.9	3.2
	5.0		8.9	20.1	0.8	2.6
	6.0		2.7	17.6	0.8	2.6
	7.0		2.4	18.3	0.6	2.4

Order code	Description	⚡	🕒	🔋	⚙️
40071354870	Exit sign luminaire Atlantic LED S, single sided, CGLine+	7.2 VA / 7.0 W	1 - 3 - 8h	LiNiMnCoO <sub>2</sub> 3.7V / 4Ah	Maintained / Non-Maintained
40071354871	Exit sign luminaire Atlantic LED D, double sided, CGLine+	7.2 VA / 7.0 W	1 - 3 - 8h	LiNiMnCoO <sub>2</sub> 3.7V / 4Ah	Maintained / Non-Maintained
40071354872	Safety luminaire Atlantic LED R CGLine+, with asymmetric optics	7.2 VA / 7.0 W	1 - 3 - 8h	LiNiMnCoO <sub>2</sub> 3.7V / 4Ah	Maintained / Non-Maintained
40071354873	Safety luminaire Atlantic LED O CGLine+, with symmetric optics	7.2 VA / 7.0 W	1 - 3 - 8h	LiNiMnCoO <sub>2</sub> 3.7V / 4Ah	Maintained / Non-Maintained
40071354875	Exit sign luminaire Atlantic LED S, single sided, CGLine+ H, with battery heater for low ambient temperature down to -20°C	9.2 VA / 9.3 W	1 - 3 - 8h	LiNiMnCoO <sub>2</sub> 3.7V / 4Ah	Maintained / Non-Maintained
40071354876	Exit sign luminaire Atlantic LED D, double sided, CGLine+ H, with battery heater for low ambient temperature down to -20°C	9.2 VA / 9.3 W	1 - 3 - 8h	LiNiMnCoO <sub>2</sub> 3.7V / 4Ah	Maintained / Non-Maintained
40071354877	Safety luminaire Atlantic LED R CGLine+ H, with asymmetric optics, with battery heater for low ambient temperature down to -20°C	9.2 VA / 9.3 W	1 - 3 - 8h	LiNiMnCoO <sub>2</sub> 3.7V / 4Ah	Maintained / Non-Maintained
40071354878	Safety luminaire Atlantic LED O CGLine+ H, with symmetric optics, with battery heater for low ambient temperature down to -20°C	9.2 VA / 9.3 W	1 - 3 - 8h	LiNiMnCoO <sub>2</sub> 3.7V / 4Ah	Maintained / Non-Maintained

Accessories 2 x cable glands 20mm included

Pictograms for Atlantic LED S

155-000-011	Pictogram RIGHT		155-000-013	Pictogram DOWN	
155-000-012	Pictogram LEFT				

Pictograms for Atlantic LED D (2 x required)

155-000-211	Pictogram RIGHT, ISO		155-000-213	Pictogram DOWN, ISO	
155-000-212	Pictogram LEFT, ISO		155-000-209	Pictogram BLIND	



# 4.2

## Safety & exit signs - High degree of protection

i-P65

4



- Versatile multi functional use (escape, open area and exit sign use)
- Low power consumption reducing cost of ownership
- Ease of installation, reducing installation time and cost
- 60.000 hour life LED for reduced maintenance
- Autotest emergency versions available, reducing maintenance costs and offering ease of compliance with testing requirements

### Light Source:

2 x 1W LED

### Materials:

Luminaire Body: Polycarbonate

Gear Tray: Polycarbonate

Battery: Ni-Cd

Base RAL7035

### Operation:

Maintained luminaire can be operated in Non-Maintained model

Optional ISO7010 or Euro pictogram exit legends

Temperature controlled battery heater kit for optimised performance in low ambient temperatures

The i-P65 is a high performance emergency bulkhead using the latest LED and optic technology to provide an attractive, robust and functional luminaire for indoor and outdoor use. The range has been designed for ease of installation with a compact attractive appearance and a uniform lighting distribution.

Boasting numerous features and benefits, the i-P65 can be used to provide escape route lighting, single-sided or optional double-sided exit sign with a common look and feel where the mix between aesthetics and robustness is a primary concern.

The use of LEDs, automatic testing and monitoring devices (CGLine+) significantly reduce the operating and maintenance costs of the installation.

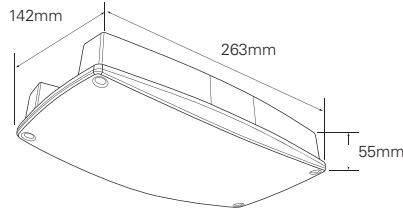

### Applications:

Hotels, cinemas, theaters, schools and hospitals

#### IP65LEDEX3H

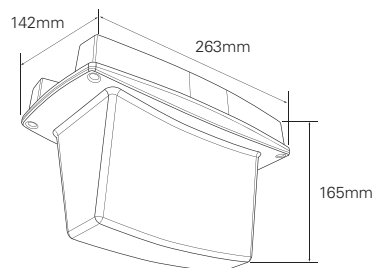

#### IP65LEDO3H



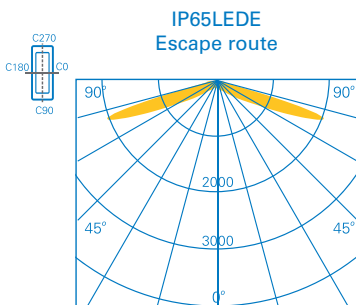

Model	Height (m)	Distance for 1 Lux	
<b>Escape optic</b>	02.50	07.80	17.10
	02.80	08.40	18.60
	03.00	08.60	19.60

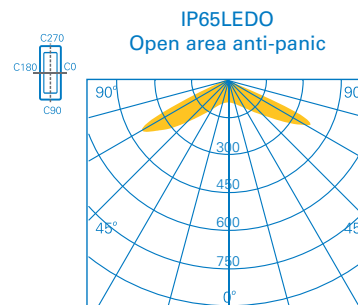

Model	Height (m)	Distance for 1 Lux		
<b>Open area optic</b>	02.50	05.30	10.50	05.30
	02.80	05.70	11.50	05.70
	03.00	05.90	12.20	05.90
	04.00	04.90	12.60	04.90

Order code	Description					
IP65LEDO3H	i-P65, 3h, open area	2.9VA/2.0W-7.6VA/5.75W	153 Lm	3h	4,8V-1,6Ah Ni-Cd	Maintained / Non-Maintained
IP65LEDE3H	i-P65, 3h, escape route	2.9VA/2.0W-7.6VA/5.75W	148 Lm	3h	4,8V-1,6Ah Ni-Cd	Maintained / Non-Maintained
IP65LEDO3HIS	i-P65, 3h, open area Auto-test	2.9VA/2.0W-7.6VA/5.75W	153 Lm	3h	4,8V-1,6Ah Ni-Cd	Maintained / Non-Maintained
IP65LEDE3HIS	i-P65, 3h, escape area Auto-test	2.9VA/2.0W-7.6VA/5.75W	148 Lm	3h	4,8V-1,6Ah Ni-Cd	Maintained / Non-Maintained
IP65LEDEX3H	i-P65, double side exit sign, 3h	2.9VA/2.0W-7.6VA/5.75W		3h	4,8V-1,6Ah Ni-Cd	Maintained / Non-Maintained
IP65LEDEX3HIS	i-P65, double side exit sign, 3h, Auto-test	2.9VA/2.0W-7.6VA/5.75W		3h	4,8V-1,6Ah Ni-Cd	Maintained / Non-Maintained
IP65LEDO3HCGL	i-P65, 3h, open area CGLine+	7.6VA/5.75W	153 Lm	3h	4,8V-1,6Ah Ni-Cd	Maintained
IP65LEDE3HCGL	i-P65, 3h, escape route CGLine+	7.6VA/5.75W	148 Lm	3h	4,8V-1,6Ah Ni-Cd	Maintained
IP65LEDEX3HCGL	i-P65, double side exit sign, 3h CGLine+	7.6VA/5.75W		3h	4,8V-1,6Ah Ni-Cd	Maintained

**Accessories**

IP65LEG	Single side legend kit, European format
IP65LEG7010	ISO7010 single side legend kit
IP65DBLLEG7010	Double side legend panel kit, ISO7010
IP65DBLLEG	European format double side legend kit
IP65CONDHEAT	Low temperature battery heater

\*Non-maintained - Maintained







Overview ..... 80

**Indoor**

5.1 CrystalWay ..... 82

5.2 GuideLed ..... 84

5.3 FlexiTech ED ..... 88

5.4 71811 / 71822 LED ..... 90

5.5 Velos ..... 92

5.6 Style 28011/28021 ..... 96

5.7 Exit Cube ..... 98

**High Degree of Protection**

6.1 Euro X LED ..... 100

6.2 Style Variant 58011/58021 ..... 102











6.3 46811 LED ..... 104



# Exit signs

## Overview

5

	Page	Performance	Aesthetic	One box solution *	No replacement parts for 10 years	Low consumption / Eco-friendly	Protection Degree	Viewing distance	Maintained	Non-Maintained	Stand alone	Autotest	Monitored (CGLine+)	Battery
<b>5.1</b> CrystalWay 	82	★ ★ ★	●	●	●	●	42	20 30	●	●		●	●	Li-Ion
<b>5.2</b> GuideLed 	84	★ ★ ★			●	●	20 40	20 30	●	●		●	●	Li-Ion
<b>5.3</b> FlexiTech ED 	88	★ ★		●	●	●	43	20	●	●		●	●	Li-Ion
<b>5.4</b> 71811/71822LED 	90	★ ★					41	32	●	●		●	●	Li-Ion
<b>5.5</b> Velos 	92	★ ★					20	30 40	●		●	●	●	Ni-Cd
<b>5.6</b> Style 28011/28021 	96	★ ★					41	32	●	●		●	●	Li-Ion
<b>5.7</b> Exit cube 	98	★ ★					40	20	●	●		●	●	Li-Ion
<b>6.1</b> Euro X LED 	100	★ ★		●			54	20	●	●		●		Li-Ion
<b>6.2</b> Style Variant 58011/58021 	102	★ ★					41 54	17 32	●	●		●	●	Li-Ion
<b>6.3</b> 46811 LED CGLine+ 	104	★ ★					65	60	●			●	●	Li-Ion

\* One box solution : delivered with set of pictograms and accessories for wall or ceiling surface mounting

Wall	Ceiling	Recessed	Suspended	Healthcare	Hotels	Cinemas / Theaters	Commercial centers	Stadia / Arenas	Offices	Industrial	Warehouse	
Installation				Applications								Best use
●	●	●	●	●	●	●	●	●	●			Aesthetic range for easy integration in differently-sized environments. Accessories and pictograms included for a wall & ceiling surface mounting.
●	●	●	●	●	●	●	●		●			Versatile mounting options enable the use in many applications and the design can be the same in the whole building.
●	●	●		●	●	●	●	●	●			FlexiTech facilitates your day to day jobs and projects thanks to an easy to manage and consistent range.
●	●		●	●	●	●	●		●			Robust solution made from extruded and anodised aluminium for public areas
●	●	●	●	●	●	●	●		●			
●	●		●	●	●		●		●			
	●		●				●			●	●	3-sided exit signage for large areas like warehouses or supermarkets
●	●				●		●		●	●		
●	●		●		●		●		●	●	●	
●							●	●		●	●	

The information given in this brochure is accurate at the time of compilation (errors and omissions excepted), however due to Eaton philosophy of constant product development we reserve the right to change specifications without prior notice.

# 5.1

## Exit signs - Indoor

CrystalWay

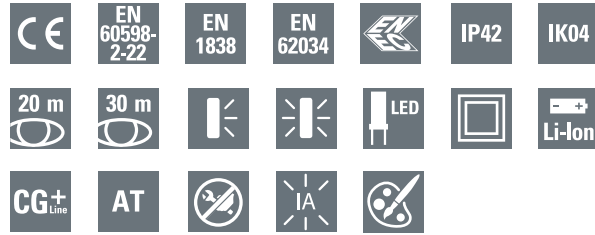

- Unit with innovative LED technology
- Lithium Batteries 10 years
- Selectable autonomy of 1h, 3h, 5h and 8h
- Wall, ceiling, suspension
- Version 20m and 30m visibility
- Available for ceiling mounting and recessed applications
- Increased Affordance functionality as standard

### Light Source:

LED strip

The CrystalWay self-contained emergency exit sign is the standard in high quality, aesthetic exit sign luminaires. It brings together a range of flexible mounting options and a modern yet discreet design perfectly suited to modern office buildings or other commercial buildings where a high-end aesthetic is required.

### Materials:

Polycarbonate

Lithium ion battery (10 years)

The clear frame and low profile allows seamless integration into the surrounding architecture and is perfect for any size of project. The LED light guide ensures the pictogram is uniformly illuminated without hot spots, this gives the luminaire a flawless finish complying to EN1838.

### Operation:

Maintained (M) / Non Maintained (NM)

Configurable level of light in mains mode via magnet (30%, 70%, 100%)

Duration selectable 1h, 3h, 5h and 8h

Installation possibilities: Wall, ceiling, recessed, suspended

Maintenance costs reduced, no replacement of spareparts needed for 10 years

This 10 years lifetime range has benefited from an eco-design in order to meet the latest environmental standards. The use of LEDs, long life components, automatic testing and monitoring devices (CGLine+) significantly reduce the operating and maintenance costs of the installation.



### New :

It is now possible to use an Eaton magnet in order to :

- carry out manual tests
- configure the level of light output in mains mode (30%, 70% or 100%)

### Applications:

Hotels, restaurants, meeting rooms, offices, shops, cinemas, theaters, museums



### New :

- Stainless steel cover for 20 and 30m variants
- Add a touch of class to your projects

### CrystalWay 20m Wall-surface mounting

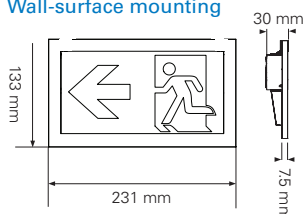

### Ceiling-surface mounting 20m

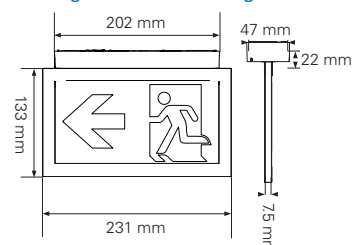

### CrystalWay 30m Wall-surface mounting

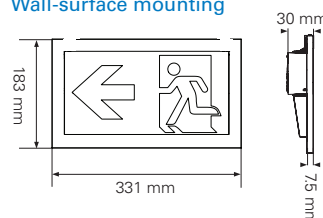

### Ceiling-surface mounting 30m

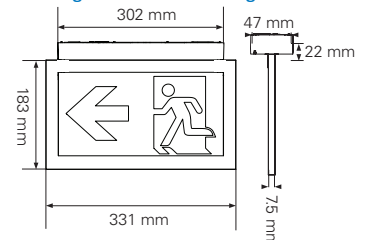

### Ceiling-surface mounting



### Recessed mounting option



### Suspension kit option

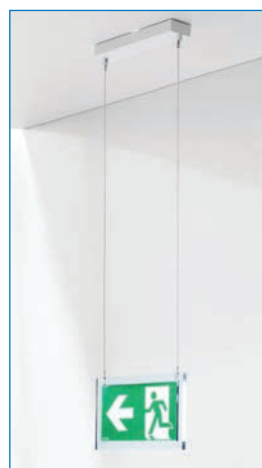

### Flag mounting



### Wall-surface mounting



### With metal cover



Order code	Description	IA	50cd	500cd*	⌚	🔋	⚙️
LUM17122U	CrystalWay 20m CGLine+ 4 Exit legends**	✓	0.7W	2.5W	1-3-5-8h	LiNiMnCoO <sub>2</sub> 3.6V-0.6 Ah	Maintained / Non Maintained
LUM17124U	CrystalWay 30m CGLine+ 4 Exit legends**	✓	0.9W	4.2W	1-3-5-8h	LiNiMnCoO <sub>2</sub> 3.6V-1.2 Ah	Maintained / Non Maintained

\*Luminous flux  $\Phi_{E,\Phi N}$  at end of rated operating time 100 % at 1 h; 45 % at 3 h; 25 % at 5 h; 18 % at 8 h

\*\* Exit legends : ISO format - Right, left, down, up

### Accessories

CrystalWay 20 m	CrystalWay 30m	Description	
LUM10319	LUM10319	TL CGLine+ for rest mode command	
40071352379	40071352379	Magnet	
LUM10560	LUM10560	Wire suspension kit	
LUM10561	LUM10562	Recessed base	
LUM10563	LUM10564	Recessed base with cover	
LUM10563S	LUM10564S	Recessed base with cover for suspension kit	
LUM10565	LUM10566	Recessed box for concrete	
LUM10567		Base for optional cable access	
40071708300	40071708287	Stainless steel metal cover	
LUM10573	LUM10587	Pictogram Arrow DOWN, ISO	
LUM10574	LUM10588	Pictogram Arrow LEFT, ISO	
LUM10575	LUM10589	Pictogram Arrow RIGHT, ISO	
LUM10577	LUM10591	Pictogram Arrow UP, ISO	
LUM10584	LUM10592	Vertical pictogram Arrow DOWN, ISO	
LUM10585	LUM10593	Vertical pictogram Arrow LEFT, ISO	
LUM10586	LUM10594	Vertical pictogram Arrow RIGHT, ISO	



### Spare parts

Order code	Description
LUM10568	Battery pack LiNiMnCoO <sub>2</sub> 3.6 V/650 mAh for CrystalWay 20m
LUM10569	Battery pack LiNiMnCoO <sub>2</sub> 3.6 V/1300 mAh for CrystalWay 30m
LUM10570	Diffuser kit 24 LEDs for CrystalWay 20m
LUM10571	Diffuser kit 38 LEDs for CrystalWay 30m
LUM10572	Set of 4 hooks for CrystalWay 20m & CrystalWay 30m diffusers



# 5.2

## Exit signs - Indoor

GuideLed



- Perfectly illuminated exit sign with by use of innovative light guide technology
- Versatile mounting options: Wall, ceiling, recessed Surface, suspended
- Available in 20 and 30 m viewing distance
- Duration selectable 1 h, 3 h, 8 h
- Environmental friendly Li-Ion battery technology

### Light Source:

LED Strip

### Materials:

Housing unit in light grey polycarbonate

Panel PMMA

Aluminum tubes for suspension

Lithium ion battery

With GuideLed, a new generation of exit sign luminaires has been developed that convinces in particular with its absolutely homogeneous, bright luminous surface. This is made possible by a new light guide technology. In addition, GuideLed also catches the eye with regard to design with a concise functionality without visible screw connections, and a very flat construction.

The wide variety of versions available make the GuideLed exit sign luminaire a versatile solution. Featuring viewing distances of 20m or 30m, single-sided or double-sided options and multiple mounting types, they are ideal for a variety of room sizes and applications.

The use of LEDs, automatic testing and monitoring devices (CGLine+) significantly reduce the operating and maintenance costs of the installation.

### Operation:

For maintained and non-maintained operations

CGLine+ (Without bus working in AT mode)

Configurable level of light in mains mode via magnet (30%, 70%, 100%)

Duration selectable 1h, 3h and 8h

Installation options: Wall, ceilings and recessed

Ceiling, recessed, tube suspension and cable versions

External push button for manual execution of test

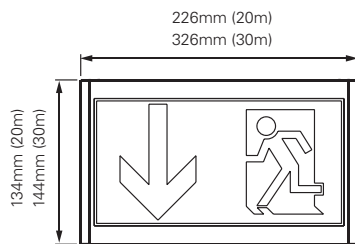

### Viewing distance

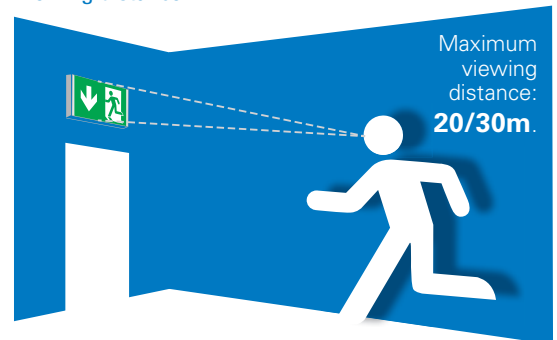

### Applications:

Hotels, restaurants, meeting rooms, offices, shops, cinemas, theaters, museums

### LEDs for increased safety

Longevity, instant start up, high efficiency and compact size are the features that make LEDs especially suitable for emergency and safety lighting. Precise matching along with low temperatures and low operating current guarantees high luminous efficiency with maximum service life.



**1 LED Lightguide technology**

- Perfect, standard compliant illumination
- Low energy requirements
- LEDs for increased safety with 50.000 hours service life

**2 CGLine+ LED electronics**

- Can be used for Maintained mode and Non-Maintained mode
- Fully automatic function test (weekly) or duration test (every 6 months)
- 1 minute switch-back delay to normal operation after mains return
- Blocking function prevents unintentional discharge during idle operating times (via CGLine+ webcontroller)
- Convenient and concise central monitoring in combination with CGLine+ webcontroller or CG Vision visualisation Software

**3 Optimised connection technology**

- Spacious insertion areas
- Equipped for through-wiring of mains cable and CGLine bus live double terminals and 4 cable terminals

**4 Display and test unit**

- Testing button for manual triggering of function test and duration test
- Simple fault analysis with bicolor LED (light source charging or battery fault) and status display (operation, function test, duration test)
- Setting of dimming level in mains operation (100%, 30%, 10%)

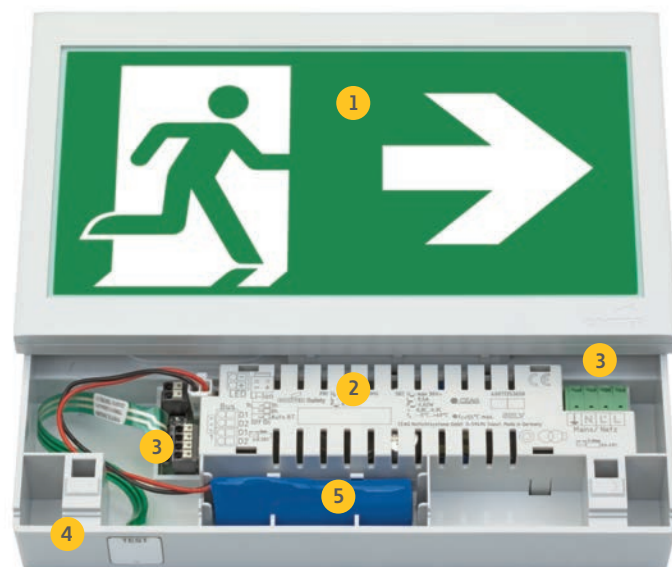

**5 Innovative Lilon technology**

- Large capacity with compact design
- 1 version for 1h, 3h and 8h emergency lighting operation
- No memory effect
- Environmental friendly: no heavy metals and energy-optimized charging process due to low self-discharge
- Simple replacement via polarity reversal protected plug-in contacts and snap mounting

**Lightguide technology for optimal illumination**

The highly developed Lightguide technology converts the high point-sourced luminance of the LED into an illuminated surface with absolute uniform brightness, with luminance of over 500 cd/m<sup>2</sup> on white surface. Therefore the escape sign always remains easily recognisable even with poor visibility conditions or in bright surroundings.

Despite the very good photometric values, the new Lightguide technology with particularly efficient LEDs requires up to 60% less energy compared to previous escape sign luminaires with fluorescent lamps.

**Photometric requirements for escape sign  
DIN 4844-1 (2005-05) and ISO 3864-1 (2002):**

$L_m \geq 500 \text{ cd/m}^2$  (white surface)  
For applications in bright ambient conditions (mains operation)

**ISO 30061 (2007):**

$L_{min} = 10 \text{ cd/m}^2$  (green surface)  
In smoky conditions. The luminaires should be suspended by at least 0.5m

**EN 1838 (2013):**

$L_{min} = 2 \text{ cd/m}^2$  (green surface)  
Emergency lighting operation



Badly illuminated escape sign

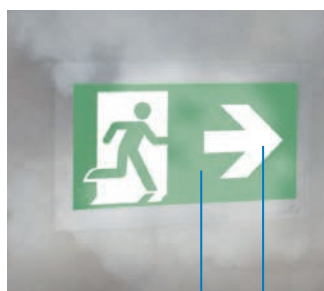

GuideLed  $\geq 100 \text{ cd/m}^2$   $\geq 500 \text{ cd/m}^2$

# 5.2

## Exit signs - Indoor

GuideLed

### Wall Mount



### Wall Recessed



5

GuideLed 10811 - 20m  
GuideLed 11811 - 30m

GuideLed 10812 - 20m  
GuideLed 11812 - 30m

Order code	Description				
40071353260	Wall mounting set for GuideLed, 20m and 30m, CGLine+	20m : 4.8 VA / 4.1 W 30m : 5.3 VA / 4.7 W	1h-3h-8h	LiNiMnCoO <sub>2</sub> 3.7 / 2Ah	Maintained / Non-Maintained
40071353261	Wall Recessed mounting set for GuideLed, 20m, CGLine+	4.8 VA / 4.1 W	1h-3h-8h	LiNiMnCoO <sub>2</sub> 3.7 / 2Ah	Maintained / Non-Maintained
40071353262	Wall Recessed mounting set for GuideLed, 30m, CGLine+	5.3 VA / 4.7 W	1h-3h-8h	LiNiMnCoO <sub>2</sub> 3.7 / 2Ah	Maintained / Non-Maintained
40071354500	LED pictogram LEFT, 11x11/11x12, 20m				
40071354501	LED pictogram RIGHT, 11x11/11x12, 20m				
40071354502	LED pictogram DOWN, 11x11/11x12, 20m				
40071354530	LED pictogram LEFT, 11x11/11x12, 30m				
40071354531	LED pictogram RIGHT, 11x11/11x12, 30m				
40071354532	LED pictogram DOWN, 11x11/11x12, 30m				

### Ceiling mounted

#### Suspended

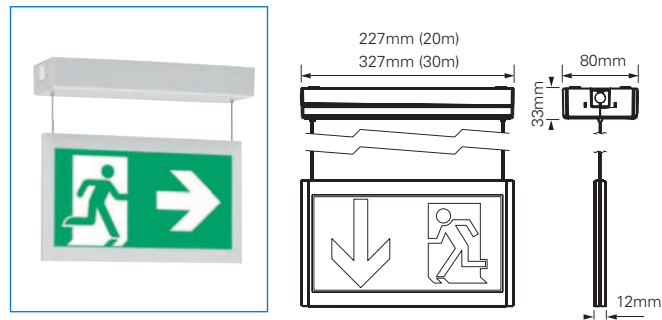

GuideLed 10825 - 20m  
GuideLed 11825 - 30m

### Ceiling recessed mounted

#### Suspended

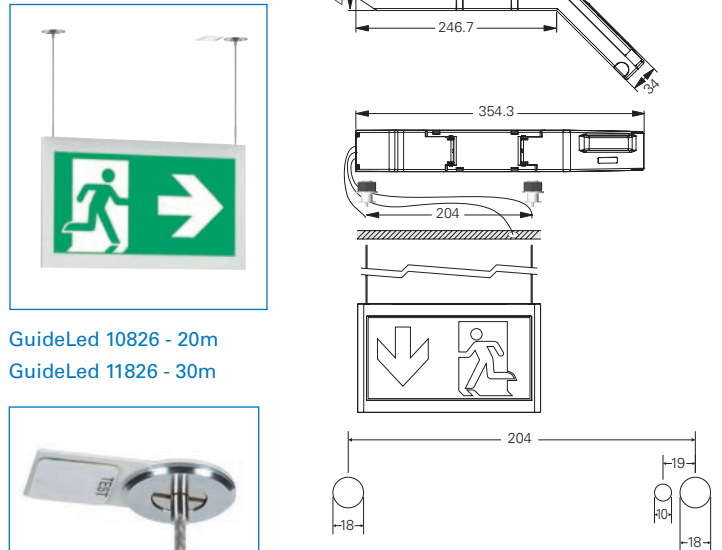

GuideLed 10826 - 20m  
GuideLed 11826 - 30m

Wire installation with ceiling wire holders, LED supply for mounting in cavity ceiling

Order code	Description				
40071353268	Wire suspension set 10825, with canopy, 20m, CGLine+	5.6 VA / 5.1 W	1h-3h-8h	LiNiMnCoO <sub>2</sub> 3.7 / 2Ah	Maintained / Non-Maintained
40071353273	Wire suspension set 11825, with canopy, 30m, CGLine+	6.6 VA / 6.3 W	1h-3h-8h	LiNiMnCoO <sub>2</sub> 3.7 / 2Ah	Maintained / Non-Maintained
40071353263	Wire suspension set 10826/11826, with ceiling holders, 20/30m	20m : 5.6 VA / 5.1 W 30m : 6.6 VA / 6.3 W	1h-3h-8h	LiNiMnCoO <sub>2</sub> 3.7 / 2Ah	Maintained / Non-Maintained
40071354510	LED pictogram (left/right), 10x25/10x26 (wire), 20m				
40071354540	LED pictogram (left/right), 11x25/11x26 (wire), 30m				
40071354511	LED pictogram (down/down), 10x25/10x26 (wire), 20m				
40071354512	LED pictogram (left/blank), 10x25/10x26 (wire), 20m				
40071354513	LED pictogram (right/blank), 10x25/10x26 (wire), 20m				
40071354514	LED pictogram (down/blank), 10x25/10x26 (wire), 20m				
40071354541	LED pictogram (down/down), 11x25/11x26 (wire), 30m				
40071354542	LED pictogram (left/blank), 11x25/11x26 (wire), 30m				
40071354543	LED pictogram (right/blank), 11x25/11x26 (wire), 30m				
40071354544	LED pictogram (down/blank), 11x25/11x26 (wire), 30m				

Ceiling Mounting



GuideLed 10821 - 20m  
GuideLed 11821 - 30m

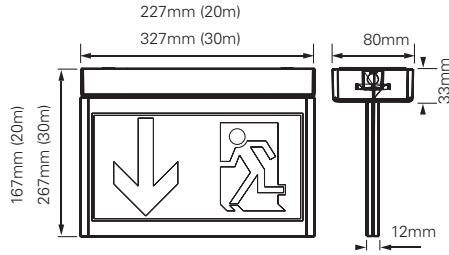

Ceiling recessed



GuideLed 10824 - 20m  
GuideLed 11824 - 30m

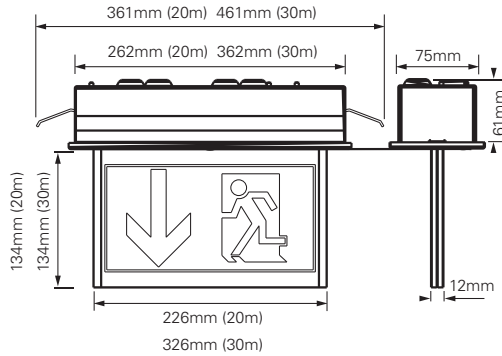

Ceiling tube suspended



GuideLed 10822 - 20m - pendant tube 0,5m  
GuideLed 11822 - 30m - pendant tube 0,5m  
GuideLed 10823 - 20m - pendant tube 1,5m  
GuideLed 11823 - 30m - pendant tube 1,5m

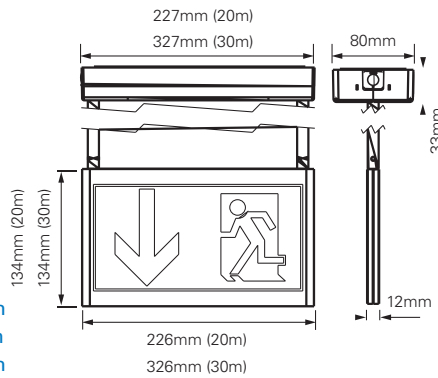

Order code	Description	⚡	🕒	🔋	⚙️
40071353264	Ceiling mounting set 10821	5.6 VA / 5.1 W	1h-3h-8h	LiNiMnCo <sub>2</sub> 3,7/2Ah	Maintained / Non-Maintained
40071353265	Ceiling mounting set 10822, with canopy and 0,5m pendant tube, 20m	5.6 VA / 5.1 W	1h-3h-8h	LiNiMnCo <sub>2</sub> 3,7/2Ah	Maintained / Non-Maintained
40071353266	Ceiling mounting set 10823, with canopy and 1,5m pendant tube, 20m	5.6 VA / 5.1 W	1h-3h-8h	LiNiMnCo <sub>2</sub> 3,7/2Ah	Maintained / Non-Maintained
40071353267	Ceiling mounting set 10824, ceiling recessed housing, 20m	5.6 VA / 5.1 W	1h-3h-8h	LiNiMnCo <sub>2</sub> 3,7/2Ah	Maintained / Non-Maintained
40071353269	Ceiling mounting set 11821, with canopy 30m	6.6 VA / 6.3 W	1h-3h-8h	LiNiMnCo <sub>2</sub> 3,7/2Ah	Maintained / Non-Maintained
40071353270	Ceiling mounting set 11822, with canopy and 0,5m pendant tube, 30m	6.6 VA / 6.3 W	1h-3h-8h	LiNiMnCo <sub>2</sub> 3,7/2Ah	Maintained / Non-Maintained
40071353271	Ceiling mounting set 11823, with canopy and 1,5m pendant tube, 30m	6.6 VA / 6.3 W	1h-3h-8h	LiNiMnCo <sub>2</sub> 3,7/2Ah	Maintained / Non-Maintained
40071353272	Ceiling mounting set 11824, ceiling recessed housing, 30m	6.6 VA / 6.3 W	1h-3h-8h	LiNiMnCo <sub>2</sub> 3,7/2Ah	Maintained / Non-Maintained
40071354503	LED pictogram (left/right), 10x21/10x22, 10x23, 10x24, 20m				
40071354504	LED pictogram (down/down), 10x21/10x22, 10x23, 10x24, 20m				
40071354505	LED pictogram (left/blank), 10x21/10x22, 10x23, 10x24, 20m				
40071354506	LED pictogram (right/blank), 10x21/10x22, 10x23, 10x24, 20m				
40071354507	LED pictogram (down/blank), 10x21/10x22, 10x23, 10x24, 20m				
40071354508	LED pictogram (left/right), 10x21/10x22, 10x23, 10x24, 20m vertical				
40071354509	LED pictogram (left/right), 10x21/10x22, 10x23, 10x24, 20m vertical				
40071354533	LED pictogram (left/right), 11x21/11x22, 11x23, 11x24, 30m				
40071354534	LED pictogram (down/down), 11x21/11x22, 11x23, 11x24, 30m				
40071354535	LED pictogram (left/blank), 11x21/11x22, 11x23, 11x24, 30m				
40071354536	LED pictogram (right/blank), 11x21/11x22, 11x23, 11x24, 30m				
40071354537	LED pictogram (down/blank), 11x21/11x22, 11x23, 11x24, 30m				
40071354538	LED pictogram (left/right), 11x21/11x22, 11x23, 11x24, 30m vertical				
40071354539	LED pictogram (left/right), 11x21/11x22, 11x23, 11x24, 30m vertical				



# 5.3

## Exit signs - Indoor

FlexiTech ED

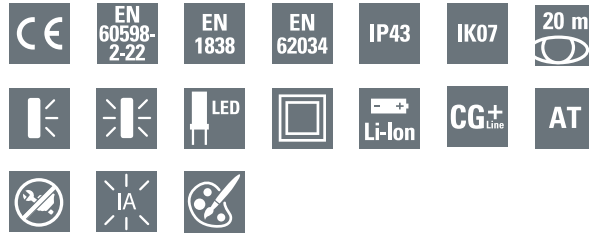

- Multiple configurations in one box
- Fast installation
- Homogenized illumination
- Increased Affordance for safer evacuation (CGLine+ version)
- Customization for improved integration
- Reduced maintenance effort, energy savings and respectful to the environment

### Light Source:

LED strip

FlexiTech facilitates your day to day jobs and projects thanks to an easy to manage and consistent range. FlexiTech ED is a one-box solution that has unique dual mounting base, and a host of other clever features that ensures everything needed for easy install is in ... one-box!

### Materials:

Polycarbonate

Lithium ion battery

Either single or double-sided, either wall or ceiling mounted and whatever the arrow direction, FlexiTech ED will meet all your expectations without additional accessories. Homogenized illumination of the pictogram and Increased Affordance optional functionality will make even more visible the exit sign and safer evacuation.

### Operation:

Maintained (M) / Non Maintained (NM) via external switch

The use of LEDs, long life components, automatic testing and monitoring devices (CGLine+) significantly reduce the operating and maintenance costs of the installation.

Configurable level of light in mains mode via magnet (30%, 70%, 100%) on CGLine+ versions

Duration selectable 1h, 2h, 3h and 8h

Installation possibilities: Wall, ceiling, recessed

Maintenance costs reduced, no replacement of spareparts needed for 10 years (CGLine+ version)

### Applications:

Hotels, restaurants, meeting rooms, offices, shops, cinemas, theaters, museums

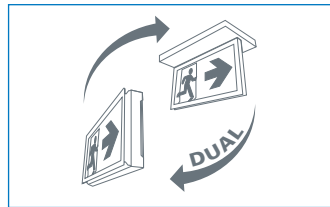

### New DUAL system



The new patented DUAL system enables the edge panel to be easily mounted into the case. This can be fitted into the wall or ceiling position without additional accessories required.



### One box solution

One product offers multiple configurations. This makes easier quoting, ordering and stock management. Thus, the installer doesn't need to anticipate the exact configuration of the building (direction of the arrow, mounting position, etc.). This One box solution also avoids risk of missing parts on worksite.



### 6 innovations that make FlexiTech easier to install

- Slotted holes for quick fixing and easy adjustment
- Screwless terminal blocks with double connection
- Transparent baseplate with a large working space for ease of installation and replacement of existing products
- Spirit level, for perfect horizontal alignment
- Possibility of direct mounting on electrical boxes
- 9 cables entries in rubber (4 backs, 2 at the top, 1 at the bottom and 2 at the side) Cables sizes : 2,5<math><math>\varnothing</math></math>13,5mm No plastic parts to break when access from the back

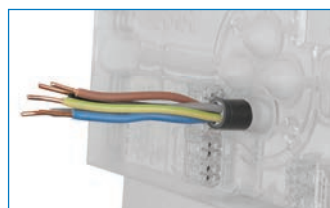







Ceiling-surface mounting

Wall-surface mounting

Recessed mounting option







Customization



Order code	Description		Illumination in mains mode (cd)				
FT2ED4IATL18	FlexiTech ED AT		50 or 500	5 VA / 2 W	1-2-3-8h	FT-BAT1	Maintained / Non Maintained
FT2ED4ICGL18	FlexiTech ED CGLLine+	✓	50 or 500	5 VA / 2 W	1-2-3-8h	FT-BATLL2	Maintained / Non Maintained

\*Luminous flux  $\Phi_E, \Phi_N$  at end of rated operating time 100% @1h, 50% @2h, 42% @3h, 16% @8h

### Accessories

Order code	Description
 FT2-RKC	Recess Kit for Ceiling, compatible with FlexiTech SE and FlexiTech ED (ceiling position)
 FT2-WG	Wire Guard, compatible with FlexiTech SE and FlexiTech ED
 40071352379	Eaton Magnet for lighting configuration and manual tests
 FT-BAT1	Battery Pack, LiFePO <sub>4</sub> 3,2V / 0,6Ah
 FT-BATLL2	Battery Pack, LiFePO <sub>4</sub> long life 3,2V / 1,5Ah
 FT2ED-4I	Set of 4 pictos for FlexiTech ED, 20m (D, L, R, U), ISO format

### FlexiTech

#### Wall-surface mounting

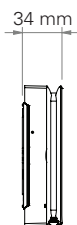
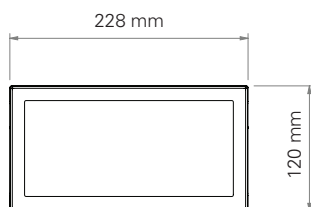

#### Ceiling-surface mounting

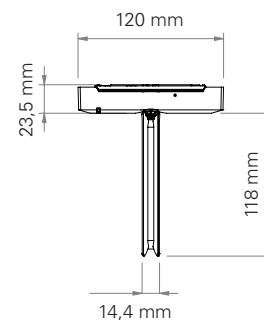
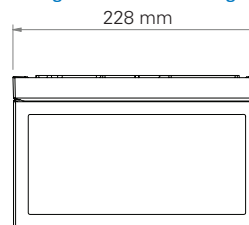

#### FT2-RKC

##### Recess Kit for Ceiling

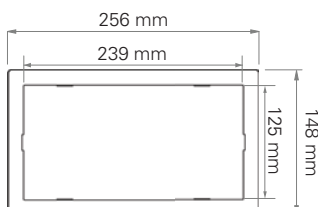

#### FT2-WG

##### Wire Guard

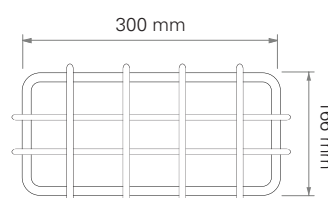

# 5.4

## Exit signs - Indoor

71811 / 71821 LED CGLine+



- Enclosure made of slim aluminium profile, anodised, with mitre cut
- No tools necessary for installation of silkscreen pictograms
- Dimmable in three steps for use in dark ambient conditions

### Light Source:

71811: 3 x 1 W LEDs

71821: 4 x 1 W LEDs

### Materials:

Aluminium housing

Colour : aluminium, anodized

Lithium ion battery

### Installation:

71811: Wall mounting

71821: Ceiling, pendant, chain or wall bracket mounting

Terminals : Through-wiring from mains (L, L', N, PE) up to 2.5 mm<sup>2</sup>

CGLine+ bus through-wiring up to 1.5 mm<sup>2</sup>

### Operation:

For maintained and non-maintained operations

CGLine+ (Without bus working in AT mode)

For 1 h, 3 h or 8 h operation

The 71811 & 71821 LED is a range of exit sign luminaires with an enclosure made from matt anodized aluminum extrusion profile. With its various mounting methods, it can be used for a wide variety of installation situations. Optimal perceptibility is achieved by the high luminance of the white contrasting colour (>500cd/m<sup>2</sup>).

One, three or eight hours rated operating duration can be freely specified according to application.

The use of LEDs, automatic testing and monitoring devices (CGLine+) significantly reduce the operating and maintenance costs of the installation.

### Viewing distance

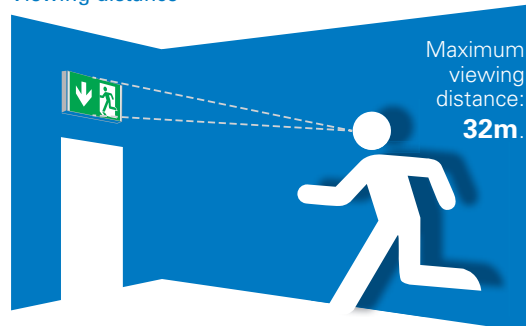

Viewing distance of 32 meters provides the ability to use fewer products and less power consumption per coverage area of an application.

### Applications:

Hotels, cinemas, theaters, schools and hospitals

Order code	Description	⚡	🕒	🔋	⚙️
40071354827	Exit sign luminaire 71811 1-8h/D LED CGLine+, single sided	7 VA/6.6 W	1-3-8h	LiNiMnCoO <sub>2</sub> 3.7V/4Ah	Maintained / Non-Maintained
40071354828	Exit sign luminaire 71821 1-8h/D LED CGLine+ WM, double-sided	8.8 VA/8.3 W	1-3-8h	LiNiMnCoO <sub>2</sub> 3.7V/4Ah	Maintained / Non-Maintained
40071354829	Exit sign luminaire 71821 1-8h/D LED CGLine+ DM, double-sided	8.8 VA/8.3 W	1-3-8h	LiNiMnCoO <sub>2</sub> 3.7V/4Ah	Maintained / Non-Maintained
40071354830	Exit sign luminaire 71821 1-8h/D LED CGLine+ PM, double-sided	8.8 VA/8.3 W	1-3-8h	LiNiMnCoO <sub>2</sub> 3.7V/4Ah	Maintained / Non-Maintained
40071354240	Cover Pictogram Arrow LEFT, ISO				Each 71821 luminaire requires 2 covers. Installation material not included. Please order separately depending on the type of mounting (see accessories). WM = Wall mounting, DM = Ceiling mounting, PM = Pendant mounting
40071354241	Cover Pictogram Arrow RIGHT, ISO				
40071354242	Cover Pictogram Arrow DOWN, ISO				
40071351197	Blind cover (cover without picto)				

71811 LED CGLine+

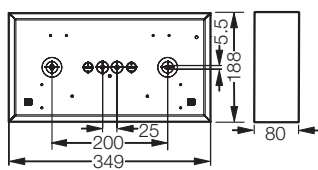

71821 CGLine+ WM

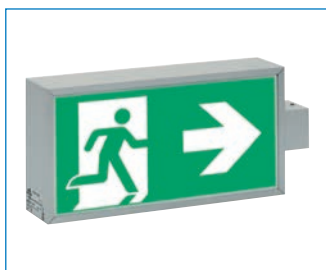

71821 CGLine+ WM

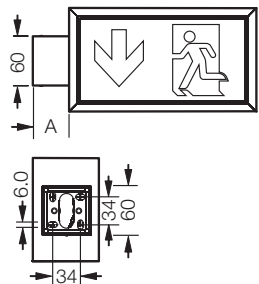

71821 CGLine+ PM

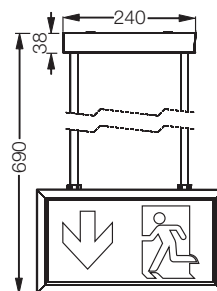

71821 CGLine+ DM

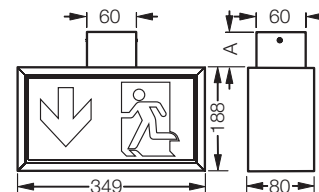

### Accessories

Order code	Description
<b>71811 LED CGLine+</b>	
40071348370	Wire guard
<b>71821 LED CGLine+</b>	
40071351011	Wall / ceiling mounting kit for WM/DM, A = 42 mm
40071351497	Wall / ceiling mounting kit for WM/DM, A = 100 mm
40071350412	Suspension set 0.5 m with canopy, silver, square form for PM
40071350416	Suspension set 1.5 m with canopy, silver, square form for PM
40071351158	Chain fastening



# 5.5

## Exit signs - Indoor

Velos



- Unit with innovative LED technology Certified family of emergency exit signs in accordance to EN 60598-2-22
- 3rd party certification
- Push button for test operation
- Ceiling, wall, suspension, recessed and lateral installation
- Models of 30m and 40m visibility
- Test functions

### Light Source:

LED Strip with a lifetime of more than 60.000 hours  
24 LEDs producing 140 lumens

### Materials:

Base and reflector unit in white Polycarbonate  
NiCd and NiMH batteries

### Operation:

Maintained, slave and CBS models available  
Autonomy from 1h up to 3h  
Adjustable brightness function to 50% in mains operation  
Functional test button  
Telecommand, Inhibition operation  
Autotest, CGLine+ and Slave models available

### Installation:

Ceiling, wall, recessed, suspended through rope or metal pipe and lateral installation  
No special tools required

### Applications:

Schools, universities, public administration, commercial environments  
Hotels, restaurants, meeting rooms, offices, shops, cinemas, theaters, museums  
Areas with large heights and long viewing distance requirements

Velos is a range of emergency exit sign luminaires designed and equipped with technical solutions that make it suitable for a wide range of applications. The choice of exit sign labels makes the Velos range appropriated for emergency lighting requirements in multiple places such as offices, restaurants, hotels, hospitals and general commercial applications.

A complete range of accessories such as the recessed base for false ceiling installations, lateral and back base as well as suspension options allow for a variety of mounting positions. Velos is equipped with LED light source to provide an excellent uniform illumination of the legend comfortably meeting the requirements of EN1838.

The use of LEDs, automatic testing and monitoring devices (CGLine+) significantly reduce the operating and maintenance costs of the installation.

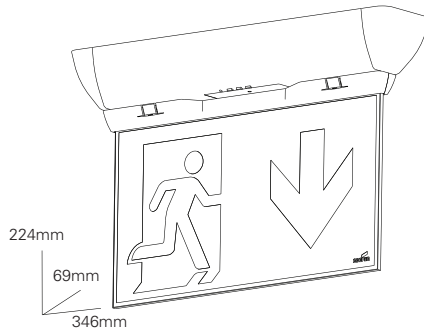

### Viewing distance

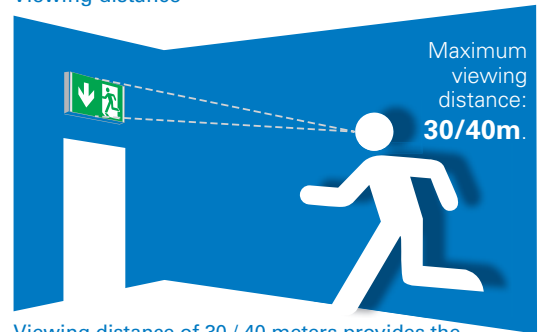

Viewing distance of 30 / 40 meters provides the ability to use fewer products and less power consumption per coverage area of an application.



### Power Supply Unit

- 1 • Easy to install with no use of special tools required.
  - Environmentally friendly: no heavy metals and energy-optimized charging process due to low self-discharge.
- 2 • Easy to connect power cables via screwless connectors for up to 2.5mm<sup>2</sup> cables.
- 3 • Multiple entrance points for power cables through base and main body of the power supply unit.
  - Construction Material: Polycarbonate.
  - Large capacity NiMH batteries with small construction size for compact luminaire design.

### 4 Velos electronics

- Fully automatic function test (weekly) or duration test (every 10 weeks).
- Testing button for manual triggering of function test.
- Autotest models available with simple fault analysis with two LED indication of battery / LED test and status display (operation, function test, duration test, failure).
- Easily set the level in mains operation to 50% or 100%.
- Increased product reliability with LED matrix orientation. By groups of 3, if one of the 24 LEDs fails, the intact LEDs will illuminate more brightly.



### 5 Velos Exit Sign

- Design life time: exceeding 60.000 hours lifetime expectancy using an EN1838 standard plate of 4mm thickness with 24 LED producing 140lm with minimum 240 cd/m<sup>2</sup> on white surface.
- 6 • Simple parts clicking with each other ensuring fast installation.

### Velos viewing distance

- Velos provides a solution regarding viewing distance and emergency exit signs
- Viewing distance from 30 up to 40 meters, minimizing the number of lights into an installation, reducing the energy consumption of the emergency lighting in a building and installation and maintenance cost.
- Various accessories for ease of installation aiming to accommodate all possible applications and areas, with recessed base, wall mounting accessories, lateral direction base, suspended from ceiling either with rope or metal pipes.

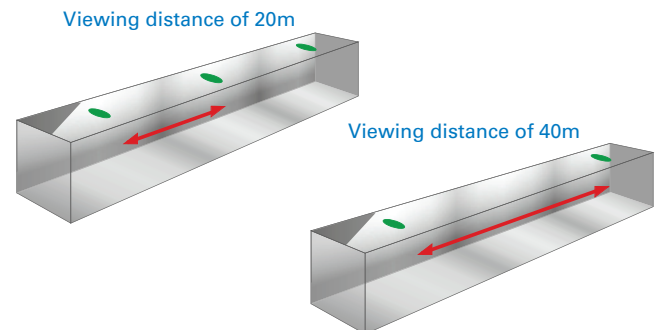

### Velos optimal illumination

New exit sign plate used in Velos converts the high luminance of the LED into an illuminated surface with homogeneous brightness, with luminance of over 38 cd/m<sup>2</sup> on the white surface. As such the escape sign always remains easily recognisable even with poor visibility conditions or in bright surroundings.

Velos LEDs illuminate with a high efficiency of more than 112lm/W.

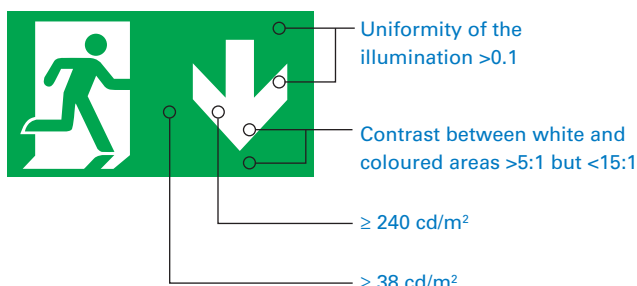

### Photometric requirements for escape sign

#### EN 1838 (1999), Emergency lighting operation:

$L_{min} = 2 \text{ cd/m}^2$  (green surface)  $L_{green} \geq 2 \text{ cd/m}^2$

$L_{white} \geq 10 \text{ cd/m}^2$

$5 \leq L_{white} / L_{green} \leq 15$

#### ISO 30061 (2007), When smoke is prime consideration:

$L_{green} \geq 10 \text{ cd/m}^2$

$L_{white} \geq 50 \text{ cd/m}^2$

# 5.5



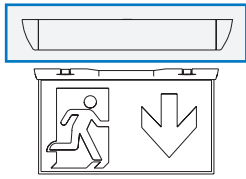

## Exit signs - Indoor

Velos



PSU unit of Velos (order separately)

5

Order code	Description				
O-ESC	Velos PSU 1.5h	8.7VA/4.4W	1.5h	4AA Ni-Cd 800mA	Maintained
O-ESC-3H	Velos PSU 3h	8.7VA/4.4W	3h	4VTCs Ni-Cd 1700mA	Maintained
O-ESM-AT	Velos PSU 1h Auto Test	8.3VA/4.6W	1h	4AA NiMH 1100mA	Maintained
O-ESM-AT-3H	Velos PSU 3h Auto Test	8.8VA/4.9W	3h	4VTCs NiMH 2000mA	Maintained
O-ESC-CGL	Velos PSU CGL+, 1h	9.6VA/5.1W	1h	4AA Ni-Cd 800mA	Maintained
O-ESC-3H-CGL	Velos PSU, CGL+, 3h	9.6VA/5.1W	3h	4VTCs Ni-Cd 1700mA	Maintained

### Ceiling mount

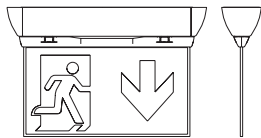

PSU + Exit Sign → Velos

### Wall mount

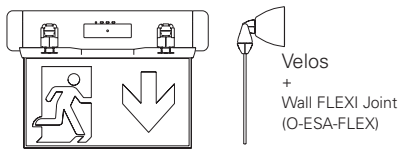

Velos + Wall FLEXI Joint (O-ESA-FLEX)

### Recessed (30m)

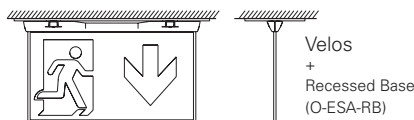

Velos + Recessed Base (O-ESA-RB)

### Recessed (40m)

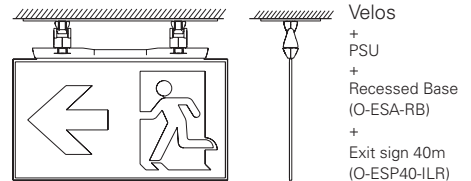

Velos + PSU + Recessed Base (O-ESA-RB) + Exit sign 40m (O-ESP40-ILR)

### Back wall mount

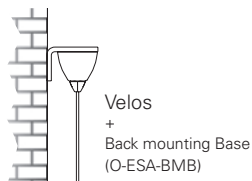

Velos + Back mounting Base (O-ESA-BMB)

### Ceiling mount (40m)

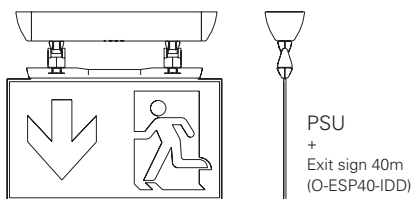

PSU + Exit sign 40m (O-ESP40-IDD)

### Suspended with metal pipes

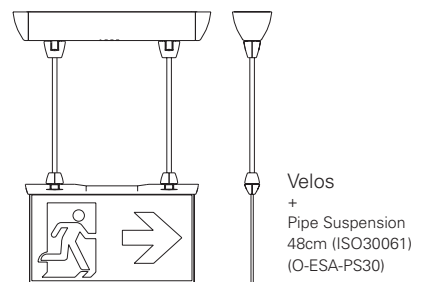

Velos + Pipe Suspension 48cm (ISO30061) (O-ESA-PS30)

### Lateral mount



Velos + Lateral Base (O-ESA-LMB)

### Suspended with adjustable rope

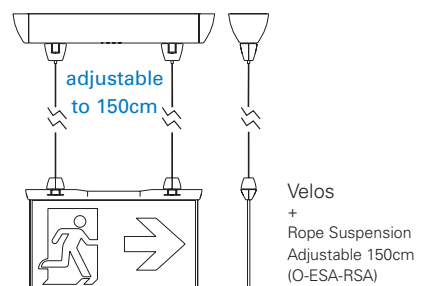







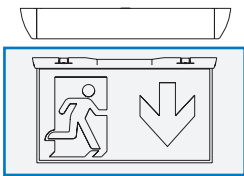





Velos + Rope Suspension Adjustable 150cm (O-ESA-RSA)

### Accessories

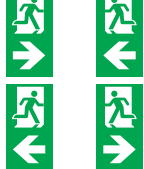



Order code	Description
O-ESA-RB	Velos Recessed base
O-ESA-FLEX	Velos Wall FLEXI Joint
O-ESA-RSA	Velos Rope Suspension adjustable 150cm
O-ESA-RSA-5M	Velos Rope Suspension adjustable 5m
O-ESA-PS30	Velos Pipe Suspension 48cm (ISO30061)
O-ESA-LMB	Velos Lateral Mounting Base
O-ESA-BMB	Velos Back Mounting Base



Exit sign of Velos

Order code	Description		Dimensions	
O-ESP-ILR	Velos pictogram ISO LEFT/RIGHT 30m	24 LEDs	288x165	
O-ESP-ID	Velos pictogram ISO DOWN/BLANK 30m	24 LEDs	288x165	
O-ESP-IDD	Velos pictogram ISO DOWN/DOWN 30m	24 LEDs	288x165	
O-ESP-IU	Velos pictogram ISO UP/BLANK 30m	24 LEDs	288x165	
O-ESP-IUU	Velos pictogram ISO UP/UP 30m	24 LEDs	288x165	
O-ESP-I2R	Velos pictogram ISO Lateral to Room	24 LEDs	288x165	
O-ESP-I2W	Velos pictogram ISO Lateral to Wall	24 LEDs	288x165	
O-ESP-H	Velos Hydrant pictogram 30m	24 LEDs	288x165	
O-ESP-FHD	Velos Fire hose down 30m	24 LEDs	288x165	
O-ESP-FH-EXT	Velos Fire hose & extinguisher 30m	24 LEDs	288x165	
O-ESP-WILR	Velos pictogram Wheel ISO LEFT/RIGHT 30m	24 LEDs	288x165	
O-ESP-WIDD	Velos pictogram Wheel ISO DOWN/DOWN 30m	24 LEDs	288x165	

Additional pictograms available

Order code	Description		Dimensions	
O-ESP40-ILR	Velos pictogram ISO LEFT/RIGHT 40m	24 LEDs	370x220	
O-ESP40-IDD	Velos pictogram ISO DOWN/DOWN 40m	24 LEDs	370x220	
O-ESP40-WILR	Velos pictogram Wheel ISO LEFT/RIGHT 40m	24 LEDs	370x220	
O-ESP40-WIDD	Velos pictogram Wheel ISO DOWN/DOWN 40m	24 LEDs	370x220	

Additional pictograms available



# 5.6

## Exit signs - Indoor

Style 28011 / 28021

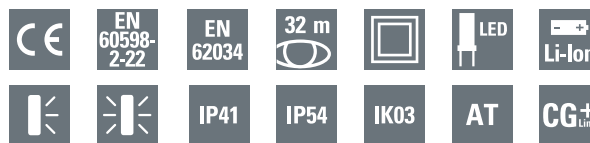

- For stand-alone operation or for connection to the self-contained luminaire monitoring system CGLine+
- Universal use for maintained and non-maintained operation and for 1 h, 3 h or 8 h operation
- Dimmable in three steps for use in dark ambient conditions
- IP54 Kit available (for 28011)

### Light Source:

28011: 3 x 1 W LEDs  
28021: 4 x 1 W LEDs

### Materials:

Polycarbonate housing  
Colour : Light grey, sim. RAL7035  
Lithium ion battery

### Installation:

28011: Wall mounting  
28021: Ceiling mounting

Terminals : Through-wiring from mains (L, L', N, PE) up to 2.5 mm<sup>2</sup>

CGLine+ bus through-wiring up to 1.5 mm<sup>2</sup>

### Operation:

For maintained and non-maintained operations  
CGLine+ (Without bus working in AT mode)  
For 1 h, 3 h or 8 h operation

Style Variant 28011 & 28021 LED is a range of exit sign luminaires with a viewing distance of 32m. Available as single and double-sided versions with a pictogram foil set, this range is suitable for a wide spectrum of applications.

Optimal perceptibility of the luminaire is achieved by the high luminance of the white contrasting colour (>500 cd/m<sup>2</sup>). One, three or eight hours rated operating duration can be freely specified according to application.

The use of LEDs, automatic testing and monitoring devices (CGLine+) significantly reduce the operating and maintenance costs of the installation.

28011 LED CGLine+

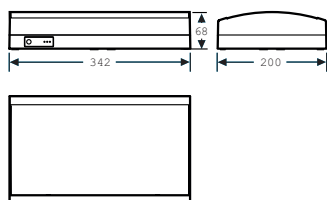

Viewing distance

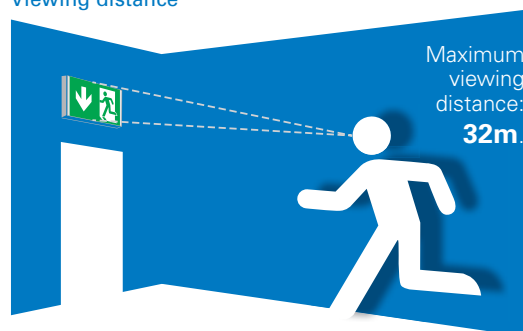

Viewing distance of 32 meters provides the ability to use fewer products and less power consumption per coverage area of an application.

### Applications:

Hotels, cinemas, theaters, schools and hospitals

Order code	Description				
40071354817	Single-sided Exit sign luminaire 28011 1-8h/D LED CGLine+ (Set), including transparent cover and 3 pictogram foils LEFT, RIGHT, DOWN 	7 VA/6.6 W	1h, 3h, 8h	LiNiMnCoO <sub>2</sub> 3.7V/4Ah	Maintained / Non-Maintained
40071354815	Single-sided Exit sign luminaire 28011 1-8h/D LED CGLine+ without cover	7 VA/6.6 W	1h, 3h, 8h	LiNiMnCoO <sub>2</sub> 3.7V/4Ah	Maintained / Non-Maintained
40071354818	Double-sided Exit sign luminaire 28021 1-8h/D LED CGLine+ (Set), including transparent cover and 3 pictogram foils LEFT, RIGHT, DOWN 	8.8 VA/8.3 W	1h, 3h, 8h	LiNiMnCoO <sub>2</sub> 3.7V/4Ah	Maintained / Non-Maintained
40071354816	Double-sided Exit sign luminaire 28021 1-8h/D LED CGLine+	8.8 VA/8.3 W	1h, 3h, 8h	LiNiMnCoO <sub>2</sub> 3.7V/4Ah	Maintained / Non-Maintained
40071354130	Cover Pictogram Arrow LEFT, ISO with silkscreen pictogram				
40071354131	Cover Pictogram Arrow RIGHT, ISO with silkscreen pictogram				
40071354132	Cover Pictogram Arrow DOWN, ISO with silkscreen pictogram				
40071354597	Blind Cover				

28021 LED CGLine+

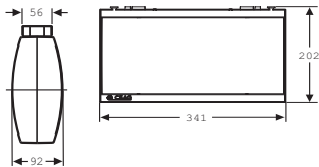

Chain fastening



Ceiling mounting



28021 LED CGLine+  
with ceiling mounting

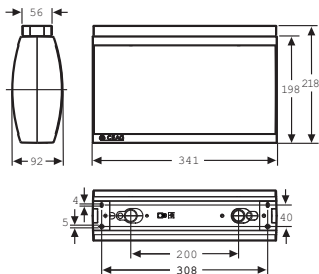

Wall bracket

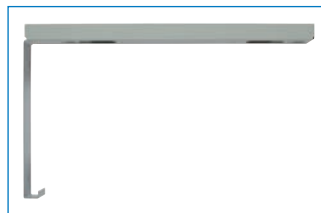

28021 LED CGLine+  
with wall bracket

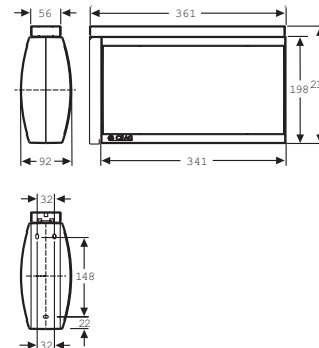

**Accessories**

Order code	Description
<b>28011 LED CGLine+</b>	
40071348370	Wire guard
40071354748	IP54 <sup>1)</sup> set for 28011 LED CGLine+
<b>28021 LED CGLine+</b>	
40071350432	Ceiling mounting for ceiling mounting and chain fastening with chain link diameter < 5 mm
40071350400	Suspension set 0.5 m with canopy
40071351158	Chain fastening <sup>2)</sup> ring-eyelet
40071350418	Wall bracket

<sup>1)</sup>IP54 for electronic and lamp. For increased tightness requirements indoor or in canopied outdoor areas

<sup>2)</sup> For chain link diameter from 5 to 12 mm ceiling mounting 40071350432 required

# 5.7

## Exit signs - Indoor

### Exit cube

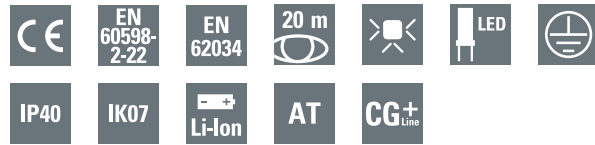

- Modular design of the polycarbonate cube for simple and safe mounting by just sliding cube onto installed luminaire
- Easy and flexible mounting options with space to land cables- Ceiling, wall, cable and chain
- Robust design with impact-resistance of IK07

#### Light Source:

4x 1W LED

The Exit Cube has three-sided illumination, making it suitable for large and wide areas, for example warehouses or retail areas. Optimal perceptibility of the luminaire is achieved by the high luminance of the white contrasting colour (>500 cd/m<sup>2</sup>).

#### Materials:

Cube: Polycarbonate;  
Enclosure: Stainless steel  
Housing White RAL9010  
Lithium ion battery

Several mounting options are available (ceiling, wall, cable or chain suspension) for use in various applications. One, three or eight hours rated operating duration can be freely specified according to application.

The use of LEDs, automatic testing and monitoring devices (CGLine+) significantly reduce the operating and maintenance costs of the installation.

#### Installation:

Easy and flexible mounting options (ceiling, wall, cable and chain)

#### Operation :

Universal use for maintained and non-maintained operation and for 1 h, 3 h or 8 h operation

#### Applications:

Large wide areas, warehouses, retail areas

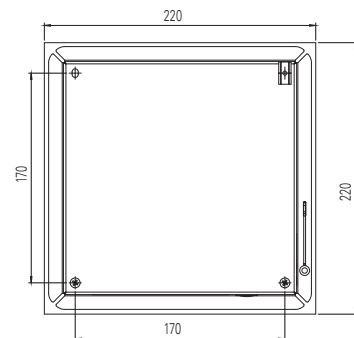
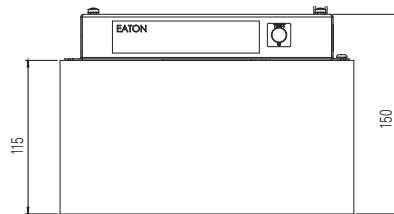

#### Viewing distance

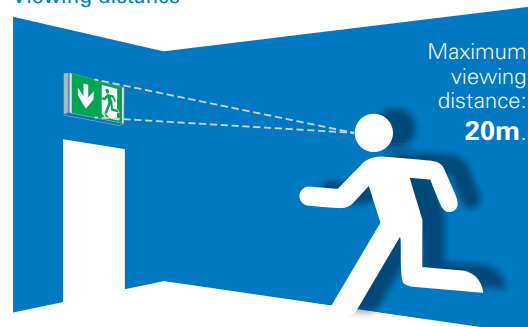

Viewing distance of 20 meters provides the ability to use fewer products and less power consumption per coverage area of an application.



Order code	Description					
40071353420	Exit Cube 33822 1-8h/D LED CGLine+: Enclosure and exit sign cube, including silkscreened pictograms (arrow left, right, down) acc. to ISO		8.8 VA/8.3 W	1h, 3h, 8h	LiNiMnCoO <sub>2</sub> 3.7V/4Ah	Maintained / Non-Maintained



Replacement escape sign cube



Wall bracket



Cable mounting kit



Chain mounting kit

Accessories

40071353444	Wall bracket incl. attachments	
40071353457	Chain mounting kit with 4 eyelets (chain not included)	
40071353443	Cable mounting kit with 4 fasteners and cables, adjustable hanging height (max. 1.5m)	
40071354450	Replacement escape sign cube (20 m viewing distance) silkscreened pictograms (arrow left, right, down) acc. to ISO	



# 6.1

## Exit signs - High degree of protection

Euro X LED

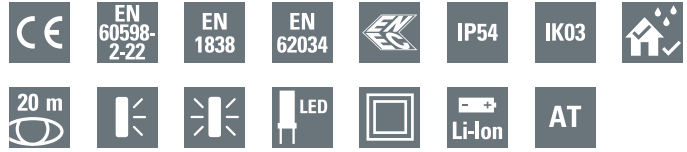

- Universal use: For wall and ceiling mounting
- Protection class IP54
- Including pictogram set
- Environmentally-friendly lithium ion battery
- Automatic test functions
- LEDs with high service life

6

### Light Source:

5 × LED

### Materials:

Polycarbonate body and diffuser  
Lithium ion battery

### Installation:

Wall mounting, ceiling mounting

### Operation:

Maintained and Non-Maintained operation selectable via a sliding switch

With automatic test functions: Weekly function test and battery capacity test twice a year.

Test results are displayed via a dual colour LED.

### Applications:

Hotels, restaurants, offices, shops

The Euro X LED has been developed to meet a wide spectrum of requirements, with no compromises to quality or functionality despite the diversity of product features. It is universally suitable for wall and ceiling mounting without the need of an accessory.

The luminaire features a high IP54 protection rating. Easy installation of this product is due to optimized cable entries and plug-in connectors.

Euro X LED is equipped with long life components (Li-Ion battery and LED light source) as well as automatic testing technology.

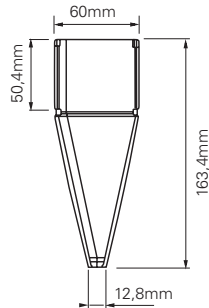
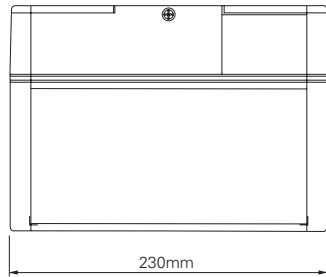

### Viewing distance

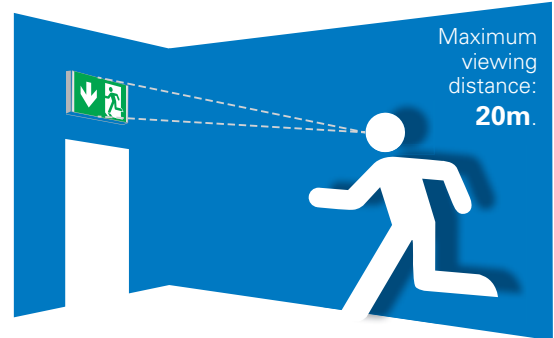

Ceiling mounting

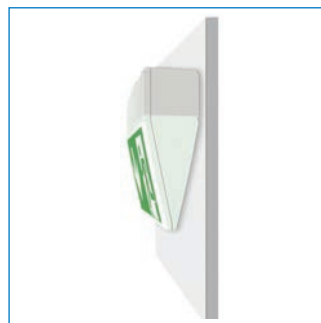

Wall mounting

Order code

Description



40071354900

Euro X LED, 3h Auto Test

8.9 VA/4.5 W

3h

LiNiMnCo<sub>2</sub> 3,6V 2Ah

Maintained / Non-Maintained



Toilets ♀ →  
Toilets ♂ →

# 6.2

## Exit signs - High degree of protection

Style Variant 58011 / 58021



58011 LED CGLine+

- Style Variant 58011: Can be used as safety luminaire or single sided exit sign
- Style Variant 58021: Double sided exit sign
- Upgradable to IP54 with optional set
- Universal use due to selectable duration (1h, 3h, 8h) and included pictogram set

### Light Source:

3 x 1 W LEDs

The 58011 LED can be either used as safety luminaire with up to 306lm or as single-sided exit sign. The 58021 LED is the solution for double-sided exit signage. This range gives several options for a reliable and efficient emergency lighting.

### Materials:

Polycarbonate  
Lithium ion battery

Both variants have a high luminance of the white contrasting colour (>500 cd/m<sup>2</sup>) and therefore optimal visibility also in bright surroundings. The IP54 set expands the range of applications additionally. One, three or eight hours rated operating duration can be freely specified according to application.

### Installation :

Wall and ceiling mounting

The use of LEDs, automatic testing and monitoring devices (CGLine+) significantly reduce the operating and maintenance costs of the installation.

Terminals : Through-wiring from mains (L, L', N, PE) up to 2.5 mm<sup>2</sup>

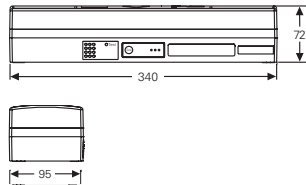

CGLine+ bus through-wiring up to 1.5 mm<sup>2</sup>

### Operation:

For maintained and non-maintained operations  
CGLine+ (Without bus working in AT mode)  
For 1 h, 3 h or 8 h operation

### Applications:

Schools, universities, stores, offices, public administration and all indoor generic environments

Order code	Description				
40071354820	58011 1-8h/D LED CGLine+	7 VA/6.6W	1h, 3h, 8h	LiNiMnCoO <sub>2</sub> 3.7V/4Ah	Maintained / Non-Maintained
40071354821	58021 1-8h/D LED CGLine+	7 VA/6.6W	1h, 3h, 8h	LiNiMnCoO <sub>2</sub> 3.7V/4Ah	Maintained / Non-Maintained

# Exit signs - High degree of protection

Style Variant 58011 / 58021

# 6.2

## Planning help for Style Variant 58011 CGLine+ for E = 1.0 lx

Measurement level 0.02 m, maintenance factor MF = 80 %, battery operation, distances in m

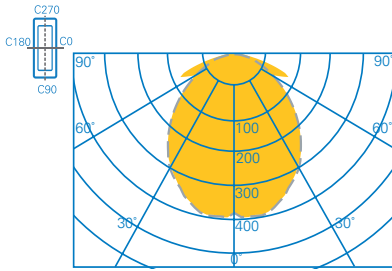

Light distribution curve  
Style Variant 58011 LED CGLine+

Emergency light operating duration	Mounting height in metres	Mounting types				Mounting types					
		L1	L2	L3	L4	L1	L2	L3	L4		
1 h	2.5	Ceiling mounting	3.7	9.0	3.7	9.1	Ceiling mounting	2.6	7.5	3.1	8.2
	3.0	Escape route centre	4.0	9.8	4.0	9.8	Room illumination	3.1	8.5	3.1	8.4
	4.0		4.3	11.0	4.3	11.0		3.3	9.6	3.4	9.6
	5.0		4.5	11.8	4.5	11.8		3.5	10.5	3.5	10.4
	6.0		4.4	12.3	4.4	12.3		3.4	11.2	3.5	11.1
	7.0		4.2	12.6	4.1	12.6		3.2	11.7	3.3	11.7
	8.0		3.6	12.6	3.6	12.6		2.9	12.1	2.9	12.1
	9.0		2.7	12.3	2.7	12.3		2.3	12.4	2.4	12.4
3 h	2.5	Ceiling mounting	3.3	8.2	3.3	8.2	Ceiling mounting	2.7	7.1	2.7	7.0
	3.0	Escape route centre	3.5	8.8	3.5	8.8	Room illumination	2.8	7.7	2.8	7.6
	4.0		3.7	9.7	3.7	9.8		2.9	8.6	3.0	8.6
	5.0		3.7	10.3	3.7	10.3		2.9	9.3	3.0	9.3
	6.0		3.4	10.5	3.4	10.5		2.8	9.9	2.8	9.8
	7.0		2.8	10.5	2.8	10.5		2.4	10.2	2.4	10.2
	8.0		1.6	10.1	1.6	10.0		1.8	10.4	1.9	10.4

6



58021 LED CGLine+



Chain fastening



Wall bracket

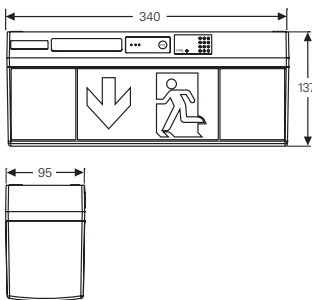

### Accessories

40071350669	Chain fastening
40071350668	Wall bracket
40071354749	IP54 <sup>1)</sup> set for 58011/58021 LED CGLine+

<sup>1)</sup>IP54 for electronic and lamp. For increased tightness requirements indoor or in canopied outdoor areas



# 6.3

## Exit signs - High degree of protection

46811 LED CGLine+



- LED escape sign luminaire with high protection class (IP65) and high viewing distance of 60m
- Excellent perceptibility on account of high luminance of the white contrasting colour > 500 cd/m<sup>2</sup> in keeping with standard DIN 4844-1 and high uniformity  $L_{min}/L_{max} > 0.8$
- The 46811 LED HYG CGLine+ is suitable for operation in food preparation facilities (for dry areas with the presence of dust) with requirements acc. HACCP and IFS

6

### Light Source:

HighPower LEDs 8 x 1W

### Materials:

Polycarbonate panel

Coated sheet metal

Silk-screened pictogram

### Installation :

Wall mounting

Terminals : 3 x 2 x 2.5 mm<sup>2</sup>

### Operation:

For maintained operations

CGLine+ (Without bus working in AT mode)

For 1 h or 3 h operation

### Applications:

Industrial areas, warehouses, food processing areas

The exit sign luminaire 46811 was developed for large areas like warehouses where the size of the building requires high viewing distances. The tough construction made from sheet steel with a IP65 ingress protection and a IK08 tested robustness together with optimized LED technology and LiFePo batteries ensure a reliable operation in industrial areas with dust or areas with high soiling. The luminaire can be configured via a switch to work for 1 h or 3 h emergency operation.

The 46811 HYG is equipped with an especially gasket and can be used in hygienic environment like food processing areas (with the presence of dust - humid areas are not recommended and would need further measures). This has been tested and certified by a 3rd party in accordance with HACCP.

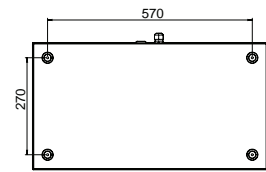
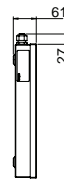
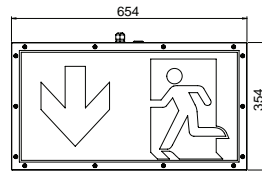

Order code	Description				
40071777015	Escape sign luminaire 46811 LED CGLine+, single sided, 1 and 3h configurable, without pictogramm	15VA / 11W	1h / 3h	6.4V/3.2Ah	Maintained
40071777016	Escape sign luminaire 46811 LED HYG CGLine+, single sided, 1 and 3h configurable, for hygienic areas, without pictogramm	15VA / 11W	1h / 3h	6.4V/3.2Ah	Maintained

### Accessories

Type	Scope of supply	Order No.
Cover, arrow left, ISO 7010	Cover with silkscreened pictogram	40071351587
Cover, arrow right, ISO 7010	Cover with silkscreened pictogram	40071351588
Cover, arrow down, ISO 7010	Cover with silkscreened pictogram	40071351589
Cable gland	Cable gland with ventilation membrane for outdoor areas	40071350005









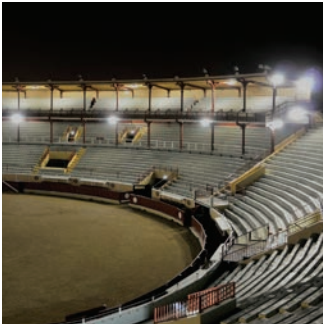







	Overview .....	108
7.1	Planete 2000 .....	110
7.2	Beam introduction .....	112
7.3	BeamTech Small PSU, 1 Light Head .....	114
7.4	BeamTech Small PSU, 2 Light Heads .....	116
7.5	BeamTech Large PSU, 2 Light Heads .....	118
7.6	BeamTech Large PSU, 4 Light Heads .....	120
7.7	Beamlite II .....	122

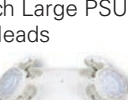

# Beam lights

## Overview

			Aesthetic	No replacement parts for 10 years	Low consumption / Eco-friendly	Protection Degree	Maintained	Non-Maintained	Stand alone	Autotest	Monitored (CGLine+)	
	Page	Performance	General features			Operation		Technology			Battery	
<b>7.1</b> Planete 2000 	110	★ ★ ★		●	●	42 65		●		●	●	Ni-Cd 10 years
<b>7.2</b> BeamTech Small PSU, 1 Light Head 	114	★ ★	●		●	65		●	●	●	●	Ni-Cd Li-Ion
<b>7.3</b> BeamTech Small PSU, 2 Light Heads 	116	★ ★ ★	●		●	65		●	●	●	●	Ni-Cd Li-Ion
<b>7.4</b> BeamTech Large PSU, 2 Light Heads 	118	★ ★ ★			●	65		●	●	●	●	Ni-Cd Li-Ion
<b>7.5</b> BeamTech Large PSU, 4 Light Heads 	120	★ ★ ★			●	65		●	●	●	●	Li-Ion
<b>7.6</b> Beamlite II 	122	★			●	65		●	●	●	●	Ni-Cd

Installation	Applications	Best use
Wall Ceiling Recessed	Healthcare Hotels Cinemas / Theaters Commercial centers Stadia / Arenas Offices Industrial Warehouse	High light output, Ideal for large areas & high ceiling installations. IP65 versions available for industrial applications. Long life batteries significantly reduce maintenance costs.
Wall Ceiling Recessed	Healthcare Hotels Cinemas / Theaters Commercial centers Stadia / Arenas Offices Industrial Warehouse	Designed as an aesthetic alternative to traditional solutions, with batteries and configurable light heads making it a choice for public commercial areas. IP65 makes it perfect for even the harshest of industrial environments.
Wall Ceiling Recessed	Healthcare Hotels Cinemas / Theaters Commercial centers Stadia / Arenas Offices Industrial Warehouse	
Wall Ceiling Recessed	Healthcare Hotels Cinemas / Theaters Commercial centers Stadia / Arenas Offices Industrial Warehouse	
Wall Ceiling Recessed	Healthcare Hotels Cinemas / Theaters Commercial centers Stadia / Arenas Offices Industrial Warehouse	
Wall Ceiling Recessed	Healthcare Hotels Cinemas / Theaters Commercial centers Stadia / Arenas Offices Industrial Warehouse	
Wall Ceiling Recessed	Healthcare Hotels Cinemas / Theaters Commercial centers Stadia / Arenas Offices Industrial Warehouse	

*The information given in this brochure is accurate at the time of compilation (errors and omissions excepted), however due to Eaton philosophy of constant product development we reserve the right to change specifications without prior notice.*

# 7.1

## Beam lights

### Planète 2000

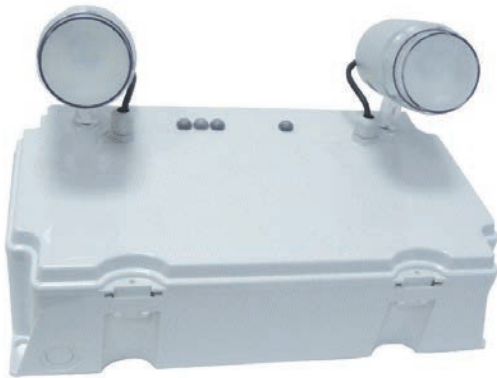

- Optical polycarbonate
- Minimal Environmental impact
- Low consumption
- Automatic tests
- Large status LED: visibility / speed reading
- Multiple cable entries
- Easy installation

#### Light Source:

LED  
 Intergrated light diffuser  
 No relamping  
 Low consumption

The high intensity light source (2000lm) and multi directional lamp heads provide efficient illumination of long escape routes or anti-panic lighting of large areas with high height of installation.

Planete 2000 is suitable for warehouse, industry, high ceiling commercial and sport areas. Low weight, keyhole holes for fixing and hinged front access door make the installation easy.

This 10 years lifetime range has benefited from an eco-design in order to meet the latest environmental standards. The use of LEDs, long life components, automatic testing and monitoring devices (CGLine+) significantly reduce the operating and maintenance costs of the installation.

#### Materials:

Body polycarbonate  
 Beam heads polycarbonate and aluminium  
 Ni-Cd battery (10 years)

#### Installation:

5 cables entries (IP42 model) and 3 cable entries (IP65 model)  
 Maintenance costs reduced, no replacement of spareparts needed for 10 years

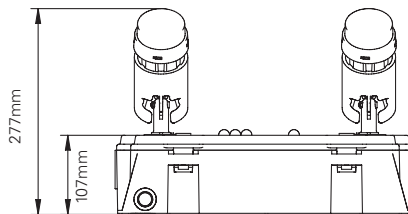

#### Applications:

Cinemas, theatres, factories, warehouses, shopping malls, industrial units and stadiums



Autotest diagnostics in all models



Waterproof model available



LED technology of 2000 lumens light output

Order code	Description					
LUM17110	PLANETE2000, IP42, CGLine+	6W	2000lm	1h	32 x1.2V - 1,6Ah	Non-Maintained
LUM17111	PLANETE2000, IP65, CGLine+	6W	2000lm	1h	32 x1.2V - 1,6Ah	Non-Maintained

#### Accessories

LUM10524	Recessed base for Planete 2000
LUM10527	Wire guard for Planete 2000







# Safety 360°

## New high performance Beam lights

### New ranges for more applications

In case of a power failure, large open plan areas need to be clearly lit to prevent panic and aid evacuation.

New Beam lights ranges provide a solution for both wide area anti-panic lighting and narrow illumination of escape routes or to highlight safety equipment such as alarms and fire extinguishers.

Rated at IP65 ingress protection and with an IK03 impact resistance, the new ranges are ideal for industrial applications such as factories or warehouses, but a complete redesign of the BeamTech range means that it can now also be used in areas where aesthetics is important, such as in entertainment venues and shopping malls.

High intensity light source provides efficient illumination of long, narrow escape routes, but can also provide general wide coverage of a specific area when positioned at any degree specified to each other, in locations where higher illumination is required.

Additionally the light output and the narrow and wide light distribution can be configured by the user (e-focus) in order to provide ease of installation and adopt the product into all relevant emergency applications.

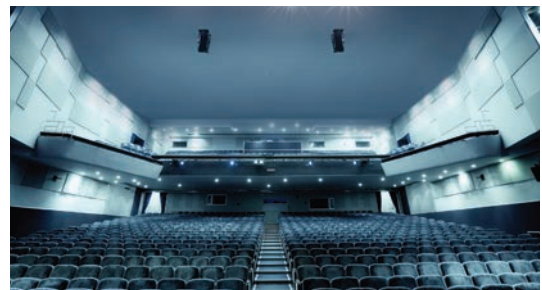



BeamTech Small PSU,  
1 Light Head

BeamTech Small PSU,  
2 Light Heads

BeamTech Large PSU,  
2 Light Heads

BeamTech Large PSU,  
4 Light Heads

BeamLite II

**E-focus patented technology to fit the application with higher performance lighting**



**Narrow light distribution** enables installations and ideal for large, escape routes and illumination of safety equipments. A maximum spacing of up to 36.5m (depending the variant and product line) between luminaires reduces the number of required light points and an application range from 5m up to 25m for 1Lux enables mounting at the normally occurring heights.



**Wide light distribution** enables higher height installations and ideal for large and high areas where no fixed escape route is defined, meaning that the complete area must be illuminated. A maximum spacing of up to 23.1m (depending the variant and product line) between luminaires reduces the number of required light points and an application range from 2.5m up to 15m for 1Lux enables mounting at the normally occurring heights.

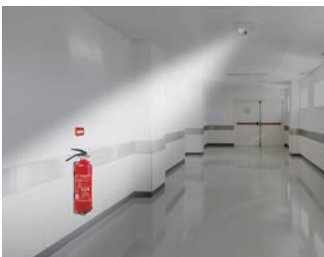

Eaton's new Beam lights flexibility makes them the ideal products to direct light into safety points. BeamTech range meets requirements of EN 1838:1 for illuminance of 5lx for safety equipment like first aid stations, fire fighting equipment and any alarm devices.

**1 or 2 LED lamp head (s), directed on specific degrees of inclination easily configurable.**



Led lamp directed on specific degrees of inclination from 0° to 90° and rotated up to 360°



Rotation stopping point with degree information displayed



The lamp head is equipped with a locking mechanism preventing accidental change of light head configuration.





# 7.3

## Beam lights

### BeamTech Small PSU, 1 Light Head

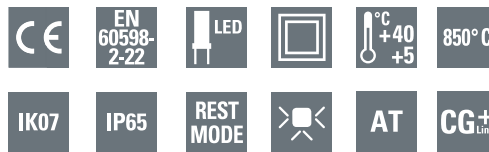

- High flux luminaire with configuration of one directional LED lamp head
- E-focus programming
- Narrow and Wide light distribution, programmed by the user
- One product applicable for Escape Route or Open area illumination
- Flexible and modular design, wall and ceiling mounted

#### Light Source:

12 LEDs Wide, (4W max)  
12 LEDs Narrow, (4W max)  
250lm & 500lm variants

#### Materials:

Body IP65, polycarbonate  
Lamp Head IP65, polycarbonate

#### Installation:

Suitable for wall and ceiling mounting

Installation up to 20m (25m) with optimum spacing of 16.6m (20.8m) for 1lux (0.5lux) illumination

Cable entries from side & back

Locking mechanism on Light Head

Eaton's BeamTech, high intensity single light source, provide efficient illumination of long, narrow escape routes. It can also provide general wide coverage of a specific area when positioned at any degree specified to each other, in locations where higher illumination is required.

Designed as an aesthetic alternative to traditional solutions, the battery and configurable light head are contained in the same unit making it a good choice for public areas. Equally, its IP65 ingress protection and IK07 impact resistance make it perfect for even the harshest of industrial environments.

This range of beam light self-contained luminaires is composed of 1h, 2h and 3h versions, from 250 to 500lm light output. The LEDs within the BeamTech alongside the automatic testing and monitoring devices (using CGLine+ versions) significantly reduces the operating and maintenance costs of the installation.

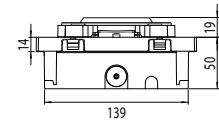
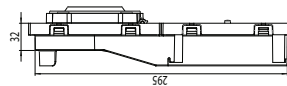
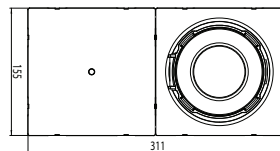

#### Applications:

Suitable for use in large open areas (supermarkets, warehouses, cinemas, theatres, factories, shopping malls, industrial units, stadiums etc..)

Order code	Description					
BT1SC-B1	BeamTech Small 1x250lm	2.3VA/1.6W	250 lm	1h	NiCd 4Cs, 4.8V / 1.7Ah	Non-Maintained
BT1SD-B3	BeamTech Small 1x250lm	3VA/2.4W	250 lm	3h	NiCd 3D, 3.6V / 4Ah	Non-Maintained
BT1SC-B1CGL	BeamTech Small 1x250lm CGL	2.3VA / 1.6W	250 lm	1h	NiCd 4Cs, 4.8V / 1.7Ah	Non-Maintained
BT1SD-B3CGL	BeamTech Small 1x250lm CGL	3VA / 2.4W	250 lm	3h	NiCd 3D, 3.6V / 4Ah	Non-Maintained
BT1SC-D1	BeamTech Small 1x500lm	2.3VA/1.6W	500 lm	1h	NiCd 4Cs, 4.8V / 1.7Ah	Non-Maintained
BT1SLD2	BeamTech Small 1x500lm	5VA/4.5W*	500lm	2h	LiFePO <sub>4</sub> 6.4V / 3.2Ah	Non-Maintained
BT1SLD3	BeamTech Small 1x500lm	5VA/4.5W*	500 lm	3h	LiFePO <sub>4</sub> 6.4V / 3.2Ah	Non-Maintained
BT1SC-D1-AT	BeamTech Small 1x500lm AT	2.3VA / 1.6W	500 lm	1h	NiCd 4Cs, 4.8V / 1.7Ah	Non-Maintained
BT1SLD3CGL	BeamTech Small 1x500lm CGL	5VA / 4.5W*	500 lm	3h	LiFePO <sub>4</sub> 6.4V / 3.2Ah	Non-Maintained

\* While charging, less than 1W in standby

#### Accessories

Order code	Description
BT1SRB	BeamTech Small 1 Recessed Base
BT2SRB	BeamTech Small 2 Recessed Base
BTSGRID	BeamTech Small Grid (53x30x22)

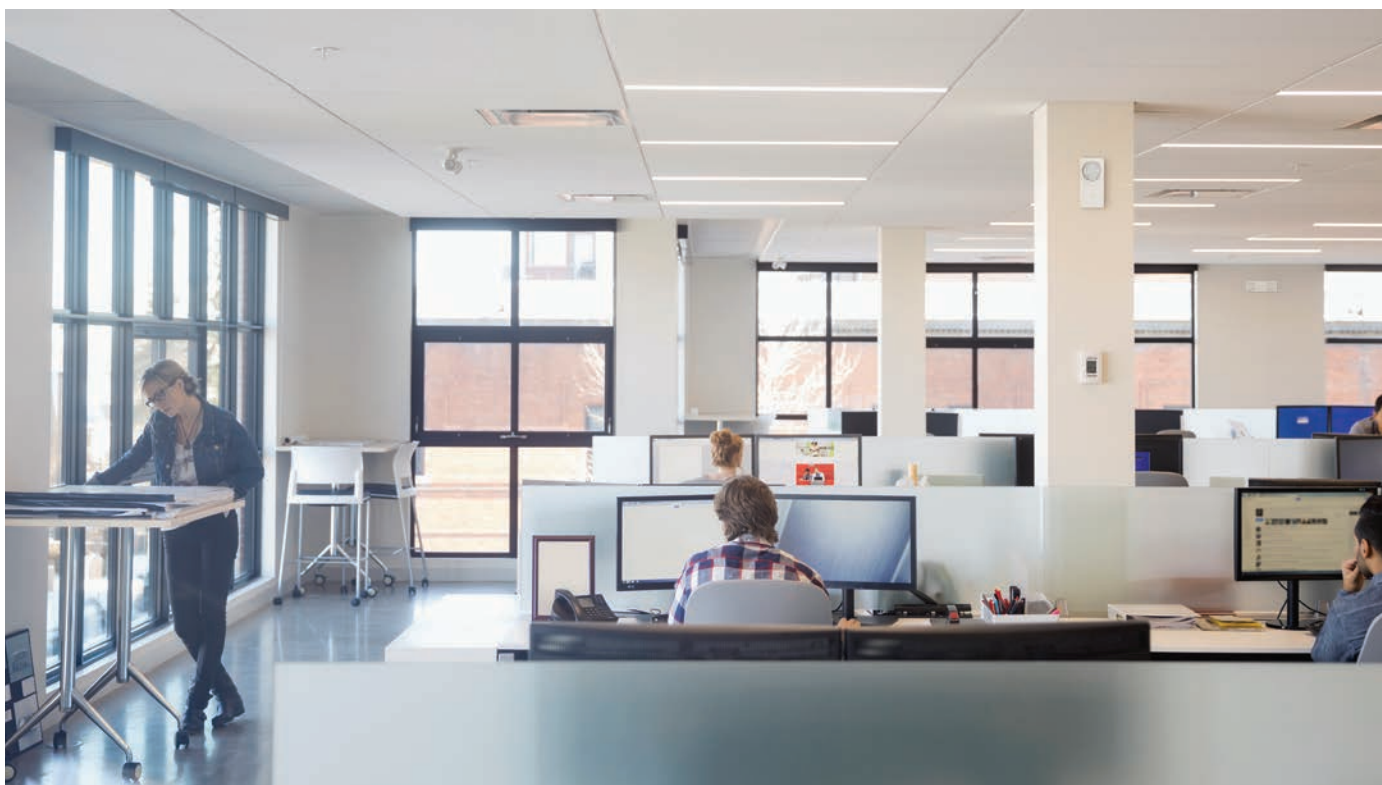

7

BeamTech 1 Light Head  
Narrow beam at 0° slope

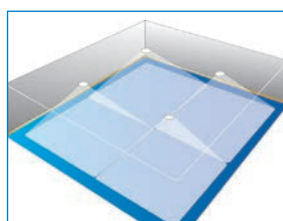
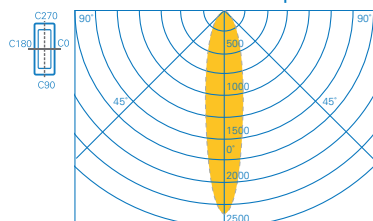

Open area for 0.5 lux

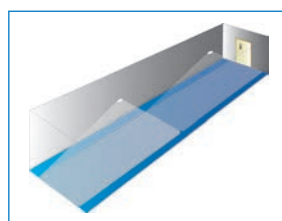

Escape route for 1 lux

BeamTech 1 Light Head  
Wide beam at 0° slope

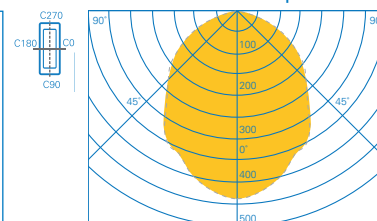

**Planning help for BeamTech 1 Light Head with Narrow & Wide beam 1.0 lx (0.5lx)**

Maintenance factor MF = 80 %, battery operation and distances in m

Luminaire type	Height (m)	Distance for 1 Lux (0.5 Lux)			
		↔	↔	↔	↔
Ceiling mounting Escape route centre 1 Light Head 250lm Narrow beam at 0°	4,00	3,45 (—)	8,65 (—)	3,45 (—)	8,73 (—)
	5,00	3,63 (3,83)	9,41 (9,7)	3,63 (3,83)	9,41 (9,6)
	7,50	3,7 (4,16)	10,41 (11,65)	3,74 (4,2)	10,41 (11,55)
	10,00	3,44 (4,23)	10,52 (12,87)	3,49 (4,29)	10,63 (12,77)
	12,50	3,06 (4,12)	10,1 (13,67)	3,06 (4,12)	10,36 (13,71)
Ceiling mounting Escape route centre 1 Light Head 500lm Narrow beam at 0°	5,00	4,7 (—)	11,61 (—)	4,7 (—)	11,61 (—)
	7,50	5,2 (5,28)	13,51 (14,05)	5,2 (5,28)	13,51 (14,08)
	10,00	5,26 (5,61)	14,53 (16,11)	5,32 (5,66)	14,53 (16,01)
	12,50	5,05 (5,74)	14,87 (17,43)	5,18 (5,88)	15,02 (17,33)
	15,00	4,8 (5,79)	14,79 (18,61)	4,8 (5,79)	14,96 (18,51)
	20,00	3,89 (5,38)	13,77 (19,72)	3,98 (5,5)	13,97 (19,83)

Luminaire type	Height (m)	Distance for 1 Lux (0.5 Lux)			
		↔	↔	↔	↔
Ceiling mounting Escape route centre 1 Light Head 250lm Wide beam at 0°	2,50	3,64 (3,66)	8,93 (8,72)	3,64 (3,66)	8,84 (8,82)
	3,00	3,84 (3,86)	9,51 (9,54)	3,84 (3,86)	9,6 (9,75)
	4,00	4,04 (4,3)	10,71 (11,09)	4 (4,27)	10,62 (10,99)
	5,00	4,01 (4,44)	11,3 (12,38)	4,05 (4,48)	11,2 (12,28)
	7,50	3,15 (4,5)	11,3 (14,2)	3,15 (4,5)	11,3 (13,97)
Ceiling mounting Escape route centre 1 Light Head 500lm Wide beam at 0°	3,00	4,75 (4,64)	11,53 (11,57)	4,8 (4,68)	11,9 (11,2)
	4,00	5,36 (5,18)	13,18 (13,06)	5,31 (5,14)	13,18 (13,4)
	5,00	5,65 (5,62)	14,55 (14,89)	5,6 (5,57)	14,55 (14,64)
	7,50	5,65 (6,14)	16,09 (18,01)	5,65 (6,14)	15,95 (17,91)
	10,00	— (6,21)	— (19,88)	— (6,14)	— (19,6)

\* Spacing tables above are examples of performance of certain models with specific lumen output, installed on specific heights at few headlamps direction options. Complete performance characteristics for all models, all installation heights and all headlamp direction options can be derived by the use of the LTD files available on request.



# 7.4

## Beam lights

### BeamTech Small PSU, 2 Light Heads

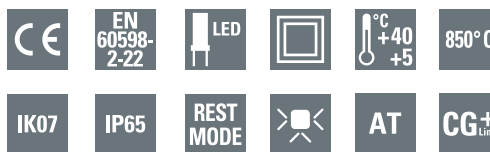

- High flux luminaire with configuration of two directional LED lamp heads
- E-focus programming
- Narrow and Wide light distribution, programmed by the user
- One product applicable for Escape Route or Open area illumination
- Flexible and modular design, wall and ceiling mounted

#### Light Source:

12 LEDs Wide, (4W max)  
12 LEDs Narrow, (4W max)  
500lm & 1000lm variants

#### Materials:

Body IP65, polycarbonate  
Lamp Head IP65, polycarbonate

#### Installation:

Suitable for wall and ceiling mounting

Installation up to 25m (30m) with optimum spacing of 36.8m (43.1m) for 1lux (0.5lux) illumination

Cable entries from side & back

Locking mechanism on Light Heads

Eaton's BeamTech, high intensity double light sources, provide efficient illumination of long, narrow escape routes. It can also provide general wide coverage of a specific area when positioned at any degree specified to each other, in locations where higher illumination is required.

Designed as an aesthetic alternative to traditional solutions, the battery and configurable light heads are contained in the same unit making it a good choice for public areas. Equally, its IP65 ingress protection and IK07 impact resistance make it perfect for even the harshest of industrial environments.

This range of beam light self-contained luminaires is composed of 1h, 2h and 3h versions, from 500 to 1000lm light output. The LEDs within the BeamTech alongside the automatic testing and monitoring devices (using CGLine+ versions) significantly reduces the operating and maintenance costs of the installation.

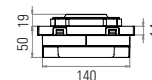
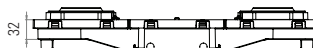
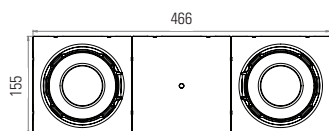

#### Applications:

Suitable for use in large open areas (supermarkets, warehouses, cinemas, theatres, factories, shopping malls, industrial units, stadiums etc..)

Order code	Description					
BT2SC-D1	BeamTech Small 2x250lm	2.3VA/1.6W	500 lm	1h	NiCd 4Cs 4.8V / 1.7Ah	Non-Maintained
BT2SLD2	BeamTech Small 2x250lm	5VA/4.5W*	500lm	2h	LiFePO <sub>4</sub> 6.4V / 3.2Ah	Non-Maintained
BT2SLD3	BeamTech Small 2x250lm	5VA/4.5W*	500 lm	3h	LiFePO <sub>4</sub> 6.4V / 3.2Ah	Non-Maintained
BT2SC-D1CGL	BeamTech Small 2x250lm CGL	2.3VA / 1.6W	500 lm	1h	NiCd 4Cs 4.8V / 1.7Ah	Non-Maintained
BT2SLD3CGL	BeamTech Small 2x250lm CGL	5VA / 4.5W*	500 lm	3h	LiFePO <sub>4</sub> 6.4V / 3.2Ah	Non-Maintained
BT2SLF1	BeamTech Small 2x500lm	5VA/4.5W*	1000 lm	1h	LiFePO <sub>4</sub> 6.4V / 3.2Ah	Non-Maintained
BT2SLF1-AT	BeamTech Small 2x500lm AT	5VA / 4.5W*	1000 lm	1h	LiFePO <sub>4</sub> 6.4V / 3.2Ah	Non-Maintained
BT2SLF1CGL	BeamTech Small 2x500lm CGL	5VA / 4.5W*	1000 lm	1h	LiFePO <sub>4</sub> 6.4V / 3.2Ah	Non-Maintained
BT2SLF2	BeamTech Small 2x500lm	5VA / 4.5W*	1000 lm	2h	LiFePO <sub>4</sub> 6.4V / 3.2Ah	Non-Maintained

#### Accessories

Order code	Description
BT1SRB	BeamTech Small 1 Recessed Base
BT2SRB	BeamTech Small 2 Recessed Base
BTSGRID	BeamTech Small Grid (53x30x22)



BeamTech 2 Light Heads  
Narrow beam at 0°-0° slope

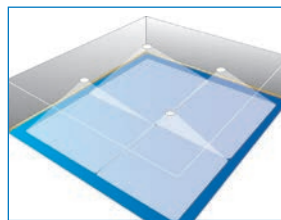
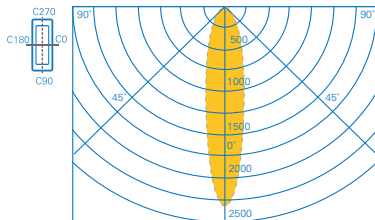

Open area for 0.5 lux

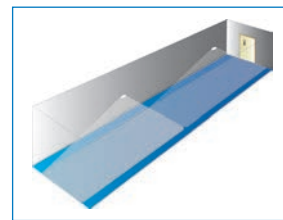

Escape route for 1 lux

BeamTech 2 Light Heads  
Wide beam at 0°-0° slope

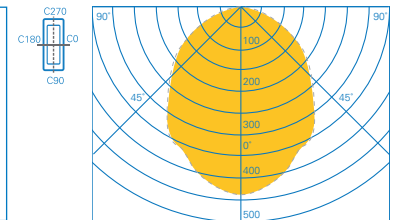

**Planning help for BeamTech with 2 Light Heads with Narrow & Wide beam 1.0 lx (0.5lx)**

Maintenance factor MF = 80 %, battery operation and distances in m

Luminaire type	Height (m)	Distance for 1 Lux (0.5 Lux)			
Ceiling mounting Escape route centre 2 Light Heads 2x250lm Narrow beam at 0°-0°	5,00	4,7 (—)	11,61 (—)	4,7 (—)	11,61 (—)
	7,50	5,2 (5,28)	13,51 (14,05)	5,2 (5,28)	13,51 (14,08)
	10,00	5,26 (5,61)	14,53 (16,11)	5,32 (5,66)	14,53 (16,01)
	12,50	5,05 (5,74)	14,87 (17,43)	5,18 (5,88)	15,02 (17,33)
	15,00	4,8 (5,79)	14,79 (18,61)	4,8 (5,79)	14,96 (18,51)
Ceiling mounting Escape route centre 2 Light Heads 2x500lm Narrow beam at 0°-0°	20,00	3,89 (5,38)	13,77 (19,72)	3,98 (5,5)	13,97 (19,83)
	7,50	6,75 (—)	16,81 (—)	6,75 (—)	16,95 (—)
	10,00	7,27 (7,15)	18,81 (19,41)	7,27 (7,15)	18,81 (19,31)
	12,50	7,44 (7,56)	20,06 (21,62)	7,51 (7,63)	20,06 (21,52)
	15,00	7,4 (7,82)	20,81 (23,21)	7,48 (7,9)	20,81 (23,11)
20,00	6,89 (7,97)	21,05 (25,73)	6,98 (8,07)	21,27 (25,63)	
25,00	6,12 (7,73)	20,2 (27,25)	6,12 (7,73)	20,71 (27,42)	

Luminaire type	Height (m)	Distance for 1 Lux (0.5 Lux)			
Ceiling mounting Escape route centre 2 Light Heads 2x250lm Wide beam at 0°-0°	2,50	4,46 (—)	10,6 (—)	4,42 (—)	10,85 (—)
	3,00	4,75 (4,64)	11,53 (11,57)	4,8 (4,68)	11,9 (11,2)
	4,00	5,36 (5,18)	13,18 (13,06)	5,31 (5,14)	13,18 (13,4)
	5,00	5,65 (5,62)	14,55 (14,89)	5,6 (5,57)	14,55 (14,64)
	7,50	5,65 (6,14)	16,09 (18,01)	5,65 (6,14)	15,95 (17,91)
Ceiling mounting Escape route centre 2 Light Heads 2x500lm Wide beam at 0°-0°	10,00	5,04 (6,21)	16,05 (19,88)	4,99 (6,14)	16,2 (19,6)
	3,00	5,76 (—)	14,14 (—)	5,95 (—)	13,8 (—)
	4,00	6,59 (6,24)	15,87 (15,91)	6,59 (6,24)	16,4 (15,42)
	5,00	7,28 (6,81)	17,86 (17,44)	7,28 (6,81)	17,67 (17,75)
	7,50	8,04 (7,97)	21,03 (21,37)	7,97 (7,9)	21,03 (21,06)
10,00	8,03 (8,39)	22,61 (24,65)	8,1 (8,46)	22,41 (24,55)	
12,50	7,81 (8,6)	22,71 (27,38)	7,81 (8,6)	22,71 (27,04)	
15,00	6,29 (8,49)	22,61 (28,39)	6,29 (8,49)	22,61 (28,05)	

\* Spacing tables above are examples of performance of certain models with specific lumen output, installed on specific heights at few headlamps direction options. Complete performance characteristics for all models, all installation heights and all headlamp direction options can be derived by the use of the LTD files available on request.

# 7.5

## Beam lights

### BeamTech Large PSU, 2 Light Heads

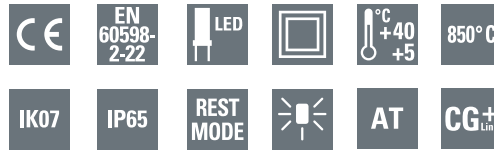

- High flux luminaire with configuration of two directional LED lamp heads
- E-focus programming
- Narrow and Wide light distribution, programmed by the user
- One product applicable for Escape Route or Open area illumination
- Flexible and modular design, wall and ceiling mounted

#### Light Source:

12 LEDs Wide, (4W max)  
12 LEDs Narrow, (4W max)  
500lm & 1000lm variants

#### Materials:

Body IP65, polycarbonate  
Lamp Head IP65, polycarbonate

#### Installation:

Suitable for wall and ceiling mounting

Installation up to 25m (30m) with optimum spacing of 36.8m (43.1m) for 1lux (0.5lux) illumination

Cable entries from side & back

Locking mechanism on Light Heads

#### Applications:

Suitable for use in large open areas (supermarkets, warehouses, cinemas, theatres, factories, shopping malls, industrial units, stadiums etc..)

Eaton's BeamTech, high intensity double light sources, provide efficient illumination of long, narrow escape routes. It can also provide general wide coverage of a specific area when positioned at any degree specified to each other, in locations where higher illumination is required.

Designed as an aesthetic alternative to traditional solutions, the battery and configurable light heads are contained in the same unit making it a good choice for public areas. Equally, its IP65 ingress protection and IK07 impact resistance make it perfect for even the harshest of industrial environments.

This range of beam light self-contained luminaires is composed of 1h and 3h versions, from 500 to 1000lm light output. The LEDs within the BeamTech alongside the automatic testing and monitoring devices (using CGLine+ versions) significantly reduces the operating and maintenance costs of the installation.

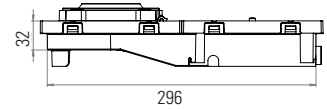
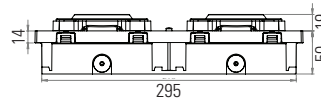
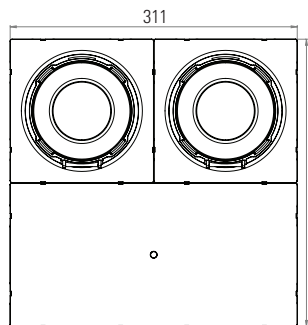

Order code	Description					
BT2LL-D3	BeamTech Large 2x250lm	5VA/4.5W*	500 lm	3h	LiFePO <sub>4</sub> 6.4V / 3.2Ah	Non-Maintained
BT2LC-D1CGL	BeamTech Large 2x250lm CGL	2.3VA/1.6W	500 lm	1h	NiCd 4Cs 4.8V / 1.7Ah	Non-Maintained
BT2LL-D3CGL	BeamTech Large 2x250lm CGL	5VA/4.5W*	500 lm	3h	LiFePO <sub>4</sub> 6.4V / 3.2Ah	Non-Maintained
BT2LL-F1	BeamTech Large 2x500lm	5VA/4.5W*	1000 lm	1h	LiFePO <sub>4</sub> 6.4V / 3.2Ah	Non-Maintained
BT2LL-F3	BeamTech Large 2x500lm	10VA/9W**	1000 lm	3h	2x LiFePO <sub>4</sub> 6.4V / 3.2Ah	Non-Maintained
BT2LL-F1-AT	BeamTech Large 2x500lm AT	5VA/4.5W*	1000 lm	1h	LiFePO <sub>4</sub> 6.4V / 3.2Ah	Non-Maintained
BT2LL-F3CGL	BeamTech Large 2x500lm CGL	10VA/9W**	1000 lm	3h	2x LiFePO <sub>4</sub> 6.4V / 3.2Ah	Non-Maintained

\*While charging, less than 1W in standby

\*\*While charging, less than 2W in standby

#### Accessories

Order code	Description
BTLGRID	BeamTech Large/BeamLitell Grid (54x44x22)



7

### BeamTech 2 Light Heads Narrow beam at 0°-0° slope

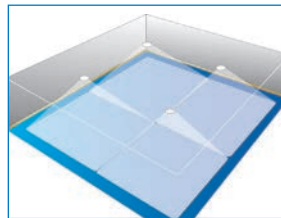
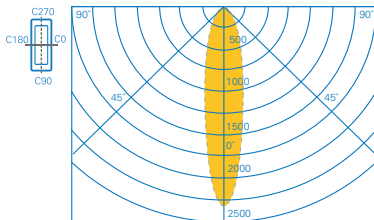

Open area for 0.5 lux

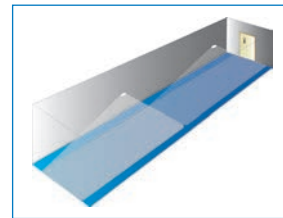

Escape route for 1 lux

### BeamTech 2 Light Heads Wide beam at 0°-0° slope

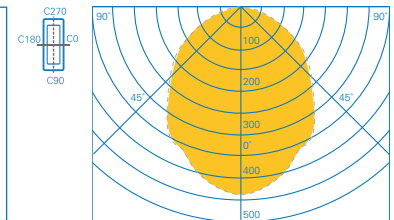

#### Planning help for BeamTech with 2 Light Heads with Narrow & Wide beam 1.0 lx (0.5lx)

Maintenance factor MF = 80 %, battery operation and distances in m

Luminaire type	Height (m)	Distance for 1 Lux (0.5 Lux)			
Ceiling mounting Escape route centre 2 Light Heads 2x250lm Narrow beam at 0°-0°	5,00	4,7 (—)	11,61 (—)	4,7 (—)	11,61 (—)
	7,50	5,2 (5,28)	13,51 (14,05)	5,2 (5,28)	13,51 (14,08)
	10,00	5,26 (5,61)	14,53 (16,11)	5,32 (5,66)	14,53 (16,01)
	12,50	5,05 (5,74)	14,87 (17,43)	5,18 (5,88)	15,02 (17,33)
	15,00	4,8 (5,79)	14,79 (18,61)	4,8 (5,79)	14,96 (18,51)
	20,00	3,89 (5,38)	13,77 (19,72)	3,98 (5,5)	13,97 (19,83)
Ceiling mounting Escape route centre 2 Light Heads 2x500lm Narrow beam at 0°-0°	7,50	6,75 (—)	16,81 (—)	6,75 (—)	16,95 (—)
	10,00	7,27 (7,15)	18,81 (19,41)	7,27 (7,15)	18,81 (19,31)
	12,50	7,44 (7,56)	20,06 (21,62)	7,51 (7,63)	20,06 (21,52)
	15,00	7,4 (7,82)	20,81 (23,21)	7,48 (7,9)	20,81 (23,11)
	20,00	6,89 (7,97)	21,05 (25,73)	6,98 (8,07)	21,27 (25,63)
	25,00	6,12 (7,73)	20,2 (27,25)	6,12 (7,73)	20,71 (27,42)

Luminaire type	Height (m)	Distance for 1 Lux (0.5 Lux)			
Ceiling mounting Escape route centre 2 Light Heads 2x250lm Wide beam at 0°-0°	2,50	4,46 (—)	10,6 (—)	4,42 (—)	10,85 (—)
	3,00	4,75 (4,64)	11,53 (11,57)	4,8 (4,68)	11,9 (11,2)
	4,00	5,36 (5,18)	13,18 (13,06)	5,31 (5,14)	13,18 (13,4)
	5,00	5,65 (5,62)	14,55 (14,89)	5,6 (5,57)	14,55 (14,64)
	7,50	5,65 (6,14)	16,09 (18,01)	5,65 (6,14)	15,95 (17,91)
	10,00	5,04 (6,21)	16,05 (19,88)	4,99 (6,14)	16,2 (19,6)
Ceiling mounting Escape route centre 2 Light Heads 2x500lm Wide beam at 0°-0°	3,00	5,76 (—)	14,14 (—)	5,95 (—)	13,8 (—)
	4,00	6,59 (6,24)	15,87 (15,91)	6,59 (6,24)	16,4 (15,42)
	5,00	7,28 (6,81)	17,86 (17,44)	7,28 (6,81)	17,67 (17,75)
	7,50	8,04 (7,97)	21,03 (21,37)	7,97 (7,9)	21,03 (21,06)
	10,00	8,03 (8,39)	22,61 (24,65)	8,1 (8,46)	22,41 (24,55)
	12,50	7,81 (8,6)	22,71 (27,38)	7,81 (8,6)	22,71 (27,04)
15,00	6,29 (8,49)	22,61 (28,39)	6,29 (8,49)	22,61 (28,05)	

\* Spacing tables above are examples of performance of certain models with specific lumen output, installed on specific heights at few headlamps direction options. Complete performance characteristics for all models, all installation heights and all headlamp direction options can be derived by the use of the LTD files available on request.



# 7.6

## Beam lights

### BeamTech Large PSU, 4 Light Heads

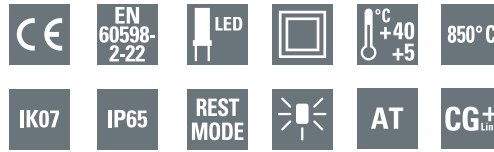

- High flux luminaire with configuration of four directional LED lamp heads
- E-focus programming
- Narrow and Wide light distribution, programmed by the user
- One product applicable for Escape Route or Open area illumination
- Flexible and modular design, wall and ceiling mounted

#### Light Source:

12 LEDs Wide, (4W max)  
12 LEDs Narrow, (4W Max)  
2000lm variant

#### Materials:

Body IP65, polycarbonate  
Lamp Head IP65, polycarbonate

#### Installation:

Suitable for wall and ceiling mounting

Installation up to 25m (30m) with optimum spacing of 36.8m (43.1m) for 1lux (0.5lux) illumination

Cable entries from side & back

Locking mechanism on Light Heads

#### Applications:

Suitable for use in large open areas (supermarkets, warehouses, cinemas, theatres, factories, shopping malls, industrial units, stadiums etc..)

Eaton's BeamTech, high intensity quadruple light sources, provide efficient illumination of long, narrow escape routes. It can also provide general wide coverage of a specific area when positioned at any degree specified to each other, in locations where higher illumination is required.

Designed as an aesthetic alternative to traditional solutions, the battery and configurable light heads are contained in the same unit making it a good choice for public areas. Equally, its IP65 ingress protection and IK07 impact resistance make it perfect for even the harshest of industrial environments.

This range of beam light self-contained luminaires is composed of 1h version, of 2000lm light output. The LEDs within the BeamTech alongside the automatic testing and monitoring devices (using CGLine+ versions) significantly reduces the operating and maintenance costs of the installation.

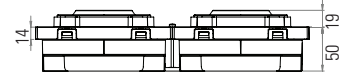
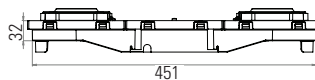
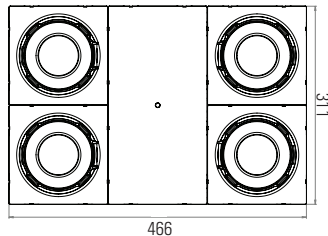

Order code	Description					
BT4LLG1	BeamTech Large 4x500lm	10VA / 9W*	2000 lm	1h	2x LiFePO <sub>4</sub> 6.4V / 3.2Ah	Non-Maintained
BT4LLG1-AT	BeamTech Large 4x500lm AT	10VA / 9W*	2000 lm	1h	2x LiFePO <sub>4</sub> 6.4V / 3.2Ah	Non-Maintained
BT4LLG1CGL	BeamTech Large 4x500lm CGL	10VA / 9W*	2000 lm	1h	2x LiFePO <sub>4</sub> 6.4V / 3.2Ah	Non-Maintained

\* While charging, less than 1W in standby

#### Accessories

Order code	Description
BTLGRID	BeamTech Large/BeamLiteII Grid (54x44x22)





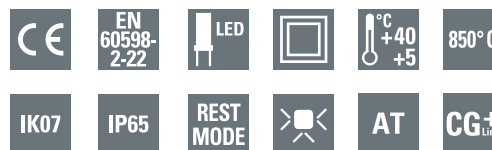

- High flux luminaire with configuration of two directional LED lamp heads
- E-focus programming
- Narrow and Wide light distribution, programmed by the user
- One product applicable for Escape Route or Open area illumination
- Industrial design, wall mounted

#### Light Source:

12 LEDs Wide, (4W max) 12 LEDs Narrow, (4W max) 200lm, 400lm & 800lm variants

#### Materials:

Body IP65, polycarbonate  
Lamp Head IP65, polycarbonate

#### Installation:

Suitable for wall and ceiling mounting

Installation up to 25m (30m) with optimum spacing of 34.6m (40.28m) for 1lux (0.5lux) illumination

Cable entries from side & back and BESA entry

Locking mechanism on Light Heads

Eaton's BeamLite II, high-intensity double light sources, provide efficient illumination of long, narrow escape routes, but can also provide general wide coverage of a specific area when positioned at any degree specified to each other, in locations where higher illumination is required. Also provides a complete solution from a single luminaire, whether you are providing lighting for a large factory floor, a shopping centre or an entertainment venue.

Rated at IP65 ingress protection and with IK07 impact resistance, BeamLite II can be used in even the harshest of environments while the new design, with compact efficient batteries and LED light heads contained in the same unit, also makes these emergency light fittings applicable for commercial applications.

This range of beam light self-contained luminaires is composed of 1h, 2h and 3h duration versions, from 200 to 800lm light output. The LEDs within the BeamLite II alongside the automatic testing and monitoring devices (using CGLine+ versions) significantly reduces the operating and maintenance costs of the installation.

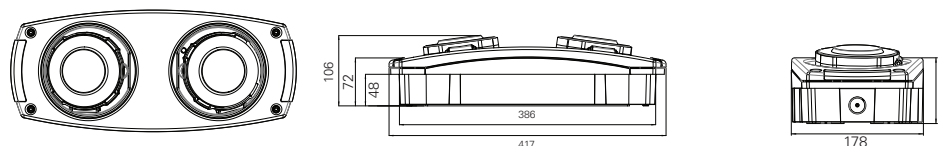

#### Applications:

Suitable for use in large open areas (supermarkets, warehouses, factories, shopping malls, industrial units, stadiums etc..)

Order code	Description	⚡	☀️	🕒	🔋	⚙️
BL2MC-A1	BeamLite II 2x100lm	2.3 VA/1.6W	200lm	1h	4Cs NiCd 4.8V / 1.7Ah	Non-Maintained
BL2MC-A2	BeamLite II 2x100lm	2.3 VA/1.6W	200lm	2h	4Cs NiCd 4.8V / 1.7Ah	Non-Maintained
BL2MC-A3	BeamLite II 2x100lm	2.3 VA/1.6W	200lm	3h	4Cs NiCd 4.8V / 1.7Ah	Non-Maintained
BL2MC-A3CGL	BeamLite II 2x100lm CGL	2.3 VA/1.6W	200lm	3h	4Cs NiCd 4.8V / 1.7Ah	Non-Maintained
BL2MC-C1	BeamLite II 2x200lm	2.3 VA/1.6W	400lm	1h	4Cs NiCd 4.8V / 1.7Ah	Non-Maintained
BL2MC-C2	BeamLite II 2x200lm	3VA / 2.4W	400lm	2h	3D NiCd 3.6V / 4Ah	Non-Maintained
BL2MC-C3	BeamLite II 2x200lm	5VA/4.5W	400lm	3h	6D NiCd 7.2V / 4Ah	Non-Maintained
BL2MD-C3-AT	BeamLite II 2x200lm AT	5VA/4.5W	400lm	3h	6D NiCd 7.2V / 4Ah	Non-Maintained
BL2MD-C3CGL	BeamLite II 2x200lm CGL	5VA/4.5W	400lm	3h	6D NiCd 7.2V / 4Ah	Non-Maintained
BL2MD-E1	BeamLite II 2x400lm	3VA / 2.4W	800lm	1h	3D NiCd 3.6V / 4Ah	Non-Maintained
BL2MD-E2	BeamLite II 2x400lm	5VA/4.5W	800lm	2h	6D NiCd 7.2V / 4Ah	Non-Maintained
BL2MD-E3	BeamLite II 2x400lm	5VA/4.5W	800lm	3h	6D NiCd 7.2V / 4Ah	Non-Maintained
BL2MD-E1CGL	BeamLite II 2x400lm CGL	5VA/4.5W	800lm	1h	3D NiCd 3.6V / 4Ah	Non-Maintained
BL2MD-E3CGL	BeamLite II 2x400lm CGL	5VA/4.5W	800lm	3h	6D NiCd 7.2V / 4Ah	Non-Maintained

#### Accessories

Order code	Description
BTLGRID	BeamTech Large/BeamLiteII Grid (54x44x22)



7

BeamLite II  
Narrow beam at 0°-0° slope

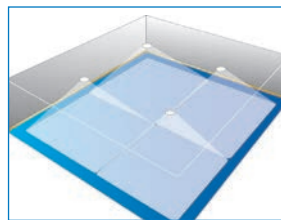
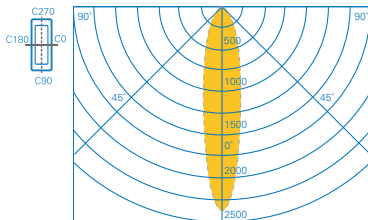

Open area for 0.5 lux

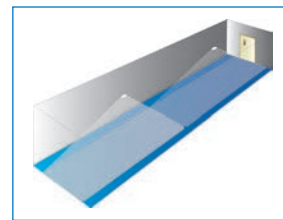

Escape route for 1 lux

BeamLite II  
Wide beam at 0°-0° slope

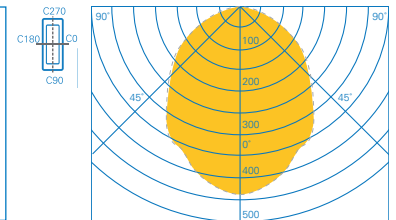

**Planning help for BeamLite II with 2 Light Heads with Narrow & Wide beam 1.0 lx (0.5lx)**

Maintenance factor MF = 80 %, battery operation and distances in m

Luminaire type	Height (m)	Distance for 1 Lux (0.5 Lux)			
Ceiling mounting Escape route centre 2 Light Heads 2x200lm Narrow beam at 0°-0°	5,00	4,35 (4,36)	10,91 (10,62)	4,35 (4,36)	10,91 (10,62)
	7,50	4,69 (4,89)	12,48 (13,4)	4,73 (4,93)	12,48 (13,3)
	10,00	4,66 (5,15)	13,24 (14,99)	4,72 (5,21)	13,24 (14,89)
	12,50	4,37 (5,22)	13,29 (16,27)	4,43 (5,28)	13,43 (16,17)
	15,00	3,95 (5,13)	13,04 (17)	4,02 (5,21)	13,2 (17,06)
	20,00	-- (4,69)	-- (17,93)	-- (4,69)	-- (18,03)
Ceiling mounting Escape route centre 2 Light Heads 2x400lm Narrow beam at 0°-0°	7,50	6,24 (6,09)	15,81 (15,57)	6,24 (6,09)	15,81 (15,61)
	10,00	6,62 (6,65)	17,39 (18,41)	6,62 (6,65)	17,39 (18,31)
	12,50	6,65 (6,95)	18,33 (20,18)	6,72 (7,01)	18,33 (20,26)
	15,00	6,52 (7,15)	18,75 (21,68)	6,6 (7,23)	18,93 (21,58)
	20,00	5,83 (7,12)	18,65 (23,84)	5,92 (7,22)	18,87 (23,74)
	25,00	4,97 (6,69)	17,46 (24,87)	5,09 (6,83)	17,71 (25,03)
	30,00	-- (6,18)	-- (25,5)	-- (6,18)	-- (25,7)

Luminaire type	Height (m)	Distance for 1 Lux (0.5 Lux)			
Ceiling mounting Escape route centre 2 Light Heads 2x200lm Wide beam at 0°-0°	2,50	4,16 (4,08)	9,92 (10,05)	4,16 (4,08)	10,37 (9,59)
	3,00	4,49 (4,41)	10,94 (10,83)	4,49 (4,41)	11,05 (10,86)
	4,00	4,94 (4,87)	12,32 (12,52)	4,9 (4,84)	12,44 (12,68)
	5,00	5,09 (5,3)	13,51 (13,92)	5,04 (5,26)	13,39 (13,82)
	7,50	5,01 (5,58)	14,49 (16,89)	5,01 (5,58)	14,36 (16,79)
	10,00	3,49 (5,54)	14,27 (18,25)	3,49 (5,54)	14,13 (17,99)
Ceiling mounting Escape route centre 2 Light Heads 2x400lm Wide beam at 0°-0°	3,00	5,47 (—)	13,17 (—)	5,53 (—)	13,32 (—)
	4,00	6,16 (5,85)	15,05 (14,96)	6,22 (5,9)	15,37 (14,68)
	5,00	6,76 (6,41)	16,64 (16,24)	6,7 (6,36)	16,64 (16,87)
	7,50	7,24 (7,38)	19,37 (20,3)	7,18 (7,32)	19,37 (20,2)
	10,00	7,13 (7,73)	20,35 (23,4)	7,07 (7,66)	20,18 (23,09)
	12,50	6,51 (7,76)	20,24 (25,05)	6,44 (7,68)	20,43 (24,73)
	15,00	4,02 (7,59)	20,05 (26,09)	4,02 (7,59)	20,05 (25,76)

\* Spacing tables above are examples of performance of certain models with specific lumen output, installed on specific heights at few headlamps direction options. Complete performance characteristics for all models, all installation heights and all headlamp direction options can be derived by the use of the LTD files available on request.







8.1	W 276 LED .....	126
8.2	W 270 LED .....	127
8.3	Conversion kit LED .....	128
8.4	Conversion kit fluorescent range .....	130

*The information given in this brochure is accurate at the time of compilation (errors and omissions excepted), however due to Eaton philosophy of constant product development we reserve the right to change specifications without prior notice.*

# 8.1

## Portable lamps & converters

W 276 LED



- LED portable hand lamp with emergency light function
- Robust construction of impact-resistant, non-abrasive plastic
- Main beam output configurable
- Flashing light function
- Up to 14 h light (ancillary light) and 5.5 h (Eco main beam) with 4 Ah battery
- Up to 27.5 h light (ancillary light) and 9 h (Eco main beam) with 7 Ah battery
- Long range up to 50 m at 1.5 lx illuminance

### Light Source:

Main beam: 3 High Power LEDs with narrow distribution reflector optic

Ancillary light: 6 x MidPower-LED (1.5 W) and wide light distribution

### Materials:

grey, impact resistant, non-abrasive plastic

### Installation:

Integrated charger – connection via flexible spiral cable with EURO plug

Includes three slip-on filters (red, orange, clear prismatic) for modification of light distribution and signalling

### Operation:

Main beam output can be set: Eco mode for longer battery operation (3.0 W) or boost mode for increased luminous flux (5.5 W)

Charging indicator by green LED

Switch function: Flashlight, maintained light and ancillary light



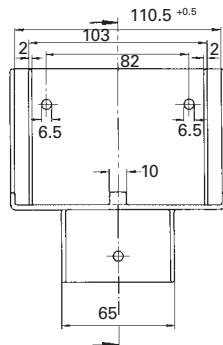

The W276 LED hand lamp combines the longtime proofed robust construction made from impact resistant plastics with the efficient and powerful LED technology. It is especially suitable as a search projector with its focused light cone and long range. The W276 is equipped with an integrated charger. The flashing function in combination with the red or orange diffuser disc also allows use as a reliable signal light.

This range has two different light characteristics: the main beam with up to 330lm and narrow beam distribution can be used as a search light or to light an area from a big distance. It has also a work light which gives diffuse light with a duration of up to 14h (4Ah version) or 27h (7Ah version).

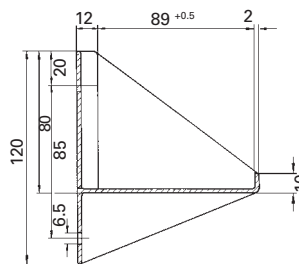

Wall bracket



Order code	Description				
40071352032	W 276.3/4 LED	10 VA	330/240/65 lm	4.8V/4Ah	Non-Maintained
40071352033	W 276.3/7 LED	10 VA	330/240/65 lm	4.8V/7Ah	Non-Maintained

### Accessories

40071345248	Rechargeable battery 4.8 V/4 Ah
40071345253	Rechargeable battery 4.8 V/7 Ah
40071344274	Shock-proofed wall holder
11145000492	Wall bracket
40018031358	Spiral cable with EURO plug
21145995000	Slip-on filter set red, orange and clear prismatic



- LED portable hand lamp with emergency light function
- Robust construction
- External charger for low luminaire weight
- Main beam output configurable
- Flashing light function
- Up to 14 h light (ancillary light) and 5.5 h (Eco main beam) with 4 Ah battery
- Up to 27.5 h light (ancillary light) and 9 h (Eco main beam) with 7 Ah battery
- Long range up to 50 m at 1.5 lx illuminance

**Light Source:**

Main beam: 3 High Power LEDs with narrow distribution reflector optic

Ancillary light: 6 x MidPower-LED (1.5 W) and wide light distribution

**Materials:**

Grey, impact resistant, non-abrasive plastic

**Installation:**

External charger for low luminaire weight

Includes three slip-on filters (red, orange, clear prismatic) for modification of light distribution and signalling

**Operation:**

Main beam output can be set: Eco mode for longer battery operation (3.0 W) or boost mode for increased luminous flux (5.5 W)

Charging indicator: green LED

Switch function: Flashlight, maintained light and ancillary light

The W270 LED hand lamp combines the longtime proofed robust construction made from impact resistant plastics with the efficient and powerful LED technology. It is especially suitable as a search projector with its focused light cone and long range. The W270 is the variant with an external charger for less luminaire weight. The flashing function in combination with the red or orange diffuser disc also allows use as a reliable signal light.

This range has two different light characteristics: the main beam with up to 330lm and narrow beam distribution can be used as a search light or to light an area from a big distance. It has also a work light which gives diffuse light with a duration of up to 14h (4Ah version) or 27h (7Ah version).

Photometric data (Main beam)	Irradiance I max = 3720 cd / Half value angle = 12.4° Illuminance: 150 lx @ 5 m, 6 lx @ 25 m, 1.5 lx @ 50 m	
Emergency duration	4 Ah battery 5.5 h Eco (main beam) 3.5 h Boost (main beam) 14.0 h (ancillary light)	7 Ah Battery 9.0 h Eco (main beam) 6.0 h Boost (main beam) 27.5 h (ancillary light)
Battery	rechargeable, maintenance free and gas tight NC-Accu - 4.8 V / 4 Ah - 4.8 V / 7 Ah	
Light source Main beam	3 x HighPower-LED 3.0 W - 240 lm (Eco) / 4.5 W - 330 lm (Boost)	
Ancillary light	6 x MidPower-LED 1.5 W - 65 lm lm = luminaire flux	
Connection voltage	230 V 50/60 Hz	



Charging unit Z 345.3

Order code	Description	⚡	☀️	🔋	⚙️
40071352030	W 270.3/4 LED		330/240/65 lm	4.8V/4Ah	Non-Maintained
40071352031	W 270.3/7 LED		330/240/65 lm	4.8V/7Ah	Non-Maintained

**Accessories**

40071341145	Charging unit Z 345.3	10 VA
40071345248	Rechargeable battery 4.8 V/4 Ah	
40071345253	Rechargeable battery 4.8 V/7 Ah	
21145995000	Slip-on filter set red, orange and clear prismatic	



# 8.3

## Portable lamps & converters

### Conversion kit LED



- For LED modules with a forward voltage of 3 – 180V.
- Selectable operating time (jumper).
- Output power limitation and SELV classified.
- Polarity reversal protection from battery connector.
- Automatic shutdown of output if LED load is out of range.
- Low profile casing (35x23x185 mm).
- Charging indicator included and optional test button

8

#### Light Source:

Emergency lighting LED Driver  
Low Voltage for 3-33Vdc  
LED lamps. Output open  
voltage 40Vdc (SELV).

Medium Voltage for 20-  
55Vdc LED lamps. Output  
open voltage 60Vdc (SELV).

High Voltage for 40-  
180Vdc LED lamps. Output  
open voltage 200Vdc.

#### Materials:

Body white polycarbonate  
Comes equipped with LED  
charging indicator to be  
fixed to the body appliance  
Batteries sealed nickel  
cadmium and LiFePo

#### Operation:

Non-Maintained operation  
Autonomy of 1h and 3h  
(jumper selectable) or  
constant voltage output mode  
(12Vdc, 24Vdc, 48Vdc)

#### Installation:

Suitable for fitting integral  
to host luminaire, where  
thermal and electro-magnetic  
test results permit  
Remote mounting of  
complete kit, or of  
batteries only.

Supplied complete with  
low profile end caps for  
mounting batteries and  
LED with 1000mm lead

#### Applications:

Universities, supermarkets,  
warehouses, offices  
and where emergency  
lighting is required.

Lighting of escape routes  
and open areas.

The Conversion Kit LED range is designed for converting mains LED lighting into emergency lighting in conjunction with LED modules and LED control gears. It is compatible with the majority of all dimmable and non-dimmable constant current mains LED Drivers for linear/area as well as down light applications. It also can be used with normal fixed output or dimming LED control gear from 2,5W up to 4,1W emergency output power.

It is designed in a very small 35x23x185mm housing, making it ideal for use in compact LED luminaires where space is at a premium. This range is certified to conform with IEC61347-2-7 standard which makes the converted luminaires easily achieve compliance to IED60598-2-22 standard.

All models available are programmable by a jumper to an emergency operation of either 1 hour and 3 hours duration. The output forward voltage range of 3Vdc to 180Vdc makes this product range an ideal choice for driving most LED modules from mains lighting manufacturers available in the market today.

#### Conversion kit body

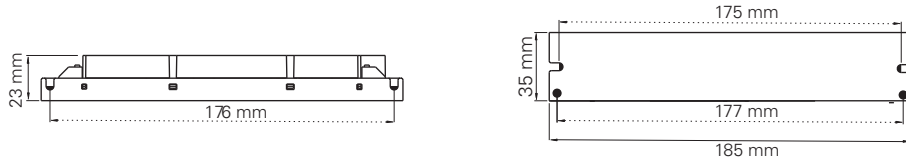

- 1 For LED modules with a forward voltage of 3 – 180V.
- 2 Selectable operating time (jumper).
- 3 Output power limitation and SELV classified.
- 4 Polarity reversal protection from battery connector.
- 5 Automatic shutdown of output if LED load is out of range.
- 6 Low profile casing (35x23x185 mm).

#### Battery dimensions (in mm)

Type	L	W	H	Fixing centers
4AA	100 (140)	30 (34)	15 (20)	(125)
3Cs	130 (160)	25 (26)	25 (26)	(150)
4Cs	173 (203)	25 (26)	25 (26)	(193)
5Cs	215 (245)	25 (26)	25 (26)	(235)
3D	182 (225)	34 (35)	34 (35)	(210)
4D	242 (285)	34 (35)	34 (35)	(270)
LifePo4	134 (173)	31 (32)	31 (32)	(157)

### Technical specification

System Mode	non-maintained
Mains input voltage	230 V AC $\pm 5\%$ (218,5 - 241,5 V AC)
Mains frequency	50/60Hz
Mains consumption	20mA AC @ AA & L cell battery 30mA AC @ Cs & D cell battery
Power factor	0,47
Recharge period	24 hours
Charging monitor	green LED with cable 1m, bi-color green/yellow LED with cable 1m for CGL+ bus
Test facility	by Normally Closed Push button by Normally Open Push button (not applicable on CGL+) by Telecommand signal
Duration	1 or 3h, selectable by jumper
Permissible ambient temperature (ta)	5..40°C
Case temperature max (tc)	converter: 60°C / battery: 50°C
Housing material	polycarbonate
Housing colour	white
Mounting	M4 screws (2 options)
Terminals	mains (L/N unswitched) (L1 switched in/out) up to 1,5 mm screwless pushwire & multicore
Battery	4AA Ni-Cd 4,8V 0,8Ah 2x2pack 3Cs Ni-Cd 3,6V 1,7Ah 3x1pack 4Cs NiCD 4,8V 1,7Ah 4x1pack 5Cs NiCD 6V 1,7Ah 5x1pack 2LiFePo4 6,4V 3,2Ah 2x1pack
IP rating	20
Overheating protection	110°C
Short circuit protection	Non-inherently short circuit proof
Weight	125gr 225gr with 4AA cell battery 275gr with 3Cs cell battery 325gr with 4Cs cell battery 375gr with 5Cs cell battery 305gr with LiFePo4 cell battery

Order code	Description	Battery
O-LVLD-4AA	Led Kit Low Voltage Driver 3-33Vdc (12Vdc)	4AA Ni-Cd 4,8V 800Ah 2x2pack
O-LVLD-4AA-TB	Led Kit Low Voltage Driver 3-33Vdc (12Vdc), with Test button LED, 35 cm	4AA Ni-Cd 4,8V 800Ah 2x2pack
O-LVLD-3CS	Led Kit Low Voltage Driver 3-33Vdc (12Vdc)	3Cs Ni-Cd 3,6V 1700Ah 3x1pack
O-LVLD-3CS-TB	Led Kit Low Voltage Driver 3-33Vdc (12Vdc), with Test button LED, 35 cm	3Cs Ni-Cd 3,6V 1700Ah 3x1pack
O-MVLD-4AA	Led Kit Medium Voltage Driver 20-55Vdc (24Vdc)	4AA Ni-Cd 4,8V 800Ah 2x2pack
O-MVLD-4AA-TB	Led Kit Medium Voltage Driver 20-55Vdc (24Vdc), with Test button LED, 35 cm	4AA Ni-Cd 4,8V 800Ah 2x2pack
O-MVLD-4CS	Led Kit Medium Voltage Driver 20-55Vdc (24Vdc)	4Cs Ni-Cd 4,8V 1700Ah 4x1pack
O-MVLD-4CS-TB	Led Kit Medium Voltage Driver 20-55Vdc (24Vdc), with Test button LED, 35cm	4Cs Ni-Cd 4,8V 1700Ah 4x1pack
O-HVLD-4AA	Led Kit High Voltage Driver 40-180Vdc (24Vdc)	4AA Ni-Cd 4,8V 800Ah 2x2pack
O-HVLD-4AA-TB	Led Kit High Voltage Driver 40-180Vdc (24Vdc), with Test button LED, 35 cm	4AA Ni-Cd 4,8V 800Ah 2x2pack
O-HVLD-5CS	Led Kit High Voltage Driver 40-180Vdc (24Vdc)	5Cs Ni-Cd 6V 1700Ah 5x1pack
O-HVLD-5CS-TB	Led Kit High Voltage Driver 40-180Vdc (24Vdc), with Test button LED, 35 cm	5Cs Ni-Cd 6V 1700Ah 5x1pack

### CGLLine+ versions

O-LVLD-2L-CGL	Led Kit Low Voltage Driver 3-33Vdc (12Vdc), CGL+	2LiFePo4 6,4V 3200Ah 2x1pack
O-LVLD-2L-CGLTB	Led Kit Low Voltage Driver 3-33Vdc (12Vdc), CGL+, with Test button	2LiFePo4 6,4V 3200Ah 2x1pack
O-MVLD-2L-CGL	Led Kit Medium Voltage Driver 20-55Vdc (24Vdc), CGL+	2LiFePo4 6,4V 3200Ah 2x1pack
O-MVLD-2L-CGLTB	Led Kit Medium Voltage Driver 20-55Vdc (24Vdc), CGL+, with Test button	2LiFePo4 6,4V 3200Ah 2x1pack
O-HVLD-2L-CGLTB	Led Kit High Voltage Driver 40-180Vdc (24Vdc), CGL+	2LiFePo4 6,4V 3200Ah 2x1pack
O-HVLD-2L-CGL	Led Kit High Voltage Driver 40-180Vdc (24Vdc), CGL+, with Test button	2LiFePo4 6,4V 3200Ah 2x1pack

### Accessory

O-CKL-TB	Conversion Kit LED Test Button, Normally Close, with LED charging indicator, 35 cm
O-CKL-TB-CGL	Conversion Kit LED CGL+ Test Button, Normally Close, with LED charging indicator, 35 cm

# 8.4

## Portable lamps & converters

### Conversion kit fluorescent range



- Easy to install
- Certificated by ENEC Kema Keur EN61347 and EN60925-2-4
- Compatible with T5 fluorescent lamps
- Suitable for electronic and electromagnetic ballasts
- LED indicator
- Charging time of 24 hours
- High temperature batteries Ni-Cd
- Fully compatible with high frequency circuits
- Extensive range, covering a diverse choice of fluorescent lamps
- Low profile design for easy integration

8

#### Light Source:

Series compatible with most fluorescent lamps (linear and compact)

#### Materials:

Body white ABS

Comes with LED status to be fixed to the body appliance

NiCd batteries

#### Operation:

Non-Maintained

Autonomy of 1h and 3h

#### Installation:

Suitable for fitting integral to host luminaire, where thermal and electro-magnetic test results permit

Remote mounting of complete kit, or of batteries only.

Supplied complete with low profile end caps for mounting batteries and LED with 1000mm lead

#### Applications:

Universities, supermarkets, warehouses, offices and where emergency lighting is required.

Lighting of escape routes and open areas.

This conversion kit range is aiming for the transformation of fluorescent lamp mains lighting apparatus to perform as emergency lighting in an emergency situation. Solutions like these are ideal for large venues such as universities, supermarkets, warehouses, offices and open spaces which are integrated with the existing ordinary lighting.

Low profile modules and unique chamfered battery end caps easing integration into swallow luminaires are standard throughout the whole range of the conversion kits particularly useful in the newest ranges of T5 lamp.

The range is available with 1h and 3h duration versions. The latest version of conversion kits delivers optimum performance for a diverse choice of fluorescence lamp types and wattages

#### Conversion kit body

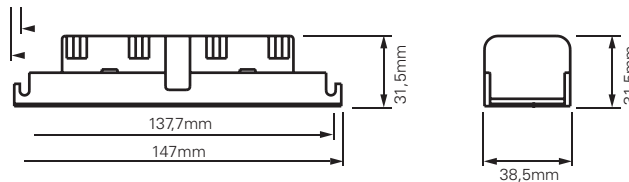

#### Technical specification

System Mode	Maintained or Non-Maintained
Normal light output (Maintained)	Full rated output of lamp
Recharge period	24 hours
Charging monitor	Green LED with cable 1m
Mains input voltage	230V ac / 50Hz
Power Consumption	Max 3VA@1H, 5VA@3H
Temperature ratings	Module 50oC - Battery 50oC
Dimensions L x W x H	148x39x31mm
Fixing centers of module	137-139mm
Certified to	EN 61347-2-7 & EN60925

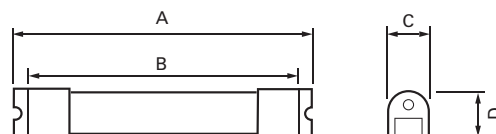

#### Battery



Type of battery	A	B	C	D
3.6 1.5Ah	155	145	26	26
3.6 4.0Ah	210	200	35	35
4.8 1.5Ah	200	190	26	26
4.8 4.0Ah	280	270	35	35
6.0 1.5Ah	245	235	26	26
6.0 4.0Ah	340	330	35	35

Lamp	Battery	BK1 BK3		max 36W		CK1 CK3		max 58W		DK1 DK3		max 70W		TK1		max 80W	
		3,6V/1,7Ah 3,6V/4Ah		Discharge Current mA	Emergency Ballast Lumen Factor %	4,8V/1,7Ah 4,8V/4Ah		Discharge Current mA	Emergency Ballast Lumen Factor %	6V/1,7Ah 6V/4Ah		Discharge Current mA	Emergency Ballast Lumen Factor %	4,8V/4Ah		Discharge Current mA	Emergency Ballast Lumen Factor %
Watts	Diameter / Holder	Minimum Duration				Minimum Duration				Minimum Duration				Minimum Duration			
TLD 18W	T8-60cm	1h	3h	700	11	2h	3h	600	12	2h	3h	510	12	-	-	-	
TLD 30W	T8-90cm	1h	3h	990	9	1,5h	3h	790	10	2h	3h	700	10	-	-	-	
TLD 36W	T8-120cm	1h	3h	1010	8	1h	3h	810	9	1,5h	3h	760	13	-	-	-	
TLD 58W	T8-150cm	-	-	-	-	1h	3h	990	7,5	1h	3h	810	9	-	-	-	
TLD 70W	T8-180cm	-	-	-	-	-	-	-	-	1h	3h	1040	6	-	-	-	
TL5 24W	T5-55cm	1h	3h	1000	7	1,5h	3h	750	7	2h	3h	600	7	2h	1200	22	
TL5 39W	T5-85cm	-	2h	1350	7	-	2,5h	1050	7	1,5h	3h	820	7	1,5h	1720	18	
TL5 54W	T5-115cm	-	-	-	-	-	2,5h	1150	5	1h	3h	950	6	1h	2050	16	
TL5 80W	T5-145cm	-	-	-	-	-	-	-	-	-	-	-	-	1h	2400	12	
PLS 11W	2G7	1,5h	3h	730	11	2h	3h	600	15	2,5h	3h	450	16	-	-	-	
PLC 13W	G24q-1	1,5h	3h	780	15	2h	3h	624	19	2h	3h	500	20	-	-	-	
PLC 18W	G24q-2	1,5h	3h	870	12	1,5h	3h	725	16	2h	3h	580	18	-	-	-	
PLC 26W	G24q-3	1h	3h	920	10	1,5h	3h	830	13	2h	3h	690	15	-	-	-	
PLL 18W	2G11	2h	3h	670	12	2h	3h	540	14	2,5h	3h	430	15	-	-	-	
PLL 24W	2G11	1h	3h	885	11	2h	3h	680	12	2h	3h	550	13	-	-	-	
PLL 36W	2G11	-	2,5h	1021	9	1,5h	3h	820	10	2h	3h	690	11	-	-	-	
PLL 40W	2G11	-	-	-	-	1h	3h	950	7	1,5h	3h	760	8	-	-	-	
PLL 55W	2G11	-	-	-	-	-	-	-	-	1h	3h	920	7	-	-	-	
2D 16W	GR10q	1,5h	3h	860	12	2h	3h	670	15	2h	3h	540	16	-	-	-	
2D 28W	GR10q	1h	3h	950	9	1,5h	3h	730	11	2h	3h	680	13	-	-	-	
2D 38W	GR10q	-	-	-	-	1,5h	3h	833	8	1,5h	3h	750	9	-	-	-	

**Note:** Make sure that the terminals on the module cannot be touched when changing the lamp or starter by shrouding them with earthed metal or thermoplastic insulation kit

Order code	Description			
O-BK1	Conversion kit, BK1	up to 36W	1h	3.6V-1.5Ah
O-CK1	Conversion kit, CK1	up to 58W	1h	4.8V-1.5Ah
O-DK1	Conversion kit, DK1	up to 70W	1h	6.0V-1.5Ah
O-TK1	Conversion kit, TK1	up to 80W	1h	4.8V-1.5Ah
O-BK3	Conversion kit, BK3	up to 36W	3h	3.6V-1.5Ah
O-CK3	Conversion kit, CK3	up to 58W	3h	4.8V-1.5Ah
O-DK3	Conversion kit, DK3	up to 70W	3h	6.0V-1.5Ah







9.1	CrystalWay .....	140
9.2	FlexiTech ED .....	142
9.3	Velos .....	144
9.4	NexiTech .....	146
9.5	GuideLed .....	148
9.6	Planete .....	149







# Custom-made products for your projects

To be completely integrated into a project, it is necessary to know how to merge in the universe of a creator while adapting itself to the particular architectural requirements.

Eaton created a core range of custom-made products and accessories to echo the diversity of your talents and the needs of your customers, without altering the certified features of the product.

- Specific pictograms
- Colored self-contained emergency lighting luminaires
- Colored recessed bases

We stay at your disposal to study any specific need for customized accessories or finishing.





# Pictogram Customization

The role of exit sign luminaires may not always be showing the escape route. Sometimes, it is necessary to easily identify the location of safety equipment, refuge, assembly point, etc.

Eaton developed a core range of specific pictograms for several product families to cover most of those signage requirements.

Want to find out more or don't see the pictogram you require? Contact our sales team and they'll be happy to discuss the specific needs of a project with you.

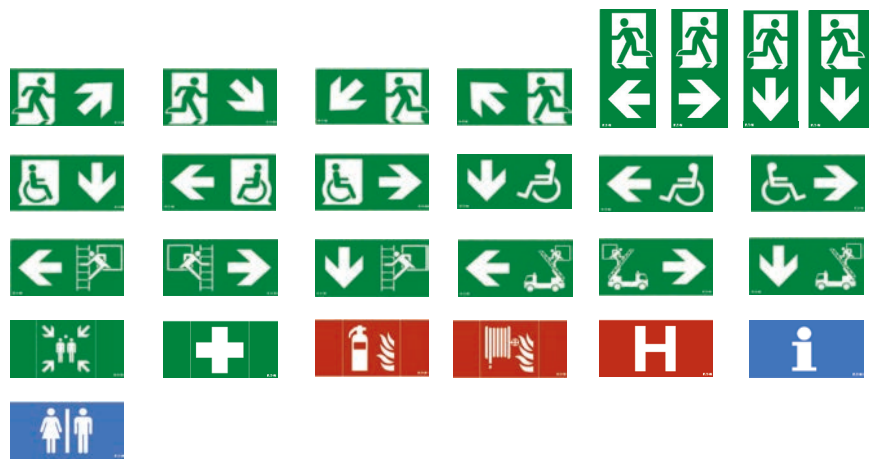

**Black mat**  
**RAL9005**

**Dark Grey**  
**RAL7015**

**Silver gloss**  
**RAL9007**

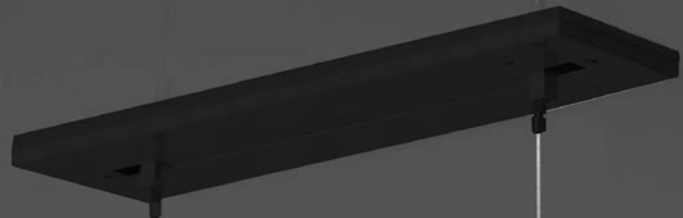

# Paint Customization

Perfect integration of self-contained luminaires into buildings' architecture is always a challenge. Eaton helps you in meeting this challenge by creating a core range of painted luminaires (painted housing) and accessories available in 3 colors:

- Silver gloss : RAL9007
- Black mat : RAL9005
- Dark Grey mat : RAL7015

## **Don't see the color to suit your project?**

Contact one of our sales team and we will work with you to create a color housing or accessory to match your project.





### CrystalWay 20, 30m specific pictograms

- Non adhesive polycarbonate pictograms to be inserted in the diffuser for a perfect finish
- Tested at high temperature
- UV proof
- Premium quality for long life service
- All exit legends comply with EN 60598-2-22
- Professional solution provided by EL manufacturer
- 20m & 30m viewing distance versions
- Single-sided pictograms



Pictogram	Order code 20m	Order code 30m	Pictogram	Order code 20m	Order code 30m
	LUM10577	LUM10591		LUM10951	LUM10977
	LUM10573	LUM10587		LUM10952	LUM10978
	LUM10574	LUM10588		LUM10958	LUM10988
	LUM10575	LUM10589		LUM10959	LUM10989
	LUM10595	LUM10972		LUM10960	LUM10990
	LUM10596	LUM10973		LUM10961	LUM10991
	LUM10597	LUM10974		LUM10962	LUM10992
	LUM10598	LUM10975		LUM10963	LUM10993
	LUM10585	LUM10593		LUM10964	LUM10994
	LUM10586	LUM10594		LUM10965	LUM10995
	LUM10584	LUM10592		LUM10966	LUM10996
	LUM10581	LUM10981		LUM10967	LUM10997
	LUM10582	LUM10982		LUM10968	LUM10998
	LUM10583	LUM10983		LUM10969	LUM10999
	LUM10950	LUM10976		LUM10971	LUM11125



**Painted versions of CrystalWay luminaires**

- Warranty period equal to standard product
- Ready to use
- Perfect finish
- Premium quality for long life service
- No modification of safety features (dielectric test, glow wire test, range of temperature, lighting performance,...)
- Professional solution provided by EL manufacturer

Designation	Black mat RAL9005	Dark Grey RAL7015	Silver gloss RAL9007
CrystalWay 45 ADR CGLine+	LUM17102B	LUM17102DG	LUM17102S
CrystalWay 45 XL ADR CGLine+	LUM17104B	LUM17104DG	LUM17104S
CrystalWay 8 ADR CGLine+	LUM17106B	LUM17106DG	LUM17106S
JSB-CrystalWay 20m CGLine+	LUM17122-JB	LUM17122-JDG	LUM17122-JS
JSB-CrystalWay 30m CGLine+	LUM17124-JB	LUM17124-JDG	LUM17124-JS
CrystalWay 20m CGLine+	LUM17122B	LUM17122DG	LUM17122S
CrystalWay 19821 1-8h/D CGLine+	40071354590B	40071354590DG	40071354590S
CrystalWay 30m CGLine+	LUM17124B	LUM17124DG	LUM17124S
CrystalWay 19822 1-8h/D CGLine+	40071354591B	40071354591DG	40071354591S
CrystalWay 20m CGLine+ - Arrow Up	LUM17122UB	LUM17122UDG	LUM17122US
CrystalWay 30m CGLine+ - Arrow Up	LUM17124UB	LUM17124UDG	LUM17124US

9



**Painted accessories for CrystalWay luminaires**

Designation	Black mat RAL9005	Dark Grey RAL7015	Silver gloss RAL9007
Recessed base CrystalWay 20m	LUM10561B	LUM10561DG	LUM10561S
Recessed base CrystalWay 30m	LUM10562B	LUM10562DG	LUM10562S
Recessed base with cover CrystalWay 20m	LUM10563B	LUM10563DG	LUM10563-S
Reces. C.Way 20m for Suspension kit	LUM10563SB	LUM10563SDG	LUM10563SS
Recessed base with cover CrystalWay 30m	LUM10564B	LUM10564DG	LUM10564-S
Reces. C.Way 30m for Suspension kit	LUM10564SB	LUM10564SDG	LUM10564SS



### FlexiTech ED, specific pictograms

- Non adhesive polyethylen pictograms to be inserted in the diffuser for a perfect finish
- Tested at high temperature
- UV proof
- Premium quality for long life service

- All exit legends comply with EN 60598-2-22
- Professional solution provided by EL manufacturer
- Single-sided pictograms



Pictogram	Order code 20m	Pictogram	Order code 20m
	FT2ED-PICTO-UR		FT2ED-PICTO-EWL
	FT2ED-PICTO-DR		FT2ED-PICTO-EWR
	FT2ED-PICTO-DL		FT2ED-PICTO-EWD
	FT2ED-PICTO-UL		FT2ED-PICTO-RWL
	FT2ED-PICTO-VL		FT2ED-PICTO-RWR
	FT2ED-PICTO-VR		FT2ED-PICTO-RWD
	FT2ED-PICTO-VD		FT2ED-PICTO-MP
	FT2ED-PICTO-DMD		FT2ED-PICTO-CR
	FT2ED-PICTO-DML		FT2ED-PICTO-H
	FT2ED-PICTO-DMR		FT2ED-PICTO-FEX
	FT2ED-PICTO-DML1		FT2ED-PICTO-FHO
	FT2ED-PICTO-DMR1		FT2ED-PICTO-INFO
	FT2ED-PICTO-DMD1		FT2ED-PICTO-WC









### Velos specific pictograms

- LED pictograms
- Tested at high temperature
- UV proof
- Premium quality for long life service





















- All exit legends comply with EN 60598-2-22
- Professional solution provided by EL manufacturer
- Single and Double-sided pictograms

Pictogram	Order code 30m	Order code 40m	Pictogram	Order code 30m	Order code 40m
	O-ESP-IUU	O-ESP40-IUU		O-ESP-ILE	-
	O-ESP-IU	O-ESP40-IU		O-ESP-IRE	-
	O-ESP-IDD	O-ESP40-IDD		O-ESP-IDE	-
	O-ESP-ID	O-ESP40-ID		O-ESP-IFA	-
	O-ESP-ILR	O-ESP40-ILR		O-ESP-H	-
	O-ESP-IL	O-ESP40-IL		O-ESP-FHD	-
	O-ESP-IR	O-ESP40-IR		O-ESP-INFO	-
	O-ESP-I2R	-			
	O-ESP-I2W	-			





**Painted versions of Velos luminaires**

- Warranty period equal to standard product
- Ready to use
- Perfect finish
- Premium quality for long life service
- No modification of safety features (dielectric test, glow wire test, range of temperature, lighting performance,...)
- Professional solution provided by EL manufacturer

	 <b>Black mat RAL9005</b>	 <b>Dark Grey RAL7015</b>	 <b>Silver gloss RAL9007</b>
<b>Pictogram 30m</b>			
	O-ESP-IUUB	O-ESP-IUUDG	O-ESP-IUUS
	O-ESP-IUB	O-ESP-IUDG	O-ESP-IUS
	O-ESP-IDDB	O-ESP-IDDDG	O-ESP-IDDS
	O-ESP-IDB	O-ESP-IDDG	O-ESP-IDS
	O-ESP-ILRB	O-ESP-ILRDG	O-ESP-ILRS
	O-ESP-ILB	O-ESP-ILDG	O-ESP-ILS
	O-ESP-IRB	O-ESP-IRDG	O-ESP-IRS
	O-ESP-I2RB	O-ESP-I2RDG	O-ESP-I2RS
	O-ESP-I2WB	O-ESP-I2WDG	O-ESP-I2WS
	O-ESP-FHDB	O-ESP-FHDDG	O-ESP-FHDS
	O-ESP-HB	O-ESP-HDG	O-ESP-HS
<b>Pictogram 40m</b>			
	O-ESP40-IUB	O-ESP40-IUDG	O-ESP40-IUS
	O-ESP40-IUUB	O-ESP40-IUUDG	O-ESP40-IUUS
	O-ESP40-IDB	O-ESP40-IDDG	O-ESP40-IDS
	O-ESP40-IDDB	O-ESP40-IDDDG	O-ESP40-IDDS
	O-ESP40-ILRB	O-ESP40-ILRDG	O-ESP40-ILRS
	O-ESP40-ILB	O-ESP40-ILDG	O-ESP40-ILS
	O-ESP40-IRB	O-ESP40-IRDG	O-ESP40-IRS

**Painted accessories for Velos luminaires**

<b>Designation</b>	 <b>Black mat RAL9005</b>	 <b>Dark Grey RAL7015</b>	 <b>Silver gloss RAL9007</b>
Velos Wall FLEXI Joint	O-ESA-FLEXB	O-ESA-FLEXDG	O-ESA-FLEXS
Velos Pipe Suspension 48cm (ISO30061)	O-ESA-PS30B	O-ESA-PS30DG	O-ESA-PS30S
Velos Recessed Base	O-ESA-RBB	O-ESA-RBDG	O-ESA-RBS
Velos Rope Suspension adjustable	O-ESA-RSAB	O-ESA-RSADG	O-ESA-RSAS
Velos Rope Suspension adjustable 5M	O-ESA-RSA-5MB	O-ESA-RSA-5MDG	O-ESA-RSA-5MS
Velos PSU 1,5h Ni-Cd	O-ESCB	O-ESCDG	O-ESCS
Velos PSU 3h Ni-Cd	O-ESC-3HB	O-ESC-3HDG	O-ESC-3HS
Velos PSU 1h NiMH Autotest	O-ESM-ATB	O-ESM-ATDG	O-ESM-ATS
Velos PSU 3h NiMH Autotest	O-ESM-AT-3HB	O-ESM-AT-3HDG	O-ESM-AT-3HS



### NexiTech single-sided specific pictograms

- Non adhesive polycarbonate pictograms to be inserted in the diffuser for a perfect finish.
- Tested at high temperature
- UV proof

- Premium quality for long life service
- All exit legends comply with EN 60598-2-22
- Single-sided pictograms
- Professional solution provided by EL manufacturer

Pictogram	Order code 20m	Pictogram	Order code 20m
	NEXI-PICTO-U		NEXI-PICTO-DML
	NEXI-PICTO-D		NEXI-PICTO-DMR
	NEXI-PICTO-L		NEXI-PICTO-DML1
	NEXI-PICTO-R		NEXI-PICTO-DMR1
	NEXI-PICTO-UR		NEXI-PICTO-DMD1
	NEXI-PICTO-DR		NEXI-PICTO-MP
	NEXI-PICTO-DL		NEXI-PICTO-CR
	NEXI-PICTO-UL		NEXI-PICTO-FEX
	NEXI-PICTO-VL		NEXI-PICTO-FHO
	NEXI-PICTO-VR		NEXI-PICTO-INFO
	NEXI-PICTO-VD		NEXI-PICTO-WC
	NEXI-PICTO-DMD		



**NexiTech edge light double-sided specific pictograms**

- Non adhesive polycarbonate pictograms to be inserted in the diffuser for a perfect finish.
- Tested at high temperature
- UV proof
- Premium quality for long life service
- All exit legends comply with EN 60598-2-22
- Double-sided pictograms
- Professional solution provided by EL manufacturer

Pictogram	Order code 30m	Pictogram	Order code 30m
	NEXI-PLEX-UU		NEXI-PLEX-DMDD
	NEXI-PLEX-DD		NEXI-PLEX-DMLR
	NEXI-PLEX-LR		NEXI-PLEX-DMLR1
	NEXI-PLEX-DB		NEXI-PLEX-DMDD1
	NEXI-PLEX-ULR		NEXI-PLEX-FEX
	NEXI-PLEX-DLR		NEXI-PLEX-FHO
	NEXI-PLEX-VLR		NEXI-PLEX-INFO
	NEXI-PLEX-VDD		NEXI-PLEX-WC

**Painted versions of NexiTech luminaires**

- Warranty period equal to standard product
- Ready to use
- Perfect finish
- Premium quality for long life service
- No modification of safety features (dielectric test, glow wire test, range of temperature, lighting performance,...)

Designation	Black mat RAL9005	Dark Grey RAL7015	Silver gloss RAL9007
NEXITECH LED 100 1H30 AT	NEXI100-ATB	NEXI100-ATDG	NEXI100-ATS
NEXITECH LED 150 1H AT	NEXI150-ATB	NEXI150-ATDG	NEXI150-ATS
NEXITECH LED 250 1H30 AT	NEXI250-ATB	NEXI250-ATDG	NEXI250-ATS
NEXITECH LED 400 1H30 AT	NEXI400-ATB	NEXI400-ATDG	NEXI400-ATS
NEXITECH LED DOOR 1H30 AT	NEXI-D-ATB	NEXI-D-ATDG	NEXI-D-ATS
NEXITECH LED 100 3H AT	NEXI100-3H-ATB	NEXI100-3H-ATDG	NEXI100-3H-ATS
NEXITECH LED 150 3H AT	NEXI150-3H-ATB	NEXI150-3H-ATDG	NEXI150-3H-ATS
NEXITECH LED 250 3H AT	NEXI250-3H-ATB	NEXI250-3H-ATDG	NEXI250-3H-ATS
NEXITECH LED 150LM 1H30 CGLINE+	NEXI150-CGLB	NEXI150-CGLDG	NEXI150-CGLS
NEXITECH LED 150LM 3H CGLINE+	NEXI150-3H-CGLB	NEXI150-3H-CGLDG	NEXI150-3H-CGLS
NEXITECH LED 400LM 1H30 CGLINE+	NEXI400-CGLB	NEXI400-CGLDG	NEXI400-CGLS
NEXITECH LED 300LM 3H CGLINE+	NEXI300-3H-CGLB	NEXI300-3H-CGLDG	NEXI300-3H-CGLS
NEXITECH LED 1000/1h 800/1h30 CGL+	NEXI1000-CGLB	NEXI1000-CGLDG	NEXI1000-CGLS
CROMPTON-NEXITECH LED 100 3H AT	NEXI100-3H-AT-CB	NEXI100-3H-AT-CDG	NEXI100-3H-AT-CS
CROMPTON-NEXITECH LED 150 3H AT	NEXI150-3H-AT-CB	NEXI150-3H-AT-CDG	NEXI150-3H-AT-CS
CROMPTON-NEXITECH LED 250 3H AT	NEXI250-3H-AT-CB	NEXI250-3H-AT-CDG	NEXI250-3H-AT-CS
JSB-NEXITECH LED 100 3H AT	NEXI100-3H-AT-JB	NEXI100-3H-AT-JDG	NEXI100-3H-AT-JS
JSB-NEXITECH LED 150 3H AT	NEXI150-3H-AT-JB	NEXI150-3H-AT-JDG	NEXI150-3H-AT-JS
JSB-NEXITECH LED 150LM 3H CGLINE+	NEXI150-3H-CGLJB	NEXI150-3H-CGLJDG	NEXI150-3H-CGLJS
JSB-NEXITECH LED 250 3H AT	NEXI250-3H-AT-JB	NEXI250-3H-AT-JDG	NEXI250-3H-AT-JS
JSB-NEXITECH LED 300LM 3H CGLINE+	NEXI300-3H-CGLJB	NEXI300-3H-CGLJDG	NEXI300-3H-CGLJS

**Painted accessories for NexiTech luminaires**

Designation	Black mat RAL9005	Dark Grey RAL7015	Silver gloss RAL9007
Frame for Nexitech LED / Nexilite	NEXI-FRB	NEXI-FRDG	NEXI-FRS





#### GuideLed 20, 30m specific pictograms

- Silk screen LED pictograms
- Tested at high temperature
- UV proof
- Premium quality for long life service
- All exit legends comply with EN 60598-2-22
- Single-sided pictograms
- Professional solution provided by EL manufacturer

Pictogram	Order code 20m	Order code 30m	Pictogram	Order code 20m	Order code 30m
	40071354500	40071354530		40071355309	40071355349
	40071354501	40071354531		40071355310	40071355350
	40071354502	40071354532		40071355311	40071355351
	40071354515	40071354545		40071355312	40071355352
	40071355300	40071355340		40071355313	40071355353
	40071355301	40071355341		40071355314	40071355354
	40071355302	40071355342		40071353048	40071353348
	40071355303	40071355343		40071353049	40071353349
	40071355304	40071355344		40071355315	40071355355
	40071355305	40071355345		40071355316	40071355356
	40071355306	40071355346		40071355317	40071355357
	40071355307	40071355347			
	40071355308	40071355348			





**Painted versions of Planete luminaires**



- Warranty period equal to standard product
- Ready to use
- Perfect finish
- Premium quality for long life service

- No modification of safety features (dielectric test, glow wire test, range of temperature, lighting performance,...)
- Professional solution provided by EL manufacturer

**Designation**

	 <b>Black mat RAL9005</b>	 <b>Dark Grey RAL7015</b>	 <b>Silver gloss RAL9007</b>
Planete 2000 ADR CGLine+	LUM17110B	LUM17110DG	LUM17110S
Planete 400 DISC ADR CGLine+	LUM17144B	LUM17144DG	LUM17144S

**Painted accessories for Ultraled, Planete luminaires**



**Designation**

	 <b>Black mat RAL9005</b>	 <b>Dark Grey RAL7015</b>	 <b>Silver gloss RAL9007</b>
Recessed base Planete 400 Disc	LUM10541B	LUM10541DG	LUM10541S

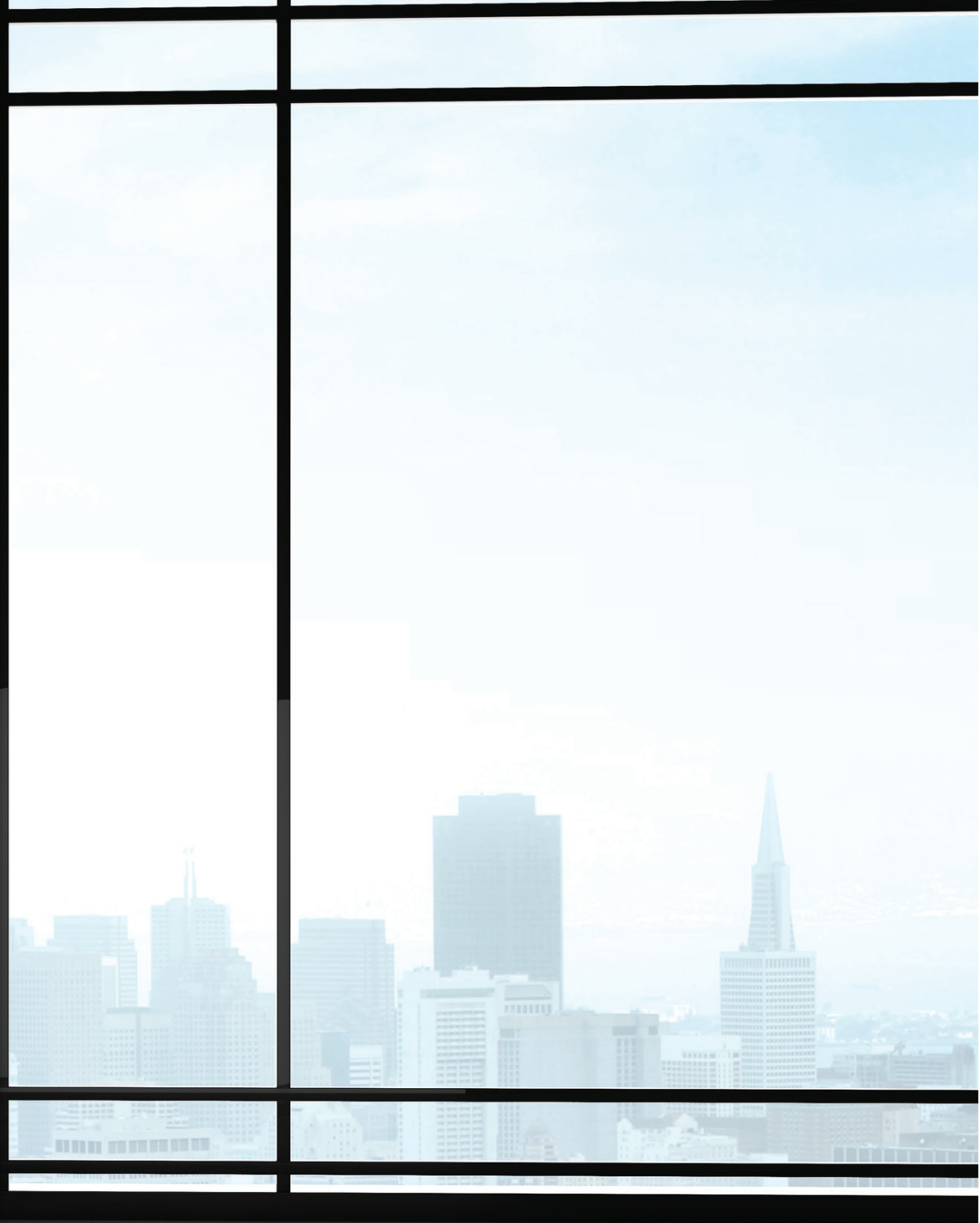



Overview .....	152
10.1 CGLine+ system .....	154
10.2 CGLine+ Web Controller .....	160
10.3 CGLine+ Web Compact Controller .....	162
10.4 CGLine+ Touchscreen Controllers .....	164
10.5 CGVision with the CGLine+ Web Controller .....	168
10.6 OPC Server for BMS .....	170



# Monitoring systems

## Overview

		Installation type	Local interface	Connected interface	Number of luminaires (max)	Number of lines (max)	Automatic functional and duration test	Blocking function
	Page	Installation	Interface		Luminaires management			
<b>10.2</b> CGLine+ Web Controller 	160	DIN rail 12 modules	LED Status	Web server	800	4	●	●
<b>10.3</b> CGLine+ Web Compact Controller 	162	Wall	Keypad / LCD Display	Web server	160	2	●	●
<b>10.4</b> CGLine+ Web Touchscreen Controller 	164	Wall	10.1" Touchscreen Display	Web server	800	4	●	●
<b>10.5</b> CGLine+ CGVision Touchscreen S/Controller 	164	Wall	10.1" Touchscreen Display	CGVision	800	4	●	●
<b>10.5</b> CGLine+ CGVision Touchscreen G/Controller 	164	Wall	10.1" Touchscreen Display	CGVision	800	4	●	●

Cybersecurity tested and approved	Ethernet connection	Integrated Web server	Email notification service	IA - Increased Affordance	AE - Adaptive Evacuation	USB Port for logbook download	General features	Best use
●	●	●	●	●	See chapter 12 dedicated to AE	●	<p>Suitable for all type of projects, must be installed inside electrical cabinet/enclosures with DIN rail.</p> <p>CGLine+ PC Software required for configuration.</p> <p>Web browser required for system interation.</p> <p>Internet connection required for remote visualization and email notification service.</p>	
●	●	●	●	●		●	<p>Small / Medium projects with less than 160 luminaires.</p> <p>No TCP/IP connection required for stand alone application.</p> <p>Internet connection required for remote visualization and email notification service.</p> <p>Easy keypad/display user interface.</p>	
●	●	●	●	●		●	<p>Suitable for all type of projects, wall mounted installation.</p> <p>CGLine+ PC Software required for configuration.</p> <p>No TCP/IP connection required for stand alone application.</p> <p>Internet connection required for remote visualization and email notification service.</p>	
●				●		●	<p>Suitable for all type of projects as stand alone application, wall mounted installation.</p> <p>No TCP/IP connection required for stand alone application.</p> <p>No remote visualization and no email notification service.</p>	
●	●	●	●	●		●	<p>Suitable for all type of projects as stand alone or remote visualization, wall mounted installation.</p> <p>No TCP/IP connection required for stand alone application.</p> <p>Internet connection required for remote visualization and email notification service.</p>	

The information given in this brochure is accurate at the time of compilation (errors and omissions excepted), however due to Eaton philosophy of constant product development we reserve the right to change specifications without prior notice.



# All safety luminaires are important. They help protect the life and health of people.

## Emergency lighting must be fully functional to provide protection in case of failure of the general lighting.

Even if a single safety luminaire or exit sign luminaire fails, depending on the particular local conditions, there is a significant risk of accidents, for example in a stairway. For this very reason legislation requires continuous testing of the emergency lighting. The operation of the luminaires in battery mode for example (function test) must be verified at least once a week.

### Self-contained luminaires without an automatic test function

The function test is performed in case of single self-contained luminaires by pressing a button on the luminaire, and the result must be recorded by hand in a log book. An additional duration test for the duration of the rated operating time (1, 3 or 8 hours) must be performed once a year. This test checks whether there is still sufficient battery capacity available. All log book entries must be kept on file for 4 years. If there are a large number of luminaires, manual testing is an extremely laborious process and therefore involves significant costs.

### Automatic testing simplifies the process

Eaton has implemented automatic test functions in all CGLine+ self-contained luminaires. A microprocessor monitors and controls all functions of the luminaires automatically. The required tests, the function test and the duration test, are performed automatically. The test results are shown on site on the luminaire by a status indicator. Without a central monitoring device, the results must be recorded by hand in the log book and kept on file in paper form for at least 4 years.



New FlexiTech range : Flexible and easy emergency lighting

### Central controller provides more safety

The CGLine+ Controllers initiate the tests, display the results centrally and store them with ease in a paperless form in an electronic log book. The electronic log book can be printed off and shown on demand. This process ensures the safe operation of the building, and the building operator meets his duty of documentation.

## CGLine+: More luminaires. More convenience. More safety!

**CG+<sub>Line</sub>** The new CGLine+ system is a more powerful system to make the operation of self-contained luminaire systems safer and even more convenient.



CGLine+ Web Controller



CGLine+ Web Compact Controller

### Now up to 800 luminaires monitored

The CGLine+ Web Controller can visualise a total of 800 CGLine+ luminaires (four lines of maximum 200 luminaires each or two lines of maximum 400 luminaires each). The number of luminaires is doubled as compared to the monitoring capacity of a controller of the CGLine 400 system. This lowers investment costs for larger-scale projects.

Typical installation with max. 4 lines of 200 luminaires each (above) or 2 lines of 400 luminaires each (below).

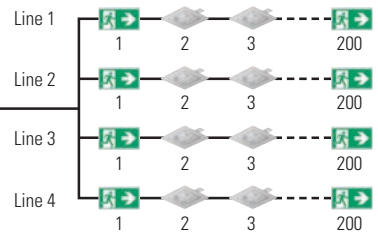
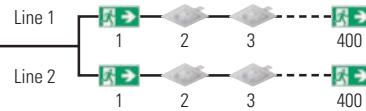

### From small to medium size installations with less than 160 luminaires

The new CGLine+ Web Compact Controller includes the functionalities of the CGLine+ Web Controller with a built-in keypad and LCD screen in a single housing for a friendly usage. This controller can visualize a total of 160 CGLine+ luminaires (2 lines with max. 80 luminaires each).

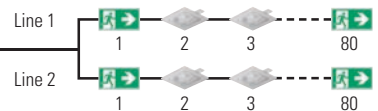

### Addressing CGLine+ luminaires

Luminaires do not need to be manually addressed in the CGLine+ system. CGLine+ luminaires are fitted with a unique address by the manufacturer consisting of a six-digit ID number in hex code format. Using this address the Controllers identify the luminaires automatically when the system is launched.

In addition, each luminaire can be configured to receive a short digital address and an individual name with a maximum of 20 characters. Hence it is possible to use a name which corresponds to the name of the location according to the planning documents. This simplifies the localisation of luminaires in the building and additional repair procedures can even be remotely planned in case of failure.

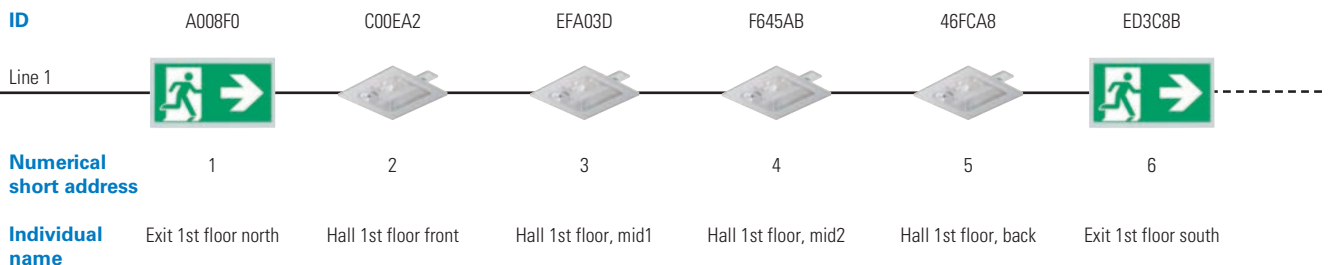





**Safety under control worldwide**

An integrated web server is available for convenient visualisation, control and monitoring of all connected CGLine+ luminaires. The controller can be accessed from any PC with an IP connection and a regular web browser without requiring any special software. The controller provides an overview of faulty luminaires, regardless of where the maintenance personnel are located. Safety issues caused by failed luminaires can be evaluated and the relevant correct measures can be implemented. Regardless of location, completed maintenance works can then be conveniently checked. This means greater efficiency for the building operator, making it simpler to meet his obligations to eliminate any safety hazards as quickly as possible.

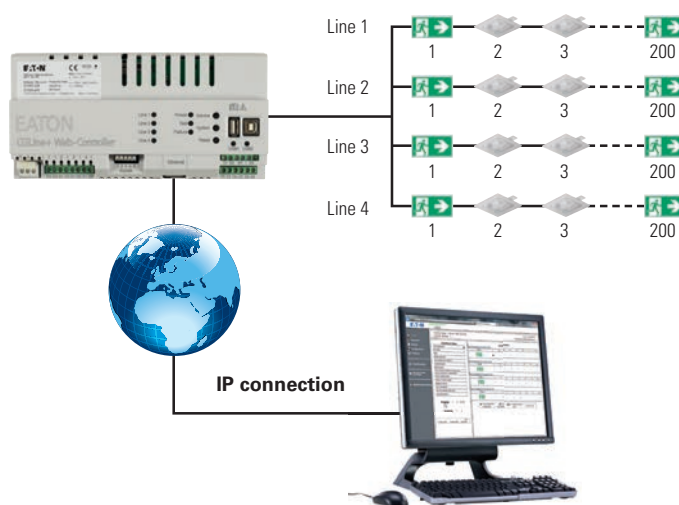

Presentation of zones on the first page in a browser view

**Maintain an overview: Allocate the luminaires to zones**

Maintaining an overview is important if there are a large number of luminaires. Luminaires of each line can be allocated to up to 8 zones (up to 16 zones in case of installing only two lines). The zones can be areas where the luminaires need be brought together, for example on a floor, in an area or in a room. The exit sign luminaires can be switched off or blocked in different parts of a building which are not being used at certain times. By doing this, energy costs are reduced. By blocking the signs, unintentionally discharging batteries when the mains power is switched off is avoided, for example when maintenance work is being carried out. The zone can be used immediately after turning on the mains power, because batteries have not been discharged and the luminaires can perform their safety function immediately being unblocked.

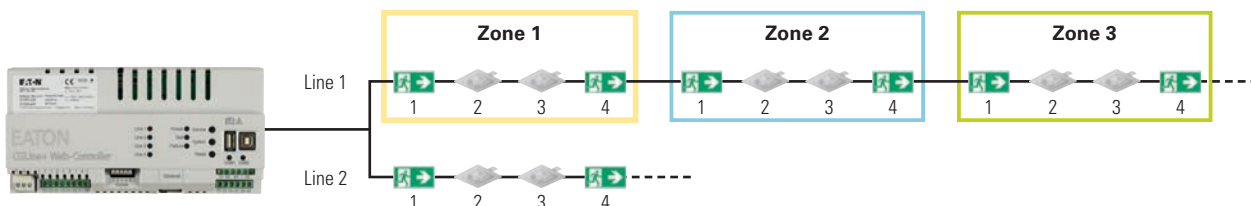

### Tests are not forgotten, and are carried out at the right intervals for maximum safety

The timing and the intervals of regular function and duration tests can be conveniently and precisely set down to the minute, ensuring that the equipment is ready for operation at any time during the operating hours of the building. This allows luminaires to be grouped into up to eight test groups for this purpose, for example to ensure that duration testing of luminaires installed next to each other is not started at the same time. The image below shows the luminaires of a floor allocated into two test groups. The period between tests is completely adjustable.

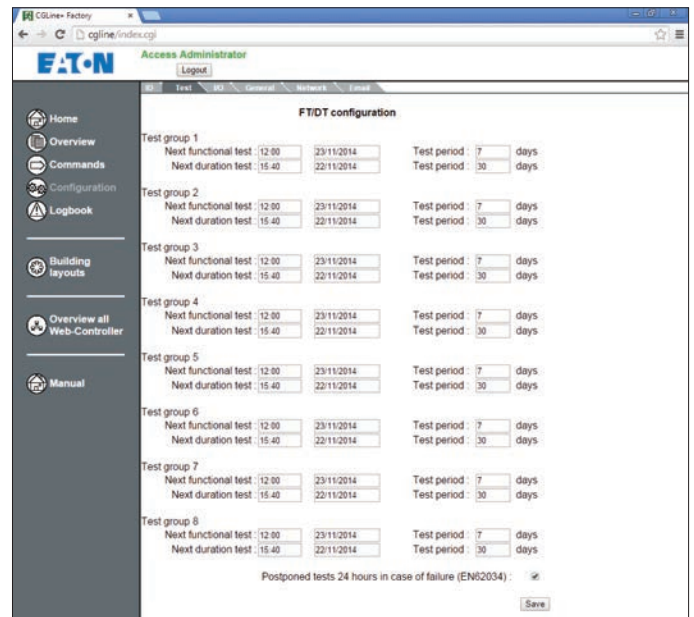

The advantages of test groups: Up to eight test groups can be created for testing in order to guarantee the operational readiness of the entire system.

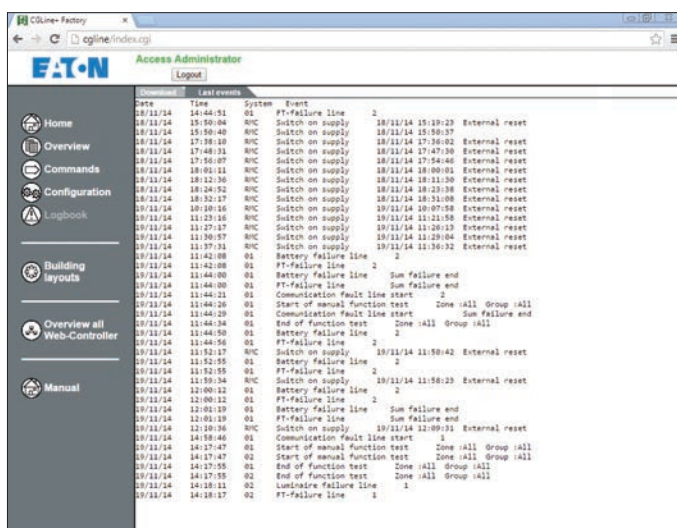
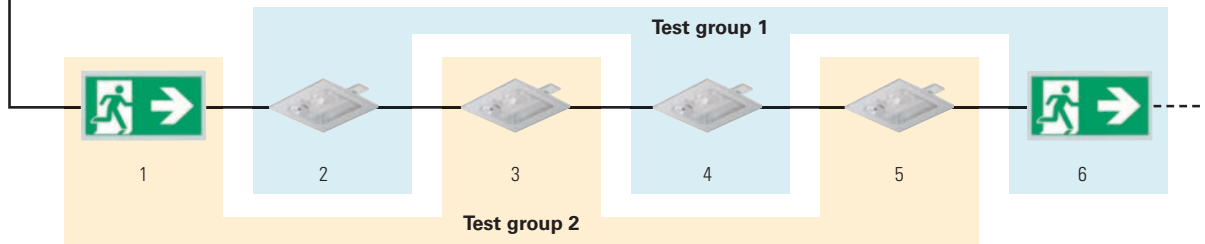

The log book is available at any time using a web browser. Data are stored for at least four years in compliance with standards.

### The electronic log book saves the need for manual logging

All test results are stored in the electronic log book for at least four years, in compliance with standards. The data is available directly using a web browser. The log book can be downloaded directly from the controller through a web server for further analysis of the log book in TXT or DAT file format. The DAT file can then be stored and transported using a regular USB memory stick. The CGLine+ PC software is used for reading the log book in DAT format, providing efficient and convenient analysis of the test results.

The electronic log book simplifies the requirement for the building operator to provide documentation, and it removes the need for laborious, manual logging.



# 10.1

## CGLine+ self-contained luminaire system

Enhanced safety by providing reliable and efficient monitoring



### Cybersecurity tested

There's no need to take chances with connected solutions. Our products are tested in our specialized labs certified for IEC and UL Cybersecurity. Customers can rest easier, knowing Eaton devices are compliant with the highest industry cybersecurity requirements before they're installed in critical systems.

Security has further been reinforced in the CGLine+ Web Controllers to meet the latest requirements:

- Three levels of passwords
- Secure communications with HTTPS for webserver encryption
- TLS email encryption
- New guidelines to securely deploy the CGLine+ Controllers and minimize the cybersecurity risk to the installer system.

10

### Automatic e-mail notification in case of faults

The integrated e-mail service automatically sends e-mails to up to ten recipients in case of allocatable events, for example in case of a luminaire failure being detected following an automatic function test. The aim of this function is to actively notify without delay those persons responsible for building safety about any faults, even if they have no direct connection with the controller at that point in time.

E-mail addresses can be divided into two groups to implement hierarchical escalation. This ensures that when a recipient in the first group is unexpectedly absent, other people are informed to ensure the safety of visitors of the building.

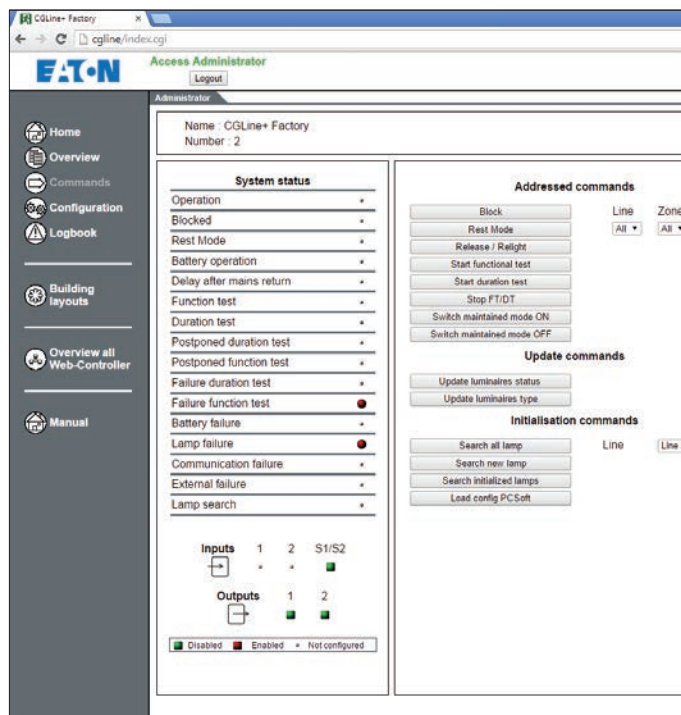

### Selective assignment of commands

The web browser interface is useful for

- Blocking/unblocking instructions
- Manual starting/stopping the function test and duration tests
- Switching on/off maintained light

This can be done in detail for all luminaires, for a line, for a zone and down to individual luminaires.

Furthermore this view offers a system status overview with the most important status messages and the operating condition of the input and output contacts.

### Easy luminaire replacement with webserver

It is now possible to configure luminaires addresses and IDs similar to how it can be done with the CGLine+ PC software. This can be used to add, exchange, remove some luminaires from an installation with the webserver interface only.

### Multiple languages

More and more languages are supported by the CGLine+ Controllers:

English, Czech, Dutch, French, German, Greek, Hebrew, Hungarian, Italian, Luxembourgish, Norwegian, Polish, Portuguese, Spanish, Swedish, etc..

# CGLine+ self-contained luminaire system

Enhanced safety by providing reliable and efficient monitoring

# 10.1

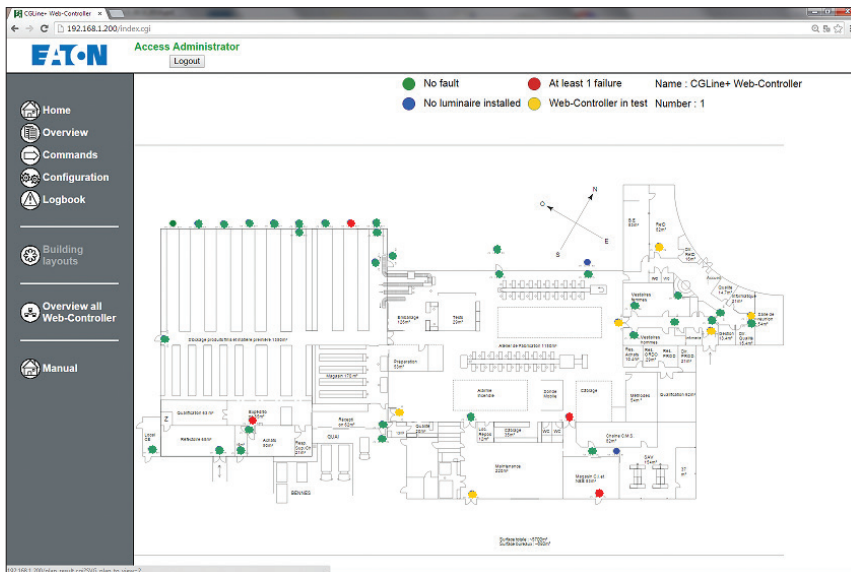

## Keep your bearings in complex buildings

The programming of building layout function offers new opportunities. Building layouts can be loaded in the program to display the status of luminaires at the installation location on the floor. Up to 30 different building layouts can be displayed for each controller. Luminaires are displayed with colour codes according to their current status. By touching a luminaire with the mouse pointer, a status window opens up with more information about the luminaire.

The overview helps provide better orientation in the building. The situation can be judged more effectively and repairs better prioritised.

10

## Compatibility with the CGLine 400 System

The comprehensive functionality of the CGLine+ controller can only be used in conjunction with CGLine+ luminaires. But of course CGLine+ luminaires and CGLine 400 luminaires can be connected to the CGLine+ controller in a straightforward manner in a mixed setup. In this set-up the controller operates in CGLine 400 mode only. The extended CGLine+ functions can be used only when only unmixed CGLine+ luminaires are installed. The new CGLine+ luminaires can also be used together with the proven CG controller CGLine 400 in CGLine 400 mode.

	CGLine+ luminaires	CGLine 400 luminaires
<b>CGLine+ Controller</b>	CGLine+ mode	CGLine 400 mode
<b>CGLine 400 Controller</b>	CGLine 400 mode	CGLine 400 mode

Comprehensive CGLine+ functions using CGLine+ luminaires connected to a CGLine+ controller

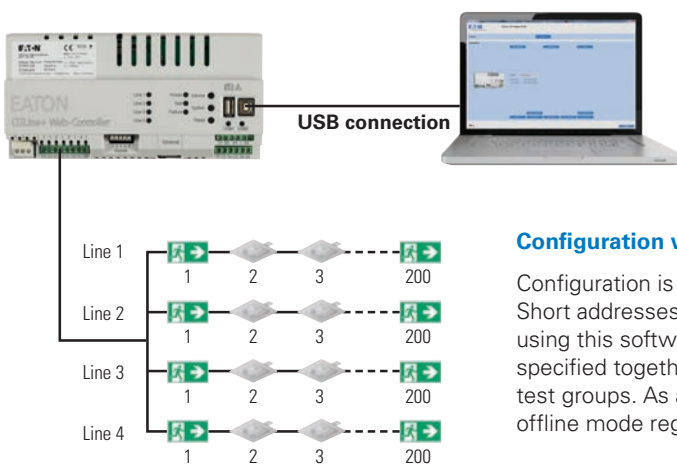

## Configuration with PC software

Configuration is carried out using the CGLine+ PC software. Short addresses and unique names of luminaires can be assigned using this software; the time and interval of automatic tests are specified together with the zone assignment and the definition of test groups. As a result, the entire system can be configured in offline mode regardless of whether the IT network is available.



# 10.2 CGLine+ self-contained luminaire system

## CGLine+ Web Controller

### CGLine+ Bus

The communication of all data and commands takes place using the CGLine+ bus installed in a free topology using a two-wire unshielded cable. Should there be a possible break in the bus cable, the additional integrated test function of each CGLine+ luminaire ensures that the tests required are performed automatically, and this is displayed on site at the luminaire. The required cross-section of the bus cable depends on the length of the wire.

### Cable length of a line

Wire cross-section	Max length of a branch (Distance to farthest luminaire)	Max total cable length per line
0.5 mm <sup>2</sup> *	260 m	660 m
1.0 mm <sup>2</sup>	520 m	1.320 m
1.5 mm <sup>2</sup>	800 m	2.000 m

\* e.g. J-Y(ST)Y 2x2x0,8

### Electrical data per line/bus

Supply voltage Bus	Max. allowable voltage drop	Bus current
25 V DC	6 V	400 mA

### Set-up of the CGLine+ Web Controller



**1 LEDs for line 1 to line 4:**  
It signals the sending or receiving of data between the CGLine+ Web Controller and the CGLine+ self-contained luminaires.

- Green LED = Receiving of data by the Web Controller

- Yellow blinking LED = Sending data to the luminaires

**2 Power LED:**  
The green light is lit as soon as the controller is connected to the 230V/AC supply voltage.

**Test LED:**

- Rapid green blinking if at least 1 luminaire is undergoing a function test
- Rapid green blinking if at least 1 luminaire is undergoing a duration test

**LED failure:**  
Showing a sum failure. Red LED light is lit if at least 1 luminaire is faulty, for example the battery has failed

**3 Button:**

- Service = Starts a function test for example
- System = Starts a USB connection using the USB2 port
- Reset = Hardware reset of the device

**4 USB1 port (Host)** for connecting a regular USB memory stick

- 5 USB2 port (Device)**, for connecting to a PC
- 6 PE/N/L 230V 50/60Hz**
- 7 Connections for the CGLine+ bus**, line 1 to line 4
- 8 RS485**
- 9 LAN (RJ45)** with LED display
  - green = connected (link)
  - yellow = data transfer (traffic)
- 10 Digital inputs and outputs:**
  - S1/S2 = Blocking input
  - In1, In2 = 2 x digital inputs
  - 11, 12, 14 / 21, 22, 24 = 2 x relay outputs

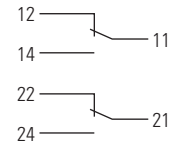

### CGLine+ in operation

**CGLine+ Web Controller:** With integrated memory for storing the configuration and the log book

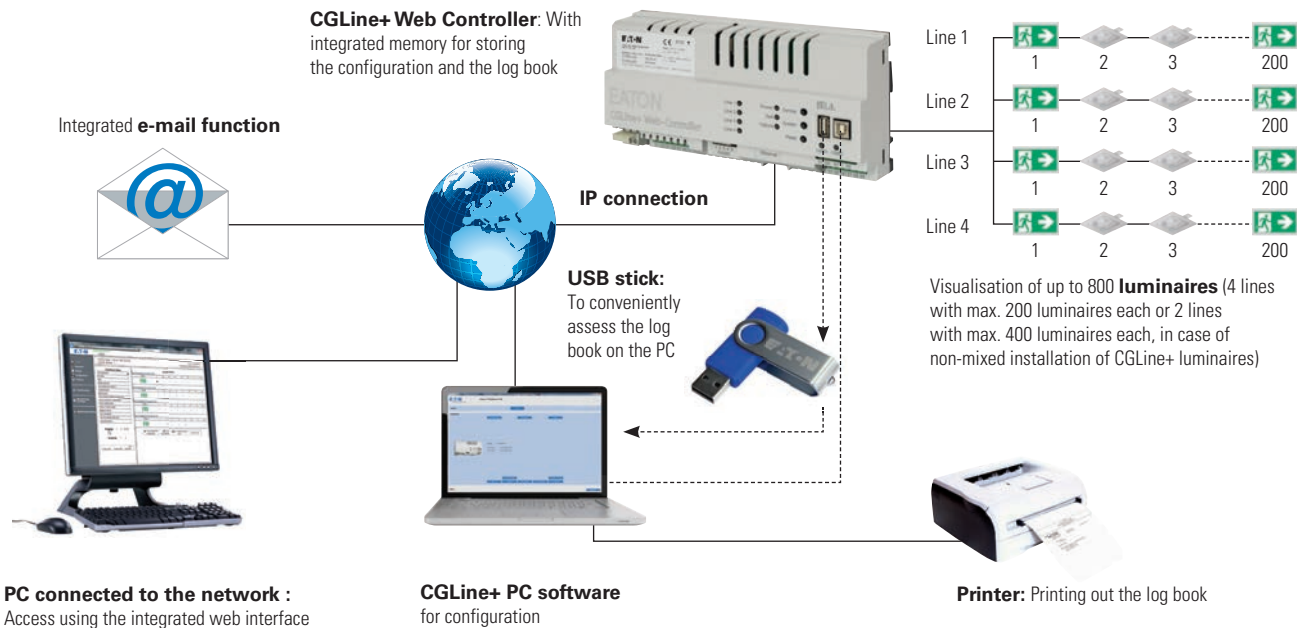

CGLine+ Web Controller with integrated web server



Dimensional drawings, data in mm

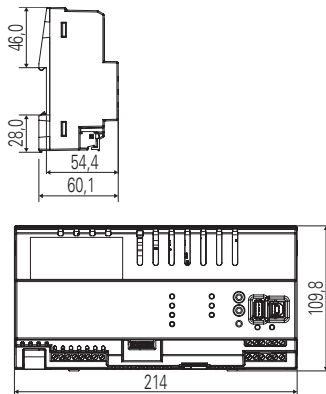

CGLine+ Web Controller connection box



Dimensional drawings, data in mm

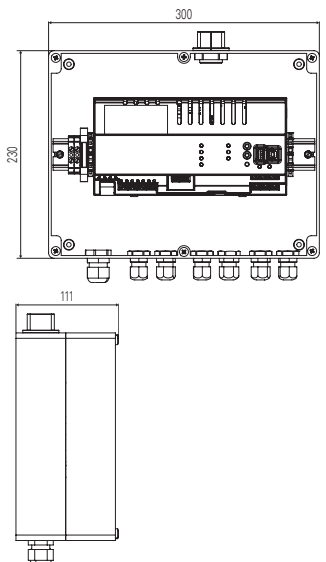

### CGLine+ Web Controller

- For connecting up to 800 luminaires in max. 4 lines
- The integrated web server enables there to be convenient visualisation, control and monitoring
- Unique ID per luminaires assigned by the manufacturer
- Automatic luminaire search function requiring no manual addressing
- Simple sorting using unrestricted short address assignment
- Unrestricted entry of target location names for the luminaires with up to 20 characters
- Clearly-shown allocation of luminaires to up to 8 zones per line
- Automatic function test and duration test
- Up to 8 test groups per luminaire can be defined for the function test (FT) and duration test (DT)
- Electronic log book storage for a period of minimum 4 years
- E-mail service for sending automatic e-mail in case of malfunctions to up to 10 e-mail addresses, assignable to 2 escalation groups
- Blocking the emergency lighting function during non-operational periods (all / per bus line/ per zone / per luminaire)
- Luminaires in maintained mode switchable (all / per bus line / per zone / per luminaire)
- Compliant with the highest industry cybersecurity requirements
- Password protected access as an administrator or user
- Visualisation of luminaires in up to 30 different building layouts
- Efficient and convenient analysis of the log book using the CGLine+ PC software
- Luminaire replacement with webserver for easy maintenance

Dimensions	214 x 109.8 x 60.1 mm
Housing type	For DIN rail 12 TE
Power supply	230 V AC, 50/60 Hz
Power consumption	< 4 W in standby, < 21 W at full load
Connection terminals	max. 2.5 mm <sup>2</sup>
Permissible ambient temperature	0 °C ... 35 °C
Storage temperature	-20 °C ... 70 °C
Degree of protection	IP20

### Ordering details

Type	Scope of supply	Order No.
CGLine+ Web Controller	Module in installation housing for DIN rails	40071361055

### Accessories

Type	Scope of supply	Order No.
CGLine+ PC software	on CD-ROM	40071361178
CGLine+ Web Controller connection box	CGLine+ Web Controller in wall-mounted housing	40071361184

# 10.3

## CGLine+ self-contained luminaire system

### CGLine+ Web Compact Controller

#### CGLine+ Bus

The communication of all data and commands takes place using the CGLine+ bus installed in a free topology using a two-wire unshielded cable. Should there be a possible break in the bus cable, the additional integrated test function of each CGLine+ luminaire ensures that the tests required are performed automatically, and this is displayed on site at the luminaire. The required cross-section of the bus cable depends on the length of the wire.

#### Cable length of a line

Wire cross-section	Max length of a branch (Distance to farthest luminaire)	Max total cable length per line
0.5 mm <sup>2</sup> *	260 m	660 m
1.0 mm <sup>2</sup>	520 m	1.320 m
1.5 mm <sup>2</sup>	800 m	2.000 m

\* e.g. J-Y(ST)Y 2x2x0,8

#### Electrical data per line/bus

Supply voltage Bus	Max. allowable voltage drop	Bus current
25 V DC	6 V	400 mA

#### Set-up of the CGLine+ Web Compact Controller

10



#### 1 Status LED indicator for the EL installation:

- Green = OK
- Green blinking = at least 1 luminaire is performing a function test or duration test
- Red : Failure / event

#### 2 TFT LCD screen with all menu, parameters and alarms

#### 3 Keypad for navigation in the menu and set parameters

#### 4 USB-1 host, for connecting a USB stick with LED indicator

#### 5 USB2 device, for connecting to PC with LED indicator

#### 6 LAN (RJ45), with LED display

- Green = connected (link)
- Yellow = data transfer (traffic)

#### 7 Cables entries for :

- Connection CGLine+ bus line 1-2
- PE/L/N 230V 50/60Hz
- S1/S2 = Block input
- In1, In2 = 2 x digital inputs
- 11, 12, 14, 21, 22, 24 = 2x relay outputs

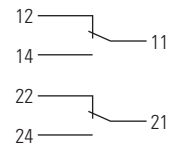

#### CGLine+ in operation

#### CGLine+ Web Compact Controller:

With integrated memory for storing the configuration and the log book

#### Integrated e-mail function

#### IP connection

#### USB stick:

To conveniently assess the log book on the PC

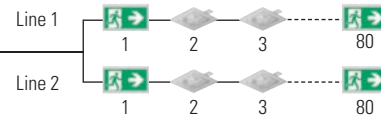

Visualisation of up to 160 luminaires (2 lines with max. 80 luminaires each)

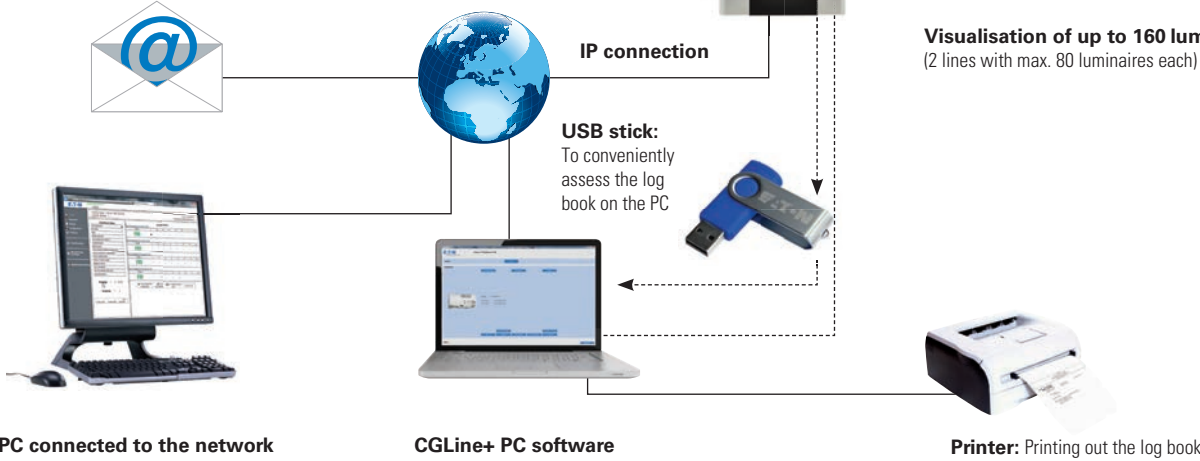

PC connected to the network or an optional CGLine+ Wireless Monitoring Set: Access using the integrated web interface

CGLine+ PC software for configuration

Printer: Printing out the log book

CGLine+ Web Compact Controller with integrated web server



Dimensional drawings, data in mm

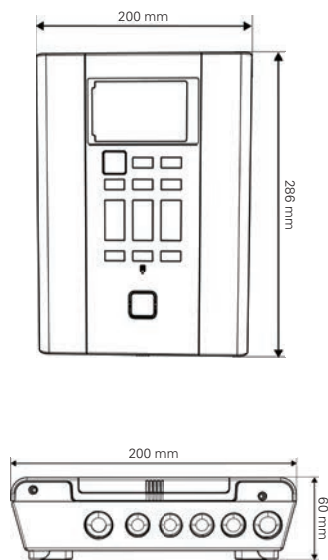

### CGLine+ Web Compact Controller

- For connecting up to 160 luminaires in 2 lines
- HMI with TFT LCD screen 320\*480 and keypad
- Led status for EL installation
- The integrated web server enables there to be convenient visualization, control and monitoring
- Unique ID per luminaires assigned by the manufacturer
- Automatic luminaire search function requiring no manual addressing
- Simple sorting using unrestricted short address assignment
- Unrestricted entry of target location names for the luminaires with up to 20 characters
- Clearly-shown allocation of luminaires to 4 zones of 20 luminaires per line
- Automatic function test and duration test
- Up to 8 test groups per luminaire can be defined for the function test (FT) and duration test (DT)
- Electronic log book storage for a period of minimum 4 years
- E-mail service for sending automatic e-mail in case of malfunctions to up to 10 e-mail addresses, assignable to 2 escalation groups
- Blocking the emergency lighting function during non-operational periods (all/per bus line/ per zone/per luminaire)
- Luminaires in maintained mode switchable (all/per bus line/per zone/per luminaire)
- Password protected access as an administrator or user
- Visualisation of luminaires in up to 30 different building layouts with the Webserver
- Efficient and convenient analysis of the log book using the CGLine+ PC software
- Compliant with the highest industry cybersecurity requirements
- Maintenance and replacement of luminaire with the local HMI

Dimensions	288 x 203 x 60 mm
Housing type	Wall mounted
Screen	TFT LCD screen 320 x 480
Power supply	230 V AC, 50/60 Hz
Power consumption	< 4 W in standby, < 21 W at full load
Connection terminals	max. 2.5 mm <sup>2</sup>
Permissible ambient temperature	0 °C ... 35 °C
Storage temperature	0 °C ... 35 °C
Degree of protection	IP20

### Ordering details

Type	Scope of supply	Order No.
CGLine+ Web Compact Controller	Wall mounted controller with LCD screen and keypad	CTR160CGL2KS

### Accessories

Type	Scope of supply	Order No.
CGLine+ PC software	on CD-ROM	40071361178



# 10 CGLine+ Touchscreen Controller

The CGLine+ Touchscreen Controller combines the Web Controller and a 10-inch touchscreen in a single housing. This product combines the power of the Web Controller (monitoring of up-to 800 self-contained luminaires) with the ease of using an intuitive touchscreen interface.

This enables visualisation of the status of all luminaires connected to the system.

There are three Touchscreen Controller packages available:

### 1. CGL+ CGVision Touchscreen S/Controller

- CGLine+ Web Controller
- 10.1 Inch Touchscreen
- CGVision Touchscreen Software

This Touchscreen package allows full configuration and visualisation of a single CGLine+ system.

### 2. CGL+ CGVision Touchscreen G/Controller

- CGLine+ Web Controller
- Ethernet connection
- 10.1 Inch Touchscreen
- CGVision Touchscreen software

This Touchscreen package allows full configuration and visualisation of the integrated CGLine+ Web Controller and up-to 9 external Web Controllers via ethernet.

### 3. CGL+ Web Touchscreen Controller

- CGLine+ Web Controller
- Ethernet connection
- 10.1 Inch Touchscreen
- Embedded Web-browser

This Touchscreen package is compatible with central CGVision software and allows full configuration and visualisation of the integrated CGLine+ Web Controller and up-to 32 external Web Controllers via Ethernet.

Building layouts can be uploaded for enhanced identification of luminaires.



 Do not connect a CGVision Touchscreen Controller with a CGVision PC



### 1. Stand-alone visualisation

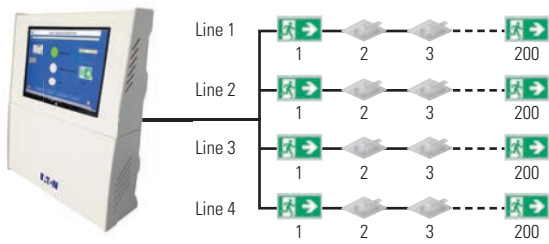

**CGLine+ CGVision Touchscreen S/Controller**

- Visualisation with CGVision Touchscreen software

OR

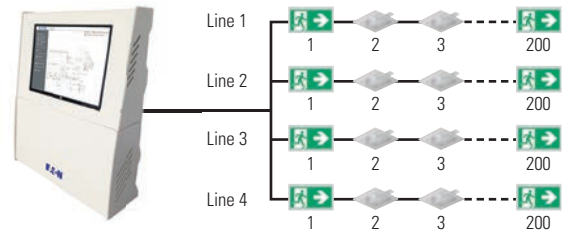

**CGLine+ Web Touchscreen Controller**

- Web based visualisation
- Building layout functionality

### 2. Group visualisation with CGLine+ Touchscreen G/Controller

Fully centralized configuration and monitoring of **up to 9** external CGLine+ Web Controllers or CGLine+ Web Touchscreen Controllers via **CGLine+ CGVision Touchscreen G/Controller**

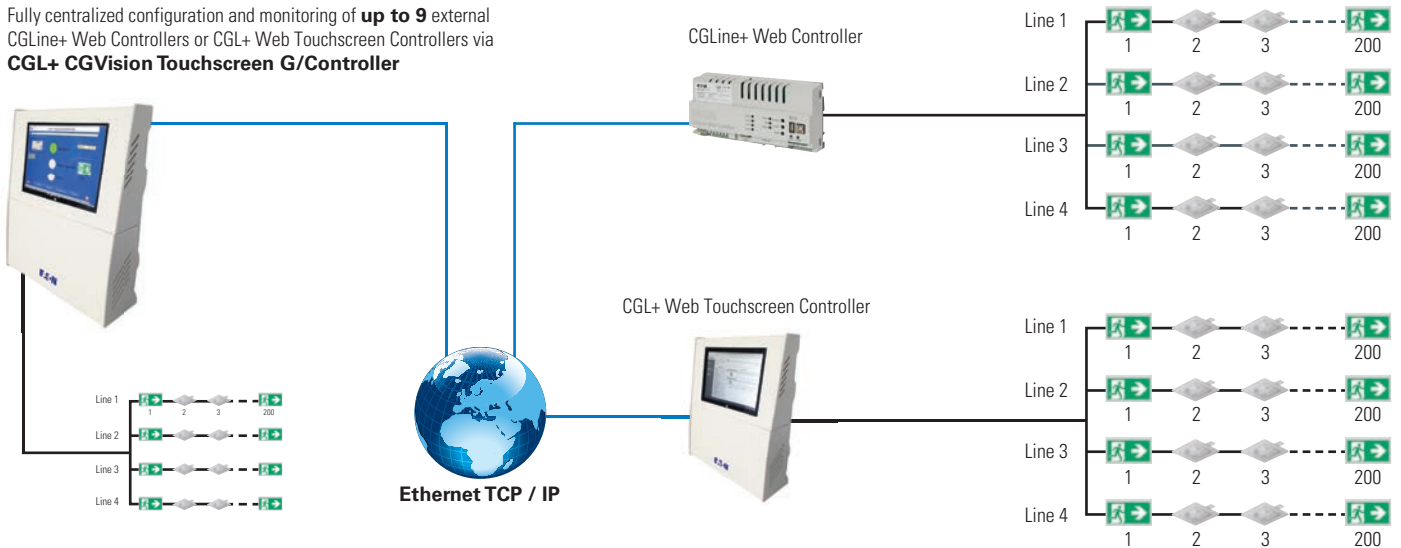

### 3. Web-based group visualisation with CGLine+ Web Touchscreen Controller

Fully centralized configuration and monitoring of CGLine+ Web Controllers & Web Touchscreen Controllers via **CGLine+ Web Touchscreen Controller**

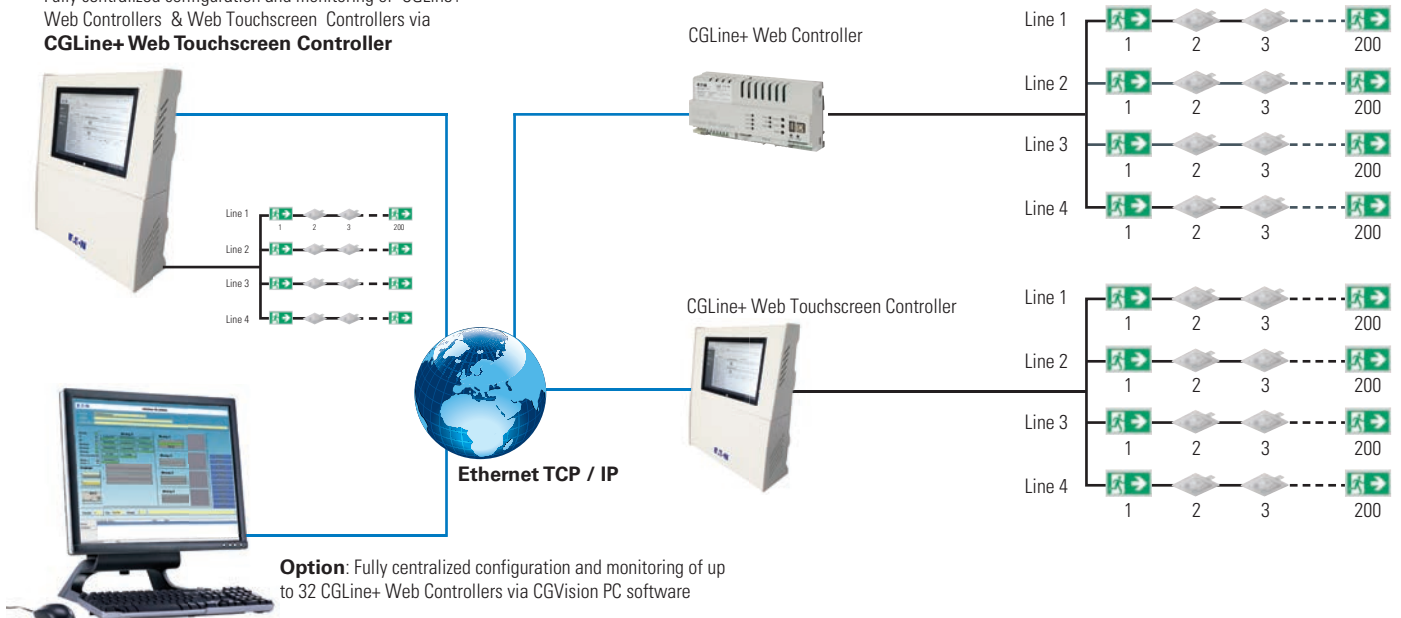

**Option:** Fully centralized configuration and monitoring of up to 32 CGLine+ Web Controllers via CGVision PC software

# 10.4 Ease of Visualisation

## CGLine+ Touchscreen Controller

### CGLine+ Web-based visualisation

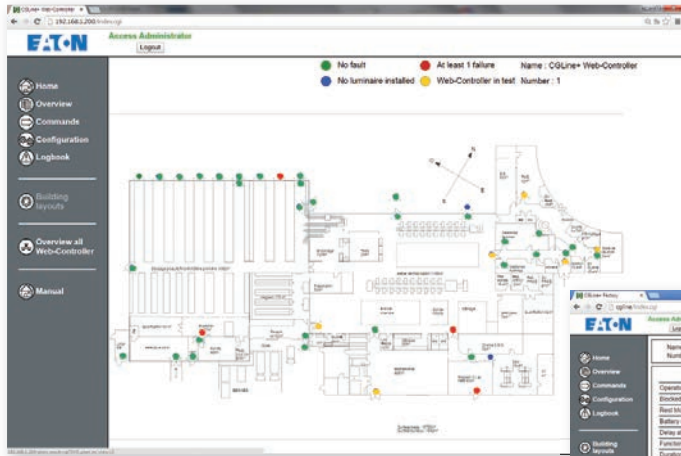

#### Fully centralized monitoring of up to 10 CGLine+ Web Controllers and Web Touchscreen Controllers:

- Secure access with username and password
- Building layout display
- Blocking / Rest mode function for all luminaires
- Manual function and duration tests (all, group or single luminaire)
- Logbook stores events and test results for a minimum of 4 years in compliance with standards.
- Customisable automatic E-Mail dispatch if faults occur
- Full description of the system : See page 154 to 159



### CGVision Touchscreen software

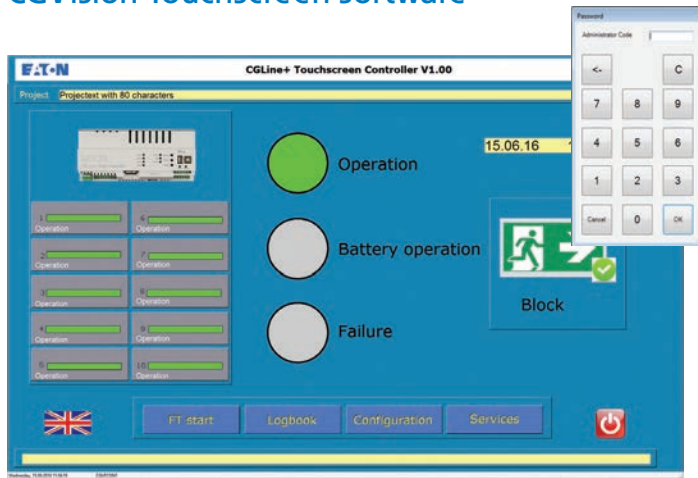

#### Home screen:

- Sum status display of up to 10 CGLine+ Web Controller and all luminaires (Operation, Battery operation, Sum Failure)
- Blocking / Rest mode function for all luminaires with PIN code protection
- Manual function and duration test of all luminaires
- Logbook stores events and test results for a minimum of 4 years in compliance with standards.
- Easy selection between 19 user languages

⚠ Do not connect a CGVision Touchscreen Controller with a CGVision PC

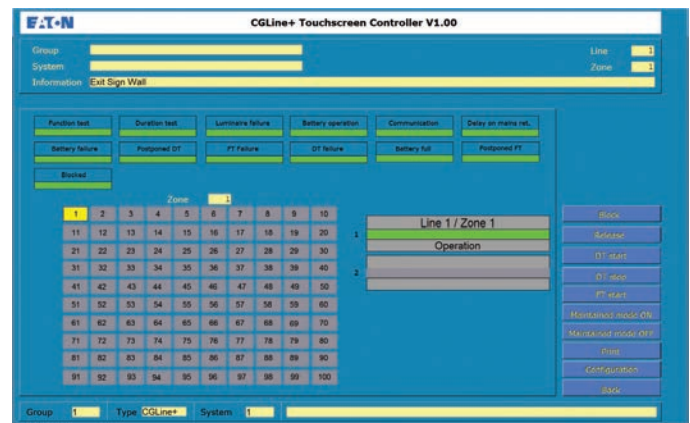
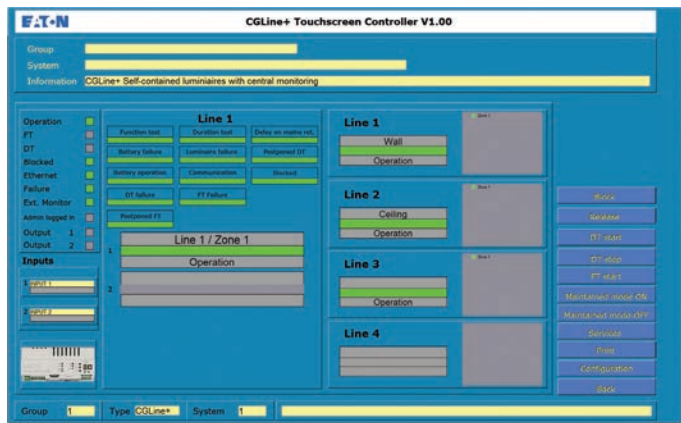

#### System screen:

- Overview of the system

#### Zone screen:

- Overview of the zone

CGLine+ Touchscreen Controller



Dimensional drawing Controller, data in mm

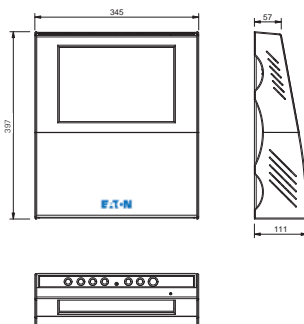

### CGLine+ Touchscreen Controllers

- 10,1 inch Touchscreen IPS display with WIN10
- For connecting up to 800 luminaires in max. 4 lines
- Unique ID per luminaire assigned by the manufacturer
- Automatic luminaire search function requiring no manual addressing
- Simple sorting using unrestricted short address assignment
- Unrestricted entry of target location names for the luminaires with up to 20 characters
- Clearly-shown allocation of luminaires to up to 16 zones per line
- Automatic function and duration test of luminaires, with customisable time/date settings
- Up to 8 test groups per luminaire can be defined for the function test (FT) and duration test (DT)
- Electronic log book storage for a period of minimum 4 years
- Blocking the emergency lighting function during non-operational periods (all / per bus line/ per zone / per luminaire)
- Luminaires in maintained mode switchable (all / per bus line / per zone / per luminaire)
- Compliant with the highest industry cybersecurity requirements
- Password protected access as an administrator or user
- Visualisation of luminaires in up to 30 different building layouts
- Efficient and convenient analysis of the log book using the CGLine+ PC software
- Luminaire replacement with webserver for easy maintenance

10

### CGL+ CGVision Touchscreen S/Controller - Specific features :

- CGVision Touchscreen Software allows full configuration and visualisation of the integrated CGLine+ Web Controller.

### CGL+ CGVision Touchscreen G/Controller - Specific features :

- Ethernet connection
- CGVision Touchscreen Software allows full configuration and visualisation of the integrated CGLine+ Web Controller and up to 9 external controllers/installations via ethernet.
- E-mail service for sending automatic e-mail in case of malfunctions to up to 10 e-mail addresses, assignable and 2 escalation groups

### CGLine+ Web Touchscreen Controller - Specific features :

- Ethernet connection
- Web-browser allows a visualisation of the integrated CGLine+ Web Controller and up to 9 external connected CGLine+ Web Controller via ethernet.
- Easy access web-based visualisation
- Building layouts could be loaded and used to localized faulty luminaires.
- Compatible with central CGVision software.
- E-mail service for sending automatic e-mail in case of malfunctions to up to 10 e-mail addresses, assignable and 2 escalation groups

Dimensions in mm (H x W x D)	345 x 397 x 111
Housing type	Plastic, wall-mounted housing
Power supply	230 V AC, 50/60 Hz
Power consumption	< 12 watts standby < 38 watts full load
Connection terminals	max. 2.5 mm <sup>2</sup> flexible
Permissible Ambient temperature	0 ° to 35 °C
Storage temperature	0 ° to 35 °C
Degree of protection	IP 20

### Ordering details

Type	Scope of supply	Order No.
CGLine+ Web Touchscreen Controller	Web-based visualisation via integrated web-browser of any no. of networked CGL+ Web Touchscreen Controller or CGLine+ Web Controller. A networked CGVision PC allows a full configuration and monitoring of up to 32 CGLine+ Controllers	40071361056
CGL+ CGVision Touchscreen S/Controller	CGL+ CGVision Touchscreen S/Controller: Stand alone operation with full configuration and monitoring	40071361083
CGL+ CGVision Touchscreen G/Controller	CGL+ CGVision Touchscreen G/Controller: Group visualisation with full configuration and monitoring of up to 9 external CGL+ Controllers	40071361084

### Accessory

Type	Scope of supply	Order No.
CGLine+ PC software	on CD-ROM	40071361178



# 10.5

## CGLine+ self-contained luminaire system

CGVision with the CGLine+ Web Controller



# CGVision with the CGLine+ Web Controller

The Web Controller can be connected to CGVision, the powerful visualisation software, to create the largest configuration level of the CGLine+ system. In this set-up, up to 32 CGLine+ Web Controllers can be visualised at once.

Using CGVision both CGLine+ luminaire systems and other emergency lighting systems (for example ZB-S, LP-STAR, AT-S+) can be monitored with a single software. There is no difficulty in extending an existing system.

CGVision takes over all the control and test functions, and it generates a comprehensive electronic log book for all connected systems - and does so completely automatically.

In order to keep an eye on a large amount of equipment, for example at a large plant or an airport, the state of the individual emergency lighting systems can be presented on an aerial photo or a site plan. The building layout helps visualise individual luminaires.

Access of any PC via the web server of the CGLine+ Web Controller can also be carried out if it is connected to CGVision. Thus for example, large, multi-building facilities can be configured and monitored centrally using CGVision. Additionally service technicians can have an overview of areas of interest to them using the Web Controller.

## Installation example

CGLine+ Web Controller with integrated memory for storing the configuration and the log book

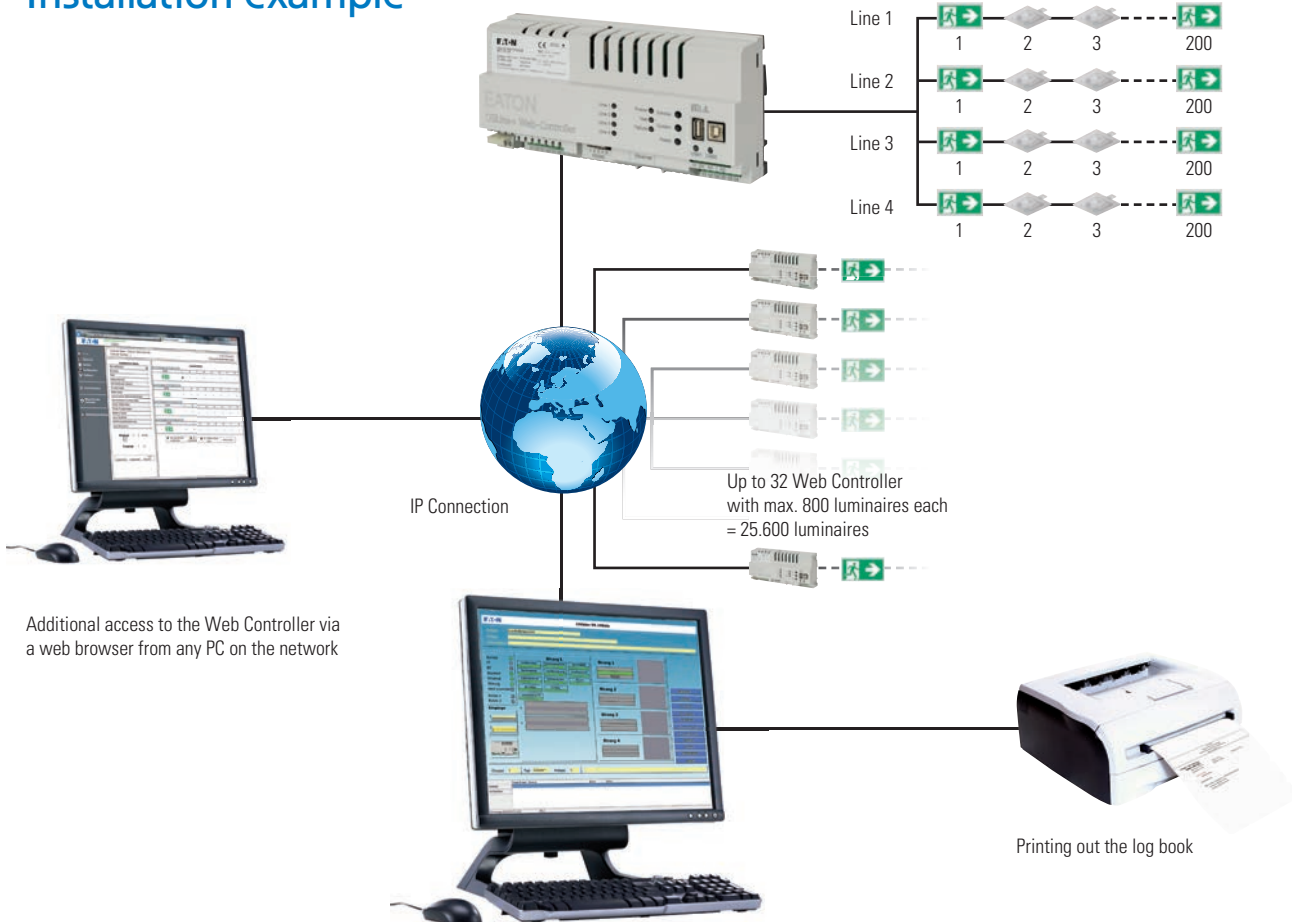

Additional access to the Web Controller via a web browser from any PC on the network

Printing out the log book

CGVision PC : Configuration and complete visualisation of all luminaires

 Do not connect a CGVision Touchscreen Controller with a CGVision PC

## Example for use of CGVision Package I

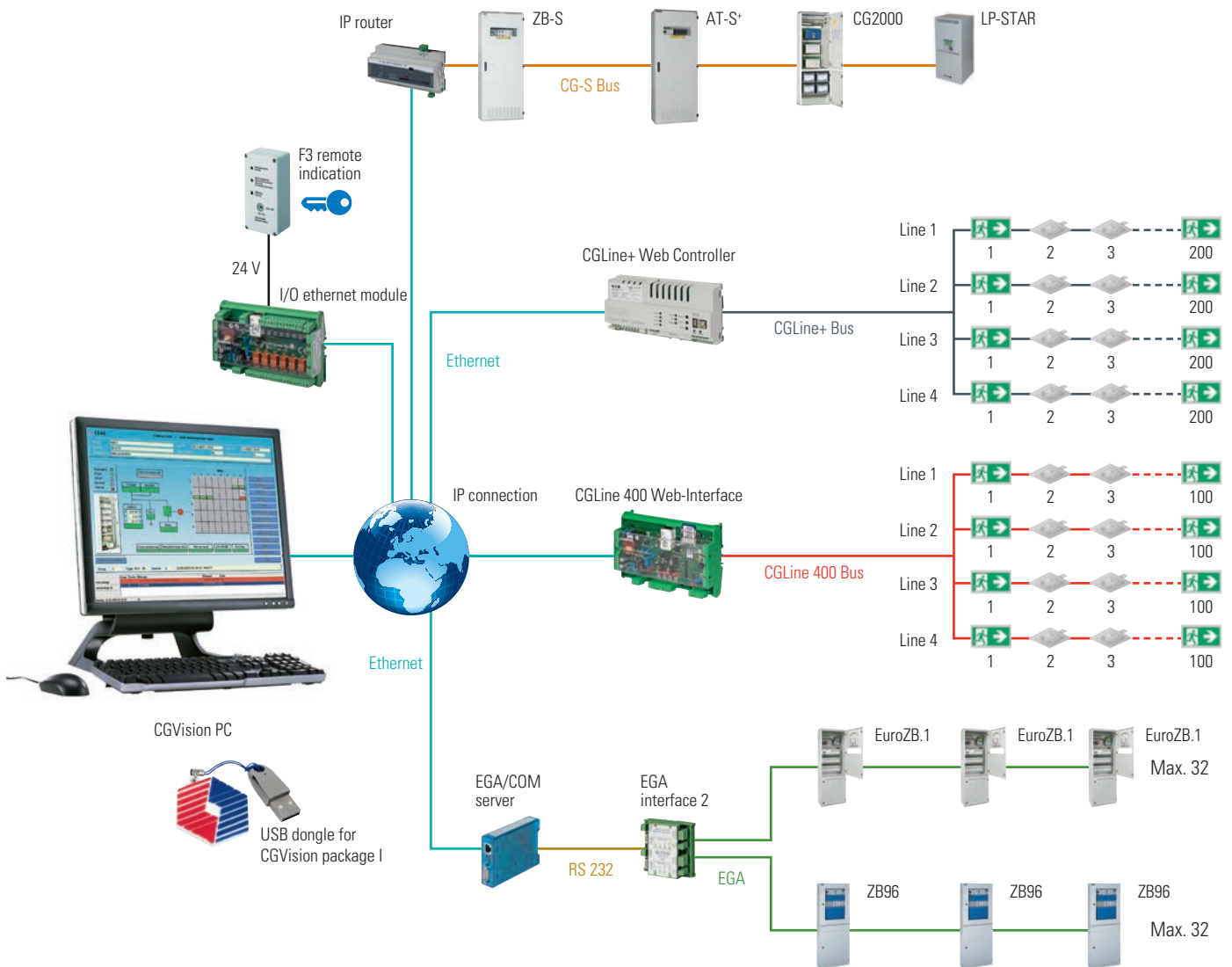

### CGVision ordering details

Scope of supply	Order No.
CGVision Basic Package I (with CG-S/IP interface)	40071361020
CGVision Basic Package II (EGA components to be ordered separately)*	40071361022
CGVision Basic Package III (with CG-S/USB interface, EGA components to be ordered separately)	40071361024
CGVision Pro Package I (including CG-S/IP interface and visualisation in a building layout)	40071361021
CGVision Pro Package II (including visualisation in a building layout, EGA components to be ordered separately)*	40071361023
CGVision Pro Package III (including CG-S/IP-Interface and visualisation in a building layout, EGA components to be ordered separately)	40071361025
PC-Anywhere remote maintenance software, 2nd licence 1 x host, 1 x remote	40071347151

For a detailed description and ordering information, see section CGVision in the emergency lighting main catalogue.

\*Preferred solution for CGLine+







# OPC Server for BMS

## For easy facility management

A building management system (BMS) is a computer-based control system usually installed in large buildings in order to control and monitor the building's mechanical and electrical equipment such as ventilation, power systems, fire systems, lighting, etc. BMS systems are important tools for managing energy consumption and improve reliability and life safety.

In order to support facility managers in their effort of monitoring and targeting energy consumption, improve life safety, save time and money during maintenance, Eaton enables its CGLine+ systems to communicate with their BMS through an OPC server.

### Features:

- Easy BMS connection via IP based OPC DA2.0
- One OPC-Server for up to 32 CGLine+ Web Controller
- 20 sum status information of each CGLine+ Web Controller
- 10 commandos from BMS to each CGLine+ Web Controller
- Definition of up to 8 function test groups & 8 duration test groups
- 20 sum status information of each single lines 1-4
- 20 sum status information of each single zone 1-16
- 16 status information of each single luminaire 1-800

### Schematic overview:

- LAN (RJ45)
- ⋯ LAN connection between PC with CGVision and PC with BMS Software
- CGLine+ Bus

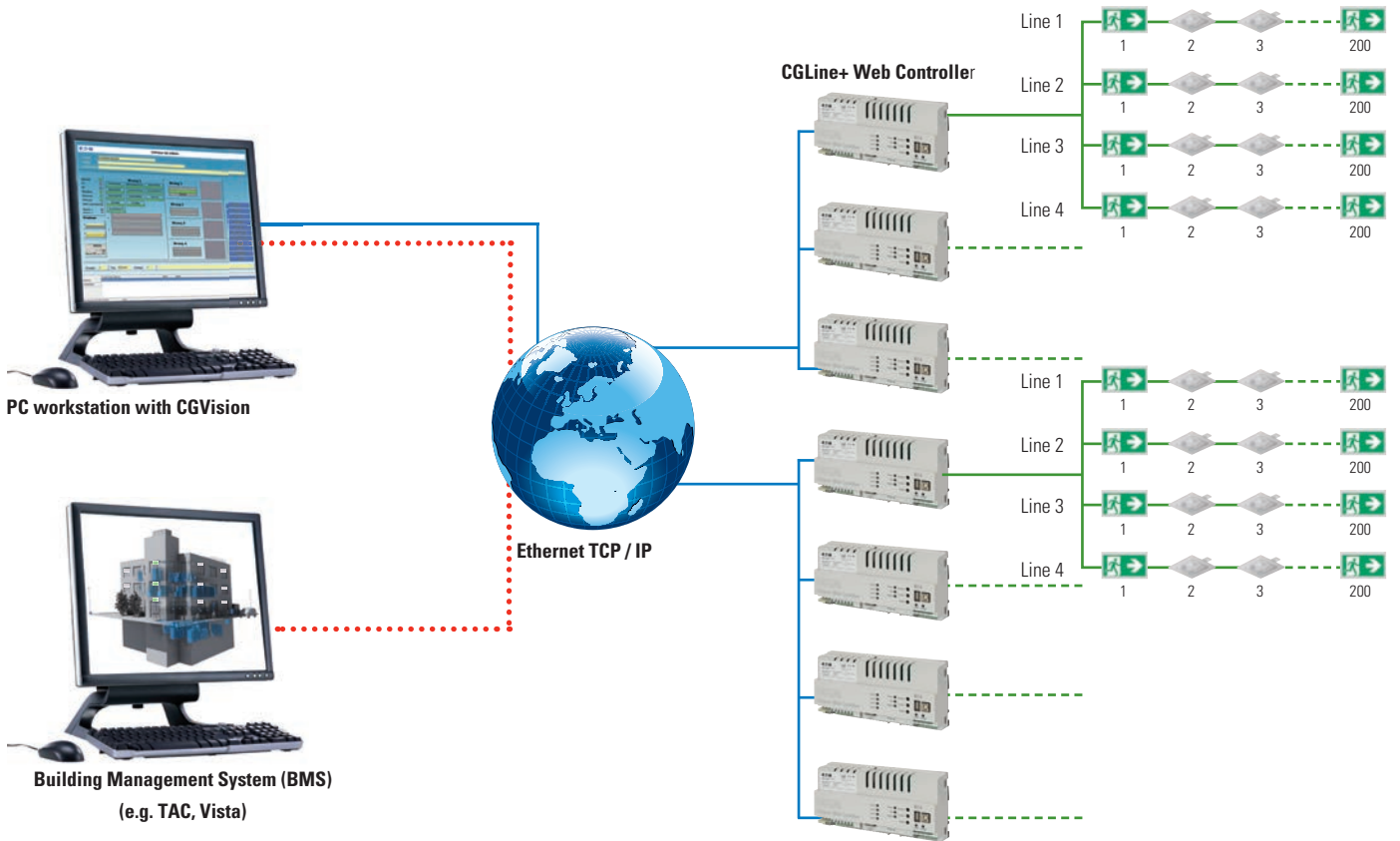





## Increased Affordance

The evacuation of commercial buildings can be inhibited by people's failure to recognise standard emergency exit signs.

To improve the visibility of signs, Eaton has introduced an Increased Affordance capability to its emergency lighting range, which enables exit signs to flash or pulse when activated manually or through automated connection to other evacuation triggers.

11.1	Increased Affordance portfolio .....	174
11.2	Increased Affordance system configurations .....	175
11.3	TL CGLine+ .....	176
11.4	CGLine+ Web Controller .....	177

# 11.1

## Increased Affordance

Increased Affordance portfolio



The Increased Affordance functionality has been added to selected emergency luminaires within Eaton's lighting range, including CrystalWay and Nexitech.

This fully programmable function can be activated manually or automated to respond to a preset trigger such as a fire alarm, panic button or other system. Eaton's Increased Affordance solution has been developed and tested by an engineering team with decades of expertise in emergency lighting.



CrystalWay IA  
(see order codes on page 83)



NexiTech IA  
(see order codes on page 61)



FlexiTech ED  
(see order codes on page 88)

11



CGLine+ Web Controller



CGLine+ Touchscreen Web Controller



TL CGline+

When connected to Eaton's monitoring and control system for emergency lighting, CGLine+, the exit sign luminaires are able to provide either soft pulsing or on-and-off flashing. In their normal mode, the luminaires offer excellent visibility thanks to a high level of contrast that exceeds the minimum requirement in most countries. When activated, Increased Affordance enables even better recognition by flashing or pulsing but never dipping below the minimum level of luminescence that is established in industry standards, thus achieving full compliance. The IA function can be started either in normal maintained mode or in emergency lighting mode because an evacuation is not necessarily linked to a mains failure. The IA function will remain activated for 30 minutes (typical evacuation times are lower) before the luminaire switches back to normal operation.

### Luminance in the green zone of an IA luminaire (flashing or pulsing) compared with the minimum luminance in battery mode defined by EN1838:

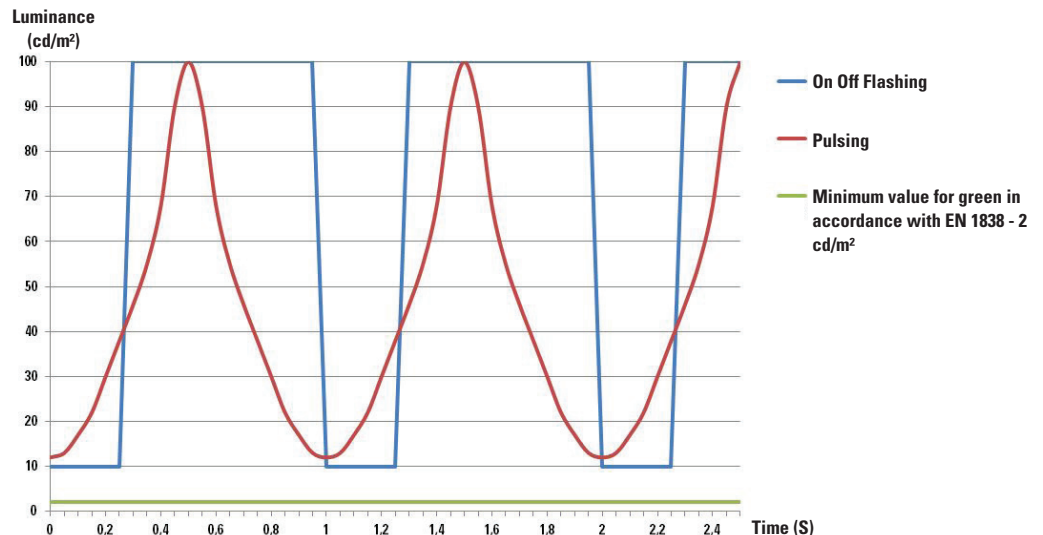

## Basic configuration with Controller

- One input signal will activate blinking of all luminaires connected to a line
- Select activation of all lines or single lines
- One controller for both: Standard CGLine+ and IA luminaires can be controlled via the same controller

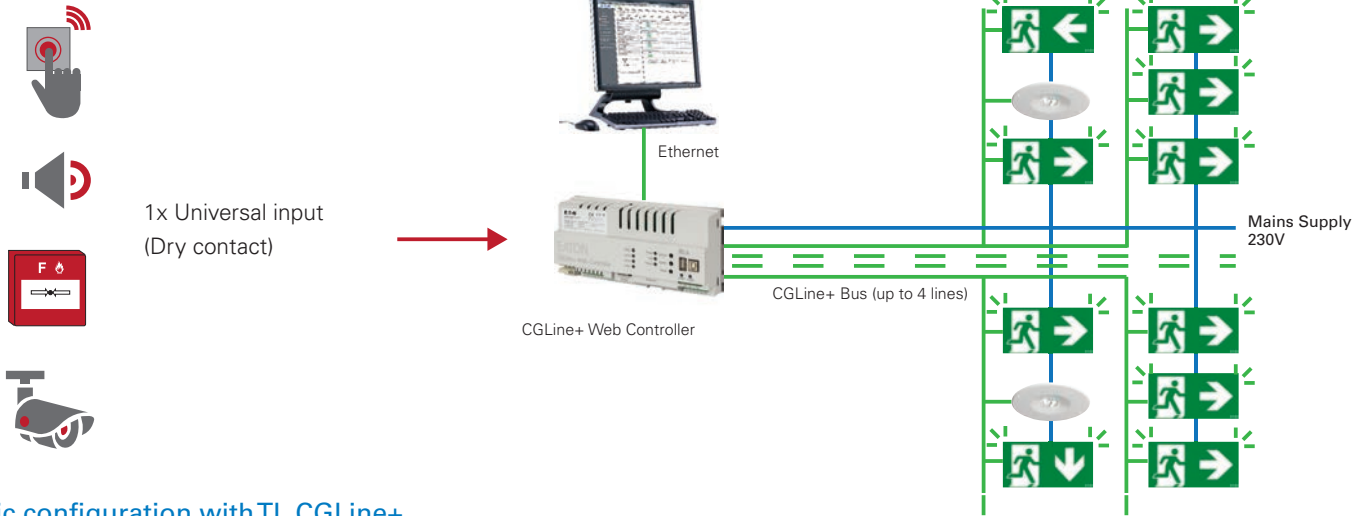

## Basic configuration with TL CGLine+

- One input signal will activate blinking of all luminaires connected to a line

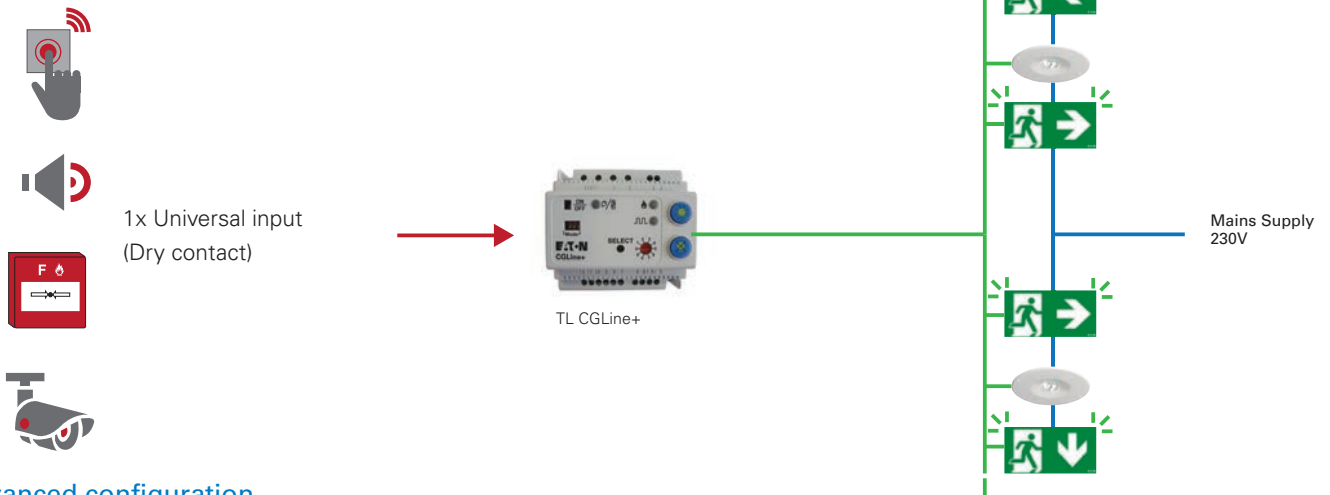

## Advanced configuration

- Scenarios will be activated via inputs (switch contacts)
- The programming will be via the PC Software
- Every single luminaire can be assigned to IA scenarios
- One controller for both: Standard CGLine+ and IA luminaires can be controlled via the same controller

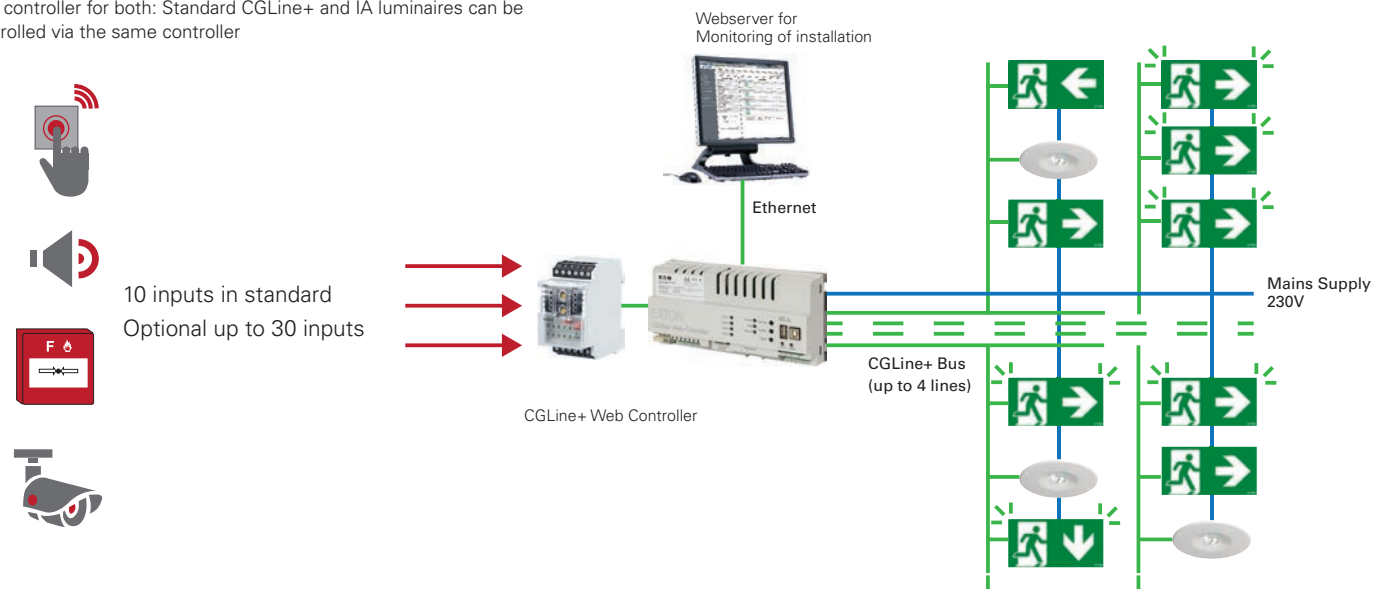



# 11.3 Increased Affordance

TL CGLine+

TL CGLine+



Dimensional drawings, data in mm

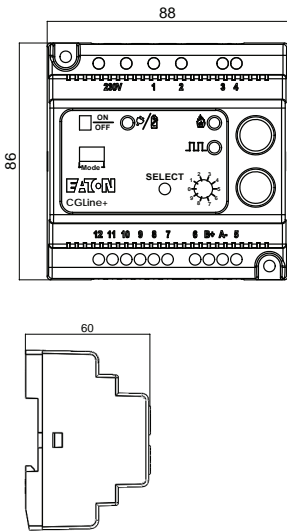

## TL CGLine+

- Control Module for up to 400 luminaires with CGLine+ bus connection
- For starting the Increased Affordance (IA) function at all connected luminaires via switch contact with this function the luminaires will start to flash (smooth pulsing). This way, evacuation can be quicker and safer.
- The input contact for starting the IA function has a differential loop monitoring for secured function of the connected switch
- Start of Rest-Mode via button at the TL CGLine+ or via switch input.  
Rest-mode: In case of planned mains outage this switches off the emergency lighting function. By this, the battery capacity is saved and the luminaires are ready for emergency mode directly after end of the planned outage
- With function for synchronizing the test times at all connected luminaires
- Function to post-poned the test times by 24 h
- Manual start of function and duration test
- With TL CGLine+ the connected CGLine+ luminaires work all in automatic test mode. That means the status and test results are visible at the luminaires but not at the control module.

Dimensions	88 x 86 x 60 mm
Housing type	For DIN rail 5 HP
Power supply	230 V AC, 50/60 Hz
Power consumption	1.5W
Connection terminals	max. 2.5 mm <sup>2</sup>
Permissible ambient temperature	5 °C ... 40 °C
Degree of protection	IP20

## Ordering details

Type	Scope of supply	Order No.
TL CGLine+	Electronic control box for 400 CGLine+ self-contained luminaires	LUM10319

11

CGLine+ Web Controller with integrated web server



Dimensional drawings, data in mm

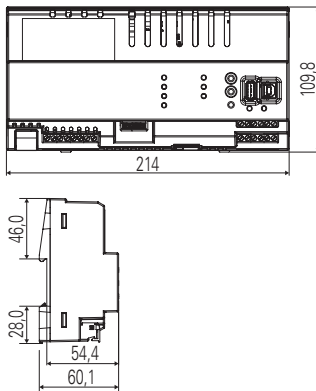

Advanced IA CGLine+ system



### CGLine+ Web Controller

- Connection of up to 800 luminaires in max. 4 lines
- The integrated web server enables convenient visualisation, control and monitoring
- With Increased Affordance (IA) functionality: In case of an evacuation the controller can send an IA command to all connected Exit signs with IA CGLine+ functionality. With this command the luminaire will start to flash (on/off or smooth pulsing)
- The IA function can help to increase the visibility of the signs and therefore lead to a faster and safer evacuations. This also increases safety for hearing impaired or deaf people, under the two-sense-principle.
- Selection of blinking scheme and line to start with the IA function can be programmed via the PC. The IA function is triggered by closing a potential free contact at the controller.
- For more complex situations an Advanced IA CGLine+ system can be used which includes an input module for 10 scenarios. This enables an individual programming of which luminaires will react to a scenario. By that the IA be started individually e.g. for different building sections. The system can be extended with up to 30 inputs (optional).
- The communication between the input module and the controller is constantly monitored and any failure is reported at the Web Controller, as well as being delivered by email report.
- Within a CGLine+ system standard CGLine+ luminaires can easily be combined with IA CGLine+ luminaires
- Each luminaire is assigned with a unique ID by the manufacturer
- Automatic luminaire search function requires no manual addressing
- Simple sorting using unrestricted short address assignment
- Unrestricted entry of target location names for the luminaires with up to 20 characters
- Allocation of luminaires - up to 8 zones per line – is clearly displayed
- Automatic function test and duration test
- Web Controller tested and approved by BSI: KM No. 636748 - Automatic test system for Battery Powered Emergency lighting to EN 62034
- Up to 8 test groups per luminaire can be defined for the function test (FT) and duration test (DT)
- Electronic logbook storage for a period of minimum 4 years
- Email service for sending automatic email (in case of malfunction) to up to 10 e-mail addresses, assignable to 2 escalation groups
- Blocking of the emergency lighting function during non-operational periods (all / per bus line/ per zone / per luminaire)
- Luminaires in maintained mode switchable (all / per bus line / per zone / per luminaire)
- Password protected access as an administrator or user
- Visualisation of luminaires in up to 30 different building layouts
- Efficient and convenient analysis of the log book using the CGLine+ PC software

11

	Web Controller	Advanced IA CGLine+ system (without backup)
Dimensions	214 x 109.8 x 60.1 mm	310 x 145 x 436 mm
Housing type	For DIN rail 12 HP	ABS
Power supply	230 V AC, 50/60 Hz	230 V AC, 50/60 Hz
Power consumption	< 4 W in standby, < 21 W at full load	22 W (max load)
Connection terminals	max. 2.5 mm <sup>2</sup>	max. 2.5 mm <sup>2</sup> (CGLine+ bus: 1.5 mm <sup>2</sup> )
Permissible ambient temperature	0 °C ... 35 °C	0 °C ... 35 °C
Storage temperature	-20 °C ... 70 °C	
Degree of protection	IP20	IP65

### Ordering details

Type	Scope of supply	Order No.
CGLine+ Web Controller	Controller, for DIN rail mounting	40071361055
Advanced AE/IA CGLine+ System, 10 inputs	Including Advanced CGLine+ Web Controller, input module for 10 trigger inputs, wall mount housing (plastic)	40071779994

### Accessories

Type	Scope of supply	Order No.
CGLine+ PC software	on CD-ROM	40071361178





12.1	From static to Adaptive Evacuation .....	180
12.2	Matrix CGLine+ luminaire .....	182
12.3	AE CGLine+ system .....	184
12.4	Planning & programming Adaptive Evacuation .....	186
12.5	Installation of AE CGLine+ system .....	188
12.6	AE CGLine+ system .....	189



# 12.1 Adaptive Evacuation

From Static to Adaptive Evacuation

## Static Emergency lighting (current state)

During an emergency situation, panic is heightened and decision-making can be impaired. This can lead to congestion, delays and, in some instances, guide people to unsafe places.

Research into crowd behaviour and advances in scenario-modelling technology have highlighted the need for evacuation strategies that are more adaptable to differing circumstances and buildings.

12

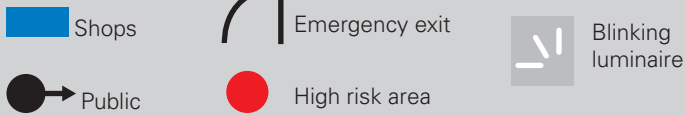

### 1. Evacuation situation with one exit blocked by works

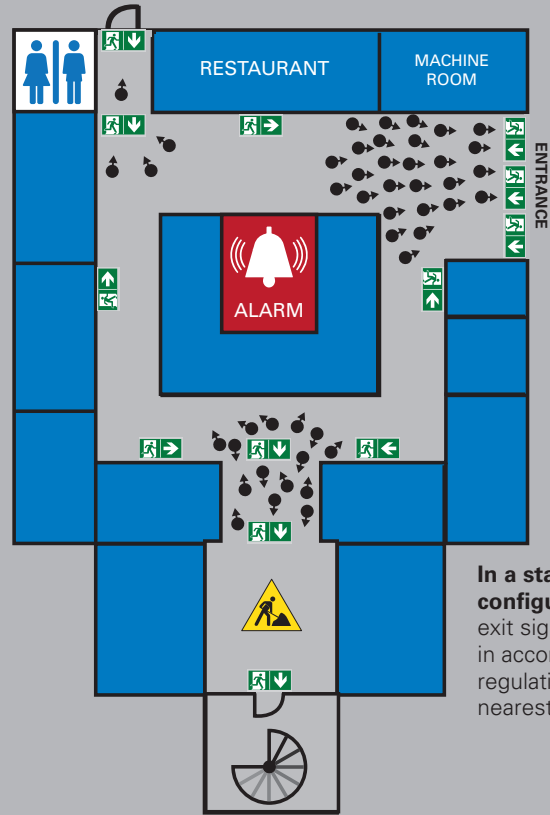

In a standard configuration, the exit signs positioned in accordance with the regulations indicate nearest exit.

## Adaptive Evacuation



Eaton has developed an **Adaptive Evacuation** System that is capable of switching between a number of predefined routes and guiding people towards the safest exit.



The Matrix luminaire can show either different arrow directions or a red cross depending on predefined scenarios. The red cross functionality is particularly effective when keeping people confined to one place is the safest option (such as during attacks in schools).



Matrix is equipped with a new **Increased Affordance** functionality (IA) which enables even better recognition by flashing or animated arrows.

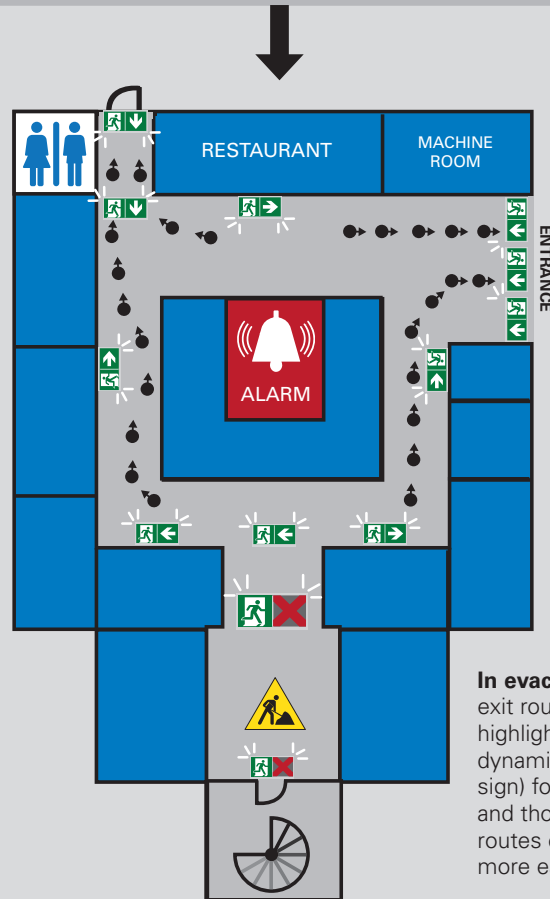

In evacuation mode, exit routes can be highlighted with a dynamic sign (blinking sign) for better visibility and though all exit routes can be found more easily.

## 2. Evacuation situation with one exit blocked by works and a high risk area on the other side of the building

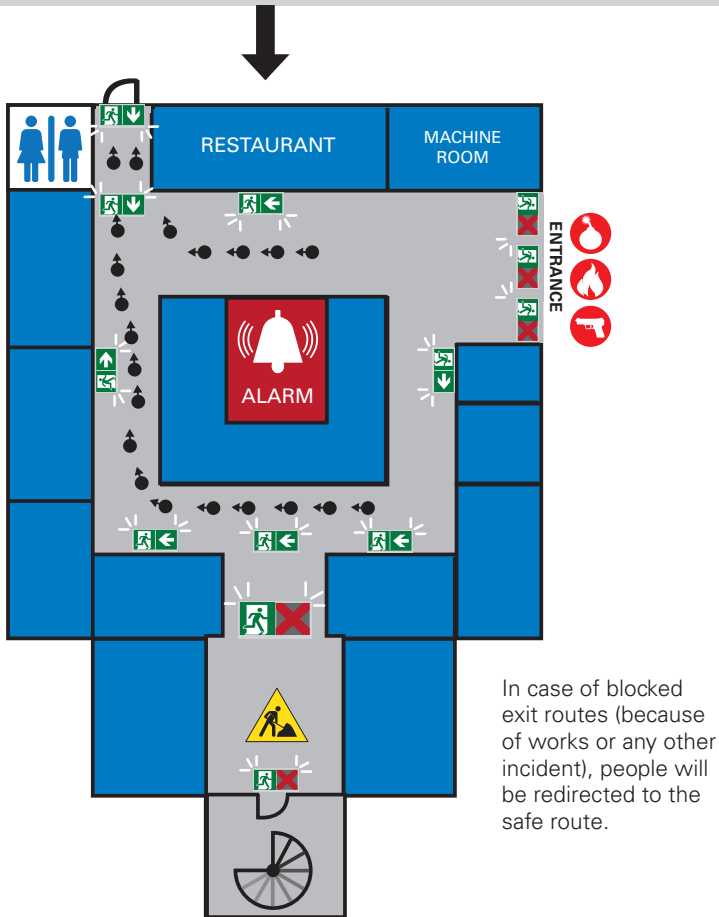
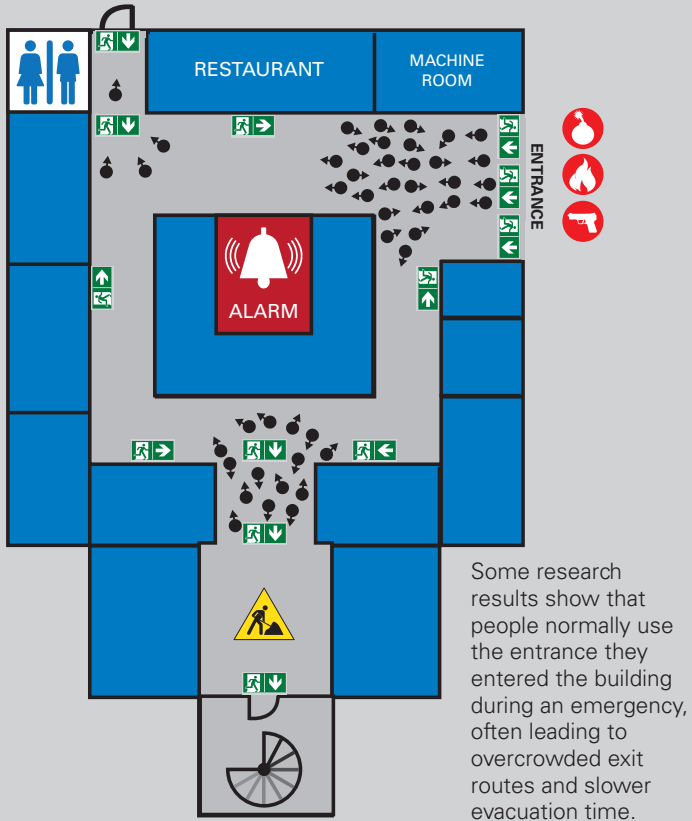

## 3. High risk situation with need to contain people in a safe room

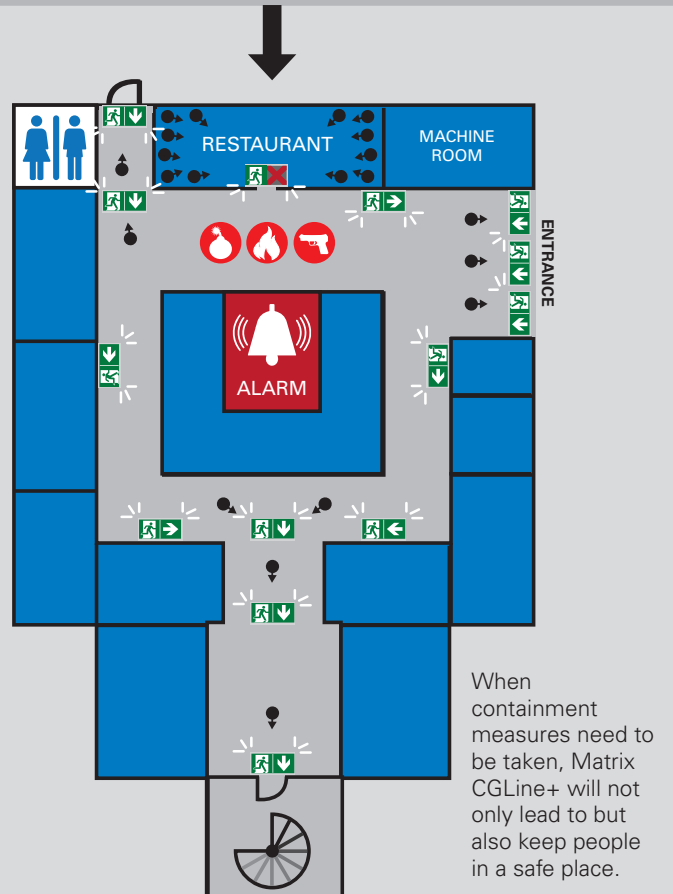
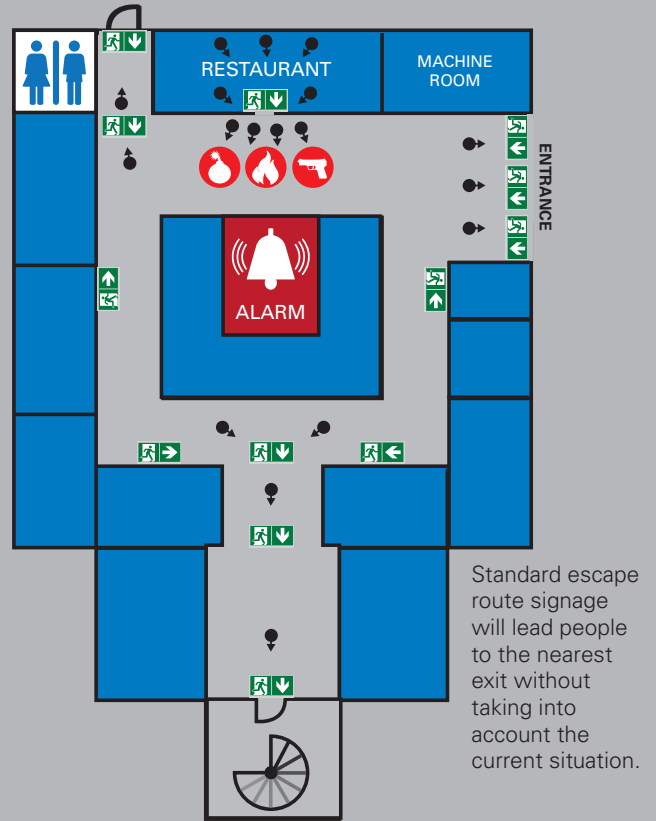

# 12.2 Adaptive Evacuation

Matrix CGLine+ luminaire

The Matrix CGLine+ is an adaptive escape sign luminaire that enables **real-time adjustment** of exit routes according to the nature and location of a hazard. Matrix CGLine+ can **adjust the direction of the arrow** it displays, with the aim of **improving the speed and safety of emergency evacuations** in commercial buildings.

The self-contained Matrix escape sign luminaire displays an arrow that can point in any one of four different directions. The additional ability to scroll the arrow from one side to the other **increases its visual impact** among the general population and helps to alert people with hearing impairments. It can also display a red cross to indicate that a particular exit route has become closed, blocked or dangerous.



12

### ...for flexible signage

Matrix is the first exit sign luminaire which can be configured in order to show a different evacuation direction (4 different arrows) or prohibit access to works zones or dangerous areas (red cross) without additional parts or pictogram foils.

The luminaire can work for 1 and 3 h emergency duration, this makes the planning easy and keeps the variance on stock low.

The luminaire is available with IP42 and IP65 and can therefore be used in normal indoor conditions and also in areas with higher level of dirt and humidity.

More of the capability of the Matrix will be used with the scenarios which can be activated locally with a universal switch input which can react e.g. on a contact at a fire sensor. With rotary switches the standard and the scenario pictogram can be chosen.

### ... for signage adapted to the situation

The full function of the Matrix is used in combination with the AE CGLine+ system. Here the arrow in standard mode and for up to 30 different scenarios can be easily programmed via the PC-software and will be applied via the AE CGLine+ Web Controller.



AE CGLine+ Web Controller

### ...for better visibility

The scenario pictogram options include the dynamic sign, which means that the arrow can be animated or blinking and the red cross can be static or blinking. This will make the luminaire more visible and help people in case of an evacuation to find the right way instinctively.

The luminaire has a high luminance of more than 1000 cd/m<sup>2</sup> and with that it can be easily recognised in bright surroundings.

### ...for low operation costs

It is equipped with an eco-friendly and reliable Li-Ion battery with improved power consumption due to less self-discharge and optimized charging technology. The complete design is made for 10 years maintenance free operation.

### Rotary switches on the luminaire

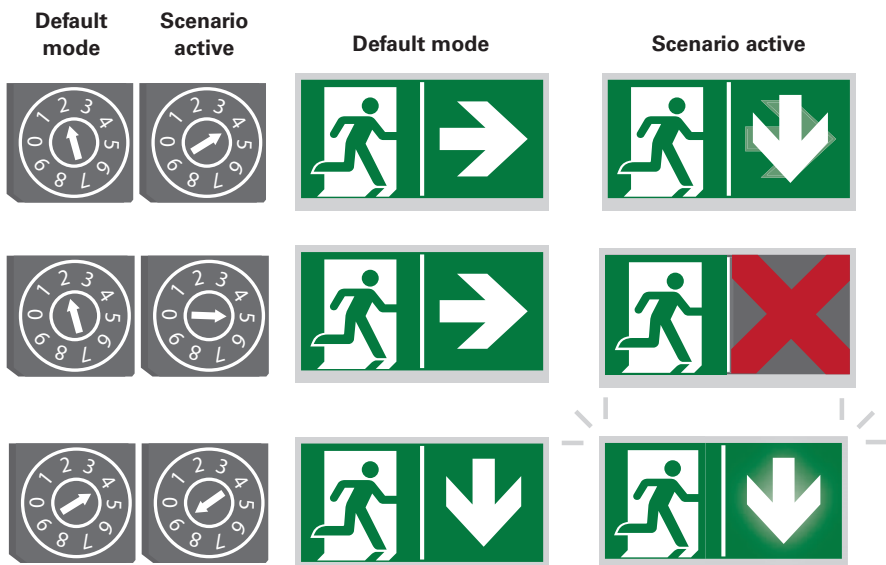

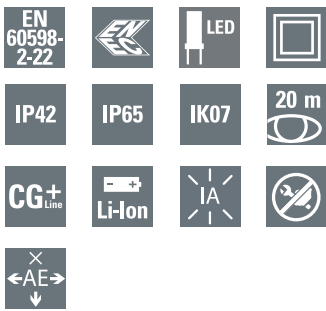

Matrix CGLine+



Dimensional drawings (mm)

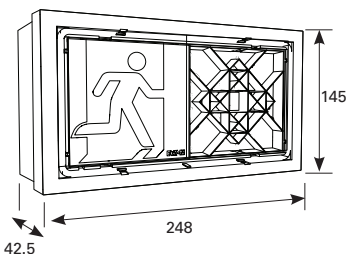

Single side ceiling adapter for Matrix



Double side ceiling adapter with canopy for Matrix



## Matrix 20m CGLine+

- Escape sign luminaire with Matrix technology for changeable signage
- Can be used for standard exit route signage as an universal exit sign
- Without need for changing any pictogram foils or plates and with a selectable operating time (1 or 3h operation) it is an all-in-one solution in line with the European emergency lighting standards or for increased visibility by animated signage
- Especially for Adaptive Evacuation (AE) which means the luminaire can change its signage dependent on an event. With this the luminaire can redirect people to an safe exit route or block an unsafe route
- Cyber-security protection with 128bit SSL encryption
- For connection to CGLine+ systems and Adaptive Evacuation AE CGLine+
- The signage can be changed via a switching contact at the luminaire connected to e.g. a smoke detector or panic switch or it can be programmed and controlled via AE CGLine+ system
- Reliable LED solution with high service lifetime and a very good perceptibility on account of high luminance of the white contrasting colour > 1000 cd/m<sup>2</sup>
- Environmentally-friendly due to modern lithium ion technology
- Robust design made from impact resistance polycarbonate with an IK grade of 07
- Available with IP42 and IP65 ingress protection (IP65 variant including two cable glands)
- Several cable entries on top and back for through-wiring of power and bus cable
- In addition to the automatic tests, manual tests can be started with a magnet
- Simple fault analysis and status display via bicolor LED
- Blocking function prevents unintended discharge during idle operating times (only with CGLine+ Web Controller)

Testing system	Automatic test in compliance with EN 62034 Connection possible to the CGLine+ monitoring system
Type of mounting	Wall surface-mounting and ceiling with adapters
Housing material	Polycarbonate
Housing colour	White
Weight	IP42 : 0,6 / IP65 : 0,7
Degree of protection	IP42, IP65
Terminals	Screwless terminals (L, L', N, PE, CGLine+ bus) for flexible and rigid wires from 0.5 to 2.5 mm <sup>2</sup>
Connection voltage	230V ~ 50/60Hz
Permissible ambient temperature	+5°C to +35°C
Battery	LiNiMnCoO <sub>2</sub> 3.6 V / 3.3 Ah
Light source	LED array

## Ordering details

Order N°	Product	Viewing Distance	Duration	Consumption
40071777002	Matrix 1-3h CGLine+ IP42	20m	1/3h	6.6 W / 13.8 VA
40071777003	Matrix 1-3h CGLine+ IP65	20m	1/3h	6.6 W / 13.8 VA

## Accessories

Order N°	Product
40071777024	Single side ceiling adapter for Matrix
40071777025	Double side ceiling adapter with canopy for Matrix

## Display possibilities with rotary switches:

### Options "Default mode"

0	1	2	3	4	5
■	←	→	↑	↓	✗

### Options "Scenario active"

						Arrows animated (IA functionality)*			
0	1	2	3	4	5	6	7	8	9
■	←	→	↑	↓	✗	←	→	↑	↓

\*In combination with AE CGLine+ Web Controller the Matrix can also show blinking arrows



# 12.3 Adaptive Evacuation

## AE CGLine+ system

### Functions & Benefits

The CGLine+ system is a powerful system, perfectly in line with emergency lighting standards and regulations, that makes the operation of self-contained luminaire systems safe and convenient. The new CGLine+ Web Controller can visualise a total of 800 CGLine+ luminaires. Maintaining an overview is important if there are a large number of luminaires. Luminaires of each line can be allocated to up to 8 zones (up to 16 zones in case of installing only two lines).

The zones can be areas where the luminaires need to be brought together, for example on a floor, in an area or in a room.

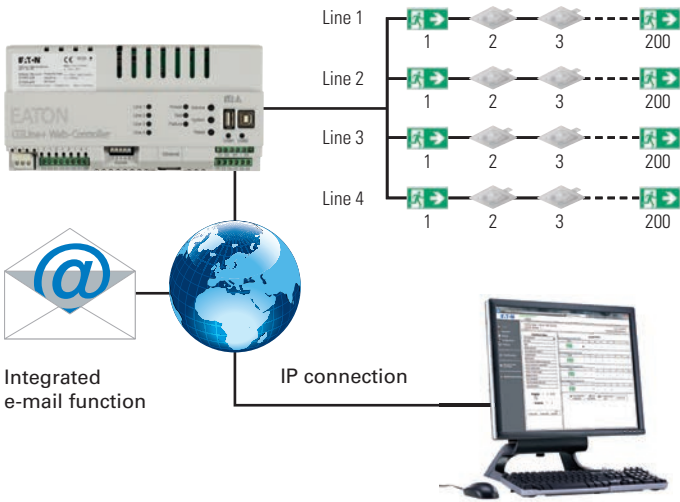

### Safety under control worldwide

An integrated web server is available for convenient visualisation, control and monitoring of all connected CGLine+ luminaires. The controller can be accessed from any PC with an IP connection and a regular web browser without requiring any special software.

### Automatic e-mail notification in case of faults

The integrated e-mail service automatically sends e-mails to up to ten recipients in case of allocatable events, for example in case of critical status. The aim of this function is to actively notify without delay those persons responsible for building safety about any faults, even if they have no direct connection with the controller at that point in time.

### Cyber-security protected

As resilience against cyber-attacks is critical, CGLine+ has been updated to be compliant with the rigorous Eaton cyber-security policy with 128bit SSL encryption, HTTPS web server encryption and TLS email encryption.

### Tests are not forgotten, and are carried out at the right intervals for maximum safety

The timing and the intervals of regular function and duration tests can be conveniently and precisely set down to the minute, ensuring that the equipment is ready for operation at any time during the operating hours of the building. All test results are stored in the electronic log book for at least four years, in compliance with standards.

### CGLine+ Bus

The communication of all data and commands takes place using the CGLine+ bus installed in a free topology using a two-wire unshielded cable.

**Please ask for the dedicated CGLine+ brochure for detailed information about all features provided by the CGLine+ system.**

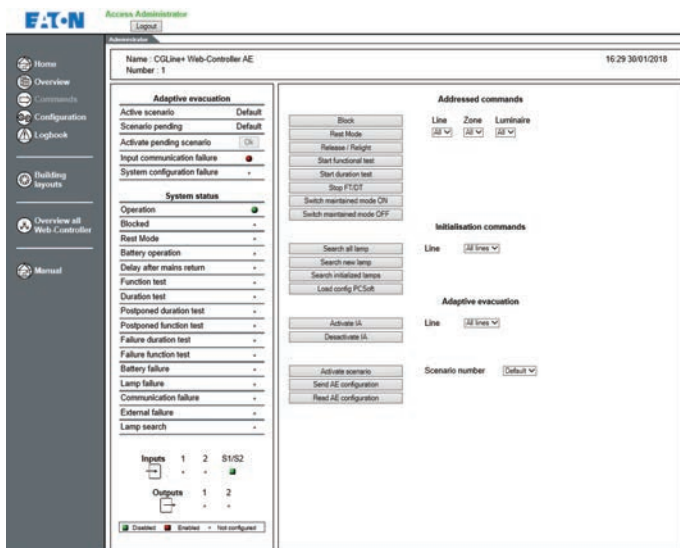

12

## Easy planning & commissioning

The AE CGLine+ system can combine standard CGLine+ luminaires and luminaires with Increased Affordance functionality or a flexible solution with a changeable display like the Matrix CGLine+. Thus, there is only one system for standard emergency lighting and Adaptive Evacuation which means less installation effort and less complexity when planning and commissioning.

## High range back-up

The system has an internal power back-up for the controller in order to be able to react to the trigger even though the mains supply might be broken.

The back-up supply is designed to keep the controller working for at least 3 hours with the maximum possible 800 luminaires connected to the 4 lines.

The function of the back-up is monitored and failure information will be submitted to the Controller if maintenance is required.

## Long life system and low operating cost

The battery and charging technology of the back-up power supply ensures a long life time of the system. The electronics are designed for lowest losses, resulting in low operating cost. The battery can be easily replaced in order to keep the system ready in the shortest time.

## Use any trigger you need

Dry contacts allow the connection of any trigger (Fire, CCTV, etc.) regardless the manufacturer, to the Eaton AE system. Commonly used, dry contacts are an easy and safe way of communication without the need for special protocols or gateways.

### AE CGLine+ System configuration:

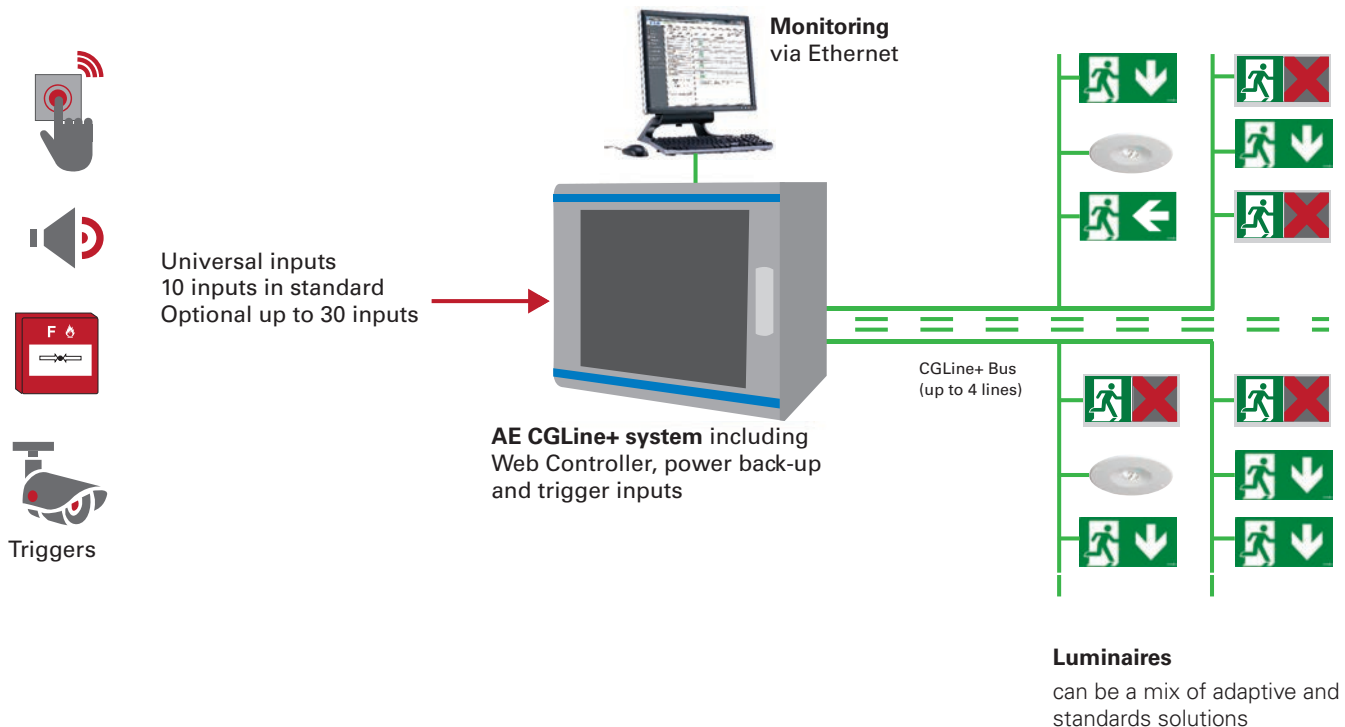

# 12.4 Adaptive Evacuation

## Planning & programming Adaptive Evacuation

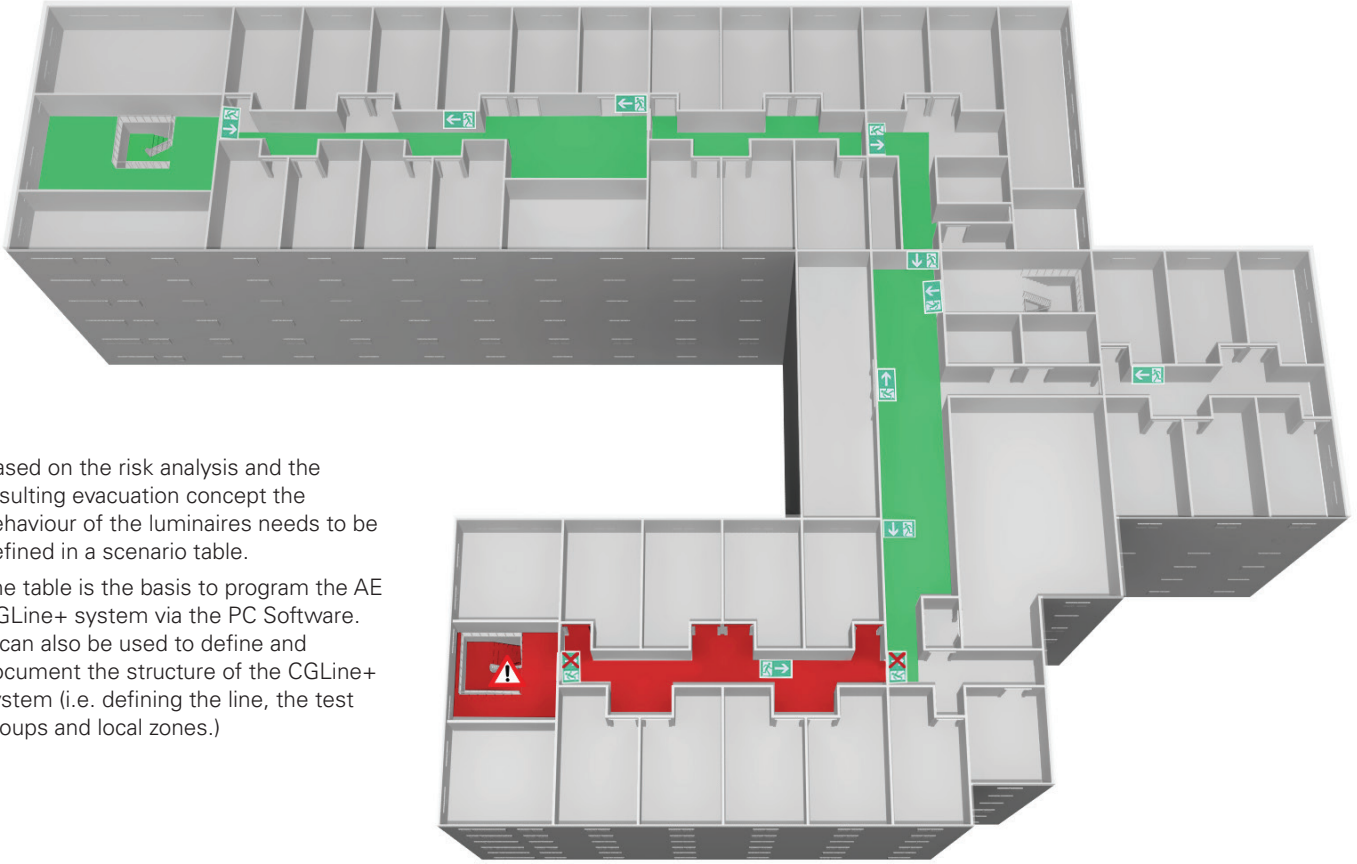

12

Based on the risk analysis and the resulting evacuation concept the behaviour of the luminaires needs to be defined in a scenario table.

The table is the basis to program the AE CGLine+ system via the PC Software. It can also be used to define and document the structure of the CGLine+ system (i.e. defining the line, the test groups and local zones.)

### AE CGLine+ Scenario definition

Project name	
Description	

Name \_\_\_\_\_

Position \_\_\_\_\_

Signature \_\_\_\_\_

Date / Revision \_\_\_\_\_

Adr.(1-800)	ID (Unique ID of luminaire)	Test Group	Zone	Name	Information (luminaire description)	Category (Standard, IA, Matrix)	Default	Scenario 1	Scenario 2	Scenario 3
1	ED93EF	1	1	Luminaire 001	Matrix 1-3h CGLine +	Matrix	SD	BR	SX	MD
2	BB48F8	2	1	Luminaire 002	Matrix 1-3h CGLine +	Matrix	SR	BR	SX	SX
3	ECFB8C	1	1	Luminaire 003	Matrix 1-3h CGLine +	Matrix	BL	SX	BR	MR
4	ECFF6B	2	1	Luminaire 004	CrystalWay 1-8h IA CGLine +	IA	B	B	B	B
5	BCFD67	1	1	Luminaire 005	NexiTech 3h IA CGLine+	IA	S	B	B	B

S : Static  
 B : Blinking  
 P : Pulsing  
 M : Moving  
 OFF : Blank

D : Down  
 L : Left  
 R : Right  
 U : Up  
 X : Red X

## Programming the scenarios with PC-Software

Configuration of the CGLine+ system is carried out using the CGLine+ PC software. Short addresses and unique names of luminaires can be assigned. Using this software, the time and interval of automatic tests are specified together with the zone assignment and the definition of test groups. As a result, the entire system can be configured in offline mode regardless of whether the IT network is available.

With the new AE programming capability, it can be easily programmed by mouse click how each AE luminaire will react per scenario.

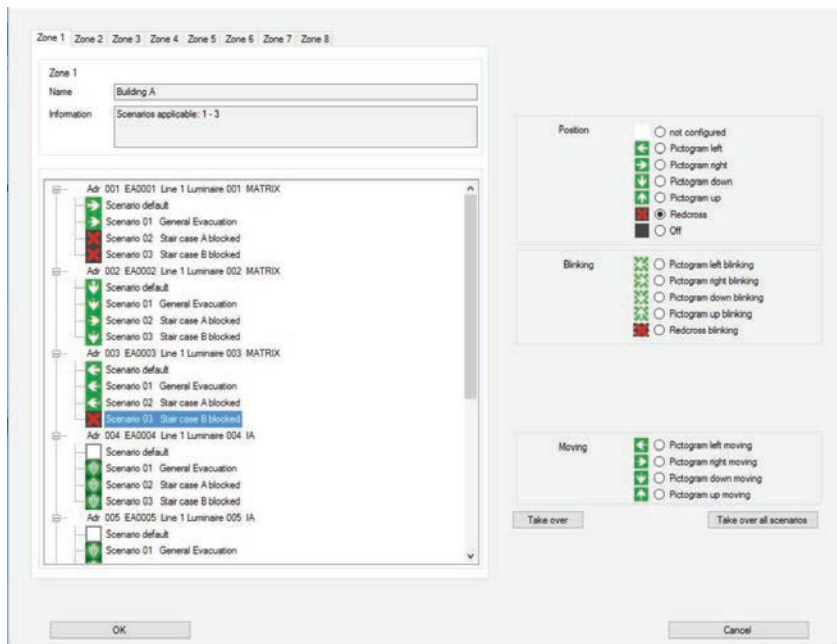

Configuration of an AE Matrix luminaire

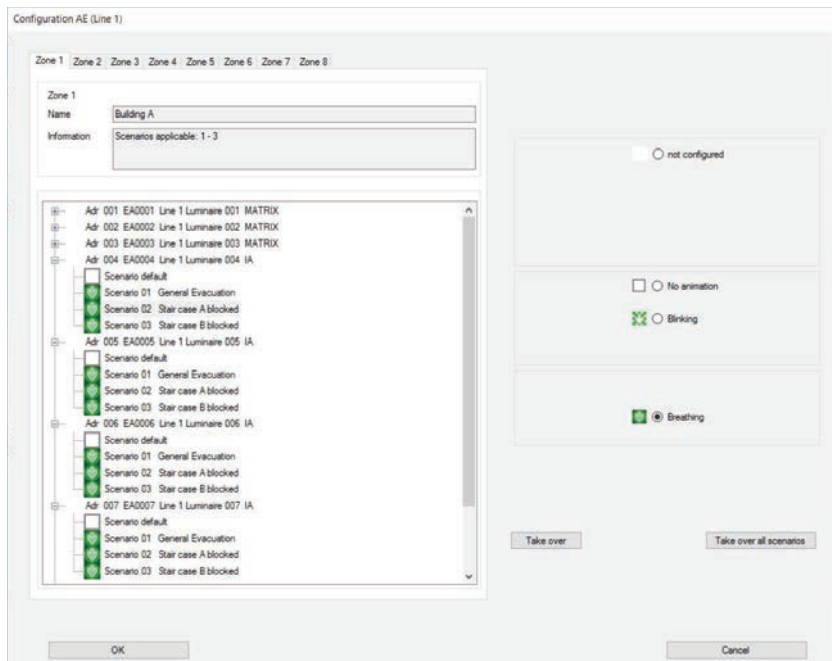

Configuration of a luminaire with IA functionality

In a tree structure all luminaires with AE and Increased Affordance (IA) capability are shown. For the currently selected luminaire it can be chosen which arrow direction will be displayed per scenario or if the luminaire will display a red cross (static or blinking) to block an unsafe route.

A scenario can be a mix of adaptive luminaires like the Matrix luminaire and other luminaires with IA functionality. Thus, in addition to the possibility to direct people in a safer direction, with the IA functionality the visibility of the exit signs can be increased and the urgency of the evacuation is emphasized.

For IA mode with the Matrix luminaire two different options are available: it can be chosen if the arrows will blink or move in the direction the arrows are directing.

CGLine+ luminaires with IA function can be programmed in the same way. Here it is possible to choose between pulsing (a smoother on and off) or blinking.

For more convenience, configurations can be copied to luminaires with same behaviour, for example for an exit with several doors side by side often used in big buildings.



# 12.5 Adaptive Evacuation

Installation of AE CGLine+ system

## Installation

The AE CGLine+ system is wall mounted and features a metal housing with a glass door providing quick visual inspection of the power back-up in addition to the web-monitoring function. There are provisions for cable entries from the top and additional openings in the back of the housing for connection of the inputs, the CGLine+ lines and the mains supply.

An additional service hatch helps accessing the cabling area during installation and commissioning.

The front door can be equipped with a key (optional accessory) to avoid unauthorized access to the system.

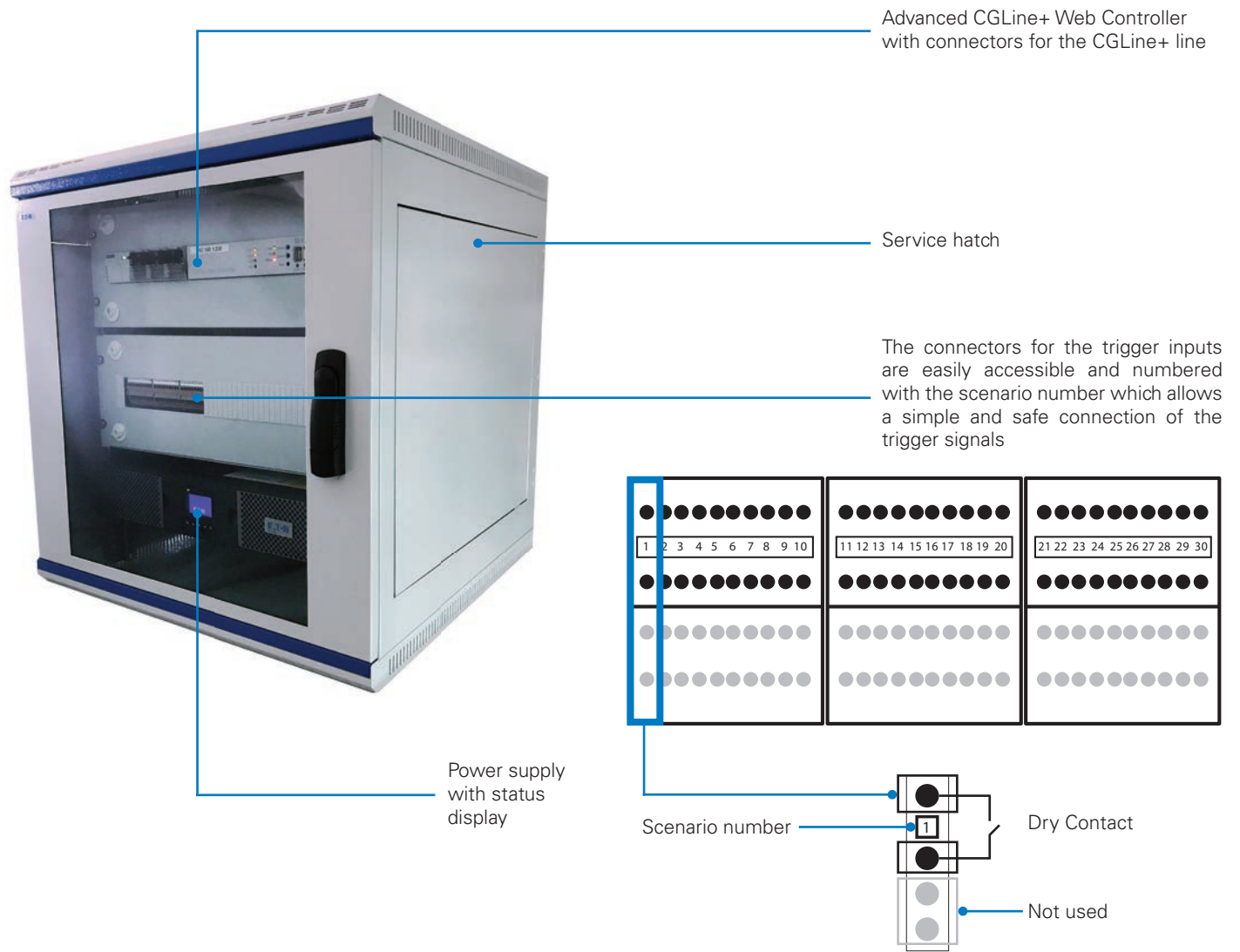

### Dimensional drawings:

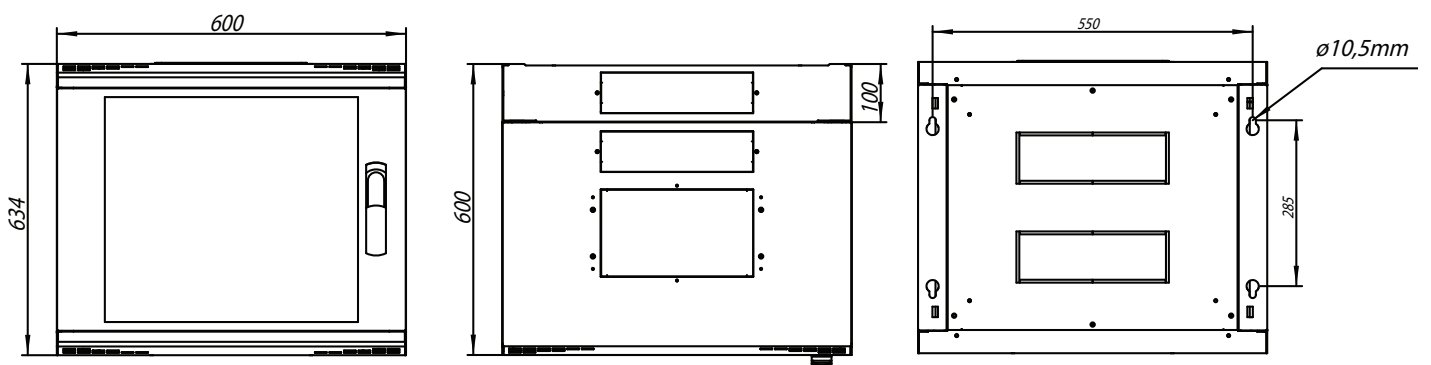

AE CGLine+ system



AE CGLine+ system without power back-up



Accessory kit for cable entry

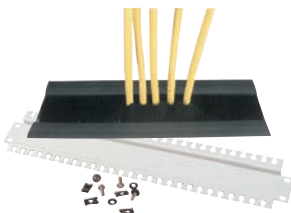

## Adaptive Evacuation CGLine+ System

- System based on CGLine+ technology which enables controlling and monitoring of static emergency luminaires as well as luminaires for Adaptive Evacuation and Increased Affordance
- Including power back-up ensuring secure function of the controller in case of failure of controller's power supply. Optional available without power back-up in case of an existing secured mains supply on site
- With 10 to 30 universal switching contacts (dry contacts) which can be easily connected to triggers like fire systems, CCTV monitoring systems, etc.
- For connecting up to 800 luminaires ( 4 lines with 200 or 2 lines with 400 luminaires)
- Luminaires for Adaptive Evacuation, Increased Affordance and standard CGLine+ products can be freely mixed
- The integrated web server enables convenient visualisation, control and monitoring
- Automatic luminaire search function requiring no manual addressing. Unique ID per luminaires assigned by the manufacturer
- Simple sorting using unrestricted short address assignment
- Unrestricted entry of target location names for the luminaires with up to 20 characters
- Clearly-shown allocation of luminaires to up to 8 zones per line
- Automatic function test and duration test, test interval can be individually defined
- Up to 8 test groups per luminaire can be defined for function test (FT) and duration test (DT)
- Electronic log book storage for a period of minimum 4 years
- E-mail service for sending automatic e-mail in case of malfunctions to up to 10 e-mail addresses, assignable to 2 escalation groups
- Blocking the emergency lighting function during non-operational periods (all / per bus line/ per zone / per luminaire)
- Luminaires in maintained mode switchable (all / per bus line / per zone / per luminaire)
- Password protected access as an administrator or standard user
- Visualisation of luminaires in up to 30 different building layouts
- Efficient and convenient analysis of the log book using the CGLine+ PC software

Dimensions (L x W x H)	With power back-up: 600 x 600 x 634 mm Without power-backup (40071777994): 310 x 145 x 436 mm
Housing type and material	Wall mount – With power back-up: Sheet metal Without power-backup (40071777994): ABS
Degree of protection	With power back-up: IP30 Without power-backup (40071777994): IP65
Power supply	230 V AC, 50/60 Hz
Power consumption	With power back-up: 63 W (max load) Without power-backup (40071777994): 22 W (max load)
Connection inputs	For mains supply: max 2.5 mm <sup>2</sup> For CGLine+: max 1.5 mm <sup>2</sup> For switch inputs (trigger): max. 2.5 mm <sup>2</sup>
Battery (powerback-up)	Lead-acid 4 x 12 V, 7 Ah
Permissible ambient temperature	0 ... 35°C
Weight	With power back-up: 55 kg Without power-backup (40071777994): 3.6 kg

## Ordering details

Type	Order No.	Scope of supply
AE CGLine+ System, 3 h backup, 10 inputs	<b>40071777991</b>	Including Advanced CGLine+ Web Controller and power back-up for up to 3 h emergency duration, connectors and input module for 10 trigger inputs, wall mount housing made from sheet metal
AE CGLine+ System, 3 h backup, 20 inputs	<b>40071777992</b>	Including Advanced CGLine+ Web Controller and power back-up for up to 3 h emergency duration, connectors and input modules for 20 trigger inputs, wall mount housing made from sheet metal
AE CGLine+ System, 3 h backup, 30 inputs	<b>40071777993</b>	Including Advanced CGLine+ Web Controller and power back-up for up to 3 h emergency duration, connectors and input modules for 30 trigger inputs, wall mount housing made from sheet metal
AE / IA CGLine+ System, 10 inputs *), (without power back-up)	<b>40071777994</b>	Including Advanced CGLine+ Web Controller, input module for 10 trigger inputs, wall mount housing (plastic), for AE systems with an existing secured mains supply on site and for advanced IA system
PC Software CGLine+	<b>40071361178</b>	CGLine+ PC Software, for programming of standard CGLine+ systems as well as AE and IA systems
Accessory kit for cable entry from top (Not for 40071777994)	<b>40071777996</b>	Brush strip for cable entry (EATON NWS-2/BUE/LEI/KF) and a cable tie rail for 19" inch housing (EATON NWS-KBL/B19/M)

\* 20 or 30 inputs on request



## Safety luminaires

Indoor / High degree of protection

GuideLed SL .....	30
Planète 400 Disc .....	32
Micropoint 2 .....	36
Micropoint 2 High Output .....	38
FlexiTech SE .....	42
3583 LED .....	46
Halo-pack 2 .....	47
i-P65+ .....	52
Outdoor Wall .....	54
Planète 400 Tube CGLine+ .....	55



## Safety & exit signs

Indoor / High degree of protection

NexiTech LED .....	60
NexiLite .....	66
SafeLite .....	68
Atlantic LED .....	74
i-P65 .....	76



## Exit signs

Indoor / High degree of protection

CrystalWay .....	82
GuideLed .....	84
FlexiTech ED .....	88
71811 / 71822 LED .....	90
Velos .....	92
Style 28011 / 28021 .....	96
Exit Cube .....	98
Euro X LED .....	100
Style Variant 58011/58021 .....	102
46811 LED CGLine+ .....	104



## Beam lights

Planète 2000 .....	110
BeamTech Small PSU, 1 Light Head .....	114
BeamTech Small PSU, 2 Light Heads .....	116
BeamTech Large PSU, 2 Light Head .....	118
BeamTech Large PSU, 4 Light Heads .....	120
Beamlite II .....	122



## Portable lamps & converters

W 276 LED .....	126
W 270 LED .....	127
Conversion kit LED .....	128
Conversion kit fluorescent range .....	130



## Customization

CrystalWay .....	140
FlexiTech ED .....	142
Velos .....	144
NexiTech .....	146
GuideLed .....	148
Planete .....	149



## Monitoring systems

CGLine+ Web Controller .....	160
CGLine+ Web Compact Controller .....	162
CGLine+ Touchscreen Controllers .....	164



## Increased Affordance

Increased Affordance portfolio .....	174
Increased Affordance system configurations.....	175
TL CGLine+ .....	176
CGLine+ Web Controller .....	177



## Adaptive Evacuation

From static to Adaptive Evacuation.....	180
Matrix CGLine+ luminaire.....	182
AE CGLine+ system.....	184
Planning & programming Adaptive Evacuation.....	186
Installation of AE CGLine+ system.....	188
AE CGLine+ system .....	189





**Adaptive Evacuation (AE)** - In large and complex commercial buildings facing a growing diversity of safety risks from fire to terrorism, evacuation planning is pivotal. To promote safer evacuations, Eaton has developed an Adaptive Evacuation System that, unlike static exit signs, uses digital technology to switch between a number of predefined routes and guide people towards the safest available exit in a given scenario.

**Anti-Panic (Open)** - Area Lighting The part of emergency escape lighting provided to avoid panic and provide illumination allowing people to reach a place where an escape route can be identified.

**Ballast** - The component that controls the operation of a lamp from a specified low or high voltage AC or DC source (typically between 12 and 240 volts).

**Ballast Lumen Factor** - The ratio of the light output of the lamp in emergency operation compared with the light output of the same lamp operated by a reference ballast at its rated voltage and frequency.

**Battery** - Secondary cells providing the source of power during mains failure.

**Battery Capacity** - The discharge capability of a battery, being a product of average current and time, expressed as Ampere-hours (Ah) over a stated duration. Note: At fast rates of discharge the full ampere hour capacity of the battery is not available.

**Candela (cd)** - The unit of luminous intensity.

**Central Power System** - A system in which the batteries for a number of emergency luminaires are housed in one location. Usually for all the emergency luminaires on one lighting sub-circuit, but sometimes for all emergency luminaires in a complete building.

**Colour Temperature (°K)** - All materials emit light when heated (e.g. metal glows red through to white as the temperature increases). The temperature to which a full radiator (or 'black body') would be heated to achieve the same chromaticity (colour quality) of the light source being considered, defines the correlated colour temperature of the lamp, quoted in degrees Kelvin.

**Combined Emergency Luminaire** - A luminaire containing two or more lamps, at least one of which is energised from the emergency supply and the remainder from the normal supply (If the emergency lamp is only illuminated in a mains failure condition this luminaire is regarded for Fire Authority approval as Non-Maintained).

**Design Voltage** - The voltage declared by the manufacturer to which all the ballast characteristics are related.

**Discomfort Glare** - Glare which causes visual discomfort.

**Emergency Lighting** - The lighting provided for use when the supply to the normal mains lighting installation fails.

**Escape Route Lighting** - Lighting provided to ensure that the means of escape can be effectively identified and safely used when a location is occupied.

**Emergency Exit** - The way out of a building, which is intended to be used at any time whilst the premises are occupied.

**Final Exit** - The terminal point of an escape route, beyond which point persons are no longer in danger from fire or any other hazard requiring evacuation of the building.

**Glare** - The discomfort or disability that occurs when there is an excessive change of luminance in the field of vision.

**High Risk Task Area** - Lighting Emergency lighting provided to ensure the safety of people involved in a potentially dangerous process or situation and to enable proper shut down procedures for the safety of the operator and other occupants of the premises.

**Housing 850°C** - Test Mandatory test for emergency luminaires used on escape routes, to establish that materials do not burn at a given temperature. Self-extinguishing grades of plastic must be used, or alternatively glass and/or steel.

**Illuminance (lux)** - The luminous flux density at a surface, indicated in  $\text{lm}/\text{m}^2$ .

**Increased Affordance (IA)** - The evacuation of commercial buildings can be inhibited by people's failure to recognise standard emergency exit signs. To improve the safety and speed of evacuations through better visibility of signs, Eaton has introduced an Increased Affordance functionality to its emergency lighting range, which enables exit signs to flash or pulse when activated manually or through automated connection to other evacuation triggers.

**Ingress Protection (IP)** - Number classification of the degree of protection a luminaire provides against the entry of solid foreign bodies and moisture.

**Isolux Diagram** - Diagram showing contours of equal illuminance

**K Factor** - The ratio of the light output from the lamp in its worst condition, normally at end of discharge and with any cable volt drop, to the output at nominal voltage.

**Light Output Ratio (LOR)** - The ratio of the total light output of a luminaire, compared with total lamp light output.

**Lumen (lm)** - The unit of luminous flux used to describe the quantity of light emitted by a source or received by a surface.

**Luminaire** - Apparatus which distributes the light given by a lamp or lamps, including all the items necessary for fixing and protecting the lamps and for connecting them to the electrical supply.

**Luminance ( $\text{cd}/\text{m}^2$ )** - The perceived brightness of a surface, measured by the intensity of light emitted or reflected from a surface area in a given direction.

**Luminous Efficacy ( $\text{lm}/\text{W}$ )** - The ratio of light emitted, to the power consumed by a lamp.

**Luminous Flux (lm)** - The total light emitted by a lamp, measured in lumens.

**Luminous Intensity (cd)** - The power of a light source or illuminated surface to emit light in a given direction, measured in candela.

**Lux** - The unit of illuminance, equal to one lumen per square metre ( $\text{lm}/\text{m}^2$ )

**Maintained Emergency Luminaire** - A luminaire containing one or more lamps, all of which operate from the normal supply or from the emergency supply at all material times.

**Mounting Height** - The vertical distance between the luminaire and the working plane. Note: For emergency lighting the floor is always taken to be the working plane.

**Non-Maintained Emergency Luminaire** - A luminaire containing one or more lamps, which operate from the emergency supply only upon failure of the normal mains supply.

**Rated Duration** - The manufacturers declared duration for a battery operated emergency lighting unit, specifying the time for which it will operate after mains failure. This may be for any reasonable period, but is normally one or three hours (when fully charged).

**Rated Load** - The maximum load which may be connected to the system which will be supplied for the rated duration.

**Re-charge Period** - The time necessary for the batteries to regain sufficient capacity to achieve their rated duration.

**Self Contained Emergency Luminaire** - A luminaire or sign providing Maintained or Non-Maintained emergency lighting, in which all the elements such as battery, the lamp and the control unit are contained within the housing or within 1 metre of the housing.

**Single Point Luminaire** - See self-contained emergency luminaire.

**Slave Luminaire** - An emergency luminaire without its own batteries, which is designed to work in conjunction with a central power system.

**Spacing to Height Ratio (SHR)** - The ratio of the distance between luminaire centres in relation to their height above the working plane. Maximum spacing to height ratio (SHRmax) is the maximum spacing of an array of luminaires that will achieve a ratio of min/max direct illuminance of at least 0.7.

**Standby Lighting** - The part of emergency lighting which may be provided to enable normal activities to continue in the event of a mains supply failure.

**Sustained Emergency Luminaire** - See combined emergency luminaire.

**Uniformity** - The ratio between minimum illuminance (or luminance) to average illuminance (or luminance), usually measured at the working plane.



### Spare Parts

Access to Authorized Eaton Spare Parts



### Onsite Support

Let Eaton be your Engineering Partner



### Site Inspection & Survey

Maximize Safety



### Technical Training

Peace of Mind



### Remote Support

Let Eaton be your Engineering Partner



### Preventative Maintenance

Preventative Maintenance Pays



### Update & Upgrade

Energy Savings & Efficiency



### Fit-Out

Solutions that Fits

Service portfolio may be different from one country to another. For more information, please contact your local sales team.





# Emergency Lighting Central Power Systems

Most of the self-contained luminaires shown in this catalogue are also available for central power systems.

For more information, please ask your usual Eaton contact.



Eaton is a power management company with 2018 sales of \$21.6 billion. Its energy-efficient solutions help customers effectively manage electrical, hydraulic and mechanical power more reliably, safely and sustainably. The company is dedicated to improving the quality of life and the environment through the use of power management technologies and services. Eaton employs 99,000 people worldwide, and sells products to customers in more than 175 countries.

For more information, visit [Eaton.com](https://www.eaton.com).

**Eaton Industries Manufacturing GmbH**

Electrical Sector EMEA  
Route de la Longeraie 7  
1110 Morges, Switzerland  
[Eaton.eu](https://www.eaton.eu)

Changes to the products, to the information contained in this document, and to prices are reserved; so are errors and omissions. Only order confirmations and technical documentation by Eaton is binding. Photos and pictures also do not warrant a specific layout or functionality. Their use in whatever form is subject to prior approval by Eaton. The same applies to Trademarks (especially Eaton, Moeller, Cutler-Hammer and CEAG). The Terms and Conditions of Eaton apply, as referenced on Eaton Internet pages and Eaton order confirmations.

© 2020 Eaton Corporation  
All Rights Reserved

Publication No. CA451012EN  
Provisional copy  
February 2020

Eaton is a registered trademark  
of Eaton Corporation.

All other trademarks are property  
of their respective owners.