

2021

Issue One



Complete Lighting Guide 2021

Manufacturers of quality lighting since 1920

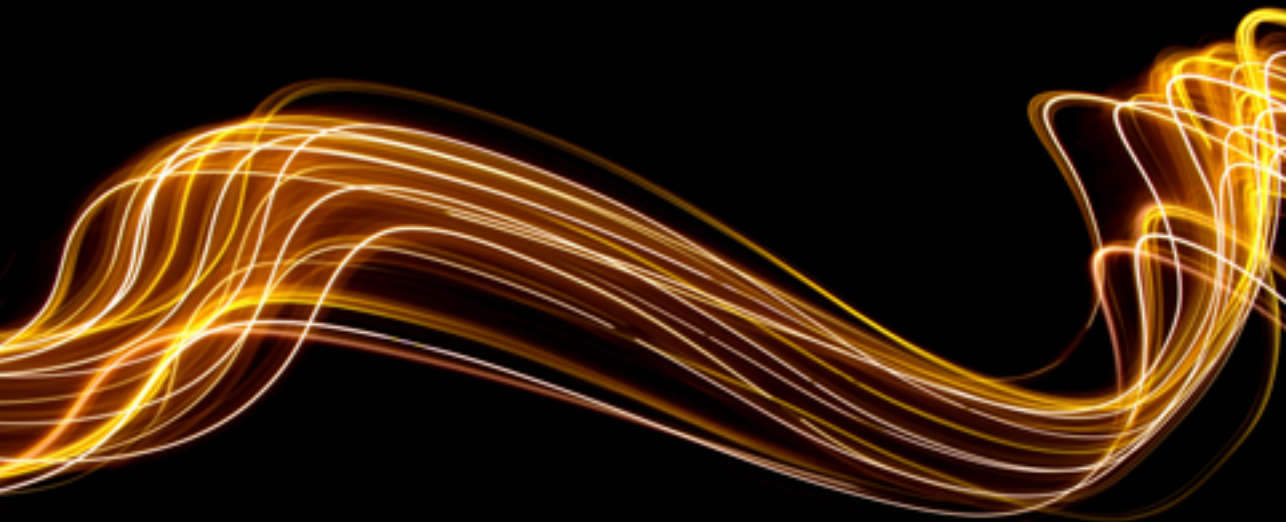

British Electric Lamps Ltd
www.bellighting.co.uk



Certificate Number 12255
ISO 9001: 2015



Exterior Lighting

Floodlights

[Skyline Elite+ Asymmetric LED Floodlight](#) Page 20

[Skyline Elite+ Symmetric LED Floodlight](#) Page 24

[Skyline Elite+ High Output Asymmetric LED Floodlight](#) Page 28

[Skyline Elite Asymmetric/Symmetric LED Floodlight](#) Page 32

[Skyline Slim LED Floodlight](#) Page 36

[Skyline Vista LED Floodlight](#) Page 40

[Skyline Vigor LED Polycarbonate Marine Grade Floodlight](#) Page 44

Wallpack

[Skyline Pro LED Wallpack](#) Page 48

Street Lights

[Strada LED Streetlight](#) Page 52

Bulkheads

[Oberon IP65 LED Bulkhead](#) Page 56

Garden Lights

[Luna Outdoor Wall / Spike Garden Light IP65](#) Page 60

[Luna Grande Outdoor Wall Light IP65](#) Page 66

[Luna LED Ground Light](#) Page 70

Bollards

[Luna LED Integrated Bollard](#) Page 74



Lanterns

[Retro Vintage Lantern](#) Page 78

Interior Lighting

Warehouse Lighting

[Illumina Slim LED High Bay](#) Page 84

[Illumina Linear LED High Intensity High/Low Bay](#) Page 88

[Illumina Calor High Bay](#) Page 92

Battens

[Dura LED Integrated Anti Corrosive Batten](#) Page 96

[Ultra LED Integrated Batten](#) Page 102

[Ultra Slim LED Integrated Batten](#) Page 108

Bulkheads

[Aqua2 LED Bulkhead](#) Page 112

[Aqua3 LED Bulkhead](#) Page 116

[Utilita LED Amenity Bulkhead](#) Page 120

[Deco Slim LED Bulkhead](#) Page 124

[Deco Grande LED Bulkhead](#) Page 130

Panels

[Arial LED Round Panel](#) Page 134

[Arial LED Converter](#) Page 140

[Arial Pro LED CCT Downlight](#) Page 144



[Arial Plus Backlit High Output LED UGR <19 Panel](#) Page 148

[Arial Backlit LED Panel](#) Page 152

[Arial IP65 LED Panel](#) Page 156

[Arial Troffer LED CCT Panel](#) Page 160

Downlights

[Firestay Integrated LED CCT Fixed Downlight](#) Page 164

[Firestay Integrated LED CCT Centre Tilt Downlight](#) Page 170

[Firestay LED Integrated Fixed Centre Tilt Downlight](#) Page 174

[Firestay LED Integrated Fixed Oversize Downlight](#) Page 178

[Firestay Slim Integrated LED Fixed/Centre Tilt Downlight](#) Page 182

[Firestay Non Integrated Downlight](#) Page 186

Accessories

Connectors

[Quick Fix Connector - 3 Pole](#) Page 192

Driver

[LED Driver](#) Page 194

Dimmers

[Smart Universal LED Trailing Edge Dimmer Module](#) Page 196

[LED Grid Dimmer](#) Page 198



Emergency Lighting

Emergency Exit Signs

[Spectrum LED Emergency Hinged Exit Box](#) Page 200

[Spectrum LED Emergency Ultra Slim Exit Box](#) Page 204

Emergency Exit Blades

[Spectrum Emergency Exit Blade](#) Page 208

[Spectrum LED Emergency 6 in 1 Exit Blade](#) Page 212

Emergency Downlights

[Spectrum 1W LED Emergency Non Maintained Downlight](#) Page 216

[Spectrum 3W Recessed Downlight](#) Page 218

[Spectrum 3W LED Emergency Non Maintained Downlight](#) Page 220

[Spectrum 3W LED Emergency Non Maintained Downlight - Surface or Recessed](#) Page 222

Emergency Twin Spots

[Spectrum LED Emergency IP65 Twin Spot](#) Page 224

Emergency Bulkheads

[Spectrum LED Emergency Mini Bulkhead](#) Page 226

[Spectrum LED Emergency Bulkhead / Recessed](#) Page 228

[Spectrum Pro LED Emergency IP65 Bulkhead](#) Page 232



LED Lamps

LED GU10 Dimming

[Dimming Chart](#) Page 240

GU10 Lamps

[LED Halo GU10](#) Page 242

[LED Halo Elite GU10](#) Page 246

[LED Halo Glass GU10](#) Page 250

[LED Halo Elite Glass GU10](#) Page 252

[LED Dim to Warm GU10](#) Page 254

[LED Long Neck GU10](#) Page 256

[LED Pro Precision GU10](#) Page 258

[LED Coloured GU10](#) Page 260

MR16 Lamps

[LED Halo MR16](#) Page 262

MR11 Lamps

[LV LED Halo MR11](#) Page 264

AR111 Lamps

[LED AR111](#) Page 266

[LV LED AR111](#) Page 266

[6 LED AR111](#) Page 266



LED PAR Lamps

[LED PAR Lamp](#) Page 270

[LED Coloured PAR 38 Lamp](#) Page 274

LED Filament Lamps

[LED Filament Candle](#) Page 276

[LED Filament Round](#) Page 282

[LED Filament GLS](#) Page 286

[LED Filament Squirrel Cage](#) Page 290

[LED Filament Tubular](#) Page 292

[LED Filament Clear Globe](#) Page 294

[LED Filament Satin Globe](#) Page 296

LED Fairy Lamps

[LED Fairy Lamps](#) Page 298

LED Soft Coil Lamps

[LED Soft Coil Candle, GLS & Squirrel Cage](#) Page 300

[LED Soft Coil Pear Drop & Large Globe](#) Page 302

[LED Soft Coil Gunmetal Large Globe & Squirrel Cage](#) Page 304

LED Vintage Lamps

[LED Vintage Squirrel Cage](#) Page 306

[LED Vintage Globe](#) Page 308

[LED Vintage Candle](#) Page 310

[LED Vintage Tubular](#)

Page 312

LED Candle Lamps

[LED Candle](#)

Page 316

LED Round Lamps

[LED Round](#)

Page 322

LED GLS Lamps

[LED GLS](#)

Page 326

LED Photocell Lamps

[LED Photocell GLS](#)

Page 332

Imperium LED High Power Lamps

[Imperium LED High Power Lamp](#)

Page 334

LED Coloured Filament Lamps

[LED Coloured Filament GLS](#)

Page 338

LED Coloured Lamps

[LED Coloured Round & GLS](#)

Page 340

LED Reflectors

[LED Reflector](#)

Page 342

LED Appliance Lamps

[LED Appliance](#)

Page 344

[LED Cooker Hood](#)

Page 344

[LED Pygmy](#)

Page 344



LED G4/G9 Capsules

[LED G4 Capsule](#) Page 346

[LED G9 Capsule](#) Page 346

LED Square Lamps

[LED Square 2/4Pin](#) Page 348

LED 110V Lamps

[LED 110V GLS](#) Page 350

LED Amenity Lamps

[LED BLD](#) Page 352

[LED BLT](#) Page 352

[LED BLL](#) Page 354

[LED BLS](#) Page 354

[LED Strip](#) Page 356

[LED Strip Architectural](#) Page 356

[LED T8](#) Page 358

CFL Lamps

[T3 Mini Spiral/Spiral](#) Page 362

[T3 4U Eco](#) Page 364

[BLD](#) Page 366

[BLT](#) Page 368



BLS	Page 370
BLL	Page 372
T9 Triphosphor Circular	Page 374
T5 Triphosphor Circular	Page 376
Square	Page 378
T5 Triphosphor Mini Tube	Page 380
T5 Triphosphor High Efficiency Tube	Page 382
T5 Triphosphor High Output Tube	Page 384
T8 Triphosphor Tube	Page 386

Halogen Lamps

Class C Halogen Capsule	Page 388
LV Capsule UV Block	Page 388
110V 117mm Linear	Page 390
Class 'C' Energy Saving 78/117mm R7's Linear	Page 390

Incandescent Lamps

Appliance Lamps	Page 392
Pygmy/Small Sign	Page 394
Night Light	Page 394
Glossary	Page 396



Energy Saving Calculations are now available whenever and wherever you are

BELL Lighting Energy Saving Calculator is a handy, easy to use tool for all lighting professionals. Simply enter your current and proposed lighting, along with electricity costs.

Hit calculate for full data including;

- Energy Saving
- Annual Cost Saving
- Savings Over Life Of Lamps
- Annual Energy Saving
- CO₂ Saving
- Built in option for control gear calculations





Lighting Design, a dedicated team of specialist engineers ready to help

Our team of professional lighting designers and engineers have over 50 years of experience in the lighting industry. We know the importance of good lighting design and the benefits a lighting engineer will bring to a project. Our lighting design service ensures correct light levels are achieved in compliance with current regulations.

Our specialised knowledge of lighting and lighting control systems provides a smooth hassle free process, delivering beautiful energy saving lighting solutions on time and on budget.



Working within the UK and internationally, the lighting team have established a reputation for designing a broad range of exciting projects of all sizes, from single rooms through to partnerships with multi-disciplined design teams on large infrastructure projects.

We are a responsive and fast moving team who can manage the complete lighting design process from concept through to the tender & supply

For all internal, external & emergency projects contact:

lightingdesign@belllighting.co.uk

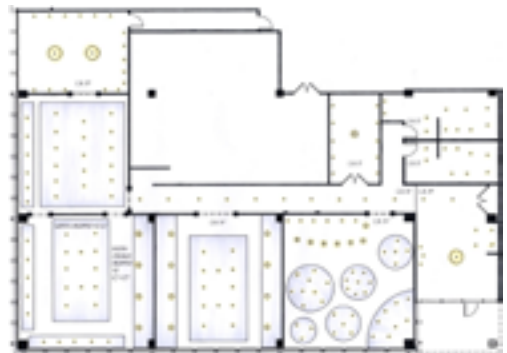

technical@belllighting.co.uk
sales@belllighting.co.uk



The BELL Difference - Research, Quality Control & Testing Facilities

14

British Electric Lamps Ltd. was established in 1920 and has built a reputation within the industry for manufacturing quality products and providing excellent service to our customers.

British Electric Lamps Research and Development department was established in 2012, this was augmented by the Lighting Laboratory and the Quality Control/Quality Assurance facility in 2013.

Secure Life Testing Area situated on-site next to the National Distribution Centre, batch tests all manufactured items to ensure continuity to life standards.



All products manufactured by British Electric Lamps undergo a stringent set of quality control procedures, carried out in accordance with the latest standards.

Be assured that when you choose BELL lamps or fittings you are getting the most energy efficient units available today, saving you money, energy and reducing your carbon footprint.





The Photometric Sphere tests all lamp output data; lumens, spectrum, colour temperature, power factor and actual power. This allows availability of photometric data and illumination data for lighting design schemes.



Thermal Imaging Cameras are used to ensure correct operation and thermal management of LED products. Thermal management is essential for LED products to prevent limited lamp life and lumen depreciation.



Extreme Electrical Conditions tests are carried out on each batch of our LED lamps in line with EN 62560:2012. All of the electrical safety tests are carried out after the lamps have aged at 35°C and 95% relative humidity in our environmental chamber.



Needle Flame Tests ensure that all insulating parts in lamps and fixtures are flame retardant.



Post production QC testing & inspection to ensure safe current protection of the product.



Circuit Overload Protection and circuit wattage is tested on product batches to ensure safety and compliance to EN60598.



Extensive Dimmer Compatibility Testing is performed on all LED products to ensure performance of smooth dimming, high loading compatibility and overall stability.



Cap Torque Test, calibrated torque test is carried out on all lamps to ensure products retain cap strength before and after life testing.

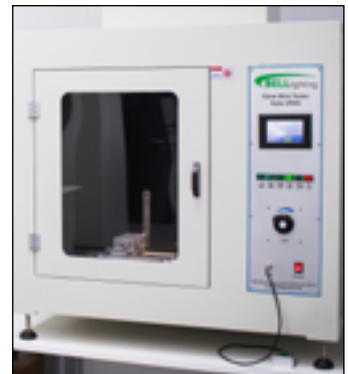

Glow Wire Test is performed on all lamps and fixtures to ensure that construction materials are self extinguishing.



BELL celebrates over 100 years in business 1920-2021!

16

In May 1920 Edwin Grote, founder, established an incandescent lamp factory in Wimbledon, London manufacturing unique incandescent decorative light sources. The company is still completely owned by Chairman Michael Grote and Managing Directors Trevor & Ralph Grote.

1940

During World War 2 the lamp making machinery was converted to produce components for the military to help fight against the German war machine.

2013

New laboratory and Quality Control facility built on-site in Normanton to meet requirements for new stringent EU safety and performance standards.

1920

Mr E R Grote, Founder, established an incandescent lamp factory in Wimbledon, manufacturing unique incandescent decorative lights.

1980

A national distribution centre was established in West Yorkshire to facilitate national next day delivery across the UK and Southern Ireland.

2020

Further expansion of the warehousing capacity along with a state of the art showroom, conference facility & hospitality centre.





2021 Expansion Moving forward into the new decade.

Due to continued growth, BELL Lighting have expanded into additional warehousing facilities in the heart of West Yorkshire. With a combined 100,000 square feet, and stocking over 1800 individual product lines, BELL Lighting are able to deliver on time and on budget with our next day delivery service as standard.

To celebrate our centenary year, we have created our new state of the art conference facility, product showroom and entertainment suite. With the ability to cater for up to 50 people, this is the perfect venue for hosting conferences, meetings and product training sessions. Post event, our entertainment suite is the perfect place to unwind and take a well-earned break. Showcasing the stunning effects Smart Lighting can create in any bar, hotel or restaurant, this is an ideal atmosphere for networking with colleagues and the BELL team.





Warranties and Guarantees

Offering quality products and service has been our mission since inception in 1920. We are still a family owned British company who pride ourselves on our original values of; outstanding innovation for lighting products & providing lighting solutions for our customers.

We have such confidence in our products, that we are now proudly offering up to a 10 year warranty, on all LED products accompanied with 2 year on site support across an extensive range of LED Fixtures. Our transparent warranties and no quibble 2 year support package has propelled us to the forefront of the market while ensuring our customers are backed by the very best support.

You can be assured that with the above guarantee, product life of up to 50,000 hours and on site support your BELL lamps and fittings offer a comprehensive 'fit and forget' solution. Saving energy, CO₂ emissions and the costs associated with maintaining old inefficient units.



3, 5, 7 & 10 Year Guarantee

Bell Lighting will repair or replace any product that fails to operate normally within a 3, 5, 7 or 10 year period (dependent on individual product warranty) from the date of purchase.

2 Year On-Site Warranty

In the event that a product covered by the 2 year On-Site Warranty fails within 2 years of the purchase date Bell Lighting will, where possible, authorise the installer to replace the failed product and reimburse fair and reasonable costs. In the event that agreement can not be reached Bell Lighting engineers will carry out the repair or replacement.

In addition to our extended warranty period, all BELL lighting fittings are rated L80B10, with a 50,000 hour product life. All fittings will still have 80% as a minimum of initial lumens, only 10% as a maximum, may fail to achieve this.



The warranty shall be void in the following circumstances:-

- Non-compliance with installation and safety regulations given in the installation instructions
- Modification or repair of any product by the installer, end user or anyone unauthorised to do so
- Improper use or installation, damage by accident or neglect, of any product by the installer, end user or any third party
- If the product is operated outside of the stated operating temperature of the lamp or luminaire.

¹ Exceeds EU standard of 70 for Lumens Maintenance Ratio ³ Subject to terms & conditions

* All BELL Lighting luminaires are rated L80 B10, so for a 50,000 hour product. L80B10 at 50,000 hours our fittings will still have 80% of initial lumen, only 10% of fittings may fail to achieve this



Customer Rewards Scheme



As a thank you, we have launched our brand new BELL Advance Customer Rewards Scheme. Our aim is to reward loyalty, the more you spend, the more we give back to you, the contractor.

All you have to do is follow these 3 simple steps:

- 1** Register at www.belladvance.co.uk and receive your complimentary reward points along with automatic entry to our monthly prize draw.
- 2** Buy BELL Lighting Products & collect points, take a photo of your invoice and upload.
- 3** Redeem once you have accumulated your well-earned points, simply redeem your rewards in the form of retail vouchers, emailed direct to your inbox.

See above website for full terms & conditions

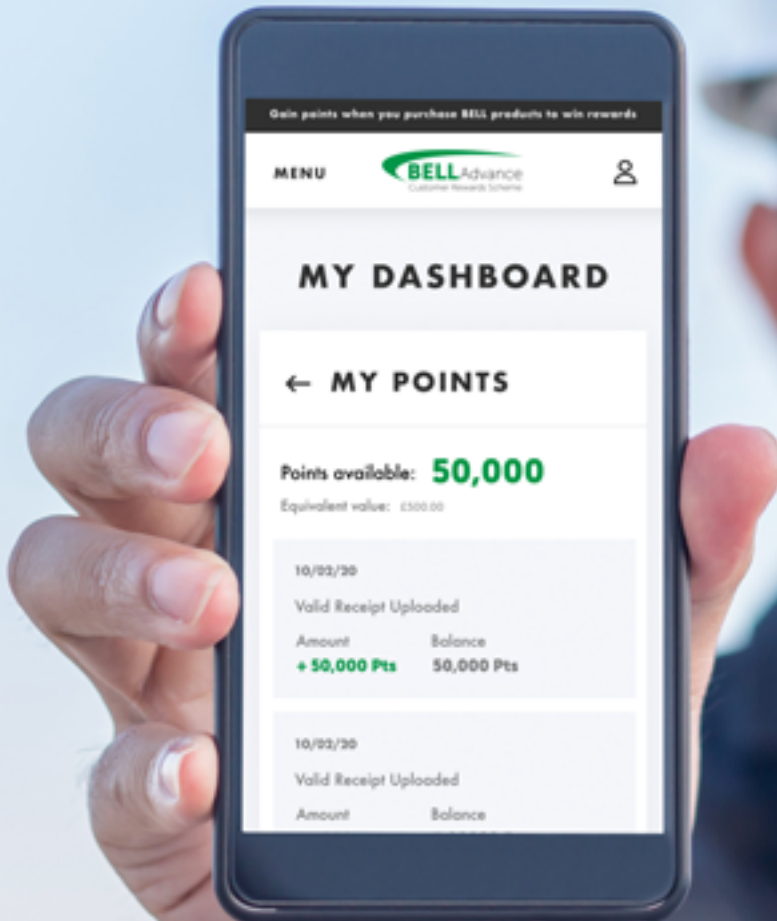



SkylineELITE+

Asymmetric LED Floodlight

Skyline Elite+ represents the latest technology in sports floodlighting. Modern aesthetic, die-cast aluminium construction with asymmetrical high output and high efficiency light distribution. Perfect for large external sports facilities or industrial applications, complete with fully adjustable mounting bracket for precise light direction. Light shielding helps avoid light trespass, giving this unit a 0% ULOR rating.

- 1200W Asymmetric Floodlight
- Genuine replacement for 2000W Metal Halide
- 126 Lm/W
- IP66
- Fully adjustable mounting bracket
- Angle markings for easy alignment
- Asymmetric 0% ULOR
- Low weight & windage when compared with HID luminaires

1200W \equiv 2000 W MH Energy Saving 46%

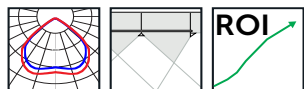
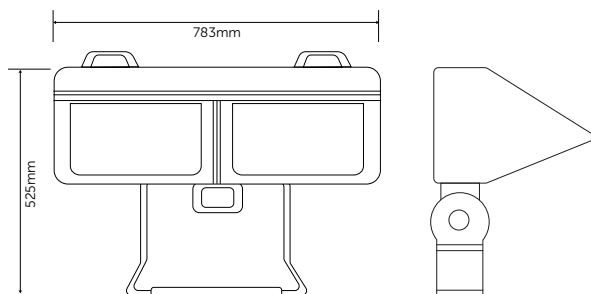

technical@belllighting.co.uk
sales@belllighting.co.uk

SkylineELITE+

Asymmetric LED Floodlight

Technical Specification	
Construction	Die Cast LM6 Aluminium & Polycarbonate lens
Driver	Inventronics 1-10V Dim
LED Chip	Sosen
IP Rating	IP66
Operating Temp	-30°C to +35°C
Input Voltage	100 - 277V (277 - 440V special order)
Power Factor	> 0.9
CRI	80 - Exceeds EU standard of Ra 70 for Colour Rendering Index
LMR	80 - Exceeds EU standard of 70 for Lumens Maintenance Ratio
Weight	28.8 Kg
Windage	0.21M ²

* All BELL Lighting luminaires are rated L80 B10, so for a 50,000 hour product. L80B10 at 50,000 hours our fittings will still have 80% of initial lumen, only 10% of fittings may fail to achieve this

Code	V	W	Description	Lm	Peak Intensity	Temp	Lm/W	Hours
10760	100-277	1200	Asymmetric LED Floodlight	151200	1241.50 cd/klm @ 71°	4000K	126	70000

¹ Exceeds EU standard of 70 for Lumens Maintenance Ratio

² Exceeds EU standard of RA 70 for Colour Rendering Index

³ Subject to terms & conditions (Contact Customer Service)







SkylineELITE+

Symmetric LED Floodlight

Skyline Elite+ represents the latest technology in sports floodlighting. Modern aesthetic, die-cast aluminium construction. With IP66 and low windage ratings this unit can handle the worst weather conditions. Perfect for large external sports facilities or industrial applications, complete with a fully adjustable mounting bracket.

- 600W Symmetric Floodlight
- Genuine replacement for 1500W Metal Halide
- Up to 155 Lm/W
- IP66
- Visor for low upward light
- Low weight & windage when compared with HID luminaires
- Fully adjustable mounting bracket
- Angle markings for easy alignment

600W \equiv 1500W MH Energy Saving **65%**

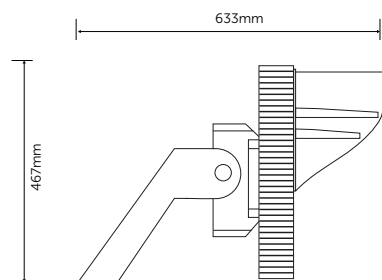

technical@bellighting.co.uk
sales@bellighting.co.uk

SkylineELITE+

Symmetric LED Floodlight

Technical Specification	
Construction	Die Cast LM6 Aluminium & Polycarbonate lens
Driver	Inventronics 1-10V Dim
LED Chip	Sosen
IP Rating	IP66
Operating Temp	-30°C to +35°C
Input Voltage	100 - 277V (277 - 440V special order)
Power Factor	> 0.9
CRI	85 - Exceeds EU standard of Ra 70 for Colour Rendering Index
LMR	80 - Exceeds EU standard of 70 for Lumens Maintenance Ratio
Weight	18.6 Kg
Windage	0.11M ²

* All BELL Lighting luminaires are rated L80 B10, so for a 50,000 hour product. L80B10 at 50,000 hours our fittings will still have 80% of initial lumen, only 10% of fittings may fail to achieve this

Code	V	W	Description	Lm	Peak Intensity	Temp	Lm/W	Hours
10770	100-277	600	Symmetric LED Floodlight 60°	89000	1192.90 cd/klm @ 10°	4000K	148	70000
10771	100-277	600	Symmetric LED Floodlight 30°	93000	2460.60 cd/klm @ 0°	4000K	155	70000

¹ Exceeds EU standard of 70 for Lumens Maintenance Ratio

² Exceeds EU standard of RA 70 for Colour Rendering Index

³ Subject to terms & conditions (Contact Customer Service)





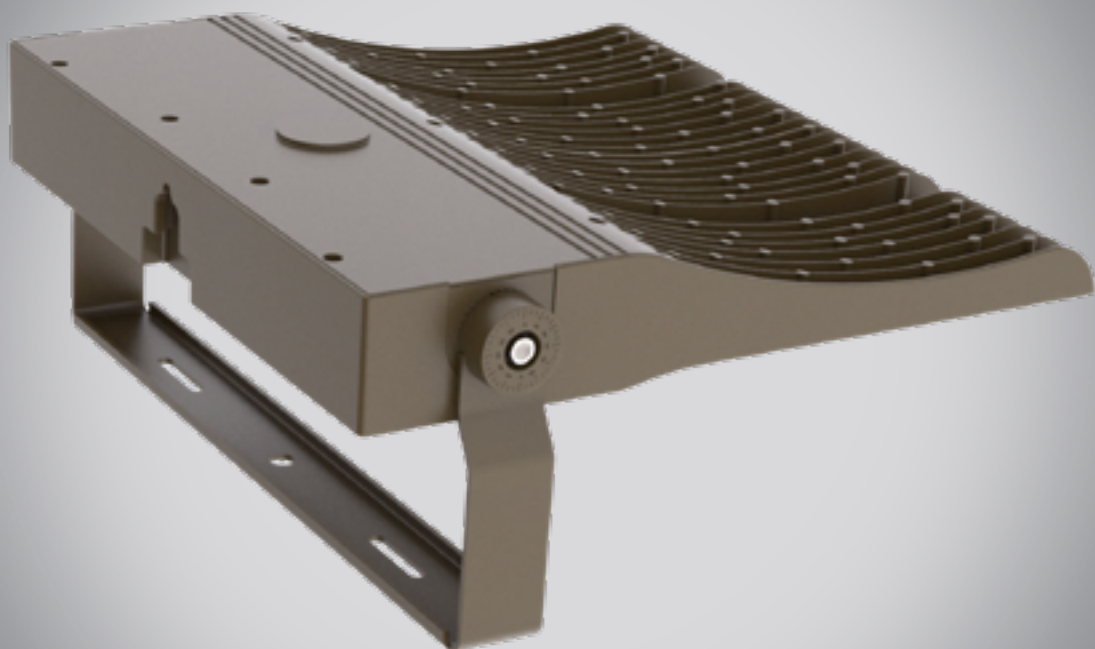

SkylineELITE+

High Output Asymmetric LED Floodlight

Skyline Elite+ represents the latest technology in sports floodlighting. Modern aesthetic, die-cast aluminium construction. With IP66 and low windage ratings this unit can handle the worst weather conditions. Perfect for large external sports facilities or industrial applications, complete with a fully adjustable mounting bracket.

- Genuine replacement for up to 1500W Metal Halide Floodlight
- Perfect for sports, building facade's, landscape, security & car park lighting
- Asymmetric distribution, low light pollution
- Up to 145 Lm/W
- Aerodynamic, streamlined design for reduced windage
- Fully encapsulated IP66 TUV certified driver
- Nichia GRT-V1 LED
- Fully adjustable mounting bracket

300W \equiv 600 W SON MH Energy Saving 50%	450W \equiv 1000 W SON MH Energy Saving 55%	600W \equiv 1500 W MH Energy Saving 65%
---	--	--

--	--	--	--	--	--	--	--	--	--

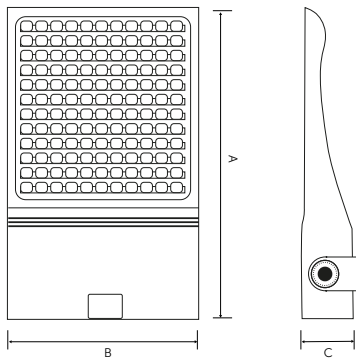

	300W	450W	600W
A	571mm	621mm	621mm
B	322mm	601mm	601mm
C	94mm	104mm	104mm

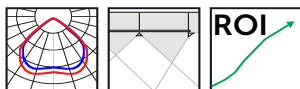

technical@belllighting.co.uk
sales@belllighting.co.uk

SkylineELITE+

High Output Asymmetric LED Floodlight

Technical Specification

Construction	Polyester coated die-cast LM6 Marine Grade aluminium & toughened safety glass
Driver	Sosen (1-10V dimmable)
LED Chip	Nichia GRT-V1
IP Rating	IP66
Operating Temp	-30°C to +45°C
Input Voltage	100 - 277V (277 - 440V special order)
Power Factor	> 0.9
CRI	80 - Exceeds EU standard of Ra 70 for Colour Rendering Index
LMR	80 - Exceeds EU standard of 70 for Lumens Maintenance Ratio
Windage	300W 0.18M ² / 450W 0.37M ² / 600W 0.37M ²
Weight	300W - 8.4Kg / 450W - 16.5Kg / 600W - 18Kg

* All BELL Lighting luminaires are rated L80 B10, so for a 50,000 hour product. L80B10 at 50,000 hours our fittings will still have 80% of initial lumen, only 10% of fittings may fail to achieve this

Code	V	W	Description	Lm	Peak Intensity	Temp	Lm/W	Hours
08867	110-277	300	Skyline Elite+ Asymmetric Floodlight IP66 Type 2	43500	471.10 cd/klm @ 36°	4000K	145	70000
08868	110-277	300	Skyline Elite+ Asymmetric Floodlight IP66 Type 3	43500	488.20 cd/klm @ 44°	4000K	145	70000
08869	110-277	300	Skyline Elite+ Asymmetric Floodlight IP66 Type 4	43500	523.40 cd/klm @ 58°	4000K	145	70000
08870	110-277	450	Skyline Elite+ Asymmetric Floodlight IP66 Type 2	62250	459.60 cd/klm @ 32°	4000K	138	70000
08871	110-277	450	Skyline Elite+ Asymmetric Floodlight IP66 Type 3	62250	488.30 cd/klm @ 44°	4000K	138	70000
08872	110-277	450	Skyline Elite+ Asymmetric Floodlight IP66 Type 4	62250	500.50 cd/klm @ 58°	4000K	138	70000
08873	110-277	600	Skyline Elite+ Asymmetric Floodlight IP66 Type 2	87000	474.60 cd/klm @ 32°	4000K	145	70000
08874	110-277	600	Skyline Elite+ Asymmetric Floodlight IP66 Type 3	87000	488.20 cd/klm @ 44°	4000K	145	70000
08875	110-277	600	Skyline Elite+ Asymmetric Floodlight IP66 Type 4	87000	546.50 cd/klm @ 60°	4000K	145	70000

¹ Exceeds EU standard of 70 for Lumens Maintenance Ratio

² Exceeds EU standard of RA 70 for Colour Rendering Index

³ Subject to terms & conditions (Contact Customer Service)







SkylineELITE

Asymmetric/Symmetric LED Floodlight

Designed and engineered in the UK specifically to meet the requirements for sports lighting and to reduce light pollution levels. The Skyline Elite is a high specification floodlight with a 70,000 hour lifespan, 7 year guarantee and 2 year on site warranty.

- Genuine replacement for 250/400/600W Metal Halide/Sodium Floodlight
- Perfect for sports, building facade's, landscape, security & car park lighting
- Asymmetric distribution, low light pollution (Asymmetric version)
- Up to 133 Lm/W
- Surge protected 10,000V (250/240W) & 4000V (80W) for lighting protection
- Cool White
- Aerodynamic, streamlined design for reduced windage
- Fully encapsulated IP66 TUV certified driver
- Nichia GRT-V1 LED / Meanwell Driver
- Long life 70,000 hours (L80 B10 @ 25°C)
- Robust construction IP66
- Standard universal mounting bracket
- Supplied pre-flexed (1.5M), tool free entry and construction for simple and quick installation
- Air pressure equalisation feature to eliminate capillary effect

80W \equiv 250 W MH/SON Energy Saving 68%	150W \equiv 400 W MH/SON Energy Saving 63%	240W \equiv 600 W MH/SON Energy Saving 60%
---	--	--

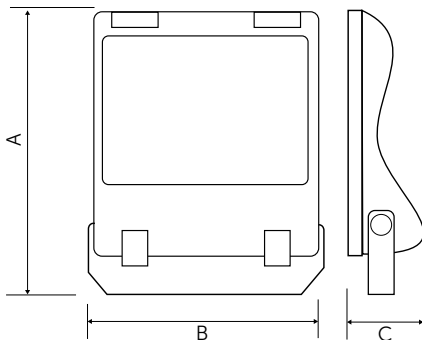

	80W	150W	240W
A	360mm	325mm	418mm
B	265mm	413mm	452mm
C	82mm	83mm	87mm

¹ Exceeds EU standard of 70 for Lumens Maintenance Ratio
² Exceeds EU standard of RA 80 for Colour Rendering Index
³ Subject to terms & conditions (Contact Customer Service)

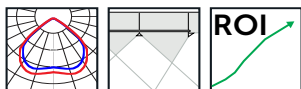

SkylineELITE

Technical Specification

Construction	Polyester coated die-cast LM6 Marine Grade aluminium & toughened safety glass
Driver	Sosen
LED Chip	Nichia GRT-V1
IP Rating	IP66
Operating Temp	-30°C to +35°C
Input Voltage	100 - 264V
Power Factor	> 0.9
CRI	80 - Exceeds EU standard of Ra 70 for Colour Rendering Index
LMR	80 - Exceeds EU standard of 70 for Lumens Maintenance Ratio
Windage	80W 0.1M ² / 150W 0.12M ² / 240W 0.2M ²
Weight	80W - 4.6Kg / 150W - 6.8Kg / 240W - 8.9Kg

* All BELL Lighting luminaires are rated L80 B10, so for a 50,000 hour product. L80B10 at 50,000 hours our fittings will still have 80% of initial lumen, only 10% of fittings may fail to achieve this

Code	V	W	Description	Lm	Peak Intensity	Temp	Lm/W	Hours
08850	110-264	80	Skyline Elite Symmetric	10000	1331.60 cd/klm @ 10°	4000K	125	70000
08851	110-264	80	Skyline Elite Asymmetric	10000	500.00 cd/klm @ 54°	4000K	125	70000
08852	110-264	80	Skyline Elite 30°	10000	2562.40 cd/klm @ 0°	4000K	125	70000
08853	110-264	80	Skyline Elite 15°	10000	5005.70 cd/klm @ 0°	4000K	125	70000
08854	110-264	150	Skyline Elite Symmetric	20000	1377.20 cd/klm @ 8°	4000K	133	70000
08855	110-264	150	Skyline Elite Asymmetric	20000	483.00 cd/klm @ 54°	4000K	133	70000
08856	110-264	150	Skyline Elite 30°	20000	2512.60 cd/klm @ 0°	4000K	133	70000
08857	110-264	150	Skyline Elite 15°	20000	4800.10 cd/klm @ 0°	4000K	133	70000
08858	110-264	240	Skyline Elite Symmetric	30000	1338.80 cd/klm @ 10°	4000K	125	70000
08859	110-264	240	Skyline Elite Asymmetric	30000	501.80 cd/klm @ 50°	4000K	125	70000
08860	110-264	240	Skyline Elite 30°	30000	1566.50 cd/klm @ 0°	4000K	125	70000
08861	110-264	240	Skyline Elite 15°	30000	4587.00 cd/klm @ 0°	4000K	125	70000

¹ Exceeds EU standard of 70 for Lumens Maintenance Ratio

² Exceeds EU standard of RA 70 for Colour Rendering Index

³ Subject to terms & conditions (Contact Customer Service)



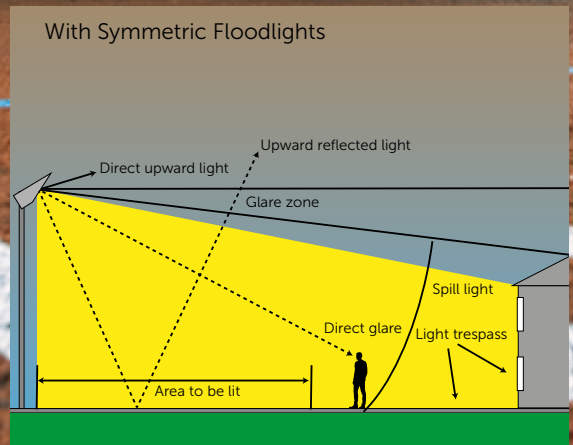
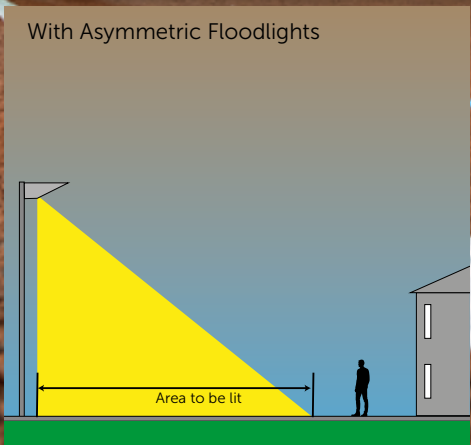



Skylineslim

LED Floodlight

The Skyline Slim LED Floodlight is suitable for a wide range of applications. Available in a vast range of wattages, this low energy floodlight is ideal for any lighting project, big or small.

- 10/20/30/50W Genuine replacement for Halogen Floodlights
- 70/100/150/200W Genuine replacement for Metal Halide Floodlights
- Marine Grade Aluminium body
- Fully encapsulated IP65 TUV certified driver
- PIR Over-ride function
- Average 8M detection range for PIR Floods
- Separately tested IP65 PIR

10W \equiv 120W Energy Saving 91%	20W \equiv 160W Energy Saving 88%	30W \equiv 240W Energy Saving 88%	50W \equiv 400W Energy Saving 88%
70W \equiv 100W MH Energy Saving 30%	100W \equiv 150W MH Energy Saving 33%	150W \equiv 250W MH Energy Saving 40%	200W \equiv 400W MH Energy Saving 50%

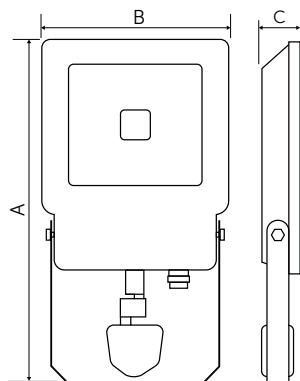

Without PIR

	10W	20W	30W	50W	70W	100W	150W	200W
A	140mm	162mm	183mm	236mm	320mm	320mm	380mm	380mm
B	116mm	142mm	160mm	186mm	245mm	245mm	336mm	336mm
C	39mm	42mm	42mm	57mm	64mm	64mm	72mm	72mm

With PIR

	10W	20W	30W	50W	70W
A	230mm	250mm	270mm	330mm	400mm
B	116mm	142mm	160mm	186mm	245mm
C	39mm	42mm	42mm	57mm	64mm

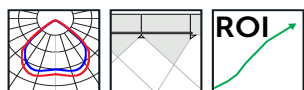

technical@belllighting.co.uk
sales@belllighting.co.uk

Skylineslim

LED Floodlight

Technical Specification

Construction	Die Cast LM6 Marine Grade Aluminium body, Stainless Steel screws and fixings
Driver	Sosen
LED Chip	Bridgelux
IP Rating	IP65
Operating Temp	-20°C to +25°C Outdoor use only
Input Voltage	110 - 240V
Power Factor	> 0.9
CRI	80 - Exceeds EU standard of Ra 70 for Colour Rendering Index
LMR	80 - Exceeds EU standard of 70 for Lumens Maintenance Ratio
Windage	10W 0.018M ² / 20W 0.030M ² / 30W 0.045M ² / 50W 0.066M ² / 70W 0.102M ² 100W 0.102M ² / 150W 0.19M ² / 200W 0.19M ²
Weight	10W Non PIR 0.7Kg / 10W PIR 0.8Kg / 20W Non PIR 1.1Kg / 20W PIR 1.2Kg / 30W Non PIR 1.8Kg / 30W PIR 2.0Kg / 50W Non PIR 2.1Kg / 50W PIR 2.4Kg / 70W Non PIR 3.2Kg / 70W PIR 3.4Kg / 100W Non PIR 3.7Kg / 150W Non PIR 5.1Kg / 200W Non PIR 8.0Kg

* All BELL Lighting luminaires are rated L80 B10, so for a 50,000 hour product. L80B10 at 50,000 hours our fittings will still have 80% of initial lumen, only 10% of fittings may fail to achieve this

Code	V	W	Description	Lm	Peak Intensity	Temp	Lm/W	Hrs
10920	110/240	10	10W Skyline Slim Floodlight	650	481.80 cd/klm @ 0°	4000K	65	50000
10921	110/240	20	20W Skyline Slim Floodlight	1500	467.20 cd/klm @ 0°	4000K	75	50000
10922	110/240	30	30W Skyline Slim Floodlight	2500	353.40 cd/klm @ 0°	4000K	83	50000
10923	110/240	50	50W Skyline Slim Floodlight	4000	359.50 cd/klm @ 0°	4000K	80	50000
10924	110/240	70	70W Skyline Slim Floodlight	7500	352.60 cd/klm @ 0°	4000K	107	50000
10930	110/240	100	100W Skyline Slim Floodlight	9600	350.90 cd/klm @ 0°	4000K	96	50000
10931	110/240	150	150W Skyline Slim Floodlight	15000	337.70 cd/klm @ 0°	4000K	100	50000
10932	110/240	200	200W Skyline Slim Floodlight	20000	326.40 cd/klm @ 0°	4000K	100	50000
10925	110/240	10	10W Skyline Slim PIR Floodlight	650	481.80 cd/klm @ 0°	4000K	65	50000
10926	110/240	20	20W Skyline Slim PIR Floodlight	1500	467.20 cd/klm @ 0°	4000K	75	50000
10927	110/240	30	30W Skyline Slim PIR Floodlight	2500	353.40 cd/klm @ 0°	4000K	83	50000
10928	110/240	50	50W Skyline Slim PIR Floodlight	4000	359.50 cd/klm @ 0°	4000K	80	50000
10929	110/240	70	70W Skyline Slim PIR Floodlight	7500	352.60 cd/klm @ 0°	4000K	107	50000

¹ Exceeds EU standard of 70 for Lumens Maintenance Ratio

² Exceeds EU standard of RA 70 for Colour Rendering Index

³ Subject to terms & conditions (Contact Customer Service)





Western Building Systems: BELL Skyline Slim 200W LED Floodlights

Over the life of the fittings, Western Building Systems could save: £28,000 in energy costs, energy Saving 40%

- Annual Energy Saving 20,996kWh
- Annual CO₂ Saving 11,741kg



Skylinevista

LED Floodlight

The Skyline Vista LED Floodlight offers a super slim compact design ideal for domestic and commercial premises. Available in a variety of wattages and colour temperatures with the option to include a PIR.

- Genuine replacement for Halogen Floodlight
- Super slim compact design
- SMD LED
- Die-cast Aluminium
- Separately tested IP65 PIR Sensor (PIR versions)
- PIR Over-ride function (PIR versions)
- Average 8M detection range for PIR Floods
- Available in 4000K & 2700K

10W \equiv 120W Energy Saving 91% 20W \equiv 160W Energy Saving 88% 30W \equiv 240W Energy Saving 88% 50W \equiv 400W Energy Saving 88%

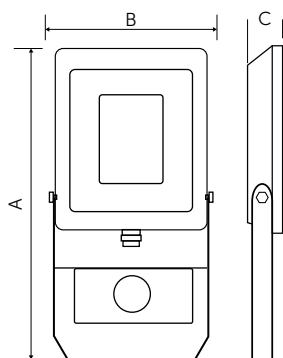

Without PIR

	10W	20W	30W	50W
A	133mm	149mm	177mm	248mm
B	100mm	116mm	145mm	209mm
C	21.5mm	23mm	23mm	23mm

With PIR

	10W	20W	30W	50W
A	215mm	230mm	275mm	347mm
B	117mm	134mm	168mm	223mm
C	46mm	46mm	46mm	46mm

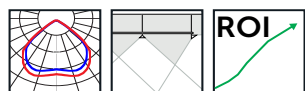

Skylinevista

LED Floodlight

Technical Specification

Construction	Die Cast Aluminium body, Stainless Steel screws and fixings
Driver	BELL
LED Chip	SMD
IP Rating	IP65
Operating Temp	-20°C to +25°C Outdoor use only
Input Voltage	240V
Power Factor	> 0.9
CRI	80 - Exceeds EU standard of Ra 70 for Colour Rendering Index
LMR	80 - Exceeds EU standard of 70 for Lumens Maintenance Ratio
Windage	10W Non PIR 0.013M ² / 20W Non PIR 0.015M ² / 30W Non PIR 0.024M ² / 50W Non PIR 0.053M ² / 10W PIR 0.023M ² / 20W PIR 0.033M ² / 30W PIR 0.043M ² / 50W PIR 0.075M ²
Weight	10W Non PIR 0.32Kg / 10W PIR 0.49Kg / 20W Non PIR 0.39Kg / 20W PIR 0.57Kg / 30W Non PIR 0.54Kg / 30W PIR 0.75Kg / 50W Non PIR 1.1Kg / 50W PIR 1.24Kg

* All BELL Lighting luminaires are rated L80 B10, so for a 50,000 hour product. L80B10 at 50,000 hours our fittings will still have 80% of initial lumen, only 10% of fittings may fail to achieve this

Code	V	W	Description	Lm	Temp	Lm/W	Hours
10700	240	10	10W Skyline Vista LED Floodlight	800	4000K	80	25000
10701	240	10	10W Skyline Vista LED PIR Floodlight	800	4000K	80	25000
10702	240	20	20W Skyline Vista LED Floodlight	1600	4000K	80	25000
10703	240	20	20W Skyline Vista LED PIR Floodlight	1600	4000K	80	25000
10704	240	30	30W Skyline Vista LED Floodlight	2400	4000K	80	25000
10705	240	30	30W Skyline Vista LED PIR Floodlight	2400	4000K	80	25000
10706	240	50	50W Skyline Vista LED Floodlight	4000	4000K	80	25000
10707	240	50	50W Skyline Vista LED PIR Floodlight	4000	4000K	80	25000
10708	240	10	10W Skyline Vista LED Floodlight	800	2700K	80	25000
10709	240	10	10W Skyline Vista LED PIR Floodlight	800	2700K	80	25000
10710	240	20	20W Skyline Vista LED Floodlight	1600	2700K	80	25000
10711	240	20	20W Skyline Vista LED PIR Floodlight	1600	2700K	80	25000
10712	240	30	30W Skyline Vista LED Floodlight	2400	2700K	80	25000
10713	240	30	30W Skyline Vista LED PIR Floodlight	2400	2700K	80	25000
10714	240	50	50W Skyline Vista LED Floodlight	4000	2700K	80	25000
10715	240	50	50W Skyline Vista LED PIR Floodlight	4000	2700K	80	25000

¹ Exceeds EU standard of 70 for Lumens Maintenance Ratio

² Exceeds EU standard of RA 70 for Colour Rendering Index

³ Subject to terms & conditions (Contact Customer Service)







Skyline Vigor

LED Polycarbonate Marine Grade Floodlight

The Skyline Vigor LED Floodlight is a genuine all-rounder. Its polycarbonate construction enables this floodlight to be used in the harshest environments. Ideal for coastal locations and available in both 20W & 30W, with and without PIR.

- Genuine replacement for Halogen Floodlight
- Super slim compact design
- Suitable for coastal areas
- Polycarbonate construction
- Separately tested IP65 PIR Sensor (PIR versions)
- PIR Over-ride function (PIR versions)
- Average 8M detection range for PIR Floods
- Available in 4000K Cool White

20W \equiv $\frac{160}{W}$ Energy Saving 88% 30W \equiv $\frac{240}{W}$ Energy Saving 88%

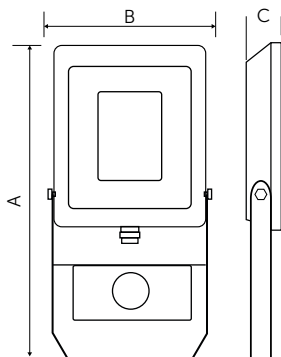

Without PIR

	20W	30W
A	281mm	281mm
B	204mm	204mm
C	37mm	37mm

With PIR

	20W	30W
A	305mm	305mm
B	206mm	206mm
C	40mm	40mm

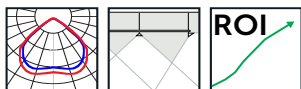

technical@bellighting.co.uk
sales@bellighting.co.uk

Skyline Vigor

LED Polycarbonate Marine Grade Floodlight

Technical Specification	
Construction	Polycarbonate body, Stainless Steel screws and fixings + toughened glass lens
Driver	BELL
LED Chip	SMD
IP Rating	IP65
Operating Temp	-20°C to +25°C Outdoor use only
Input Voltage	240V
Power Factor	> 0.9
CRI	80 - Exceeds EU standard of Ra 70 for Colour Rendering Index
LMR	80 - Exceeds EU standard of 70 for Lumens Maintenance Ratio
Windage	20W Non PIR 0.057M ² / 30W Non PIR 0.057M ² / 20W PIR 0.057M ² / 30W PIR 0.057M ²
Weight	20W Non PIR 0.9Kg / 30W Non PIR 0.9Kg / 20W PIR 1.1Kg / 30W PIR 1.1Kg

* All BELL Lighting luminaires are rated L80 B10, so for a 50,000 hour product. L80B10 at 50,000 hours our fittings will still have 80% of initial lumen, only 10% of fittings may fail to achieve this

Code	V	W	Description	Lm	Temp	Lm/W	Hours
10720	240	20	20W Skyline Vigor LED Floodlight	1700	4000K	85	25000
10721	240	30	30W Skyline Vigor LED Floodlight	2500	4000K	83	25000
10722	240	20	20W Skyline Vigor LED PIR Floodlight	1700	4000K	85	25000
10723	240	30	30W Skyline Vigor LED PIR Floodlight	2500	4000K	83	25000

¹ Exceeds EU standard of 70 for Lumens Maintenance Ratio

² Exceeds EU standard of RA 70 for Colour Rendering Index

³ Subject to terms & conditions (Contact Customer Service)







skylinePRO

LED Wallpack

Designed to be used where the aesthetics of the light fitting, along with a tough robust construction is needed. The fittings are IP65 and IK8 compliant, supplied complete with an opal diffuser for even light distribution. Available in emergency and non emergency versions, the latter having a super-slim profile.

- Genuine replacement for 70W Metal Halide & Sodium
- Fully encapsulated IP65 TUV Certified Driver
- High impact polycarbonate lens
- Up to 65% energy saving
- 50000 hours

Options

- Photocell version complete with Lucy Zodion miniature photocell (55 lux)
- Emergency / Emergency Photocell version
- Asymmetric product available on request



30W \equiv 70W Energy Saving 57%



04425 Standard Version
04428 Photocell Version 30W

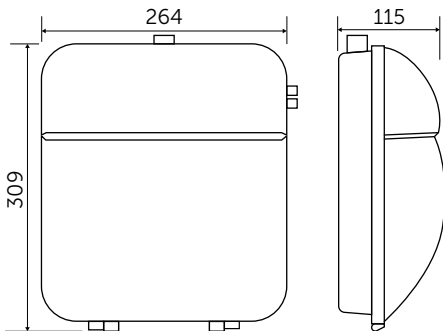

04419 Emergency Version
04417 Emergency / Photocell Version 30W

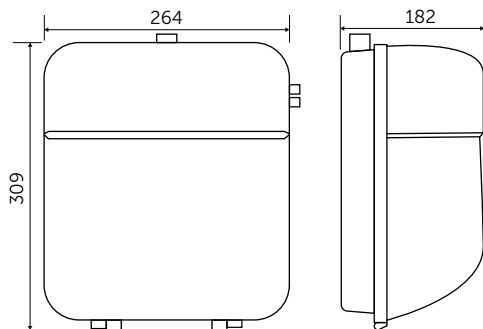

technical@belllighting.co.uk
sales@belllighting.co.uk

SkylinePRO

LED Wallpack

Technical Specification

Construction	Die Cast Aluminium Base / PVC Cover
Driver	Sosen
LED Chip	Samsung
IP Rating	IP65
Operating Temp	-30°C to +35°C / Emergency version minimum temperature -5°C
Input Voltage	100 - 240V (Photocell and emergency versions 240V only)
Power Factor	> 0.9
CRI	80 - Exceeds EU standard of Ra 70 for Colour Rendering Index
LMR	80 - Exceeds EU standard of 70 for Lumens Maintenance Ratio

* All BELL Lighting luminaires are rated L80 B10, so for a 50,000 hour product. L80B10 at 50,000 hours our fittings will still have 80% of initial lumen, only 10% of fittings may fail to achieve this

Code	V	W	Description	Lm	Lm/W	Viewing Angle	Temp	Hours
04425	110/240	30	Skyline Pro LED Wallpack	2550	85	120°	4200K	50000
04428	240	30	Skyline Pro LED Wallpack Photocell version	2550	85	120°	4200K	50000
04419	240	30	Skyline Pro LED Wallpack Emergency version	2550	85	120°	4200K	50000
04417	240	30	Skyline Pro LED Wallpack Emergency Photocell version	2550	85	120°	4200K	50000

Emergency versions must be tested in line with the requirements of BS5266, failure to do so may effect battery life and warranty.

¹ Exceeds EU standard of 70 for Lumens Maintenance Ratio
² Exceeds EU standard of RA 70 for Colour Rendering Index
³ Subject to terms & conditions (Contact Customer Service)









LED Street Light

The Strada LED Street light offers flexibility, it is suitable for use in many locations, including rural towns, car parks and access roads. A precision lens system directs light only where it is needed, reducing overspill. Three wattages for a variety of applications, robust weatherproof construction with IP66 and IK8 rating.

- Ideal for car parks and pedestrian walkways to ensure safe passage of visitors and staff
- Cool White
- Reduced light pollution
- Precision lens system directs light only where it is needed, reducing overspill
- Long life 50000 hours
- Aerodynamic design for reduced windage
- 60mm Side entry
- Nema socket with blanking plug options

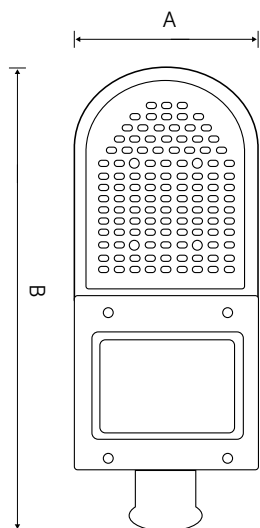

	30W	50W	70W
A	166mm	166mm	202mm
B	478mm	478mm	507mm
Depth	81mm	81mm	88mm

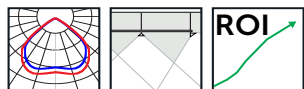

technical@belllighting.co.uk
sales@belllighting.co.uk



LED Street Light

Technical Specification

Construction	Die Cast Marine Grade Aluminium, polycarbonate lens
Driver	Sosen
LED Chip	Samsung
IP Rating	IP66
Operating Temp	-30°C to +35°C
Input Voltage	100-264V
Power Factor	> 0.9
CRI	80 - Exceeds EU standard of Ra 70 for Colour Rendering Index
LMR	80 - Exceeds EU standard of 70 for Lumens Maintenance Ratio
Windage	30W 0.07M ² / 50W 0.07M ² / 70W 0.095M ²

* All BELL Lighting luminaires are rated L80 B10, so for a 50,000 hour product. L80B10 at 50,000 hours our fittings will still have 80% of initial lumen, only 10% of fittings may fail to achieve this

Code	V	W	Lm	Description	Temp	Hours
10753	100-264	30	3900	30W Strada LED Street Light - IP66, Nema Socket	4000K	50000
10754	100-264	50	6500	50W Strada LED Street Light - IP66, Nema Socket	4000K	50000
10755	100-264	70	9100	70W Strada LED Street Light - IP66, Nema Socket	4000K	50000
31139	-	-	-	Strada Photocell	-	-

¹ Exceeds EU standard of 70 for Lumens Maintenance Ratio

² Exceeds EU standard of RA 70 for Colour Rendering Index

³ Subject to terms & conditions (Contact Customer Service)









IP65 LED Bulkhead

The Oberon IP65 LED Bulkhead is a sleek bulkhead supplied with a matt black bezel. This anti-corrosive bulkhead is suitable for BESA box mounting with the option to add a variety of interchangeable bezels.

- Anti-corrosive polycarbonate body
- Standard / Emergency Version / Microwave Version / Emergency Microwave Version
- Supplied with black bezel
- No maintenance / lamp replacement
- 8M Detection range on sensor versions
- 50000 Hours
- 20mm side, bottom & top entry
- Eyelid and louvre bezels available

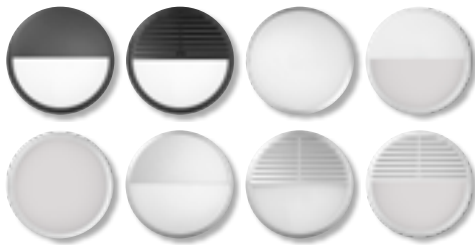
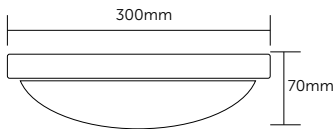

Easy Fit bezel accessories





IP65 LED Bulkhead

Technical Specification	
Construction	Polycarbonate
Driver	BELL
LED Chip	Samsung
IP Rating	IP65
Operating Temp	-20°C to +35°C
Input Voltage	220 - 240V
Power Factor	> 0.9
CRI	85 - Exceeds EU standard of Ra 70 for Colour Rendering Index
LMR	80 - Exceeds EU standard of 70 for Lumens Maintenance Ratio
L1A / L1B / L2A / L2B Compliant	Yes

* All BELL Lighting luminaires are rated L80 B10, so for a 50,000 hour product. L80B10 at 50,000 hours our fittings will still have 80% of initial lumen, only 10% of fittings may fail to achieve this

Code	V	W	Temp	Lm	Description	Hours
10600	240	20	4000K	1800	Oberon LED Bulkhead, with black bezel	50000
10601	240	20	4000K	1800	Oberon LED Bulkhead Emergency, with black bezel	50000
10602	240	20	4000K	1800	Oberon LED Bulkhead M/W Sensor, with black bezel	50000
10603	240	20	4000K	1800	Oberon LED Bulkhead Emergency M/W Sensor, with black bezel	50000
10607	-	-	-	-	White Bezel, (optional accessory)	-
10608	-	-	-	-	Silver Bezel, (optional accessory)	-
10609	-	-	-	-	Black Eyelid, (optional accessory)	-
10610	-	-	-	-	White Eyelid, (optional accessory)	-
10611	-	-	-	-	Silver Eyelid, (optional accessory)	-
10612	-	-	-	-	Black Louvre, (optional accessory)	-
10613	-	-	-	-	White Louvre, (optional accessory)	-
10614	-	-	-	-	Silver Louvre (optional accessory)	-

Microwave Max Operating Height 3.2m

Emergency versions must be tested in line with the requirements of BS5266, failure to do so may effect battery life and warranty.

¹ Exceeds EU standard of 70 for Lumens Maintenance Ratio
² Exceeds EU standard of RA 70 for Colour Rendering Index
³ Subject to terms & conditions (Contact Customer Service)









Outdoor Wall/Spike Garden Lights

The Luna Outdoor Wall & Spike Lights offer a universal solution ideal for domestic applications. Available in different colour options, the Luna range is ideal for decorative and accent lighting on properties of all shapes and sizes.

- Stainless Steel (black version - powder coated die-cast aluminium)
- Compatible with GU10 LED and Halogen lamps
- Spiked garden light ideal for highlighting garden ornaments, trees and shrubs
- Creates warm, welcoming atmosphere to your outside space
- Fixed single or twin wall-lights ideal for exterior feature lighting
- Dimmable when used with suitable lamp
- PIR options available (with over-ride function)



(PIR version IP44)

Use with BELL GU10's for optimum light performance



5W LED Halo GU10.
Ideal for all applications.
Available in 3 colour temperatures, dimmable and non-dimmable.



6W LED Halo Glass GU10.
High lumen output with halogen look.
Available in 3 colour temperatures, dimmable and non-dimmable.

See LED GU10 lamps section for further details

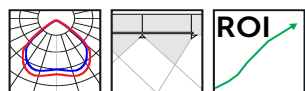

technical@belllighting.co.uk
sales@belllighting.co.uk



Outdoor Wall/Spike Garden Lights



10336



10337



10415



10420



10421



10416



10338



10339



10417



10422

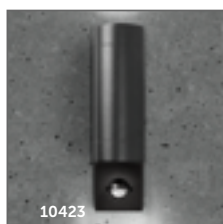

10423



10418



10340



10341



10419



10342

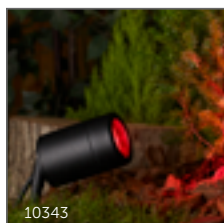

10343

Lamps Not Included



Outdoor Wall/Spike Garden Lights

Technical Specification	
Construction	Powder Black Coated Aluminium / Stainless Steel
IP Rating	IP65
Input Voltage	220-240
Operating Temp	-30°C to +35°C
Lampholder	GU10

Code	Volts	Lamp	Description	Height	Depth
10336	240	GU10	Luna GU10 Wall Light - Fixed Single, Stainless Steel, IP65	120mm	85mm
10337	240	GU10	Luna GU10 Wall Light - Fixed Single, Black, IP65	112mm	92.5mm
10415	240	GU10	Luna GU10 Wall Light - Fixed Single, Copper, IP65	120mm	85mm
10420	240	GU10	Luna GU10 Wall Light - Fixed PIR, Stainless Steel, IP44	183mm	112mm
10421	240	GU10	Luna GU10 Wall Light - Fixed PIR, Black, IP44	183mm	112mm
10416	240	GU10	Luna GU10 Wall Light - Fixed PIR, Copper, IP44	183mm	112mm
10338	240	GU10	Luna GU10 Wall Light - Fixed Up/Down, Stainless Steel, IP65	161mm	85mm
10339	240	GU10	Luna GU10 Wall Light - Fixed Up/Down, Black, IP65	162mm	85mm
10417	240	GU10	Luna GU10 Wall Light - Fixed Up/Down, Copper, IP65	161mm	85mm
10422	240	GU10	Luna GU10 Wall Light - Fixed Up/Down PIR, Stainless Steel, IP44	221mm	112mm
10423	240	GU10	Luna GU10 Wall Light - Fixed Up/Down PIR, Black, IP44	221mm	112mm
10418	240	GU10	Luna GU10 Wall Light - Fixed Up/Down PIR, Copper, IP44	221mm	112mm
10340	240	GU10	Luna GU10 Wall Light - Adjustable, Stainless Steel, IP65	165mm	92mm
10341	240	GU10	Luna GU10 Wall Light - Adjustable, Black, IP65	155mm	90mm
10419	240	GU10	Luna GU10 Wall Light - Adjustable, Copper, IP65	155mm	90mm
10342	240	GU10	Luna GU10 LED Garden Spike - Stainless Steel, IP65	150mm	100mm
10343	240	GU10	Luna GU10 LED Garden Spike - Black, IP65	150mm	100mm









Grande Outdoor Wall Light

The Luna Grande Outdoor Wall Light combines aesthetics with an industrial feel. The largest up/down light in the BELL range features a frosted diffuser to emit a soft, welcoming light.

- Die-cast aluminium construction for durability and strength
- Compatible with GU10 LED and Halogen lamps
- Large size 265mm (height) x 145mm (depth) x Ø90mm
- Creates warm, welcoming atmosphere to your outside space
- Dimmable when used with suitable lamp
- Features a frosted diffuser to emit a soft directional light



Use with BELL GU10's for optimum light performance



5W LED Halo GU10.
Ideal for all applications.
Available in 3 colour temperatures, dimmable and non-dimmable.



6W LED Halo Glass GU10.
High lumen output with halogen look.
Available in 3 colour temperatures, dimmable and non-dimmable.

See LED GU10 lamps section for further details



technical@belllighting.co.uk
sales@belllighting.co.uk



Grande Outdoor Wall Light

Technical Specification

Construction	Powder Black Coated Aluminium
IP Rating	IP65
Input Voltage	220-240
Operating Temp	-30°C to +35°C
Lampholder	GU10

Code	Volts	Lampholder	Description
10424	240	GU10	Luna Grande GU10 Wall Light - Fixed Up/Down, Black, IP65
10425	240	GU10	Luna Grande GU10 Wall Light - Fixed Up/Down, Grey, IP65



¹ Exceeds EU standard of 70 for Lumens Maintenance Ratio
² Exceeds EU standard of Ra 80 for Colour Rendering Index
³ Subject to terms & conditions (Contact Customer Service)









LED Ground Light

The Luna Ground Light offers a robust construction with a sleek modern design. Resin filled to prevent water ingress, the Luna LED Ground Lights are the perfect way to define boundaries and walkways, whether that be on a commercial property or domestic dwelling.

- Define the boundaries of your outside space
- Robust construction, withstands being driven over (Max 2000 Kg)
- Fully encapsulated in resin to prevent water ingress
- 50000 Hours
- Cool White
- 3W - 157lm / 6W - 300lm / 9W - 580lm
- 304 Stainless Steel
- Ensure safe passage of personnel
- No lamp changes - 'fit & forget'

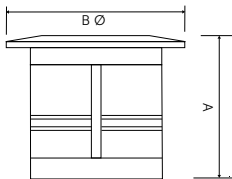

	3W	6W	9W
A	106mm	97mm	124mm
B Ø	100mm	129mm	180mm
Cut Out Ø	Ø 90mm	Ø 122mm	Ø 165mm



technical@belllighting.co.uk
sales@belllighting.co.uk



LED Ground Light

Technical Specification

Construction	Stainless Steel
IP Rating	IP67
Input Voltage	220-240
Operating Temp	-20°C to +35°C
CRI	80 - Exceeds EU standard of Ra 70 for Colour Rendering Index
LMR	80 - Exceeds EU standard of 70 for Lumens Maintenance Ratio

* All BELL Lighting luminaires are rated L80 B10, so for a 50,000 hour product. L80B10 at 50,000 hours our fittings will still have 80% of initial lumen, only 10% of fittings may fail to achieve this

Code	W	Lm	Description	Hours
10410	3	157	Stainless Steel LED Ground Light	50000
10411	6	300	Stainless Steel LED Ground Light	50000
10412	9	580	Stainless Steel LED Ground Light	50000

¹ Exceeds EU standard of 70 for Lumens Maintenance Ratio

² Exceeds EU standard of Ra 80 for Colour Rendering Index

³ Subject to terms & conditions (Contact Customer Service)





technical@belllighting.co.uk
sales@belllighting.co.uk





LED Integrated Bollard

The Luna Integrated Bollard Range, available in 3 different wattages with root mounting kits provided as standard for secure fitting. Perfect for driveways and amenity lighting to ensure safe passage of visitors and staff. Sleek, modern design, powder coated aluminium construction coupled with the efficiency of LED means these units are 'fit and forget'.

- Clear polycarbonate diffuser
- Root mounting kit included
- Powder coated aluminium construction
- Choice of heights 500/700/1000mm
- Designed to minimise light pollution
- 360° Light distribution
- Warm White
- 30000 Hours

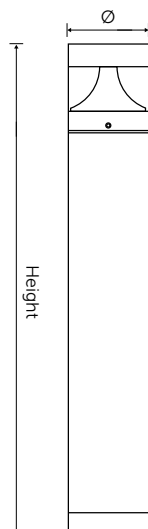

	6W	8W	10W
Height	500mm	700mm	1000mm
∅	120mm	120mm	160mm

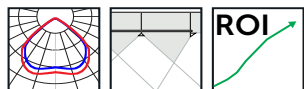

technical@belllighting.co.uk
sales@belllighting.co.uk



LED IP65 Integrated Bollard

Technical Specification	
Construction	Powder coated aluminium
Driver	BELL
LED Chip	Samsung
IP Rating	IP65
Operating Temp	-30°C to +35°C
Input Voltage	220-240V
Power Factor	> 0.9
CRI	85 - Exceeds EU standard of Ra 70 for Colour Rendering Index
LMR	80 - Exceeds EU standard of 70 for Lumens Maintenance Ratio

* All BELL Lighting luminaires are rated L80 B10, so for a 50,000 hour product. L80B10 at 50,000 hours our fittings will still have 80% of initial lumen, only 10% of fittings may fail to achieve this

Code	V	W	Lm	Description	Temp	Hours
10440	100-240	6	366	Luna 6W IP65 LED 500mm Bollard	3000K	30000
10441	100-240	8	605	Luna 8W IP65 LED 700mm Bollard	3000K	30000
10442	100-240	10	685	Luna 10W IP65 LED 1000mm Bollard	3000K	30000

¹ Exceeds EU standard of 70 for Lumens Maintenance Ratio

² Exceeds EU standard of Ra 70 for Colour Rendering Index

³ Subject to terms & conditions (Contact Customer Service)







Retro

Vintage Lantern

The Retro Vintage Lantern is manufactured from vandal resistant polycarbonate. Ideal for installation close to doors and entrances to provide a welcoming glow for visitors. Available in PIR and Non PIR versions with a choice of an integrated fitting or use a BELL LED photocell or standard lamp in non integrated versions.

- Integrated version with frosted glazing (No lamp needed)
- Clear glazing for use with BELL ES/E27 Vintage and Soft Coil Lamps
- PIR versions available
- Manufactured from vandal resistant polycarbonate
- Tough, weather resistant IP54 construction
- Traditional, elegant designs
- Install close to doorways to optimise illumination for entrance areas
- 90° PIR detection area to minimise nuisance activations (PIR Versions)
- Suitable for coastal areas



Use with BELL Photocell Vintage and Soft Coil Lamps (Non Integrated versions)



LED Technology with the elegance of Incandescent Lamps

- Ideal replacement for Incandescent Lamps
- Creates a welcoming atmosphere
- Smooth dimming on rotary and digital dimming systems
- Quartz Filament on Vintage and Filament lamps
- Amber Glass Coating for decorative vintage look on vintage lamps
- Over 90% Energy Saving compared to incandescent lamps
- Super low energy consumption

See LED lamps section for further details



technical@belllighting.co.uk
sales@belllighting.co.uk

Retro

Vintage Lantern

80

ES Lampholder Versions

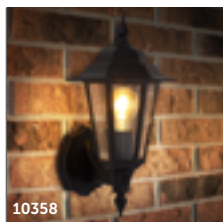

10358



10360



10362



10364

Integrated Versions



10350



10352



10354



10356

Version	Height	Depth	Width
Retro Lantern	375mm	230mm	177mm
Retro Half Lantern	362mm	99mm	175mm
Retro LED Integrated Lantern	375mm	230mm	177mm
Retro LED Integrated Half Lantern	362mm	99mm	175mm

Technical Specification

Construction	Polycarbonate
IP Rating	IP54
LED Chip	Samsung (Integrated version)
Input Voltage	220-240V
Operating Temp	-30°C to +35°C
Lampholder	ES/E27 (Non Integrated versions)



Retro

Vintage Lantern

Code	Volts	W	Lampholder	L m	Hrs	Description
10358	220 - 240	-	ES/E27	-	-	Retro Lantern Black (lamp not included)
10359	220 - 240	-	ES/E27	-	-	Retro Lantern Black with PIR (lamp not included)
10360	220 - 240	-	ES/E27	-	-	Retro Half Lantern Black (lamp not included)
10361	220 - 240	-	ES/E27	-	-	Retro Half Lantern Black with PIR (lamp not included)
10362	220 - 240	-	ES/E27	-	-	Retro Lantern White (lamp not included)
10363	220 - 240	-	ES/E27	-	-	Retro Lantern White with PIR (lamp not included)
10364	220 - 240	-	ES/E27	-	-	Retro Half Lantern White (lamp not included)
10365	220 - 240	-	ES/E27	-	-	Retro Half Lantern White with PIR (lamp not included)
10350	220 - 240	8	-	400	15000	Retro LED Integrated Lantern Black
10351	220 - 240	8	-	400	15000	Retro LED Integrated Lantern Black with PIR
10352	220 - 240	8	-	270	15000	Retro LED Integrated Half Lantern Black
10353	220 - 240	8	-	270	15000	Retro LED Integrated Half Lantern Black with PIR
10354	220 - 240	8	-	400	15000	Retro LED Integrated Lantern White
10355	220 - 240	8	-	400	15000	Retro LED Integrated Lantern White with PIR
10356	220 - 240	8	-	270	15000	Retro LED Integrated Half Lantern White
10357	220 - 240	8	-	270	15000	Retro LED Integrated Half Lantern White with PIR
10366	-	-	-	-	-	Universal Black Corner Bracket for Retro Vintage Integrated & ES Lanterns
10367	-	-	-	-	-	Universal White Corner Bracket for Retro Vintage Integrated & ES Lanterns

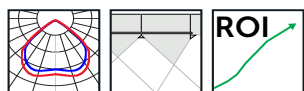







Illuminaslim

LED High Bay

The Illumina Slim high bay is a highly efficient versatile LED luminaire, ideally suited to a wide range of industrial applications for both new installations and retrofit applications.

- 1-10V dimming as standard
- Seoul Semiconductor LED
- Integrated microwave sensor versions available
- Sensor parameters can be set by optional remote control (sensor versions)
- High ambient temperature version also available on request
- Genuine Replacement for 250W/400W/600W Metal Halide or Sodium
- Perfect for warehousing, large retail and factories
- Emergency options available
- Self Test options available

100W \equiv 250W MH/SON Energy Saving 60%	150W \equiv 400W MH/SON Energy Saving 63%	200W \equiv 600W MH/SON Energy Saving 66%
---	---	---

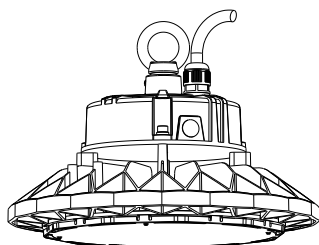

	100W	150W	200W
Diameter	250mm	250mm	280mm
Height	173mm	203mm	203mm

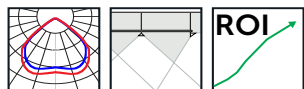

technical@belllighting.co.uk
sales@belllighting.co.uk

Illuminaslim

LED High Bay

Technical Specification

Construction	Die Cast Aluminium
Driver	Sosen
LED Chip	Seoul
IP Rating	IP65
Operating Temp	-30°C to +35°C / Emergency version minimum temperature -5°C
Input Voltage	220 - 240V
Power Factor	> 0.9
CRI	85 - Exceeds EU standard of Ra 70 for Colour Rendering Index
LMR	80 - Exceeds EU standard of 70 for Lumens Maintenance Ratio
Weight	100W 2.15Kg / 100W Sensor 2.78Kg / 150W 2.9Kg / 150W Sensor 3.53kg 200W 2.9kg / 200W Sensor 3.53Kg

* All BELL Lighting luminaires are rated L80 B10, so for a 50,000 hour product. L80B10 at 50,000 hours our fittings will still have 80% of initial lumen, only 10% of fittings may fail to achieve this.

Code	W	Description	Lm	Temp	Hours
08900	100	Illumina Slim 100W LED Highbay 120° lens	14000	4000K	50000
08902	100	Illumina Slim 100W LED Highbay 90° lens	14000	4000K	50000
08901	150	Illumina Slim 150W LED Highbay 120° lens	21000	4000K	50000
08903	150	Illumina Slim 150W LED Highbay 90° lens	21000	4000K	50000
08917	200	Illumina Slim 200W LED Highbay 120° lens	28000	4000K	50000
08916	200	Illumina Slim 200W LED Highbay 90° lens	28000	4000K	50000
08904	100	Illumina Slim 100W LED High/Low Bay 120° lens + Sensor	14000	4000K	50000
08906	100	Illumina Slim 100W LED High/Low Bay 90° lens + Sensor	14000	4000K	50000
08905	150	Illumina Slim 150W LED High/Low Bay 120° lens + Sensor	21000	4000K	50000
08907	150	Illumina Slim 150W LED High/Low Bay 90° lens + Sensor	21000	4000K	50000
08919	200	Illumina Slim 200W LED High/Low Bay 120° lens + Sensor	28000	4000K	50000
08918	200	Illumina Slim 200W LED High/Low Bay 90° lens + Sensor	28000	4000K	50000
08970	-	Prismatic Reflector	-	-	-
08971	-	Aluminium Reflector	-	-	-
08962	-	Remote control	-	-	-
90336	-	Illumina Slim Mounting Bracket	-	-	-



Optional infra-red remote control available for sensor versions

Quick and easy adjustment for multiple fittings; dimming level, presence detection, light levels & automatic on-off time. Average 15M range.



¹ Exceeds EU standard of 70 for Lumens Maintenance Ratio
² Exceeds EU standard of RA 70 for Colour Rendering Index
³ Subject to terms & conditions (Contact Customer Service)

3 Step Dimming Function

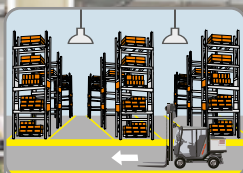

With sufficient natural light, the fitting does not switch on when presence is detected.



With insufficient natural light, the sensor switches on automatically when presence is detected.

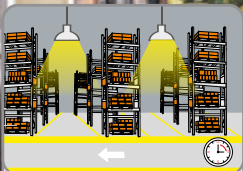

After the hold-time, the sensor dims the fitting to the pre-set low light level if no motion is detected.



Fitting switches off after the stand-by period has elapsed if no motion is detected.

Meadows and Byrne: BELL Illumina Slim High Bay Fittings

Over the life of the fittings, Meadows and Byrne could save £169,916 in energy costs, energy saving 63%

- Annual Energy Saving 24,024kWh
- Annual CO₂ Saving 13,453kg
- Annual Maintenance Saving £500



IlluminaLinear

LED High Intensity High/Low Bay

The Illumina Linear offers a sleek design coupled with high performance. Perfect for high ceiling warehouses, industrial facilities, exhibition centres, shopping malls & stadiums.

- Genuine replacement for 400W Metal Halide
- Perfect for racking, warehouse, large retail and factories
- TUV Isolated Driver
- 1-10V dimming as standard
- Suitable for High Bay and Low Bay applications 4-12m
- Built-in adjustable motion sensor (sensor versions)
- Sensor parameters can be set by optional remote control (sensor versions)
- High efficiency up to 130Lm/w
- Specially designed for warehouse aisles with the fitting's rectangular lighting patterns
- Long and narrow patterns not only contribute to lighting lux levels but also give improved uniformity
- Emergency options available
- Self Test options available

200W \equiv 400W MH/SON Energy Saving 50%

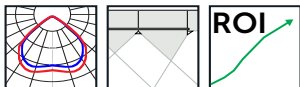
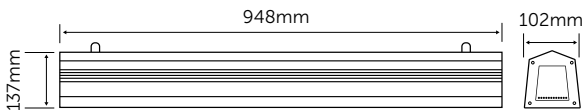

technical@bellighting.co.uk
sales@bellighting.co.uk

illuminaxlinear

LED High Intensity High/Low Bay

Technical Specification

Construction	Extruded Aluminium
Driver	Sosen
LED Chip	Seoul
IP Rating	IP65
Operating Temp	-30°C to +35°C / Emergency version minimum temperature -5°C
Input Voltage	110-264V
Power Factor	> 0.9
CRI	85 - Exceeds EU standard of Ra 70 for Colour Rendering Index
LMR	80 - Exceeds EU standard of 70 for Lumens Maintenance Ratio
Weight	7.0Kg

* All BELL Lighting luminaires are rated L80 B10, so for a 50,000 hour product. L80B10 at 50,000 hours our fittings will still have 80% of initial lumen, only 10% of fittings may fail to achieve this.

Code	W	Description	Lm	Temp	Hours
08950	200	200W Illumina Linear High Rack 30x70°	26000	4000K	50000
08951	200	200W Illumina Linear Low Rack 40x120°	26000	4000K	50000
08952	200	200W Illumina Linear High Open Area 90°	26000	4000K	50000
08953	200	200W Illumina Linear Low Open Area 120°	26000	4000K	50000
08954	200	200W Illumina Linear High Rack & Sensor 30x70°	26000	4000K	50000
08955	200	200W Illumina Linear Low Rack & Sensor 40x120°	26000	4000K	50000
08956	200	200W Illumina Linear High Open Area & Sensor 90°	26000	4000K	50000
08957	200	200W Illumina Linear Low Open Area & Sensor 120°	26000	4000K	50000
08962	-	Remote control	-	-	-



Optional infra-red remote control available for sensor versions

Quick and easy adjustment for multiple fittings; dimming level, presence detection, light levels & automatic on-off time. Average 15M range.

¹ Exceeds EU standard of 70 for Lumens Maintenance Ratio
² Exceeds EU standard of RA 80 for Colour Rendering Index
³ Subject to terms & conditions (Contact Customer Service)



3 Step Dimming Function

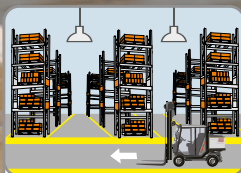

With sufficient natural light, the fitting does not switch on when presence is detected.



With insufficient natural light, the sensor switches on automatically when presence is detected.

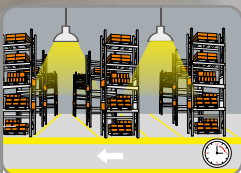

After the hold-time, the sensor dims the fitting to the pre-set low light level if no motion is detected.

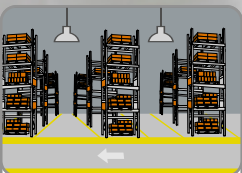

Fitting switches off after the stand-by period has elapsed if no motion is detected.



Illuminacalor

LED High Bay

The Illumina Calor offers a sleek design coupled with high performance. With a high ambient temperature rating of 65°C, this fitting is perfect for applications where extreme high temperatures are encountered eg; foundries, steelworks and bottling plants.

- Philips Isolated Driver
- 1-10V dimming as standard
- Philips Lumileds LED
- Sensor versions available
- Sensor parameters can be set by optional remote control (sensor versions)
- High ambient temperature version 65°C
- Genuine Replacement for 250W/400W/600W Metal Halide or Sodium

100W \equiv 250W MH/SON Energy Saving 60%	150W \equiv 400W MH/SON Energy Saving 63%	200W \equiv 600W MH/SON Energy Saving 66%
---	---	---

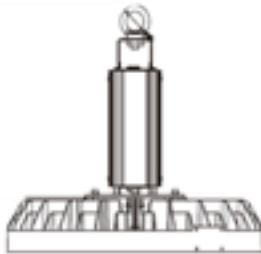

	100W	150W	250W
Diameter	360mm	360mm	360mm
Height	309mm	309mm	387mm

Illuminacalor

LED High Bay

Technical Specification

Construction	Die Cast Aluminium
Driver	Philips High Temperature Driver
LED Chip	Philips Lumileds
IP Rating	IP65
Operating Temp	-30°C to +65°C
Input Voltage	220 - 240V
Power Factor	> 0.9
CRI	85 - Exceeds EU standard of Ra 70 for Colour Rendering Index
LMR	80 - Exceeds EU standard of 70 for Lumens Maintenance Ratio
Weight	100W 3.90Kg / 100W Sensor 4.10Kg / 150W 3.90Kg / 150W Sensor 4.10kg / 200W 4.30kg / 200W Sensor 4.50Kg

* All BELL Lighting luminaires are rated L80 B10, so for a 50,000 hour product. L80B10 at 50,000 hours our fittings will still have 80% of initial lumen, only 10% of fittings may fail to achieve this.

Code	W	Description	Lm	Temp	Hours
10900	100	Illumina Calor 100W LED Highbay 120° lens	14000	4000K	50000
10901	100	Illumina Calor 100W LED Highbay 90° lens	14000	4000K	50000
10902	150	Illumina Calor 150W LED Highbay 120° lens	21000	4000K	50000
10903	150	Illumina Calor 150W LED Highbay 90° lens	21000	4000K	50000
10904	200	Illumina Calor 200W LED Highbay 120° lens	28000	4000K	50000
10905	200	Illumina Calor 200W LED Highbay 90° lens	28000	4000K	50000
10906	100	Illumina Calor 100W LED High/Low Bay 120° lens + Sensor	14000	4000K	50000
10907	100	Illumina Calor 100W LED High/Low Bay 90° lens + Sensor	14000	4000K	50000
10908	150	Illumina Calor 150W LED High/Low Bay 120° lens + Sensor	21000	4000K	50000
10909	150	Illumina Calor 150W LED High/Low Bay 90° lens + Sensor	21000	4000K	50000
10910	200	Illumina Calor 200W LED High/Low Bay 120° lens + Sensor	28000	4000K	50000
10911	200	Illumina Calor 200W LED High/Low Bay 90° lens + Sensor	28000	4000K	50000
10912	-	Prismatic Reflector	-	-	-
10913	-	Aluminium Reflector	-	-	-
10914	-	Remote control	-	-	-



Optional infra-red remote control available for sensor versions

Quick and easy adjustment for multiple fittings; dimming level, presence detection, light levels & automatic on-off time. Average 15M range.



¹ Exceeds EU standard of 70 for Lumens Maintenance Ratio
² Exceeds EU standard of RA 70 for Colour Rendering Index
³ Subject to terms & conditions (Contact Customer Service)

3 Step Dimming Function

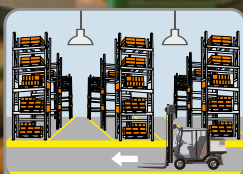

With sufficient natural light, the fitting does not switch on when presence is detected.



With insufficient natural light, the sensor switches on automatically when presence is detected.



After the hold-time, the sensor dims the fitting to the pre-set low light level if no motion is detected.

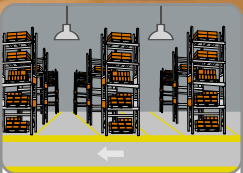

Fitting switches off after the stand-by period has elapsed if no motion is detected.





LED Integrated Anti Corrosive Batten

The Dura LED Anti Corrosive Batten is one of BELL's flagship Luminaires. This fully enclosed luminaire comes with stainless steel diffuser clips, ideal for exterior lighting projects that are open to the elements.

- The Smart Replacement for Single/Twin Fluorescent T8 and T5 Fixtures
- Injection moulded polycarbonate body - suitable for food environments
- Special high light transmission frosted polycarbonate diffuser for smooth uniform lighting
- Stainless steel clips & suspension brackets
- Tool-free termination
- Shatterproof
- Up to 140 Lm/W
- PIR versions available on request

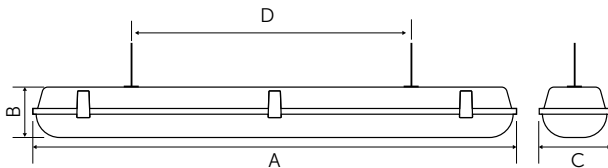

	A	B	C	D
10W 2' Batten	654mm	90mm	90mm	390-430mm
20W 2' Batten	654mm	90mm	125mm	390-430mm
20W 4' Batten	1263mm	90mm	90mm	900-955mm
40W 4' Batten	1263mm	90mm	125mm	900-955mm
25W 5' Batten	1530mm	90mm	90mm	1000-1055mm
52W 5' Batten	1530mm	90mm	125mm	1000-1055mm
28W 6' Batten	1828mm	90mm	90mm	1000-1055mm
60W 6' Batten	1828mm	90mm	125mm	1000-1055mm



technical@belllighting.co.uk
sales@belllighting.co.uk



LED Integrated Anti Corrosive Batten

Technical Specification

Construction	Polycarbonate Body & lens
Driver	BELL
LED Chip	Samsung
IP Rating	IP65
Operating Temp	-30°C to +35°C / Emergency version minimum temperature -5°C
Input Voltage	220 - 240V
Power Factor	> 0.9
CRI	85 - Exceeds EU standard of Ra 80 for Colour Rendering Index
LMR	80 - Exceeds EU standard of 70 for Lumens Maintenance Ratio
L1A / L1B / L2A / L2B Compliant	Yes

* All BELL Lighting luminaires are rated L80 B10, so for a 50,000 hour product. L80B10 at 50,000 hours our fittings will still have 80% of initial lumen, only 10% of fittings may fail to achieve this

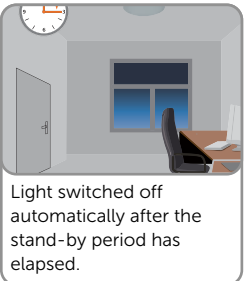
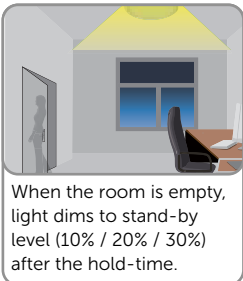
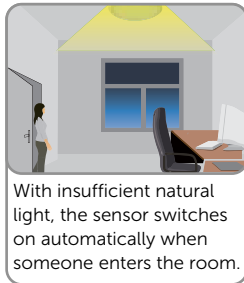
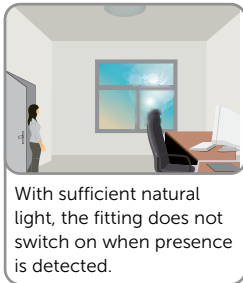

Tri-Level Control (Corridor Function)



Optional infra-red remote control available for microwave sensor versions

Quick and easy adjustment for multiple fittings; dimming level, presence detection, light levels & automatic on-off time. Average 4M range.

Offers 3 levels of light: 100%-dimmed light (10%, 20%, 30%)-off; and 2 periods of selectable waiting time: motion hold-time and stand-by period; selectable daylight threshold and choice of detection area.

¹ Exceeds EU standard of 70 for Lumens Maintenance Ratio

² Exceeds EU standard of RA 80 for Colour Rendering Index

³ Subject to terms & conditions (Contact Customer Service)





LED Integrated Anti Corrosive Batten

Code	W	Description	Lm	Temp	Hours
10257	10	Dura Anti Corrosive Batten - Single 600mm (2ft)	1260	4000K	50000
10256	20	Dura Anti Corrosive Batten - Double 600mm (2ft)	2420	4000K	50000
10255	20	Dura Anti Corrosive Batten - Double Emergency 600mm (2ft)	2420	4000K	50000
06722	20	Dura Anti Corrosive Batten - Single 1200mm (4ft)	2700	4000K	50000
06723	20	Dura Anti Corrosive Batten - Single Emergency 1200mm (4ft)	2700	4000K	50000
06728	40	Dura Anti Corrosive Batten - Double 1200mm (4ft)	5550	4000K	50000
06729	40	Dura Anti Corrosive Batten - Double Emergency 1200mm (4ft)	5550	4000K	50000
06710	25	Dura Anti Corrosive Batten - Single 1500mm (5ft)	3430	4000K	50000
06711	25	Dura Anti Corrosive Batten - Single Emergency 1500mm (5ft)	3430	4000K	50000
06712	25	Dura Anti Corrosive Batten - Single with Microwave Sensor + Corridor Dim Function 1500mm (5ft)	3430	4000K	50000
06713	25	Dura Anti Corrosive Batten - Single Emergency with Microwave Sensor + Corridor Dim Function 1500mm (5ft)	3430	4000K	50000
06714	25	Dura Anti Corrosive Batten - Single with Microwave Sensor 1500mm (5ft)	3430	4000K	50000
06715	25	Dura Anti Corrosive Batten - Single Emergency with Microwave Sensor 1500mm (5ft)	3430	4000K	50000
06716	52	Dura Anti Corrosive Batten - Double 1500mm (5ft)	6850	4000K	50000
06717	52	Dura Anti Corrosive Batten - Double Emergency 1500mm (5ft)	6850	4000K	50000
06718	52	Dura Anti Corrosive Batten - Double with Microwave Sensor + Corridor Dim Function 1500mm (5ft)	6850	4000K	50000
06719	52	Dura Anti Corrosive Batten - Double Emergency / Microwave Sensor + Corridor Dim Function 1500mm (5ft)	6850	4000K	50000
06720	52	Dura Anti Corrosive Batten - Double with Microwave Sensor 1500mm (5ft)	6850	4000K	50000
06721	52	Dura Anti Corrosive Batten - Emergency with Microwave Sensor 1500mm (5ft)	6850	4000K	50000
06760	28	Dura Anti Corrosive Batten - Single 1800mm (6ft)	4050	4000K	50000
06761	28	Dura Anti Corrosive Batten - Single Emergency 1800mm (6ft)	4050	4000K	50000
06766	60	Dura Anti Corrosive Batten - Double 1800mm (6ft)	7790	4000K	50000
06767	60	Dura Anti Corrosive Batten - Double Emergency 1800mm (6ft)	7790	4000K	50000

Microwave Max Operating Height 3.2m

Emergency versions must be tested in line with the requirements of BS5266, failure to do so may effect battery life and warranty





Northern Ireland Water: BELL Dura LED Integrated Anti Corrosive Battens

Over the life of the fitting, Northern Ireland Water could save: £86,384 in energy costs, energy saving 46%

- Annual Energy Saving 54,787kWh
- Annual CO₂ Saving 25,750kg
- Annual Maintenance £9000





LED Integrated Batten

The Ultra Batten is a versatile general-purpose luminaire. With a sleek look, this Ultra Batten is an ideal candidate for office, classroom and corridor installations. Offered in 4, 5 & 6ft lengths, and boasting a 7 year guarantee with a 2 year on site warranty.

- The smart replacement for Single/Twin Fluorescent T8 and T5 Fixtures
- Special high light transmission frosted polycarbonate diffuser for smooth uniform lighting
- Perfect for all commercial environments
- Tool-free termination
- Integrated controls
- Shatterproof
- Suitable for BESA Box mounting
- 8M detection range on corridor dim option (2.6m mounting height)
- 147 Lm/W



Model	A	B	C (From Centre)	D
20W	69mm	1230mm	290mm / 170mm / 320mm	82mm
40W	109mm	1230mm	290mm / 170mm / 320mm	82mm
30W	69mm	1530mm	290mm / 170mm / 320mm	82mm
60W	109mm	1530mm	290mm / 170mm / 320mm	82mm
50W	69mm	1795mm	415mm / 170mm / 320mm	82mm
80W	109mm	1795mm	415mm / 170mm / 320mm	82mm

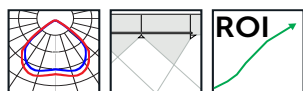

technical@bellighting.co.uk
sales@bellighting.co.uk



LED Integrated Batten

104

Technical Specification

Construction	Steel Body, Polycarbonate lens
Driver	BELL
LED Chip	Samsung
IP Rating	IP20
Operating Temp	-30°C to +35°C / Emergency version minimum temperature -5°C
Input Voltage	220 - 240V
Power Factor	> 0.9
CRI	85 - Exceeds EU standard of Ra 80 for Colour Rendering Index
LMR	80 - Exceeds EU standard of 70 for Lumens Maintenance Ratio
L1A / L1B / L2A / L2B Compliant	Yes

* All BELL Lighting luminaires are rated L80 B10, so for a 50,000 hour product. L80B10 at 50,000 hours our fittings will still have 80% of initial lumen, only 10% of fittings may fail to achieve this.

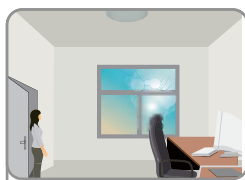

With sufficient natural light, the fitting does not switch on when presence is detected.



With insufficient natural light, the sensor switches on automatically when someone enters the room.



When the room is empty, light dims to stand-by level (10% / 20% / 30%) after the hold-time.

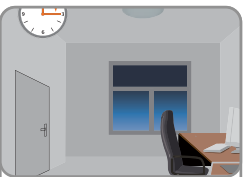

Light switched off automatically after the stand-by period has elapsed.

Tri-Level Control (Corridor Function)



Optional infra-red remote control available for sensor versions

Quick and easy adjustment for multiple fittings; dimming level, presence detection, light levels & automatic on-off time. Average 4M range.

Offers 3 levels of light: 100%-dimmed light (10%, 20%, 30%)-off; and 2 periods of selectable waiting time: motion hold-time and stand-by period; selectable daylight threshold and choice of detection area.

¹ Exceeds EU standard of 70 for Lumens Maintenance Ratio

² Exceeds EU standard of RA 80 for Colour Rendering Index

³ Subject to terms & conditions (Contact Customer Service)





LED Integrated Batten

Code	W	Description	Temp	Lm	Hrs
10200	20	Ultra LED Integrated - Single 1230mm (4ft)	4000K	2850	50000
10202	20	Ultra LED Integrated - Single with Microwave Sensor 1230mm (4ft)	4000K	2850	50000
10204	20	Ultra LED Integrated - Single with Microwave Sensor + Corridor Dim Function 1230mm (4ft)	4000K	2850	50000
10201	20	Ultra LED Integrated - Single Emergency 1230mm (4ft)	4000K	2850	50000
10203	20	Ultra LED Integrated - Single Emergency with Microwave Sensor 1230mm (4ft)	4000K	2850	50000
10205	20	Ultra LED Integrated - Single Emergency with Microwave Sensor + Corridor Dim Function 1230mm (4ft)	4000K	2850	50000
10206	40	Ultra LED Integrated - Double 1230mm (4ft)	4000K	5360	50000
10208	40	Ultra LED Integrated - Double with Microwave Sensor 1230mm (4ft)	4000K	5360	50000
10210	40	Ultra LED Integrated - Double with Microwave Sensor + Corridor Dim Function 1230mm (4ft)	4000K	5360	50000
10207	40	Ultra LED Integrated - Double Emergency 1230mm (4ft)	4000K	5360	50000
10209	40	Ultra LED Integrated - Double Emergency with Microwave Sensor 1230mm (4ft)	4000K	5360	50000
10211	40	Ultra LED Integrated - Double Emergency with Microwave Sensor + Corridor Dim Function 1230mm (4ft)	4000K	5360	50000
10212	30	Ultra LED Integrated - Single 1530mm (5ft)	4000K	4410	50000
10214	30	Ultra LED Integrated - Single with Microwave Sensor 1530mm (5ft)	4000K	4410	50000
10216	30	Ultra LED Integrated - Single with Microwave Sensor + Corridor Dim Function 1530mm (5ft)	4000K	4410	50000
10213	30	Ultra LED Integrated - Single Emergency 1530mm (5ft)	4000K	4410	50000
10215	30	Ultra LED Integrated - Single Emergency with Microwave Sensor 1530mm (5ft)	4000K	4410	50000
10217	30	Ultra LED Integrated - 4000K, Single Emergency with Microwave Sensor + Corridor Dim Function 1530mm (5ft)	4000K	4410	50000
10218	60	Ultra LED Integrated - Double 1530mm (5ft)	4000K	7600	50000
10220	60	Ultra LED Integrated - Double with Microwave Sensor 1530mm (5ft)	4000K	7600	50000
10222	60	Ultra LED Integrated - Double with Microwave Sensor + Corridor Dim Function 1530mm (5ft)	4000K	7600	50000
10219	60	Ultra LED Integrated - Double Emergency 1530mm (5ft)	4000K	7600	50000
10221	60	Ultra LED Integrated - Double Emergency with Microwave Sensor 1530mm (5ft)	4000K	7600	50000
10223	60	Ultra LED Integrated - Double Emergency with Microwave Sensor + Corridor Dim Function 1530mm (5ft)	4000K	7600	50000
10224	50	Ultra LED Integrated - Single 1795mm (6ft)	4000K	6350	50000
10226	50	Ultra LED Integrated - Single with Microwave Sensor 1795mm (6ft)	4000K	6350	50000

Microwave Max Operating Height 3.2m

Emergency versions must be tested in line with the requirements of BS5266, failure to do so may effect battery life and warranty



LED Integrated Batten

106

Code	W	Description	Temp	Lm	Hrs
10228	50	Ultra LED Integrated - Single with Microwave Sensor + Corridor Dim Function 1795mm (6ft)	4000K	6350	50000
10225	50	Ultra LED Integrated - Single Emergency 1795mm (6ft)	4000K	6350	50000
10227	50	Ultra LED Integrated - Single Emergency with Microwave Sensor 1795mm (6ft)	4000K	6350	50000
10229	50	Ultra LED Integrated - Single Emergency with Microwave Sensor + Corridor Dim Function 1795mm (6ft)	4000K	6350	50000
10230	80	Ultra LED Integrated - Double 1795mm (6ft)	4000K	10600	50000
10232	80	Ultra LED Integrated - Double with Microwave Sensor 1795mm (6ft)	4000K	10600	50000
10234	80	Ultra LED Integrated - Double with Microwave Sensor + Corridor Dim Function 1795mm (6ft)	4000K	10600	50000
10231	80	Ultra LED Integrated - Double Emergency 1795mm (6ft)	4000K	10600	50000
10233	80	Ultra LED Integrated - Double Emergency with Microwave Sensor 1795mm (6ft)	4000K	10600	50000
10235	80	Ultra LED Integrated - Double Emergency with Microwave Sensor + Corridor Dim Function 1795mm (6ft)	4000K	10600	50000

Microwave Max Operating Height 3.2m

Emergency versions must be tested in line with the requirements of BS5266, failure to do so may effect battery life and warranty





Vauxhall Assembly Plant, Luton: BELL Ultra LED Integrated Battens

Over the life of the fittings, Vauxhall Assembly Plant could save £2,159,231 in energy & maintenance costs, energy saving 64%

- Annual Energy Saving 1,228,500kWh
- Annual CO₂ Saving 687,960kg
- Annual Maintenance Saving £21,000

technical@belllighting.co.uk
sales@belllighting.co.uk





LED Integrated Batten

The Ultra Slim LED Integrated Batten is a cost-effective shatterproof luminaire ideal for domestic applications. The Ultra Slim streamlined design gives the ability to seamlessly illuminate small spaces without the need for a large luminaire.

- The smart replacement for Single/Twin Fluorescent T8 and T5 Fixtures
- Special high light transmission frosted polycarbonate diffuser for smooth uniform lighting
- Cool White
- Quick and easy installation
- Shatterproof
- Class 2 product, no need for earth

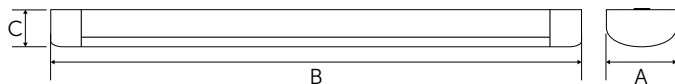

Model	A	B	C
38W	75mm	1230mm	26mm
45W	75mm	1530mm	26mm
56W	75mm	1850mm	26mm

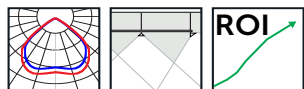

technical@bellighting.co.uk
sales@bellighting.co.uk



LED Integrated Batten

110

Technical Specification	
Construction	Aluminium Body, Polycarbonate lens
Driver	BELL
LED Chip	Samsung
IP Rating	IP20
Operating Temp	-30°C to +35°C / Emergency Version -10°C to +35°C
Input Voltage	220 - 240V
Power Factor	> 0.9
CRI	85 - Exceeds EU standard of Ra 80 for Colour Rendering Index
LMR	80 - Exceeds EU standard of 70 for Lumens Maintenance Ratio
L1A / L1B / L2A / L2B Compliant	Yes

Code	W	Description	Temp	Lm	Hrs
10270	38	Ultra Slim LED Integrated - Single 1230mm (4ft)	4000K	4400	35000
10271	45	Ultra Slim LED Integrated - Single 1530mm (5ft)	4000K	5300	35000
10272	56	Ultra Slim LED Integrated - Single 1850mm (6ft)	4000K	6600	35000

¹ Exceeds EU standard of 70 for Lumens Maintenance Ratio
² Exceeds EU standard of RA 80 for Colour Rendering Index
³ Subject to terms & conditions (Contact Customer Service)









LED Bulkhead

One of our most popular LED Bulkheads, the Aqua2 has stood the test of time. This cost-effective replacement for 28W 2D fittings is supplied with a high transmission frosted diffuser and is IP65 as standard.

- Supplied with white trim, easy fit chrome and satin trims available
- The smart replacement for 28W 2D Fittings
- Tri level control now included on corridor dim versions
- Emergency option
- Microwave and corridor dimming function option
- High transmission frosted diffuser
- No lamp replacement
- No maintenance
- 35000 hour life
- IP65 Sealed fitting
- 8M detection range on corridor dim option (2.6m mounting height)
- Rear cable entry

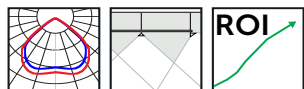
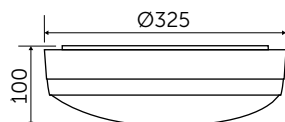

technical@belllighting.co.uk
sales@belllighting.co.uk

LED Bulkhead

Technical Specification	
Construction	Polycarbonate body and lens
Driver	BELL
LED Chip	Samsung
IP Rating	IP65
Operating Temp	-20°C to +35°C
Input Voltage	220 - 240V
Power Factor	> 0.9
CRI	85 - Exceeds EU standard of Ra 80 for Colour Rendering Index
LMR	80 - Exceeds EU standard of 70 for Lumens Maintenance Ratio

* All BELL Lighting luminaires are rated L80 B10, so for a 50,000 hour product. L80B10 at 50,000 hours our fittings will still have 80% of initial lumen, only 10% of fittings may fail to achieve this.

Code	W	Description	Lm	Temp	Hours
06636	14	Aqua2 LED Bulkhead Standard Version (No Sensor)	1100	3500K	35000
06637	14	Aqua2 LED Bulkhead Standard Version (No Sensor) Emergency 3 hour maintained	1100	3500K	35000
06638	14	Aqua2 LED Bulkhead Microwave Version On/Off With Presence Detection	1100	3500K	35000
06639	14	Aqua2 LED Bulkhead Microwave Version On/Off With Presence Detection, Emergency 3 hour maintained	1100	3500K	35000
06640	14	Aqua2 LED Bulkhead Microwave Version with Corridor Dim Function	1100	3500K	35000
06641	14	Aqua2 LED Bulkhead Microwave Version with Corridor Dim Function, Emergency 3 hour maintained	1100	3500K	35000
06634	-	Chrome ring accessory	-	-	-
06635	-	Satin ring accessory	-	-	-

Microwave Max Operating Height 3.2m

Emergency versions must be tested in line with the requirements of BS5266, failure to do so may effect battery life and warranty

Tri-Level Control (Corridor Function)

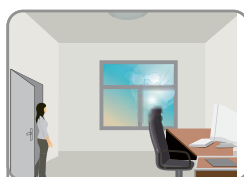

With sufficient natural light, the fitting does not switch on when presence is detected.

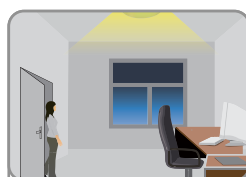

With insufficient natural light, the sensor switches on automatically when someone enters the room.

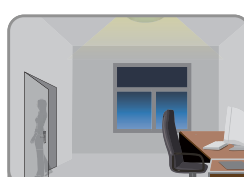

When the room is empty, light dims to stand-by level (10% / 20% / 30%) after the hold-time.



Light switched off automatically after the stand-by period has elapsed.

Offers 3 levels of light: 100%-dimmed light (10%, 20%, 30%-off); and 2 periods of selectable waiting time: motion hold-time and stand-by period; selectable daylight threshold and choice of detection area.









LED Bulkhead

The Aqua3 LED Bulkhead is the latest addition to the bulkhead family. Suitable for BESA box, side and rear entry, a versatile solution for commercial premises.

- The smart replacement for 28W 2D Fittings
- Integral motion sensor options
- No lamp replacement
- No maintenance
- Opal diffuser
- 35000 hour life
- Ø325 mm x 101 mm
- Sealed durable fitting
- Suitable for BESA box, side and rear entry

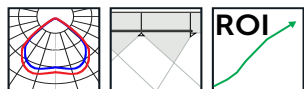
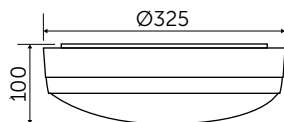



LED Bulkhead

Technical Specification	
Construction	Polycarbonate body and lens
Driver	BELL
LED Chip	Samsung
IP Rating	IP65
Operating Temp	-20°C to +35°C
Input Voltage	220 - 240V
Power Factor	> 0.9
CRI	85 - Exceeds EU standard of Ra 80 for Colour Rendering Index
LMR	80 - Exceeds EU standard of 70 for Lumens Maintenance Ratio

* All BELL Lighting luminaires are rated L80 B10, so for a 50,000 hour product. L80B10 at 50,000 hours our fittings will still have 80% of initial lumen, only 10% of fittings may fail to achieve this.

Code	W	Description	Lm	Temp	Hours
10883	13	Aqua3 LED Bulkhead Standard Version (No Sensor)	1200	4000K	35000
10887	13	Aqua3 LED Bulkhead Standard Version (No Sensor) Emergency 3 hour maintained	1200	4000K	35000
10891	13	Aqua3 LED Bulkhead Microwave Version On/Off with Presence Detection	1200	4000K	35000
10895	13	Aqua3 LED Bulkhead Microwave Version On/Off with Presence Detection. Emergency 3 hour maintained	1200	4000K	35000

Microwave Max Operating Height 3.2m

Emergency versions must be tested in line with the requirements of BS5266, failure to do so may effect battery life and warranty

¹ Exceeds EU standard of 70 for Lumens Maintenance Ratio
² Exceeds EU standard of RA 80 for Colour Rendering Index
³ Subject to terms & conditions (Contact Customer Service)





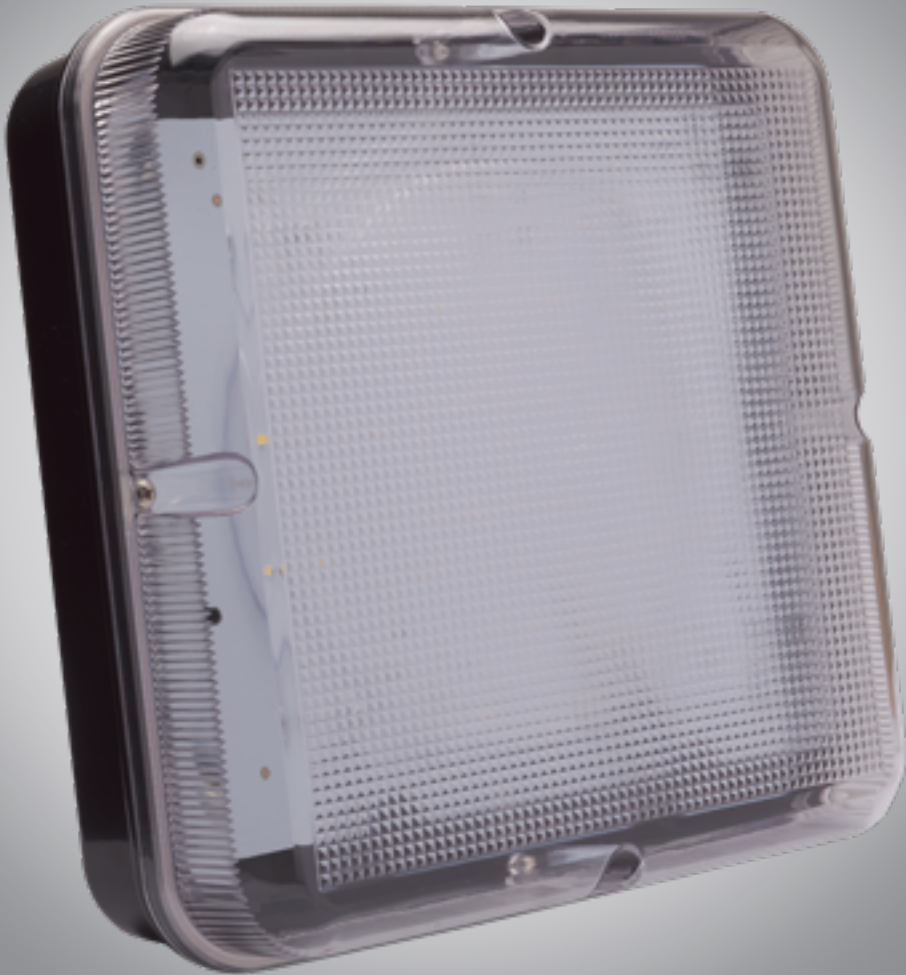



LED Amenity Bulkhead

The Utilita LED Amenity Bulkhead is available in a variety of wattages, sizes, and finishes making this luminaire ideal for all amenity applications. This cost-effective bulkhead offers up to 50% energy saving on standard compact fluorescent units.

- Ideal for all amenity applications
- Polycarbonate shatterproof construction
- Up to 50% Energy Saving
- Square/Round versions
- Clear/Opal finish available
- 20mm Conduit entry
- Suitable for BESA box entry (Square Version)
- 20mm side & rear entry conduit

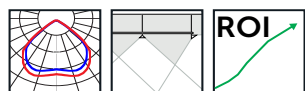
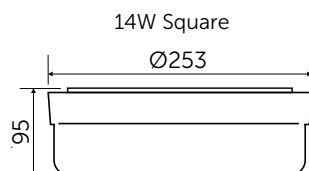
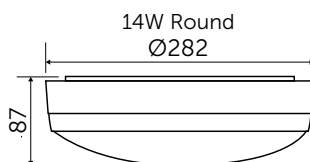
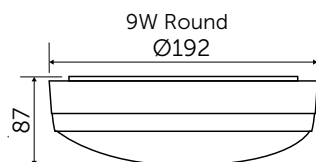



LED Amenity Bulkhead

122

Technical Specification	
Construction	Polycarbonate Body and lens
Driver	BELL
LED Chip	Samsung
IP Rating	IP65
Operating Temp	-20°C to +35°C / Emergency version minimum temperature -5°C
Input Voltage	220 - 240V
Power Factor	> 0.9
CRI	85 - Exceeds EU standard of Ra 80 for Colour Rendering Index
LMR	80 - Exceeds EU standard of 70 for Lumens Maintenance Ratio

* All BELL Lighting luminaires are rated L80 B10, so for a 50,000 hour product. L80B10 at 50,000 hours our fittings will still have 80% of initial lumen, only 10% of fittings may fail to achieve this.

Code	W	Description	Lm	Temp	Hours
10810	9	Utilita LED Bulkhead, Round - Black w/Clear Bezel	900	4000	30000
10811	9	Utilita LED Bulkhead, Round - White w/Clear Bezel	900	4000	30000
10812	9	Utilita LED Bulkhead, Round - Black w/Opal Bezel	900	4000	30000
10813	9	Utilita LED Bulkhead, Round - White w/Opal Bezel	900	4000	30000
10826	14	Utilita LED Bulkhead, Round - Black w/Clear Bezel	1500	4000	30000
10827	14	Utilita LED Bulkhead, Round - White w/Clear Bezel	1500	4000	30000
10828	14	Utilita LED Bulkhead, Round - Black w/Opal Bezel	1500	4000	30000
10829	14	Utilita LED Bulkhead, Round - White w/Opal Bezel	1500	4000	30000
10830	14	Utilita LED Bulkhead, Round Emergency - Black w/Clear Bezel	1500	4000	30000
10832	14	Utilita LED Bulkhead, Round Emergency - White w/Clear Bezel	1500	4000	30000
10831	14	Utilita LED Bulkhead, Round Emergency - Black w/Opal Bezel	1500	4000	30000
10833	14	Utilita LED Bulkhead, Round Emergency - White w/Opal Bezel	1500	4000	30000
10834	14	Utilita LED Bulkhead, Square - Black w/Clear Bezel	1500	4000	30000
10835	14	Utilita LED Bulkhead, Square - White w/Clear Bezel	1500	4000	30000
10836	14	Utilita LED Bulkhead, Square - Black w/Opal Bezel	1500	4000	30000
10837	14	Utilita LED Bulkhead, Square - White w/Opal Bezel	1500	4000	30000
10838	14	Utilita LED Bulkhead, Square Emergency - Black w/Clear Bezel	1500	4000	30000
10839	14	Utilita LED Bulkhead, Square Emergency - White w/Clear Bezel	1500	4000	30000
10840	14	Utilita LED Bulkhead, Square Emergency - Black w/Opal Bezel	1500	4000	30000
10841	14	Utilita LED Bulkhead, Square Emergency - White w/Opal Bezel	1500	4000	30000

Microwave Max Operating Height 3.2m

Emergency versions must be tested in line with the requirements of BS5266, failure to do so may effect battery life and warranty

¹ Exceeds EU standard of 70 for Lumens Maintenance Ratio

² Exceeds EU standard of RA 80 for Colour Rendering Index

³ Subject to terms & conditions (Contact Customer Service)





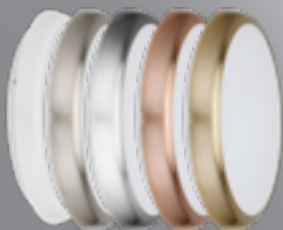



LED Bulkhead

The colour selectable Deco Slim LED Bulkhead is one of the most decorative, aesthetically pleasing bulkheads in the BELL range. Supplied with white bezel as standard with the option to add a variety of decorative bezels.

- Selectable colour temperature version 3000K/4000K/6000K available
- Supplied with white trim, chrome, satin, copper and antique brass trims available
- The smart replacement for 2D and PL decorative fittings
- 8M detection range on corridor dim option (2.6m mounting height)
- Emergency option
- Microwave and corridor dimming function option (non CCT version)
- Rear entry

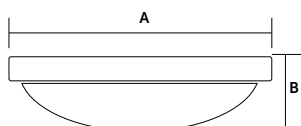

Model	A \varnothing	B Depth
12W	250mm	48mm
18W	300mm	48mm
25W	300mm	48mm

Selectable Colour Temperature

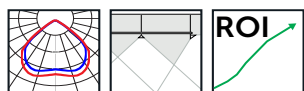
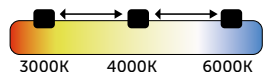

technical@bellighting.co.uk
sales@bellighting.co.uk

LED Bulkhead

Technical Specification

Construction	Polycarbonate
Driver	BELL
LED Chip	Samsung
IP Rating	IP54
Operating Temp	-20°C to +35°C / Emergency version minimum temperature -5°C
Input Voltage	220 - 240V
Power Factor	> 0.9
CRI	85 - Exceeds EU standard of Ra 80 for Colour Rendering Index
LMR	80 - Exceeds EU standard of 70 for Lumens Maintenance Ratio
L1A / L1B / L2A / L2B Compliant	Yes

* All BELL Lighting luminaires are rated L80 B10, so for a 50,000 hour product. L80B10 at 50,000 hours our fittings will still have 80% of initial lumen, only 10% of fittings may fail to achieve this.

Tri-Level Control (Corridor Function)

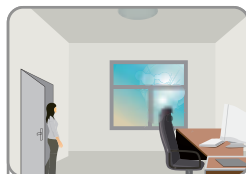

With sufficient natural light, the fitting does not switch on when presence is detected.

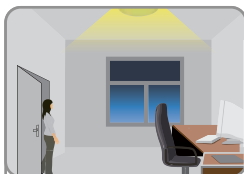

With insufficient natural light, the sensor switches on automatically when someone enters the room.

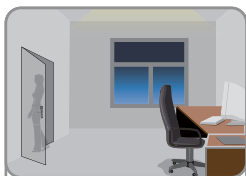

When the room is empty, light dims to stand-by level (10% / 20% / 30%) after the hold-time.



Light switched off automatically after the stand-by period has elapsed.



Optional infra-red remote control available for sensor versions

Quick and easy adjustment for multiple fittings; dimming level, presence detection, light levels & automatic on-off time. Average 4M range.

Offers 3 levels of light: 100%-dimmed light (10%, 20%, 30%)-off; and 2 periods of selectable waiting time: motion hold-time and stand-by period; selectable daylight threshold and choice of detection area.

¹ Exceeds EU standard of 70 for Lumens Maintenance Ratio

² Exceeds EU standard of RA 80 for Colour Rendering Index

³ Subject to terms & conditions (Contact Customer Service)



Code	W	Description	Lm	Lm/w	Temp	Hours
06830	12	Deco Slim LED Bulkhead CCT Standard On/Off	1056	88	3/4/6000K	35000
06831	18	Deco Slim LED Bulkhead CCT Standard On/Off	1620	90	3/4/6000K	35000
06832	25	Deco Slim LED Bulkhead CCT Standard On/Off	2150	86	3/4/6000K	35000
06833	12	Deco Slim LED Bulkhead CCT Emergency	1056	88	3/4/6000K	35000
06834	18	Deco Slim LED Bulkhead CCT Emergency	1620	90	3/4/6000K	35000
06835	25	Deco Slim LED Bulkhead CCT Emergency	2150	86	3/4/6000K	35000
06740	12	Deco Slim LED Bulkhead Standard On/Off	1056	88	4000K	35000
06741	18	Deco Slim LED Bulkhead Standard On/Off	1620	90	4000K	35000
06742	25	Deco Slim LED Bulkhead Standard On/Off	2150	86	4000K	35000
06743	12	Deco Slim LED Bulkhead Emergency	1056	88	4000K	35000
06744	18	Deco Slim LED Bulkhead Emergency	1620	90	4000K	35000
06745	25	Deco Slim LED Bulkhead Emergency	2150	86	4000K	35000
06752	-	Satin Trim for 12W Deco Slim LED Bulkhead	-	-	-	-
06753	-	Satin Trim for 18/25W Deco Slim LED Bulkhead	-	-	-	-
06754	-	Chrome Trim for 12W Deco Slim LED Bulkhead	-	-	-	-
06755	-	Chrome Trim for 18/25W Deco Slim LED Bulkhead	-	-	-	-
06756	-	Copper Trim for 12W Deco Slim LED Bulkhead	-	-	-	-
06757	-	Copper Trim for 18/25W Deco Slim LED Bulkhead	-	-	-	-
06758	-	Antique Brass Trim for 12W Deco Slim LED Bulkhead	-	-	-	-
06759	-	Antique Brass Trim for 18/25W Deco Slim LED Bulkhead	-	-	-	-

Contact Customer Service for Emergency, Microwave and Corridor Dimming options

Microwave Max Operating Height 3.2m

Emergency versions must be tested in line with the requirements of BS5266, failure to do so may effect battery life and warranty





Rotherham College: BELL Deco Slim LED Bulkheads

Over the life of the fittings, Rotherham College could save: £5376 in energy costs, energy saving 34%

- Annual Energy Saving 2,796kWh
- Annual CO₂ Saving 1,565kg
- Annual Maintenance £600

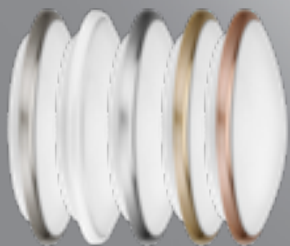

DecoGrande

CCT 3 way selectable colour switch

LED Bulkhead

Colour selectable as standard, the Deco Grande is a unique bulkhead that combines a large surface area of light with a decorative feel. Supplied with a white bezel as standard with additional coloured bezels available on request.

- Selectable colour temperature 3000K/4000K/6000K
- Supplied with white trim, chrome, satin nickel, copper and antique brass trims available
- Colour change switch under diffuser for easy access
- The smart replacement for 2D and PL decorative fittings
- 8M detection range on corridor dim option (2.6m mounting height)
- Emergency option
- Microwave and corridor dimming function option
- 20mm side & rear entry conduit

25W \equiv 55W Energy Saving 54%

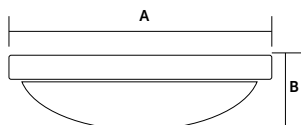

Model	A \varnothing	B Depth
25W	390mm	94mm

Selectable Colour Temperature

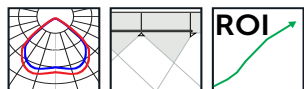
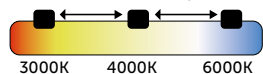

technical@bellighting.co.uk
sales@bellighting.co.uk

LED Bulkhead

Technical Specification	
Construction	Polycarbonate
Driver	BELL
LED Chip	Samsung
IP Rating	IP20
Operating Temp	-20°C to +35°C
Input Voltage	220 - 240V
Power Factor	> 0.9
CRI	85 - Exceeds EU standard of Ra 80 for Colour Rendering Index
LMR	80 - Exceeds EU standard of 70 for Lumens Maintenance Ratio
L1A / L1B / L2A / L2B Compliant	Yes

* All BELL Lighting luminaires are rated L80 B10, so for a 50,000 hour product. L80B10 at 50,000 hours our fittings will still have 80% of initial lumen, only 10% of fittings may fail to achieve this.

Code	V	W	Temp	Lm	Description	Hours
06810	240	25	3000/4000/6000K	2000	Deco Grande CCT Colour Change LED Bulk-head	35000
06811	240	25	3000/4000/6000K	2000	Deco Grande CCT Colour Change LED Bulkhead - Emergency	35000
06812	240	25	3000/4000/6000K	2000	Deco Grande CCT Colour Change LED Bulkhead - Corridor Dim	35000
06813	240	25	3000/4000/6000K	2000	Deco Grande CCT Colour Change LED Bulkhead - Emergency, Corridor Dim	35000
06816	-	-	-	-	Satin Nickel Trim Ring for 25W Deco Grande CCT Colour Change LED Bulkhead	-
06817	-	-	-	-	Chrome Trim Ring for 25W Deco Grande CCT Colour Change LED Bulkhead	-
06818	-	-	-	-	Copper Trim Ring for 25W Deco Grande CCT Colour Change LED Bulkhead	-
06819	-	-	-	-	Antique Brass Trim Ring for 25W Deco Grande CCT Colour Change LED Bulkhead	-

Microwave Max Operating Height 3.2m

Emergency versions must be tested in line with the requirements of BS5266, failure to do so may effect battery life and warranty

¹ Exceeds EU standard of 70 for Lumens Maintenance Ratio
² Exceeds EU standard of RA 80 for Colour Rendering Index
³ Subject to terms & conditions (Contact Customer Service)



Tri-Level Control (Corridor Function)



With sufficient natural light, the fitting does not switch on when presence is detected.



With insufficient natural light, the sensor switches on automatically when someone enters the room.



When the room is empty, light dims to stand-by level (10% / 20% / 30%) after the hold-time.



Light switched off automatically after the stand-by period has elapsed.

Offers 3 levels of light: 100%-dimmed light (10%, 20%, 30%)-off; and 2 periods of selectable waiting time: motion hold-time and stand-by period; selectable daylight threshold and choice of detection area.

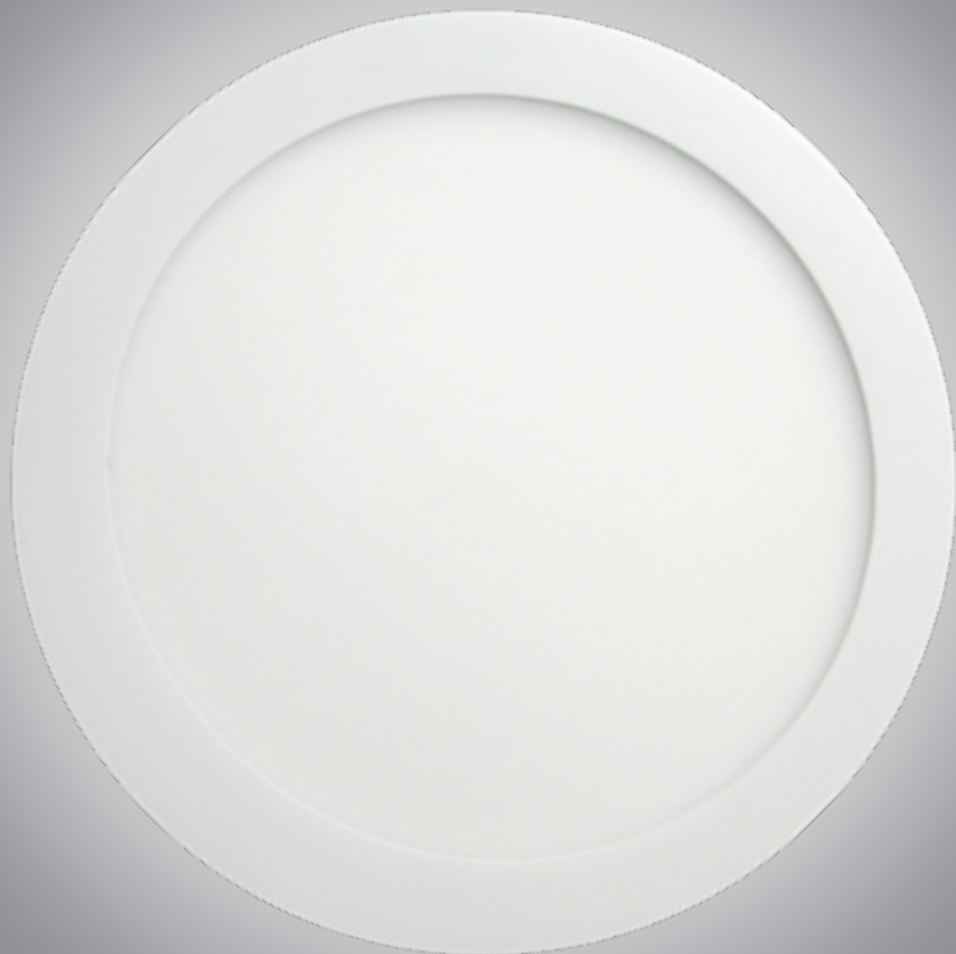



LED Round Panel

The super slim design of the BELL Ariel LED Round Panel makes this range of products ideal for office & educational environments alike. The complete range covers cut outs ranging from 130mm up to 282mm.

- Super slimline profile
- Remote Micro Driver
- Complete range covering sizes 146mm - 300mm
- Flicker Free Driver to ensure safety in public areas
- 30000 Hours
- 0-10V dimming or DALI dimming options available
- Emergency panels with 3 year battery guarantee available

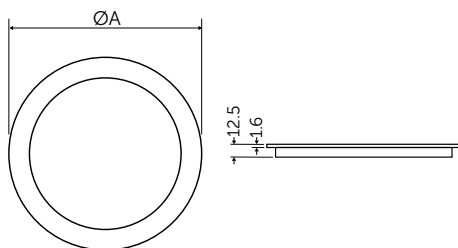

Model	A	Cut-Out
9W	146mm	130mm
12W	170mm	160mm
15W	190mm	180mm
18W	225mm	210mm
24W	300mm	282mm

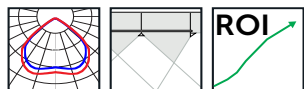

technical@belllighting.co.uk
sales@belllighting.co.uk



LED Round Panel

136

Technical Specification	
Construction	Aluminium + PMMA
Driver	BELL
LED Chip	Philips
IP Rating	IP44
Operating Temp	0°C to +35°C
Input Voltage	220 - 240V
Power Factor	> 0.9
CRI	85 - Exceeds EU standard of Ra 80 for Colour Rendering Index
LMR	80 - Exceeds EU standard of 70 for Lumens Maintenance Ratio
L1A / L1B / L2A / L2B Compliant	Yes
Emergency Battery Type	NiCd 1 Year Emergency / LiFePO4 3 Year Emergency

* All BELL Lighting luminaires are rated L80 B10, so for a 50,000 hour product. L80B10 at 50,000 hours our fittings will still have 80% of initial lumen, only 10% of fittings may fail to achieve this.

Code	W	Description	Lm	Temp	Hours
09730	9	Ø 146mm Ariel Round LED Panel	630	4000K	30000
09729	12	Ø 170mm Ariel Round LED Panel	1130	4000K	30000
09731	15	Ø 190mm Ariel Round LED Panel	1520	4000K	30000
09732	18	Ø 225mm Ariel Round LED Panel	1800	4000K	30000
09733	24	Ø 300mm Ariel Round LED Panel	2430	4000K	30000
09695	9	Ø 146mm Ariel Round LED Panel - Emergency	630	4000K	30000
09696	12	Ø 170mm Ariel Round LED Panel - Emergency	1130	4000K	30000
09697	15	Ø 190mm Ariel Round LED Panel - Emergency	1520	4000K	30000
09698	18	Ø 225mm Ariel Round LED Panel - Emergency	1800	4000K	30000
09699	24	Ø 300mm Ariel Round LED Panel - Emergency	2430	4000K	30000
09744	9	Ø 146mm Ariel Round LED Panel - 0-10v Dim	630	4000K	30000
09745	12	Ø 170mm Ariel Round LED Panel - 0-10v Dim	1130	4000K	30000
09746	15	Ø 190mm Ariel Round LED Panel - 0-10v Dim	1520	4000K	30000
09747	18	Ø 225mm Ariel Round LED Panel - 0-10v Dim	1800	4000K	30000
09748	24	Ø 300mm Ariel Round LED Panel - 0-10v Dim	2430	4000K	30000
09739	9	Ø 146mm Ariel Round LED Panel - Dali Dim	630	4000K	30000
09740	12	Ø 170mm Ariel Round LED Panel - Dali Dim	1130	4000K	30000
09741	15	Ø 190mm Ariel Round LED Panel - Dali Dim	1520	4000K	30000

¹ Exceeds EU standard of 70 for Lumens Maintenance Ratio

² Exceeds EU standard of RA 80 for Colour Rendering Index

³ Subject to terms & conditions (Contact Customer Service)





Code	W	Description	Lm	Temp	Hours
09742	18	Ø 225mm Arial Round LED Panel - Dali Dim	1800	4000K	30000
09743	24	Ø 300mm Arial Round LED Panel - Dali Dim	2430	4000K	30000

Available on request:

- Emergency panels with 3 year battery guarantee
- Emergency 0-10V Dim
- Emergency Dali Dim

For further information call 01924 893380 or email sales@belllighting.co.uk

Emergency versions must be tested in line with the requirements of BS5266, failure to do so may effect battery life and warranty.





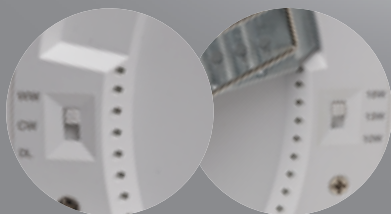



LED Converter

The Arial LED Converter is an unrivalled product when it comes to versatility in the LED market.

- All in one solution
- Selectable colour temperature
- Integral switches for multiple wattages and CCT
- Cool White / Warm White / Daylight
- Selectable wattage
- Fully adjustable / Innovative bracket
- Fits cut-outs 65mm to 205mm
- 50000 Hours

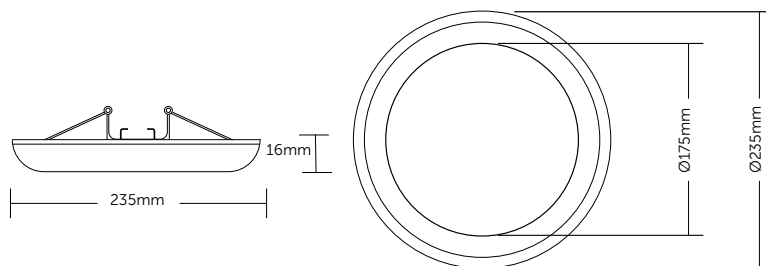

Selectable Colour Temperature

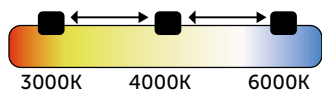

Selectable Wattage

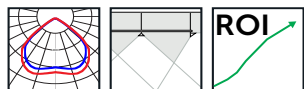
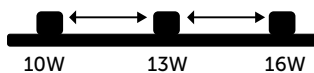

technical@bellighting.co.uk
sales@bellighting.co.uk



LED Converter

Technical Specification	
Construction	Polycarbonate
Driver	BELL
LED Chip	Samsung
IP Rating	IP20
Operating Temp	0°C to +35°C
Input Voltage	220 - 240V
Power Factor	> 0.9
CRI	85 - Exceeds EU standard of Ra 80 for Colour Rendering Index
LMR	80 - Exceeds EU standard of 70 for Lumens Maintenance Ratio
L1A / L1B / L2A / L2B Compliant	Yes

* All BELL Lighting luminaires are rated L80 B10, so for a 50,000 hour product. L80B10 at 50,000 hours our fittings will still have 80% of initial lumen, only 10% of fittings may fail to achieve this.

Code	W	Description	Lm	Temp	Hours
06840	10/13/16	Arial LED Converter	950-1800	3000K / 4000K / 6000K	50000
08196	-	Emergency Pack for above	-	-	-

	Colour Temperature			
	3000K	4000K	6000K	
Watts	10W	1100 Lumens	1200 Lumens	1000 Lumens
	13W	1400 Lumens	1500 Lumens	1300 Lumens
	16W	1600 Lumens	1700 Lumens	1400 Lumens

¹ Exceeds EU standard of 70 for Lumens Maintenance Ratio
² Exceeds EU standard of RA 80 for Colour Rendering Index
³ Subject to terms & conditions (Contact Customer Service)







ArialPro

LED CCT Downlight

The Arial Pro LED Downlight is a sleek looking luminaire designed to replace cumbersome CFL fittings. With a 7 year guarantee across both the IP44 & IP65 range, the Arial Pro can be installed in a variety of applications with the confidence of knowing this product will stand the test of time.

- Switchable colour temperature 3000/4000/6000K
- Ideal for home and office environments
- Equivalent up to 2x26W fluorescent
- Anti-glare
- IP44 and IP65 options available
- Tool Free - Plug & Play
- Emergency downlights with 5 year battery guarantee available

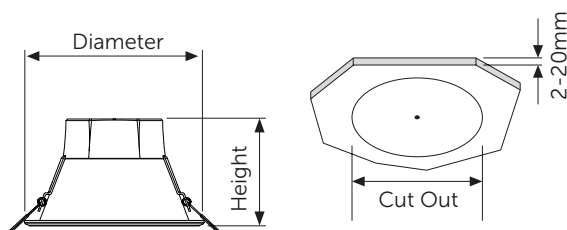

	9W	16W	20W
Diameter	115mm	190mm	240mm
Height	70.5mm	102mm	117mm
Cut Out	90mm	160mm	200mm

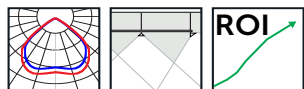

technical@bellighting.co.uk
sales@bellighting.co.uk

Arialpro

LED Downlight

146

Technical Specification	
Construction	Polycarbonate
Driver	Tridonic
LED Chip	Philips
IP Rating	IP65 & IP44
Operating Temp	-5°C to +35°C
Input Voltage	220 - 240V
Power Factor	> 0.9
CRI	85 - Exceeds EU standard of Ra 80 for Colour Rendering Index
LMR	80 - Exceeds EU standard of 70 for Lumens Maintenance Ratio
L1A / L1B / L2A / L2B Compliant	Yes
Emergency Battery Type	NiCd

* All BELL Lighting luminaires are rated L80 B10, so for a 50,000 hour product. L80B10 at 50,000 hours our fittings will still have 80% of initial lumen, only 10% of fittings may fail to achieve this.

Code	W	Description	Lm	Temp	Hours
10950	9	9W Arial Pro CCT Downlight IP44	910	3/4/6000K	50000
10951	16	16W Arial Pro CCT Downlight IP44	1660	3/4/6000K	50000
10952	20	20W Arial Pro CCT Downlight IP44	2250	3/4/6000K	50000
10956	9	9W Arial Pro CCT Downlight IP44 - Emergency, (1 Year Battery Guarantee)	910	3/4/6000K	50000
10957	16	16W Arial Pro CCT Downlight IP44 - Emergency, (1 Year Battery Guarantee)	1660	3/4/6000K	50000
10958	20	20W Arial Pro CCT Downlight IP44 - Emergency, (1 Year Battery Guarantee)	2250	3/4/6000K	50000
10959	9	9W Arial Pro CCT Downlight IP44 - 1-10V Dim	910	3/4/6000K	50000
10960	16	16W Arial Pro CCT Downlight IP44 - 1-10V Dim	1660	3/4/6000K	50000
10961	20	20W Arial Pro CCT Downlight IP44 - 1-10V Dim	2250	3/4/6000K	50000
10962	9	9W Arial Pro CCT Downlight IP44 - Dali Dim	910	3/4/6000K	50000
10963	16	16W Arial Pro CCT Downlight IP44 - Dali Dim	1660	3/4/6000K	50000
10964	20	20W Arial Pro CCT Downlight IP44 - Dali Dim	2250	3/4/6000K	50000

¹ Exceeds EU standard of 70 for Lumens Maintenance Ratio

² Exceeds EU standard of RA 80 for Colour Rendering Index

³ Subject to terms & conditions (Contact Customer Service)



LED Downlight

Code	W	Description	Lm	Temp	Hours
10953	9	9W Arial Pro CCT Downlight IP65	910	3/4/6000K	50000
10954	16	16W Arial Pro CCT Downlight IP65	1660	3/4/6000K	50000
10955	20	20W Arial Pro CCT Downlight IP65	2250	3/4/6000K	50000
10965	9	9W Arial Pro CCT Downlight IP65 - Emergency, (1 Year Battery Guarantee)	910	3/4/6000K	50000
10966	16	16W Arial Pro CCT Downlight IP65 - Emergency, (1 Year Battery Guarantee)	1660	3/4/6000K	50000
10967	20	20W Arial Pro CCT Downlight IP65 - Emergency, (1 Year Battery Guarantee)	2250	3/4/6000K	50000
10968	9	9W Arial Pro CCT Downlight IP65 - 1-10V Dim	910	3/4/6000K	50000
10969	16	16W Arial Pro CCT Downlight IP65 - 1-10V Dim	1660	3/4/6000K	50000
10970	20	20W Arial Pro CCT Downlight IP65 - 1-10V Dim	2250	3/4/6000K	50000
10971	9	9W Arial Pro CCT Downlight IP65 - Dali Dim	910	3/4/6000K	50000
10972	16	16W Arial Pro CCT Downlight IP65 - Dali Dim	1660	3/4/6000K	50000
10973	20	20W Arial Pro CCT Downlight IP65 - Dali Dim	2250	3/4/6000K	50000

Available on request:

- Emergency panels with 5 year battery guarantee
- Emergency 0-10V Dim
- Emergency Dali Dim

For further information call 01924 893380 or email sales@belllighting.co.uk

Emergency versions must be tested in line with the requirements of BS5266, failure to do so may effect battery life and warranty.

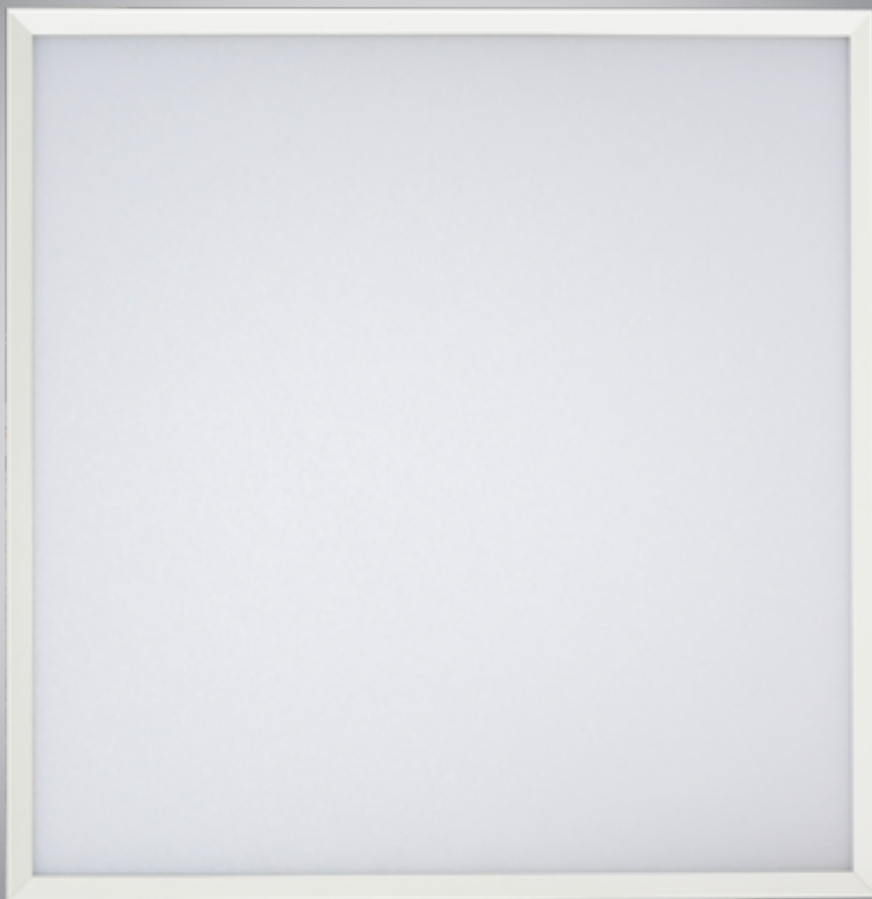

ArialPlus

Backlit High Output UGR<19 LED Panel

The Arial Plus is our leading panel when it comes to performance. With a high lumen output of over 120 lumens per watt, this panel is ideal for areas that require high lux levels. The Arial Plus can be installed in areas where TPa rated lighting products are essential, such as emergency exit routes including stairways and corridors.

- High efficiency
- TPa
- Uniform light distribution
- Professional LED Panel
- 0-10V Dimming or DALI Dimming options available
- White finish
- Anti-twist frame
- Emergency panels with 5 year battery guarantee available
- CCT option available on request

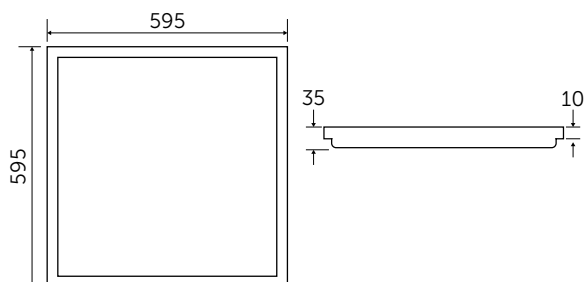

UGR (Unified Glare Rating) is a method of calculating glare from light sources.

The UGR rating helps to determine how likely a light source is to cause discomfort to those around it. This classification ranges from 5 to 40, with low numbers indicating low glare.

Glare can be a common problem in workplaces. Inappropriate lighting or excessive brightness can be bounced off reflective surfaces, such as computer screens, whiteboards etc. This can cause disruption for the occupants of offices.

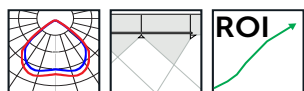

technical@bellighting.co.uk
sales@bellighting.co.uk

Backlit High Output UGR<19 LED Panel

150

Technical Specification	
Construction	Steel + Polycarbonate
Driver	BELL
LED Chip	Philips
IP Rating	IP20
Operating Temp	0°C to +35°C
Input Voltage	220 - 240V
Power Factor	> 0.9
CRI	85 - Exceeds EU standard of Ra 80 for Colour Rendering Index
LMR	80 - Exceeds EU standard of 70 for Lumens Maintenance Ratio
L1A / L1B / L2A / L2B Compliant	Yes
Emergency Battery Type	NiCd 1 Year Emergency / LiFePO4 5 Year Emergency

* All BELL Lighting luminaires are rated L80 B10, so for a 50,000 hour product. L80B10 at 50,000 hours our fittings will still have 80% of initial lumen, only 10% of fittings may fail to achieve this.

Code	W	Description - High Output UGR <19 LED Panel	Lm/W	Lm	Temp	Finish	Hours
10140	36	Arial Backlit High Output UGR <19 LED Panel 600x600mm, 4000K, White	120	4320	4000K	White	50000
10142	36	Arial Backlit High Output UGR <19 LED Panel 600x600mm, 4000K, Emergency, White	120	4320	4000K	White	50000
10144	36	Arial Backlit High Output UGR <19 LED Panel 600x600mm, 4000K, White, 0-10V Dim	120	4320	4000K	White	50000
10143	36	Arial Backlit High Output UGR <19 LED Panel 600x600mm, 4000K, White, Dali Dim	120	4320	4000K	White	50000
10160	36	Arial Backlit High Output UGR <19 LED Panel 600x600mm, 4000K, White. CCT	120	4320	3/4/6000K	White	50000
10162	36	Arial Backlit High Output UGR <19 LED Panel 600x600mm, 4000K, Emergency, White. CCT	120	4320	3/4/6000K	White	50000
10164	36	Arial Backlit High Output UGR <19 LED Panel 600x600mm, 4000K, White, 0-10V Dim. CCT	120	4320	3/4/6000K	White	50000
10163	36	Arial Backlit High Output UGR <19 LED Panel 600x600mm, 4000K, White, Dali Dim. CCT	120	4320	3/4/6000K	White	50000
10168	25	Arial Backlit High Output UGR <19 LED Panel 600x600mm, 4000K, White	130	3250	4000K	White	50000
10170	25	Arial Backlit High Output UGR <19 LED Panel 600x600mm, 4000K, Emergency, White	130	3250	4000K	White	50000

¹ Exceeds EU standard of 70 for Lumens Maintenance Ratio

² Exceeds EU standard of RA 80 for Colour Rendering Index

³ Subject to terms & conditions (Contact Customer Service)



Backlit High Output UGR<19 LED Panel

10172	25	Arial Backlit High Output UGR <19 LED Panel 600x600mm, 4000K, White, 0-10V Dim	130	3250	4000K	White	50000
10171	25	Arial Backlit High Output UGR <19 LED Panel 600x600mm, 4000K, White, Dali Dim	130	3250	4000K	White	50000
11010	36	Arial Backlit High Output UGR <19 LED Panel 1200x300mm, 4000K	120	4320	4000K	White	50000
11011	36	Arial Backlit High Output UGR <19 LED Panel 1200x300mm, 4000K, Emergency	120	4320	4000K	White	50000
11014	36	Arial Backlit High Output UGR <19 LED Panel 1200x300mm, 4000K, 0-10V Dim	120	4320	4000K	White	50000
11013	36	Arial Backlit High Output UGR <19 LED Panel 1200x300mm, 4000K, Dali Dim	120	4320	4000K	White	50000
11020	58	Arial Backlit High Output UGR <19 LED Panel 1200x600mm, 4000K	120	6960	4000K	White	50000
11021	58	Arial Backlit High Output UGR <19 LED Panel 1200x600mm, 4000K, Emergency	120	6960	4000K	White	50000
11024	58	Arial Backlit High Output UGR <19 LED Panel 1200x600mm, 4000K, 0-10V Dim	120	6960	4000K	White	50000
11023	58	Arial Backlit High Output UGR <19 LED Panel 1200x600mm, 4000K, Dali Dim	120	6960	4000K	White	50000
10190	-	Surface Mount Unit for 600x600 Arial Plus Backlit High Output UGR<19 LED Panel	-	-	-	-	-
10192	-	Surface Mount Unit for 1200x300 Arial Plus Backlit High Output UGR<19 LED Panel	-	-	-	-	-
10193	-	Surface Mount Unit for 1200x600 Arial Plus Backlit High Output UGR<19 LED Panel	-	-	-	-	-

Available on request:

- Emergency panels with 5 year battery guarantee
- Emergency 0-10V Dim
- Emergency Dali Dim

For further information call 01924 893380 or email sales@bellighting.co.uk

Emergency versions must be tested in line with the requirements of BS5266, failure to do so may effect battery life and warranty.





Backlit LED Panel

One of the newest panels in the Arial range, the Arial Backlit LED Panel comes with a 7 year guarantee and 2 year on site warranty as standard. This cost-effective lighting solution is available with a multitude of optional extras.

- Uniform light distribution
- Professional LED Panel
- 0-10V Dimming or DALI Dimming options available
- White finish
- Anti-twist frame
- Emergency panels with 5 year battery guarantee available
- CCT option available on request

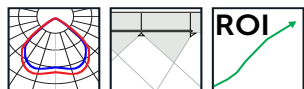
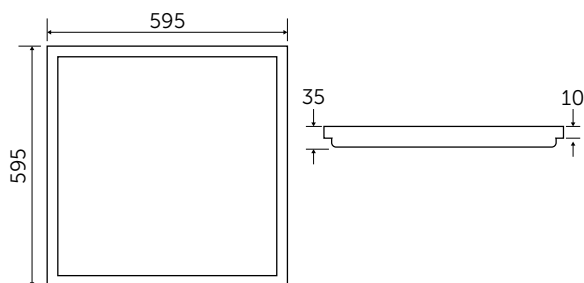

technical@bellighting.co.uk
sales@bellighting.co.uk



Backlit LED Panel

154

Technical Specification	
Construction	Steel + PMMA
Driver	BELL
LED Chip	Philips
IP Rating	IP20
Operating Temp	0°C to +35°C
Input Voltage	220 - 240V
Power Factor	> 0.9
CRI	85 - Exceeds EU standard of Ra 80 for Colour Rendering Index
LMR	80 - Exceeds EU standard of 70 for Lumens Maintenance Ratio
L1A / L1B / L2A / L2B Compliant	Yes
Emergency Battery Type	NiCd 1 Year Emergency / LiFePO4 5 Year Emergency

* All BELL Lighting luminaires are rated L80 B10, so for a 50,000 hour product. L80B10 at 50,000 hours our fittings will still have 80% of initial lumen, only 10% of fittings may fail to achieve this.

Code	W	Description	Lm/W	Lm	Temp	Finish	Hours
10130	36	Arial Backlit LED Panel - 600x600mm,	100	3600	4000K	White	50000
10132	36	Arial Backlit LED Panel - 600x600mm, Emergency	100	3600	4000K	White	50000
10134	36	Arial Backlit LED Panel - 600x600mm, 0-10V Dim	100	3600	4000K	White	50000
10133	36	Arial Backlit LED Panel - 600x600mm, Dali Dim	100	3600	4000K	White	50000
10150	36	Arial Backlit LED Panel - 600x600mm. CCT	100	3600	3/4/6000K	White	50000
10152	36	Arial Backlit LED Panel - 600x600mm, Emgcy. CCT	100	3600	3/4/6000K	White	50000
10154	36	Arial Backlit LED Panel - 600x600mm, 0-10V Dim. CCT	100	3600	3/4/6000K	White	50000
10153	36	Arial Backlit LED Panel - 600x600mm, Dali Dim. CCT	100	3600	3/4/6000K	White	50000
10176	25	Arial Backlit LED Panel - 600x600mm	120	3000	4000K	White	50000
10178	25	Arial Backlit LED Panel - 600x600mm, Emergency	120	3000	4000K	White	50000
10180	25	Arial Backlit LED Panel - 600x600mm, 0-10V Dim	120	3000	4000K	White	50000
10179	25	Arial Backlit LED Panel - 600x600mm, Dali Dim	120	3000	4000K	White	50000
10190	-	Surface Mount Unit for 600x600 Arial Backlit Panel	-	-	-	-	-

Available on request:

- Emergency panels with 5 year battery guarantee
- Emergency 0-10V Dim
- Emergency Dali Dim

For further information call 01924 893380 or email sales@bellighting.co.uk

Emergency versions must be tested in line with the requirements of BS5266, failure to do so may effect battery life and warranty.

¹ Exceeds EU standard of 70 for Lumens Maintenance Ratio

² Exceeds EU standard of RA 80 for Colour Rendering Index

³ Subject to terms & conditions (Contact Customer Service)









IP65 LED Panel

The IP65 version of our Arial LED Panel is an ideal product for areas that may contain moisture such as changing rooms, locker rooms & commercial kitchen environments.

- Front face IP65
- Professional LED panel
- 0-10V Dimming or DALI Dimming options available
- White frame
- BELL Driver
- Anti-twist frame
- Emergency panels with 5 year battery guarantee available

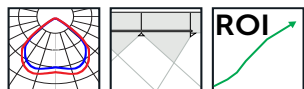
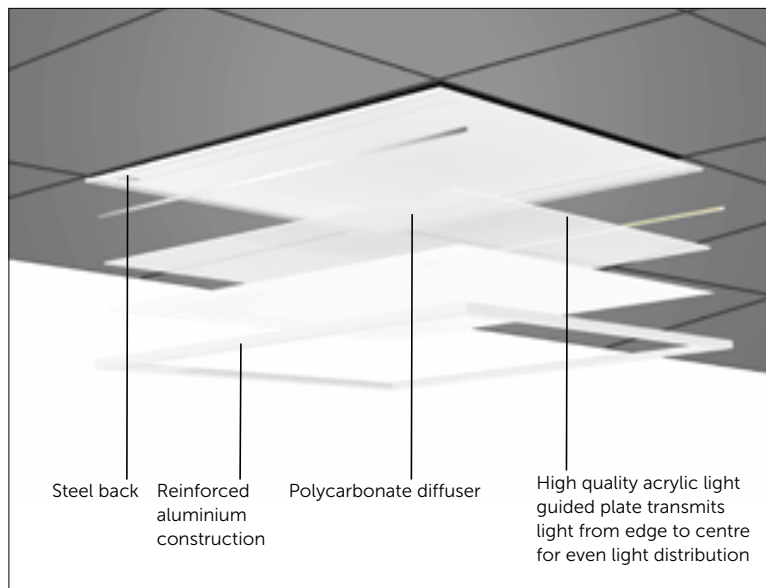

technical@belllighting.co.uk
sales@belllighting.co.uk



IP65 LED Panel

158

Technical Specification

Construction	Aluminium + PMMA
Driver	BELL
LED Chip	Philips
IP Rating	IP65 (Front face)
Operating Temp	0°C to +35°C
Input Voltage	220 - 240V
Power Factor	> 0.9
CRI	85 - Exceeds EU standard of Ra 80 for Colour Rendering Index
LMR	80 - Exceeds EU standard of 70 for Lumens Maintenance Ratio
L1A / L1B / L2A / L2B Compliant	Yes
Emergency Battery Type	NiCd 1 Year Emergency / LiFePO4 5 Year Emergency

* All BELL Lighting luminaires are rated L80 B10, so for a 50,000 hour product. L80B10 at 50,000 hours our fittings will still have 80% of initial lumen, only 10% of fittings may fail to achieve this.

Code	W	Description	Lm/W	Lm	Temp	Finish	Hours
10047	36	600 x 600 IP65 LED Panel	105	4000	4000K	White	50000
10097	36	600 x 600 IP65 LED Panel Emergency	105	4000	4000K	White	50000
10050	36	600 x 600 IP65 LED Panel 0-10V Dim	105	4000	4000K	White	50000
10049	36	600 x 600 IP65 LED Panel Dali Dim	105	4000	4000K	White	50000

Available on request:

- Emergency panels with 5 year battery guarantee
- Emergency 0-10V Dim
- Emergency Dali Dim

For further information call 01924 893380 or email sales@bellighting.co.uk

Emergency versions must be tested in line with the requirements of BS5266, failure to do so may effect battery life and warranty.

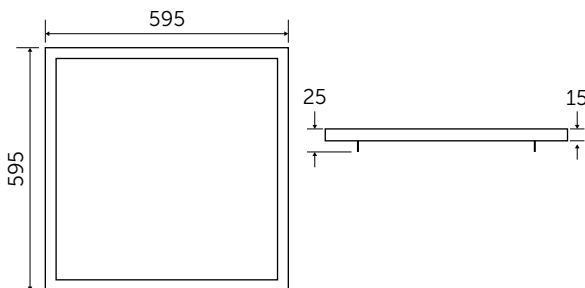

¹ Exceeds EU standard of 70 for Lumens Maintenance Ratio
² Exceeds EU standard of RA 80 for Colour Rendering Index
³ Subject to terms & conditions (Contact Customer Service)









Troffer LED CCT Panel

The Arial Troffer gives a unique twist on a standard LED Panel. The contemporary design and aesthetic light distribution works well in areas that want something unique and different to the standard familiar panel we have all become accustomed to. With 115 lumens per watt and colour selectable as standard.

- High efficiency
- Aesthetic light distribution
- Contemporary design
- TPa
- Professional LED Panel
- 0-10V Dimming or DALI Dimming options available
- White finish
- Innovative fixed connector
- Emergency panels with 5 year battery guarantee available

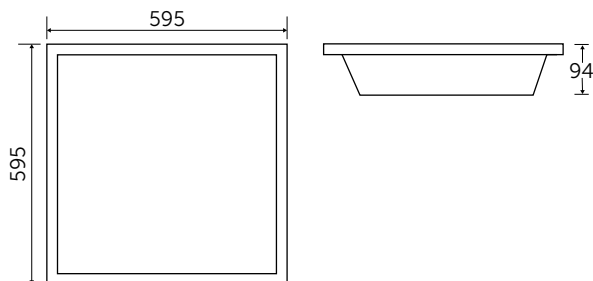

Selectable Colour Temperature

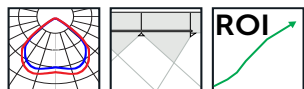
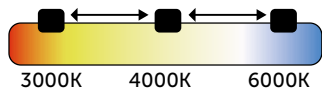

technical@bellighting.co.uk
sales@bellighting.co.uk



Troffer LED CCT Panel

162

Technical Specification	
Construction	Steel + Polycarbonate
Driver	BELL
LED Chip	Philips
IP Rating	IP20
Operating Temp	0°C to +35°C
Input Voltage	220 - 240V
Power Factor	> 0.9
CRI	85 - Exceeds EU standard of Ra 80 for Colour Rendering Index
LMR	80 - Exceeds EU standard of 70 for Lumens Maintenance Ratio
L1A / L1B / L2A / L2B Compliant	Yes
Emergency Battery Type	NiCd 1 Year Emergency / LiFePO4 5 Year Emergency

* All BELL Lighting luminaires are rated L80 B10, so for a 50,000 hour product. L80B10 at 50,000 hours our fittings will still have 80% of initial lumen, only 10% of fittings may fail to achieve this.

Code	W	Description	Lm/W	Lm	Temp	Finish	Hours
10120	36	Arial Troffer CCT LED Panel - 600x600mm, White	115	3800	3/4/6000K	White	50000
10121	36	Arial Troffer CCT LED Panel - 600x600mm, Emergency, White	115	3800	3/4/6000K	White	50000
10125	36	Arial Troffer CCT LED Panel - 600x600mm, White, 0-10V Dim	115	3800	3/4/6000K	White	50000
10122	36	Arial Troffer CCT LED Panel - 600x600mm, White, Dali Dim	115	3800	3/4/6000K	White	50000

Available on request:

- Emergency panels with 5 year battery guarantee
- Emergency 0-10V Dim
- Emergency Dali Dim

For further information call 01924 893380 or email sales@bellighting.co.uk

Emergency versions must be tested in line with the requirements of BS5266, failure to do so may effect battery life and warranty.

¹ Exceeds EU standard of 70 for Lumens Maintenance Ratio
² Exceeds EU standard of RA 80 for Colour Rendering Index
³ Subject to terms & conditions (Contact Customer Service)







IC Rated up to 350mm insulation

www.belllighting.co.uk



FirestayLED

CCT 3 way selectable colour switch

Integrated LED Fixed Downlight

The Firestay LED CCT 3 way colour switch downlight is one of our flagship products. Colour selectable as standard with a 7 year guarantee, the Firestay LED CCT downlight is a market leader when it comes to downlights. The front facing switch enables the user to seamlessly change the colour temperature to suit the mood of any space.

- Firestay Certification: 30, 60 and 90 minute solid joist ceilings, 30 minute I-Joist & Metal Web ceiling systems
- IP65
- Front CCT switch
- 6 in 1 Fixture, 3 colour temperatures, 2 bezels
- Includes satin & white magnetic bezels
- Part B / C / E compliant
- IC rated
- 40° & 60° beam angle options
- Tool-Free & Screwfix termination options

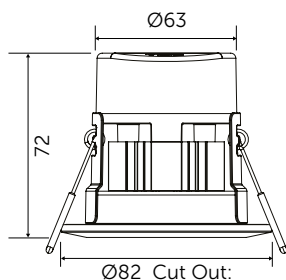

technical@bellighting.co.uk
sales@bellighting.co.uk

FirestayLED

CCT 3 way selectable colour switch

Integrated LED Fixed Downlight

166

The Firestay LED CCT has an easily accessible colour selectable switch located under the bezel on the front of the downlights. Simply move the switch to select your colour temperature option.

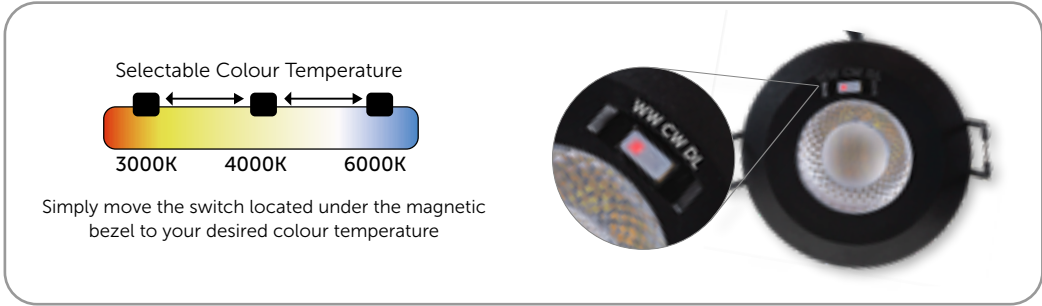

Technical Specification	
Construction	Die-Cast Aluminium
Driver	On Board
LED Chip	Epistar
IP Rating	IP65
Operating Temp	-5°C to +35°C
Input Voltage	220 - 240V
Power Factor	> 0.9
CRI	85 - Exceeds EU standard of Ra 80 for Colour Rendering Index
LMR	80 - Exceeds EU standard of 70 for Lumens Maintenance Ratio

* All BELL Lighting luminaires are rated L80 B10, so for a 50,000 hour product. L80B10 at 50,000 hours our fittings will still have 80% of initial lumen, only 10% of fittings may fail to achieve this.

Code	Description	Colour Temperature	Lm	Cd	Beam ^o	Hrs
08186	7W Firestay LED CCT 3 Way Selectable Colour Switch Downlight Dimmable, Plug & Play, 60° Beam Angle. Screw Fix Termination	3/4/6000K	530/550/600	370	60°	50000
08187	7W Firestay LED CCT 3 Way Selectable Colour Switch Downlight Dimmable, Plug & Play, 40° Beam Angle. Screw Fix Termination	3/4/6000K	530/550/600	530	40°	50000
10510	7W Firestay LED CCT 3 Way Selectable Colour Switch Downlight Dimmable, Plug & Play, 40° Beam Angle. Tool Free Termination	3/4/6000K	530/550/600	530	40°	50000
10560	Chrome Magnetic Bezel for above	-	-	-	-	-
10561	Brass Magnetic Bezel for above	-	-	-	-	-
10562	Antique Brass Magnetic Bezel for above	-	-	-	-	-
10563	Matt Black Magnetic Bezel for above	-	-	-	-	-
08193	White Spacer Plate for above (100mm cut out)	-	-	-	-	-
08194	Satin Spacer Plate for above (100mm cut out)	-	-	-	-	-
08196	Emergency Pack for above	-	-	-	-	-
10803	Smart Universal LED Trailing/Leading Edge Dimmer Module	-	-	-	-	-

Emergency versions must be tested in line with the requirements of B55266, failure to do so may effect battery life and warranty.

¹ Exceeds EU standard of 70 for Lumens Maintenance Ratio

² Exceeds EU standard of RA 80 for Colour Rendering Index

³ Subject to terms & conditions (Contact Customer Service)







IC Rated up to 350mm insulation

www.belllighting.co.uk



FirestayLED

CCT 3 way selectable colour switch

Integrated LED Centre Tilt Downlight

The Centre Tilt version of our CCT Downlight has all the benefits of our fixed CCT Downlight, combined with the added functionality centre tilt lens. Colour selectable as standard with a 7 year guarantee.

- IP65
- Front CCT switch
- 6 in 1 Fixture, 3 colour temperatures, 2 bezels
- Includes satin & white magnetic bezels
- Part B/C/E compliant
- IC rated

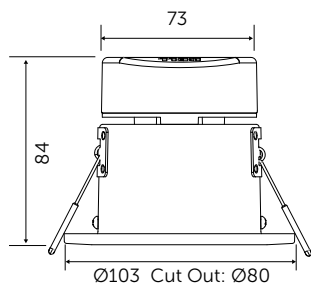

technical@bellighting.co.uk
sales@bellighting.co.uk

FirestayLED

CCT 3 way selectable colour switch

Integrated LED Centre Tilt Downlight

172

The Firestay LED CCT has an easily accessible colour selectable switch located under the bezel on the front of the downlights. Simply move the switch to select your colour temperature option.

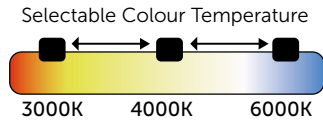

Simply move the switch located under the magnetic bezel to your desired colour temperature

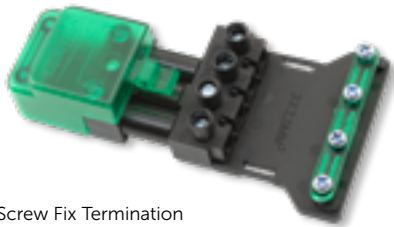
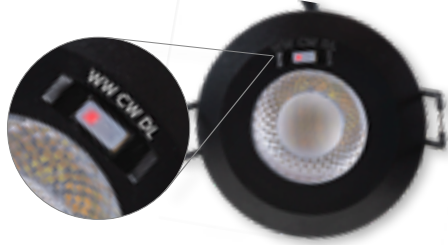

Screw Fix Termination



Technical Specification	
Construction	Die-Cast Aluminium
Driver	On Board
LED Chip	Epistar
IP Rating	IP65
Operating Temp	-5°C to +35°C
Input Voltage	220 - 240V
Power Factor	> 0.9
CRI	85 - Exceeds EU standard of Ra 80 for Colour Rendering Index
LMR	80 - Exceeds EU standard of 70 for Lumens Maintenance Ratio

* All BELL Lighting luminaires are rated L80 B10, so for a 50,000 hour product. L80B10 at 50,000 hours our fittings will still have 80% of initial lumen, only 10% of fittings may fail to achieve this.

Code	Description	Colour Temperature	Lm	Cd	Beam°	Hrs
08190	7W Firestay CCT 3 Way Selectable Colour Switch Center Tilt LED Downlight, Dimmable, Plug & Play, 40° Beam Angle. Screw Fix Termination	3/4/6000K	530/550/600	660	40°	50000
08200	Chrome Magnetic Bezel for above	-	-	-	-	-
08201	Brass Magnetic Bezel for above	-	-	-	-	-
08202	Antique Brass Magnetic Bezel for above	-	-	-	-	-
08203	Matt Black Magnetic Bezel for above	-	-	-	-	-
08196	Emergency Pack for Firestay LED Downlights	-	-	-	-	-
10803	Smart Universal LED Trailing/Leading Edge Dimmer Module	-	-	-	-	-

Emergency versions must be tested in line with the requirements of BS5266, failure to do so may effect battery life and warranty.

¹ Exceeds EU standard of 70 for Lumens Maintenance Ratio
² Exceeds EU standard of RA 80 for Colour Rendering Index
³ Subject to terms & conditions (Contact Customer Service)



IC Rated up to 350mm insulation

www.belllighting.co.uk



FirestayLED

Integrated LED Fixed Downlight

The Firestay Integrated Fixed Downlight boasts a 5 year guarantee and is supplied with white & chrome bezels as standard.

- Firestay Certification: 30, 60 and 90 minute solid joist ceilings, 30 minute I-Joist & metal web ceiling systems
- IP65
- Part B/C/E compliant
- White bezel & magnetic satin bezel
- Part L compliant
- Easy Fit Magnetic Bezel

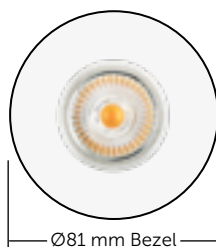
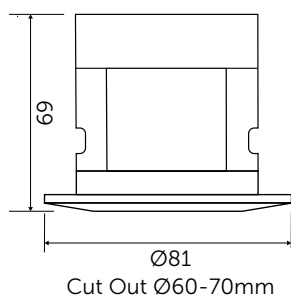

Quick Fix Connector
Tool Free Termination

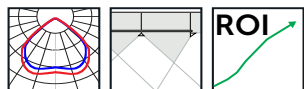

technical@bellighting.co.uk
sales@bellighting.co.uk

Integrated LED Fixed Downlight

Technical Specification	
Construction	Aluminium
Driver	BELL
LED Chip	Samsung
IP Rating	IP65
Operating Temp	-5°C to +35°C
Input Voltage	220 - 240V
Power Factor	> 0.9
CRI	85 - Exceeds EU standard of Ra 80 for Colour Rendering Index
LMR	80 - Exceeds EU standard of 70 for Lumens Maintenance Ratio

* All BELL Lighting luminaires are rated L80 B10, so for a 50,000 hour product, L80B10 at 50,000 hours our fittings will still have 80% of initial lumen, only 10% of fittings may fail to achieve this.

Code	Description	Colour Temp	Lm	Cd	Beam ⁰	Hrs
10499	6W Firestay LED Integrated Fixed Dimmable Downlight, incl White & Satin Bezels. Tool Free Termination	2700K	575	1000	40°	35000
10496	6W Firestay LED Integrated Fixed Dimmable Downlight, incl White & Satin Bezels. Tool Free Termination	2700K	575	700	60°	35000
10500	6W Firestay LED Integrated Fixed Dimmable Downlight, incl White & Satin Bezels. Tool Free Termination	3000K	580	1050	40°	35000
10497	6W Firestay LED Integrated Fixed Dimmable Downlight, incl White & Satin Bezels. Tool Free Termination	3000K	580	750	60°	35000
10501	6W Firestay LED Integrated Fixed Dimmable Downlight, incl White & Satin Bezels. Tool Free Termination	4000K	595	1200	40°	35000
10498	6W Firestay LED Integrated Fixed Dimmable Downlight, incl White & Satin Bezels. Tool Free Termination	4000K	595	900	60°	35000
10560	Chrome Magnetic Bezel for above	-	-	-	-	-
10561	Brass Magnetic Bezel for above	-	-	-	-	-
10562	Antique Brass Magnetic Bezel for above	-	-	-	-	-
10563	Matt Black Magnetic Bezel for above	-	-	-	-	-
08193	White Spacer Plate for above (100mm cut out)	-	-	-	-	-
08194	Satin Spacer Plate for above (100mm cut out)	-	-	-	-	-
08196	Emergency Pack for above	-	-	-	-	-
10803	Smart Universal LED Trailing/Leading Edge Dimmer Module	-	-	-	-	-

Emergency versions must be tested in line with the requirements of BS5266, failure to do so may effect battery life and warranty.

¹ Exceeds EU standard of 70 for Lumens Maintenance Ratio

² Exceeds EU standard of RA 80 for Colour Rendering Index

³ Subject to terms & conditions (Contact Customer Service)







IC Rated up to 350mm insulation

www.belllighting.co.uk



FirestayLED

Integrated LED Fixed Oversize Downlight

The Firestay LED Oversized Downlight does exactly what it says on the tin. The oversized bezel gives users the opportunity to 'make good' on large holes when switching from outdated CFL technology.

- Firestay Certification: 30, 60 and 90 minute solid joist ceilings, 30 minute I-Joist ceiling systems (certification pending)
- IP65
- Part B/C/E compliant
- White bezel & magnetic satin bezel
- Part L compliant
- Easy Fit Magnetic Bezel

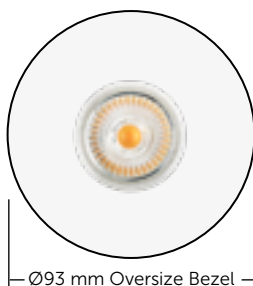
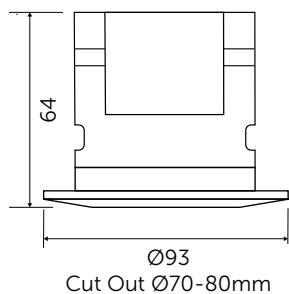

Quick Fix Connector
Tool Free Termination

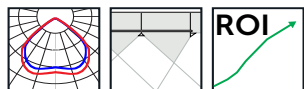

Integrated LED Fixed Oversize Downlight

Technical Specification

Construction	Aluminium
Driver	BELL
LED Chip	Samsung
IP Rating	IP65
Operating Temp	-5°C to +35°C
Input Voltage	220 - 240V
Power Factor	> 0.9
CRI	85 - Exceeds EU standard of Ra 80 for Colour Rendering Index
LMR	80 - Exceeds EU standard of 70 for Lumens Maintenance Ratio

* All BELL Lighting luminaires are rated L80 B10, so for a 50,000 hour product, L80B10 at 50,000 hours our fittings will still have 80% of initial lumen, only 10% of fittings may fail to achieve this.

Code	Description	Colour Temp	Lm	Cd	Beam ⁰	Hrs
10515	6W Firestay LED Integrated Fixed Dimmable Downlight, incl White & Satin Oversize Bezels. Tool Free Termination	3000K	580	1050	40°	35000
10516	6W Firestay LED Integrated Fixed Dimmable Downlight, incl White & Satin Oversize Bezels. Tool Free Termination	4000K	595	1200	40°	35000
10517	6W Firestay LED Integrated Fixed Dimmable Downlight, incl White & Satin Oversize Bezels. Tool Free Termination	6000K	610	1150	40°	35000
10518	Chrome Magnetic Oversize Bezel for above					
10519	Brass Magnetic Oversize Bezel for above					
10803	Smart Universal LED Trailing/Leading Edge Dimmer Module	-	-	-	-	-
08196	Emergency Pack for Firestay LED Downlight					

Emergency versions must be tested in line with the requirements of B55266, failure to do so may effect battery life and warranty.

¹ Exceeds EU standard of 70 for Lumens Maintenance Ratio
² Exceeds EU standard of RA 80 for Colour Rendering Index
³ Subject to terms & conditions (Contact Customer Service)







IC Rated up to 270mm insulation

www.belllighting.co.uk



Firestayslim

Integrated LED Fixed/Tilt Downlight

The most cost effective integrated downlight in the BELL range, the Firestay Slim comes with a 3 year quality guarantee. Fixed and Centre Tilt options available with a choice of finishes and colour temperatures.

- Firestay Certification: 30, 60 and 90 minute solid joist ceilings, 30 minute I-Joist & Metal Web ceiling systems
- IP65 - Fixed Versions / IP44 - Tilt Version
- 30/60/90 minutes firestay
- Part B/C/E compliant
- Choice of finishes
- Dimmable
- Cut Out Ø55-68 mm
- Tool Free Connector

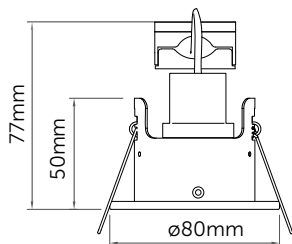

Fixed Downlight

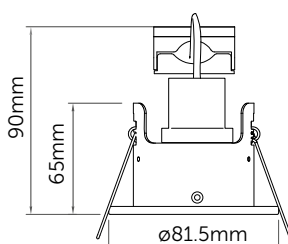

Centre Tilt Downlight



Tool Free Connector
2.5mm twin earth loop in /
loop out push-fit connectors

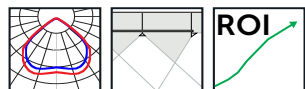

technical@bellighting.co.uk
sales@bellighting.co.uk

Integrated LED Fixed/Tilt Downlight

Technical Specification	
Construction	Pressed Steel
Driver	On Board
LED Chip	Samsung
IP Rating	Fixed IP65 / Centre Tilt IP44
Operating Temp	-5°C to +35°C
Input Voltage	220 - 240V
Power Factor	> 0.9
CRI	85 - Exceeds EU standard of Ra 80 for Colour Rendering Index
LMR	80 - Exceeds EU standard of 70 for Lumens Maintenance Ratio

* All BELL Lighting luminaires are rated L80 B10, so for a 50,000 hour product. L80B10 at 50,000 hours our fittings will still have 80% of initial lumen, only 10% of fittings may fail to achieve this.

Code	Description	Colour Temp	Lm	Beam ⁰	Hrs
10675	5W Firestay Integrated LED Fixed Downlight White Bezel	3000K	462	60°	35000
10676	5W Firestay Integrated LED Fixed Downlight White Bezel	4000K	492	60°	35000
10677	5W Firestay Integrated LED Fixed Downlight Satin Bezel	3000K	462	60°	35000
10678	5W Firestay Integrated LED Fixed Downlight Satin Bezel	4000K	492	60°	35000
10679	5W Firestay Integrated LED Fixed Downlight Chrome Bezel	3000K	462	60°	35000
10680	5W Firestay Integrated LED Fixed Downlight Chrome Bezel	4000K	492	60°	35000
10681	5W Firestay Integrated LED Centre Tilt Downlight White Bezel	3000K	450	60°	35000
10682	5W Firestay Integrated LED Centre Tilt Downlight White Bezel	4000K	478	60°	35000
10683	5W Firestay Integrated LED Centre Tilt Downlight Satin Bezel	3000K	450	60°	35000
10684	5W Firestay Integrated LED Centre Tilt Downlight Satin Bezel	4000K	478	60°	35000
10685	5W Firestay Integrated LED Centre Tilt Downlight Chrome Bezel	3000K	450	60°	35000
10686	5W Firestay Integrated LED Centre Tilt Downlight Chrome Bezel	4000K	478	60°	35000

¹ Exceeds EU standard of 70 for Lumens Maintenance Ratio

² Exceeds EU standard of RA 80 for Colour Rendering Index

³ Subject to terms & conditions (Contact Customer Service)







Firestay

Non Integrated Downlight

The Firestay Non Integrated Downlight gives you the freedom to choose your lamp without the need to replace the complete fitting. Available as Fixed, Centre Tilt & IP65 Showerlight with a choice of finishes and accessories.

- Firestay Certification: 30, 60 and 90 minute solid joist ceilings, 30 minute I-Joist ceiling systems
- Fixed / Centre Tilt / Showerlight IP65 Downlights
- Part B/C/E compliant
- Suitable for 240V lamps (GU10 lamp holder included)
- Loop in/out terminals for speed of installation
- Die-cast aluminium body
- Part L compliant with BELL Halo Elite/Halo Glass LED GU10
- Low voltage lampholder available separately (Code 09906)

One fitting to fit all standard type lamps. Simply choose a BELL lamp for the application required (See LED Lamps section)



Tool Free Connector
2.5mm twin earth loop in /
loop out push-fit connectors

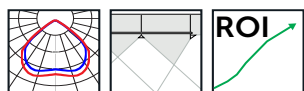

Non Integrated Downlight

Fixed Downlight

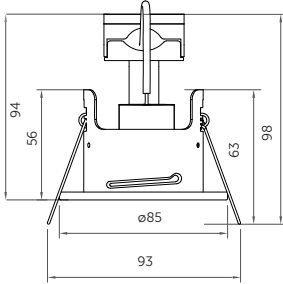

Cut-Out: 68mm

Centre Tilt Downlight

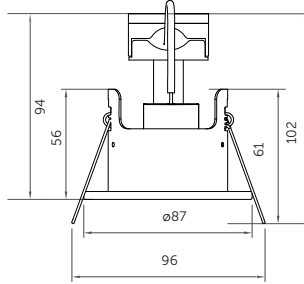

Cut-Out: 78mm

Showerlight IP65

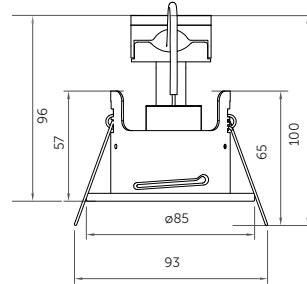

Cut-Out: 68mm

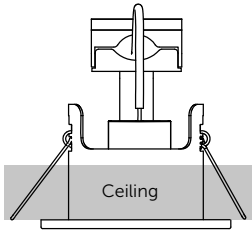

Ultra Low Profile for 100mm
ceiling voids



IC Cage
Available for all
Firestay Downlights



Technical Specification	
Construction	Pressed Steel
LED Chip	n/a
IP Rating	IP65 (Showerlight)
Operating Temp	n/a
Input Voltage	n/a
Power Factor	n/a
CRI	n/a
LMR	n/a

Code	V	Description	Finish	Cut Out (mm)
10660	240	Fixed Downlight	White	68
10661	240	Fixed Downlight	Satin Nickel	68
10662	240	Fixed Downlight	Chrome	68
10663	240	Fixed Downlight	Antique Brass	68
10664	240	Fixed Downlight	Brass	68
10665	240	Fixed Downlight	Matt White	68
10655	240	Centre Tilt Downlight	White	78
10656	240	Centre Tilt Downlight	Satin Nickel	78
10657	240	Centre Tilt Downlight	Chrome	78
10658	240	Centre Tilt Downlight	Antique Brass	78
10659	240	Centre Tilt Downlight	Brass	78
10667	240	Centre Tilt Downlight	Matt White	78
10650	240	Showerlight IP65	White	68
10651	240	Showerlight IP65	Satin Nickel	68
10652	240	Showerlight IP65	Chrome	68
10653	240	Showerlight IP65	Antique Brass	68
10654	240	Showerlight IP65	Brass	68
10666	240	Showerlight IP65	Matt White	68
10670	-	IC Cage for Firestay Showerlight/Fixed Downlight	-	-
10671	-	IC Cage for Firestay Centre Tilt Downlight	-	-

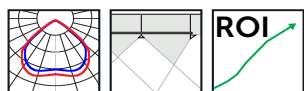





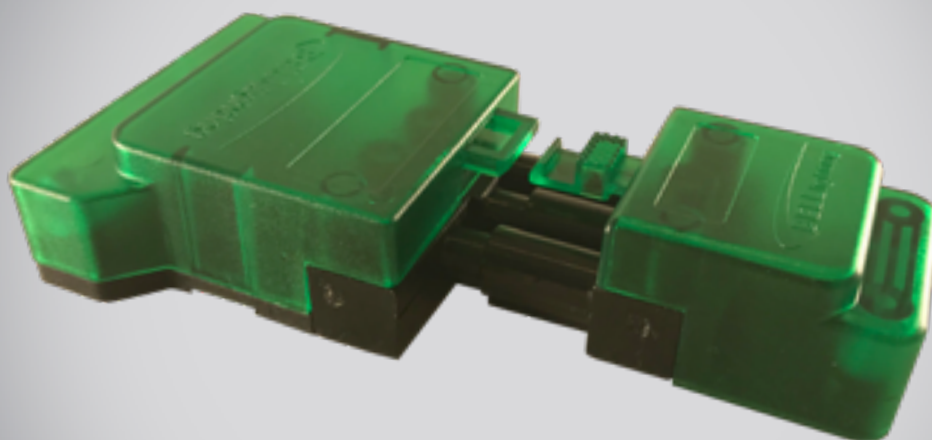



Quick Fix Connector - 3 Pole

The BELL 3 Pole Quick Fix is a tool free connector designed for quick and easy installations.

- 20 Amp 250 Volt
- Robust Plug Connector
- Up to 3 x 2.5mm cables

Code	Description	Inner Box Qty	Outer Box Qty
08212	Quick Fix Connector - 3 Pole Connector Tool Free connection	50	200
08199	FREE Quick Fix Connector Trade Counter Display (For 08212)	50	200

Free display Box for 3 Pole Quick Fix Connector available on request.
BULK packaging for quick access, no individual poly bags

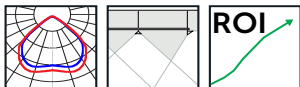

technical@belllighting.co.uk
sales@belllighting.co.uk





LED Driver

15W LED Constant Voltage Line Driver 12V.

- Short-circuit protection
- Thermal protection
- Loop-in, loop-out primary wiring terminals
- EMC compliance - EN 55015, EN 61000, EN 61547

Code	Description	Box Qty
05100	15W LED Constant Voltage Line Driver 12V Short-circuit protection Thermal protection Loop-in, loop-out primary wiring terminals EMC compliance - EN 55015, EN 61000, EN 61547	1

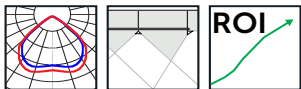





Smart Universal LED Trailing/Leading Edge Dimmer Module

Smooth, flicker free, silent, buzz free dimming and easy set up

- Completely silent dimming
- Smooth flicker free dimming
- Wide dimming ranging from 100% to 10%
- Compatible with most lamps and fittings in the market
- 5W - 100W LED lamps (10 lamps maximum)
- 5W - 150W including Incandescent, Halogen & CFL lamps

Code	Description	Box Qty
10803	<p>LED Dimmer Module Ideal for replacing existing backplate dimmer modules when retro-fitting LED lamps or downlights Suitable for dimming: LED / CFL / Halogen / Incandescent</p> <p>Resistive Load GLS - Min 5W ~ Max 150W Mains voltage Halogen - Min 5W ~ Max 150W</p> <p>Inductive Load UNSUITABLE FOR dimmable magnetic transformer Electronic transformer Min 10W ~ Max 150W</p> <p>LED Load LED Dimmable lamps - Min 5W ~ Max 100W - 10 lamps maximum LED Dimmable lamps - Min 5W ~ Max 120W - 10 lamps maximum</p> <p>Compact Fluorescent Load CFL Dimmable lamps - Min 15W ~ Max 150W</p>	50

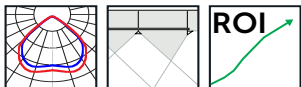

technical@belllighting.co.uk
 sales@belllighting.co.uk

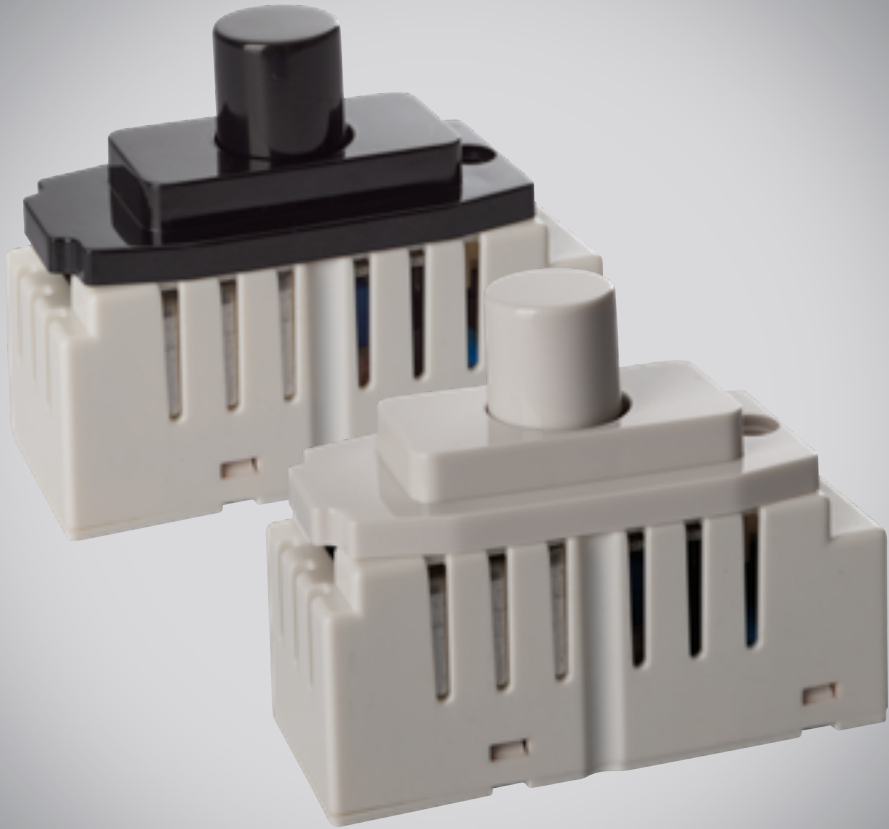



LED Grid Dimmer

Smooth, flicker free, silent, buzz free dimming.

- Completely silent dimming
- Smooth flicker free dimming
- Wide dimming ranging from 100% to 10%
- Compatible with most lamps and fittings in the market
- 5W - 250W LED Lamps (30 lamps maximum)
- 10W - 400W including Incandescent, Halogen & CFL lamps
- Includes 8 adaptors
- Compatible with all standard grid plates
- Push on

Code	Description	Box Qty
10800	<p>LED Grid Dimmer Ideal for replacing existing Grid Dimmer modules when retro-fitting LED lamps or fittings Suitable for dimming: LED / CFL / Halogen / Incandescent</p> <p>Resistive Load GLS - Min 10W ~ Max 400W Mains voltage Halogen - Min 10W ~ Max 400W</p> <p>Inductive Load UNSUITABLE FOR Dimmable magnetic transformer Electronic transformer Min 10W ~ Max 150W</p> <p>LED Load LED Dimmable bulb - Min 5W ~ Max 250W - 30 lamps maximum LED Dimmable driver - Min 5W ~ Max 250W - 30 lamps maximum</p> <p>Compact Fluorescent Load CFL Dimmable bulb - Min 15W ~ Max 250W</p>	50

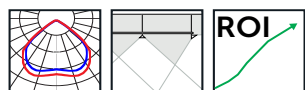
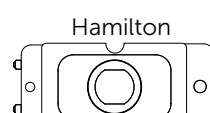
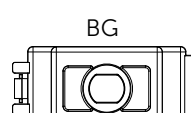
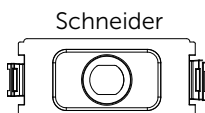
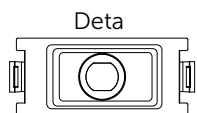
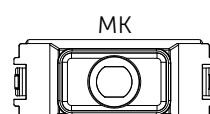
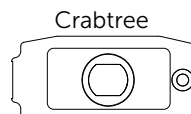
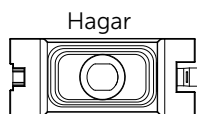





LED Emergency Hinged Exit Box

Our Spectrum LED Emergency Hinged Exit Box is one of our most popular emergency products. The tried and tested robust design and polycarbonate construction makes this exit box ideal for all commercial and industrial environments.

- Hinged for quick and easy installation and maintenance
- Tool free termination
- Sleek, energy efficient design
- Different legend options available
- Suitable for commercial and industrial installations
- IP20
- Viewing distance 25m



Auto Self Test Indicator. No requirement for manual key test (Code: 09084)

Normal operation: Green indicator illuminated

Battery failure: Red indicator flashes once every 3 seconds

Light source failure: Red indicator flashes twice every 3 seconds

Less than rated duration time: Red indicator flashes three times every 3 seconds.

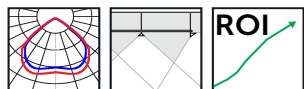
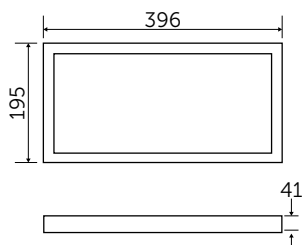

technical@bellighting.co.uk
sales@bellighting.co.uk

Spectrum

LED Emergency Hinged Exit Box

Legend Options



09085 New (ISO) Legend Reversible
Left & Right



09087 New (ISO)
Legend Down



09086 New (ISO)
Legend Up

Technical Specification

Construction	Polycarbonate
LED Chip	Samsung
IP Rating	IP20
Operating Temp	-5°C to +35°C
Input Voltage	220 - 240V
Power Factor	> 0.9
Battery	NiCd

Code	W	Description	Viewing Distance	Temp	Hours
09083	4	LED Emergency Hinged Exit Box including Up Legend.	25M	6500K	30000
09084	4	LED Emergency Hinged Exit Box, Self Test including Up Legend	25M	6500K	30000
09085	-	New (ISO) Legend Reversible Left & Right (spare accessory)	-	-	-
09087	-	New (ISO) Legend Down (spare accessory)	-	-	-
09086	-	New (ISO) Legend Up (spare accessory)	-	-	-

Must be tested in line with the requirements of BS5266, failure to do so may effect battery life and warranty.

¹ Exceeds EU standard of 70 for Lumens Maintenance Ratio

² Exceeds EU standard of Ra 80 for Colour Rendering Index

³ Subject to terms & conditions (Contact Customer Service)







Spectrum

LED Emergency Ultra Slim Exit Sign

The Spectrum Ultra Slim Exit Sign combines the functionality of an exit sign with the ability to effortlessly blend in with its decorative surroundings until illuminated. The sleek design along with the decorative bezel options truly makes this Ultra Slim Exit Sign unique.

- 50% smaller than standard exit sign
- 270mm x 130mm
- Easy Fit trim options available
- Sleek, energy efficient design
- Different legend options available
- Suitable for commercial & industrial installations
- Wall mountable
- Maintained / Non Maintained
- 18M Viewing distance



Auto Self Test Indicator. No requirement for manual key test (Code: 09053)

Normal operation: Green indicator illuminated

Battery failure: Red indicator flashes once every 3 seconds

Light source failure: Red indicator flashes twice every 3 seconds

Less than rated duration time: Red indicator flashes three times every 3 seconds.

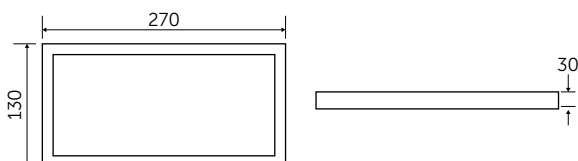

Spectrum

LED Emergency Ultra Slim Exit Sign

Legend Options



09058 New (ISO)
Left & right

09057 New (ISO)
Legend Down

09056 New (ISO)
Legend Up



09061 Old (Euro) Legend
Left & Right

09060 Old (Euro)
Legend Down

09059 Old (Euro)
Legend Up

Technical Specification

Construction	Polycarbonate
LED Chip	Samsung
IP Rating	IP20
Operating Temp	-5°C to +35°C
Input Voltage	220 - 240V
Power Factor	> 0.9
Battery	NiCd

Code	W	Description	Viewing Distance	Temp	Hours
09052	3	3W Spectrum LED Emergency Ultra Slim Exit Sign Including Up Legend, Maintained, supplied with white bezel	18M	6500K	30000
09053	3	3W Spectrum LED Emergency Ultra Slim Exit Sign Including Up Legend, Maintained - Self Test, supplied with white bezel	18M	6500K	30000
09054	-	Satin Bezel for Spectrum Ultra Slim Exit Box	-	-	30000
09055	-	Antique Brass Bezel for Spectrum Ultra Slim Exit Box	-	-	30000
09056	-	New (ISO) Legend Up for Ultra Slim Exit Box	-	-	30000
09057	-	New (ISO) Legend Down for Ultra Slim Exit Box	-	-	30000
09058	-	New (ISO) Legend Left / Right for Ultra Slim Exit Box	-	-	30000
09059	-	Old (Euro) Legend Up for Ultra Slim Exit Box	-	-	30000
09060	-	Old (Euro) Legend Down for Ultra Slim Exit Box	-	-	30000
09061	-	Old (Euro) Legend Left / Right for Ultra Slim Exit Box	-	-	30000

Must be tested in line with the requirements of BS5266, failure to do so may affect battery life and warranty.







Spectrum

LED Emergency Exit Blade

The Spectrum LED Emergency Surface Exit Blade is one of our most cost-effective emergency products. With a viewing distance of 25m, this Maintained/Non maintained is viewable for both sides to ensure safe passage in the unlikely event of an emergency.

- Sleek, low profile design
- Easy switching from non maintained to maintained via removable link
- Can be mounted to ceiling or wall
- Supplied with New Up Legend as standard
- Suitable for Commercial and Industrial installations
- Maintained / Non Maintained
- 25M Viewing Distance
- Viewable from both sides
- Recessing Kit option (Code 09048)



Manual Push Test Indicator

Once activated, unit illuminates for 5 minutes to indicate fitting is functioning correctly. Key Test feature can also be used.

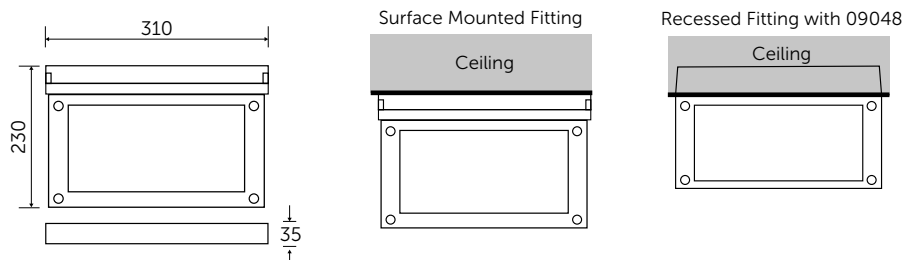

Rotating fixing, can be mounted to ceiling or wall at 90° angle

Spectrum

LED Emergency Exit Blade

Legend Options



09058 New (ISO)
Left & right

09057 New (ISO)
Legend Down

09056 New (ISO)
Legend Up



09061 Old (Euro) Legend
Left & Right

09060 Old (Euro)
Legend Down

09059 Old (Euro)
Legend Up

Technical Specification

Construction	Polycarbonate
LED Chip	Samsung
IP Rating	IP20
Operating Temp	-5°C to +35°C
Input Voltage	220 - 240V
Power Factor	> 0.9
Battery	NiCd

Code	W	Description	Viewing Distance	Temp	Hours
09012	2.5	LED Emergency Exit Blade Surface including Up Legend. Maintained/Non Maintained	25M	6500K	25000
09013	-	New Legend Left + Right for Exit Blade		-	-
09014	-	New Legend Down for Exit Blade		-	-
09015	-	New Legend Up for Surface Exit Blade (spare accessory)		-	-
09016	-	Old Legend Left + Right for Exit Blade		-	-
09017	-	Old Legend Down for Exit Blade		-	-
09018	-	Old Legend Up for Exit Blade		-	-
09048	-	Recessing kit for Emergency Surface Exit Blade (09012)			

Must be tested in line with the requirements of BS5266, failure to do so may effect battery life and warranty.







Spectrum

LED Emergency 6 in 1 Exit Blade

Surface / Suspended / Recessed / Wall / Parallel / Angled Mounting

The Spectrum 6 in 1 Exit Blade is a product unique to BELL. This product has the ability to be displayed in 6 different ways, so therefore is one of the most cost-effective, complete products on the market.

- Sleek, energy efficient design
- Suitable for commercial and industrial installations
- Different legend options available
- Maintained / Non Maintained
- Viewable from both sides
- Viewing distance 25m
- IP20



Manual Push Test Indicator

Once activated, unit illuminates for 5 minutes to indicate fitting is functioning correctly. Key Test feature can also be used.

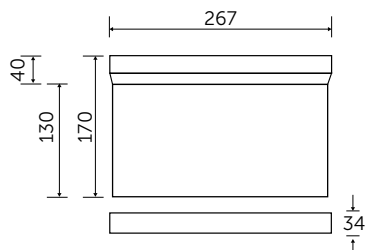

Spectrum

LED Emergency 6 in 1 Exit Blade

Legend Options



09067 New (ISO) Legend Reversible
Left & Right

09068 (ISO) New
Legend Down

Technical Specification

Construction	Polycarbonate
LED Chip	Samsung
IP Rating	IP20
Operating Temp	0°C to +35°C
Input Voltage	220 - 240V
Power Factor	> 0.9
Battery	LiFeP04

Code	W	Description	Viewing Distance	Temp	Hours
09066	2.5	LED Emergency 6 in 1 Exit Blade	25M	6500K	30000
09067	_	New (ISO) Legend Reversible Left & Right	_	_	_
09068	_	New (ISO) Legend Down	_	_	_

Must be tested in line with the requirements of BS5266, failure to do so may effect battery life and warranty.

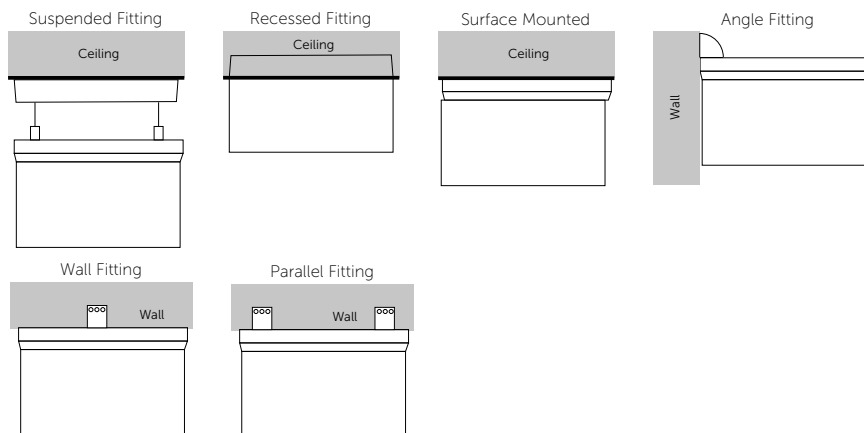







LED Emergency Non Maintained Downlights

The 1W Spectrum Non Maintained Downlights have a green charge indicator and come complete with a sheathed battery pack. This IP20 rated fixture can be purchased for both Open Area and Corridor applications.

- Open Area / Corridor versions
- Green charge indicator
- Complete with driver and sheathed battery pack
- Cut Out Ø32mm



Technical Specification	
Construction	Polycarbonate
LED Chip	Samsung
IP Rating	IP20
Operating Temp	0°C to +35°C
Input Voltage	220 - 240V
Power Factor	> 0.9
Battery	LiFeP04

Code	W	Description	Temp	Lm	Hours
09080	1	LED Emergency Non Maintained Downlight Open Area	6000K	66	25000
09081	1	LED Emergency Non Maintained Downlight Corridor	6000K	66	25000

See end of Emergency Lighting section for spacing tables

Must be tested in line with the requirements of BS5266, failure to do so may effect battery life and warranty.



Spectrum

Recessed Downlights

The 3W Spectrum Non Maintained Downlights have a green charge indicator and come complete with a sheathed battery pack. This IP20 rated fixture can be purchased for both Open Area and Corridor applications.

- Open Area / Corridor versions
- Green charge indicator
- Complete with driver and fire rated sheathed battery pack
- 3W recessed



Technical Specification	
Construction	Polycarbonate
LED Chip	Samsung
IP Rating	IP20
Operating Temp	0°C to +35°C
Input Voltage	220 - 240V
Power Factor	> 0.9
Battery	NiCd

Code	W	Description	Temp	Lm	Hours
09030	3	LED Emergency Non Maintained Downlight Open Area	6000K	120	25000
09031	3	LED Emergency Non Maintained Downlight Corridor	6000K	120	25000

See end of Emergency Lighting section for spacing tables

Must be tested in line with the requirements of BS5266, failure to do so may effect battery life and warranty.



Spectrum

LED Emergency Non Maintained Downlight

The 3W Spectrum Auto Self Test Downlights have a green charge indicator and come complete with a sheathed battery pack. This IP20 rated fixture includes both Open Area and Corridor lenses which are easily interchangeable to suit the application.

- Green charge indicator, complete with driver and sheathed battery pack
- Open area & corridor lenses included
- Cut Out Ø55mm



Auto Self Test Indicator. No requirement for manual key test.

Normal operation: Green indicator illuminated

Battery failure: Red indicator flashes once every 3 seconds

Light source failure: Red indicator flashes twice every 3 seconds

Less than rated duration time: Red indicator flashes three times every 3 seconds.

Technical Specification	
Construction	Polycarbonate
LED Chip	Samsung
IP Rating	IP20
Operating Temp	0°C to +35°C
Input Voltage	220 - 240V
Power Factor	> 0.9

Code	W	Description	Temp	Lm	Hours
09075	3	LED Emergency Non Maintained Downlight Open Area & Corridor	6500K	260	25000

See end of Emergency Lighting section for spacing tables

Must be tested in line with the requirements of BS5266, failure to do so may effect battery life and warranty.

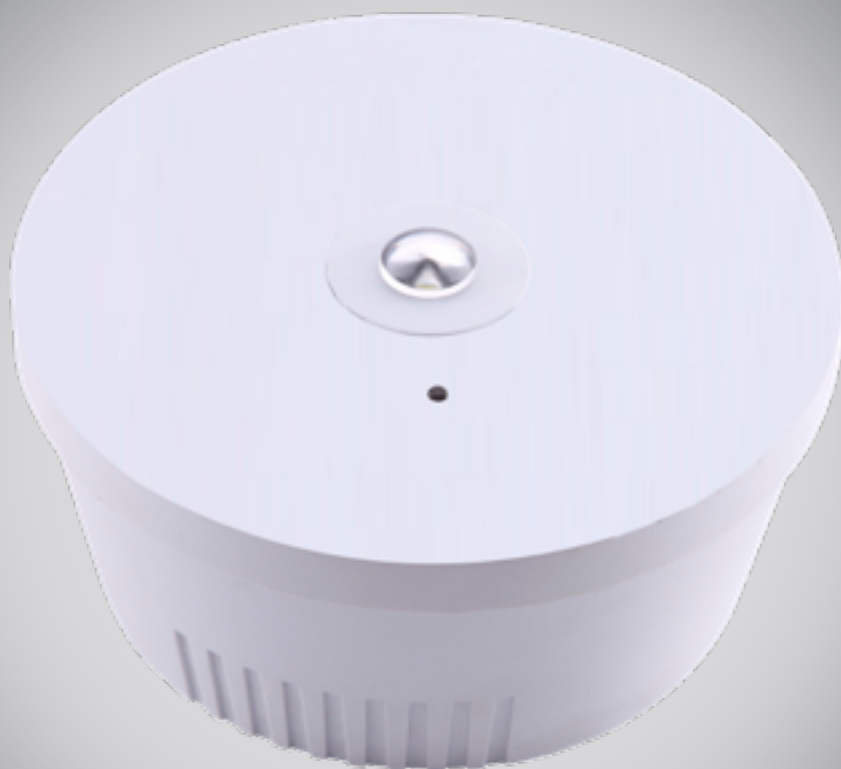

Spectrum

Spectrum 3W LED Emergency Non Maintained Downlight - Surface or Recessed

The 3W Spectrum Auto Self Test Downlight is a 4 in 1 product which makes it one of the most versatile in the range. The downlight can be surface and recessed mounted and is supplied with both the Open Area & Corridor lenses.

- 3W Open Area / Corridor Downlight
- Surface mount or recessed
- Suitable for open area or corridor
- Green charge indicator, complete with driver and battery pack
- Cut Out Ø105mm
- 6500K



Technical Specification	
Construction	Polycarbonate
LED Chip	Samsung
IP Rating	IP20
Operating Temp	0°C to +35°C
Input Voltage	220 - 240V
Power Factor	> 0.9
Battery	LiFeP04

Code	W	Description	Temp	Lm	Hours
09065	3	LED Emergency Non Maintained Downlight	6500K	1460	30000

See end of Emergency Lighting section for spacing tables

Must be tested in line with the requirements of BS5266, failure to do so may effect battery life and warranty.

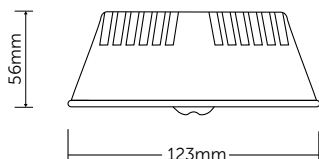



Spectrum

LED Emergency IP65 Twin Spot

The Spectrum IP65 Twin Spot is IP65 as standard. Supplied as both Self Test & Non Self Test, with 20mm side & rear entry and a 5 year guarantee.

- Long life & low maintenance
- Compact design
- Robust Construction
- 20mm Side & rear entry



Auto Self Test Indicator. No requirement for manual key test (09089 Version).

Normal operation: Green indicator illuminated

Battery failure: Red indicator flashes once every 3 seconds

Light source failure: Red indicator flashes twice every 3 seconds

Less than rated duration time: Red indicator flashes three times every 3 seconds.

Technical Specification	
Construction	Polycarbonate
LED Chip	Samsung
IP Rating	IP65
Operating Temp	-5°C to +35°C
Input Voltage	220 - 240V
Power Factor	> 0.9
Battery	LiFePO4

Code	W	Description	Temp	Lm	Hours
09088	12	LED Emergency Twin Spot IP65. Non Maintained	6500K	550	30000
09089	12	LED Emergency Twin Spot IP65. Self Test Non Maintained	6500K	550	30000

See end of Emergency Lighting section for spacing tables

Must be tested in line with the requirements of BS5266, failure to do so may effect battery life and warranty.

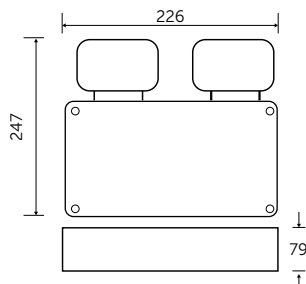

technical@bellighting.co.uk
sales@bellighting.co.uk

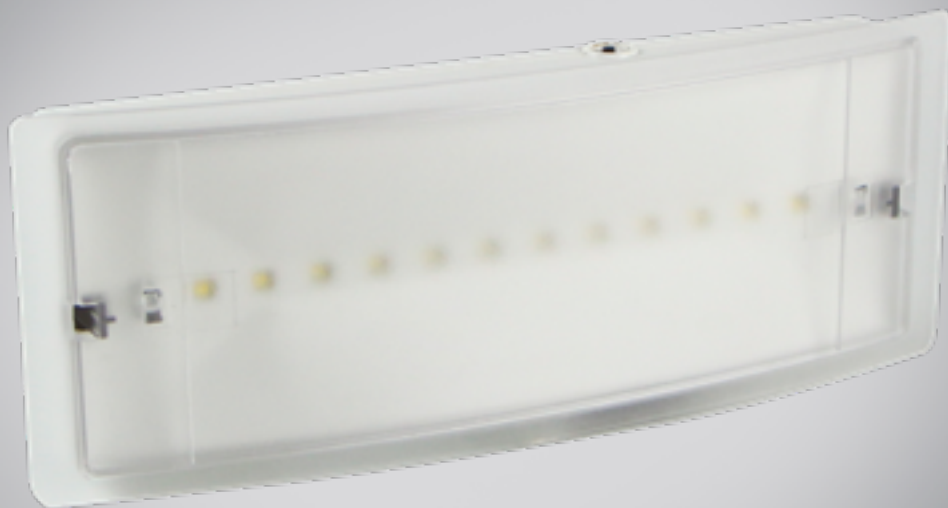

Spectrum

LED Emergency Mini Bulkhead

Our most cost effective Emergency Bulkhead and a relative new comer to the range, the Mini Bulkhead's slender profile lends itself to design conscious applications.

- 3W Bulkhead
- Sleek, energy efficient design
- Suitable for commercial and industrial installations
- Maintained/Non Maintained
- Supplied with legend kit
- Tool-Free termination



Includes all New (ISO) Legends



09045 Old (Euro) Legends Kit

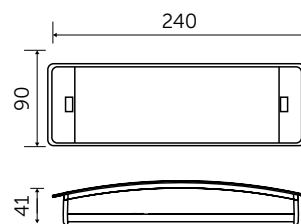

Technical Specification	
Construction	Polycarbonate
LED Chip	Samsung
IP Rating	IP20
Operating Temp	0°C to +35°C
Input Voltage	220 - 240V
Power Factor	> 0.9
Battery	NiCd

Code	W	Description	Temp	Lm	Hours
09082	3	LED Emergency Bulkhead IP20. Maintained/Non Maintained Includes set of 4 New Legends	6500K	110	25000

See end of Emergency Lighting section for spacing tables

Must be tested in line with the requirements of BS5266, failure to do so may effect battery life and warranty.



Spectrum

LED Emergency Bulkhead / Recessed

Our most popular emergency bulkhead, the 3.3W IP65 bulkhead has a low-profile design and is suitable for both internal & external use. The optional exit blade accessory transforms this Emergency Bulkhead into an IP65 Exit Blade.

- 3.3W IP65 Bulkhead
- Low profile slim design
- Long life
- Low maintenance
- Includes full set of New Legends
- Old Legends also available
- Internal/external use
- Viewing distance 18M
- Daylight 6500K
- Optional Exit Blade Accessory transforms Emergency Bulkhead to IP65 Exit Blade
- 20mm Conduit entry
- Hinged Gear Tray for easy install
- Tool-Free termination

09046 Exit Blade Accessory available, when fitted this adapts 3.3W Bulkhead (09040) in to a cost effective IP65 Exit Blade.

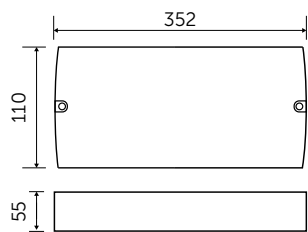

Cut Out: 350mm x 110mm
When used with Semi
Recessing Kit (09041)

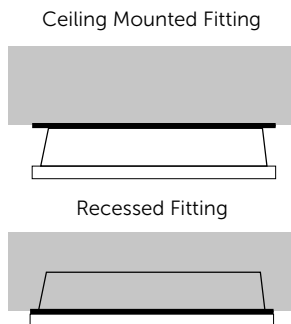

Spectrum

LED Emergency Bulkhead / Recessed



Includes all New (ISO) Legends



09043 Old (Euro) Legends Kit

Technical Specification

Construction	Polycarbonate
LED Chip	Samsung
IP Rating	IP65
Operating Temp	-5°C to +35°C
Input Voltage	220 - 240V
Power Factor	> 0.9
Battery	NiCd

Code	W	Description	Temp	Lm	Hours
09040	3.3	LED Emergency Bulkhead IP65. Maintained/Non Maintained Includes set of 4 New Legends	6500K	190	25000
09041	-	Semi Recessing Kit for LED Emergency Bulkhead	-	-	-
09043	-	Old Legend Kit for Emergency Bulkhead (Set of 4)	-	-	-
09046	-	Exit Blade Accessory			

See end of Emergency Lighting section for spacing tables

Must be tested in line with the requirements of BS5266, failure to do so may effect battery life and warranty.







SpectrumPro

LED Emergency IP65 Bulkhead

The Spectrum Pro Emergency Bulkhead is our premium performance bulkhead. It's sleek energy efficient design combined with the high wattage and lumen output makes this one of our flagship Emergency products.

- Long Life
- Sleek, energy efficient design
- Different legend options available
- Suitable for commercial and industrial installations
- Maintained/Non Maintained
- Viewing distance 18M
- 20mm conduit entry
- Hinged gear tray for easy install
- Tool-Free termination



Auto Self Test Indicator. No requirement for manual key test.

Normal operation: Green indicator illuminated

Battery failure: Red indicator flashes once every 3 seconds

Light source failure: Red indicator flashes twice every 3 seconds

Less than rated duration time: Red indicator flashes three times every 3 seconds.

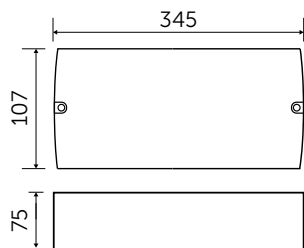

Ceiling Mounted Fitting



SpectrumPRO

LED Emergency IP65 Bulkhead



Includes all New (ISO) Legends



09045 Old (Euro) Legends Kit

Technical Specification

Construction	Polycarbonate
LED Chip	Samsung
IP Rating	IP65
Operating Temp	-5°C to +35°C
Input Voltage	220 - 240V
Power Factor	> 0.9
Battery	NiCd

Code	W	Description	Temp	Lm	Hours
09044	7	LED Emergency Bulkhead IP65, maintained includes set of 4 New (ISO) Legends	6500K	250	25000
09045	-	Old (Euro) Legend Kit for Emergency Bulkhead (Set of 4)	-	-	-

See end of Emergency Lighting section for spacing tables

Must be tested in line with the requirements of BS5266, failure to do so may effect battery life and warranty.





Spectrum

Downlight Spacing Tables

3W Open Area Recessed Downlight (09030) Spacing Table

Open Area (0.5 lux minimum)

Mounting Height (M)	Transverse To Wall (M)	Transverse To Transverse (M)	Axial To Wall (M)	Axial To Axial (M)
2.5	3	7.8	-	-
4	3.6	9	-	-
6	3.6	10.8	-	-

3W Corridor Recessed Downlight (09031) Spacing Table

Escape Route (1 lux across central line)

Mounting Height (M)	Transverse To Wall (M)	Transverse To Transverse (M)	Axial To Wall (M)	Axial To Axial (M)
2.5	3	7.2	-	-
4	2.4	7.8	-	-
6	-	-	-	-



3W Open Area (09065) Spacing Table

Open Area (0.5 lux minimum)

Mounting Height (M)	Transverse To Wall (M)	Transverse To Transverse (M)	Axial To Wall (M)	Axial To Axial (M)
2.5	3.2	6.6	3.2	6.6
4	3.8	9	3.8	9
6	3.6	11.2	3.6	11.2

3W Corridor (09065) Spacing Table

Escape Route (1 lux across central line)

Mounting Height (M)	Transverse To Wall (M)	Transverse To Transverse (M)	Axial To Wall (M)	Axial To Axial (M)
2.5	3.8	7.2	-	-
4	5.0	10.8	-	-
6	-	-	-	-



Spectrum

Downlight Spacing Tables

3W Corridor Recessed Downlight (09075) Spacing Table				
Escape Route (1 lux across central line)				
Mounting Height (M)	Transverse To Wall (M)	Transverse To Transverse (M)	Axial To Wall (M)	Axial To Axial (M)
2.5	7.2	18	-	-
4	9	20.4	-	-
6	7.8	21.6	-	-

3W Open Area Recessed Downlight (09075) Spacing Table				
Open Area (0.5 lux minimum)				
Mounting Height (M)	Transverse To Wall (M)	Transverse To Transverse (M)	Axial To Wall (M)	Axial To Axial (M)
2.5	4.2	10.8	4.2	10.8
4	4.2	11.4	4.2	11.4
6	4.2	12.6	4.2	12.6

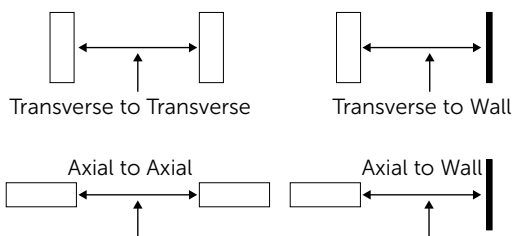

Spectrum

Bulkhead Spacing Tables

3W Bulkhead (09040) Spacing Table

Escape Route (1 lux across central line)

Mounting Height (M)	Transverse To Wall (M)	Transverse To Transverse (M)	Axial To Wall (M)	Axial To Axial (M)
2.5	4.5	9.4	3.5	6
4	4.5	10	3.5	6.5
6	4.5	9.5	2.5	5.5

Open Area (0.5 lux minimum) Spacing Table

Mounting Height (M)	Transverse To Wall (M)	Transverse To Transverse (M)	Axial To Wall (M)	Axial To Axial (M)
2.5	4	9	3.5	8
4	5	10	4	9
6	5	11.5	4	10



SpectrumPRO

Bulkhead Spacing Tables

7W Bulkhead (09044) Spacing Table				
Escape Route (1 lux across central line)				
Mounting Height (M)	Transverse To Wall	Transverse To Transverse	Axial To Wall	Axial To Axial
4	5	9.5	4	9.5
6	4.5	10	4	9.5
8	4	7.5	3.5	8.5

Open Area (0.5 lux minimum) Spacing Table				
Mounting Height (M)	Transverse To Wall	Transverse To Transverse	Axial To Wall	Axial To Axial
4	3.5	11	3.5	10
6	4	12.5	3.5	11.5
8	4	11.5	4	10.5

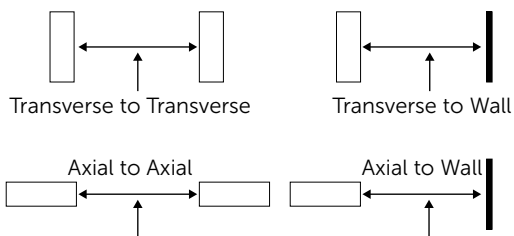



LED GU10 Dimming



LED Halo/Halo Elite GU10

- Energy saving benefits of LED
- Up to 90 Lm/W
- Rimless lens for improved aesthetics
- True fit GU10 size
- Suitable for fire rated and IP rated fixtures

LED Halo Glass/Halo Elite Glass GU10

Traditional halogen look with the energy saving benefits of LED

- True fit GU10 size
- High performance 86 Lm/W
- Suitable for fire rated and IP rated fixtures
- 38° beam angle
- High grade driver designed for smooth dimming at min & max load levels, operating effectively with rotary and digital dimming system



Sharp SMT Multi LED Chip

Precision moulded polycarbonate lens to ensure precise beam angles

High performance aluminium heat sink, rated to 45° ambient temperature

BELL designed IC Driver for enhanced dimming performance

Surge protected circuitry at 3kV



Precision moulded polycarbonate lens to ensure precise beam angles

Sharp SMT Multi LED Chip

Shatterproof frost glass casing for safety and improved aesthetics

Unique IC Switch Driver designed for optimum dimming and flicker free performance



¹ Exceeds EU standard of 70 for Lumens Maintenance Ratio

² Exceeds EU standard of RA 80 for Colour Rendering Index

³ Subject to terms & conditions (Contact Customer Service)



LED GU10 Dimming



5W LED Halo / 6W LED Halo Elite / 6W LED Halo Glass / 6W LED Halo Elite Glass	
Smart Universal LED Trailing/Leading Edge Dimmer Module (Code 10803)	2 to 20
BELL Grid Dimmer (Code 10800)	2 to 20
Aurora DSP651 650W	2 to 20
Aurora AUDSP400X 60-400VA	1 to 20
Aurora DSP801 800W	2 to 20
Aurora AUDSP 250W	5 to 10
Aurora AUDSP 400	2 to 20
BE AT091 60-500W	3 to 30
BG 1P01 400W	2 to 20
Crabtree 8250 DS55 250W	5 to 20
Click MD9042 60-400W	1 to 20
Danler DPID 250W	1 to 20
Hamilton 741X40 400W	1 to 20
Hamilton 8413XU 40-300VA	1 to 20
Hamilton Litestat 40-400W	2 to 20
Hamilton L400/2 40-400W	2 to 20
Hamilton Mercury MDP4x600+VFR	1 to 32
Le Grande Synergy 7300	2 to 20
Lutron Grafik Eye QSGRK-4PCE-TWH	1 to 25
Lutron QS Link	1 to 14
MK KU511 WHILV 4-700 LED	1 to 14
MK K1532 40-250W	3 to 20
MK 1501 RD 60-500W	1 to 16
Superswitch 1G2W 250W	2 to 20
Varilight V-PRO ZOJP250-P 100W	1 to 20
Varilight HQ7W 120W	2 to 20
Varilight IJSI 101 100W	4 to 20
Varilight KQP401W 400W	2 to 20
Varilight KQP601W 600W	3 to 20
Varilight VPRO MJP300	2 to 40
Varilight GKP 180 180W	2 to 30
Varilight HQ7 120W	2 to 20
Varilight HQ3W 400W	1 to 20
Varilight HQ1 400W	1 to 20

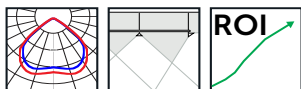

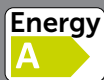



LED Halo GU10

The Halo GU10 is our most popular GU10 lamp to date. This 5W cost effective GU10 is available as Non-Dimmable and Dimmable in 4 colour temperatures and wattages. This true fit size GU10 combines price fighting qualities with sleek aesthetics to feature as one of our best "all-rounders".

- Energy saving benefits of LED
- Improved efficiency up to 70 Lm/W
- Rimless lens for improved aesthetics
- True fit GU10 size
- Suitable for fire rated and IP rated fixtures
- 38° & 60° beam angle options



Warm White

Cool White

Daylight

H 54mm Ø50mm

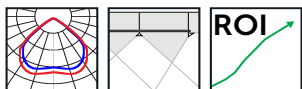

technical@belllighting.co.uk
sales@belllighting.co.uk



LED Halo GU10

244

Code	Lamp Type	CCT	Lm	Cd	Dim	V	Hours
Non Dimmable							
05760	5W LED Halo GU10 Non Dim - 38°	2700K	330	510	Non Dim	240	20000
05785	5W LED Halo GU10 Non Dim - 38°	3000K	330	510	Non Dim	240	20000
05761	5W LED Halo GU10 Non Dim - 38°	4000K	350	510	Non Dim	240	20000
05762	5W LED Halo GU10 Non Dim - 38°	6500K	360	510	Non Dim	240	20000
05775	5W LED Halo GU10 Non Dim - 60°	2700K	330	490	Non Dim	240	20000
05776	5W LED Halo GU10 Non Dim - 60°	4000K	350	490	Non Dim	240	20000
05777	5W LED Halo GU10 Non Dim - 60°	6500K	360	490	Non Dim	240	20000
05900	5W LED Halo GU10 - 38°, 2700K, In Packs of 5, Supplied in 2 Counter Display Units	2700K	330	-	Non Dim	240	-
05901	5W LED Halo GU10 - 38°, 4000K, In Packs of 5, Supplied in 2 Counter Display Units	4000K	350	-	Non Dim	240	-
Dimmable							
05763	5W LED Halo GU10 Dimmable - 38°	2700K	330	510	Dim	240	20000
05786	5W LED Halo GU10 Dimmable - 38°	3000K	330	510	Dim	240	20000
05764	5W LED Halo GU10 Dimmable - 38°	4000K	350	510	Dim	240	20000
05765	5W LED Halo GU10 Dimmable - 38°	6500K	360	510	Dim	240	20000
05778	5W LED Halo GU10 Dimmable - 60°	2700K	330	490	Dim	240	20000
05779	5W LED Halo GU10 Dimmable - 60°	4000K	350	490	Dim	240	20000
05780	5W LED Halo GU10 Dimmable - 60°	6500K	360	490	Dim	240	20000

¹ Exceeds EU standard of 70 for Lumens Maintenance Ratio

² Exceeds EU standard of RA 80 for Colour Rendering Index

³ Subject to terms & conditions (Contact Customer Service)

Call Customer Service or see website for maximum loading and dimmer compatibility.









LED Halo Elite GU10

The Halo Elite GU10 combines the tried and tested technology of the Halo GU10 with a high lumen output. Ideal for illuminating spaces at a higher lux level while not breaking the bank.

- High output GU10
- Energy saving benefits of LED
- Improved efficiency up to 90 Lm/W
- Rimless lens for improved aesthetics
- True fit GU10 size
- Suitable for fire rated and IP rated fixtures



Warm White

Cool White

Daylight

H 54mm Ø50mm



technical@belllighting.co.uk
sales@belllighting.co.uk



LED Halo Elite GU10

248

Code	Lamp Type	CCT	Lm	Cd	Dim	V	Hours
Non Dimmable							
05907	6W LED Halo Elite GU10 Non Dim - 38°	2700K	500	750	Non Dim	240	25000
05909	6W LED Halo Elite GU10 Non Dim - 38°	3000K	500	750	Non Dim	240	25000
05910	6W LED Halo Elite GU10 Non Dim - 38°	4000K	520	750	Non Dim	240	25000
05911	6W LED Halo Elite GU10 Non Dim - 38°	6500K	540	750	Non Dim	240	25000
05956	6W LED Halo Elite GU10 Non Dim - 60°	2700K	500	500	Non Dim	240	25000
05950	6W LED Halo Elite GU10 Non Dim - 60°	3000K	500	500	Non Dim	240	25000
05951	6W LED Halo Elite GU10 Non Dim - 60°	4000K	520	500	Non Dim	240	25000
05952	6W LED Halo Elite GU10 Non Dim - 60°	6500K	540	500	Non Dim	240	25000
Dimmable							
05908	6W LED Halo Elite GU10 Dimmable - 38°	2700K	500	750	Dim	240	25000
05912	6W LED Halo Elite GU10 Dimmable - 38°	3000K	500	750	Dim	240	25000
05913	6W LED Halo Elite GU10 Dimmable - 38°	4000K	520	750	Dim	240	25000
05914	6W LED Halo Elite GU10 Dimmable - 38°	6500K	540	750	Dim	240	25000
05957	6W LED Halo Elite GU10 Dimmable - 60°	2700K	500	500	Dim	240	25000
05953	6W LED Halo Elite GU10 Dimmable - 60°	3000K	500	500	Dim	240	25000
05954	6W LED Halo Elite GU10 Dimmable - 60°	4000K	520	500	Dim	240	25000
05955	6W LED Halo Elite GU10 Dimmable - 60°	6500K	540	500	Dim	240	25000

¹ Exceeds EU standard of 70 for Lumens Maintenance Ratio

² Exceeds EU standard of RA 80 for Colour Rendering Index

³ Subject to terms & conditions (Contact Customer Service)

Call Customer Service or see website for maximum loading and dimmer compatibility.





technical@belllighting.co.uk
sales@belllighting.co.uk





LED Halo Glass GU10

The Halo Glass combines the retro feel of halogen lamps with the efficiency of LED technology. The high-grade driver within the Halo Glass allows for smooth dimming at minimum and maximum load levels. The precision moulded polycarbonate lens ensures precise beam angle light distribution.

- True fit GU10 size
- Dimmable & Non Dim available
- Suitable for fire rated and IP rated fixtures
- 38° beam angle
- High grade driver designed for smooth dimming at min & max load levels, operating effectively with rotary and digital dimming system (dimmable version)



Warm White

Cool White

Daylight

H 54mm Ø50mm

Code	Lamp Type	CCT	Lm	Cd	Dim	V	Hours
Non Dimmable							
05967	5W LED Halo Glass GU10	2700K	320	510	Non Dim	240	20000
05973	5W LED Halo Glass GU10	3000K	320	510	Non Dim	240	20000
05968	5W LED Halo Glass GU10	4000K	320	510	Non Dim	240	20000
05969	5W LED Halo Glass GU10	6000K	320	510	Non Dim	240	20000
Dimmable							
05970	5W LED Halo Glass GU10 Dimmable	2700K	320	510	Dim	240	20000
05974	5W LED Halo Glass GU10 Dimmable	3000K	320	510	Dim	240	20000
05971	5W LED Halo Glass GU10 Dimmable	4000K	320	510	Dim	240	20000
05972	5W LED Halo Glass GU10 Dimmable	6000K	320	510	Dim	240	20000

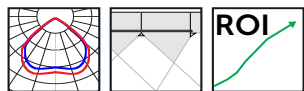

technical@belllighting.co.uk
sales@belllighting.co.uk





LED Halo Elite Glass GU10

The Halo Glass combines the retro feel of halogen lamps with the efficiency of LED technology. The high-grade driver within the Halo Glass allows for smooth dimming at minimum and maximum load levels. The precision moulded polycarbonate lens ensures precise beam angle light distribution

- True fit GU10 size
- Dimmable & Non Dim available
- High performance 86 Lm/W
- Suitable for fire rated and IP rated fixtures
- 38° beam angle
- High grade driver designed for smooth dimming at min & max load levels, operating effectively with rotary and digital dimming system (dimmable version)



Warm White

Cool White

Daylight

H 54mm Ø50mm

Code	Lamp Type	CCT	Lm	Cd	Dim	V	Hours
Non Dimmable							
05960	6W LED Halo Elite Glass Non Dim GU10 - 38°	2700K	520	800	Non Dim	240	25000
05961	6W LED Halo Elite Glass Non Dim GU10 - 38°	4000K	520	800	Non Dim	240	25000
05962	6W LED Halo Elite Glass Non Dim GU10 - 38°	6000K	520	800	Non Dim	240	25000
Dimmable							
05963	6W LED Halo Elite Glass GU10 Dimmable - 38°	2700K	520	800	Dim	240	25000
05964	6W LED Halo Elite Glass GU10 Dimmable - 38°	4000K	520	800	Dim	240	100
05965	6W LED Halo Elite Glass GU10 Dimmable - 38°	6000K	520	800	Dim	240	100

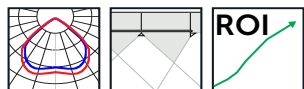

technical@belllighting.co.uk
sales@belllighting.co.uk





LED Dim to Warm GU10

With this BELL Dim to Warm GU10 lamp you can now access 2700K–2300K CCT. With a warm glow dimming effect, light levels dim to warm tones of traditional lamps.

When you reduce the brightness using a dimmer switch, you will see a drop in the color temperature from 2700K down to a soothing, warm 2300K. Perfect for a more relaxing atmosphere in residential buildings, hotels, restaurants and bars.

Traditional halogen look with the energy saving benefits of LED

- True fit GU10 size
- Emits a warmer light when dimmed
- Creates cosy ambience when dimmed
- Replicates dimming of halogen lamps
- Colour temperature range 2300K-2700K
- 92% Energy Saving
- Part L



Warm White

H 54mm Ø50mm

Code	Lamp Type	CCT	Lm	Cd	Dim	V	Hours
Dimmable							
05966	6W LED Halo GU10 Dim to Warm - 38°	2300-2700K	450	800	Dim	240	25000



technical@belllighting.co.uk
sales@belllighting.co.uk





LED Long Neck GU10

The Long Neck GU10 is well known for being somewhat a problem solver within the GU10 market. This ideal replacement for Long Neck CFL GU10's has been specifically designed to fit deep recessed downlight fittings. Available in Warm White & Cool White, this lamp incorporates a wide beam angle for a broad light distribution

- Ideal Replacement for Long Neck CFL GU10
- Designed to fit deep recessed downlight fittings
- Suitable for fire rated and IP rated fixtures
- 15000 Hours
- Available in Warm White and Cool White
- H 74mm Ø 50mm



Warm White

Cool White

H 74mm Ø50mm

Code	Lamp Type	CCT	Lm	Cd	Dim	V	Hours
Non Dimmable							
05887	5W Long Neck Non Dim GU10 100°	3000K	400	140	Non Dim	240	15000
05888	5W Long Neck Non Dim GU10 100°	4000K	400	140	Non Dim	240	15000

¹ Exceeds EU standard of 70 for Lumens Maintenance Ratio

² Exceeds EU standard of RA 80 for Colour Rendering Index

³ Subject to terms & conditions (Contact Customer Service)

Call Customer Service or see website for maximum loading and dimmer compatibility.

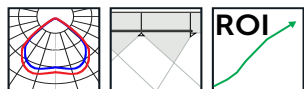

technical@belllighting.co.uk
sales@belllighting.co.uk





LED Pro Precision GU10

The 6W Pro Precision LED GU10 provides clean, crisp, directional lighting, ideal for the retail environment to highlight products. With a high (95) Colour Rendering Index (CRI) which ensures brightly coloured products are displayed to their full potential.

- True fit GU10 size
- Colour Rendering Index 95
- Suitable for fire rated and IP rated fixtures
- High grade driver designed for smooth dimming at min & max load levels, operating effectively with rotary and digital dimming systems
- Cool White/Warm White
- H 74mm Ø 50mm
- Suitable for museums and galleries



Warm White

Cool White

H 55mm Ø50mm

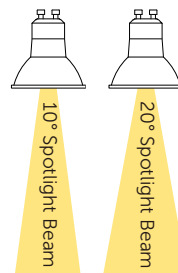

Code	Lamp Type	CCT	Lm	Cd	Dim	Volts	Hours
Dimmable							
05766	5W Pro Precision GU10 - 10° Beam	2700K	540	6000	Non Dim	240	30000
05767	5W Pro Precision GU10 - 10° Beam	4000K	550	6200	Non Dim	240	30000
05768	5W Pro Precision GU10 - 20° Beam	2700K	540	2400	Non Dim	240	30000
05769	5W Pro Precision GU10 - 20° Beam	4000K	550	2500	Non Dim	240	30000

¹ Exceeds EU standard of 70 for Lumens Maintenance Ratio

² Exceeds EU standard of RA 80 for Colour Rendering Index

³ Subject to terms & conditions (Contact Customer Service)

Call Customer Service or see website for maximum loading and dimmer compatibility.



technical@belllighting.co.uk
sales@belllighting.co.uk

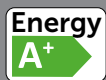



LED Coloured GU10

The Coloured GU10's are commonly used in track-style spot lights, kitchens, showrooms, display, and for directional down lighting. Available in 5 colours to suit any style and mood of lighting

- True fit GU10 size
- Available in 5 colours
- Suitable for fire rated and IP rated fixtures
- Ideal for clubs, bars and garden displays



White

Blue

Green

Red

Amber

H 57mm Ø50mm

Code	Lamp Type	CCT	Lm	Dim	Volts	Hours
Non Dimmable						
60070	LED Coloured GU10 - 38° Beam Angle	White	-	Non Dim	240	25000
60071	LED Coloured GU10 - 38° Beam Angle	Blue	-	Non Dim	240	25000
60072	LED Coloured GU10 - 38° Beam Angle	Green	-	Non Dim	240	25000
60073	LED Coloured GU10 - 38° Beam Angle	Red	-	Non Dim	240	25000
60074	LED Coloured GU10 - 38° Beam Angle	Amber	-	Non Dim	240	25000

¹ Exceeds EU standard of 70 for Lumens Maintenance Ratio

² Exceeds EU standard of RA 80 for Colour Rendering Index

³ Subject to terms & conditions (Contact Customer Service)

Call Customer Service or see website for maximum loading and dimmer compatibility.



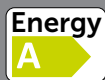



LED Halo MR16

The Halo MR16 provides a low voltage solution combined with sleek aesthetics. This lamp's recently improved efficiency now means that it offers 100 lumens per watt as standard.

- High output MR16
- Energy saving benefits of LED
- Improved efficiency up to 100 Lm/W
- Rimless lens for improved aesthetics
- True fit MR16 size
- Suitable for fire rated and IP rated fixtures



Warm White
Cool White
Daylight
H 52mm Ø50mm

Code	Lamp Type	CCT	Lm	Cd	Dim	V	Hours
Non Dimmable							
05525	6W LED Halo MR16 Non Dim 38°	2700K	420	770	Non Dim	12	25000
05526	6W LED Halo MR16 Non Dim 38°	4000K	420	770	Non Dim	12	25000
05527	6W LED Halo MR16 Non Dim 38°	6500K	420	770	Non Dim	12	25000

12V LED lamps require a BELL line driver or quality branded transformer

¹ Exceeds EU standard of 70 for Lumens Maintenance Ratio

² Exceeds EU standard of RA 80 for Colour Rendering Index

³ Subject to terms & conditions (Contact Customer Service)

Call Customer Service or see website for maximum loading and dimmer compatibility.

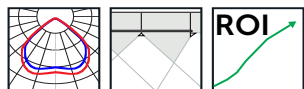

technical@belllighting.co.uk
sales@belllighting.co.uk





LV LED Halo MR11

The Halo MR11 provides a sleek, contemporary design with the energy saving benefits of LED. This low voltage lamp is an ideal replacement when retrofitting inefficient light sources.

- True fit MR11 size
- 5 year Guarantee
- 85% Energy Saving
- Warm White, 3000K
- 24° Beam angle creates a focussed beam of light, that can be used for multiple applications



Warm White

H 40mm Ø50mm

Code	Lamp Type	CCT	Lm	Cd	Dim	V	Hours
Non Dimmable							
05611	3W LED MR11, Non Dim 38°	3000K	190	600	Non Dim	12	30000

12V LED lamps require a BELL line driver or quality branded transformer

¹ Exceeds EU standard of 70 for Lumens Maintenance Ratio

² Exceeds EU standard of RA 80 for Colour Rendering Index

³ Subject to terms & conditions (Contact Customer Service)

Call Customer Service or see website for maximum loading and dimmer compatibility.





LED AR111

The AR111 provides clean, crisp lighting, ideal for the retail environment, along with a high Colour Rendering Index (CRI) which ensures products are displayed to their full potential.

Lamps with poor CRI will distort some colours which may mean you end up with a black sock when you wanted blue.

- Direct replacement for standard AR111
- Dimmable & Non Dimmable versions
- A Energy Rating
- Retrofit Size
- Up to 50000 Hours Life
- 40° Beam



23W \equiv $\frac{125}{W}$ Energy Saving 81%

16W \equiv $\frac{100}{W}$ Energy Saving 84%

14W \equiv $\frac{100}{W}$ Energy Saving 86%

Warm White

Cool White

23W H 55mm Ø110mm

16W H 50mm Ø110mm

23W H 86mm Ø111mm

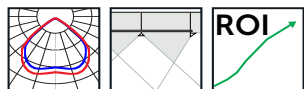



LED AR111 - Dimmable

268

Code	Lamp Type	CCT	Lm	Dim	V	Hours
Dimmable						
60041	23W LED AR111 Dimmable - G53, 40°	4000K	1750	Dim	12	50000
60042	23W LED AR111 Dimmable - G53, 40°	2700K	1650	Dim	12	50000

Compatible with most quality branded transformers and dimmers

LV LED AR111 - Non Dimmable

Code	Lamp Type	CCT	Lm	Dim	V	Hours
Non Dimmable						
05088	16W LED AR111 Non Dimmable - G53, 40°	4000K	1250	Non Dim	12	30000
05089	16W LED AR111 Non Dimmable - G53, 40°	2700K	1120	Non Dim	12	30000
05101	LED Constant Voltage Line Driver	-	-	-	30	-

12V LED lamps require a BELL line driver or quality branded transformer

LED AR111 - GU10, Dimmable

Code	Lamp Type	CCT	Lm	Dim	V	Hours
Dimmable						
04411	14W LED AR111 Dimmable - GU10, 40°	2700K	900	Dim	240	30000

Mains voltage dimming

¹ Exceeds EU standard of 70 for Lumens Maintenance Ratio

² Exceeds EU standard of RA 80 for Colour Rendering Index

³ Subject to terms & conditions (Contact Customer Service)

Call Customer Service or see website for maximum loading and dimmer compatibility.





technical@bellighting.co.uk
sales@bellighting.co.uk





LED PAR Lamps

The BELL LED Par Lamps are perfect for all retail and display applications. Available in a variety of sizes & wattages to ensure we have a solution for each individual retail space.

- Specially designed to replace existing Halogen Lamps
- Retro fit for halogen
- Perfect for all retail and display applications
- PAR 16/20/25/30/38
- 30000 hours
- Full dimming on rotary and digital dimming systems
- 2700K Warm White colour temperature



Warm White

6W LED PAR 16 H 78mm Ø50mm

9W LED PAR 20 H 89mm Ø63.5mm

9W LED PAR 25 H 100.5mm Ø79.5mm

12W LED PAR 30 H 91.5mm Ø95mm

14W LED PAR 38 H 132.5mm Ø121mm

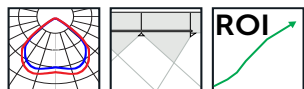

technical@belllighting.co.uk
sales@belllighting.co.uk



LED PAR Lamps

272

Code	Lamp Type	CCT	Lm	Dim	V	Hours
Dimmable						
05864	6W LED PAR16 Dimmable - SES	2700K	400	Dim	240	30000
05865	9W LED PAR20 Dimmable - ES	2700K	580	Dim	240	30000
05866	9W LED PAR25 Dimmable - ES	2700K	580	Dim	240	30000
05867	12W LED PAR30 Dimmable - ES	2700K	1000	Dim	240	30000
05868	14W LED PAR38 Dimmable - ES	2700K	1050	Dim	240	30000

¹ Exceeds EU standard of 70 for Lumens Maintenance Ratio

² Exceeds EU standard of RA 80 for Colour Rendering Index

³ Subject to terms & conditions (Contact Customer Service)

Call Customer Service or see website for maximum loading and dimmer compatibility.





technical@bellighting.co.uk
sales@bellighting.co.uk

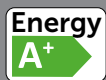



LED Coloured PAR 38 Lamps

The LED Coloured Par 38 Lamps are ideal for all accent lighting. Available in a wide variety of colours and often used on the exterior of premises to give a warm welcoming feel on walkways, paths, entrance lobbies and gardens.

- New LED PAR38 lamps provide energy efficient accent lighting
- Suitable for outdoor use in a certified IP rated fixture
- Long life of 30,000 hours
- Low maintenance costs
- Sustainable lighting technology



Clear

Coloured

H 130mm Ø121mm

Code	Lamp Type	CCT	Lm	Dim	V	Hours
Non Dimmable						
05650	15W LED PAR38 External Non Dim - ES, Clear	2700K	1300	Non Dim	240	30000
05651	15W LED PAR 38 External Non Dim - ES, Green	2700K	1300	Non Dim	240	30000
05652	15W LED PAR38 External Non Dim - ES, Red	2700K	1300	Non Dim	240	30000
05653	15W LED PAR 38 External Non Dim - ES, Blue	2700K	1300	Non Dim	240	30000
05654	15W LED PAR38 External Non Dim - ES, Yellow	2700K	1300	Non Dim	240	30000

Suitable for outdoor use in a certified IP rated fixture

¹ Exceeds EU standard of 70 for Lumens Maintenance Ratio

² Exceeds EU standard of RA 80 for Colour Rendering Index

³ Subject to terms & conditions (Contact Customer Service)

Call Customer Service or see website for maximum loading and dimmer compatibility.

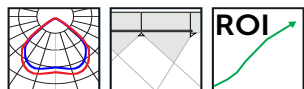





LED Filament Candle

The LED Filament Range combines LED technology with the elegance of Incandescent Lamps. Creating a welcoming atmosphere with a retro feel, our LED Filament Range offers smooth dimming on rotary and digital dimming systems. The Filament Candle is ideal for all chandeliers and wall lights.

- LED Technology with the elegance of Incandescent Lamps
- Ideal Replacement for Incandescent Lamps
- Creates a welcoming atmosphere with retro feel
- 90% Energy Saving
- Argon gas filled to improve life
- High temperature capping cement
- Smooth dimming on rotary and digital dimming systems
- Full glass envelope



Warm White

Cool White

4W Candle H 90mm Ø35mm

4W Chandelier H 86mm Ø22mm

4W Bent Tip Candle H 115mm Ø35mm

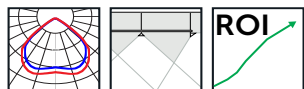

technical@belllighting.co.uk
sales@belllighting.co.uk



LED Filament Candle

278

Code	Lamp Type	CCT	Lm	Dim	V	Hours
Non Dimmable						
05022	4W LED Filament Clear Candle Non Dim - BC	2700K	470	Non Dim	240	15000
05023	4W LED Filament Clear Candle Non Dim - SBC	2700K	470	Non Dim	240	15000
05024	4W LED Filament Clear Candle Non Dim - ES	2700K	470	Non Dim	240	15000
05025	4W LED Filament Clear Candle Non Dim - SES	2700K	470	Non Dim	240	15000
05127	4W LED Filament Satin Candle Non Dim - BC	2700K	470	Non Dim	240	15000
05128	4W LED Filament Satin Candle Non Dim - SBC	2700K	470	Non Dim	240	15000
05129	4W LED Filament Satin Candle Non Dim - ES	2700K	470	Non Dim	240	15000
05130	4W LED Filament Satin Candle Non Dim - SES	2700K	470	Non Dim	240	15000
60110	4W LED Filament Clear Candle Non Dim - BC	4000K	470	Non Dim	240	15000
60113	4W LED Filament Clear Candle Non Dim - SBC	4000K	470	Non Dim	240	15000
60111	4W LED Filament Clear Candle Non Dim - ES	4000K	470	Non Dim	240	15000
60112	4W LED Filament Clear Candle Non Dim - SES	4000K	470	Non Dim	240	15000
05026	4W LED Filament Bent Tip Clear Candle Non Dim - SES	2700K	470	Non Dim	240	15000
05027	4W LED Filament Bent Tip Satin Candle Non Dim - SES	2700K	470	Non Dim	240	15000
05028	1W LED Filament Chandelier - Clear Non Dim SES	2700K	100	Non Dim	240	15000
05029	1W LED Filament Chandelier - Clear Non Dim MES	2700K	100	Non Dim	240	15000

¹ Exceeds EU standard of 70 for Lumens Maintenance Ratio

² Exceeds EU standard of RA 80 for Colour Rendering Index

³ Subject to terms & conditions (Contact Customer Service)

Call Customer Service or see website for maximum loading and dimmer compatibility.



LED Filament Candle

Code	Lamp Type	CCT	Lm	Dim	V	Hours
Dimmable						
05305	4W LED Filament Clear Candle Dimmable - BC	2700K	470	Dim	240	15000
05306	4W LED Filament Clear Candle Dimmable - SBC	2700K	470	Dim	240	15000
05308	4W LED Filament Clear Candle Dimmable - ES	2700K	470	Dim	240	15000
05309	4W LED Filament Clear Candle Dimmable - SES	2700K	470	Dim	240	15000
05312	4W LED Filament Satin Candle Dimmable - BC	2700K	470	Dim	240	15000
05313	4W LED Filament Satin Candle Dimmable - SBC	2700K	470	Dim	240	15000
05314	4W LED Filament Satin Candle Dimmable - ES	2700K	470	Dim	240	15000
05315	4W LED Filament Satin Candle Dimmable - SES	2700K	470	Dim	240	15000
60114	4W LED Filament Clear Candle Dimmable - BC	2700K	470	Dim	240	15000
60117	4W LED Filament Clear Candle Dimmable - SBC	2700K	470	Dim	240	15000
60115	4W LED Filament Clear Candle Dimmable - ES	2700K	470	Dim	240	15000
60116	4W LED Filament Clear Candle Dimmable - SES	2700K	470	Dim	240	15000
05033	4W LED Filament Bent Tip Clear Candle Dimmable - SES	2700K	470	Dim	240	15000
05034	4W LED Filament Bent Tip Satin Candle Dimmable - SES	2700K	470	Dim	240	15000







Talbot Hotel Malton: BELL 4W Filament Candles

Over the life of the lamps, Talbot Hotel could save: £39,204 in energy costs, Energy Saving 90%

- Annual Energy Saving 47,500kWh
- Annual CO₂ Saving 26,700kg
- Annual Maintenance Saving £1000





LED Filament Round

The LED Filament Range combines LED technology with the elegance of Incandescent Lamps. Creating a welcoming atmosphere with a retro feel, our LED Filament Range offers smooth dimming on rotary and digital dimming systems. The Filament Round is ideal for all bedside decorative lighting along with all other similar applications.

- LED Technology with the elegance of Incandescent Lamps
- Ideal Replacement for Incandescent Lamps
- Creates a welcoming atmosphere with retro feel
- 90% Energy Saving
- Argon gas filled to improve life
- High temperature capping cement
- Smooth dimming on rotary and digital dimming systems
- Full glass envelope (exc SBC & SES)



Clear

Satin

Warm White

Cool White

H 78mm Ø45mm



technical@belllighting.co.uk
sales@belllighting.co.uk



LED Filament Round

284

Code	Lamp Type	CCT	Lm	Dim	V	Hours
Non Dimmable						
05030	4W LED Filament Clear Round Non Dim - BC	2700K	470	Non Dim	240	15000
05031	4W LED Filament Clear Round Non Dim - ES	2700K	470	Non Dim	240	15000
05032	4W LED Filament Clear Round Non Dim - SES	2700K	470	Non Dim	240	15000
60100	4W LED Filament Satin Round Non Dim - BC	2700K	470	Non Dim	240	15000
60101	4W LED Filament Satin Round Non Dim - ES	2700K	470	Non Dim	240	15000
60102	4W LED Filament Satin Round Non Dim - SES	2700K	470	Non Dim	240	15000
60120	4W LED Filament Clear Round Non Dim - BC	4000K	470	Non Dim	240	15000
60121	4W LED Filament Clear Round Non Dim - ES	4000K	470	Non Dim	240	15000
60122	4W LED Filament Clear Round Non Dim - SES	4000K	470	Non Dim	240	15000
Dimmable						
05310	4W LED Filament Clear Round Dimmable - BC	2700K	470	Dim	240	15000
05316	4W LED Filament Clear Round Dimmable - ES	2700K	470	Dim	240	15000
05317	4W LED Filament Clear Round Dimmable - SES	2700K	470	Dim	240	15000
60103	4W LED Filament Satin Round Dimmable - BC	2700K	470	Dim	240	15000
60104	4W LED Filament Satin Round Dimmable - ES	2700K	470	Dim	240	15000
60105	4W LED Filament Satin Round Dimmable - SES	2700K	470	Dim	240	15000
60123	4W LED Filament Clear Round Dimmable - BC	4000K	470	Dim	240	15000
60124	4W LED Filament Clear Round Dimmable - ES	4000K	470	Dim	240	15000
60125	4W LED Filament Clear Round Dimmable - SES	4000K	470	Dim	240	15000

¹ Exceeds EU standard of 70 for Lumens Maintenance Ratio

² Exceeds EU standard of RA 80 for Colour Rendering Index

³ Subject to terms & conditions (Contact Customer Service)

Call Customer Service or see website for maximum loading and dimmer compatibility.





technical@bellighting.co.uk
sales@bellighting.co.uk





LED Filament GLS

The LED Filament Range combines LED technology with the elegance of Incandescent Lamps. Creating a welcoming atmosphere with a retro feel, our LED Filament Range offers smooth dimming on rotary and digital dimming systems. The Filament GLS is an all rounder for decorative applications due to the wide range of wattages we offer.

- LED Technology with the elegance of Incandescent Lamps
- Ideal Replacement for Incandescent Lamps
- Creates a welcoming atmosphere with retro feel
- 90% Energy Saving
- Argon gas filled to improve life
- High temperature capping cement
- Smooth dimming on rotary and digital dimming systems
- Full glass envelope



Clear

Satin

Warm White

Cool White

H 102mm Ø60mm



technical@belllighting.co.uk
sales@belllighting.co.uk



LED Filament GLS

Code	Lamp Type	CCT	Lm	Dim	V	Hours
Non Dimmable						
05016	4W LED Filament Clear GLS Non Dim - BC	2700K	470	Non Dim	240	15000
05017	4W LED Filament Clear GLS Non Dim - ES	2700K	470	Non Dim	240	15000
05018	6W LED Filament Clear GLS Non Dim - BC	2700K	810	Non Dim	240	15000
05019	6W LED Filament Clear GLS Non Dim - ES	2700K	810	Non Dim	240	15000
05121	4W LED Filament Satin GLS Non Dim - BC	2700K	470	Non Dim	240	15000
05122	4W LED Filament Satin GLS Non Dim - ES	2700K	470	Non Dim	240	15000
05123	6W LED Filament Satin GLS Non Dim - BC	2700K	810	Non Dim	240	15000
05124	6W LED Filament Satin GLS Non Dim - ES	2700K	810	Non Dim	240	15000
60045	4W LED Filament Clear GLS Non Dim - BC	4000K	470	Non Dim	240	15000
60046	4W LED Filament Clear GLS Non Dim - ES	4000K	470	Non Dim	240	15000
60047	6W LED Filament Clear GLS Non Dim - BC	4000K	810	Non Dim	240	15000
60048	6W LED Filament Clear GLS Non Dim - ES	4000K	810	Non Dim	240	15000
60180	12W LED Filament Clear GLS Non Dim - ES	2700K	1550	Non Dim	240	15000
Dimmable						
05300	4W LED Filament Clear GLS Dimmable - BC	2700K	470	Dim	240	15000
05301	4W LED Filament Clear GLS Dimmable - ES	2700K	470	Dim	240	15000
05302	6W LED Filament Clear GLS Dimmable - BC	2700K	810	Dim	240	15000
05304	6W LED Filament Clear GLS Dimmable - ES	2700K	810	Dim	240	15000
05286	4W LED Filament Satin GLS Dimmable - BC	2700K	470	Dim	240	15000
05287	4W LED Filament Satin GLS Dimmable - ES	2700K	470	Dim	240	15000
05288	6W LED Filament Satin GLS Dimmable - BC	2700K	810	Dim	240	15000
05289	6W LED Filament Satin GLS Dimmable - ES	2700K	810	Dim	240	15000
60049	4W LED Filament Clear GLS Dimmable - BC	4000K	470	Dim	240	15000
60050	4W LED Filament Clear GLS Dimmable - ES	4000K	470	Dim	240	15000
60051	6W LED Filament Clear GLS Dimmable - BC	4000K	810	Dim	240	15000
60052	6W LED Filament Clear GLS Dimmable - ES	4000K	810	Dim	240	15000
60181	12W LED Filament Clear GLS Dimmable - ES	2700K	1550	Dim	240	15000

¹ Exceeds EU standard of 70 for Lumens Maintenance Ratio

² Exceeds EU standard of RA 80 for Colour Rendering Index

³ Subject to terms & conditions (Contact Customer Service)

Call Customer Service or see website for maximum loading and dimmer compatibility.





technical@belllighting.co.uk
sales@belllighting.co.uk





LED Filament Squirrel Cage

The LED Filament Range combines LED technology with the elegance of Incandescent Lamps. Creating a welcoming atmosphere with a retro feel, our LED Filament Range offers smooth dimming on rotary and digital dimming systems. The Filament Squirrel Cage has a contemporary timeless design ideal for bars & restaurants.

- LED Technology with the elegance of Incandescent Lamps
- Ideal Replacement for Incandescent Lamps
- Creates a welcoming atmosphere with retro feel
- 90% Energy Saving
- Argon gas filled to improve life
- High temperature capping cement
- Smooth dimming on rotary and digital dimming systems
- Full glass envelope



Clear

H 126mm Ø58mm

Code	Lamp Type	CCT	Lm	Dim	V	Hours
Non Dimmable						
60130	4W LED Filament Squirrel Cage Non Dim - BC	2700K	470	Non Dim	240	15000
60131	4W LED Filament Squirrel Cage Non Dim - ES	2700K	470	Non Dim	240	15000
Dimmable						
60132	4W LED Filament Squirrel Cage Dimmable - BC	2700K	470	Dim	240	15000
60133	4W LED Filament Squirrel Cage Dimmable - ES	2700K	470	Dim	240	15000

¹ Exceeds EU standard of 70 for Lumens Maintenance Ratio

² Exceeds EU standard of RA 80 for Colour Rendering Index

³ Subject to terms & conditions (Contact Customer Service)

Call Customer Service or see website for maximum loading and dimmer compatibility.

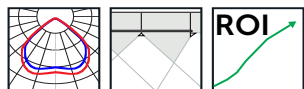

technical@belllighting.co.uk
sales@belllighting.co.uk





LED Filament Tubular

The LED Filament Range combines LED technology with the elegance of Incandescent Lamps. Creating a welcoming atmosphere with a retro feel, our LED Filament Range offers smooth dimming on rotary and digital dimming systems. The Tubular Filaments provide a distinctive look when illuminated in any bar or restaurant.

- LED Technology with the elegance of Incandescent Lamps
- Creates a welcoming atmosphere with retro feel
- Argon gas filled to improve life



Clear

Warm White

Short H 110mm Ø45mm

Medium H 130mm Ø30mm

Long H 280mm Ø30mm

Code	Lamp Type	CCT	Lm	Dim	V	Hours
Non Dimmable						
60145	4W LED Filament Tubular Short Non Dim - BC	2700K	470	Non Dim	240	15000
60146	4W LED Filament Tubular Short Non Dim - ES	2700K	470	Non Dim	240	15000
60147	4W LED Filament Tubular Med Non Dim - ES	2700K	470	Non Dim	240	15000
60148	7W LED Filament Tubular Long Non Dim - ES	2700K	860	Non Dim	240	15000
Dimmable						
60149	4W LED Filament Tubular Short Dimmable - BC	2700K	470	Dim	240	15000
60150	4W LED Filament Tubular Short Dimmable - ES	2700K	470	Dim	240	15000
60151	4W LED Filament Tubular Med Dimmable - ES	2700K	470	Dim	240	15000
60152	7W LED Filament Tubular Long Dimmable - ES	2700K	860	Dim	240	15000

¹ Exceeds EU standard of 70 for Lumens Maintenance Ratio

² Exceeds EU standard of RA 80 for Colour Rendering Index

³ Subject to terms & conditions (Contact Customer Service)

Call Customer Service or see website for maximum loading and dimmer compatibility.



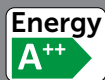



LED Filament Clear Globe

The LED Filament Range combines LED technology with the elegance of Incandescent Lamps. Creating a welcoming atmosphere with a retro feel, our LED Filament Range offers smooth dimming on rotary and digital dimming systems. The Filament Globes are available in two sizes and are an ideal lamp to illuminate any home, hotel, bar or restaurant.

- LED Technology with the elegance of Incandescent Lamps
- Creates a welcoming atmosphere with retro feel
- Argon gas filled to improve life



Clear

Warm White

60134/5 60136/7 H 115mm Ø80mm

60138/9 60140/1 H 178mm Ø125mm

Code	Lamp Type	CCT	Lm	Dim	V	Hours
Non Dimmable						
60134	4W LED Filament Globe Non Dim - BC	2700K	470	Non Dim	240	15000
60135	4W LED Filament Globe Non Dim - ES	2700K	470	Non Dim	240	15000
60138	4W LED Filament Large Globe Non Dim - BC	2700K	470	Non Dim	240	15000
60139	4W LED Filament Large Globe Non Dim - ES	2700K	470	Non Dim	240	15000
Dimmable						
60136	4W LED Filament Globe Dimmable - BC	2700K	470	Dim	240	15000
60137	4W LED Filament Globe Cage Dimmable - ES	2700K	470	Dim	240	15000
60140	4W LED Filament Large Globe Dimmable - BC	2700K	470	Dim	240	15000
60141	4W LED Filament Large Globe Dimmable - ES	2700K	470	Dim	240	15000

¹ Exceeds EU standard of 70 for Lumens Maintenance Ratio

² Exceeds EU standard of RA 80 for Colour Rendering Index

³ Subject to terms & conditions (Contact Customer Service)

Call Customer Service or see website for maximum loading and dimmer compatibility.

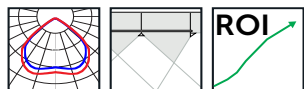





LED Filament Satin Globe

The LED Filament Range combines LED technology with the elegance of Incandescent Lamps. Creating a welcoming atmosphere with a retro feel, our LED Filament Range offers smooth dimming on rotary and digital dimming systems. The Filament Satin Globe emits a soft, warm glow which will create an ambient atmosphere in multiple applications.

- LED Technology with the elegance of Incandescent Lamps
- Creates a welcoming atmosphere with retro feel
- Argon gas filled to improve life
- Smooth dimming on rotary and digital dimming systems



Satin

Warm White

H 134mm Ø95mm

Code	Lamp Type	CCT	Lm	Dim	V	Hours
Non Dimmable						
60155	4W LED Filament Satin Globe Non Dim - ES	2700K	470	Non Dim	240	15000
60156	4W LED Filament Satin Globe Non Dim - BC	2700K	470	Non Dim	240	15000

¹ Exceeds EU standard of 70 for Lumens Maintenance Ratio

² Exceeds EU standard of RA 80 for Colour Rendering Index

³ Subject to terms & conditions (Contact Customer Service)

Call Customer Service or see website for maximum loading and dimmer compatibility.



technical@belllighting.co.uk
sales@belllighting.co.uk

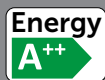



LED Fairy Lamps

Our new LED Fairy Lamps deliver a unique twist to LED Lighting. Ideal for accent lighting, providing a decorative sparkle. Perfect for events and celebrations both indoor and outside when used with a suitable weatherproof fitting.

- Warm White / Cool White / RGB
- Clear finish
- Decorative Sparkle
- Creates welcoming ambience
- Ideal for events & celebrations
- Add interest to any room
- Perfect for outdoor use (with suitable weatherproof fitting)
- 10000 Hours
- 2.2W / 1.5W
- H 164mm Ø125mm



Clear

H 164mm Ø125mm

Code	Lamp Type	CCT	Lm	Dim	V	Hours
Non Dimmable						
60160	2.2W LED Fairy Lamp - ES	2700K	75	Non Dim	240	10000
60161	2.2W LED Fairy Lamp - ES	4000K	75	Non Dim	240	10000
60162	1.5W LED Fairy Lamp - ES	RGB	75	Non Dim	240	10000

¹ Exceeds EU standard of 70 for Lumens Maintenance Ratio

² Exceeds EU standard of RA 80 for Colour Rendering Index

³ Subject to terms & conditions (Contact Customer Service)

Call Customer Service or see website for maximum loading and dimmer compatibility.



technical@belllighting.co.uk
sales@belllighting.co.uk



LED Soft Coil Candle/GLS/Squirrel

Our LED Soft Coil Lamps give a unique take on standard LED Vintage Lamps. Each lamp includes a decorative soft coil which makes this range of lamps ideal for accent lighting a wide variety of applications.

- Ideal replacement for Incandescent Lamps
- Creates a welcoming atmosphere with retro feel
- Smooth dimming on rotary and digital dimming systems
- Special Extended Filament to replicate traditional Vintage Amber Glow
- Amber Glass Coating for decorative vintage look
- Over 90% Energy Saving compared to Incandescent Vintage Lamps
- Super low energy consumption



Ultra Warm White

Candle H 95mm Ø35mm

GLS H 115mm Ø60mm

Squirrel Cage H 140mm Ø64mm

Code	Lamp Type	CCT	Lm	Dim	V	Hours
Dimmable						
60027	4W LED Vintage Soft Coil Vertical Filament Candle - SES Dimmable, Amber	2200K	150	Dim	240	15000
60015	4W LED Vintage Soft Coil Horizontal Filament GLS - ES Dimmable, Amber	2200K	150	Dim	240	15000
60016	4W LED Vintage Soft Coil Horizontal Filament GLS - BC Dimmable, Amber	2200K	150	Dim	240	15000
60017	4W LED Vintage Soft Coil Vertical Filament Squirrel Cage - ES Dimmable, Amber	2200K	150	Dim	240	15000
60018	4W LED Vintage Soft Coil Vertical Filament Squirrel Cage - BC Dimmable, Amber	2200K	150	Dim	240	15000

¹ Exceeds EU standard of 70 for Lumens Maintenance Ratio

² Exceeds EU standard of RA 80 for Colour Rendering Index

³ Subject to terms & conditions (Contact Customer Service)

Call Customer Service or see website for maximum loading and dimmer compatibility.

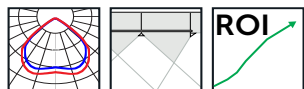

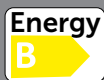

LED Soft Coil Pear Drop/Large Globe

The Soft Coil Pear Drop and Large Globes are perfect for those wanting to make a statement. With each of the oversized coils giving off an ultra-warm white glow, the large Pear Drops & Globes can be used to give any large space an intimate, welcoming feel.

- Ideal replacement for Incandescent Lamps
- Creates a welcoming atmosphere with retro feel
- Smooth dimming on rotary and digital dimming systems
- Special Extended Filament to replicate traditional Vintage Amber Glow
- Amber Glass Coating for decorative vintage look
- Over 90% Energy Saving compared to Incandescent Vintage Lamps
- Super low energy consumption



Ultra Warm White

Pear Drop H 300mm Ø160mm

Globe H 150mm Ø95mm

Large Globe H 175mm Ø125mm

Giant Globe H 266 Ø200mm

Code	Lamp Type	CCT	Lm	Dim	V	Hours
Dimmable						
60025	4W LED Vintage Soft Coil Vertical Filament Giant Pear Drop Dimmable - ES, Amber	2200K	150	Dim	240	15000
60019	4W LED Vintage Soft Coil Vertical Filament Globe Dimmable - ES, Amber	2200K	150	Dim	240	15000
60021	4W LED Vintage Soft Coil Vertical Filament Large Globe Dimmable - ES, Amber	2200K	150	Dim	240	15000
60023	4W LED Vintage Soft Coil Vertical Filament Giant Globe Dimmable - ES, Amber	2200K	150	Dim	240	15000

¹ Exceeds EU standard of 70 for Lumens Maintenance Ratio

² Exceeds EU standard of RA 80 for Colour Rendering Index

³ Subject to terms & conditions (Contact Customer Service)

Call Customer Service or see website for maximum loading and dimmer compatibility.

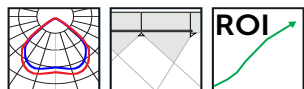

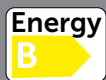



LED Soft Coil Gunmetal Squirrel Cage & Large Globe

The Soft Coil Gunmetal lamp is the most abstract lamp in the Soft Coil product family. This gunmetal finish combined with either a warm white or cool white glow creates two totally different ambiances depending on the what type of mood lighting is required for the application.

- Modern twist on a classic lamp
- Ideal replacement for Incandescent Lamps
- Creates a welcoming atmosphere with retro feel
- Smooth dimming on rotary and digital dimming systems
- 2000K & 4000K colour temperatures available
- Gunmetal Glass Coating for decorative modern look
- 90% Energy Saving compared to Incandescent Vintage Lamps
- Super low energy consumption



Ultra Warm White

Cool White

Squirrel Cage H 140mm Ø64mm

Large Globe H 175mm Ø125mm

Code	Lamp Type	CCT	Lm	Dim	V	Hours
Dimmable						
60028	4W LED Vintage Soft Coil Squirrel Cage Dimmable - ES, Gunmetal	2000K	150	Dim	240	15000
60030	4W LED Vintage Soft Coil Squirrel Cage Dimmable - ES, Gunmetal	4000K	150	Dim	240	15000
60029	4W LED Vintage Soft Coil 125mm Globe Dimmable - ES, Gunmetal	2000K	150	Dim	240	15000
60031	4W LED Vintage Soft Coil 125mm Globe Dimmable - ES, Gunmetal	4000K	150	Dim	240	15000

¹ Exceeds EU standard of 70 for Lumens Maintenance Ratio

² Exceeds EU standard of RA 80 for Colour Rendering Index

³ Subject to terms & conditions (Contact Customer Service)

Call Customer Service or see website for maximum loading and dimmer compatibility.

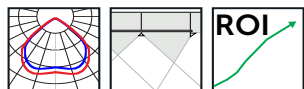





LED Vintage Squirrel Cage

The LED Vintage Lamp has become one of the most recognisable lamp types on the market. Widely used in the hospitality sector and domestically alike, the LED Vintage Lamp combines a traditional look with the energy saving benefits of LED Lighting. The universally used Squirrel Cage provides a warm white glow ideal when creating mood lighting.

- Dimmable and Non-Dimmable available
- Special extended filament to replicate traditional vintage amber glow
- Amber Glass Coating For Decorative Vintage Look
- Over 90% energy saving compared to incandescent vintage lamps
- Super low energy consumption



Ultra Warm White
H 126mm Ø58mm

Code	Lamp Type	CCT	Lm	Dim	V	Hours
Non Dimmable						
01461	4W LED Vintage Squirrel Cage Non Dim - BC	2000K	300	Non Dim	240	15000
01462	4W LED Vintage Squirrel Cage Non Dim - ES	2000K	300	Non Dim	240	15000
Dimmable						
01468	4W LED Vintage Squirrel Cage Dimmable - BC	2000K	300	Dim	240	15000
01469	4W LED Vintage Squirrel Cage Dimmable - ES	2000K	300	Dim	240	15000

¹ Exceeds EU standard of 70 for Lumens Maintenance Ratio

² Exceeds EU standard of RA 80 for Colour Rendering Index

³ Subject to terms & conditions (Contact Customer Service)

Call Customer Service or see website for maximum loading and dimmer compatibility.

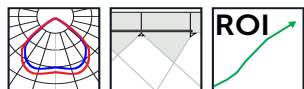

technical@belllighting.co.uk
sales@belllighting.co.uk





LED Vintage Globe

The LED Vintage Lamp has become one of the most recognisable lamp types on the market. Widely used in the hospitality sector and domestically alike, the LED Vintage Lamp combines a traditional look with the energy saving benefits of LED Lighting. With 2 sizes available, the Vintage Globes can be used in a variety of applications, whether that be a cosy lounge or large bar & restaurant

- Dimmable and Non-Dimmable available
- Special extended filament to replicate traditional vintage amber glow
- Amber Glass Coating For Decorative Vintage Look
- Over 90% energy saving compared to Incandescent Vintage Lamps
- Super low energy consumption



Ultra Warm White

Globe H 115mm Ø80mm

Large Globe H 178mm Ø125mm

Code	Lamp Type	CCT	Lm	Dim	V	Hours
Non Dimmable						
01463	4W LED Vintage Globe Non Dim - BC	2000K	300	Non Dim	240	15000
01464	4W LED Vintage Globe Non Dim - ES	2000K	300	Non Dim	240	15000
01436	4W LED Vintage Large Globe Non Dim - BC	2000K	300	Non Dim	240	15000
01437	4W LED Vintage Large Globe Non Dim - ES	2000K	300	Non Dim	240	15000
Dimmable						
01473	4W LED Vintage Globe Dimmable - BC	2000K	300	Dim	240	15000
01474	4W LED Vintage Globe Dimmable - ES	2000K	300	Dim	240	15000
01471	4W LED Vintage Large Globe Dimmable - BC	2000K	300	Dim	240	15000
01472	4W LED Vintage Large Globe Dimmable - ES	2000K	300	Dim	240	15000

¹ Exceeds EU standard of 70 for Lumens Maintenance Ratio

² Exceeds EU standard of RA 80 for Colour Rendering Index

³ Subject to terms & conditions (Contact Customer Service)

Call Customer Service or see website for maximum loading and dimmer compatibility.

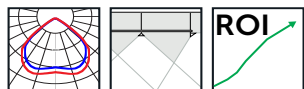





LED Vintage Candle

The LED Vintage Lamp has become one of the most recognisable lamp types on the market. Widely used in both the hospitality & domestic sectors, the LED Vintage Lamp combines a traditional look with the energy saving benefits of LED Lighting. The Vintage Candle is an ideal replacement for inefficient light sources in wall lights and chandeliers.

- Dimmable and Non-Dimmable available
- Special extended filament to replicate traditional vintage amber glow
- Amber Glass Coating For Decorative Vintage Look
- Over 90% energy saving compared to incandescent vintage lamps
- Super low energy consumption



Ultra Warm White

BC & ES H 90mm Ø35mm

SBC & SES H 96mm Ø35mm

Code	Lamp Type	CCT	Lm	Dim	V	Hours
Non Dimmable						
01430	4W LED Vintage Candle Non Dim - BC	2000K	300	Non Dim	240	15000
01431	4W LED Vintage Candle Non Dim - SBC	2000K	300	Non Dim	240	15000
01433	4W LED Vintage Candle Non Dim - SES	2000K	300	Non Dim	240	15000
01432	4W LED Vintage Candle Non Dim - ES	2000K	300	Non Dim	240	15000
Dimmable						
01451	4W LED Vintage Candle Dimmable - BC	2000K	300	Dim	240	15000
01452	4W LED Vintage Candle Dimmable - SBC	2000K	300	Dim	240	15000
01454	4W LED Vintage Candle Dimmable - SES	2000K	300	Dim	240	15000
01453	4W LED Vintage Candle Dimmable - ES	2000K	300	Dim	240	15000

¹ Exceeds EU standard of 70 for Lumens Maintenance Ratio

² Exceeds EU standard of RA 80 for Colour Rendering Index

³ Subject to terms & conditions (Contact Customer Service)

Call Customer Service or see website for maximum loading and dimmer compatibility.

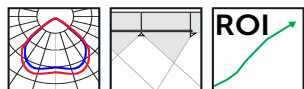

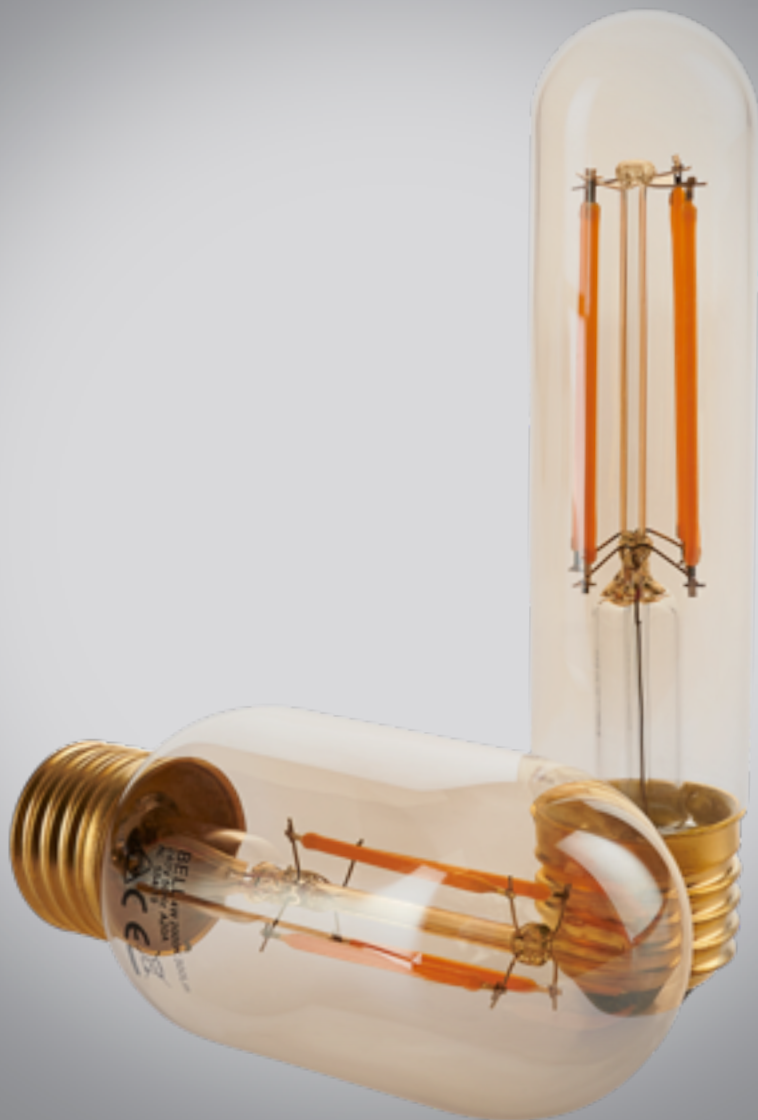



LED Vintage Tubular

The LED Vintage Lamp has become one of the most recognisable lamp types on the market. Widely used in the hospitality sector and domestically alike, the LED Vintage Lamp combines a traditional look with the energy saving benefits of LED Lighting. The Vintage Tubular's can provide a distinctive look when illuminated in any bar or restaurant.

- Dimmable and Non-Dimmable available
- Special extended filament to replicate traditional vintage amber glow
- Amber Glass Coating For Decorative Vintage Look
- Over 90% energy saving compared to Incandescent Vintage Lamps
- Super low energy consumption



Ultra Warm White

Short H 110mm Ø45mm

Medium H 130mm Ø30mm

Long H 280mm Ø30mm

Code	Lamp Type	CCT	Lm	Dim	V	Hours
Non Dimmable						
01438	4W LED Vintage Tubular Non Dim - BC	2000K	300	Non Dim	240	15000
01439	4W LED Vintage Tubular Non Dim - ES	2000K	300	Non Dim	240	15000
01441	4W LED Vintage Tubular Non Dim - ES	2000K	300	Non Dim	240	15000
01445	7W LED Vintage Tubular Non Dim - ES	2000K	640	Non Dim	240	15000
Dimmable						
01500	4W LED Vintage Tubular Dimmable - BC	2000K	300	Dim	240	15000
01501	4W LED Vintage Tubular Dimmable - ES	2000K	300	Dim	240	15000
01443	4W LED Vintage Tubular Dimmable - ES	2000K	300	Dim	240	15000
01447	7W LED Vintage Tubular Dimmable - ES	2000K	640	Dim	240	15000

¹ Exceeds EU standard of 70 for Lumens Maintenance Ratio

² Exceeds EU standard of RA 80 for Colour Rendering Index

³ Subject to terms & conditions (Contact Customer Service)

Call Customer Service or see website for maximum loading and dimmer compatibility.

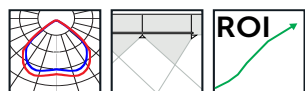





Country House Hotel: BELL 4W Vintage Lamps

Over the life of the lamps, the hotel could save: £1,944 in energy costs, Energy Saving 90%

- Annual Energy Saving 4,717kWh
- Annual CO2 Saving 2,642kg
- Annual Maintenance Saving £300

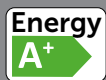



LED Candle

The most cost-effective way of upgrading inefficient lighting. The foundation of LED Lighting (the SMD Candle, Round & GLS) are lamps that the market has become heavily reliant on over the past 10 years. Our LED Candles are available in both 4W & 7W, Clear & Opal, with a Warm or Cool White light output.

- Direct replacement for Standard Candle
- Retrofit size
- Opal / Clear with crystal lens for multi-directional light and sparkle
- Non Dim / Dimmable with special components for use with UK digital and rotary dimming systems



Clear

Opal

Warm White

Cool White

Daylight

4W Candle H 100mm Ø37mm

7W Candle H 100mm Ø39mm

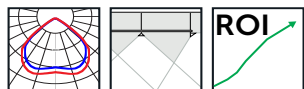

technical@belllighting.co.uk
sales@belllighting.co.uk



LED Candle Non Dimmable

318

Code	Lamp Type	CCT	Lm	Dim	V	Hours
Non Dimmable						
05057	4W LED Candle Opal Non Dim - BC	2700K	250	Non Dim	240	15000
05096	4W LED Candle Opal Non Dim - SBC	2700K	250	Non Dim	240	15000
05056	4W LED Candle Opal Non Dim - SES	2700K	250	Non Dim	240	15000
05055	4W LED Candle Opal Non Dim - ES	2700K	250	Non Dim	240	15000
60191	4W LED Candle Opal Non Dim - ES	6000K	250	Non Dim	240	15000
05700	4W LED Candle Clear Non Dim - BC	2700K	250	Non Dim	240	15000
05701	4W LED Candle Clear Non Dim- SBC	2700K	250	Non Dim	240	15000
05702	4W LED Candle Clear Non Dim - SES	2700K	250	Non Dim	240	15000
05703	4W LED Candle Clear Non Dim - ES	2700K	250	Non Dim	240	15000
05838	7W LED Candle Opal Non Dim - BC	2700K	500	Non Dim	240	15000
05839	7W LED Candle Opal Non Dim - SBC	2700K	500	Non Dim	240	15000
05840	7W LED Candle Opal Non Dim - ES	2700K	500	Non Dim	240	15000
05841	7W LED Candle Opal Non Dim- SES	2700K	500	Non Dim	240	15000
05820	7W LED Candle Clear Non Dim - BC	2700K	500	Non Dim	240	15000
05821	7W LED Candle Clear Non Dim - SBC	2700K	500	Non Dim	240	15000
05822	7W LED Candle Clear Non Dim - ES	2700K	500	Non Dim	240	15000
05823	7W LED Candle Clear Non Dim - SES	2700K	500	Non Dim	240	15000

¹ Exceeds EU standard of 70 for Lumens Maintenance Ratio

² Exceeds EU standard of RA 80 for Colour Rendering Index

³ Subject to terms & conditions (Contact Customer Service)

Call Customer Service or see website for maximum loading and dimmer compatibility.



LED Candle Dimmable

Code	Lamp Type	CCT	Lm	Dim	V	Hours
Dimmable						
05850	4W LED Dimmable Candle Opal - BC	2700K	250	Dim	240	15000
05851	4W LED Dimmable Candle Opal - SBC	2700K	250	Dim	240	15000
05853	4W LED Dimmable Candle Opal - SES	2700K	250	Dim	240	15000
05852	4W LED Dimmable Candle Opal - ES	2700K	250	Dim	240	15000
60193	4W LED Dimmable Candle Opal - ES	6000K	250	Dim	240	15000
05138	4W LED 35mm Dimmable Candle Clear - BC	2700K	250	Dim	240	15000
05144	4W LED 35mm Dimmable Candle Clear - SBC	2700K	250	Dim	240	15000
05139	4W LED 35mm Dimmable Candle Clear - SES	2700K	250	Dim	240	15000
05146	4W LED 35mm Dimmable Candle Clear - ES	2700K	250	Dim	240	15000
05075	4W LED 35mm Dimmable Candle Clear - BC	4000K	250	Dim	240	15000
05076	4W LED 35mm Dimmable Candle Clear - SBC	4000K	250	Dim	240	15000
05077	4W LED 35mm Dimmable Candle Clear - SES	4000K	250	Dim	240	15000
05115	4W LED 35mm Dimmable Candle Clear - ES	4000K	250	Dim	240	15000
05842	7W LED Dimmable Candle Opal - BC	2700K	500	Dim	240	15000
05854	7W LED Dimmable Candle Opal - SBC	2700K	500	Dim	240	15000
05843	7W LED Dimmable Candle Opal - ES	2700K	500	Dim	240	15000
05844	7W LED Dimmable Candle Opal - SES	2700K	500	Dim	240	15000
05830	7W LED Dimmable Candle Clear - BC	2700K	500	Dim	240	15000
05831	7W LED Dimmable Candle Clear - SBC	2700K	500	Dim	240	15000
05832	7W LED Dimmable Candle Clear - ES	2700K	500	Dim	240	15000
05833	7W LED Dimmable Candle Clear - SES	2700K	500	Dim	240	15000

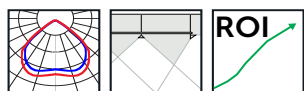





Moor Park Golf Club: BELL 4W Dimmable Candles

Over the life of the lamps, Moor Park Golf Club could save: £30,462 in energy costs, Energy Saving 93%

- Annual Energy Saving 16,307kWh
- Annual CO2 Saving 9,132kg
- Annual Maintenance Saving £1000

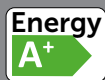



LED Round

The most cost-effective way of upgrading inefficient lighting. The foundation of LED Lighting (the SMD Candle, Round & GLS) are lamps that the market has become heavily reliant on over the past 10 years. Our LED Rounds are available in 4W with the choice of Clear & Opal finishes

- Direct replacement for Standard Round
- Retrofit size
- Opal / Clear
- Non Dimmable & Dimmable



Warm White

Cool White

Opal

Clear

Opal Non Dimmable

BC/B22 H 82mm Ø45mm

ES/E27 H 80mm Ø45mm

SES/E14 H 82mm Ø45mm

Clear Non Dimmable

BC H 77mm Ø50mm

ES H 82mm Ø45mm

SES H 83mm Ø50mm

Clear Dimmable

BC/B22 H 82mm Ø45mm

SBC/B15 H 77mm Ø50m

SES/E14 H 77mm Ø50mm

ES/E27 H 82mm Ø45mm

¹ Exceeds EU standard of 70 for Lumens Maintenance Ratio

² Exceeds EU standard of RA 80 for Colour Rendering Index

³ Subject to terms & conditions (Contact Customer Service)

Call Customer Service or see website for maximum loading and dimmer compatibility.

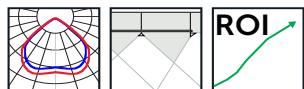



LED Round

324

Code	Lamp Type	CCT	Lm	Dim	V	Hours
Non Dimmable						
05102	4W LED Round Ball Opal Non Dim - BC	2700K	250	Non Dim	240	15000
05103	4W LED Round Ball Opal Non Dim - SES	2700K	250	Non Dim	240	15000
05104	4W LED Round Ball Opal Non Dim - ES	2700K	250	Non Dim	240	15000
05708	4W LED Round Clear Non Dim - BC	2700K	250	Non Dim	240	15000
05709	4W LED Round Clear Non Dim - SES	2700K	250	Non Dim	240	15000
05710	4W LED Round Clear Non Dim - ES	2700K	250	Non Dim	240	15000
Dimmable						
05187	4W LED Dimmable Round Ball Clear - BC	2700K	250	Dim	240	15000
05184	4W LED Dimmable Round Ball Clear - SBC	2700K	250	Dim	240	15000
05189	4W LED Dimmable Round Ball Clear - SES	2700K	250	Dim	240	15000
05188	4W LED Dimmable Round Ball Clear - ES	2700K	250	Dim	240	15000
05147	4W LED Dimmable Round Ball Clear - BC	4000K	250	Dim	240	15000
05158	4W LED Dimmable Round Ball Clear - SBC	4000K	250	Dim	240	15000
05149	4W LED Dimmable Round Ball Clear - SES	4000K	250	Dim	240	15000
05148	4W LED Dimmable Round Ball Clear - ES	4000K	250	Dim	240	15000





technical@bellighting.co.uk
sales@bellighting.co.uk





LED GLS

The most cost-effective way of upgrading inefficient lighting. The foundation of LED Lighting (the SMD Candle, Round & GLS) are lamps that the market has become heavily reliant on over the past 10 years. Our LED GLS comes in 4 different wattage options, Clear & Opal with Warm or Cool White output.

- Direct size replacement for Standard GLS
- Suitable for fire-rated fixtures
- 30000 hours



Warm White

Cool White

Daylight

Pearl

7W H 95mm Ø55mm

9W H 113mm Ø58mm

12W H 117mm Ø60mm

18W H 130mm Ø74mm

¹ Exceeds EU standard of 70 for Lumens Maintenance Ratio

² Exceeds EU standard of RA 80 for Colour Rendering Index

³ Subject to terms & conditions (Contact Customer Service)

Call Customer Service or see website for maximum loading and dimmer compatibility.

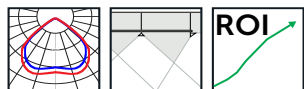

technical@belllighting.co.uk
sales@belllighting.co.uk



LED GLS Non Dimmable

328

Code	Lamp Type	CCT	Lm	Dim	V	Hours
Non Dimmable						
05116	7W LED GLS Opal Non Dim - BC	2700K	470	Non Dim	240	30000
05117	7W LED GLS Opal Non Dim - ES	2700K	470	Non Dim	240	30000
05118	7W LED GLS Opal Non Dim - BC	4000K	470	Non Dim	240	30000
05119	7W LED GLS Opal Non Dim - ES	4000K	470	Non Dim	240	30000
60185	7W LED GLS Opal Non Dim - ES	6000K	470	Non Dim	240	30000
05719	9W LED GLS Opal Non Dim - BC	2700K	810	Non Dim	240	30000
05720	9W LED GLS Opal Non Dim - ES	2700K	810	Non Dim	240	30000
05724	9W LED GLS Opal Non Dim - BC	4000K	810	Non Dim	240	30000
05725	9W LED GLS Opal Non Dim - ES	4000K	810	Non Dim	240	30000
60186	9W LED GLS Opal Non Dim - ES	6000K	810	Non Dim	240	30000
60170	12W LED GLS Opal Non Dim - BC	2700K	1110	Non Dim	240	30000
60171	12W LED GLS Opal Non Dim - ES	2700K	1110	Non Dim	240	30000
60172	12W LED GLS Opal Non Dim - BC	4000K	1110	Non Dim	240	30000
60173	12W LED GLS Opal Non Dim - ES	4000K	1110	Non Dim	240	30000
05625	18W LED GLS Opal Non Dim - BC	2700K	1600	Non Dim	240	30000
05626	18W LED GLS Opal Non Dim - ES	2700K	1600	Non Dim	240	30000
05627	18W LED GLS Opal Non Dim - BC	4000K	1600	Non Dim	240	30000
05628	18W LED GLS Opal Non Dim - ES	4000K	1600	Non Dim	240	30000
60187	18W LED GLS Opal Non Dim - ES	6000K	1600	Non Dim	240	30000



LED GLS Dimmable

Code	Lamp Type	CCT	Lm	Dim	V	Hours
Dimmable						
05179	7W LED Dimmable GLS Opal - BC	2700K	470	Dim	240	30000
05181	7W LED Dimmable GLS Opal - ES	2700K	470	Dim	240	30000
05182	7W LED Dimmable GLS Opal - BC	4000K	470	Dim	240	30000
05183	7W LED Dimmable GLS Opal - ES	4000K	470	Dim	240	30000
60183	7W LED Dimmable GLS Opal - ES	6000K	470	Dim	240	30000
05616	9W LED Dimmable GLS Opal - BC	2700K	810	Dim	240	30000
05617	9W LED Dimmable GLS Opal - ES	2700K	810	Dim	240	30000
05618	9W LED Dimmable GLS Opal - BC	4000K	810	Dim	240	30000
05619	9W LED Dimmable GLS Opal - ES	4000K	810	Dim	240	30000
60189	9W LED Dimmable GLS Opal - ES	6000K	810	Dim	240	30000
60174	12W LED Dimmable GLS Opal - BC	2700K	1110	Dim	240	30000
60175	12W LED Dimmable GLS Opal - ES	2700K	1110	Dim	240	30000
60176	12W LED Dimmable GLS Opal - BC	4000K	1110	Dim	240	30000
60177	12W LED Dimmable GLS Opal - ES	4000K	1110	Dim	240	30000
05633	18W LED Dimmable GLS Opal - BC	2700K	1600	Dim	240	30000
05634	18W LED Dimmable GLS Opal - ES	2700K	1600	Dim	240	30000
05635	18W LED Dimmable GLS Opal - BC	4000K	1600	Dim	240	30000
05636	18W LED Dimmable GLS Opal - ES	4000K	1600	Dim	240	30000
60190	18W LED Dimmable GLS Opal - ES	6000K	1600	Dim	240	30000

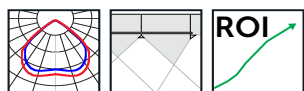





technical@belllighting.co.uk
sales@belllighting.co.uk





LED Photocell GLS

The LED Photocell GLS is the ideal lamp to reduce the amount of wasted energy while increasing security at any premises. With automatic dusk till dawn switching, this lamp is the lamp of choice for applications such as porches, hallways and suitable IP rated outdoor fixtures.

- Reduce your amount of wasted energy and increase security
- Automatic Dusk Till Dawn Switching
- Ideal for porches, hallways and suitable outdoor fittings
- Dual 360 degree sensors to detect light from all angles
- 810 lumens
- Warm White



Pearl

Warm White

H 120mm Ø60mm

Code	Lamp Type	CCT	Lm	Dim	V	Hours
Non Dimmable						
05730	9W LED GLS - BC, Photocell	2700K	810	Non Dim	240	25000
05731	9W LED GLS - ES, Photocell	2700K	810	Non Dim	240	25000
Automatic dusk till dawn switching						

¹ Exceeds EU standard of 70 for Lumens Maintenance Ratio

² Exceeds EU standard of RA 80 for Colour Rendering Index

³ Subject to terms & conditions (Contact Customer Service)

Call Customer Service or see website for maximum loading and dimmer compatibility.

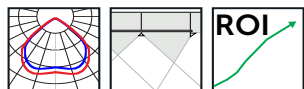

technical@belllighting.co.uk
sales@belllighting.co.uk

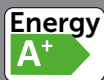



Imperium LED High Power Lamp

The Imperium LED High Power Lamp is the ideal lamp when high output, cost and energy saving benefits of LED technology are required. With an IP65 rating this lamp is perfect for heritage applications such as Railway Stations, Bridges, Vintage Lanterns along with High Bay, Low Bay and Post Top fittings.

- Patented Remote Phosphor Activate LED Technology
- Longer lifespan as remote phosphor technology reduces temperatures and slows down the rate at which the phosphor layer degenerates
- Better color stability with longer life of phosphors
- No fan design, excellent heat dissipation solution, working temperature -30°C to +35°C
- Up to 155 Lm/W
- Less glaring than normal SMD LED lighting products, better lumen maintenance
- Surge Protection 5KV
- Up to 76% Energy Saving



Cool White

12W H 145mm Ø68mm

18W H 155mm Ø68mm

25W H 180mm Ø85mm

42W H 230mm Ø98mm

65W H 280mm Ø128mm

77W H 310mm Ø130mm



Appearance of lamp when un-illuminated

¹Exceeds EU standard of 70 for Lumens Maintenance Ratio

²Exceeds EU standard of RA 80 for Colour Rendering Index

³Subject to terms & conditions (Contact Customer Service)

Call Customer Service or see website for maximum loading and dimmer compatibility.

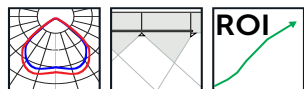



336

Code	Description	Temp	Lm	HID Replacement (W)	Volts	Hours
Non Dimmable						
04600	12W Imperium LED High Power Lamp - ES	4000K	1740	50	240	50000
04601	18W Imperium LED High Power Lamp - ES	4000K	2610	75	240	50000
04602	25W Imperium LED High Power Lamp - ES	4000K	3625	100	240	50000
04603	42W Imperium LED High Power Lamp - GES	4000K	6090	175	240	50000
04604	65W Imperium LED High Power Lamp - GES	4000K	9425	200	240	50000
04605	77W Imperium LED High Power Lamp - GES	4000K	12000	250	240	50000





¹ Exceeds EU standard of 70 for Lumens Maintenance Ratio

² Exceeds EU standard of RA 80 for Colour Rendering Index

³ Subject to terms & conditions (Contact Customer Service)

Call Customer Service or see website for maximum loading and dimming compatibility.



technical@bellighting.co.uk
 Technical Helpline: 144 0116 24 29 3386
 sales@bellighting.co.uk

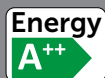

LED Coloured Filament GLS

The Coloured Filament GLS is one of the most decorative, aesthetically pleasing lamps on the market. Perfect for high-quality decorative lighting schemes in bars & festoons for external events. Available in 4 decorative colours.

- Perfect for high-quality decorative lighting schemes in bars, hotels, restaurants
- Excellent on festoons for external events; weddings, parties and festivals
- Ideal replacement for Incandescent Coloured Lamps
- 90% Energy Saving
- Non Dimmable



H 108mm Ø60mm

Code	Lamp Type	CCT	Lm	Dim	V	Hours
Non Dimmable						
60060	4W LED Coloured Filament GLS ES, Amber	-	-	Non Dim	240	15000
60061	4W LED Coloured Filament GLS BC, Amber	-	-	Non Dim	240	15000
60062	4W LED Coloured Filament GLS - ES, Blue	-	-	Non Dim	240	15000
60063	4W LED Coloured Filament GLS - BC, Blue	-	-	Non Dim	240	15000
60064	4W LED Coloured Filament GLS - ES, Green	-	-	Non Dim	240	15000
60065	4W LED Coloured Filament GLS - BC, Green	-	-	Non Dim	240	15000
60066	4W LED Coloured Filament GLS - ES, Red	-	-	Non Dim	240	15000
60067	4W LED Coloured Filament GLS - BC, Red	-	-	Non Dim	240	15000

¹ Exceeds EU standard of 70 for Lumens Maintenance Ratio

² Exceeds EU standard of RA 80 for Colour Rendering Index

³ Subject to terms & conditions (Contact Customer Service)

Call Customer Service or see website for maximum loading and dimmer compatibility.







LED Coloured Round/GLS

The Coloured Rounds & GLS are a robust yet decorative lamp designed for 110/240V festoons and all other decorative lighting applications. Available in 5 different colour variants with a bayonet cap.

- These indoor and outdoor LED light sources are suitable for festoons and all decorative lighting applications, (when used with suitable weatherproof fitting)
- Coloured LED Chip
- Plastic Envelope



H 108mm Ø60mm

Code	Lamp Type	CCT	Lm	Dim	V	Hours
Non Dimmable						
60000	1W LED Amber Round Non Dim - BC	-	-	Non Dim	110/240	2500
60001	1W LED Blue Round Non Dim - BC	-	-	Non Dim	110/240	2500
60002	1W LED Green Round Non Dim - BC	-	-	Non Dim	110/240	2500
60003	1W LED Red Round Non Dim - BC	-	-	Non Dim	110/240	2500
60004	1W LED White Round Non Dim - BC	-	-	Non Dim	110/240	25000
60005	5W LED Amber GLS Non Dim - ES, Outdoor	-	-	Non Dim	110/240	2500
60006	5W LED Blue GLS Non Dim - ES, Outdoor	-	-	Non Dim	110/240	2500
60007	5W LED Green GLS Non Dim - ES, Outdoor	-	-	Non Dim	110/240	2500
60008	5W LED Red GLS Non Dim - ES, Outdoor	-	-	Non Dim	110/240	2500
60009	5W LED White GLS Non Dim - ES, Outdoor	-	-	Non Dim	110/240	2500
LED chip determines light colour						
Plastic envelope, suitable for outdoor use if used with IP rated festoon or fixture						

¹ Exceeds EU standard of 70 for Lumens Maintenance Ratio

² Exceeds EU standard of RA 80 for Colour Rendering Index

³ Subject to terms & conditions (Contact Customer Service)

Call Customer Service or see website for maximum loading and dimmer compatibility.

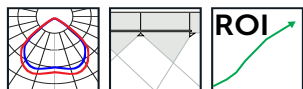





LED Reflector

The ever-popular LED Reflectors are ideal for multiple applications. Available in 5 different sizes, 3 different wattages and 2 different cap types.

- Direct replacement for incandescent reflector spots
- Long life of 25,000 hours
- Low maintenance costs
- Sustainable lighting technology



Warm White

R39 H 70mm Ø39mm

R50 H 87mm Ø50mm

R63 H 100mm Ø63mm

R80 H 111mm Ø80mm

Code	Lamp Type	CCT	Lm	Dim	V	Hours
Non Dimmable						
05680	4W LED R39 Non Dim - SES	3000K	300	Non Dim	240	25000
05683	7W LED R50 Non Dim - SES	3000K	450	Non Dim	240	25000
05681	7W LED R63 Non Dim - ES	3000K	450	Non Dim	240	25000
05684	7W LED R80 Non Dim - ES	3000K	500	Non Dim	240	25000
05682	12W LED R80 Non Dim - ES	3000K	800	Non Dim	240	25000

¹ Exceeds EU standard of 70 for Lumens Maintenance Ratio

² Exceeds EU standard of RA 80 for Colour Rendering Index

³ Subject to terms & conditions (Contact Customer Service)

Call Customer Service or see website for maximum loading and dimmer compatibility.

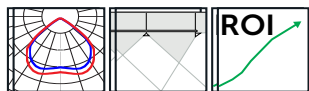

technical@belllighting.co.uk
sales@belllighting.co.uk





LED Appliance Lamp

Our LED Appliance Lamps are the ideal replacements for inefficient Incandescent lighting. With a 25,000 lamp life and 3 year guarantee these lamps are truly a fit & forget product.

- Direct replacement for standard Cooker Hood, Pygmy & Appliance lamps
- Shatterproof, suitable for signage and domestic applications



Warm White

Cool White

Cooker Hood H 85mm Ø23mm

Appliance H 61mm Ø26mm

Pygmy Lamp H 57mm Ø27mm

Code	Lamp Type	CCT	Lm	Dim	V	Hours
Non Dimmable						
05665	1W LED Appliance Lamp Non Dim - SES Clear	4000K	40	Non Dim	240	25000
05655	3W LED Cooker Hood Non Dim - SES Clear	3000K	350	Non Dim	240	25000
05663	2W Pygmy Lamp Non Dim - SES Clear	2700K	100	Non Dim	240	25000
05664	1.2W Pygmy Lamp Non Dim - SES Opal	2700K	90	Non Dim	240	25000

¹ Exceeds EU standard of 70 for Lumens Maintenance Ratio

² Exceeds EU standard of RA 80 for Colour Rendering Index

³ Subject to terms & conditions (Contact Customer Service)

Call Customer Service or see website for maximum loading and dimmer compatibility.



technical@belllighting.co.uk
sales@belllighting.co.uk





LED G4/G9 Capsules

Our sleek looking LED G9 Capsules can be used in both open & closed fixtures. The Opal finish enables them to seamlessly blend into any light fixture while providing a high light output.

- Ideal for domestic & commercial applications
- Warm White 2700K
- Direct retrofit into existing fittings.
- Perfect for display and accent light fixtures
- Up to 90% Energy saving
- 20000 Hours



Warm White

1.5W G4 H 40mm W 15mm

3W G9 H 48mm Ø15mm

Code	Lamp Type	CCT	Lm	Dim	V	Hours
Non Dimmable						
05645	1.5W LED G4 Capsule - Non Dim	2700K	120	Non Dim	12	20000
12V intensity LED bulbs require a BELL line driver or quality branded transformer						
Dimmable						
05674	3W LED Flat G9 Capsule - Dimmable	2700K	250	Dim	240	20000
Compatible with most branded Trailing Edge Dimmers including BELL Smart Universal LED Trailing/Leading Edge Dimmer Module. Code: 10803						

¹ Exceeds EU standard of 70 for Lumens Maintenance Ratio

² Exceeds EU standard of RA 80 for Colour Rendering Index

³ Subject to terms & conditions (Contact Customer Service)

Call Customer Service or see website for maximum loading and dimmer compatibility.



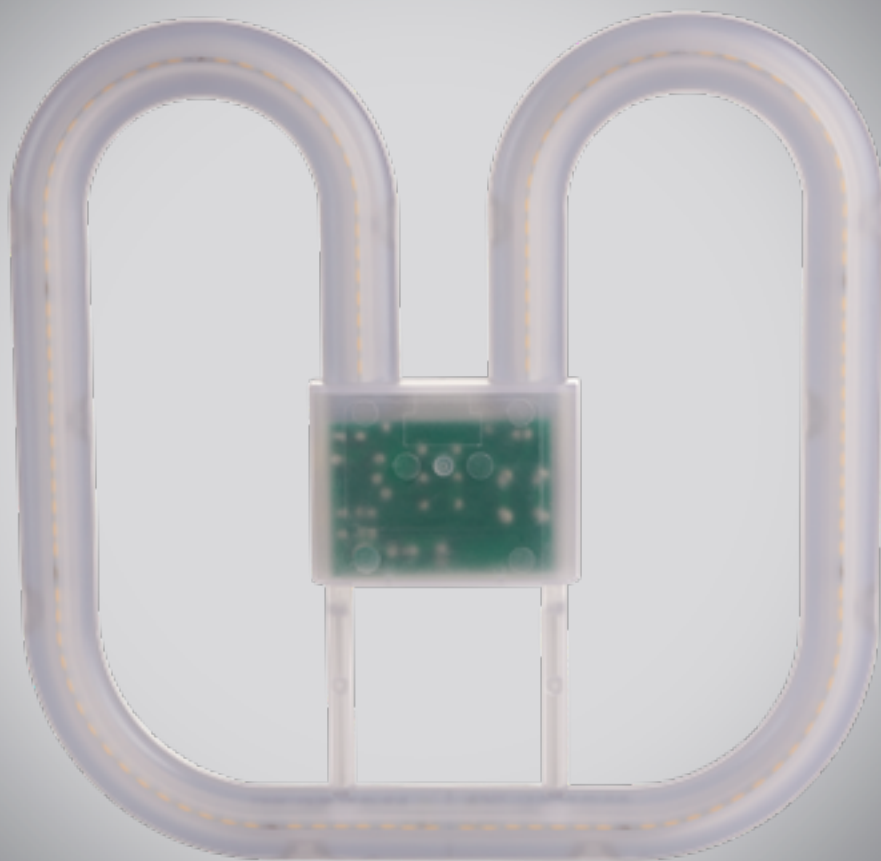



LED Square 2/4 Pin

Our LED Square 2/4 Pin Lamps give the user the familiarity of the renowned CFL Square Lamps combined with the energy saving benefits of LED lighting. With a 5 year guarantee, these 16W & 8W CFL replacements will stand the test of time.

- Replacement for CFL Square lamps
- Same aesthetic as CFL Square lamp but reduced energy consumption
- Cool White 4000K
- Retrofit
- 25000 Hours
- Perfect for commercial & domestic applications
- Quick, easy installation



Cool White

9W H 144mm W 144mm

12W H 193mm W 193mm

Code	Lamp Type	CCT	Lm	Dim	V	Hours
Non Dimmable						
05670	9W LED 2D Lamp - Non Dim - GR8	4000K	1000	Non Dim	240	25000
05673	12W LED 2D Lamp - Non Dim - GR10q	4000K	1350	Non Dim	240	25000

For use with magnetic ballast: Remove starter and capacitor

For use with electronic ballast: Remove control gear and wire directly to mains

Not suitable for emergency

¹ Exceeds EU standard of 70 for Lumens Maintenance Ratio

² Exceeds EU standard of RA 80 for Colour Rendering Index

³ Subject to terms & conditions (Contact Customer Service)

Call Customer Service or see website for maximum loading and dimmer compatibility.

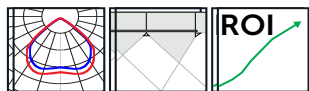

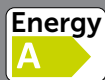



110V LED GLS

The 110V LED GLS has been specially designed for safety applications. As a direct replacement for standard GLS, this tough, robust GLS is suitable for site lighting, with a colour coded yellow base for easy identification.

- Suitable for site lighting
- Direct replacement for standard GLS
- Retrofit size
- Suitable for use with low voltage site transformers
- Colour coded yellow base for easy identification
- 83% Energy Saving
- IP65 when used with suitable lamp holder
- Tough, robust design
- Plastic envelope



Cool White

Warm White

Opal

H 103mm Ø57mm

Code	Lamp Type	CCT	Lm	Dim	V	Hours
Non Dimmable						
05860	10W LED 110V GLS Non Dim - BC	2700K	810	Non Dim	110	25000
05861	10W LED 110V GLS Non Dim - ES	2700K	810	Non Dim	110	25000
05862	10W LED 110V GLS Non Dim - BC	4000K	810	Non Dim	110	25000
05863	10W LED 110V GLS Non Dim - ES	4000K	810	Non Dim	110	25000

¹ Exceeds EU standard of 70 for Lumens Maintenance Ratio

² Exceeds EU standard of RA 80 for Colour Rendering Index

³ Subject to terms & conditions (Contact Customer Service)

Call Customer Service or see website for maximum loading and dimmer compatibility.







LED BLD/BLT

The LED BLD/BLT Lamps are an ideal replacement for old hat CFL technology. With a 5 year guarantee the LED BL Lamps offer a cost-effective energy saving solution without the need to replace a complete fitting.

- Energy saving benefits of LED without having to change fittings
- Aluminium heat sink for improved life
- True retrofit size
- High CRI
- Not suitable for emergency or dimming
- Suitable for switch start/magnetic control gear
- Must bypass High Frequency control gear



Cool White

12W BLD H 174mm Ø35mm

8W BLT H 132mm W 41mm

Code	Lamp Type	CCT	Lm	Dim	V	Hours
Non Dimmable						
04325	12W LED BLD - 2/4 Pin - Non Dim G24d/Gx24q	4000K	1020	Non Dim	240	45000
04326	8W LED BLT Horizontal 2/4 Pin Non Dim G24d/Gx24q	4000K	1000	Non Dim	240	45000

For use with magnetic ballast: Remove starter and capacitor

For use with electronic ballast: Remove control gear and wire directly to mains

Not suitable for emergency

¹ Exceeds EU standard of 70 for Lumens Maintenance Ratio

² Exceeds EU standard of RA 80 for Colour Rendering Index

³ Subject to terms & conditions (Contact Customer Service)

Call Customer Service or see website for maximum loading and dimmer compatibility.







LED BLL/BLS

The LED BLL/BLS Lamps are an ideal replacement for old hat CFL technology. With a 5 year guarantee the LED BLL Lamps offer a cost-effective energy saving solution without the need to replace a complete fitting. Ideal for public buildings, offices, shops, supermarkets, hotels, restaurants and around the home.

- Energy saving benefits of LED without having to change fittings
- Aluminium heat sink for improved life
- True retrofit size
- High CRI
- Not suitable for emergency or dimming
- Suitable for switch start/magnetic control gear
- Must bypass High Frequency control gear



Cool White

8W BLL L 240mm W 48mm

15W BLL L 430mm W 48mm

24W BLL L 550mm W 48mm

4.5W BLS L 166mm W 32mm

6W BLS L 236mm W 32mm

Code	Lamp Type	CCT	Lm	Dim	V	Hours
Non Dimmable						
04328	8W LED Linear 4 Pin Non Dim - 2G11	4000K	720	Non Dim	240	45000
04329	15W LED Linear 4 Pin Non Dim - 2G11	4000K	1350	Non Dim	240	45000
04330	24W LED Linear 4 Pin Non Dim - 2G11	4000K	2160	Non Dim	240	450000
04331	4.5W LED BLS 2 Pin Non Dim - G23	4000K	405	Non Dim	240	45000
04332	6W LED BLS 2 Pin Non Dim - G23K	4000K	540	Non Dim	240	45000

For use with magnetic ballast: Remove starter and capacitor

For use with electronic ballast: Remove control gear and wire directly to mains

Not suitable for emergency

¹ Exceeds EU standard of 70 for Lumens Maintenance Ratio

² Exceeds EU standard of RA 80 for Colour Rendering Index

³ Subject to terms & conditions (Contact Customer Service)



technical@belllighting.co.uk
sales@belllighting.co.uk

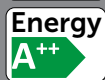
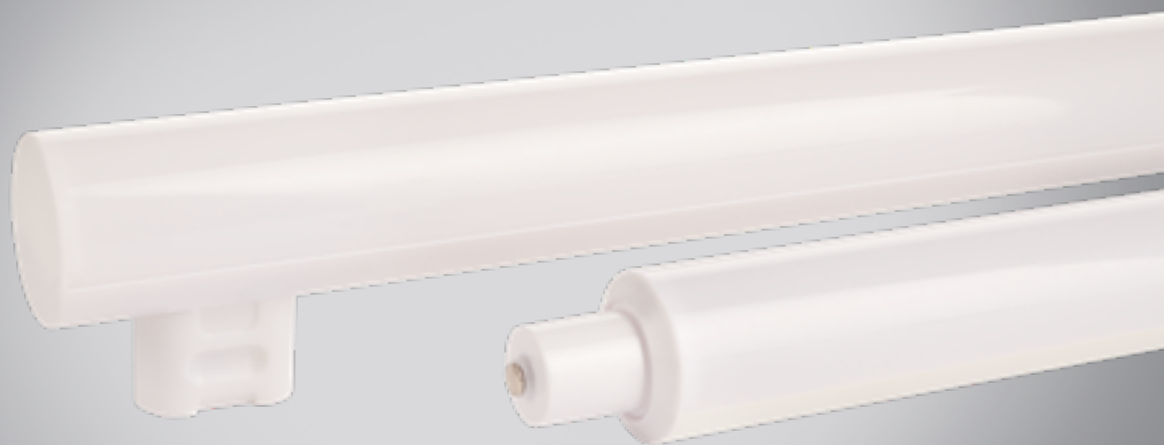



LED Strip/Architectural

Both our LED Strip Lamps & Architectural Lamps are perfect replacements for inefficient incandescent lighting. With a 3 year guarantee, these lamps offer a cost effective way to upgrade lighting without the need for a full replacement of a fitting or fixture.

- Direct size replacement for Standard Architectural Strip Lamp
- Lasts 15 times longer than Standard Architectural Strip Lamp
- Up to 90% Energy Saving
- 25000 hours



Opal

Warm White

2.5W Strip H 221mm Ø26mm

4W Strip H 284 Ø26mm

4W Architectural H 300m Ø30mm

6W Architectural H 500m Ø30mm



Code	Lamp Type	CCT	Lm	Dim	V	Hours
Non Dimmable						
05156	2.5W LED 221mm Opal Strip Lamp Non Dim S15	3000K	300	Non Dim	240	25000
05157	4W LED 284mm Opal Strip Lamp Non Dim S15	3000K	500	Non Dim	240	25000
02040	4W LED Architectural Non Dim - S14S	3000K	300	Non Dim	240	25000
02041	4W LED Architectural Non Dim - S14D	3000K	300	Non Dim	240	25000
02042	6W LED Architectural Non Dim - S14S	3000K	500	Non Dim	240	25000
02043	6W LED Architectural Non Dim - S14D	3000K	500	Non Dim	240	25000

¹ Exceeds EU standard of 70 for Lumens Maintenance Ratio

² Exceeds EU standard of RA 80 for Colour Rendering Index

³ Subject to terms & conditions (Contact Customer Service)

Call Customer Service or see website for maximum loading and dimmer compatibility.

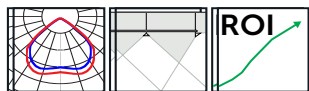





LED T8

Our LED T8 tubes are suitable for both switch start and high frequency and are the perfect way to replace conventional fluorescent tubes. A cost-effective energy saving solution without the need to replace a complete fitting while reaping the energy saving benefits of LED.

- Designed to replace conventional fluorescent tubes.
- Long life of 50000 hours
- Low maintenance costs
- 5 Year Guarantee³
- Up to 59% Energy Savings
- Simple Retrofit



Frosted Glass

Cool White

Warm White

Daylight

Tube Ø 28mm

9W L 600mm

14W L 900mm

22W L 1200mm

24W L 1500mm

30W L 1800mm

3 Year Guarantee (9/14/22/24W)³

5 Year Guarantee (30W)³



technical@belllighting.co.uk
sales@belllighting.co.uk



LED T8

360

Code	Lamp Type	CCT	Lm	Dim	V	Hours
Non Dimmable						
05487	9W LED T8 Tube - G13, Non Dim, 600mm	4000K	650	Non Dim	240	25000
05488	14W LED T8 Tube - G13, Non Dim, 900mm	4000K	1130	Non Dim	240	25000
05489	22W LED T8 Tube - G13, Non Dim, 1200mm	4000K	1900	Non Dim	240	25000
05492	24W LED T8 Tube - G13, Non Dim, 1500mm	2700K	2200	Non Dim	240	25000
05490	24W LED T8 Tube - G13, Non Dim, 1500mm	4000K	2200	Non Dim	240	25000
05493	24W LED T8 Tube - G13, Non Dim, 1500mm	6500K	2200	Non Dim	240	25000
05491	30W LED T8 Tube - G13, Non Dim, 1800mm	4000K	2900	Non Dim	240	25000

For use with magnetic ballast: Remove starter and capacitor

For use with electronic ballast: Remove control gear and wire directly to mains

Not suitable for emergency

¹ Exceeds EU standard of 70 for Lumens Maintenance Ratio

² Exceeds EU standard of RA 80 for Colour Rendering Index

³ Subject to terms & conditions (Contact Customer Service)

Call Customer Service or see website for maximum loading and dimmer compatibility.





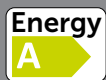

T3 Mini Spiral/Spiral

Available in a variety of wattages and caps, the T3 Spirals are still widely used domestically as incandescent lighting replacements. The T3 spiral is a non-dimmable product, available in Warm White.

- Quick Start Technology
- 10000 Hours
- Last up to 10 times longer than a standard lamp

Warm White

9W H 102mm Ø37

11W H 109mm Ø37

15W H 121mm Ø48

20W H 130mm Ø48

25W H 142mm Ø48

Code	Lamp Type	CCT	Lm	Dim	V	Hours
Non Dimmable						
05002	9W T3 Mini Spiral Non Dim - BC	2700K	512	Non Dim	240	10000
04997	9W T3 Mini Spiral Non Dim - SES	2700K	512	Non Dim	240	10000
05011	9W T3 Mini Spiral Non Dim - ES	2700K	512	Non Dim	240	10000
05003	11W T3 Spiral Non Dim - BC	2700K	600	Non Dim	240	10000
05007	11W T3 Spiral Non Dim - SES	2700K	600	Non Dim	240	10000
05012	11W T3 Spiral Non Dim - ES	2700K	600	Non Dim	240	10000
05004	15W T3 Spiral Non Dim - BC	2700K	900	Non Dim	240	10000
05013	15W T3 Spiral Non Dim - ES	2700K	900	Non Dim	240	10000
05005	20W T3 Spiral Non Dim - BC	2700K	1200	Non Dim	240	10000
05014	20W T3 Spiral Non Dim - ES	2700K	1200	Non Dim	240	10000
05006	25W T3 Spiral Non Dim - BC	2700K	1520	Non Dim	240	10000
05015	25W T3 Spiral Non Dim - ES	2700K	1520	Non Dim	240	10000

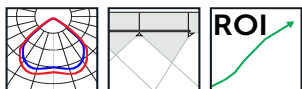

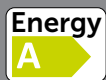

T3 4U Eco

Available in a variety of wattages and caps, the T3 4U Lamps are still widely used domestically as incandescent lighting replacements. The most cost-effective lamp of its type, the T3 4U Lamps are non-dimmable, available in Warm White.

- Quick Start Technology
- 10000 Hours
- Last up to 10 times longer than a standard lamp

Warm White

11W H 100mm Ø47mm

15W H 112mm Ø47mm

20W H 128mm Ø47mm

Code	Lamp Type	CCT	Lm	Dim	V	Hours
Non Dimmable						
04984	11W 4U T3 ECO Non Dim - BC	2700K	532	Non Dim	240	10000
04985	11W 4U T3 ECO Non Dim - ES	2700K	630	Non Dim	240	10000
04986	15W 4U T3 ECO Non Dim - BC	2700K	800	Non Dim	240	10000
04987	15W 4U T3 ECO Non Dim - ES	2700K	800	Non Dim	240	10000
04988	20W 4U T3 ECO Non Dim - BC	2700K	1215	Non Dim	240	10000
04989	20W 4U T3 ECO Non Dim - ES	2700K	1215	Non Dim	240	10000

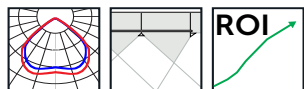

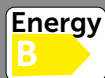

BLD

The CFL BLD range features a G24Q-2 base and Warm White, White & Cool White colour temperatures, this long-lasting lamp is ideal for functional domestic and commercial applications.

- Quick Start Technology
- 10000 Hours
- Last up to 10 times longer than a standard lamp

Cool White

Warm White

White

10W L 119mm W 27mm

13W L 137mm W 27mm

18W L 153mm W 27mm

26W L 173mm W 27mm

Code	Lamp Type	CCT	Lm	Dim	V	Hours
Non Dimmable						
04150	10W BLD - 2 Pin Non Dim	4000K	600	Non Dim	-	10000
04157	10W BLD - 4 Pin Non Dim	4000K	600	Non Dim	-	10000
04151	13W BLD - 2 Pin Non Dim	4000K	900	Non Dim	-	10000
04158	13W BLD - 4 Pin Non Dim	4000K	900	Non Dim	-	10000
04231	13W BLD - 2 Pin Non Dim	3500K	900	Non Dim	-	10000
04247	13W BLD - 4 Pin Non Dim	3500K	900	Non Dim	-	10000
04239	13W BLD - 2 Pin Non Dim	2700K	900	Non Dim	-	10000
04255	13W BLD - 4 Pin Non Dim	2700K	900	Non Dim	-	10000
04152	18W BLD - 2 Pin Non Dim	4000K	1200	Non Dim	-	10000
04159	18W BLD - 4 Pin Non Dim	4000K	1200	Non Dim	-	10000
04232	18W BLD - 2 Pin Non Dim	3500K	1200	Non Dim	-	10000
04248	18W BLD - 4 Pin Non Dim	3500K	1200	Non Dim	-	10000
04153	26W BLD - 2 Pin Non Dim	4000K	1800	Non Dim	-	10000
04160	26W BLD - 4 Pin Non Dim	4000K	1800	Non Dim	-	10000
04233	26W BLD - 2 Pin, Non Dim	3500K	1800	Non Dim	-	10000
04249	26W BLD - 4 Pin Non Dim	3500K	1800	Non Dim	-	10000

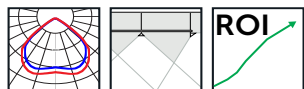

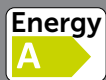

BLT

The CFL BLT range features a GX24-D3 base and a Cool White colour temperature, this long-lasting lamp is ideal for functional domestic and commercial applications.

- Quick Start Technology
- 10000 Hours
- Last up to 10 times longer than a standard lamp

Cool White

13W L 110mm W 42mm

18W L 125mm W 42mm

26W L 145mm W 42mm

32W L 150mm W 42mm

42W L 168mm W42mm

Code	Lamp Type	CCT	Lm	Dim	V	Hours
Non Dimmable						
04164	13W BLT - 2 Pin, Non Dim	4000K	900	Non Dim	-	10000
04166	13W BLT - 4 Pin, Non Dim	4000K	900	Non Dim	-	10000
04165	18W BLT - 2 Pin, Non Dim	4000K	1200	Non Dim	-	10000
04167	18W BLT - 4 Pin, Non Dim	4000K	1200	Non Dim	-	10000
04168	26W BLT - 2 Pin, Non Dim	4000K	1800	Non Dim	-	10000
04169	26W BLT - 4 Pin, Non Dim	4000K	1800	Non Dim	-	10000
04277	32W BLT - 4 Pin, Non Dim	4000K	2400	Non Dim	-	10000
04278	42W BLT - 4 Pin, Non Dim	4000K	3200	Non Dim	-	10000

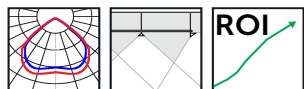

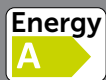

BLS

The CFL BLS range features a G23 base and a White & Cool White colour temperature, this long-lasting lamp is ideal for functional domestic and commercial applications.

- Quick Start Technology
- 10000 Hours
- Last up to 10 times longer than a standard lamp

Cool White

White

5W L 90mm W 32 mm

7W L 121mm W 32 mm

9W L 149mm W 32mm

11W L 219mm W 32mm

Code	Lamp Type	CCT	Lm	Dim	V	Hours
Non Dimmable						
04200	5W BLS - 2 Pin, Non Dim	4000K	250	Non Dim	-	10000
04202	9W BLS - 2 Pin, Non Dim	4000K	600	Non Dim	-	10000
04211	9W BLS - 2 Pin, Non Dim	3500K	600	Non Dim	-	10000
04203	11W BLS - 2 Pin, Non Dim	4000K	900	Non Dim	-	10000
04212	11W BLS - 2 Pin, Non Dim	3500K	900	Non Dim	-	10000

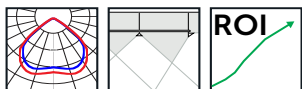

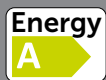

BLL

The CFL BLL range features a 2G11 base and a White & Cool White colour temperature. This long-lasting lamp is ideal for functional domestic and commercial applications.

- Quick Start Technology
- 10000 Hours
- Lasts up to 10 times longer than a standard lamp

Cool White

5W L 90mm W 32 mm

7W L 121mm W 32 mm

9W L 149mm W 32 mm

11W L 219mm W 32 mm

Code	Lamp Type	CCT	Lm	Dim	V	Hours
Non Dimmable						
04302	18W BLL - 4 Pin Non Dim	4000K	1200	Non Dim	-	10000
04303	24W BLL - 4 Pin Non Dim	4000K	1800	Non Dim	-	10000
04304	36W BLL - 4 Pin Non Dim	4000K	2900	Non Dim	-	10000
04305	40W BLL - 4 Pin Non Dim	4000K	3325	Non Dim	-	10000
04306	55W BLL - 4 Pin Non Dim	4000K	4800	Non Dim	-	10000



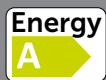

T9 Triphosphor Circular

The T9 Triphosphor range features a G10q base and a White & Cool White colour temperature, this long-lasting lamp is ideal for functional domestic and commercial applications.

- Quick Start Technology
- 16000 Hours
- Last up to 10 times longer than a standard lamp

Cool White

White

22W Overall Ø210 mm

32W Overall Ø300 mm

40W Overall Ø400 mm

60W Overall Ø400 mm

Tube Ø29 mm

Code	Lamp Type	CCT	Lm	Dim	V	Hours
Non Dimmable						
04194	22W T9 Triphosphor Circular Tube Non Dim - 4 Pin	4100K	1300	Non Dim	-	16000
04191	32W T9 Triphosphor Circular Tube Non Dim - 4 Pin	3000K	2450	Non Dim	-	16000
04195	32W T9 Triphosphor Circular Tube Non Dim - 4 Pin	4100K	2300	Non Dim	-	16000
04192	40W T9 Triphosphor Circular Tube Non Dim - 4 Pin	3000K	3450	Non Dim	-	16000
04196	40W T9 Triphosphor Circular Tube Non Dim - 4 Pin	4100K	3200	Non Dim	-	16000
04193	60W T9 Triphosphor Circular Tube Non Dim - 4 Pin	3000K	4300	Non Dim	-	16000
04197	60W T9 Triphosphor Circular Tube Non Dim - 4 Pin	4100K	4100	Non Dim	-	16000

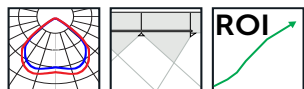



T5 Triphosphor Circular

The T5 Triphosphor range features a 2GX13 base and a White & Cool White colour temperature, this long-lasting lamp is ideal for functional domestic and commercial applications.

- Quick Start Technology
- 16000 Hours
- Last up to 10 times longer than a standard lamp

Cool White

White

22W Overall Ø225 mm

40W Overall Ø299 mm

55W Overall Ø299 mm

60W Overall Ø373 mm

Tube Ø16 mm

Code	Lamp Type	CCT	Lm	Dim	V	Hours
Non Dimmable						
05460	22W T5 Circular Tube - Non Dim 2GX13	4000K	1900	Non Dim	-	16000
05461	22W T5 Circular Tube - Non Dim 2GX13	3000K	1900	Non Dim	-	16000
05463	40W T5 Circular Tube - Non Dim 2GX13	4000K	3350	Non Dim	-	16000
05466	55W T5 Circular Tube - Non Dim 2GX13	4000K	4300	Non Dim	-	16000
05469	60W T5 Circular Tube - Non Dim 2GX13	4000K	5000	Non Dim	-	16000
05470	60W T5 Circular Tube - Non Dim 2GX13	3000K	5000	Non Dim	-	16000

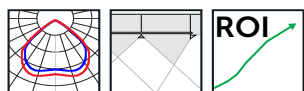

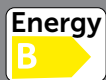

Square

Our CFL Square Lamps are the perfect low-profile bulb for surface mounted fittings, corridors, bathrooms and bulkheads. Available in Warm White, White & Cool White, the CFL Square Lamps are a tried and tested product suitable for both domestic & commercial applications.

- Quick Start Technology
- 10000 Hours
- Last up to 10 times longer than a standard lamp

Cool White

Warm White

White

16W H 135mm W 135mm D 30mm

28W H 205mm W 205mm D 30mm

38W H 205mm W 205mm D 30mm

Code	Lamp Type	CCT	Lm	Dim	V	Hours
Non Dimmable						
04170	16W Square - Non Dim 2 Pin	3500K	1050	Non Dim	-	10000
04175	16W Square - Non Dim 4 Pin	3500K	1050	Non Dim	-	10000
04183	16W Square - Non Dim 2 Pin	2700K	1050	Non Dim	-	10000
04185	16W Square - Non Dim 4 Pin	2700K	1050	Non Dim	-	10000
04131	16W Square - Non Dim 2 Pin	4000K	1050	Non Dim	-	10000
04133	16W Square - Non Dim 4 Pin	4000K	1050	Non Dim	-	10000
04171	28W Square - Non Dim 2 Pin	3500K	2050	Non Dim	-	10000
04176	28W Square - Non Dim 4 Pin	3500K	2050	Non Dim	-	10000
04184	28W Square - Non Dim 2 Pin	2700K	2050	Non Dim	-	10000
04186	28W Square - Non Dim 4 Pin	2700K	2050	Non Dim	-	10000
04132	28W Square - Non Dim 2 Pin	4000K	2050	Non Dim	-	10000
04134	28W Square - Non Dim 4 Pin	4000K	2050	Non Dim	-	10000
04180	38W Square - Non Dim 4 Pin	3500K	2700	Non Dim	-	10000
04135	38W Square - Non Dim 4 Pin	4000K	2700	Non Dim	-	10000

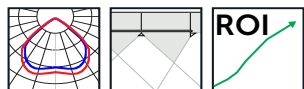



T5 Triphosphor Mini Tube

Fluorescent Tubes are commonly used in recessed lighting applications. This quality light source offers high lumen maintenance and good colour rendering. This energy efficient lamp offers an impressive 5,000 hour lamp life.

- 5000 Hours

Cool White

White

Daylight

Length measurement is from pin end to pin end

Tube Ø16 mm

Code	Lamp Type	CCT	Lm	Dim	V	Hours
Non Dimmable						
05405	4W T5 Halophosphor Mini Tube, 150mm	3500K	150	Non Dim	-	5000
05406	4W T5 Halophosphor Mini Tube, 150mm	4000K	150	Non Dim	-	5000
05407	6W T5 Halophosphor Mini Tube, 225mm	3500K	260	Non Dim	-	5000
05408	6W T5 Halophosphor Mini Tube, 225mm	4000K	260	Non Dim	-	5000
05409	8W T5 Halophosphor Mini Tube , 300mm	3500K	380	Non Dim	-	5000
05410	8W T5 Halophosphor Mini Tube, 300mm	4000K	380	Non Dim	-	5000
05411	13W T5 Halophosphor Mini Tube, 525mm	3500K	800	Non Dim	-	5000
05412	13W T5 Halophosphor Mini Tube, 525mm	4000K	800	Non Dim	-	5000
12055	4W - 80W Starter	-	-	-	-	-
12056	4W - 22W Series Starter	-	-	-	-	-
12057	70W - 125W Starter	-	-	-	-	-
12059	4W - 125W Electronic Starter	-	-	-	-	-

All 25 way or 40 way outer boxes are individually bubble wrapped to avoid breakages in transit.

WEEE Registration Number: Wee/GJ0117XV

No Additional Charge on Invoice

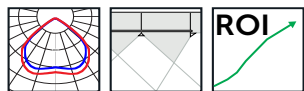



T5 Triphosphor High Efficiency Tube

Fluorescent Tubes are commonly used in recessed lighting applications. This quality light source offers high lumen maintenance and good colour rendering. This energy efficient lamp offers an impressive 20,000 hour lamp life.

- 20000 Hours

Cool White

White

Tube Ø16mm

Length measurement is from pin end to pin end

Code	Lamp Type	CCT	Lm	Dim	V	Hours
Non Dimmable						
05415	14W T5 Triphosphor H/E Tube Non Dim - 549mm	4000K	1200	Non Dim	-	20000
05416	14W T5 Triphosphor H/E Tube Non Dim - 549mm	6500K	1100	Non Dim	-	20000
05417	14W T5 Triphosphor H/E Tube Non Dim - 549mm	3500K	1200	Non Dim	-	20000
05418	21W T5 Triphosphor H/E Tube Non Dim - 849mm	4000K	1900	Non Dim	-	20000
05419	21W T5 Triphosphor H/E Tube Non Dim - 849mm	6500K	1900	Non Dim	-	20000
05420	21W T5 Triphosphor H/E Tube Non Dim - 849mm	3500K	2000	Non Dim	-	20000
05421	28W T5 Triphosphor H/E Tube Non Dim - 1149mm	4000K	2600	Non Dim	-	20000
05422	28W T5 Triphosphor H/E Tube Non Dim - 1149mm	6500K	2400	Non Dim	-	20000
05423	28W T5 Triphosphor H/E Tube Non Dim - 1149mm	3500K	2600	Non Dim	-	20000
05424	35W T5 Triphosphor H/E Tube Non Dim - 1449mm	4000K	3300	Non Dim	-	20000
05425	35W T5 Triphosphor H/E Tube Non Dim - 1449mm	6500K	3000	Non Dim	-	20000
05426	35W T5 Triphosphor H/E Tube Non Dim - 1449mm	3500K	3300	Non Dim	-	20000
12055	4W - 80W Starter	-	-	-	-	-
12056	4W - 22W Series Starter	-	-	-	-	-
12057	70W - 125W Starter	-	-	-	-	-
12059	4W - 125W Electronic Starter	-	-	-	-	-

All 25 way or 40 way outer boxes are individually bubble wrapped to avoid breakages in transit.

WEEE Registration Number: Wee/GJ0117XV

No Additional Charge on Invoice



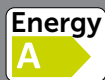

T5 Triphosphor High Output Tube

Fluorescent Tubes are commonly used in recessed lighting applications. This quality light source offers high lumen maintenance and good colour rendering. This energy efficient lamp offers an impressive 20,000 hour lamp life.

- 20000 Hours

Cool White

Daylight

Tube Ø16mm

Length measurement is from pin end to pin end

Code	Lamp Type	CCT	Lm	Dim	V	Hours
Non Dimmable						
05428	24W T5 Triphosphor H/O Tube - Non Dim, 549mm	4000K	1755	Non Dim	-	20000
05429	24W T5 Triphosphor H/O Tube - Non Dim, 549mm	6500K	1600	Non Dim	-	20000
05431	39W T5 Triphosphor H/O Tube - Non Dim, 849mm	4000K	3100	Non Dim	-	20000
05432	39W T5 Triphosphor H/O Tube - Non Dim, 849mm	6500K	2950	Non Dim	-	20000
05435	49W T5 Triphosphor H/O Tube - Non Dim, 1449mm	4000K	4315	Non Dim	-	20000
05436	49W T5 Triphosphor H/O Tube - Non Dim, 1449mm	6500K	4100	Non Dim	-	20000
05439	54W T5 Triphosphor H/O Tube - Non Dim, 1149mm	4000K	4950	Non Dim	-	20000
05440	54W T5 Triphosphor H/O Tube - Non Dim, 1149mm	6500K	4800	Non Dim	-	20000
05443	80W T5 Triphosphor H/O Tube - Non Dim, 1449mm	4000K	6500	Non Dim	-	20000
05444	80W T5 Triphosphor H/O Tube - Non Dim, 1449mm	6500K	6300	Non Dim	-	20000
12055	4W - 80W Starter	-	-	-	-	-
12056	4W - 22W Series Starter	-	-	-	-	-
12057	70W - 125W Starter	-	-	-	-	-
12059	4W - 125W Electronic Starter	-	-	-	-	-

All 25 way or 40 way outer boxes are individually bubble wrapped to avoid breakages in transit.

WEEE Registration Number: Wee/GJ0117XV

No Additional Charge on Invoice

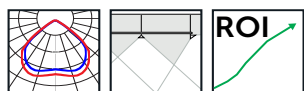

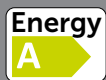

T8 Triphosphor Tube

Fluorescent Tubes are commonly used in recessed lighting applications. This quality light source offers high lumen maintenance, energy efficiency and an impressive 20,000 hour lamp life.

- 20000 Hours

Cool White / White / Daylight / Tube Ø16mm / Length measurement is from pin end to pin end

Code	Lamp Type	CCT	Lm	Dim	V	Hours
Non Dimmable						
05447	15W T8 Triphosphor Tube - Non Dim, 451mm	3500K	960	Non Dim	-	20000
05448	15W T8 Triphosphor Tube - Non Dim, 451mm	4000K	960	Non Dim	-	20000
05449	15W T8 Triphosphor Tube - Non Dim, 451mm	6500K	900	Non Dim	-	20000
05551	18W T8 Triphosphor Tube - Non Dim, 600mm	3500K	1350	Non Dim	-	20000
05552	18W T8 Triphosphor Tube - Non Dim, 600mm	4000K	1350	Non Dim	-	20000
05553	18W T8 Triphosphor Tube - Non Dim, 600mm	6500K	1300	Non Dim	-	20000
05556	30W T8 Triphosphor Tube - Non Dim, 900mm	3500K	2400	Non Dim	-	20000
05557	30W T8 Triphosphor Tube - Non Dim, 900mm	4000K	2400	Non Dim	-	20000
05558	30W T8 Triphosphor Tube - Non Dim, 900mm	6500K	2200	Non Dim	-	20000
05560	36W T8 Triphosphor Tube - Non Dim, 1200mm	3500K	3350	Non Dim	-	20000
05561	36W T8 Triphosphor Tube - Non Dim, 1200mm	4000K	3350	Non Dim	-	20000
05562	36W T8 Triphosphor Tube - Non Dim, 1200mm	6500K	3100	Non Dim	-	20000
05565	58W T8 Triphosphor Tube - Non Dim, 1500mm	3500K	5220	Non Dim	-	20000
05566	58W T8 Triphosphor Tube - Non Dim, 1500mm	4000K	5220	Non Dim	-	20000
05567	58W T8 Triphosphor Tube - Non Dim, 1500mm	6500K	5000	Non Dim	-	20000
05570	70W T8 Triphosphor Tube - Non Dim, 1800mm	3500K	6300	Non Dim	-	20000
05571	70W T8 Triphosphor Tube - Non Dim, 1800mm	4000K	6300	Non Dim	-	20000
05572	70W T8 Triphosphor Tube - Non Dim, 1800mm	6500K	5700	Non Dim	-	20000
12055	4W - 80W Starter	-	-	-	-	-
12056	4W - 22W Series Starter	-	-	-	-	-
12057	70W - 125W Starter	-	-	-	-	-
12059	4W - 125W Electronic Starter	-	-	-	-	-

All 25 way or 40 way outer boxes are individually bubble wrapped to avoid breakages in transit.

WEEE Registration Number: Wee/GJ0117XV. No Additional Charge on Invoice

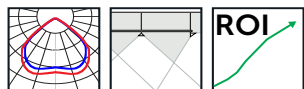

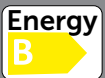

Class 'C' Halogen Capsule

LV Capsule UV Block

Our range of Halogen capsules are ideal for all decorative lighting applications. Dimmable as standard and available in a wide variety of wattages.

- 2000 Hours
- Dimmable
- Retro-Fit

Warm White

G9 H 47mm Ø13mm

G4 H 30mm W 8mm

GY6-35 H 48mm W 10mm

20W H 130mm Ø48

25W H 142mm Ø48

Code	Lamp Type	CCT	Lm	Dim	V	Hours
Dimmable						
04079	18W E/S G9 Capsule Clear - Dimmable, Class C	2700K	205	Dim	240	2000
04080	28W E/S G9 Capsule Clear - Dimmable, Class C	2700K	370	Dim	240	2000
04081	42W E/S G9 Capsule Clear - Dimmable, Class C	2700K	625	Dim	240	2000
04090	5W Capsule- G4, M9 - Dimmable	2700K	40	Dim	12	2000
04120	10W Capsule- G4, M91 - Dimmable	2700K	59	Dim	12	2000
04100	20W Capsule- G4, M47 - Dimmable	2700K	160	Dim	12	2000
04129	20W Capsule- GY6-35, M76 - Dimmable	2700K	155	Dim	12	2000
04130	35W Capsule- GY6-35, M75 - Dimmable	2700K	300	Dim	12	2000
04110	50W Capsule- GY6-35, M32 - Dimmable	2700K	520	Dim	12	2000

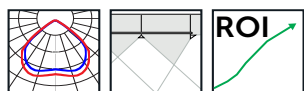

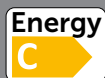

110V 117mm Linear

Class 'C' Energy Saving 78/117mm R7's Linear

Our range of Linear Halogen lamps are ideal for both domestic & commercial applications. Dimmable as standard and available in a wide variety of sizes & wattages.

- 2000 Hours
- Dimmable
- Retro-Fit

Clear

Warm White

Code	Lamp Type	CCT	Lm	Dim	V	Hours
Dimmable						
03796	200W 110V 117mm Halogen Linear - R7 Dimmable	2700K	2800	Dim	110	20000
03797	300W 110V 117mm Halogen Linear - R7 Dimmable	2700K	4500	Dim	110	20000
03798	500W 110V 117mm Halogen Linear - R7 Dimmable	2700K	8500	Dim	110	20000
03841	80W 240V 78mm Halogen Linear - R7 Dimmable	-	-	Dim	240	20000
03842	120W 240V 78mm Halogen Linear - R7 Dimmable	-	-	Dim	240	2000
03847	80W 240V 117mm Halogen Linear - R7 Dimmable	-	-	Dim	240	2000
03843	120W 240V 117mm Halogen Linear - R7 Dimmable	-	-	Dim	240	2000
03844	160W 240V 117mm Halogen Linear - R7 Dimmable	-	-	Dim	240	2000
03845	240W 240V 117mm Halogen Linear - R7 Dimmable	-	-	Dim	240	2000
03846	400W 240V 117mm Halogen Linear - R7 Dimmable	-	-	Dim	240	2000

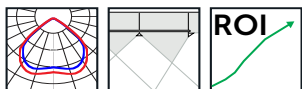



Appliance Lamps

Our range of Appliance Lamps cover a wide range of applications for all domestic appliances. Available in multiple wattages and sizes. Dimmable as standard.

- Traditional Lamps
- Dimmable
- 1000 Hours

Clear

Warm White

Microwave/Fridge H 35mm Ø17mm

Cooker Hood H 85mm Ø25mm

Oven Lamp 300° H 50mm Ø22mm

Oven Lamp G45 H 70mm Ø50mm

Code	Lamp Type	CCT	Lm	Dim	V	Hours
Dimmable						
02400	15W Appliance Microwave/Fridge Lamp Dimmable SBC Clear	2700K	80	Dim	240	1000
02410	15W Appliance Microwave/Fridge Lamp Dimmable SES Clear	2700K	80	Dim	240	1000
02420	40W Cooker Hood Lamp Dimmable SBC Clear	2700K	360	Dim	240	1000
02430	40W Cooker Hood Lamp Dimmable SES Clear	2700K	360	Dim	240	1000
02431	15W Oven Lamp 300 Degree Dimmable SES Clear	2700K	85	Dim	240	1000
02432	25W Oven Lamp 300 Degree Dimmable SES Clear	2700K	190	Dim	240	1000

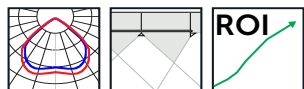



Pygmy/Small Sign Night Light

Our Small Sign & Night Light Lamps are available in a variety of wattages and cap types. Dimmable as standard with a Warm White finish.

- Traditional Lamps
- Dimmable
- 1000 Hours

Clear

Warm White

Pygmy H 50mm Ø26mm

Night Light H 49mm Ø20mm

Code	Lamp Type	CCT	Lm	Dim	V	Hours
Dimmable						
02530	15W Small Sign (Pygmy) Dimmable - BC Clear	2700K	90	Dim	240	1000
02610	15W Small Sign (Pygmy) Dimmable - SES Clear	2700K	90	Dim	240	1000
02630	25W Small Sign (Pygmy) Dimmable - BC Clear	2700K	170	Dim	240	1000
02640	25W Small Sign (Pygmy) Dimmable - SBC Clear	2700K	170	Dim	240	1000
02650	25W Small Sign (Pygmy) Dimmable - SES Clear	2700K	170	Dim	240	1000
02393	7W Nightlight Dimmable - CES Clear	2700K	34	Dim	240	1000
02392	7W Nightlight Dimmable - SES Clear	2700K	34	Dim	240	1000

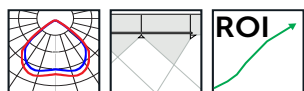



IP Ratings

396

Classification of the degree of protection a luminaire provides against the entry of solid foreign bodies and moisture. IP65 rated units are protected against dust and offer protection against water jets.

Recommended Light Levels - CIBSE Guidelines

Public areas with dark surroundings 10-50 Lux

Car parks 10-50 Lux

Warehouse racking 150 Lux

Brighter areas such as bathrooms 150-200 Lux

Warehouses, homes & theatres 150-200 Lux

Simple office work and classrooms 300-500 Lux

Normal office work with computers 300-500 Lux

Supermarkets and workshops 500-1000 Lux

Typical Lighting requirements for commercial applications

Meeting & boardroom

The main lighting should be focused on the table areas. Allowing control of lighting near screens and displays. Use feature lighting to provide depth and impact.

Office area

Allow for flexible use of the space so that desks can be repositioned. Consider using occupancy detection and natural daylight, this will require lighting control. Light emergency escape routes.

Reception

The reception area provides the first impression of a business. The main and accent lighting should be varied to provide an interesting environment.

Stairwells

Focus on safety ensuring good light levels. Also ensure the emergency requirements for escape are met.

Showroom

Focus should be on the products being displayed. Good CRI is important to ensure that colours are displayed correctly, BELL LED lamps have good and consistent CRI. Also consider the reliability of the lighting, a long lamp life is important or the products will become dimly lit over time as lamp performance deteriorates.

Exterior

Think about the security requirements and the safe passage of staff and visitors when entering and leaving a building. Good exterior lighting can dramatically improve the look of a building so consider both lighting the area around the building and the elevations of the entrance area and side walls. The correct choice of fittings and colour temperature is important.

Making the most of your lighting

Good lighting design recognises the need for depth of view. Both ambient and accent lighting should be used, whilst combining colour temperatures to create a more comfortable working environment.

Ambient lighting is the general lighting within an area and typically contributes 80% of the overall lighting level.

Accent lighting adds interest and depth to a design and should compliment but not conflict with the ambient lighting.

This can include wall washing, the subtle use of colour, up lighting and spotlighting.



IP Ratings

Ingress	Description	Protection	Short Description
0	Not Protected	0	Not Protected
1	Protection against solid objects greater than 50mm	1	Protected against dripping water
2	Protected against solid objects greater than 12mm	2	Protected against dripping water when tilted up to 15°
3	Protected against solid objects greater than 2.5mm	3	Protected against spraying water
4	Protected against solid objects greater than 2.5mm	4	Protected against splashing water
5	Protected against solid objects greater than 1mm	5	Protected against water jets
6	Dust protected	6	Protected against heavy seas
7	Dust Tight	7	Protected against the effects of immersion
		8	Protected against submersion



Lighting Glossary - a guide to terms used in lighting

398

Wattage (W)

The unit for measuring electrical power. It defines the rate of energy consumption by an electrical device when it is in operation. The energy costs of operating a device is calculated as its wattage times the hours of use. In single phase circuits, it is related to volts and amps by the formula: Volts x amps x PF = Watts (Note for AC circuits PF must be included).

Lumens (Lm)

A unit of light flow, or luminous flux. The lumen rating of a lamp is a measurement of the total light output of the lamp.

Light Output Ratio (LOR)

The ratio of the total light output of a luminaire, compared with total lamp light output.

Lux (Lx)

A unit of illuminance or light falling onto a surface. One lux is equal to one lumen per square meter. Ten lux approximately equals one footcandle.

Candela (Cd)

Unit of luminous intensity, describing the intensity of a light source in a specific direction.

Colour Rendering Index (CRI)

A scale of the effect of a light source on the colour appearance of an object compared to its colour appearance under a referenced light source. Expressed on a scale of 1-100, where 100 indicates no colour shift. A low CRI rating suggests the colours of objects will appear unnatural under that particular light source.

Lumen Maintenance Ratio (LMR)

The proportion of light output of a lamp after a stated period compared with initial lumen output.

Colour Temperature

The colour temperature is a specification of the colour appearance of a light source, relating the colour to a reference source heated to a particular temperature, measured by the thermal unit Kelvin. The measurement can also be described as the "warmth" or "coolness" of a light source. Generally, sources below 3200K are considered warm, while those above 4000K are considered cool sources.

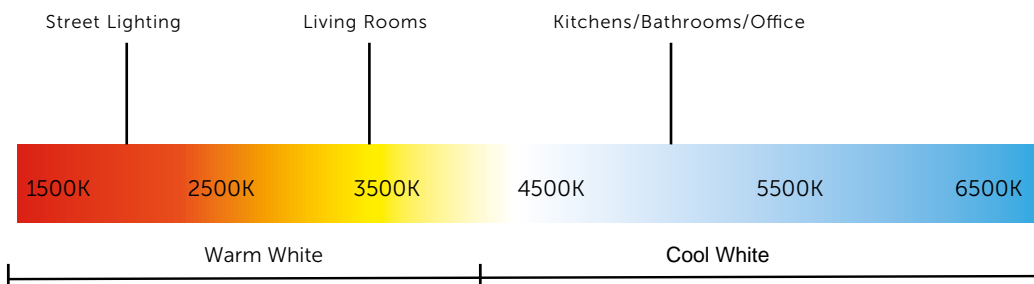

The colour temperature of a light source is measured in degrees Kelvin. Above is a Kelvin temperature chart with examples of how colour temperature is used for different applications.





Light Pollution

What is light pollution?

Most of us are familiar with air, water, and land pollution, but did you know that light can also be a pollutant?

The inappropriate or excessive use of artificial light – known as light pollution – can have serious environmental consequences for humans, wildlife, and our climate. Components of light pollution include:

Glare:

Excessive brightness that causes visual discomfort.

Skyglow:

Brightening of the night sky over inhabited areas, also known as upward light ratio (ULR).

Light trespass:

Light falling where it is not intended.

Clutter:

Bright, confusing and excessive light sources.

Light pollution is a side effect of industrial civilization. Its sources include building exterior and interior lighting, advertising, commercial properties, offices, factories, street lights and illuminated sporting venues.

The fact is that much of the outdoor lighting used at night is inefficient, overly bright, poorly targeted, improperly shielded, and, in many cases, completely unnecessary. This light, and the electricity used to create it, is being wasted by spilling it into the sky, rather than focusing it on to the actual objects.

Modern society requires outdoor lighting for a variety of needs, including safety and commerce.

The Institute of Lighting Engineers recognises this but advocates that any required lighting be used wisely. To minimise the harmful effects of light pollution, lighting should:

Only be on when needed / Only light the area that needs it / Be no brighter than necessary / Minimise blue light emissions / Be fully shielded (pointing downward).

The transition from sodium to LED exterior lighting over recent years appears to have made global light pollution worse not better, scientists have reported.

The findings are certain to increase the pressure on the lighting industry to take light pollution seriously and improve the optics and upward light control.

BELL LED Asymmetric Floodlights minimise light pollution.

Skyline Elite Asymmetric floodlights have been designed and developed to meet the strict requirements for a range of sports and area lighting applications.

Specifically designed to control obtrusive light, a precision lensing system ensures a tight beam pattern, reducing overspill upwards light and directing light only where it is needed.

BELL lighting is constantly striving towards reducing light skyglow (ULR), and the Skyline Elite Floodlight is at the forefront of this pollution reducing technology.



Social Media - Follow our channels

400

In less than 10 years, social media has become an essential part of our lives, follow BELL Lighting on our channels for all the latest LED lighting news, product updates, special promotions and much more.





Distributed by

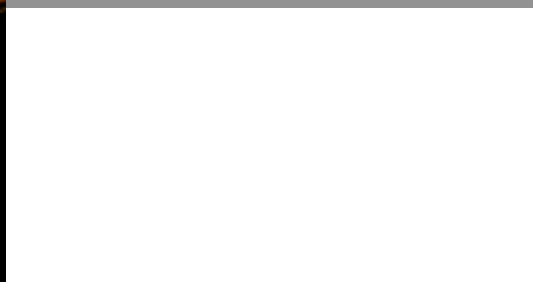

©2021 British Electric Lamps Ltd. No part of this publication may be reproduced, stored in a retrieval system, or transmitted in any form, or by any means, electronic, mechanical, photocopying, recording or otherwise, without the prior permission of the publisher and copyright holder.

E&OE. As it is our policy to continually update our products with the latest in technological advances, the information and images contained in this catalogue are subject to change without notice. All measurements stated are approximate to within production tolerances of +/-5mm.



British Electric Lamps Ltd
Unit A Foxbridge Way
Normanton Ind Est, Normanton
West Yorkshire. WF6 1TN

T: +44 (0)1924 893380
E: sales@belllighting.co.uk

www.belllighting.co.uk