

### Safety Information

> All electrical work must be undertaken by a qualified contractor to ensure compliance with latest edition BS7671 and IEE/IET wiring regulations.

> Before installing a Bulkhead or doing any maintenance, ensure power supply is turned off at the circuit breaker or fuse box.

> This product is designed for permanent connection to fixed wiring; the circuit should be protected with the appropriate MCB or fuse.

### Environment

> Please DO NOT dispose of electrical items or packaging as unsorted waste. Use the recycling facilities provided by your local authorities.

### Installation (Non-user replaceable light source)

> The light source contained in this luminaire shall be replaced by the manufacturer/service agent or similar qualified person.

## PRODUCT DIMENSIONS

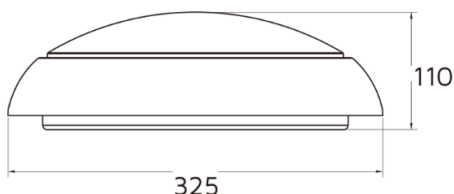
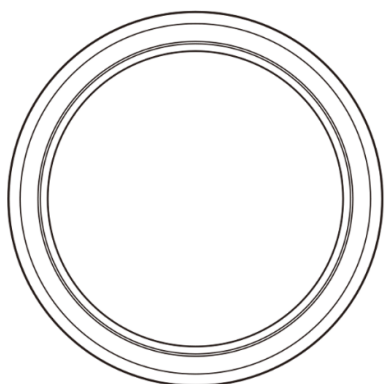

All units are in mm

### Important Warranty Information

The LED Bulkhead has a 3 Year Warranty. The registrant must provide the product part number and date of manufacture, which can be found on the label attached to the Luminaire housing along with the original invoice. The Battery has a 1 Year Warranty.



theLIA

MEMBER



Certificate No. FS 571788



Certificate No. EMS 571787

NET LED Limited  
Buckingway Business Park  
300 Anderson Road  
Cambridge  
CB24 4UQ UK  
sales@netled.co.uk  
www.netled.co.uk

Technical Helpline: 01223 851505  
Email: support@netled.co.uk

[www.netled.co.uk/downloads](http://www.netled.co.uk/downloads)

Manufactured by

**NET LED**  
LIGHTING

**LED BULKHEAD  
INSTALLATION  
GUIDE**

## LED BULKHEAD NET-33-06-XX

### KEY DATA

Light Source	LED
Power	16W
Luminous Flux (3000K)	1300lm
Luminous Flux (4000K)	1550lm
Luminous Flux (5500K)	1400lm
Luminous Efficacy	86lm/W / 105lm/W / 91lm/W
Colour Temperature	3000K / 4000K / 5500K
Colour Rendering	>80 CRI
Housing Material	Polycarbonate
Diffuser Material	Polycarbonate
IP Rating	IP65
Manufacturer	NET LED Lighting

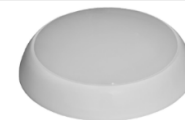

### SUPPLY/EARTH CLASS

220-240V AC 50/60 Hz  Class I

Fig.1 Mains Input Termination

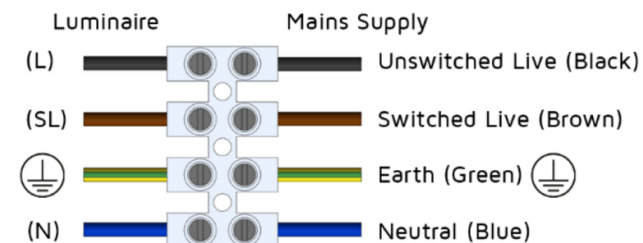

UK  
CA

CE



Installation procedure: Carefully read the installation instructions and ensure the mains supply is isolated before installation. Please read the safety information overleaf before carrying out any installation. Please retain this leaflet for future reference.

**Bulkhead installation:**



Replaceable control gear by professional



Replaceable (LED only) light source by professional

**Step 1:** Hold down the Bulkhead and rotate the Outer Ring anti-clockwise to remove it. Then remove the Diffuser.

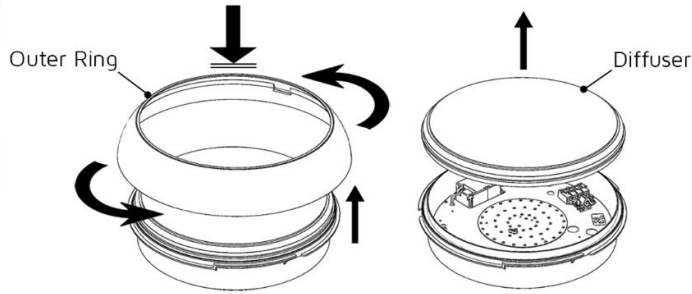

**Step 2:** Remove the Gear Tray from the housing by loosening the quick release screws. Drill out the screw holes in the housing and screw it into a solid surface using suitable wall plugs and screws.

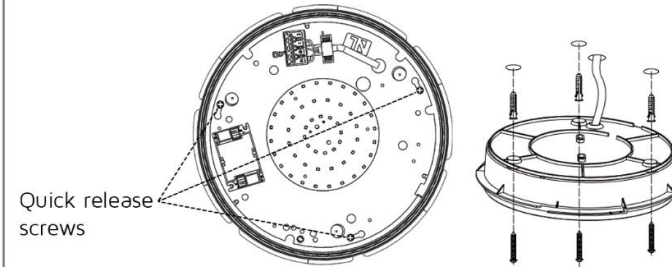

**Step 3:** Wire the Gear Tray as per the diagram below.

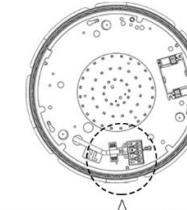

**Note:** A qualified electrician is required to carry out the electrical wiring. All wiring must be double insulated where there is a possibility of coming in contact with live wires.

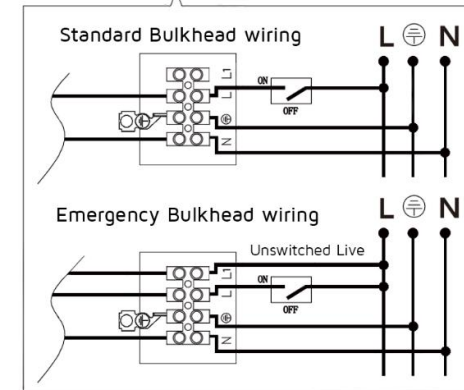

**Step 4:** Re-insert the Gear Tray into the housing and secure the power cable.

**Step 5:** Replace the diffuser by aligning it with the Gear Tray housing then align the Outer Ring and rotate it clockwise. Switch on the mains supply.

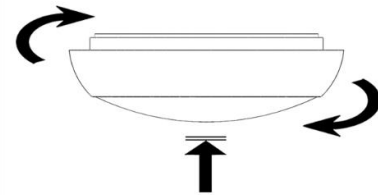

**Daylight Sensor Configuration (Only for units with the Daylight Sensor option):**

Night/Light Sensor Function

	1	2	3	4	open	close
I	ON	ON	ON	ON	5Lux	25Lux
II	ON	ON	ON	-	10Lux	50Lux
III	ON	ON	-	ON	25Lux	75Lux
IV	ON	ON	-	-	50Lux	100Lux
V	ON	-	ON	-	100Lux	200Lux
VI	ON	-	-	-	150Lux	300Lux
VII	-	ON	-	-	200Lux	400Lux
VIII	-	-	-	-	Disable	

← Default Settings

When ambient light level is below the open lux level, the sensor automatically switches on luminaire at 100% brightness. When ambient level is over close lux level, the luminaire switches off.

**Important Battery Warranty information**

The Battery has a 1 Year Warranty. To claim, you must provide the product part number and date of manufacture, which can be found on the label attached to the Luminaire housing along with the original purchase invoice.



**Microwave Motion Sensor Configuration:** These settings are only for the LED Gear Tray with Microwave Sensor option.



Please note: Dip switch in the 'Up' position is ON.

Detection Area			Full Brightness Hold Time			Daylight Sensor			10% Corridor Function Time		
ch1	ON	100%	ch3	ON	5S	ch5	ON	Disable	ch7	ON	Off/OS
ch2	ON		ch4	ON		ch6	ON		ch8	ON	
ch1	-	75%	ch3	-	90S	ch5	-	50Lux	ch7	-	30S
ch2	ON		ch4	ON		ch6	ON		ch8	ON	
ch1	ON	50%	ch3	ON	3min	ch5	ON	15Lux	ch7	ON	10min
ch2	-		ch4	-		ch6	-		ch8	-	
ch1	-	25%	ch3	-	10min	ch5	-	5Lux	ch7	-	Always On/+∞
ch2	-		ch4	-		ch6	-		ch8	-	

Default Set Up On Delivery