

NL



Need any of these?
Give us a call.

 01223 851505

The UK's most reliable supplier when you're in a last minute panic.

Imagine placing an order as late as 5:30pm and having it arrive on your doorstep the very next day.

That's where NET LED Lighting comes in.

We don't supply the boring stuff.

From 300x300 Panels to DALI Addressable Emergency Battens, we've honed the art of delivering those lighting solutions that are a little "out of the ordinary".



Reduce your stock holding and save your contractor time on-site

Most of our products are fitted with Sensors, Emergency Kits and Dimmable Drivers before they leave our warehouse.

So, you don't have to order extra parts, and your contractor saves time on-site.

Ensure the fittings you supply comply with industry standards, and reduce the risk of non-compliance issues.

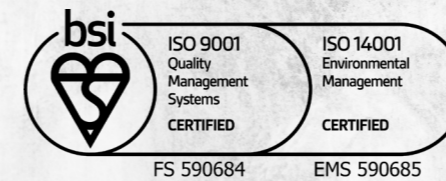

Meet your contractor's demands quickly with Made In Britain lighting

Did you know we manufacture Bulkheads, Gear Trays, Slim Circulares and Street Lights at our HQ in Cambridge?

Faster lead times, reduced faults and customised lighting opportunities await you when you order Made In Britain.

ORDER BY 6PM
FOR NEXT DAY DELIVERY

Need a single unit, or 100?

Our processes can handle both. We will deliver smaller batches of lighting according to YOUR schedule. So, you don't have to stock the lighting in advance.

We can even deliver straight to your contractor's site if needed!

Meet safety, performance, and efficiency requirements, and ensure your contractor's fittings are suitable for installation and use.



*"Always fantastic service
and the Online Portal is great!"*

Matt Davies, Rexel UK

*"I've dealt with a few great companies, but
you embrace the precision engineering approach
that tickles my fancy."*

Kevin Victor, electrical contractor

*"Superb staff, products, availability of stock
and super swift delivery."*

Kevin Nichols, Edmundson Electrical



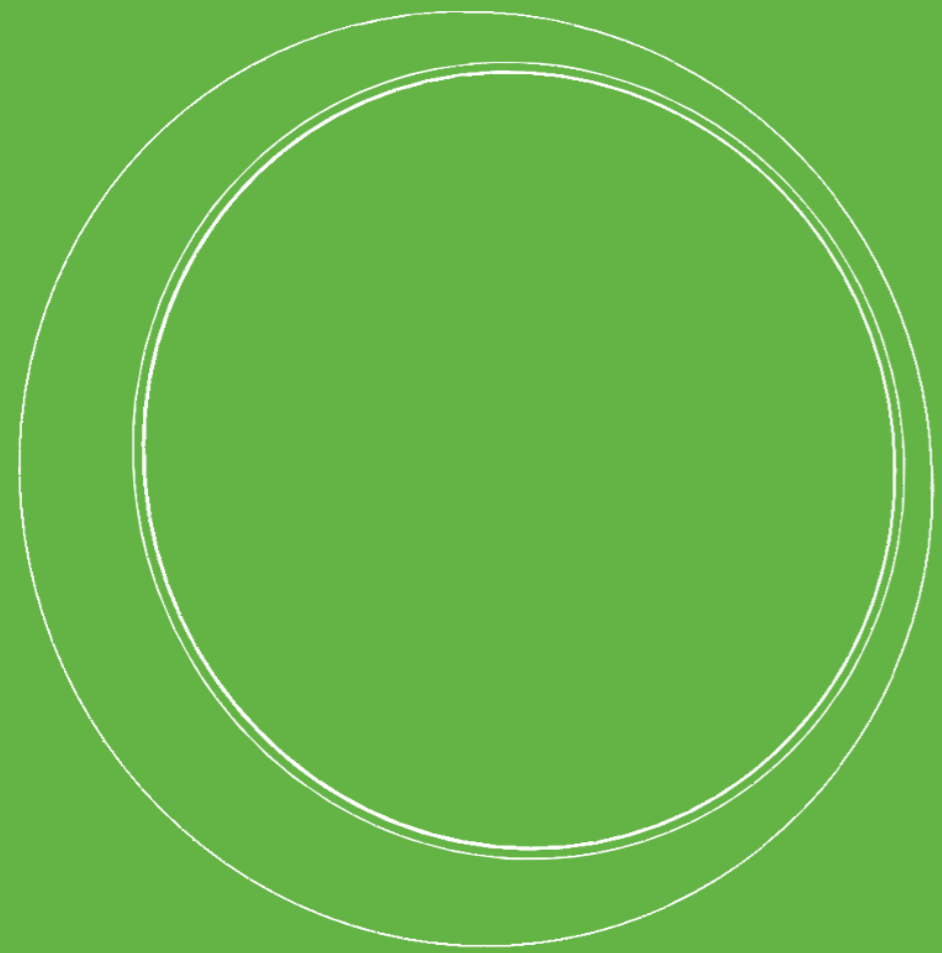

Bulkheads and Gear Trays

A mix of polycarbonate and aluminium Tri-Colour or single colour Bulkheads, and retrofit Gear Trays

SHATTERPROOF POLYCARBONATE DIFFUSER

Prevents the fitting from breaking into multiple small pieces

IP65 RATED HOUSING

Protect your bulkhead from water and dust

LITHIUM ION BATTERY

Requires little maintenance and has a long lifespan

Emergency options only

PUSH CONNECTOR

Reduce installation time with easy-to-use push fit terminals

DUSK TO DAWN FUNCTION

Detects ambient light levels and adjusts the light accordingly

Photocell options only



SELECTABLE COLOUR TEMPERATURE

Choose your colour temperature 3000K, 4000K or 5500K

INTEGRAL MICROWAVE SENSOR

Featuring a 0 or 10% Standby Mode, 2-10m detection range and 5sec to 10min hold time

Microwave Sensor options only

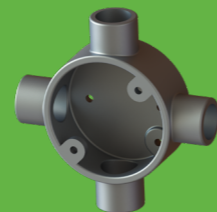

SUITABLE FOR BESA BOX INSTALLATION

Save time on site with pre-made cable entry points

DUXFORD RANGE

Tri-Colour And Single Colour 4000K
IP65 Polycarbonate Bulkheads

AVAILABLE IN



Emergency



Self Test Emergency



Microwave Sensor



Photocell



Part Number	Description	Dimensions	Power	Lumens	Colour Temp.
NET-33-06-20	Standard	Ø325 x 110mm	16W	1300lm/1550lm/1400lm	3000K/4000K/5500K
NET-33-06-30	Emergency	Ø325 x 110mm	16W	1300lm/1550lm/1400lm	3000K/4000K/5500K
NET-33-06-25	Self Test Emergency	Ø325 x 110mm	16W	1300lm/1550lm/1400lm	3000K/4000K/5500K
NET-33-06-24	Microwave Sensor	Ø325 x 110mm	16W	1300lm/1550lm/1400lm	3000K/4000K/5500K
NET-33-06-34	Microwave Sensor Emergency	Ø325 x 110mm	16W	1300lm/1550lm/1400lm	3000K/4000K/5500K
NET-33-06-27	Microwave Sensor Self Test Emergency	Ø325 x 110mm	16W	1300lm/1550lm/1400lm	3000K/4000K/5500K
NET-33-06-70	Photocell	Ø325 x 110mm	16W	1300lm/1550lm/1400lm	3000K/4000K/5500K
NET-33-06-71	Photocell Emergency	Ø325 x 110mm	16W	1300lm/1550lm/1400lm	3000K/4000K/5500K
NET-33-06-48	Photocell Microwave Sensor	Ø325 x 110mm	16W	1300lm/1550lm/1400lm	3000K/4000K/5500K
NET-33-06-49	Photocell Microwave Sensor Emergency	Ø325 x 110mm	16W	1300lm/1550lm/1400lm	3000K/4000K/5500K
NET-33-06-40	Standard	Ø325 x 110mm	15W	1550lm	4000K
NET-33-06-42	Emergency	Ø325 x 110mm	15W	1550lm	4000K
NET-33-06-45	Self Test Emergency	Ø325 x 110mm	15W	1550lm	4000K
NET-33-06-44	Microwave Sensor	Ø325 x 110mm	15W	1550lm	4000K
NET-33-06-46	Microwave Sensor Emergency	Ø325 x 110mm	15W	1550lm	4000K
NET-33-06-47	Microwave Sensor Self Test Emergency	Ø325 x 110mm	15W	1550lm	4000K

COMPATIBLE ACCESSORIES



Chrome Ring



Black Ring

NET-33-06-06

NET-33-06-08

powered by
TRIDONIC



3K 4K 5.5K

PUSH CONNECTOR

Reduce installation time with easy-to-use push fit terminals

SELECTABLE COLOUR TEMPERATURE

Choose your colour temperature 3000K, 4000K or 5500K

DUSK TO DAWN FUNCTION

Detects ambient light levels and adjusts the light accordingly

Photocell options only

INTEGRAL MICROWAVE SENSOR

Featuring a 0 or 10% Standby Mode, 2-10m detection range and 5sec to 10min hold time

Microwave Sensor options only

LITHIUM ION BATTERY

Requires little maintenance and has a long lifespan

Emergency options only

MULTIPLE MOUNTING POINTS

Retro fit into existing housings quickly and easily

DUXFORD RANGE

Tri-Colour Retrofit Gear Trays

AVAILABLE IN

-  Emergency
-  Self Test Emergency
-  Microwave Sensor
-  Photocell



Part Number	Description	Dimensions	Power	Lumens	Colour Temp.
NET-33-06-12	Standard	Ø261 x 23.6mm	16W	1650lm/1900lm/1650lm	3000K/4000K/5500K
NET-33-06-32	Emergency	Ø261 x 23.6mm	16W	1650lm/1900lm/1650lm	3000K/4000K/5500K
NET-33-06-15	Self Test Emergency	Ø261 x 23.6mm	16W	1650lm/1900lm/1650lm	3000K/4000K/5500K
NET-33-06-16	Microwave Sensor	Ø261 x 23.6mm	16W	1650lm/1900lm/1650lm	3000K/4000K/5500K
NET-33-06-36	Microwave Sensor Emergency	Ø261 x 23.6mm	16W	1650lm/1900lm/1650lm	3000K/4000K/5500K
NET-33-06-17	Microwave Sensor Self Test Emergency	Ø261 x 23.6mm	16W	1650lm/1900lm/1650lm	3000K/4000K/5500K
NET-33-06-72	Photocell	Ø261 x 23.6mm	16W	1650lm/1900lm/1650lm	3000K/4000K/5500K
NET-33-06-73	Photocell Emergency	Ø261 x 23.6mm	16W	1650lm/1900lm/1650lm	3000K/4000K/5500K
NET-33-06-78	Photocell Microwave Sensor	Ø261 x 23.6mm	16W	1650lm/1900lm/1650lm	3000K/4000K/5500K
NET-33-06-79	Photocell Microwave Sensor Emergency	Ø261 x 23.6mm	16W	1650lm/1900lm/1650lm	3000K/4000K/5500K

DRIVERS USED



Tridonic Advanced 2 on Standard and Emergency options



Microwave Sensor Merrytek Driver on Microwave Sensor options

powered by **TRIDONIC**

STOP WASTING TIME ON SITE

Designed to be retrofitted into existing housings

- Preserve the integrity of the existing housing
- Up to 75% cheaper than replacing the entire fitting

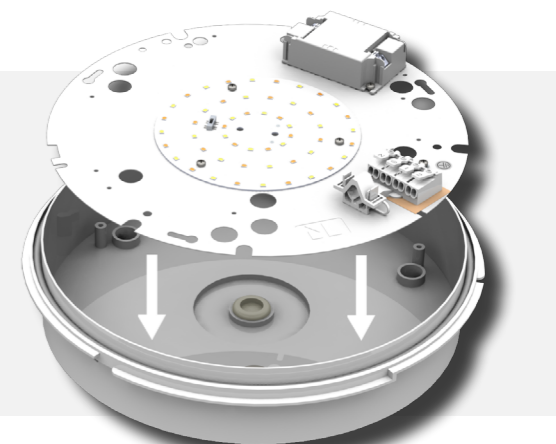

IP65 RATED HOUSING

Protect your bulkhead from water and dust

TAMPER PROOF SCREWS

Prevent unwanted removal or tampering

SELF TEST OR NON-SELF TEST AS STANDARD

Choose Self Test Emergency at the time of installation

Emergency options only

INTEGRAL MICROWAVE SENSOR

Featuring a 2-10m detection range and 5sec to 10min hold time

Microwave Sensor options only

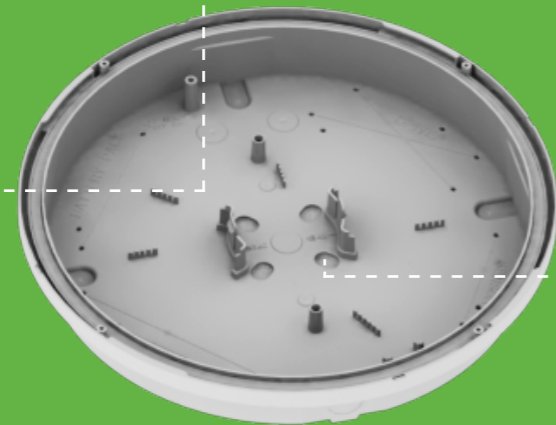
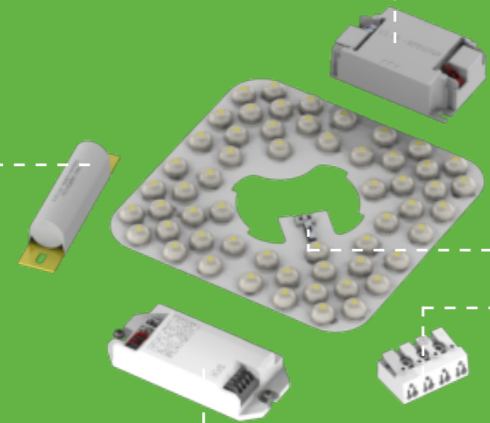
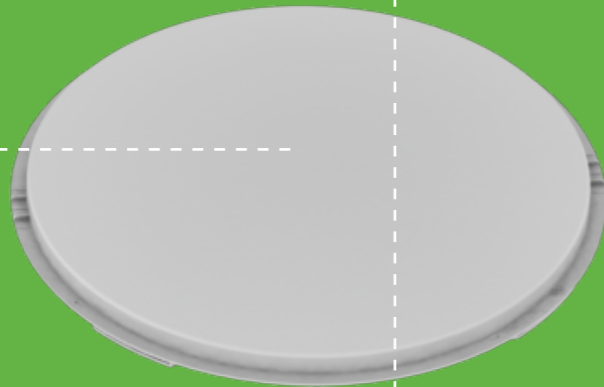
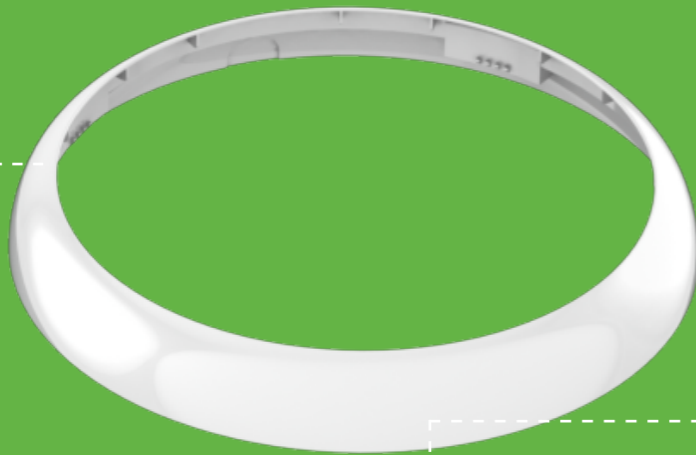

DUAL WATTAGE DRIVER

Choose your power (12W or 18W) at the time of installation

3K

4K

6.5K

SELECTABLE COLOUR TEMPERATURE

Choose your colour temperature 3000K, 4000K or 6500K

PUSH CONNECTOR

Reduce installation time with easy-to-use push fit terminals

5 CABLE ENTRY POINTS

Reduce installation time with multiple entry points at the side and rear for easy wiring

SHELFORD RANGE

NEW

Dual Wattage Tri-Colour
IP65 Polycarbonate Slim Bulkheads

AVAILABLE IN



Emergency



Self Test Emergency



Microwave Sensor



Part Number	Description	Dimensions	Power	Lumens	Colour Temp.
NET-41-06-02	Standard	Ø320 x 70mm	12W/18W	1600lm/1800lm/1700lm	3000K/4000K/6500K
NET-41-06-04	Emergency	Ø320 x 70mm	12W/18W	1600lm/1800lm/1700lm	3000K/4000K/6500K
NET-41-06-06	Microwave Sensor	Ø320 x 70mm	12W/18W	1600lm/1800lm/1700lm	3000K/4000K/6500K
NET-41-06-08	Microwave Sensor Emergency	Ø320 x 70mm	12W/18W	1600lm/1800lm/1700lm	3000K/4000K/6500K

COMPATIBLE ACCESSORIES



Chrome Ring

NET-41-06-10



Black Ring

NET-41-06-12

OUR SLIMMEST BULKHEAD YET

With a depth of just 70mm, it's sleek profile not only adds a modern touch but simplifies installation in areas with limited clearance.

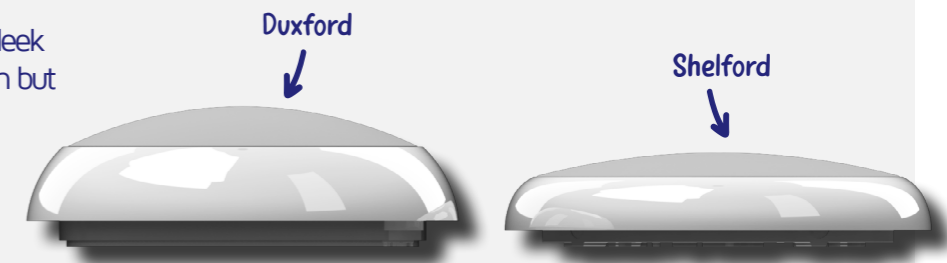

3K 4K 5.5K

SELECTABLE COLOUR TEMPERATURE

Choose your colour temperature 3000K, 4000K or 5500K

SHATTERPROOF POLYCARBONATE DIFFUSER

Designed to prevent the diffuser shattering into small, indistinct pieces

PUSH CONNECTOR

Reduce installation time with easy-to-use push fit terminals

DUSK TO DAWN FUNCTION

Detects ambient light levels and adjusts the light accordingly

Photocell options only

REAR CABLE ENTRY

Protect your wiring from harsh weather and possible tampering

LITHIUM ION BATTERY

Requires little maintenance and has a long lifespan

Emergency options only

INTEGRAL MICROWAVE SENSOR

Featuring a 0 or 10% Standby Mode, 2-10m detection range and 5sec to 10min hold time

Microwave Sensor options only

IK10 AND IP65 ALUMINIUM HOUSING

Protect your fitting from harsh weather and impact

NEWTON RANGE

Tri-Colour Aluminium
IP65 And IK10 Bulkheads

AVAILABLE IN



Emergency



Self Test Emergency



Microwave Sensor



Photocell



Part Number	Description	Dimensions	Power	Lumens	Colour Temp.
NET-33-06-61	Standard	Ø323 x 101mm	16W	1300lm/1550lm/1400lm	3000K/4000K/5500K
NET-33-06-63	Emergency	Ø323 x 101mm	16W	1300lm/1550lm/1400lm	3000K/4000K/5500K
NET-33-06-64	Self Test Emergency	Ø323 x 101mm	16W	1300lm/1550lm/1400lm	3000K/4000K/5500K
NET-33-06-65	Microwave Sensor	Ø323 x 101mm	16W	1300lm/1550lm/1400lm	3000K/4000K/5500K
NET-33-06-67	Microwave Sensor Emergency	Ø323 x 101mm	16W	1300lm/1550lm/1400lm	3000K/4000K/5500K
NET-33-06-68	Microwave Sensor Self Test Emergency	Ø323 x 101mm	16W	1300lm/1550lm/1400lm	3000K/4000K/5500K
NET-33-06-74	Photocell	Ø323 x 101mm	16W	1300lm/1550lm/1400lm	3000K/4000K/5500K
NET-33-06-75	Photocell Emergency	Ø323 x 101mm	16W	1300lm/1550lm/1400lm	3000K/4000K/5500K

DRIVERS USED



Tridonic Advanced 2 on Standard and Emergency options



Microwave Sensor Merrytek Driver on Microwave Sensor options



powered by
TRIDONIC

3K 4K 5.5K

SHATTERPROOF POLYCARBONATE DIFFUSER

Designed to prevent the diffuser shattering into small, indistinct pieces

PUSH CONNECTOR

Reduce installation time with easy-to-use push fit terminals

DUSK TO DAWN FUNCTION

Detects ambient light levels and adjusts the light accordingly

Photocell options only

REAR CABLE ENTRY

Protect your wiring from harsh weather and possible tampering

SELECTABLE COLOUR TEMPERATURE

Choose your colour temperature 3000K, 4000K or 5500K

HALF MOON COVER

Reduces light spillage and ensures the light is diffused evenly

LITHIUM ION BATTERY

Requires little maintenance and has a long lifespan

Emergency options only

INTEGRAL MICROWAVE SENSOR

Featuring a 0 or 10% Standby Mode, 2-10m detection range and 5sec to 10min hold time

Microwave Sensor options only

IK10 AND IP65 ALUMINIUM HOUSING

Protect your fitting from harsh weather and impact

NEWTON RANGE

Tri-Colour Aluminium
IP65 And IK10 Half Moon Bulkheads

AVAILABLE IN

-  Emergency
-  Self Test Emergency
-  Microwave Sensor
-  Photocell



Part Number	Description	Dimensions	Power	Lumens	Colour Temp.
NET-33-06-90	Standard	Ø332 x 101mm	16W	1300lm/1550lm/1400lm	3000K/4000K/5500K
NET-33-06-91	Emergency	Ø332 x 101mm	16W	1300lm/1550lm/1400lm	3000K/4000K/5500K
NET-33-06-92	Self Test Emergency	Ø332 x 101mm	16W	1300lm/1550lm/1400lm	3000K/4000K/5500K
NET-33-06-93	Microwave Sensor	Ø332 x 101mm	16W	1300lm/1550lm/1400lm	3000K/4000K/5500K
NET-33-06-94	Microwave Sensor Emergency	Ø332 x 101mm	16W	1300lm/1550lm/1400lm	3000K/4000K/5500K
NET-33-06-95	Microwave Sensor Self Test Emergency	Ø332 x 101mm	16W	1300lm/1550lm/1400lm	3000K/4000K/5500K
NET-33-06-96	Photocell	Ø332 x 101mm	16W	1300lm/1550lm/1400lm	3000K/4000K/5500K
NET-33-06-97	Photocell Emergency	Ø332 x 101mm	16W	1300lm/1550lm/1400lm	3000K/4000K/5500K

DRIVERS USED



Tridonic Advanced 2 on Standard and Emergency options



Microwave Sensor Merrytek Driver on Microwave Sensor options



powered by
TRIDONIC

3K 4K 5.5K

INTEGRAL MICROWAVE SENSOR

Featuring a 0 or 10% Standby Mode, 2-10m detection range and 5sec to 10min hold time

Microwave Sensor options only

SELECTABLE COLOUR TEMPERATURE

Choose your colour temperature 3000K, 4000K or 5500K

SHATTERPROOF POLYCARBONATE DIFFUSER

Designed to prevent the diffuser shattering into small, indistinct pieces

LITHIUM ION BATTERY

Requires little maintenance and has a long lifespan

Emergency options only

DUSK TO DAWN FUNCTION

Detects ambient light levels and adjusts the light accordingly

Photocell options only

PUSH CONNECTOR

Reduce installation time with easy-to-use push fit terminals

REAR OR SIDE CABLE ENTRY

Protect your wiring from harsh weather and possible tampering

IP65 RATED HOUSING

Protect your bulkhead from water and dust

NEWTON RANGE

Tri-Colour And Single Colour 4000K
IP65 Polycarbonate Bulkheads

AVAILABLE IN



Emergency



Self Test Emergency



Microwave Sensor



Photocell



Part Number	Description	Dimensions	Power	Lumens	Colour Temp.
NET-33-06-52	Standard	Ø282 x 86.5mm	16W	1300lm/1550lm/1400lm	3000K/4000K/5500K
NET-33-06-54	Emergency	Ø282 x 86.5mm	16W	1300lm/1550lm/1400lm	3000K/4000K/5500K
NET-33-06-50	Self Test Emergency	Ø282 x 86.5mm	16W	1300lm/1550lm/1400lm	3000K/4000K/5500K
NET-33-06-56	Microwave Sensor	Ø282 x 86.5mm	16W	1300lm/1550lm/1400lm	3000K/4000K/5500K
NET-33-06-58	Microwave Sensor Emergency	Ø282 x 86.5mm	16W	1300lm/1550lm/1400lm	3000K/4000K/5500K
NET-33-06-51	Microwave Sensor Self Test Emergency	Ø282 x 86.5mm	16W	1300lm/1550lm/1400lm	3000K/4000K/5500K
NET-33-06-76	Photocell	Ø282 x 86.5mm	16W	1300lm/1550lm/1400lm	3000K/4000K/5500K
NET-33-06-77	Photocell Emergency	Ø282 x 86.5mm	16W	1300lm/1550lm/1400lm	3000K/4000K/5500K
NET-33-06-80	Standard	Ø282 x 86.5mm	16W	1550lm	4000K
NET-33-06-88	Emergency	Ø282 x 86.5mm	16W	1550lm	4000K
NET-33-06-84	Microwave Sensor	Ø282 x 86.5mm	16W	1550lm	4000K
NET-33-06-86	Microwave Sensor Emergency	Ø282 x 86.5mm	16W	1550lm	4000K

DRIVERS USED



Tridonic Advanced 2 on Standard and Emergency options



Microwave Sensor Merrytek Driver on Microwave Sensor options



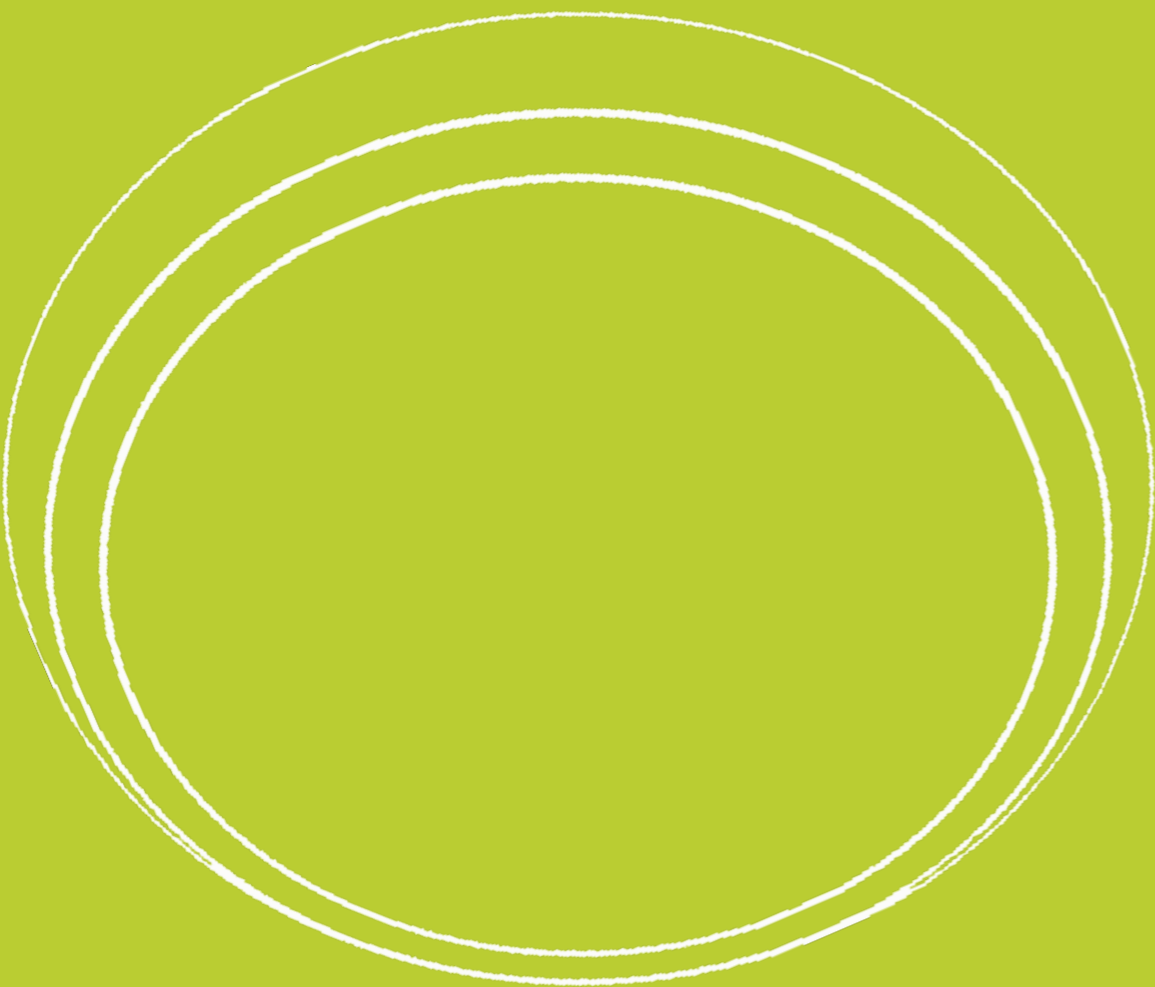

Slim Circulares

Tri-Colour and Dual Wattage circular fittings
ideal for corridor, hallways and stairwells

SHATTERPROOF POLYCARBONATE DIFFUSER

Designed to prevent the diffuser shattering into small, indistinct pieces

HINGED GEAR TRAY

Get easy access to wiring and components

3K 4K 5.5K

SELECTABLE COLOUR TEMPERATURE

Choose your colour temperature 3000K, 4000K or 5500K

HIGH OUTPUT EMERGENCY OPERATION

Ensures the fitting comes on in the event of a power failure

TRIDONIC PREMIUM DIMMABLE DRIVER

Customise lighting levels and reduce electricity consumption

Dimmable options only

0, 10 OR 25% STANDBY MODE

Reduce unnecessary energy consumption by avoiding lighting in areas that don't need it

IP65 RATED GASKET

Protect your fitting from water and dust

Microwave Sensor options only

PUSH CONNECTOR

Reduce installation time with easy-to-use push fit terminals

YAXLEY RANGE

Tri-Colour Dual Wattage
IP65 Slim Circulars

AVAILABLE IN

-  Emergency
-  Self Test Emergency
-  Dimmable
-  Microwave Sensor



Part Number	Description	Dimensions	Power	Lumens	Colour Temp.
NET-33-06-31	Standard	Ø470 x 92mm	14W/20W	1440lm/2000lm	3000K/4000K/5500K
NET-33-06-33	Emergency	Ø470 x 92mm	14W/20W	1440lm/2000lm	3000K/4000K/5500K
NET-33-35-33	Self Test Emergency	Ø470 x 92mm	14W/20W	1440lm/2000lm	3000K/4000K/5500K
NET-33-06-38	Dimmable one4all	Ø470 x 92mm	20W	2000lm	3000K/4000K/5500K
NET-33-06-39	Dimmable Emergency	Ø470 x 92mm	20W	2000lm	3000K/4000K/5500K
NET-33-06-26	Dimmable Self Test Emergency	Ø470 x 92mm	20W	2000lm	3000K/4000K/5500K
NET-33-06-28	Dimmable DALI Emergency	Ø470 x 92mm	20W	2000lm	3000K/4000K/5500K
NET-33-06-35	Microwave Sensor	Ø470 x 92mm	14W/20W	1440lm/2000lm	3000K/4000K/5500K
NET-33-06-37	Microwave Sensor Emergency	Ø470 x 92mm	14W/20W	1440lm/2000lm	3000K/4000K/5500K
NET-33-06-29	Microwave Sensor Self Test Emergency	Ø470 x 92mm	14W/20W	1440lm/2000lm	3000K/4000K/5500K

COMPATIBLE ACCESSORIES



Matte Black Ring

Chrome Ring

NET-33-06-04

NET-33-06-02

powered by
TRIDONIC



DRIVERS USED



Tridonic Advanced Dual Wattage Driver as standard



Tridonic Premium Dimmable Driver on Dimmable options



Microwave Sensor Merytek Driver on Microwave Sensor options



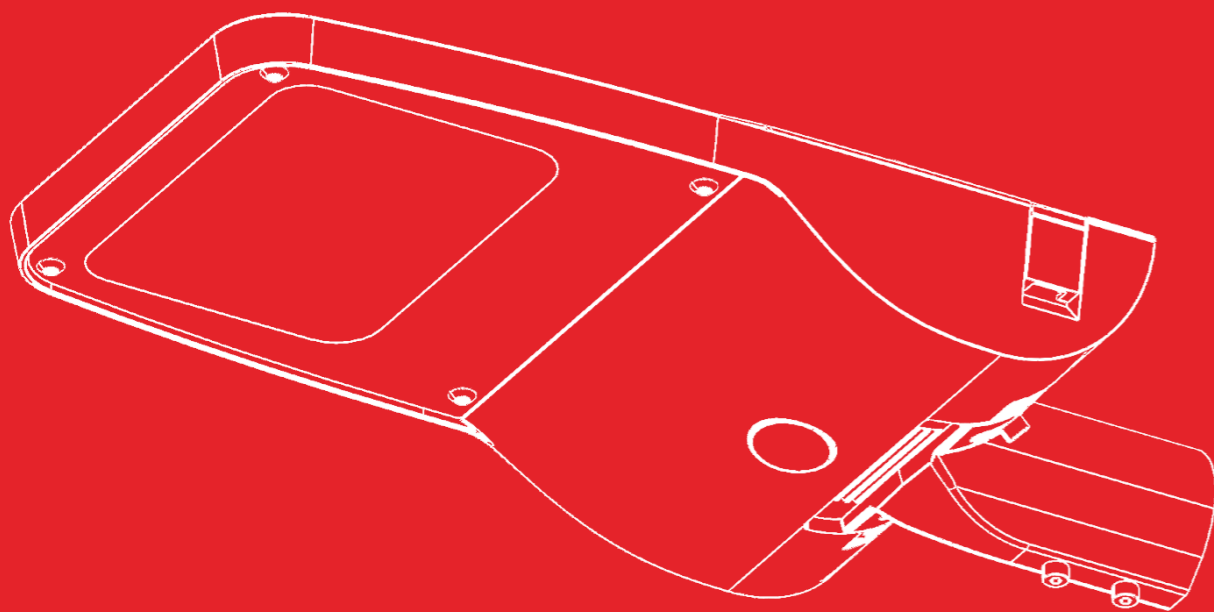

Pathway and Street Lighting

A mix of aluminium Street Lights with energy saving Virtual Midnight function,
and floor mounted Tri-Colour Bollards

Up to
150
lm/W

BUILT-IN VIRTUAL MIDNIGHT FUNCTION

Dim at the mid-point of sunset to sunrise to save additional energy

OPTIONAL 3 PIN NEMA PHOTOCELL SENSOR

Reduce energy costs and ensure your street light comes on only when required

TRIDONIC ADVANCED DRIVER WITH 10KV SURGE PROTECTION

100,000 hour driver lifespan

ADJUSTABLE SPIGOT

Adjust the head in 5° increments from -15° to +15°

SPECIALIST LENS

Create a Batwing Beam Angle for improved uniformity and larger light distribution

3K

4K

6K

AVAILABLE IN THREE DIFFERENT COLOUR TEMPERATURES

Choose between 3000K, 4000K or 6000K

HISTON RANGE

30W-130W Tri-Colour
Aluminium Street Lights



Various colours are available - get in touch with our Sales Team on 01223 851505 for more information



Part Number	Power	Dimensions	Lumens	Colour Temp.
NET-33-20-03	30W	508 x 180 x 109mm	4000lm	3000K
NET-33-20-04	30W	508 x 180 x 109mm	4000lm	4000K
NET-33-20-06	30W	508 x 180 x 109mm	4000lm	6000K
NET-33-20-13	50W	508 x 180 x 109mm	6200lm	3000K
NET-33-20-14	50W	508 x 180 x 109mm	6200lm	4000K
NET-33-20-16	50W	508 x 180 x 109mm	6200lm	6000K
NET-33-20-23	80W	608 x 300 x 105mm	11800lm	3000K
NET-33-20-24	80W	608 x 300 x 105mm	11800lm	4000K
NET-33-20-26	80W	608 x 300 x 105mm	11800lm	6000K
NET-33-20-33	100W	608 x 300 x 105mm	14500lm	3000K
NET-33-20-34	100W	608 x 300 x 105mm	14500lm	4000K
NET-33-20-36	100W	608 x 300 x 105mm	14500lm	6000K
NET-33-20-43	130W	608 x 300 x 105mm	18100lm	3000K
NET-33-20-44	130W	608 x 300 x 105mm	18100lm	4000K
NET-33-20-46	130W	608 x 300 x 105mm	18100lm	6000K

COMPATIBLE ACCESSORIES



3 Pin NEMA Photocell Sensor

NET-23-20-08



Flat Wall Bracket

NET-23-16-53



Double Outreach Arm Bracket

NET-23-16-51

powered by
TRIDONIC



DOMED HEAD OR LOUVRE REFLECTOR AVAILABLE

Choose between diffused, ambient lighting with a Dome Head or directed, controlled lighting with the Louvre Reflector

WHITE REFLECTOR

Help distribute the light evenly and reduce glare

WEATHERPROOF CONNECTOR

Protect your wiring from water and moisture

3K

4K

6K

SELECTABLE COLOUR TEMPERATURE

Choose your colour temperature 3000K, 4000K or 6000K

3H EMERGENCY OPERATION

Ensures the fitting comes on in the event of a power failure

Emergency options only

DUSK TO DAWN FUNCTION

Detects ambient light levels and adjusts the light accordingly

Photocell options only

IK10 RATED HOUSING

Protect your bollard from impact with its durable, aluminium outer sleeve

ELY RANGE

Tri-Colour Aluminium
Floor Mounted Bollards

AVAILABLE IN



Emergency



Photocell



Part Number	Description	Dimensions	Power	Lumens	Colour Temp.
NET-53-14-02	Dome Head - Standard	Ø160 x 1000m	22W	2000lm	3000K/4000K/6000K
NET-53-14-03	Dome Head - Emergency	Ø160 x 1000m	22W	2000lm	3000K/4000K/6000K
NET-53-14-04	Dome Head - Photocell	Ø160 x 1000m	22W	2000lm	3000K/4000K/6000K
NET-53-14-05	Dome Head - Photocell Emergency	Ø160 x 1000m	22W	2000lm	3000K/4000K/6000K
NET-53-14-06	Louvre Reflector - Standard	Ø160 x 1000m	22W	2000lm	3000K/4000K/6000K
NET-53-14-10	Louvre Reflector - Emergency	Ø160 x 1000m	22W	2000lm	3000K/4000K/6000K
NET-53-14-04	Louvre Reflector - Photocell	Ø160 x 1000m	22W	2000lm	3000K/4000K/6000K
NET-53-14-05	Louvre Reflector - Photocell Emergency	Ø160 x 1000m	22W	2000lm	3000K/4000K/6000K

COMPATIBLE ACCESSORIES



Root J Bolt
Mounting Kit

NET-53-14-08

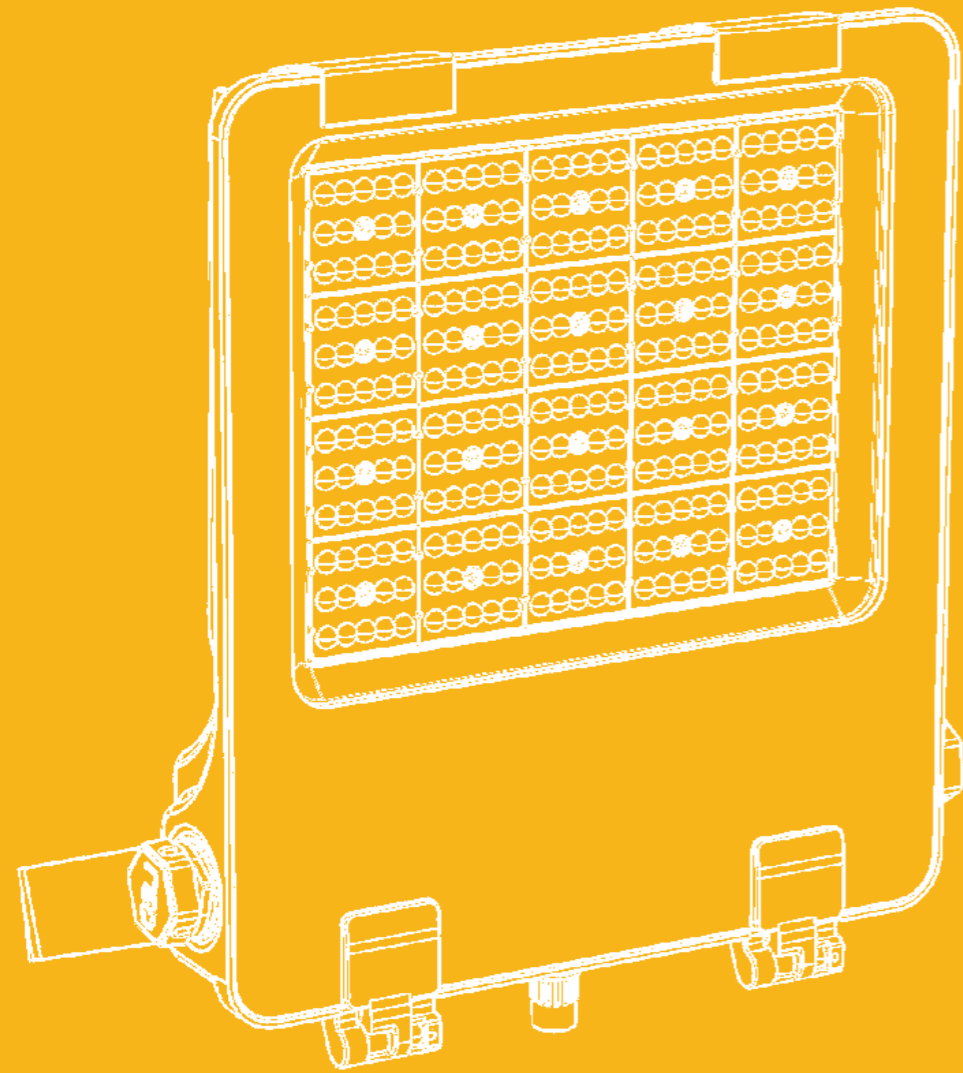

Flood Lights

A mix of High Power Open Area Flood Lights for sports pitches,
Marine Grade Flood Lights for outdoor applications
and Tri-Colour Flood Lights for industrial environments

6K

6000K COLOUR TEMPERATURE

Bright and crisp light best used for industrial and sports applications

IP66 AND IK10 RATED HOUSING

Protected from impact and harsh weather conditions

MULTIPLE DRIVERS WITH 10KV SURGE PROTECTION

Greater reliability and provides robust protection against voltage spikes

BACK PLATE WITH PROTECTIVE MESH

Protects the fitting's internal components, safeguarding against physical damage and exposure to the weather conditions

ADJUSTABLE BRACKET

Allows for easier mounting and provides flexibility when positioning the fitting

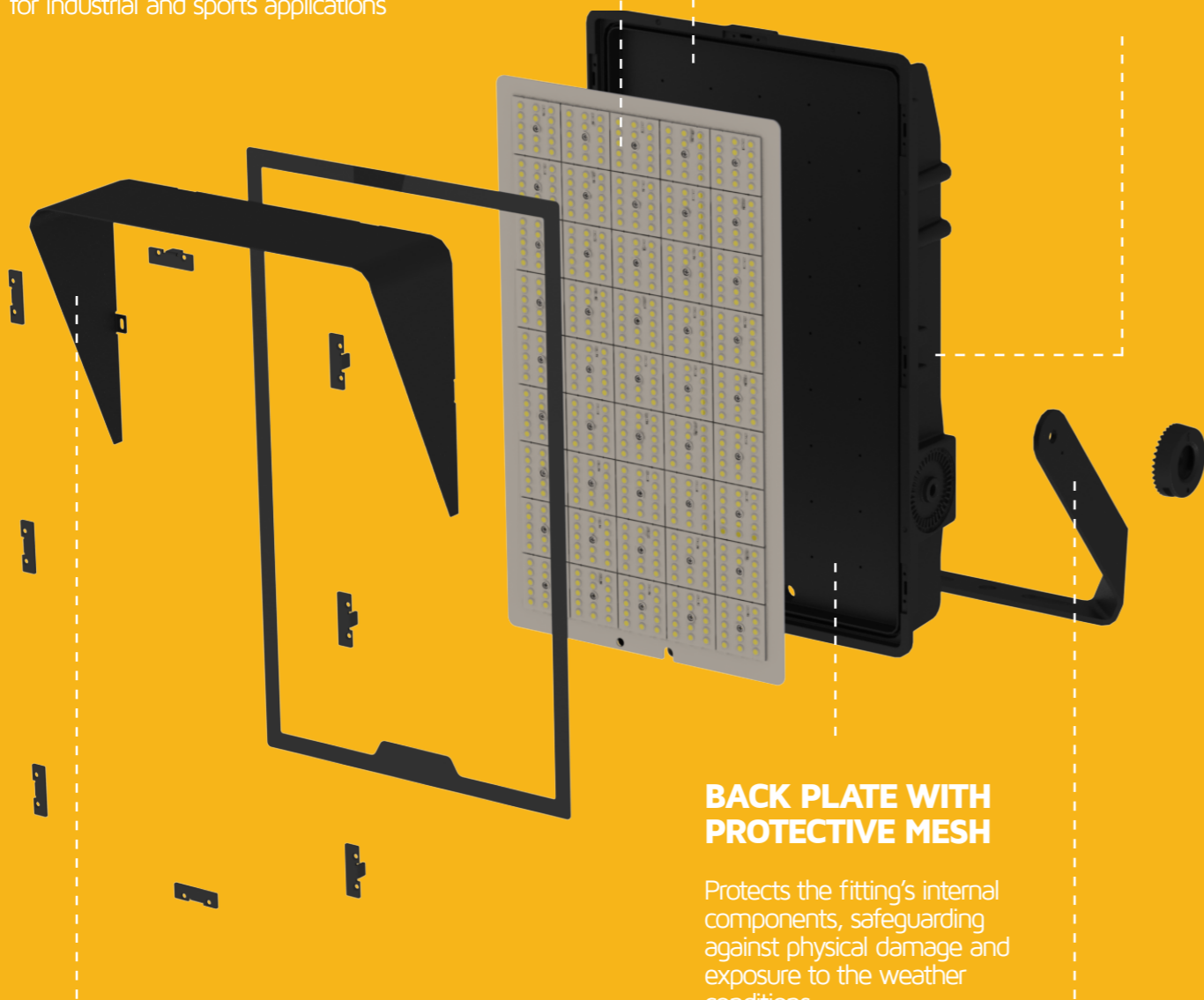

BENWICK RANGE

High Power Open Area Flood Lights



Part Number	Dimensions	Power	Lumens	Colour Temp.	IP Rating	IK Rating
NET-23-04-65	691 x 378 x 261mm	500W	70400lm	6000K	IP66	IK10

COMPATIBLE ACCESSORIES

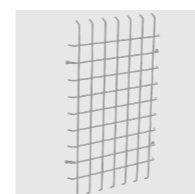

Wire Guard

NET-23-04-67



Single Column Bracket

NET-23-16-61



Twin Column Bracket

NET-23-16-63

IT'S TIME TO UP YOUR GAME.

Illuminate the game with precision and purpose.

We offer bespoke lighting designed for sports areas, equipped with a specialist lens engineered to channel light precisely where it's needed most.

The integrated light shield ensures minimal light pollution, keeping the focus sharp on the field while minimising environmental impact.

Reduce the Upward Light Ratio (ULR) through near horizontal mounting, minimising disruption to nocturnal wildlife and preserving the night sky.



Got a sports project?
Call our team now on 01223 851505

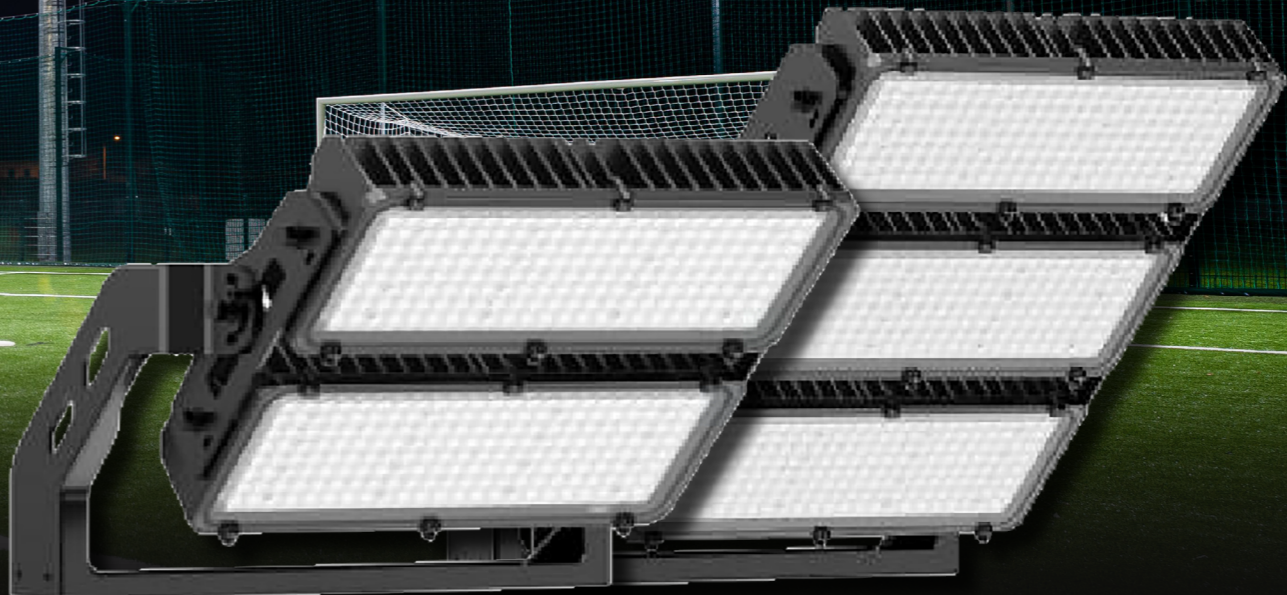

Power	Lumens	Colour Temp.	Dimensions
-------	--------	--------------	------------

400W	56000lm	5700K (3000K and 4000K optional)	479 x 250 x 185mm
480W	67200lm	5700K (3000K and 4000K optional)	479 x 266 x 185mm
600W	84000lm	5700K (3000K and 4000K optional)	479 x 283 x 185mm

Power	Lumens	Colour Temp.	Dimensions
-------	--------	--------------	------------

Two Mods

800W	112000lm	5700K (3000K and 4000K optional)	510 x 429 x 232mm
960W	134400lm	5700K (3000K and 4000K optional)	510 x 527 x 298mm
1200W	168000lm	5700K (3000K and 4000K optional)	510 x 560 x 298mm

Three Mods

1500W	210000lm	5700K (3000K and 4000K optional)	515 x 777 x 310mm
1800W	252000lm	5700K (3000K and 4000K optional)	515 x 833 x 310mm

TEMPERED GLASS

Provides double protection and self clean

IK08 AND IP65 RATED HOUSING

Protect your flood light from water, dust and impact

6K

6000K COLOUR TEMPERATURE

Bright and crisp light best used for industrial spaces

BREATHER VALVE

Prevents condensation from building up inside the fitting

MARINE GRADE COATING

Protect your flood light from harsh weather and sea salt - perfect for coastal applications

TOOL-FREE BOLTS

Set the angle of the flood light without the need for tools

UP TO 3,000 LUMENS IN EMERGENCY MODE

Its high output Emergency operation ensures the fitting comes on in the event of a power failure

Emergency options only

RAMSEY RANGE

High Power Marine Grade Flood Lights

AVAILABLE IN



Part Number	Description	Dimensions	Power	Lumens	Colour Temp.	IP Rating	IK Rating
NET-23-04-11	Standard	463 x 295 x 73.5mm	100W	14600lm	6000K	IP65	IK08
NET-23-04-13	Standard	511 x 295 x 73.5mm	150W	22800lm	6000K	IP65	IK08
NET-23-04-21	Emergency	511 x 295 x 73.5mm	150W	22800lm	6000K	IP65	IK08
NET-23-04-15	Standard	562 x 295 x 73.5mm	200W	29200lm	6000K	IP65	IK08
NET-23-04-22	Emergency	562 x 295 x 73.5mm	200W	29200lm	6000K	IP65	IK08
NET-23-04-17	Standard	515 x 393 x 78mm	240W	34500lm	6000K	IP65	IK08

COMPATIBLE ACCESSORIES

2-in-1 Motion and Photocell Sensor	Single Column Bracket	Twin Column Bracket	Pivot Bracket	Twin Pivot Bracket
NET-42-04-39	NET-23-16-61	NET-23-16-63	NET-23-16-65	NET-23-16-67

SAVINGS CALCULATOR (based on an average combined electricity cost of £0.27 pence/kwh as of November 2023)

	Fitting	Power (W)	Quantity	Hours per Year (10 hours a day/5 days a week)	kWh per Year	kgCO2 per Year	Electricity Cost per Year
Existing	400W HPS	480W	20	2,607	25,209	5,835	£6,806.43
Our Proposal	200W LED	200W	20	2,607	10,429	2,431	£2,815.83

SAVE £3,990.60 PER YEAR BASED ON AN INSTALL OF 20 FITTINGS

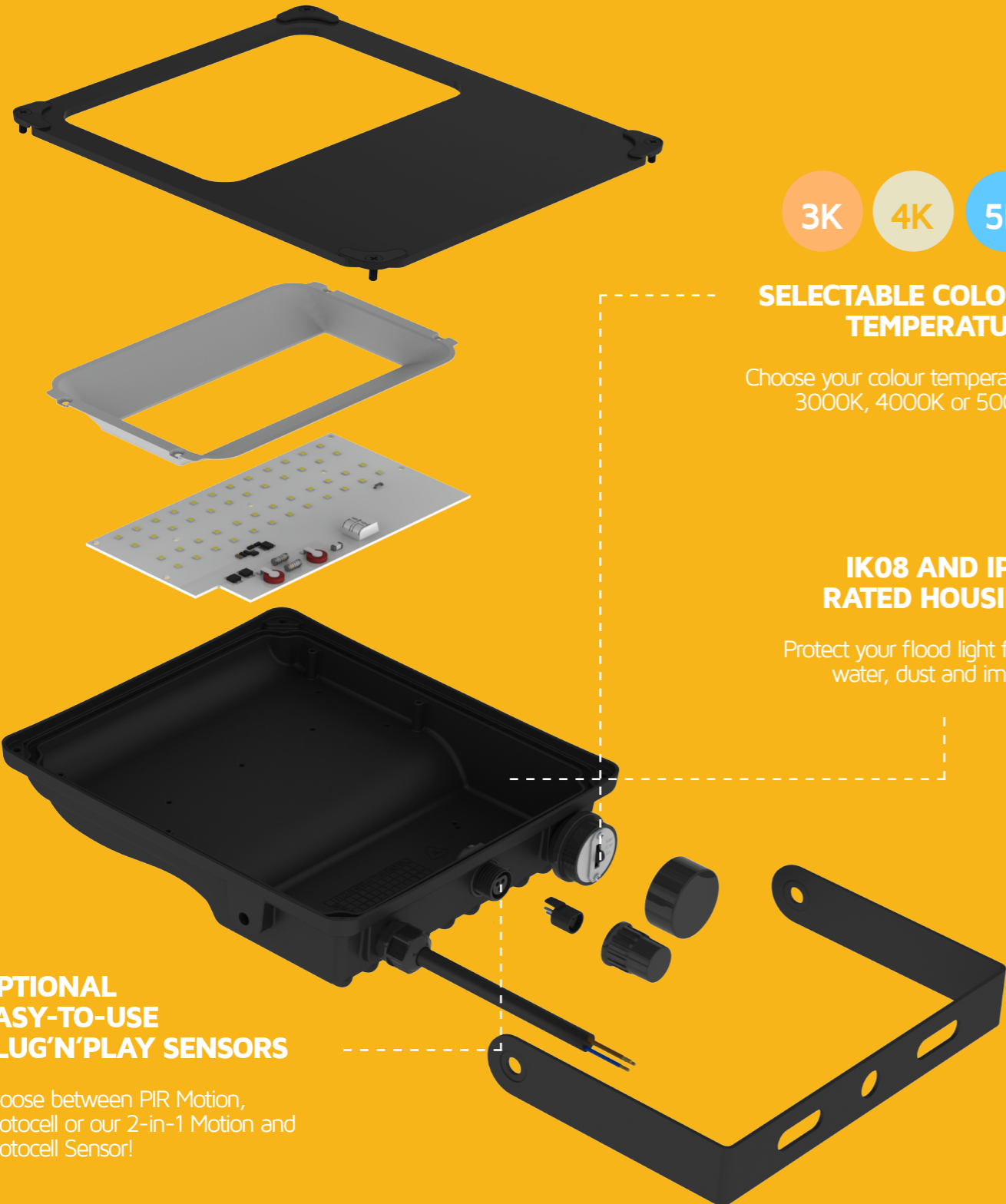

3K 4K 5K

SELECTABLE COLOUR TEMPERATURE

Choose your colour temperature 3000K, 4000K or 5000K

IK08 AND IP65 RATED HOUSING

Protect your flood light from water, dust and impact

OPTIONAL EASY-TO-USE PLUG'N'PLAY SENSORS

Choose between PIR Motion, Photocell or our 2-in-1 Motion and Photocell Sensor!

KEYSTON RANGE

Tri-Colour Flood Lights With Plug-In Controls



Part Number	Power	Dimensions	Lumens	Colour Temp.	IP Rating	IK Rating
NET-70-04-20	20W	232 x 109 x 46mm	1900lm	3000K/4000K/5000K	IP65	IK08
NET-70-04-30	30W	282 x 155 x 50mm	2500lm	3000K/4000K/5000K	IP65	IK08
NET-70-04-10	100W	425 x 270 x 52mm	10000lm	3000K/4000K/5000K	IP65	IK08

COMPATIBLE ACCESSORIES



PIR Sensor

NET-15-04-39



Photocell Sensor

NET-15-04-49



2-in-1 Motion and Photocell Sensor

NET-42-04-39

EASY-TO-USE PLUG'N'PLAY SENSORS

Simply plug your chosen sensor into the bottom of the fitting - and away you go!

It's that easy.



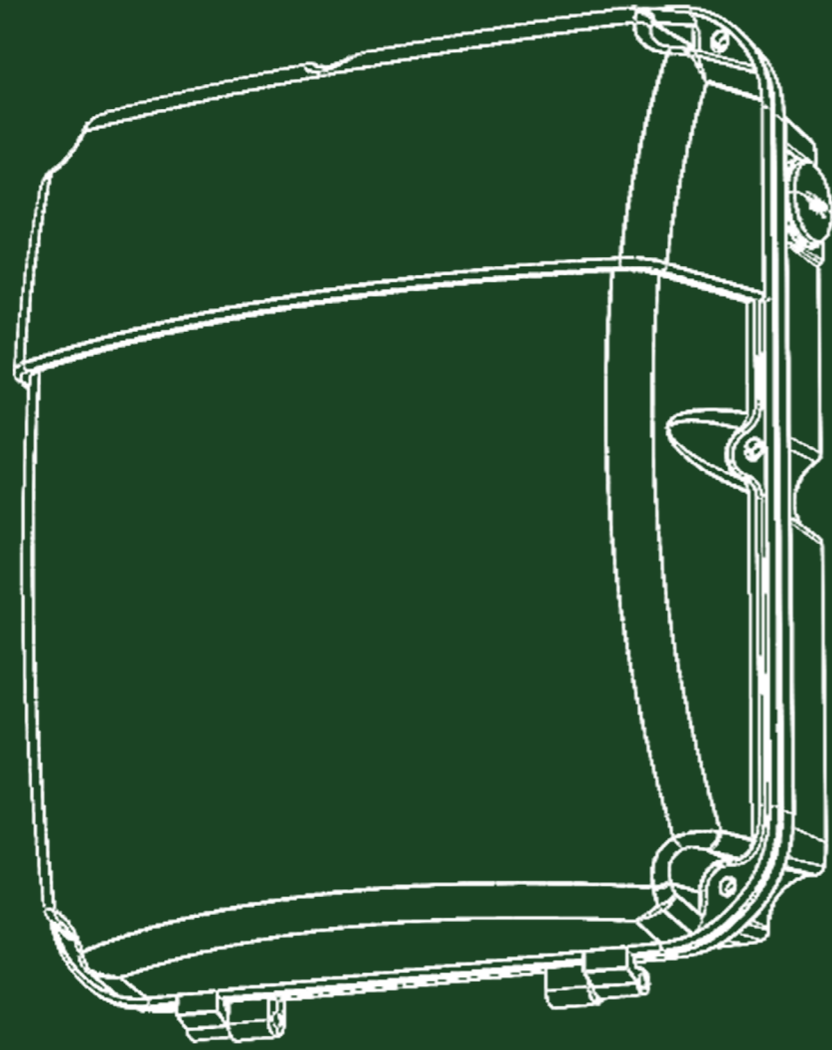

Wallpacks and Wall Lights

A mix of Tri-Colour Wallpacks best used for industrial and commercial applications and single colour Up/Down Wall Lights

3K 4K 5.5K

SELECTABLE COLOUR TEMPERATURE

Choose your colour temperature 3000K, 4000K or 5500K

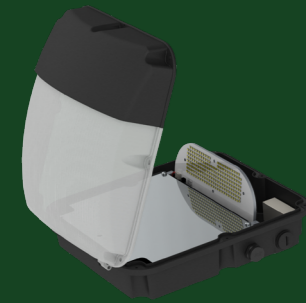

HINGED DIFFUSER

Get easy access to internal components

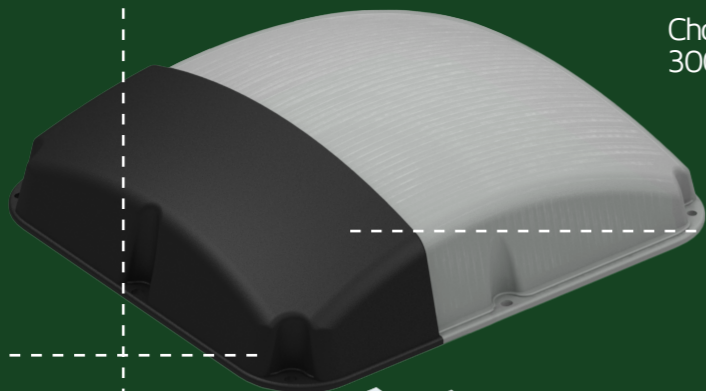

IP65 AND IK10 RATED HOUSING

Protect the fitting from water, dust and impact

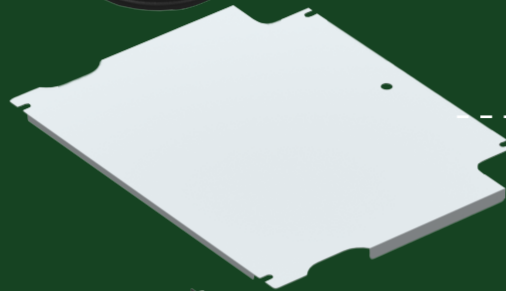

REFLECTOR PLATE

Directs the light down towards the ground - perfect for walkways and the side of buildings

PUSH CONNECTOR

Reduce installation time with easy-to-use push fit terminals

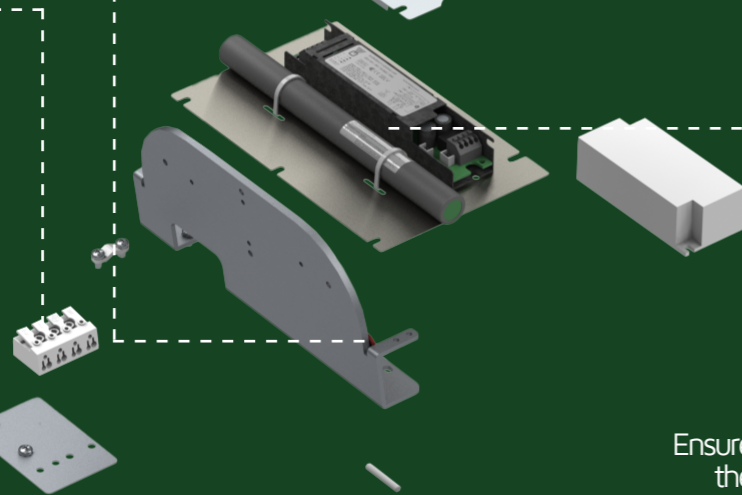

3H EMERGENCY OPERATION

Ensures the fitting comes on in the event of a power failure

INTEGRAL PHOTOCELL SENSOR

Built-in photocell sensor which can be bypassed if required

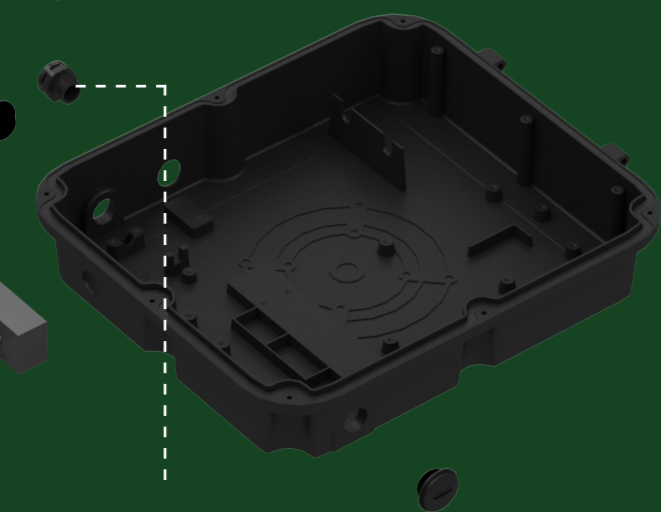

BREATHER VALVE

Prevent heat and condensation building up inside the fitting

Emergency options only

EASTON RANGE

Tri-Colour, IP65 Wallpacks
With A Integral Photocell

AVAILABLE IN



Emergency



Part Number	Description	Power	Dimensions	Lumens	Colour Temp.
NET-51-11-41	Standard	40W	300 x 264 x 130mm	1900lm	3000K/4000K/5500K
NET-51-11-42	Emergency	40W	300 x 264 x 130mm	1900lm	3000K/4000K/5500K

DRIVERS USED



Tridonic Advanced 2 Driver as standard

Ideal for accent or feature lighting, the Hatley Up/Down Wall Lights are a modern and stylish range designed to give any exterior application a little more security.

Available in

- Black** ✓
- Silver** ✓
- Single Direction** ✓
- PIR Sensor** ✓

Get £50 off your order when you spend £500 on our Hatley Wall Lights

Use the code below at checkout over at www.mynetled.co.uk

HAT50



HATLEY RANGE

Single Colour 4000K Wallpack
And Stainless Steel Up/Down Wall Lights



GU10 Lamps are not included with the Up/Down Wall Lights



Part Number	Description	Power	Dimensions	Lumens	Colour Temp.
NET-53-01-01	Silver Up/Down Wall Light	Max. 2 x 5W	93 x 60 x 163mm	n/a	n/a
NET-53-01-03	Black Up/Down Wall Light	Max. 2 x 5W	93 x 60 x 163mm	n/a	n/a
NET-53-01-05	Black Up/Down Wall Light - PIR Sensor	Max. 2 x 5W	93 x 60 x 163mm	n/a	n/a
NET-53-01-07	Black Up/Down Wall Light - Single Direction	Max. 2 x 5W	93 x 60 x 163mm	n/a	n/a

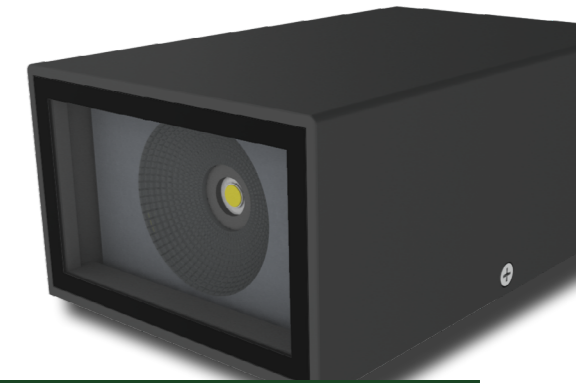

Part Number	Description	Power	Dimensions	Lumens	Colour Temp.
NET-51-11-54	Black Wallpack with Built-in LEDs	10W (2 x 5W)	160 x 100 x 65mm	n/a	n/a

COMPATIBLE ACCESSORIES

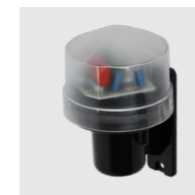

Photocell Kit (Daylight Switch)

NET-51-04-59



LG GU10 LED Lamp for Up/Down Wall Lights

NET-40-07-02

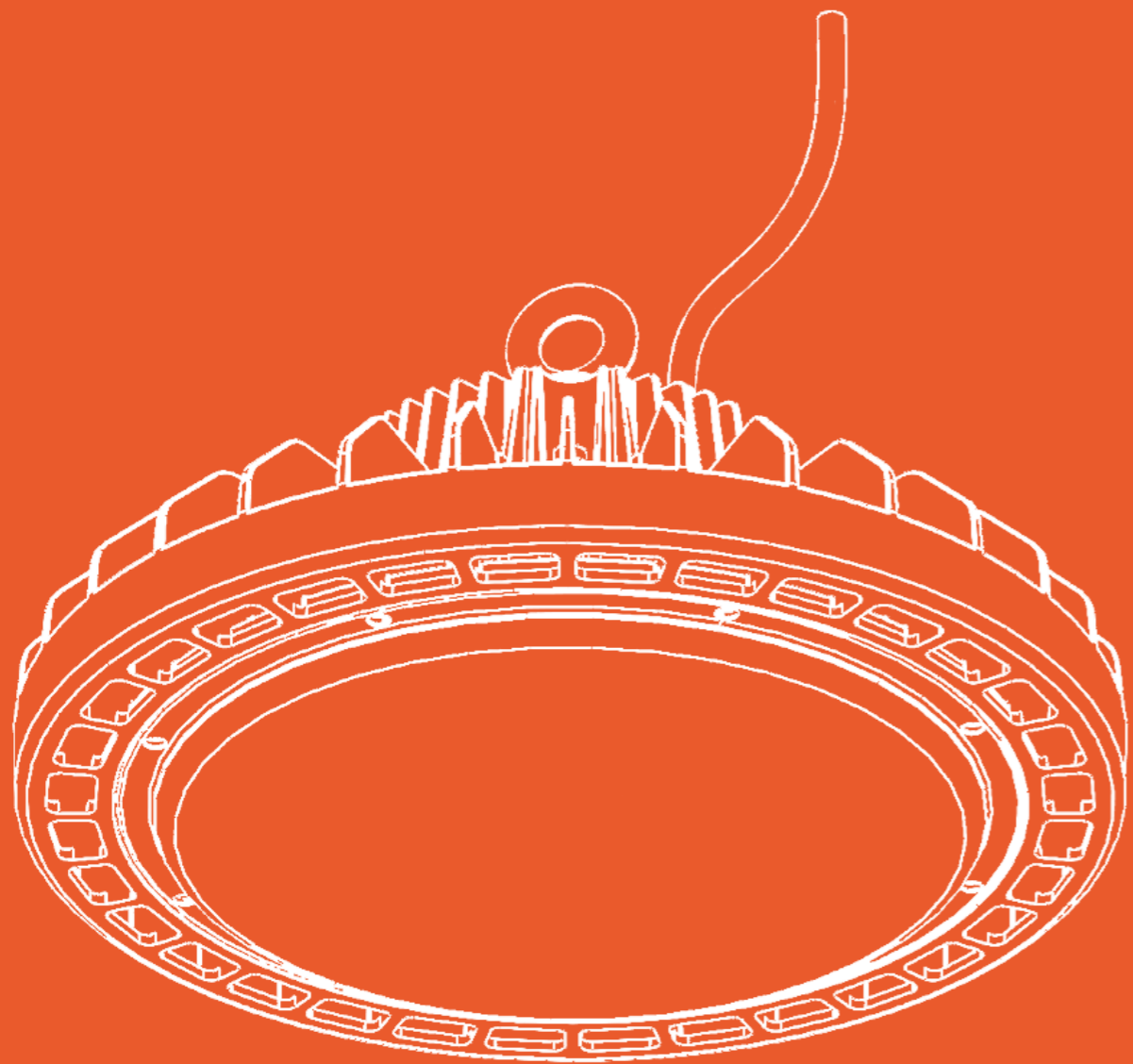

High Bays and Low Bays

A range of high lumen High Bays and Low Bays specifically designed for industrial applications

**SELECTABLE
POWER SETTING**

Choose between 85W, 100W,
150W or 200W

**CENTRAL
MOUNTED HOOK**

Suspend your High Bay
or purchase an optional
Mounting Bracket

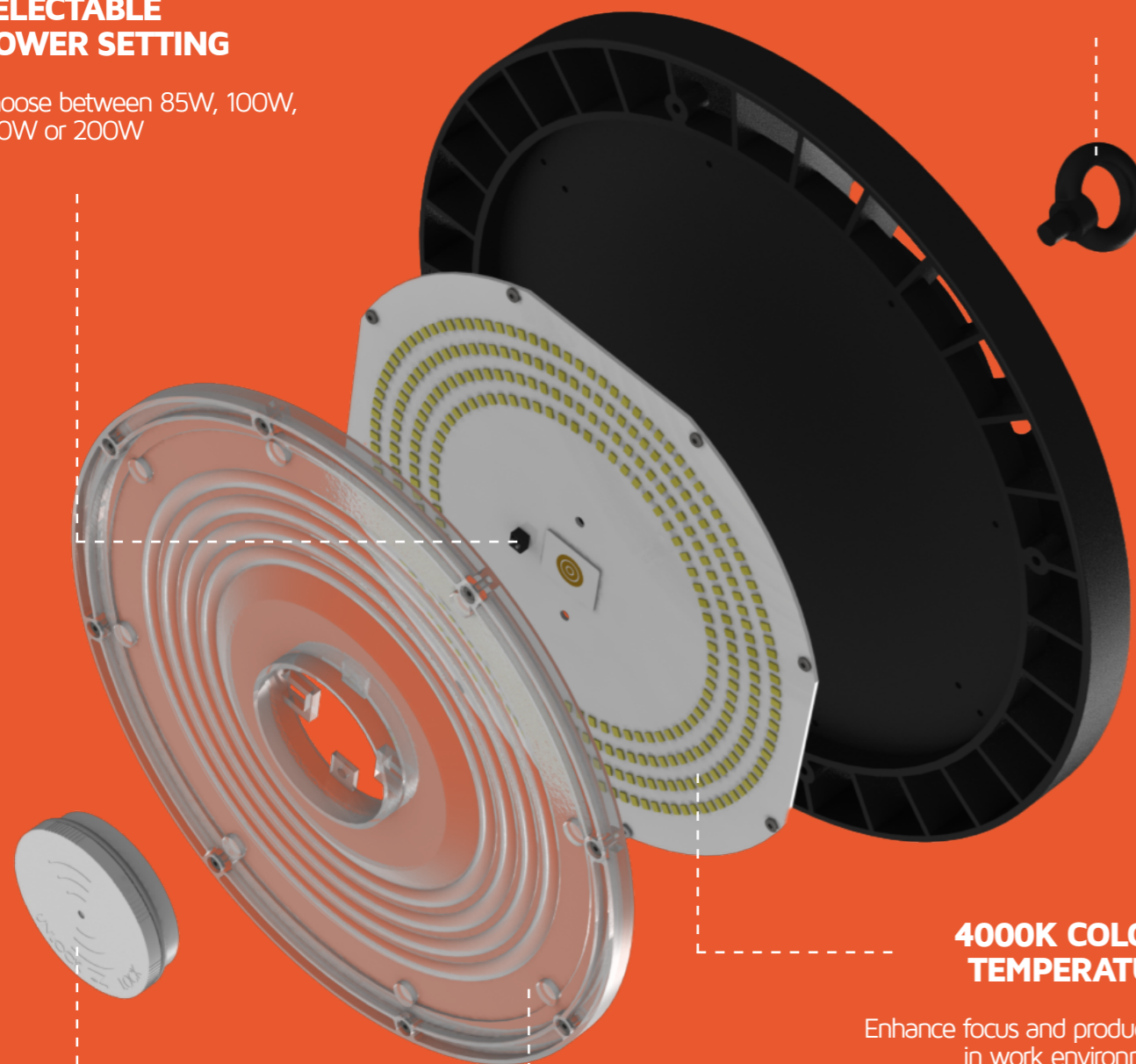

**OPTIONAL MICROWAVE
SENSOR AVAILABLE**

Featuring up to 13m detection range, a
hold time of 3 seconds to 30 minutes, and
a Standby Mode of 10, 20, 30 or 50%

**4000K COLOUR
TEMPERATURE**

Enhance focus and productivity
in work environments



**IP65 AND IK09
RATED HOUSING**

Protect your High Bay from
water, dust and impact with its
durable and highly transparent PC cover

ARBURY RANGE

Multi-Wattage High Lumen Output
High Bay



Part Number	Description	Power	Dimensions	Lumens	Colour Temp.
NET-53-20-02	Standard	85W/100W/150W/200W	Ø300 x 97mm	16900lm/24600lm/30900lm	5000K

COMPATIBLE ACCESSORIES

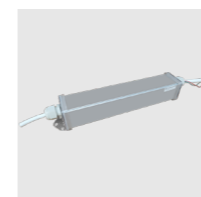

Emergency Kit

NET-53-20-08



Microwave Sensor

NET-53-20-04



Remote Control
for Microwave Sensors

NET-53-20-06



Remote Control
for Emergency Kit

NET-61-35-10



Microwave Sensor requires Remote Control NET-53-20-06

2 EMERGENCY MODES, 1 KIT

Choose between 3H Emergency or
Self Test Emergency in just one kit!

No need to purchase extra parts.

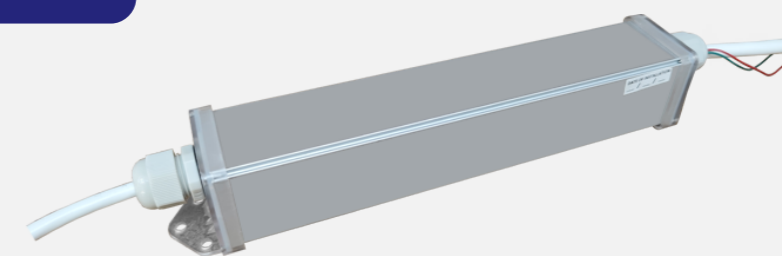

**20W HIGH OUTPUT
EMERGENCY OPERATION**

Ensures the fitting comes on in the event of a power failure

Emergency options only

**CENTRAL
MOUNTED HOOK**

Suspend your High Bay or purchase an optional Mounting Bracket

**ALUMINIUM
DIE-CAST
HEAT SINK**

Prevent the driver and LEDs from overheating and keep your High Bay cool

**MICROWAVE SENSOR
AND PIR SENSOR
OPTIONS
AVAILABLE**

Choose between a Microwave Sensor with a 0, 10 or 25% Standby Mode with 15m detection range, or a PIR Sensor with 6m detection range

**IP65 AND IK10
RATED HOUSING**

Protect your High Bay from water, dust and impact with its durable and highly transparent PC cover

**120° LEDs WITH
OPTIONAL 60°
OR 90° LENS**

Provide a broad, even distribution of light with the optional lenses enabling a more narrow beam if required

ORWELL RANGE

High Lumen Output High Bays

AVAILABLE IN



Emergency



Microwave Sensor



PIR Sensor



Part Number	Description	Power	Dimensions	Lumens	Colour Temp.
NET-23-12-42	Standard	100W	Ø240 x 166mm	17600lm	5000K
NET-23-12-43	Emergency	100W	Ø305 x 280mm	17600lm	5000K
NET-23-12-52	Microwave Sensor	100W	Ø240 x 166mm	17600lm	5000K
NET-23-12-53	Microwave Sensor Emergency	100W	Ø305 x 280mm	17600lm	5000K
NET-23-12-48	PIR Sensor (up to 6m)	100W	Ø305 x 280mm	17600lm	5000K
NET-23-12-49	PIR Sensor Emergency (up to 6m)	100W	Ø305 x 280mm	17600lm	5000K
NET-23-12-44	Standard	150W	Ø280 x 166mm	25600lm	5000K
NET-23-12-45	Emergency	150W	Ø305 x 280mm	25600lm	5000K
NET-23-12-54	Microwave Sensor	150W	Ø280 x 166mm	25600lm	5000K
NET-23-12-55	Microwave Sensor Emergency	150W	Ø305 x 280mm	25600lm	5000K
NET-23-12-50	PIR Sensor (up to 6m)	150W	Ø305 x 280mm	25600lm	5000K
NET-23-12-51	PIR Sensor Emergency (up to 6m)	150W	Ø305 x 280mm	25600lm	5000K



Microwave Sensor options require Remote Control NET-42-43-22

COMPATIBLE ACCESSORIES

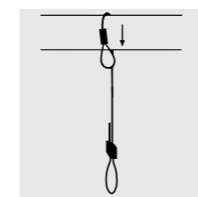

Suspension Kit

NET-46-16-06



Mounting Bracket

NET-40-07-02



Remote Control for Microwave Sensors

NET-42-43-22

**AVAILABLE WITH
E27 OR E40 SCREW**

Compatible with a broad range of light fixtures and lamps, making it a perfect retrofitting solution

IP40 RATED HOUSING

Protect your fitting and it's internal components from dust ingress

4.5K

**4500K COLOUR
TEMPERATURE**

Enhance focus and productivity in work environments

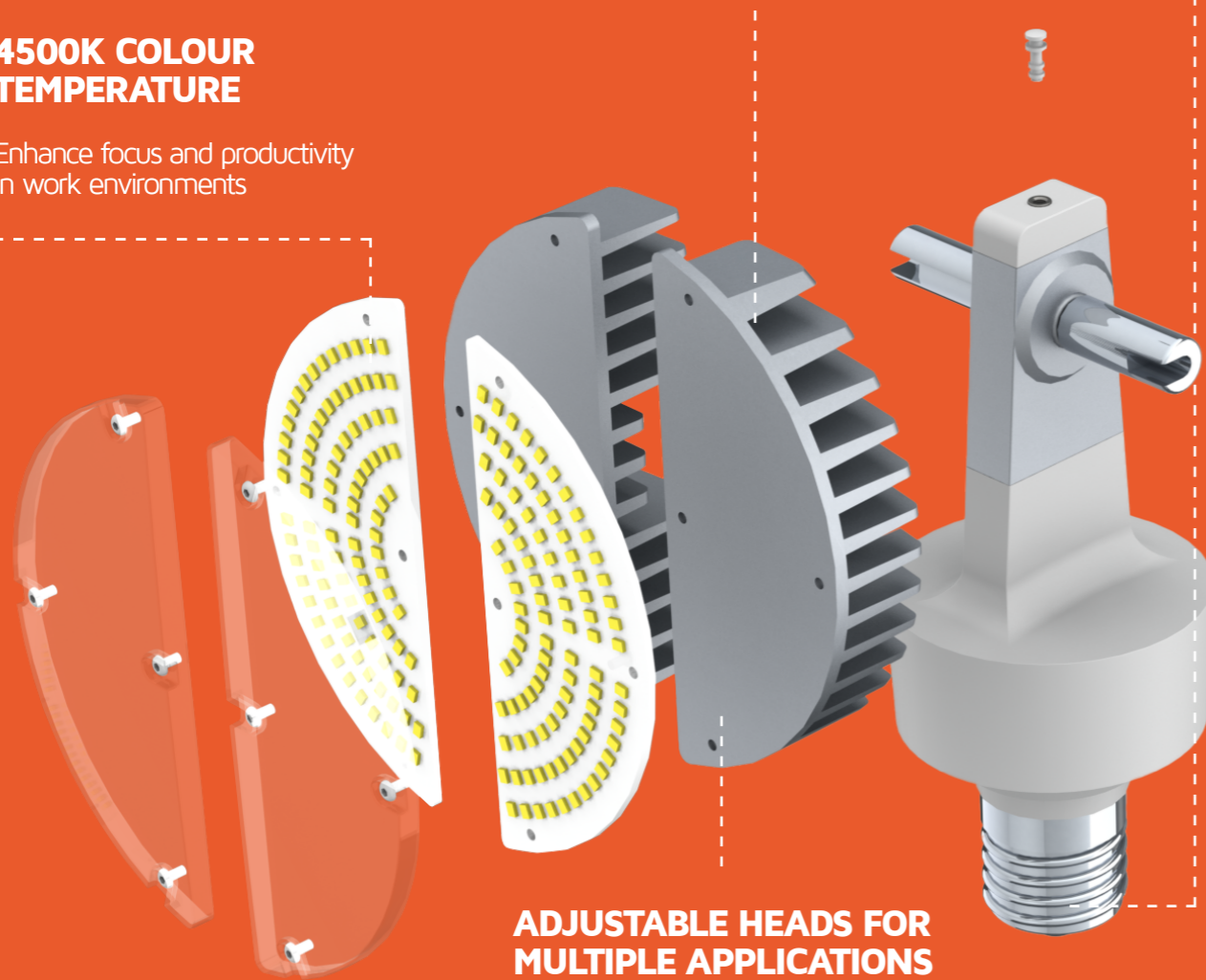

**ADJUSTABLE HEADS FOR
MULTIPLE APPLICATIONS**

Adaptable for High Bay, Lantern/Post Top, or Shoebox/Low Bay applications

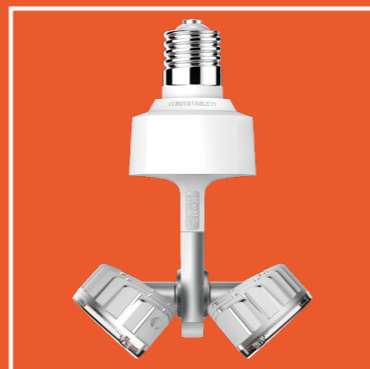
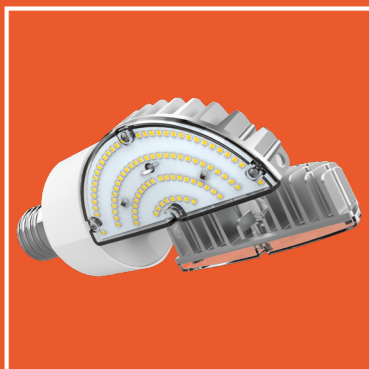

BURY RANGE

Multi-Functional Corn Lamps
E27 And E40 Screw

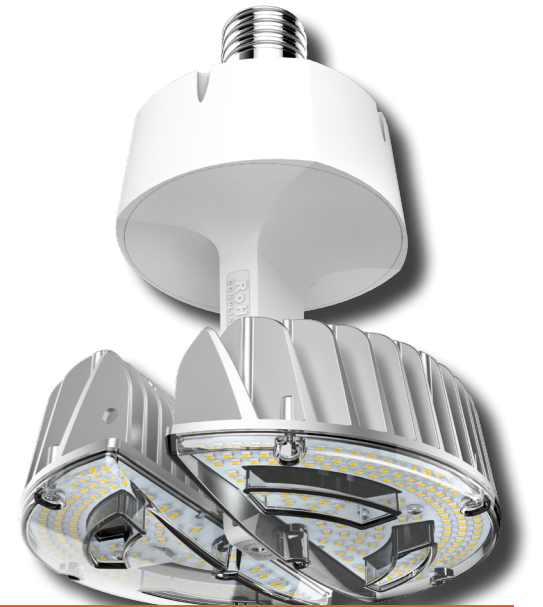

Part Number	Description	Power	Dimensions	Lumens	Colour Temp.
NET-53-12-50	E27 Screw	50W	141 x 85 x 232mm	7500lm	4500K
NET-53-12-10	E40 Screw	100W	178 x 117 x 318mm	15000lm	4500K

COMPATIBLE ACCESSORIES



PIR Sensor

NET-53-12-20

SAVINGS CALCULATOR (based on an average combined electricity cost of £0.27 pence/kwh as of November 2023)

	Fitting	Power (W)	Quantity	Hours per Year (10 hours a day/5 days a week)	kWh per Year	kgCO2 per Year	Electricity Cost per Year
Existing	250W MH	275W	20	2,607	14,339	3,343	£3,871.53
Our Proposal	100W LED	100W	20	2,607	5,214	1,216	£1,407.78

SAVE £2,463.75 PER YEAR BASED ON AN INSTALL OF 20 FITTINGS

140
lm/W

IP65 AND IK10 RATED HOUSING

Protect your fitting from high pressure water and impact



NON-TOXIC ALUMINIUM EXTERIOR

Prevent yellowing with the food safe powder coated housing

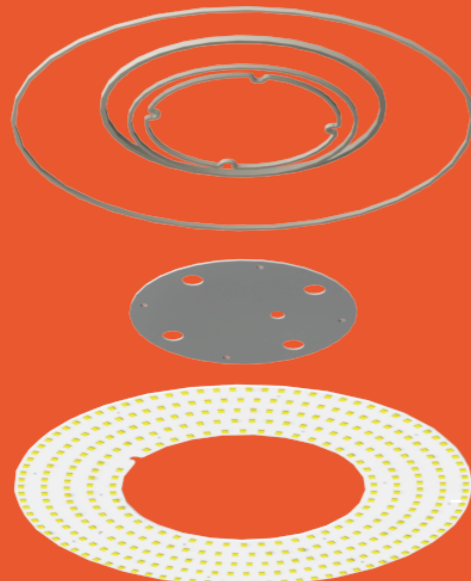

POLYCARBONATE LENS

Comply with food safety regulations with this glass-free fitting

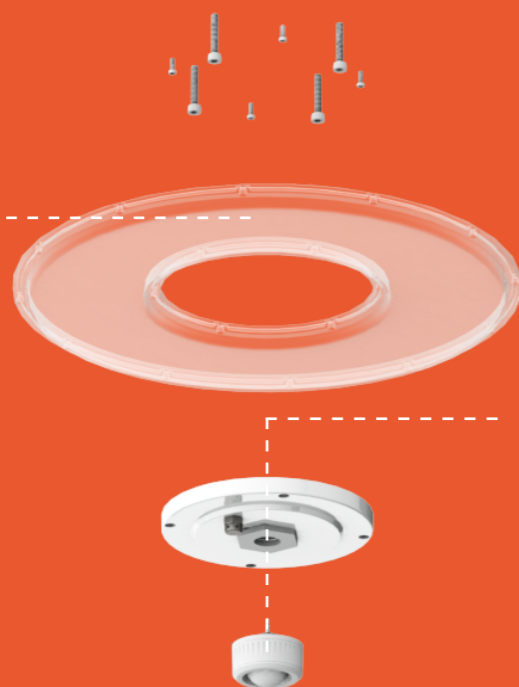

5000K COLOUR TEMPERATURE

Bright and crisp light best used for industrial spaces

5K

0-50% STANDBY MODE AND 8M DETECTION DISTANCE

Reduce unnecessary energy consumption by avoiding lighting in areas that don't need it

PIR Sensor only

COTON RANGE

High Lumen Output
Clean Area High Bay

NSF[®]

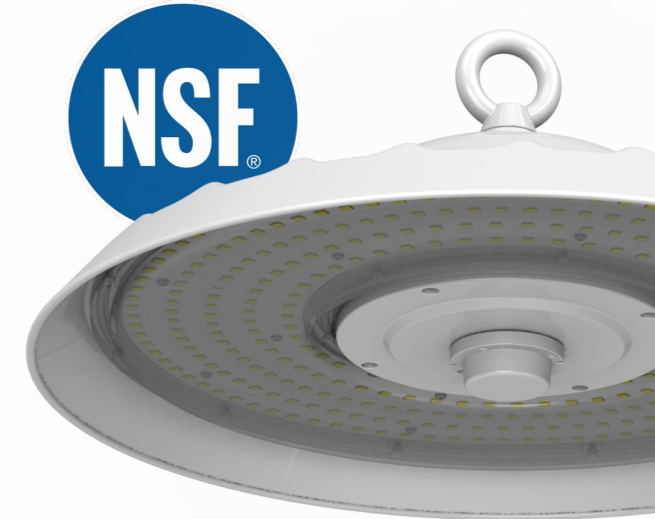

Part Number	Description	Power	Dimensions	Lumens	Colour Temp.
NET-23-12-30	Standard	150W	Ø460 x 177mm	21000lm	5000K

COMPATIBLE ACCESSORIES



PIR Sensor

NET-23-12-32



Remote Control for PIR Sensor

NET-23-12-34



PIR Sensor requires Remote Control NET-23-12-34

SAFETY FIRST

Maintain a high level of sanitation while reducing time and effort on maintenance - perfect for food and beverage production facilities.



1-10V DIMMABLE AS STANDARD

Turn your Standard fitting into a Dimmable one in minutes

0 OR 25% STANDBY MODE

Reduce unnecessary energy consumption by avoiding lighting in areas that don't need it

Microwave Sensor options only

20W HIGH OUTPUT EMERGENCY OPERATION

Ensures the fitting comes on in the event of a power failure

Emergency options only

5000K COLOUR TEMPERATURE

Bright and crisp light best used for warehouses or sports halls

5K

HONEYCOMB REFLECTOR

Reduce glare and improve eye comfort in sports halls and warehouses

IP65 AND IK10 RATED ALUMINIUM HOUSING

Protect your fitting from water, dust and impact

BURWELL RANGE

High Lumen Output
Reduced Glare Linear High Bays

AVAILABLE IN



Emergency



Microwave Sensor



Part Number	Description	Power	Dimensions	Lumens	Colour Temp.
NET-23-12-18	Standard	150W	905 x 135 x 72mm	20000lm	5000K
NET-23-12-20	Emergency	150W	905 x 135 x 72mm	20000lm	5000K
NET-23-12-28	Microwave Sensor	150W	905 x 135 x 72mm	20000lm	5000K
NET-23-12-29	Microwave Sensor Emergency	150W	905 x 135 x 72mm	20000lm	5000K

COMPATIBLE ACCESSORIES



Surface Mount Kit



Remote Control for Microwave Sensors

NET-23-16-23

NET-42-43-22



Microwave Sensor options require Remote Control NET-42-43-22

SAVINGS CALCULATOR (based on an average combined electricity cost of £0.27 pence/kWh as of November 2023)

	Fitting	Power (W)	Quantity	Hours per Year (10 hours a day/5 days a week)	kWh per Year	kgCO2 per Year	Electricity Cost per Year
Existing	400W MH	440W	20	2,607	22,942	5,349	£6,194.34
Our Proposal	150W LED	150W	20	2,607	7,821	1,823	£2,111.67

SAVE £4,082.67 PER YEAR BASED ON AN INSTALL OF 20 FITTINGS

**20W HIGH OUTPUT
EMERGENCY OPERATION**

Ensures the fitting comes on in the event of a power failure

Emergency options only

**MICROWAVE SENSOR AND
PIR SENSOR OPTIONS
AVAILABLE**

Choose between a Microwave Sensor with 0, 10 or 25% Standby Mode with 15m detection range, or a PIR Sensor with 6m detection range

**5700K COLOUR
TEMPERATURE**

Bright and crisp light best used for industrial spaces

5.7K

HARLTON RANGE

High Lumen Output Low Bays

AVAILABLE IN



Emergency



Microwave Sensor



PIR Sensor

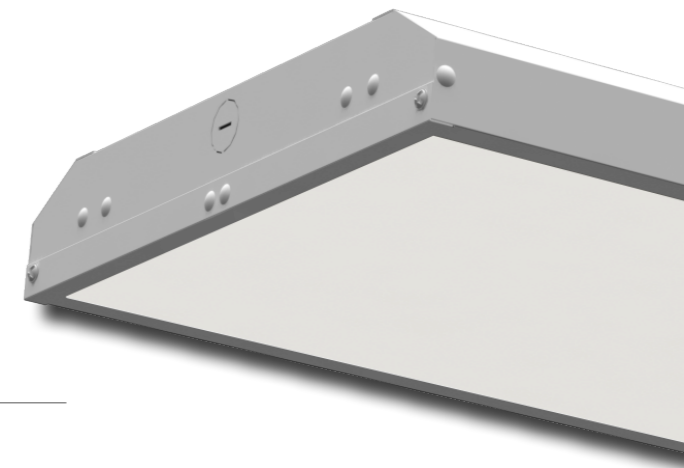

Part Number	Description	Power	Dimensions	Lumens	Colour Temp.
NET-51-12-96	Standard	120W	600 x 320 x 52.6mm	16000lm	5700K
NET-51-12-86	Emergency	120W	600 x 320 x 52.6mm	16000lm	5700K
NET-51-12-94	PIR Sensor (up to 6m)	120W	600 x 320 x 52.6mm	16000lm	5700K
NET-51-12-84	PIR Sensor Emergency (up to 6m)	120W	600 x 320 x 52.6mm	16000lm	5700K
NET-51-12-99	Microwave Sensor	120W	600 x 320 x 52.6mm	16000lm	5700K
NET-51-12-89	Microwave Sensor Emergency	120W	600 x 320 x 52.6mm	16000lm	5700K

COMPATIBLE ACCESSORIES

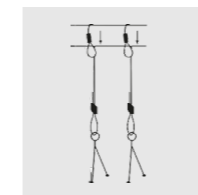

Suspension Kit



Remote Control for Microwave Sensors

NET-46-16-08

NET-42-43-22



Microwave Sensor options require Remote Control NET-42-43-22

powered by

TRIDONIC

SAVINGS CALCULATOR (based on an average combined electricity cost of £0.27 pence/kWh as of November 2023)

	Fitting	Power (W)	Quantity	Hours per Year (10 hours a day/5 days a week)	kWh per Year	kgCO2 per Year	Electricity Cost per Year
Existing	250W MH	275W	20	2,607	14,339	3,343	£3,871.53
Our Proposal	120W LED	120W	20	2,607	6,257	1,459	£1,689.39

SAVE £2,182.14 PER YEAR BASED ON AN INSTALL OF 20 FITTINGS

INTEGRAL PIR AND DAYLIGHT HARVESTING SENSOR

Automatically regulates the fitting's light output and maintains the required light levels

IK10 POWDER COATED HOUSING

Protects your fitting from impact, and prevent corrosion

PHILLIPS DRIVER AS STANDARD

Ensure reliability, durability and performance leading to long-lasting LEDs

4000K COLOUR TEMPERATURE

Bright and crisp light best used for industrial spaces

HIGH RACK, WIDE AND NARROW OPTICAL LENS OPTIONS AVAILABLE

Direct your light precisely where you need it, providing maximum efficiency, visibility and safety in any industrial space

4K

PAXTON RANGE

Single Colour 4000K LED Bays With An Integral PIR And Daylight Harvesting Sensor

AVAILABLE IN



Emergency

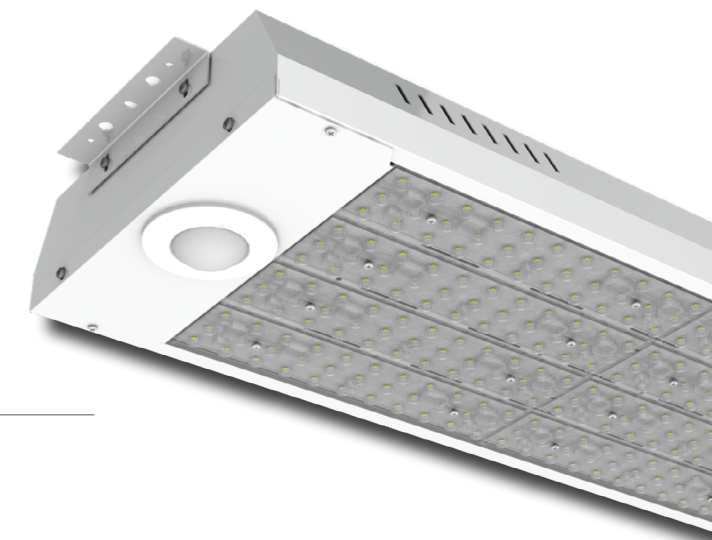

Part Number	Description	Power	Dimensions	Lumens	Colour Temp.
NET-55-12-01	Wide Optic Standard	134W	695 x 300 x 80mm	21000lm	4000K
NET-55-12-07	Wide Optic Emergency	134W	695 x 300 x 80mm	21000lm	4000K
NET-55-12-13	High Rack Optic Standard	134W	695 x 300 x 80mm	21000lm	4000K
NET-55-12-19	High Rack Optic Emergency	134W	695 x 300 x 80mm	21000lm	4000K
NET-55-12-25	Narrow Beam Optic Standard	134W	695 x 300 x 80mm	21000lm	4000K
NET-55-12-31	Narrow Beam Optic Emergency	134W	695 x 300 x 80mm	21000lm	4000K
NET-55-12-03	Wide Optic Standard	173W	695 x 300 x 80mm	26000lm	4000K
NET-55-12-09	Wide Optic Emergency	173W	695 x 300 x 80mm	26000lm	4000K
NET-55-12-15	High Rack Optic Standard	173W	695 x 300 x 80mm	26000lm	4000K
NET-55-12-21	High Rack Optic Emergency	173W	695 x 300 x 80mm	26000lm	4000K
NET-55-12-27	Narrow Beam Optic Standard	173W	695 x 300 x 80mm	26000lm	4000K
NET-55-12-33	Narrow Beam Optic Emergency	173W	695 x 300 x 80mm	26000lm	4000K
NET-55-12-05	Wide Optic Standard	220W	695 x 300 x 80mm	32000lm	4000K
NET-55-12-11	Wide Optic Emergency	220W	695 x 300 x 80mm	32000lm	4000K
NET-55-12-17	High Rack Optic Standard	220W	695 x 300 x 80mm	32000lm	4000K
NET-55-12-23	High Rack Optic Emergency	220W	695 x 300 x 80mm	32000lm	4000K
NET-55-12-29	Narrow Beam Optic Standard	220W	695 x 300 x 80mm	32000lm	4000K
NET-55-12-35	Narrow Beam Optic Emergency	220W	695 x 300 x 80mm	32000lm	4000K

SAVINGS CALCULATOR (based on an average combined electricity cost of £0.27 pence/kwh as of November 2023)

	Fitting	Power (W)	Quantity	Hours per Year (10 hours a day/5 days a week)	kWh per Year	kgCO2 per Year	Electricity Cost per Year
Existing	400W HPI	60W	20	2,607	22,880	11,356	£6,177.60
Our Proposal	134W LED	134W	20	2,607	6,987	1,629	£1,886.49

SAVE £4,291.11 PER YEAR BASED ON AN INSTALL OF 20 FITTINGS

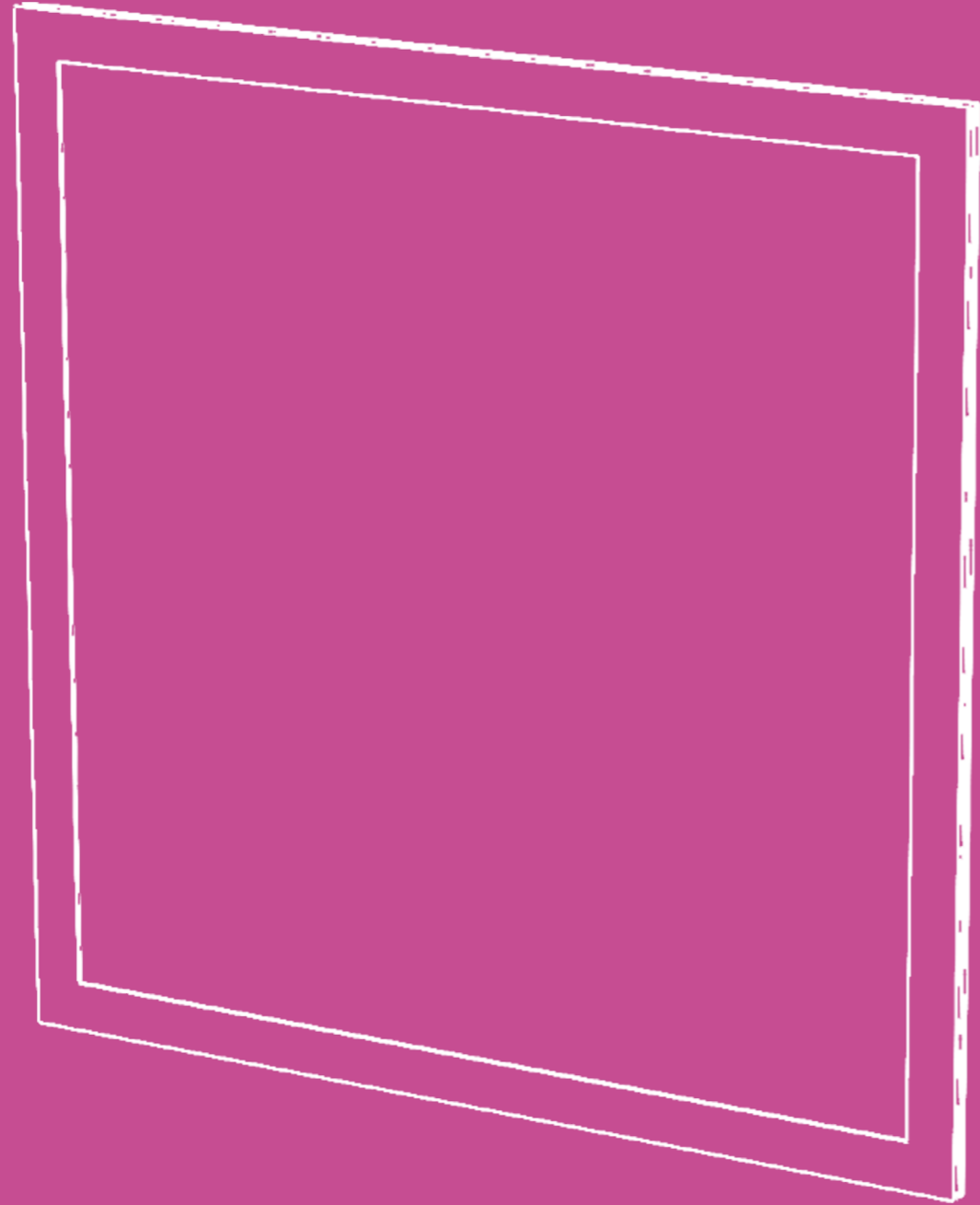

Panel Lights

A mix of Tri-Colour, single colour 4000K and Tunable White Panels
with sizes ranging from 300x300mm to 1200x600mm

Up to
145
lm/W

**FLICKER-FREE
OSRAM DRIVER**

Reduce headaches, eye strain and fatigue with a fitting that doesn't flicker

**3H EMERGENCY
OPERATION**

Ensures the fitting comes on in the event of a power failure

Emergency options only

ASHLEY RANGE

Low Glare UGR<19 Tri-Colour IP50
Backlit Panels With TP(a) Flammability
Rated Diffusers

AVAILABLE IN



Emergency



Self Test Emergency

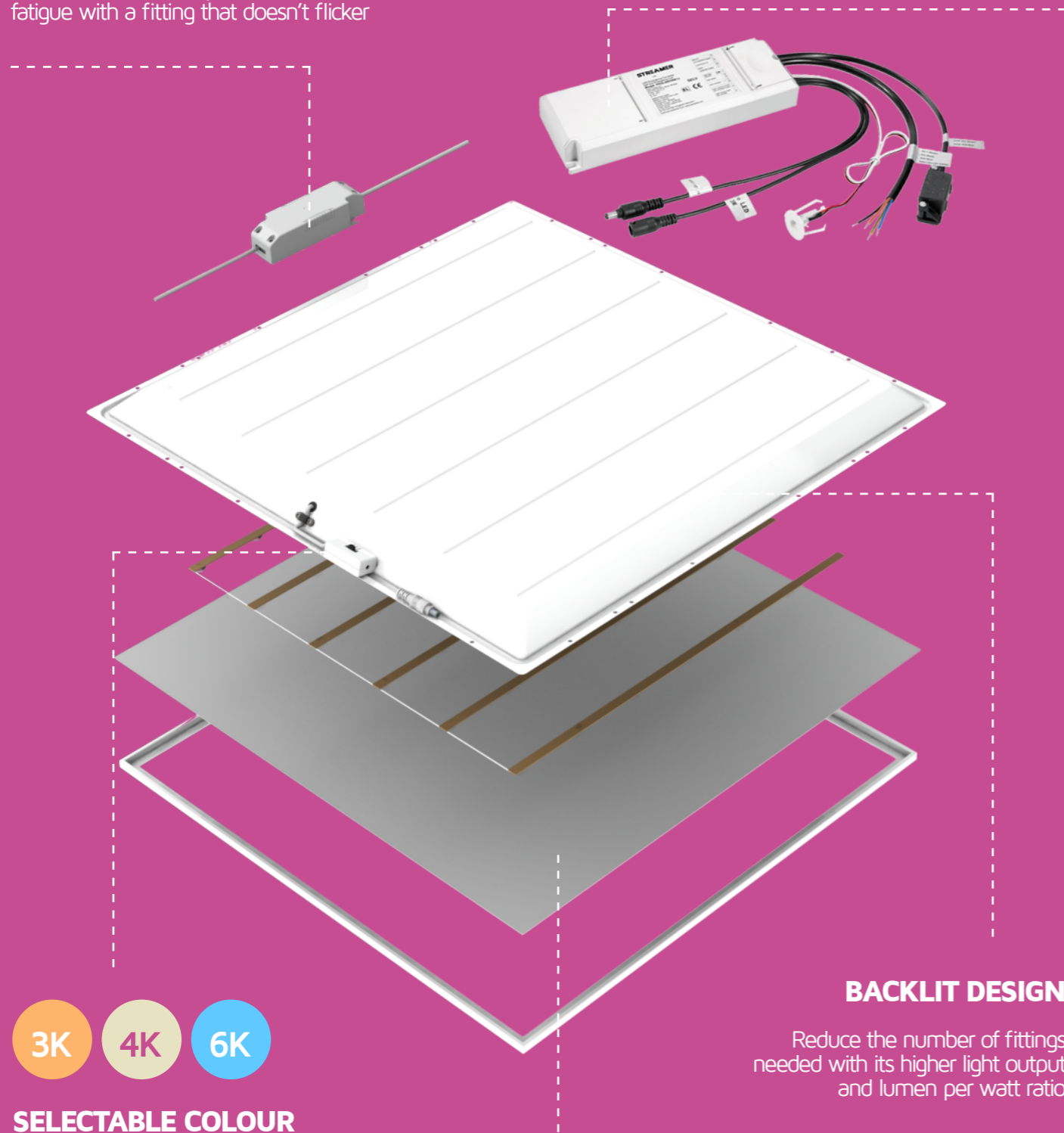

BACKLIT DESIGN

Reduce the number of fittings needed with its higher light output and lumen per watt ratio

3K 4K 6K

**SELECTABLE COLOUR
TEMPERATURE**

Choose your colour temperature 3000K, 4000K or 6000K

**LOW GLARE UGR<19 AND TP(A)
FLAMMABILITY RATED DIFFUSER**

Reduce headaches and comply with Building Regulations

Part Number	Dimensions	Description	Power	Lumens	Colour Temp.
NET-43-03-20	600x600mm	Standard	30W	3600lm/3750lm/3650lm	3000K/4000K/6000K
NET-43-03-21	600x600mm	Emergency	30W	3600lm/3750lm/3650lm	3000K/4000K/6000K
NET-43-03-29	600x600mm	Self Test Emergency	30W	3600lm/3750lm/3650lm	3000K/4000K/6000K
NET-43-03-30	1200x600mm	Standard	50W	6000lm/6750lm/6250lm	3000K/4000K/6000K
NET-43-03-31	1200x600mm	Emergency	50W	6000lm/6750lm/6250lm	3000K/4000K/6000K
NET-43-03-36	1200x600mm	Self Test Emergency	50W	6000lm/6750lm/6250lm	3000K/4000K/6000K

COMPATIBLE ACCESSORIES

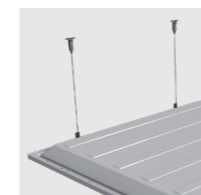

Suspension Kit for 600x600mm Panels

NET-43-16-04

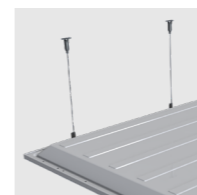

Suspension Kit for 1200x600mm Panels

NET-43-16-05



Surface Mount Box for 600x600mm Panels

NET-39-03-39



Surface Mount Box for 1200x600mm Panels

NET-39-03-43

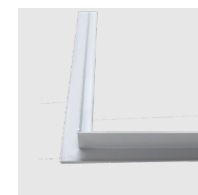

Recessed Mounting Frame for 600x600mm Panels

NET-39-03-47



Burgess Adjustable Z Clips

NET-39-16-05

DRIVERS USED



OSRAM Element Driver as standard

OSRAM

Up to
145
lm/W

DIMMABLE DRIVER

Customise lighting levels and reduce electricity consumption

Dimmable options only

3H EMERGENCY OPERATION

Ensures the fitting comes on in the event of a power failure

Emergency options only

WIRELESS CONTROL

Control the panel remotely via smartphone or tablet with it's Bluetooth Dimmable Driver

Bluetooth options only

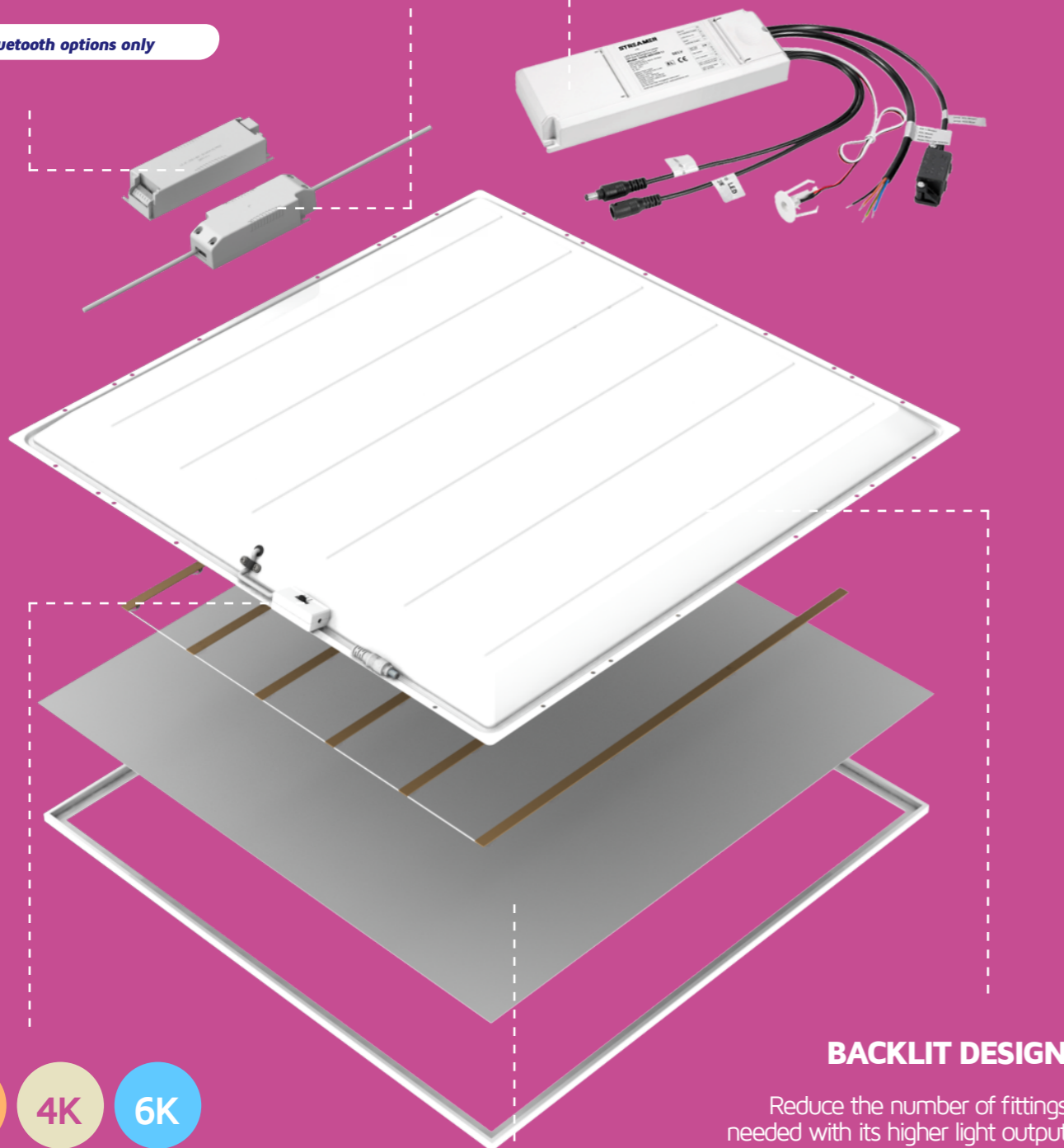

BACKLIT DESIGN

Reduce the number of fittings needed with its higher light output and lumen per watt ratio

3K 4K 6K

SELECTABLE COLOUR TEMPERATURE

Choose your colour temperature 3000K, 4000K or 6000K

LOW GLARE UGR<19 AND TP(A) FLAMMABILITY RATED DIFFUSER

Reduce headaches and comply with Building Regulations

ASHLEY RANGE

Dimmable Low Glare UGR<19 Tri-Colour IP50 Front Face Backlit Panels With TP(a) Flammability Rated Diffusers

AVAILABLE IN



Part Number	Dimensions	Description	Power	Lumens	Colour Temp.
NET-43-03-22	600x600mm	Dimmable 1-10V/Push/DALI	30W	3600lm/3750lm/3650lm	3000K/4000K/6000K
NET-43-03-23	600x600mm	Dimmable Emergency	30W	3600lm/3750lm/3650lm	3000K/4000K/6000K
NET-43-03-24	600x600mm	Dimmable Self Test Emergency	30W	3600lm/3750lm/3650lm	3000K/4000K/6000K
NET-43-03-25	600x600mm	Dimmable DALI Emergency	30W	3600lm/3750lm/3650lm	3000K/4000K/6000K
NET-43-03-26	600x600mm	Bluetooth	30W	3600lm/3750lm/3650lm	3000K/4000K/6000K
NET-43-03-27	600x600mm	Bluetooth Emergency	30W	3600lm/3750lm/3650lm	3000K/4000K/6000K
NET-43-03-28	600x600mm	Bluetooth Self Test Emergency	30W	3600lm/3750lm/3650lm	3000K/4000K/6000K
NET-43-03-32	1200x600mm	Dimmable 1-10V/Push/DALI	50W	6000lm/6750lm/6250lm	3000K/4000K/6000K
NET-43-03-33	1200x600mm	Dimmable Emergency	50W	6000lm/6750lm/6250lm	3000K/4000K/6000K
NET-43-03-34	1200x600mm	Dimmable Self Test Emergency	50W	6000lm/6750lm/6250lm	3000K/4000K/6000K
NET-43-03-35	1200x600mm	Dimmable DALI Emergency	50W	6000lm/6750lm/6250lm	3000K/4000K/6000K

COMPATIBLE ACCESSORIES

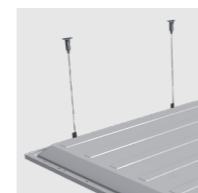

Suspension Kit for 600x600mm Panels

NET-43-16-04

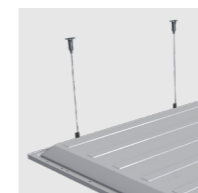

Suspension Kit for 1200x600mm Panels

NET-43-16-05



Surface Mount Box for 600x600mm Panels

NET-39-03-39



Surface Mount Box for 1200x600mm Panels

NET-39-03-43

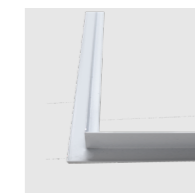

Recessed Mounting Frame for 600x600mm Panels

NET-39-03-47

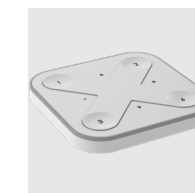

Bluetooth Dimmable/Scene Switch

NET-60-16-80



3K

4K

6K

SELECTABLE COLOUR TEMPERATURE

Choose your colour temperature 3000K, 4000K or 6000K

3-IN-1 DIMMABLE DRIVER

Choose between 1-10V, Push or DALI Dimming

Dimmable options only

3H EMERGENCY OPERATION

Ensures the fitting comes on in the event of a power failure

Emergency options only

ASHLEY RANGE

Low Glare UGR<19 Tri-Colour IP65 Front Face Backlit Panels With TP(a) Flammability Rated Diffusers

AVAILABLE IN



Emergency



Self Test Emergency



Dimmable

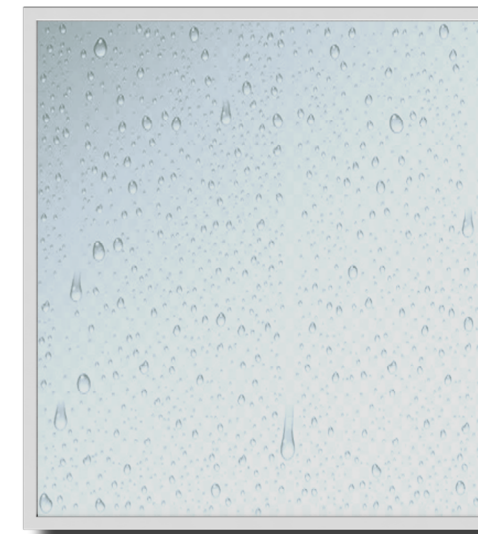

Part Number	Dimensions	Description	Power	Lumens	Colour Temp.
NET-43-03-65	600x600mm	Standard	30W	3600lm/3750lm/3650lm	3000K/4000K/6000K
NET-43-03-66	600x600mm	Emergency	30W	3600lm/3750lm/3650lm	3000K/4000K/6000K
NET-43-03-67	600x600mm	Self Test Emergency	30W	3600lm/3750lm/3650lm	3000K/4000K/6000K
NET-43-03-68	600x600mm	Dimmable 1-10V/Push/DALI	30W	3600lm/3750lm/3650lm	3000K/4000K/6000K
NET-43-03-69	600x600mm	Dimmable Emergency	30W	3600lm/3750lm/3650lm	3000K/4000K/6000K
NET-43-03-70	600x600mm	Dimmable Self Test Emergency	30W	3600lm/3750lm/3650lm	3000K/4000K/6000K
NET-43-03-71	600x600mm	Dimmable DALI Emergency	30W	3600lm/3750lm/3650lm	3000K/4000K/6000K

COMPATIBLE ACCESSORIES



Surface Mount Box for 600x600mm Panels

NET-39-03-39



Recessed Mounting Frame for 600x600mm Panels

NET-39-03-47



Burgess Adjustable Z Clips

NET-39-16-05

IP65 RATED FRONT FACE

Protects the fitting from dust and moisture

BACKLIT DESIGN

Reduce the number of fittings needed with its higher light output and lumen per watt ratio

LOW GLARE UGR<19 AND TP(A) FLAMMABILITY RATED DIFFUSER

Reduce headaches and comply with Building Regulations

DRIVERS USED



OSRAM Element Driver as standard



Merrytek 3-in-1 Dimmable Driver on Dimmable options

OSRAM



3-IN-1 DIMMABLE DRIVER

Choose between 1-10V, Push or DALI Dimming

Dimmable options only

3H EMERGENCY OPERATION

Ensures the fitting comes on in the event of a power failure

Emergency options only

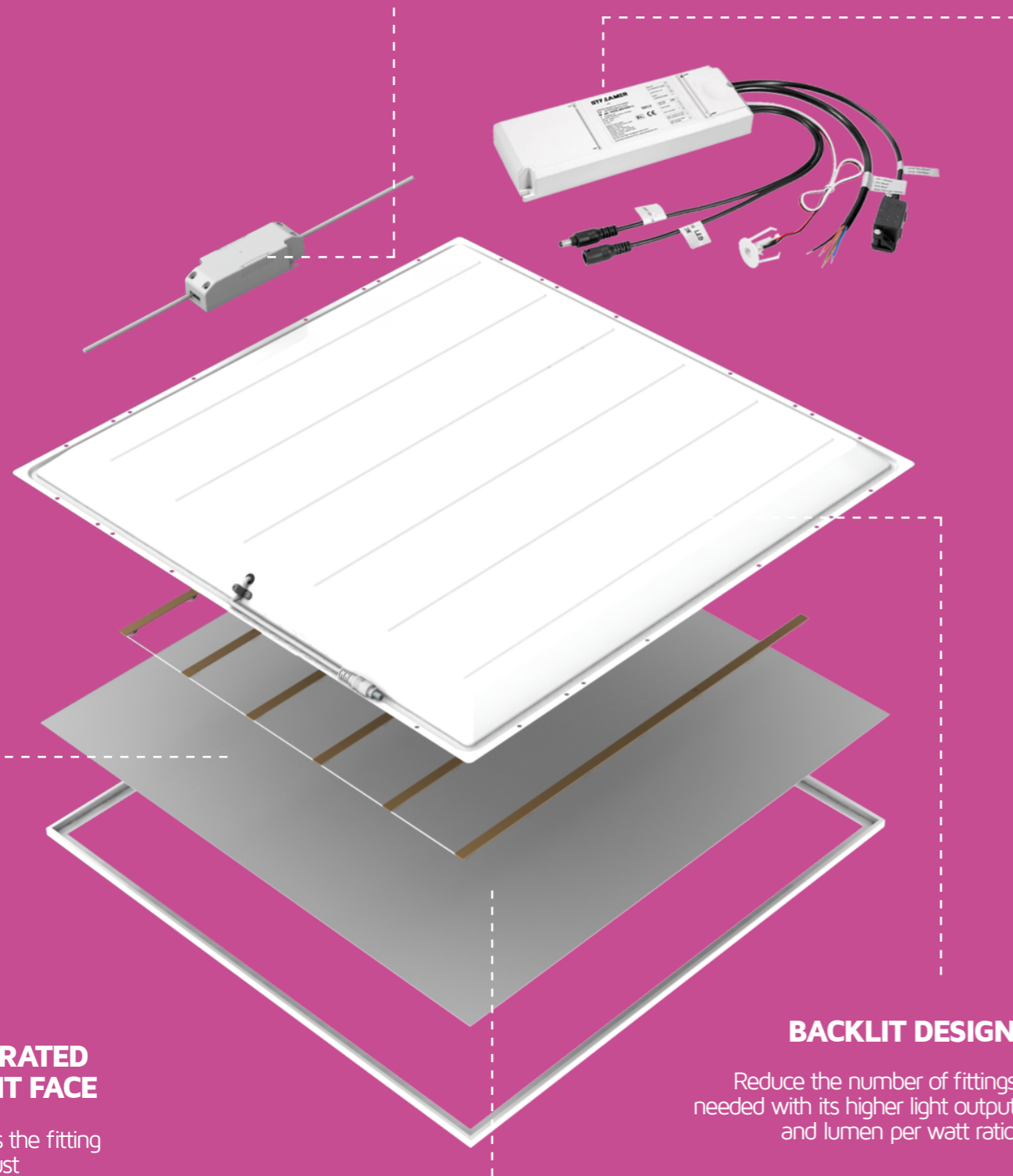

IP50 RATED FRONT FACE

Protects the fitting from dust

BACKLIT DESIGN

Reduce the number of fittings needed with its higher light output and lumen per watt ratio

LOW GLARE UGR<19 AND TP(A) FLAMMABILITY RATED DIFFUSER

Reduce headaches and comply with Building Regulations

ASHLEY RANGE

Low Glare UGR<19 Single Colour 4000K
IP50 Front Face Backlit Panels With TP(a)
Flammability Rated Diffusers



AVAILABLE IN

-  Emergency
-  Self Test Emergency
-  Dimmable

Part Number	Dimensions	Description	Power	Lumens	Colour Temp.
NET-43-03-60	600x600mm	Standard	36W	3600lm	4000K
NET-43-03-61	600x600mm	Emergency	36W	3600lm	4000K
NET-43-03-37	600x600mm	Self Test Emergency	36W	3600lm	4000K
NET-43-03-62	600x600mm	Dimmable 1-10V/Push/DALI	36W	3600lm	4000K
NET-43-03-63	600x600mm	Dimmable Emergency	36W	3600lm	4000K
NET-43-03-38	600x600mm	Dimmable Self Test Emergency	36W	3600lm	4000K
NET-43-03-39	600x600mm	Dimmable DALI Emergency	36W	3600lm	4000K

COMPATIBLE ACCESSORIES

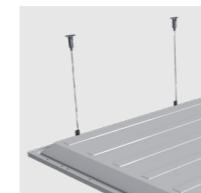

Suspension Kit for 600x600mm Panels

NET-43-16-04



Surface Mount Box for 600x600mm Panels

NET-39-03-39



Recessed Mounting Frame for 600x600mm Panels

NET-39-03-47



Burgess Adjustable Z Clips

NET-39-16-05

DRIVERS USED



Merrytek 3-in-1 Dimmable Driver on Dimmable options



3K 4K 5.5K

SELECTABLE COLOUR TEMPERATURE

Choose your colour temperature 3000K, 4000K or 5500K

3H EMERGENCY OPERATION

Ensures the fitting comes on in the event of a power failure

Emergency options only

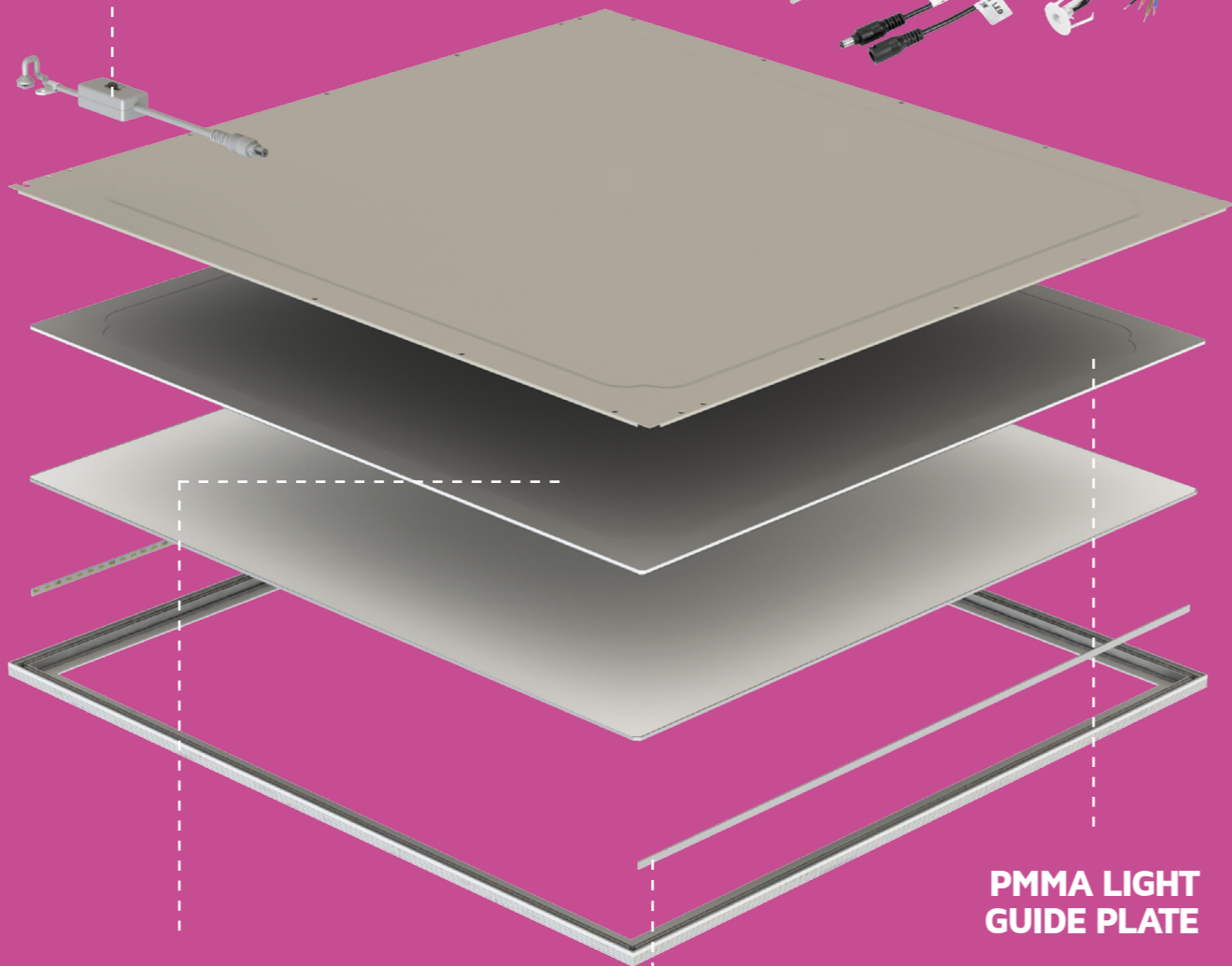

LOW GLARE UGR<19 AND TP(A) FLAMMABILITY RATED DIFFUSER

Reduce headaches and comply with Building Regulations

PMMA LIGHT GUIDE PLATE

Creates a uniform light distribution and extend the lifespan

EDGELIT DESIGN

Allows the fitting to have a sleek and slim profile, making them suitable for applications where space is limited

KINGSTON RANGE

Low Glare UGR<19 Tri-Colour Edgelit Panels With TP(a) Flammability Rated Diffusers

AVAILABLE IN



Emergency



Self Test Emergency

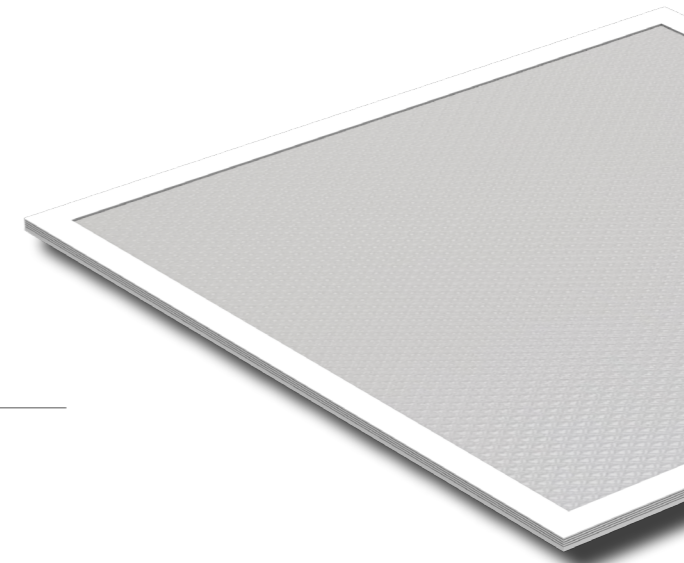

Part Number	Dimensions	Description	Power	Lumens	Colour Temp.
NET-39-03-00	300x300mm	Standard	10W	950lm/1080lm/1000lm	3000K/4000K/5500K
NET-39-03-32	300x300mm	Emergency	10W	950lm/1080lm/1000lm	3000K/4000K/5500K
NET-39-03-34	300x300mm	Self Test Emergency	10W	950lm/1080lm/1000lm	3000K/4000K/5500K
NET-39-03-02	500x500mm	Standard	16W	1800lm/2100lm/1900lm	3000K/4000K/5500K
NET-39-03-03	500x500mm	Emergency	16W	1800lm/2100lm/1900lm	3000K/4000K/5500K
NET-39-03-50	500x500mm	Self Test Emergency	16W	1800lm/2100lm/1900lm	3000K/4000K/5500K
NET-39-03-01	600x300mm	Standard	16W	1800lm/2100lm/1900lm	3000K/4000K/5500K
NET-39-03-33	600x300mm	Emergency	16W	1800lm/2100lm/1900lm	3000K/4000K/5500K
NET-39-03-42	600x300mm	Self Test Emergency	16W	1800lm/2100lm/1900lm	3000K/4000K/5500K
NET-39-03-04	600x600mm	Standard	27W	2900lm/3300lm/3000lm	3000K/4000K/5500K
NET-39-03-09	600x600mm	Emergency	27W	2900lm/3300lm/3000lm	3000K/4000K/5500K
NET-39-03-53	600x600mm	Self Test Emergency	27W	2900lm/3300lm/3000lm	3000K/4000K/5500K
NET-39-03-06	1200x300mm	Standard	27W	3000lm/3300lm/3200lm	3000K/4000K/5500K
NET-39-03-12	1200x300mm	Emergency	27W	3000lm/3300lm/3200lm	3000K/4000K/5500K
NET-39-03-60	1200x300mm	Self Test Emergency	27W	3000lm/3300lm/3200lm	3000K/4000K/5500K
NET-39-03-08	1200x600mm	Standard	50W	4800lm/5500lm/5200lm	3000K/4000K/5500K
NET-39-03-15	1200x600mm	Emergency	50W	4800lm/5500lm/5200lm	3000K/4000K/5500K
NET-39-03-63	1200x600mm	Self Test Emergency	50W	4800lm/5500lm/5200lm	3000K/4000K/5500K

COMPATIBLE ACCESSORIES



Surface Mount Box for 600x600mm Panels

NET-39-03-39



Surface Mount Box for 1200x600mm Panels

NET-39-03-43

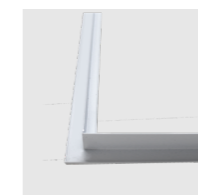

Recessed Mounting Frame for 600x600mm Panels

NET-39-03-47



Universal Suspension Kit

NET-46-16-02



Burgess Adjustable Z Clips

NET-39-16-05

WIRELESS CONTROL

Control the panel remotely via smartphone or tablet with its Bluetooth Dimmable Driver

Bluetooth options only

TRIDONIC DIMMABLE DRIVER

Customise lighting levels and reduce electricity consumption

Dimmable options only

3H EMERGENCY OPERATION

Ensures the fitting comes on in the event of a power failure

Emergency options only

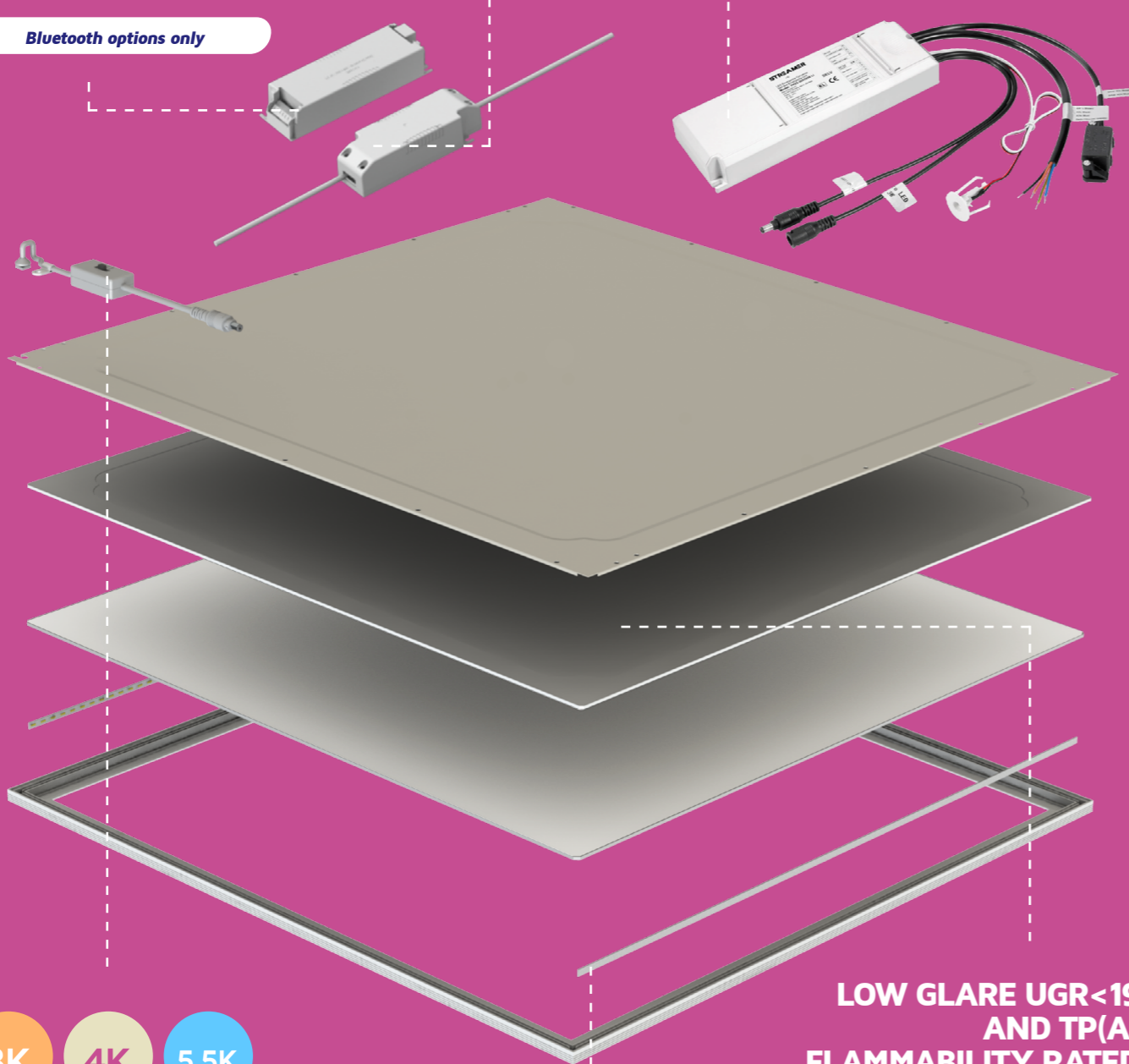

3K 4K 5.5K

SELECTABLE COLOUR TEMPERATURE

Choose your colour temperature 3000K, 4000K or 5500K

LOW GLARE UGR<19 AND TP(A) FLAMMABILITY RATED DIFFUSER

Reduce headaches and comply with Building Regulations

EDGELIT DESIGN

Allows the fitting to have a sleek and slim profile, making them suitable for applications where space is limited

KINGSTON RANGE

Dimmable Low Glare UGR<19 Tri-Colour Edgelit Panels With TP(a) Flammability Rated Diffusers

AVAILABLE IN

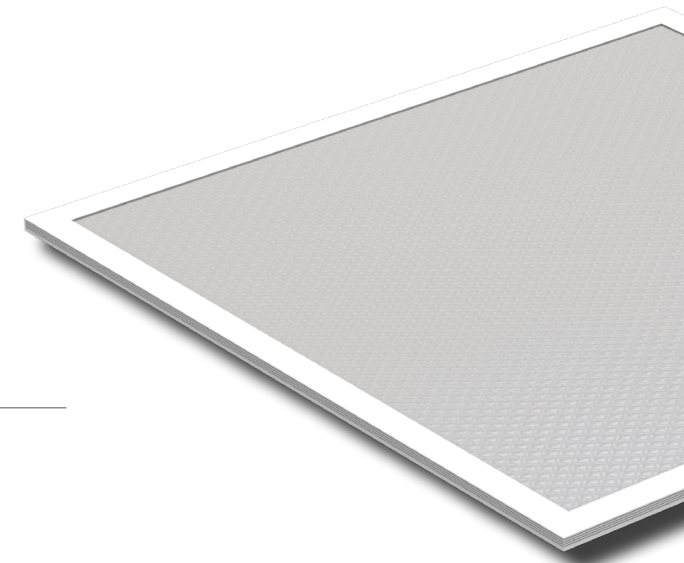

Part Number	Dimensions	Description	Power	Lumens	Colour Temp.
NET-39-03-35	300x300mm	Dimmable one4all	10W	950lm/1080lm/1000lm	3000K/4000K/5500K
NET-39-03-36	300x300mm	Dimmable Emergency	10W	950lm/1080lm/1000lm	3000K/4000K/5500K
NET-39-03-37	300x300mm	Dimmable Self Test Emergency	10W	950lm/1080lm/1000lm	3000K/4000K/5500K
NET-39-03-38	300x300mm	Dimmable DALI Emergency	10W	950lm/1080lm/1000lm	3000K/4000K/5500K
NET-39-03-05	500x500mm	Dimmable one4all	16W	1800lm/2100lm/1900lm	3000K/4000K/5500K
NET-39-03-07	500x500mm	Dimmable Emergency	16W	1800lm/2100lm/1900lm	3000K/4000K/5500K
NET-39-03-51	500x500mm	Dimmable Self Test Emergency	16W	1800lm/2100lm/1900lm	3000K/4000K/5500K
NET-39-03-52	500x500mm	Dimmable DALI Emergency	16W	1800lm/2100lm/1900lm	3000K/4000K/5500K
NET-39-03-44	600x300mm	Dimmable one4all	16W	1800lm/2100lm/1900lm	3000K/4000K/5500K
NET-39-03-46	600x300mm	Dimmable Emergency	16W	1800lm/2100lm/1900lm	3000K/4000K/5500K
NET-39-03-48	600x300mm	Dimmable Self Test Emergency	16W	1800lm/2100lm/1900lm	3000K/4000K/5500K
NET-39-03-49	600x300mm	Dimmable DALI Emergency	16W	1800lm/2100lm/1900lm	3000K/4000K/5500K
NET-39-03-10	600x600mm	Dimmable one4all	27W	2900lm/3300lm/3000lm	3000K/4000K/5500K
NET-39-03-11	600x600mm	Dimmable Emergency	27W	2900lm/3300lm/3000lm	3000K/4000K/5500K
NET-39-03-54	600x600mm	Dimmable Self Test Emergency	27W	2900lm/3300lm/3000lm	3000K/4000K/5500K
NET-39-03-55	600x600mm	Dimmable DALI Emergency	27W	2900lm/3300lm/3000lm	3000K/4000K/5500K
NET-39-03-56	600x600mm	Bluetooth	27W	2900lm/3300lm/3000lm	3000K/4000K/5500K
NET-39-03-57	600x600mm	Bluetooth Emergency	27W	2900lm/3300lm/3000lm	3000K/4000K/5500K
NET-39-03-58	600x600mm	Bluetooth Self Test Emergency	27W	2900lm/3300lm/3000lm	3000K/4000K/5500K
NET-39-03-13	1200x300mm	Dimmable one4all	27W	3000lm/3300lm/3200lm	3000K/4000K/5500K
NET-39-03-14	1200x300mm	Dimmable Emergency	27W	3000lm/3300lm/3200lm	3000K/4000K/5500K
NET-39-03-61	1200x300mm	Dimmable Self Test Emergency	27W	3000lm/3300lm/3200lm	3000K/4000K/5500K
NET-39-03-62	1200x300mm	Dimmable DALI Emergency	27W	3000lm/3300lm/3200lm	3000K/4000K/5500K
NET-39-03-16	1200x600mm	Dimmable one4all	50W	4800lm/5500lm/5200lm	3000K/4000K/5500K
NET-39-03-17	1200x600mm	Dimmable Emergency	50W	4800lm/5500lm/5200lm	3000K/4000K/5500K
NET-39-03-64	1200x600mm	Dimmable Self Test Emergency	50W	4800lm/5500lm/5200lm	3000K/4000K/5500K
NET-39-03-66	1200x600mm	Dimmable DALI Emergency	50W	4800lm/5500lm/5200lm	3000K/4000K/5500K

Control the colour temperature and brightness of your lighting directly from your phone or tablet.

Control multiple or individual fittings, or set the scene with pre-set colours and brightness levels.

Simply install our Tunable White Panel, pair it and you're good to go!

2700K - 6500K

Don't forget to download the free App!

Using your phone's camera, scan the QR code to download the Tridonic 4remote BT App!

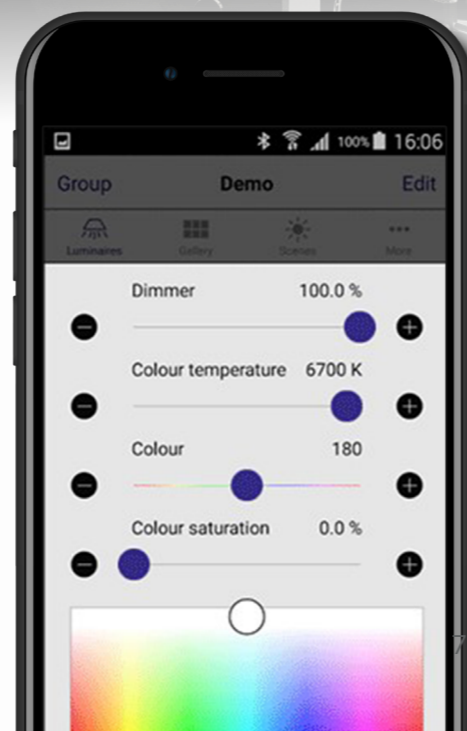

KINGSTON RANGE

Tunable White 2700K-6500K
Low Glare Edgelit Panels

AVAILABLE IN



Emergency



Self Test Emergency

Part Number	Dimensions	Description	Power	Lumens	Colour Temp.
NET-39-03-30	600x600mm	Standard	30W	Max. 3300lm	Tunable 2700K-6500K
NET-39-03-31	600x600mm	Emergency	30W	Max. 3300lm	Tunable 2700K-6500K
NET-39-03-39	600x600mm	Self Test Emergency	30W	Max. 3300lm	Tunable 2700K-6500K

COMPATIBLE ACCESSORIES



Surface Mount Box for 600x600mm Panels

NET-39-03-39



Recessed Mounting Frame for 600x600mm Panels

NET-39-03-47



Universal Suspension Kit

NET-46-16-02



Burgess Adjustable Z Clips

NET-39-16-05

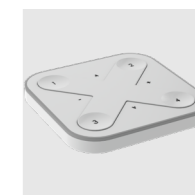

Bluetooth Dimmable/Scene Switch

NET-60-16-80



Tridonic BT Wireless Sensor basicDIM 5DP 38rc

PRD-70-10-55

powered by
TRIDONIC

PRE-SET SCENES & BRIGHTNESS LEVELS

Customise the lighting of your room to suit a variety of applications.

The Dimmable/Scene Switch works with any of our Bluetooth Dimmable Drivers, and gives you ultimate multi-room scene control.



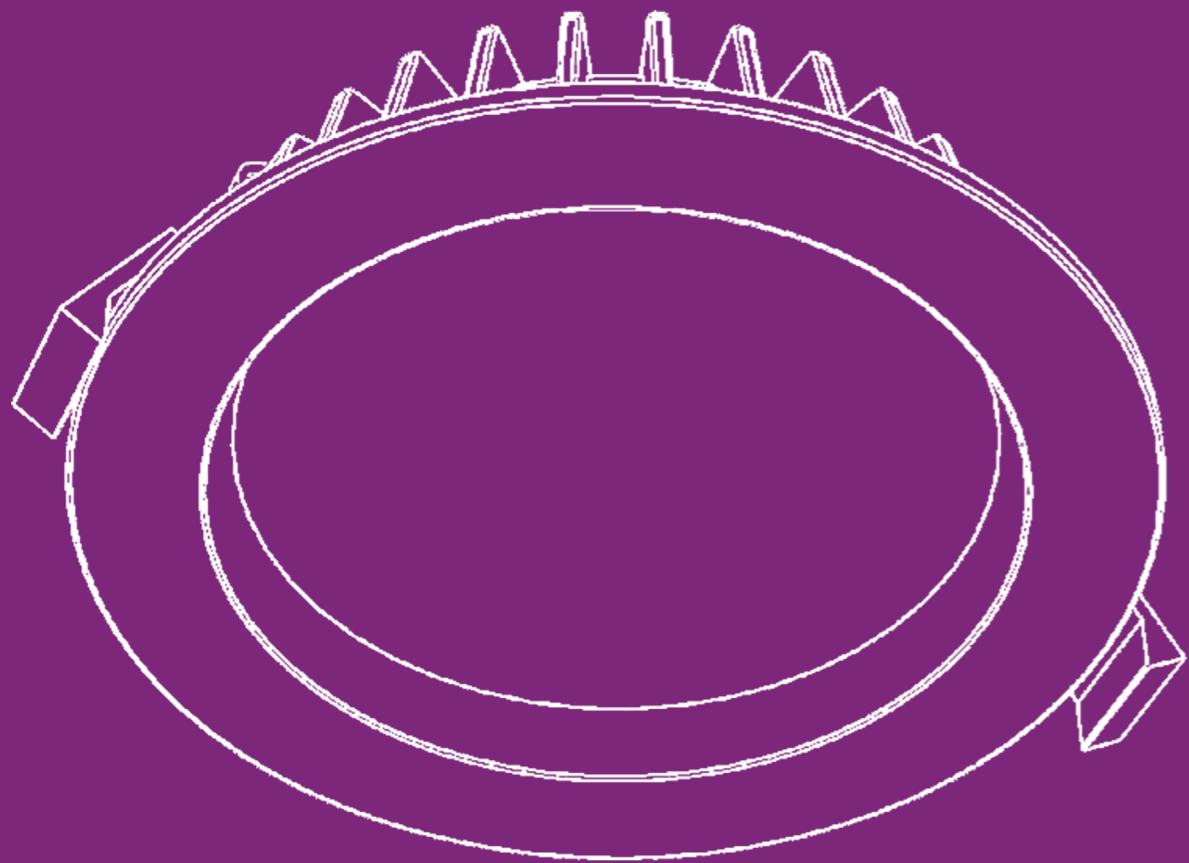

Downlights

Tri-Colour and single colour 4000K recessed downlights including 3", 4", 6" and 8" sizes

STAINLESS STEEL RETAINING CLIPS

Quick and simple installation
with no need for additional tools

Ø145-210MM CUT-OUT SIZES

Available in 6" and 8",
these downlights are designed
to fit existing holes

LOW GLARE UGR<19 RATED DIFFUSER

Reduce headaches and
improve focus

3H EMERGENCY OPERATION

Ensures the fitting comes on in
the event of a power failure

Emergency options only

TRIDONIC DIMMABLE DRIVER

Customise lighting levels and
reduce electricity consumption

Dimmable options only

KINGSTON RANGE

NEW

Single Colour 4000K Recessed Downlights
With Low Glare UGR<19 Diffusers

AVAILABLE IN



Emergency



Dimmable

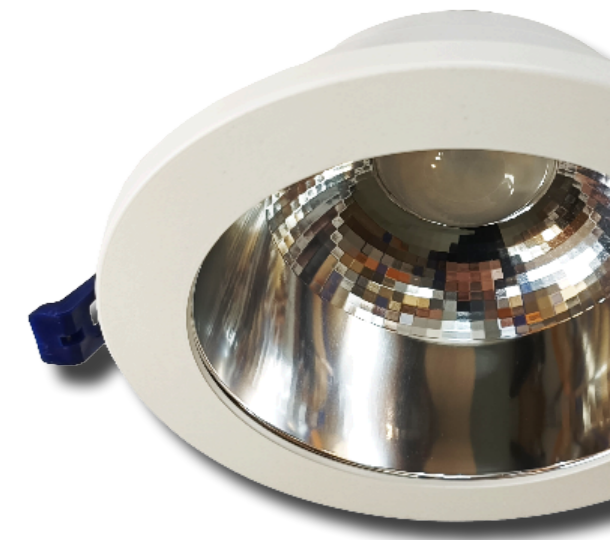

Part Number	Description	Cut-Out Size	Power	Lumens	Colour Temp.
NET-60-05-06	Standard 6"	Ø145-158mm	21W	2210lm	4000K
NET-60-05-07	Emergency 6"	Ø145-158mm	21W	2210lm	4000K
NET-60-05-08	Dimmable one4all 6"	Ø145-158mm	21W	2210lm	4000K
NET-60-05-09	Dimmable Emergency 6"	Ø145-158mm	21W	2210lm	4000K
NET-60-05-10	Dimmable DALI Emergency 6"	Ø145-158mm	21W	2210lm	4000K
NET-60-05-26	Standard 8"	Ø190-210mm	35W	3180lm	4000K
NET-60-05-27	Emergency 8"	Ø190-210mm	35W	3180lm	4000K
NET-60-05-28	Dimmable one4all 8"	Ø190-210mm	35W	3180lm	4000K
NET-60-05-29	Dimmable Emergency 8"	Ø190-210mm	35W	3180lm	4000K
NET-60-05-30	Dimmable DALI Emergency 8"	Ø190-210mm	35W	3180lm	4000K

DRIVERS USED



Tridonic Advanced 2
Driver as standard



Tridonic Premium Dimmable
Driver on Dimmable options

powered by
TRIDONIC



Ø90-210MM CUT-OUT SIZES

Available in 3", 4", 6" and 8", these downlights are designed to fit most existing holes

STAINLESS STEEL RETAINING CLIPS

Quick and simple installation with no need for additional tools

TRIDONIC DIMMABLE DRIVER

Customise lighting levels and reduce electricity consumption

Dimmable options only

TP(A) FLAMMABILITY RATED DIFFUSER

Comply with Building Regulations and prevent flaming particles

IP65 RATED FASCIA

Protect the downlight from water and dust

SHATTERPROOF POLYCARBONATE DIFFUSER

Designed to prevent the diffuser shattering into small, indistinct pieces

SELECTABLE COLOUR TEMPERATURE

Choose your colour temperature
3000K, 4000K or 5500K

3K

4K

5.5K

3H EMERGENCY OPERATION

Ensures the fitting comes on in the event of a power failure

Emergency options only

CAXTON RANGE

Tri-Colour IP65 Recessed Downlights With
TP(a) Flammability Rated Diffusers

AVAILABLE IN



Emergency



Self Test Emergency



Dimmable

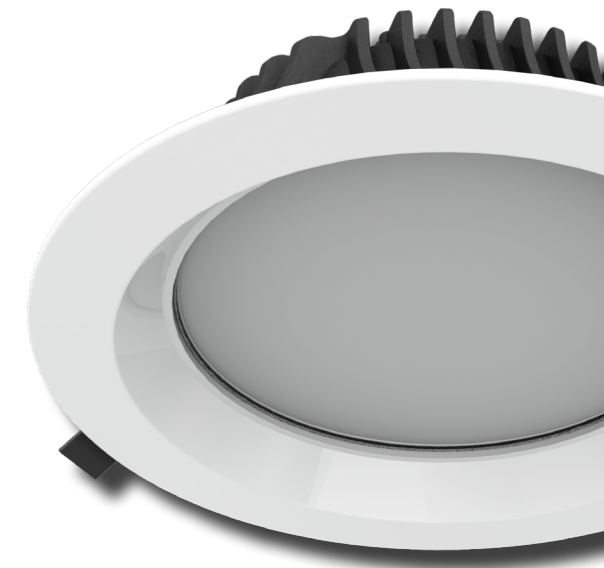

Part Number	Description	Cut-Out Size	Power	Lumens	Colour Temp.
NET-49-05-70	Standard 3"	Ø90-100mm	5W	475lm/500lm/470lm	3000K/4000K/5500K
NET-49-05-71	Emergency 3"	Ø90-100mm	5W	475lm/500lm/470lm	3000K/4000K/5500K
NET-49-05-72	Standard 4"	Ø120-130mm	7W	700lm/750lm/700lm	3000K/4000K/5500K
NET-49-05-77	Emergency 4"	Ø120-130mm	7W	700lm/750lm/700lm	3000K/4000K/5500K
NET-49-05-20	Self Test Emergency 4"	Ø120-130mm	7W	700lm/750lm/700lm	3000K/4000K/5500K
NET-49-05-21	Dimmable one4all 4"	Ø120-130mm	7W	700lm/750lm/700lm	3000K/4000K/5500K
NET-49-05-22	Dimmable Emergency 4"	Ø120-130mm	7W	700lm/750lm/700lm	3000K/4000K/5500K
NET-49-05-23	Dimmable Self Test Emergency 4"	Ø120-130mm	7W	700lm/750lm/700lm	3000K/4000K/5500K
NET-49-05-24	Dimmable DALI Emergency 4"	Ø120-130mm	7W	700lm/750lm/700lm	3000K/4000K/5500K
NET-49-05-74	Standard 6"	Ø165-175mm	16W	1600lm/1700lm/1650lm	3000K/4000K/5500K
NET-49-05-82	Emergency 6"	Ø165-175mm	16W	1600lm/1700lm/1650lm	3000K/4000K/5500K
NET-49-05-25	Self Test Emergency 6"	Ø165-175mm	16W	1600lm/1700lm/1650lm	3000K/4000K/5500K
NET-49-05-84	Dimmable one4all 6"	Ø165-175mm	16W	1600lm/1700lm/1650lm	3000K/4000K/5500K
NET-49-05-86	Dimmable Emergency 6"	Ø165-175mm	16W	1600lm/1700lm/1650lm	3000K/4000K/5500K
NET-49-05-26	Dimmable Self Test Emergency 6"	Ø165-175mm	16W	1600lm/1700lm/1650lm	3000K/4000K/5500K
NET-49-05-27	Dimmable DALI Emergency 6"	Ø165-175mm	16W	1600lm/1700lm/1650lm	3000K/4000K/5500K
NET-49-05-76	Standard 8"	Ø200-210mm	20W	2100lm/2200lm/2100lm	3000K/4000K/5500K
NET-49-05-87	Emergency 8"	Ø200-210mm	20W	2100lm/2200lm/2100lm	3000K/4000K/5500K
NET-49-05-28	Self Test Emergency 8"	Ø200-210mm	20W	2100lm/2200lm/2100lm	3000K/4000K/5500K
NET-49-05-88	Dimmable one4all 8"	Ø200-210mm	20W	2100lm/2200lm/2100lm	3000K/4000K/5500K
NET-49-05-89	Dimmable Emergency 8"	Ø200-210mm	20W	2100lm/2200lm/2100lm	3000K/4000K/5500K
NET-49-05-29	Dimmable Self Test Emergency 8"	Ø200-210mm	20W	2100lm/2200lm/2100lm	3000K/4000K/5500K
NET-49-05-30	Dimmable DALI Emergency 8"	Ø200-210mm	20W	2100lm/2200lm/2100lm	3000K/4000K/5500K

powered by
TRIDONIC



10MM DEPTH

Essential for shallow ceiling voids

STAINLESS STEEL RETAINING CLIPS

Quick and simple installation with no need for additional tools

4K

4000K COLOUR TEMPERATURE

Create a focused environment perfect for offices and commercial spaces

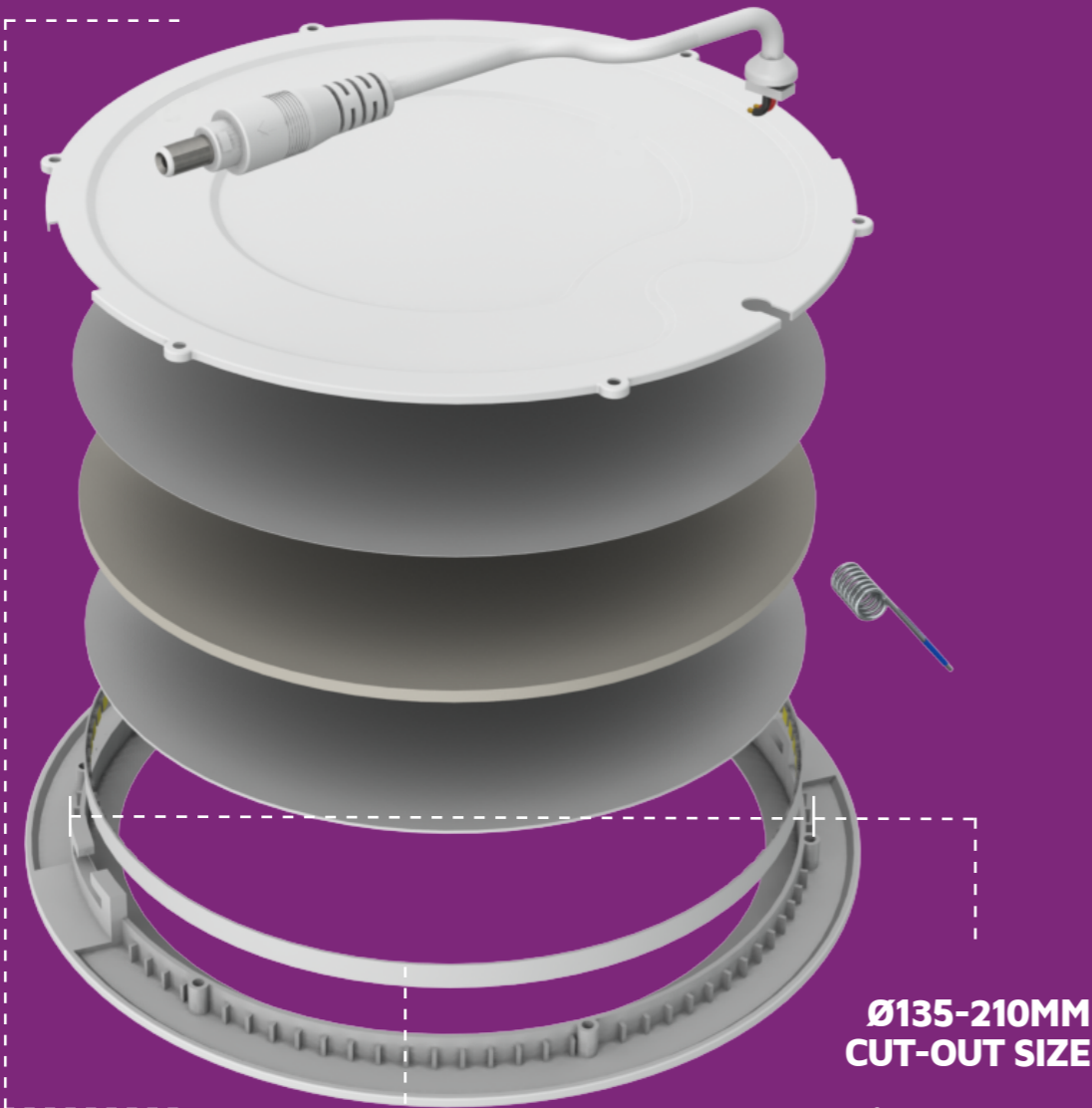

Ø135-210MM CUT-OUT SIZE

Retrofit over an existing cut-out from anywhere between Ø135mm and Ø210mm

ASHLEY RANGE

Single Colour Recessed
IP20 Slim Downlights

AVAILABLE IN



Emergency



Part Number	Description	Cut-Out Size	Power	Lumens	Colour Temp.
NET-53-05-81	Standard 4"	Ø135mm	10W	900lm	4000K
NET-53-05-90	Emergency 4"	Ø135mm	10W	900lm	4000K
NET-53-05-83	Standard 6"	Ø175mm	15W	1350lm	4000K
NET-53-05-91	Emergency 6"	Ø175mm	15W	1350lm	4000K
NET-53-05-85	Standard 8"	Ø210mm	18W	1750lm	4000K
NET-53-05-92	Emergency 8"	Ø210mm	18W	1750lm	4000K

COMPATIBLE ACCESSORIES



Recessed Ceiling
Microwave Sensor
IP20

NET-42-43-05



Self Test
Emergency Kit

NET-61-35-13

USES A 3H LIFEPO4 EMERGENCY KIT

All Emergency options use a 3H LiFePO4 Emergency Kit meaning your fitting will have a longer lifespan, making them durable and reliable for long-term use.



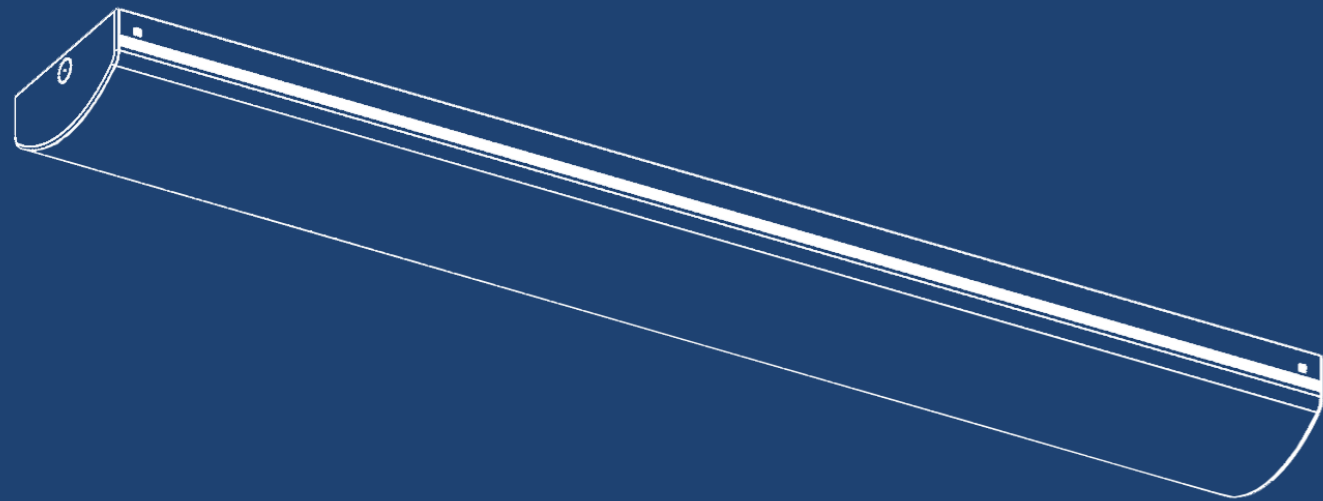

Surface Linears

Dual Wattage, Tri-Colour linear fittings ideal for educational applications
in sizes 4ft, 5ft and 6ft

3H EMERGENCY OPERATION

Ensures the fitting comes on in the event of a power failure

Emergency options only

HINGED DIFFUSER

Get quick and easy access to wiring

REAR OR END CABLE ENTRY

Create seamless end-to-end lighting designs

TRIDONIC PREMIUM DIMMABLE DRIVER

Customise lighting levels and reduce electricity consumption

Dimmable options only

INTEGRAL MICROWAVE SENSOR WITH 6M DETECTION DISTANCE AND 5S-30MIN HOLD TIME

Save energy costs with a fitting that only lights the room when movement is detected

Microwave Sensor options only

DUAL WATTAGE TRIDONIC DRIVER

Choose between 38W or 50W at the time of installation

Standard, Emergency and Microwave Sensor options only



SELECTABLE COLOUR TEMPERATURE

Choose your colour temperature 3000K, 4000K or 5500K

CAMBRIDGE RANGE

Dual Wattage Tri-Colour
5ft Surface Linears

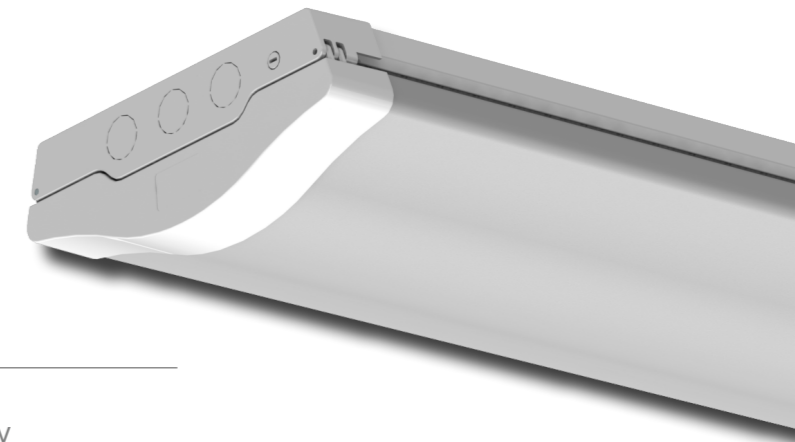

AVAILABLE IN

-  Emergency
-  Self Test Emergency
-  Dimmable
-  Microwave Sensor

Part Number	Description	Dimensions	Power	Lumens	Colour Temp.
NET-51-11-65	Standard	1500 x 215 x 77mm	38W/50W	5024lm/5000lm/6490lm	3000K/4000K/5500K
NET-51-11-67	Emergency	1500 x 215 x 77mm	38W/50W	5024lm/5000lm/6490lm	3000K/4000K/5500K
NET-51-11-68	Self Test Emergency	1500 x 215 x 77mm	38W/50W	5024lm/5000lm/6490lm	3000K/4000K/5500K
NET-51-11-75	Microwave Sensor	1500 x 215 x 77mm	38W/50W	5024lm/5000lm/6490lm	3000K/4000K/5500K
NET-51-11-76	Microwave Sensor Emergency	1500 x 215 x 77mm	38W/50W	5024lm/5000lm/6490lm	3000K/4000K/5500K
NET-51-11-77	Microwave Sensor Self Test Emergency	1500 x 215 x 77mm	38W/50W	5024lm/5000lm/6490lm	3000K/4000K/5500K
NET-51-11-70	Dimmable one4all	1500 x 215 x 77mm	50W	6490lm	3000K/4000K/5500K
NET-51-11-72	Dimmable Emergency	1500 x 215 x 77mm	50W	6490lm	3000K/4000K/5500K
NET-51-11-73	Dimmable Self Test Emergency	1500 x 215 x 77mm	50W	6490lm	3000K/4000K/5500K
NET-51-11-74	Dimmable DALI Emergency	1500 x 215 x 77mm	50W	6490lm	3000K/4000K/5500K

COMPATIBLE ACCESSORIES

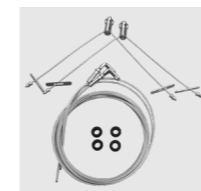

Suspension Kit



Photocell Sensor (Daylight Switch)



DALI Dimmer Switch

NET-51-11-02

NET-42-43-10

NET-42-43-24

DRIVERS USED



Tridonic Advanced Dual Wattage Driver as standard



Tridonic Premium Dimmable Driver on Dimmable options

powered by
TRIDONIC



140
lm/W

SELECTABLE COLOUR TEMPERATURE

Choose your colour temperature at the time of installation 3000K, 4000K or 5700K



DUAL WATTAGE TRIDONIC DRIVER

Choose the power setting at the time of installation

INTEGRAL MICROWAVE SENSOR WITH 6M DETECTION DISTANCE AND 5S-30MIN HOLD TIME

Save energy costs with a fitting that only lights the room when movement is detected

Microwave Sensor options only

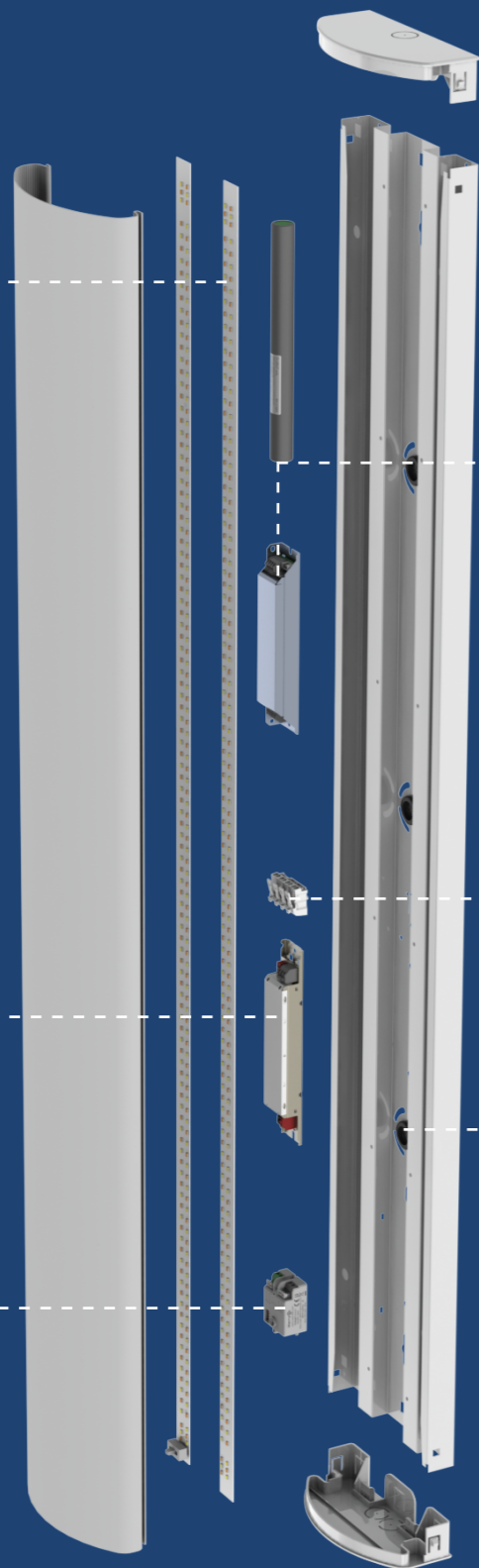

3H EMERGENCY OPERATION

Ensures the fitting comes on in the event of a power failure

Emergency options only

PUSH CONNECTOR

Reduce installation time with easy-to-use push fit terminals

REAR OR END CABLE ENTRY

Create seamless end-to-end lighting designs

TRINITY RANGE

4ft-6ft Dual Wattage
Tri-Colour Surface Linears



AVAILABLE IN



Emergency



Self Test Emergency



Microwave Sensor

Part Number	Description	Dimensions	Power	Lumens	Colour Temp.
NET-41-11-30	Standard	1200 x 170 x 79mm (4ft)	23W/32W	3300lm/4560lm	3000K/4000K/5700K
NET-41-11-32	Emergency	1200 x 170 x 79mm (4ft)	23W/32W	3300lm/4560lm	3000K/4000K/5700K
NET-41-11-34	Self Test Emergency	1200 x 170 x 79mm (4ft)	23W/32W	3300lm/4560lm	3000K/4000K/5700K
NET-41-11-35	Microwave Sensor	1200 x 170 x 79mm (4ft)	23W/32W	3300lm/4560lm	3000K/4000K/5700K
NET-41-11-37	Microwave Sensor Emergency	1200 x 170 x 79mm (4ft)	23W/32W	3300lm/4560lm	3000K/4000K/5700K
NET-41-11-39	Microwave Sensor Self Test Emergency	1200 x 170 x 79mm (4ft)	23W/32W	3300lm/4560lm	3000K/4000K/5700K
NET-41-11-40	Standard	1500 x 170 x 79mm (5ft)	34W/50W	4830lm/7120lm	3000K/4000K/5700K
NET-41-11-42	Emergency	1500 x 170 x 79mm (5ft)	34W/50W	4830lm/7120lm	3000K/4000K/5700K
NET-41-11-44	Self Test Emergency	1500 x 170 x 79mm (5ft)	34W/50W	4830lm/7120lm	3000K/4000K/5700K
NET-41-11-45	Microwave Sensor	1500 x 170 x 79mm (5ft)	34W/50W	4830lm/7120lm	3000K/4000K/5700K
NET-41-11-47	Microwave Sensor Emergency	1500 x 170 x 79mm (5ft)	34W/50W	4830lm/7120lm	3000K/4000K/5700K
NET-41-11-49	Microwave Sensor Self Test Emergency	1500 x 170 x 79mm (5ft)	34W/50W	4830lm/7120lm	3000K/4000K/5700K
NET-41-11-50	Standard	1800 x 170 x 79mm (6ft)	41W/60W	5760lm/8625lm	3000K/4000K/5700K
NET-41-11-52	Emergency	1800 x 170 x 79mm (6ft)	41W/60W	5760lm/8625lm	3000K/4000K/5700K
NET-41-11-54	Self Test Emergency	1800 x 170 x 79mm (6ft)	41W/60W	5760lm/8625lm	3000K/4000K/5700K
NET-41-11-55	Microwave Sensor	1800 x 170 x 79mm (6ft)	41W/60W	5760lm/8625lm	3000K/4000K/5700K
NET-41-11-57	Microwave Sensor Emergency	1800 x 170 x 79mm (6ft)	41W/60W	5760lm/8625lm	3000K/4000K/5700K
NET-41-11-59	Microwave Sensor Self Test Emergency	1800 x 170 x 79mm (6ft)	41W/60W	5760lm/8625lm	3000K/4000K/5700K

COMPATIBLE ACCESSORIES

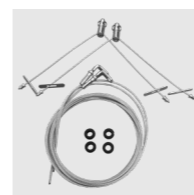

Suspension Kit

NET-51-11-02

powered by
TRIDONIC

140
lm/W

SELECTABLE COLOUR TEMPERATURE

Choose your colour temperature at the time of installation 3000K, 4000K or 5700K



TRIDONIC PREMIUM DIMMABLE DRIVER

Customise lighting levels and reduce electricity consumption

Dimmable options only

WIRELESS CONTROL

Control the panel remotely via smartphone or tablet with it's Bluetooth Dimmable Driver

Bluetooth options only

PUSH CONNECTOR

Reduce installation time with easy-to-use push fit terminals

REAR OR END CABLE ENTRY

Create seamless end-to-end lighting designs

TRINITY RANGE

Dimmable 4ft-6ft Tri-Colour Surface Linears

AVAILABLE IN

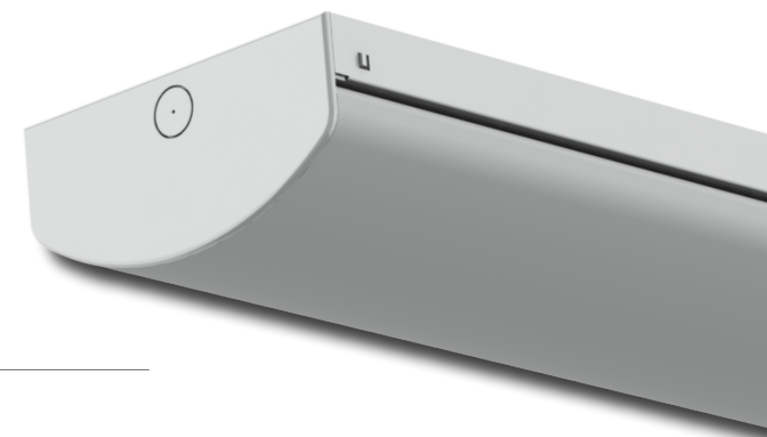

Part Number	Description	Dimensions	Power	Lumens	Colour Temp.
NET-41-11-36	Dimmable one4all	1200 x 170 x 79mm (4ft)	32W	4560lm	3000K/4000K/5700K
NET-41-11-38	Dimmable Emergency	1200 x 170 x 79mm (4ft)	32W	4560lm	3000K/4000K/5700K
NET-41-11-31	Dimmable Self Test Emergency	1200 x 170 x 79mm (4ft)	32W	4560lm	3000K/4000K/5700K
NET-41-11-33	Dimmable DALI Emergency	1200 x 170 x 79mm (4ft)	32W	4560lm	3000K/4000K/5700K
NET-41-11-46	Dimmable one4all	1500 x 170 x 79mm (5ft)	50W	7120lm	3000K/4000K/5700K
NET-41-11-48	Dimmable Emergency	1500 x 170 x 79mm (5ft)	50W	7120lm	3000K/4000K/5700K
NET-41-12-48	Dimmable Self Test Emergency	1500 x 170 x 79mm (5ft)	50W	7120lm	3000K/4000K/5700K
NET-41-11-43	Dimmable DALI Emergency	1500 x 170 x 79mm (5ft)	50W	7120lm	3000K/4000K/5700K
NET-41-11-41	Bluetooth	1500 x 170 x 79mm (5ft)	50W	7120lm	3000K/4000K/5700K
NET-41-12-41	Bluetooth Emergency	1500 x 170 x 79mm (5ft)	50W	7120lm	3000K/4000K/5700K
NET-41-11-56	Dimmable one4all	1800 x 170 x 79mm (6ft)	60W	8625lm	3000K/4000K/5700K
NET-41-11-58	Dimmable Emergency	1800 x 170 x 79mm (6ft)	60W	8625lm	3000K/4000K/5700K
NET-41-11-51	Dimmable Self Test Emergency	1800 x 170 x 79mm (6ft)	60W	8625lm	3000K/4000K/5700K
NET-41-11-53	Dimmable DALI Emergency	1800 x 170 x 79mm (6ft)	60W	8625lm	3000K/4000K/5700K



COMPATIBLE ACCESSORIES

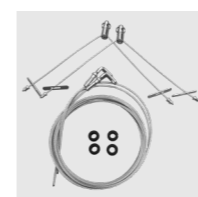

Suspension Kit

NET-51-11-02



Microwave Sensor On/Off

NET-42-43-02



DALI Dimmer Switch

NET-42-43-24



Bluetooth Dimmable/Scene Switch

NET-60-16-80

3H EMERGENCY OPERATION

Ensures the fitting comes on in the event of a power failure

Emergency options only

3K 4K 5.7K

SELECTABLE COLOUR TEMPERATURE

Choose your colour temperature 3000K, 4000K or 5700K

REAR OR END CABLE ENTRY

Create seamless end-to-end lighting designs

LOW GLARE RATED UGR<19

Reduce headaches and improve focus

DIMMABLE DRIVER

Customise lighting levels and reduce electricity consumption

Dimmable options only

PUSH CONNECTOR

Reduce installation time with easy-to-use push fit terminals

MARCH RANGE

4ft Tri-Colour Low Glare 1-10V As Standard Linear Light Bars

AVAILABLE IN



Emergency



Self Test Emergency



Dimmable

Part Number	Description	Dimensions	Power	Lumens	Colour Temp.
NET-43-11-30	Standard	1204 x 56 x 75mm (4ft)	36W	3700lm/3800lm/4000lm	3000K/4000K/5700K
NET-43-11-32	Emergency	1204 x 56 x 75mm (4ft)	36W	3700lm/3800lm/4000lm	3000K/4000K/5700K
NET-43-11-34	Self Test Emergency	1204 x 56 x 75mm (4ft)	36W	3700lm/3800lm/4000lm	3000K/4000K/5700K
NET-43-11-36	Dimmable	1204 x 56 x 75mm (4ft)	36W	3700lm/3800lm/4000lm	3000K/4000K/5700K
NET-43-11-38	Dimmable Emergency	1204 x 56 x 75mm (4ft)	36W	3700lm/3800lm/4000lm	3000K/4000K/5700K
NET-43-11-39	Dimmable DALI Emergency	1204 x 56 x 75mm (4ft)	36W	3700lm/3800lm/4000lm	3000K/4000K/5700K

COMPATIBLE ACCESSORIES



Straight Link Connector

NET-43-11-40

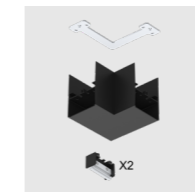

L Shape Non-Illuminated Corner Connector

NET-43-11-42



Suspension Kit

NET-43-11-44



Wall Mounting Kit

NET-43-11-46

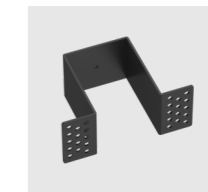

Recessed Mounting Kit

NET-43-11-48

A simple fitting for complicated installs.

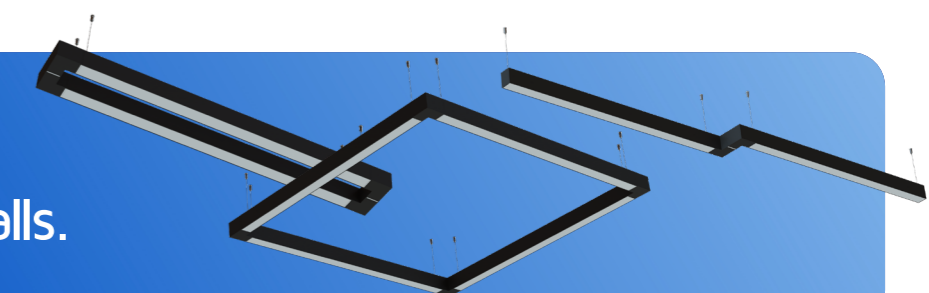

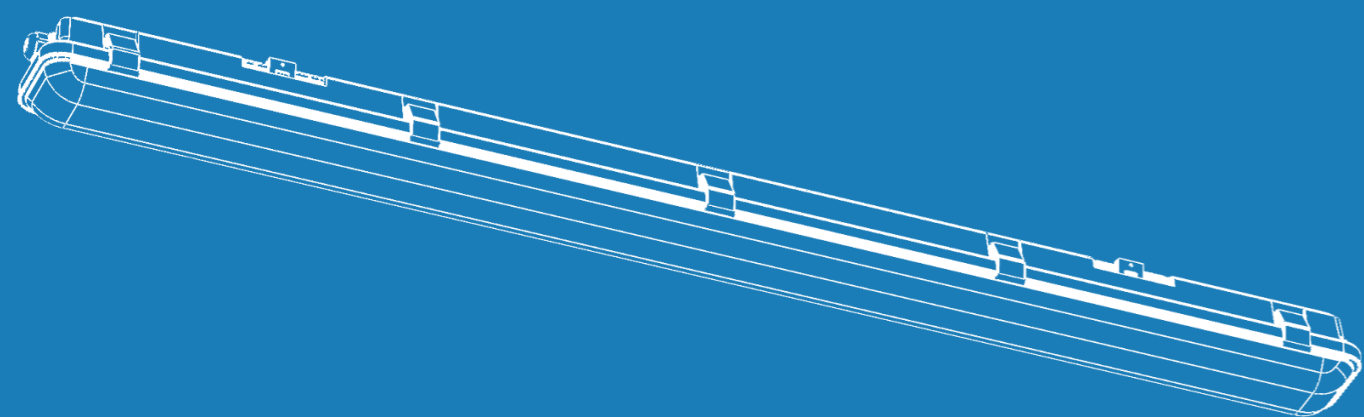

Battens and Non-Corrosives

A collection of linear fittings ranging from 2ft-6ft
designed for both commercial and industrial applications

3K 4K 5.7K

**SELECTABLE
COLOUR
TEMPERATURE**

Choose your colour temperature
3000K, 4000K or 5700K

**COMBINED DIFFUSER
AND LEDs**

Stop juggling multiple parts
and install a diffuser that comes
with built-in LEDs

PUSH CONNECTOR

Reduce installation time with
easy-to-use push fit terminals

**TRIDONIC DRIVER
AS STANDARD**

Ensure reliability, durability and
performance leading to
long-lasting LEDs

**REAR OR END
CABLE ENTRY**

Create seamless
end-to-end lighting designs

FOXTON RANGE

2ft-6ft Tri-Colour
High Lumen Output Battens



AVAILABLE IN



Emergency



Self Test Emergency

Part Number	Description	Dimensions	Power	Lumens	Colour Temp.
NET-41-11-68	Standard	670 x 63 x 73mm (2ft)	10W	1300lm	3000K/4000K/5700K
NET-41-11-69	Emergency	670 x 63 x 73mm (2ft)	10W	1300lm	3000K/4000K/5700K
NET-41-11-91	Standard	1220 x 63 x 73mm (4ft)	20W	2600lm	3000K/4000K/5700K
NET-41-11-92	Emergency	1220 x 63 x 73mm (4ft)	20W	2600lm	3000K/4000K/5700K
NET-41-12-92	Self Test Emergency	1220 x 63 x 73mm (4ft)	20W	2600lm	3000K/4000K/5700K
NET-41-11-93	Standard	1520 x 63 x 73mm (5ft)	25W	3250lm	3000K/4000K/5700K
NET-41-11-94	Emergency	1520 x 63 x 73mm (5ft)	25W	3250lm	3000K/4000K/5700K
NET-41-12-94	Self Test Emergency	1520 x 63 x 73mm (5ft)	25W	3250lm	3000K/4000K/5700K
NET-41-11-96	Standard	1520 x 63 x 73mm (5ft)	50W	6500lm	3000K/4000K/5700K
NET-41-11-95	Emergency	1520 x 63 x 73mm (5ft)	50W	6500lm	3000K/4000K/5700K
NET-41-12-95	Self Test Emergency	1520 x 63 x 73mm (5ft)	50W	6500lm	3000K/4000K/5700K
NET-41-11-97	Standard	1820 x 63 x 73mm (6ft)	35W	4550lm	3000K/4000K/5700K
NET-41-11-98	Emergency	1820 x 63 x 73mm (6ft)	35W	4550lm	3000K/4000K/5700K
NET-41-12-98	Self Test Emergency	1820 x 63 x 73mm (6ft)	35W	4550lm	3000K/4000K/5700K
NET-41-11-10	Standard	1820 x 63 x 73mm (6ft)	75W	9750lm	3000K/4000K/5700K
NET-41-11-99	Emergency	1820 x 63 x 73mm (6ft)	75W	9750lm	3000K/4000K/5700K
NET-41-12-99	Self Test Emergency	1820 x 63 x 73mm (6ft)	75W	9750lm	3000K/4000K/5700K

COMPATIBLE ACCESSORIES



Suspension Kit

NET-46-16-04



Microwave Sensor
On/Off

NET-42-43-38

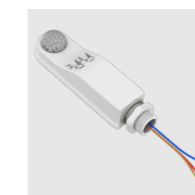

PIR Sensor
On/Off

NET-51-11-01

Step Dimming Tri-Colour LED Battens

Integral Microwave **and** Daylight Sensor ensures the fitting only comes on when insufficient light and movement are detected.

Its 0, 10 or 30% Standby Mode provides a lower lighting level when full brightness isn't necessary, providing visibility and safety whilst minimising energy consumption.

Part Number	Description	Dimensions	Power	Lumens	Colour Temp.
NET-41-11-87	Step Dimming Microwave Sensor	1520 x 63 x 73mm (5ft)	50W	6500lm	3000K/4000K/5700K
NET-41-11-88	Step Dimming Microwave Sensor Emergency	1520 x 63 x 73mm (5ft)	50W	6500lm	3000K/4000K/5700K

**Comes with
integral 2-in-1
Microwave and
Daylight sensor**

FOXTON RANGE

2ft-6ft Tri-Colour High Lumen Output Battens
With External PIR And Microwave Sensors

AVAILABLE IN



Microwave Sensor



PIR Sensor



Part Number	Description	Dimensions	Power	Lumens	Colour Temp.
NET-41-11-70	PIR Sensor On/Off	670 x 63 x 73mm (2ft)	10W	1300lm	3000K/4000K/5700K
NET-41-12-70	PIR Sensor On/Off Emergency	670 x 63 x 73mm (2ft)	10W	1300lm	3000K/4000K/5700K
NET-41-11-71	Microwave Sensor On/Off	670 x 63 x 73mm (2ft)	10W	1300lm	3000K/4000K/5700K
NET-41-12-71	Microwave Sensor On/Off Emergency	670 x 63 x 73mm (2ft)	10W	1300lm	3000K/4000K/5700K
NET-41-11-73	PIR Sensor On/Off	1220 x 63 x 73mm (4ft)	20W	2600lm	3000K/4000K/5700K
NET-41-11-74	PIR Sensor On/Off Emergency	1220 x 63 x 73mm (4ft)	20W	2600lm	3000K/4000K/5700K
NET-41-11-75	Microwave Sensor On/Off	1220 x 63 x 73mm (4ft)	20W	2600lm	3000K/4000K/5700K
NET-41-11-76	Microwave Sensor On/Off Emergency	1220 x 63 x 73mm (4ft)	20W	2600lm	3000K/4000K/5700K
NET-41-11-78	PIR Sensor On/Off	1520 x 63 x 73mm (5ft)	25W	3250lm	3000K/4000K/5700K
NET-41-11-79	PIR Sensor On/Off Emergency	1520 x 63 x 73mm (5ft)	25W	3250lm	3000K/4000K/5700K
NET-41-11-80	Microwave Sensor On/Off	1520 x 63 x 73mm (5ft)	25W	3250lm	3000K/4000K/5700K
NET-41-11-81	Microwave Sensor On/Off Emergency	1520 x 63 x 73mm (5ft)	25W	3250lm	3000K/4000K/5700K
NET-41-11-83	PIR Sensor On/Off	1520 x 63 x 73mm (5ft)	50W	6500lm	3000K/4000K/5700K
NET-41-12-83	PIR Sensor On/Off Emergency	1520 x 63 x 73mm (5ft)	50W	6500lm	3000K/4000K/5700K
NET-41-11-62	PIR Sensor On/Off	1820 x 63 x 73mm (6ft)	35W	4550lm	3000K/4000K/5700K
NET-41-11-63	PIR Sensor On/Off Emergency	1820 x 63 x 73mm (6ft)	35W	4550lm	3000K/4000K/5700K
NET-41-11-64	Microwave Sensor On/Off	1820 x 63 x 73mm (6ft)	35W	4550lm	3000K/4000K/5700K
NET-41-11-65	Microwave Sensor On/Off Emergency	1820 x 63 x 73mm (6ft)	35W	4550lm	3000K/4000K/5700K
NET-41-11-24	PIR Sensor On/Off	1820 x 63 x 73mm (6ft)	75W	9750lm	3000K/4000K/5700K
NET-41-11-25	PIR Sensor On/Off Emergency	1820 x 63 x 73mm (6ft)	75W	9750lm	3000K/4000K/5700K
NET-41-11-26	Microwave Sensor On/Off	1820 x 63 x 73mm (6ft)	75W	9750lm	3000K/4000K/5700K
NET-41-11-27	Microwave Sensor On/Off Emergency	1820 x 63 x 73mm (6ft)	75W	9750lm	3000K/4000K/5700K

powered by
TRIDONIC

COMBINED DIFFUSER AND LEDS

Stop juggling multiple parts and install a diffuser that comes with built-in LEDs

PUSH CONNECTOR

Reduce installation time with easy-to-use push fit terminals

REAR OR END CABLE ENTRY

Create seamless end-to-end lighting designs

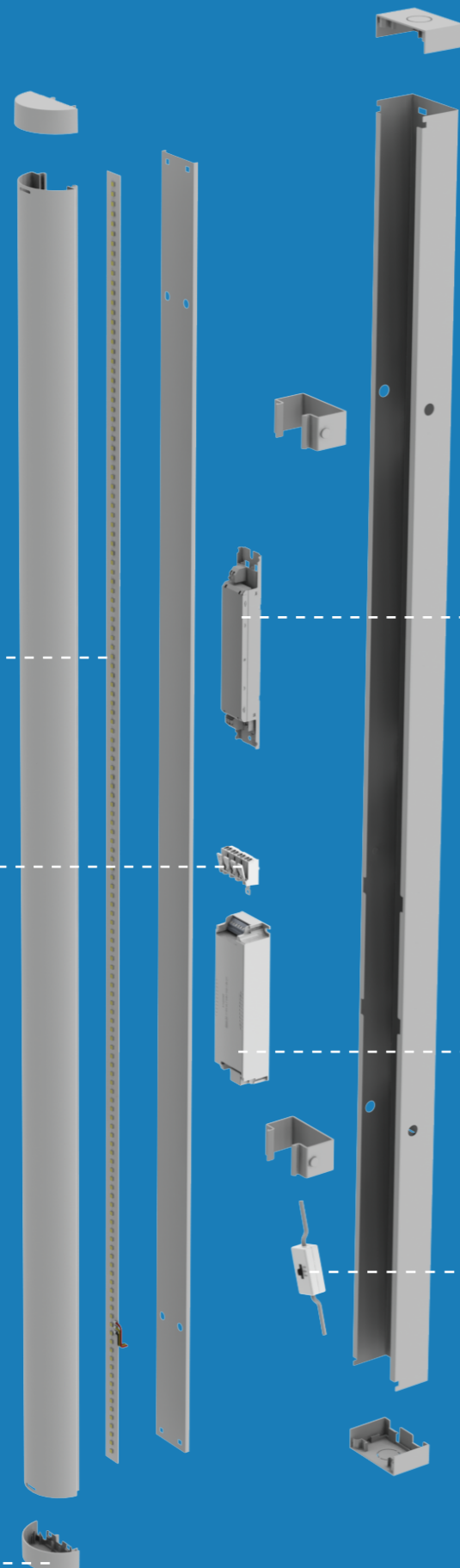

FLICKER-FREE TRIDONIC DIMMABLE DRIVER

Ensure reliability, durability and performance leading to long-lasting LEDs

Dimmable options only

WIRELESS CONTROL

Control the panel remotely via smartphone or tablet with it's Bluetooth Dimmable Driver

Bluetooth options only

3K

4K

5.7K

SELECTABLE COLOUR TEMPERATURE

Choose your colour temperature 3000K, 4000K or 5700K

FOXTON RANGE

4ft-6ft Dimmable And Bluetooth Tri-Colour High Lumen Output Battens

AVAILABLE IN



Part Number	Description	Dimensions	Power	Lumens	Colour Temp.
NET-41-11-08	Dimmable one4all	1220 x 63 x 73mm (4ft)	20W	2600lm	3000K/4000K/5700K
NET-41-11-09	Dimmable Emergency	1220 x 63 x 73mm (4ft)	20W	2600lm	3000K/4000K/5700K
NET-41-11-72	Dimmable DALI Emergency	1220 x 63 x 73mm (4ft)	20W	2600lm	3000K/4000K/5700K
NET-41-11-06	Dimmable one4all	1520 x 63 x 73mm (5ft)	25W	3250lm	3000K/4000K/5700K
NET-41-11-07	Dimmable Emergency	1520 x 63 x 73mm (5ft)	25W	3250lm	3000K/4000K/5700K
NET-41-11-77	Dimmable DALI Emergency	1520 x 63 x 73mm (5ft)	25W	3250lm	3000K/4000K/5700K
NET-41-11-13	Dimmable one4all	1520 x 63 x 73mm (5ft)	50W	6500lm	3000K/4000K/5700K
NET-41-11-14	Dimmable Emergency	1520 x 63 x 73mm (5ft)	50W	6500lm	3000K/4000K/5700K
NET-41-11-82	Dimmable DALI Emergency	1520 x 63 x 73mm (5ft)	50W	6500lm	3000K/4000K/5700K
NET-41-11-84	Bluetooth	1520 x 63 x 73mm (5ft)	50W	6500lm	3000K/4000K/5700K
NET-41-12-84	Bluetooth Emergency	1520 x 63 x 73mm (5ft)	50W	6500lm	3000K/4000K/5700K
NET-41-11-15	Dimmable one4all	1820 x 63 x 73mm (6ft)	35W	4550lm	3000K/4000K/5700K
NET-41-11-16	Dimmable Emergency	1820 x 63 x 73mm (6ft)	35W	4550lm	3000K/4000K/5700K
NET-41-11-61	Dimmable DALI Emergency	1820 x 63 x 73mm (6ft)	35W	4550lm	3000K/4000K/5700K
NET-41-11-17	Dimmable one4all	1820 x 63 x 73mm (6ft)	75W	9750lm	3000K/4000K/5700K
NET-41-11-18	Dimmable Emergency	1820 x 63 x 73mm (6ft)	75W	9750lm	3000K/4000K/5700K
NET-41-11-23	Dimmable DALI Emergency	1820 x 63 x 73mm (6ft)	75W	9750lm	3000K/4000K/5700K

COMPATIBLE ACCESSORIES

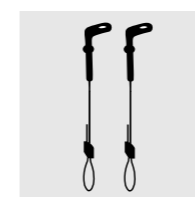

Suspension Kit

NET-46-16-04



DALI Dimmer Switch

NET-42-43-24



Bluetooth Dimmable/Scene Switch

NET-60-16-80

COMBINED DIFFUSER AND LEDS

Stop juggling multiple parts when installing with a diffuser that comes with built-in LEDs

0-10V DIMMABLE DUAL WATTAGE BOKE DRIVER

Choose your power setting at the time of installation and easily add controls with 0-10V protocol

3H EMERGENCY OPERATION

Ensures the fitting comes on in the event of a power failure

Emergency options only

PUSH CONNECTOR

Reduce installation time with easy-to-use push fit terminals

IP65 AND IK10 RATED HOUSING

Protect your fitting from water, dust and impact

TAMPER-PROOF FIXINGS

Prevent unwanted removal or tampering

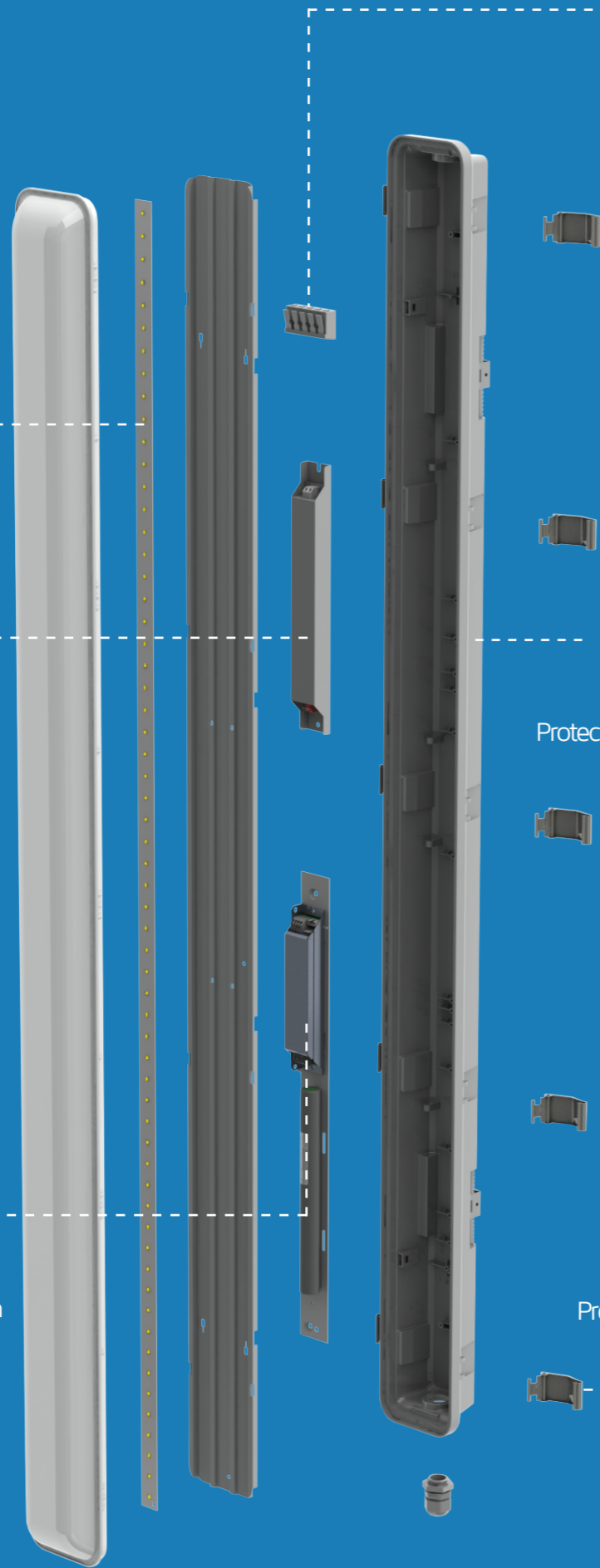

HILTON RANGE

2ft-6ft Dual Wattage High Lumen Output IP65 And IK10 Polycarbonate Non-Corrosive Fittings

AVAILABLE IN



Emergency



Self Test Emergency



Part Number	Description	Dimensions	Power	Lumens	Colour Temp.
NET-41-11-01	Standard	640 x 100 x 85mm (2ft)	14W/20W	1820lm/2600lm	3000K/4000K/5700K
NET-41-12-01	Emergency	640 x 100 x 85mm (2ft)	14W/20W	1820lm/2600lm	3000K/4000K/5700K
NET-41-11-03	Standard	1240 x 100 x 85mm (4ft)	24W/40W	3120lm/5200lm	3000K/4000K/5700K
NET-41-12-03	Emergency	1240 x 100 x 85mm (4ft)	24W/40W	3120lm/5200lm	3000K/4000K/5700K
NET-41-12-04	Self Test Emergency	1240 x 100 x 85mm (4ft)	24W/40W	3120lm/5200lm	3000K/4000K/5700K
NET-41-11-05	Standard	1540 x 100 x 85mm (5ft)	48W/60W	6240lm/7800lm	3000K/4000K/5700K
NET-41-12-05	Emergency	1540 x 100 x 85mm (5ft)	48W/60W	6240lm/7800lm	3000K/4000K/5700K
NET-41-12-06	Self Test Emergency	1540 x 100 x 85mm (5ft)	48W/60W	6240lm/7800lm	3000K/4000K/5700K
NET-41-11-11	Standard	1840 x 100 x 85mm (6ft)	62W/80W	8060lm/10400lm	3000K/4000K/5700K
NET-41-12-11	Emergency	1840 x 100 x 85mm (6ft)	62W/80W	8060lm/10400lm	3000K/4000K/5700K
NET-41-12-13	Self Test Emergency	1840 x 100 x 85mm (6ft)	62W/80W	8060lm/10400lm	3000K/4000K/5700K



COMPATIBLE ACCESSORIES



Suspension Kit

NET-46-16-04



Microwave Sensor On/Off

NET-42-43-38



Microwave Sensor with Step Dimming

NET-42-43-33

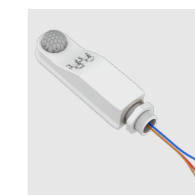

PIR Sensor On/Off

NET-51-11-01

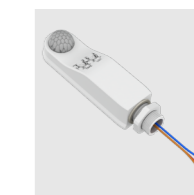

PIR Sensor with Step Dimming

NET-51-11-03



Comes with integral 2-in-1 Microwave and Daylight sensor

Step Dimming Tri-Colour Dual Wattage LED NCFs

Integral Microwave **and** Daylight Sensor ensures the fitting only comes on when insufficient light and movement are detected.

Its 0, 10 or 30% Standby Mode provides a lower lighting level when full brightness isn't necessary, providing visibility and safety whilst minimising energy consumption.

Part Number	Description	Dimensions	Power	Lumens	Colour Temp.
NET-41-11-66	Microwave Sensor with Step Dimming	1540 x 100 x 85mm (5ft)	48W/60W	6240lm/7800lm	3000K/4000K/5700K
NET-41-12-66	Microwave Sensor Emergency with Step Dimming	1540 x 100 x 85mm (5ft)	48W/60W	6240lm/7800lm	3000K/4000K/5700K

HILTON RANGE

2ft-6ft Dual Wattage High Lumen Output IP65 And IK10 Polycarbonate Non-Corrosive Fittings With External PIR And Microwave Sensors With Step Dimming

AVAILABLE IN



Microwave Sensor



PIR Sensor



Part Number	Description	Dimensions	Power	Lumens	Colour Temp.
NET-41-11-02	PIR Sensor with Step Dimming	640 x 100 x 85mm (2ft)	14W/20W	1820lm/2600lm	3000K/4000K/5700K
NET-41-11-04	PIR Sensor Emergency with Step Dimming	640 x 100 x 85mm (2ft)	14W/20W	1820lm/2600lm	3000K/4000K/5700K
NET-41-11-19	Microwave Sensor with Step Dimming	640 x 100 x 85mm (2ft)	14W/20W	1820lm/2600lm	3000K/4000K/5700K
NET-41-11-22	Microwave Sensor Emergency with Step Dimming	640 x 100 x 85mm (2ft)	14W/20W	1820lm/2600lm	3000K/4000K/5700K
NET-41-11-28	PIR Sensor with Step Dimming	1240 x 100 x 85mm (4ft)	24W/40W	3120lm/5200lm	3000K/4000K/5700K
NET-41-12-28	PIR Sensor Emergency with Step Dimming	1240 x 100 x 85mm (4ft)	24W/40W	3120lm/5200lm	3000K/4000K/5700K
NET-41-11-29	Microwave Sensor with Step Dimming	1240 x 100 x 85mm (4ft)	24W/40W	3120lm/5200lm	3000K/4000K/5700K
NET-41-12-29	Microwave Sensor Emergency with Step Dimming	1240 x 100 x 85mm (4ft)	24W/40W	3120lm/5200lm	3000K/4000K/5700K
NET-41-11-60	PIR Sensor with Step Dimming	1540 x 100 x 85mm (5ft)	48W/60W	6240lm/7800lm	3000K/4000K/5700K
NET-41-12-60	PIR Sensor Emergency with Step Dimming	1540 x 100 x 85mm (5ft)	48W/60W	6240lm/7800lm	3000K/4000K/5700K
NET-41-11-67	PIR Sensor with Step Dimming	1840 x 100 x 85mm (6ft)	62W/80W	8060lm/10400lm	3000K/4000K/5700K
NET-41-12-67	PIR Sensor Emergency with Step Dimming	1840 x 100 x 85mm (6ft)	62W/80W	8060lm/10400lm	3000K/4000K/5700K
NET-41-11-89	Microwave Sensor with Step Dimming	1840 x 100 x 85mm (6ft)	62W/80W	8060lm/10400lm	3000K/4000K/5700K
NET-41-12-89	Microwave Sensor Emergency with Step Dimming	1840 x 100 x 85mm (6ft)	62W/80W	8060lm/10400lm	3000K/4000K/5700K

COMPATIBLE ACCESSORIES



Suspension Kit

NET-46-16-04

130
lm/W

COMBINED DIFFUSER AND LEDS

Stop juggling multiple parts when installing with a diffuser that comes with built-in LEDs

FLICKER-FREE TRIDONIC DIMMABLE DRIVER

Ensure reliability, durability and performance leading to long-lasting LEDs

Dimmable options only

SELECTABLE COLOUR TEMPERATURE

Choose your colour temperature 3000K, 4000K or 5700K

3K

4K

5.7K

PUSH CONNECTOR

Reduce installation time with easy-to-use push fit terminals

IP65 AND IK10 RATED HOUSING

Protect your fitting from water, dust and impact

TAMPER-PROOF FIXINGS

Prevent unwanted removal or tampering

HILTON RANGE

4ft-6ft Dimmable High Lumen Output IP65 And IK10 Polycarbonate Non-Corrosive Fittings

AVAILABLE IN



Part Number	Description	Dimensions	Power	Lumens	Colour Temp.
NET-41-11-20	Dimmable one4all	1240 x 100 x 85mm (4ft)	40W	5200lm	3000K/4000K/5700K
NET-41-11-09	Dimmable Emergency	1240 x 100 x 85mm (4ft)	40W	5200lm	3000K/4000K/5700K
NET-41-12-20	Dimmable DALI Emergency	1240 x 100 x 85mm (4ft)	40W	5200lm	3000K/4000K/5700K
NET-41-11-12	Dimmable one4all	1540 x 100 x 85mm (5ft)	60W	7800lm	3000K/4000K/5700K
NET-41-12-12	Dimmable Emergency	1540 x 100 x 85mm (5ft)	60W	7800lm	3000K/4000K/5700K
NET-41-11-90	Dimmable DALI Emergency	1540 x 100 x 85mm (5ft)	60W	7800lm	3000K/4000K/5700K
NET-41-11-21	Dimmable one4all	1840 x 100 x 85mm (6ft)	75W	9750lm	3000K/4000K/5700K
NET-41-12-15	Dimmable Emergency	1840 x 100 x 85mm (6ft)	75W	9750lm	3000K/4000K/5700K
NET-41-12-21	Dimmable DALI Emergency	1840 x 100 x 85mm (6ft)	75W	9750lm	3000K/4000K/5700K

COMPATIBLE ACCESSORIES



Suspension Kit

NET-46-16-04



DALI Dimmer Switch

NET-42-43-24

DRIVERS USED



Tridonic Premium Dimmable Driver as standard

powered by
TRIDONIC



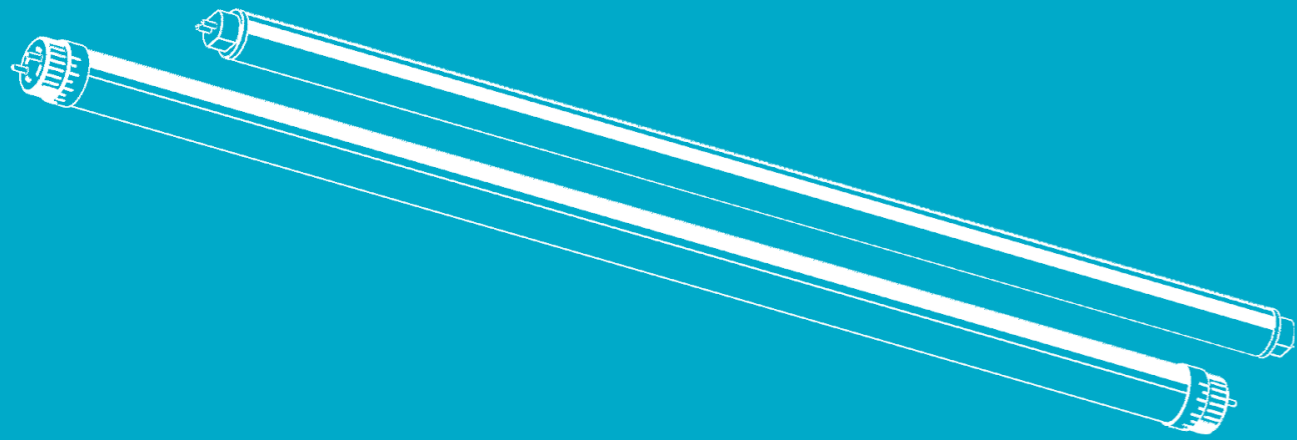

T5 and T8 Tubes

A range of T5 and T8 Tubes available in three different colour temperatures
3000K, 4000K or 5500K

3K 4K 5.5K

3000K, 4000K AND 5500K COLOUR TEMPERATURES AVAILABLE

Can be used for a variety of applications from commercial and retail spaces to residential environments

T8

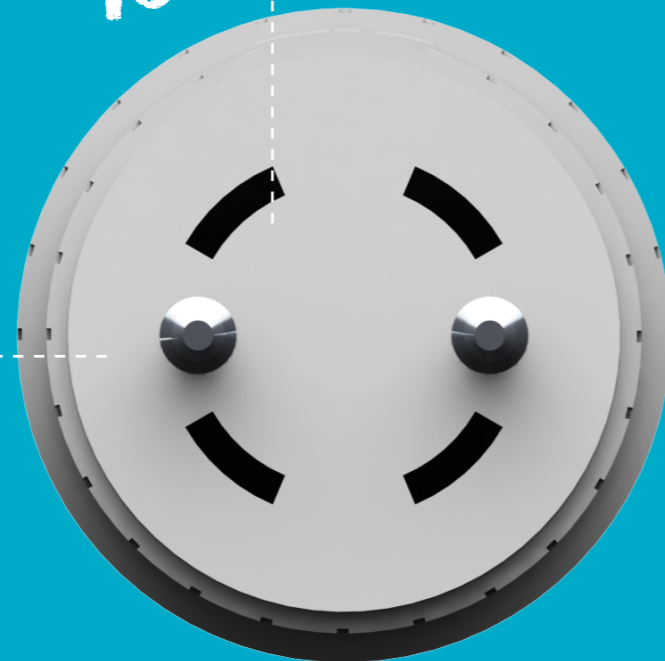

ROTATABLE END CAPS

Direct the light exactly where it's needed

4K 5.5K

4000K AND 5500K COLOUR TEMPERATURES AVAILABLE

Can be used for a variety of applications from commercial and retail spaces to residential environments

T5

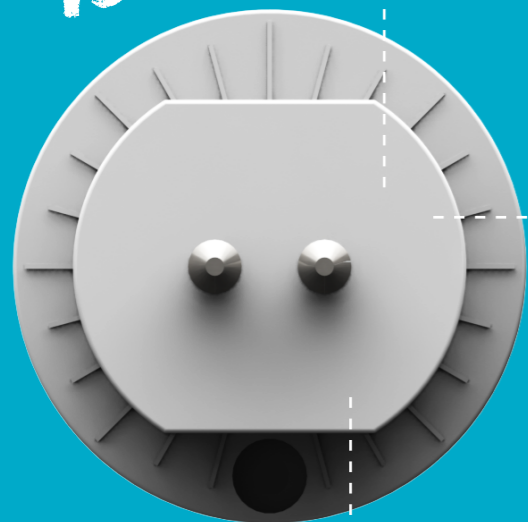

DALI DIMMABLE DRIVER OPTIONS AVAILABLE

Customise lighting levels and reduce electricity consumption

DALI options only

CARLTON RANGE

3000K, 4000K and 5500K T5 and T8 Tubes
With Aluminium Housing And Rotatable End Caps



AVAILABLE IN



Part Number	Description	Dimensions	Power	Lumens	Colour Temp.
NET-55-01-03	T5 Tube (1ft)	302.5 x 22mm	4W	560lm	5500K
NET-55-01-05	T5 Tube (2ft)	563.2 x 22mm	8W	1120lm	5500K
NET-55-01-08	T5 Tube (3ft)	863.2 x 22mm	9W	1280lm	4000K
NET-55-01-07	T5 Tube (3ft)	863.2 x 22mm	9W	1280lm	5500K
NET-55-01-10	T5 Tube (4ft)	1163.2 x 22mm	11W	1540lm	4000K
NET-55-01-09	T5 Tube (4ft)	1163.2 x 22mm	11W	1540lm	5500K
NET-55-01-12	T5 Tube (5ft)	1463.2 x 22mm	14W	1980lm	4000K
NET-55-01-11	T5 Tube (5ft)	1463.2 x 22mm	14W	1980lm	5500K
NET-55-01-14	T5 DALI Tube inc. Driver (3ft)	863.2 x 22mm	12W	1560lm	4000K
NET-55-01-02	T5 DALI Tube exc. Driver (3ft)	863.2 x 22mm	12W	1560lm	4000K
NET-55-01-16	T5 DALI Tube inc. Driver (4ft)	1163.2 x 22mm	16W	2200lm	4000K
NET-55-01-04	T5 DALI Tube exc. Driver (4ft)	1163.2 x 22mm	16W	2200lm	4000K
NET-55-01-18	T5 DALI Tube inc. Driver (5ft)	1463.2 x 22mm	20W	2600lm	4000K
NET-55-01-06	T5 DALI Tube exc. Driver (5ft)	1463.2 x 22mm	20W	2600lm	4000K
NET-55-02-01	T8 Tube (2ft)	604 x 28mm	8W	1080lm	5500K
NET-55-02-02	T8 Tube (3ft)	908.8 x 28mm	9W	1220lm	5500K
NET-55-02-03	T8 Tube (4ft)	1213.6 x 28mm	15W	2050lm	5500K
NET-55-02-13	T8 Tube (5ft)	1514.2 x 28mm	16W	2200lm	3000K
NET-55-02-07	T8 Tube (5ft)	1514.2 x 28mm	16W	2200lm	4000K
NET-55-02-04	T8 Tube (5ft)	1514.2 x 28mm	16W	2200lm	5500K
NET-55-02-15	T8 Tube (6ft)	1778 x 28mm	22W	3000lm	3000K
NET-55-02-09	T8 Tube (6ft)	1778 x 28mm	22W	3000lm	4000K
NET-55-02-05	T8 Tube (6ft)	1778 x 28mm	22W	3000lm	5500K

COMPATIBLE ACCESSORIES

Manual/Self Test Emergency Selectable LED Converter	3H Emergency Kit	DALI Emergency Kit	Replacement Starter
NET-50-12-10	NET-50-33-01	NET-19-33-17	NET-51-11-01

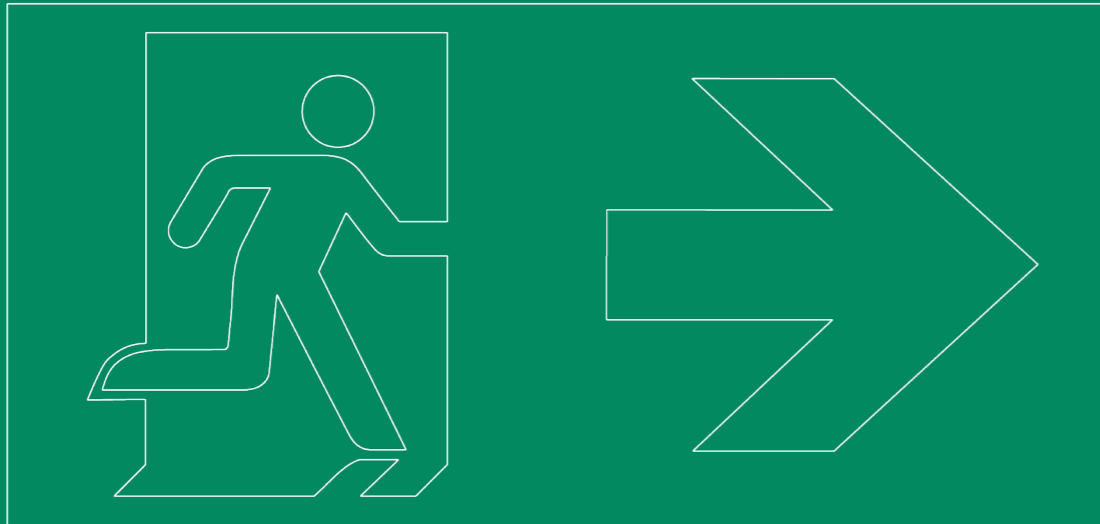

Emergency Lighting

A mix of DALI, self-test, maintained and non-maintained emergency lighting

Put us to the Self Test.

Get your hands on Self Test Emergency options on our most popular ranges, including our very own **Made In Britain Bulkheads and Slim Circulares!**

- ✓ Save time and money on tedious manual inspections
- ✓ Rest easy knowing all areas of your building are protected in the event of power failure
- ✓ No disruptions to your daily operations with easy installation and hassle-free maintenance



Full prices and specifications available at www.mynetled.co.uk



BUCKDEN RANGE

Self Test Emergency Lighting With 5 Year Warranties



Part Number	Description	Power	Luminous Flux	Colour Temp.	Self Test
NET-61-35-13	Emergency Kit for Panels and Downlights	3W	N/A	N/A	Yes
NET-61-35-76	IP65 Emergency Bulkhead	3W	320lm	4000K	Yes
NET-61-35-72	Emergency EXIT Box	3W	30lm	4000K	Yes
NET-61-35-82	Left Arrow for Emergency EXIT Box	N/A	N/A	N/A	N/A
NET-61-35-83	Right Arrow for Emergency EXIT Box	N/A	N/A	N/A	N/A
NET-61-35-84	Down Arrow for Emergency EXIT Box	N/A	N/A	N/A	N/A
NET-61-35-64	Mini Recessed Emergency Downlight	1.5W	150lm	4000K	Yes
NET-61-35-50	Emergency EXIT Blade	3W	30lm	4000K	Yes
NET-61-35-51	Left and Right Arrow for Emergency EXIT Blade	N/A	N/A	N/A	N/A
NET-61-35-52	Down Arrow for Emergency EXIT Blade	N/A	N/A	N/A	N/A
NET-61-35-53	Recess Mounting Kit for Emergency EXIT Blade	N/A	N/A	N/A	N/A

COMPATIBLE ACCESSORIES



Suspension Wire Kit

NET-43-11-44



Only compatible with Emergency EXIT Blade



Remote Control for Self Test EXIT Signage

NET-61-35-10



Only compatible with Emergency EXIT Box and Emergency EXIT Blade

What are the benefits of DALI Emergency Lighting?

Flexibility.

It's adaptable to various building layouts and designs, allowing for easier installation and integration into existing systems.

Centralised control.

Enables remote monitoring and management of emergency lighting, simplifying maintenance and troubleshooting.

Cost savings.

Reduces maintenance costs due to its self-diagnostic capabilities and longer-lasting components.

Reliability.

Provides a robust and reliable system that ensures the lighting functions as intended during emergencies, enhancing safety for building occupants.

BOURNE RANGE

DALI Emergency Lighting Able To Integrate With A DALI Lighting Control System



Multi-Installation DALI Emergency IP20 EXIT Blade



DALI Emergency IP65 EXIT Bulkhead inc. Legends



DALI Emergency IP65 Twin Spot

Part Number	Description	Power	Lumens	Colour Temp.	Self Test
NET-51-10-75	Multi-Installation DALI Emergency IP20 EXIT Blade	3W	54lm	6000K	No
NET-51-10-71	DALI Emergency IP65 EXIT Bulkhead inc. Legends	2W	220lm	5000K	No
NET-51-10-85	DALI Emergency IP65 Twin Spot	9W	1200lm	5000K	No

COMPATIBLE ACCESSORIES



Only compatible with Multi-Installation DALI Emergency IP20 EXIT Blade



Left and Right Arrow

NET-51-10-77



Down Arrow

NET-51-10-76



Suspension Kit

NET-51-10-79



Recess Mount Kit

NET-51-10-78



Did you know you're ordering Emergency Lighting that complies with ICEL requirements?

ICEL is The Industry Committee for Emergency Lighting.

Its mission is to strengthen the industry and promote
the benefits of good quality lighting.

It represents all aspects of the UK, EU and international legislation
and standards at the highest level, whilst protecting the
interests of the public and LIA ICEL Members.

Products complying with ICEL requirements are designed to be
effective in a building emergency, especially when the normal mains
supply fails, when efficient evacuation is absolutely essential.



BOURNE RANGE

Maintained And Non-
Maintained Emergency Lighting

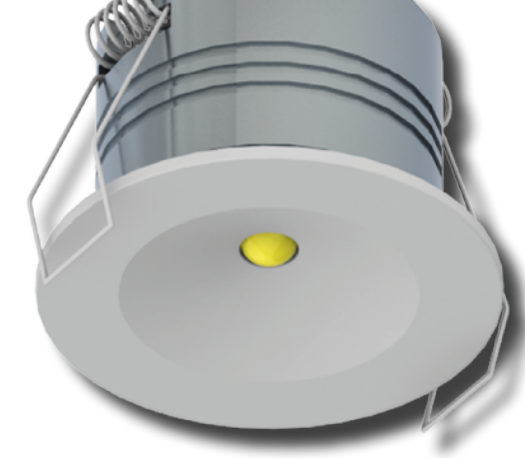

Mini Non-Maintained
Emergency Downlight



Surface Mount Emergency
Escape Route



Emergency
Twin Spot



Self Test Emergency
IP65 Twin Spot

Part Number	Description	Power	Lumens	Colour Temp.	Self Test
NET-51-10-64	Mini Non-Maintained Emergency Downlight	3W	140lm	6000K	No
NET-44-10-66	Surface Mount Emergency Escape Route	2.2W	130lm	6500K	No
NET-44-10-68	Emergency Twin Spot	5.2W	2 x 193lm	6500K	No
NET-44-10-70	Self Test Emergency IP65 Twin Spot	5.4W	2 x 393lm	6500K	Yes

Bourne to save lives.

Emergency Lighting that's on
when you need it most.



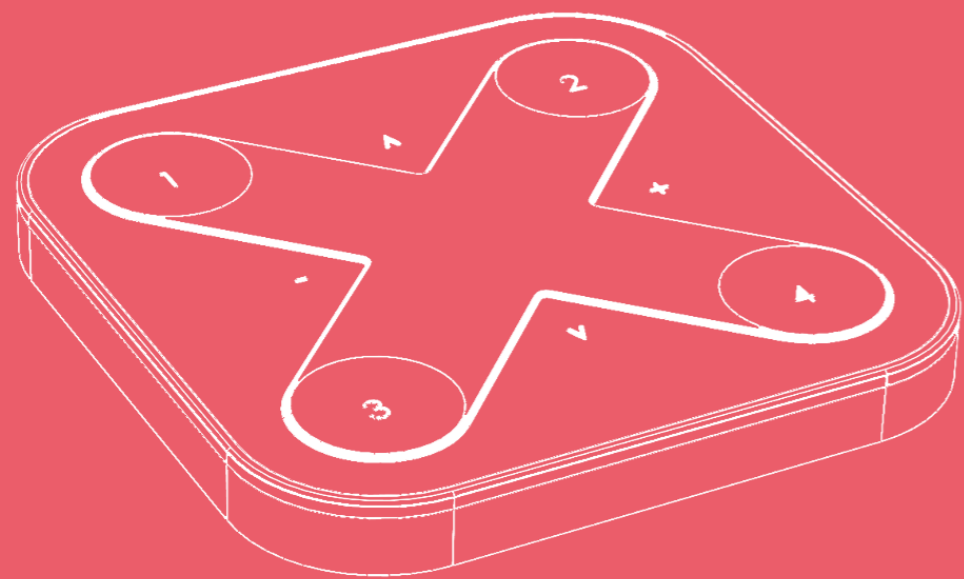

Wireless Controls

A range of LED controls including Bluetooth Wireless, DALI, Triac and one4all drivers

TRIDONIC

Pre-set scenes and brightness levels at the touch of a button.

Customise the lighting of your room to suit a variety of applications.

The Dimmable/Scene Switch works with any of our Bluetooth Dimmable Drivers, and gives you ultimate multi-room scene control.



WIRELESS CONTROLS

Bluetooth Dimmable Drivers
And Smart Bluetooth Wireless Controls



Part Number	Description	Power	Output Current	Radio Properties	Input Voltage (AC)
NET-60-16-60	Bluetooth Dimmable Driver	25W	350mA	N/A	220-240V
NET-60-16-70	Bluetooth Dimmable Driver	25W	500mA	N/A	220-240V
NET-60-16-40	Bluetooth Tunable Driver	30W	300mA	N/A	220-240V
NET-60-16-20	Bluetooth Dimmable Driver	45W	800mA	N/A	220-240V
NET-60-16-22	Bluetooth Dimmable Driver	45W	700mA	N/A	220-240V
NET-60-16-30	Bluetooth Dimmable Driver	45W	1200mA	N/A	220-240V
NET-60-16-80	Dimmable/Scene Switch	N/A	N/A	2.4 - 2.484GHz	220-240V



What's the difference between Daylight Harvesting and Photocell?

A standard photocell will detect levels of natural light and switch on/off accordingly. So, lights can be switched on as natural light levels drop, and switched off when natural light levels increase.

More sophisticated Daylight Harvesting sensors will dim the lights gradually when they detect increasing levels of natural light. Providing consistent lighting levels and only use as much energy needed to light the space to a set level.

Photocell sensors provide consistent lighting levels and only use as much light as necessary, reducing energy usage.



What's the difference between PIR and Microwave Sensors?

PIR sensors detect heat signatures by measuring the ambient temperatures of the room. When a difference in temperature is detected, the sensor is activated, switching on the light.

Microwave sensors detect motion by emitting microwave signals. When the sensor detects movement, it will activate and turn on the lights. When it is unable to detect any movement, it will turn the light off.



UNIVERSAL CONTROLS

Controls Offering Increased Efficiency Using Motion And Daylight Sensors



Part Number	Description	Max. Detection Distance	Max. LED Load	Duration
20mm Knock Out Sensors				
NET-42-43-38	Microwave Sensor On/Off*	4m	400W	5s - 30min
NET-42-43-33	Microwave Sensor with Step Dimming*	15m	400W	5s - 30min
NET-51-11-01	PIR Sensor On/Off	10m	500W	10s - 30min
NET-51-11-03	PIR Sensor with Step Dimming	10m	500W	10s - 30min
Recessed/Surface Mount Ceiling Sensors				
PRD-70-10-55	Tridonic BT Wireless Sensor basicDIM 5DP 38rc	Ø8m	n/a	n/a
NET-51-11-05	Ceiling PIR Sensor IP65	10m	600W	10s - 30min
NET-51-11-06	Ceiling/Surface Mount PIR Sensor IP20	10m	n/a	10s - 30min
NET-42-43-05	Recessed Ceiling Microwave Sensor IP20*	4m	400W	5s - 30min
NET-42-43-40	DALI Daylight Harvesting Microwave Sensor*	5m	400W	5s - 30min
External Sensors				
NET-51-04-59	Photocell Kit (Daylight Switch)	N/A	400W	N/A
NET-42-43-36	Microwave Sensor with Step Dimming*	15m	400W	5s - 30min
Integrated Sensors				
NET-42-43-02	Microwave Sensor On/Off	6m	400W	5s - 30min
NET-42-43-10	Photocell Sensor (Daylight Switch)	N/A	400W	N/A
NET-42-43-12	1-10V Daylight Harvesting Sensor	N/A	N/A	N/A
Remote Control for Sensors				
NET-42-43-22	Remote Control for Microwave Sensors	N/A	N/A	N/A



*Requires Remote Control NET-42-43-22

DIMMING simplified!

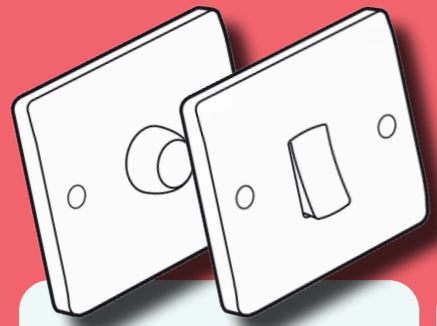

QUESTION...

DALI

1-10V

PUSH/ SWITCH

TRIAC

Are you dimming from more than one point?

Yes

No

No

No

How many luminaires?

1-25

1-6

1-10

1-6

Is there any wiring already in place?

4/5 Core
(Mains + Signal)

4/5 Core
(Mains + Signal)

3 Core
(Permanent +
Switched + Neutral)

2 Core
(Live + Neutral)

What switch type?

Rotary
DALI switch

Rotary

Retractive

Mains

DIMMING DRIVERS

DALI 1 & 2, switchDIM (Push),
1-10V And Triac (Mains) Dimmable Options



Part Number	Description	Power	Output Current	Dimming Input Type
NET-60-43-50	Tridonic one4all Dimmable Driver	25W	250mA	DALI 1 & 2 and switchDIM (Push)
NET-60-43-60	Tridonic one4all Dimmable Driver	25W	350mA	DALI 1 & 2 and switchDIM (Push)
NET-60-43-70	Tridonic one4all Dimmable Driver	25W	500mA	DALI 1 & 2 and switchDIM (Push)
NET-60-43-40	Tridonic one4all Dimmable Driver	25W	700mA	DALI 1 & 2 and switchDIM (Push)
NET-60-43-10	Tridonic one4all Dimmable Driver	45W	700mA	DALI 1 & 2 and switchDIM (Push)
NET-60-43-20	Tridonic one4all Dimmable Driver	45W	800mA	DALI 1 & 2 and switchDIM (Push)
NET-60-43-30	Tridonic one4all Dimmable Driver	45W	1200mA	DALI 1 & 2 and switchDIM (Push)
NET-60-43-82	Tridonic Triac Dimmable Driver	21W	300mA/500mA	Triac Mains Dimming
NET-60-43-80	Tridonic Triac Dimmable Driver	30W/45W	700mA/1050mA	Triac Mains Dimming
NET-42-43-26	Merrytek Dimming Driver	10W	200mA-700mA	Push Dimming and DALI 2
NET-42-43-14	Merrytek Dimming Driver	20W	250mA-700mA	Push Dimming, DALI 2 and 1-10V
NET-42-43-17	Kreat Dimming Driver	40W	700mA-1200mA	Push Dimming, DALI 2 and 1-10V
NET-42-43-18	Merrytek Dimming Driver	60W	900mA-1750mA	Push Dimming, DALI 2 and 1-10V

COMPATIBLE ACCESSORIES



DALI
Dimmer Switch

NET-42-43-24



We don't mess around when it comes to depth of range.

Dual Wattage, Tri-Colour, Single Colour, Emergency, Dimmable, Motion Sensor, Photocell... these are just a few of the options available to you when you order through the myNETLED Portal.

The best thing about it? They all come in one part number, so you don't have to order any extras!

Accessories galore!

Need a Suspension Kit, Surface Mount Box, Emergency Kit, PIR/Microwave Sensor, or Dimmer Switch?

Our warehouse is full of optional accessories for those tricky installs.



ACCESSORIES

Universal Suspension Kits, Surface/Recessed Mounting Kits And Emergency Kits

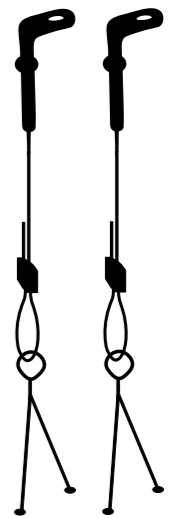

Part Number	Description	Suspension Point	Max. Suspended Weight	Product Fixing Method
NET-39-16-03	Burgess Adjustable Z Clips for Kingston Panels	N/A	N/A	Pull Up
NET-39-16-05	Burgess Z Clips for Kingston Panels	N/A	N/A	Pull Up
NET-46-16-02	Suspension Kit for Kingston Panels	Ceiling Mounted 90° Eyelet	10Kg/Fixing Point	Y Wires with Clips
NET-39-03-45	Suspension Rails for 1200mm Panels	N/A	N/A	N/A
NET-43-16-04	Suspension Kit for 600x600mm Ashley Panels	4 Suspension Points	20Kg	Wires with Clips
NET-43-16-05	Suspension Kit for 1200x600mm Ashley Panels	6 Suspension Points	20Kg	Wires with Clips
NET-39-03-39	Surface Mount Box for 600x600mm Panels	N/A	N/A	N/A
NET-39-03-41	Surface Mount Box for 1200x300mm Panels	N/A	N/A	N/A
NET-39-03-43	Surface Mount Box for 1200x600mm Panels	N/A	N/A	N/A
NET-39-03-47	Recessed Frame for 600x600mm Panels	N/A	N/A	N/A
NET-46-16-04	Suspension Kit for Battens and NCFs	Ceiling Mounted 90° Eyelet	10Kg/Fixing Point	Loop'n'Lock
NET-46-16-06	Suspension Kit for High Bays	Purlin Loop-a-round	45Kg/Fixing Point	Loop'n'Lock
NET-46-16-08	Suspension Kit for Low Bays	Purlin Loop-a-round	45Kg/Fixing Point	Y Wires with Clips



Suspension Rails require Suspension Kit NET-46-16-02

Part Number	Description	Power	Output Voltage	Battery Pack
NET-50-12-08	Manual/Self Test Emergency Selectable LED Converter for Panels and Downlights	2.5W	10-50V DC	LiFePO4 3.2V 3.2Ah
NET-50-12-10	Manual/Self Test Emergency Selectable LED Converter for Tubes	2.5W	50-300V DC	LiFePO4 3.2V 3.2Ah
NET-50-33-01	Streamer Emergency Kit for Tubes	3W	50-300V DC	6.4V3000mAh
NET-19-33-17	Liteplan DALI Emergency Kit for Tubes	3W	85-300V DC	3 x 4.5Ah D Ni-Cd 3.6V
NET-55-33-03	Streamer Emergency Kit for Panels and Downlights	3W	10-50V DC	6.4V2200mAh
NET-19-33-15	Luxbox DALI Emergency Kit for Panels and Downlights	3W	Up to 45V	LiFePO4 3.2V 4.5Ah
NET-61-35-13	Buckden Self Test Emergency Kit for Panels and Downlights	3W	Up to 55V DC	Li-on 3.6V 5.0Ah
NET-61-33-03	DALI Emergency Kit for Panels and Downlights	3W	Up to 55V DC	Li-on 3.6V 50Ah
NET-61-33-04	DALI Emergency Kit for Battens and NCFs	3W	Up to 55V DC	Li-on 3.6V 50Ah

Get in touch

Contact our team today and discover how we can become your favourite next day commercial and industrial LED lighting supplier!



The myNETLED Portal.

Quicker. Easier. Online.

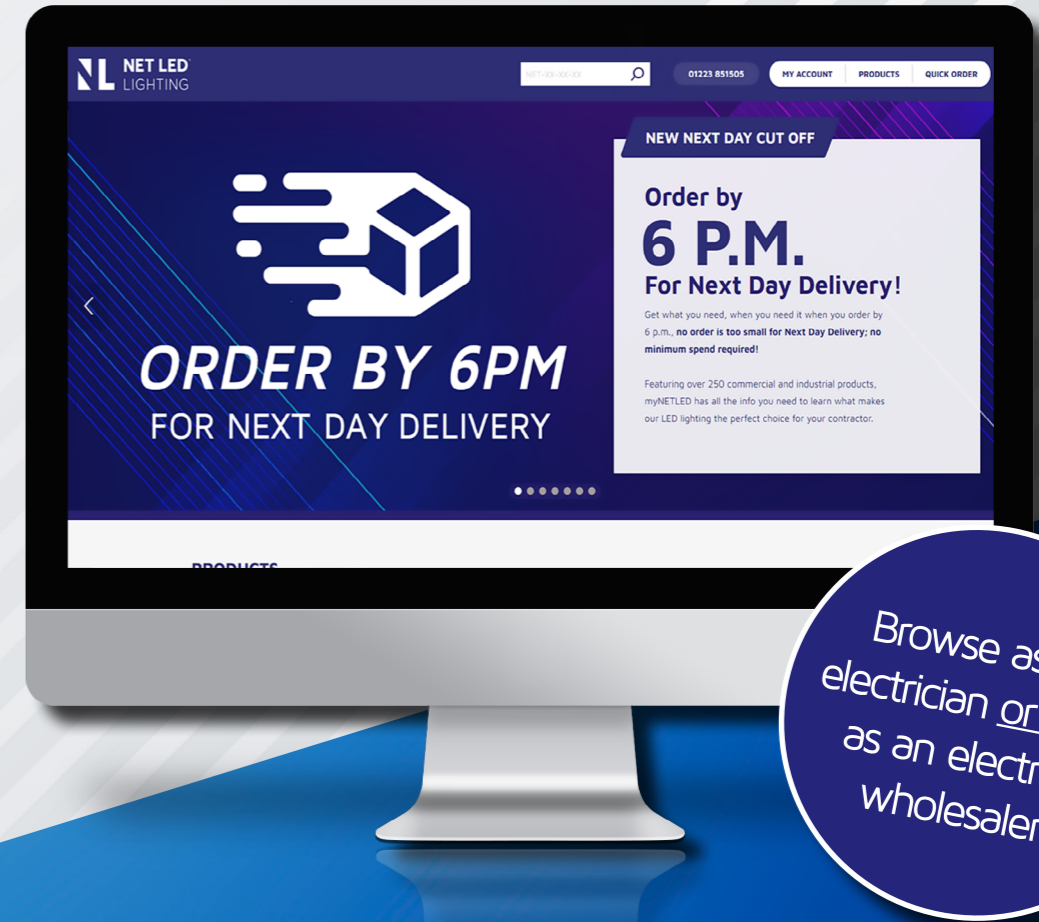

- ✓ Wholesaler quotes in 60 seconds
- ✓ Electrician access to trade pricing
- ✓ Data sheets at the click of a button
- ✓ Access to lead times and live stock data

Start taking the hassle out of those last minute orders over at www.mynetled.co.uk



NET LED Lighting
Buckingway Business Park
300 Anderson Road
Cambridge CB24 4UQ

T: 01223 851505
E: sales@netled.co.uk
W: www.netled.co.uk



In keeping with the company's policy of continued development, NET LED reserves the right to change specifications without notice. The information contained herein is representative only and does not form part of any contract.