

TECHNICAL CATALOGUE

# SACE Emax 2

## Low voltage air circuit-breakers



# SACE Emax 2

## Consultation guide



Chapter 1

### Main characteristics

Overview of the SACE Emax 2 family, distinctive features of the series, product conformity and service.



Chapter 2

### The ranges

Electrical characteristics of automatic circuit breakers, switch disconnectors and derived versions.



Chapter 3

### Protection trip units

Latest generation Ekip protection trip units for power distribution and generation.



Chapter 4

### Software functions

New generation of functionalities ready for every type of system and simple to use.



Chapter 5

### Supervision and connectivity

Supervision, Energy Management and complete integration in the systems with the possibility of communicating with several protocols and energy management via cloud.



Chapter 6

### Accessories

Accessories for SACE Emax 2 circuit breakers (signaling, control, interlocks, etc..) and for Ekip protection trip units (connectivity, measurements, protection, etc).



Chapter 7

### Installation

Installation and circuit breaker performance in switchgear, installation environment, degree of protection and limiting curves.



Chapter 8

### Overall dimensions

Overall dimensions for fixed circuit breakers, withdrawable circuit breakers and accessories.



Chapter 9

### Wiring diagrams

Circuit-breaker and accessories wiring diagrams.



Chapter 10

### Ordering codes

Ordering codes with configuration examples.

---

# SACE Emax 2

## Index

MAIN  
CHARACTERISTICS

01

THE RANGES

02

PROTECTION  
TRIP UNITS

03

SOFTWARE  
FUNCTIONS

04

SUPERVISION AND  
CONNECTIVITY

05

ACCESSORIES

06

INSTALLATION

07

OVERALL DIMENSIONS

08

WIRING DIAGRAMS

09

ORDERING CODES

10



---

# Main characteristics

- 1/2**      **Overview of the SACE Emax 2 family**
- 1/3**      **Distinctive features**
- 1/3      Performance
- 1/4      Control
- 1/4      Connectivity
- 1/6      Ease of use
- 1/8**      **Product conformity**
- 1/8      Approvals and certifications
- 1/9      Quality and Sustainability
- 1/10**     **ABB Low Voltage Product Service**

# Overview of the SACE Emax 2 family

## SACE Emax 2, a further leap forward

The world of the electrical power distribution changes fast and major new trends such as energy efficiency, connectivity and smart grids are now crowding onto the stage. These trends lead to new customer and application demands. To meet these demands, ABB has now further improved SACE Emax 2. SACE Emax 2 air circuit breaker is now a multifunctional platform able to manage the next generation of electrical plants such as microgrids, evolving into a true Power Manager.

SACE Emax 2 is the first air circuit breaker that matches all the new grid requirements. It enables

a direct communication to the new energy management cloud-computing platform ABB Ability™ Electrical Distribution Control System.

If the smart and plug & play architecture makes SACE Emax 2 easy to use, the cutting-edge connectivity capabilities create a circuit breaker able to evolve during the lifecycle. Thanks to the ABB Ability Marketplace™ offering and the full portfolio of commissioning tools, it is always possible to enhance the device, even when installed.

SACE Emax 2 sets a new circuit breaker benchmark for the needs of today and tomorrow, leveraging also unmatched electrical performances.



# Distinctive features

SACE Emax 2 evolution from circuit breaker to Power Manager continues, embedding more and more functionalities to become the all-in-one solution to manage "low-voltage distribution systems".

## Performance

The SACE Emax 2 range is made up of 4 sizes: E1.2, E2.2, E4.2 and E6.2 up to 6300A, which enable switchgear of compact dimensions and high ratings to be built with busbars of reduced length and cross-section.

The protection trip units, auxiliary connections and main accessories are the same throughout the range to simplify design and installation. Furthermore, the sizes from E2.2 to E6.2 have the same height and depth.

The rating levels are updated and standardized throughout the sizes to meet the demands and needs of today's installations, from 42kA to 150kA, and to standardize switchgear projects. High short-time currents, together with the efficiency of the protection functions, guarantee complete selectivity in all situations.

Accurate design and choice of materials enable optimization of the overall dimensions of the circuit breaker. In this way switchgear of compact dimensions can be built and outstanding savings at the same performance can be obtained.

The SACE Emax 2 range is extended also to the UL market, up to 5000A. Furthermore it can be ordered with a triple marking label, IEC, UL and CCC.

SACE Emax 2 air circuit breakers are certified for Class 1 active energy measurement in compliance with the IEC61557-12 standard. This permits to satisfy highly demanding requirements of energy efficiency and to perfectly fit into SCADA systems thanks to a current detection proximal to 0. Achieving maximum efficiency of an electrical installation requires intelligent management of power supplies and energy use. For this reason, the new technologies used in SACE Emax 2 circuit breakers allow the productivity and reliability of installations to be optimized, and at the same time, power consumption to be reduced while fully respecting the environment. New advanced functionalities, together with Protection trip units and Communication and system devices contribute to make SACE Emax 2 the circuit breaker that maximizes efficiency in all low-voltage electrical installation.

# Distinctive features

## Control

SACE Emax 2 circuit breaker is the first single device ready to manage all the dynamics of a low-voltage electrical installation.

Managing loads in any condition is now possible thanks to Advanced Functionalities such as:

- **Load shedding:** fast load shedding to guarantee continuity for critical loads during black-outs. Typical scenario is when LV distribution is disconnected from the grid (MV).
- **Power controller:** patented algorithm to reduce the peak of power consumed, allowing savings on electricity bills. Managing different power sources and connecting them to main grid is also crucial, so that service continuity is maximized.
- **Embedded ATS functions:** an automatic transfer switch system used in all application where continuity is essential and where there are multi source supplies.
- **Synchrocheck logics:** Synchronization of voltage and frequency to allow plant reconnection to the Utility. SACE Emax 2 is able to act as a controller of Main grid condition, disconnecting a plant when necessary and also to adapt protection to on-grid or off-grid conditions.
- **Interface protection system:** Check of Main grid conditions and plant disconnection whenever grid voltage and frequency are out of the ranges.
- **Adaptive protection:** Network changes recognition and automatic set of thresholds to guarantee protection and coordination in on-grid and off-grid conditions.

## Connectivity

SACE Emax 2 series circuit breakers can be integrated perfectly into all automation and energy management systems to improve productivity and energy consumption and to carry out remote service.

All circuit breakers can be equipped with communication units for use with Modbus, Profibus, and DeviceNet™ protocols as well as the modern Modbus TCP, Profinet, EtherNet/IP™ and Open ADR. The cartridge-type modules can be easily installed directly on the terminal box, even at a later date. Furthermore, the integrated IEC61850 communication module enables connection to automation systems widely used in medium voltage power distribution to create intelligent networks (Smart Grids).

All circuit breaker settings and functions are also accessible via Bluetooth, using EPiC mobile app. This remote connection allows a safer interaction with the device mitigating the risk of arc flash accidents.

Furthermore with an easy connection thanks to Ekip Com Hub module, SACE Emax 2 can be integrated in ABB Ability™ Electrical Distribution Control System, exploiting all the capabilities of a cloud computing platform such as predictive maintenance, analysis and report download. The power and auxiliary connections are optimized to simplify connection to the switchgear. The power terminals, which can be oriented horizontally or vertically, have been designed for the most common busbars, while the push-in connections of the auxiliaries ensure immediate and safe wiring.





# Distinctive features

## Ease of use

The entire range is available in fixed and withdrawable versions, with double insulation between the front of the switchgear and the live parts to ensure operation in complete safety. The circuit breakers can be powered indifferently from above or below.

All essential information is available in the central area of the front shield and enables immediate identification of the status of the circuit breaker: open, closed, ready to close, charged and discharged springs.

Maintenance is simple and safe. Thanks to the new front shield design, the main accessories can be installed without completely removing it.

The withdrawable circuit breaker is inserted and removed via dedicated guide rails that simplify movement. The correct movement from racked-in, test isolated, to racked-out position is guaranteed by a lock in each position.

As a further guarantee of safety, the shutters of the fixed part can be locked from the front when the circuit breaker is removed.

The shutters of the upper terminals are independent of those of the lower terminals to facilitate checking and maintenance operations.

The Ekip Touch protection trip units are equipped with a large colour touch-screen display which enables safe and intuitive operation. Furthermore the Ekip trip units can be accessed by means of smartphone, tablet or portable PC, thanks to enhanced connectivity capabilities and a full portfolio of commissioning tools. The increased computing power allows to update the circuit breaker maintaining it closed and in service during the operation.

SACE Emax 2 is now able to evolve during the life-cycle thanks to dedicated software packages available on the ABB Ability Marketplace™. Upgrade and customize the circuit breaker has never been so easy. Thanks to the customization simplicity, communication modules installation ease and clear user interface, SACE Emax 2 is making the complex system ready for a new digital experience.



- Key
- 1 Trademark and size of circuit-breaker
  - 2 SACE Ekip protection trip unit
  - 3 Pushbutton for manual opening
  - 4 Pushbutton for manual closing
  - 5 Lever to manually charge closing springs
  - 6 Electrical rating plate
  - 7 Mechanical device to signal circuit breaker open "O" and closed "I"
  - 8 Signal for springs charged or discharged
  - 9 Mechanical signalling of overcurrent release tripped
  - 10 Size and serial number



# Product conformity

SACE Emax 2 circuit breakers and their accessories conform to IEC 60947, EN 60947 international Standard

## Approvals and certifications

SACE Emax 2 circuit breakers and their accessories conform to the international IEC 60947, EN 60947 (harmonized in 30 CENELEC countries), CEI EN 60947 and IEC 61000 Standards and comply with the following EC directives:

- “Low-Voltage Directives” (LVD) no. 2014/35/EU
- “Electromagnetic Compatibility Directive” (EMC) no. 2014/30/EU.

The ABB air circuit breakers include a range that has been certified according to American UL 1066 Standards; it is also certified by the Russian certification body GOST (Russia Certificate of Conformity) and has achieved China CCC Certification (China Compulsory Certification).

Certification of conformity with the above-mentioned product Standards is carried out in compliance with the European EN 45011 Standard by the Italian certification body ACAE (Association for the Certification of Electrical Equipment), which is recognized by the European organization LOVAG (Low-Voltage Agreement Group), and by the Swedish Intertek SEMKO certification organization Intertek Semko which is recognized by the international organization IECEE.

**The main versions of the devices are about to be approved by the following shipping registers.**



Registro Italiano Navale (RINA):  
Italian



Lloyd's Register of Shipping (LR):  
English



American Bureau of Shipping (ABS):  
American



Germanischer Lloyd (GL):  
Deutsch



Bureau Veritas (BV):  
French



Det Norske Veritas (DNV):  
Norway



Russian Maritime Register of Shipping (RMRS):  
Russian



Nippon Kaiji Kyokai (NKK):  
Japan



Gost - Eac



Low-Voltage Agreement Group

For the types of certified circuit breakers, certified ratings and corresponding validity, please contact ABB SACE.



Quality and Sustainability: company efficiency and integrated management systems. Quality, Sustainability and Customer Satisfaction have always been ABB SACE's major commitment.

The involvement of all company departments and organization of processes have led the company to develop, implement and certify management systems in compliance with international Standards:

- ISO 9001 for quality management
- IRIS for the quality of supplies in the railway sector (International Railway Industry Standards)
- ISO 14001 for environmental management
- OHSAS 18001 for the management of the health and safety of employees in the workplace
- SA 8000 for the management of social responsibility.

The ABB SACE testing laboratory, accredited by ACCREDIA in compliance with ISO/IEC 17025 Standard, provides both ABB and external customers with a qualified service for performing certification tests on devices and electric equipment of low and medium voltage in accordance with the relevant product Standards.

Thanks to the implementation of systems and their integration (Integrated Management System), ABB SACE, with a view to continuous improvement, has implemented processes with a focus on:

- quality, preventing defects and faults along the entire supply chain
- environment, reviewing production processes in terms of ecology and waste reduction, rationalizing the consumption of raw materials and energy, preventing pollution, containing noise emissions and reducing the quantity of rejects in the production processes
- health and safety of employees, offering a healthy and safe workplace in all of the various stages of work with a "zero accident objective"
- social responsibility, guaranteeing the respect of human rights and the absence of any discrimination throughout the supply chain, and offering a favourable and transparent working atmosphere.

A further commitment aimed at safeguarding the environment has been achieved by assessing products' life cycles (LCA, Life Cycle Assessment): this includes the assessment and improvement of the environmental performance of products from the engineering stage throughout their entire life cycle.

The materials, processes and packaging used are chosen with a view to optimising the actual environmental impact of each product, including its energy efficiency and recyclability.



# ABB Low Voltage Product Service

ABB's technical assistance service offers solutions aimed at supporting the customer in all stages of the lifespan of the circuit breaker in service and covering the entire chain of value; ABB is present from the moment of selection to the end of the life of the product, thereby guaranteeing the investments of its customers.



ABB supplies annual updates regarding the evolution of the circuit breaker ranges (Life Cycle Management) and for each product it provides details of associated services and the level of support available, so that customers can choose the products and spare parts best suited to their needs.

ABB's organisation offers services that include installation and commissioning, technical training on the use and maintenance of products, the supply of original spare parts, corrective and preventive maintenance, equipment diagnostics, modernisation of systems with upgrades and retrofitting kits, consultancy services and personalised maintenance and service contracts.

All this is supported by one of the most extensive global sales and service networks.

## Retrofitting kit

Through continuous research targeted at the needs of the customer, ABB SACE Service has developed innovative retrofitting kits in order to simplify and speed up installation of a new circuit breaker, updating the customer's investment with the latest technology available and with very limited down times.

The retrofitting kit between Emax2 and Emax is a retrofit solution: it is therefore possible to replace the withdrawable version of Emax with an equivalent Emax2 model without changing the switchboard busbars, by simply removing the fixed part of Emax replacing it with a fixed part of Emax2 which has been suitably modified with dedicated terminals.



---

# The ranges

- 2/2**      **SACE Emax 2 automatic circuit breakers**
- 2/4**      **SACE Emax 2 switch disconnectors**
- 2/6**      **SACE Emax 2/E9 circuit breakers up to 900V**
- 2/7**      **SACE Emax 2 derived versions**

# SACE Emax 2 automatic circuit breakers

Common data		
Rated service voltage Ue	[V]	690
Rated insulation voltage Ui	[V]	1000
Rated impulse withstand voltage Uimp	[kV]	12
Frequency	[Hz]	50 - 60
Number of poles		3- 4
Version		Fixed - Withdrawable
Suitable for isolation according to		IEC 60947-2



## SACE Emax 2

## E1.2

### Performance levels

### B

### C

### N

Rated uninterrupted current I <sub>u</sub> @ 40°C		[A]	630	630	250
		[A]	800	800	630
		[A]	1000	1000	800
		[A]	1250	1250	1000
		[A]	1600	1600	1250
		[A]			1600
		[A]			
Neutral pole current-carrying capacity for 4-pole CBs		[%I <sub>u</sub> ]	100	100	100
Rated ultimate short-circuit breaking capacity I <sub>cu</sub>	400-415 V	[kA]	42	50	66
	440 V	[kA]	42	50	66
	500-525 V	[kA]	42	42	50
	690 V	[kA]	42	42	50
Rated service short-circuit breaking capacity I <sub>cs</sub>		[%I <sub>cu</sub> ]	100	100	100 <sup>1)</sup>
Rated short-time withstand current I <sub>cw</sub>	(1s)	[kA]	42	42	50
	(3s)	[kA]	24	24	30
Rated short-circuit making capacity (peak value) I <sub>cm</sub>	400-415 V	[kA]	88	105	145
	440 V	[kA]	88	105	145
	500-525 V	[kA]	88	88	105
	690 V	[kA]	88	88	105
Utilization category (according to IEC 60947-2)			B	B	B
Breaking	Breaking time for I < I <sub>cw</sub>	[ms]	40	40	40
	Breaking time for I > I <sub>cw</sub>	[ms]	25	25	25
Dimensions	H - Fixed/Withdrawable	[mm]	296/363.5	296/363.5	296/363.5
	D - Fixed/Withdrawable	[mm]	183/271	183/271	183/271
	W - Fixed 3p/4p/4p FS	[mm]	210/280		
	W - Withdrawable 3p/4p/4p FS	[mm]	278/348		
Weights (CB with trip unit and current sensor)	Fixed 3p/4p	kg	14/16		
	Withdrawable 3p/4p/4p FS including fixed part	kg	38/43		

1) I<sub>cs</sub> : 50kA for 400V...440V voltage; 2) I<sub>cs</sub>: 125kA for 400V...440V voltage; 3) E4.2H 3200A: 66 I<sub>cw</sub> (3s)

## SACE Emax 2

## E1.2

Mechanical life with regular ordinary maintenance prescribed by the manufacturer		[I <sub>u</sub> ]	≤ 1000	1250	1600
		[No. cycles x 1000]	20	20	20
	Frequency	[Oper./Hour]	60	60	60
Electrical life with regular ordinary maintenance prescribed by the manufacturer	440 V	[No. cycles x 1000]	8	8	8
	690 V	[No. cycles x 1000]	8	6,5	6,5
	Frequency	[Oper./Hour]	30	30	30





E2.2				E4.2				E6.2			
B	N	S	H	N	S	H	V	H	V	X	
1600	800	250	800	3200	3200	3200	2000	4000	4000	4000	
2000	1000	800	1000	4000	4000	4000	2500	5000	5000	5000	
	1250	1000	1250				3200	6300	6300	6300	
	1600	1250	1600				4000				
	2000	1600	2000								
	2500	2000	2500								
		2500									
100	100	100	100	100	100	100	100	50-100	50-100	50-100	
42	66	85	100	66	85	100	150	100	150	150	
42	66	85	100	66	85	100	150	100	150	150	
42	66	66	85	66	66	85	100	100	130	130	
42	66	66	85	66	66	85	100	100	100	100	
100	100	100	100	100	100	100	100 <sup>2)</sup>	100	100	100	
42	66	66	85	66	66	85	100	100	100	120	
42	50	50	66	50	66	75 <sup>3)</sup>	75	100	100	100	
88	145	187	220	145	187	220	330	220	330	440	
88	145	187	220	145	187	220	330	220	330	440	
88	145	145	187	145	145	187	220	220	286	286	
88	145	145	187	145	145	187	220	220	220	264	
B	B	B	B	B	B	B	B	B	B	B	
40	40	40	40	40	40	40	40	40	40	40	
25	25	25	25	25	25	25	25	25	25	25	
371/425	371/425	371/425	371/425	371/425	371/425	371/425	371/425	371/425	371/425	371/425	
270/383	270/383	270/383	270/383	270/383	270/383	270/383	270/383	270/383	270/383	270/383	
276/366				384/510				762/888/1014			
317/407				425/551				803/929/1069			
41/53				56/70				109/125/140			
84/99				110/136				207/234/260			

E2.2				E4.2				E6.2			
< 1600	1600	2000	2500	< 2500	2500	3200	4000	4000	5000	6300	
25	25	25	20	20	20	20	15	12	12	12	
60	60	60	60	60	60	60	60	60	60	60	
15	12	10	8	10	8	7	5	4	3	2	
15	10	8	7	10	8	7	4	4	2	2	
30	30	30	30	20	20	20	20	10	10	10	

# SACE Emax 2 switch disconnectors

Switch disconnectors, identified with the abbreviation “/MS”, are devices that satisfy the isolating specifications provided by the IEC 60947-3 Standard. The switch disconnectors are derived from the corresponding automatic circuit breakers, and they have the same dimensions and accessory options.

This version differs from the automatic circuit-breakers only because of the absence of protection trip units.

The device, when in the open position, guarantees an isolating distance between the main contacts of the circuit breaker that is sufficient to ensure that the installation downstream is not live.

Furthermore the switch disconnectors, if used with an external protection relay with maximum delay of 500ms, enable a breaking capacity at a maximum rated operating voltage ( $U_e$ ) equal to the value of rated short-time withstand current ( $I_{cw}$ ) for one second.

Common data		
Rated service voltage $U_e$	[V]	690
Rated insulation voltage $U_i$	[V]	1000
Rated impulse withstand voltage $U_{imp}$	[kV]	12
Frequency	[Hz]	50 - 60
Number of poles		3- 4
Version		Fixed - Withdrawable
Suitable for isolation according to		IEC 60947-3



SACE Emax 2		E1.2		
Performance levels		B/MS	N/MS	
Rated uninterrupted current $I_u$ @ 40°C		[A]	630	250
		[A]	800	630
		[A]	1000	800
		[A]	1250	1000
		[A]	1600	1250
		[A]		1600
Neutral pole current-carrying capacity for 4-pole CBs		[% $I_u$ ]	100	100
Rated short-time withstand current $I_{cw}$	(1s)	[kA]	42	50
	(3s)	[kA]	24	30
Rated short-circuit making capacity (peak value) $I_{cm}$	400-415 V	[kA]	88	105
	440 V	[kA]	88	105
	500-525 V	[kA]	88	105
	690 V	[kA]	88	105
Utilization category (according to IEC 60947-3)			AC-23A	AC-23A
Dimensions	H - Fixed / Withdrawable	[mm]	296 / 363.5	296 / 363.5
	D - Fixed / Withdrawable	[mm]	183 / 271	183 / 271
	W - Fixed 3p/4p/4p FS	[mm]	210 / 280	
	W - Withdrawable 3p/4p/4p FS	[mm]	278 / 348	

1) E4.2H/MS 3200A: 66KA  $I_{cw}$  (3s)

SACE Emax 2		E1.2			
Mechanical life with regular ordinary maintenance prescribed by the manufacturer		[ $I_u$ ]	< 1000	1000	1600
		[No. cycles x 1000]	20	20	20
Electrical life with regular ordinary maintenance prescribed by the manufacturer	Frequency	[Oper./Hour]	60	60	60
	440 V	[No. cycles x 1000]	8	8	8
	690 V	[No. cycles x 1000]	8	6.5	6.5
	Frequency	[Oper./Hour]	30	30	30



<b>E2.2</b>			<b>E4.2</b>			<b>E6.2</b>		
B/MS	N/MS	H/MS	N/MS	H/MS	V/MS	H/MS	X/MS	
1600	800	800	3200	3200	2000	4000	4000	
2000	1000	1000	4000	4000	2500	5000	5000	
	1250	1250			3200	6300	6300	
	1600	1600			4000			
	2000	2000						
	2500	2500						
100	100	100	100	100	100	50-100	50-100	
42	66	85	66	85	100	100	120	
42	50	66	50	75 <sup>1)</sup>	75	100	100	
88	145	187	145	187	220	220	264	
88	145	187	145	187	220	220	264	
88	145	187	145	187	220	220	264	
88	145	187	145	187	220	220	264	
AC-23A	AC-23A	AC-23A	AC-23A	AC-23A	AC-23A	AC-23A	AC-23A	
371 / 425	371 / 425	371 / 425	371 / 425	371 / 425	371 / 425	371 / 425	371 / 425	
270 / 383	270 / 383	270 / 383	270 / 383	270 / 383	270 / 383	270 / 383	270 / 383	
276 / 366			384 / 510			762 / 888 / 1014		
317 / 407			425 / 551			803 / 929 / 1069		

<b>E2.2</b>			<b>E4.2</b>			<b>E6.2</b>				
< 1600	1600	2000	2500	< 2500	2500	3200	4000	4000	5000	6300
25	25	25	20	20	20	20	15	12	12	12
60	60	60	60	60	60	60	60	60	60	60
15	12	10	8	10	8	7	5	4	3	2
15	10	8	7	10	8	7	4	4	2	2
30	30	30	30	20	20	20	20	10	10	10

# SACE Emax 2/E9 circuit breakers up to 900V

ABB SACE Emax 2/E9 circuit breakers can effectively and simply control all wind and solar applications - with the highest availability and continuity of service.

The world of renewable energy is evolving rapidly causing major changes in electrical power distribution trends. This causes an increased focus on:

- Power continuity for critical loads and the best performance, even at high altitudes
- Optimized, fast maintenance
- Minimized device footprint

These trends lead to new customer and application demands. To meet these demands, ABB has now unveiled the innovative Emax 2/E9 all-in-one, the evolution of the Emax 2 into a multifunctional platform that is able to manage the next generation of electrical plants such as microgrids.

Emax 2/E9 all-in-one is the first smart circuit breaker that enables direct communication with the new energy management cloud-computing platform ABB Ability™ Electrical Distribution Control System. Smart and plug-and-play architecture makes Emax 2/E9 all-in-one easy to use.

With the best performance up to 900 V of any device on the market, Emax 2/E9 is ready to control and protect all applications with voltages over 690 V.

Emax 2/E9 sets a new circuit-breaker benchmark for the electrical power distribution systems of today and tomorrow.

Common data		
Rated service voltage Ue	[V]	900
Rated insulation voltage Ui	[V]	1000
Rated impulse withstand voltage Uimp	[kV]	12
Frequency	[Hz]	50 - 60
Number of poles		3- 4
Version		Fixed - Withdrawable
Suitable for isolation according to		IEC 60947-2



SACE Emax 2/E9		E1.2	E2.2	E4.2		E6.2		
Performance levels		N/E9	S/E9	H/E9	S/E9	H/E9	H/E9	X/E9
Rated uninterrupted current Iu @ 40°C	[A]	1250	1250	1250	3200	3200	5000	5000
	[A]		2000	2000	4000	4000	6300	6300
	[A]		2500	2500				
Neutral pole current-carrying capacity for 4-pole CBs	[%Iu]	100	100	100	100	100	50-100	50-100
Rated ultimate short-circuit breaking capacity Icu	800V [kA]	35	50	65	65	90	90	100
	900V [kA]		50	65	65	75	75	90
Rated service short-circuit breaking capacity Ics	[%Icu]	100	100	100	100	100	100	100
Rated short-time withstand current Icw	(1s) 800V [kA]	35	50	65	65	75	75	90
	(3s) 800V [kA]	30	50	65	65	75*	75	90
	(1s) 900V [kA]		50	65	65	75	75	90
	(3s) 900V [kA]		50	65	65	75*	75	90
Rated short-circuit making capacity (peak value) Icm	800V [kA]	73.5	105	143	143	200	200	220
	900V [kA]		105	143	143	165	165	198
Utilization category (according to IEC 60947-2)		B	B	B	B	B	B	B

SACE Emax 2/E9		E1.2**		E2.2		E4.2			E6.2			
	[Iu]	<1000	1250	<2000	2000	< 2500	<3200	3200	4000	4000	5000	6300
Mechanical life*	[No. cycles x 1000]	20	20	25	25	20	20	20	15	12	12	12
	Frequency [Oper./Hour]	60	60	60	60	60	60	60	60	60	60	60
Electrical life	900 V [No. cycles x 1000]	0,5	0,5	2	2	2	1	1	1	1	1	1
	Frequency [Oper./Hour]	30	30	30	30	30	10	10	10	10	10	10

\*with regular ordinary maintenance prescribed by the manufacturer. \*\* For E1.2, electrical life is at 800V.

# SACE Emax 2 derived versions

Safety is an indispensable requirement that must always be guaranteed in electrical installations. In this regard, ABB SACE offers devices developed to further increase safety standards during inspection and maintenance activities on electrical installations.

In particular, in a withdrawable version, ABB SACE Emax 2 offers:

— The earthing circuit is dimensioned for a short-time current equal to 60% of the maximum Icw of the circuit breaker from which it is derived (IEC 60439-1)

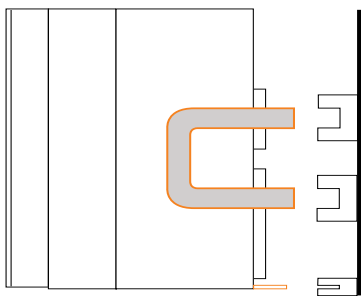

- **Sectionnalizing truck CS:** in normal operating conditions of the electrical circuit, this device is inserted in the part. It short-circuits the upper and lower terminals of the power circuit. When maintenance activities need to be carried out, the sectionnalizing truck is removed and the part of the system involved is isolated. The device can be accessorized with a keylock and padlocks for locking in the withdrawn position.

— The standard fixed parts can not accept MT/MTP device. In order to allow the utilization of MT/MTP mobile parts is mandatory to install the grounding clamps on fixed parts. Accessorizing only in the factory.

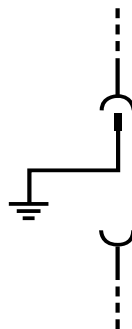
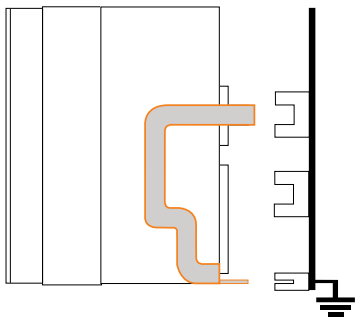

- **Earthing truck MT:** this device enables all phases of the electrical circuit on which maintenance needs to be performed to be earthed<sup>1)</sup>. The earthing truck is available in two versions: for earth connection from the upper or lower terminals.

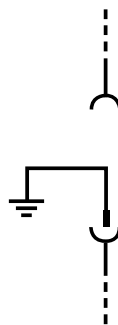
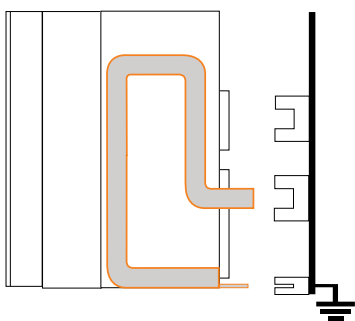

# SACE Emax 2 derived versions

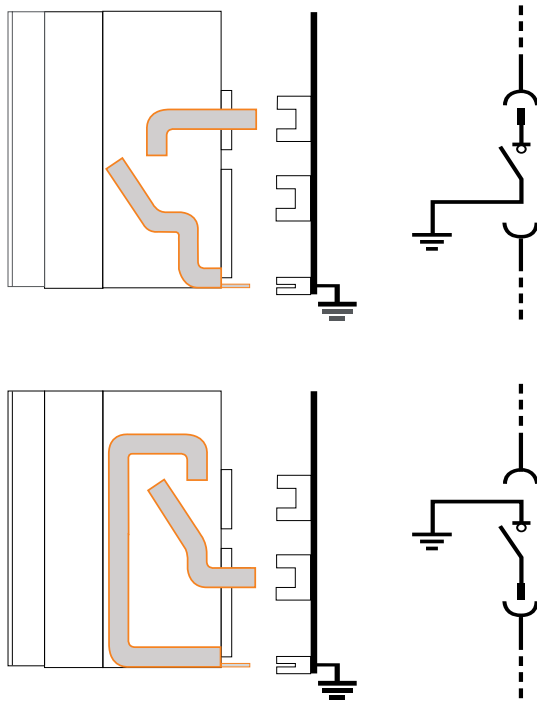

- **Earthing switch with making capacity MTP:** similar to the MT device, this differs due to the presence of a mechanical stored energy control which allows the circuit to be opened and closed. Two versions of this earthing switch are also available: for earth connection from the upper or lower terminals. It can also be accessorized
- with a keylock or padlocks for locking in the open position.

## Common data

Rated service voltage Ue	[V]	690
Rated insulation voltage Ui	[V]	1000
Rated impulse withstand voltage Uimp	[kV]	12
Frequency	[Hz]	50 - 60
Number of poles		3 - 4
Version		Withdrawable

SACE Emax 2	E2.2			E4.2			E6.2		
Performance levels	CS	MT	MTP	CS	MT	MTP	CS	MT	MTP
Rated uninterrupted current Iu @ 40°C	2500	2500	2500	4000	4000	4000	6300	6300	6300
Neutral pole current-carrying capacity for 4-pole CBs	100	100	100	100	100	100	50-100	50-100	50-100
Rated short-time withstand current Icw (1s) [kA]	-	30	30	-	50	50	-	50	50

---

# Protection trip units

<b>3/2</b>	<b>Introduction</b>
<b>3/4</b>	<b>New digital experience</b>
<b>3/12</b>	<b>Architecture</b>
<b>3/14</b>	<b>Overview</b>
<b>3/18</b>	<b>Technical characteristics for protection trip units</b>
<b>3/18</b>	Protection functions
<b>3/26</b>	Measurement functions
<b>3/32</b>	<b>Description of protection functions</b>

---

# Introduction

SACE Emax 2 Ekip protection trip units are the new benchmark for the protection, measurement and control of low-voltage electrical systems.

The SACE Emax 2 trip units are designed to be used in a wide range of applications. This complete, flexible protection trip unit can be adapted to the actual level of protection required, independently of the complexity of the system. The range is available for three levels of performances, to meet any requirement, from simple to advanced applications.

- Ekip Dip, standard applications
- Ekip Touch and Ekip Hi-Touch, the smart trip units
- Ekip G Touch and Ekip G Hi-Touch, generator protection

The protection units for power distribution, available in the LI, LSI and LSI G versions, are suited to all distribution systems. These trip units have been designed for a vast range of applications, to be used with transformers, motors and drives. Depending on the complexity of the system, voltage and energy measurements can be also included.

The Ekip G range enables the protection of generators without the use of external devices that require dedicated relays and wiring. These trip units increase efficiency from the design phase to installation, minimizing the time needed for the realization and commissioning of the system. They also ensure high levels of accuracy and reliability of all protection devices required for running generators in applications such as naval, GenSet or cogeneration.





---

## Ekip Dip trip units

The first level of electronic trip units for the standard protection of AC system, able to guarantee high reliability and tripping precision. They provide protection against overloads, selective short-circuits, short-circuits and earth faults. The power required for their operation is provided directly from the current sensors.

---

## Ekip Touch and Ekip Hi-Touch trip units

These represent the state of the art in terms of technology for AC network protection with advanced protection and system management

functions. Several communication protocols allow to remotely supervise electrical systems and control the circuit breaker. Class 1 active energy measurement in compliance with IEC 61557-12 satisfies high demanding requirements in terms of energy efficiency. The integrated display offers an easy and intuitive experience to the user, while the new embedded Bluetooth technology allows fast interaction through EPiC mobile app.

### **New digital experience**

The new Ekip Touch and Ekip Hi-Touch trip units guarantee maximum flexibility by offering a wide range of software solutions to always upgrade the circuit breaker. These functions can be selected when ordering the circuit-breaker or downloaded directly from the ABB Ability Marketplace™, even from a smart phone or tablet, thus reducing installation time to zero.



# New digital experience

Ekip Touch/Hi-Touch trip units can be now customized with the functions required.

—

Ekip Touch/Hi-Touch always allow the user to enter in a new product experience thanks to the possibility to build up his own tailor-made trip unit by selecting the set of protections, measurements and logics.

Circuit-breakers' customization has never been so easy.

With the new Ekip Touch and Hi-Touch trip units, the most advanced functionalities can be enabled following two different purchasing processes:

- **ABB Ability Marketplace™**

Users can download digital upgrades via web and enable them directly on the trip unit, without removing the circuit-breaker from the installation point, with zero shipping time and no installation costs. This process allows additional functions to be selected after the trip unit has been already received on site and installed. Moreover, stock can be optimized by keeping in the warehouse few types of trip units and customizing them according to the customer's specific needs. Once purchased, each function can be easily activated by using a smartphone or tablet via EPiC app mobile and embedded Bluetooth connectivity, or a laptop through Ekip Connect 3.

- **Traditional ordering**

This option represents the standard way to order ABB devices. The traditional process allows the users to select and directly install the desired functions when ordering the circuit-breaker. Once received and installed, SACE Emax 2 always offers the possibility to add new functionalities via ABB Ability Marketplace™.

The new Ekip digital offering includes:

- **Packages**

The software packages offer the possibility to customize the circuit-breaker by selecting additional protection functions and measurements. The device can be customized to create tailor-made solutions according to the specific application. Maximum flexibility is guaranteed by offering specific technical features that can be combined in the Ekip Touch/Hi-Touch during the product life cycle.

- **Bundles**

Simplify the selection of advanced functions and logics with group of packages able to satisfy requirements by market segments and applications.

Bundles shall require additional plug and play hardware modules.

- **Solutions**

The SACE Emax 2 circuit-breaker is no more intended as a simply stand-alone protection device, but it has become an active player in the electrical system, able to exchange data and trigger actions managing the behavior of other connected devices. Thanks to the new electronic trip units, it is possible to implement transfer logics, load shedding and peak shaving strategies. Such solutions require additional plug and play hardware modules and other smart devices.

SACE Emax 2 allows to easily upgrade and customize the Ekip Touch and Hi-Touch trip units, guaranteeing maximum flexibility for any application, delivering value throughout the entire customer journey.

### 1. Design

Build the circuit-breaker according to specific project requirements.



#### Key drivers

- Ease of doing business
- Technical specifications
- Application and function

#### Benefits

- Flexibility of choice
- Customization by application

### 2. Commissioning

Customize the device thanks to the digital offering. Manage last minute changes through digital upgrades.



#### Key drivers

- Ease of doing business
- Management of components
- Time to market

#### Benefits

- Stock optimization
- Zero lead time and installation effort

### 3. Service

Unlock the full potential of your circuit-breaker at any time, minimizing downtime and installation changes.



#### Key drivers

- Manage installed base
- Simplify diagnostics
- Simplify the hardware re-design

#### Benefits

- Zero lead time and installation effort
- Avoid downtime

# New digital experience

## Packages

Each package includes a set of protection functions or measurements that can be enabled in the trip unit.

Six packages relate to protection functions: Voltage Protections, Frequency Protections, Power Protections, Advanced Voltage Protections, RO-COF Protections and Adaptive Protections.



### Voltage Protections

Set of protections included: UV - Undervoltage, OV - Overvoltage, UV2 - 2nd Undervoltage, OV2 - 2nd Overvoltage, PS - Phase Sequence, VU - Voltage unbalance.

How to order: via ABB Ability Marketplace™ or traditional ordering channels.



### Frequency Protections

Set of protections included: UF - Underfrequency, OF - Overfrequency, UF2 - 2nd Underfrequency, OF2 - 2nd Overfrequency.

How to order: via ABB Ability Marketplace™ or traditional ordering channels.



### Power Protections

Set of protections included: RP - Reverse active power, CosΦ - Power factor, D - Directional overcurrent, RQ - Loss of field or reverse reactive power, OQ - Reactive overpower, OP - Active overpower, UP - Active underpower, RQ - 2nd Loss of field or Reverse reactive power.

How to order: via ABB Ability Marketplace™ or traditional ordering channels.



### Advanced Voltage Protections

Set of protections included: S(V) - Voltage controlled overcurrent, S(V)2 - 2nd Voltage controlled overcurrent, R - Residual voltage.

How to order: via ABB Ability Marketplace™ or traditional ordering channels.

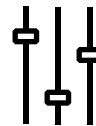

### ROCOF Protections

Set of protections included: ROCOF - Rate of change of frequency.

How to order: via ABB Ability Marketplace™ or traditional ordering channels.



### Adaptive Protections

Set of protections included: Dual Setting - Set A-B.

How to order: via ABB Ability Marketplace™ or traditional ordering channels.

Three packages relate to measurements and diagnostics: Measuring Package, Data Logger and Network Analyzer.



**Measuring Package**

To monitor the plant through several measurements: Phase-to-phase voltage, Phase-to-neutral voltage, Phase sequence, Frequency, Active power, Reactive power, Apparent power, Power factor, Peak factor, Active energy, Reactive energy, Apparent energy.

How to order: via ABB Ability Marketplace™ or traditional ordering channels.

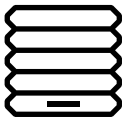

**Data Logger**

To record data about events in the plant: Currents, Voltages, Sampling rate, Maximum recording duration, Recording stop delay, Number of registers.

How to order: via ABB Ability Marketplace™ or traditional ordering channels.

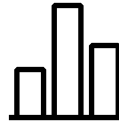

**Network Analyzer**

To monitor the power quality of the network through: Harmonic analysis, Hourly average voltage value, Short voltage interruption, Short voltage spikes, Slow-voltage sags and swells, Voltage unbalance.

How to order: via ABB Ability Marketplace™ or traditional ordering channels.

When a package is purchased via ABB Ability Marketplace™, it must be activated through:

- Ekip Connect 3 installed on a PC using Ekip T&P to scan the trip unit
- EPiC app mobile installed on a mobile device, by directly using the embedded Bluetooth connection available in the new Ekip trip units.

Thanks to the maximum flexibility guaranteed by these packages, the new Ekip trip units are now completely customizable. Depending on the specific trip unit version, different packages are available by default, but all of them can be added to the trip unit.

Default functionalities and upgradability of the trip units:

	Standard Protection	Standard Measures	Measuring Package	Voltage Protections	Frequency Protections	Power Protections	Adaptive Protections	Data Logger	Network Analyzer	Advanced Voltage Protections	ROCOF Protections
<b>Ekip Touch</b>	●	●	↑	↑	↑	↑	↑	↑	↑	↑	↑
<b>Ekip G Touch</b>	●	●	●	↑	↑	↑	↑	●	↑	↑	↑
<b>Ekip Hi-Touch</b>	●	●	●	●	●	↑	●	●	●	↑	↑
<b>Ekip G Hi-Touch</b>	●	●	●	●	●	●	●	●	●	●	●

● Available by default

↑ Upgradable

↑ Some elements of the package are already provided by default. It is possible to upgrade the trip unit to achieve the complete package.

# New digital experience

## Bundles

Each bundle includes a set of packages that can be enabled on the trip unit.

Five bundles are available to satisfy different needs: Intelligent Grid Edge, Power Management, Grid Connection, Diagnostics and Measure Advanced.

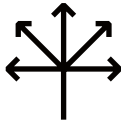

### Intelligent Grid Edge

Make your grid smart.

Thanks to this bundle, the circuit-breaker becomes the main player of the smart interconnection of power distribution and loads for demand-supply coordination. Packages included: Measuring Package, Adaptive Protections, Power Protections, Voltage Protections and Ekip Power Controller.

How to order: via ABB Ability Marketplace™.

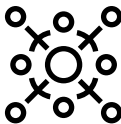

### Power Management

Embedded demand management.

Thanks to this bundle, the circuit-breaker is ready for demand management to ensure service continuity and reduce energy costs. Packages included: Measuring Package, Adaptive Protections, Power Protections and Voltage Protections.

How to order: via ABB Ability Marketplace™.

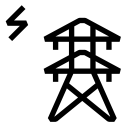

### Grid Connection

Optimize renewable power generation.

No more external and additional relays are needed with this bundle. It enhances tracking and improved energy harvesting. Packages included: Measuring Package, Adaptive Protections, Power Protections and Ekip Power Controller.

How to order: via ABB Ability Marketplace™.



### Diagnostics

Comprehensive data for root-cause analysis and preventive maintenance.

This bundle gives full diagnostics of the system to guarantee a full control of the plant status.

Packages included: Measuring Package, Network Analyzer and Data Logger.

How to order: via ABB Ability Marketplace™.

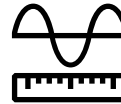

### Measure Advanced

Embedded advanced metering and power quality information.

This bundle gives the possibility to preserve the loads, by avoiding equipment malfunctioning and optimizing energy consumption thanks to additional measurements and full power quality analysis. Packages included: Measuring Package, Network Analyzer.

How to order: via ABB Ability Marketplace™.

When a bundle is purchased via ABB Ability Marketplace™, it must be activated through:

- Ekip Connect 3 installed on a PC using Ekip T&P to scan the trip unit
- EPiC app mobile installed on a mobile device, by directly using the embedded Bluetooth connection available in the new Ekip trip units.

# New digital experience

## Solutions

Five solutions are available to fully exploit the potential of the Ekip architecture: Interface Protection System, Embedded ATS, Adaptive Load Shedding and Power Controller.

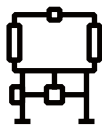

### Interface Protection System

This solution is used to disconnect the generating units from the grid when voltage and frequency values are out of the ranges prescribed by the Standard. This disconnection is usually carried out through an Interface Device and an Interface Protection System. Thanks to the Ekip Touch/Hi-Touch trip units, this function is integrated in one single circuit-breaker.

How to order: via ABB Ability Marketplace™ or traditional ordering channels.

The hardware accessories must be ordered via traditional ordering channels.

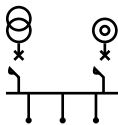

### Embedded ATS

This function enables the activation of auxiliary generation sources (e.g. generators) and transfers the feed of the loads from the distribution network to such auxiliary sources, thus ensuring a secure transfer to maintain service continuity and reliability of the system.

How to order: via ABB Ability Marketplace™ or traditional ordering channels.

The hardware accessories must be ordered via traditional ordering channels.

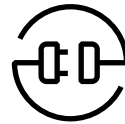

### Adaptive Load Shedding

Thanks to this solution, the circuit-breaker enables islanding transition to avoid blackouts. It actively controls the power consumption based on the priorities set by the user.

How to order: via ABB Ability Marketplace™ or traditional ordering channels.

The hardware accessories must be ordered via traditional ordering channels.



### Power Controller

This function is the ideal solution for load management and represents an optimum compromise between reliability, simplicity and cost-effectiveness. Based on a patented calculation algorithm, Ekip Power Controller allows a list of loads to be controlled from remote according to the priorities defined by the user.

How to order: via ABB Ability Marketplace™ or traditional ordering channels. The hardware accessories must be ordered via traditional ordering channels.

When a solution is purchased via ABB Ability Marketplace™, it must be activated through Ekip Connect 3 installed on a PC using Ekip T&P to scan the trip unit.

These solutions require the installation of hardware components that have to be ordered through the traditional ordering channels. For further information, please refer to the specific documentation available on ABB Library ([www.abb.com/abblibrary/DownloadCenter/](http://www.abb.com/abblibrary/DownloadCenter/)).

# New digital experience

## Solutions

	Functions included	Hardware accessories
<b>PACKAGES</b>		
Voltage Protections	UV - Undervoltage OV - Overvoltage UV2 – 2nd Undervoltage OV2 – 2nd Overvoltage PS – Phase sequence VU – Voltage unbalance	-
Frequency Protections	UF - Underfrequency OF - Overfrequency UF2 – 2nd Underfrequency OF2 - 2nd Overfrequency	-
Power Protections	RP – Reverse active power Cos $\Phi$ - Power factor D – Directional current RQ – Loss of field or Reverse reactive power OQ – Reactive overpower OP – Active overpower UP – Active underpower 2RQ – 2nd Loss of field or Reverse reactive power	-
Advanced Voltage Protections	S(V) – Voltage controlled overcurrent S(V)2 – 2nd Voltage controlled overcurrent R – Residual voltage	-
ROCOF Protections	ROCOF	-
Adaptive Protections	Dual setting	Ekip Signalling
Measuring Package	Phase-to-phase voltage Phase-to-neutral voltage Phase sequence Frequency Active power Reactive power Apparent power Power factor Peak factor Active energy Reactive energy Apparent energy	-
Data Logger	Currents Voltages Sampling rate Maximum recording duration Recording stop delay Number of registers	-
Network Analyzer	Hourly average voltage value Short voltage interruptions Short voltage spikes Slow voltage sags and swells Voltage unbalance Harmonic analysis	-



	Functions included	Hardware accessories
<b>BUNDLES</b>		
Intelligent Grid Edge	Measuring Package	Ekip Link, Ekip Signalling, motor operators and coils
	Adaptive Protections	
	Power Protections	
	Voltage Protections	
	Ekip Power Controller	
Power Management	Measuring Package	Ekip Signalling
	Adaptive Protections	
	Power Protections	
	Voltage Protections	
Grid Connection	Measuring Package	Ekip Link, Ekip Signalling, motor operators and coils
	Adaptive Protections	
	Power Protections	
	Ekip Power Controller	
Diagnostics	Measuring Package	-
	Network Analyzer	
	Data Logger	
Measure Advanced	Measuring Package	-
	Network Analyzer	
<b>SOLUTIONS</b>		
Interface Protection System	-	Ekip Link, Ekip Signalling, motor operators and coils
Embedded ATS	-	Ekip Link, Ekip Signalling, motor operators and coils
Adaptive Load Shedding	-	Ekip Link, Ekip Signalling, motor operators and coils
Power Controller	-	Ekip Link, Ekip Signalling, motor operators and coils

# Architecture

All SACE Emax 2 circuit breakers are equipped with protection trip units that are able to evolve during the life cycle.

Ekip trip units are easily interchangeable from the front, with no need to dismantle the circuit breaker or access any internal or sensitive parts. In particular, they consist of:

- **Protection trip unit**, available with different interfaces and versions that range from basic to more complete; it contains a latest generation microprocessor that performs all the functions of protection and control.
- **Measurement enabler module**, connected internally to Emax 2, enables voltage, power and energy measurements and protections with high accuracy without requiring any external connection or voltage transformer. Measurement enabler with voltage sockets allows to directly supply the trip unit through direct connection to the busbar system.
- **Interchangeable rating plug** enables all protection thresholds to be adjusted according to the rated current, increasing flexibility for the customer. It is useful in installations that are prepared for future development or in cases in which the power supplied may be limited temporarily.
- **Main board** is the mechanical housing of the trip unit, which includes a micro-controller for measuring currents and the self-protection functions. The separation of trip units ensures excellent reliability and immunity to conducted and radiated emissions. Integrated new generation Rogowski sensors, which are sensitive to the true r.m.s. value of the current, guarantee high accuracy of both measurements and protection.



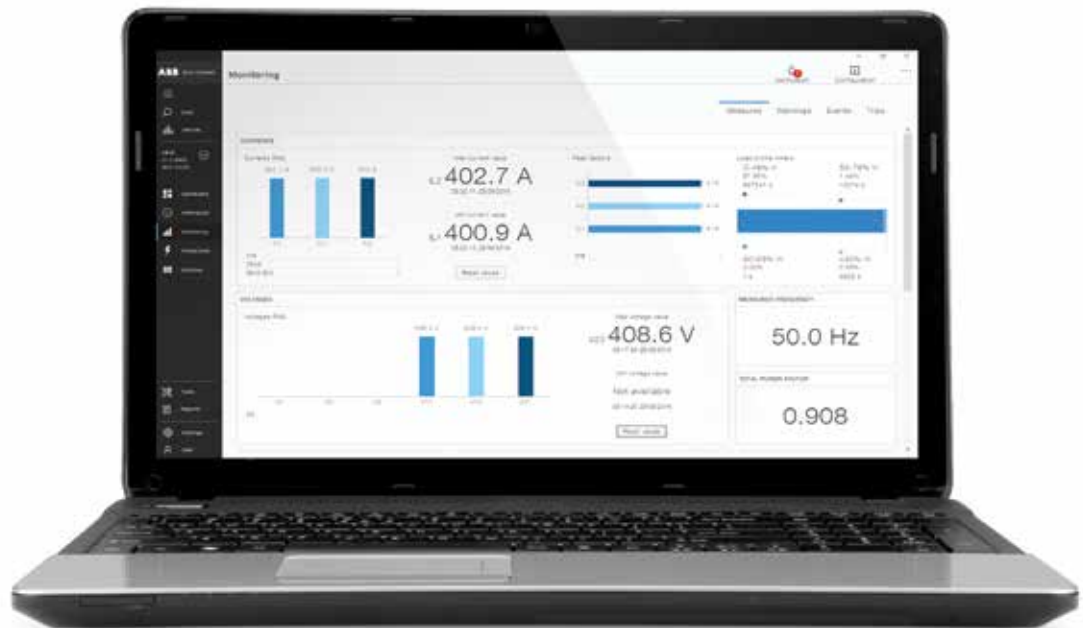

All protection trip units in the SACE Emax 2 family are self-powered by current that crosses the circuit breaker. They guarantee excellent reliability due to a system of self-control of internal connections.

The setting, testing and downloading of reports can be carried out directly from a Smartphone, Tablet or PC. In addition, the commissioning stage can be further accelerated, minimizing the possibility of errors, by directly configuring the protection trip unit with the DOC design software settings. Cartridge-type modules that are easily installed on-board enable the units to be integrated into the most complex systems. Additional functions can be created, such as:

- **Synchrocheck**, to check the synchronization of the two half-busbars before enabling circuit-breaker closing;
- Communication with all **supervision systems** available in the Modbus, Profibus and DeviceNet™ protocols as well as the modern Modbus TCP, Profinet, EtherNet/IP™;
- **Integration into Smart Grids** thanks to the possibility of communicating without the assistance of any external converter, according to standards (IEC 61850) already in use in the automation systems of high and medium voltage substations;
- Multi-voltage **supply module**, which enables the protection trip unit and modules present to be supplied with any auxiliary voltage available in direct or alternating current;
- Programmable logic management with **Ekip Signalling** modules that provide a high number of electrical input and output contacts;
- Logical interlocks between circuit breakers, which can be made with the **Ekip Link** proprietary communication protocol, avoiding complex wiring thanks to the transmission of all signals via a bus..

# Overview

SACE Emax 2 trip units offer a complete range of solutions for any installation requirements, for both distribution and generator protection. New features are now available with a renewed black look and feel.

## Ekip Dip: The standard trip unit



**Ekip Dip LI**  
**Ekip Dip LSI**  
**Ekip Dip LSIG**

- Overcurrent protection for distribution systems
- Phase and neutral current measurements
- LED Permanent trip cause signalization
- Ekip Multimeter to display data and measurements

## Ekip Touch: The smart trip unit



**Ekip Touch LI**  
**Ekip Touch LSI**  
**Ekip Touch LSIG**

- Advanced set of protections and measurements, always upgradable and customizable
- Intuitive touchscreen interface
- High measurement accuracy of electrical parameters

## Ekip Hi-Touch: The ultimate trip unit



**Ekip Hi-Touch LSI**  
**Ekip Hi-Touch LSIG**

- Complete set of protections and measurements
- Dual settings of protection
- Network Analyzer function

### Ekip G: The generator trip unit



#### Ekip G Touch LSIG Ekip G Hi-Touch LSIG

- Designed for installations with generators such as Genset, cogeneration and marine applications
- Dedicated set of generator protections

### Ekip LCD: The hardened trip unit



#### Ekip LCD LI Ekip LCD LSI Ekip LCD LSIG Ekip Hi-LCD LSI Ekip Hi-LCD LSIG Ekip G LCD LSIG Ekip G Hi-LCD LSIG

- Suitable for installation in aggressive environments and secure applications
- Available for both distribution and generator protection functions

### Protection

SACE Emax 2 trip units offer a great variety of overcurrent protection functions, with thresholds and timing that can be easily set through dip switches or few simple steps directly from the touchscreen display. These units are available in different versions: LI, LSI, LSIG.

All the Ekip trip units also include a thermal memory function. The protection unit is able to record the trips which have occurred in the last few minutes. Since the trip causes overheating, in order to protect the cables and let them cool down, the trip unit imposes a shorter delay tripping time in case of a fault. In this way, the system is protected against damages due to cumulative overheating.

### Watchdog

The Ekip trip units ensure high reliability thanks to an electronic circuit that periodically checks the continuity of internal connections, such as trip coil, rating plug and each current sensor (ANSI 74).

In case of an alarm, a message is shown on the display (Ekip Touch) or through LEDs signalization (Ekip Dip). If a protection function intervenes, the unit always checks that the circuit breaker has been opened through auxiliary contacts that indicate the position of the main contacts. Otherwise, the unit creates an alarm (ANSI BF code - Breaker Failure) that can be used to command the opening of the upstream circuit breaker. Ekip trip units are also provided with self-protection against abnormal temperature (OT) to ensure correct operations.

# Overview

## Test function

All SACE Emax 2 trip units are equipped with a test port on the front that can be used to carry out circuit breaker tests by connecting one of the following devices:

- Ekip TT to perform trip tests, LED tests and checks for the absence of alarms detected by the watchdog function
- Ekip T&P not only for the trip and LED tests, but also for testing the individual protection functions and the saving of the relative report

In addition, the iTest key allows to run a battery test when the circuit breaker is disconnected.

## User interface

Ekip trip units allow to clearly identify the status of the circuit breaker through LEDs activation or an intuitive graphical interface. A password system is used to manage “Read” or “Edit” modes. The default password (00001) can be directly inserted by the user. The protection parameters are settable in “Edit” mode, whereas it is always possible to consult the information in “Read” mode.

## Data & Measurements

SACE Emax 2 trip units are no longer simply protection devices. The Ekip Dip trip unit measures phase and neutral current with great accuracy, while the other advanced units integrate multi-meter and network analyzer functionalities, being also compliant with IEC 61557-12 (Class 1 in energy accuracy).

A complete set of information about the circuit breaker and its operation is available for effective fault analysis and preventive scheduling of maintenance.

## Communication & Connectivity

Ekip Touch and Hi-Touch trip units can be easily integrated into the most modern supervision systems through several communication protocols:

- IEC 61850
- Modbus TCP
- Modbus RS-485
- Profibus
- Profinet
- DeviceNet™
- EtherNet/IP™

Measurements, statuses and alarms can be easily programmed and viewed by remote function, with no need of external interface devices. Moreover, the Ekip Com Actuator module can be installed in the front of the device to remotely control the circuit breaker. Several communication modules with different protocols can be used simultaneously. In addition, up to two modules using the same protocol can be installed to ensure a higher reliability of the installation. The Ekip Com Hub module allows cloud connectivity to ABB Ability™ EDCS platform. The new embedded Bluetooth Low Energy technology makes the circuit breaker easier to be accessed, thus reducing time for commissioning and parameter settings. Ekip Dip and Ekip LCD trip units are not provided with this feature.

**Supply**

SACE Emax 2 protection trip units are self-supplied through the current sensors installed on the circuit breaker and do not require any external supply devices for basic protection and alarm indication functions. A three-phase current of 100A is sufficient for the activation. All protection settings are stored in non-volatile memory that maintains the information without power supply. The Ekip Supply module can be easily connected to both direct and alternating current to activate additional functions such as:

- Using the unit when the circuit breaker is opened
- Using additional modules such as Ekip Signaling and Ekip Com
- Connection to external devices such as Ekip Multimeter
- Recording the number of operations
- G protection with values below 100A or 0.2 In
- Zone selectivity
- Gext and MCR protection functions

SACE Emax 2 trip units are always supplied with an internal battery that enables the cause of a fault to be indicated after a trip, without limit of time. This battery also ensures the update of time and date, thus guaranteeing the chronology of any events. When the unit switched off, the battery test can be run by simply pressing the iTest key on the front.

**Grey platform**

The previous Ekip trip units and their accessories are now available as spare parts only.

# Technical characteristics for protection trip units

## Protection functions

ABB Code	ANSI/IEEE C37.2 Code	Function	Threshold
L	49	Overload protection	I1 = 0.4 - 0.42 - 0.45 - 0.47 - 0.5 - 0.52 - 0.55 - 0.57 - 0.6 - 0.62 - 0.65 - 0.67 - 0.7 - 0.72 - 0.75 - 0.77 - 0.8 - 0.82 - 0.85 - 0.87 - 0.9 - 0.92 - 0.95 - 0.97 - 1 x In
		Thermal memory	
		Tolerance	trip between 1.05 and 1.2 x I1
S	50TD	Time-delayed overcurrent protection	I2 = 0.6 - 0.8 - 1 - 1.5 - 2 - 2.5 - 3 - 3.5 - 4 - 5 - 6 - 7 - 8 - 9 - 10 x In
		Tolerance	± 7% If ≤ 6 x In ± 10% If > 6 x In
	51	Time-delayed overcurrent protection	I2 = 0.6 - 0.8 - 1 - 1.5 - 2 - 2.5 - 3 - 3.5 - 4 - 5 - 6 - 7 - 8 - 9 - 10 x In
		Tolerance	± 7% If ≤ 6 x In ± 10% If > 6 x In
I	50	Instantaneous overcurrent protection	I3 = 1.5 - 2 - 3 - 4 - 5 - 6 - 7 - 8 - 9 - 10 - 11 - 12 - 13 - 14 - 15 x In
		Tolerance	± 10%
G	50N TD	Earth fault protection	I4 <sup>(1)</sup> = 0.1 - 0.2 - 0.3 - 0.4 - 0.6 - 0.8 - 1 x In
		Tolerance	± 7%
	51N	Earth fault protection	I4 <sup>(1)</sup> = 0.1 - 0.2 - 0.3 - 0.4 - 0.6 - 0.8 - 1 x In
		Tolerance	± 7%

(1) With Vaux all thresholds are available. Without Vaux minimum threshold is limited to: 0.3In (with In = 100A), 0.25In (with In = 400A) or 0.2In (for all other ratings)

(2) The minimum trip time is 1s, regardless of the type of curve set (self-protection)

The tolerances above apply to trip units already powered by the main circuit with current flowing in at least two phases or an auxiliary power supply. In all other cases the following tolerance values apply

ABB Code	Trip threshold	Trip time
L	Trip between 1.05 and 1.2 x I1	± 20%
S	± 10%	± 20%
I	± 15%	≤ 60ms
G	± 15%	± 20%





Trip time	Excludibility	Pre Alarm	Trip curve	Ekip Dip
with $I_f = 3 I_n$ , $t_1 = 3 - 12 - 24 - 36 - 48 - 72 - 108 - 144s^{(2)}$	no	50 ... 90% $I_1$ Step 1%	$t = k / I^2$	●
	no			●
$\pm 10\% I_f \leq 6 \times I_n$ $\pm 20\% I_f > 6 \times I_n$				
with $I_f > I_2$ , $t_2 = 0.1 - 0.2 - 0.3 - 0.4 - 0.5 - 0.6 - 0.7 - 0.8s$	yes	-	$t = k$	●
The better of the two data: $\pm 10\% t_2$ or $\pm 40 ms$				
with $I_f = 10 I_n$ , $t_2 = 0.1 - 0.2 - 0.3 - 0.4 - 0.5 - 0.6 - 0.7 - 0.8s$	yes	-	$t = k / I^2$	●
	yes	-		
$\pm 15\% I_f \leq 6 \times I_n$ $\pm 20\% I_f > 6 \times I_n$				
Instantaneous	yes	-	$t = k$	●
$\leq 30 ms$				
with $I_f > I_4$ , $t_4 = 0.1 - 0.2 - 0.4 - 0.8s$	yes	50 ... 90% $I_4$ Step 1%	$t = k$	●
The better of the two data: $\pm 10\% t_4$ or $\pm 40 ms$				
with $I_f = 3 I_n$ , $t_4 = 0.1 - 0.2 - 0.4 - 0.8s$	yes	50 ... 90% $I_4$ Step 1%	$t = k / I^2$	●
$\pm 15\%$				

# Technical characteristics for protection trip units

## Protection functions

ABB Code	ANSI Code	Function	Threshold	Threshold step	Trip time	Time Step
L	49	Overload Protection	$I1 = 0.4...1 \times I_n$	$0.001 \times I_n$	with $I = 3 I1$ , $t1 = 3...144 \text{ s}$	1s
		Thermal Memory				
		Tolerance	trip between $1.05$ and $1.2 \times I1$		$\pm 10\% I \leq 6 \times I_n / \pm 20\% I > 6 \times I_n$	
	49	Overload Protection	$I1 = 0.4...1 \times I_n$	$0.001 \times I_n$	with $I = 3 I1$ , $t1 = 3...144 \text{ s}$ Standard inverse SI: $k=0.14 \alpha=0,02$ Very Inverse VI: $k=13.5 \alpha=1$ Extremely Inverse EI: $k=80 \alpha=2$	1s
		Tolerance	trip between $1.05$ and $1.2 \times I1$		$\pm 10\% I \leq 6 \times I_n / \pm 20\% I > 6 \times I_n$	
S	50TD	Time-delayed overcurrent protection	$I2 = 0.6...10 \times I_n$	$0.1 \times I_n$	With $I > I2$ , $t2 = 0.05...0.8 \text{ s}$	0.01s
	68	Zone selectivity			$t2sel = 0.04...0.2 \text{ s}$	0.01s
		Start up	Activation: $0.6...10 \times I_n$	$0.1 \times I_n$	Range: $0.1...30 \text{ s}$	0.01s
		Tolerance	$\pm 7\% I \leq 6 \times I_n$ $\pm 10\% I > 6 \times I_n$		The better of the two data: $\pm 10\%$ or $\pm 40 \text{ ms}$	
	51	Time-delayed overcurrent protection	$I2 = 0.6...10 \times I_n$	$0.1 \times I_n$	with $I = 10 I_n$ , $t2 = 0.05...0.8 \text{ s}$	0.01s
		Thermal Memory				
		Tolerance	$\pm 7\% I \leq 6 \times I_n$ $\pm 10\% I > 6 \times I_n$		$\pm 15\% I \leq 6 \times I_n$ $\pm 20\% I > 6 \times I_n$	
I	50	Istantaneous overcurrent protection	$I3 = 1.5...15 \times I_n$	$0.1 \times I_n$	With $I > I3$ , instantaneous	-
		Start up	Activation: $1.5...15 \times I_n$	$0.1 \times I_n$	Range: $0.1...30 \text{ s}$	0.01s
		Tolerance	$\pm 10\%$		$\leq 30 \text{ ms}$	
G	50N TD	Earth fault protection	$I4^{(1)} = 0.1...1 \times I_n$	$0.001 \times I_n$	with $I > I4$ , $t4 = \text{Instantaneous (with Vaux) } + 0,1...1 \text{ s}$	0.05s
		Zone selectivity			$t4sel = 0.04...0,2 \text{ s}$	0.01s
		Start up	Activation: $0.2...1 \times I_n$	$0.02 \times I_n$	range: $0.1...30 \text{ s}$	0.01s
		Tolerance	$\pm 7\%$		The better of the two data: $\pm 10\%$ or $\pm 40 \text{ ms}$ or $50 \text{ ms}$ with $t4 = \text{instantaneous}$	
	51N	Earth fault protection	$I4^{(1)} = 0.1...1 \times I_n$	$0.001 \times I_n$	with $I = 4 I_n$ , $t4 = 0.1...1 \text{ s}$	0.05s
		Tolerance	$\pm 7\%$		$\pm 15\%$	
IU	46	Current unbalance protection	$I6 = 2...90\% I_n$ unbalance	$1\% I_n$	with unbalance $> I6$ , $t6 = 0.5...60 \text{ s}$	0.5s
		Tolerance	$\pm 10\%$		The better of the two data: $\pm 10\%$ or $\pm 40 \text{ ms}$ (for $t < 5 \text{ s}$ ) / $\pm 100 \text{ ms}$ (for $t \geq 5 \text{ s}$ )	
2I	50	Programmable instantaneous overcurrent protection	$I31 = 1.5...15 \times I_n$	$0.1 \times I_n$	with $I > I31$ , instantaneous	
		Tolerance	$\pm 10\%$		$\leq 30 \text{ ms}$	
MCR		Closing on short-circuit protection	$I3 = 1.5...15 \times I_n$	$0.1 \times I_n$	With $I > I3$ , instantaneous Monitor time range: $40...500 \text{ ms}$	0.01s
		Tolerance	$\pm 10\%$		$\leq 30 \text{ ms}$	
Gext	50G TD	Earth fault protection	$I41^{(1)} = 0.1...1 \times I_n$ Toroid	$0.001 \times I_n$ Toroid	with $I > I41$ , $t41 = 0.1...1 \text{ s}$	0.05s
		Zone selectivity			$t41sel = 0.04...0,2 \text{ s}$	0.01s
		Start up	Activation: $0.1...1 \times I_n$	$0.02 \times I_n$	range: $0.1...30 \text{ s}$	0.01s
		Tolerance	$\pm 7\%$		The better of the two data: $\pm 10\%$ or $\pm 40 \text{ ms}$	
	51G	Earth fault protection	$I41^{(1)} = 0.1...1 \times I_n$	$0.001 \times I_n$	with $I = 4 I_n$ , $t41 = 0.1...1 \text{ s}$	0.05s
	Tolerance	$\pm 7\%$		$\pm 15\%$		
Rc	64 50N TD	Residual current protection	$I\Delta n = 3 - 5 - 7 - 10 - 20 - 30 \text{ A}$		with $I > I\Delta n$ , $t\Delta n = 0.06 - 0.1 - 0.2 - 0.3 - 0.4 - 0.5 - 0.8 \text{ s}$	
	87N	Differential ground fault protection			$140 \text{ ms @ } 0.06 \text{ s}$ (max trip time) $950 \text{ ms @ } 0.80 \text{ s}$ (max trip time)	
		Tolerance	$- 20\% \div 0\%$			
UV	27	Undervoltage Protection	$U8 = 0.5...0.98 \times U_n$	$0.001 \times U_n$	with $U < U8$ , $t8 = 0.05...120 \text{ s}$	0.01s
		Tolerance	$\pm 2\%$		The better of the two data: $\pm 10\%$ or $\pm 40 \text{ ms}$ (for $t < 5 \text{ s}$ ) / $\pm 100 \text{ ms}$ (for $t \geq 5 \text{ s}$ )	
OV	59	Overvoltage protection	$U9 = 1.02...1.5 \times U_n$	$0.001 \times U_n$	with $U > U9$ , $t9 = 0.05...120 \text{ s}$	0.01s
		Tolerance	$\pm 2\%$		The better of the two data: $\pm 10\%$ or $\pm 40 \text{ ms}$ (for $t < 5 \text{ s}$ ) / $\pm 100 \text{ ms}$ (for $t \geq 5 \text{ s}$ )	



Excludibility	Excludibility trip	Pre-alarm	Trip curve	Ekip Touch	Ekip Hi-Touch	Ekip G Touch	Ekip G Hi-Touch
yes, with rating plug L=off	no	50...90% I1 step 1%	$t = k / I^2$	●	●	●	●
yes				●	●	●	●
yes, with rating plug L=off	no	50...90% I1 step 1%	$t = \frac{t1xaxb}{\left(\frac{If}{I1}\right)^k - 1}$	●	●	●	●
yes	yes	no	$t = k$	●	●	●	●
yes				●	●	●	●
yes				●	●	●	●
yes	yes	no	$t = k / I^2$	●	●	●	●
yes				●	●	●	●
yes	no	no	$t = k$	●	●	●	●
yes				●	●	●	●
yes	yes	50...90% I4 step 1%	$t = k$	●	●	●	●
yes				●	●	●	●
yes				●	●	●	●
yes	yes	50...90% I4 step 1%	$t = k / I^2$	●	●	●	●
yes	yes	no	$t = k$	●	●	●	●
yes	no	no	$t = k$	●	●	●	●
yes	no	no	$t = k$	●	●	●	●
yes	yes	50...90% I41 step 1%	$t = k$	●	●	●	●
yes				●	●	●	●
yes				●	●	●	●
yes	yes	50...90% I41 step 1%	$t = k / I^2$	●	●	●	●
Available with rating plug Rc	no	no	$t = k$	○	●	●	●
yes	yes	no	$t = k$	○	●	●	●
yes	yes	no	$t = k$	○	●	●	●

Table continued on next page

# Technical characteristics for protection trip units

## Protection functions

ABB Code	ANSI Code	Function	Threshold	Threshold step	Trip time	Time Step
VU	47	Voltage unbalance protection Tolerance	U14 = 2...90% Un unbalance ± 5%	1%Un	with unbalance > U14, t14 = 0.5...60s The better of the two data: ± 10% or ± 40 ms (for t<5s) / ± 100 ms (for t≥5s)	0.5s
UF	81L	Underfrequency protection Tolerance	f12 = 0.9...0.999 x fn ± 1% (with fn ±2%)	0.001 x fn	with f < f12, t12 = 0.15...300s The better of the two data: ± 10% or ± 40 ms (for t<5s) / ± 100 ms (for t≥5s)	0.01s
OF	81H	Overfrequency protection Tolerance	f13 = 1.001...1.1 x fn ± 1% (with fn ±2%)	0.001 x fn	with f > f13, t13 = 0.15...300s The better of the two data: ± 10% or ± 40 ms (for t<5s) / ± 100 ms (for t≥5s)	0.01s
RP	32R	Reverse active power protection Tolerance	P11 = -1...-0.05 Sn ± 10%	0.001 Sn	with P > P11, t11 = 0.5...100s The better of the two data: ± 10% or ± 40 ms (for t<5s) / ± 100 ms (for t≥5s)	0.1s
ABB: Cyclical direction	47	Cyclical direction of the phases	1-2-3 or 3-2-1			
ABB: Power factor LC1/2 lw1/2	78	3phase Power factor  Current threshold  Tolerance	PF3 = 0.5...0.95  LC1 = 50%...100% I1 LC2 = 50%...100% I1 lw1 = 0.1...10 In lw2 = 0.1...10 In Activation: up/down ± 10%	0.01  1% 1% 0.01 x In		
S2	50TD	Time-delayed overcurrent protection	I5 = 0.6...10 x In	0.1 x In	With I > I5, t5 = 0.05...0.8s	0.01s
	68	Zone selectivity Start up Tolerance	Activation: 0.6...10 x In ± 7% I ≤ 6 x In ± 10% I > 6 x In	0.1 x In	t5sel = 0.04...0.2s Range: 0.1...30s The better of the two data: ± 10% or ± 40 ms	0.01s 0.01s
D	67	Directional overcurrent protection (forward &/or backward)	I7 = 0.6...10 x In	0.1 x In	with I > I7, t7 = 0.1...0.8s	0.01s
	68	Zone selectivity Start up (forward &/or backward) Trip direction Minimum angle direction (°) Tolerance	Activation: 0.6...10 x In forward &/or backward 3.6, 7.2, 10.8, 14.5, 18.2, 22, 25.9, 30, 34.2, 38.7, 43.4, 48.6, 54.3, 61, 69.6 ± 7% I ≤ 6 x In ± 10% I > 6 x In	0.1 x In	t7sel = 0.1...0.8s Range: 0.1...30s The better of the two data: ± 10% or ± 40 ms	0.01s 0.01s
UV2	27	Undervoltage Protection Tolerance	U15 = 0.5...0.98 x Un ± 2%	0.001 x Un	with U < U15, t15 = 0.05...120s The better of the two data: ± 10% or ± 40 ms (for t<5s) / ± 100 ms (for t≥5s)	0.01s
OV2	59	Overvoltage protection Tolerance	U16 = 1.02...1.5 x Un ± 2%	0.001 x Un	with U > U16, t16 = 0.05...120s The better of the two data: ± 10% or ± 40 ms (for t<5s) / ± 100 ms (for t≥5s)	0.01s
UF2	81L	Underfrequency protection Tolerance	f17 = 0.9...0.999 x fn ± 1% (with fn ±2%)	0.001 x fn	with f < f17, t17 = 0.15...300s The better of the two data: ± 10% or ± 40 ms (for t<5s) / ± 100 ms (for t≥5s)	0.01s
OF2	81H	Overfrequency protection Tolerance	f18 = 1.001...1.1 x fn ± 1% (with fn ±2%)	0.001 x fn	with f > f18, t18 = 0.15...300s The better of the two data: ± 10% or ± 40 ms (for t<5s) / ± 100 ms (for t≥5s)	0.01s
S(V)	51V	Voltage controlled overcurrent protection Step mode  Linear mode  Tolerance	I20 = 0.6...10 x In Ul = 0.2...1 x Un Ks = 0.1...1 Ul = 0.2...1 x Un Uh = 0.2...1 x Un Ks = 0.1...1 ± 10%	0.1 x In 0.01 x Un 0.01 0.01 x Un 0.01 x Un 0.01	With I > I20, t20 = 0.05...30s The better of the two data: ± 10% or ± 40 ms (for t<5s) / ± 100 ms (for t≥5s)	0.01s



Excludibility	Excludibility trip	Pre-alarm	Trip curve	Ekip Touch	Ekip Hi-Touch	Ekip G Touch	Ekip G Hi-Touch
yes	yes	no	t = k	○	●	●	●
yes	yes	no	t = k	○	●	●	●
yes	yes	no	t = k	○	●	●	●
yes	yes	no	t = k	○	●	●	●
yes	only signalling	no	-	○	●	●	●
yes	only signalling	no	-	○	●	●	●
yes	only signalling	no	-	●	●	●	●
yes	yes	no	t = k	○	●	○	●
yes	yes			○	●	○	●
yes	yes			○	●	○	●
yes	yes	no	t = k	○	●	○	●
yes				○	●	○	●
yes				○	●	○	●
yes	yes	no	t = k	○	●	○	●
yes	yes	no	t = k	○	●	○	●
yes	yes	no	t = k	○	○	○	●
				○	○	○	●
				○	○	○	●
				○	○	○	●

Table continued on next page

# Technical characteristics for protection trip units

## Protection functions

ABB Code	ANSI Code	Function	Threshold	Threshold step	Tripping time	Time Step		
RV	59N	Residual overvoltage protection Tolerance	$U_{22} = 0.05...0.5 \times U_n$ $\pm 5\%$	$0.001 \times U_n$	with $U > U_{22}$ , $t_{22} = 0.5...120s$ The better of the two data: $\pm 10\%$ or $\pm 40 ms$ (for $t < 5s$ ) / $\pm 100 ms$ (for $t \geq 5s$ )	0.01s		
OP	32OF	Active overpower protection Tolerance	$P_{26} = 0.4...2 S_n$ $\pm 10\%$	$0.001 S_n$	with $P > P_{26}$ , $t_{26} = 0.5...100s$ The better of the two data: $\pm 10\%$ or $\pm 40 ms$ (for $t < 5s$ ) / $\pm 100 ms$ (for $t \geq 5s$ )	0.5s		
OQ	32OF	Reactive overpower protection Tolerance	$Q_{27} = 0.4...2 S_n$ $\pm 10\%$	$0.001 S_n$	with $Q > Q_{27}$ , $t_{27} = 0.5...100s$ The better of the two data: $\pm 10\%$ or $\pm 40 ms$ (for $t < 5s$ ) / $\pm 100 ms$ (for $t \geq 5s$ )	0.5s		
UP	32LF	Active underpower protection Start up Tolerance	$P_{23} = 0.1...1 \times S_n$ $\pm 10\%$	$0.001 \times S_n$	with $P < P_{23}$ , $t_{23} = 0.5...100s$ range: $0.1...30s$ The better of the two data: $\pm 10\%$ or $\pm 40 ms$ (for $t < 5s$ ) / $\pm 100 ms$ (for $t \geq 5s$ )	0.5s 0.01s		
RQ	40/32R	Loss of field or reverse reactive power protection	$Q_{24} = -1...-0.1 S_n$ $K_{q2} = -2...2$	$0.001 S_n$ 0.01	with $Q > Q_{24}$ , $t_{24} = 0.5...100s$	0.1s		
		Loss of field or reverse reactive power protection	$Q_{25} = -1...-0.1 S_n$ $K_{q2} = -2...2$	$0.001 S_n$ 0.01	with $Q > Q_{25}$ , $t_{25} = 0.5...100s$	0.5s		
		Voltage minimum threshold	$V_{min.} = 0.5...1.2$	0.01				
		Tolerance	$\pm 10\%$		The better of the two data: $\pm 10\%$ or $\pm 40 ms$ (for $t < 5s$ ) / $\pm 100 ms$ (for $t \geq 5s$ )			
S2(V)	51V	Voltage controlled overcurrent protection Step mode	$I_{21} = 0.6...10 \times I_n$ $U_{I2} = 0.2...1 \times U_n$ $K_{s2} = 0.1...1$	$0.1 \times I_n$ $0.01 \times U_n$ 0.01	With $I > I_{21}$ , $t_{21} = 0.05...30s$	0.01s		
		Linear mode	$U_{I2} = 0.2...1 \times U_n$ $U_{h2} = 0.2...1 \times U_n$ $K_{s2} = 0.1...1$	$0.01 \times U_n$ $0.01 \times U_n$ 0.01				
		Tolerance	$\pm 10\%$		The better of the two data: $\pm 10\%$ or $\pm 40 ms$ (for $t < 5s$ ) / $\pm 100 ms$ (for $t \geq 5s$ )			
		ROCOF	81R	Rate of change of frequency protection Trip direction Tolerance	$f_{28} = 0.4...10 Hz/s$ up &/or down $\pm 5\%$	$0.2 Hz/s$	with $f > f_{28}$ , $t_{28} = 0.5...10s$ The better of the two data: $\pm 20\%$ or $\pm 200 ms$	0.01s
		Synchro-check SC	25	Synchrocheck (Live busbars) Tolerance	$U_{live} = 0.5...1.1 U_n$ $\Delta U = 0.02...0.12 U_n$ $\Delta f = 0.1...1 Hz$ $\Delta \Phi = 5...50^\circ \text{ elt}$ $\pm 10\%$	$0.001 U_n$ $0.001 U_n$ 0.1 Hz 5° elt	Stability voltage time for live state = $100...30000ms$ Minimum matching Time = $100...3000ms$	0.001s 0.01 s
Synchrocheck (Live, Dead busbars) Frequency check off	$U_{live} = 0.5...1.1 U_n$ $U_{dead} = 0.02...0.2 U_n$			$0.001 U_n$ $0.001 U_n$	$t_{ref} = 0.1...30s$	0.1s		
Phase check off								
Dead bar configuration	Reverse/standard							
Primary voltage	100...1150			100, 115, 120, 190, 208, 220, 230, 240, 277, 347, 380, 400, 415, 440, 480, 500, 550, 600, 660, 690, 910, 950, 1000, 1150				
Secondary voltage	100...120			100, 110, 115, 120				
Tolerance	$\pm 10\%$							

(1) With Vaux all thresholds are available. Without Vaux minimum threshold is limited to:  $0.3I_n$  (with  $I_n = 100A$ ),  $0.25I_n$  (with  $I_n = 400A$ ) or  $0.2I_n$  (for all other ratings)  
The tolerances above apply to trip units already powered by the main circuit with current flowing in at least two-phases or an auxiliary power supply.

In all other cases the following tolerance values apply:

ABB Code	Trip threshold	Trip time
L	Trip between $1.05$ and $1.2 \times I_1$	$\pm 20\%$
S	$\pm 10\%$	$\pm 20\%$
I	$\pm 15\%$	$\leq 60ms$
G	$\pm 15\%$	$\pm 20\%$
Other protection	$\pm 15\%$	$\pm 20\%$



Excludibility	Excludibility trip	Pre-allarm	Trip curve	Ekip Touch	Ekip Hi-Touch	Ekip G Touch	Ekip G Hi-Touch
yes	yes	no	t = k	○	○	●	●
yes	yes	no	t = k	○	○	●	●
yes	yes	no	t = k	○	○	●	●
yes	yes	no	t = k	○	○	●	●
yes	yes	no	t = k	○	○	●	●
yes	yes	no	t = k	○	○	○	●
yes	yes	no	t = k	○	○	○	●
yes	yes	no	t = k	○	○	○	●
yes	yes	no	t = k	○	○	○	●
yes	yes	no	t = k	○	○	○	●
yes	yes	no	t = k	○	○	○	●
yes	yes	no	t = k	○	○	○	●
yes	yes	no	t = k	○	○	○	●
yes	yes	no	t = k	○	○	○	●
yes	yes	no	t = k	○	○	○	●
yes	yes	no	t = k	○	○	○	●
yes	only signalling	no	-	○ ○○	○○	○○	○○
yes	only signalling	no	-				
yes							
yes							
yes							

**Key:**  
 - not available  
 ● available  
 ○ available with the dedicated software package. The Measuring Package has to be activated first, if not provided by default. For RC protection, Measurement Enabler with voltage sockets and Ekip Supply are needed.  
 ○○ available with Ekip Synchrocheck

# Technical characteristics for protection trip units

## Measurement functions

Instantaneous measurements		Displayed with Ekip Multimeter	Parameters
Currents (RMS)	[A]	•	L1, L2, L3, Ne
Earth fault current (RMS)	[A]	•	Ig
Record of values: of the parameter for each interval with time-stamping			Parameters
Current: minimum and maximum	[A]	•	I Min, I Max
Information on trip and opening data: after a fault with or without auxiliary supply			Parameters
Type of protection tripped		•	eg. L, S, I, G
Fault values per phase	[A]	•	eg. I1, I2, I3, neutral for S protection
Time-stamping		•	Date, time and progressive number
Maintenance indicators			Parameters
Information on last 30 trips		•	Type of protection, fault values and time-stamping
Information on last 200 events		•	Type of event, time-stamping
Number of mechanical operations <sup>(1)</sup>	[no]	•	Can be associated to alarm
Total number of trips	[no]	•	
Total operating time	[h]	•	
Wear of contacts	[%]	•	Prealarm >80%, Alarm = 100%
Date of maintenance operations performed		•	Last
Indication of maintenance operation needed		•	
Circuit-breaker I.D.		•	Type of circuit breaker, assigned device name, serial number
Self-diagnosis			Parameters
Check of continuity of internal connections		•	Alarm due to disconnection: rating plug, sensors, trip coil
Failure of circuit breaker to open (ANSI 50BF)		•	Alarm following non-tripping of protection functions
Temperature (T)		•	Pre-alarm and alarm for abnormal temperature

(1) with auxiliary supply present





Precision	Standard	Ekip Dip
1%	IEC 61557-12	●
2%		●
Window	Intervals	
Fixed, synchronizable by remote	Duration: 5...120min Number of intervals: 24	●
		●
		●
		●
		●
		●
		●
		●
		●
		●
		●
		●
		●
		●
Note: Opening of circuit breaker can be set in the event of alarm		●
		●

# Technical characteristics for protection trip units

## Measurement functions

Instantaneous measurements		Parameters
Currents (RMS)	[A]	L1, L2, L3, Ne
Earth fault current (RMS)	[A]	Ig
Phase-phase voltage (RMS)	[V]	U12, U23, U31
Phase-neutral voltage (RMS)	[V]	U1, U2, U3
Phase sequence		
Frequency	[Hz]	f
Active power	[kW]	P1, P2, P3, Ptot
Reactive power	[kVAR]	Q1, Q2, Q3, Qtot
Apparent power	[KVA]	S1, S2, S3, Stot
Power factor		total
Peak factor		L1, L2, L3, Ne
Counters recorded from installation or from the last reset		Parameters
Active energy	[kWh]	Ep total, Ep positive, Ep negative
Reactive energy	[kVARh]	Eq total, Ep positive, Ep negative
Apparent energy	[KVAh]	Es total
Network Analyzer		Parameters
Hourly average voltage value	[V] [no]	- Umin= 0.75...0.95 x Un - Umax= 1.05...1.25 x Un - Events counter (nr. of events day by day in the last year plus the total events in the breaker's lifetime)
Short voltage interruptions	[no]	- Umin= 0.75...0.95 x Un - Events counter (nr. of events day by day in the last year plus the total events in the breaker's lifetime)
Short voltage spikes	[no]	- Umax= 1,05...1,25 x Un - Events counter (nr. of events day by day in the last year plus the total events in the breaker's lifetime)
Slow-voltage sags and swells	[no]	- Umin1= 0.75...0.95 x Un - Umin2= 0.75...0.95 x Un - Umin3= 0.75...0.95 x Un - Umax1= 1.05...1.25 x Un - Umax2= 1.05...1.25 x Un - Events counter (nr. of events day by day in the last year plus the total events in the breaker's lifetime)
Voltage unbalance	[V] [no]	- U neg. seq.= 0.02...0.10 x Un - Events counter (nr. of events day by day in the last year plus the total events in the breaker's lifetime)
Harmonic analysis		Current and Voltage - up to 50° - Alarm THD: 5...20% - Single harmonic alarm: 3...10% plus a count of minutes the harmonic has been exceeded



Precision (Class 1)	Ekip Touch (*)	Ekip Hi-Touch	Ekip G Touch (*)	Ekip G Hi-Touch
0.5%	●	●	●	●
2%	●	●	●	●
0.5%	○	●	●	●
0.5%	○	●	●	●
	○	●	●	●
0.1%	○	●	●	●
1%	○	●	●	●
2%	○	●	●	●
1%	○	●	●	●
2%	○	●	●	●
	○	●	●	●
<b>Precision (Class 1)</b>				
1%	○	●	●	●
2%	○	●	●	●
1%	○	●	●	●
<b>Intervals</b>				
t = 5...120min	○	●	○	●
t <40ms	○	●	○	●
t <40ms	○	●	○	●
t = 0.02s...60s	○	●	○	●
t = 5...120min	○	●	○	●
	○	●	○	●

(\*) Precision (Class 1) available with dedicated extracode  
 With no Class 1, please refer to the precision values below:

Current (RMS)	1%	Frequency	0.2%	Power factor	2%
Earth fault current (RMS)	2%	Active power	2%	Active energy	2%
Phase-phase voltage (RMS)	0.5%	Reactive power	2%	Reactive energy	2%
Phase-neutral voltage (RMS)	0.5%	Apparent power	2%	Apparent energy	2%

# Technical characteristics for protection trip units

## Measurement functions

Record of values: of the parameter for each interval with time-stamping		Parameters
Current: minimum and maximum	[A]	I Min, I Max
Phase-phase voltage: minimum and maximum	[V]	U Min, U max
Active power: average and maximum	[kW]	P Avg, P Max
Reactive power: average and maximum	[kVAR]	Q Avg, Q Max
Apparent power: average and maximum	[KVA]	S Avg, S Max
Data logger: record of high sampling rate parameters		Parameters
Currents	[A]	L1, L2, L3, Ne, Ig
Voltages	[V]	U12, U23, U31
Sampling rate	[Hz]	1200-2400-4800-9600
Maximum recording duration	[s]	16
Recording stop delay	[s]	0-10s
Number of registers	[no]	2 independent
Information on trip and opening data: after a fault without auxiliary supply		Parameters
Type of protection tripped		eg. L, S, I, G, UV, OV
Fault values per phase	[A/V/Hz W/var]	eg. I1, I2, I3, neutral for S protection V12, V23, V32 for UV protection
Time-stamping		Date, time and progressive number
Maintenance indicators		Parameters
Information on last 30 trips		Type of protection, fault values and time-stamping
Information on last 200 events		Type of event, time-stamping
Number of mechanical operations <sup>(1)</sup>	[no]	Can be associated to alarm
Total number of trips	[no]	
Total operating time	[h]	
Wear of contacts	[%]	Prealarm >80% Alarm = 100%
Date of maintenance operations performed		Last
Indication of maintenance operation needed		
Circuit-breaker I.D.		Type of circuit breaker, assigned device name, serial number
Self-diagnosis		Parameters
Check of continuity of internal connections		Alarm due to disconnection: rating plug, sensors, trip coil
Failure of circuit breaker to open (ANSI 50BF)		Alarm following non-tripping of protection functions
Temperature (OT)		Prealarm and alarm for abnormal temperature

(1) with auxiliary supply present



Window	Intervals	Ekip Touch	Ekip Hi-Touch	Ekip G Touch	Ekip G Hi-Touch
Fixed synchronizable by remote	Duration: 5...120min Number of intervals: 24	●	●	●	●
		●	●	●	●
		○	●	●	●
		○	●	●	●
		○	●	●	●
		○	●	●	●
		○	●	●	●
		○	●	●	●
		○	●	●	●
		○	●	●	●
		○	●	●	●
		○	●	●	●
		○	●	●	●
		●	●	●	●
		●	●	●	●
		●	●	●	●
		●	●	●	●
		●	●	●	●
		●	●	●	●
		●	●	●	●
		●	●	●	●
		●	●	●	●
		●	●	●	●
		●	●	●	●
		●	●	●	●
		●	●	●	●
		●	●	●	●
		●	●	●	●
		●	●	●	●
		●	●	●	●
		●	●	●	●
Note: Opening of circuit breaker can be set in the event of alarm		●	●	●	●
		●	●	●	●
		●	●	●	●

Key:

- not available
- available
- available with the dedicated software package

# Description of protection functions

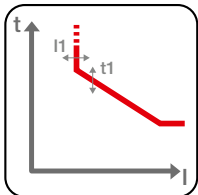

**Overload (L - ANSI 49):** available with three different types of trip curve:

1.  $t = k/I^2$  with inverse long time;
2. IDMT in accordance with 60255-151 for coordination with medium voltage protections, that are available according to the Standard Inverse (SI), Very Inverse (VI) and Extremely Inverse (EI) curves;
3. with  $t = k/I^4$  curve for better coordination with upstream circuit-breakers or with fuses.

The thresholds can be fine tuned (for example 1A for circuit-breaker E1.2 1000A) and the timings to the second can be set directly from the display. The settable pre-alarm indicates the set threshold is reached before the protection is tripped. The protection can be disabled by rating plug L=off.

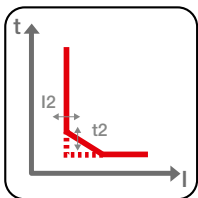

**Time-delayed overcurrent (S - ANSI 51 & 50TD):** with constant tripping time ( $t = k$ ), or with constant specific let-through energy ( $t = k/I^2$ ), this provides 15 current thresholds and 8 curves, for fine adjustment. The function can be excluded by setting the dip switch combination to "OFF".

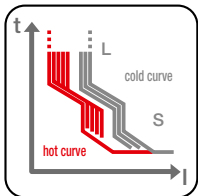

**Thermal memory:** for L and S protection functions, this is used to protect components, such as transformers, from overheating following an overload. The function, which can be enabled by the Ekip Connect software, adjusts the protection tripping time according to the length of time that has elapsed since the first overload, taking into account the amount of heat generated.

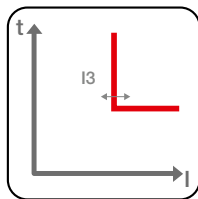

**Instantaneous overcurrent (I - ANSI 50):** with tripping curve without intentional delay, it offers 15 tripping thresholds and can be excluded by setting the dip switch combination to "OFF".

**Closing on short-circuit (MCR):** the protection uses the same algorithm of the protection I, limiting operation to a settable time window from the closing of the circuit-breaker. The protection can be disabled, also alternatively to protection I. The function is active with an auxiliary supply.

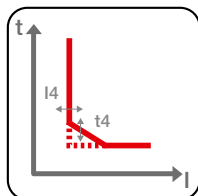

**Earth fault (G - ANSI 51N & 50NTD):** with tripping time independent of current ( $t = k$ ) or constant specific let-through energy ( $t = k/I^2$ ). The function can be excluded by setting the dip switch combination to "OFF".

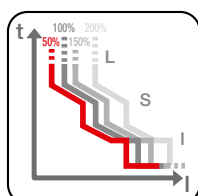

**Neutral protection:** available at 50%, 100% or 200% of the phase currents, or disabled, it is applied to the overcurrent protections L, S and I.

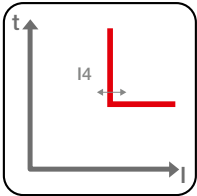

**Instantaneous Earth Fault (G-ANSI 50N):** with trip curve without instantaneous delay.

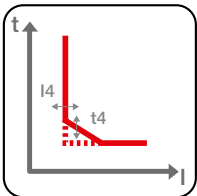

**Earth fault on toroid (G ext - ANSI 51G & 50GTD):** with trip time independent of the current ( $t = k$ ) or with constant specific let-through energy ( $t = k/I^2$ ). Pre-alarm that 90% threshold has been reached permits the fault to be reported to supervision systems without interruption of continuity. The protection uses the external toroid installed, for example, on the star centre of the transformer, and is an alternative to the G and Rc functions. The function is active with an auxiliary supply.

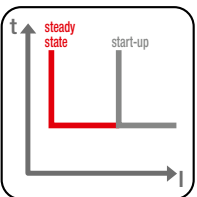

**Start-up function:** enables protections S, I and G to operate with higher trip thresholds during the starting phase, avoiding untimely trips due to high inrush currents of certain loads (motors, transformers, lamps). The starting phase lasts 100 ms to 30 s and is recognized automatically by the trip unit:

- at the closing of the circuit breaker with a self-supplied trip unit;
- when the peak value of the maximum current exceeds the set threshold ( $0.1...10 \times I_n$ ) with an externally supplied trip unit; a new start-up is possible after the current falls below the threshold.

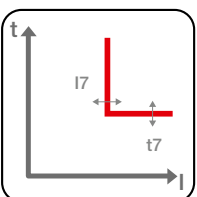

**Current unbalance (IU - ANSI 46):** with constant trip time ( $t = k$ ), protects from an unbalance between the currents of the single phases protected by the circuit breaker.

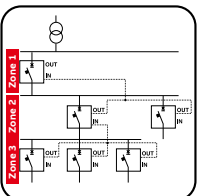

**Zone selectivity for S and G protection (ANSI 68):** can be used to minimize circuit-breaker trip times closer to the fault. The protection is provided by connecting all the zone selectivity outputs of the trip units belonging to the same zone and taking this signal to the trip unit input that is immediately upstream. Each circuit breaker that detects a fault reports it to the circuit breaker upstream; the circuit-breaker thus detects the fault but does not receive any communication from those downstream and opens without waiting for the set delay to elapse. It is possible to enable zone selectivity if the fixed-time curve has been selected and the auxiliary supply is present.

# Description of protection functions

**Current thresholds:** this function enables four independent thresholds to be indicated in order to enable corrective action implementation before the overload L protection trips the circuit breaker. For example, by disconnecting loads located downstream of the circuit breaker that are controlled by Ekip Signalling.

## Advanced protection functions

A different operating mode can be chosen for the following protection function:

1. Active: protection enabled by opening of the circuit- breaker when the threshold is reached;
2. Only alarm: protection active, with only alarm indication when the threshold is reached;
3. Deactivated: protection disabled.

Furthermore, when the voltage and frequency protections are activated, they indicate an alarm status even when the circuit breaker is open so that a fault can be identified before the circuit breaker closes.

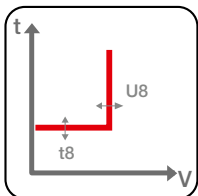

**Undervoltage (UV - ANSI 27):** with constant trip time ( $t = k$ ), function is tripped when phase voltage falls below set threshold.

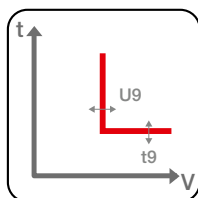

**Overvoltage (OV - ANSI 59):** with constant trip time ( $t = k$ ), function is tripped when phase voltage exceeds the set threshold.

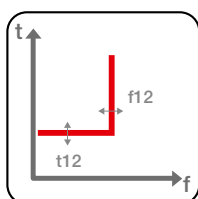

**Underfrequency (UF - ANSI 81L):** with constant trip time ( $t = k$ ), function is tripped when network frequency falls below set threshold.



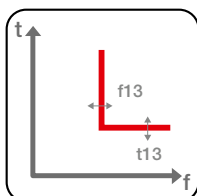

**Overfrequency (OF - ANSI 81H):** with constant trip time ( $t = k$ ), function is tripped when network frequency exceeds the set threshold.

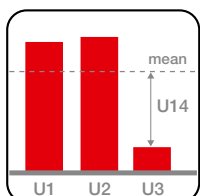

**Voltage unbalance (VU – ANSI 47):** with constant trip time ( $t = k$ ), protects against an unbalance between the voltages of the individual phases that are protected by the circuit- breaker.

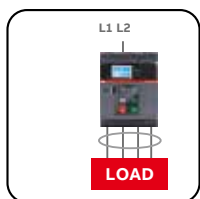

**Residual current (Rc – ANSI 64 & 50NDT):** with constant temperature ( $t=k$ ) protects against indirect contacts and is integrated into Ekip Touch LSIG with Measurement Enabler with voltage sockets by a dedicated residual current rating plug and external toroid. The protection is an alternative to the functions G and Gext.

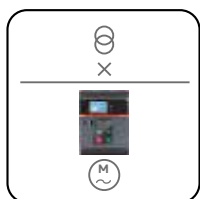

**Reverse active power (RP - ANSI 32R):** with constant trip time ( $t = k$ ), function is tripped when total active power – in the opposite direction of the current - exceeds the set threshold.

# Description of protection functions

In addition to the protection functions, the following indication and control functions are available to warn the user that a given condition has been reached. The active indications are always shown on the display and are also available by communication on the system bus (with Ekip Com modules) or electrical indication (with Ekip Signalling modules).

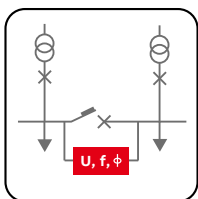

**Synchrocheck (SC - ANSI 25):** the synchronism control function compares the voltages in the modules as well as the frequencies and phases of two circuit breakers to which the circuit breaker is connected. Ekip Touch indicates that conditions have been reached that enable the two lines to be made parallel. The function is available with two work modes:

- In systems with both busbars supplied, where synchronism is determined by:
  1. voltage of the two half-busbars above the  $U_{live}$  threshold for the set time
  2. difference of the module of the two voltages below the threshold  $\Delta U$
  3. difference in the frequency of the two voltages below the threshold  $\Delta f$
  4. difference in the phase of the two voltages below the threshold  $\Delta$
  5. desirable time for synchronism condition  $t_{syn}$
  6. circuit breaker open
- In systems with an out-of-service line (dead busbar), where the synchronism condition is determined by the concurrence of the following conditions for the  $t_{ref}$  set time:
  1. voltage of the active half-busbar above threshold  $U_{live}$
  2. voltage of the dead half-busbar below threshold  $U_{dead}$
  3. circuit breaker open

In both cases, synchronism consent is withdrawn when one of the above conditions is missing and it has not been less than 200ms from the change of the circuit-breaker condition (when the relationship has been set).

The indication of reached synchronism is available directly as an electrical indication via a contact that is always supplied with the module. The function can be activated simply by connecting the Ekip Synchrocheck module.

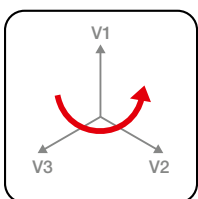

**Cyclical direction of the phases (ANSI 47):** indicates an alarm through inversion of the phases sequence.

**Power factor (ANSI 78):** available with a three-phase threshold, warns when the system operates with a power factor that is less than the set power factor.

The following protections are also available:

**Second time-delayed overcurrent protection (S2 – ANSI 50TD):** in addition to the standard protection S, a second (excludable) time-constant protection is available that enables two independent thresholds to be set in order to ensure precise selectivity, especially in highly critical conditions.

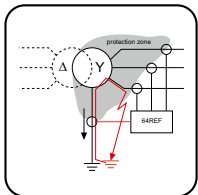

**Second protection against earth fault (ANSI 50GTD/51G & 64REF):** whereas with Ekip Touch the user has to choose between implementation of the protection G by internal current sensors (calculating the vector sum of the currents) or G ext external toroids (direct measurement of the earth fault current), Ekip Hi-Touch offers the exclusive feature of simultaneous management of both configurations by two independent earth fault protection curves. Owing to this characteristic, the trip unit is able to distinguish a non-restricted earth fault and then activate the opening of Emax 2, from a restricted earth fault, and to thus command the opening of the medium voltage circuit breaker.

Another possible configuration is with the residual current protection replacing the Gext protection, whilst the G protection remains active. The residual current protection is activated in the presence of the residual current rating-plug and of the toroid.

**Directional overcurrent (D – ANSI 67):** the protection is able to recognize the direction of the current during the fault period and thus detect if the fault is upstream or downstream of the circuit-breaker. The protection, with fixed time trip curve ( $t=k$ ), intervenes with two different time delays ( $t_{7bw}$  and  $t_{7fw}$ ), according to the current direction. In ring distribution systems, this enables the distribution portion to be identified in which the fault occurred and to disconnect it while maintaining the operation of the rest of the installation.

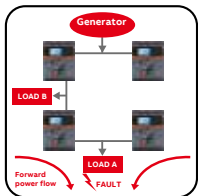

**Zone selectivity for protection D (ANSI 68):** enables the possibility to interconnect circuit breakers so that, in the event of a fault, the fault area can be rapidly isolated. Disconnection only occurs at the level close to the fault and operation to the rest of the operation continues uninterrupted. The function is particularly useful in ring and grid installations where, in addition to the zone, it is also essential to define the flow direction of the power that supplies the fault. It is possible to enable directional zone selectivity alternatively to the zone selectivity of the protections S and G, and in the presence of an auxiliary supply.

**Start-up function** for protection D: enables higher trip thresholds to be set at the outgoing point, as available for protections S, I and G.

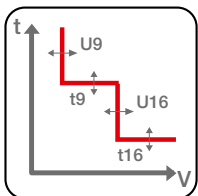

**Second protection against undervoltage and overvoltage (UV2 and OV2 – ANSI 27 and 59):** enables two minimum and maximum voltage thresholds to be set with different delays in order to be able to discriminate, for example, between voltage dip transients due to the start-up of a motor and an actual fault.

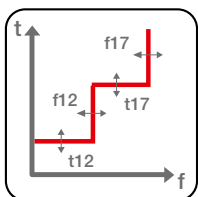

**Second protection against underfrequency and overfrequency (UF2 and OF2 – ANSI 81L and 87H):** enables two minimum and maximum frequency thresholds to be set simultaneously. For example, only an alarm can be set to be tripped when the first threshold is reached, and the circuit breaker can be set to be opened when the second threshold is reached.

# Description of protection functions

**Dual setting of protections:** Ekip Hi-Touch can store a set of alternative parameters for all protections. This second series (set B) can replace, if necessary, the default series (set A) by an external command. The command can be given when the network configuration is edited, for example when an emergency source is activated in the system, changing the load capacity and the short-circuit levels. Another typical application is protecting the operator opposite the switchgear against the electric arc. In this case, protection delays are minimized to safeguard the operator (Set A), whereas in the absence of an operator the protections are set to ensure selectivity with the circuit breakers downstream (Set B). It is possible to activate series B by:

- Digital input available with an Ekip Signalling module;
- Communication network, by means of one of the Ekip Com communication modules;
- Directly from the Ekip Hi-Touch display;
- By a settable internal time, after the circuit-breaker has closed.

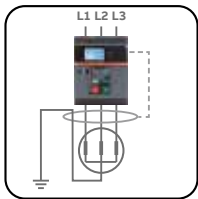

**Differential ground fault (Rc - ANSI 87N):** protects against internal earth fault on generator winding. It is required that the toroid hugs the active conductors and the ground conductor. Rc protection is integrated by a dedicated residual current rating plug and the external toroid.

The specific functions for generator protections are described below. For each of these it is possible to choose the operating mode: active, only alarm or deactivated. All the voltage and frequency protections also operate when the circuit-breaker is open, enabling the fault to be identified before the closing of the circuit breaker.

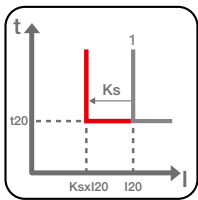

**Voltage controlled overcurrent protection (S(V) - ANSI 51V):** protection from maximum current with a constant trip time ( $t = k$ ) that is sensitive to the voltage value. The set current threshold, following a voltage drop, decreases by steps or linearly.

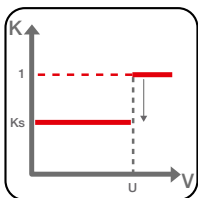

In step mode (controlled mode) the protection is tripped at the set threshold ( $I_{20}$ ) if the voltage is above  $U$ , whereas it is tripped at the lower threshold of the factor  $K_s$  ( $I_{20} * K_s$ ) if the voltage is below  $U$ .

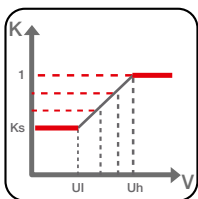

On the other hand, in linear mode (restrained mode) two voltage limits are selected within which the protection is tripped at the set threshold ( $I_{20}$ ) reduced by the factor  $K$  corresponding to the measured voltage. The variation of the factor  $K$  is proportional to the voltage, and for voltages greater than the upper threshold ( $U_h$ ) the threshold  $I_{20}$  works, whereas for voltages below the lower threshold ( $U_l$ ) the minimum threshold ( $I_{20} * K_s$ ) applies.

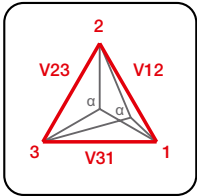

**Residual overvoltage (RV – ANSI 59N):** with constant trip time ( $t = k$ ), protects against insulation loss in systems with insulated neutral or with neutral earthed with impedance.

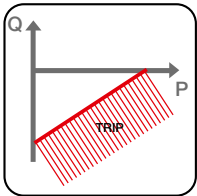

**Loss of field or reverse reactive power (RQ – ANSI 40 or 32RQ):** with constant trip time ( $t = k$ ), the circuit breaker tripped when the total reactive power absorbed by the generator exceeds the set threshold. It is possible to select the constant threshold ( $k=0$ ) or a function of the delivered active power of the generator ( $k \neq 0$ ).

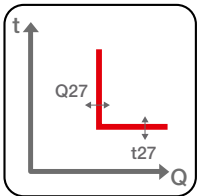

**Reactive overpower (OQ – ANSI 32OF):** with constant trip time ( $t = k$ ), the function is tripped when reactive power exceeds the set threshold in the generator to network direction.

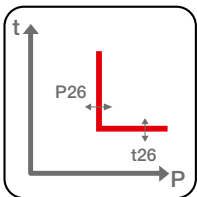

**Active overpower (OP – ANSI 32OF):** with constant trip time ( $t = k$ ), the function is tripped when the active power exceeds the threshold set in the delivering direction of the generator.

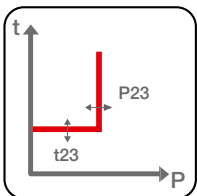

**Active underpower (UP – ANSI 32LF):** with constant trip time ( $t = k$ ), the function is tripped when the active power delivered by the generator is lower than the set threshold. It is possible to disable the protection temporarily, to manage the start-up phase, by setting a time window from the closing of the circuit breaker, by using an electrical signal or via incoming communication to a relay.

# Description of protection functions

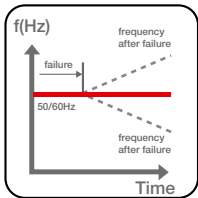

**Rate of change of frequency (ROCOF – ANSI 81R):** enables both positive and negative frequency variations to be rapidly detected. The protection is constant and is tripped when the frequency variation in Hz/s is greater than the set threshold.

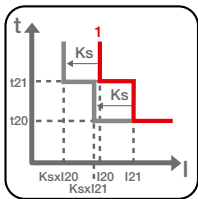

**Second protection against voltage controlled overcurrent protection (S2(V) - ANSI 51V):** available in addition to the protection S(V), enables total selectivity to be achieved in all installations.

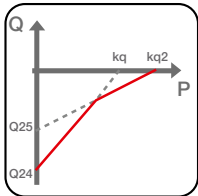

**Second protection against loss of field or reverse reactive power (RQ – ANSI 40 or 32R):** enables the generator's de-energization curve to be followed very accurately, thereby avoiding any unnecessary disconnection.

---

# Software functions

<b>4/2</b>	<b>Introduction</b>
<b>4/4</b>	<b>Interface Protection System</b>
<b>4/6</b>	<b>Adaptive Protections</b>
<b>4/8</b>	<b>Load Shedding</b>
<b>4/10</b>	<b>Automatic Transfer Switch</b>
<b>4/12</b>	<b>Synchrocheck logics</b>
<b>4/14</b>	<b>Power Controller</b>

# Introduction

Renewables have been growing during the last 10 years reducing the polluting emission for a greenest world. Due to environmental changes, people has started to think about ecology and sustainability, increasing their awareness of energy self-consumption in a perspective of energy efficiency.

Emax 2 is the first smart circuit breaker enabling all-in-one solutions that combine advanced protection, programmable logic, full connectivity, easy integration and comprehensive energy management in a single revolutionary device or at the local generation side.

Installed downstream the MV/LV transformer, Emax 2 works like a certified **Interface Protection System** in order to check the Main Grid conditions and disconnect the User's plant whenever grid voltage and frequency are out of the ranges prescribed by the connection local standard.

Emax 2 and its **Adaptive Protections** recognize the network change and automatically set new thresholds to guarantee protection and coordination in on-grid and off-grid conditions.

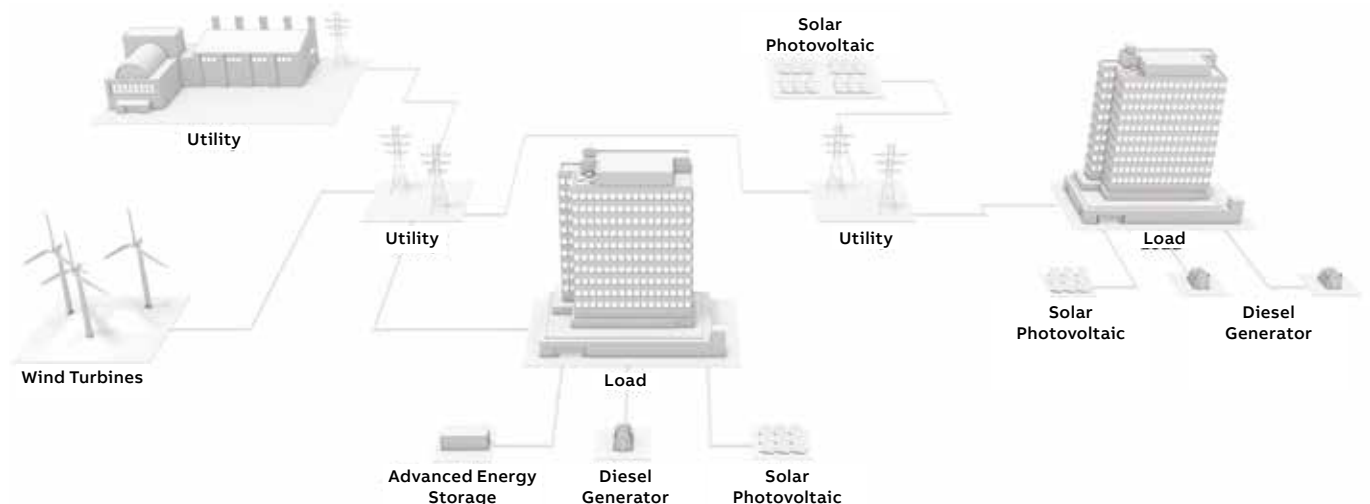



In order to maximize the service continuity, local generation starts to supply the islanded User's plant. Emax 2 is the first circuit breaker able to integrate in one device protection features and **Automatic Transfer Switching (ATS)** programmable logics. This unique integrated solution avoids the usage of other external control unit, guaranteeing switchgear footprint and commissioning time saving.

Strong reduction of wiring connection simplify the installation and commissioning phase.

The **Load Shedding** embedded algorithm is able to manage power system for the comprehensive microgrid energy management.

Before the transfer from the main grid to local line, selected loads are shed to support power balance. Emax 2 using slope of frequency disconnects loads only in case of emergency unbalance condition.

When the main grid comes back stable, thanks to **Synchrocheck** logics, manages the plant voltage and frequency to reconnect it. in grid-connected operation, Emax 2 manages the **Power Controller** algorithm to shave peaks and shift loads in order to optimize system performance and productivity. Emax 2 advanced features are easily customized thanks to commissioning software tools which do not require high level engineering competencies. Ready to use templates enable the download of all the logics directly into the trip unit. The solutions become plug & play, increasing modularization and standardization for design and installation. Here following the description of the several Advanced functionalities which have been developed and integrated in Emax 2 follows the below compatibility table.

	Interface Protection	Load Shedding	Automatic Transfer Switch	Synchrocheck logics	Power Controller
Interface Protection	●	●			●
Load Shedding	●	●	●	●	●
Automatic Transfer Switch		●	●	●	●
Synchrocheck logics		●	●	●	●
Power Controller	●	●	●	●	●

# Interface Protection System

Emax 2 embeds in a single device both the functions of Interface Protection System and Interface Device.

## Purpose

The connection of Active Users to the Utility is subject to the satisfaction of the Standard requirements. The Interface Protection System is a relay with dedicated protections able to satisfy such requirements. In particular, the generating units installed in the User's plant shall be disconnected from the grid whenever voltage and frequency values of the grid itself are out of the ranges prescribed by the standard. Such a disconnection is usually carried out by means of an Interface Device that trips after receiving an opening command provided by an external Interface Protection System.

ABB has developed an integrated solution which embeds in a single device both the functions of Interface Protection System and Interface Device. This advanced feature is possible thanks to the integration of the several interface protections into the Ekip Hi-Touch trip unit installed on board Emax 2. Today Emax 2 is suitable for Standard CEI 0-16, the most important Standard for the connection of Active Users. A lot of local Standards take CEI 0-16 as reference.

## Application examples

ABB has been able to integrate in a single device the following functions to be used in the scenarios described below. Thanks to these embedded functions, the number of devices to be installed is reduced, with consequent space saving inside the switchboard. Emax 2 with embedded Interface Protection System have been tested and certified in compliance with the Standard CEI 0-16 and are suitable for the following scenarios.

### Emax 2 as Microgrid Main protection unit

In such scenario, Emax 2 with embedded Interface Protection System can fulfill the function of Interface Protection System (IPS). In case of IPS tripping, microgrid, downstream Emax 2 main unit, remains active thanks to both the local generation and the load shedding feature also embedded in the main unit.

### Emax 2 as local generation protection unit

In such scenario, there are loads non-operating in islanding condition, so, when there is an Utility outage, Emax 2 detects that voltage and frequency values are out of the range prescribed. According to the standard the local generation must be disconnected from the Utility, so Emax 2 opens, acting as interface device, thanks to the IPS embedded. In this condition loads are not operating as there is no voltage on the secondary of the MV/LV transformer and no local generation connected.

## Benefits

Thanks to Emax 2 with embedded Interface Protection System, the following benefits are guaranteed:

- Emax 2 performs interface protections with every possible switching device, ensuring also reclosing operation.
- If the Emax 2 is installed on the generator feeder, the unit will be able to perform the triple function of Interface Protection System and Generator Device thanks to the Interface Protection System integrated also in the Ekip G Hi-Touch trip unit.
- Ease of use, thanks to Ekip Connect software which allows an immediate and intuitive commissioning phase.

For further information, please refer to the White Paper "Emax 2, all-in-one innovation – Interface Protection System and Interface Device" (1SDC007117G0201).



—  
Emax 2 as Microgrid  
Main protection unit

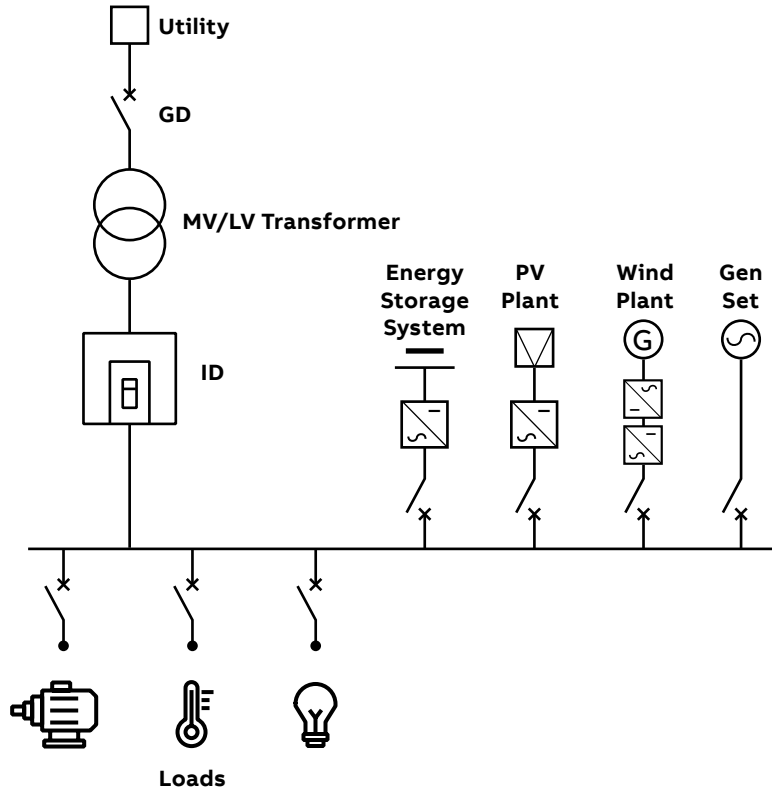

—  
Emax 2 as local gener-  
ation protection unit

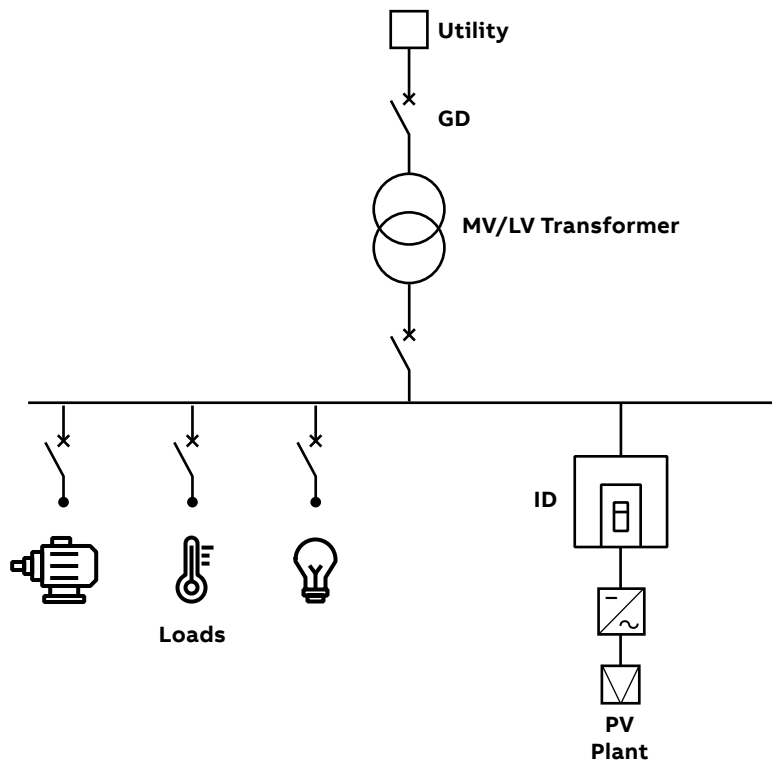

# Adaptive Protections

Emax 2 adds dual setting capability to switching device to ensure continuous coordination

**Purpose**

User's plants can work as a LV Microgrid thanks to the energy produced by renewable and local power sources, in particular as a consequence of lacking of the Utility power supply, e.g. due to a fault on the MV voltage side. In order to still guarantee a high level of selectivity and continuity of service, it is important to take into account the variation of the short circuit power when moving from. Indeed, during grid connected condition the fault current on a microgrid feeder is supplied by the Utility, so it is higher than the one supplied only by the local generation during islanded condition.

As a result, it is desirable that the several protection thresholds of the units can be automatically changed during the transition to the islanding condition.

**Application example**

We have a plant connected to the MV Utility by means of a MV/LV transformer. If the Utility shuts down, the plant will become a Microgrid supplied by the local generator G, which will feed the priority loads by using the loads shedding feature of Emax 2.

In grid-connected condition, the generator G is disconnected. With reference to fig.1:

- Circuit breaker A is closed
- Circuit breaker B is open
- Circuit breakers C are closed. The protections of the one that supplies loads D are upgraded using "Set A" of Emax 2 unit.
- Circuit breakers D are closed
- Circuit breaker E is closed
- Circuit breaker QS1 is closed
- All loads supplied.

The circuit breakers C are selectively coordinated with the upstream main circuit breaker A, supplied by the Utility, and the downstream load circuit breakers D (fig. 2).

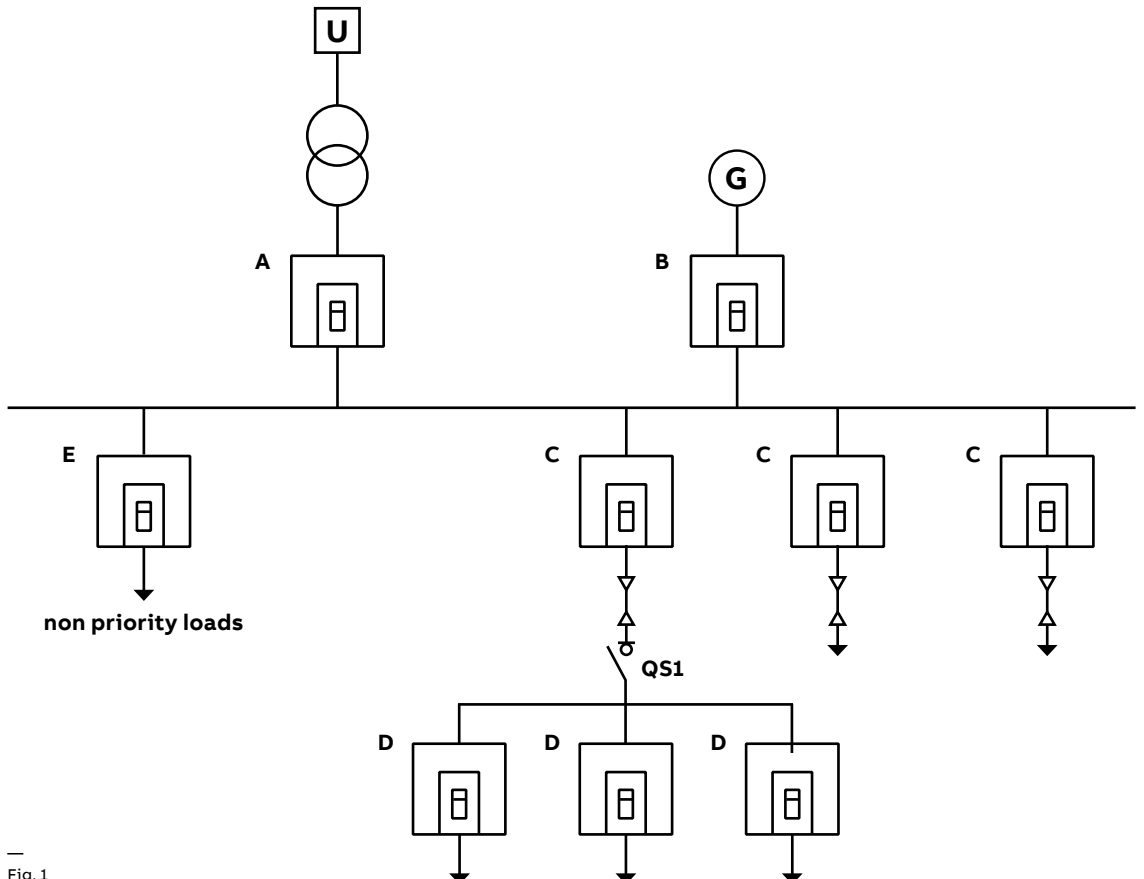

Fig. 1

With Adaptive protections when there is a Utility outage, circuit breaker A opens and B closes in order to have operation in islanded condition. In order to still guarantee selectivity, an alternate set of protection settings is required. Adding Emax 2 adaptive protections to circuit breaker C ensure this behaviour. The second protection setting is optimized for the characteristics of the local generator ensuring the incoming supply and load side switching devices will remain selectively coordinated.

With reference to Figure 1:

- Circuit breaker A is open
- Circuit breaker B is closed
- Circuit breakers C are closed and the protection thresholds move automatically to “Set B”
- Circuit breakers D are closed
- Circuit breaker E is open
- Circuit breaker QS1 is closed
- No priority loads can be disconnected using another functionality of Emax 2 units (see next paragraph).

The following Figure shows how it is possible to switch to a set of parameters which guarantees selective coordination between circuit breakers C and B by means of the “Adaptive protections” function embedded in the trip unit of the circuit-breaker C.

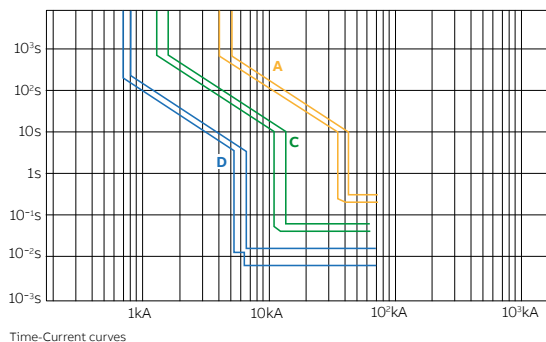

Fig. 2

### Benefits

Thanks to Emax 2 it is possible to have two sets of settings implemented in a single device. As a result, the following benefits are guaranteed:

- Overcurrent protection and selectivity 100% guaranteed both in grid-connected and islanded condition
- The service continuity is granted just adding a single unit in the switchboard in every plant condition
- Ease of use, thanks to the Ekip Connect software which allows an immediate and intuitive commissioning phase.

For further information, please refer to the White Paper “Emax 2, all-in-one innovation – Adaptive protections” (1SDC007116G0201).

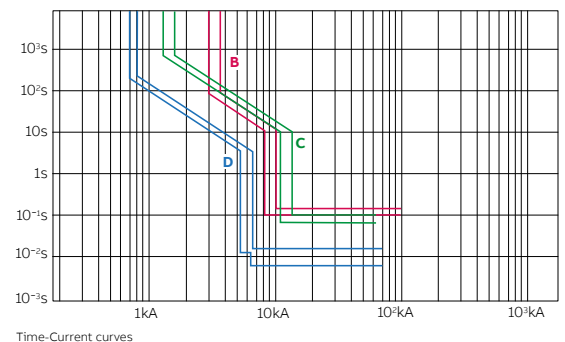

Fig. 3

# Load Shedding

Emax 2 has built-in load shedding algorithms to avoid power unbalance in the low voltage plant and stress for all the components.

## Purpose

ABB Emax 2 embeds patented functions based on load shedding which reduces the Microgrid stress in all situations. Typically it is the main protection relay of the low voltage Microgrid located at the interface point with the medium voltage grid, able to control the plant in every circumstances.

## Microgrid in islanding operation

After the Emax 2 circuit breaker opens, because of interface protection systems intervention or external command, the Microgrid should transit from on-grid to off-grid state with bumpless transition. When it is standalone, the power absorption from the main grid ceases, so that the Microgrid loads remains supplied by the local generation, like diesel GenSet or energy storage systems. This Microgrid generation can be always active or started up by an automatic transfer switching (ATS) logic after the disconnection from the main grid, depending on the plant configuration. During the islanding transition, it is very important to avoid the frequency drop, otherwise the generation protections could trip jeopardizing the Microgrid stability with consequently a long downtime. Emax 2, employing the current and voltage measurements, integrates two different fast load shedding logics to reduce this blackout risk, protecting the Microgrid during the intentional or unintentional islanding operation:

- Basic Load Shedding, simple logic able to recognize the Microgrid disconnection event and shed a group of not priority loads thus ensuring a fast time response and power balance.
- Adaptive Load Shedding, the advanced algorithm available with Emax 2 as an enhancement of the basic version. The intelligent software embedded in the unit sheds very quickly the not priority loads according to the Microgrid power consumption and frequency measurements. Moreover, such software has a dedicated configuration for backup generation related to ATS and the software itself is even able to estimate the energy produced by a solar plant based on plant geography settings.

All the versions are available on Emax 2 platform for both the Microgrid situations, sharing some information about the loads under control in the plant.

## Application examples

- **Grid-connected plants with running GenSets**, which contribute to the self-consumption together with potential renewable sources and support the load power supply in emergency conditions. It is the case of hybrid PV-diesel remote communities connected to weak distribution-grids where there are a lot of daily faults, or of facilities located in geographical areas where there are frequent environmental events, for example hurricanes or earthquakes.
- **Grid-connected plants with back-up GenSets** started up after main - gen transfer switching logics that require high reliability. For example, hospitals, banks or data centers.

## Benefits

Thanks to Emax 2 with embedded Load Shedding innovation, the following benefits are guaranteed:

### Service continuity

- When a plant remain disconnected from the main grid, even if local production is present, there is a significant stress that turns off all the generators with consequent blackout. Load Shedding logics embedded in Emax 2 reduce the frequency drop that usually makes the local generation protection trip, maintaining the plant live.

**Space saving**

- No other Programmable Logic Controllers (PLC) are needed as Emax 2 has embedded the intelligence to realize the load shedding logics, taking advantage of the current and voltage sensors for electrical parameter measurements.
- In addition, static converters for low voltage photovoltaic production have typically anti-islanding protections: this implies another power deficit to be added to the main grid contribution during the Microgrid islanding. Emax 2 is the first circuit breaker that estimates solar production without additional sensors.
- Load Shedding is suitable with ATS architectures like Main-BusTie-Gen used to distinguish priority/not priority loads.

Where feasible, BusTie switching device is not required anymore and this means:

- Significant space and material saving up to 50% in the power distribution switchgear for panel builders.
- Load Shedding is self-tuned with the specific power unbalance identification and dynamically choses the controllable loads to be shed, reducing constraints for consultants during plant design.

- ATS unit manages only two sources, without interlock, logic programming and wiring connections for the third circuitbreaker with less time required for installation.

**Ease of use**

- Load shedding logics are generally set with high engineering skills and customization effort with devices as programmable logic controllers.
- Emax 2 guarantees easy installation thanks to predefined templates and the user-friendly graphic interface in the SW commissioning tool.

For further information, please refer to the White Paper “Emax 2, all-in-one innovation – Load Shedding” (1SDC007119G0201).



Typical load shedding application

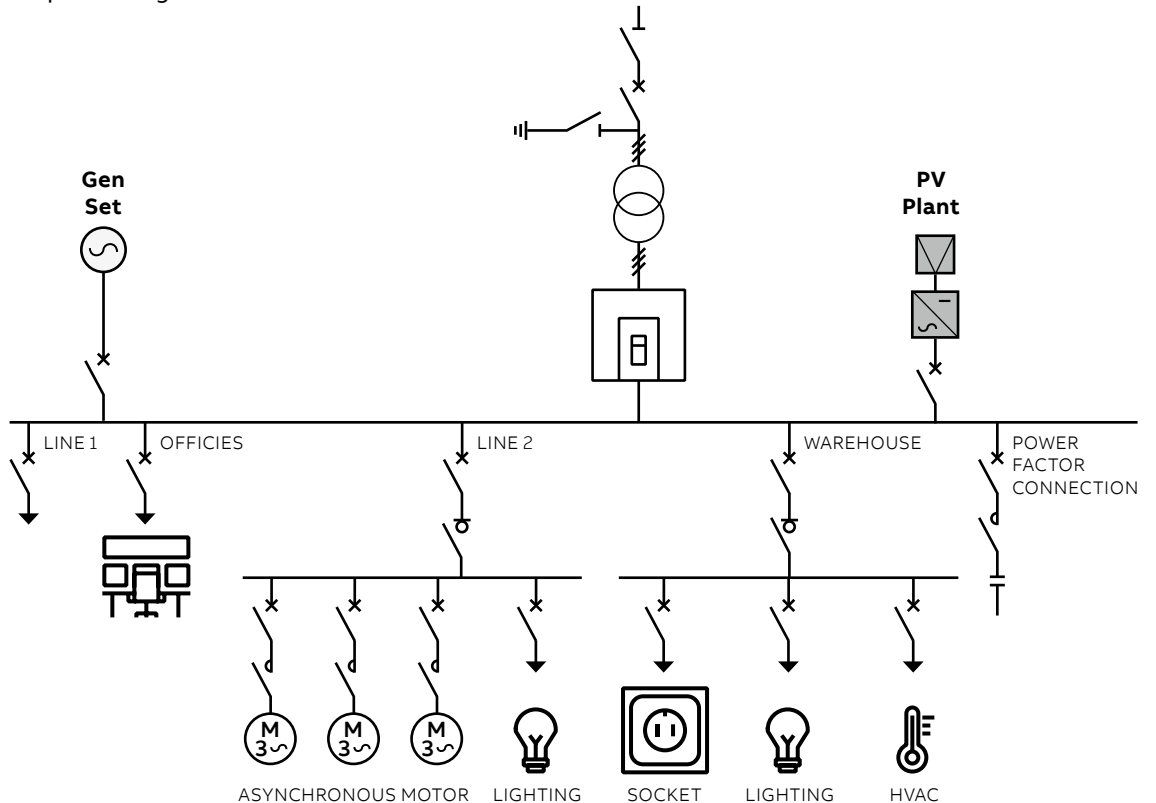

# Automatic Transfer Switch

Emax 2 is ready for transfer switching applications reducing time for logics programming and commissioning.

## The ATS solution

ABB's Automatic Switching (ATS) system takes advantage of the new capabilities provided by the new Ekip Connect 3 Software and the intelligent digital unit such as Emax 2 to deliver versatile and reliable solution.

## Application example

Automatic Transfer Switch systems is common in all application where service continuity is essential and where there are multi source supplies.

The main applications are:

- Power supplies of UPS groups in general
- Oil & Gas
- Operating theatres and primary hospital services
- Emergency power supplies for civil building, hotels and airports
- Data banks and telecommunication systems
- Power supply of industrial line for continuous processes.

Another case of use of ATS is in all cases where a portion of grid with local generation, called microgrid, can be disconnected from main grid.

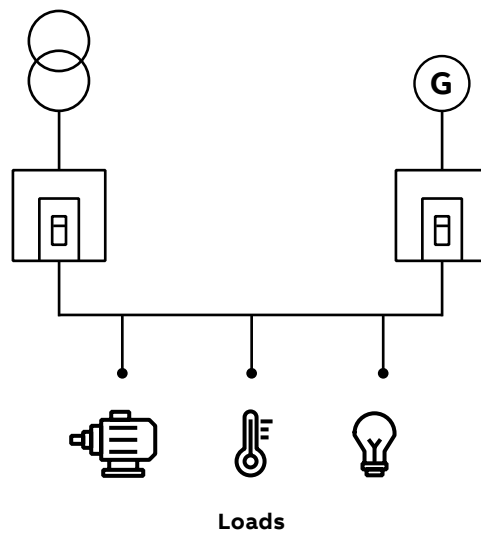



The ATS is a high-performances energy automation system, easy to install and program.

**Benefits****Ready-to-go Programming**

Estimated time and cost savings on the ATS Engineering on the low voltage project 95%.

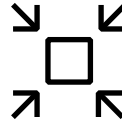
**Emax 2 compactness**

Space saving on the power switchboard: up to 30%.

**Simplify the connections**

Estimated time and cost savings on cabling and commissioning of the power switchboard: 50%.

**Top rate reliability**

With watchdog functions and fewer installed components.



For more info check out the white paper "Emax 2, all in one innovation: Embedded ATS system" (1SDC007115G0201).

# Synchrocheck logics

Emax 2 is able to analyze voltage waveforms from different power sources.

## Purpose

Thanks to its advanced electronics, Emax 2 is the first smart unit able to island the Microgrid from disturbances such as in the presence of faults or power quality events and reconnect it to the distribution network, when there are the right conditions.

Synchrocheck logics operate the ANSI 25A, with additional automatic re-closing capabilities based on the synchronism status detection.

Using the Ekip Synchrocheck cartridge module, Emax 2 monitors the voltage amplitude, the frequencies and the phase displacement and realizes simple logics to adapt the Microgrid voltage and frequency to the main grid ones. This regulation based on up and down signals sent to the local generator controllers can be realized by Ekip Signalling contacts in order to reach synchronization. The circuit breaker automatically recloses when it understands that the synchronism is achieved using Ekip Synchrocheck and the integrated closing coil.

As an alternative, Ekip Synchrocheck can send an indication signal of synchronism achieved. The cartridge module plugged-into Emax 2 works in dead or live busbar mode, even with automatic check.

## Application examples

Synchrocheck logics and protection are useful in the following plant-engineering situations:

- During the Microgrid reconnection to the main grid, speeding up the paralleling procedure between two systems with different steady states. This scenario comes after the islanding Microgrid operation.
- When there is the closed transition of an automatic transfer switch, the main grid should be connected to the same busbar with the backup Microgrid generation in order to guarantee continuous load operation, with or without a bus-tie switching device.
- Besides Microgrid cases, it is possible to adopt this solution also for single GenSet paralleling operation.

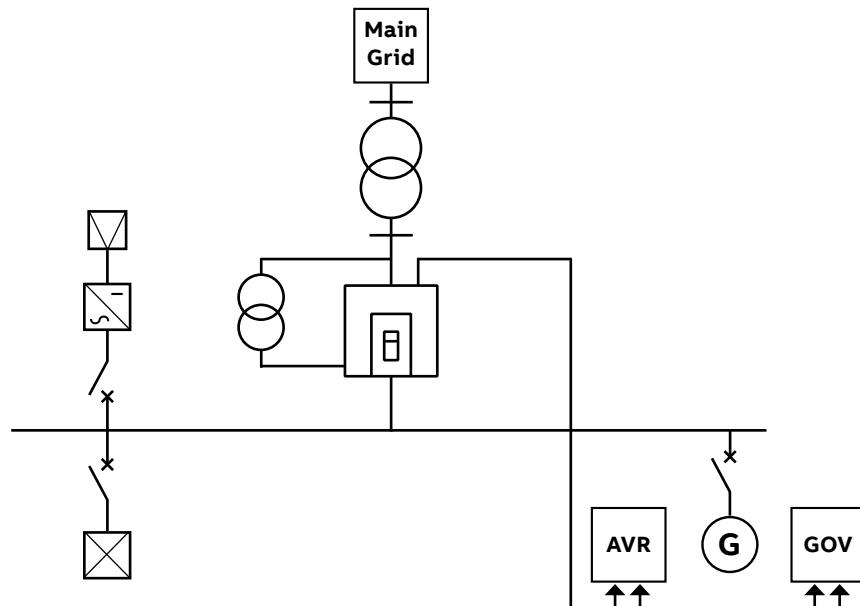

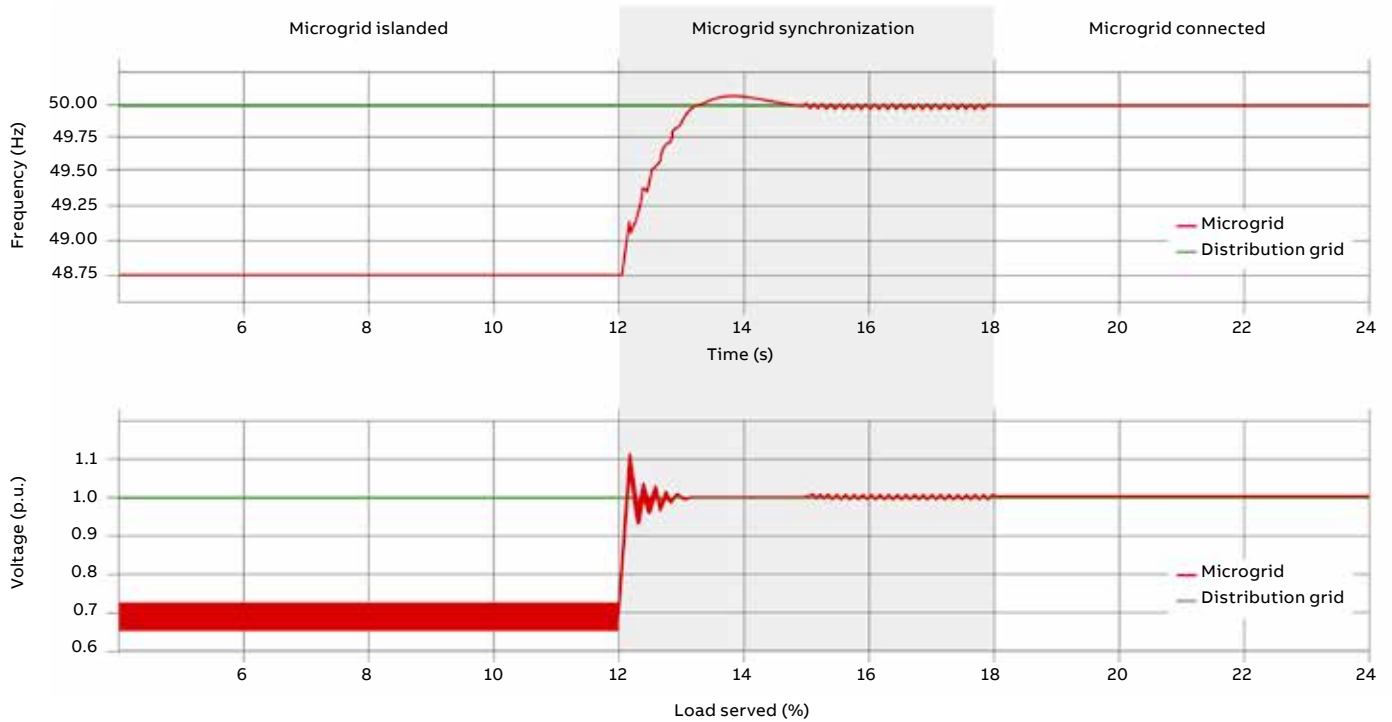

### Benefits

Thanks to Emax 2 with embedded Synchrocheck logics, the following benefits are guaranteed:

- Space Savings
  - Components reduction with no external synchronizer and less voltage transformers required if compared with traditional approaches.
  - Increased reliability & time saving during the installation having less cabling and related installation complexity.

### Ease of use

Embedded protections and logics simplified configuration eliminate the need for programming and engineering efforts.

For further information, please refer to the White Paper "Emax 2, all-in-one innovation – Synchro Reclosing" (1SDC007118G0201).

# Power Controller

Emax 2 is able to control loads and generator to ensure bill savings and enable demand response applications according to power management strategies.

### Purpose

Thanks to Power Controller software, Emax 2 manages the power to shave the peaks and shift the loads. In this way, it is possible to cut electricity bills, increase energy efficiency up to 20% and be ready for demand response programs. Power Controller function is based on a patented calculation algorithm that allows a load list to be controlled through the remote command of relevant switching device (like switching device, switching device, contactor, drive) or control circuit according to a priority defined locally by the user or remotely by a load aggregator or utility, based on his own requirements and types of load.

The algorithm is designed on a foreseen average power absorption which can be set by the user over a determined time interval. Whenever this value exceeds the fixed power, Power Controller function intervenes to bring it back within the limits.

This system can be realized with a single Emax 2 Control or Emax 2 Control+ standard equipped with this function and installed as the low voltage plant controller. Furthermore, the control unit, shall not only command the passive loads, but it can also manage a reserve generator.

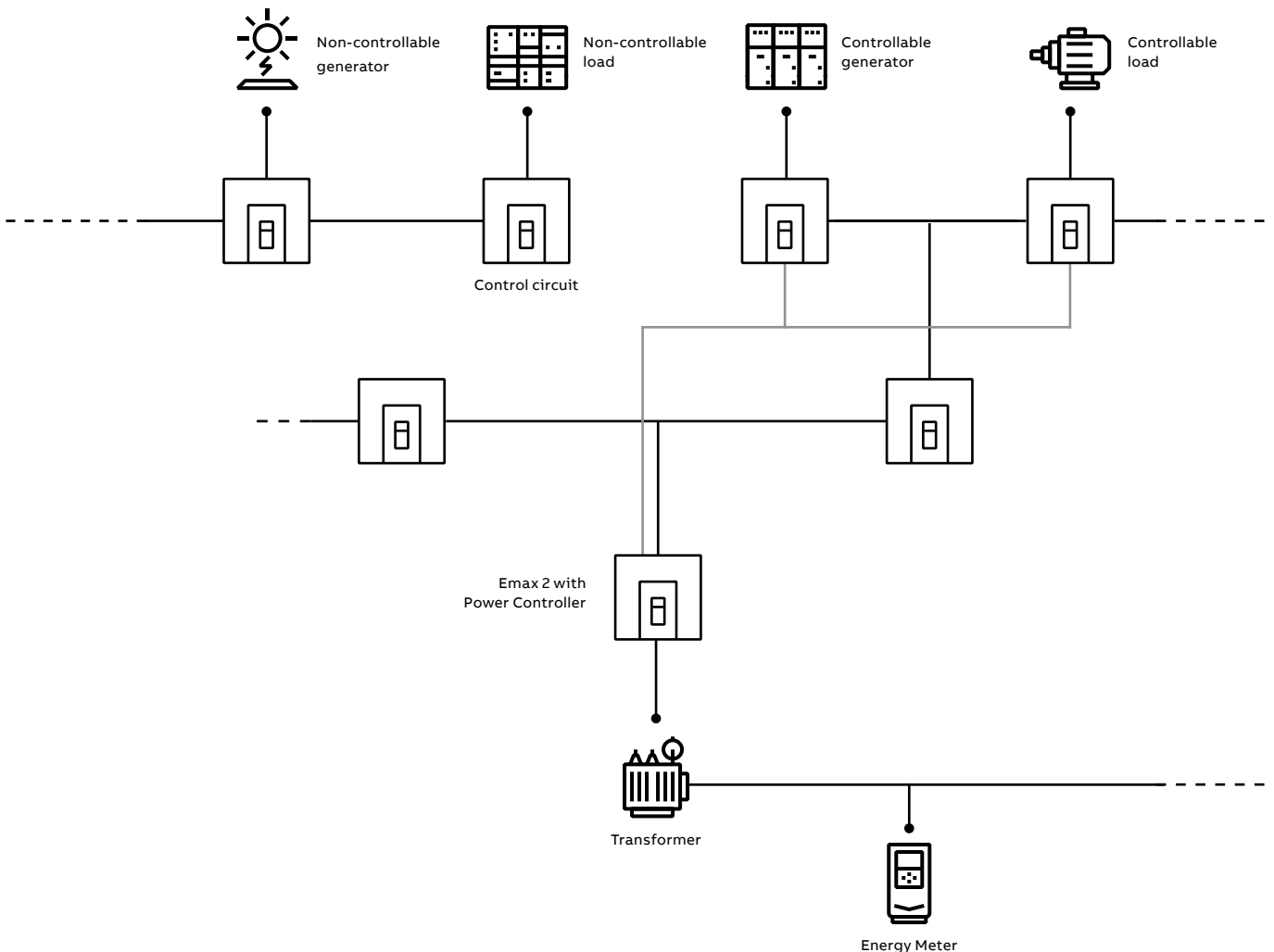

Ekip Power Controller, which can be used with all Ekip Touch trip units of the Emax 2 series, effectively helps to improve energy efficiency by managing the entire low-voltage electrical system. It is, in fact, able to adapt the demand for power according to the availability of the energy source, the time of day and the costs indicated in the current pricing plan.

In this way Ekip Power Controller is able to maintain power consumption within the limits defined, thereby optimizing the costs of managing the installation and reducing emissions.

The command sent to the downstream devices can be performed in two different ways:

- through the wired solution, by commanding the shunt opening/closing releases or acting on the motor operators of the loads to be managed;
- through a dedicated communication system.

The ability to control the loads according to a list of priorities already defined provides significant advantages from both economic as well as technical points of view:

- **economical:** energy consumption optimization is focused on the control of the costs linked in particular to the penalties that are levied when the contractual power is exceeded or when the contractual power is increased by the Distribution System Operator (DSO) as a consequence of exceeding the limit repeatedly.
- **technical:** the possibility of power absorption over the contractual limits for shorter periods and, as well as, the management and the control of the power consumption over long periods of time. Thus it is possible to reduce the likelihood of malfunctioning due to overloads, or worse, complete inefficiency of the entire plant due to tripping of the LV main switching device.

---

The exclusive Power Controller function available on the new Emax 2 units monitors the power, keeping it below the limit set by the user. As a result of this more effective use, the peak of power consumed can be limited allowing savings on electricity bills.

The Power Controller, patented by ABB, disconnects non-priority utilities, such as electric car charging stations, lighting or refrigeration units, during the times when consumption limits need to be respected, and connects them again as soon as it is appropriate. When required, it automatically activates auxiliary power supplies such as generator sets. No other supervision and control system is required: it is sufficient to set the required load limit on Emax 2, which can control any switching device located downstream, even if it is not equipped with a measurement function.

#### **Application examples**

Electricity bill savings, demand response, avoiding power overload are the typical scenarios where Power Controller is adopted.

As it operates on not critical loads, it is common of office building, shopping malls, hotels, campuses, waste and water industries or every plant that works like a low voltage microgrid.

# Power Controller

## Benefits

Thanks to Emax 2 with embedded Power Controller, the following benefits are guaranteed:

- **Reduction of energy costs with minimum impact.**

The loads are disconnected from the power supply for short periods, in the minimum number necessary and in a fixed order of priority, enabling power consumption peaks to be limited. This allows the contract drawn up with the energy provider to be renegotiated, reducing the power allocated, with a consequent reduction in total energy costs.

- **Power limited only when necessary.**

Power Controller function manages up to four different time bands, it is therefore possible to respect a particular power limit according to whether it is during the day (peak) or night (off peak). In this way, consumption during the day when rates are at their highest can be limited.

- **Easy of use**

Power Controller function allows the installation to be managed efficiently with a simple architecture. Thanks to a patented design, it is sufficient to measure the total power of the installation without having to measure the power consumed by each load. Installation costs and times are thereby reduced to a minimum.

Power Controller function does not require the writing, implementation and testing of complicated programmes for PLC or computer because the logic has already been implemented in the protection unit and is ready to use; it is sufficient to set the installation parameters from a smartphone or directly from the switching device display.

Power Controller significantly helps to flatten the load curve, limiting the use of peaking power plants in favour of base load power plants with greater efficiency.

- Thanks to integrated communication modules, Power Controller can receive the maximum absorbable power directly from the medium voltage control system, determining consumption for the next 15 minutes. Ekip Power Controller, according to the information received, manages the switching off of non-priority loads or the switching on of reserve generators. The software gives maximum priority to non-programmable preferred energy sources, such as wind and solar, and they are therefore considered uninterruptable. In the event the production of internal power to the controlled network is reduced, due, for example, to decreased production of solar power, Power Controller will disconnect the necessary loads to respect the consumption limit set.
- This benefit is used, for example, in installations with a system of cogeneration. Indeed Power Controller controls the total consumption drawn from the electrical network, interrupting non-indispensable loads when production is reduced and reconnecting them when generator power is sufficient to not exceed limits. There are multiple advantages: reduction in energy costs, maximum use of local production and greater overall energy efficiency.

For further information, please refer to the White Paper "Load management with Ekip Power Controller for SACE Emax 2" (1SDC007410G0202).

---

# Supervision and connectivity

- 5/2**      **Introduction**
- 5/4**      **Supervision and control**
- 5/4**      Switchgear compartment
- 5/6**      Electrical switchgear
- 5/8**      Electrical system
- 5/10**    **Software and web applications**
- 5/10**    Ekip Connect
- 5/14**    Ekip View
- 5/16**    ABB Ability™ Electrical Distribution Control System
- 5/18**    **Energy Measurements**
- 5/18**    Introduction
- 5/20**    Class 1 accuracy
- 5/21**    Network Analyzer
- 5/21**    Applications
- 5/23**    The first step towards better power quality: measurement
- 5/24**    Operating principles

# Introduction

SACE Emax 2 circuit breakers provide a complete and flexible offering that can be adapted to the actual level of supervision and control required.

According to their complexity, the supervision of low-voltage systems may involve different levels:

- **switchgear compartment:** for control of the main electrical values of the circuit breaker, thanks to Ekip Touch trip units with high resolution display and the Ekip Multimeter display.
- **electrical switchgear:** to display the data of all circuit breakers installed in the switchgear from a single point: in local mode via control panel on the front of the switchgear, or remotely via several communication protocol.
- **electrical system:** to manage complex systems in which devices must be integrated with automated industrial processes or in intelligent electrical networks, better known as smart grids. The system can be supervised by the Ekip View software or via Internet with the ABB Ability™ Electrical Distribution Control System webapp.







# Supervision and control

## Switchgear compartment

—  
For the list of information available for each trip unit, consult chapter 3.

—  
The SACE Emax 2 circuit breakers equipped with Ekip electronic trip units enable electrical measurements and diagnostic data to be displayed on the front of the switchgear.

### **Solution with Ekip Touch trip units**

The Ekip Touch electronic trip units are the ideal solution for supervision and control of the compartments in switchgear. In particular:

- their use is simple and intuitive thanks to a large, high resolution, colour touch screen;
- they do not require an auxiliary power supply for safety; the Ekip Touch trip units are directly supplied by the current sensors integrated in the circuit breaker, thereby avoiding the use of external power supplies.

—  
The Ekip Multimeter is a display unit to be installed on the front of the switchgear for SACE Emax 2 air circuit breakers equipped with Ekip electronic trip units.

### **Solution with Ekip Multimeter Display on the front of the switchgear**

This device remotely displays the information about the system that is available in the trip unit to which it is connected.

The main characteristics of the Ekip Multimeter unit are:

- **Graphical and functional uniformity with the Ekip Touch trip units;** Ekip Multimeter uses the same display as the trip unit to which it is connected, ensuring perfect continuity between the graphic display and the menu items.
- **Reduced dimensions;** the Ekip Multimeter guarantees the precision of the trip unit to which it is connected and performs the function of a measuring instrument without requiring the installation of external current and voltage transformers.
- **Flexible installation;** the Ekip Multimeter can be installed at a distance from the trip unit, enabling access to information from the most convenient point.
- **Simultaneous reading of the various electrical values;** the advanced connection system used allows several Ekip Multimeter devices to be connected to the same protection trip unit.

Furthermore, if connected to trip units equipped with display, the Ekip Multimeter enables adjustment of the parameters and protection thresholds.

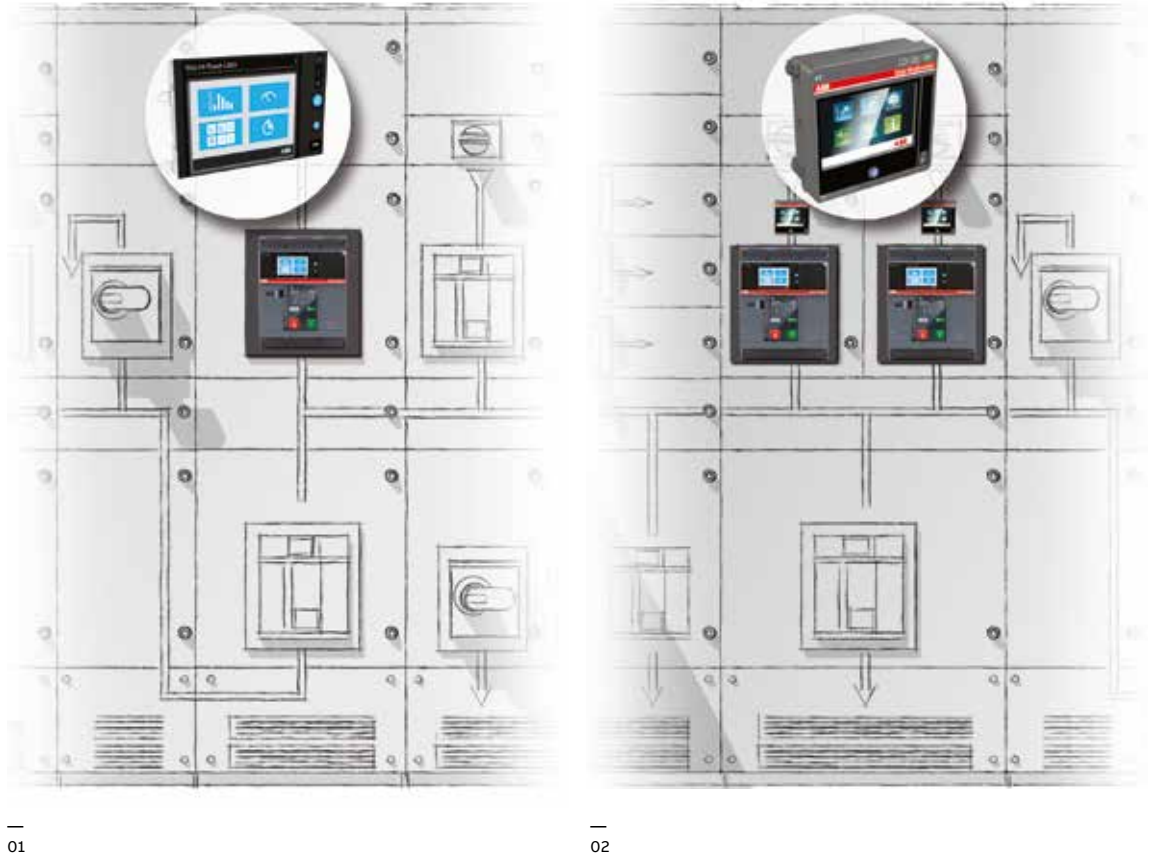

—  
01 Ekip Touch  
—  
02 Ekip Multimeter

05

Electronic trip unit	Ekip Dip	Ekip Touch	Ekip G Touch	Ekip Hi Touch Ekip Hi-G Touch
<b>Solution</b>	Ekip trip units + Ekip Multimeter			
Type of trip units connectable to Ekip Multimeter	Ekip trip units			
Number of trip units connectable to Ekip Multimeter	1			
<b>Measurement functions</b>				
Currents	●	●	●	●
Voltages	-	○	●	●
Powers	-	○	●	●
Energies	-	○	●	●
Harmonics	-	○	○	●
Network analyzer	-	○	○	●
<b>Adjustment functions</b>				
Setting of thresholds	-	●	●	●
Setting of thresholds second set	-	-	-	●
Resetting of alarms	●	●	●	●
<b>Diagnostics</b>				
<b>Protection function alarms</b>	●	●	●	●
<b>Device alarms</b>	●	●	●	●
<b>Protection unit tripping details</b>	●	●	●	●
<b>Events log</b>	●	●	●	●
<b>Protection unit tripping log</b>	●	●	●	●
<b>Maintenance</b>				
Number of operations	●	●	●	●
Number of trips	●	●	●	●
Wear of contacts	●	●	●	●
<b>Other data</b>				
<b>Status of circuit breaker</b>	●	●	●	●
<b>Circuit-breaker position <sup>1)</sup></b>	●	●	●	●
<b>Local/remote mode</b>	●	●	●	●

1) Circuit-breakers equipped with auxiliary contacts to indicate position

- not available

● available

○ available with the dedicated software package

# Supervision and control

## Electrical switchgear

Ekip Link is a flexible and efficient solution for controlling and supervising low-voltage electrical switchgear.

It is a system that enables SACE Emax 2 circuit-breakers to be connected to the Ekip Control Panel operator panel by means of Ekip Link interface modules.

### Ekip Link system

The main characteristics of the Ekip Link System are:

- **centralized control;** from the Ekip Control Panel operator panel, all the main values of the installation (electrical measurements, system diagnostics, trends...) can be monitored and controlled.
- **adaptation to real requirements;** when the electrical values to be monitored are limited to currents only, the Ekip Dip trip unit can be connected to the Ekip Link without having to use circuit breakers equipped with communication modules.

- **access via the Internet** with any Internet browser using the web server function performed by the Ekip Control Panel.
- **rapid installation,** through the use of standardized EtherNet™ components such as STP cables and RJ45 type connectors.
- **ease of use;** due to the Ekip Control Panel operator panel in front of the switchgear with colour touch screen, the system mimic panel can be displayed so that the entire installation can be controlled rapidly and intuitively.
- **ready to use;** Ekip Control Panel is supplied with pre-configured software that requires no programming. It is only necessary to start scanning the Ekip Link system from the operator panel and in a few seconds communication with the connected devices is active.

Ekip Link enables supervision of electrical switchgear on which up to 30 ABB SACE circuit breakers have been installed. Tmax T and Tmax XT series circuit breakers equipped with Modbus RTU communication can also be easily integrated into the Ekip Link system using the multi-serial port fitted on the Ekip Control Panel.



Electronic trip unit	Ekip Dip	Ekip Touch	Ekip G Touch	Ekip Hi Touch Ekip Hi-G Touch
<b>Solution</b>	Ekip protection trip units equipped with Ekip link module + Ekip Control Panel operator panel + standard EtherNet™ components			
Type of trip units connectable	Ekip protection trip units			
Number of trip units connectable to the Ekip link system	up to 30 <sup>1)</sup>			
Data exchange rate of Ekip link system	100 Mbit/sec			
<b>Supervision and control functions</b>				
Opening and Closing of circuit breakers <sup>2)</sup>	●	●	●	●
Electrical value trends			I,V,P	I,V,P
Log of electrical value trends			I,V,P	I,V,P
Dynamic installation mimic panel	•	•	●	●
Automatic scanning of the Ekip link system	•	•	●	●
Centralized synchronizing of time	•	•	●	●
Web server function	● <sup>3)</sup>	● <sup>3)</sup>	● <sup>3)</sup>	● <sup>3)</sup>
<b>Measurement functions</b>				
Currents	●	●	●	●
Voltages	-	○	●	●
Powers	-	○	●	●
Energies	-	○	●	●
Harmonics	-	○	○	●
Network analyzer	-	○	○	●
Data logger	-	●	●	●
<b>Adjustment functions</b>				
Setting of thresholds	-	●	●	●
Resetting of alarms	●	●	●	●
<b>Diagnostics</b>				
Protection function alarms	●	●	●	●
Device alarms	●	●	●	●
Protection unit tripping details	●	●	●	●
Events log	●	●	●	●
Protection unit tripping log	●	●	●	●
Transmission of alarms via text message	optional	optional	optional	optional
Transmission of alarms via e-mail	optional	optional	optional	optional
<b>Maintenance</b>				
Number of operations	●	●	●	●
Number of trips	●	●	●	●
Wear of contacts	●	●	●	●
<b>Other data</b>				
Status of circuit breaker	●	●	●	●
Circuit-breaker position <sup>4)</sup>	●	●	●	●
Local/remote mode	●	●	●	●

1) Ekip Control Panel is available in two versions that can manage a maximum of 10 or 30 circuit breakers. The number of circuit breakers may vary depending on their type. For details, ask ABB SACE

2) Circuit-breakers equipped with actuation module, electric accessories, opening and closing releases and spring charging motor

3) Two client web accesses included in the licence

4) Circuit-breakers equipped with auxiliary contacts to indicate position

- not available

● available

○ available with the dedicated software package

# Supervision and control

## Electrical system

The integration of low-voltage devices in communication networks is required in particular for: automated industrial processes, industrial and petrochemical sites, modern data centres and intelligent electricity networks, better known as smart grids.

### Ekip Com Modules

Thanks to the wide range of communication protocols supported, SACE Emax 2 circuit breakers equipped with Ekip Touch electronic trip units can be integrated into communication networks without the need for external interface devices. The distinctive characteristics of the SACE Emax 2 circuit breakers offering for industrial communication are:

- **Wide range of protocols supported;** the Ekip Com communication modules enable integration with the most common communication protocols based on RS485 serial lines and the most modern communication systems based on EtherNet™ infrastructures, which guarantee an exchange of data in the order of 100 Mbit/s.
- **Installation times reduced to a minimum** due to the plug & play technology of the communication modules, which are connected directly to the circuit breaker terminal box without having to remove the electronic trip unit.
- **Repetition of communication for greater reliability of the system;** the circuit breaker can be equipped with two communication modules at the same time, allowing the information on two buses to be exchanged simultaneously.
- **Ready to smart grid;** the Ekip Com 61850 module is the solution for integrating SACE Emax 2 circuit breakers into the automated systems of electrical substations based on the IEC 61850 standard without the need for complex external devices.
- **Complete supervision** of Modbus RTU or Modbus TCP/IP networks via the software for PC Ekip View.

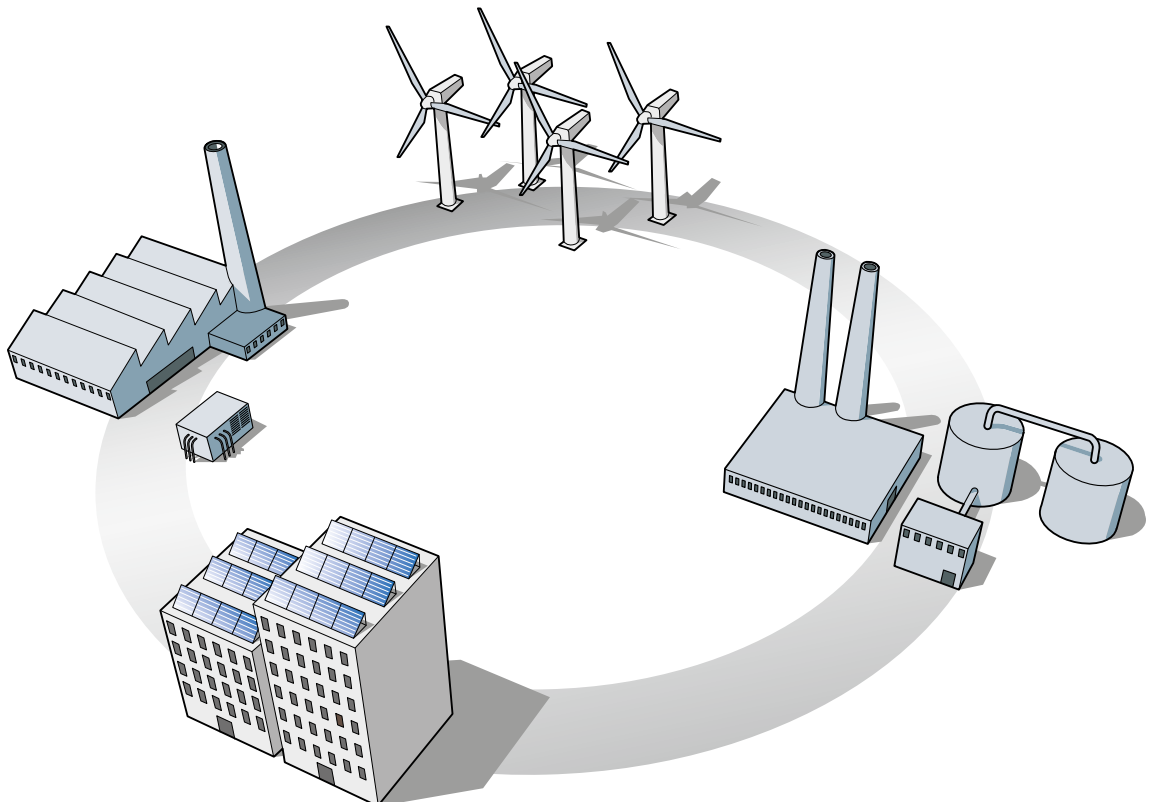

Electronic trip unit	Ekip Touch	Ekip G Touch	Ekip Hi Touch Ekip Hi-G Touch
<b>Solution</b>	Ekip Touch trip units + Ekip com modules		
Protocols supported:			
Modbus RTU	Ekip com Modbus RTU		
Profibus-DP	Ekip com Profibus		
DeviceNet™	Ekip com DeviceNet™		
Modbus TCP/IP	Ekip com Modbus TCP		
Profinet	Ekip com Profinet		
EtherNet/IP™	Ekip com EtherNet™		
IEC61850	Ekip com IEC61850		
Hub	Ekip com Hub		
<b>Control functions</b>			
Circuit-breakers opening and closing <sup>1)</sup>	●	●	●
<b>Measurement functions</b>			
Currents	●	●	●
Voltages	○	●	●
Powers	○	●	●
Energies	○	●	●
Harmonics	○	○	●
Network analyzer	○	○	●
Data logger	●	●	●
<b>Adjustment functions</b>			
Setting of thresholds	●	●	●
Resetting of alarms	●	●	●
<b>Diagnostic</b>			
Protection function alarms	●	●	●
Device alarms	●	●	●
Protection unit tripping details	●	●	●
Events log	●	●	●
Protection unit tripping log	●	●	●
<b>Maintenance</b>			
Number of operations	●	●	●
Number of trips	●	●	●
Wear of contacts	●	●	●
<b>Other data</b>			
Status of circuit breaker	●	●	●
Circuit-breaker position <sup>2)</sup>	●	●	●
Local/remote mode	●	●	●

1) Circuit-breakers equipped with Ekip Com Actuator module, electrical accessories, opening and closing releases and spring charging motor

2) Circuit-breakers equipped with auxiliary contacts to indicate position

- not available, ● available, ○ available with the dedicated software package

### Ekip E-Hub

This is a DIN-rail mounted communication module for cloud-connectivity. Ekip E-Hub can collect data throughout the system from ACBs to MCCBs, multimeter, miniature CBs. Moreover, it is possi-

ble to connect sensors for environmental parameters (temperature, water, gas) via both analog and digital I/O. Modules for Wi-Fi or GPRS connection are provided as optional features.

# Software and web applications

## Ekip Connect

ABB SACE offers software applications that allow to exploit the full potential of Ekip trip units in terms of power management, acquisition and analysis of electrical data, protection testing, maintenance and diagnostic functions.

Ekip Connect is the ABB commissioning and programming software tool that allows the user to unlock the full potential of circuit breakers, improving the efficiency of the electrical plant. A circuit breaker is an essential part of any electrical system that guarantees that the day-by-day

processes can be performed safely and continuously. For this reason, it is vital that the installation and use of the circuit breaker is made as error-free and simple as possible.

From commissioning to implementation, through monitoring, testing and analysis, Ekip Connect is the perfect tool for guiding the user in the management of ABB circuit breakers throughout the whole product life cycle.

Using Ekip Connect, the user can manage power, acquire and analyze electrical values, and test protection, maintenance and diagnostic functions. Just as Emax 2 has evolved into a true power manager that has simplified the electrical plant, so too has Ekip Connect software become the user's key to access the full capability of the breaker.

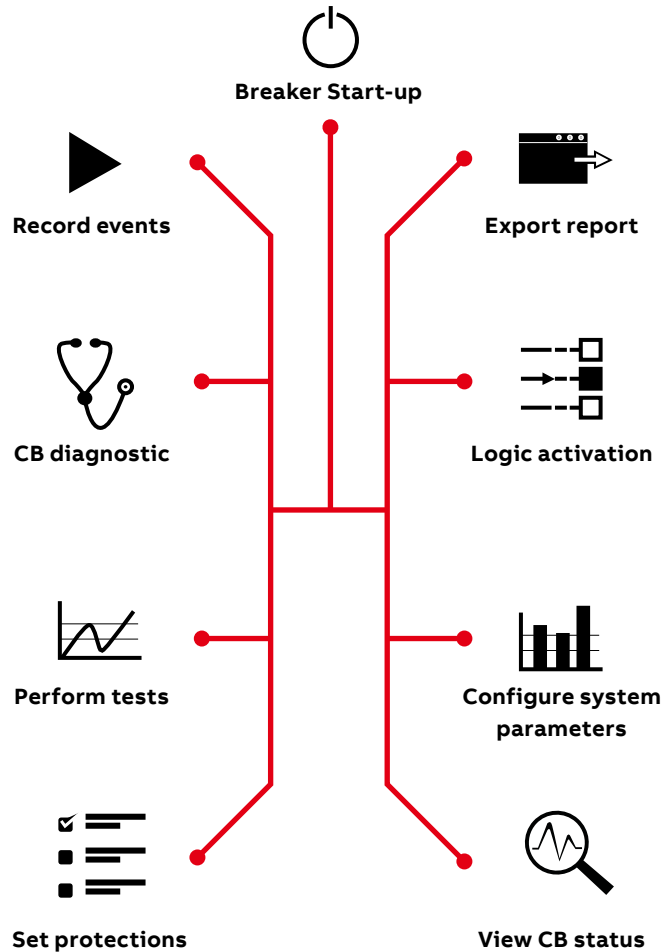



—  
Panel builders  
- 50% commissioning time



#### Ease of use

Imagine you are a panel builder. You have to commission a circuit breaker and you need to save time. Using Ekip Connect – instead of managing it manually – you can cut commissioning time up to 50%. Providing a stress-free relationship with the device complexity, Ekip Connect is an easy-to-use software that has all the answers you need. Ekip Connect simple and intuitive interface guarantees, from the very start, easy navigation throughout the tool and quick access to every circuit breaker operation. At a glance, the user can see all the information he needs, thus being able to quickly and effectively assess any situation.

—  
Facility manager  
100% full exploitation  
of your device



#### Full exploitation

Imagine you are a facility manager. You need to perform fast and precise diagnosis to have everything under control and avoid failures. Using Ekip Connect you can exploit the full capabilities of your device and, thanks to the customizable dashboard, you can organize your windows to manage any function of the device just the way you want it. It is possible to manage all the circuit breaker settings and specifications directly with Ekip Connect, the perfect instrument for exploring and using the breaker. Diagnostics are easy too: it is possible to consult and download event log, alarms and trips, thereby facilitating identification and understanding of any anomalies. One single software to manage all ABB low-voltage circuit breakers equipped with an electronic trip unit, granting full integration between air and molded case circuit breakers.

—  
Consultant/system  
integrator  
Complex logic at your  
fingertips



#### Product enhancement

Imagine you are a consultant or a system integrator and you want to implement advanced features while avoiding any risk of mistakes. Using Ekip Connect you can implement complex logics with just a few clicks. To add, set and manage advanced functions has never been so easy. Cloud platform, automatic transfer switch logic, load shedding, advanced protection and demand management can be managed and easily set through the Ekip Connect software. Expand your software features by purchasing and downloading software packages for advanced functions directly using Ekip Connect.

---

# Software and web applications

## Ekip Connect

---

Accessing the full potential of the circuit breaker is finally possible. Thanks to Ekip Connect software, you can achieve complete utilization of the breaker and more with a few clicks.



### Configuration

- Set protections
- Configure system and communication parameters
- Breaker start-up



### Monitoring & analysis

- View CB status and measure
- Read events list
- CB diagnostic



### Product implementation

- Set advanced protections
- Logic activation
- Enable advanced functions

Test



### Testing & reporting

- Check correct functionality
- Perform tests
- Export report

Ekip Connect is available for free download at <https://library.abb.com>

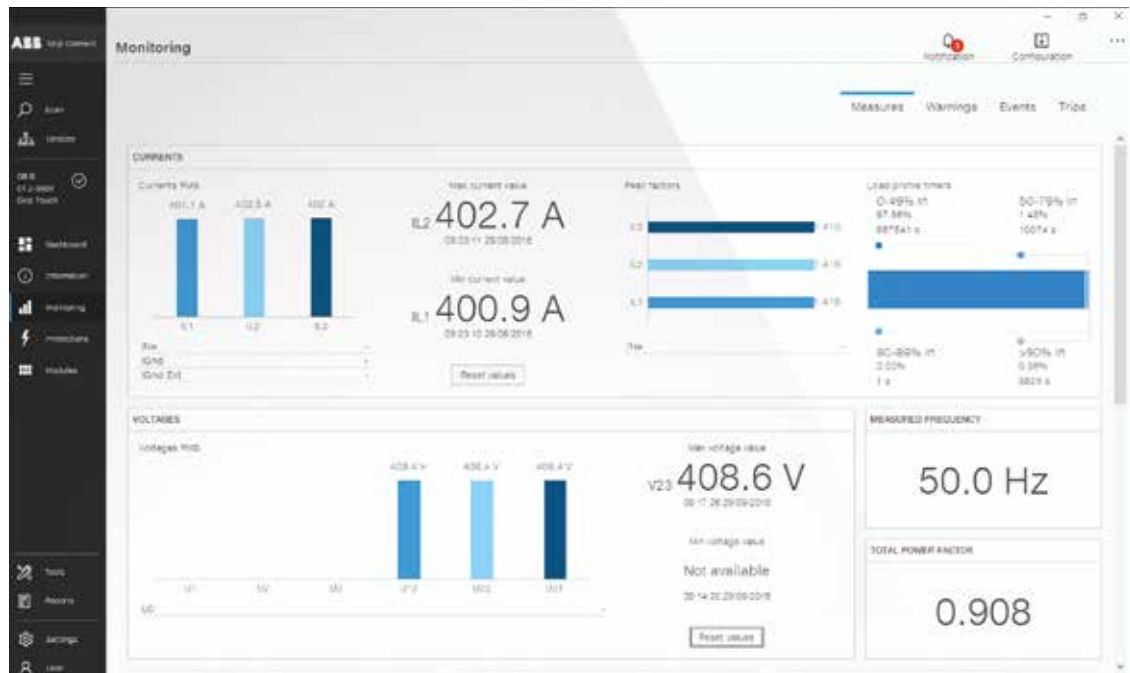

### EPiC mobile app

With Bluetooth embedded into the trip units it is possible to connect rapidly to the EPiC mobile app. Buy additional protection functions or measures, register the product and configure your

device. EPiC helps the customer during the commissioning of the system; all system parameters and protection thresholds can be set rapidly in the Ekip Touch trip units thanks to the easy and intuitive navigation pages of the app.

# Software and web applications

## Ekip View

Ekip View is the software for supervising devices connected to a communication network that uses the Modbus RTU or Modbus TCP protocol.

It is the ideal tool for all applications that require:

- remote control of the system,
- monitoring of power consumption,
- fault detection of the system,
- allocation of energy consumption to the different processes and departments,
- preventative planning of maintenance.

The main characteristics of Ekip View are:

- **Engineering** free and ready to use software which guides the user in the recognition and configuration of the protection units without the need for any supervision system engineering activities.

- **Dynamic mimic panel;** after automatic scanning of the network, for each of the devices found, Ekip View proposes a dynamic symbol that summarizes the most important information (status, electrical measurements, alarms). The extensive library of electrical symbols enables the entire electrical system to be depicted in detail.
- **Analysis of trends;** the instantaneous and past trends of currents, powers and power factors are represented graphically and can be exported into Microsoft Excel for detailed analysis.
- **Reports;** advanced reports can be created regarding system and communication network diagnostics. Using the Alarm Dispatcher option, the user can receive the most important notifications via text message.
- **Access via web** to the installation, thanks to Ekip View's Web Server function.

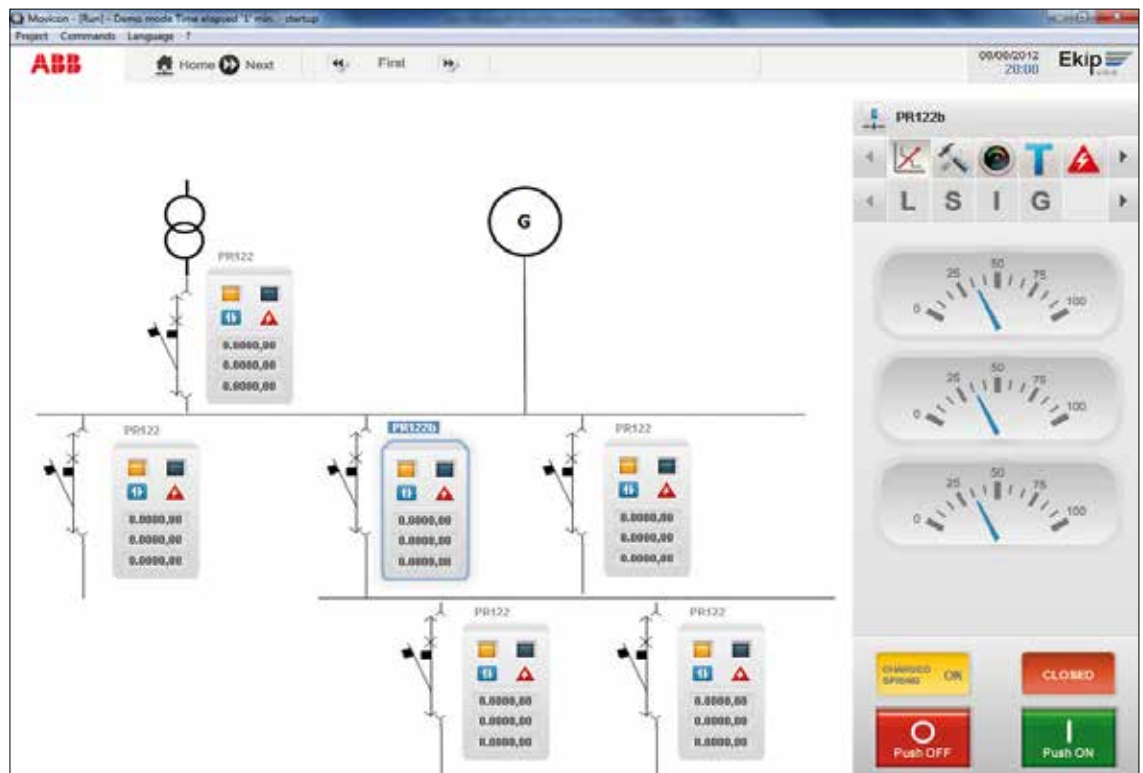

<b>Ekip View Software</b>		
<b>Communication characteristics</b>		
Protocol Supported	Modbus RTU	Modbus TCP
Physical layer	RS 485	EtherNet™
Maximum data exchange rate	19200 bps	100 Mbps
Operating system	Windows XP, Windows 7, Windows Vista	
<b>Devices supported</b>		
SACE Emax 2 trip units	Ekip com Modbus RS485	Ekip com Modbus TCP
SACE Emax,T7,X1,T8 trip units	PR120/D-M, PR330/D-M	-
SACE Tmax T trip units	PR222DS/PD, PR223DS	-
SACE Tmax XT trip units	Ekip com	-
Third party devices	optional <sup>1)</sup>	optional <sup>1)</sup>
Licences available	- up to 30 <sup>2)</sup> controllable devices	- up to 30 <sup>2)</sup> controllable devices
	- up to 60 <sup>2)</sup> controllable devices	- up to 60 <sup>2)</sup> controllable devices
	- unlimited number <sup>3)</sup> controllable devices	- unlimited number <sup>3)</sup> controllable devices
<b>Supervision and control functions</b>		
Opening and Closing of circuit breakers <sup>4)</sup>	●	●
Electrical value trends	●	●
Log of electrical value trends	●	●
Dynamic installation mimic panel	●	●
Automatic scanning	●	●
Centralized synchronizing of time	●	●
Web server function <sup>5)</sup>	● <sup>5)</sup>	● <sup>5)</sup>
<b>Measurement functions</b>		
Currents	●	●
Voltages	●	●
Powers	●	●
Energies	●	●
Harmonics	●	●
Network analyzer	●	●
Data logger	●	●
<b>Adjustment functions</b>		
Setting of thresholds	●	●
Resetting of alarms	●	●
<b>Diagnostics</b>		
Protection function alarms	●	●
Device alarms	●	●
Communication system alarms	●	●
Protection unit tripping details	●	●
Events log	●	●
Protection unit tripping log	●	●
Generation of Reports	●	●
<b>Maintenance</b>		
Number of operations	●	●
Number of trips	●	●
Wear of contacts	●	●
<b>Other data</b>		
Status of circuit breaker	●	●
Circuit-breaker position <sup>7)</sup>	●	●
local/remote mode	●	●

1) Contact ABB SACE to integrate other devices in the Ekip View software

2) can be increased

3) within the physical limit of the protocol used

4) circuit breakers equipped with Ekip com Actuator module and electrical accessories

5) two client web accesses included in the licence

6) according to the values supported by the trip units

7) circuit breakers equipped with auxiliary contacts for position indication

# Software and web applications

## ABB Ability™ Electrical Distribution Control System

ABB Ability™ Electrical Distribution Control System is the innovative cloud computing platform designed to monitor, optimize and control the electrical system.

Part of the ABB Ability™ offering, ABB Ability™ Electrical Distribution Control System is built on a state-of-the-art cloud architecture for data collection, processing and storage. This cloud architecture has been developed together with Microsoft in order to enhance performance and guarantee the highest reliability and security. Through a compelling web app interface, ABB Ability™ Electrical Distribution Control System assists anytime and anywhere via smartphone, tablet or personal computer so the user can:

- **Monitor**  
Discover plant performance, supervise the electrical system and allocate costs.
- **Optimize**  
Schedule and analyze automatic reports, improve the use of assets and take the right business decision.

- **Control**

Set up alerts and notify key personnel, and remotely implement an effective power management strategy to achieve energy savings in a simple way.

ABB Ability™ Electrical Distribution Control System also provides access on a multi-site level - monitoring and comparing the performances of different facilities at the same time. In addition, it allows profiling of the users' experience according to the level of access they require. According to the customer needs and application, the user can choose between two configurations to connect the system to ABB Ability™ Electrical Distribution Control System: embedded or external. The first, just a cartridge-type module, the innovative Ekip Com Hub, has to be provided to Emax 2 circuit breaker. The second, the Ekip E-Hub module has to be mounted on DIN-rail.

### Embedded solution with Ekip Com Hub

Emax 2 equipped with the new Ekip Com Hub establishes the cloud connection for the whole switchboard. This dedicated cartridge type communication module just needs to be inserted into the terminal box and connected to the internet.

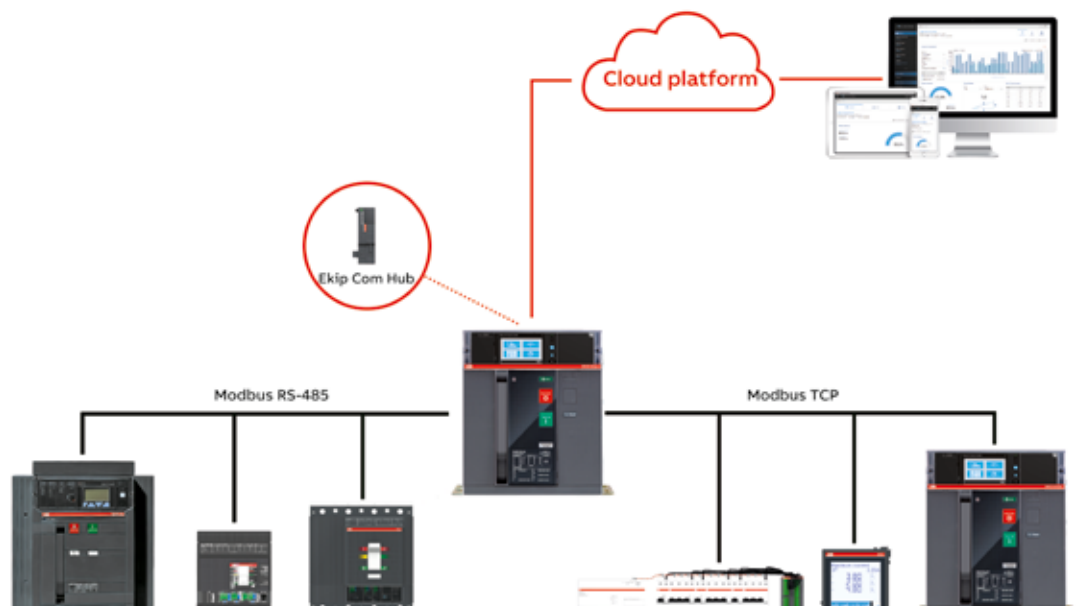



#### External solution with Ekip E-Hub

The Ekip E-Hub module can be mounted on DIN rail to collect data throughout the system. Moreover, it is possible to connect sensors for environmental parameters (temperature, water, gas) via both analog and digital I/O. Modules for Wi-Fi or GPRS connection are provided as optional features.

For any further information please visit our website : <http://new.abb.com/low-voltage/launches/abb-ability-edcs>.

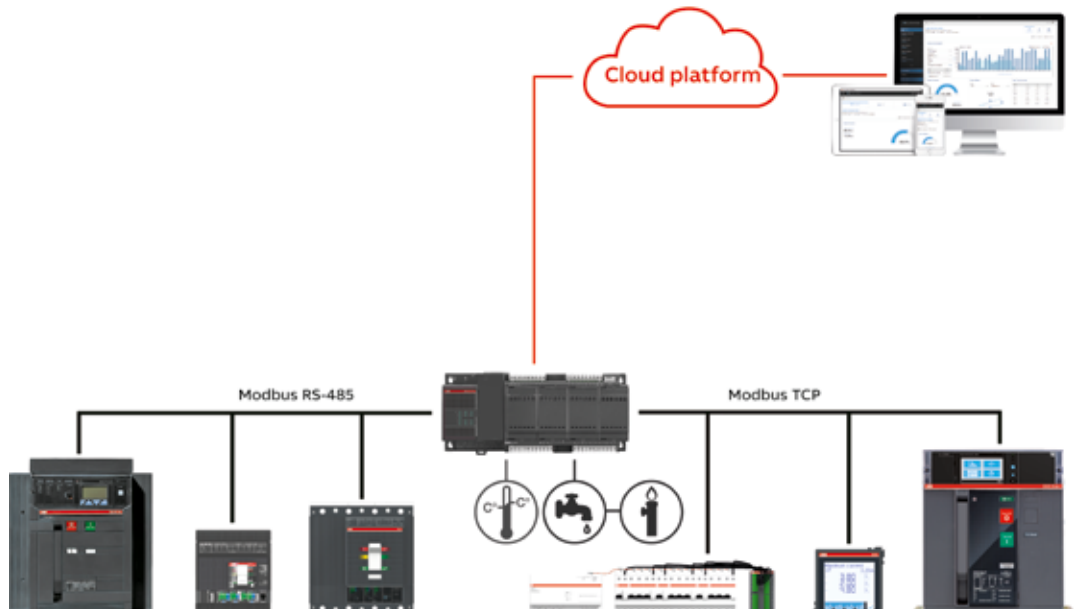

---

# Energy Measurements

## Introduction

The Emax 2 circuit-breakers have been designed to manage all low voltage electrical installations with maximum efficiency: from industrial plants, naval applications, traditional and renewable power generation installations to buildings, shopping centers, data centers and communication networks.

Achieving maximum efficiency of an electrical installation in order to reduce consumption and waste requires intelligent management of power supplies and energy. For this reason, the new technologies used in the Emax 2 circuit-breakers

with Ekip Touch trip units allow the productivity and reliability of any installation to be optimized, and at the same time, power consumption to be reduced while fully respecting the environment.





**Class 1 in power and energy measurements**

Before starting to take any action on electrical systems and to analyze the available data, top accuracy on measurements must be guaranteed. Thanks to the Ekip Touch trip units, the SACE Emax 2 range of circuit-breakers guarantees extremely accurate measures, in compliance with the relevant IEC 61557-12 Standard.

**Network Analyzer**

The quality of the power supply is an important factor to consider in order to preserve the loads, to avoid equipment malfunctions, and to optimize energy consumption. The power quality of a power system is never a perfect sinusoidal waveform, distortions and harmonics are always present. Several parameters that cause reductions in power quality can be monitored and controlled thanks to the Network Analyzer embedded function. In this way, the use of expensive external devices can be avoided.

# Energy Measurements

## Class 1 accuracy

With the Ekip Touch trip units the embedded measurement functionalities allow the measurement of power and energy to a Class 1 degree of accuracy, as specified by the IEC 61557-12 Standard, avoiding the need of additional device saving costs, space and installation time.

With the Ekip Touch trip units, measurements of power and energy to a IEC 61557-12 Standard compliant, Class 1 level of accuracy, are guaranteed by the embedded measurement functionalities. Thus, there is no need for additional devices, with consequent advantages in terms of cost savings, space reduction and installation time optimization.

When energy needs monitoring, even a minimal percentage of errors would result in a waste of money. Accuracy is everything and depends on the design and manufacturing quality of solution used. SACE Emax 2 with Ekip Touch trip units guarantee 1% accuracy for power and energy monitoring.



Thanks to the extremely accurate Rogowsky coil, ABB Ekip Touch trip units are able to guarantee Class 0.5 for voltage and current measurements and Class 1 for active power and energy measurements, complying with and certified by the IEC 61557-12 Standard.

IEC 61557-12 can be applied to both AC and DC electrical networks up to 1000 V AC or 1500V DC. Moreover, an upgrade of the device is always guaranteed to be quick and easy: the measurement functions not included in an installed trip unit can be downloaded directly from the Market-

Place via EPiC mobile app, thus allowing new system requirements to be met with ease.

Measurement data can be displayed in several ways:

- On the embedded display on the trip unit
- On a smartphone via Bluetooth (EPiC mobile app)
- Using the Ekip Connect software on a PC
- On an Ekip Multimeter external display
- On a cloud-platform thanks to ABB Ability™ EDCS
- In the supervision system (ex SCADA) thanks to several communication protocols
- On the control panel display

# Energy Measurements

## Network Analyzer

Thanks to the Network Analyzer function available in all Ekip Touch trip units, the quality of energy based on harmonics, micro-interruptions or voltage dips is monitored without the need for dedicated instrumentation.

Thanks to Network Analyzer, effective preventive and corrective action can be implemented through accurate analysis of faults, thereby improving the efficiency of the system.

### Applications

Electrical equipment is designed for optimum operation under constant and uniform voltage level, as close as possible to the rated value. In addition, industrial equipment, working on a three phase supply, requires the three phase voltage levels to be balanced. Power quality is a description of how well a power system complies with the above ideal conditions. Power quality issues can have negative consequences on the components and on the energy efficiency of the network. Thus, power quality monitoring is becoming more important in modern power systems, and will be a key part of the smart grid of the future.

In particular, power quality evaluation includes the following aspects:

- Deviations of voltage average value from the rated value
- Short decreases (sags) or increases (swells) of voltage value
- Voltage unbalance, i.e., difference in voltage values between different phases
- The presence of current and voltage harmonics.

Distortions of the voltage value (sags, swells) and/or frequency can have fatal consequences, especially for process industries, leading to possible production stoppages with consequently expensive downtime, damage to motor drives and damage to PLCs. Examples of process industries that can be badly hit by voltage instabilities include the plastics, petrochemicals, textiles, paper, semiconductor, and glass industries.

Voltage sag is defined as when the value of the voltage is reduced below the rated one for a certain amount of time. Similarly, voltage swell is defined as when the voltage is increased above the rated value for a certain amount of time.

RMS voltage values and frequency are two fundamental features of a voltage signal, but the “purity” of the voltage waveform is also an important point. An ideal voltage waveform should be a perfect sinusoid, but this is not something that is normally seen in the real world. Frequencies other than the fundamental are always present.

These frequencies are called harmonics: a harmonic of a signal is a component frequency of the wave spectrum that is a multiple of the fundamental frequency. Harmonic content is an issue that is becoming increasingly debated: technological developments in the industrial and household field have led to the spread of electronic equipment which, due to their operating principles, absorb a non-sinusoidal current (non-linear load). Such current causes a non-sinusoidal voltage drop on the supply side of the network with the consequence that the linear loads are also supplied with a distorted voltage.

# Energy Measurements

## Network Analyzer

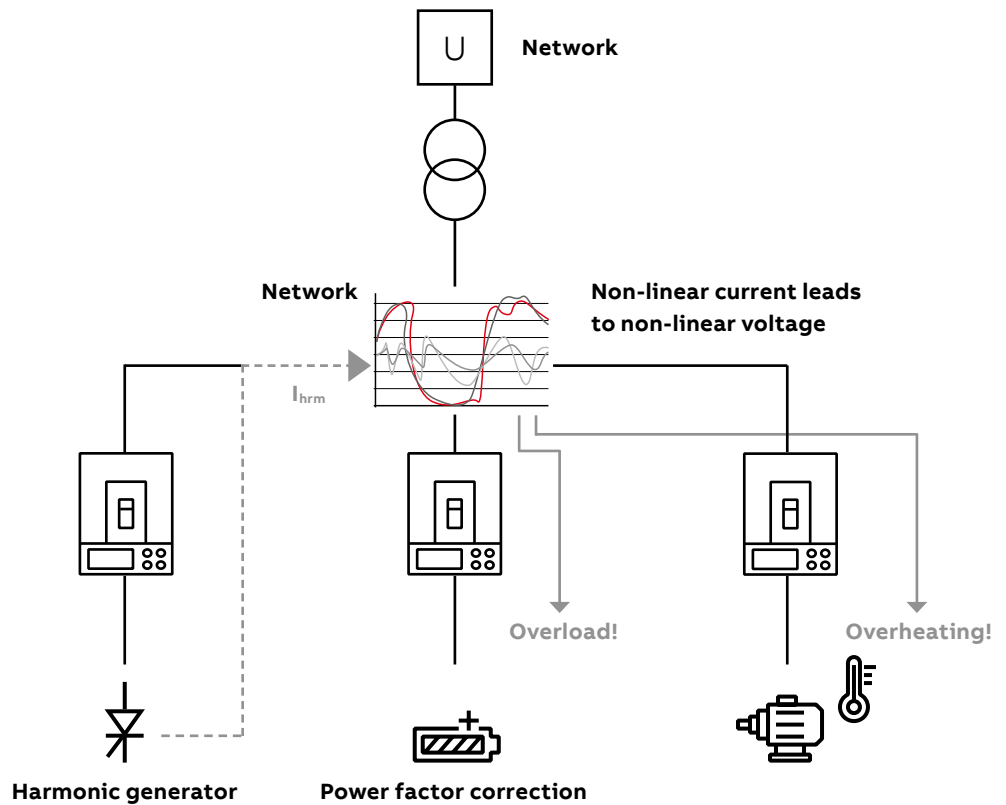

Power electronics produce harmonic content that can affect other loads in the plant: the result can be an overheating of the asynchronous motor and an overload on the power factor correction capacitors. To get information about the harmonic con-

tent of voltage and current waveforms and to take measures if such values are high, a dedicated index has been defined. The total harmonic distortion (THD) of a signal is a measurement of the harmonic distortion present.

## The first step towards better Power Quality: measurement

A Power Quality monitor is the most commonly used tool for detecting voltage sags and power quality issues. Measurement is the first step for checking the status of the installation and starting the root cause analysis. Power Quality measurements and related instrumentation are described in specific industrial Standards such as IEC61000-4-30 and IEEE 1250. For the first time, thanks to the Ekip Touch trip units for the Emax 2, the power quality monitor is embedded in a low voltage molded case circuit-breaker. The Network Analyzer function complies with the prescriptions of IEC 61000-4-30 and IEEE 1250.

The Network Analyzer function allows the user to set controls on the voltage in order to analyze the operation of the system: any time a control parameter exceeds a preset threshold, an alarm is generated. The accuracy of voltage measurements by the Emax 2 is excellent at 0.5%. The Emax 2 Network Analyzer complies with IEEE 1250-2011, Section 3 for the monitoring of the voltage value, unbalance and harmonic content, which is the equivalent of IEC61000-4-30 Class S for voltage values and unbalance and Class B for the harmonic content.

### Network Analyzer

Hourly average voltage value
Short voltage interruption
Short voltage spikes
Slow voltage sags and swells
Voltage unbalance
Armonic analysis

Referring to the voltage sag ambit, as an example, the Network Analyzer function has the ability to control three kinds of sag classes, defined by the user:

Parameter	Description
Sag Threshold (First Class)	This defines the first alarm threshold. It is expressed as % Un.
Sag Times (First Class)	In the event of dropping under the first alarm threshold, this defines the time beyond which the alarm counter is increased.
Sag Threshold (Second Class)	This defines the second alarm threshold. It is expressed as % Un.
Sag Times (Second Class)	In the event of dropping under the second alarm threshold, this defines the time beyond which the alarm counter is increased.
Sag Threshold (Third Class)	This defines the third alarm threshold. It is expressed as % Un.
Sag Times (Third Class)	In the event of dropping under the third alarm threshold, this defines the time beyond which the alarm counter is increased.

Two different types of counters for each power quality monitoring function are made available directly on the trip unit touch screen: one is a cumulative counter, which stores all the alarms (for example, all the voltage sags) from the beginning, and one is a 24h counter, that shows the alarms in the last 24 hours.

With the optional communication module (Modbus, Profibus, Profinet, etc.) eight counters for each power quality monitoring function are available: one is the cumulative and the other seven are the daily counters of the last seven days of activity.

# Energy Measurements

## Network Analyzer

### Operating Principle

The Network Analyzer function performs continuous monitoring of the quality of energy, and shows all results through a display or communication module. In particular:

- **Hourly average voltage value:** in accordance with international Standards, this must remain within 10% of the rated value, but different limits can be defined according to the needs of the installation. The positive sequence voltage is compared with the limits. If the limits are exceeded, the Ekip Touch trip units generates a signaling event. The number of these events is stored in a suitable counter. The counter values are available for each of last 7 days, as well as the total. The measures available are the positive and negative sequence voltages and positive and negative sequence currents of the last interval monitored. The time of the calculation of the average values can be set between 5 minutes and 2 hours.
- **Interruptions / short dips in voltage:** if the voltage remains below a threshold for more than 40ms, the Ekip Touch trip units generates an event that is counted in a dedicated log. The voltage is monitored on all lines.
- **Short voltage spikes** (voltage transients, spikes): if the voltage exceeds a threshold for 40ms, set for a pre-determined time, the Ekip Hi-Touch generates an event that is counted.
- **Slow voltage sags and swells:** when the voltage strays outside a range of acceptable limit values for a time greater than the one set, the Ekip Hi-Touch generates an event that is counted. Three values can be configured for voltage sags and two for voltage swells, each associated with a time limit: this enables verification of whether the voltage remains within a curve of values that are acceptable by equipment such as computers. The voltage is monitored on all lines.
- **Voltage unbalances:** if the voltage values are not equal or the phase displacements between them are not exactly 120°, an unbalance occurs, which is manifested with a negative sequence voltage value. If this limit exceeds the threshold value set, an event is stored which is counted.
- **Harmonic analysis:** the harmonic content of voltages and currents, measured to the 50th harmonic, as well as the value of the total harmonic distortion (THD), are available in real time on the display or through the communication modules. The Ekip Touch trip units also generates an alarm if the THD value or a magnitude of at least one of the harmonics exceeds the values set. The voltage and current values are monitored on all phases.

All information can be displayed directly on the screen or on a smartphone, a PC or in a network system with any of the communication modules. This is an embedded function of Ekip Touch trip units and analyzes important parameters of the distribution network including:

- The average Voltage value
- Short Voltage interruptions and spikes
- Slow Voltage sags and swells
- Voltage unbalance
- Harmonic analysis

---

# Accessories

- 6/2**      **Functional areas**
- 6/3**      **Standard supply**
- 6/4**      **Accessories for circuit-breakers**
- 6/5**      Signalling
- 6/8**      Control
- 6/11**     Safety
- 6/12**     Protection devices
- 6/14**     Connections
- 6/16**     Interlocks and switching devices
- 6/19**     **Accessories for Ekip trip units**
- 6/21**     Power supply
- 6/21**     Connectivity
- 6/23**     Signalling
- 6/24**     Measurements and protection
- 6/28**     Displaying and supervision
- 6/29**     Testing and programming
- 6/30**     **Service**

# Functional areas

The new SACE Emax 2 circuit-breakers have been designed to optimize the installation and commissioning of accessories.

The front of the circuit-breaker features two functional areas, which are protected by separate covers:

- **Accessories area** for the installation of accessories inside the circuit-breaker and Ekip trip unit. The areas dedicated to accessories can be accessed by removing the flange and the accessories covers. On removal, the operating mechanism area remains segregated and protected, providing safety for operators.
- **Safety area**, which delimits the housing of the stored energy operating mechanism of the circuit-breaker. To carry out maintenance on the operating mechanism, the covers of the accessories and safety area must be removed.

The auxiliary connection terminal box also features two areas:

- **Terminal area** for housing and inserting the terminals for wiring the auxiliary connections. The terminals can be wired first and then installed on the circuit-breaker terminal box, thereby facilitating cable connection for the operator.
- **Cartridge module area**, housing for the Ekip modules. These are installed directly on the upper part of the circuit-breaker or of the fixed part without having to remove the Ekip electronic trip unit, thereby minimizing the time required for the installation and commissioning of accessories.





# Standard supply

The fixed versions of SACE Emax 2 automatic circuit-breakers and switch-disconnectors are always supplied as standard with the following accessories:

- IP30 protection for switchgear door
- lifting plates for E2.2 ... E6.2 circuit-breaker
- front terminals for E1.2 circuit-breaker
- adjustable rear terminals for E2.2 ... E6.2 circuit-breaker, mounted in HR – HR configuration.

In addition, for **fixed automatic circuit-breakers** only:

- four standard open/closed auxiliary contacts - AUX 4Q 400V
- four terminals for auxiliary connections
- mechanical signalling of the tripping of the protection trip unit - TU Reset
- contact signalling tripping of Ekip protection trip unit S51 250V.

The withdrawable versions of automatic circuit-breakers and switch-disconnectors are always supplied as standard with the following accessories:

- closed circuit-breaker racked-out mechanism lock
- lifting plates for E2.2 ... E2.6 circuit-breakers
- lever for racking in and racking out
- anti-insertion lock.

In addition, for **withdrawable automatic circuit-breakers** only:

- four standard open/closed auxiliary contacts - AUX 4Q 400V
- four terminals for auxiliary connections
- mechanical signalling of the tripping of the protection trip unit - TU Reset
- contact signalling tripping of Ekip protection trip unit S51 250V.

The fixed parts feature:

- IP30 protection for switchgear door
- anti-insertion lock
- standard shutter lock – SL
- adjustable rear terminals, mounted in HR – HR configuration.



# Accessories for circuit-breakers

SACE Emax 2 circuit-breakers offer a wide range of accessories developed to satisfy the applica-

tion and installation requirements of every customer.

	Automatic circuit-breaker		Switch-disconnector		Derived versions		
	E1.2	E2.2 - E4.2 - E6.2	E1.2	E2.2 - E4.2 - E6.2	CS	MT	MTP
					E2.2 - E4.2 - E6.2		
<b>Signalling</b>							
Standard open/closed auxiliary contacts - AUX 4Q	●/●●	●/●●	○/∞	○/∞	-	-	●●
Open/closed auxiliary contacts - AUX 6Q	-	○/∞	-	○/∞	-	-	∞
Open/closed auxiliary contacts- AUX 15Q	○/△	○/△	○/△	○/△	-	-	∞
Auxiliary position contacts - AUP	△	△	△	△	△	△	△
Ready to close signalling contact - RTC	○/∞	○/∞	○/∞	○/∞	-	-	-
TU Reset mechanical signalling of the tripping of protection trip unit - TU Reset	●/●●	●/●●	-	-	-	-	-
Contact signalling tripping of Ekip protection trip unit - S51	●/●●	●/●●	-	-	-	-	-
Second contact signalling tripping of Ekip protection trip unit - S51/2	-	○/∞	-	-	-	-	-
Contact signalling loaded springs – S33 M/2 (supplied with Motor)	○/∞	○/∞	○/∞	○/∞	-	-	∞
<b>Control</b>							
Opening and closing release - YO/YC	○/∞	○/∞	○/∞	○/∞	-	-	∞*
Second opening and closing release - YO2/YC2	○/∞	○/∞	○/∞	○/∞	-	-	-
Undervoltage release - YU	○/∞	○/∞	○/∞	○/∞	-	-	-
Electronic time-delay device for undervoltage release - UVD	○/∞	○/∞	○/∞	○/∞	-	-	-
Motor - M	○/∞	○/∞	○/∞	○/∞	-	-	∞
Remote reset - YR	○/∞	○/∞	-	-	-	-	-
Opening and closing release test unit - YO/YC Test Unit	○/△	○/△	○/△	○/△	-	-	△*
<b>Safety</b>							
Key lock and padlock in open position - KLC and PLC	○/∞	○/∞	○/∞	○/∞	-	-	∞
Key lock and padlock in racked-in / test / racked-out position - KLP and PLP	△	∞	△	∞	∞	∞	∞
Shutter lock - SL	▲	▲	▲	▲	▲	▲	▲
Lock for racking-out mechanism with circuit-breaker in closed position	▲	●●	▲	●●	●●	●●	●●
Lock for racking in / racking out the mobile part when the door is open - DLR	-	△	-	△	-	-	∞
Lock to prevent door opening when circuit-breaker is in racked-in / test position - DLP	-	△	-	△	△	△	△
Lock to prevent door opening when circuit-breaker is in closed position - DLC	○/∞	○/∞	○/∞	○/∞	-	-	∞
Anti-insertion lock	●/●●	●/●●	●/●●	●/●●	●●	●●	●●
Mechanical operation counter - MOC	○/∞	○/∞	○/∞	○/∞	-	-	∞
<b>Protection devices</b>							
Protection device for opening and closing pushbuttons - PBC	○/∞	○/∞	○/∞	○/∞	-	-	∞
IP30 Protection	●/▲	●/▲	●/▲	●/▲	-	-	▲
IP54 Protection	○/△	○/△	○/△	○/△	-	-	△
Terminal covers - HTC / LTC	○/∞	-	-	-	-	-	-
Separators - PB	○/△	○/△	○/△	○/△	-	-	-
<b>Connections</b>							
Orientable rear terminal - HR/VR	○/▲	●/▲	○/▲	●/▲	-	-	●
Front terminal - F	●	○/△	●	○/△	-	-	△
Other configurations	○/△	○/△	○/△	○/△	-	-	△
<b>Interlocks and switching devices</b>							
Mechanical interlock - MI	○/∞/ △	○/∞/ △	○/∞/ △	○/∞/ △	-	-	-
Automatic transfer switches - ATS	○/∞	○/∞	○/∞	○/∞	-	-	-

- Standard accessory for fixed circuit-breaker
- Accessory on request for fixed circuit-breaker
- Standard accessory for mobile part
- Accessory on request for mobile part

- ▲ Standard accessory for fixed part
- △ Accessory on request for fixed part
- \* Only closing release YC



Fig. 01-A



Fig. 01-B



Fig. 01-C

## Signalling

### Open / closed auxiliary contacts - AUX (Fig. 01A/B/C)

SACE Emax 2 circuit-breakers can be equipped with auxiliary contacts that signal the open or closed status of the circuit-breaker. The first block of four standard contacts is always provided with the automatic circuit-breakers. The switching contacts are available in the following configurations:

<b>Open / closed auxiliary contacts (AUX 4Q)</b>		<b>E1.2</b>	<b>E2.2 ... E6.2</b>
4 auxiliary contacts	standard	●	●
	digital signals	●	●
	mixed	●	●
<b>Open / closed supplementary auxiliary contacts (AUX 6Q)</b>			
6 auxiliary contacts	standard	-	●
	digital signals	-	●
	mixed	-	●
<b>Open / closed external supplementary auxiliary contacts (AUX 15Q)</b>			
15 auxiliary contacts	standard	●	●
	digital signals	●	●
<b>Maximum number of open / closed auxiliary contacts that can be installed</b>		19	25

		<b>Standard contact</b>	<b>Contact for digital signals</b>
Type		changeover contacts	changeover contacts
Minimum load		100mA @ 24V	1mA @ 5V
<b>Breaking capacity</b>			
DC	24V	-	0.1A
	125V	0.3A @ 10ms	-
	250V	0.15A @ 10ms	-
AC	250V	5A @ cosφ 1	-
		5A @ cosφ 0.7	-
		5A @ cosφ 0.3	-
	400V	3A @ cosφ 1	-
		2A @ cosφ 0.7	-
		1A @ cosφ 0.3	-

Electrical diagram reference: figures 1, 81, 91

Aux 6Q is an alternative to the Ekip Signalling 4K module. AUX 15Q is an alternative to the mechanical interlock (MI), the DLC for E1.2 lock or the DLP lock if mounted on the right side.

# Accessories for circuit-breakers



Fig. 02-A



Fig. 02-B

## Auxiliary position contacts - AUP (Fig. 02A/B)

When the circuit-breaker is a withdrawable version, the position of the mobile part can be signalled electrically by accessorizing the fixed part with one of the following signalling contact units:

Auxiliary position contacts (AUP)		E1.2	E2.2 ... E6.2
6 auxiliary contacts	standard	●	-
	digital signals	●	-
5 auxiliary contacts	standard	-	●
	digital signals	-	●
5 supplementary auxiliary contacts	standard	-	●
	digital signals	-	-
<b>Maximum number of auxiliary position contacts that can be installed</b>		6	10

		Standard contact	Contact for digital signals
Type		changeover contacts	changeover contacts
Minimum load		100mA @ 24V	1mA @ 5V
<b>Breaking capacity</b>			
DC	24V	-	0.1A
	125V	0.3A @ 0ms	-
	250V	0.15A @ 0ms	-
AC	250V	5A @ cosφ 1	-
		5A @ cosφ 0.7	-
		5A @ cosφ 0.3	-
	400V	3A @ cosφ 1	-
		2A @ cosφ 0.7	-
		1A @ cosφ 0.3	-

Electrical diagram reference: figures 95, 96, 97



Fig. 03

## Ready to close signalling contact - RTC (Fig. 03)

The ready to close signalling contact – RTC – indicates that the circuit-breaker is ready to receive the closing command. The circuit-breaker is ready to close when the following conditions have been met:

- circuit-breaker open
- springs loaded
- no opening command or locks on the opening command
- circuit-breaker reset following tripping of Ekip protection trip unit
- YU energized.

		Standard contact	Contact for digital signals
Type		Switching	
Minimum load		100mA @ 24V	1mA @ 5V
<b>Breaking capacity</b>			
DC	24V	-	0.1
	250V	0.5A @ 0ms / 0.2A 10ms	-
AC	250V	3A @ cosφ 0.7	-

Electrical diagram reference: figure 71



Fig. 04

#### Mechanical signalling of the tripping of protection trip unit - TU Reset (Fig. 04)

The automatic circuit-breakers are always equipped with a mechanical device that signals the tripping status of the protection trip units. After the Ekip trip unit has tripped due to an electrical fault, the signalling device clearly indicates the tripping status on the front of the circuit-breaker. The circuit-breaker can be reset only after the signalling pushbutton has been restored to its normal operating position. The device conforms to the Ansi 86T standard.

Emax 2 is fitted with the anti-pumping function. With the anti-pumping function the opening order always takes priority over a closing order. Moreover, when the Circuit Breaker is in open position due to a trip, the anti-pumping function allows the reclosing of the operating mechanism only after a reset of the trip, avoiding improper or accidental closing.



Fig. 05

#### Contact signalling tripping of protection trip unit Ekip – S51 (Fig. 05)

The contact signals the opening of the circuit-breaker after the Ekip protection trip unit has tripped. The circuit-breaker can only be closed after the “TU Reset” tripped trip unit mechanical signalling pushbutton has been restored to its normal operating position.

The switching contact, which is always supplied with the standard version of the automatic circuit-breakers, is also available on request in a version for digital signals (for electrical characteristics, please refer to the RTC contact). It can also be associated with an optional accessory for resetting by remote control - YR. For electromechanical characteristics, please refer to the RTC contact.

For E2.2, E4.2 and E6.2 it is possible to double the signal for the tripping of the Ekip Trip Unit specifying the dedicated code for the S51/2. The S51/2 is an alternative of the YR contact.

Electrical diagram reference: figure 11

#### Contact signalling loaded springs – S33 M/2

This contact is always supplied with a geared motor; it remotely signals the spring status of the circuit-breaker operating mechanism. It is available in both standard version and version for digital signals.

		Standard contact	Contact for digital signals
Type		changeover contacts	changeover contacts
Minimum load		100mA @ 24V	1mA @ 5V
<b>Breaking capacity</b>			
DC	24V	-	0.1A
	125V	0.3A @ 0ms	-
	250V	0.15A @ 0ms	-
AC	250V	5A @ cosφ 1	-
		5A @ cosφ 0.7	-
		5A @ cosφ 0.3	-
	400V	3A @ cosφ 1	-
		2A @ cosφ 0.7	-
		1A @ cosφ 0.3	-

Electrical diagram reference: figure 12

# Accessories for circuit-breakers



Fig. 06

## Control

### Opening and closing release- YO/YC (Fig. 06)

The opening and closing releases enable the circuit-breaker to be controlled remotely. Opening is always possible, while closing is available only when the closing springs of the operating mechanism are loaded and the circuit-breakers is ready to close. The releases operate by means of minimum impulse current duration time of 100 ms.

Furthermore, they can operate in permanent service. In this case, if opening command is given by means of the opening release, the circuit-breaker can be closed by de-energizing the opening release and, after a time of at least 30 ms, by controlling the closing.

The circuit breaker operating mechanism has an anti-pumping function that ensures safety and reliability.

—  
Electrical diagram reference: figures 75, 77



### Second opening and closing release - YO2/YC2

For certain installations the redundancy of mechanisms and circuit-breaker operating circuits is often requested. To answer these needs, the SACE Emax 2 circuit-breakers can be equipped with double opening release and double closing release. The technical characteristics of the second opening release remain the same as those of the first opening and closing release. A double closing release can be used for E2.2, E4.2 and E6.2 circuit-breakers; a second open release in an alternative to undervoltage release.

—  
Electrical diagram reference: figures 72, 79

General characteristics		
Power supply (Un)	AC	DC
24V	●	●
30V	●	●
48V	●	●
60V	●	●
110V...120V	●	●
120V...127V	●	●
220V...240V	●	●
240V...250V	●	●
380V...400V	●	-
415V...440V	●	-
480V...500V	●	-
Operating limits (IEC60947-2 standards)	YO/YO2: 70%...110% Un YC/YC2: 85%...110% Un	
Inrush power (Ps)	300VA	300W
Continuous power (Pc)	3.5VA	3.5W
Opening time (YO/YO2)		
E1.2	35 ms	
E2.2 ... E6.2	35 ms	
Closing time (YC/YC2)		
E1.2	50 ms	
E2.2 ... E6.2	70 ms	

### Opening and closing release test unit - YO/YC Test Unit

The opening and closing releases test unit helps ensure that the various version of releases are running smoothly, to guarantee a high level of reliability in controlling circuit-breaker opening.

The test unit ensures the continuity of the opening and closing releases with a rated operating voltage between 24V and 250V (AC and DC), as well as verifies the functions of the opening and closing coil electronic circuit. Continuity is checked cyclically with an interval of 30s between tests. The unit has optic signals via LEDs on the front, which provide the following information:

**POWER ON:** correct power supply of the YO/YC Test Unit

**OPEN ON:** coil switch absent, power supply absent or insufficient, interrupted cables

**SHORT ON:** coil switch failure, short-circuited cables

**OPEN and SHORT FLASHING:** faulty coil switch or incorrect supply

**OPEN and SHORT OFF:** correct operation of the coil switch.

Two relays with one change-over area also available on board the unit, to allow remote signalling of the following events:

**Failure of a test** - resetting takes place automatically when the alarm stops

**Failure of three tests** - resetting occurs only by pressing the manual RESET on the unit.

Characteristics of device	
Auxiliary power supply	24V...250V AC/DC
Specification of the signalling relays	
Maximum interrupted current	6A
Maximum interrupted voltage	250V AC



Fig. 07

### Undervoltage release – YU (Fig. 07)

The undervoltage release opens the circuit- breaker when there is a significant voltage drop or power failure. It can be used for safe remote tripping, for blocking closing or to control the voltage in the primary and secondary circuits. The power supply for the release is therefore obtained on the supply side of the circuit-breaker or from an independent source. Circuit-breaker closing is permitted only when the release is powered. The undervoltage release is an alternative to as second shunt trip or the anti-racking out device. The circuit-breaker is opened with trip unit power supply voltages of 35-70%  $U_n$ . The circuit-breaker can be closed with a trip unit power supply voltage of 85-110%  $U_n$ .

General characteristics		
Power supply ( $U_n$ )	AC	DC
24V	●	●
30V	●	●
48V	●	●
60V	●	●
110V...120V	●	●
120V...127V	●	●
220V...240V	●	●
240V...250V	●	-
380V...400V	●	-
415V...440V	●	-
480V...500V	●	-
Inrush power ( $P_s$ )	300VA	300W
Continuous power ( $P_c$ )	3.5VA	3.5W
Opening time (YU)		
E1.2	30 ms	
E2.2 ... E6.2	50 ms	

Electrical diagram reference: figure 73

# Accessories for circuit-breakers



Fig. 08

## Time-delay device for undervoltage release (UVD) (Fig. 08)

The undervoltage release can be combined with an electronic time-delay device for the circuitbreaker, allowing for delayed external tripping with adjustable preset times. Use of the delayed undervoltage trip unit is recommended to prevent tripping when the power supply network for the trip unit is subject to brief voltage drops or power supply failures. Circuit-breaker closing is inhibited when it is not powered. The time-delay device must be used with an undervoltage release with the same voltage.

### General characteristics

Power supply (UVD)	AC	DC
24-30V	-	●
48V	●	●
60V	●	●
110-127V	●	●
220-250V	●	●
Adjustable opening time (YU + D):	0.5-1-1.5-2-3 s	



## Resetting remotely- YR

The reset coil YR permits remote resetting of the circuit-breaker after a release has tripped due to an overcurrent condition. It is available for all automatic circuit-breakers, in different voltage supply:

### General characteristics

Power supply (Un)	AC	DC
24V	●	●
110V	●	●
220V	●	●
Operating limits	90%...110% Un	

Electrical diagram reference: figure 4



## Motor – M (Fig. 09A/B)

The motor automatically loads the closing springs of the circuit-breaker. The device, which can be installed from the front, automatically reloads the springs of the operating device when they are unloaded and power is present. In the event no power is present, the springs can be manually loaded by a dedicated lever on the operating device. The motor is always supplied with the limit switch contact S33 M/2 which signals the status of the springs.

### General characteristics

Power supply (Un)	AC	DC
24V-30V	●	●
48V-60V	●	●
100V...130V	●	●
220V...250V	●	●
380V...415V	●	-
440V...480V (E2.2 ... E6.2)	●	-
Operating limits (IEC60947-2 standards)	85%...110% Un	
Inrush power (Ps)	300VA E1.2 500VA E2.2 ... E6.2	300W E1.2 500W E2.2 ... E6.2
Inrush time	200ms	
Continuous power (Pc)	100VA E1.2 150VA E2.2 ... E6.2	100W E1.2 150W E2.2 ... E6.2
Charging time		
E1.2	8 sec	
E2.2 ... E6.2	7 sec	



Fig. 09A



Fig. 09B

Electrical diagram reference: figure 13





Fig. 10

## Safety

### Key lock in open position - KLC (Fig. 10)

Due to these safety devices, the SACE Emax 2 circuit-breaker can be locked in the open position. The lock can also be used during maintenance activities when the shield of the accessories area is removed. The device is available with lock with different keys – KLC-D (for only one circuit-breaker) or with the same keys – KLC-S (for several circuit-breakers). Four different key numbers are available for the KLC-S. SACE Emax 2 also allows alternative key lock to be installed. The following key lock set-ups are also available:

- Ronis
- STI
- Kirk
- Castell

In this case, the key locks must be supplied by the customer.



Fig. 11

### Padlocks - PLC (Fig. 11)

These padlock options allow the circuit-breaker to be kept open by acting directly on the mechanical operating device (opening pushbutton). Three different padlock versions are available:

- Locking device with plastic structure for up to a maximum of three padlocks of 4 mm
- Locking device with metal structure for up to a maximum of two padlocks of 8 mm
- Locking device with metal structure for one padlock of 7 mm or for padlock holders

The padlocks must be supplied by the customer. This device is an alternative to the PBC.

### Key lock in racked-in / test / racked-out position - KLP (Fig. 12)

This device enables the mobile part to be locked in one of the three positions: racked-in, test and racked-out. This device can be supplied with locks with different keys – KLP-D or with the same keys – KLP-S.

A second key lock option can be added for a maximum of two key locks per breaker. Locking in the racked-in, test and racked-out positions can be achieved by using other key locks – KLP-A. Adapters are offered for acceptance of Ronis, STI, Kirk and Castell locks, which are to be provided by the customer. With the exception of the Castell version, every circuit-breaker can accept up to two key locks. Moreover, it is possible to allow locking only when in the racked-out position with a supplementary accessory.



Fig. 12

### Padlock in racked-in / test / racked-out position - PLP (Fig. 13)

This device can hold up to three padlocks of 8 mm in diameter. The structure housing the padlocks can also be used in combination with the 2 lock KLP keylock option. Furthermore, it enables the lock of the moving part in the racked-out position only by means of the supplementary lock in racked-out position.

### Shutter lock – SL

When the mobile part is in the test position, the shutters of the fixed part close, maintaining the insulation distance and physically segregating the live parts of the of the cradle from the internal breaker compartment of the cradle. Using two dedicated mechanisms, the upper and lower shutters can be locked independently of one another. The shutter lock is always supplied with the fixed part of the SACE Emax 2 circuit-breakers and locks the shutters, using a maximum of three padlocks of 4 mm, 6 mm or 8 mm.



Fig. 13

# Accessories for circuit-breakers



Fig. 14

## Protection devices

### Lock for racking-out mechanism with circuit-breaker in closed position (Fig. 14)

All SACE Emax 2 withdrawable circuit-breakers are always supplied with a lock that prevents the mobile part from being racked in and racked out when the circuit-breaker is in the closed position. To rack in the mobile part, the circuit-breaker must be in the open position.

### Lock for racking in / racking out the mobile part when the door is open - DLR

This accessory, which is mounted on the fixed part, prevents the mobile part from being racked in or out when the switchgear door is open.



Fig. 15

### Lock to prevent door opening when the circuit-breaker is in racked-in / test position - DLP (Fig. 15)

This safety device prevents the switchgear door from being opened when the mobile part of the withdrawable version of the circuit-breaker is in the racked-in or test position. This accessory can be installed on either the right-hand or left-hand side of the fixed part. It is available for circuit-breakers E2.2, E4.2 and E6.2. If mounted on the right side, it is an alternative to the mechanical interlock, the AUX 15Q or the DLC.



Fig. 16

### Lock to prevent door opening when the circuit-breaker is in the closed position - DLC (Fig. 16)

This prevents the compartment door from being opened when the circuit-breaker is in the closed position (and with the circuit-breaker racked in for withdrawable circuit-breakers). It also blocks the circuit breaker from closing when the compartment door is open. DLC for E1.2 is an alternative to the mechanical interlock and the AUX 15Q. DLC direct door for E2.2...E6.2 is compatible with mechanical interlocks type A-B-D and the AUX 15Q. DLC cable door for E2.2...E6.2 is not compatible with mechanical interlock. DLC cable door for E2.2... E6.2 is compatible with the AUX 15Q.

### Anti-insertion lock

The withdrawable circuit-breakers are equipped with special locks that allow the mobile part to be inserted only into the corresponding fixed part.



### Mechanical operation counter - MOC (Fig. 17)

The number of mechanical operations is often one of the elements that determines the frequency of ordinary maintenance operations on circuit-breakers. With this mechanical operation counter, which is always visible on the front of the circuit-breaker, the user knows how many mechanical operations the device has performed.



Fig. 17



### Protection device for opening and closing pushbuttons - PBC (Fig. 18)

This accessory is applied to the safety cover of the circuit-breaker and is available in two versions:

- Pushbutton protection device, which blocks operations on both the opening and closing pushbuttons unless the special key is used.
- Padlockable pushbutton protection device, which makes it possible to block either or both pushbuttons and lock the covers in place. It does not trip the breaker as a standard "Padlock device" would.
- PBC is an alternative to PLC padlocks.



Fig. 18

### IP30 Protection (Fig. 19)

Supplied with every circuit-breaker, the cover frame is installed on the door of the switchgear to achieve IP30 degree of protection on the front part of the circuit-breaker.

### IP54 Protection (Fig. 20)

This transparent cover completely protects the front of the circuit-breaker, enabling an IP54 degree of protection to be achieved. This accessory is provided with double key lock (same or different keys).



Fig. 19

### Terminal covers – HTC / LTC (Fig. 21)

These accessories are installed over in the terminal area, thereby reducing the risk of direct contact with the live parts of the circuit-breaker. Two versions are available for E1.2: HTC high terminal covers and LTC low terminal covers.

### Separators - PB (Fig. 22)

These protection devices increase the insulation distance between adjacent phases. They are available for all the frames.



Fig. 20

### 0-ARC Distance top cover

This accessory allows the circuit-breakers to reach the 0-arc distance performance. Installable on the fixed part of E2.2, E4.2 and E6.2 gives the possibility to dimension the cubicle at the same height of the fixed part. The 0-arc distance top cover is not compatible with the AUP auxiliary contacts IEC version, but alternatively it is possible to install the AUP auxiliary contacts UL version.



Fig. 21



Fig. 22

# Accessories for circuit-breakers

## Connections

The SACE Emax 2 circuit-breakers offer a wide variety of terminals, thereby always guaranteeing an optimal solution for connection to the power circuit.

### Solution for fixed circuit-breakers

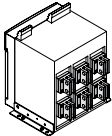
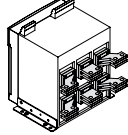
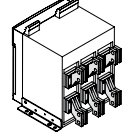
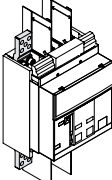
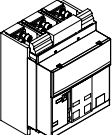
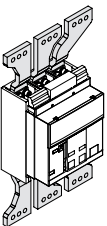
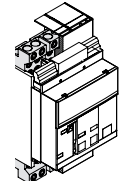
Type	Abbreviation		E1.2	E2.2	E4.2	E6.2
Rear adjustable terminal *	HR VR		Single stab design			
			○	● Iu = 2000A	● Iu = 3200A	● Iu = 5000A
Horizontal rear spread terminal	SHR		Single stab design			
				○ Iu = 2000A	○ Iu = 3200A	
Vertical rear spread terminal	SVR		Single stab design			
				○ Iu = 2000A	○ Iu = 3200A	
Extended front terminal	EF		Multiple stab design			
				○ Iu = 2500A	○ Iu = 4000A	
Front terminal	F		Single stab design			
			●	○	○	○
Front spread terminal	ES		Multiple stab design			
			○			
Terminal for cable FcCuAl 4x240mm <sup>2</sup>	FcCuAl		○			

- Standard configuration
- Configuration on request

(\*) The adjustable terminals are supplied as standard in the HR – HR configuration.

**Solutions for fixed parts, withdrawable circuit-breakers**

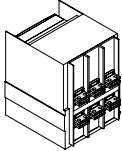
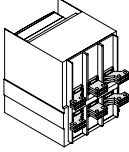
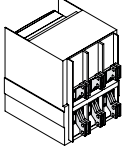
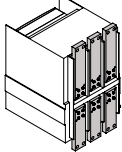
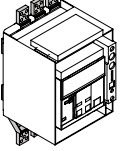
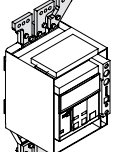
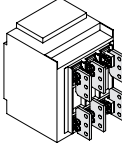
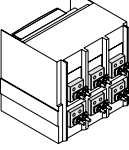
Type	Abbreviation		E1.2	E2.2	E4.2	E6.2
Rear adjustable terminal *	HR VR		Single stab design			
			●	● Iu = 2000A	● Iu = 3200A	● Iu = 5000A
			Multiple stab design			
				● Iu = 2500A	● Iu = 4000A ○ Iu = 3200A**	● Iu = 6300A or X performance
Horizontal rear terminal	SHR		Single stab design			
				○ Iu = 2000A	○ Iu = 3200A	
			Multiple stab design			
				○ Iu = 2500A	○ Iu = 4000A	
Vertical rear spread terminal	SVR		Single stab design			
				○ Iu = 2000A	○ Iu = 3200A	
			Multiple stab design			
				○ Iu = 2500A	○ Iu = 4000A	
Front terminal	F			○	○	○
Extended front terminal	EF		○			
Front spread terminal	ES		○			
Terminal for cable FcCuAl 4x240mm <sup>2</sup>	Fc CuAl		○			
Flat terminal	FL			○	○	○

- Standard configuration
- Configuration on request

(\*) The adjustable terminals are supplied as standard in the HR – HR configuration.

(\*\*) Fixed parts with Iu 3200A accessorized with rear orientable terminals with multiple stabs guarantee higher performances in switchboard installations.

# Accessories for circuit-breakers

## Interlocks and switching devices

### Mechanical interlocks

These interlock systems enable various opening and closing configurations to be obtained between two or three circuit-breakers. Four types of interlock configuration are available:

Types of interlock	Possible application	Logic	Circuit-breakers																								
<b>Type A</b>	<p>Excludes the possibility of having two circuit-breakers in the closed position at the same time.</p> <p>Main line power supply and emergency power supply.</p>	<table border="1"> <tr> <th>1</th> <th>2</th> </tr> <tr> <td>O</td> <td>O</td> </tr> <tr> <td>I</td> <td>O</td> </tr> <tr> <td>O</td> <td>I</td> </tr> </table>	1	2	O	O	I	O	O	I	<p>Available between circuit-breakers of different sizes and with any fixed / withdrawable version</p>																
1	2																										
O	O																										
I	O																										
O	I																										
<b>Type B</b>	<p>Permits a pair of circuit-breakers to be closed if the third is open. The latter can only be closed when the pair is open.</p> <p>Two power supplies from transformers and one emergency power supply.</p>	<table border="1"> <tr> <th>1</th> <th>2</th> <th>3</th> </tr> <tr> <td>O</td> <td>O</td> <td>O</td> </tr> <tr> <td>I</td> <td>O</td> <td>O</td> </tr> <tr> <td>O</td> <td>O</td> <td>I</td> </tr> <tr> <td>I</td> <td>O</td> <td>I</td> </tr> <tr> <td>O</td> <td>I</td> <td>O</td> </tr> </table>	1	2	3	O	O	O	I	O	O	O	O	I	I	O	I	O	I	O	<p>Available between E2.2, E4.2 and E6.2 circuit-breakers and with any fixed / withdrawable version</p>						
1	2	3																									
O	O	O																									
I	O	O																									
O	O	I																									
I	O	I																									
O	I	O																									
<b>Type C</b>	<p>Permits two out of three circuit-breakers to be closed at the same time.</p> <p>Two half-busbars can be powered by a single transformer (bus-tie closed) or by both at the same time (bus-tie open).</p>	<table border="1"> <tr> <th>1</th> <th>2</th> <th>3</th> </tr> <tr> <td>O</td> <td>O</td> <td>O</td> </tr> <tr> <td>I</td> <td>O</td> <td>O</td> </tr> <tr> <td>O</td> <td>I</td> <td>O</td> </tr> <tr> <td>O</td> <td>O</td> <td>I</td> </tr> <tr> <td>O</td> <td>I</td> <td>I</td> </tr> <tr> <td>I</td> <td>I</td> <td>O</td> </tr> <tr> <td>I</td> <td>O</td> <td>I</td> </tr> </table>	1	2	3	O	O	O	I	O	O	O	I	O	O	O	I	O	I	I	I	I	O	I	O	I	<p>Available between E2.2, E4.2 and E6.2 circuit-breakers and with any fixed / withdrawable version</p>
1	2	3																									
O	O	O																									
I	O	O																									
O	I	O																									
O	O	I																									
O	I	I																									
I	I	O																									
I	O	I																									
<b>Type D</b>	<p>Permits one out of three interlocked circuit-breakers to be closed.</p> <p>Three power supplies on the same busbar that must not operate in parallel.</p>	<table border="1"> <tr> <th>1</th> <th>2</th> <th>3</th> </tr> <tr> <td>O</td> <td>O</td> <td>O</td> </tr> <tr> <td>I</td> <td>O</td> <td>O</td> </tr> <tr> <td>O</td> <td>I</td> <td>O</td> </tr> <tr> <td>O</td> <td>O</td> <td>I</td> </tr> </table>	1	2	3	O	O	O	I	O	O	O	I	O	O	O	I	<p>Available between E2.2, E4.2 and E6.2 circuit-breakers and with any fixed / withdrawable version</p>									
1	2	3																									
O	O	O																									
I	O	O																									
O	I	O																									
O	O	I																									

The mechanical interlocks offer multiple solutions for installation that simplify their integration into the switchgear. The interlocks can be mounted:

- vertically VR
- horizontally HR
- mixed L

Different types of interlocks can be supplied according to the maximum distance between two interlocked breakers:

Configuration		Type A	Type B, C, D
Horizontal		2750mm	1600mm
Vertical		1000mm	1000mm
Breakers	E1.2	●	-
	E2.2	●	●
	E4.2	●	●
	E6.2	●	●

For B, C and D types, the maximum distance between the two furthest breakers is 3200mm for horizontal configurations and 2000mm for vertical configurations. It is possible to make the mechanical interlock among three circuit-breakers disposed in 'L position' by using the cables of three horizontal circuit-breakers interlock. Make sure the distance between the horizontal and vertical circuit-breakers respects the minimum and maximum distance. All cables can be cut to guarantee easy installation in switchboards. Mechanical interlocks are not compatible with AUX 15Q, the lock for preventing door opening when the circuit breaker is in the closed position (DLC) or when the circuit breaker is in the racked in or test position (DLP). if mounted on the right side.

#### External Automatic Transfer Switches ATS

The ATS (Automatic Transfer Switch) is a network-unit transfer device used in installations where switching from the main power line to an emergency line is required in order to ensure that power is supplied to the loads in the case of power loss or abnormalities from the main line. These devices are able to control the entire transfer procedure automatically, but also offer commands for performing the procedure manually. The new generation of ATSs (ATS021 and ATS022) offers the most advanced and complete solution for ensuring service continuity. The ATS021 and ATS022 devices can also be used with all automatic circuit-breakers and switch-disconnectors of the Tmax XT family. The ATS021 and ATS022 devices have been designed to be self-powered.

ATS022 is also designed for the connection of an auxiliary supply, which enables the use of further functions.

The ATS021 and ATS022 devices carry out control of both power supply lines and also analyze:

- phase imbalance;
- frequency imbalance;
- phase loss.

In addition to the standard control functions, the ATS022 unit also permits:

- the priority line to be selected;
- a third circuit-breaker to be controlled;
- the device to be integrated into a supervision system with Modbus communication (auxiliary supply needed);
- parameters to be read and set, and measurements and alarms to be displayed by means of a graphical display.

Typical applications are: supply of UPS (Uninterrupted Power Supply) units, operating rooms and primary hospital services, emergency power for civil buildings, airports, hotels, databases and telecommunication systems and power supply of industrial lines in continuous processes.

For correct configuration, each circuit-breaker connected to the ATS021 or ATS022 device must be fitted with the following accessories:

- mechanical interlock;
- motorized control of opening and closing;
- contact for signalling status (open / closed) and contact for signalling tripping;
- contact for signalling circuit-breaker racked in (for withdrawable circuit-breaker).

# Accessories for circuit-breakers



## Technical characteristics

		ATS021	ATS022	
General	Auxiliary supply voltage	Not required	Not required (24-110V DC is required only for Modbus communication and systems of 16 2/3 Hz)	
	Supply voltage, Un	Max 480V AC	Max 480V AC	
	Frequency, fn	50, 60 Hz	16 2/3, 50, 60, 400 Hz	
	Dimensions		H mm	96
			W mm	144
D mm			170	
Type of installation	Installation on front of switchgear Installation on DIN rail	Installation on front of switchgear Installation on DIN rail		
Operating mode	Automatic/Manual	Automatic/Manual		
Characteristics	Monitoring of normal and emergency line	●	●	
	Control of circuit-breakers on normal and emergency line	●	●	
	Setting start-up of generator	●	●	
	Setting switch-off of generator with settable time delay	●	●	
	Third circuit-breaker	-	●	
	Selection priority line	-	●	
	Modbus Rs485 communication	-	●	
	Display	-	●	
Environmental conditions	Protection degree	IP20*	IP20*	
	Operating temperature	-20 ... +60 °C	-20 ... +60 °C	
	Humidity	5% - 90% without condensation	5% - 90% without condensation	
Operating thresholds	Undervoltage	-30% ... -5% Un	-30% ... -5% Un	
	Overvoltage	+5% ... +30% Un	+5% ... +30% Un	
	Frequency thresholds	-10% / +10% fn	-10% ... +10% fn	
Tests	Test Mode	●	●	
	Mode Test Gen set	●	●	
Standards	Electronic devices for use in electrical installations	EN-IEC 50178	EN-IEC 50178	
	Electromagnetic compatibility	EN 50081-2	EN 50081-2	
		EN 50082-2	EN 50082-2	
	Environmental conditions	IEC 68-2-1	IEC 68-2-1	
		IEC 68-2-2	IEC 68-2-2	
IEC 68-2-3		IEC 68-2-3		

Electrical diagram reference: figures 100,101 and 102.

\* IP54 available with 1SCA101001R1001 accessory



# Accessories for Ekip trip units

The electronic trip unit accessories enable utilization of all the potential of Ekip protection trip units in terms of signalling, connectivity, protection functions and testing.

	Electronic trip unit				
	Ekip DIP	Ekip Touch	Ekip Hi-Touch	Ekip G Touch	Ekip G Hi-Touch
<b>Power supply</b>					
Ekip Supply	○	○	○	○	○
Battery for Ekip trip units	○	○	○	○	○
<b>Connectivity</b>					
Ekip Com		○	○	○	○
Ekip Com Redundant		○	○	○	○
Ekip Com Actuator	○	○	○	○	○
Ekip Link	○	○	○	○	○
Ekip Bluetooth	○	●	●	●	●
<b>Signalling</b>					
Ekip Signalling 2K		○	○	○	○
Ekip Signalling 3T		○	○	○	○
Ekip Signalling 4K <sup>(1)</sup>		○	○	○	○
Ekip Signalling 10K	○	○	○	○	○
Ekip Signalling Modbus TCP	○	○	○	○	○
Ekip AUP	○	○	○	○	○
Ekip RTC	○	○	○	○	○
<b>Measurement and Protection</b>					
Measurement Enabler with voltage sockets		○	●	●	●
Measurement Enabler		● <sup>(2)</sup>			
Ekip Synchrocheck		○	○	○	○
Ekip LCD		○	○	○	○
Rating Plug	○	○	○	○	○
Homopolar toroid		○	○	○	○
Toroid for differential protection		○	○	○	○
Current sensor for neutral conductor outside the circuit-breaker	○	○	○	○	○
<b>Displaying and Supervision</b>					
Ekip Multimeter	○	○	○	○	○
Ekip Control Panel <sup>(3)</sup>	○	○	○	○	○
<b>Testing and Programming</b>					
Ekip TT	○	○	○	○	○
Ekip T&P	○	○	○	○	○
Ekip T&P: Ekip Programming	○	○	○	○	○

● Standard accessory

○ Accessory on request

(1) Not available for E1.2

(2) Measurements to be activated with the dedicated software package

(3) Available for Ekip trip units, Grey Platform only

# Accessories for Ekip trip units

All accessories are automatically recognized by the Ekip units without the need for any specific configuration. Based on the installation method and connection of the trip units, the electronic accessories can be divided into:

Installation	Modules	Highlights
Terminal box	Cartridge modules: - Ekip Com - Ekip Link - Ekip Signalling 2K - Ekip Signalling 3T - Ekip Supply - Ekip Synchrocheck	<ul style="list-style-type: none"> <li>- The Ekip Supply module enables the trip units to be supplied with a wide range of control voltages</li> <li>- The Ekip supply module must be present for the other modules to be used</li> <li>- The Ekip Supply module has a dedicated position in the installation area in the terminal box; the other modules can be installed as desired in the positions available</li> <li>- When fitted with the Ekip Supply module, up to 2 additional modules can be installed on E1.2, and up to 3 on E2.2, E4.2 and E6.2</li> </ul>
Accessorizing area	Ekip LCD Ekip Com Actuator Ekip RTC Ekip AUP Ekip Signalling 4K Rating Plug Battery for Ekip	<ul style="list-style-type: none"> <li>- These are installed in specific housings from the front of the circuit-breaker</li> <li>- For all the trip units with a touch screen interface, an LCD version is available with any adjustment in the protection and measurements functions</li> <li>- Thanks to the optional modules Ekip RTC and Ekip AUP, all the Ekip trip units can acquire and monitor the ready to close state and the racked-in/test isolated/racked-out position of the circuit-breaker. The module to acquire the open/closed position is supplied as standard for all Ekip trip units.</li> <li>- The Ekip Signalling 4k module increases the remote signalling possibilities for E2.2, E4.2 and E6.2 and can be installed if the Ekip Supply module or another 24V auxiliary power supply is present</li> </ul>
Ekip trip unit test port	Ekip T&P Ekip TT Ekip Bluetooth	<ul style="list-style-type: none"> <li>- These can be connected to the front test port of the trip units even with the device in operation</li> <li>- Compatible also with the SACE Tmax XT range</li> </ul>
External	Ekip Multimeter Ekip Control Panel Ekip Signalling 10K Ekip Signalling Modbus TCP External neutral sensor Homopolar toroid Differential toroid	<ul style="list-style-type: none"> <li>- Ekip Multimeter can supply a 24V DC output to the trip unit it is connected to</li> <li>- Several Ekip units and / or Ekip Signalling 10K can be connected at the same time to the same Ekip trip unit</li> <li>- These are connected to the trip unit by the terminal box of the circuit-breaker</li> </ul>



Fig. 23

## Power supply

### Ekip Supply module (Fig. 23)

The Ekip Supply module supplies all Ekip trip units and modules present on the terminal box and of the circuit-breaker with several auxiliary power (in AC or DC) available in the switchgear. The module is mounted in the terminal box and permits the installation of the other advanced modules. It can be field installed at any time.

Two versions are available according to the control voltage available:

- Ekip Supply 110-240V AC/DC
- Ekip Supply 24-48V DC

	Supply	Ekip Supply	
<b>Ekip Dip</b>	<b>Nominal voltage</b>	24-48V DC	110-240V AC/DC
	<b>Voltage range</b>	21,5-53V DC	105-265V AC/DC
	<b>Rated power (including modules)</b>	10W max.	10W max.
	<b>Inrush current</b>	~2A for 20ms	~2A for 20ms
<b>Ekip Touch/ Hi-Touch</b>	<b>Nominal voltage</b>	24-48V DC	110-240V AC/DC
	<b>Voltage range</b>	21,5-53V DC	105-265V AC/DC
	<b>Rated power (including modules)</b>	10W max.	10W max.
	<b>Inrush current</b>	~2A for 20ms	~2A for 20ms



Fig. 24

## Connectivity

### Ekip Com modules (Fig. 24)

The Ekip communication modules enable SACE Emax 2 circuit-breakers to be integrated in an industrial communication network for remote supervision and control of the circuit-breaker. They are suitable for all distribution and generator protection versions of the Ekip Touch and Hi-Touch trip units. Since they are mounted in the terminal box, communication can be maintained with withdrawable circuit-breakers, even while in the racked-out position. Several Ekip Com modules can be installed at the same time, thereby enabling connection to communication systems that use different protocols.

The Ekip Com modules for Modbus RTU, Profibus-DP and DeviceNet™ contain a terminating resistor and dip switch for optional activation to terminate the serial network or bus.

The Profibus-DP module also contains a polarization resistor and dip switch for its activation.

The Ekip Com modules are supplied with auxiliary position contacts Ekip AUP and ready to close circuit-breaker contacts Ekip RTC.

For industrial applications in which a higher reliability of the communication network is required, the Ekip Com Redundant modules can be installed together with the corresponding Ekip Com modules in order to guarantee a back-up connection to the network.

The following communication protocols are available for Ekip trip units:

Protocol	Ekip Com Module	Ekip Com Redundant Module
Modbus RTU	Ekip Com Modbus RS-485	Ekip Com R Modbus RS-485
Modbus TCP	Ekip Com Modbus TCP	Ekip com R Modbus TCP
Profibus-DP	Ekip Com Profibus	Ekip Com R Profibus
Profinet	Ekip Com Profinet	Ekip Com R Profinet
EtherNet/IP™	Ekip Com EtherNet/IP™	Ekip Com R EtherNet/IP™
DeviceNet™	Ekip Com DeviceNet™	Ekip Com R DeviceNet™
IEC61850	Ekip Com IEC61850	Ekip Com R IEC61850
Cloud connectivity	Ekip Com Hub	-

Electrical diagram reference: figures from 51 to 57. Redundant version from 61 to 66.

# Accessories for Ekip trip units



## Ekip Link Module (Fig. 25)

The Ekip Link module enables the SACE Emax 2 circuit-breaker to be connected to ABB communication system for locally supervising switchgear by means of the Ekip Control Panel and to act as Power Controller. It is suitable for all Ekip trip units and can be factory or field installed in time to the circuit-breaker terminal box, even when Ekip Com communication modules are present. In this way, it is possible to have both local supervision of the control panel by means of the Ekip Control Panel and supervision of the system by means of the Ekip Com modules connected to the communication network. The Ekip Link modules are supplied complete with auxiliary position contacts Ekip AUP and ready to close circuit-breaker contacts Ekip RTC.

—  
Electrical diagram reference: figure 58



—  
Fig. 25



—  
Fig. 26

## Ekip Com Hub (Fig. 26)

Ekip Com Hub is the new communication module for Emax 2 cloud-connectivity.

Emax 2 equipped with Ekip Com Hub can establish the connection to ABB Ability™ EDCS for the whole low-voltage power distribution panel. This dedicated cartridge-type communication module just needs to be inserted into the terminal box and connected to the internet.

For further information related to ABB Ability™ EDCS, please visit the dedicated website

<https://new.abb.com/low-voltage/launches/abb-ability-edcs>.



## Ekip Com Actuator module (Fig. 27)

The Ekip Com Actuator module enables the SACE Emax 2 circuit-breakers to be opened and closed remotely. The Ekip com Actuator is optional and can be ordered for all Ekip trip units equipped with Ekip Com or Ekip Link modules; it is installed on the front of the circuit-breaker in the right-hand accessories area.

—  
Electrical diagram reference: figures 76, 78



—  
Fig. 27

## Ekip Bluetooth wireless communication unit (Fig. 28)

Ekip Bluetooth permits remote connection with the trip unit by portable PC, tablet or smart phone on which Ekip Connect software has been installed. The device is connected to the front test connector found on all Ekip trip units in SACE Emax 2 and SACE Tmax XT circuitbreakers and supplies power by means of a rechargeable Li-ion battery.



—  
Fig. 28



Fig. 29

## Signalling

### Ekip 2K Signalling modules (Fig. 29)

The Ekip 2K Signalling modules supply two input and two output contacts for control and remote signalling of alarms and circuit-breaker trips. They can be programmed from the trip unit's display or through the Ekip Connect software. Furthermore, when using Ekip Connect, combinations of events can be freely configured. They are suitable for all distribution and generator protection versions of the Ekip Touch and Hi-Touch trip units. Three versions of the Ekip 2K Signalling modules are available: Ekip 2K-1, Ekip 2K-2, Ekip 2K-3. In this way, a maximum of three modules for E2.2, E4.2, E6.2, and two for E1.2 can be installed at the same time.

—  
Electrical diagram reference: figures 41, 42, 43



Fig. 29A

### Ekip 3T Signalling modules (Fig. 29A)

The Ekip 3T Signalling modules provide three analog inputs for PT100/PT1000 thermo-resistances and one analog input 4-20mA for external sensors. Through the Ekip Connect commissioning tool, it is possible to set different control thresholds and associate them to digital signals. The Ekip 3T Signalling modules are suitable for all the versions of Ekip Touch and Hi-Touch trip units. However, PT100 sensors are compatible with the Ekip black platform only. Up to two modules can be installed simultaneously on SACE Emax 2: one Ekip Signalling 3T-1 and one Ekip Signalling 3T-2. ABB external probes PT1000 are available for busbar applications.



Fig. 30

### Ekip 4K Signalling module (Fig.30)

The Ekip 4K Signalling module is available for E2.2, E4.2, E6.2. This module provides four input contacts and four output contacts for control and remote signalling. It can be programmed from the trip unit's display or through the Ekip Connect software. Furthermore, when using Ekip Connect, combinations of events can be freely configured.

It is installed in the housing provided in the front left of distribution and generator protection versions of the Ekip Touch and Hi-Touch trip units, without having to remove the trip unit itself and is an alternative to the AUX 6Q auxiliary contacts unit.

—  
Electrical diagram reference: figure 2



Fig. 31

### Ekip 10K Signalling modules (Fig. 31)

Ekip 10K Signalling is an external signalling unit designed for DIN rail installation for SACE Emax 2 automatic circuit-breakers. The unit provides ten contacts for electrical signalling of timing and tripping of protection devices.

If connected via the Ekip Connect software, the contacts can be freely configured in association with any event and alarm or combination of both.

Several Ekip 10K Signalling modules (up to 3) can be installed at the same time on the same Ekip trip unit. The Ekip 10K Signalling module can be powered either by direct or alternating current and can be connected to all the trip units via internal bus or Ekip Link modules.

—  
Electrical diagram reference: figure 103

# Accessories for Ekip trip units



## Ekip Signalling Modbus TCP (Fig. 32)

It is an external signalling unit designed for DIN rail installation. Function of the signalling module is to share, via an Ethernet network with Modbus TCP communication protocol, information about the state of circuit-breakers that might not have the ability to provide such information via Ethernet, and also to allow these circuit-breakers to be operated via remote control.



Fig. 32

Characteristics of output contacts		Number of contacts		
Type	Monostable	Ekip 2K	Ekip 4K	Ekip 10K
Maximum switching voltage	150V DC / 250V AC			
Maximum switching current				
30V DC	2A	2	4	10
50V DC	0.8A	output	output	output
150V DC	0.2A	+ 2	+ 4	+ 11
250V AC	4A	input	input	input
Contact/coil insulation	1000 Vrms (1min @50Hz)			

## Ekip 10K/Ekip Signalling Modbus TCP power supply

Auxiliary supply	24-48V DC, 110-240V AC/DC
Voltage range	21.5-53V DC, 105-265V AC/DC
Rated power	10VA/W
Inrush current	1A for 10ms



Fig. 33

## Ekip RTC and Ekip AUP Signalling contacts (Fig. 33)

The signalling contacts allow the Ekip trip units to acquire the ready-to-close status of the circuit-breaker, as well as its racked-in, test or racked-out position. These contacts can be optionally installed in the accessories area of SACE Emax 2 equipped with Ekip Dip, Ekip Touch and Ekip Hi-Touch trip units. Ekip Link and Ekip Com modules are always supplied with Ekip RTC and Ekip AUP.

## Measurement and protection

### Measurement Enabler module (Fig. 34)

The Measurement Enabler module is supplied with Ekip Touch trip units by default, directly installed on the front of the circuit-breaker (total black label on the right). This module enables the trip unit to measure phase and neutral voltages, as well as power and energy. In particular, the Measurement Enabler module makes the platform always customizable through the activation of dedicated software packages available in the ABB Ability Marketplace™.

The voltage outlets are installed on the lower terminals by default and can be moved to the upper terminals on request. No external connection is required, except for rated voltages higher than 690V. In this case, the voltage outlet connection is moved outside the circuit-breaker by using voltmetric transformers connected to the terminal box. The installation of external outlets does not guarantee Class 1 accuracy.



Fig. 34



**Measurement Enabler with voltage sockets (Fig. 35)**

This module is featured with the same connection and installation characteristics of the Measurement Enabler module. In addition, it offers power supply for Ekip trip units directly from the busbar voltage (thanks to the internal voltage sockets, in case of line voltages higher than 85V). The Measurement Enabler with voltage sockets is thus mandatory for Rc protection. The module is always supplied with Ekip Hi-Touch and Ekip G trip units. On request, it can be also installed with the Ekip Touch version.

Fig. 35



**Ekip Synchrocheck (Fig. 36)**

This module enables the control of the synchronism condition when placing two lines in parallel. The module can be used with distribution and generator protection versions of the Ekip Touch and Hi-Touch trip units with the measurement function enabled.

Ekip Synchrocheck measures the voltages from two phases of one line through an external transformer and compares them to the measured voltages at the breaker. An output contact is available, which is activated upon reaching synchronism, and enables the circuit-breaker to be closed by means of wiring with the closing coil.



Fig. 36

Characteristics of output contacts		Number of contacts
Type	Monostable	Ekip Synchrocheck
Maximum switching voltage	150V DC / 250V AC	
Maximum switching current		
30V DC	2A	1 output
50V DC	0.8A	
150V DC	0.2A	
250V AC	4A	
Contact/coil insulation	1000 Vrms (1min @50Hz)	

Electrical diagram reference: figure 48

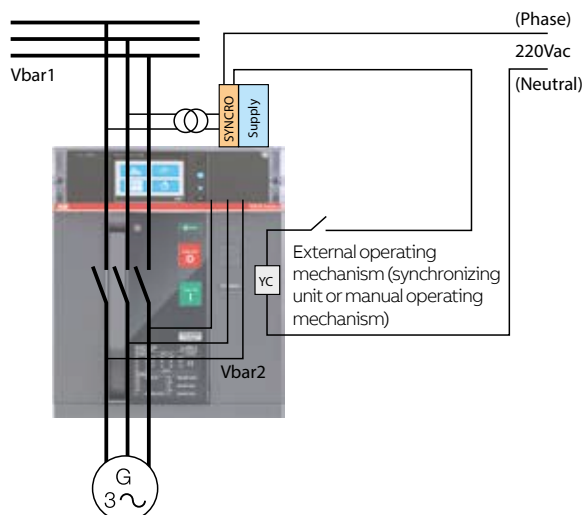

# Accessories for Ekip trip units



Fig. 37

### Ekip LCD interface (Fig. 37)

The Ekip trip units can be supplied with LCD black and white display, equipped with dedicated push-buttons to easily interact with the circuit-breaker. This option is well suited for aggressive environments characterized by low temperatures, high humidity or the presence of dust and chemical agents. The Ekip LCD trip units share the same advanced features with the touchscreen trip units in terms of protections, measurements and accuracy levels. However, the LCD version is not equipped with the embedded Bluetooth antenna.



Fig. 38

### Rating Plug (Fig. 38)

The rating plugs are field interchangeable from the front on all trip units and enable the protection thresholds to be adjusted according to the actual rated current of the system. This function is particularly advantageous in installations that may require future expansion or in cases in which the power supplied needs to be limited temporarily (e.g. mobile Gen Set). The Overload (L) protection function can be disabled at any time by using an L OFF version of the rating plug. There is a matching L OFF version for each standard version of rating plug.

Circuit-breaker	Rating plugs available (both in standard and L OFF versions)
E1.2	400-630-800-1000-1250-1600
E1.2 250	100-200-250
E2.2	400-630-800-1000-1250-1600-2000-2500
E2.2 250	100-200-250
E4.2	400-630-800-1000-1250-1600-2000-2500-3200-4000
E6.2	400-630-800-1000-1250-1600-2000-2500-3200-4000-5000-6300

Special rating plugs are also available for differential protection against earthing faults in combination with a suitable toroid to be installed externally.

Circuit-breaker	Rating plug available for Rc protection
E1.2	400-630-800-1250
E1.2 250	100-200-250
E2.2	400-630-800-1250-2000
E2.2 250	100-200-250
E4.2 / E6.2	400-630-800-1250-2000-3200-3600-4000





Fig. 39

#### **Current sensor for neutral conductor outside the circuit-breaker (Fig. 39)**

This is only for three-pole circuit-breakers; it enables protection of the neutral conductor to be achieved through connection to the Ekip trip unit. It is supplied on request.

—  
Electrical diagram reference: figure 27



Fig. 40

#### **Homopolar toroid for the earthing conductor of main power supply (Fig. 40)**

The distribution and generator protection versions of the Ekip Touch and Hi-Touch trip units can be used with an external toroid positioned, for example, on the conductor that connects the star centre of the MV/LV transformer to earth (homopolar transformer): in this case, the earth protection is called Source Ground Return. There are four sizes of the toroid: 100A, 250A, 400A, 800A. The homopolar toroid is an alternative to the toroid for differential protection.

—  
Electrical diagram reference: figure 25



Fig. 41

#### **Toroid for differential protection (Fig. 41)**

Connected to the Ekip Touch and Hi-Touch LSIG trip units equipped with a rating plug for differential protection, this toroid enables earth fault currents of 3...30A to be monitored. To be installed on the busbar system, it is an alternative to the homopolar toroid.

—  
Electrical diagram reference: figure 24

# Accessories for Ekip trip units

## Displaying and supervision

### Ekip Multimeter (Fig. 42)



Fig. 42

Ekip Multimeter is a display unit to be installed on the front of the switchgear for SACE Emax 2 circuit-breakers equipped with Ekip electronic trip units. The device is equipped with a large touch screen display and enables measurements to be displayed with the same levels of precision. If connected to trip units with a display, Ekip Multimeter enables the adjustment of parameters and protection thresholds. Up to 4 Ekip Multimeter devices can be connected at the same time to the same Ekip protection trip unit to display currents, voltage, powers and energy.

Ekip Multimeter can be powered either in direct current or in alternating current. It is equipped with a 24V DC output that supplies the trip unit to which it is connected.

Power supply	24-48V DC, 110-240V AC/DC
Tolerance	21.5-53V DC, 105-265V AC/DC
Rated Power	10VA/W
Inrush current	2A for 20ms



Fig. 43

### Ekip Control Panel on front of switchgear (Fig. 43)

The Ekip Control Panel enables the SACE Emax 2 circuit-breakers connected to the Ekip Link system to be controlled and monitored.

The panel is supplied already equipped with supervision software and requires no programming. Ekip Control Panel requires a 24V DC power supply and is equipped with:

- 2 RJ45 EtherNet ports for connection to the Ekip Link system and to the local network for remote control via web server option
- 1 RS485 serial port for integration of the Modbus network if it is to be used with circuitbreakers of the Tmax series
- 4 USB ports for downloading data.

## Testing and programming

### **Ekip TT testing and power supply unit (Fig. 44)**

Ekip TT allows to supply the Ekip trip unit with no need of auxiliary power supply. In this way, the last protection device tripped can be displayed directly on the screen or by the lighting up of corresponding LEDs. Moreover, the unit permits to verify that the circuit-breaker trip mechanism properly works (trip test). Ekip TT can be directly connected through the front test connector of any Ekip trip units of SACE Emax 2 and allows to set all protection functions.



Fig. 44

### **Ekip T&P testing kit (Fig. 45)**

Ekip T&P is a kit that includes different components for programming and testing the electronic protection trip units.

The kit includes:

- Ekip T&P unit;
- Ekip TT unit;
- adaptors for Emax and Tmax trip units;
- USB cable to connect the T&P unit to the Ekip trip units;
- installation CD for Ekip Connect and Ekip T&P interface software.

The Ekip T&P unit is easily connects from your PC (via USB) to the trip unit (via mini USB) with the cable provided.

The Ekip T&P unit can perform simple manual or automatic tests on the trip unit functions. The Ekip T&P will also provide the ability to conduct more advanced function testing that allows the addition of harmonics and the shifting of phases to more accurately represent the real conditions of an application. Thus, leading to more concise protection function parameters that may be required for critical applications. It can also generate a test report as well as help you to monitor maintenance schedules.



Fig. 45

### **Ekip Programming Module (Fig. 46)**

The Ekip Programming module is used for programming Ekip trip units via USB to a PC using the Ekip Connect software that can be downloaded on-line. This can be useful for uploading/downloading entire sets of parameters for multiple breakers both for set-up as well as for maintenance (for periodic cataloging breaker parameters in case of a catastrophic situation).



Fig. 46

# Service



## Extended warranty

For ABB Low Voltage circuit breakers, extending the 1-year standard factory warranty to up to 5 years has never been so simple.

Extended warranty activation can be requested after the online registration in the Extended Warranty tool. This web-tool verifies that the application of the circuit breaker is within the recommended guidelines, and grant the registration of the circuit breaker.

When end users details are registered, one year of extra warranty is offered free-of-charge.

Extended Warranty can be ordered by following the steps:

- 1) Registration in the online tool (Extended Warranty Tool) to verify the application.
- 2) Extended Warranty part number(s) and registration code received by email
- 3) Place the order of the circuit breaker(s) together with:
  - Extended warranty part number(s)
  - Unique registration code

### Warranty coverage:

- Any possible issues related to circuit breaker quality for the complete extra warranty time
- Accessories mounted by the factory only.

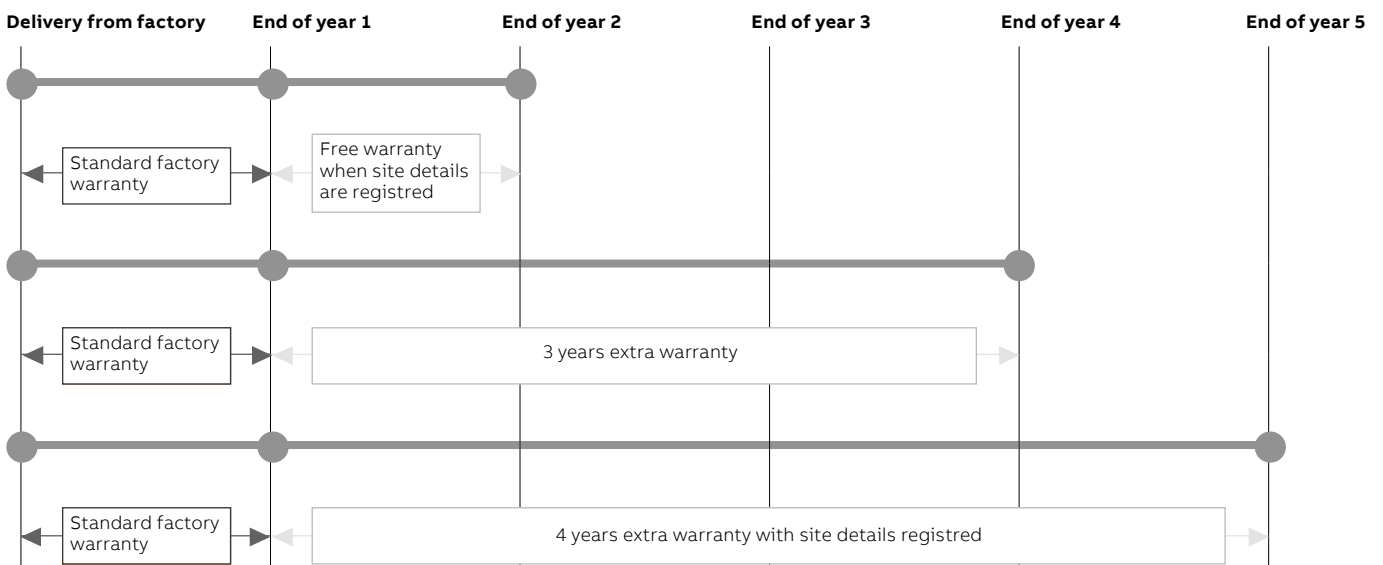



## Spare parts

The following original and guaranteed spare parts are available:

- Accessories and Safety Covers
- Closed Door lock lever
- Closing Spring
- Conversion kit from Fixed to Moving part
- Conversion kit from Moving Part into Fixed version
- Conversion kit into Switch Disconnecter MS
- Earth sliding contacts
- Fixing screws kit
- Arching chambers
- Jaw contacts
- Moving part Terminals
- Poles
- Kit front cover plugs
- Lateral guides for Fixed and Moving part
- Left and Right plates for accessories (Left MID, Right MID)

- Main board
- Lifting plates
- Main board + Sensors + cables
- Operating mechanism
- Racked in and out device
- Racking in and out lever
- Safety shutters for fixed part
- Side walls
- Sliding contacts/ Terminal Box
- Transparent cover
- Trip coil
- Trip Unit Battery
- Tripping mechanism
- Spring charging device
- Spring Charging lever
- Grey platform spare parts (trip units, Ekip Measuring modules, rating plugs).

For further details, please refer pag 296-301 or to ABB SACE Spare Parts Catalogue (1SDC001007D0203).

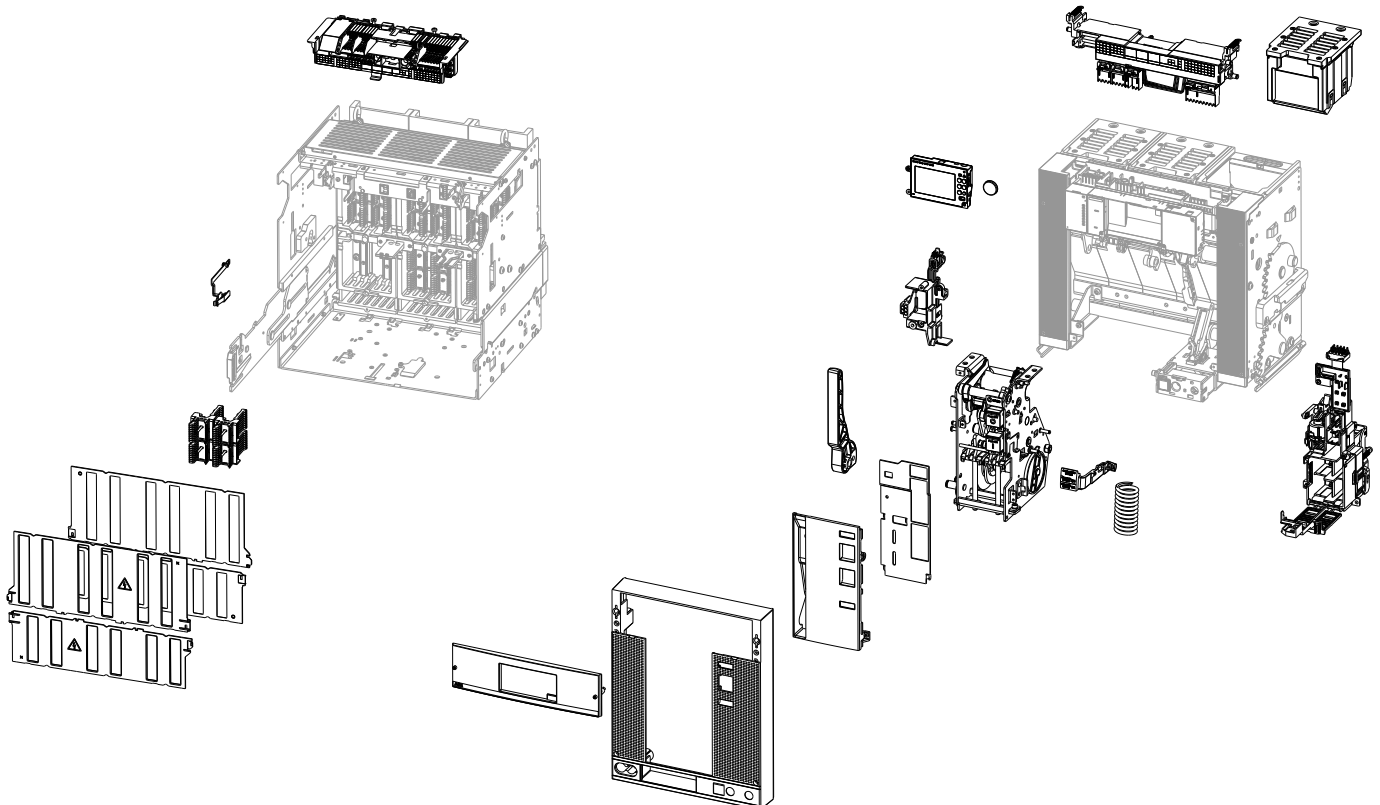



---

# Installation

<b>7/2</b>	<b>Circuit-breaker</b>
<b>7/3</b>	Sizes
<b>7/4</b>	Versions
<b>7/5</b>	Poles
<b>7/6</b>	Terminals
<b>7/7</b>	Degree of protection
<b>7/7</b>	Power losses
<b>7/8</b>	Temperature derating
<b>7/9</b>	Current-limiting curves
<b>7/10</b>	<b>Installation environment</b>
<b>7/10</b>	Temperature
<b>7/10</b>	Environmental conditions
<b>7/11</b>	Vibration
<b>7/11</b>	Electromagnetic compatibility
<b>7/14</b>	<b>Installation in switchgear</b>
<b>7/14</b>	Position
<b>7/14</b>	Power supply
<b>7/14</b>	Insulation distances and connection
<b>7/15</b>	Earthing connection
<b>7/16</b>	Busbar types
<b>7/16</b>	Accessories
<b>7/17</b>	<b>Performance in switchgear</b>

# Circuit-breaker

The new SACE Emax 2 family maintains the characteristics of strength and reliability that have always distinguished the tradition of ABB SACE air circuit breakers.

The new SACE Emax 2 circuit breakers, available in four sizes, are extremely compact due to their new dimensions: with reduced depths and heights, combined with standardized widths, they provide the answer to the most stringent installation requirements.

Safety is guaranteed thanks to the double insulation of the live parts and total segregation of the phases. Furthermore, the new functional design of the SACE Emax 2 circuit breakers has been developed with the purpose of improving installation operations and use of the devices and accessories; making them simple, intuitive and safe.

	<b>Distinctive characteristics</b>	<b>Benefits</b>
	- Ekip protection trip units are interchangeable from front of circuit breaker	Reduced times during the stages of: - installation - wiring - configuration - commissioning - maintenance
	- Rapid configuration of the Ekip trip units	
	- Electronic modules can be installed on terminal box without removing the electronic trip units and protection shield	
	- Electrical plug-in accessories can be installed from the front of circuit breaker	
Simplicity of use and safety	- New push-in terminal box allows rapid auxiliary connections	Increased level of safety
	- Horizontal or vertical rear connections can be modified on-site by turning 90°	
	- Accessorizing logic common to the entire family of circuit breakers	
	- Accessory cabinet and terminal box are stamped with accessory codes for easy identification	
	- Accessories area is separated functionally from the safety area	
	- Mechanical safety locks in open position are active when the shield is removed	
	- Guided racking in and out of the mobile part	



### Sizes

The SACE Emax 2 circuit breakers, available in 4 sizes up to 6300A, provide:

- **Versatility**, where installation space is a critical and influential factor, such as naval applications, wind turbine towers or switchgear

- **Opportunities**, optimization of the dimensions of the electrical switchgear results in a potential reduction in the consumption of the materials used.

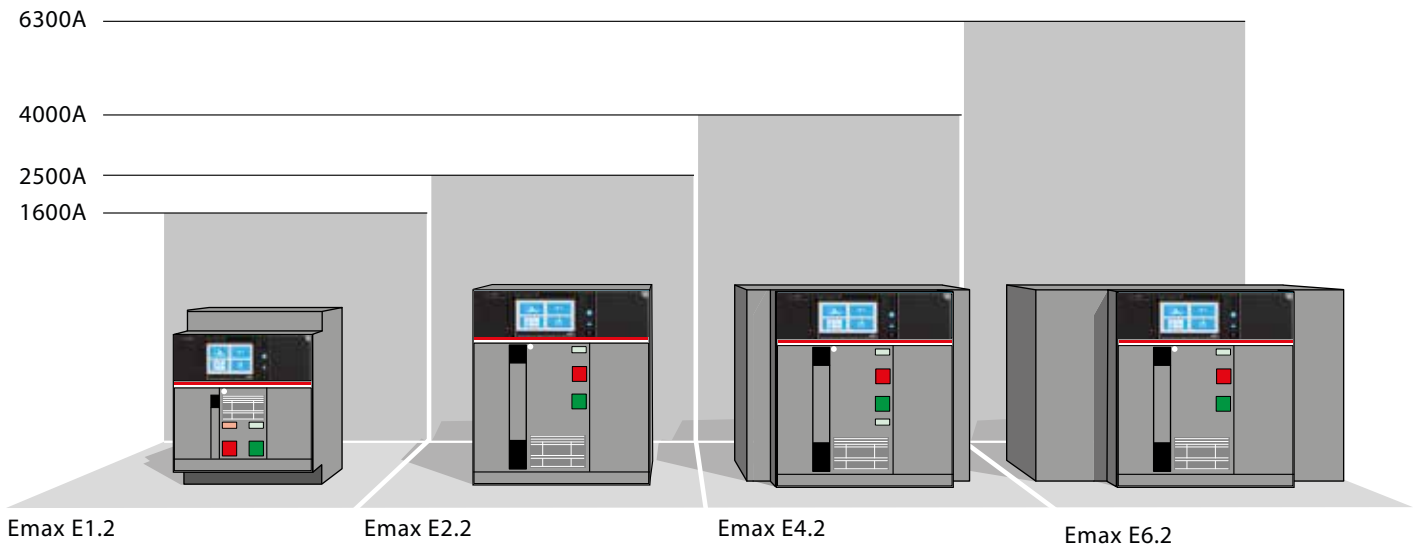

# Circuit-breaker

## Versions

The SACE Emax 2 circuit breakers are available in both fixed and withdrawable versions. The withdrawable version is recommended in applications in which service continuity is a fundamental requirement.

Replacement of the moving part with a new device does not require any intervention on power connections or on auxiliary connections, thus permitting reset in the shortest time possible.

The fixed version, which is connected directly to power system through the circuit breaker terminals, is recommended in applications in which the need for space means that compact products are required without compromising the performance and possibility of fitting accessories.

1. Moving part
2. Sliding contacts
3. Fixed part
4. Terminal box
5. Racking-out mechanism
6. Racking-out guide rails
7. Pushbuttons
8. Data label and accessories

**Fixed**



**Withdrawable**



## Poles

SACE Emax 2 circuit breakers are available in three-pole and four-pole versions and can be used in all types of distribution systems. Furthermore, with the possibility of connecting the external current sensor, three-pole circuit breakers can be used efficiently even in systems in which the neutral conductor cannot be isolated.

The four-pole circuit breakers E1.2, E2.2 and E4.2 are always provided with full-size neutral pole with rated uninterrupted current-carrying capacity identical to the phase poles. The E6.2 circuit-breakers, thanks to their construction modularity,

are available with neutral set at 50 percent of normal supply and with full-sized neutral, so that the customer does not need to oversize the neutral unless strictly necessary.

The standard supplied circuit breakers are suitable for connection of phases in the sequence L1, L2, L3 for three-pole circuitbreakers, or N, L1, L2 and L3 for four-pole circuit breakers with neutral on the left; a special optional kit enables the position of the circuit breaker neutral to be changed to the right, making the sequence L1, L2, L3, N available (refer to page 9/53 for the commercial codes).

Circuit-breaker	Standard version			Optional version with neutral on the right			
	Three-pole			Four-pole			
Emax E1.2	L1	L2	L3	N	L1	L2	L3
Emax E2.2							
Emax E4.2							
Emax E6.2							

# Circuit-breaker

## Terminals

The integration of the circuit breaker in the electrical system is simplified because of the connection terminals of the circuit breakers.

The silver-plated copper terminals are designed to assist installation of connecting bars according to the change in the rated capacity of the circuit-breaker. Each terminal has been created to

the standard width of busbar for that amperage and is equipped with one, two or three terminal stabs for easy connection to multiple bus runs that may be required for the application. For particular installation requirements, the circuit breakers can be equipped with different combinations of terminals for the upper and lower part.

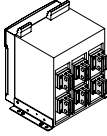
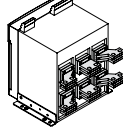
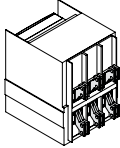
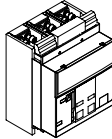
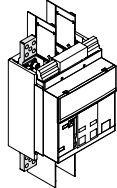
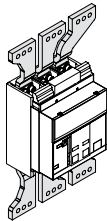
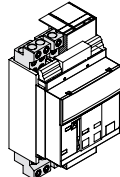
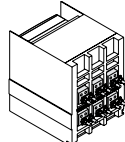
Type	Abbreviation		E1.2	E2.2	E4.2	E6.2
Rear adjustable terminal <sup>(1)</sup>	HR VR		F, W	F, W	F, W	F, W
Horizontal rear spread terminal	SHR		W	F, W	F, W	
Vertical rear spread terminal	SVR			F, W	F, W	
Front terminal	F		F	F, W	F, W	F, W
Extended front terminal	EF		F, W			
Front spread terminal	ES		F, W			
Terminal for cable FcCuAl 4x240mm <sup>2</sup>	Fc CuAl		F, W			
Flat terminal	FL			W	W	W

(1) The rear adjustable terminals are supplied as standard in the HR-HR configuration.

### Degree of protection

The SACE Emax 2 circuit breakers guarantee the following degrees of protection:

- IP20 for circuit breakers in fixed or withdrawable versions, excluding the terminals.
- IP30 for the front parts of the circuit breaker when installed in switchgear with IP30 flange mounted on the door.
- IP54 for circuit breakers equipped with optional IP54 transparent flange fixed on the door in front of the switchgear.

### Power losses

To guarantee the performance of the electrical switchgear in terms of rated uninterrupted current-carrying capacity, the design of the electrical switchgear must take into consideration the power losses of the apparatus and by live parts installed.

These power losses are measured according to IEC60947 product standard. The values given in the table below refer to total power for three and four pole circuit breakers with balanced loads with a current flow equal to rated uninterrupted current "Iu" at 50/60Hz.

Circuit-breaker type	Iu	630A	800A	1000A	1250A	1600A	2000A	2500A	3200A	4000A	5000A	6300A
<b>Fixed</b>	<b>E1.2 B/C/N</b> [W]	31	50	78	122	201	-	-	-	-	-	-
	<b>E2.2 B/N/S/H</b> [W]	-	34	53	83	136	212	267	-	-	-	-
	<b>E4.2 N/S/H/V</b> [W]	-	-	-	-	-	-	-	425	465	-	-
	<b>E6.2 H/V/X</b> [W]	-	-	-	-	-	-	-	-	309	483	767
<b>Withdrawable</b>	<b>E1.2 B/C/N</b> [W]	62	100	156	244	400	-	-	-	-	-	-
	<b>E2.2 B/N/S/H</b> [W]	-	72	113	176	288	450	550	-	-	-	-
	<b>E4.2 N/S/H/V</b> [W]	-	-	-	-	-	-	-	743	900	-	-
	<b>E6.2 H/V/X</b> [W]	-	-	-	-	-	-	-	-	544	850	1550

# Circuit-breaker

## Temperature derating

Under certain installation conditions, the circuit-breakers can operate at higher temperatures than the reference temperature of 40 °C. In this case the current-carrying capacity of the circuit-breaker may be lower than the rated current-

carrying capacity at the reference temperature: therefore the derating coefficients shown in the table must be applied. Percentage values refer to withdrawable and fixed circuit breaker.

If not specified, all data refer to a copper according to IEC60947.

Emax 2 E1.2		Cross section	Temperature [°C]						
			<40	45	50	55	60	65	70
E1.2	250		100%	100%	100%	100%	100%	100%	100%
E1.2	630		100%	100%	100%	100%	100%	100%	100%
E1.2	800		100%	100%	100%	100%	100%	100%	100%
E1.2	1000		100%	100%	100%	100%	100%	100%	100%
E1.2	1250		100%	100%	100%	100%	100%	100%	100%
E1.2	1600		100%	100%	100%	98%	95%	93%	90%
E1.2	1600	1200 mm <sup>2</sup>	100%	100%	100%	100%	97%	95%	92%

Emax 2 E2.2		Cross section	Temperature [°C]						
			<40	45	50	55	60	65	70
E2.2	250		100%	100%	100%	100%	100%	100%	100%
E2.2	800		100%	100%	100%	100%	100%	100%	100%
E2.2	1000		100%	100%	100%	100%	100%	100%	100%
E2.2	1250		100%	100%	100%	100%	100%	100%	100%
E2.2	1600		100%	100%	100%	100%	100%	100%	98%
E2.2	2000		100%	100%	100%	100%	95%	91%	87%
E2.2	2500		100%	100%	100%	100%	98%	94%	90%

Emax 2 E4.2		Cross section	Temperature [°C]						
			<40	45	50	55	60	65	70
E4.2	2000		100%	100%	100%	100%	100%	100%	100%
E4.2	2500		100%	100%	100%	100%	100%	100%	100%
E4.2	3200	3000 mm <sup>2</sup>	100%	100%	97%	93%	89%	86%	82%
E4.2 (*)	3200	3000 mm <sup>2</sup>	100%	100%	100%	100%	95%	93%	89%
E4.2	4000	4000 mm <sup>2</sup>	100%	100%	97%	93%	89%	86%	83%

(\*) Three stabs terminal kit only for withdrawable version

Emax 2 E6.2		Cross section	Temperature [°C]						
			<40	45	50	55	60	65	70
E6.2	4000	4000 mm <sup>2</sup>	100%	100%	100%	100%	100%	100%	100%
E6.2	5000	5000 mm <sup>2</sup>	100%	100%	100%	100%	100%	98%	95%
E6.2	6300	6000 mm <sup>2</sup>	100%	100%	95%	91%	87%	84%	81%

### Current-limiting curves

The SACE Emax 2 series features a series of current-limiting circuit breakers in sizes E1.2 up to 1600A. These circuit breakers are distinguished constructively by:

- Dedicated stored energy operating mechanism, which reduces opening times.
- Specific main contacts that, utilizing the electrodynamic forces generated by the short-circuit current, accelerate opening of the main contacts.

These features ensure rapid interruption which consequently reduces electromechanical and thermal stress on the system during a short-circuit.

The current-limiting circuit breakers are distinguished by short-time withstand currents  $I_{cw}$  that are not particularly high and therefore not indicated for applications in which chronoamperometric selectivity is required with several downstream devices or in which devices are present with high inrush current in the start-up stage.

# Installation environment

SACE Emax 2 circuit breakers have been designed and tested in accordance with major international Standards to manage the electrical plant.

The installation requirements prescribed by the international Standards are listed below.

In addition, ABB provides instructions for the use of circuit breakers in nonstandard environments, as for example personalized maintenance program or installation solutions aimed at increasing performances and extending the lifecycle of the circuit breaker.

## Temperature

SACE Emax 2 circuit breakers can operate in the following environmental conditions:

	Temperature (°C)		
	Operating	Active Display	Storage
Emax 2 with Ekip DIP	-25°C ... +70°C	-	-40°C ... +70°C
Emax 2 with Ekip Touch	-25°C ... +70°C	-20°C ... +70°C	-30°C ... +70°C
Emax 2 with LCD	-25°C ... +70°C	-25°C ... +70°C	-40°C ... +70°C
Emax 2 switch-disconnectors	-25°C ... +70°C	-	-40°C ... +70°C

## Environmental conditions

The devices can be installed in industrial environments with pollution level 3, IEC60947. SACE Emax 2 circuit breakers also comply with:

- IEC60721-3-6 class 6C3
- IEC60721-3-3 class 3C2

## Altitude

SACE Emax 2 air circuit breakers do not undergo changes in rated performance up to 2000 metres. Beyond this altitude, the properties of the atmosphere in terms of composition, dielectric capacitance, cooling power and pressure can vary and, therefore, the performance of the circuit breakers is subject to derating, which can be measured by means of the variation in maximum rated service voltage and rated uninterrupted current.

Altitude		[m]	2000	3000	4000	5000
Rated service voltage - U <sub>e</sub>	Versions 690V	[V]	690	624	544	477
Rated current		[% I <sub>n</sub> ]	100	98	93	90



An installation at 3000 m of a 690V AC rated service voltage can be an explicative example. The altitude, as shown in the table, may cause a derating which precludes the use of a standard automatic circuit breaker. To use a circuit breaker at a 690 V AC service voltage, a 1,150 V AC version has to be used. This version, even after derating, fulfils the service voltage required. In addition, the selection of the circuit breakers has to be based on the short -circuit performance required by the application.

## Vibration

The circuit breakers have been tested according to:

- IEC60068-2-6
- From 1 to 13 Hz with amplitude 1mm
- From 13 to 100 Hz with constant acceleration 0.7g
- IEC60721-3-1
- Storage: 1M3
- IEC60721-3-2
- Transport: 2M2
- IEC60721-3-3
- Operational conditions: 3M2
- Shipping registers or certifications

## Electromagnetic compatibility

The use of specific devices in industrial installations may cause electromagnetic interference in the electrical system. SACE Emax 2 circuit breakers have been developed and tested for electromagnetic compatibility in accordance with IEC 60947-2, Appendices J and F.

# Installation environment

Due to the four construction sizes and the reduced insulation distances required, SACE Emax 2 circuit breakers optimize the installation spaces

of the compartments of electrical switchgear, thereby providing a rational solution to the customers' application needs.

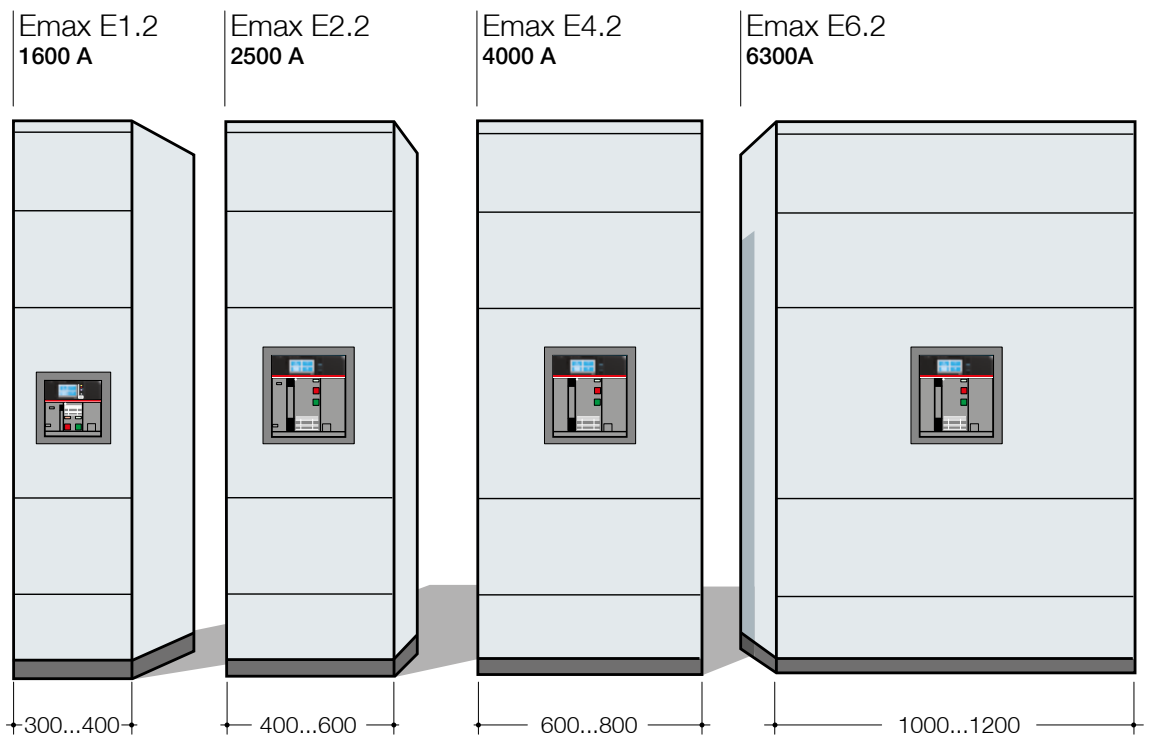

SACE Emax 2 circuit breakers enable the design of electrical switchgear to be improved, optimization in terms of performance and also in the use of the main materials:

- **Copper:** thanks to the possibility of developing compact units, the length of the distribution system / busbar can be minimized.
- **Metal frame and structure:** reduced volumes also mean less surface space is used for panels and internal structures.
- **Space:** the optimization of the individual units benefits the entire switchgear, which is more compact and can therefore be installed taking up less surface space.

**Traditional circuit breaker  
3p 1u 2500A**

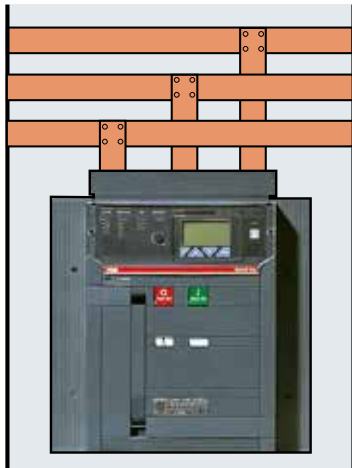

600

**Emax E2.2 3p 1u 2500A**

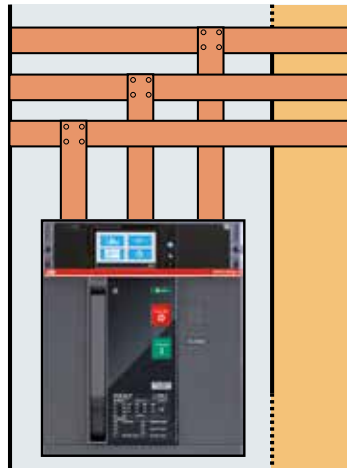

400 200

- Efficiencies with Emax 2:
- ▶ Possibility of saving in copper
  - ▶ Possibility of saving in metal frame, segregation and plates
  - ▶ Possibility of saving in the installation surface

# Installation in switchgear

## Position

All SACE Emax 2 circuit breakers can be floor mounted in a vertical position inside the switchgear compartment.

The E1.2 circuit breaker can also be installed in a horizontal position and wall mounted. Conveniently, the screens of the Ekip Touch and Hi-Touch versions rotate to a horizontal view for key data when the E1.2 is installed horizontally.

## Power supply

The Emax 2 circuit breakers can be supplied, from either the upper or lower terminals. In the event a measurement module is present, in order to make use of all information when the circuit breaker is in the open position, the voltage sockets must be installed on the power supply side.

## Insulation distances and connection

The circuit breakers can be connected to the main power system using the most common configurations and dimensions of copper bars.

Installation of live parts must ensure:

- **Minimum insulation distances between the phases**

Rated insulation voltage $U_i$	Minimum distance [mm]
1000V	for voltages upper to 440V in fixed circuit breakers, please use phase separators

### • Insulation distance of installation cubicle

#### Fixed circuit breakers

	A	B	C	D
[mm]	3p	4P		
E1.2	250	322	382.5*	130
E2.2	400	490	500	221
E4.2	500	600	500	221
E6.2	900	1000	500	221
E6.2/f	-	1200	500	221

\* 332.5mm for voltage less  $\leq$  440V AC

#### Withdrawable circuit breakers

	A	B	C	D
[mm]	3p	4P		
E1.2	280	350	440*	252
E2.2	400	490	500	355
E4.2	500	600	500	355
E6.2	900	1000	500	355
E6.2/f	-	1200	500	355

\* 390mm for voltage less  $\leq$  440V AC

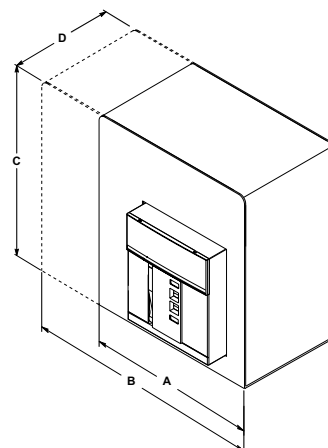
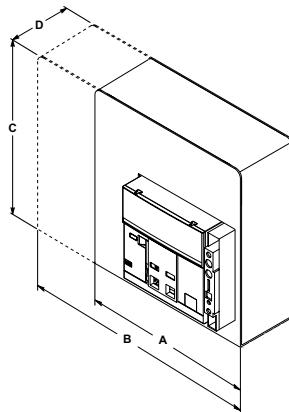

• **Anchorage plates**

The electrodynamic force released during a short-circuit can cause high levels of mechanical stress on the devices and structures of the

switchgear. To minimize this, fastening plates must be positioned near the circuit breaker terminals.

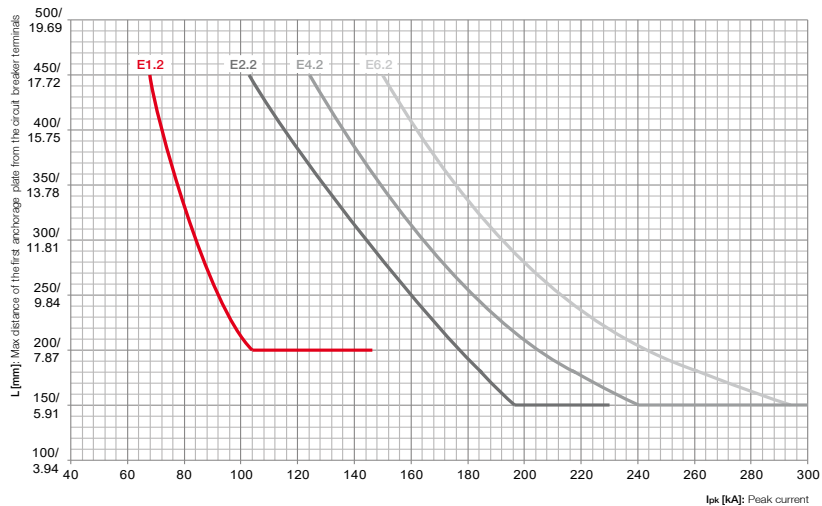

In case of flat terminals, please refer to the Instruction Manual 1SDH001000R0809

• **Tightening torques**

The following table indicates the values required for connecting the circuit breaker terminal and the connecting bars.

Terminals	E1.2	E2.2 / E4.2 / E6.2
Modifiable HR/VR rear	40 Nm	70 Nm
Spread rear	40 Nm	70 Nm
Front	40 Nm	70 Nm
Extended front	40 Nm	70 Nm
Spread front	70 Nm	70 Nm
Front for cables	43 Nm	70 Nm

• **Segregation plates and separator plates**

The rear part of the circuit breaker has been designed with specific slots in which insulating walls can be housed to facilitate segregation of live parts. In addition, phase separators are available as optional accessories.

**Earthing connection**

To achieve continuity and equal potential of earthing between the Emax 2 circuitbreaker and the protection circuit of the switchboard, customers can do either of the options below:

- Connect the Emax 2 fixed circuit breaker or the fixed part of the withdrawable circuit breaker to the protective circuit by means of a cable with suitable crosssectional area to fulfil the requirements of clause 10.5.2 of the Standard IEC 61439-1.

- If the continuity of the circuit breaker frame with the switchboard earthing is guaranteed by the metal contact (support) between the circuit breaker and the metal structure of the switchboard (which is a part of the protective circuit) no connection is necessary (provided that no panels of insulating material are interposed between the circuit breaker and the metal frame of the switchboard).  
Emax E1.2, fixed version, does not require any earthing connection.

# Installation in switchgear

## Busbar types

The circuit breakers, via the terminals, can be connected to the main distribution system by busbars of different types: copper, silver-plated copper and tinned aluminium when the main distribution system is made of aluminium.

The circuit breakers can be connected directly with copper or aluminium cables in the case of E1.2 circuit breakers, or indirectly by cable-carrying bars in the case of E2.2, E4.2 and E6.2.

## Accessories

The SACE Emax 2 circuit breakers offer a wide range of accessories that improve safety levels for technicians working on the switchgear and circuit breakers. Furthermore, thanks to the different types of mechanical interlock available, pre-determined coordination strategies can be achieved between the circuit breakers. In detail:

- Horizontal and vertical interlocks between circuit breakers
- Door lock with circuit breaker in closed position
- Switchgear door lock in racked-in/out position
- Lock of racked-out mechanism with door open
- External lock of shutters
- Flange for switchgear door IP30 and IP54

For further information of the operation of accessories, see chapter 5.

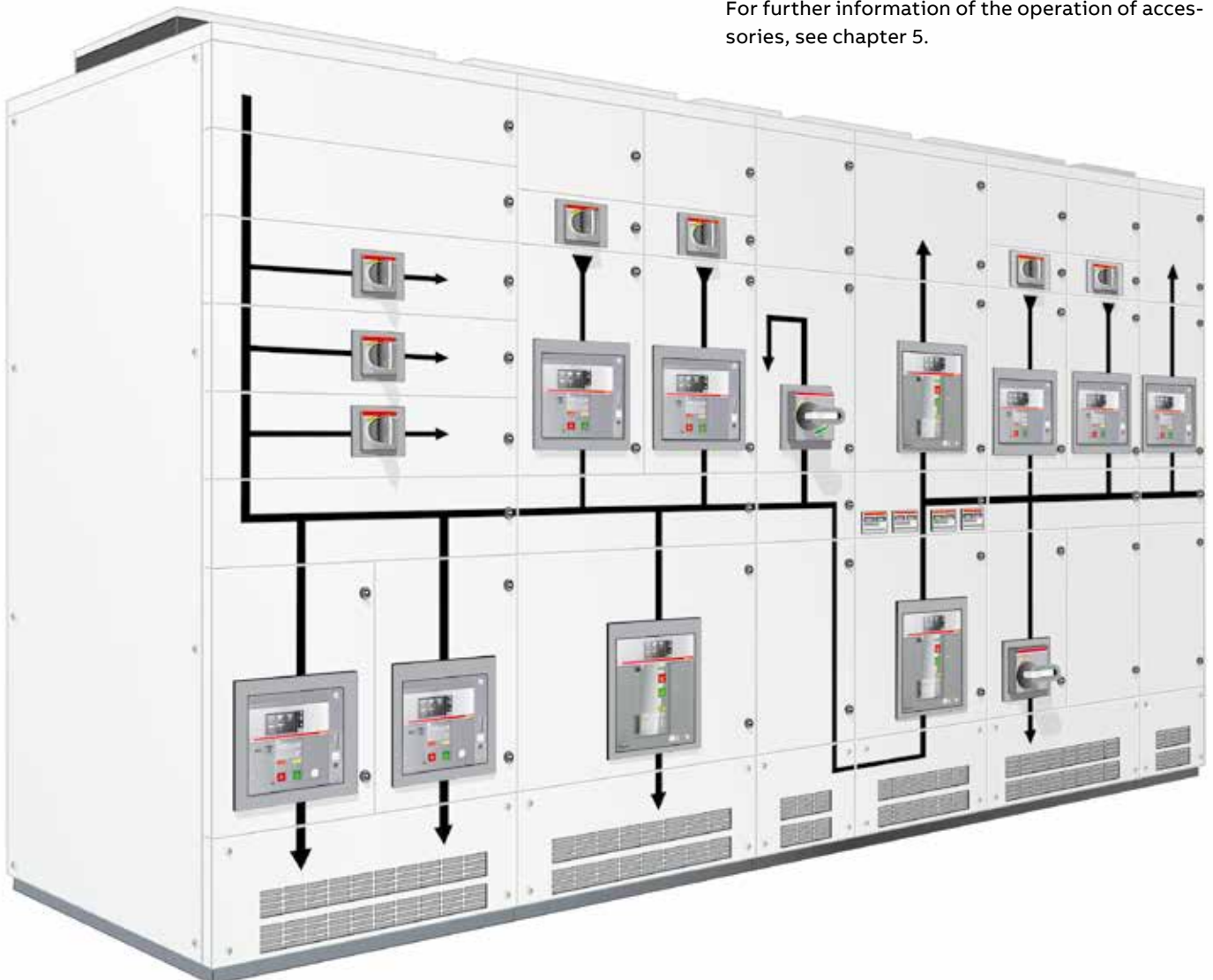

# Performance in switchgear

The many types of switchgear that can be created and the installation and environmental conditions can considerably influence the performance of the circuit breaker. In this regard, SACE Emax 2 circuit breakers offer the best solution for improving the capacity in switchgear.

The following application situations have been assessed by taking into consideration the main factors that can influence the performance of the circuit breaker in switchgear:

- Type of switchgear
- Switchgear degree of protection
- Segregation form 3
- Size of circuit breaker
- Number of devices connected at the same time in the unit
- Type of terminal and connection
- Ambient temperature  $T_a$  (IEC61439-1 )
- Withdrawable circuit breakers
- Maximum withstand temperature for the terminal 120° C

# Performance in switchgear

The following tables provide an indication of the performance of the apparatus inside the switchgear. The data shown are a summary of software model simulations and real tests.

## SACE Emax 2 E1.2 B C N Circuit-breaker Switchgear dimensions 2200x400x600 (HxWxD)

### HR Terminal One circuit breaker in the column

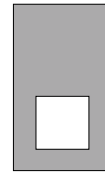

### Environment temperature

IP	Iu	Connection [mm]	Compartment	35 °C	45 °C	55 °C
IP31	630	2x40x5	2	630	630	630
			1			
	800	2x50x5	2	800	800	800
			1			
Compartment 2	1000	2x50x10	2	1000	1000	1000
			1			
	1250	2x50x8	2	1250	1250	1200
			1			
Compartment 1	1600	3x50x8	2	1440	1360	1290
			1			
	2x50x10	2	1440	1360	1290	
		1				

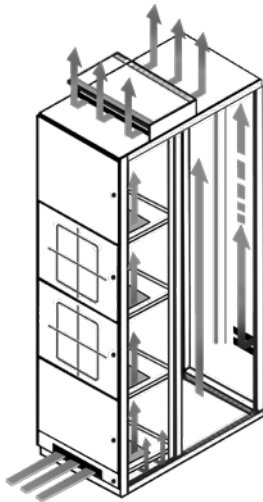

Performances with EF, SHR and F terminals can be compared, with the same connection sections, to the performances of circuit breaker with HR terminal.

Performances with ES terminals can be compared to the VR terminals.

Performances with FC CuAl terminals, with cables in the prescribed sections, can be compared to HR performances.

Performances depend on switchboard design and testing condition. ABB is not responsible for the overall performances result.

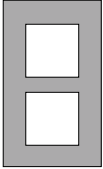
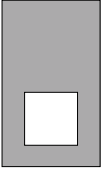
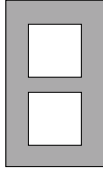

HR Terminal Two circuit breakers in the column			VR Terminal One circuit breaker in the column			VR Terminal Two circuit breakers in the column		
								
Environment temperature			Environment temperature			Environment temperature		
35 °C	45 °C	55 °C	35 °C	45 °C	55 °C	35 °C	45 °C	55 °C
630	630	630				630	630	630
630	630	630	630	630	630	630	630	630
800	800	800				800	800	800
800	800	800	800	800	800	800	800	800
970	930	900						
1000	960	920						
						1000	1000	950
			1000	1000	1000	1000	1000	970
1200	1150	1100						
1250	1200	1140						
						1250	1250	1150
			1250	1250	1250	1250	1250	1200
1330	1260	1220						
1370	1315	1262						
						1430	1355	1265
			1520	1440	1330	1475	1415	1310

# Performance in switchgear

The following tables provide an indication of the performance of the apparatus inside the switchgear. The data shown are a summary of software model simulations and real tests.

## SACE Emax 2 E2.2 B N S H Circuit-breaker

Switchgear dimensions 2200x600x900 (HxWxD)

HR Terminal  
One circuit breaker in the column

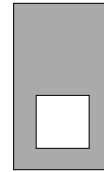

Environment temperature

IP	lu	Connection [mm]	Compartment	Environment temperature			
				35 °C	45 °C	55 °C	
IP31	800	1x60x10	2	800	800	800	
			1				
	1000	1x60x10	2	1000	1000	1000	
			1				
	1250	2x60x10	2	1250	1250	1250	
			1				
	1600	2x60x10	2	1600	1540	1480	
			1				
	Compartment 2	1600	1x100x10	2	2000	1940	1850
				1			
	Compartment 1	2000	3x60x10	2	2000	2000	1940
				1			
	2000	2x80x10	2	2400	2320	2200	
			1				
	2000	3x60x10 *	2	2500	2460	2320	
			1				
	2000	2x80x10 *	2	2500	2460	2320	
			1				
	2500	3x60x10	2	2500	2460	2320	
			1				
	2500	4x100x5	2	2500	2460	2320	
			1				
	2500	3x60x10 *	2	2500	2460	2320	
			1				
	2500	4x100x5 *	2	2500	2460	2320	
			1				

\* Performances refer to SHR and SVR terminals.

Performances with F and FL terminals can be compared to the performance of circuit breakers with HR terminals.

Performances depend on switchboard design and testing condition. ABB is not responsible for the overall performances result.

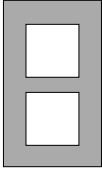
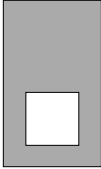
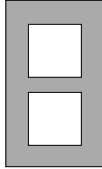
HR Terminal Two circuit breakers in the column			VR Terminal One circuit breaker in the column			VR Terminal Two circuit breakers in the column		
								
Environment temperature			Environment temperature			Environment temperature		
35 °C	45 °C	55 °C	35 °C	45 °C	55 °C	35 °C	45 °C	55 °C
800	800	800				800	800	800
800	800	800	800	800	800	800	800	800
1000	1000	1000				1000	1000	1000
1000	1000	1000	1000	1000	1000	1000	1000	1000
1250	1250	1250				1250	1250	1250
1250	1250	1250	1250	1250	1250	1250	1250	1250
1470	1410	1360						
1550	1490	1430						
						1500	1470	1400
			1600	1600	1520	1580	1550	1475
1920	1810	1720						
1950	1850	1760						
						1950	1860	1760
			2000	2000	1920	2000	1920	1810
2000	1900	1810						
2000	1945	1850						
						2000	1950	1850
			2000	2000	2000	2000	2000	1900
2280	2200	2100						
2400	2310	2170						
						2400	2270	2160
			2500	2450	2350	2500	2380	2270
2394	2310	2205						
2500	2430	2280						
						2500	2390	2270
			2500	2500	2460	2500	2500	2380

# Performance in switchgear

The following tables provide an indication of the performance of the apparatus inside the switchgear. The data shown are a summary of software model simulations and real tests.

**SACE Emax 2 E4.2 N S H V Circuit-breaker**  
Switchgear dimensions 2200x800x900 (HxWxD)

IP	Iu	Connection [mm]	Compartment	HR Terminal One circuit breaker in the column			VR Terminal One circuit breaker in the column		
				Environment temperature 35 °C	45 °C	55 °C	Environment temperature 35 °C	45 °C	55 °C
IP31	2000	2x80x10	1	2000	2000	2000	2000	2000	2000
	2500	2x100x10	1	2500	2450	2400	2500	2500	2500
	3200	3x100x10	1	3050	2900	2755	3200	3080	2920
	3200	3x100x10*	1	3200	3050	2850	3200	3200	3020
	4000	4x100x10	1	3450	3200	2970	3650	3400	3200

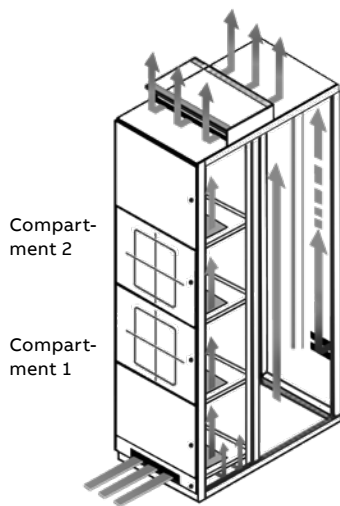

\* Performances refer to withdrawable circuit breakers with a fixed part accessorized with three stab rear terminals for 4000A (Example: 1SDA074021R1 - KIT VR 4000A)  
Performances with F and FL terminals can be compared to the performances of circuit breaker with HR terminal.  
Performances depend on switchboard design and testing condition. ABB is not responsible for the overall performances result.

The following tables provide an indication of the performance of the apparatus inside the switch-gear. The data shown are a summary of software model simulations and real tests.

**SACE Emax 2 E6.2 H V X Circuit-breaker**  
 Switchgear dimensions 2200x1200x900 (HxLxD)

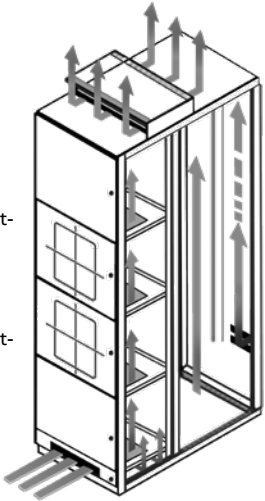
IP	lu	Connection [mm]	Compartment	HR Terminal One circuit breaker in the column			VR Terminal One circuit breaker in the column		
				Environment temperature 35 °C	45 °C	55 °C	Environment temperature 35 °C	45 °C	55 °C
 IP31  Compartment 2  Compartment 1	4000	4x100x10	1	4000	4000	4000	4000	4000	4000
	5000	5x100x10	1	5000	5000	4900	5000	5000	5000
	6300	6x100x10	1	5650	5350	5100	6000	5700	5250

Performances with F and FL terminals can be compared to the performances of circuit breaker with HR terminal.



---

# Dimensions

<b>8/2</b>	<b>Fixed circuit-breaker</b>
<b>8/4</b>	E1.2
<b>8/8</b>	E2.2
<b>8/12</b>	E4.2
<b>8/16</b>	E6.2
<b>8/20</b>	<b>Installation environment</b>
<b>8/22</b>	E1.2
<b>8/26</b>	E2.2
<b>8/32</b>	E4.2
<b>8/38</b>	E6.2

# Fixed circuit-breaker

**E1.2**

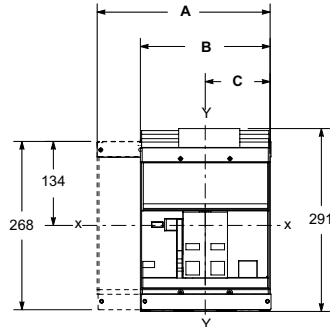

**E2.2 - E4.2 - E6.2**

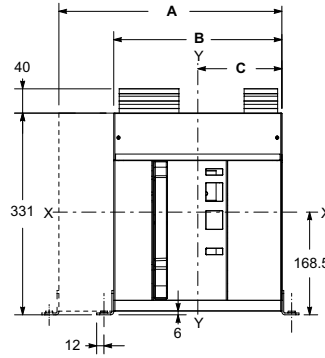

	A	B	C	
[mm]	4p	3p	3p	4p
<b>E1.2</b>	284	214	107	107
<b>E2.2</b>	366	276	138	138
<b>E4.2</b>	510	384	192	192
<b>E6.2</b>	888	762	318	444
<b>E6.2/f</b>	1014	-	-	444

## Compartment door drilling

**E1.2**

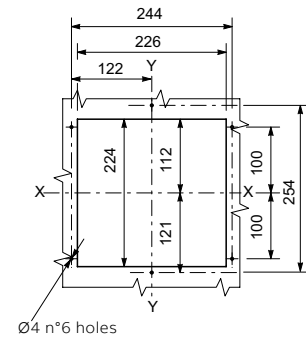

**E2.2 - E4.2 - E6.2**

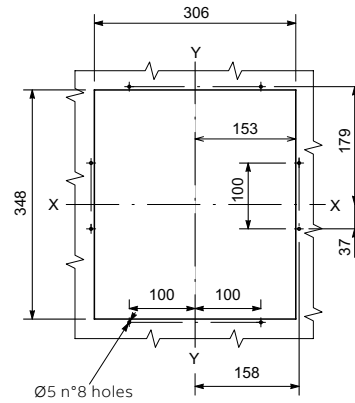

	Standard	Ronis/STI	Kirk	Castell
<b>A MIN</b> [mm]	49.5	63.5	63.5	83.5
<b>A MAX</b> [mm]	83.5	97.5	97.5	117.5

**E1.2**

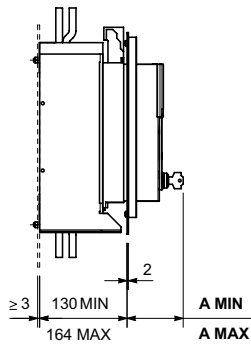

**E2.2 - E4.2 - E6.2**

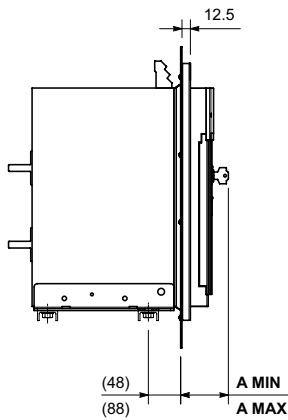

	Standard	Ronis/STI	Kirk	Castell
<b>A MIN</b> [mm]	29.5	41.5	46.5	65
<b>A MAX</b> [mm]	69.5	81.5	86.5	105



Dimensions of the compartment

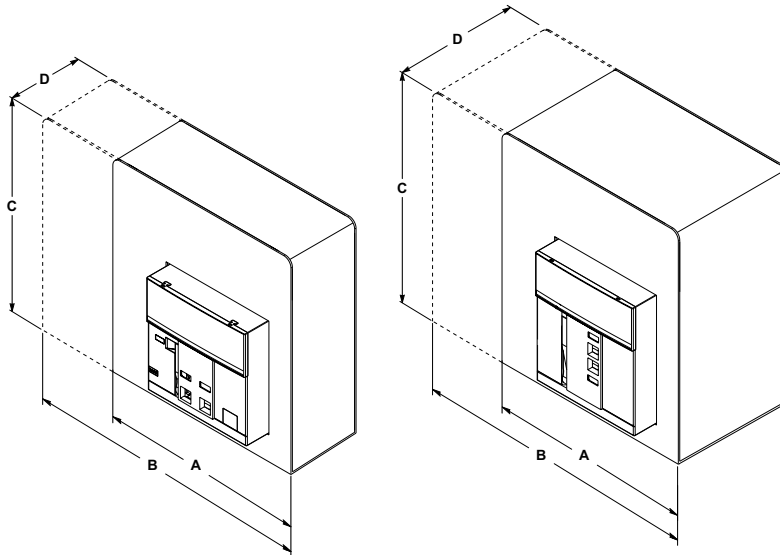

	A	B	C	D
[mm]	<b>3p</b>	<b>4p</b>		
<b>E1.2</b>	250	322	382.5*	130
<b>E2.2</b>	400	490	500	221
<b>E4.2</b>	500	600	500	221
<b>E6.2</b>	900	1000	500	221
<b>E6.2/f</b>	-	1200	500	221

\* 332.5 for voltages ≤ 440V AC

Floor fixing

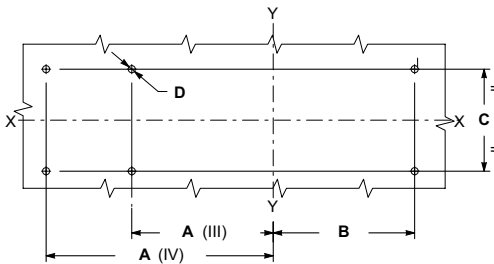

	A		B		C	D
[mm]	<b>3p</b>	<b>4p</b>	<b>3p</b>	<b>4p</b>		
<b>E1.2</b>	117	187	117	117	80	5.5
<b>E2.2</b>	154	244	154	154	150	10.5
<b>E4.2</b>	208	334	208	208	150	10.5
<b>E6.2</b>	460	460	334	460	150	10.5
<b>E6.2/f</b>	-	586	-	460	150	10.5

Wall fixing (only for E1.2)

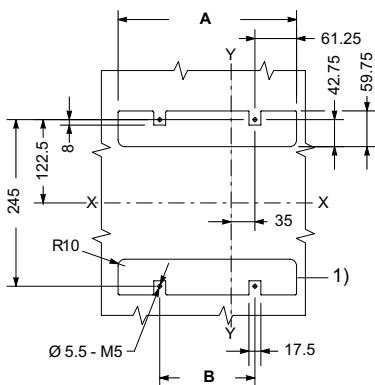

[mm]	<b>3p</b>	<b>4p</b>
<b>A</b>	192.5	262.5
<b>B</b>	70	140

Earthing device E2.2 - E4.2 - E6.2

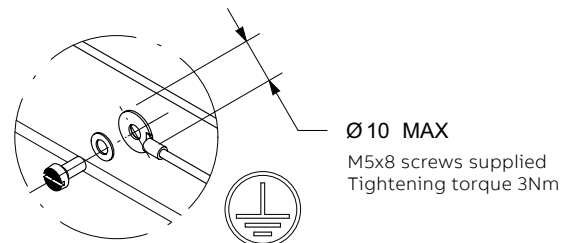

1) for fixing with rear terminals

# Fixed circuit-breaker - E1.2

## Front terminals – F

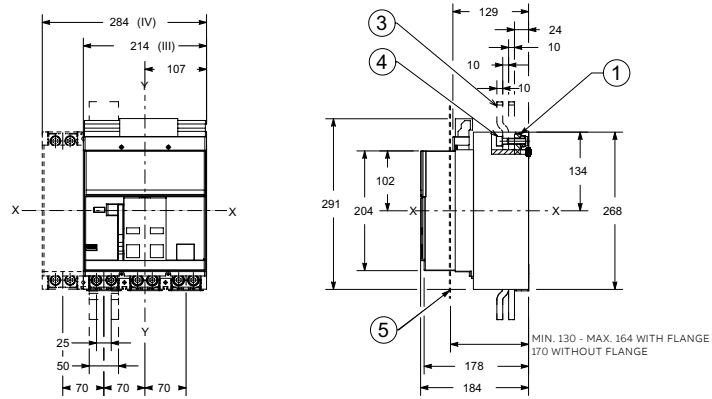

## Extended front terminals – EF

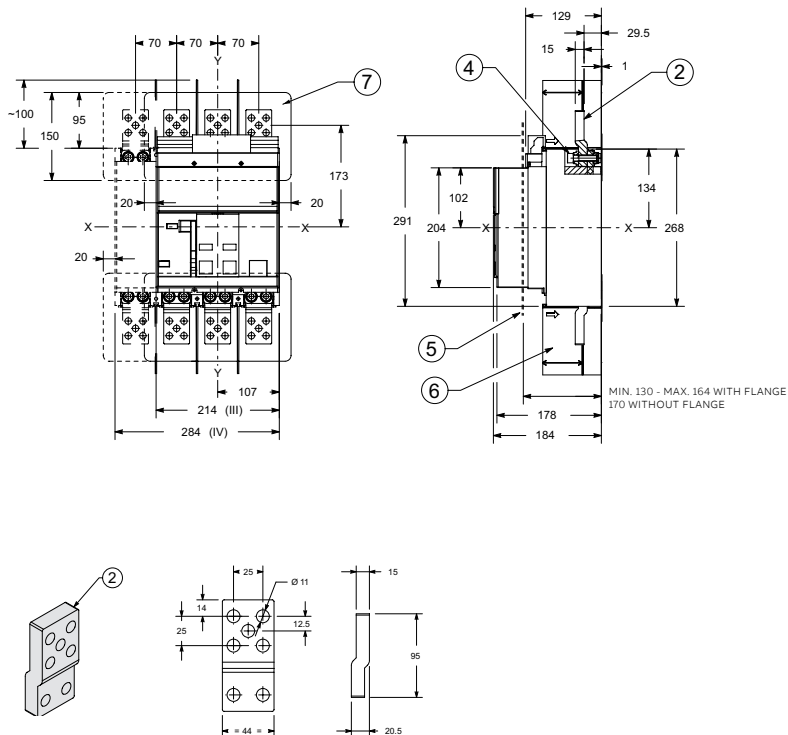

### Key

- 1 Front terminals for flat connection
- 2 Extended front terminals
- 3 To be supplied by the customer
- 4 Tightening torque 18Nm
- 5 Door position - Ref. page 7/2
- 6 Obligatory phase separators 100mm
- 7 Obligatory insulating plate to be supplied by the customer

Orientable rear terminals - HR/VR

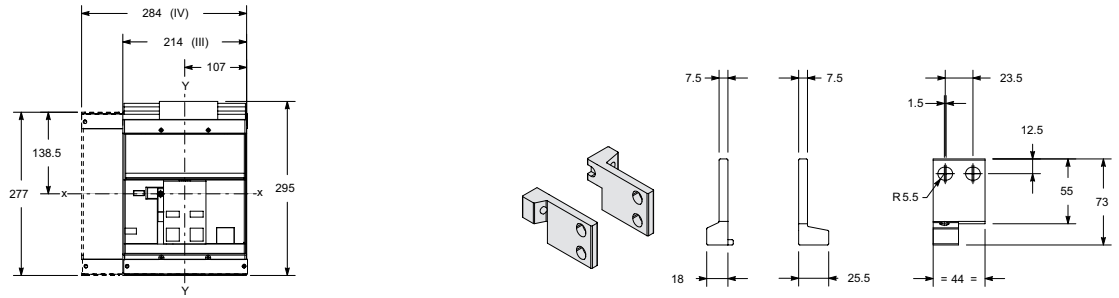

Terminals HR

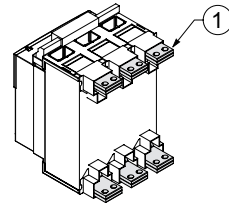
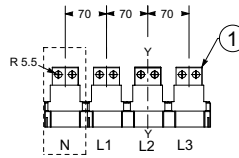
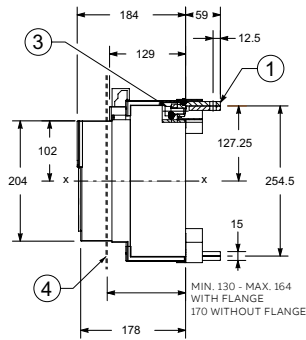

Terminals VR

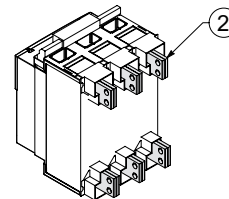
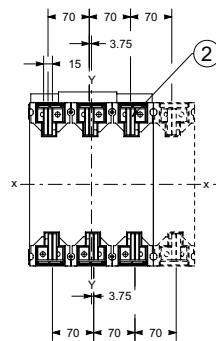
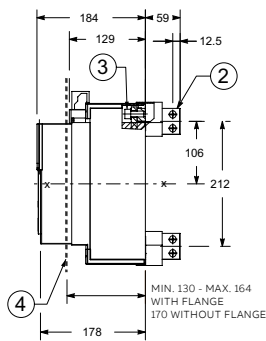

- Key
- 1 Horizontal orientable terminals HR
  - 2 Vertical orientable terminals VR
  - 3 Tightening torque 20Nm
  - 4 Door position - Ref. page 7/2

# Fixed circuit-breaker - E1.2

Splayed extended front terminals - ES

3-pole version

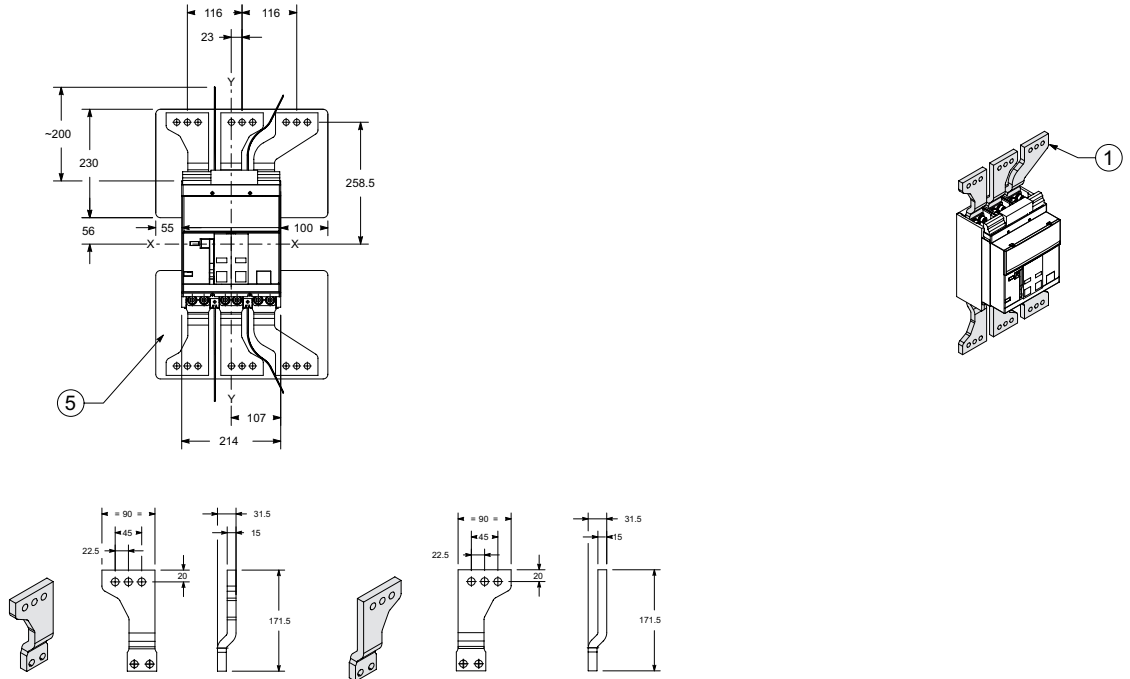

4-pole version

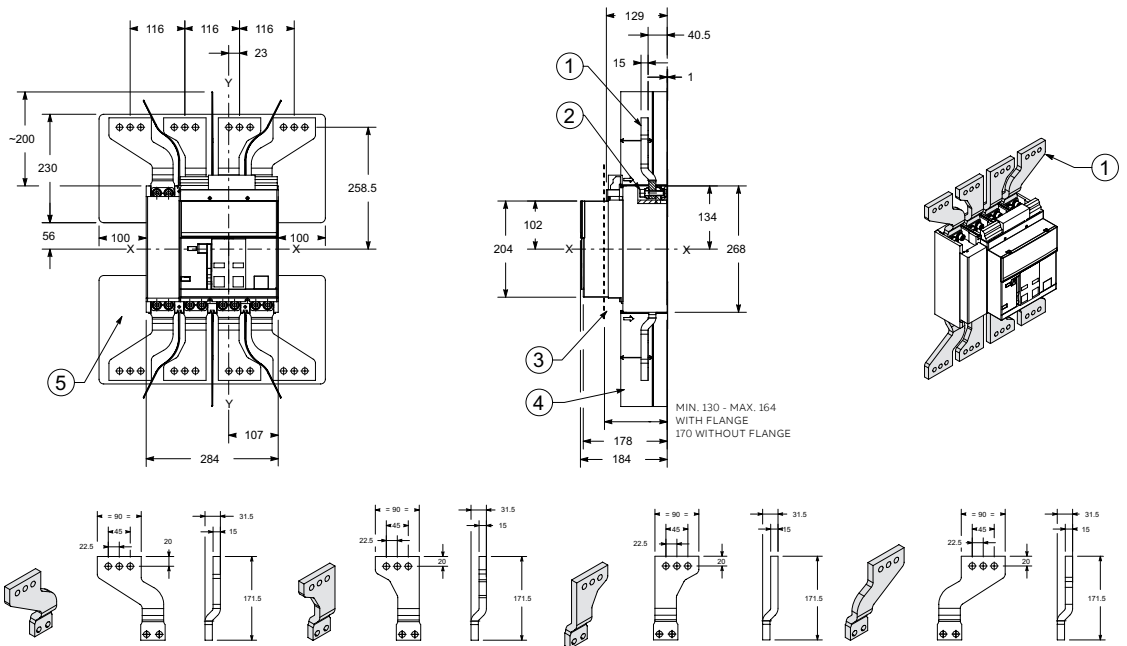

- Key
- 1 Splayed extended front terminals
  - 2 Tightening torque 18Nm
  - 3 Door position - Ref. page 7/2
  - 4 Obligatory phase separators 200mm
  - 5 Obligatory insulating plate to be supplied by the customer

Front terminals for cables – FcCuAl

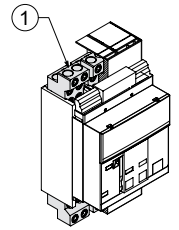
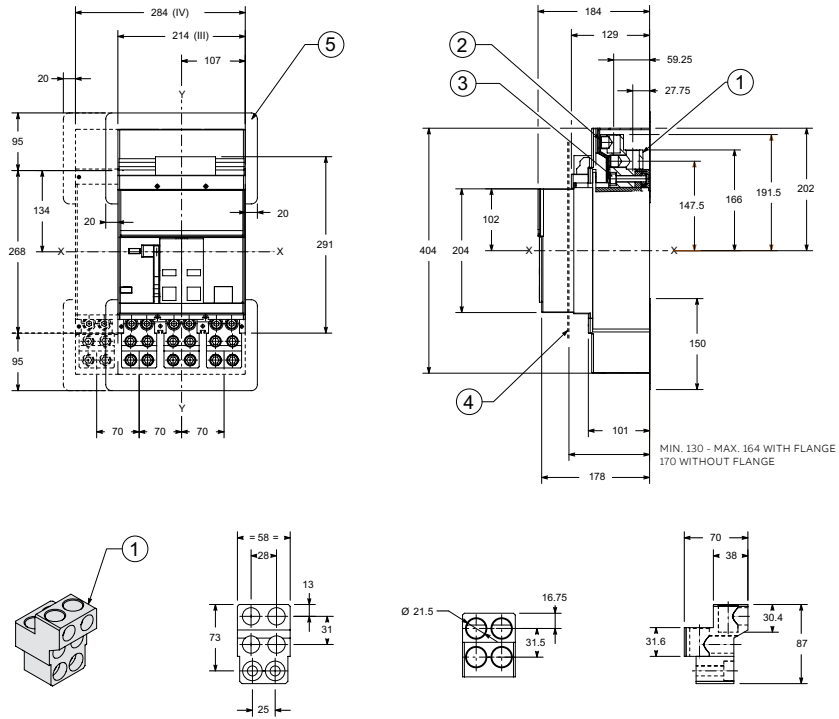

- Key
- 1 Front terminals for cables FC CU AL
  - 2 Tightening torque 43Nm
  - 3 Tightening torque 18Nm
  - 4 Door position - Ref. page 7/2
  - 5 Obligatory insulating plate to be supplied by the customer

# Fixed circuit-breaker - E2.2

Orientable rear terminals - HR/VR

**E2.2 B/N/S/H 2000A**

**E2.2 N/S/H 2500A**

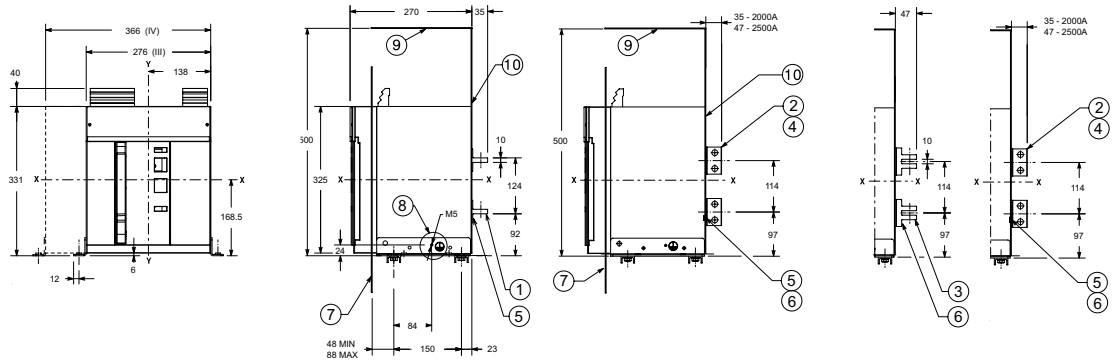

**E2.2 B/N/S/H 2000A**

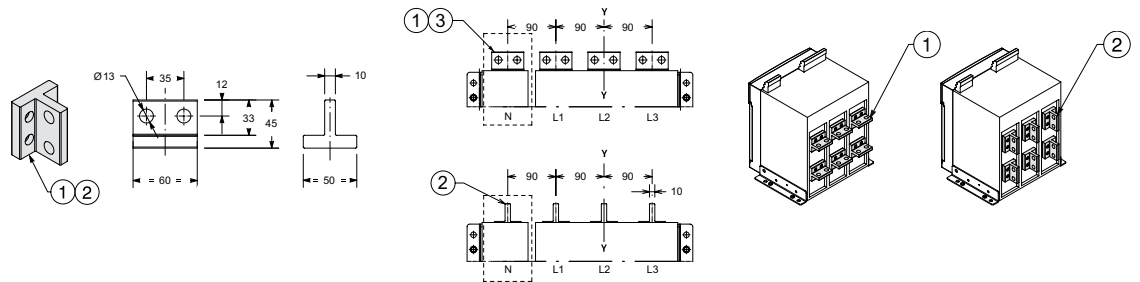

**E2.2 N/S/H 2500A**

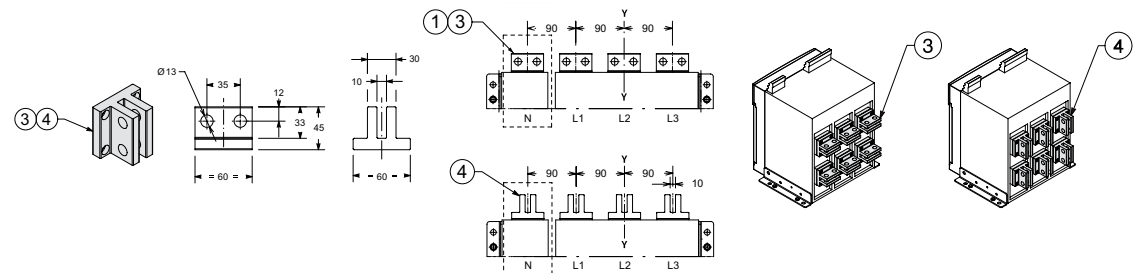

- Key
- 1 Horizontal terminals 2000A
  - 2 Vertical terminals 2000A
  - 3 Horizontal terminals 2500A
  - 4 Vertical terminals 2500A
  - 5 Tightening torque 2000A 8.6Nm
  - 6 Tightening torque 2500A 8.6Nm
  - 7 Door position - Ref. page 7/2
  - 8 Earthing device - Ref. page 7/3
  - 9 Metallic sheet
  - 10 Insulating sheet or insulated metallic sheet

Front terminals – F

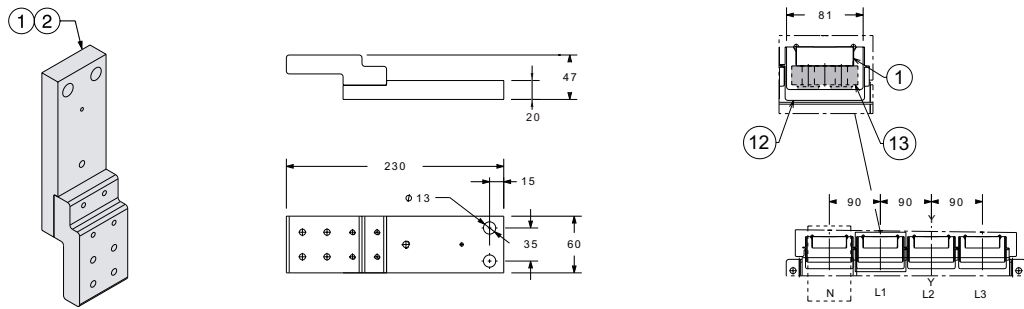
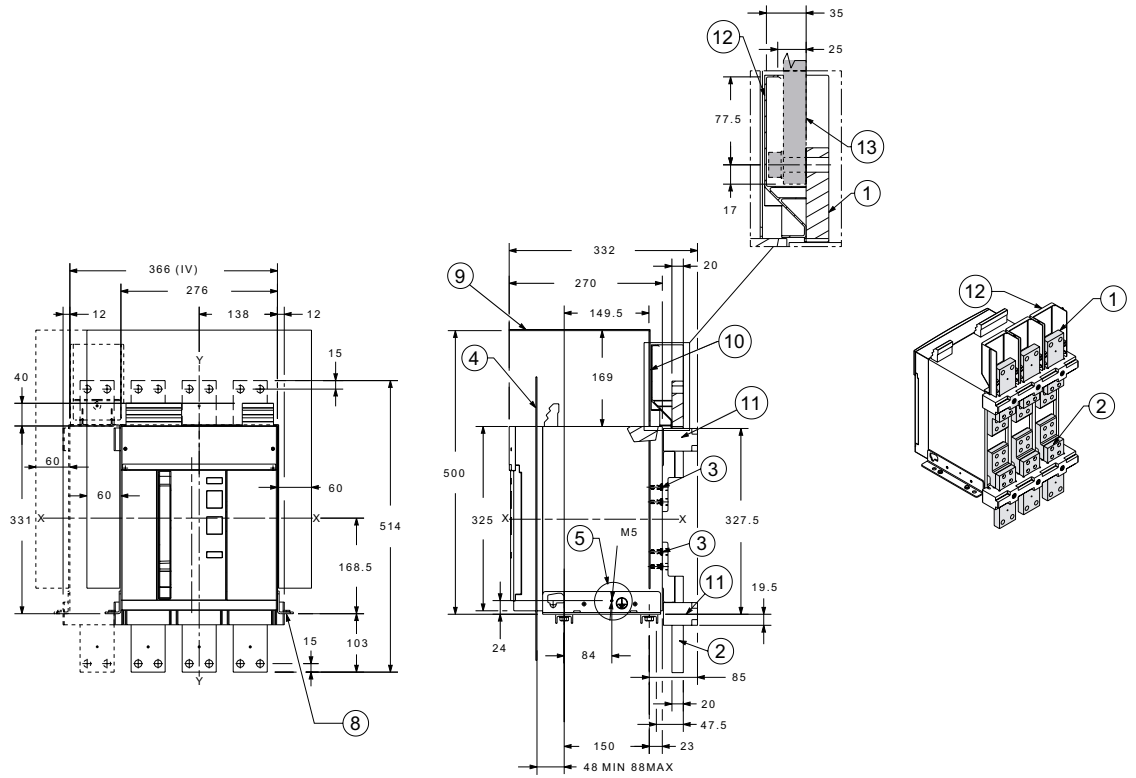

- Key
- 1 Upper front terminals
  - 2 Lower front terminals
  - 3 Tightening torque 8.6Nm
  - 4 Door position - Ref. page 7/2
  - 5 Earthing device - Ref. page 7/3
  - 8 External fixing point. Recommended screws M10x25 high class
  - 9 Metallic sheet
  - 10 Insulating sheet or insulated metallic sheet
  - 11 Crossbeam front terminals
  - 12 Plastic protection
  - 13 Customer bus bar and screws (not provided)

# Fixed circuit-breaker - E2.2

Horizontal spread terminals – SHR

E2.2 B/N/S/H 2000A

E2.2 N/S/H 2500A

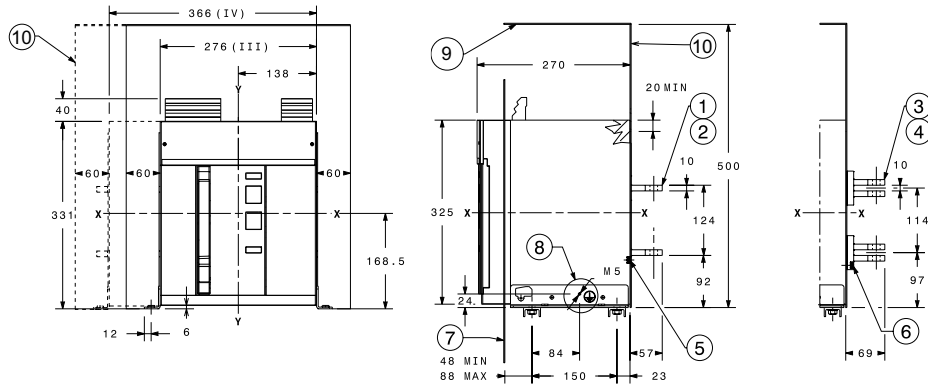

E2.2 B/N/S/H 2000A

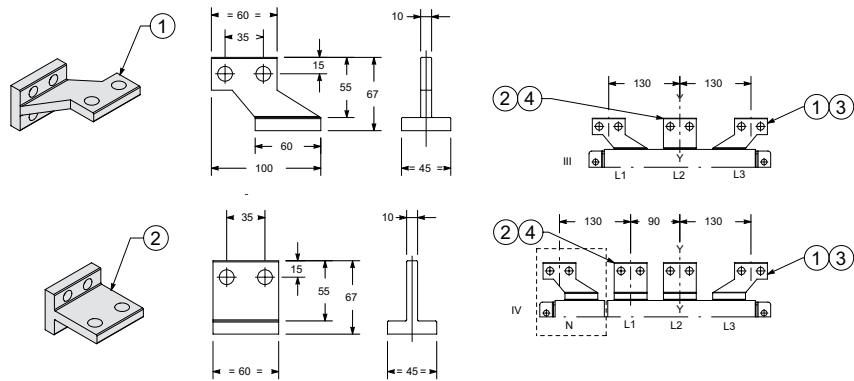

E2.2 N/S/H 2500A

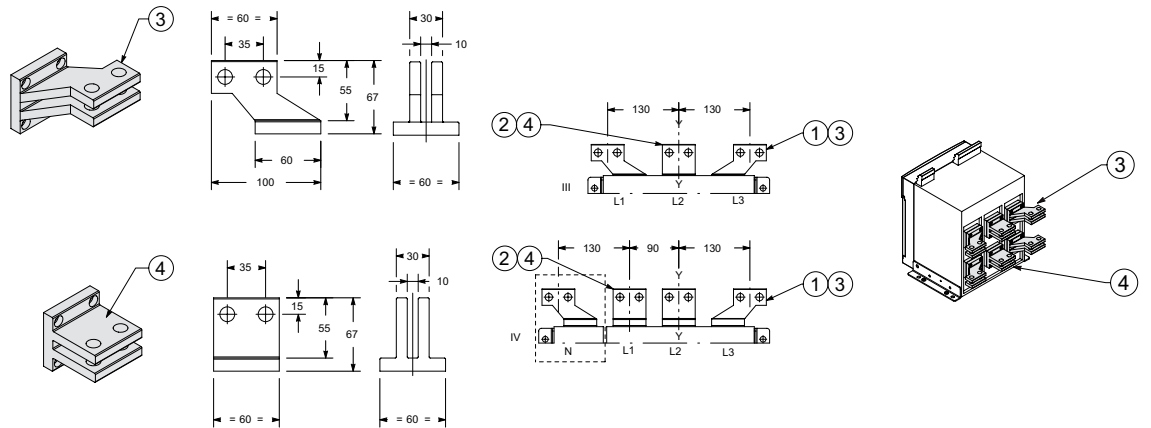

- Key
- 1 Side horizontal splayed terminals 2000A
  - 2 Central horizontal splayed terminals 2000A
  - 3 Side horizontal splayed terminals 2500A
  - 4 Central horizontal splayed terminals 2500A
  - 5 Tightening torque 2000A 8.6Nm
  - 6 Tightening torque 2500A 8.6Nm
  - 7 Door position - Ref. page 7/2
  - 8 Earthing device - Ref. page 7/3
  - 9 Metallic sheet
  - 10 Insulating sheet or insulated metallic sheet



Vertical spread terminals – SVR

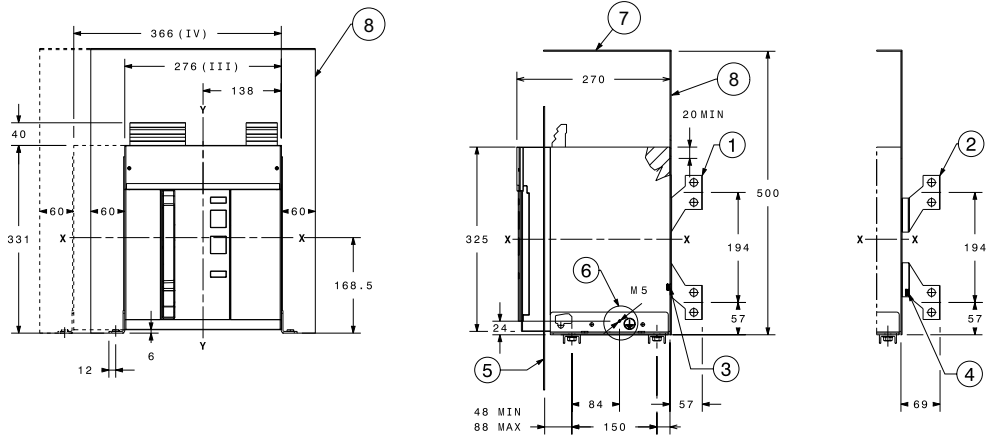

E2.2 B/N/S/H 2000A

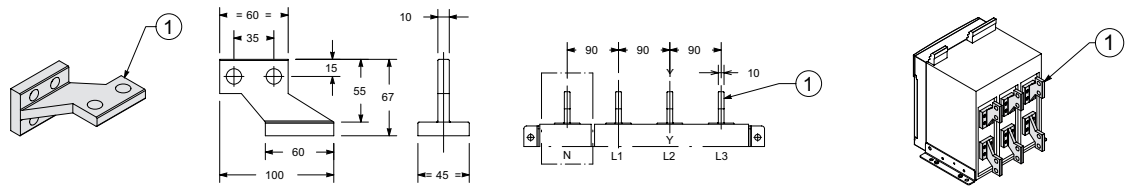

E2.2 N/S/H 2500A

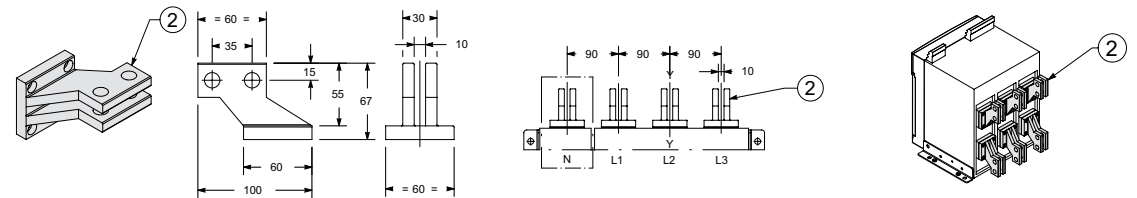

- Key
- 1 Vertical splayed terminals 2000A
  - 2 Vertical splayed terminals 2500A
  - 3 Tightening torque 2000A 8.6Nm
  - 4 Tightening torque 2500A 8.6Nm
  - 5 Door position - Ref. page 7/2
  - 6 Earthing device - Ref. page 7/3
  - 7 Metallic sheet
  - 8 Insulating sheet or insulated metallic sheet

# Fixed circuit-breaker - E4.2

Orientable rear terminals - HR/VR

E4.2 N/S/H/V 3200A

E4.2 N/S/H/V 4000A

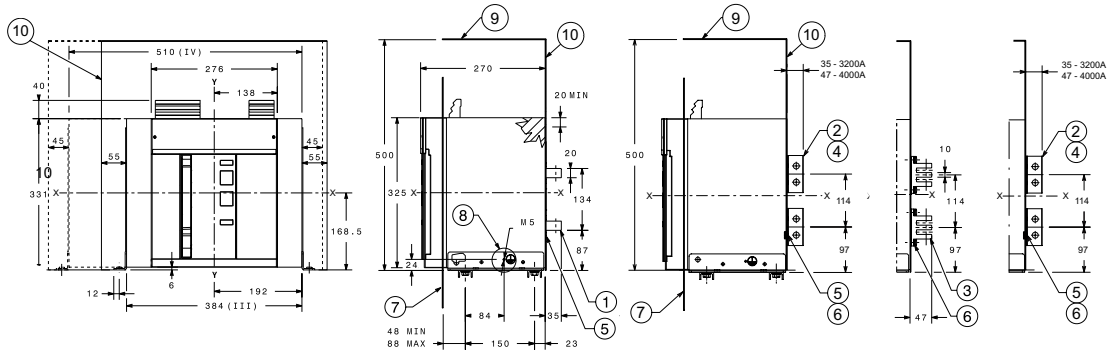

E4.2 N/S/H/V 3200A

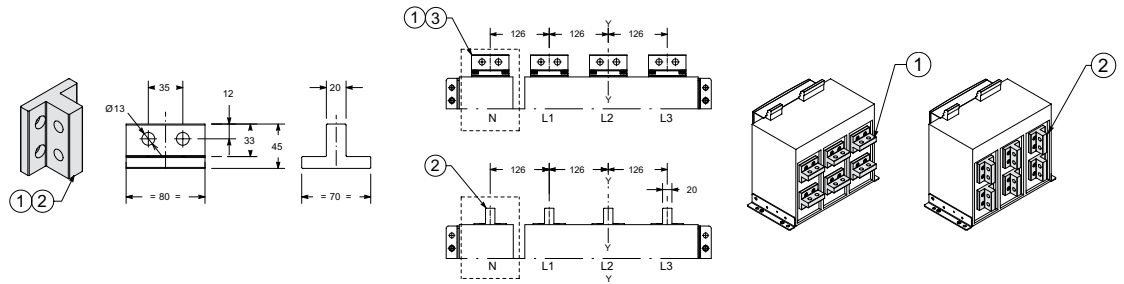

E4.2 N/S/H/V 4000A

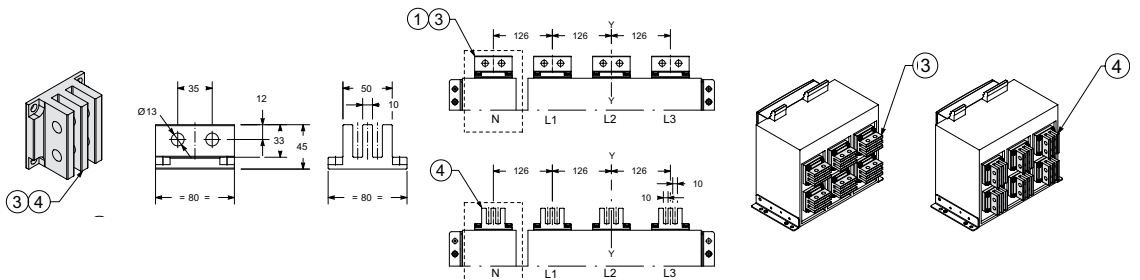

- Key
- 1 Horizontal terminals 3200A
  - 2 Vertical terminals 3200A
  - 3 Horizontal terminals 4000A
  - 4 Vertical terminals 4000A
  - 5 Tightening torque 3200A 20Nm
  - 6 Tightening torque 4000A 20Nm
  - 7 Door position - Ref. page 7/2
  - 8 Earthing device - Ref. page 7/3
  - 9 Metallic sheet
  - 10 Insulating sheet or insulated metallic sheet

Front terminals – F

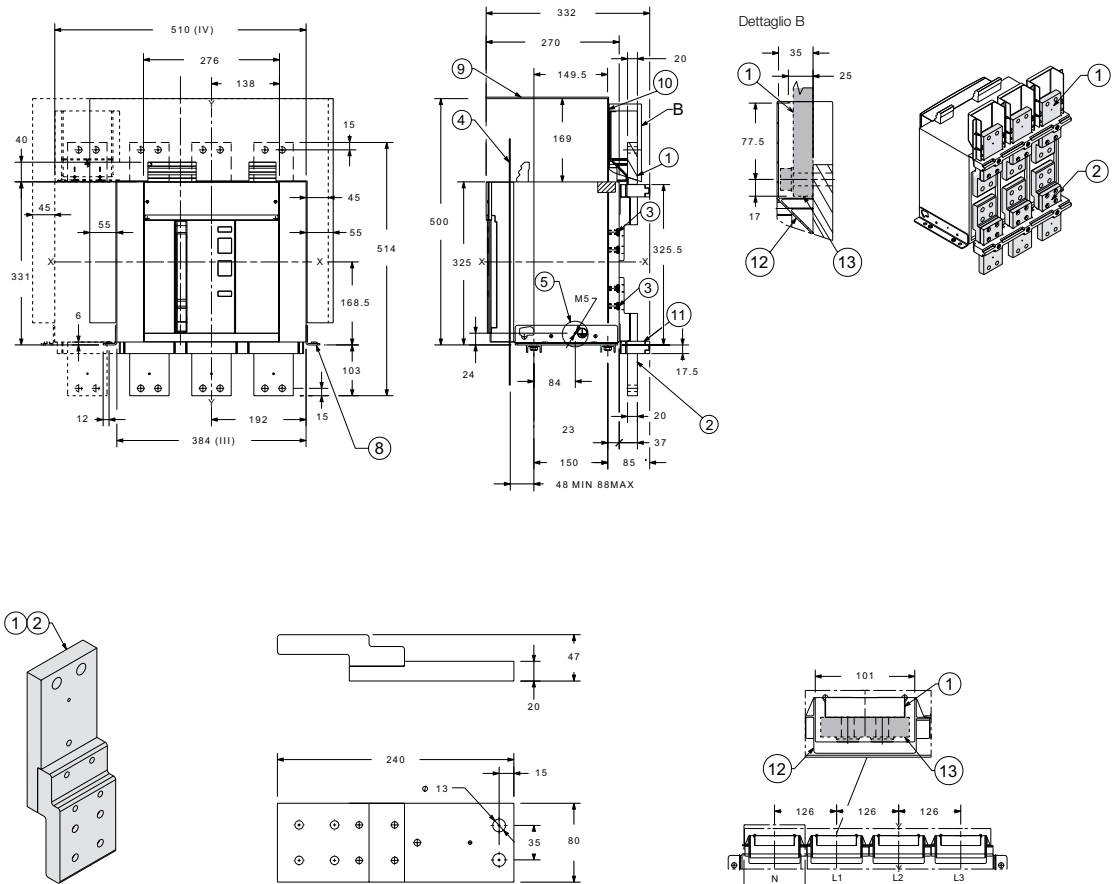

Key

- 1 Upper front terminals
- 2 Lower front terminals
- 3 Tightening torque 8.6Nm
- 4 Door position - Ref. page 7/2
- 5 Earthing device - Ref. page 7/3
- 8 External fixing point. Recommended screws M10x25 high class
- 9 Metallic sheet
- 10 Insulating sheet or insulated metallic sheet
- 11 Crossbeam front terminals
- 12 Plastic protection
- 13 Customer busbar and screws (not provided)

# Fixed circuit-breaker - E4.2

Horizontal spread terminals – SHR

E4.2 N/S/H 3200A

E4.2 N/S/H 4000A  
E4.2 V 2000 ... 4000A

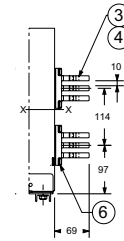
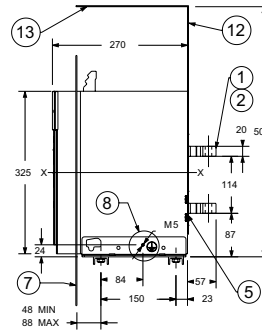
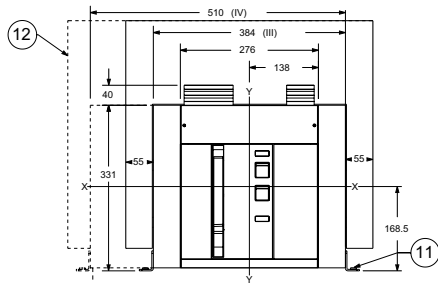

E4.2 N/S/H 3200A

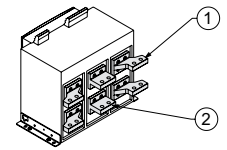
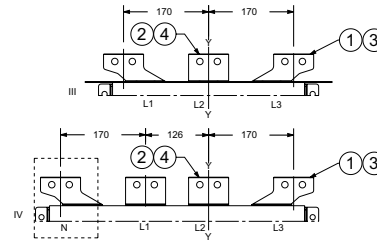
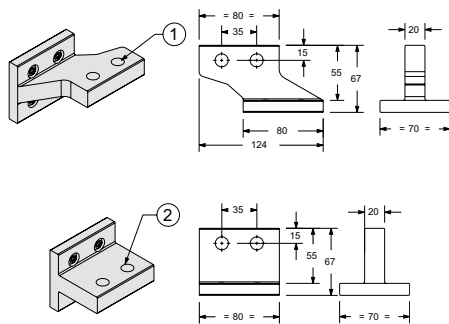

E4.2 N/S/H 4000A

E4.2 V 2000 ... 4000A

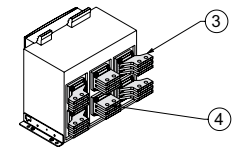
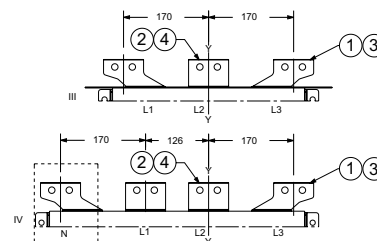
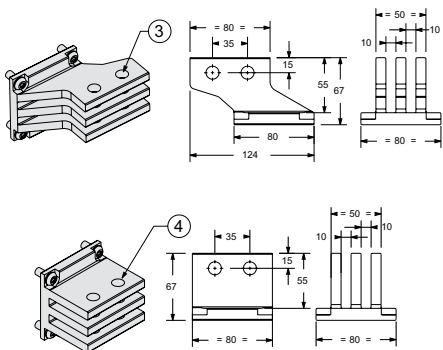

- Key
- 1 Side horizontal divaricate terminals 3200A
  - 2 Central horizontal divaricate terminals 3200A
  - 3 Side horizontal divaricate terminals 4000A
  - 4 Central horizontal divaricate terminals 4000A
  - 5 Tightening torque 3200A 8.6Nm
  - 6 Tightening torque 4000A 8.6Nm
  - 7 Door position - Ref. page 7/2
  - 8 Grounding
  - 11 Mounting outside feet - screws recommend M10x25 high class 8.8 or couple superior Tightening torque 40Nm compulsory fixing screws from high
  - 12 Insulating sheet or insulated metallic sheet
  - 13 Metallic sheet

Vertical spread terminals – SVR

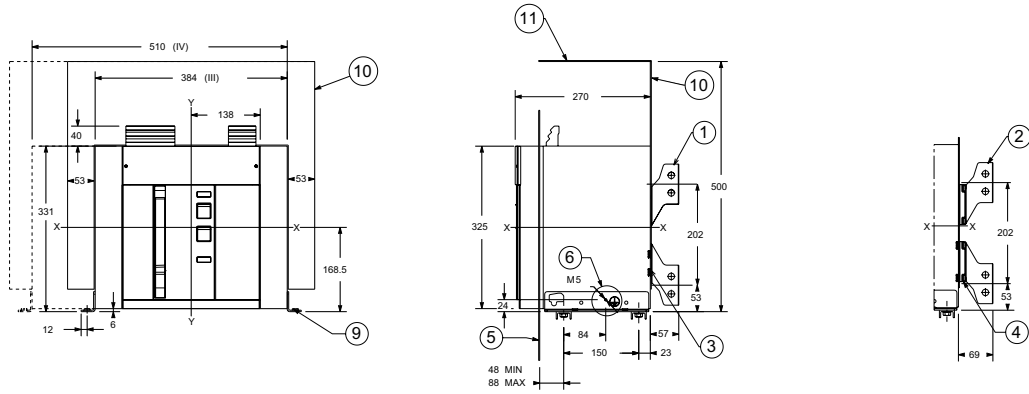

E4.2 N/S/H 3200A

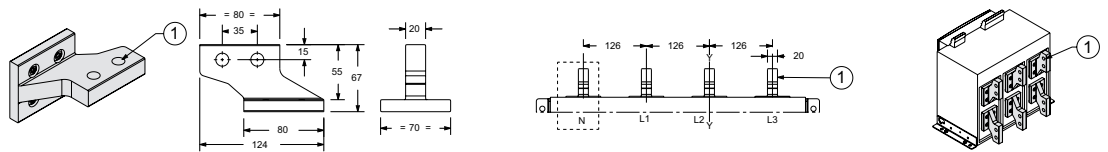

E4.2 N/S/H 4000A  
E4.2 V 2000 ... 4000A

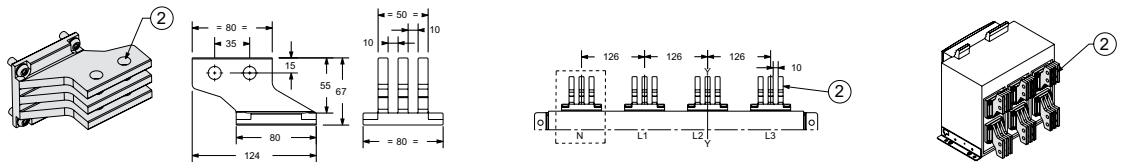

—  
Key

- 1 Vertical divaricate terminals 3200A
- 2 Vertical divaricate terminals 4000A
- 3 Tightening torque 3200A 8.6Nm
- 4 Tightening torque 4000A 8.6Nm
- 5 Door position - Ref. page 7/2
- 6 Grounding
- 9 Mounting outside feet - screws recommend M10x25 high class 8.8 or couple superior Tightening torque 40Nm compulsory fixing screws from high
- 10 Insulating sheet or insulated metallic sheet
- 11 Metallic sheet

# Fixed circuit-breaker - E6.2

Horizontal rear terminals – HR

E6.2 H/V/X 4000-5000A

E6.2 H/V/X 4000-6300A

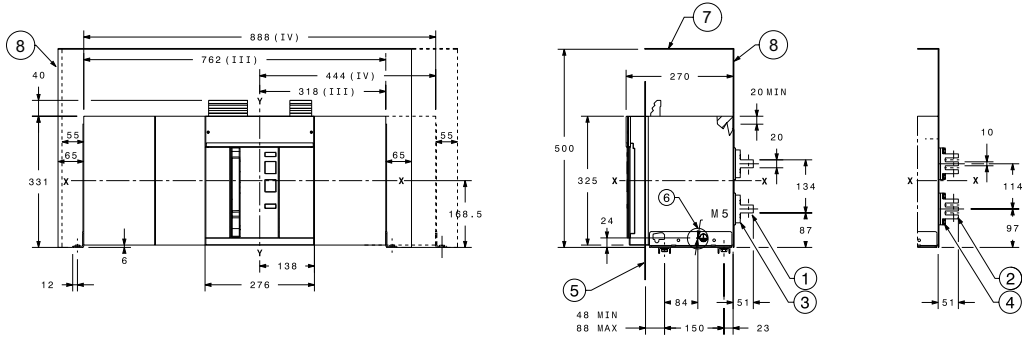

E6.2 H/V/X 4000-5000A

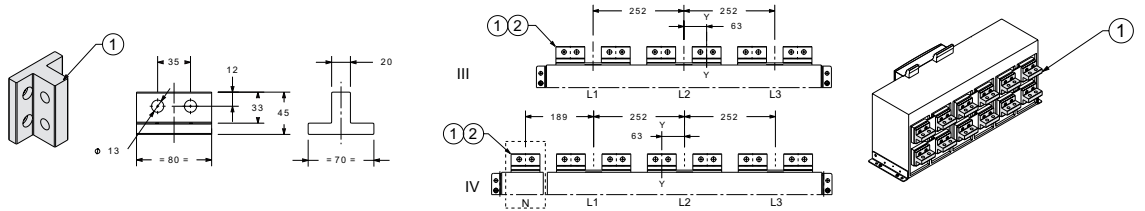

E6.2 H/V/X 4000-6300A

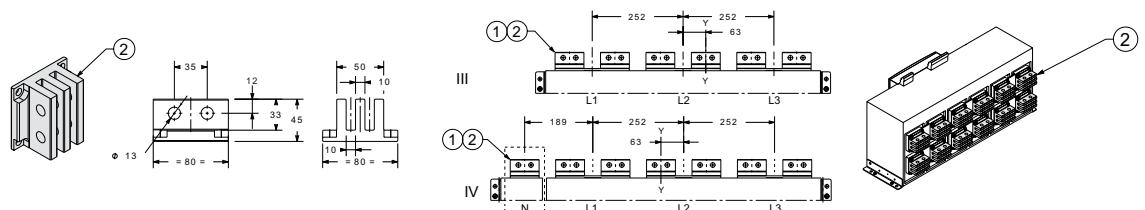

Key

- 1 Horizontal terminals 5000A
- 2 Horizontal terminals 6300A
- 3 Tightening torque 5000A 20Nm
- 4 Tightening torque 6300A 20Nm
- 5 Door position - Ref. page 7/2
- 6 Earthing device - Ref. page 7/3
- 7 Metallic sheet
- 8 Insulating sheet or insulated metallic sheet

Vertical rear terminals – VR

**E6.2 H/V/X 4000...6300A**

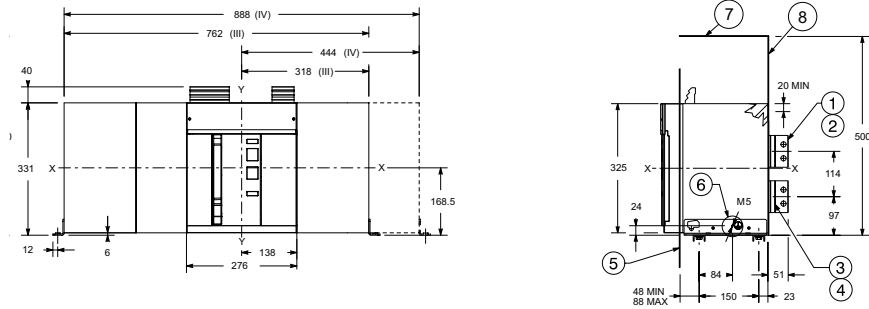

**E6.2 H/V/X 4000-5000A**

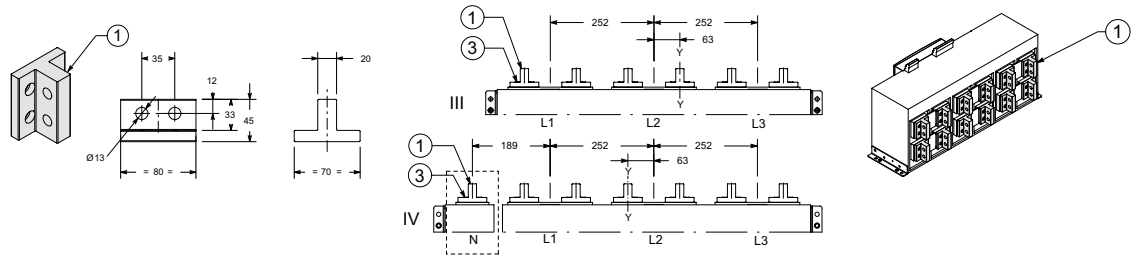

**E6.2 H/V/X 4000-6300A**

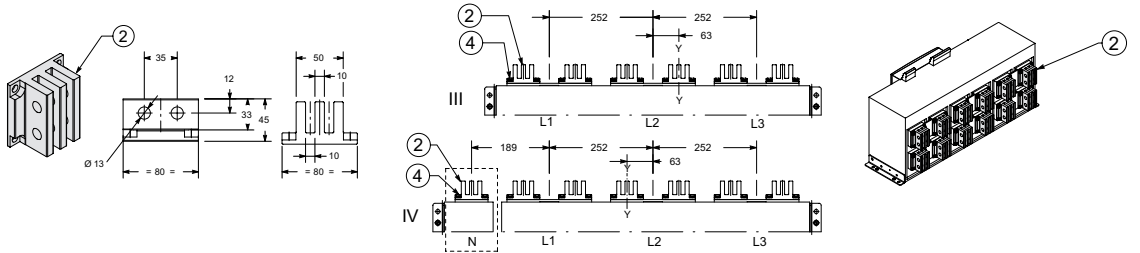

Key

- 1 Vertical terminals 5000A
- 2 Vertical terminals 6300A
- 3 Tightening torque 5000A 20Nm
- 4 Tightening torque 6300A 20Nm
- 5 Door position - Ref. page 7/2
- 6 Earthing device - Ref. page 7/3
- 7 Metallic sheet
- 8 Insulating sheet or insulated metallic sheet

# Fixed circuit-breaker - E6.2

Orientable rear terminals - HR/VR full size

E6.2 H/V/X 4000-5000A

E6.2 H/V/X 4000-6300A

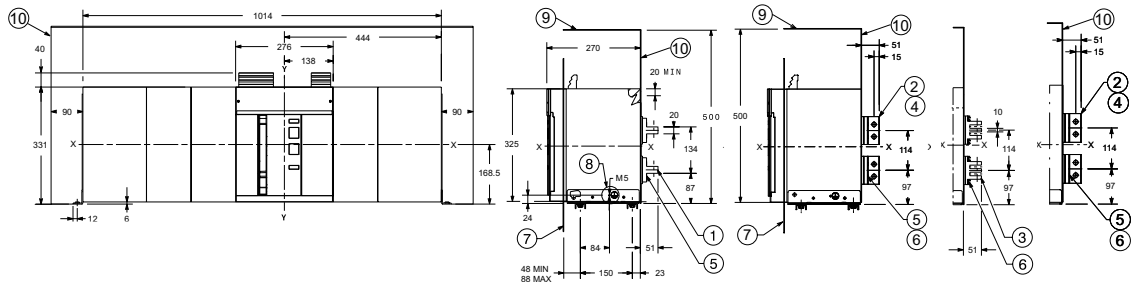

E6.2 H/V/X 4000-5000A

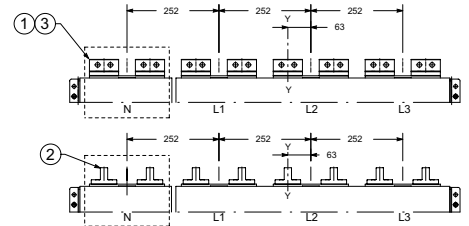
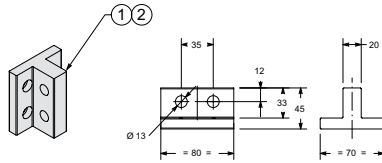

E6.2 H/V/X 4000-6300A

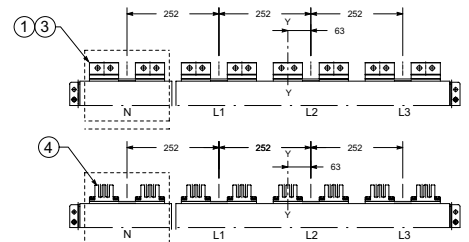
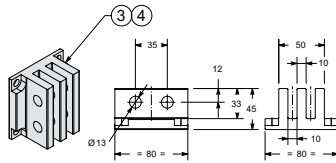

Key

- 1 Horizontal terminals 5000A
- 2 Vertical terminals 5000A
- 3 Horizontal terminals 6300A
- 4 Vertical terminals 6300A
- 5 Tightening torque 5000A 20Nm
- 6 Tightening torque 6300A 20Nm
- 7 Door position - Ref. page 7/2
- 8 Earthing device - Ref. page 7/3
- 9 Metallic sheet
- 10 Insulating sheet or insulated metallic sheet



Front terminals – F

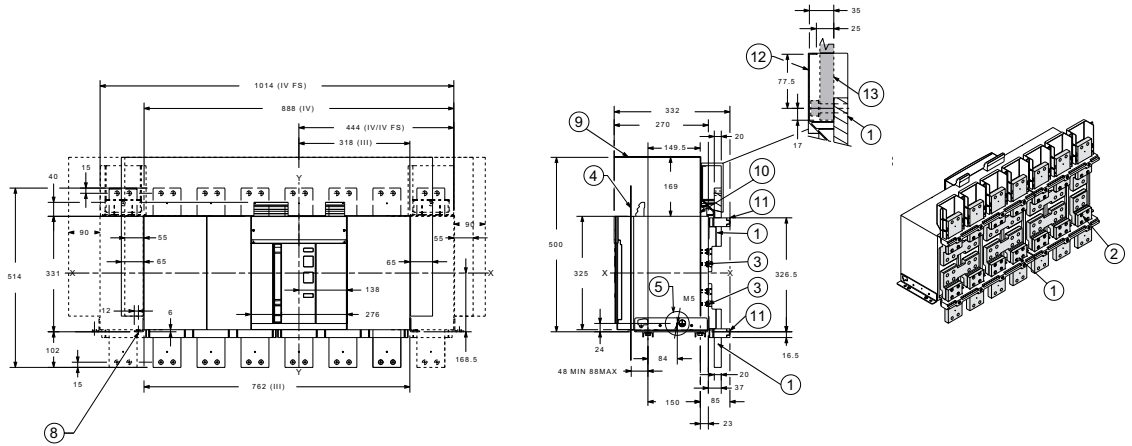

Upper front terminals

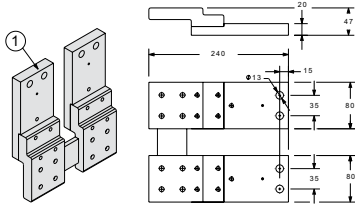

Lower front terminal

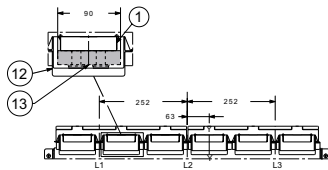
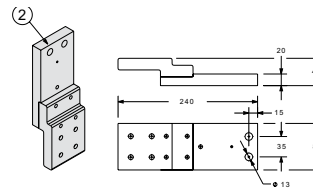

3-pole



4-pole



4-pole full size

- Key
- 1 Upper front terminals
  - 2 Lower front terminals
  - 3 Tightening torque 8.6Nm
  - 4 Door position - Ref. page 7/2
  - 5 Earthing device - Ref. page 7/3
  - 8 External fixing point. Recommended screws M10x25 high class
  - 9 Metallic sheet
  - 10 Insulating sheet or insulated metallic sheet
  - 11 Crossbeam front terminals
  - 12 Plastic protection
  - 13 Customer busbar and screws (not provided)

# Withdrawable circuit-breaker

**E1.2**

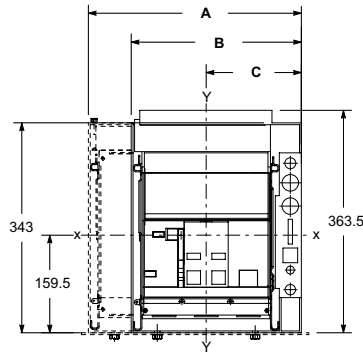

**E2.2 - E4.2 - E6.2**

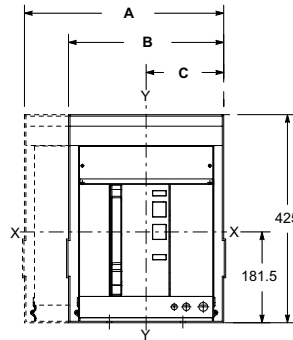

	A	B	C	
[mm]	4p	3p	3p	4p
<b>E1.2</b>	348	278	155.5	155.5
<b>E2.2</b>	407	317	158.5	158.5
<b>E4.2</b>	551	425	212.5	212.5
<b>E6.2</b>	929	803	338.5	464.5
<b>E6.2/f</b>	1055	-	-	464.5

## Compartment door drilling

**E1.2**

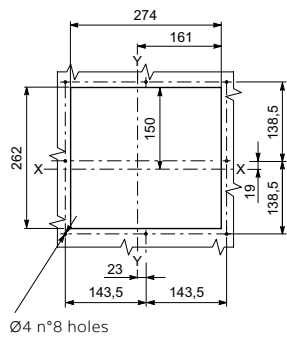

**E2.2 - E4.2 - E6.2**

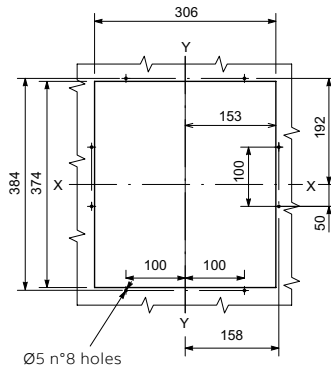

## Distance from connected to isolated position

**E1.2**

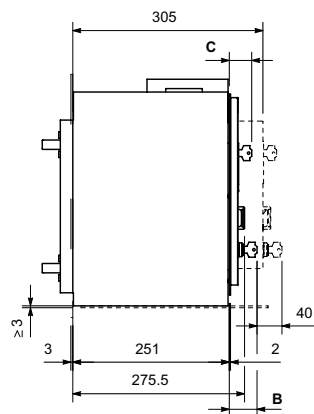

**E2.2 - E4.2 - E6.2**

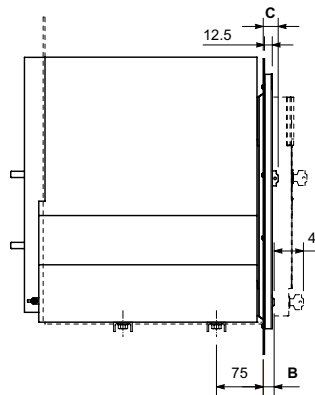

<b>E1.2</b>		Standard	Ronis/STI	Kirk	Castell
<b>B</b>	[mm]	44.5	55	55	85
<b>C</b>	[mm]	36	46.5	46.5	76.5

<b>E2.2-E4.2-E6.2</b>		Standard	Ronis/STI	Kirk	Castell
<b>B</b>	[mm]	22	34	39	57.5
<b>C</b>	[mm]	23	35	40	58.5

B refers to KLC; C refers to KLP

Dimensions of the compartment

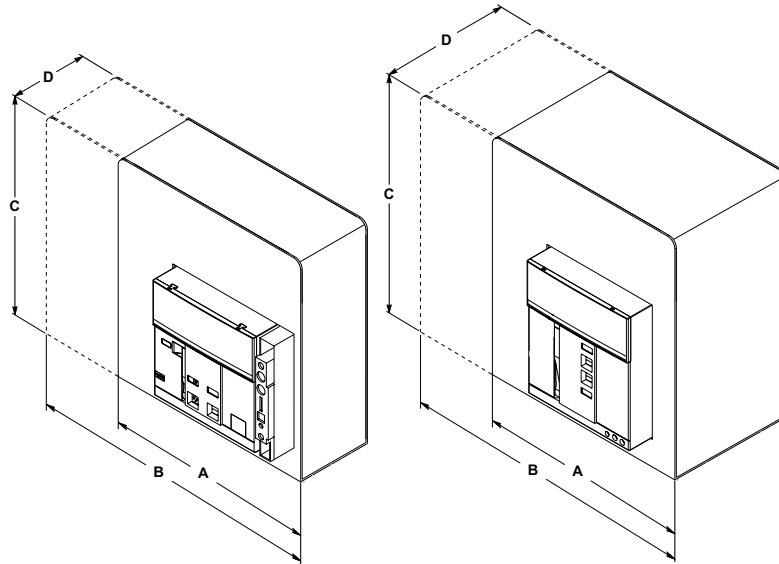

	A	B	C	D
[mm]	3p	4p		
<b>E1.2</b>	280	350	440*	252
<b>E2.2</b>	400	490	500	355
<b>E4.2</b>	500	600	500	355
<b>E6.2</b>	900	1000	500	355
<b>E6.2/f</b>	-	1200	500	355

\* 390 for voltages ≤ 440V AC

Floor fixing

Wall fixing (only for E1.2)

—  
Key  
1 Ventilation drilling on the switchgear

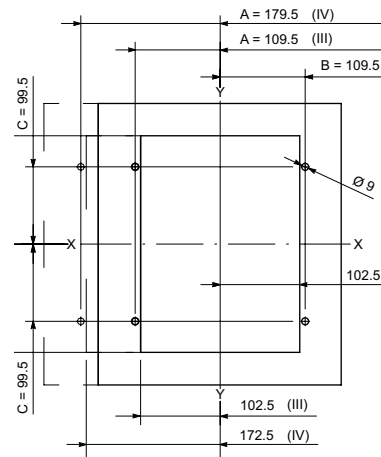
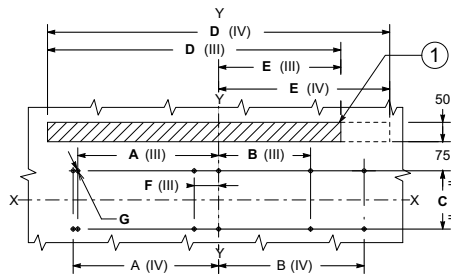

	A		B		C	D		E	F	G
[mm]	3p	4p	3p	4p		3p	4p	3p	4p	
<b>E1.2</b>	80	150	80	80	100	-	-	-	-	9
<b>E2.2</b>	75	175	75	75	150	270	360	135	135	10
<b>E4.2</b>	100	225	100	100	150	378	504	189	189	10
<b>E6.2</b>	363	375	237	375	150	756	882	315	441	63
<b>E6.2/f</b>	-	425	-	425	150	-	1008	-	441	10

Earthing device E2.2 - E4.2 - E6.2

Fixing on support sheet (only for E1.2)

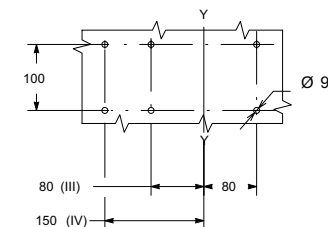
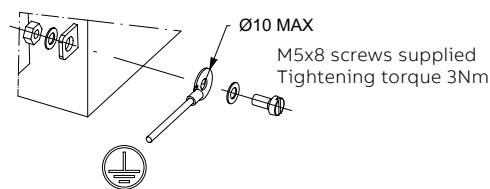

# Withdrawable circuit-breaker - E1.2

## Rear orientable terminals - HR/VR

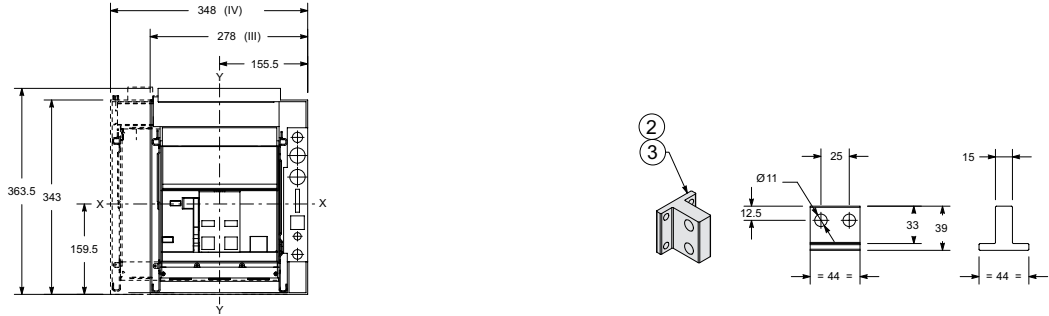

### Terminals HR

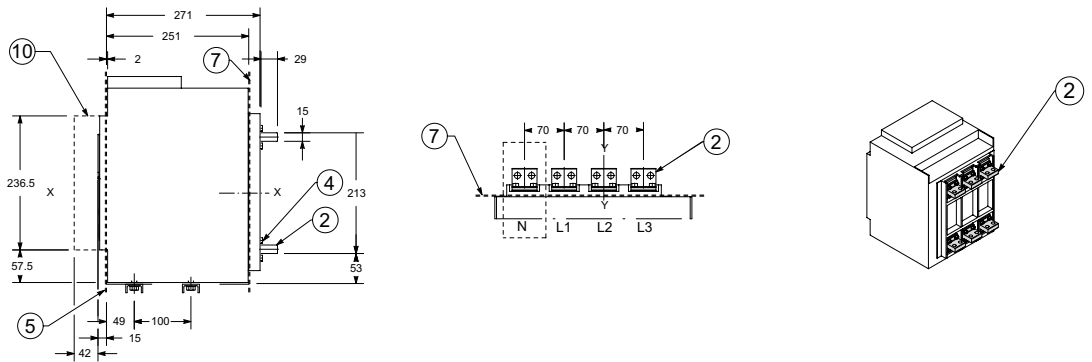

### Terminals VR

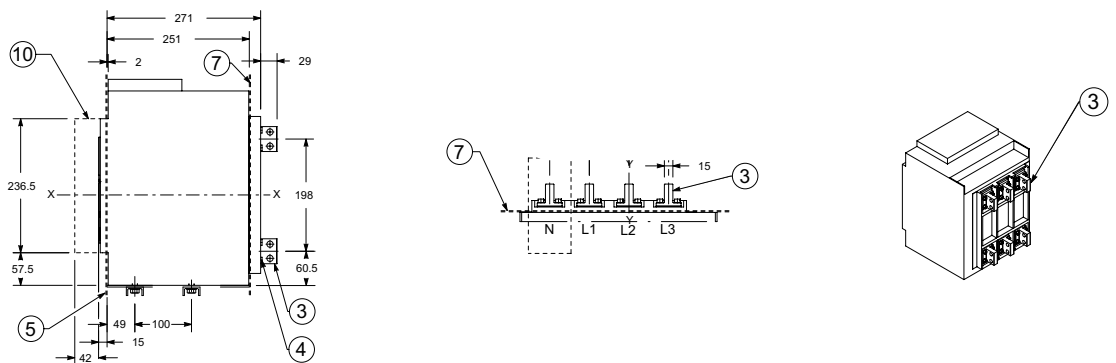

- Key
- 2 Horizontal rear terminals
  - 3 Vertical rear terminals
  - 4 Tightening torque 12 Nm
  - 5 Door position - Ref. page 7/20
  - 7 Rear segregation for rear terminals
  - 10 Sectioning run



# Withdrawable circuit-breaker - E1.2

## Front spread terminals - ES

### 3-pole version

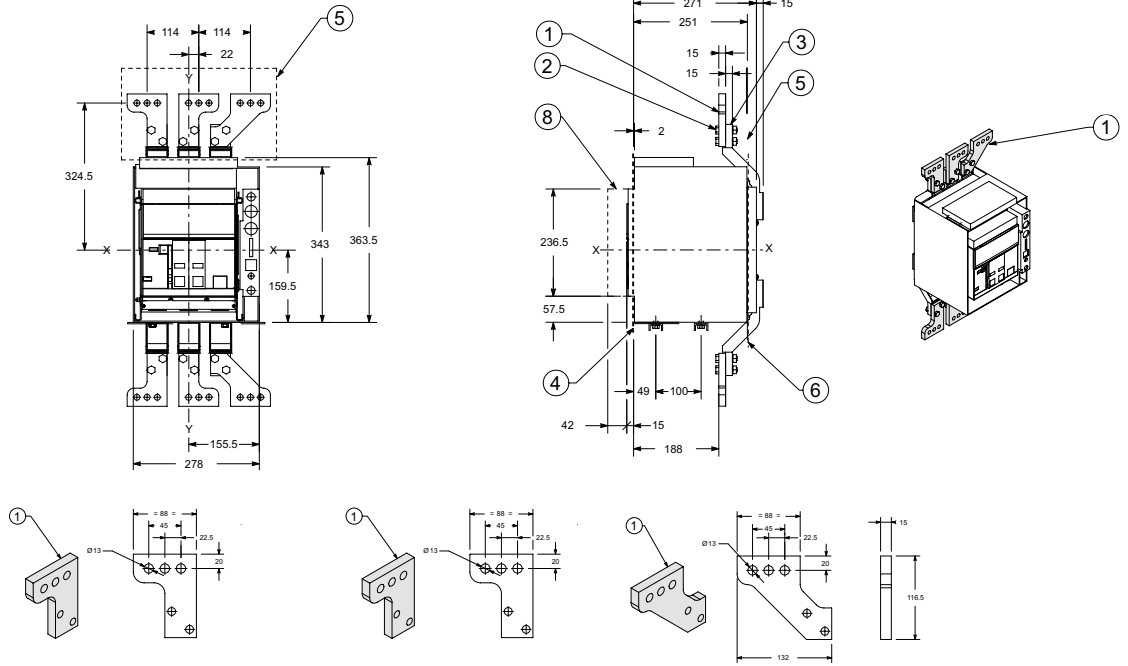

### 4-pole version

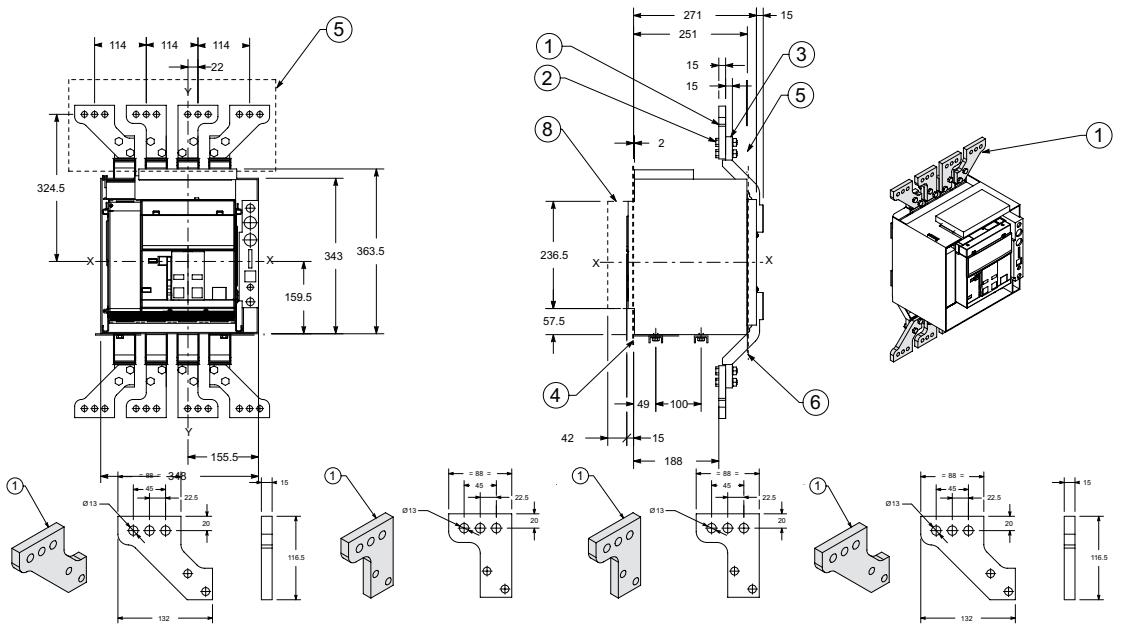

- Key
- 1 Spread terminal
  - 2 Tightening torque 40 Nm
  - 3 Front terminal
  - 4 Door position - Ref. page 7/20
  - 5 Insulating protection (refer to front terminals page 7/23)
  - 6 Rear segregation for front terminals - Ref. page 7/23
  - 8 Sectioning run

### Horizontal rear spread terminals – SHR

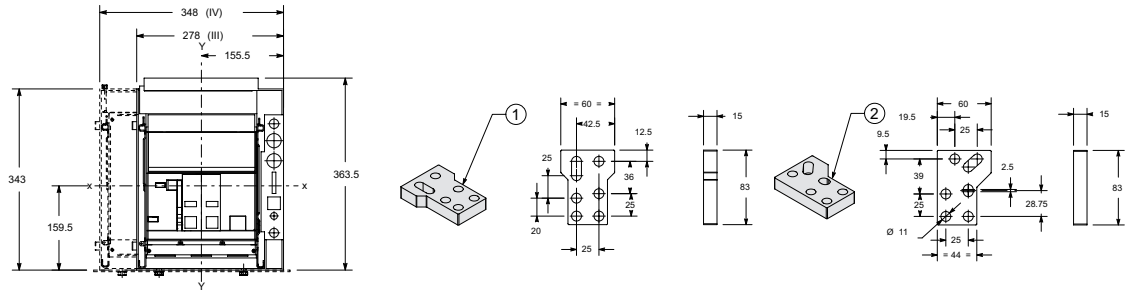

#### 3-pole version

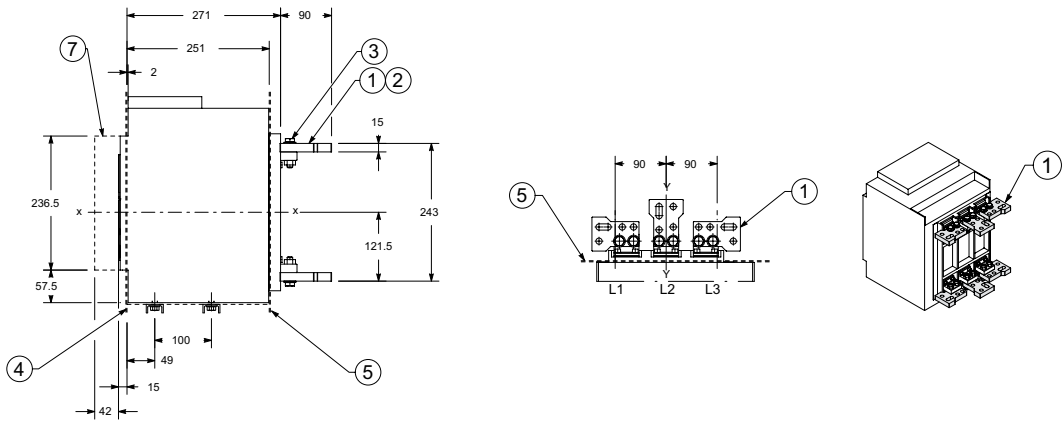

#### 4-pole version

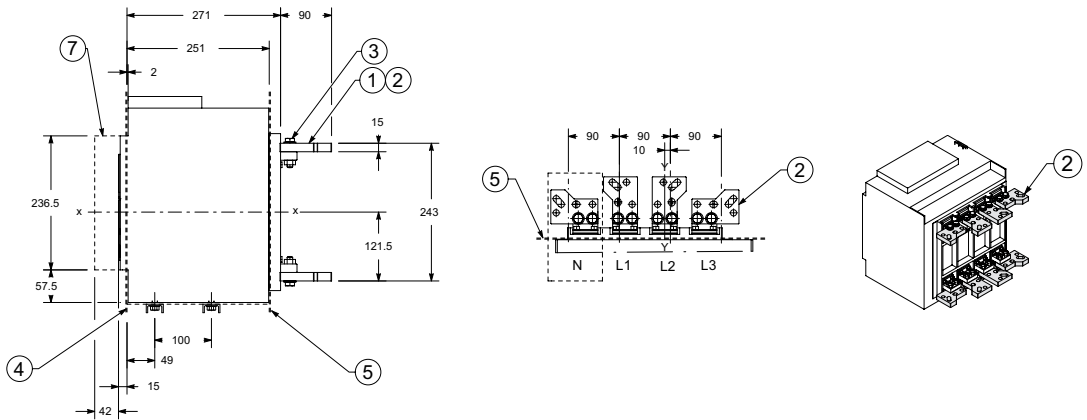

- Key
- 1 Spread rear terminals for 3-pole version
  - 2 Spread rear terminals for 4-pole version
  - 3 Tightening torque 18 Nm
  - 4 Door position - Ref. page 7/20
  - 5 Rear segregation of rear terminals
  - 7 Sectioning run

# Withdrawable circuit-breaker - E2.2

Rear orientable terminals - HR/VR

E2.2 B/N/S/H 2000A

E2.2 N/S/H 2500A

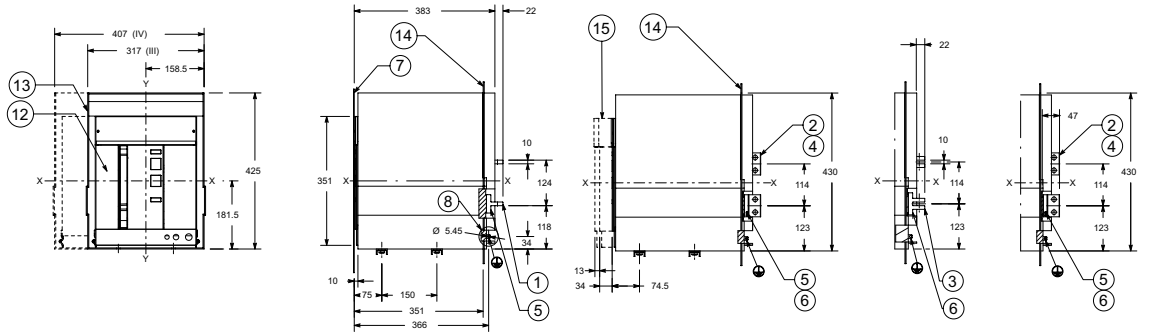

E2.2 B/N/S/H 2000A

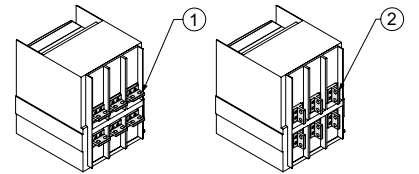
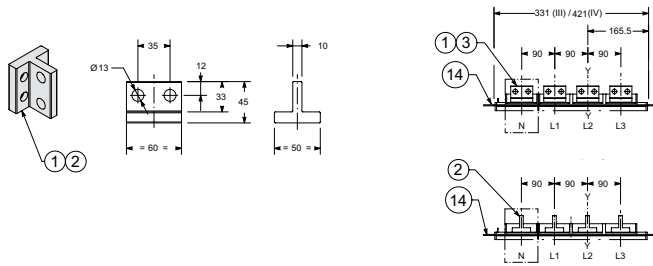

E2.2 N/S/H 2500A

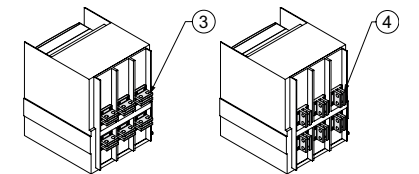
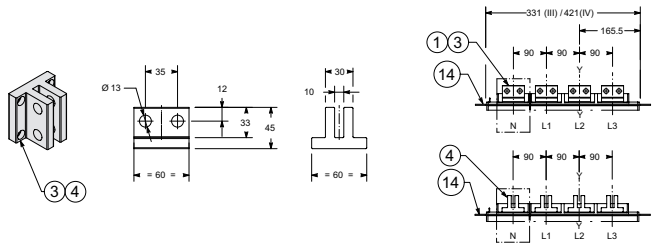

- Key
- 1 Horizontal terminals 2000A
  - 2 Vertical terminals 2000A
  - 3 Horizontal terminals 2500A
  - 4 Vertical terminals 2500A
  - 5 Tightening torque 2000A 8.6Nm
  - 6 Tightening torque 2500A 8.6Nm
  - 7 Door position - Ref. page 7/20
  - 8 Earthing device
  - 12 Mobile part
  - 13 Fixed part
  - 14 Segregation (where envisaged)
  - 15 Distance from connected for testing to isolated



## Front terminals – F

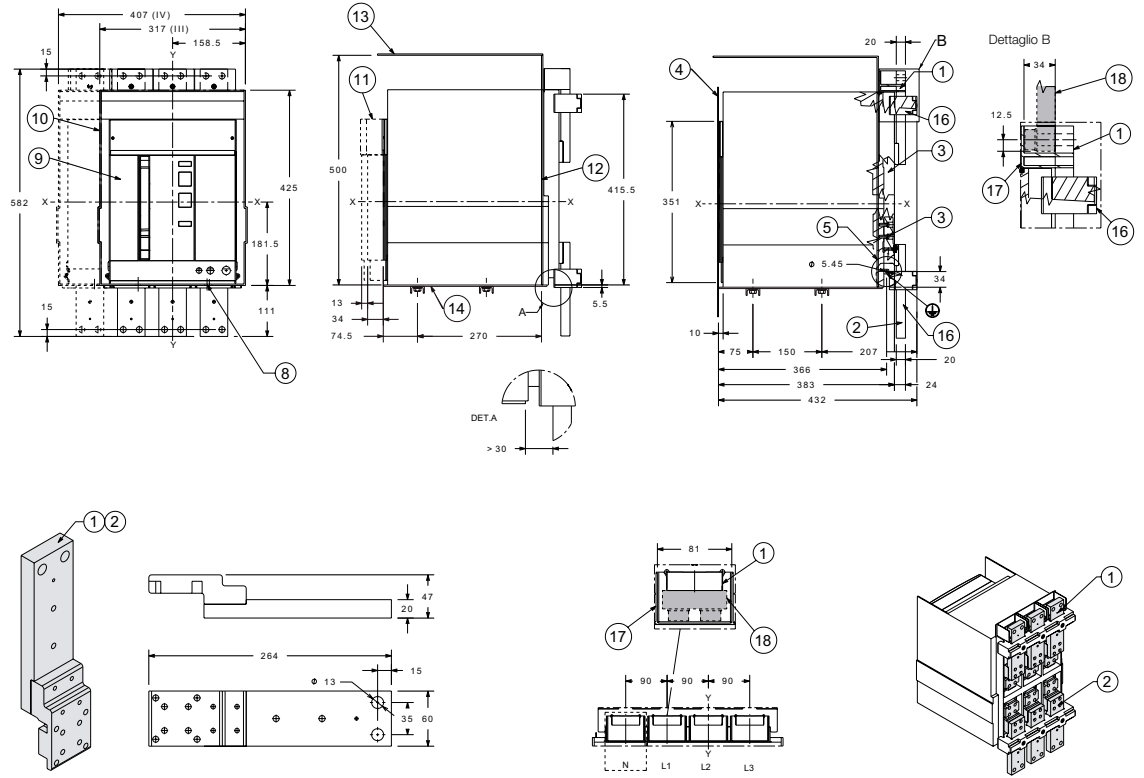

## Key

- 1 Upper front terminals
- 2 Lower front terminals
- 3 Tightening torque 8.6Nm
- 4 Door position - Ref. page 7/20
- 5 Earthing device
- 8 External fixing point  
Recommended screws  
M10x25 high class
- 9 Moving part
- 10 Fixed part
- 11 Connected, test, disconnected distances
- 12 Insulating sheet or insulated metallic sheet
- 13 Roof insulation or insulated metal
- 14 Fixing plate
- 15 Crossbeam front terminal
- 16 Plastic protection
- 17 Customer busbar and screws (not provided)

# Withdrawable circuit-breaker - E2.2

Horizontal rear spread terminals – SHR

E2.2 B/N/S/H 2000A

E2.2 N/S/H 2500A

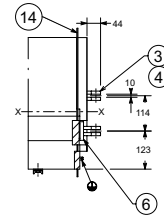
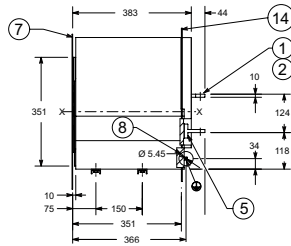
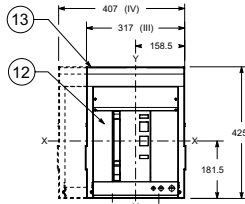

E2.2 B/N/S/H 2000A

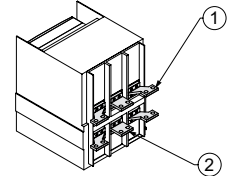
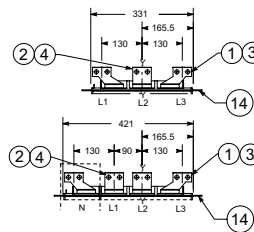
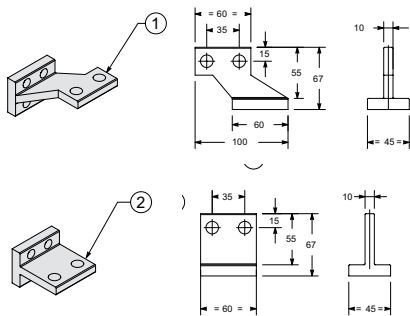

E2.2 N/S/H 2500A

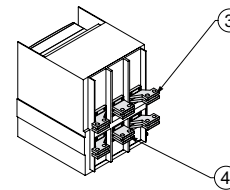
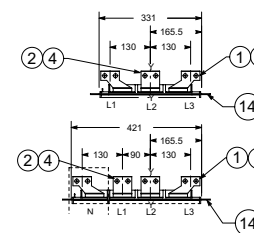
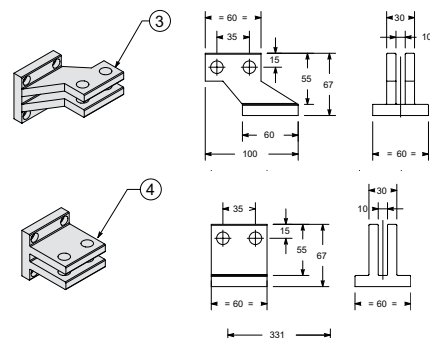

- Key
- 1 Side horizontal splayed terminals 2000A
  - 2 Central horizontal splayed terminals 2000A
  - 3 Side horizontal splayed terminals 2500A
  - 4 Central horizontal splayed terminals 2500A
  - 5 Tightening torque 2000A 8.6Nm
  - 6 Tightening torque 2500A 8.6Nm
  - 7 Door position - Ref. page 7/20
  - 8 Earthing device
  - 12 Mobile part
  - 13 Fixed part
  - 14 Segregation (where envisaged)

Vertical rear spread terminals – SVR

**E2.2 B/N/S/H 2000A**

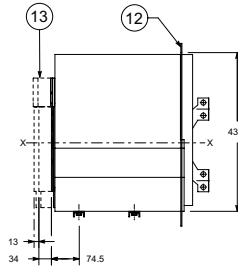
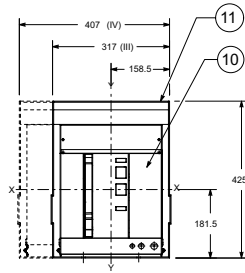

**E2.2 N/S/H 2500A**

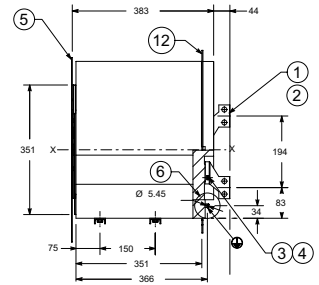

**E2.2 B/N/S/H 2000A**

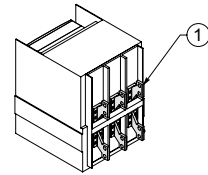
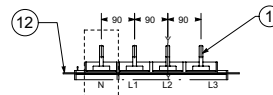
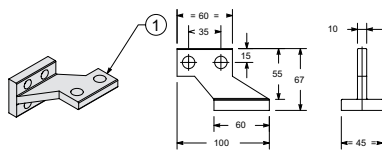

**E2.2 N/S/H 2500A**

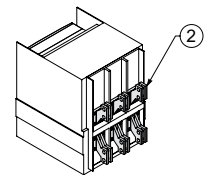
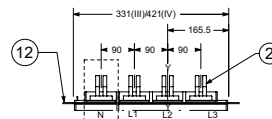
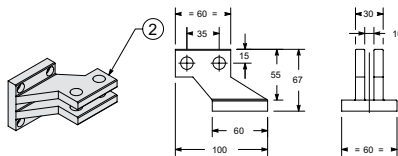

Key

- 1 Vertical splayed terminals 2000A
- 2 Vertical splayed terminals 2500A
- 3 Tightening torque 2000A 8.6Nm
- 4 Tightening torque 2500A 8.6Nm
- 5 Door position - Ref. page 7/20
- 6 Earthing device
- 10 Mobile part
- 11 Fixed part
- 12 Segregation (where envisaged)
- 13 Distance from connected for testing to isolated

# Withdrawable circuit-breaker - E2.2

## Flat terminals

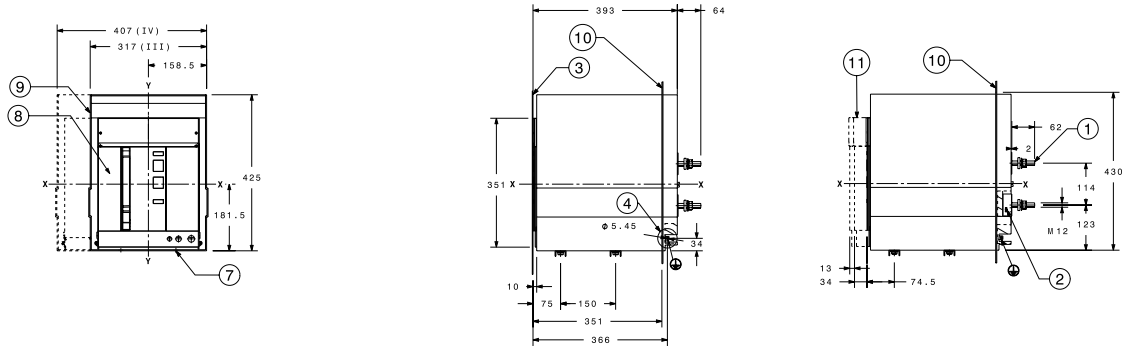

## E2.2 B/N/S/H 2000A

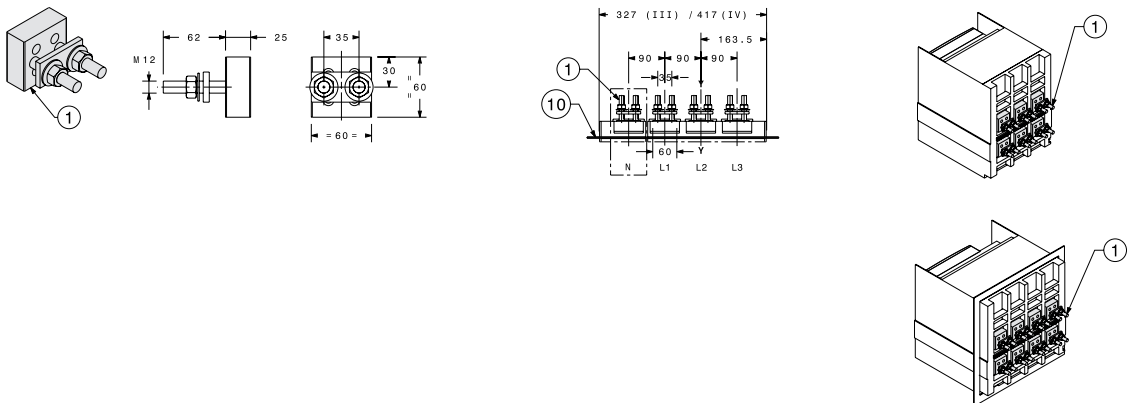

### Key

- 1 Flat terminals 2000A
- 2 Tightening torque  
8.6Nm
- 3 Door position -  
Ref. page 7/20
- 4 Grounding
- 7 Mounting fixed part  
screws provided  
M8x25
- 8 Moving part
- 9 Fixed part
- 10 Segregation (where  
envisaged)
- 11 Connected, test,  
disconnected  
distances

Flat terminals

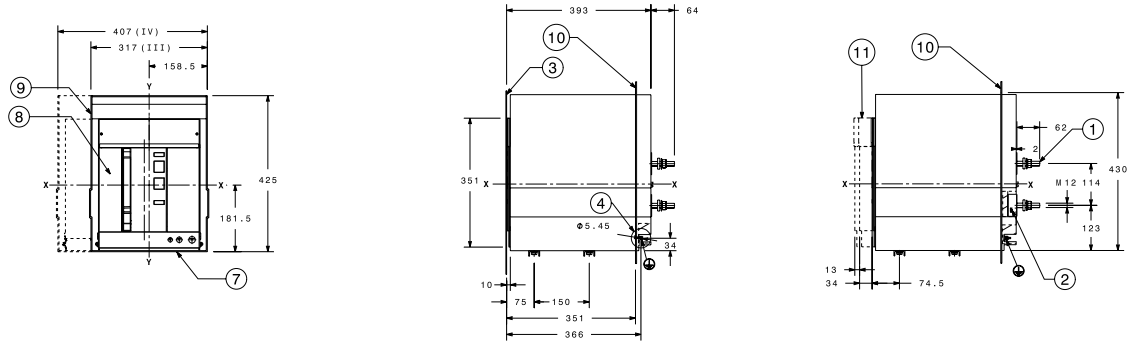

E2.2 N/S/H 2500A

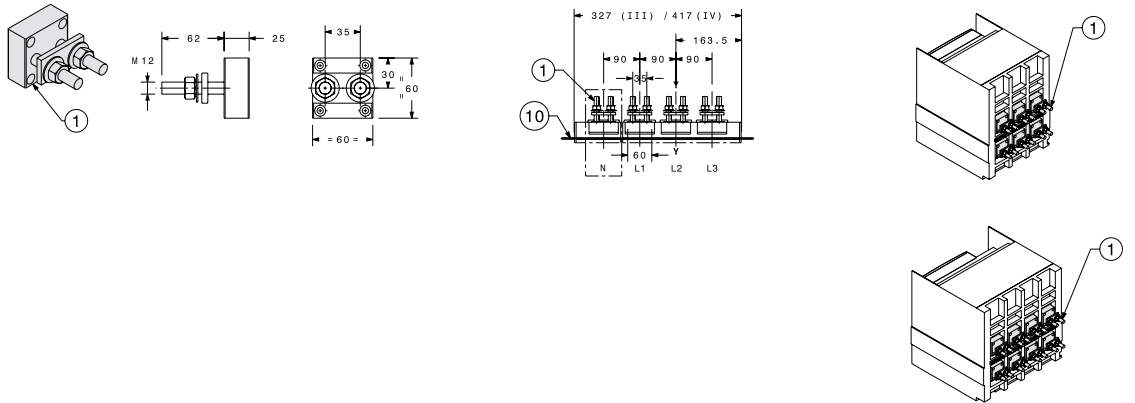

Key

- 1 Flat terminals 2500A
- 2 Tightening torque 8.6Nm
- 3 Door position - Ref. page 7/20
- 4 Grounding
- 7 Mounting fixed part screws provided M8x25
- 8 Moving part
- 9 Fixed part
- 10 Segregation (where envisaged)
- 11 Connected, test, disconnected distances

# Withdrawable circuit-breaker - E4.2

Rear orientable terminals - HR/VR

**E4.2 N/S/H 3200A**

**E4.2 N/S/H 4000A  
E4.2 V 2000...4000A**

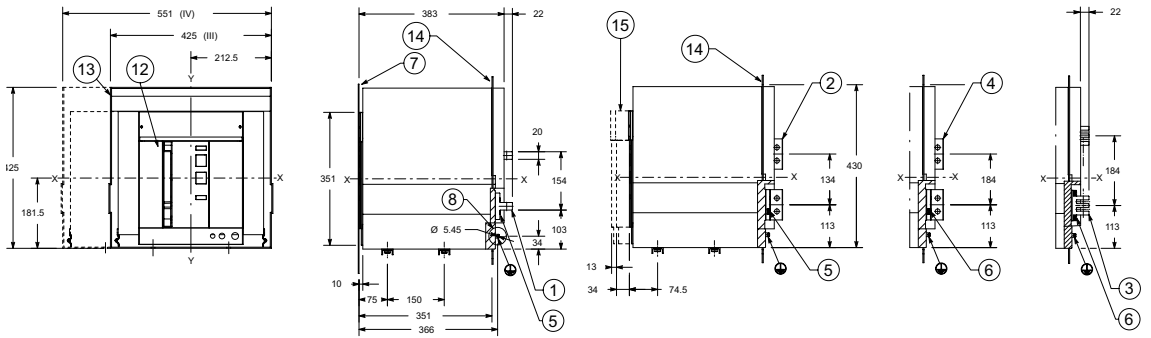

**E4.2 N/S/H 3200A**

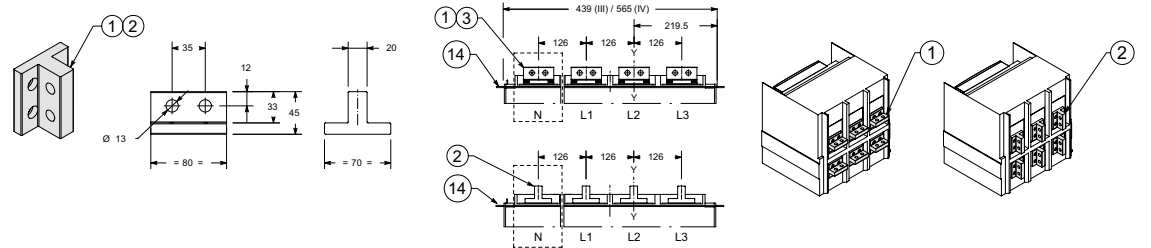

**E4.2 N/S/H 4000A  
E4.2 V 2000...4000A**

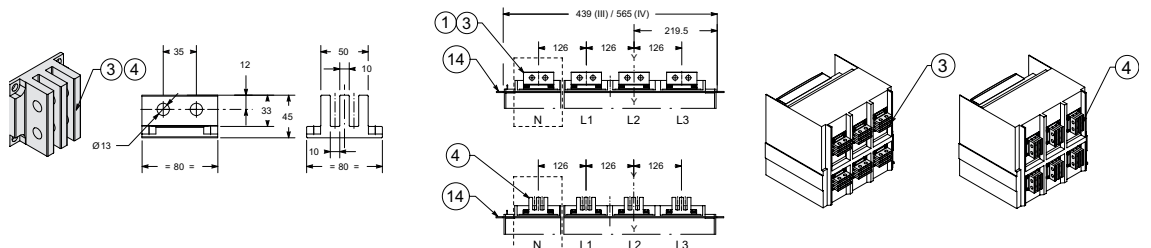

- Key
- 1 Horizontal terminals 3200A
  - 2 Vertical terminals 3200A
  - 3 Horizontal terminals 4000A
  - 4 Vertical terminals 4000A
  - 5 Tightening torque 3200A 20Nm
  - 6 Tightening torque 4000A 20Nm
  - 7 Door position - Ref. page 7/20
  - 8 Earthing device
  - 12 Mobile part
  - 13 Fixed part
  - 14 Segregation (where envisaged)
  - 15 Distance from connected for testing to isolated

Front terminals – F

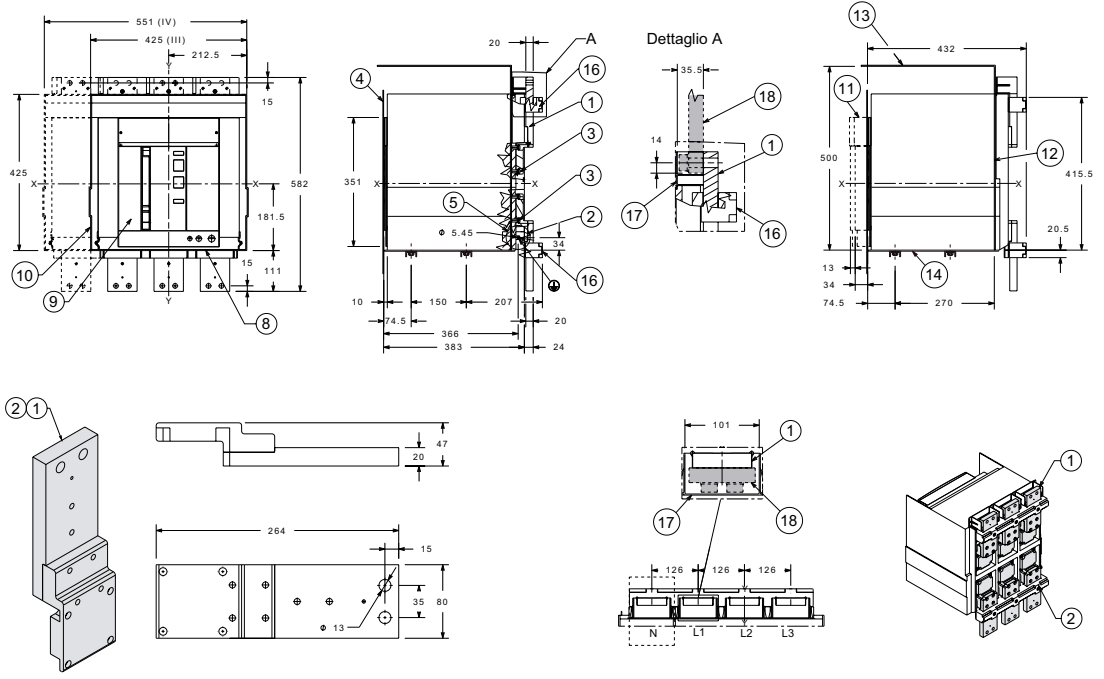

- Key
- 1 Upper front terminals
  - 2 Lower front terminals
  - 3 Tightening torque  
8.6Nm
  - 4 Door position -  
Ref. page 7/20
  - 5 Earthing device
  - 8 External fixing point  
Recommended screws  
M10x25 high class
  - 9 Moving part
  - 10 Fixed part
  - 11 Connected, test,  
disconnected  
distances
  - 12 Insulating sheet or  
insulated metallic sheet
  - 13 Roof insulation or  
insulated metal
  - 14 Fixing plate
  - 15 Crossbeam front  
terminal
  - 16 Plastic protection
  - 17 Customer busbar  
and screws  
(not provided)

# Withdrawable circuit-breaker - E4.2

Horizontal rear spread terminals – SHR

**E4.2 N/S/H 3200A**

**E4.2 N/S/H 4000A**  
**E4.2 V 2000 ... 4000A**

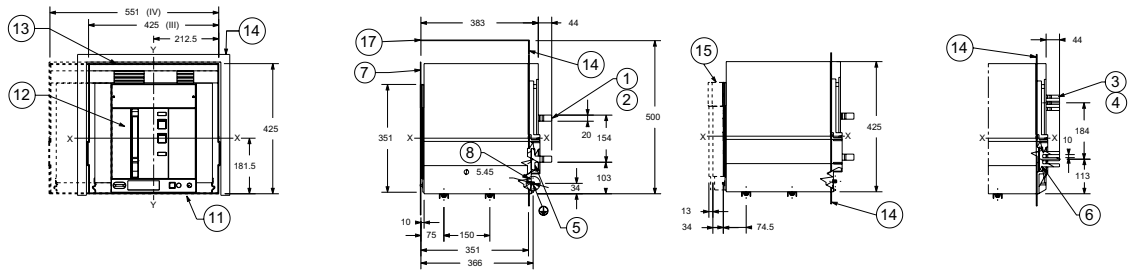

**E4.2 N/S/H 3200A**

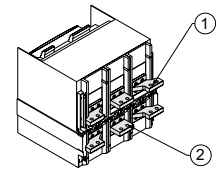
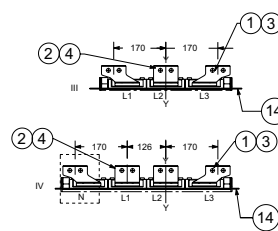
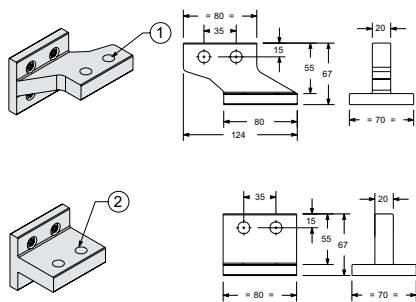

**E4.2 N/S/H 4000A**  
**E4.2 V 2000 ... 4000A**

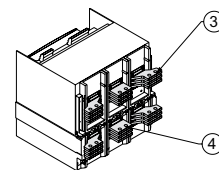
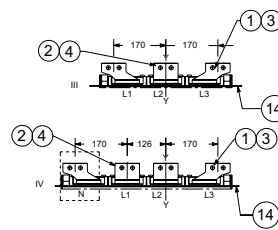
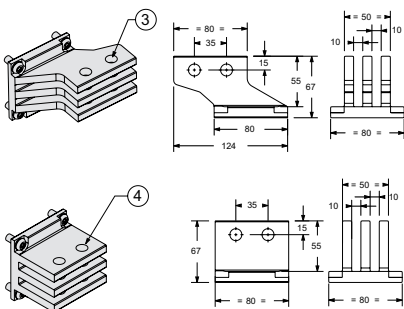

—  
Key

- 1 Side horizontal divaricated terminals 3200A
- 2 Central horizontal divaricated terminals 3200A
- 3 Side horizontal divaricated terminals 4000A
- 4 Central horizontal divaricated terminals 4000A
- 5 Tightening torque 3200A 8.6Nm
- 6 Tightening torque 4000A 8.6Nm
- 7 Door position - Ref. page 7/20
- 8 Grounding
- 11 Mounting fixed part - screws recommend M8x25 high class 8.8 or couple superior Tightening torque 20Nm compulsory fixing screws from high
- 12 Moving part
- 13 Fixed part
- 15 Connected, test, disconnected distances
- 17 Metallic sheet



Vertical rear spread terminals – SVR

**E4.2 N/S/H 3200A**

**E4.2 N/S/H 4000A  
E4.2 V 2000 ... 4000A**

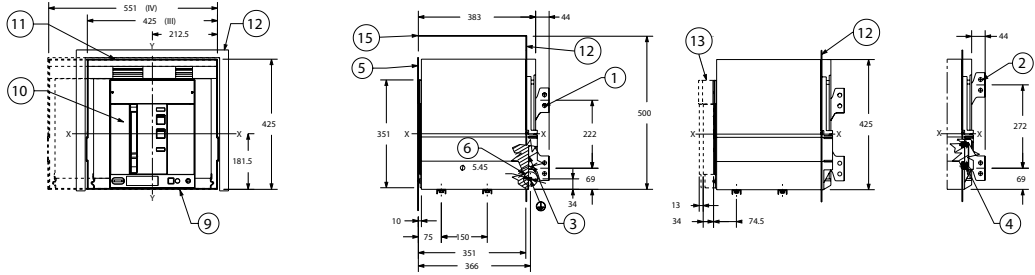

**E4.2 N/S/H 3200A**

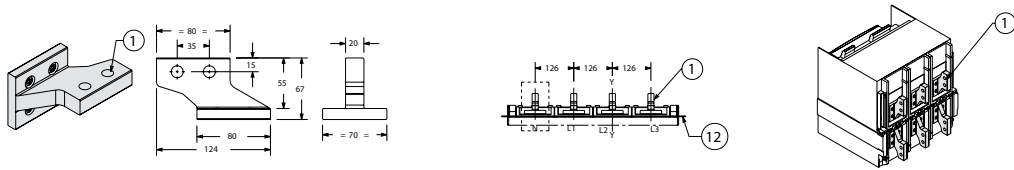

**E4.2 N/S/H 4000A  
E4.2 V 2000 ... 4000A**

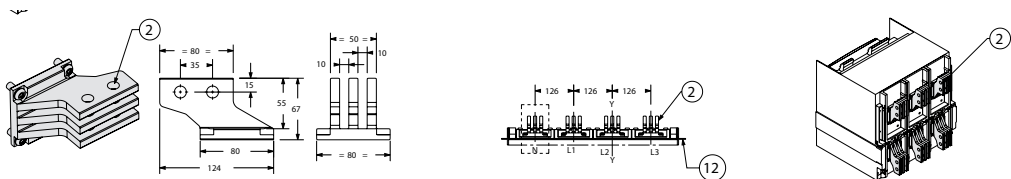

- Key
- 1 Vertical divaricated terminals 3200A
  - 2 Vertical divaricated terminals 4000A
  - 3 Tightening torque 3200A 8.6Nm
  - 4 Tightening torque 4000A 8.6Nm
  - 5 Door position - Ref. page 7/20
  - 6 Grounding
  - 9 Mounting fixed part - screws recommend M8x25 high class 8.8 or couple superior Tightening torque 20Nm compulsory fixing screws from high
  - 10 Moving part
  - 11 Fixed part
  - 12 Metallic segregation (when provided)
  - 13 Connected, test, disconnected distances
  - 15 Metallic sheet

# Withdrawable circuit-breaker - E4.2

## Flat terminals

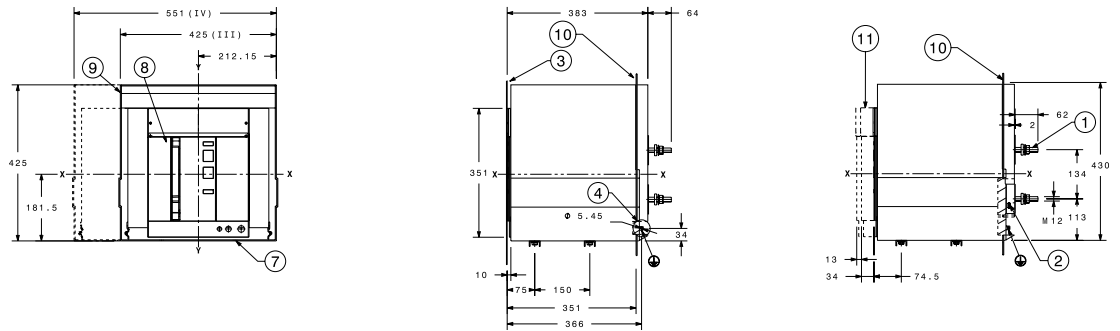

## E4.2 N/S/H 3200A

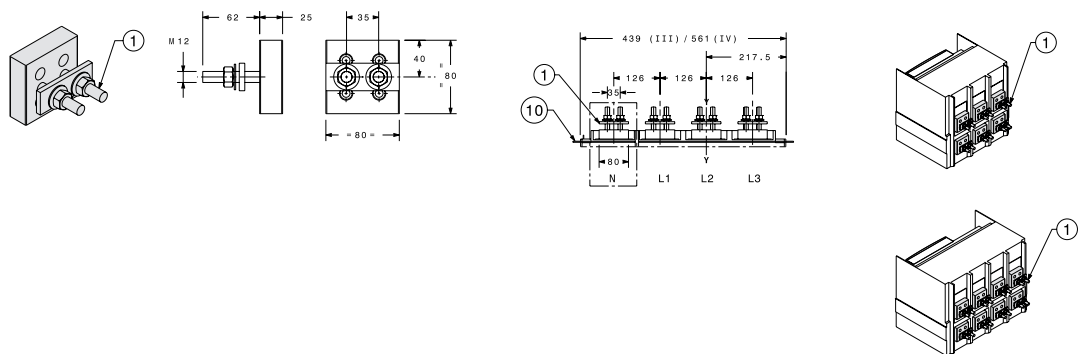

### Key

- 1 Flat terminals 3200A
- 2 Tightening torque  
20Nm
- 3 Door position -  
Ref. page 7/20
- 4 Grounding
- 7 Mounting fixed part  
screws provided  
M8x25
- 8 Moving part
- 9 Fixed part
- 10 Segregation  
(where envisaged)
- 11 Connected, test,  
disconnected  
distances

Flat terminals

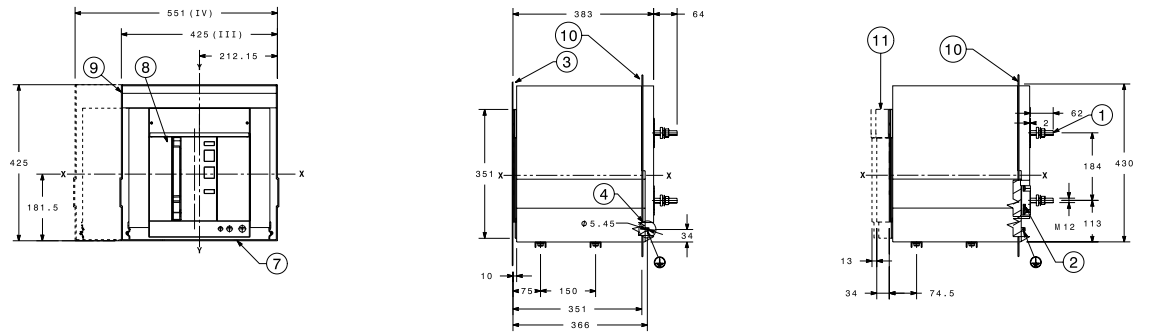

**E4.2 N/S/H 4000A**  
**E4.2 V 2000...4000A**

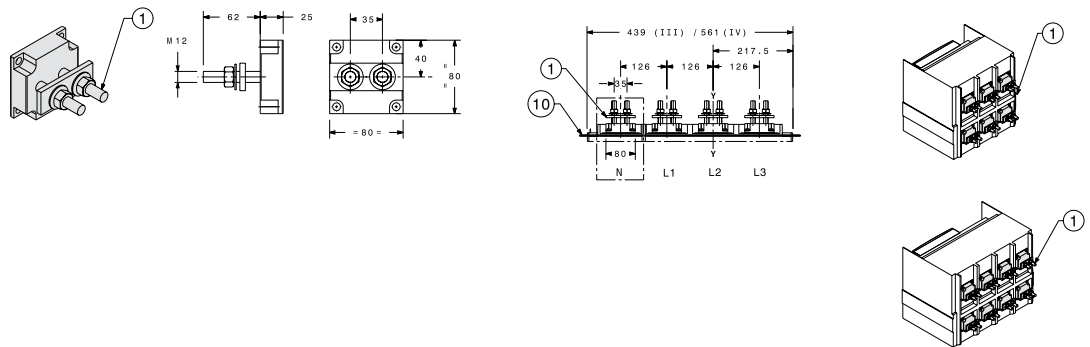

Key

- 1 Flat terminals 4000A
- 2 Tightening torque 20Nm
- 3 Door position - Ref. page 7/20
- 4 Grounding
- 7 Mounting fixed part screws provided M8x25
- 8 Moving part
- 9 Fixed part
- 10 Segregation (where envisaged)
- 11 Connected, test, disconnected distances

# Withdrawable circuit-breaker - E6.2

Horizontal rear terminals – HR

**E6.2 H/V 4000-5000A**

**E6.2 H/V 6300A  
E6.2 X 4000...6300A**

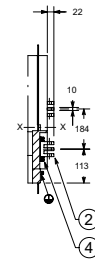
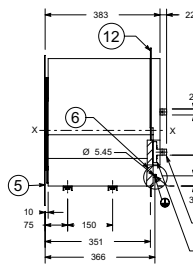
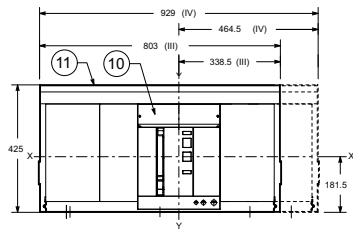

**E6.2 H/V 4000-5000A**

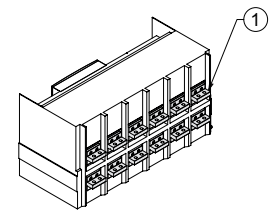
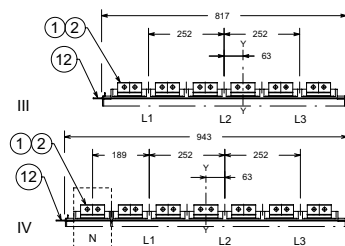
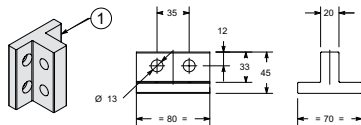

**E6.2 H/V 6300A  
E6.2 X 4000...6300A**

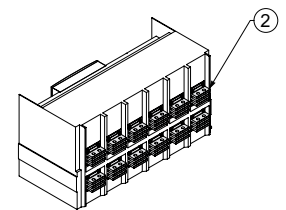
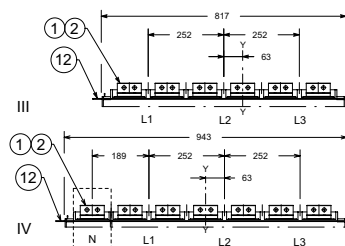
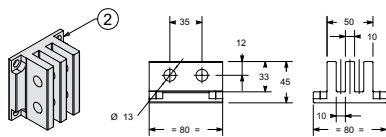

## Key

- 1 Horizontal terminals  
4000-5000A
- 2 Horizontal terminals  
6300A
- 3 Tightening torque  
4000-5000A 20Nm
- 4 Tightening torque  
6300A 20Nm
- 5 Door position -  
Ref. page 7/20
- 6 Earthing device
- 10 Mobile part
- 11 Fixed part
- 12 Segregation  
(where envisaged)

Vertical rear terminals – VR

**E6.2 H/V 4000-5000A**

**E6.2 H/V 6300A  
E6.2 X 4000...6300A**

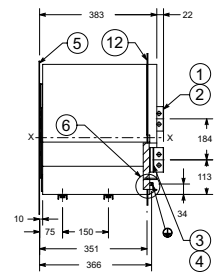
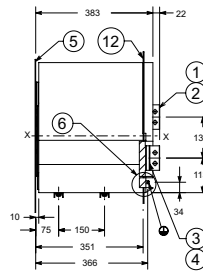
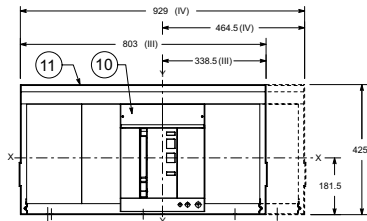

**E6.2 H/V 4000-5000A**

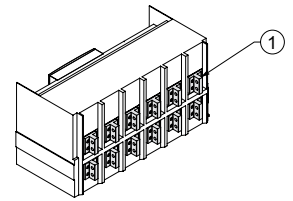
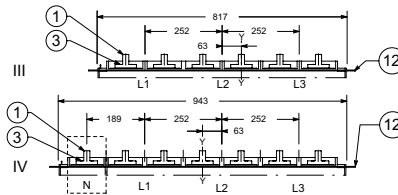
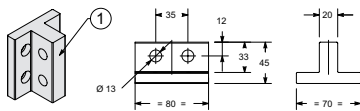

**E6.2 H/V 6300A  
E6.2 X 4000...6300A**

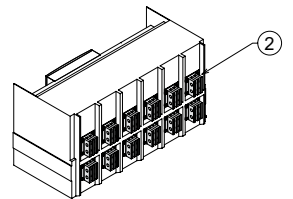
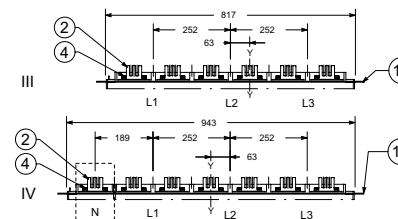
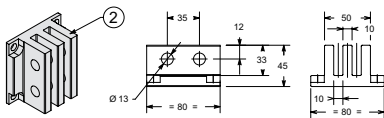

Key

- 1 Vertical terminals 4000-5000A
- 2 Vertical terminals 6300A
- 3 Tightening torque 4000-5000A 20Nm
- 4 Tightening torque 6300A 20Nm
- 5 Door position - Ref. page 7/20
- 6 Earthing device
- 10 Mobile part
- 11 Fixed part
- 12 Segregation (where envisaged)

# Withdrawable circuit-breaker - E6.2

Rear orientable terminals - HR/VR full size

**E6.2 H/V 4000...5000A**

**E6.2 H/V 6300A**  
**E6.2 X 4000...6300A**

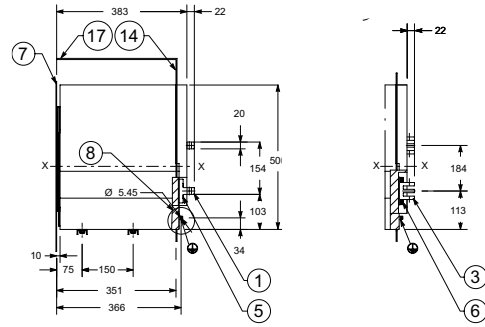
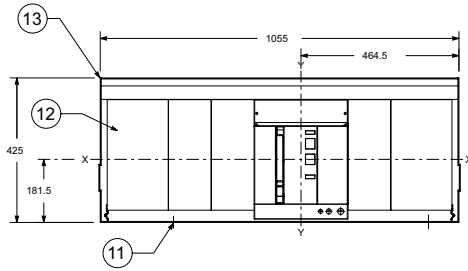

**E6.2 H/V 4000-5000A**

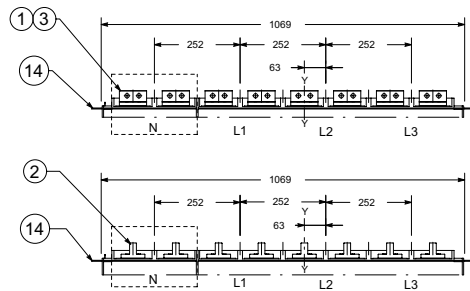
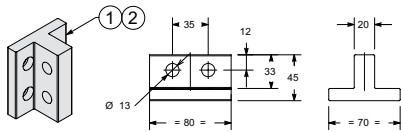

**E6.2 H/V 6300A**  
**E6.2 X 4000...6300A**

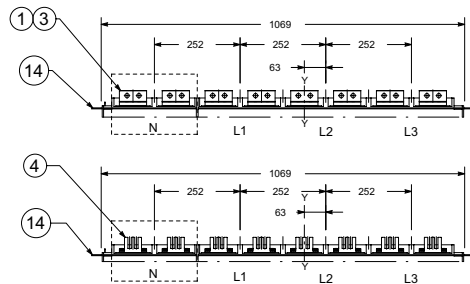
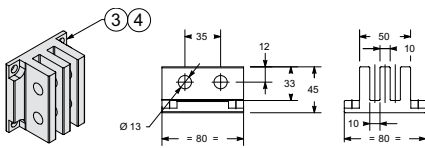

- Key
- 1 Horizontal terminals 4000-5000A
  - 2 Vertical terminals 4000-5000A
  - 3 Horizontal terminals 6300A
  - 4 Vertical terminals 6300A
  - 5 Tightening torque 4000-5000A 20Nm
  - 6 Tightening torque 6300A 20Nm
  - 7 Door position - Ref. page 7/20
  - 8 Earthing device
  - 12 Mobile part
  - 13 Fixed part
  - 14 Segregation (where envisaged)
  - 17 Metallic sheet







---

# Electrical diagrams

- 9/2**      **Reading information**
- 9/7**      **Circuit-breakers**
- 9/8**      **Terminal box E1.2**
- 9/9**      **Terminal box E2.2 - E4.2 - E6.2**
- 9/10**     **Electrical accessories**

# Reading information

## Circuit-breakers

### Operating state shown

The diagram is shown in the following conditions:

- withdrawable version circuit-breaker, open and racked-in
- with de-energized circuits
- trip units not tripped
- motor operator with unloaded springs.

### Versions

The diagram shows a withdrawable version circuit-breaker, but it is also valid for fixed version circuit-breakers.

### Fixed version

The control circuits are included between the XV terminals (the X connector is not supplied).

### Withdrawable version

The control circuits are included between the poles of the X connector (the XV terminal box is not supplied).

### Description of figures

- 1) Supplementary open/closed auxiliary contacts of the circuit-breaker - AUX 6Q (6 Form C)
- 2) Ekip Signalling 4K
  - 11) Trip signalling contact
  - 12) Contact for signalling position of loaded springs - S33 M/2
  - 13) Motor for loading closing springs- M
  - 14) Remote reset - YR
- 20) Measurement Enabler/Measurement Enabler with voltage sockets inside the four-pole circuit breaker
- 21) Measurement Enabler/Measurement Enabler with voltage sockets inside the three-pole circuit breaker and connection to the external neutral
- 22) Measurement Enabler/Measurement Enabler with voltage sockets for residual voltage protection (for Ekip G only)
- 23) Measurement Enabler/Measurement Enabler with voltage sockets with external voltage transformer
- 24) Rc residual current protection sensor input
- 25) Transformer star center sensor input
- 26) Zone selectivity
- 27) Current sensor input on external neutral (only for 3-pole circuit-breakers)
- 31) Direct auxiliary supply 24V DC and local bus - Ekip Supply
- 32) Auxiliary supply through module 110-240V AC/DC or 24-48V DC and local bus - Ekip Supply
- 41) Ekip signalling 2K-1
- 42) Ekip signalling 2K-2
- 43) Ekip signalling 2K-3
- 48) Ekip sinchrocheck
- 51) Ekip COM Modbus RS-485
- 52) Ekip COM Modbus TCP
- 53) Ekip COM Profibus
- 54) Ekip COM Profinet
- 55) Ekip COM EtherNet/IP™
- 56) Ekip COM EtherNet/IP™
- 57) Ekip COM IEC61850
- 58) Ekip LINK
- 59) Ekip Com Hub
- 61) Ekip COM R Modbus RS-485 Redundant
- 62) Ekip COM R Modbus TCP Redundant
- 63) Ekip COM R Profibus Redundant
- 64) Ekip COM R Profinet Redundant
- 65) Ekip COM R DeviceNet™ Redundant
- 66) Ekip COM R EtherNet/IP™ Redundant
- 71) Ready to close contact - RTC
- 72) Second opening coil - YO2
- 73) Undervoltage coil - YU
- 74) Undervoltage coil with external time-lag device - YU, D
- 75) First opening coil - YO
- 76) First opening coil with control from protection trip unit - YO, Ekip Com Actuator
- 77) First closing coil - YC
- 78) First closing coil with control from protection trip unit - YC, Ekip Com Actuator
- 79) Second closing coil - YC2

- 81) Open/closed auxiliary contacts of circuit-breaker - AUX 4Q (4 Form C)
- 91) External supplementary open/closed auxiliary contacts of circuit-breaker - AUX 15Q (15 Form C)
- 95) Contacts for signalling of circuit-breaker in racked-in, test, racked-out position
- 96) Contacts for signalling of circuit-breaker in racked-in, test, racked-out position (first set)
- 97) Contacts for signalling of circuit-breaker in racked-in, test, racked-out position (second set)
- 97A) Contacts for signalling of circuit-breaker in

# Reading information

## Circuit-breakers

<b>Key</b>			
*	= See the note indicated by the letter	Q/1...Q/25	= Auxiliary contacts of circuit- breaker
A1	= Applications located on the mobile part of the circuit-breaker	Q/26...Q/27	= Auxiliary open/close contacts used internally by the trip unit
A3	= Applications located on the fixed part of the circuit-breaker	RC	= RC (residual current) protection sensor
A4	= Indicative devices and connections for control and signalling, outside the circuit-breaker	RT1...RT3	= Temperature sensors
BUS1	= Serial interface with external bus	RTC EKIP	= Auxiliary ready to close contact of circuit-breaker, used internally by the trip unit
D	= Electronic time-lag device of YU undervoltage coil, outside the circuit-breaker	RTC	= Contact for signalling circuit-breaker is ready to close
F1	= Time-delayed trip fuse	S33M/1...2	= Limit contacts of spring loading motor
GZi(DBi)	= Zone selectivity input for G protection or input in "reverse" direction for D protection	S43	= Switch for presetting remote/local control
GZo(DBo)	= Zone selectivity output for G protection or output in "reverse" direction for D protection	S51	= Trip signalling contact
I O1...32	= Programmable digital inputs of the EKIP protection trip unit	S75E/1...4	= Contacts for signalling circuit-breaker in racked-out position (provided only with withdrawable version)
K51	= Electronic overcurrent protection trip unit of the types: EKIP DIP, EKIP TOUCH, EKIP LCD, EKIP HI-TOUCH , EKIP HI-LCD, EKIP G TOUCH, EKIP G LCD, EKIP G HI-TOUCH , EKIP G HI-LCD	S75I/1...5	= Contacts for signalling circuit-breaker in racked-in position (provided only with withdrawable version)
K51/COM	= Communication module	S75T/1...2	= Contact for signalling circuit-breaker in test position (provided only with withdrawable version)
K51/MEAS	= Measurement module	SC	= Pushbutton or contact for closing the circuit-breaker
K51/SIGN	= Signalling module	SO	= Pushbutton or contact for immediate opening of the circuit-breaker
K51/SUPPLY	= Optional auxiliary supply module (110-220VAC/DC and 24-48VDC)	SO1	= Pushbutton or contact for opening the circuit-breaker with time-delayed trip
K51/SYNC	= Synchronization module	SR	= Pushbutton or contact for electrical resetting of S51trip contact
K51/YC	= Closing control from the EKIP protection trip unit	SZi(DFi)	= Input for zone selectivity for S protection or input in "direct" direction for S protection
K51/YO	= Opening control from the EKIP protection trip unit	SZo(DFo)	= Output for zone selectivity for S protection or output in "direct" direction for D protection
M	= Motor for loading closing springs		
O 01...32	= Programmable signalling contacts of the EKIP protection trip unit		
O SC	= EKIP protection trip unit contact for synchronism control		
Q	= Circuit-breaker		

TI/L1	= Current transformer phase L1
TI/L2	= Current transformer phase L2
TI/L3	= Current transformer phase L3
TI/N	= Current transformer on neutral
TU1...TU2	= Insulation voltage transformer (outside circuit-breaker)
Uaux	= Auxiliary supply voltage
UI/L1	= Current sensor phase L1
UI/L2	= Current sensor phase L2
UI/L3	= Current sensor on phase L3
UI/N	= Current sensor on neutral
UI/O	= Single-pole current sensor
W2	= Serial interface with internal bus (local bus)
W9...W13	= RJ45 connector for communication modules
W9R.W11R	= RJ45 connector for redundant communication modules
X	= Delivery connector for auxiliary cir- cuits for withdrawable version of circuit-breaker
XB1...XB7	= Connectors for circuit-breaker applications
XF	= Delivery terminal board for position contacts of withdrawable version of circuit-breaker
XK1...XK3	= Connectors for auxiliary circuits of the EKIP protection trip unit
XK7	= Connector for auxiliary circuits of communication module
XV	= Delivery terminal box for auxiliary circuits of fixed version circuit- breaker
YC	= Closing coil
YC2	= Second closing coil
YO	= Opening coil
YO1	= Opening coil for overcurrent
YO2	= Second opening coil
YR	= Coil for electrical resetting of trip contact S51
YU	= Undervoltage coil

# Reading information

## Circuit-breakers

### Notes

- A) Auxiliary supply for Ekip trip unit is mandatory (refer to diagram 1SDM00009R0001 figures 31 - 32- 33 - 34).
- B) When there are mixed auxiliary contacts Q1 and Q2 are 400V, while Q3 and Q4 are 24V. Then Q5, Q6, Q7 are 400V, while Q8, Q9, Q10 are 24V.
- C) Always supplied with Ekip Com module.
- D) Always supplied with motor for loading closing springs in Fig. 13.
- E) Obligatory voltage transformer in the case of external sockets. Obligatory external sockets for systems with rated voltage greater than 690V.
- F) The connections between the RC residual current protection sensor and the poles of the X connector (or XV) of the circuitbreaker must be made with 4-pole shielded cable with conductors interwoven in pairs (type BELDEN 9696 paired or equivalent), of a length no greater than 10 m. The shield should be earthed on circuit-breaker side.
- G) With all electronic protection trip units equipped with display interface with LSIG protections, protection against an earth fault is available (Gext) by means of current sensor positioned on the star centre of the MV/LV transformer. The connection between terminals 1 and 2 of the UI/O current transformer and Ge+ and Ge- poles of the X connector (or XV) must be made with shielded and stranded 2-pole cable (type BELDEN 9841 or equivalent) of length no greater than 15 m.
- H) The connection between the terminal box and external neutral sensor must be made with the 2m cable provided. For three pole circuit-breakers, the Ne+ and Ne- poles of the X connector (or XV) must be short-circuited if no sensor is present on the external neutral conductor.
- I) Obligatory in the case of the presence of any Ekip module.
- J) Only for E2.2, E4.2 and E6.2 withdrawable version circuit-breakers as an alternative to Fig. 31-32-34.
- K) Only for E2.2, E4.2 and E6.2 withdrawable version circuit-breakers as an alternative to Fig. 31-32-33.
- K) Only for E2.2, E4.2 and E6.2 withdrawable version circuit-breakers as an alternative to Fig. 31-32-33.
- L) In the presence of Fig. 32, for E2.2, E4.2 and E6.2 circuit-breakers up to three applications between Fig. 41...58 taken only once can be supplied, instead for E1.2 circuit-breakers, up to two applications between Fig. 41...58 taken only once can be supplied. The Ekip Com module selected can be duplicated if required, by choosing between Fig. 61...66.
- M) In the presence of Fig. 33, for E2.2, E4.2 and E6.2 circuit-breakers, up to two applications between Fig. 41...58 taken only once can be supplied. The Ekip Com module selected can be duplicated if required, by choosing between Fig. 61...66.
- N) In the presence of Fig. 34, for E2.2, E4.2 and E6.2 circuit-breakers, a single application between Fig. 41...58 can be supplied.
- O) In the presence of several Ekip Com modules with withdrawable version circuit-breakers, the contact S751/5 should be connected only once to a single module.
- P) The auxiliary voltage Uaux. enables activation of all the functions of the EKIP electronic protection trip units. Since an earth insulated Uaux was requested, it is necessary to use "galvanically separated convertors" which comply with the standards IEC 60950 (UL 1950) or equivalent, which guarantee a common mode current or leakage current (refer to IEC 478/1, CEI 22/3) no greater than 3.5mA, IEC 60364-41 and CEI 64-8.
- Q) Regarding local bus the maximum cable length is 15m.
- R) Suggested RJ45 cable: CAT6 STP.
- T) Connect terminals 120  $\Omega$  on if you want to insert a termination resistance on the Local Bus.

# Circuit-breakers (IEC60617 standards)

3-pole or 4-pole circuit-breaker

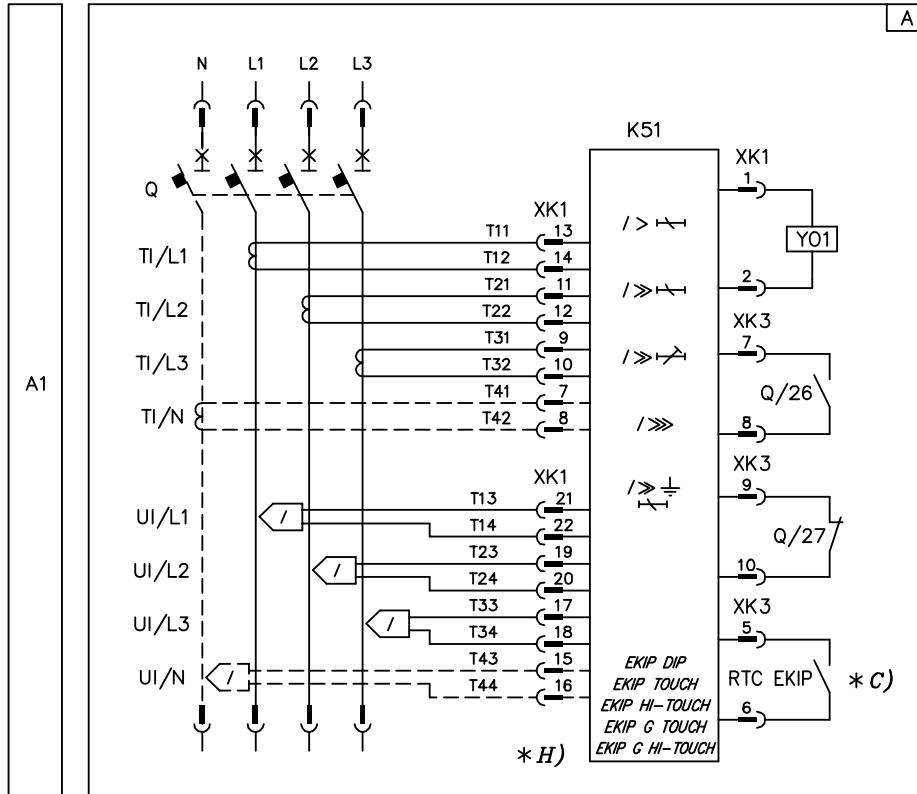

3-pole or 4-pole switch-disconnector

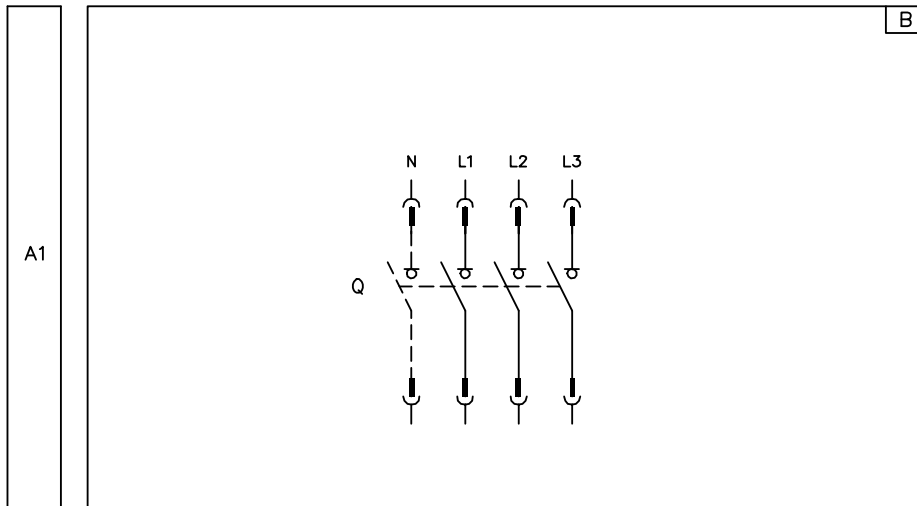

# Terminal box E1.2

Diagram figure number n

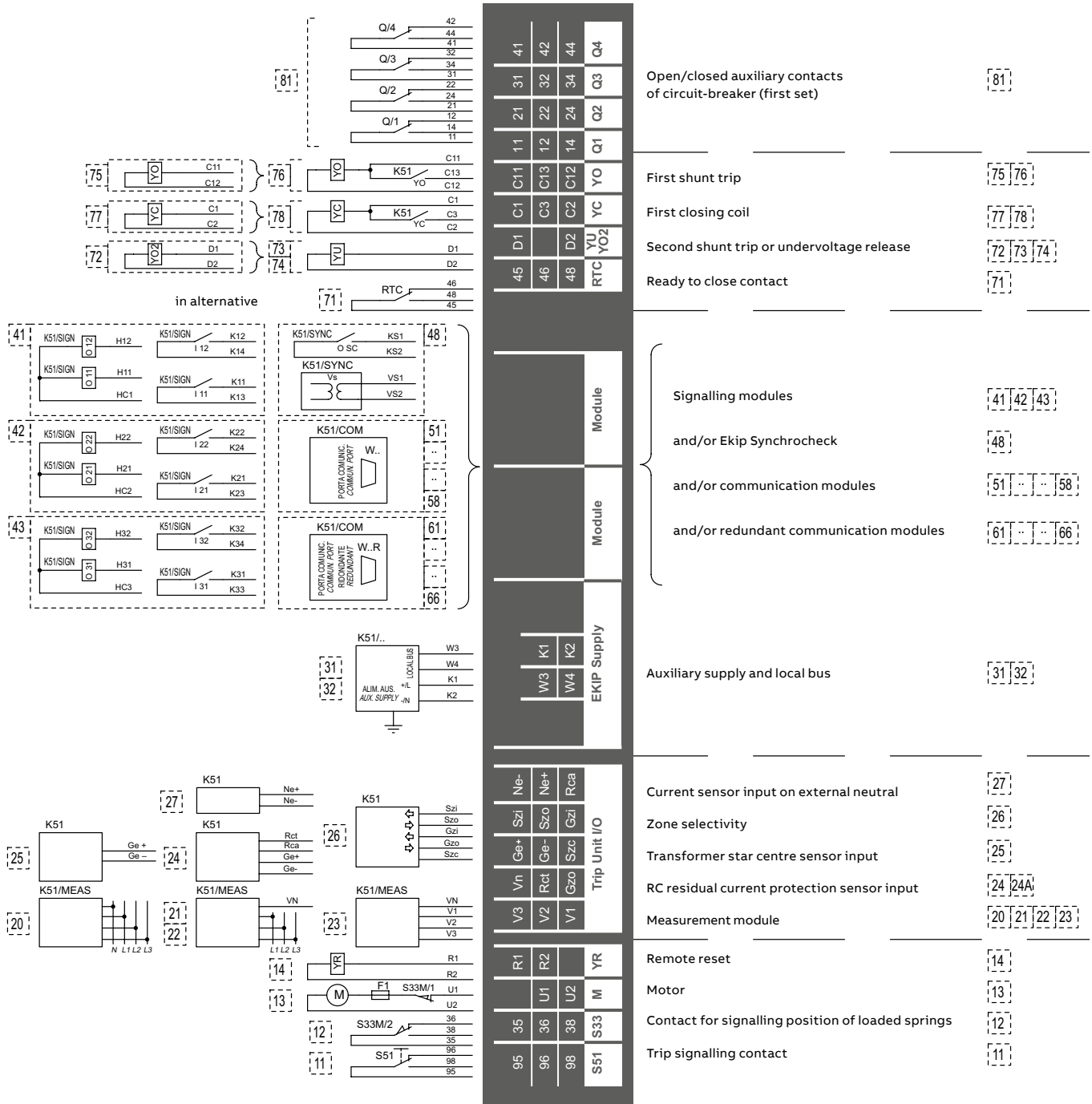





# Electrical accessories

51	61	71	81	91	01	95	35	R1	V3	Vn	Ge+	Szi	Ne-	45	D1	C1	C11	C21	11	21	31	41	
52	62	72	82	92	02	96	36	U1	R2	V2	Rct	Ge-	Szo	Ne	46		C3	C13		12	22	32	42
54	64	74	84	94	04	98	38	U2		V1	Gzo	Szc	Gzi	Rca	48	D2	C2	C12	C22	14	24	34	44
55..Q10	EKIP Signalling 4K	S51	S33	M	YR										RTC	YU	YC	YO	YC2	Q1	Q2	Q3	Q4

11	21	31	41
12	22	32	42
14	24	34	44
Q1	Q2	Q3	Q4

## 81) Open/closed auxiliary contacts of circuit-breaker - AUX 4Q (4 Form C)

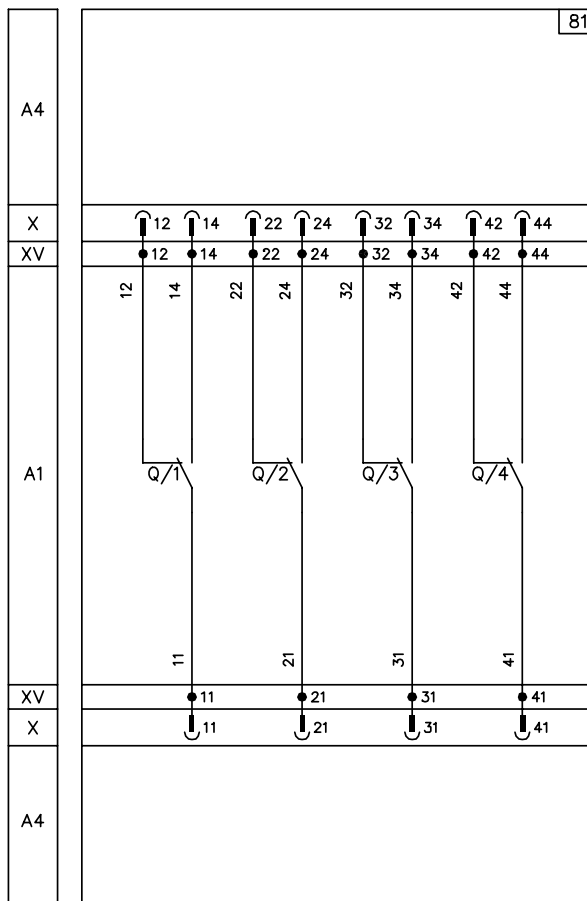

\*B)

51	61	71	81	91	01	95	35	R1	V3	Vn	Ge+	Szi	Ne-	45	D1	C1	C11	C21	11	21	31	41			
52	62	72	82	92	02	96	36	U1	R2	V2	Rct	Ge-	Szo	Ne	46		C3	C13		12	22	32	42		
54	64	74	84	94	04	98	38	U2		V1	Gzo	Szc	Gzi	Rca	48	D2	C2	C12	C22	14	24	34	44		
Q5..Q10 EKIP Signalling 4K						S51	S33	M	YR	Trip Unit I/O				EKIP Supply		Module		Module		Module		Module			
										W3 K1		W4 K2													

45	D1	C1	C11	C21
46		C3	C13	
48	D2	C2	C12	C22
RTC	YU YO2	YC	YO	YC2

**77) First closing coil - YC**

**78) First closing coil with control from protection trip unit - YC, Ekup Com Actuator**

**79) Second closing coil - YC2**

77- 78 as an alternative to each other

79 valid only for E2.2 - E4.2 - E6.2

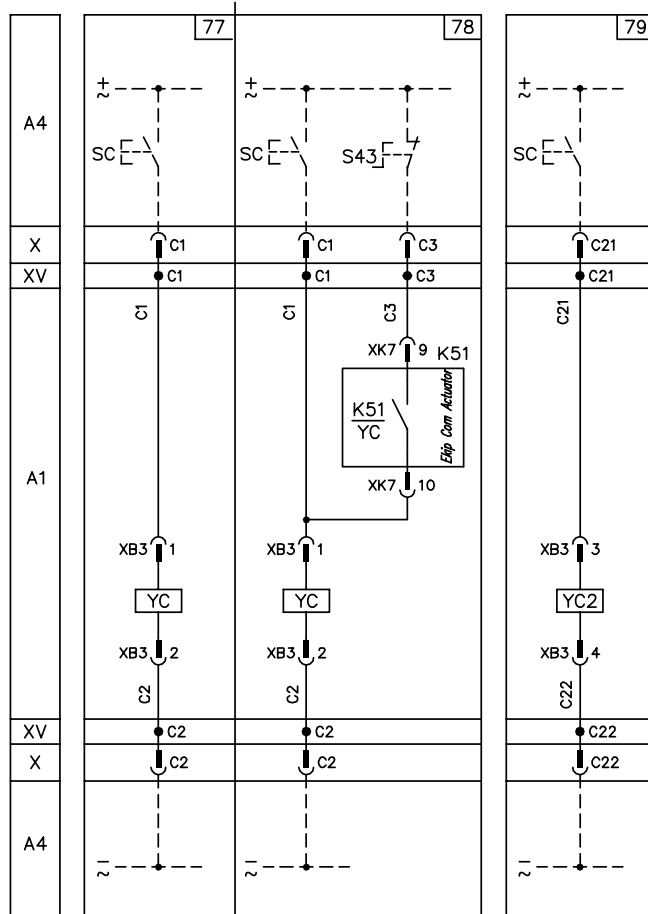

\*M)

# Electrical accessories

51	61	71	81	91	01	95	35	R1	V3	Vn	Ge+	Szi	Ne-	45	D1	C1	C11	C21	11	21	31	41					
52	62	72	82	92	02	96	36	U1	R2	V2	Rct	Ge-	Szo	Ne	46		C3	C13		12	22	32	42				
54	64	74	84	94	04	98	38	U2		V1	Gzo	Szc	Gzi	Rca	48	D2	C2	C12	C22	14	24	34	44				
Q5...Q10 EKIP Signalling 4K										S51 S33 M YR			Trip Unit I/O			W3 K1		W4 K2		Module		Module		Module		RTC YU YO2 YC YO YC2 Q1 Q2 Q3 Q4	

45	D1	C1	C11	C21
46		C3	C13	
48	D2	C2	C12	C22
RTC	YU YO2	YC	YO	YC2

75) First opening coil - YO

76) First opening coil with control from protection trip unit - YO, Ekip Com Actuator

75-76 as an alternative to each other

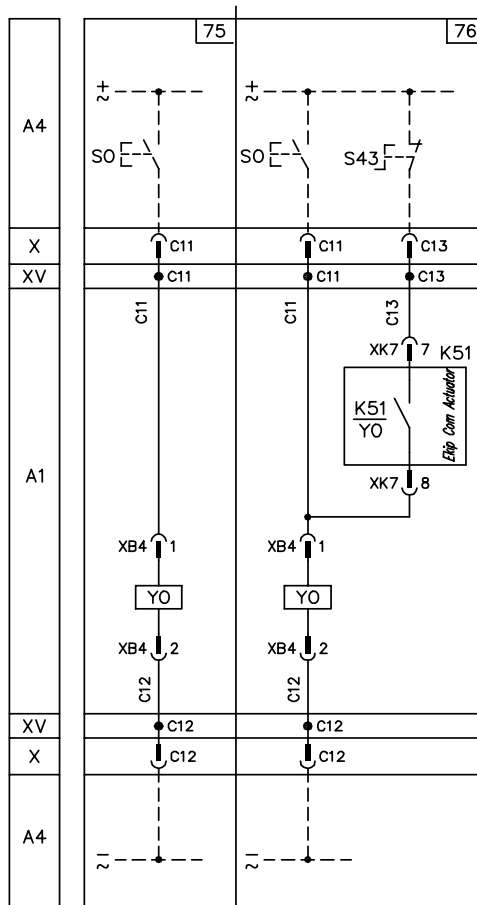

\*M)

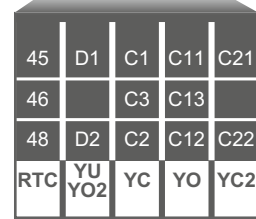

- 71) Ready to close signalling contact - RTC
- 72) Second opening coil - YO2
- 73) Undervoltage coil - YU
- 74) Undervoltage coil with external time-lag device - YU, D

72-73 or 74 as an alternative to each other

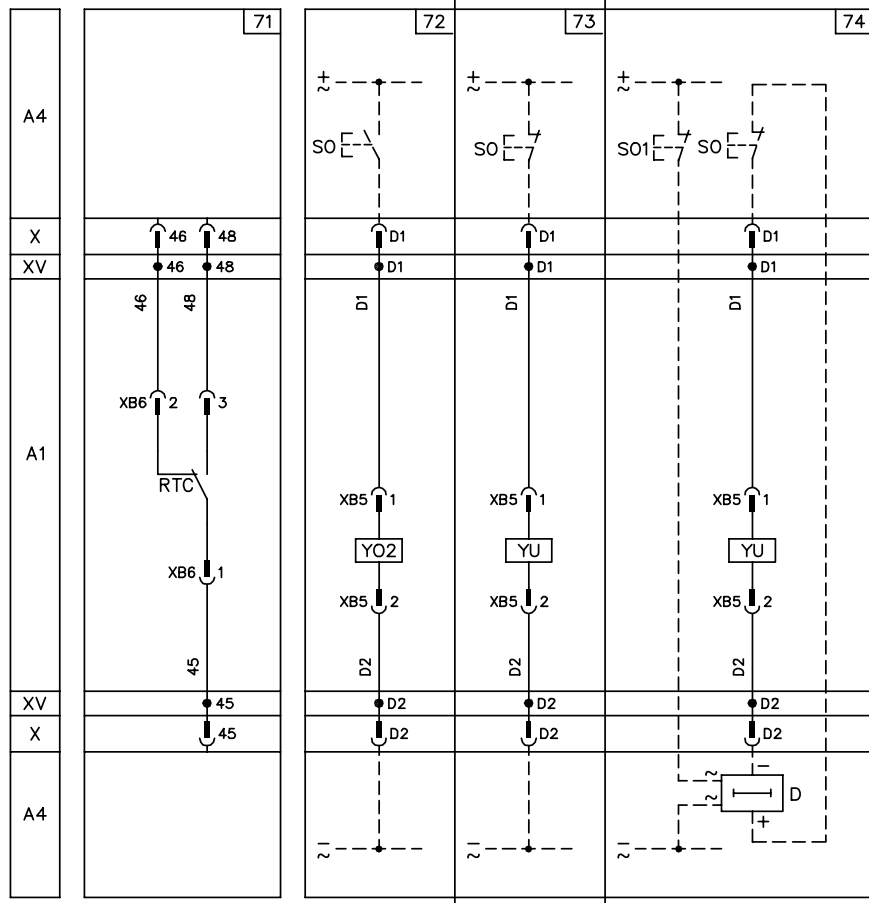

# Electrical accessories

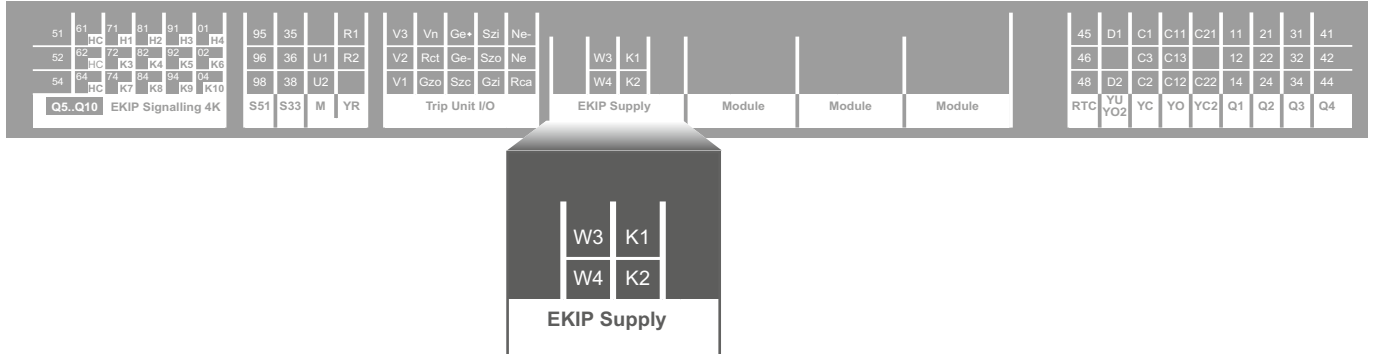

## 32) Auxiliary supply through module 110-240V AC/DC or 24-48V DC and local bus - Ekip Supply

As an alternative to figures 31

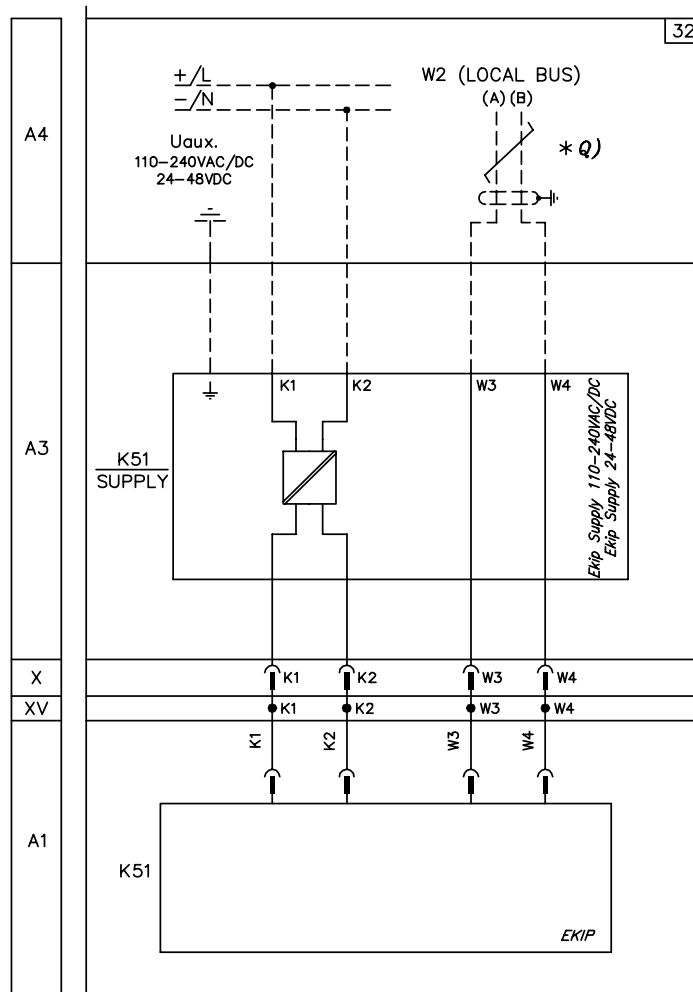

\*A) \*I)

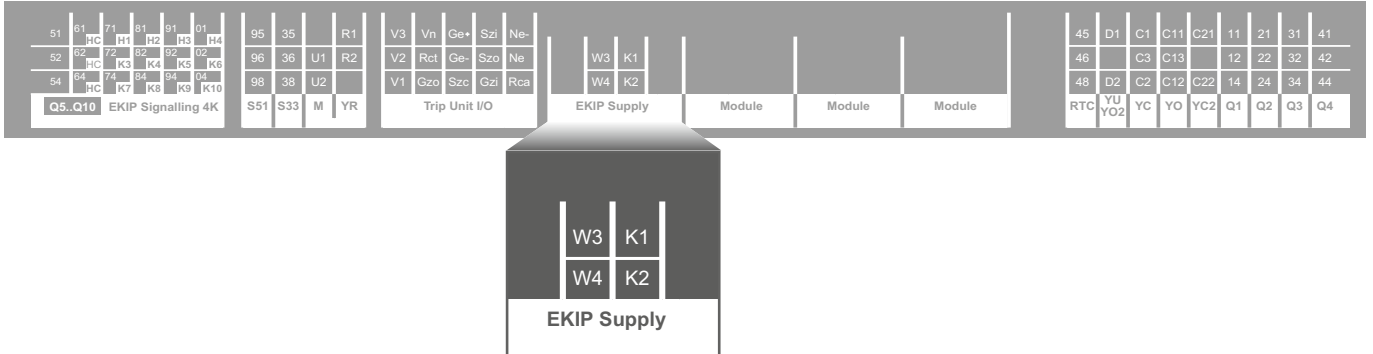

**31) Direct auxiliary supply 24V DC and local bus - Ekip Supply**

As an alternative to figures 32

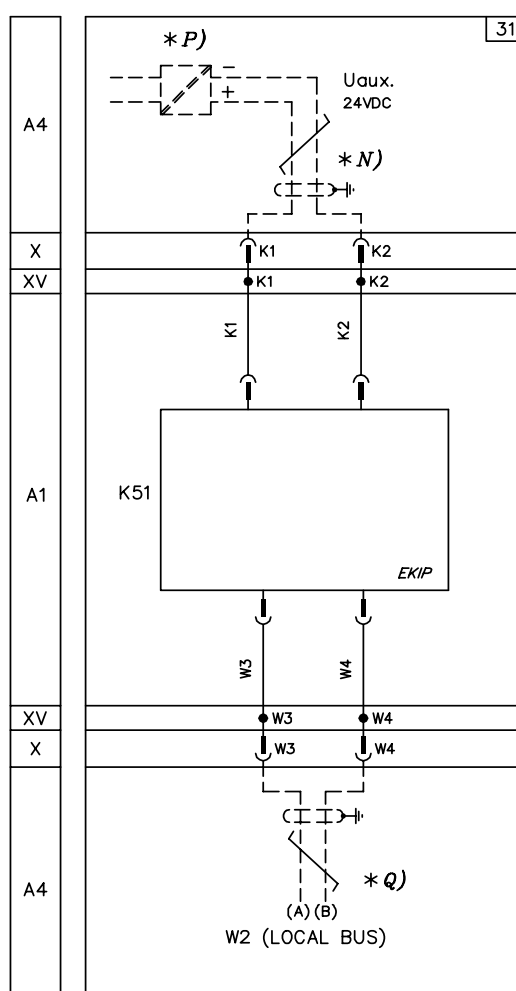

\*A)

# Electrical accessories

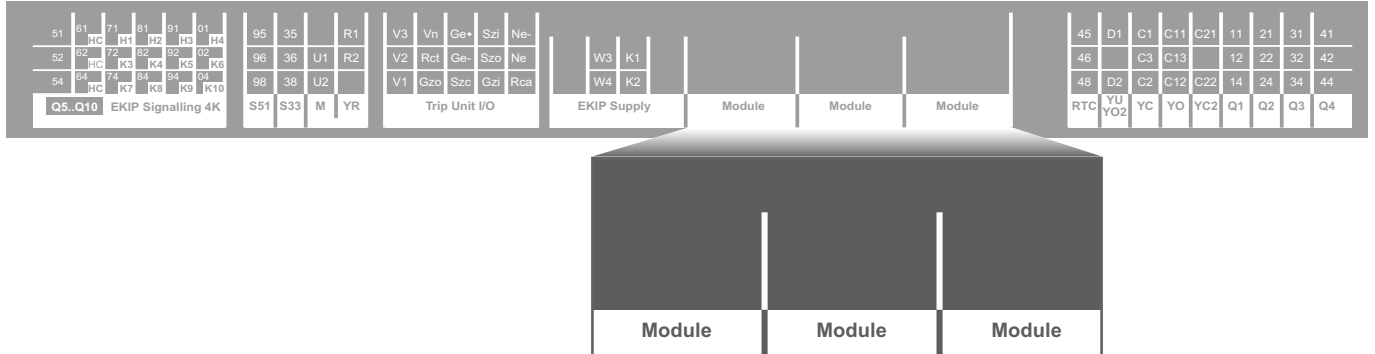

- 41) Ekip signalling 2K-1
- 42) Ekip signalling 2K-2

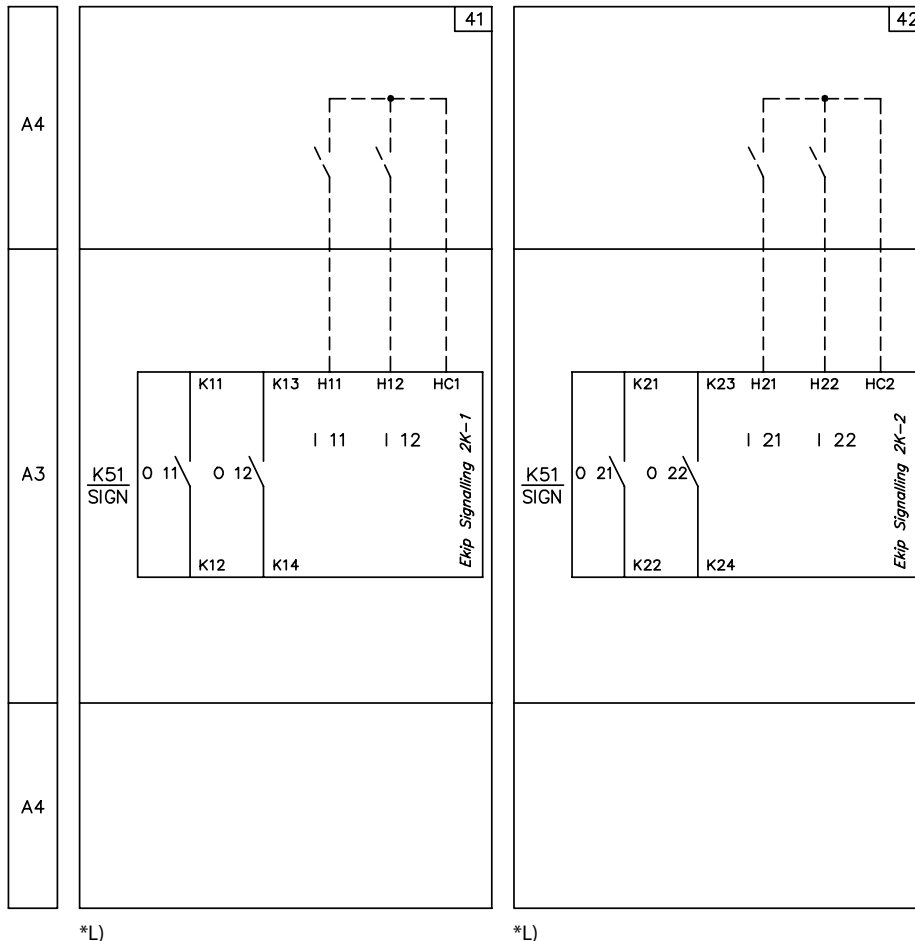

\*L)

\*L)



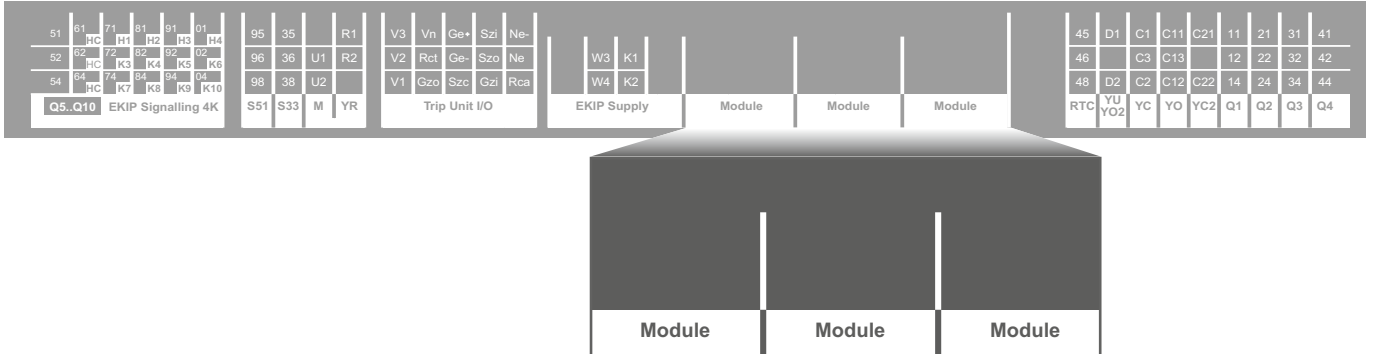

**43) Ekip signalling 2K-3**

**48) Ekip Synchrocheck**

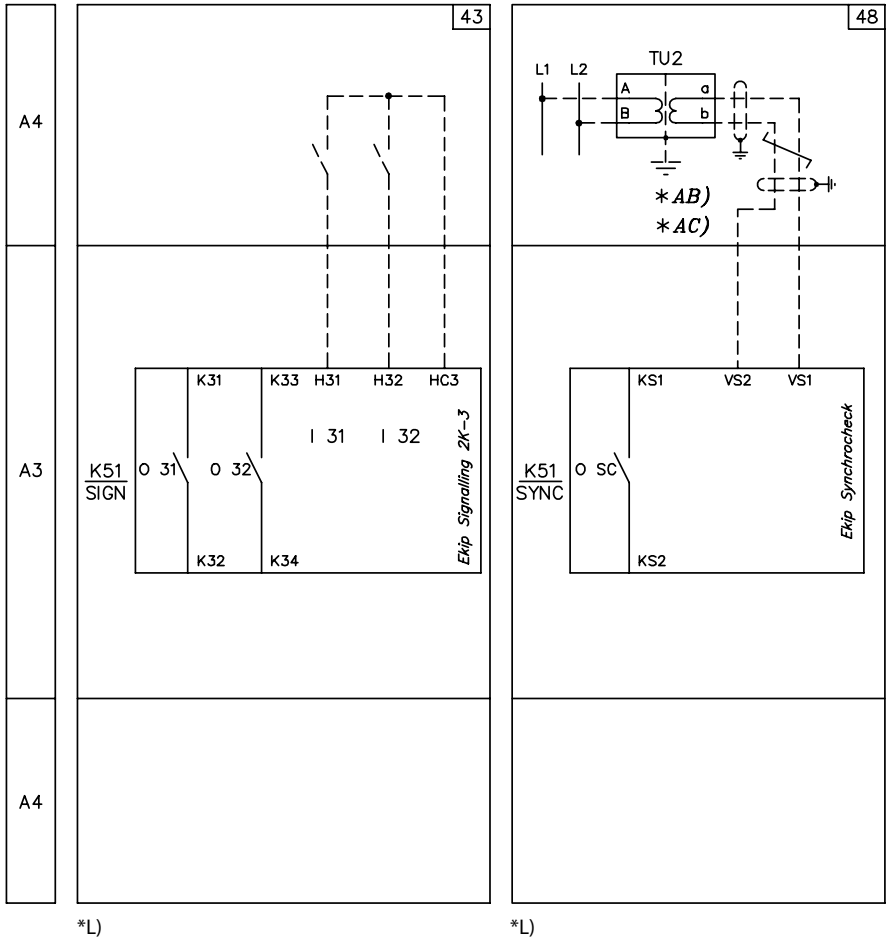

# Electrical accessories

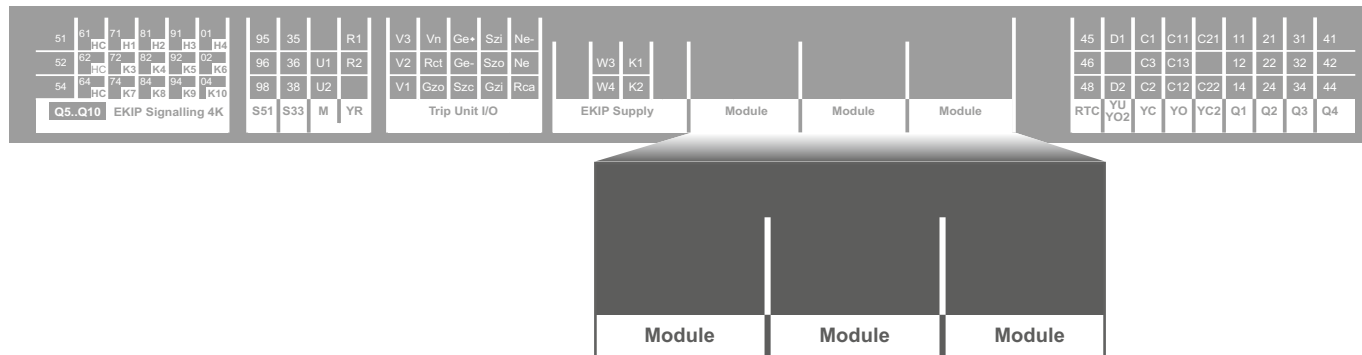

- 51) Ekip COM Modbus RS-485
- 52) Ekip COM Modbus TCP
- 53) Ekip COM Profibus

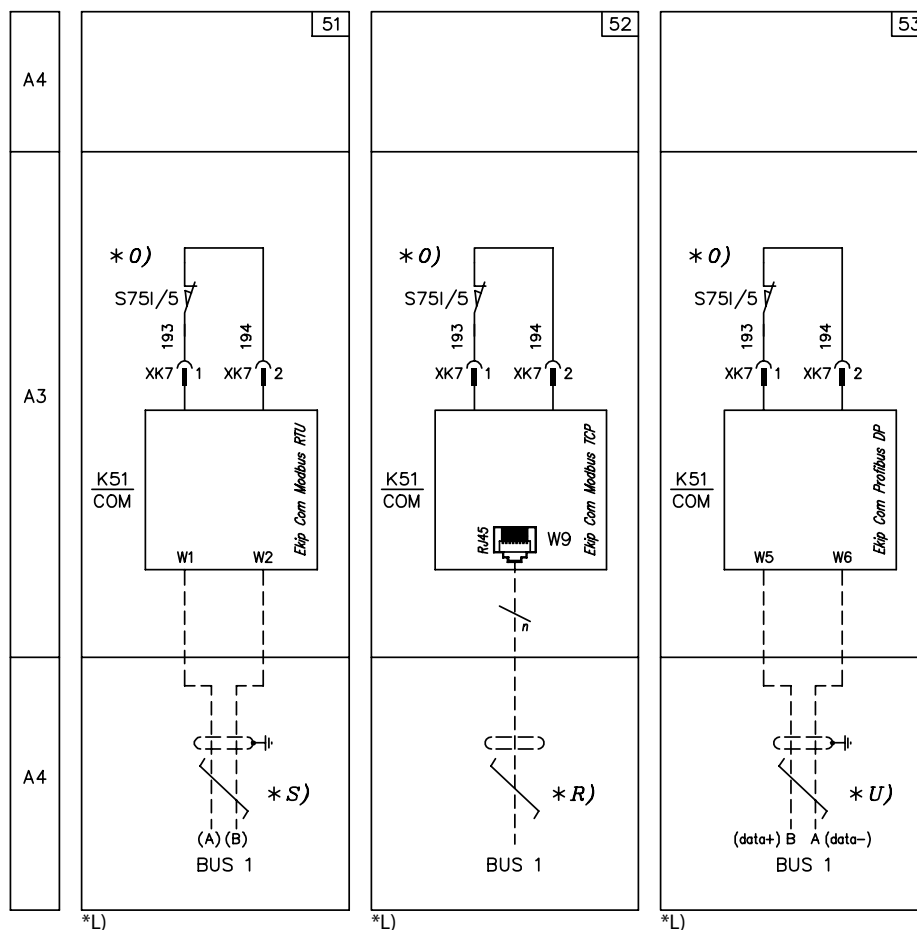

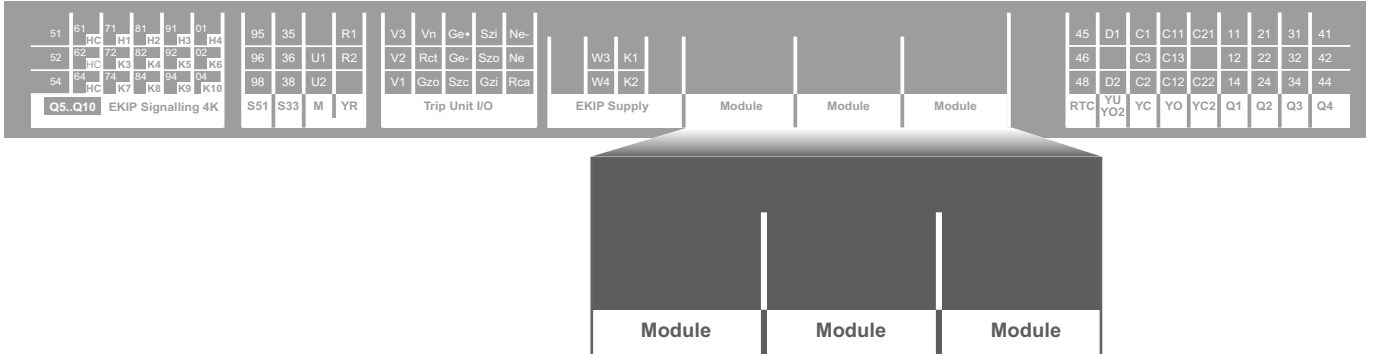

- 54) Ekip COM Profinet
- 55) Ekip COM DeviceNet™
- 56) Ekip COM EtherNet/IP™

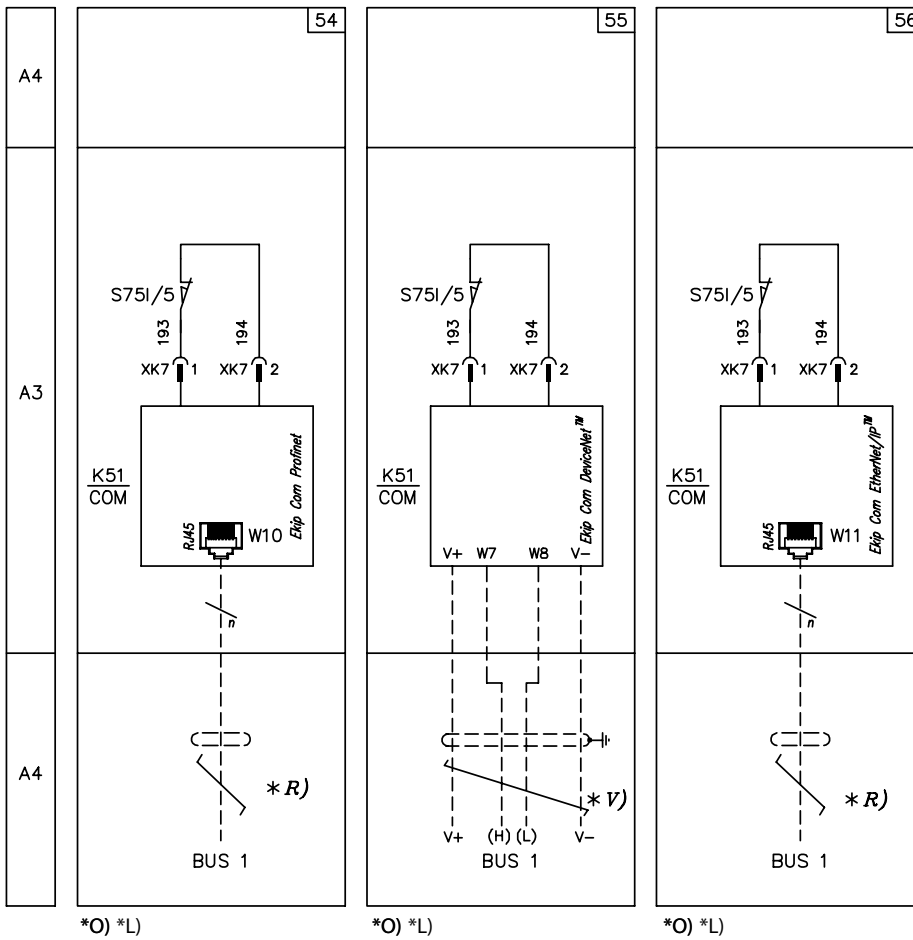

# Electrical accessories

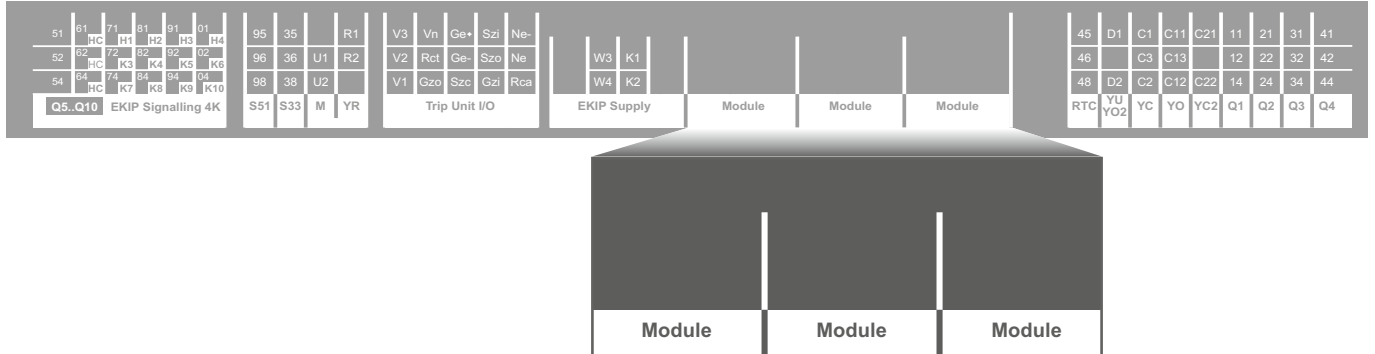

- 57) Ekip COM IEC61850
- 58) Ekip LINK
- 59) Ekip Com Hub
- 61) Ekip COM R Modbus RS-485 Redundant

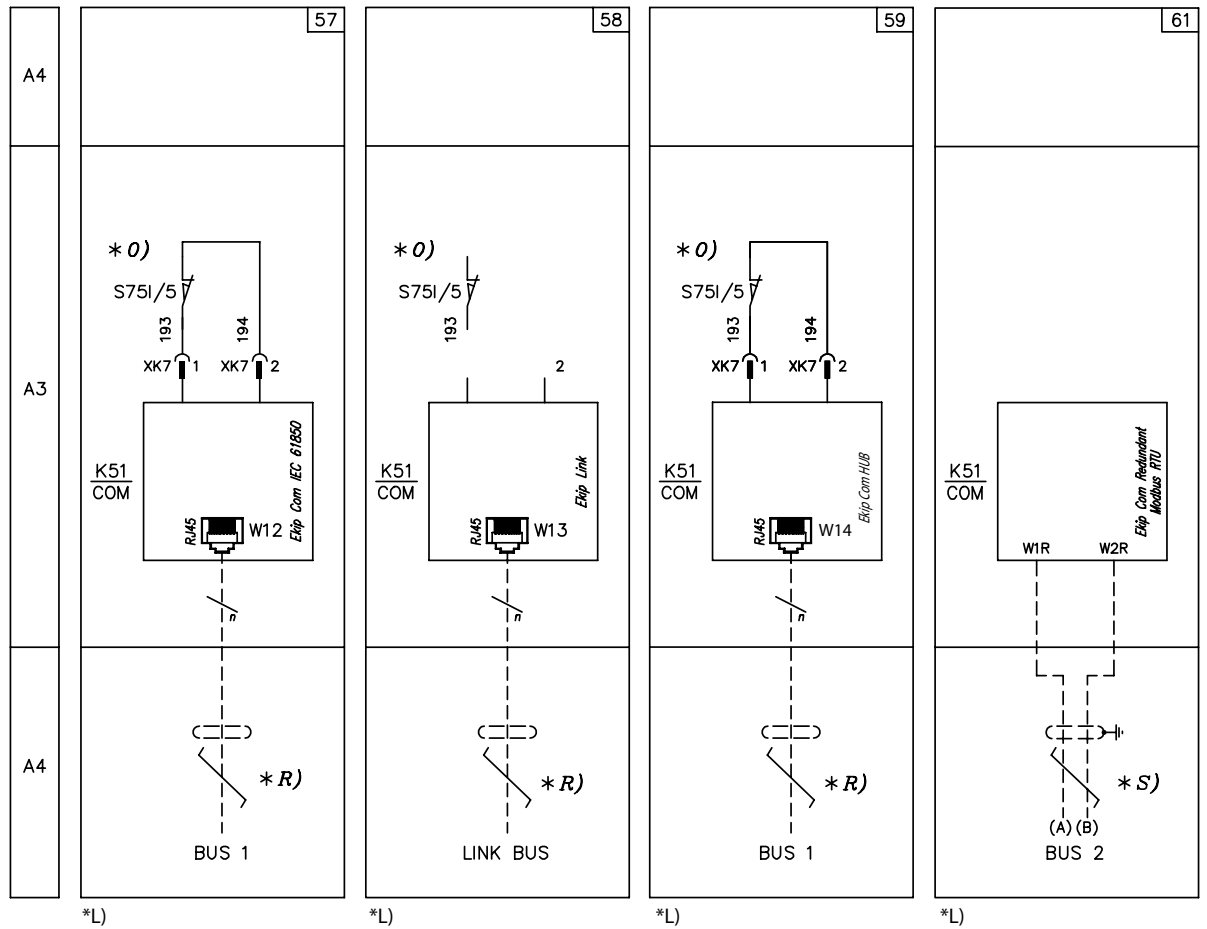

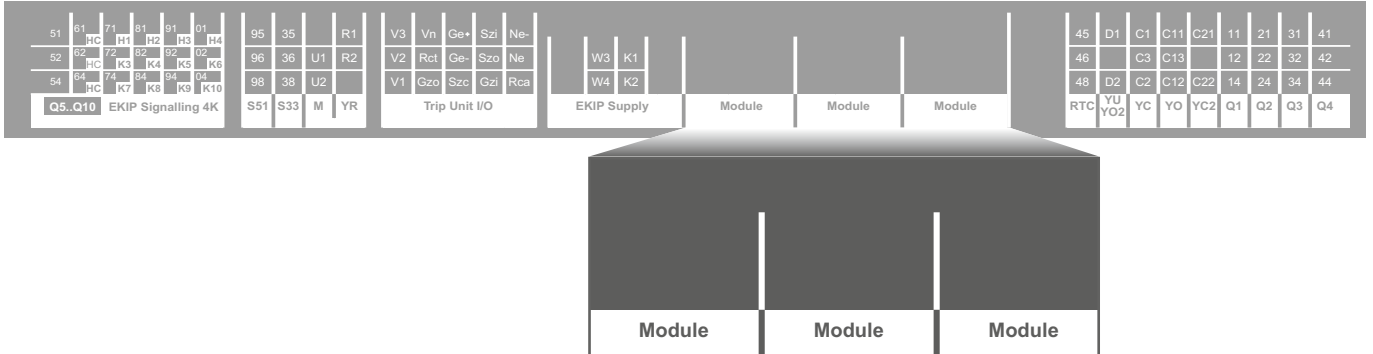

**62) Ekip COM R Modbus TCP Redundant**

**63) Ekip COM R Profibus Redundant**

**64) Ekip COM R ProfiNet Redundant**

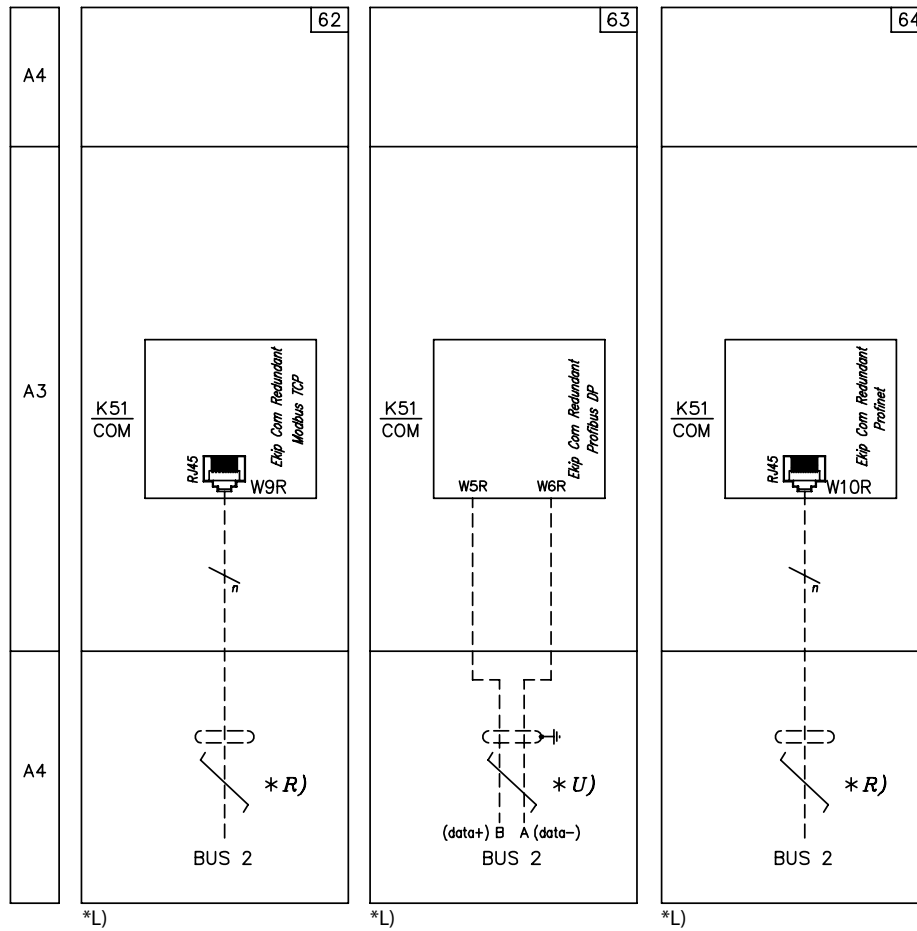

# Electrical accessories

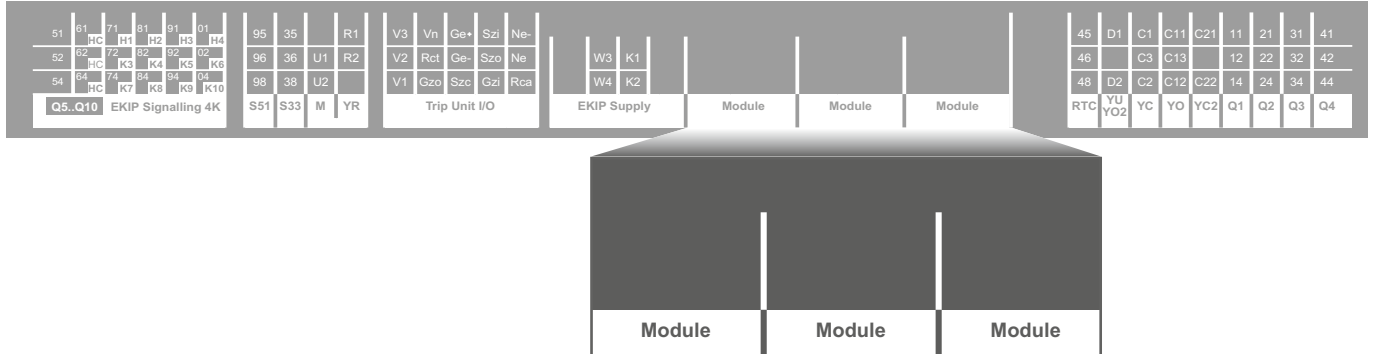

- 65) Ekip COM R DeviceNet™ Redundant
- 66) Ekip COM R EtherNet/IP™ Redundant
- 66) Ekip COM R IEC 61850 Redundant

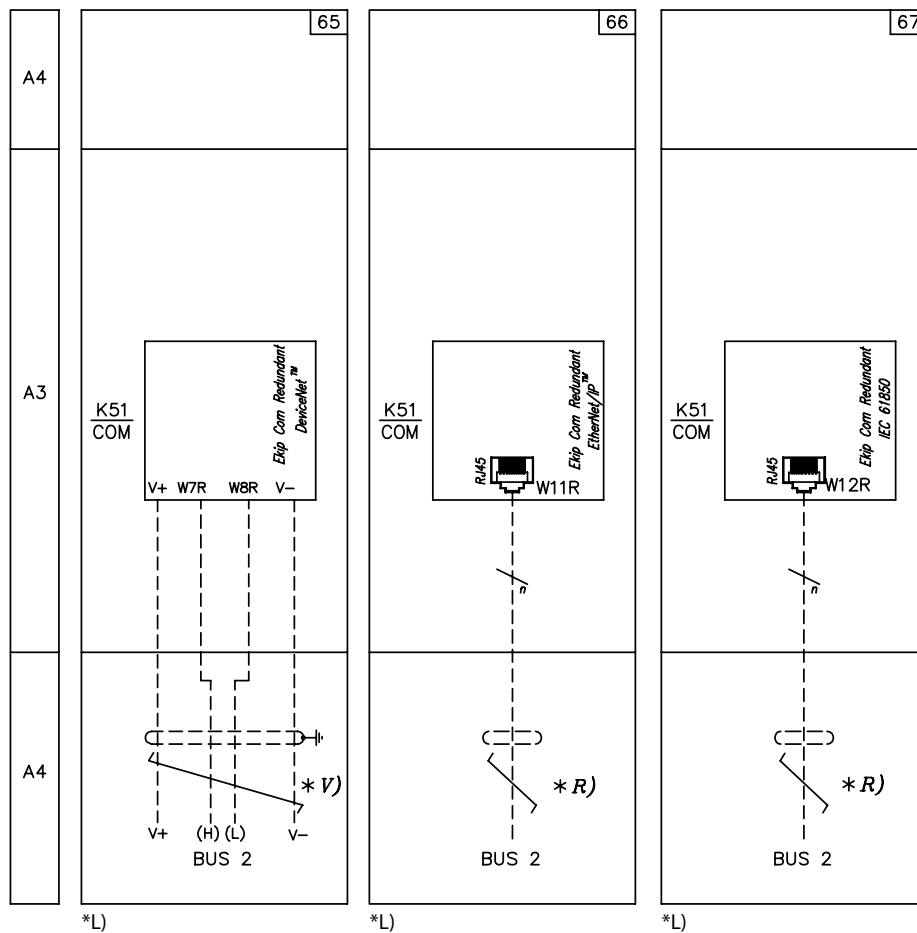

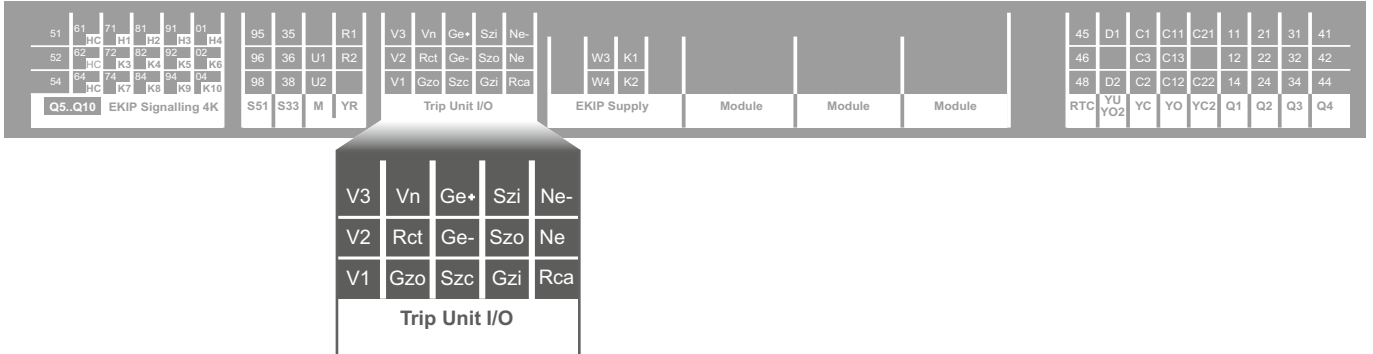

25) Transformer star center sensor input (homopolar toroid for the earthing conductor of main power supply)

27) Current sensor input on external neutral (only for 3-pole circuit-breakers)

As an alternative to figures 24 - 24A

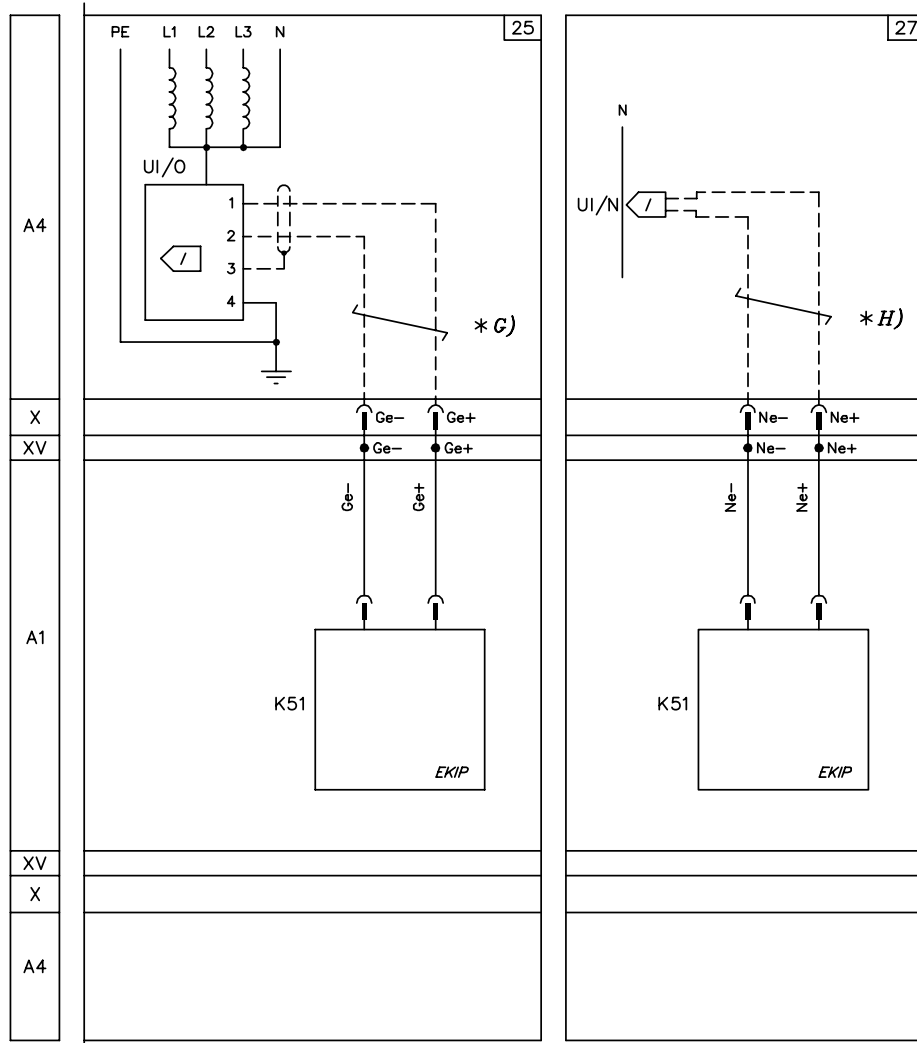

# Electrical accessories

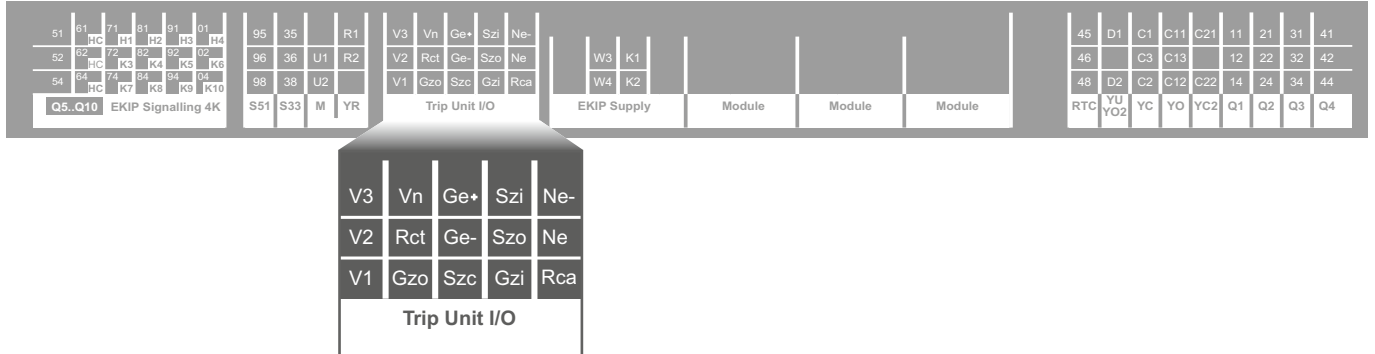

**24) Rc residual current protection sensor input (ANSI 64 & 50NTD)**  
**24a) Rc differential ground fault protection (ANSI 87N)**

As an alternative to figures 25

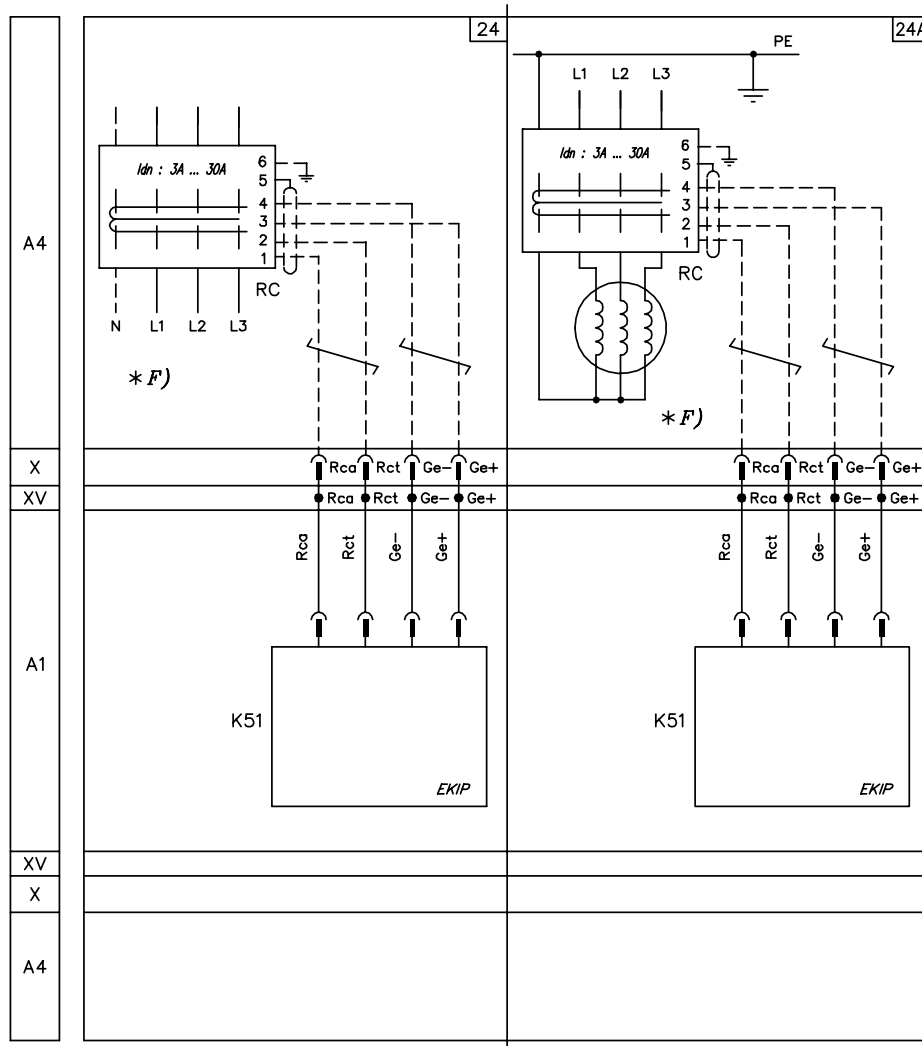



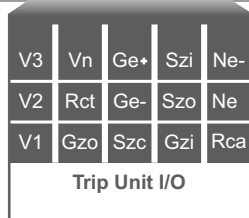

**22) Measurement Enabler/Measurement Enabler with voltage sockets for residual voltage protection (for Ekip G only)**

**23) Measurement Enabler/Measurement Enabler with voltage sockets with external voltage transformer**

As an alternative to each other or to 20-21 diagram

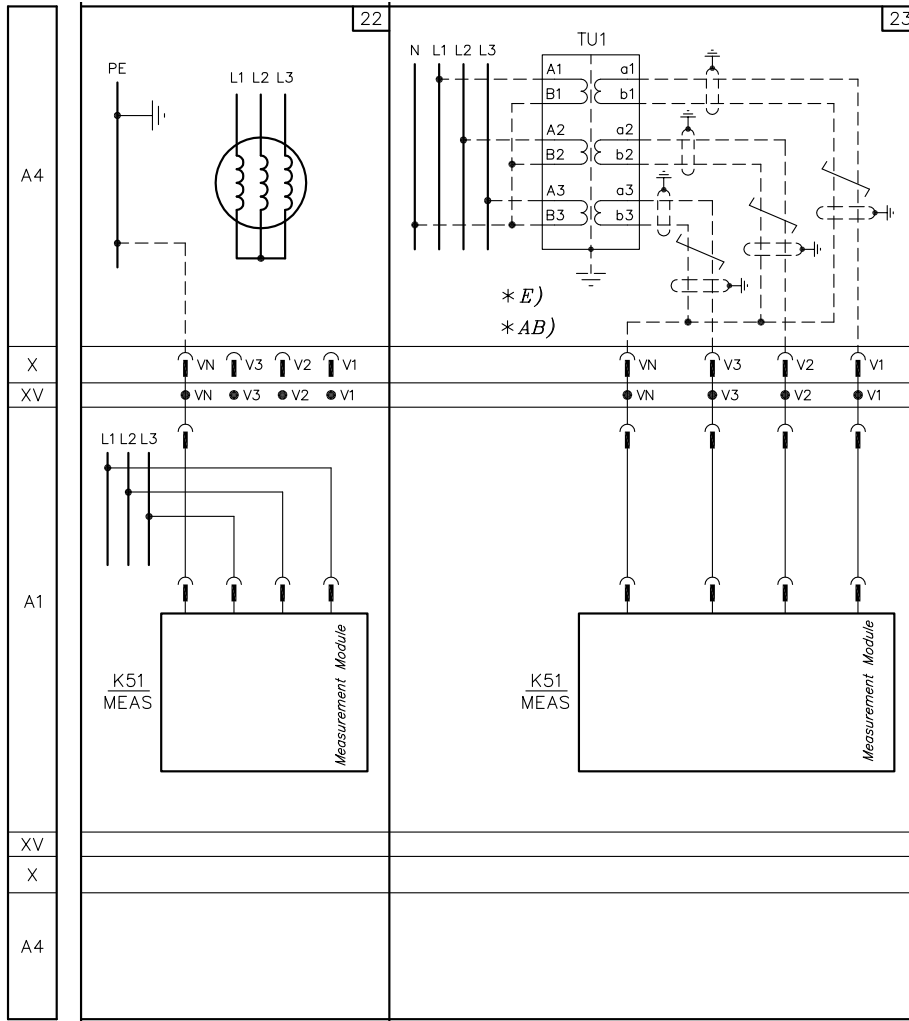

# Electrical accessories

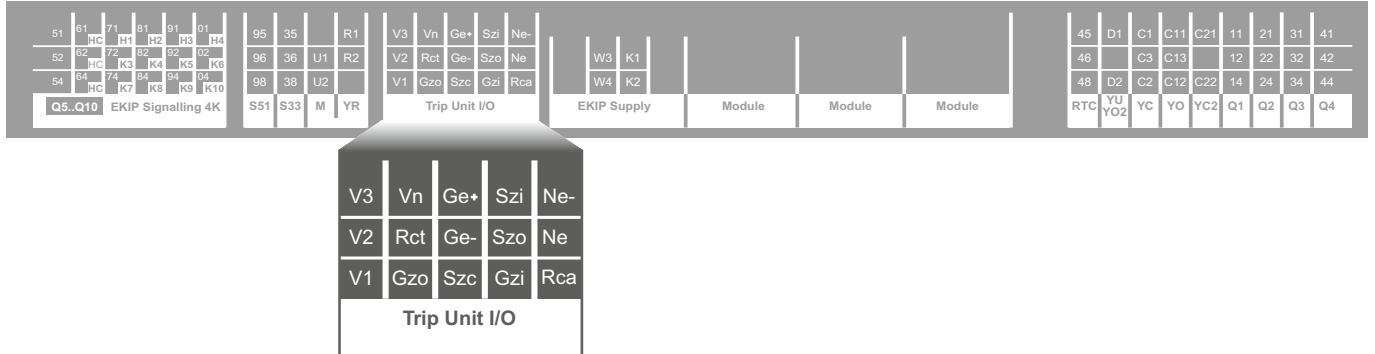

- 20) Measurement Enabler/Measurement Enabler with voltage sockets inside the four-pole circuit breaker
- 21) Measurement Enabler/Measurement Enabler with voltage sockets inside the three-pole circuit breaker and connection to the external neutral

As an alternative to each other or to 22-23 diagram

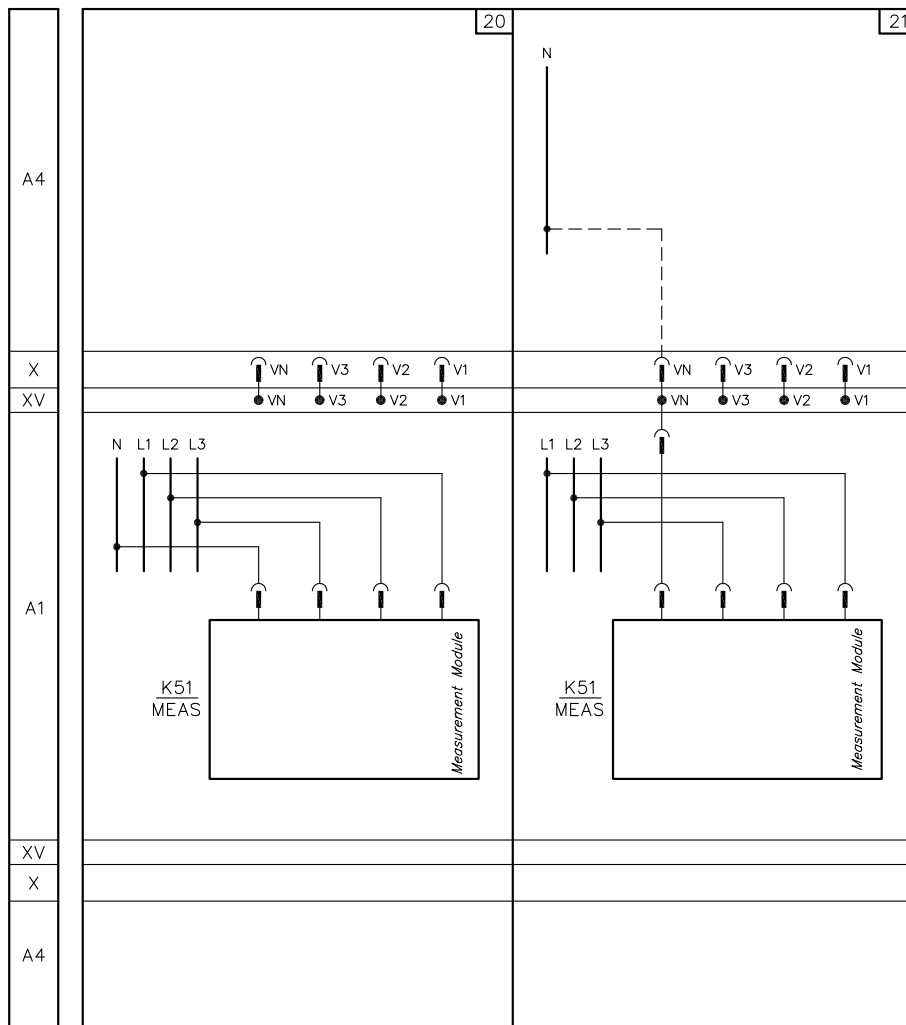



# Electrical accessories

51	61	71	81	91	01	95	35		R1	V3	Vn	Ge+	Szi	Ne-							45	D1	C1	C11	C21	11	21	31	41																									
52	62	72	82	92	02	96	36	U1	R2	V2	Rct	Ge-	Szo	Ne		W3	K1				46		C3	C13		12	22	32	42																									
54	64	74	84	94	04	98	38	U2		V1	Gzo	Szc	Gzi	Rca		W4	K2				48	D2	C2	C12	C22	14	24	34	44																									
Q5...Q10					EKIP Signalling 4K					S51	S33	M	YR	Trip Unit I/O					EKIP Supply					Module					Module					Module																				

95	35		R1
96	36	U1	R2
98	38	U2	
S51	S33	M	YR

- 11) Trip signalling contact - S51
- 12) Contact for signalling position of loaded springs - S33 M/2
- 13) Motor for loading closing springs - M
- 14) Trip contact reset coil – YR

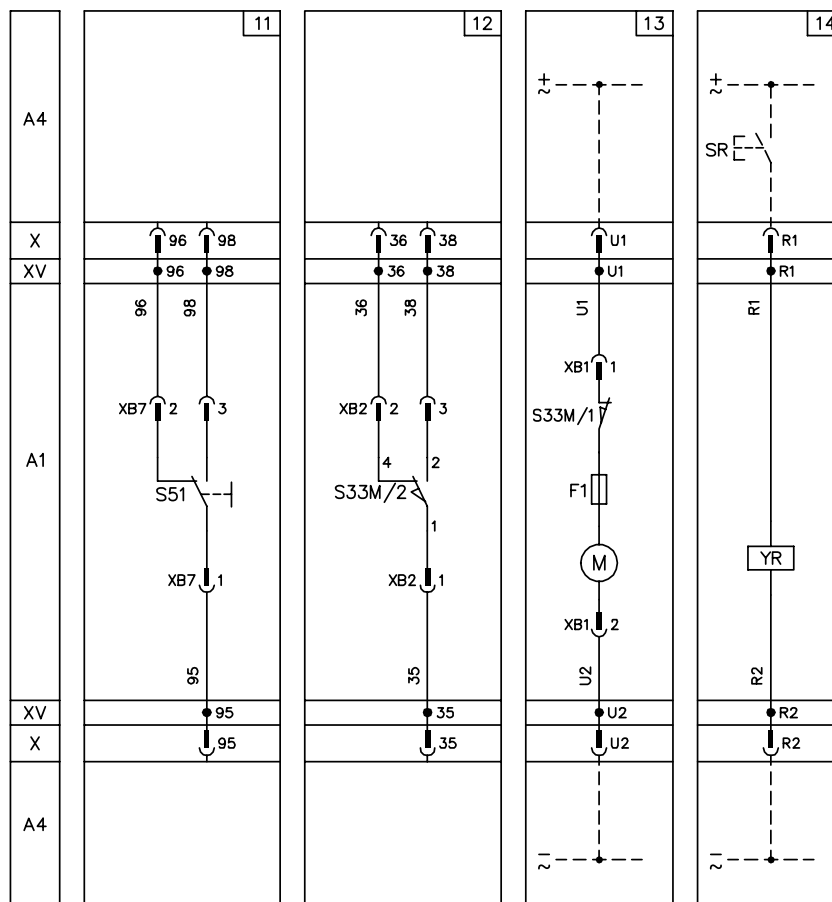

\*D)

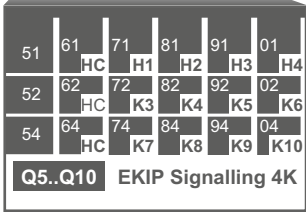

2) Ekip Signalling 4K

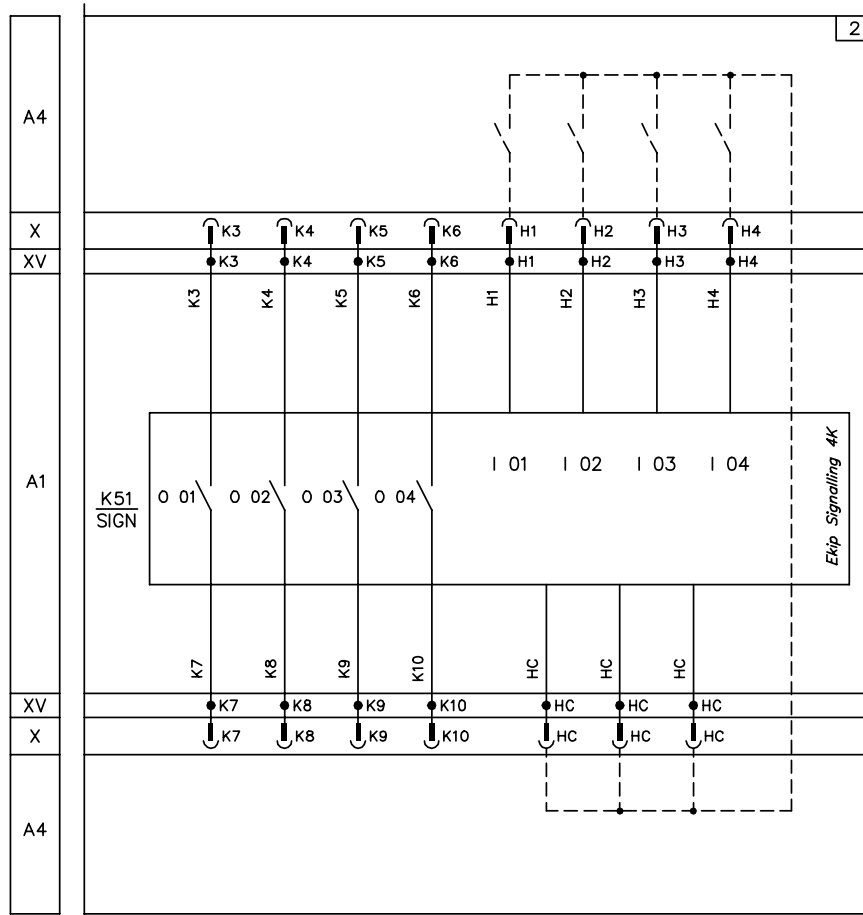

# Electrical accessories

51	61	71	81	91	01	95	35	R1	V3	Vn	Ge+	Szi	Ne-	W3	K1				45	D1	C1	C11	C21	11	21	31	41	
52	62	72	82	92	02	96	36	U1	R2	V2	Rct	Ge-	Szo	Ne	W4	K2				46		C3	C13		12	22	32	42
54	64	74	84	94	04	98	38	U2		V1	Gzo	Szc	Gzi	Rca						48	D2	C2	C12	C22	14	24	34	44
Q5..Q10 EKIP Signalling 4K						S51	S33	M	YR	Trip Unit I/O				EKIP Supply		Module	Module	Module	RTC	YU	YO2	YC	YO	YC2	Q1	Q2	Q3	Q4

51	61	71	81	91	01
52	62	72	82	92	02
54	64	74	84	94	04
Q5..Q10 EKIP Signalling 4K					

## 1) Supplementary open/closed auxiliary contacts of the circuit-breaker - AUX 6Q (6 Form C)

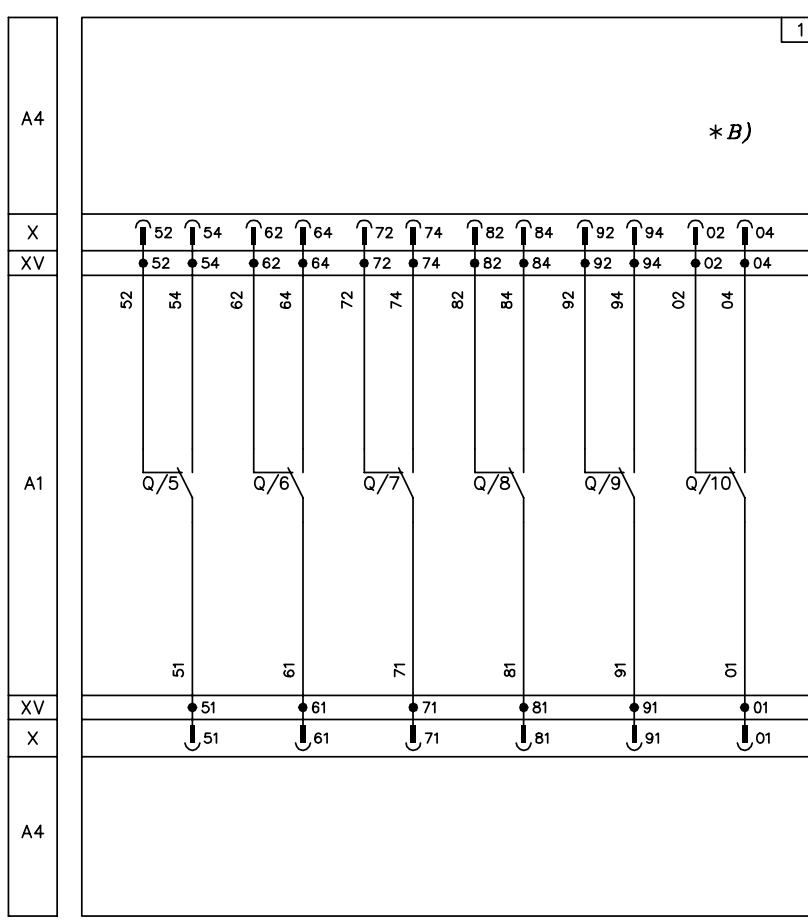

**91) Supplementary open/closed auxiliary contacts outside the circuit-breaker - AUX 15Q (15 Form C)**

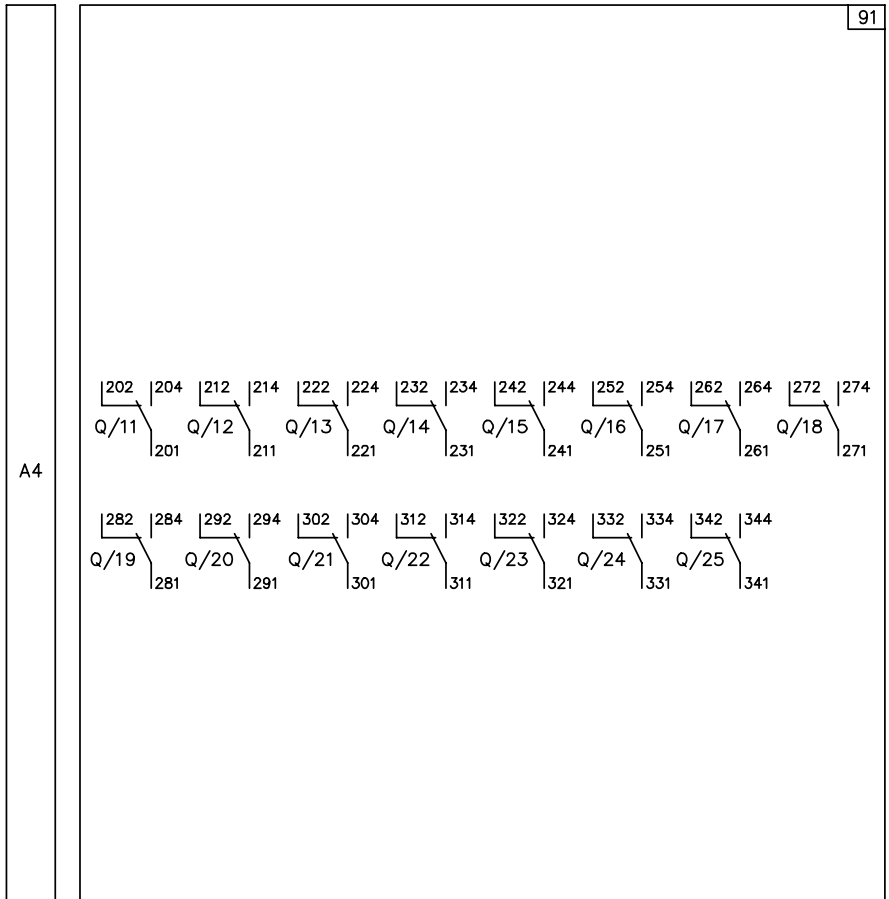

# Electrical accessories

## 95) Contacts for signalling of circuit-breaker in racked-in, test, racked-out position

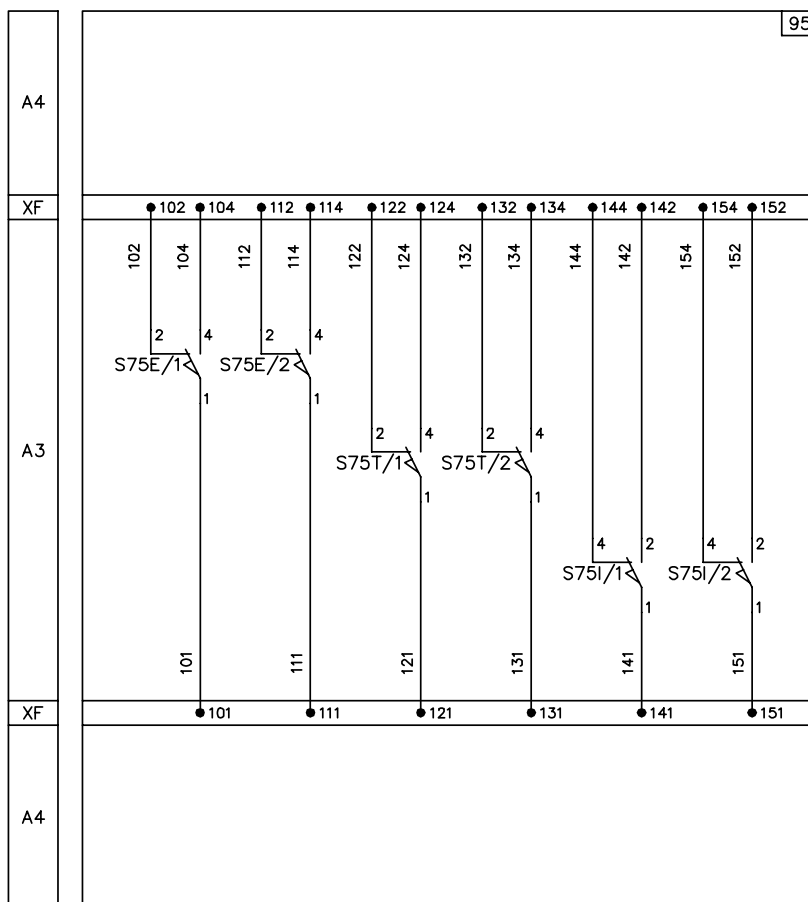



**96) Contacts for signalling of circuit-breaker in racked-in, test, racked-out position (first set)**

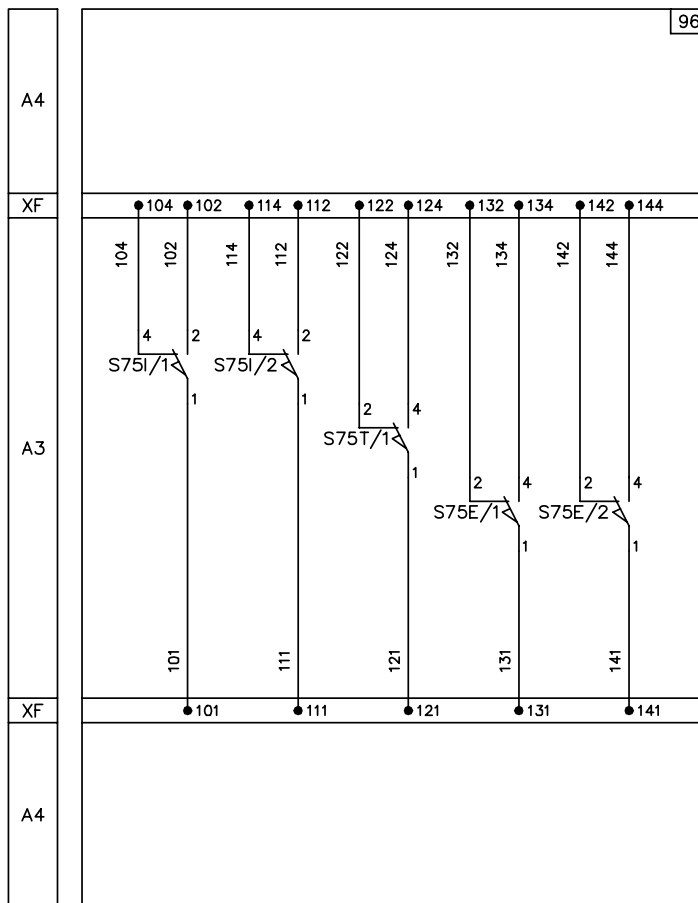

# Electrical accessories

97) Contacts for signalling of circuit-breaker in racked-in, test, racked-out position (second set)

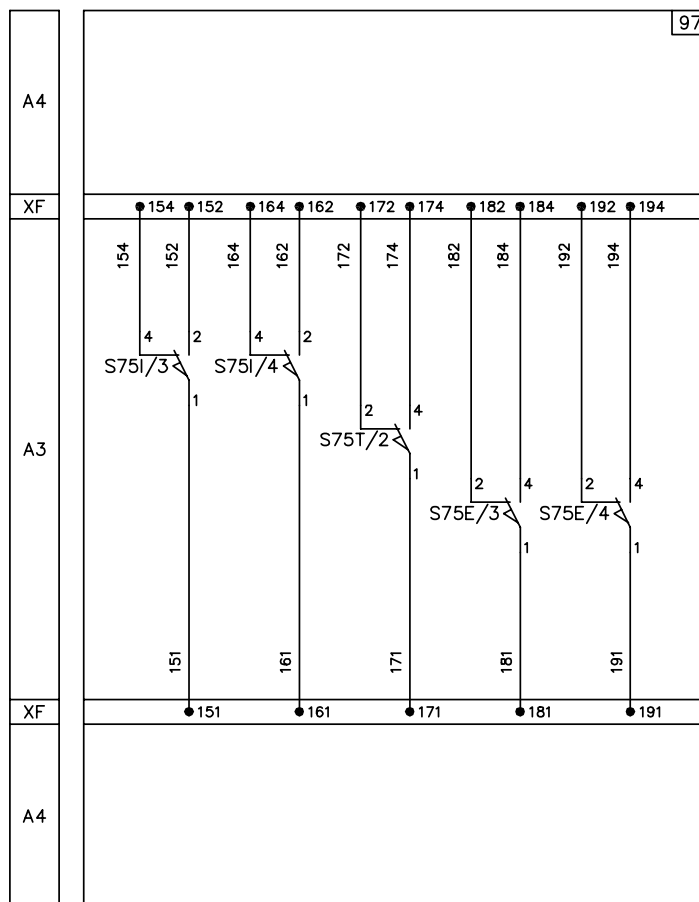

**97A) Contacts for signalling of circuit-breaker in racked-in, test, racked-out position (second set)**

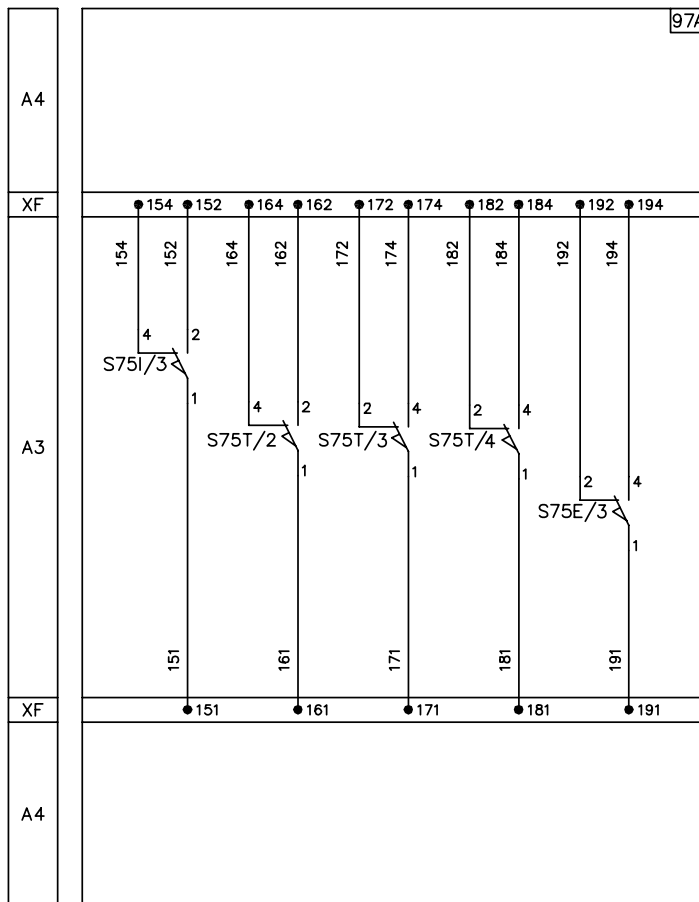



---

# Ordering codes

<b>10/2</b>	<b>Instructions for ordering</b>
<b>10/2</b>	Ordering examples
<b>10/5</b>	<b>General information</b>
<b>10/6</b>	<b>Automatic circuit-breakers</b>
<b>10/6</b>	Fixed version for power distribution
<b>10/21</b>	Withdrawable version for power distribution
<b>10/35</b>	Fixed version for generators
<b>10/40</b>	Withdrawable version for generators
<b>10/45</b>	<b>Switch-disconnectors</b>
<b>10/45</b>	Fixed version
<b>10/47</b>	Withdrawable version
<b>10/49</b>	<b>Automatic circuit-breakers</b>
<b>10/49</b>	Fixed version for Emax 2/E9 up to 900V
<b>10/51</b>	Withdrawable version for Emax 2/E9 up to 900V
<b>10/53</b>	<b>Derived versions</b>
<b>10/53</b>	Sectionalizing truck
<b>10/53</b>	Earthing truck
<b>10/53</b>	Earthing switch with making capacity
<b>10/54</b>	<b>Fixed parts</b>
<b>10/55</b>	<b>Accessories</b>
<b>10/55</b>	Electrical accessories
<b>10/58</b>	Mechanical accessories
<b>10/61</b>	Mechanical interlock
<b>10/62</b>	Ekip modules
<b>10/66</b>	Terminals
<b>10/71</b>	Spare parts Grey Platform
<b>10/73</b>	Service
<b>10/74</b>	Spare Parts

# Instructions for ordering

## Ordering examples

Standard version Emax 2 series circuit-breakers are identified by means of commercial codes that can be accessorized.

### Ordering examples

- Terminal kit codes (other than standard supply) for fixed circuit-breaker or for fixed part of withdrawable circuit-breaker. The codes refer to 3 or

4 pieces (for mounting on top or bottom terminals). To convert a complete circuit-breaker, 1 kit for upper terminals and 1 kit for lower terminals must be specified in the order.

#### Example no. 1

##### Emax E2.2N 3 poles fixed with vertical rear terminals (VR)

1SDA071066R1	E2.2N 2500 Ekip Touch LSIG 3p F HR
1SDA074009R1	Kit VR Sup E2.2 Iu=2500 3pcs INST
1SDA074011R1	Kit VR Inf E2.2 Iu=2500 3pcs INST

#### Example no. 2

##### Emax E1.2N 4 poles fixed with upper vertical rear (VR) and front (F) terminals (standard supply)

1SDA071513R1	E1.2N 1600 Ekip Dip LSIG 4p F F
1SDA073986R1	Kit VR Upper E1.2 F 4pcs INST

#### Example no. 3

##### Emax E4.2H 3 poles fixed with upper front terminals (F) and adjustable rear bottom vertical (VR) terminals

1SDA071169R1	E4.2H 3200 Ekip Hi-Touch LSIG 3p F HR
1SDA074126R1	Kit F upper E4.2 F 3pcs INST
1SDA074017R1	Kit VR lower E4.2 Iu=3200 3pcs INST

#### Example no. 4

##### Emax E2.2 2000A 3 poles fixed part with spread upper vertical terminals (SVR) and rear bottom adjustable horizontal (HR) terminals (standard supply)

1SDA073909R1	E2.2 W FP Iu=2000 3p HR HR
1SDA074057R1	Kit SVR upper E2.2 Iu=2000 3pcs INST

- Rating Plug for lower values than rated current. Rating plug installed on the circuit-breaker enables to obtain lower current values than rated current.

#### Example no. 5

##### Emax E2.2S 2500 4 poles fixed In=1600A

1SDA071706R1	E2.2S 2500 Ekip Touch LSIG 4p F HR
1SDA074266R1	Rating Plug 1600 E1.2..E6.2 INST

- **Ordering for Ekip modules.**  
Ekip Supply module enables Ekip Com, Ekip Link, Ekip 2K, Ekip Syncrocheck cartridge modules to be installed.
- In addition to Ekip Supply modules, up to 3 cartridge modules can be installed on E2.2, E4.2 and E6.2 and up to 2 modules on E1.2.

**Example no. 6**

**Emax E4.2H 3 poles fixed with modules: Ekip Supply, Ekip Com Modbus TCP, Ekip Signalling 2K-1, Ekip Com Modbus TCP Redundant and Ekip Signalling 4K**

1SDA071169R1	E4.2H 3200 Ekip Hi-Touch LSIG 3p F HR
1SDA074173R1	Ekip Supply 24-48V DC E1.2..E6.2
1SDA074151R1	Ekip Com Modbus TCP E1.2..E6.2
1SDA074158R1	Ekip Com R Modbus TCP E1.2..E6.2
1SDA074167R1	Ekip Sign. 2K-1 E1.2..E6.2
1SDA074170R1	Ekip Sign. 4K E2.2..E6.2

**Example no. 7**

**Emax E4.2H 3 poles fixed with modules: Ekip Supply, Ekip Com Modbus RS-485, RC protection, Measurement Enabler with voltage sockets**

1SDA071166R1	E4.2H 3200 Ekip Touch LSIG 3p F HR
1SDA074173R1	Ekip Supply 24-48V DC E1.2...E6.2
1SDA074150R1	Ekip Com Modbus RS-485 E1.2...E6.2
1SDA074269R1	Rating Plug RC 3200 E4.2-E6.2 INST
1SDA107548R1	Measurement Enabler with voltage sockets E4.2*
1SDA073742R1	Toroid RC E2.2 4p, E4.2 3p

\* By default Ekip Touch trip unit has the Measurement Enabler module installed. The RC protection requires busbar supply, so Measurement Enabler with voltage sockets is required.

**Example no. 8**

**Emax E1.2B 3 poles fixed with modules: Ekip Supply, Ekip Com Modbus RS-485, Measuring package, 1% Accuracy**

1SDA070785R1	E1.2B 1000 Ekip Touch LSI 3p F F
1SDA074173R1	Ekip Supply 24-48V DC E1.2...E6.2
1SDA074150R1	Ekip Com Modbus RS-485 E1.2...E6.2
1SDA107525R1	Measuring Package for Emax 2
1SDA107551R1	Class 1 Power&Energy Metering E1.2

- **Ordering for electrical accessories.**  
All the accessories are available. In particular, up to 3 coils can be ordered for E1.2, whereas up to 4 coils for E2.2, E4.2 and E6.2.

**Example no. 9**

**Emax E2.2S 3 poles withdrawable with accessories: opening release, closing release, motor for automatic charging of the springs, second opening release**

1SDA072395R1	E2.2S 2000 Ekip Touch LSi LSIG 3p WMP
1SDA073674R1	YO E1.2..E6.2 220-240V AC/DC
1SDA073687R1	YC E1.2..E6.2 220-240V AC/DC
1SDA073725R1	M E2.2...E6.2 220-250V AC/DC
1SDA073674R1	YO E1.2..E6.2 220-240V AC/DC

- **Ordering for key locks.**

**Example no. 10**

**Emax E2.2N 3 poles with double key lock in racked-in / test / racked-out position, using different keys**

1SDA071066R1	E2.2N 2500 Ekip Touch LSIG 3p F HR
1SDA073806R1	KLP-D Bl. Racked in/out E2.2...E6.2 1st key
1SDA073812R1	KLP-D Bl. Racked in/out E2.2...E6.2 2nd key

# Instructions for ordering

## Ordering examples

- **Ordering for mechanical Interlocks.**  
Interlocks have several strategy configuration, suitable for fixed circuit-breakers and withdrawable circuit-breakers.  
Each configuration requires different groups:
  - **Cables**, select one Kit for strategy A / B / C / D. The cables must be ordered on fixed circuit-breaker or fixed part of withdrawable circuit-breaker.
  - **Lever**, required only for E2.2, E4.2 and E6.2. These lever must be mounted on fixed circuit-breaker or on mobile part of withdrawable circuit-breaker.
  - **Support**, installed on fixed circuit-breaker or on fixed part of withdrawable circuit-breaker. This support is mounted on the external right side of the circuit-breaker.

### Example no. 12

#### Interlock between two fixed circuit-breakers: E1.2 and E2.2

E1.2 Fixed circuit-breaker	E2.2 Fixed circuit-breaker
Cables [Group 1]: 1 Item	Lever [Group 2]: 1 Item
Support [Group 3]: 1 Item	Support [Group 3]: 1 Item

### Example no. 13

#### Interlock between three fixed breakers: one E2.2 and two E4.2

E2.2 Fixed circuit-breaker	E4.2 Fixed circuit-breaker	E4.2 Fixed circuit-breaker
Cables [Group 1]: 1 Item	Lever [Group 2]: 1 Item	Lever [Group 2]: 1 Item
Lever [Group 2]: 1 Item	Support [Group 3]: 1 Item	Support [Group 3]: 1 Item
Support [Group 3]: 1 Item		

### Example no. 14

#### Interlock between two withdrawable breakers: E1.2 and E2.2

E1.2 Fixed Part	E2.2 Mobile Part
Cables [Group 1]: 1 Item	Lever [Group 2]: 1 Item
Support [Group 4]: 1 Item	+
	E2.2 Fixed Part
	Support [Group 4]: 1 Item

### Example no. 15

#### Interlock between three withdrawable breakers: one E2.2 and two E4.2

E2.2 Mobile Part	E4.2 Mobile Part	E4.2 Mobile Part
Lever [Group 2]: 1 Item	Lever [Group 2]: 1 Item	Lever [Group 2]: 1 Item
+		
E2.2 Fixed Part	E4.2 Fixed Part	E4.2 Fixed Part
Cables [Group 1]: 1 Item	Support [Group 4]: 1 Item	Support [Group 4]: 1 Item
Support [Group 4]: 1 Item	Support [Group 4]: 1 Item	Support [Group 4]: 1 Item



# General informations

## Abbreviations used for the description of the product

<b>Versions and terminals</b>	
<b>F</b>	Fixed circuit-breaker
<b>W</b>	Withdrawable circuit-breaker
<b>MP</b>	Mobile part of withdrawable circuit-breaker
<b>FP</b>	Fixed part of withdrawable circuit-breaker
<b>Iu</b>	Rated uninterrupted current
<b>In</b>	Rated current of the rating plug
<b>Icu</b>	Rated ultimate short-circuit breaking capacity
<b>Icw</b>	Rated short-time withstand current
<b>/MS</b>	Switch-disconnector
<b>/f</b>	Four-pole circuit-breakers with neutral pole at 100%
<b>CS</b>	Sectionalizing truck
<b>MT</b>	Earthing truck
<b>MTP</b>	Earthing switch with making capacity
<b>HR VR</b>	Rear orientable terminals
<b>SHR</b>	Horizontal rear spread terminals
<b>SVR</b>	Vertical rear spread terminals
<b>F</b>	Front terminals
<b>FL</b>	Flat terminals
<b>EF</b>	Extended front terminals
<b>ES</b>	Front spread terminals
<b>Fc CuAl</b>	Terminals for cables
<b>Protection trip units and functions</b>	
<b>Ekip Dip</b>	Protection trip unit for power distribution
<b>Ekip Touch</b>	Measurement and protection trip unit for power distribution
<b>Ekip Hi Touch</b>	Measurement and protection trip unit and network analyzer for power distribution
<b>Ekip G Touch</b>	Measurement and protection trip unit for generators
<b>Ekip G Hi-Touch</b>	Measurement and protection trip unit and protection network analyzer for generators
<b>L</b>	Overload protection
<b>S</b>	Protection against selective short circuit
<b>I</b>	Protection against instantaneous short circuit
<b>G</b>	Earth fault protection
<b>Rc</b>	Residual current protection
<b>Power Controller</b>	Load management function

# Automatic circuit-breakers

## Fixed version for power distribution



### SACE Emax E1.2B • Front terminals (F)

Size	I <sub>u</sub>	I <sub>cu</sub> (440 V) (1s)	I <sub>cw</sub> (1s)	Type	3 Poles	4 Poles
					Code	Code
E1.2B	630	42	42	E1.2B 630 Ekip Dip LI	1SDA070701R1	1SDA071331R1
				E1.2B 630 Ekip Dip LSI	1SDA070702R1	1SDA071332R1
				E1.2B 630 Ekip Dip LSIg	1SDA070703R1	1SDA071333R1
				E1.2B 630 Ekip Touch LI	1SDA070704R1	1SDA071334R1
				E1.2B 630 Ekip Touch LSI	1SDA070705R1	1SDA071335R1
				E1.2B 630 Ekip Touch LSIg	1SDA070706R1	1SDA071336R1
				E1.2B 630 Ekip Hi-Touch LSI	1SDA070708R1	1SDA071338R1
				E1.2B 630 Ekip Hi-Touch LSIg	1SDA070709R1	1SDA071339R1
800	42	42	E1.2B 800 Ekip Dip LI	1SDA070741R1	1SDA071371R1	
			E1.2B 800 Ekip Dip LSI	1SDA070742R1	1SDA071372R1	
			E1.2B 800 Ekip Dip LSIg	1SDA070743R1	1SDA071373R1	
			E1.2B 800 Ekip Touch LI	1SDA070744R1	1SDA071374R1	
			E1.2B 800 Ekip Touch LSI	1SDA070745R1	1SDA071375R1	
			E1.2B 800 Ekip Touch LSIg	1SDA070746R1	1SDA071376R1	
			E1.2B 800 Ekip Hi-Touch LSI	1SDA070748R1	1SDA071378R1	
			E1.2B 800 Ekip Hi-Touch LSIg	1SDA070749R1	1SDA071379R1	
1000	42	42	E1.2B 1000 Ekip Dip LI	1SDA070781R1	1SDA071411R1	
			E1.2B 1000 Ekip Dip LSI	1SDA070782R1	1SDA071412R1	
			E1.2B 1000 Ekip Dip LSIg	1SDA070783R1	1SDA071413R1	
			E1.2B 1000 Ekip Touch LI	1SDA070784R1	1SDA071414R1	
			E1.2B 1000 Ekip Touch LSI	1SDA070785R1	1SDA071415R1	
			E1.2B 1000 Ekip Touch LSIg	1SDA070786R1	1SDA071416R1	
			E1.2B 1000 Ekip Hi-Touch LSI	1SDA070788R1	1SDA071418R1	
			E1.2B 1000 Ekip Hi-Touch LSIg	1SDA070789R1	1SDA071419R1	
1250	42	42	E1.2B 1250 Ekip Dip LI	1SDA070821R1	1SDA071451R1	
			E1.2B 1250 Ekip Dip LSI	1SDA070822R1	1SDA071452R1	
			E1.2B 1250 Ekip Dip LSIg	1SDA070823R1	1SDA071453R1	
			E1.2B 1250 Ekip Touch LI	1SDA070824R1	1SDA071454R1	
			E1.2B 1250 Ekip Touch LSI	1SDA070825R1	1SDA071455R1	
			E1.2B 1250 Ekip Touch LSIg	1SDA070826R1	1SDA071456R1	
			E1.2B 1250 Ekip Hi-Touch LSI	1SDA070828R1	1SDA071458R1	
			E1.2B 1250 Ekip Hi-Touch LSIg	1SDA070829R1	1SDA071459R1	
1600	42	42	E1.2B 1600 Ekip Dip LI	1SDA070861R1	1SDA071491R1	
			E1.2B 1600 Ekip Dip LSI	1SDA070862R1	1SDA071492R1	
			E1.2B 1600 Ekip Dip LSIg	1SDA070863R1	1SDA071493R1	
			E1.2B 1600 Ekip Touch LI	1SDA070864R1	1SDA071494R1	
			E1.2B 1600 Ekip Touch LSI	1SDA070865R1	1SDA071495R1	
			E1.2B 1600 Ekip Touch LSIg	1SDA070866R1	1SDA071496R1	
			E1.2B 1600 Ekip Hi-Touch LSI	1SDA070868R1	1SDA071498R1	
			E1.2B 1600 Ekip Hi-Touch LSIg	1SDA070869R1	1SDA071499R1	



**SACE Emax E1.2C • Front terminals (F)**

Size	Iu	Icu (440 V) (1s)	Icw (1s)	Type	3 Poles	4 Poles
					Code	Code
E1.2C	630	50	42	E1.2C 630 Ekip Dip LI	1SDA070711R1	1SDA071341R1
				E1.2C 630 Ekip Dip LSI	1SDA070712R1	1SDA071342R1
				E1.2C 630 Ekip Dip LSIG	1SDA070713R1	1SDA071343R1
				E1.2C 630 Ekip Touch LI	1SDA070714R1	1SDA071344R1
				E1.2C 630 Ekip Touch LSI	1SDA070715R1	1SDA071345R1
				E1.2C 630 Ekip Touch LSIG	1SDA070716R1	1SDA071346R1
				E1.2C 630 Ekip Hi-Touch LSI	1SDA070718R1	1SDA071348R1
				E1.2C 630 Ekip Hi-Touch LSIG	1SDA070719R1	1SDA071349R1
800	50	42	E1.2C 800 Ekip Dip LI	1SDA070751R1	1SDA071381R1	
			E1.2C 800 Ekip Dip LSI	1SDA070752R1	1SDA071382R1	
			E1.2C 800 Ekip Dip LSIG	1SDA070753R1	1SDA071383R1	
			E1.2C 800 Ekip Touch LI	1SDA070754R1	1SDA071384R1	
			E1.2C 800 Ekip Touch LSI	1SDA070755R1	1SDA071385R1	
			E1.2C 800 Ekip Touch LSIG	1SDA070756R1	1SDA071386R1	
			E1.2C 800 Ekip Hi-Touch LSI	1SDA070758R1	1SDA071388R1	
			E1.2C 800 Ekip Hi-Touch LSIG	1SDA070759R1	1SDA071389R1	
1000	50	42	E1.2C 1000 Ekip Dip LI	1SDA070791R1	1SDA071421R1	
			E1.2C 1000 Ekip Dip LSI	1SDA070792R1	1SDA071422R1	
			E1.2C 1000 Ekip Dip LSIG	1SDA070793R1	1SDA071423R1	
			E1.2C 1000 Ekip Touch LI	1SDA070794R1	1SDA071424R1	
			E1.2C 1000 Ekip Touch LSI	1SDA070795R1	1SDA071425R1	
			E1.2C 1000 Ekip Touch LSIG	1SDA070796R1	1SDA071426R1	
			E1.2C 1000 Ekip Hi-Touch LSI	1SDA070798R1	1SDA071428R1	
			E1.2C 1000 Ekip Hi-Touch LSIG	1SDA070799R1	1SDA071429R1	
1250	50	42	E1.2C 1250 Ekip Dip LI	1SDA070831R1	1SDA071461R1	
			E1.2C 1250 Ekip Dip LSI	1SDA070832R1	1SDA071462R1	
			E1.2C 1250 Ekip Dip LSIG	1SDA070833R1	1SDA071463R1	
			E1.2C 1250 Ekip Touch LI	1SDA070834R1	1SDA071464R1	
			E1.2C 1250 Ekip Touch LSI	1SDA070835R1	1SDA071465R1	
			E1.2C 1250 Ekip Touch LSIG	1SDA070836R1	1SDA071466R1	
			E1.2C 1250 Ekip Hi-Touch LSI	1SDA070838R1	1SDA071468R1	
			E1.2C 1250 Ekip Hi-Touch LSIG	1SDA070839R1	1SDA071469R1	
1600	50	42	E1.2C 1600 Ekip Dip LI	1SDA070871R1	1SDA071501R1	
			E1.2C 1600 Ekip Dip LSI	1SDA070872R1	1SDA071502R1	
			E1.2C 1600 Ekip Dip LSIG	1SDA070873R1	1SDA071503R1	
			E1.2C 1600 Ekip Touch LI	1SDA070874R1	1SDA071504R1	
			E1.2C 1600 Ekip Touch LSI	1SDA070875R1	1SDA071505R1	
			E1.2C 1600 Ekip Touch LSIG	1SDA070876R1	1SDA071506R1	
			E1.2C 1600 Ekip Hi-Touch LSI	1SDA070878R1	1SDA071508R1	
			E1.2C 1600 Ekip Hi-Touch LSIG	1SDA070879R1	1SDA071509R1	

# Automatic circuit-breakers

## Fixed version for power distribution



### SACE Emax E1.2N • Front terminals (F)

Size	I <sub>u</sub>	I <sub>cu</sub> (440 V) (1s)	I <sub>cw</sub> (1s)	Type	3 Poles	4 Poles
					Code	Code
E1.2N	250	66	50	E1.2N 250 Ekip Dip LI	1SDA070691R1	1SDA071321R1
				E1.2N 250 Ekip Dip LSI	1SDA070692R1	1SDA071322R1
				E1.2N 250 Ekip Dip LSIG	1SDA070693R1	1SDA071323R1
				E1.2N 250 Ekip Touch LI	1SDA070694R1	1SDA071324R1
				E1.2N 250 Ekip Touch LSI	1SDA070695R1	1SDA071325R1
				E1.2N 250 Ekip Touch LSIG	1SDA070696R1	1SDA071326R1
				E1.2N 250 Ekip Hi-Touch LSI	1SDA070698R1	1SDA071328R1
				E1.2N 250 Ekip Hi-Touch LSIG	1SDA070699R1	1SDA071329R1
	630	66	50	E1.2N 630 Ekip Dip LI	1SDA070721R1	1SDA071351R1
				E1.2N 630 Ekip Dip LSI	1SDA070722R1	1SDA071352R1
				E1.2N 630 Ekip Dip LSIG	1SDA070723R1	1SDA071353R1
				E1.2N 630 Ekip Touch LI	1SDA070724R1	1SDA071354R1
				E1.2N 630 Ekip Touch LSI	1SDA070725R1	1SDA071355R1
				E1.2N 630 Ekip Touch LSIG	1SDA070726R1	1SDA071356R1
				E1.2N 630 Ekip Hi-Touch LSI	1SDA070728R1	1SDA071358R1
				E1.2N 630 Ekip Hi-Touch LSIG	1SDA070729R1	1SDA071359R1
	800	66	50	E1.2N 800 Ekip Dip LI	1SDA070761R1	1SDA071391R1
				E1.2N 800 Ekip Dip LSI	1SDA070762R1	1SDA071392R1
				E1.2N 800 Ekip Dip LSIG	1SDA070763R1	1SDA071393R1
				E1.2N 800 Ekip Touch LI	1SDA070764R1	1SDA071394R1
				E1.2N 800 Ekip Touch LSI	1SDA070765R1	1SDA071395R1
				E1.2N 800 Ekip Touch LSIG	1SDA070766R1	1SDA071396R1
				E1.2N 800 Ekip Hi-Touch LSI	1SDA070768R1	1SDA071398R1
				E1.2N 800 Ekip Hi-Touch LSIG	1SDA070769R1	1SDA071399R1
	1000	66	50	E1.2N 1000 Ekip Dip LI	1SDA070801R1	1SDA071431R1
				E1.2N 1000 Ekip Dip LSI	1SDA070802R1	1SDA071432R1
				E1.2N 1000 Ekip Dip LSIG	1SDA070803R1	1SDA071433R1
				E1.2N 1000 Ekip Touch LI	1SDA070804R1	1SDA071434R1
				E1.2N 1000 Ekip Touch LSI	1SDA070805R1	1SDA071435R1
				E1.2N 1000 Ekip Touch LSIG	1SDA070806R1	1SDA071436R1
				E1.2N 1000 Ekip Hi-Touch LSI	1SDA070808R1	1SDA071438R1
				E1.2N 1000 Ekip Hi-Touch LSIG	1SDA070809R1	1SDA071439R1



**SACE Emax E1.2N • Front terminals (F)**

Size	Iu	Icu (440 V) (1s)	Icw (1s)	Type	3 Poles	4 Poles
					Code	Code
E1.2N	1250	66	50	E1.2N 1250 Ekip Dip LI	1SDA070841R1	1SDA071471R1
				E1.2N 1250 Ekip Dip LSI	1SDA070842R1	1SDA071472R1
				E1.2N 1250 Ekip Dip LSIg	1SDA070843R1	1SDA071473R1
				E1.2N 1250 Ekip Touch LI	1SDA070844R1	1SDA071474R1
				E1.2N 1250 Ekip Touch LSI	1SDA070845R1	1SDA071475R1
				E1.2N 1250 Ekip Touch LSIg	1SDA070846R1	1SDA071476R1
				E1.2N 1250 Ekip Hi-Touch LSI	1SDA070848R1	1SDA071478R1
				E1.2N 1250 Ekip Hi-Touch LSIg	1SDA070849R1	1SDA071479R1
				1600	66	50
E1.2N 1600 Ekip Dip LSI	1SDA070882R1	1SDA071512R1				
E1.2N 1600 Ekip Dip LSIg	1SDA070883R1	1SDA071513R1				
E1.2N 1600 Ekip Touch LI	1SDA070884R1	1SDA071514R1				
E1.2N 1600 Ekip Touch LSI	1SDA070885R1	1SDA071515R1				
E1.2N 1600 Ekip Touch LSIg	1SDA070886R1	1SDA071516R1				
E1.2N 1600 Ekip Hi-Touch LSI	1SDA070888R1	1SDA071518R1				
E1.2N 1600 Ekip Hi-Touch LSIg	1SDA070889R1	1SDA071519R1				

# Automatic circuit-breakers

## Fixed version for power distribution



### SACE Emax E2.2B • Orientable rear terminals (HR)

Size	I <sub>u</sub>	I <sub>cu</sub> (440 V) (1s)	I <sub>cw</sub> (1s)	Type	3 Poles	4 Poles
					Code	Code
E2.2B	1600	42	42	E2.2B 1600 Ekip Dip LI	1SDA070981R1	1SDA071611R1
				E2.2B 1600 Ekip Dip LSI	1SDA070982R1	1SDA071612R1
				E2.2B 1600 Ekip Dip LSI <sub>G</sub>	1SDA070983R1	1SDA071613R1
				E2.2B 1600 Ekip Touch LI	1SDA070984R1	1SDA071614R1
				E2.2B 1600 Ekip Touch LSI	1SDA070985R1	1SDA071615R1
				E2.2B 1600 Ekip Touch LSI <sub>G</sub>	1SDA070986R1	1SDA071616R1
				E2.2B 1600 Ekip Hi-Touch LSI	1SDA070988R1	1SDA071618R1
				E2.2B 1600 Ekip Hi-Touch LSI <sub>G</sub>	1SDA070989R1	1SDA071619R1
	2000	42	42	E2.2B 2000 Ekip Dip LI	1SDA071021R1	1SDA071651R1
				E2.2B 2000 Ekip Dip LSI	1SDA071022R1	1SDA071652R1
				E2.2B 2000 Ekip Dip LSI <sub>G</sub>	1SDA071023R1	1SDA071653R1
				E2.2B 2000 Ekip Touch LI	1SDA071024R1	1SDA071654R1
				E2.2B 2000 Ekip Touch LSI	1SDA071025R1	1SDA071655R1
				E2.2B 2000 Ekip Touch LSI <sub>G</sub>	1SDA071026R1	1SDA071656R1
				E2.2B 2000 Ekip Hi-Touch LSI	1SDA071028R1	1SDA071658R1
				E2.2B 2000 Ekip Hi-Touch LSI <sub>G</sub>	1SDA071029R1	1SDA071659R1



**SACE Emax E2.2N • Orientable rear terminals (HR)**

Size	Iu	Icu (440 V)	Icw (1s)	Type	3 Poles	4 Poles
					Code	Code
E2.2N	800	66	66	E2.2N 800 Ekip Dip LI	1SDA070891R1	1SDA071521R1
				E2.2N 800 Ekip Dip LSI	1SDA070892R1	1SDA071522R1
				E2.2N 800 Ekip Dip LSIG	1SDA070893R1	1SDA071523R1
				E2.2N 800 Ekip Touch LI	1SDA070894R1	1SDA071524R1
				E2.2N 800 Ekip Touch LSI	1SDA070895R1	1SDA071525R1
				E2.2N 800 Ekip Touch LSIG	1SDA070896R1	1SDA071526R1
				E2.2N 800 Ekip Hi-Touch LSI	1SDA070898R1	1SDA071528R1
				E2.2N 800 Ekip Hi-Touch LSIG	1SDA070899R1	1SDA071529R1
1000	66	66	E2.2N 1000 Ekip Dip LI	1SDA070921R1	1SDA071551R1	
			E2.2N 1000 Ekip Dip LSI	1SDA070922R1	1SDA071552R1	
			E2.2N 1000 Ekip Dip LSIG	1SDA070923R1	1SDA071553R1	
			E2.2N 1000 Ekip Touch LI	1SDA070924R1	1SDA071554R1	
			E2.2N 1000 Ekip Touch LSI	1SDA070925R1	1SDA071555R1	
			E2.2N 1000 Ekip Touch LSIG	1SDA070926R1	1SDA071556R1	
			E2.2N 1000 Ekip Hi-Touch LSI	1SDA070928R1	1SDA071558R1	
			E2.2N 1000 Ekip Hi-Touch LSIG	1SDA070929R1	1SDA071559R1	
1250	66	66	E2.2N 1250 Ekip Dip LI	1SDA070951R1	1SDA071581R1	
			E2.2N 1250 Ekip Dip LSI	1SDA070952R1	1SDA071582R1	
			E2.2N 1250 Ekip Dip LSIG	1SDA070953R1	1SDA071583R1	
			E2.2N 1250 Ekip Touch LI	1SDA070954R1	1SDA071584R1	
			E2.2N 1250 Ekip Touch LSI	1SDA070955R1	1SDA071585R1	
			E2.2N 1250 Ekip Touch LSIG	1SDA070956R1	1SDA071586R1	
			E2.2N 1250 Ekip Hi-Touch LSI	1SDA070958R1	1SDA071588R1	
			E2.2N 1250 Ekip Hi-Touch LSIG	1SDA070959R1	1SDA071589R1	
1600	66	66	E2.2N 1600 Ekip Dip LI	1SDA070991R1	1SDA071621R1	
			E2.2N 1600 Ekip Dip LSI	1SDA070992R1	1SDA071622R1	
			E2.2N 1600 Ekip Dip LSIG	1SDA070993R1	1SDA071623R1	
			E2.2N 1600 Ekip Touch LI	1SDA070994R1	1SDA071624R1	
			E2.2N 1600 Ekip Touch LSI	1SDA070995R1	1SDA071625R1	
			E2.2N 1600 Ekip Touch LSIG	1SDA070996R1	1SDA071626R1	
			E2.2N 1600 Ekip Hi-Touch LSI	1SDA070998R1	1SDA071628R1	
			E2.2N 1600 Ekip Hi-Touch LSIG	1SDA070999R1	1SDA071629R1	
2000	66	66	E2.2N 2000 Ekip Dip LI	1SDA071031R1	1SDA071661R1	
			E2.2N 2000 Ekip Dip LSI	1SDA071032R1	1SDA071662R1	
			E2.2N 2000 Ekip Dip LSIG	1SDA071033R1	1SDA071663R1	
			E2.2N 2000 Ekip Touch LI	1SDA071034R1	1SDA071664R1	
			E2.2N 2000 Ekip Touch LSI	1SDA071035R1	1SDA071665R1	
			E2.2N 2000 Ekip Touch LSIG	1SDA071036R1	1SDA071666R1	
			E2.2N 2000 Ekip Hi-Touch LSI	1SDA071038R1	1SDA071668R1	
			E2.2N 2000 Ekip Hi-Touch LSIG	1SDA071039R1	1SDA071669R1	
2500	66	66	E2.2N 2500 Ekip Dip LI	1SDA071061R1	1SDA071691R1	
			E2.2N 2500 Ekip Dip LSI	1SDA071062R1	1SDA071692R1	
			E2.2N 2500 Ekip Dip LSIG	1SDA071063R1	1SDA071693R1	
			E2.2N 2500 Ekip Touch LI	1SDA071064R1	1SDA071694R1	
			E2.2N 2500 Ekip Touch LSI	1SDA071065R1	1SDA071695R1	
			E2.2N 2500 Ekip Touch LSIG	1SDA071066R1	1SDA071696R1	
			E2.2N 2500 Ekip Hi-Touch LSI	1SDA071068R1	1SDA071698R1	
			E2.2N 2500 Ekip Hi-Touch LSIG	1SDA071069R1	1SDA071699R1	

# Automatic circuit-breakers

## Fixed version for power distribution



### SACE Emax E2.2S • Orientable rear terminals (HR)

Size	Iu	Icu (440 V) (1s)	Icw (1s)	Type	3 Poles	4 Poles
					Code	Code
E2.2S	250	85	66	E2.2S 250 Ekip Dip LI	1SDA073628R1	1SDA073638R1
				E2.2S 250 Ekip Dip LSI	1SDA073629R1	1SDA073639R1
				E2.2S 250 Ekip Dip LSIg	1SDA073630R1	1SDA073640R1
				E2.2S 250 Ekip Touch LI	1SDA073631R1	1SDA073641R1
				E2.2S 250 Ekip Touch LSI	1SDA073632R1	1SDA073642R1
				E2.2S 250 Ekip Touch LSIg	1SDA073633R1	1SDA073643R1
				E2.2S 250 Ekip Hi-Touch LSI	1SDA073635R1	1SDA073645R1
				E2.2S 250 Ekip Hi-Touch LSIg	1SDA073636R1	1SDA073646R1
	800	85	66	E2.2S 800 Ekip Dip LI	1SDA070901R1	1SDA071531R1
				E2.2S 800 Ekip Dip LSI	1SDA070902R1	1SDA071532R1
				E2.2S 800 Ekip Dip LSIg	1SDA070903R1	1SDA071533R1
				E2.2S 800 Ekip Touch LI	1SDA070904R1	1SDA071534R1
				E2.2S 800 Ekip Touch LSI	1SDA070905R1	1SDA071535R1
				E2.2S 800 Ekip Touch LSIg	1SDA070906R1	1SDA071536R1
				E2.2S 800 Ekip Hi-Touch LSI	1SDA070908R1	1SDA071538R1
				E2.2S 800 Ekip Hi-Touch LSIg	1SDA070909R1	1SDA071539R1
	1000	85	66	E2.2S 1000 Ekip Dip LI	1SDA070931R1	1SDA071561R1
				E2.2S 1000 Ekip Dip LSI	1SDA070932R1	1SDA071562R1
				E2.2S 1000 Ekip Dip LSIg	1SDA070933R1	1SDA071563R1
				E2.2S 1000 Ekip Touch LI	1SDA070934R1	1SDA071564R1
				E2.2S 1000 Ekip Touch LSI	1SDA070935R1	1SDA071565R1
				E2.2S 1000 Ekip Touch LSIg	1SDA070936R1	1SDA071566R1
				E2.2S 1000 Ekip Hi-Touch LSI	1SDA070938R1	1SDA071568R1
				E2.2S 1000 Ekip Hi-Touch LSIg	1SDA070939R1	1SDA071569R1
	1250	85	66	E2.2S 1250 Ekip Dip LI	1SDA070961R1	1SDA071591R1
				E2.2S 1250 Ekip Dip LSI	1SDA070962R1	1SDA071592R1
				E2.2S 1250 Ekip Dip LSIg	1SDA070963R1	1SDA071593R1
				E2.2S 1250 Ekip Touch LI	1SDA070964R1	1SDA071594R1
				E2.2S 1250 Ekip Touch LSI	1SDA070965R1	1SDA071595R1
				E2.2S 1250 Ekip Touch LSIg	1SDA070966R1	1SDA071596R1
				E2.2S 1250 Ekip Hi-Touch LSI	1SDA070968R1	1SDA071598R1
				E2.2S 1250 Ekip Hi-Touch LSIg	1SDA070969R1	1SDA071599R1





**SACE Emax E2.2S • Orientable rear terminals (HR)**

Size	Iu	Icu (440 V)	Icw (1s)	Type	3 Poles	4 Poles
					Code	Code
E2.2S	1600	85	66	E2.2S 1600 Ekip Dip LI	1SDA071001R1	1SDA071631R1
				E2.2S 1600 Ekip Dip LSI	1SDA071002R1	1SDA071632R1
				E2.2S 1600 Ekip Dip LSIG	1SDA071003R1	1SDA071633R1
				E2.2S 1600 Ekip Touch LI	1SDA071004R1	1SDA071634R1
				E2.2S 1600 Ekip Touch LSI	1SDA071005R1	1SDA071635R1
				E2.2S 1600 Ekip Touch LSIG	1SDA071006R1	1SDA071636R1
				E2.2S 1600 Ekip Hi-Touch LSI	1SDA071008R1	1SDA071638R1
				E2.2S 1600 Ekip Hi-Touch LSIG	1SDA071009R1	1SDA071639R1
	2000	85	66	E2.2S 2000 Ekip Dip LI	1SDA071041R1	1SDA071671R1
				E2.2S 2000 Ekip Dip LSI	1SDA071042R1	1SDA071672R1
				E2.2S 2000 Ekip Dip LSIG	1SDA071043R1	1SDA071673R1
				E2.2S 2000 Ekip Touch LI	1SDA071044R1	1SDA071674R1
				E2.2S 2000 Ekip Touch LSI	1SDA071045R1	1SDA071675R1
				E2.2S 2000 Ekip Touch LSIG	1SDA071046R1	1SDA071676R1
				E2.2S 2000 Ekip Hi-Touch LSI	1SDA071048R1	1SDA071678R1
				E2.2S 2000 Ekip Hi-Touch LSIG	1SDA071049R1	1SDA071679R1
	2500	85	66	E2.2S 2500 Ekip Dip LI	1SDA071071R1	1SDA071701R1
				E2.2S 2500 Ekip Dip LSI	1SDA071072R1	1SDA071702R1
				E2.2S 2500 Ekip Dip LSIG	1SDA071073R1	1SDA071703R1
				E2.2S 2500 Ekip Touch LI	1SDA071074R1	1SDA071704R1
				E2.2S 2500 Ekip Touch LSI	1SDA071075R1	1SDA071705R1
				E2.2S 2500 Ekip Touch LSIG	1SDA071076R1	1SDA071706R1
				E2.2S 2500 Ekip Hi-Touch LSI	1SDA071078R1	1SDA071708R1
				E2.2S 2500 Ekip Hi-Touch LSIG	1SDA071079R1	1SDA071709R1

# Automatic circuit-breakers

## Fixed version for power distribution



### SACE Emax E2.2H • Orientable rear terminals (HR)

Size	I <sub>u</sub>	I <sub>cu</sub> (440 V)	I <sub>cw</sub> (1s)	Type	3 Poles	4 Poles
					Code	Code
E2.2H	800	100	85	E2.2H 800 Ekip Dip LI	1SDA070911R1	1SDA071541R1
				E2.2H 800 Ekip Dip LSI	1SDA070912R1	1SDA071542R1
				E2.2H 800 Ekip Dip LSIG	1SDA070913R1	1SDA071543R1
				E2.2H 800 Ekip Touch LI	1SDA070914R1	1SDA071544R1
				E2.2H 800 Ekip Touch LSI	1SDA070915R1	1SDA071545R1
				E2.2H 800 Ekip Touch LSIG	1SDA070916R1	1SDA071546R1
				E2.2H 800 Ekip Hi-Touch LSI	1SDA070918R1	1SDA071548R1
				E2.2H 800 Ekip Hi-Touch LSIG	1SDA070919R1	1SDA071549R1
1000	100	85	E2.2H 1000 Ekip Dip LI	1SDA070941R1	1SDA071571R1	
			E2.2H 1000 Ekip Dip LSI	1SDA070942R1	1SDA071572R1	
			E2.2H 1000 Ekip Dip LSIG	1SDA070943R1	1SDA071573R1	
			E2.2H 1000 Ekip Touch LI	1SDA070944R1	1SDA071574R1	
			E2.2H 1000 Ekip Touch LSI	1SDA070945R1	1SDA071575R1	
			E2.2H 1000 Ekip Touch LSIG	1SDA070946R1	1SDA071576R1	
			E2.2H 1000 Ekip Hi-Touch LSI	1SDA070948R1	1SDA071578R1	
			E2.2H 1000 Ekip Hi-Touch LSIG	1SDA070949R1	1SDA071579R1	
1250	100	85	E2.2H 1250 Ekip Dip LI	1SDA070971R1	1SDA071601R1	
			E2.2H 1250 Ekip Dip LSI	1SDA070972R1	1SDA071602R1	
			E2.2H 1250 Ekip Dip LSIG	1SDA070973R1	1SDA071603R1	
			E2.2H 1250 Ekip Touch LI	1SDA070974R1	1SDA071604R1	
			E2.2H 1250 Ekip Touch LSI	1SDA070975R1	1SDA071605R1	
			E2.2H 1250 Ekip Touch LSIG	1SDA070976R1	1SDA071606R1	
			E2.2H 1250 Ekip Hi-Touch LSI	1SDA070978R1	1SDA071608R1	
			E2.2H 1250 Ekip Hi-Touch LSIG	1SDA070979R1	1SDA071609R1	
1600	100	85	E2.2H 1600 Ekip Dip LI	1SDA071011R1	1SDA071641R1	
			E2.2H 1600 Ekip Dip LSI	1SDA071012R1	1SDA071642R1	
			E2.2H 1600 Ekip Dip LSIG	1SDA071013R1	1SDA071643R1	
			E2.2H 1600 Ekip Touch LI	1SDA071014R1	1SDA071644R1	
			E2.2H 1600 Ekip Touch LSI	1SDA071015R1	1SDA071645R1	
			E2.2H 1600 Ekip Touch LSIG	1SDA071016R1	1SDA071646R1	
			E2.2H 1600 Ekip Hi-Touch LSI	1SDA071018R1	1SDA071648R1	
			E2.2H 1600 Ekip Hi-Touch LSIG	1SDA071019R1	1SDA071649R1	
2000	100	85	E2.2H 2000 Ekip Dip LI	1SDA071051R1	1SDA071681R1	
			E2.2H 2000 Ekip Dip LSI	1SDA071052R1	1SDA071682R1	
			E2.2H 2000 Ekip Dip LSIG	1SDA071053R1	1SDA071683R1	
			E2.2H 2000 Ekip Touch LI	1SDA071054R1	1SDA071684R1	
			E2.2H 2000 Ekip Touch LSI	1SDA071055R1	1SDA071685R1	
			E2.2H 2000 Ekip Touch LSIG	1SDA071056R1	1SDA071686R1	
			E2.2H 2000 Ekip Hi-Touch LSI	1SDA071058R1	1SDA071688R1	
			E2.2H 2000 Ekip Hi-Touch LSIG	1SDA071059R1	1SDA071689R1	
2500	100	85	E2.2H 2500 Ekip Dip LI	1SDA071081R1	1SDA071711R1	
			E2.2H 2500 Ekip Dip LSI	1SDA071082R1	1SDA071712R1	
			E2.2H 2500 Ekip Dip LSIG	1SDA071083R1	1SDA071713R1	
			E2.2H 2500 Ekip Touch LI	1SDA071084R1	1SDA071714R1	
			E2.2H 2500 Ekip Touch LSI	1SDA071085R1	1SDA071715R1	
			E2.2H 2500 Ekip Touch LSIG	1SDA071086R1	1SDA071716R1	
			E2.2H 2500 Ekip Hi-Touch LSI	1SDA071088R1	1SDA071718R1	
			E2.2H 2500 Ekip Hi-Touch LSIG	1SDA071089R1	1SDA071719R1	



**SACE Emax E4.2N-S • Orientable rear terminals (HR)**

Size	Iu	Icu (440 V) (1s)	Icw (1s)	Type	3 Poles	4 Poles
					Code	Code
<b>E4.2N</b>	3200	66	66	E4.2N 3200 Ekip Dip LI	1SDA071141R1	1SDA071771R1
				E4.2N 3200 Ekip Dip LSI	1SDA071142R1	1SDA071772R1
				E4.2N 3200 Ekip Dip LSIG	1SDA071143R1	1SDA071773R1
				E4.2N 3200 Ekip Touch LI	1SDA071144R1	1SDA071774R1
				E4.2N 3200 Ekip Touch LSI	1SDA071145R1	1SDA071775R1
				E4.2N 3200 Ekip Touch LSIG	1SDA071146R1	1SDA071776R1
				E4.2N 3200 Ekip Hi-Touch LSI	1SDA071148R1	1SDA071778R1
				E4.2N 3200 Ekip Hi-Touch LSIG	1SDA071149R1	1SDA071779R1
	4000	66	66	E4.2N 4000 Ekip Dip LI	1SDA071191R1	1SDA071821R1
				E4.2N 4000 Ekip Dip LSI	1SDA071192R1	1SDA071822R1
				E4.2N 4000 Ekip Dip LSIG	1SDA071193R1	1SDA071823R1
				E4.2N 4000 Ekip Touch LI	1SDA071194R1	1SDA071824R1
				E4.2N 4000 Ekip Touch LSI	1SDA071195R1	1SDA071825R1
				E4.2N 4000 Ekip Touch LSIG	1SDA071196R1	1SDA071826R1
				E4.2N 4000 Ekip Hi-Touch LSI	1SDA071198R1	1SDA071828R1
				E4.2N 4000 Ekip Hi-Touch LSIG	1SDA071199R1	1SDA071829R1
<b>E4.2S</b>	3200	85	66	E4.2S 3200 Ekip Dip LI	1SDA071151R1	1SDA071781R1
				E4.2S 3200 Ekip Dip LSI	1SDA071152R1	1SDA071782R1
				E4.2S 3200 Ekip Dip LSIG	1SDA071153R1	1SDA071783R1
				E4.2S 3200 Ekip Touch LI	1SDA071154R1	1SDA071784R1
				E4.2S 3200 Ekip Touch LSI	1SDA071155R1	1SDA071785R1
				E4.2S 3200 Ekip Touch LSIG	1SDA071156R1	1SDA071786R1
				E4.2S 3200 Ekip Hi-Touch LSI	1SDA071158R1	1SDA071788R1
				E4.2S 3200 Ekip Hi-Touch LSIG	1SDA071159R1	1SDA071789R1
	4000	85	66	E4.2S 4000 Ekip Dip LI	1SDA071201R1	1SDA071831R1
				E4.2S 4000 Ekip Dip LSI	1SDA071202R1	1SDA071832R1
				E4.2S 4000 Ekip Dip LSIG	1SDA071203R1	1SDA071833R1
				E4.2S 4000 Ekip Touch LI	1SDA071204R1	1SDA071834R1
				E4.2S 4000 Ekip Touch LSI	1SDA071205R1	1SDA071835R1
				E4.2S 4000 Ekip Touch LSIG	1SDA071206R1	1SDA071836R1
				E4.2S 4000 Ekip Hi-Touch LSI	1SDA071208R1	1SDA071838R1
				E4.2S 4000 Ekip Hi-Touch LSIG	1SDA071209R1	1SDA071839R1

# Automatic circuit-breakers

## Fixed version for power distribution



### SACE Emax E4.2H-V • Orientable rear terminals (HR)

Size	Iu	Icu (440 V)	Icw (1s)	Type	3 Poles	4 Poles
					Code	Code
E4.2H	3200	100	85	E4.2H 3200 Ekip Dip LI	1SDA071161R1	1SDA071791R1
				E4.2H 3200 Ekip Dip LSI	1SDA071162R1	1SDA071792R1
				E4.2H 3200 Ekip Dip LSIG	1SDA071163R1	1SDA071793R1
				E4.2H 3200 Ekip Touch LI	1SDA071164R1	1SDA071794R1
				E4.2H 3200 Ekip Touch LSI	1SDA071165R1	1SDA071795R1
				E4.2H 3200 Ekip Touch LSIG	1SDA071166R1	1SDA071796R1
				E4.2H 3200 Ekip Hi-Touch LSI	1SDA071168R1	1SDA071798R1
				E4.2H 3200 Ekip Hi-Touch LSIG	1SDA071169R1	1SDA071799R1
	4000	100	85	E4.2H 4000 Ekip Dip LI	1SDA071211R1	1SDA071841R1
				E4.2H 4000 Ekip Dip LSI	1SDA071212R1	1SDA071842R1
				E4.2H 4000 Ekip Dip LSIG	1SDA071213R1	1SDA071843R1
				E4.2H 4000 Ekip Touch LI	1SDA071214R1	1SDA071844R1
				E4.2H 4000 Ekip Touch LSI	1SDA071215R1	1SDA071845R1
				E4.2H 4000 Ekip Touch LSIG	1SDA071216R1	1SDA071846R1
				E4.2H 4000 Ekip Hi-Touch LSI	1SDA071218R1	1SDA071848R1
				E4.2H 4000 Ekip Hi-Touch LSIG	1SDA071219R1	1SDA071849R1
E4.2V	2000	150	100	E4.2V 2000 Ekip Dip LI	1SDA071101R1	1SDA071731R1
				E4.2V 2000 Ekip Dip LSI	1SDA071102R1	1SDA071732R1
				E4.2V 2000 Ekip Dip LSIG	1SDA071103R1	1SDA071733R1
				E4.2V 2000 Ekip Touch LI	1SDA071104R1	1SDA071734R1
				E4.2V 2000 Ekip Touch LSI	1SDA071105R1	1SDA071735R1
				E4.2V 2000 Ekip Touch LSIG	1SDA071106R1	1SDA071736R1
				E4.2V 2000 Ekip Hi-Touch LSI	1SDA071108R1	1SDA071738R1
				E4.2V 2000 Ekip Hi-Touch LSIG	1SDA071109R1	1SDA071739R1
	2500	150	100	E4.2V 2500 Ekip Dip LI	1SDA071121R1	1SDA071751R1
				E4.2V 2500 Ekip Dip LSI	1SDA071122R1	1SDA071752R1
				E4.2V 2500 Ekip Dip LSIG	1SDA071123R1	1SDA071753R1
				E4.2V 2500 Ekip Touch LI	1SDA071124R1	1SDA071754R1
				E4.2V 2500 Ekip Touch LSI	1SDA071125R1	1SDA071755R1
				E4.2V 2500 Ekip Touch LSIG	1SDA071126R1	1SDA071756R1
				E4.2V 2500 Ekip Hi-Touch LSI	1SDA071128R1	1SDA071758R1
				E4.2V 2500 Ekip Hi-Touch LSIG	1SDA071129R1	1SDA071759R1
	3200	150	100	E4.2V 3200 Ekip Dip LI	1SDA071171R1	1SDA071801R1
				E4.2V 3200 Ekip Dip LSI	1SDA071172R1	1SDA071802R1
				E4.2V 3200 Ekip Dip LSIG	1SDA071173R1	1SDA071803R1
				E4.2V 3200 Ekip Touch LI	1SDA071174R1	1SDA071804R1
				E4.2V 3200 Ekip Touch LSI	1SDA071175R1	1SDA071805R1
				E4.2V 3200 Ekip Touch LSIG	1SDA071176R1	1SDA071806R1
				E4.2V 3200 Ekip Hi-Touch LSI	1SDA071178R1	1SDA071808R1
				E4.2V 3200 Ekip Hi-Touch LSIG	1SDA071179R1	1SDA071809R1
	4000	150	100	E4.2V 4000 Ekip Dip LI	1SDA071221R1	1SDA071851R1
				E4.2V 4000 Ekip Dip LSI	1SDA071222R1	1SDA071852R1
				E4.2V 4000 Ekip Dip LSIG	1SDA071223R1	1SDA071853R1
				E4.2V 4000 Ekip Touch LI	1SDA071224R1	1SDA071854R1
				E4.2V 4000 Ekip Touch LSI	1SDA071225R1	1SDA071855R1
				E4.2V 4000 Ekip Touch LSIG	1SDA071226R1	1SDA071856R1
				E4.2V 4000 Ekip Hi-Touch LSI	1SDA071228R1	1SDA071858R1
				E4.2V 4000 Ekip Hi-Touch LSIG	1SDA071229R1	1SDA071859R1



**SACE Emax E6.2H-V • Orientable rear terminals (HR)**

Size	lu	lcu (440 V)	lcw (1s)	Type	3 Poles	4 Poles
					Code	Code
<b>E6.2H</b>	4000	100	100	E6.2H 4000 Ekip Dip LI	1SDA071231R1	1SDA071861R1
				E6.2H 4000 Ekip Dip LSI	1SDA071232R1	1SDA071862R1
				E6.2H 4000 Ekip Dip LSIG	1SDA071233R1	1SDA071863R1
				E6.2H 4000 Ekip Touch LI	1SDA071234R1	1SDA071864R1
				E6.2H 4000 Ekip Touch LSI	1SDA071235R1	1SDA071865R1
				E6.2H 4000 Ekip Touch LSIG	1SDA071236R1	1SDA071866R1
				E6.2H 4000 Ekip Hi-Touch LSI	1SDA071238R1	1SDA071868R1
				E6.2H 4000 Ekip Hi-Touch LSIG	1SDA071239R1	1SDA071869R1
	5000	100	100	E6.2H 5000 Ekip Dip LI	1SDA071261R1	1SDA071891R1
				E6.2H 5000 Ekip Dip LSI	1SDA071262R1	1SDA071892R1
				E6.2H 5000 Ekip Dip LSIG	1SDA071263R1	1SDA071893R1
				E6.2H 5000 Ekip Touch LI	1SDA071264R1	1SDA071894R1
				E6.2H 5000 Ekip Touch LSI	1SDA071265R1	1SDA071895R1
				E6.2H 5000 Ekip Touch LSIG	1SDA071266R1	1SDA071896R1
				E6.2H 5000 Ekip Hi-Touch LSI	1SDA071268R1	1SDA071898R1
				E6.2H 5000 Ekip Hi-Touch LSIG	1SDA071269R1	1SDA071899R1
	6300	100	100	E6.2H 6300 Ekip Dip LI	1SDA071291R1	1SDA071921R1
				E6.2H 6300 Ekip Dip LSI	1SDA071292R1	1SDA071922R1
				E6.2H 6300 Ekip Dip LSIG	1SDA071293R1	1SDA071923R1
				E6.2H 6300 Ekip Touch LI	1SDA071294R1	1SDA071924R1
				E6.2H 6300 Ekip Touch LSI	1SDA071295R1	1SDA071925R1
				E6.2H 6300 Ekip Touch LSIG	1SDA071296R1	1SDA071926R1
				E6.2H 6300 Ekip Hi-Touch LSI	1SDA071298R1	1SDA071928R1
				E6.2H 6300 Ekip Hi-Touch LSIG	1SDA071299R1	1SDA071929R1
<b>E6.2V</b>	4000	150	100	E6.2V 4000 Ekip Dip LI	1SDA071241R1	1SDA071871R1
				E6.2V 4000 Ekip Dip LSI	1SDA071242R1	1SDA071872R1
				E6.2V 4000 Ekip Dip LSIG	1SDA071243R1	1SDA071873R1
				E6.2V 4000 Ekip Touch LI	1SDA071244R1	1SDA071874R1
				E6.2V 4000 Ekip Touch LSI	1SDA071245R1	1SDA071875R1
				E6.2V 4000 Ekip Touch LSIG	1SDA071246R1	1SDA071876R1
				E6.2V 4000 Ekip Hi-Touch LSI	1SDA071248R1	1SDA071878R1
				E6.2V 4000 Ekip Hi-Touch LSIG	1SDA071249R1	1SDA071879R1
	5000	150	100	E6.2V 5000 Ekip Dip LI	1SDA071271R1	1SDA071901R1
				E6.2V 5000 Ekip Dip LSI	1SDA071272R1	1SDA071902R1
				E6.2V 5000 Ekip Dip LSIG	1SDA071273R1	1SDA071903R1
				E6.2V 5000 Ekip Touch LI	1SDA071274R1	1SDA071904R1
				E6.2V 5000 Ekip Touch LSI	1SDA071275R1	1SDA071905R1
				E6.2V 5000 Ekip Touch LSIG	1SDA071276R1	1SDA071906R1
				E6.2V 5000 Ekip Hi-Touch LSI	1SDA071278R1	1SDA071908R1
				E6.2V 5000 Ekip Hi-Touch LSIG	1SDA071279R1	1SDA071909R1
	6300	150	100	E6.2V 6300 Ekip Dip LI	1SDA071301R1	1SDA071931R1
				E6.2V 6300 Ekip Dip LSI	1SDA071302R1	1SDA071932R1
				E6.2V 6300 Ekip Dip LSIG	1SDA071303R1	1SDA071933R1
				E6.2V 6300 Ekip Touch LI	1SDA071304R1	1SDA071934R1
				E6.2V 6300 Ekip Touch LSI	1SDA071305R1	1SDA071935R1
				E6.2V 6300 Ekip Touch LSIG	1SDA071306R1	1SDA071936R1
				E6.2V 6300 Ekip Hi-Touch LSI	1SDA071308R1	1SDA071938R1
				E6.2V 6300 Ekip Hi-Touch LSIG	1SDA071309R1	1SDA071939R1

# Automatic circuit-breakers

## Fixed version for power distribution



### SACE Emax E6.2X • Orientable rear terminals (HR)

Size	Iu	Icu (440 V)	Icw (1s)	Type	3 Poles	4 Poles
					Code	Code
E6.2X	4000	150	120	E6.2X 4000 Ekip Dip LI	1SDA071251R1	1SDA071881R1
				E6.2X 4000 Ekip Dip LSI	1SDA071252R1	1SDA071882R1
				E6.2X 4000 Ekip Dip LSIG	1SDA071253R1	1SDA071883R1
				E6.2X 4000 Ekip Touch LI	1SDA071254R1	1SDA071884R1
				E6.2X 4000 Ekip Touch LSI	1SDA071255R1	1SDA071885R1
				E6.2X 4000 Ekip Touch LSIG	1SDA071256R1	1SDA071886R1
				E6.2X 4000 Ekip Hi-Touch LSI	1SDA071258R1	1SDA071888R1
				E6.2X 4000 Ekip Hi-Touch LSIG	1SDA071259R1	1SDA071889R1
	5000	150	120	E6.2X 5000 Ekip Dip LI	1SDA071281R1	1SDA071911R1
				E6.2X 5000 Ekip Dip LSI	1SDA071282R1	1SDA071912R1
				E6.2X 5000 Ekip Dip LSIG	1SDA071283R1	1SDA071913R1
				E6.2X 5000 Ekip Touch LI	1SDA071284R1	1SDA071914R1
				E6.2X 5000 Ekip Touch LSI	1SDA071285R1	1SDA071915R1
				E6.2X 5000 Ekip Touch LSIG	1SDA071286R1	1SDA071916R1
				E6.2X 5000 Ekip Hi-Touch LSI	1SDA071288R1	1SDA071918R1
				E6.2X 5000 Ekip Hi-Touch LSIG	1SDA071289R1	1SDA071919R1
	6300	150	120	E6.2X 6300 Ekip Dip LI	1SDA071311R1	1SDA071941R1
				E6.2X 6300 Ekip Dip LSI	1SDA071312R1	1SDA071942R1
				E6.2X 6300 Ekip Dip LSIG	1SDA071313R1	1SDA071943R1
				E6.2X 6300 Ekip Touch LI	1SDA071314R1	1SDA071944R1
				E6.2X 6300 Ekip Touch LSI	1SDA071315R1	1SDA071945R1
				E6.2X 6300 Ekip Touch LSIG	1SDA071316R1	1SDA071946R1
				E6.2X 6300 Ekip Hi-Touch LSI	1SDA071318R1	1SDA071948R1
				E6.2X 6300 Ekip Hi-Touch LSIG	1SDA071319R1	1SDA071949R1



**SACE Emax E6.2H-V/f Full size • Orientable rear terminals (HR)**

Size	Iu	Icu (440V)	Icw (1s)	Type	4 Poles	
					Code	
E6.2H/f	4000	100	100	E6.2H/f 4000 Ekip Dip LI	1SDA071951R1	
				E6.2H/f 4000 Ekip Dip LSI	1SDA071952R1	
				E6.2H/f 4000 Ekip Dip LSIG	1SDA071953R1	
				E6.2H/f 4000 Ekip Touch LI	1SDA071954R1	
				E6.2H/f 4000 Ekip Touch LSI	1SDA071955R1	
				E6.2H/f 4000 Ekip Touch LSIG	1SDA071956R1	
				E6.2H/f 4000 Ekip Hi-Touch LSI	1SDA071958R1	
				E6.2H/f 4000 Ekip Hi-Touch LSIG	1SDA071959R1	
	5000	100	100	E6.2H/f 5000 Ekip Dip LI	1SDA071981R1	
				E6.2H/f 5000 Ekip Dip LSI	1SDA071982R1	
				E6.2H/f 5000 Ekip Dip LSIG	1SDA071983R1	
				E6.2H/f 5000 Ekip Touch LI	1SDA071984R1	
				E6.2H/f 5000 Ekip Touch LSI	1SDA071985R1	
				E6.2H/f 5000 Ekip Touch LSIG	1SDA071986R1	
				E6.2H/f 5000 Ekip Hi-Touch LSI	1SDA071988R1	
				E6.2H/f 5000 Ekip Hi-Touch LSIG	1SDA071989R1	
	6300	100	100	E6.2H/f 6300 Ekip Dip LI	1SDA072011R1	
				E6.2H/f 6300 Ekip Dip LSI	1SDA072012R1	
				E6.2H/f 6300 Ekip Dip LSIG	1SDA072013R1	
				E6.2H/f 6300 Ekip Touch LI	1SDA072014R1	
				E6.2H/f 6300 Ekip Touch LSI	1SDA072015R1	
				E6.2H/f 6300 Ekip Touch LSIG	1SDA072016R1	
				E6.2H/f 6300 Ekip Hi-Touch LSI	1SDA072018R1	
				E6.2H/f 6300 Ekip Hi-Touch LSIG	1SDA072019R1	
	E6.2V/f	4000	150	100	E6.2V/f 4000 Ekip Dip LI	1SDA071961R1
					E6.2V/f 4000 Ekip Dip LSI	1SDA071962R1
					E6.2V/f 4000 Ekip Dip LSIG	1SDA071963R1
					E6.2V/f 4000 Ekip Touch LI	1SDA071964R1
E6.2V/f 4000 Ekip Touch LSI					1SDA071965R1	
E6.2V/f 4000 Ekip Touch LSIG					1SDA071966R1	
E6.2V/f 4000 Ekip Hi-Touch LSI					1SDA071968R1	
E6.2V/f 4000 Ekip Hi-Touch LSIG					1SDA071969R1	
5000		150	100	E6.2V/f 5000 Ekip Dip LI	1SDA071991R1	
				E6.2V/f 5000 Ekip Dip LSI	1SDA071992R1	
				E6.2V/f 5000 Ekip Dip LSIG	1SDA071993R1	
				E6.2V/f 5000 Ekip Touch LI	1SDA071994R1	
				E6.2V/f 5000 Ekip Touch LSI	1SDA071995R1	
				E6.2V/f 5000 Ekip Touch LSIG	1SDA071996R1	
				E6.2V/f 5000 Ekip Hi-Touch LSI	1SDA071998R1	
				E6.2V/f 5000 Ekip Hi-Touch LSIG	1SDA071999R1	
6300		150	100	E6.2V/f 6300 Ekip Dip LI	1SDA072021R1	
				E6.2V/f 6300 Ekip Dip LSI	1SDA072022R1	
				E6.2V/f 6300 Ekip Dip LSIG	1SDA072023R1	
				E6.2V/f 6300 Ekip Touch LI	1SDA072024R1	
				E6.2V/f 6300 Ekip Touch LSI	1SDA072025R1	
				E6.2V/f 6300 Ekip Touch LSIG	1SDA072026R1	
				E6.2V/f 6300 Ekip Hi-Touch LSI	1SDA072028R1	
				E6.2V/f 6300 Ekip Hi-Touch LSIG	1SDA072029R1	

# Automatic circuit-breakers

## Fixed version for power distribution



### SACE Emax E6.2X/f Full size - Orientable rear terminals (HR)

Size	Iu	Icu (440V)	Icw (1s)	Type	4 Poles
					Code
E6.2X/f	4000	150	120	E6.2X/f 4000 Ekip Dip LI	1SDA071971R1
				E6.2X/f 4000 Ekip Dip LSI	1SDA071972R1
				E6.2X/f 4000 Ekip Dip LSIG	1SDA071973R1
				E6.2X/f 4000 Ekip Touch LI	1SDA071974R1
				E6.2X/f 4000 Ekip Touch LSI	1SDA071975R1
				E6.2X/f 4000 Ekip Touch LSIG	1SDA071976R1
				E6.2X/f 4000 Ekip Hi-Touch LSI	1SDA071978R1
				E6.2X/f 4000 Ekip Hi-Touch LSIG	1SDA071979R1
	5000	150	120	E6.2X/f 5000 Ekip Dip LI	1SDA072001R1
				E6.2X/f 5000 Ekip Dip LSI	1SDA072002R1
				E6.2X/f 5000 Ekip Dip LSIG	1SDA072003R1
				E6.2X/f 5000 Ekip Touch LI	1SDA072004R1
				E6.2X/f 5000 Ekip Touch LSI	1SDA072005R1
				E6.2X/f 5000 Ekip Touch LSIG	1SDA072006R1
				E6.2X/f 5000 Ekip Hi-Touch LSI	1SDA072008R1
				E6.2X/f 5000 Ekip Hi-Touch LSIG	1SDA072009R1
	6300	150	120	E6.2X/f 6300 Ekip Dip LI	1SDA072031R1
				E6.2X/f 6300 Ekip Dip LSI	1SDA072032R1
				E6.2X/f 6300 Ekip Dip LSIG	1SDA072033R1
				E6.2X/f 6300 Ekip Touch LI	1SDA072034R1
				E6.2X/f 6300 Ekip Touch LSI	1SDA072035R1
				E6.2X/f 6300 Ekip Touch LSIG	1SDA072036R1
				E6.2X/f 6300 Ekip Hi-Touch LSI	1SDA072038R1
				E6.2X/f 6300 Ekip Hi-Touch LSIG	1SDA072039R1



# Automatic circuit-breakers

## Withdrawable version for power distribution



### SACE Emax E1.2B • Mobile part of withdrawable circuit-breaker (MP)

Size	Iu	Icu (440 V) (1s)	Icw (1s)	Type	3 Poles	4 Poles
					Code	Code
E1.2B	630	42	42	E1.2B 630 Ekip Dip LI	1SDA072051R1	1SDA072681R1
				E1.2B 630 Ekip Dip LSI	1SDA072052R1	1SDA072682R1
				E1.2B 630 Ekip Dip LSIG	1SDA072053R1	1SDA072683R1
				E1.2B 630 Ekip Touch LI	1SDA072054R1	1SDA072684R1
				E1.2B 630 Ekip Touch LSI	1SDA072055R1	1SDA072685R1
				E1.2B 630 Ekip Touch LSIG	1SDA072056R1	1SDA072686R1
				E1.2B 630 Ekip Hi-Touch LSI	1SDA072058R1	1SDA072688R1
				E1.2B 630 Ekip Hi-Touch LSIG	1SDA072059R1	1SDA072689R1
800	42	42	E1.2B 800 Ekip Dip LI	1SDA072091R1	1SDA072721R1	
			E1.2B 800 Ekip Dip LSI	1SDA072092R1	1SDA072722R1	
			E1.2B 800 Ekip Dip LSIG	1SDA072093R1	1SDA072723R1	
			E1.2B 800 Ekip Touch LI	1SDA072094R1	1SDA072724R1	
			E1.2B 800 Ekip Touch LSI	1SDA072095R1	1SDA072725R1	
			E1.2B 800 Ekip Touch LSIG	1SDA072096R1	1SDA072726R1	
			E1.2B 800 Ekip Hi-Touch LSI	1SDA072098R1	1SDA072728R1	
			E1.2B 800 Ekip Hi-Touch LSIG	1SDA072099R1	1SDA072729R1	
1000	42	42	E1.2B 1000 Ekip Dip LI	1SDA072131R1	1SDA072761R1	
			E1.2B 1000 Ekip Dip LSI	1SDA072132R1	1SDA072762R1	
			E1.2B 1000 Ekip Dip LSIG	1SDA072133R1	1SDA072763R1	
			E1.2B 1000 Ekip Touch LI	1SDA072134R1	1SDA072764R1	
			E1.2B 1000 Ekip Touch LSI	1SDA072135R1	1SDA072765R1	
			E1.2B 1000 Ekip Touch LSIG	1SDA072136R1	1SDA072766R1	
			E1.2B 1000 Ekip Hi-Touch LSI	1SDA072138R1	1SDA072768R1	
			E1.2B 1000 Ekip Hi-Touch LSIG	1SDA072139R1	1SDA072769R1	
1250	42	42	E1.2B 1250 Ekip Dip LI	1SDA072171R1	1SDA072801R1	
			E1.2B 1250 Ekip Dip LSI	1SDA072172R1	1SDA072802R1	
			E1.2B 1250 Ekip Dip LSIG	1SDA072173R1	1SDA072803R1	
			E1.2B 1250 Ekip Touch LI	1SDA072174R1	1SDA072804R1	
			E1.2B 1250 Ekip Touch LSI	1SDA072175R1	1SDA072805R1	
			E1.2B 1250 Ekip Touch LSIG	1SDA072176R1	1SDA072806R1	
			E1.2B 1250 Ekip Hi-Touch LSI	1SDA072178R1	1SDA072808R1	
			E1.2B 1250 Ekip Hi-Touch LSIG	1SDA072179R1	1SDA072809R1	
1600	42	42	E1.2B 1600 Ekip Dip LI	1SDA072211R1	1SDA072841R1	
			E1.2B 1600 Ekip Dip LSI	1SDA072212R1	1SDA072842R1	
			E1.2B 1600 Ekip Dip LSIG	1SDA072213R1	1SDA072843R1	
			E1.2B 1600 Ekip Touch LI	1SDA072214R1	1SDA072844R1	
			E1.2B 1600 Ekip Touch LSI	1SDA072215R1	1SDA072845R1	
			E1.2B 1600 Ekip Touch LSIG	1SDA072216R1	1SDA072846R1	
			E1.2B 1600 Ekip Hi-Touch LSI	1SDA072218R1	1SDA072848R1	
			E1.2B 1600 Ekip Hi-Touch LSIG	1SDA072219R1	1SDA072849R1	

# Automatic circuit-breakers

## Withdrawable version for power distribution



### SACE Emax E1.2C • Mobile part of withdrawable circuit-breaker (MP)

Size	I <sub>u</sub>	I <sub>cu</sub> (440 V)	I <sub>cw</sub> (1s)	Type	3 Poles	4 Poles
					Code	Code
E1.2C	630	50	42	E1.2C 630 Ekip Dip LI	1SDA072061R1	1SDA072691R1
				E1.2C 630 Ekip Dip LSI	1SDA072062R1	1SDA072692R1
				E1.2C 630 Ekip Dip LSIG	1SDA072063R1	1SDA072693R1
				E1.2C 630 Ekip Touch LI	1SDA072064R1	1SDA072694R1
				E1.2C 630 Ekip Touch LSI	1SDA072065R1	1SDA072695R1
				E1.2C 630 Ekip Touch LSIG	1SDA072066R1	1SDA072696R1
				E1.2C 630 Ekip Hi-Touch LSI	1SDA072068R1	1SDA072698R1
				E1.2C 630 Ekip Hi-Touch LSIG	1SDA072069R1	1SDA072699R1
800	50	42	E1.2C 800 Ekip Dip LI	1SDA072101R1	1SDA072731R1	
			E1.2C 800 Ekip Dip LSI	1SDA072102R1	1SDA072732R1	
			E1.2C 800 Ekip Dip LSIG	1SDA072103R1	1SDA072733R1	
			E1.2C 800 Ekip Touch LI	1SDA072104R1	1SDA072734R1	
			E1.2C 800 Ekip Touch LSI	1SDA072105R1	1SDA072735R1	
			E1.2C 800 Ekip Touch LSIG	1SDA072106R1	1SDA072736R1	
			E1.2C 800 Ekip Hi-Touch LSI	1SDA072108R1	1SDA072738R1	
			E1.2C 800 Ekip Hi-Touch LSIG	1SDA072109R1	1SDA072739R1	
1000	50	42	E1.2C 1000 Ekip Dip LI	1SDA072141R1	1SDA072771R1	
			E1.2C 1000 Ekip Dip LSI	1SDA072142R1	1SDA072772R1	
			E1.2C 1000 Ekip Dip LSIG	1SDA072143R1	1SDA072773R1	
			E1.2C 1000 Ekip Touch LI	1SDA072144R1	1SDA072774R1	
			E1.2C 1000 Ekip Touch LSI	1SDA072145R1	1SDA072775R1	
			E1.2C 1000 Ekip Touch LSIG	1SDA072146R1	1SDA072776R1	
			E1.2C 1000 Ekip Hi-Touch LSI	1SDA072148R1	1SDA072778R1	
			E1.2C 1000 Ekip Hi-Touch LSIG	1SDA072149R1	1SDA072779R1	
1250	50	42	E1.2C 1250 Ekip Dip LI	1SDA072181R1	1SDA072811R1	
			E1.2C 1250 Ekip Dip LSI	1SDA072182R1	1SDA072812R1	
			E1.2C 1250 Ekip Dip LSIG	1SDA072183R1	1SDA072813R1	
			E1.2C 1250 Ekip Touch LI	1SDA072184R1	1SDA072814R1	
			E1.2C 1250 Ekip Touch LSI	1SDA072185R1	1SDA072815R1	
			E1.2C 1250 Ekip Touch LSIG	1SDA072186R1	1SDA072816R1	
			E1.2C 1250 Ekip Hi-Touch LSI	1SDA072188R1	1SDA072818R1	
			E1.2C 1250 Ekip Hi-Touch LSIG	1SDA072189R1	1SDA072819R1	
1600	50	42	E1.2C 1600 Ekip Dip LI	1SDA072221R1	1SDA072851R1	
			E1.2C 1600 Ekip Dip LSI	1SDA072222R1	1SDA072852R1	
			E1.2C 1600 Ekip Dip LSIG	1SDA072223R1	1SDA072853R1	
			E1.2C 1600 Ekip Touch LI	1SDA072224R1	1SDA072854R1	
			E1.2C 1600 Ekip Touch LSI	1SDA072225R1	1SDA072855R1	
			E1.2C 1600 Ekip Touch LSIG	1SDA072226R1	1SDA072856R1	
			E1.2C 1600 Ekip Hi-Touch LSI	1SDA072228R1	1SDA072858R1	
			E1.2C 1600 Ekip Hi-Touch LSIG	1SDA072229R1	1SDA072859R1	



**SACE Emax E1.2N • Mobile part of withdrawable circuit-breaker (MP)**

Size	Iu	Icu (440 V)	Icw (1s)	Type	3 Poles	4 Poles
					Code	Code
E1.2N	250	66	50	E1.2N 250 Ekip Dip LI	1SDA072041R1	1SDA072671R1
				E1.2N 250 Ekip Dip LSI	1SDA072042R1	1SDA072672R1
				E1.2N 250 Ekip Dip LSIG	1SDA072043R1	1SDA072673R1
				E1.2N 250 Ekip Touch LI	1SDA072044R1	1SDA072674R1
				E1.2N 250 Ekip Touch LSI	1SDA072045R1	1SDA072675R1
				E1.2N 250 Ekip Touch LSIG	1SDA072046R1	1SDA072676R1
				E1.2N 250 Ekip Hi-Touch LSI	1SDA072048R1	1SDA072678R1
				E1.2N 250 Ekip Hi-Touch LSIG	1SDA072049R1	1SDA072679R1
630	66	50	E1.2N 630 Ekip Dip LI	1SDA072071R1	1SDA072701R1	
			E1.2N 630 Ekip Dip LSI	1SDA072072R1	1SDA072702R1	
			E1.2N 630 Ekip Dip LSIG	1SDA072073R1	1SDA072703R1	
			E1.2N 630 Ekip Touch LI	1SDA072074R1	1SDA072704R1	
			E1.2N 630 Ekip Touch LSI	1SDA072075R1	1SDA072705R1	
			E1.2N 630 Ekip Touch LSIG	1SDA072076R1	1SDA072706R1	
			E1.2N 630 Ekip Hi-Touch LSI	1SDA072078R1	1SDA072708R1	
			E1.2N 630 Ekip Hi-Touch LSIG	1SDA072079R1	1SDA072709R1	
800	66	50	E1.2N 800 Ekip Dip LI	1SDA072111R1	1SDA072741R1	
			E1.2N 800 Ekip Dip LSI	1SDA072112R1	1SDA072742R1	
			E1.2N 800 Ekip Dip LSIG	1SDA072113R1	1SDA072743R1	
			E1.2N 800 Ekip Touch LI	1SDA072114R1	1SDA072744R1	
			E1.2N 800 Ekip Touch LSI	1SDA072115R1	1SDA072745R1	
			E1.2N 800 Ekip Touch LSIG	1SDA072116R1	1SDA072746R1	
			E1.2N 800 Ekip Hi-Touch LSI	1SDA072118R1	1SDA072748R1	
			E1.2N 800 Ekip Hi-Touch LSIG	1SDA072119R1	1SDA072749R1	
1000	66	50	E1.2N 1000 Ekip Dip LI	1SDA072151R1	1SDA072781R1	
			E1.2N 1000 Ekip Dip LSI	1SDA072152R1	1SDA072782R1	
			E1.2N 1000 Ekip Dip LSIG	1SDA072153R1	1SDA072783R1	
			E1.2N 1000 Ekip Touch LI	1SDA072154R1	1SDA072784R1	
			E1.2N 1000 Ekip Touch LSI	1SDA072155R1	1SDA072785R1	
			E1.2N 1000 Ekip Touch LSIG	1SDA072156R1	1SDA072786R1	
			E1.2N 1000 Ekip Hi-Touch LSI	1SDA072158R1	1SDA072788R1	
			E1.2N 1000 Ekip Hi-Touch LSIG	1SDA072159R1	1SDA072789R1	
1250	66	50	E1.2N 1250 Ekip Dip LI	1SDA072191R1	1SDA072821R1	
			E1.2N 1250 Ekip Dip LSI	1SDA072192R1	1SDA072822R1	
			E1.2N 1250 Ekip Dip LSIG	1SDA072193R1	1SDA072823R1	
			E1.2N 1250 Ekip Touch LI	1SDA072194R1	1SDA072824R1	
			E1.2N 1250 Ekip Touch LSI	1SDA072195R1	1SDA072825R1	
			E1.2N 1250 Ekip Touch LSIG	1SDA072196R1	1SDA072826R1	
			E1.2N 1250 Ekip Hi-Touch LSI	1SDA072198R1	1SDA072828R1	
			E1.2N 1250 Ekip Hi-Touch LSIG	1SDA072199R1	1SDA072829R1	
1600	66	50	E1.2N 1600 Ekip Dip LI	1SDA072231R1	1SDA072861R1	
			E1.2N 1600 Ekip Dip LSI	1SDA072232R1	1SDA072862R1	
			E1.2N 1600 Ekip Dip LSIG	1SDA072233R1	1SDA072863R1	
			E1.2N 1600 Ekip Touch LI	1SDA072234R1	1SDA072864R1	
			E1.2N 1600 Ekip Touch LSI	1SDA072235R1	1SDA072865R1	
			E1.2N 1600 Ekip Touch LSIG	1SDA072236R1	1SDA072866R1	
			E1.2N 1600 Ekip Hi-Touch LSI	1SDA072238R1	1SDA072868R1	
			E1.2N 1600 Ekip Hi-Touch LSIG	1SDA072239R1	1SDA072869R1	

# Automatic circuit-breakers

Withdrawable version for power distribution



## SACE Emax E2.2B • Mobile part of withdrawable circuit-breaker (MP)

Size	Iu	Icu (440 V) (1s)	Icw (1s)	Type	3 Poles	4 Poles
					Code	Code
E2.2B	1600	42	42	E2.2B 1600 Ekip Dip LI	1SDA072331R1	1SDA072961R1
				E2.2B 1600 Ekip Dip LSI	1SDA072332R1	1SDA072962R1
				E2.2B 1600 Ekip Dip LSIG	1SDA072333R1	1SDA072963R1
				E2.2B 1600 Ekip Touch LI	1SDA072334R1	1SDA072964R1
				E2.2B 1600 Ekip Touch LSI	1SDA072335R1	1SDA072965R1
				E2.2B 1600 Ekip Touch LSIG	1SDA072336R1	1SDA072966R1
				E2.2B 1600 Ekip Hi-Touch LSI	1SDA072338R1	1SDA072968R1
				E2.2B 1600 Ekip Hi-Touch LSIG	1SDA072339R1	1SDA072969R1
	2000	42	42	E2.2B 2000 Ekip Dip LI	1SDA072371R1	1SDA073001R1
				E2.2B 2000 Ekip Dip LSI	1SDA072372R1	1SDA073002R1
				E2.2B 2000 Ekip Dip LSIG	1SDA072373R1	1SDA073003R1
				E2.2B 2000 Ekip Touch LI	1SDA072374R1	1SDA073004R1
				E2.2B 2000 Ekip Touch LSI	1SDA072375R1	1SDA073005R1
				E2.2B 2000 Ekip Touch LSIG	1SDA072376R1	1SDA073006R1
				E2.2B 2000 Ekip Hi-Touch LSI	1SDA072378R1	1SDA073008R1
				E2.2B 2000 Ekip Hi-Touch LSIG	1SDA072379R1	1SDA073009R1



**SACE Emax E2.2N • Mobile part of withdrawable circuit-breaker (MP)**

Size	Iu	Icu (440 V)	Icw (1s)	Type	3 Poles	4 Poles
					Code	Code
E2.2N	800	66	66	E2.2N 800 Ekip Dip LI	1SDA072241R1	1SDA072871R1
				E2.2N 800 Ekip Dip LSI	1SDA072242R1	1SDA072872R1
				E2.2N 800 Ekip Dip LSIG	1SDA072243R1	1SDA072873R1
				E2.2N 800 Ekip Touch LI	1SDA072244R1	1SDA072874R1
				E2.2N 800 Ekip Touch LSI	1SDA072245R1	1SDA072875R1
				E2.2N 800 Ekip Touch LSIG	1SDA072246R1	1SDA072876R1
				E2.2N 800 Ekip Hi-Touch LSI	1SDA072248R1	1SDA072878R1
				E2.2N 800 Ekip Hi-Touch LSIG	1SDA072249R1	1SDA072879R1
1000	66	66	E2.2N 1000 Ekip Dip LI	1SDA072271R1	1SDA072901R1	
			E2.2N 1000 Ekip Dip LSI	1SDA072272R1	1SDA072902R1	
			E2.2N 1000 Ekip Dip LSIG	1SDA072273R1	1SDA072903R1	
			E2.2N 1000 Ekip Touch LI	1SDA072274R1	1SDA072904R1	
			E2.2N 1000 Ekip Touch LSI	1SDA072275R1	1SDA072905R1	
			E2.2N 1000 Ekip Touch LSIG	1SDA072276R1	1SDA072906R1	
			E2.2N 1000 Ekip Hi-Touch LSI	1SDA072278R1	1SDA072908R1	
			E2.2N 1000 Ekip Hi-Touch LSIG	1SDA072279R1	1SDA072909R1	
1250	66	66	E2.2N 1250 Ekip Dip LI	1SDA072301R1	1SDA072931R1	
			E2.2N 1250 Ekip Dip LSI	1SDA072302R1	1SDA072932R1	
			E2.2N 1250 Ekip Dip LSIG	1SDA072303R1	1SDA072933R1	
			E2.2N 1250 Ekip Touch LI	1SDA072304R1	1SDA072934R1	
			E2.2N 1250 Ekip Touch LSI	1SDA072305R1	1SDA072935R1	
			E2.2N 1250 Ekip Touch LSIG	1SDA072306R1	1SDA072936R1	
			E2.2N 1250 Ekip Hi-Touch LSI	1SDA072308R1	1SDA072938R1	
			E2.2N 1250 Ekip Hi-Touch LSIG	1SDA072309R1	1SDA072939R1	
1600	66	66	E2.2N 1600 Ekip Dip LI	1SDA072341R1	1SDA072971R1	
			E2.2N 1600 Ekip Dip LSI	1SDA072342R1	1SDA072972R1	
			E2.2N 1600 Ekip Dip LSIG	1SDA072343R1	1SDA072973R1	
			E2.2N 1600 Ekip Touch LI	1SDA072344R1	1SDA072974R1	
			E2.2N 1600 Ekip Touch LSI	1SDA072345R1	1SDA072975R1	
			E2.2N 1600 Ekip Touch LSIG	1SDA072346R1	1SDA072976R1	
			E2.2N 1600 Ekip Hi-Touch LSI	1SDA072348R1	1SDA072978R1	
			E2.2N 1600 Ekip Hi-Touch LSIG	1SDA072349R1	1SDA072979R1	
2000	66	66	E2.2N 2000 Ekip Dip LI	1SDA072381R1	1SDA073011R1	
			E2.2N 2000 Ekip Dip LSI	1SDA072382R1	1SDA073012R1	
			E2.2N 2000 Ekip Dip LSIG	1SDA072383R1	1SDA073013R1	
			E2.2N 2000 Ekip Touch LI	1SDA072384R1	1SDA073014R1	
			E2.2N 2000 Ekip Touch LSI	1SDA072385R1	1SDA073015R1	
			E2.2N 2000 Ekip Touch LSIG	1SDA072386R1	1SDA073016R1	
			E2.2N 2000 Ekip Hi-Touch LSI	1SDA072388R1	1SDA073018R1	
			E2.2N 2000 Ekip Hi-Touch LSIG	1SDA072389R1	1SDA073019R1	
2500	66	66	E2.2N 2500 Ekip Dip LI	1SDA072411R1	1SDA073041R1	
			E2.2N 2500 Ekip Dip LSI	1SDA072412R1	1SDA073042R1	
			E2.2N 2500 Ekip Dip LSIG	1SDA072413R1	1SDA073043R1	
			E2.2N 2500 Ekip Touch LI	1SDA072414R1	1SDA073044R1	
			E2.2N 2500 Ekip Touch LSI	1SDA072415R1	1SDA073045R1	
			E2.2N 2500 Ekip Touch LSIG	1SDA072416R1	1SDA073046R1	
			E2.2N 2500 Ekip Hi-Touch LSI	1SDA072418R1	1SDA073048R1	
			E2.2N 2500 Ekip Hi-Touch LSIG	1SDA072419R1	1SDA073049R1	

# Automatic circuit-breakers

## Withdrawable version for power distribution



### SACE Emax E2.2S • Mobile part of withdrawable circuit-breaker (MP)

Size	I <sub>u</sub>	I <sub>cu</sub> (440 V) (1s)	I <sub>cw</sub> (1s)	Type	3 Poles	4 Poles
					Code	Code
E2.2S	250	85	66	E2.2S 250 Ekip Dip LI	1SDA073648R1	1SDA073658R1
				E2.2S 250 Ekip Dip LSI	1SDA073649R1	1SDA073659R1
				E2.2S 250 Ekip Dip LSI <sub>G</sub>	1SDA073650R1	1SDA073660R1
				E2.2S 250 Ekip Touch LI	1SDA073651R1	1SDA073661R1
				E2.2S 250 Ekip Touch LSI	1SDA073652R1	1SDA073662R1
				E2.2S 250 Ekip Touch LSI <sub>G</sub>	1SDA073653R1	1SDA073663R1
				E2.2S 250 Ekip Hi-Touch LSI	1SDA073655R1	1SDA073665R1
				E2.2S 250 Ekip Hi-Touch LSI <sub>G</sub>	1SDA073656R1	1SDA073666R1
	800	85	66	E2.2S 800 Ekip Dip LI	1SDA072251R1	1SDA072881R1
				E2.2S 800 Ekip Dip LSI	1SDA072252R1	1SDA072882R1
				E2.2S 800 Ekip Dip LSI <sub>G</sub>	1SDA072253R1	1SDA072883R1
				E2.2S 800 Ekip Touch LI	1SDA072254R1	1SDA072884R1
				E2.2S 800 Ekip Touch LSI	1SDA072255R1	1SDA072885R1
				E2.2S 800 Ekip Touch LSI <sub>G</sub>	1SDA072256R1	1SDA072886R1
				E2.2S 800 Ekip Hi-Touch LSI	1SDA072258R1	1SDA072888R1
				E2.2S 800 Ekip Hi-Touch LSI <sub>G</sub>	1SDA072259R1	1SDA072889R1
	1000	85	66	E2.2S 1000 Ekip Dip LI	1SDA072281R1	1SDA072911R1
				E2.2S 1000 Ekip Dip LSI	1SDA072282R1	1SDA072912R1
				E2.2S 1000 Ekip Dip LSI <sub>G</sub>	1SDA072283R1	1SDA072913R1
				E2.2S 1000 Ekip Touch LI	1SDA072284R1	1SDA072914R1
				E2.2S 1000 Ekip Touch LSI	1SDA072285R1	1SDA072915R1
				E2.2S 1000 Ekip Touch LSI <sub>G</sub>	1SDA072286R1	1SDA072916R1
				E2.2S 1000 Ekip Hi-Touch LSI	1SDA072288R1	1SDA072918R1
				E2.2S 1000 Ekip Hi-Touch LSI <sub>G</sub>	1SDA072289R1	1SDA072919R1
	1250	85	66	E2.2S 1250 Ekip Dip LI	1SDA072311R1	1SDA072941R1
				E2.2S 1250 Ekip Dip LSI	1SDA072312R1	1SDA072942R1
				E2.2S 1250 Ekip Dip LSI <sub>G</sub>	1SDA072313R1	1SDA072943R1
				E2.2S 1250 Ekip Touch LI	1SDA072314R1	1SDA072944R1
				E2.2S 1250 Ekip Touch LSI	1SDA072315R1	1SDA072945R1
				E2.2S 1250 Ekip Touch LSI <sub>G</sub>	1SDA072316R1	1SDA072946R1
				E2.2S 1250 Ekip Hi-Touch LSI	1SDA072318R1	1SDA072948R1
				E2.2S 1250 Ekip Hi-Touch LSI <sub>G</sub>	1SDA072319R1	1SDA072949R1



**SACE Emax E2.2S • Mobile part of withdrawable circuit-breaker (MP)**

Size	Iu	Icu (440 V)	Icw (1s)	Type	3 Poles	4 Poles
					Code	Code
E2.2S	1600	85	66	E2.2S 1600 Ekip Dip LI	1SDA072351R1	1SDA072981R1
				E2.2S 1600 Ekip Dip LSI	1SDA072352R1	1SDA072982R1
				E2.2S 1600 Ekip Dip LSIG	1SDA072353R1	1SDA072983R1
				E2.2S 1600 Ekip Touch LI	1SDA072354R1	1SDA072984R1
				E2.2S 1600 Ekip Touch LSI	1SDA072355R1	1SDA072985R1
				E2.2S 1600 Ekip Touch LSIG	1SDA072356R1	1SDA072986R1
				E2.2S 1600 Ekip Hi-Touch LSI	1SDA072358R1	1SDA072988R1
				E2.2S 1600 Ekip Hi-Touch LSIG	1SDA072359R1	1SDA072989R1
	2000	85	66	E2.2S 2000 Ekip Dip LI	1SDA072391R1	1SDA073021R1
				E2.2S 2000 Ekip Dip LSI	1SDA072392R1	1SDA073022R1
				E2.2S 2000 Ekip Dip LSIG	1SDA072393R1	1SDA073023R1
				E2.2S 2000 Ekip Touch LI	1SDA072394R1	1SDA073024R1
				E2.2S 2000 Ekip Touch LSI	1SDA072395R1	1SDA073025R1
				E2.2S 2000 Ekip Touch LSIG	1SDA072396R1	1SDA073026R1
				E2.2S 2000 Ekip Hi-Touch LSI	1SDA072398R1	1SDA073028R1
				E2.2S 2000 Ekip Hi-Touch LSIG	1SDA072399R1	1SDA073029R1
	2500	85	66	E2.2S 2500 Ekip Dip LI	1SDA072421R1	1SDA073051R1
				E2.2S 2500 Ekip Dip LSI	1SDA072422R1	1SDA073052R1
				E2.2S 2500 Ekip Dip LSIG	1SDA072423R1	1SDA073053R1
				E2.2S 2500 Ekip Touch LI	1SDA072424R1	1SDA073054R1
				E2.2S 2500 Ekip Touch LSI	1SDA072425R1	1SDA073055R1
				E2.2S 2500 Ekip Touch LSIG	1SDA072426R1	1SDA073056R1
				E2.2S 2500 Ekip Hi-Touch LSI	1SDA072428R1	1SDA073058R1
				E2.2S 2500 Ekip Hi-Touch LSIG	1SDA072429R1	1SDA073059R1

# Automatic circuit-breakers

## Withdrawable version for power distribution



### SACE Emax E2.2H • Mobile part of withdrawable circuit-breaker (MP)

Size	I <sub>u</sub>	I <sub>cu</sub> (440 V)	I <sub>cw</sub> (1s)	Type	3 Poles	4 Poles
					Code	Code
E2.2H	800	100	85	E2.2H 800 Ekip Dip LI	1SDA072261R1	1SDA072891R1
				E2.2H 800 Ekip Dip LSI	1SDA072262R1	1SDA072892R1
				E2.2H 800 Ekip Dip LSIG	1SDA072263R1	1SDA072893R1
				E2.2H 800 Ekip Touch LI	1SDA072264R1	1SDA072894R1
				E2.2H 800 Ekip Touch LSI	1SDA072265R1	1SDA072895R1
				E2.2H 800 Ekip Touch LSIG	1SDA072266R1	1SDA072896R1
				E2.2H 800 Ekip Hi-Touch LSI	1SDA072268R1	1SDA072898R1
				E2.2H 800 Ekip Hi-Touch LSIG	1SDA072269R1	1SDA072899R1
1000	100	85	E2.2H 1000 Ekip Dip LI	1SDA072291R1	1SDA072921R1	
			E2.2H 1000 Ekip Dip LSI	1SDA072292R1	1SDA072922R1	
			E2.2H 1000 Ekip Dip LSIG	1SDA072293R1	1SDA072923R1	
			E2.2H 1000 Ekip Touch LI	1SDA072294R1	1SDA072924R1	
			E2.2H 1000 Ekip Touch LSI	1SDA072295R1	1SDA072925R1	
			E2.2H 1000 Ekip Touch LSIG	1SDA072296R1	1SDA072926R1	
			E2.2H 1000 Ekip Hi-Touch LSI	1SDA072298R1	1SDA072928R1	
			E2.2H 1000 Ekip Hi-Touch LSIG	1SDA072299R1	1SDA072929R1	
1250	100	85	E2.2H 1250 Ekip Dip LI	1SDA072321R1	1SDA072951R1	
			E2.2H 1250 Ekip Dip LSI	1SDA072322R1	1SDA072952R1	
			E2.2H 1250 Ekip Dip LSIG	1SDA072323R1	1SDA072953R1	
			E2.2H 1250 Ekip Touch LI	1SDA072324R1	1SDA072954R1	
			E2.2H 1250 Ekip Touch LSI	1SDA072325R1	1SDA072955R1	
			E2.2H 1250 Ekip Touch LSIG	1SDA072326R1	1SDA072956R1	
			E2.2H 1250 Ekip Hi-Touch LSI	1SDA072328R1	1SDA072958R1	
			E2.2H 1250 Ekip Hi-Touch LSIG	1SDA072329R1	1SDA072959R1	
1600	100	85	E2.2H 1600 Ekip Dip LI	1SDA072361R1	1SDA072991R1	
			E2.2H 1600 Ekip Dip LSI	1SDA072362R1	1SDA072992R1	
			E2.2H 1600 Ekip Dip LSIG	1SDA072363R1	1SDA072993R1	
			E2.2H 1600 Ekip Touch LI	1SDA072364R1	1SDA072994R1	
			E2.2H 1600 Ekip Touch LSI	1SDA072365R1	1SDA072995R1	
			E2.2H 1600 Ekip Touch LSIG	1SDA072366R1	1SDA072996R1	
			E2.2H 1600 Ekip Hi-Touch LSI	1SDA072368R1	1SDA072998R1	
			E2.2H 1600 Ekip Hi-Touch LSIG	1SDA072369R1	1SDA072999R1	
2000	100	85	E2.2H 2000 Ekip Dip LI	1SDA072401R1	1SDA073031R1	
			E2.2H 2000 Ekip Dip LSI	1SDA072402R1	1SDA073032R1	
			E2.2H 2000 Ekip Dip LSIG	1SDA072403R1	1SDA073033R1	
			E2.2H 2000 Ekip Touch LI	1SDA072404R1	1SDA073034R1	
			E2.2H 2000 Ekip Touch LSI	1SDA072405R1	1SDA073035R1	
			E2.2H 2000 Ekip Touch LSIG	1SDA072406R1	1SDA073036R1	
			E2.2H 2000 Ekip Hi-Touch LSI	1SDA072408R1	1SDA073038R1	
			E2.2H 2000 Ekip Hi-Touch LSIG	1SDA072409R1	1SDA073039R1	
2500	100	85	E2.2H 2500 Ekip Dip LI	1SDA072431R1	1SDA073061R1	
			E2.2H 2500 Ekip Dip LSI	1SDA072432R1	1SDA073062R1	
			E2.2H 2500 Ekip Dip LSIG	1SDA072433R1	1SDA073063R1	
			E2.2H 2500 Ekip Touch LI	1SDA072434R1	1SDA073064R1	
			E2.2H 2500 Ekip Touch LSI	1SDA072435R1	1SDA073065R1	
			E2.2H 2500 Ekip Touch LSIG	1SDA072436R1	1SDA073066R1	
			E2.2H 2500 Ekip Hi-Touch LSI	1SDA072438R1	1SDA073068R1	
			E2.2H 2500 Ekip Hi-Touch LSIG	1SDA072439R1	1SDA073069R1	





**SACE Emax E4.2N-S-H • Mobile part of withdrawable circuit-breaker (MP)**

Size	Iu	Icu (440 V)	Icw (1s)	Type	3 Poles	4 Poles
					Code	Code
E4.2N	3200	66	66	E4.2N 3200 Ekip Dip LI	1SDA072491R1	1SDA073121R1
				E4.2N 3200 Ekip Dip LSI	1SDA072492R1	1SDA073122R1
				E4.2N 3200 Ekip Dip LSIG	1SDA072493R1	1SDA073123R1
				E4.2N 3200 Ekip Touch LI	1SDA072494R1	1SDA073124R1
				E4.2N 3200 Ekip Touch LSI	1SDA072495R1	1SDA073125R1
				E4.2N 3200 Ekip Touch LSIG	1SDA072496R1	1SDA073126R1
				E4.2N 3200 Ekip Hi-Touch LSI	1SDA072498R1	1SDA073128R1
				E4.2N 3200 Ekip Hi-Touch LSIG	1SDA072499R1	1SDA073129R1
	4000	66	66	E4.2N 4000 Ekip Dip LI	1SDA072541R1	1SDA073171R1
				E4.2N 4000 Ekip Dip LSI	1SDA072542R1	1SDA073172R1
				E4.2N 4000 Ekip Dip LSIG	1SDA072543R1	1SDA073173R1
				E4.2N 4000 Ekip Touch LI	1SDA072544R1	1SDA073174R1
				E4.2N 4000 Ekip Touch LSI	1SDA072545R1	1SDA073175R1
				E4.2N 4000 Ekip Touch LSIG	1SDA072546R1	1SDA073176R1
				E4.2N 4000 Ekip Hi-Touch LSI	1SDA072548R1	1SDA073178R1
				E4.2N 4000 Ekip Hi-Touch LSIG	1SDA072549R1	1SDA073179R1
E4.2S	3200	85	66	E4.2S 3200 Ekip Dip LI	1SDA072501R1	1SDA073131R1
				E4.2S 3200 Ekip Dip LSI	1SDA072502R1	1SDA073132R1
				E4.2S 3200 Ekip Dip LSIG	1SDA072503R1	1SDA073133R1
				E4.2S 3200 Ekip Touch LI	1SDA072504R1	1SDA073134R1
				E4.2S 3200 Ekip Touch LSI	1SDA072505R1	1SDA073135R1
				E4.2S 3200 Ekip Touch LSIG	1SDA072506R1	1SDA073136R1
				E4.2S 3200 Ekip Hi-Touch LSI	1SDA072508R1	1SDA073138R1
				E4.2S 3200 Ekip Hi-Touch LSIG	1SDA072509R1	1SDA073139R1
	4000	85	66	E4.2S 4000 Ekip Dip LI	1SDA072551R1	1SDA073181R1
				E4.2S 4000 Ekip Dip LSI	1SDA072552R1	1SDA073182R1
				E4.2S 4000 Ekip Dip LSIG	1SDA072553R1	1SDA073183R1
				E4.2S 4000 Ekip Touch LI	1SDA072554R1	1SDA073184R1
				E4.2S 4000 Ekip Touch LSI	1SDA072555R1	1SDA073185R1
				E4.2S 4000 Ekip Touch LSIG	1SDA072556R1	1SDA073186R1
				E4.2S 4000 Ekip Hi-Touch LSI	1SDA072558R1	1SDA073188R1
				E4.2S 4000 Ekip Hi-Touch LSIG	1SDA072559R1	1SDA073189R1
E4.2H	3200	100	85	E4.2H 3200 Ekip Dip LI	1SDA072511R1	1SDA073141R1
				E4.2H 3200 Ekip Dip LSI	1SDA072512R1	1SDA073142R1
				E4.2H 3200 Ekip Dip LSIG	1SDA072513R1	1SDA073143R1
				E4.2H 3200 Ekip Touch LI	1SDA072514R1	1SDA073144R1
				E4.2H 3200 Ekip Touch LSI	1SDA072515R1	1SDA073145R1
				E4.2H 3200 Ekip Touch LSIG	1SDA072516R1	1SDA073146R1
				E4.2H 3200 Ekip Hi-Touch LSI	1SDA072518R1	1SDA073148R1
				E4.2H 3200 Ekip Hi-Touch LSIG	1SDA072519R1	1SDA073149R1
	4000	100	85	E4.2H 4000 Ekip Dip LI	1SDA072561R1	1SDA073191R1
				E4.2H 4000 Ekip Dip LSI	1SDA072562R1	1SDA073192R1
				E4.2H 4000 Ekip Dip LSIG	1SDA072563R1	1SDA073193R1
				E4.2H 4000 Ekip Touch LI	1SDA072564R1	1SDA073194R1
				E4.2H 4000 Ekip Touch LSI	1SDA072565R1	1SDA073195R1
				E4.2H 4000 Ekip Touch LSIG	1SDA072566R1	1SDA073196R1
				E4.2H 4000 Ekip Hi-Touch LSI	1SDA072568R1	1SDA073198R1
				E4.2H 4000 Ekip Hi-Touch LSIG	1SDA072569R1	1SDA073199R1

# Automatic circuit-breakers

## Withdrawable version for power distribution



### SACE Emax E4.2V • Mobile part of withdrawable circuit-breaker (MP)

Size	I <sub>u</sub>	I <sub>cu</sub> (440 V)	I <sub>cw</sub> (1s)	Type	3 Poles	4 Poles
					Code	Code
E4.2V	2000	150	100	E4.2V 2000 Ekip Dip LI	1SDA072451R1	1SDA073081R1
				E4.2V 2000 Ekip Dip LSI	1SDA072452R1	1SDA073082R1
				E4.2V 2000 Ekip Dip LSIG	1SDA072453R1	1SDA073083R1
				E4.2V 2000 Ekip Touch LI	1SDA072454R1	1SDA073084R1
				E4.2V 2000 Ekip Touch LSI	1SDA072455R1	1SDA073085R1
				E4.2V 2000 Ekip Touch LSIG	1SDA072456R1	1SDA073086R1
				E4.2V 2000 Ekip Hi-Touch LSI	1SDA072458R1	1SDA073088R1
				E4.2V 2000 Ekip Hi-Touch LSIG	1SDA072459R1	1SDA073089R1
2500	150	100	E4.2V 2500 Ekip Dip LI	1SDA072471R1	1SDA073101R1	
			E4.2V 2500 Ekip Dip LSI	1SDA072472R1	1SDA073102R1	
			E4.2V 2500 Ekip Dip LSIG	1SDA072473R1	1SDA073103R1	
			E4.2V 2500 Ekip Touch LI	1SDA072474R1	1SDA073104R1	
			E4.2V 2500 Ekip Touch LSI	1SDA072475R1	1SDA073105R1	
			E4.2V 2500 Ekip Touch LSIG	1SDA072476R1	1SDA073106R1	
			E4.2V 2500 Ekip Hi-Touch LSI	1SDA072478R1	1SDA073108R1	
			E4.2V 2500 Ekip Hi-Touch LSIG	1SDA072479R1	1SDA073109R1	
3200	150	100	E4.2V 3200 Ekip Dip LI	1SDA072521R1	1SDA073151R1	
			E4.2V 3200 Ekip Dip LSI	1SDA072522R1	1SDA073152R1	
			E4.2V 3200 Ekip Dip LSIG	1SDA072523R1	1SDA073153R1	
			E4.2V 3200 Ekip Touch LI	1SDA072524R1	1SDA073154R1	
			E4.2V 3200 Ekip Touch LSI	1SDA072525R1	1SDA073155R1	
			E4.2V 3200 Ekip Touch LSIG	1SDA072526R1	1SDA073156R1	
			E4.2V 3200 Ekip Hi-Touch LSI	1SDA072528R1	1SDA073158R1	
			E4.2V 3200 Ekip Hi-Touch LSIG	1SDA072529R1	1SDA073159R1	
4000	150	100	E4.2V 4000 Ekip Dip LI	1SDA072571R1	1SDA073201R1	
			E4.2V 4000 Ekip Dip LSI	1SDA072572R1	1SDA073202R1	
			E4.2V 4000 Ekip Dip LSIG	1SDA072573R1	1SDA073203R1	
			E4.2V 4000 Ekip Touch LI	1SDA072574R1	1SDA073204R1	
			E4.2V 4000 Ekip Touch LSI	1SDA072575R1	1SDA073205R1	
			E4.2V 4000 Ekip Touch LSIG	1SDA072576R1	1SDA073206R1	
			E4.2V 4000 Ekip Hi-Touch LSI	1SDA072578R1	1SDA073208R1	
			E4.2V 4000 Ekip Hi-Touch LSIG	1SDA072579R1	1SDA073209R1	



**SACE Emax E6.2H-V • Mobile part of withdrawable circuit-breaker (MP)**

Size	Iu	Icu (440 V)	Icw (1s)	Type	3 Poles	4 Poles	
					Code	Code	
<b>E6.2H</b>	4000	100	100	E6.2H 4000 Ekip Dip LI	1SDA072581R1	1SDA073211R1	
				E6.2H 4000 Ekip Dip LSI	1SDA072582R1	1SDA073212R1	
				E6.2H 4000 Ekip Dip LSIG	1SDA072583R1	1SDA073213R1	
				E6.2H 4000 Ekip Touch LI	1SDA072584R1	1SDA073214R1	
				E6.2H 4000 Ekip Touch LSI	1SDA072585R1	1SDA073215R1	
				E6.2H 4000 Ekip Touch LSIG	1SDA072586R1	1SDA073216R1	
				E6.2H 4000 Ekip Hi-Touch LSI	1SDA072588R1	1SDA073218R1	
				E6.2H 4000 Ekip Hi-Touch LSIG	1SDA072589R1	1SDA073219R1	
	5000	100	100	E6.2H 5000 Ekip Dip LI	1SDA072611R1	1SDA073241R1	
				E6.2H 5000 Ekip Dip LSI	1SDA072612R1	1SDA073242R1	
				E6.2H 5000 Ekip Dip LSIG	1SDA072613R1	1SDA073243R1	
				E6.2H 5000 Ekip Touch LI	1SDA072614R1	1SDA073244R1	
				E6.2H 5000 Ekip Touch LSI	1SDA072615R1	1SDA073245R1	
				E6.2H 5000 Ekip Touch LSIG	1SDA072616R1	1SDA073246R1	
				E6.2H 5000 Ekip Hi-Touch LSI	1SDA072618R1	1SDA073248R1	
				E6.2H 5000 Ekip Hi-Touch LSIG	1SDA072619R1	1SDA073249R1	
	6300	100	100	E6.2H 6300 Ekip Dip LI	1SDA072641R1	1SDA073271R1	
				E6.2H 6300 Ekip Dip LSI	1SDA072642R1	1SDA073272R1	
				E6.2H 6300 Ekip Dip LSIG	1SDA072643R1	1SDA073273R1	
				E6.2H 6300 Ekip Touch LI	1SDA072644R1	1SDA073274R1	
				E6.2H 6300 Ekip Touch LSI	1SDA072645R1	1SDA073275R1	
				E6.2H 6300 Ekip Touch LSIG	1SDA072646R1	1SDA073276R1	
				E6.2H 6300 Ekip Hi-Touch LSI	1SDA072648R1	1SDA073278R1	
				E6.2H 6300 Ekip Hi-Touch LSIG	1SDA072649R1	1SDA073279R1	
	<b>E6.2V</b>	4000	150	100	E6.2V 4000 Ekip Dip LI	1SDA072591R1	1SDA073221R1
					E6.2V 4000 Ekip Dip LSI	1SDA072592R1	1SDA073222R1
					E6.2V 4000 Ekip Dip LSIG	1SDA072593R1	1SDA073223R1
					E6.2V 4000 Ekip Touch LI	1SDA072594R1	1SDA073224R1
E6.2V 4000 Ekip Touch LSI					1SDA072595R1	1SDA073225R1	
E6.2V 4000 Ekip Touch LSIG					1SDA072596R1	1SDA073226R1	
E6.2V 4000 Ekip Hi-Touch LSI					1SDA072598R1	1SDA073228R1	
E6.2V 4000 Ekip Hi-Touch LSIG					1SDA072599R1	1SDA073229R1	
5000		150	100	E6.2V 5000 Ekip Dip LI	1SDA072621R1	1SDA073251R1	
				E6.2V 5000 Ekip Dip LSI	1SDA072622R1	1SDA073252R1	
				E6.2V 5000 Ekip Dip LSIG	1SDA072623R1	1SDA073253R1	
				E6.2V 5000 Ekip Touch LI	1SDA072624R1	1SDA073254R1	
				E6.2V 5000 Ekip Touch LSI	1SDA072625R1	1SDA073255R1	
				E6.2V 5000 Ekip Touch LSIG	1SDA072626R1	1SDA073256R1	
				E6.2V 5000 Ekip Hi-Touch LSI	1SDA072628R1	1SDA073258R1	
				E6.2V 5000 Ekip Hi-Touch LSIG	1SDA072629R1	1SDA073259R1	
6300		150	100	E6.2V 6300 Ekip Dip LI	1SDA072651R1	1SDA073281R1	
				E6.2V 6300 Ekip Dip LSI	1SDA072652R1	1SDA073282R1	
				E6.2V 6300 Ekip Dip LSIG	1SDA072653R1	1SDA073283R1	
				E6.2V 6300 Ekip Touch LI	1SDA072654R1	1SDA073284R1	
				E6.2V 6300 Ekip Touch LSI	1SDA072655R1	1SDA073285R1	
				E6.2V 6300 Ekip Touch LSIG	1SDA072656R1	1SDA073286R1	
				E6.2V 6300 Ekip Hi-Touch LSI	1SDA072658R1	1SDA073288R1	
				E6.2V 6300 Ekip Hi-Touch LSIG	1SDA072659R1	1SDA073289R1	

# Automatic circuit-breakers

## Withdrawable version for power distribution



### SACE Emax E6.2X • Mobile part of withdrawable circuit-breaker (MP)

Size	I <sub>u</sub>	I <sub>cu</sub> (440 V) (1s)	I <sub>cw</sub> (1s)	Type	3 Poles	4 Poles
					Code	Code
E6.2X	4000	150	120	E6.2X 4000 Ekip Dip LI	1SDA072601R1	1SDA073231R1
				E6.2X 4000 Ekip Dip LSI	1SDA072602R1	1SDA073232R1
				E6.2X 4000 Ekip Dip LSIG	1SDA072603R1	1SDA073233R1
				E6.2X 4000 Ekip Touch LI	1SDA072604R1	1SDA073234R1
				E6.2X 4000 Ekip Touch LSI	1SDA072605R1	1SDA073235R1
				E6.2X 4000 Ekip Touch LSIG	1SDA072606R1	1SDA073236R1
				E6.2X 4000 Ekip Hi-Touch LSI	1SDA072608R1	1SDA073238R1
				E6.2X 4000 Ekip Hi-Touch LSIG	1SDA072609R1	1SDA073239R1
5000	150	120	E6.2X 5000 Ekip Dip LI	1SDA072631R1	1SDA073261R1	
			E6.2X 5000 Ekip Dip LSI	1SDA072632R1	1SDA073262R1	
			E6.2X 5000 Ekip Dip LSIG	1SDA072633R1	1SDA073263R1	
			E6.2X 5000 Ekip Touch LI	1SDA072634R1	1SDA073264R1	
			E6.2X 5000 Ekip Touch LSI	1SDA072635R1	1SDA073265R1	
			E6.2X 5000 Ekip Touch LSIG	1SDA072636R1	1SDA073266R1	
			E6.2X 5000 Ekip Hi-Touch LSI	1SDA072638R1	1SDA073268R1	
			E6.2X 5000 Ekip Hi-Touch LSIG	1SDA072639R1	1SDA073269R1	
6300	150	120	E6.2X 6300 Ekip Dip LI	1SDA072661R1	1SDA073291R1	
			E6.2X 6300 Ekip Dip LSI	1SDA072662R1	1SDA073292R1	
			E6.2X 6300 Ekip Dip LSIG	1SDA072663R1	1SDA073293R1	
			E6.2X 6300 Ekip Touch LI	1SDA072664R1	1SDA073294R1	
			E6.2X 6300 Ekip Touch LSI	1SDA072665R1	1SDA073295R1	
			E6.2X 6300 Ekip Touch LSIG	1SDA072666R1	1SDA073296R1	
			E6.2X 6300 Ekip Hi-Touch LSI	1SDA072668R1	1SDA073298R1	
			E6.2X 6300 Ekip Hi-Touch LSIG	1SDA072669R1	1SDA073299R1	



**SACE Emax E6.2H-V/f Full size • Mobile part of withdrawable circuit-breaker (MP)**

Size	Iu	Icu (440 V)	Icw (1s)	Type	4 Poles Code
<b>E6.2H/f</b>	4000	100	100	E6.2H/f 4000 Ekip Dip LI	1SDA073301R1
				E6.2H/f 4000 Ekip Dip LSI	1SDA073302R1
				E6.2H/f 4000 Ekip Dip LSIG	1SDA073303R1
				E6.2H/f 4000 Ekip Touch LI	1SDA073304R1
				E6.2H/f 4000 Ekip Touch LSI	1SDA073305R1
				E6.2H/f 4000 Ekip Touch LSIG	1SDA073306R1
				E6.2H/f 4000 Ekip Hi-Touch LSI	1SDA073308R1
				E6.2H/f 4000 Ekip Hi-Touch LSIG	1SDA073309R1
	5000	100	100	E6.2H/f 5000 Ekip Dip LI	1SDA073331R1
				E6.2H/f 5000 Ekip Dip LSI	1SDA073332R1
				E6.2H/f 5000 Ekip Dip LSIG	1SDA073333R1
				E6.2H/f 5000 Ekip Touch LI	1SDA073334R1
				E6.2H/f 5000 Ekip Touch LSI	1SDA073335R1
				E6.2H/f 5000 Ekip Touch LSIG	1SDA073336R1
				E6.2H/f 5000 Ekip Hi-Touch LSI	1SDA073338R1
				E6.2H/f 5000 Ekip Hi-Touch LSIG	1SDA073339R1
	6300	100	100	E6.2H/f 6300 Ekip Dip LI	1SDA073361R1
				E6.2H/f 6300 Ekip Dip LSI	1SDA073362R1
				E6.2H/f 6300 Ekip Dip LSIG	1SDA073363R1
				E6.2H/f 6300 Ekip Touch LI	1SDA073364R1
				E6.2H/f 6300 Ekip Touch LSI	1SDA073365R1
				E6.2H/f 6300 Ekip Touch LSIG	1SDA073366R1
				E6.2H/f 6300 Ekip Hi-Touch LSI	1SDA073368R1
				E6.2H/f 6300 Ekip Hi-Touch LSIG	1SDA073369R1
<b>E6.2V/f</b>	4000	150	100	E6.2V/f 4000 Ekip Dip LI	1SDA073311R1
				E6.2V/f 4000 Ekip Dip LSI	1SDA073312R1
				E6.2V/f 4000 Ekip Dip LSIG	1SDA073313R1
				E6.2V/f 4000 Ekip Touch LI	1SDA073314R1
				E6.2V/f 4000 Ekip Touch LSI	1SDA073315R1
				E6.2V/f 4000 Ekip Touch LSIG	1SDA073316R1
				E6.2V/f 4000 Ekip Hi-Touch LSI	1SDA073318R1
				E6.2V/f 4000 Ekip Hi-Touch LSIG	1SDA073319R1
	5000	150	100	E6.2V/f 5000 Ekip Dip LI	1SDA073341R1
				E6.2V/f 5000 Ekip Dip LSI	1SDA073342R1
				E6.2V/f 5000 Ekip Dip LSIG	1SDA073343R1
				E6.2V/f 5000 Ekip Touch LI	1SDA073344R1
				E6.2V/f 5000 Ekip Touch LSI	1SDA073345R1
				E6.2V/f 5000 Ekip Touch LSIG	1SDA073346R1
				E6.2V/f 5000 Ekip Hi-Touch LSI	1SDA073348R1
				E6.2V/f 5000 Ekip Hi-Touch LSIG	1SDA073349R1
	6300	150	100	E6.2V/f 6300 Ekip Dip LI	1SDA073371R1
				E6.2V/f 6300 Ekip Dip LSI	1SDA073372R1
				E6.2V/f 6300 Ekip Dip LSIG	1SDA073373R1
				E6.2V/f 6300 Ekip Touch LI	1SDA073374R1
				E6.2V/f 6300 Ekip Touch LSI	1SDA073375R1
				E6.2V/f 6300 Ekip Touch LSIG	1SDA073376R1
				E6.2V/f 6300 Ekip Hi-Touch LSI	1SDA073378R1
				E6.2V/f 6300 Ekip Hi-Touch LSIG	1SDA073379R1

# Automatic circuit-breakers

## Withdrawable version for power distribution



### SACE Emax E6.2X/f Full size - Mobile part of withdrawable circuit-breaker (MP)

Size	Iu	Icu (440 V)	Icw (1s)	Type	4 Poles Code
E6.2X/f	4000	150	120	E6.2X/f 4000 Ekip Dip LI	1SDA073321R1
				E6.2X/f 4000 Ekip Dip LSI	1SDA073322R1
				E6.2X/f 4000 Ekip Dip LSIG	1SDA073323R1
				E6.2X/f 4000 Ekip Touch LI	1SDA073324R1
				E6.2X/f 4000 Ekip Touch LSI	1SDA073325R1
				E6.2X/f 4000 Ekip Touch LSIG	1SDA073326R1
				E6.2X/f 4000 Ekip Hi-Touch LSI	1SDA073328R1
				E6.2X/f 4000 Ekip Hi-Touch LSIG	1SDA073329R1
	5000	150	120	E6.2X/f 5000 Ekip Dip LI	1SDA073351R1
				E6.2X/f 5000 Ekip Dip LSI	1SDA073352R1
				E6.2X/f 5000 Ekip Dip LSIG	1SDA073353R1
				E6.2X/f 5000 Ekip Touch LI	1SDA073354R1
				E6.2X/f 5000 Ekip Touch LSI	1SDA073355R1
				E6.2X/f 5000 Ekip Touch LSIG	1SDA073356R1
				E6.2X/f 5000 Ekip Hi-Touch LSI	1SDA073358R1
				E6.2X/f 5000 Ekip Hi-Touch LSIG	1SDA073359R1
	6300	150	120	E6.2X/f 6300 Ekip Dip LI	1SDA073381R1
				E6.2X/f 6300 Ekip Dip LSI	1SDA073382R1
				E6.2X/f 6300 Ekip Dip LSIG	1SDA073383R1
				E6.2X/f 6300 Ekip Touch LI	1SDA073384R1
				E6.2X/f 6300 Ekip Touch LSI	1SDA073385R1
				E6.2X/f 6300 Ekip Touch LSIG	1SDA073386R1
				E6.2X/f 6300 Ekip Hi-Touch LSI	1SDA073388R1
				E6.2X/f 6300 Ekip Hi-Touch LSIG	1SDA073389R1

# Automatic circuit-breakers

## Fixed version for generators



### SACE Emax E1.2B-C-N-L • Front terminals (F)

Size	I <sub>u</sub>	I <sub>cu</sub> (440 V) (1s)	I <sub>cw</sub> (1s)	Type	3 Poles	4 Poles	
					Code	Code	
<b>E1.2B</b>	630	42	42	E1.2B 630 Ekip G Touch LSIG	1SDA070707R1	1SDA071337R1	
				E1.2B 630 Ekip G Hi-Touch LSIG	1SDA070710R1	1SDA071340R1	
	800	42	42	E1.2B 800 Ekip G Touch LSIG	1SDA070747R1	1SDA071377R1	
				E1.2B 800 Ekip G Hi-Touch LSIG	1SDA070750R1	1SDA071380R1	
	1000	42	42	E1.2B 1000 Ekip G Touch LSIG	1SDA070787R1	1SDA071417R1	
				E1.2B 1000 Ekip G Hi-Touch LSIG	1SDA070790R1	1SDA071420R1	
	1250	42	42	E1.2B 1250 Ekip G Touch LSIG	1SDA070827R1	1SDA071457R1	
				E1.2B 1250 Ekip G Hi-Touch LSIG	1SDA070830R1	1SDA071460R1	
	1600	42	42	E1.2B 1600 Ekip G Touch LSIG	1SDA070867R1	1SDA071497R1	
				E1.2B 1600 Ekip G Hi-Touch LSIG	1SDA070870R1	1SDA071500R1	
	<b>E1.2C</b>	630	50	42	E1.2C 630 Ekip G Touch LSIG	1SDA070717R1	1SDA071347R1
					E1.2C 630 Ekip G Hi-Touch LSIG	1SDA070720R1	1SDA071350R1
800		50	42	E1.2C 800 Ekip G Touch LSIG	1SDA070757R1	1SDA071387R1	
				E1.2C 800 Ekip G Hi-Touch LSIG	1SDA070760R1	1SDA071390R1	
1000		50	42	E1.2C 1000 Ekip G Touch LSIG	1SDA070797R1	1SDA071427R1	
				E1.2C 1000 Ekip G Hi-Touch LSIG	1SDA070800R1	1SDA071430R1	
1250		50	42	E1.2C 1250 Ekip G Touch LSIG	1SDA070837R1	1SDA071467R1	
				E1.2C 1250 Ekip G Hi-Touch LSIG	1SDA070840R1	1SDA071470R1	
1600		50	42	E1.2C 1600 Ekip G Touch LSIG	1SDA070877R1	1SDA071507R1	
				E1.2C 1600 Ekip G Hi-Touch LSIG	1SDA070880R1	1SDA071510R1	
<b>E1.2N</b>		250	66	50	E1.2N 250 Ekip G Touch LSIG	1SDA070697R1	1SDA071327R1
					E1.2N 250 Ekip G Hi-Touch LSIG	1SDA070700R1	1SDA071330R1
	630	66	50	E1.2N 630 Ekip G Touch LSIG	1SDA070727R1	1SDA071357R1	
				E1.2N 630 Ekip G Hi-Touch LSIG	1SDA070730R1	1SDA071360R1	
	800	66	50	E1.2N 800 Ekip G Touch LSIG	1SDA070767R1	1SDA071397R1	
				E1.2N 800 Ekip G Hi-Touch LSIG	1SDA070770R1	1SDA071400R1	
	1000	66	50	E1.2N 1000 Ekip G Touch LSIG	1SDA070807R1	1SDA071437R1	
				E1.2N 1000 Ekip G Hi-Touch LSIG	1SDA070810R1	1SDA071440R1	
	1250	66	50	E1.2N 1250 Ekip G Touch LSIG	1SDA070847R1	1SDA071477R1	
				E1.2N 1250 Ekip G Hi-Touch LSIG	1SDA070850R1	1SDA071480R1	
	1600	66	50	E1.2N 1600 Ekip G Touch LSIG	1SDA070887R1	1SDA071517R1	
				E1.2N 1600 Ekip G Hi-Touch LSIG	1SDA070890R1	1SDA071520R1	

# Automatic circuit-breakers

## Fixed version for generators



### SACE Emax E2.2B-N-S-H • Orientable rear terminals (HR)

Size	I <sub>u</sub>	I <sub>cu</sub> (440 V)	I <sub>cw</sub> (1s)	Type	3 Poles	4 Poles	
					Code	Code	
<b>E2.2B</b>	1600	42	42	E2.2B 1600 Ekip G Touch L SIG	1SDA070987R1	1SDA071617R1	
				E2.2B 1600 Ekip G Hi-Touch L SIG	1SDA070990R1	1SDA071620R1	
	2000	42	42	E2.2B 2000 Ekip G Touch L SIG	1SDA071027R1	1SDA071657R1	
				E2.2B 2000 Ekip G Hi-Touch L SIG	1SDA071030R1	1SDA071660R1	
<b>E2.2N</b>	800	66	66	E2.2N 800 Ekip G Touch L SIG	1SDA070897R1	1SDA071527R1	
				E2.2N 800 Ekip G Hi-Touch L SIG	1SDA070900R1	1SDA071530R1	
	1000	66	66	E2.2N 1000 Ekip G Touch L SIG	1SDA070927R1	1SDA071557R1	
				E2.2N 1000 Ekip G Hi-Touch L SIG	1SDA070930R1	1SDA071560R1	
	1250	66	66	E2.2N 1250 Ekip G Touch L SIG	1SDA070957R1	1SDA071587R1	
				E2.2N 1250 Ekip G Hi-Touch L SIG	1SDA070960R1	1SDA071590R1	
	1600	66	66	E2.2N 1600 Ekip G Touch L SIG	1SDA070997R1	1SDA071627R1	
				E2.2N 1600 Ekip G Hi-Touch L SIG	1SDA071000R1	1SDA071630R1	
	2000	66	66	E2.2N 2000 Ekip G Touch L SIG	1SDA071037R1	1SDA071667R1	
				E2.2N 2000 Ekip G Hi-Touch L SIG	1SDA071040R1	1SDA071670R1	
	2500	66	66	E2.2N 2500 Ekip G Touch L SIG	1SDA071067R1	1SDA071697R1	
				E2.2N 2500 Ekip G Hi-Touch L SIG	1SDA071070R1	1SDA071700R1	
<b>E2.2S</b>	250	85	66	E2.2S 250 Ekip G Touch L SIG	1SDA073634R1	1SDA073644R1	
				E2.2S 250 Ekip G Hi-Touch L SIG	1SDA073637R1	1SDA073647R1	
	800	85	66	E2.2S 800 Ekip G Touch L SIG	1SDA070907R1	1SDA071537R1	
				E2.2S 800 Ekip G Hi-Touch L SIG	1SDA070910R1	1SDA071540R1	
	1000	85	66	E2.2S 1000 Ekip G Touch L SIG	1SDA070937R1	1SDA071567R1	
				E2.2S 1000 Ekip G Hi-Touch L SIG	1SDA070940R1	1SDA071570R1	
	1250	85	66	E2.2S 1250 Ekip G Touch L SIG	1SDA070967R1	1SDA071597R1	
				E2.2S 1250 Ekip G Hi-Touch L SIG	1SDA070970R1	1SDA071600R1	
	1600	85	66	E2.2S 1600 Ekip G Touch L SIG	1SDA071007R1	1SDA071637R1	
				E2.2S 1600 Ekip G Hi-Touch L SIG	1SDA071010R1	1SDA071640R1	
	2000	85	66	E2.2S 2000 Ekip G Touch L SIG	1SDA071047R1	1SDA071677R1	
				E2.2S 2000 Ekip G Hi-Touch L SIG	1SDA071050R1	1SDA071680R1	
	2500	85	66	E2.2S 2500 Ekip G Touch L SIG	1SDA071077R1	1SDA071707R1	
				E2.2S 2500 Ekip G Hi-Touch L SIG	1SDA071080R1	1SDA071710R1	
	<b>E2.2H</b>	800	100	85	E2.2H 800 Ekip G Touch L SIG	1SDA070917R1	1SDA071547R1
					E2.2H 800 Ekip G Hi-Touch L SIG	1SDA070920R1	1SDA071550R1
		1000	100	85	E2.2H 1000 Ekip G Touch L SIG	1SDA070947R1	1SDA071577R1
					E2.2H 1000 Ekip G Hi-Touch L SIG	1SDA070950R1	1SDA071580R1
1250		100	85	E2.2H 1250 Ekip G Touch L SIG	1SDA070977R1	1SDA071607R1	
				E2.2H 1250 Ekip G Hi-Touch L SIG	1SDA070980R1	1SDA071610R1	
1600		100	85	E2.2H 1600 Ekip G Touch L SIG	1SDA071017R1	1SDA071647R1	
				E2.2H 1600 Ekip G Hi-Touch L SIG	1SDA071020R1	1SDA071650R1	
2000		100	85	E2.2H 2000 Ekip G Touch L SIG	1SDA071057R1	1SDA071687R1	
				E2.2H 2000 Ekip G Hi-Touch L SIG	1SDA071060R1	1SDA071690R1	
2500		100	85	E2.2H 2500 Ekip G Touch L SIG	1SDA071087R1	1SDA071717R1	
				E2.2H 2500 Ekip G Hi-Touch L SIG	1SDA071090R1	1SDA071720R1	



**SACE Emax E4.2N-S-H-V • Orientable rear terminals (HR)**

Size	Iu	Icu (440 V)	Icw (1s)	Type	3 Poles	4 Poles
					Code	Code
<b>E4.2N</b>	3200	66	66	E4.2N 3200 Ekip G Touch LSIG	1SDA071147R1	1SDA071777R1
				E4.2N 3200 Ekip G Hi-Touch LSIG	1SDA071150R1	1SDA071780R1
	4000	66	66	E4.2N 4000 Ekip G Touch LSIG	1SDA071197R1	1SDA071827R1
				E4.2N 4000 Ekip G Hi-Touch LSIG	1SDA071200R1	1SDA071830R1
<b>E4.2S</b>	3200	85	66	E4.2S 3200 Ekip G Touch LSIG	1SDA071157R1	1SDA071787R1
				E4.2S 3200 Ekip G Hi-Touch LSIG	1SDA071160R1	1SDA071790R1
	4000	85	66	E4.2S 4000 Ekip G Touch LSIG	1SDA071207R1	1SDA071837R1
				E4.2S 4000 Ekip G Hi-Touch LSIG	1SDA071210R1	1SDA071840R1
<b>E4.2H</b>	3200	100	85	E4.2H 3200 Ekip G Touch LSIG	1SDA071167R1	1SDA071797R1
				E4.2H 3200 Ekip G Hi-Touch LSIG	1SDA071170R1	1SDA071800R1
	4000	100	85	E4.2H 4000 Ekip G Touch LSIG	1SDA071217R1	1SDA071847R1
				E4.2H 4000 Ekip G Hi-Touch LSIG	1SDA071220R1	1SDA071850R1
<b>E4.2V</b>	2000	150	100	E4.2V 2000 Ekip G Touch LSIG	1SDA071107R1	1SDA071737R1
				E4.2V 2000 Ekip G Hi-Touch LSIG	1SDA071110R1	1SDA071740R1
	2500	150	100	E4.2V 2500 Ekip G Touch LSIG	1SDA071127R1	1SDA071757R1
				E4.2V 2500 Ekip G Hi-Touch LSIG	1SDA071130R1	1SDA071760R1
	3200	150	100	E4.2V 3200 Ekip G Touch LSIG	1SDA071177R1	1SDA071807R1
				E4.2V 3200 Ekip G Hi-Touch LSIG	1SDA071180R1	1SDA071810R1
	4000	150	100	E4.2V 4000 Ekip G Touch LSIG	1SDA071227R1	1SDA071857R1
				E4.2V 4000 Ekip G Hi-Touch LSIG	1SDA071230R1	1SDA071860R1

# Automatic circuit-breakers

## Fixed version for generators



### SACE Emax E6.2H-V-X • Orientable rear terminals (HR)

Size	I <sub>u</sub>	I <sub>cu</sub> (440 V)	I <sub>cw</sub> (1s)	Type	3 Poles	4 Poles
					Code	Code
<b>E6.2H</b>	4000	100	100	E6.2H 4000 Ekip G Touch LSIG	1SDA071237R1	1SDA071867R1
				E6.2H 4000 Ekip G Hi-Touch LSIG	1SDA071240R1	1SDA071870R1
	5000	100	100	E6.2H 5000 Ekip G Touch LSIG	1SDA071267R1	1SDA071897R1
				E6.2H 5000 Ekip G Hi-Touch LSIG	1SDA071270R1	1SDA071900R1
	6300	100	100	E6.2H 6300 Ekip G Touch LSIG	1SDA071297R1	1SDA071927R1
				E6.2H 6300 Ekip G Hi-Touch LSIG	1SDA071300R1	1SDA071930R1
<b>E6.2V</b>	4000	150	100	E6.2V 4000 Ekip G Touch LSIG	1SDA071247R1	1SDA071877R1
				E6.2V 4000 Ekip G Hi-Touch LSIG	1SDA071250R1	1SDA071880R1
	5000	150	100	E6.2V 5000 Ekip G Touch LSIG	1SDA071277R1	1SDA071907R1
				E6.2V 5000 Ekip G Hi-Touch LSIG	1SDA071280R1	1SDA071910R1
	6300	150	100	E6.2V 6300 Ekip G Touch LSIG	1SDA071307R1	1SDA071937R1
				E6.2V 6300 Ekip G Hi-Touch LSIG	1SDA071310R1	1SDA071940R1
<b>E6.2X</b>	4000	150	120	E6.2X 4000 Ekip G Touch LSIG	1SDA071257R1	1SDA071887R1
				E6.2X 4000 Ekip G Hi-Touch LSIG	1SDA071260R1	1SDA071890R1
	5000	150	120	E6.2X 5000 Ekip G Touch LSIG	1SDA071287R1	1SDA071917R1
				E6.2X 5000 Ekip G Hi-Touch LSIG	1SDA071290R1	1SDA071920R1
	6300	150	120	E6.2X 6300 Ekip G Touch LSIG	1SDA071317R1	1SDA071947R1
				E6.2X 6300 Ekip G Hi-Touch LSIG	1SDA071320R1	1SDA071950R1

**SACE Emax E6.2H-V-X/f Full size • Orientable rear terminals (HR)**

Size	Iu	Icu (440 V)	Icw (1s)	Type	4 Poles
					Code
<b>E6.2H/f</b>	4000	100	100	E6.2H/f 4000 Ekip G Touch LSIG	1SDA071957R1
				E6.2H/f 4000 Ekip G Hi-Touch LSIG	1SDA071960R1
	5000	100	100	E6.2H/f 5000 Ekip G Touch LSIG	1SDA071987R1
				E6.2H/f 5000 Ekip G Hi-Touch LSIG	1SDA071990R1
	6300	100	100	E6.2H/f 6300 Ekip G Touch LSIG	1SDA072017R1
				E6.2H/f 6300 Ekip G Hi-Touch LSIG	1SDA072020R1
<b>E6.2V/f</b>	4000	150	100	E6.2V/f 4000 Ekip G Touch LSIG	1SDA071967R1
				E6.2V/f 4000 Ekip G Hi-Touch LSIG	1SDA071970R1
	5000	150	100	E6.2V/f 5000 Ekip G Touch LSIG	1SDA071997R1
				E6.2V/f 5000 Ekip G Hi-Touch LSIG	1SDA072000R1
	6300	150	100	E6.2V/f 6300 Ekip G Touch LSIG	1SDA072027R1
				E6.2V/f 6300 Ekip G Hi-Touch LSIG	1SDA072030R1
<b>E6.2X/f</b>	4000	150	120	E6.2X/f 4000 Ekip G Touch LSIG	1SDA071977R1
				E6.2X/f 4000 Ekip G Hi-Touch LSIG	1SDA071980R1
	5000	150	120	E6.2X/f 5000 Ekip G Touch LSIG	1SDA072007R1
				E6.2X/f 5000 Ekip G Hi-Touch LSIG	1SDA072010R1
	6300	150	120	E6.2X/f 6300 Ekip G Touch LSIG	1SDA072037R1
				E6.2X/f 6300 Ekip G Hi-Touch LSIG	1SDA072040R1

# Automatic circuit-breakers

## Withdrawable version for generators



### SACE Emax E1.2B-C-N-L • Mobile part of withdrawable circuit-breaker (MP)

Size	Iu	Icu (440 V)	Icw (1s)	Type	3 Poles	4 Poles	
					Code	Code	
<b>E1.2B</b>	630	42	42	E1.2B 630 Ekip G Touch LSIG	1SDA072057R1	1SDA072687R1	
				E1.2B 630 Ekip G Hi-Touch LSIG	1SDA072060R1	1SDA072690R1	
	800	42	42	E1.2B 800 Ekip G Touch LSIG	1SDA072097R1	1SDA072727R1	
				E1.2B 800 Ekip G Hi-Touch LSIG	1SDA072100R1	1SDA072730R1	
	1000	42	42	E1.2B 1000 Ekip G Touch LSIG	1SDA072137R1	1SDA072767R1	
				E1.2B 1000 Ekip G Hi-Touch LSIG	1SDA072140R1	1SDA072770R1	
	1250	42	42	E1.2B 1250 Ekip G Touch LSIG	1SDA072177R1	1SDA072807R1	
				E1.2B 1250 Ekip G Hi-Touch LSIG	1SDA072180R1	1SDA072810R1	
	1600	42	42	E1.2B 1600 Ekip G Touch LSIG	1SDA072217R1	1SDA072847R1	
				E1.2B 1600 Ekip G Hi-Touch LSIG	1SDA072220R1	1SDA072850R1	
	<b>E1.2C</b>	630	50	42	E1.2C 630 Ekip G Touch LSIG	1SDA072067R1	1SDA072697R1
					E1.2C 630 Ekip G Hi-Touch LSIG	1SDA072070R1	1SDA072700R1
800		50	42	E1.2C 800 Ekip G Touch LSIG	1SDA072107R1	1SDA072737R1	
				E1.2C 800 Ekip G Hi-Touch LSIG	1SDA072110R1	1SDA072740R1	
1000		50	42	E1.2C 1000 Ekip G Touch LSIG	1SDA072147R1	1SDA072777R1	
				E1.2C 1000 Ekip G Hi-Touch LSIG	1SDA072150R1	1SDA072780R1	
1250		50	42	E1.2C 1250 Ekip G Touch LSIG	1SDA072187R1	1SDA072817R1	
				E1.2C 1250 Ekip G Hi-Touch LSIG	1SDA072190R1	1SDA072820R1	
1600		50	42	E1.2C 1600 Ekip G Touch LSIG	1SDA072227R1	1SDA072857R1	
				E1.2C 1600 Ekip G Hi-Touch LSIG	1SDA072230R1	1SDA072860R1	
<b>E1.2N</b>		250	66	50	E1.2N 250 Ekip G Touch LSIG	1SDA072047R1	1SDA072677R1
					E1.2N 250 Ekip G Hi-Touch LSIG	1SDA072050R1	1SDA072680R1
	630	66	50	E1.2N 630 Ekip G Touch LSIG	1SDA072077R1	1SDA072707R1	
				E1.2N 630 Ekip G Hi-Touch LSIG	1SDA072080R1	1SDA072710R1	
	800	66	50	E1.2N 800 Ekip G Touch LSIG	1SDA072117R1	1SDA072747R1	
				E1.2N 800 Ekip G Hi-Touch LSIG	1SDA072120R1	1SDA072750R1	
	1000	66	50	E1.2N 1000 Ekip G Touch LSIG	1SDA072157R1	1SDA072787R1	
				E1.2N 1000 Ekip G Hi-Touch LSIG	1SDA072160R1	1SDA072790R1	
	1250	66	50	E1.2N 1250 Ekip G Touch LSIG	1SDA072197R1	1SDA072827R1	
				E1.2N 1250 Ekip G Hi-Touch LSIG	1SDA072200R1	1SDA072830R1	
	1600	66	50	E1.2N 1600 Ekip G Touch LSIG	1SDA072237R1	1SDA072867R1	
				E1.2N 1600 Ekip G Hi-Touch LSIG	1SDA072240R1	1SDA072870R1	



**SACE Emax E2.2B-N-S-H • Mobile part of withdrawable circuit-breaker (MP)**

Size	Iu	Icu (440 V)	Icw (1s)	Type	3 Poles	4 Poles	
					Code	Code	
<b>E2.2B</b>	1600	42	42	E2.2B 1600 Ekip G Touch LSIG	1SDA072337R1	1SDA072967R1	
				E2.2B 1600 Ekip G Hi-Touch LSIG	1SDA072340R1	1SDA072970R1	
	2000	42	42	E2.2B 2000 Ekip G Touch LSIG	1SDA072377R1	1SDA073007R1	
				E2.2B 2000 Ekip G Hi-Touch LSIG	1SDA072380R1	1SDA073010R1	
<b>E2.2N</b>	800	66	66	E2.2N 800 Ekip G Touch LSIG	1SDA072247R1	1SDA072877R1	
				E2.2N 800 Ekip G Hi-Touch LSIG	1SDA072250R1	1SDA072880R1	
	1000	66	66	E2.2N 1000 Ekip G Touch LSIG	1SDA072277R1	1SDA072907R1	
				E2.2N 1000 Ekip G Hi-Touch LSIG	1SDA072280R1	1SDA072910R1	
	1250	66	66	E2.2N 1250 Ekip G Touch LSIG	1SDA072307R1	1SDA072937R1	
				E2.2N 1250 Ekip G Hi-Touch LSIG	1SDA072310R1	1SDA072940R1	
	1600	66	66	E2.2N 1600 Ekip G Touch LSIG	1SDA072347R1	1SDA072977R1	
				E2.2N 1600 Ekip G Hi-Touch LSIG	1SDA072350R1	1SDA072980R1	
	2000	66	66	E2.2N 2000 Ekip G Touch LSIG	1SDA072387R1	1SDA073017R1	
				E2.2N 2000 Ekip G Hi-Touch LSIG	1SDA072390R1	1SDA073020R1	
	2500	66	66	E2.2N 2500 Ekip G Touch LSIG	1SDA072417R1	1SDA073047R1	
				E2.2N 2500 Ekip G Hi-Touch LSIG	1SDA072420R1	1SDA073050R1	
	<b>E2.2S</b>	250	85	66	E2.2S 250 Ekip G Touch LSIG	1SDA073654R1	1SDA073664R1
					E2.2S 250 Ekip G Hi-Touch LSIG	1SDA073657R1	1SDA073667R1
		800	85	66	E2.2S 800 Ekip G Touch LSIG	1SDA072257R1	1SDA072887R1
					E2.2S 800 Ekip G Hi-Touch LSIG	1SDA072260R1	1SDA072890R1
1000		85	66	E2.2S 1000 Ekip G Touch LSIG	1SDA072287R1	1SDA072917R1	
				E2.2S 1000 Ekip G Hi-Touch LSIG	1SDA072290R1	1SDA072920R1	
1250		85	66	E2.2S 1250 Ekip G Touch LSIG	1SDA072317R1	1SDA072947R1	
				E2.2S 1250 Ekip G Hi-Touch LSIG	1SDA072320R1	1SDA072950R1	
1600		85	66	E2.2S 1600 Ekip G Touch LSIG	1SDA072357R1	1SDA072987R1	
				E2.2S 1600 Ekip G Hi-Touch LSIG	1SDA072360R1	1SDA072990R1	
2000		85	66	E2.2S 2000 Ekip G Touch LSIG	1SDA072397R1	1SDA073027R1	
				E2.2S 2000 Ekip G Hi-Touch LSIG	1SDA072400R1	1SDA073030R1	
2500		85	66	E2.2S 2500 Ekip G Touch LSIG	1SDA072427R1	1SDA073057R1	
				E2.2S 2500 Ekip G Hi-Touch LSIG	1SDA072430R1	1SDA073060R1	
<b>E2.2H</b>		800	100	85	E2.2H 800 Ekip G Touch LSIG	1SDA072267R1	1SDA072897R1
					E2.2H 800 Ekip G Hi-Touch LSIG	1SDA072270R1	1SDA072900R1
		1000	100	85	E2.2H 1000 Ekip G Touch LSIG	1SDA072297R1	1SDA072927R1
					E2.2H 1000 Ekip G Hi-Touch LSIG	1SDA072300R1	1SDA072930R1
	1250	100	85	E2.2H 1250 Ekip G Touch LSIG	1SDA072327R1	1SDA072957R1	
				E2.2H 1250 Ekip G Hi-Touch LSIG	1SDA072330R1	1SDA072960R1	
	1600	100	85	E2.2H 1600 Ekip G Touch LSIG	1SDA072367R1	1SDA072997R1	
				E2.2H 1600 Ekip G Hi-Touch LSIG	1SDA072370R1	1SDA073000R1	
	2000	100	85	E2.2H 2000 Ekip G Touch LSIG	1SDA072407R1	1SDA073037R1	
				E2.2H 2000 Ekip G Hi-Touch LSIG	1SDA072410R1	1SDA073040R1	
	2500	100	85	E2.2H 2500 Ekip G Touch LSIG	1SDA072437R1	1SDA073067R1	
				E2.2H 2500 Ekip G Hi-Touch LSIG	1SDA072440R1	1SDA073070R1	

# Automatic circuit-breakers

## Withdrawable version for generators



### SACE Emax E4.2N-S-H-V • Mobile part of withdrawable circuit-breaker (MP)

Size	I <sub>u</sub>	I <sub>cu</sub> (440 V) (1s)	I <sub>cw</sub> (1s)	Type	3 Poles		4 Poles	
					Code		Code	
E4.2N	3200	66	66	E4.2N 3200 Ekip G Touch L SIG	1SDA072497R1	1SDA073127R1		
				E4.2N 3200 Ekip G Hi-Touch L SIG	1SDA072500R1	1SDA073130R1		
	4000	66	66	E4.2N 4000 Ekip G Touch L SIG	1SDA072547R1	1SDA073177R1		
				E4.2N 4000 Ekip G Hi-Touch L SIG	1SDA072550R1	1SDA073180R1		
E4.2S	3200	85	66	E4.2S 3200 Ekip G Touch L SIG	1SDA072507R1	1SDA073137R1		
				E4.2S 3200 Ekip G Hi-Touch L SIG	1SDA072510R1	1SDA073140R1		
	4000	85	66	E4.2S 4000 Ekip G Touch L SIG	1SDA072557R1	1SDA073187R1		
				E4.2S 4000 Ekip G Hi-Touch L SIG	1SDA072560R1	1SDA073190R1		
E4.2H	3200	100	85	E4.2H 3200 Ekip G Touch L SIG	1SDA072517R1	1SDA073147R1		
				E4.2H 3200 Ekip G Hi-Touch L SIG	1SDA072520R1	1SDA073150R1		
	4000	100	85	E4.2H 4000 Ekip G Touch L SIG	1SDA072567R1	1SDA073197R1		
				E4.2H 4000 Ekip G Hi-Touch L SIG	1SDA072570R1	1SDA073200R1		
E4.2V	2000	150	100	E4.2V 2000 Ekip G Touch L SIG	1SDA072457R1	1SDA073087R1		
				E4.2V 2000 Ekip G Hi-Touch L SIG	1SDA072460R1	1SDA073090R1		
	2500	150	100	E4.2V 2500 Ekip G Touch L SIG	1SDA072477R1	1SDA073107R1		
				E4.2V 2500 Ekip G Hi-Touch L SIG	1SDA072480R1	1SDA073110R1		
	3200	150	100	E4.2V 3200 Ekip G Touch L SIG	1SDA072527R1	1SDA073157R1		
				E4.2V 3200 Ekip G Hi-Touch L SIG	1SDA072530R1	1SDA073160R1		
	4000	150	100	E4.2V 4000 Ekip G Touch L SIG	1SDA072577R1	1SDA073207R1		
				E4.2V 4000 Ekip G Hi-Touch L SIG	1SDA072580R1	1SDA073210R1		

**SACE Emax E6.2H-V-X • Mobile part of withdrawable circuit-breaker (MP)**

Size	I <sub>u</sub>	I <sub>cu</sub> (440 V) (1s)	I <sub>cw</sub> (1s)	Type	3 Poles	4 Poles
					Code	Code
<b>E6.2H</b>	4000	100	100	E6.2H 4000 Ekip G Touch LSIG	1SDA072587R1	1SDA073217R1
				E6.2H 4000 Ekip G Hi-Touch LSIG	1SDA072590R1	1SDA073220R1
	5000	100	100	E6.2H 5000 Ekip G Touch LSIG	1SDA072617R1	1SDA073247R1
				E6.2H 5000 Ekip G Hi-Touch LSIG	1SDA072620R1	1SDA073250R1
	6300	100	100	E6.2H 6300 Ekip G Touch LSIG	1SDA072647R1	1SDA073277R1
				E6.2H 6300 Ekip G Hi-Touch LSIG	1SDA072650R1	1SDA073280R1
<b>E6.2V</b>	4000	150	100	E6.2V 4000 Ekip G Touch LSIG	1SDA072597R1	1SDA073227R1
				E6.2V 4000 Ekip G Hi-Touch LSIG	1SDA072600R1	1SDA073230R1
	5000	150	100	E6.2V 5000 Ekip G Touch LSIG	1SDA072627R1	1SDA073257R1
				E6.2V 5000 Ekip G Hi-Touch LSIG	1SDA072630R1	1SDA073260R1
	6300	150	100	E6.2V 6300 Ekip G Touch LSIG	1SDA072657R1	1SDA073287R1
				E6.2V 6300 Ekip G Hi-Touch LSIG	1SDA072660R1	1SDA073290R1
<b>E6.2X</b>	4000	150	120	E6.2X 4000 Ekip G Touch LSIG	1SDA072607R1	1SDA073237R1
				E6.2X 4000 Ekip G Hi-Touch LSIG	1SDA072610R1	1SDA073240R1
	5000	150	120	E6.2X 5000 Ekip G Touch LSIG	1SDA072637R1	1SDA073267R1
				E6.2X 5000 Ekip G Hi-Touch LSIG	1SDA072640R1	1SDA073270R1
	6300	150	120	E6.2X 6300 Ekip G Touch LSIG	1SDA072667R1	1SDA073297R1
				E6.2X 6300 Ekip G Hi-Touch LSIG	1SDA072670R1	1SDA073300R1

# Automatic circuit-breakers

## Withdrawable version for generators



**SACE Emax E6.2H-V-X/f Full size - Mobile part of withdrawable circuit-breaker (MP)**

Size	Iu	Icu (440 V)	Icw (1s)	Type	4 Poles
					Code
<b>E6.2H/f</b>	4000	100	100	E6.2H/f 4000 Ekip G Touch LSIG	1SDA073307R1
				E6.2H/f 4000 Ekip G Hi-Touch LSIG	1SDA073310R1
	5000	100	100	E6.2H/f 5000 Ekip G Touch LSIG	1SDA073337R1
				E6.2H/f 5000 Ekip G Hi-Touch LSIG	1SDA073340R1
	6300	100	100	E6.2H/f 6300 Ekip G Touch LSIG	1SDA073367R1
				E6.2H/f 6300 Ekip G Hi-Touch LSIG	1SDA073370R1
<b>E6.2V/f</b>	4000	150	100	E6.2V/f 4000 Ekip G Touch LSIG	1SDA073317R1
				E6.2V/f 4000 Ekip G Hi-Touch LSIG	1SDA073320R1
	5000	150	100	E6.2V/f 5000 Ekip G Touch LSIG	1SDA073347R1
				E6.2V/f 5000 Ekip G Hi-Touch LSIG	1SDA073350R1
	6300	150	100	E6.2V/f 6300 Ekip G Touch LSIG	1SDA073377R1
				E6.2V/f 6300 Ekip G Hi-Touch LSIG	1SDA073380R1
<b>E6.2X/f</b>	4000	150	120	E6.2X/f 4000 Ekip G Touch LSIG	1SDA073327R1
				E6.2X/f 4000 Ekip G Hi-Touch LSIG	1SDA073330R1
	5000	150	120	E6.2X/f 5000 Ekip G Touch LSIG	1SDA073357R1
				E6.2X/f 5000 Ekip G Hi-Touch LSIG	1SDA073360R1
	6300	150	120	E6.2X/f 6300 Ekip G Touch LSIG	1SDA073387R1
				E6.2X/f 6300 Ekip G Hi-Touch LSIG	1SDA073390R1



# Switch-disconnectors

## Fixed version



### SACE Emax E1.2B-N/MS • Front terminals (F)

Size	Iu	Icw (1s)	Type	3 Poles	4 Poles
				Code	Code
<b>E1.2B/MS</b>	630	42	E1.2B/MS 630	1SDA073392R1	1SDA073431R1
	800	42	E1.2B/MS 800	1SDA073394R1	1SDA073433R1
	1000	42	E1.2B/MS 1000	1SDA073396R1	1SDA073435R1
	1250	42	E1.2B/MS 1250	1SDA073398R1	1SDA073437R1
	1600	42	E1.2B/MS 1600	1SDA073400R1	1SDA073439R1
<b>E1.2N/MS</b>	250	50	E1.2N/MS 250	1SDA073391R1	1SDA073430R1
	630	50	E1.2N/MS 630	1SDA073393R1	1SDA073432R1
	800	50	E1.2N/MS 800	1SDA073395R1	1SDA073434R1
	1000	50	E1.2N/MS 1000	1SDA073397R1	1SDA073436R1
	1250	50	E1.2N/MS 1250	1SDA073399R1	1SDA073438R1
	1600	50	E1.2N/MS 1600	1SDA073401R1	1SDA073440R1



### SACE Emax E2.2B-N-H/MS • Orientable rear terminals (HR)

Size	Iu	Icw (1s)	Type	3 Poles	4 Poles
				Code	Code
<b>E2.2B/MS</b>	1600	42	E2.2B/MS 1600	1SDA073408R1	1SDA073447R1
	2000	42	E2.2B/MS 2000	1SDA073411R1	1SDA073450R1
<b>E2.2N/MS</b>	800	66	E2.2N/MS 800	1SDA073402R1	1SDA073441R1
	1000	66	E2.2N/MS 1000	1SDA073404R1	1SDA073443R1
	1250	66	E2.2N/MS 1250	1SDA073406R1	1SDA073445R1
	1600	66	E2.2N/MS 1600	1SDA073409R1	1SDA073448R1
	2000	66	E2.2N/MS 2000	1SDA073412R1	1SDA073451R1
	2500	66	E2.2N/MS 2500	1SDA073414R1	1SDA073453R1
<b>E2.2H/MS</b>	800	85	E2.2H/MS 800	1SDA073403R1	1SDA073442R1
	1000	85	E2.2H/MS 1000	1SDA073405R1	1SDA073444R1
	1250	85	E2.2H/MS 1250	1SDA073407R1	1SDA073446R1
	1600	85	E2.2H/MS 1600	1SDA073410R1	1SDA073449R1
	2000	85	E2.2H/MS 2000	1SDA073413R1	1SDA073452R1
	2500	85	E2.2H/MS 2500	1SDA073415R1	1SDA073454R1

# Switch-disconnectors

## Fixed version



### SACE Emax E4.2N-H-V/MS • Orientable rear terminals (HR)

Size	Iu	Icw (1s)	Type	3 Poles		4 Poles	
				Code		Code	
E4.2N/MS	3200	66	E4.2N/MS 3200	1SDA073418R1		1SDA073457R1	
	4000	66	E4.2N/MS 4000	1SDA073421R1		1SDA073460R1	
E4.2H/MS	3200	85	E4.2H/MS 3200	1SDA073419R1		1SDA073458R1	
	4000	85	E4.2H/MS 4000	1SDA073422R1		1SDA073461R1	
E4.2V/MS	2000	100	E4.2V/MS 2000	1SDA073416R1		1SDA073455R1	
	2500	100	E4.2V/MS 2500	1SDA073417R1		1SDA073456R1	
	3200	100	E4.2V/MS 3200	1SDA073420R1		1SDA073459R1	
	4000	100	E4.2V/MS 4000	1SDA073423R1		1SDA073462R1	



### SACE Emax E6.2H-X/MS • Orientable rear terminals (HR)

Size	Iu	Icw (1s)	Type	3 Poles		4 Poles	
				Code		Code	
E6.2H/MS	4000	100	E6.2H/MS 4000	1SDA073424R1		1SDA073463R1	
	5000	100	E6.2H/MS 5000	1SDA073426R1		1SDA073465R1	
	6300	100	E6.2H/MS 6300	1SDA073428R1		1SDA073467R1	
E6.2X/MS	4000	120	E6.2X/MS 4000	1SDA073425R1		1SDA073464R1	
	5000	120	E6.2X/MS 5000	1SDA073427R1		1SDA073466R1	
	6300	120	E6.2X/MS 6300	1SDA073429R1		1SDA073468R1	



### SACE Emax E6.2H-X/MS/f Full size • Orientable rear terminals (HR)

Size	Iu	Icw (1s)	Type	4 Poles	
				Code	
E6.2H/MS/f	4000	100	E6.2H/MS/f 4000	1SDA073469R1	
	5000	100	E6.2H/MS/f 5000	1SDA073471R1	
	6300	100	E6.2H/MS/f 6300	1SDA073473R1	
E6.2X/MS/f	4000	120	E6.2X/MS/f 4000	1SDA073470R1	
	5000	120	E6.2X/MS/f 5000	1SDA073472R1	
	6300	120	E6.2X/MS/f 6300	1SDA073474R1	

# Switch-disconnectors

## Withdrawable version



### SACE Emax E1.2B-N/MS • Mobile part of withdrawable circuit-breaker (MP)

Size	Iu	Icw (1s)	Type	3 Poles	4 Poles
				Code	Code
<b>E1.2B/MS</b>	630	42	E1.2B/MS 630	1SDA073476R1	1SDA073515R1
	800	42	E1.2B/MS 800	1SDA073478R1	1SDA073517R1
	1000	42	E1.2B/MS 1000	1SDA073480R1	1SDA073519R1
	1250	42	E1.2B/MS 1250	1SDA073482R1	1SDA073521R1
	1600	42	E1.2B/MS 1600	1SDA073484R1	1SDA073523R1
<b>E1.2N/MS</b>	250	50	E1.2N/MS 250	1SDA073475R1	1SDA073514R1
	630	50	E1.2N/MS 630	1SDA073477R1	1SDA073516R1
	800	50	E1.2N/MS 800	1SDA073479R1	1SDA073518R1
	1000	50	E1.2N/MS 1000	1SDA073481R1	1SDA073520R1
	1250	50	E1.2N/MS 1250	1SDA073483R1	1SDA073522R1
	1600	50	E1.2N/MS 1600	1SDA073485R1	1SDA073524R1



### SACE Emax E2.2B-N-H/MS • Mobile part of withdrawable circuit-breaker (MP)

Size	Iu	Icw (1s)	Type	3 Poles	4 Poles
				Code	Code
<b>E2.2B/MS</b>	1600	42	E2.2B/MS 1600	1SDA073492R1	1SDA073531R1
	2000	42	E2.2B/MS 2000	1SDA073495R1	1SDA073534R1
<b>E2.2N/MS</b>	800	66	E2.2N/MS 800	1SDA073486R1	1SDA073525R1
	1000	66	E2.2N/MS 1000	1SDA073488R1	1SDA073527R1
	1250	66	E2.2N/MS 1250	1SDA073490R1	1SDA073529R1
	1600	66	E2.2N/MS 1600	1SDA073493R1	1SDA073532R1
	2000	66	E2.2N/MS 2000	1SDA073496R1	1SDA073535R1
	2500	66	E2.2N/MS 2500	1SDA073498R1	1SDA073537R1
<b>E2.2H/MS</b>	800	85	E2.2H/MS 800	1SDA073487R1	1SDA073526R1
	1000	85	E2.2H/MS 1000	1SDA073489R1	1SDA073528R1
	1250	85	E2.2H/MS 1250	1SDA073491R1	1SDA073530R1
	1600	85	E2.2H/MS 1600	1SDA073494R1	1SDA073533R1
	2000	85	E2.2H/MS 2000	1SDA073497R1	1SDA073536R1
	2500	85	E2.2H/MS 2500	1SDA073499R1	1SDA073538R1

# Switch-disconnectors

## Withdrawable version



### SACE Emax E4.2N-H-V/MS • Mobile part of withdrawable circuit-breaker (MP)

Size	Iu	Icw (1s)	Type	3 Poles	4 Poles
				Code	Code
E4.2N/MS	3200	66	E4.2N/MS 3200	1SDA073502R1	1SDA073541R1
	4000	66	E4.2N/MS 4000	1SDA073505R1	1SDA073544R1
E4.2H/MS	3200	85	E4.2H/MS 3200	1SDA073503R1	1SDA073542R1
	4000	85	E4.2H/MS 4000	1SDA073506R1	1SDA073545R1
E4.2V/MS	2000	100	E4.2V/MS 2000	1SDA073500R1	1SDA073539R1
	2500	100	E4.2V/MS 2500	1SDA073501R1	1SDA073540R1
	3200	100	E4.2V/MS 3200	1SDA073504R1	1SDA073543R1
	4000	100	E4.2V/MS 4000	1SDA073507R1	1SDA073546R1



### SACE Emax E6.2H-X/MS • Mobile part of withdrawable circuit-breaker (MP)

Size	Iu	Icw (1s)	Type	3 Poles	4 Poles
				Code	Code
E6.2H/MS	4000	100	E6.2H/MS 4000	1SDA073508R1	1SDA073547R1
	5000	100	E6.2H/MS 5000	1SDA073510R1	1SDA073549R1
	6300	100	E6.2H/MS 6300	1SDA073512R1	1SDA073551R1
E6.2X/MS	4000	120	E6.2X/MS 4000	1SDA073509R1	1SDA073548R1
	5000	120	E6.2X/MS 5000	1SDA073511R1	1SDA073550R1
	6300	120	E6.2X/MS 6300	1SDA073513R1	1SDA073552R1

### SACE Emax E6.2H-X/MS/f Full size • Mobile part of withdrawable circuit-breaker (MP)

Size	Iu	Icw (1s)	Type	4 Poles
				Code
E6.2H/MS/f	4000	100	E6.2H/MS/f 4000	1SDA073553R1
	5000	100	E6.2H/MS/f 5000	1SDA073555R1
	6300	100	E6.2H/MS/f 6300	1SDA073557R1
E6.2X/MS/f	4000	120	E6.2X/MS/f 4000	1SDA073554R1
	5000	120	E6.2X/MS/f 5000	1SDA073556R1
	6300	120	E6.2X/MS/f 6300	1SDA073558R1

# Automatic circuit-breakers

## Fixed version Emax 2/E9 up to 900V



Size	Iu	Icu (900V)*	Type	3 Poles	4 Poles
E1.2N	1250	35	E1.2N/E9 1250 Ekip Dip LSI F F	1SDA104274R1	1SDA104284R1
			E1.2N/E9 1250 Ekip Dip LSI G F F	1SDA104275R1	1SDA104285R1
			E1.2N/E9 1250 Ekip Touch LSI F F	1SDA104278R1	1SDA104288R1
			E1.2N/E9 1250 Ekip Touch LSI G F F	1SDA104276R1	1SDA104286R1
			E1.2N/E9 1250 Ekip Hi-Touch LSI G F F	1SDA104277R1	1SDA104287R1
E2.2H	1250	65	E2.2H/E9 1250 Ekip Dip LSI FHR	1SDA104347R1	1SDA104362R1
			E2.2H/E9 1250 Ekip Dip LSI G FHR	1SDA104348R1	1SDA104363R1
			E2.2H/E9 1250 Ekip Touch LSI FHR	1SDA104351R1	1SDA104366R1
			E2.2H/E9 1250 Ekip Touch LSI G FHR	1SDA104349R1	1SDA104364R1
			E2.2H/E9 1250 Ekip Hi-Touch LSI G FHR	1SDA104350R1	1SDA104365R1
	2000	65	E2.2H/E9 2000 Ekip Dip LSI FHR	1SDA104352R1	1SDA104367R1
			E2.2H/E9 2000 Ekip Dip LSI G FHR	1SDA104353R1	1SDA104368R1
			E2.2H/E9 2000 Ekip Touch LSI FHR	1SDA104356R1	1SDA104371R1
			E2.2H/E9 2000 Ekip Touch LSI G FHR	1SDA104354R1	1SDA104369R1
			E2.2H/E9 2000 Ekip Hi-Touch LSI G FHR	1SDA104355R1	1SDA104370R1
	2500	65	E2.2H/E9 2500 Ekip Dip LSI FHR	1SDA104357R1	1SDA104372R1
			E2.2H/E9 2500 Ekip Dip LSI G FHR	1SDA104358R1	1SDA104373R1
			E2.2H/E9 2500 Ekip Touch LSI FHR	1SDA104361R1	1SDA104376R1
			E2.2H/E9 2500 Ekip Touch LSI G FHR	1SDA104359R1	1SDA104374R1
			E2.2H/E9 2500 Ekip Hi-Touch LSI G FHR	1SDA104360R1	1SDA104375R1
E2.2S	1250	50	E2.2S/E9 1250 Ekip Dip LSI FHR	1SDA104317R1	1SDA104332R1
			E2.2S/E9 1250 Ekip Dip LSI G FHR	1SDA104318R1	1SDA104333R1
			E2.2S/E9 1250 Ekip Touch LSI FHR	1SDA104321R1	1SDA104336R1
			E2.2S/E9 1250 Ekip Touch LSI G FHR	1SDA104319R1	1SDA104334R1
			E2.2S/E9 1250 Ekip Hi-Touch LSI G FHR	1SDA104320R1	1SDA104335R1
	2000	50	E2.2S/E9 2000 Ekip Dip LSI FHR	1SDA104322R1	1SDA104337R1
			E2.2S/E9 2000 Ekip Dip LSI G FHR	1SDA104323R1	1SDA104338R1
			E2.2S/E9 2000 Ekip Touch LSI FHR	1SDA104326R1	1SDA104341R1
			E2.2S/E9 2000 Ekip Touch LSI G FHR	1SDA104324R1	1SDA104339R1
			E2.2S/E9 2000 Ekip Hi-Touch LSI G FHR	1SDA104325R1	1SDA104340R1
	2500	50	E2.2S/E9 2500 Ekip Dip LSI FHR	1SDA104327R1	1SDA104342R1
			E2.2S/E9 2500 Ekip Dip LSI G FHR	1SDA104328R1	1SDA104343R1
			E2.2S/E9 2500 Ekip Touch LSI FHR	1SDA104331R1	1SDA104346R1
			E2.2S/E9 2500 Ekip Touch LSI G FHR	1SDA104329R1	1SDA104344R1
			E2.2S/E9 2500 Ekip Hi-Touch LSI G FHR	1SDA104330R1	1SDA104345R1

\*For E1.2, Icu at 800V

# Automatic circuit-breakers

## Fixed version Emax 2/E9 up to 900V



Size	Iu	Icu (900V)	Type	3 Poles	4 Poles
E4.2H	3200	75	E4.2H/E9 3200 Ekip Dip LSI FHR	1SDA104397R1	1SDA104407R1
			E4.2H/E9 3200 Ekip Dip LSIG FHR	1SDA104398R1	1SDA104408R1
			E4.2H/E9 3200 Ekip Touch LSI FHR	1SDA104401R1	1SDA104411R1
			E4.2H/E9 3200 Ekip Touch LSIG FHR	1SDA104399R1	1SDA104409R1
			E4.2H/E9 3200 Ekip Hi-Touch LSIG FHR	1SDA104400R1	1SDA104410R1
	4000	75	E4.2H/E9 4000 Ekip Dip LSI FHR	1SDA104402R1	1SDA104412R1
			E4.2H/E9 4000 Ekip Dip LSIG FHR	1SDA104403R1	1SDA104413R1
			E4.2H/E9 4000 Ekip Touch LSI FHR	1SDA104406R1	1SDA104416R1
			E4.2H/E9 4000 Ekip Touch LSIG FHR	1SDA104404R1	1SDA104414R1
			E4.2H/E9 4000 Ekip Hi-Touch LSIG FHR	1SDA104405R1	1SDA104415R1
E4.2S	3200	65	E4.2S/E9 3200 Ekip Dip LSI FHR	1SDA104377R1	1SDA104387R1
			E4.2S/E9 3200 Ekip Dip LSIG FHR	1SDA104378R1	1SDA104388R1
			E4.2S/E9 3200 Ekip Touch LSI FHR	1SDA104381R1	1SDA104391R1
			E4.2S/E9 3200 Ekip Touch LSIG FHR	1SDA104379R1	1SDA104389R1
			E4.2S/E9 3200 Ekip Hi-Touch LSIG FHR	1SDA104380R1	1SDA104390R1
	4000	65	E4.2S/E9 4000 Ekip Dip LSI FHR	1SDA104382R1	1SDA104392R1
			E4.2S/E9 4000 Ekip Dip LSIG FHR	1SDA104383R1	1SDA104393R1
			E4.2S/E9 4000 Ekip Touch LSI FHR	1SDA104386R1	1SDA104396R1
			E4.2S/E9 4000 Ekip Touch LSIG FHR	1SDA104384R1	1SDA104394R1
			E4.2S/E9 4000 Ekip Hi-Touch LSIG FHR	1SDA104385R1	1SDA104395R1
E6.2H	5000	75	E6.2H/E9 5000 Ekip Dip LSI FHR	1SDA104605R1	1SDA104615R1
			E6.2H/E9 5000 Ekip Dip LSIG FHR	1SDA104606R1	1SDA104616R1
			E6.2H/E9 5000 Ekip Touch LSI FHR	1SDA104609R1	1SDA104619R1
			E6.2H/E9 5000 Ekip Touch LSIG FHR	1SDA104607R1	1SDA104617R1
			E6.2H/E9 5000 Ekip Hi-Touch LSIG FHR	1SDA104608R1	1SDA104618R1
	6300	75	E6.2H/E9 6300 Ekip Dip LSI FHR	1SDA104610R1	1SDA104620R1
			E6.2H/E9 6300 Ekip Dip LSIG FHR	1SDA104611R1	1SDA104621R1
			E6.2H/E9 6300 Ekip Touch LSI FHR	1SDA104614R1	1SDA104624R1
			E6.2H/E9 6300 Ekip Touch LSIG FHR	1SDA104612R1	1SDA104622R1
			E6.2H/E9 6300 Ekip Hi-Touch LSIG FHR	1SDA104613R1	1SDA104623R1
E6.2X	5000	90	E6.2X/E9 5000 Ekip Dip LSI FHR	1SDA104417R1	1SDA104427R1
			E6.2X/E9 5000 Ekip Dip LSIG FHR	1SDA104418R1	1SDA104428R1
			E6.2X/E9 5000 Ekip Touch LSI FHR	1SDA104421R1	1SDA104431R1
			E6.2X/E9 5000 Ekip Touch LSIG FHR	1SDA104419R1	1SDA104429R1
			E6.2X/E9 5000 Ekip Hi-Touch LSIG FHR	1SDA104420R1	1SDA104430R1
	6300	90	E6.2X/E9 6300 Ekip Dip LSI FHR	1SDA104422R1	1SDA104432R1
			E6.2X/E9 6300 Ekip Dip LSIG FHR	1SDA104423R1	1SDA104433R1
			E6.2X/E9 6300 Ekip Touch LSI FHR	1SDA104426R1	1SDA104436R1
			E6.2X/E9 6300 Ekip Touch LSIG FHR	1SDA104424R1	1SDA104434R1
			E6.2X/E9 6300 Ekip Hi-Touch LSIG FHR	1SDA104425R1	1SDA104435R1



# Automatic circuit-breakers

## Withdrawable version Emax 2/E9 up to 900V



Size	Iu	Icu (900V)*	Type	3 Poles	4 Poles
E1.2N	1250	35	E1.2N/E9 1250 Ekip Dip LSI WMP	1SDA104294R1	1SDA104304R1
			E1.2N/E9 1250 Ekip Dip LSI WMP	1SDA104295R1	1SDA104305R1
			E1.2N/E9 1250 Ekip Touch LSI WMP	1SDA104298R1	1SDA104308R1
			E1.2N/E9 1250 Ekip Touch LSI WMP	1SDA104296R1	1SDA104306R1
			E1.2N/E9 1250 Ekip Hi-Touch LSI WMP	1SDA104297R1	1SDA104307R1
E2.2H	1250	65	E2.2H/E9 1250 Ekip Dip LSI WMP	1SDA104467R1	1SDA104482R1
			E2.2H/E9 1250 Ekip Dip LSI WMP	1SDA104468R1	1SDA104483R1
			E2.2H/E9 1250 Ekip Touch LSI WMP	1SDA104471R1	1SDA104486R1
			E2.2H/E9 1250 Ekip Touch LSI WMP	1SDA104469R1	1SDA104484R1
			E2.2H/E9 1250 Ekip Hi-Touch LSI WMP	1SDA104470R1	1SDA104485R1
	2000	65	E2.2H/E9 2000 Ekip Dip LSI WMP	1SDA104472R1	1SDA104487R1
			E2.2H/E9 2000 Ekip Dip LSI WMP	1SDA104473R1	1SDA104488R1
			E2.2H/E9 2000 Ekip Touch LSI WMP	1SDA104476R1	1SDA104491R1
			E2.2H/E9 2000 Ekip Touch LSI WMP	1SDA104474R1	1SDA104489R1
			E2.2H/E9 2000 Ekip Hi-Touch LSI WMP	1SDA104475R1	1SDA104490R1
	2500	65	E2.2H/E9 2500 Ekip Dip LSI WMP	1SDA104477R1	1SDA104492R1
			E2.2H/E9 2500 Ekip Dip LSI WMP	1SDA104478R1	1SDA104493R1
			E2.2H/E9 2500 Ekip Touch LSI WMP	1SDA104481R1	1SDA104496R1
			E2.2H/E9 2500 Ekip Touch LSI WMP	1SDA104479R1	1SDA104494R1
			E2.2H/E9 2500 Ekip Hi-Touch LSI WMP	1SDA104480R1	1SDA104495R1
E2.2S	1250	50	E2.2S/E9 1250 Ekip Dip LSI WMP	1SDA104437R1	1SDA104452R1
			E2.2S/E9 1250 Ekip Dip LSI WMP	1SDA104438R1	1SDA104453R1
			E2.2S/E9 1250 Ekip Touch LSI WMP	1SDA104441R1	1SDA104456R1
			E2.2S/E9 1250 Ekip Touch LSI WMP	1SDA104439R1	1SDA104454R1
			E2.2S/E9 1250 Ekip Hi-Touch LSI WMP	1SDA104440R1	1SDA104455R1
	2000	50	E2.2S/E9 2000 Ekip Dip LSI WMP	1SDA104442R1	1SDA104457R1
			E2.2S/E9 2000 Ekip Dip LSI WMP	1SDA104443R1	1SDA104458R1
			E2.2S/E9 2000 Ekip Touch LSI WMP	1SDA104446R1	1SDA104461R1
			E2.2S/E9 2000 Ekip Touch LSI WMP	1SDA104444R1	1SDA104459R1
			E2.2S/E9 2000 Ekip Hi-Touch LSI WMP	1SDA104445R1	1SDA104460R1
	2500	50	E2.2S/E9 2500 Ekip Dip LSI WMP	1SDA104447R1	1SDA104462R1
			E2.2S/E9 2500 Ekip Dip LSI WMP	1SDA104448R1	1SDA104463R1
			E2.2S/E9 2500 Ekip Touch LSI WMP	1SDA104451R1	1SDA104466R1
			E2.2S/E9 2500 Ekip Touch LSI WMP	1SDA104449R1	1SDA104464R1
			E2.2S/E9 2500 Ekip Hi-Touch LSI WMP	1SDA104450R1	1SDA104465R1

\*For E1.2, Icu at 800V

# Automatic circuit-breakers

## Withdrawable version Emax 2/E9 up to 900V



Size	Iu	Icu (900V)	Type	3 Poles	4 Poles
E4.2H	3200	75	E4.2H/E9 3200 Ekip Dip LSI WMP	1SDA104517R1	1SDA104527R1
			E4.2H/E9 3200 Ekip Dip LSIG WMP	1SDA104518R1	1SDA104528R1
			E4.2H/E9 3200 Ekip Touch LSI WMP	1SDA104521R1	1SDA104531R1
			E4.2H/E9 3200 Ekip Touch LSIG WMP	1SDA104519R1	1SDA104529R1
			E4.2H/E9 3200 Ekip Hi-Touch LSIG WMP	1SDA104520R1	1SDA104530R1
	4000	75	E4.2H/E9 4000 Ekip Dip LSI WMP	1SDA104522R1	1SDA104532R1
			E4.2H/E9 4000 Ekip Dip LSIG WMP	1SDA104523R1	1SDA104533R1
			E4.2H/E9 4000 Ekip Touch LSI WMP	1SDA104526R1	1SDA104536R1
			E4.2H/E9 4000 Ekip Touch LSIG WMP	1SDA104524R1	1SDA104534R1
			E4.2H/E9 4000 Ekip Hi-Touch LSIG WMP	1SDA104525R1	1SDA104535R1
E4.2S	3200	65	E4.2S/E9 3200 Ekip Dip LSI WMP	1SDA104497R1	1SDA104507R1
			E4.2S/E9 3200 Ekip Dip LSIG WMP	1SDA104498R1	1SDA104508R1
			E4.2S/E9 3200 Ekip Touch LSI WMP	1SDA104501R1	1SDA104511R1
			E4.2S/E9 3200 Ekip Touch LSIG WMP	1SDA104499R1	1SDA104509R1
			E4.2S/E9 3200 Ekip Hi-Touch LSIG WMP	1SDA104500R1	1SDA104510R1
	4000	65	E4.2S/E9 4000 Ekip Dip LSI WMP	1SDA104502R1	1SDA104512R1
			E4.2S/E9 4000 Ekip Dip LSIG WMP	1SDA104503R1	1SDA104513R1
			E4.2S/E9 4000 Ekip Touch LSI WMP	1SDA104506R1	1SDA104516R1
			E4.2S/E9 4000 Ekip Touch LSIG WMP	1SDA104504R1	1SDA104514R1
			E4.2S/E9 4000 Ekip Hi-Touch LSIG WMP	1SDA104505R1	1SDA104515R1
E6.2H	5000	75	E6.2H/E9 5000 Ekip Dip LSI WMP	1SDA104625R1	1SDA104635R1
			E6.2H/E9 5000 Ekip Dip LSIG WMP	1SDA104626R1	1SDA104636R1
			E6.2H/E9 5000 Ekip Touch LSI WMP	1SDA104629R1	1SDA104639R1
			E6.2H/E9 5000 Ekip Touch LSIG WMP	1SDA104627R1	1SDA104637R1
			E6.2H/E9 5000 Ekip Hi-Touch LSIG WMP	1SDA104628R1	1SDA104638R1
	6300	75	E6.2H/E9 6300 Ekip Dip LSI WMP	1SDA104630R1	1SDA104640R1
			E6.2H/E9 6300 Ekip Dip LSIG WMP	1SDA104631R1	1SDA104641R1
			E6.2H/E9 6300 Ekip Touch LSI WMP	1SDA104634R1	1SDA104644R1
			E6.2H/E9 6300 Ekip Touch LSIG WMP	1SDA104632R1	1SDA104642R1
			E6.2H/E9 6300 Ekip Hi-Touch LSIG WMP	1SDA104633R1	1SDA104643R1
E6.2X	5000	90	E6.2X/E9 5000 Ekip Dip LSI WMP	1SDA104537R1	1SDA104547R1
			E6.2X/E9 5000 Ekip Dip LSIG WMP	1SDA104538R1	1SDA104548R1
			E6.2X/E9 5000 Ekip Touch LSI WMP	1SDA104541R1	1SDA104551R1
			E6.2X/E9 5000 Ekip Touch LSIG WMP	1SDA104539R1	1SDA104549R1
			E6.2X/E9 5000 Ekip Hi-Touch LSIG WMP	1SDA104540R1	1SDA104550R1
	6300	90	E6.2X/E9 6300 Ekip Dip LSI WMP	1SDA104542R1	1SDA104552R1
			E6.2X/E9 6300 Ekip Dip LSIG WMP	1SDA104543R1	1SDA104553R1
			E6.2X/E9 6300 Ekip Touch LSI WMP	1SDA104546R1	1SDA104556R1
			E6.2X/E9 6300 Ekip Touch LSIG WMP	1SDA104544R1	1SDA104554R1
			E6.2X/E9 6300 Ekip Hi-Touch LSIG WMP	1SDA104545R1	1SDA104555R1





# Derived versions

## Sectionalizing truck - CS

Size	lu	Type	3 poles	4 poles
			Code	Code
E2.2/CS	2000	E2.2/CS 2000 MP	1SDA081778R1	1SDA081779R1
E2.2/CS	2500	E2.2/CS 2500 MP	1SDA074348R1	1SDA074349R1
E4.2/CS	3200	E4.2/CS 3200 MP	1SDA081780R1	1SDA081781R1
E4.2/CS	4000	E4.2/CS 4000 MP	1SDA074350R1	1SDA074351R1
E6.2/CS	6300	E6.2/CS 6300 MP	1SDA074352R1	1SDA074353R1
E6.2/CS/f	6300	E6.2/CS/f 6300 MP	-	1SDA082504R1

## Earthing truck - MT

Size	lu	Type	3 poles	4 poles
			Code	Code
E2.2/MT	2000	E2.2/MT 2000 MP Earth connection from upper terminals	1SDA081782R1	1SDA081783R1
E2.2/MT	2500	E2.2/MT 2500 MP Earth connection from upper terminals	1SDA074354R1	1SDA074355R1
E4.2/MT	3200	E4.2/MT 3200 MP Earth connection from upper terminals	1SDA081784R1	1SDA081785R1
E4.2/MT	4000	E4.2/MT 4000 MP Earth connection from upper terminals	1SDA074356R1	1SDA074357R1
E6.2/MT	6300	E6.2/MT 6300 MP Earth connection from upper terminals	1SDA074358R1	1SDA074359R1
E2.2/MT	2000	E2.2/MT 2000 MP Earth connection from lower terminals	1SDA081786R1	1SDA081787R1
E2.27MT	2500	E2.2/MT 2500 MP Earth connection from lower terminals	1SDA074360R1	1SDA074361R1
E4.2/MT	3200	E4.2/MT 3200 MP Earth connection from lower terminals	1SDA081788R1	1SDA081789R1
E4.2/MT	4000	E4.2/MT 4000 MP Earth connection from lower terminals	1SDA074362R1	1SDA074363R1
E6.2/MT	6300	E6.2/MT 6300 MP Earth connection from lower terminals	1SDA074364R1	1SDA074365R1
E6.2/MT/f	6300	E6.2/MT/f 6300 MP Earth connection from upper terminals	-	1SDA082505R1
E6.2/MT/f	6300	E6.2/MT/f 6300 MP Earth connection from lower terminals	-	1SDA082506R1

## Earthing switch with making capacity - MTP

Size	lu	Type	3 poles	4 poles
			Code	Code
E2.2/MTP	2000	E2.2/MTP 2000 MP Earth connection from upper terminals	1SDA081790R1	1SDA081791R1
E2.2/MTP	2500	E2.2/MTP 2500 MP Earth connection from upper terminals	1SDA074366R1	1SDA074367R1
E4.2/MTP	3200	E4.2/MTP 3200 MP Earth connection from upper terminals	1SDA081792R1	1SDA081793R1
E4.2/MTP	4000	E4.2/MTP 4000 MP Earth connection from upper terminals	1SDA074368R1	1SDA074369R1
E6.2/MTP	6300	E6.2/MTP 6300 MP Earth connection from upper terminals	1SDA074370R1	1SDA074371R1
E2.2/MTP	2000	E2.2/MTP 2000 MP Earth connection from lower terminals	1SDA081794R1	1SDA081795R1
E2.2/MTP	2500	E2.2/MTP 2500 MP Earth connection from lower terminals	1SDA074372R1	1SDA074373R1
E4.2/MTP	3200	E4.2/MTP 3200 MP Earth connection from lower terminals	1SDA081796R1	1SDA081797R1
E4.2/MTP	4000	E4.2/MTP 4000 MP Earth connection from lower terminals	1SDA074374R1	1SDA074375R1
E6.2/MTP	6300	E6.2/MTP 6300 MP Earth connection from lower terminals	1SDA074376R1	1SDA074377R1
E6.2/MTP/f	6300	E6.2/MTP/f 6300 MP Earth connection from upper terminals	-	1SDA082507R1
E6.2/MTP/f	6300	E6.2/MTP/f 6300 MP Earth connection from lower terminals	-	1SDA082508R1

## Accessories for MT and MTP

Size	Type	Code
E2.2*	Grounding clamp PF E2.2 for MT/MTP	1SDA074378R1
E4.2-E6.2*	Grounding clamp PF E4.2-E6.2 for MT/MTP	1SDA074379R1
E2.2	Grounding clamp retrofitting FP E2.2 for MT/MTP (Front/Side mounting)	1SDA085591R1
E4.2-E6.2	Grounding clamp retrofitting FP E4.2-E6.2 for MT/MTP (Front/Side mounting)	1SDA085592R1

Grounding clamps must be installed in every fixed parts in which a MT/MTP mobile parts is foreseen. Otherwise the standard fixed parts can not accept MT/MTP device.  
\* Only mounted. For loose supply contact ABB.

## Fixed or Mobile Part with neutral on right side

Size	Type	Code
E1.2...E6.2	Installation with neutral on right side sequence L1,L2,L3,N	1SDA076153R1

# Fixed parts



Size	Performance	Iu range	Type of terminal	Type	3 Poles		4 Poles	
					Code		Code	
E1.2	B, C, N, L	250 - 1600	HR - HR	E1.2 W FP Iu=1600 HR HR	1SDA073907R1	1SDA073908R1		
E2.2	B, N, S, H	250 - 2000	HR - HR	E2.2 W FP Iu=2000 HR HR	1SDA073909R1	1SDA073910R1		
E2.2	N, S, H	2500	HR - HR	E2.2 W FP Iu=2500 HR HR	1SDA073911R1	1SDA073912R1		
E4.2	N, S, H	3200	HR - HR	E4.2 W FP Iu=3200 HR HR	1SDA073913R1	1SDA073914R1		
E4.2	N, S, H	4000	HR - HR	E4.2 W FP Iu=4000 or V version HR HR	1SDA073915R1	1SDA073916R1		
E4.2	V	2000-4000	HR - HR	E4.2 W FP Iu=4000 or V version HR HR	1SDA073915R1	1SDA073916R1		
E6.2	H, V	4000-5000	HR - HR	E6.2 W FP Iu=5000 HR HR	1SDA073917R1	1SDA073918R1		
E6.2/f	H, V	4000-5000	HR - HR	E6.2 W FP Iu=5000 HR HR	1SDA073919R1			
E6.2*	H, V, X	4000-6300	HR - HR	E6.2 W FP Iu=6300 or X version HR HR	1SDA073920R1	1SDA073921R1		
E6.2/f*	H, V, X	4000-6300	HR - HR	E6.2 W FP Iu=6300 or X version HR HR	1SDA073922R1			

\*These types of fixed parts are suitable for all types of E6.2 mobile parts from 4000A to 6300A (all Icu performance level)

Phase separators are mandatory with Emax 2/E9 circuit breakers. For withdrawable version, phase separators have to be ordered as loose part. For fixed version, they are provided as standard.

## 0-Arc distance top cover for fixed parts

Size	Type	Code
E2.2...E6.2*	0-arc distance top cover E2.2...6.2 W FP	1SDA085710R1

\* Factory fitted only. Not compatible with standard AUP, it is necessary to order the following codes:

AUP 5 contacts 400V E2.2...E6.2 - left set 1SDA080373R1  
 AUP 5 contacts 24V E2.2...E6.2 - left set 1SDA080374R1  
 AUP 5 suppl. contacts 400V E2.2...E6.2 - right set 1SDA080375R1  
 AUP 5 suppl. contacts 24V E2.2...E6.2 - right set 1SDA080376R1

NOTE: the standard fixed parts can not accept MT/MTP device. In order to allow the utilization of MT/MTP mobile parts is mandatory to install the grounding clamps on fixed parts. Accessorizing only in the factory

# Accessories

## Electrical accessories



### First and second opening release - YO

Size	Type	Code
E1.2..E6.2	YO E1.2..E6.2 24V AC/DC	1SDA073668R1
E1.2..E6.2	YO E1.2..E6.2 30V AC/DC	1SDA073669R1
E1.2..E6.2	YO E1.2..E6.2 48V AC/DC	1SDA073670R1
E1.2..E6.2	YO E1.2..E6.2 60V AC/DC	1SDA073671R1
E1.2..E6.2	YO E1.2..E6.2 110-120V AC/DC	1SDA073672R1
E1.2..E6.2	YO E1.2..E6.2 120-127V AC/DC	1SDA073673R1
E1.2..E6.2	YO E1.2..E6.2 220-240V AC/DC	1SDA073674R1
E1.2..E6.2	YO E1.2..E6.2 240-250V AC/DC	1SDA073675R1
E1.2..E6.2	YO E1.2..E6.2 277V AC	1SDA073676R1
E1.2..E6.2	YO E1.2..E6.2 380-400V AC	1SDA073677R1
E1.2..E6.2	YO E1.2..E6.2 415-440V AC	1SDA073678R1
E1.2..E6.2	YO E1.2..E6.2 480-500V AC	1SDA073679R1

### First and second closing release - YC

Size	Type	Code
E1.2..E6.2	YC E1.2..E6.2 24V AC/DC	1SDA073681R1
E1.2..E6.2	YC E1.2..E6.2 30V AC/DC	1SDA073682R1
E1.2..E6.2	YC E1.2..E6.2 48V AC/DC	1SDA073683R1
E1.2..E6.2	YC E1.2..E6.2 60V AC/DC	1SDA073684R1
E1.2..E6.2	YC E1.2..E6.2 110-120V AC/DC	1SDA073685R1
E1.2..E6.2	YC E1.2..E6.2 120-127V AC/DC	1SDA073686R1
E1.2..E6.2	YC E1.2..E6.2 220-240V AC/DC	1SDA073687R1
E1.2..E6.2	YC E1.2..E6.2 240-250V AC/DC	1SDA073688R1
E1.2..E6.2	YC E1.2..E6.2 277V AC	1SDA073689R1
E1.2..E6.2	YC E1.2..E6.2 380-400V AC	1SDA073690R1
E1.2..E6.2	YC E1.2..E6.2 415-440V AC	1SDA073691R1
E1.2..E6.2	YC E1.2..E6.2 480-500V AC	1SDA073692R1

### YO/YC test unit

Size	Type	Code
E1.2...E6.2 <sup>a)</sup>	YO/YC test unit E1.2...E6.2	1SDA082751R1

a) Only as loose part

### Undervoltage release - YU

Size	Type	Code
E1.2..E6.2	YU E1.2..E6.2 24V AC/DC	1SDA073694R1
E1.2..E6.2	YU E1.2..E6.2 30V AC/DC	1SDA073695R1
E1.2..E6.2	YU E1.2..E6.2 48V AC/DC	1SDA073696R1
E1.2..E6.2	YU E1.2..E6.2 60V AC/DC	1SDA073697R1
E1.2..E6.2	YU E1.2..E6.2 110-120V AC/DC	1SDA073698R1
E1.2..E6.2	YU E1.2..E6.2 120-127V AC/DC	1SDA073699R1
E1.2..E6.2	YU E1.2..E6.2 220-240V AC/DC	1SDA073700R1
E1.2..E6.2	YU E1.2..E6.2 240-250V AC/DC	1SDA073701R1
E1.2..E6.2	YU E1.2..E6.2 277V AC	1SDA073702R1
E1.2..E6.2	YU E1.2..E6.2 380-400V AC	1SDA073703R1
E1.2..E6.2	YU E1.2..E6.2 415-440V AC	1SDA073704R1
E1.2..E6.2	YU E1.2..E6.2 480-500V AC	1SDA073705R1

### Electronic time-delay device for undervoltage release - UVD

Size	Type	Code
E1.2...E6.2	24...30V DC	1SDA038316R1
E1.2...E6.2	48V AC/DC	1SDA038317R1
E1.2...E6.2	60V AC/DC	1SDA038318R1
E1.2...E6.2	110...127V AC/DC	1SDA038319R1
E1.2...E6.2	220...250V AC/DC	1SDA038320R1

# Accessories

## Electrical accessories



### Remote Reset - YR

Size	Type	Code
E1.2	YR 24V DC E1.2	1SDA073744R1
E1.2 <sup>a)</sup>	YR 110V AC/DC E1.2	1SDA073745R1
E1.2 <sup>a)</sup>	YR 220V AC/DC E1.2	1SDA073746R1
E2.2...E6.2	YR 24V DC E2.2...E6.2	1SDA073747R1
E2.2...E6.2 <sup>a)</sup>	YR 110V AC/DC E2.2...E6.2	1SDA073748R1
E2.2...E6.2 <sup>a)</sup>	YR 220V AC/DC E2.2...E6.2	1SDA073749R1

a) when YR is used in DC, the activation of YR must be done with a maximum impulse time of 50ms. The YR cannot be powered permanently.



### Motor - M

Size	Type	Code
E1.2	M E1.2 24-30V AC/DC+S33 M/2 250V	1SDA073708R1
E1.2	M E1.2 48-60V AC/DC+S33 M/2 250V	1SDA073709R1
E1.2	M E1.2 100-130V AC/DC+S33 M/2 250V	1SDA073710R1
E1.2	M E1.2 220-250V AC/DC+S33 M/2 250V	1SDA073711R1
E1.2	M E1.2 380-415V AC+S33 M/2 250V	1SDA073713R1
E2.2...E6.2	M E2.2...E6.2 24-30V AC/DC+S33 M/2 400V	1SDA073722R1
E2.2...E6.2	M E2.2...E6.2 48-60V AC/DC+S33 M/2 400V	1SDA073723R1
E2.2...E6.2	M E2.2...E6.2 100-130V AC/DC+S33 M/2 400V	1SDA073724R1
E2.2...E6.2	M E2.2...E6.2 220-250V AC/DC+S33 M/2 400V	1SDA073725R1
E2.2...E6.2	M E2.2...E6.2 380-415V AC+S33 M/2 400V	1SDA073727R1
E2.2...E6.2	M E2.2...E6.2 440-480V AC+S33 M/2 400V	1SDA073728R1
E1.2	M E1.2 24-30V AC/DC + S33 M/2 24V DC	1SDA073715R1
E1.2	M E1.2 48-60V AC/DC + S33 M/2 24V DC	1SDA073716R1
E1.2	M E1.2 100-130V AC/DC + S33 M/2 24V DC	1SDA073717R1
E1.2	M E1.2 220-250V AC/DC + S33 M/2 24V DC	1SDA073718R1
E1.2	M E1.2 380-415V AC + S33 M/2 24V DC	1SDA073720R1
E2.2...E6.2	M E2.2...E6.2 24-30V AC/DC + S33 M/2 24V DC	1SDA073729R1
E2.2...E6.2	M E2.2...E6.2 48-60V AC/DC + S33 M/2 24V DC	1SDA073730R1
E2.2...E6.2	M E2.2...E6.2 100-130V AC/DC + S33 M/2 24V DC	1SDA073731R1
E2.2...E6.2	M E2.2...E6.2 220-250V AC/DC + S33 M/2 24V DC	1SDA073732R1
E2.2...E6.2	M E2.2...E6.2 380-415V AC + S33 M/2 24V DC	1SDA073734R1
E2.2...E6.2	M E2.2...E6.2 440-480V AC + S33 M/2 24V DC	1SDA073735R1

### Current sensor for neutral conductor outside the circuit-breaker<sup>b)</sup>

Size	Type	Code
E1.2 - E2.2	Ext CS N E1.2 E2.2 2000A	1SDA073736R1
E2.2	Ext CS N E2.2 2500A	1SDA073737R1
E4.2	Ext CS N E4.2 3200A	1SDA073738R1
E4.2 - E6.2	Ext CS N E4.2 4000A E6.2 50%	1SDA073739R1
E6.2	Ext CS N E6.2	1SDA073740R1
E1.2 - E2.2	Ext CS N E1.2 - E2.2 2000A for 1% CB*	1SDA107553R1
E2.2	Ext CS N E2.2 2500A for 1% CB*	1SDA107554R1
E4.2	Ext CS N E4.2 3200A for 1% CB*	1SDA107555R1
E4.2 - E6.2	Ext CS N E4.2 4000A - E6.2 N 50% for 1% CB*	1SDA107556R1
E6.2	Ext CS N E6.2 for 1% CB*	1SDA107557R1

b) Only as loose part

\* To be used with circuit-breakers equipped with 1% accuracy feature only. The external neutral is not certified for 1% accuracy.



### Homopolar toroid for the earthing conductor of main power supply<sup>c)</sup>

Size	Type	Code
E1.2...E6.2	Homopolar toroid E1.2 ... E6.2 100A	1SDA073743R1
E1.2...E6.2	Homopolar toroid E1.2 ... E6.2 250A	1SDA076248R1
E1.2...E6.2	Homopolar toroid E1.2 ... E6.2 400A	1SDA076249R1
E1.2...E6.2	Homopolar toroid E1.2 ... E6.2 800A	1SDA076250R1

c) Only as loose part

### Toroid for differential protection<sup>d)</sup>

Size	Type	Code
E1.2 - E2.2	Toroid RC E1.2 3p/4p, E2.2 3p	1SDA073741R1
E2.2 - E4.2	Toroid RC E2.2 4p, E4.2 3p	1SDA073742R1

d) Only as loose part





**Open/closed auxiliary contacts - AUX**

Size	Type	Code
E1.2 <sup>b)</sup>	AUX 4Q 400V E1.2	1SDA073750R1
E1.2	AUX 4Q 24V E1.2	1SDA073751R1
E1.2	AUX 2Q 400V + 2Q 24V E1.2	1SDA073752R1
E2.2...E6.2 <sup>b)</sup>	AUX 4Q 400V E2.2...E6.2	1SDA073753R1
E2.2...E6.2	AUX 4Q 24V E2.2...E6.2	1SDA073754R1
E2.2...E6.2	AUX 2Q 400V + 2Q 24V E2.2...E6.2	1SDA073755R1
E2.2...E6.2	AUX 6Q 400V E2.2...E6.2	1SDA073756R1
E2.2...E6.2	AUX 6Q 24V E2.2...E6.2	1SDA073757R1
E2.2...E6.2	AUX 3Q 400V AC + 3Q 24V DC E2.2...E6.2	1SDA075973R1
E1.2 <sup>a) d)</sup>	AUX 15Q 400V E1.2	1SDA073758R1
E1.2 <sup>a) d)</sup>	AUX 15Q 24V E1.2	1SDA073759R1
E2.2...E6.2 <sup>a)</sup>	AUX 15Q 400V (for fixed or withdrawable with signaling in racked in)	1SDA073760R1
E2.2...E6.2 <sup>a)</sup>	AUX 15Q 24V (for fixed or withdrawable with signaling in racked in)	1SDA073761R1
E2.2...E6.2 <sup>a) c)</sup>	AUX15Q 400V (for withdrawable with signaling in racked in/test isolated)	1SDA073846R1
E2.2...E6.2 <sup>a) c)</sup>	AUX15Q 24V (for withdrawable with signaling in racked in/test isolated)	1SDA073847R1

a) not compatible with mechanical locks on compartment doors or mechanical interlocks.

For E1.2 you need to order also one of the following items:

- Plate for fixed - floor mounted 1SDA079783R1
- Plate for fixed - wall mounted 1SDA079782R1
- Plate for withdrawable 1SDA079784R1

b) Standard supply with automatic circuit-breakers; c) also compatible with fixed version;

d) For E1.2 withdrawable, the AUX 15Q works only in racked-in position

**Auxiliary position contacts - AUP**

Size	Type	Code
E1.2	AUP 6 contacts 400V E1.2	1SDA073762R1
E1.2	AUP 6 contacts 24V E1.2	1SDA073763R1
E2.2...E6.2	AUP 5 contacts 400V E2.2...E6.2 - left set	1SDA073764R1
E2.2...E6.2	AUP 5 contacts 24V E2.2...E6.2 - left set	1SDA073765R1
E2.2...E6.2	AUP 5 suppl. contacts 400V E2.2...E6.2 - right set	1SDA073766R1
E2.2...E6.2	AUP 5 suppl. contacts 24V E2.2...E6.2 - right set	1SDA073767R1
E2.2...E6.2	AUP 5 suppl. contacts 400V E2.2...E6.2 - 1in 3test 1out - right set	1SDA082749R1
E1.2...E6.2	AUP Ekip auxiliary position contact E1.2...E6.2	1SDA073768R1

**Ready to close signalling contact- RTC**

Size	Type	Code
E1.2	RTC 250V E1.2	1SDA073770R1
E1.2	RTC 24V E1.2	1SDA073771R1
E1.2	RTC Ekip 24V E1.2	1SDA073772R1
E2.2...E6.2	RTC 250V E2.2...E6.2	1SDA073773R1
E2.2...E6.2	RTC 24V E2.2...E6.2	1SDA073774R1
E2.2...E6.2	RTC Ekip 24V E2.2...E6.2	1SDA073775R1

**Contact signalling tripping of Ekip protection trip unit - S51**

Size	Type	Code
E1.2	S51 250V E1.2 <sup>a)</sup>	1SDA073776R1
E1.2	S51 24V E1.2	1SDA073777R1
E2.2...E6.2	S51 250V E2.2...E6.2 <sup>a)</sup>	1SDA073778R1
E2.2...E6.2	S51 24V E2.2...E6.2	1SDA073779R1
E2.2...E6.2	S51/2 250V	1SDA085699R1
E2.2...E6.2	S51/2 24V	1SDA085700R1

a) Standard supply with automatic circuit-breakers.

**Terminals for auxiliary connection**

Size	Type	Code
E1.2...E6.2	Terminals 10 pcs	1SDA073906R1



# Accessories

## Mechanical accessories



### Mechanical operation counter - MOC

Size	Type	Code
E1.2 <sup>a)</sup>	MOC Mechanical operation counter	1SDA073780R1
E2.2...E6.2	MOC Mechanical operation counter	1SDA073781R1

a) only available with Motor, for installation without Motor the support 1SDA105237R1 is required



### Key lock in open position - KLC

Size	Type	Code
E1.2	KLC-D Key lock open E1.2	1SDA073782R1
E1.2	KLC-S Key lock open N.20005 E1.2	1SDA073783R1
E1.2	KLC-S Key lock open N.20006 E1.2	1SDA073784R1
E1.2	KLC-S Key lock open N.20007 E1.2	1SDA073785R1
E1.2	KLC-S Key lock open N.20008 E1.2	1SDA073786R1
E1.2	KLC-S Key lock open N.20009 E1.2	1SDA073787R1
E1.2 <sup>c)</sup>	KLC-A Castell key lock open E1.2	1SDA073788R1
E1.2 <sup>c)</sup>	KLC-A Kirk key lock open E1.2	1SDA073789R1
E1.2 <sup>c) e)</sup>	KLC-A STI key lock open E1.2	1SDA073790R1
E1.2 <sup>c) d)</sup>	KLC-A Ronis-STI lock Open E1.2	1SDA085733R1
E2.2...E6.2	KLC-D Key lock open E2.2...E6.2	1SDA073791R1
E2.2...E6.2	KLC-S key lock open N.20005 E2.2..E6.2	1SDA073792R1
E2.2...E6.2	KLC-S key lock open N.20006 E2.2..E6.2	1SDA073793R1
E2.2...E6.2	KLC-S key lock open N.20007 E2.2..E6.2	1SDA073794R1
E2.2...E6.2	KLC-S key lock open N.20008 E2.2..E6.2	1SDA073795R1
E2.2...E6.2	KLC-S key lock open N.20009 E2.2..E6.2	1SDA073796R1
E2.2...E6.2 <sup>b) c)</sup>	KLC-A Castell key lock open E2.2...E6.2	1SDA073797R1
E2.2...E6.2 <sup>c)</sup>	KLC-A Kirk key lock open E2.2..E6.2	1SDA073798R1
E2.2...E6.2 <sup>c) e)</sup>	KLC-A STI key lock open E2.2..E6.2	1SDA073799R1
E2.2...E6.2 <sup>c) d)</sup>	KLC-A Ronis-STI lock open E2.2...E6.2	1SDA085734R1

b) you need to order also the cover. Please select the suitable one at pag. 298; c) arrangement only;

d) compatible models: Ronis 1104B - STI ABA90DEL5000 - STI HBA90DPS5000;

e) compatible models: STI ABA90DEL5000 - STI HBA90DPS5000



### Padlocks in open position - PLC

Size	Type	Code
E1.2	PLC E1.2 Padlocks in open position D=4mm	1SDA073800R1
E1.2	PLC E1.2 Padlocks in open position D=7mm	1SDA073801R1
E1.2	PLC E1.2 Padlocks in open position D=8mm	1SDA073802R1
E2.2...E6.2	PLC E2.2..E6.2 Padlocks in open position D=4mm	1SDA073803R1
E2.2...E6.2	PLC E2.2..E6.2 Padlocks in open position D=7mm	1SDA073804R1
E2.2...E6.2	PLC E2.2..E6.2 Padlocks in open position D=8mm	1SDA073805R1

### Floor fixing plate - F

Size	Type	Code
E1.2	Floor fixing plate for fixed unit	1SDA076020R1

**Key lock in racked-in / test / racked-out position- KLP**

Size	Type	Code
E1.2	KLP-D Racked in/out E1.2 1st key	1SDA073822R1
E1.2	KLP-S Racked in/out N.20005 E1.2 1st key	1SDA073823R1
E1.2	KLP-S Racked in/out N.20006 E1.2 1st key	1SDA073824R1
E1.2	KLP-S Racked in/out N.20007 E1.2 1st key	1SDA073825R1
E1.2	KLP-S Racked in/out N.20008 E1.2 1st key	1SDA073826R1
E1.2	KLP-S Racked in/out N.20009 E1.2 1st key	1SDA073827R1
E1.2	KLP-D Racked in/out E1.2 2nd key	1SDA073828R1
E1.2	KLP-S Racked in/out N.20005 E1.2 2nd key	1SDA073829R1
E1.2	KLP-S Racked in/out N.20006 E1.2 2nd key	1SDA073830R1
E1.2	KLP-S Racked in/out N.20007 E1.2 2nd key	1SDA073831R1
E1.2	KLP-S Racked in/out N.20008 E1.2 2nd key	1SDA073832R1
E1.2	KLP-S Racked in/out N.20009 E1.2 2nd key	1SDA073833R1
E1.2 <sup>d)</sup>	KLP-A Racked in/out STI Kirk E1.2 1st key	1SDA073834R1
E1.2 <sup>d)</sup>	KLP-A Racked in/out STI Kirk E1.2 2nd key	1SDA073835R1
E1.2 <sup>b)</sup>	KLP-A Racked in/out Castell E1.2 1st key	1SDA073836R1
E1.2 <sup>b)</sup>	KLP-A Racked in/out Castell E1.2 2nd key	1SDA073837R1
E1.2 <sup>b) c)</sup>	KLP-A Racked in/out Ronis-STI E1.2 1st key	1SDA085737R1
E1.2 <sup>b) c)</sup>	KLP-A Racked in/out Ronis-STI E1.2 2nd key	1SDA085738R1
E2.2...E6.2	KLP-D Racked in/out E2.2...E6.2 1st key	1SDA073806R1
E2.2...E6.2	KLP-S Racked in/out N.20005 E2.2...E6.2 1st key	1SDA073807R1
E2.2...E6.2	KLP-S Racked in/out N.20006 E2.2...E6.2 1st key	1SDA073808R1
E2.2...E6.2	KLP-S Racked in/out N.20007 E2.2...E6.2 1st key	1SDA073809R1
E2.2...E6.2	KLP-S Racked in/out N.20008 E2.2...E6.2 1st key	1SDA073810R1
E2.2...E6.2	KLP-S Racked in/out N.20009 E2.2...E6.2 1st key	1SDA073811R1
E2.2...E6.2	KLP-D Racked in/out E2.2...E6.2 2nd key	1SDA073812R1
E2.2...E6.2	KLP-S Racked in/out N.20005 E2.2...E6.2 2nd key	1SDA073813R1
E2.2...E6.2	KLP-S Racked in/out N.20006 E2.2...E6.2 2nd key	1SDA073814R1
E2.2...E6.2	KLP-S Racked in/out N.20007 E2.2...E6.2 2nd key	1SDA073815R1
E2.2...E6.2	KLP-S Racked in/out N.20008 E2.2...E6.2 2nd key	1SDA073816R1
E2.2...E6.2	KLP-S Racked in/out N.20009 E2.2...E6.2 2nd key	1SDA073817R1
E2.2...E6.2 <sup>b) d)</sup>	KLP-A Racked in/out STI Kirk E2.2...E6.2 1st key	1SDA073818R1
E2.2...E6.2 <sup>b) d)</sup>	KLP-A Racked in/out STI Kirk E2.2...E6.2 2nd key	1SDA073819R1
E2.2...E6.2 <sup>a) b)</sup>	KLP-A Racked in/out Castell E2.2...E6.2 1st key	1SDA073820R1
E2.2...E6.2 <sup>a) b)</sup>	KLP-A Racked in/out Castell E2.2...E6.2 2nd key	1SDA073821R1
E2.2...E6.2 <sup>b) c)</sup>	KLP-A Racked in/out Ronis-STI E2.2/E6.2 1st key	1SDA085735R1
E2.2...E6.2 <sup>b) c)</sup>	KLP-A Racked in/out Ronis-STI E2.2/E6.2 2nd key	1SDA085736R1

When the PLP is already present, you have to order the KLP 2nd key and not the KLP 1st key

a) you need to order also the cover. Please select the suitable one at pag. 298; b) arrangement only;

c) compatible models: Ronis 1104B - STI ABA90DEL5000 - STI HBA90DPS5000;

d) compatible models: STI ABA90DEL5000 - STI HBA90DPS5000 - KIRK KCAM00010

**Accessory for supplementary lock in racked-out position**

Size	Type	Code
E1.2	Suppl. locks in racked-out E1.2	1SDA073838R1
E2.2...E6.2	Suppl. locks in racked-out E2.2...E6.2	1SDA073839R1

**Padlock in racked-in / test / racked-out position - PLP**

Size	Type	Code
E1.2	PLP Bl. padlocks Racked in/out D=4/6/8mm E1.2	1SDA073840R1
E2.2...E6.2	PLP Bl. padlocks Racked in/out D=4/6/8mm E2.2...E6.2	1SDA073841R1

# Accessories

## Mechanical accessories



### Lock for racking in / racking out the mobile part when the door is open - DLR

Size	Type	Code
E2.2...E6.2 <sup>a)</sup>	DLR E2.2..E6.2	1SDA073845R1

a) Only as loose part



### Lock to prevent door opening when circuit-breaker is in racked-in / test position - DLP

Size	Type	Code
E2.2...E6.2*	DLP E2.2...E6.2	1SDA073849R1

a) Only as loose part

### Lock to prevent door opening when circuit-breaker is in closed position - DLC

Size	Type	Code
E1.2	DLC Interlock cable door for fixed to wall E1.2	1SDA081032R1
E1.2	DLC Interlock cable door for fixed to floor E1.2	1SDA081033R1
E1.2	DLC Interlock cable door for fixed part withdrawable E1.2	1SDA081034R1
E1.2	DLC Interlock direct door for fixed to wall E1.2	1SDA079779R1
E1.2	DLC Interlock direct door for fixed to floor E1.2	1SDA079780R1
E1.2	DLC Interlock direct door for fixed part withdrawable E1.2	1SDA079781R1
E2.2...E6.2 <sup>b)</sup>	DLC Interlock cable door E2.2...E6.2	1SDA073852R1
E2.2...E6.2 <sup>b)</sup>	DLC Interlock direct door E2.2...E6.2	1SDA073853R1

b) To be ordered with lever for interlock [group 2] and support for interlock [1SDA073895R1]



### Protection device for opening and closing pushbuttons - PBC

Size	Type	Code
E1.2	PBC Prot. Pushbuttons AP/CH E1.2	1SDA073854R1
E1.2	PBC Prot. Pushbuttons AP/CH D=4mm E1.2	1SDA073855R1
E1.2	PBC Prot. Pushbuttons AP/CH D=7mm E1.2	1SDA073856R1
E1.2	PBC Prot. Pushbuttons AP/CH D=8mm E1.2	1SDA073857R1
E2.2...E6.2	PBC Prot. Pushbuttons AP/CH E2.2...E6.2	1SDA073858R1
E2.2...E6.2	PBC Prot. Pushbuttons AP/CH D=4mm E2.2..E6.2	1SDA073859R1
E2.2...E6.2	PBC Prot. Pushbuttons AP/CH D=7mm E2.2..E6.2	1SDA073860R1
E2.2...E6.2	PBC Prot. Pushbuttons AP/CH D=8mm E2.2..E6.2	1SDA073861R1

### Circuit-breaker flange

Size	Type	Code
E1.2	IP30 Flange E1.2 F	1SDA073862R1
E1.2	IP30 Flange E1.2 W	1SDA073863R1
E2.2...E6.2	IP30 Flange E2.2...E6.2 F	1SDA073864R1
E2.2...E6.2	IP30 Flange E2.2...E6.2 W	1SDA073865R1
E1.2 <sup>a)</sup>	IP54 Flange different keys E1.2	1SDA073866R1
E2.2...E6.2 <sup>a)</sup>	IP54 Flange different keys E2.2...E6.2	1SDA073867R1
E1.2 <sup>a)</sup>	IP54 Flange key No. 20005 E1.2	1SDA073868R1
E2.2...E6.2 <sup>a)</sup>	IP54 Flange key No. 20005 E2.2...E6.2	1SDA073869R1
E2.2...E6.2	Sealable trip unit cover	1SDA073870R1

a) Only as loose part





# Accessories

## Mechanical interlock



### High or low terminal covers- HTC/LTC

Size	Type	3 poles	4 poles
		Code	Code
E1.2	HTC high terminal covers E1.2 2pcs	1SDA073871R1	1SDA073872R1
E1.2	LTC low terminal covers E1.2 F 2pcs	1SDA073873R1	1SDA073874R1



### Separators - PB<sup>a)</sup>

Size	Type	Code
E1.2	PB Separators H=100mm 4pz E1.2 F 3P	1SDA073877R1
E1.2	PB Separators H=100mm 6pz E1.2 F 4P	1SDA073878R1
E1.2	PB Separators H=200mm 4pz E1.2 F 3P	1SDA073879R1
E1.2	PB Separators H=200mm 6pz E1.2 F 4P	1SDA073880R1
E1.2	PB Separators 2 pz E1.2 W FP 3P	1SDA076164R1
E1.2	PB Separators 3 pz E1.2 W FP 4P	1SDA076165R1
E2.2...E6.2	PB Separators 2 pz E2.2..E6.2 F 3P	1SDA076166R1
E2.2...E6.2	PB Separators 3 pz E2.2..E6.2 F 4P	1SDA076167R1
E2.2...E6.2	PB Separators 2 pz E2.2..E6.2 W FP 3P	1SDA076168R1
E2.2...E6.2	PB Separators 3 pz E2.2..E6.2 W FP 4P	1SDA076169R1

a) Only as loose part

### Cables for mechanical interlock [Group 1]

Size	Type	Code
E1.2..E6.2	Type A horizontal	1SDA073881R1
E2.2..E6.2	Type B,C,D horizontal	1SDA073882R1
E1.2..E6.2	Type A vertical	1SDA073885R1
E2.2..E6.2	Type B,C,D vertical	1SDA073886R1

Order one type of cable for each interlock. The cable must be ordered on the fixed circuit-breaker or on the fixed part of withdrawable circuit-breaker.

### Lever for mechanical interlock of fixed circuit-breaker or mobile part [Group 2]

Size	Type	3 Poles	4 Poles
		Code	Code
E2.2	Lever for mechanical interlock	1SDA073889R1	1SDA073889R1
E4.2	Lever for mechanical interlock	1SDA073890R1	1SDA073890R1
E6.2	Lever for mechanical interlock	1SDA073891R1	1SDA073892R1

The lever for mechanical interlock is not required for E1.2

### Support for mechanical interlock of fixed circuit-breaker [Group 3]

Size	Type	Code
E1.2	Type A - floor mounted	1SDA073893R1
E1.2	Type A - wall mounted	1SDA073894R1
E2.2 ... E6.2	Type A / B / D	1SDA073895R1
E2.2 ... E6.2	Type C	1SDA073897R1

### Support for mechanical interlock of fixed part [Group 4]

Size	Type	Code
E1.2	Type A	1SDA073896R1
E2.2 ... E6.2	Type A / B / D	1SDA073895R1
E2.2 ... E6.2	Type C	1SDA073897R1

### Automatic transfer switch

Size	Type	Code
E1.2..E6.2	ATS021	1SDA065523R1
E1.2..E6.2	ATS022	1SDA065524R1



# Accessories

## Ekip modules



### Ekip trip units, Black Platform - loose supply

Size	Type	Code
E1.2..E6.2	Ekip Dip LI (Black)	1SDA107526R1
E1.2..E6.2	Ekip Dip LSI (Black)	1SDA107527R1
E1.2..E6.2	Ekip Dip LSIG (Black)	1SDA107528R1
E1.2..E6.2	Ekip Touch LI (Black)	1SDA107529R1
E1.2..E6.2	Ekip Touch LSI (Black)	1SDA107530R1
E1.2..E6.2	Ekip Touch LSIG (Black)	1SDA107531R1
E1.2..E6.2 <sup>a)</sup>	Ekip Hi-Touch LSI (Black)	1SDA107532R1
E1.2..E6.2 <sup>a)</sup>	Ekip Hi-Touch LSIG (Black)	1SDA107533R1
E1.2..E6.2 <sup>a)</sup>	Ekip G Touch LSIG (Black)	1SDA107534R1
E1.2..E6.2 <sup>a)</sup>	Ekip G Hi-Touch LSIG (Black)	1SDA107535R1
E1.2..E6.2 <sup>a)</sup>	Ekip LCD LI (Black)	1SDA107536R1
E1.2..E6.2 <sup>a)</sup>	Ekip LCD LSI (Black)	1SDA107537R1
E1.2..E6.2 <sup>a)</sup>	Ekip LCD LSIG (Black)	1SDA107538R1
E1.2..E6.2 <sup>a)</sup>	Ekip Hi-LCD LSI (Black)	1SDA107539R1
E1.2..E6.2 <sup>a)</sup>	Ekip Hi-LCD LSIG (Black)	1SDA107540R1
E1.2..E6.2 <sup>a)</sup>	Ekip G LCD LSIG (Black)	1SDA107541R1
E1.2..E6.2 <sup>a)</sup>	Ekip G Hi-LCD LSIG (Black)	1SDA107542R1
E1.2..E6.2	Battery for Ekip trip units	1SDA074193R1

a) provided without Measurement Enabler/Measurement Enabler with voltage sockets.

### Options for Ekip trip units

Size	Type	Code
E1.2..E6.2	Ekip LCD Installed	1SDA074211R1
E1.2..E6.2 <sup>b)</sup>	Upper internal installed voltage outlets	1SDA074216R1
E1.2..E6.2 <sup>b)</sup>	External installed voltage outlets	1SDA074217R1
E1.2..E6.2 <sup>c)</sup>	Arrangement for cables with lower internal voltage outlets	1SDA074213R1
E1.2..E6.2 <sup>c)</sup>	Arrangement for cables with upper internal voltage outlets	1SDA074214R1
E1.2..E6.2 <sup>c)</sup>	Arrangement for cables with external voltage outlets	1SDA074215R1

b) All Ekip Touch and Ekip Hi-Touch trip units have lower voltage outlets installed by default.

c) For Ekip trip units, Grey Platform only

### Power Supply modules

Size	Type	Code
E1.2..E6.2	Ekip Supply 110-240V AC/DC	1SDA074172R1
E1.2..E6.2	Ekip Supply 24-48V DC	1SDA074173R1

### Connectivity modules

Size	Type	Code
E1.2..E6.2	Ekip Com Modbus RS-485	1SDA074150R1
E1.2..E6.2	Ekip Com Modbus TCP	1SDA074151R1
E1.2..E6.2	Ekip Com Profibus	1SDA074152R1
E1.2..E6.2	Ekip Com Profinet	1SDA074153R1
E1.2..E6.2	Ekip Com DeviceNet™	1SDA074154R1
E1.2..E6.2	Ekip Com EtherNet/IP™	1SDA074155R1
E1.2..E6.2	Ekip Com IEC61850	1SDA074156R1
E1.2..E6.2	Ekip Com Hub	1SDA082894R1
E1.2..E6.2	Ekip Com R Modbus RS-485	1SDA074157R1
E1.2..E6.2	Ekip Com R Modbus TCP	1SDA074158R1
E1.2..E6.2	Ekip Com R Profibus	1SDA074159R1
E1.2..E6.2	Ekip Com R Profinet	1SDA074160R1
E1.2..E6.2	Ekip Com R DeviceNet™	1SDA074161R1
E1.2..E6.2	Ekip Com R EtherNet/IP™	1SDA074162R1
E1.2..E6.2	Ekip Com R IEC61850	1SDA076170R1
E1.2..E6.2	Ekip Link	1SDA074163R1
E1.2..E6.2	Ekip Bluetooth	1SDA074164R1
E1.2..E6.2	Ekip Com GPRS-M	1SDA074165R1
E1.2..E6.2	Ekip Com Actuator	1SDA074166R1





### Signalling modules

Size	Type	Code
E1.2..E6.2	Ekip Signalling 2K-1	1SDA074167R1
E1.2..E6.2	Ekip Signalling 2K-2	1SDA074168R1
E1.2..E6.2	Ekip Signalling 2K-3	1SDA074169R1
E2.2..E6.2	Ekip Signalling 4K (Black)	1SDA074170R1
E1.2..E6.2 <sup>a)</sup>	Ekip Signalling 10K	1SDA074171R1
E1.2..E6.2 <sup>b)</sup>	Ekip Signalling 3T-1	1SDA085693R1
E1.2..E6.2 <sup>b)</sup>	Ekip Signalling 3T-2	1SDA085694R1
E1.2..E6.2	Ekip Signalling ModBus TCP	1SDA082485R1

a) Only as loose part; b) External probe PT100/PT1000 not supplied



### Measurement Enabler and Measurement Enabler with voltage sockets

Size	Type	Code
E1.2	Measurement Enabler E1.2	1SDA107543R1
E1.2	Measurement Enabler with voltage sockets E1.2	1SDA107544R1
E2.2	Measurement Enabler E2.2	1SDA107545R1
E2.2	Measurement Enabler with voltage sockets E2.2	1SDA107546R1
E4.2	Measurement Enabler E4.2	1SDA107547R1
E4.2	Measurement Enabler with voltage sockets E4.2	1SDA107548R1
E6.2	Measurement Enabler E6.2	1SDA107549R1
E6.2	Measurement Enabler with voltage sockets E6.2	1SDA107550R1
E1.2 <sup>c)</sup>	Voltage socket for neutral on right side L1 L2 L3 N - E1.2	1SDA076244R1
E2.2 <sup>c)</sup>	Voltage socket for neutral on right side L1 L2 L3 N - E2.2	1SDA076245R1
E4.2 <sup>c)</sup>	Voltage socket for neutral on right side L1 L2 L3 N - E4.2	1SDA076246R1
E6.2 <sup>c)</sup>	Voltage socket for neutral on right side L1 L2 L3 N - E6.2	1SDA076247R1

c) Suitable for circuit-breakers with neutral on the right side (L1 L2 L3 N)

### Synchrocheck modules

Size	Type	Code
E1.2..E6.2	Ekip Synchrocheck	1SDA074183R1

### External Probe for Ekip 3T Signalling modules

Size	Type	Code
E1.2..E6.2 <sup>d)</sup>	External Probe PT1000 3mt	1SDA085695R1

d) For busbar applications only



### Displaying and supervision systems

Size	Type	Code
E1.2..E6.2	Ekip T&P - Programming and Test unit	1SDA066989R1
E1.2..E6.2	Ekip TT - Trip Test unit	1SDA066988R1
E1.2..E6.2	Ekip Programming	1SDA076154R1
E1.2..E6.2 <sup>e)</sup>	Ekip Multimeter	1SDA074192R1
E1.2..E6.2 <sup>f)</sup>	Ekip Control Panel for 10 circuit-breakers	1SDA074311R1
E1.2..E6.2 <sup>f)</sup>	Ekip Control Panel for 30 circuit-breakers	1SDA074312R1
E1.2..E6.2 <sup>f)</sup>	Ekip View Software for 30 circuit-breakers	1SDA074298R1
E1.2..E6.2 <sup>f)</sup>	Ekip View software for 60 circuit-breakers	1SDA074299R1
E1.2..E6.2 <sup>f)</sup>	Ekip View software for unlimited circuit-breakers	1SDA074300R1

e) Only as loose part

f) Suitable for Ekip trip units, Grey Platform only



# Accessories

## Ekip modules

Advanced functionalities



### Software functions

Size	Type	Code
E1.2..E6.2	IPS - Interface Protection*	1SDA082919R1
E1.2..E6.2	Load shedding - adaptive	1SDA082921R1
E1.2..E6.2	ATS main-tie-main closed	1SDA082886R1
E1.2..E6.2	ATS main-main open	1SDA082889R1
E1.2..E6.2	Power Controller	1SDA074212R1

\*Not available yet. Please contact ABB for further information.

### Software packages

Size	Type	Code
E1.2..E6.2	Measuring Package	1SDA107525R1
E1.2..E6.2	Voltage Protection	1SDA105227R1
E1.2..E6.2	Advanced Voltage Protection	1SDA105228R1
E1.2..E6.2	Frequency Protection	1SDA105229R1
E1.2..E6.2	Power Protection	1SDA105230R1
E1.2..E6.2	ROCOF Protection	1SDA105231R1
E1.2..E6.2	Adaptive Protection	1SDA105232R1
E1.2..E6.2	Data Logger	1SDA105233R1
E1.2..E6.2	Network Analyzer	1SDA105234R1

### Metering functions - Class 1 accuracy<sup>a) b)</sup>

Size	Type	Code
E1.2	Class 1 Power&Energy Metering E1.2	1SDA107551R1
E2.2	Class 1 Power&Energy Metering E2.2	1SDA107675R1
E4.2	Class 1 Power&Energy Metering E4.2	1SDA107676R1
E6.2	Class 1 Power&Energy Metering E6.2	1SDA107677R1

a) Factory fitted only. Extracodes available for Ekip Touch and Ekip G Touch trip units.

b) Class 1 accuracy not available for Emax 2/E9.



### Rating plug for Ekip trip units

Size	Type	Code (loose supply)	Code (installed)
E1.2..E2.2	Rating Plug 100A (Black)	1SDA112840R1	1SDA074258R1
E1.2..E2.2	Rating Plug 200A (Black)	1SDA112841R1	1SDA074259R1
E1.2..E2.2	Rating Plug 250A (Black)	1SDA112842R1	1SDA074260R1
E1.2..E6.2	Rating Plug 400A (Black)	1SDA112843R1	1SDA074261R1
E1.2..E6.2	Rating Plug 630A (Black)	1SDA112845R1	1SDA074262R1
E1.2..E6.2	Rating Plug 800A (Black)	1SDA112846R1	1SDA074263R1
E1.2..E6.2	Rating Plug 1000A (Black)	1SDA112847R1	1SDA074264R1
E1.2..E6.2	Rating Plug 1250A (Black)	1SDA112849R1	1SDA074265R1
E1.2..E6.2	Rating Plug 1600A (Black)	1SDA112850R1	1SDA074266R1
E2.2..E6.2	Rating Plug 2000A (Black)	1SDA112851R1	1SDA074267R1
E2.2..E6.2	Rating Plug 2500A (Black)	1SDA112852R1	1SDA074268R1
E4.2..E6.2	Rating Plug 3200A (Black)	1SDA112854R1	1SDA074269R1
E4.2..E6.2	Rating Plug 4000A (Black)	1SDA112856R1	1SDA074270R1
E6.2	Rating Plug 5000A (Black)	1SDA112857R1	1SDA074271R1
E6.2	Rating Plug 6300A (Black)	1SDA112859R1	-
E1.2..E2.2 <sup>(a)</sup>	Rating Plug 100A L OFF (Black)	1SDA112860R1	1SDA074273R1
E1.2..E2.2 <sup>(a)</sup>	Rating Plug 200A L OFF (Black)	1SDA112861R1	1SDA074274R1
E1.2..E2.2 <sup>(a)</sup>	Rating Plug 250A L OFF (Black)	1SDA112862R1	1SDA074275R1
E1.2..E6.2 <sup>(a)</sup>	Rating Plug 400A L OFF (Black)	1SDA112863R1	1SDA074276R1
E1.2..E6.2 <sup>(a)</sup>	Rating Plug 630A L OFF (Black)	1SDA112865R1	1SDA074277R1
E1.2..E6.2 <sup>(a)</sup>	Rating Plug 800A L OFF (Black)	1SDA112866R1	1SDA074278R1
E1.2..E6.2 <sup>(a)</sup>	Rating Plug 1000A L OFF (Black)	1SDA112867R1	1SDA074279R1
E1.2..E6.2 <sup>(a)</sup>	Rating Plug 1250A L OFF (Black)	1SDA112869R1	1SDA074280R1
E1.2..E6.2 <sup>(a)</sup>	Rating Plug 1600A L OFF (Black)	1SDA112870R1	1SDA074281R1
E2.2..E6.2 <sup>(a)</sup>	Rating Plug 2000A L OFF (Black)	1SDA112871R1	1SDA074282R1
E2.2..E6.2 <sup>(a)</sup>	Rating Plug 2500A L OFF (Black)	1SDA112872R1	1SDA074283R1
E4.2..E6.2 <sup>(a)</sup>	Rating Plug 3200A L OFF (Black)	1SDA112873R1	1SDA074284R1
E4.2..E6.2 <sup>(a)</sup>	Rating Plug 4000A L OFF (Black)	1SDA112875R1	1SDA074285R1
E6.2 <sup>(a)</sup>	Rating Plug 5000A L OFF (Black)	1SDA112876R1	1SDA074286R1
E6.2 <sup>(a)</sup>	Rating Plug 6300A L OFF (Black)	1SDA112878R1	1SDA074287R1
E1.2..E2.2	Rating Plug RC 100A (Black)	1SDA112879R1	1SDA074288R1
E1.2..E2.2	Rating Plug RC 200A (Black)	1SDA112880R1	1SDA074289R1
E1.2..E2.2	Rating Plug RC 250A (Black)	1SDA112881R1	1SDA074290R1
E1.2..E6.2	Rating Plug RC 400A (Black)	1SDA112882R1	1SDA074291R1
E1.2..E6.2	Rating Plug RC 630A (Black)	1SDA112884R1	1SDA074292R1
E1.2..E6.2	Rating Plug RC 800A (Black)	1SDA112885R1	1SDA074293R1
E1.2..E6.2	Rating Plug RC 1250A (Black)	1SDA112887R1	1SDA074294R1
E2.2..E6.2	Rating Plug RC 2000A (Black)	1SDA112888R1	1SDA074295R1
E4.2..E6.2	Rating Plug RC 3200A (Black)	1SDA112889R1	1SDA074296R1
E4.2..E6.2	Rating Plug RC 4000A (Black)	1SDA112891R1	1SDA074297R1

a) Available only with Ekip Touch and Ekip Hi-Touch

# Accessories

## Terminals

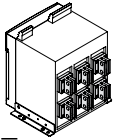

Rear orientable terminal - HR VR

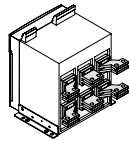

Horizontal rear spread terminal - SHR

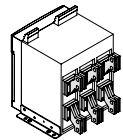

Vertical rear spread terminal - SVR

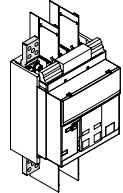

Extended front terminal - EF

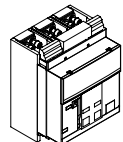

Front terminal - F

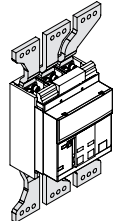

Front spread terminal - ES

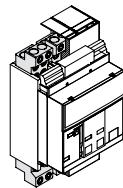

Terminal for cable FcCuAl 4x240mm<sup>2</sup> - Fc CuAl

### Kit for terminals - installed for fixed circuit-breaker

Size	Version	I <sub>u</sub> max	Type	3 Poles	4 Poles
				Code	Code
E1.2 <sup>a)</sup>	F	1600	Kit EF Upper	1SDA073963R1	1SDA073964R1
E1.2 <sup>a)</sup>	F	1600	Kit EF Lower	1SDA073965R1	1SDA073966R1
E1.2 <sup>a)</sup>	F	1600	Kit ES Upper	1SDA073975R1	1SDA073976R1
E1.2 <sup>a)</sup>	F	1600	Kit ES Lower	1SDA073977R1	1SDA073978R1
E1.2 <sup>a)</sup>	F	1600	Kit HR Upper	1SDA073981R1	1SDA073982R1
E1.2 <sup>a)</sup>	F	1600	Kit HR Lower	1SDA073983R1	1SDA073984R1
E1.2 <sup>a)</sup>	F	1600	Kit VR Upper	1SDA073985R1	1SDA073986R1
E1.2 <sup>a)</sup>	F	1600	Kit VR Lower	1SDA073987R1	1SDA073988R1
E1.2 <sup>a)</sup>	F	1600	Kit FC CuAl 4x240 mm <sup>2</sup> Upper	1SDA073997R1	1SDA073998R1
E1.2 <sup>a)</sup>	F	1600	Kit FC CuAl 4x240 mm <sup>2</sup> Lower	1SDA073999R1	1SDA074000R1
E2.2	F	2000	Kit VR Upper	1SDA074003R1	1SDA074004R1
E2.2	F	2000	Kit VR Lower	1SDA074005R1	1SDA074006R1
E2.2	F	2500	Kit VR Upper	1SDA074009R1	1SDA074010R1
E2.2	F	2500	Kit VR Lower	1SDA074011R1	1SDA074012R1
E2.2	F	2000	Kit SHR Upper	1SDA074045R1	1SDA074046R1
E2.2	F	2000	Kit SHR Lower	1SDA074047R1	1SDA074048R1
E2.2	F	2500	Kit SHR Upper	1SDA074051R1	1SDA074052R1
E2.2	F	2500	Kit SHR Lower	1SDA074053R1	1SDA074054R1
E2.2	F	2000	Kit SVR Upper	1SDA074057R1	1SDA074058R1
E2.2	F	2000	Kit SVR Lower	1SDA074059R1	1SDA074060R1
E2.2	F	2500	Kit SVR Upper	1SDA074063R1	1SDA074064R1
E2.2	F	2500	Kit SVR Lower	1SDA074065R1	1SDA074066R1
E2.2 <sup>a)</sup>	F	2500	Kit F Upper	1SDA074118R1	1SDA074119R1
E2.2 <sup>a)</sup>	F	2500	Kit F Lower	1SDA074120R1	1SDA074121R1
E4.2	F	3200	Kit VR Upper	1SDA074015R1	1SDA074016R1
E4.2	F	3200	Kit VR Lower	1SDA074017R1	1SDA074018R1
E4.2	F	3200	Kit SHR Upper	1SDA082816R1	1SDA082817R1
E4.2	F	3200	Kit SHR Lower	1SDA082818R1	1SDA082819R1
E4.2	F	3200	Kit SVR Upper	1SDA082828R1	1SDA082829R1
E4.2	F	3200	Kit SVR Lower	1SDA082830R1	1SDA082831R1
E4.2	F	4000	Kit VR Upper	1SDA074021R1	1SDA074022R1
E4.2	F	4000	Kit VR Lower	1SDA074023R1	1SDA074024R1
E4.2 <sup>a)</sup>	F	4000	Kit F Upper	1SDA074126R1	1SDA074127R1
E4.2 <sup>a)</sup>	F	4000	Kit F Lower	1SDA074128R1	1SDA074129R1
E4.2	F	4000	Kit SHR Upper	1SDA082822R1	1SDA082823R1
E4.2	F	4000	Kit SHR Lower	1SDA082824R1	1SDA082825R1
E4.2	F	4000	Kit SVR Upper	1SDA082834R1	1SDA082835R1
E4.2	F	4000	Kit SVR Lower	1SDA082836R1	1SDA082837R1
E6.2	F	5000	Kit VR Upper	1SDA074027R1	1SDA074028R1
E6.2	F	5000	Kit VR Lower	1SDA074030R1	1SDA074031R1
E6.2/f	F	5000	Kit VR Upper		1SDA074029R1
E6.2/f	F	5000	Kit VR Lower		1SDA074032R1
E6.2a)	F	6300	Kit F Upper	1SDA074134R1	1SDA074135R1
E6.2a)	F	6300	Kit F Lower	1SDA074137R1	1SDA074138R1
E6.2/f <sup>a)</sup>	F	6300	Kit F Upper		1SDA074136R1
E6.2/f <sup>a)</sup>	F	6300	Kit F Lower		1SDA074139R1
E6.2	F	6300	Kit VR Upper	1SDA074036R1	1SDA074037R1
E6.2	F	6300	Kit VR Lower	1SDA074039R1	1SDA074040R1
E6.2/f	F	6300	Kit VR Upper		1SDA074038R1
E6.2/f	F	6300	Kit VR Lower		1SDA074041R1

a) terminals supplied, but not physically installed

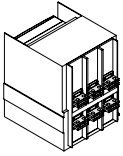

Rear adjustable terminal - HR VR

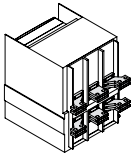

Horizontal rear terminal - SHR

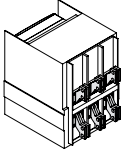

Vertical rear spread terminal - SVR

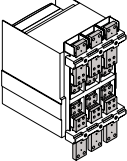

Front terminal - F

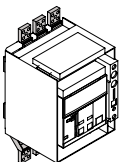

Extended front terminal - EF

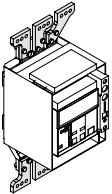

Front spread terminal - ES

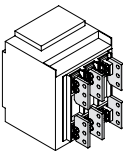

Terminal for cable FcCuAl 4x240mm<sup>2</sup> - Fc CuAl

**Kit for terminals - installed for fixed part of withdrawable circuit-breaker**

Size	Version	Iu max	Type	3 Poles	4 Poles
				Code	Code
E1.2 <sup>a)</sup>	W	1600	Kit EF Upper	1SDA073939R1	1SDA073940R1
E1.2 <sup>a)</sup>	W	1600	Kit EF Lower	1SDA073941R1	1SDA073942R1
E1.2 <sup>a)</sup>	W	1600	Kit VR Upper	1SDA073945R1	1SDA073946R1
E1.2 <sup>a)</sup>	W	1600	Kit VR Lower	1SDA073947R1	1SDA073948R1
E1.2 <sup>a)</sup>	W	1600	Kit ES Upper	1SDA073951R1	1SDA073952R1
E1.2 <sup>a)</sup>	W	1600	Kit ES Lower	1SDA073953R1	1SDA073954R1
E1.2 <sup>a)</sup>	W	1600	Kit SHR Upper	1SDA073957R1	1SDA073958R1
E1.2 <sup>a)</sup>	W	1600	Kit SHR Lower	1SDA073959R1	1SDA073960R1
E1.2 <sup>a)</sup>	W	1600	Kit FC CuAl Upper	1SDA073991R1	1SDA073993R1
E1.2 <sup>a)</sup>	W	1600	Kit FC CuAl Lower	1SDA073992R1	1SDA073994R1
E2.2	W	2000	Kit FL Upper	1SDA081120R1	1SDA081121R1
E2.2	W	2000	Kit FL Lower	1SDA081122R1	1SDA081123R1
E2.2	W	2000	Kit VR Upper	1SDA074577R1	1SDA074578R1
E2.2	W	2000	Kit VR Lower	1SDA074579R1	1SDA074580R1
E2.2	W	2500	Kit VR Upper	1SDA074581R1	1SDA074582R1
E2.2	W	2500	Kit VR Lower	1SDA074583R1	1SDA074584R1
E2.2	W	2000	Kit SHR Upper	1SDA074585R1	1SDA074586R1
E2.2	W	2000	Kit SHR Lower	1SDA074587R1	1SDA074588R1
E2.2	W	2500	Kit SHR Upper	1SDA074589R1	1SDA074590R1
E2.2	W	2500	Kit SHR Lower	1SDA074591R1	1SDA074592R1
E2.2	W	2000	Kit SVR Upper	1SDA074593R1	1SDA074594R1
E2.2	W	2000	Kit SVR Lower	1SDA074595R1	1SDA074596R1
E2.2	W	2500	Kit SVR Upper	1SDA074597R1	1SDA074598R1
E2.2	W	2500	Kit SVR Lower	1SDA074599R1	1SDA074600R1
E2.2	W	2500	Kit FL Upper	1SDA074069R1	1SDA074070R1
E2.2	W	2500	Kit FL Lower	1SDA074071R1	1SDA074072R1
E2.2 <sup>a)</sup>	W	2500	Kit F Upper	1SDA074090R1	1SDA074091R1
E2.2 <sup>a)</sup>	W	2500	Kit F Lower	1SDA074092R1	1SDA074093R1
E4.2	W	3200	Kit FL Upper	1SDA081125R1	1SDA081127R1
E4.2	W	3200	Kit FL Lower	1SDA081128R1	1SDA081129R1
E4.2	W	3200	Kit VR Upper	1SDA074601R1	1SDA074602R1
E4.2	W	3200	Kit VR Lower	1SDA074603R1	1SDA074604R1
E4.2	W	3200	Kit SHR Upper	1SDA082840R1	1SDA082841R1
E4.2	W	3200	Kit SHR Lower	1SDA082842R1	1SDA082843R1
E4.2	W	3200	Kit SVR Upper	1SDA082848R1	1SDA082849R1
E4.2	W	3200	Kit SVR Lower	1SDA082850R1	1SDA082851R1
E4.2	W	4000	Kit VR Upper	1SDA074605R1	1SDA074606R1
E4.2	W	4000	Kit VR Lower	1SDA074607R1	1SDA074608R1
E4.2 <sup>a)</sup>	W	4000	Kit F Upper	1SDA074098R1	1SDA074099R1
E4.2 <sup>a)</sup>	W	4000	Kit F Lower	1SDA074100R1	1SDA074101R1
E4.2	W	4000	Kit FL Upper	1SDA074075R1	1SDA074076R1
E4.2	W	4000	Kit FL Lower	1SDA074077R1	1SDA074078R1
E4.2	W	4000	Kit HR Upper	1SDA076878R1	1SDA076879R1
E4.2	W	4000	Kit HR Lower	1SDA076880R1	1SDA076881R1
E4.2	W	4000	Kit SHR Upper	1SDA082844R1	1SDA082845R1
E4.2	W	4000	Kit SHR Lower	1SDA082846R1	1SDA082847R1
E4.2	W	4000	Kit SVR Upper	1SDA082852R1	1SDA082853R1
E4.2	W	4000	Kit SVR Lower	1SDA082854R1	1SDA082855R1

a) terminals supplied, but not physically installed.

# Accessories

## Terminals

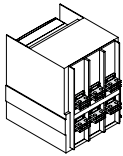

Rear adjustable terminal - HR VR

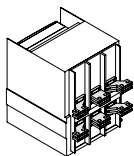

Horizontal rear terminal - SHR

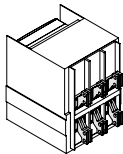

Vertical rear spread terminal - SVR

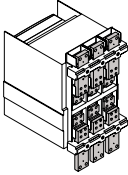

Front terminal - F

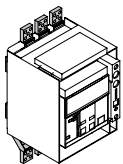

Extended front terminal - EF

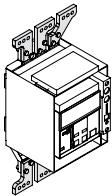

Front spread terminal - ES

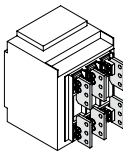

Terminal for cable FcCuAl  
4x240mm<sup>2</sup> - Fc CuAl

### Kit for terminals - installed for fixed part of withdrawable circuit-breaker

Size	Version	Iu max	Type	3 Poles	4 Poles
				Code	Code
E6.2	W	5000	Kit VR Upper	1SDA074609R1	1SDA074610R1
E6.2	W	5000	Kit VR Lower	1SDA074612R1	1SDA074613R1
E6.2/f	W	5000	Kit VR Upper		1SDA074611R1
E6.2/f	W	5000	Kit VR Lower		1SDA074614R1
E6.2	W	6300	Kit VR Upper	1SDA074615R1	1SDA074616R1
E6.2	W	6300	Kit VR Lower	1SDA074618R1	1SDA074619R1
E6.2/f	W	6300	Kit VR Upper		1SDA074617R1
E6.2/f	W	6300	Kit VR Lower		1SDA074620R1
E6.2 <sup>a)</sup>	W	6300	Kit F Upper	1SDA074106R1	1SDA074107R1
E6.2 <sup>a)</sup>	W	6300	Kit F Lower	1SDA074109R1	1SDA074110R1
E6.2/f <sup>a)</sup>	W	6300	Kit F Upper		1SDA074108R1
E6.2/f <sup>a)</sup>	W	6300	Kit F Lower		1SDA074111R1
E6.2	W	6300	Kit FL Upper	1SDA074081R1	1SDA074082R1
E6.2	W	6300	Kit FL Lower	1SDA074084R1	1SDA074085R1
E6.2/f	W	6300	Kit FL Upper		1SDA074083R1
E6.2/f	W	6300	Kit FL Lower		1SDA074086R1

a) terminals supplied, but not physically installed.



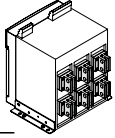

Rear adjustable terminal - HR VR

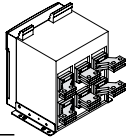

Horizontal rear spread terminal - SHR

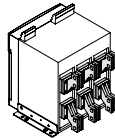

Vertical rear spread terminal - SVR

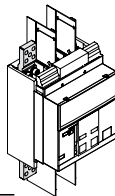

Extended front terminal - EF

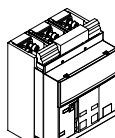

Front terminal - F

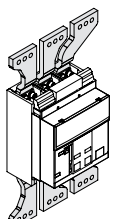

Front spread terminal - ES

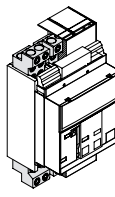

Terminal for cable FcCuAl 4x240mm<sup>2</sup> - Fc CuAl

**Kit for terminals - loose supply for fixed circuit-breaker**

Size	Version	Iu max	Type	Code	Pieces	Code	Pieces
E1.2	F	1600	Kit EF	1SDA073967R1	3	1SDA073968R1	4
E1.2	F	1600	Kit F	1SDA073973R1	3	1SDA073974R1	4
E1.2	F	1600	Kit ES	1SDA073979R1	3	1SDA073980R1	4
E1.2	F	1600	Kit Adjustable HR/VR	1SDA073989R1	3	1SDA073990R1	4
E1.2	F	1600	Kit FC CuAl 4x240 mm <sup>2</sup>	1SDA074001R1	3	1SDA074002R1	4
E2.2	F	2000	Kit Adjustable HR/VR	1SDA074007R1	3	1SDA074008R1	4
E2.2**	F	2500	Kit Adjustable HR/VR	1SDA074013R1	3	1SDA074014R1	4
E2.2	F	2000	Kit SHR	1SDA074049R1	3	1SDA074050R1	4
E2.2	F	2500	Kit SHR	1SDA074055R1	3	1SDA074056R1	4
E2.2	F	2000	Kit SVR	1SDA074061R1	3	1SDA074062R1	4
E2.2	F	2500	Kit SVR	1SDA074067R1	3	1SDA074068R1	4
E2.2	F	2500	Kit F Upper	1SDA074122R1	3	1SDA074123R1	4
E2.2	F	2500	Kit F Lower	1SDA074124R1	3	1SDA074125R1	4
E4.2	F	3200	Kit Adjustable HR/VR	1SDA074019R1	3	1SDA074020R1	4
E4.2	F	3200	Kit SHR	1SDA082820R1	3	1SDA082821R1	4
E4.2	F	3200	Kit SVR	1SDA082832R1	3	1SDA082833R1	4
E4.2**	F	4000	Kit Adjustable HR/VR	1SDA074025R1	3	1SDA074026R1	4
E4.2	F	4000	Kit F Upper	1SDA074130R1	3	1SDA074131R1	4
E4.2	F	4000	Kit F Lower	1SDA074132R1	3	1SDA074133R1	4
E4.2	F	4000	Kit SHR	1SDA082826R1	3	1SDA082827R1	4
E4.2	F	4000	Kit SVR	1SDA082838R1	3	1SDA082839R1	4
E6.2**	F	5000	Kit Adjustable HR/VR	1SDA081672R1	6	1SDA081673R1	7
E6.2/f**	F	5000	Kit Adjustable HR/VR			1SDA081674R1	8
E6.2**	F	6300	Kit Adjustable HR/VR	1SDA074042R1	6	1SDA074043R1	7
E6.2/f**	F	6300	Kit Adjustable HR/VR			1SDA074044R1	8
E6.2	F	6300	Kit F Upper	1SDA074140R1	6	1SDA074141R1	7
E6.2	F	6300	Kit F Lower	1SDA074143R1	6	1SDA074144R1	7
E6.2/f	F	6300	Kit F Upper			1SDA074142R1	8
E6.2/f	F	6300	Kit F Lower			1SDA074145R1	8

\*\* In case of replacement with F terminal please contact ABB

# Accessories

## Terminals

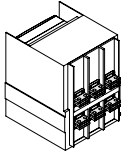

Rear orientable terminal - HR VR

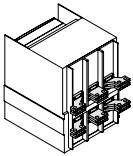

Horizontal rear terminal - SHR

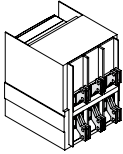

Vertical rear spread terminal - SVR

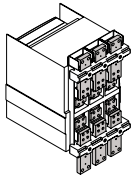

Front terminal - F

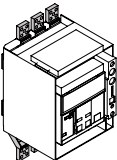

Extended front terminal - EF

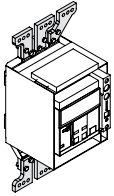

Front spread terminal - ES

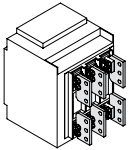

Terminal for cable FcCuAl  
4x240mm<sup>2</sup> - Fc CuAl

### Kit for terminals - loose supply for fixed part of withdrawable circuit-breaker

Size	Version	Iu max	Type	Code	Pieces	Code	Pieces
E1.2	W	1600	Kit EF	1SDA073943R1	3	1SDA073944R1	4
E1.2	W	1600	Kit Adjustable HR/VR	1SDA073949R1	3	1SDA073950R1	4
E1.2 <sup>a)</sup>	W	1600	Kit ES	1SDA073955R1	3	1SDA073956R1	4
E1.2	W	1600	Kit SHR	1SDA073961R1	3	1SDA073962R1	4
E1.2	W	1600	Kit FC CuAl	1SDA073995R1	3	1SDA073996R1	4
E2.2	W	2000	Kit Adjustable HR/VR	1SDA074007R1	3	1SDA074008R1	4
E2.2	W	2500	Kit Adjustable HR/VR	1SDA074013R1	3	1SDA074014R1	4
E2.2	W	2000	Kit SHR	1SDA074049R1	3	1SDA074050R1	4
E2.2	W	2500	Kit SHR	1SDA074055R1	3	1SDA074056R1	4
E2.2	W	2000	Kit SVR	1SDA074061R1	3	1SDA074062R1	4
E2.2	W	2500	Kit SVR	1SDA074067R1	3	1SDA074068R1	4
E2.2	W	2500	Kit F Upper	1SDA074094R1	3	1SDA074095R1	4
E2.2	W	2500	Kit F Lower	1SDA074096R1	3	1SDA074097R1	4
E4.2	W	3200	Kit Adjustable HR/VR	1SDA074019R1	3	1SDA074020R1	4
E4.2	W	3200	Kit SHR	1SDA082820R1	3	1SDA082821R1	4
E4.2	W	3200	Kit SVR	1SDA082832R1	3	1SDA082833R1	4
E4.2	W	4000	Kit Adjustable HR/VR	1SDA074025R1	3	1SDA074026R1	4
E4.2	W	4000	Kit F Upper	1SDA074102R1	3	1SDA074103R1	4
E4.2	W	4000	Kit F Lower	1SDA074104R1	3	1SDA074105R1	4
E4.2	W	4000	Kit SHR	1SDA082826R1	3	1SDA082827R1	4
E4.2	W	4000	Kit SVR	1SDA082838R1	3	1SDA082839R1	4
E6.2	W	5000	Kit Adjustable HR/VR	1SDA074033R1	6	1SDA074034R1	7
E6.2/f	W	5000	Kit Adjustable HR/VR			1SDA074035R1	8
E6.2	W	6300	Kit Adjustable HR/VR	1SDA074042R1	6	1SDA074043R1	7
E6.2/f	W	6300	Kit Adjustable HR/VR			1SDA074044R1	8
E6.2	W	6300	Kit F Upper	1SDA074112R1	6	1SDA074113R1	7
E6.2	W	6300	Kit F Lower	1SDA074115R1	6	1SDA074116R1	7
E6.2/f	W	6300	Kit F Upper			1SDA074114R1	8
E6.2/f	W	6300	Kit F Lower			1SDA074117R1	8

a) can be ordered only if the fixed part has EF terminals.

# Accessories

## Spare parts Grey Platform



### Ekip trip units, Grey Platform - loose supply

Size	Type	Code
E1.2..E6.2	Ekip Dip LI	1SDA074194R1
E1.2..E6.2	Ekip Dip LSI	1SDA074195R1
E1.2..E6.2	Ekip Dip LSIG	1SDA074196R1
E1.2..E6.2	Ekip Touch LI	1SDA074197R1
E1.2..E6.2	Ekip Touch LSI	1SDA074198R1
E1.2..E6.2	Ekip Touch LSIG	1SDA074199R1
E1.2..E6.2 <sup>a)</sup>	Ekip G Touch LSIG	1SDA074200R1
E1.2..E6.2 <sup>a)</sup>	Ekip Hi-Touch LSI	1SDA074201R1
E1.2..E6.2 <sup>a)</sup>	Ekip Hi-Touch LSIG	1SDA074202R1
E1.2..E6.2 <sup>a)</sup>	Ekip G Hi-Touch LSIG	1SDA074203R1
E1.2..E6.2 <sup>a)</sup>	Ekip LCD LI	1SDA074204R1
E1.2..E6.2 <sup>a)</sup>	Ekip LCD LSI	1SDA074205R1
E1.2..E6.2 <sup>a)</sup>	Ekip LCD LSIG	1SDA074206R1
E1.2..E6.2 <sup>a)</sup>	Ekip G LCD LSIG	1SDA074207R1
E1.2..E6.2 <sup>a)</sup>	Ekip Hi-LCD LSI	1SDA074208R1
E1.2..E6.2 <sup>a)</sup>	Ekip Hi-LCD LSIG	1SDA074209R1
E1.2..E6.2 <sup>a)</sup>	Ekip G Hi-LCD LSIG	1SDA074210R1
E1.2..E6.2	Battery for Ekip trip units	1SDA074193R1

a) provided without Ekip Measuring/Ekip Measuring Pro.



### Measuring and Measuring Pro modules

Size	Type	Code
E1.2	Ekip Measuring	1SDA074184R1
E1.2	Ekip Measuring Pro	1SDA074185R1
E2.2	Ekip Measuring	1SDA074186R1
E2.2	Ekip Measuring Pro	1SDA074187R1
E4.2	Ekip Measuring	1SDA074188R1
E4.2	Ekip Measuring Pro	1SDA074189R1
E6.2	Ekip Measuring	1SDA074190R1
E6.2	Ekip Measuring Pro	1SDA074191R1
E1.2 <sup>c)</sup>	Voltage socket for neutral on right side L1 L2 L3 N - E1.2	1SDA076244R1
E2.2 <sup>c)</sup>	Voltage socket for neutral on right side L1 L2 L3 N - E2.2	1SDA076245R1
E4.2 <sup>c)</sup>	Voltage socket for neutral on right side L1 L2 L3 N - E4.2	1SDA076246R1
E6.2 <sup>c)</sup>	Voltage socket for neutral on right side L1 L2 L3 N - E6.2	1SDA076247R1

c) use only with circuit breakers with neutral on right side L1 L2 L3 N

### Signalling modules

Size	Type	Code
E2.2...E6.2	Ekip Signalling 4k	1SDA114475R1

# Accessories

## Spare parts Grey Platform



### Rating plug for Ekip trip units

Size	Type	Code (loose supply)
E1.2..E2.2	Rating Plug 100A	1SDA074218R1
E1.2..E2.2	Rating Plug 200A	1SDA074219R1
E1.2..E2.2	Rating Plug 250A	1SDA074220R1
E1.2..E6.2	Rating Plug 400A	1SDA074221R1
E1.2..E6.2	Rating Plug 630A	1SDA074222R1
E1.2..E6.2	Rating Plug 800A	1SDA074223R1
E1.2..E6.2	Rating Plug 1000A	1SDA074224R1
E1.2..E6.2	Rating Plug 1250A	1SDA074225R1
E1.2..E6.2	Rating Plug 1600A	1SDA074226R1
E2.2..E6.2	Rating Plug 2000A	1SDA074227R1
E2.2..E6.2	Rating Plug 2500A	1SDA074228R1
E4.2..E6.2	Rating Plug 3200A	1SDA074229R1
E4.2..E6.2	Rating Plug 4000A	1SDA074230R1
E6.2	Rating Plug 5000A	1SDA074231R1
E6.2	Rating Plug 6300A	1SDA074232R1
E1.2..E2.2 <sup>(a)</sup>	Rating Plug 100A L OFF	1SDA074233R1
E1.2..E2.2 <sup>(a)</sup>	Rating Plug 200A L OFF	1SDA074234R1
E1.2..E2.2 <sup>(a)</sup>	Rating Plug 250A L OFF	1SDA074235R1
E1.2..E6.2 <sup>(a)</sup>	Rating Plug 400A L OFF	1SDA074236R1
E1.2..E6.2 <sup>(a)</sup>	Rating Plug 630A L OFF	1SDA074237R1
E1.2..E6.2 <sup>(a)</sup>	Rating Plug 800A L OFF	1SDA074238R1
E1.2..E6.2 <sup>(a)</sup>	Rating Plug 1000A L OFF	1SDA074239R1
E1.2..E6.2 <sup>(a)</sup>	Rating Plug 1250A L OFF	1SDA074240R1
E1.2..E6.2 <sup>(a)</sup>	Rating Plug 1600A L OFF	1SDA074241R1
E2.2..E6.2 <sup>(a)</sup>	Rating Plug 2000A L OFF	1SDA074242R1
E2.2..E6.2 <sup>(a)</sup>	Rating Plug 2500A L OFF	1SDA074243R1
E4.2..E6.2 <sup>(a)</sup>	Rating Plug 3200A L OFF	1SDA074244R1
E4.2..E6.2 <sup>(a)</sup>	Rating Plug 4000A L OFF	1SDA074245R1
E6.2 <sup>(a)</sup>	Rating Plug 5000A L OFF	1SDA074246R1
E6.2 <sup>(a)</sup>	Rating Plug 6300A L OFF	1SDA074247R1
E1.2..E2.2	Rating Plug RC 100A	1SDA074248R1
E1.2..E2.2	Rating Plug RC 200A	1SDA074249R1
E1.2..E2.2	Rating Plug RC 250A	1SDA074250R1
E1.2..E6.2	Rating Plug RC 400A	1SDA074251R1
E1.2..E6.2	Rating Plug RC 630A	1SDA074252R1
E1.2..E6.2	Rating Plug RC 800A	1SDA074253R1
E1.2..E6.2	Rating Plug RC 1250A	1SDA074254R1
E2.2..E6.2	Rating Plug RC 2000A	1SDA074255R1
E4.2..E6.2	Rating Plug RC 3200A	1SDA074256R1
E4.2..E6.2	Rating Plug RC 4000A	1SDA074257R1

a) Available only with Ekip Touch and Ekip Hi-Touch

# Accessories

## Service



Note:  
Warranty periods are measured from the date the circuit breaker leaves the factory.

### Extended warranty

Size	Type	Code <sup>c)</sup>
<b>E1.2...E6.2</b>	Warranty 2 years E1.2...E6.2 <sup>a)</sup>	1SDA082413R1
<b>E1.2</b>	Warranty 4 years E1.2 <sup>b)</sup>	1SDA082414R1
<b>E2.2</b>	Warranty 4 years E2.2 <sup>b)</sup>	1SDA082415R1
<b>E4.2</b>	Warranty 4 years E4.2 <sup>b)</sup>	1SDA082416R1
<b>E6.2</b>	Warranty 4 years E6.2 <sup>b)</sup>	1SDA082417R1
<b>E1.2</b>	Warranty 5 years E1.2 <sup>b)</sup>	1SDA082418R1
<b>E2.2</b>	Warranty 5 years E2.2 <sup>b)</sup>	1SDA082419R1
<b>E4.2</b>	Warranty 5 years E4.2 <sup>b)</sup>	1SDA082420R1
<b>E6.2</b>	Warranty 5 years E6.2 <sup>b)</sup>	1SDA082421R1

The registration in the Extended Warranty online tool is mandatory

a) Free-of-charge with site details entered

b) Warranty durations:

- 4 years when site details not entered into the Extended Warranty online tool

- 5 years when site details entered into the Extended Warranty online tool

c) Order only with the circuit breaker. Specify Registration code in the order to activate the warranty.

### Test certificate

Size	Type	Code
<b>E2.2...E6.2</b>	Test certificate - Italian version	1SDA070197R1
<b>E2.2...E6.2</b>	Test certificate - English version	1SDA070198R1
<b>E2.2...E6.2</b>	Test certificate - German version	1SDA070199R1
<b>E2.2...E6.2</b>	Test certificate - French version	1SDA070200R1
<b>E2.2...E6.2</b>	Test certificate - Spanish version	1SDA070201R1

# Accessories

## Spare parts

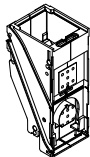

### Single phase pole

Size	Poles	IEC/UL	Version	Code	Type spare	Min quantity
E2.2 - Iu≤2000A	3p; 4p	IEC	F; W (MP)	1SDA081187R1	A	3 or 4
E2.2 - Iu=2500A	3p; 4p	IEC	F; W (MP)	1SDA081188R1	A	3 or 4
E4.2	3p; 4p	IEC	F; W (MP)	1SDA081189R1	A	3 or 4
E6.2 - Half phase	3p; 4p; 4p/f	IEC	F; W (MP)	1SDA081190R1	A	6 or 7 or 8

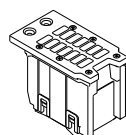

### Arching chamber

Size	Poles	IEC/UL	Version	Code	Type spare	Min quantity
E2.2	3p; 4p	IEC	F; W (MP)	1SDA081430R1		3 or 4
E4.2; E6.2	3p; 4p	IEC	F; W (MP)	1SDA081431R1		3 or 4 for E4.2, 6 or 7 or 8 for E6.2

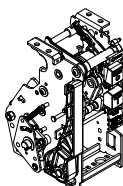

### Operating mechanism <sup>a)</sup>

Size	Poles	IEC/UL	Version	Code	Type spare	Min quantity
E2.2	3p; 4p	IEC/UL	F; W (MP)	1SDA081191R1	A	1
E4.2	3p; 4p	IEC/UL	F; W (MP)	1SDA081192R1	A	1
E6.2	3p; 4p	IEC/UL	F; W (MP)	1SDA081193R1	A	1
E6.2	4p/f	IEC/UL	F; W (MP)	1SDA081194R1	A	1

a) Add closing spring

### Closing Spring

Size	Poles	IEC/UL	Version	Code	Type spare	Min quantity
E2.2 - Iu≤2000A	3p	IEC/UL	F; W (MP)	1SDA081207R1	A	1
E2.2 - Iu≤2000A	4p	IEC/UL	F; W (MP)	1SDA081208R1	A	1
E2.2 - Iu=2500A; E4.2	3p	IEC/UL	F; W (MP)	1SDA081208R1	A	1
E2.2 - Iu=2500A; E4.2	4p	IEC/UL	F; W (MP)	1SDA081209R1	A	1
E6.2	3p	IEC/UL	F; W (MP)	1SDA081210R1	A	1
E6.2	4p; 4p/f	IEC/UL	F; W (MP)	1SDA081211R1	A	1

### Spring Charging lever

Size	Poles	IEC/UL	Version	Code	Type spare	Min quantity
E2.2; E4.2; E6.2	3p; 4p	IEC/UL	F; W (MP)	1SDA081217R1	A	1

### Signalling charged spring lever

Size	Poles	IEC/UL	Version	Code	Type spare	Min quantity
E2.2; E4.2; E6.2	3p; 4p	IEC/UL	F; W (MP)	1SDA081242R1	A	1

### Spring charging device

Size	Poles	IEC/UL	Version	Code	Type spare	Min quantity
E2.2; E4.2; E6.2	3p; 4p	IEC	F; W(MP)	1SDA082230R1	A	1

### Tripping mechanism

Size	Poles	IEC/UL	Version	Code	Type spare	Min quantity
E2.2; E4.2; E6.2	3p; 4p	IEC	F; W (MP)	1SDA082187R1	A	1

### Fixing screws kit - 50 pcs

Size	Poles	IEC/UL	Version	Code	Type spare	Min quantity
E1.2 - wall mounted	3p; 4p	IEC/UL	F	1SDA081179R1		1
E1.2 - floor mounted	3p; 4p	IEC/UL	F	1SDA081413R1		1
E1.2 - floor mounted	3p; 4p	IEC/UL	W (FP)	1SDA081414R1		1
E2.2; E4.2; E6.2	3p; 4p	IEC/UL	F; W (FP)	1SDA081467R1		1

Min quantity = min quantity to complete a circuit-breaker: The quantity is related to the number of phases (3 or 4 poles) of the circuit-breaker (E6.2 has half phases so quantities are double).  
Type A Spare part = only for ABB L3 technicians

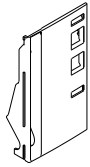

**Safety cover**

Size	Poles	IEC/UL	Version	Code	Type spare	Min quantity
E1.2	3p; 4p	IEC/UL	F; W (MP)	1SDA081402R1		1
E2.2; E4.2; E6.2	3p; 4p	IEC/UL	F; W (MP)	1SDA081432R1		1

For each part ordered, specify the Serial number of the circuit-breaker it is intended for.

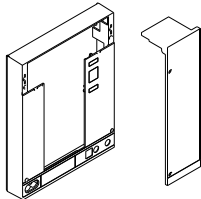

**Accessories cover <sup>b)</sup>**

Size	Poles	IEC/UL	Version	Code	Type spare	Min quantity
E1.2	3p	IEC/UL	F; W (MP)	1SDA081403R1		1
E1.2	4p	IEC/UL	F; W (MP)	1SDA081404R1		1
E2.2	3p	IEC/UL	F	1SDA081433R1		1
E2.2	4p	IEC/UL	F	1SDA081434R1		1
E2.2	3p	IEC/UL	W (MP)	1SDA081435R1		1
E2.2	4p	IEC/UL	W (MP)	1SDA081436R1		1
E4.2	3p	IEC/UL	F	1SDA081437R1		1
E4.2	4p	IEC/UL	F	1SDA081438R1		1
E4.2	3p	IEC/UL	W (MP)	1SDA081439R1		1
E4.2	4p	IEC/UL	W (MP)	1SDA081440R1		1
E6.2	3p	IEC/UL	F	1SDA081441R1		1
E6.2	4p	IEC/UL	F	1SDA081442R1		1
E6.2	3p	IEC/UL	W (MP)	1SDA081443R1		1
E6.2	4p	IEC/UL	W (MP)	1SDA081444R1		1
E6.2	4p/f	IEC/UL	F	1SDA081445R1		1
E6.2	4p/f	IEC/UL	W (MP)	1SDA081446R1		1
E1.2 - Castell <sup>a)</sup>	3p; 4p	IEC	F; W (MP)	1SDA082145R1		1
E2.2...E6.2 - Castell <sup>a)</sup>	3p; 4p	IEC	F	1SDA082146R1		1
E2.2...E6.2 - Castell <sup>a)</sup> KLC	3p; 4p	IEC	W (MP)	1SDA082149R1		1
E2.2...E6.2 - Castell <sup>a)</sup> KLC+ KLP	3p; 4p	IEC	W (MP)	1SDA082150R1		1
E2.2...E6.2 - Castell <sup>a)</sup> KLP	3p; 4p	IEC	W (MP)	1SDA082151R1		1

a) The lock is not included; b) TU Reset not included. Use the existing one.

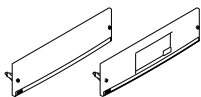

**Transparent cover for trip unit**

Size	Poles	IEC/UL	Version	Code	Type spare	Min quantity
E1.2 DIP	3p; 4p	IEC/UL	F; W (MP)	1SDA081405R1		1
E1.2 Touch	3p; 4p	IEC/UL	F; W (MP)	1SDA081406R1		1
E2.2; E4.2; E6.2 DIP	3p; 4p	IEC/UL	F; W (MP)	1SDA081447R1		1
E2.2; E4.2; E6.2 Touch	3p; 4p	IEC/UL	F; W (MP)	1SDA081448R1		1

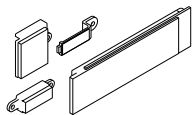

**Kit front cover plugs**

Size	Poles	IEC/UL	Version	Code	Type spare	Min quantity
E1.2	3p; 4p	IEC/UL	F; W (MP)	1SDA081415R1		1
E2.2; E4.2; E6.2	3p; 4p	IEC/UL	F; W (MP)	1SDA081471R1		1

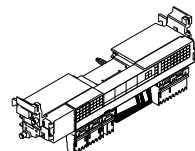

**Sliding contact for Moving Part**

Size	Poles	IEC/UL	Version	Code	Type spare	Min quantity
E1.2	3p	IEC/UL	W (MP)	1SDA081167R1		1
E1.2	4p	IEC/UL	W (MP)	1SDA081168R1		1
E2.2; E4.2; E6.2	3p; 4p	IEC/UL	W (MP)	1SDA081212R1		1
E2.2; E4.2; E6.2 - MS	3p; 4p	IEC/UL	W (MP)	1SDA081213R1		1

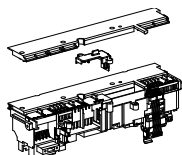

**Terminal box connection interface**

Size	Poles	IEC/UL	Version	Code	Type spare	Min quantity
E1.2	3p; 4p	IEC/UL	F	1SDA081409R1	A	1
E2.2; E4.2; E6.2	3p; 4p	IEC/UL	F; W (MP)	1SDA081451R1	A	1
E2.2; E4.2; E6.2 - MS	3p; 4p	IEC/UL	F; W (MP)	1SDA081452R1	A	1

— Type A Spare part = only for ABB L3 technicians

# Accessories

## Spare parts

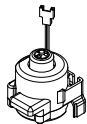

### Trip coil

Size	Poles	IEC/UL	Version	Code	Type spare	Min quantity
E1.2	3p; 4p	IEC/UL	F; W (MP)	1SDA081407R1		1
E2.2; E4.2; E6.2	3p; 4p	IEC/UL	F; W (MP)	1SDA081449R1		1

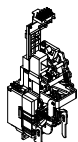

### Right plate for accessories (Right MID)

Size	Poles	IEC/UL	Version	Code	Type spare	Min quantity
E2.2; E4.2; E6.2	3p; 4p	IEC/UL	F; W (MP)	1SDA081214R1	A	1
E2.2; E4.2; E6.2 - MS	3p; 4p	IEC/UL	F; W (MP)	1SDA081215R1	A	1

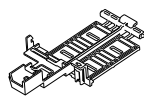

### Cover for right plate for accessories (Right MID Cover)

Size	Poles	IEC/UL	Version	Code	Type spare	Min quantity
E2.2; E4.2; E6.2	3p; 4p	IEC/UL	F; W (MP)	1SDA081466R1		1

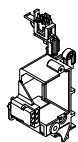

### Left plate for accessories (Left MID)

Size	Poles	IEC/UL	Version	Code	Type spare	Min quantity
E1.2	3p; 4p	IEC/UL	F; W (MP)	1SDA081170R1		1
E2.2; E4.2; E6.2	3p; 4p	IEC/UL	F; W (MP)	1SDA081453R1		1

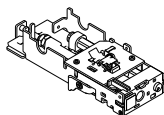

### Racked in and out device (CD)

Size	Poles	IEC/UL	Version	Code	Type spare	Min quantity
E2.2; E4.2; E6.2	3p; 4p	IEC/UL	W (MP)	1SDA081216R1	A	1



### CD lock lever

Size	Poles	IEC/UL	Version	Code	Type spare	Min quantity
E2.2; E4.2; E6.2	3p; 4p	IEC/UL	W (MP)	1SDA081256R1	A	1

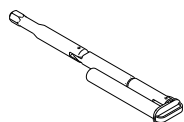

### Racking in and out lever

Size	Poles	IEC/UL	Version	Code	Type spare	Min quantity
E1.2	3p; 4p	IEC/UL	W (MP)	1SDA081410R1		1
E2.2; E4.2; E6.2	3p; 4p	IEC/UL	W (MP)	1SDA081455R1		1

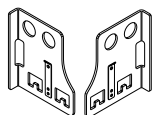

### Lifting plates

Size	Poles	IEC/UL	Version	Code	Type spare	Min quantity
E2.2; E4.2; E6.2	3p; 4p	IEC/UL	F; W (MP)	1SDA081454R1		1

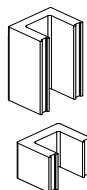

### Moving part terminals

Size	Poles	IEC/UL	Version	Code	Type spare	Min quantity
E2.2 - Iu≤2000A	3p; 4p	IEC	W (MP)	1SDA081243R1	A	3 or 4
E2.2 - Iu=2500A	3p; 4p	IEC	W (MP)	1SDA081244R1	A	3 or 4
E4.2 - Iu≤3200A	3p; 4p	IEC	W (MP)	1SDA081245R1	A	3 or 4
E4.2 - Iu=4000A	3p; 4p	IEC	W (MP)	1SDA081246R1	A	3 or 4
E6.2	3p; 4p/f	IEC	W (MP)	1SDA081247R1	A	6 or 7 or 8

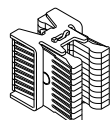

### Jaw contacts

Size	Poles	IEC/UL	Version	Code	Type spare	Min quantity
E1.2	3p; 4p	IEC	W (FP)	1SDA081164R1	A	3 or 4
E2.2 - Iu≤2000A	3p; 4p	IEC	W (FP)	1SDA081195R1	A	3 or 4
E2.2 - Iu=2500A	3p; 4p	IEC	W (FP)	1SDA081196R1	A	3 or 4
E4.2 - Iu≤3200A	3p; 4p	IEC	W (FP)	1SDA081197R1	A	3 or 4
E4.2 - Iu=4000A	3p; 4p	IEC	W (FP)	1SDA081198R1	A	3 or 4
E6.2	3p; 4p; 4p/f	IEC	W (FP)	1SDA081199R1	A	6 or 7 or 8



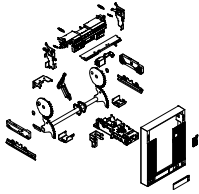

**Conversion kit from Fixed to Moving part \***

Size	Poles	IEC/UL	Version	Code	Type spare	Min quantity
E1.2	3p	IEC	F	1SDA081176R1	A	1
E1.2	4p	IEC	F	1SDA081177R1	A	1
E2.2	3p	IEC	F	1SDA081234R1	A	1
E2.2	4p	IEC	F	1SDA081235R1	A	1
E4.2	3p	IEC	F	1SDA081236R1	A	1
E4.2	4p	IEC	F	1SDA081237R1	A	1
E6.2	3p	IEC	F	1SDA081238R1	A	1
E6.2	4p	IEC	F	1SDA081239R1	A	1
E6.2	4p/f	IEC	F	1SDA081240R1	A	1

For each part ordered, specify the Serial number of the circuit-breaker it is intended for; \* moving part terminals not included

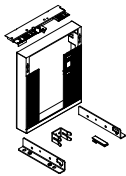

**Conversion kit from Moving Part into Fixed version \***

Size	Poles	IEC/UL	Version	Code	Type spare	Min quantity
E1.2 - wall mounted	3p; 4p	IEC/UL	W (MP)	1SDA081178R1	A	1
E1.2 - floor mounted	3p; 4p	IEC/UL	W (MP)	1SDA082303R1	A	1
E2.2; E4.2; E6.2	3p; 4p	IEC/UL	W (MP)	1SDA081241R1	A	1

For each part ordered, it is mandatory to specify the Serial number of the circuit-breaker it is intended for; \* Standard terminals not included

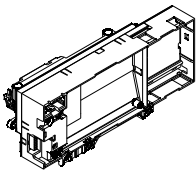

**Main board**

Size	Poles	IEC/UL	Version	Code	Type spare	Min quantity
E1.2 (Grey platform)	3p; 4p	IEC/UL	F; W (MP)	1SDA081408R1		1
E2.2; E4.2; E6.2 (Grey platform)	3p; 4p	IEC/UL	F; W (MP)	1SDA081450R1		1
E1.2 (Black platform)	3p; 4p	IEC/UL	F; W (MP)	1SDA107517R1		1
E2.2; E4.2; E6.2 (Black platform)	3p; 4p	IEC/UL	F; W (MP)	1SDA107516R1		1

For each part ordered, it is mandatory to specify the Serial number of the circuit-breaker it is intended for.



**Trip Unit Battery**

Size	Poles	IEC/UL	Version	Code	Type spare	Min quantity
E1.2; E2.2; E4.2; E6.2	3p; 4p	IEC/UL	F; W (MP)	1SDA074193R1		1

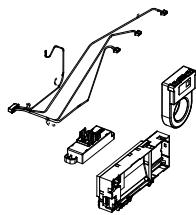

**Main board + Sensors + cables**

Size	Poles	IEC/UL	Version	Code	Type spare	Min quantity
E2.2	3p	IEC/UL	F; W (MP)	1SDA081200R1	A	1
E2.2	4p	IEC/UL	F; W (MP)	1SDA081201R1	A	1
E4.2	3p	IEC/UL	F; W (MP)	1SDA081202R1	A	1
E4.2	4p	IEC/UL	F; W (MP)	1SDA081203R1	A	1
E6.2	3p	IEC/UL	F; W (MP)	1SDA081204R1	A	1
E6.2	4p	IEC/UL	F; W (MP)	1SDA081205R1	A	1
E6.2	4p/f	IEC/UL	F; W (MP)	1SDA081206R1	A	1

For each part ordered, it is mandatory to specify the Serial number of the circuit-breaker it is intended for.

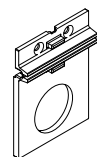

**Sensors plastic covers**

Size	Poles	IEC/UL	Version	Code	Type spare	Min quantity
E2.2	3p; 4p	IEC/UL	F; W (MP)	1SDA081468R1		1
E4.2	3p; 4p	IEC/UL	F; W (MP)	1SDA081469R1		1
E6.2	3p; 4p; 4p/f	IEC/UL	F; W (MP)	1SDA081470R1		1

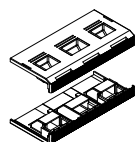

**Terminal covers**

Size	Poles	IEC/UL	Version	Code	Type spare	Min quantity
E1.2	3p	IEC/UL	W (MP)	1SDA081182R1		1
E1.2	4p	IEC/UL	W (MP)	1SDA081183R1		1

Type A Spare part = only for ABB L3 technicians

# Accessories

## Spare parts

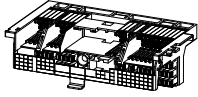

### Terminal box fixed part

Size	Poles	IEC/UL	Version	Code	Type spare	Min quantity
E1.2	3p; 4p	IEC/UL	W (FP)	1SDA081180R1	A	1
E2.2; E4.2	3p; 4p	IEC	W (FP)	1SDA082152R1	A	1
E6.2	3p; 4p; 4p/f	IEC	W (FP)	1SDA082153R1	A	1

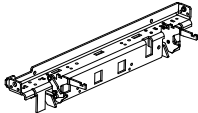

### Support for terminal box of Fixed Part

Size	Poles	IEC/UL	Version	Code	Type spare	Min quantity
E1.2	3p	IEC/UL	W (FP)	1SDA082237R1	A	1
E1.2	4p	IEC/UL	W (FP)	1SDA082238R1	A	1
E2.2	3p	IEC/UL	W (FP)	1SDA081249R1	A	1
E2.2	4p	IEC/UL	W (FP)	1SDA081250R1	A	1
E4.2	3p	IEC/UL	W (FP)	1SDA081251R1	A	1
E4.2	4p	IEC/UL	W (FP)	1SDA081252R1	A	1
E6.2	3p	IEC/UL	W (FP)	1SDA081253R1	A	1
E6.2	4p	IEC/UL	W (FP)	1SDA081254R1	A	1
E6.2	4p/f	IEC/UL	W (FP)	1SDA081255R1	A	1

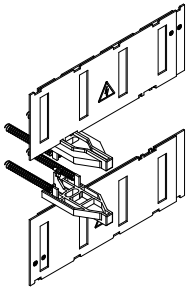

### Safety shutters for fixed part

Size	Poles	IEC/UL	Version	Code	Type spare	Min quantity
E1.2	3p	IEC	W (FP)	1SDA081411R1		1
E1.2	4p	IEC	W (FP)	1SDA081412R1		1
E2.2	3p	IEC	W (FP)	1SDA081457R1		1
E2.2	4p	IEC	W (FP)	1SDA081458R1		1
E4.2	3p	IEC	W (FP)	1SDA081459R1		1
E4.2	4p	IEC	W (FP)	1SDA081460R1		1
E6.2	3p	IEC	W (FP)	1SDA081461R1		1
E6.2	4p	IEC	W (FP)	1SDA081462R1		1
E6.2	4p/f	IEC	W (FP)	1SDA081463R1		1

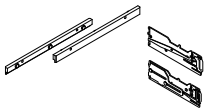

### Lateral guides for fixed part

Size	Poles	IEC/UL	Version	Code	Type spare	Min quantity
E2.2; E4.2; E6.2	3p; 4p	IEC	W (FP)	1SDA082154R1	A	1

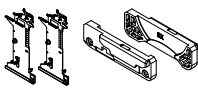

### Lateral guides for Moving part

Size	Poles	IEC/UL	Version	Code	Type spare	Min quantity
E1.2	3p; 4p	IEC	W (MP)	1SDA082188R1		1
E2.2; E4.2; E6.2	3p; 4p	IEC	W (MP)	1SDA082302R1		1

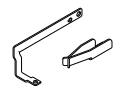

### Earth sliding contact for Fixed Part

Size	Poles	IEC/UL	Version	Code	Type spare	Min quantity
E2.2; E4.2; E6.2	3p; 4p	IEC/UL	W (FP)	1SDA081465R1		1

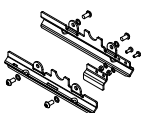

### Safety cover

Size	Poles	IEC/UL	Version	Code	Type spare	Min quantity
E2.2; E4.2; E6.2	3p; 4p	IEC/UL	W (MP)	1SDA081464R1		1

—

**ABB S.p.A.**

5, Via Pescaria

I-24123, Bergamo

Phone: +39 035 395.111

**[www.abb.com](http://www.abb.com)**



Stay tuned. Discover more by visiting the webpages reserved to Emax 2 and be always up-to-date with the latest edition of the catalogue.