



# Portable Power Accessories

Make the Right Connection

# CONTACT US SALES ENQUIRIES

## HEAD OFFICE

Email: [info@luceco.com](mailto:info@luceco.com)  
Luceco plc  
4th Floor, Caparo House  
103 Baker Street, London  
United Kingdom, W1U 6LN

## UK SALES

Tel: +44 (0) 1952 238 100  
Email: [sales@masterplug.com](mailto:sales@masterplug.com)  
Luceco plc  
Luceco Distribution Centre  
Stafford Park 1  
Telford, Shropshire  
England, TF3 3BD

## TECHNICAL SUPPORT

Tel: 03300 249 279  
Email: [technical.support@masterplug.uk](mailto:technical.support@masterplug.uk)  
Lines open Monday to Friday 8:30am to 5pm,  
with answer-phone service outside these hours.

## WEBSITE

For further information and other literature items  
[www.masterplug.uk](http://www.masterplug.uk)



make *the right connection*

# CONTENTS

 <b>BASICS</b> 	<ul style="list-style-type: none"><li>• Extension Leads</li><li>• Trailing Sockets</li><li>• Plugs &amp; Adaptors</li></ul>	<b>06</b>
 <b>SWITCHED</b> 	<ul style="list-style-type: none"><li>• Extension Leads</li><li>• Trailing Sockets</li><li>• Adaptors</li></ul>	<b>22</b>
 <b>SURGE</b> 	<ul style="list-style-type: none"><li>• Extension Leads</li><li>• Adaptors</li></ul>	<b>28</b>
 <b>USB</b> 	<ul style="list-style-type: none"><li>• Extension Leads</li><li>• Trailing Sockets</li><li>• Plugs / Adaptors</li><li>• High Gloss Range</li></ul>	<b>36</b>
 <b>WORK</b> 	<ul style="list-style-type: none"><li>• Heavy Duty Plugs &amp; Extension Leads</li><li>• Trailing Sockets</li><li>• In-line Connectors</li><li>• Cassette, Case &amp; Cable Reels</li></ul>	<b>50</b>
 <b>PRO-XT</b> 	<ul style="list-style-type: none"><li>• Open Reels</li><li>• Case Reels</li><li>• Cassette Reels</li><li>• Accessories</li></ul>	<b>72</b>
 <b>OUTDOOR</b> 	<ul style="list-style-type: none"><li>• Extension Leads</li><li>• IP Rated</li><li>• RCD Protection</li></ul>	<b>88</b>
 <b>TRAVEL</b> 	<ul style="list-style-type: none"><li>• UK - Europe Adaptors</li><li>• UK - USA Adaptors</li><li>• Universal Adaptors</li></ul>	<b>102</b>
 <b>TIMER</b> 	<ul style="list-style-type: none"><li>• Mechanical</li><li>• Electronic</li><li>• Immersion Heater</li></ul>	<b>112</b>
 <b>HOME</b> 	<ul style="list-style-type: none"><li>• Adaptors</li><li>• Door Chimes</li><li>• Night Lights</li></ul>	<b>118</b>
 <b>UNIVERSAL</b> 	<ul style="list-style-type: none"><li>• Extension Leads</li><li>• Cable Reels</li></ul>	<b>128</b>



**Masterplug** is one of the most recognisable brands in the world and has been at the forefront of Portable Power for many decades.

With over 75 years of sales, distribution and manufacturing expertise, we fully understand our customers' requirements and as such we can offer tailor made solutions to our retail partners. These solutions combine high-quality market-leading products with low cost production to ensure our products not only meet the current market trends but exceed our consumers' expectations.

The benefits of buying our products include:

### QUALITY ASSURANCE

As one of the world's leading manufacturers, our products are made to the highest possible quality standards. We consider our corporate social responsibility at each step to bring security and peace of mind.

### COMPLIANCE TESTING

Our on-site ISO9001 certified laboratory ensures that all our products are manufactured to the relevant internationally recognised quality standards. Ongoing mass production testing and pre-shipment inspections ensure our products leave our facilities in the best possible condition.

### PRODUCT DEVELOPMENT

Analysis of market trends combined with our global design teams gives us a unique position from which to drive our product categories. In-house production engineering, rapid tool making and on-site prototyping delivers timely and continuous product development and improvements to the market.

### LOGISTICS

Our flexibility in production and raw material stock holding improves the manufacturing and delivery lead times to our partners. We have very flexible supply routes and can ship direct from our 100% wholly owned factory in China, or from our various global warehouses.

### ETHICAL POLICY

Masterplug has an overriding obligation to the welfare of workers within its own manufacturing facility and supply chain. Masterplug uses the Ethical Trading Initiative (ETI) Base Code as its standard for its own manufacturing operation and all primary suppliers across all our businesses. Please visit [www.ethicaltrade.org](http://www.ethicaltrade.org) for further information on the ETI Base Code.



make *the right connection*

The Masterplug range is versatile, with many configurable options for customers with larger order quantities. Subject to MOQs and lead time constraints, we can offer a variety of packaging, cable length, plug and colour options. Please speak to your Masterplug Sales Manager for more details.

## CONFIGURABLE OPTIONS

	CABLE LENGTHS	PLUG	COLOUR	PACKAGING
Extension Leads	Up to 15m	10A and 13A	Wide Range available	Polybag, Shrink wrap, Slide Blister, Box, SRP
Cable Reels	10A, 13A and 16A available	Standard, Heavy Duty, RCD	Wide range available	Up to 3 colours faceplate printing



## PACKAGING OPTIONS

Packaging options include shrink wrap, eco-blister, clamshell, polybag, colour box and SRP. Masterplug can also supply products in multipacks, on request, subject to MOQ and lead time constraints.



## MERCHANDISING

**Masterplug can provide the highest level of merchandising support. We have a wealth of experience in planogram design, and program implementation.**

In order to boost sales, we can offer numerous merchandising solutions to suit retail space available, including quarter or full pallet promotional displays and fixture clip strips for accessories and extension leads. Tailored promotions can be arranged to suit all quality and price requirements so that retailers can provide additional value offers to the customer.



# BASICS



## POWER |

Giving you power where you need it most, our basics range covers the essentials of indoor power



**SATELLITE REELS**



**EXTENSION LEADS**



**TRAILING SOCKETS**



**PLUGS**



**ADAPTORS**



**ACCESSORIES**

# SATELLITE REEL

- Ideal for domestic and office use
- Slimline design
- 13A fused plug
- Manufactured to BS EN 61242
- Maximum load (wound) 720 Watts, 240V
- Maximum load (unwound) 3120 Watts, 240V



Part No.	Description	Cable Length	Fuse	Colour	Pack Type	EAN	Box Qty
UK STOCKED							
SATT0413/4W	4 Socket Satellite Reel	4m	13A	White	Barcode label	5015056384559	8

## KEY FEATURES

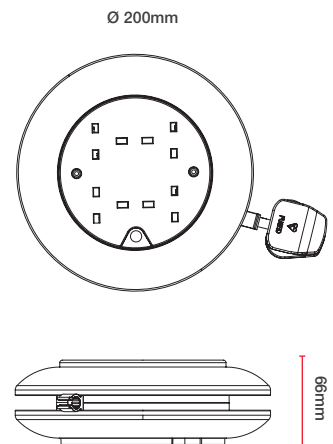
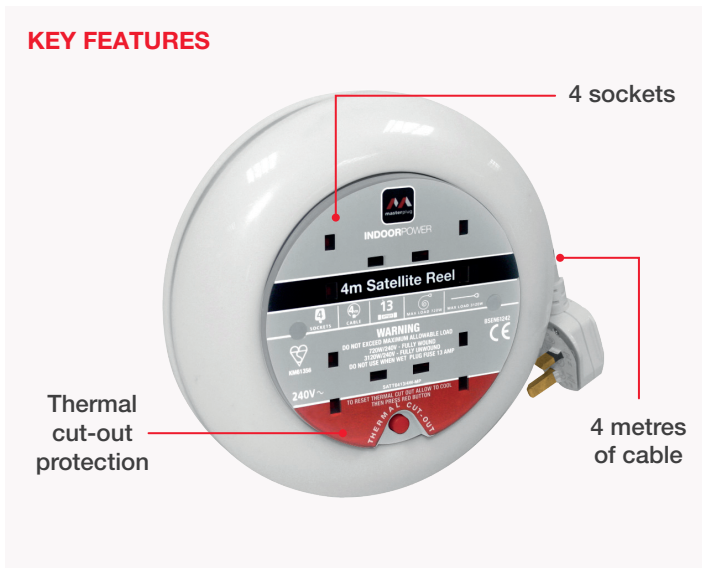

# SINGLE SOCKET EXTENSION LEAD

- Single socket extension lead
- Rounded slimline appearance
- 13A fused plug
- Manufactured to BS1363-2
- Maximum load 3120 Watts, 240V AC



Part No.	Description	Cable Length	Fuse	Colour	Pack Type	EAN	Box Qty
UK STOCKED							
BOG5	1 Socket	5m	13A	White	Hanging Polybag	5015056011103	10
BOG10	1 Socket	10m	13A	White	Hanging Polybag	5015056378039	20

## KEY FEATURES

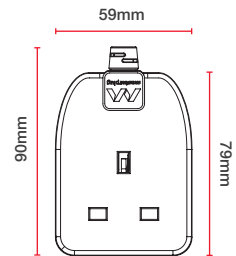
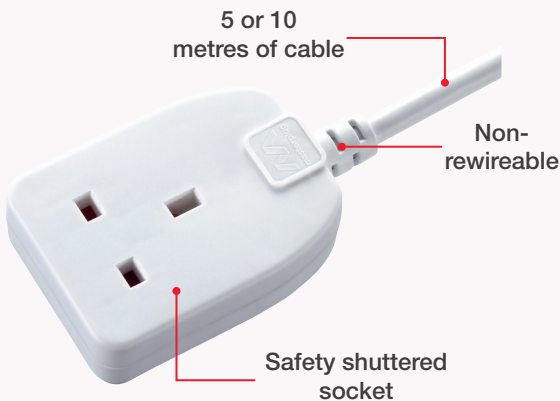



# DOUBLE SOCKET EXTENSION LEAD

- Double socket extension lead
- Rounded slimline appearance
- 13A fused plug
- Power indicator (BTN10N only)
- Manufactured to BS1363-2
- Maximum load 3120 Watts, 240V AC



Part No.	Description	Cable Length	Fuse	Colour	Pack Type	EAN	Box Qty
UK STOCKED							
BTG5N	2 Socket	5m	13A	White	Hanging Polybag	5015056379173	8
BTN10N	2 Socket with power indicator	10m	13A	White	Hanging Polybag	5015056009018	10

## KEY FEATURES

5 or 10 metres of cable



Non-rewireable

Safety shuttered sockets

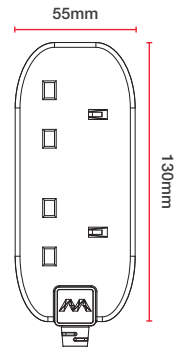

# FOUR SOCKET EXTENSION LEAD

- Plug four items safely into one socket
- Rounded slimline appearance
- 13A fused plug
- Manufactured to BS1363-2
- Maximum load 3120 Watts, 240V AC



Part No.	Description	Cable Length	Fuse	Colour	Pack Type	EAN	Box Qty
UK STOCKED							
BFG1N	4 Socket	1m	13A	White	Hanging Polybag	5015056008905	25
BFG2N	4 Socket	2m	13A	White	Hanging Polybag	5015056011301	20
BFG3N	4 Socket	3m	13A	White	Hanging Polybag	5015056011318	20
BFG5N	4 Socket	5m	13A	White	Hanging Polybag	5015056353227	10

## KEY FEATURES



Wall-fixing capability

Non-rewireable

1, 2, 3 or 5 metres of cable

Safety shuttered sockets

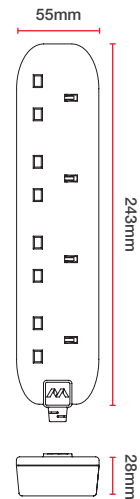

# SIX SOCKET EXTENSION LEAD

- Plug six items safely into one socket
- Rounded slimline appearance
- 13A fused plug
- Manufactured to BS1363-2
- Maximum load 3120 Watts, 240V AC



Part No.	Description	Cable Length	Fuse	Colour	Pack Type	EAN	Box Qty
UK STOCKED							
BSG2N	6 Socket	2m	13A	White	Hanging Polybag	5015056353586	20
BSG3N	6 Socket	3m	13A	White	Hanging Polybag	5015056353005	15

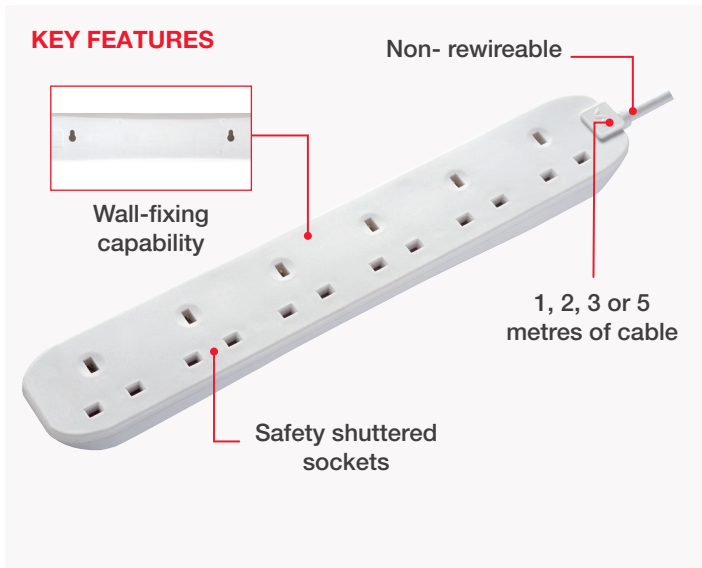

# EIGHT SOCKET EXTENSION LEAD WITH POWER INDICATOR

- Plug eight items safely into one socket
- 13A fused plug
- Manufactured to BS1363-2
- Maximum load 3120 Watts, 240V AC

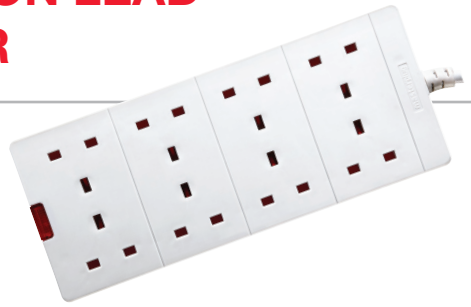

Part No.	Description	Cable Length	Fuse	Colour	Pack Type	EAN	Box Qty
UK STOCKED							
BEN2	8 Socket	2m	13A	White	Hanging Polybag	5015056359632	10

## KEY FEATURES



Wall-fixing capability

Safety shuttered sockets

Non-rewireable

Power Indicator

Compact design

2 metres of cable

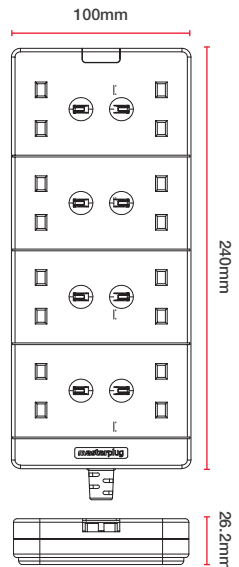

# FOUR SOCKET COMPACT EXTENSION LEAD

- Plug four items safely into one socket
- Back-to-back compact design
- 13A fused plug
- Manufactured to BS1363-2
- Maximum load 3120 Watts, 240V AC



Part No.	Description	Cable Length	Fuse	Colour	Pack Type	EAN	Box Qty
UK STOCKED							
BDFN1	4 Socket	1m	13A	White	Hanging Polybag	5015056506104	10

## KEY FEATURES

Power indicator

Non-rewireable



Safety shuttered sockets

1 metre of cable

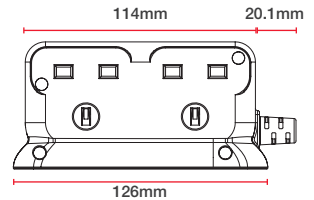
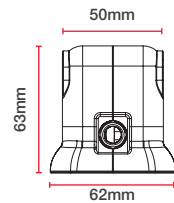

# TEN SOCKET TOWER EXTENSION LEAD

- Plug ten items safely into one socket
- Versatile tower design – mount vertically or horizontally
- 13A fused plug
- Manufactured to BS1363-2
- Maximum load 3120 Watts, 240V AC



Part No.	Description	Cable Length	Fuse	Colour	Pack Type	EAN	Box Qty
UK STOCKED							
BTOW101	10 Socket	1m	13A	White	Printed Box	5015056528274	5

## KEY FEATURES

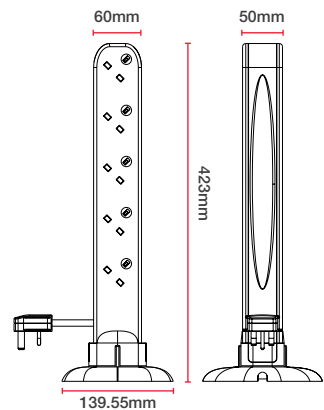
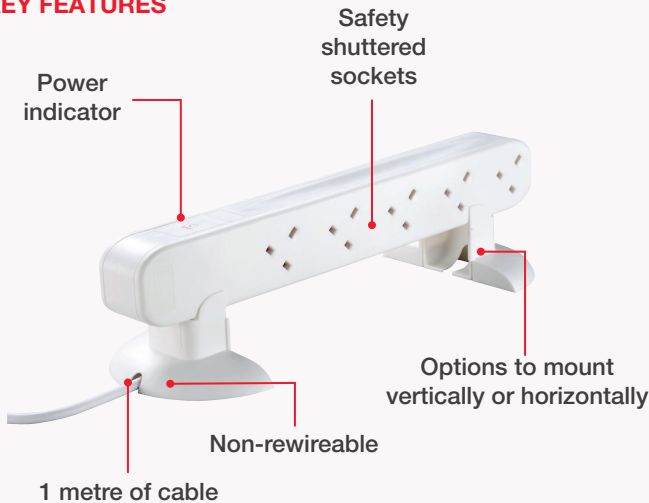

# REWIREABLE TRAILING SOCKET

- Plug one, two, four or six items safely into one socket
- Power indicator on TN, UG and SXG
- Manufactured from high-quality ABS material
- Manufactured to BS1363-2



Part No.	Description	Cable Length	Fuse	Colour	Pack Type	EAN	Box Qty
<b>UK STOCKED</b>							
SS	1 Socket	N/A	13A	White	Hanging Polybag	5015056005010	100
TN	2 Socket with power indicator	N/A	13A	White	Hanging Polybag	5015056011202	20
UG	4 Socket with power indicator	N/A	13A	White	Hanging Polybag	5015056008622	10
SXG	6 Socket with power indicator	N/A	13A	White	Hanging Polybag	5015056031156	10

## KEY FEATURES

Simple moulded design

Rewireable

Power indicator

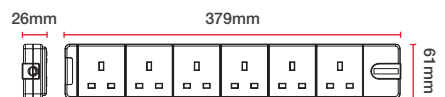
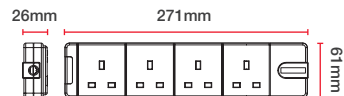
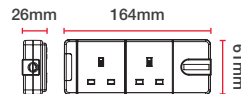
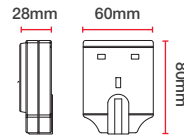
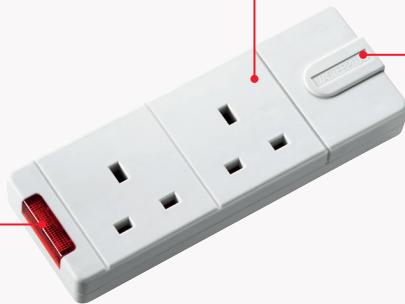

# REWIREABLE PLUG

- Black or white moulded plug
- Sleeved pins, extruded from solid brass
- Ideal for indoor power
- 3A, 5A or 13A fused plug
- Manufactured to BS1363/A
- Rewireable



Part No.	Description	Cable Length	Fuse	Colour	Pack Type	EAN	Box Qty
 UK STOCKED							
PT13B	Rewireable BS 3 Pin plug, 13A fused	N/A	13A	Black	Bulk Pack	5015056528694	200
PT13W	Rewireable BS 3 Pin plug, 13A fused	N/A	13A	White	Bulk Pack	5015056350189	200
PT133W	Rewireable BS 3 Pin plug, 3A fused	N/A	3A	White	Bulk Pack	N/A	200
PT135W	Rewireable BS 3 Pin plug, 5A fused	N/A	5A	White	Bulk Pack	N/A	200

## KEY FEATURES

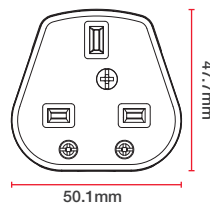
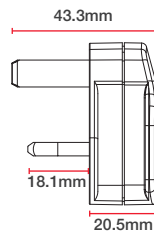



# REWIREABLE PLUG WITH HANDLE

- White moulded plug
- Sleeved pins, extruded from solid brass
- Ideal for indoor power
- 13A fused plug
- Manufactured to BS1363/A
- Rewireable



Part No.	Description	Cable Length	Fuse	Colour	Pack Type	EAN	Box Qty
 UK STOCKED							
PT13HW	Rewireable BS 3 Pin plug with handle, 13A fused	N/A	13A	White	Polybag	5015056365145	48

## KEY FEATURES

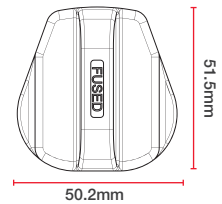
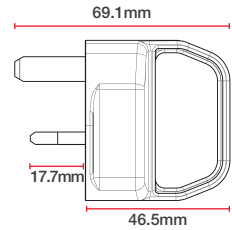
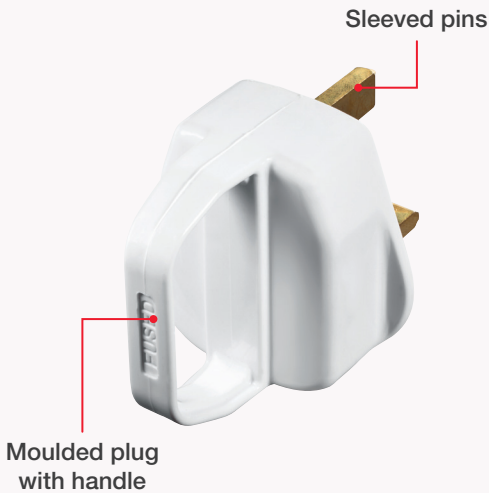

# HEAVY DUTY REWIREABLE PLUG

- Black or white moulded plug
- Sleeved pins, extruded from solid brass
- Ideal for indoor power
- 13A fused plug
- Manufactured to BS1363/A
- Rewireable



Part No.	Description	Cable Length	Fuse	Colour	Pack Type	EAN	Box Qty
UK STOCKED							
7B	Rewireable BS 3 Pin heavy duty plug, 13A fused	N/A	13A	Black	Bulk Pack	N/A	200
7W	Rewireable BS 3 Pin heavy duty plug, 13A fused	N/A	13A	White	Bulk Pack	N/A	200

## KEY FEATURES

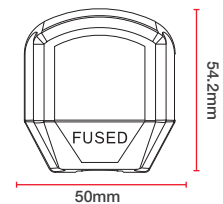
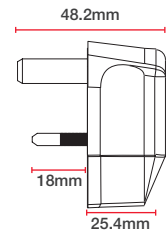

# REWIREABLE ROUND PIN PLUG

- Black or white moulded plug
- Sleeved round pins, extruded from solid brass
- Ideal for indoor power
- 2A, 5A or 15A plug
- Manufactured to BS546
- Rewireable

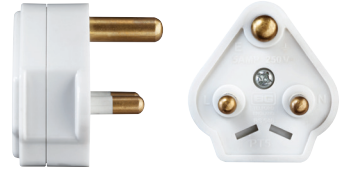
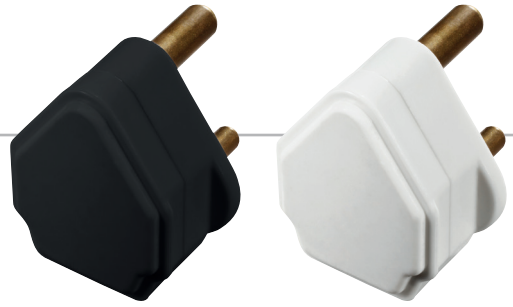

Part No.	Description	Cable Length	Fuse	Colour	Pack Type	EAN	Box Qty
UK STOCKED							
PT2W	Round Pin Plug	N/A	2A	White	Bulk Pack	N/A	1000
PT5B	Round Pin Plug	N/A	5A	Black	Bulk Pack	N/A	400
PT5W	Round Pin Plug	N/A	5A	White	Bulk Pack	N/A	400
PT15W	Round Pin Plug	N/A	15A	White	Bulk Pack	N/A	200

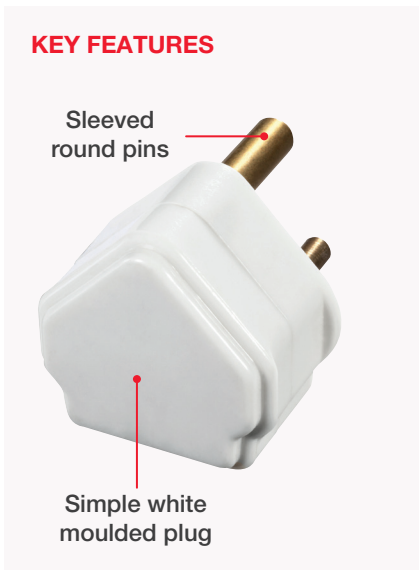

PT2W

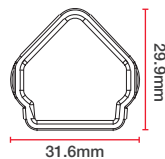
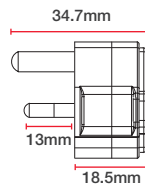

PT5B & PT5W

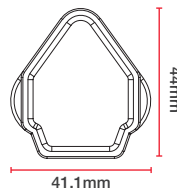
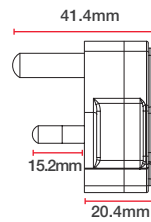

PT15W

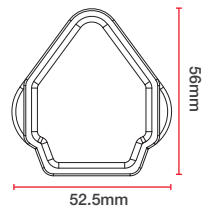
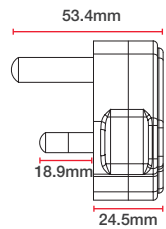

# SHAVER ADAPTOR

- Connect an electric shaver or toothbrush to a standard 3-pin mains socket
- Fitted with 1A fuse to BS646 for electric shavers only
- Sleeved pins, extruded from solid brass
- Manufactured to BS1363-3



Part No.	Description	Cable Length	Fuse	Colour	Pack Type	EAN	Box Qty
UK STOCKED							
SHADC	Shaver Adaptor	N/A	1A	White	Eco-Blister	5015056353050	30

## KEY FEATURES

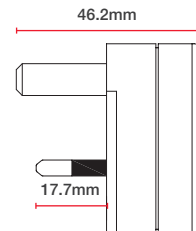
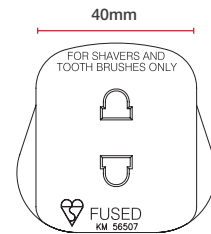
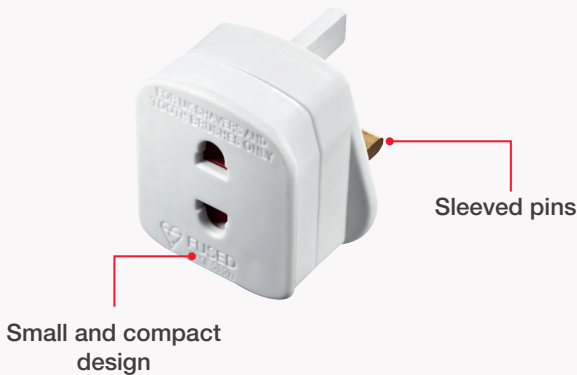

# MULTI-SOCKET ADAPTOR

- Compact design
- MSF3 is supplied with a replaceable 13A fuse
- Plug two (MSU2) or three (MSF3) items safely into one socket
- Manufactured to BS1363-3

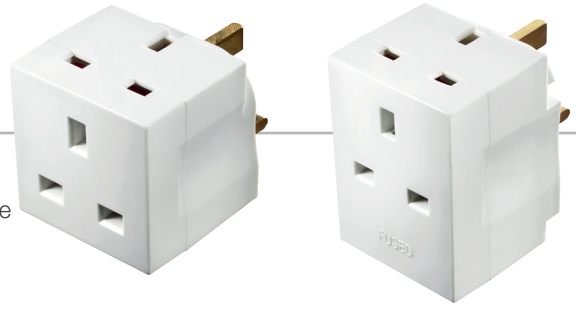

Part No.	Description	Cable Length	Fuse	Colour	Pack Type	EAN	Box Qty
UK STOCKED							
MSU2/NK	2 socket adaptor	N/A	N/A	White	Barcode label	5015056354842	80
MSF3/NK	3 socket fused adaptor	N/A	13A	White	Barcode label	5015056353067	80

## KEY FEATURES

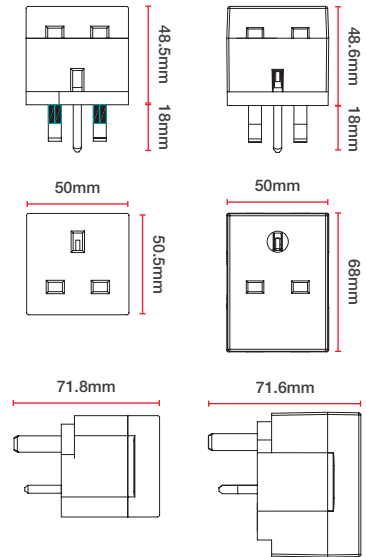
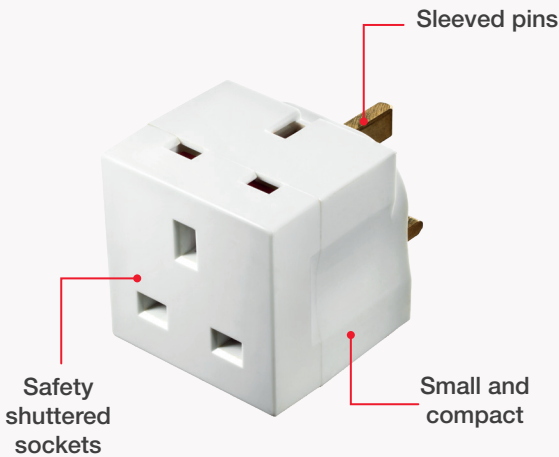

# MULTI-VOLTAGE ADAPTOR



- Ideal for powering a variety of low voltage appliances
- Ideal for use when travelling
- Fully regulated power supply to BS EN 60950
- Output voltage: 3-12V DC
- Input voltage 220-240V AC



Part No.	Description	Cable Length	Fuse	Colour	Pack Type	EAN	Box Qty
 UK STOCKED							
MVA1200	Multi Voltage Adaptor	N/A	N/A	Black	Clamshell	5015056368818	16

## KEY FEATURES

Compact design



Includes seven jack plug adaptors

# FUSES

- Available in packs of 4 or as mixed packs
- Suitable for most applications
- Manufactured to BS1362 or IEC 269-3A where applicable



Part No.	Description	Cable Length	Fuse	Colour	Pack Type	EAN	Box Qty
UK STOCKED							
FUSE3	4x 3A Fuses	N/A	3A	N/A	Blister	5015056353012	900
FUSE5	4x 5A Fuses	N/A	5A	N/A	Blister	5015056353029	900
FUSE10	4x 10A Fuses	N/A	10A	N/A	Blister	5015056520988	900
FUSE13	4x 13A Fuses	N/A	13A	N/A	Blister	5015056353036	900
FUSEM	4x Mixed Fuses	N/A	Mixed	N/A	Blister	5015056353043	900
FUSEM10	10x Mixed Fuses	N/A	Mixed	N/A	Blister	5015056510590	900
FUSEW	Fuse Wire	N/A	-	N/A	Blister	5015056363776	900

## KEY FEATURES

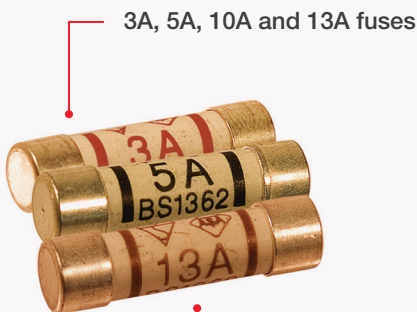

3A, 5A, 10A and 13A fuses

Easy to install – simply clip in



Suitable for appliances up to 720W



Suitable for appliances between 720W and 1200W



Suitable for appliances between 1200W and 2400W



Suitable for appliances between 2400W and 3120W





# SWITCHED POWER



Control the power to each individual socket with our switched range



EXTENSION LEADS



TRAILING SOCKETS



ADAPTORS



# COMPACT SWITCHED EXTENSION LEAD

- Compact design
- Plug three items safely into one socket
- Wall-fixing capability
- Manufactured to BS1363-2

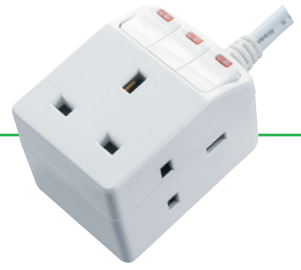

Part No.	Description	Cable Length	Fuse	Colour	Pack Type	EAN	Box Qty
<b>UK STOCKED</b>							
SWG32C	3 socket	2m	13A	White	Clamshell & insert card	5015056383576	5

## KEY FEATURES



Wall-fixing capability

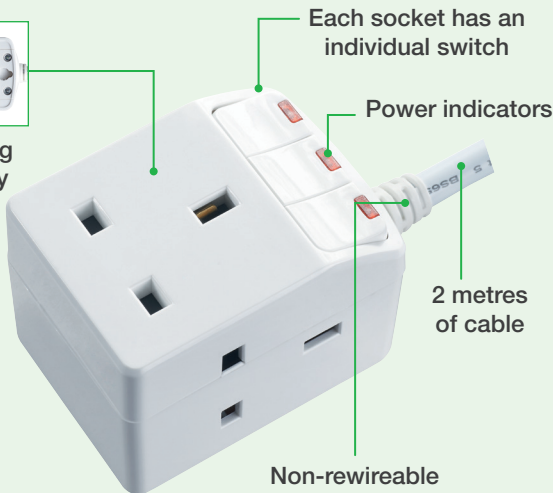

50.8mm

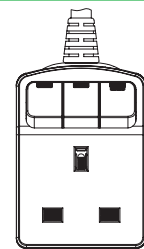

52mm

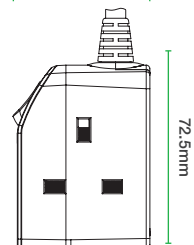

# SWITCHED EXTENSION LEAD

- Plug four or six items safely into one socket
- Rounded slimline appearance
- 2 metres of cable
- Non-rewireable
- Manufactured to BS1363-2



Part No.	Description	Cable Length	Fuse	Colour	Pack Type	EAN	Box Qty
<b>UK STOCKED</b>							
SWC42N	4 socket	2m	13A	White	Clamshell & insert card	5015056031255	10
SWC62N	6 socket	2m	13A	White	Clamshell & insert card	5015056092003	10

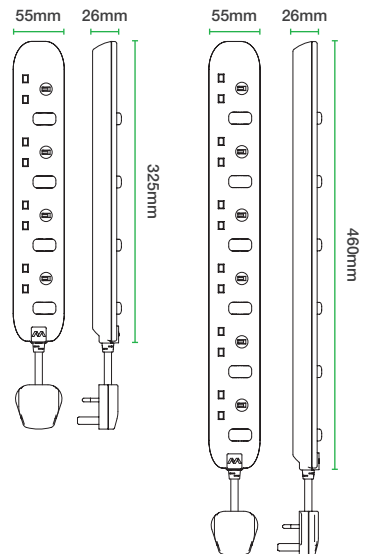
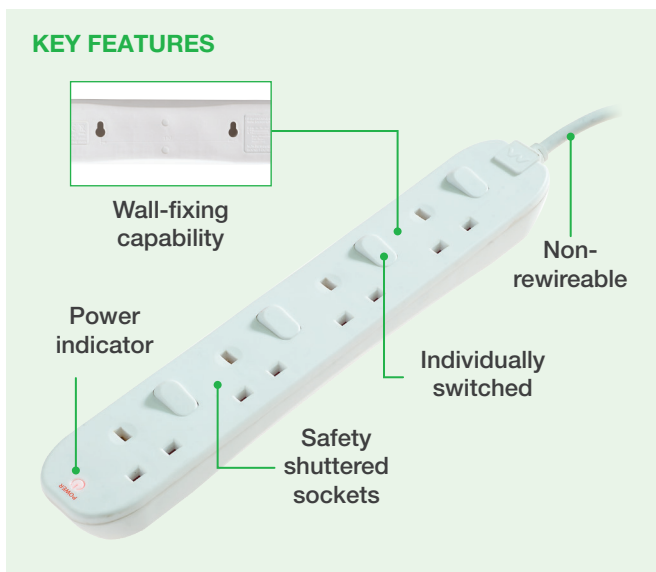

# SWITCHED REWIREABLE TRAILING SOCKET

- White moulded trailing socket
- Manufactured from high-quality plastic
- Plug four or six items safely into one socket
- Manufactured to BS1363-2

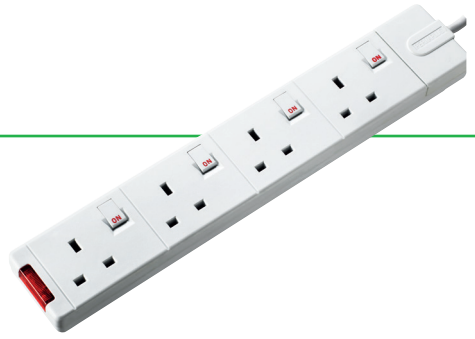

Part No.	Description	Cable Length	Fuse	Colour	Pack Type	EAN	Box Qty
<b>UK STOCKED</b>							
SWG4	4 socket	N/A	13A	White	Hanging Polybag	5015056031002	10
SWG6	6 socket	N/A	13A	White	Hanging Polybag	5015056352479	10

### KEY FEATURES

Wall-fixing capability

Rewireable

Individually switched

Power indicator

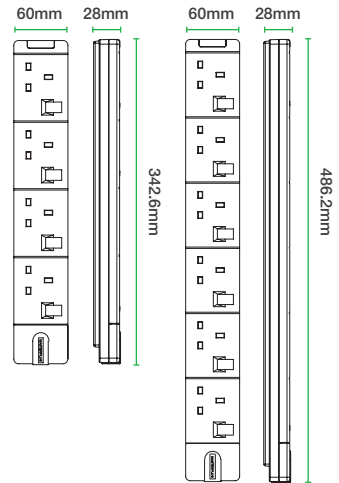

# TRAILING SOCKET WITH SWITCH & FUSE

- Trailing socket available with or without cable
- Manufactured from high-quality plastic
- Plug four or six items safely into one socket
- Manufactured to BS1363-2



Part No.	Description	Cable Length	Fuse	Colour	Pack Type	EAN	Box Qty
<b>UK STOCKED</b>							
SWFG4W	4 socket trailing socket	N/A	13A	White	Printed Box	5015056070018	20
SWFG44W	4 socket extension lead	4m	13A	White	Hanging Polybag	5015056363554	10
SWFG6W	6 socket trailing socket	N/A	13A	White	Printed Box	5015056357478	20

## KEY FEATURES

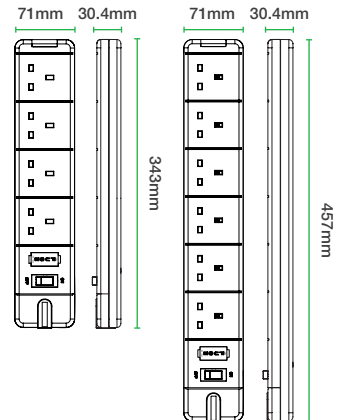
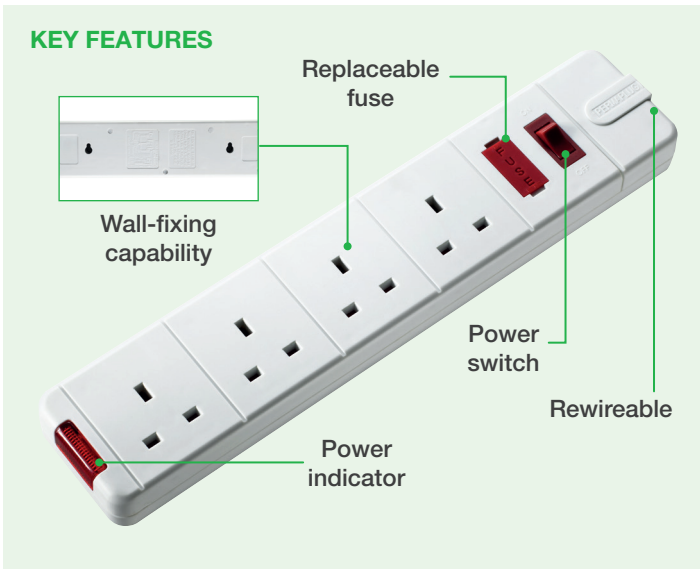

# SWITCHED ADAPTOR

- Three safety shuttered sockets
- Fitted with replaceable 13A fuse
- Manufactured to BS1363-3

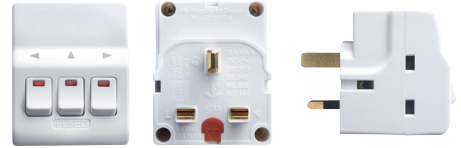
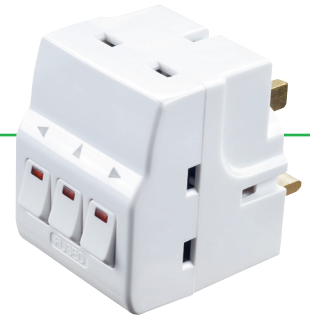

Part No.	Description	Cable Length	Fuse	Colour	Pack Type	EAN	Box Qty
<b>UK STOCKED</b>							
MSWG3	3 socket	N/A	13A	White	Blister	5015056361178	10

## KEY FEATURES

Compact design

Individual power indicators

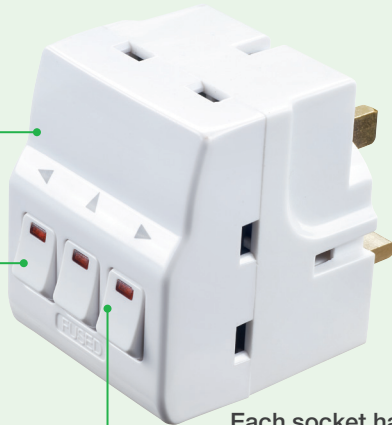

Each socket has an individual switch

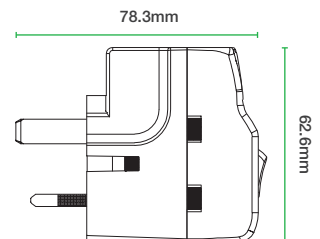
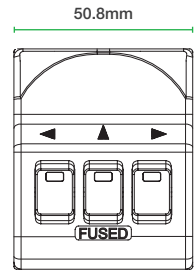



# SURGE POWER



Protects your valuable equipment from  
damaging surges and spikes

## WHAT IS SURGE?

Hundreds of power surges can occur in your home or office every day; the switching on/off of fluorescent lights and household appliances can cause power surges, which can seriously damage electronic equipment. Even low energy surges can cause gradual component degradation, leading to early hardware failure.

Masterplug Surge products protect your devices against these surges and spikes.



**BASIC**



**SWITCHED**



**COMPACT**



**TOWER**



**ADAPTOR**

# SURGE EXTENSION LEAD

- Plug four or six items safely into one socket
- £1,000 connected equipment warranty
- Two or four metres of cable
- Rounded slimline appearance
- Safety shuttered sockets
- Protect valuable electrical equipment from surges and spikes
- Manufactured to BS1363-2, BS EN 61643-11 and BS5733



Part No.	Description	Cable Length	Fuse	Colour	Pack Type	EAN	Box Qty
<b>UK STOCKED</b>							
SRG42N	4 Socket	2m	13A	White	Clamshell & insert card	5015056092300	10
SRG44N	4 Socket	4m	13A	White	Clamshell & insert card	5015056506074	8
SRG62N	6 Socket	2m	13A	White	Clamshell & insert card	5015056092201	10

### KEY FEATURES

- Wall-fixing capability
- LED surge indicator
- Surge protected
- LED power indicator
- Non-rewireable

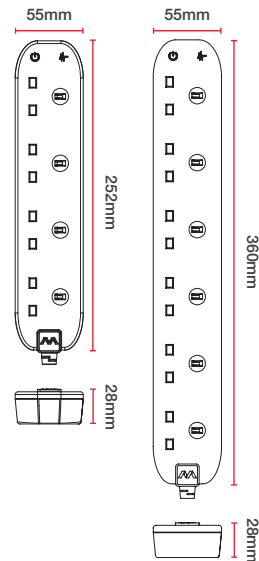

<b>Max Surge Energy</b>	375 Joules
<b>Max Current</b>	13,500A
<b>Clamping Voltage</b>	775 Volts
<b>Response Time</b>	<10ns
<b>3 Channel Protection</b>	Yes
<b>Thermal Cutout</b>	Yes

# COMPACT SURGE EXTENSION LEAD



- Plug eight items safely into one socket
- £1,000 connected equipment warranty
- Two metres of cable
- Compact design
- Protect valuable electrical equipment from surges and spikes
- Manufactured to BS1363-2, BS EN 61643-11 and BS5733

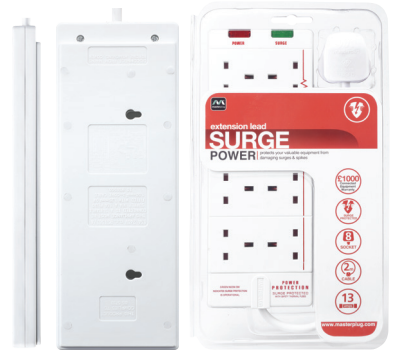

Part No.	Description	Cable Length	Fuse	Colour	Pack Type	EAN	Box Qty
<b>UK STOCKED</b>							
SRG82	8 Socket	2m	13A	White	Clamshell & insert card	5015056358192	10

## KEY FEATURES

Wall-fixing capability

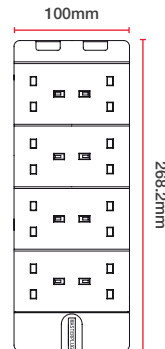
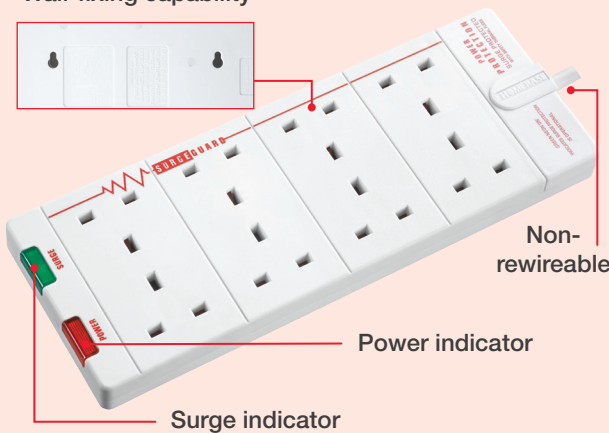

<b>Max Surge Energy</b>	375 Joules
<b>Max Current</b>	13,500A
<b>Clamping Voltage</b>	775 Volts
<b>Response Time</b>	<10ns
<b>3 Channel Protection</b>	Yes
<b>Thermal Cutout</b>	Yes



# SURGE EXTENSION LEAD INDIVIDUALLY SWITCHED

- Plug four or six items safely into one socket
- £1,000 connected equipment warranty
- Non-rewireable
- Protect valuable electrical equipment from surges and spikes
- Manufactured to BS1363-2, BS EN 61643-11 and BS5733

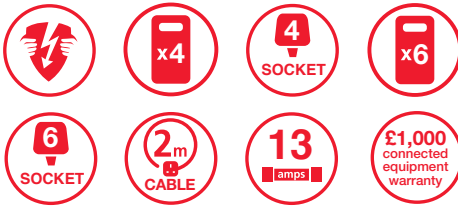

Part No.	Description	Cable Length	Fuse	Colour	Pack Type	EAN	Box Qty
UK STOCKED							
SWSRG42N	4 Socket	2m	13A	White	Clamshell & insert card	5015056512075	10
SWSRG62N	6 Socket	2m	13A	White	Clamshell & insert card	5015056356952	10

### KEY FEATURES

LED surge indicator

LED power indicator

Individually switched sockets

Wall-fixing capability

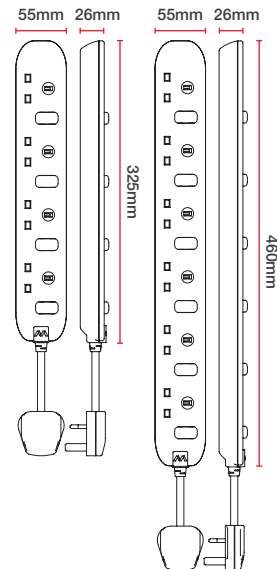

<b>Max Surge Energy</b>	375 Joules
<b>Max Current</b>	13,500A
<b>Clamping Voltage</b>	775 Volts
<b>Response Time</b>	<10ns
<b>3 Channel Protection</b>	Yes
<b>Thermal Cutout</b>	Yes

# SURGE COMPACT EXTENSION LEAD

- Compact back-to-back design
- Plug four or six items safely into one socket
- Unique matt black finish with attractive high gloss trim
- £1,000 connected equipment warranty
- Protect valuable electrical equipment from surges and spikes
- Manufactured to BS1363-2, BS EN 61643-11 and BS5733



Part No.	Description	Cable Length	Fuse	Colour	Pack Type	EAN	Box Qty
<b>UK STOCKED</b>							
SRGD41MB	4 Socket	1m	13A	Matt Black	Printed Box	5015056551777	6
SRGD61MB	6 Socket	1m	13A	Matt Black	Printed Box	5015056568539	6

## KEY FEATURES



Wall-fixing capability

LED surge indicator

1 metre of cable



LED power indicator

Safety shuttered sockets

Non-rewireable

133mm	73.8mm	<b>Max Surge Energy</b>
		375 Joules
	62mm	<b>Max Current</b>
		13,500A
	187mm	<b>Clamping Voltage</b>
		775 Volts
	72.9mm	<b>Response Time</b>
		<10ns
	62mm	<b>3 Channel Protection</b>
		Yes
		<b>Thermal Cutout</b>
		Yes

# SURGE TOWER EXTENSION LEAD

- Space-saving tower design
- Vertical and horizontal mounting options
- Plug ten items safely into one socket
- £1,000 connected equipment warranty
- One metre of cable
- 13A fused plug
- Protect valuable electrical equipment from surges and spikes
- Manufactured to BS1363-2, BS EN 61643-11 and BS5733



Part No.	Description	Cable Length	Fuse	Colour	Pack Type	EAN	Box Qty
<b>UK STOCKED</b>							
SRGTOW101	10 Socket	1m	13A	White	Printed Box	5015056538921	5
SRGTOW101B	10 Socket	1m	13A	Black	Printed Box	5015056538938	5

## KEY FEATURES

Safety shuttered sockets

LED surge indicator

LED power indicator

Surge protected

Non-rewireable

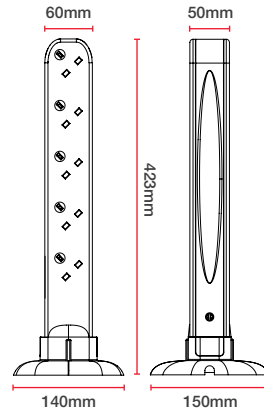
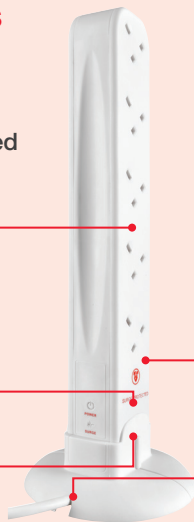

<b>Max Surge Energy</b>	375 Joules
<b>Max Current</b>	13,500A
<b>Clamping Voltage</b>	775 Volts
<b>Response Time</b>	<10ns
<b>3 Channel Protection</b>	Yes
<b>Thermal Cutout</b>	Yes

# SURGE COMPACT EXTENSION LEAD

- Three safety shuttered, individually switched sockets
- £1,000 connected equipment warranty (3 years)
- Protect valuable electrical equipment from surges and spikes
- Manufactured to BS1363-3, BS EN 61643-11 and BS5733



Part No.	Description	Cable Length	Fuse	Colour	Pack Type	EAN	Box Qty
UK STOCKED							
MSWRG3	3 Socket	N/A	13A	White	Blister	5015056378183	10

## KEY FEATURES

Replaceable  
13A fuse



Surge protected

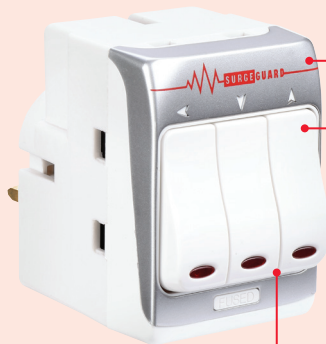

Individually  
switched

Individual LED  
power indicators

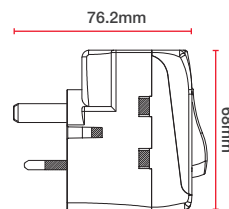
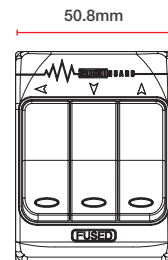

<b>Max Surge Energy</b>	375 Joules
<b>Max Current</b>	13,500A
<b>Clamping Voltage</b>	775 Volts
<b>Response Time</b>	<10ns
<b>3 Channel Protection</b>	Yes
<b>Thermal Cutout</b>	Yes





# USB POWER



Power and charge your portable USB devices, without losing socket space



CABLE REELS



COMPACT



SURGE



TOWER



HIGH GLOSS

# SATELLITE REEL WITH USB

- Ideal for domestic and office use
- 13A fused plug
- Thermal cut-out prevents risk of fire due to temperature rise caused by power overload
- Manufactured to BS EN 61242 and BS EN 60950-1



Part No.	Description	Cable Length	Fuse	Colour	Pack Type	EAN	Box Qty
<b>UK STOCKED</b>							
SATU04132USLW	2 Socket Satellite Reel with USB (2.1A)	4m	13A	White	Barcode label + 13A warning label	5015056551814	4

## KEY FEATURES

2 sockets

Two USB ports (2.1A shared)

4 metres of cable

Thermal cut-out protection

Ø200mm

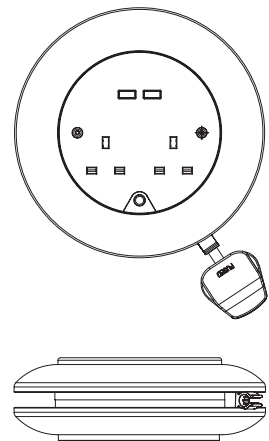

66mm

# SURGE USB COMPACT EXTENSION LEAD



- Compact back-to-back design
- Plug four or six items safely into one socket
- Unique matt black finish with attractive high gloss trim
- £1,000 connected equipment warranty
- Protects valuable electrical equipment from surges and spikes
- Manufactured to BS5733, BS1363-2, BS EN 61643-11 and BS EN 60950-1



Part No.	Description	Cable Length	Fuse	Colour	Pack Type	EAN	Box Qty
UK STOCKED							
SRGDU41MB2	4 Socket	1m	13A	Matt Black	Printed Box	5015056568546	6
SRGDU61MB2	6 Socket	1m	13A	Matt Black	Printed Box	5015056568553	6

## KEY FEATURES

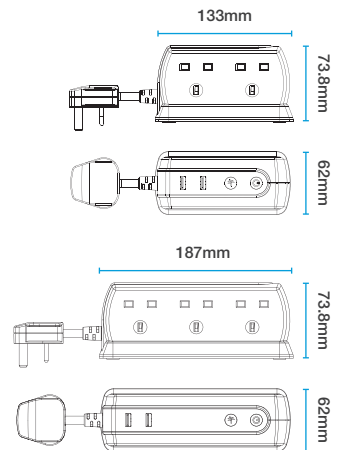



# SURGE USB EXTENSION LEAD

- Plug four or six items safely into one socket
- Two or four metres of cable
- £1,000 connected equipment warranty
- Protects valuable electrical equipment from surges and spikes
- Manufactured to BS5733, BS1363-2, BS EN 61643-11 and BS EN 60950-1



Part No.	Description	Cable Length	Fuse	Colour	Pack Type	EAN	Box Qty
<b>UK STOCKED</b>							
SRGU42N	4 Socket	2m	13A	White	Clamshell & insert card	5015056528243	10
SRGU44N	4 Socket	4m	13A	White	Clamshell & insert card	5015056539171	10
SRGU62N	6 Socket	2m	13A	White	Clamshell & insert card	5015056528250	10

### KEY FEATURES

- Rounded slimline appearance
- Wall-fixing capability
- LED surge indicator
- Safety shuttered sockets
- Two USB ports (2.1A shared)
- LED power indicator

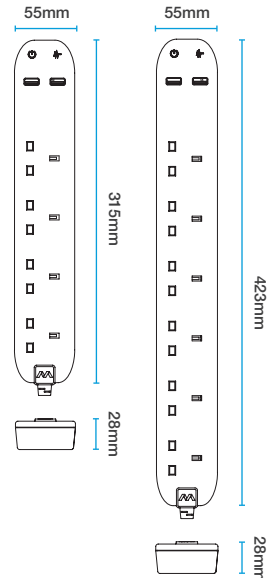

<b>Max Surge Energy</b>	375 Joules
<b>Max Current</b>	13,500A
<b>Clamping Voltage</b>	775 Volts
<b>Response Time</b>	<10ns
<b>3 Channel Protection</b>	Yes
<b>Thermal Cutout</b>	Yes

# SURGE USB TOWER EXTENSION LEAD

- Vertical and horizontal mounting options
- Plug ten items safely into one socket
- £1,000 connected equipment warranty
- 13A fused plug
- Protects valuable electrical equipment from surges and spikes
- Manufactured to BS5733, BS1363-2, BS EN 61643-11 and BS EN 60950-1



Part No.	Description	Cable Length	Fuse	Colour	Pack Type	EAN	Box Qty
UK STOCKED							
SRGU101B	10 Socket	1m	13A	Black	Printed Box	5015056528281	5
SRGU104	10 Socket	4m	13A	White	Printed box	5015056539164	5

## KEY FEATURES

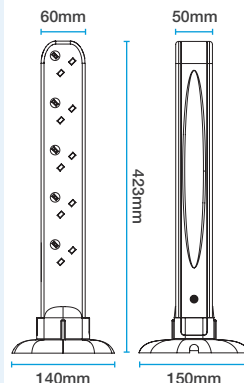
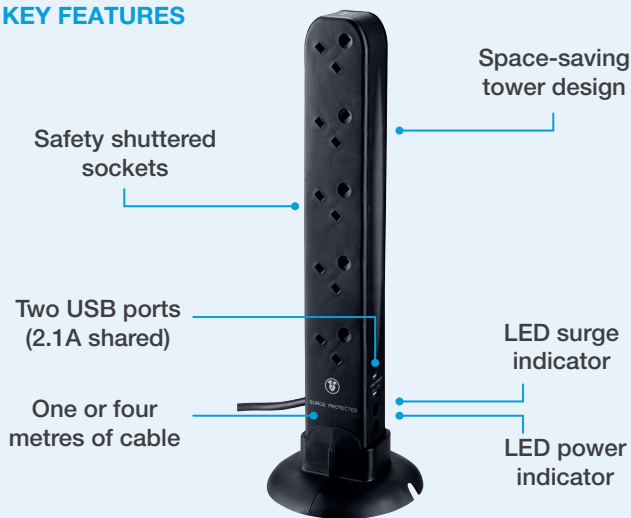

<b>Max Surge Energy</b>	375 Joules
<b>Max Current</b>	13,500A
<b>Clamping Voltage</b>	775 Volts
<b>Response Time</b>	<10ns
<b>3 Channel Protection</b>	Yes
<b>Thermal Cutout</b>	Yes



# HIGH GLOSS USB POWER



Power and charge your portable USB devices, without losing socket space, with our premium high gloss USB range



**INDIVIDUALLY SWITCHED  
EXTENSION LEADS**



**SURGE PROTECTED  
EXTENSION LEADS**



**COMPACT  
EXTENSION LEADS**



**MASTER EXTENSION LEADS**



**ADAPTORS**



# HIGH GLOSS USB INDIVIDUALLY SWITCHED EXTENSION LEAD



- Individually switched sockets
- Plug four items safely into one socket
- Unlimited value, 3 year connected equipment warranty
- One metre of cable
- Premium high gloss black or white finish
- Protects valuable electrical equipment from surges and spikes
- Manufactured to BS5733, BS1363-2, BS EN 61643-11 and BS EN 60950-1



Part No.	Description	Cable Length	Fuse	Colour	Pack Type	EAN	Box Qty
<b>UK STOCKED</b>							
SWSRGU41PB2	4 Socket	1m	13A	Black	Printed Box	5015056538976	6
SWSRGU41PW2	4 Socket	1m	13A	White	Printed Box	5015056539034	6

## KEY FEATURES

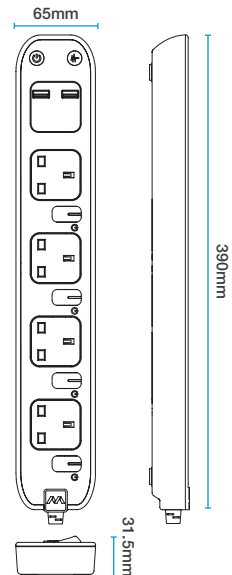
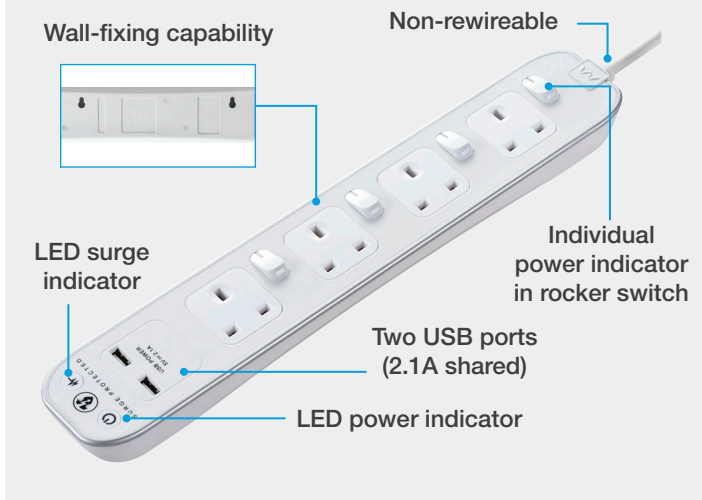

# HIGH GLOSS USB SURGE EXTENSION LEAD

- Plug four items safely into one socket
- Unlimited value, 3 year connected equipment warranty
- One metre of cable
- Premium high gloss black or white finish
- Safety shuttered sockets
- Protects valuable electrical equipment from surges and spikes
- Manufactured to BS5733, BS1363-2, BS EN 61643-11 and BS EN 60950-1



Part No.	Description	Cable Length	Fuse	Colour	Pack Type	EAN	Box Qty
<b>UK STOCKED</b>							
SRGU41PB2	4 Socket	1m	13A	Black	Printed Box	5015056574783	6
SRGU41PW2	4 Socket	1m	13A	White	Printed Box	5015056539027	6

### KEY FEATURES

Wall-fixing capability

LED power indicator

Two USB ports (2.1A shared)

Surge protected

LED surge indicator

Non-rewireable

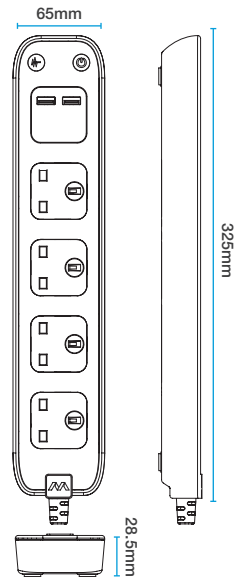

# HIGH GLOSS USB COMPACT EXTENSION LEAD

- Compact back-to-back design
- Plug four or six items safely into one socket
- Premium high gloss black or white finish
- Unlimited value, 3 year connected equipment warranty
- One metre of cable
- Protects valuable electrical equipment from surges and spikes
- Manufactured to BS5733, BS1363-2, BS EN 61643-11 and BS EN 60950-1



2 USB SOCKETS

SURGE PROTECTION

4 SOCKET

6 SOCKET

1m CABLE

13 amps

£Unlimited connected equipment warranty



Part No.	Description	Cable Length	Fuse	Colour	Pack Type	EAN	Box Qty
<b>UK STOCKED</b>							
SRGDU41PB2	4 Socket	1m	13A	Black	Printed Box	5015056539058	6
SRGDU41PW2	4 Socket	1m	13A	White	Printed Box	5015056539041	6
SRGDU61PB2	6 Socket	1m	13A	Black	Printed Box	5015056539072	6
SRGDU61PW2	6 Socket	1m	13A	White	Printed Box	5015056539065	6

## KEY FEATURES

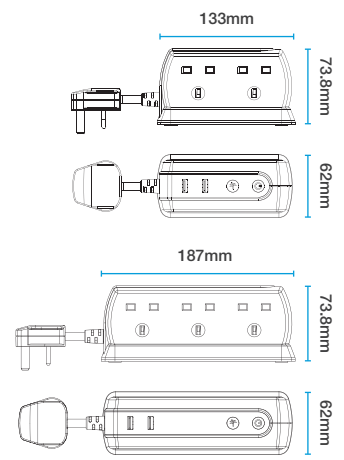
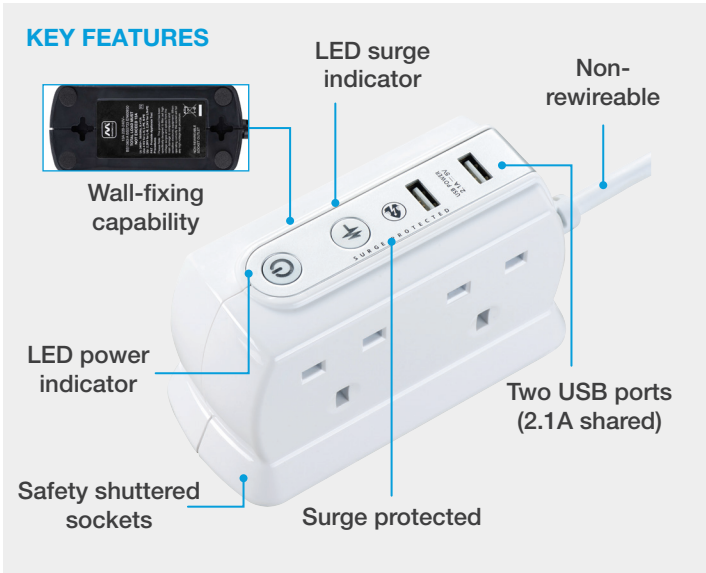

# HIGH GLOSS USB ENERGY SAVING EXTENSION LEAD

- Power saving 'master-slave' functionality – five sockets automatically switch off when the master device is powered down, whilst two sockets remain powered
- Unlimited value, 3 year connected equipment warranty
- One metre of cable
- Protects valuable electrical equipment from surges and spikes
- Telecom protection further protects your equipment from damaging surge or spikes via broadband, ISDN or modem connections
- Manufactured to BS5733, BS1363-2, BS EN 61643-11 and BS EN 60950-1



Part No.	Description	Cable Length	Fuse	Colour	Pack Type	EAN	Box Qty
<b>UK STOCKED</b>							
SRPMSTU81PB2	8 Socket	1m	13A	Black	Printed Box	5015056539119	5
SRPMSTU81PW2	8 Socket	1m	13A	White	Printed Box	5015056539102	5

### KEY FEATURES

- Wall-fixing capability
- LED surge indicator
- LED power indicator
- Two USB ports (2.1A shared)
- Telecom ports
- Non-rewireable

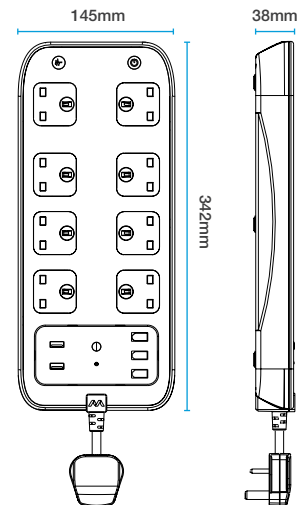

# HIGH GLOSS USB & TELECOM TOWER EXTENSION LEAD

- Space-saving tower design
- Plug ten or twelve items safely into one socket
- Premium high gloss black finish
- Unlimited value, 3 year connected equipment warranty
- Two metres of cable
- Protects valuable electrical equipment from surges and spikes
- Telecom protection further protects your equipment from damaging surge or spikes via broadband, ISDN or modem connections
- Manufactured to BS5733, BS1363-2, BS EN 61643-11 and BS EN 60950-1



Part No.	Description	Cable Length	Fuse	Colour	Pack Type	EAN	Box Qty
<b>UK STOCKED</b>							
SRPTU102PB	10 Socket	2m	13A	Black	Printed Box	5015056513072	5
SRPTU122PB	12 Socket	2m	13A	Black	Printed Box	5015056513089	5

## KEY FEATURES

Power switch

Two USB ports  
(2.1A shared)

Telecom ports

LED power  
and surge  
indicators

Safety shuttered  
sockets

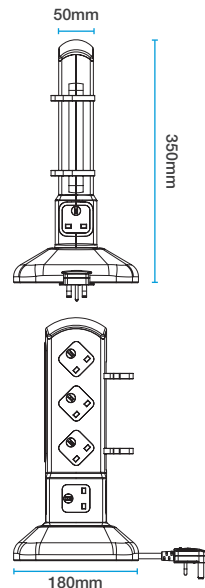



# HIGH GLOSS USB & TELECOM COMPACT EXTENSION LEAD

- Compact design
- Plug eight items safely into one socket
- Premium high gloss black or white finish
- Unlimited value, 3 year connected equipment warranty
- One metre of cable
- Protects valuable electrical equipment from surges and spikes
- Telecom protection further protects your equipment from damaging surge or spikes via broadband, ISDN or modem connections
- Manufactured to BS5733, BS1363-2, BS EN 61643-11 and BS EN 60950-1



Part No.	Description	Cable Length	Fuse	Colour	Pack Type	EAN	Box Qty
<b>UK STOCKED</b>							
SRPTU81PB2	8 Socket	1m	13A	Black	Printed Box	5015056539096	5
SRPTU81PW2	8 Socket	1m	13A	White	Printed Box	5015056539089	5

### KEY FEATURES

- Wall-fixing capability
- LED power indicator
- Power switch
- LED surge indicator
- Safety shuttered sockets
- Two USB ports (2.1A shared)
- Telecom ports

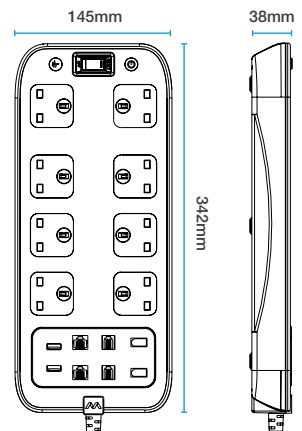

# HIGH GLOSS USB SURGE ADAPTOR

- Plug-through design means no loss of socket space
- Premium high gloss black or white finish
- Unlimited value, 3 year connected equipment warranty
- Protects valuable electrical equipment from surges and spikes
- Manufactured to BS5733, BS EN 60950, BS EN 61643-11 and BS1363-3



Part No.	Description	Cable Length	Fuse	Colour	Pack Type	EAN	Box Qty
<b>UK STOCKED</b>							
SRGAUSBPB2	USB Surge adaptor	N/A		Black	Printed box	5015056539010	6
SRGAUSBPW2	USB Surge adaptor	N/A		White	Printed box	5015056539003	6

## KEY FEATURES

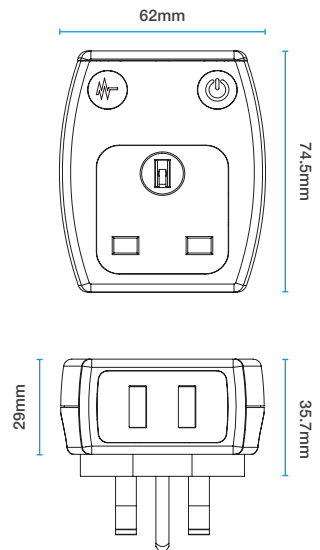
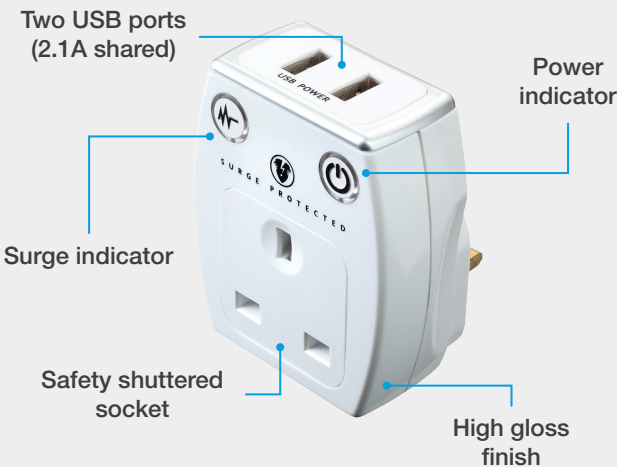

# HIGH GLOSS USB CHARGER PLUG

- One USB port (2.1A) for charging portable devices
- Premium high gloss black or white finish
- Manufactured to BS5733, BS EN 60950, BS1363-3

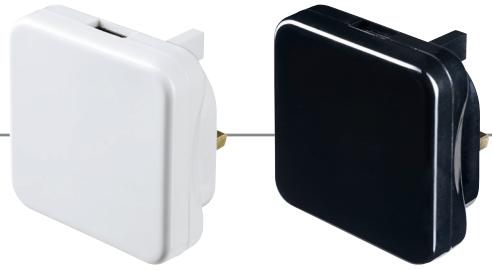

### KEY FEATURES

- USB port (2.1A)
- High gloss finish
- Slimline design

Part No.	Description	Cable Length	Fuse	Colour	Pack Type	EAN	Box Qty
<b>UK STOCKED</b>							
USBPLGB2	USB Charger plug	N/A		Black	Eco-B blister	5015056538990	10
USBPLGW2	USB Charger plug	N/A		White	Eco-B blister	5015056538983	10

## USBBeautiful

Free your sockets and charge all your devices

**FITS 25MM BOX**

2.1A CHARGE SHARED

3.1A CHARGE SHARED

4.2A CHARGE SHARED

Single or double sockets

**SMART USB**

## USB ACCESSORIES

We have an extended range of USB products available for FOB customers, including Apple charger leads, power packs, car chargers and USB sockets.



\*Subject to MOQ and lead time constraints



# WORK POWER



A range of heavy duty leads, reels and accessories, ideal for DIY and light industrial use



HEAVY DUTY PLUGS



TRAILING SOCKETS



INLINE CONNECTORS



HEAVY DUTY LEADS



CASSETTE REELS



CASE & CABLE REELS



SITE POWER

# HEAVY DUTY PLUG

- Heavy duty construction
- Supplied with 13A fuse
- Ideal for heavy duty power applications
- Manufactured to BS1363-A



Part No.	Description	Cable Length	Fuse	Colour	Pack Type	EAN	Box Qty
UK STOCKED							
HDPT13B	Heavy Duty Rewireable Plug	N/A	13A	Black	Bulk Pack	N/A	100
HDPT13O	Heavy Duty Rewireable Plug	N/A	13A	Orange	Bulk Pack	N/A	100
HDPT13W	Heavy Duty Rewireable Plug	N/A	13A	White	Bulk Pack	N/A	100

## KEY FEATURES

Impact resistant, strain relief and sleeved pins



Rewireable

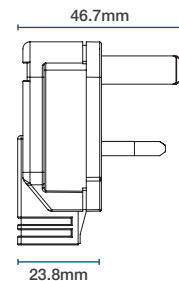
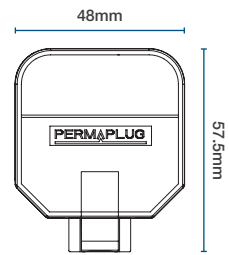

# HEAVY DUTY ROUND PIN PLUG

- Round pin plug
- Heavy duty construction
- Ideal for heavy duty power applications
- Manufactured to BS546



Part No.	Description	Cable Length	Fuse	Colour	Pack Type	EAN	Box Qty
UK STOCKED							
HDPT15B	Heavy Duty Round Pin Plug	N/A	15A	Black	Bulk Pack	N/A	100

## KEY FEATURES

Impact resistant, strain relief and sleeved pins



Rewireable

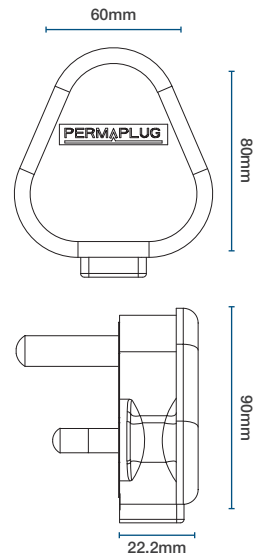

# TRAILING SINGLE SOCKET

- Heavy duty construction
- Ideal for use with power tools and portable lighting
- Manufactured to BS1363-2



Part No.	Description	Cable Length	Fuse	Colour	Pack Type	EAN	Box Qty
<b>UK STOCKED</b>							
ELS13B	Heavy Duty Trailing Single Socket	N/A	13A	Black	Bulk Pack	N/A	100
ELS13O	Heavy Duty Trailing Single Socket	N/A	13A	Orange	Bulk Pack	N/A	100
ELS13W	Heavy Duty Trailing Single Socket	N/A	13A	White	Bulk Pack	N/A	100

## KEY FEATURES

Rewireable



Single socket for connecting devices

Industrial grade plastic

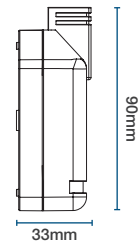
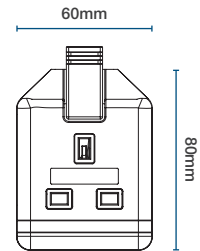

# ROUND PIN TRAILING SINGLE SOCKET



- Round pin trailing socket
- Heavy duty construction
- Ideal for use with power tools and portable lighting
- 5A and 15A options
- Manufactured to BS546



Part No.	Description	Cable Length	Fuse	Colour	Pack Type	EAN	Box Qty
<b>UK STOCKED</b>							
ELS5B	Heavy Duty Round Pin Trailing Single Socket	N/A	5A	Black	Bulk Pack	N/A	100
ELS15B	Heavy Duty Round Pin Trailing Single Socket	N/A	15A	Black	Bulk Pack	N/A	100

## KEY FEATURES

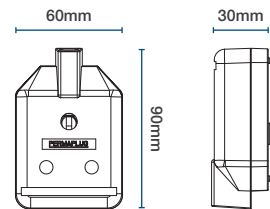
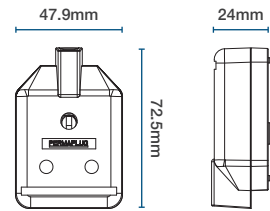
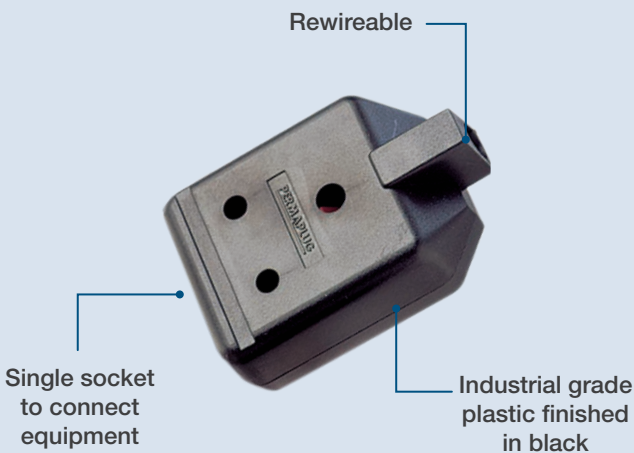



# TRAILING DOUBLE SOCKET

- Heavy duty construction
- Ideal for use with power tools and portable lighting
- Manufactured to BS1363-2



Part No.	Description	Cable Length	Fuse	Colour	Pack Type	EAN	Box Qty
<b>UK STOCKED</b>							
ELS132B	Heavy Duty Trailing 2 Socket	N/A	13A	Black	Bulk Pack	N/A	50
ELS132O	Heavy Duty Trailing 2 Socket	N/A	13A	Orange	Bulk Pack	N/A	50
ELS132W	Heavy Duty Trailing 2 Socket	N/A	13A	White	Bulk Pack	N/A	50

## KEY FEATURES

Industrial grade plastic available in three finishes



Rewireable

Two sockets for connecting equipment

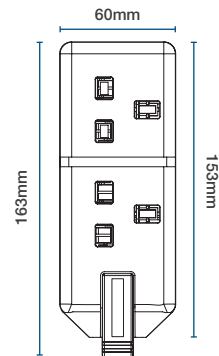

# TRAILING FOUR GANG SOCKET

- Heavy duty construction
- Ideal for use with power tools and portable lighting
- Manufactured to BS1363-2

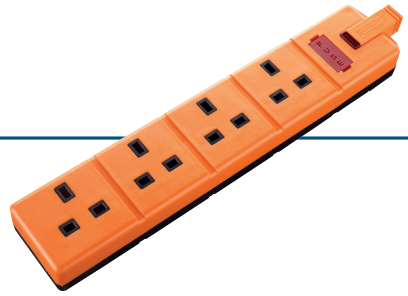

Part No.	Description	Cable Length	Fuse	Colour	Pack Type	EAN	Box Qty
<b>UK STOCKED</b>							
ELS134B	Heavy Duty Trailing 4 Socket with Power Indicator	N/A	13A	Black	Bulk Pack	N/A	25
ELS134O	Heavy Duty Trailing 4 Socket with Power Indicator	N/A	13A	Orange	Bulk Pack	N/A	25
ELS134W	Heavy Duty Trailing 4 Socket with Power Indicator	N/A	13A	White	Bulk Pack	N/A	25

## KEY FEATURES

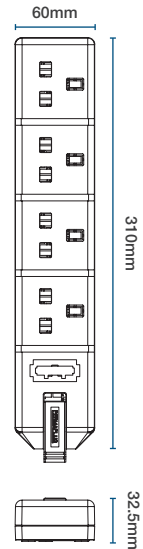
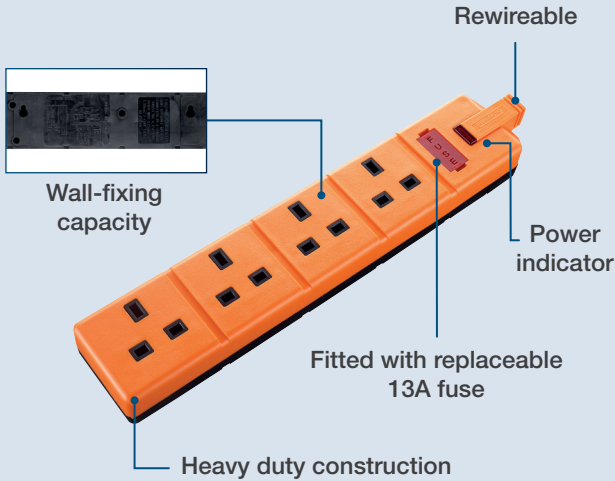

# HEAVY DUTY INLINE CONNECTOR

- Heavy duty construction
- Ideal for use with power tools and portable lighting
- Two pin reversible connection block
- Three pin non-reversible connection block
- Manufactured to BS5733



Part No.	Description	Cable Length	Fuse	Colour	Pack Type	EAN	Box Qty
<b>UK STOCKED</b>							
NC102B	Heavy Duty Inline 2 Pin Connector	N/A	10A	Black	Bulk Pack	N/A	100
NC102O	Heavy Duty Inline 2 Pin Connector	N/A	10A	Orange	Bulk Pack	N/A	100
NC103B	Heavy Duty Inline 3 Pin Connector	N/A	10A	Black	Bulk Pack	N/A	100
NC103W	Heavy Duty Inline 3 Pin Connector	N/A	10A	White	Bulk Pack	N/A	100

## KEY FEATURES

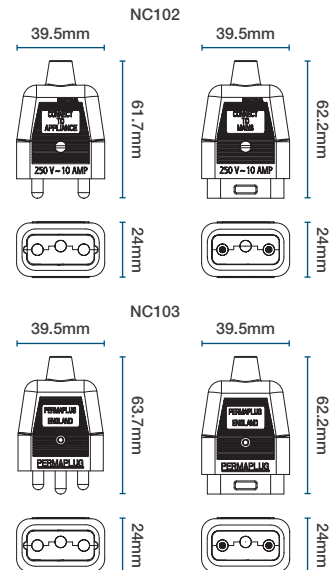

Half options are available on request, subject to terms and conditions

# SINGLE SOCKET HEAVY DUTY EXTENSION LEAD



- Heavy duty construction
- Ideal for use with power tools and portable lighting
- Black, orange or white finish
- Manufactured to BS1363-2



Part No.	Description	Cable Length	Fuse	Colour	Pack Type	EAN	Box Qty
UK STOCKED							
EXS1315B	1 Socket Heavy Duty Extension Lead	5m	13A	Black	Hanging Polybag	5015056356402	10
EXS1315O	1 Socket Heavy Duty Extension Lead	5m	13A	Orange	Hanging Polybag	5015056356426	10
EXS1315W	1 Socket Heavy Duty Extension Lead	5m	13A	White	Hanging Polybag	5015056356440	10
EXS13110B	1 Socket Heavy Duty Extension Lead	10m	13A	Black	Hanging Polybag	5015056356464	10
EXS13110O	1 Socket Heavy Duty Extension Lead	10m	13A	Orange	Hanging Polybag	5015056356488	10
EXS13110W	1 Socket Heavy Duty Extension Lead	10m	13A	White	Hanging Polybag	5015056356501	10

## KEY FEATURES

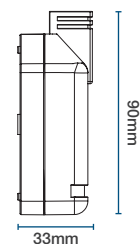
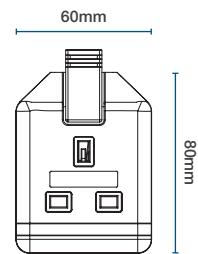
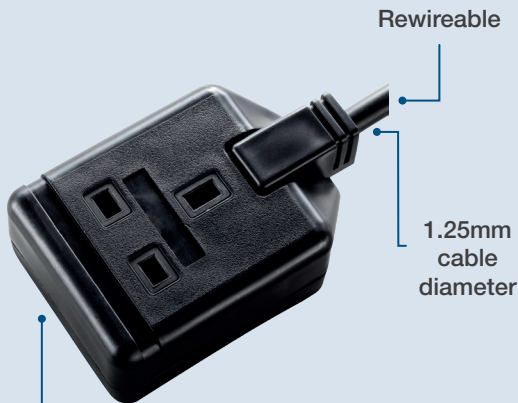

# DOUBLE SOCKET HEAVY DUTY EXTENSION LEAD

- Heavy duty construction
- Ideal for use with power tools and portable lighting
- Black, orange or white finish
- Manufactured to BS1363-2



Part No.	Description	Cable Length	Fuse	Colour	Pack Type	EAN	Box Qty
<b>UK STOCKED</b>							
EXS1324B	2 Socket Heavy Duty Extension Lead	4m	13A	Black	Hanging Polybag	5015056356587	10
EXS1324O	2 Socket Heavy Duty Extension Lead	4m	13A	Orange	Hanging Polybag	5015056356600	10
EXS1324W	2 Socket Heavy Duty Extension Lead	4m	13A	White	Hanging Polybag	5015056356624	10

## KEY FEATURES

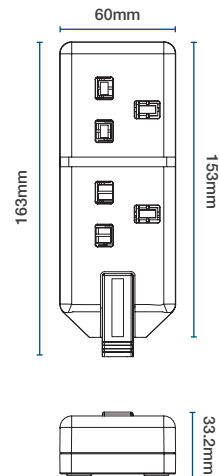
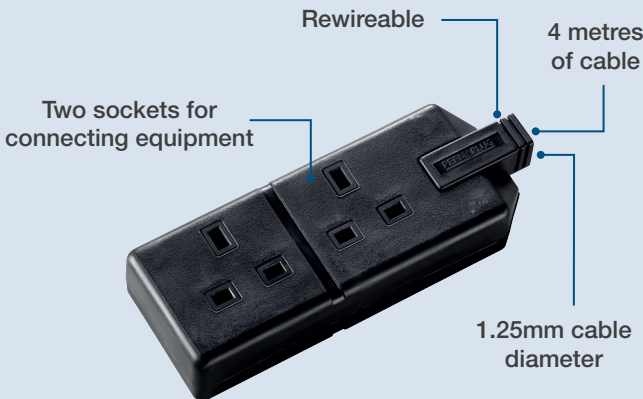

# FOUR SOCKET HEAVY DUTY EXTENSION LEAD

- Heavy duty construction
- Ideal for use with power tools and portable lighting
- Black, orange or white finish
- Manufactured to BS1363-2

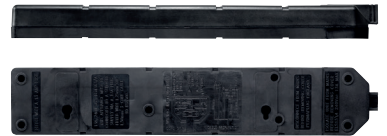
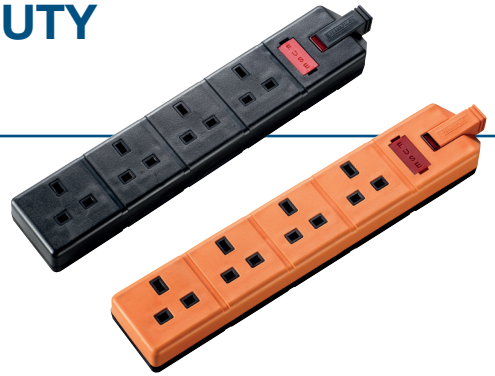

Part No.	Description	Cable Length	Fuse	Colour	Pack Type	EAN	Box Qty
UK STOCKED							
EXS1342B	4 Socket Heavy Duty Extension Lead	2m	13A	Black	Hanging Polybag	5015056356648	10
EXS1342O	4 Socket Heavy Duty Extension Lead	2m	13A	Orange	Hanging Polybag	5015056356662	10
EXS1342W	4 Socket Heavy Duty Extension Lead	2m	13A	White	Hanging Polybag	5015056356686	10
EXS1344B	4 Socket Heavy Duty Extension Lead	4m	13A	Black	Hanging Polybag	5015056357195	10
EXS1344O	4 Socket Heavy Duty Extension Lead	4m	13A	Orange	Hanging Polybag	5015056362311	10
EXS1344W	4 Socket Heavy Duty Extension Lead	4m	13A	White	Hanging Polybag	5015056357317	10

## KEY FEATURES

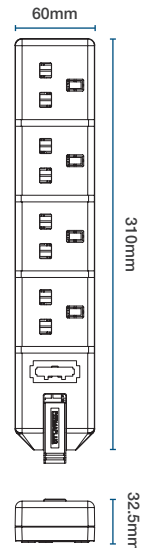
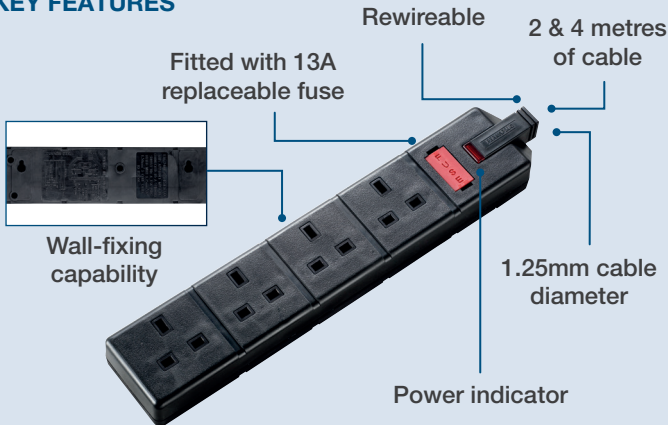

# SMALL CASSETTE REEL

- Ideal for domestic use and DIY
- Thermal cut-out prevents risk of fire due to temperature rise caused by power overload
- Easy hold rear grip
- Manufactured to BS EN 61242



Part No.	Description	Cable Length	Fuse	Colour	Pack Type	EAN	Box Qty
UK STOCKED							
SCT0510/4BL	4 Socket Small Cassette Reel	5m	10A	Blue	Barcode label + 10A warning label	5015056368566	5

## KEY FEATURES

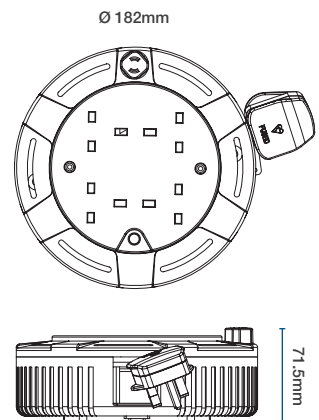

# MEDIUM CASSETTE REEL

- Ideal for domestic use and DIY
- Thermal cut-out prevents risk of fire due to temperature rise caused by power overload
- Easy hold rear grip
- Manufactured to BS EN 61242



Part No.	Description	Cable Length	Fuse	Colour	Pack Type	EAN	Box Qty
UK STOCKED							
MCT0813/4BL	4 Socket Medium Cassette Reel	8m	13A	Blue	13A warning label	5015056360768	10
MCT1010/4BL	4 Socket Medium Cassette Reel	10m	10A	Blue	Barcode label + 10A warning label	5015056354125	10

## KEY FEATURES

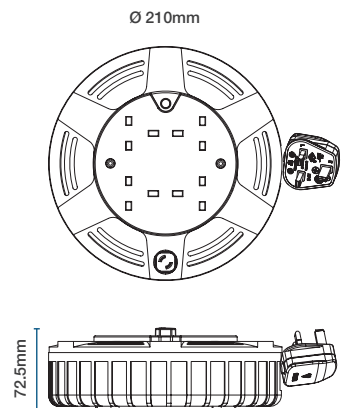



# LARGE CASSETTE REEL

- Ideal for domestic use and DIY
- Thermal cut-out prevents risk of fire due to temperature rise caused by power overload
- Easy hold rear grip
- Manufactured to BS EN 61242



Part No.	Description	Cable Length	Fuse	Colour	Pack Type	EAN	Box Qty
<b>UK STOCKED</b>							
LCT1213/4BL	4 Socket Large Cassette Reel	12m	13A	Blue	Barcode label + 13A warning label	5015056360751	10
LCT1510/4BL	4 Socket Large Cassette Reel	15m	10A	Blue	Barcode label + 10A warning label	5015056360775	10

## KEY FEATURES

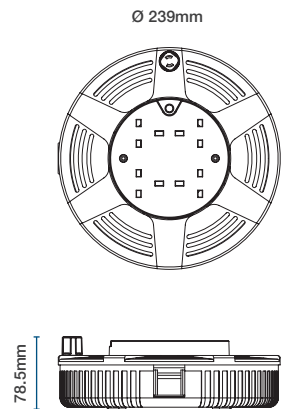

# SMALL CASE REEL

- Robust design, ideal for home, DIY and light commercial use
- Thermal cut-out prevents risk of fire due to temperature rise caused by power overload
- Manufactured to BS EN 61242



Part No.	Description	Cable Length	Fuse	Colour	Pack Type	EAN	Box Qty
UK STOCKED							
HST1513/4BL	4 Socket Case Reel	15m	13A	Blue	Barcode label + 13A warning label	5015056573083	3

## KEY FEATURES

Carry handle for easy transportation

Four sockets for connecting equipment

15 metres of cable

Thermal cut-out protection

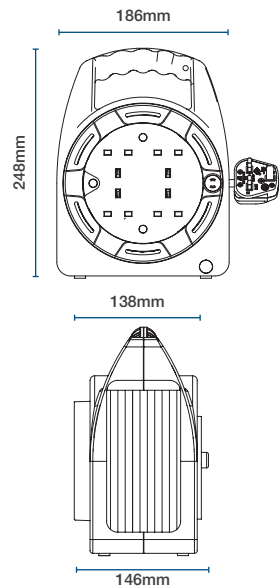

# LARGE CASE REEL

- Robust design, ideal for home, DIY and light commercial use
- Thermal cut-out prevents risk of fire due to temperature rise caused by power overload
- RCD Plug for added protection against fatal electric shocks
- Manufactured to BS EN 61242



Part No.	Description	Cable Length	Fuse	Colour	Pack Type	EAN	Box Qty
<b>UK STOCKED</b>							
HBT2013/4BL	4 Socket Case Reel	20m	13A	Blue	Barcode label + 13A warning label	5015056360782	6
HBT2013/4BLRCD	4 Socket Case Reel with RCD	20m	13A	Blue	Barcode label + 13A warning label	5015056380179	6

## KEY FEATURES

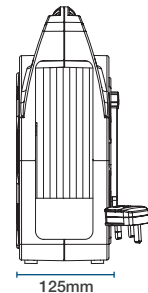
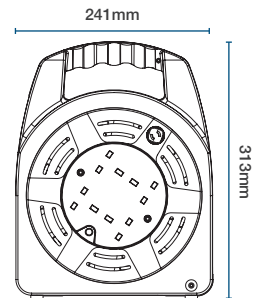

# MEDIUM OPEN REEL

- Robust design, ideal for home, DIY and light commercial use
- Thermal cut-out prevents risk of fire due to temperature rise caused by power overload
- Manufactured to BS EN 61242



Part No.	Description	Cable Length	Fuse	Colour	Pack Type	EAN	Box Qty
<b>UK STOCKED</b>							
LDCC2513/4BL	4 Socket Open Medium Cable Reel	25m	13A	Blue	Barcode label + 13A warning label	5015056355740	1
LDCC2513/4BLRCD	4 Socket Open Medium Cable Reel with RCD	25m	13A	Blue	Barcode label + 13A warning label	5015056356358	1
LDCC3013/4BL	4 Socket Open Medium Cable Reel	30m	13A	Blue	Barcode label + 13A warning label	5015056361024	1

## KEY FEATURES

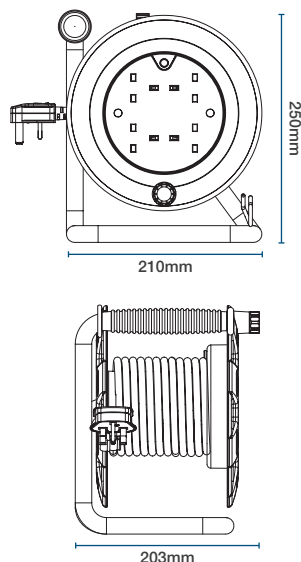

# LARGE OPEN REEL

- Robust design, ideal for home, DIY and light commercial use
- Thermal cut-out prevents risk of fire due to temperature rise caused by power overload
- Manufactured to BS EN 61242

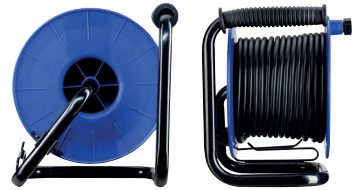

Part No.	Description	Cable Length	Fuse	Colour	Pack Type	EAN	Box Qty
<b>UK STOCKED</b>							
HDOC5013/4BL	4 Socket Open Large Cable Reel	50m	13A	Blue	Brown Box	5015056356327	1

## KEY FEATURES

Drum wind handle for retracting the cable after use

Thermal cut-out protection

Strong steel frame

Carry handle for easy transportation

Four sockets for connecting equipment

50 metres of cable

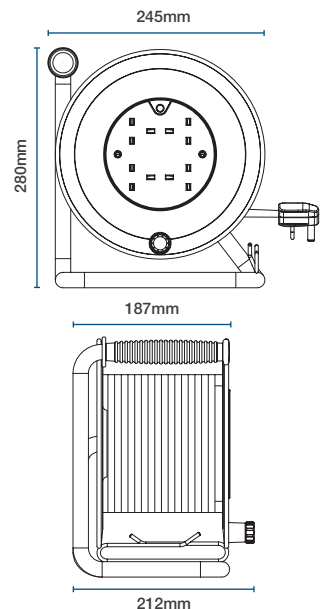

# 110V SITE POWER 2 SOCKET CABLE REEL

- Robust design, ideal for home, DIY and light commercial use
- Fitted with 1.5mm<sup>2</sup> 16A yellow cable
- Thermal cut-out prevents risk of fire due to temperature rise caused by power overload
- Manufactured to BS EN 61242 and BS EN 60309



Part No.	Description	Cable Length	Fuse	Colour	Pack Type	EAN	Box Qty
<b>UK STOCKED</b>							
LVCT2516/2	2 Socket 110V Cable Reel 25M	25m	16A	Yellow	Barcode label + 16A warning label	5015056354146	1
LVCT5016/2	2 Socket 110V Cable Reel 50M	50m	16A	Yellow	Barcode label + 16A warning label	5015056351568	1

## KEY FEATURES

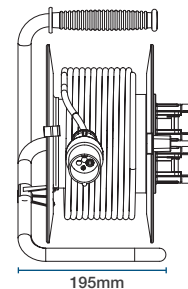
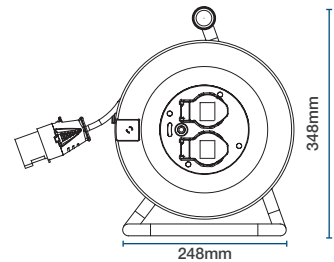
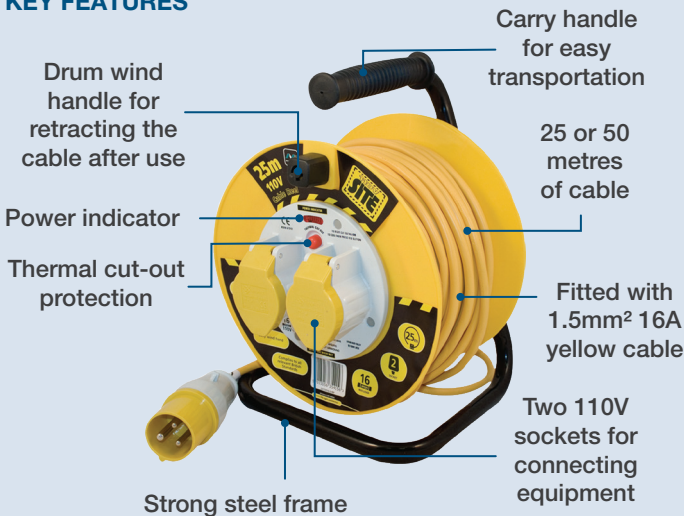

Larger 110V range is available upon request, subject to terms and conditions

# 110V SITE POWER 2 SOCKET CASE REEL

- Robust industrial grade plastic housing
- Fitted with 1.5mm<sup>2</sup> 16A yellow cable
- Thermal cut-out prevents risk of fire due to temperature rise caused by power overload
- Manufactured to BS EN 61242 and BS EN 60309



Part No.	Description	Cable Length	Fuse	Colour	Pack Type	EAN	Box Qty
<b>UK STOCKED</b>							
LVHLT2516/2	2 Socket 110V Case Reel	25m	16A	Yellow	Barcode label + warning label	5015056385358	1

## KEY FEATURES

Drum wind handle for retracting the cable after use

Power indicator

Thermal cut-out protection

Two 110V sockets for connecting equipment



Carry handle for easy transportation

25 metres of cable

Fitted with 1.5mm<sup>2</sup> 16A yellow cable

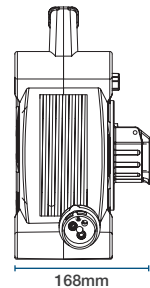
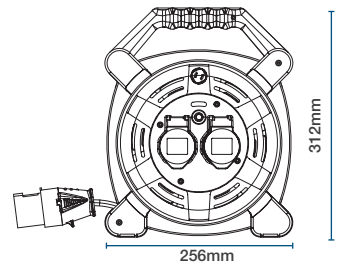

Larger 110V range is available upon request, subject to terms and conditions

# 110V SITE POWER INLINE EXTENSION LEAD



- Inline 110V extension lead
- Sturdy cable tidy with handle for easy transportation
- Highly visible yellow coloured cable
- Ideal for site use



Part No.	Description	Cable Length	Fuse	Colour	Pack Type	EAN	Box Qty
<b>UK STOCKED</b>							
LVIL15	Inline 110V Extension Lead with Cable Tidy	15m	-	Yellow	Card wrap	5015056393155	4

## KEY FEATURES

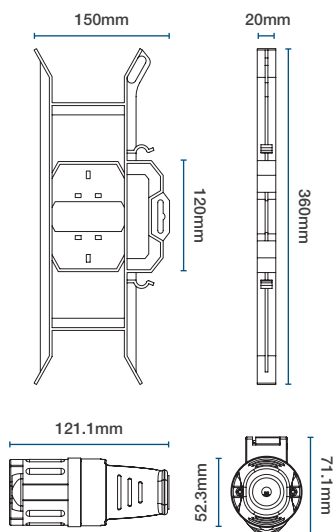
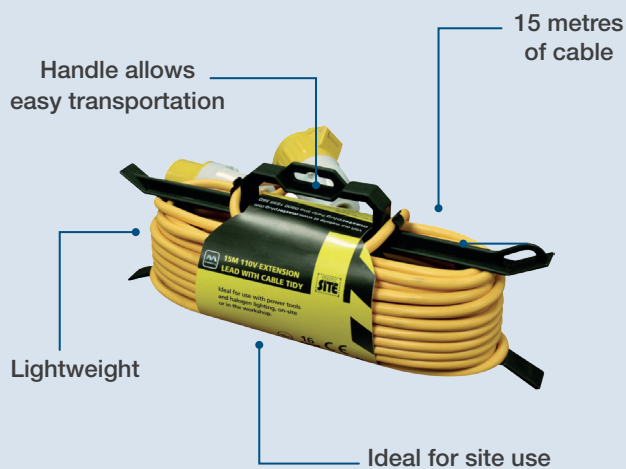

Larger 110V range is available upon request, subject to terms and conditions



# 110V SITE POWER OPTIONS

A larger 110V range, including plugs, adaptors, transformers and lighting, is available on request, subject to MOQ and lead time constraints.



**PRO-XT METAL 110V CABLE REEL**



SEE PAGE 82 FOR MORE DETAILS





# PRO-XT POWER



The professional's choice  
for Portable Power



CASSETTE REEL



CASE REEL



OPEN REEL



REVERSE REEL



ANTI-TWIST



ACCESSORIES



# PRO-XT

Pro-XT is the professional's choice for Portable Power. Developed as the first globally viable portable power offer for trade, Pro-XT delivers a new level of performance and innovation. The Pro-XT brand recognises the true requirements of trade, providing reliability, choice and value for end users.



## Five Year Warranty

Masterplug offers a five year warranty on its Pro-XT cable reels.

This warranty is an acknowledgement that Masterplug will repair or replace the reel if a fault appears within five years of purchase.

## Key Features

- Robust construction
- Guaranteed reliability
- Unique functional design
- Engineered versatility



# FEATURES & BENEFITS

## ERGONOMIC HANDLE GRIP

A two-tone superior handle grip, for comfort and longevity.

## PULL-OUT, DRUM WIND HANDLE

Quickly wind in the cable at the end of each use.

## LOCALISED POWER SWITCH

Control the power where you are working.

## INTEGRATED CABLE GUIDE

Cable guide reduces tangle and speeds up winding in.



## THERMAL CUT-OUT

Prevents cable overheating when fully reeled, and allows you to reset if cut-out occurs.



## HIGH VISIBILITY CABLE

High visibility ensures against tripping hazard and cable cut through.



## POWER LED INDICATOR

LED indicator shows that power is live.



## ROBUST BUILD

Designed and engineered for durability and longevity.



## SPEED WIND HANDLE

Increased speed and control when winding in long lengths of cable from ground level or mounted anchor point.



## WALL MOUNT ACCESSORY

Wall hanging brackets available for extra stability or easy storage.



## USB CHARGING

Optional USB ports allow charging of mobile devices whilst working, keeping power tools connected.

# CASSETTE REEL



A portable solution for use in heavy duty applications, delivering up to 10m of power cable extension.

- Easy wind handle and rear grip
- Ergonomically designed
- Integrated power switch
- Optimised design for increased cable capacity



**THERMAL CUT OUT**

**HIGH VIS**

**LED INDICATOR**

**ROBUST BUILD**

**10m**

**13 amps**

**4 SOCKETS**

**5 YEAR WARRANTY**



Cat No.	Description	Socket	Size	Cable Length	Plug	Barcode	Box Qty
<b>UK STOCKED</b>							
CMU10134SL	10M Cassette Reel	4 Sockets, Switch + LED	S	10m	13A Fused	5015056526577	5

NOTE - Additional options available on page 16-19

## LINE DIAGRAMS

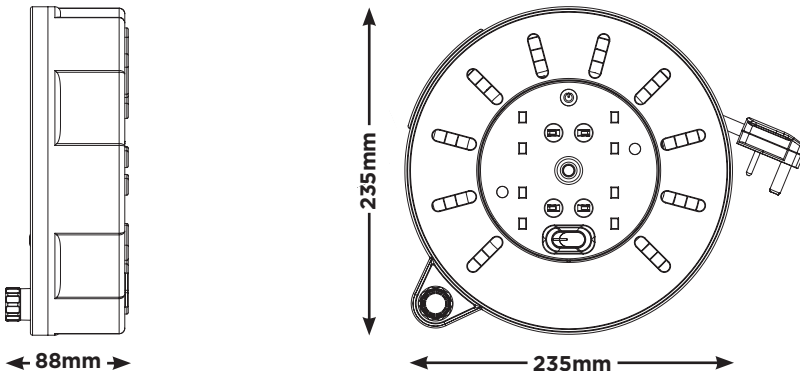

# CASE REEL



A compact, sturdy solution for use in heavy duty applications.

- Optimised design for ease of use and storage
- Easy wind handle and rear grip
- Ergonomically designed
- Integrated power switch



**THERMAL CUT OUT**

**HIGH VIS**

**LED INDICATOR**

**ROBUST BUILD**

**15m**

**13 amps**

**4 SOCKETS**

**5 YEAR WARRANTY**



Cat No.	Description	Socket	Size	Cable Length	Plug	Barcode	Box Qty
<b>UK STOCKED</b>							
HMU15134SL	15M Case Reel	4 Sockets, Switch + LED	M	15m	13A Fused	5015056526560	3

NOTE - Additional options available on page 16-19

## LINE DIAGRAMS

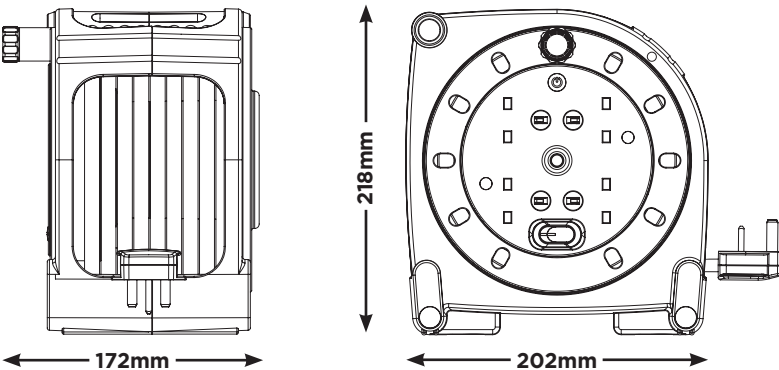

# MEDIUM OPEN REEL



Lightweight and sturdy, this portable open reel, with 25 metres of cable is designed for heavy duty applications.

- Optimised design for ease of use and storage
- Easy wind handle
- Two-tone, ergonomic carry handle
- Integrated power switch
- Built-in cable guide
- Compatible with wall mount bracket

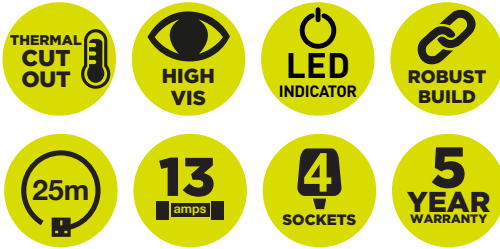

Cat No.	Description	Socket	Size	Cable Length	Plug	Barcode	Box Qty
UK STOCKED							
OMU25134SL	25M Open Reel	4 Sockets, Switch + LED	L	25m	13A Fused	5015056526546	2

NOTE - Additional options available on page 16-19

## LINE DIAGRAMS

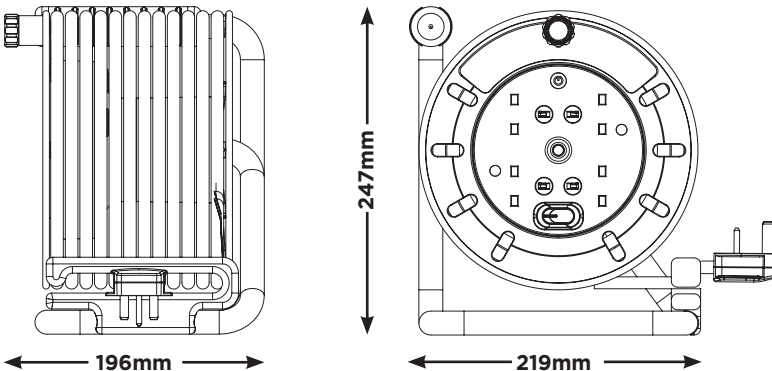

# LARGE OPEN REEL

**XL**

An extra large, robust reel with 50 metres of cable, suitable for all heavy duty applications.

- Optimised design for ease of use and storage
- Easy wind handle
- Two-tone, ergonomic carry handle
- Integrated power switch
- Built-in cable guide
- Compatible with wall mount bracket



**THERMAL CUT OUT**

**HIGH VIS**

**LED INDICATOR**

**ROBUST BUILD**

**50m**

**13 amps**

**4 SOCKETS**

**5 YEAR WARRANTY**



Cat No.	Description	Socket	Size	Cable Length	Plug	Barcode	Box Qty
<b>UK STOCKED</b>							
OLU50134SL	50M Open Reel	4 Sockets, Switch + LED	XL	50m	13A Fused	5015056526539	1

NOTE - Additional options available on page 16-19

## LINE DIAGRAMS

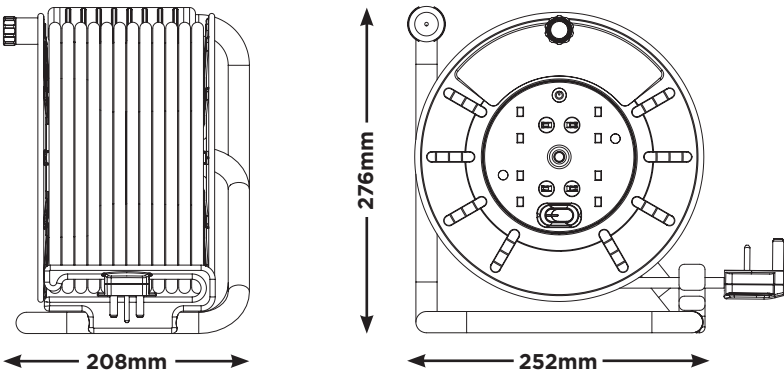



# METAL OPEN REEL



A metal drum provides additional security for the most heavy duty tasks. Designed and engineered for longevity with up to 40 metres of high vis cable.

- Optimised design for ease of use and storage
- Heavy duty steel drum
- Two-tone, ergonomic carry handle
- Integrated power switch
- Built-in cable guide
- Compatible with wall mount bracket



**THERMAL CUT OUT**

**HIGH VIS**

**LED INDICATOR**

**ROBUST BUILD**

**40m**

**13**  
  
**amps**

**4**  
  
**SOCKETS**

**5**  
  
**YEAR WARRANTY**



Cat No.	Description	Socket	Size	Cable Length	Plug	Barcode	Box Qty
<b>UK STOCKED</b>							
OTLU40134SL	40M Metal Open Reel	4 Sockets, Switch + LED	XL	40m	13A Fused	5015056526522	1

NOTE - Additional options available on page 16-19

## LINE DIAGRAMS

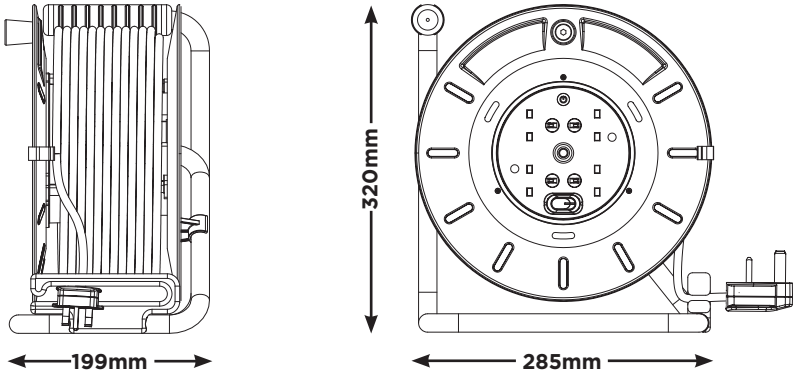

# 110V METAL OPEN REEL



**110V power cable reel, heavy duty metal drum, engineered for use on-site.**

- Heavy duty steel drum
- Weatherproof (IP44 rated) socket covers
- Two-tone, ergonomic carry handle
- Built-in cable guide



**THERMAL CUT OUT**

**HIGH VIS**

**LED INDICATOR**

**ROBUST BUILD**

**30m**

**16 amps**

**2 SOCKETS**

**5 YEAR WARRANTY**



Cat No.	Description	Socket	Size	Cable Length	Plug	Barcode	Box Qty
<b>UK STOCKED</b>							
OTMU30162LV	110V Metal Open Reel	2 Sockets + LED	L	30m	16A 2P+E	55015056538624	1

**NOTE - Additional options available on page 16-19**

## LINE DIAGRAMS

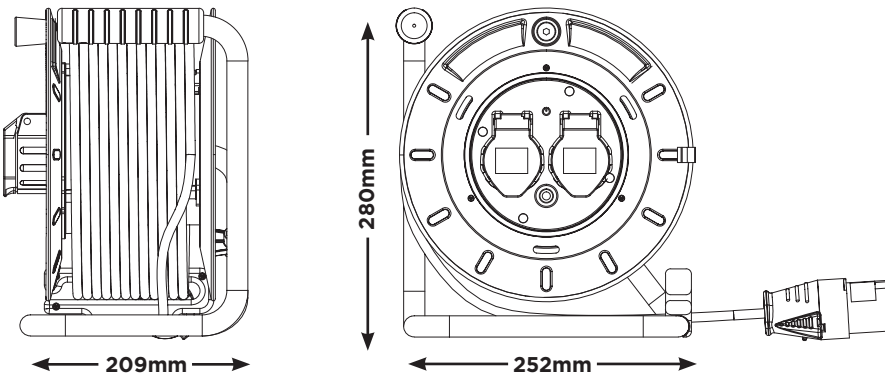

# IP RATED REVERSE REEL WITH PULL OUT SOCKET



A reverse cable reel where the socket is pulled away to the point of use providing versatility and power where you need it.

- Easy wind handle
- Two-tone, ergonomic carry handle
- Built-in cable guide
- Compatible with wall mount bracket
- IP rated weatherproof socket



**THERMAL CUT OUT**

**HIGH VIS**

**LED INDICATOR**

**ROBUST BUILD**

**25m +3m**

**13 amps**

**IP54**

**5 YEAR WARRANTY**

Cat No.	Description	Socket	Size	Cable Length	Plug	Barcode	Box Qty
<b>UK STOCKED</b>							
OMU2513FL3IP	Reverse Reel With Pull Out Socket	1 IP54 Socket + LED	L	25m + 3m	13A Fused	5015056526553	1

NOTE - Additional options available on page 16-19

## LINE DIAGRAMS

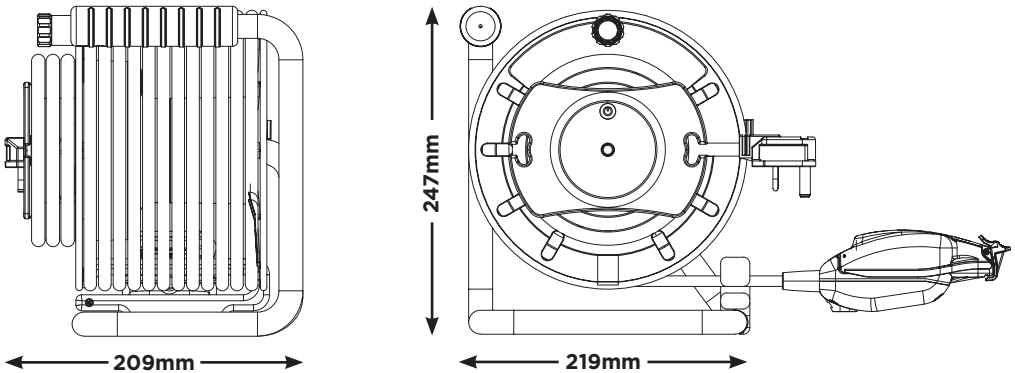

# ANTI-TWIST REVERSE REEL



Innovative reverse reel with pull out socket and anti-twist design that keeps cables from getting tangled.

- Fold-out speed wind handle
- Supplied with wall mount bracket
- IP rated weatherproof socket
- IP rated socket ideal for use with pressure washers and in damp conditions



THERMAL CUT OUT	HIGH VIS	LED INDICATOR	ROBUST BUILD
30m + 3m	13 amps	IP54	5 YEAR WARRANTY

Cat No.	Description	Socket	Size	Cable Length	Plug	Barcode	Box Qty
UK STOCKED							
OATRU3013FL3IP	Anti-Twist Reverse Reel	1 IP54 Socket, + LED	M	30m + 3m	13A Fused	5015056538952	1

NOTE - Additional options available on page 16-19

## LINE DIAGRAMS

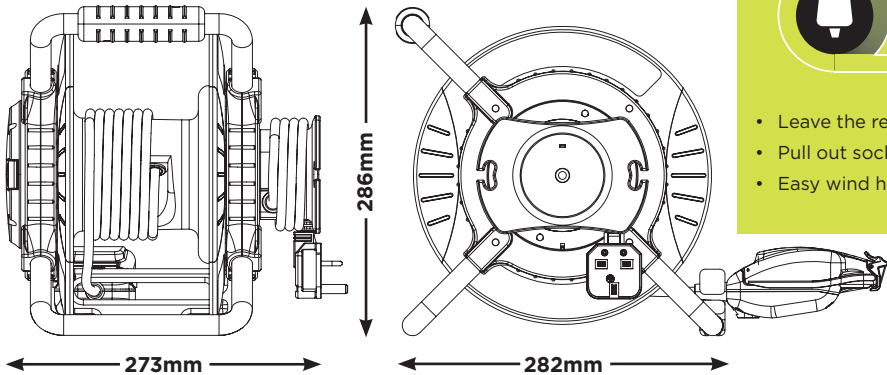

# ANTI-TWIST FIXED SOCKET



This robust cable reel has a fixed anti twist socket which prevents connected plugs and sockets from tangling.

- Fold-out speed wind handle
- Integrated power switch
- Compatible with wall mount bracket



**THERMAL CUT OUT**

**HIGH VIS**

**LED INDICATOR**

**ROBUST BUILD**

**30m**

**13 amps**

**4 SOCKETS**

**5 YEAR WARRANTY**



Cat No.	Description	Socket	Size	Cable Length	Plug	Barcode	Box Qty
<b>UK STOCKED</b>							
OATFU30134SL	Anti-Twist Fixed Socket	4 Sockets, Switch + LED	M	30m	13A Fused	5015056538945	1

NOTE - Additional options available on page 16-19

## LINE DIAGRAMS

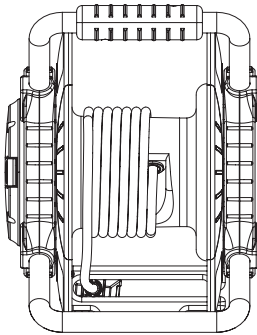

222mm

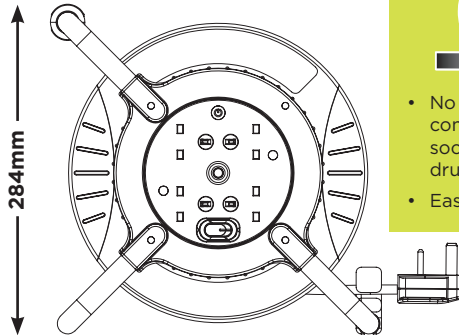

284mm  
282mm

- No tangling of connected cables, sockets stay fixed as drum rotates
- Easy wind handle

# OPEN REEL WITH USB CHARGING



Light weight open reel with two USB ports for charging mobile devices whilst working.

- Two USB ports (2.1A shared)
- Easy wind handle
- Two-tone, ergonomic carry handle
- Built-in cable guide
- Integrated power switch



**THERMAL CUT OUT**

**HIGH VIS**

**LED INDICATOR**

**ROBUST BUILD**

**25m**

**13 amps**

**2 SOCKETS**

**5 YEAR WARRANTY**

**2 USB SOCKETS**

Cat No.	Description	Socket	Size	Cable Length	Plug	Barcode	Box Qty
<b>UK STOCKED</b>							
OMU25132USL	Open Reel With USB Charging	2 Sockets, Switched + USB	M	25m	13A Fused	5015056560366	2

NOTE - Additional options available on page 16-19

## LINE DIAGRAMS

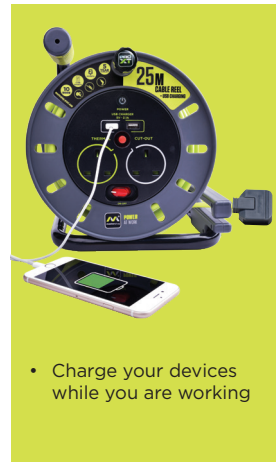
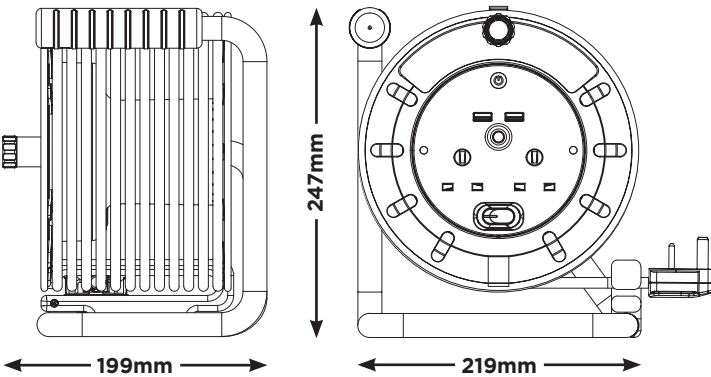

- Charge your devices while you are working

# ACCESSORIES



## CABLE TIDY

This wall mounted cable storage solution ensures loose extension leads are kept neat and tidy, as well as making them easy to transport.

- Two tone, ergonomic carry handle
- Home, garden and light commercial use



Keyhole wall fixings

## WALL HANGING BRACKET

This simple accessory allows you to store your cable reel neatly on the wall when not required or provides a convenient anchor point when in use.

Ideal for use with “Reverse Reel” - pull out the socket and leave the reel behind.

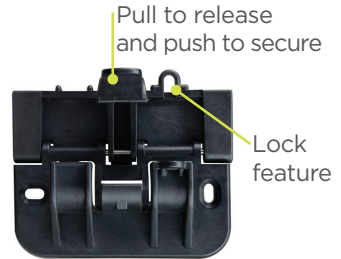

## 3 STEP INSTALLATION



**1** Secure bracket to wall



**2** Place cable reel within bracket



**3** Secure cable reel

Cat No.	Description	Size	Barcode	Box Qty
<b>UK STOCKED</b>				
CHT	Cable Tidy	A	5015056531656	10
OWHB	Wall Hanging Bracket	A	5015056531700	10

# RANGE EXTENSIONS

A

## CABLE REELS

The modular design of Pro-XT cable reels allows for multiple options in configuration. Pro-XT has been designed to deliver the bespoke requirements of trade.

### FRONT PLATE OPTIONS:

- Country specific sockets
- USB charger
- 110V sockets
- Reverse reel with pull out sockets
- Anti-twist reverse reel sockets
- Anti-twist fixed sockets

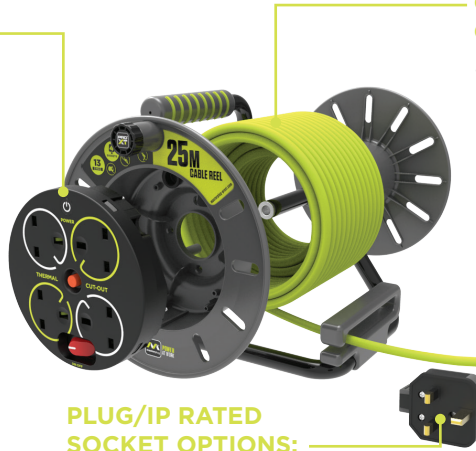

### CABLE OPTIONS:

- PVC or rubber in various diameters and lengths

### PLUG/IP RATED SOCKET OPTIONS:

- Country specific plugs
- RCD plug - available as part of the Pro-XT range
- Weatherproof socket



## COMBINATION POSSIBILITIES



Metal Open Reel with USB



Reverse Case Reel



110V Plastic Open Reel



Blue Plastic Open Reel



# RANGE EXTENSIONS



## EXTENSION LEAD

- Heavy duty extension leads are available as part of the Pro-XT range
- 1, 2 and 4 gang options
- Additional weatherproof IP54 in-line socket options
- Power indicator and replaceable fuse on the 4 gang unit
- Available with cable tidy option

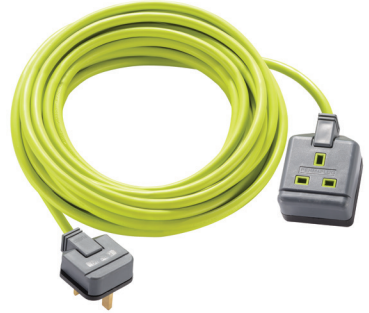

## NOTE:

Range extensions are available upon request from your sales manager, subject to MOQ and lead time constraints.





# OUTDOOR POWER



Designed with outdoor activities in mind, this range provides safe power solutions for garden and light DIY use



**EXTENSION LEADS  
& ACCESSORIES**



**WEATHERPROOF**



**RCD PROTECTION**

# SINGLE SOCKET GARDEN EXTENSION LEAD WITH CABLE TIDY

- Easy to transport on cable tidy
- Ideal for garden use
- 13A fused plug
- Manufactured to BS1363-2



Part No.	Description	Cable Length	Fuse	Colour	Pack Type	EAN	Box Qty
UK STOCKED							
CT1513	Single Socket Garden Extension Lead with Cable Tidy	15m	13A	Orange/Black	Card Wrap	5015056091907	4

## KEY FEATURES

Handle allows easy transportation

15 metre orange cable

Heavy duty socket

Lightweight cable tidy

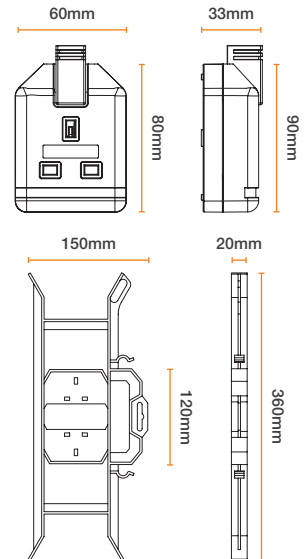

# HEAVY DUTY SINGLE SOCKET GARDEN EXTENSION LEAD

- Single socket extension lead
- 13A fused plug
- Maximum load 3120 Watts, 240V AC
- Manufactured to BS1363-2



Part No.	Description	Cable Length	Fuse	Colour	Pack Type	EAN	Box Qty
UK STOCKED							
BOG100	Heavy Duty Single Socket Garden Extension Lead	10m	13A	Orange/Black	Hanging Polybag	5015056506210	10

## KEY FEATURES

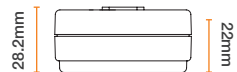
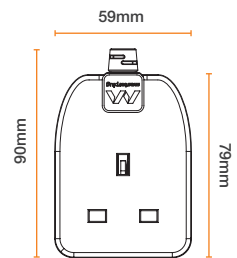

# CABLE TIDY



- Ideal for tidying loose extension leads and cables around the house and garage
- Stores up to 15 metres of 13A 1.25mm<sup>2</sup> or 20 metres of 10A 1.0mm<sup>2</sup> three core cable
- Strong and sturdy with carry handle and plug holders
- Flexible to suit all lengths of cable

Part No.	Description	Cable Length	Fuse	Colour	Pack Type	EAN	Box Qty
UK STOCKED							
CT100	Cable Tidy	N/A	N/A	Black	Card Wrap	5015056009117	10

## KEY FEATURES

Handle allows easy transportation

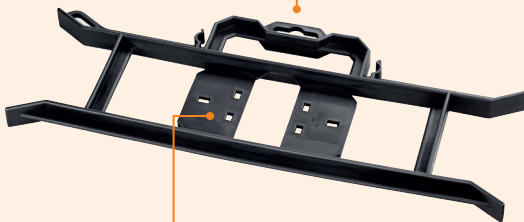

Plug holders

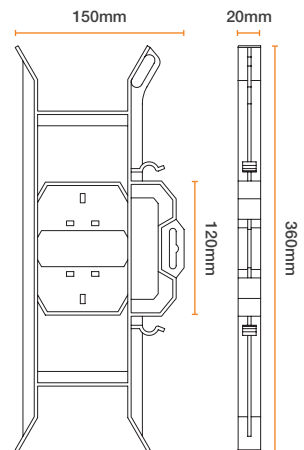

# SPLASHPROOF PLUG AND SOCKET COVER

- Splashproof socket cover
- Prevents accidental plug and socket detachment
- Suitable for use with garden and household power tools
- Reduced risk of electric shock
- Protects power connections



Part No.	Description	Cable Length	Fuse	Colour	Pack Type	EAN	Box Qty
 UK STOCKED							
SPTO	Splashproof Plug and One Gang Socket Cover	N/A	N/A	Orange	Card Wrap	5015056394459	10

## KEY FEATURES



Highly visible

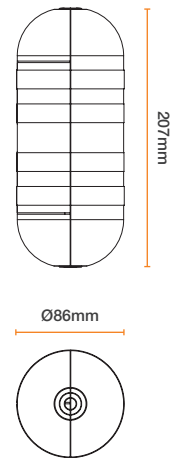

# WEATHERPROOF EXTENSION LEAD WITH CABLE TIDY

- Single socket extension lead
- Easy to transport on cable tidy
- Ideal for garden use
- Weatherproof socket – IP54 rated in use
- 13A fused plug
- Manufactured to BS1363-2



Part No.	Description	Cable Length	Fuse	Colour	Pack Type	EAN	Box Qty
UK STOCKED							
CT1513P/IPS	Extension Lead with Weatherproof Socket	15m	13A	Orange	Card Wrap	5015056506203	4

## KEY FEATURES

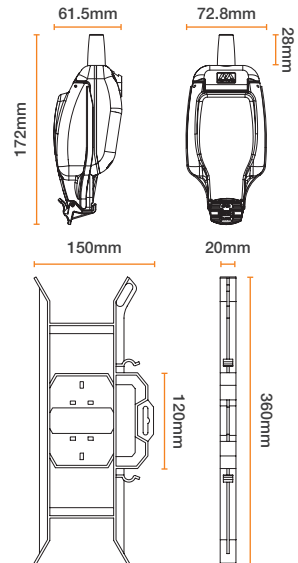
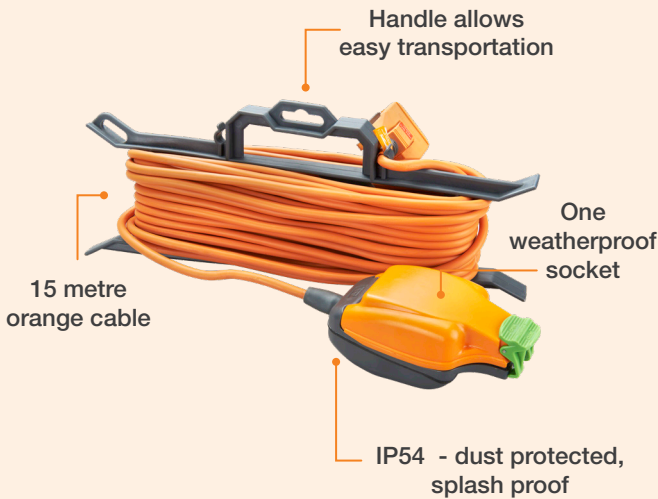

# WEATHERPROOF DOUBLE SOCKET GARDEN SPIKE



Part No.	Description	Cable Length	Fuse	Colour	Pack Type	EAN	Box Qty
UK STOCKED							
IPGS1510/2	Weatherproof Garden Spike – Double Socket	15m	10A	Dark Grey/ Orange/Green	Colour box	5015056524412	6

## KEY FEATURES

Two dust and splash-proof (IP54 rated) sockets

15 metres of cable



Handle allows easy transportation

Tapered 'spike' to fix into the ground

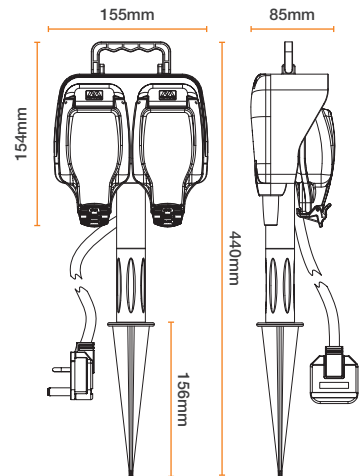



# WEATHERPROOF DOUBLE SOCKET CASE REEL

- Convenient and safe temporary outdoor power source, ideal for use with DIY tools or garden equipment
- 13A fused plug
- Thermal cut-out prevents risk of fire due to temperature rise caused by power overload
- Manufactured to BS EN 61242



Part No.	Description	Cable Length	Fuse	Colour	Pack Type	EAN	Box Qty
UK STOCKED							
HLP2013/2IP	Case Reel with Two Weatherproof Sockets	20m	13A	Dark Grey/Orange/Green		5015056506265	2

## KEY FEATURES

Drum wind handle for retracting the cable after use

Handle allows easy transportation

Thermal cut-out protection

20 metres of cable

Two dust and splash-proof (IP54 rated) sockets

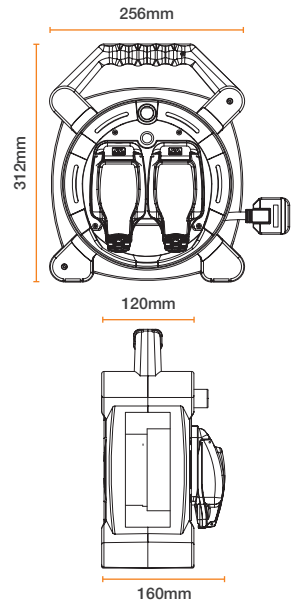
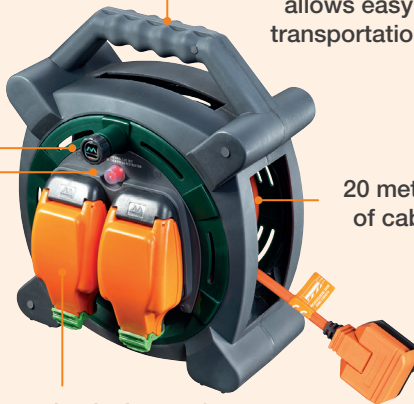

# WEATHERPROOF BOX

- IP54 rated, dust-protected, splash-proof box
- Suitable for use with up to four socket extension leads
- Weatherproof housing for power supplies and outdoor equipment
- Wall-fixing capability
- Socket fixing kit is supplied
- Manufactured to BS EN 62208:2003



Part No.	Description	Cable Length	Fuse	Colour	Pack Type	EAN	Box Qty
 UK STOCKED							
WBX	Weatherproof Box	N/A	N/A	Dark Grey	Card Wrap	5015056506289	2
WBXG	Weatherproof Box	N/A	N/A	Green	Card Wrap	5015056530758	4

## KEY FEATURES

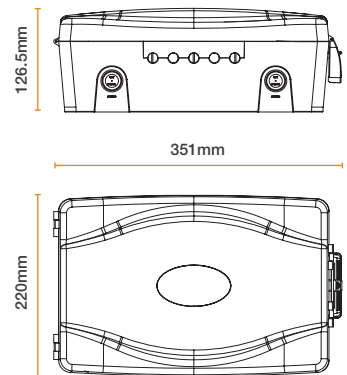

# WEATHERPROOF INLINE SOCKET

- IP54 rated, weatherproof socket
- Highly visible colour makes it ideal for outdoor use
- Rewireable
- Manufactured to BS1363-2



Part No.	Description	Cable Length	Fuse	Colour	Pack Type	EAN	Box Qty
UK STOCKED							
IPS	Weatherproof IP54 Inline Socket	N/A	13A	Orange/ Black	CDU	5015056506296	12

## KEY FEATURES

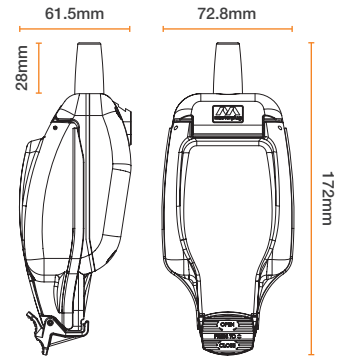

# RCD SAFETY PLUG-THROUGH ADAPTOR

- One socket for connecting devices to the RCD adaptor
- Added protection against fatal electric shocks
- Maximum load 3120 Watts, 240V AC
- 30mA trip speed 40ms (typical) to provide fast protection
- Non-latching (every time the supply to the RCD is interrupted it will trip and will need to be reset)
- Double pole contact break
- Ideal for home appliance spike protection
- Manufactured to BS 7071 1991



Part No.	Description	Cable Length	Fuse	Colour	Pack Type	EAN	Box Qty
UK STOCKED							
ARCDKG	RCD Safety Adaptor	N/A	13A	Grey	Clamshell	5015056379500	10

## KEY FEATURES

Large reset and test buttons



Plug-through design

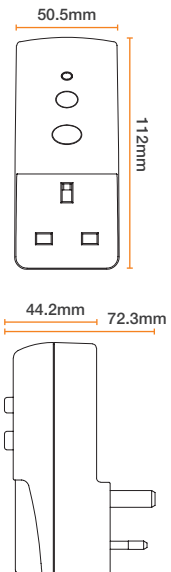

# RCD SAFETY PLUG

- Added protection against fatal electric shocks
- Ideal for lawnmowers, hedge trimmers, or any portable power tool
- Maximum load 3120 Watts, 240V AC
- 30mA trip speed 40ms (typical) to provide fast protection
- Double pole contact break
- Manufactured to BS 7071 1991



Part No.	Description	Cable Length	Fuse	Colour	Pack Type	EAN	Box Qty
UK STOCKED							
PRCDKB	RCD Safety Plug	N/A	13A	Black	Blister	5015056149370	10

## KEY FEATURES

Large reset and test buttons

Rewireable design

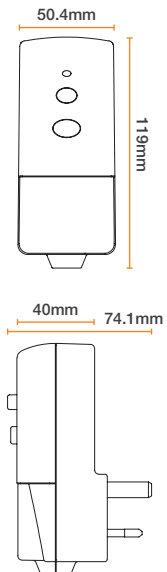

# INLINE SAFETY RCD



- Easy to wire into an existing cable lead for instant protection
- Added protection against fatal electric shocks
- Maximum load 3120 Watts, 240V AC
- 30mA trip speed 40ms (typical) to provide fast protection
- Active (non-latching) type – when power is cut to the device, the RCD will trip and have to be reset
- Double pole contact break
- Manufactured to BS7071:1992



Part No.	Description	Cable Length	Fuse	Colour	Pack Type	EAN	Box Qty
UK STOCKED							
ILRCDNG	Inline Safety RCD	N/A	13A	Black	Blister	5015056506896	10

## KEY FEATURES

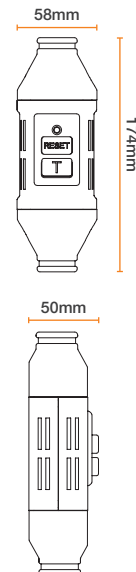





# TRAVEL POWER



Charge and power your portable devices wherever you go with our worldwide travel range



UK TO EUROPE



UNIVERSAL TO EUROPE



UK TO USA



UNIVERSAL



TRAVEL AND USB



# TRAVEL ADAPTOR UK TO EUROPE

- Connect UK plugs for use with European sockets
- Ideal for use when travelling in Europe
- Small and compact
- Easy to use
- Manufactured to BS5733



Part No.	Description	Cable Length	Fuse	Colour	Pack Type	EAN	Box Qty
UK STOCKED							
TAEUR	Travel Adaptor UK-EUR	N/A	N/A	White	Eco-B blister	5015056361154	60
TAEUR/2	Travel Adaptor UK-EUR (2pk)	N/A	N/A	White	Eco-B blister	5015056537252	60

## KEY FEATURES

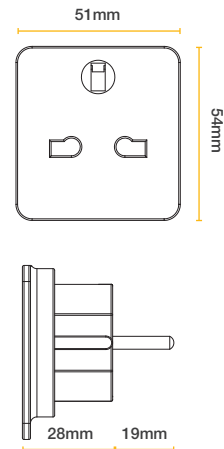
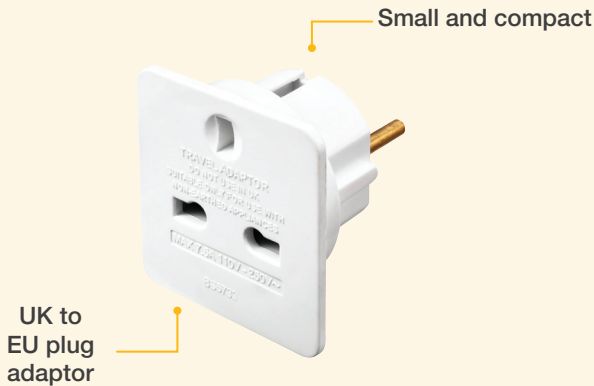

# TRAVEL ADAPTOR UK TO USA

- Convert UK plugs for use with US sockets
- Ideal when travelling in the US, Australia or Asia
- Easy to use
- Manufactured to BS5733

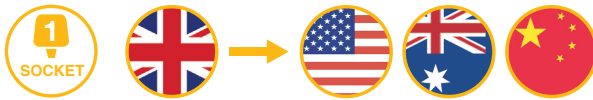

Part No.	Description	Cable Length	Fuse	Colour	Pack Type	EAN	Box Qty
UK STOCKED							
TAUSA	Travel Adaptor UK-USA	N/A	N/A	White	Clamshell	5015056361161	50
TAUSA/2	Travel Adaptor UK-USA 2pk	N/A	N/A	White	Eco-Blister	5015056537269	60

## KEY FEATURES

Adjustable pins for wider compatibility

Small and compact

UK to USA adaptor

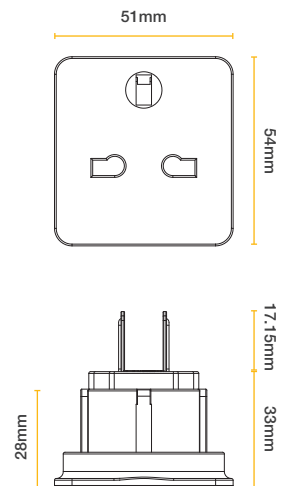

# TRAVEL ADAPTOR UK TO GLOBAL

- Power your devices whilst travelling worldwide
- 1x UK to European adaptor and 1x UK to USA adaptor
- Two adaptors supplied in a clear case
- Manufactured to BS5733

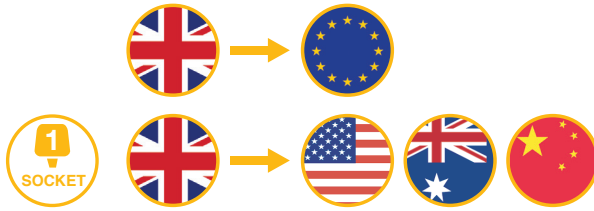

Part No.	Description	Cable Length	Fuse	Colour	Pack Type	EAN	Box Qty
UK STOCKED							
TACOM	Travel Adaptor Combined UK-EUR/US/AUS/JAP	N/A	N/A	White	Eco-B blister	5015056360942	10

## KEY FEATURES

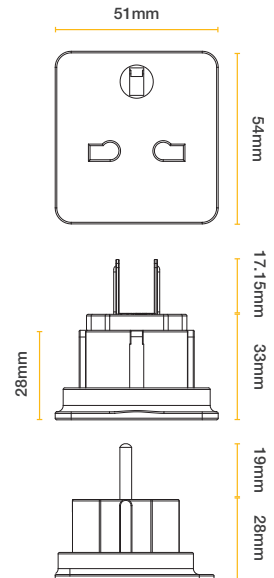
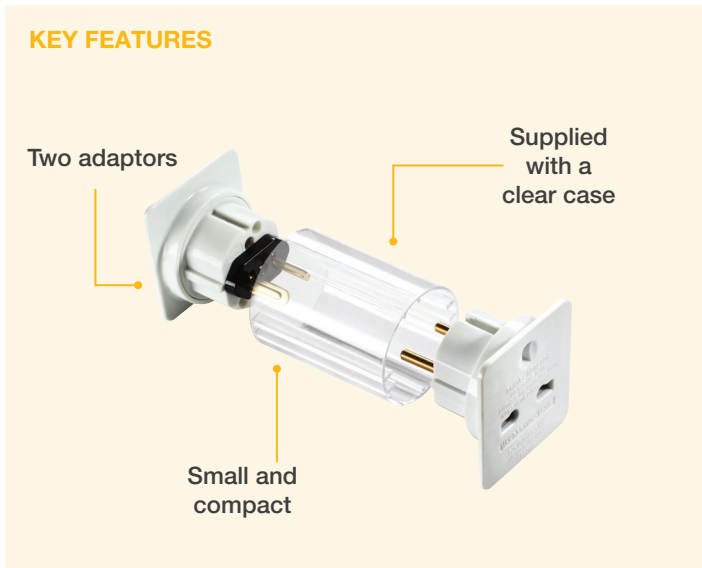

# TRAVEL ADAPTOR UNIVERSAL TO UK



- Ideal for visitors to the UK
- Convert European, American, Australian, Middle and Far Eastern and Asian plugs to UK electrical systems
- Ideal for use when travelling
- Manufactured to BS5733



Part No.	Description	Cable Length	Fuse	Colour	Pack Type	EAN	Box Qty
UK STOCKED							
TAVUK	Travel Adaptor Universal-UK	N/A	N/A	White	Eco-Blister	5015056360959	10

## KEY FEATURES

Universal socket for wider compatibility

Small and compact



Fused

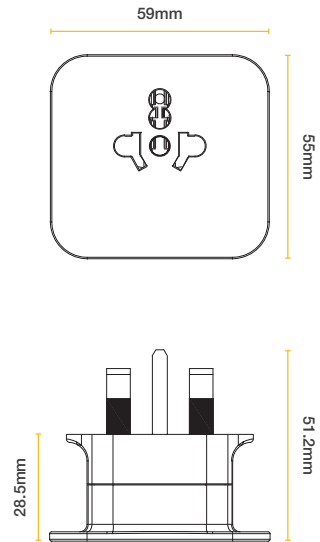

# TRAVEL ADAPTOR UNIVERSAL TO EUROPE

- Plug two items safely into one European socket
- Ideal for use when travelling in Europe
- Two universal sockets for wider compatibility
- Easy to use
- Manufactured to BS5733



Part No.	Description	Cable Length	Fuse	Colour	Pack Type	EAN	Box Qty
UK STOCKED							
TAU2	2 socket Universal-EUR (eco)	N/A	N/A	White	Eco-Blister	5015056537276	60

## KEY FEATURES

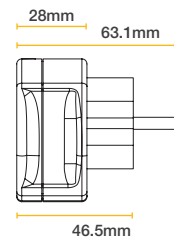
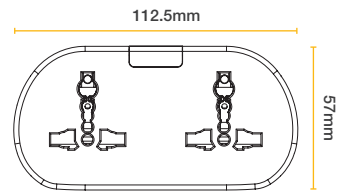
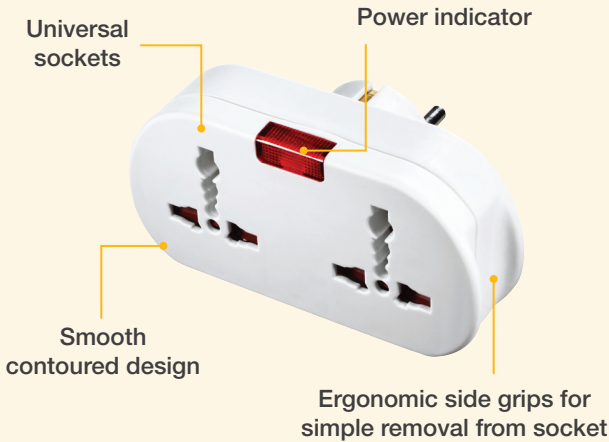

# EUROPEAN PLUG USB CHARGER

- Charge your USB devices whilst travelling in Europe
- Three 3.4A USB ports for charging your portable devices
- Ideal for use when travelling in Europe
- Manufactured to BS5733



Part No.	Description	Cable Length	Fuse	Colour	Pack Type	EAN	Box Qty
UK STOCKED							
TAUSBEUPLG	USB Travel Adaptor European	N/A	N/A	White	Eco-Blister	5015056526805	60

## KEY FEATURES

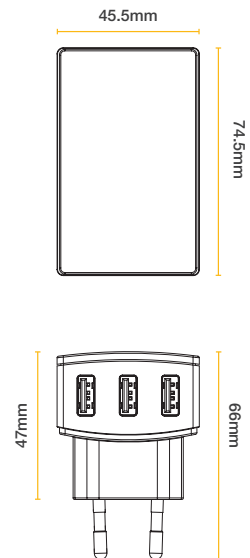
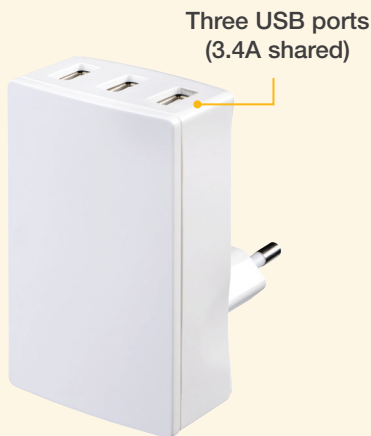

# USB TRAVEL ADAPTOR UK TO EUROPE

- Convert UK plugs for use with European sockets
- Ideal for use when travelling in Europe
- Two 2.1A USB ports for charging your portable devices
- Manufactured to BS5733



Part No.	Description	Cable Length	Fuse	Colour	Pack Type	EAN	Box Qty
UK STOCKED							
TAUSBEUR2	USB Travel Adaptor UK-EUR	N/A	N/A	White	Clamshell	5015056537313	60

## KEY FEATURES

Two USB ports  
(2.1A) shared



Plug-through  
socket

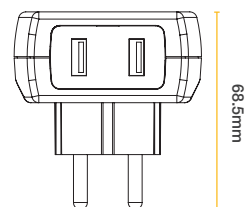
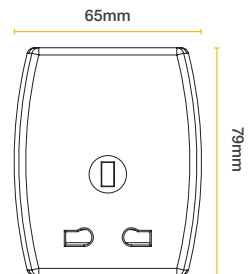

# USB TRAVEL ADAPTOR UK TO USA

- Convert UK plugs for use with American sockets
- Ideal for use when travelling in the US, Australia and Asia
- Plug has adjustable pins to suit the power requirements of different countries
- Two 2.1A USB ports for charging your portable devices
- Manufactured to BS5733



Part No.	Description	Cable Length	Fuse	Colour	Pack Type	EAN	Box Qty
UK STOCKED							
TAUSBUSA2	USB Travel Adaptor UK-USA	N/A	N/A	White	Eco-Blister	5015056537320	60

### KEY FEATURES

Two USB ports (2.1A) shared

Adjustable pins

Plug-through socket

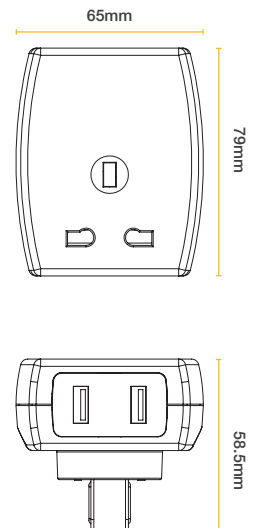







# TIMER POWER



Time control for your appliances. Easy operation, with daily and weekly programs



**MECHANICAL**



**ELECTRONIC**



**IMMERSION HEATER**

# DAILY MECHANICAL SEGMENT TIMER

- 24 hour mechanical segment timer
- Ideal for indoor power applications
- Simple to use
- White moulded design
- Manufactured to EN60730-2-7



Part No.	Description	Cable Length	Fuse	Colour	Pack Type	EAN	Box Qty
UK STOCKED							
TMS24	24hr Mechanical Timer	N/A	N/A	White	Clamshell	5015056352763	20
TMS24/3	24hr Mechanical Timer 3pk	N/A	N/A	White	Blister	5015056363189	20

## KEY FEATURES

15 minutes per segment

One socket for connecting equipment

Manual override switch

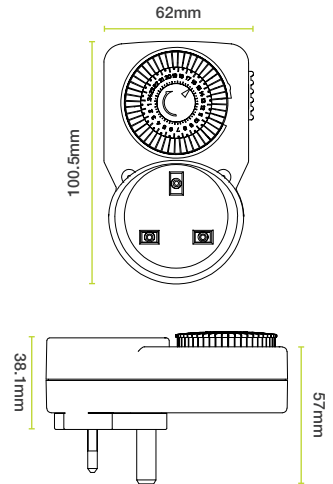

# PROGRAMMABLE ELECTRONIC TIMER

- Compact programmable plug-in timer
- Simple to use
- Automatic time control of home appliances and security devices
- 16 selectable options and 10 programmes
- Manufactured to EN60730-2-7



**10**  
amps

Part No.	Description	Cable Length	Fuse	Colour	Pack Type	EAN	Box Qty
UK STOCKED							
TES7	Digital 7 Day Timer	N/A	N/A	White	Clamshell	5015056363196	20

## KEY FEATURES

12 / 24 hour  
time display



Power indicator

Manual override

One socket  
for connecting  
equipment

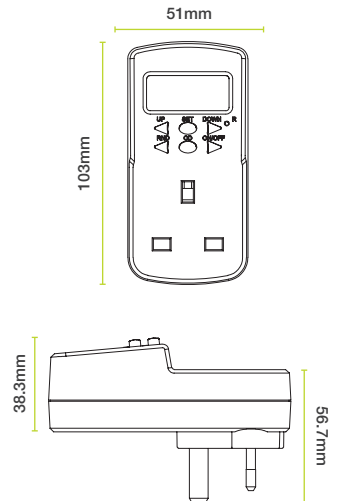

# MECHANICAL DAILY IMMERSION TIMER

- Complete with manual override and LED indicator
- General purpose timer to offer complete control
- Ideal for immersion heaters, towel rails and lighting
- 24 hour control
- Manufactured to EN60730-2-7

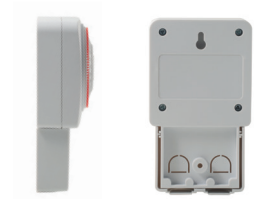

**16**  
amps

Part No.	Description	Cable Length	Fuse	Colour	Pack Type	EAN	Box Qty
UK STOCKED							
TMIHMEC	Mechanical Immersion Timer	N/A	16A	White	Clamshell	5015056555140	

## KEY FEATURES

Integrated clock face for easy time setting

15 minutes per segment

Internal cable grips



LED power indicator

Two fixing points

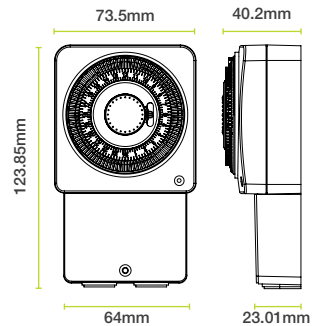

# DIGITAL WEEKLY IMMERSION TIMER

- Easy operation, daily and weekly programmes
- Boost feature provides 1 or 2 hour power extension to the connected appliance
- Battery backup retains programmes and clock times during loss of mains power
- Ideal for immersion heaters, towel rails and lighting
- 24 hour, 7 day control
- Easy to install, complete with instructions
- Manufactured to EN60730-2-7



**16**  
amps

Part No.	Description	Cable Length	Fuse	Colour	Pack Type	EAN	Box Qty
<b>UK STOCKED</b>							
TMIHDIG	Digital Immersion Timer	N/A	16A	White	Clamshell	501505655171	20

## KEY FEATURES

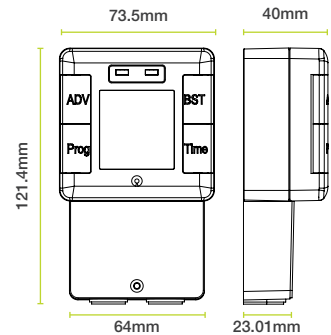
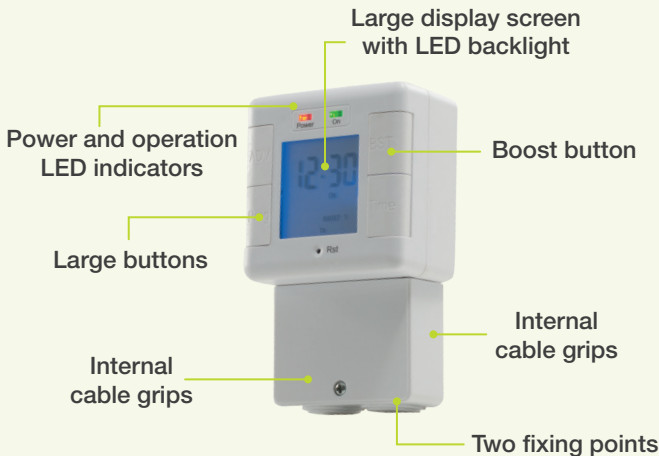





# HOME POWER



A range of home power solutions to complement day-to-day activities



ACCESSORIES

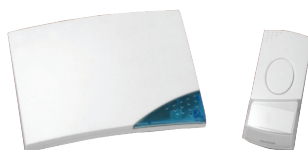

DOOR CHIMES



NIGHT LIGHTS



# SOCKET SAFETY COVERS

- Protect your sockets and ensure safety when devices are unplugged
- Deter children from pushing objects into electrical sockets
- Neutral colour to blend into the home
- Pack of 5

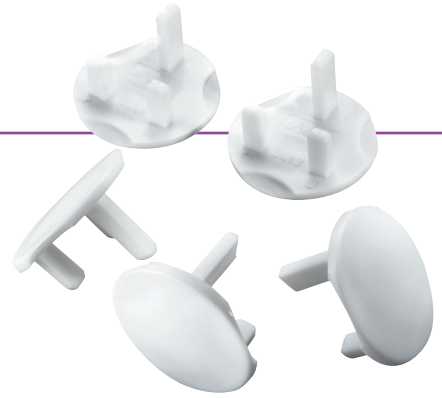

Part No.	Description	Cable Length	Fuse	Colour	Pack Type	EAN	Box Qty
UK STOCKED							
SC13/5	Socket Covers 5pk	N/A	N/A	White	Clamshell	5015056363202	150

## KEY FEATURES

Neutral colour  
blends into  
your home



# PHOTOELECTRIC SMOKE ALARM



- Loud 85dB alarm
- Easy to install
- Power operation indicator
- Supplied with a 9V battery
- Battery missing indicator
- Low battery warning indicator
- Kitemarked
- Complies with BS5446-1:2000



EN14604 : 2005  
KM503487

Part No.	Description	Cable Length	Fuse	Colour	Pack Type	EAN	Box Qty
UK STOCKED							
SD361HS	Smoke Alarm	N/A	N/A	White	Clamshell	5015056376066	24

## KEY FEATURES



# BATTERY DOOR CHIME

- Choice of 8 sounds
- 64 radio frequency channels available to avoid interference
- 50 metre working range
- Includes 12V 23A battery for bell push
- Easy installation
- Requires 3x 4.5V AA batteries (not included)

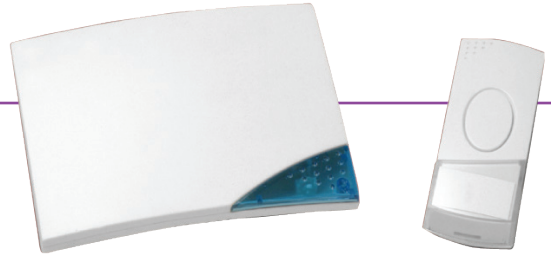

Part No.	Description	Cable Length	Fuse	Colour	Pack Type	EAN	Box Qty
 UK STOCKED							
DC1	Battery Door Chime	N/A	N/A	White	Eco Blister	5015056363301	40

## KEY FEATURES



Visual indicator that illuminates on operation

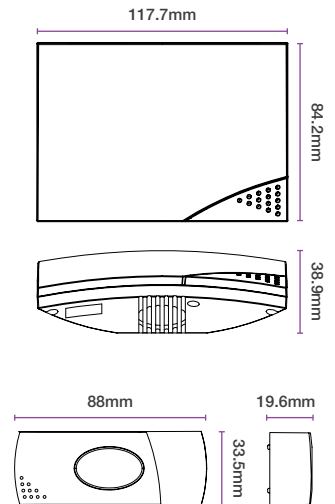

# MAINS DOOR CHIME

- Choice of 8 sounds
- 64 radio frequency channels available to avoid interference
- 50 metre working range
- Includes 12V 23A battery for bell push
- Easy installation



Part No.	Description	Cable Length	Fuse	Colour	Pack Type	EAN	Box Qty
 UK STOCKED							
DC2	Mains Door Chime	N/A	N/A	White	Eco Blister	5015056376967	40

## KEY FEATURES



Visual indicator that illuminates on operation

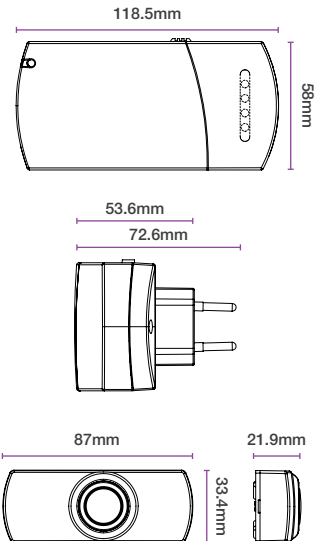

# SOFT GLOW NIGHT LIGHT

- Provides a soft background light
- All night lights fitted with LED bulbs, for low energy consumption, long life span and no hot lamps
- Twin pack
- Manufactured to BS1363 & BS EN 60598

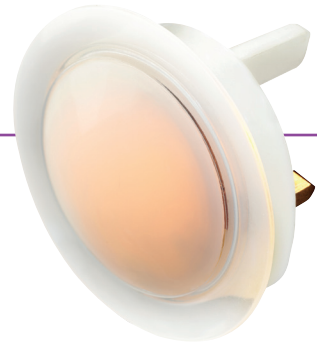

Part No.	Description	Cable Length	Fuse	Colour	Pack Type	EAN	Box Qty
UK STOCKED							
GL1/2	Soft Glow Night Light. 2pk	N/A	N/A	White	Eco-Blister	5015056361185	20

## KEY FEATURES

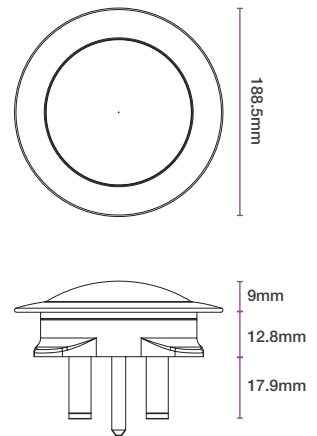
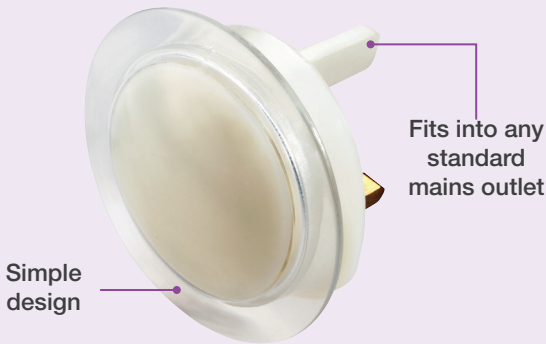

# ROUND GLOW PUSH LIGHT

- Battery powered background light
- Ideal for use in a loft, shed, under stairs, in a wardrobe, caravan or garage
- Fitted with an LED bulb, for low energy consumption and longer battery life
- Requires 2x AA batteries (not included)



Part No.	Description	Cable Length	Fuse	Colour	Pack Type	EAN	Box Qty
 UK STOCKED							
RPL1	Round Glow Push Light 10pk	N/A	N/A	White	Clamshell	5015056366227	10

## KEY FEATURES



Wall-fixing capability



Ø 143mm

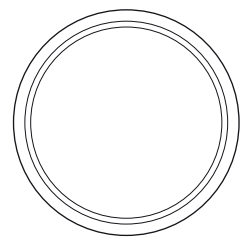

55mm

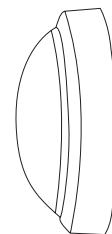

# DUSK-DAWN NIGHT LIGHT

- Provides a soft background light
- Night light turns on at dusk and off at dawn
- All night lights fitted with LED bulbs, for low energy consumption, long life span and no hot lamps
- Twin pack
- Manufactured to BS1363 & BS EN 60598



Part No.	Description	Cable Length	Fuse	Colour	Pack Type	EAN	Box Qty
UK STOCKED							
NLTD/2	Dusk-Dawn Night Light 2pk	N/A	N/A	White	Eco-Blister	5015056379487	20

## KEY FEATURES

Teardrop shape



Fits into any standard mains outlet

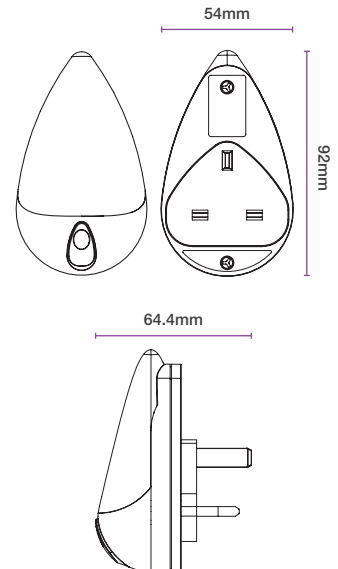

# MOTION DETECTOR LED NIGHT LIGHT



- Night light turns on and off when movement is detected
- Selectable sensor allows you to choose between PIR motion detection, dusk-til-dawn or permanent light settings
- All night lights fitted with LED bulbs, for low energy consumption, long life span and no hot lamps
- Twin pack
- Manufactured to BS1363 & BS EN 60598

Part No.	Description	Cable Length	Fuse	Colour	Pack Type	EAN	Box Qty
 UK STOCKED							
NLPIR/2	Motion Detector LED Night Light	N/A	N/A	White	Eco-Blister	5015056379975	5

## KEY FEATURES





# PLUG THROUGH DUSK-DAWN NIGHT LIGHT



- All night lights fitted with LED bulbs, for low energy consumption, long life span and no hot lamps
- Night light turns on at dusk and off at dawn
- Twin pack
- Manufactured to BS1363 & BS EN 60598

Part No.	Description	Cable Length	Fuse	Colour	Pack Type	EAN	Box Qty
 UK STOCKED							
NLPT/2	Plug through Dusk-Dawn 2pk	N/A	N/A	White	Eco-Blistar	5015056376882	20

## KEY FEATURES

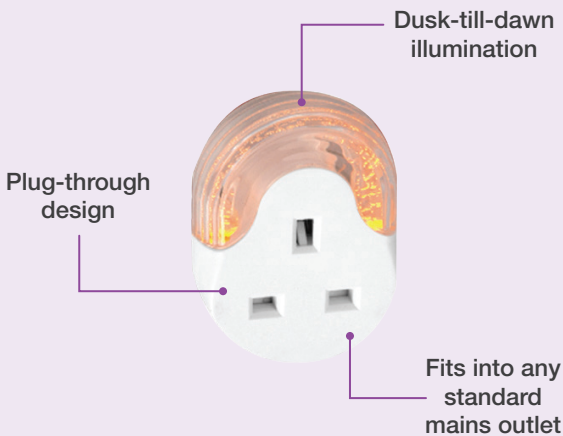



# UNIVERSAL POWER



Providing power where you need it most, our universal sockets provide a worldwide solution

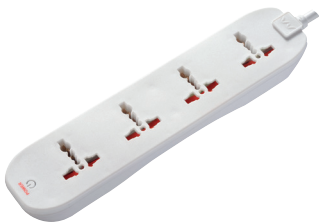

BASIC

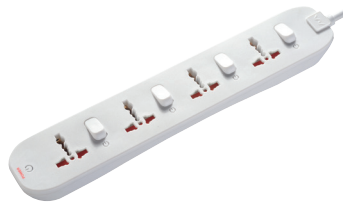

SWITCHED

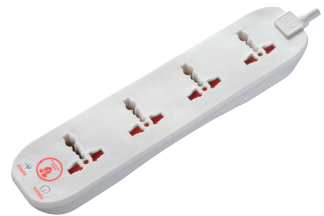

SURGE



USB



WORK

# UNIVERSAL EXTENSION LEAD

- Universal sockets suitable for most plug types
- Four or six sockets for connecting equipment
- Rounded slimline appearance
- Global plug options available



Part No.	Description	Cable Length	Fuse	Colour	Pack Type	EAN	Box Qty
BFN2UN	4 Socket	2m	13A	White	Clamshell & insert card	5015056564395	10
BSN2UN	6 Socket	2m	13A	White	Clamshell & insert card	5015056564456	10

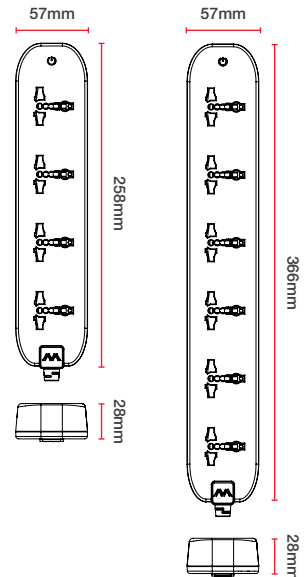
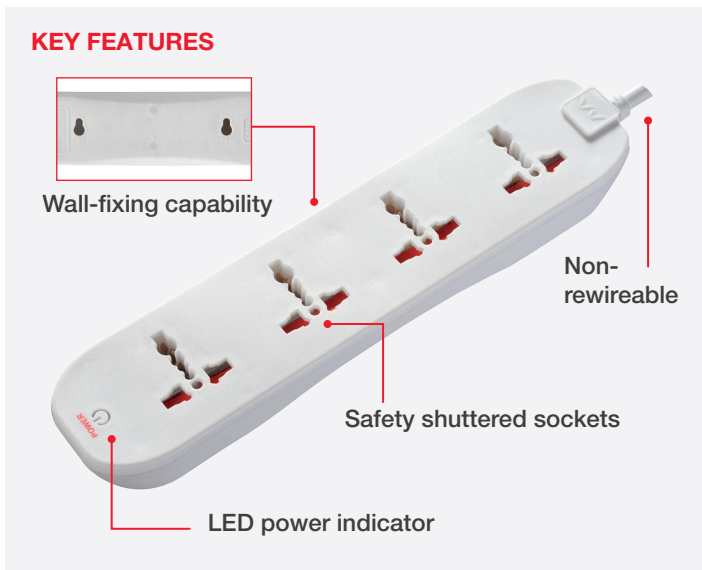

# UNIVERSAL EXTENSION LEAD WITH SWITCH

- Universal sockets suitable for most plug types
- Four or six sockets for connecting equipment
- Integrated power switch
- Rounded slimline appearance
- Global plug options available



Part No.	Description	Cable Length	Fuse	Colour	Pack Type	EAN	Box Qty
BFNS2UN	4 Socket	2m	13A	White	Clamshell & insert card	5015056564401	10
BSNS2UN	6 Socket	2m	13A	White	Clamshell & insert card	5015056564463	10

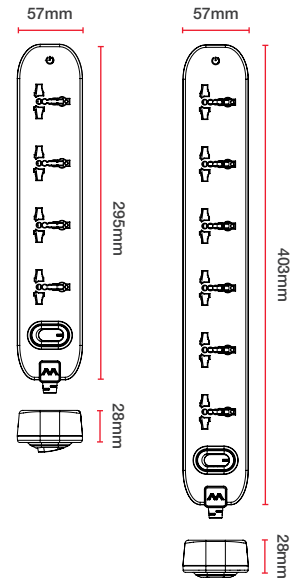
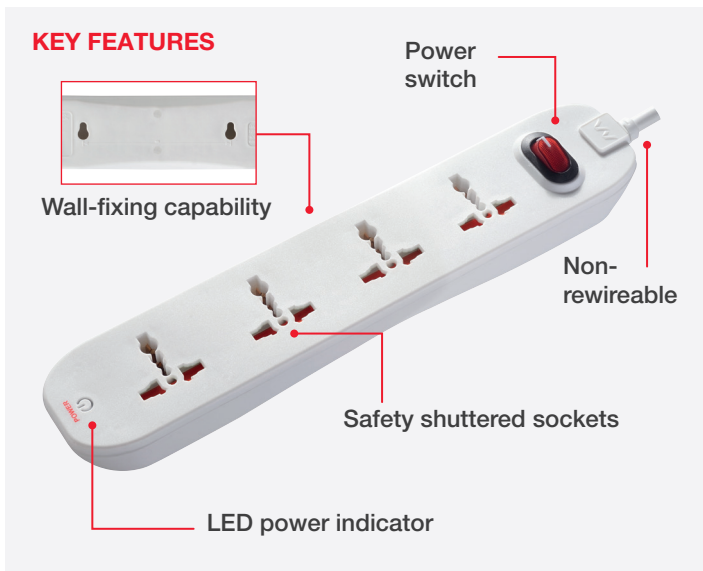

# UNIVERSAL INDIVIDUALLY SWITCHED EXTENSION LEAD

- Universal sockets suitable for most plug types
- Four or six sockets for connecting equipment
- Individual power indicators
- Rounded slimline appearance
- Global plug options available



Part No.	Description	Cable Length	Fuse	Colour	Pack Type	EAN	Box Qty
SWN42UN	4 Socket	2m	13A	White	Clamshell & insert card	5015056564418	10
SWN62UN	6 Socket	2m	13A	White	Clamshell & insert card	5015056564470	10

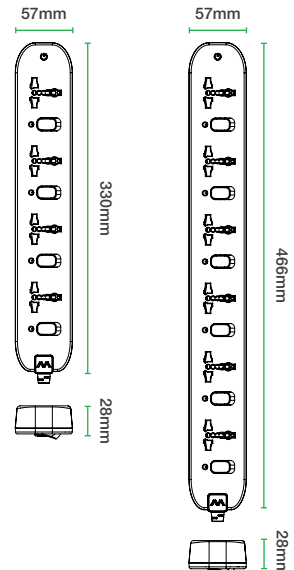
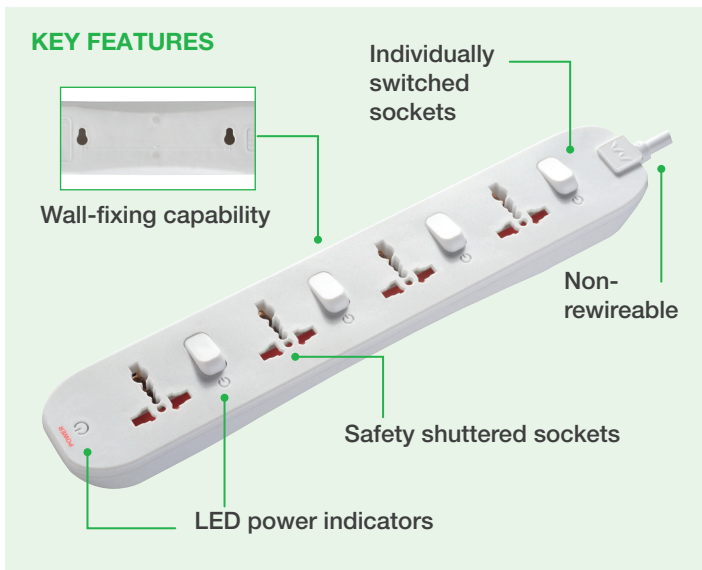

# UNIVERSAL SURGE EXTENSION LEAD

- Universal sockets suitable for most plug types
- Four sockets for connecting equipment
- Sockets protected from the damaging effects of surges and spikes
- Rounded slimline appearance
- Global plug options available

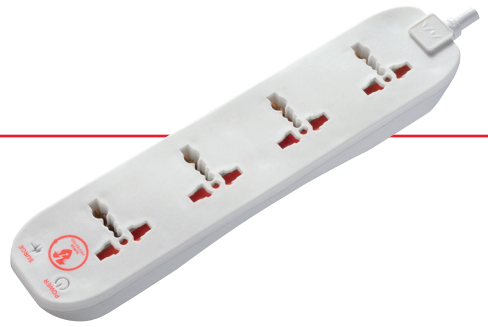

Part No.	Description	Cable Length	Fuse	Colour	Pack Type	EAN	Box Qty
SRG42UN	4 Socket	2m	13A	White	Clamshell & insert card	5015056564432	10

**KEY FEATURES**

- Wall-fixing capability
- LED surge indicator
- LED power indicator
- Surge protected
- Safety shuttered sockets
- Non-rewireable

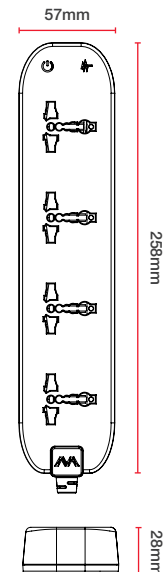

<b>Max Surge Energy</b>	375 Joules
<b>Max Current</b>	13,500A
<b>Clamping Voltage</b>	775 Volts
<b>Response Time</b>	<10ns
<b>3 Channel Protection</b>	Yes
<b>Thermal Cutout</b>	Yes



# UNIVERSAL USB SWITCHED EXTENSION LEAD

- Universal sockets suitable for most plug types
- Four sockets for connecting equipment
- Two USB ports (2.1A shared) for charging portable devices
- Rounded slimline appearance
- Global plug options available



Part No.	Description	Cable Length	Fuse	Colour	Pack Type	EAN	Box Qty
SWNU42UN	4 Socket	2m	13A	White	Clamshell & insert card	5015056564425	10

**KEY FEATURES**

Individually switched sockets

Non-rewireable

Safety shuttered sockets

Two USB ports (2.1A shared)

LED power indicators

Wall-fixing capability

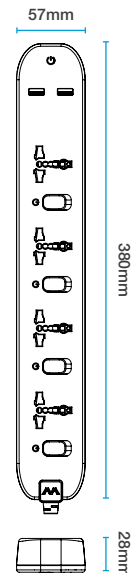

# UNIVERSAL USB SURGE EXTENSION LEAD

- Universal sockets suitable for most plug types
- Four sockets for connecting equipment
- Sockets protected from the damaging effects of surges and spikes
- Two USB ports (2.1A shared) for charging portable devices
- Rounded slimline appearance
- Global plug options available

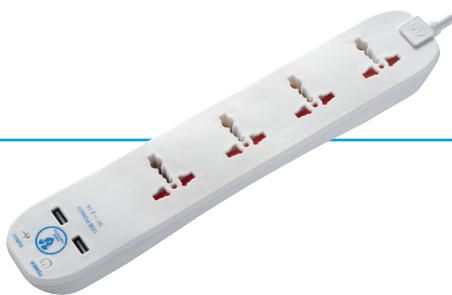

Part No.	Description	Cable Length	Fuse	Colour	Pack Type	EAN	Box Qty
SRGU42UN	4 Socket	2m	13A	White	Clamshell & insert card	5015056564449	10

### KEY FEATURES

- Wall-fixing capability
- LED surge indicator
- LED power indicator
- Two USB ports (2.1A shared)
- Safety shuttered sockets
- Non-rewireable

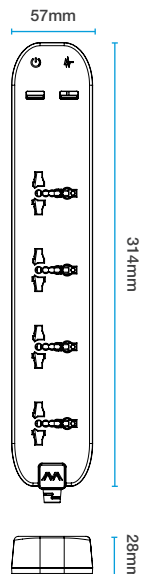

<b>Max Surge Energy</b>	375 Joules
<b>Max Current</b>	13,500A
<b>Clamping Voltage</b>	775 Volts
<b>Response Time</b>	<10ns
<b>3 Channel Protection</b>	Yes
<b>Thermal Cutout</b>	Yes





# UNIVERSAL CABLE REELS



## UNIVERSAL CABLE REEL OPTIONS

All of our cable, cassette and open reels come with the following options:

- 10A or 13A cable
- Up to three colours face-plate printing
- Choice of colours
- Choice of plug types – UK Standard, Heavy Duty, RCD or options of European and US plugs
- LED power indicator fitted as standard

## CASSETTE REEL

Our universal cassette reels come in four different sizes, with 10A, 13A and 16A cable options available to choose from, up to a maximum of 15m for 10A large cassette reels.

**MCT1010/4UNBL Medium Cassette Reel 10M**

## CASE REEL

Our universal case reels come in four different sizes, with 10A, 13A and 16A cable options, up to a maximum of 35mm for 10A performance case reels.

**HBT1510/4UNBL Medium Case Reel 15M**

## OPEN REEL

Our universal open reels come in four different sizes, with 10A, 13A and 16A cable options available to choose from, up to a maximum of 50m for a 16A large heavy duty open reel.

**LDCC2516/4UNBLS Large Open Reel 25M with Schuko plug**

Type			Max Cable (H05VV-F) length (m)		
Code	Reel	Size	10A 1.0mm <sup>2</sup>	13A 1.25mm <sup>2</sup>	16A 1.5mm <sup>2</sup>
SCT	Cassette	Small	5	4	4
MCT	Cassette	Medium	10	8	8
LCT	Cassette	Large	15	12	12
MCP	Cassette	Performance	10	8	8
HST	Case	Small	20	16	16
HBT	Case	Medium	25	20	20
HLT	Case	Large	30	25	25
HLP	Case	Performance	35	30	30
SOC	Open	Small	20	15	15
MOC	Open	Medium	25	20	20
LDCC	Open	Large	35	30	30
HDCC	Open	Large / Heavy Duty	40	50	50

# INDEX

## #

7B-MP	18
7W-MP	18

## A

ARCDKG-MP	100
-----------	-----

## B

BDFN1-MP	13
BEN2-MP	12
BFG1N-MP	10
BFG2N-MP	10
BFG3N-MP	10
BFG5N-MP	10
BFN2UN-MP	131
BFNS2UN-MP	132
BOG5-MP	8
BOG10-MP	8
BOG100-MP	92
BSG2N-MP	11
BSG3N-MP	11
BSN2UN-MP	131
BSNS2UN-MP	132
BTG5N	9
BTN10N	9
BTOW101-MP	14

## C

CHT-PX	87
CMU10134SL-PX	77
CT100-MP	93
CT1513-MP	91
CT1513P/IPS-MP	95

## D

DC1-MP	123
DC2-MP	124

## E

ELS13B-MP	55
ELS13O-MP	55
ELS13W-MP	55
ELS132B-MP	57
ELS132O-MP	57
ELS132W-MP	57
ELS134B-MP	58
ELS134O-MP	58
ELS134W-MP	58
ELS15B-MP	56
ELS5B-MP	56
EXS13110B-MP	60
EXS13110O-MP	60
EXS13110W-MP	60
EXS1315B-MP	60
EXS1315O-MP	60
EXS1315W-MP	60
EXS1324B-MP	61
EXS1324O-MP	61
EXS1324W-MP	61
EXS1342B-MP	62
EXS1342O-MP	62
EXS1342W-MP	62
EXS1344B-MP	62
EXS1344O-MP	62
EXS1344W-MP	62

## F

FUSE10-MP	23
FUSE13-MP	23
FUSE3-MP	23
FUSE5-MP	23
FUSEM-MP	23
FUSEM10-MP	23
FUSEW-MP	23

## G

GL1/2-MP	125
----------	-----

## H

HBT2013/4BL-MP	67
HBT2013/4BLRCD-MP	67
HDCC5013/4BL-MP	69
HDPT13B-MP	53
HDPT13O-MP	53
HDPT13W-MP	53
HDPT15B-MP	54
HLP2013/2IP-MP	97
HMU15134SL-PX	78
HST1513/4BL-MP	66

## I

ILRCDNG-MP	102
IPGS1510/2-MP	96
IPS-MP	99

## L

LCT1213/4BL-MP	65
LCT1510/4BL-MP	65
LDCC2513/4BL-MP	68
LDCC2513/4BLRCD-MP	68
LDCC3013/4BL-MP	68
LVCT2516/2-MP	70
LVCT5016/2-MP	70
LVHLT2516/2-MP	71
LVIL15-MP	72

## M

MCT0813/4BL-MP	64
MCT1010/4BL-MP	64
MSF3/NK-MP	21
MSU2/NK-MP	21
MSWG3-MP	29
MSWRG3-MP	36
MVA1200-MP	22

# INDEX

## N

NC102B-MP	59
NC102O-MP	59
NC103B-MP	59
NC103W-MP	59
NLPIR/2-MP	128
NLPT/2-MP	129
NLTD/2-MP	127

## O

OATFU30134SL-PX	85
OATRU3013FL3IP-PX	84
OLU50134SL-PX	80
OMU25132USL-PX	86
OMU25134SL-PX	79
OMU2513FL3IP-PX	83
OTLU40134SL-PX	81
OTMU30162LV-PX	82

## P

PRCDKB-MP	101
PT13B-MP	16
PT13HW-MP	17
PT13W-MP	16
PT133W-MP	16
PT135W-MP	16
PT15W-MP	19
PT2W-MP	19
PT5B-MP	19
PT5W-MP	19

## R

RPL1-MP	126
---------	-----

## S

SATT0413/4W-MP	7
SATU04132USLW-MP	39
SC13/5-MP	121

## S

SCT0510/4BL-MP	63
SD361HS-MP	122
SHADC-MP	20
SPTO-MP	94
SRG42N-MP	31
SRG42UN-MP	134
SRG44N-MP	31
SRG62N-MP	31
SRG82-MP	32
SRGAUSBPB2-MP	50
SRGAUSBPW2-MP	50
SRGD41MB-MP	34
SRGD61MB-MP	34
SRGDU41MB2-MP	40
SRGDU41PB2-MP	46
SRGDU41PW2-MP	46
SRGDU61MB2-MP	40
SRGDU61PB2-MP	46
SRGDU61PW2-MP	46
SRGTOW101-MP	35
SRGTOW101B-MP	35
SRGU101B-MP	42
SRGU104-MP	42
SRGU41PB2-MP	45
SRGU41PW2-MP	45
SRGU42N-MP	41
SRGU42UN-MP	136
SRGU44N-MP	41
SRGU62N-MP	41
SRPMSTU81PB2-MP	47
SRPMSTU81PW2-MP	47
SRPTU102PB-MP	48
SRPTU122PB-MP	48
SRPTU81PB2-MP	49
SRPTU81PW2-MP	49
SS-MP	15
SWC42N-MP	26
SWC62N-MP	26
SWFG4W-MP	28
SWFG44W-MP	28
SWFG6W-MP	28

## S

SWG32C-MP	25
SWG4-MP	27
SWG6-MP	27
SWN42UN-MP	133
SWN62UN-MP	133
SWNU42UN-MP	135
SWSRG42N-MP	33
SWSRG62N-MP	33
SWSRGU41PB2-MP	44
SWSRGU41PW2-MP	44
SXG-MP	15

## T

TACOM-MP	107
TAEUR-MP	105
TAEUR/2-MP	105
TAU2-MP	109
TAUSA-MP	106
TAUSA/2-MP	106
TAUSBEUPLG-MP	110
TAUSBEUR2-MP	111
TAUSBUSA2-MP	112
TAVUK-MP	108
TES7-MP	116
TMIHDIG-MP	118
TMIHMEC-MP	117
TMS24-MP	115
TMS24/3-MP	115
TN-MP	15

## U

UG-MP	15
USBPLGB2-MP	51
USBPLGW2-MP	51

## W

WBX-MP	98
WBXG-MP	98

**UK:****HEAD OFFICE:**

Email: [info@luceco.com](mailto:info@luceco.com)  
 Luceco plc, Caparo House  
 103 Baker Street, London  
 England, W1U 6LN

**DISTRIBUTION CENTRE:**

Tel: +44 (0) 1952 238 100  
 Email: [sales@masterplug.com](mailto:sales@masterplug.com)  
 Luceco plc  
 Luceco Distribution Centre  
 Stafford Park 1, Telford  
 Shropshire, England, TF3 3BD

**GERMANY:**

Tel: +49 40 89066 878 - 0  
 Email: [eu\\_sales@luceco.com](mailto:eu_sales@luceco.com)  
 Nexus Industries GmbH  
 Holstenplatz 20b  
 22765 Hamburg, Germany

**FRANCE:**

Tel: +33 (0)1 61 10 10 35  
 Email: [fr\\_sales@luceco.com](mailto:fr_sales@luceco.com)  
 Luceco SAS France & Belux  
 3 Rue de Courtalin  
 Magny Le Hongre 77700  
 Paris, France

**ITALY:**

Tel: +39 0434 1696795  
 Email: [it\\_sales@luceco.com](mailto:it_sales@luceco.com)  
 Nexus Italia, Via Amman 10  
 33170 Pordenone, Italy

**SPAIN:**

Tel: +34 93 829 55 75  
 Email: [es\\_sales@luceco.com](mailto:es_sales@luceco.com)  
 Nexus Industries LTD  
 C/ Bobinadora 1-5  
 08302 Mataró  
 Barcelona (SPAIN)

**MIDDLE EAST:**

Tel: +971 4 609 1867  
 Email: [mea\\_sales@luceco.com](mailto:mea_sales@luceco.com)  
 Luceco Middle East FZCO  
 Bldg. 5EB, Office 342  
 PO Box 371128, DAFZA  
 Dubai, UAE

**ASIA PACIFIC:**

**JIAXING:**  
 Tel: +86 (0) 573 8357 0200  
 Email: [asia\\_sales@luceco.com](mailto:asia_sales@luceco.com)  
 No 1438, Jiachuang Road  
 Xiuzhou Industrial Park, Jiaxing  
 Zhejiang, China, P.C. 314031

**HONG KONG:**

Tel: +852 3520 2622  
 Email: [hk\\_sales@luceco.com](mailto:hk_sales@luceco.com)  
 Luceco (Hong Kong) Ltd  
 Unit D, 15th Floor MG Tower  
 133 Hoi Bun Road  
 Kwun Tong, Kowloon  
 Hong Kong

**UNITED STATES:**

Tel: +1 281 978 2509  
 Email: [us\\_sales@luceco.com](mailto:us_sales@luceco.com)  
 Luceco Inc, 11050 W Little York Road  
 Building C-2, Houston, TX 77041,  
 USA

**MEXICO & LATIN AMERICA:**

Tel: +52 (81) 5000 9437  
 Email: [ventas@luceco.com](mailto:ventas@luceco.com)  
 Luceco México S. de R.L. de C.V.  
 Batallón de San Patricio #109 Sur,  
 Col. Valle Oriente, San Pedro Garza  
 García N.L. México CP 66260  
 (Torre Avalanz, Piso #20, Oficina  
 2009)

**AFRICA:**

Tel: +27 11 432 6779  
 Email: [africa\\_sales@luceco.com](mailto:africa_sales@luceco.com)  
 Unit 2, Cedarwood Office Park  
 Cnr. Western Service and  
 Mount Lebanon Road, Woodmead  
 South Africa, 2144

**TECHNICAL SUPPORT:**

Tel: 03300 249 279  
 Email:  
[technical.support@masterplug.com](mailto:technical.support@masterplug.com)  
 Lines open Monday to Friday  
 8:30am to 5pm, with answer phone  
 service outside these hours.

# LUCECO plc

[www.luceco.com](http://www.luceco.com)



LUCECO 

[www.masterplug.com](http://www.masterplug.com)