

LUCECO

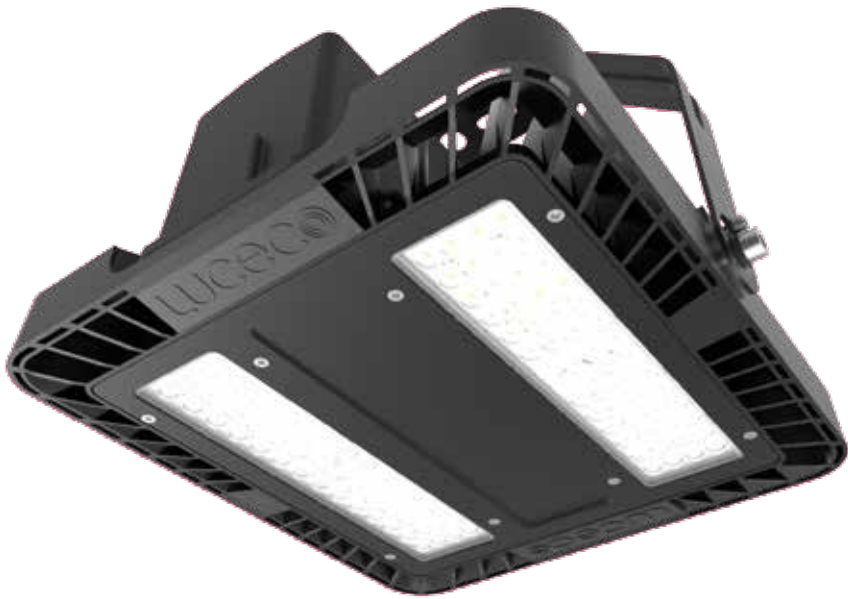

LED Lighting

Environmental & Energy Saving

EDITION 9.3 

The Luceco logo features the word "LUCECO" in a bold, green, sans-serif font. The letter "O" is replaced by a stylized green circle with a white center, resembling an eye or a lens. The background of the top half of the page is a dark, abstract image with blue and white light streaks, suggesting a high-tech or energy theme.

A SMARTER USE OF

ELECTRICITY

CONTACT US

UK:

HEAD OFFICE:

Email: info@luceco.com

Luceco plc, Caparo House
103 Baker Street, London
England, W1U 6LN

DISTRIBUTION CENTRE:

Tel: +44 (0) 1952 238 100

Email: uk_sales@luceco.com

Luceco plc
Luceco Distribution Centre
Stafford Park 1, Telford
Shropshire, England, TF3 3BD

GERMANY:

Tel: +49 40 89066 878 - 0

Email: eu_sales@luceco.com

Nexus Industries GmbH
Holstenplatz 20b
22765 Hamburg, Germany

FRANCE:

Tel: +33 (0)1 61 10 10 35

Email: fr_sales@luceco.com

Luceco SAS France & Belux
3 Rue de Courtalin
Magny Le Hongre 77700
Paris, France

ITALY:

Tel: +39 0434 1696795

Email: it_sales@luceco.com

Nexus Italia, Via Amman 10
33170 Pordenone, Italy

SPAIN:

Tel: +34 93 829 55 75

Email: es_sales@luceco.com

Nexus Industries LTD
C/ Bobinadora 1-5
08302 Mataró
Barcelona (SPAIN)

MIDDLE EAST:

Tel: +971 4 609 1867

Email: mea_sales@luceco.com

Luceco Middle East FZCO
Bldg. 5EB, Office 342
PO Box 371128, DAFZA
Dubai, UAE

ASIA PACIFIC:

JIAXING:

Tel: +86 (0) 573 8357 0200

Email: asia_sales@luceco.com

No 1438, Jiachuang Road
Xiuzhou Industrial Park, Jiaxing
Zhejiang, China, P.C. 314031

HONG KONG:

Tel: +852 3520 2622

Email: hk_sales@luceco.com

Luceco (Hong Kong) Ltd
Unit D, 15th Floor MG Tower
133 Hoi Bun Road
Kwun Tong, Kowloon
Hong Kong

UNITED STATES:

Tel: +1 281 978 2509

Email: us_sales@luceco.com

Luceco Inc, 11050 W Little York Road
Building C-2, Houston, TX 77041, USA

MEXICO & LATIN AMERICA:

Tel: +52 (81) 5000 9437

Email: ventas@luceco.com

Luceco México S. de R.L. de C.V.
Batallón de San Patricio #109 Sur, Col.
Valle Oriente, San Pedro Garza García
N.L. México CP 66260
(Torre Avalanz, Piso #20, Oficina 2009)

AFRICA:

Tel: +27 11 432 6779

Email: africa_sales@luceco.com

Unit 2, Cedarwood Office Park
Cnr. Western Service and
Mount Lebanon Road, Woodmead
South Africa, 2144

TECHNICAL SUPPORT:

Tel: 03300 249 279

Email: technical@luceco.com

Lines open Monday to Friday
8.30am to 5pm, with answer phone
service outside these hours.

WEBSITE:

For further information and other
literature items please visit

www.luceco.com

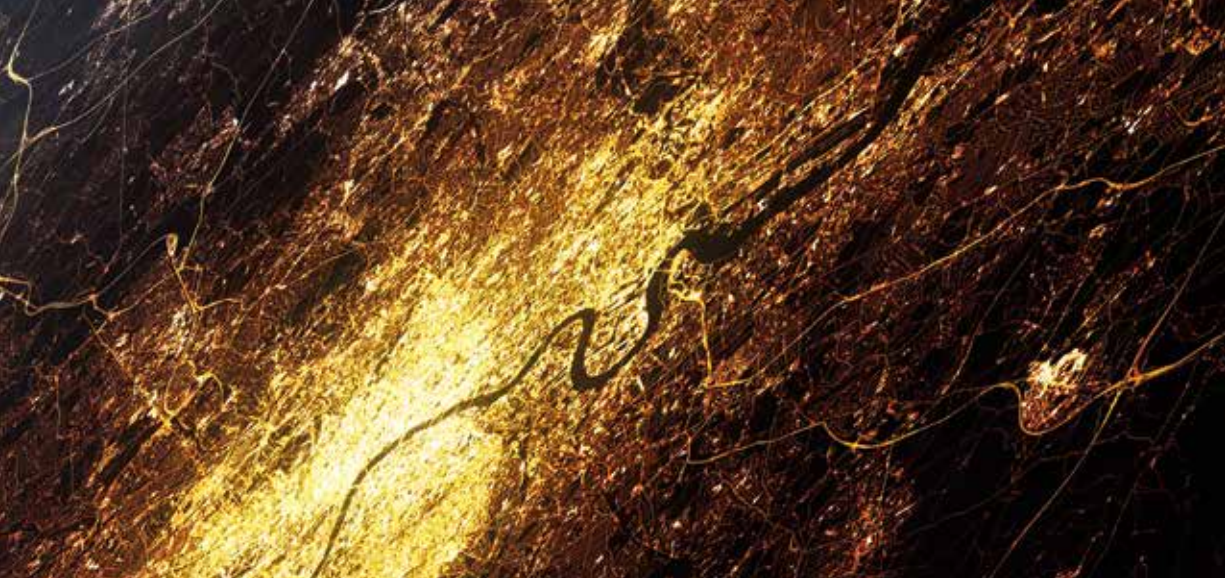

CONTENTS

INTERIOR LIGHTING

COMMERCIAL/EDUCATION 10

Epsilon
LuxPanel Backlit
LuxPanel Edgelit
ECO LuxPanel
Surface Modular
Accessories
LuxPanel Circular
ECO Circular Panels
LuxPanel IP65
Academy
Decorative Surface
Pendant

ACCENT/DISPLAY 28

FType
Atom
ECO GU10 FR Downlight
ECO GU10 Downlight
Platinum
Carbon
Track
Surface Spots
Decorative
Modular
Taska
Under Cabinet Tile

AMBIENT/AMENITY 48

Mosi
Atlas
ECO Bulkhead
Wall Mounted Accent

INDUSTRIAL 54

LuxBay
Ceres
Titan
Indus
LuxPack
Climate
ECO Climate T8

EMERGENCY 62

EXTERIOR LIGHTING 68

Atlas
Fortis Bulkhead
Fortis Wallpack
Guardian Pro
Commercial Exterior
Slimline Guardian Floodlights
Slimline Work Lights
Decorative Exterior
Eco Bulkheads

LAMPS & TUBES 98

FILAMENT

A60 Classic
C35 Candle
B45 Mini Globe

GLASS

GU10
MR16

CLASSIC

GU10
DIM2WARM GU10
MR16
A60 Classic
DIM2WARM A60
A70 Classic
B45 Mini Globe

C35 Candle
Capsules
GX53
PLC Series
R Series
PAR
S15

COMMERCIAL

Glass T8
Corn

STRIPS

Luxband
USB Strip Kit

CONTROLS 138

Sensors
PIR
Programmable



MASSIVE SAVINGS

Luceco, the global lighting brand from Luceco plc, is a £170m manufacturing business supplying high efficiency, energy saving LED luminaires to the trade, retail and specification markets.

Our reputation is based on the reliability and functionality of our innovative products. By offering market leading warranties, technical support, dedicated customer service and marketing backup, we aim to make it easy for customers to specify and install sustainable lighting.

The teams behind Luceco have over 100 years combined lighting industry experience gained over disciplines such as product design, development, testing and product management. This enviable expertise coupled with the group resources mean that Luceco have the knowledge and ability to be at the forefront of LED lighting technology.

Luceco believe that we have a responsibility to care for and protect the environment in which we operate. We are fully committed to improving environmental performance across all of our manufacturing and other business activities, continually looking for new methods and materials to provide environmentally friendly solutions.

Our international offices provide sales and support to the UK, Europe, Middle East, USA, Asia-Pacific and Africa.

WARRANTY*

1 YEAR ON SITE WARRANTY (UK ONLY)

Should a product that has been correctly specified, professionally installed by a registered trades person and operated in accordance with the specified parameters, fail during its first year of installation, Luceco will arrange for the product to be repaired or replaced at our discretion.

3 YEAR STANDARD WARRANTY**

Luceco offers a standard 3 year warranty for non registered products. If a product was to fail during this period, Luceco will arrange for the product to be repaired or replaced with an equal or substitute product at our discretion.

5 YEAR EXTENDED WARRANTIES

Luceco offers 5 year*** extended warranties against selected products where the installation is registered on www.luceco.com. Installations must be carried out by a approved contractor and in accordance with the terms and conditions detailed on the Luceco website.

For specific product warranty details please see page 147.



*1 year on site warranty, 3 year warranty and 5 year extended warranties only available in the UK. Rest of the world may vary, please ask your local distributor for more information. ECO products not covered by 1 year on site warranty.

**Work lights are limited to 2 year warranty.

***For products with emergency control gear, the extended warranty is limited to 4 years for the emergency components, due to the rated service life of the batteries.

EU ENERGY LABELLING

Luceco LED products are characterised by very low energy consumption. Our luminaires are very effective and can meet the requirements of minimum Class A, many at A+ or A++.

The EU energy label gives information about the energy efficiency of a product. The label rates products from dark green (most efficient) to red (least efficient). Dark green rated products use less energy and help you to lower your energy bills and CO₂ emissions.

www.gov.uk/guidance/the-energy-labelling-of-products

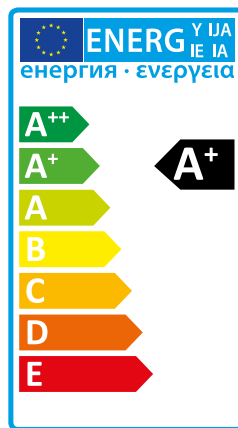

LIGHTING INDUSTRY ASSOCIATION

The Lighting Industry Association is the largest lighting industry trade association in Europe. Their mission is to strengthen the industry and promote the benefits of good quality lighting by representing all aspects of UK, EU and international legislation and standards at the highest level whilst protecting the interests of both the public and its members.

www.thelia.org.uk





CARBON TRUST

The Carbon Trust is a world-leading organisation helping businesses, governments and the public sector to accelerate the move to a sustainable, low carbon economy through carbon reduction, energy-saving strategies and commercialising low carbon technologies.

As a Carbon Trust Accredited Supplier, Luceco joins a market-leading scheme for high quality energy efficient equipment and renewable technology suppliers. It provides independent validation and recognition of a supplier's skills and services - a much needed and trusted quality standard in a crowded and fast growing market place. Accredited Suppliers must meet or exceed criteria set by the Carbon Trust, designed to examine their capability to deliver thoughtful, well-designed, energy efficient and renewable energy systems.



COST SAVINGS & ENERGY REDUCTION

Incandescent lighting converts only 5% of energy into light; the remaining energy is converted into heat. LEDs convert up to 80% of energy into light, so they greatly reduce power consumption.

Lighting accounts for approximately 30% of the power used in offices. LED therefore provides huge potential to **reduce electricity consumption** and its associated costs.

Other financial benefits include **less maintenance** (lamp change); **no expensive disposal** (unlike fluorescent lamps, LEDs contain no mercury or other harmful materials); and **improved staff productivity** (LED light provides a bright and pleasant working environment). **Air conditioning costs are also reduced** due to the lower amount of heat emitted from LED lighting, as well as life extension of the air conditioning unit because it is not worked so hard.

ENHANCED CAPITAL ALLOWANCE

The Enhanced Capital Allowance (ECA) scheme is a key part of the Government's programme to manage climate change. It provides businesses with enhanced tax relief for investments in equipment that meets published energy-saving criteria. Luceco can offer a wide number of products that meet the eligibility criteria. Using ECA compliant luminaires can drastically improve ROI figures.

www.luceco.com/uk/tax-benefits



Why LED?

ENVIRONMENTALLY FRIENDLY

Fluorescent lighting contains mercury. LEDs do not. This makes LEDs safer both to use and dispose of. The mercury contained in just one fluorescent lamp is enough to contaminate 30,000 litres of water beyond safe drinking level limits. Fluorescent lamps are therefore classified as 'hazardous waste'.



COST EFFECTIVE

The true cost of traditional lighting source is not only in its energy consumption. There is also maintenance over its lifetime, replacement labour and lamp outlay, and disposal costs. With LED, these costs don't exist. LED is a Fit-&-Forget solution.



SAFE LIGHTING

LEDs emit minimal Ultra Violet light (UV). UV light attracts insects and can be harmful to skin, clothing and artwork. Heat emissions are greatly reduced with LED, which means they are cool to touch and perfect for heat sensitive applications.



INSTANT LIGHT

LEDs produce 100% light instantly, with none of the warm up time required by fluorescents. Plus they are free of visible flicker - ideal to help prevent discomfort associated with traditional lighting.



DURABILITY

LEDs do not contain a filament that can be damaged by shock and vibration - making LED one of the most stable light sources available.



LONG LIFE

The life of LED is between 4 and 40 times greater than traditional products. What's more, they produce consistent light output over their entire life.



ECO



Introducing the new "ECO by Luceco" range of LED lighting products. The ECO range is made up of lighting products with the specific focus of providing LED technology at the prices of traditional inefficient technology such as halogen and fluorescent.

All products are designed specifically for everyday applications and requirements with wholesalers, contractors and end users in mind, providing true unmatched value and reliability. This is why all ECO products carry the Luceco brand name, meaning customers can rely on the reputation, sales and customer service they have to rely on on Luceco.

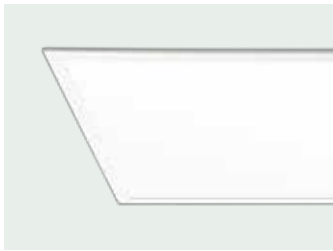

ECO LuxPanel

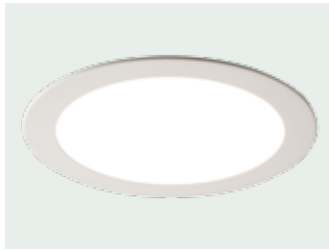

15 ECO Circular Panel Downlights



21 ECO FType Fire Rated Downlights 29



ECO GU10 Fire Rated Downlights



32 ECO GU10 Standard Downlights

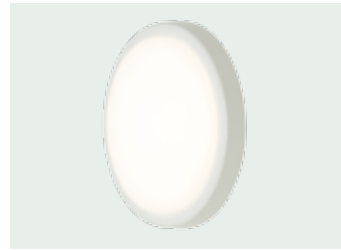

33 ECO Decorative IP54 Bulkhead 51



ECO Climate T8 IP65 Anti-corrosive



61 ECO Bulkheads 94



ECO LuxPanel



ECO
Circular Panel



ECO Climate T8

COMMERCIAL/EDUCATION

Epsilon	11
LuxPanel Backlit	13
LuxPanel Edgelit	14
ECO LuxPanel	15
Surface Modular	16
Accessories	18
LuxPanel Circular	20
ECO Circular Panels	21
LuxPanel IP65	23
Academy	24
Decorative Surface	26
Pendant	26

A range of high efficiency luminaires suitable for commercial environments including offices and education spaces.

RANGE FEATURES

- Designed to replace existing technology in terms of size and output
- Ideal to use with lighting controls
- Standard, Emergency and Dimmable options

230v
/50hz

CRI
>80

EPSILON

Direct/in-direct recessed luminaire
for low glare applications

- Integral sensor versions available
- Complies with SLL LG7 requirements



CAT NO.	DRIVER	LUMINAIRE LUMENS	WATTAGE	EFFICACY Llm/W	CURRENT
LEP66W025IS40	Standard	2500	21W	119	500mA
LEP66W025IE40	Emergency	2500	21W	119	500mA
LEP66W025ID40	Digital Dimmable	2500	21W	119	500mA
LEP66W025IED40	Emergency Dimmable	2500	21W	119	500mA
LEP66W025ID40PIR	Digital Dimmable	2500	21W	119	500mA
LEP66W025IED40PIR	Emergency Dimmable	2500	21W	119	500mA
LEP66W035IS40	Standard	3500	31W	113	700mA
LEP66W035IE40	Emergency	3500	31W	113	700mA
LEP66W035ID40	Digital Dimmable	3500	31W	113	700mA
LEP66W035IED40	Emergency Dimmable	3500	31W	113	700mA
LEP66W035ID40PIR	Digital Dimmable	3500	31W	113	700mA
LEP66W035IED40PIR	Emergency Dimmable	3500	31W	113	700mA

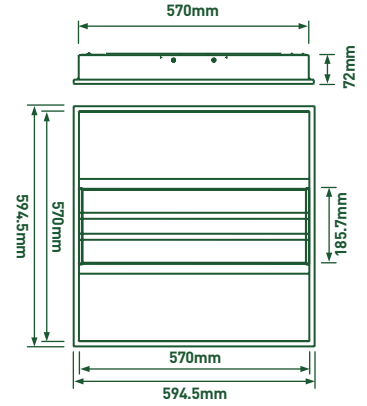

Epsilon



BACKLIT FRAMELESS

Premium frameless appearance, boasting even lower wattage and higher efficacy.



600mm x 600mm

CAT NO.	DRIVER	LUMINAIRE LUMENS	WATTAGE	EFFICACY Llm/W	CURRENT
LPB66H25S48	Standard	2500	17W	140	350mA
LPB66H25D48	Dimmable	2500	17W	140	350mA
LPB66H35S48	Standard	3500	23W	140	500mA
LPB66H35D48	Dimmable	3500	23W	140	500mA

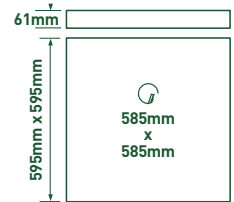

1200mm x 600mm

CAT NO.	DRIVER	LUMINAIRE LUMENS	WATTAGE	EFFICACY Llm/W	CURRENT
LPB612H50S48	Standard	5000	33W	140	700mA
LPB612H50D48	Dimmable	5000	33W	140	700mA
LPB612H70S48	Standard	7000	47W	140	1050mA
LPB612H70D48	Dimmable	7000	47W	140	1050mA

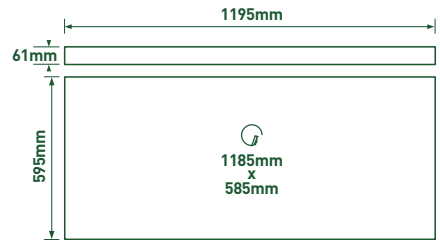

1200mm x 300mm

CAT NO.	DRIVER	LUMINAIRE LUMENS	WATTAGE	EFFICACY Llm/W	CURRENT
LPB312H25S48	Standard	2500	17W	140	350mA
LPB312H25D48	Dimmable	2500	17W	140	350mA
LPB312H35S48	Standard	3500	23W	140	500mA
LPB312H35D48	Dimmable	3500	23W	140	500mA

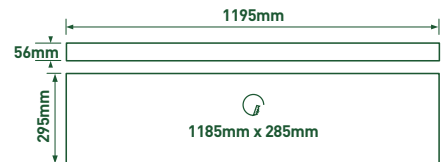

- LED3EP80-0J - Emergency pack available, see page 19

LuxPanel Backlit Frameless
600mm x 600mm



OFFICE LIGHTING COMPLIANT



Exceeds the requirements of the Society of Light and Lighting's Lighting Guide 7 (SLL LG7) and EN12464-1;

- 65° cut-off angle to limit glare on screens
- UGR of 19 or lower to eliminate discomfort glare to room occupants

In addition to the above, LuxPanel's can also offer exceptional efficacy of over 140 Luminaire lumens per circuit Watt (Llm/W) whilst providing illuminance and uniformity in accordance with the requirements of LG7 and EN12464-1. Many other LED panels can not meet all these requirements.

EDGE LIT FRAMED

600mm x 600mm

The classic LuxPanel design, with a subtle white frame surround.



CAT NO.	DRIVER	LUMINAIRE LUMENS	WATTAGE	EFFICACY Lm/W
LP66W28S40	Standard	2800	25W	110
LP66W28D40	Dimmable	2800	25W	110
LP66W35S40	Standard	3500	32W	110
LP66W35D40	Dimmable	3500	32W	110

- LED3EP80-0J - Emergency pack available, see page 19

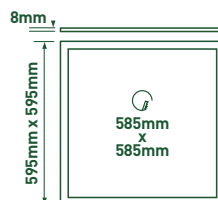

EDGE LIT FRAMED

1200mm x 600mm

The classic LuxPanel design, with a subtle white frame surround.



CAT NO.	DRIVER	LUMINAIRE LUMENS	WATTAGE	EFFICACY Lm/W
LP612W50S40	Standard	5000	60W	84
LP612W50D40	Dimmable	5000	60W	84

- LED3EP80-0J - Emergency pack available, see page 19

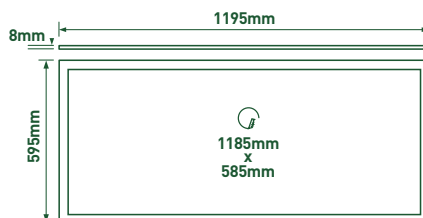
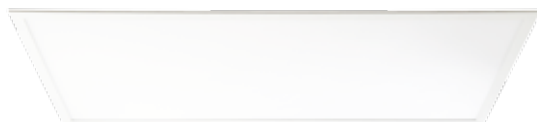

EDGE LIT FRAMED

1200mm x 300mm

The classic LuxPanel design, with a subtle white frame surround.



CAT NO.	DRIVER	LUMINAIRE LUMENS	WATTAGE	EFFICACY Lm/W
LP312W28S40	Standard	2800	28W	100
LP312W28D40	Dimmable	2800	28W	100
LP312W35S40	Standard	3500	35W	100
LP312W35D40	Dimmable	3500	35W	100

- LED3EP80-0J - Emergency pack available, see page 19

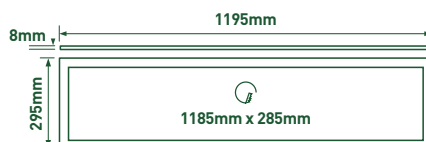
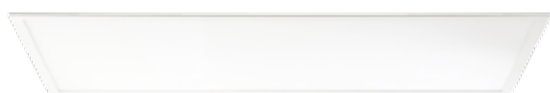

EDGE LIT FRAMED



- Classic Eco LuxPanel design with seamless joints and subtle white frame surround
- "Plug-and-play" & Luceco Driver
- Recessed Mounting suitable with fitting
- Surface mounting accessories available
- Maintenance free



4800K
NEUTRAL
WHITE

30,000
HOURS

WHITE
FINISH

NEW
RANGE

CAT NO.	SIZE	LUMINAIRE LUMENS	WATTAGE	EFFICACY Llm/W
E66L28N	595 x 595mm	2800	33W	84
E66L35N	595 x 595mm	3500	41W	85
E612L50N	1195 x 595mm	60W	83	

- LED3EP80-0J - Emergency pack available, see page 19
- LPF66W - Surface Mounting Frame for 600 x 600mm Panel, see page 18
- LPF612W - Surface Mounting Frame for 1200 x 600mm Panel, see page 18

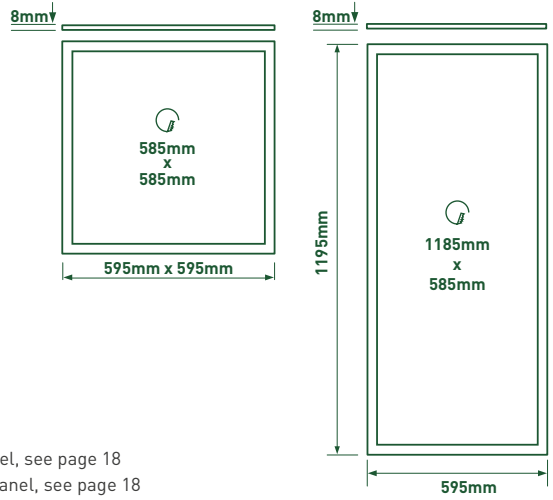

LuxPanel Edgelit Framed
600mm x 600mm

SURFACE MODULAR

A range of surface mounted Edgelit Framed LuxPanels designed to replace traditional fluorescent modular fittings. This range brings all the benefits of the LED LuxPanel range with a simple to install extruded aluminium frame. This minimalist design allows use of existing cable entry and fixing position, to any solid ceiling type, perfect for retrofit installations.

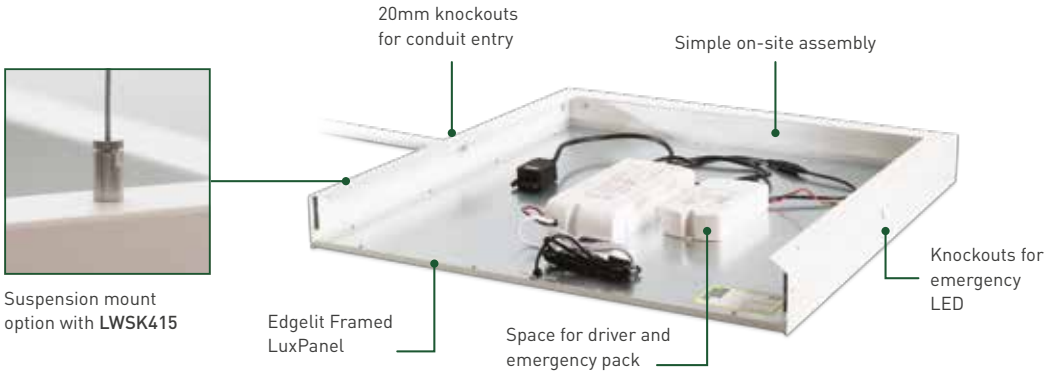

1. SCREW THREE SIDES TO CEILING



2. WIRE AND INSERT PANEL

Space for emergency pack, driver and wiring.



3. ATTACH CLOSING SECTION

Flush grub screws included for a seamless appearance.





LuxPanel Surface Modular
600mm x 600mm

600mm x 600mm

CAT NO.	DRIVER	LUMINAIRE LUMENS	WATTAGE	EFFICACY Llm/W	CURRENT
LPS66W28S40	Standard	2800	25W	112	700mA
LPS66W28D40	Dimmable	2800	25W	112	700mA
LPS66W35S40	Standard	3500	32W	110	900mA
LPS66W35D40	Dimmable	3500	32W	110	900mA

- LED3EP80-OJ - Emergency pack available, see page 19

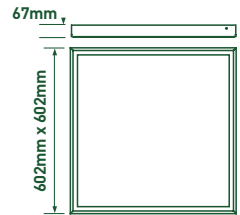

1200mm x 600mm

CAT NO.	DRIVER	LUMINAIRE LUMENS	WATTAGE	EFFICACY Llm/W	CURRENT
LPS612W50S40	Standard	5000	60W	84	1400mA
LPS612W50D40	Dimmable	5000	60W	84	1400mA

- LED3EP80-OJ - Emergency pack available, see page 19

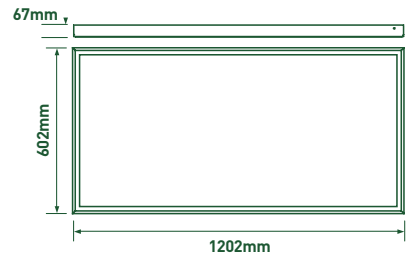

1200mm x 300mm

CAT NO.	DRIVER	LUMINAIRE LUMENS	WATTAGE	EFFICACY Llm/W	CURRENT
LPS312W28S40	Standard	2800	28W	100	700mA
LPS312W28D40	Dimmable	2800	28W	100	700mA
LPS312W35S40	Standard	3500	35W	100	900mA
LPS312W35D40	Dimmable	3500	35W	100	900mA

- LED3EP80-OJ - Emergency pack available, see page 19

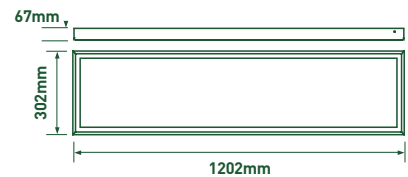

SURFACE MOUNTING FRAME

Surface mounting frame for Edgelit Framed panels.

- Simple on-site assembly
- Space for driver and emergency pack
- Can be surface mounted or suspended with LWSK415
- Knockouts for conduit entry and emergency LED

UNIQUE DESIGN



WHITE FINISH

CAT NO.	SIZE
LPF66W	602mm x 602mm x 66mm
LPF612W	1202mm x 602mm x 66mm
LPF312W	1202mm x 302mm x 66mm

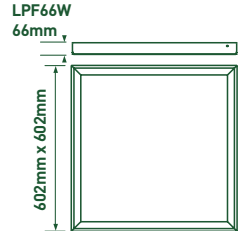

RECESS FRAME

- For use with 600mm x 600mm LuxPanels
- Suitable for installation into plasterboard ceilings up to 15mm thick

WHITE FINISH



CAT NO.	SIZE
LPF66SCRF	595mm x 595mm

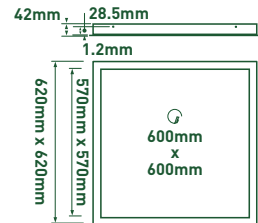

WIRE SUSPENSION KIT

Wire suspension kit (4 part kit) (for Edgelit Framed only).

- Compatible with 600mm x 600mm, 600mm x 1200mm (non IP65) Edgelit Framed, (not Backlit)
- Can also be used with surface mounting frames, (LPF66W, LPF312W and LPF612W)



CAT NO.	SIZE
LWSK415	Maximum suspension - 1500mm

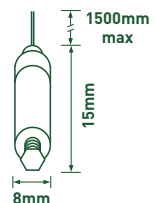

EMERGENCY PACK

- Compatible with all LuxPanels, Platinum and Carbon downlights
- Can be retro-fitted to fixed output or dimmable drivers
- Battery pack can be replaced
- Supplied with all required connections and mini bezel for charge indicator

UNIQUE DESIGN



CAT NO.	DESCRIPTION
LED3EP80-0J	Emergency pack

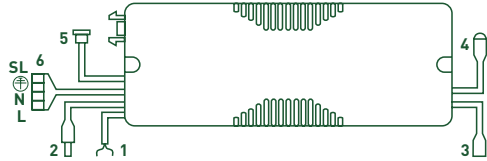

1. Live/Neutral to input of Driver
2. LED luminaire input
3. Output of driver to inverter
4. Indicator light
5. Connect Battery
6. Mains input



Emergency LED indicator in suspended ceiling tile



Emergency LED indicator within Surface Mounting Frame

CIRCULAR EDGELIT

Circular LuxPanel design, with a subtle white frame surround.



Ø240mm

CAT NO.	DRIVER	LUMINAIRE LUMENS	WATTAGE	EFFICACY Lm/W
LP240WS40	Standard	1260	14W	90
LP240WD40	Dimmable	1260	14W	90

- LED3EP80-0J - Emergency pack available, see page 19

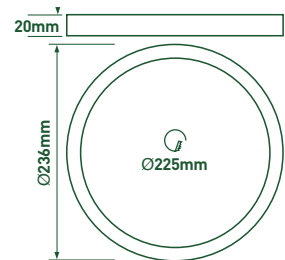

Ø180mm

CAT NO.	DRIVER	LUMINAIRE LUMENS	WATTAGE	EFFICACY Lm/W
LP180WS40	Standard	900	10W	90
LP180WD40	Dimmable	900	10W	90

- LED3EP80-0J - Emergency pack available, see page 19

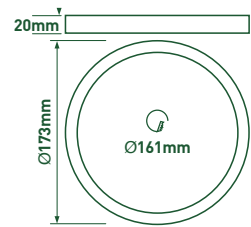

Ø150mm

CAT NO.	DRIVER	LUMINAIRE LUMENS	WATTAGE	EFFICACY Lm/W
LP150WS40	Standard	675	9W	75
LP150WD40	Dimmable	675	9W	75

- LED3EP80-0J - Emergency pack available, see page 19

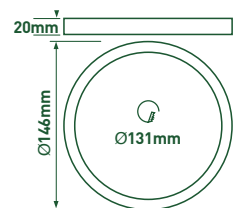

Ø120mm

CAT NO.	DRIVER	LUMINAIRE LUMENS	WATTAGE	EFFICACY Lm/W
LP120WS40	Standard	390	6W	65
LP120WD40	Dimmable	390	6W	65

- LED3EP80-0J - Emergency pack available, see page 19

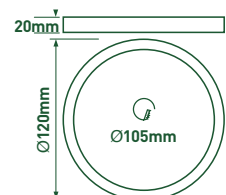

ECO CIRCULAR PANEL

ECO



DOWNLIGHTS

ECO Circular Panels - the cost saving alternative to commercial fluorescent and residential lighting

- White aluminium
- Maintenance free - no bulb to replace
- Fast and easy installation
- Plug and play driver included
- Recessed installation

3000K
WARM
WHITE

4000K
NEUTRAL
WHITE

25,000
HOURS

BEAM
ANGLE
110°

WHITE
FINISH

NEW
RANGE

Ø300mm

CAT NO.	LUMINAIRE LUMENS	WATTAGE	EFFICACY Lm/W	COLOUR TEMP
ELP30W24L30	2040	24W	85	3000K
ELP30W24L40	2040	24W	85	4000K

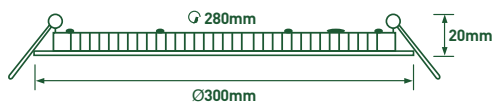

Ø220mm

CAT NO.	LUMINAIRE LUMENS	WATTAGE	EFFICACY Lm/W	COLOUR TEMP
ELP22W18L30	1530	18W	85	3000K
ELP22W18L40	1530	18W	85	4000K

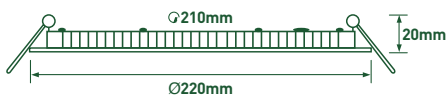

Ø200mm

CAT NO.	LUMINAIRE LUMENS	WATTAGE	EFFICACY Lm/W	COLOUR TEMP
ELP20W15L30	1200	15W	80	3000K
ELP20W15L40	1200	15W	80	4000K

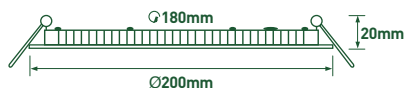

Ø170mm

CAT NO.	LUMINAIRE LUMENS	WATTAGE	EFFICACY Lm/W	COLOUR TEMP
ELP17W12L30	900	12W	75	3000K
ELP17W12L40	900	12W	75	4000K

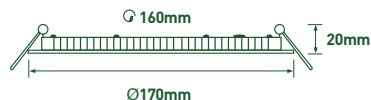

Ø150mm

CAT NO.	LUMINAIRE LUMENS	WATTAGE	EFFICACY Lm/W	COLOUR TEMP
ELP15W9L30	630	9W	70	3000K
ELP15W9L40	630	9W	70	4000K

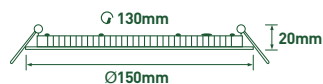

Ø120mm

CAT NO.	LUMINAIRE LUMENS	WATTAGE	EFFICACY Lm/W	COLOUR TEMP
ELP12W6L30	360	6W	60	3000K
ELP12W6L40	360	6W	60	4000K

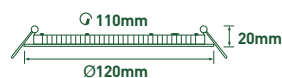

Ø85mm

CAT NO.	LUMINAIRE LUMENS	WATTAGE	EFFICACY Lm/W	COLOUR TEMP
ELP85W3L30	210	3W	70	3000K
ELP85W3L40	210	3W	70	4000K





IP65 EDGELIT FRAMED

600mm x 600mm

The classic LuxPanel design, with a subtle white frame surround. Rated IP65 protected against low pressure jets of water from all directions when installed.



CAT NO.	DRIVER	LUMINAIRE LUMENS	WATTAGE	EFFICACY Lm/W
LP661P35S40	Standard	3500	32W	110
LP661P35D40	Dimmable	3500	32W	110

- LED3EP80-OJ - Emergency pack available, see page 19

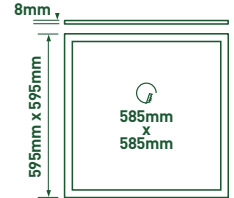

IP65 EDGELIT FRAMED

1200mm x 600mm

The classic LuxPanel design, with a subtle white frame surround. Rated IP65 protected against low pressure jets of water from all directions when installed.



CAT NO.	DRIVER	LUMINAIRE LUMENS	WATTAGE	EFFICACY Lm/W
LP612IP50S40	Standard	5000	60W	84
LP612IP50D40	Dimmable	5000	60W	84

- LED3EP80-OJ - Emergency pack available, see page 19

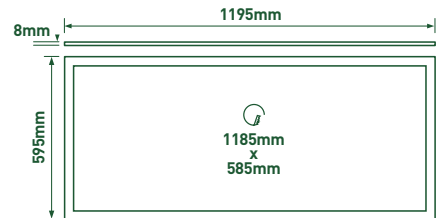
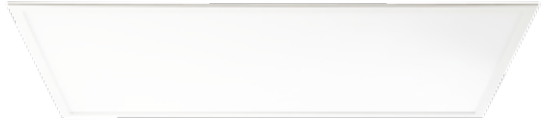

IP65 CIRCULAR EDGELIT

Ø240mm

Circular LuxPanel design, with a subtle white frame surround. Rated IP65 protected against low pressure jets of water from all directions when installed.



CAT NO.	DRIVER	LUMINAIRE LUMENS	WATTAGE	EFFICACY Lm/W
LPIP240WS40	Standard	1200	16W	75
LPIP240WD40	Dimmable	1200	16W	75

- LED3EP80-OJ - Emergency pack available, see page 19

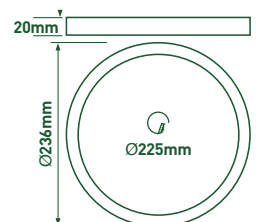



ACADEMY

- Ideal replacement for linear fluorescent
- Designed for surface mounting in office and educational environments
- Steel backplate with polycarbonate diffuser, secured by screwed endcaps
- Uses high quality opal prism diffuser for reduced glare
- Suitable for suspended mounting, see page 18 (LWSK415 ordered separately)
Available with integrated micro-wave sensor, in standard or corridor mode



4000K
NEUTRAL
WHITE

50,000
HOURS

WHITE
FINISH

OPAL PRISM

CAT NO.	DRIVER	SIZE	LUMINAIRE LUMENS	WATTAGE	EFFICACY Llm/W	CURRENT
LAC12P22S40	Standard	4ft / 1260mm	2200	22W	100	900mA
LAC12P22E40	Emergency	4ft / 1260mm	2200	22W	100	900mA
LAC12P22D40	Dimmable	4ft / 1260mm	2200	22W	100	900mA
LAC12P22ED40	Emergency Dim	4ft / 1260mm	2200	22W	100	900mA
LAC12P22S40MW	Microwave	4ft / 1260mm	2200	22W	100	900mA
LAC12P40S40	Standard	4ft / 1260mm	4000	39W	103	1050mA
LAC12P40E40	Emergency	4ft / 1260mm	4000	39W	103	1050mA
LAC12P40D40	Dimmable	4ft / 1260mm	4000	39W	103	1050mA
LAC12P40ED40	Emergency Dim	4ft / 1260mm	4000	39W	103	1050mA
LAC12P40S40MW	Microwave	4ft / 1260mm	4000	39W	103	1050mA

CAT NO.	DRIVER	SIZE	LUMINAIRE LUMENS	WATTAGE	EFFICACY Llm/W	CURRENT
LAC15P32S40	Standard	5ft / 1560mm	3200	31W	103	1050mA
LAC15P32E40	Emergency	5ft / 1560mm	3200	31W	103	1050mA
LAC15P32D40	Dimmable	5ft / 1560mm	3200	31W	103	1050mA
LAC15P32ED40	Emergency Dim	5ft / 1560mm	3200	31W	103	1050mA
LAC15P32S40MW	Microwave	5ft / 1560mm	3200	31W	103	1050mA
LAC15P60S40	Standard	5ft / 1560mm	6000	58W	103	1400mA
LAC15P60E40	Emergency	5ft / 1560mm	6000	58W	103	1400mA
LAC15P60D40	Dimmable	5ft / 1560mm	6000	58W	103	1400mA
LAC15P60ED40	Emergency Dim	5ft / 1560mm	6000	58W	103	1400mA
LAC15P60S40MW	Microwave	5ft / 1560mm	6000	58W	103	1400mA

CAT NO.	DRIVER	SIZE	LUMINAIRE LUMENS	WATTAGE	EFFICACY Llm/W	CURRENT
LAC18P45S40	Standard	6ft / 1825mm	4500	46W	98	1400mA
LAC18P45E40	Emergency	6ft / 1825mm	4500	46W	98	1400mA
LAC18P45D40	Dimmable	6ft / 1825mm	4500	46W	98	1400mA
LAC18P45ED40	Emergency Dim	6ft / 1825mm	4500	46W	98	1400mA
LAC18P45S40MW	Microwave	6ft / 1825mm	4500	46W	98	1400mA
LAC18P80S40	Standard	6ft / 1825mm	8000	85W	94	1050mA
LAC18P80E40	Emergency	6ft / 1825mm	8000	85W	94	1050mA
LAC18P80D40	Dimmable	6ft / 1825mm	8000	85W	94	1050mA
LAC18P80ED40	Emergency Dim	6ft / 1825mm	8000	85W	94	1050mA
LAC18P80S40MW	Microwave	6ft / 1825mm	8000	85W	94	1050mA

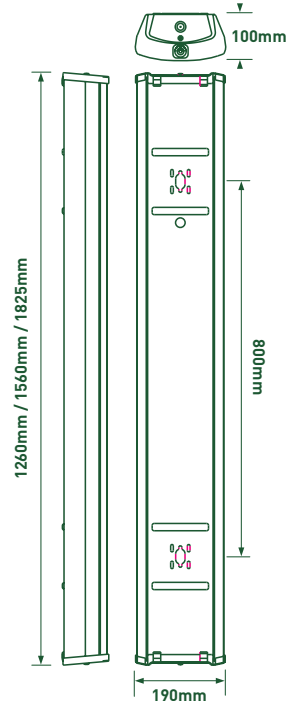

CLEAR PRISM - T8

- Fitted with LED T8 Tubes
- Integrated driver

4000K
NEUTRAL
WHITE

30,000
HOURS

WHITE
FINISH

CAT NO.	DRIVER	SIZE	LUMINAIRE LUMENS	WATTAGE	EFFICACY Llm/W
LACT12P38S40	Standard	4ft / 1260mm	3800	48W	80
LACT12P38E40	Emergency	4ft / 1260mm	3800	48W	80
LACT15P51S40	Standard	5ft / 1560mm	5120	64W	80
LACT15P51E40	Emergency	5ft / 1560mm	5120	64W	80
LACT18P64S40	Standard	6ft / 1825mm	6400	80W	80
LACT18P64E40	Emergency	6ft / 1825mm	6400	80W	80





DECORATIVE SURFACE

- Fixed position
- Optical diffuser panel
- Suitable for mounting on wall or ceiling
- Polished finish with black driver housing
- Integral fixed output driver



CAT NO.	LUMINAIRE LUMENS	WATTAGE	EFFICACY Llm/W
LKT2017	1400	20W	70

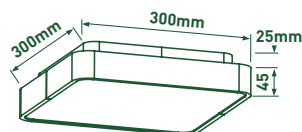

PENDANT

- Anodised aluminium finish
- Suspension cables and transparent feed cable
- Suspension height can be adjusted without tools
- Fixed output constant current driver
- Anti-glare microprismatic surface

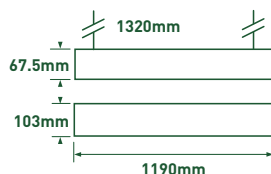
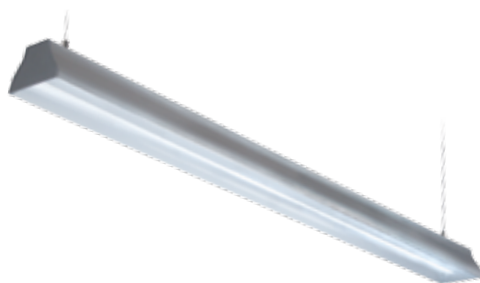

CAT NO.	LUMINAIRE LUMENS	WATTAGE	EFFICACY Llm/W
LKT1013CW	3100	42W	74

PENDANT

- Anodised aluminium finish
- Suspension cables and transparent feed cable
- Suspension height can be adjusted without tools
- Fixed output constant current driver
- Anti-glare microprismatic surface

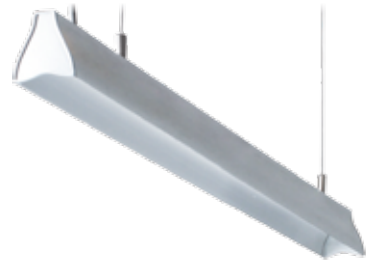

CAT NO.	LUMINAIRE LUMENS	WATTAGE	EFFICACY Llm/W
LKT1012ACW	1400	18.5W	76
LKT1012BCW	2000	30W	67

LKT1012ACW

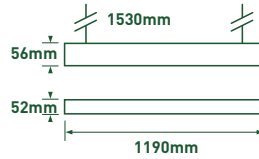

LKT1012BCW

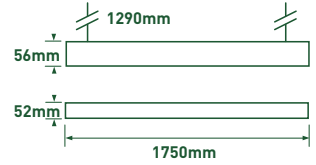

LKT1012BCW Pendant



ACCENT/DISPLAY

F Type	29
Atom	31
ECO FR Downlight	32
ECO Downlight	33
Platinum Mini	34
Platinum	35
Carbon	36
Track	37
Surface Spots	38
Decorative	39
Modular	44
Taska	46
Under Cabinet Tile	47

A range of luminaires designed to meet the varied requirements of commercial applications, including office and retail installations. Alternatives and retrofit replacements to Tungsten, HID and CFL luminaires. Offering savings of up to 80%.

RANGE FEATURES

- Designed to fit common ceiling cutouts
- Ideal for use with sensors
- Standard, dimmable and emergency versions

230v
/50hz

CRI
>80

FTYPE
FIRE RATED

The NEW All Integrated FType range of Fire Rated LED Downlights from Luceco have been designed and engineered with true performance at their heart.

3000K WARM WHITE	4000K NEUTRAL WHITE	30,60 & 90^{min} FIRE RATED	EASY INSTALLATION
IP65 RATED	25,000 HOURS	DIMMABLE	INSULATION COVERABLE

NEW RANGE



FTYPE™

FLAWLESS FUNCTIONALITY

- Direct Insulation coverable
- Thermal Rod heat sink design for optimum performance
- Super efficient Samsung LED chips - latest technology, maximum reliability
- IP65 rated - also ideal for bathrooms
- Interchangeable bezel - range of design and colour finishes
- Crystalline Optics engineered baffled back lens
- Speedfit loop in/ out push fit terminals for solid or stranded cable
- Clip & Fit cable clamp housing



3000K WARM WHITE	4000K NEUTRAL WHITE	30,60 & 90min FIRE RATED	EASY INSTALLATION	IP65 RATED	25,000 HOURS	DIMMABLE	INSULATION COVERABLE
-------------------------------	----------------------------------	--	-----------------------------	----------------------	------------------------	-----------------	--------------------------------

CAT NO.	WATTAGE	LUMINAIRE LUMENS	COLOUR TEMPERATURE	EFFICACY Lm/W	POWER FACTOR	CUTOUT
EFT60W30	6W	600	3000K	100	>0.9	75mm
EFT60W40	6W	600	4000K	100	>0.9	75mm
EFT80W30	8W	800	3000K	100	>0.9	75mm
EFT80W40	8W	800	4000K	100	>0.9	75mm



ALTERNATIVE FINISH BEZELS

CAT NO.	DESCRIPTION
EFTBZMW	Bevelled Profile Bezel - Matt White
EFTBZPC	Bevelled Profile Bezel - Polished Chrome
EFTBZBS	Bevelled Profile Bezel - Brushed Steel
EFTBZBK	Bevelled Profile Bezel - Black
EFTBZBN	Bevelled Profile Bezel - Black Nickel
EFTBZFMW	Flat Profile Bezel - Matt White
EFTBZFPC	Flat Profile Bezel - Polished Chrome
EFTBZFBS	Flat Profile Bezel - Brushed Steel
EFTBZFBK	Flat Profile Bezel - Black
EFTBZFBN	Flat Profile Bezel - Black Nickel

FLAT OR BEVELLED DESIGN BEZEL*

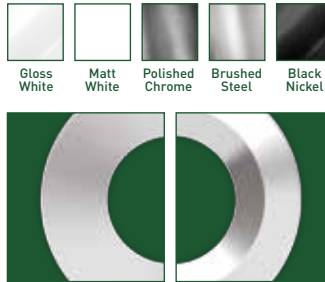

*Supplied with flat matt white bezel

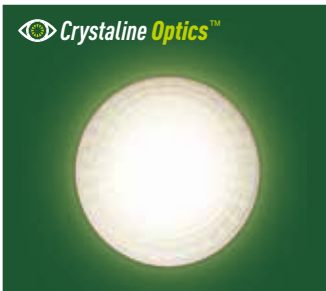
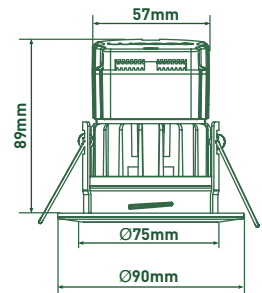

ATOM

FIRE RATED

- Fully tested to 30, 60 and 90mins fire resistance
- Integrated driver
- Dimmable with Leading Edge/Triac type dimmers
- True halogen appearance



AVAILABLE IN 3 FINISHES



BRUSHED STEEL



POLISHED CHROME



WHITE

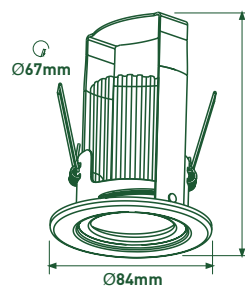

CAT NO.	BEZEL	LUMINAIRE LUMENS	WATTAGE	EFFICACY Lm/W	COLOUR TEMP
LFR5WH475D40	White	475	5.2W	91	4000K
LFR5PC475D40	Polished Chrome	475	5.2W	91	4000K
LFR5BS475D40	Brushed Steel	475	5.2W	91	4000K
LFR5WH450D27	White	450	5.2W	87	2700K
LFR5PC450D27	Polished Chrome	450	5.2W	87	2700K
LFR5BS450D27	Brushed Steel	450	5.2W	87	2700K



Brushed Steel Fire Rated Atom Downlight

GU10 FIRE RATED DOWNLIGHTS



- Rapid and easy installation
- Tool-less access & loop in loop out terminals
- Polished Chrome, Brushed Steel & White finishes available
- GU10 lamp holder - 35W MAX (lamp NOT included)
- Tool-less access & loop in loop out terminals
- Fully tested to 30, 60 and 90mins fire resistance



CAT NO.	VERSION	BEZEL
EFRDGUFWH	Fixed	White
EFRDGUFBS	Fixed	Brushed Steel
EFRDGUFPC	Fixed	Polished Chrome
EFRDGUIPWH	IP65	White
EFRDGUIPBS	IP65	Brushed Steel
EFRDGUIPPC	IP65	Polished Chrome
EFRDUAWH	Adjustable	White
EFRDUAABS	Adjustable	Brushed Steel
EFRDUAAPC	Adjustable	Polished Chrome



LOOP IN/ LOOP OUT PUSH FIT TERMINAL

AVAILABLE IN 3 FINISHES & VERSIONS

WHITE

POLISHED CHROME

BRUSHED STEEL



FIXED



IP65



ADJUSTABLE

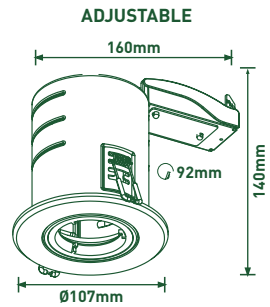
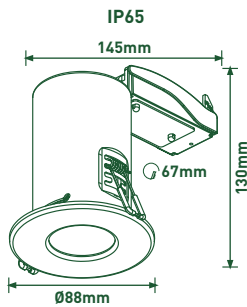
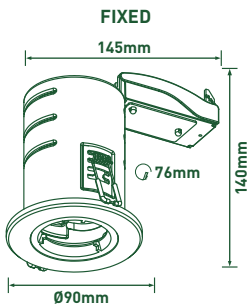



Brushed Steel
Fire Rated Downlight

GU10 STANDARD DOWNLIGHTS



- Easy installation
- Polished Chrome, Brushed Steel & White finishes available
- GU10 lamp holder - 50W MAX (lamp NOT included)
- Tool-less access & loop in loop out terminals

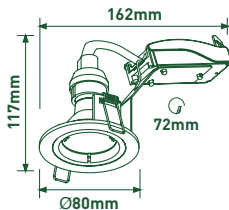

FIXED

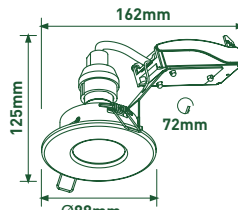

IP65

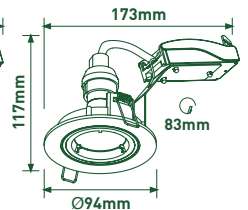

ADJUSTABLE

CAT NO.	VERSION	BEZEL
EDLGUFWH	Fixed	White
EDLGUFBS	Fixed	Brushed Steel
EDLGUFPC	Fixed	Polished Chrome
EDLGUIPWH	IP65	White
EDLGUIPBS	IP65	Brushed Steel
EDLGUIPPC	IP65	Polished Chrome
EDLGUAWH	Adjustable	White
EDLGUABS	Adjustable	Brushed Steel
EDLGUAPC	Adjustable	Polished Chrome

AVAILABLE IN 3 FINISHES



BRUSHED STEEL



POLISHED CHROME



WHITE

PLATINUM MINI

- Ideal alternative to CFL downlights
- Suitable for 150mm - 155mm cutout
- Easy fit positive locating swing tabs
- Supplied with white bezel
- Gloss reflector finish

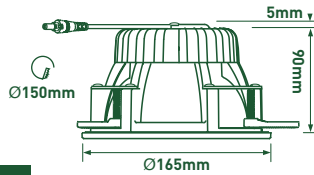

Positive location swing tabs - easy fit and adjustment

4000K NEUTRAL WHITE	50,000 HOURS	BEAM ANGLE 65°	WHITE FINISH	IP44 RATED
----------------------------------	------------------------	------------------------------------	------------------------	----------------------



CAT NO.	DRIVER	LUMINAIRE LUMENS	WATTAGE	EFFICACY Ltm/W	CURRENT
LDP15W11GS40	Standard	1050	9W	117	350mA
LDP15W11GD40	Dimmable	1050	9W	117	350mA
LDP15W15GS40	Standard	1500	13W	115	500mA
LDP15W15GD40	Dimmable	1500	13W	115	500mA
LDP15W21GS40	Standard	2050	19W	108	700mA
LDP15W21GD40	Dimmable	2050	19W	108	700mA

- LED3EP80-0J - Emergency pack available, see page 19



Shown with LDP15BWHM integrated Emergency indicator bezel

ACCESSORIES

- 10 bezel options

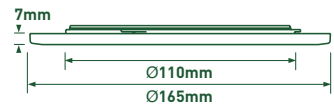
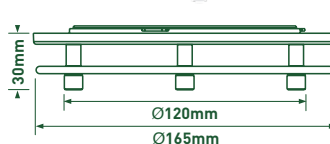
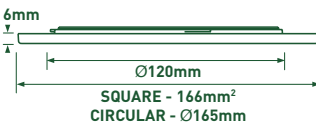

ALTERNATIVE FINISHES

CAT NO.	BEZEL
LDP15BPC	Circular polished chrome
LDP15BBS	Circular brushed steel
LDP15BSQWH	Square white
LDP15BSQPC	Square polished chrome
LDP15BSQBS	Square brushed steel
LDP15BWHM	White emergency indicator

DECORATIVE GLASS BEZELS

CAT NO.	BEZEL
LDP15BWHDF	White - Dropped frosted
LDP15BPCDF	Polished chrome - Dropped frosted
LDP15BBSDF	Brushed steel - Dropped frosted

IP65 BEZELS

CAT NO.	BEZEL
LDP15BWHIP	White - Clear diffuser
LDP15BWHIPF	White - Frosted diffuser

PLATINUM

- Ideal alternative to CFL downlights
- Suitable for 203mm - 210mm cutout, recommended 205mm
- Easy fit positive locating swing tabs
- Supplied with white bezel

4000K
NEUTRAL
WHITE



50,000
HOURS

BEAM
ANGLE
90°

WHITE
FINISH

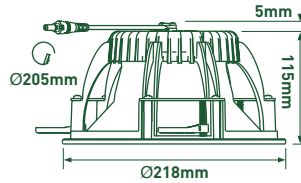

Positive location swing tabs - easy fit and adjustment



GLOSS REFLECTOR



MATT REFLECTOR

CAT NO.	DRIVER	LUMINAIRE LUMENS	WATTAGE	EFFICACY Llm/W	CURRENT
LDP20W32GS40	Standard	3200	33W	97	1050mA
LDP20W32GD40	Dimmable	3200	33W	97	1050mA
LDP20W22GS40	Standard	2200	22W	98	700mA
LDP20W22GD40	Dimmable	2200	22W	98	700mA
LDP20W16GS40	Standard	1600	16W	100	500mA
LDP20W16GD40	Dimmable	1600	16W	100	500mA
LDP20W12GS40	Standard	1200	12W	100	350mA
LDP20W12GD40	Dimmable	1200	12W	100	350mA

CAT NO.	DRIVER	LUMINAIRE LUMENS	WATTAGE	EFFICACY Llm/W	CURRENT
LDP20W31MS40	Standard	3050	33W	92	1050mA
LDP20W31MD40	Dimmable	3050	33W	92	1050mA
LDP20W21MS40	Standard	2050	22W	93	700mA
LDP20W21MD40	Dimmable	2050	22W	93	700mA
LDP20W15MS40	Standard	1500	16W	94	500mA
LDP20W15MD40	Dimmable	1500	16W	94	500mA
LDP20W11MS40	Standard	1100	12W	92	350mA
LDP20W11MD40	Dimmable	1100	12W	92	350mA

- LED3EP80-OJ - Emergency pack available, see page 19

ACCESSORIES

- 13 bezel options

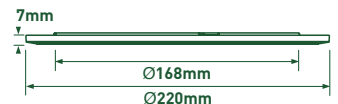
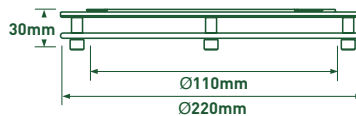
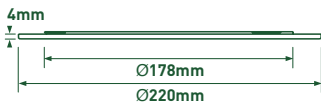

ALTERNATIVE FINISH BEZELS

CAT NO.	BEZEL
LDPBPC	Polished chrome
LDPBBS	Brushed steel

DECORATIVE GLASS BEZELS

CAT NO.	BEZEL
LDPBWHDH	White - Dropped halo
LDPBWHDF	White - Frosted glass
LDPBPCDH	Polished chrome - Dropped halo
LDPBPCDF	Polished chrome - Frosted glass
LDPBBSDH	Brushed steel - Dropped halo
LDPBBSDF	Brushed steel - Frosted glass

IP RATED BEZELS

CAT NO.	BEZEL	IP
LDP20BWH	White	IP44
LDP20BPC	Polished Chrome	IP44
LDP20BBS	Brushed steel	IP44
LDPWHIPF	White - Frosted diffuser	IP54
LDPWHIP	White - Clear diffuser	IP54



Carbon Downlight

CARBON DOWNLIGHT

- Ideal replacement and designed to retrofit/match ceiling cut outs of compact fluorescent downlights

4000K
NEUTRAL
WHITE

50,000
HOURS

BEAM
ANGLE
110°

WHITE
FINISH

IP44
RATED



Ø245mm

CAT NO.	DRIVER	LUMINAIRE LUMENS	WATTAGE	EFFICACY Llm/W	CURRENT
LBDL6S40	Standard	2000	22W	90	500mA
LBDL8D40	Digital Dimmable	2000	22W	90	500mA

- LED3EP80-0J - Emergency pack available, see page 19

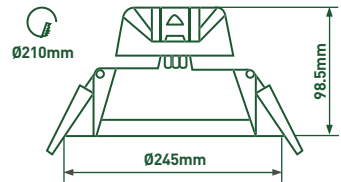

Ø197mm

CAT NO.	DRIVER	LUMINAIRE LUMENS	WATTAGE	EFFICACY Llm/W	CURRENT
LBDL4S40	Standard	1500	15.5W	100	500mA
LBDL6D40	Digital Dimmable	1500	15.5W	100	500mA

- LED3EP80-0J - Emergency pack available, see page 19

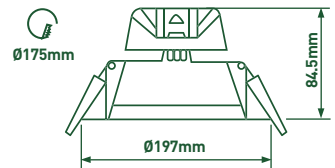

Ø145mm

CAT NO.	DRIVER	LUMINAIRE LUMENS	WATTAGE	EFFICACY Llm/W	CURRENT
LBDL4S40	Standard	1000	11W	90	350mA
LBDL4D40	Digital Dimmable	1000	11W	90	350mA

- LED3EP80-0J - Emergency pack available, see page 19

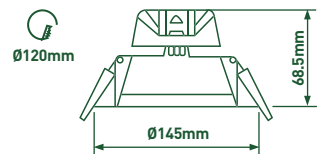

TRACK SPOT

SQUARE

- Spotlight for 3 circuit lighting track
- Lumen outputs comparable to CDM-T lamps
- Integral fixed output driver included
- 24° and 38° lenses included



CAT NO.	LUMINAIRE LUMENS	WATTAGE	EFFICACY Llm/W	CURRENT	EQUIVALENT WATTAGE
LTSW20S40	2000	24W	83	550mA	35W
LTSW28S40	2800	34W	82	800mA	70W

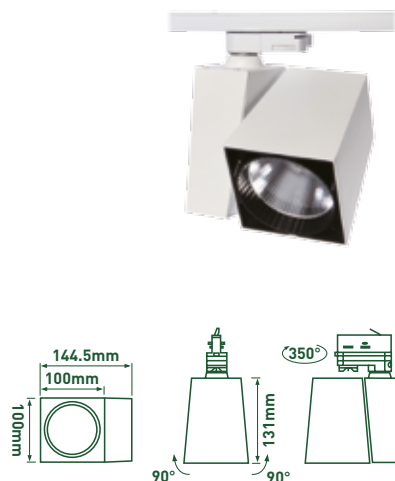

TRACK SPOT

CIRCULAR

- Spotlight for 3 circuit lighting track
- Lumen outputs comparable to CDM-T lamps
- Integral fixed output driver included
- 24° and 38° lenses included



CAT NO.	LUMINAIRE LUMENS	WATTAGE	EFFICACY Llm/W	CURRENT	EQUIVALENT WATTAGE
LTCW20S40	2050	25W	82	700mA	35W
LTCW28S40	2800	35W	80	900mA	70W



TRACK SPOT

- Spotlight for 3 circuit lighting track
- Track not included
- Allows a tilt of 90° and a 350° swivel
- Integral fixed output driver
- Highly efficient
- Generate less heat, UV & IR free compared to traditional track lights
- Universal track adaptor for use on popular 3 circuit mains track systems



CAT NO.	LUMINAIRE LUMENS	WATTAGE	EFFICACY Llm/W
LKT8562	990	16.1W	61



CIRCULAR SPOT LIGHT

SURFACE MOUNTED

- Lumen outputs comparable to CDM-T lamps
- Integral fixed output driver included
- 24° and 38° lenses included



CAT NO.	LUMINAIRE LUMENS	WATTAGE	EFFICACY Lm/W	CURRENT	EQUIVALENT WATTAGE
LSSW20S40	2000	25W	80	700mA	35W



CIRCULAR PENDANT

SURFACE MOUNTED

- Pendant designed for localised lighting
- Lumen outputs comparable to CDM-T lamps
- 1.5m adjustable pendant
- Integral fixed output driver included
- 24° and 38° lenses included



CAT NO.	LUMINAIRE LUMENS	WATTAGE	EFFICACY Lm/W	CURRENT	EQUIVALENT WATTAGE
LSPW20S40	2000	25W	80	700mA	35W

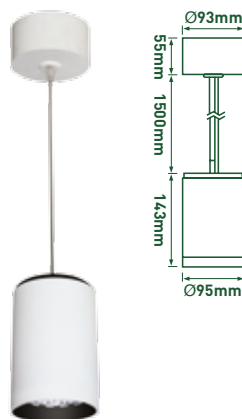

PULLOUT SPOT LIGHT

RECESSED

- Recessed spotlight with retractable head to match Luceco track spot circular range
- Lumen outputs comparable to CDM-T Lamps
- Remote fixed output driver included
- 24° and 38° lenses included



CAT NO.	LUMINAIRE LUMENS	WATTAGE	EFFICACY Lm/W	CURRENT	EQUIVALENT WATTAGE
LSRW20S40	1950	25W	78	700mA	35W



DROP ROD DOWNLIGHT

SURFACE MOUNTED

- Gimbal - adjustable positioning
- Allows a tilt of 90° and a 350° swivel
- Manufactured in aluminium
- Optimised thermal design allows for excellent heat dissipation
- Integral fixed output driver

4000K NEUTRAL WHITE	30,000 HOURS	BEAM ANGLE 17°	WHITE FINISH
----------------------------------	------------------------	------------------------------------	------------------------

CAT NO.	LUMINAIRE LUMENS	WATTAGE	EFFICACY Llm/W
LKT2022-L50	2100	24.2W	87



SQUARE DOWNLIGHT

RECESSED

- Remote fixed output driver included
- Running cost savings up to 60% vs fluorescent

4000K NEUTRAL WHITE	350 mA	35,000 HOURS	WHITE FINISH
----------------------------------	------------------	------------------------	------------------------

CAT NO.	LUMINAIRE LUMENS	WATTAGE	EFFICACY Llm/W
LDSW4S40	350	4.5W	78
LDSW12S40	1200	15W	80

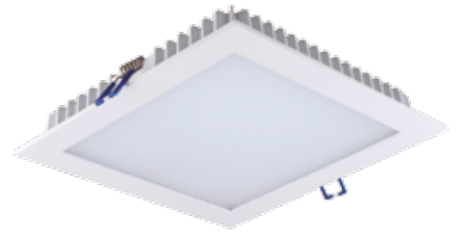

LKT206
Recessed Wallwasher

WALLWASHER

RECESSED

- Gimbal - adjustable positioning
- Adjustable 60° in single direction and 359° rotatable
- Manufactured in aluminium
- Double insulated
- Fixed output driver = LDR10350
Dimmable driver = LDRDIM15500

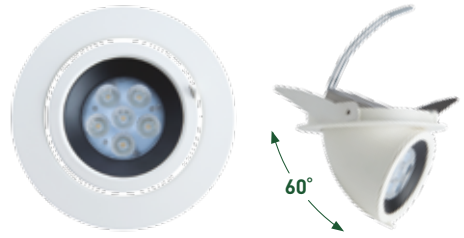

4000K NEUTRAL WHITE	350 mA	50,000 HOURS.	BEAM ANGLE 21°	WHITE FINISH
----------------------------------	------------------	-------------------------	------------------------------------	------------------------

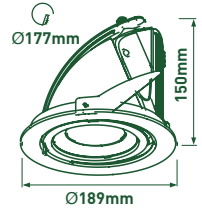

CAT NO.	LUMINAIRE LUMENS	WATTAGE	EFFICACY Llm/W
LKT206	630	9.7W	65

WALLWASHER

RECESSED

- True CDM-T equivalent lumen outputs
- Energy savings of 40%
- Gimbal with up to 340° adjustment
- 24° and 38° lenses included

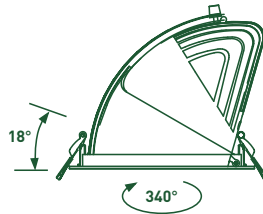

4000K NEUTRAL WHITE	550 mA	35,000 HOURS.	WHITE FINISH
----------------------------------	------------------	-------------------------	------------------------

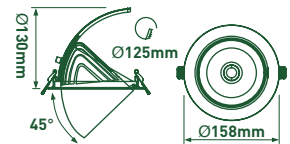

CAT NO.	LUMINAIRE LUMENS	WATTAGE	EFFICACY Llm/W	CURRENT	EQUIVALENT WATTAGE
LWCW20540	1900	22W	86	550mA	35W

WALLWASHER

RECESSED

- True CDM-T equivalent lumen outputs
- Energy savings of 40%
- Gimbal with up to 340° adjustment
- 40° lens included

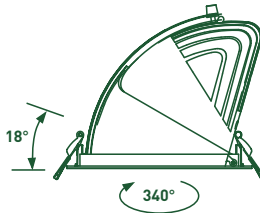

4000K NEUTRAL WHITE	550 mA	35,000 HOURS.	WHITE FINISH
----------------------------------	------------------	-------------------------	------------------------

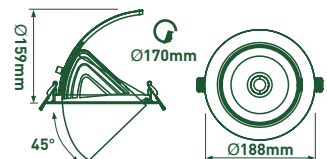

CAT NO.	LUMINAIRE LUMENS	WATTAGE	EFFICACY Llm/W	CURRENT	EQUIVALENT WATTAGE
LWCW34540	3200	38W	84	900mA	70W

WALLWASHER

RECESSED

- Tilt-able positioning
- Spring clip installation
- Thermal design allows for excellent heat dissipation
- Manufactured in aluminium
- Double insulated
- Fixed output driver = LDR42900
Dimmable driver = LDRDIM35900



CAT NO.	LUMINAIRE LUMENS	WATTAGE	EFFICACY Llm/W
LKT103	2500	29.4W	85

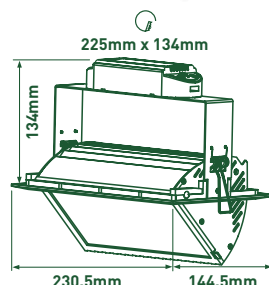

LOW GLARE DOWNLIGHT

RECESSED

- Manufactured in aluminium
- Fixed position
- Double insulated
- Slim trim bezel for clean contemporary appearance and LED light source is mounted deep in the housing to limit glare
- Fixed output driver = LDR10350
Dimmable = LDRDIM15350



CAT NO.	LUMINAIRE LUMENS	WATTAGE	EFFICACY Llm/W
LKT6564	720	6.2W	116

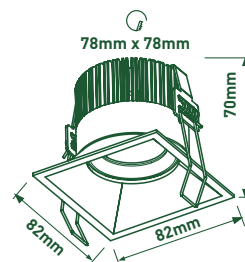
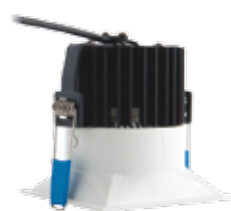

LOW GLARE DOWNLIGHT

RECESSED

- Manufactured in aluminium
- Fixed position
- Double insulated
- Fixed output driver = LDR10350
Dimmable = LDRDIM15350
- Slim trim bezel for clean contemporary appearance and LED light source is mounted deep in the housing to limit glare



CAT NO.	LUMINAIRE LUMENS	WATTAGE	EFFICACY Llm/W
LKT6565	720	6.2W	116

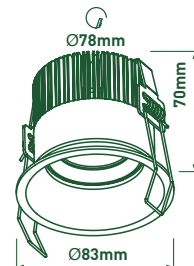

SEMI RECESSED DOWNLIGHT

- Manufactured in aluminium
- Leaf clip installation
- Gimbal - adjustable positioning
- Double insulated
- Fixed output driver = LDR20500
Dimmable driver = LDRDIM15500



4000K NEUTRAL WHITE	500 mA	50,000 HOURS	BEAM ANGLE 15°	WHITE FINISH
----------------------------------	------------------	------------------------	------------------------------------	------------------------

CAT NO.	LUMINAIRE LUMENS	WATTAGE	EFFICACY Llm/W
LKT6566	1280	14.3W	90

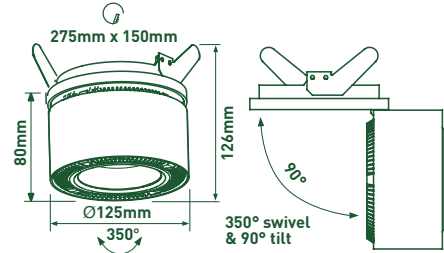

IP RATED DOWNLIGHT

RECESSED

- An ideal alternative to low voltage halogen 35W lamp or mains voltage halogen 50W lamp
- Manufactured in aluminium
- Fixed position
- Double insulated
- Fixed output driver = LDR10350
Dimmable = LDRDIM15350



4000K NEUTRAL WHITE	350 mA	50,000 HOURS	BEAM ANGLE 30°	IP65 RATED	WHITE FINISH
----------------------------------	------------------	------------------------	------------------------------------	----------------------	------------------------

CAT NO.	LUMINAIRE LUMENS	WATTAGE	EFFICACY Llm/W
LKT6594A	720	6.2W	116

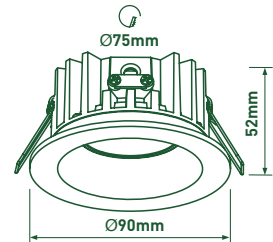

IP RATED DOWNLIGHT

RECESSED

- An ideal alternative to low voltage halogen 35W lamp or mains voltage halogen 50W lamp
- Manufactured in aluminium
- Gimbal - adjustable positioning
- Double insulated
- Fixed output driver = LDR10350
Dimmable = LDRDIM15350



4000K NEUTRAL WHITE	350 mA	50,000 HOURS	BEAM ANGLE 29°	IP44 RATED	WHITE FINISH
----------------------------------	------------------	------------------------	------------------------------------	----------------------	------------------------

CAT NO.	LUMINAIRE LUMENS	WATTAGE	EFFICACY Llm/W
LKT6595	720	6.2W	116

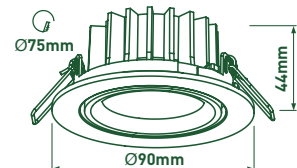

RECESSED DOWNLIGHT

- Manufactured in aluminium
- Leaf clip installation
- Fixed position
- Double insulated
- Fixed output driver = LDR20500
- Dimmable driver = LDRDIM15500



4000K NEUTRAL WHITE	500 mA	BEAM ANGLE 14°	50,000 HOURS	WHITE FINISH
----------------------------------	------------------	-----------------------------	------------------------	------------------------

CAT NO.	LUMINAIRE LUMENS	WATTAGE	EFFICACY Llm/W
LKT6563	910	9.5W	96

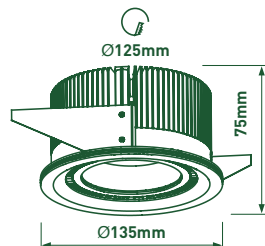

SQUARE MODULE

RECESSED

- Single module
- Lumen outputs comparable to CDM-T lamps (35W)
- Remote fixed output driver included
- 24° and 38° lenses included
- Max 30° tilt adjustment



4000K NEUTRAL WHITE	550 mA	35,000 HOURS	WHITE FINISH
----------------------------------	------------------	------------------------	------------------------

CAT NO.	LUMINAIRE LUMENS	WATTAGE	EFFICACY Llm/W
LMSRW20S40	1900	22W	86

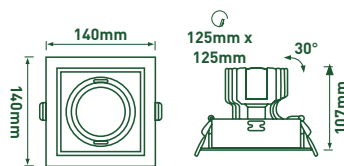

SQUARE MODULES

RECESSED

- Twin modules
- Lumen outputs comparable to CDM-T lamps (35W)
- 2x Remote fixed output driver included
- 24° and 38° lenses included
- Max 30° tilt adjustment



4000K NEUTRAL WHITE	550 mA	35,000 HOURS	WHITE FINISH
----------------------------------	------------------	------------------------	------------------------

CAT NO.	LUMINAIRE LUMENS	WATTAGE	EFFICACY Llm/W
LMSRW40S40	3800	44W	86

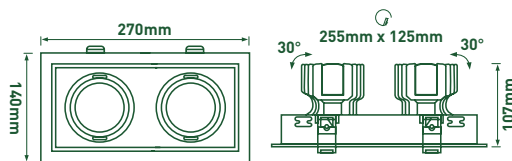

MODULAR RANGE

Choose different styles to suit each individual application -

1. PICK YOUR FRAMES

Singular or double frames are available in various shapes (circular, square or gimbal) and colours (white as standard, grey and black special order).

2. CHOOSE YOUR MODULES

Modules are available in white or black.

3. CHOOSE YOUR DRIVERS

One driver per module, therefore 2 drivers for a double frame.

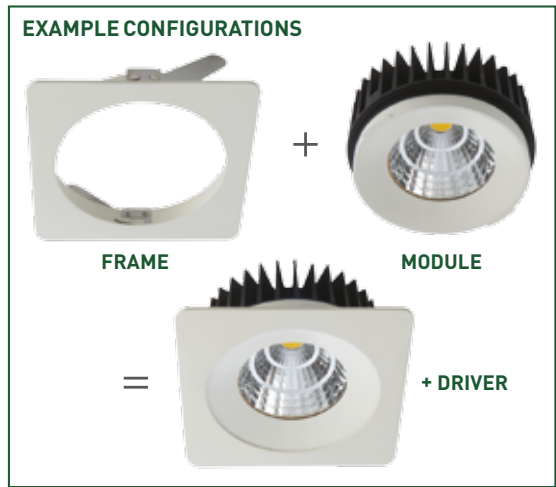

SINGLE FRAMES



	CAT NO. WHITE	CAT NO. BLACK
CIRCULAR	LKTMODSRFWH	LKTMODSRFBL
SQUARE	LKTMODSSFHWH	LKTMODSSFBL
SQUARE GIMBAL	LKTMODSSGWH	LKTMODSSGBL

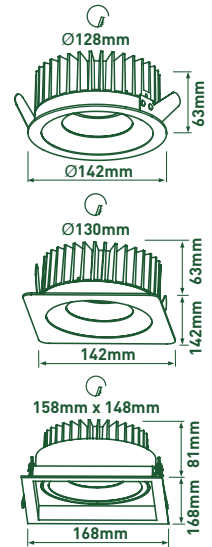

DOUBLE FRAMES



	CAT NO. WHITE	CAT NO. BLACK
CIRCULAR	LKTMODDRFWH	LKTMODDRFBL
SQUARE	LKTMODDSFWH	LKTMODDSFBL
SQUARE GIMBAL	LKTMODDSGWH	LKTMODDSGBL

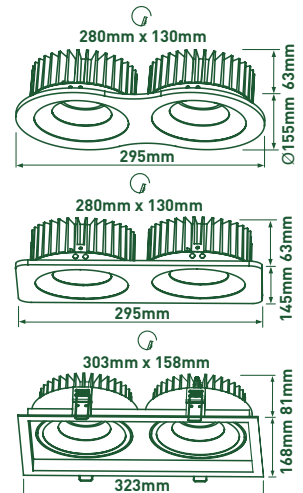

MODULES

- Manufactured in aluminium
- Double insulated
- Spring clip installation
- Thermal design allows for excellent heat dissipation
- Fixed output driver = LDR20350
- Dimmable driver = LDRDIM15350



4000K NEUTRAL WHITE	350 mA	50,000 HOURS	BEAM ANGLE 24°
----------------------------------	------------------	------------------------	------------------------------------

CAT NO.	COLOUR	LUMINAIRE LUMENS	WATTAGE	EFFICACY Lm/W
LKTMOD1WH	White	1100	15W	73
LKTMOD1BL	Black	1100	15W	73



LKTMODSSGWH and LKTMOD1BL
Single White Square Gimbal Frame with Black Module



LKTMODSSGWH and LKTMOD1BL
Double White Square Gimbal Frame with Black Module

TASKA

UNDER CABINET

- No LED 'spots' reflected in work tops
- Warm and neutral white options to suit traditional and contemporary kitchens
- Connectors to allow linking
- 50W remote driver (4100mA) = LUCLDR50
24W plug in driver (2000mA) = LUCLDP24



300mm

CAT NO.	LUMINAIRE LUMENS	WATTAGE	EFFICACY Lm/W	COLOUR TEMP
LUCL300CW	290	5W	58	4000K
LUCL300WW	250	5W	50	2700K

500mm

CAT NO.	LUMINAIRE LUMENS	WATTAGE	EFFICACY Lm/W	COLOUR TEMP
LUCL500CW	620	9W	69	4000K
LUCL500WW	520	9W	58	2700K



50W Driver

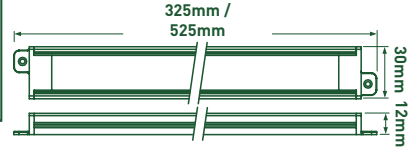

ACCESSORIES

LUCLACCL
Connecting Lead

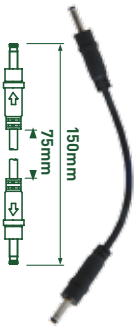

LUCLAC90
Corner Connector

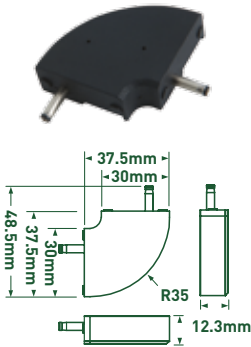

LUCLACSC
Straight Connector

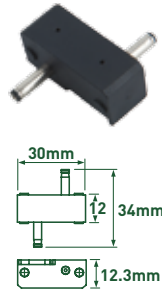

LUCLACSW
Switch

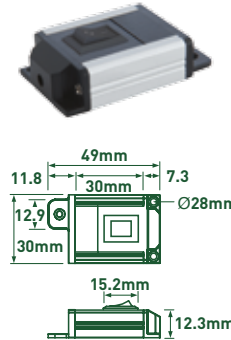

LUCLACPIR
PIR Switch

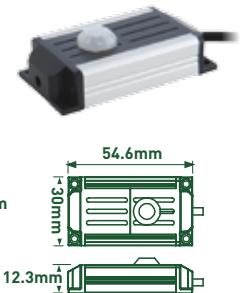

LINKING OPERATION

2700K
WARM
WHITE



4000K
NEUTRAL
WHITE





UNDER CABINET TILE

- Directly interconnectable end-to-end or with accessory leads for both straight or angled installations – interconnectable up to x3
- Motion Sensor plug and play switch provides both on / off and dimming control - 3 pin plug driver
- Ideal for many discrete lighting applications including above, inside or under kitchen cabinets, shelving, book and display cases, caravans and mobile homes
- Simple bracket connector for quick and easy installation – supplied with mounting accessories
- Extension packs with add-on panels and accessory leads supplied separately
- Available in both warm and cool white colour temperatures to suit desired lighting and room requirements



WITH MOTION SENSOR

CAT NO.	DRIVER	LUMINAIRE LUMENS	WATTAGE	EFFICACY Lm/W	COLOUR TEMP
LUCP50WH30P	Dimmable	500	8W	63	3000K
LUCP50WH40P	Dimmable	500	8W	63	4000K

EXTENSION AND ACCESSORY

CAT NO.	DRIVER	LUMINAIRE LUMENS	WATTAGE	EFFICACY Lm/W	COLOUR TEMP
LUCP50WH30	Dimmable	500	8W	63	3000K
LUCP50WH40	Dimmable	500	8W	63	4000K

APPLICATIONS



**Straight Installation
with Connector**

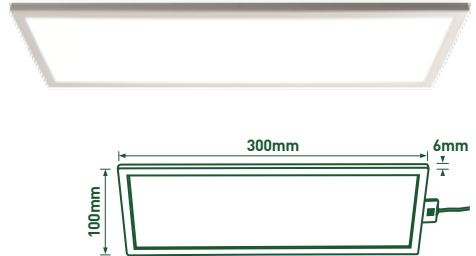

Motion sensor and
dimming control

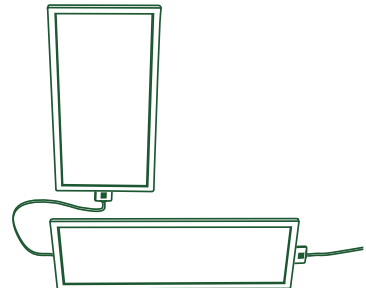

Angled Installation



AMBIENT/AMENITY

LBM290B11S40 Mosi

Mosi	49
Atlas	50
ECO Bulkhead	51
Wall Mounted Accent	52

Energy efficient designs for circulation areas and accent lighting applications. Multiple mounting options and models - including microwave presence detecting and emergency lighting.

RANGE FEATURES

- Suitable for corridors, stairwells and circulation areas
- IP65 products can also be used for exterior use
- Task lighting

230v /50hz	CRI > 80
---------------	-------------

MOSI BULKHEAD

ROUND

- Polycarbonate construction
- Opal prism diffuser for lower glare
- Black and white base options
- 4 side and 1 rear conduit entry points



CAT NO.	DRIVER	SIZE	COLOUR	LUMINAIRE LUMENS	WATTAGE	EFFICACY Lm/W	EQUIVALENT WATTAGE
LBM290B11S40	Standard	Ø290mm	Black	1150	11W	105	28W 2D
LBM290B11S40MW	Microwave	Ø290mm	Black	1150	12W	95	28W 2D
LBM290B11E40	Emergency	Ø290mm	Black	1150	12W	95	28W 2D
LBM290W11S40	Standard	Ø290mm	White	1150	11W	105	28W 2D
LBM290W11S40MW	Microwave	Ø290mm	White	1150	12W	95	28W 2D
LBM290W11E40	Emergency	Ø290mm	White	1150	12W	95	28W 2D
LBM200B7S40	Standard	Ø200mm	Black	735	7W	105	16W 2D
LBM200W7S40	Standard	Ø200mm	White	735	7W	105	16W 2D

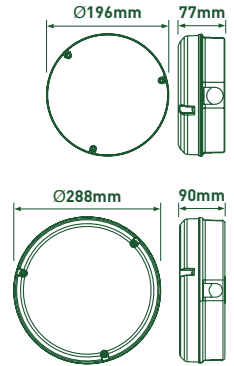

MOSI BULKHEAD

SQUARE

- Opal prism diffuser for lower glare
- Polycarbonate construction
- Simple installation
- 4 side and 1 rear conduit entry point



CAT NO.	DRIVER	SIZE	COLOUR	LUMINAIRE LUMENS	WATTAGE	EFFICACY Lm/W	EQUIVALENT WATTAGE
LBM33B11S40	Standard	280mm ²	Black	1150	11W	105	28W 2D
LBM33B11S40MW	Microwave	280mm ²	Black	1150	12W	95	28W 2D
LBM33B11E40	Emergency	280mm ²	Black	1150	12W	95	28W 2D
LBM33W11S40	Standard	280mm ²	White	1150	11W	105	28W 2D
LBM33W11S40MW	Microwave	280mm ²	White	1150	12W	95	28W 2D
LBM33W11E40	Emergency	280mm ²	White	1150	12W	95	28W 2D
LBM22B7S40	Standard	190mm ²	Black	735	7W	105	16W 2D
LBM22W7S40	Standard	190mm ²	White	735	7W	105	16W 2D

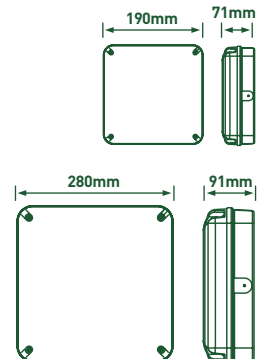

ATLAS BULKHEAD

- Alternative to 28 watt and 38 watt TC-DD (2D) compact fluorescent
- Multiple mounting options include ceiling surface, ceiling semi-recessed, wall mounted and provision for BESA and four side conduit entries
- Double insulated
- Microwave presence detector switches the output to 10% in "corridor function" standby mode or 0%, selectable during installation
- Microwave version includes photocell for dusk-till-dawn switching option
- Integral driver
- Order the accessories separately or in addition to the bulkhead



Ceiling semi-recessed



CAT NO.	DRIVER	LUMINAIRE LUMENS	WATTAGE	EFFICACY Llm/W	EQUIVALENT WATTAGE
LBH154K	Standard	1250	17W	75	28W
LBH154K3M	3hr Emergency	1250	19W	66	28W
LBH154KMW	Microwave sensor	1250	18W	69	28W
LBH154KMW3M	Microwave and emergency	1250	20W	64	28W
LBH214K	Standard	2100	24W	88	38W
LBH214K3M	3hr Emergency	2100	26W	81	38W
LBH214KMW	Microwave sensor	2100	25W	84	38W
LBH214KMW3M	Microwave and emergency	2100	27W	78	38W

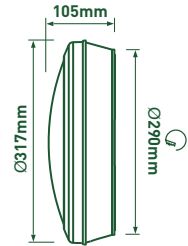

ACCESSORIES

- For use with Atlas bulkhead (order bulkhead separately)
- Comes with front and back covers and tamper proof screws, a high security screw kit is also available including special tool - LBHATK
- All die-cast aluminium accessories are finished in RAL7026 'Granite Grey'
- Front covers can be rotated every 90°
- Access to rear BESA and four side entry points

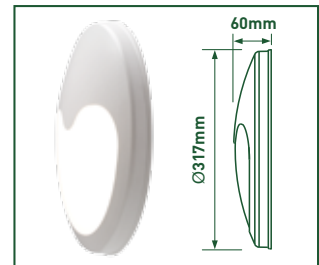
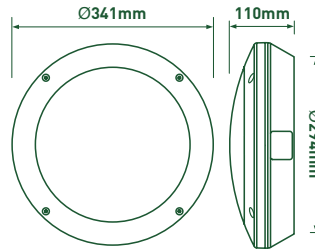

LBH154APE - Plastic Eyelid Cover



LBH154AME - Metal Eyelid



LBH154AMG - Metal Grille



LBH154AMP - Metal Standard



LBH154AMS - Metal Split Eyelid

DECORATIVE INDOOR BULKHEAD

CEILING/WALL MOUNT

- IP54 rated ideal for bathrooms, utility and decorative installations
- Easy quick installation - Wall or Ceiling mounted
- Suitable for most residential and commercial applications including bathrooms/toilets, hallways, corridors, and functional utility
- Supplied with both White and Chrome interchangeable bezels
- Piano key push fit quick install terminal block



Loop in / loop out push fit terminal

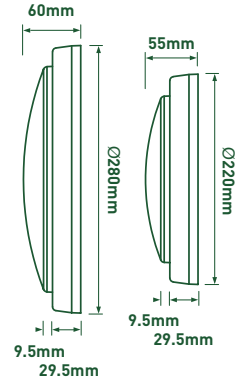

CAT NO.	SIZE	LUMINAIRE LUMENS	WATTAGE	EFFICACY Lm/W
EBH22S40	Ø220mm	1250	15W	83
EBH28S40	Ø280mm	1500	18W	83



LBH154K Atlas

WALL LIGHT

- All wall lights can be used vertically or horizontally to give different lighting effects
- High efficiency, energy saving & low glare
- Fixed output integrated driver

3000K WARM WHITE	25,000 HOURS	BEAM ANGLE 147°	WHITE FINISH
-------------------------------	------------------------	------------------------------	------------------------

CAT NO.	LUMINAIRE LUMENS	WATTAGE	EFFICACY Llm/W
LKT391A	200	4W	50

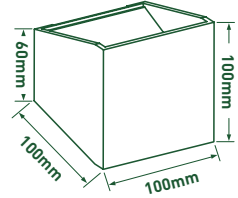

WALL LIGHT

- All wall lights can be used vertically or horizontally to give different lighting effects
- High efficiency, energy saving & low glare
- Fixed output integrated driver

3000K WARM WHITE	25,000 HOURS	BEAM ANGLE 150°	WHITE FINISH
-------------------------------	------------------------	------------------------------	------------------------

CAT NO.	LUMINAIRE LUMENS	WATTAGE	EFFICACY Llm/W
LKT393A	255	8.3W	31

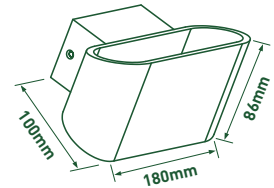

LKT396
Wall light



LKT36A
Wall light

WALL LIGHT

- All wall lights can be used vertically or horizontally to give different lighting effects
- High efficiency, energy saving & low glare
- Adjustable beam angle from 10°-120°
- Fixed output integrated driver

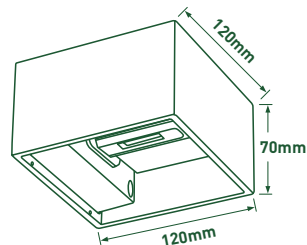
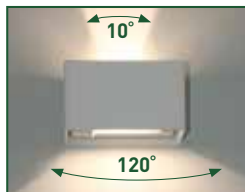

CAT NO.	LUMINAIRE LUMENS	WATTAGE	EFFICACY Lm/W
LKT536A	165	8W	21

WALL LIGHTS

- All wall lights can be used vertically or horizontally to give different lighting effects
- High efficiency, energy saving & low glare
- Fixed output integrated driver



CAT NO.	SIZE	LUMINAIRE LUMENS	WATTAGE	EFFICACY Lm/W
LKT396A	600mm	540	20W	27
LKT396	300mm	415	10W	42

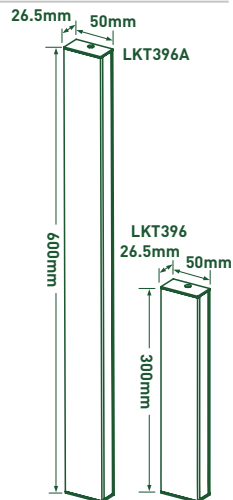



INDUSTRIAL

Climate Single LED Array

LuxBay	55
Ceres	56
Titan	57
Indus	58
LuxPack	58
Climate	59
ECO Climate T8	61

Robust luminaires perfect for the demands of the industrial environment. LED alternatives to traditional HID high bay and fluorescent.

RANGE FEATURES

- Standard, dimmable and emergency versions available
- Up to 50,000 hours maintenance free operations
- Impact resistance

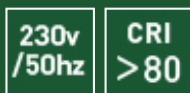

LUXBAY

- Suitable for trunking/surface or suspension mounting
- Alternative to T5, PL and HID lowbay luminaries



EQUIVALENTS

PRODUCT	T5 EQUIVALENT	PL EQUIVALENT	METAL HALIDE EQUIVALENT
LLBW11S40 / LLBN11S40	2 x 80W T5 HO	-	150W
LLBW16S40 / LLBN16S40	3 x 80W T5 HO	4 x 55W PL	250W
LLBW21S40 / LLBN21S40	4 x 80W T5 HO	6 x 55W PL	400W

ACCESSORIES

CAT NO.	DESCRIPTION
LLBXDIF	LuxBay clear diffuser
LLBXWIRE	LuxBay wire guard

WIDE CLEAR LENS

CAT NO.	DRIVER	LUMINAIRE LUMENS	WATTAGE	EFFICACY Lm/W	CURRENT
LLBW11S40	Standard	10,500	100W	105	1400mA
LLBW11E40	Emergency	10,500	100W	105	1400mA
LLBW16S40	Standard	15,800	150W	105	2100mA
LLBW16E40	Emergency	15,800	150W	105	2100mA
LLBW21S40	Standard	21,000	200W	105	2x1400mA
LLBW21E40	Emergency	21,000	200W	105	2x1400mA

NARROW AISLE LENS

CAT NO.	DRIVER	LUMINAIRE LUMENS	WATTAGE	EFFICACY Lm/W	CURRENT
LLBN11S40	Standard	10,500	100W	105	1400mA
LLBN11E40	Emergency	10,500	100W	105	1400mA
LLBN16S40	Standard	15,800	150W	105	2100mA
LLBN16E40	Emergency	15,800	150W	105	2100mA
LLBN21S40	Standard	21,000	200W	105	2x1400mA
LLBN21E40	Emergency	21,000	200W	105	2x1400mA

Available versions: Integrated presence and daylight sensors for use with fixed output or dimmable control gear

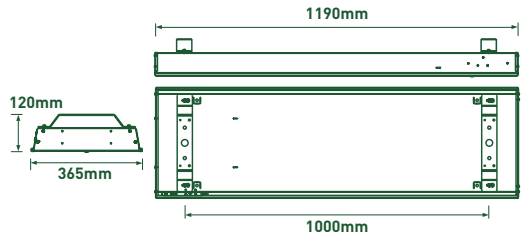



LHB120W and LHBRFL120
Titan High Bay

CERES

HIGH BAY

- Available with on/off presence detection
- Compact high bay using latest lens technology
- Computer designed die-cast aluminium housing with vortex cooling effect for maximum led chip performance

4000K
NEUTRAL
WHITE

BLACK
FINISH

IP65
RATED



60°

CAT NO.	DRIVER	LUMINAIRE LUMENS	WATTAGE	EFFICACY Llm/W
LHBC11S60	Standard	11000	100W	110
LHBC11E60	Emergency	11000	100W	110
LHBC22S60	Standard	22000	200W	110
LHBC22E60	Emergency	22000	200W	110

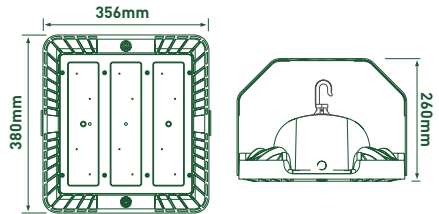

LHBC11

90°

CAT NO.	DRIVER	LUMINAIRE LUMENS	WATTAGE	EFFICACY Llm/W
LHBC11S90	Standard	11000	100W	110
LHBC11E90	Emergency	11000	100W	110
LHBC22S90	Standard	22000	200W	110
LHBC22E90	Emergency	22000	200W	110

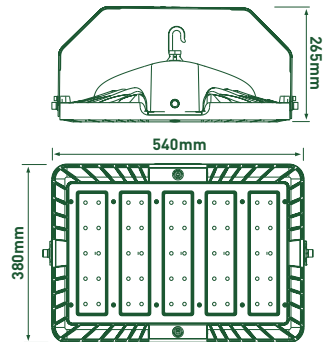

LHBC22

120°

CAT NO.	DRIVER	LUMINAIRE LUMENS	WATTAGE	EFFICACY Llm/W
LHBC11S120	Standard	11000	100W	110
LHBC11E120	Emergency	11000	100W	110
LHBC22S120	Standard	22000	200W	110
LHBC22E120	Emergency	22000	200W	110

TITAN HIGH BAY

BODY

- 120W and 200W LED offering >93lm/W
- Alternative to HID High bay luminaires of 250W-400W
- Recommended for mounting heights of 6m to 12m
- Instant light output and re-strike unlike most HID
- No exposed glass so ideal for food storage areas
- Pre-wired with 1.5m of H05RN-F rubber cable
- Reflector/refractor not included
- Fixed output integrated driver

4000K NEUTRAL WHITE	50,000 HOURS	IP65 RATED	BLACK FINISH
----------------------------------	------------------------	----------------------	------------------------

CAT NO.	LUMINAIRE LUMENS	WATTAGE	EFFICACY Lm/W
LHB120W	11,190	120W	93
LHB200W	19,350	200W	96



LHB200W

LHB120W

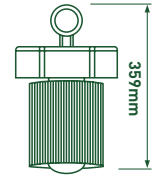
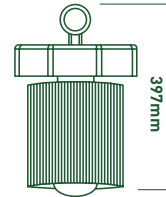

TITAN HIGH BAY

REFLECTOR / REFRACTOR

- 60°, 90° or 120° beam angle reflector/refractor to be ordered separately



LHBRFT



LHBRFL60



LHBRFL90



LHBRFL120

CAT NO.	DESCRIPTION	BEAM ANGLE
LHBRFL60	Aluminium reflector	60°
LHBRFL90	Aluminium reflector	90°
LHBRFL120	Aluminium reflector	120°
LHBRFT	Polycarbonate refractor	60°

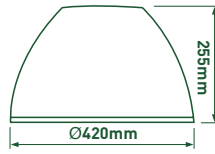

LHBRFL60 / LHBRFT

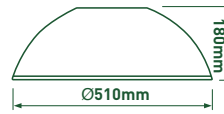

LHBRFL90

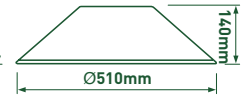

LHBRFL120



LHB120W and LHBRFL120
Titan High Bay

INDUS

LINKABLE HIGH OUTPUT LINEAR

- Supplied with mounting brackets and wiring connectors
- Mounting brackets suitable for surface, trunking or suspension mounting
- Linkable with accessories
- 1200mm inter connecting lead = LHOL3CL120
Butt connector = LHOL3CC



4000K
NEUTRAL
WHITE

50,000
HOURS

BEAM
ANGLE
60°

CAT NO.	SIZE	LUMINAIRE LUMENS	WATTAGE	EFFICACY Lm/W
LHOL95S40	1200mm	9500	100W	95
LHOL115S40	1500mm	11500	120W	95

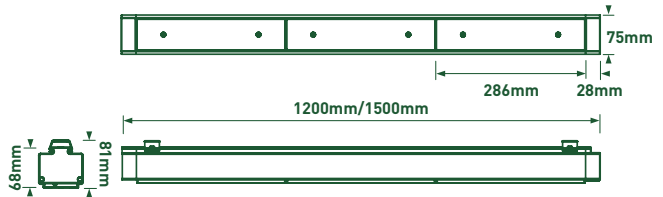

LUXPACK

BATTEN

- Surface mounted with Luceco driver
- Available in standard or high output for 4ft, 5ft and 6ft lengths
- Suitable for use with batten mount sensors
- For batten mount PIR presence detectors see page 135 (LPC3BSP65/ LPC3BDP65)



4000K
NEUTRAL
WHITE

30,000
HOURS

WIDE OPAL LENS

CAT NO.	DRIVER	SIZE	LUMINAIRE LUMENS	WATTAGE	EFFICACY Lm/W	CURRENT
LXB12W25L40	Standard	4ft / 1200mm	2500	24W	104	800mA
LXB12W25EL40	Emergency	4ft / 1200mm	2500	24W	104	800mA
LXB12W48L40	High output	4ft / 1200mm	4800	46W	104	1500mA
LXB12W48EL40	Emergency	4ft / 1200mm	4800	46W	104	1500mA
LXB15W38L40	Standard	5ft / 1500mm	3800	35W	108	1000mA
LXB15W38EL40	Emergency	5ft / 1500mm	3800	35W	108	1000mA
LXB15W72L40	High output	5ft / 1500mm	7200	71W	101	1000mA
LXB15W72EL40	Emergency	5ft / 1500mm	7200	71W	101	1000mA
LXB18W48L40	Standard	6ft / 1800mm	4800	46W	104	1500mA
LXB18W48EL40	Emergency	6ft / 1800mm	4800	46W	104	1500mA
LXB18W92L40	High output	6ft / 1800mm	9200	94W	96	1500mA
LXB18W92EL40	Emergency	6ft / 1800mm	9200	94W	96	1500mA

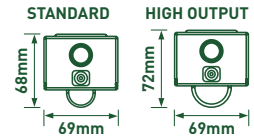

NARROW CLEAR LENS

CAT NO.	DRIVER	SIZE	LUMINAIRE LUMENS	WATTAGE	EFFICACY Lm/W	CURRENT
LXB12R28L40	Standard	4ft / 1200mm	2800	24W	116	800mA
LXB12R28EL40	Emergency	4ft / 1200mm	2800	24W	116	800mA
LXB12R53L40	High output	4ft / 1200mm	5300	46W	115	1500mA
LXB12R53EL40	Emergency	4ft / 1200mm	5300	46W	115	1500mA
LXB15R42L40	Standard	5ft / 1500mm	4200	35W	120	1000mA
LXB15R42EL40	Emergency	5ft / 1500mm	4200	35W	120	1000mA
LXB15R79L40	High output	5ft / 1500mm	7900	71W	111	1000mA
LXB15R79EL40	Emergency	5ft / 1500mm	7900	71W	111	1000mA
LXB18R53L40	Standard	6ft / 1800mm	5300	46W	115	1500mA
LXB18R53EL40	Emergency	6ft / 1800mm	5300	46W	115	1500mA
LXB18R98L40	High output	6ft / 1800mm	9800	94W	104	1500mA
LXB18R98EL40	Emergency	6ft / 1800mm	9800	94W	104	1500mA

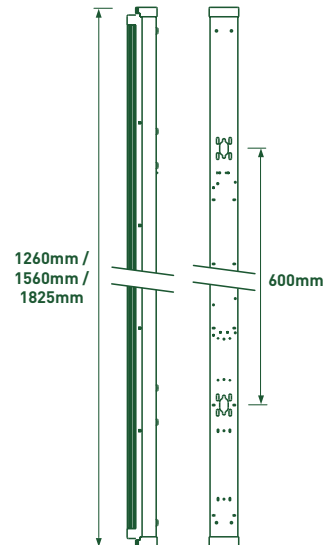

CLIMATE

- Complete with LED array, ideal replacement for linear fluorescent
- Designed for surface mount application in industrial and commercial environments
- Polycarbonate body and diffuser with stainless steel anti-tamper clips
- Mounting bracket, gland kit and screws included for installation
- For batten mount PIR presence detectors see page 135 (LPC3BSP65/LPC3BDP65)
- Supplied with 4000K LEDs as standard, other colour temperatures are available subject to minimum order
- Integrated microwave sensor available to operate with fixed output or dimmable drivers
- Integral fixed output driver



SINGLE LED ARRAY

CAT NO.	DRIVER	SIZE	LUMINAIRE LUMENS	WATTAGE	EFFICACY Llm/W
LCL12W22S40	Standard	4ft/1240mm	2200	25W	88
LCL12W22E40	Emergency	4ft/1240mm	2200	25W	88
LCL12W22D40	Digital Dimmable	4ft/1240mm	2200	25W	88
LCL12W22ED40	Emerg Digital Dim	4ft/1240mm	2200	25W	88
LCL12W22S40MW	Microwave	4ft/1240mm	2200	25W	88
LCL12W22D40MW	MicroW Digital Dim	4ft/1240mm	2200	25W	88
LCL15W34S40	Standard	5ft/1540mm	3400	37W	92
LCL15W34E40	Emergency	5ft/1540mm	3400	37W	92
LCL15W34D40	Digital Dimmable	5ft/1540mm	3400	37W	92
LCL15W34ED40	Emerg Digital Dim	5ft/1540mm	3400	37W	92
LCL15W34S40MW	Microwave	5ft/1540mm	3400	37W	92
LCL15W34D40MW	MicroW Digital Dim	5ft/1540mm	3400	37W	92
LCL18W44S40	Standard	6ft/1840mm	4400	49W	90
LCL18W44E40	Emergency	6ft/1840mm	4400	49W	90
LCL18W44D40	Digital Dimmable	6ft/1840mm	4400	49W	90
LCL18W44ED40	Emerg Digital Dim	6ft/1840mm	4400	49W	90
LCL18W44S40MW	Microwave	6ft/1840mm	4400	49W	90
LCL18W44D40MW	MicroW Digital Dim	6ft/1840mm	4400	49W	90

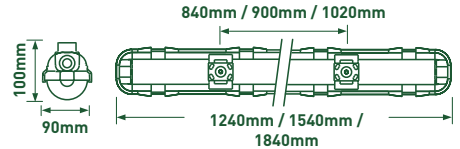

TWIN LED ARRAY

CAT NO.	DRIVER	SIZE	LUMINAIRE LUMENS	WATTAGE	EFFICACY Llm/W
LCL12W44S40	Standard	4ft/1240mm	4400	47W	94
LCL12W44E40	Emergency	4ft/1240mm	4400	47W	94
LCL12W44D40	Digital Dimmable	4ft/1240mm	4400	47W	94
LCL12W44ED40	Emerg Digital Dim	4ft/1240mm	4400	47W	94
LCL12W44S40MW	Microwave	4ft/1240mm	4400	47W	94
LCL12W44D40MW	MicroW Digital Dim	4ft/1240mm	4400	47W	94
LCL15W66S40	Standard	5ft/1540mm	6600	69W	96
LCL15W66E40	Emergency	5ft/1540mm	6600	69W	96
LCL15W66D40	Digital Dimmable	5ft/1540mm	6600	69W	96
LCL15W66ED40	Emerg Digital Dim	5ft/1540mm	6600	69W	96
LCL15W66S40MW	Microwave	5ft/1540mm	6600	69W	96
LCL15W66D40MW	MicroW Digital Dim	5ft/1540mm	6600	69W	96
LCL18W87S40	Standard	6ft/1840mm	8700	97W	90
LCL18W87E40	Emergency	6ft/1840mm	8700	97W	90
LCL18W87D40	Digital Dimmable	6ft/1840mm	8700	97W	90
LCL18W87ED40	Emerg Digital Dim	6ft/1840mm	8700	97W	90
LCL18W87S40MW	Microwave	6ft/1840mm	8700	97W	90
LCL18W87D40MW	MicroW Digital Dim	6ft/1840mm	8700	97W	90

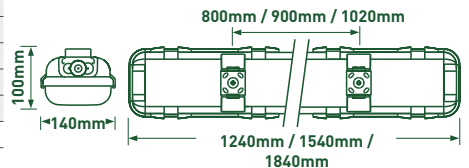



CLIMATE T8

- Fitted with LED tubes, ideal replacement for linear fluorescent
- Designed for surface mount applications in industrial environments
- Polycarbonate body and diffuser
- Mounting bracket, gland kit and screws included for installation
- For batten mount PIR presence detector see page 135 (LPC3BSP65)
- Integral fixed output driver
- Stainless steel retainer clips
- Emergency versions available



SINGLE LED TUBES

CAT NO.	DRIVER	SIZE	LUMINAIRE LUMENS	WATTAGE	EFFICACY LLM/W
LCLT12W21S40	Standard	4ft / 1240mm	2160	24W	90
LCLT12W21E40	Emergency	4ft / 1240mm	2160	24W	90
LCLT15W28S40	Standard	5ft / 1540mm	2880	32W	90
LCLT15W28E40	Emergency	5ft / 1540mm	2880	32W	90
LCLT18W35S40	Standard	6ft / 1840mm	3580	40W	90
LCLT18W35E40	Emergency	6ft / 1840mm	3580	40W	90

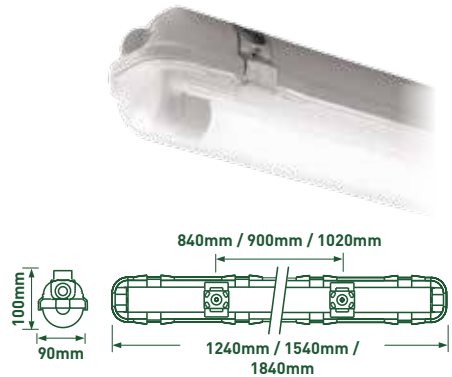

TWIN LED TUBES

CAT NO.	DRIVER	SIZE	LUMINAIRE LUMENS	WATTAGE	EFFICACY LLM/W
LCLT12W43S40	Standard	4ft / 1240mm	4320	48W	90
LCLT12W43E40	Emergency	4ft / 1240mm	4320	48W	90
LCLT15W57S40	Standard	5ft / 1540mm	5760	64W	90
LCLT15W57E40	Emergency	5ft / 1540mm	5760	64W	90
LCLT18W71S40	Standard	6ft / 1840mm	7160	80W	90
LCLT18W71E40	Emergency	6ft / 1840mm	7160	80W	90

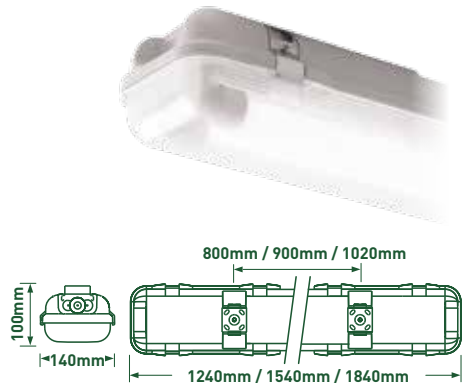

ECO CLIMATE T8

LED TUBE



- Fitted with LED tubes, ideal replacement for linear fluorescent
- Designed for surface mount applications in industrial environments
- Polycarbonate body and diffuser
- Mounting bracket, gland kit and screws included for installation
- Plastic retainer clips



4000K
NEUTRAL
WHITE

20,000
HOURS

BEAM
ANGLE
120°

WHITE
FINISH

IP65
RATED

NEW
RANGE

SINGLE

CAT NO.	DRIVER	SIZE	LUMINAIRE LUMENS	WATTAGE	EFFICACY Llm/W
ECLT6W10S40	Standard	2ft / 600mm	800	10W	80
ECLT12W18S40	Standard	4ft / 1200mm	1500	18W	83
ECLT15W22S40	Standard	5ft / 1500mm	1950	22W	88

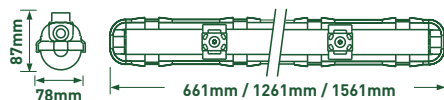

TWIN

CAT NO.	DRIVER	SIZE	LUMINAIRE LUMENS	WATTAGE	EFFICACY Llm/W
ECLT6W20S40	Standard	2ft / 600mm	1600	20W	80
ECLT12W36S40	Standard	4ft / 1200mm	3000	36W	83
ECLT15W44S40	Standard	5ft / 1500mm	3900	44W	88

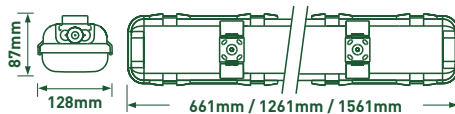



EMERGENCY

Emergency

63

Low energy emergency lighting products, perfect for retrofit replacement of fluorescent fittings. LED emergency lighting includes exit signs, bulkheads, downlights and twin spots.

RANGE FEATURES

- Self test and DALI versions available



EXIT BOX

3HR MAINTAINED

- Materials: Polycarbonate body and opal panel with legend
- 3.6V 2Ah Ni-MH batteries
- Complete with white LED
- High brightness
- DC or AC/DC operated
- Viewing distance = 32m
- Can be also used as non-maintained
- Easy installation with replaceable exit panel
- Latest ISO 7010 format legend
- Fixed output integrated driver



CAT NO.	DESCRIPTION	LUMINAIRE LUMENS	WATTAGE
LEMEXM3	Standard with arrow DOWN legend	45	1.3W
LEMEXUA	Arrow UP legend [order with LEMEXM3]	-	-
LEMEXLA	Arrow LEFT legend [order with LEMEXM3]	-	-
LEMEXRA	Arrow RIGHT legend [order with LEMEXM3]	-	-

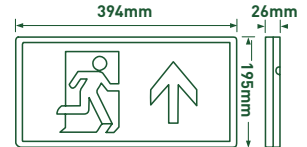

DECORATIVE EXIT

3HR MAINTAINED

- Materials: Aluminium alloy body, double sided edge lit acrylic blade with legends
- 3.6V 600mh Ni-Cd batteries
- Complete with white LED
- AC/DC operated
- Latest ISO 7010 format legend
- Viewing distance = 32m
- Fixed output integrated driver
- Double sided legend
- Supplied with chain
- Cable length - 280mm max



CAT NO.	LUMINAIRE LUMENS	WATTAGE
LEMDEM3	50	3W

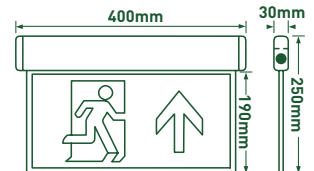

IP65 BULKHEAD

3HR MAINTAINED WITH SELF ADHESIVE LEGEND

- Materials: Polycarbonate body and diffuser
- 2.4V 4.5Ah Ni-Cd batteries
- Complete with white LED
- DC or AC/DC operated
- Latest ISO 7010 format legend
- Viewing distance = 24m
- Can also be used as non-maintained
- Fixed output integrated driver



CAT NO.	LUMINAIRE LUMENS	WATTAGE
LEMBHM3	102	3.8W

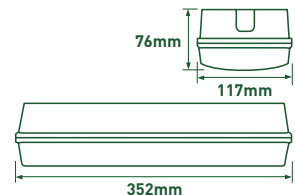

DOWNLIGHT

3HR NON-MAINTAINED

- AC/DC, AC or DC
- Built-in battery: 3.6V 4.5Ah Ni-Cd
- Downlight is illuminated green in normal use, white in emergency mode
- Fixed output integrated driver



CAT NO.	LUMINAIRE LUMENS	WATTAGE
LEM5DLNM3	180	5W

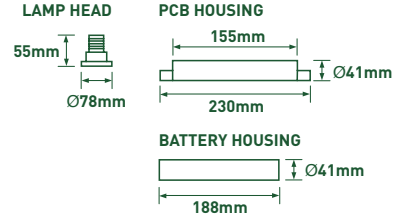

IP65 TWIN-SPOT

3HR NON-MAINTAINED

- Materials: Polycarbonate adjustable heads
- 3.6V 6Ah Ni-Cd battery
- Complete with white LED
- AC operated
- All plastic construction, ideal for food areas
- Fixed output integrated driver



CAT NO.	LUMINAIRE LUMENS	WATTAGE
LEM1PTWNM3	420	5W

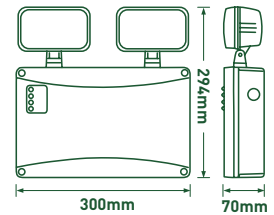

EXIT BOX

3HR MAINTAINED

- Materials: Steel body and opal PVC diffuser
- Ni-Cd batteries
- Viewing distance = 36m
- 24 hours initial battery charge
- Can be used as non-maintained



CAT NO.	DESCRIPTION	LUMINAIRE LUMENS	WATTAGE
LEMEXM3LG	3hr Emergency	240	6W
LEMEXM3LST	Self test emergency	240	8W
LEMEXM3LDA	DALI emergency	240	6W

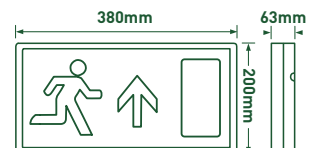

HANGING BLADE

3HR MAINTAINED

- Materials: Steel body and acrylic diffuser
- Ni-Cd batteries
- Viewing distance = 27m
- 24 hours initial battery charge
- Can be used as non-maintained



CAT NO.	DESCRIPTION	LUMINAIRE LUMENS	WATTAGE
LEMDEMELG	3hr Emergency	100	4W
LEMDEMEST	Self test emergency	100	8W
LEMDEMEDA	DALI emergency	100	6W

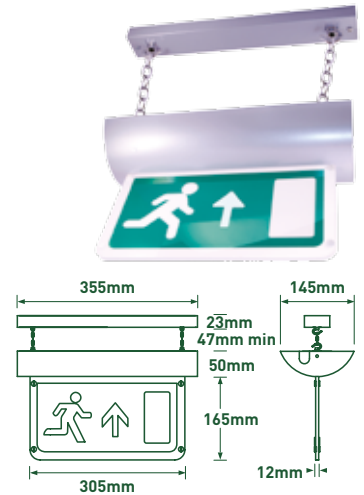

RECESSED BLADE

3HR MAINTAINED

- Materials: Steel body and acrylic diffuser
- Ni-Cd batteries
- Viewing distance = 27m
- 24 hours initial battery charge
- Can be used as non-maintained



CAT NO.	DESCRIPTION	LUMINAIRE LUMENS	WATTAGE
LEMREMELG	3hr Emergency	80	4W
LEMREMEST	Self test emergency	80	8W
LEMREMEDA	DALI emergency	80	6W

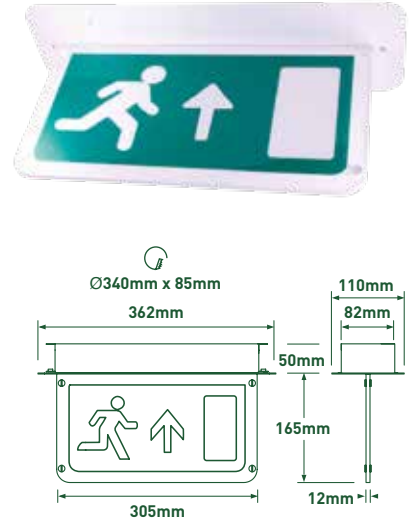

IP65 BULKHEAD

3HR MAINTAINED

- Materials: Polycarbonate body and diffuser
- Ni-Cd batteries
- Viewing distance = 24m
- 24 hours initial battery charge
- Can be used as non-maintained



CAT NO.	DESCRIPTION	LUMINAIRE LUMENS	WATTAGE
LEMBHM3LG	3hr Emergency	100	4W
LEMBHM3ST	Self test emergency	100	8W
LEMBHM3DA	DALI emergency	100	6W



DOWNLIGHT

EMERGENCY

- Materials: Makrolon® body and polycarbonate diffuser
- Ni-Cd batteries
- 24 hours initial battery charge

500 mA	3HR EMERGENCY	BEAM ANGLE 110°
------------------	-------------------------	--

CAT NO.	DESCRIPTION	LUMINAIRE LUMENS	WATTAGE
LEM6DLM3LG	3hr Maintained emergency	149	6W
LEM8DLM3ST	3hr Maintained self test emergency	149	8W
LEM6DLM3DA	3hr Maintained DALI emergency	149	6W
LEM2DLNM3LG	3hr Non-maintained emergency	150	2W



REMOTE DOWNLIGHT

WITH WIDE AREA DISTRIBUTION

- Materials: Makrolon® body and polycarbonate diffuser
- Ni-Cd batteries
- 24 hours initial battery charge

500 mA	3HR EMERGENCY	BEAM ANGLE 110°
------------------	-------------------------	--

CAT NO.	DESCRIPTION	LUMINAIRE LUMENS	WATTAGE
LEM6DLM3WA	3hr Maintained emergency	160	6W
LEM8DLM3WS	3hr Maintained self test emergency	160	8W
LEM6DLM3WD	3hr Maintained DALI emergency	160	6W
LEM2DLNM3WA	3hr Non-maintained emergency	150	2W



REMOTE DOWNLIGHT

WITH LINEAR AREA DISTRIBUTION

- Materials: Makrolon® body and polycarbonate diffuser
- Ni-Cd batteries
- 24 hours initial battery charge

500 mA	3HR EMERGENCY	BEAM ANGLE 125x50°
------------------	-------------------------	---

CAT NO.	DESCRIPTION	LUMINAIRE LUMENS	WATTAGE
LEM6DLM3CA	3hr Maintained emergency	160	6W
LEM8DLM3CS	3hr Maintained self test emergency	160	8W
LEM6DLM3CD	3hr Maintained DALI emergency	160	6W
LEM2DLNM3CA	3hr Non-maintained emergency	150	2W



EMERGENCY PACK

- Compatible with all LuxPanels, Platinum and Carbon downlights
- Can be retro-fitted to fixed output or dimmable drivers
- Battery pack can be replaced
- Supplied with all required connections and mini bezel for charge indicator

UNIQUE DESIGN



CAT NO.	DESCRIPTION
LED3EP80-0J	Emergency pack

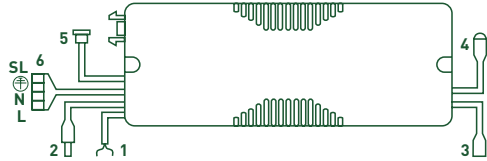

1. Live/Neutral to input of Driver
2. LED luminaire input
3. Output of driver to inverter
4. Indicator light
5. Connect Battery
6. Mains input



LEMBHM3
3HR Maintained IP65 Bulkhead
with Arrow Up Legend



EXTERIOR LIGHTING

LBH154K &
LBH154AMP
Atlas Bulkhead with
Metal Accessory

Atlas	69
Fortis Bulkhead	70
Fortis Wallpack	70
Guardian Pro	72
Commercial Exterior	74
Slimline Guardian Floodlights	78
Slimline Work Lights	80
Decorative Exterior	84
Eco Bulkheads	94

LED exterior lighting from residential to roadway, car park to business park. Multiple mounting options and models - including presence detecting.

RANGE FEATURES

- Up to 50,000 hours long life maintenance free
- Instant light, high CRI, ideal for security lighting
- Up to IP65 - No ingress of dust, protected against low pressure jets of water from all directions

230v
/50hz

CRI
>80

ATLAS BULKHEAD

- Alternative to 28 watt and 38 watt TC-DD (2D) compact fluorescent
- Multiple mounting options include ceiling surface, ceiling semi-recessed, wall mounted and provision for BESA and four side conduit entries
- Double insulated
- Microwave presence detector switches the output to 10% in "corridor function" standby mode or 0%, selectable during installation
- Microwave version includes photocell for dusk-till-down switching option
- Integral driver
- Order the accessories separately or in addition to the bulkhead



Ceiling semi-recessed



4000K
NEUTRAL
WHITE

50,000
HOURS

WHITE
FINISH

IP65
RATED

IK08

CAT NO.	DRIVER	LUMINAIRE LUMENS	WATTAGE	EFFICACY Lm/W	EQUIVALENT WATTAGE
LBH154K	Standard	1250	17W	75	28W
LBH154K3M	3hr Emergency	1250	19W	66	28W
LBH154KMW	Microwave sensor	1250	18W	69	28W
LBH154KMW3M	Microwave and emergency	1250	20W	64	28W
LBH214K	Standard	2100	24W	88	38W
LBH214K3M	3hr Emergency	2100	26W	81	38W
LBH214KMW	Microwave sensor	2100	25W	84	38W
LBH214KMW3M	Microwave and emergency	2100	27W	78	38W

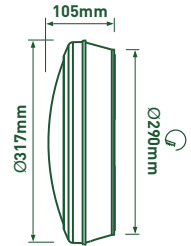

ACCESSORIES

- For use with Atlas bulkhead (order bulkhead separately)
- Comes with front and back covers and tamper proof screws, a high security screw kit is also available including special tool - LBHATK
- All die-cast aluminium accessories are finished in RAL7026 'Granite Grey'
- Front covers can be rotated every 90°
- Access to rear BESA and four side entry points

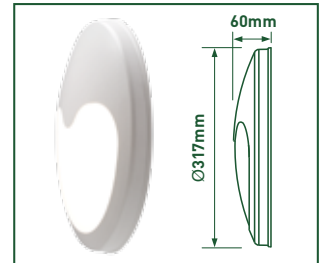
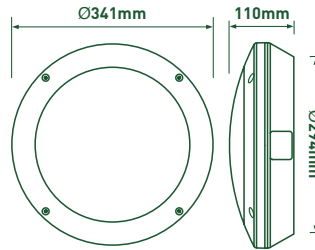

LBH154APE - Plastic Eyelid Cover



LBH154AME - Metal Eyelid



LBH154AMG - Metal Grille



LBH154AMP - Metal Standard



LBH154AMS - Metal Split Eyelid

FORTIS BULKHEAD

- Replacement for TC-DD (2D)
- Multiple mounting options
- Microwave sensor and emergency versions
- Die-Cast housing and polycarbonate diffuser



CAT NO.	DRIVER	LUMINAIRE LUMENS	WATTAGE	EFFICACY Lm/W	EQUIVALENT WATTAGE
LBF13L40	Standard	1250	14W	89	28W 2D
LBF13L40MW	Microwave	1250	14W	89	28W 2D
LBF13E40	Emergency	1250	15W	83	28W 2D
LBF13E40MW	Microwave Emergency	1250	15W	83	28W 2D
LBF21L40	Standard	2100	24W	88	38W 2D
LBF21L40MW	Microwave	2100	24W	88	38W 2D
LBF21E40	Emergency	2100	25W	84	38W 2D
LBF21E40MW	Microwave Emergency	2100	25W	84	38W 2D

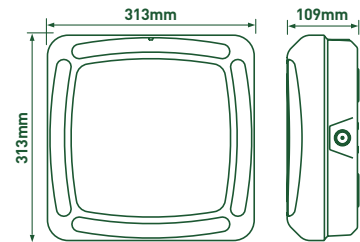

FORTIS WALLPACK

- Replacement for HID
- CRI>80 ideal for CCTV areas
- Die-Cast housing with polycarbonate diffuser

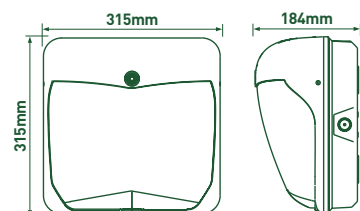

CAT NO.	DRIVER	LUMINAIRE LUMENS	WATTAGE	EFFICACY Lm/W	EQUIVALENT WATTAGE
LWF40S40	Standard	4000	45W	89	70W HID
LWF40S40PC	Photocell	4000	45W	89	70W HID
LWF40E40	Emergency	4000	47W	85	70W HID
LWF40E40PC	Photocell Emergency	4000	47W	85	70W HID



GUARDIAN PRO

FLOODLIGHTS

- Horizontal mounting floodlight
- Maintenance free
- Pre-wired 1m of H05RN-F rubber cable
- "Fit and tilt" bracket for simple installation
- Tilt adjustment locks



LCFL EQUIVALENT WATTAGES TO HID

LCFL	MBF	HQI/SO/N	SUGGEST MOUNT HT
LFP50	125W	70W	3 - 5m
LFP100	250W	150W	4 - 6m
LFP160	400W	250W	5 - 8m

NOTE - All figures are suggestions and it is recommended to have a full lighting design prepared to validate

5000Llm (50W)

CAT NO.	DRIVER	LUMINAIRE LUMENS	WATTAGE	EFFICACY Llm/W
LFP50B140F	Standard	5200	50W	105
LFPL50B140F	Integrated Photocell	5200	50W	105

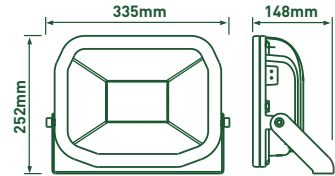

10 000Llm (100W)

CAT NO.	DRIVER	LUMINAIRE LUMENS	WATTAGE	EFFICACY Llm/W
LFP100B140F	Standard	10 500	100W	105
LFPL100B140F	Integrated Photocell	10 500	100W	105

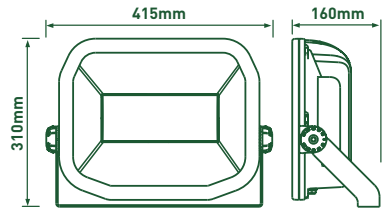

16 000Llm (160W)

CAT NO.	DRIVER	LUMINAIRE LUMENS	WATTAGE	EFFICACY Llm/W
LFP160B140F	Standard	16 000	155W	105
LFPL160B140F	Integrated Photocell	16 000	155W	105

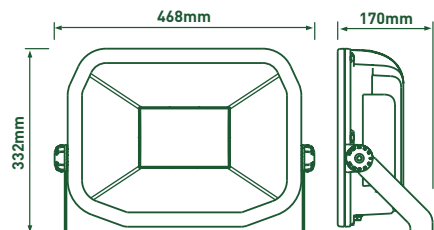

LFP160B140F
16 000Lm (160W)
Guardian Pro Floodlight



POST TOP

AMENITY LANTERN

- No upward light pollution
- Aluminium and toughened glass construction
- Low glare design
- Recommended height 3-5 metre

5000K NEUTRAL WHITE	30,000 HOURS	IP65 RATED
----------------------------------	------------------------	----------------------

CAT NO.	LUMINAIRE LUMENS	WATTAGE	EFFICACY Llm/W
LEAMPT30C50	2250	30W	75



POST TOP

AMENITY LANTERN

- No upward light pollution
- Aluminium and polycarbonate construction
- Low glare design
- Recommended height 3-5 metre

5000K NEUTRAL WHITE	30,000 HOURS	IP65 RATED
----------------------------------	------------------------	----------------------

CAT NO.	LUMINAIRE LUMENS	WATTAGE	EFFICACY Llm/W
LEAMPT30G50	2000	30W	66



POST TOP

AMENITY LANTERN

- No upward light pollution
- Aluminium and polycarbonate construction
- Contemporary design
- Recommended height 3-5 metre

5000K NEUTRAL WHITE	30,000 HOURS	IP65 RATED
----------------------------------	------------------------	----------------------

CAT NO.	LUMINAIRE LUMENS	WATTAGE	EFFICACY Llm/W
LEAMPT62V50	2500	62W	40

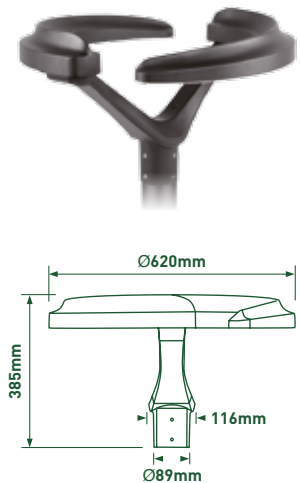

POST TOP

AMENITY LANTERN

- Aluminium and polycarbonate construction
- No upward light pollution
- Recommended height 4-6 metre

5000K NEUTRAL WHITE	30,000 HOURS	IP66 RATED
----------------------------------	------------------------	----------------------

CAT NO.	LUMINAIRE LUMENS	WATTAGE	EFFICACY Lm/W
LEAMPT55D50	5200	55W	94



ROAD LANTERN

- Aluminium and toughened glass
- Two part construction allowing easy 'first fix' installation
- No upward light pollution
- Modern slim design
- Accepts 48mm or 60mm diameter mounting bracket/arm

5000K NEUTRAL WHITE	30,000 HOURS	IP66 RATED
----------------------------------	------------------------	----------------------

CAT NO.	LUMINAIRE LUMENS	WATTAGE	EFFICACY Lm/W
LESRT59R50	6200	59W	105

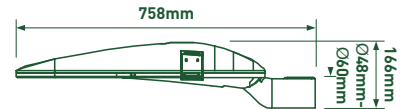

ROAD LANTERN

- No upward light pollution
- Aluminium and polycarbonate construction

5000K NEUTRAL WHITE	30,000 HOURS	IP65 RATED
----------------------------------	------------------------	----------------------

CAT NO.	LUMINAIRE LUMENS	WATTAGE	EFFICACY Lm/W
LESRTB50R50	4930	50W	98

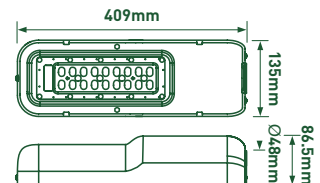

SPOT

EXTERIOR ARCHITECTURAL

- Durable die cast construction
- Toughened glass lens
- Adjustable 350°
- Rotation 15°

5000K NEUTRAL WHITE	30,000 HOURS	BEAM ANGLE 25°	IP65 RATED
----------------------------------	------------------------	-----------------------------	----------------------

CAT NO.	LUMINAIRE LUMENS	WATTAGE	EFFICACY Llm/W
LEAR42550	250	4.1W	60

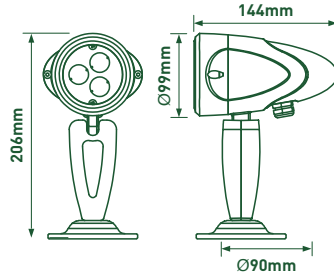

SPOT

EXTERIOR ARCHITECTURAL

- Durable die cast construction
- Toughened glass lens
- Adjustable 350°
- Rotation 15°

5000K NEUTRAL WHITE	30,000 HOURS	BEAM ANGLE 25°	IP65 RATED
----------------------------------	------------------------	-----------------------------	----------------------

CAT NO.	LUMINAIRE LUMENS	WATTAGE	EFFICACY Llm/W
LEAR82550	480	8.2W	58

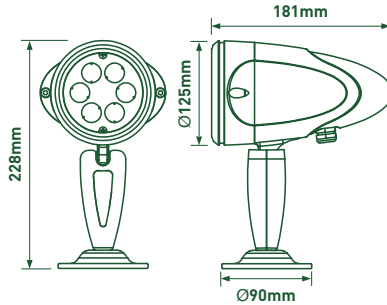

Buried Uplight LEAMBU4F50
and Spot LEAR42550

FIXED

BURIED UPLIGHT

- Fixed beam
- 2500kg max loading
- Low surface temperature glass



CAT NO.	LUMINAIRE LUMENS	WATTAGE	EFFICACY Lm/W
LEAMBU1F50	87	1.4W	62

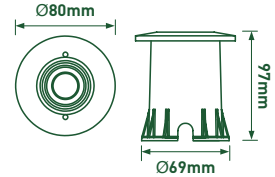

FIXED

BURIED UPLIGHT

- Fixed beam
- 2500kg max loading
- Low surface temperature glass



CAT NO.	LUMINAIRE LUMENS	WATTAGE	EFFICACY Lm/W
LEAMBU4F50	284	4W	71

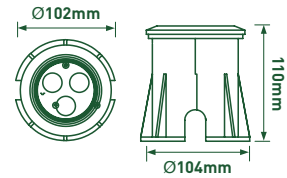

ADJUSTABLE

BURIED UPLIGHT

- Adjustable, beam can be tilted at 10°, 30° or 40° settings
- 2500kg max loading
- Low surface temperature glass



CAT NO.	LUMINAIRE LUMENS	WATTAGE	EFFICACY Lm/W
LEAMBU12A50	840	12.4W	67

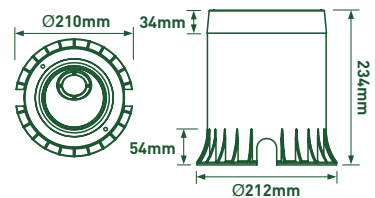

SLIMLINE GUARDIAN FLOODLIGHTS

UNIQUE DESIGN

- Over 90% energy saving over halogen
- Maintenance free
- Pre-wired 1m of H05RN-F rubber cable
- Instant 100% light output
- Unique 'fit and tilt' bracket for simple installation



600Lm (8W)

CAT NO.	LUMINAIRE LUMENS	WATTAGE	EFFICACY Lm/W	COLOUR TEMP.	FINISH	EQUIVALENT WATTAGE
LFS6B130-02	600	8W	75	3000K	Black	100W
LFS6W130-02	600	8W	75	3000K	White	100W
LFS6B150-02	600	8W	75	5000K	Black	100W
LFS6W150-02	600	8W	75	5000K	White	100W

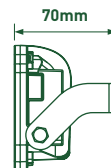
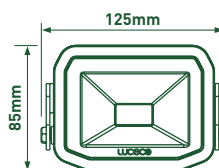

1200Lm (15W)

CAT NO.	LUMINAIRE LUMENS	WATTAGE	EFFICACY Lm/W	COLOUR TEMP.	FINISH	EQUIVALENT WATTAGE
LFS12B130-02	1200	15W	80	3000K	Black	200W
LFS12W130-02	1200	15W	80	3000K	White	200W
LFS12B150-02	1200	15W	80	5000K	Black	200W
LFS12W150-02	1200	15W	80	5000K	White	200W

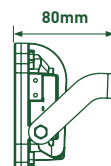
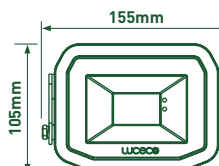

1800Lm (22W)

CAT NO.	LUMINAIRE LUMENS	WATTAGE	EFFICACY Lm/W	COLOUR TEMP.	FINISH	EQUIVALENT WATTAGE
LFS18B130-02	1800	22W	80	3000K	Black	300W
LFS18W130-02	1800	22W	80	3000K	White	300W
LFS18B150-02	1800	22W	80	5000K	Black	300W
LFS18W150-02	1800	22W	80	5000K	White	300W

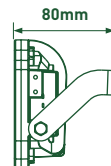
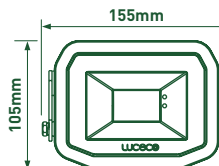

3000Lm (38W)

CAT NO.	LUMINAIRE LUMENS	WATTAGE	EFFICACY Lm/W	COLOUR TEMP.	FINISH	EQUIVALENT WATTAGE
LFS30B130-02	3000	38W	80	3000K	Black	500W
LFS30B150-02	3000	38W	80	5000K	Black	500W

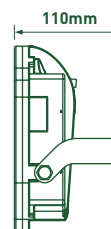
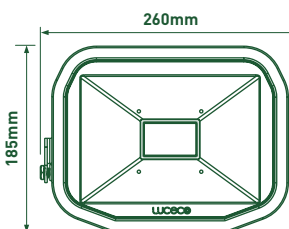

SLIMLINE GUARDIAN FLOODLIGHTS WITH PIR

- 90% energy saving over halogen
- Maintenance free
- Instant 100% output
- 10m max detection range
- Adjustable time = 10 sec - 8 min
- Adjustable Lux = 2 - 2000Lux
- Override function for dusk till dawn operation
- Pre-wired 1m of H05RN-F rubber cable
- Supplied with two brackets for column or wall mounting
- Unique 'fit and tilt' bracket for simple installation



600Llm (8W)

CAT NO.	LUMINAIRE LUMENS	WATTAGE	EFFICACY Llm/W	COLOUR TEMP.	FINISH	EQUIVALENT WATTAGE
LFSP6B130-02	600	8W	75	3000K	Black	100W
LFSP6W130-02	600	8W	75	3000K	White	100W
LFSP6B150-02	600	8W	75	5000K	Black	100W
LFSP6W150-02	600	8W	75	5000K	White	100W

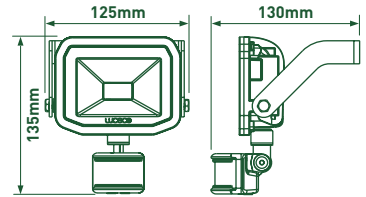

1200Llm (15W)

CAT NO.	LUMINAIRE LUMENS	WATTAGE	EFFICACY Llm/W	COLOUR TEMP.	FINISH	EQUIVALENT WATTAGE
LFSP12B130-02	1200	15W	80	3000K	Black	200W
LFSP12W130-02	1200	15W	80	3000K	White	200W
LFSP12B150-02	1200	15W	80	5000K	Black	200W
LFSP12W150-02	1200	15W	80	5000K	White	200W

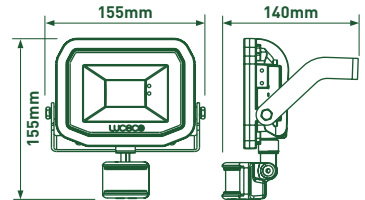

1800Llm (22W)

CAT NO.	LUMINAIRE LUMENS	WATTAGE	EFFICACY Llm/W	COLOUR TEMP.	FINISH	EQUIVALENT WATTAGE
LFSP18B130-02	1800	22W	80	3000K	Black	300W
LFSP18W130-02	1800	22W	80	3000K	White	300W
LFSP18B150-02	1800	22W	80	5000K	Black	300W
LFSP18W150-02	1800	22W	80	5000K	White	300W

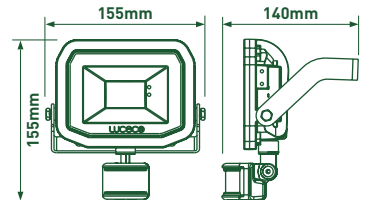

3000Llm (38W)

CAT NO.	LUMINAIRE LUMENS	WATTAGE	EFFICACY Llm/W	COLOUR TEMP.	FINISH	EQUIVALENT WATTAGE
LFSP30B130-02	3000	38W	80	3000K	Black	500W
LFSP30B150-02	3000	38W	80	5000K	Black	500W

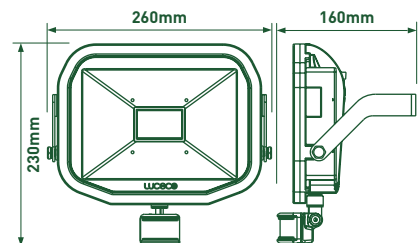

SLIMLINE RECHARGEABLE WORK LIGHTS

- 400 charge cycles
- 90% energy saving over halogen
- Fixed output integrated driver
- Supplied with USB lead (USB to Micro USB) & car charger

5000K
NEUTRAL
WHITE



BEAM
ANGLE
95°

IP65
RATED

CAT NO.	LUMINAIRE LUMENS	WATTAGE	EFFICACY Llm/W	EQUIVALENT WATTAGE
LSWR5BR	375	5W	75	50W
LSWR10BR	750	10W	75	100W

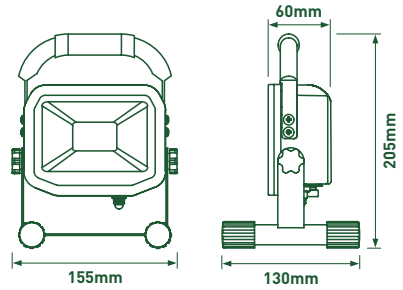

UNIQUE DESIGN



- Weatherproof power switch
- USB charging output - 1.8 Amp





INTERIOR



EXTERIOR



IN-CAR CHARGING

SLIMLINE PORTABLE WORK LIGHTS

- 90% energy saving over halogen
- Maintenance free
- Weatherproof power switch
- Lightweight frame with soft grip handle
- Supplied with a 10A UK plug
- Sturdy steel stand, die cast housing with tempered glass
- 2m of H05RN-F rubber cable
- Fixed output integrated driver



5000K
NEUTRAL
WHITE

30,000
HOURS

BEAM
ANGLE
95°

IP65
RATED

600Llm (10W)

CAT NO.	LUMINAIRE LUMENS	WATTAGE	EFFICACY Llm/W	EQUIVALENT WATTAGE
LSW10BR2	600	10W	60	100W

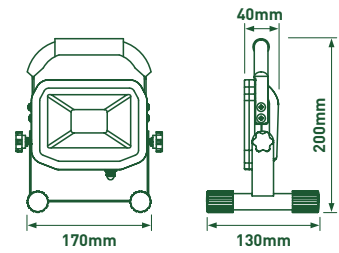

1200Llm (20W)

CAT NO.	LUMINAIRE LUMENS	WATTAGE	EFFICACY Llm/W	EQUIVALENT WATTAGE
LSW20BR2	1200	20W	60	200W

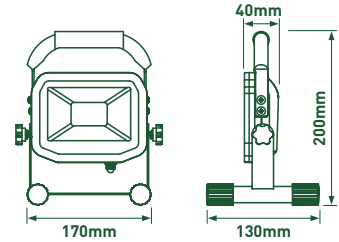

1800Llm (30W)

CAT NO.	LUMINAIRE LUMENS	WATTAGE	EFFICACY Llm/W	EQUIVALENT WATTAGE
LSW30BR2	1800	30W	60	300W

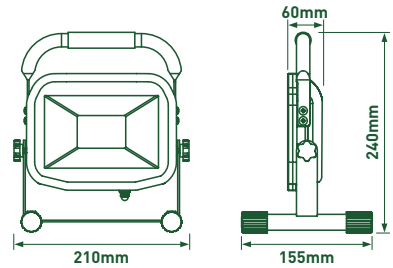

3000Llm (50W)

CAT NO.	LUMINAIRE LUMENS	WATTAGE	EFFICACY Llm/W	EQUIVALENT WATTAGE
LSW50BR2	3000	50W	60	500W

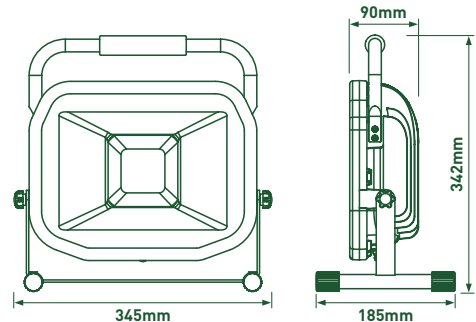

SLIMLINE TWIN TRIPOD WORK LIGHTS

- 90% energy saving over halogen
- Maintenance free
- Weatherproof power switch on each floodlight for independent switching
- Lightweight frame
- Supplied with a 10A UK plug
- Sturdy steel stand, die cast housing with tempered glass
- 3m of H05RN-F rubber cable
- Inbuilt cable storage
- Fixed output integrated driver

5000K
NEUTRAL
WHITE

30,000
HOURS

BEAM
ANGLE
95°

IP65
RATED



2x 600Llm (10W)

CAT NO.	LUMINAIRE LUMENS	WATTAGE	EFFICACY Llm/W	EQUIVALENT WATTAGE
LSWT210BR3	2x 600	2x 10W	60	2x 100W

2x 1200Llm (20W)

CAT NO.	LUMINAIRE LUMENS	WATTAGE	EFFICACY Llm/W	EQUIVALENT WATTAGE
LSWT220BR3	2x 1200	2x 20W	60	2x 200W

2x 1800Llm (30W)

CAT NO.	LUMINAIRE LUMENS	WATTAGE	EFFICACY Llm/W	EQUIVALENT WATTAGE
LSWT230BR3	2x 1800	2x 30W	60	2x 300W

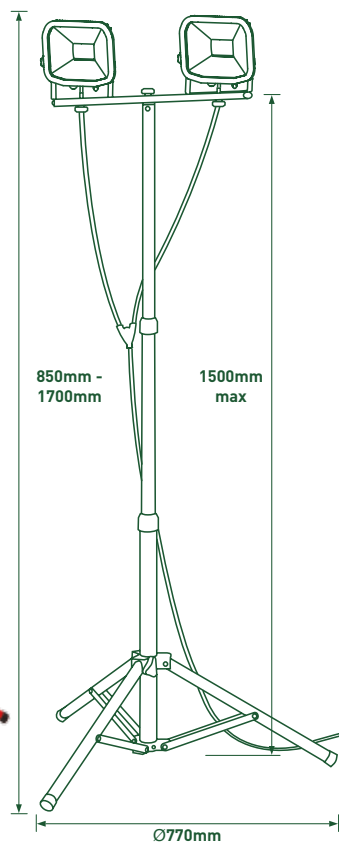
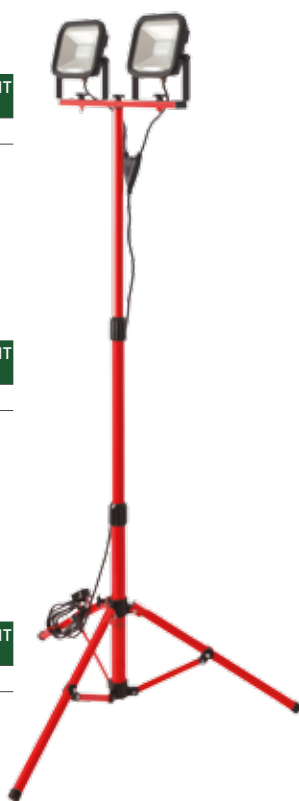

WALL LIGHT

DECORATIVE EXTERIOR

- Aluminium die-casting body
- Powder coated, smooth and ageing resistant paint finish
- Integral LED



CAT NO.	LUMINAIRE LUMENS	WATTAGE	EFFICACY Llm/W
LEXD5724	396	9W	44

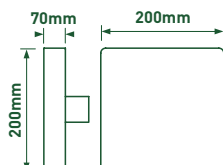

WALL LIGHT

DECORATIVE EXTERIOR

- Stainless steel body
- Clear PC diffuser
- Integral LED



CAT NO.	LUMINAIRE LUMENS	WATTAGE	EFFICACY Llm/W
LEXD1103	450	7W	64

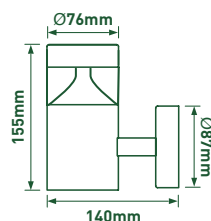

WALL LIGHT

DECORATIVE EXTERIOR

- Stainless steel body
- Electrophoresis coated with clear lacquer - acid and alkali resistant
- Clear PC diffuser
- Integral LED



CAT NO.	LUMINAIRE LUMENS	WATTAGE	EFFICACY Llm/W
LEXD3413	217	4.5W	48

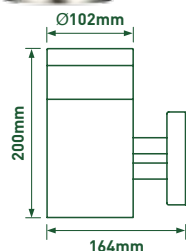



LEXD5724
Wall light

WALL LIGHT

DECORATIVE EXTERIOR

- Stainless steel body
- Clear PC diffuser
- Integral LED

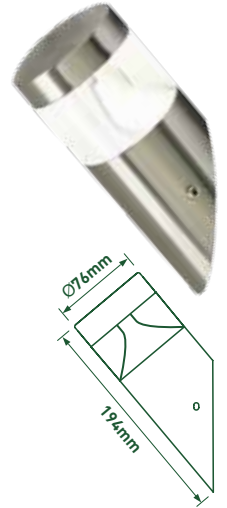

CAT NO.	LUMINAIRE LUMENS	WATTAGE	EFFICACY Lm/W
LEXD1104	450	7W	64

BOLLARD

DECORATIVE EXTERIOR

- Stainless steel body
- Electrophoresis coated with clear lacquer - acid and alkali resistant
- Clear PC diffuser
- Integral LED

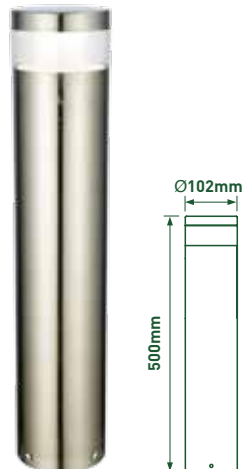

CAT NO.	LUMINAIRE LUMENS	WATTAGE	EFFICACY Lm/W
LEXD3414	217	4.5W	48

WALL LIGHT

DECORATIVE EXTERIOR

- Stainless steel body, powder coated
- Electrophoresis coated with clear lacquer - acid and alkali resistant
- Opal PC diffuser
- E27 LED lamp recommended (LA27W9W81), not included

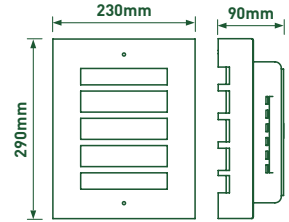

CAT NO.	LUMINAIRE LUMENS	WATTAGE	EFFICACY Lm/W
LEXD1016	806*	9W*	90*

*Based on recommended lamp

WALL LIGHT

DECORATIVE EXTERIOR

- Aluminium die-casting body
- Powder coated, smooth and ageing resistant paint finish
- Opal PC diffuser
- Integral LED

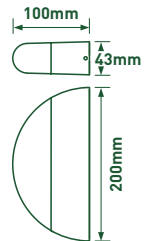

CAT NO.	LUMINAIRE LUMENS	WATTAGE	EFFICACY Lm/W
LEXD5827	350	9W	42

GARDEN SPIKE

SPOT

- Aluminium housing and frame - acid and alkali resistant
- Clear tempered glass diffuser
- GU10 LED lamp recommended (LGN5W37P), not included

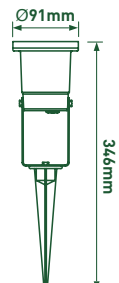

CAT NO.	LUMINAIRE LUMENS	WATTAGE	EFFICACY Lm/W
LEXD9001	370*	5W*	74*

*Based on recommended lamp

WALL LIGHT WITH PIR

DECORATIVE EXTERIOR

- Stainless steel body, powder coated
- Electrophoresis coated with clear lacquer - acid and alkali resistant
- Opal PC diffuser
- Motion sensor system - distance of 10m
- Time adjusted from 7 seconds to 5 minutes
- E27 LED lamp recommended (LA27W9W81), not included



CAT NO.	LUMINAIRE LUMENS	WATTAGE	EFFICACY Lm/W
LEXD1016P	806*	9W*	90*

*Based on recommended lamp

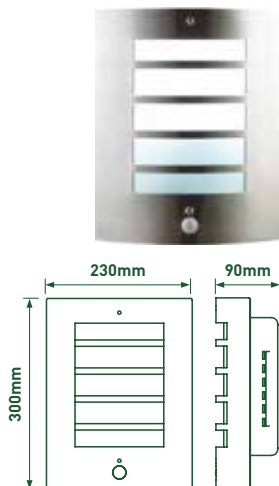

WALL LIGHT

DECORATIVE EXTERIOR

- Aluminium die-casting body
- Powder coated, smooth and ageing resistant paint finish
- Clear glass diffuser
- Integral LED



CAT NO.	LUMINAIRE LUMENS	WATTAGE	EFFICACY Lm/W
LEXD5828	207	6W	34

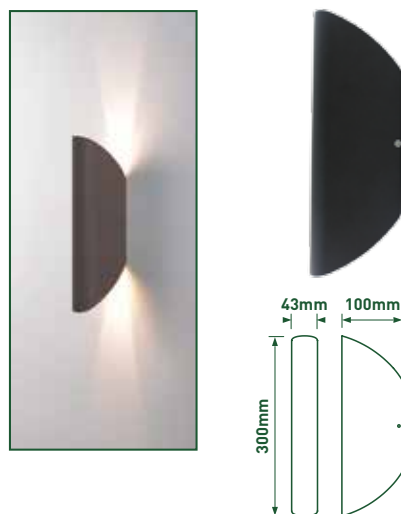

SOLAR POWERED WALL LIGHT

DECORATIVE EXTERIOR

- PIR operation can be selected during install
ON = will only illuminate when movement is detected
OFF = will not illuminate
- PIR range: 5-10m approx.
- Up to 8 hours illumination from full charge
- 1x Li-ion 1200mAh 3.7V battery included



CAT NO.	LUMINAIRE LUMENS	WATTAGE	EFFICACY Lm/W
LEXD1540	330	4.5W	70

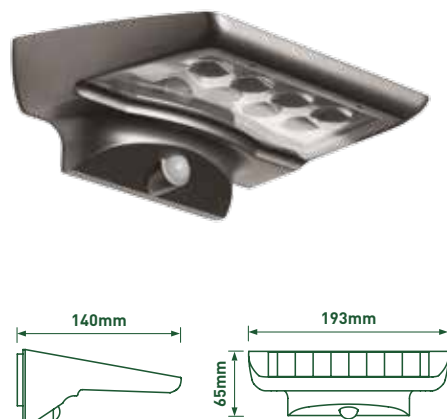

SOLAR GUARDIAN PIR

EXTERIOR WALL LIGHT

- Front & rear facing LED light chips provide both functional and ambient illumination
- Automatically turns onto standby night glow mode when it gets dark (<30lux) and boosts to full power when occupancy detected
- Perfect for outdoor entrance areas, balconies, paths, decorative garden lighting, and sheds/outhouses
- No wiring, easy & simple installation

4000K
NEUTRAL
WHITE

IP44
RATED

NEW
RANGE

CAT NO.	FINISH	LUMINAIRE LUMENS	WATTAGE	EFFICACY Ltm/W
LEXS30B30	Black	180	1.5W	83
LEXS30W30	White	180	1.5W	83

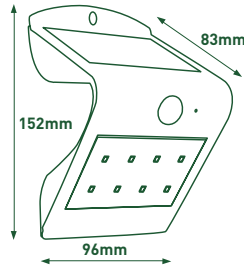

Auto charged from sunlight - 6hrs charge = up to 72hrs illumination

ZERO Electricity cost = 100% energy saving

PIR detection range - 2-6 metres

Auto on at night, auto off at day

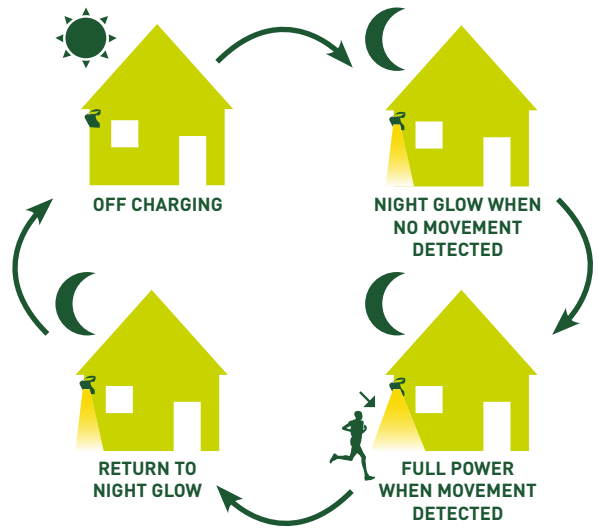

BACK LIGHT LED ARRAY



FRONT & REAR ILLUMINATION



FULL & STANDBY NIGHT GLOW MODE



EXTERIOR WALL



ENTRANCE AREA



GARDEN SHED

ADJUSTABLE SPOT LIGHT

DECORATIVE EXTERIOR

- Stainless steel body
- Electrophoresis coated with clear lacquer - acid and alkali resistant
- Clear tempered glass diffuser
- GU10 LED lamp recommended (LGN5W37P), not included



CAT NO.	LUMINAIRE LUMENS	WATTAGE	EFFICACY Lm/W
LEXD7132	370*	5W*	74*

*Based on recommended lamp

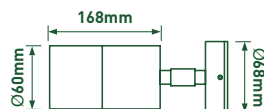

LANTERN

DECORATIVE EXTERIOR

- Stainless steel body
- Electrophoresis coated with clear lacquer - acid and alkali resistant
- Clear glass diffuser
- E27 LED lamp recommended (LA27W9W81), not included



CAT NO.	LUMINAIRE LUMENS	WATTAGE	EFFICACY Lm/W
LEXD1028	806*	9W*	90*

*Based on recommended lamp

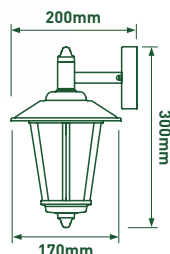

WALL LIGHT

DECORATIVE EXTERIOR

- Stainless steel body
- Electrophoresis coated with clear lacquer - acid and alkali resistant
- Clear glass diffuser
- Integral LED



CAT NO.	LUMINAIRE LUMENS	WATTAGE	EFFICACY Lm/W
LEXD1098	412	9W	45

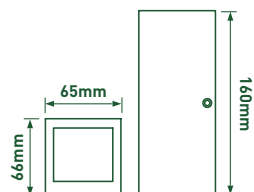



LEXD1098
Wall Light

LANTERN

DECORATIVE EXTERIOR

- Stainless steel body
- Electrophoresis coated with clear lacquer - acid and alkali resistant
- Clear diffuser
- E27 LED lamp recommended (LA27W9W81), not included



CAT NO.	LUMINAIRE LUMENS	WATTAGE	EFFICACY Lm/W
LEXD1059	806*	9W*	90*

*Based on recommended lamp



WALL LIGHT

DECORATIVE EXTERIOR

- Stainless steel body
- Integral LED



CAT NO.	LUMINAIRE LUMENS	WATTAGE	EFFICACY Lm/W
LEXD5859	600	12W	50

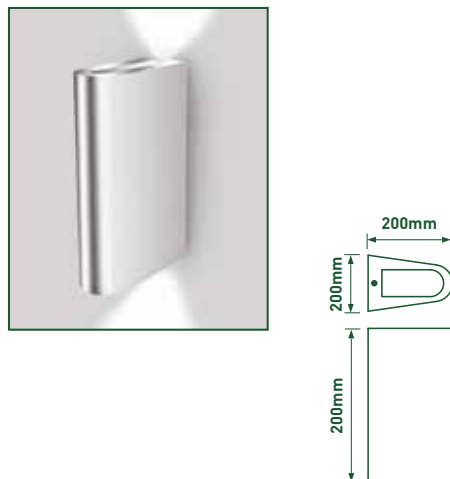

CUBE LED WALL LIGHT

DECORATIVE EXTERIOR

- Bold contemporary design
- Advanced high output LED chip provides maximum illumination and energy savings
- Indirect light source produces glare free vertical lighting effect
- Perfect for indoor and outdoor residential and commercial applications including interior and exterior walls, garden and communal spaces, patios and walkways
- Easy surface mounted installation
- IP54 die-cast aluminium with corrosion resistant Grey Slate finish

3000K WARM WHITE	25,000 HOURS	GREY FINISH	IP54 RATED	NEW RANGE
-------------------------------	------------------------	-----------------------	----------------------	---------------------

CAT NO.	LUMINAIRE LUMENS	WATTAGE	EFFICACY Llm/W
LEXD9SUDG3	306	10W	30

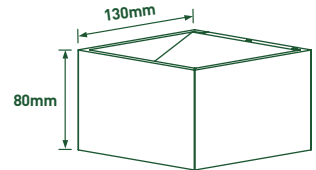

LOW PROFILE LED WALL LIGHT

DECORATIVE EXTERIOR

- Unobtrusive slimline design
- High output LED chips allow maximum illumination and energy savings
- Dual top and bottom LED array provides both up and down illumination and lighting effect
- Perfect for indoor and outdoor residential and commercial applications including interior and exterior walls, garden and communal spaces, patios and walkways
- Easy surface mounted installation
- IP54 die-cast aluminium with corrosion resistant Grey Slate finish

3000K WARM WHITE	25,000 HOURS	GREY FINISH	IP54 RATED	NEW RANGE
-------------------------------	------------------------	-----------------------	----------------------	---------------------

CAT NO.	LUMINAIRE LUMENS	WATTAGE	EFFICACY Llm/W
LEXD8FUDG3	400	8W	50

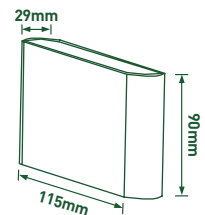

LEXD8FUDG3
Wall Light



LEXD5SUDG3
Wall Light

SQUARE LED WALL LIGHT DECORATIVE EXTERIOR

- Bold contemporary design
- Advanced high output LED chip provides maximum illumination and energy savings
- Indirect light source produces glare free vertical lighting effect
- Perfect for indoor and outdoor residential and commercial applications including interior and exterior walls, garden and communal spaces, patios and walkways
- Easy surface mounted installation
- IP54 die-cast aluminium with corrosion resistant Grey Slate finish



CAT NO.	LUMINAIRE LUMENS	WATTAGE	EFFICACY Llm/W
LEXD5SUDG3	150	5.6W	26

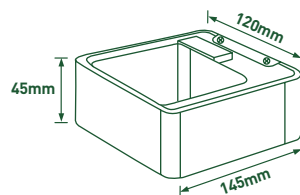

WEDGE LED WALL LIGHT DECORATIVE EXTERIOR

- Slimline contemporary design
- High output LED chips for maximum illumination and energy savings
- Providing both functional and single directional accent lighting
- Perfect for unobtrusive residential and commercial applications such as decorative outdoor, garden, entrance areas, pathways and steps
- Dual position mounting for either Up or Down illumination



CAT NO.	LUMINAIRE LUMENS	WATTAGE	EFFICACY Llm/W
LEXD3WDG3	120	3W	38

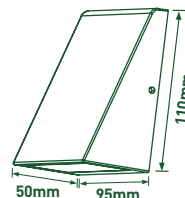

IP54 OVAL MINI BULKHEAD



DECORATIVE EXTERIOR

- IP54 rated - ideal for internal, external and utility installations
- Easy quick installation - Wall or Ceiling mounted
- Suitable for residential and commercial applications
- High impact durable polycarbonate housing



CAT NO.	LUMINAIRE LUMENS	WATTAGE	FINISH
EBE5040W	450	5.5W	White
EBE5040B	450	5.5W	Black

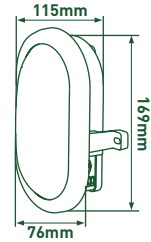

IP54 ROUND MINI BULKHEAD

DECORATIVE EXTERIOR

- IP54 rated - ideal for internal, external and utility installations
- Easy quick installation - Wall or Ceiling mounted
- Suitable for residential and commercial applications
- High impact durable polycarbonate housing
- Supplied with interchangeable Black and White bezels



CAT NO.	LUMINAIRE LUMENS	WATTAGE	FINISH
EBE5R40	450	5.5W	White/Black

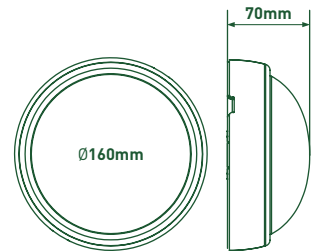

EBE5040B
IP54 Round Mini
Bulkhead

IP54 OVAL ROUND EYELID BULKHEAD

DECORATIVE EXTERIOR

- IP54 rated - ideal for external, utility and decorative installations
- Easy quick installation - Wall or Ceiling mounted
- Suitable for residential and commercial applications
- High impact durable polycarbonate housing
- Supplied with interchangeable Black and White bezels

4000K NEUTRAL WHITE	IP54 RATED	25,000 HOURS	NEW RANGE
----------------------------------	----------------------	------------------------	---------------------

CAT NO.	LUMINAIRE LUMENS	WATTAGE	FINISH
EBEE10S40	400	10W	White/Black

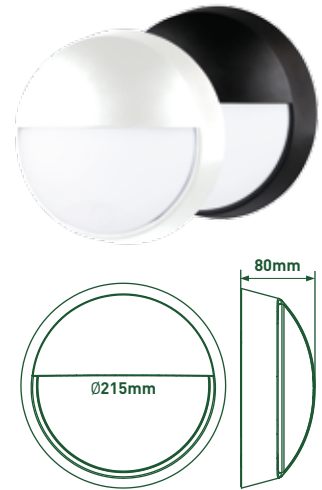

IP54 OVAL ROUND EYELID BULKHEAD WITH PIR SENSOR

DECORATIVE EXTERIOR

- IP54 rated - ideal for external, utility and decorative installations
- Easy quick installation - Wall or Ceiling mounted
- Suitable for residential and commercial applications
- High impact durable polycarbonate housing
- Supplied with interchangeable Black and White bezels
- Inbuilt adjustable day and night PIR motion sensor

4000K NEUTRAL WHITE	IP54 RATED	25,000 HOURS	NEW RANGE
----------------------------------	----------------------	------------------------	---------------------

CAT NO.	LUMINAIRE LUMENS	WATTAGE	FINISH
EBEE10P40	400	10W	White/Black



IP54 OVAL BULKHEAD

DECORATIVE EXTERIOR

- IP54 rated - ideal for external, utility and decorative installations
- Easy quick installation - Wall or Ceiling mounted
- Suitable for residential and commercial applications
- High impact durable polycarbonate housing
- Supplied with interchangeable Black and White bezels

4000K NEUTRAL WHITE	IP54 RATED	25,000 HOURS	NEW RANGE
----------------------------------	----------------------	------------------------	---------------------

CAT NO.	LUMINAIRE LUMENS	WATTAGE	FINISH
EBE010S40	700	10W	White/Black

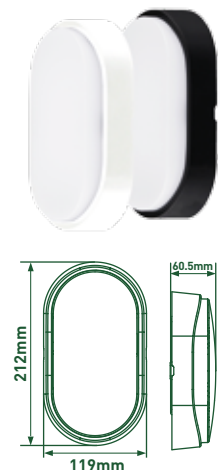

IP54 OVAL ROUND BULKHEAD WITH PIR SENSOR



DECORATIVE EXTERIOR

- IP54 rated - ideal for external, utility and decorative installations
- Easy quick installation - Wall or Ceiling mounted
- Suitable for residential and commercial applications, high impact polycarbonate housing
- Supplied with interchangeable Black and White bezels
- Inbuilt adjustable day and night PIR motion sensor

4000K NEUTRAL WHITE	IP54 RATED	25,000 HOURS	NEW RANGE
----------------------------------	----------------------	------------------------	---------------------

CAT NO.	LUMINAIRE LUMENS	WATTAGE	FINISH
EBE010P40	700	10W	White/Black

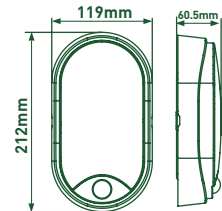

IP54 ROUND BULKHEAD



DECORATIVE EXTERIOR

- IP54 rated - ideal for internal, external and utility installations
- Easy quick installation - Wall or Ceiling mounted
- Suitable for residential and commercial applications
- High impact durable polycarbonate housing
- Supplied with interchangeable Black and White bezels

4000K NEUTRAL WHITE	IP54 RATED	25,000 HOURS	NEW RANGE
----------------------------------	----------------------	------------------------	---------------------

CAT NO.	LUMINAIRE LUMENS	WATTAGE	FINISH
EBER10S40	700	10W	White/Black

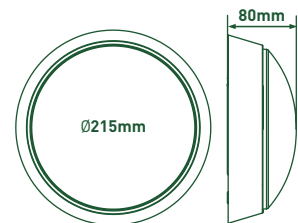

IP54 OVAL ROUND BULKHEAD WITH PIR SENSOR



DECORATIVE EXTERIOR

- IP54 rated - ideal for external, utility and decorative installations
- Easy quick installation - Wall or Ceiling mounted
- Suitable for residential and commercial applications, high impact polycarbonate housing
- Supplied with interchangeable Black and White bezels
- Inbuilt adjustable day and night PIR motion sensor

4000K NEUTRAL WHITE	IP54 RATED	25,000 HOURS	NEW RANGE
----------------------------------	----------------------	------------------------	---------------------

CAT NO.	LUMINAIRE LUMENS	WATTAGE	FINISH
EBER10P40	700	10W	White/Black

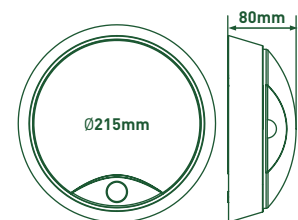





LAMPS & TUBES

Aluminium die-casting /
thermoplastic construction
using the latest LED technology.

Filament	100
Glass	104
Classic	108
Commercial	130

RANGE FEATURES

- **FITS INTO EXISTING FITTINGS** - No need to replace your fittings; just install your new LED lamps and start saving money.
- **SPOT THE DIFFERENCE** - LED lamps look the same as fluorescent lamps, using a fraction of the energy.
- **REPLACE ONE AT A TIME** - LED lamps can be combined with fluorescent or tungsten filament lamps, allowing gradual replacement over a period of time.

INSTANT ON 	MERCURY 0.0mg 0 Hg	CRI >80
-----------------------	---	-----------------------------



FILAMENT

- Traditional clear glass appearance and illumination
- All the advantages and energy savings of LED technology
- Perfect for retrofit and decorative installations



GLASS

- Traditional glass dichroic appearance
- All the advantages and energy savings of LED technology
- Perfect for retrofit and decorative installations



CLASSIC

- Complete range of classic LED lamps
- A range of specification, types & bases available
- Perfect for all retrofit or new build applications



COMMERCIAL

- Aluminium die-casting/thermoplastic construction
- Uses the latest LED technology



FILAMENT - BACK TO CLASSIC

Don't sacrifice looks. Classic traditional clear glass appearance and illumination with all the advantages and energy savings of LED technology. Perfect for retrofit and decorative installations.

RANGE FEATURES

- **SPOT THE DIFFERENCE** - Designed to mimic and replicate traditional filament incandescent lamps, using a fraction of the electrical energy.
- **BENEFIT FROM LED** - Very low energy consumption, long life, and no UV or IR radiation, Instant 100% light, no warm-up time.
- **SUPERIOR TECHNOLOGY** - Now available in dimmable and non-dimmable without separate driver base - maximising illumination beam angle and aesthetics
- **FULL RANGE FOR RETROFIT** - A range of colour temperatures and base caps. No need to replace your fittings; just install your new LED lamps and start saving money.

A60 Classic Filament	101
C35 Candle Filament	102
B45 Mini Globe Filament	103



A60 CLASSIC CLEAR FILAMENT



- LED technology with traditional filament effect
- Exceptional efficacy up to 135lm/W
- Dimmable options available – no separate housing base
- Full range of colour temperatures and base caps

2700K
WARM
WHITE

4000K
NEUTRAL
WHITE

≥ 15,000

15,000
HOURS
L70

A+
RATED

ECO BLISTERS

CAT NO.	DESCRIPTION	CAP TYPE	LUMENS	WATTAGE	EFFICACY lm/W	LIFETIME	COLOUR TEMP	EQUIVALENT WATTAGE	INNER QTY	OUTER QTY
LA22W4F47-LE	Non-dimmable	B22	470	4W	117	15,000	2700K	40W	5	50
LA22N4F47-LE	Non-dimmable	B22	470	4W	117	15,000	4000K	40W	5	50
LA27W4F47-LE	Non-dimmable	E27	470	4W	117	15,000	2700K	40W	5	50
LA27N4F47-LE	Non-dimmable	E27	470	4W	117	15,000	4000K	40W	5	50
LA22W4F47/3-LE	Non-dimmable (3 Pack)	B22	470	4W	117	15,000	2700K	40W	5	50
LA27W4F47/3-LE	Non-dimmable (3 Pack)	E27	470	4W	117	15,000	2700K	40W	5	50
LA22W6F81-LE	Non-dimmable	B22	810	6W	135	15,000	2700K	60W	5	50
LA22N6F81-LE	Non-dimmable	B22	810	6W	135	15,000	4000K	60W	5	50
LA27W6F81-LE	Non-dimmable	E27	810	6W	135	15,000	2700K	60W	5	50
LA27N6F81-LE	Non-dimmable	E27	810	6W	135	15,000	4000K	60W	5	50
LA22W6F81/3-LE	Non-dimmable (3 Pack)	B22	810	6W	135	15,000	2700K	60W	5	50
LA27W6F81/3-LE	Non-dimmable (3 Pack)	E27	810	6W	135	15,000	4000K	60W	5	50
LAD22W4F47-LE	Dimmable	B22	470	4W	117	15,000	2700K	40W	5	50
LAD22N4F47-LE	Dimmable	B22	470	4W	117	15,000	4000K	40W	5	50
LAD27W4F47-LE	Dimmable	E27	470	4W	117	15,000	2700K	40W	5	50
LAD27N4F47-LE	Dimmable	E27	470	4W	117	15,000	4000K	40W	5	50
LAD22W6F81-LE	Dimmable	B22	810	6W	135	15,000	2700K	60W	5	50
LAD22N6F81-LE	Dimmable	B22	810	6W	135	15,000	4000K	60W	5	50
LAD27W6F81-LE	Dimmable	E27	810	6W	135	15,000	2700K	60W	5	50
LAD27N6F81-LE	Dimmable	E27	810	6W	135	15,000	4000K	60W	5	50

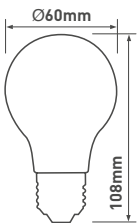

-LE



/3-LE

C35 CANDLE CLEAR FILAMENT

- LED technology with traditional filament effect
- Exceptional efficacy up to 125lm/W
- Dimmable options available
- Full range of base caps and pack sizes



* Non-dimmable variant shown*

ECO BLISTERS

CAT NO.	DESCRIPTION	CAP TYPE	LUMENS	WATTAGE	EFFICACY lm/W	LIFETIME	COLOUR TEMP	EQUIVALENT WATTAGE	INNER QTY	OUTER QTY
LC14W2F25-LE	Non-dimmable	E14	250	2W	125	15,000	2700K	25W	5	50
LC15W2F25-LE	Non-dimmable	B15	250	2W	125	15,000	2700K	25W	5	50
LC22W2F25-LE	Non-dimmable	B22	250	2W	125	15,000	2700K	25W	5	50
LC27W2F25-LE	Non-dimmable	E27	250	2W	125	15,000	2700K	25W	5	50
LC14W2F25/3-LE	Non-dimmable (3 Pack)	E14	250	2W	125	15,000	2700K	25W	5	50
LC22W2F25/3-LE	Non-dimmable (3 Pack)	B22	250	2W	125	15,000	2700K	25W	5	50
LC14W4F47-LE	Non-dimmable	E14	470	4W	117	15,000	2700K	40W	5	50
LC15W4F47-LE	Non-dimmable	B15	470	4W	117	15,000	2700K	40W	5	50
LC22W4F47-LE	Non-dimmable	B22	470	4W	117	15,000	2700K	40W	5	50
LC27W4F47-LE	Non-dimmable	E27	470	4W	117	15,000	2700K	40W	5	50
LC14W4F47/3-LE	Non-dimmable (3 Pack)	E14	470	4W	117	15,000	2700K	40W	5	50
LCD14W4F47-LE	Dimmable	E14	470	4W	117	15,000	2700K	40W	5	50
LCD22W4F47-LE	Dimmable	B22	470	4W	117	15,000	2700K	40W	5	50
LCD27W4F47-LE	Dimmable	E27	470	4W	117	15,000	2700K	40W	5	50

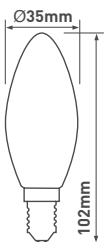

-LE



/3-LE

B45 MINI GLOBE CLEAR FILAMENT

- LED technology with traditional filament effect
- Exceptional efficacy up to 117lm/W
- Full range of base caps and pack sizes



2700K
 WARM
 WHITE

$\geq 15,000$

15,000
 HOURS
 L70

A+
 RATED

ECO BLISTERS

CAT NO.	DESCRIPTION	CAP TYPE	LUMENS	WATTAGE	EFFICACY lm/W	LIFETIME	COLOUR TEMP	EQUIVALENT WATTAGE	INNER QTY	OUTER QTY
LB14W4F47-LE	Non-dimmable	E14	470	4W	117	15,000	2700K	40W	5	50
LB15W4F47-LE	Non-dimmable	B15	470	4W	117	15,000	2700K	40W	5	50
LB22W4F47-LE	Non-dimmable	B22	470	4W	117	15,000	2700K	40W	5	50
LB27W4F47-LE	Non-dimmable	E27	470	4W	117	15,000	2700K	40W	5	50





GLASS - BACK TO CLASSIC

Don't sacrifice looks. Classic traditional glass dichroic appearance with all the advantages and energy savings of LED technology. Perfect for retrofit and decorative installations.

RANGE FEATURES

- **SPOT THE DIFFERENCE** - Engineered to perfectly replicate traditional dichroic lamps, the multifaceted lens and glass reflective body provide the same light output and traditional appearance using a fraction of the electrical energy.
- **BENEFIT FROM LED** - Very low energy consumption, long life, and no UV or IR radiation, Instant 100 % light, no warm-up time.
- **FULL RANGE FOR RETROFIT** - A range of colour temperatures including GU10 and MR16 base caps. No need to replace your fittings; just install your new LED lamps and start saving money.

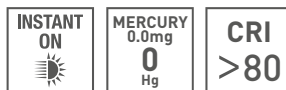

MR16 Glass
GU10 Glass

105
106

MR16 GLASS

- Replicates traditional glass halogen in appearance and output
- Sparkling Edge2Edge lens maximises illumination
- 90% energy saving versus halogen
- Upgraded IC driver technology



ECO BLISTERS

CAT NO.	DESCRIPTION	LUMENS	WATTAGE	EFFICACY lm/W	LIFETIME	COLOUR TEMP	EQUIVALENT WATTAGE	INNER QTY	OUTER QTY
LMW5G37-LE	Non-dimmable	370	5W	74	25,000	2700K	35W	5	50
LMN5G37-LE	Non-dimmable	370	5W	74	25,000	4000K	35W	5	50
LMW5G37/3-LE	Non-dimmable (3 Pack)	370	5W	74	25,000	2700K	35W	5	50
LMN5G37/3-LE	Non-dimmable (3 Pack)	370	5W	74	25,000	4000K	35W	5	50

x5 MULTI-PACK BOXES

CAT NO.	DESCRIPTION	LUMENS	WATTAGE	EFFICACY lm/W	LIFETIME	COLOUR TEMP	EQUIVALENT WATTAGE	INNER QTY	OUTER QTY
LMW5G37/5-01	Non-dimmable	370	5W	74	25,000	2700K	35W	-	10
LMN5G37/5-01	Non-dimmable	370	5W	74	25,000	4000K	35W	-	10

BOXES

CAT NO.	DESCRIPTION	LUMENS	WATTAGE	EFFICACY lm/W	LIFETIME	COLOUR TEMP	EQUIVALENT WATTAGE	INNER QTY	OUTER QTY
LMW5G37-01	Non-dimmable	370	5W	74	25,000	2700K	35W	5	50

- 12V operating voltage
- Cap fitting GU5.3

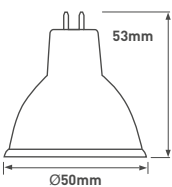

-LE



/3-LE



/5-01



EDGE2EDGE
LENS

GU10 GLASS

- Replicates traditional glass halogen in appearance and output
- Sparkling Edge2Edge lens maximises illumination
- 90% energy saving versus halogen
- Dimmable options available
- Upgraded IC driver technology



ECO BLISTERS

CAT NO.	DESCRIPTION	LUMENS	WATTAGE	EFFICACY lm/W	LIFETIME	COLOUR TEMP	EQUIVALENT WATTAGE	INNER QTY	OUTER QTY
LGW3G26-LE	Non-dimmable	260	3.5W	74	25,000	2700K	35W	5	50
LGN3G26-LE	Non-dimmable	260	3.5W	74	25,000	4000K	35W	5	50
LGW3G26/3-LE	Non-dimmable (3 Pack)	260	3.5W	74	25,000	2700K	35W	5	50
LGN3G26/3-LE	Non-dimmable (3 Pack)	260	3.5W	74	25,000	4000K	35W	5	50
LGW5G37-LE	Non-dimmable	370	5W	74	25,000	2700K	50W	5	50
LGN5G37-LE	Non-dimmable	370	5W	74	25,000	4000K	50W	5	50
LGW5G37/3-LE	Non-dimmable (3 Pack)	370	5W	74	25,000	2700K	50W	5	50
LGN5G37/3-LE	Non-dimmable (3 Pack)	370	5W	74	25,000	4000K	50W	5	50
LGDW5G37-LE	Dimmable	370	5W	74	25,000	2700K	50W	5	50
LGDN5G37-LE	Dimmable	370	5W	74	25,000	4000K	50W	5	50
LGDW5G37/3-LE	Dimmable (3 Pack)	370	5W	74	25,000	2700K	50W	5	50
LGDN5G37/3-LE	Dimmable (3 Pack)	370	5W	74	25,000	4000K	50W	5	50

x5 MULTI-PACK BOXES

CAT NO.	DESCRIPTION	LUMENS	WATTAGE	EFFICACY lm/W	LIFETIME	COLOUR TEMP	EQUIVALENT WATTAGE	INNER QTY	OUTER QTY
LGW3G26/5-01	Non-dimmable	260	3.5W	74	25,000	2700K	35W	-	10
LGN3G26/5-01	Non-dimmable	260	3.5W	74	25,000	4000K	35W	-	10
LGW5G37/5-01	Non-dimmable	370	5W	74	25,000	2700K	50W	-	10
LGN5G37/5-01	Non-dimmable	370	5W	74	25,000	4000K	50W	-	10
LGDW5G37/5-01	Dimmable	370	5W	74	25,000	2700K	50W	-	10
LGDN5G37/5-01	Dimmable	370	5W	74	25,000	4000K	50W	-	10

BOXES

CAT NO.	DESCRIPTION	LUMENS	WATTAGE	EFFICACY lm/W	LIFETIME	COLOUR TEMP	EQUIVALENT WATTAGE	INNER QTY	OUTER QTY
LGW3G26-01	Non-dimmable	260	3.5W	74	25,000	2700K	35W	10	200
LGN3G26-01	Non-dimmable	260	3.5W	74	25,000	4000K	35W	10	200
LGC3G26-01	Non-dimmable	260	3.5W	74	25,000	6500K	35W	10	200
LGW5G37-01	Non-dimmable	370	5W	74	25,000	2700K	50W	10	200
LGN5G37-01	Non-dimmable	370	5W	74	25,000	4000K	50W	10	200
LGC5G37-01	Non-dimmable	370	5W	74	25,000	6500K	50W	10	200
LGDW5G37-01	Dimmable	370	5W	74	25,000	2700K	50W	10	200
LGDN5G37-01	Dimmable	370	5W	74	25,000	4000K	50W	10	200
LGDC5G37-01	Dimmable	370	5W	74	25,000	6500K	50W	10	200

* Supplied in trade counter display boxes, 10 per box

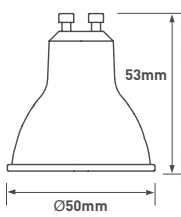

-LE



/3-LE



-01*



/5-01



EDGE2EDGE
LENS



CLASSIC

Complete range of classic LED lamps in a range of specifications, types, bases – perfect for all retrofit or new build applications and projects

GU10	109
MR16 TrueFit	114
A60 Range	115
A70 Classic	119
B45 Mini Globe	120
C35 Candle	122
Capsules	123
GX53	124
PLC Series	125
R Series	126
PAR	127
S15	128

RANGE FEATURES

- **FULL RANGE FOR RETROFIT** - Full range of types, sizes, colour temperatures and base caps. No need to replace your fittings; just install your new LED lamps and start saving money.
- **SUPERIOR TECHNOLOGY** - New designed Dim2Warm and Emergency backup ranges allow for completely new lighting applications. Benefit from the advances LED technology is now able to offer.
- **BENEFIT FROM LED** -Very low energy consumption, long life, and no UV or IR radiation, Instant 100 % light, no warm-up time.
- **REPLACE ONE AT A TIME** - LED lamps can be combined with fluorescent or tungsten filament lamps, allowing gradual replacement over a period of time.



GU10

- True halogen appearance and perfect fit
- New Edge2Edge lens design drastically reduces lamp bezel edge to improve aesthetics when lit or unlit
- Upgraded IC driver option for superior performance and reliability
- 90% energy saving versus halogen
- Up to 25,000 hours' life to L70 in enclosed downlights
- All BG dimmers are LED compatible and available in white moulded and metal finishes



2700K WARM WHITE	4000K NEUTRAL WHITE	6500K COOL WHITE	≥15,000	BEAM ANGLE 38°	A+ RATED
-------------------------------	----------------------------------	-------------------------------	---------	----------------------	--------------------

ECO BLISTERS

CAT NO.	DESCRIPTION	LUMENS	WATTAGE	EFFICACY lm/W	LIFETIME	COLOUR TEMP	EQUIVALENT WATTAGE	INNER QTY	OUTER QTY
LGDW5W37P-LE	Dimmable	370	5W	74	25,000	2700K	50W	5	50
LGDN5W37P-LE	Dimmable	370	5W	74	25,000	4000K	50W	5	50
LGDW5W37P/2-LE	Dimmable (2 Pack)	370	5W	74	25,000	2700K	50W	5	50
LGDW5W37P/3-LE	Dimmable (3 Pack)	370	5W	74	25,000	2700K	50W	5	50
LGDN5W37P/3-LE	Dimmable (3 Pack)	370	5W	74	25,000	4000K	50W	5	50

x5 MULTI-PACK BOXES

CAT NO.	DESCRIPTION	LUMENS	WATTAGE	EFFICACY lm/W	LIFETIME	COLOUR TEMP	EQUIVALENT WATTAGE	INNER QTY	OUTER QTY
LGDW5W37P/5-01	Dimmable	370	5W	70	25,000	2700K	50W	-	10
LGDN5W37P/5-01	Dimmable	370	5W	70	25,000	4000K	50W	-	10

BOXES

CAT NO.	DESCRIPTION	LUMENS	WATTAGE	EFFICACY lm/W	LIFETIME	COLOUR TEMP	EQUIVALENT WATTAGE	INNER QTY	OUTER QTY
LGW3W26P-01	Non-dimmable	260	3.5W	74	25,000	2700K	35W	10	200
LGN3W26P-01	Non-dimmable	260	3.5W	74	25,000	4000K	35W	10	200
LGC3W26P-01	Non-dimmable	260	3.5W	74	25,000	6500K	35W	10	200
LGW5W37P-01	Non-dimmable	370	5W	74	25,000	2700K	50W	10	200
LGN5W37P-01	Non-dimmable	370	5W	74	25,000	4000K	50W	10	200
LGC5W37P-01	Non-dimmable	370	5W	74	25,000	6500K	50W	10	200
LGDW5W37P-01	Dimmable	370	5W	74	25,000	2700K	50W	10	200
LGDN5W37P-01	Dimmable	370	5W	74	25,000	4000K	50W	10	200
LGDC5W37P-01	Dimmable	370	5W	74	25,000	6500K	50W	10	200

* Supplied in trade counter display boxes, 10 per box



GU10 WIDE ANGLE

- True halogen appearance and perfect fit
- Wide beam angle allows for maximum light distribution and reduced "shadow spots"
- Ideal for kitchen lighting and bar spotlights
- 10 times lifetime versus halogen
- Upgraded IC driver option for superior performance and reliability
- 90% energy saving versus halogen
- All BG dimmers are LED compatible and available in white moulded and metal finishes



2700K WARM WHITE	4000K NEUTRAL WHITE	6500K COOL WHITE	≥15,000 	BEAM ANGLE 100°	A+ RATED
-------------------------------	----------------------------------	-------------------------------	--------------------	--------------------------------	--------------------

BOXES

CAT NO.	DESCRIPTION	LUMENS	WATTAGE	EFFICACY lm/W	LIFETIME	COLOUR TEMP	EQUIVALENT WATTAGE	INNER QTY	OUTER QTY
LGW5W30W-01	Non-dimmable	300	5W	60	20,000	2700K	35W	10	200
LGN5W30W-01	Non-dimmable	300	5W	60	20,000	4000K	35W	10	200
LGC5W30W-01	Non-dimmable	300	5W	60	20,000	6500K	35W	10	200

* Supplied in trade counter display boxes, 10 per box

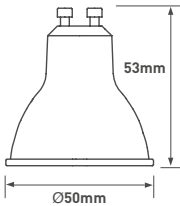

-01*



EDGE2EDGE
LENS



BEAM
ANGLE
38°



BEAM
ANGLE
100°

GU10 ECO RANGE

- True halogen appearance and perfect fit
- New Edge2Edge lens design drastically reduces lamp bezel edge to improve aesthetics when lit or unlit
- 90% energy saving versus halogen
- All BG dimmers are LED compatible and available in white moulded and metal finishes



ECO BLISTERS

CAT NO.	DESCRIPTION	LUMENS	WATTAGE	EFFICACY lm/W	LIFETIME	COLOUR TEMP	EQUIVALENT WATTAGE	INNER QTY	OUTER QTY
LGW3W26P-LE	Non-dimmable	260	3.5W	74	15,000	2700K	35W	5	50
LGN3W26P-LE	Non-dimmable	260	3.5W	74	15,000	4000K	35W	5	50
LGW3W26P/2-LE	Non-dimmable [2 Pack]	260	3.5W	74	15,000	2700K	35W	5	50
LGW3W26P/3-LE	Non-dimmable [3 Pack]	260	3.5W	74	15,000	2700K	35W	5	50
LGW5W37P-LE	Non-dimmable	370	5W	74	15,000	2700K	50W	5	50
LGN5W37P-LE	Non-dimmable	370	5W	74	15,000	4000K	50W	5	50
LGW5W37P/2-LE	Non-dimmable [2 Pack]	370	5W	74	15,000	2700K	50W	5	50
LGW5W37P/3-LE	Non-dimmable [3 Pack]	370	5W	74	15,000	2700K	50W	5	50

x5 MULTI-PACK BOXES

CAT NO.	DESCRIPTION	LUMENS	WATTAGE	EFFICACY lm/W	LIFETIME	COLOUR TEMP	EQUIVALENT WATTAGE	INNER QTY	OUTER QTY
LGW3W26P/5-01	Non-dimmable	260	3.5W	70	15,000	2700K	35W	-	10
LGN3W26P/5-01	Non-dimmable	260	3.5W	70	15,000	4000K	35W	-	10
LGW5W37P/5-01	Non-dimmable	370	5W	70	15,000	2700K	50W	-	10
LGN5W37P/5-01	Non-dimmable	370	5W	70	15,000	4000K	50W	-	10

x10 MULTI-PACK BOXES

CAT NO.	DESCRIPTION	LUMENS	WATTAGE	EFFICACY lm/W	LIFETIME	COLOUR TEMP	EQUIVALENT WATTAGE	INNER QTY	OUTER QTY
LGW5W37P/10-01	Non-dimmable	370	5W	70	15,000	2700K	50W	-	10
LGN5W37P/10-01	Non-dimmable	370	5W	70	15,000	4000K	50W	-	10

x20 MULTI-PACK BOXES

CAT NO.	DESCRIPTION	LUMENS	WATTAGE	EFFICACY lm/W	LIFETIME	COLOUR TEMP	EQUIVALENT WATTAGE	INNER QTY	OUTER QTY
LGW5W37P/20-01	Non-dimmable	370	5W	70	15,000	2700K	50W	-	10

* Supplied in trade counter display boxes, 10 per box

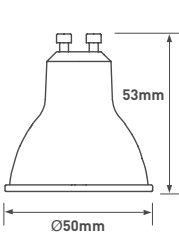

EDGE2EDGE LENS

DIM2WARM



Our new Dim2Warm range incorporates the latest LED technology and circuitry design to truly mimic the warm glow effect of halogen.

Now you can easily adjust the atmosphere and colour temperature of spaces such as living rooms and bedrooms to achieve a warm cosy feel by simply adjusting the existing dimmer switch to adjust between 2200K & 2700K

No longer does a warmer light output mean reduced unusable lumen levels. New technology regulates the power to the LED chips while maintaining light output to achieve different colour temperatures and higher lumen outputs

Both GU10 & A60 versions are available



Warm Glow



2200K WARM WHITE

2700K WARM WHITE



GU10 DIM2WARM

- Adjust the colour temperature between warm 2200K-2700K
- True halogen appearance and perfect fit
- All BG dimmers are LED compatible and available in white moulded and metal finishes
- New Edge2Edge lens design drastically reduces lamp the bezel edge to improve aesthetics when lit or unlit



ECO BLISTERS

CAT NO.	DESCRIPTION	LUMENS	WATTAGE	EFFICACY lm/W	LIFETIME	COLOUR TEMP	EQUIVALENT WATTAGE	INNER QTY	OUTER QTY
LGDWW5W37-LE	Non-dimmable	370	5W	74	25,000	2200K-2700K	50W	5	50

x5 MULTI-PACK BOXES

CAT NO.	DESCRIPTION	LUMENS	WATTAGE	EFFICACY lm/W	LIFETIME	COLOUR TEMP	EQUIVALENT WATTAGE	INNER QTY	OUTER QTY
LGDWW5W37/5-01	Non-dimmable	370	5W	74	25,000	2200K-2700K	50W	-	10

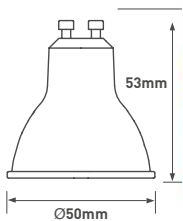

-LE



/5-01



EDGE2EDGE LENS

MR16 TRUEFIT

- True halogen appearance and perfect fit
- New Edge2Edge lens design drastically reduces lamp bezel edge to improve aesthetics when lit or unlit
- 90% energy saving versus halogen
- 10 times lifetime versus halogen
- Non-dimmable
- Up to 25,000 hours' life to L70 in enclosed downlights



2700K
WARM
WHITE

4000K
NEUTRAL
WHITE

6500K
COOL
WHITE

$\geq 15,000$

25,000
HOURS
L70

BEAM
ANGLE

38°

A+
RATED

ECO BLISTERS

CAT NO.	DESCRIPTION	LUMENS	WATTAGE	EFFICACY lm/W	LIFETIME	COLOUR TEMP	EQUIVALENT WATTAGE	INNER QTY	OUTER QTY
LMW3W26P-LE	Non-dimmable	260	3.5W	74	25,000	2700K	20W	5	50
LMN3W26P-LE	Non-dimmable	260	3.5W	74	25,000	4000K	20W	5	50
LMW5W37P-LE	Non-dimmable	370	5W	74	25,000	2700K	35W	5	50
LMN5W37P-LE	Non-dimmable	370	5W	74	25,000	4000K	35W	5	50
LMC5W37P-LE	Non-dimmable	370	5W	74	25,000	6500K	35W	5	50

BOXES

CAT NO.	DESCRIPTION	LUMENS	WATTAGE	EFFICACY lm/W	LIFETIME	COLOUR TEMP	EQUIVALENT WATTAGE	INNER QTY	OUTER QTY
LMW5W37P-01	Non-dimmable	370	5W	74	25,000	2700K	35W	10	200
LMN5W37P-01	Non-dimmable	370	5W	74	25,000	4000K	35W	10	200
LMC5W37P-01	Non-dimmable	370	5W	74	25,000	6500K	35W	10	200

- 12V operating voltage
- Cap fitting GU53

* Supplied in trade counter display boxes, 10 per box

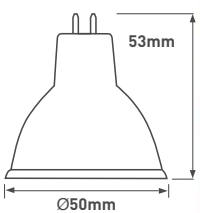

-LE



-01*



EDGE2EDGE
LENS

A60 POWERLITE

NEW RANGE



- Provides automatic background illumination during a power outage
- 2 hour power storage built into existing A60 lamp profile – no bulky separate housing
- High 750lm during normal operation
- Available in both E27 and B22 base caps
- **PowerLite** must be connected to an electrical circuit where other electrical products are drawing power, not an independent lighting circuit
- 30% energy saving versus CFLs



BOXES

CAT NO.	DESCRIPTION	CAP TYPE	LUMENS	WATTAGE	EFFICACY lm/W	SWITCH CYCLE	LIFETIME	COLOUR TEMP	BEAM ANGLE	EQUIVALENT WATTAGE	INNER QUANTITY	OUTER QUANTITY
LAEM22W8W81-01	Non-dimmable	B22	750	8W	85	15,000	25,000	2700K	180	40W	5	50
LAEM27W8W81-01	Non-dimmable	E27	750	8W	85	15,000	25,000	2700K	180	40W	5	50

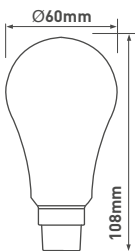

New Features

Featuring advanced power storage capacitors, PowerLite provides up to 2 hours of background illumination during a power outage providing enough time to find candles or torches until power is restored. In normal operation, a powerful 750lm is output from the lamp across a wide beam angle.



A60 CLASSIC

- 30% energy saving compared to CFLs
- Double lifetime compared to CFLs
- Exceptional efficacy up to 90lm/W
- Dimmable options available
- Full range of colour temperatures, base caps and pack sizes



ECO BLISTERS

CAT NO.	DESCRIPTION	CAP TYPE	LUMENS	WATTAGE	EFFICACY lm/W	SWITCH CYCLE	LIFETIME	COLOUR TEMP	BEAM ANGLE	EQUIVALENT WATTAGE	INNER QUANTITY	OUTER QUANTITY
LA22W5W47-LE	Non-dimmable	B22	470	5.5W	85	15,000	20,000	2700K	240°	40W	5	50
LA22N5W47-LE	Non-dimmable	B22	470	5.5W	85	15,000	20,000	4000K	240°	40W	5	50
LA27W5W47-LE	Non-dimmable	E27	470	5.5W	85	15,000	20,000	2700K	240°	40W	5	50
LA27N5W47-LE	Non-dimmable	E27	470	5.5W	85	15,000	20,000	4000K	240°	40W	5	50
LA27C5W47-LE	Non-dimmable	E27	470	5.5W	85	15,000	20,000	6500K	240°	40W	5	50
LA22W5W47/3-LE	Non-dim (3pk)	B22	470	5.5W	85	15,000	20,000	2700K	240°	40W	5	50
LA27W5W47/3-LE	Non-dim (3pk)	E27	470	5.5W	85	15,000	20,000	2700K	240°	40W	5	50
LA22W9W81-LE	Non-dimmable	B22	806	9W	90	15,000	20,000	2700K	240°	60W	5	50
LA22N9W81-LE	Non-dimmable	B22	806	9W	90	15,000	20,000	4000K	240°	60W	5	50
LA27W9W81-LE	Non-dimmable	E27	806	9W	90	15,000	20,000	2700K	240°	60W	5	50
LA27N9W81-LE	Non-dimmable	E27	806	9W	90	15,000	20,000	4000K	240°	60W	5	50
LA27C9W81-LE	Non-dimmable	E27	806	9W	90	15,000	20,000	6500K	240°	60W	5	50
LA22W9W81/3-LE	Non-dim (3pk)	B22	806	9W	90	15,000	20,000	2700K	240°	60W	5	50
LA27W9W81/3-LE	Non-dim (3pk)	E27	806	9W	90	15,000	20,000	2700K	240°	60W	5	50
LAD27W5W47-LE	Dimmable	E27	470	5.5W	85	15,000	20,000	2700K	240°	40W	5	50
LAD22W9W81-LE	Dimmable	B22	806	9W	90	15,000	20,000	2700K	240°	60W	5	50
LAD22N9W81-LE	Dimmable	B22	806	9W	90	15,000	20,000	4000K	240°	60W	5	50
LAD27W9W81-LE	Dimmable	E27	806	9W	90	15,000	20,000	2700K	240°	60W	5	50
LAD27N9W81-LE	Dimmable	E27	806	9W	90	15,000	20,000	4000K	240°	60W	5	50
LAD27C9W81-LE	Dimmable	E27	806	9W	90	15,000	20,000	6500K	240°	60W	5	50
LAD22W9W81/3-LE	Dimmable	B22	806	9W	90	15,000	20,000	2700K	240°	60W	5	50
LAD27W9W81/3-LE	Dimmable	E27	806	9W	90	15,000	20,000	2700K	240°	60W	5	50

x3 MULTI-PACK BOXES

CAT NO.	DESCRIPTION	CAP TYPE	LUMENS	WATTAGE	EFFICACY lm/W	SWITCH CYCLE	LIFETIME	COLOUR TEMP	BEAM ANGLE	EQUIVALENT WATTAGE	INNER QUANTITY	OUTER QUANTITY
LA22W5W47/3-01	Non-dimmable	B22	470	6W	78	15,000	25,000	2700K	240°	40W	5	50
LA27W5W47/3-01	Non-dimmable	E27	470	6W	78	15,000	25,000	2700K	240°	40W	5	50
LA22W9W81/3-01	Non-dimmable	B22	810	10W	81	15,000	25,000	2700K	240°	60W	5	50
LA27W9W81/3-01	Non-dimmable	E27	810	10W	81	15,000	25,000	2700K	240°	60W	5	50

x5 MULTI-PACK BOXES

CAT NO.	DESCRIPTION	CAP TYPE	LUMENS	WATTAGE	EFFICACY lm/W	SWITCH CYCLE	LIFETIME	COLOUR TEMP	BEAM ANGLE	EQUIVALENT WATTAGE	INNER QUANTITY	OUTER QUANTITY
LA22W5W47/5-01	Non-dimmable	B22	470	6W	78	15,000	25,000	2700K	240°	40W	5	50
LA27W5W47/5-01	Non-dimmable	E27	470	6W	78	15,000	25,000	2700K	240°	40W	5	50
LA22W9W81/5-01	Non-dimmable	B22	810	10W	81	15,000	25,000	2700K	240°	60W	5	50
LA27W9W81/5-01	Non-dimmable	E27	810	10W	81	15,000	25,000	2700K	240°	60W	5	50

BOXES

CAT NO.	DESCRIPTION	CAP TYPE	LUMENS	WATTAGE	EFFICACY lm/W	SWITCH CYCLE	LIFETIME	COLOUR TEMP	BEAM ANGLE	EQUIVALENT WATTAGE	INNER QUANTITY	OUTER QUANTITY
LA22W5W47-01	Non-dimmable	B22	470	6W	78	15,000	25,000	2700K	240°	40W	10	100
LA22N5W47-01	Non-dimmable	B22	470	6W	78	15,000	25,000	4000K	240°	40W	10	100
LA22C5W47-01	Non-dimmable	B22	470	6W	78	15,000	25,000	6500K	240°	40W	10	100
LA27W5W47-01	Non-dimmable	E27	470	6W	78	15,000	25,000	2700K	240°	40W	10	100
LA27N5W47-01	Non-dimmable	E27	470	6W	78	15,000	25,000	4000K	240°	40W	10	100
LA27C5W47-01	Non-dimmable	E27	470	6W	78	15,000	25,000	6500K	240°	40W	10	100
LA22W9W81-01	Non-dimmable	B22	810	9W	90	15,000	25,000	2700K	240°	60W	10	100
LA22N9W81-01	Non-dimmable	B22	810	9W	90	15,000	25,000	4000K	240°	60W	10	100
LA22C9W81-01	Non-dimmable	B22	810	9W	90	15,000	25,000	6500K	240°	60W	10	100
LA27W9W81-01	Non-dimmable	E27	810	9W	90	15,000	25,000	2700K	240°	60W	10	100
LA27N9W81-01	Non-dimmable	E27	810	9W	90	15,000	25,000	4000K	240°	60W	10	100
LA27C9W81-01	Non-dimmable	E27	810	9W	90	15,000	25,000	6500K	240°	60W	10	100
LAD22W9W81-01	Dimmable	B22	810	9W	90	15,000	25,000	2700K	240°	60W	10	100
LAD22N9W81-01	Dimmable	B22	810	9W	90	15,000	25,000	4000K	240°	60W	10	100
LAD22C9W81-01	Dimmable	B22	810	9W	90	15,000	25,000	6500K	240°	60W	10	100
LAD27W9W81-01	Dimmable	E27	810	9W	90	15,000	25,000	2700K	240°	60W	10	100
LAD27N9W81-01	Dimmable	E27	810	9W	90	15,000	25,000	4000K	240°	60W	10	100
LAD27C9W81-01	Dimmable	E27	810	9W	90	15,000	25,000	6500K	240°	60W	10	100

* Supplied in trade counter display boxes, 10 per box



A60 DIM2WARM

- True filament lighting and colour temperature effect when dimmed
- 85% energy saving versus tungsten filament
- Adjust colour temperature between warm 2200K-2700K
- Up to 15,000 hours' life to L70



ECO BLISTERS

CAT NO.	DESCRIPTION	CAP TYPE	LUMENS	WATTAGE	EFFICACY lm/W	LIFETIME	COLOUR TEMP	EQUIVALENT WATTAGE	INNER QUANTITY	OUTER QUANTITY
LADW22W10W81-LE	Dimmable	B22	810	10W	81	15,000	2200K-2700K	60W	5	50
LADW27W10W81-LE	Dimmable	E27	810	10W	81	15,000	2200K-2700K	60W	5	50

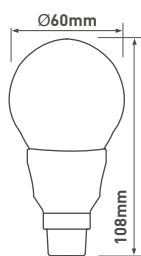

-LE



A70 CLASSIC

- 30% energy saving versus CFLs
- 100 Watt Equivalent
- Double lifetime versus CFLs
- Full range of colour temperatures, base caps



ECO BLISTERS

CAT NO.	DESCRIPTION	CAP TYPE	LUMENS	WATTAGE	EFFICACY lm/W	LIFETIME	COLOUR TEMP	EQUIVALENT WATTAGE	INNER QUANTITY	OUTER QUANTITY
LA22W15W15-LE	Non-dimmable	B22	1521	16W	95	15,000	2700K	100W	5	50
LA22N15W15-LE	Non-dimmable	B22	1521	16W	95	15,000	4000K	100W	5	50
LA22C15W15-LE	Non-dimmable	B22	1521	16W	95	15,000	6500K	100W	5	50
LA27W15W15-LE	Non-dimmable	E27	1521	16W	95	15,000	2700K	100W	5	50
LA27N15W15-LE	Non-dimmable	E27	1521	16W	95	15,000	4000K	100W	5	50
LA27C15W15-LE	Non-dimmable	E27	1521	16W	95	15,000	6500K	100W	5	50

BOXES

CAT NO.	DESCRIPTION	CAP TYPE	LUMENS	WATTAGE	EFFICACY lm/W	LIFETIME	COLOUR TEMP	EQUIVALENT WATTAGE	INNER QUANTITY	OUTER QUANTITY
LA22W15W15-01	Non-dimmable	B22	1521	16W	95	15,000	2700K	100W	10	100
LA22N15W15-01	Non-dimmable	B22	1521	16W	95	15,000	4000K	100W	10	100
LA22C15W15-01	Non-dimmable	B22	1521	16W	95	15,000	6500K	100W	10	100
LA27W15W15-01	Non-dimmable	E27	1521	16W	95	15,000	2700K	100W	10	100
LA27N15W15-01	Non-dimmable	E27	1521	16W	95	15,000	4000K	100W	10	100
LA27C15W15-01	Non-dimmable	E27	1521	16W	95	15,000	6500K	100W	10	100

* Supplied in trade counter display boxes, 10 per box



B45 MINI GLOBE

- 80% energy saving versus filament
- Up to 25,000 hours' life to L70
- Dimmable options available
- Full range of base caps



ECO BLISTERS

CAT NO.	DESCRIPTION	CAP TYPE	LUMENS	WATTAGE	EFFICACY lm/W	COLOUR TEMP	EQUIVALENT WATTAGE	INNER QUANTITY	OUTER QUANTITY
LB14W3W25-LE	Non-dimmable	E14	250	3W	83	2700K	25W	5	50
LB14C3W25-LE	Non-dimmable	E14	250	3W	83	6500K	25W	5	50
LB22W3W25-LE	Non-dimmable	B22	250	3W	83	2700K	25W	5	50
LB27W3W25-LE	Non-dimmable	E27	250	3W	83	2700K	25W	5	50
LB27C3W25-LE	Non-dimmable	E27	250	3W	83	6500K	25W	5	50
LB14W3W25/3-LE	Non-dimmable (3 Pack)	E14	250	3W	83	2700K	25W	5	50
LB22W3W25/3-LE	Non-dimmable (3 Pack)	B22	250	3W	83	2700K	25W	5	50
LB27W3W25/3-LE	Non-dimmable (3 Pack)	E27	250	3W	83	2700K	25W	5	50
LB14W5W47-LE	Non-dimmable	E14	470	5.5W	85	2700K	40W	5	50
LB14C5W47-LE	Non-dimmable	E14	470	5.5W	85	6500K	40W	5	50
LB22W5W47-LE	Non-dimmable	B22	470	5.5W	85	2700K	40W	5	50
LB27W5W47-LE	Non-dimmable	E27	470	5.5W	85	2700K	40W	5	50
LB14W5W47/3-LE	Non-dimmable (3 Pack)	E14	470	5.5W	85	2700K	40W	5	50
LB22W5W47/3-LE	Non-dimmable (3 Pack)	B22	470	5.5W	85	2700K	40W	5	50
LB27W5W47/3-LE	Non-dimmable (3 Pack)	E27	470	5.5W	85	2700K	40W	5	50
LBD14W5W47-LE	Dimmable	E14	470	5.5W	85	2700K	40W	5	50
LBD27W5W47-LE	Dimmable	E27	470	5.5W	85	2700K	40W	5	50
LBD14W5W47/3-LE	Dimmable (3 Pack)	E14	470	5.5W	85	2700K	40W	5	50





C35 CANDLE

- 80% energy saving versus filament
- Dimmable and Non-dimmable versions available
- Most popular equivalents



ECO BLISTERS

CAT NO.	DESCRIPTION	CAP TYPE	LUMENS	WATTAGE	EFFICACY lm/W	COLOUR TEMP	EQUIVALENT WATTAGE	INNER QUANTITY	OUTER QUANTITY
LC14W3W25-LE	Non-dimmable	E14	250	3W	83	2700K	25W	5	50
LC14C3W25-LE	Non-dimmable	E14	250	3W	83	6500K	25W	5	50
LC15W3W25-LE	Non-dimmable	B15	250	3W	83	2700K	25W	5	50
LC22W3W25-LE	Non-dimmable	B22	250	3W	83	2700K	25W	5	50
LC27W3W25-LE	Non-dimmable	E27	250	3W	83	2700K	25W	5	50
LC14W3W25/3-LE	Non-dimmable (3 Pack)	E14	250	3W	83	2700K	25W	5	50
LC15W3W25/3-LE	Non-dimmable (3 Pack)	B15	250	3W	83	2700K	25W	5	50
LC22W3W25/3-LE	Non-dimmable (3 Pack)	B22	250	3W	83	2700K	25W	5	50
LC27W3W25/3-LE	Non-dimmable (3 Pack)	E27	250	3W	83	2700K	25W	5	50
LC14W5W47-LE	Non-dimmable	E14	470	5.5W	85	2700K	40W	5	50
LC14C5W47-LE	Non-dimmable	E14	470	5.5W	85	6500K	40W	5	50
LC14W5W47/3-LE	Non-dimmable (3 Pack)	E14	470	5.5W	85	2700K	40W	5	50
LC15W5W47/3-LE	Non-dimmable (3 Pack)	B15	470	5.5W	85	2700K	40W	5	50
LC22W5W47/3-LE	Non-dimmable (3 Pack)	B22	470	5.5W	85	2700K	40W	5	50
LC27W5W47/3-LE	Non-dimmable (3 Pack)	E27	470	5.5W	85	2700K	40W	5	50
LCD22W5W47-LE	Dimmable	B22	470	5.5W	85	2700K	40W	5	50
LCD27W5W47-LE	Dimmable	E27	470	5.5W	85	2700K	40W	5	50

BOXES

CAT NO.	DESCRIPTION	CAP TYPE	LUMENS	WATTAGE	EFFICACY lm/W	COLOUR TEMP	EQUIVALENT WATTAGE	INNER QUANTITY	OUTER QUANTITY
LC15W3W25-01	Non-dimmable	B15	250	3W	83	2700K	25W	10	100
LC22W3W25-01	Non-dimmable	B22	250	3W	83	2700K	25W	10	100
LC27W3W25-01	Non-dimmable	E27	250	3W	83	2700K	25W	10	100
LC14W5W47-01	Non-dimmable	E14	470	5.5W	85	2700K	40W	10	100
LC15W5W47-01	Non-dimmable	B15	470	5.5W	85	2700K	40W	10	100
LC22W5W47-01	Non-dimmable	B22	470	5.5W	85	2700K	40W	10	100
LC27W5W47-01	Non-dimmable	E27	470	5.5W	85	2700K	40W	10	100



CAPSULES

- Ideal for decorative light fittings
- 85% energy saving versus halogen
- Non-dimmable



G4

G9

ECO BLISTERS

CAT NO.	CAP TYPE	LUMENS	WATTAGE	EFFICACY lm/W	EQUIVALENT WATTAGE	VOLTAGE	INNER QUANTITY	OUTER QUANTITY
LG4W2W19-LE	G4	190	2.3W	83	20W	12V AC	5	50
LG9W2W20-LE	G9	200	2.5W	80	20W	220-240V	5	50

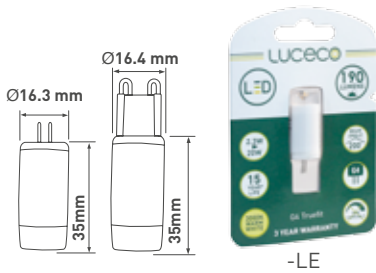

-LE



GX53

- 40% energy saving versus CFLs
- One to one replacement with traditional fluorescent products
- Non-dimmable



CAT NO.	LUMENS	WATTAGE	EFFICACY lm/W	LIFETIME	CFL EQUIVALENT WATTAGE	INCANDESCENT EQUIVALENT WATTAGE	COLOUR TEMP	INNER QTY	OUTER QTY
LGXW4W32-01	320	4W	87	20,000	7W	35W	2700K	10	100
LGXN4W32-01	320	4W	87	20,000	7W	35W	4000K	10	100
LGXC4W32-01	320	4W	87	20,000	7W	35W	6400K	10	100
LGXW5W40-01	400	5W	90	20,000	9W	45W	2700K	10	100
LGXN5W40-01	400	5W	90	20,000	9W	45W	4000K	10	100
LGXC5W40-01	400	5W	90	20,000	9W	45W	6400K	10	100
LGXW6W48-01	480	6W	91	20,000	11W	55W	2700K	10	100
LGXN6W48-01	480	6W	91	20,000	11W	55W	4000K	10	100
LGXC6W48-01	480	6W	91	20,000	11W	55W	6400K	10	100
LGXW8W68-01	680	8W	93	20,000	18W	75W	2700K	10	100
LGXN8W68-01	680	8W	93	20,000	18W	75W	4000K	10	100
LGXC8W68-01	680	8W	93	20,000	18W	75W	6400K	10	100

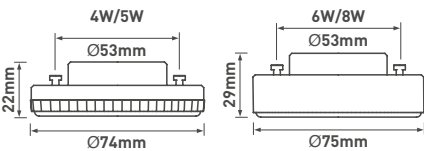

-01

PLC SERIES

- Up to 40% energy saving versus CFL
- Rotating end cap to focus illumination
- 2 bases fit all fixture types -1;-2;-3:-d
- Non-dimmable

4000K
NEUTRAL
WHITE

6500K
COOL
WHITE

$\geq 15,000$

25,000
HOURS
L70

BEAM
ANGLE

110°

A+
RATED



9W

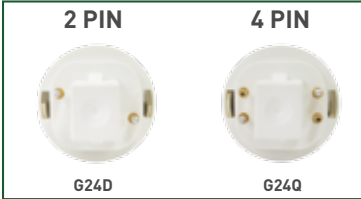

CAT NO.	PIN	LUMENS	WATTAGE	EFFICACY lm/W	LIFETIME	COLOUR TEMP	CFL EQUIVALENT WATTAGE	INCANDESCENT EQUIVALENT WATTAGE	INNER QUANTITY	OUTER QUANTITY
LPL2N9W80-01	G24D	800	9W	88	25,000	4000K	15W	60W	10	100
LPL4N9W80-01	G24Q	800	9W	88	25,000	4000K	15W	60W	10	100
LPL2N11W10-01	G24D	1000	11W	90	25,000	4000K	18W	70W	10	100
LPL4N11W10-01	G24Q	1000	11W	90	25,000	4000K	18W	70W	10	100
LPL2C9W80-01	G24D	800	9W	88	25,000	6500K	15W	60W	10	100
LPL4C9W80-01	G24Q	800	9W	88	25,000	6500K	15W	60W	10	100
LPL2C11W10-01	G24D	1000	11W	90	25,000	6500K	18W	70W	10	100
LPL4C11W10-01	G24Q	1000	11W	90	25,000	6500K	18W	70W	10	100

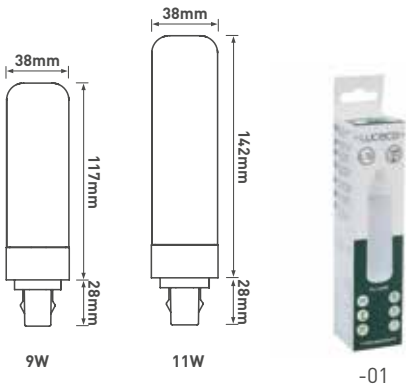

R SERIES

- 85% energy saving versus halogen
- Dimmable versions available
- One to one substitute with parabolic aluminised reflector Lamps



ECO BLISTERS

CAT NO.	DESCRIPTION	TYPE	CAP TYPE	LUMENS	WATTAGE	EFFICACY lm/W	EQUIVALENT WATTAGE	SWITCH CYCLE	LIFETIME	INNER QUANTITY	OUTER QUANTITY
LR50W5W40-LE	Non-dimmable	R50	E14	400	5W	80	35W	>15,000	20,000	-	50
LRD50W5W38-LE	Dimmable	R50	E14	380	5W	76	35W	>15,000	20,000	-	50
LR63W7W55-LE	Non-dimmable	R63	E27	550	7W	79	45W	>15,000	20,000	-	50
LRD63W7W55-LE	Dimmable	R63	E27	550	7W	79	45W	>15,000	20,000	-	50

BOXES

CAT NO.	DESCRIPTION	TYPE	CAP TYPE	LUMENS	WATTAGE	EFFICACY lm/W	EQUIVALENT WATTAGE	SWITCH CYCLE	LIFETIME	INNER QUANTITY	OUTER QUANTITY
LR50W5W40-01	Non-dimmable	R50	E14	400	5W	80	35W	>15,000	20,000	-	100
LRD50W5W38-01	Dimmable	R50	E14	380	5W	76	35W	>15,000	20,000	-	100
LR63W7W55-01	Non-dimmable	R63	E27	550	7W	79	45W	>15,000	20,000	-	100
LRD63W7W55-01	Dimmable	R63	E27	550	7W	79	45W	>15,000	20,000	-	100
LR80W9W85-01	Non-dimmable	R80	E27	850	9W	94	60W	>15,000	20,000	-	50
LRD80W9W82-01	Dimmable	R80	E27	820	9W	91	60W	>15,000	20,000	-	50
LR90W12W10-01	Non-dimmable	R90	E27	1050	12W	88	80W	>15,000	20,000	-	20
LRD90W12W10-01	Dimmable	R90	E27	1050	12W	88	80W	>15,000	20,000	-	20

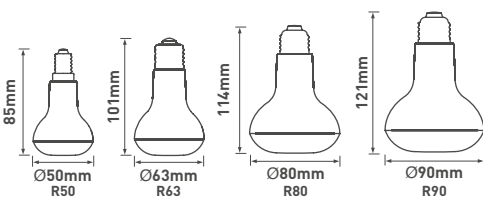

-LE

-01

PAR

- 85% energy saving versus halogen
- Non-dimmable



PAR20



IP65 PAR38

ECO BLISTERS

CAT NO.	TYPE	CAP TYPE	LUMENS	WATTAGE	EFFICACY lm/W	COLOUR TEMP	EQUIVALENT WATTAGE	SWITCH CYCLE	LIFETIME	IP RATED	INNER QUANTITY	OUTER QUANTITY
LP38W15W12-LE	PAR38	E27	1200	15W	80	2700K	120W	>15,000	25,000	IP20	-	5
LP38N15W12-LE	PAR38	E27	1200	15W	80	4000K	120W	>15,000	25,000	IP20	-	5

BOXES

CAT NO.	TYPE	CAP TYPE	LUMENS	WATTAGE	EFFICACY lm/W	COLOUR TEMP	EQUIVALENT WATTAGE	SWITCH CYCLE	LIFETIME	IP RATED	INNER QUANTITY	OUTER QUANTITY
LP20W6W45-01	PAR20	E27	450	6.5W	69	2700K	70W	>15,000	15,000	IP20	-	100
LP30W10W80-01	PAR30	E27	800	10W	80	2700K	95W	>15,000	15,000	IP20	-	50
LP38W15W12-01	PAR38	E27	1200	15W	80	2700K	120W	>15,000	15,000	IP20	-	20
LP38N15W12-01	PAR38	E27	1200	15W	80	4000K	120W	>15,000	15,000	IP20	-	20
LP38W15W12IP65-01	PAR38	E27	1200	15W	80	2700K	120W	>15,000	25,000	IP65	-	20
LP38N15W12IP65-01	PAR38	E27	1200	15W	80	4000K	120W	>15,000	25,000	IP65	-	20

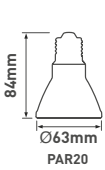

PAR20

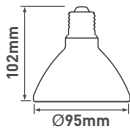

PAR30

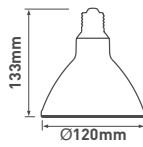

PAR38

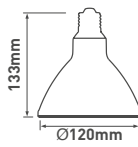

IP65 PAR38



-LE



-01



S15

- Perfect incandescent replacement
- 90% energy saving
- Ideal for bathroom shaver sockets and under cabinet lighting



3000K
 WARM
 WHITE

$\geq 15,000$

30,000
 HOURS
 L70

BEAM
 ANGLE

140°

A+
 RATED

CAT NO.	SIZE	LUMENS	WATTAGE	EFFICACY lm/W	EQUIVALENT WATTAGE	INNER QUANTITY	OUTER QUANTITY
LS15W2W20-01	221mm	200	2.5W	80	20W	10	50
LS15W4W28-01	284mm	280	4W	70	28W	10	50

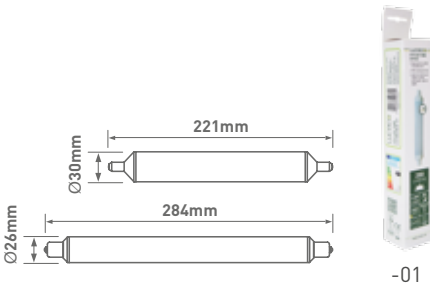

GU10



EDGE2EDGE LENS

With our multifaceted Edge2Edge lens, we can replicate the look of halogen with our near edgeless design



COMMERCIAL

Aluminium die-casting /
thermoplastic construction
using the latest LED technology.

RANGE FEATURES

- **FITS INTO EXISTING FITTINGS** - No need to replace your fittings; just install your new LED lamps and start saving money.
- **SPOT THE DIFFERENCE** - LED lamps look the same as fluorescent lamps, using a fraction of the energy.
- **REPLACE ONE AT A TIME** - LED lamps can be combined with fluorescent or tungsten filament lamps, allowing gradual replacement over a period of time.



Glass T8
Corn

131
132

GLASS T8

- 50% energy saving against fluorescent for similar lux levels
- Retrofit with most T8 luminaires (non-dimming)
- Shorted end, supplied with dummy replacement LED starter
- Fragment retention PET film
- Integrated Constant Current driver
- Operating temperature environment is -20°C to 40°C
- G13 cap
- Ignition time - <0.5 sec
- Start up time (95%) - <0.5 sec
- Tubes are powered from one end (fitting rewiring may be required)
- Compatible Luceco emergency battery pack available



GLASS

CAT NO.	DESCRIPTION	SIZE	LUMENS	WATTAGE	EFFICACY lm/W	COLOUR TEMP	EQUIVALENT WATTAGE	OUTER QUANTITY
LT8G2N10W11-01	Standard	2ft/600mm	1100	10W	110	4000K	16W	25
LT8G2C10W11-01	Standard	2ft/600mm	1100	10W	110	6500K	16W	25
LT8G4N18W20-01	Standard	4ft/1200mm	2000	18W	110	4000K	30W	25
LT8G4C18W20-01	Standard	4ft/1200mm	2000	18W	110	6500K	30W	25
LT8G4N22W24-01	Standard	4ft/1200mm	2400	22W	110	4000K	36W	25
LT8G4C22W24-01	Standard	4ft/1200mm	2400	22W	110	6500K	36W	25
LT8G5N22W24-01	Standard	5ft/1500mm	2400	22W	110	4000K	36W	25
LT8G5C22W24-01	Standard	5ft/1500mm	2400	22W	110	6500K	36W	25
LT8G5N32W35-01	Standard	5ft/1500mm	3500	32W	110	4000K	45W	25
LT8G5C32W35-01	Standard	5ft/1500mm	3500	32W	110	6500K	45W	25
LT8G6N40W44-01	Standard	6ft/1800mm	4400	40W	110	4000K	72W	25
LT8G6C40W44-01	Standard	6ft/1800mm	4400	40W	110	6500K	72W	25

ECO GLASS

CAT NO.	DESCRIPTION	SIZE	LUMENS	WATTAGE	EFFICACY lm/W	COLOUR TEMP	EQUIVALENT WATTAGE	OUTER QUANTITY
LT8G2N10W90-01	Standard	2ft/600mm	950	10W	95	4000K	16W	25
LT8G2C10W90-01	Standard	2ft/600mm	950	10W	95	6500K	16W	25
LT8G4N18W16-01	Standard	4ft/1200mm	1700	18W	94	4000K	30W	25
LT8G5N22W20-01	Standard	5ft/1500mm	2000	22W	91	4000k	30W	25

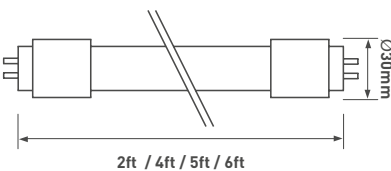

-01

CORN

- Up to 70% energy saving versus HID lamps (high intensity discharge); Son (high pressure sodium) and HQI (metal halide) lamp types
- Horizontal and vertical positions
- Non-enclosed fixtures only
- High lm/W efficacy upto 107 lm/W
- Non-dimmable

4000K
NEUTRAL
WHITE

6500K
COOL
WHITE

50,000
HOURS
L70

BEAM
ANGLE
180°

A+
RATED



120W

2900lm

CAT NO.	CAP TYPE	LUMENS	WATTAGE	EFFICACY lm/W	COLOUR TEMP	EQUIVALENT WATTAGE	OUTER QUANTITY
LCR27N27W29-01	E27	2900	27W	107	4000K	70W	5
LCR27C27W29-01	E27	2900	27W	107	6500K	70W	5

8400lm

CAT NO.	CAP TYPE	LUMENS	WATTAGE	EFFICACY lm/W	COLOUR TEMP	EQUIVALENT WATTAGE	OUTER QUANTITY
LCR40N80W84-01	E40	8400	80W	105	4000K	250W	5
LCR40C80W84-01	E40	8400	80W	105	6500K	250W	5

12600lm

CAT NO.	CAP TYPE	LUMENS	WATTAGE	EFFICACY lm/W	COLOUR TEMP	EQUIVALENT WATTAGE	OUTER QUANTITY
LCR40N120W12-01	E40	12600	120W	105	4000K	400W	5
LCR40C120W12-01	E40	12600	120W	105	6500K	400W	5

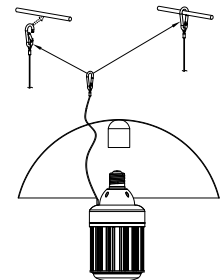

Support Strap Included

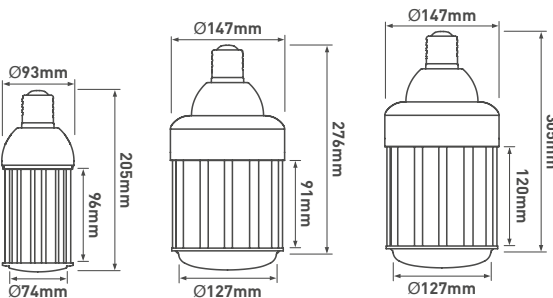



LUXBAND

RGB 16 COLOUR LED STRIP

- Kit contains - 5 metre IP65 RGB LED strip, IP65 driver, remote controller, IR receiver and connectors
- 3M adhesive tape for positive fixing
- LuxBand can be cut to size and joined
- Dimensions - 5400mm x 14.5mm x 4mm
Including input cable, excluding driver/controller
- 16 colour combinations
- Dim, fade, flash and strobe settings

14.4W per metre LED	5 metre LENGTH	30,000 HOURS	BEAM ANGLE 120°	IP65 RATED
---	--------------------------	------------------------	-------------------------------------	----------------------

CAT NO.	DESCRIPTION	SIZE
LTK5MRGB	RGB colour changing LED strip	5 metre (16 feet)



KIT CONTAINS



5 metre IP65 RGB LED strip



IP65 driver



Remote controller



Accessories



Infra-red receiver

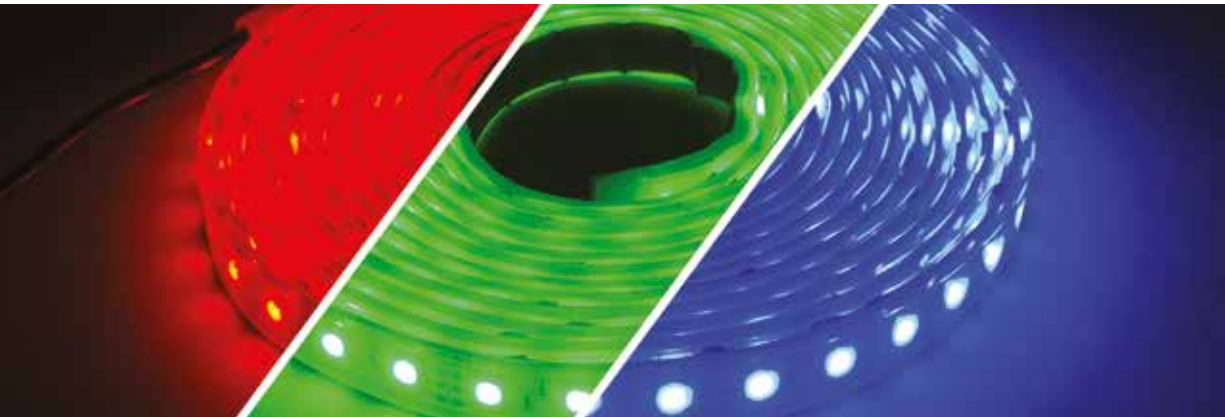

LUXBAND

WHITE LED STRIP

- Kit contains - 5 metre IP65 LED strip, IP65 driver and connectors
- 3M adhesive tape for positive fixing
- LuxBand can be cut to size and joined
- Dimensions - 5400mm x 14,5mm x 4mm
Including input cable, excluding driver/controller

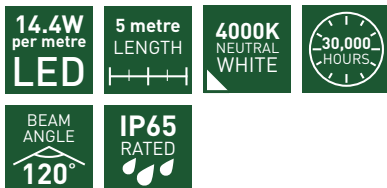

CAT NO.	DESCRIPTION	SIZE
LTK5M40	White LED strip	5 metre (16 feet)

KIT CONTAINS



5 metre IP65 LED strip

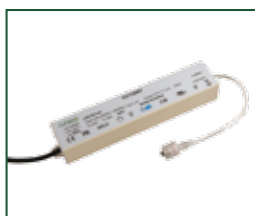

IP65 driver



Weatherproof connector



Accessories

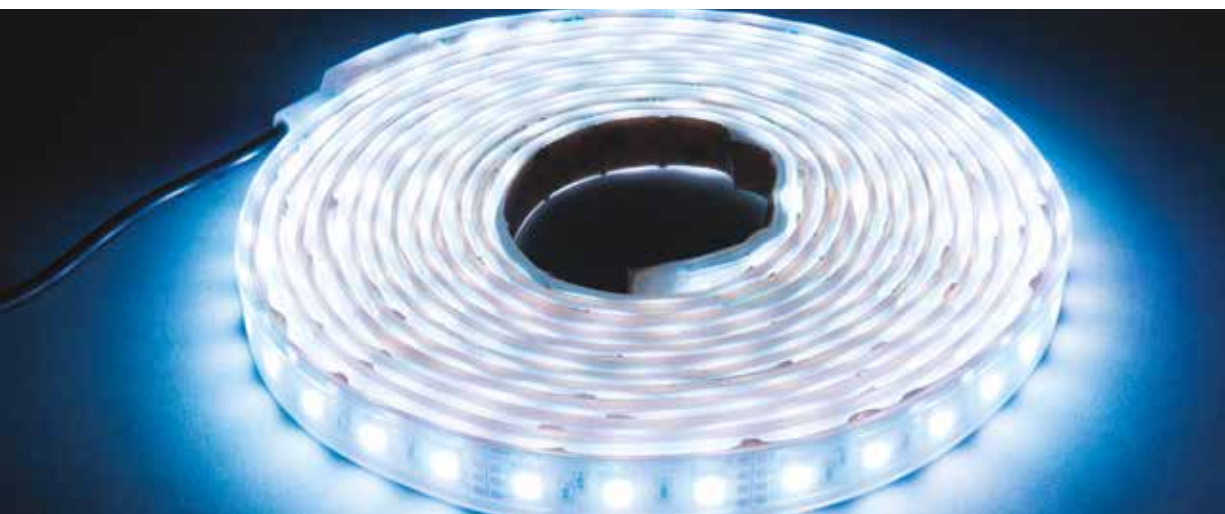



USB STRIP KIT

- Kit contains - x2 50mm LED strips & on/off contro
- USB powered
- Suitable for TV/PC display
- Perfect for ambient lighting
- Reduced eye strain
- Cuttable to screen size
- 3M adhesive for easy installation

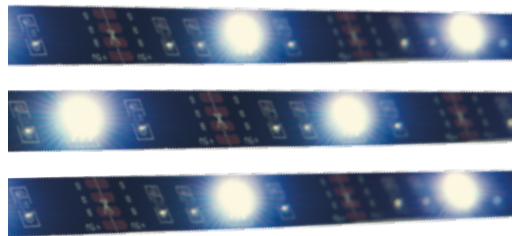

**2.5W
LED**

**2 x 50cm
LENGTH**

**30,000
HOURS**

**BEAM
ANGLE
120°**

NEW
RANGE

Max screen 78.8" / 200cm



SINGLE COLOUR LED STRIP

CAT NO.	WATTAGE	COLOUR	COLOUR TEMP
LUSB5030	2W	Warm white	3000K
LUSB5040	2W	Neutral white	4000K
LUSB50BL	2W	Blue	-

4 STEP EASY INSTALLATION

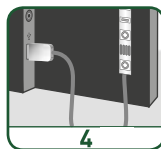
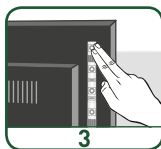
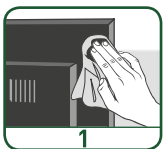



RGBW STRIP KIT

WITH CONTROLLER

- Kit contains - x2 50mm LED strips, IR receiver & RGB controller
- USB powered
- Suitable for TV/PC display
- Perfect for ambient lighting
- Reduced eye strain
- Cuttable to screen size
- 3M adhesive for easy installation

2.5W
LED

2 x 50cm
LENGTH

30,000
HOURS

BEAM
ANGLE
120°

NEW
RANGE

RGBW COLOUR LED STRIP

CAT NO.	DRIVER	WATTAGE	COLOUR
LUSB50RGB	Dimmable	2.5W	RGB

5 STEP EASY INSTALLATION

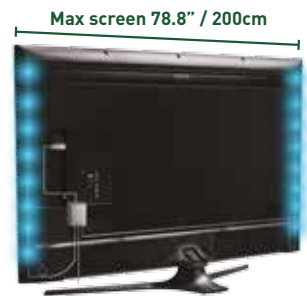
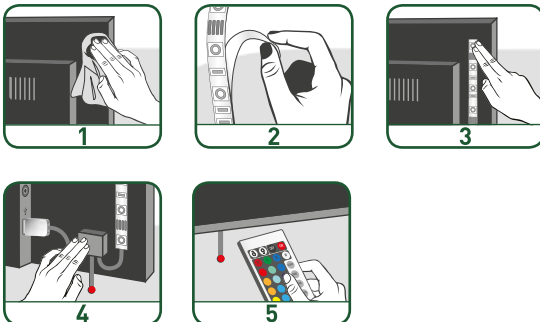



CONTROLS

A wide range of passive infrared (PIR) & microwave lighting controls for the automatic control of lighting.

Sensors	139
PIR	139
Programmiers	141

RANGE FEATURES

SWITCHING DETECTOR

- Switching with lux level sensing (IR handset adjustment)
- Active photocell
- Time delay function: 10 sec - 99 min
- Presence detection switching
- Programmable via IR handset
- Adjustable detection sensitivity
- On/off override via optional IR handset

DIMMING DETECTOR

- Step-down illuminance
- Maintained illuminance (daylight harvesting)
- Burn in feature for fluorescent tubes
- Control of DALI & DSI

PRESENCE / ABSENCE DETECTOR

LOW PROFILE PIR

IP55
RATED

LOAD
RATING
10A

SWITCHING DETECTOR

- Absence detection switching
- Manual on/off override via switch input

DIMMING DETECTOR

- Dimming functionality
- Two channel flexibility
- Scene setting and recall
- Integral relay to reduce parasitic power

CAT NO.	DESCRIPTION
LPCMPIRM	Switching PIR
LPCMPIRDSI	Switching Direct Dim DALI/DSI
LPCLRBOX	Surface mount box

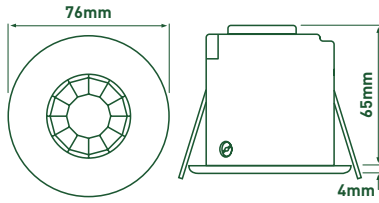

Surface mount box
(including PIR)

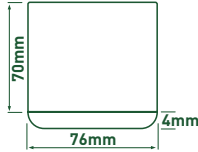

DETECTION PATTERN

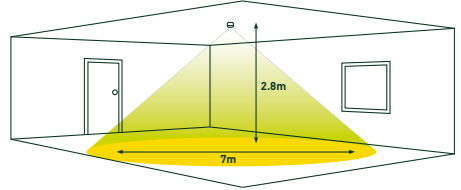

PRESENCE / ABSENCE DETECTOR

ADJUSTABLE MICROWAVE

- Unique adjustable head design
- Locking mechanism to prevent tampering
- Flush or surface mounted options

LOAD
RATING
10A

SWITCHING DETECTOR

- Absence detection switching
- Manual on/off override via switch input

DIMMING DETECTOR

- Dimming functionality
- Two channel flexibility
- Integral relay to reduce parasitic power
- Suitable for all lighting types
- Manual dimming with IR
- Manual dimming with switch input

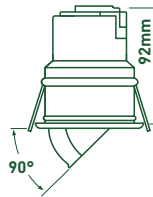

Surface mount box
(including PIR)

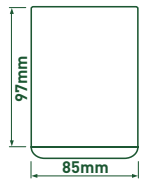

DETECTION PATTERN

CORRIDORS

Sensitivity set to maximum
Detector head position set to 0°

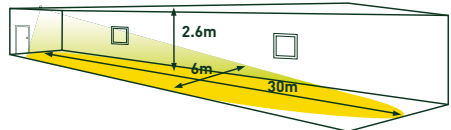

LARGE OFFICE / CLASSROOM

Sensitivity set to 80°
Detector head position set to 80°

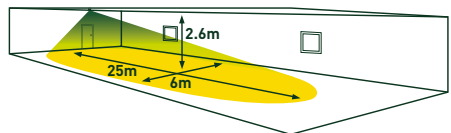

MID SIZED OFFICE

Sensitivity set to maximum
Detector head position set to 0°

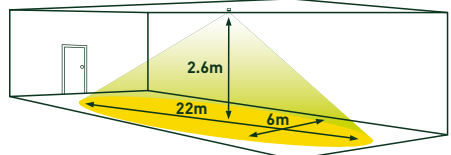

CAT NO.	DESCRIPTION
LPCLRPIRM	Switching MW
LPCLRPIRDSI	Switching Direct Dim DALI/DSI
LPCLRBOX	Surface mount box

PRESENCE / ABSENCE DETECTOR

HIGH CEILING MOUNTED PIR

- Ground breaking detection range up to 40m (dependent on location)
- Mounting height up to 20m
- Unique lens technology – high sensitivity within the detection range
- Ideal for high mounting applications
- Adjustable masking shields to tailor detection zones (supplied)

**IP54
RATED**

**LOAD
RATING
10A**

SWITCHING DETECTOR

- Absence detection switching
- Manual on/off override via switch input
- Verify feature – reduce false triggering by ensuring detection from more than one of the internal sensors

DIMMING DETECTOR

- Dimming functionality
- Two channel flexibility
- Scene setting and recall
- Integral relay to reduce parasitic power
- Suitable for all lighting types
- Manual dimming with IR
- Manual dimming with switch input



NO SHIELD DETECTION PATTERN

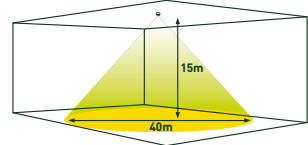

AISLE DETECTION PATTERN

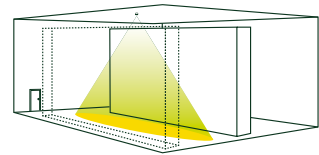

FOCUSED DETECTION PATTERN

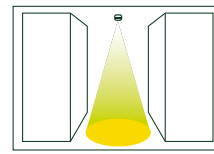

END OF AISLE DETECTION PATTERN

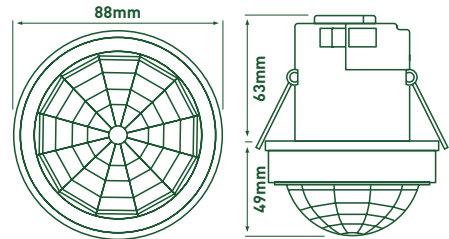
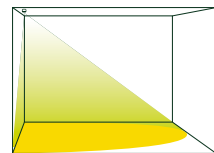

CAT NO.	DESCRIPTION
LPCMHMPIRM65	Switching PIR
LPCMHMPIRDSI65	Switching Direct Dim DALI/DSI

PRESENCE DETECTOR

CEILING/WALL MOUNTED MICROWAVE

- Built in lux level sensing - enhanced energy saving
- Fixing screw cap covers - smooth plate finish
- Vandal resistant design
- Minimal parasitic power
- Override facility

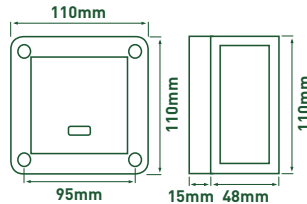

**IP65
RATED**

**LOAD
RATING
10A**

CAT NO.	DESCRIPTION
LPCSMP66	Switching PIR

CEILING MOUNTED DETECTION PATTERN

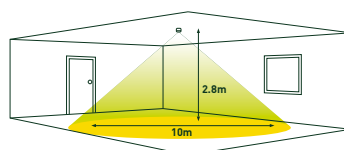

WALL MOUNTED DETECTION PATTERN

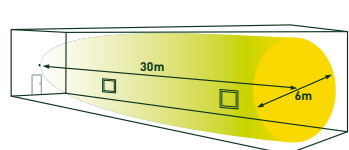

PRESENCE DETECTOR

BATTEN MOUNT PIR

- Integrated unit - no separate power supply required
- Suitable for a wide range of luminaires
- Supplied with comprehensive fitting kit
- Retrofit solution

DIMMING DETECTOR

- Scene setting and recall
- Suitable for all lighting types
- Manual dimming with IR



CAT NO.	DESCRIPTION	LOAD RATING
LPC3BSP65	Switching PIR	2A
LPC3BDP65	Switching Direct Dim DALI/DSI	N/A

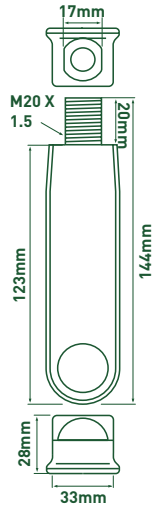

DETECTION PATTERN

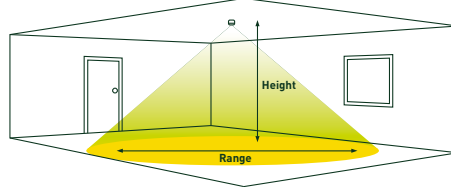

REMOTE CONTROL

FOR CEILING MOUNTED PIR

Our range of infrared (IR) handsets have been designed to allow simple configuration and maximum user convenience.

There's a handset to suit every user whether it's the contractor or building manager making a simple adjustment to a single detector, or a room user who simply wishes to override a setting or switch between pre-programmed scenes.

Compatible with all Luceco sensors.



LPCUHC - Commissioning handset

- Compact infrared handset
- Basic programming of IR enabled products



LPCUSER - User handset

- Simple scene setting
- On/off, raise/lower

GLOSSARY OF TERMS

AC (~)

Alternating Current, as found in the mains power supply.

ACCENT LIGHTING

Also commonly called display or highlighting. Accent lighting is typically at a higher intensity to emphasise an object or area. A Ratio of 3:1 versus ambient lighting is recommended for accent lighting to be noticeable.

AMBIENT LIGHTING

The general background illumination is usually at a low level and with task and/or accent lighting used for the task or display.

AMBIENT TEMPERATURE (TA)

The air temperature surrounding the luminaire or component. LED luminaires are particularly temperature sensitive with excess temperature affecting performance and rated life. See also Junction Temperature.

AMPERE (AMP)

The unit for measuring rate of flow of electrical current:

Current (Amps) = Power (Watts) / Voltage (Volts)

ASYMMETRIC LIGHT DISTRIBUTION

Where the distribution of light from a luminaire is not even in one plane. Common in display luminaires such as 'wall washers' where light is directed intentionally in one direction.

AZIMUTH

The 'swivel' angle, as used in floodlighting or display lighting designs and installations.

BALLAST LUMEN FACTOR (BLF)

The proportion of light emitted by a luminaire when in emergency mode, usually powered by batteries, compared to the normal mains powered output. BLF figures can be <10% or 0.1 as emergency lighting levels are far lower than those required for normal lighting.

BAYONET CAP (BC)

A common lamp cap found on many lamps in domestic use in the UK. The lamp cap has two small pins that protrude from the base, these are inserted into the lamp holder and lock the lamp in place as it is rotated. B15 and B22 are the most common types.

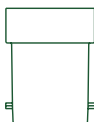

B15d

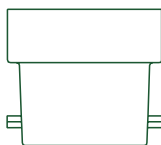

B22d

BEAM ANGLE

Not, as commonly thought, the width or angle of light emitted from the lamp/luminaire. Instead, the point where intensity reaches 50% of the peak value.



BINNING

The method used for sorting LED chips during manufacture, typically based on output and colour temperature. The latest manufacturing techniques employed by leading chip manufacturers are yielding chips that no longer require binning as the consistency and tolerance is greatly improved.

BRIGHTNESS

Whilst brightness is what people see and react to, luminance is the actual surface brightness of an object and is measured in candelas per metre².

BATHROOM ZONES

Bathroom lighting needs to be functional and safe. It is divided into zones where only suitable light fittings should be used.

- **ZONE 0** is inside the bath or shower. Any fitting used in this zone must be low voltage, (max 12v) and rated at least IP67 which is immersion proof.
- **ZONE 1** is the area above the bath to a height of 2.25m from floor. In this zone a minimum rating of IP65 is required.
- **ZONE 2** is the area stretching 0.6m outside the perimeter of the bath and the area between zone 1 and the ceiling upto 3m. Also the area around the wash basin, within a 60cm radius of any tap. In this zone a minimum rating of IP44 is required.

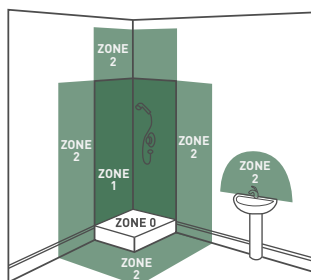
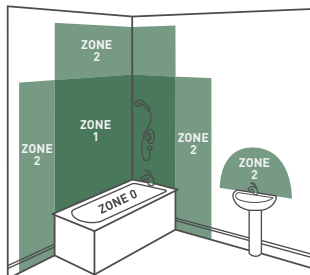

BRITISH BUILDING REGULATIONS

Various building regulations, usually referred to as the approved regulation document letter, exist not only to ensure that buildings are constructed safely but also that materials or equipment installed is of the current requirement. Various products comply with:

- **DOCUMENT B** - Fire Safety
- **DOCUMENT C** - Resistance to contaminants and moisture
- **DOCUMENT E** - Resistance to sound
- **DOCUMENT L** - Conservation of fuel and power

BUILDING
REGULATION
COMPLIANT:
PART B

BUILDING
REGULATION
COMPLIANT:
PART C

BUILDING
REGULATION
COMPLIANT:
PART E

BUILDING
REGULATION
COMPLIANT:
PART L

GLOSSARY OF TERMS

BRITISH STANDARDS INSTITUTE (BSI)

The national standards organisation is responsible for publication of standards that ensure products are constructed and operated safely and efficiently. Standards are prefixed with BS for a British Standard, EN for a European Standard and BS EN where the European Standard has been adopted as a British Standard. All BG Electrical products are conceived and produced to comply with the relevant standards, key standards for the LED range include:

- **EN 60598-1** - Luminaires - General requirements
- **EN 55015** - Limits and methods of measurement of radio disturbance characteristics of electrical lighting and similar equipment
- **EN 61547** - Equipment for general lighting purposes - EMC immunity requirements
- **EN 61000-3-2** - Electromagnetic compatibility (EMC) - Part 3-2: Limits - Limits for Harmonic current emissions
- **EN 62471** - Photobiological safety of lamps and lamp systems
- **EN 62560** - Self-ballasted LED-lamps for general lighting services by voltage 50 V. Safety specifications
- **EN 61347-1** - Lamp control gear - Part 1: General and safety requirements
- **2002/96/EC** - Waste Electrical & Electronic Equipment (WEEE)
- **2002/95/EC** - Restriction of the use of certain Hazardous Substances in EEE (RoHS)
- **(EC) No 1907/2006** - The Registration, Evaluation, Authorisation and Restriction of Chemicals (REACH)

CANDELA (CD)

The SI unit for luminous intensity.

CE

The European Community mark 'Conformité Européenne' signifying all relevant standards and directives have been complied with.



CHIP

The LED Chip is the light source.

CHIP ON BOARD (COB)

Is the latest generation of LED light source. Many small LED chips are incorporated in one packaged light source to provide a more efficient solution that can be combined with a lens and/or reflector to maximise the light distribution.

CLASS I

Class one luminaires require an Earth connection for electrical safety.



CLASS II

Class two luminaires do not require an earth connection and are also referred to as double insulated.



COLOUR APPEARANCE

Term used to describe how 'white' the emitted light looks. Commonly, warm, neutral, cool and daylight are used to categorise.

COLOUR RENDERING INDEX (CRI)

A measure of the degree of colour shift objects undergo when illuminated by the light source as compared with those same objects when illuminated by a reference source of comparable colour temperature. The reference source has a CRI of 100. Natural light (daylight) would also be 100.



CORRELATED COLOUR TEMPERATURE (CCT)

The description used to describe the effect of heating an object until it glows incandescently, the emitted radiation, and apparent colour, changes proportional to the temperature; easily envisioned when considering hot metal in a forge that glows red, then orange, and then white as the temperature increases. Measured in degrees Kelvin.

<3300K	WARM WHITE
3300K - 5300K	NEUTRAL WHITE
>5300K	COOL WHITE



CORRIDOR FUNCTION

Refers to luminaires that when not required to emit 100% light output, switch to 10% output. This 'standby mode' allows the luminaire to provide a low level of illumination for a feeling of security so the area is not totally dark. Upon sensing movement the output automatically and instantly switches to 100%. This is particularly useful in circulation areas such as corridors and stairwells.

CUT-OUT DIMENSION

Size of hole required to install luminaire.



CUT OFF ANGLE

Small downlights can appear too intense and very glary, so cut off angle illustrates the point where the light source can't be seen.

DALI

Stands for Digital Addressable Lighting Interface, where each driver and control component such as a sensor or switch has a unique address on the lighting installation. This allows for infinite configuration of the lighting installation and flexibility in the future.

DIMMING

Many Luceco luminaires are available as a dimmable version option. Generally this requires a different driver to the standard fixed output driver and also may require additional wiring on site to operate/control the dimming function.

DIRECT LIGHTING

Luminous flux that reaches the working plane without being reflected from walls/ceiling or within the luminaire itself.

DLOR

Downward Light Output Ratio is the percentage of luminous flux output from the lamp/luminaire that is emitted in the 180° angle below horizontal.

DOUBLE INSULATION

Also known as Class II, where two levels of insulation (such as two cable coverings) protect live parts from exposure.



GLOSSARY OF TERMS

DRIVER

The driver is often the critical component in a LED luminaire or lamp, more so than the LED chip itself. The driver has to be matched to the power requirements of the LED chip and also have quality components. Drivers that use inferior components such as capacitors, will fail before the rated life of the LED chip, reducing the claimed life by as much as 50%.

EDGE LIT

All LuxPanels are edge lit; this means that the LED chips are positioned vertically around the perimeter of the panel. This provides an excellent uniformly illuminated panel in a fixture as slim as 8mm.

EDISON SCREW

A lamp cap that features a screw thread for a positive fit in the lampholder, common sizes include E15 and E27.

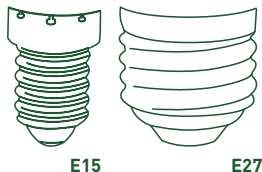

EFFICACY

Is the measure of how efficient a lamp or luminaire is. This can be expressed as (source) lumens per watt, which is the normal measure for lamps. Or, as luminaire lumens per circuit watt that is common for luminaires. The figure for luminaires will also include the LOR of the luminaire in the calculation.

EMERGENCY LIGHTING

Is to allow the safe evacuation of an area in the event of a mains failure. The positioning and number of emergency lighting luminaires is detailed in a British Standard, BS5266. It is vital that emergency lighting is maintained correctly to ensure batteries are conditioned so it operates when required.

ESCAPE ROUTE

Emergency lighting along a route such as a corridor or staircase to enable safe evacuation.

FIRE RATED

Where a luminaire is installed in a fire barrier such as into a ceiling, it must have the same resistance to fire rating as that barrier. For domestic installations there are ratings of 30, 60 and 90mins and each limit must be tested for. A 90min rated product does not automatically comply with 30 or 60mins due to the different ceiling constructions. Non domestic applications usually have a fire resistant barrier such as a concrete slab between floors. So, do not have the requirement in many cases.



FLUX / LUMINOUS FLUX

Luminous flux is the measure of the perceived power of light, adjusted to reflect the varying sensitivity of the human eye to different wavelengths of light and is expressed in Lumens (lm).

F MARK

Denotes luminaires that can be mounted on to flammable surfaces as the heat generated will not cause any combustion. Previously luminaires that were suitable had to be marked, but the most recent standard requires only luminaires that don't comply to be marked.

FREQUENCY

Is the rate that the power supply wavelength fluctuates and is measured in Hertz.

GENERAL LIGHTING

Lighting to illuminate the general area without supplementary task lighting.

GLARE

Is difficulty seeing in the presence of bright light such as direct or reflected sunlight or artificial light and is proportional to the background illuminance, a good example is a car headlight that provides glare at night time but not during the day.

GONIOPHOTOMETER

A photometric device for testing the luminous intensity distribution, efficiency, and luminous flux of luminaires.

HEAT SINK

A part of the thermal system that conducts or convects heat away from sensitive components, such as LEDs and electronics.

HERTZ (HZ)

The unit to measure frequency.

HIGH POWER LED

A high power LED, sometimes referred to as a power LED, is one that is driven at a current of 350mA or higher.

HIGH RISK AREA

A requirement in Emergency lighting where a process may require safe shut down or an increased hazard. Higher emergency lighting levels are therefore required local to the risk.

INGRESS PROTECTION (IP) RATING

A system that identifies the protection that a lamp or luminaire has against solid objects and water. The first digit being solid object protection and the second one resistance to water. All Luceco products IP20 unless otherwise stated.



PROTECTION AGAINST SOLID FOREIGN OBJECTS		PROTECTION AGAINST HARMFUL INGRESS OF WATER	
IP	TESTS	IP	TEST
0	No protection	0	No protection
1	Full penetration of 50mm diameter of sphere not allowed. Contact with hazardous parts not permitted.	1	Protected against vertically falling drops of water.
2	Full penetration of 12.5mm diameter of sphere not allowed. The jointed test finger shall have adequate clearance from hazardous parts.	2	Protected against vertically falling drops of water with enclosure tilted 15° from the vertical.
3	The access probe of 2.5mm diameter shall not penetrate.	3	Protected against sprays to 60° from the vertical.
4	The access probe of 1mm diameter shall not penetrate.	4	Protected against water splashed from all directions - limited ingress permitted.
5	Limited ingress of dust permitted (no harmful deposit).	5	Protected against low pressure jets of water from all directions - limited ingress permitted.
6	No ingress of dust.	6	Protected against strong jets of water e.g. for use on ship decks - limited ingress permitted.
		7	Protected against the effects of immersion between 150mm and 1m.
		8	Protected against continuous submersion at a specified depth.

GLOSSARY OF TERMS

IES

Illuminating Engineering Society, an American organisation that provides standards and recommendations. Photometric data files are common in .ies file format.

ILLUMINANCE

The intensity of light falling on a surface area. If the area is measured in square feet, the unit of illuminance is footcandles (fc). If measured in square meters, the unit of illuminance is lux (lx).

INDIRECT LIGHTING

Lighting that is reflected by room surfaces or within the luminaire before falling on to the working area. As a result of reflection it is often lower in intensity and glare.

INITIAL LUMENS

The output up to 100 hours use.

INRUSH CURRENT

Components such as drivers can have high inrush currents for milliseconds due to the use of capacitors, this should be considered when specifying switching and breaker ratings.

INTEGRATING SPHERE

A device used for a variety of optical, photometric, or radiometric measurements.

ISOLUX DIAGRAM

A graphical representation of common illuminance levels to show lighting levels over a calculated area.

JUNCTION

The point at which the Positive and Negative conductors meet in a LED.

JUNCTION TEMPERATURE

A critical consideration in LED lamp or luminaire design. For every 10°C that the junction temperature exceeds the optimum figure, life of the LED chip is reduced by 50%. Overrunning LEDs by operating at higher amps will cause this to happen.

KELVIN

The SI unit used to measure and denote colour temperature, degrees Kelvin.

kWh

Kilo-Watt-hour is the typical billing unit for electricity costs and represents 1kW of power over a 1 hour duration.

LAMP

A lamp converts electrical power into light and sometimes they are called 'bulbs' due to the traditional lamp shape.

LED

Light Emitting Diode. An LED is a solid-state semiconductor device that converts electrical energy directly into light. On its most basic level, the semiconductor is comprised of two regions. The p-region contains positive electrical charges while the n-region contains negative electrical charges. When voltage is applied and current begins to flow, the electrons move across the n-region into the p-region. The process of an electron moving through the p-n junction releases energy. The dispersion of this energy produces photons with visible wavelengths. Most LEDs emit a blue light as that is the most efficient format, a phosphor coating turns the blue light into the white light required.

LED RATED LIFE

LED chip figures are quoted by the chip manufacturer and in some cases these are not translated when the chip is used in a luminaire where it can run hotter. As heat affects the LED chip, the life can be reduced dramatically.



LIGHT OUTPUT RATIO (LOR)

Light Output Ratio is the percentage difference between the luminous flux emitted by the light source and the amount emitted from the fixture it is housed in.

Lm/W

Luminaire lumens per circuit watt is total lumens emitted from the luminaire (source lumens x LOR) / total luminaire wattage including control gear.



LUMENS (lm)

The international (SI) unit of luminous flux. Lumens will become the measure of light output as watts can not be a reliable measure due to the different efficacy of light sources and the ongoing improvement in LED efficacy through development.

LUMEN DEPRECIATION

Describes the percentage of light lost relative to the initial lumen output. LEDs depreciate at a far slower rate than other light sources, so a LED with a lower initial output can quickly provide more light than a faster depreciating light source.

LUMEN MAINTENANCE

The luminous flux at a given time in the life of the LED. This is expressed as a percentage of the initial luminous flux. This usually determines the rated life of a LED product as the point it should be replaced.

LUMINAIRE

A lighting fixture complete with installed lamps or light source.



LUMINAIRE LUMENS (Llm)

The light emitted from a luminaire will typically differ from the source lumens. This can be from losses within the luminaire housing. Also it is common for LED's to operate at a higher temperature in the luminaire, this can lead to the output increasing when compared to the source (chip) lumens. Luminaire lumens will be Source lumens x LOR.

LUMINAIRE WATTAGE

Is the total of the LED and any control gear included.

LUMINANCE

The surface brightness of an object and measured in candelas/m².

LUMINOUS EFFICIENCY

The percentage of total lamp lumens that a lighting fixture, luminaire, or system emits, minus any blocked or wasted light.

LUX (LX)

The SI (International) unit of illuminance, or luminous flux incident on a unit area, frequently defined as one lumen per square metre (lm/m²).

MAINTAINED EMERGENCY

A maintained emergency luminaire is able to be used for both general and emergency lighting, a second live cable allows it to be turned on/off as required and detect a mains power circuit failure.

GLOSSARY OF TERMS

MICROWAVE SENSOR

The sensor emits low power microwaves that form a pattern in the area covered. When movement disturbs the pattern, movement is detected and the sensor turns the light source on. Microwave sensors are only recommended for indoor use as they are sensitive to movement and not heat.

NON-MAINTAINED EMERGENCY

A Non-Maintained emergency luminaire ONLY operates in emergency mode and is not for general lighting.

OPEN AREA

Lighting also called 'anti-panic' area lighting is emergency lighting where not a high risk area or escape route.

ORGANIC LIGHT-EMITTING DIODES (OLED)

Organic light-emitting diodes (OLEDs) are based on organic (carbon based) materials. In contrast to LEDs, which are small point sources, OLEDs are made in sheets which provide a diffuse area light source. OLED technology is developing rapidly and is increasingly used in display applications such as mobile phones and PDA screens. However, OLEDs are still some years away from becoming a practical general illumination source.

PIR

Passive Infra Red sensors detect movement by the change in background temperature as body heat moves into the area.

PHOSPHOR

A coating of phosphorescent material which photons from a royal blue LED pass through causing those photons to exit with a different colour property.

PHOTOMETRIC DATA

Is a generic term for light output and distribution data for a lamp or luminaire and can be shown in many formats. Generally data is produced following the IES or ELUMDAT method to provide a .ies or .ldt computer file for use in a lighting design program such as Relux or Dialux. Photometric data is available for a wide selection of Luceco luminaires from our website.

POWER FACTOR

The active power divided by the apparent power [i.e., product of the rms input voltage and rms input current of a driver].

POWER FACTOR CORRECTION

In an electronic device, such as an LED lighting fixture, a system of inductors, capacitors, or voltage converters to adjust the power factor of electronic devices toward the ideal power factor of 1.0.

REACH

Registration, Evaluation, Authorisation & restriction of Chemicals. The EU Directive covering the use of hazardous chemicals used in the manufacturing process and supply of products.

REMOTE LED DRIVER

Some LED lights in our range use a remote plug and play LED Driver, that offers flexibility to select either a fixed output, dimmable driver or emergency versions, with all being interchangeable.

REMOTE PHOSPHOR

A phosphor conversion technique in which photons from a royal blue LED pass through a phosphor material that is not attached to the LED chip.

RoHS

Restriction of Hazardous Substances (2002/95/EC) is an article 95 directive, meaning it is across all European Union member states. Since July 1st 2006 the use of hazardous substances is restricted in products, to prevent environmental harm. The prohibited substances are Lead, Mercury, Cadmium, Hexavalent Chromium, Polybrominated Biphenyls and Polybrominated Diphenyl Ethers. All relevant Luceco products comply.

SELF-CONTAINED

The most common type of Emergency lighting luminaire, where all of the components are within one Emergency luminaire. This can include gear boxes connected directly to individual luminaires but outside the main luminaire housing. If within 1m, it is classed as self-contained.

SMDs

Surface-mount LEDs.

SOURCE LUMENS (LM)

Source or Chip lumens is the output of the LED array and does not allow for any reduction or increase from the luminaire.

SOURCE WATTAGE

Also could be referred to as chip wattage is for the LED only and does not include any control gear.

TASK LIGHTING

Localised lighting intended for a specific task.

THERMAL MANAGEMENT

Controlling the operating temperature of the product through design, examples include heat sinks and improved airflow.

Tp(a)

Diffusers used in recessed luminaires are classified in relevance to their resistance to fire and spread of flame. TP(a) is the highest classification but has lower efficacy due to the compromise in light transmittance.

Tp(b)

Diffusers are acceptable for the majority of applications, following the 2013 revision of the building regulations. Approved Document B – Fire Safety: Volume: Building other than dwellinghouses, includes further detail.

ULOR

Upward Light Output Ratio, the percentage of light emitted from a lamp or luminaire above the horizontal plane.

ULTRAVIOLET (UV)

Electromagnetic radiation with wavelength shorter than that of visible light. LEDs emit minimal UV and therefore do not attract insects or potentially damage sensitive materials illuminated by them.

UTILISATION FACTOR

In lighting design, the proportion of the luminous flux emitted by a light source, which reaches the working plane.

VOLTAGE

The term used to describe the electrical potential difference between oppositely charged conductors.

WATTAGE

The power consumed by the LED.

**5W
LED**

WARRANTY OVERVIEW (UK ONLY)

PRODUCT	1 YEAR ON SITE WARRANTY	2 YEAR STANDARD WARRANTY	3 YEAR STANDARD WARRANTY	5 YEAR EXTENDED WARRANTY (WITH REGISTRATION)
COMMERCIAL/EDUCATION				
Epsilon	✓	-	-	✓
Panels (Square, Surface Modular, Circular, IP65)	✓	-	✓	✓
ECO LuxPanel	-	-	✓	-
ECO Circular Panel Downlight	-	-	✓	-
Accessories	-	-	✓	-
Academy	✓	-	✓	✓
Academy T8	-	-	✓	-
Decorative Surface	✓	-	✓	-
Pendant	✓	-	✓	-
ACCENT/DISPLAY				
F Type	-	-	✓	-
Atom Fire Rated	-	-	✓	✓
ECO FR Downlight	-	-	✓	-
ECO Downlight	-	-	✓	-
Platinum	✓	-	✓	✓
Carbon	✓	-	✓	-
Track	✓	-	✓	-
Surface Spots	✓	-	✓	-
Decorative	✓	-	✓	-
Modular	✓	-	✓	✓
Taska Under Cabinet	-	-	✓	-
Under Cabinet Panel	-	-	✓	-
AMBIENT/AMENITY				
Mosi Bulkhead	-	-	✓	-
Atlas Bulkhead	✓	-	✓	-
ECO Bulkhead	-	-	✓	-
Wall Mounted Accent	✓	-	✓	-
INDUSTRIAL				
LuxBay	✓	-	✓	✓
Ceres	✓	-	✓	-
Titan High Bay	✓	-	✓	✓
Indus	✓	-	✓	-
LuxPack Batten	-	-	✓	-
Climate	✓	-	✓	✓
Climate T8	-	-	✓	-
ECO Climate	-	✓	-	-
EMERGENCY				
Emergency	✓	-	✓	-
EXTERIOR LIGHTING				
Fortis	✓	-	-	✓
Guardian Pro	✓	-	-	✓
Slimline Guardian Floodlights	-	-	✓	-
Slimline Work Lights	-	✓	-	-
Eco Bulkheads	-	✓	-	-
Decorative Exterior	-	-	✓	-
Commercial Exterior	✓	-	✓	-
LAMPS & TUBES				
Lamps / Tubes	-	-	✓	-
Strips	-	-	✓	-
SENSORS				
Stand Alone Lighting Controls	-	-	✓	-

Register your extended warranty at: www.luceco.com

INDEX

CAT NO.	SECTION	PAGE
E612L50N	COMMERCIAL/EDUCATION	15
E66L28N	COMMERCIAL/EDUCATION	15
E66L35N	COMMERCIAL/EDUCATION	15
EBE5040B	EXTERIOR LIGHTING	94
EBE5040W	EXTERIOR LIGHTING	94
EBE5R40	EXTERIOR LIGHTING	94
EBEE10P40	EXTERIOR LIGHTING	95
EBEE10S40	EXTERIOR LIGHTING	95
EBE010P40	EXTERIOR LIGHTING	96
EBE010S40	EXTERIOR LIGHTING	95
EBER10P40	EXTERIOR LIGHTING	96
EBER10S40	EXTERIOR LIGHTING	96
EBH22S40	AMBIENT/AMENITY	51
EBH28S40	AMBIENT/AMENITY	51
ECLT12W18S40	INDUSTRIAL	61
ECLT12W36S40	INDUSTRIAL	61
ECLT15W22S40	INDUSTRIAL	61
ECLT15W44S40	INDUSTRIAL	61
ECLT6W10S40	INDUSTRIAL	61
ECLT6W20S40	INDUSTRIAL	61
EDLGUABS	ACCENT/DISPLAY	33
EDLGUAPC	ACCENT/DISPLAY	33
EDLGUAWH	ACCENT/DISPLAY	33
EDLGUFBS	ACCENT/DISPLAY	33
EDLGUFPC	ACCENT/DISPLAY	33
EDLGUFWH	ACCENT/DISPLAY	33
EDLGUIPBS	ACCENT/DISPLAY	33
EDLGUIPPC	ACCENT/DISPLAY	33
EDLGUIPWH	ACCENT/DISPLAY	33
EFRDGUABS	ACCENT/DISPLAY	32
EFRDGUAPC	ACCENT/DISPLAY	32
EFRDGUAWH	ACCENT/DISPLAY	32
EFRDGUFBS	ACCENT/DISPLAY	32
EFRDGUFPC	ACCENT/DISPLAY	32
EFRDGUFWH	ACCENT/DISPLAY	32
EFRDGUIPBS	ACCENT/DISPLAY	32
EFRDGUIPPC	ACCENT/DISPLAY	32
EFRDGUIPWH	ACCENT/DISPLAY	32
EFT60W30	ACCENT/DISPLAY	30
EFT60W40	ACCENT/DISPLAY	30
EFT80W30	ACCENT/DISPLAY	30
EFT80W40	ACCENT/DISPLAY	30
EFTBZBK	ACCENT/DISPLAY	30
EFTBZBN	ACCENT/DISPLAY	30
EFTBZBS	ACCENT/DISPLAY	30
EFTBZFBK	ACCENT/DISPLAY	30
EFTBZFBN	ACCENT/DISPLAY	30
EFTBZFBS	ACCENT/DISPLAY	30
EFTBZFMW	ACCENT/DISPLAY	30
EFTBZFPC	ACCENT/DISPLAY	30
EFTBZMW	ACCENT/DISPLAY	30
EFTBZPC	ACCENT/DISPLAY	30
ELP12W6L30	COMMERCIAL/EDUCATION	21
ELP12W6L40	COMMERCIAL/EDUCATION	21
ELP15W9L30	COMMERCIAL/EDUCATION	21
ELP15W9L40	COMMERCIAL/EDUCATION	21
ELP17W12L30	COMMERCIAL/EDUCATION	21
ELP17W12L40	COMMERCIAL/EDUCATION	21
ELP20W15L30	COMMERCIAL/EDUCATION	21
ELP20W15L40	COMMERCIAL/EDUCATION	21
ELP22W18L30	COMMERCIAL/EDUCATION	21
ELP22W18L40	COMMERCIAL/EDUCATION	21
ELP30W24L30	COMMERCIAL/EDUCATION	21
ELP30W24L40	COMMERCIAL/EDUCATION	21
ELP85W3L30	COMMERCIAL/EDUCATION	21

CAT NO.	SECTION	PAGE
ELP85W3L40	COMMERCIAL/EDUCATION	21
LA22C15W15-01	LAMPS & TUBES	119
LA22C15W15-LE	LAMPS & TUBES	119
LA22C5W47-01	LAMPS & TUBES	117
LA22C9W81-01	LAMPS & TUBES	117
LA22N15W15-01	LAMPS & TUBES	119
LA22N15W15-LE	LAMPS & TUBES	119
LA22N4F47-LE	LAMPS & TUBES	101
LA22N5W47-01	LAMPS & TUBES	117
LA22N5W47-LE	LAMPS & TUBES	116
LA22N6F81-LE	LAMPS & TUBES	101
LA22N9W81-01	LAMPS & TUBES	117
LA22N9W81-LE	LAMPS & TUBES	116
LA22W15W15-01	LAMPS & TUBES	119
LA22W15W15-LE	LAMPS & TUBES	119
LA22W4F47-LE	LAMPS & TUBES	101
LA22W4F47/3-LE	LAMPS & TUBES	101
LA22W5W47-01	LAMPS & TUBES	117
LA22W5W47-LE	LAMPS & TUBES	116
LA22W5W47/3-01	LAMPS & TUBES	116
LA22W5W47/3-LE	LAMPS & TUBES	116
LA22W6F81-LE	LAMPS & TUBES	101
LA22W6F81/3-LE	LAMPS & TUBES	101
LA22W9W81-01	LAMPS & TUBES	117
LA22W9W81-LE	LAMPS & TUBES	116
LA22W9W81/3-01	LAMPS & TUBES	116
LA22W9W81/3-LE	LAMPS & TUBES	116
LA27C15W15-01	LAMPS & TUBES	119
LA27C15W15-LE	LAMPS & TUBES	119
LA27C5W47-01	LAMPS & TUBES	117
LA27C5W47-LE	LAMPS & TUBES	116
LA27C9W81-01	LAMPS & TUBES	117
LA27C9W81-LE	LAMPS & TUBES	116
LA27N15W15-01	LAMPS & TUBES	119
LA27N15W15-LE	LAMPS & TUBES	119
LA27N4F47-LE	LAMPS & TUBES	101
LA27N5W47-01	LAMPS & TUBES	117
LA27N5W47-LE	LAMPS & TUBES	116
LA27N6F81-LE	LAMPS & TUBES	101
LA27N9W81-01	LAMPS & TUBES	117
LA27N9W81-LE	LAMPS & TUBES	116
LA27W15W15-01	LAMPS & TUBES	119
LA27W15W15-LE	LAMPS & TUBES	119
LA27W4F47-LE	LAMPS & TUBES	101
LA27W4F47/3-LE	LAMPS & TUBES	101
LA27W5W47-01	LAMPS & TUBES	117
LA27W5W47-LE	LAMPS & TUBES	116
LA27W5W47/3-01	LAMPS & TUBES	116
LA27W5W47/3-LE	LAMPS & TUBES	116
LA27W5W47/5-01	LAMPS & TUBES	116
LA27W6F81-LE	LAMPS & TUBES	101
LA27W6F81/3-LE	LAMPS & TUBES	101
LA27W9W81-01	LAMPS & TUBES	117
LA27W9W81-LE	LAMPS & TUBES	116
LA27W9W81/3-01	LAMPS & TUBES	116
LA27W9W81/3-LE	LAMPS & TUBES	116
LA27W9W81/5-01	LAMPS & TUBES	116
LAC12P22D40	COMMERCIAL/EDUCATION	25
LAC12P22E40	COMMERCIAL/EDUCATION	25
LAC12P22ED40	COMMERCIAL/EDUCATION	25
LAC12P22S40	COMMERCIAL/EDUCATION	25
LAC12P22S40MW	COMMERCIAL/EDUCATION	25
LAC12P40D40	COMMERCIAL/EDUCATION	25

CAT NO.	SECTION	PAGE
LAC12P40E40	COMMERCIAL/EDUCATION	25
LAC12P40ED40	COMMERCIAL/EDUCATION	25
LAC12P40S40	COMMERCIAL/EDUCATION	25
LAC12P40S40MW	COMMERCIAL/EDUCATION	25
LACT12P38E40	COMMERCIAL/EDUCATION	25
LACT12P38S40	COMMERCIAL/EDUCATION	25
LACT15P51E40	COMMERCIAL/EDUCATION	25
LACT15P51S40	COMMERCIAL/EDUCATION	25
LACT18P64E40	COMMERCIAL/EDUCATION	25
LACT18P64S40	COMMERCIAL/EDUCATION	25
LAD22C9W81-01	LAMPS & TUBES	117
LAD22N4F47-LE	LAMPS & TUBES	101
LAD22N6F81-LE	LAMPS & TUBES	101
LAD22N9W81-01	LAMPS & TUBES	117
LAD22N9W81-LE	LAMPS & TUBES	116
LAD22W4F47-LE	LAMPS & TUBES	101
LAD22W6F81-LE	LAMPS & TUBES	101
LAD22W9W81-01	LAMPS & TUBES	117
LAD22W9W81-LE	LAMPS & TUBES	116
LAD22W9W81/3-LE	LAMPS & TUBES	116
LAD27C9W81-01	LAMPS & TUBES	117
LAD27C9W81-LE	LAMPS & TUBES	116
LAD27N4F47-LE	LAMPS & TUBES	101
LAD27N6F81-LE	LAMPS & TUBES	101
LAD27N9W81-01	LAMPS & TUBES	117
LAD27N9W81-LE	LAMPS & TUBES	116
LAD27W4F47-LE	LAMPS & TUBES	101
LAD27W5W47-LE	LAMPS & TUBES	116
LAD27W6F81-LE	LAMPS & TUBES	101
LAD27W9W81-01	LAMPS & TUBES	117
LAD27W9W81-LE	LAMPS & TUBES	116
LAD27W9W81/3-LE	LAMPS & TUBES	116
LADW22W10W81-LE	LAMPS & TUBES	118
LADW27W10W81-LE	LAMPS & TUBES	118
LAEM22W8W81-01	LAMPS & TUBES	115
LAEM27W8W81-01	LAMPS & TUBES	115
LB14C3W25-LE	LAMPS & TUBES	120
LB14C5W47-LE	LAMPS & TUBES	120
LB14W3W25-LE	LAMPS & TUBES	120
LB14W3W25/3-LE	LAMPS & TUBES	120
LB14W4F47-LE	LAMPS & TUBES	103
LB14W5W47-LE	LAMPS & TUBES	120
LB14W5W47/3-LE	LAMPS & TUBES	120
LB15W4F47-LE	LAMPS & TUBES	103
LB22W3W25-LE	LAMPS & TUBES	120
LB22W3W25/3-LE	LAMPS & TUBES	120
LB22W4F47-LE	LAMPS & TUBES	103
LB22W5W47-LE	LAMPS & TUBES	120
LB22W5W47/3-LE	LAMPS & TUBES	120
LB27C3W25-LE	LAMPS & TUBES	120
LB27W3W25-LE	LAMPS & TUBES	120
LB27W3W25/3-LE	LAMPS & TUBES	120
LB27W4F47-LE	LAMPS & TUBES	103
LB27W5W47-LE	LAMPS & TUBES	120
LB27W5W47/3-LE	LAMPS & TUBES	120
LBD14W5W47-LE	LAMPS & TUBES	120
LBD14W5W47/3-LE	LAMPS & TUBES	120
LBD27W5W47-LE	LAMPS & TUBES	120
LBDL4D40	ACCENT/DISPLAY	36
LBDL4S40	ACCENT/DISPLAY	36
LBDL6D40	ACCENT/DISPLAY	36
LBDL6S40	ACCENT/DISPLAY	36
LBDL8D40	ACCENT/DISPLAY	36
LBDL8S40	ACCENT/DISPLAY	36
LBF13E40	EXTERIOR LIGHTING	70

CAT NO.	SECTION	PAGE
LBF13E40MW	EXTERIOR LIGHTING	70
LBF13L40	EXTERIOR LIGHTING	70
LBF13L40MW	EXTERIOR LIGHTING	70
LBF21E40	EXTERIOR LIGHTING	70
LBF21E40MW	EXTERIOR LIGHTING	70
LBF21L40	EXTERIOR LIGHTING	70
LBF21L40MW	EXTERIOR LIGHTING	70
LBH154AME	AMBIENT/AMENITY	50
LBH154AME	EXTERIOR LIGHTING	69
LBH154AMG	AMBIENT/AMENITY	50
LBH154AMG	EXTERIOR LIGHTING	69
LBH154AMP	AMBIENT/AMENITY	50
LBH154AMP	EXTERIOR LIGHTING	69
LBH154AMS	AMBIENT/AMENITY	50
LBH154AMS	EXTERIOR LIGHTING	69
LBH154APE	AMBIENT/AMENITY	50
LBH154K	AMBIENT/AMENITY	50
LBH154K	EXTERIOR LIGHTING	69
LBH154K3M	AMBIENT/AMENITY	50
LBH154K3M	EXTERIOR LIGHTING	69
LBH154KMW	AMBIENT/AMENITY	50
LBH154KMW	EXTERIOR LIGHTING	69
LBH154KMW3M	AMBIENT/AMENITY	50
LBH154KMW3M	EXTERIOR LIGHTING	69
LBH214K	AMBIENT/AMENITY	50
LBH214K	EXTERIOR LIGHTING	69
LBH214K3M	AMBIENT/AMENITY	50
LBH214K3M	EXTERIOR LIGHTING	69
LBH214KMW	AMBIENT/AMENITY	50
LBH214KMW	EXTERIOR LIGHTING	69
LBH214KMW3M	AMBIENT/AMENITY	50
LBH214KMW3M	EXTERIOR LIGHTING	69
LBM200B7S40	AMBIENT/AMENITY	49
LBM200W7S40	AMBIENT/AMENITY	49
LBM22B7S40	AMBIENT/AMENITY	49
LBM22W7S40	AMBIENT/AMENITY	49
LBM290B11E40	AMBIENT/AMENITY	49
LBM290B11S40	AMBIENT/AMENITY	49
LBM290B11S40MW	AMBIENT/AMENITY	49
LBM290W11E40	AMBIENT/AMENITY	49
LBM290W11S40	AMBIENT/AMENITY	49
LBM290W11S40MW	AMBIENT/AMENITY	49
LBM33B11E40	AMBIENT/AMENITY	49
LBM33B11S40	AMBIENT/AMENITY	49
LBM33B11S40MW	AMBIENT/AMENITY	49
LBM33W11E40	AMBIENT/AMENITY	49
LBM33W11S40	AMBIENT/AMENITY	49
LBM33W11S40MW	AMBIENT/AMENITY	49
LC14C3W25-LE	LAMPS & TUBES	122
LC14C5W47-LE	LAMPS & TUBES	122
LC14W2F25-LE	LAMPS & TUBES	102
LC14W2F25/3-LE	LAMPS & TUBES	102
LC14W3W25-LE	LAMPS & TUBES	122
LC14W3W25/3-LE	LAMPS & TUBES	122
LC14W4F47-LE	LAMPS & TUBES	102
LC14W4F47/3-LE	LAMPS & TUBES	102
LC14W5W47-01	LAMPS & TUBES	122
LC14W5W47-LE	LAMPS & TUBES	122
LC14W5W47/3-LE	LAMPS & TUBES	122
LC15W2F25-LE	LAMPS & TUBES	102
LC15W3W25-01	LAMPS & TUBES	122
LC15W3W25-LE	LAMPS & TUBES	122
LC15W3W25/3-LE	LAMPS & TUBES	122
LC15W4F47-LE	LAMPS & TUBES	102
LC15W5W47-01	LAMPS & TUBES	122

INDEX

CAT NO.	SECTION	PAGE
LC15W5W47/3-LE	LAMPS & TUBES	122
LC22W2F25-LE	LAMPS & TUBES	102
LC22W2F25/3-LE	LAMPS & TUBES	102
LC22W3W25-01	LAMPS & TUBES	122
LC22W3W25-LE	LAMPS & TUBES	122
LC22W3W25/3-LE	LAMPS & TUBES	122
LC22W4F47-LE	LAMPS & TUBES	102
LC22W5W47-01	LAMPS & TUBES	122
LC22W5W47/3-LE	LAMPS & TUBES	122
LC27W2F25-LE	LAMPS & TUBES	102
LC27W3W25-01	LAMPS & TUBES	122
LC27W3W25-LE	LAMPS & TUBES	122
LC27W3W25/3-LE	LAMPS & TUBES	122
LC27W4F47-LE	LAMPS & TUBES	102
LC27W5W47-01	LAMPS & TUBES	122
LC27W5W47/3-LE	LAMPS & TUBES	122
LCD14W4F47-LE	LAMPS & TUBES	102
LCD22W4F47-LE	LAMPS & TUBES	102
LCD22W5W47-LE	LAMPS & TUBES	122
LCD27W4F47-LE	LAMPS & TUBES	102
LCD27W5W47-LE	LAMPS & TUBES	122
LCL12W22D40	INDUSTRIAL	59
LCL12W22D40MW	INDUSTRIAL	59
LCL12W22E40	INDUSTRIAL	59
LCL12W22ED40	INDUSTRIAL	59
LCL12W22S40	INDUSTRIAL	59
LCL12W22S40MW	INDUSTRIAL	59
LCL12W44D40	INDUSTRIAL	59
LCL12W44D40MW	INDUSTRIAL	59
LCL12W44E40	INDUSTRIAL	59
LCL12W44ED40	INDUSTRIAL	59
LCL12W44S40	INDUSTRIAL	59
LCL12W44S40MW	INDUSTRIAL	59
LCL15W34D40	INDUSTRIAL	59
LCL15W34D40MW	INDUSTRIAL	59
LCL15W34E40	INDUSTRIAL	59
LCL15W34ED40	INDUSTRIAL	59
LCL15W34S40	INDUSTRIAL	59
LCL15W34S40MW	INDUSTRIAL	59
LCL15W66D40	INDUSTRIAL	59
LCL15W66D40MW	INDUSTRIAL	59
LCL15W66E40	INDUSTRIAL	59
LCL15W66ED40	INDUSTRIAL	59
LCL15W66S40	INDUSTRIAL	59
LCL15W66S40MW	INDUSTRIAL	59
LCL18W44D40	INDUSTRIAL	59
LCL18W44D40MW	INDUSTRIAL	59
LCL18W44E40	INDUSTRIAL	59
LCL18W44ED40	INDUSTRIAL	59
LCL18W44S40	INDUSTRIAL	59
LCL18W44S40MW	INDUSTRIAL	59
LCL18W87D40	INDUSTRIAL	59
LCL18W87D40MW	INDUSTRIAL	59
LCL18W87E40	INDUSTRIAL	59
LCL18W87ED40	INDUSTRIAL	59
LCL18W87S40	INDUSTRIAL	59
LCL18W87S40MW	INDUSTRIAL	59
LCLT12W21E40	INDUSTRIAL	60
LCLT12W21S40	INDUSTRIAL	60
LCLT12W43E40	INDUSTRIAL	60
LCLT12W43S40	INDUSTRIAL	60
LCLT15W28E40	INDUSTRIAL	60
LCLT15W28S40	INDUSTRIAL	60
LCLT15W57E40	INDUSTRIAL	60
LCLT15W57S40	INDUSTRIAL	60

CAT NO.	SECTION	PAGE
LCLT18W35E40	INDUSTRIAL	60
LCLT18W35S40	INDUSTRIAL	60
LCLT18W71E40	INDUSTRIAL	60
LCLT18W71S40	INDUSTRIAL	60
LCR27C27W29-01	LAMPS & TUBES	132
LCR27N27W29-01	LAMPS & TUBES	132
LCR40C120W12-01	LAMPS & TUBES	132
LCR40C80W84-01	LAMPS & TUBES	132
LCR40N120W12-01	LAMPS & TUBES	132
LCR40N80W84-01	LAMPS & TUBES	132
LDP15BBS	ACCENT/DISPLAY	34
LDP15BBSDF	ACCENT/DISPLAY	34
LDP15BPC	ACCENT/DISPLAY	34
LDP15BPCDF	ACCENT/DISPLAY	34
LDP15BSQBS	ACCENT/DISPLAY	34
LDP15BSQPC	ACCENT/DISPLAY	34
LDP15BSQWH	ACCENT/DISPLAY	34
LDP15BWHDF	ACCENT/DISPLAY	34
LDP15BWHEM	ACCENT/DISPLAY	34
LDP15BWHIP	ACCENT/DISPLAY	34
LDP15BWHIPF	ACCENT/DISPLAY	34
LDP15W11GD40	ACCENT/DISPLAY	34
LDP15W11GS40	ACCENT/DISPLAY	34
LDP15W15GD40	ACCENT/DISPLAY	34
LDP15W15GS40	ACCENT/DISPLAY	34
LDP15W21GD40	ACCENT/DISPLAY	34
LDP15W21GS40	ACCENT/DISPLAY	34
LDP20W11MD40	ACCENT/DISPLAY	35
LDP20W11MS40	ACCENT/DISPLAY	35
LDP20W12GD40	ACCENT/DISPLAY	35
LDP20W12GS40	ACCENT/DISPLAY	35
LDP20W15MD40	ACCENT/DISPLAY	35
LDP20W15MS40	ACCENT/DISPLAY	35
LDP20W16GD40	ACCENT/DISPLAY	35
LDP20W16GS40	ACCENT/DISPLAY	35
LDP20W21MD40	ACCENT/DISPLAY	35
LDP20W21MS40	ACCENT/DISPLAY	35
LDP20W22GD40	ACCENT/DISPLAY	35
LDP20W22GS40	ACCENT/DISPLAY	35
LDP20W31MD40	ACCENT/DISPLAY	35
LDP20W31MS40	ACCENT/DISPLAY	35
LDP20W32GD40	ACCENT/DISPLAY	35
LDP20W32GS40	ACCENT/DISPLAY	35
LDSW12S40	ACCENT/DISPLAY	39
LDSW4S40	ACCENT/DISPLAY	39
LEAMBU12A50	EXTERIOR LIGHTING	77
LEAMBU1F50	EXTERIOR LIGHTING	77
LEAMBU4F50	EXTERIOR LIGHTING	77
LEAMPT30C50	EXTERIOR LIGHTING	74
LEAMPT30G50	EXTERIOR LIGHTING	74
LEAMPT55D50	EXTERIOR LIGHTING	75
LEAMPT62V50	EXTERIOR LIGHTING	74
LEAR42550	EXTERIOR LIGHTING	76
LEAR82550	EXTERIOR LIGHTING	76
LED3EP80-0J	COMMERCIAL/EDUCATION	19
LED3EP80-0J	EMERGENCY	67
LEM2DLNM3CA	EMERGENCY	66
LEM2DLNM3LG	EMERGENCY	66
LEM2DLNM3WA	EMERGENCY	66
LEM5DLNM3	EMERGENCY	64
LEM6DLM3CA	EMERGENCY	66
LEM6DLM3CD	EMERGENCY	66
LEM6DLM3DA	EMERGENCY	66
LEM6DLM3LG	EMERGENCY	66
LEM6DLM3WA	EMERGENCY	66

CAT NO.	SECTION	PAGE
LEM6DLM3WD	EMERGENCY	66
LEM8DLM3CS	EMERGENCY	66
LEM8DLM3ST	EMERGENCY	66
LEM8DLM3WS	EMERGENCY	66
LEMBHM3	EMERGENCY	63
LEMBHM3DA	EMERGENCY	65
LEMBHM3LG	EMERGENCY	65
LEMBHM3ST	EMERGENCY	65
LEMDEM3	EMERGENCY	63
LEMDEMEDA	EMERGENCY	65
LEMDEMELG	EMERGENCY	65
LEMDEMEST	EMERGENCY	65
LEMEXLA	EMERGENCY	63
LEMEXM3	EMERGENCY	63
LEMEXM3LDA	EMERGENCY	64
LEMEXM3LG	EMERGENCY	64
LEMEXM3LST	EMERGENCY	64
LEMEXRA	EMERGENCY	63
LEMEXUA	EMERGENCY	63
LEMIPTWNM3	EMERGENCY	64
LEMREMEDA	EMERGENCY	65
LEMREMELG	EMERGENCY	65
LEMREMEST	EMERGENCY	65
LEP66W025ID40	COMMERCIAL/EDUCATION	11
LEP66W025ID40PIR	COMMERCIAL/EDUCATION	11
LEP66W025IE40	COMMERCIAL/EDUCATION	11
LEP66W025IED40	COMMERCIAL/EDUCATION	11
LEP66W025IED40PIR	COMMERCIAL/EDUCATION	11
LEP66W025IS40	COMMERCIAL/EDUCATION	11
LEP66W035ID40	COMMERCIAL/EDUCATION	11
LEP66W035ID40PIR	COMMERCIAL/EDUCATION	11
LEP66W035IE40	COMMERCIAL/EDUCATION	11
LEP66W035IED40	COMMERCIAL/EDUCATION	11
LEP66W035IED40PIR	COMMERCIAL/EDUCATION	11
LEP66W035IS40	COMMERCIAL/EDUCATION	11
LESRTB50R50	EXTERIOR LIGHTING	75
LESRTP59R50	EXTERIOR LIGHTING	75
LEXD1016	EXTERIOR LIGHTING	86
LEXD1016P	EXTERIOR LIGHTING	87
LEXD1028	EXTERIOR LIGHTING	90
LEXD1059	EXTERIOR LIGHTING	91
LEXD1098	EXTERIOR LIGHTING	90
LEXD1103	EXTERIOR LIGHTING	84
LEXD1104	EXTERIOR LIGHTING	85
LEXD1540	EXTERIOR LIGHTING	87
LEXD3413	EXTERIOR LIGHTING	84
LEXD3414	EXTERIOR LIGHTING	85
LEXD3WDG3	EXTERIOR LIGHTING	93
LEXD5724	EXTERIOR LIGHTING	84
LEXD5827	EXTERIOR LIGHTING	86
LEXD5828	EXTERIOR LIGHTING	87
LEXD5859	EXTERIOR LIGHTING	91
LEXD5SUDG3	EXTERIOR LIGHTING	93
LEXD7132	EXTERIOR LIGHTING	90
LEXD8FUDG3	EXTERIOR LIGHTING	92
LEXD9001	EXTERIOR LIGHTING	86
LEXD9SUDG3	EXTERIOR LIGHTING	92
LEXS30B30	EXTERIOR LIGHTING	88
LEXS30W30	EXTERIOR LIGHTING	88
LFP100B140F	EXTERIOR LIGHTING	72
LFP160B140F	EXTERIOR LIGHTING	72
LFP50B140F	EXTERIOR LIGHTING	72
LFPL100B140F	EXTERIOR LIGHTING	72
LFPL160B140F	EXTERIOR LIGHTING	72
LFPL50B140F	EXTERIOR LIGHTING	72

CAT NO.	SECTION	PAGE
LFR5BS450D27	ACCENT/DISPLAY	31
LFR5BS475D40	ACCENT/DISPLAY	31
LFR5PC450D27	ACCENT/DISPLAY	31
LFR5PC475D40	ACCENT/DISPLAY	31
LFR5WH450D27	ACCENT/DISPLAY	31
LFR5WH475D40	ACCENT/DISPLAY	31
LFS12B130-02	EXTERIOR LIGHTING	78
LFS12B150-02	EXTERIOR LIGHTING	78
LFS12W130-02	EXTERIOR LIGHTING	78
LFS12W150-02	EXTERIOR LIGHTING	78
LFS18B130-02	EXTERIOR LIGHTING	78
LFS18B150-02	EXTERIOR LIGHTING	78
LFS18W130-02	EXTERIOR LIGHTING	78
LFS18W150-02	EXTERIOR LIGHTING	78
LFS30B130-02	EXTERIOR LIGHTING	78
LFS30B150-02	EXTERIOR LIGHTING	78
LFS6B130-02	EXTERIOR LIGHTING	78
LFS6B150-02	EXTERIOR LIGHTING	78
LFS6W130-02	EXTERIOR LIGHTING	78
LFS6W150-02	EXTERIOR LIGHTING	78
LFSFP12B130-02	EXTERIOR LIGHTING	79
LFSFP12B150-02	EXTERIOR LIGHTING	79
LFSFP12W130-02	EXTERIOR LIGHTING	79
LFSFP12W150-02	EXTERIOR LIGHTING	79
LFSFP18B130-02	EXTERIOR LIGHTING	79
LFSFP18B150-02	EXTERIOR LIGHTING	79
LFSFP18W130-02	EXTERIOR LIGHTING	79
LFSFP18W150-02	EXTERIOR LIGHTING	79
LFSFP30B130-02	EXTERIOR LIGHTING	79
LFSFP30B150-02	EXTERIOR LIGHTING	79
LFSFP6B130-02	EXTERIOR LIGHTING	79
LFSFP6B150-02	EXTERIOR LIGHTING	79
LFSFP6W130-02	EXTERIOR LIGHTING	79
LFSFP6W150-02	EXTERIOR LIGHTING	79
LG4W2W19-LE	LAMPS & TUBES	123
LG9W2W20-LE	LAMPS & TUBES	123
LGC3G26-01	LAMPS & TUBES	106
LGC3W26P-01	LAMPS & TUBES	109
LGC5G37-01	LAMPS & TUBES	106
LGC5W30W-01	LAMPS & TUBES	110
LGC5W37P-01	LAMPS & TUBES	109
LGC7W50P-01	LAMPS & TUBES	109
LGC7W50P-LE	LAMPS & TUBES	111
LGC7W50W-01	LAMPS & TUBES	110
LGDC5G37-01	LAMPS & TUBES	106
LGDC5W37P-01	LAMPS & TUBES	109
LGDN5G37-01	LAMPS & TUBES	106
LGDN5G37-LE	LAMPS & TUBES	106
LGDN5G37/3-LE	LAMPS & TUBES	106
LGDN5G37/5-01	LAMPS & TUBES	106
LGDN5W37P-01	LAMPS & TUBES	109
LGDN5W37P-LE	LAMPS & TUBES	109
LGDN5W37P/3-LE	LAMPS & TUBES	109
LGDN5W37P/5-01	LAMPS & TUBES	109
LGDW5G37-01	LAMPS & TUBES	106
LGDW5G37-LE	LAMPS & TUBES	106
LGDW5G37/3-LE	LAMPS & TUBES	106
LGDW5G37/5-01	LAMPS & TUBES	106
LGDW5W37P-01	LAMPS & TUBES	109
LGDW5W37P-LE	LAMPS & TUBES	109
LGDW5W37P/2-LE	LAMPS & TUBES	109
LGDW5W37P/3-LE	LAMPS & TUBES	109
LGDW5W37P/5-01	LAMPS & TUBES	109
LGDWW5W37-LE	LAMPS & TUBES	113
LGDWW5W37/5-01	LAMPS & TUBES	113

INDEX

CAT NO.	SECTION	PAGE
LGN3G26-01	LAMPS & TUBES	106
LGN3G26-LE	LAMPS & TUBES	106
LGN3G26/3-LE	LAMPS & TUBES	106
LGN3G26/5-01	LAMPS & TUBES	106
LGN3W26P-01	LAMPS & TUBES	109
LGN3W26P-LE	LAMPS & TUBES	111
LGN3W26P/5-01	LAMPS & TUBES	111
LGN5G37-01	LAMPS & TUBES	106
LGN5G37-LE	LAMPS & TUBES	106
LGN5G37/3-LE	LAMPS & TUBES	106
LGN5G37/5-01	LAMPS & TUBES	106
LGN5W30W-01	LAMPS & TUBES	110
LGN5W37P-01	LAMPS & TUBES	109
LGN5W37P-LE	LAMPS & TUBES	111
LGN5W37P/10-01	LAMPS & TUBES	111
LGN5W37P/5-01	LAMPS & TUBES	111
LGN7W50P-01	LAMPS & TUBES	109
LGN7W50P-LE	LAMPS & TUBES	111
LGN7W50W-01	LAMPS & TUBES	110
LGW3G26-01	LAMPS & TUBES	106
LGW3G26-LE	LAMPS & TUBES	106
LGW3G26/3-LE	LAMPS & TUBES	106
LGW3G26/5-01	LAMPS & TUBES	106
LGW3W26P-01	LAMPS & TUBES	109
LGW3W26P-LE	LAMPS & TUBES	111
LGW3W26P/2-LE	LAMPS & TUBES	111
LGW3W26P/3-LE	LAMPS & TUBES	111
LGW3W26P/5-01	LAMPS & TUBES	111
LGW5G37-01	LAMPS & TUBES	106
LGW5G37-LE	LAMPS & TUBES	106
LGW5G37/3-LE	LAMPS & TUBES	106
LGW5G37/5-01	LAMPS & TUBES	106
LGW5W30W-01	LAMPS & TUBES	110
LGW5W37P-01	LAMPS & TUBES	109
LGW5W37P-LE	LAMPS & TUBES	111
LGW5W37P/10-01	LAMPS & TUBES	111
LGW5W37P/2-LE	LAMPS & TUBES	111
LGW5W37P/20-01	LAMPS & TUBES	111
LGW5W37P/3-LE	LAMPS & TUBES	111
LGW5W37P/5-01	LAMPS & TUBES	111
LGW7W50P-01	LAMPS & TUBES	109
LGW7W50P-LE	LAMPS & TUBES	111
LGW7W50W-01	LAMPS & TUBES	110
LGXC4W32-01	LAMPS & TUBES	124
LGXC5W40-01	LAMPS & TUBES	124
LGXC6W48-01	LAMPS & TUBES	124
LGXC8W68-01	LAMPS & TUBES	124
LGXN4W32-01	LAMPS & TUBES	124
LGXN5W40-01	LAMPS & TUBES	124
LGXN6W48-01	LAMPS & TUBES	124
LGXN8W68-01	LAMPS & TUBES	124
LGXW4W32-01	LAMPS & TUBES	124
LGXW5W40-01	LAMPS & TUBES	124
LGXW6W48-01	LAMPS & TUBES	124
LGXW8W68-01	LAMPS & TUBES	124
LHB120W	INDUSTRIAL	57
LHB200W	INDUSTRIAL	57
LHBC11E120	INDUSTRIAL	56
LHBC11E60	INDUSTRIAL	56
LHBC11E90	INDUSTRIAL	56
LHBC11S120	INDUSTRIAL	56
LHBC11S60	INDUSTRIAL	56
LHBC11S90	INDUSTRIAL	56
LHBC22E120	INDUSTRIAL	56
LHBC22E60	INDUSTRIAL	56

CAT NO.	SECTION	PAGE
LHBC22E90	INDUSTRIAL	56
LHBC22S120	INDUSTRIAL	56
LHBC22S60	INDUSTRIAL	56
LHBC22S90	INDUSTRIAL	56
LHBRFL120	INDUSTRIAL	57
LHBRFL60	INDUSTRIAL	57
LHBRFL90	INDUSTRIAL	57
LHBRFT	INDUSTRIAL	57
LHOL11S540	INDUSTRIAL	58
LHOL95S40	INDUSTRIAL	58
LKT1012ACW	COMMERCIAL/EDUCATION	27
LKT1012BCW	COMMERCIAL/EDUCATION	27
LKT1013CW	COMMERCIAL/EDUCATION	26
LKT103	ACCENT/DISPLAY	41
LKT2017	COMMERCIAL/EDUCATION	26
LKT2022-L50	ACCENT/DISPLAY	39
LKT206	ACCENT/DISPLAY	40
LKT391A	AMBIENT/AMENITY	52
LKT393A	AMBIENT/AMENITY	52
LKT396	AMBIENT/AMENITY	53
LKT396A	AMBIENT/AMENITY	53
LKT536A	AMBIENT/AMENITY	53
LKT6563	ACCENT/DISPLAY	43
LKT6564	ACCENT/DISPLAY	41
LKT6565	ACCENT/DISPLAY	41
LKT6566	ACCENT/DISPLAY	42
LKT6594A	ACCENT/DISPLAY	42
LKT6595	ACCENT/DISPLAY	42
LKT8562	ACCENT/DISPLAY	37
LKTMOD1BL	ACCENT/DISPLAY	45
LKTMOD1WH	ACCENT/DISPLAY	45
LKTMODSRFBL	ACCENT/DISPLAY	44
LKTMODSRFWH	ACCENT/DISPLAY	44
LKTMODSSFBL	ACCENT/DISPLAY	44
LKTMODSSFWH	ACCENT/DISPLAY	44
LKTMODSSGBL	ACCENT/DISPLAY	44
LKTMODSSGWH	ACCENT/DISPLAY	44
LLBN11E40	INDUSTRIAL	55
LLBN11S40	INDUSTRIAL	55
LLBN16E40	INDUSTRIAL	55
LLBN16S40	INDUSTRIAL	55
LLBN21E40	INDUSTRIAL	55
LLBN21S40	INDUSTRIAL	55
LLBW11E40	INDUSTRIAL	55
LLBW11S40	INDUSTRIAL	55
LLBW11S40 / LLBN11S40	INDUSTRIAL	55
LLBW16E40	INDUSTRIAL	55
LLBW16S40	INDUSTRIAL	55
LLBW16S40 / LLBN16S40	INDUSTRIAL	55
LLBW21E40	INDUSTRIAL	55
LLBW21S40	INDUSTRIAL	55
LLBW21S40 / LLBN21S40	INDUSTRIAL	55
LLBXDIF	INDUSTRIAL	55
LLBXWIRE	INDUSTRIAL	55
LMC5W37P-01	LAMPS & TUBES	114
LMC5W37P-LE	LAMPS & TUBES	114
LMN3W26P-LE	LAMPS & TUBES	114
LMN5G37-LE	LAMPS & TUBES	105
LMN5G37/3-LE	LAMPS & TUBES	105
LMN5G37/5-01	LAMPS & TUBES	105
LMN5W37P-01	LAMPS & TUBES	114
LMN5W37P-LE	LAMPS & TUBES	114
LMSRW20S40	ACCENT/DISPLAY	43
LMSRW40S40	ACCENT/DISPLAY	43
LMW3W26P-LE	LAMPS & TUBES	114

CAT NO.	SECTION	PAGE
LMW5G37-01	LAMPS & TUBES	105
LMW5G37-LE	LAMPS & TUBES	105
LMW5G37/3-LE	LAMPS & TUBES	105
LMW5G37/5-01	LAMPS & TUBES	105
LMW5W37P-01	LAMPS & TUBES	114
LMW5W37P-LE	LAMPS & TUBES	114
LP120WD40	COMMERCIAL/EDUCATION	20
LP120WS40	COMMERCIAL/EDUCATION	20
LP150WD40	COMMERCIAL/EDUCATION	20
LP150WS40	COMMERCIAL/EDUCATION	20
LP180WD40	COMMERCIAL/EDUCATION	20
LP180WS40	COMMERCIAL/EDUCATION	20
LP20W6W45-01	LAMPS & TUBES	127
LP240WD40	COMMERCIAL/EDUCATION	20
LP240WS40	COMMERCIAL/EDUCATION	20
LP30W10W80-01	LAMPS & TUBES	127
LP312W28D40	COMMERCIAL/EDUCATION	14
LP312W28S40	COMMERCIAL/EDUCATION	14
LP312W35D40	COMMERCIAL/EDUCATION	14
LP312W35S40	COMMERCIAL/EDUCATION	14
LP38N15W12-01	LAMPS & TUBES	127
LP38N15W12-LE	LAMPS & TUBES	127
LP38N15W12IP65-01	LAMPS & TUBES	127
LP38W15W12-01	LAMPS & TUBES	127
LP38W15W12-LE	LAMPS & TUBES	127
LP38W15W12IP65-01	LAMPS & TUBES	127
LP612IP50D40	COMMERCIAL/EDUCATION	23
LP612IP50S40	COMMERCIAL/EDUCATION	23
LP612W50D40	COMMERCIAL/EDUCATION	14
LP612W50S40	COMMERCIAL/EDUCATION	14
LP66IP35D40	COMMERCIAL/EDUCATION	23
LP66IP35S40	COMMERCIAL/EDUCATION	23
LP66W28D40	COMMERCIAL/EDUCATION	14
LP66W28S40	COMMERCIAL/EDUCATION	14
LP66W35D40	COMMERCIAL/EDUCATION	14
LP66W35S40	COMMERCIAL/EDUCATION	14
LPB312H25D48	COMMERCIAL/EDUCATION	13
LPB312H25S48	COMMERCIAL/EDUCATION	13
LPB312H35D48	COMMERCIAL/EDUCATION	13
LPB312H35S48	COMMERCIAL/EDUCATION	13
LPB612H50D48	COMMERCIAL/EDUCATION	13
LPB612H50S48	COMMERCIAL/EDUCATION	13
LPB612H70D48	COMMERCIAL/EDUCATION	13
LPB612H70S48	COMMERCIAL/EDUCATION	13
LPB66H25D48	COMMERCIAL/EDUCATION	13
LPB66H25S48	COMMERCIAL/EDUCATION	13
LPB66H35D48	COMMERCIAL/EDUCATION	13
LPB66H35S48	COMMERCIAL/EDUCATION	13
LPC3BDP65	CONTROLS	141
LPC3BSP65	CONTROLS	141
LPCLRBOX	CONTROLS	139
LPCLRRCMBOX	CONTROLS	139
LPCLRPIRDSI	CONTROLS	139
LPCLRPIRM	CONTROLS	139
LPCMHPIRDSI65	CONTROLS	140
LPCMHPIRM65	CONTROLS	140
LPCMPIRDSI	CONTROLS	139
LPCMPIRM	CONTROLS	139
LPCSMFP66	CONTROLS	140
LPCUHC	CONTROLS	141
LPCUSER	CONTROLS	141
LPF312W	COMMERCIAL/EDUCATION	18
LPF612W	COMMERCIAL/EDUCATION	18
LPF66SCRF	COMMERCIAL/EDUCATION	18
LPF66W	COMMERCIAL/EDUCATION	18

CAT NO.	SECTION	PAGE
LPIP240WD40	COMMERCIAL/EDUCATION	23
LPIP240WS40	COMMERCIAL/EDUCATION	23
LPL2C11W10-01	LAMPS & TUBES	125
LPL2C9W80-01	LAMPS & TUBES	125
LPL2N11W10-01	LAMPS & TUBES	125
LPL2N9W80-01	LAMPS & TUBES	125
LPL4C11W10-01	LAMPS & TUBES	125
LPL4C9W80-01	LAMPS & TUBES	125
LPL4N11W10-01	LAMPS & TUBES	125
LPL4N9W80-01	LAMPS & TUBES	125
LPS312W28D40	COMMERCIAL/EDUCATION	17
LPS312W28S40	COMMERCIAL/EDUCATION	17
LPS312W35D40	COMMERCIAL/EDUCATION	17
LPS312W35S40	COMMERCIAL/EDUCATION	17
LPS612W50D40	COMMERCIAL/EDUCATION	17
LPS612W50S40	COMMERCIAL/EDUCATION	17
LPS66W28D40	COMMERCIAL/EDUCATION	17
LPS66W28S40	COMMERCIAL/EDUCATION	17
LPS66W35D40	COMMERCIAL/EDUCATION	17
LPS66W35S40	COMMERCIAL/EDUCATION	17
LR50W5W40-01	LAMPS & TUBES	126
LR50W5W40-LE	LAMPS & TUBES	126
LR63W7W55-01	LAMPS & TUBES	126
LR63W7W55-LE	LAMPS & TUBES	126
LR80W9W85-01	LAMPS & TUBES	126
LR90W12W10-01	LAMPS & TUBES	126
LRD50W5W38-01	LAMPS & TUBES	126
LRD50W5W38-LE	LAMPS & TUBES	126
LRD63W7W55-01	LAMPS & TUBES	126
LRD63W7W55-LE	LAMPS & TUBES	126
LRD80W9W82-01	LAMPS & TUBES	126
LRD90W12W10-01	LAMPS & TUBES	126
LS15W2W20-01	LAMPS & TUBES	128
LS15W4W28-01	LAMPS & TUBES	128
LSPW20S40	ACCENT/DISPLAY	38
LSRW20S40	ACCENT/DISPLAY	38
LS5W20S40	ACCENT/DISPLAY	38
LSW10BR2	EXTERIOR LIGHTING	82
LSW20BR2	EXTERIOR LIGHTING	82
LSW30BR2	EXTERIOR LIGHTING	82
LSW50BR2	EXTERIOR LIGHTING	82
LSWR10BR	EXTERIOR LIGHTING	80
LSWRSBR	EXTERIOR LIGHTING	80
LSWT210BR3	EXTERIOR LIGHTING	83
LSWT220BR3	EXTERIOR LIGHTING	83
LSWT230BR3	EXTERIOR LIGHTING	83
LT862C10W11-01	LAMPS & TUBES	131
LT862C10W90-01	LAMPS & TUBES	131
LT862N10W11-01	LAMPS & TUBES	131
LT862N10W90-01	LAMPS & TUBES	131
LT864C18W20-01	LAMPS & TUBES	131
LT864C22W24-01	LAMPS & TUBES	131
LT864N18W16-01	LAMPS & TUBES	131
LT864N18W20-01	LAMPS & TUBES	131
LT864N22W24-01	LAMPS & TUBES	131
LT865C22W24-01	LAMPS & TUBES	131
LT865C32W35-01	LAMPS & TUBES	131
LT865N22W20-01	LAMPS & TUBES	131
LT865N22W24-01	LAMPS & TUBES	131
LT865N32W35-01	LAMPS & TUBES	131
LT866C40W44-01	LAMPS & TUBES	131
LT866N40W44-01	LAMPS & TUBES	131
LTWCW20S40	ACCENT/DISPLAY	37
LTWCW28S40	ACCENT/DISPLAY	37
LTK5M40	LAMPS & TUBES	135

INDEX

CAT NO.	SECTION	PAGE
LTK5MRGB	LAMPS & TUBES	134
LTSW20S40	ACCENT/DISPLAY	37
LTSW28S40	ACCENT/DISPLAY	37
LUCL300CW	ACCENT/DISPLAY	46
LUCL300WW	ACCENT/DISPLAY	46
LUCL500CW	ACCENT/DISPLAY	46
LUCL500WW	ACCENT/DISPLAY	46
LUCLAC90	ACCENT/DISPLAY	46
LUCLACCL	ACCENT/DISPLAY	46
LUCLACPIR	ACCENT/DISPLAY	46
LUCLACSC	ACCENT/DISPLAY	46
LUCLACSW	ACCENT/DISPLAY	46
LUCP50WH30	ACCENT/DISPLAY	47
LUCP50WH30P	ACCENT/DISPLAY	47
LUCP50WH40	ACCENT/DISPLAY	47
LUCP50WH40P	ACCENT/DISPLAY	47
LUSB5030	LAMPS & TUBES	136
LUSB5040	LAMPS & TUBES	136
LUSB50BL	LAMPS & TUBES	136
LUSB50RGB	LAMPS & TUBES	137
LWCW20S40	ACCENT/DISPLAY	40
LWCW34S40	ACCENT/DISPLAY	40
LWF40E40	EXTERIOR LIGHTING	70
LWF40E40PC	EXTERIOR LIGHTING	70
LWF40S40	EXTERIOR LIGHTING	70
LWF40S40PC	EXTERIOR LIGHTING	70
LWSK415	COMMERCIAL/EDUCATION	18
LXB12R28EL40	INDUSTRIAL	58
LXB12R28L40	INDUSTRIAL	58
LXB12R53EL40	INDUSTRIAL	58
LXB12R53L40	INDUSTRIAL	58
LXB12W25EL40	INDUSTRIAL	58
LXB12W25L40	INDUSTRIAL	58
LXB12W48EL40	INDUSTRIAL	58
LXB12W48L40	INDUSTRIAL	58
LXB15R42EL40	INDUSTRIAL	58
LXB15R42L40	INDUSTRIAL	58
LXB15R79EL40	INDUSTRIAL	58
LXB15R79L40	INDUSTRIAL	58
LXB15W38EL40	INDUSTRIAL	58
LXB15W38L40	INDUSTRIAL	58
LXB15W72EL40	INDUSTRIAL	58
LXB15W72L40	INDUSTRIAL	58
LXB18R53EL40	INDUSTRIAL	58
LXB18R53L40	INDUSTRIAL	58
LXB18R98EL40	INDUSTRIAL	58
LXB18R98L40	INDUSTRIAL	58
LXB18W48EL40	INDUSTRIAL	58
LXB18W48L40	INDUSTRIAL	58
LXB18W92EL40	INDUSTRIAL	58
LXB18W92L40	INDUSTRIAL	58
LXB15R79EL40	INDUSTRIAL	56
LXB15R79L40	INDUSTRIAL	56
LXB15W38EL40	INDUSTRIAL	56
LXB15W38L40	INDUSTRIAL	56
LXB15W72EL40	INDUSTRIAL	56
LXB15W72L40	INDUSTRIAL	56
LXB18R53EL40	INDUSTRIAL	56
LXB18R53L40	INDUSTRIAL	56
LXB18R98EL40	INDUSTRIAL	56
LXB18R98L40	INDUSTRIAL	56
LXB18W48EL40	INDUSTRIAL	56
LXB18W48L40	INDUSTRIAL	56
LXB18W92EL40	INDUSTRIAL	56
LXB18W92L40	INDUSTRIAL	56

E & O E

Luceco are committed to a program of continuous product development. Therefore we reserve the right to change product specification and/or availability without prior notice. It is the responsibility of the purchaser to check all details before taking any critical action and the information contained in this catalogue does not form part of any contract or guarantee.

	PAGE		PAGE
A			
A60 Classic	116-117	- Lantern Post Top	74 - 75
A60 Classic Clear Filament	101	- Road Lantern	75
A60 DIM2WARM	118	- Spot (Exterior)	76
A60 POWERLITE	115	- Buried Uplight	77
A70 Classic	119	COMMERCIAL/EDUCATION	10 - 27
Academy	25	- Epsilon	11
- Opal Prism Academy	25	- Backlit Frameless LuxPanel	13
- Clear Prism Academy T8	25	- Edgelit Framed LuxPanel	14
ACCENT/DISPLAY	28 - 47	- ECO Edgelit Framed LuxPanel	10
- FType	29 - 30	- Surface Modular LuxPanel	16 - 17
- Atom Downlight	31	- Surface Mounting LuxPanel Frame	18
- GU10 Fire Rated Downlights	32	- Recess LuxPanel Frame	18
- GU10 Standard Downlights	33	- Wire Suspension	18
- Platinum Mini Downlight	34	- Emergency Pack	19 & 67
- Platinum Downlight	35	- Circular Edgelit LuxPanel	20
- Carbon Downlight	36	- ECO Circular Panel	21
- Track Spot	37	- IP Rated LuxPanels	23
- Spot Light	38	- Academy	25
- Drop Rod Downlight	39	- Opal Prism Academy	25
- Square Downlight	39	- Clear Prism Academy T8	25
- Wallwasher	40 - 41	- Decorative Surface	26
- Low Glare Downlights	41	- Pendant	26 - 27
- Semi Recessed Downlight	42	Contact Us	2
- IP Rated Downlights	42	CONTROLS	138 - 141
- Recessed Downlight	43	- Sensors	139
- Modular Downlight Range	43 - 45	- PIR	139
- Taska Under Cabinet	46	- Programmers	141
- Under Cabinet Tile	47	Corn	132
Adjustable Spot Light (Exterior)	90	Cost Savings	6
AMBIENT/AMENITY	48 - 53	D	
- Mosi Bulkhead	49	Decorative Exit (Emergency)	63
- Atlas Bulkhead	50 & 69	Decorative Exterior	84 - 97
- ECO Decorative Bulkhead	51	- Wall Light (Exterior)	84 - 93
- Wall Light	52 - 53	- Bollard	85
Atlas Bulkhead	50 & 69	- Garden Spike	86
Atom Downlight	31	- Wall Light (Exterior) with PIR	87
B		- Wall Light with Solar Panel	87
B45 Mini Globe	120	- Solar Guardian PIR Wall Light	88 - 89
B45 Mini Globe Clear Filament	103	- Adjustable Spot Light (Exterior)	90
Backlit Frameless LuxPanel	13	- Lantern	90 - 91
Bollard	85	Decorative Surface	26
Buried Uplight	77	Downlights (Emergency)	64 & 66
C		Drop Rod Downlight	39
C35 Candle	122	E	
C35 Candle Clear Filament	102	ECO Introduction	8
Capsules	123	ECO Bulkheads	94 - 97
Carbon Downlight	36	ECO Circular Panel	21
Carbon Trust	6	ECO Climate T8	61
Ceres High Bay	56	ECO Decorative Bulkhead	51
Circular Edgelit LuxPanel	20	ECO Edgelit Framed LuxPanel	10
Clear Prism Academy T8	25	Edgelit Framed LuxPanel	14
Climate	59	EMERGENCY	62 - 67
Climate T8	60	- Exit Box	63 & 64
Commercial Exterior	74 - 77	- Decorative Exit	63
		- IP65 Bulkhead	63 & 65

INDEX

- Downlights	64 & 66		
- Twin Spot	64		
- Hanging Blade	65		
- Recessed Blade	65		
Emergency Pack	19 & 67		
Enhanced Capital Allowance	6		
Epsilon	11		
EU Energy Label	5		
Exit Box (Emergency)	63 & 64		
EXTERIOR	68 - 97		
- Atlas Bulkhead	50 & 69		
- Fortis Bulkhead	70		
- Fortis Wallpack	70		
- Guardian Pro Floodlights	72		
- Commercial Exterior	74 - 77		
- Lantern Post Top	74 - 75		
- Road Lantern	75		
- Spot (Exterior)	76		
- Buried Uplight	77		
- Slimline Guardian Floodlights	78		
- Slimline Guardian Floodlights with PIR	79		
- Slimline Rechargeable Work Lights	80 - 81		
- Slimline Portable Work Lights	82		
- Slimline Twin Tripod Work Lights	83		
- Decorative Exterior	84 - 97		
- Wall Light (Exterior)	84 - 93		
- Bollard	85		
- Garden Spike	86		
- Wall Light (Exterior) with PIR	87		
- Wall Light with Solar Panel	87		
- Solar Guardian PIR Wall Light	88 - 89		
- Adjustable Spot Light (Exterior)	90		
- Lantern	90 - 91		
- Eco Bulkheads	94 - 97		
F			
Fortis Bulkhead	70		
Fortis Wallpack	70		
G			
G4 (Capsules)	123		
G9 (Capsules)	123		
Garden Spike	86		
Glass T8	131		
Glossary of Terms	142 - 146		
GU10	109		
GU10 DIM2WARM	113		
GU10 ECO	111		
GU10 Fire Rated Downlights	32		
GU10 Glass	106		
GU10 Standard Downlights	33		
GU10 Wide Angle	110		
Guardian Pro Floodlights	72		
GX53	124		
H			
Hanging Blade (Emergency)	65		
		I	
		Indus	58
		INDUSTRIAL	54 - 61
		- LuxBay	55
		- Ceres High Bay	56
		- Titan High Bay	57
		- Indus	58
		- LuxPack Batten	58
		- Climate	59
		- Climate T8	60
		- ECO Climate T8	61
		IP Rated Downlights	42
		IP Rated LuxPanels	23
		IP65 Bulkhead	63 & 65
		L	
		LAMPS & TUBES	98 - 133
		- A60 Classic Clear Filament	101
		- C35 Candle Clear Filament	102
		- B45 Mini Globe Clear Filament	103
		- MR16 Glass	105
		- GU10 Glass	106
		- GU10	109
		- GU10 Wide Angle	110
		- GU10 ECO	111
		- GU10 DIM2WARM	113
		- MR16 TRUEFIT	114
		- A60 POWERLITE	115
		- A60 Classic	116 - 117
		- A60 DIM2WARM	118
		- A70 Classic	119
		- B45 Mini Globe	120
		- C35 Candle	122
		- G4 Capsule	123
		- G9 Capsules	123
		- GX53	124
		- PLC Series	125
		- R Series	126
		- Par Series	127
		- S15	128
		- Glass T8	131
		- Corn	132
		- RGB 16 Colour LED Strip LuxBand	134
		- White LED Strip LuxBand	135
		- USB Strip Kit	136
		- RGBW Strip Kit	137
		Lantern	90 - 91
		Lantern Post Top	74 - 75
		Lighting Industry Association	5
		Low Glare Downlights	41
		LuxBand	134 - 135
		LuxBay	55
		LuxPack Batten	58
		M	
		Modular Downlight Range	43 - 45

	PAGE		PAGE
Mosi Bulkhead	49	White LED Strip	135
MR16 Glass	105	Why LED	7
MR16 TRUEFIT	114	Wire Suspension	18
O			
Opal Prism Academy	25		
P			
Par Lamps Series	127		
Pendant	26 - 27		
PIR Sensors	139		
Platinum Downlight	35		
Platinum Mini Downlight	34		
PLC Lamps Series	125		
Programmers	141		
R			
R Lamps Series	126		
Recess LuxPanel Frame	18		
Recessed Blade (Emergency)	65		
Recessed Downlight	43		
RGB 16 Colour LED Strip	134		
RGBW Strip Kit	137		
Road Lantern	75		
S			
S15	128		
Semi Recessed Downlight	42		
Sensors	139		
Slimline Guardian Floodlights	78		
Slimline Guardian Floodlights with PIR	79		
Slimline Portable Work Lights	82		
Slimline Rechargeable Work Lights	80 - 81		
Slimline Twin Tripod Work Lights	83		
Solar Guardian PIR Wall Light	88 - 89		
Spot (Exterior)	76		
Spot Light	38		
Square Downlight	39		
Surface Modular LuxPanel	16 - 17		
Surface Mounting LuxPanel Frame	18		
T			
Taska Under Cabinet	46		
Titan High Bay	57		
Track Spot	37		
Twin Spot	64		
U			
Under Cabinet Tile	47		
USB Strip Kit	136		
W			
Wall Light	52 - 53		
Wall Light (Exterior)	84 - 93		
Wall Light (Exterior) with PIR	87		
Wall Light with Solar Panel	87		
Wallwasher	40 - 41		
Warranty	5 & 147		

NOTES

UK:**HEAD OFFICE:**

Email: info@luceco.com
 Luceco plc, Caparo House
 103 Baker Street, London
 England, W1U 6LN

DISTRIBUTION CENTRE:

Tel: +44 (0) 1952 238 100
 Email: uk_sales@luceco.com
 Luceco plc
 Luceco Distribution Centre
 Stafford Park 1, Telford
 Shropshire, England, TF3 3BD

GERMANY:

Tel: +49 40 89066 878 - 0
 Email: eu_sales@luceco.com
 Luceco GmbH
 Holstenplatz 20b
 22765 Hamburg, Germany

FRANCE:

Tel: +33 (0)1 61 10 10 35
 Email: fr_sales@luceco.com
 Luceco SAS France & Belux
 3 Rue de Courtalin
 Magny Le Hongre 77700
 Paris, France

ITALY:

Tel: +39 0434 1696795
 Email: it_sales@luceco.com
 Nexus Italia, Via Amman 10
 33170 Pordenone, Italy

SPAIN:

Tel: +34 93 829 55 75
 Email: es_sales@luceco.com
 Nexus Industries LTD
 C/ Bobinadora 1-5
 08302 Mataró
 Barcelona (SPAIN)

MIDDLE EAST:

Tel: +971 4 609 1867
 Email: mea_sales@luceco.com
 Luceco Middle East FZCO
 Bldg. 5EB, Office 342
 PO Box 371128, DAFZA
 Dubai, UAE

ASIA PACIFIC:**JIAXING:**

Tel: +86 (0) 573 8357 0200
 Email: asia_sales@luceco.com
 No 1438, Jiachuang Road
 Xiuzhou Industrial Park, Jiaxing
 Zhejiang, China, P.C. 314031

HONG KONG:

Tel: +852 3520 2622
 Email: hk_sales@luceco.com
 Luceco (Hong Kong) Ltd
 Unit D, 15th Floor MG Tower
 133 Hoi Bun Road
 Kwun Tong, Kowloon
 Hong Kong

UNITED STATES:

Tel: +1 281 978 2509
 Email: us_sales@luceco.com
 Luceco Inc, 11050 W Little York Road
 Building C-2, Houston, TX 77041,
 USA

MEXICO & LATIN AMERICA:

Tel: +52 (81) 5000 9437
 Email: ventas@luceco.com
 Luceco México S. de R.L. de C.V.
 Batallón de San Patricio #109 Sur,
 Col. Valle Oriente, San Pedro Garza
 García N.L. México CP 66260
 (Torre Avalanz, Piso #20, Oficina
 2009)

AFRICA:

Tel: +27 11 432 6779
 Email: africa_sales@luceco.com
 Unit 2, Cedarwood Office Park
 Cnr. Western Service and
 Mount Lebanon Road, Woodmead
 South Africa, 2144

TECHNICAL SUPPORT:

Tel: 03300 249 279
 Email: technical@luceco.com
 Lines open Monday to Friday
 8.30am to 5pm, with answer phone
 service outside these hours.

LUCECO plc



LUCECO

www.luceco.com