

# THORN

**Fast. Simple. Affordable.**

Contractor Guide 2017



# Thorn contractor guide

## The easy way to buy

We offer products with outstanding quality, easy installation and competitive prices. All this is provided to you in close cooperation with your local wholesaler.

**Save time. Save money. Save energy.**

With our comprehensive portfolio you can realise smaller and larger projects in a fast, cost-effective and energy-efficient manner. According to project requirements, solutions with conventional technology as well as up-to-date LED luminaires can be implemented – depending on your budget.



**Fast.Simple.  
Affordable.  
The Contractor  
range.**



# 5 Year Warranty



As a globally leading luminaire manufacturer, Thorn Lighting provides a five-year warranty for its complete product range within all European Countries. Effective from 1st May 2015.  
[www.thornlighting.co.uk/warranty](http://www.thornlighting.co.uk/warranty)



# Understanding our catalogue numbers

We recognise the importance of making it easier to identify our products through our ordering guides and part numbering system

To support our eControl philosophy and improve our ease to do business with we have now rolled out an initiative to simplify ordering our products. To support this we are listing all of our indoor and outdoor luminaires with an alpha numeric catalogue number in addition to the SAP code and SAP description.

The benefits of this initiative are:

- Easily identifiable part numbers by product range
- Clear and consistent logic across indoor and outdoor product offers
- Orders into our business can now be accepted for all products using a catalogue reference number
- Simplified order placement and processing
- Reduction in order complexity and potential ordering errors

## LER128ZEPRW – Sample catalogue number

# LE R 128 Z

Range (eg.)		Sub-range		LED lumen output		Gear	
AQ	AquaForce	E	Eco	2000	2000 lumens	Z	High Frequency
CH	Chalice	S	Small	4000	4000 lumens	D	DSI/DALI dimmable
LE	Leopard	L	Large	6000	6000 lumens	X	DALI dimmable
JU	Jupiter	<b>Shape</b>		14000	14000 lumens	ZS	High Frequency + Sensor
MN	Menlo	R	Round	<b>Lamp no + wattage</b>		DS	DSI/DALI dim + Sensor
		S	Square	135	1 x 35W	DC	DSI/DALI dim + Corridor Function
		<b>Mounting option</b>		249	2 x 49W		
		R	Recessed	314	3 x 14W		
		SR	Semi-recessed	424	4 x 24W		
		SF	Surface	170	1 x 70W		
		S	Suspended	150	1 x 150W		
		SS	System Suspended				
		SSF	System Surface				
		DI	Direct/Indirect				
		SDI	System Direct/Indirect				

**Notes:**

The logic set out below is followed as closely as possible for all Indoor/Outdoor Product ranges within the Thorn Lighting portfolio. As all ranges differ in scope the requirement for each element of the catalogue number is defined range by range, where some ranges require more fields than others.

The examples above show for each element of the catalogue number how some of the most common product features are defined.

In some instances the same abbreviation may be used for different features.

eg B = Black, B = Blue or MP = Microprism technology, MP = Microperforated.

This is not the case if both these features are common to the same product range and an extra letter may be used to differentiate each version.

**E****PR****W**

Emergency		Optic		Colour		Miscellaneous	
E	3hr standard emergency	LV	Louvre	W	White	PB	Plasterboard version
EX	3hr adressable emergency	OP	Opal	B	Black/Blue	FIL	Filter
EH	3hr high output emergency	PR	Prismatic	G	Grey/Green	REF	Reflector
		MP	Micro prism tech/perforated	R	Red	DIF	Diffuser
		RK	Rack	Y	Yellow	3K	3000K
		WD	Wide			4K	4000K
		NW	Narrow			C	Connect version
		SP	Spot				
		FL	Flood				
		M	Medium beam				
		AS	Asymetric				
		MB	Mirrorbrite				
		SB	Satinbrite				

# Contents

---

## RECESSED MOUNTED

**NEW**



10 LIMO Set

**NEW**



12 IQ Wave



16 Omega LED



18 Omega LED Circular



20 Omega Pro

**NEW**



22 Beta Panel/Beta Office

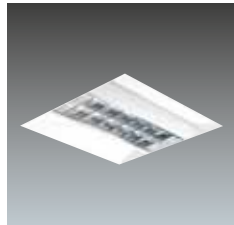

24 IndiQuattro

## SURFACE MOUNTED

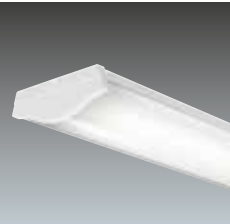

26 Diffusalux

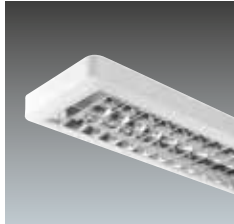

28 Punch II



30 College LED



32 College

## DOWNLIGHTS



34 Cetus LED

**NEW**



36 Cetus Mini

BATTENS



38 ArrowFlex



40 PopPack LED



42 PopPack



46 PopPack Pro

WATERPROOF



48 AquaForce II LED

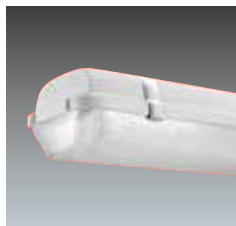

50 AquaForce II

INDUSTRIAL



52 HiPak



54 HiPak Pro LED



56 ImpactForce LED



58 CorrsionForce LED



60 Hi-Rack

# Contents

---

## WALL MOUNTED



62 Leopard LED 64 Leopard



66 Loire LED



68 Danube LED



70 Club LED



72 Novaline LED

## EMERGENCY



74 Voyager Blade Series



76 Voyager Escape



78 Voyager Compact LED



80 Voyager Twin Spot



AREA FLOODLIGHTING

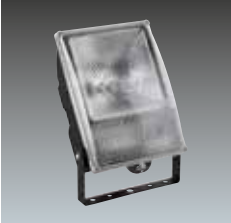

82 Sonpak LX

WALL MOUNTED



84 Piazza II

URBAN AMENITY LIGHTING



86 Charior



88 D-CO LED Bollard

SURFACE ARCHITECTURAL FLOOD



90 D-CO LED Floodlight

RECESSED ARCHITECTURAL FLOOD



92 D-CO LED Recessed

STREET LIGHTING



94 FleXity

# LIMO Set NEW

Choice of modern LED luminaires



Omega LED r2m



Omega Pro r2m



Chalice r2m



Chalice Pro r2m



r2m Refurbishment Kit

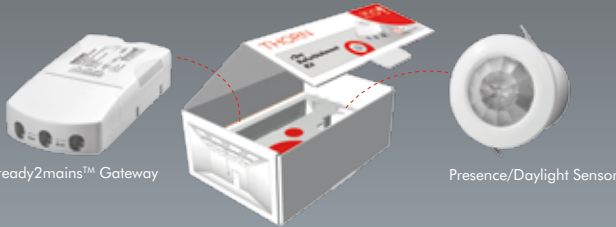

ready2mains™ Gateway

Presence/Daylight Sensor

- The Light Modernisation Set based on the ready2mains™ technology is ideal for a quick and easy 1:1 replacement of luminaires with conventional technology
- Instant solution for energy saving
- Presence detection and daylight control (optional with push-button for manual control)
- No dedicated dimming cables to the luminaires necessary, existing cables can be reused

## Case study



7 r2m Refurbishment Kits



37 Omega Pro r2m

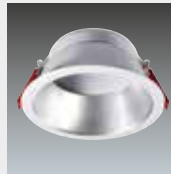

13 Chalice r2m



### Energy efficiency

#### Investment costs vs. running costs of solution (10 years, absolute)

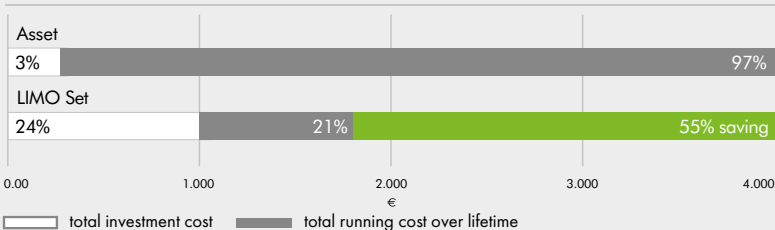

### Before

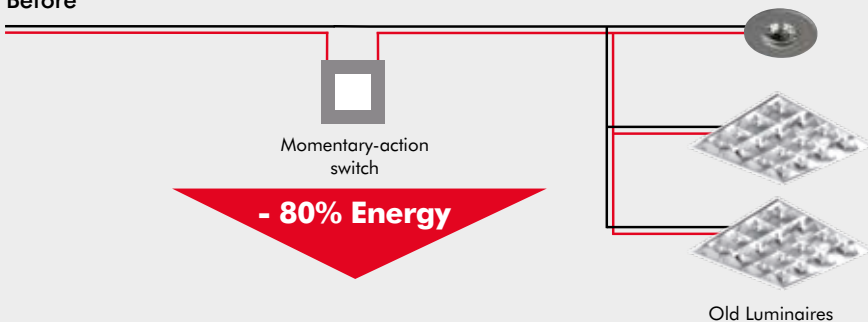

### After

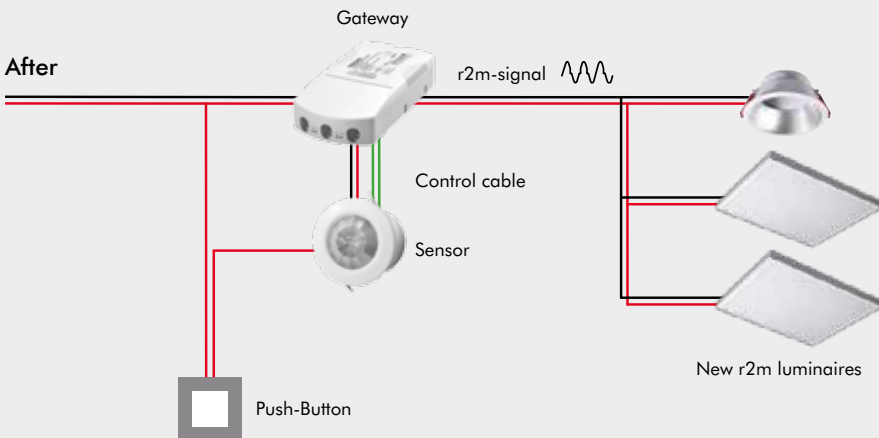

- ready2mains™ uses simple phase-cuts to send digital commands via the mains wiring
- Dimming capabilities without any control cables to luminaires
- Cost-effective installation in next to no time
- Up to 15 r2m luminaires (or max. 400 VA) are controlled as a group, broadcast control for all connected luminaires in that group
- Very stable technology, which uses the existing mains
- No powerline problems, gateway protects supply lines from system incidents



Better lighting quality



Easy installation



Quick 1:1 replacement



Cost effective



Smart controls without costly rewiring



Recessed

# IQ Wave NEW

Standards



Installation Options



Our next generation office luminaire features intelligent innovation in 4 key areas, design, optic, control and installation

- Design: simple and flowing lines create a modern but simplistic aesthetic perfect for an elegant office interior
- Optics: innovative MV tech optic designed by our expert optical team offers excellent uniformity and glare control, direct/indirect light for illuminance on faces and walls to encourage a comfortable, communicative working environment
- Controls: integrated sensors allow you to create flexible controls systems suited to your needs. We have introduced a wireless RF solution for easy retro fit with no rewiring. Also available are integrated PIR and Microwave sensors
- Installation: with our new red flag design you can easily access the pull up set from below the ceiling without the need to remove the optics from the product, allowing for a more secure fixing to the ceiling

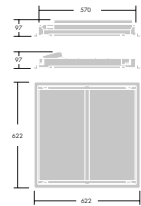
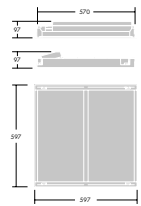

## Materials and Finish

- Frame and end caps: polycarbonate
- Diffuser: polycarbonate, aluminium designed heat sink
- Body: high reflective steel coffer
- Gear tray: pre-coated white steel

## Installation and Mounting

- Suitable for lay in, with accessory
- Suitable for pull up into concealed grid and plasterboard ceilings



# IQ Wave <sup>NEW</sup>

## Ordering Guide

Description	Circuit Power (W)	Wt (kg)	SAP Code	Cat No.
<b>IQ WAVE - HIGH FREQUENCY/READY2MAINS</b>				
IQ WAVE LED3100-830 R2M Q597 MRE	30.0	4.6	96628132	IQWR3100R3K
IQ WAVE LED3100-840 R2M Q597 MRE	30.0	4.6	96628133	IQWR3100R4K
IQ WAVE LED3100-865 R2M Q597 MRE	30.0	4.6	96628134	IQWR3100R6K
IQ WAVE LED4100-830 R2M Q597 MRE	40.5	4.6	96628135	IQWR4100R3K
IQ WAVE LED4100-840 R2M Q597 MRE	40.5	4.6	96628136	IQWR4100R4K
IQ WAVE LED4100-865 R2M Q597 MRE	40.5	4.6	96628137	IQWR4100R6K
<b>IQ WAVE - HIGH FREQUENCY/READY2MAINS EMERGENCY</b>				
IQ WAVE LED3100-840 R2M E3 Q597 MRE	30.0	-	96628316	IQWR3100RE4K
IQ WAVE LED4100-840 R2M E3 Q597 MRE	40.5	-	96628317	IQWR4100RE4K
<b>IQ WAVE - HIGH FREQUENCY/READY2MAINS COMPLETE WITH INTEGRAL MICROWAVE SENSOR</b>				
IQ WAVE LED3100-840 R2M MWS Q597 MRE	-	-	myProduct	IQWR3100ZM4K
IQ WAVE LED4100-840 R2M MWS Q597 MRE	-	-	myProduct	IQWR4100ZM4K
<b>IQ WAVE - DALI DIMMABLE</b>				
IQ WAVE LED3100-840 HFIX Q597 MRE	-	-	myProduct	IQWR3100X4K
IQ WAVE LED4100-840 HFIX Q597 MRE	-	-	myProduct	IQWR4100X4K
IQ WAVE LED3100-840 HFIX E3 Q597 MRE	-	-	myProduct	IQWR3100XE4K
IQ WAVE LED4100-840 HFIX E3 Q597 MRE	-	-	myProduct	IQWR4100XE4K
IQ WAVE LED3100-840 HFIX E3TX Q597 MRE	-	-	myProduct	IQWR3100EX4K
IQ WAVE LED4100-840 HFIX E3TX Q597 MRE	-	-	myProduct	IQWR4100EX4K
<b>IQ WAVE - DALI DIMMABLE COMPLETE WITH INTEGRAL PIR SENSOR</b>				
IQ WAVE LED3100-840 HFSX Q597 MRE	-	-	myProduct	IQWR3100XS4K
IQ WAVE LED4100-840 HFSX Q597 MRE	-	-	myProduct	IQWR4100XS4K
<b>IQ WAVE - WIRELESS RADIO FREQUENCY</b>				
IQ WAVE LED3100-840 RF Q597 MRE	-	-	myProduct	IQWR3100W4K
IQ WAVE LED4100-840 RF Q597 MRE	-	-	myProduct	IQWR4100W4K
IQ WAVE LED3100-840 RF E3 Q597 MRE	-	-	myProduct	IQWR3100WE4K
IQ WAVE LED4100-840 RF E3 Q597 MRE	-	-	myProduct	IQWR4100WE4K
IQ WAVE LED3100-840 RF E3TX Q597 MRE	-	-	myProduct	IQWR3100WEX4K
IQ WAVE LED4100-840 RF E3TX Q597 MRE	-	-	myProduct	IQWR4100WEX4K
IQ WAVE LED3100-840 RF MWS Q597 MRE	-	-	myProduct	IQWR3100WM4K
IQ WAVE LED4100-840 RF MWS Q597 MRE	-	-	myProduct	IQWR4100WM4K
<b>IQ WAVE - MOUNTING ACCESSORY</b>				
IQ WAVE RED FLAG PULL UP KIT		1.0	96628290	IQWRPULLUPKIT

## Performance Guide - 3100 lumens

Open plan office

Ceiling Height	Luminaire Spacings	Lux Level Average	Uniformity	UGR	Cylindrical Illuminance	Modelling Index
Metres	Metres	$E_m$	$U_o$	UGR	$E_{cyl}$	$E_{cyl}/E_m$
2.4	3.0 x 3.0	327 lux	0.65	18	142 lux	0.43
	3.0 x 2.4	403 lux	0.76	18	168 lux	0.42
	2.4 x 2.4	493 lux	0.87	18	200 lux	0.41
2.7	3.0 x 3.0	319 lux	0.84	18	135 lux	0.42
	3.0 x 2.4	388 lux	0.81	18	164 lux	0.42
	2.4 x 2.4	473 lux	0.88	18	196 lux	0.41
3.0	3.0 x 3.0	310 lux	0.89	18	129 lux	0.42
	3.0 x 2.4	376 lux	0.83	18	155 lux	0.41
	2.4 x 2.4	459 lux	0.88	18	187 lux	0.41

Based on a 13.8 x 13.8 metre open plan office with 70/50/20 reflectances, a 0.80 maintenance factor and 0.8 working plane

## Performance Guide - 4100 lumens

Open plan office

Ceiling Height	Luminaire Spacings	Lux Level Average	Uniformity	UGR	Cylindrical Illuminance	Modelling Index
Metres	Metres	$E_m$	$U_o$	UGR	$E_{cyl}$	$E_{cyl}/E_m$
2.4	3.0 x 3.0	433 lux	0.65	19	187 lux	0.43
	3.0 x 2.4	534 lux	0.76	19	223 lux	0.42
	2.4 x 2.4	652 lux	0.87	19	265 lux	0.41
2.7	3.0 x 3.0	422 lux	0.84	19	178 lux	0.42
	3.0 x 2.4	513 lux	0.81	19	217 lux	0.42
	2.4 x 2.4	625 lux	0.88	19	260 lux	0.42
3.0	3.0 x 3.0	410 lux	0.89	19	170 lux	0.41
	3.0 x 2.4	498 lux	0.83	19	205 lux	0.41
	2.4 x 2.4	607 lux	0.88	19	247 lux	0.41

Based on a 13.8 x 13.8 metre open plan office with 70/50/20 reflectances, a 0.80 maintenance factor and 0.8 working plane



Recessed

# Omega LED

Standards



Installation Options

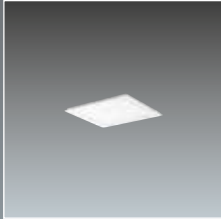

300 x 300



600 x 600

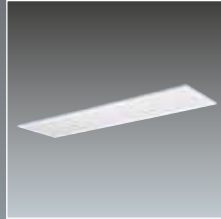

300 x 1200

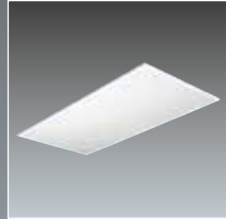

600 x 1200

LED edge lit panel, direct replacement for traditional T8 linear fluorescent with additional choice of installation method

- Only 40W total load, up to 55% energy saving vs fluorescent equivalents
- >100lm/W – exceeding building regulation requirements
- 50 000 hours rated life, equivalent to 13 years at 10 hours per day operation
- Choice of 3000K warm white or 4000K cool white to suit application use
- DALI dimming option further increases energy savings
- Integral 3 hour emergency option reduces installation time and complexity

**Materials and Finish**

- Body: mild steel sheet, white (RAL9016)
- Diffuser: UV-stabilized, opal acrylic

**Installation and Mounting**

- Recessed: lay in for most suspended T15/24 ceilings
- 300x300 suitable for pull up installations (concealed & plasterboard ceilings)
- Surface: collar type – fixed to the ceiling with 4 screws via keyhole slots, product to be layed in
- Suspended: suspended via adjustable wire suspension (1500mm), 4 fixing points to the ceiling, 300x300, 300x1200 and 1200x600 are not suitable for suspension

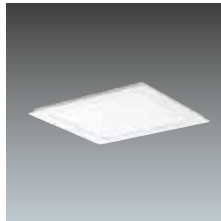

300x300



300x1200

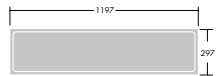
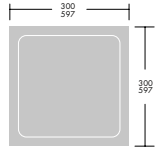

**Omega LED**

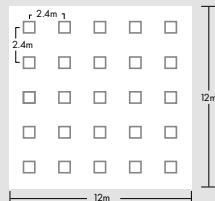

Room height	2.8m
Work Plane	0.75m
Maintenance factor	0.8
Reflectances	Ceiling: 80%
	Floor: 20%
Cat. No.	OM3250Z4K
Lamp	LED
Lumens	3250 lm
Lux	479 lux



## Ordering Guide

Option	Description	Circuit Power (W)	Wt (Kg)	SAP Code	Cat No.
<b>OMEGA LED - 300x300 1000lm</b>					
HF	OMEGA LED 1000 HF L830	12.3	2.3	96602036	OM1000Z3K
	OMEGA LED 1000 HF L840	12.3	2.3	96602040	OM1000Z4K
HF Emergency	OMEGA LED 1000 HF E3 L830	12.3	3.8	96602038	OM1000ZE3K
	OMEGA LED 1000 HF E3 L840	12.3	3.8	96602042	OM1000ZE4K
HF Dimming	OMEGA LED 1000 HFIX L830	12.3	2.3	96602037	OM1000X3K
	OMEGA LED 1000 HFIX L840	12.3	2.3	96602041	OM1000X4K
HF Dimming Emergency	OMEGA LED 1000 HFIX E3 L830	12.3	3.8	96602039	OM1000XE3K
	OMEGA LED 1000 HFIX E3 L840	12.3	3.8	96602043	OM1000XE4K
<b>OMEGA LED - 600x600 3250lm</b>					
HF	OMEGA LED 3250 HF L830 597	32.0	5.0	96241575	OM3250Z3K
	OMEGA LED 3250 HF L840 597	32.0	5.0	96241576	OM3250Z4K
HF Emergency	OMEGA LED 3250 HF E3 L830 597	32.0	6.1	96241583	OM3250ZE3K
	OMEGA LED 3250 HF E3 L840 597	32.0	6.1	96241584	OM3250ZE4K
HF Dimming	OMEGA LED 3250 HFIX L830 597	32.0	5.0	96241579	OM3250X3K
	OMEGA LED 3250 HFIX L840 597	32.0	5.0	96241580	OM3250X4K
HF Dimming Emergency	OMEGA LED 3250 HFIX E3 L830 597	32.0	6.1	96241585	OM3250XE3K
	OMEGA LED 3250 HFIX E3 L840 597	32.0	6.1	96241586	OM3250XE4K
<b>OMEGA LED - 600x600 3900lm</b>					
HF	OMEGA LED 3900 HF L830 597	40.0	5.0	96627648	OM3900Z3K
	OMEGA LED 3900 HF L840 597	40.0	5.0	96627647	OM3900Z4K
HF Emergency	OMEGA LED 3900 HF E3 L830 597	40.0	6.1	96627640	OM3900ZE3K
	OMEGA LED 3900 HF E3 L840 597	40.0	6.1	96627639	OM3900ZE4K
HF Dimming	OMEGA LED 3900 HFIX L830 597	40.0	5.0	96627644	OM3900X3K
	OMEGA LED 3900 HFIX L840 597	40.0	5.0	96627643	OM3900X4K
HF Dimming Emergency	OMEGA LED 3900 HFIX E3 L830 597	40.0	6.1	96627638	OM3900XE3K
	OMEGA LED 3900 HFIX E3 L840 597	40.0	6.1	96627637	OM3900XE4K
<b>OMEGA LED - 300x1200 4000lm</b>					
HF	OMEGA LED 4000 HF L830 297x1197	44.4	4.6	96241587	OM4000Z3K
	OMEGA LED 4000 HF L840 297x1197	44.4	4.6	96241588	OM4000Z4K
HF Emergency	OMEGA LED 4000 HF E3 L830 297x1197	44.4	6.1	96241591	OM4000ZE3K
	OMEGA LED 4000 HF E3 L840 297x1197	44.4	6.1	96241592	OM4000ZE4K
HF Dimming	OMEGA LED 4000 HFIX L830 297x1197	44.4	4.6	96241589	OM4000X3K
	OMEGA LED 4000 HFIX L840 297x1197	44.4	4.6	96241590	OM4000X4K
HF Dimming Emergency	OMEGA LED 4000 HFIX E3 L830 297x1197	44.4	6.1	96241593	OM4000XE3K
	OMEGA LED 4000 HFIX E3 L840 297x1197	44.4	6.1	96241594	OM4000XE4K
<b>OMEGA LED - 600x1200 5700lm</b>					
HF	OMEGA LED 5700-830 HF 597X1197 MRE	64.0	6.0	96627787	OM5700Z3K
	OMEGA LED 5700-840 HF 597X1197 MRE	64.0	6.0	96627786	OM5700Z4K
HF Dimming	OMEGA LED 5700-830 HFIX 597X1197 MRE	64.0	6.0	96627789	OM5700X3K
	OMEGA LED 5700-840 HFIX 597X1197 MRE	64.0	6.0	96627788	OM5700X4K
<b>OMEGA LED MOUNTING ACCESSORIES</b>					
	GRIPPLE SAFETY WIRE	-	0.1	96239327	GSWIRE
	OMEGA LED SURFACE MTG KIT 297x1197	-	2.7	96241760	OMSUR12X3KIT
	OMEGA LED SURFACE MTG KIT 597	-	2.5	96241603	OMSM3250KIT
	OMEGA LED SUSPENSION KIT	-	0.8	96241604	OMSUSKIT
	OMEGA PLASTERBOARD MOUNTING KIT E3 Q597	-	1.6	96627712	OMPBE36X6KIT
	OMEGA PLASTERBOARD MOUNTING KIT Q597	-	1.6	96627893	OMPBE36X6KIT
	OMEGA SLIM SURFACE MOUNT KIT 297X297*	-	1.0	96628002	OMS3X3KIT
	OMEGA SLIM SURFACE MOUNT KIT 597X597*	-	1.8	96628003	OMS6X6KIT
	OMEGA SLIM SURFACE MOUNT KIT 297X1197*	-	2.6	96628005	OMS12X3KIT

\*These kits are not suitable with emergency luminaires



Recessed

# Omega LED Circular

Standards



Installation Options



Versatile circular alternative to traditional 600x600 luminaires

- 90Lm/W – exceeding building regulation requirements
- 50 000 hours rated life, equivalent to 13 years at 10 hours per day operation
- Choice of 3000K warm white or 4000K cool white to suit application use
- DALI dimming option further increases energy savings
- Integral 3 hour emergency option reduces installation time and complexity

## Materials and Finish

- Aluminium frame with white finish steel body/diffuser UV-stabilized, opal acrylic
- Available in 3 sizes:  
200mm: 1600lm, 400mm: 2800lm, 500mm: 3200lm

## Installation and Mounting

- Recessed: using the unique additional housing it can be installed in plasterboard, with no need for special tools
- With the use of simple mounting kits, the recessed version offers increased flexibility, for use where either surface or suspended mounting is required
- Surface: surface mount box - fixed to the ceiling with 4 screws via keyhole slots

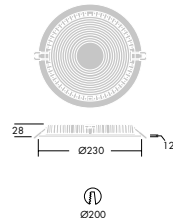

Ø200

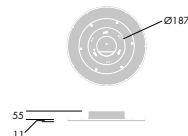

Ø400

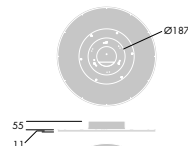

Ø500



## Ordering Guide

Description	Circuit Power (W)	Wt (Kg)	SAP Code	Cat No.	
<b>OMEGA LED CIRCULAR</b>					
HF	OMEGA C LED1600-840 HF R200	16.4	1.0	96627762	OMC1600Z4K
	OMEGA C LED1600-830 HF R200	16.4	1.0	96627763	OMC1600Z3K
	OMEGA C LED2800-840 HF R400	33.0	3.3	96627770	OMC2800Z4K
	OMEGA C LED2800-830 HF R400	33.0	3.3	96627771	OMC2800Z3K
	OMEGA C LED3200-840 HF R500	42.0	4.5	96627778	OMC3200Z4K
	OMEGA C LED3200-830 HF R500	42.0	4.5	96627779	OMC3200Z3K
HF Dimming	OMEGA C LED1600-840 HFIX R200	16.4	1.0	96627764	OMC1600X4K
	OMEGA C LED1600-830 HFIX R200	16.4	1.0	96627765	OMC1600X3K
	OMEGA C LED2800-840 HFIX R400	33.0	3.3	96627772	OMC2800X4K
	OMEGA C LED2800-830 HFIX R400	33.0	3.3	96627773	OMC2800X3K
	OMEGA C LED3200-840 HFIX R500	42.0	4.5	96627780	OMC3200X4K
	OMEGA C LED3200-830 HFIX R500	42.0	4.5	96627781	OMC3200X3K
HF Emergency	OMEGA C LED1600-840 HF E3 R200	16.4	1.0	96627766	OMC1600ZE4K
	OMEGA C LED1600-830 HF E3 R200	16.4	1.0	96627767	OMC1600ZE3K
	OMEGA C LED2800-840 HF E3 R400	33.0	3.3	96627774	OMC2800ZE4K
	OMEGA C LED2800-830 HF E3 R400	33.0	3.3	96627775	OMC2800ZE3K
	OMEGA C LED3200-840 HF E3 R500	42.0	4.5	96627782	OMC3200ZE4K
	OMEGA C LED3200-830 HF E3 R500	42.0	4.5	96627783	OMC3200ZE3K
HF Dimming Emergency	OMEGA C LED1600-840 HFIX E3 R200	16.4	1.0	96627768	OMC1600XE4K
	OMEGA C LED1600-830 HFIX E3 R200	16.4	1.0	96627769	OMC1600XE3K
	OMEGA C LED2800-840 HFIX E3 R400	33.0	3.3	96627776	OMC2800XE4K
	OMEGA C LED2800-830 HFIX E3 R400	33.0	3.3	96627777	OMC2800XE3K
	OMEGA C LED3200-840 HFIX E3 R500	42.0	4.5	96627784	OMC3200XE4K
	OMEGA C LED3200-830 HFIX E3 R500	42.0	4.5	96627785	OMC3200XE3K

Recessed

# Omega Pro

## Standards



## Installation Options



600 x 600



300 x 1200

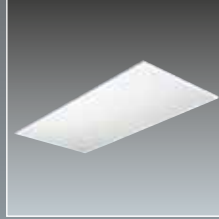

600 x 1200

Glare controlled LED edge lit panel, direct replacement for traditional T8 linear fluorescent for use in applications using VDU screens

- Suitable for an office environment
- Only 40W total load, up to 55% energy saving vs fluorescent equivalents
- >100lm/W – exceeding building regulation requirements
- 50 000 hours rated life, equivalent to 13 years at 10 hours per day operation
- Choice of 3000K warm white or 4000K cool white to suit application use
- DALI dimming further increases energy savings
- Integral 3 hour emergency option reduces installation time and complexity

## Materials and Finish

- Body: mild steel sheet, white (RAL9016)
- Diffuser: UV-stabilized, opal acrylic

## Installation and Mounting

- Recessed: lay in for most suspended T15/24 ceilings
- Surface: collar type – fixed to the ceiling with 4 screws via keyhole slots, product to be layed in
- Suspended: suspended via adjustable wire suspension (1500mm), 4 fixing points to the ceiling, 1200x300 and 1200x600 not suitable for suspension.

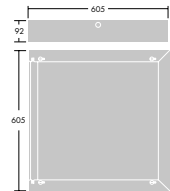
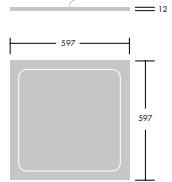
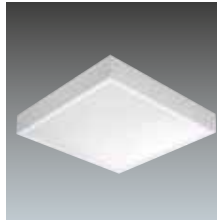

## Ordering Guide

Option	Description	Circuit Power (W)	Wt (Kg)	SAP Code	Cat No.
<b>OMEGA PRO</b>					
HF	OMEGA PRO 4100 HF Q597 LED840	41.0	5.6	96627254	OMP4100Z4K
	OMEGA PRO 4100 HF Q597 LED830	41.0	5.6	96627259	OMP4100Z3K
	OMEGA PRO 4100 HF Q597 MRM LED840	41.0	6.0	96637287	OMP4100Z4KM
	OMEGA PRO 4100 HF Q597 MRM LED830	41.0	6.0	96637292	OMP4100Z3KM
HF Emergency	OMEGA PRO 4100 HF E3 Q597 LED840	41.0	7.2	96627258	OMP4100ZE4K
	OMEGA PRO 4100 HF E3 Q597 LED830	41.0	7.2	-	OMP4100ZE3K
	OMEGA PRO 4100 HF E3 Q597 MRM LED840	41.0	7.6	96637291	OMP4100ZE4KM
	OMEGA PRO 4100 HF E3 Q597 MRM LED830	41.0	7.6	-	OMP4100ZE3KM
HF Dimming	OMEGA PRO 4100 HFIX Q597 LED840	41.0	5.6	96627255	OMP4100D4K
	OMEGA PRO 4100 HFIX Q597 LED830	41.0	5.6	96627260	OMP4100D3K
	OMEGA PRO 4100 HFIX Q597 MRM LED840	41.0	6.0	96637288	OMP4100D4KM
	OMEGA PRO 4100 HFIX Q597 MRM LED830	41.0	6.0	96637293	OMP4100D3KM
HF Dimming Emergency	OMEGA PRO 4100 HFIX E3 Q597 LED840	41.0	7.2	96637278	OMP4100DE4K
	OMEGA PRO 4100 HFIX E3 Q597 LED830	41.0	7.2	-	OMP4100DE3K
	OMEGA PRO 4100 HFIX E3 Q597 MRM LED840	41.0	7.6	96637297	OMP4100DE4KM
	OMEGA PRO 4100 HFIX E3 Q597 MRM LED830	41.0	7.6	-	OMP4100DE3KM

## OMEGA PRO 3X12

HF	OMEGA PRO 3150 HF 3X12 LED840	30.6	5.6	96627424	OMP3150Z4K
	OMEGA PRO 3150 HF 3X12 LED830	30.6	5.6	96627425	OMP3150Z3K
HF Emergency	OMEGA PRO 3150 HF E3 3X12 LED840	30.6	7.4	96627428	OMP3150ZE4K
	OMEGA PRO 3150 HF E3 3X12 LED830	36	7.4	96627429	OMP3150ZE3K
HF Dimming	OMEGA PRO 3150 HFIX 3X12 LED840	30.6	5.6	96627426	OMP3150X4K
	OMEGA PRO 3150 HFIX 3X12 LED830	30.6	5.6	96627427	OMP3150X3K
HF Dimming Emergency	OMEGA PRO 3150 HFIX E3 3X12 LED840	36	7.4	96627432	OMP3150XE4K
	OMEGA PRO 3150 HFIX E3 3X12 LED830	36	7.4	96627433	OMP3150XE3K
	OMEGA PRO 3150 HFI-X E3TX 3X12 LED840	36	7.4	96627434	OMP3150XEX4K
	OMEGA PRO 3150 HFI-X E3TX 3X12 LED830	36	7.4	96627435	OMP3150XEX3K

## OMEGA PRO 6X12

HF	OMEGA PRO 6000 HF 597X1197 LED840	53	11.5	96627456	OMP6000Z4K
	OMEGA PRO 6000 HF 597X1197 LED830	53	11.5	96627457	OMP6000Z3K
HF Emergency	OMEGA PRO 6000 HF E3 597X1197 LED840	53	13.0	96627460	OMP6000ZE4K
	OMEGA PRO 6000 HF E3 597X1197 LED830	53	13.0	96627461	OMP6000ZE3K
HF Dimming	OMEGA PRO 6000 HFIX 597X1197 LED840	53	11.5	96627458	OMP6000D4K
	OMEGA PRO 6000 HFIX 597X1197 LED830	53	11.5	96627459	OMP6000D3K
HF Dimming Emergency	OMEGA PRO 6000 HFIX E3 597X1197 LED840	53	13.0	96627464	OMP6000DE4K
	OMEGA PRO 6000 HFIX E3 597X1197 LED830	53	13.0	96627465	OMP6000DE3K
	OMEGA PRO 6000 HFI-X E3TX 597X1197 LED840	53	13.0	96627466	OMP6000DEX4K
	OMEGA PRO 6000 HFI-X E3TX 597X1197 LED830	53	13.0	96627467	OMP6000DEX3K

## OMEGA PRO MOUNTING ACCESSORIES

GRIPPLE SAFETY WIRE	-	0.01	96239327	GSWIRE
OMEGA LED SURFACE MTG KIT 297x1197	-	2.7	96241760	OMSUR12X3KIT
OMEGA LED SURFACE MTG KIT 597	-	2.5	96241603	OMSM3250KIT
OMEGA LED SUSPENSION KIT	-	0.8	96241604	OMSUKIT
OMEGA PLASTERBOARD MOUNTING KIT E3 Q597	-	1.6	96627712	OMPBS6X6KIT
OMEGA PLASTERBOARD MOUNTING KIT Q597	-	1.8	96627893	OMPBE36X6KIT
OMEGA SLIM SURFACE MOUNT KIT 297X297*	-	1.0	96628002	OMS3X3KIT
OMEGA SLIM SURFACE MOUNT KIT 597X597*	-	1.8	96628003	OMS6X6KIT
OMEGA SLIM SURFACE MOUNT KIT 297X1197*	-	2.6	96628005	OMS12X3KIT

\*These kits are not suitable with emergency luminaires

Recessed

# Beta Panel/Beta Office NEW

Standards

IP20 40	IK03	650°C		T <sub>a</sub> 25
------------	------	-------	---	-------------------



Installation Options



An alternative recessed panel which bridges the economic gap between LED technology and conventional light sources

- Beta Panel has an opal acrylic diffuser and offers a UGR glare rating of <22, making it suitable for circulation and breakout areas
- Beta Office has a prismatic diffuser offering a UGR glare rating of <19 in most room sizes and <2500 cd/m<sup>2</sup> at 65°, complying with EN12464 makes it perfect for an office environment
- High performance luminaire whilst maintaining minimalistic construction ensuring affordability
- Option to surface mount using accessory code: 96241603

## Materials and Finish

- Aluminium frame, Beta Panel with opal diffuser and Beta Office with prismatic version

## Installation and Mounting

- Suitable for lay-in mounting in exposed T grid systems

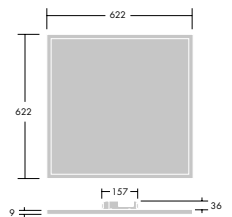
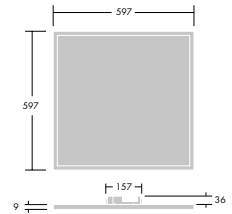
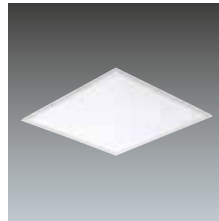



## Ordering Guide

Description	Circuit Power (W)	Wt (Kg)	SAP Code	Cat No.
<b>BETA PANEL</b>				
BETA LED3400-840 HF Q597	34.4	4.0	96628021	BET3400Z4K
BETA LED3400-830 HF Q597	34.4	4.0	96628022	BET3400Z3K
BETA LED3400-840 HF E3 Q597	34.4	4.0	96644037	BET3400ZE4K
<b>BETA OFFICE</b>				
BETA OFFICE LED3400-840 HF Q597	34.4	4.0	96644029	BETO3400Z4K
BETA OFFICE LED3400-830 HF Q597	34.4	4.0	96644031	BETO3400Z3K
BETA OFFICE LED3400-840 HF E3 Q597	34.4	6.0	96644035	BETO3400ZE4K
BETA OFFICE LED3400-830 HF E3 Q597	34.4	6.0	96644036	BETO3400ZE3K
<b>SURFACE MOUNTING ACCESSORIES</b>				
OMEGA LED SURFACE MTG KIT 597			96241603	OMSM3250KIT
SURFACE MOUNT KIT 597X597*			96628003	OMS6X6KIT

\*These kits are not suitable with emergency luminaires

## Performance Guide

Open plan office

Ceiling Height	Luminaire Spacings	Lux Level Average	Cylindrical Illuminance
Metres	Metres	$E_m$	$E_{cyl}$
2.4	3.0 x 3.0	355 lux	179 lux
	3.0 x 2.4	434 lux	215 lux
	2.4 x 2.4	530 lux	256 lux
2.7	3.0 x 3.0	344 lux	168 lux
	3.0 x 2.4	419 lux	202 lux
	2.4 x 2.4	512 lux	243 lux
3.0	3.0 x 3.0	333 lux	158 lux
	3.0 x 2.4	406 lux	190 lux
	2.4 x 2.4	495 lux	229 lux

Based on a 13.8 x 13.8 metre open plan office with 70/50/20 reflectances, a 0.80 maintenance factor and 0.8 working plane

Recessed

# IndiQuattro

## Standards



## Installation Options

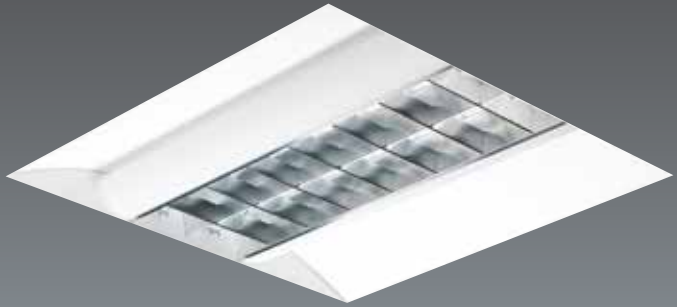

A range of slim recessed fluorescent direct/indirect luminaires providing efficient and well balanced task and ambient lighting

- Easy to install and maintain, even in shallow ceiling voids, due to robust but slim 70 mm body with easily removed and retained optics
- Fast access to terminal block via flap in rear of body
- High light output and efficacy >55 lm/W, as well as luminance limit options below 1500 cd/m<sup>2</sup> or 3000 cd/m<sup>2</sup>
- The same great looking IndiQuattro louvre and diffuser optics and a shallow coffer for good architectural integration and ceiling brightness impression
- Supplied complete with lamp(s)

## Materials and Finish

- Body: white pre-painted steel (close to RAL 9010)
- Coffer: sheet steel, post painted textured white (close to RAL 9010)
- Diffuser: micro-perforated white painted steel or reeded opal acrylic
- Louvre: aluminium in Satinbrite finish with micro-perforated white-painted steel sides

## Installation and Mounting

- Suitable for lay-in only into 15mm or 24mm exposed tee grids.
- Luminaire is offered into the ceiling and simply lays onto the ceiling grid, with easy electrical connection via external access flap on rear of body.
- Optics are easily removed and self-retained on one side for ease of lamp access

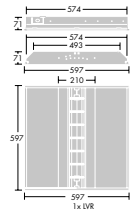
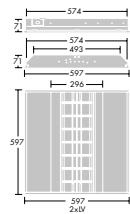

## IndiQuattro

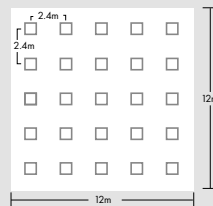

Room height	2.8m
Work Plane	0.75m
Maintenance factor	0.8
Reflectances	Ceiling: 80%
	Wall: 60%
	Floor: 20%
Cat. No.	IQ155ZLV
Lamp	CFL
Lumens	2400 lm
Lux	504 lux





## Ordering Guide

Option	Description	Circuit Power (W)	Wt (Kg)	SAP Code	Cat No.
<b>INDIQUATTRO</b>					
HF	IQ 1x55W TC-L HF LV L840	57.0	3.7	96239769	IQ155ZLV
	IQ 2x24W T16 HF LV L840	49.0	3.7	96239767	IQ224ZLV
	IQ 2x40W TC-L HF LV L840	90.0	3.9	96239766	IQ240ZLV
	IQ 2x55W TC-L HF LV L840	97.0	3.9	96547374	IQ255ZLV
HF Emergency	IQ 4x14W T16 HF LV L840	63.0	3.9	96547375	IQ414ZLV
	IQ 1x55W TC-L HF E3 LV L840	57.0	4.7	96547399	IQ155ZELV
	IQ 2x24W T16 HF E3 LV L840	49.0	4.5	96547411	IQ224ZELV
	IQ 2x40W TC-L HF E3 LV L840	90.0	4.8	96547400	IQ240ZELV
HF Dimming	IQ 2x55W TC-L HF E3 LV L840	97.0	4.9	96547410	IQ255ZELV
	IQ 4x14W T16 HF E3 LV L840	67.0	4.5	96547412	IQ414ZELV
	IQ 1x55W TC-L HFI LV L840	60.0	4.8	96549971	IQ155DLV
	IQ 2x24W T16 HFI LV L840	49.5	4.8	96549980	IQ224DLV
HF Dimming Emergency	IQ 2x40W TC-L HFI LV L840	86.0	4.6	96549989	IQ240DLV
	IQ 2x55W TC-L HFI LV L840	117.0	4.3	96550004	IQ255DLV
	IQ 4x14W T16 HFIX LV L840	60.5	4.7	96549998	IQ414XLV
HF Dimming Emergency	IQ 1x55W TC-L HFI E3 LV L840	60.0	5.2	96549967	IQ155DELV
	IQ 2x24W T16 HFI E3 LV L840	49.5	5.4	96549976	IQ224DELV
	IQ 2x40W TC-L HFI E3 LV L840	86.0	3.9	96549985	IQ240DELV
	IQ 2x55W TC-L HFI E3 LV L840	117.0	5.2	96550005	IQ255DELV
	IQ 4x14W T16 HFIX E3 LV L840	60.5	5.2	96550001	IQ414XELV

Micro-perforated and reed opal diffuser versions available. Visit [www.thornlighting.co.uk/INDQ](http://www.thornlighting.co.uk/INDQ) for more information

# Diffusalux

## Standards



## Installation Options



A range of curved profile linear fluorescent luminaires with clear or opal diffusers for surface or suspended mounting

- Light control is enhanced through curved shape prism diffuser
- Surface, suspended or conduit mounting possible
- All versions balanced
- Supplied complete with lamp(s)

## Materials and Finish

- Body: white pre-painted steel
- End caps: polycarbonate
- Diffuser: precision extruded clear prismatic or opal styrene (polycarbonate for emergency versions)

## Installation and Mounting

- Cable entry holes (Ø21.5mm) in the centre of the back spine
- Optional cable entry through each end cap
- Fitting supplied with end cap sealing grommets and 'quick fix' horseshoe sliding washers for direct screw fixing to surface
- 5 x 2 x 2.5mm<sup>2</sup> piano key terminal block suitable for easy and quick looping
- Standard BESA fixings included

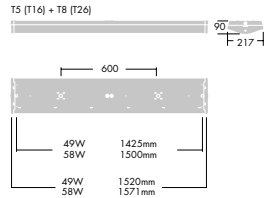

## Diffusalux

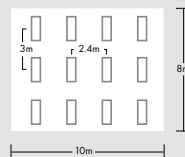

Room height	3.0m
Work Plane	0.75m
Maintenance factor	0.8
Reflectances	Ceiling: 80%
	Wall: 60%
	Floor: 20%
Cat. No.	DF149ZCL
Lamp	T5
Lumens	4075 lm
Lux	336 lux



## Ordering Guide

Option	Description	Circuit Power (W)	Wt (Kg)	SAP Code	Cat No.
<b>DIFFUSALUX</b>					
HF	DIFFUSALUX 1x28W HF PS CL L840	30.6	3.4	96535877	DF128ZCL
	DIFFUSALUX 1x35W HF PS CL L840	37.6	4.2	96535879	DF135ZCL
	DIFFUSALUX 1x49W HF PS CL L840	52.3	4.6	96535883	DF149ZCL
	DIFFUSALUX 2x28W HF PS CL L840	61.2	3.6	96535889	DF228ZCL
	DIFFUSALUX 2x35W HF PS CL L840	75.5	4.4	96535891	DF235ZCL
HF Emergency	DIFFUSALUX 2x49W HF PS CL L840	106.6	4.6	96535895	DF249ZCL
	DIFFUSALUX 1x35W HF PC CL E3 L840	37.8	6.1	96535901	DF135ZECL
	DIFFUSALUX 1x49W HF PC CL E3 L840	52.2	6.1	96535904	DF149ZECL
	DIFFUSALUX 2x35W HF PC CL E3 L840	76.0	6.4	96535909	DF235ZECL
HF Dimming	DIFFUSALUX 2x49W HF PC CL E3 L840	106.0	6.4	96535912	DF249ZECL
	DIFFUSALUX 1x35W HFI PS CL L840	39.0	4.2	96241140	DF135DCL
	DIFFUSALUX 1x49W HFI PS CL L840	53.0	4.6	96241142	DF149DCL
	DIFFUSALUX 2x35W HFI PS CL L840	74.5	4.4	96241141	DF235DCL
HF Dimming Emergency	DIFFUSALUX 2x49W HFI PS CL L840	106.0	4.6	96549151	DF249DCL
	DIFFUSALUX 1x35W HFI PC CL E3 L840	39.0	6.1	96241143	DF135DECL
	DIFFUSALUX 1x49W HFI PC CL E3 L840	53.0	6.1	96241145	DF149DECL
	DIFFUSALUX 2x35W HFI PC CL E3 L840	74.5	6.4	96241144	DF235DECL
	DIFFUSALUX 2x49W HFI PC CL E3 L840	105.5	6.4	96241146	DF249DECL
<b>ACCESSORIES</b>					
	Lock-Set (2 pce)		0.04	96004393	LKSET2
	WIRE SUSPENSION KIT 1,5M		0.2	96204619	WSPK1500
	SWITCHLITE SLD BATTEN PIR		-	96601988	-
	SWITCHLITE CC PROGRAMMER		-	96240295	-

Opal diffuser versions available. Visit [www.thornlighting.co.uk/DFX2](http://www.thornlighting.co.uk/DFX2) for more information

# Punch II

Standards

EN 60958	IP20	IK07	T <sub>a</sub> -5 +25	960 °C

Installation Options

--	--	--	--



A range of surface mounted or suspended luminaires, combining T16 (T5) direct lighting with louvres for high light output

- Smooth, rounded body design gives unobtrusive appearance
- Excellent optical performance with LOR up to 74%
- Surface luminaires can also be suspended for suspended direct illumination
- Supplied complete with lamp(s)

**Materials and Finish**

- Body: sheet steel painted white (close to RAL9010)
- End cap: moulded in white polycarbonate
- Louvres: aluminium anodised

**Installation and Mounting**

- Electrical installation via piano-key terminal blocks, two cable entry points at centre of fitting
- Hinged louvre for ease of lamp replacement
- Surface versions mounted with spacers via keyholes and C-washers. Single/twin surface and DI versions can be suspended by using a wire, rod or pendant kit (to be ordered separately)
- Use our connect kit to mount Punch in a continuous line

See the accessories section of our ordering guide to select the kit you require for your installation.

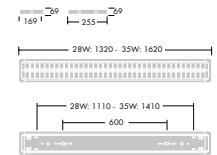
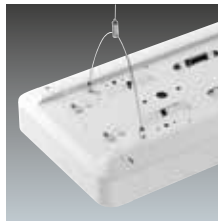
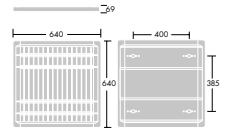
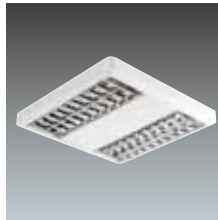

**Punch II**

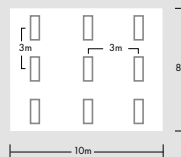

Room height	3.0m
Work Plane	0.75m
Maintenance factor	0.8
Reflectances	Ceiling: 80%
	Wall: 60%
	Floor: 20%
Cat. No.	PU235ZMB
Lamp	T5
Lumens	4891 lm
Lux	483 lux

## Ordering Guide

Option	Description	Circuit Power (W)	Wt (Kg)	SAP Code	Cat No.
<b>PUNCH II – SURFACE MOUNTED</b>					
HF	PUNCH II 1x28W T16 HF DMB L840	31.0	3.4	96536190	PU128ZMB
	PUNCH II 1x35W T16 HF DMB L840	39.0	4.6	96536195	PU135ZMB
	PUNCH II 1x49W T16 HF DMB L840	53.0	4.1	96547358	PU149ZMB
	PUNCH II 2x28W T16 HF DMB L840	61.0	4.8	96536221	PU228ZMB
	PUNCH II 2x35W T16 HF DMB L840	77.0	6.3	96536229	PU235ZMB
	PUNCH II 2x49W T16 HF DMB L840	107.0	5.5	96547362	PU249ZMB
HF Emergency	PUNCH II 4x14W T16 HF DMB L840	63.0	4.5	96536262	PU414ZMB
	PUNCH II 1x28W T16 HF DMB E3 L840	35.9	4.4	96536191	PU128ZEMB
	PUNCH II 1x35W T16 HF DMB E3 L840	44.5	5.6	96536196	PU135ZEMB
	PUNCH II 1x49W T16 HF DMB E3 L840	58.2	5.1	96547359	PU149ZEMB
	PUNCH II 2x28W T16 HF DMB E3 L840	66.5	5.8	96536222	PU228ZEMB
	PUNCH II 2x35W T16 HF DMB E3 L840	84.4	7.3	96536230	PU235ZEMB
HF Dimming	PUNCH II 2x49W T16 HF DMB E3 L840	112.0	6.5	96547363	PU249ZEMB
	PUNCH II 4x14W T16 HF DMB E3 L840	62.0	5.6	96536263	PU414ZEMB
	PUNCH II 2x28W T16 HFI DMB L840	60.5	12.8	96549846	PU228DMB
	PUNCH II 2x35W T16 HFI DMB L840	74.5	4.8	96549860	PU235DMB
	PUNCH II 2x49W T16 HFI DMB L840	105.5	8.5	96549870	PU249DMB
	PUNCH II 4x14W T16 HFI DMB L840	60.5	6.3	96549894	PU414XMB
HF Dimming Emergency	PUNCH II 2x28W T16 HFI DMB E3 L840	60.5	12.5	96549845	PU228DEMB
	PUNCH II 2x35W T16 HFI DMB E3 L840	74.5	8.5	96549859	PU235DEMB
	PUNCH II 2x49W T16 HFI DMB E3 L840	106.0	8.5	96549869	PU249DEMB
	PUNCH II 4x14W T16 HFI DMB E3 L840	60.5	5.5	96549895	PU414XEMB
<b>PUNCH II – SUSPENDED</b>					
HF	PUNCH II DI 1x28W T16 HF DMB LI840	31.0	3.4	96547368	PUDI128ZMB
	PUNCH II DI 1x35W T16 HF DMB LI840	39.0	4.6	96547369	PUDI135ZMB
	PUNCH II DI 1x49W T16 HF DMB LI840	53.0	4.6	96547370	PUDI149ZMB
	PUNCH II DI 2x28W T16 HF DMB LI840	61.0	4.8	96547371	PUDI228ZMB
	PUNCH II DI 2x35W T16 HF DMB LI840	77.0	6.3	96547372	PUDI235ZMB
	PUNCH II DI 2x49W T16 HF DMB LI840	107.0	6.3	96547373	PUDI249ZMB
HF Emergency	PUNCH II DI 1x35W T16 HF DMB E3 LI840	44.5	5.6	96547381	PUDI135ZEMB
	PUNCH II DI 1x49W T16 HF DMB E3 LI840	58.2	5.6	96547382	PUDI149ZEMB
	PUNCH II DI 2x28W T16 HF DMB E3 LI840	66.5	5.8	96547383	PUDI228ZEMB
HF Dimming	PUNCH II DI 2x35W T16 HF DMB E3 LI840	84.4	7.3	96547384	PUDI235ZEMB
	PUNCH II DI 2x49W T16 HF DMB E3 LI840	112.0	7.3	96547385	PUDI249ZEMB
	PUNCH II DI 2x28W T16 HFI DMB LI840	60.5	8.2	96549852	PUDI228DMB
	PUNCH II DI 2x35W T16 HFI DMB LI840	74.5	8.3	96549866	PUDI235DMB
	PUNCH II DI 2x49W T16 HFI DMB LI840	105.5	8.5	96549875	PUDI249DMB
	PUNCH II DI 2x28W T16 HFI DMB E3 LI840	60.5	6.1	96549851	PUDI228DEMB
HF Dimming Emergency	PUNCH II DI 2x35W T16 HFI DMB E3 LI840	74.5	8.3	96549865	PUDI235DEMB
	PUNCH II DI 2x49W T16 HFI DMB E3 LI840	106.0	8.5	96549874	PUDI249DEMB
<b>ACCESSORIES</b>					
	PUNCH 2 WHITEBOARD SUSPENSION KIT		5.2	96238614	-
	PUNCH 2 CONNECT KIT - TWIN		0.7	96238615	-
	PUNCH 2 CONNECT KIT - SINGLE		0.8	96238616	-
	PUNCH II PENDANT ROD KIT 150mm		1.5	96238860	-
	PUNCH II ROD SUSPENSION BRACKETS		0.2	96238861	-
	PUNCH II MSW1 1500mm		0.24	96238862	-
	PUNCH II ROD SUSPENSION KIT 1450mm		2.0	96238859	-

Satinbrite louvre versions available. Visit [www.thornlighting.co.uk/PNC5](http://www.thornlighting.co.uk/PNC5) for more information

# College LED

## Standards



## Installation Options



A range of curved profile LED luminaires with clear prismatic diffusers for surface or suspended mounting

- Clear prismatic diffuser in tough polycarbonate for specific light control and impact resistance
- Rigidly fixed diffuser held in place by screwed on polycarbonate end caps for improved diffuser security and vandal/impact resistance
- Sealed to IP44
- 80Lm/W – exceeding building regulation requirements
- 50 000 hours rated life
- Integral 3 hour emergency option reduces installation time and complexity

### Materials and Finish

- Body and gear tray: white galvanised pre-painted steel
- End caps: polycarbonate
- Diffuser: precision extruded clear prismatic polycarbonate

### Installation and Mounting

- Two cable entry holes (Ø21.5mm) in the centre of the back spine
- Optional cable entry through each end cap
- Fitting supplied with sealing grommets and 'quick-fix' horseshoe sliding washers for direct screw fixing to surface
- Standard BESA fixings
- 5 x 2 x 2.5mm<sup>2</sup> piano key terminal block supplied for easy and quick looping
- 5 x 2 x 2.5mm<sup>2</sup> + 3 x 2 x 2.5mm<sup>2</sup> piano key terminal block for dimmable emergency versions

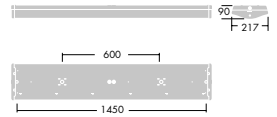



## Ordering Guide

Option	Description	Circuit Power (W)	Wt (Kg)	SAP Code	Cat No.
<b>COLLEGE LED</b>					
HF	COLLEGE LED 2900 HF PC CL L840	34.8	4.7	96241614	CO2900ZCL
	COLLEGE LED 4650 HF PC CL L840	61.4	4.6	96241610	CO4650ZCL
HF	COLLEGE LED 2900 HF E3 PC CL L840	34.8	5.2	96241615	CO2900ZECL
Emergency	COLLEGE LED 4650 HF E3 PC CL L840	61.4	5.1	96241611	CO4650ZECL
HF	COLLEGE LED 2900 HFIX PC CL L840	36.3	4.8	96241616	CO2900XCL
Dimming	COLLEGE LED 4650 HFIX PC CL L840	63.0	4.8	96241612	CO4650XCL
HF Dimming	COLLEGE LED 2900 HFIX E3 PC CL L840	36.3	5.3	96241617	CO2900XECL
Emergency	COLLEGE LED 4650 HFIX E3 PC CL L840	63.0	5.3	96241613	CO4650XECL
<b>ACCESSORIES</b>					
	Lock-Set (2 pce)		0.04	96004393	LKSET2
	WIRE SUSPENSION KIT 1,5M		0.2	96204619	WSPK1500
	SWITCHLITE SLD BATTEN PIR		-	96601988	-
	SWITCHLITE CC PROGRAMMER		-	96240295	-

### College LED

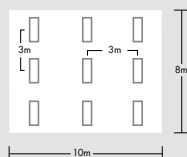

Room height	3.0m
Work Plane	0.75m
Maintenance factor	0.8
Reflectances	Ceiling: 80%
	Wall: 60%
	Floor: 20%
Cat. No.	CO4650ZCL
Lamp	LED
Lumens	4650 lm
Lux	310 lux

# College

## Standards



## Installation Options



A range of curved profile linear fluorescent luminaires with clear prismatic diffusers for surface or suspended mounting

- Clear prismatic diffuser in tough polycarbonate for specific light control and impact resistance
- Rigidly fixed diffuser held in place by screwed on polycarbonate end caps for improved diffuser security and vandal/impact resistance
- Sealed to IP44
- Easy to remove and replace gear cover protects components
- Supplied complete with lamp(s)

## Materials and Finish

- Body and gear tray: white galvanised pre-painted steel
- End caps: polycarbonate
- Diffuser: precision extruded clear prismatic polycarbonate

## Installation and Mounting

- Two cable entry holes (Ø21.5mm) in the centre of the back spine
- Optional cable entry through each end cap
- Fitting supplied with sealing grommets and 'quick-fix' horseshoe sliding washers for direct screw fixing to surface
- Standard BESA fixings
- T5 x 2 x 2.5mm<sup>2</sup> piano key terminal block supplied for easy and quick looping
- T5 x 2 x 2.5mm<sup>2</sup> + 3 x 2 x 2.5mm<sup>2</sup> piano key terminal block for dimmable emergency versions

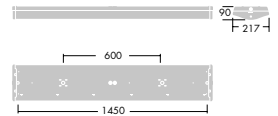

## College

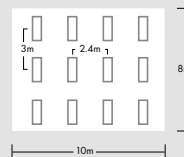

Room height	3.0m
Work Plane	0.75m
Maintenance factor	0.8
Reflectances	Ceiling: 80%
	Wall: 60%
	Floor: 20%
Cat. No.	CO149ZCL
Lamp	T5
Lumens	3049 lm
Lux	336 lux





## Ordering Guide

Option	Description	Circuit Power (W)	Wt (Kg)	SAP Code	Cat No.
<b>COLLEGE</b>					
HF	COLLEGE 1x28W HF PC CL L840	30.6	4.0	96535821	CO128ZCL
	COLLEGE 1x35W HF PC CL L840	37.6	4.3	96535822	CO135ZCL
	COLLEGE 1x49W HF PC CL L840	52.3	4.5	96535824	CO149ZCL
	COLLEGE 2x28W HF PC CL L840	61.2	4.2	96535826	CO228ZCL
	COLLEGE 2x35W HF PC CL L840	75.5	4.3	96535828	CO235ZCL
	COLLEGE 2x49W HF PC CL L840	106.6	4.3	96535830	CO249ZCL
HF Emergency	COLLEGE 1x28W HF E3 PC CL L840	30.4	5.7	96535866	CO128ZECL
	COLLEGE 1x35W HF E3 PC CL L840	37.8	5.8	96535867	CO135ZECL
	COLLEGE 1x49W HF E3 PC CL L840	52.2	5.8	96535869	CO149ZECL
	COLLEGE 2x28W HF E3 PC CL L840	60.2	6.0	96535871	CO228ZECL
	COLLEGE 2x35W HF E3 PC CL L840	76.0	6.5	96535873	CO235ZECL
	COLLEGE 2x49W HF E3 PC CL L840	106.0	7.1	96535875	CO249ZECL
HF Dimming	COLLEGE 1x35W HFI PC CL L840	39.0	4.2	96549136	CO135DCL
	COLLEGE 1x49W HFI PC CL L840	53.0	5.2	96549141	CO149DCL
	COLLEGE 2x28W HFI PC CL L840	60.5	4.3	96549145	CO228DCL
	COLLEGE 2x35W HFI PC CL L840	74.5	4.3	96549150	CO235DCL
	COLLEGE 2x49W HFI PC CL L840	105.5	5.4	96549132	CO249DCL
HF Dimming Emergency	COLLEGE 1x35W HFI E3 PC CL L840	39.0	5.8	96549135	CO135DECL
	COLLEGE 1x49W HFI E3 PC CL L840	53.0	5.8	96549140	CO149DECL
	COLLEGE 2x28W HFI E3 PC CL L840	60.5	4.1	96549144	CO228DECL
	COLLEGE 2x35W HFI E3 PC CL L840	74.5	5.5	96549149	CO235DECL
	COLLEGE 2x49W HFI E3 PC CL L840	106.0	7.1	96549131	CO249DECL
<b>ACCESSORIES</b>					
	Lock-Set (2 pce)		0.04	96004393	LKSET2
	WIRE SUSPENSION KIT 1,5M		0.2	96204619	WSPK1500
	SWITCHLITE SLD BATTEN PIR		-	96601988	-
	SWITCHLITE CC PROGRAMMER		-	96240295	-

# Cetus LED

## Standards



## Installation Options



Recessed LED downlight with low height, direct replacement for traditional 1x26W or 2x26W compact fluorescent downlights

- Direct replacement for traditional 1x26W or 2x26W compact fluorescent downlights with up to 65% energy saving
- Only 88mm overall height to allow installation into low and restricted ceiling voids
- Sealed to IP44 as standard, suitable for use in bathrooms without the need for separate attachments
- 50 000 hours rated life
- Integral 3 hour emergency option reduces installation time and complexity

## Materials and Finish

- Housing/body: aluminium, powder coated white RAL 9016
- Reflector: powder coated white RAL 9016

## Installation and Mounting

- Tool free installation direct out of box
- Suitable for a wide range of ceiling types and depths from 1-40mm thickness
- Overall height of 88mm allows installation into low and restricted ceiling voids
- Remote driver for quick and easy installation and maintenance
- Cut out diameter = 190mm

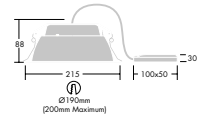
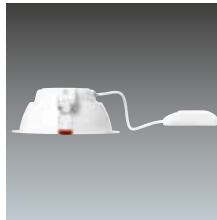

CETUS LED 1000LM

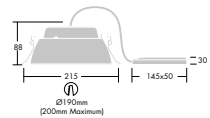

CETUS LED 2000LM



### Ordering Guide

Option	Description	Circuit Power (W)	Wt (Kg)	SAP Code	Cat No.
<b>CETUS LED</b>					
HF	CETUS LED 1000 HF 830	12.8	0.7	96242095	CU1000Z3K
	CETUS LED 1000 HF 840	12.8	0.7	96242096	CU1000Z4K
	CETUS LED 2000 HF 830	24.6	0.7	96242097	CU2000Z3K
	CETUS LED 2000 HF 840	24.6	0.7	96242098	CU2000Z4K
HF Emergency	CETUS LED 1000 HF E3 830	12.8	1.8	96242209	CU1000ZE3K
	CETUS LED 1000 HF E3 840	12.8	1.8	96242099	CU1000ZE4K
	CETUS LED 2000 HF E3 830	24.6	1.8	96242210	CU2000ZE3K
	CETUS LED 2000 HF E3 840	24.6	1.8	96242100	CU2000ZE4K

### Cetus LED



Room height	2.7m
Work Plane	0m
Maintenance factor	0.8
Reflectances	Ceiling: 80%
	Wall: 60%
	Floor: 20%
Cat. No.	CU2000Z4K
Lamp	LED
Lumens	2000 lm
Lux	216 lux

# Cetus Mini NEW

Standards

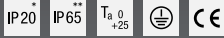

Installation Option



\* Fixed and adjustable version  
 \*\* IP65 fixed version

Highly efficient and economical downlight range with 30, 60 & 90 minute fire rated variants

- 550lm LED downlight range
- Only 6W total load with up to 90% energy savings compared to traditional downlights
- Highly efficient with 95lm/W
- 30, 60 and 90 minute fire rated variants
- 40 000 hours rated life, equivalent to 11 years at 10 hours per day operation
- Choice of 3000K warm white or 4000K cool white to suit application use

**Materials and Finish**

- White steel body with white bezel
- IP20 or IP65 (suitable for bathroom applications)
- Integrated phase-cut dimmable LED driver

**Installation and Mounting**

- Flexible installation - suitable for 13-35mm ceiling thickness
- Simple installation with through wiring and integrated cable gland
- Cut-out diameters:  
 fire rated fixed: 77mm  
 fire rated adjustable: 87mm

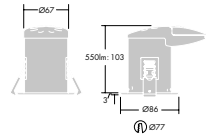

Fire rated fixed

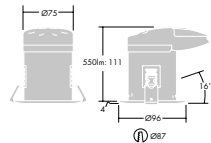

Fire rated adjustable

**Corridor** - 21m x 2m x 2.8m - 12 luminaires

Mounting height	2.8m
Work plane	Floor
Maintenance factor	0.80
Reflectances	Ceiling: 70% Wall: 50% Floor: 20%
Luminaire	CETUS MINI LED 550-840 IP20
Lamp	LED
Lumens	550lm
Lux	100lx

**Reception Area** - 10m x 6m x 3m - 30 luminaires

Mounting height	3.0m
Work plane	0.75m
Maintenance factor	0.80
Reflectances	Ceiling: 70% Wall: 50% Floor: 20%
Luminaire	CETUS MINI LED 550-840 IP20
Lamp	LED
Lumens	550lm
Lux	200lx



## Ordering Guide

Description	Circuit Power (W)	Wt (kg)	SAP Code	Cat. No.
<b>CETUS MINI FIRE RATED DIMMABLE FIXED DOWNLIGHT</b>				
CETUS MINI FH LED550-840 IP65 WH	5.8	0.5	96272518	CMP550W4K
CETUS MINI FH LED550-830 IP65 WH	5.7	0.5	96272519	CMP550W3K
CETUS MINI FH LED550-840 IP20 WH	5.8	0.5	96272526	CMF550W4K
CETUS MINI FH LED550-830 IP20 WH	5.7	0.5	96272527	CMF550W3K
<b>CETUS MINI FIRE RATED DIMMABLE ADJUSTABLE DOWNLIGHT</b>				
CETUS MINI FH LED550-840 AJ IP20 WH	5.8	0.55	96272520	CMA550W4K
CETUS MINI FH LED550-830 AJ IP20 WH	5.9	0.55	96272521	CMA550W3K

# ArrowFlex NEW

## Standards

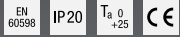

## Installation Option

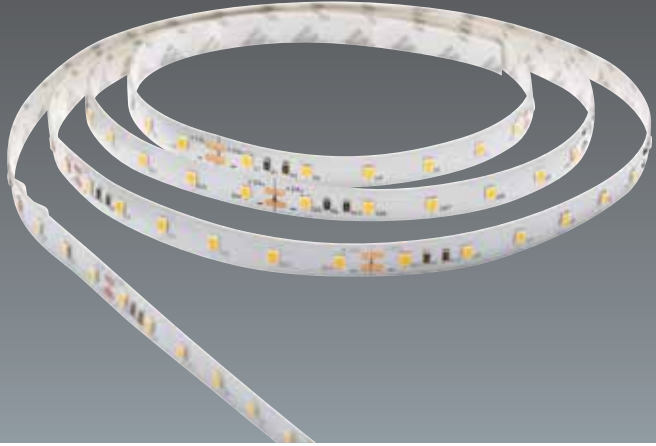

Compact LED strip ideal for adding atmosphere and indirect lighting

- 5m LED reel offering seamless shadow free lighting, adding atmosphere and indirect lighting in retail, residential and all dry interior applications
- Efficient performance with 79-87 Llm/W
- 30 000 hours rated life, equivalent to 5.8 years at 14 hours per day operation
- Available in a range of cool to warm whites - 2700K, 3000K, 4000K to suit a great variety of applications
- A choice of outputs - 400 – 870Llm/m

### Materials and Finish

- 5m reel of flexible PCB with plastic connectors
- Pre-defined cutting areas to easily cut to required lengths on site
- 60 highly efficient LED per metre
- Compatible driver included, 1 driver can power 1 x 5m reel

### Installation and Mounting

- Suitable for surface mounting on any smooth clean surface
- Can be positioned horizontally or vertically
- Attaches to surface via self-adhesive tape on the reverse of the product
- Lengths can be joined via a solderless connection system for seamless light

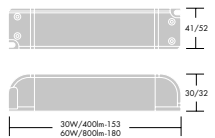
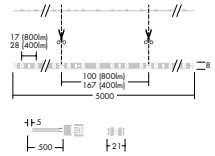
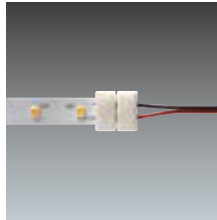



## Ordering Guide

Description	Circuit Power (W)	Wt (kg)	SAP Code	Cat. No.
<b>ARROWFLEX</b>				
ARROWFLEX LED430-840 120° IP20	5	0.4	96642783	ARX430Z4K
ARROWFLEX LED400-830 120° IP20	5	0.4	96642784	ARX400Z3K
ARROWFLEX LED400-827 120° IP20	5	0.4	96642785	ARX400Z27K
ARROWFLEX LED870-840 120° IP20	10	0.4	96642786	ARX870Z4K
ARROWFLEX LED870-830 120° IP20	10	0.4	96642787	ARX870Z3K
ARROWFLEX LED790-827 120° IP20	10	0.4	96642788	ARX790Z27K
<b>ACCESSORIES</b>				
ARROWFLEX CONVERTER (DRIVER) 45W IP20	-	-	96665181	ARX45
ARROWFLEX CONVERTER (DRIVER) 75W IP20	-	-	96665182	ARX75

# PopPack LED NEW

## Standards



## Installation Options



The original PopPack batten with integrated LED technology for ultra-low energy consumption and ideal upgrade for existing PopPack installations

- Up to 67% energy reduction vs traditional switch start T8 battens. Direct replacement for 1x36W, 1x58W & 2x58W T8
- Further savings can be achieved via the DALI dimmable options
- > 100lm/W – exceeding building regulation requirements
- 50 000 hour rated life
- Integral 3 hour emergency option reduces installation time and complexity

### Materials and Finish

- Batten: pre-coated roll form steel, white (RAL9016)
- End caps/lamp holders: injection moulded polycarbonate, white
- Diffuser: textured opal acrylic

### Installation and Mounting

- Direct ceiling mount via central BESA box mounting
- Through-wiring possible through central cable entry/exit or via knock out holes in the end caps
- 4/6 way terminal block with capacity for loop in loop out of 2.5mm<sup>2</sup> cables
- Fixation of spine to ceiling, then connect via tool less plug & play connector the light engine and snap it onto the spine

Lamp Type	Lamp Length	Lamp Wattage	PopPack LED Replacement
T8 SINGLE	2FT	1 x 18W	PP2000Z2F
	4FT	1 x 36W	PP3000Z4F
	5FT	1 x 58W	PP4000Z5F
	6FT	1 x 70W	PP6500Z6F
T8 TWIN	8FT	1 x 100W	PP6500Z6F
	2FT	2 x 18W	PP2000Z2F
	4FT	2 x 36W	PP7000Z4F
	5FT	2 x 58W	PP6000Z5F
	6FT	2 x 70W	PP9000Z5F
T5 SINGLE	8FT	2 x 100W	BY REQUEST
	2FT	1 x 14W	PP2000Z2F
	2FT	1 x 24W	PP2000Z2F
	4FT	1 x 28W	PP3000Z4F
	5FT	1 x 35W	PP4000Z5F
	5FT	1 x 49W	PP4000Z5F
T8 TWIN	4FT	1 x 54W	PP4500Z4F
	5FT	1 x 80W	PP6000Z5F
	2FT	2 x 14W	PP2000Z2F
	2FT	2 x 24W	PP2000Z2F
	4FT	2 x 28W	PP4500Z4F
	5FT	2 x 35W	PP6000Z5F
	5FT	2 x 49W	PP6000Z5F
T8 TWIN	4FT	2 x 54W	PP7000Z4F
	5FT	2 x 80W	PP9000Z5F

The above table is a guide for replacement of similar PopPack fluorescent luminaires, using the closest LED alternative offer



**Ordering Guide**

Description	Circuit Power (W)	Wt (kg)	SAP Code	Cat No.
<b>POPPACK LED HF VERSIONS</b>				
<b>POPPACK LED</b>				
POPPACK LED3000-840 HF L1200	28.0	1.4	96242241	PP3000Z4F
POPPACK LED4500-840 HF L1200	40.0	1.4	96242245	PP4500Z4F
POPPACK +LED7000-840 HF L1200	59.8	1.4	96628127	PP7000Z4F
POPPACK LED4000-840 HF L1500	37.6	1.7	96643378	PP4000Z5F
POPPACK LED6000-840 HF L1500	58.9	1.7	96643382	PP6000Z5F
POPPACK LED6500-840 HF L1800	60.0	2.0	96242249	PP6500Z6F
<b>POPPACK LED WITH 3HR EMERGENCY</b>				
POPPACK LED3000-840 HF L1200	28.0	2.0	96242242	PP3000ZE4F
POPPACK LED4500-840 HF L1200	41.0	2.0	96242246	PP4500ZE4F
POPPACK +LED7000-840 HF L1200	59.8	2.0	96628128	PP7000ZE4F
POPPACK LED4000-840 HF L1500	37.6	2.3	96643379	PP4000ZE5F
POPPACK LED6000-840 HF L1500	58.9	2.3	96643383	PP6000ZE5F
POPPACK LED6500-840 HF L1800	60.0	2.6	96242250	PP6500ZE6F
<b>POPPACK LED WITH PRE-WIRED PIR SENSOR</b>				
POPPACK LED3000-840 HF L1200	28.0	1.5	96627653	PP3000ZS4F
POPPACK LED4500-840 HF L1200	41.0	1.5	96627654	PP4500ZS4F
POPPACK +LED7000-840 HF L1200	59.8	1.5	96628129	PP7000ZS4F
POPPACK LED4000-840 HF L1500	37.6	1.8	96643390	PP4000ZS5F
POPPACK LED6000-840 HF L1500	58.9	1.8	96643391	PP6000ZS5F
POPPACK +LED9000-840 HF L1500	75.2	1.8	96628130	PP9000ZS5F
POPPACK LED6500-840 HF L1800	60.0	2.1	96627655	PP6500ZS6F
<b>POPPACK LED HFI VERSIONS</b>				
<b>POPPACK LED</b>				
POPPACK LED3000-840 HFI L1200	28.0	1.4	96242243	PP3000D4F
POPPACK LED4500-840 HFI L1200	41.0	1.4	96242247	PP4500D4F
POPPACK +LED7000-840 HFI L1200	59.8	1.4	96643386	PP7000D4F
POPPACK LED4000-840 HFI L1500	37.6	1.7	96643380	PP4000D5F
POPPACK LED6000-840 HFI L1500	58.9	1.7	96643384	PP6000D5F
POPPACK +LED9000-840 HFI L1500	75.2	1.7	96643388	PP9000D5F
POPPACK LED6500-840 HFI L1800	60.0	2.0	96242251	PP6500D6F
<b>POPPACK LED WITH 3HR EMERGENCY INSERT</b>				
POPPACK LED3000-840 HFI L1200	28.0	2.0	96242244	PP3000DE4F
POPPACK LED4500-840 HFI L1200	41.0	2.0	96242248	PP4500DE4F
POPPACK +LED7000-840 HFI L1200	59.8	2.0	96643387	PP7000DE4F
POPPACK LED4000-840 HFI L1500	37.6	2.3	96643381	PP4000DE5F
POPPACK LED6000-840 HFI L1500	58.9	2.3	96643385	PP6000DE5F
POPPACK +LED9000-840 HFI L1500	75.2	2.3	96643389	PP9000DE5F
POPPACK LED6500-840 HFI L1800	60.0	2.6	96242252	PP6500DE6F
<b>POPPACK LED ACCESSORIES</b>				
POPPACK LED Wire Suspension Kit 2m			96627711	PPSUS2M
POPPACK LED Wire Guard 1.2m			96627902	PPWG4F
POPPACK LED Wire Guard 1.5m			96628147	PPWG5F
POPPACK LED Wire Guard 1.8m			96627903	PPWG6F

HF - Fixed output electronic driver

HFI - DALI/DSI dimmable driver

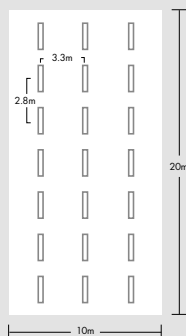
**PopPack LED**

Room height	5m
Work Plane	0m
Maintenance factor	0.8
Reflectances	Ceiling: 50%
	Wall: 30%
	Floor: 20%
Cat. No.	PP6500Z
Lamp	LED
Lumens	6550lm
Lux	281 lux

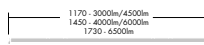

# PopPack

## Standards



## Installation Options



The original popular range fluorescent batten

- Adjustable twin lampholder alters distribution, to suit desired mounting height
- Tool free, clip-on cover plate for quick installation
- Twist-lock lampholders for reliable electrical contact
- A range of diffusers and reflectors covering every application requirement
- Supplied complete with lamp(s)

## Materials and Finish

- Batten: rolled steel section in pre-coated high reflectivity white paint
- Lampholder assembly: tough white polycarbonate

## Installation and Mounting

- Four-way terminal block with capacity for 2 x 2.5mm<sup>2</sup> cables
- Angled terminal block for easy wiring.
- Ambient temperature: -5°C to 25°C, normal, dry, indoor atmospheres
- Fixings via two BESA piercings, one central and two at fixing centres: 600mm – 500mm, 1200/1500/1800mm – 600mm
- Bare battens can be mounted end-to-end (except emergency versions – recommended minimum space between luminaires 50mm)
- Emergency fixing centres: 600mm, 1110mm and 1410mm

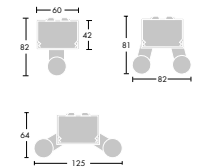
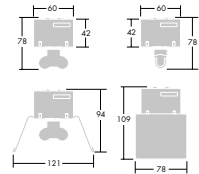



# PopPack

## Ordering Guide

Option	Description	Circuit Power (W)	Wt (Kg)	SAP Code	Cat No.
<b>POPPACK – T5 HIGH EFFICIENCY (HE)</b>					
HF	POPPACK BATTEN 1x14W T16 HF L840	17.5	0.7	96550703	PP114Z
	POPPACK BATTEN 1x28W T16 HF L840	32.0	1.2	96550704	PP128Z
	POPPACK BATTEN 1x35W T16 HF L840	37.8	1.5	96550705	PP135Z
	POPPACK BATTEN 2x14W T16 HF L840	35.0	0.8	96550706	PP214Z
	POPPACK BATTEN 2x28W T16 HF L840	64.0	1.4	96550707	PP228Z
	POPPACK BATTEN 2x35W T16 HF L840	75.0	1.7	96550708	PP235Z
HF Emergency	POPPACK BATTEN 1x14W T16 HF E3 L840	17.5	1.6	96550715	PP114ZE
	POPPACK BATTEN 1x28W T16 HF E3 L840	32.0	2.1	96550716	PP128ZE
	POPPACK BATTEN 1x35W T16 HF E3 L840	37.8	2.4	96550717	PP135ZE
	POPPACK BATTEN 2x14W T16 HF E3 L840	35.0	1.7	96550718	PP214ZE
	POPPACK BATTEN 2x28W T16 HF E3 L840	64.0	2.3	96550719	PP228ZE
	POPPACK BATTEN 2x35W T16 HF E3 L840	75.0	2.6	96550720	PP235ZE
HF Dimming	POPPACK BATTEN 1x14W T16 HFI L840	17.5	2.5	96550727	PP114D
	POPPACK BATTEN 1x28W T16 HFI L840	32.0	1.3	96550728	PP128D
	POPPACK BATTEN 1x35W T16 HFI L840	37.8	1.5	96550729	PP135D
	POPPACK BATTEN 2x14W T16 HFI L840	35.0	2.6	96550730	PP214D
	POPPACK BATTEN 2x28W T16 HFI L840	64.0	1.5	96550731	PP228D
	POPPACK BATTEN 2x35W T16 HFI L840	75.0	1.7	96550732	PP235D
HF Dimming Emergency	POPPACK BATTEN 1x14W T16 HFI E3 L840	17.5	3.4	96550739	PP114DE
	POPPACK BATTEN 1x28W T16 HFI E3 L840	32.0	3.4	96550740	PP128DE
	POPPACK BATTEN 1x35W T16 HFI E3 L840	37.8	2.2	96550741	PP135DE
	POPPACK BATTEN 2x14W T16 HFI E3 L840	35.0	2.4	96550742	PP214DE
	POPPACK BATTEN 2x28W T16 HFI E3 L840	64.0	2.4	96550743	PP228DE
	POPPACK BATTEN 2x35W T16 HFI E3 L840	75.0	2.2	96550744	PP235DE
<b>POPPACK – T5 HIGH OUTPUT (HO)</b>					
HF	POPPACK BATTEN 1x24W T16 HF L840	25.0	0.7	96550709	PP124Z
	POPPACK BATTEN 1x49W T16 HF L840	52.2	1.5	96550711	PP149Z
	POPPACK BATTEN 1x54W T16 HF L840	57.0	1.2	96550710	PP154Z
	POPPACK BATTEN 2x24W T16 HF L840	48.5	0.8	96550712	PP224Z
	POPPACK BATTEN 2x49W T16 HF L840	110.6	1.7	96550714	PP249Z
	POPPACK BATTEN 2x54W T16 HF L840	120.0	1.4	96550713	PP254Z
HF Emergency	POPPACK BATTEN 1x24W T16 HF E3 L840	25.0	1.6	96550721	PP124ZE
	POPPACK BATTEN 1x49W T16 HF E3 L840	52.2	2.4	96550723	PP149ZE
	POPPACK BATTEN 1x54W T16 HF E3 L840	57.0	2.1	96550722	PP154ZE
	POPPACK BATTEN 2x24W T16 HF E3 L840	48.5	1.7	96550724	PP224ZE
	POPPACK BATTEN 2x49W T16 HF E3 L840	110.6	2.6	96550726	PP249ZE
	POPPACK BATTEN 2x54W T16 HF E3 L840	120.0	2.3	96550725	PP254ZE
HF Dimming	POPPACK BATTEN 1x24W T16 HFI L840	25.0	2.5	96550733	PP124D
	POPPACK BATTEN 1x49W T16 HFI L840	52.2	1.5	96550735	PP149D
	POPPACK BATTEN 1x54W T16 HFI L840	57.0	1.3	96550734	PP154D
	POPPACK BATTEN 2x24W T16 HFI L840	48.5	2.6	96550736	PP224D
	POPPACK BATTEN 2x49W T16 HFI L840	110.6	1.7	96550738	PP249D
	POPPACK BATTEN 2x54W T16 HFI L840	120.0	1.5	96550737	PP254D
HF Dimming Emergency	POPPACK BATTEN 1x24W T16 HFI E3 L840	25.0	3.5	96550745	PP124DE
	POPPACK BATTEN 1x54W T16 HFI E3 L840	52.2	3.5	96550746	PP154DE
	POPPACK BATTEN 1x49W T16 HFI E3 L840	57.0	2.4	96550747	PP149DE
	POPPACK BATTEN 2x24W T16 HFI E3 L840	48.5	2.6	96550748	PP224DE
	POPPACK BATTEN 2x54W T16 HFI E3 L840	110.6	2.6	96550749	PP254DE
	POPPACK BATTEN 2x49W T16 HFI E3 L840	120.0	2.4	96550750	PP249DE

Option	Description	Circuit Power (W)	Wt (Kg)	SAP Code	Cat No.
<b>POPPACK – T8</b>					
HF	POPPACK BATTEN 1x36W T26 HF L840	35.0	1.9	96229554	PP136Z
	POPPACK BATTEN 1x58W T26 HF L840	54.0	2.1	96229555	PP158Z
	POPPACK BATTEN 1x70W T26 HF L840	68.0	2.3	96229556	PP170Z
	POPPACK BATTEN 2x36W T26 HF L840	70.0	2.1	96229557	PP236Z
	POPPACK BATTEN 2x58W T26 HF L840	107.0	2.3	96229558	PP258Z
	POPPACK BATTEN 2x70W T26 HF L840	124.0	2.5	96229559	PP270Z
HF Emergency	POPPACK BATTEN 1x36W T26 HF E3 L840	39.0	2.8	96229560	PP136ZE
	POPPACK BATTEN 1x58W T26 HF E3 L840	60.0	3.1	96229561	PP158ZE
	POPPACK BATTEN 1x70W T26 HF E3 L840	68.0	3.5	96229562	PP170ZE
	POPPACK BATTEN 2x36W T26 HF E3 L840	75.0	3.0	96229563	PP236ZE
	POPPACK BATTEN 2x58W T26 HF E3 L840	115.0	3.3	96229564	PP258ZE
	POPPACK BATTEN 2x70W T26 HF E3 L840	124.0	3.7	96229565	PP270ZE

**POPPACK – ATTACHMENTS**

T5 Prismatic Diffuser	POPPACK DIFFUSER 1/2x14/24 PR	0.3	96550751	PP14/24PRDIF
	POPPACK DIFFUSER 1/2x28/54 PR	0.5	96550752	PP28/54PRDIF
	POPPACK DIFFUSER 1/2x35/49 PR	0.7	96550753	PP35/49PRDIF
T5 Narrow Reflector	POPPACK REFLECTOR 1/2x14/24 RNW	0.5	96550763	PP14/24NWREF
	POPPACK REFLECTOR 1/2x28/54 RNW	1.0	96550764	PP28/54NWREF
	POPPACK REFLECTOR 1/2x35/49 RNW	1.3	96550765	PP35/49NWREF
T8 Opal Diffuser	POPPACK DIFFUSER 1x36 OP	0.6	96012850	PP136OPDIF
	POPPACK DIFFUSER 1x58 OP	1.2	96007456	PP158OPDIF
	POPPACK DIFFUSER 1x70 OP	1.4	96217844	PP170OPDIF
	POPPACK DIFFUSER 2x36 OP	0.9	96217840	PP236OPDIF
	POPPACK DIFFUSER 2x58 OP	1.7	96217841	PP258OPDIF
	POPPACK DIFFUSER 2x70 OP	1.9	96217842	PP270OPDIF
T8 Prismatic Diffuser	POPPACK DIFFUSER 1x36 PR	0.6	96014688	PP136PRDIF
	POPPACK DIFFUSER 1x58 PR	1.2	96008902	PP158PRDIF
	POPPACK DIFFUSER 1x70 PR	1.4	96217836	PP170PRDIF
	POPPACK DIFFUSER 2x36 PR	0.9	96014716	PP236PRDIF
	POPPACK DIFFUSER 2x58 PR	1.7	96014774	PP258PRDIF
	POPPACK DIFFUSER 2x70 PR	1.9	96217834	PP270PRDIF
T5 Wide Reflector	POPPACK REFLECTOR 1/2x36 RWD	0.6	96014870	PP36WDREF
	POPPACK REFLECTOR 1/2x58 RWD	0.8	96200583	PP58WDREF
	POPPACK REFLECTOR 1/2x70 RWD	0.9	96217778	PP70WDREF
T5 Narrow Reflector	POPPACK REFLECTOR 1/2x36 RNW	0.6	96014640	PP36NWREF
	POPPACK REFLECTOR 1/2x58 RNW	0.8	96014695	PP58NWREF
	POPPACK REFLECTOR 1/2x70 RNW	0.9	96217849	PP70NWREF

**PopPack**

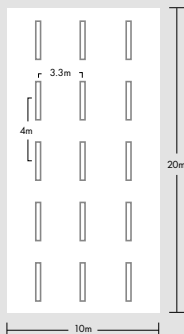

Room height	5m
Work Plane	0m
Maintenance factor	0.8
Reflectances	Ceiling: 50%
	Wall: 30%
	Floor: 20%
Cat. No.	PP258Z+PP58NWREF
Lamp	T8
Lumens	6781 lm
Lux	273 lux

# PopPack Pro

## Standards

EN 60998	IP20	IK02	Ta25	650°C
850°C				

## Installation Options

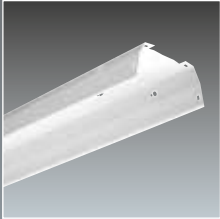
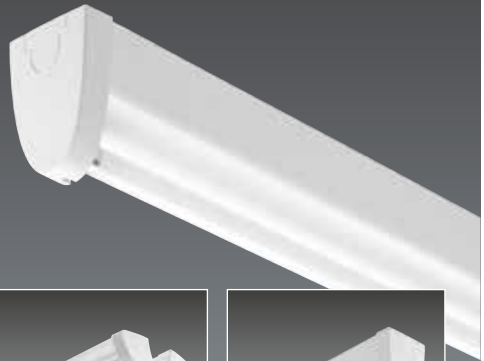

White reflector

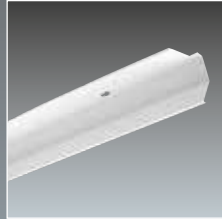

Asymmetric reflector

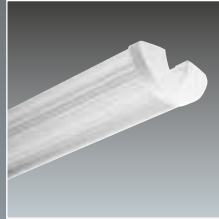

Clear prismatic acrylic diffuser

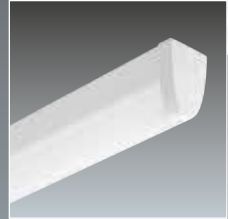

Opal diffuser

Innovative fluorescent batten range featuring patented quick-fix mounting, sensor/emergency plug-ins and attachments

- Contemporary slimline design
- Quick and easy installation using patented quick fix mounting plate
- Flexibility – plug and play sensor/emergency modules for safe and simple conversion
- A choice of attachments with outstanding optical performance
- Supplied complete with lamp(s)

## Materials and Finish

- Batten: pre-coated roll form steel, white
- End caps/lamp holders: injection moulded polycarbonate, white
- FixExpress mounting plates: injection moulded polycarbonate, white
- Sensor and emergency modules: injection moulded polycarbonate
- ClipLine diffusers: opal acrylic

## Installation and Mounting

- FixExpress mounting plates to ensure rapid installation directly onto a surface or BESA box (for trunking via 20mm connectors an accessory kit is required)
- 600mm fixing centres except for 14/24W versions which are at 445mm centres
- Supplied with a screw terminal block that accepts 2x2.5mm<sup>2</sup> cable and is suitable for loop in/loop out wiring
- All internal wiring uses halogen free cable
- Sensor and emergency modules push fit on the ends, after the end caps have been removed, and are connected with 'one-way' plugs and sockets (not suitable for 14/24W versions)

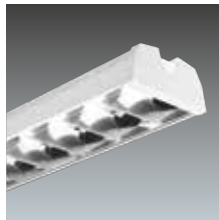
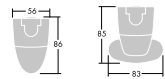

White reflector with satinbrite louvre insert

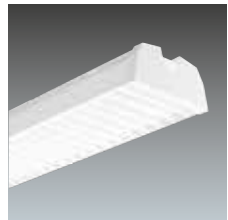

White reflector with white vane louvre insert

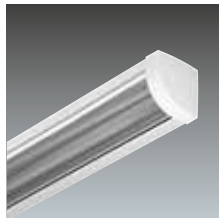

Cornice diffuser in clear prismatic

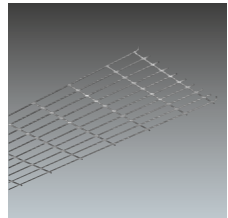

Wireguard kit



### Ordering Guide

Option	Description	Circuit Power (W)	Wt (Kg)	SAP Code	Cat No.
<b>POPPACK PRO</b>					
HF	POPPACK PRO 1X14W T16 HF L840	16.0	1.0	96548068	PPP114Z
	POPPACK PRO 1X28W T16 HF L840	31.0	1.2	96548069	PPP128Z
	POPPACK PRO 1X35W T16 HF L840	39.0	1.3	96548071	PPP135Z
	POPPACK PRO 1X49W T16 HF L840	53.0	1.3	96548073	PPP149Z
	POPPACK PRO 1X54W T16 HF L840	58.0	1.2	96548075	PPP154Z
	POPPACK PRO 2X28W T16 HF L840	61.0	1.2	96548070	PPP228Z
	POPPACK PRO 2X35W T16 HF L840	76.0	1.4	96548072	PPP235Z
	POPPACK PRO 2X49W T16 HF L840	107.0	1.4	96548074	PPP249Z
	POPPACK PRO 2X54W T16 HF L840	115.0	1.2	96548076	PPP254Z
HF Dimming	POPPACK PRO 1X49W T16 HFI L840	53.0	5.4	96549703	PPP149D
	POPPACK PRO 1X54W T16 HFI L840	58.0	2.1	96549705	PPP154D
	POPPACK PRO 2X49W T16 HFI L840	105.5	2.3	96549706	PPP249D
	POPPACK PRO 2X54W T16 HFI L840	116.5	1.6	96549707	PPP254D
HF with Clipline Diffuser	POPPACK PRO 1X24W T16 HF OP L840	26.0	1.2	96548077	PPP124ZOP
	POPPACK PRO 1X49W T16 HF OP L840	53.0	1.7	96548078	PPP149ZOP
	POPPACK PRO 1X54W T16 HF OP L840	58.0	1.5	96548080	PPP154ZOP
	POPPACK PRO 2X49W T16 HF OP L840	107.0	1.9	96548079	PPP249ZOP
Emergency & Control Modules	POPPACK PRO 2X54W T16 HF OP L840	115.0	1.6	96548081	PPP254ZOP
	POPPACK LED E3 KIT	2.0	0.4	96504901	PPPE
	POPPACK LED E3T KIT	2.0	0.4	96504902	PPPET
	POPPACK SLD PIR KIT	-	0.2	96504903	PPPS

### PopPack Pro

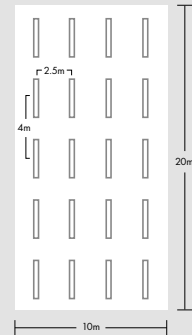

Room height	5m
Work Plane	0m
Maintenance factor	0.8
Reflectances	Ceiling: 50%
	Wall: 30%
	Floor: 20%
Cat. No.	PPP235Z+PPP35/49REF
Lamp	T5
Lumens	5478 lm
Lux	303 lux

Waterproof

# AquaForce II LED

## Standards



## Installation Options



A range of IP65 rated LED luminaires for high quality low energy lighting in wet, dusty environments

- The traditional design gives an aesthetically pleasing appearance – ideal for direct replacement on refurbishment projects
- Installation features include quick fix with Connect options, through wiring and BESA box compatibility (600mm spacing)
- Highly efficient LEDs reduce energy consumption and costs, and provide further savings arising from longer maintenance lifecycles
- 102Llm/W – exceeding building regulation requirements
- 50 000 hour rated life
- Integral 3 hour emergency option reduces installation time and complexity

## Materials and Finish

- Canopy: polycarbonate
- Diffuser: polycarbonate with linear prisms
- Gasket: expanded polyurethane
- Toggles: stainless steel
- Gear tray: steel, white enamelled finish

## Installation and Mounting

- Cable entry positions at the back and each end of the fitting
- Supplied with IP65 grommet
- Stainless steel quick fix brackets supplied with each luminaire
- Stainless steel toggles are captive in the canopy to prevent loss during maintenance
- Steel gear tray is retained and suspended by spring latches
- Conduit mounting, chain suspension and catenary suspension kits are all available as accessories

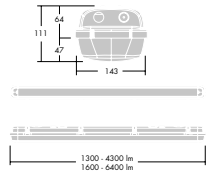

## Aquaforce II LED

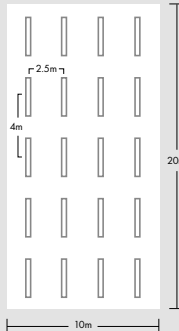

Room height	5m
Work Plane	0m
Maintenance factor	0.8
Reflectances	Ceiling: 50%
	Wall: 30%
	Floor: 20%
Cat. No.	AQ6400Z
Lamp	LED
Lumens	6400 lm
Lux	289 lux





## Ordering Guide

Option	Description	Circuit Power (W)	Wt (Kg)	SAP Code	Cat No.
<b>AQUAFORCE II LED</b>					
HF	AQUAF2 LED 4300 HF L840	41.7	2.4	96241869	AQ4300Z
	AQUAF2 LED 6400 HF L840	61.8	2.8	96241871	AQ6400Z
HF Quick Connect	AQUAF2 LED 4300 HF QF CONNECT L840	41.7	2.6	96241870	AQ4300ZQF
	AQUAF2 LED 6400 HF QF CONNECT L840	61.8	3.0	96241872	AQ6400ZQF
HF Through Wire	AQUAF2 LED 4300 HF TW L840	41.7	2.8	96241941	AQ4300ZTW
	AQUAF2 LED 6400 HF TW L840	61.8	3.3	96241944	AQ6400ZTW
HF Emergency	AQUAF2 LED 4300 HF E3 L840	41.7	2.7	96241939	AQ4300ZE
	AQUAF2 LED 6400 HF E3 L840	61.8	3.1	96241942	AQ6400ZE
HF Dimming	AQUAF2 LED 4300 HFI L840	41.7	2.5	96241940	AQ4300D
	AQUAF2 LED 6400 HFI L840	61.8	2.9	96241943	AQ6400D
<b>AQUAFORCE II LED ACCESSORIES</b>					
	SWITCHLITE SLD BATTEN PIR		-	96601988	-
	SWITCHLITE CC PROGRAMMER		-	96240295	-
	FORCE2 FIX/CH KIT		0.02	96503167	AQCHASUS
	FORCE2 MCA KIT		0.1	96233817	AQCATSUS
	FORCE2 MRS KIT		0.06	96503169	AQCONKIT
	FORCE2 BESA KIT		0.53	96503168	AQBESAKIT

Waterproof

# AquaForce II

Standards



Installation Options



A highly durable, IP65 rated, luminaire for use in wet and dusty areas, where reliability is important.

- Deep gasket channel for an assured IP65 seal
- Suspendable gear tray for easy maintenance
- Connect, ready to install versions
- Supplied complete with lamp(s)

**Materials and Finish**

- Canopy and diffuser: injection moulded fire retardant polycarbonate
- Gear tray: sheet steel, white enamel finish
- Toggles: polycarbonate (stainless steel available)

**Installation and Mounting**

- Cable entry positions at the back and each end of the fitting
- Stainless steel quick-fix brackets supplied with each luminaire
- Toggle clips easy to fit and close by hand.
- Connect versions available with fast electrical connection facility
- Conduit box mounting, chain suspension, conduit suspension and catenary suspension kits, plus through wire kits are all available

Visit [www.thornlighting.co.uk/AQU2](http://www.thornlighting.co.uk/AQU2) for accessory information

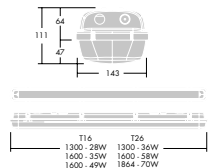
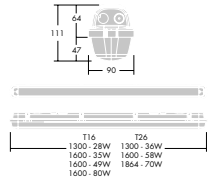

**Aquaforce II**

<b>Room height</b>	5m
<b>Work Plane</b>	0m
<b>Maintenance factor</b>	0.8
<b>Reflectances</b>	Ceiling: 50%
	Wall: 30%
	Floor: 20%
<b>Cat. No.</b>	AQ2492
<b>Lamp</b>	T5
<b>Lumens</b>	8239 lm
<b>Lux</b>	325 lux



## Ordering Guide

Option	Description	Circuit Power (W)	Wt (Kg)	SAP Code	Cat No.
<b>AQUAFORCE II – T5</b>					
HF	AQUAF2 1x28W T16 HF L840	31.5	2.1	96236923	AQ128Z
	AQUAF2 1x35W T16 HF L840	39.0	2.4	96236924	AQ135Z
	AQUAF2 1x49W T16 HF L840	54.5	2.5	96236925	AQ149Z
	AQUAF2 1x80W T16 HF L840	86.0	2.5	96236926	AQ180Z
	AQUAF2 2x28W T16 HF L840	62.0	2.5	96236927	AQ228Z
	AQUAF2 2x35W T16 HF L840	77.0	2.5	96236928	AQ235Z
	AQUAF2 2x49W T16 HF L840	109.0	2.5	96236929	AQ249Z
HF Emergency	AQUAF2 1x28W T16 HF E3 L840	31.5	2.9	96236930	AQ128ZE
	AQUAF2 1x35W T16 HF E3 L840	39.0	2.9	96236931	AQ135ZE
	AQUAF2 1x49W T16 HF E3 L840	54.5	3.5	96236932	AQ149ZE
	AQUAF2 2x28W T16 HF E3 L840	62.0	3.5	96236933	AQ228ZE
	AQUAF2 2x35W T16 HF E3 L840	77.0	4.7	96236934	AQ235ZE
AQUAF2 2x49W T16 HF E3 L840	109.0	3.5	96236935	AQ249ZE	

## AQUAFORCE II – T8

HF	AQUAF2 1x36W T26 HF L840	35.5	1.8	96503023	AQ136Z
	AQUAF2 1x58W T26 HF L840	54.5	1.8	96503046	AQ158Z
	AQUAF2 1x70W T26 HF L840	68.0	3.7	96503069	AQ170Z
	AQUAF2 2x36W T26 HF L840	72.0	2.6	96503092	AQ236Z
	AQUAF2 2x58W T26 HF L840	107.0	3.1	96503115	AQ258Z
	AQUAF2 2x70W T26 HF L840	130.0	3.0	96503138	AQ270Z
HF Emergency	AQUAF2 1x36W T26 HF E3 L840	35.5	2.6	96503031	AQ136ZE
	AQUAF2 1x58W T26 HF E3 L840	54.5	3.1	96503054	AQ158ZE
	AQUAF2 1x70W T26 HF E3 L840	68.0	4.0	96503077	AQ170ZE
	AQUAF2 2x36W T26 HF E3 L840	72.0	3.4	96503100	AQ236ZE
	AQUAF2 2x58W T26 HF E3 L840	107.0	4.1	96503123	AQ258ZE
AQUAF2 2x70W T26 HF E3 L840	130.0	4.0	96503146	AQ270ZE	
HF Connect	AQUAF2 1x36W T26 HF CON L840	35.5	1.9	96503041	AQ136ZC
	AQUAF2 1x58W T26 HF CON L840	54.5	2.5	96503064	AQ158ZC
	AQUAF2 1x70W T26 HF CON L840	68.0	3.0	96503087	AQ170ZC
	AQUAF2 2x36W T26 HF CON L840	72.0	1.9	96503110	AQ236ZC
	AQUAF2 2x58W T26 HF CON L840	107.0	2.5	96503133	AQ258ZC
AQUAF2 2x70W T26 HF CON L840	130.0	3.0	96503156	AQ270ZC	

# HiPak NEW

Standards



Installation Options



Direct replacement of HID high bays in open areas and racking aisles

- 10 000, 15 000 and 20 000 and 25 000 LED lumen packages for direct replacement of HID high bays
- 150W - 250W total load with up to 50% energy saving compared to traditional high bays
- Highly efficient operation with 105Lm/W
- Precise lens technology provides light exactly where it is needed, reducing waste light and maximising energy savings
- Cooling fin housing design allows air to flow through the luminaire and prevents overheating of components
- A choice of rack or wide beam optics to fit different application requirements
- DALI options available to further increase energy savings
- 50 000 hours rated life, equivalent to 12 years, 5 days per week at 16 hours per day operation

**Materials and Finish**

- Die cast aluminium housing
- Lens/diffuser: polycarbonate
- Luminaire is silicon free
- IK08 housing for robust operation
- IP65 protection

**Installation and Mounting**

- All supplied pre-wired with a quick connector, for easy plug and play connection
- Hook supplied as standard with each luminaire
- Wire, wall/ceiling and pendant mounting possible with additional accessories (each to be ordered separately)

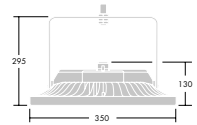

15 000lm

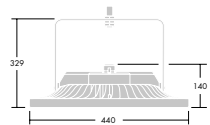

20 000 - 25 000lm

**HiPak - 100m x 100m - 110 luminaires**

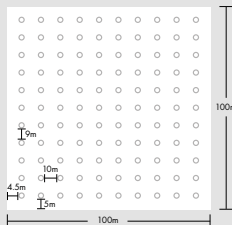

Room height	9m
Work plane	0.2m
Maintenance factor	0.7
Reflectances	Ceiling: 50%
	Wall: 30%
	Floor: 20%
SAP Code	96642757
Lamp	LED
Lumens	25,000lm
Lux	200 lux



## Ordering Guide

Description	Circuit Power (W)	Wt (kg)	SAP Code	Cat. No.
<b>HIPAK - WIDE DISTRIBUTION</b>				
HIPAK LED10000-840 HF WD	99	5.60	96628171	HK10000ZWD
HIPAK LED10000-840 HFIX WD	99	7.30	96628172	HK10000XWD
HIPAK LED15000-840 HF WD	140	5.60	96642741	HK15000ZWD
HIPAK LED20000-840 HF WD	192	7.30	96642749	HK20000ZWD
HIPAK LED25000-840 HF WD	240	7.30	96642757	HK25000ZWD
HIPAK LED15000-840 HFIX WD	140	5.60	96642742	HK15000XWD
HIPAK LED20000-840 HFIX WD	192	7.30	96642750	HK20000XWD
HIPAK LED25000-840 HFIX WD	240	7.30	96642758	HK25000XWD
<b>HIPAK - RACK DISTRIBUTION</b>				
HIPAK LED15000-840 HF RK	140	5.60	96642745	HK15000ZRK
HIPAK LED20000-840 HF RK	192	7.30	96642753	HK20000ZRK
HIPAK LED25000-840 HF RK	240	7.30	96642761	HK25000ZRK
HIPAK LED15000-840 HFIX RK	140	5.60	96642746	HK15000XRK
HIPAK LED20000-840 HFIX RK	192	7.30	96642754	HK20000XRK
HIPAK LED25000-840 HFIX RK	240	7.30	96642762	HK25000XRK
<b>HIPAK ACCESSORIES</b>				
HIPAK STIRRUP MCE/MWA		6.00	96642765	HKBRA
HIPAK ROD SUSPENSION		0.5	96642766	HKRS
SWITCHLITE MRE SLD HIBAY PIR		-	96601981	-
SENSA MRE DDP HIBAY PIR		-	96601982	-
SWITCHLITE KIT MSF		-	96218678	-
SWITCHLITE CC PROGRAMMER		-	96240295	-
SWITCHLITE IR LCD PROGRAMMER		-	96241421	-



# HiPak Pro LED

Standards

EN 60998	EN 60598 -2-22	IK07	IK08	IP20	IP43	IP66
T <sub>a</sub> +35	E3 T <sub>a</sub> +30°C	650°C	850°C			

Installation Options

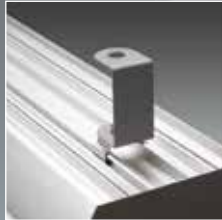
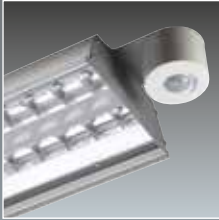

Robust, low maintenance, energy saving industrial LED High Bay

- Ideal alternative to 250/400W solutions – up to 45% more energy efficient
- Dedicated individual LED optics for precise light control for racking and open areas
- Integral PIR sensor and DALI dimmable to maximise energy savings
- Dedicated body profile and on board thermal management system ensures LED performance and lifetime
- 87 Lm/W – exceeding building regulation requirements
- 50 000 hour rated life

**Materials and Finish**

- Housing: anodised aluminium extrusion with steel powder coated end caps (close to RAL 9006)
- Reflector: high grade MIRO 5 aluminium with plastic front cover

**Installation and Mounting**

- All mounting kits to be ordered separately and clip tool free onto the back of the body
- For chain suspension use kit HPCH
- For trunking mounting via 20mm holes use bracket HPBRA
- For catenary suspension use kit HPMCA
- To mechanically join two luminaires together both a mounting kit and accessory HPBRT need to be ordered
- A 2.5mm<sup>2</sup> piano key terminal block is accessed via a sliding gear tray cover offering two 20mm cable entries
- Integral sensor versions offer movement detection as well as daylight control and can be mounted up to 16m heights
- Hand held programmer can be used from the floor to customise sensor settings
- Emergency versions suitable for maximum ambient temperature up to 30°C

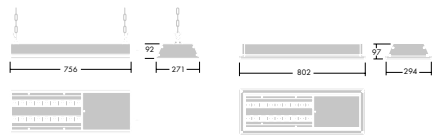

IP43

**HiPak Pro LED**

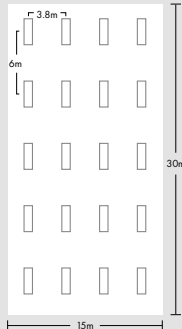

Room height	12m
Work Plane	0m
Maintenance factor	0.8
Reflectances	Ceiling: 50%
	Floor: 20%
Cat. No.	HP13000XWD
Lamp	LED
Lumens	13000 lm
Lux	312 lux

## Ordering Guide

Description	Circuit Power (W)	Wt (kg)	SAP Code	Cat No.	Description	Circuit Power (W)	Wt (kg)	SAP Code	Cat No.
<b>HIPAK PRO LED - IP43</b>					<b>HIPAK PRO LED - IP66</b>				
HIPAK PRO LED 13500-740 HFI-X WD	104	8.8	96628026	HP13500YWD	HIPAK PRO IP66 LED 13500-740 HFI-X RK	104	13.9	96628020	HP6613500YRK
HIPAK PRO LED 13500-740 HFI-X RK	104	8.8	96628027	HP13500YRK	HIPAK PRO IP66 LED 13500-740 HFI-X WD	104	13.9	96628025	HP6613500YWD
HIPAK PRO LED 12500-840 HFI-X RK	104	8.8	96642939	HP12500YRK	HIPAK PRO IP66 LED 12500-840 HFI-X RK	104	13.9	96642963	HP6612500YRK
HIPAK PRO LED 12500-840 HFI-X WD	104	8.8	96642940	HP12500YWD	HIPAK PRO IP66 LED 12500-840 HFI-X WD	104	13.9	96642964	HP6612500YWD
HIPAK PRO LED 18500-740 HFI-X RK	152	8.8	96642951	HP18500YRK	HIPAK PRO IP66 LED 18500-740 HFI-X RK	152	13.9	96642990	HP6618500YRK
HIPAK PRO LED 18500-740 HFI-X WD	152	8.8	96642952	HP18500YWD	HIPAK PRO IP66 LED 18500-740 HFI-X WD	152	13.9	96642991	HP6618500YWD
HIPAK PRO LED 17000-840 HFI-X RK	152	8.8	96642945	HP17000YRK	HIPAK PRO IP66 LED 17000-840 HFI-X RK	152	13.9	96642978	HP6617000YRK
HIPAK PRO LED 17000-840 HFI-X WD	152	8.8	96642946	HP17000YWD	HIPAK PRO IP66 LED 17000-840 HFI-X WD	152	13.9	96642979	HP6617000YWD
HIPAK PRO IP40 LED 13500-740 HFI-S-X RK	104	9.3	96642927	HP13500YSRK	HIPAK PRO IP66 LED 13500-740 HFI-X E3 RK	104	14.3	96628051	HP6613500YERK
HIPAK PRO IP40 LED 13500-740 HFI-S-X WD	104	9.3	96642928	HP13500YSWD	HIPAK PRO IP66 LED 13500-740 HFI-X E3 WD	104	14.3	96628085	HP6613500YEWWD
HIPAK PRO IP40 LED 12500-840 HFI-S-X RK	104	9.3	96642924	HP12500YSRK	HIPAK PRO IP66 LED 12500-840 HFI-X E3 RK	104	14.3	96642961	HP6612500YERK
HIPAK PRO IP40 LED 12500-840 HFI-S-X WD	104	9.3	96642925	HP12500YSWD	HIPAK PRO IP66 LED 12500-840 HFI-X E3 WD	104	14.3	96642962	HP6612500YEWWD
HIPAK PRO IP40 LED 18500-740 HFI-S-X RK	152	9.3	96642933	HP18500YSRK	HIPAK PRO IP66 LED 18500-740 HFI-X E3 RK	152	14.3	96642987	HP6618500YERK
HIPAK PRO IP40 LED 18500-740 HFI-S-X WD	152	9.3	96642934	HP18500YSWD	HIPAK PRO IP66 LED 18500-740 HFI-X E3 WD	152	14.3	96642988	HP6618500YEWWD
HIPAK PRO IP40 LED 17000-840 HFI-S-X RK	152	9.3	96642930	HP17000YSRK	HIPAK PRO IP66 LED 17000-840 HFI-X E3 RK	152	14.3	96642976	HP6617000YERK
HIPAK PRO IP40 LED 17000-840 HFI-S-X WD	152	9.3	96642931	HP17000YSWD	HIPAK PRO IP66 LED 17000-840 HFI-X E3 WD	152	14.3	96642977	HP6617000YEWWD
HIPAK PRO LED 13500-740 HFI-X E3 WD	104	9.2	96628019	HP13500YEWWD	<b>HIPAK PRO LED - SPORT</b>				
HIPAK PRO LED 13500-740 HFI-X E3 RK	104	9.2	96628052	HP13500YERK	HIPAK PRO LED 13500-740 HFI-X WD SPRT	104	8.8	96642929	HPS13500YWD
HIPAK PRO LED 12500-840 HFI-X E3 RK	104	9.2	96642937	HP12500YERK	HIPAK PRO LED 12500-840 HFI-X WD SPRT	104	14.3	96642966	HPS12500YWD
HIPAK PRO LED 12500-840 HFI-X E3 WD	104	9.2	96642938	HP12500YEWWD	HIPAK PRO LED 18500-740 HFI-X WD SPRT	152	8.8	96642923	HPS18500YWD
HIPAK PRO LED 18500-740 HFI-X E3 RK	152	9.2	96642948	HP18500YERK	HIPAK PRO LED 17000-840 HFI-X WD SPRT	152	8.8	96642941	HPS17000YWD
HIPAK PRO LED 18500-740 HFI-X E3 WD	152	9.2	96642949	HP18500YEWWD	HIPAK PRO LED 13500-740 HFI-X ASY SPRT	104	8.8	96628053	HPS13500YAS
HIPAK PRO LED 17000-840 HFI-X E3 RK	152	9.2	96642943	HP17000YERK	HIPAK PRO LED 12500-840 HFI-X ASY SPRT	104	9.2	96642965	HPS12500YAS
HIPAK PRO LED 17000-840 HFI-X E3 WD	152	9.2	96642944	HP17000YEWWD	HIPAK PRO LED 18500-740 HFI-X ASY SPRT	152	8.8	96642950	HPS18500YAS
HIPAK PRO IP40 LED 13500-740 HFI-S-X E3 RK	104	-	96665228	HP13500YSERK	HIPAK PRO LED 17000-840 HFI-X ASY SPRT	152	9.2	96642936	HPS17000YAS
HIPAK PRO IP40 LED 13500-740 HFI-S-X E3 WD	104	5.6	96665229	HP13500YSEWWD	HIPAK PRO LED 13500-740 HFI-X E3 WD SPRT	104	8.8	96642932	HPS13500YEWWD
HIPAK PRO IP40 LED 12500-840 HFI-S-X E3 RK	104	-	96665232	HP12500YSERK	HIPAK PRO LED 12500-840 HFI-X E3 WD SPRT	104	8.8	96642935	HPS12500YEWWD
HIPAK PRO IP40 LED 12500-840 HFI-S-X E3 WD	104	-	96665233	HP12500YSEWWD	HIPAK PRO LED 18500-740 HFI-X E3 WD SPRT	152	8.8	96642926	HPS18500YEWWD
HIPAK PRO IP40 LED 18500-740 HFI-S-X E3 RK	152	-	96665230	HP18500YSERK	HIPAK PRO LED 17000-840 HFI-X E3 WD SPRT	152	9.2	96642942	HPS17000YEWWD
HIPAK PRO IP40 LED 18500-740 HFI-S-X E3 WD	152	9.2	96665231	HP18500YSEWWD	HIPAK PRO LED 13500-740 HFI-X E3 ASY SPRT	104	9.2	96628018	HPS13500YEAS
HIPAK PRO IP40 LED 17000-840 HFI-S-X E3 RK	152	-	96665234	HP17000YSERK	HIPAK PRO LED 12500-840 HFI-X E3 ASY SPRT	104	14.3	96642967	HPS12500YEAS
HIPAK PRO IP40 LED 17000-840 HFI-S-X E3 WD	152	-	96665235	HP17000YSEWWD	HIPAK PRO LED 18500-740 HFI-X E3 ASY SPRT	152	9.2	96642947	HPS18500YEAS
<b>HIPAK PRO LED - IP43 ACCESSORIES</b>					HIPAK PRO LED 17000-840 HFI-X E3 ASY SPRT	152	9.2	96628050	HPS17000YEAS
HIPAK LED BRA	0.4		96241497	HPTRUBRA	<b>HIPAK PRO LED - SPORT ACCESSORIES</b>				
HIPAK PRO KIT FIX/CH	0.2		96241507	HPCHAIN	HIPAK PRO KIT FIX SPORT				
HIPAK PRO KIT FIX BRA JOINT	0.9		96241508	HPJOINT	1.8		96628086	HPSBRA	
HIPAK PRO KIT FIX MCA	0.2		96241515	HPCATSUS	High ambient temperature versions available. Visit <a href="http://www.thornlighting.co.uk/HIPP">www.thornlighting.co.uk/HIPP</a> for more information				



# ImpactForce LED

## Standards

EN 60998	IP65	IK03	IK07	T <sub>a</sub> 25
850 °C				

## Installation Options



A high performance impact resistant, IP65 proof fluorescent range

- Unique shape and flush toggle design promotes easy cleaning
- For quick and easy maintenance, gear tray simply hangs from internal clips
- Vandal resistant
- Certified for use in food processing plants from a hygiene point of view (HACCP/IFS/BRC Standard)
- 91Llm/W – exceeding building regulation requirements
- 50 000 hour rated life

## Materials and Finish

- Canopy: glass-fibre reinforced polyester
- Diffuser: polycarbonate with linear prisms
- Gasket: expanded polyurethane
- Toggles: stainless steel
- Gear tray: steel, white enamelled finish

## Installation and Mounting

- Cable entry positions at the back and each end of the fitting
- Supplied with IP65 grommet
- Stainless steel quick-fix brackets supplied with each luminaire
- Stainless steel toggles are captive in the canopy to prevent loss during maintenance, and steel gear tray is retained by spring latches
- BESA box and conduit mounting, chain suspension and catenary suspension kits, plus through wire kits are all available as accessories
- Looping in and out possible if one end
- LSOH cabling as standard

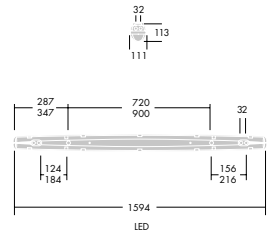





### Ordering Guide

Option	Description	Circuit Power (W)	Wt (Kg)	SAP Code	Cat No.
<b>IMPACTFORCE LED</b>					
HF Dimming	IMPACTF2 LED 4260 HFI L840	47.0	3.2	96241738	IF4260D
<b>IMPACTFORCE LED - ACCESSORIES</b>					
	FORCE2 FIX/CH KIT		0.02	96503167	AQCHASUS
	FORCE2 MCA KIT		0.1	96233817	AQCATSUS
	FORCE2 MRS KIT		0.06	96503169	AQCONKIT
	FORCE2 BESA KIT		0.53	96503168	AQBESAKIT

T5 fluorescent versions available. Visit [www.thornlighting.co.uk/IMPf](http://www.thornlighting.co.uk/IMPf) for more information

### Impactforce LED

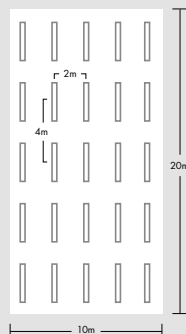

Room height	3m
Work Plane	0m
Maintenance factor	0.8
Reflectances	Ceiling: 50%
	Wall: 30%
	Floor: 20%
Cat. No.	IF4260D
Lamp	LED
Lumens	4260 lm
Lux	312 lux

# CorrosionForce LED

## Standards



## Installation Options



A corrosion resistant IP65 proof fluorescent range for use in all atmospheres laden with salts acids and mineral oils

- Good resistance to chemicals and corrosion (polycarbonate free)
- Unique shape and flush toggle design promotes easy cleaning
- For quick and easy maintenance, gear tray simply hangs from internal clips
- Certified for use in food processing plants from a hygiene point of view (HACCP/IFS/BRC Standard)
- 91Llm/W – exceeding building regulation requirements
- 50 000 hour rated life

### Materials and Finish

- Canopy: glass-fibre reinforced polyester
- Diffuser: PMMA with linear prisms
- Gasket: expanded polyurethane
- Toggles: stainless steel
- Gear tray: steel, white enamelled finish

### Installation and Mounting

- Cable entry positions at the back and each end of the fitting
- Supplied with IP65 grommet
- Stainless steel quick-fix brackets supplied with each luminaire
- Stainless steel toggles are captive in the canopy to prevent loss during maintenance, and steel gear tray is retained by spring latches
- BESA box and conduit mounting, chain suspension and catenary suspension kits, plus through wire kits are all available as accessories
- Looping in and out possible at one end
- LSOH cabling as standard

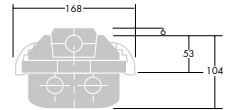



### Ordering Guide

Option	Description	Circuit Power (W)	Wt (Kg)	SAP Code	Cat No.
<b>CORROSIONFORCE LED</b>					
HF Dimming	CORRF2 LED 4260 HFI L840	47.0	2.0	96241739	CF4260D
<b>IMPACTFORCE LED - ACCESSORIES</b>					
	FORCE2 FIX/CH KIT		0.02	96503167	AQCHASUS
	FORCE2 MCA KIT		0.1	96233817	AQCATSUS
	FORCE2 MRS KIT		0.06	96503169	AQCONKIT
	FORCE2 BESA KIT		0.53	96503168	AQBESAKIT

T5 fluorescent versions available. Visit [www.thornlighting.co.uk/CORR](http://www.thornlighting.co.uk/CORR) for more information

#### Corrosionforce LED

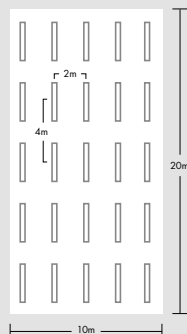

Room height	3m
Work Plane	0m
Maintenance factor	0.8
Reflectances	Ceiling: 50%
	Wall: 30%
	Floor: 20%
Cat. No.	CF4260D
Lamp	LED
Lumens	4260 lm
Lux	314 lux

# Hi-Rack

## Standards

EN 60958	IP20	IK07	IK08	T <sub>a</sub> 5 +25
850°C		CE		

## Installation Options



A range of fluorescent luminaires with 'area' or 'rack' reflectors for interior spaces with high ceilings

- Optional integral sensor maximises energy savings compared to traditional HID hi-bays
- Quick and simple installation – external direct wiring access removes the need to dismantle the luminaire
- High output emergency solutions enable higher mounting heights, with better spacings, to be achieved
- Plastic cover versions available
- Supplied complete with lamps

## Materials and Finish

- Housing: white steel with polycarbonate end caps
- Reflector: high grade aluminium, wide optic – Satinbrite, rack optic – Mirrorbrite
- Attachment cover: UV stable polycarbonate

## Installation and Mounting

- Mounting kits to be ordered separately
- 100mm gap must be left between the top of the luminaire and any surface
- For wire suspension, accessory kit HRMSWK slides directly on to the back of the body and can be easily adjusted
- Accessory kit HRBRFK allows trunking mounting via 20mm holes or rod mounting via 10mm holes. For canalis trunking system mounting accessory HRBRFK2 can be used via M6 screw fixings
- A 2.5mm<sup>2</sup> piano key terminal block is accessed externally via a hinged lid
- Integral sensor versions come factory pre set as follows (off time delay – 10 minutes, after off time delay lights stay on at 10% for 3 hours then turn off, daylight linking deactivated) can be mounted up to 16m. Coverage is on a 1:1 ratio i.e. at 16m height, the detectors footprint is a 16m diameter circle
- Hand held programmer can be used from the floor to customise sensor settings

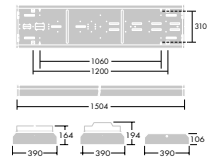
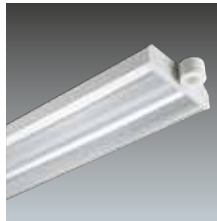

## Hi-Rack

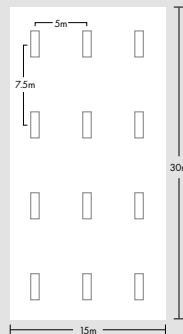

Room height	12m
Work Plane	0m
Maintenance factor	0.8
Reflectances	Ceiling: 50%
	Wall: 30%
	Floor: 20%
Cat. No.	HR4802WD
Lamp	T5
Lumens	21771lm
Lux	289 lux



## Ordering Guide

Option	Description	Circuit Power (W)	Wt (Kg)	SAP Code	Cat No.
<b>HI-RACK – WIDE OPTIC</b>					
HF	HI-RACK 4x49W HF WD L840	214.0	5.6	96535219	HR449ZWD
	HI-RACK 4x80W HF WD L840	350.0	5.6	96535227	HR480ZWD
HF	HI-RACK 4x49W HF E3 WD L840	214.0	6.6	96535220	HR449ZEW
Emergency	HI-RACK 4x80W HF E3 WD L840	350.0	6.6	96535228	HR480ZEW
HF Dimming	HI-RACK 4x49W HFI WD L840	212.0	10.5	96549193	HR449DWD
	HI-RACK 4x80W HFI WD L840	335.0	10.8	96549215	HR480DWD
HF Dimming	HI-RACK 4x49W HFI E3 WD L840	212.0	6.6	96549185	HR449DEWD
Emergency	HI-RACK 4x80W HFI E3 WD L840	335.0	8.5	96549209	HR480DEWD
HF Dimming with Sensor	HI-RACK 4x49W HFSI WD L840	212.0	7.1	96549205	HR449DSWD
	HI-RACK 4x80W HFSI WD L840	335.0	10.5	96549225	HR480DSWD
HF Dimming Em with Sensor	HI-RACK 4x49W HFSI E3 WD L840	212.0	15.5	96549197	HR449DSEWD
	HI-RACK 4x80W HFSI E3 WD L840	335.0	8.2	96549219	HR480DSEWD

## HI-RACK – RACK OPTIC

HF	HI-RACK 4x49W HF RK L840	214.0	5.6	96535203	HR449ZRK
	HI-RACK 4x80W HF RK L840	350.0	5.6	96535211	HR480ZRK
HF	HI-RACK 4x49W HF E3 RK L840	214.0	6.6	96535204	HR449ZERK
Emergency	HI-RACK 4x80W HF E3 RK L840	350.0	6.6	96535212	HR480ZERK
HF Dimming	HI-RACK 4x49W HFI RK L840	212.0	10.2	96549191	HR449DRK
	HI-RACK 4x80W HFI RK L840	335.0	10.0	96549213	HR480DRK
HF Dimming	HI-RACK 4x49W HFI E3 RK L840	212.0	6.6	96549183	HR449DERK
Emergency	HI-RACK 4x80W HFI E3 RK L840	335.0	6.6	96549207	HR480DERK
HF Dimming with Sensor	HI-RACK 4x49W HFSI RK L840	212.0	8.2	96549203	HR449DSRK
	HI-RACK 4x80W HFSI RK L840	335.0	11.6	96549223	HR480DSRK
HF Dimming Em with Sensor	HI-RACK 4x49W HFSI E3 RK L840	212.0	6.9	96549195	HR449DSERK
	HI-RACK 4x80W HFSI E3 RK L840	335.0	8.5	96549217	HR480DSERK

## ACCESSORIES

HI-RACK KIT FIX TRUNKING BRACKET	0.8	96535235	HRBRFK
HI-RACK KIT FIX CATENARY TRUNKING BRACKET	0.7	96239583	HRBRFK2
HI-RACK KIT MSW	0.1	96535236	HRMSWK

## REMOTE HANDHELD CONTROLLER

SWITCHLITE MRE SLD HIBAY PIR	-	96601981	-
SENSA MRE DDP HIBAY PIR	-	96601982	-
SWITCHLITE KIT MSF	-	96218678	-
SWITCHLITE CC PROGRAMMER	-	96240295	-
SWITCHLITE IR LCD PROGRAMMER	-	96241421	-



High output emergency versions available.  
Visit [www.thornlighting.co.uk/HIRK](http://www.thornlighting.co.uk/HIRK) for more information

# Leopard LED

## Standards



## Installation Options



Series of vandal resistant LED luminaires for wall or ceiling mounting, direct alternative to traditional 2D luminaires

- Sealed to IP65 for exterior applications when supplied gasket fitted
- Energy saving sensor options, luminaire is activated when movement has been detected, then will switch off
- Integral emergency version as standard
- 92 Lm/W – exceeding building regulation requirements
- 900lm replaces 16W 2D
- 1200lm replaces 28W 2D
- 1900lm replaces 38W 2D
- 50 000 hour rated life

## Materials and Finish

- Bodies: polycarbonate, white
- Diffusers: polycarbonate opal prismatic
- Geartray: Pre-coated steel

## Installation and Mounting

- Suitable for surface mounting with rear BESA provision
- Side entry (25mm conduit) for through wiring with entry into 3 way terminal block suitable to accept 2 x 2.5mm
- Vandal resistant screw kit available as an accessory
- All internal components are fixed to a white pre-coated gear tray which has a unique (tool free) click fit into base

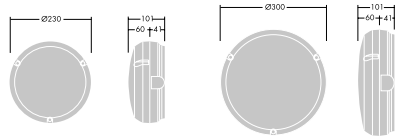

## Leopard LED



Room height	1.8m
Work Plane	0m
Maintenance factor	0.8
Reflectances	Ceiling: 50%
	Wall: 30%
	Floor: 20%
Cat. No.	LERL19ZOPW
Lamp	LED
Lumens	1900 lm
Lux	121 lux



## Ordering Guide

Option	Description	Circuit Power (W)	Wt (Kg)	SAP Code	Cat No.
<b>LEOPARD LED - SMALL BODY - 230mmØ</b>					
	LEOPARD 900 LED2 OP RD WH L840	10.0	0.73	96627757	LER9ZOPW
HF &	LEOPARD 900 LED2 MWS OP RD WH L840	10.0	0.81	96627758	LER9ZSOPW
Emergency	LEOPARD 1200 LED OP RD WHT L840	13.0	0.9	96617046	LER12ZOPW
	LEOPARD 1200 LED E3 OP RD WHT L840	13.0	1.2	96617047	LER12ZEOPW
<b>LEOPARD LED - LARGE BODY - 300mmØ</b>					
HF	LEOPARD 1200 LED OP RD WHT L840	13.0	1.3	96242233	LERL12ZOPW
	LEOPARD 1900 LED OP RD WH L840	20.4	1.3	96617051	LERL19ZOPW
HF	LEOPARD 1200 LED E3 OP RD WHT L840	13.0	1.6	96242234	LERL12ZEOPW
Emergency	LEOPARD 1900 LED E3 OP RD WH L840	20.4	1.6	96617052	LERL19ZEOPW
	LEOPARD 1200 LED MWS OPRD WHI L840	13.0	1.4	96242235	LERL12ZSOPW
HF Sensor	LEOPARD 1900 LED MWS OP RD WHT L840	20.4	1.4	96242237	LERL19ZSOPW
HF Sensor	LEOPARD 1200 LED E3 MWS OPRD WHI L840	13.0	1.7	96242236	LERL12ZSEOPW
Emergency	LEOPARD 1900 LED E3 MWS OP RD WHT L840	20.4	1.7	96242238	LERL19ZSEOPW
<b>ACCESSORIES</b>					
	LEOPARD VANDAL PROOF SCREW KIT		0.1	96010366	LEVPKIT



# Leopard

## Standards



## Installation Options



Series of vandal resistant luminaires for wall or ceiling mounting, in black or white with opal or prismatic diffusers

- Sealed to IP65 for exterior applications when supplied gasket fitted
- Energy saving sensor options, luminaire is activated when movement has been detected, then will switch off
- 28W 2D integral emergency version as standard
- Choice of diffuser, body shape and colour
- HF control gear as standard
- Supplied complete with lamp

## Materials and Finish

- Bodies: polycarbonate, black or white
- Diffusers: polycarbonate opal and clear honeycomb prismatic
- Gear-tray: Pre-coated steel

## Installation and Mounting

- Suitable for surface mounting with rear BESA provision
- Side entry (25mm conduit) for through wiring with entry into 3 way terminal block suitable to accept 2 x 2.5mm
- Vandal resistant screw kit available as an accessory
- All internal components are fixed to a white pre-coated gear tray which has a unique (tool free) click fit into base
- Screw fixed diffuser

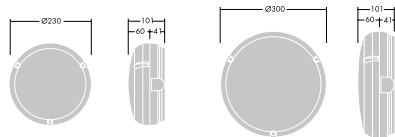





## Ordering Guide

Option	Description	Circuit Power (W)	Wt (Kg)	SAP Code	Cat No.
<b>LEOPARD – ROUND SMALL BODY</b>					
Prismatic, White	LEOPARD 1x16W TC-DD HF PR RD WHI L830	18.0	1.1	96238460	LER1 16ZPRW
Prismatic, Black	LEOPARD 1x16W TC-DD HF PR RD BLK L830	18.0	1.1	96238459	LER1 16ZPRB
Opal, White	LEOPARD 1x16W TC-DD HF OP RD WHI L830	18.0	1.1	96238458	LER1 16ZOPW
Opal, Black	LEOPARD 1x16W TC-DD HF OP RD BLK L830	18.0	1.1	96238457	LER1 16ZOPB

<b>LEOPARD – ROUND LARGE BODY</b>					
	LEOPARD 1x28W TC-DDEL HF PR RD WHI L840	32.0	1.8	96230498	LER1 28ZPRW
	LEOPARD 1x28W TC-DDEL HF E3 PR RD WHI L840	33.0	2.8	96230490	LER1 28ZPRW
Prismatic, White	LEOPARD 1x28W TC-DDEL HF MWS PRRD WHI L84	32.0	1.9	96239802	LER1 28ZSPRW
	LEOPARD 1x28W TC-DDEL HF MWS E3 PRRD WH L84	33.0	2.9	96239810	LER1 28ZSEPRW
	LEOPARD 1x38W TC-DDEL HF PR RD WHI L840	41.0	1.8	96238468	LER1 38ZPRW
	LEOPARD 1x28W TC-DDEL HF PR RD BLK L840	32.0	1.8	96230497	LER1 28ZPRB
	LEOPARD 1x28W TC-DDEL HF E3 PR RD BLK 40	33.0	2.8	96230489	LER1 28ZPRB
Prismatic, Black	LEOPARD 1x28W TC-DDELHF MWS PRRD BLK L84	32.0	1.9	96239801	LER1 28ZSPRB
	LEOPARD 1x28W TC-DDELHF MWS E3PRRD BK L84	33.0	2.9	96239809	LER1 28ZSEPRB
	LEOPARD 1x38W TC-DDEL HF PR RD BLK L840	41.0	1.8	96238467	LER1 38ZPRB
	LEOPARD 1x28W TC-DDEL HF OP RD WHI L840	32.0	1.8	96230494	LER1 28ZOPW
	LEOPARD 1x28W TC-DDEL HF E3 OP RD WHI 40	33.0	2.8	96230486	LER1 28ZOPW
Opal, White	LEOPARD 1x28W TC-DDELHF MWS OPRD WHI L84	32.0	1.9	96239797	LER1 28ZSOPW
	LEOPARD 1x28W TC-DDELHF MWS E3OPRD WH L84	33.0	2.9	96239806	LER1 28ZSEOPW
	LEOPARD 1x38W TC-DDEL HF OP RD WHI L840	41.0	1.8	96238466	LER1 38ZOPW
	LEOPARD 1x28W TC-DDEL HF OP RD BLK L840	32.0	1.8	96230493	LER1 28ZOPB
	LEOPARD 1x28W TC-DDEL HF E3 OP RD BLK 40	33.0	2.8	96230485	LER1 28ZOPB
Opal, Black	LEOPARD 1x28W TC-DDELHF MWS OPRD BLK L84	32.0	1.9	96239796	LER1 28ZSOPB
	LEOPARD 1x28WTC-DDELHF MWS E3OPRD BK L84	33.0	2.9	96239805	LER1 28ZSEOPB
	LEOPARD 1x38W TC-DDEL HF OP RD BLK L840	41.0	1.8	96238465	LER1 38ZOPB

## ACCESSORIES

LEOPARD 1X28W TC-DD HF E3 CONVERSION KIT	1.5	96010367	LE128EKIT
LEOPARD PHOTOCCELL KIT	0.3	96010365	LEPCKIT
LEOPARD VANDAL PROOF SCREW KIT	0.1	96010366	LEVPKIT

High output emergency versions available. Visit [www.thornlighting.co.uk/LPRD](http://www.thornlighting.co.uk/LPRD) for more information

# Loire LED

## Standards



## Installation Options



Decorative luminaire for wall or ceiling mounting with dome shaped diffuser

- Sealed to IP65
- Supplied with Quick Fix Bracket for safe and rapid electrical installation
- Integral emergency version as standard
- Direct replacement for traditional 28W 2D
- 50 000 hour rated life

### Materials and Finish

- Body: die-cast aluminium
- Bezel: polycarbonate white finish
- Diffuser: opal polycarbonate

### Installation and Mounting

- Suitable for surface mounting on wall or ceiling for both interior and exterior use
- Quick Fix Bracket is screw fixed onto mounting surface by 4 oblong holes (4.5mm x 10mm)
- Mains connection via 6x2x2.5mm<sup>2</sup> terminal block
- 'Light Box' mechanically and electrically auto-connected to the Quick Fix Bracket
- For loop wiring there are two Ø20mm cable entry holes on the Quick Fix Bracket

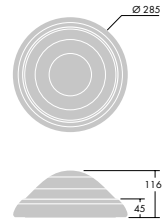



## Ordering Guide

Option	Description	Circuit Power (W)	Wt (Kg)	SAP Code	Cat No.
<b>LOIRE LED</b>					
HF	LO 1200 LED HF OP RD WHI L840	15.5	1.6	96241358	LO1200Z
HF Emergency	LO 1200 LED HF E3 OP RD WHI L840	15.5	1.8	96241359	LO1200ZE

### Loire LED



Room height	1.8m
Work Plane	0m
Maintenance factor	0.8
Reflectances	Ceiling: 50%
	Wall: 30%
	Floor: 20%
Cat. No.	LO1200Z
Lamp	LED
Lumens	1200 lm
Lux	100 lux

# Danube LED

## Standards



## Installation Options



Stylish luminaire for wall or ceiling mounting with low profile flared bezel and diffuser

- Sealed to IP65
- Supplied with Quick Fix Bracket for safe and rapid electrical installation
- Integral emergency version as standard
- Direct replacement for traditional 28W 2D
- 50 000 hour rated life

### Materials and Finish

- Body: die-cast aluminium
- Diffuser: opal polycarbonate
- Bezel: polycarbonate, white

### Installation and Mounting

- Suitable for surface mounting on wall or ceiling for both interior and exterior use
- Quick Fix Bracket is screw fixed onto mounting surface by 4 oblong holes (4.5mm x 10mm)
- Mains connection via 6x2x2.5mm<sup>2</sup> terminal block
- 'Light Box' mechanically and electrically auto-connected to the Quick Fix Bracket
- For loop wiring there are two Ø20mm cable entry holes on the Quick Fix Bracket

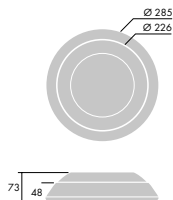



### Ordering Guide

Option	Description	Circuit Power (W)	Wt (Kg)	SAP Code	Cat No.
<b>DANUBE LED</b>					
HF	DA 1200 LED HF OP RD WHI L840	15.5	1.6	96241362	DA1200ZOP
HF Emergency	DA 1200 LED HF E3 OP RD WHI L840	15.5	1.8	96241363	DA1200ZEOP

#### Danube LED



Room height	1.8m
Work Plane	0m
Maintenance factor	0.8
Reflectances	Ceiling: 50%
	Wall: 30%
	Floor: 20%
Cat. No.	DA1200ZOP
Lamp	LED
Lumens	1200 lm
Lux	97 lux

Wall Mounted

# Club LED

## Standards



## Installation Options



Stylish, tough wall or ceiling mounted luminaire with the emphasis on its slim section

- Sealed to IP54
- Choice of bezel colour, complemented by an opal diffuser
- Energy saving sensor options, luminaire is activated when movement has been detected, then will switch off
- Integral emergency version as standard
- Direct replacement for traditional 28W 2D
- 50 000 hour rated life

### Materials and Finish

- Body and trim: injection moulded polycarbonate
- Diffuser: opal polycarbonate
- Body and trim colours: white body with white or polished chrome trim

### Installation and Mounting

- Suitable for surface mounting
- Rear BESA mounting provision
- Cable entry into 3 way terminal block suitable to accept 2x2.5mm<sup>2</sup>

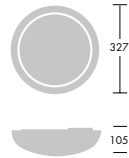



### Ordering Guide

Option	Description	Circuit Power (W)	Wt (Kg)	SAP Code	Cat No.
<b>CLUB LED</b>					
White	CLUB 1000 LED2 OP RD WH L840	13.0	1.5	96617056	CL10ZW4K
	CLUB 1000 LED2 OP RD WH L830	13.0	1.7	96242277	CL10ZW3K
	CLUB 1000 LED2 E3 OP RD WH L840	13.0	1.6	96617057	CL10ZEW4K
	CLUB 1000 LED2 MWS OP RD WH L840	13.0	1.8	96242239	CL10ZSW4K
	CLUB 1000 LED2 E3 MWS OP RD WH L840	13.0	1.8	96242240	CL10ZSEW4K
Chrome	CLUB 1000 LED2 OP RD CHR L840	13.0	1.5	96242253	CL10ZCH4K
	CLUB 1000 LED2 OP RD CHR L830	13.0	1.7	96627554	CL10ZCH3K
	CLUB 1000 LED2 E3 OP RD CHR L840	13.0	1.6	96242254	CL10ZECH4K
	CLUB 1000 LED2 MWS OP RD CHR L840	13.0	1.8	96242255	CL10ZSCH4K
	CLUB 1000 LED2 E3 MWS OP RD CHR L840	13.0	1.8	96242256	CL10ZSECH4K

### Club LED



Room height	1.8m
Work Plane	0m
Maintenance factor	0.8
Reflectances	Ceiling: 50%
	Wall: 30%
	Floor: 20%
Cat. No.	CL10ZW
Lamp	LED
Lumens	1000 lm
Lux	108 lux

# Novaline LED

Standards

EN 60958	IP40	T <sub>a</sub> 0 +25	T <sub>a</sub> -10 +30	850 °C

Installation Options



A low profile surface mounted luminaire featuring the next generation of high efficiency LED

- Available in lumen packages of 1 250 - 3 500 lumens, providing flexibility in lighting design and applications
- Advanced LED technology combined with excellent optics ensures a high >100lm/W efficiency
- Integrated presence sensor and master-slave installation capabilities increase energy saving opportunities
- Clean design and a slim profile available in two sizes

**Materials and Finish**

- Body: spun aluminium, white or satin chrome finish
- Diffuser: opal polycarbonate

**Installation and Mounting**

- Suitable for wall or ceiling mounting for interior use
- Simple installation with central BESA fixings and rear cable entry
- 3-way mains terminal block (4-way for emergency version)

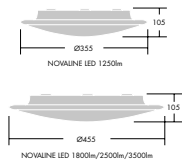

**Novaline LED 150lx**

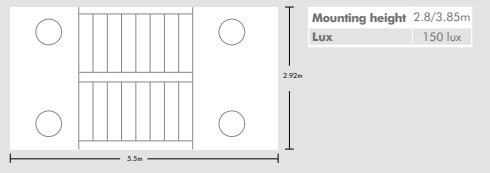

**Novaline LED**

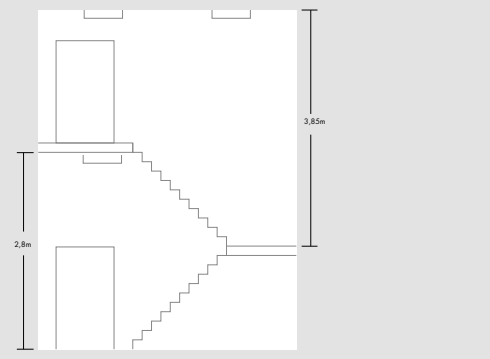

**Novaline LED**

Room height	1.8m
Work Plane	0m
Maintenance factor	0.8
Reflectances	Ceiling: 70%
	Wall: 50%
	Floor: 20%
Cat. No.	NV1800ZW4K
Lamp	LED
Lumens	1250 lm
Lux	107 lux



## Ordering Guide Supplied complete with lamp.

Description	Wt (Kg)	SAP Code	Cat No.	Description	Wt (Kg)	SAP Code	Cat No.
<b>NOVALINE LED</b>				<b>NOVALINE LED RF SLAVE</b>			
NOVALINE LED1250-830 HF WH	1.17	96642686	NV1250ZW3K	NOVALINE LED1800-830 HF RF CHR	2.19	96644002	NV1800ZWC3K
NOVALINE LED1250-840 HF WH	1.17	96642682	NV1250ZW4K	NOVALINE LED1800-830 HF RF WH	2.19	96643993	NV1800ZWW3K
NOVALINE LED1800-830 HF WH	2.14	96642694	NV1800ZW3K	NOVALINE LED1800-840 HF RF CHR	2.19	96644020	NV1800ZWC4K
NOVALINE LED1800-840 HF WH	2.14	96642690	NV1800ZW4K	NOVALINE LED1800-840 HF RF WH	2.19	96644011	NV1800ZWW4K
NOVALINE LED2500-830 HF WH	2.14	96642700	NV2500ZW3K	NOVALINE LED2500-830 COR RF CHR	2.19	96628154	NV2500CWC3K
NOVALINE LED2500-840 HF WH	2.14	96642696	NV2500ZW4K	NOVALINE LED2500-830 COR RF WH	2.19	96628151	NV2500CWW3K
NOVALINE LED3500-830 HF WH	2.14	96642706	NV3500ZW3K	NOVALINE LED2500-830 HF RF CHR	2.19	96644005	NV2500ZWC3K
NOVALINE LED3500-840 HF WH	2.14	96642702	NV3500ZW4K	NOVALINE LED2500-830 HF RF WH	2.19	96643996	NV2500ZWW3K
<b>NOVALINE LED EMERGENCY</b>				NOVALINE LED2500-840 COR RF CHR	2.19	96628160	NV2500CWC4K
NOVALINE LED1250-830 HF E3 WH	1.42	96642688	NV1250ZE3K	NOVALINE LED2500-840 COR RF WH	2.19	96628157	NV2500CWW4K
NOVALINE LED1250-840 HF E3 WH	1.42	96642684	NV1250ZE4K	NOVALINE LED2500-840 HF RF CHR	2.19	96644023	NV2500ZWC4K
NOVALINE LED1800-840 HF E3 WH	2.39	96642692	NV1800ZE4K	NOVALINE LED2500-840 HF RF WH	2.19	96644014	NV2500ZWW4K
NOVALINE LED2500-840 HF E3 WH	2.39	96642698	NV2500ZE4K	NOVALINE LED3500-830 HF RF CHR	2.19	96644008	NV3500ZWC3K
NOVALINE LED3500-840 HF E3 WH	2.39	96642704	NV3500ZE4K	NOVALINE LED3500-830 HF RF WH	2.19	96643999	NV3500ZWW3K
<b>NOVALINE LED MICROWAVE SENSOR</b>				NOVALINE LED3500-840 HF RF CHR	2.19	96644026	NV3500ZWC4K
NOVALINE LED1250-830 MWS WH	1.31	96642687	NV1250ZSW3K	NOVALINE LED3500-840 HF RF WH	2.19	96644017	NV3500ZWW4K
NOVALINE LED1250-840 MWS WH	1.31	96642683	NV1250ZSW4K	<b>NOVALINE LED RF SLAVE EMERGENCY</b>			
NOVALINE LED1800-830 MWS WH	2.28	96642695	NV1800ZSW3K	NOVALINE LED1800-830 HF RF E3 CHR	2.58	96644004	NV1800ZWE3K
NOVALINE LED1800-840 MWS WH	2.28	96642691	NV1800ZSW4K	NOVALINE LED1800-830 HF RF E3 WH	2.58	96643995	NV1800ZWEW3K
NOVALINE LED2500-830 MWS WH	2.28	96642701	NV2500ZSW3K	NOVALINE LED1800-840 HF RF E3 CHR	2.58	96644022	NV1800ZWE4K
NOVALINE LED2500-840 MWS WH	2.28	96642697	NV2500ZSW4K	NOVALINE LED1800-840 HF RF E3 WH	2.58	96644013	NV1800ZWEW4K
NOVALINE LED3500-830 MWS WH	2.28	96642707	NV3500ZSW3K	NOVALINE LED2500-830 COR RF E3 CHR	2.58	96628156	NV2500CWE3K
NOVALINE LED3500-840 MWS WH	2.28	96642703	NV3500ZSW4K	NOVALINE LED2500-830 COR RF E3 WH	2.58	96628153	NV2500CWEW3K
<b>NOVALINE LED MICROWAVE SENSOR EMERGENCY</b>				NOVALINE LED2500-830 HF RF E3 CHR	2.58	96644007	NV2500ZWE3K
NOVALINE LED1250-830 MWS E3 WH	1.56	96642689	NV1250ZSEW3K	NOVALINE LED2500-830 HF RF E3 WH	2.58	96643998	NV2500ZWEW3K
NOVALINE LED1250-840 MWS E3 WH	1.56	96642685	NV1250ZSEW4K	NOVALINE LED2500-840 COR RF E3 CHR	2.58	96628162	NV2500CWE4K
NOVALINE LED1800-840 MWS E3 WH	2.53	96642693	NV1800ZSEW4K	NOVALINE LED2500-840 COR RF E3 WH	2.58	96628159	NV2500CWEW4K
NOVALINE LED2500-840 MWS E3 WH	2.53	96642699	NV2500ZSEW4K	NOVALINE LED2500-840 HF RF E3 CHR	2.58	96644025	NV2500ZWE4K
NOVALINE LED3500-840 MWS E3 WH	2.53	96642705	NV3500ZSEW4K	NOVALINE LED2500-840 HF RF E3 WH	2.58	96644016	NV2500ZWEW4K
<b>NOVALINE LED RF MASTER</b>				NOVALINE LED3500-830 HF RF E3 CHR	2.58	96644010	NV3500ZWE3K
NOVALINE LED1800-830 MWS RF CHR	2.33	96644003	NV1800ZWMC3K	NOVALINE LED3500-830 HF RF E3 WH	2.58	96644001	NV3500ZWEW3K
NOVALINE LED1800-830 MWS RF WH	2.33	96643994	NV1800ZWMW3K	NOVALINE LED3500-840 HF RF E3 CHR	2.58	96644028	NV3500ZWE4K
NOVALINE LED1800-840 MWS RF CHR	2.33	96644021	NV1800ZWMC4K	NOVALINE LED3500-840 HF RF E3 WH	2.58	96644019	NV3500ZWEW4K
NOVALINE LED1800-840 MWS RF WH	2.33	96644012	NV1800ZWMW4K	<b>NOVALINE LED ACCESSORY</b>			
NOVALINE LED2500-830 COR MWS RF CHR	2.33	96628155	NV2500CWM3K	NVLORK SEMI-RECESSING KIT	1.16	96014873	-
NOVALINE LED2500-830 COR MWS RF WH	2.33	96628152	NV2500CWMW3K	Other configurations are available via MyProduct: <a href="http://www.thornlighting.co.uk/en-gb/products/myproduct">http://www.thornlighting.co.uk/en-gb/products/myproduct</a>			
NOVALINE LED2500-830 MWS RF CHR	2.33	96644006	NV2500ZWMC3K				
NOVALINE LED2500-830 MWS RF WH	2.33	96643997	NV2500ZWMW3K				
NOVALINE LED2500-840 COR MWS RF CHR	2.33	96628161	NV2500CWM4K				
NOVALINE LED2500-840 COR MWS RF WH	2.33	96628158	NV2500CWMW4K				
NOVALINE LED2500-840 MWS RF CHR	2.33	96644024	NV2500ZWMC4K				
NOVALINE LED2500-840 MWS RF WH	2.33	96644015	NV2500ZWMW4K				
NOVALINE LED3500-830 MWS RF CHR	2.33	96644009	NV3500ZWMC3K				
NOVALINE LED3500-830 MWS RF WH	2.33	96644000	NV3500ZWMW3K				
NOVALINE LED3500-840 MWS RF CHR	2.33	96644027	NV3500ZWMC4K				
NOVALINE LED3500-840 MWS RF WH	2.33	96644018	NV3500ZWMW4K				

# Voyager Blade Series NEW

## Standards



## Installation Option



Ultra slim aluminium bodied LED exit sign for surface/suspended application

- 60lm LED output
- Reduced power consumption when compared to T5 8W exit signs
- A choice of maintained and non-maintained operation
- Low energy consumption – only 4W in maintained mode
- 50 000 hours rated life without the need for lamp changes

### Materials and Finish

- Robust aluminium body with thin Perspex blade
- Silver finish

### Installation and Mounting

- Suitable for small area use with viewing distances up to 23 metres
- The ceiling/wall version mounts easily with fixing bracket
- For suspended mounting fix plate to ceiling and suspend via the two chains (2x1m) provided

### Installation of legend

Voyager Blade is supplied as standard with 1 x transparent left/right ISO legend (VYBISOLR) which can be inserted into the luminaire sleeve in the direction which you require.

If the exit sign is to be used single sided only, then a white blanking plate (VYBWH) is required.

For double sided viewing two legends are required.

## ISO - The format to be used for all new buildings



The exit is in front of you. This sign would indicate travelling along a corridor or moving up stairs to get out of a building. The arrow up format is chosen in common with arrows used on road signs, upwards always indicates forward.



The exit is down from here. For example take the stairs down from this location. Note this sign is NOT generally accepted to indicate that you should simply move forward from this location towards the exit. It can be used over a final exit from the building to indicate that you should use this door to exit.



The exit is to the right of here, or turn right towards the exit.



The exit is to the left of here, or turn left towards the exit.

## BSEN - To be used in existing buildings where this format is already installed



Move forwards or down to the exit. This sign using arrow down is accepted as "move forwards", though in some cases the building control officer will request arrow upward.



Move forwards or up to the exit.



Move right to the exit.



Move left to the exit.



## Ordering Guide

Description	Wt (kg)	SAP Code	Cat. No.
<b>VOYAGER BLADE - SURFACE MOUNTED</b>			
VOYAGER BLADE EXIT E3M MSF	1.00	96642778	VYBLMS
VOYAGER BLADE EXIT E3NM MSF	1.00	96642779	VYBLNMS
<b>VOYAGER BLADE - SUSPENDED</b>			
VOYAGER BLADE EXIT E3M MCH	1.15	96642780	VYBLMC
VOYAGER BLADE EXIT E3NM MCH	1.15	96642781	VYBLNMC
<b>VOYAGER BLADE - RECESSED</b>			
VOYAGER BLADE EXIT E3M MRC	1.15	96642992	VYBLMR
VOYAGER BLADE EXIT E3NM MRC	1.15	96642993	VYBLNMR
<b>LEGENDS - All legends are single sided and only for use with Voyager Blade luminaires</b>			
VOYAGER BLADE LEGEND EU DOWN		96643982	VYBEUD
VOYAGER BLADE LEGEND EU LEFT/RIGHT		96643980	VYBEULR
VOYAGER BLADE LEGEND EU UP		96643981	VYBEUU
VOYAGER BLADE LEGEND ISO DOWN		96643979	VYBISOD
VOYAGER BLADE LEGEND ISO LEFT/RIGHT*		96643977	VYBISOLR
VOYAGER BLADE LEGEND ISO UP		96643978	VYBISOU
VOYAGER BLADE WHITE BLANKING PLATE		96643983	VYBWH

\* Supplied as standard with luminaire

### Voyager Blade

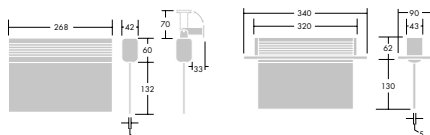
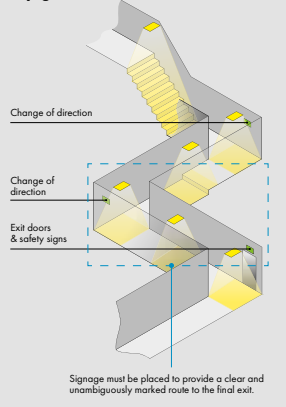

Wall/Ceiling/Suspended version

Recessed version



# Voyager Escape NEW

## Standards



## Installation Option

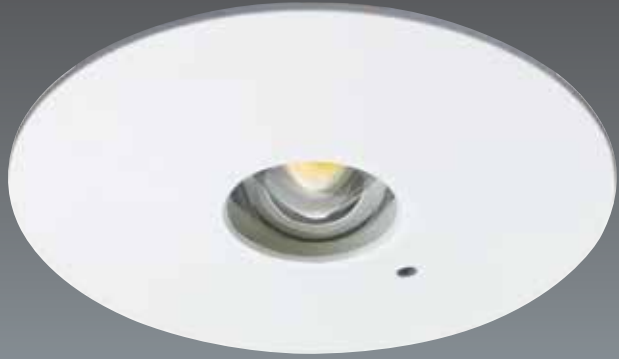

Easy to install emergency recessed luminaire

- 110lm luminaire output
- Low energy consumption – only 3W, offering reduced power consumption compared to a traditional emergency bulkhead
- 30 000 hours rated life without the need for lamp changes
- Easily achieves 8 metres spacing reducing the number of luminaires required per project
- Suitable for stairwells, corridors, circulation areas and toilets
- 3 hour emergency non-maintained operation

### Materials and Finish

- White aluminium alloy body
- Suitable for escape routes and open area emergency lighting
- Suitable for indoor use only
- Robust stainless steel clips

### Installation and Mounting

- Plug and play connection for rapid installation
- Easy installation designed to avoid incorrect connection

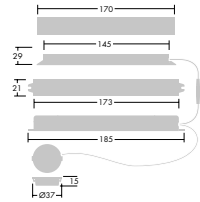



## Ordering Guide

Description	Wt (kg)	SAP Code	Cat. No.
<b>VOYAGER ESCAPE - STANDARD VERSIONS 4000K</b>			
VOYAGER ESCAPE E3NM MRE	0.31	96642782	VYERNM

Spacing Data for 2m Escape Route					
Centre-line Minimum Illuminance (lux)	Mounting height (m)	Centre to end		Between centres	
		Maximum spacing (m)	Diversity	Maximum spacing (m)	Diversity
0.2 Trans	2.5	3.80	0.037	8.95	0.037
	3.0	4.20	0.056	9.85	0.053
	3.5	4.65	0.074	10.70	0.072
0.2 Axial	2.5	3.80	0.037	8.95	0.037
	3.0	4.20	0.056	9.85	0.053
	3.5	4.65	0.074	10.70	0.072
1.0 Trans	2.5	3.80	0.037	8.95	0.037
	3.0	4.20	0.056	9.85	0.053
	3.5	4.65	0.074	10.70	0.072
1.0 Axial	2.5	3.80	0.037	8.95	0.037
	3.0	4.20	0.056	9.85	0.053
	3.5	4.65	0.074	10.70	0.072

Open Area						
Minimum Illuminance (lux)	Mounting height (m)	Maximum spacing				
		Centre to end		Between centres		Diversity
		Trans	Axial	Trans	Axial	
0.5	2.5	2.25	2.25	6.00	6.00	0.087
	3.0	2.55	2.55	6.60	6.60	0.127
	3.5	2.75	2.75	7.20	7.20	0.172
5.0	2.5	0.70	0.70	3.75	3.75	0.727
	3.0	-	-	3.50	3.50	0.665
	3.5	-	-	3.30	3.30	0.634

High Risk Task Area			
Minimum Illuminance (lux)	Mounting height (m)	Maximum distance (m)	
		Trans	Axial
15.0	1.5	0.15	0.15
	2.0	-	-
	2.5	-	-

# Voyager Compact LED

## Standards



## Installation Options



LED emergency luminaire suitable for maintained or non-maintained operation, offering low maintenance in multiple applications

- 100lm LED, direct replacement for traditional 8W emergency bulkhead
- Sealed to IP65
- Maintained and non-maintained operation within the same luminaire, reducing installation complexity
- Low energy consumption – only 3W in maintained mode
- 50 000 hours rated life without the need for lamp changes
- Suitable for escape routes and anti-panic/ open areas
- Conical and side optical prisms to maximise performance and spacing
- 20m viewing distance when used as an exit sign – ISO and BSEN legend kits available

### Materials and Finish

- Base: Polycarbonate, white
- Secondary cowl: Polycarbonate, white
- Diffuser: Polycarbonate, clear

### Installation and Mounting

- 4 x screw fixing complete with drilling guide points
- BESA and side entry facility
- Loop in/loop out terminal block with rising clamps to prevent excessive tightening and cable damage
- One piece installation – no mounting kit necessary

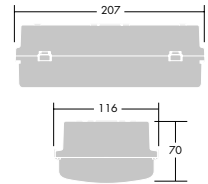



## Ordering Guide

Option	Description	Circuit Power (W)	Wt (Kg)	SAP Code	Cat No.
<b>VOYAGER COMPACT LED</b>					
Luminaire	VOYAGER BULKHEAD E3 MTD/NMTD	3.0	0.5	96242092	VYBE3
Legend Kits	VOYAGER BULKHEAD EURO 7010 LEGEND KIT	-	0.1	96242093	VYLIKE
	VOYAGER BULKHEAD ISO LEGEND KIT	-	0.1	96242094	VYLIKI

Open Area						
Minimum Illuminance (lux)	Mounting height (m)	Maximum spacing				Diversity
		Centre to end		Between centres		
		Trans	Axial	Trans	Axial	
0.5	2.5	2.35	2.35	7.65	7.60	0.229
	3.0	2.35	2.30	8.15	8.10	0.325
	3.5	2.05	2.05	8.55	8.50	0.429
5.0	2.5	-	-	2.15	2.00	0.877
	3.0	-	-	1.15	1.15	0.930
	3.5	-	-	-	-	1.000

# Voyager Twin Spot

## Standards



A non-maintained, tungsten halogen twin spot luminaire for large open area and high risk applications

- Switches to emergency operation instantaneously (<250mS) - ideal for high risk areas such as machine shops, control rooms and intensive care units
- Adjustable head to match light output to application
- 3 hour duration for 20W versions, 1 hour for 55W ratings
- Maintenance free 12V batteries – sealed lead acid 4-7 year design life
- 24 hour recharge period
- Low voltage cut off, thermal and reverse polarity protection
- Weatherproof IP65 versions available

## Materials and Finish

- IP20: mild steel enclosure
- IP65: polycarbonate enclosure

## Installation and Mounting

- IP20: Enclosure has an easy access front panel
- IP65: Enclosure has screw locked front panel seal.  
Lamps separately supplied on angle brackets, with glands for wiring remotely to the enclosure.  
Glanding points on side for cable gland fixing
- Cable entry: provision for 20mm knockouts
- Current consumption: 0.1A
- Units should be mounted at least 30° above the line of sight

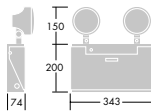
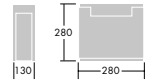





## Ordering Guide

Option	Description	Circuit Power (W)	Wt (Kg)	SAP Code	Cat No.
<b>VOYAGER TWIN SPOT</b>					
IP20	VOYAGER TWINSPOT 2x20W E3NM IP20 LI	-	8.6	96004128	VYTS203NMIP20
	VOYAGER TWINSPOT 2x55W E1NM IP20 LI	-	9.0	96211175	VYTS551NMIP20
IP65	VOYAGER TWINSPOT 2x20W E3NM IP65 LI	-	8.5	96102984	VYTS203NMIP65
	VOYAGER TWINSPOT 2x55W E1NM IP65 LI	-	8.2	96211177	VYTS551NMIP65

**Lamp:** 2 x 20W QT-ax at 60° angle

Non maintained

2m Escape Route			
Minimum Illuminance (lux)	Mounting height (m)	Maximum spacing	
		Centre to end	Between centres
1.0	2.5	7.11	16.48
	4.0	-	21.49

Open Area			
Minimum Illuminance (lux)	Mounting height (m)	Maximum spacing	
		Centre to end	Between centres
0.5	2.5	6.03	17.92
	4.0	7.72	23.80
	6.0	-	29.76

# Sonpak LX

## Standards

EN 60998	IP65	IK06	IK08	Ta25
960°C				

## Installation Options



A range of easy to install performance floodlights supplied complete with lamp

- Asymmetric reflector
- Integral control gear and sealed to IP65
- Easy to install with drop down front glass and cable entry
- Vandal resistant option with polypropylene body and high impact clear polycarbonate visor. Exterior optical attachments available
- Supplied complete with lamp

## Materials and Finish

### 70W

- Body: polypropylene, black colour, reinforced with fibreglass and mineral loads
- Lens : self-extinguishing polycarbonate or flat toughened glass, thickness 5mm
- Reflector: Hammered aluminium sheet
- Screws: Chrome-galvanised steel
- Cable gland: M20 cable gland Ø9-11 mm
- Gasket: anti-ageing rubber
- Bracket : in steel and (black colour) RAL 9005, can be fixed through M6 screws, supplied with graduated scale for floodlight aiming

### 150-400W

- Body: Die-cast aluminium alloy UNI EN 46100, painted with polyester powders, black colour
- Lens: Flat toughened glass, thickness 5mm
- Reflector: Hammered aluminium sheet
- Screws: Chrome-galvanised steel
- Cable gland: PG 13.5 nylon cable gland for cables Ø9-12 mm
- Gasket: anti-ageing foamed silicone
- Bracket: in steel and black colour RAL 9005, fixed with M10 screws maximum; supplied with graduated scale for floodlight aiming

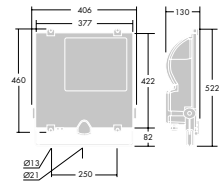
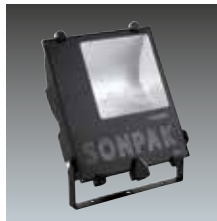
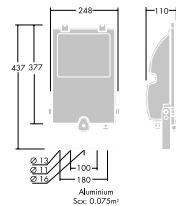

## Installation and Mounting

- All products have one cable glanded entry for Ø9-11mm cable. 3 pole terminal blocks
- 70W stirrup fixed by single bolt through Ø16mm hole
- Two additional Ø11mm fixing holes at 100mm centres, with a further two Ø13mm fixing holes at 180mm centres
- 150-400W stirrup fixed by single bolt through Ø21mm hole
- Two additional Ø13mm fixing holes at 250mm centres
- Cable gland and stirrup already mounted on body



## Ordering Guide

Option	Description	Circuit Power (W)	Wt (Kg)	SAP Code	Cat No.
<b>SONPAK – 70W</b>					
Floodlight	SONPAK LX 70W 240V HIT-DE/RX7s A/S P	85.0	2.7	96232643	OTXPM70
	SONPAK LX 70W 240V HIT-DE/RX7s/730 A/S	85.0	2.7	96232642	OTXM70
	SONPAK LX 70W 240V HSE-I/E27 A/S P	84.0	2.7	96232641	OTXPS70
	SONPAK LX 70W 240V HSE-I/E27/220 A/S	84.0	2.7	96232640	OTXS70
Attachment	SONPAK LX FIX/MA 76	-	1.6	96250695	OTX76S
<b>SONPAK – 150-400W</b>					
Floodlight	SONPAK LX 70W 240V HIT-DE/RX7s A/S P	85.0	2.7	96232643	OTXPM70
	SONPAK LX 70W 240V HIT-DE/RX7s/730 A/S	85.0	2.7	96232642	OTXM70
	SONPAK LX 70W 240V HSE-I/E27 A/S P	84.0	2.7	96232641	OTXPS70
	SONPAK LX 70W 240V HIT-DE/RX7s/730 A/S	85.0	2.7	96232642	OTXM70
	SONPAK LX 70W 240V HSE-I/E27 A/S P	84.0	2.7	96232641	OTXPS70
	SONPAK LX 70W 240V HSE-I/E27/220 A/S	84.0	2.7	96232640	OTXS70
Attachment	SONPAK LX 150/250/400W WG	-	0.5	96250694	OTX250WG
	SONPAK LX FIX/MA 76	-	1.6	96250695	OTX76S

Sonpak LX7 A/S	
Lamp	HSE-I
Wattage	70W
Mounting height (H)	5m
Width (W) x Length (L)	10x10m
Average horizontal illuminance (lx)	17
Uniformity (minimum/average)	0.1
Aiming angle (α)	20°

Sonpak LX7 A/S	
Lamp	HSE-I
Wattage	70W
Mounting height (H)	7m
Width (W) x Length (L)	15x15m
Average horizontal illuminance	9
Uniformity (minimum/average)	0.1
Aiming angle (α)	20°

Sonpak LX15/25/40 A/S		
Lamp	HST	HST
Wattage	150W	150W
Mounting height (H)	7m	10m
Width (W) x Length (L)	20x20m	25x20m
Average horizontal illuminance	18	14
Uniformity (minimum/average)	0.1	0.1
Aiming angle (α)	25°	10°

Sonpak LX15/25/40 A/S		
Lamp	HST	HST
Wattage	250W	400W
Mounting height (H)	12m	15m
Width (W) x Length (L)	30x30m	35x25m
Average horizontal illuminance	14	25
Uniformity (minimum/average)	0.2	0.1
Aiming angle (α)	30°	15°

# Piazza II

Standards



Installation Options



Robust, IP65 luminaires designed to provide security, surround or accent illumination with a touch of style

- Excellent light distribution and uniformity (up to 11m spacing)
- Versions with built-in photocell or emergency lighting
- Multi-option mounting: wall or brackets for corners and poles
- Supplied complete with lamp

**Materials and Finish**

- Body: polycarbonate, anthracite finish
- Diffuser: polycarbonate. Small: smooth opal Large: clear prismatic, smooth opal
- Eyelid: polycarbonate, anthracite finish
- Pole/wall mounting brackets: galvanised steel, polyester powder coated

**Installation and Mounting**

- 20mm cable entry via rear grommeted hole or top and side conduit entries
- Internal or external corner installation possible with wall bracket accessory
- Pole mounting brackets allow 1 to 4 large luminaires on one pole between 60mm and 76mm diameter
- Recommended mounting height:  
Large 3-6m;  
Small 1-3m

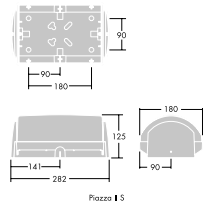

Piazza II S

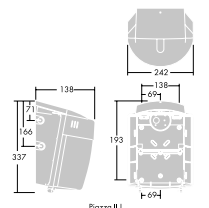

Piazza II L

**2m Escape route**

Min Illum lux	Mounting Height Metres	Max Spacing (m)	
		centre to end	between centres
0.2 Perp	2.0	3.60	9.50
	2.5	3.70	10.00
	3.0	3.70	10.30
0.2 Parl	2.5	2.95	8.00
	3.0	2.90	8.30
	3.5	2.75	8.40
1.0 Perp	2.0	1.35	4.60
	2.5	n/a	n/a
	3.0	n/a	n/a
1.0 Parl	2.0	0.70	3.40
	2.5	n/a	n/a
	3.0	n/a	n/a



### Ordering Guide

Option	Description	Circuit Power (W)	Wt (Kg)	SAP Code	Cat No.
<b>PIAZZA – SMALL</b>					
Opal	PIAZZA II S 1x18W TC-TEL HF OP FR L840	19.0	1.1	96233240	PZSF18O
	PIAZZA II S 1x26W TC-TEL HF OP FR L840	27.0	1.2	96233242	PZSF26O
	PIAZZA II S 1x35W HIT-CE G12 HF OP FR LI	43.0	1.4	96233244	PZSM35O
	PIAZZA II S 2x18W TC-DEL HF OP FR L840	38.0	1.3	96233276	PZSF218O
	PIAZZA II S 2x26W TC-DEL HF OP FR L840	51.0	1.3	96233277	PZSF226O
Emergency Opal	PIAZZA II S 1x18W TC-TEL HF E3 OP FR LI8	24.0	1.8	96233241	PZSF18EO
<b>PIAZZA – LARGE</b>					
Prismatic	PIAZZA II L 1x42W TC-T HF PR RAL L840	46.0	2.1	96233272	PZLF42P
	PIAZZA II L 50W 240V HSE PR RAL LI	63.0	3.6	96233252	PZLS50P
	PIAZZA II L 70W 240V HIT-CE E27 PR RAL L	85.0	3.6	96233235	PZLM70P
	PIAZZA II L 70W 240V HSE-I PR RAL LI	85.0	3.5	96233234	PZLS70P
	PIAZZA II L 70W 240V HST PR RAL LI	85.0	3.6	96233264	PZLT70P
	PIAZZA II L 70W HIT DGE E27 PR RAL LI	78.0	2.5	96233267	PZLM70ZP
Prismatic with Photocell	PIAZZA II L 70W 240V HSE-I P PR RAL LI	85.0	3.5	96233237	PZLS70PP
	PIAZZA II L 70W 240V HST P PR RAL LI	85.0	3.6	96233233	PZLT70PP
Prismatic Emerg	PIAZZA II L 1x42W TC-TEL HF E3 PR RAL L	47.0	3.1	96241455	PZLF42EP
Opal	PIAZZA II L 1x42W TC-TEL HF OP RAL L840	46.0	2.1	96233273	PZLF42O
Opal Emerg	PIAZZA II L 1x42W TC-TEL HF E3 OP RAL L	47.0	3.1	96241454	PZLF42EO
Attachments	PIAZZA II L BRACKET EXT MWA	-	0.4	96233286	PZLXWB
	PIAZZA II L BRACKET INT MWA MA76	-	0.3	96233246	PZLWPB
	PIAZZA II L BRACKET x4 MWA MA76	-	0.3	96233731	PZLPB4
	PIAZZA II L MA76 2XTORQUE CLIP	-	0.3	96233730	PZLTC

### Open area

Min Illum lux	Mounting Height Metres	Max Spacing (m)				
		centre to end		between centres		
0.5	2.5	Perp	Parl	Perp	Parl	
		1.70	1.70	6.40	5.40	
	3.0	1.55	1.40	6.70	5.20	
		3.5	1.25	0.80	6.60	4.70

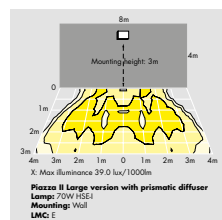
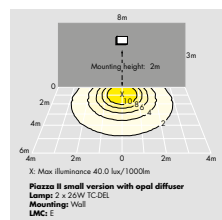
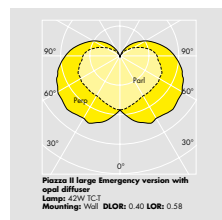

# Chartor

## Standards



## Installation Options



A range of robust, circular aluminium bollards for pedestrian paths, parks and gardens

- Simple design that appears unobtrusive in the landscape
- Choice of fresnel lens or louvre optic to optimise comfort and performance
- Robust construction
- Choice of discharge or CFL sources
- Flange or root mounted
- Supplied complete with lamp

## Materials and Finish

- Head: die-cast aluminium, painted textured grey close to RAL7043
- Optic: fresnel lens in clear polycarbonate or aluminised plastic louvres protected by clear polycarbonate sleeve
- Post: Aluminium, textured grey finish

## Installation and Mounting

- Flange or root mounting, latter option embeds 450mm into the ground
- 250mm flange plate version fixes via four Ø15mm holes at 200mm centres
- Ø60mm central hole for wiring
- Three way terminal block for 2 x 4mm<sup>2</sup> cable

## Ordering Guide

Option	Description	Circuit Power (W)	Wt (Kg)	SAP Code	Cat No.
<b>CHARTOR BOLLARD</b>					
Heads	CHARTOR HEAD LF	-	1.4	96011221	CAFL
	CHARTOR HEAD LV	-	1.6	96011222	CALV
Gears	CHARTOR 50W HSE AE/L	63.0	0.0	96546804	CA50
	CHARTOR GT 18W TC-D/L	28.0	0.0	96546803	CA18
Posts	CHARTOR MGR (ROOT MOUNTED)	-	3.4	96011247	CABOLRT
	CHARTOR MPL (FLANGE MOUNTED)	-	3.0	96011220	CABOLFP

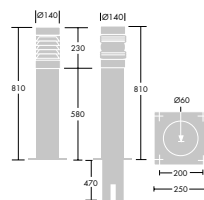



# D-CO LED Bollard

## Standards



## Installation Options



A contemporary slim bollard offering comfortable visual guidance

- Comfortable white light with no glare provided by a semi-opal anti-UV PC diffuser
- Suitable for any application thanks to high specs and two heights
- 60 000 hour lifetime (L80, 25°) ensures low maintenance costs
- Flange mounting, compatible with root spikes

### Materials and Finish

- Top and body: aluminium, powder coated grey 900
- Diffuser: semi-opal anti-UV polycarbonate

### Installation and Mounting

- Suitable for flange mounting
- 500mm root spike (PMB1RT) to be fixed into concrete base
- 800mm root spike (PMB2RT) to be fixed into the ground

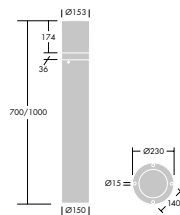





### Ordering Guide

Option	Description	Circuit Power (W)	Wt (Kg)	SAP Code	Cat No.
<b>D-CO LED BOLLARD</b>					
Bollard	D-CO LED BOLLARD 1000 30L50 830 CL1	14.0	5.5	96262100	DCB23K14
	D-CO LED BOLLARD 1000 30L50 840 CL1	14.0	5.5	96262145	DCB24K14
	D-CO LED BOLLARD 700 30L50 830 CL1	14.0	4.2	96262101	DCB13K14
	D-CO LED BOLLARD 700 30L50 840 CL1	14.0	4.2	96262146	DCB14K14
Adapters	MGR BASE PROM/AVENUE/MADISON/DCO	-	10.0	96100253	PMB1RT
	MGR SPIKE PROM/AVENUE/MADISON/DCO	-	10.0	96005367	PMB2RT

#### Urban Project 1: Street/Path width: 4m

	ULOR or upward flux (LED)	DLOR or downward flux (LED)	Lighting Class	Spacing	Eav	Emin
D-CO LED Bollard 4K	234	310	S5	8m	3.57	0.67

#### Urban Project 2: Street/Path width: 2m

	ULOR or upward flux (LED)	DLOR or downward flux (LED)	Lighting Class	Spacing	Eav	Emin
D-CO LED Bollard 4K	234	310	S4	8m	5.45	1.19

# D-CO LED Floodlight

## Standards



## Installation Options



A range of extremely compact LED floodlights in two

- body sizes with a simple aesthetic design
- Supplied with stirrup and ground spike
- Visor to prevent obtrusive light
- Integral power supplies
- Pre-wired with 5m cable

### Materials and Finish

- Body: aluminium, finished in grey
- Glass: toughened glass
- Gasket: anti-ageing silicone
- Stirrup: aluminium finished in grey
- Spike: aluminium finished in black
- Connection boxes body: PC/ABS blend

### Installation and Mounting

- Floodlights supplied pre-wired with 5m cable
- Installation on surface with stirrup or in the ground with a spike
- Connection box DCCB21: 3 glanded cable entries 2 x PG13 (in) and 1 x PG9 (out)
- Connection box DCCB26: 8 glanded cable entries 2 x PG13 (in) and 6 x PG9 (out)

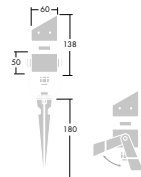

Size 1

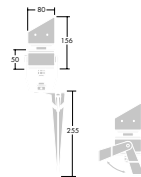

Size 2



## Ordering Guide

Option	Description	Circuit Power (W)	Wt (Kg)	SAP Code	Cat No.
<b>D-CO LED FLOODLIGHT</b>					
Floodlights	D-CO F LED FLOOD1 3L35 830	5.0	0.4	96257244	DCF13K12
Size 1	D-CO F LED FLOOD1 3L35 840	5.0	0.4	96257245	DCF14K12
Floodlights	D-CO F LED FLOOD2 6L50 830	12.0	0.9	96257246	DCF23K12
Size 2	D-CO F LED FLOOD2 6L50 840	12.0	0.9	96257247	DCF24K12
Connection	CON CABLE BOX 2 ENTRIES 1 EXIT IP67	-	0.3	96257258	DCCB21
boxes	CON CABLE BOX 2 ENTRIES 6 EXIT IP67	-	0.4	96257259	DCCB26

# D-CO LED Recessed

## Standards



## Installation Options



A range of LED based, recessed 'walk-over' luminaires for guidance and accent applications

- High quality finish
- Complies with the contact temperature standard (EN60598-2-13)
- Plastic end caps supplied for installation in concrete
- Pre-wired with 5m cable

## Materials and Finish

- Body: aluminium (except medium, PC/ABS blend), CNC Electrophoresis
- Recessed housing: aluminium (except Maxi – ABS) with plastic end cap
- Glass: toughened frosted or clear
- Frames/Windows: stainless steel 316L
- Gasket: anti-ageing silicone
- Connection box body: PC/ABS blend

## Installation and Mounting

- To ensure efficient drainage, gravel must be used to a depth of 300mm beneath the housing
- The plastic end cap prevents ingress of concrete during installation.
- All the fittings are supplied with 5m cable
- Single Mini units are supplied pre-wired with cable with remote gear, recessed box, plastic end cap, connectors and 3 way connection box
- Mini kit luminaires are individually pre-wired with cable and supplied with an 8 way connection box, containing gear and connectors – including a specific connector for through wiring
- If a single LED fails, the other system LEDs continues to operate. Connector has LED failure alerting display
- Static load: 500kg
- Connection box DCCB21:  
3 glanded cable entries 2 x PG13 (in) and 1 x PG9 (out)
- Connection box DCCB26:  
8 glanded cable entries 2 x PG13 (in) and 6 x PG9 (out)

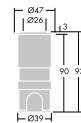

Mini CL/R8

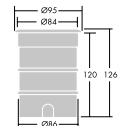

Medium

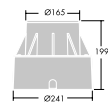

Maxi



## Ordering Guide

Option	Description	Circuit Power (W)	Wt (Kg)	SAP Code	Cat No.
<b>D-CO LED RECESSED</b>					
Mini	D-CO R LED MINI 1L35 830 CL	1.2	0.5	96257228	DCS3K12C
	D-CO R LED MINI 1L35 830 EW2	1.2	0.5	96257234	DCS3K12W2
	D-CO R LED MINI 1L35 830 FR	1.2	0.5	96257231	DCS3K12F
	D-CO R LED MINI 1L35 840 CL	1.2	0.5	96257227	DCS4K12C
Mini Kits	D-CO R LED MINI 6X1L35 830 CL KIT	7.2	1.3	96257249	DCS3K12KITC
	D-CO R LED MINI 6X1L35 830 EW2 KIT	7.2	1.3	96257255	DCS3K12KITW2
	D-CO R LED MINI 6X1L35 830 FR KIT	7.2	1.3	96257252	DCS3K12KITF
	D-CO R LED MINI 6X1L35 840 CL KIT	7.2	1.3	96257248	DCS4K12KITC
Medium	D-CO R LED MEDIUM 1X1,2W BLU FR	2.7	0.7	96257238	DCORMBF
	D-CO R LED MEDIUM 1X1,2W WHI 3K FR	2.7	0.7	96257237	DCORM3KF
	D-CO R LED MEDIUM 1X1,2W WHI 4K FR	2.7	0.7	96257236	DCORM4KF
Maxi	D-CO R LED MAXI 6L50 830 CL	12.0	3.0	96257240	DCL3K12C
	D-CO R LED MAXI 6L50 840 CL	12.0	3.0	96257239	DCL4K12C
Connection boxes	CON CABLE BOX 2 ENTRIES 1 EXIT IP67	-	0.3	96257258	DCCB21
	CON CABLE BOX 2 ENTRIES 6 EXIT IP67	-	0.4	96257259	DCCB26

# FleXity NEW

## Standards



## Installation Options



Discreet and versatile LED lantern with a fast return on investment for city space lighting

- Modern, discreet and versatile post top LED lantern which is easy to integrate into the cityscape and residential areas
- 100 000 hour maintenance-free lifetime for fast return on investment and low total cost of ownership
- LED lamp, dedicated optics and integrated Bi power dimming for energy savings
- Two enclosures: clear for optimised performance and diffuser for optimised comfort

### Materials and Finish

- Canopy and base: die cast aluminium (EN AC-46100), powdered coated dark grey (close to RAL 7043) finish
- Flat enclosures: Clear glass and UV stabilised polycarbonate diffuser

### Installation and Mounting

- Recommended mounting height: 3 to 6m
- Distribution: clear glass: symmetric or asymmetric (street optic) and diffuser: radial symmetric
- Post top mounting on spigot/columns Ø60mm or Ø76mm. Internal height of base: 75mm
- 5m pre-wired version available
- Connector version supplied with 1m wire and connector



Clear - optimised for performance



Round shape and smooth lines for easy integration

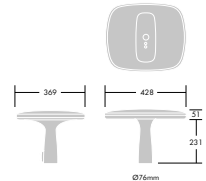

**Gamma LED** also available, please visit: [www.thornlighting.co.uk](http://www.thornlighting.co.uk) for more information





# FleXity NEW

## Ordering Guide Supplied complete with LED

Description	Circuit Power(W)	Wt (Kg)	SAP Code
<b>FLEXITY 250MA DIFFUSE - RADIAL SYMMETRIC DISTRIBUTION</b>			
FLEXITY 24L25 R/SC CL1 W5M D60 L730	20	4.5	96270775
FLEXITY 24L25 R/SC CL1 W5M D60 L740	20	4.5	96270776
FLEXITY 24L25 R/SC CL1 W5M D76 L730	20	4.7	96270783
FLEXITY 24L25 R/SC CL1 W5M D76 L740	20	4.7	96270784
FLEXITY 24L25 R/SC XIT CL1 CON D60 L730	20	3.9	96242257
FLEXITY 24L25 R/SC XIT CL1 CON D60 L740	20	3.9	96242258
<b>FLEXITY 250MA CLEAR - SYMMETRIC DISTRIBUTION</b>			
FLEXITY 24L25 SYM CL1 W5M D60 L730	20	4.5	96271223
FLEXITY 24L25 SYM CL1 W5M D60 L740	20	4.5	96271224
FLEXITY 24L25 SYM CL1 W5M D76 L730	20	4.7	96271227
FLEXITY 24L25 SYM CL1 W5M D76 L740	20	4.7	96271228
FLEXITY 24L25 SYM XIT CL1 CON D60 L730	20	3.9	96242261
FLEXITY 24L25 SYM XIT CL1 CON D60 L740	20	3.9	96242262
<b>FLEXITY 500MA DIFFUSE - RADIAL SYMMETRIC DISTRIBUTION</b>			
FLEXITY 24L50 R/SC CL1 HT W5M D60 L740	40	4.5	96271408
FLEXITY 24L50 R/SC XIT CL1 CON D60 L730	40	3.9	96242263
FLEXITY 24L50 R/SC XIT CL1 CON D60 L740	40	3.9	96242264
<b>FLEXITY 500MA CLEAR - SYMMETRIC DISTRIBUTION</b>			
FLEXITY 24L50 SYM CL1 HT W5M D60 L740	40	4.5	96271407
FLEXITY 24L50 SYM CL1 W5M D60 L730	40	4.5	96270777
FLEXITY 24L50 SYM CL1 W5M D60 L740	40	4.5	96270778
FLEXITY 24L50 SYM CL1 W5M D76 L730	40	4.7	96270785
FLEXITY 24L50 SYM CL1 W5M D76 L740	40	4.7	96270786
FLEXITY 24L50 SYM XIT CL1 CON D60 L730	40	3.9	96242265
FLEXITY 24L50 SYM XIT CL1 CON D60 L740	40	3.9	96242266
<b>FLEXITY 500MA CLEAR - SYMMETRIC DISTRIBUTION, BI-POWER</b>			
FLEXITY 24L50 SYM BP8 CL1 W5M D60 L730	40	4.5	96270801
FLEXITY 24L50 SYM BP8 CL1 W5M D60 L740	40	4.5	96270802
FLEXITY 24L50 SYM BP8 CL1 W5M D76 L730	40	4.7	96270809
FLEXITY 24L50 SYM BP8 CL1 W5M D76 L740	40	4.7	96270810
<b>FLEXITY 500MA CLEAR - ASYMMETRIC DISTRIBUTION (STREET OPTIC)</b>			
FLEXITY 24L50 STR CL1 HT W5M D60 L740	40	4.5	96271406
FLEXITY 24L50 STR CL1 W5M D60 L730	40	4.5	96270789
FLEXITY 24L50 STR CL1 W5M D60 L740	40	4.5	96270790
FLEXITY 24L50 STR CL1 W5M D76 L730	40	4.7	96270793
FLEXITY 24L50 STR XIT CL1 CON D60 L730	40	3.9	96242267
FLEXITY 24L50 STR XIT CL1 CON D60 L740	20	3.9	96242268
<b>FLEXITY 500MA CLEAR - ASYMMETRIC DISTRIBUTION (STREET OPTIC), BI-POWER</b>			
FLEXITY 24L50 STR BP8 CL1 W5M D60 L730	40	4.5	96270813
FLEXITY 24L50 STR BP8 CL1 W5M D60 L740	40	4.5	96270814
FLEXITY 24L50 STR BP8 CL1 W5M D76 L730	40	4.7	96270817
FLEXITY 24L50 STR BP8 CL1 W5M D76 L740	40	4.7	96270818

### FleXity LED Private Street

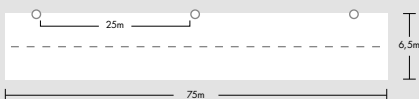

FleXity 'Street' 2.000lm

Mounting height 6m

Illuminance 5lx



Description	Circuit Power(W)	Wt (Kg)	SAP Code
<b>FLEXITY 700MA DIFFUSE - RADIAL SYMMETRIC DISTRIBUTION</b>			
FLEXITY 24L70 R/SC CL1 HT W5M D60 L740	54	4.5	96271141
<b>FLEXITY 700MA CLEAR - SYMMETRIC DISTRIBUTION</b>			
FLEXITY 24L70 SYM CL1 HT W5M D60 L740	54	4.5	96271140
<b>FLEXITY 700MA CLEAR - ASYMMETRIC DISTRIBUTION (STREET OPTIC)</b>			
<b>FLEXITY 1,05A CLEAR - SYMMETRIC DISTRIBUTION</b>			
FLEXITY 24L105 SYM CL1 W5M D60 L730	83	4.5	96271117
FLEXITY 24L105 SYM CL1 W5M D60 L740	83	4.5	96271118
FLEXITY 24L105 SYM CL1 W5M D76 L730	83	4.7	96271121
FLEXITY 24L105 SYM CL1 W5M D76 L740	83	4.7	96271122
<b>FLEXITY 1,05A CLEAR - SYMMETRIC DISTRIBUTION, BI-POWER</b>			
FLEXITY 24L105 SYM BP8 CL1 W5M D60 L730	83	4.5	96271115
FLEXITY 24L105 SYM BP8 CL1 W5M D60 L740	83	4.5	96271116
FLEXITY 24L105 SYM BP8 CL1 W5M D76 L730	83	4.7	96271119
FLEXITY 24L105 SYM BP8 CL1 W5M D76 L740	83	4.7	96271120
<b>FLEXITY 1,05A CLEAR - ASYMMETRIC DISTRIBUTION (STREET OPTIC)</b>			
FLEXITY 24L105 STR CL1 W5M D60 L730	83	4.5	96271133
FLEXITY 24L105 STR CL1 W5M D60 L740	83	4.5	96271134
FLEXITY 24L105 STR CL1 W5M D76 L730	83	4.7	96271137
FLEXITY 24L105 STR CL1 W5M D76 L740	83	4.7	96271138
<b>FLEXITY 1,05A CLEAR - ASYMMETRIC DISTRIBUTION (STREET OPTIC), BI-POWER</b>			
FLEXITY 24L105 STR BP8 CL1 W5M D60 L730	83	4.5	96271131
FLEXITY 24L105 STR BP8 CL1 W5M D60 L740	83	4.5	96271132
FLEXITY 24L105 STR BP8 CL1 W5M D76 L730	83	4.7	96271135
FLEXITY 24L105 STR BP8 CL1 W5M D76 L740	83	4.7	96271136
<b>FLEXITY COLUMNS</b>			
FLEXITY COL SLIT 3.5 D60 BIC MPL FAI			96271281
FLEXITY COL SLIT 4M D60 BIC MPL FAI			96271282
FLEXITY COL SLIT 5M D60 BIC MPL FAI			96271283
FLEXITY COL CCO 3M AL D60 ANT MPL			96271284
FLEXITY COL STEP 3.2M D60 ANT MPL FAI			96271285

**Replacement: S4 applications**

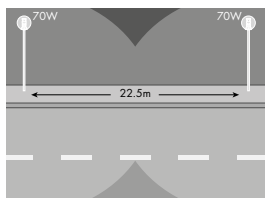

Opal Sphere 125W HME

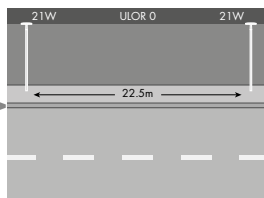

Diffusing FLEXITY 21W

**Street: S2 applications**

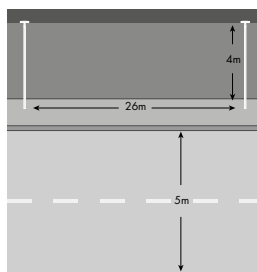

FLEXITY 40W ASY

# Safety and Quality

Thorn Lighting is committed to providing its customers with products and services that are of the highest quality, ensuring safety, reliability and performance.

Our expertise in meeting these goals is recognised internationally. Thorn is an active participant in developing the European and International Standards which are used through the Lighting Industry and that third party endorsements, such as BSI approvals/registrations are based upon.

## Quality Assurance (BSEN/ISO 9000)

All activities associated with providing a quality product – design, development, testing, production, despatch, customer service – are covered by BSEN/ISO 9000. The Group's site at Spennymoor, including UK Distribution, is registered by IQNET to the highest standard, ISO 9001. Additional operations in Europe also operate to the same exacting standards and have achieved EN ISO9001 quality system registration.

 Quality in test and measurement has been further independently assessed to BSEN ISO/IEC 17025 – Operation of testing laboratories. In-house test facilities cover all aspects of lighting product performance and safety including ENEC+ and are considered to be amongst the finest in the world.

## Environment & Sustainability

Thorn takes seriously its drive to reduce the environmental impact of its business and products. Our ISO 14001 certification for the European factories demonstrates this commitment, ensuring our environmental management meets the highest standards. Acknowledging our responsibility for the environment by having an Environmental Management System means we can identify and target aspects of our

business that impact on the environment and relevant legislation. As part of our sustainability programme we then produce objectives for improvement and our management programme supports this with regular reviews for continual improvement.



## European Harmonisation

For luminaires and lighting components, European harmonisation of national approval marks (above) has been achieved through introduction of the ENEC+ mark.

 The ENEC+ mark may be awarded by any one of the recognised European approval authorities, such as OVE, VDE or SEMKO, in the same way as a national approval mark. ENEC+ is important however, because it indicates that the product is suitable for use throughout Europe and that all of the most onerous special national conditions of test standards have been complied with.

In the case of lighting, now including LED, components such as ballasts, transformers, emergency lighting units etc. the ENEC+ mark indicates that both safety and performance standards have been complied with.

 The CE mark signifies that a product conforms with the requirements of relevant EEC directives. The prime purpose of the mark is to assist customs and market inspectors in facilitating the free trading and movement of products within the EEC.

At this time the directives appropriate to general lighting products are the Low Voltage Directive (LVD), the Electromagnetic Compatibility (EMC) Directive and the Energy Related Products Directive (ErP), WEEE (Waste of Electrical and Electronic Equipment Directive) and RoHS (Restriction of Hazardous Substances).

CE marking is compulsory to indicate LVD, EMC, RoHS and ErP conformity.

Thorn Lighting's comprehensive compliance with all relevant standards, and implementation of systems to meet them, means its products automatically comply with these directives.

## WEEE compliance and approach

### Thorn fully complies with the WEEE Directive

The latest recast of the Waste of Electrical and Electronic Equipment Directive, 2012/19/EU, came into force on 13th August 2012.

Thorn have joined an approved compliance scheme run by Lumicom, a not-for-profit organisation set up by the Lighting Industry Federation to administer the WEEE Directive on behalf of the professional lighting manufacturers in the UK. As a member of an approved compliance scheme Thorn has been given a registration number, WEE/KG0108WX. Since the 1st July 2007 Thorn have been paying its WEEE provider, Lumicom, to manage the collection, recycling and disposal of luminaires.

*What does the WEEE directive mean for customers of Thorn Lighting?*

Thorn Lighting is paying for its responsibility under the directive by paying on a per luminaire basis. For every luminaire that Thorn puts onto the market, as a Producer under the terms of the WEEE Directive, it pays a fee to Lumicom. Therefore you can be sure that every Thorn product you specify or buy is covered in the future under the WEEE Directive. Lumicom will collect, recycle and dispose of Thorn luminaires. There will be no charges from Thorn to cover the cost of collection, recycling and disposal of waste Thorn luminaires at the end of their life. The future cost is covered by the small upfront charge made at the initial sale of the luminaires.

### Historic Waste

Luminaires stripped out of a building that were manufactured prior to 13th August 2005 are regarded as Historic Waste. As a responsible manufacturer Thorn is also taking responsibility for any products, regardless of the manufacturer, put onto the market before 13th August 2005 as long as the luminaires purchased to replace the old luminaires are manufactured by Thorn.

### Products manufactured after 13th August 2005.

These products are identified by the crossed out wheelie-bin symbol. These products are the responsibility of the manufacturer regardless of whose products they are being replaced by.

### Lamps and Batteries

Thorn is not responsible for the collection, recycling and disposal of lamps. They are the responsibility of the lamp manufacturer marked on the lamp. Most lamps are returned via the Recolight Scheme at [www.recolight.com](http://www.recolight.com). Batteries are not deemed as WEEE but are covered by the Battery Directive, under the Directive Thorn operate a take back service.

**All products returned must have their lamps and any batteries removed before return.**

## RoHS

Directive 2011/65/EU on the restriction of the use of certain hazardous substances in electrical and electronic equipment is an EU directive, and products purchased within the European Union must conform to these restrictions.

Certain exemptions exist including mercury in lamps, lead in the glass of fluorescent tubes and nickel cadmium in batteries for emergency lighting products. However, these exempted items are still required to be correctly disposed of.

Therefore when purchasing exempted items it is important to ascertain how these items will be managed at their end of life, and when removing exempted items it must be ensured that they are handled separately

### Assurance of Safety

Under the Consumer Protection Act 1987, it is unlawful to make, or hold in stock, or to offer for sale any electrical appliance that is unsafe. In order to give assurance that lighting products are safe, manufacturers have two options:

#### 1. To mark with the symbol of a third party approval authority.

This is a mark of guarantee endorsed by an independent testing authority. The mark guarantees that compliance has been checked by an independent test house and that third party monitoring of the producing factory's quality system has been undertaken.

#### 2. Self certification

The manufacturer claims that the product is safe and fit for purpose. The value of such a claim is directly related to the standing of the firm making it. In the case of Thorn Lighting, all products are designed, developed, tested and manufactured under the scope of BSEN/ISO 9000 quality systems that are registered and audited by independent third parties.

Consequently Thorn products, approval marked or not, are designed, tested and manufactured to the same exacting standards – not all companies apply this principle.

# Safety and Quality

## Standards

Some of the relevant British Standards, together with their European and International equivalents, relating to lighting are listed in the table.

Subject	British Standard	European Standard	International Standard
Luminaires – Safety	BS EN 60598	EN 60598	IEC 60598
Luminaire Track Systems – Safety	BS EN 60570	EN 60570	IEC 60570
Luminaires – Performance (General)	DD IEC PAS 62772-1	No Standard	IEC PAS 62772-1
Luminaires – Performance (LED)	DD IEC PAS 62772-2-1	No Standard	IEC PAS 62772-2-1
Luminaires – IK Code (Impact Resistance)	BS EN 62262	EN 62262	IEC 62262 + IEC/TR 62696
EMC Emissions – Lighting	BS EN 50015	EN 55015	CISPR 15
EMC Immunity – Lighting	BS EN 61547	EN 61547	IEC 61547
EMC Harmonic – Currents	BS EN 61000-3-2	EN 61000-3-2	IEC 61000-3-2
EMC Voltage Fluctuation/Flicker	BS EN 61000-3-3	EN 61000-3-3	IEC 61000-3-3
EMF – Lighting Equipment	BS EN 62493	EN 62493	IEC 62493
Photo-biological Safety – Lamps	BS EN 62471	EN 62471	IEC 62471
Control Gear – Safety	BS EN 61347	EN 61347	IEC 61347
LED Modules – Safety	BS EN 62031	EN 62031	IEC 62031
LED Modules – Performance	DD IEC PAS 62717	No Standard	IEC PAS 62717
Fluorescent Lamps – Safety	BS EN 60081/ BS EN 61199	EN 60081/ EN 61199	IEC 60081/ IEC 61199
HID Lamps – Safety	BS EN 62035	EN 62035	IEC 62035
Quality Management Systems	BS EN ISO 9001	EN ISO 9001	ISO 9001
Environmental Management Systems	BS EN ISO 14001	EN ISO 14001	ISO 14001
Code of Practice – Emergency Lighting	BS 5266/ BS EN 1838	EN 1838	
Photometric Measurements/Data	BS EN 13032	EN 13032	CIE 121
Lighting Columns	BS 5649	EN 40	

## Emergency Lighting

Emergency lighting is provided when the supply to the mains lighting fails. It helps people avoid panic, restores their confidence and guides them quickly and safely out of the building.

Thorn Lighting offers a wide range of emergency lighting luminaires. These may be integrated standard luminaires or separate dedicated emergency units.

Thorn luminaires are supplied complete with electronic gear for d.c. operation, white fluorescent tubes and nickel cadmium batteries (unless otherwise stated).

A test record card is included so that a maintenance programme can be followed in accordance with the Code of Practice BS 5266.

All Thorn emergency products carry a tamper-evident holographic security label, on both the product and the outer carton. This gives the customer a guarantee of an authentic Thorn emergency lighting product.

# THORN

✓ Authentic Emergency Product

### Safety Classifications



The following provides an explanation of some of the most common classifications applied to luminaires:

 **Class I**  
Luminaires in this class are electrically insulated and provided with a connection to earth. Exposed metal parts that could become live in the event of basic insulation failure are protected by earthing.



**Class II**  
 Class II luminaires are designed and constructed so that protection against electric shock does not rely on basic insulation only. This can be achieved by means of reinforced or double insulation. No provision for earthing is provided.

 **Class III** Protection against electric shock relies on supply at Safety Extra – Low Voltage (SELV) and in which voltages higher than those of SELV are not generated (max. 50V ac rms). Luminaires not suitable for covering with thermally insulating material

 **Note.** Previously luminaires suitable for covering with thermally insulating material displayed the F mark. This has been replaced by this warning symbol.

  Luminaires not suitable for direct mounting on normally flammable surfaces (i.e. suitable only for mounting on non-combustible surfaces)

**Note.** Previously luminaires suitable for mounting on normally combustible surfaces displayed the F mark. This has been replaced by this warning symbol.

 **T<sub>a</sub> 0** Ta classification  
 **+25** Denotes the maximum ambient temperature in which the luminaire is suitable for use. No ta mark indicates suitable for use in max. 25 °C ambients.  
**850°C** 850° hot wire  
**850°C** Abbreviation for compliance with glow wire test for plastic parts tested at the stated temperature.

### Ingress Protection

The ingress protection (IP) code denotes the protection against dust, solid objects and moisture provided by the luminaire enclosure. If no code is marked the luminaire is deemed to be IP20.

Ingress protection (IP) code

- i) First digit of code denotes protection against dust and solid objects
  - IP2X No entry of standard test finger to live parts
  - IP3X No entry of 2.5mm ø probe to the enclosure/live parts
  - IP4X No entry of 1mm ø probe to the enclosure/live parts
  - IP5X Dust proof. (no dust deposit around live parts)
  - IP6X Dust tight (no dust entry)
- ii) Second digit of code denotes protection against moisture
  - IPX0 No special protection
  - IPX1 Protection against drops of condensed water
  - IPX2 Drip-proof (vertical falling drops of liquid)
  - IPX3 Rain-proof (rain up to angles of 60°)
  - IPX4 Splash proof (spray from any angle)
  - IPX5 Water jet
  - IPX6 Strong Water jet
  - IPX7 Temporary immersion up to 1m
  - IPX8 Long-term immersion to declared depth

### Impact Resistance

The use of Joules (Newton metres – Nm) has been common for many years.

More recently an IK rating normally used for electrical enclosures and cabinets (EN 50102:1995) has emerged as manufacturers apply it to their luminaires, as they also enclose electrical circuits. This chart compares both ratings:

IK rating	IK01	IK02	IK03	IK04	IK05	IK06	IK07	IK08	IK09	IK10
Impact Energy (Joules)	0.15J	0.23J	0.35J	0.5J	0.7J	1J	2J	5J	10J	20J

# Safety and Quality

## Lighting for people using Display Screen Equipment

Readers are referred to The Society of Light and Lighting's (SLL) Lighting Guide 7 (LG7), published in 2015 and to EN 12464-1:2011 which contains some further elements of the advice.

### LG7

SLL LG7 offers advice on all aspects of lighting design concerned with office spaces and ancillary areas, and for areas using display screen equipment. The document has two main criteria that have to be addressed. The first is the decision that the designer has to take over the required luminance limit of the optic to be used (all luminance limits are based on an average value taken radially around the luminaire at an angle of 65°). The limits for luminance relate to the type of screen and its anti-reflective treatment, together with the software type in use. (See below).

#### Luminance limits for screen types:

Screen High State Luminance	>200cd/m <sup>2</sup>	<200cd/m <sup>2</sup>
Case A	3000cd/m <sup>2</sup>	1500cd/m <sup>2</sup>
Case B	1500cd/m <sup>2</sup>	1000cd/m <sup>2</sup>

Case A means Positive polarity software and normal requirements concerning colour and detail, such as used in office, education etc.

Case B means negative polarity and/or higher requirements concerning colour and detail, such as used for CAD, colour inspection, etc.

Note: Screen high state luminance (see ISO 9241-302) describes the maximum luminance of the white part of the screen and this value is available from the manufacturer of the screen.

The second criteria concern the illuminance to the major surfaces within the room. In all enclosed places the maintained illuminance on the major surfaces shall be:

Em > 50 lx with U<sub>o</sub> > 0.1 on the walls and  
Em > 30 lx with U<sub>o</sub> > 0.1 on the ceiling

It is recognised that in some applications such as racked storage, heavy industrial premises, travel terminals, generally due to the size, complexity and operational constraints the desired light levels on these surfaces may not be achievable. In such cases reduced levels are acceptable. In some applications such as offices, education, health care and general areas of entrance, corridors, stairs the walls and ceiling need to be brighter to aid good communications. In these places it is recommended that the maintained illuminance on the major surfaces should be:

Em > 75 lx with U<sub>o</sub> > 0.1 on the walls and  
Em > 50 lx with U<sub>o</sub> > 0.1 on the ceiling.

LG7 recognises that it is hard to achieve the luminance ratios mentioned above in large open plan offices with low ceilings.

Copies of LG7 can be purchased on-line at [www.cibse.org/publications](http://www.cibse.org/publications)

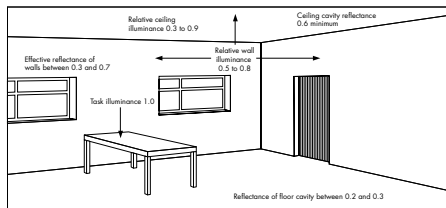

### Colour Rendering

The European Lighting Application Standard EN 12464-1:2011 and new SLL Lighting Code give design advice concerning minimum colour rendering index figures (Ra). Besides specific Ra's, recommended in the schedule for various task types, all continuously occupied spaces, that are used for more than two hours, should employ light sources with an Ra of not less than 80. An exception is made for high bay applications where high pressure sodium lamps are accepted.

### Local Energy Legislation

The current version of Approved Document L of the Building Regulations for England and Wales, which includes limits on the energy efficiency of lighting in domestic and non-domestic buildings, came into force on October 1, 2010. The amended documents have been published and will come into force on 6th April 2014. Advice on compliance can be obtained by Thorn offices.

### Climate Change Legislation

Climate Change Levy (CCL) and Enhanced Capital Allowances (ECA). Having chosen the fiscal route to encourage UK commerce and industry to use less energy the UK Government introduced the CCL on all non-domestic energy use in April 2001. To enable businesses to claim 100% first year capital allowances on investments in energy saving equipment the ECA scheme was introduced from 7 August 2001. Businesses are now able to write off the whole cost of their investment against their taxable profit of the period during which they make the investment. Qualifying products have to meet minimum performance targets issued in August 2013. Thorn can help with performance figures for the majority of its luminaires, LED luminaires and controls, which are detailed on the company website.

### Luminaires for Hazardous Areas

The Atex Directive is a mandatory requirement for all hazardous equipment sold in the EU.

Atex Category 1 applies to areas where the risk of explosion is constantly present. Atex Category 2 applies to areas where there is a risk of explosion during normal operation of a building or plant.

Atex Category 3 applies to areas where there will only be occasional risk of explosion and only during abnormal operation conditions.

Thorn offers product suitable for Category 2 or 3 areas.



# THORN

LIGHTING PEOPLE



## Download our free **Thorn Lighting Contractor** app

Our new app has the latest contractor product ranges, 'how to' application design guides and details of where you can buy Thorn products. After one quick sync, you can view the app on the move without the need for internet connectivity.

Suitable for mobile and tablet.



### Thorn Lighting Limited

Durhamgate, Spennymoor,  
County Durham, DL16 6HL  
Tel: +44 (0) 1388 420 042

#### Sales support

Tel: +44 (0) 844 855 4810  
Fax: +44 (0) 844 855 4811

#### Quotations

Tel: +44 (0) 191 301 3036  
uk.quotations@zumtobelgroup.com

#### TCS (After Sales)

Tel: +44 (0) 191 301 3939  
tcs.uk@zumtobelgroup.com

#### Technical support

Tel: +44 (0) 844 855 4812  
Fax: +44 (0) 191 301 3107  
technical@zumtobelgroup.com

#### Spare parts

Tel: +44 (0) 191 301 3131  
Fax: +44 (0) 191 301 3038  
spares@zumtobelgroup.com

#### Literature requests

Brochures on specific  
products/ranges  
literature@zumtobelgroup.com

### Thorn Lighting (Ireland) Limited

Century House  
Harolds Cross Road,  
Dublin 6W  
Ireland  
Tel: +353 0 1 4922 877  
Fax: +353 0 1 4922 724  
dublinsales@zumtobelgroup.com

[www.thornlighting.co.uk](http://www.thornlighting.co.uk)  
[www.thornlighting.ie](http://www.thornlighting.ie)

Thorn Lighting is constantly developing and improving its products. All descriptions, illustrations, drawings and specifications in this publication present only general particulars and shall not form part of any contract. The right is reserved to change specifications without prior notification or public announcement. All goods supplied by the company are supplied subject to the company's General Conditions of Sale, a copy of which is available on request. All measurements are in millimetres and weights in kilograms unless otherwise stated. Printed on Luxo Light.

Publication No: CG\_GB Publication Date: 09/16 SAP: 96644206



www.pefc.org



Member of the Lighting  
Industry Association



ISO 9001:2008  
Reg: AF00033/5  
ISO 14001:2004  
Reg: AF00247/2  
Manufacturing