

CI/SfB

	(57.7)		
--	--------	--	--

10th Edition



Specification Range

Residential and Non-Residential Sectors



Vent-Axia®

Ventilation Solutions

A warm welcome to the latest edition of the Vent-Axia Specification Range catalogue.

Legislative pressures continue to build, and this is our first publication following the new ErP legislation that came into force on 1st January 2016. As part of the ongoing drive for energy efficiency within Europe, ventilation devices over 30 Watts come under the scope of the Energy Related Products Directive. The legislation sets minimum performance criteria across a range of fans and ventilation devices under two sets of legislation; 'residential' ventilation and 'non-residential' ventilation. As a result of the legislation we have reviewed our products and where required made updates to ensure they comply. In line with Vent-Axia's drive to provide the best solution for our customer, we have taken the opportunity to update and improve some products at the same time as bringing the products in-line with ErP regulations. We have also improved the way we supply some of them - giving you more choice and flexibility over how you stock and sell the products.

This edition of our Specification Range catalogue shows the continued investment we are making in our products and services to improve and add to our already comprehensive range. In this catalogue, we have brought together our Lo-Carbon residential and our non-residential products in one place providing what we believe to be the best solutions for a wide range of specification today.

We have introduced many new models which expand upon our traditional, well-proven products as well as broadening our capabilities further with a whole host of innovations in Vent-Axia Lo-Carbon and energy reducing ventilation solutions.

For example, the new EKF kitchen fan has a built in EC motor speed control, high temperature rating of up to 120 degrees, motor out of the airstream and specific fan powers of below 1 W/l/s; we believe there is no better solution available.

We thank you for your continued custom and feedback, and are always willing to answer any questions you may have. If you need to contact us, please email sales@vent-axia.com, or speak to your local representative who will be happy to help.

Kind Regards

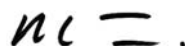

Mark Hoskins
Managing Director



Why choose Vent-Axia

Vent-Axia supplies heat recovery solutions to countries around the world, whose building regulations already demand the most effective, sustainable and energy efficient ventilation solutions.

We are with you all the way

- Unparalleled customer service
- Industry leading design support
- Providing support and solutions on-site

Availability

- With the widest distribution network of any manufacturer in the UK we pride ourselves on having products available when and where you need them

Product solutions

- Whatever the product category, we have the most energy efficient solutions available
- Unique solutions designed to fit into all your buildings
- With absolute focus on the end user we work hard to produce the quietest, most comfortable products for occupiers to live with



Unparalleled Customer Service



On-site Support



Industry Leading Design Support



Widest UK Distribution Network

Legislation

Approved Document F 2010 - Means of Ventilation

The purpose of this regulation is to ensure adequate means of ventilation is provided for people in the building. According to the document, ventilation is the 'removal of stale air from a building and replacement with fresh outside air.'

By providing fresh outside air to breathe, ventilation assists in the dilution and removal of pollutants as well as a reduction in humidity/condensation, which combined create a more pleasant environment and relief for asthma and allergy sufferers.

Part F is a performance based whole building solution stating not only what should be achieved, but also guidance on how this can be achieved.

The pollutants in today's modern dwellings has lead to these changes, with the types of pollutant and the acceptable levels now detailed in the Approved Document Part F 2010.

Nitrogen Dioxide (NO₂)

Carbon Monoxide (CO₂)

Total volatile compounds (TVOC)

Bio-effluents (body odours)

Within ADF 2010, Ventilation requirements for new build properties reference the whole dwelling based on an analysis of floor area, number of bedrooms and occupants. There are four systems covered in ADF 2010 including Intermittent Extract Fans, Passive Stack, Continuous Mechanical Extract Ventilation (MEV) and Mechanical Ventilation with Heat Recovery (MVHR).

A guide called the 'Domestic Ventilation Compliance Guide' is available. This covers installation practices as well as sign off and commissioning.

Efficiency regulations require buildings to be better sealed and more airtight. In ADF 2010 there are two ventilation rates based on the design infiltration rate of your building. There is one rate for properties with infiltration rates over 5m³/h/m² (leakier properties) and a higher ventilation rate for properties below 5m³/h/m² (tighter properties). The practical outcome of this means that in airtight properties, the following applies:

- Trickle vents with intermittent fans are up to 50% bigger
- MVHR rates are increased

With MEV in properties at 5m³/h/m² or over no trickle vents are needed.

Guidance is available for ventilation of basements in houses and trickle ventilation for replacement windows.

Compliance with Part F requires installed performance to meet the ventilation rates quoted in the Document. This means that ventilation has to be commissioned and signed off by a competent person.

Noise

With increasing airtightness the acoustic properties also improve leading to a reduction in external noise entering our dwellings. However this makes any noise generated inside the property even more noticeable, so in Part F a maximum noise level of 35dB(A) has been set for the trickle speed on continuous ventilation systems.

Approved Document L 2013 – Conservation of Fuel and Power

These documents set minimum performance levels for ventilation efficiencies and reducing the consumption of the systems.

These regulations have brought some significant changes to the ventilation sector in a bid to improve both air quality and energy efficiency.

Part L - Overview

- Target emission rates, along with fabric energy efficiency standards are aimed at reducing the carbon emissions by 6%
- Non-domestic building services compliance guide shows specific fan power requirements. Heat recovery efficiency minimums to EN308 test standard
- Specific fan power (SFP) targets of 1 W/l/s for new or replacement commercial kitchen extract systems
- Minimum energy efficiency level for all ventilation systems. New build and refurbishment applications for intermittent fans must have an SFP of less than 0.5 W/l/s.



Energy Related Products Directive (ErP)

As part of the ongoing drive for energy efficiency within Europe, as of January 2016 ventilation devices over 30 Watts come under the scope of the Energy Related Products Directive. The legislation sets minimum performance criteria across a range of fans and ventilation devices under two sets of legislation; 'residential' ventilation and 'non-residential' ventilation.

As a result of the legislation we have reviewed our products and where required made updates to ensure they comply. The primary changes have meant that a number of products have had alternative motors specified or have been updated to enable speed control. However, we have ensured that the installation methods remain unaffected. Through the review we have also taken the opportunity to rationalise our range where needed. The detail within this document clarifies those changes. Please note that where a product changes due to ErP, there will be a transitional period as we move from the old to the new model, and any stock you currently hold will not be affected by this regulation and can be sold as normal.

Residential Products

Residential Products have a secondary directive which require some products to carry an energy label.

Residential Ranges - Small fans

The majority of small residential fans are unaffected by the legislation as any device below 30 Watts is currently out of scope. The information on them is recorded however and can be found at www.vent-axia.com/erp

As of January 1st 2016, the Duet and Gemini fans will be delisted, but are still available as spares so please contact sales@vent-axia for more information.

MVHR and MEV products

These products do come into the scope of the legislation and will carry an energy label. There are some minimum energy efficiency requirements as well as the requirement for a summer bypass on heat recovery models. A small number of our products have been updated to ensure they meet these requirements. The literature on individual products has been updated and can be found on the Vent-Axia website. The following product however has been discontinued:

- Kinetic E

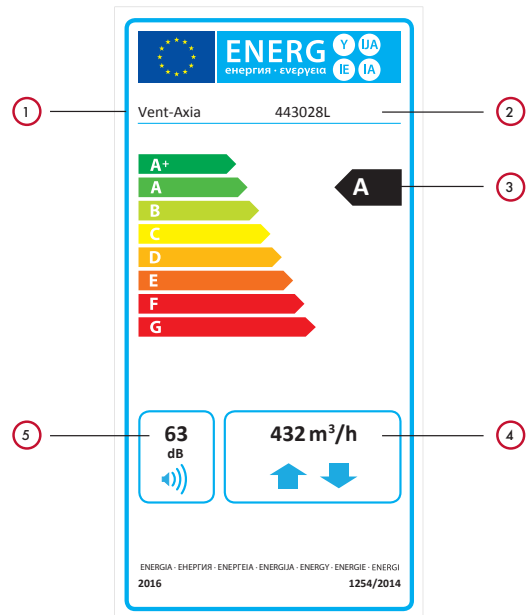

- ① Manufacturer's name
- ② Model name
- ③ Energy Efficiency Class
- ④ Max flow rate
- ⑤ Sound Level



Non-Residential Ranges

Non-Residential products have had minimum performance and efficiency levels established, but there is no requirement to introduce energy labels. Some products have been updated with new motors and enabled for speed control.

Non-Residential ranges are split into a number of different categories dependent on their application and function. These can be described as follows:

1. Fans
2. Uni-directional Ventilation Units
3. Bi-directional Ventilation Units

1. Fans

These are products where there is a simple single case that directs air on and off the impellor. Examples include axial plate and case fans. These examples are out of scope of the legislation.

Changes to the way we sell products

A limited number of products have been made modular to ensure they fall within the 'Fans' legislation which guarantees that they can continue to be purchased. In many cases these are long established product ranges which are now sold primarily for replacement. As many installations would be difficult to upgrade on site, we believe that this will provide the easiest and lowest cost route for our customers. Examples of this include T-Series and Standard Range as well as axial roof fans. In order to ensure continuity of supply we would encourage customers to update their systems with the amended product codes with effect from 1st January 2016. If there are instances where the pre-ERP product codes have been included on a purchase order, Vent-Axia may ask for this to be re-submitted using the new product codes. This will ensure the process is aligned from order receipt through to invoice payment.

If you are unsure of the new part number don't worry, as we will be able to tell you what the new one is. In some instances however you may receive more than one box.

Example of new modular format - T-Series Range

The T-Series will now be purchased in a modular form. You will buy the Fan Core size that you need e.g. 9", and you will then select the kit you need for the application e.g Window kit. This will give you the flexibility to use the Fan Core with any kit, as required. Within the product size e.g 9", the Fan Core will be the same Stock Ref, regardless of the kit required. See the Commercial Section for more information.



Size	Fan Core*	Kit Types (excludes core)			
		Window	Wall	Roof	Panel
9"	472014	472022	472018	472030	472026

* The Fan Core remains the same, no matter which kit is purchased.



COMPLIANT

Energy Related Products Directive (ErP)

2. Unidirectional ventilation units

This includes products that are one direction only, and where there is a secondary housing around a fan.

This is the product category which has required the most changes. The impact of the efficiency legislation has meant that it has become virtually impossible to comply using a forward curved AC centrifugal fan. We will therefore be moving to backward curved centrifugal fans in all of our AC box fan ranges. This will mean changes to the box sizes and adjustment to performances across the range. The product ranges have therefore been updated:

ACQ/ATQ



QP/QPTW



We have a number of product ranges that have been reaching the end of their life cycle and we have taken the opportunity to rationalise these. The following product ranges will NO LONGER be available:

VMD



RMV



GRB



GDB



GRD



Other product ranges have been rationalised to provide one solution, these include:

ARH - rationalised to MFQ



RBH - rationalised to RMH



3. Bi-directional ventilation units

These are product ranges that both supply and extract such as heat recovery.

There are now minimum energy requirements set for heat recovery efficiency. Any product with an efficiency of 67% or lower does not comply. Both the Totus² and ERV-HIBOX ranges are unaffected by these changes, however the low efficiency heat recovery ERV-BOX products will be discontinued.

Heat recovery minimum efficiency





Future Direction - Drive towards energy efficiency

Things have moved on a bit since 1992 when ventilation was first introduced into the Building Regulations. Here is an overview of the changes from 2006.

2006 - Part F included continuous ventilation for the first time.

Ventilation systems were being installed by skilled persons but the performance data was never tested. Part L changes meant that SAP Q products could be included as part of the dwelling's SAP calculations.

2010 - Design, install and ensure its used correctly. With dwellings being designed with increased energy efficiency and reduced air permeability, ventilation systems now require specific flow rates and there is more demand for highly efficient heat recovery to help reduce the DER's. Ventilation is now required to be installed correctly with the installation recorded and measured plus there needs to be guidance to the home occupier as to how it operates.

2013 - New Part L requirements meant a reduction in air leakage and increased air tightness.

These trends continue to drive the adoption of higher efficiencies and the importance of installation increases as the advantageous air from leakage is reducing further.

2016 - With the commitments made in the recent COP21 meeting and the Paris climate agreement, focus on decarbonisation and energy efficiency is set to continue.

The Energy Performance of Buildings directive and the Energy related Product Directive are having an impact on the performance and efficiency standards of ventilation. These drivers will continue to develop and are expected to transform into standards in the future meaning an even greater focus on energy efficiency. The commitment to zero carbon buildings in 2019 will mean revisions to Part F and L of the building regulations are likely.

As we focus our efforts to drive down the energy that we use in buildings, the risk of airtight, well insulated buildings being the potential cause of respiratory problems increase. Therefore the importance of well-designed and well installed systems that perform as designed increases. This will lead to increased focus on competence when installing ventilation and is likely to drive advances in the way installers are trained.

Things to Remember

Airflow
performance

Minimum energy
efficiency limits

Good
installation

Use by
occupiers

Contents - Products

Lo-Carbon Residential Fans 12-33



Lo-Carbon Svara
- Up to 30l/s
Page 14-15



Lo-Carbon VA100®/SELV
- Up to 21l/s
Page 16-17



Lo-Carbon Silhouette® 100/SELV
- Up to 30l/s
Page 18-19



Lo-Carbon Centra®/SELV
- Up to 15l/s Continuous Running
Page 20-21



Lo-Carbon iQ
- Up to 37l/s Continuous Running
Page 22-23



Lo-Carbon Solo® Plus/SELV
- Up to 21l/s Continuous Running
Page 24-25



Lo-Carbon Minivent
- Up to 31l/s
Page 26



Lo-Carbon Vent-A-light
- Up to 31l/s
Page 27



Lo-Carbon Quadra®/SELV
- Up to 63l/s Continuous Running
Page 28-29



Lo-Carbon Silhouette 125
- Up to 44l/s
Page 30



Lo-Carbon VA150
- Up to 64l/s
Page 31



Lo-Carbon Silhouette® 150
- Up to 65l/s
Page 32-33

dMEV, MEV & PIV Systems 34-49



Lo-Carbon Response
- Up to 13l/s (47m³/h) Continuous Running
Page 36-37



Lo-Carbon Centra®/SELV
- Up to 15l/s (54m³/h) Continuous Running
Page 38-39



Lo-Carbon Multivent
- Up to 120l/s (432m³/h)
Page 40



Multivent
- Up to 123l/s (443m³/h)
Page 41



Lo-Carbon Sentinel® Multivent/Plus
- Up to 165l/s (595m³/h)
Page 42-44



Lo-Carbon Multivent MVDC-MS/MSH
- Up to 121l/s (436m³/h)
Page 45



Lo-Carbon PoziDry
- Up to 50l/s (180m³/h)
Page 46-47



Lo-Carbon PoziDry Compact
- Up to 34l/s (122m³/h)
Page 48-49

Single Room dMVHR 50-57



Lo-Carbon Tempra/SELV
- Up to 15l/s (54m³/h) Continuous Running
Page 52-53



Lo-Carbon HR25
- Up to 15l/s (54m³/h)
Page 54



HR200WK
- Up to 61l/s (220m³/h)
Page 55



HR300
- Up to 83l/s (299m³/h)
Page 56

MVHR Units For Residential & Commercial Applications 58-101



Lo-Carbon Sentinel Kinetic® Advance
- Up to 115l/s (414m³/h)
Page 60-61



Lo-Carbon Sentinel Kinetic®
- Up to 76l/s (274m³/h)
Page 66-69



Lo-Carbon
Sentinel Kinetic® F
- Up to 93l/s (335m³/h)

Page 70-73



Lo-Carbon
Sentinel Kinetic® Plus
- Up to 136l/s (490m³/h)

Page 74-77



Lo-Carbon
Sentinel Kinetic® High Flow
- Up to 195l/s (702m³/h)

Page 78-79



Lo-Carbon Sentinel Kinetic®
Cooker Hood
- Up to 76l/s (274m³/h)

Page 80-83



Lo-Carbon Sentinel Kinetic®
Horizontal
- Up to 98l/s (353m³/h)

Page 84-89



Lo-Carbon
Kinetic® Plus E
- Up to 141l/s (508m³/h)

Page 90-93



Integra®
- Up to 48l/s (173m³/h)

Page 94



Integra® Plus
- Up to 150l/s (54m³/h)

Page 95



HR100R/RS
- Up to 18l/s (65m³/h)

Page 96



HR200V
- Up to 103l/s (371m³/h)

Page 97



HR500
- Up to 250l/s (900m³/h)

Page 98



HR500D
- Up to 174l/s (626m³/h)

Page 99



HR500EP/IP
- Up to 244l/s (878m³/h)

Page 100



HR500DP
- Up to 333l/s (1,199m³/h)

Page 101

Ducting & Fittings

102-119

Commercial Range

120-149



ACM® 100 - 200
- Up to 240l/s (864m³/h)

Page 122-123



ACM® 250 - 315
- Up to 653l/s (2,351m³/h)

Page 124-125



Powerflow
- Up to 420l/s (1,512m³/h)

Page 126-127



Lo-Carbon T-Series® Window
Model
- Up to 430l/s (1,550m³/h)

Page 130



Lo-Carbon T-Series® Wall
Model
- Up to 460l/s (1,650m³/h)

Page 131



Lo-Carbon T-Series®
Roof Model
- Up to 330l/s (1,194m³/h)

Page 132



Lo-Carbon T-Series® Panel
Model
- Up to 490l/s (1,761m³/h)

Page 133



Traditional T-Series® Window
Model
- Up to 449l/s (1,615m³/h)

Page 136



Traditional T-Series®
Wall Model
- Up to 485l/s (1,745m³/h)

Page 137



Traditional T-Series®
Roof Model
- Up to 412l/s (1,485m³/h)

Page 138



Traditional T-Series® Panel
Model
- Up to 524l/s (1,885m³/h)

Page 139



Traditional T-Series®
Darkroom Model
- Up to 314l/s (1,130m³/h)

Page 140

Contents - Products



Traditional T-Series®
Inline Model
- Up to 620l/s (2,230m³/h)

Page 141



Super T-Series
- Up to 1372l/s (4,940m³/h)

Page 142-143



Traditional Standard
Window Model
- Up to 433l/s (1,560m³/h)

Page 146



Traditional Standard
Roof Model
- Up to 314l/s (1,130m³/h)

Page 147



Traditional Standard
Wall Model
- Up to 491l/s (1,767m³/h)

Page 148



Traditional Standard
Panel Model
- Up to 531l/s (1,910m³/h)

Page 149

Electric Heating

150-165



Bluothermal™ Underfloor
Heating
- Up to 3,300W

Page 152-155



Heated Towel Rails
- Up to 400W

Page 156-157



Radiant Heaters
- Up to 6,000W

Page 158-159



Opal®
Aluminium Radiators
- Up to 1,500W

Page 160



Optimax Plus®
Panel Heaters
- Up to 2,000W

Page 161



Optimax Plus®
Combination
Storage Heaters
- Up to 3,400W

Page 162



Optimax Plus®
Storage Heaters
- Up to 3,400W

Page 163



Plinth Heaters
- Up to 2,000W

Page 164



Warm Air Curtains
- Up to 6,000W

Page 164



Downflow Heater
- Up to 2,000W

Page 164



Convactor Heater
- Up to 2,000W

Page 165



Portable Fan Heater
- Up to 2,000W

Page 165

Accessories & Controllers - Residential & Light Commercial Systems

166-185

Plate & Case Fan Range

186-261



Owlett Impeller
Sabre Plate Mounted Sickle
Fans (VSP)
- Up to 5.71m³/s
(20,556m³/hr)

Page 188-193

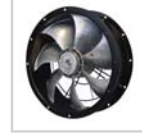

Owlett Impeller Sabre Sickle
Short Case Fans (VSC)
- Up to 5.81m³/s
(20,916m³/hr)

Page 194-201



Long Case Axial Fans (LCA)
- Up to 36.01m³/s
(129,600m³/hr)

Page 202-231



Kitchen Axial Fans (KAF)
- Up to 5.93m³/s
(21,348m³/hr)

Page 232-235



Bifurcated Case Axial Fans
(BIFA)
- Up to 19.10m³/s
(68,760m³/hr)

Page 236-261

In-Line Fan Range

262-299



Lo-Carbon Kitchen Box Fan
(EKF)
- Up to 3.69m³/s
(13,284m³/hr)

Page 264-271



Eco Mix Flow Fans (eMF)
- Up to 5.63m³/s
(20,268m³/hr)

Page 272-277



Powerflow In-Line Duct Fans (ACP)
- Up to 0.34m³/s
(1,220m³/hr)
Page 278-281

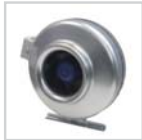

EuroSeries (SDX)
In-Line Centrifugal Duct Fans
- Up to 0.35m³/s
(1,260m³/hr)
Page 282-285



Slimpak® In-Line Centrifugal Duct Fans (SLP)
- Up to 0.38m³/s
(1,368m³/hr)
Page 286-289



New & Improved Acoustic In-Line Fans (ACQ)
- Up to 1.5m³/s
(5,400m³/hr)
Page 290-293



Mixed Flow Fans (MFQ)
- Up to 3.67m³/s
(13,212m³/hr)
Page 294-299

Sentinel D-Box 314-341



Sentinel D-Box Single Fan
- Up to 1.49m³/s
(5,364m³/hr)
Page 320-329



Sentinel D-Box Twin Fan
- Up to 1.20m³/s
(4,320m³/hr)
Page 330-339



Sentinel D-Box Sensors & Controls
Page 340-341

Air Handling Units 380-389



Slimline Range (SL)
- Up to 0.66m³/s
(2,376m³/hr)
Page 382-385



D1 to D6 Mini Direct Range
- Up to 2.25m³/s
(8,100m³/hr)
Page 386-389

Accessories & Controllers Non-Residential 390-411

Sentinel Totus² D-ERV 342-359



Sentinel Totus² D-ERV Fans
- Up to 0.59m³/s
(2,124m³/hr)
Page 354-359

Twin Fan Range 300-313



New & Improved Acoustic In-Line Direct Driven Twin Fans (ATQ)
- Up to 1.35m³/s
(4,860m³/hr)
Page 302-307



Power Twin Fans (TDF)
- Up to 3.52m³/s
(12,672m³/hr)
Page 308-311



Trakmaster Twin Fan Controllers
Page 312-313

Roof Fan Range 360-379



Sabre® Sickle fan assisted roof cowl (VSR)
- Up to 5.00m³/s
(18,000m³/hr)
Page 362-369



Mixed Flow Roof Fans (RMH)
- Up to 3.63m³/s
(13,068m³/hr)
Page 370-375



LoWatt MX Roof Fans (MX)
- Up to 1.86m³/s
(6,696m³/hr)
Page 376-379

Lo-Carbon Residential Fans

Continuing our commitment to energy efficiency in this section you will find Lo-Carbon solutions for intermittent and continuous fan applications.

In axial or centrifugal, wall, ceiling or window applications in bathrooms or kitchens we have a Lo-Carbon fan offering up to 90% energy saving over the equivalent traditional fan.

We are proud to be market leaders and continually strive to bring you the best products available. Our newest addition to the range is no different - the NEW Vent-Axia Svara is the UK's first App controlled unitary fan! Making installation simple, and giving the homeowner a range of control options the Svara really is the first of the next generation of unitary fans. See page 14 for more details.



	NEW Lo-Carbon Svara Axial Bathroom/Toilet Fans	14-15
	Lo-Carbon VA100®/SELV Axial Bathroom/Toilet Fans	16-17
	Lo-Carbon Silhouette® 100/SELV Bathroom/Toilet Fans	18-19
	Lo-Carbon Centra®/SELV dMEV Unit	20-21
	Lo-Carbon iQ Intelligent Axial Bathroom Fan	22-23
	Lo-Carbon Solo Plus/SELV Centrifugal Bathroom/Toilet Fans	24-25
	Lo-Carbon Minivent Ducted Bath/Shower Fan Kit	26
	Lo-Carbon LED Vent-A-light Ducted Bath/Shower Fan Kit	27
	Lo-Carbon Quadra®/SELV Centrifugal Fans	28-29
	Lo-Carbon Silhouette® 125 Bathroom/Toilet Fans	30
	Lo-Carbon VA150 Axial Kitchen & Utility Room Fans	31
	Lo-Carbon Silhouette® 150 Axial Kitchen Fans	32-33

Vent-Axia

Lo-Carbon Residential Fans



NEW Lo-Carbon Svara

Axial Kitchen/Bathroom Fans

Features & Benefits

- **The UK's first App controlled unitary fan!**
- **Set up and control through the App via Bluetooth**
- **Continuous or intermittent. Humidity and timer (via light sensor) function**
- **1 model for all applications**
- **Silent and purge modes available**
- **Silent hours scheduling function**
- **Intelligent light sensor with overrun timer - allows replacement of a basic model fan**
- **3 Speed**
- **IP44 Rated, DC motor with 5 year guarantee**
- **Only 17 dBA**

The UK's first App controlled unitary fan!

The launch of Svara marks the next generation of unitary fans.

For consumers Svara offers improved comfort in their homes since it has been developed to allow households to take control of their indoor air quality via the App.

For electricians, installation is made simple through Svara's Bluetooth-enabled App allowing you to choose whether to opt for intermittent or continuous ventilation; whether you would like the humidistat to trigger operation or not; and whether the overrun timer is required. No more fiddly switches and jumpers!

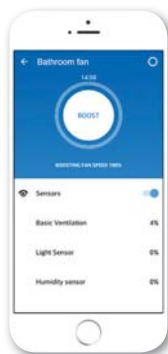

Aesthetics and silence

The name Svara takes its influence from the fan's Swedish heritage - a country well known for iconic and well thought out designs. Consumers will be attracted to Svara's good looks with its sleek modern design, plus with noise a key issue

for consumers, households will also be impressed by Svara's quiet running, operating at just 17 dBA on low trickle. It is also easy to clean as the central module disconnects the motor from the rest of the fan allowing it to be simply wiped with a soft cloth, and at only 4W the energy efficient Svara also boasts low power consumption.

One model fits all

Vent-Axia Svara is programmed to cope with the vast majority of installations.

The fan is set as default to work continuously at a trickle flow of 10l/s.

When the fan senses a somebody in the room it increases the flow to 19l/s. If the humidity rises rapidly, for example when the shower is on, the fan goes up to maximum flow at 30l/s.

When the fan senses the humidity level has returned to normal it reverts to the trickle flow of 10l/s.

If other settings or functions are desired, they can be selected through the Vent-Axia Connect App which can be downloaded from the App Store and Google Play.

Functions

Light sensor

When the light sensor is enabled Svara senses when someone is in the room and then activates. Its sophisticated light sensor is triggered by light movement and shadows. It is possible to set a delay-on so the fan is not triggered by the light during quick night time bathroom visits. The light sensor can also distinguish between headlight flashes from cars and room occupancy, so it is not triggered by passing cars, avoiding nuisance running. The sensitivity of the light sensor can be adjusted via the App.

Overrun Timer

The light sensor provides an overrun timer but only requires a live and neutral. In houses where there is only a basic fan installed, the home owner can upgrade to a timer fan without having to rewire.

Humidistat

Svara features a humidistat which reacts to sharp changes in humidity, for instance when someone is taking a shower. When set to continuous running, once the humidity sensor is activated the fan runs at 30l/s until humidity returns to normal levels then the fan powers down to 10l/s. Ambient humidity changes will not trigger the humidistat. It is possible to change the sensitivity of the humidity sensor via the App.

Silent scheduling and Automatic cycles

The silent hours scheduling function allows you to deactivate the boost function on the Svara via the App, for example, this would prevent nuisance noise over night. Additionally during a vacation you can set Svara to an airing mode which operates a purge function every 12 hours for either 30, 60 or 90 minutes depending on selection. However, Svara's sophisticated controls, will not purge if the light sensor detects that there is someone in the house.



Models

Svara kitchen and bathroom fan

100 mm Axial fan. Factory set at continuous running with Humidistat and Light Sensor/overrun timer On.

Stock Ref
409802

Accessories

Wall Kit

Stock Ref
254102



Back draught shutter

Stock Ref
406605



Cover plate

For duct dimensions between Ø140-160mm

Stock Ref
409820

Dimensions (mm)

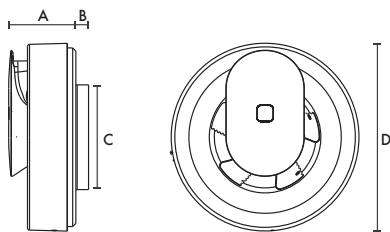

A	B	CØ	DØ
60	21	99	177

Performance

Low Trickle	Extract Performance - FID (l/s)			Max Watts	Sound dB(A)	SFP (W/l/s)
	High Trickle	Boost	@ 3m		@ 0Pa	
10	19	30	4	17-20	0.13	

Lo-Carbon VA100®/SELV

Axial Bathroom/Toilet Fans

Features & Benefits

- Meets current Building Regulations Approved Document F & L
- Suitable for wall, ceiling, panel and window mounting
- Fitted with a motorised shutter
- 5 Year Motor Guarantee
- Protected against low energy lighting circuits
- Reduces your carbon footprint
- IPX4 rated - IPX7 rated (SELV)
- Efficient long life DC motor
- Uses up to 87% less energy
- Low sound levels
- 1 of 2 speeds selectable at installation
- Low specific fan power
- SELV Models - Supplied with a remote transformer
- Datalogger as standard on all models

Long Life Ventilation VA100

The improved Vent-Axia Lo-Carbon VA100 range features Lo-Carbon long life DC motors that are more efficient than conventional motors whilst delivering up to 87% energy savings.

Shutters

The Vent-Axia Lo-Carbon VA100 range is fitted with a motorised shutter mechanism that uses no extra power in operation or off.

Installation

Fitted with integral protection against low energy lighting circuits, the Lo-Carbon VA100 is a 100mm axial fan suitable for use in the bathroom or toilet. VA100 is quick and simple to fit with easy-wire on one line terminals. Suitable for installation in windows, walls or panels/ceilings using kits available. The 100mm telescopic wall kit fits walls 225 to 360mm thick. The range meets the requirements of the current Building Regulations for the ventilation of toilets 6l/s and bathrooms 15l/s with a 15 minute overrun timer for internal rooms on the LT, XT and HTP models.

Safety Extra Low Voltage (SELV) Fan

Safety Extra Low Voltage (SELV) is designed for areas where a fan has to be fitted within zone 1 in a room containing a fixed bath or shower according to IEE wiring regulations. The VA100 SELV can be safely installed within the spray area. The fan is rated IPX7, control is by a mains safety isolating transformer with 12V DC SELV output, which is sited away from any source of spray and out of reach of a person using a fixed bath or shower.

Models

Lo-Carbon VA100 LP/SELV LP (Pullcord)

Ultra long life DC motor. Pullcord On/Off override switch with indication light. 2 speed options.

Model	Stock Ref
LP	443159
SELV LP	441614

Lo-Carbon VA100 XP/SELV XP (Shutter/Pullcord)

Ultra long life DC motor. Pullcord and On/Off override switch with indication light. 2 speed options.

Model	Stock Ref
XP	443160
SELV XP	459049

Lo-Carbon VA100 LT/SELV LT (Timer)

Electronic adjustable overrun timer (5-30 minutes). Indication light. 2 speed options.

Model	Stock Ref
LT	443161
SELV LT	441615

Lo-Carbon VA100 XT/SELV XT (Shutter/Timer)

Integral electronic adjustable overrun timer (5-30 minutes). Indication light. 2 speed options.

Model	Stock Ref
XT	443162
SELV XT	459050

Lo-Carbon VA100 LHTP/SELV LHTP (Integral Humidity Sensor/Pullcord/Timer)

Complete with integral humidity control with pullcord override. Indication light which operates on the manual override only. 2 speed options.

Model	Stock Ref
LHTP	443163
SELV LHTP	441616

Lo-Carbon VA100 XHTP/SELV XHTP (Shutter/Integral Humidity Sensor/Pullcord/Timer)

Complete with integral humidity control with pullcord override. Indication light which operates on the manual override only. IPX4 rated. 2 speed options.

Model	Stock Ref
XHTP	443164
SELV XHTP	436064

Accessories

Wall Kit

Fixing hole diameter 117mmØ

Stock Ref

254102 (White)
254100 (Brown)

Window Kit

Fixing hole diameter 105mmØ

Stock Ref

254101



Dimensions (mm)

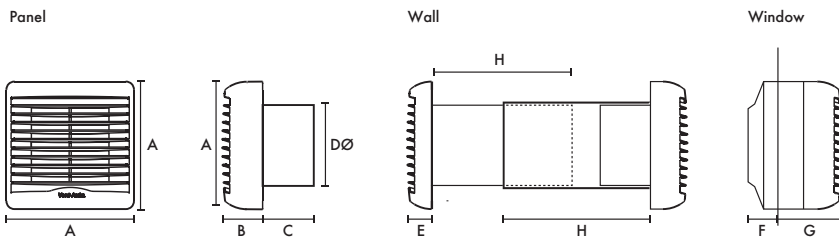

	A	B	C	DØ	E	F	G	H
Bathroom/Toilet	155	47	63	98	31	32	76	200
SELV Transformer (W x H x D) 87 x 87 x 33								
Weight 1kg								

Performance

Area	Models	Extract Performance - FID			Sound dB(A)	SFP (W/l/s)
		m ³ /h	l/s	Watts	@ 3m	@ 0Pa
Toilet	Lo-Carbon VA100/SELV LP/XP/LHTP/XHTP/LT/XT	60	17	3.4	32	0.20
Bathrooms	Lo-Carbon VA100/SELV LP/XP/LHTP/XHTP/LT/XT	74	21	7.0	36	0.33

Lo-Carbon Silhouette® 100/SELV

Bathroom/Toilet Fans

Features & Benefits

- Models Basic/Timer/Humidity - Installation options
- Low power consumption - Lower running costs
- Quiet running
- Fully opening and closing shutters - Improved insulation
- Meets current Building Regulations Approved Document F & L
- 1 of 2 speeds selectable at installation
- Non transparent shutters - Enhanced privacy
- Blue power indication light (except B model) - Modern aesthetics
- Ball bearing motors for vertical or horizontal application
- Unique humidity sensor track - Improved response
- 5 Year Motor Guarantee
- IPX4 rated - IPX7 rated (SELV)
- Suitable for wall, ceiling, panel and window* mounting
- SELV Transformer to BS EN 60742
- SELV Models - Supplied with a remote transformer

Slimline Bathroom Ventilation

With a slim profile of only 17mm, Lo-Carbon Silhouette blends in with the wall surface to provide an unobtrusive installation. Lo-Carbon Silhouette has an FID performance of up to 24l/s. It can be ceiling/panel mounted and connected to an appropriate duct run to the outside.

Safety Extra Low Voltage (SELV) Fan

Safety Extra Low Voltage (SELV) is designed for areas where a fan has to be fitted within zone 1 in a room containing a fixed bath or shower according to IEE wiring regulations. The Silhouette SELV can be safely installed within the spray area. The fan is rated IPX7, control is by a mains safety isolating transformer with 12V DC SELV output, which is sited away from any source of spray and out of reach of a person using a fixed bath or shower.

Models

Lo-Carbon Silhouette 100B/SELV 100SVB

100mm bathroom/toilet fan with back draught shutter.

Model	Stock Ref
100B	441624
SELV 100SVB	441511

Lo-Carbon Silhouette 100T/ SELV 100SVT (Timer)

100mm bathroom/toilet fan with integral adjustable electronic overrun timer (5-30 minutes), indicator light which operates on manual override only, and back draught shutter.

Model	Stock Ref
100T	441625
SELV 100SVT	441512

Lo-Carbon Silhouette 100HT (Humidistat/Timer)

100mm bathroom/toilet fan with adjustable auto humidity sensor from 60-90% RH and overrun timer, indicator light which operates on manual override only, and back draught shutter. Datalogger as standard on all Lo-Carbon humidity controlled Silhouette fans.

Model	Stock Ref
100HT	441626

Lo-Carbon Silhouette 100H SELV (Humidistat)

100mm bathroom/toilet fan with ambient response humidity sensor from 60-90% RH, indicator light which operates on manual override only, and back draught shutter.

Safety Extra Low Voltage version.

Model	Stock Ref
SELV 100SVH	441513

Accessories

Wall Kit

Fixing hole diameter 117mmØ

Stock Ref

254102 (White)
254100 (Brown)

Window Kit

Fixing hole diameter 117mmØ

Stock Ref

442947



17mm actual profile



Dimensions (mm)

Panel

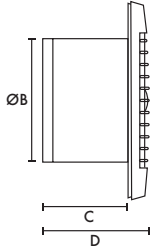
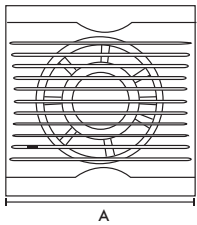

Wall Kit

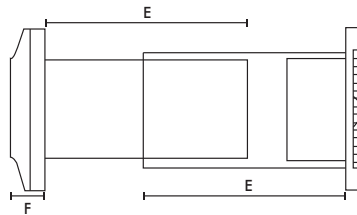

A	BØ	C	D	E	F
160	99	115	132	200	32
SELV Transformer (W X H X D) 87 X 87 X 33					
Weight 0,6kg					

Performance Curve

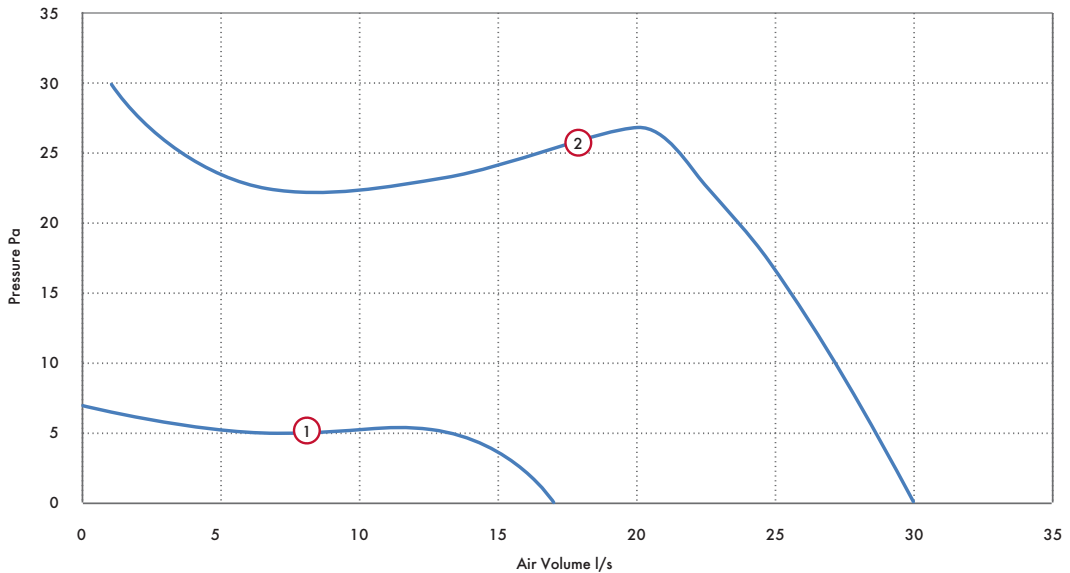

Performance Guide

Area	Model	Curve Ref	Extract Performance - FID			Sound dB(A)	SFP (W/l/s)
			m³/h	l/s	Watts	@ 3m	@ 0Pa
Toilet	Lo-Carbon Silhouette 100 B/T/H/SVB/SVT/SVH	①	60	17	3.4	34	0.20
Bathrooms	Lo-Carbon Silhouette 100 B/T/H/SVB/SVT/SVH	②	108	30	8.7	38	0.30

For window mounting shutter cannot be used and must be removed

Lo-Carbon Centra®/SELV

dMEV Unit

Features & Benefits

- Building Regulations Approved Documents F and L compliant, System 3 Continuous mechanical extract
- Recognised in SAP Appendix Q - Low SFP on SAP Q
- Quietest dMEV available
- Discreet, tasteful styling
- Single fan for use in all applications
- IPX4 rated - IPX7 rated (SELV)
- Pressure detection device
- Normal and Boost speeds
- Lo-Carbon motor offering 90% energy savings and long life
- 5 Year Motor Guarantee
- Suitable for wall, ceiling, panel and window mounting
- SELV Models - Supplied with a remote transformer
- SELV Models Suitable for 'Zone 1' installation

What is de-centralised MEV (dMEV)?

Building Regulations Approved Document F gives examples of four main methods of ventilation. System 3, Continuous mechanical extract ventilation, can be achieved using a single centralised extract unit such as the Sentinel Multivent ducted to 'wet' rooms (kitchen, bathroom, en-suite and W/C) or by decentralised individual fans, such as the Lo-Carbon Centra in the 'wet' rooms. The fans run continuously at near silent levels providing a simple and effective form of ventilation.

SELV (Safety Extra Low Voltage) is designed for areas where a fan can be installed within Zone 1 in a room where there is a fixed bath or shower. Ingress Protected (IP) to IPX7 Lo-Carbon Centra SELV can be fitted safely within the spray area. The separate transformer can be mounted away from the spray zone and out of reach from the bath or shower.

The Lo-Carbon Centra meets the latest requirements of the Building Regulations Approved Document F for wholehouse system ventilation.

Selection of the two normal flow rates (6l/s or 9l/s) is via a simple 'jumper' on the control board. Different methods are available for operating boost speed from a simple switched live to integral humidistat. See individual models for further details.

The attractive and discreet styling of the Vent-Axia Lo-Carbon Centra will complement the décor of any new home while virtually silent operation ensures optimum ventilation is achieved without intrusive noise.

Lo-Carbon Centra

dMEV version recognised in SAP Appendix Q. Lo-Carbon Centra has a specific fan power of only 0.18 W/l/s in through-the-wall kitchen applications.

Models

Lo-Carbon Centra dMEV

Auto speed selection at installation. The integral air pressure sensor checks the airflow when first installed and also helps the fan to compensate for external wind pressure.

Stock Ref
441782

Lo-Carbon Centra T/SELV T

(Timer)

Ideal for bathroom and toilet applications, this unit runs continuously on trickle setting and may be boosted by the switched live input which activates the adjustable timer (5-30 minutes).

Model	Stock Ref
T	442954
SELV T	443175

Lo-Carbon Centra TP/SELV TP

(Timer/Pullcord)

For bathroom/toilet applications, the continuous running TP model is boosted by the pullcord which activates the adjustable timer (5-30 minutes).

Model	Stock Ref
TP	447127
SELV TP	447128

Lo-Carbon Centra HT/SELV HT (Humidistat/Timer)

For bathroom/toilet applications, the continuous running HT model is automatically boosted by the built-in humidistat or by a switched live input which activates the adjustable timer (5-30 minutes).

Model	Stock Ref
HT	442955
SELV HT	443176

Lo-Carbon Centra HTP/SELV HTP (Humidistat/Timer/Pullcord)

For bathroom/toilet applications, the continuous running HTP model is automatically boosted by the built-in humidistat or by the pullcord which activates the adjustable timer (5-30 minutes).

Model	Stock Ref
HTP	443045
SELV HTP	443177

150mm Conversion Kit

Stock Ref
443334

Wall Kit

Stock Ref
254102 (White)
254100 (Brown)

Window Kit

Stock Ref
442947

Ceiling Kit

Stock Ref
443800



the ELECTRICAL
industry awards
WINNER 2011

Winners of the Energy Efficiency Initiative 2011 Award
with our Lo-Carbon Continuous Ventilation Product Range

Dimensions (mm)

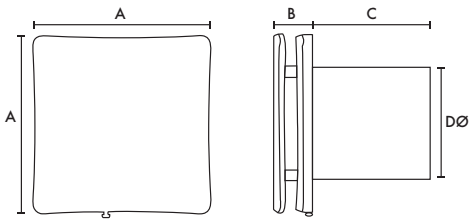

Model	A	B	C	DØ
Lo-Carbon Centra dMEV/All SELV	160	35	115	99
Lo-Carbon Centra T/TP/HT/HTP	160	35	80	99

Transformer 87 x 87 x 33mm (W x H x D)
(SELV models only)

Performance Guide

Model	Extract Performance (l/s)			Power Consumption (Watts)			Sound dB(A)@ 3m		
	Trickle	Trickle	Boost	Trickle	Trickle	Boost	Trickle	Trickle	Boost
	Low	High		Low	High		Low	High	
Lo-Carbon Centra dMEV/All SELV	6	9	15	1.4	1.6	2.4	10.8	15.5	25.2
Lo-Carbon Centra T/TP/HT/HTP	6	9	15	3.2	3.5	4.2	10.8	15.5	25.2

SAP Appendix Q Performance (dMEV model)

Systems With Rigid Ductwork Installation Only

Unit Configuration	Location	Fan Speed Setting	Flow Rate (l/s)	SFP (W/l/s)
In Room (Ducted)	Kitchen	High	13.2	0.32
In Room (Ducted)	Wet Room	9 l/s	8.4	0.28
Through Wall	Kitchen	High	13.5	0.18
Through Wall	Wet Room	9 l/s	8.6	0.20

Systems With Flexible Or Mixed Ductwork Installation Only

Unit Configuration	Location	Fan Speed Setting	Flow Rate (l/s)	SFP (W/l/s)
In Room (Ducted)	Kitchen	High	13.2	0.37
In Room (Ducted)	Wet Room	9 l/s	8.6	0.31
Through Wall	Kitchen	High	13.5	0.18
Through Wall	Wet Room	9 l/s	8.6	0.20

Lo-Carbon iQ

Intelligent Axial Bathroom/Toilet Fan

Features & Benefits

- Minimal retro design to match bathroom décor
- Extremely quiet- only 21 dB(A)
- Truly surface mountable with removable spigots
- Intelligent controls and control panel for easy and flexible set up and commissioning
- Low power consumption – only 5 W
- Easy cleaning and maintenance
- 5 year Lo-carbon motor guarantee
- Intelligent humidistat control as standard
- Innovative airing function to ensure good air quality
- IP44 rated

Market Leading Design

With the launch of the Lo-Carbon iQ fan, we not only spent time perfecting the operation and user's experience of the fan but also worked hard on the design. The result is a stylish fan with a surface depth that appeals to the eye and that matches modern fittings found in today's bathrooms. The visible blades give a retro-feel and helps to give the fan a very quiet noise level.

Silent Operation

The open impellor and the unique method of operating the motor enables a greater array of operating options including silent continuous ventilation along with adaptable speed control and flexible timer functions.

Humidity Control

For the first time we can now introduce an intelligent, fully automatic humidity sensor for moisture control. This means the fan learns to run only when it can make a difference to the indoor air quality. The fan continually monitors and records the moisture content to allow it to map the humidity profile throughout the year. This process enables the fan to ensure that it runs only when the fan can lower the moisture content in the air. This reduces nuisance running. The fan also has two modes for moisture control, silent or boost mode which can be selected via the touch pad control.

Control Panel

Our aim has been for the end user to be able to control and understand the basic fan functions, without the need of reading the manual. When the fan is connected to the power supply, it also performs a self-test where all the status lamps on the control panel are tested, as well as the function of the motor. Ideal for those installing to ensure that everything works. The simple controls, along with the LED feedback make the commissioning and any readjustment, quick and easy to complete.



LED Feedback

With many fans it is difficult to understand the exact mode that they are running in. We have now simplified this to provide a visual indicator to see what the fan is doing and which mode is currently active. The fan uses three different colours on the visible status lamp to communicate exactly what it is doing. A blue light signifies that the fan is working to evacuate moisture via the humidity sensor. A yellow light signifies that the timer is running. And a purple light signifies that the fully automatic airing function is active.

You Choose How The Fan Works

The intelligent overrun timer can be operated in several different ways, either via the light switch, integral pull-cord or a separate switch either as a standard On/Off or as a momentary switch stopping automatically after the overrun on time. You use the control panel to easily set the required post-running time at 15 or 30 minutes, depending on your choice.

Full surface mounted installation

With the impellor and motor assembly designed to be low profile and accessible for maintenance, spigots on the fan are completely removable. This design enables the fan to be mounted onto a wall without any spigot

so that it can be truly surface mounted. This is an ideal function if you have a duct with a smaller dimension than 100 mm or a duct that bends directly off the back of the fan not providing any depth in the wall for the spigot.

Automatic Airing Function

The airing function means when the fan has been inactive for 26 hours, it runs an airing programme for 60 minutes to exchange the air in the bathroom. No more worries about stuffy, musty odours in the bathroom when returning from holiday.

Cleaning and Maintenance

For a fan to ventilate effectively, it is vital that it is kept clean and that the ductwork and grilles are free from dust that can reduce the air flowing through them. This is the first fan to be introduced with the ability to simply remove the impellor and open the centre of the fan to gain free access to the duct. Using the 'swing-out' function you can easily clean and clear the fan e.g. a clogged grille on the outside of the façade. Click the button to remove the impellor, then press the snap in catch and swing out the motor - that's it!



Lo-Carbon 5 year guarantee

As there is an integrated power adapter in the fan we have been able to use a low voltage motor that has a life span of approximately 60,000 hours. This is about 3-5 times longer than a standard fan. The motor features extremely quiet bearings. By using a low voltage motor we can significantly limit power consumption. The fan only consumes 5 Watts, about a third of a conventional AC bathroom fan.



Models

Lo-Carbon iQ

Multi control fan with option to run on intermittent or continuous setting. Adjustable timer and humidity options with integral pullcord included.

Stock Ref

405155

Accessories



Backdraft Shutters

Designed to reduce any incoming draughts when the fan is off.

Stock Ref

406605



Wall Mounting Back Plate

Designed to cover up marks where a previous fan has a different foot print. 242mm x 190mm.

Stock Ref

406762

Dimensions (mm)

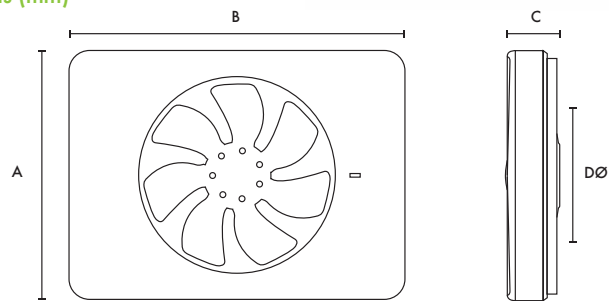

A	B	C	DØ
152	202	31	99/125

Product is supplied with a removable spigot 30mm deep in 99mmØ and 125mm Ø

Performance

Duct Ø	Trickle/Boost	Extract Performance - FID		Sound dB(A)
		m ³ /h	l/s	@ 3m
100mm	Max	108	30	28
100mm	Silent	72	20	21
100mm	Trickle	43.2	12	12
125mm	Max	133.2	37	29
125mm	Silent	86.4	24	21
125mm	Trickle	54	15	13

Lo-Carbon Solo Plus/SELV

Centrifugal Bathroom/Toilet Fan

Features & Benefits

- Up to 70% energy saving
- Filterless as standard - innovative impeller design means no need for a filter
- Integral Lo-Carbon power supply
- Meets current Building Regulations Approved Documents F & L
- IPX4 rated - IPX7 rated (SELV)
- Flush or surface mountable
- Adjustable rear or side exit spigot
- Lo-Carbon Solo Plus SELV is suitable for installation over or within reach of a shower or bath
- Extremely low sound levels
- 5 Year Motor Guarantee
- Suitable for wall, ceiling and panel mounting
- SELV Models - Supplied with a remote transformer

Long Life Ventilation

The Lo-Carbon Solo Plus range from Vent-Axia has been specially designed for through the wall and ducted applications, suitable for internal bathrooms, toilets and other small rooms. Finished in white, the Lo-Carbon Solo Plus can be flush or surface mounted, with a 2 position 100mm circular spigot for rear entry or connecting to a vertical ducting system. The powerful centrifugal impeller allows installations using 100mm ducting in straight runs, whilst still achieving 15l/s as required by Building Regulations Approved Document F.

Continuous running products, such as the Lo-Carbon Solo Plus, installed in all wet areas of a dwelling are classed as a wholehouse ventilation system and therefore only need to move the amount of air as outlined in table 5.1a and 5.1b of Building Regulations Approved Document F.

The Lo-Carbon Solo Plus has an adjustable boost speed which is set at installation variable between a wall or duct setting for boost/override operation

to meet Building Regulations thus ensuring minimum energy usage and low sound levels. All models have an optional speed for constant trickle ventilation (12l/s), selectable at installation. Depending on the model, the fan will switch from trickle (if selected) to boost via the pullcord/light switch/humidity sensor/PIR.

All models can be wall, panel or ceiling mounted and can be connected to either circular, rectangular or Vent-Axia's flat ducting. Enclosure of the electrical components is manufactured from flame retardant grade material.

Safety Extra Low Voltage Fan (SELV)

Designed for areas where a fan has to be fitted over or within Zone 1 in a room containing a fixed bath or shower according to IEE wiring regulations (BS 7671), the Lo-Carbon Solo Plus SELV fan can be safely installed within the spray area. The fan is rated IPX7. Control is by mains safety isolating transformer unit with 12V DC SELV output, which is sited away from any source of spray and out of reach of a person using a fixed bath or shower. Controller Supply voltage 220-240V/1/50Hz. Output to fan SELV 12V DC.

Models

Lo-Carbon Solo Plus P/SELV P (Pullcord)

Flush or surface mountable. Control by Pullcord. 2 Speed. Constant trickle option. Adjustable boost. In-built Lo-Carbon controller.

Model	Stock Ref
P	427481
SELV P	427485

Lo-Carbon Solo Plus T/SELV T (Timer)

Flush or surface mountable. Control by room light or switch. 2 Speed. Constant trickle option. Adjustable boost. Adjustable timer overrun. Delay on timer. In-built Lo-Carbon controller.

Model	Stock Ref
T	427482
SELV T	427486

Lo-Carbon Solo Plus HT/SELV HT (Humidistat-Timer)

Flush or surface mountable. Humidity controlled fan with override pullcord. Constant trickle option. Adjustable boost. Adjustable timer overrun. Delay on timer. Adjustable humidity sensor. In-built Lo-Carbon controller. Datalogger as standard on all Lo-Carbon humidity controlled Solo Plus fans.

Model	Stock Ref
HT	427483
SELV HT	427487

Lo-Carbon Solo Plus TM/SELV TM (Timer/PIR)

Flush or surface mountable. Control by integral PIR detector. 2 Speed. Constant trickle option. Adjustable boost. In-built Lo-Carbon controller.

Model	Stock Ref
TM	427484
SELV TM	427488

Accessories

Lo-Carbon Solo Plus Bezel

Used when flush mounting - reduces the need to make good.

Stock Ref
404106

Wall Kit

Stock Ref
254102 (White)
254100 (Brown)

Filter pack (1 per pack)

The design of the Lo-Carbon Solo Plus means that it does not need a filter. However, if you are going to install the product in a heavily greasy environment, you may want to protect the product by fitting a filter.

Stock Ref
449265



the **ELECTRICAL**
industry awards
WINNER 2013

Dimensions (mm)

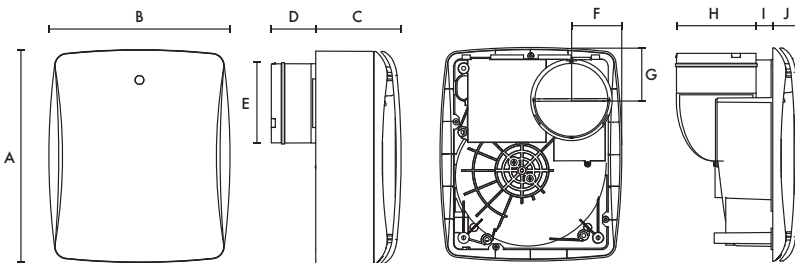

A	B	C	D	EØ
263	224	106	55	98
F	G	H	I	J
62	65	98	21	34

Weight 2.2kg, SELV Weight 2.7kg.
Dimensions: (W x H x D) 87x87x33mm.

Performance Curve (Duct Mode)

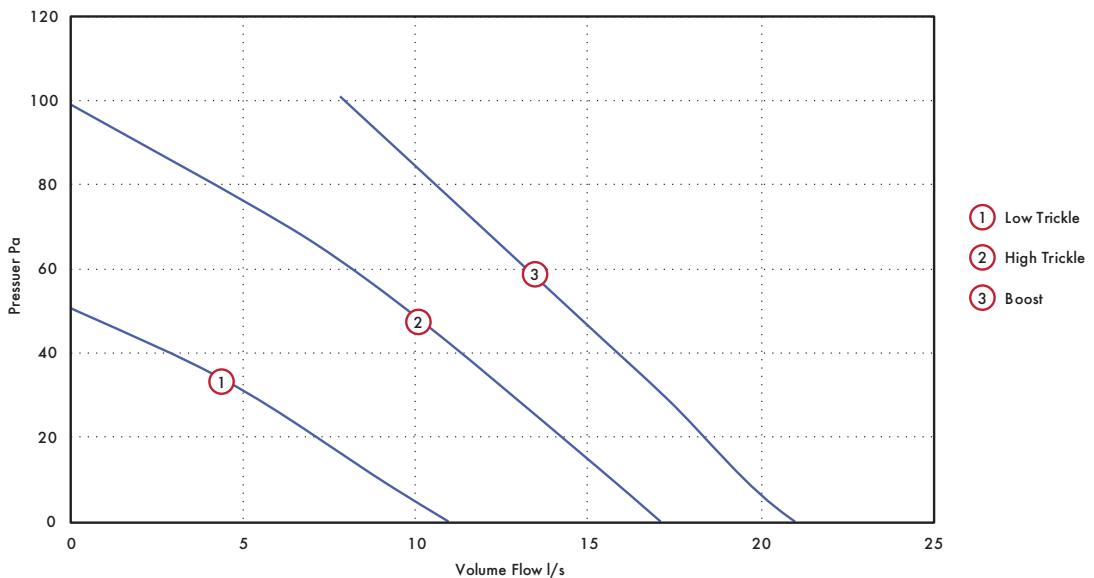

Performance Guide

Model		Extract Performance l/s (m³/h)			Power consumption - Watts			dB(A) @ 3m			SFP (W/l/s)
		Boost	High trickle	Low Trickle	Boost	High trickle	Low Trickle	Boost	High trickle	Low Trickle	@ 0Pa
Lo-Carbon Solo Plus/SELV P/T/HT/TM	Wall mode	18 (64.8)	12 (43.2)	8 (28.8)	6	2.9	2.3	33.5	27	23.5	0.28
	Duct mode	21 (75.6)	17 (61.2)	11 (39.6)	8.4	5.3	3.2	35.5	33	26	0.29

Tested at 240VAC @ 50Hz

Lo-Carbon Minivent

Ducted Bath/ Shower Fan Kit



Features & Benefits

- Complete kit supplied
- Meets Building Regulations Approved Document F & L requirements for toilets and bathrooms at max 1.5m of ducting and 1 x 90° bend
- Adjustable timer version available
- 5 Year Motor Guarantee
- 1 of 2 speeds selectable at installation

Powerful Lo-Carbon In-Line Fan Kit

The Vent-Axia Lo-Carbon Minivent ducted bath/shower kit includes all the components necessary to install a ducted 100mm system. This simplifies fitting of an efficient ventilation system to small rooms including bathrooms, shower rooms and toilets. It is especially suitable for en-suite bathrooms.

When installed, the fan kit has ample performance to meet the Building Regulations requirements for toilets and bathrooms. The timer version should be used for internal rooms.

The kit consists of a Lo-Carbon Minivent In-Line fan, a white ceiling grille and spigot, 3 metres of flexible duct and an external louvre for soffit or wall mounting. The duct should be cut to the required length and the bend radius kept to a maximum to provide optimum fan performance.

Enclosed terminal compartment, Class 2 appliance. Supply voltage 220-240/1/50Hz.

Models

Lo-Carbon Minivent Shower Fan (Basic)

Comprises - high output tube fan, 3 metres of flexible duct, ceiling inlet grille and spigot, soffit/wall outlet grille.

Stock Ref
441421

Lo-Carbon Minivent Shower Fan (Timer)

Comprises - high output tube fan, 3 metres of flexible duct, ceiling inlet grille and spigot, soffit/wall outlet grille.

Stock Ref
441422

Dimensions (mm)

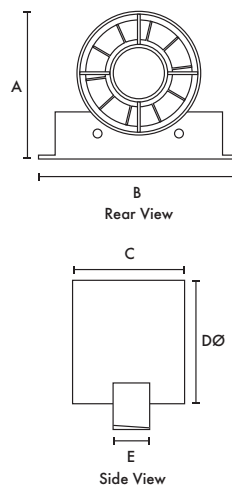

A	B	C	DØ	E
130	155	90	98	27

Internal/External Grille Dimensions 140x140mm
Transformer (W x H x D) 87 x 87 x 33

Lo-Carbon Minivent Shower Kit installed

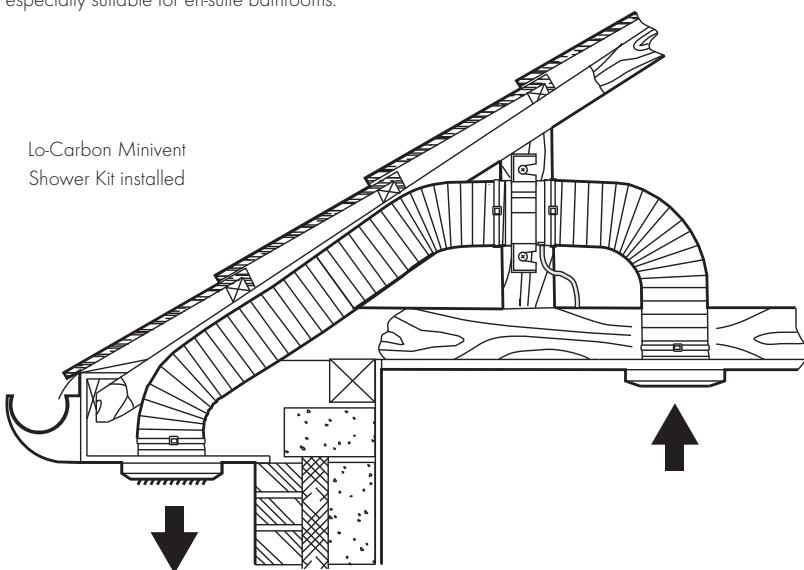

Performance

Model	Extract performance - FID		Watts	Sound dB(A)	SFP (W/l/s)
	m ³ /h	l/s		@ 3m	@ 0Pa
Lo-Carbon Minivent B/T	110	31	6.5	23	0.21

Lo-Carbon LED Vent-A-Light

Ducted Bath/Shower Fan & Light Kit



Features & Benefits

- Suitable for shower enclosure and wet areas
- Now with a 3W LED Lamp
- Provides simultaneous fan and light operation
- Meets current Building Regulations Approved Documents F & L
- 1 of 2 speeds selectable at installation
- Double insulated fan
- Light assembly Class III
- 5 Year Motor Guarantee
- Supplied with white and chrome bezels

100mm Lo-Carbon axial in-line shower fan and light kit. Provides simultaneous fan and light operation. Suitable for shower enclosures and wet areas. Available with both a white and chrome bezel on light assembly. The light assembly can be held in place using fixing clips or screws.

Typical Specification

CE marked in accordance with all the relevant EEC Harmonised Directives.

Fan double insulated and the motor is fitted with Thermal Protection. Light assembly class III.

Electrical

12 volt DC 3W GU5.3 sealed lamp.
Powered by an LED Driver.

LED lamp lumens output 180lm - 200lm

Input, AC. Output - 12 volt DC. 1A.

Models

Lo-Carbon Vent-A-Light Fan and LED Light Kit (Standard)

100mm axial in-line shower fan and light kit. Includes fan, 3m flexible ducting, white grille, LED lamp light transformer and light assembly with white and chrome bezels.

Stock Ref
441423

Lo-Carbon Vent-A-Light Fan and LED Light Kit (Timer)

100mm axial in-line shower fan and light kit. Fan has electronic overrun timer adjustable from 5 to 30 minutes. The factory setting is 15 minutes. Includes fan, 3m flexible ducting, white grille, LED lamp light transformer and light assembly with white and chrome bezels.

Stock Ref
441424

Dimensions (mm)

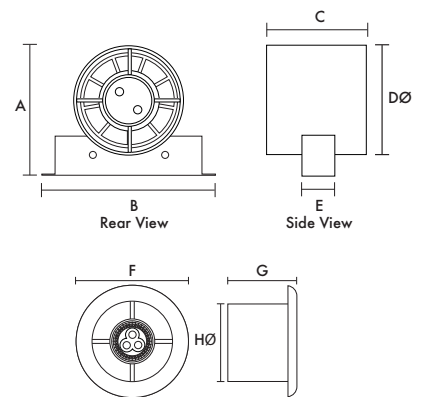

A	B	C	DØ	E	FØ	G	HØ
130	155	90	98	27	140	74	98

Internal/External Grille Dimensions 140x140mm
Fan Transformer (W x H x D) 87 x 87 x 33

Performance

Model	Extract performance - FID				Sound dB(A)	SFP (W/l/s)
	m ³ /h	l/s	Fan Watts	Light Watts	@ 3m	@ 0Pa
Lo-Carbon Vent-A-Light B/T	110	31	6.5	3	23	0.21

Tested at 240V 50Hz

Lo-Carbon Quadra®/SELV

'One Fan fits all' Centrifugal Fan

Features & Benefits

- Single fan for use in toilets, bathrooms, utility rooms and kitchens
- Meets current Building Regulations Approved Document F & L for intermittent or continuous use
- Guaranteed installed performance
- Recognised in SAP Appendix Q - Low SFP on SAP Q 0.38 W/l/s
- 100mm circular spigot for easy installation and replacement of any existing fan
- Filterless technology and maintenance free
- Lo-Carbon motors offering 90% energy savings and long life
- Motor cassette cartridge for simple replacement
- Suitable for flush or surface mounting
- 5 Year Motor Guarantee
- IPX4 rated - IPX7 rated (SELV)
- Suitable for wall, ceiling and panel mounting
- Integral datalogger (option available on SELV models)

Ventilation for any room

The Lo-Carbon Quadra offers a single fan suitable for surface or flush mounting. Low speed selectable between 6, 9 and 12l/s and high between 15, 30 and 60l/s all with through the wall or two ducted selections to ensure installed performance is met.

Lo-Carbon Quadra SELV

The Lo-Carbon Quadra SELV has been designed to meet building requirements where there is a need to fit in Zone 1 containing a fixed bath or shower according to IEE wiring regulations. The Lo-Carbon Quadra SELV can be safely installed within the spray area with the 24VDC Safety Isolating Power Supply situated away from the spray zone and out of reach of the person using the facility.

Discrete

With discrete aesthetics and low noise levels due to an accurately balanced impeller, it is also one of the most unobtrusive centrifugal kitchen fans available. The front cover design also provides no area for dirt to build up so it stays looking better for longer.

Models

Lo-Carbon Quadra TP/SVTP (Timer/Pullcord)

Dual speed: continuous running or intermittent to high speed. High speed via pullcord (On/Off) or switch live (with overrun timer).

Model	Stock Ref
TP	439251
SVTP	442865
SVTP Datalogger	446269

Lo-Carbon Quadra HTP/SVHTP (Humidistat/Timer/Pullcord)

Dual speed: continuous running or intermittent to high speed. High speed via integral pullcord (On/Off), integral adjustable humidity sensor or switch live (with overrun timer). When humidity sensor is triggered the flow rate increases proportionally with %RH to 50% of the set Boost speed.

Model	Stock Ref
HTP	439181
SVHTP	442866
SVHTP Datalogger	446270

Lo-Carbon Quadra TM/SVTM (Timer/PIR)

Dual speed: continuous running or intermittent to high speed. High speed via integral PIR sensor or switch live (both with overrun timer).

Model	Stock Ref
TM	439253
SVTM	442867

Accessories

Flush Mounting Kit

Stock Ref
439256

Filter (optional)

Stock Ref
439927

Decoration Frame

Stock Ref
442551

Wall Kit

Stock Ref
254102 (White)
254100 (Brown)



the ELECTRICAL
industry awards
WINNER 2011

Winners of the Energy Efficiency Initiative 2011 Award
with our Lo-Carbon Continuous Ventilation Product Range.

Dimensions (mm)

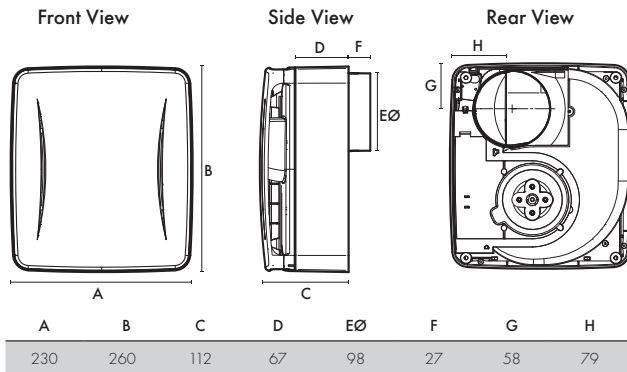

Performance Curve*

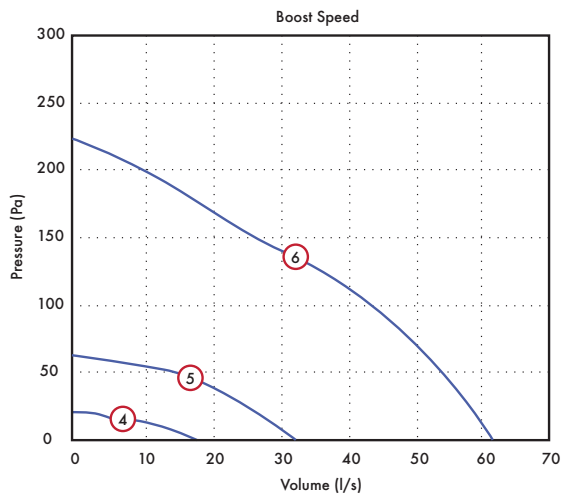
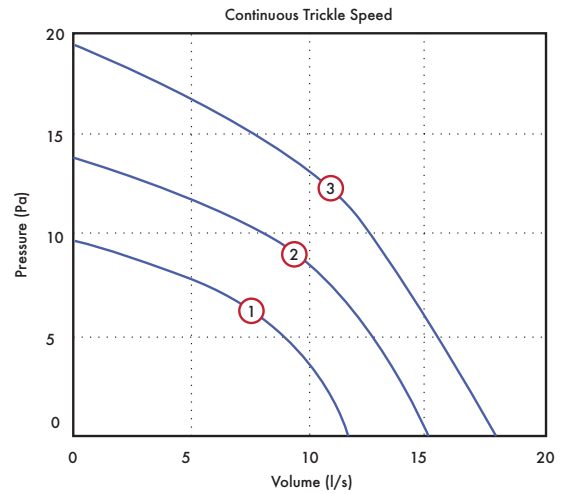

- ① Quadra 6 l/s
- ④ Quadra 15 l/s
- ② Quadra 9 l/s
- ⑤ Quadra 30 l/s
- ③ Quadra 12 l/s
- ⑥ Quadra 60 l/s

SAP Appendix Q Performance

Systems With Rigid Ductwork Installation Only

Unit Configuration	Location	Fan Speed Setting	Flow Rate (l/s)	SFP (W/l/s)
In Room	Kitchen	15 l/s	15.8	0.41
In Room	Wet Room	9 l/s	14.6	0.61
Through Wall	Kitchen	15 l/s	21.4	0.38
Through Wall	Wet Room	9 l/s	19.5	0.50

Systems With Flexible Or Mixed Ductwork Installation Only

Unit Configuration	Location	Fan Speed Setting	Flow Rate (l/s)	SFP (W/l/s)
In Room	Kitchen	15 l/s	13.7	0.41
In Room	Wet Room	9 l/s	12.9	0.63
Through Wall	Kitchen	15 l/s	21.4	0.38
Through Wall	Wet Room	9 l/s	19.5	0.50

Performance Guide

Model	Extract Performance				Power		Sound		
	High		Low		High	Low	dB(A) @ 3m		SEC
	m³/h	l/s	m³/h	l/s	Watts	Watts	High	Low	Class
Lo-Carbon Quadra/ SELV TP/ HTP/ TM	223	63	22	6	38	3.8	50	20	D

* Tested in through the wall installation

* FID Performance

Lo-Carbon Silhouette® 125 Bathroom/Toilet Fans



Features & Benefits

- **Models Basic/Timer/Humidity**
- Installation options
- **Low power consumption**
- Lower running costs
- **Quiet running**
- **Fully opening and closing shutters**
- Improved insulation
- **1 of 2 speeds selectable at installation**
- **Non transparent shutters**
- Enhanced privacy
- **Ball bearing motors for vertical or horizontal application**
- **Unique humidity sensor track**
- Improved response
- **5 Year Motor Guarantee**
- **IPX4 rated**
- **Suitable for wall, ceiling and panel mounting**

Lo-Carbon Silhouette 125HT (Timer/Humidistat)

125mm bathroom/toilet fan with integral adjustable auto humidity sensor from 60-90% RH and overrun timer, indicator light which operates on manual override only, and back draught shutter. Datalogger as standard on all Lo-Carbon humidity controlled Silhouette fans.

Model 125HT **Stock Ref** 446485

Accessories



Wall Kit
Stock Ref 455226

Dimensions (mm)

Panel

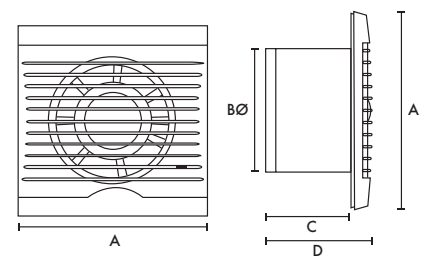

A	BØ	C	D
187	125	131	149

Slimline Bathroom Ventilation

With a slim profile of only 18mm, Lo-Carbon Silhouette blends in with the wall surface to provide an unobtrusive installation. Lo-Carbon Silhouette has a FID performance up to 149m³/h. It can be ceiling/panel mounted and connected to an appropriate duct run to the outside.

Models

Lo-Carbon Silhouette 125B

125mm bathroom/toilet fan with indicator light and back draught shutter.

Model 125B **Stock Ref** 446483

Lo-Carbon Silhouette 125T (Timer)

125mm bathroom/toilet fan with integral adjustable electronic overrun timer (5-30 minutes), indicator light which operates on manual override only, and back draught shutter.

Model 125T **Stock Ref** 446484

Performance Curve

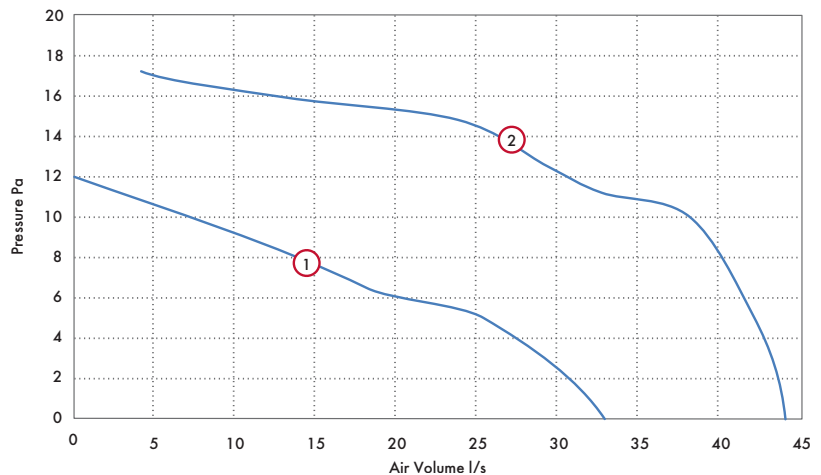

Performance Guide

Model	Curve Ref	Extract Performance			Sound dB(A) SFP (W/l/s)	
		m ³ /h	l/s	Watts	@ 3m	@ 0Pa
Lo-Carbon Silhouette 125B/T/HT	Low ①	120	33	4.5	33	0.14
Lo-Carbon Silhouette 125B/T/HT	High ②	160	44	8	37	0.18

Lo-Carbon VA150

Axial Kitchen & Utility Room Fans



Features & Benefits

- Reduces the home's carbon footprint
- Long life Lo-Carbon motor lasts up to 5 times longer than conventional motors
- Up to 60% energy saving
- Meets current Building Regulations Approved Document F & L when installed
- IP44 rated
- Low sound levels
- 5 Year Motor Guarantee
- Suitable for wall, ceiling, window and panel mounting
- Fitted with a motorised shutter
- 1 of 2 speeds selectable at installation

Long Life Ventilation

Vent-Axia Lo-Carbon VA150 fans feature Lo-Carbon long life DC energy saving motors that last up to 5 times longer than conventional motors, whilst delivering up to 60% energy savings. The extended life of Lo-Carbon fans is due to the use of a new generation of high quality electronically controlled ball-bearing motors especially developed for this range. The motors are perfectly designed for the wet conditions of utility rooms and kitchens, extracting stale, moisture-laden air quietly and efficiently.

Shutters

The Vent-Axia Lo-Carbon VA150 range is fitted with a motorised shutter mechanism that uses no extra power in operation or off.

Installation

The Lo-Carbon VA150 range is suitable for installation in panels, walls or windows using the kits available. Lo-Carbon fans are quick and simple to fit using reversible grommets and easy-wire terminals, and are suitable for wall or ceiling mounting at any angle.

Performance

Setting	Model	Extract Performance		Sound	SFP (W/l/s)	
		m ³ /h	l/s	dB(A) @ 3m	Watts	@ 0Pa
Utility Setting	Lo-Carbon VA150P/T/HP	160	46	33	7.5	0.16
Kitchen Setting	Lo-Carbon VA150P/T/HP	230	64	36	11.5	0.18

150mm telescopic wall kits are available with a white or brown outside grille. The kit is supplied with a telescopic wall sleeve to fit walls 225-360mm thick. Hole diameter 152mm.

Window fitting kits are available for use with all Lo-Carbon 150mm models through single or double glazed windows up to 40mm thick. Hole diameter 152mm.

Models

Lo-Carbon VA150P (Shutter/Pullcord)

Ultra long life DC energy saving motor. Fitted with a motorised shutter. Controlled via pullcord On/Off switch.

Stock Ref
459123

Lo-Carbon VA150T (Shutter/Timer)

Ultra long life DC energy saving motor. Fitted with a motorised shutter. Controlled via integral power supply with electronic adjustable overrun timer (5-30 minutes).

Stock Ref
459124

Lo-Carbon VA150HP (Shutter/Humidistat)

Ultra long life DC energy saving motor. Fitted with a motorised shutter. Controlled via integral power supply with pullcord override switch and adjustable humidity sensor (60-95% RH).

Stock Ref
459125

Dimensions (mm)

A	B	C	DØ	E	F	G	H	I
216	224	80	146	60	220	37	55	104

Weight 1.2kg

Panel

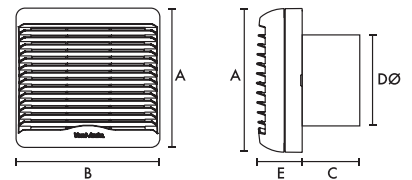

Panel fixing hole Ø 152mm

Wall

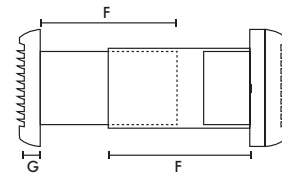

Wall fixing hole Ø 152mm

Window

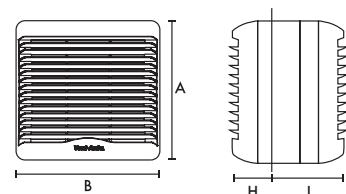

Window fixing hole Ø 152mm

Accessories

Wall Kit

Stock Ref
140902 (White)
140903 (Brown)

Window Kit

Stock Ref
140901

Lo-Carbon Silhouette® 150

Axial Kitchen Fans

Features & Benefits

- Stylish ultra low profile grille
- Downstream airflow guide vanes for improved pressure development
- Ball bearing motors for vertical or horizontal application
- Wall kit design meets Building Regulations Approved Document F requirements
- 5 Year Motor Guarantee
- 1 of 2 speeds selectable at installation
- IPX4 rated
- Low Specific Fan Power
- Suitable for wall, ceiling and panel mounting

Slimline Lo-Carbon Kitchen Ventilation

The Lo-Carbon Silhouette 150 range is designed for modern living. With a profile of only 19mm on the kitchen models, Lo-Carbon Silhouette blends in with the wall surface to provide an unobtrusive installation.

Mounted in the centre of the fan, beneath the ultra slim profile grille, are the electronics, incorporating a humidistat (HT model) for detecting a change in internal humidity or an overrun timer option that is adjustable between 5 and 30 minutes.

FID performance of 67l/s, double insulated. Power consumption only 8.2 Watts.

Models

Lo-Carbon Silhouette 150B

150mm kitchen fan with indicator light and back draught shutter.

Stock Ref
441628

Lo-Carbon Silhouette 150T (Timer)

150mm kitchen fan with integral adjustable electronic overrun timer (5-30 minutes), indicator light which operates on manual override only and spring back draught shutter.

Stock Ref
441629

Lo-Carbon Silhouette 150HT (Humidistat/Timer)

150mm with integral adjustable auto humidity sensor from 60-90% RH and overrun timer, indicator light which operates on manual override only and back draught shutter. Datalogger as standard on all Lo-Carbon humidity controlled Silhouette fans.

Stock Ref
441630

Accessories

Wall Kit

Stock Ref

140902 (White)

140903 (Brown)

Dimensions (mm)

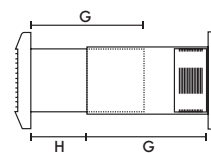
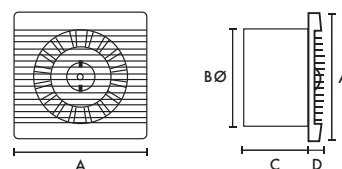

A	BØ	C	D	G	H
223	147	130	19	220	37

Weight 1.75kg



Performance Curve

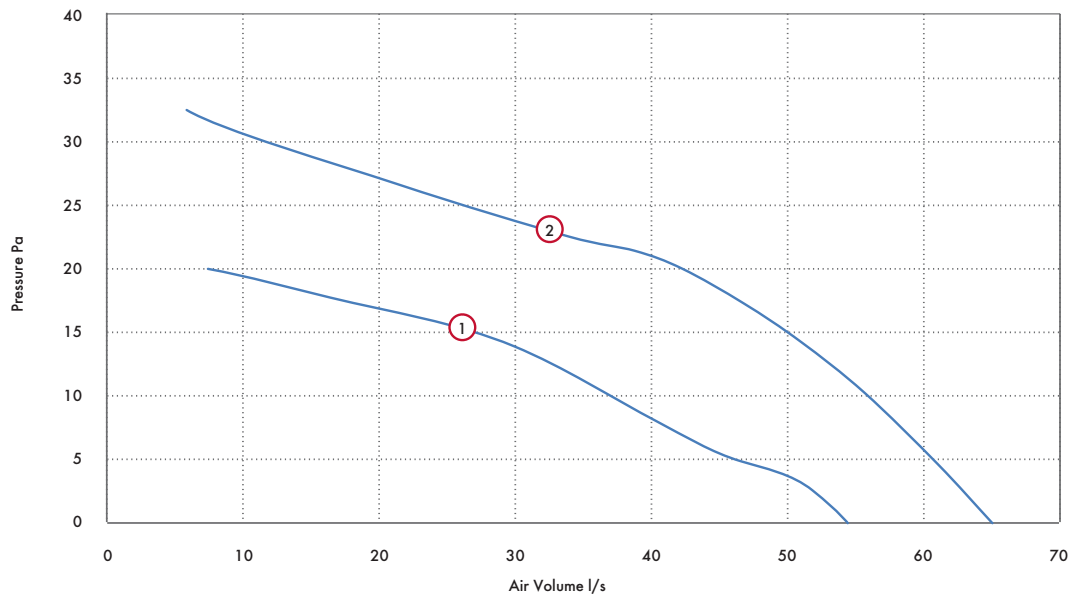

Performance Guide

Setting	Model	Curve	Extract Performance			Sound dB(A)	SFP (W/l/s)
		Ref	m ³ /h	l/s	Watts	@ 3m	@ 0Pa
Utility Setting	Lo-Carbon Silhouette 150B/T/HT	1	200	55	6	35	0.11
Kitchen Setting	Lo-Carbon Silhouette 150B/T/HT	2	234	65	9	43	0.14

Fixing hole diameter 152mmØ (when wall kit used)

dMEV, MEV & PIV Systems

What is MEV & dMEV?

The current Building Regulations Approved Document F gives examples of four main methods of ventilation. System 3, continuous mechanical extract ventilation, can be achieved using a single centralised extract unit such as the Sentinel Multivent ducted from 'wet' rooms (kitchen, bathroom, en-suite and WC) or by decentralised individual fans (dMEV) in the 'wet' rooms. The fans run continuously at near silent levels providing a simple and effective form of ventilation.

Lo-Carbon Response

The NEW continuous running, constant volume Response dMEV unit features an innovative digital display. The unique display (patent pending) provides the calibrated installed airflow and pressure of the installation meaning that there is no need to test the installation with an airflow measuring device.

Quiet running and with high pressure development, the Response is best in class - an achievement that was recognised when it won Product of the Year at the prestigious Housebuilder Awards 2014.



	Lo-Carbon Response/SELV dMEV Unit	36-37
	Lo-Carbon Centra®/SELV dMEV Unit	38-39
	Lo-Carbon Multivent MEV Unit	40
	Multivent MEV Unit	41
	Lo-Carbon Sentinel® Multivent & Controllers	42-44
	Lo-Carbon Multivent MVDC-MS/MSH MEV Unit	45
	Lo-Carbon PoziDry Positive Pressure Unit	46-47
	Lo-Carbon PoziDry Compact Positive Pressure Unit	48-49

Vent-Axia

dMEV, MEV & PIV Systems

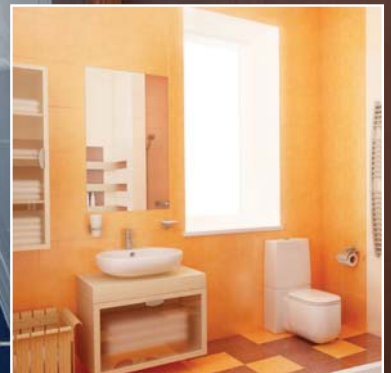
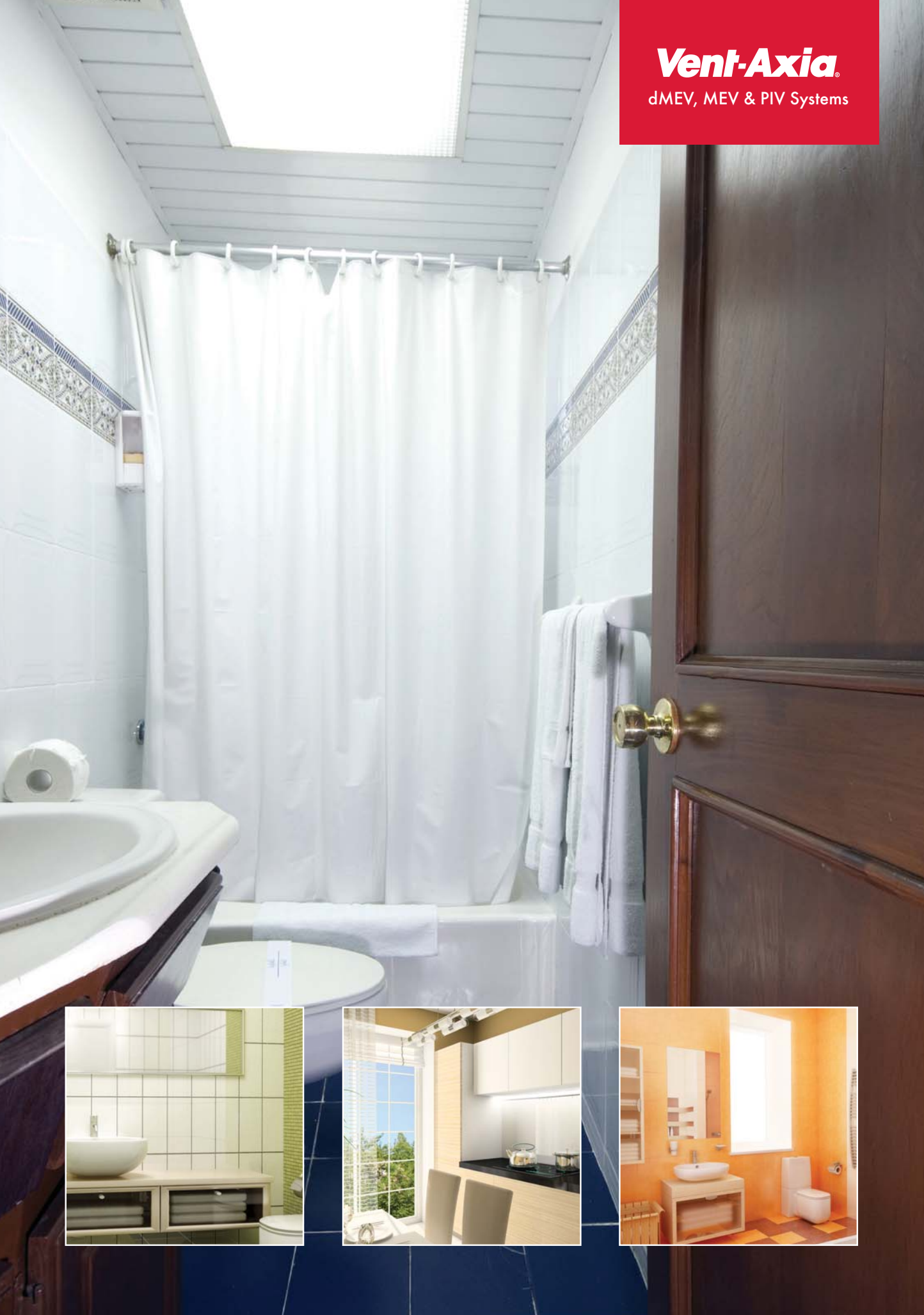

Lo-Carbon Response/SELV dMEV Unit

Features & Benefits

- Recognised in SAP Appendix Q
- Constant volume
- Display showing airflow and system pressure (Patent pending)
- Switched live connection for external switches/sensors
- 220-240V input
- Datalogger feature on Humidistat models
- 6l/s or 8l/s trickle speed selection
- 13l/s boost speed
- IPX4 rated
- Multi-orientation grille – grille can be rotated by 90/180 degrees to suit ceiling configuration requirements
- New comfort control option (Patent pending)

Lo-Carbon Response

Continuous running, constant volume dMEV unit with switched live (LS) and innovative digital display. Quiet running and with high pressure development, the Response is best in class.

The Response Fan from Vent-Axia

Following the introduction of the Domestic Ventilation Compliance Guide within Part F 2010, and the requirement to test the installed airflow of extract fans, the new Response fan from Vent-Axia provides the easiest install available.

The unique display (patent pending) provides the calibrated installed airflow and pressure of the installation meaning that there is no need to test the installation with an airflow measuring device.

The constant volume technology automatically adjusts the speed of the fan to ensure the desired airflow is delivered. With a new silent higher pressure axial impeller Lo-Carbon Response can meet the requirements of many domestic installation without the need to use a traditional centrifugal fan.

Axial, rather than centrifugal?

Using the new high pressure silent axial impeller has enabled the fan to not only develop great installed performance over duct runs, but to do it in the most energy efficient way. Response can provide excellent pressure whilst still maintaining the energy efficiency and not wasting energy on high pressure at low air volumes.

Configuration	Location	Alternative Centrifugal Fan SFP	Vent-Axia Response SFP
In room	Kitchen	0.38	0.17
	Wet Room	0.29	0.18
Through Wall	Kitchen	0.36	0.13
	Wet Room	0.28	0.15

Existing centrifugal fans often develop pressure but the actual installed airflows can mean that the pressure is of no use as the airflow falls below the requirement. This enables the fan to save up to 64% of the specific fan power (SFP) of the SAP Appendix Q data for existing centrifugal alternatives.

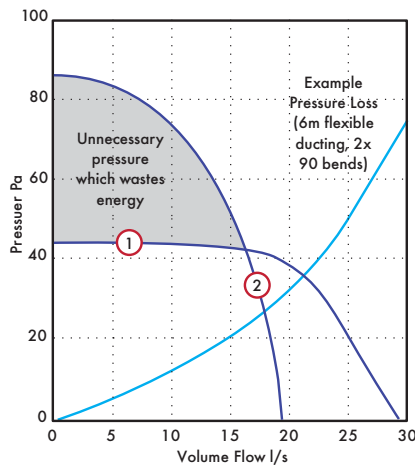

- 1 Vent-Axia Lo-Carbon Response Fan
- 2 Competitor Product

Side view of airflow display



Be confident that the Response is delivering the right performance with our innovative digital display showing the airflow and system pressure of the installed product.

Comfort Control Option

Designed to offer a more relaxing environment to the homeowner, the Lo-Carbon Response features a delayed start option. This new, patent pending comfort control option is selectable at installation and allows the homeowner to enjoy a quiet, peaceful bathroom for up to 20 minutes before the Boost activates. Furthermore, if the light switch turns On and Off within 3 minutes, the Boost will not activate. No more disturbing the family if the bathroom light is turned on during the night.

SAP Appendix Q Performance

Unit		
Configuration	Location	SFP (W/l/s)
In room (rigid duct)	Kitchen	0.17
In room (rigid duct)	Wet Room	0.18
In room (flex duct)	Kitchen	0.17
In room (flex duct)	Wet Room	0.16
Through wall	Kitchen	0.13
Through wall	Wet Room	0.15



winner of
housebuilder
awards
2014

Model

Lo-Carbon Response dMEV

Auto speed selection at installation. The integral air pressure sensor checks the airflow when first installed and also helps the fan to compensate for external wind pressure.

Stock Ref
404535

Lo-Carbon Response/SELV TP (Timer/Pullcord)

For kitchen, utility and bathroom/toilet applications, the continuous running TP model incorporates an adjustable overrun timer. This adjusts the time the fan will continue to run on boost after the LS connection has been deactivated. This is also the run time period for the pullcord.

Model	Stock Ref
TP	404876
SELV TP	404878

Lo-Carbon Response/SELV HTP (Humidistat/Timer/Pullcord)

For kitchen, utility and bathroom/toilet applications, the continuous running HTP model incorporates an adjustable (40% - 90%) ambient response humidistat. The fan will increase the extract rate if the humidity rises above the point set at installation. Datalogger as standard.

Model	Stock Ref
HTP	404877
Response SELV HTP	404879

Accessories

Wall Kit

Model	Stock Ref
White	254102
Brown	254100



150mm Conversion kit
Stock Ref
408680



Ceiling kit
Stock Ref
407928



Window kit
Stock Ref
407927

Dimensions (mm)

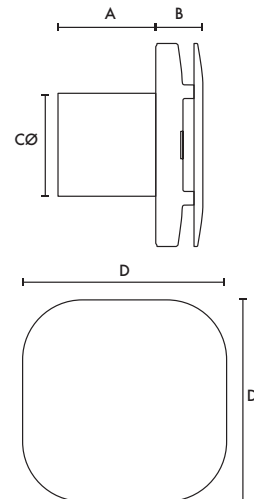

A	B	CØ	D
90	45	99	190

Performance Curve

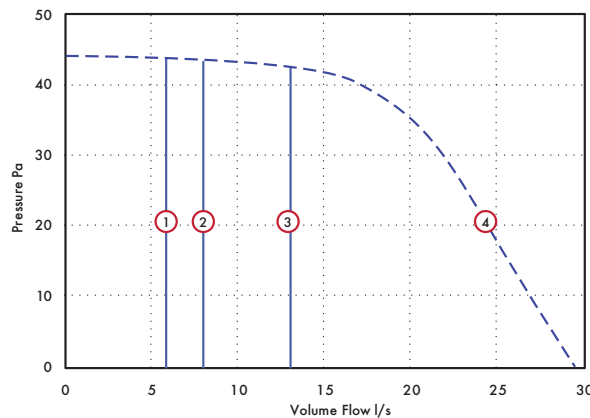

- ① 6l/s Constant Volume
- ② 8l/s Constant Volume
- ③ 13l/s Constant Volume
- ④ Maximum pressure available to deliver airflow

Performance Curve

Model	Extract Performance l/s (m³/h) - FID			Watts			dB(A) @ 3m		
	Trickle Low	Trickle High	Boost	Trickle Low	Trickle High	Boost	Trickle Low	Trickle High	Boost
Lo-Carbon Response	6 (21)	8 (29)	13 (43)	1.0	1.2	1.7	12	17	32.5

Lo-Carbon Centra®/SELV

dMEV Unit

Features & Benefits

- Building Regulations Approved Documents F and L compliant, System 3 Continuous mechanical extract
- Recognised in SAP Appendix Q - Low SFP on SAP Q
- Quietest dMEV available
- Discreet, tasteful styling
- Single fan for use in all applications
- IPX4 rated - IPX7 rated (SELV)
- Pressure detection device
- Normal and Boost speeds
- Lo-Carbon motor offering 90% energy savings and long life
- 5 Year Motor Guarantee
- Suitable for wall, ceiling, panel and window mounting
- SELV Models - Supplied with a remote transformer
- SELV Models Suitable for 'Zone 1' installation

What is de-centralised MEV (dMEV)?

Building Regulations Approved Document F gives examples of four main methods of ventilation. System 3, Continuous mechanical extract ventilation, can be achieved using a single centralised extract unit such as the Sentinel Multivent ducted to 'wet' rooms (kitchen, bathroom, en-suite and WC) or by decentralised individual fans, such as the Lo-Carbon Centra in the 'wet' rooms. The fans run continuously at near silent levels providing a simple and effective form of ventilation.

SELV (Safety Extra Low Voltage) is designed for areas where a fan can be installed within Zone 1 in a room where there is a fixed bath or shower. Ingress Protected (IP) to IPX7 Lo-Carbon Centra SELV can be fitted safely within the spray area. The separate transformer can be mounted away from the spray zone and out of reach from the bath or shower.

The Lo-Carbon Centra meets the latest requirements of the Building Regulations Approved Document F for wholehouse system ventilation.

Selection of the two normal flow rates (6l/s or 9l/s) is via a simple 'jumper' on the control board. Different methods are available for operating boost speed from a simple switched live to integral humidistat. See individual models for further details.

The attractive and discreet styling of the Vent-Axia Lo-Carbon Centra will complement the décor of any new home while virtually silent operation ensures optimum ventilation is achieved without intrusive noise.

Lo-Carbon Centra

dMEV version recognised in SAP Appendix Q. Lo-Carbon Centra has a specific fan power of only 0.18 W/l/s in through-the-wall kitchen applications.

Models

Lo-Carbon Centra dMEV

Auto speed selection at installation. The integral air pressure sensor checks the airflow when first installed and also helps the fan to compensate for external wind pressure.

Stock Ref
441782

Lo-Carbon Centra T/SELV T (Timer)

Ideal for bathroom and toilet applications, this unit runs continuously on trickle setting and may be boosted by the switched live input which activates the adjustable timer (5-30 minutes).

Model	Stock Ref
T	442954
SELV T	443175

Lo-Carbon Centra TP/SELV TP (Timer/Pullcord)

For bathroom/toilet applications, the continuous running TP model is boosted by the pullcord which activates the adjustable timer (5-30 minutes).

Model	Stock Ref
TP	447127
SELV TP	447128

Lo-Carbon Centra HT/SELV HT (Humidistat/Timer)

For bathroom/toilet applications, the continuous running HT model is automatically boosted by the built-in humidistat or by a switched live input which activates the adjustable timer (5-30 minutes).

Model	Stock Ref
HT	442955
SELV HT	443176

Lo-Carbon Centra HTP/SELV HTP (Humidistat/Timer/Pullcord)

For bathroom/toilet applications, the continuous running HTP model is automatically boosted by the built-in humidistat or by the pullcord which activates the adjustable timer (5-30 minutes).

Model	Stock Ref
HTP	443045
SELV HTP	443177

150mm Conversion Kit

Stock Ref
443334

Wall Kit

Stock Ref
254102 (White)
254100 (Brown)

Window Kit

Stock Ref
442947

Ceiling Kit

Stock Ref
443800



the **ELECTRICAL**
industry awards
WINNER 2011

Winners of the Energy Efficiency Initiative 2011 Award
with our Lo-Carbon Continuous Ventilation Product Range



Dimensions (mm)

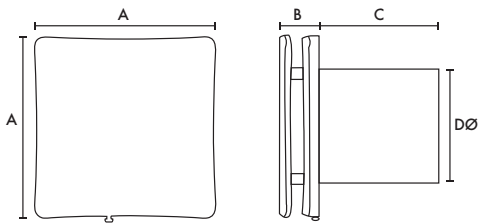

Model	A	B	C	DØ
Lo-Carbon Centra dMEV/All SELV	160	35	115	99
Lo-Carbon Centra T/TP/HT/HTP	160	35	80	99

Transformer 87 x 87 x 33mm (W x H x D)
(SELV models only)

Performance Guide

Model	Extract Performance (l/s)			Power Consumption (Watts)			Sound dB(A)@ 3m		
	Trickle	Trickle	Boost	Trickle	Trickle	Boost	Trickle	Trickle	Boost
	Low	High		Low	High		Low	High	
Lo-Carbon Centra dMEV/All SELV	6	9	15	1.4	1.6	2.4	10.8	15.5	25.2
Lo-Carbon Centra T/TP/HT/HTP	6	9	15	3.2	3.5	4.2	10.8	15.5	25.2

SAP Appendix Q Performance (dMEV model)

Systems With Rigid Ductwork Installation Only

Unit Configuration	Location	Fan Speed Setting	Flow Rate (l/s)	SFP (W/l/s)
In Room (Ducted)	Kitchen	High	13.2	0.32
In Room (Ducted)	Wet Room	9 l/s	8.4	0.28
Through Wall	Kitchen	High	13.5	0.18
Through Wall	Wet Room	9 l/s	8.6	0.20

Systems With Flexible Or Mixed Ductwork Installation Only

Unit Configuration	Location	Fan Speed Setting	Flow Rate (l/s)	SFP (W/l/s)
In Room (Ducted)	Kitchen	High	13.2	0.37
In Room (Ducted)	Wet Room	9 l/s	8.6	0.31
Through Wall	Kitchen	High	13.5	0.18
Through Wall	Wet Room	9 l/s	8.6	0.20

Lo-Carbon Multivent MEV Unit



Features & Benefits

- Reduces your carbon footprint
- Fitted with four extract 100 or 125mm diameter spigots allowing quick connection to ducts
- Option of wall, ceiling and loft mounting
- Quiet running suitable for continuous operation
- Can extract from a number of rooms, depending on the dwelling
- Wireless Controller available

The Lo-Carbon Multivent continuous mechanical extract ventilation range is designed for the simultaneous ventilation of separate areas in the home or as a multipoint extractor system for a wide range of commercial applications.

In the home the system is usually located in the loft or airing cupboard with ducts taken to the bathroom, kitchen and utility room to remove water vapour at source and from toilets to remove odours.

Lo-Carbon Multivent is ideal for a range of commercial applications such as toilets, fitting rooms, and kiosks. The units can be installed at any angle and where the ambient air has a high humidity content condensate drains are provided.

The Lo-Carbon Multivent H version incorporates a built-in humidity sensor to switch between two of the three speeds. A Wireless Controller is available for use with the Lo-Carbon Multivent H with three speed options offering total control of the system.

Technical Data

Model	Low		Medium		High		SEC Class	SEC Class (inc. LDC)
	Current Amps	Power Watts	Current Amps	Power Watts	Current Amps	Power Watts		
MVDC	0.1	9	0.23	20	0.39	44	E	B
MVDCH	0.1	9	0.23	20	0.39	44	D	B

Lo-Carbon MVDC

The Lo-Carbon MVDC Multivent minimises running costs by incorporating the latest DC technology. DC efficiency means less wear and tear on the motor which guarantees longer life.

Extended motor guarantee to 5 years offered.

Models

Model	Stock Ref
MVDC	181520
MVDCH	183020

Accessories

Acoustic Lining Kit

For reducing noise in sensitive installations

Stock Ref
438195

Multivent Wireless Controller

(for use with MVDCH only)

Stock Ref
426035

Sound Level

Model	FID Perf. m ³ /h (l/s)	Sound dB(A) @ 3m		
		Casing Breakout	Duct Inlet 100mmØ	Duct Inlet 125mmØ
MVDC				
low	232 (64)	33.3	36.5	36.5
medium	365 (100)	33.7	47.9	47
high	434 (120)	38.8	51.7	51.5
MVDCH				
low	232 (64)	33.3	36.3	36.5
medium	365 (100)	33.7	47.9	47
high	434 (120)	38.8	51.7	51.5

Performance Curve

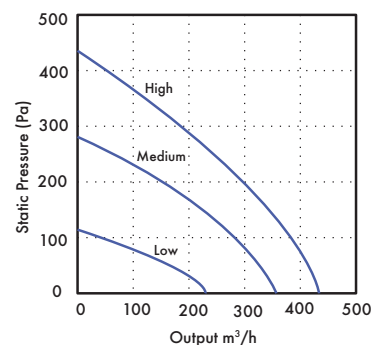

Dimensions (mm)

Weight: 5.50kg

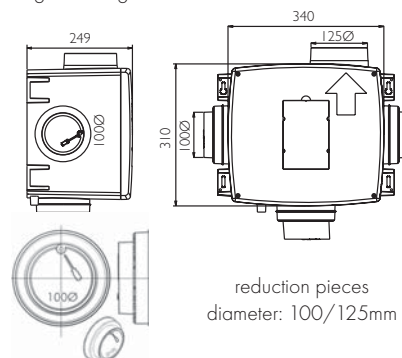

Multivent

MEV Unit



Features & Benefits

- Fitted with four extract 100 or 125mm diameter spigots allowing quick connection to ducts
- Option of wall, ceiling and loft mounting
- Quiet running suitable for continuous operation
- Can extract from a number of rooms, depending on the dwelling
- Wireless Controller available

The Multivent continuous mechanical extract ventilation range is designed for the simultaneous ventilation of separate areas in the home or as a multipoint extractor system for a wide range of commercial applications.

In the home the system is usually located in the loft or airing cupboard with ducts taken to the bathroom, kitchen and utility room to remove water vapour at source and from toilets to remove odours.

Multivent is ideal for a range of commercial applications such as toilets, fitting rooms and kiosks. The units can be installed at any angle and where the ambient air has a high humidity content condensate drains are provided.

The Multivent H version incorporates a built-in humidity sensor to switch between two of the three speeds. A Wireless Controller is available for use with the Multivent H with three speed options offering total control of the systems.

Models

Model	Stock Ref
MV250	181510
MV250H	183010

Accessories

Acoustic Lining Kit

For reducing noise in sensitive installations

Stock Ref

438195

Multivent Wireless Controller

(for use with MV250H only)

Stock Ref

426035

Sound Level

Model	FID Perf. m ³ /h (l/s)	Sound dB(A) @ 3m		
		Casing Breakout	Duct Inlet 100mmØ	Duct Inlet 125mmØ
MV 250				
low	161 (45)	22.4	27.9	27.8
medium	305 (85)	31.0	42.9	43.2
high	443 (123)	35.4	48.6	48.0
MV 250H				
low	175 (48)	22.4	27.9	27.6
medium	344 (95)	31.0	42.9	43.2
high	443 (123)	35.4	48.6	48.0

Performance Curve

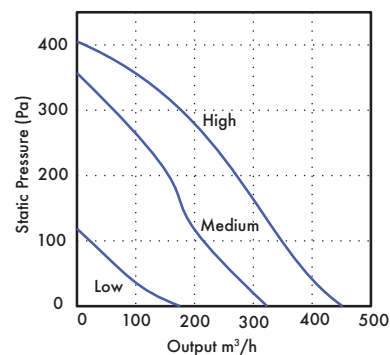

Dimensions (mm)

Weight: 5.50kg

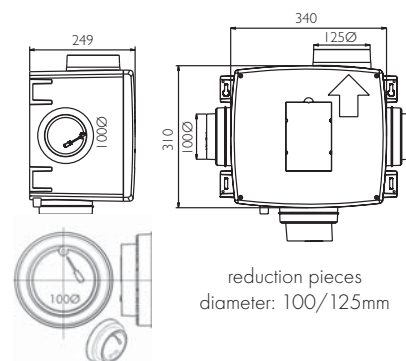

Technical Data

Model	Low		Medium		High		SEC Class	SEC Class (inc. LDC)
	Current Amps	Power Watts	Current Amps	Power Watts	Current Amps	Power Watts		
MV250	0.2	25	0.30	54	0.34	81	E	C
MV250H	0.2	25	0.30	54	0.34	81	E	C

Lo-Carbon

Sentinel® Multivent/Plus

MEV Unit

Features & Benefits

- Reduces your carbon footprint
- Recognised in SAP Appendix Q
- Specific fan power 0.16 W/l/s (K+1)
- Suitable for use with external sensors and controllers
- Wireless control option
- Complies with Building Regulations ADF and ADL
- Manufactured in the UK from recyclable materials

Sentinel Multivent continuous mechanical extract ventilation, C-MEV is designed for the simultaneous ventilation of separate areas in the home or as a multipoint extraction system for a wide range of commercial applications. The units can be installed at any angle. Where the ambient air has a high humidity content condensate drains are provided.

In support of Sentinel Multivent, Vent-Axia offers:

- Practical advice on product selection and installation
- Guidance on solutions to meet legislation requirements
- Project management and site deliveries
- After sales support and maintenance information

The need to improve efficiency

Sentinel Multivent has been designed to meet the exacting demands of developers, installers and users offering advanced control options and easier installation and commissioning.

- Demand Control - enables precise ventilation rate, is set in 1% increments based on property size
- Integral LCD display allows the installer to select appropriate low, normal and boost speeds to meet demand
- Manual and automatic control options

- Integral adjustable overrun timer and delay on timer
- Plug-n-Play automatic sensor detection
- Switched live and SELV connections
- Dry Out setting - Option set at installation, Sentinel Multivent will run on boost for 1 week to assist in removing moisture
- Optional Wireless Control - up to 4 controllers on any one system
- Energy efficient EC/DC motors - 1/3 less energy lost to heat than a conventional AC motor
- Low Specific Fan Power (SFP) making it one of the most efficient products on the market

Legislation

- Meets Building Regulations Approved Document F (System 3)
- Recognised in SAP Appendix Q up to kitchen + 6 wet rooms
- Meets carbon footprint reduction targets
- Lowest SFP figures of any demand control MEV system

The need for better health

Removal of pollutants such as moisture, carbon dioxide and external fumes are all important factors in maintaining indoor air quality, helping to create a healthier living environment.

- The integral humidity sensor (Sentinel Multivent H) increases fan speed in proportion to relative humidity levels, saving energy and reducing noise
- The sensor also reacts to small but rapid increases in humidity, even if the normal trigger threshold is not reached. This unique feature ensures adequate ventilation, even for the smallest wet room
- Night time relative humidity increment setback feature suppresses nuisance tripping as humidity gradually increases with falling temperature
- Acoustically lined - low noise levels only 18.1 dB(A) @ 3m

SAP Appendix Q

In order to make the right choice, developers and contractors should refer to Building Regulations ADL1a, SAP 2012 and Appendix Q.

SAP Appendix Q was launched in June 2006 to reward innovative ventilation manufacturers by testing and listing energy efficient products that assist in helping developers meet their Target Emission Rates (TER).

SAP is the underpinning methodology behind the Energy Performance Certificates and is used to demonstrate compliance with Building Regulations for Dwellings - Approved Document L (England and Wales), Section 6 (Scotland) and Approved Document F (Northern Ireland). Appendix Q specifically relates to wholehouse ventilation systems and lists a number of Vent-Axia Mechanical Ventilation solutions which offer an improved SAP rating over and above the default for these product types.

SAP Appendix Q Test Results (Sentinel Multivent)

Exhaust Terminal Configuration	Fan Speed Setting	Total Flow Rate	SFP (W/l/s)
K + 1	32%	21	0.16
K + 2	39%	29	0.16
K + 3	49%	37	0.17
K + 4	59%	45	0.21
K + 5	68%	53	0.24
K + 6	77%	61	0.29

To assist developers and contractors Vent-Axia can provide detailed scheme designs together with installation guidance and training.



Your Carbon Footprint

The Carbon Footprint is a measure of the amount of carbon dioxide (CO₂) emitted through the burning of fossil fuels. From a residential and commercial building perspective, it is the amount of carbon generated when you consume a kilowatt of electricity. Reducing a building's carbon footprint will ultimately reduce electricity bills and save money for every individual household or business. It will also help meet the UK target for the reduction of emissions, as well as allowing you to help the environment.

Model

	Stock Ref
Sentinel Multivalent	437601
Sentinel Multivalent H	445655
Sentinel Multivalent Plus	407001
Sentinel Multivalent Plus H	407849

Dimensions (mm)

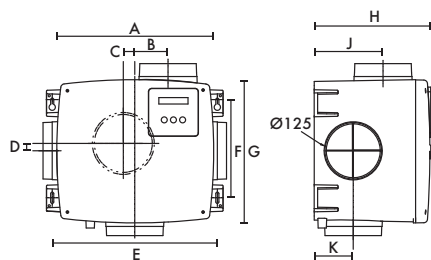

Reduction Pieces
Diameter: 100/125mm

A	B	C	D	E	F	G	H	I	J
340	72.5	25	15	360	214	310	260	150	85

Performance Curve

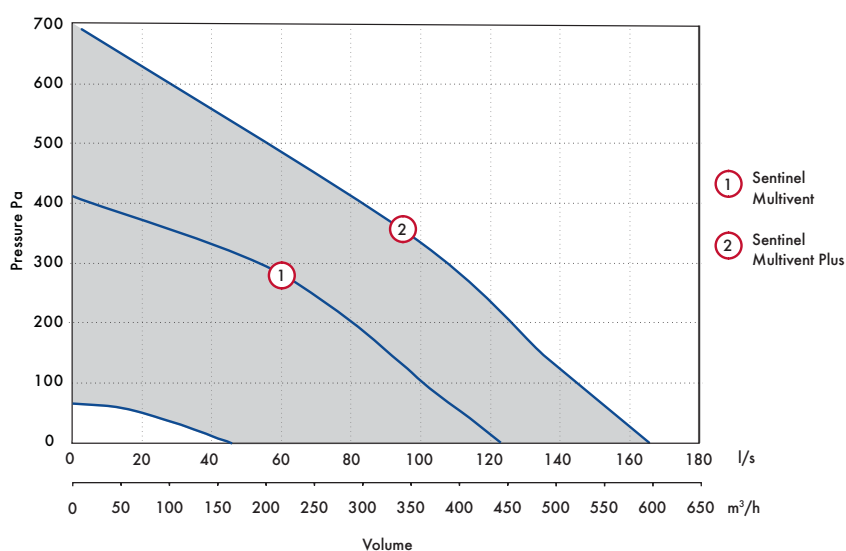

Performance Guide

Stock Ref	Model	Curve Ref	Inlet Duct dB(A)	FID l/s	Power Watts	SEC Class	SEC Class (inc. LDC)
437601 / 445655	Multivalent	1 (max)	38	121	45	E	B
407001 / 407849	Multivalent Plus	2 (max)	-	165	83	E	B

Sound Data (Sentinel Multivalent)

Speed		Induct sound power levels dB								dB(A) @ 3m
		63	125	250	500	1K	2K	4K	8K	
10%	Breakout	43.6	37	36.9	30.6	26.2	22.8	23.6	30.4	18.1
10%	Extract	43.8	39.9	36.1	30.4	24.6	21.8	22	30.3	17.8
28%	Breakout	44	44.4	43.3	39	31.1	26.1	24.3	30.1	22
28%	Extract	42.2	40.1	42.2	40.5	32	23.3	23.4	30.5	22
46%	Breakout	45	42.8	46.7	44.1	38.8	35.6	26.7	30.6	25.8
46%	Extract	40.8	42.5	46.4	44.4	41	31.1	25.3	30.3	26
82%	Breakout	46.3	48.3	50	52.1	48.4	47.7	37.8	32.4	33.7
82%	Extract	46.7	49.6	48.9	54.3	51.8	42.7	38.1	34.2	36.1

Controllers and Sensors

Sentinel Multivent can be used with a wide range of Vent-Axia controllers and sensors. Ranging from integral humidistats, through to wireless controllers to wired remote sensors.



Integral Humidistat

- Simple Plug-n-Play installation
- Eliminates the need for additional controllers or sensors
- Reacts to any rapid increases in relative humidity or when humidity rises above adjustable threshold
- Future proof - can be fitted after installation
- Self programming

Stock Ref
437598



Wireless Transmitter Controller Receiver Kit

- Manual boost
- Adjustable overrun timer
- Easy wireless installation
- Reduces installation time
- Future proof - add more controllers any time

Stock Ref
439352



Wireless Transmitter Controller

- Additional controller for 439352
- A maximum of 4 controllers can be used per system
- Can be connected to other accessories (e.g. Humidistat) to send a boost signal wirelessly

Stock Ref
437827



Ambient Response Humidity Sensor

- Pullcord override and indication light
- Changeover relay switch
- Operating range: 30% - 90%RH
- Ambient operating temp. 5°C to 40°C
- 220-240V AC
- Will fit single gang box for surface mounting

Stock Ref
563550



Visonex PIR Sensor

- Fits any UK single gang mounting box
- Adjustable timer overrun (5-25 mins)
- Range of detection up to 10 metres
- Designed to meet IP43
- Ambient operating temp. range 0°C to 50°C

Stock Ref
459623



Ecotronic Humidity Sensor

- Set point adjustable
- Maximum switching load 1 Amp inductive
- Pullcord override indicator
- Ambient operating temp. 0°C to 40°C
- Supply voltage 220-240V

Stock Ref
563532



CO₂ + Temp Room Sensor

- 240V DC
- 0 - 2000ppm CO₂ working range
- 0 - 50°C working range
- Auto-calibrating NDIR CO₂ absorption sensor
- Thin film platinum temperature sensor for high accuracy

Stock Ref
433257



Air Quality Sensor

- Ambient operating temp. 0°C to 50°C
- DEMKO approved
- Surface mounted
- 1 - 25 min O/R timer
- Supply voltage 220-240V

Stock Ref
563506



Ventwise

- Automatically boosts fan when temperature of the supply pipe to a shower or bath increases
- Automatically boosts fan when electric hob is switched on
- Can be used in conjunction with manual override input
- Adjustable overrun timer
- Two sensor options available

Stock Ref
435960

Lo-Carbon

Multivent MVDC-MS/MSH

MEV Unit

Vent-Axia
dMEV, MEV & PIV Systems



Features & Benefits

- Best in class Specific Fan Power
- Reduces your carbon footprint
- Recognised in SAP Appendix Q
- Fitted with four extract 125 or 100mm diameter spigots allowing quick connection to ducts
- Complies with Building ADF (System 3)
- Option of wall, ceiling and loft mounting
- Improved controllability
- Switched Live Boost connection
- Fully variable normal and boost speeds
- Ultra quiet - acoustically lined for low noise levels
- Integral humidistat (H version)

With growing concerns about accurate ventilation of properties, the Lo-Carbon Multivent MVDC range offers the option of 'Close Control' both in the residential and the commercial sectors. With a DC motor the multi speed Lo-Carbon Multivent is one of the most efficient central extract units available.

The units have two fully variable speeds for trickle and boost, with a switched live (LS) activation for the boost speed. An additional third speed (purge) is available using a second switched live connection.

An acoustic lining is included as standard, ensuring minimum noise levels.

The potentiometer controlled speed selector allows accurate setting of airflow, ensuring exactly the right ventilation rate. This feature also reduces noise, and energy consumption.

Models

	Stock Ref
MVDC-MS	437634
MVDC-MSH	443298

SAP Appendix Q Test Results

Exhaust Terminal Configuration	Total Flow Rate	SFP (W/l/s)
K + 1	21	0.16
K + 2	29	0.15
K + 3	37	0.17
K + 4	45	0.20
K + 5	53	0.24
K + 6	61	0.28

Dimensions (mm)

Weight: 5.50kg

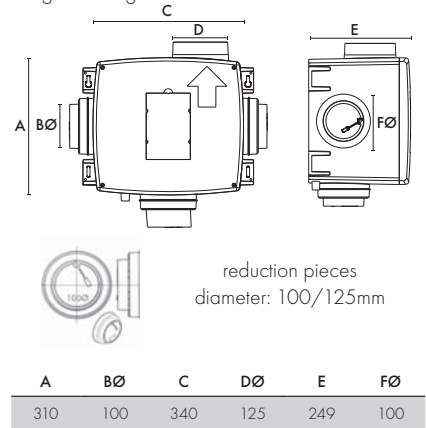

Performance

MVDC-MSH features an integral humidistat which triggers the unit to boost when humidity levels in the duct system exceed 70%.

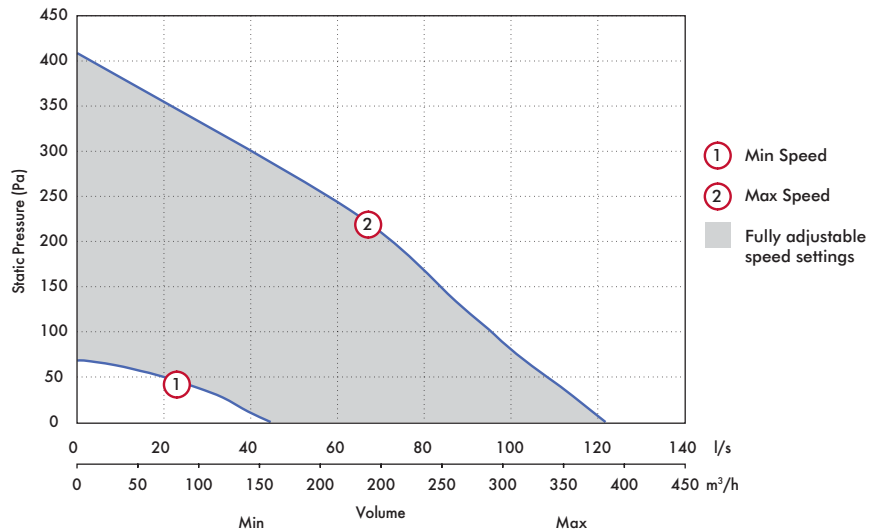

Model	Min				Max				SEC Class (inc. LDC)	
	Casing Breakout dB(A) @ 3m	Inlet Duct dB(A)	FID l/s	Power Watts	Casing Breakout dB(A) @ 3m	Inlet Duct dB(A)	FID l/s	Power Watts		
MVDC-MS	19	18	43	6	37	38	121	45	E	B
MCDC-MSH	19	18	43	6	37	38	121	45	E	B

Lo-Carbon

PoziDry

Positive Pressure Unit

Features & Benefits

- BBA approved
- Reduces your carbon footprint
- Selectable air capacities to suit floor area up to 150m²
- Datalogger feature as standard
- Uses latest Lo-Carbon technology motor for low running costs
- Ultra low sound level
- Lo-Carbon PoziDry comes complete with ceiling diffuser, flexible duct and worm drive clips
- Standard 5 year guarantee
- Up to 5 year maintenance free G4 filter
- IPX2 rated
- SFP of 0.22W/l/s

Positive Pressure Ventilation

For controlling condensation particularly in the refurbishment sector, the BBA approved Lo-Carbon PoziDry offers a quick and simple solution. A loft mounted positive input fan draws fresh air from the insulated loft, filters it and gently feeds it into the dwelling via a ceiling mounted diffuser. Stale air in the property is forced out through the natural forms of ventilation, such as window mounted trickle vents.

Installation

The Lo-Carbon PoziDry can be installed in a loft space and can be suspended from a roof beam or be floor mounted, with a purpose-designed diffuser normally located over the stairwell of a conventional two storey dwelling or in the main hall of a bungalow. The Lo-Carbon PoziDry is set to the appropriate speed at installation based on the size of the dwelling, providing positive pressure input ventilation. Background ventilation openings provide the exhaust points.

Performance

The robust construction of the Lo-Carbon PoziDry features a specially developed Lo-Carbon DC fan/motor arrangement which runs quietly and delivers incredibly low running costs. The Lo-Carbon PoziDry

uses a sensor to monitor the temperature in the loft, automatically adjusting the air volume when necessary. 'Trickle' speed is automatically selected when the ambient loft temperature is up to 18°C. 'Normal' is automatically selected when the ambient loft temperature is between 18 and 27°C providing partial heat recovery.

If the ambient loft temperature exceeds 27°C, the Lo-Carbon PoziDry will automatically switch to standby (no airflow). The standby power consumption is 2W.

In the case of the integral 500W heater version, the heater element is automatically activated when necessary and tempers the supply air to 10°C. Can be used for air replacement in conjunction with an extract fan.

Filter

The unit includes a filter with up to 5 years maintenance intervals to reduce the number of call outs needed throughout its life span.

Datalogger

As standard. Measures the number of days the product has been switched on to provide precise running information.

Speed Control

With selection of 2 of 6 speeds available up to 50l/s, the unit is suitable for houses up to 360m³.

Heater

An optional comfort heater is available for operation when the incoming air temperature becomes low.

Air Replacement Grille Set

For air replacement through doors. Consists of a two-piece telescopic set, which fits unobtrusively on either side of the door panel. Minimum fixing thickness 30mm. Plastic. Dimensions: 454 x 90mm.

Typical Specification

The unit should be mounted in the loft space with a diffuser in self-extinguishing ABS positioned at the top of the stairwell. The unit meets the EMC and low voltage directives.

Motor

The electronically controlled DC motor is manufactured with long life ball bearings and is fitted with Standard Thermal Overload Protection (S.T.O.P.). Suitable for ambient operating temperatures of -25°C to +40°C. For complete peace of mind, the Vent-Axia Lo-Carbon PoziDry is backed by a 5 year guarantee.

Models

Without heater

Stock Ref
444075

With integral heater

Stock Ref
444766

Accessories

Twin Spigot Kit

An additional kit to allow an extra circular diffuser to be installed near the PoziDry unit.

Stock Ref
449071

Includes:

- 1 x **436592** (200mm Duct)
- 2 x **561707** (Worm Clips)
- 1 x **452085** (200mm equal Y Piece)
- 1 x **10544200** (Diffuser)



Dimensions (mm)

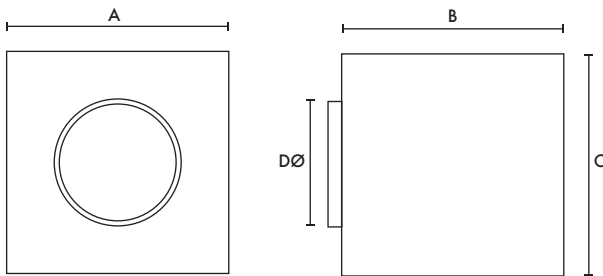

A	B (depth)	C	DØ	Weight
438	411	379	200	11.5kg

Performance

Speed	FID (l/s)	Power (W)*	Floor Area up to (m ²)
1	10	2.5	30
2	18	3	54
3	26	4	78
4	34	5	102
5	42	7	126
6	50	13	150

*add 500W for heater version

Sound Data

Setting	Test mode	Octave band, Hz, dB SWL								SPL dB(A) at 3m
		63	125	250	500	1k	2k	4k	8k	
Speed 1	Supply	33.2	28.3	25.4	15.3	17.2	12.6	16.4	22.7	8.5
	Breakout/Intake	36.7	25.3	26.9	16.1	28.6	30.4	18.4	23.8	13.5
Speed 6	Supply	40.7	41.8	39.7	32.7	33.3	18.9	16.7	22.8	19
	Breakout/Intake	39.7	37.0	43.9	41.1	37.6	32.5	27.1	26.1	22.0

Lo-Carbon

PoziDry Compact

Positive Pressure Unit

Features & Benefits

- BBA Approved
- Ultra low sound level
- Selectable air capacities to suit volumes of up to 34 l/s or floor area up to 100m²
- Extremely low running costs - from less than one pence per day
- Washable, high capacity filter
- Datalogger feature as standard
- Round to rectangular duct adaptor included
- 5 Year Guarantee
- Ideal for flats

Positive Pressure Ventilation

For those properties that do not have a loft, the BBA approved Lo-Carbon PoziDry Compact provides an easy to install solution. The unit is duct mounted and can be fitted in a number of locations within a single floor flat or apartment.

Air is drawn into the Lo-Carbon PoziDry Compact unit via an external inlet and through a short length of duct. The specially developed fan/motor assembly (using the Lo-Carbon DC motor technology) draws the air through an integral, high capacity, washable filter. The backward curved impeller guarantees increased efficiency, lower sound levels and better performance.

The fresh, filtered airflow passes along the ducting and terminates on an internal wall with a discreet grille. This directs the airflow upwards where the incoming air mixes with the warm air that gathers at ceiling height.

The system provides fresh, tempered air into the home and creates an indoor environment where the damaging effects of condensation find it hard to exist, benefiting both the occupants and the structure of the building.

The Lo-Carbon PoziDry Compact can be used for air replacement in conjunction with an extractor fan. A G4 filter is included as standard.

Performance

The Lo-Carbon PoziDry Compact uses a sensor to monitor the ambient temperature, automatically adjusting the air volume when necessary and providing partial heat recovery.

'Trickle' speed is automatically selected when the ambient temperature is up to 18°C.

'Normal' is automatically selected when the ambient temperature is between 18 and 27°C.

If the ambient temperature exceeds 27°C, the Lo-Carbon PoziDry Compact will automatically switch to standby (no airflow). The standby power consumption is 2W.

In the case of the integral 300W heater version, the heater element is automatically activated when necessary and tempers the supply air to 10°C.

Air Replacement Grille Set

For air replacement through doors. Consists of a two-piece telescopic set, which fits unobtrusively on either side of the door panel. Minimum fixing thickness 30mm. Plastic. Dimensions: 454 x 90mm. See page 139.

Datalogger

As standard. Measures the number of days the product has been switched on to provide precise running information.

Model

Without heater
Stock Ref
444076

With integral heater
Stock Ref
444767

Installation Packs

Stock Ref	453546	453547	453548
Quick Fit Grille (White)	1	1	1
Wall fitting kit (Brown)	1	1	1
Round to Rectangle Adaptor	1	3	3
Vertical 90° bend	2	2	2
Elbow/Spigot	1	1	1
1m Flat Channel	1	2	2
1.5m Flat Channel	1	2	2
Connector	1	4	4
Horizontal 90° Bend	-	-	2
Channel Clip	4	6	2



Dimensions (mm)

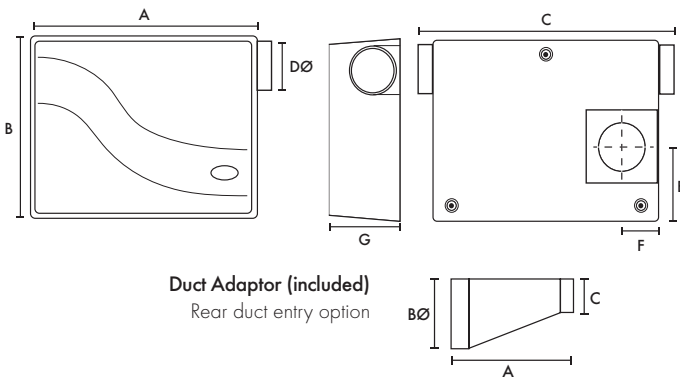

A	B	C	DØ	E	F	G	Weight
435	365	490	100	160	58	160	7kg

A	BØ	C
180	105	55 x 110

Performance

Speed	FID (l/s)	Power (W)*	Floor Area (m ²)	SEC Class
1	10	5.7	30	E
2	18	12.2	54	
3	26	24.6	78	
4	34	49.8	100	

*add 300W for heater version

Sound Data

Setting	Test mode	Octave band, Hz, dB SWL								SPL dB(A) @ 3m
		63	125	250	500	1k	2k	4k	8k	
Speed 1	Supply	37.6	32.7	33.4	35.0	29.8	27.5	18.2	22.6	18.0
	Extract	37.0	32.3	32.5	32.4	21.9	25.3	16.8	22.6	15.5
	Breakout	35.3	46.9	38.8	33.1	22.9	22.2	17.8	23.3	15.0
Speed 4	Supply	65.2	57.2	60.8	67.6	62.2	59.7	50.8	41.2	50.0
	Extract	60.8	51.7	58.5	62.1	56.1	56.4	45.2	37.9	45.5
	Breakout	57.2	55.2	55.5	63.3	55.1	52.2	44.1	32.9	41.5

Residential & Commercial Single Room dMVHR

Improving air quality on a room-by-room basis, the Vent-Axia through-the-wall mounted range of heat recovery ventilation units simultaneously extract stale air and introduce fresh air – warming the incoming airflow with heat recovered from the exhaust stream.

Lo-Carbon Tempra

The Vent-Axia Lo-Carbon Tempra through-the-wall heat recovery unit provides a flexible solution, which meets the requirements for high efficiency ventilation. Tempra is ideal for refurbishment projects and is designed for use in bathrooms, toilets, utility rooms and kitchens. Tempra also meets the current Building Regulations Approved Document F and L.



	Lo-Carbon Tempra/SELV	52-53
	Lo-Carbon HR25	54
	HR200WK	55
	HR300	56

Vent-Axia

Single Room dMVHR

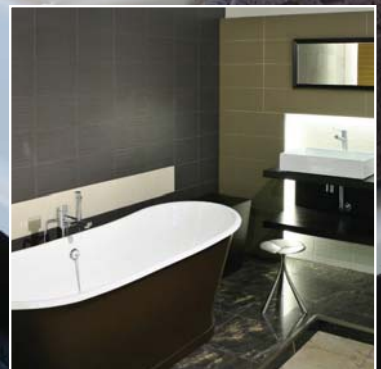

Lo-Carbon Tempra/SELV

Single Room Heat Recovery Unit

Features & Benefits

- Fits in 100mm diameter hole – ideal for refurbishments
- Up to 78% heat recovery
- Available in 2 wall depths: 320mm and 460mm
- Reduces the home's carbon footprint
- Choice of control options
- Summer setting (extract only)
- Helps prevent noise ingress
- Continuous running or intermittent extract
- Meets current Building Regulations Approved Documents F and L
- Low power consumption - only 3.2 W
- IPX4 rated

Through-The-Wall Heat Recovery Unit

The Vent-Axia Lo-Carbon Tempra is designed to fit in 100mm diameter hole and is suitable for refurbished properties in kitchen, bathroom, toilet or utility rooms. The unit meets the performance requirements for continuous extract fans under the current Building Regulations Approved Document F.

The Tempra is available in three models, a P version with pullcord control, a T version with overrun timer and an HTP version with built-in pullcord, overrun timer and humidistat. Two spigot lengths are available; 320mm and 460mm.

The manual summer setting allows the unit to be set to extract only, helping to prevent a dwelling becoming too warm in hot summer conditions.

Performance

Tempra can be set to run continuously at 6 l/s or 9 l/s, boosting up to 15 l/s, recovering heat from extracted air and returning it to the dwelling. The unique, compact heat exchanger has a temperature efficiency up to 78%, saving energy and reducing your carbon footprint. For intermittent extract the Tempra is set to 15 l/s.

The Tempra is also designed so that the replacement air being introduced is at a reduced rate ensuring that the room being ventilated is still under a slight negative pressure. This ensures that fresh air is brought into the room from the rest of the house preventing humid air migrating.

The Lo-Carbon EC/DC motor with twin impellers consumes as little as 3.2 Watts on trickle rate and runs almost silently at only 20dB(A).

Typical Installation

The unique heat exchanger design allows the Tempra to be fitted in a 100mm diameter hole, allowing it to replace standard 100mm extract fans while giving all the benefits of heat recovery. Maximum wall thickness is 460mm.

A longer version of the Tempra is available, designed for installations where the wall thickness is between 321mm and 460mm. 460mm models are identified by an 'L'.

Models

Lo-Carbon Tempra P (Pullcord)

Constant trickle speed with pullcord to boost or intermittent operation by pullcord.

Model	Stock Ref
320mm P	443312
320mm SELV P	444368
460mm LP	403832
460mm SELV LP	403833

Lo-Carbon Tempra T (Timer)

Constant trickle speed with switch live to boost or intermittent operation by switch live.

Model	Stock Ref
320mm T	443310
320mm SELV T	444369
460mm LT	403834
460mm SELV LT	403835

Lo-Carbon Tempra HTP (Humidistat/Timer/Pullcord)

Constant trickle speed with humidistat and linked overrun timer to boost or intermittent operation by switch live.

Model	Stock Ref
320mm HTP	443311
320mm SELV HTP	444370
460mm LHTP	403836
460mm SELV LHTP	403837

Accessories

100mm High Rise Kit
320mm white duct with black seal.

Stock Ref
449011

Wall kit

Extendable Wall Tube suitable for both spigot lengths.

Stock Ref
445529

150mm Conversion kit

For replacement of 150 diameter fan.

Stock Ref
403847



Dimensions (mm)

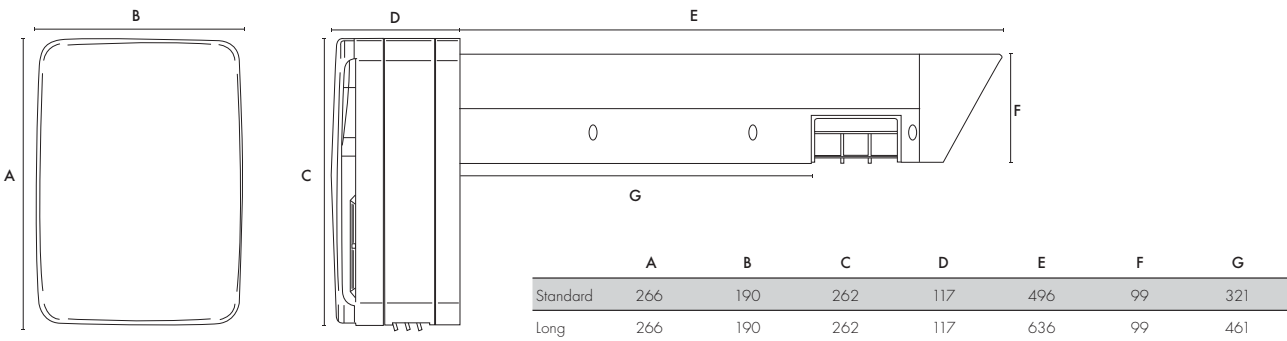

Performance

Model	Extract Performance l/s			Power Consumption Watts			Sound @dB(A) *		
	Trickle Low	Trickle High	Boost	Trickle Low	Trickle High	Boost	Trickle Low	Trickle High	Boost
Lo-Carbon Tempra (All Models)	6	9	15	3.2	5.7	26.6	20	22	36

*Octave band frequency range of 250Hz to 4KHz at 3m. Unit mounted on a reflective surface.

Heat Exchange - what is heat recovery?

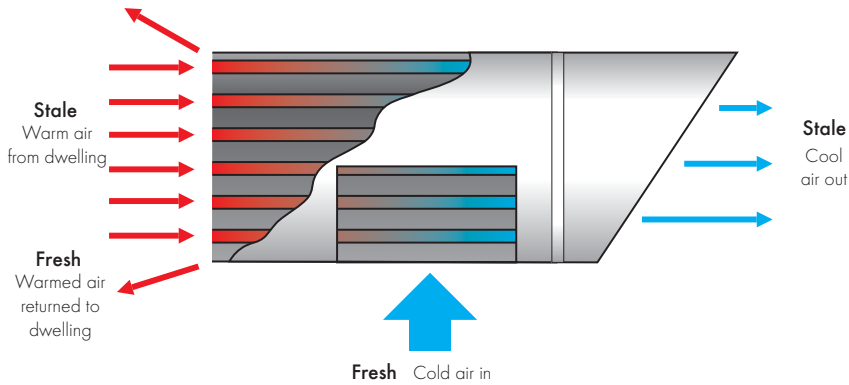

Lo-Carbon HR25

Single Room Heat Recovery Unit



Features & Benefits

- Reduces the home's carbon footprint
- Designed for installations in bathrooms, toilets and utility areas
- 84% temperature based heat recovery
- Up to 90% energy saving
- Controls condensation and eliminates mould
- Choice of control options
- Long life, low energy DC motor
- IP24 rated

Long Life Ventilation

The Vent-Axia Lo-Carbon HR25 range of through-the-wall heat recovery units are suitable for fitting through a 152mm (6") circular hole and are designed for use in bathrooms, toilets and utility areas. The Lo-Carbon HR25 is available in two lengths, a standard version suitable for wall thicknesses of up to 310mm and an extended version suitable for wall thicknesses of up to 425mm. From a controllability perspective, the HR25 is available either with a standard pullcord switch or with an integral adjustable humidity sensor ('H' version), which will work automatically depending on the relative humidity in the room.

Performance

The units are fitted with a 24V DC motor and are supplied with a transformer which has the ability to operate at only 2 Watts power consumption on normal setting.

Maintenance

Apart from removing odours, providing fresh air and recovering heat, this appliance extracts airborne impurities such as dust, dirt and grease. Filters should be replaced every six months or as conditions necessitate.

Models

Lo-Carbon HR25

The HR25 is fitted with a pullcord switch which operates the twin speed control function.

Stock Ref
372261

Lo-Carbon HR25H

The HR25H is fitted with an adjustable humidity sensor which automatically switches between its high and low settings depending on the relative humidity in the room.

Stock Ref
372262

Lo-Carbon HR25L

An extended version of the HR25 is available, designed for installations where the wall thickness is between 311mm and 425mm.

Stock Ref
372264

Lo-Carbon HR25LH

An extended version of the HR25H is available, designed for installations where the wall thickness is between 311mm and 425mm.

Stock Ref
372265

Dimensions (mm)

	A	B	C	D	E	F
Standard	508	451	318	147	204	54
Long	666	548	433	147	204	54

Standard - Weight 3.4kg

Long - Weight 3.5kg

Fixing hole Ø 152mm

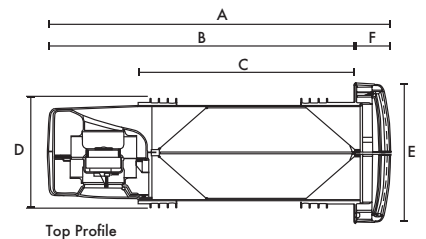

Top Profile

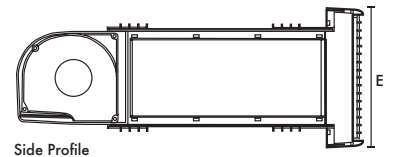

Side Profile

Performance

Model	Extract Performance		Intake Performance		Watts		Sound	
	l/s (m³/h)		l/s (m³/h)				dB(A) @ 3m*	
	Boost	Trickle	Boost	Trickle	Boost	Trickle	Boost	Trickle
HR25	15 (55)	5 (20)	10 (36)	2 (8)	23	2	49.2	16.8
HR25H	15 (55)	5 (20)	10 (36)	2 (8)	23	2	49.2	16.8
HR25L	15 (55)	5 (20)	10 (36)	2 (8)	23	2	49.2	16.8
HR25LH	15 (55)	5 (20)	10 (36)	2 (8)	23	2	49.2	16.8

*Octave band frequency range of 250Hz to 4KHz at 3m. Unit mounted on a reflective surface.

HR200WK

Single Room Heat Recovery Unit



Features & Benefits

- Single room domestic heat recovery ventilation unit
- 3 speed motor
- Integral washable filter
- Up to 75% heat recovery
- Saves energy - controls condensation
- Low noise

Heat Recovery Ventilation

The Vent-Axia HR200WK is a heat recovery ventilation unit specifically designed for use in domestic kitchens and utility rooms to meet the Building Regulations. The unit is also suitable for light commercial applications up to 220m³/h (50l/s). The compact, self contained unit is designed for through-the-wall mounting.

The three speed, external rotor motor has two matched impellers to ensure a controlled airflow through the unit, with exceptionally economical 25 Watt low speed power consumption.

Easy Installation

The HR200WK fits through walls up to 335mm thick requiring a fixing hole 250mm square. The internal grille has washable, polymeric foam supply and extract filters. Only the neat internal twin grille is visible from the room. A wall extension sleeve is available for walls up to 550mm thick.

Heat Exchanger

The highly efficient, polymeric heat exchanger cube is washable. The compact cube interleaves outgoing moist warm air with incoming fresh air and allows the heat from one to warm the other without the two air streams mixing. Up to 75% of the heat, which would otherwise be lost, is transferred to the intake air, ensuring energy saving ventilation.

Electrical

HR200WK 220-240V/1/50Hz Class 1 earthed appliance. The 3 speed motor, can be wired to operate On/Off for any one of the three speeds. Alternatively, an Ambient Response Humidity Sensor or simple changeover switch can be used to provide switching between any two speeds, giving permanent trickle ventilation and automatic changeover to a higher speed during periods of high moisture generation. Also the 3 speed controller enables the unit to be switched from permanent trickle to either medium or boost speed.

Accessories

Extension Wall Sleeve

Stock Ref
370421

Electronic Controller

Stock Ref
W300310

Models

HR200WK

A heat recovery unit specifically designed for use in domestic kitchens and utility rooms to meet the latest building regulations. 3 speed motor, trickle ventilation mode, optional range of switches available.

Stock Ref
14120020

HR200WK Controller

A three position rotary control which enables the unit to be switched from permanent trickle ventilation to either medium or boost speed.

Stock Ref
563533

Dimensions (mm)

A	B	C	D	E	F
270	270	245	85	68min	335max

Weight 9.7kg

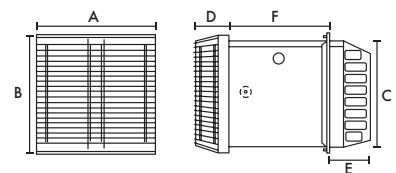

Wall fixing hole 250mm x 250mm sq.

Performance

	Performance l/s (m ³ /h)			% Heat Recovery	Sound dB(A) @ 3m	SEC Class	SEC Class (inc. LDC)
	Extract	Intake	Watts				
Speed 1	16 (60)	13 (50)	25	75	19	D	B
Speed 2	30 (110)	27 (100)	60	70	33		
Speed 3	61 (220)	55 (200)	140	65	46		

HR300

Single Room Heat Recovery Unit



Features & Benefits

- Designed for continuous operation, providing up to 70% heat recovery
- Controls condensation and eliminates mould
- Speed controllable
- Quiet operation
- Washable filters

Heat Recovery Ventilation

The HR300 provides ventilation with heat recovery. It is ideal for light commercial applications including function rooms, offices, classrooms etc. The HR300 unit comes complete with an integral shutter.

Performance

The HR300 unit is designed for continuous operation providing up to 70% heat recovery. Effectively lowering internal relative humidity the HR300 unit controls condensation and eliminates mould.

Fresh, pre-warmed air from the outside is continually supplied to the room with simultaneous extraction of stale moist air and smells. Heat is transferred via a unique plastic heat exchanger from outgoing air to the fresh air supply with no cross contamination, maintaining internal temperatures and providing a fresh indoor environment.

The unit is fully controllable for speed using a small dedicated speed controller. Automatic ON/OFF control or switching to boost is easily achieved using sensors/timers e.g. humidistat. For summer operation the heat exchanger can be removed and replaced with a plastic divider board to provide positive cooling to rooms.

Installation

The HR300 unit requires a 380mm x 280mm hole. Units should be level and square in the wall. The unit should be fitted so that it overhangs by a minimum of 50mm on the inside, and a minimum of 70mm on the outside. An extension sleeve is available for walls up to 650mm thick.

Maintenance

The heat exchanger should be washed in warm soapy water every twelve months, or as conditions necessitate. Access to the filter and heat exchanger is via two screws on the internal grille.

Filters should be cleaned by washing every six months or as conditions necessitate. Replacement filters can be purchased in packs of two.

Accessories

Filters
Stock Ref
370402

Extension Sleeve
Stock Ref
370422

Electronic Controller
Stock Ref
W300310

VCON6 Controller
Stock Ref
370356

Models

HR300
Stock Ref
370394

Dimensions (mm)

A	B	C
370	270	400

Weight 11kg

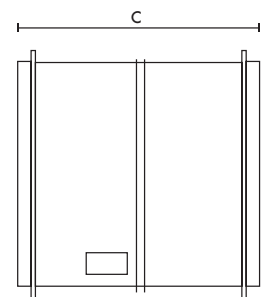
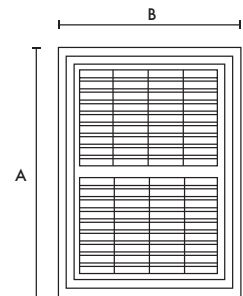

Performance

Model	Extract Performance l/s (m ³ /h)			Intake Performance l/s (m ³ /h)			Max Watts	Sound dB(A) @ 3m			SEC Class (inc. LDC)	
	Low	Normal	Boost	Low	Normal	Boost		Low	Normal	Boost		
HR300	20 (75)	58 (210)	83 (300)	19 (70)	52 (190)	75 (270)	108	37	40	44	D	A

MVHR units for residential & commercial

A complete range of Mechanical Ventilation with Heat Recovery (MVHR) units for residential and commercial applications, including many that are recognised in the SAP Product Characteristics Database.

Lo-Carbon Sentinel Kinetic® Advance

The first of our new generation of MVHR systems incorporating a range of unique features. Offering units with wifi and app control options along with integrated digital controls for easy installation the range is designed with developers, specifiers and installers in mind. With over 90% efficiency and low specific fan powers down to 0.38 W/l/s, designers will see a reduction in their dwelling emission rate.



	NEW Lo-Carbon Sentinel Kinetic® Advance MVHR Units	60-61
	Lo-Carbon Sentinel Kinetic® Range Overview	62-63
	Lo-Carbon Kinetic® Range Overview	64-65
	Lo-Carbon Sentinel Kinetic® MVHR Units	66-69
	NEW Lo-Carbon Sentinel Kinetic® F MVHR Units	70-73
	Lo-Carbon Sentinel Kinetic® Plus MVHR Units	74-77
	NEW Lo-Carbon Sentinel Kinetic® High Flow MVHR Unit	78-79
	Lo-Carbon Sentinel Kinetic® Cooker Hood MVHR Units	80-83
	Lo-Carbon Sentinel Kinetic® Horizontal MVHR Units	84-89
	Lo-Carbon Kinetic® Plus E MVHR Unit	90-93
	Integra Ducted MVHR Unit	94
	Integra Plus Ducted MVHR Unit	95
	HR100R/RS Ducted MVHR Units	96
	HR200V Ducted MVHR Unit	97
	HR500 Single Room Heat Recovery Units	98
	HR500D Ducted MVHR Unit	99
	HR500EP/IP Passive HR Units	100
	HR500DP Passive HR Unit	101

Vent-Axia

MVHR Units



NEW Lo-Carbon Sentinel Kinetic® Advance MVHR Units

Features & Benefits

- Ultra quiet
- Touch screen controller
- Lightweight for easier installation
- 100% Summer bypass
- WiFi connectivity option
- Wireless commissioning
- Pre-commissioning via USB
- App control option
- Left/Right handing through the controller
- Pre-heater option for cold climates
- Post-heater control option
- Developed and manufactured in the UK
- G3, M5 and F7 filter options

The Sentinel Kinetic® Advance from Vent-Axia is the next generation of heat recovery ventilation systems. It is designed to offer the highest level of comfort and control available ensuring the best possible customer experience.

A whole new experience

The highly sculpted interior surfaces, designed using the latest CFD techniques, ensures airflows are maximised through the unit minimising noise and energy use. This feature alone provides an experience which we are confident will delight home owners and fulfil our ambition of providing the most discrete and efficient ventilation available.

With the widest range of options available, installers can now order a system that is tailored to their client's needs.

Air Quality and Health

We have strived to make the Advance system the most flexible solution available on the market. Optimisation has been targeted in every aspect of the design to ensure that it really does improve quality of life. Whatever the outside environment, we have a method to help reduce air pollution from entering the living space. Our range of filter options, up to and including F7, ensure that even homes in

heavily urbanised areas have the opportunity to filter out the impurities and help protect their family from respiratory issues.

Nuisance noise – There isn't any...

The most common concern with home owners is that ventilation devices create noise. With Advance, absolute optimisation of every element does everything possible to minimise generation and transmission of both motor and airflow noise. We believe that we have one of the quietest units available.

Ventilation how you want it

We have spent our time considering every element of the ventilation control. Should you want to run the system at certain times and at certain speeds, all of the options are available for you. With a programmable controller, it is possible to boost the unit if required, for example during hot periods in the summer, or even reduce the speed if needed, perhaps when a baby is due to go to bed. Whatever the situation, Advance can be made to operate as needed.

At the same time, automatic functions such as frost protection and summer bypass even have a choice of algorithms designed to suit different climates and lifestyles.

Controllability

With building services often hidden away in cupboards or in lofts we have developed a number of options for system control. From an App which provides instant access wherever you are, to full on-board touch screen controls, an option will be available to support your needs.

Model

Model Stock Ref
Advance S 405215
Advance SX 405216

Accessories

Model Stock Ref
Wifi Controller 409195

Dimensions (mm)

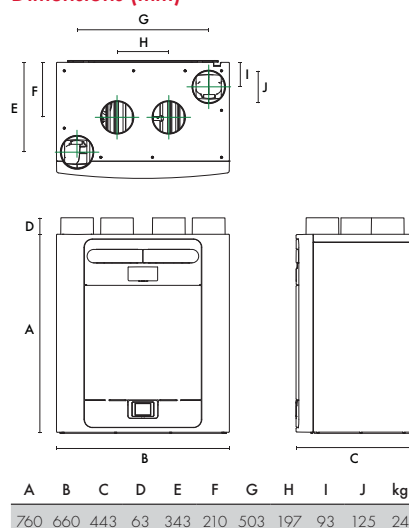

SAP PCDB Test Results

	Thermal	
	Efficiency %	SFP (W/l/s)
K+1	93	0.38
K+2	93	0.38
K+3	92	0.42
K+4	92	0.50
K+5	91	0.58
K+6	91	0.68
K+7	90	0.82

SEC Rating

Model	SEC Class
Advance S/SX	A+

Spigot Configuration

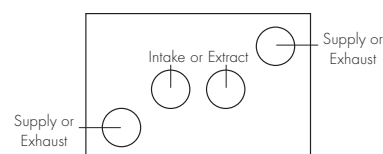

Hand-able through controller (except if pre-heater fitted)



Range Overview

Models	Advance S	Advance SX
Sentinel Touch Screen Controller	✓	✓
App Control	○	✓
App Commissioning	○	✓
Auto 100% Summer Bypass	✓	✓
Easy Access Filters	✓	✓
G3 Filter	✓	✓
M5, F7 Filter Options	✓	✓
Very Low Noise Levels	✓	✓
Built-In Humidistat	✓	✓
Active Frost Protection to -20C	✓	✓
Delay-On	✓	✓
Clean Filter Indicator (Time)	✓	✓
Clean Filter Indicator (Pressure)	X	✓
Fault Code Indicator	✓	✓
Switched Live	✓	✓
Volt Free	✓	✓
0V - 10V Proportional Control	✓	✓
BMS Input/Output	X	✓
Lightweight	✓	✓
22mm or 32mm Condensate Connection	✓	✓
Left/Right Orientation Through Control	✓	✓
Ventwise Control	○	○
PIN Number Lock	✓	✓
Running Time Indicator	✓	✓
Pre-Heater Controller	○	○
Post-Heater Controller	○	○
Enthalpy Heater Exchanger	○	○
Fan Curve Flow	✓	✓
Constant Volume	X	✓
Constant Pressure	X	✓
Email/Text Status Notifications	X	✓
Soft-Start Boost	✓	✓

Mounting Options



○ - Optional extra contact us for more information

Maximum Airflow

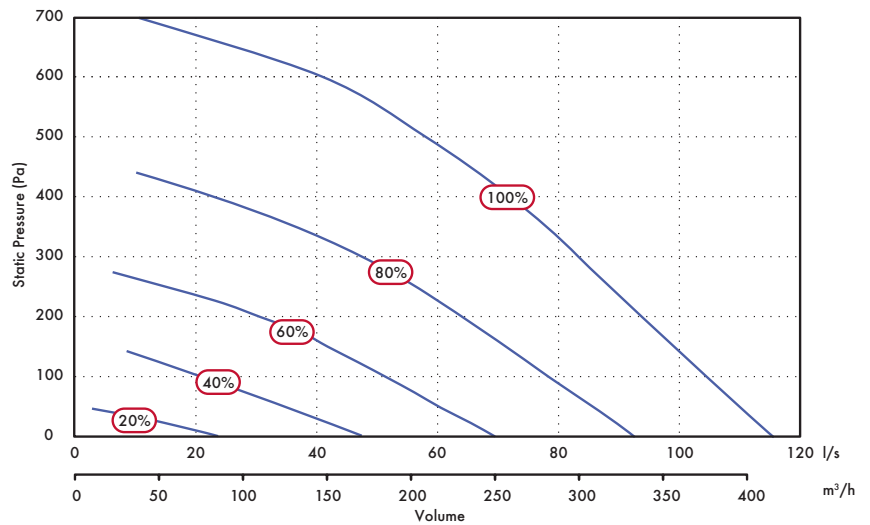

Sound Spectrum

Breakout	63Hz	125Hz	250Hz	500Hz	1kHz	2kHz	4kHz	8kHz	SPL dB(A) @3m
20%	30.7	28.3	32.2	26.9	18.6	15.3	17.9	21.5	8.4
40%	42.6	39.2	43.9	39.2	31.5	26.3	24.1	22	19.6
60%	60.2	49.5	48.2	47.4	40.2	35.7	33.3	28.7	27.4
80%	58	56.3	50.4	62	44.8	42.1	38.1	35.3	38.4
100%	64.9	54.4	51.4	57.8	46.2	43.8	39.7	36.9	35.6

Lo-Carbon Sentinel Kinetic®

Range Overview

Mechanical Ventilation with Heat Recovery

Features & Benefits

- Manufactured in the UK
- Building Regulations ADF and ADL compliant
- Recognised in SAP Appendix Q
- Specific Fan Power down to 0.4 W/l/s
- Up to 94% heat recovery
- Fully automatic Summer bypass
- Horizontal and/or vertical duct outlets
- Integrated digital controller for simple and accurate commissioning
- Lightweight for easy installation
- External condensate connection
- Plug and play controls; Humidistat, Ventwise, Wireless Remote
- BMS connectivity
- LS inputs (Light Switch)
- Volt-free inputs
- Self diagnosis for simplified fault finding
- Adjustable delay On/delay Off timer
- 0V to 10V proportional inputs
- Enthalpy heat recovery option

The Sentinel Kinetic Range Incorporates:

- A wholehouse heat recovery system with up to 94% energy efficiency
- An easily accessible heat recovery cube protected by two removable G3 filters
- Two Lo-Carbon energy saving EC/DC fans which ensure long life (typically over double the life of AC motors) and lowest possible energy use
- Fully insulated construction with built-in condensation drain
- Specifically designed for new build constructions with a high level of insulation

The Lo-Carbon Sentinel Kinetic meets the latest requirements of the Building Regulations ADF and ADL for wholehouse system ventilation: System 4 - Continuous mechanical supply and extract with heat

recovery. The Lo-Carbon Sentinel Kinetic models have 3 fully adjustable speeds and a purge setting (maximum flow). Provided with the unit is a digital controller that can be used to preset the speeds to any required airflow within the performance range.

Integral Humidity Sensor

The integral humidity sensor (models with H suffix) increases speed in proportion to relative humidity levels, saving energy and reducing noise. The sensor also reacts to small but rapid increases in humidity, even if the normal trigger threshold is not reached. This unique feature ensures adequate ventilation, even for the smallest wet room. The night time relative humidity setback feature suppresses nuisance tripping as humidity gradually increases with falling temperature.

Optional M5 Supply Filters

Kinetic B, BH, V & Cooker Hoods Filter

Stock Ref

444199

Kinetic Plus Range Filter

Stock Ref

444201

For sensors see Accessories & Controllers section.

Sentinel Control

The Sentinel controller is the most advanced system available, providing Demand Control Ventilation (DCV), minimising energy consumption and noise levels, and optimising ventilation performance. Sentinel controlled units may be set to operate fully automatically or with varying levels of manual intervention.

Building Management System (BMS) Options

There are two levels of BMS available: Basic Output and full Electronic BMS.

Basic Output provides a 5 volt output from the LED terminals on the controller. This output occurs whenever a message appears in the digital display, for example; 'Check Filters' or a fault code. The output can also be converted to volt-free with the

addition of an optional Opto-Coupler.

Electronic BMS: A full range of two-way digital signals are available through the RJ11 connector on the control board. The BMS system provider will translate this signal to extract the desired data. Contact Vent-Axia to discuss your specific requirements.

LED Alarm

MVHR units are often installed in lofts or other locations where they are difficult to monitor. The optional remote LED alarm illuminates when any message is visible in the MVHR unit display panel. The LED alarm can be installed in a convenient location within the dwelling allowing end users to see that the unit requires attention.

Control Inputs

Five volt-free pairs of switch terminals for sensor inputs allow boosting from a full range of Vent-Axia controllers - humidistats, PIR, timers.

Two terminals with 0-24V outputs allow 0V to 10V proportional control by sophisticated controllers such as CO₂ sensors and proportional humidistats.

The optional Ventwise controller senses temperature rise in a bath/shower hot water supply and/or current in a cooker/hob electrical circuit to activate boost, ensuring additional ventilation when needed.

Switched-live for boosting via light switches (220-240 V AC) or manual Normal/Boost switches. This connection has the advantage of Delay-On and Delay-Off facility. Delay-On enables you to prevent the Boost airflow between 0 and 10 minutes, after a light switch has been activated. Delay-Off allows the Boost airflow to continue after a light switch is turned off to ensure effective clearance of humidity. This timer is adjustable between 0 and 25 minutes.



The units can be boosted incrementally via the on-board controller or the Wired Remote Controller: One press = 30 minutes, two presses = 60 minutes, three presses = continuous.

Optional Controls

LED Alarm with 15 metre cable

Stock Ref

448356

Wired Remote Controller with 15 metre cable

Stock Ref

443283

Wireless Enable Kit (includes one switch)

Stock Ref

441865

Additional Wireless Boost Switch

(max 3 switches)

Stock Ref

437827

Ventwise Controller (also requires sensors, see Accessories & Controllers section)

Stock Ref

441780

Purge Setting

The unit can be set to maximum flow (100%) by pressing and holding the Boost button on the unit itself or optional wired controller for 5 seconds. Purge will continue for two hours unless cancelled by pressing the Boost button again.

Summer Bypass

An internal damper operates when the external temperature is below the internal temperature, and the internal temperature is too high.

The bypass opens and allows the cooler outside air to help cool the dwelling.

Normal mode: Fans run on Normal speed with bypass open until the internal dwelling temperature falls below the set 'Indoor' (maximum desired) temperature.

Evening Purge mode: The fans run on Boost speed until the internal temperature falls below the set 'Indoor' temperature. If, after five hours the internal temperature is still above the set 'Indoor' temperature, the unit will switch down to normal speed for the remainder of the 'bypass open' period.

Night-time Purge mode: As Evening Purge, except that the unit will continue on Boost speed until the internal air temperature reaches the 'Outdoor' temperature set point (Default 14°C). This mode gives pre-cooling of the dwelling for the following day.

In Evening and Night Time Purge modes, the user can turn off the boost function by pressing the Boost button.

Frost Protection

In order to prevent frost forming inside the unit in winter conditions, the Kinetic range employs a sophisticated frost protection strategy that modifies the airflows ensuring heat recovery continues down to -20°C. Below this temperature, the units will operate as 'extract only' fans. If balanced ventilation is required at low temperatures, a duct pre-heater should be used.

System Cooker Hood Range



System canopy hoods are a motorless hood with extract being provided by the MVHR unit. When the Boost button on the canopy is activated, the MVHR unit goes to boost setting and the summer bypass opens preventing cooking by-products entering the heat exchanger cell.

White Pull-out System Hood

Stock ref

407509

Aluminium Pull-out System Hood

Stock ref

407206

Wired Remote Controller



Standard with horizontal units, optional extra with vertical units. Supplied with 15 metres of cable (max length), the Wired Remote Controller duplicates all the features of the on-board control panel, allowing commissioning, diagnosis and user control. Flush mounting, suitable for a single gang pattress box 16mm deep.

Lo-Carbon

Kinetic® Range Overview

Mechanical Ventilation with Heat Recovery

Model Range Overview

Sentinel Kinetic Range

Kinetic E Range



Model Ranges	Lo-Carbon Sentinel Kinetic			Lo-Carbon Sentinel Kinetic F	Lo-Carbon Sentinel Kinetic Plus	Lo-Carbon Sentinel Kinetic High Flow	Lo-Carbon Sentinel Kinetic Cooker Hood	Lo-Carbon Sentinel Kinetic Horizontal			Lo-Carbon Kinetic Plus E
	V	B	BH	F	Plus	High Flow	CH	200ZP/ ZPH	300ZH	200Z/ZH /ZMH*	Plus E
Auto Summer Bypass		✓	✓	✓	✓	✓	✓	✓	✓	✓	
Easy Access Filters	✓	✓	✓	✓	✓	✓	✓	✓	✓	✓	✓
Very Low Noise Levels	✓	✓	✓	✓	✓	✓	✓	✓	✓	✓	✓
Integral Cooker Hood							✓				
Built-In Humidistat			✓	✓	✓	✓	✓	✓			
Kitchen Cupboard Installation	✓	✓	✓	✓							
Max Airflow @ 100Pa	68	68	68	79	117	117	68	34	81	50	117
Frost Protection	✓	✓	✓	✓	✓	✓	✓	✓	✓	✓	✓
Delay-On	✓	✓	✓	✓	✓	✓	✓	✓	✓	✓	✓
Wired Remote Control	○	○	○	○	○	○	○	○	○	○	○
Wireless Boost	○	○	○	○	○	○	○	○	○	○	○
Clean Filter Indicator (Time)	✓	✓	✓	✓	✓	✓	✓	✓	✓	✓	✓
Fault Code Indicator	✓	✓	✓	✓	✓	✓	✓	✓	✓	✓	
Potentiometer Control											✓
Sentinel Control	✓	✓	✓	✓	✓	✓	✓	✓	✓	✓	
Switched Live	✓	✓	✓	✓	✓	✓	✓	✓	✓	✓	✓
Volt Free Contact	✓	✓	✓	✓	✓	✓	✓	✓	✓	✓	
0V - 10V Proportional Control	✓	✓	✓	✓	✓	✓	✓	✓	✓	✓	
BMS Input/Output	✓1	✓1	✓1	✓1	✓1	✓1	✓1	✓1	✓1	✓1	
Lightweight	✓	✓	✓	✓	✓	✓	✓	✓	✓	✓	✓
External Condensate	✓	✓	✓	✓	✓	✓	✓	✓	✓	✓	✓
Horizontal Duct Option	✓	✓	✓	✓	✓	✓	✓	✓	✓	✓	✓
Horizontal (Slab) Installation								✓	✓	✓	
Left/Right Orientation	✓	✓	✓	✓	✓	✓	✓	✓	✓	✓	✓
Ventwise Control	✓	✓	✓	✓	✓	✓	✓	✓	✓	✓	
PIN Number Lock	✓	✓	✓	✓	✓	✓	✓	✓	✓	✓	
Running Time Indicator	✓	✓	✓	✓	✓	✓	✓	✓	✓	✓	
Enthalpy Heater Exchanger		○	○	○	○	○	○				
Mounting Options											

○ - Denote Optional, 1- Seek technical advice from Vent-Axia. *ZMH rectangular spigot model.



Sentinel Demand Control

The Lo-Carbon Sentinel Kinetic Range can be used with a wide range of optional Vent-Axia controllers and sensors. Ranging from integral humidistats, through wireless controllers to wired remote sensors.



Wired Remote Controller

- Standard with horizontal units, optional extra with vertical units
- Supplied with 15 metres of cable (max length), the Wired Remote Controller duplicates all the features of the on-board control panel, allowing commissioning, diagnosis and user control
- Flush mounting, suitable for a single gang pattress box 16mm deep

Stock Ref
443283



Wireless Transmitter Controller Receiver Kit

- Manual boost
- Adjustable overrun timer
- Easy wireless installation
- Reduces installation time
- Future proof - add more controllers at any time

Stock Ref
441865



Wireless Transmitter Controller

- Additional controller for 441865
- A maximum of 4 controllers can be used per system
- Can be connected to other accessories (eg Humidistat) to send a boost signal wirelessly

Stock Ref
437827



Ambient Response Humidity Sensor

- Pullcord override and neon indicator
- Changeover relay switch
- Operating range: 30% - 90%RH
- Ambient operating temp. 5°C to 40°C
- 220-240V AC
- Will fit single gang box for surface mounting

Stock Ref
563550



Ecotronic Humidity Sensor

- Set Point adjustable
- Maximum switching load 1 amp inductive
- Pullcord override indicator
- Ambient operating temp. 0°C to 40°C
- Supply voltage 220-240V

Stock Ref
563532



Air Quality Sensor

- Ambient operating temp. 0°C to 50°C
- Min - Max mode or direct damper control
- Surface mounted
- 1 - 25 min O/R timer
- Supply voltage 220-240V

Stock Ref
563506



Normal Boost Switch

- A single gang switch to boost from low to high speeds on heat recovery systems
- 85 x 85 x 10mm (H x W x D)

Stock Ref
455213



Visonex PIR Sensor

- Fits any UK single gang mounting box
- Adjustable timer overrun (5-25 mins)
- Range of detection up to 10 metres
- Designed to meet IP43
- Ambient operating temp. range 0°C to 50°C

Stock Ref
459623



CO₂ + Temp Room Sensor

- 240V DC
- 0 - 2000ppm CO₂ working range
- 0 - 50°C working range
- Auto-calibrating NDIR CO₂
- Thin film platinum temperature sensor for high accuracy

Stock Ref
433257



Ventwise

- Automatically boosts fan when temperature of the supply pipe to a shower or bath increases
- Automatically boosts fan when electric hob is switched on
- Can be used in conjunction with manual override input
- Adjustable overrun timer
- 3 sensor inputs

Stock Ref
441780



Momentary Push Switch

- Compatible with Sentinel Kinetic range, the momentary switch boosts the unit for 30 minutes
- 85 x 85 x 10mm (H x W x D)

Stock Ref
448929



Normal Boost Switch with Light Indicator

- Single gang switch with LED illumination when in the Boost condition
- 85 x 85 x 10mm (H x W x D)

Stock Ref
449060



Normal Boost Switch - Stainless Steel

- A single gang switch to operate normal/boost functions on MVHR systems
- Brushed stainless steel finish
- 90 x 90 x 18 (H x W x D)

Stock Ref
437320



Isolator Relay Controller

- Allows fan unit to be isolated from other mains circuit when used with TIM2 trickle/boost switch or light switch control

Stock Ref
442030

Lo-Carbon Sentinel Kinetic®

MVHR Units

Features & Benefits

- Recognised in SAP Appendix Q
- Ultra quiet
- Lightweight for easier installation
- Horizontal duct option for space-saving installations
- Fits within a 290mm deep kitchen cupboard (B & BH)
- Integrated digital controller for simple and accurate commissioning
- Plug and play controls; Humidistat, Ventwise, Wireless Remote
- BMS connectivity
- LS inputs (Light Switch)
- Horizontal duct options
- Volt-free inputs
- Self diagnosis for simplified fault finding
- Adjustable delay On/delay Off timer

Easy Installation

The Sentinel Kinetic models can be mounted vertically in a roof space, hallway cupboard or kitchen or within a kitchen cupboard. When mounted in an unheated area ducting should be insulated. Ducting can be attached to the unit horizontally, vertically or both. Minimum internal depth of kitchen cupboard: V, B & BH models 290mm.

Left (L) or right (R) hand installation. The unit is supplied with duct spigots to outside on the right hand side. These can be reversed on site by simply removing the control panel, rotating the unit 180 degrees and re-attaching the control panel.

Spigot Options

The combination of spigot options allows installation in confined locations. If vertical and horizontal connection is required on the same outlet/inlet, additional spigots can be supplied.

The condensate drain can be taken out through the back, side or bottom of the unit. Using the fittings supplied, the final condensate connection is made outside the unit and can be completed after installation.

Integral Humidity Sensor (BH Models)

The integral humidity sensor increases speed in proportion to relative humidity levels, saving energy and reducing noise. The sensor also reacts to small but rapid increases in humidity, even if the normal trigger threshold is not reached. This unique feature ensures adequate ventilation, even for the smallest wet room. The night time relative humidity setback feature suppresses nuisance tripping as humidity gradually increases with falling temperature.

Models

Model	Stock Ref
Kinetic V	438342
Kinetic B Right	438222
Kinetic B Left	438222L
(with summer bypass)	
Kinetic BH Right	443319
Kinetic BH Left	443319L
(with summer bypass & humidity sensor)	

B & BH models available in left hand or right hand configurations (L).

Accessories

Model	Stock Ref
Wired Remote Controller	443283
Wireless Enable Kit	441865
Wireless Transmitter Controller	437827
Ventwise Controller	441780
LED alarm with 15m cable	448356
Kinetic V, B & BH	Stock Ref
Kinetic Spare Filter 2 pk	442356
M5 Pollen Filter	444199

Dimensions (mm)

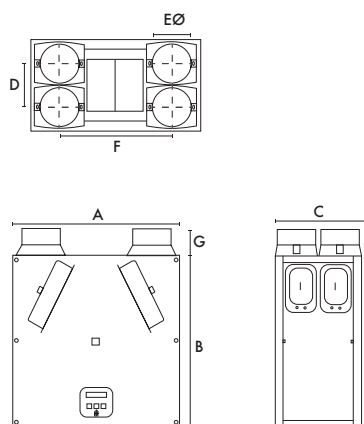

A	B	C	D	EØ	F	G	kg
550	550	285	140	125	360	90	15

SAP PCDB Test Results (Kinetic V)

	Thermal	
	Efficiency %	SFP (W/l/s)
K+1	90	0.60
K+2	90	0.59
K+3	90	0.68
K+4	89	0.79
K+5	90	0.97

SEC Rating

Model	SEC Class
Kinetic V/B/BH	A



Performance

Fan speeds are fully adjustable within the performance range.

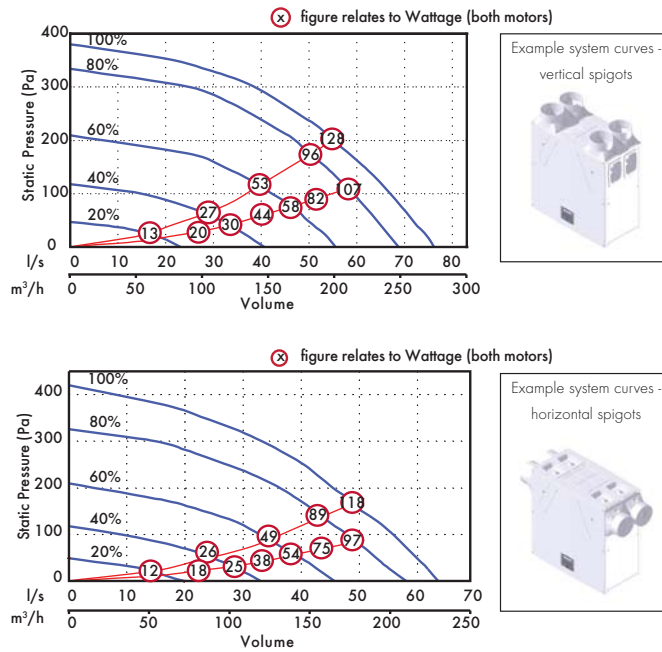

Sound Data (Kinetic B & V)

Flow l/s	Test mode	Octave band, Hz, dB SWL								SPL dB(A) @ 3m
		63	125	250	500	1K	2k	4K	8K	
10	Supply	47.8	40.2	38	31.1	28.2	22.1	23.6	30.9	21.4
	Extract	47	38.7	36	29.9	25	22.4	23.3	30.8	20.6
	Breakout	43.6	36.2	37.4	30.9	27.4	23.3	24.2	31.4	18.6
20	Supply	54	46.6	50.2	44.5	44.4	38.3	28.8	31.9	31.2
	Extract	46.8	40.5	34.6	34.2	34.6	25.9	23.7	30.3	22.9
	Breakout	45.9	39.9	40.6	35.7	33.5	28.4	25.3	31.2	21.3
30	Supply	58.1	54.5	57.6	52.2	51.7	47.6	38.6	35.8	38.5
	Extract	47.6	46.2	38.7	41.3	42.8	33.9	26.4	30.5	28.4
	Breakout	45.2	42.4	48.2	40.8	37.7	35.2	30	31.1	25.2
40	Supply	65.2	58.4	62.3	58	56.5	52.5	44.1	41.4	43.6
	Extract	53.5	53	44	47.7	48.1	39.7	31.5	31.5	33.5
	Breakout	50.9	47.6	47.4	48.1	42.5	40.8	36.3	34.4	29.3
50	Supply	66.4	63.2	66.3	62.5	61.7	57.4	50	47.8	48.3
	Extract	64.2	55.2	48	50.9	52.1	44.5	35.9	35	37.2
	Breakout	55	51	51.3	51.6	46.9	46.0	42	38.3	33.2

Tested according to BS848. Breakout quoted spherical. Supply and Extract quoted hemispherical.

Lo-Carbon Sentinel Kinetic®

Consultant's Specification (B and BH Models)

Operation

The supply and extract ventilation unit shall be a Sentinel Kinetic as manufactured by Vent-Axia and shall be sized as indicated on the drawings and shall be in accordance with the particular specification.

Supply air to the room shall be pre-heated by the extract air via the integrated composite plastic counterflow heat recovery cell. The Sentinel Kinetic shall automatically vary the ventilation rate via EC/DC motors, as it receives signals from one of the optional interconnected sensors. When a signal is received, the fans shall either vary their speed proportionally or on a trickle and boost principle.

The unit shall have the facility to commission the supply and extract fans individually via in-built minimum and maximum speed adjustment, or alternative wired remote control unit. The fans themselves shall have independent, infinitely variable speed control.

Unit specification

The unit shall be manufactured with an ABS outer case construction, and incorporate a reversible core to allow for left or right hand mounting.

The unit shall have a high efficiency composite plastic counterflow heat exchanger, supply and extract filters, automatic summer bypass, (B/BH) integral minimum and maximum infinitely variable speed controls with fascia mounted failure indication. The unit shall have low energy, high efficiency EC/DC fan/motor assemblies with sealed for life bearings. The impellers shall be high efficiency forward curved centrifugal type.

The unit shall have a heat exchanger cell with a thermal efficiency of up to 92% when tested to EN 308. This shall be protected by G3 grade synthetic filters on supply and extract. Complete with a condensate drip tray and drain connection.

The unit shall be constructed with a removable Core allowing full maintenance access. The removable Core shall provide access to the following:

- ✓ Supply and extract filter
- ✓ Heat exchanger
- ✓ Access to the electrical connections

Access shall be provided for wiring termination and setup/commissioning. The backlit LCD user interface therein shall be removable for remote mounting if required.

Units shall be as manufactured by Vent-Axia Ltd.

Standard controls

All Sentinel Kinetic units shall incorporate the following functions integrally mounted, pre-wired and factory fitted by the manufacturer:

- ✓ Integral infinitely variable fan speed control on supply and extract
- ✓ Integral min/max ventilation control/set point
- ✓ Integral BMS interfaces - control and status indication
- ✓ Heating interlocks
- ✓ 0-10V proportional speed adjustment
- ✓ Volt free contacts
- ✓ 24V sensor supply
- ✓ Integral on/off or trickle boost function from remote switch e.g. PIR occupancy detector
- ✓ The unit shall be controlled by the 'Sentinel' control devices (enablers and sensors) as detailed in the schedule or on the drawings
- ✓ Fully automatic summer bypass
- ✓ Switched Live input with adjustable 'delay-on' feature
- ✓ Fan failure or component failure indicated via individual fault code display
- ✓ Running time counter
- ✓ Control panel PIN number lock
- ✓ Automatic frost protection effective to -20°C
- ✓ Tool free filter access

- ✓ The unit shall incorporate ('H' models) an integral humidity sensor with the following features:

- Ambient Response; Raises the humidity trigger point as dwelling temperature reduces
- Rapid Response; Monitors the rate of change in humidity and triggers increased airflow even if the humidity trigger threshold is not reached
- Proportional Response; Incrementally increases the fan speed to reduce noise and reduce energy consumption

Airflow Direction

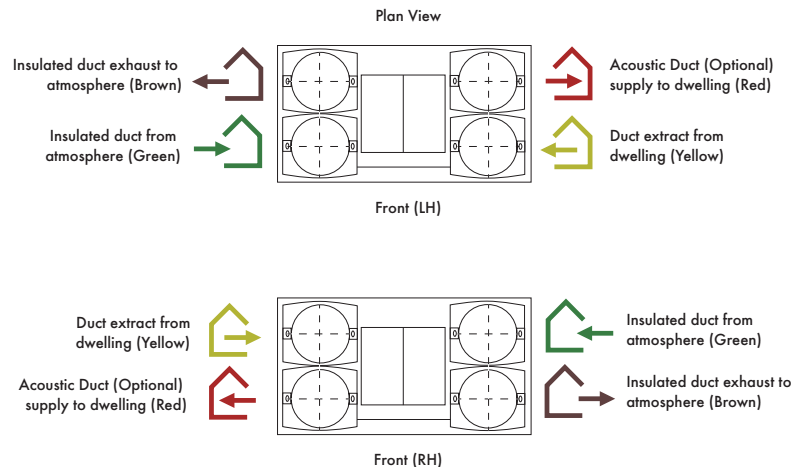

Electrical Connection (B and BH Models)

Please note: Electrical connection should be carried out by an appropriately qualified person and in accordance with current wiring regulations.

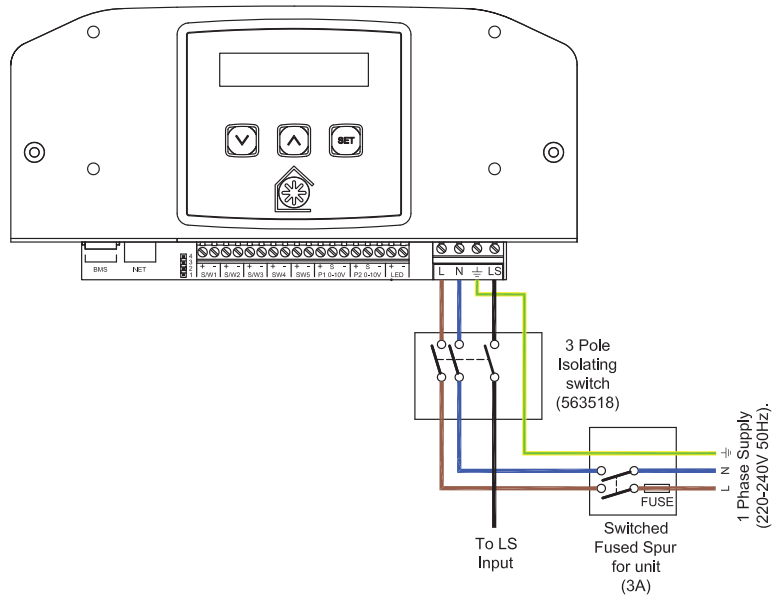

Trickle to Boost by Trickle/Boost switch

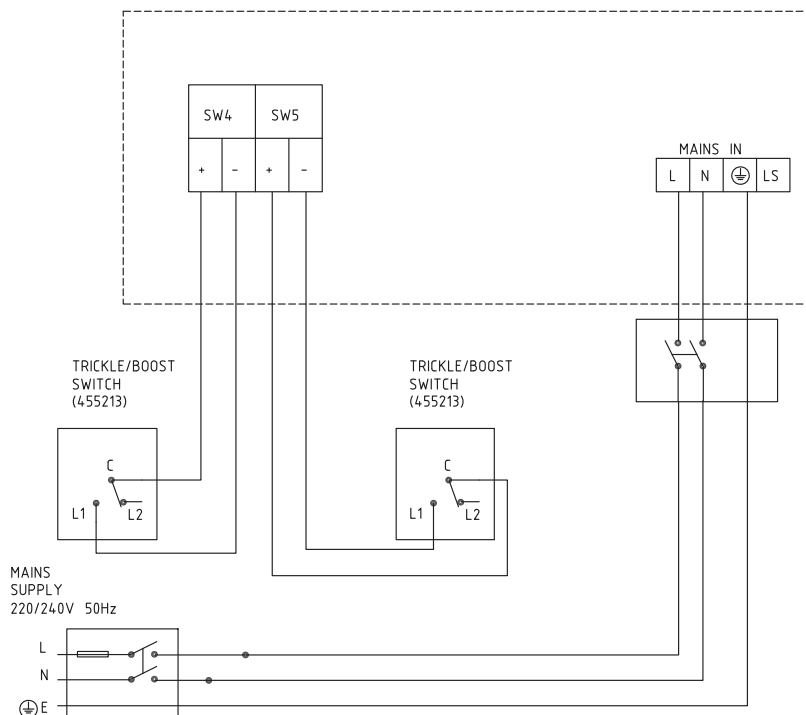

NEW Lo-Carbon Sentinel Kinetic® F MVHR Units

Features & Benefits

- Ultra quiet
- Lightweight for easier installation
- Horizontal duct option for space-saving installations
- Integrated digital controller for simple and accurate commissioning
- Plug and play controls; Humidistat, Ventwise, Wireless Remote
- BMS connectivity
- LS inputs (Light Switch)
- Volt-free inputs
- Self diagnosis for simplified fault finding
- Adjustable delay On/delay Off timer

Easy Installation

The Sentinel Kinetic models can be mounted vertically in a roof space or in an appropriate cupboard within the dwelling. When mounted in an unheated area the ducting and unit must be insulated in accordance with the Domestic Ventilation Compliance Guide. Ducting can be attached to the unit horizontally, vertically or both.

Left (L) or right (R) hand installation. Left hand and right hand units are available.

Spigot Options

The combination of spigot options allows installation in confined locations. If vertical and horizontal connection is required on the same outlet/inlet, additional spigots can be supplied.

The condensate drain can be taken out through the back, side or bottom of the unit. Using the fittings supplied, the final condensate connection is made outside the unit and can be completed after installation.

Integral Humidity Sensor

The integral humidity sensor increases speed in proportion to relative humidity levels, saving energy and reducing noise. The sensor also reacts to small but rapid increases in humidity, even if the normal trigger threshold is not reached. This unique feature ensures adequate ventilation, even for the smallest wet room. The night time relative humidity setback feature suppresses nuisance tripping as humidity gradually increases with falling temperature.

Model	Stock Ref
Kinetic FH Right	408167
(right handed with summer bypass & humidity sensor)	
Kinetic FHL Left	408169
(left handed with summer bypass & humidity sensor)	

Accessories

Model	Stock Ref
Wired Remote Controller	443283
Wireless Enable Kit	441865
Wireless Transmitter Controller	437827
Ventwise Controller	441780
LED alarm with 15m cable	448356
Kinetic Spare Filter 2pk	409158

Dimensions (mm)

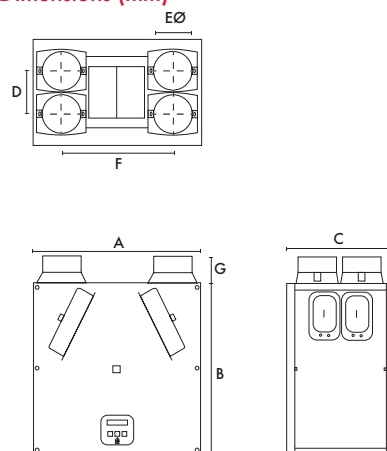

A	B	C	D	EØ	F	G
555	550	350	140	125	360	90

Weight: 18kg

SAP PCDB performance

	Thermal	
	Efficiency %	SFP (W/l/s)
K+1	90	0.53
K+2	89	0.51
K+3	88	0.56
K+4	87	0.65
K+5	85	0.75

SEC Rating

Model	SEC Class
Kinetic FH/FHL	A+



Target Performance

Fan speeds are fully adjustable within the performance range.

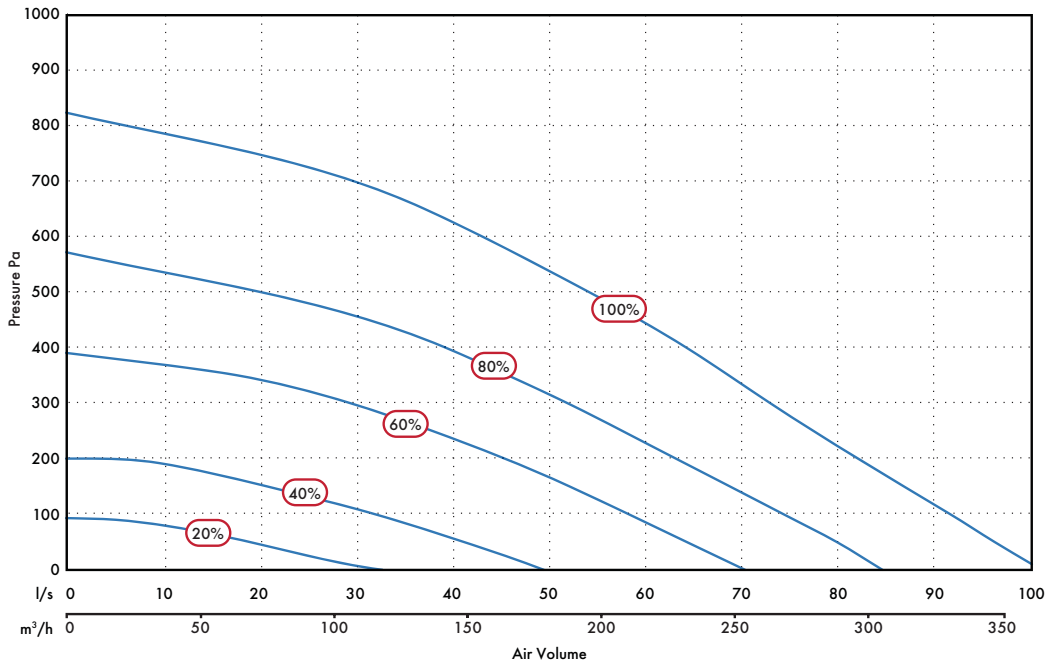

Sound data to follow. Please view our website for the latest information.

Lo-Carbon Sentinel Kinetic® F

Consultant's Specification

Operation

The supply and extract ventilation unit shall be a Sentinel Kinetic as manufactured by Vent-Axia and shall be sized as indicated on the drawings and shall be in accordance with the particular specification.

Supply air to the room shall be pre-heated by the extract air via the integrated composite plastic counterflow heat recovery cell. The Sentinel Kinetic shall automatically vary the ventilation rate via EC/DC motors, as it receives signals from one of the optional interconnected sensors. When a signal is received, the fans shall either vary their speed proportionally or on a trickle and boost principle.

The unit shall have the facility to commission the supply and extract fans individually via in-built minimum and maximum speed adjustment, or alternative wired remote control unit. The fans themselves shall have independent, infinitely variable speed control.

Unit specification

The unit shall be manufactured with an ABS outer case construction, and incorporate a reversible core to allow for left or right hand mounting.

The unit shall have a high efficiency composite plastic counterflow heat exchanger, supply and extract filters, automatic summer bypass, integral minimum and maximum infinitely variable speed controls with fascia mounted failure indication. The unit shall have low energy, high efficiency EC/DC fan/motor assemblies with sealed for life bearings. The impellers shall be high efficiency backward curved centrifugal type.

The unit shall have a heat exchanger cell with a thermal efficiency of up to 87% when tested to EN 308. This shall be protected by G3 grade synthetic filters on supply and extract. Complete with a condensate drip tray and drain connection.

The unit shall be constructed with a removable Core allowing full maintenance access. The removable Core shall provide access to the following:

- ✓ Supply and extract filter
- ✓ Heat exchanger
- ✓ Access to the electrical connections

Access shall be provided for wiring termination and setup/commissioning. The backlit LCD user interface therein shall be removable for remote mounting if required.

Units shall be as manufactured by Vent-Axia Ltd.

Standard controls

All Sentinel Kinetic units shall incorporate the following functions integrally mounted, pre-wired and factory fitted by the manufacturer:

- ✓ Integral infinitely variable fan speed control on supply and extract
- ✓ Integral min/max ventilation control/set point
- ✓ Integral BMS interfaces - control and status indication
- ✓ Heating interlocks
- ✓ 0-10V proportional speed adjustment
- ✓ Volt free contacts
- ✓ 24V sensor supply
- ✓ Integral on/off or trickle boost function from remote switch e.g. PIR occupancy detector
- ✓ The unit shall be controlled by the 'Sentinel' control devices (enablers and sensors) as detailed in the schedule or on the drawings
- ✓ Fully automatic summer bypass
- ✓ Switched Live input with adjustable 'delay-on' feature
- ✓ Fan failure or component failure indicated via individual fault code display
- ✓ Running time counter
- ✓ Control panel PIN number lock
- ✓ Automatic frost protection effective to -20°C
- ✓ Tool free filter access

- ✓ The unit shall incorporate ('H' models) an integral humidity sensor with the following features:

- Ambient Response; Raises the humidity trigger point as dwelling temperature reduces
- Rapid Response; Monitors the rate of change in humidity and triggers increased airflow even if the humidity trigger threshold is not reached
- Proportional Response; Incrementally increases the fan speed to reduce noise and reduce energy consumption

Airflow Direction

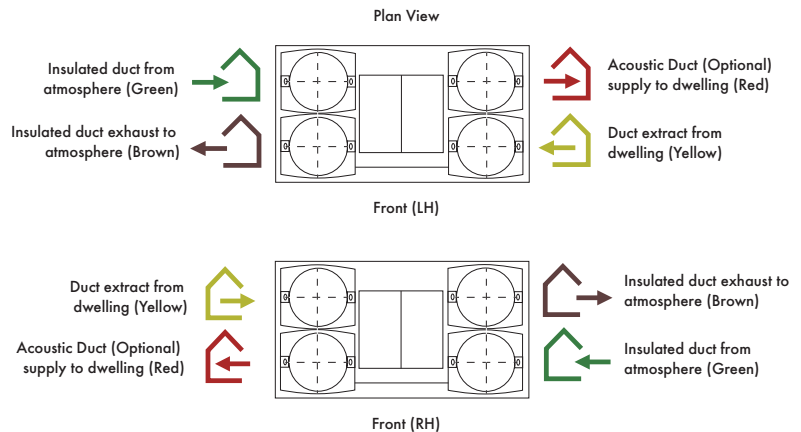

Electrical Connection

Please note: Electrical connection should be carried out by an appropriately qualified person and in accordance with current wiring regulations.

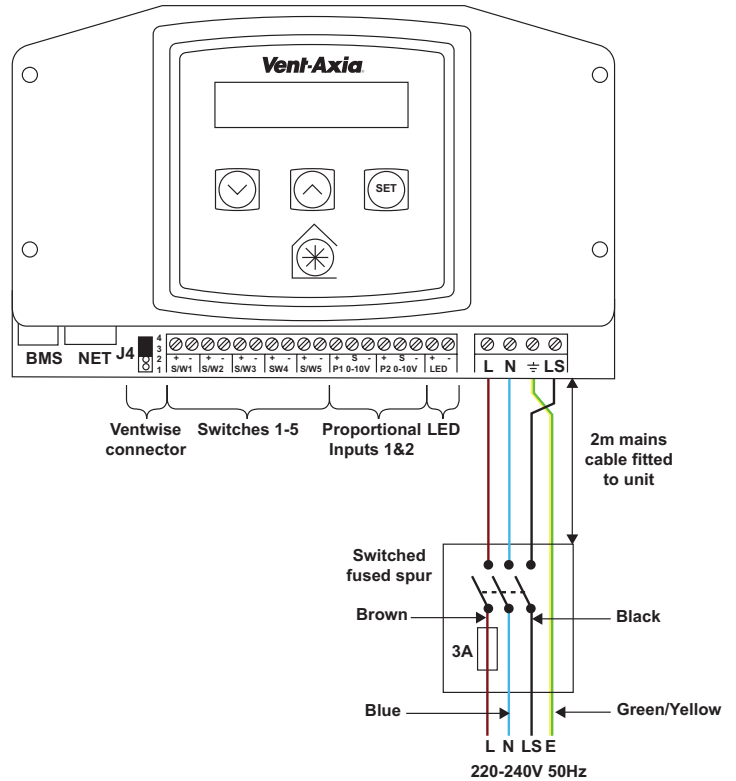

Trickle to Boost by Trickle/Boost switch

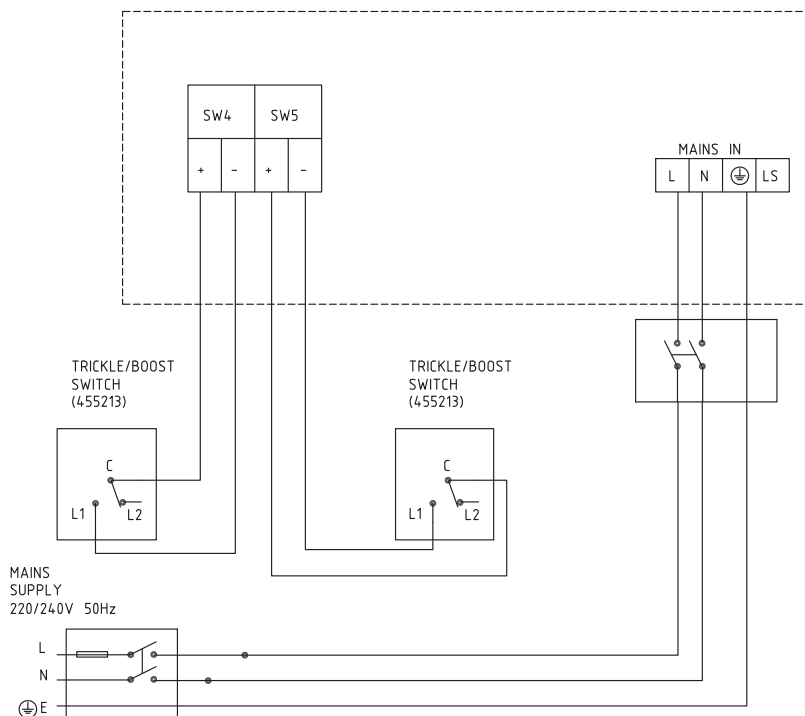

Lo-Carbon Sentinel Kinetic® Plus MVHR Unit

Features & Benefits

- Recognised in SAP Appendix Q
- Ultra quiet
- Horizontal duct option for space-saving installations
- High airflow, ideal for student accommodation clusters
- Unique folding filter for removal when access is restricted
- Integrated digital controller for simple and accurate commissioning
- Lightweight for easy installation
- Plug and play controls; Humidistat, Ventwise, Wireless Remote
- BMS connectivity
- LS inputs (Light Switch)
- Volt-free inputs
- Self diagnosis for simplified fault finding
- Adjustable delay On/delay Off timer
- Summer bypass and frost protection

Increased Performance

The Sentinel Kinetic Plus benefits from the latest high efficiency, backward curved impeller design, ensuring the lowest possible energy consumption, ultra quiet operation and an exceptional performance range covering small one bed apartments to the largest of houses.

Care Homes & Student Accommodation

The Sentinel Kinetic Plus is ideal for larger homes and multiple occupancy units such as care homes and student accommodation. Capable of 400m³/hr at 150Pa, the unit can extract from up to ten bathrooms and a communal kitchen while still achieving almost 90% heat recovery. The fully automatic capability of the Kinetic range means that adequate ventilation is always achieved.

The Kinetic's BMS capability is also ideal for those commercial applications where landlords or property managers want to monitor and optimise building performance and maintenance. The Kinetic BMS can provide status information and

its self diagnostics can report if any fault is found.

Spigot Options

Spigots may be re-positioned to give horizontal connection or a combination of vertical and horizontal connection.

Optional 180mm/200mm spigots can simplify connection in commercial installations where larger diameter duct work has been used.

Quick Change Filter

As many systems are placed within cupboards the unique filter design folds as you remove it to ensure easy access in restricted spaces.

Integral Humidity Sensor

The integral humidity sensor increases speed in proportion to relative humidity levels, saving energy and reducing noise. The sensor also reacts to small but rapid increases in humidity, even if the normal trigger threshold is not reached. This unique feature ensures adequate ventilation, even for the smallest wet room. The night time relative humidity setback feature suppresses nuisance tripping as humidity gradually increases with falling temperature.

Models

	Stock Ref
Kinetic Plus B Right	443028
Kinetic Plus B Left	443028L

Accessories

Model	Stock Ref
Wired Remote Controller	443283
Wireless Enable Kit	441865
Wireless Transmitter	437827
Controller	
Ventwise Controller	441780
LED Alarm with 15m cable	448356
Opto-coupler	447340
For volt-free bms connection	
Kinetic Spare Filters 2 pk.	443351
M5 Pollen Filter	444201
180mm/200mm Spigot Kit	446523
(One per pack)	

Dimensions (mm)

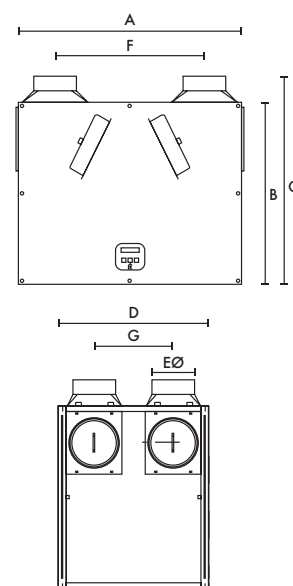

A	B	C	D	EØ	F	G
785	635	722	550	150	520	275

Weight: 24kg

SAP PCDB Test Results

	Thermal	
	Efficiency %	SFP (W/l/s)
K+1	91	0.51
K+2	91	0.40
K+3	90	0.41
K+4	90	0.45
K+5	90	0.53
K+6	90	0.60
K+7	90	0.70

SEC Class Rating

Model	SEC Class
Kinetic Plus B	A+



Performance

Fan speeds are fully adjustable within the performance range.

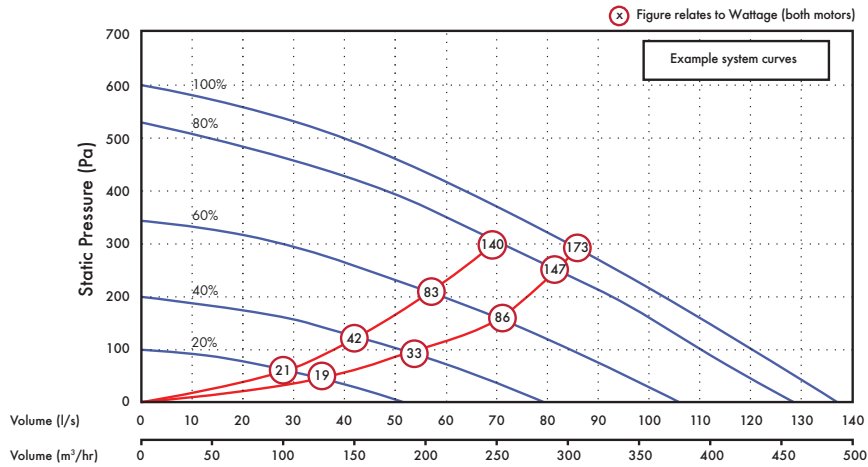

Sound Data

Flow l/s	Unit setting	Test mode	Octave band, Hz, dB SWL							SPL dB(A) at 3m	
			63	125	250	500	1k	2k	4k		8k
50	20%	Supply	46.5	54.3	46.4	44.8	36.2	28.5	24.5	31.2	28.5
		Extract	46	52.2	42.3	38.7	27.6	24.2	24	31.7	25
		Breakout	48.5	42.6	43.3	38.9	35.8	29.3	23.8	30.7	22.8
78	40%	Supply	50.3	59.1	54.5	56.5	47	39.9	26.3	31.7	38
		Extract	46.8	51.6	47.8	44.4	32.7	27.4	24.4	31.7	28
		Breakout	48.4	51.2	53.4	46	41	34.6	25	30.3	28.5
104	60%	Supply	52.4	57.2	60.4	60.9	55.8	50.3	33.1	33.9	43.6
		Extract	50	49.8	56.8	52.4	40.2	35.9	33.4	39.8	35.2
		Breakout	55	49.6	59.7	54.5	46.9	39.9	33.6	39.2	34.9
127	80%	Supply	54.9	60.7	67.4	66.6	61.8	56	39.6	37.7	49.5
		Extract	50.4	52	61.2	56.6	45.1	39.6	34.2	40.2	39.1
		Breakout	53.5	53.4	60.8	59.1	53	45.3	36	40.1	38.7
137	100%	Supply	54.7	61.7	70.5	69.9	62.7	57.5	42.1	38.3	52
		Extract	54.4	55.1	65.8	57.5	46.9	40.6	33.7	40	41.8
		Breakout	56.6	54.6	60.5	60.7	54.7	45.9	36.5	39.6	40

Lo-Carbon Sentinel Kinetic® Plus

Consultants Specification

Operation

The supply and extract ventilation unit shall be as Sentinel Kinetic Plus as manufactured by Vent-Axia and shall be sized as indicated on the drawings and shall be in accordance with the particular specification.

Supply air to the room shall be pre-heated by the extract air via the integrated composite plastic counterflow heat recovery cell. The Sentinel Kinetic Plus shall automatically vary the ventilation rate via EC/DC motors, as it receives signals from one of the optional interconnected sensors.

When a signal is received, the fans shall either vary their speed proportionally or on a trickle and boost principle.

The unit shall have the facility to commission the supply and extract fans individually via in-built minimum and maximum speed adjustment, or alternative wired remote control unit. The fans themselves shall have independent, infinitely variable speed control.

Unit specification

The unit shall be manufactured with an ABS outer case construction, and incorporate a reversible core to allow for left or right hand mounting.

The unit shall have a high efficiency composite plastic counterflow heat exchanger, supply and extract filters, automatic summer bypass, integral minimum and maximum infinitely variable speed controls with fascia mounted failure indication.

The unit shall have low energy, high efficiency EC/DC fan/motor assemblies with sealed for life bearings. The impellers shall be high efficiency backward curved centrifugal type.

The unit shall have a heat exchanger cell with a thermal efficiency of up to 92% when tested to EN 308. This shall be protected by G3 grade synthetic filters on supply and extract. Complete with a condensate drip tray and drain connection.

The unit shall be constructed with a removable Core allowing full maintenance access. The removable Core shall provide access to the following:

- ✓ Supply and extract filter
- ✓ Heat exchanger
- ✓ Access to the electrical connections

Access shall be provided for wiring termination and setup/commissioning. The backlit LCD user interface therein may be duplicated for remote mounting if required. Units shall be as manufactured by Vent-Axia Ltd.

Standard controls

All Sentinel Kinetic units shall incorporate the following functions integrally mounted, pre-wired and factory fitted by the manufacturer:

- ✓ Integral infinitely variable fan speed control on supply and extract
- ✓ Integral min/max ventilation control/set point
- ✓ Integral BMS input/output interfaces - control and status indication
- ✓ Heating interlocks
- ✓ 0-10V proportional speed adjustment
- ✓ Volt free contacts
- ✓ 24V sensor supply
- ✓ Integral on/off or trickle boost function from remote switch, e.g. PIR occupancy detector
- ✓ Fully automatic summer bypass
- ✓ Switched Live input with adjustable 'delay-on' feature
- ✓ Fan failure or component failure indicated via individual fault code display

- ✓ Running time counter
- ✓ Control panel PIN number lock
- ✓ Automatic frost protection effective to -20°C
- ✓ The unit shall incorporate an integral humidity sensor with the following features:
 - Ambient Response; Raises the humidity trigger point as dwelling temperature reduces
 - Rapid Response; Monitors the rate of change in humidity and triggers increased airflow even if the humidity trigger threshold is not reached
 - Proportional Response; Incrementally increases the fan speed to reduce noise and reduce energy consumption
- ✓ The unit shall be controlled by the 'Sentinel' control devices (enablers and sensors) as detailed in the schedule or on the drawings.
- ✓ Tool free filter access

Airflow Direction

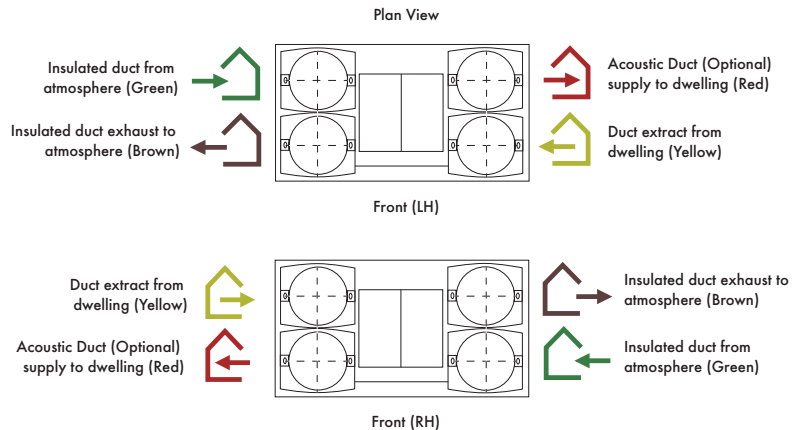

Electrical Connection

Please note: Electrical connection should be carried out by an appropriately qualified person and in accordance with current wiring regulations.

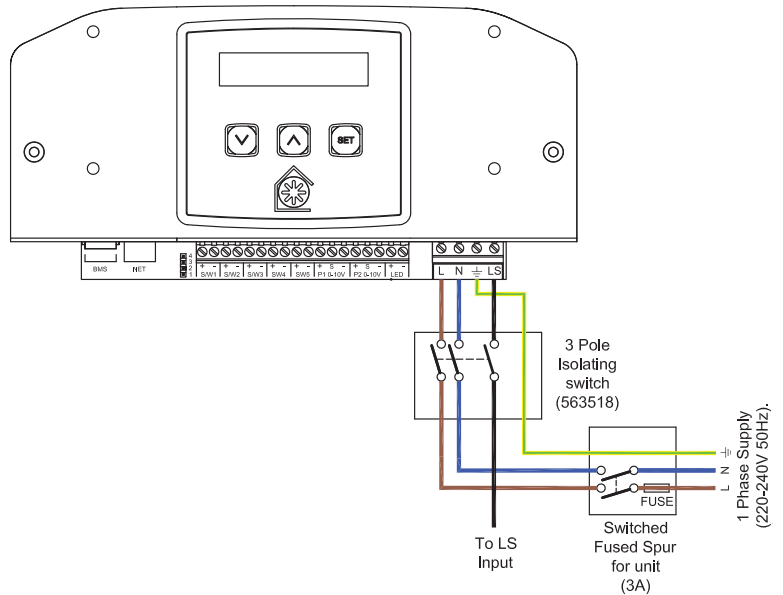

Trickle to Boost by two lighting circuits or Trickle/Boost switch

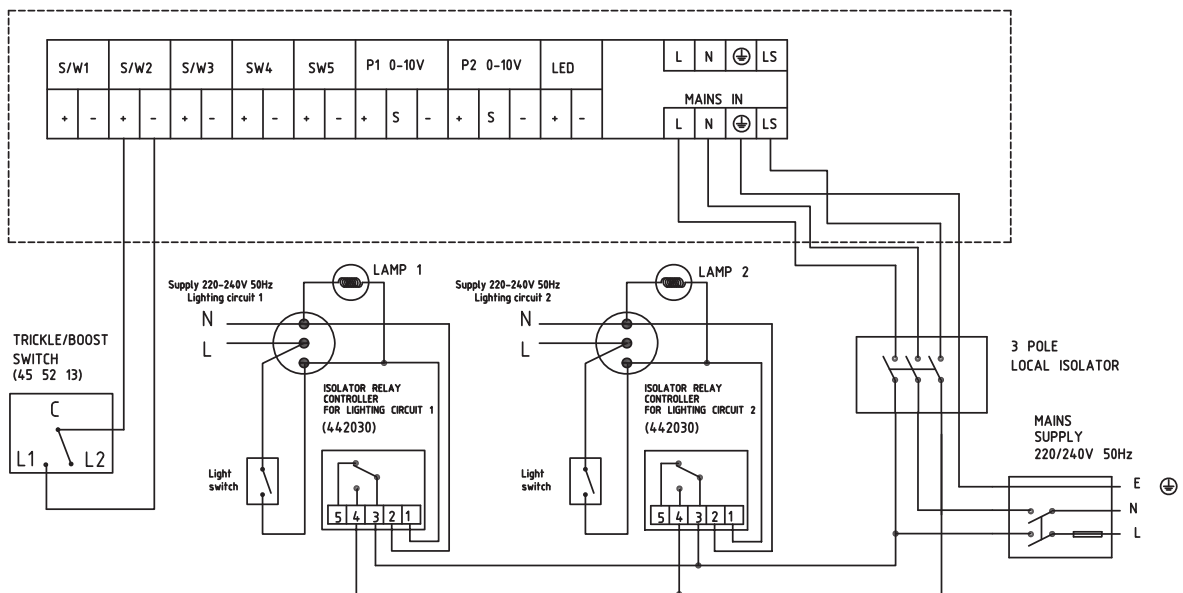

NEW Lo-Carbon Sentinel Kinetic® High Flow MVHR Unit

Features & Benefits

- Recognised in SAP Appendix Q
- 180mm/200mm spigots
- Horizontal duct option for space-saving installations
- High airflow, ideal for student accommodation clusters
- Unique folding filter for removal when access is restricted
- Integrated digital controller for simple and accurate commissioning
- Plug and play controls; Humidistat, Ventwise, Wireless Remote
- BMS connectivity
- LS inputs (Light Switch)
- Volt-free inputs
- Self diagnosis for simplified fault finding
- Adjustable delay On/delay Off timer
- Summer bypass and frost protection

Increased Performance

The **Sentinel Kinetic High Flow** benefits from the latest high efficiency, backward curved impeller design, ensuring the lowest possible energy consumption, and an exceptional performance range covering small one bed apartments to the largest of houses.

Care Homes & Student Accommodation

The **Sentinel Kinetic High Flow** is ideal for larger homes and multiple occupancy units such as **care** homes and student accommodation. Capable of **175l/s** at 150Pa, the unit can extract from up to **fourteen** bathrooms and a communal kitchen while still achieving almost 90% heat recovery. The fully automatic capability of the Kinetic range means that adequate ventilation is always achieved.

The Kinetic's BMS capability is also ideal for those commercial applications where landlords or property managers want to monitor and optimise building performance and maintenance. The Kinetic BMS can provide status information and its self diagnostics can report if any fault is found.

Spigot Options

180mm/200mm Spigots may be re-positioned to give horizontal connection or a combination of vertical and horizontal connection.

Models

	Stock Ref
Kinetic High Flow Right	408449
Kinetic High Flow Left	408451

For further details, see Sentinel Kinetic Plus.

SAP PCDB Test Results

Exhaust Terminal Configuration	Thermal Efficiency %	SFP (W/l/s)
K + 1	88%	0.65
K + 2	88%	0.54
K + 3	90%	0.52
K + 4	90%	0.55
K + 5	91%	0.6
K + 6	91%	0.66
K + 7	90%	0.74

SEC Rating

Model	SEC Class
Kinetic High Flow	A

Dimensions (mm)

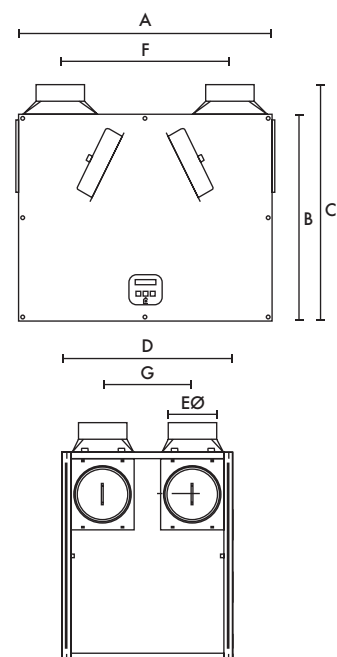

A	B	C	D	EØ	F	G
785	635	722	550	180/200	520	275

Weight: 34kg



Performance

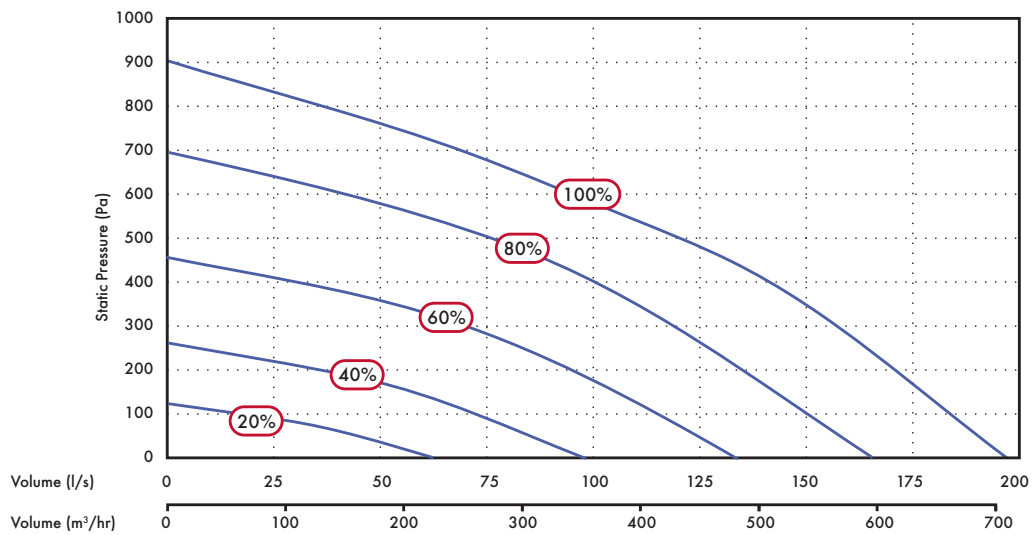

Sound Data

Test Mode	Flow %	Octave band, Hz, dB SWL								SPL dB(A) @ 3m
		63	125	250	500	1.0K	2.0K	4.0K	8.0K	
Supply	20	55.1	65.9	55.2	53.8	44.4	37.4	25.3	24.9	37.4
Extract		58.2	57.4	48	45.6	43.8	34.5	20	24.5	31.1
Breakout		43.3	46.6	44.9	44.7	41.8	30.4	21.6	22.5	25
Supply	40	63.1	69	67.1	64	55	51.6	39.7	32.4	46.8
Extract		58.6	58.4	60.1	53.7	41.9	41.5	31.7	25.1	37.5
Breakout		55.4	49.6	60.6	53.8	46.5	41.5	33.2	27.4	34
Supply	60	70.3	74.3	81.4	71.5	63.6	59.9	49.6	43.1	57.4
Extract		64.4	64.2	72.6	59.1	48.7	45.7	37.8	29.3	47.6
Breakout		62.8	54.6	65.7	57.2	55.5	49.2	41.4	36.4	40.5
Supply	80	75.3	77.9	88.1	78.7	68.4	65.1	56	50.1	64
Extract		71.1	68.2	73.6	61.8	51.9	49.5	42.7	37.6	49.1
Breakout		66.2	59	73.4	61.8	57	54.6	47.3	43.1	47.5
Supply	100	90.9	80.9	84.4	80.1	71.5	68	59.3	54.5	63.3
Extract		92.4	71.8	78.1	67.4	54.9	51.5	44.6	41.4	55.1
Breakout		69.3	62.9	74.9	67.5	59.2	56.6	49.1	44.7	49.5

Lo-Carbon Sentinel Kinetic® Cooker Hood

MVHR Units

Features & Benefits

- Recognised in SAP Appendix Q
- Includes Cooker Hood Canopy
- Ultra quiet
- Horizontal duct option for space-saving installations
- Fits within a 600mm wide aperture (300mm deep)
- Integrated digital controller for simple and accurate commissioning
- Plug and play controls; Humidistat, Ventwise, Wireless Remote
- BMS connectivity
- LS inputs (Light Switch)
- Volt-free inputs
- Self diagnosis for simplified fault finding
- Adjustable delay On/delay Off timer
- Summer bypass and frost protection

Easy Installation

Ducting can be attached to the unit horizontally, vertically or both. Minimum internal depth of kitchen cupboard: 300mm.

Horizontal and vertical spigots: The combination of spigot options allows installation in confined locations. If vertical and horizontal connection are required on the same outlet/inlet, additional spigots can be supplied.

The condensate connection can be taken through the rear of the unit or through the side of the unit into an adjacent cupboard prior to connection into pre-installed domestic waste water system.

Cooker Hood Unit

The Sentinel Kinetic Cooker Hood is designed to fit in a 600mm aperture above a hob. The telescopic hood incorporates two flat removable metal grease filters, low energy light bulbs and is available with a White or Brushed Aluminium front trim.

The hood contains an integral fire damper in accordance with BRE Digest 398 and is connected to the heat recovery unit by a galvanised steel duct

with access for cleaning. When the hood is opened, the heat recovery unit goes to boost speed and the summer bypass automatically opens to prevent cooking by-products entering the heat recovery cell. As an additional safety feature, the duct also contains a thermal cut-out fuse which turns off the MVHR unit in the event of excessive temperature in the airway. Cooker Hood units cannot be handed on-site and must be purchased as left hand (L) or right hand (R) models.

Models

Lo-Carbon Sentinel Kinetic with summer bypass and humidity sensor.

Model	Stock Ref
Kinetic CWH L (with White Cooker Hood)	446756
Kinetic CSH L (with Brushed Aluminium Cooker Hood)	446757
Kinetic CWH R (with White Cooker Hood)	446758
Kinetic CSH R (with Brushed Aluminium Cooker Hood)	446759

Integral Humidity Sensor

The integral humidity (models with H suffix) sensor increases speed in proportion to relative humidity levels, saving energy and reducing noise. The sensor also reacts to small but rapid increases in humidity, even if the normal trigger threshold is not reached. This unique feature ensures adequate ventilation, even for the smallest wet room. The night time relative humidity setback feature suppresses nuisance tripping as humidity gradually increases with falling temperature.

Accessories

Model	Stock Ref
Wired Remote Controller	443283
Wireless Enable Kit	441865
Wireless Transmitter	437827
Controller	
Ventwise Controller	441780
LED Alarm with 15m cable	448356
Opto-coupler	447340
For volt-free bms connection	
Kinetic Spare Filters 2 pk.	441774
M5 Pollen Filter	444200

Dimensions (mm)

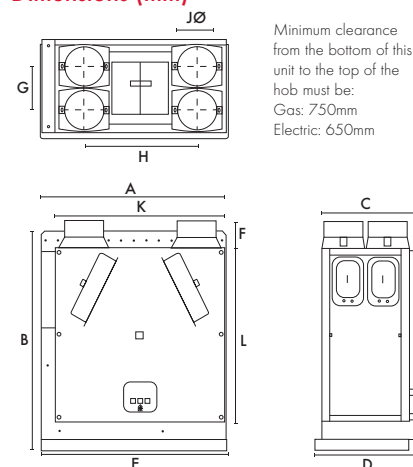

Weight: 27kg

A	B	C	D	E	F
590	710	295	316	598	90
G	H	Jø	K	L	
140	360	125	550	550	

SAP PCDB Test Results

	Thermal	
	Efficiency %	SFP (W/l/s)
K+1	85	0.72
K+2	85	0.74
K+3	84	0.83
K+4	83	0.92

SEC Class Rating

Model	SEC Class
Kinetic CWH/CSH	A+



Performance

Fan speeds are fully adjustable within the performance range.

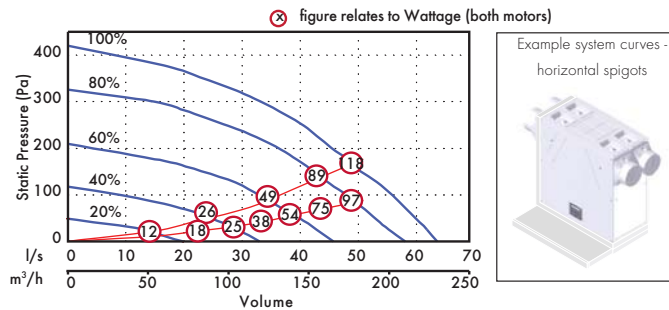
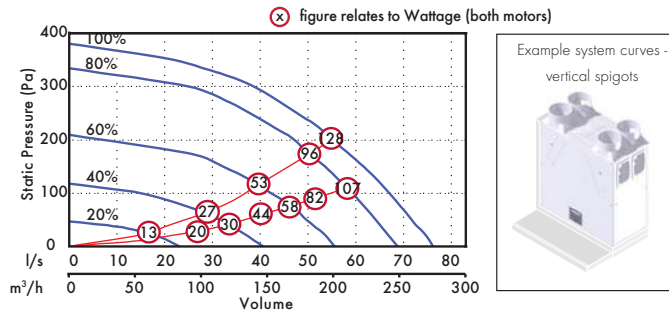

Sound Data

Flow l/s	Test mode	Octave band, Hz, dB SWL							SPL dB(A) @ 3m	
		63	125	250	500	1K	2k	4K		8K
10	Supply	47.8	40.2	38	31.1	28.2	22.1	23.6	30.9	21.4
	Extract	47	38.7	36	29.9	25	22.4	23.3	30.8	20.6
	Breakout	43.6	36.2	37.4	30.9	27.4	23.3	24.2	31.4	18.6
20	Supply	54	46.6	50.2	44.5	44.4	38.3	28.8	31.9	31.2
	Extract	46.8	40.5	34.6	34.2	34.6	25.9	23.7	30.3	22.9
	Breakout	45.9	39.9	40.6	35.7	33.5	28.4	25.3	31.2	21.3
30	Supply	58.1	54.5	57.6	52.2	51.7	47.6	38.6	35.8	38.5
	Extract	47.6	46.2	38.7	41.3	42.8	33.9	26.4	30.5	28.4
	Breakout	45.2	42.4	48.2	40.8	37.7	35.2	30	31.1	25.2
40	Supply	65.2	58.4	62.3	58	56.5	52.5	44.1	41.4	43.6
	Extract	53.5	53	44	47.7	48.1	39.7	31.5	31.5	33.5
	Breakout	50.9	47.6	47.4	48.1	42.5	40.8	36.3	34.4	29.3
50	Supply	66.4	63.2	66.3	62.5	61.7	57.4	50	47.8	48.3
	Extract	64.2	55.2	48	50.9	52.1	44.5	35.9	35	37.2
	Breakout	55	51	51.3	51.6	46.9	46.0	42	38.3	33.2

Lo-Carbon Sentinel Kinetic® Cooker Hood

Consultants Specification

Operation

The supply and extract ventilation unit shall be a Sentinel Kinetic as manufactured by Vent-Axia and shall be sized as indicated on the drawings and shall be in accordance with the particular specification.

Supply air to the room shall be pre-heated by the extract air via the integrated composite plastic counterflow heat recovery cell. The Sentinel Kinetic shall automatically vary the ventilation rate via EC/DC motors, as it receives signals from one of the optional interconnected sensors. When a signal is received, the fans shall either vary their speed proportionally or on a trickle and boost principle.

The unit shall have the facility to commission the supply and extract fans individually via in-built minimum and maximum speed adjustment, or alternative wired remote control unit. The fans themselves shall have independent, infinitely variable speed control.

Unit specification

The unit shall be manufactured with an ABS outer case construction, and incorporate a metal duct to the cooker hood, intumescent fire damper and thermal switch, in accordance with BRE Digest 398.

The unit shall have a high efficiency composite plastic counterflow heat exchanger, supply and extract filters, automatic summer bypass, integral minimum and maximum infinitely variable speed controls with fascia mounted failure indication. The unit shall have low energy, high efficiency EC/DC fan/motor assemblies with sealed for life bearings. The impellers shall be high efficiency forward curved centrifugal type.

The unit shall have a heat exchanger cell with a thermal efficiency of up to 92% when tested to EN 308. This shall be protected by G3 grade synthetic filters on supply and extract. Complete with a condensate drip tray and drain connection.

The unit shall be constructed with a removable Core allowing full maintenance access. The removable Core shall provide access to the following:

- ✓ Supply and extract filter
- ✓ Heat exchanger
- ✓ Access to the electrical connections

Access shall be provided for wiring termination and setup/commissioning. The backlit LCD user interface therein shall be removable for remote mounting if required.

Units shall be as manufactured by Vent-Axia Ltd.

Standard controls

All Sentinel Kinetic units shall incorporate the following functions integrally mounted, pre-wired and factory fitted by the manufacturer:

- ✓ Integral infinitely variable fan speed control on supply and extract
- ✓ Integral min/max ventilation control/set point
- ✓ Integral BMS interfaces - control and status indication
- ✓ Heating interlocks
- ✓ 0-10V proportional speed adjustment
- ✓ Volt free contacts
- ✓ 24V sensor supply
- ✓ Integral on/off or trickle boost function from remote switch e.g. PIR occupancy detector
- ✓ The unit shall be controlled by the 'Sentinel' control devices (enablers and sensors) as detailed in the schedule or on the drawings
- ✓ Fully automatic summer bypass
- ✓ Switched Live input with adjustable 'Delay-On' feature
- ✓ Fan failure or component failure indicated via individual fault code display
- ✓ Running time counter
- ✓ Control panel PIN number lock
- ✓ Automatic frost protection effective to -20°C
- ✓ Tool free filter access
- ✓ The unit shall incorporate ('H' models) an integral humidity sensor with the following features:
 - Ambient Response; Raises the humidity trigger point as dwelling temperature reduces
 - Rapid Response; Monitors the rate of change in humidity and triggers increased airflow even if the humidity trigger threshold is not reached

- Proportional Response; Incrementally increases the fan speed to reduce noise and reduce energy consumption

Integral Cooker Hood Specification

The Sentinel Kinetic Cooker Hood shall consist of a telescopic Hood and galvanised steel duct connection to the MVHR Unit.

The Hood construction shall be of grey powder coated steel with Brushed Aluminium or White painted fascia.

The Hood shall trigger the MVHR unit to a pre-defined boost speed and open the summer bypass when opened, and shall have two low-energy lamps illuminating the hob top.

Filter shall be a flat metal grease filter, removable for cleaning.

The galvanised steel ductwork shall provide a continuous fire barrier between the Hood and the MVHR unit. It shall contain an Intumescent fire damper, thermal cut-out and volume balancing damper. The thermal cut-out shall switch off the MVHR unit at a pre-defined safety temperature.

The duct shall have an access panel for cleaning by the end-user.

Airflow Direction

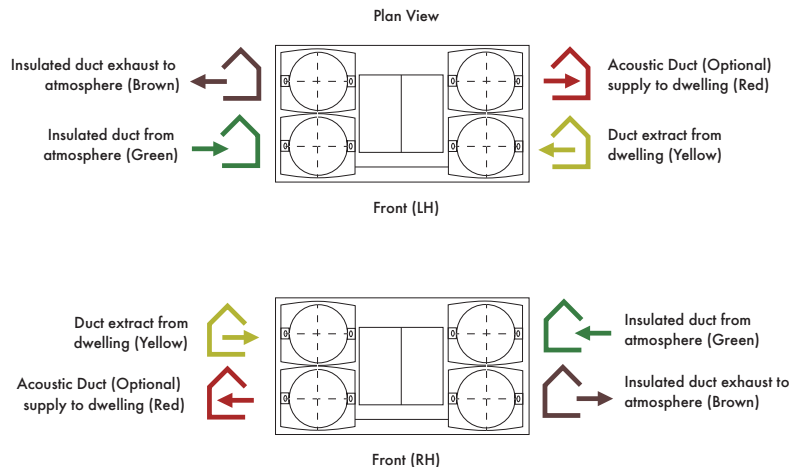

Electrical Connection

Please note: Electrical connection should be carried out by an appropriately qualified person and in accordance with current wiring regulations.

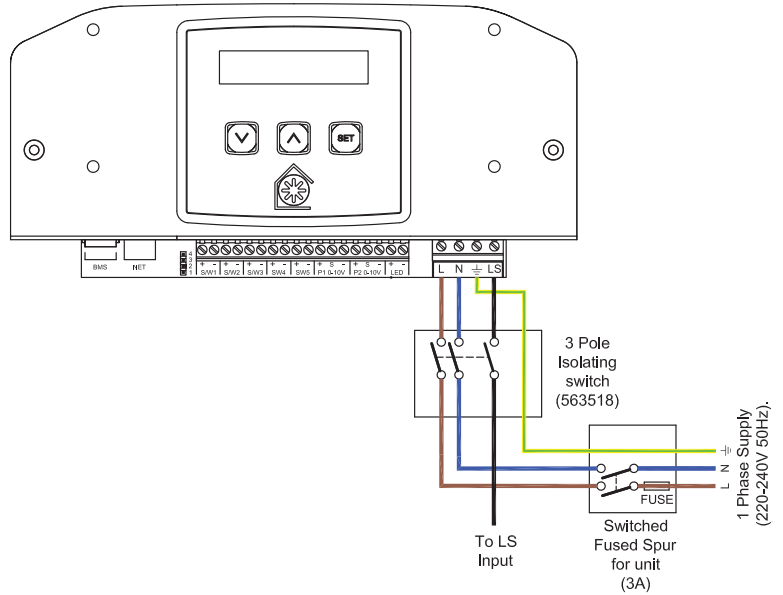

Trickle to Boost by a light circuit

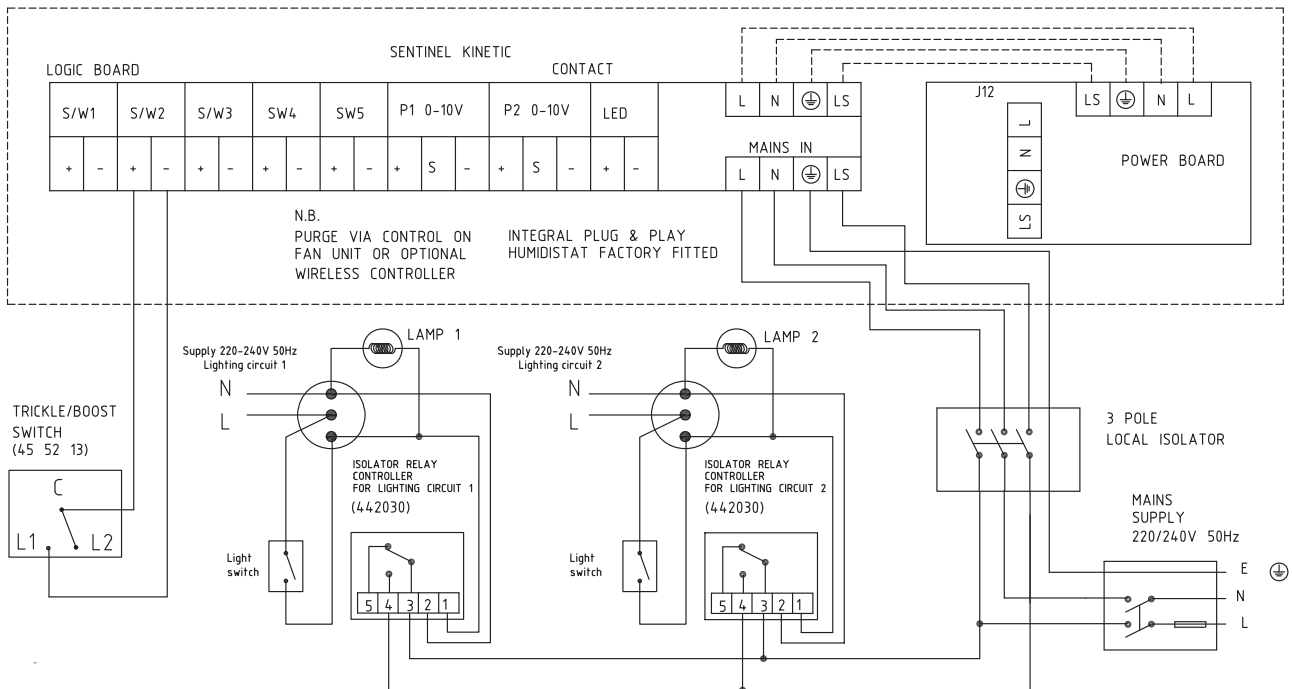

Lo-Carbon Sentinel Kinetic® Horizontal MVHR Units

Features & Benefits

- **Manufactured in the UK**
- **Building Regulations ADF compliant**
- **Recognised in SAP Appendix Q**
- **Energy Savings Trust best practice compliant**
- **Up to 81% heat recovery whilst controlling condensation**
- **Programmable Summer bypass**
- **Digital controller for simple and accurate commissioning**
- **External condensate connection**
- **Plug and play controls; Humidistat, Ventwise, Wireless remote**
- **LS inputs (Light Switch)**
- **Volt-free inputs**
- **Self diagnosis for simplified fault finding**
- **Adjustable delay On/delay Off timer**

The Sentinel Kinetic Horizontal Range

A wholehouse heat recovery system with up to 81% heat exchange efficiency. An easily accessible heat recovery cube protected by two removable GU3 filters. Two Lo-Carbon Energy Saving EC/DC fans ensure long life (typically over double the life of AC motors) and lowest possible energy use. Fully insulated construction with built-in condensation drain. Specifically designed for new build constructions with a high level of insulation.

Lo-Carbon Sentinel Kinetic Horizontal meets the latest requirements of the Building Regulations ADF for wholehouse system ventilation: System 4. Continuous mechanical supply and extract with heat recovery. Each model has three fully adjustable speeds and a purge setting (maximum flow). Supplied with the unit is a digital controller that can be used to pre-set the speeds to any required airflow within the performance range.

Integral Humidity Sensor

The integral humidity sensor ('H' models) increases speed in proportion to relative humidity levels, saving energy and reducing noise. The sensor also reacts to small but rapid increases in humidity, even if the normal trigger threshold is not reached. This unique feature ensures adequate ventilation, even for the smallest wet room. The night time relative humidity setback feature

suppresses nuisance tripping as humidity gradually increases with falling temperature. Acoustically lined - low noise levels from only 20dB(A) @ 3m.

Models

Model	Stock Ref
Kinetic 200ZP	407161
Kinetic 200ZPH	407162
Kinetic 200Z	448733
Kinetic 200ZH	449540
Kinetic 300ZH	449536
Kinetic 200ZMH	448778

Optional Controls

Model	Stock Ref
Wireless Enable Kit (includes one switch)	441865
Wireless Boost Switch (max 3 switches)	437827
Ventwise Controller (also requires sensors: see Accessories & Controllers section)	441780

Accessories

Model	Stock Ref
Spare Filters Kinetic 200Z/ZH (2 pack)	449524
Spare Filters Kinetic 300ZH (2 pack)	449575
Spare Filters Kinetic 200ZMH (2 pack)	449524

Multiple control options:

Five Volt-free pairs of switch terminals for sensor inputs allow boosting from a full range of Vent-Axia controllers - humidistats, PIR, timers.

Two terminals with 0-24V outputs allow 0V to 10V proportional control by sophisticated controllers such as CO₂ sensors and proportional humidistats.

The optional Ventwise controller senses temperature rise in a bath/shower hot water supply and/or current in a cooker/hob electrical circuit to activate boost, ensuring additional ventilation when needed. Switch-live for boosting via light switches (220-240V AC) or manual Normal/Boost switches. This connection has the advantage of Delay-On and Delay-Off facility.

Delay-On enables you to prevent the Boost airflow between 0 and 10 minutes after a light switch has been activated. Delay-Off allows the Boost airflow to continue after a light switch is turned off to ensure effective clearance of humidity. This timer is adjustable between 0 and 25 minutes.

Summer Bypass

An internal damper operates when the external temperature is below the internal temperature, and the internal temperature is too high.

The bypass opens and allows the cooler outside air to help cool the dwelling.

Normal mode: Fans run on Normal speed with bypass open until the internal dwelling temperature falls below the set 'Indoor' (maximum desired) temperature.

Evening Purge mode: The fans run on Boost speed until the internal temperature falls below the set 'Indoor' temperature. If, after five hours the internal temperature is still above the set 'Indoor' temperature, the unit will switch down to normal speed for the remainder of the 'bypass open' period.

NightTime Purge mode: As Evening Purge, except that the unit will continue on Boost speed until the internal air temperature reaches the 'Outdoor' temperature set point (Default 14°C). This mode gives pre-cooling of the dwelling for the following day.

In Evening and Night Time Purge modes, the user can turn off the boost function by pressing the Boost button.

Frost Protection

In cold climates there is a possibility of frost building up on the intake side of the heat exchanger. In order to prevent damage, the Kinetic reduces supply flow while maintaining extract flow at temperatures down to -20°C.

SEC Class Rating

Model	SEC Class
Kinetic 200ZH/ZPH/ZMH	A
Kinetic 200ZP/Z 300ZH/Z	A



SAP PCDB Test Results

200ZP/ZPH		
	Thermal Efficiency %	SFP (W/l/s)
K+1	86	0.62
K+2	84	0.65
K+3	83	0.76

200Z/ZH/ZMH		
	Thermal Efficiency %	SFP (W/l/s)
K+1	80	0.69
K+2	81	0.70
K+3	80	0.80
K+4	80	0.97
K+5	79	1.14

300ZH		
	Thermal Efficiency %	SFP (W/l/s)
K+1	77	0.59
K+2	78	0.51
K+3	78	0.57
K+4	78	0.66
K+5	78	0.76
K+6	78	0.88
K+7	77	1.05

Dimensions (mm)

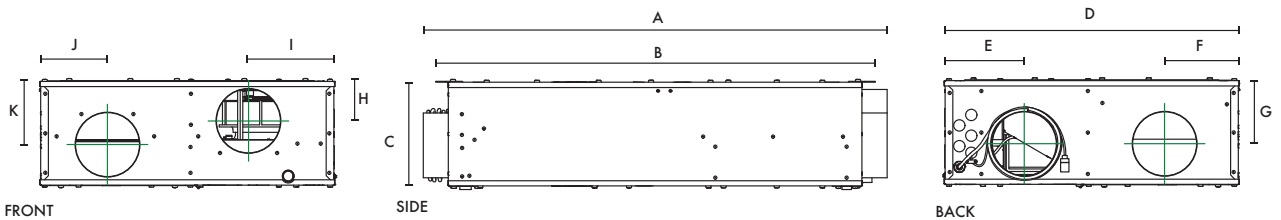

Model	A	B	C	D	E	F	G	H	I	J	K	Spigots Ø
200Z	895	849	200	570	155	144	122	76	167	131	122	125
300ZH	985	940	301	720	184	179	187	102	279	174	187	150

Weight: 200Z - 26kg, 300Z - 38kg

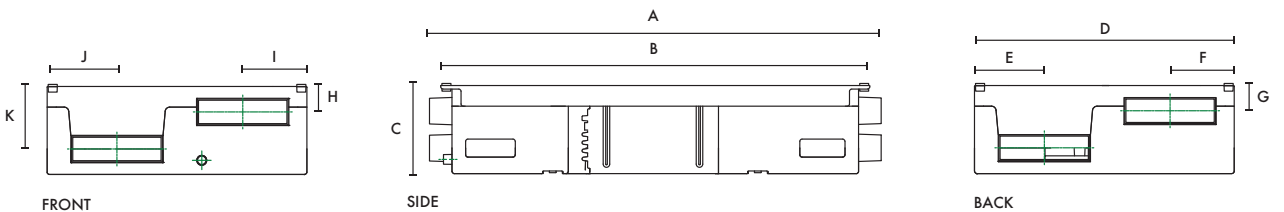

Model	A	B	C	D	E	F	G	H	I	J	K	Spigots
200ZP	1000	950	200	575	155	142	60	61	142	154	143	204x60
200ZMH*	895	849	200	570	195	140	54	66	168	138	143	204x60

Weight: 200ZP - 14kg, 200ZM - 26kg

*Galvanized steel outer case construction

Lo-Carbon Sentinel Kinetic® Horizontal

Performance - 200Z/ZP/ZMH Model

Fan speeds are fully adjustable within the performance range.

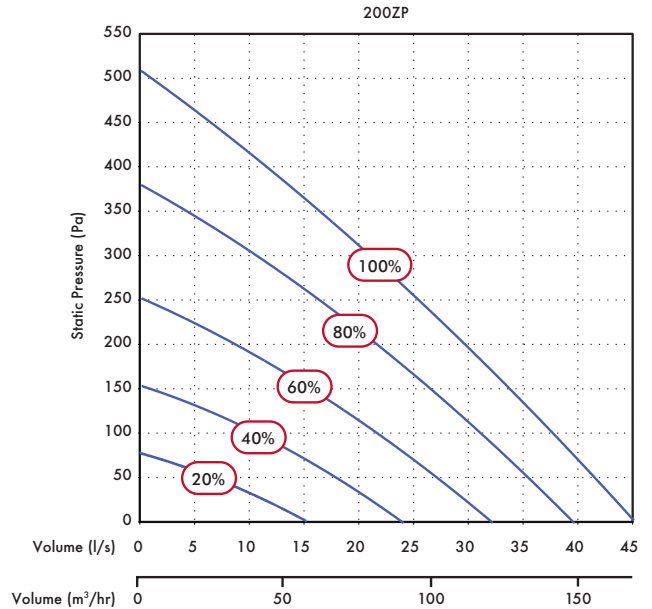
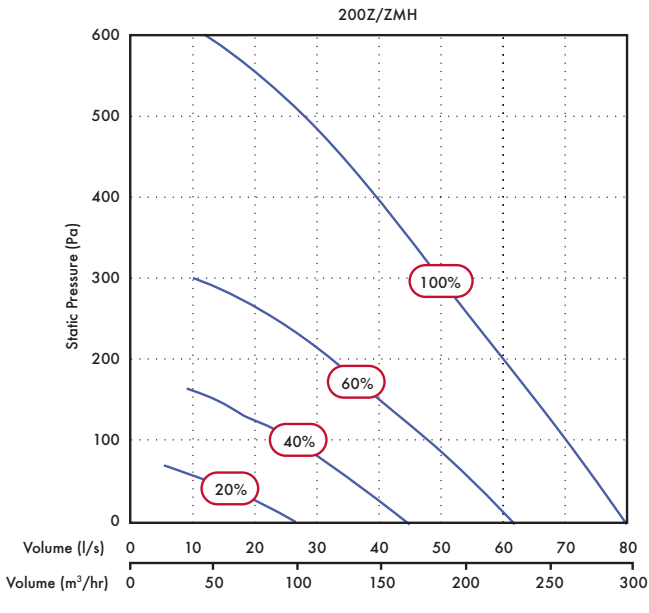

Sound Data - 200Z/ZMH Model

Flow l/s	Flow %	Test mode	63	125	250	500	1k	2k	4k	8k	dB(A) at 3m
25	20	Supply	50.3	54	50.1	45.5	37	36	27.5	31.1	30.0
		Extract	47.2	47.7	46.6	41.8	30.7	27.9	24.6	30.5	26.3
		Breakout	48.8	55.8	51.2	43.8	32.4	29.0	25.4	30.8	26.8
39	40	Supply	52.7	61.7	60.1	61.8	47.4	45.1	38.1	40.1	42.7
		Extract	50.7	55.4	55.0	51.5	37.5	34.6	25.9	30.7	33.9
		Breakout	53.7	60.1	61.1	50.7	40.2	35.8	27.1	30.3	34.0
51	60	Supply	52.8	64.5	66.7	59.4	51.1	51.1	42.9	39.3	44.0
		Extract	50.6	59.0	62.1	57.1	43.7	40.0	29.0	31.6	39.7
		Breakout	55.1	64.4	66.8	57.5	47.0	41.4	32.0	32.0	39.7
60	100	Supply	58.3	69.2	68.6	64.6	56.9	56.1	47.9	45.6	48.1
		Extract	51.8	63.1	64.9	63.9	52.4	45.9	34.8	34.8	45.2
		Breakout	59.4	68.1	69.7	68.3	53.1	47.1	36.5	34.3	46.5

Tested according to BS848. Breakout quoted spherical. Supply and Extract quoted hemispherical.

Performance - 300ZH Model

Fan speeds are fully adjustable within the performance range.

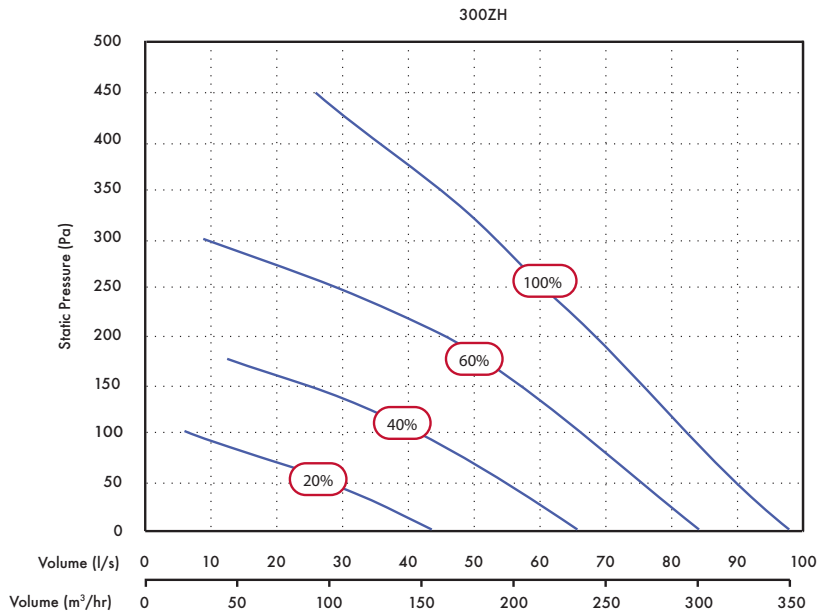

Sound Data - 300ZH Model

Flow l/s	Flow %	Test mode	63	125	250	500	1k	2k	4k	8k	dB(A) at 3m
26	10	Supply	42.5	42.8	38.3	32.9	28	24.6	25.5	30.3	26.3
		Extract	46.9	45	40.3	34.4	27.4	23	24.3	30.1	22.5
		Breakout	48.7	52.1	47.7	40.5	32.9	27.3	25.1	31.6	24.4
44	20	Supply	45.6	47	41.7	35.7	31.7	26.7	24.8	30	29.9
		Extract	46.9	48.6	47	38.2	29.5	25.3	23.8	29.9	25.3
		Breakout	50.2	56.4	53.9	46.3	37.5	32.5	25.2	31.4	28.8
55	30	Supply	44.4	46	52.9	39.4	35.1	31.9	25.5	30.5	33.9
		Extract	47	48	55.5	42.5	32.2	29.9	25.7	30.6	30.6
		Breakout	52.2	59.6	62	51.4	41.9	37.4	28.1	31.4	34.7
66	40	Supply	43.1	44.4	54.3	43.5	39.2	35.7	27.7	29.9	35.0
		Extract	48.9	49	58.4	45.9	35.7	33.4	25.3	29.9	33.4
		Breakout	54.6	58.3	66.1	52.6	39.3	36.5	31.1	35.3	37.7
85	60	Supply	44.7	49.8	58	50.4	45	41.9	30.6	30.3	39.1
		Extract	51	53.6	61.2	50.1	41.6	40.1	30.7	31.1	36.7
		Breakout	57.5	62.6	68.7	57.5	45.9	41	36.3	34	40.7
96	80	Supply	46	52.2	57.1	56.5	47.2	44.2	32.3	30.5	40.5
		Extract	55.5	55	63.1	53.4	44.3	41	33.5	31.4	38.8
		Breakout	62.2	65.7	68.8	63	50.8	43.8	38.8	35.4	42.9
98	100	Supply	46.6	52.3	57	55.4	47.1	43.7	32.1	30.3	40.1
		Extract	53.7	55.2	63.3	53.3	44.1	41.2	33.2	31.5	38.9
		Breakout	62.2	73.8	77.4	74.1	67.4	61	53.6	45.4	53.9

Tested according to BS848. Breakout quoted spherical. Supply and Extract quoted hemispherical.

Lo-Carbon Sentinel Kinetic® Horizontal

Consultants Specification

Operation

The supply and extract ventilation unit shall be as Sentinel Kinetic Z as manufactured by Vent-Axia and shall be sized as indicated on the drawings and shall be in accordance with the particular specification; 200Z - 200mm deep, 300Z - 300mm deep.

The Sentinel Kinetic Z shall automatically vary the ventilation rate via EC/DC motors, as it receives signals from one of the optional interconnected sensors. When a signal is received, the fans shall either vary their speed proportionally or on a trickle and boost principle.

The unit shall have the facility to commission the supply and extract fans individually via the wired remote control unit. The fans themselves shall have independent, infinitely variable speed control.

Unit specification (200Z/ZM, 300ZH)

The unit shall be manufactured with a galvanized steel outer case construction and shall have a high efficiency aluminium heat exchanger.

Unit specification (200ZP)

The unit shall be manufactured with high density EPP case and shall have a high efficiency polymer heat exchanger.

The unit shall have supply and extract filters, automatic summer bypass, integral minimum and maximum infinitely variable speed controls with failure indication via the wired remote controller.

The unit shall have low energy, high efficiency EC/DC fan/motor assemblies with sealed for life bearings. The impellers shall be high efficiency backward curved centrifugal type.

The unit shall have a heat exchanger cell with a thermal efficiency of up to 81% when tested to EN 308. This shall be protected by G3 grade synthetic filters on supply and extract. Complete with a condensate drip tray and drain connection.

The unit shall be constructed with a removable access panel allowing full maintenance access from below. The removable panel shall provide access to the following:

- ✓ Supply or extract fan
- ✓ Supply and extract filter
- ✓ Heat exchanger
- ✓ Access to the electrical connections

Access shall be provided for wiring termination and setup/commissioning.

Standard controls

All Sentinel Kinetic Z units shall incorporate the following functions integrally mounted, pre-wired and factory fitted by the manufacturer:

- ✓ Infinitely variable fan speed control on supply and extract
- ✓ Min/max ventilation control/set point
- ✓ Heating interlocks
- ✓ 0-10V proportional speed adjustment
- ✓ Volt free contacts
- ✓ 24V sensor supply
- ✓ On/off or trickle boost function from remote switch, e.g. PIR occupancy detector
- ✓ The unit shall be controlled by the 'Sentinel' control devices (enablers and sensors) as detailed in the schedule or on the drawings
- ✓ Fully automatic summer bypass
- ✓ Switched Live input with adjustable 'delay-on' feature
- ✓ Fan failure or component failure indicated via individual fault code display
- ✓ Running time counter
- ✓ Control panel PIN number lock
- ✓ Automatic frost protection effective to -20°C
- ✓ The unit shall incorporate ('H' models) an integral humidity sensor with the following features:
 - Ambient Response: Raises the humidity trigger point as dwelling temperature reduces
 - Rapid Response: Monitors the rate of change in humidity and triggers increased airflow even if the humidity trigger threshold is not reached
 - Proportional Response: Incrementally increases the fan speed to reduce noise and reduce energy consumption

The unit shall be controlled by the 'Sentinel' control devices (enablers and sensors) as detailed in the schedule or on the drawings.

Airflow Direction

View from beneath (drawing for airflow demonstration only - not intended to be an accurate representation of the product)

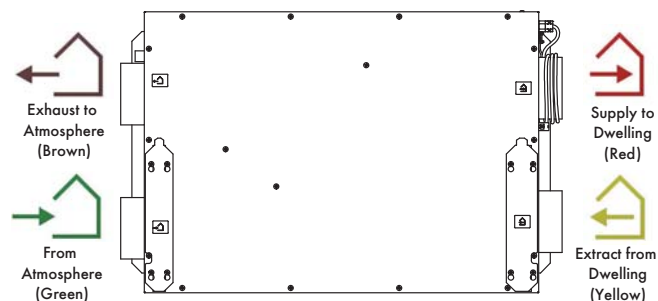

Electrical Connection

Please note: Electrical connection should be carried out by an appropriately qualified person and in accordance with current wiring regulations.

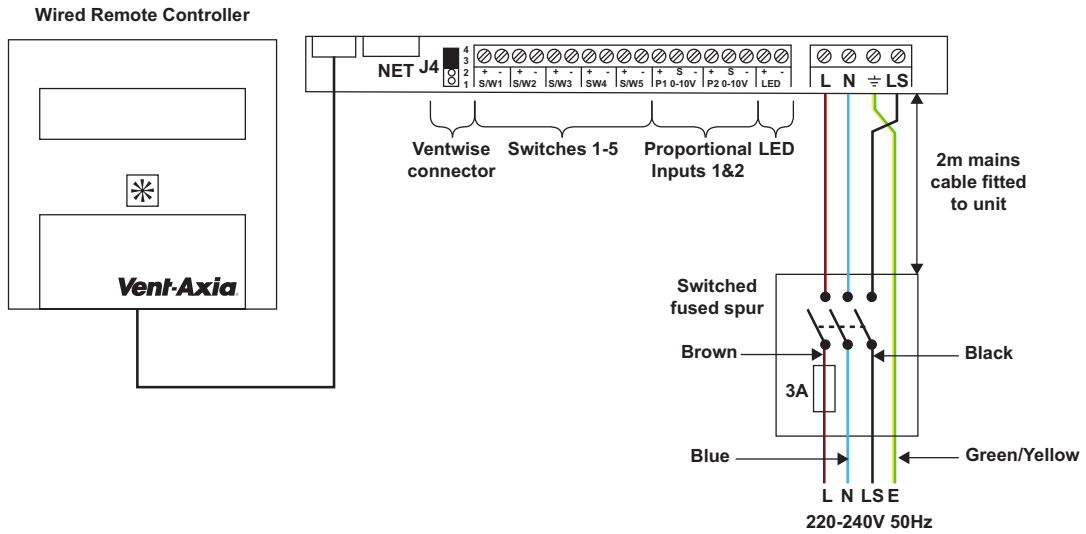

Trickle to Boost by two lighting circuits or Trickle/Boost switch

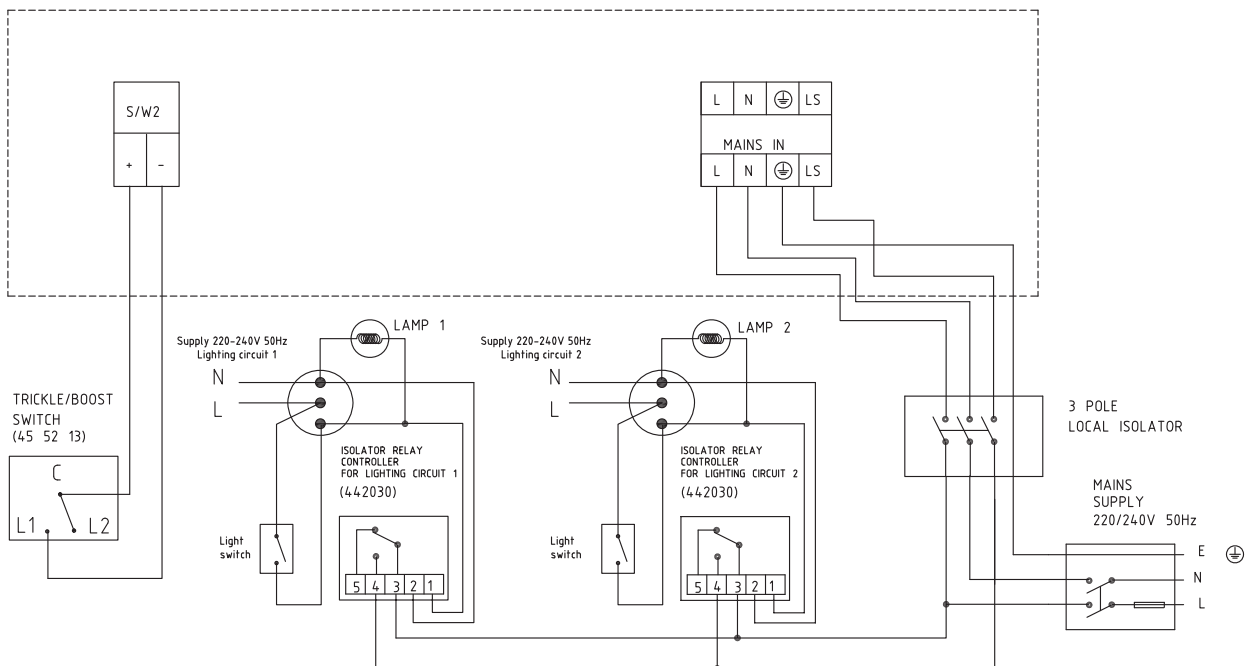

Lo-Carbon Kinetic® Plus E

MVHR Unit

Features & Benefits

- Lightweight for easy installation
- Easy access filters
- External condensate connection
- Compatible with a range of controls: PIR, Humidistat
- Horizontal duct option for space-saving installations
- Up to 94% heat recovery
- Quiet operation
- Manufactured in the UK
- Switched live inputs (Light switch control)

A wholehouse heat recovery system with up to 94% energy efficiency. An easily accessible heat recovery cube protected by two removable GU3 filters. Two Lo-Carbon Energy Saving EC/DC fans ensure long life (typically over double the life of AC motors) and lowest possible energy use. Fully insulated construction with built-in condensation drain.

Lo-Carbon Kinetic Plus E meets the latest requirements of the Building Regulations Approved Document F for wholehouse system ventilation.

The Lo-Carbon Kinetic Plus E model has two adjustable speeds, normal and boost. On the front of the unit is the controller that can be used to preset the speeds to any required performance, up to 111l/s (400m³/hr) 150Pa. Offering 'Close Control' to prevent over ventilating. Acoustically lined - low noise levels from only 20dB(A) @ 3m.

Left or Right Hand Installation

Units are supplied right handed with duct spigots to outside on the right hand side. These can be reversed onsite by simply removing the control panel, rotating the unit 180 degrees and reattaching the control panel.

Spigot Options

The combination of spigot options allows installation in confined locations. If vertical and horizontal connections are required on the same outlet/inlet, additional spigots can be supplied.

Filter Check

An LED on the control panel illuminates at 6 month intervals to remind users to check and clean the filters.

Frost Protection

The Kinetic E range benefits from an automatic frost protection system to prevent the heat recovery cell freezing in very cold weather, while at the same time maintaining ventilation.

Control Options

There are two LS (Switched Live) inputs allowing the unit to be connected to a number of sensors and controllers such as Ventwise, Timespan, Ambient Response Humidistat. One of the LS connections also benefits from a 'Delay-On' feature which prevents the unit boosting unnecessarily.

Model

Model Kinetic Plus E Stock Ref 449059

Accessories

Model Kinetic Spare Filters 2 pack Stock Ref 443351
 Optional M5 Pollen Filter Stock Ref 444201
 Isolator Relay Controller Stock Ref 442030
 180mm/200mm Spigot Kit Stock Ref 446523 (One per pack)

SAP PCDB Test Results

Exhaust Terminal Configuration	Thermal Efficiency %	SFP (W/l/s)
K + 1	94	0.41
K + 2	94	0.40
K + 3	94	0.43
K + 4	94	0.45
K + 5	93	0.52
K + 6	93	0.61
K + 7	93	0.73

Dimensions (mm)

A	B	C	D	EØ	F	G	H
785	635	722	550	150	520	275	135

Weight: 24kg

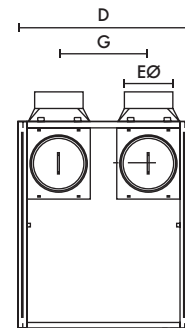
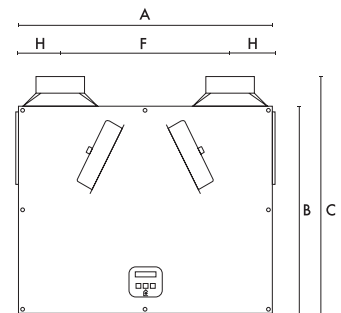

BACK

FRONT

SEC Rating

Model	SEC Class
Kinetic Plus E	A+



Performance

Fan speeds are fully adjustable within the performance range.

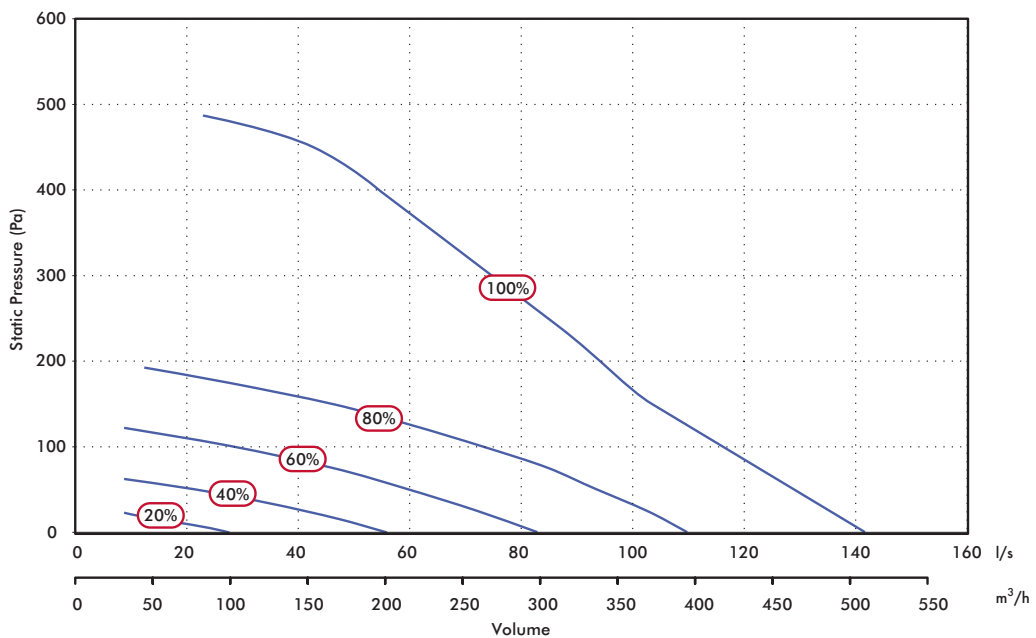

Sound Data

Flow l/s	Unit setting	Test mode	Octave band, Hz, dB SWL								SPL dB(A) at 3m
			63	125	250	500	1k	2k	4k	8k	
50	20%	Supply	46.5	54.3	46.4	44.8	36.2	28.5	24.5	31.2	28.5
		Extract	46	52.2	42.3	38.7	27.6	24.2	24	31.7	25
		Breakout	48.5	42.6	43.3	38.9	35.8	29.3	23.8	30.7	22.8
78	40%	Supply	50.3	59.1	54.5	56.5	47	39.9	26.3	31.7	38
		Extract	46.8	51.6	47.8	44.4	32.7	27.4	24.4	31.7	28
		Breakout	48.4	51.2	53.4	46	41	34.6	25	30.3	28.5
104	60%	Supply	52.4	57.2	60.4	60.9	55.8	50.3	33.1	33.9	43.6
		Extract	50	49.8	56.8	52.4	40.2	35.9	33.4	39.8	35.2
		Breakout	55	49.6	59.7	54.5	46.9	39.9	33.6	39.2	34.9
127	80%	Supply	54.9	60.7	67.4	66.6	61.8	56	39.6	37.7	49.5
		Extract	50.4	52	61.2	56.6	45.1	39.6	34.2	40.2	39.1
		Breakout	53.5	53.4	60.8	59.1	53	45.3	36	40.1	38.7
137	100%	Supply	54.7	61.7	70.5	69.9	62.7	57.5	42.1	38.3	52
		Extract	54.4	55.1	65.8	57.5	46.9	40.6	33.7	40	41.8
		Breakout	56.6	54.6	60.5	60.7	54.7	45.9	36.5	39.6	40

Tested according to BS848. Breakout quoted spherical. Supply and Extract quoted hemispherical.

Lo-Carbon Kinetic® Plus E

Consultants Specification

Operation

The supply and extract ventilation unit shall be as Kinetic Plus E as manufactured by Vent-Axia and shall be sized as indicated on the drawings and shall be in accordance with the particular specification.

Supply air to the room shall be pre-heated by the extract air via the integrated composite plastic counterflow heat recovery cell. The Kinetic Plus E shall automatically vary the ventilation rate via EC/DC motors, as it receives signals from one of the optional interconnected sensors. When a signal is received, the fans shall vary their speed on a trickle and boost principle. The unit shall have the facility to commission the supply and extract fans individually via in-built minimum and maximum speed adjustment. The fans themselves shall have independent, infinitely variable speed control.

Unit specification

The unit shall be manufactured with an ABS outer case construction, and incorporate a reversible core to allow for left or right hand mounting. The unit shall have a high efficiency composite plastic counterflow heat exchanger, supply and extract filters, integral minimum and maximum infinitely variable speed controls with fascia mounted failure indication.

The unit shall have low energy, high efficiency EC/DC fan/motor assemblies with sealed for life bearings. The impellers shall be high efficiency backward curved centrifugal type. The unit shall have a heat exchanger cell with a thermal efficiency of up to 94% when tested to EN 308. This shall be protected by G3 grade synthetic filters on supply and extract. Complete with a condensate drip tray and drain connection.

The unit shall be constructed with a removable Core allowing full maintenance access. The removable Core shall provide access to the following:

- ✓ Supply and extract filter
- ✓ Heat exchanger
- ✓ Access to the electrical connections

Access shall be provided for wiring termination and setup/commissioning.

Standard controls

All Kinetic Plus E units shall incorporate the following functions integrally mounted, pre-wired and factory fitted by the manufacturer:

- ✓ Integral infinitely variable fan speed control on supply and extract
- ✓ Integral min/max ventilation control/set point
- ✓ Integral on/off or trickle boost function from remote switch, e.g. PIR occupancy detector
- ✓ Switched Live input with adjustable 'delay-on' feature
- ✓ Tool free filter access
- ✓ Frost protection down to -20°C
- ✓ LED 'filter check' indicator

Airflow Direction

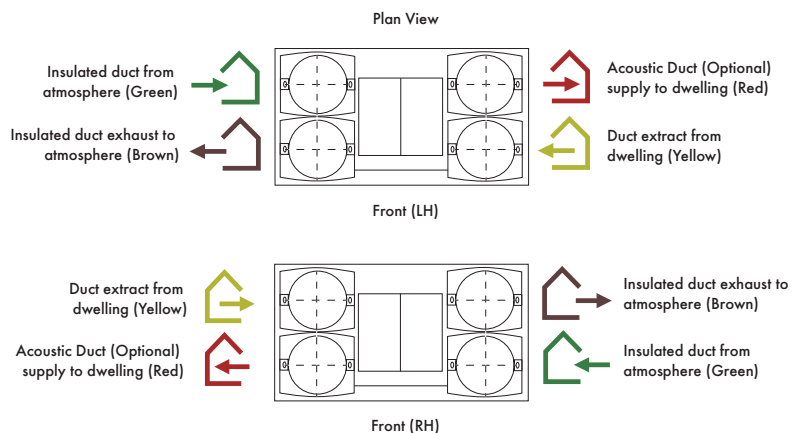

Electrical Connection

The unit can be switched to boost by applying 230 V to the LS1 or LS2 inputs. Alternatively, the boost button on the control unit may be used.

Mains Cable Connections

Terminal No.	Name	Description
L	Mains Live	220-240 V AC, 50 Hz input
N	Mains Neutral	220-240 V AC, 50 Hz input
EARTH	Mains Earth	Earthing connector
LS1	Switched Live 1	220-240 V AC, 50 Hz input
LS2	Switched Live 2	220-240 V AC, 50 Hz input

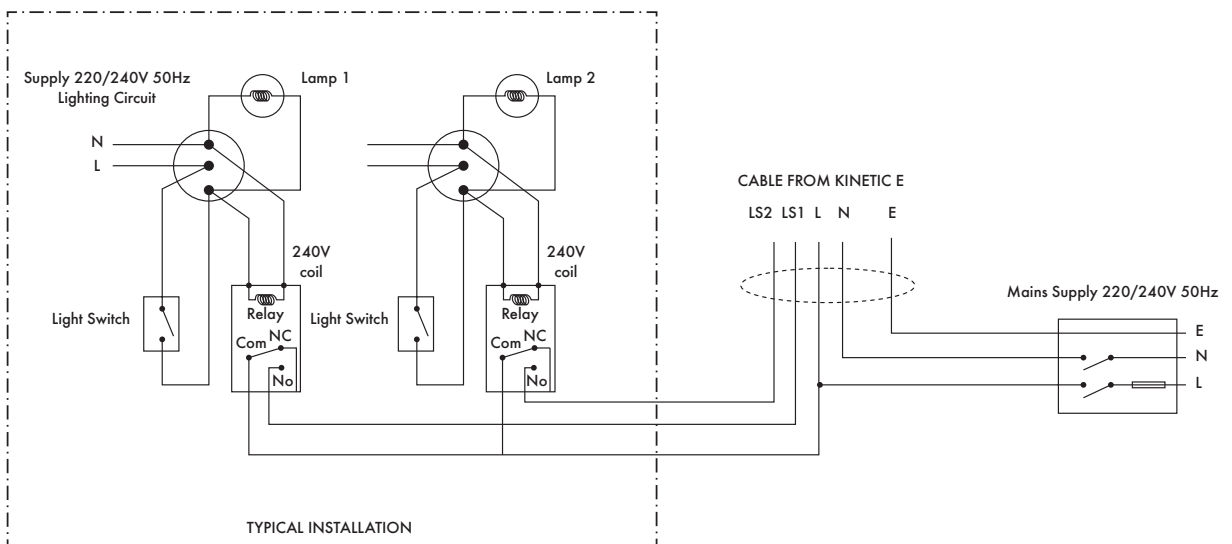

Integra® Ducted MVHR Unit



Features & Benefits

- Powered heat recovery unit for smaller residential or commercial applications up to 180m²
- Up to 70% heat recovery
- Low power consumption
- Effective condensation control

The Integra heat recovery unit has been specially designed to provide ventilation for flats or rooms in residential, commercial, educational or leisure applications. Balanced ventilation is achieved by using nominal 100mm diameter rigid ducting.

Using a high performance, polymeric heat exchange cube, together with two powerful fans, the Vent-Axia Integra achieves efficiencies of up to 70%.

The compact cube interleaves outgoing moist air with incoming fresh air, allowing the heat from one to warm the other without the two air streams mixing. Energy is saved on room heating, with no power being used by the cube itself.

Performance of Integra: Up to 49l/s FID. Ideal for installation in ceilings voids or cupboards.

The 150VA Transformer enables the selection of trickle settings to match dwelling volume.

Models

Integra
Stock Ref
456864

Controller
Controller 150VA
Stock Ref
563538

Dimensions (mm)

Weight: 6.5kg

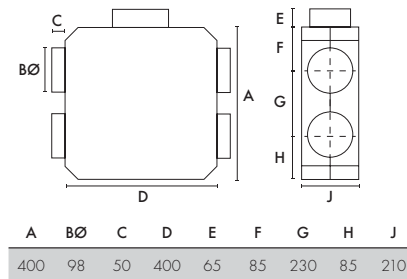

Performance

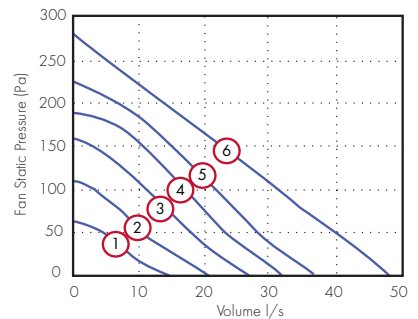

Motor Speed/	Volume (l/s)		
Curve	(FID)	Voltage (V)	Wattage (W)
1	15	80	32
2	21	100	47
3	27	120	64
4	32	140	81
5	37	160	99
6	49	240	182

Integra to be used with a 150VA Transformer for maximum controllability.

SEC Class Rating

Model	SEC Class	SEC Class (inc. LDC)
Integra	F	C

Airflow Direction

Horizontal mounting

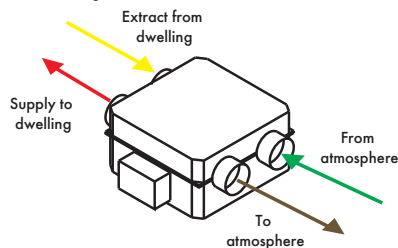

Integra® Plus

Ducted MVHR Unit



Features & Benefits

- Powered heat recovery unit for larger residential or commercial applications
- Up to 70% heat recovery
- Low power consumption
- Effective condensation control
- 3 speed control

Easy Installation

The Vent-Axia Integra Plus is designed for mounting in ceiling voids, lofts and above a suspended ceiling. Four 150mm spigots are provided for simple connection to insulated flexible or rigid ventilation ducting. The unit comes complete with a 22mm condensate outlet.

Model

Integra Plus
Stock Ref
437666

Dimensions (mm)

A	B	C	D	E	F	G	H	J	K
603	150	100	580	125	350	125	355	125	305

Weight: 15.5kg fan box, 5kg controller

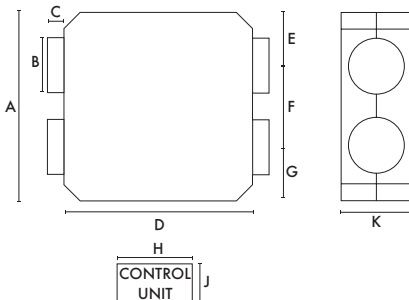

Performance

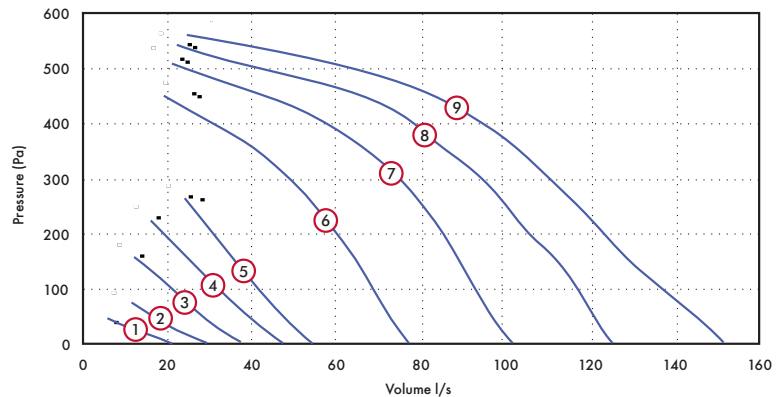

Motor Speed/ Curve	Volume (l/s) (FID)	Wattage (W)	Voltage (V)	dB(A) @ 3m
1	22	30	50	19.2
2	30	45	62	19.5
3	38	66	74	20.9
4	48	85	86	21.9
5	55	115	98	24.5
6	78	188	130	30.8
7	102	262	160	34.3
8	128	330	190	36.9
9	154	425	230	39.2

Controllers & Sensors



Units supplied complete with transformer

Airflow Direction

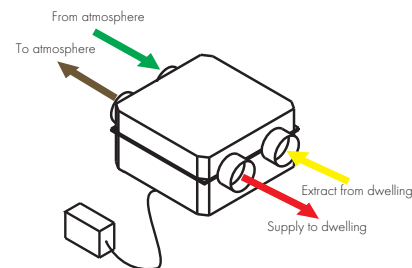

SEC Rating

Model	SEC Class	SEC Class (inc. LDC)
Integra Plus	E	B

HR100R/RS

Ducted MVHR Units



Features & Benefits

- Controls condensation and odours - saves energy
- Eliminates mould growth
- Up to 70% heat recovery
- Extremely quiet operation
- Two speed settings

The HR100R and HR100RS are ideal for single bedrooms/bathroom applications situated in hotel rooms, nursing homes and residential care homes.

The HR100R features top access and is ideal for loft installations.

The HR100RS features bottom access and is ideal for installation on the ceiling slab above a suspended ceiling.

The HR100R/RS is a self-contained heat recovery unit for mounting in lofts and suspended ceilings. The unit is supplied without controls to allow for the unit to be tailored to suit the individual requirements.

Compatible with standard 100mm ducting for connection to internal grilles and external cowl.

The unit comes fitted with a single 2-speed motor, and provides continuous low volume ventilation with a boost option. A variety of control devices are available for manual or automatic speed control.

An integral heat exchanger transfers heat from the outgoing stale air to the fresh air supply, raising the supply air temperature whilst at the same time reducing it's relative humidity.

Up to 18l/s FID capacity. The unit provides superior control of condensation and odours, ideal for bathrooms or small internal rooms.

Models

HR100R

Top access - ideal in loft installations.

Stock Ref
370377

HR100RS

Bottom access - ideal for suspended ceilings.

Stock Ref
435004

HR100RS Version

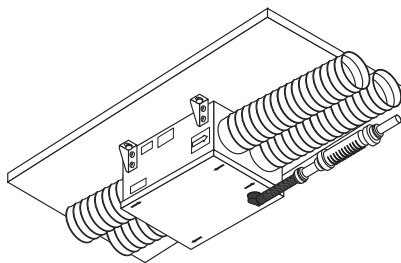

Dimensions (mm)

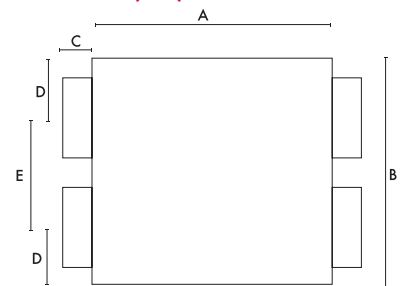

A	B	C	D	E	F	G	HØ
305	240	50	60	120	70	160	98



Normal Boost Switch

A single gang switch to boost from high to low speeds on all heat recovery systems.
85 x 85 x 10mm (H x W x D)

Stock Ref
455213

Performance

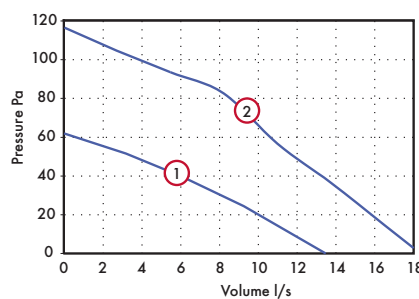

① Trickle ② Boost

Model	Weight kg	Extract Perf. l/s		Watts		dB(A) @ 3m*	
		Boost	Trickle	Boost	Trickle	Boost	Trickle
HR100R	5.6	18.3	13.6	29	19	30	20
HR100RS	5.6	18.3	13.6	29	19	30	20

Mains electrical supply: 230V/50Hz

HR200V

Ducted MVHR Unit



Features & Benefits

- Powered heat recovery module for smaller commercial applications
- Up to 70% heat recovery
- 150mm duct connection
- Extremely quiet on low speeds
- Low power consumption
- Washable heat exchanger
- Pre-wired to a flexible cable

A ducted heat recovery unit for residential or commercial applications. The HR200V is self-contained and includes two mixed flow speed controllable fans. Using a high performance, polymeric heat exchange cube together with two power fans, the HR200V can boast a temperature efficiency of up to 70%. Low speed for trickle ventilation mode.

Specially designed to provide ventilation for small internal rooms in commercial, educational and leisure applications. Ventilation is achieved by using nominal 150mm diameter ducting.

Models

HR200V
Stock Ref
14120010

Accessory

Transformer 150VA
Stock Ref
563538

Performance

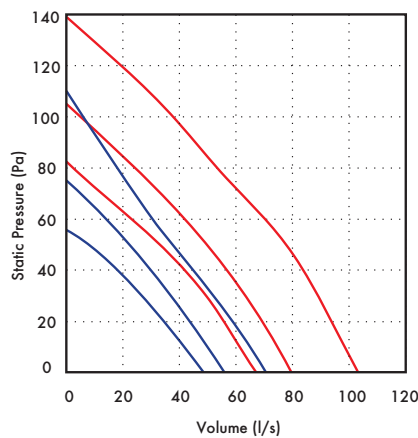

Motor Speed	1	2	3
Voltage	140	160	240
Watts	51.5	60	110
Volume l/s (FID) Supply	48.3	55.8	70.3
Extract	241	286	371

HR200V to be used with a 150VA Transformer for maximum controllability.

SEC Class Rating

Model	SEC Class	SEC Class (inc. LDC)
HR200V	C	B

Dimensions (mm)

Weight: 15.5kg fan box, 5kg controller

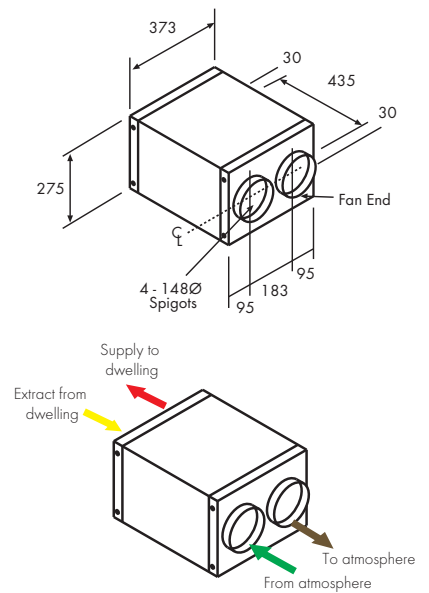

HR500

Single Room Heat Recovery Units



Features & Benefits

- Efficient 550m³/h heat recovery ventilation unit or high performance 900m³/h extract fan
- Lightweight, compact and easy to install
- Integral shutters on X type model
- Easy to clean
- Up to 70% heat recovery
- Controller with sensor mode, allows a range of sensors to be used in conjunction with the HR500 and HR500X units
- IPX5 rated

Heat Recovery Ventilation

HR500 heat recovery ventilation units for through the wall installation, which exhaust stale air whilst introducing warmed fresh air from the outside.

Ideal for computer rooms, classrooms, offices and the health and leisure industries. The Vent-Axia HR500 unit is the perfect solution for commercial areas that require a high performance balanced intake/extract ventilation scheme. As a heat recovery ventilation unit it moves a useful 153l/s of air.

The compact heat recovery cube interleaves outgoing warm air with incoming fresh air and allows the heat from one to warm the other without the two air streams mixing. Energy is saved on room heating with no power being used by the cube itself.

The HR500 and HR500X consist of a tough telescopic wall sleeve into which the main body of the unit is housed. Walls of up to 670mm thick can be easily accommodated. Behind the neat deflecting fascia grilles are the filters, the heat exchange cube and fan units. All wall sleeve components, the heat exchange cube and the fascia grilles are made of tough polymeric materials.

Electrical

Maximum ambient temperature +40°C.
Supply Voltage 220-240V/1/50Hz.

Models

HR500 Commercial

Wall-mounted intake/extract ventilation unit with built-in heat recovery facility. For commercial and leisure areas. Lightweight, compact and easy to install.

Stock Ref

14101010

HR500X

As HR500 with shutters.

Stock Ref

14101070

Controller

HR500 Controller

Surface mounting. On/Off remote sensor mode. Heat exchange, single fan extract or twin fan extract modes. Infinitely variable speed. Minimum speed setting. Suitable for controlling up to 2x HR500. 86 x 156 x 53 (W x H x D).

Stock Ref

W14301010

Performance

Model	Airflow performance (l/s)		Watts (max)	Sound dB(A) @ 3m (max)
	Heat recovery mode	Extract mode (max)		
HR500	153l/s	250l/s	200	53
HR500X	153l/s	250l/s	220	53

HR500 & HR500X

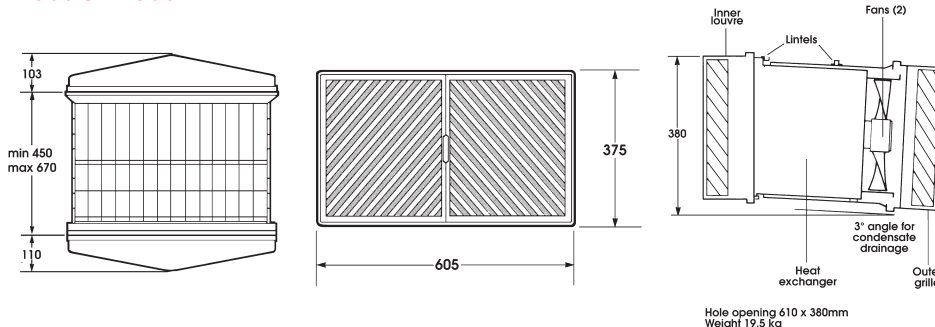

HR500D

Ducted MVHR Unit



Features & Benefits

- Self-contained unit with integral fans
- Up to 70% heat recovery
- Compatible with 200, 250 and 315mm Ø, ducting and accessories
- External wall mounting

The HR500D is a self-contained unit with integral extract and supply fans to provide balanced ventilation and heat recovery via supply diffusers and extraction grilles. The unit is fully speed controllable.

The compact heat recovery cube interleaves outgoing warm air with incoming fresh air and allows the heat from one to warm the other without the two air streams mixing.

Performance

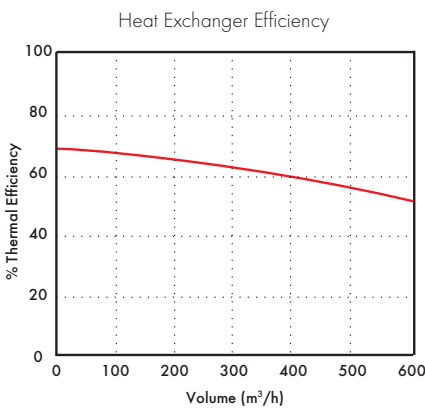

Airflow performance l/s (max)	Watts (max)	dB(A) @ 3m (max)	Weight kg
174 l/s	210	53	19

Energy is saved on room heating with no power being used by the cube itself.

Performance of HR500D: Supply and extract up to 174l/s FID capacity on heat recovery mode. Ideal for offices, computer rooms, pubs and clubs, etc.

Model

Surface mounting. On/Off remote sensor mode. Heat exchange, single fan extract or twin fan extract modes. Infinitely variable speed. Minimum speed setting. Suitable for controlling up to 2x HR500.

HR500D

Stock Ref
370450

Controller

Speed Controller

Stock Ref
W14301010

Spigot Sets

200mm Spigot set
Stock Ref
434806
434805

250mm Spigot set
Stock Ref
434806
434805

315mm Spigot
Stock Ref
434806

Dimensions (mm)

Hole opening: 610 x 381 mm

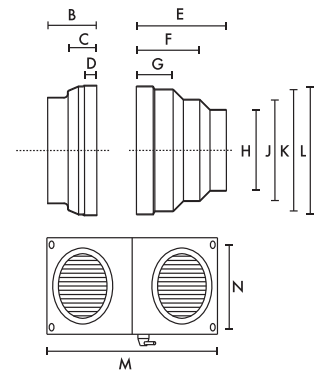
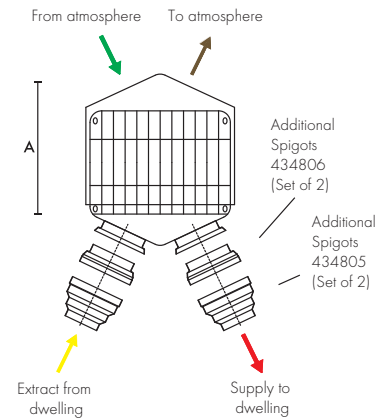

A	B	C	D	E	F	G
480-750	120	70	30	220	155	90
H	J	K	L	M	N	
Ø200	Ø250	Ø300	Ø315	600	340	

HR500EP/IP

Passive HR Units



Features & Benefits

- **Passive** - no fans
- **Lightweight** - easy installation
- **Compatible** with 200, 250 and 315mm Ø ducting and accessories
- **Up to 70%** heat recovery
- **Internal wall mounting** HR500IP
- **External wall mounting** HR500EP

Performance

Pressure Drop over Heat Exchange Unit

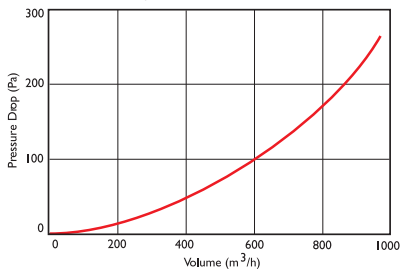

Thermal Efficiency Graph

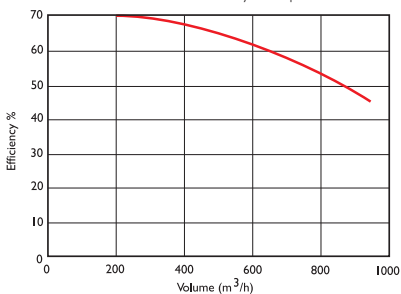

The unit is a semi-remote heat exchange unit with 70% heat recovery, designed for mounting in internal walls (HR500IP) and external walls (HR500EP) for installations using ducted extraction and fresh air supply. The HR500 units provides air movement via two independent in-line duct fans to suit length and configuration of ducting systems. The unit is ideal for use with in-line centrifugal type fans and compatible accessories.

Performance of HR500EP and HR500IP: Up to 244 l/s FID capacity (balanced airflow). Ideal for computer rooms, classrooms, offices and the health & leisure industries.

Model

Model
HR500IP
HR500EP

Stock Ref
370447
370451

EP Unit

Hole opening: 610 x 381 mm

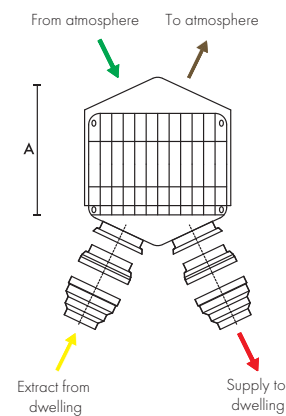

IP Unit

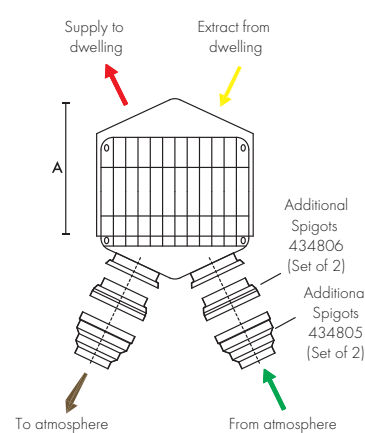

Spigot Sets

200mm Spigot set
Stock Ref
434806
434805

250mm Spigot set
Stock Ref
434806
434805

315mm Spigot
Stock Ref
434806

Dimensions (mm)

EP & IP Unit

Hole opening: 610 x 381 mm

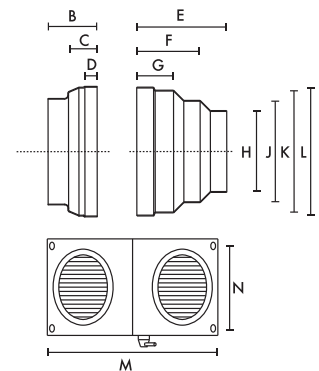

A	B	C	D	E	F	G
480-750	120	70	30	220	155	90
H	J	K	L	M	N	
Ø200	Ø250	Ø300	Ø315	600	340	

Weight: 9kg

HR500DP

Passive HR Unit



Features & Benefits

- **Passive - no fans**
- **Lightweight, compact and easy to install**
- **Up to 70% heat recovery**
- **Easy to clean**

A 'stand alone' heat exchange module which will transfer up to 70% of the outgoing heat to incoming air. Polymeric construction with spigots to suit 200, 250 and 315mm Ø flexible ductwork.

Module accessible for routine cleaning. Condensate outlet provided. Ideal for use in air conditioned environments.

Performance

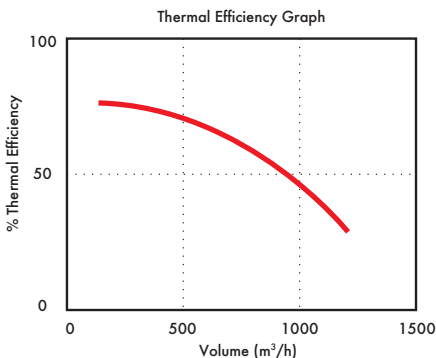
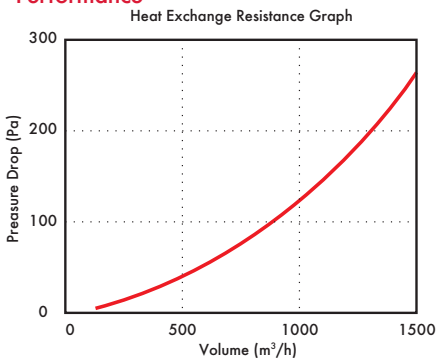

The heat exchanger works at the same high efficiency, automatically keeping a cool room cool. Performance of the Heat Exchange Unit: At 180l/s achieves 70% temperature efficiency (balanced airflow). Ideal for schools, pubs, offices and leisure industries.

Model

HR500DP
Stock Ref
10538290

Spigot Sets

200mm Spigot sets
Stock Ref
10577315
10578315

250mm Spigot sets
Stock Ref
10577315
10578315

315mm Spigot sets
Stock Ref
10577315

Dimensions (mm)

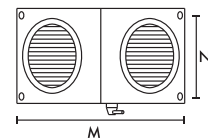
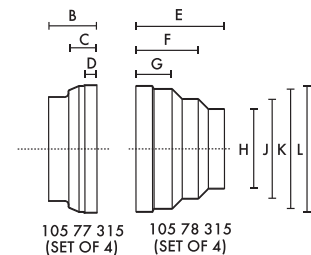
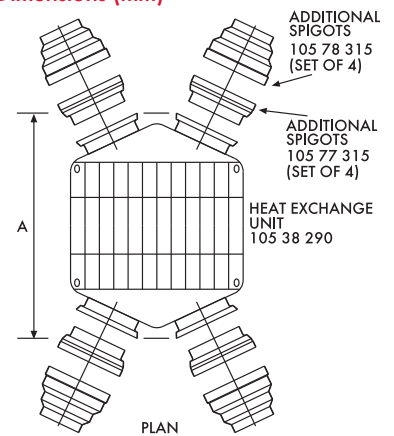

A	B	C	D	E	F	G
700	120	70	30	220	155	90
H	J	K	L	M	N	
Ø200	Ø250	Ø300	Ø315	600	340	

Weight: 9kg

Ducting & Fittings

Since 1936, Vent-Axia have been known for providing a complete ventilation solution. This has not changed, and now we offer one of the widest ranges of ancillaries available today.



Vent-Axia

Ducting & fittings

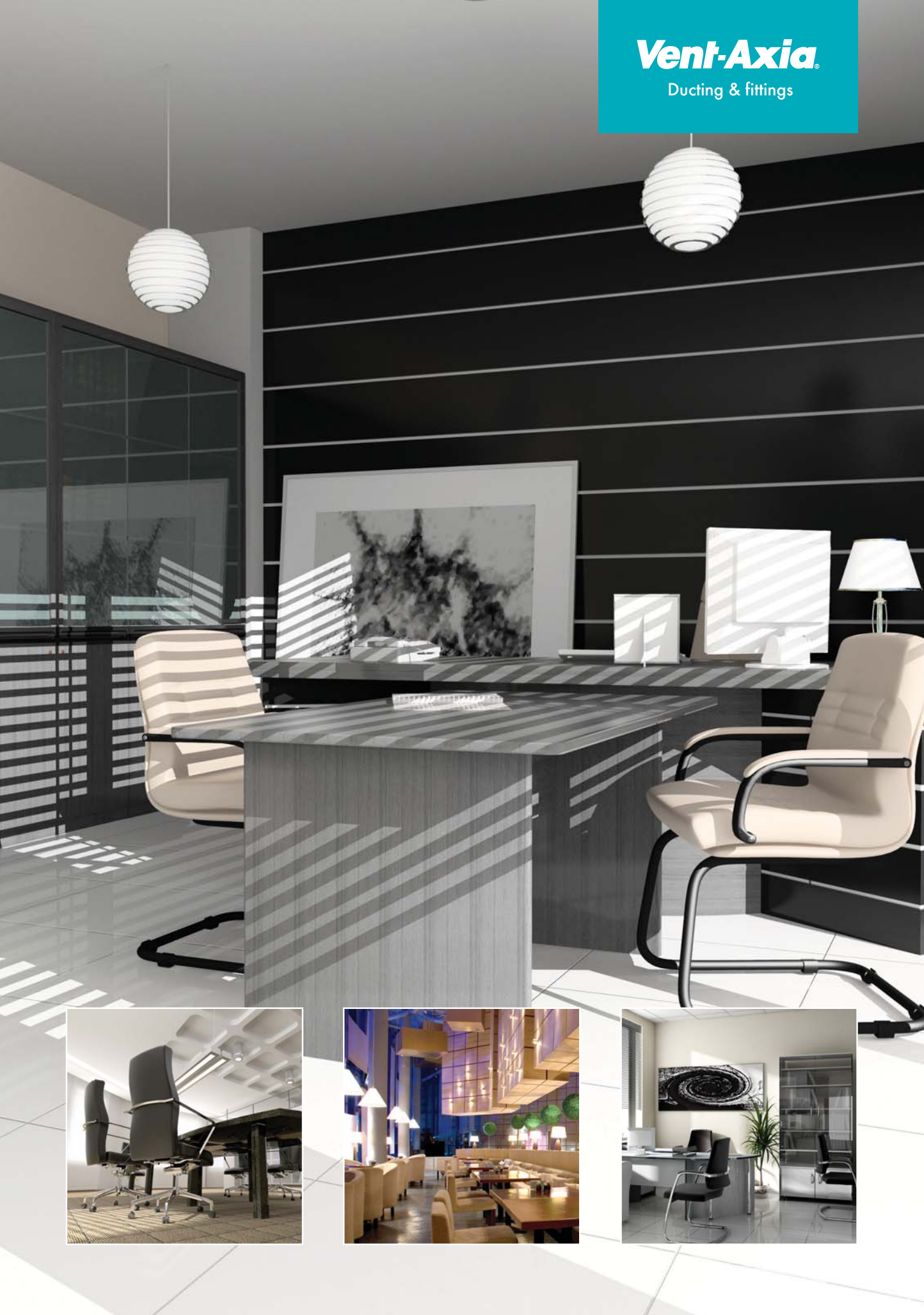

Arterial Duct System

Combines the advantages of rigid ducting with the versatility of a semi-rigid system

Features & Benefits

- Reduces installation time
- Can be applied in SAP as a rigid duct system
- Crush resistant semi-rigid duct
- Unique low-resistance manifolds
- Simple installation through joists
- Smooth inner surface with antistatic and antibacterial coating

Arterial System

Vent-Axia is pleased to introduce the latest addition to our innovative range of ventilation ancillaries. For use with MVHR systems, the NEW Arterial air distribution system provides a flexible, highly robust solution, which can significantly reduce the installation time when compared to a standard system.

Rigid vs Semi-Rigid Systems

Both traditional duct types have limitations in modern construction. **Rigid systems:** Passing rigid duct through a floor cassette at right-angles to the joists is time consuming and multiple connections increase the risk of leaking ductwork.

Semi-rigid systems: It can often be difficult to accommodate two distribution boxes and multiple semi-rigid pipe runs in new buildings and the time saving advantages are soon overtaken by the additional cost of materials.

Reduced Installation Time

The Vent-Axia Arterial range combines the advantages of semi-rigid and traditional rigid ducting in one simple system. The system is independently tested and can be applied in SAP as a standard rigid system. Drops between floors to/from the MVHR unit remain in rigid PVC, having the advantage of low space usage and low cost. Traversing through joists in a floor cassette is much simpler and faster when using semi-rigid duct. The secret to the Arterial System is the unique low-resistance distribution plenum (Patent Pending) which is sited between joists allowing connection between semi-rigid and rigid sections.

System Configuration Examples

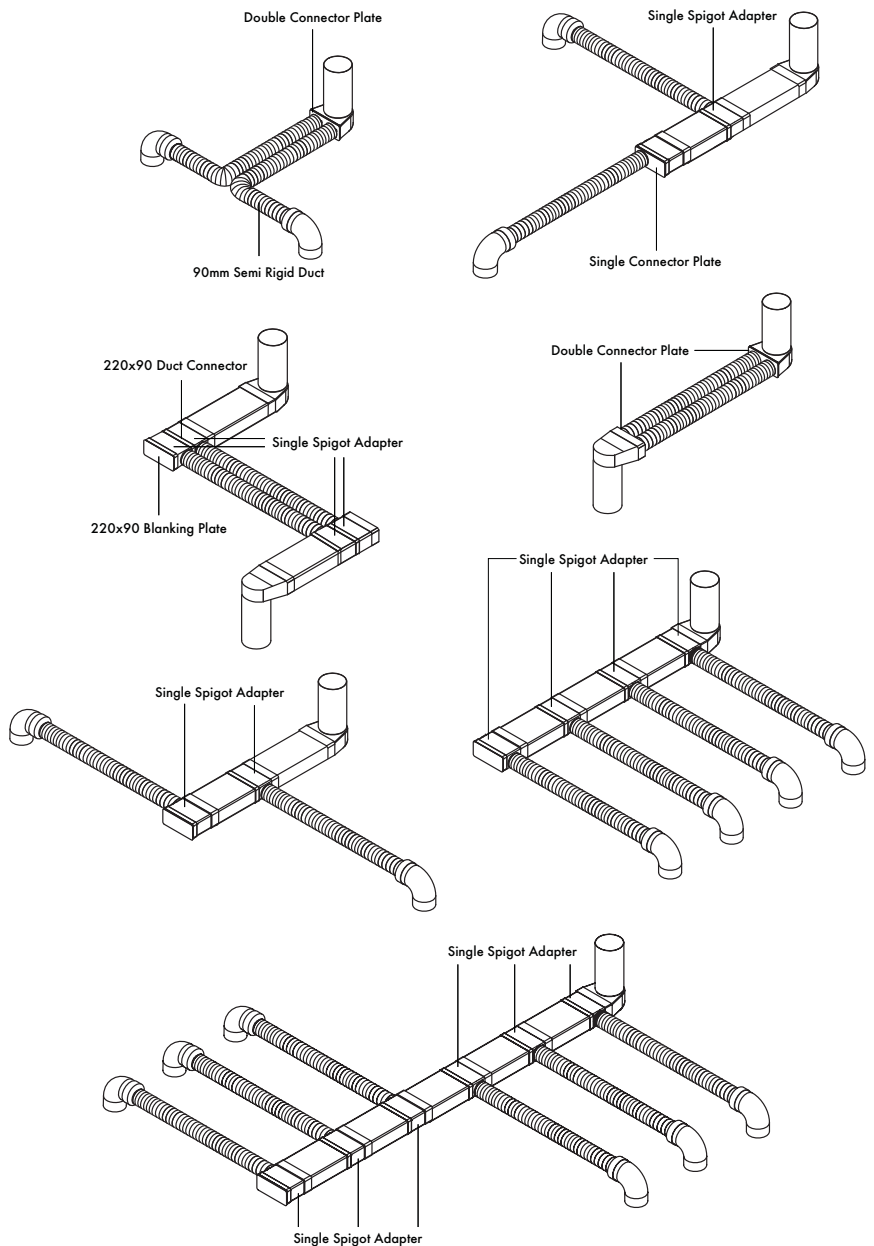



Complete System Setup Example

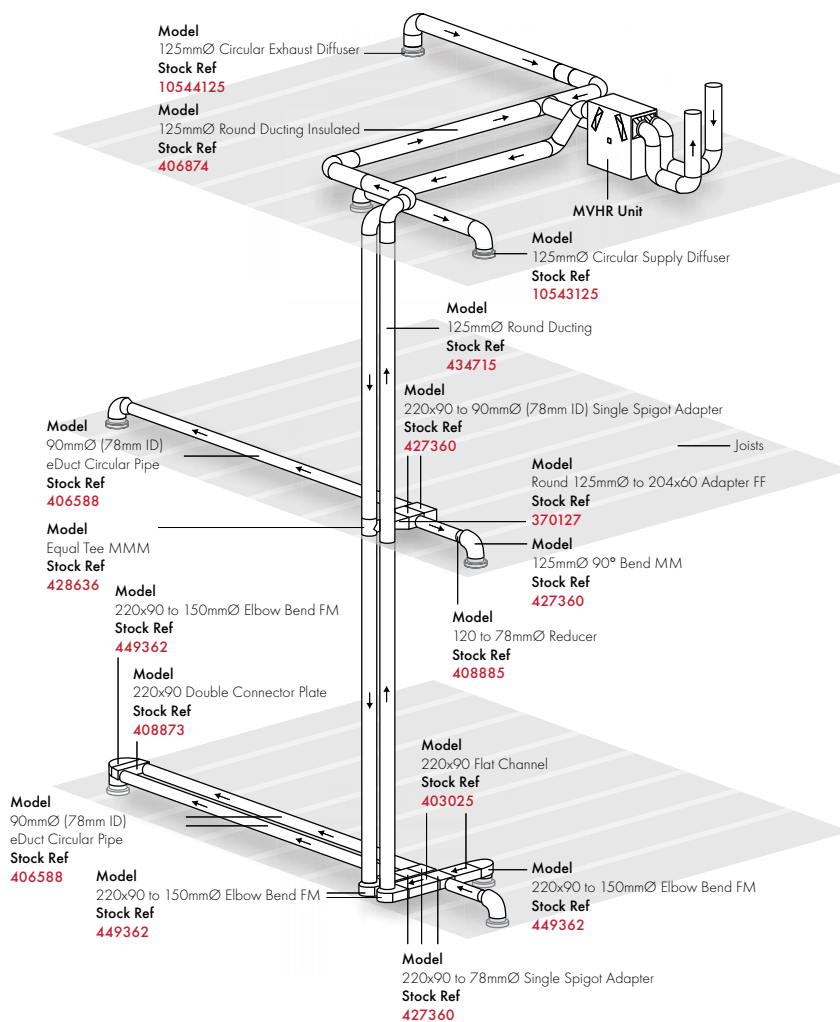

Single Spigot Adaptor



Stock Ref	Duct Size	External Dimensions		
		A	B	C
408872	220x90 to 78Ø	94	258	150

Double Connector Plate



Stock Ref	Duct Size	External Dimensions		
		A	B	C
408873	220x90 to 78Ø	98	226	66

Single Connector Plate



Stock Ref	Duct Size	External Dimensions		
		A	B	C
408874	220x90 to 78Ø	98	226	66

Blank Plate

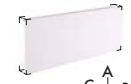

Stock Ref	Duct Size	External Dimensions		
		A	B	C
408875	220x90 to 78Ø	98	226	26

Reducer



Stock Ref	Duct Size	External Dimensions		
		A	B	C
408885	120 to 78Ø	129	105	129

Semi-Rigid Ducting



Stock Ref	Duct Size	Length (mm)
406588	90mmØ (78mm ID)	20m

NEW Uniflexplus+

Semi-Rigid Duct System



Features & Benefits

- Highly flexible and robust
- Extremely crush resistant
- Quick and easy to install
- SAP Q Approved
- Ideal for installation in concrete
- Corrosion proof
- Smooth inner surface with antistatic and antibacterial coating
- Low profile system - suitable for tight spaces
- Independently tested and accredited for air tightness

Uniflexplus+ Semi-Rigid Range

The new Uniflexplus+ Semi-Rigid Range sets the standard for easy to install, low profile ducting solutions. The system gives all of the flexibility that semi-rigid ducting provides - without taking up vital space. With minimal components, the system is uncomplicated to ensure a hassle-free, speedy install.

The Uniflexplus+ Semi-Rigid Range is compatible with most wholehouse ventilation systems including the Lo-Carbon Sentinel Kinetic (MVHR).

Products



90° Valve Collector

The 90° Valve Collector connects a section of 125mm diameter ducting and turns 90° into 2 spigots to connect to the semi rigid - ideal for dropping semi-rigid into ceiling diffusers..

Duct Size	Stock Ref
2xØ90 - Ø125mm	472248
1xØ90 - Ø125mm	472249
2xØ75 - Ø125mm	472255



Straight Valve Collector

The straight valve collector takes 125mm ducting and turns it straight into 2 spigots to connect to semi-rigid.

Model	Stock Ref
2xØ75mm - Ø125mm	472261
2xØ90mm - Ø125mm	472262



Semi-Rigid Ducting

Suitable for installation in concrete ceilings, suspended ceilings, installation walls, risers or frames, the Semi-Rigid Ducting is double-walled providing optimum flexibility. With an antistatic and antibacterial coating, the internal surface of the Semi-Rigid Ducting is smooth to ensure minimal resistance to airflow. Admissible operating temperature: -25°C to 60°C.

O/I Ømm	Length m	Coil Ømm	Coil Height mm	Weight kg
75/63	50	1100	350	17
90/78	20	1130	250	9

Pipe Size	Stock Ref
75mmØ x 50m	406587
90mmØ x 20m	406588



Distribution Box

The low-profile distribution box runs a central spigot of diameter 125mm into a set of either 8 or 12 sub-spigots, depending on requirements. Available with either 75mm or 90mm semi-rigid spigots.

Model	Stock Ref
12xØ90 - Ø125mm	472250
8xØ90 - Ø125mm	472251
12xØ75 - Ø125mm	472256
8xØ75 - Ø125mm	472257

Accessories

Circular Extract Diffusers

Duct Size	Stock Ref
125mmØ	10544125

Circular Supply Diffusers

Duct Size	Stock Ref
125mmØ	10543125

Duct Knife

Duct Size	Stock Ref
Ø90mm	472252
Ø75mm	472258

90° Bend

Duct Size	Stock Ref
Ø90mm	472253
Ø75mm	472259

Coupler

Duct Size	Stock Ref
Ø90mm	472254
Ø75mm	472260

Universal Roof Vents



Features & Benefits

- Models available for both pitched and flat roof types
- Complies with Building Regulations
- Suitable for most installations
- Corrosion and weather proof
- Compatible with both mechanical and natural ventilation systems
- Three colours available for pitched roof vents

Wholehouse ventilation systems will require some form of termination to the external atmosphere, often through the roof. To ensure that the ventilation system is able to achieve it's optimum level of performance, it is important that a suitable roof termination product is installed.

With this in mind, Vent-Axia is pleased to introduce a new range of Universal Roof Vents; including products suitable for both pitched and flat roof types.

A selection of colours and sizes should ensure that our range offers a product suitable for most residential applications with a pitched or flat roof.

Models



Universal Roof Vent suitable for pitched roofs

Manufactured in the UK, these products have been specifically developed for use with both natural and mechanical ventilation systems.

All models have been independently tested by the BRE to BS476 Part 3: 2004 and have been awarded an AA classification - the highest possible. Thus they can be installed without restriction on any pitched roof.

All models have low resistances to airflow (see table below) and incorporate condensation grooves to prevent any condensate running back down the

duct. Universal Roof Vents are designed to resist the ingress of deluge and driving rain.

Universal Roof Vents (pitched roof models) are suitable for roof pitches between 20° and 60°.



Universal Roof Vent suitable for flat roofs

Capped stacks for use in asphalt and built-up felt roofs. Special low air resistance cowl - the pressure/airflow resistance is <1.0 Pascal at 63 l/s. The pipework above the roofline is twin walled and incorporates an integral condensation drain. The stack pipe has an integral collar and separate aluminium flange for use with both felt and asphalt.

Specification

Stock Ref	Roof Type	Tile Type	Spigot Size mm	Colour	Airflow Resistance (Pa) at l/s				
					14	28	56	83	140
407329	Pitched	Tile	125	Red	1.1	4.1	16.8	N/A	N/A
407330	Pitched	Tile	125	Brown	1.1	4.1	16.8	N/A	N/A
407331	Pitched	Tile	125	Grey	1.1	4.1	16.8	N/A	N/A
407332	Pitched	Tile	150	Red	0.3	1.0	4.2	9.5	27.4
407333	Pitched	Tile	150	Brown	0.3	1.0	4.2	9.5	27.4
407334	Pitched	Tile	150	Grey	0.3	1.0	4.2	9.5	27.4
407335	Pitched	Slate	125	Slate Blue/Black	1.1	4.1	16.8	N/A	N/A
407336	Pitched	Slate	150	Slate Blue/Black	0.3	1.0	4.2	9.5	27.4

Stock Ref	Roof Type	Colour	Free vent area mm ²	Pressure/air-flow resistance	Diameter mm	Height above roof mm	Flange diameter mm	Depth
								below flange mm
407337	Flat	Black	8,400	<1.0	110	300	395	350
407338	Flat	Black	12,000	<1.0	131	400	450	350
407339	Flat	Black	20,000	<1.0	166	540	450	510

NEW Internal fit wall kit

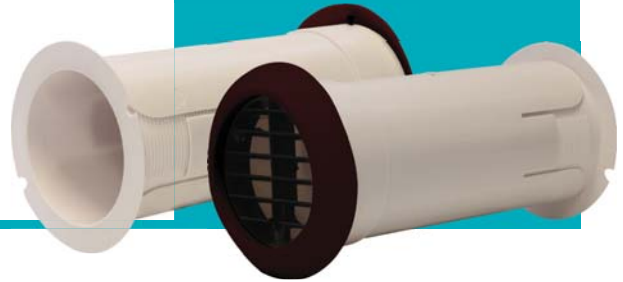

Features & Benefits

- Ideal for high-rise applications
- Suitable for 100mm fans
- Quick & easy installation
- Extendable length
- Fits from inside the property
- Prevents water ingress
- Includes low-resistance external grille
- Suitable as a passive air grille
- Covers external break-out

Internal fit wall kit

The NEW Internal Fit Wall Kit is designed to simplify installation and improve the finish of 100mm through the wall installations, also providing an external grille and water ingress protection shroud.

High rise buildings

The Kit can be fully installed from inside the building, significantly reducing the cost and complexity associated with these sites. After core-drilling a 117mm hole, or utilising an appropriate existing hole, the Kit simply pushes through from the inside of the building. Spring pins secure the external grille in position and the external shroud deploys around the grille covering up break-out from the external surface.

Installer friendly

The internal flange thickness is minimised to allow a variety of fans or grilles to be installed and indicators on both the external grill and internal flange ensure perfect alignment. The tubes extend to accommodate wall thicknesses from 225mm up to 390mm and lock into position for a secure fit. The internal flange is also flexible enough to accommodate deviations in the internal surface finish.

Building Regulations

The external grille free area is greater than 90% of the area of the duct making it suitable for continuous running systems as well as for intermittent fans.

Models

Model	Stock Ref
White	472318
Brown	472319

Dimensions (mm)

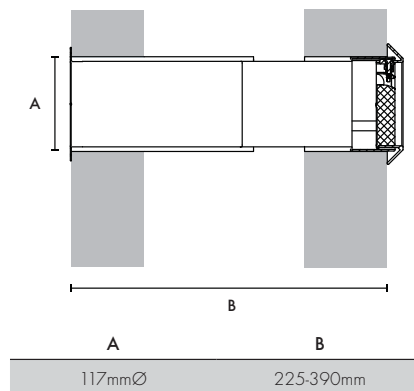

Low Resistance Inlet/Outlet Air Brick



Features & Benefits

- Provides over 90% free area of duct
- Easier to install than a double air brick
- Guide vanes for improved duct connection
- Optional first fix duct section

Available in five colours, this low resistance air brick has been designed to comply with the latest Building Regulations Approved Document F, which requires a ventilation outlet to achieve a minimum of 90% of the cross sectional area of the ductwork.

Installing a single air brick is much simpler than a double air brick and offers more versatility for locations.

Suitable for installation with round 100mm and 125mm diameter and rectangular 204 x 60mm ducting.

Attaching duct to the air brick is simplified by the use of guide vanes which help locate the duct onto the spigot.

A 500mm section of 204 x 60 duct is available for first fix which ensures that connections are accessible after completion of building works.

Five colour options ensure that the low resistance air brick will be a match for almost any application.

Models

Model	Stock Ref
White	449223
Brown	449224
Cotswold Stone	449225
Grey	449226
Terracotta	449227
1st Fix duct section	403255

500 x 204 x 60

Available Colours



Performance Curve

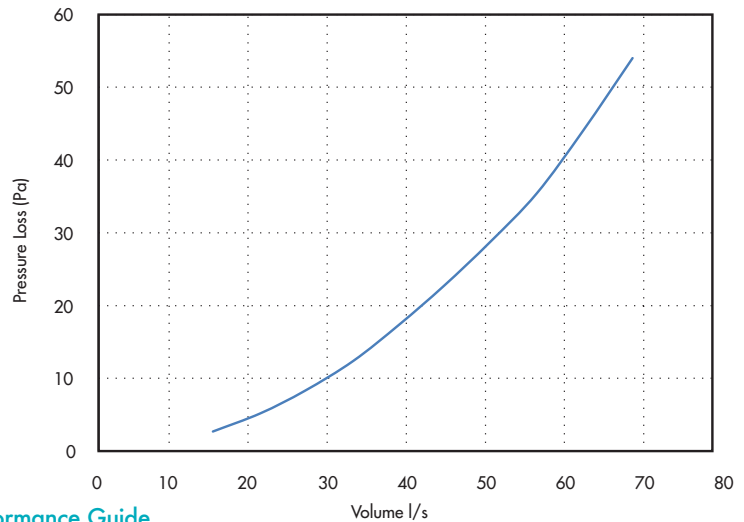

Performance Guide

Pressure (Pa)	Volume (m ³ /h)	Volume (l/s)
2.7	53.7	14.9
5.2	75.9	21.1
8.3	97.0	26.9
12.4	119.4	33.2
17.4	141.0	39.2
22.7	162.0	45.0
28.7	183.7	51.0
35.4	205.6	57.1
44.1	227.6	63.2
54.0	250.4	69.6

Dimensions (mm)

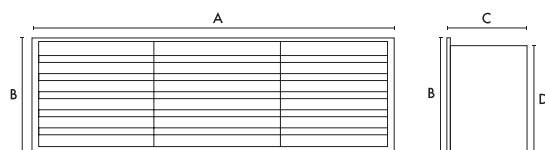

A	B	C	D
212	67	58	65

Ducting & Accessories

Flat Channel 1.5 metre length

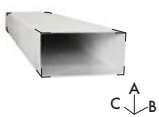

Stock Ref	Duct Size	External Dimensions			Resistance (Pa) at flow rate							
		A	B	C	8 l/s	13 l/s	21 l/s	29 l/s	37 l/s	45 l/s	53 l/s	61 l/s
406870	Insulated 204 x 60	160	304	1600	<1	<1	1.3	2.2	3.3	4.5	5.9	7.8
436617	Uninsulated 204 x 60	60	204	1500	<1	<1	1.3	2.2	3.3	4.5	5.9	7.8
436599	Uninsulated 110 x 54	54	110	1500	1.2	2.4	5.3	9.1	13.9	19.8	25.9	32
Stock Ref	Duct Size	A	B	C	60 l/s			120 l/s			180 l/s	
407343	Insulated 220 x 90	190	320	1600	1.4			4.9			10.2	
403025	Uninsulated 220 x 90	90	220	1500	1.4			4.9			10.2	

Flat Channel Connector. F to F

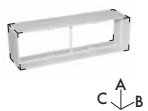

Stock Ref	Duct Size	External Dimensions			Resistance (Pa) at flow rate							
		A	B	C	8 l/s	13 l/s	21 l/s	29 l/s	37 l/s	45 l/s	53 l/s	61 l/s
436623	204 x 60	64	212	100	<1	<1	<1	<1	<1	<1	1.2	1.5
436605	110 x 54	54	114	100	<1	<1	1.1	1.4	2.2	3.4	4.8	6.4
Stock Ref	Duct Size	A	B	C	60 l/s			120 l/s			180 l/s	
403026	220 x 90	95	224	52	<1			<1			<1	

Channel Fixing Clip (Pack of 10)



Stock Ref	Duct Size	External Dimensions			60 l/s			120 l/s			180 l/s	
		A	B	C	N/A			N/A			N/A	
403030	220 x 90	97	44	19	N/A			N/A			N/A	

Horizontal 90° Bend. F to F



Stock Ref	Duct Size	External Dimensions			Resistance (Pa) at flow rate							
		A	B	C	8 l/s	13 l/s	21 l/s	29 l/s	37 l/s	45 l/s	53 l/s	61 l/s
406879	Insulated 204 x 60	160	360	360	0.7	1.7	4.1	8.4	13	18	25	34
436620	Uninsulated 204 x 60	65	260	260	0.7	1.7	4.1	8.4	13	18	25	34
436602	Uninsulated 110 x 54	60	152	152	2.3	9.9	21	38	64	93	124	162
Stock Ref	Duct Size	A	B	C	60 l/s			120 l/s			180 l/s	
407342	Insulated 220 x 90	190	350	350	9			36			80	
403028	Uninsulated 220 x 90	95	250	250	9			36			80	

Horizontal 45° Bend. F to F

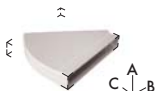

Stock Ref	Duct Size	External Dimensions			Resistance (Pa) at flow rate							
		A	B	C	8 l/s	13 l/s	21 l/s	29 l/s	37 l/s	45 l/s	53 l/s	61 l/s
406876	Insulated 204 x 60	160	340	360	0.2	0.7	1.2	2.1	3.8	6.1	9.2	13
249944	Uninsulated 204 x 60	65	240	260	0.2	0.7	1.2	2.1	3.8	6.1	9.2	13
Stock Ref	Duct Size	A	B	C	60 l/s			120 l/s			180 l/s	
449363	Uninsulated 220 x 90	95	240	200	5			20			46	

Horizontal T. F to F to F

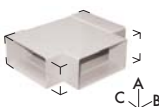

Stock Ref	Duct Size	External Dimensions			Resistance (Pa) at flow rate							
		A	B	C	8 l/s	13 l/s	21 l/s	29 l/s	37 l/s	45 l/s	53 l/s	61 l/s
406883	Insulated 204 x 60	160	410	355	vary on installation							
436551	Uninsulated 204 x 60	65	310	255	vary on installation							
436614	Uninsulated 110 x 54	60	185	150	vary on installation							
Stock Ref	Duct Size	A	B	C	60 l/s			120 l/s			180 l/s	
449365	Uninsulated 220 x 90	95	275	250	vary on installation							

Vertical 90° Bend. F to F

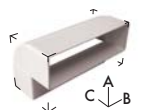

Stock Ref	Duct Size	External Dimensions			Resistance (Pa) at flow rate							
		A	B	C	8 l/s	13 l/s	21 l/s	29 l/s	37 l/s	45 l/s	53 l/s	61 l/s
406872	Insulated 204 x 60	215	310	215	1.1	2.5	5.2	9.8	16.1	24	33.6	45
436621	Uninsulated 204 x 60	115	210	115	1.1	2.5	5.2	9.8	16.1	24	33.6	45
436603	Uninsulated 110 x 54	95	115	95	3.3	15.5	36	61	96	138	190	253
Stock Ref	Duct Size	A	B	C	60 l/s			120 l/s			180 l/s	
403029	Uninsulated 220 x 90	117	224	120	7			28			66	

Vertical 45° Bend. F to F



Stock Ref	Duct Size	External Dimensions			Resistance (Pa) at flow rate							
		A	B	C	8 l/s	13 l/s	21 l/s	29 l/s	37 l/s	45 l/s	53 l/s	61 l/s
406871	Insulated 204 x 60	200	310	215	0.1	0.5	1.3	2.5	4.4	6.9	10	13.3
445196	Uninsulated 204 x 60	100	210	115	0.1	0.5	1.3	2.5	4.4	6.9	10	13.3
441655	Uninsulated 110 x 54	115	115	70	1	2.4	6.6	12.9	23.1	35.1	48	64
Stock Ref	Duct Size	A	B	C	60 l/s			120 l/s			180 l/s	
449364	Uninsulated 220 x 90	110	225	115	6			27			65	

Elbow Bend. 100mm to Rectangular. M to F



Stock Ref	Duct Size	External Dimensions			Resistance (Pa) at flow rate								
		A	B	C	8 l/s	13 l/s	21 l/s	29 l/s	37 l/s	45 l/s	53 l/s	61 l/s	
436624	204 x 60	80	215	195	2.9	7.1	15.1	28	45.1	68.1	92.2	118	
436607	110 x 54	90	115	140	3	8	17.7	33	49.9	74.5	101	137	
Stock Ref	Duct Size	A	B	C	60 l/s			120 l/s			180 l/s		
403027	220 x 90	118	226	240	N/A			N/A			N/A		

Elbow Bend. 125mm to Rectangular. M to F

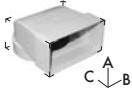

Stock Ref	Duct Size	External Dimensions			Resistance (Pa) at flow rate								
		A	B	C	8 l/s	13 l/s	21 l/s	29 l/s	37 l/s	45 l/s	53 l/s	61 l/s	
436625	204 x 60	80	215	195	3.1	5.9	12.2	25	43.6	62.2	86	111	
Stock Ref	Duct Size	A	B	C	60 l/s			120 l/s			180 l/s		
449361	220 x 90	118	226	240	N/A			N/A			N/A		

Elbow Bend. 150mm to Rectangular. M to F

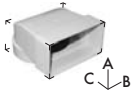

Stock Ref	Duct Size	External Dimensions			Resistance (Pa) at flow rate								
		A	B	C	8 l/s	13 l/s	21 l/s	29 l/s	37 l/s	45 l/s	53 l/s	61 l/s	
436626	204 x 60	80	215	195	2.8	4.9	11.6	21	31	41	53	67	
Stock Ref	Duct Size	A	B	C	60 l/s			120 l/s			180 l/s		
449362	220 x 90	118	226	240	N/A			N/A			N/A		

Elbow Bend. 100mm to Rectangular. F to F

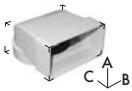

Stock Ref	Duct Size	External Dimensions			Resistance (Pa) at flow rate								
		A	B	C	8 l/s	13 l/s	21 l/s	29 l/s	37 l/s	45 l/s	53 l/s	61 l/s	
436608	110 x 54	90	115	140	2.1	5.5	14.3	27.2	44.3	69	93	118	

Flat Channel connector with Damper



Stock Ref	Duct Size	External Dimensions			Resistance (Pa) at flow rate								
		A	B	C	8 l/s	13 l/s	21 l/s	29 l/s	37 l/s	45 l/s	53 l/s	61 l/s	
400735	110 x 54	60	115	75	16	17.5	19.5	22	25.5	30.5	36	42	

Drop down section F to F



Stock Ref	Duct Size	External Dimensions			Resistance (Pa) at flow rate								
		A	B	C	8 l/s	13 l/s	21 l/s	29 l/s	37 l/s	45 l/s	53 l/s	61 l/s	
442273	204 x 60	120	220	210	0.2	0.5	1.7	3.6	6.0	9.1	12.4	16.6	

Single Air Brick Horizontal (System 60 Air Grille Adaptor is supplied with the Single Air Bricks)

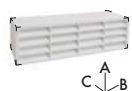

Stock Ref	Duct Size	External Dimensions			Resistance (Pa) at flow rate								
		A	B	C	8 l/s	13 l/s	21 l/s	29 l/s	37 l/s	45 l/s	53 l/s	61 l/s	
436610	110 x 54 (White)	65	210	85	3.2	7.8	20.9	39	65	96	128	176	
436612	110 x 54 (Terracotta)	65	210	85	3.2	7.8	20.9	39	65	96	128	176	
436611	110 x 54 (Brown)	65	210	85	3.2	7.8	20.9	39	65	96	128	176	
436613	110 x 54 (Beige)	65	210	85	3.2	7.8	20.9	39	65	96	128	176	

Single Air Grille Soldier



Stock Ref	Duct Size	External Dimensions			Resistance (Pa) at flow rate								
		A	B	C	8 l/s	13 l/s	21 l/s	29 l/s	37 l/s	45 l/s	53 l/s	61 l/s	
438594	204 x 60 (White)	210	65	15	3.3	10	20.6	40	63	92.8	128	168	
468728	204 x 60 (Terracotta)	210	65	15	3.3	10	20.6	40	63	92.8	128	168	
468730	204 x 60 (Brown)	210	65	15	3.3	10	20.6	40	63	92.8	128	168	
468729	204 x 60 (Beige)	210	65	15	3.3	10	20.6	40	63	92.8	128	168	

Ducting & Accessories

Double Air Brick



Stock Ref	Duct Size	External Dimensions			Resistance (Pa) at flow rate							
		A	B	C	8 l/s	13 l/s	21 l/s	29 l/s	37 l/s	45 l/s	53 l/s	61 l/s
438604	204 x 60 (White)	145	245	80	0.2	1.6	4.3	8.7	13.9	21.1	27.5	37.4
438607	204 x 60 (Terracotta)	145	245	80	0.2	1.6	4.3	8.7	13.9	21.1	27.5	37.4
438605	204 x 60 (Brown)	145	245	80	0.2	1.6	4.3	8.7	13.9	21.1	27.5	37.4
438606	204 x 60 (Beige)	145	245	80	0.2	1.6	4.3	8.7	13.9	21.1	27.5	37.4

Double Air Brick Adaptor

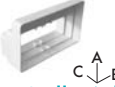

Stock Ref	Duct Size	External Dimensions			Resistance (Pa) at flow rate							
		A	B	C	8 l/s	13 l/s	21 l/s	29 l/s	37 l/s	45 l/s	53 l/s	61 l/s
438608	204 x 60	135	220	85	-	-	-	-	-	-	-	-

Air Grille Adaptor



Stock Ref	Duct Size	External Dimensions			Resistance (Pa) at flow rate							
		A	B	C	8 l/s	13 l/s	21 l/s	29 l/s	37 l/s	45 l/s	53 l/s	61 l/s
436609	110 x 54	65	210	85	0.2	1.2	2.5	4.7	7.8	11	14	18

Flexible Ducting



Stock Ref	Duct Size	External Dimensions			Resistance (Pa) at flow rate							
		A	B	C	8 l/s	13 l/s	21 l/s	29 l/s	37 l/s	45 l/s	53 l/s	61 l/s
5109662	204 x 60	-	-	-	0.2	0.6	1.5	2.6	4.1	6.0	8.2	11.5
Stock Ref	Duct Size	A	B	C	60 l/s		120 l/s			180 l/s		
449366	220 x 90	-	-	-	N/A		N/A			N/A		

Louvred Grille with Flyscreen fitting



Stock Ref	Duct Size	External Dimensions			Resistance (Pa) at flow rate							
		A	B	C	8 l/s	13 l/s	21 l/s	29 l/s	37 l/s	45 l/s	53 l/s	61 l/s
400743	110 x 54	140	140	50	5.7	14.5	37	75	120	-	-	-

Round (M) 100mm to Rectangular (F/M) Adaptor



Stock Ref	Duct Size	External Dimensions			Resistance (Pa) at flow rate							
		A	B	C	8 l/s	13 l/s	21 l/s	29 l/s	37 l/s	45 l/s	53 l/s	61 l/s
441654	M to F 204 x 60	140	210	215	1.0	1.96	3.2	4.9	6.7	8.7	11.2	14.5
400740	M to M 110 x 54	100	115	180	1.2	4.2	8.3	19.8	29.9	42	60	86

Round (F) 125mm to Rectangular (F) Adaptor



Stock Ref	Duct Size	External Dimensions			Resistance (Pa) at flow rate							
		A	B	C	8 l/s	13 l/s	21 l/s	29 l/s	37 l/s	45 l/s	53 l/s	61 l/s
370127	F to F 204 x 60	140	210	213	<1	<1	1.5	2.8	4.5	6.7	9	11.5

Round (F) 150mm to Rectangular (F) Adaptor



Stock Ref	Duct Size	External Dimensions			Resistance (Pa) at flow rate							
		A	B	C	60 l/s		120 l/s			180 l/s		
403031	F to F 220 x 90	160	225	203	N/A		N/A			N/A		

Short Round (M) 100mm to 110 x 54 (F) Adaptor



Stock Ref	Duct Size	External Dimensions			Resistance (Pa) at flow rate							
		A	B	C	8 l/s	13 l/s	21 l/s	29 l/s	37 l/s	45 l/s	53 l/s	61 l/s
455035	M to F 110 x 54	60	110	105	1.2	4.3	8.4	20	30.2	43	62	88

Round 2m Ducting length Insulated/Uninsulated

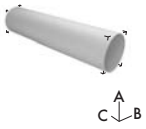

Stock Ref	Duct Size	External Dimensions			Resistance (Pa) at flow rate							
		A	B	C	8 l/s	13 l/s	21 l/s	29 l/s	37 l/s	45 l/s	53 l/s	61 l/s
406873	Insulated 100 Ø	200	200	2100	<1	<1	1.7	2.8	3.6	4.5	5.3	6.2
5108250	Uninsulated 100 Ø	100	100	2000	<1	<1	1.7	2.8	3.6	4.5	5.3	6.2
406874	Insulated 125 Ø	225	225	2100	<1	<1	<1	1.3	1.8	2.4	3.1	3.8
434715*	Uninsulated 125 Ø	125	125	1500	<1	<1	<1	1.3	1.8	2.4	3.1	3.8
406875	Insulated 150 Ø	265	265	2100	<1	<1	<1	<1	1.2	1.6	2	2.5
5108248	Uninsulated 150 Ø	150	150	2000	<1	<1	<1	<	1.2	1.6	2	2.5

*1.5 metres

Equal Tee Insulated/Uninsulated MMM

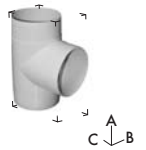

Stock Ref	Duct Size	External Dimensions			Resistance (Pa) at flow rate							
		A	B	C	8 l/s	13 l/s	21 l/s	29 l/s	37 l/s	45 l/s	53 l/s	61 l/s
406884	Insulated 100 Ø	290	210	235	vary on installation							
372007	Uninsulated 100 Ø	190	110	135	vary on installation							
406885	Insulated 125 Ø	310	215	260	vary on installation							
428636	Uninsulated 125 Ø	210	115	160	vary on installation							
406886	Insulated 150 Ø	335	245	285	vary on installation							
370237	Uninsulated 150 Ø	235	130	177	vary on installation							

90° Bend Insulated/Uninsulated MM

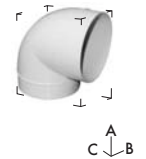

Stock Ref	Duct Size	External Dimensions			Resistance (Pa) at flow rate							
		A	B	C	8 l/s	13 l/s	21 l/s	29 l/s	37 l/s	45 l/s	53 l/s	61 l/s
406880	Insulated 100 Ø	230	200	200	2.8	5.5	11	20.3	33	45	60	79
372004	Uninsulated 100 Ø	130	100	100	2.8	5.5	11	20.3	33	45	60	79
406881	Insulated 125 Ø	260	230	230	<1	1.8	5	8.2	11.8	18	26	35
427360	Uninsulated 125 Ø	160	130	130	<1	1.8	5	8.2	11.8	18	26	35
406882	Insulated 150 Ø	290	255	255	<1	1.0	2.5	4.1	6.4	9.6	13.5	18
370295	Uninsulated 150 Ø	190	155	155	<1	1.0	2.5	4.1	6.4	9.6	13.5	18

45° Bend Insulated/Uninsulated MM



Stock Ref	Duct Size	External Dimensions			Resistance (Pa) at flow rate							
		A	B	C	8 l/s	13 l/s	21 l/s	29 l/s	37 l/s	45 l/s	53 l/s	61 l/s
406877	Insulated 100 Ø	280	200	230	<1	1.9	8.1	11.7	17.5	24.6	31.4	-
372005	Uninsulated 100 Ø	180	100	130	<1	1.9	8.1	11.7	17.5	24.6	31.4	-
406878	Insulated 125 Ø	300	230	250	<1	<1	1.8	2.9	4.6	6.6	9	12.2
441657	Uninsulated 125 Ø	200	130	150	<1	<1	1.8	2.9	4.6	6.6	9	12.2

Connector MM

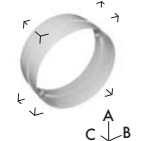

Stock Ref	Duct Size	External Dimensions			Resistance (Pa) at flow rate							
		A	B	C	8 l/s	13 l/s	21 l/s	29 l/s	37 l/s	45 l/s	53 l/s	61 l/s
372006	100 Ø	100	60	-	-	-	-	-	-	-	-	-
428633	125 Ø	125	60	-	-	-	-	-	-	-	-	-
370299	150 Ø	150	60	-	-	-	-	-	-	-	-	-

Reducer



Stock Ref	Duct Size	External Dimensions			Resistance (Pa) at flow rate							
		A	B	C	8 l/s	13 l/s	21 l/s	29 l/s	37 l/s	45 l/s	53 l/s	61 l/s
VA54119	125mm to 100mm	130	57	-	-	-	-	-	-	-	-	-
428632	150mm to 125mm	155	57	-	-	-	-	-	-	-	-	-

Ducting & Accessories



PVC Flexible Ducting

Manufactured using PVC with wire helix. Used with single spigots and in multi-duct schemes.

6 metre lengths

Duct Dia	Stock Ref
100mm	436580
125mm	436584
150mm	436588
200mm	436592

T-Series Flexible Ducting

PVC with wire helix. For use with T-Series.

6m lengths

Size	Duct Dia	Stock Ref
Size 6	175mm	566607
Size 7	225mm	566609
Size 9	300mm	566612
Size 12	400mm	566616



Insulated Flexible Ducting

Insulated ducting should be used when duct passes through an unheated area. Minimised heat loss when used with heat recovery fans. Available in 6 diameters. An additional benefit is that thermally insulated duct offers some measure of acoustic attenuation.

Fire Rating: When assessed against the integrity criterion of BS476: Part 20; 1987, the ducting is capable of providing in excess of 25 minutes integrity from inside to outside.

10 metre lengths

Duct Dia	Stock Ref
100mm	561654
125mm	561655
150mm	561656



Duct Y Pieces

For dividing a ventilation system, providing ducting to multiple supply or extract grilles using only a single fan source.

2x Into	1x	Stock Ref
100mm	100mm	452081
100mm	150mm	452082
125mm	125mm	455211
125mm	150mm	455212
150mm	150mm	452083
150mm	200mm	452084
200mm	200mm	452085
200mm	250mm	452078
250mm	250mm	452076
250mm	300mm	452079



Acoustic Insulated Ducting

Multiple layer aluminium/polyester laminate with micro perforated flexible core to enhance acoustic performance. Core surrounded by 25mm fibreglass insulation with outer vapour barrier.

Duct Dia	Length	Stock Ref
100mm	1m	443273
125mm	1.5m	443793
150mm	1m	443274



Reducer

Duct Size	Stock Ref
R125/100	370302
R150/100	370303
R150/125	370304
R200/150	370307
R250/200	370309
R300/100	370310
R300/200	370312



Circular Extract Diffusers

Manufactured from powder coated steel. Suitable for exhausting air and can be fitted directly to the duct or in the ceiling.

Duct Size	Stock Ref
100 Ø	10544100
125 Ø	10544125
150 Ø	10544150
200 Ø	10544200



Circular Supply Diffusers

Manufactured from powder coated steel. Suitable for supplying air and can be fitted directly to the duct or in the ceiling.

Duct Size	Stock Ref
100 Ø	10543100
125 Ø	10543125
150 Ø	10543150
200 Ø	10544200



Aircheck Bathroom Grille

An auto humidity operated extract grille. Constant airflow of 10m³/h opening to 45m³/h when humidity is detected.

Additional PIR (presence detector) function with timer providing extract airflow rate of 45m³/h can be activated by adding 3 x AA batteries (not supplied) to the grille.

Stock Ref
407381



Collar for Exhaust & Supply Diffusers

Stock Ref
371301



Aircheck Kitchen Grille

An auto humidity operated extract grille. Constant airflow of 10 m³/h opening to 45m³/h when humidity is detected.

Further extract airflow rate of 135m³/h can be achieved using additional boost push button. Boost button controlled by 30 min overrun timer. 3 x AA batteries required (not supplied).

Stock Ref
407287

Boost Push Button

Stock Ref
448929



VT100 Tile Vent

5 in 1 roof ventilation terminal kit available in grey. The kit comprises of a streamlined hood on a circular upstand with a 500 x 500mm non lead skirt and a stepped adaptor which allows connections from 100mm to 160mm diameter ducting.

Stock Ref
370538



Aircheck Ceiling Adaptor (CA125)

A ceiling adaptor for connection between Aircheck grilles and ducting.

Stock Ref
CA125 455219



Acoustic Mat

486mm x 486mm x 25mm thick foam mat for use as a resilient mounting for wholehouse units.

Stock Ref
ACM/House 370179

Galvanised Spiral Wound Ducting



Spiral Ductwork - 3m length

Duct Size	Stock Ref
100 Ø	400900
125 Ø	400901
150 Ø	400902
200 Ø	410922
250 Ø	410923
315 Ø	410924



Joining Piece

In sheet metal. For joining lengths of flexible ducting to give long lasting airtight connection.

Duct Size	Stock Ref
100 Ø	561804
125 Ø	561805
150 Ø	561806
200 Ø	561808
250 Ø	561810
315 Ø	561813



Equal Tee

Duct Size	Stock Ref
100 Ø	400749
125 Ø	400750
150 Ø	400751
200 Ø	370238
250 Ø	370239
315 Ø	410925



Rectangular Balancing Damper

Duct Size	Stock Ref
110 x 54	405156
204 x 60	403698
220 x 90	403699



90° Bend

Duct Size	Stock Ref
100 Ø	400752
125 Ø	400753
150 Ø	400754
200 Ø	370202
250 Ø	370203
315 Ø	410926



Circular Balancing Damper

Duct Size	Stock Ref
100 Ø	400758
125 Ø	400759
150 Ø	400760
200 Ø	410930
250 Ø	410931
315 Ø	410932



Female Coupler

Duct Size	Stock Ref
100 Ø	400755
125 Ø	400756
150 Ø	400757
200 Ø	410927
315 Ø	410929

Fire Stopping – Round and Flat ducting

Vent-Axia provides a complete range of fire stopping products specifically tested with ventilation ducting. This versatile selection allows for stacking and parallel installation in certain circumstances, along with creative solutions for partition walls and slab mounting.

The table highlights the type of fire stopping required for most common applications.

	Minutes Protection	Fire Valves		Round Fire Sleeve			Rectangular Fire Sleeve			Rectangular Fire Wrap	
		100mm	125mm	100mm	125mm	150mm	110 x 54	204 x 60	220 x 90	110 x 54	204 x 60
72mm Stud Partition	30										
	60						#407658	407659	407660		
	120										
100mm Stud Partition	30										
	60						#407658	407659	407660		
	120										
130mm Stud Partition	30										
	60			407655	407656	407657	#407658	407659	407660	404276	404274
	120										
130mm Masonary	30										
	60			407655	407656	407657	#407658	407659	407660	435137	435138
	120										
140mm Masonary	30										
	60			407655	407656	407657	#407658	407659	407660	435137	435138
	120										
Ceilings	30										
	60	403431	403432								
	120										

Fire Test Assessment also covers multiple ducts to be installed in series / side by side, max. 3No., 30, 60 & 120 Minute Partitions, Single & Double Boards

Note: For a copy of the Fire Certificates for the product(s) above, visit our webpage www.vent-axia.com/range/ventilation-fire-stopping



Circular Fire Valve

Duct Size	Stock Ref
100mm	403431
125mm	403432
150mm	403433
200mm	408828



Round Fire Sleeve

Thickness:	10-15mm
Length:	280mm (180mm 407655)
CE Marked	
Duct Size	Stock Ref
100mm	407655
125mm	407656
150mm	407657



Rectangular Fire Sleeve - 4 sided

Thickness:	10-15mm
Length:	180mm
CE Marked	
Duct Size	Stock Ref
110x54mm	407658
204x60mm	407659
220x90mm	407660



Rectangular Fire Wrap

Duct Size	Stock Ref
204x60mm	435138



Pyrocheck

Duct Size	Stock Ref
4" Ø	CVT100
5" Ø	CVT130

Vent-Axia does not guarantee compliance with Building Regulations Part B, Fire Spread or other regulations that relate to fire planning. Suitability to comply with these regulations should be determined prior to installation and in conjunction with Building Control Officers. Compliance with the Regulations is specifically excluded from quotations and designs.

100mm & 150mm Accessories



Wall Fitting Kit

A range of wall kits suitable for Vent-Axia range of 100 and 150mm fans. The kit can be installed into most walls using the telescopic liners supplied.

White	
Model	Stock Ref
VA100	254102
VA140/150	140902
Silhouette 150	140902

Brown	
Model	Stock Ref
VA100	254100
VA140/150	140903
Silhouette 150	140903



Window Fitting Kit

For use in single or sealed double glazing and most materials up to 40mm thick.

White	
Model	Stock Ref
VA100 (105Ø)	254101
VA100 (110Ø)	443234
Centra/Sil 100	442947
VA140/150	140901
Solo	11461685



Air Grille

Louvre grille for external termination of 100mm diameter rigid ducting. Consists of wall mounting piece and grille with 2 fixing screws.

Colour: White or Brown
 Dimensions: 155 x 155 x 32mm
 Material: ABS plastic

Colour	Stock Ref
White	563511
Brown	563500



Termination Set

Used as a decorative inlet grille or soffit termination set in conjunction with 100mm or 125mm diameter ducting. Two fixing screws supplied to secure grille to the spigot through material up to 25mm thick. Dimension 155mm x 155mm.

Colour: White
 Material: ABS plastic

Stock Ref
563513



Decoration Frame

A decoration frame that converts old Centrif to new Centrif Duo without the need to redecorate. The frame can be used with Quadra and Centrif Duo Plus.

The frame is simply installed using two wall fixing screws, allowing the fan to be mounted via it's standard mountings. Finished in a high moulded material plastic colour matched to the fan.

Color: White
 Size: 386mm x 296 x 32 mm deep

Stock Ref
442551



Quick Fit 100mm Airflow Shutter

Shutter with gravity flaps to protect against backdraught. The spigot connects to 100mm rigid ducting using quick fix grips provided.

Dimensions: 155 x 155 x 20mm
 Material: Plastic

Colour	Stock Ref
White	563522
Brown	563542



Terminal Connector & Grille

Used for the termination of 100mm flexible ducting to the ceiling or wall of small areas, such as internal toilets.

Connector: Manufactured in high impact thermoplastic
 Colour: Grey
 Grille: ABS plastic eggcrate, white finish

Description	Stock Ref
Grille	560846
Connector	560856

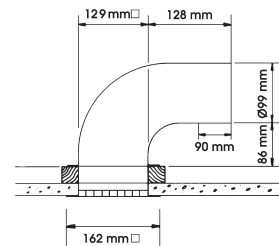

External Terminations louvre Grilles with Spigot

Plastic louvre grilles with either 100mm or 150mm diameter spigots.

100mm Ø	Stock Ref
RD104TC	370328
RD104BR	370329
RD104WH	370330

150mm Ø	Stock Ref
RD604BR	370337
RD604TC	370338
RD604WH	370339

100mm & 150mm Accessories



Quick Fit 100mm Grille

Terminates a rigid duct on an outside wall using the 'quick fix' side grips without the need for additional fixings.

Colour	Stock Ref
White	563521
Brown	563541



Quick Fix Termination

The quick fix termination is designed to be installed from inside the building to a nominal 117mm or 165mm diameter core-cut hole, saving time and cost. Four sealing rings ensure a weather tight fit to the wall external leaf. Effective length 370mm.

Duct Size	Stock Ref
100mm	563535
150mm	434656



Vent Cowl

External termination for 110mm diameter rigid ducting through roofs and walls in exposed situations. Overall diameter 200mm. Not suitable for use with flexible ducting.

Material	Stock Ref
Grey PVCu	561403
White	457845



Air Replacement Set

Bathroom and toilet ventilation is only effective when there is adequate air replacement into the room. This is often most effectively achieved by fitting a pair of air replacement grilles at low level in a door. Consists of a two piece telescopic set which fits unobtrusively on either side of the door panel.

Minimum fixing thickness:	30mm
Dimensions:	454 x 90mm
Hole size:	435 x 76mm
Material:	High impact thermoplastic
Free area:	1150mm ²

Colour	Stock Ref
Brown	561400
Ivory	561401



Condensation Trap

Condensation trap, for fitting in vertical rigid PVCu pipe ducting. Must be used where pipe ducts pass through unheated roof voids. Fitted with 20mm pipe connection for running off condensate. Not suitable for use with flexible ducting.

Length	85mm
Material:	Grey PVCu

Size	Stock Ref
110mm	563516
125mm	455191
150mm	455190



VA140/150 Window wind cowl

Wind cowl for exposed areas.

Stock Ref
455262

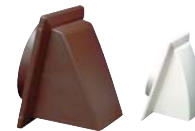

Wind Baffles

A range of 100mm and 150mm wind baffles. Cowled wall outlet with damper protected gravity grille.

Available in white and brown they are ideal for exposed coastal applications, helping to prevent unwanted backdraughts.

100mm	
Colour	Stock Ref
White	452094
Brown	452095

150mm	
Colour	Stock Ref
White	452096
Brown	452097



Wind Baffle Kits

100mm wind baffle kit consisting of a telescopic wall tube and wind baffle. Available with either a white or brown wind baffle.

Colour	Stock Ref
White	407382
Brown	407577

Commercial Range

Lo-Carbon T-Series®

The UK's No. 1 Commercial Fan is available with a low energy DC motor providing up to 65% energy saving. The motor is designed to provide longer life, improved performance, lower running costs and maintain the T-Series rugged reliability. Vent-Axia have improved the way this product can be purchased for the refurbishment market. Now supplied as a fan core plus optional application specific fitting kit, this gives you more flexibility in both stocking and installing the product. It also supports our lo-carbon drive to reduce waste and landfill.



	ACM® 100-200	122-123
	ACM® 250-315	124-125
	Powerflow Range	126-127
	Lo-Carbon T-Series® Overview	128-129
	Lo-Carbon T-Series® Window Kit & Fan Core	130
	Lo-Carbon T-Series® Wall Kit & Fan Core	131
	Lo-Carbon T-Series® Roof Kit & Fan Core	132
	Lo-Carbon T-Series® Panel Kit & Fan Core	133
	Traditional T-Series® Overview	134-135
	Traditional T-Series® Window Kit & Fan Core	136
	Traditional T-Series® Wall Kit & Fan Core	137
	Traditional T-Series® Roof Kit & Fan Core	138
	Traditional T-Series® Panel/Ceiling Kit & Fan Core	139
	Traditional T-Series® Darkroom Kit & Fan Core	140
	Traditional T-Series® In-line Kit & Fan Core	141
	Super T-Series® Heavy Duty Wall Fans	142-143
	Standard Range® Overview	144-145
	Standard Range® Window Kit & Fan Core	146
	Standard Range® Roof Kit & Fan Core	147
	Standard Range® Wall Kit & Fan Core	148
	Standard Range® Panel fan	149

Vent-Axia

Commercial Range

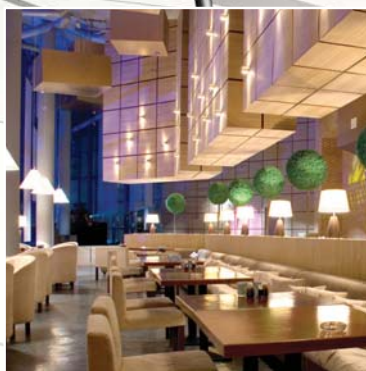
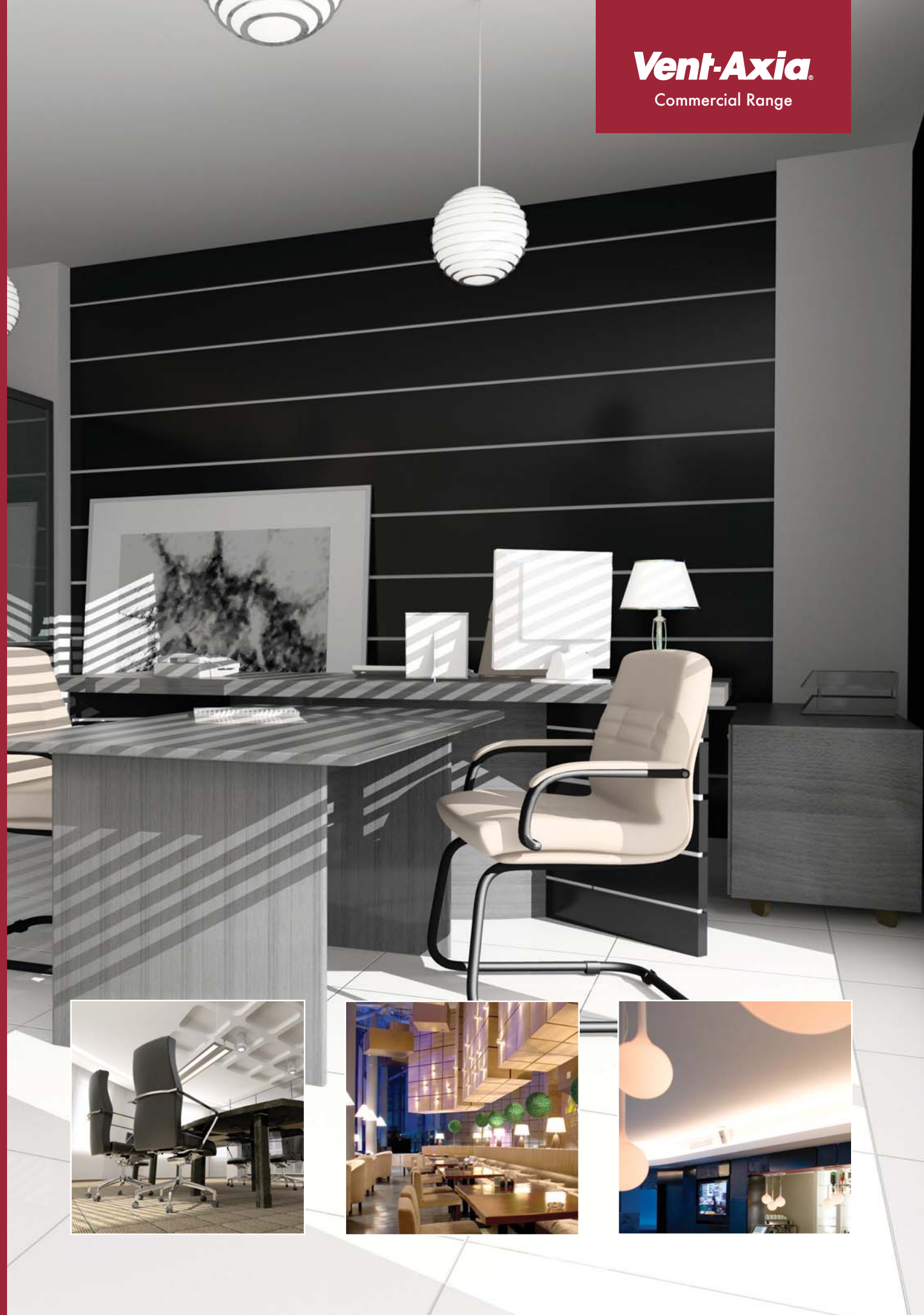

ACM® 100-200

In-Line Mixed Flow Fan Models

Features & Benefits

- Designed and manufactured in UK
- Multiple speed motor
- Timer versions available
- Removable motor core assembly
- Rotating motor chassis assembly
- IP44 rated
- Aesthetically pleasing with wipe clean polymer casing
- Sound data from independent testing
- Running speed selected on installation

Ducted Ventilation

Vent Axia has designed a complete range of energy efficient Mixed Flow In-Line fans that are now quieter, offer two and half times the pressure of conventional axial fans and are dimensionally more compact making them ideal for many ducted applications.

The ACM Mixed Flow In-Line fan can operate in both horizontal and vertical positions.

Motor

All motors have multiple speeds and fitted with Standard Thermal Overload Protection (S.T.O.P.). Designed for ambient temperatures up to +50°C. All sizes with capacitor run motors. All sizes are Class II appliances. Supply voltage 220-240V/1/50Hz.

Installation

These units have a separate footplate for simple location mounting and detachable spigots for simple connection to ducting. The motor body chassis rotates to provide connection in acute spaces. Cleaning the product has also become simple as all parts can be removed without removing the ducting.

Controller

For optimum variable speed performance use a Vent-Axia 1.5 Amp electronic controller. Surface mounted providing variable speed control with an On/Off/sensor slider with indication light. There is an adjustable minimum speed setting. The controller has electrical connections for use with suitable external sensors. Cannot be used with timer models.

1.5 Amp Controller (Suitable for 100mm - 200mm models) Dimensions: 86 x 156 x 53mm (H x W x D).

Stock Ref
W300310

For flush fitting a metal wall box accessory is available.

Stock Ref
400144

Hole for wall box: 80 x 150 x 150mm (H x W x D).

Models

Model	Stock Ref
ACM100	17104010
ACM100T	17104020
ACM125	17105010
ACM125T	17105020
ACM150	17106010
ACM150T	17106020
ACM200	17108010
ACM200T	17108020

Dimensions (mm)

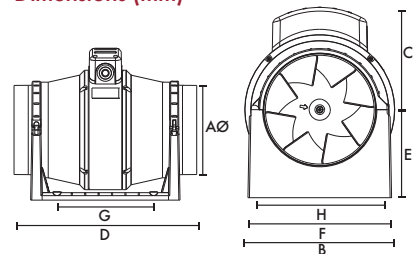

Size	100	125	150	200
AØ	97	122	147	199.5
B	178	178	200	223
C	124	124	138	146
D	298	259	350	300
E	96	96	118	130
F	168	168	192	195
G (fixing hole)	120	120	162	100
H (fixing hole)	153.5	153.5	178	180



Performance

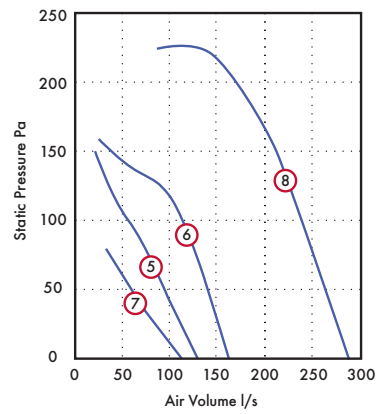
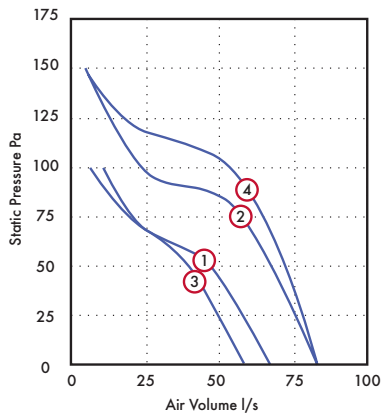

Size	Curve	Nominal r.p.m	l/s @ 0Pa	Watts	Amps	dB(A) at 3m
100	1	L 1670	52	18	0.09	17
	2	H 2200	71	23	0.1	23
125	3	L 1800	65	25	0.12	18
	4	H 2400	91	30	0.13	25
150	5	L 1870	123	42	0.19	29
	6	H 2350	145	48	0.21	36
200	7	L 1411	111	107	0.48	17
	8	H 2250	240	114	0.51	42

ACM® 250-315

In-Line Mixed Flow Fan Models

Features & Benefits

- Available in two sizes
- Simple Installation
- Supplied complete for installation
- Optimise fan performance by using an approved Vent Axia controller
- Diagonal impeller with stator
- Galvanized metal housing
- Integrated thermal switch
- Includes a mounting bracket
- Designed to meet IP54

Ducted Ventilation

Vent Axia has designed a complete range of energy efficient Mixed Flow In-Line fans for use with rigid and flexible ducting.

In-line Mixed Flow fans offer two and half times the pressure of conventional axial fans and are dimensionally more compact making them ideal for many ducted applications.

The ACM Mixed Flow In-Line fan can operate in both horizontal and vertical positions and can be mounted to meet its optimum performance.

Motor

All motors are fitted with Standard Thermal Overload Protection (S.T.O.P.). Designed for ambient temperatures up to +50°C. All sizes with capacitor run motors. ACM 250 and 315 are Class I appliances. Supply voltage 220-240V/1/50Hz.

Models

Model	Stock Ref
ACM250	17110010
ACM315	17112010

Controller

For optimum performance use a Vent-Axia electronic controller. Surface mounted providing variable speed control with an On/Off/sensor slider with indication light. There is an adjustable minimum speed setting. The controller is radio suppressed to BS EN 55014 and electrical connections for use with suitable external sensors are provided.

1.5 Amp Controller - Suitable for 250mm model
Dimensions: 86 x 156 x 53mm (H x W x D).

Stock Ref

W300310

Used in conjunction with speed controllable fans to provide 5 stepped speed without electronic motor 'hum'. Several fans can be connected to one transformer provided their combined load does not exceed the controller rating.

Single phase: 3.0amp. Rotary switch giving On/Off and five speeds.

Output voltages at 240V/1PH/50Hz 0, 90, 115, 140, 175, 240 volts.

Neon indicator. Enclosures are protected to IP54.

Dimensions: 135 x 170 x 117mm (H x W x D).

Stock Ref

10314103

Dimensions (mm)

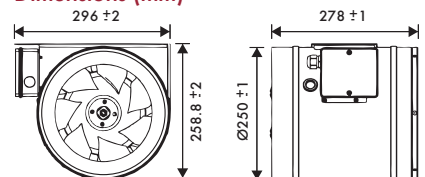

ACM250

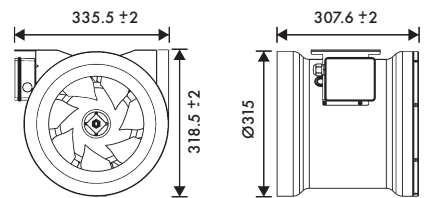

ACM315



Performance

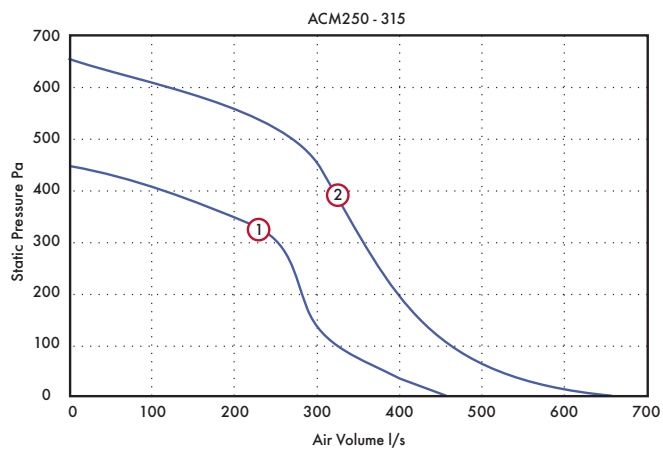

Size	Curve	Nominal r.p.m	l/s @ 0Pa	Watts	Amps	dB(A) at 3m
250	1	H 2720	450	145	0.8	52
315	2	H 2840	653	270	1.2	56

Powerflow

In-Line Duct Fan Models

Features & Benefits

- Tough plastic in-line range in seven models
- 50-80mm long ribbed spigots
- Flame retardant casing
- All models speed controllable
- Fitted with Standard Thermal Overload Protection (S.T.O.P.)
- For the best performance from your fan, use a Vent-Axia controller
- IP44 Rated

Ducted Ventilation

Powerflow models provide a compact yet versatile range designed with the installer in mind, combining the acoustic benefits of a tough plastic casing with the pressure characteristics of a centrifugal fan.

A range of seven models from 100 to 315mm dia. duct sizes. The 315mm dia. model has been specifically developed for use with rigid ductwork. Air volumes from 59l/s to 340l/s in free air and capable of pressure development up to 500 Pa.

Powerflow has 50-80mm long inlet and discharge spigots allowing easy installation and fixing. The adjustable mounting foot allows the terminal box to be rotated to any angle and allows plenty of space and adjustment for screw fixing. The robust fire retardant polymeric casing combined with internal guide vanes ensures optimum airflow management through the unit.

Electrical

Motors are 220-240V single phase 50Hz. Capacitor start and run. The terminal box is integral with the case moulding. All motors are fitted with Standard Thermal Overload Protection (S.T.O.P.).

Motor/Impeller

All models are fitted with an external rotor motor and backward curved impeller assembly for long life and reliability.

All sizes are IP44 according to BS EN 60529. Ball bearings are greased for life and designed to run at any angle. Insulation is Class 'B' (from -30°C to +40°C). Manufacture is controlled to BS EN ISO 9001.

Models

2 Pole In-Line Duct Fan - Single Phase.

Stock Ref

ACP10012
ACP12512
ACP15012
ACP16012
ACP20012
ACP25012
ACP31512

2.5A Electronic Controller

On/Off indication light. Infinitely variable speed control. Adjustable minimum speed setting and optional sensor mode. The controller is radio-suppressed to BS800 and rated at 2.5 amps.

Stock Ref

W10303102M

Dimensions (mm)

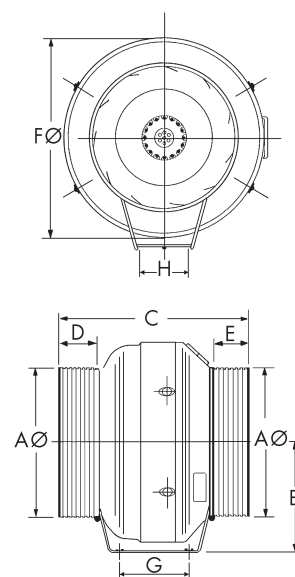

Dia	AØ	B	C	D	E	FØ	G	H	Weight
100	100	146	287	52	52	254	110	270*	2.2
125	125	146	287	60	60	254	110	270*	2.2
150	149	175	287	52	52	301	110	270*	3.1
160	160	175	287	52	52	301	110	270*	3.1
200	200	193	290	47	47	344	92	130	4.3
250	250	218	312	65	65	367	92	130	4.6
315	315	250	366	76	76	405	92	130	5.9

*Sizes 100, 125, 150 & 160 have a flat mounting foot



Performance Curve

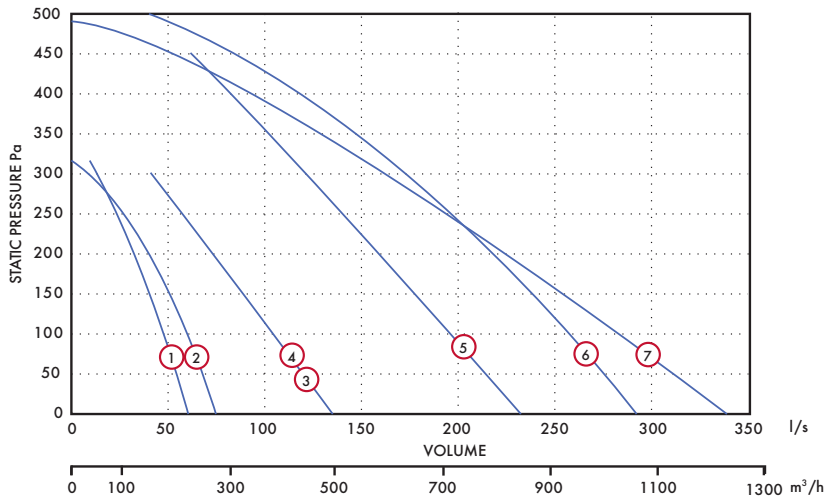

Performance Data

Dia.	Curve Ref.	Nominal r.p.m.	l/s @ Pa												S.C. amps	F.L.C. amps	dB(A) at 3m
			0	25	50	100	150	200	250	300	350	400	Watts				
100	1	2740	59	56	52	46	39	31	21					83	0.85	0.34	35
125	2	2410	78	73	69	60	50	39	27					86	0.85	0.34	35
150	3	2520	137	130	122	106	89	73	57	39				100	1.10	0.43	45
160	4	2520	137	130	122	106	89	73	57	39				100	1.10	0.43	45
200	5	2620	234	224	214	194	177	159	138	119	100	82	150	1.52	0.68	47	
250	6	2720	290	283	270	250	234	216	197	177	156	124	185	1.60	0.77	48	
315	7	2720	339	329	313	274	244	218	191	161	131	98	182	1.57	0.75	51	

Acoustic Sound Power Level

Stock Ref.		63	125	250	500	1K	2K	4K	8K	dB(A)	
										@3m	
ACP10012	INLET	81	84	75	68	61	52	46	40	51	
ACP10012	OUTLET	82	84	77	68	61	52	49	43	52	
ACP10012	BREAKOUT	52	48	57	53	53	48	40	38	35	
ACP12512	INLET	80	79	76	70	61	57	51	45	51	
ACP12512	OUTLET	82	80	76	71	61	54	51	43	52	
ACP12512	BREAKOUT	52	48	57	53	53	48	40	38	35	
ACP15012	INLET	79	84	84	76	69	65	61	52	59	
ACP15012	OUTLET	78	84	83	74	69	65	60	50	58	
ACP15012	BREAKOUT	59	62	66	62	62	58	51	43	45	
ACP16012	INLET	81	81	79	76	66	61	58	49	55	
ACP16012	OUTLET	80	82	81	73	67	62	57	49	54	
ACP16012	BREAKOUT	59	62	66	62	62	58	51	43	45	

Stock Ref.		63	125	250	500	1K	2K	4K	8K	dB(A)	
										@3m	
ACP20012	INLET	80	79	74	76	67	65	66	60	57	
ACP20012	OUTLET	79	79	74	71	69	69	65	59	55	
ACP20012	BREAKOUT	54	70	67	66	62	59	53	43	47	
ACP25012	INLET	84	80	74	74	69	69	67	63	57	
ACP25012	OUTLET	75	79	73	72	72	73	68	64	59	
ACP25012	BREAKOUT	60	71	70	66	65	62	55	44	48	
ACP31512	INLET	84	80	74	74	69	69	67	63	56	
ACP31512	OUTLET	75	79	73	72	72	73	68	64	59	
ACP31512	BREAKOUT	72	71	73	71	66	63	55	45	51	

Lo-Carbon T-Series® Range Overview

ErP Regulations

The introduction of the ErP regulations has given us the opportunity to review our product ranges and has enabled us to improve the way we stock and sell them.

The T-Series will now be purchased in modular form. Now supplied as a fan core plus optional application specific fitting kit, this gives you more flexibility in both stocking and installing the product. It also supports our lo-carbon drive to reduce waste and landfill.

You will buy the Fan Core size that you need e.g. 9", and you will then select the kit you need for the application e.g. Window kit. This will give you the flexibility to use the Fan Core with any kit, as required. Within the product size e.g. 9", the Fan Core will be the same Stock Ref, regardless of the kit required.

Available as either Wired or Wireless control variants with controllers available, the Lo-Carbon T-series range offers the most flexible, efficient and controllable range of commercial fan systems.

Supplied Parts example - window

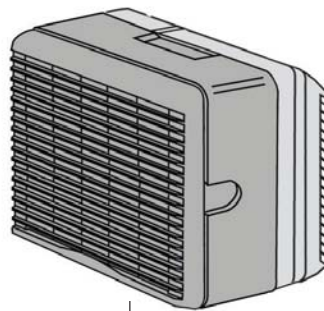

Fitting Kit assembled

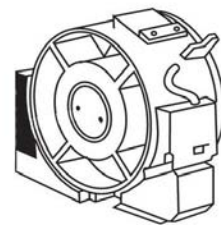

Fan core

Installation example - window

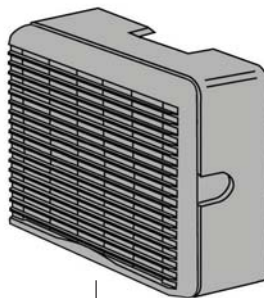

Fitting Kit

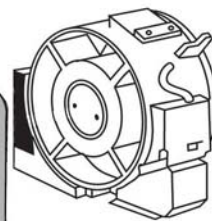

Fan Core

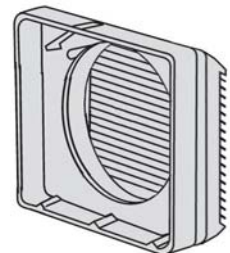

Fitting Kit



Lo-Carbon T-Series Range



Fitting Kit Options (excludes Fan Core)

	Controller		Fan Core	Fitting Kit Options (excludes Fan Core)			
	Type*	Size		Window	Wall	Roof	Panel
Stock Ref	Wired	9"	472039	472047	472043	472055	472051
Page			130	130	131	132	133
Stock Ref	Wired	12"	472040	472048	472044	472056	472052
Page			130	130	131	132	133
Stock Ref	Wireless	9"	472041	472049	472045	472057	472053
Page			130	130	131	132	133
Stock Ref	Wireless	12"	472042	472050	472046	472058	472054
Page			130	130	131	132	133

* Wired or Wireless refers to the controller type that can be utilised with the particular model.

Lo-Carbon T-Series® Window Kit & Fan Core



Features & Benefits

- Reduces your carbon footprint
- Extract/intake model in 2 sizes: 9" and 12"
- Long life Lo-Carbon motor lasts twice as long as conventional motors
- Up to 70% energy saving
- Wired or Wireless fan models available
- Easy fit connector Top Socket, standard on all models

UK's No. 1 Commercial Fan

The Lo-Carbon T-Series Fan Core range utilises a low energy DC motor, developed to improve performance, lower running costs and maintain T-Series' rugged reliability.

Window Fitting Kit

The fitting kit is designed for installation through single or double glazing and material up to 32mm thick. Greater thicknesses can be accommodated using extended fixing rod sets. Alternatively, the Lo-Carbon T-Series range can be used in conjunction with Vent-Axia ventilation accessories in flexible and rigid ducting systems to suit individual requirements. It can also be mounted in a fixing plate on walls or above ceilings.

Instantaneous Shutter

With energy saving in mind, units are supplied complete with an integral instantaneous automatic louvre shutter concealed behind the interior grille. It operates on both extract and intake and at any angle of mounting.

The shutter is electronically controlled by an actuator located on the Fan Core with a damped action giving quiet operation during instant opening and closing. The interlocking edges of the shutter blades provide maximum back draught protection. When the fan is used with the Lo-Carbon T-Series controller, the shutter can be set open with the fan motor switched Off to provide natural ventilation without the security risk of an open window.

Models

Fan Core (excludes Window Kit)

Size	Stock Ref
9" Wired	472039
12" Wired	472040
9" Wireless	472041
12" Wireless	472042

Window Kit (excludes Fan Core)

Size	Stock Ref
9" Wired	472047
12" Wired	472048
9" Wireless	472049
12" Wireless	472050

Accessory

Extended Fixing Rod set

Size	Stock Ref
9"	568104
12"	568106

Top Socket

A connector Top Socket is standard on all T-Series fans. Allowing fast and trouble-free mains connection.

Controllers



Models	Stock Ref
Wireless	455874
Wired	455873

Fitting Kit Dimensions (mm)

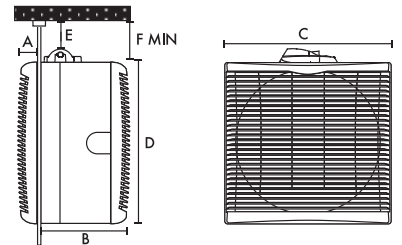

Size Dim.	9 in	12 in
A	39	41
B	150	177
C	304	381
D	302	378
E	19	19
F	54	54
Fixing hole Ø	260	337
Weight kg*	5.35	7.7

*Fan Core and Fitting Kit combined weight Controller (W x H x D) 97 x 99 x 32

Performance Graph

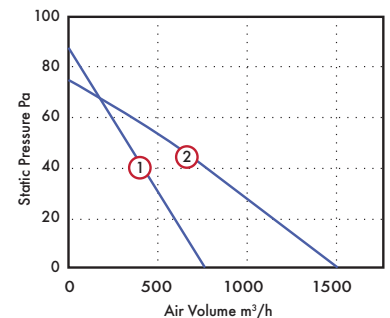

Performance (Kit & Core)

Model	Curve	Extract performance m³/h (l/s)			Watts (high)	Sound dB(A) (med) @ 3m	Amps @ 240V
		low	medium	high			
Lo-Carbon 9" Window - Wireless/Wired	①	332 (90)	571 (160)	761 (210)	30.8	40	0.35
Lo-Carbon 12" Window - Wireless/Wired	②	660 (185)	1295 (360)	1550 (430)	68.6	46	0.73

Lo-Carbon

T-Series®

Wall Kit & Fan Core



Features & Benefits

- Long life Lo-Carbon motor lasts twice as long as conventional motors
- Reduces your carbon footprint
- Extract/intake model in 2 sizes: 9" and 12"
- Up to 70% energy saving
- Wired or Wireless fan models available
- Easy fit connector Top Socket, standard on all models

UK's No. 1 Commercial Fan

The Lo-Carbon T-Series Fan Core range utilises a low energy DC motor, developed to improve performance, lower running costs and maintain T-Series' rugged reliability.

Wall Fitting Kit

Lo-Carbon T-Series wall models are designed to fit directly into double brick, solid and cavity walls. The two part telescopic liner accommodates wall thicknesses from 240 to 315mm. For thicker walls additional liner sections are available. Lo-Carbon T-Series wall models are provided with internal and external wall frames which fit flush with both faces of the wall.

Instantaneous Shutter

Lo-Carbon T-Series models are supplied complete with an integral instantaneous automatic louvre shutter which will operate on both intake and extract and at any angle of mounting.

When the fan is used with a Lo-Carbon T-Series controller, the shutter can be set open with the fan motor switched Off to provide natural ventilation without the security risk of an open window.

Electrical - Fan Core

Motor purpose-designed. Suitable for running at any angle. Quiet running. Suitable for operation in ambient temperatures from -40°C to +50°C.

Fitted with self resetting Standard Thermal Overload Protection (S.T.O.P.).

Supply voltage 220-240V/1/50Hz.

Top Socket

A connector Top Socket is standard on all T-Series fans. Allowing fast and trouble-free mains connection.

Models

Fan Core (excludes Wall Kit)

Size	Stock Ref
9" Wired	472039
12" Wired	472040
9" Wireless	472041
12" Wireless	472042

Wall Kit (excludes Fan Core)

Size	Stock Ref
9" Wired	472043
12" Wired	472044
9" Wireless	472045
12" Wireless	472046

Accessory

Wall Liner Section

Size	Stock Ref
9"	460096
12"	460086

Controllers



Models	Stock Ref
Wireless	455874
Wired	455873

Fitting Kit Dimensions (mm)

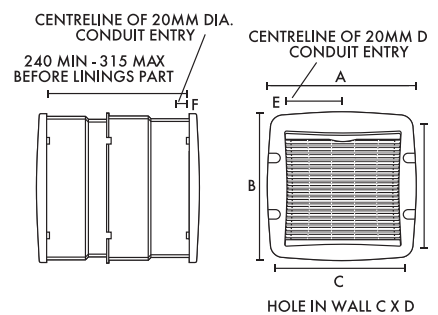

Size Dim.	9 in	12 in
A	391	470
B	388	467
C	365	442
D	375	450
E	143	182
F	25	25
Weight kg*	7.77	10.86

* Fan Core and Fitting Kit combined weight Controller (W x H x D) 97 x 99 x 32

Performance Graph

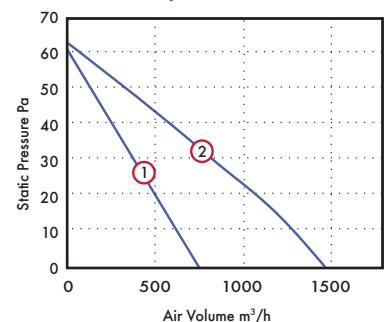

Performance (Kit & Core)

Model	Curve	Extract performance m³/h (l/s)			Watts (high)	Sound dB(A) (med) @ 3m	Amps @ 240V
		low	medium	high			
Lo-Carbon 9" Window - Wireless/Wired	1	326 (90)	562 (160)	732 (210)	27	39	0.31
Lo-Carbon 12" Window - Wireless/Wired	2	660 (185)	1355 (360)	1650 (430)	68	48	0.70

Lo-Carbon T-Series® Roof Kit & Fan Core



Features & Benefits

- Reduces your carbon footprint
- Extract / intake model in 2 sizes: 9" and 12"
- Long life Lo-Carbon motor lasts twice as long as other conventional motors
- Up to 70% energy saving
- Wired or Wireless fan models available
- Easy fit connector Top Socket, standard on all models

UK's No. 1 Commercial Fan

The Lo-Carbon T-Series Fan Core range utilises a low energy DC motor, developed to improve performance, lower running costs and maintain T-Series' rugged reliability.

Roof Fitting Kit

Designing ventilation systems with the unit mounted in a skylight or a flat roof is easy. With a low profile cowl, the Lo-Carbon T-Series Roof model is suitable for installation in horizontal, angled and vertical glass and for fixing plates in roofs. For vertical windows or walls in exposed areas and single and double glazing including most types of glass up to 32mm thick. Greater thicknesses can be accommodated using extended fixing rod sets. Both sizes of Vent-Axia roof plate assemblies can be fitted easily into flat roofs.

Instantaneous Shutter

With energy saving in mind, Lo-Carbon T-Series models are supplied complete with an integral, instantaneous, automatic louvre shutter concealed behind the interior grille.

Performance (Kit & Core)

Model	Curve	Extract performance m³/h (l/s)			Watts (high)	Sound dB(A) (med) @ 3m	Amps @ 240V
		low	medium	high			
Lo-Carbon 9" Window - Wireless/Wired	①	313 (85)	562 (155)	693 (190)	27	40	0.34
Lo-Carbon 12" Window - Wireless/Wired	②	518 (143)	1017 (282)	1194 (330)	67	48	0.69

It will operate on both intake and extract and at any angle of mounting. The shutter is electronically controlled by an actuator with a damped action giving quiet operation during instant opening and closing.

When the fan is used with a Lo-Carbon T-Series controller, the shutter can be set open with the fan motor switched off to provide natural ventilation without the security risk of an open window.

Top Socket

A connector Top Socket is standard on all T-Series fans. Allowing fast and trouble-free mains connection.

Electrical - Fan Core

Motor purpose-designed. Suitable for running at any angle. Quiet running, enclosed. Suitable for operation in ambient temperatures from -40°C to +50°C.

Fitted with self resetting Standard Thermal Overload Protection (S.T.O.P.).

Supply voltage 220-240V/1/50Hz.

Models

Fan Core (excludes Roof Kit)

Size	Stock Ref
9" Wired	472039
12" Wired	472040
9" Wireless	472041
12" Wireless	472042

Roof Kit (excludes Fan Core)

Size	Stock Ref
9" Wired	472055
12" Wired	472056
9" Wireless	472057
12" Wireless	472058

Controllers



Models	Stock Ref
Wireless	455874
Wired	455873

Fitting Kit Dimensions (mm)

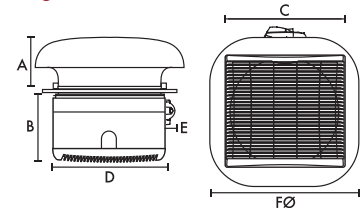

Size Dim.	9 in	12 in
A	136	171
B	150	177
C	304	381
D	302	378
E	54	54
FØ	400	500
Fixing Hole	260	337
Weight kg*	6.22	9.28

*Fan Core and Fitting Kit combined weight
Controller (W x H x D) 97 x 99 x 32

Performance Graph

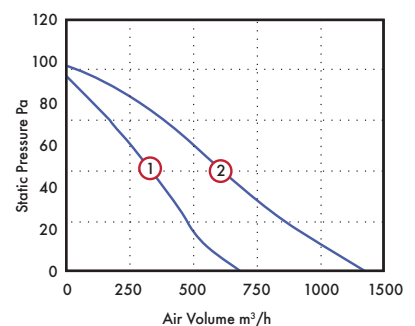

Lo-Carbon T-Series® Panel Kit & Fan Core



Features & Benefits

- Reduces your carbon footprint
- Extract / intake model in 2 sizes: 9" and 12"
- Long life Lo-Carbon motor last twice as long as other conventional motors
- Up to 70% energy saving
- Wired or Wireless fan models available
- Easy fit connector Top Socket, standard on all models

UK's No. 1 Commercial Fan

The Lo-Carbon T-Series Fan Core range utilises a low energy DC motor, developed to improve performance, lower running costs and maintain T-Series' rugged reliability.

Panel Fitting Kit

Lo-Carbon T-Series panel/ceiling models are suitable for mounting at any angle in internal partitions, ceilings, ducts and, with louvre grilles, through external walls. When installed only the louvre grille is visible.

Instantaneous Shutter

With energy saving in mind, Lo-Carbon T-Series models are supplied complete with an integral instantaneous automatic louvre shutter concealed behind the interior grille. With a Lo-Carbon T-Series Controller the fan will operate on both extract and intake, suitable for any angle of mounting. When the fan is used with a Lo-Carbon T-Series controller, the shutter can be set open with the fan motor switched off to provide natural ventilation without the security risk of an open window.

Wireless Control

Every Lo-Carbon T-Series Wireless FM Controller uses unique digital signals to ensure trouble free operation. The controller will transmit through walls

and floors allowing complete flexibility of design to control fans up to 30m away.

Top Socket

A connector Top Socket is standard on all T-Series fans. Allowing fast and trouble-free mains connection.

Electrical - Fan Core

Suitable for operation in ambient temperatures from -40°C to +50°C.

Fitted with self resetting Standard Thermal Overload Protection (S.T.O.P).

Supply voltage: 220-240V/1/50Hz.

Easy Cleaning

Integrated component design allows all parts to be dismantled for cleaning without the use of specialist tools.

Models

Fan Core (excludes wired Panel Kit)

Size	Stock Ref
9" Wired	472039
12" Wired	472040
9" Wireless	472041
12" Wireless	472042

Panel Kit (excludes Fan Core)

Size	Stock Ref
9" Wired	472051
12" Wired	472052
9" Wireless	472053
12" Wireless	472054

Controllers



Models	Stock Ref
Wireless	455874
Wired	455873

Performance (Kit & Core)

Model	Curve	Extract performance m ³ /h (l/s)			Watts (high)	Sound dB(A) (med) @ 3m	Amps @ 240V
		low	medium	high			
Lo-Carbon 9" Window - Wireless/Wired	①	357 (100)	601 (166)	799 (221)	30	41	0.33
Lo-Carbon 12" Window - Wireless/Wired	②	737 (205)	1487 (413)	1761 (490)	67	48	0.70

Fitting Kit Dimensions (mm)

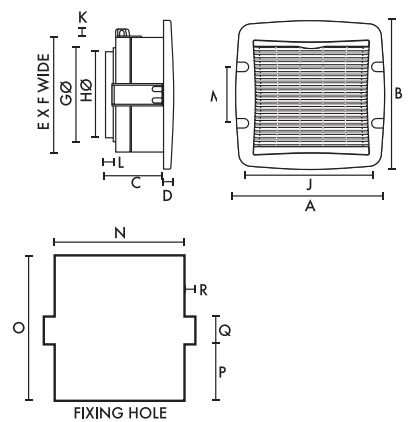

Size	9 in	12 in	Size	9 in	12 in
A	391	470	J	345	422
B	388	467	K	19	19
C	129	152	L	22	22
D	39	41	M	180	180
E	302	378	N	309	386
F	304	381	O	326	402
GØ	255	334	P	126	164
HØ	247	325	Q	55	55

Weight kg*: 9mm - 5.13, 12mm - 7.44

* Fan Core and Fitting Kit combined weight Controller (W x H x D) 97 x 99 x 32

Performance Graph

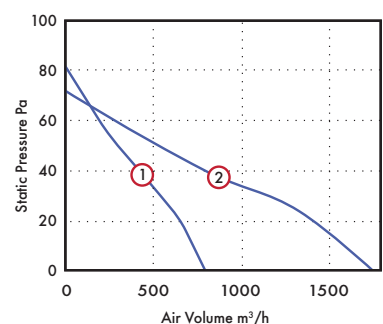

Traditional T-Series® Range Overview

ErP Regulations

The introduction of the ErP regulations has given us the opportunity to review our product ranges and has enabled us to improve the way we stock and sell them.

The T-Series will now be purchased in modular form. Now supplied as a fan core plus optional application specific fitting kit, this gives you more flexibility in both stocking and installing the product. It also supports our Lo-Carbon drive to reduce waste and landfill.

You will buy the Fan Core size that you need e.g. 9", and you will then select the kit you need for the application e.g. Window kit. This will give you the flexibility to use the Fan Core with any kit, as required. Within the product size e.g. 9", the Fan Core will be the same Stock Ref, regardless of the kit required.

The Super T-Series range of fans have not changed and continue to be purchased as one unit.

Supplied Parts example - window

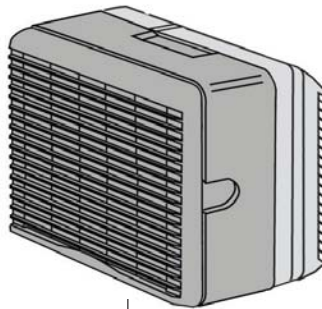

Fitting Kit assembled

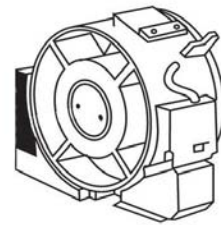

Fan core

Installation example - window

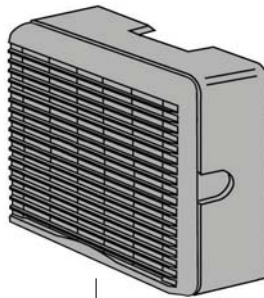

Fitting Kit

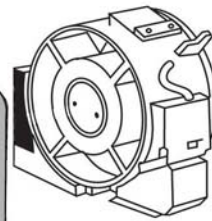

Fan Core

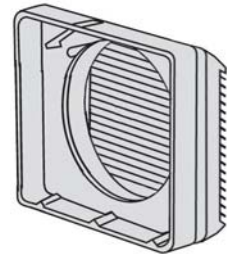

Fitting Kit



Traditional T-Series Range



Fitting Kit Options (excludes Fan Core)

	Size	Fan Core	Fitting Kit Options (excludes Fan Core)					
			Window	Wall	Roof	Panel	Darkroom	In-line
Stock Ref	6"	472012	472020	472016	472028	472024	472032	472036
Page		136	136	137	138	139	140	141
Stock Ref	7"	472013	472021	472017	472029	472025	472033	N/A
Page		136	136	137	138	139	140	
Stock Ref	9"	472014	472022	472018	472030	472026	472034	472037
Page		136	136	137	138	139	140	141
Stock Ref	12"	472015	472023	472019	472031	472027	472035	472038
Page		136	136	137	138	139	140	141

Traditional T-Series® Window Kit & Fan Core



Features & Benefits

- Extract/intake fans in 4 sizes: 6", 7", 9" and 12"
- Patented electronic shutter system ensures quiet trouble free operation
- To obtain the best from your fan, use the Ecotronic controller
- Shutter open/fan off mode
- Low sound levels
- Easy fit connector Top Socket, standard on all models
- Designed for single or double glazing up to 32mm thick

UK's No. 1 Commercial Fan

The T-Series fan core range is fitted with a Vent-Axia M-Tech motor, developed to improve performance, lower running costs and maintain the T-Series' rugged reliability. A patented speed control pack is simply plugged in one of 3 positions to provide low, medium or boost speed matching the fan performance to the requirements of the installation.

Instantaneous Shutter

With energy saving in mind T-Series Fitting Kits are supplied complete with an integral instantaneous automatic louvre shutter concealed behind the interior grille. It operates on both extract and intake and at any angle of mounting.

When the fan is used with a T-Series controller, the shutter can be set open with the fan motor switched off to provide natural ventilation without the security risk of an open window.

Top Socket

A connector Top Socket is standard on all T-Series fans allowing fast and trouble-free mains connection.

Easy Cleaning

Integrated component design allows all parts to be dismantled for cleaning without the use of specialist tools.

Electrical - Fan Core

Motor purpose-designed. Suitable for running at any angle. Quiet running. Suitable for operation in ambient temperatures from -40°C to +50°C.

Fitted with Standard Thermal Overload Protection (S.T.O.P.).

Supply voltage 220-240V/1/50Hz.

Models

Fan Core (excludes Fitting Kit)	Stock Ref
Size TX6	472012
TX7	472013
TX9	472014
TX12	472015

Window Kits (excludes Fan Core)

Designed for use in single or double glazing, most types of glass and materials up to 32mm thick. Greater thicknesses can be accommodated using Extended Fixing Rod Sets. Can also be mounted in a fixing plate or wall, in ducts or above ceilings.

Size	Stock Ref
TX6	472020
TX7	472021
TX9	472022
TX12	472023

Accessories

Extended Fitting Rod set	Stock Ref
Size 6/7/9"	568104
12"	568106

Performance (Kit & Core)

Model	Extract performance m ³ /h (l/s)			Watts	Sound dB(A)	Amps
	low	medium	high	(high)	(med) @ 3m	@ 240V
TX6 Window	245 (68)	315 (88)	360 (100)	30	41	0.24
TX7 Window	305 (85)	395 (110)	485 (135)	40	37	0.24
TX9 Window	465 (130)	685 (190)	795 (220)	85	43	0.42
TX12 Window	1095 (305)	1415 (393)	1615 (449)	105	48	0.51

Controllers

Ecotronic Controller Surface Mounting
Stock Ref
W362320

T-Series® Controller Surface Mounting
Stock Ref
W361119

Fitting Kit Dimensions (mm)

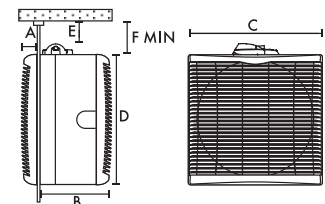

Size Dim.	6 in	7 in	9 in	12 in
A	31	31	39	41
B	130	130	150	177
C	226	265	304	381
D	220	258	302	378
E	19	19	19	19
F	54	54	54	54
Fixing hole Ø	184	222	260	337
Weight kg*	3.57	3.93	5.35	7.7

*Fan Core and Fitting Kit combined weight

Traditional T-Series® Wall Kit & Fan Core



Features & Benefits

- Extract/intake model in 4 sizes: 6", 7", 9" and 12"
- Patented electronic shutter system ensures quiet, trouble free operation
- For the very best from your fan use the Ecotronic controller
- Easy fit connector Top Socket, standard on all models

UK's No. 1 Commercial Fan

Behind the grille of the Vent-Axia T-Series Wall model is a range of high performance extract/intake fans designed to fit through most wall thicknesses using telescopic liners supplied.

T-Series also features a unique speed control pack which enables high, medium or low speed to be preset to suit room size or required duty.

T-Series controllers may be used with this model to obtain a choice of speeds, reversible airflow direction and automatic sensor operation. The Vent-Axia Ecotronic controller gives even greater running economy with its minimum speed setting and 'E' mode.

Top Socket

A connector Top Socket is standard on all T-Series fans. Allowing fast and trouble-free mains connection.

Shutter

TX models are supplied complete with an integral instantaneous automatic louvre shutter which will operate on both intake and extract and at any angle of mounting.

When the fan is used with a T-Series controller, the shutter can be set open with the fan motor switched off to provide natural ventilation without the security risk of an open window.

Electrical - Fan Core

Motor purpose-designed. Suitable for running at any angle. Quiet running, enclosed. Suitable for

operation in ambient temperatures from -40°C to +50°C.

Fitted with Standard Thermal Overload Protection (S.T.O.P.).

Supply voltage 220-240V/1/50Hz.

Models

Fan Core (excludes Fitting Kit)

Size	Stock Ref
TX6	472012
TX7	472013
TX9	472014
TX12	472015

Wall Kits (excludes Fan Core)

Designed to fit into most double brick walls using the telescopic liners, supplied. Additional liners are available to accommodate exceptionally thick brick walls.

Size	Stock Ref
TX6	472016
TX7	472017
TX9	472018
TX12	472019

Accessories

Wall Liner Section

Size	Stock Ref
TX6	460094
TX7	460095
TX9	460096
TX12	460086

Performance (Kit & Core)

Model	Extract performance m ³ /h (l/s)			Watts (high)	Sound dB(A) (med) @ 3m	Amps @ 240V
	low	medium	high			
TX6 Window	270 (75)	350 (97)	395 (110)	40	43	0.24
TX7 Window	335 (93)	435 (120)	530 (147)	40	39	0.24
TX9 Window	515 (143)	755 (210)	870 (241)	85	43	0.42
TX12 Window	1185 (329)	1530 (425)	1745 (485)	105	49	0.51

Controllers

Ecotronic Controller Surface Mounting
Stock Ref
W362320

T-Series® Controller Surface Mounting
Stock Ref
W361119

Fitting Kit Dimensions (mm)

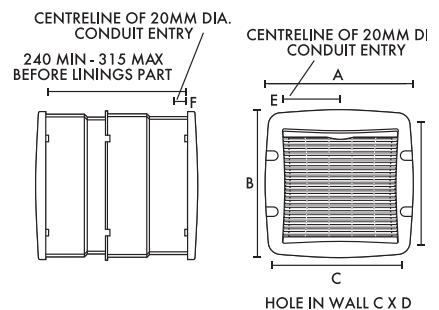

Size Dim.	6 in	7 in	9 in	12 in
A	310	352	391	470
B	303	345	388	467
C	290	330	365	442
D	290	330	375	450
E	104	124	143	182
F	25	25	25	25
Weight kg	5.54	6.13	7.77	10.86

*Fan Core and Fitting Kit combined weight

Traditional T-Series® Roof Kit & Fan Core



Features & Benefits

- Extract/intake model in 4 sizes: 6", 7", 9" and 12"
- Patented electronic shutter system ensures quiet, trouble free operation
- For the very best from your fan use the Ecotronic controller
- T-Series controllers and sensors save energy by only switching on the units when you want them to, either manually or automatically
- Easy fit connector Top Socket, standard on all models

UK's No. 1 Commercial Fan

With a low profile cowl, the T-Series Roof model is suitable for installation in horizontal, angled and vertical glass and for fixing plates in roofs. For vertical windows or walls in exposed areas and single or double glazing including most types of glass up to 32mm thick. Greater thicknesses can be accommodated using extended fixing rod sets. All four sizes of Vent-Axia roof plate assemblies can be fitted easily into flat roofs.

T-Series features a unique speed control pack which enables high, medium or low speed to be preset to suit room size or required duty. When used with a T-Series TSC controller, the speed control pack is removed from the T-Series fan and fitted into the 3-pin socket in the back of the controller. The Vent-Axia Ecotronic controller gives even greater running economy with its minimum speed setting and 'E' mode. When using the Ecotronic controller the speed control pack remains in the fan.

Shutter

With energy saving in mind, T-Series Fitting Kits are supplied complete with an integral instantaneous automatic louvre shutter concealed behind the interior grille. It will operate on both intake and extract and at any angle of mounting.

When the fan is used with a T-Series controller, the shutter can be set open with the fan motor switched off to provide natural ventilation without the security risk of an open window.

Electrical - Fan Core

Motor purpose-designed. Suitable for running at any angle. Quiet running, enclosed. Suitable for operation in ambient temperatures from -40°C to +50°C.

Fitted with Standard Thermal Overload Protection (S.T.O.P.).

Supply voltage 220-240V/1/50 Hz .

Top Socket

A connector Top Socket is standard on all T-Series fans. Allowing fast and trouble-free mains connection.

Models

Fan Core (excludes Fitting Kit)

Size	Stock Ref
TX6	472012
TX7	472013
TX9	472014
TX12	472015

Roof Kit (excludes Fan Core)

Size	Stock Ref
TX6	472028
TX7	472029
TX9	472030
TX12	472031

Controllers

Ecotronic Controller Surface Mounting

Stock Ref
W362320

T-Series® Controller Surface Mounting

Stock Ref
W361119

Fitting Kit Dimensions (mm)

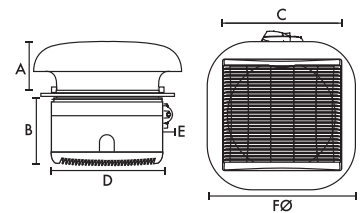

Size Dim.	6 in	7 in	9 in	12 in
A	100	136	136	171
B	130	130	150	177
C	226	265	304	381
D	220	258	302	378
E	54	54	54	54
F Ø	285	400	400	500
Fixing Hole Ø	184	222	260	337
Weight kg*	3.96	4.89	6.22	9.28

*Fan Core and Fitting Kit combined weight

Performance (Kit & Core)

Model	Extract performance m ³ /h (l/s)			Watts (high)	Sound dB(A) (med) @ 3m	Amps @ 240V
	low	medium	high			
TX6 Window	195 (55)	250 (70)	290 (80)	30	41	0.24
TX7 Window	305 (85)	395 (110)	485 (135)	40	37	0.24
TX9 Window	465 (130)	685 (190)	795 (220)	85	43	0.42
TX12 Window	1010 (280)	1305 (362)	1485 (412)	105	48	0.51

Traditional T-Series®

Panel/Ceiling Kit & Fan Core



Features & Benefits

- Extract/intake model in 4 sizes: 6", 7", 9" and 12"
- Colour: soft tone grey
- Patented electronic shutter system ensures quiet trouble-free operation
- For the very best from your fan use the Ecotronic controller
- East fit connector Top Socket, standard on all models

UK's No. 1 Commercial Fan

Vent-Axia T-Series Panel/Ceiling models are suitable for mounting at any angle in internal partitions, ceilings, ducts and, with louvre grilles, through external walls. When installed only the louvre grille is visible. The range features a unique speed control pack which enables high, medium or low speed to be preset to suit a specific room size or required duty.

T-Series controllers may be used with this model to obtain a choice of speeds, reversible airflow direction and automatic sensor operation. When used with a controller, the speed control pack is removed from the T-Series fan and fitted into the 3-pin socket in the back of the controller. The Vent-Axia Ecotronic controller gives even greater running economy with its minimum speed setting on 'E' mode and infinitely variable speed control. For this controller the speed control pack remains in the fan.

Electrical - Fan Core

Suitable for operation in ambient temperatures from -40°C to +50°C.

Fitted with Standard Thermal Overload Protection (S.T.O.P.).

Supply voltage: 220-240V/1/50Hz.

Top Socket

A connector Top Socket is standard on all T-Series fans allowing fast and trouble-free mains connection.

Shutter

With energy saving in mind, panel/ceiling kits are supplied complete with an integral instantaneous automatic louvre shutter concealed behind the interior grille. It will operate on both intake and extract and at any angle of mounting.

When the fan is used with a T-Series controller, the shutter can be set open with the fan motor switched off to provide natural ventilation without the security risk of an open window.

Models

Fan Core (excludes Fitting Kit)

Size	Stock Ref
TX6	472012
TX7	472013
TX9	472014
TX12	472015

Panel/Ceiling Kit (excludes Fan Core)

Size	Stock Ref
TX6	472024
TX7	472025
TX9	472026
TX12	472027

Controllers

Ecotronic Controller Surface Mounting

Stock Ref
W362320

T-Series® Controller Surface Mounting

Stock Ref
W361119

Fitting Kit Dimensions (mm)

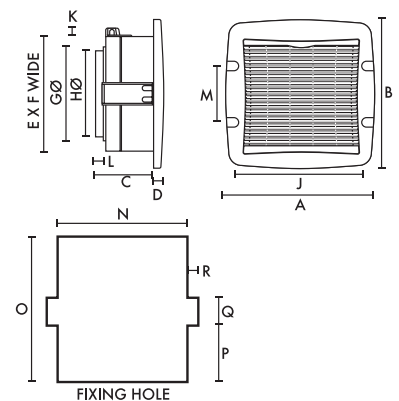

Size Dim.	6 in	7 in	9 in	12 in
A	310	352	391	470
B	303	345	388	467
C	117	117	129	152
D	32	32	39	41
E	220	258	302	378
F	226	265	304	381
GØ	180	218	255	334
HØ	171	210	247	325
J	267	306	345	422
K	19	19	19	19
L	22	22	22	22
M	180	180	180	180
N	231	270	309	386
O	244	282	326	402
P	85	104	126	164
Q	55	55	55	55
R	12	12	12	12
Weight kg*	3.50	3.82	5.13	7.44

*Fan Core and Fitting Kit combined weight

Performance (Kit & Core)

Model	Extract performance m ³ /h (l/s)			Watts (high)	Sound dB(A) (med) @ 3m	Amps @ 240V
	low	medium	high			
TX6 Window	295 (81)	380 (105)	435 (120)	30	41	0.24
TX7 Window	365 (101)	480 (133)	585 (162)	40	37	0.24
TX9 Window	565 (157)	830 (230)	960 (267)	85	43	0.42
TX12 Window	1270 (353)	1640 (456)	1885 (524)	105	44	0.51

Traditional T-Series®

Darkroom Kit & Fan Core



Features & Benefits

- Extract/intake models in 4 sizes: 6", 7", 9" and 12"
- Specially designed to provide extract/intake ventilation in darkrooms, X-ray areas, etc
- Patented electronic shutter system ensures quiet, trouble free operation
- For the very best from your fan use the Ecotronic controller
- Integrated component design allows all parts to be dismantled for cleaning without the use of specialist tools
- Easy fit connector Top Socket, standard on all models

UK's No. 1 Commercial Fan

A range designed for photographic, medical, dental and veterinarian applications - used also for opticians and other specialist applications. Most darkrooms need a minimum of ten air changes per hour for comfort and efficiency. For rooms containing heat producing equipment (eg: print glazers) a higher rate of air change may be desirable.

The Darkroom fitting kit has two cowls, the interior cowl being designed to give light protection. It can be installed in windows, partitions, external walls or roofs. Extended fixing rods for fixing thicknesses up to 370mm are supplied with the unit. Provision should be made for adequate air replacement through Vent-Axia non-vision grilles.

Shutter

With energy savings in mind Darkroom models are supplied complete with an integral instantaneous automatic louvre shutter concealed behind the interior cowl. Operates on intake and extract at any angle of mounting.

When used with a T-Series controller, the shutter can be set open with the fan motor switched Off to provide natural ventilation without the security risk of an open window.

Top Socket

A connector Top Socket is standard on all T-Series fans. Allowing fast and trouble-free mains connection.

Electrical - Fan Core

Suitable for running at any angle. Quiet running, enclosed. Fitted with Standard Thermal Overload Protection (S.T.O.P.).

Supply voltage: 220-240V/1/50Hz.

Suitable for operation in ambient temperatures from -40°C to +50°C.

Models

Fan Core (excludes Fitting Kit)

Size	Stock Ref
TX6	472012
TX7	472013
TX9	472014
TX12	472015

Darkroom Kit (excludes Fan Core)

Size	Stock Ref
TX6	472032
TX7	472033
TX9	472034
TX12	472035

Controllers

Ecotronic Controller Surface Mounting
Stock Ref
W362320

T-Series® Controller Surface Mounting
Stock Ref
W361119

Performance (Kit & Core)

Model	Extract performance m ³ /h (l/s)			Watts (high)	Sound dB(A) (med) @ 3m	Amps @ 240V
	low	medium	high			
TX6 Window	200 (55)	240 (67)	265 (74)	30	43	0.24
TX7 Window	330 (92)	415 (115)	530 (147)	40	42	0.24
TX9 Window	455 (126)	630 (175)	725 (201)	85	45	0.42
TX12 Window	870 (242)	1040 (289)	1130 (314)	100	42	0.51

Fitting Kit Dimensions (mm)

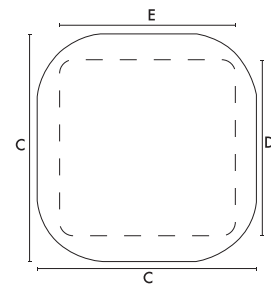
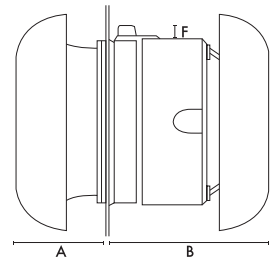

Size Dim.	6 in	7 in	9 in	12 in
A	100	136	136	171
B	196	206	229	308
C	285	400	400	500
D	220	258	302	378
E	226	265	304	381
F	19	19	19	19
Fixing Hole Ø	184	222	260	337
Weight kg*	4.13	5.33	6.60	10.05

*Fan Core and Fitting Kit combined weight

Traditional T-Series®

In-Line Kit & Fan Core



Features & Benefits

- Extract/intake model in 3 sizes: 6", 9" and 12"
- Patented instantaneous electronic shutter system ensures quiet, trouble free operation
- For the best from your fan use the Ecotronic controller
- T-Series controllers and sensor save energy by only switching on the units when you want them to, either manually or automatically
- Easy fit connector Top Socket, standard on all models

UK's No. 1 Commercial Fan

No other range of high performance in-line duct fans offers a combination of 3 impeller diameters, reversibility, low sound level, speed control and built-in electric shutter. T-Series features a unique speed control pack which enables high, medium or low speed to be preset to suit room size or required duty. Designed for use with rigid or flexible ducting, T-Series In-Line models can be plate mounted or fixed through partitions and in ceiling voids.

T-Series controllers may be used with this model to obtain a choice of speeds, extract/intake airflow direction and automatic sensor operation. The Vent-Axia Ecotronic controller gives even greater running economy with its minimum speed setting and 'E' mode.

Top Socket

A connector Top Socket is standard on all T-Series fans. Allowing fast and trouble-free mains connection.

Shutter

The shutter is electronically controlled by an actuator with a damped action giving quiet operation during instant opening and closing. The interlocking edges of the shutter blades provide maximum back draught protection.

When the fan is used with a T-Series controller, the shutter can be set open with the fan motor switched off to provide natural ventilation without the security risk of an open window.

Ducts

Where ducts pass through an unheated roof void, the duct should be insulated. Horizontal ducts should fall away from the fan unit. In circumstances where an excessive amount of moisture is present, a condensation trap should be installed in the exhaust duct. The fan unit should be accessible for regular maintenance.

Electrical - Fan Core

Suitable for operation in ambient temperatures from -40°C to +50°C.

Fitted with Standard Thermal Overload Protection (S.T.O.P.).

Supply voltage 220-240V/1/50 Hz.

Models

Fan Core (excludes Fitting Kit)

Model	Stock Ref
TX6	472012
TX9	472014
TX12	472015

In-line Kit (excludes Fan Core)

Model	Stock Ref
TX6	472036
TX9	472037
TX12	472038

For use with rigid and flexible ducting. Can be plate-mounted or fixed to partitions and in ceiling voids.

Controllers

Ecotronic Controller Surface Mounting

Stock Ref
W362320

T-Series® Controller Surface Mounting

Stock Ref
W361119

Fitting Kit Dimensions (mm)

Sizes 6 & 9

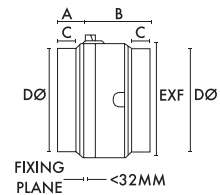

Size 12

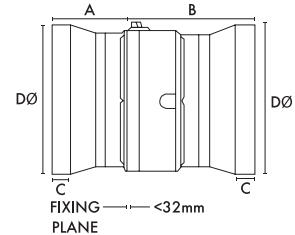

Size Dim.	6 in	9 in	12 in
A	75	71	200
B	175	183	337
C	45	41	45
DØ	175	300	400
E	220	302	378
F	226	304	381
Fixing Hole Ø	184	260	337

Performance (Kit & Core)

Model	Extract performance m³/h (l/s)			Watts (high)	Sound dB(A) (med) @ 3m	Amps @ 240V
	low	medium	high			
TX6 Window	318 (88)	398 (110)	444 (123)	30	45	0.24
TX9 Window	703 (195)	966 (268)	1050 (292)	85	47	0.42
TX12* Window	1674 (465)	2000 (556)	2230 (620)	100	51	0.51

Super T-Series®

Powerful Heavy Duty Wall Fans

Features & Benefits

- 4 impeller diameters 355, 400, 450, 500mm
- Complete with telescopic wall sleeve and shutter, ready for installation
- IP54 motor and terminal box
- Smart internal grille and external shutter with flange trim
- Super quiet operation
- For the very best performance from your fan, use the Vent-Axia 25 Amp electronic controller

Powerful Ventilation

Vent-Axia's Super T-Series 355, 400, 450 and 500mm fans provide efficient, quiet powerful ventilation with performances up to 4940m³/h. Tough heavy duty internal grilles and external weather shutters ensure longevity, performance and peace of mind.

Construction

The axial fan at the heart of the Super T range is based on an integrated impeller and internal rotor motor design which produces a very compact unit. A specially designed bellmouth inlet and mounting plate ensures an excellent performance to sound level ratio.

Electrical

Single phase 220-240V 50Hz. Capacitor start and run. An IP54 terminal box is supplied with all models with conduit entry from the side of the wall liner. All motors are fitted with Standard Thermal Overload Protection (S.T.O.P.), which should be wired via the controller.

Models

Super T - Gravity shutter

When installed, only the room side aluminium fascia grille is visible. The outside is finished with an external gravity shutter and frame.

Model	Stock Ref
ST355-16-WL	165510
ST400-16-WL	166510
ST450-16-WL	167510
ST500-16-WL	168510

Super T TX - Electric shutter

Super T TX extract or intake models with powerful, quiet, smooth-operation electric shutters.

Model	Stock Ref
STX355	165710
STX400	166710
STX450	167710
STX500	168710

Super T Filtered Air Input

Super T ARX and AR filtered passive air replacement input unit. Consisting of a wall liner with high capacity high disposable EU4 pleated filter which fits inside the wall liner.

ARX Models

With electronically controlled integral shutter AR Models - external louvre fixed blade.

Model	Stock Ref
Units with integral shutter	
STARX355	165810
STARX450	167810
Units with louvre fixed blades	
STAR355	165910
STAR450	167910

Filtered Kitchen Extract - Super T GF

Super T GF extract unit without internal grille, but with matching stainless steel filter housing and tray kit ready for assembly on site and 50mm stainless steel framed mesh grease filter with handles.

Model	Stock Ref
STGF355	165620
STGF400	166620

Accessories

Replacement Grease Filters

Super T replacement grease filters 50mm stainless steel mesh filter with handles. Supplied in packs of two.

Model	Stock Ref
355	452550
400	452551

Replacement Air Filters

High capacity EU4 pleated filter which fits inside wall liner. Supplied in packs of five.

Model	Stock Ref
355	452814
450	452815

Electronic 2.5A Controller

Provides variable motor speed control. On/Off with indication light. Infinitely variable speed slider control. Presettable minimum speed and sensor mode option: can be connected to a range of Vent-Axia sensors. Radio suppressed to BS 800. Includes electric shutter output.

Stock Ref
W10303102M



Performance

Model	Extract Performance m ³ /h (l/s) F.I.D.	Watts	S.C. amps	F.L.C. amps	Sound dB(A) @ 3m
355-16	1735 (482)	150	1.38	0.7	40
400-16	2165 (601)	90	1.2	0.46	45
450-16	3550 (986)	130	1.4	0.46	48
500-16	4940 (1372)	360	3.6	1.6	51
355-14	2150 (597)	150	1.38	0.7	56
400-14	3500 (972)	190	1.45	0.84	59

Dimensions (mm)

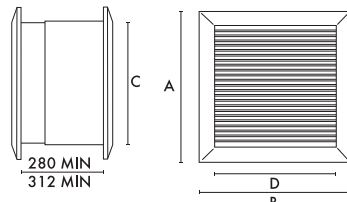

CxD SQ. HOLE THROUGH WALL

Impeller dia.	355	400	450	500
A	550	597	657	727
B	550	597	657	727
C	470	520	580	650
D	470	520	580	650
Weight kg	17	22	28	33

Traditional Standard Range® Overview

ErP Regulations

The introduction of the ErP regulations has given us the opportunity to review our product ranges and has enabled us to improve the way we stock and sell them.

The Standard Range is now supplied as a Fan Core plus optional application specific fitting kit, this gives you more flexibility in both stocking and installing the product. It also supports our Lo-Carbon drive to reduce waste and landfill.

With the Standard Range unit being primarily a replacement unit for historical installations it can now be purchased in modular form. There are two variants of Core assembly, the Window/Roof Core and the Panel / Wall Core.

The Window / Roof core are the circular fitting assemblies and consists of all internal components. The fitting kit consists of the externally mounted components (eg cowl or grill).

The Wall and Panel core assemblies are square and contains the wiring loom for connecting to the relevant fixing kit (if required). The Wall fitting kit consists of the external grill and the wall mounting sleeve. The panel fan has no separate fixing kit.

Window Installation example & Supplied Parts



Fitting Kit

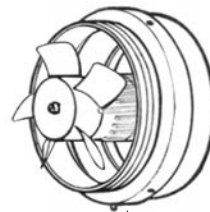

Fan Core

Wall installation example & Supplied Parts

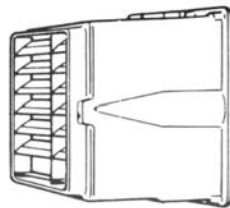

Fitting Kit

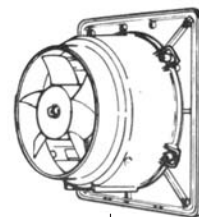

Fan Core

Panel Installation example & Supplied Parts

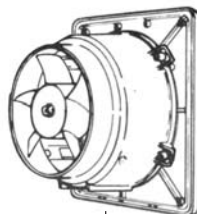

Panel Fan only (no fitting kit)



Traditional Standard Window & Roof Range



Size	Window/Roof Fan Core	Fitting Kit Options (excludes Fan Core)	
		Window	Roof
6"	Stock Ref 472226	Stock Ref 472230	Stock Ref 472234
Page	146	146	147
7"	Stock Ref 472227	Stock Ref 472231	Stock Ref 472235
Page	146	146	147
9"	Stock Ref 472228	Stock Ref 472232	Stock Ref 472236
Page	146	146	147
12"	Stock Ref 472229	Stock Ref 472233	Stock Ref 472237
Page	146	146	147

Traditional Standard Wall & Panel Range



Size	Wall Fan Core	Wall Fitting Kit (excludes Fan Core)	Size	Panel Fan
6"	Stock Ref 472222	Stock Ref 472274	6"	Stock Ref 472442
Page	148	148	Page	149
7"	Stock Ref 472223	Stock Ref 472275	7"	Stock Ref 472443
Page	148	148	Page	149
9"	Stock Ref 472224	Stock Ref 472276	9"	Stock Ref 472444
Page	148	148	Page	149
12"	Stock Ref 472225	Stock Ref 472277	12"	Stock Ref 472445
Page	148	148	Page	149

Traditional Standard Range®

Window Kit & Fan Core



Features & Benefits

- Extract / intake model in 4 sizes: 6", 7", 9" and 12"
- IPX4 Rated
- Colour: White
- Manufactured in weather-resistant polymeric materials
- For the best performance from your fan, use an Ecotronic controller
- Suitable for glass or panels up to 10mm thick

Classic Retro-Style Ventilation

This ever popular range of extract/intake fans continues to satisfy the most demanding requirements for efficient ventilation. The Vent-Axia Standard Range fitting kit unit is supplied without a shutter. The shutter is available as an accessory, which can be easily fitted within the unit.

Standard Range Window Fans and Fitting Kits are suitable for most forms of single glazing or can be wall mounted in a Vent-Axia fixing plate. Vent-Axia's patented spigot and ring method of fixing ensures easy installation and a weather proof joint. The simple integrated component design makes installation and servicing easy.

Fan Core Motor

Purpose designed enclosed motor. Suitable for running at any angle. Quiet running.

Supply voltage 220-240V/1/50 Hz. Suitable for operation in ambient temperatures from -40° to +50°C. Fitted with Standard Thermal Overload Protection (S.T.O.P.).

Shutter Type SD/R

The extract/intake shutter fits inside the Vent-Axia unit and closes against unwanted back draughts. It can be fitted at the same time as the unit or at a later date if required.

Airflow operated for extract use, cord operated lock for intake use. For all models mounted in vertical surfaces only.

Controller

The Ecotronic controller is recommended for use with this model to provide full function control of the fan plus the option of sensor mode using a selection of electro-mechanical switches to provide automatic switching of the fan.

Alternatively, single speed extract is achieved using a normal On/Off switch.

Easy Cleaning

Integrated component design allows all parts to be dismantled for cleaning without the use of specialist tools.

Protective Grilles

Where Standard Range units are installed in low positions, finger guards provide extra protection to VDE, DIN 31001.

Models

Fan Core (excludes Window Kit)	Stock Ref
Size 6"	472226
Size 7"	472227
Size 9"	472228
Size 12"	472229

Window Kit (excludes Fan Core)

Size	Stock Ref
6"	472230
7"	472231
9"	472232
12"	472233

Accessories

Shutters

Size	Stock Ref
6"	231710
7"	232710
9"	233710
12"	234710

Fan & Fitting Kit Dimensions (mm)

Size	6 in	7 in	9 in	12 in
A	140	147	166	201
B Ø	216	254	295	381
C	21	21	21	21
D	83	83	92	105
E (max)	10	10	10	13
Fixing hole Ø	184	222	260	337
Weight kg*	2.9	3.2	4.6	7.0

*Fan Core and Fitting Kit combined weight

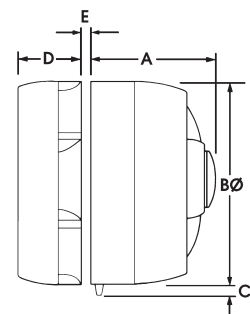

Performance (Kit & Core)

Model	Extract Performance m ³ /h (l/s) F.I.D.	Watts MAX.	Sound dB(A) @ 3m	Amps @ 240V
TX6 Window	285 (79)	32	35	0.16
TX7 Window	425 (118)	34	31	0.16
9" Window	710 (197)	53	39	0.24
12" Window	1560 (433)	84	42	0.36

Traditional Standard Range®

Roof Kit & Fan Core



Features & Benefits

- Extract model in 4 sizes: 6", 7", 9" and 12"
- IPX4 Rated
- Colour: White
- Wide range of sensors available
- Manufactured in weather-resistant polymeric materials
- For the best performance from your fan, use an Ecotronic controller

Classic Retro-Styled Ventilation

A versatile and robust range of roof extract fans designed to satisfy the requirements of efficient ventilation in commercial and industrial applications. The simple, proven design of Standard Range makes installation and routine cleaning easy.

Featuring a low profile cowl, the unit is ready for fitting into horizontal, angled and vertical glass, fixing plates on roofs and in vertical windows or walls in exposed areas. With Vent-Axia roof plate assemblies, all four sizes can be fitted easily into flat roofs. Suitable for roof installation plus window and wall installation in exposed areas eg: coastal positions. Vent-Axia's spigot and ring method of fixing ensures easy installation and a weather proof joint. We recommend the use of sealing compound under the upper part of the unit when fitted in roofs.

Fan Core Motor

Purpose designed enclosed motor. Suitable for running at any angle. Quiet running, continuous rated motor with sealed for life ball bearings.

Suitable for operation in ambient temperatures from -40°C to +50°C. Fitted with Standard Thermal Overload Protection (S.T.O.P.).

Supply voltage 220-240V/1/50Hz.

All Standard Range roof models are designed to fit directly into horizontal and sloping windows including wired cast, up to 10mm thick.

In solid roofs, install using a roof plate assembly and, if required, and eggcrate grille in the ceiling below. A suitable sealing compound should be used between the glass/roof plate and the exterior seal.

Models

Fan Core (excludes Roof Kit)

Size	Stock Ref
6"	472226
7"	472227
9"	472228
12"	472229

Roof Kit (excludes Fan Core)

Size	Stock Ref
6"	472234
7"	472235
9"	472236
12"	472237

Fan & Fitting Kit Dimensions (mm)

Size	6 in	7 in	9 in	12 in
A	140	147	166	201
B Ø	216	254	295	381
C	21	21	21	21
D	95	108	121	146
E Ø	267	330	394	508
Fixing hole Ø	184	222	260	337
Weight kg*	3.2	3.9	5.5	8.5

*Fan Core and Fitting Kit combined weight

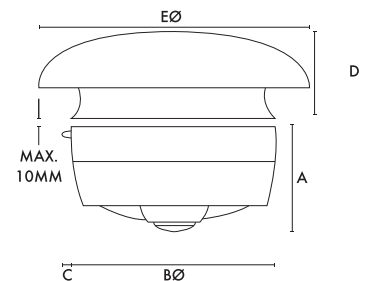

Performance (Kit & Core)

Model	Extract Performance m ³ /h (l/s) F.I.D.	Watts MAX.	Sound dB(A) @ 3m	Amps @ 240V
TX6 Window	240 (67)	32	36	0.16
TX7 Window	350 (97)	34	31	0.16
9" Window	625 (174)	53	39	0.24
12" Window	1130 (314)	84	42	0.36

Traditional Standard Range®

Wall Kit & Fan Core



Features & Benefits

- Extract/intake models in 4 sizes: 6", 7", 9" and 12"
- IPX4 Rated
- White fascia, wall sleeve and black external weather louvre
- Optional shutter available
- Manufactured in weather-resistant polymeric materials
- For the best performance from your fan, use an Ecotronic controller

Classic Retro-Styled Ventilation

The proven Standard Range Wall Fans and Fitting Kits are designed to fit flush into most double brick walls using the rigid wall liner supplied. Provision is made within the liner for conduit entry. When installed, only the ivory fascia is visible on the internal wall face. The external weather louvre fits flush to the outside. A shutter is available as an accessory which can be easily fitted within the unit.

On new building work the installation and wiring of the wall liner can be completed prior to the final installation of the unit and controller. Fully shrouded connectors on the fascia automatically connect the wiring to the motor when fitted to the wall liner.

Fan Core Motor

The motor is purpose-designed. Suitable for running at any angle. Quiet running, enclosed, sealed for life ball bearings.

Supply voltage: 220-240V/1/50Hz.

Suitable for operation in ambient temperatures from -40°C to +50°C.

Fitted with Standard Thermal Overload Protection (S.T.O.P.).

Shutter

Type SD/R

The extract/intake shutter fits inside the Vent-Axia unit and closes against unwanted back draughts. It can be fitted at the same time as the unit or at a later date if required. Airflow operated for extract use, cord operated lock for intake use.

Controller

The Ecotronic controller is recommended for use with this model to give full function control of the fan including auto mode using an electro-mechanical sensor from Vent-Axia's sensor range. Alternatively, single speed extract is achieved using a normal On/Off switch.

Models

Fan Core (excludes Wall Kit)

Size	Stock Ref
6"	472222
7"	472223
9"	472224
12"	472225

Wall Kit (excludes Fan Core)

Size	Stock Ref
6"	472274
7"	472275
9"	472276
12"	472277

Accessories

Shutters

Size	Stock Ref
S6SD/R	231710
S7SD/R	232710
S9SD/R	233710
S12SD/R	234710

Fitting Kit Dimensions (mm)

Size	6 in	7 in	9 in	12 in
A	279	279	279	279
B	203	279	279	356
C	279	362	362	448
Fixing hole Ø	235	311	311	400
Weight kg*	4.1	5.7	6.7	10.1

*Fan Core and Fitting Kit combined weight

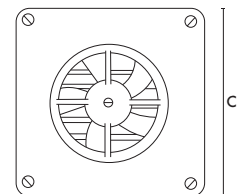
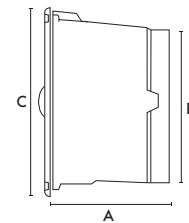

Performance (Kit & Core)

Model	Extract Performance m³/h (l/s) F.I.D.	Watts MAX.	Sound dB(A) @ 3m	Amps @ 240V
S6/WL	340 (94)	32	39	0.16
S7/WL	544 (151)	34	35	0.16
S9/WL	856 (238)	53	43	0.24
S12/WL	1767 (491)	84	46	0.36

Please note that the Standard Range Panel model is not suitable for fitting within an existing Standard Range Wall fitting kit. Please use the correct Standard range Wall Core assembly.

Traditional Standard Range® Panel Fan



Features & Benefits

- Extract / intake model in 4 sizes: 6", 7", 9" and 12"
- IPX4 Rated
- Built-in shutter available
- Colour: White Fascia
- Pre-wired lead for easy installation
- Manufactured in weather-resistant polymeric materials
- For the best performance from your fan, use a Ecotronic controller

Classic Retro-Styled Ventilation

A versatile range of extract/intake fans designed to satisfy the most demanding requirements of efficient ventilation. Available in four sizes, the Standard Range Panel Fan is supplied without a shutter for vertical installations. The shutter is available as an accessory which can be easily fitted within the unit.

Suitable for mounting at any angle, this range may be installed in internal partitions, ceilings, ducts, and (with external louvres) through external walls.

The outer spigot may be connected directly to flexible ducting and other Vent-Axia ventilation accessories to suit individual applications. When installed, only the white fascia is visible.

Shutter

Type SD/R

The vertical extract/intake shutter fits inside the Vent-Axia unit and closes against unwanted back draughts. It can be fitted at the same time as the unit or at a later date if required.

Performance

Model	Extract Performance m ³ /h (l/s) F.I.D.	Watts MAX.	Sound dB(A) @ 3m	Amps @ 240V
S6/PL	354 (98)	32	41	0.16
S7/PL	561 (156)	34	37	0.16
S9/PL	927 (258)	53	45	0.24
S12/PL	1910 (531)	84	48	0.36

Airflow operated for extract use, cord operated for intake use.

For all models mounted in vertical surfaces.

Motor

Purpose-designed enclosed ball bearing motor. Suitable for running at any angle. Quiet running.

Supply voltage 220-240V/1/50 Hz.

Suitable for operation in ambient temperatures from -40°C to +50°C.

Fitted with Standard Thermal Overload Protection. (S.T.O.P.).

Controller

The Ecotronic Controller is recommended for use with this model to provide full function control of the fan plus the option of sensor mode using a selection of electro-mechanical switches to provide automatic switching of the fan. Alternatively, single speed extract is achieved using a normal On/Off switch.

Model

Size	Stock Ref
6"	472442
7"	472443
9"	472444
12"	472445

Accessories

Shutters

Size	Stock Ref
S6SD/R	231710
S7SD/R	232710
S9SD/R	233710
S12SD/R	234710

Dimensions (mm)

Size	6 in	7 in	9 in	12 in
A	127	137	156	197
BØ	171	210	248	324
CØ	219	250	302	387
D	226	311	311	397
E	254	337	337	419
Fixing Hole Ø	254	337	337	419
Weight kg	2.5	3.0	3.5	5.8

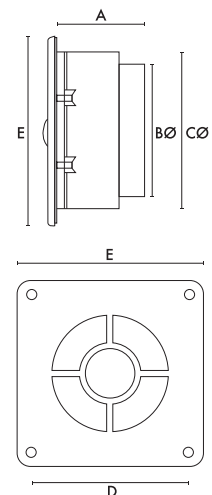

Please note that the Standard Range Panel model is not suitable for fitting within an existing Standard Range Wall fitting kit. Please use the correct Standard range Wall Core assembly.

Electric Heating

Vent-Axia heating is ideal for residential or commercial applications. So whether it's a bedroom or hallway, office or shop, we can provide the solution.

The simplicity of installing electric heating, particularly in high rise apartments means it is the natural choice for your project.

Comfort Heating products with innovative zone control features provide energy savings for the occupier without compromising comfort in the home, coupled with low capital outlay they offer a cost effective solution for both parties.

With a slim, stylish design our Opal Aluminium Radiator range offers households attractive, energy efficient comfort. Featuring an advanced digitally controlled thermostat, the Opal range gives you one of the most cost effective and energy efficient electric heating systems available.



	Bluethermal® Underfloor Heating	152-155
	Heated Towel Rails	156-157
	Radiant Heaters	158-159
	Opal Aluminium Radiators	160
	Optimax® Plus Panel Heaters	161
	Optimax® Plus Combination Storage Heaters	162
	Optimax® Plus Storage Heaters	163
	Plinth Heaters	164
	Warm Air Curtains	164
	Downflow Heater	164
	Convactor Heater	165
	Portable Fan Heater	165

Vent-Axia

Electric Heating



Underfloor Heating

Bluethermal® Mat Thin Twin Conductor Heating Mat

Renovating with Heating Mats

Minimum floor thickness can be important in renovation processes in order to avoid extra work on doors and thresholds. For these projects our Bluethermal® Mat range is the ideal product. The heating mat consists of a thin twin conductor heating cable attached to an adhesive flexible glass fibre net. The thin heating cable has a total thickness of only 4mm, is delivered with a 2.5m cold lead and has a width of 0.5m.

The 100W/m² mat can be installed on any type of levelled and stable sub floor, and can also be used under parquet or other wooden floor coverings. The 150W/m² must be installed on a non-combustible levelled and stable sub floor. With all our products we recommend the use of our Bluethermal® Thermostatic Controller thermostat with a temperature limiting function.

Vent-Axia offers a 2 year standard warranty on underfloor heating and their components from the date of purchase. A 10 year extended warranty is also available upon completing the 'Warranty Form' found in the Fitting and Wiring Instructions.

Construction:

- Solid resistance wires
- FEP insulation
- Solid copper earth wire
- Fibre-glass net
- PVC outer jacket
- Aluminium sheath
- Cable thickness is 4mm
- Mat width 0.5m (19.7")

Technical data:

- Area load 100W or 150W/m² (9.3 or 14.0W/sq.ft.)
- Loads from 100W to 1800W
- Max. continuously operating temperature outer jacket: 65°C
- Tolerance on conductor resistance: -5 / + 10 %
- Rated voltage: 230V

Installation Detail

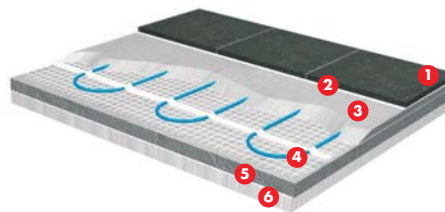

- 1 Floor covering
- 2 Tile adhesive
- 3 Recommended screed depth 10-30mm
- 4 Bluethermal® Mat 4mm
- 5 Insulation board
- 6 Stable and levelled sub-floor

Performance Guide

Stock Ref	Model	Mat Area m ²	Output W	Dimensions m		Element Nom. Resistance Ω
446175	VAUFHM 100	1.0	100	0.5	2	529.0
446176	VAUFHM 100	1.5	150	0.5	3	352.7
446177	VAUFHM 100	2.0	200	0.5	4	264.5
446178	VAUFHM 100	2.5	250	0.5	5	211.6
446179	VAUFHM 100	3.0	300	0.5	6	176.3
446180	VAUFHM 100/HS	3.5	350	0.5	7	151.1
446181	VAUFHM 100/HS	4.0	400	0.5	8	132.3
446182	VAUFHM 100/HS	5.0	500	0.5	10	105.8
446183	VAUFHM 100/HS	6.0	600	0.5	12	88.2
446184	VAUFHM 100/HS	7.0	700	0.5	14	75.6
446185	VAUFHM 100/HS	8.0	800	0.5	16	66.1
446186	VAUFHM 100/HS	10.0	1000	0.5	20	52.9
446187	VAUFHM 100/HS	12.0	1200	0.5	24	44.1
446188	VAUFHM 150	1.0	150	0.5	2	352.7
446189	VAUFHM 150	1.5	225	0.5	3	235.1
446190	VAUFHM 150	2.0	300	0.5	4	176.3
446191	VAUFHM 150/HS	2.5	375	0.5	5	141.1
446192	VAUFHM 150/HS	3.0	450	0.5	6	117.6
446193	VAUFHM 150/HS	3.5	525	0.5	7	100.8
446194	VAUFHM 150/HS	4.0	600	0.5	8	88.2
446195	VAUFHM 150/HS	5.0	750	0.5	10	70.5
446196	VAUFHM 150/HS	6.0	900	0.5	12	58.8
446197	VAUFHM 150/HS	7.0	1050	0.5	14	50.4
446198	VAUFHM 150/HS	8.0	1200	0.5	16	44.1
446199	VAUFHM 150/HS	10.0	1500	0.5	20	35.3
446200	VAUFHM 150/HS	12.0	1800	0.5	24	29.4

*HS = hidden splice

The mats are equipped with a 2.5m cold lead

Convection Heating and Underfloor Heating Comparison

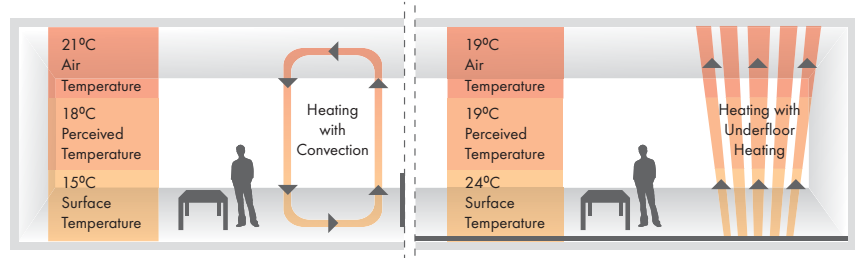



Bluethermal® Cable Twin Conductor Cable For Direct Heating

Renovation with Heating Cables

When renovating with our Bluethermal® Cable range, apply the cable to a non-combustible subfloor (minimum thickness 5mm) and take into consideration the placement of permanent installations such as showers, baths, toilets, cupboards etc. Place the end seal away from potentially wet areas of the floor. See 'Installation Example' below detailing the placement of a free laid heating cable. Note that the cable is not crossing or touching itself, this is to provide the best possible heat conductivity to the surroundings of the cable.

The heating cable is embedded in a screed/concrete with low overall construction height. After drying and hardening, a moisture barrier/membrane can be put on top of the screed/concrete before the floor covering is installed.

Construction:

- Solid resistance wire
- XLPE insulation
- Tinned copper drain wire
- Aluminium screen
- PVC outer jacket
- Cable thickness is 7mm

Technical data:

- Series resistance, element values from 300W to 3300W
- Linear load: 17W/m (5.2W/ft)
- UV resistant
- Max. cont. operating temperature outer jacket: 65°C (149°F)
- Min. bending radius: 5 x cable diameter
- Tolerance on conductor resistance: - 5 / + 10 %
- Highest system voltage: 300/500V
- Rated voltage: 230V

Installation Detail

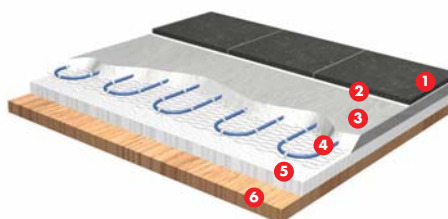

- 1 Floor covering
- 2 Tile adhesive
- 3 Recommended screed depth 40-60mm
- 4 Bluethermal® Cable 7mm
- 5 Insulation board
- 6 5-10mm stable and levelled subfloor

Performance Guide

Stock Ref	Model	Load @ 230V		Element length		Element Nom Resistance Ω	Outer diameter mm
		W		m	ft		
446201	VAUFHC	300		17.6	58	176.30	7
446202	VAUFHC	400		23.5	77	132.30	7
446203	VAUFHC	500		29.3	96	105.80	7
446204	VAUFHC	600		35.2	115	88.20	7
446205	VAUFHC	700		41.0	135	75.60	7
446206	VAUFHC	840		49.7	162	63.00	7
446207	VAUFHC	1000		58.3	191	52.90	7
446208	VAUFHC	1250		72.4	237	42.30	7
446209	VAUFHC	1370		80.8	265	38.60	7
446210	VAUFHC	1700		100.0	328	31.10	7
446211	VAUFHC	2100		123.7	405	25.20	7
446212	VAUFHC	2600		154.5	507	20.30	7
446213	VAUFHC	3300		194.0	615	16.00	7

The cables are equipped with a 2.3m cold lead

Installation Example

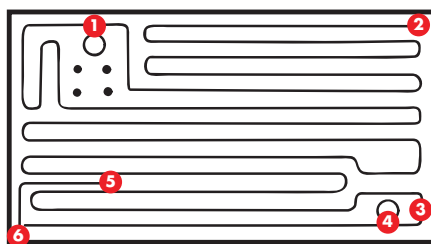

- 1 Cable laid behind the toilet to dry up condensation
- 2 End seal preferably placed in a dry zone of the floor
- 3 Put some distance between drain and cable to avoid excessive dryness of gully and odour problems
- 4 Drain/gully
- 5 Floor sensor
- 6 Transition between heating cable and cold end attachment

Accessories

Bluethermal® Thermostatic Controller

Applications

Precise and accurate temperature control is important to fully achieve the advantages of underfloor heating, without using more electric energy than necessary.

The use of heating mats and cables in combination with an accurate thermostat can provide an energy efficient and comfortable floor heating solution for most modern buildings.



Features

- Large screen with blue backlighting
- 4-event programme or constant temperature control
- Clock: 12 hours (am/pm) / 24 hours
- Day display: Monday - Sunday
- Celsius or Fahrenheit display selection
- Frost protection setting
- 5 to 40°C working range (default)

Specifications

- Accuracy: +0.5°C / 1°F
- Maximum load: 16A
- Power supply: 230V
- Dimensions: 86 x 86 x 13mm (WxHxD)
- IP24 rated

Model VAUFHTC
Stock Ref 446174

Splicing Kit

In the unlikely event that you need to repair your heating cables, this kit provides you with the necessary joints to get your systems back running.

Model VAUFHS
Stock Ref 446214

Recommended Application Guide

Application	Output Min	Output Max	Model		
	W/m ²	W/m ²	VAUFHM 100	VAUFHM 150	VAUFHC
Entrance/Hall	80	150	X		X
Entrance/Porch	120	150		X	X
Hall/Corridor	80	100	X		X
Living Room	70	100	X		X
Kitchen	70	100	X		X
WC	120	150		X	X
Utility Room	120	150		X	X
Bedroom	70	100	X		X
Bathroom	120	150		X	X
Office	80	100	X		X
Storage Room	80	100	X		X
Shop	80	100	X		X
Workshop	80	100	X		X



Bluethermal® Insulation Boards

Applications

Our insulation boards limit the downward heat loss within the system directing the heat to where you need it.

Vent-Axia underfloor heating insulation boards are recommended for use with our products to increase the efficiency and minimise the warm up time of the system, saving both energy and money. They are available from 6mm to 70mm thick.



Fixing to Wooden Floors

By Adhesive - The boards must be laid onto a level floor, with a suitable flexible rapid set cementitious tile adhesive - solvent based or ready mixed adhesives MUST NOT be used.

By Mechanical Fixing - The boards (other than 6mm boards) can be installed with mechanical fixings only to flat and level timber floors using approximately 12 fixings per 1200mm x 600mm board, with suitable screws and a 35mm fixing washer under the head. Fixing kits are available as detailed in the table below.

Fixing to Concrete Floors

A suitable flexible rapid set cementitious tile adhesive should be used - solvent based adhesives or ready mixed adhesives MUST NOT be used.

Vent-Axia Underfloor Heating Insulation Boards

Stock Ref	Model	Thickness mm	Number of boards per box	Pack coverage m ²	U-Value W/m ² /K
447267	VAUFHIB6	6	8	5.76	4.5
447268	VAUFHIB10	10	6	4.32	2.7
447269	VAUFHIB12	12.5	6	4.32	2.16
447270	VAUFHIB20	20	6	4.32	1.35
447271	VAUFHIB30	30	4	2.88	0.9
447272	VAUFHIB40	40	3	2.16	0.67
447273	VAUFHIB50	50	2	1.44	0.54
447274	VAUFHIB60	60	2	1.44	0.45
447275	VAUFHIB70	70	2	1.44	0.39

Vent-Axia Underfloor Heating Insulation Board Accessories

Stock Ref	Model	Type	To be used with insulation board	Size
447277	VAUFHIB10S	Screws (50 per pack)	VAUFHIB6 -12	25mm (L)
447278	VAUFHIB20S	Screws (50 per pack)	VAUFHIB20	35mm (L)
447279	VAUFHIB30S	Screws (50 per pack)	VAUFHIB30	45mm (L)
447280	VAUFHIB40S	Screws (50 per pack)	VAUFHIB40	60mm (L)
447281	VAUFHIB50S	Screws (50 per pack)	VAUFHIB50	65mm (L)
447282	VAUFHIB60S	Screws (50 per pack)	VAUFHIB60	75mm (L)
447283	VAUFHIBW	Washers (50 per pack)	All	35mmØ
447276	VAUFHIBT	Tape	All	100mm (W) x 50m roll (L)

Heated Towel Rails

Features & Benefits

- IP55 rated
- Wall fixings included
- Plug and vent included
- Five year leakage warranty
- One year manufacturer's guarantee
- Heating element included
- Stylish designs
- One year surface and element warranty
- Steel construction with high quality white and chrome finishes
- Production is carried out using latest technology resulting in absolute consistency in quality
- Complete fitting set supplied
- Pressure tested to 13 bar
- Comprehensive step by step fitting instructions

Vent-Axia Heated Towel Rails quickly warm and dry towels. Their presence on the wall also adds to the overall style, temperature and comfort of the room.

This comprehensive range of white and chrome towel rails offers 10 different models across the flat, curved and designer ranges. The range offers sizes from 500 x 600mm to 500 x 1500mm available in four heat outputs of 100, 150, 250 and 400W matched to the size of the rail.

The range is complemented by an advanced controller available in white and chrome giving you control of five heat outputs. The controller also offers an eco mode ideal for use when drying your towels to ensure minimal energy use. This feature turns on the rail on full power for 30 minutes then reduces the output to the user setting for a further 90 minutes before turning the towel rail off.

Controller

- IPX4 rated
- White or chrome finish
- Five power settings
- Eco timed function
- Two year warranty



Specification

Stock Ref	Model	Description	Finish	Dimensions mm		Output
				W	H	W
Towel Rails						
447854	VATRS100C	'S' Shape	Chrome	600	500	100
447855	VATRF150C	Flat	Chrome	400	700	150
447856	VATRF250W		White	500	1100	250
447857	VATRF250C		Chrome	500	1100	250
447858	VATRF400C		Chrome	500	1500	400
447859	VATRC250C	Curved	Chrome	500	1100	250
447860	VATRC400C		Chrome	500	1500	400
447861	Atacama LS	Designer	Chrome	400	700	150
447862	Atacama OS		Chrome	300	650	150
447863	Atacama SS		Chrome	500	1000	250
Accessories						
447864	VATRCW	Controller	White	single gang		n/a
447865	VATRCC		Chrome	single gang		n/a
447866	VATRDFK150	Replacement element / dual fuel kit	n/a	n/a	150	
447867	VATRDFK250		n/a	n/a	250	
447868	VATRDFK400		n/a	n/a	400	



Heated Towel Rail Range



S-shaped chrome towel rail
VATRS100C
Stock Ref
447854



Flat chrome towel rail
VATRF150C
Stock Ref
447855



Flat white towel rail
VATRF250W
Stock Ref
447856



Flat chrome towel rail
VATRF250C
Stock Ref
447857



Flat chrome towel rail
VATRF400C
Stock Ref
447858



Curved chrome towel rail
VATRC250C
Stock Ref
447859



Curved chrome towel rail
VATRC400C
Stock Ref
447860



Flat designer towel rail
Atacama LS
Stock Ref
447861



Oval designer towel rail
Atacama OS
Stock Ref
447862



Flat designer towel rail
Atacama SS
Stock Ref
447863

Radiant Heaters

Features and Benefits

- Economical and easy to install
- Silent in operation
- No yearly maintenance cost
- Shortwave IR halogen lamp
- One second heat up time
- Precision heating directed where you need it
- Up to 5000 hours element life span
- IP65 rated (VARO model)

Profile

Our radiant heating product range gives the flexibility to deal with large and small unheated spaces which would be uneconomical to heat using traditional space heating.

Areas such as bars, restaurants, terraces, delivery areas, warehouses and churches are some examples where our radiant heating products will provide an economical heating solution.

Radiant heat and its advantages

The heat we feel from the sun is called radiant heat and is part of the electromagnetic spectrum called infrared. Ultra violet and visible light also belong to the same family.

Visible light is the easiest part of this spectrum to understand, light travels in a straight line from the source, is unaffected by air and is invisible until it hits a surface. Shadows are a good example of this and are the absence of light.

Infrared rays behave in the same way, we cannot see them but we can feel them as warmth. A good example of this is the effect created when you move from the shade into the sun, although the temperature is the same, the perceived temperature when in direct sunlight is much higher. This phenomenon makes sunbathing possible during winter holidays. There are three categories of infrared; short wave (IR A), medium wave (IR B) and long wave (IR C), the shorter the wave length the easier it travels through the air.

The advantage when using short wave infrared heating is that the rays cut through the air and are not affected by air movement and only transmits its energy when it collides with a solid object. The rays also travel in a straight line so can be directed where you need it, ideal in locations which feature high ceilings, have high air change rates or are outside.

Convection Heating and Radiant Heating Comparison

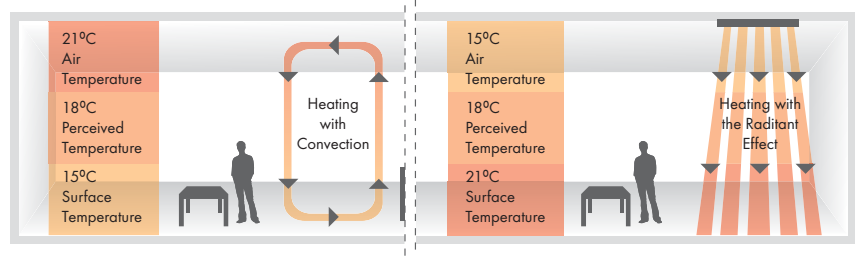

Wave spectrum

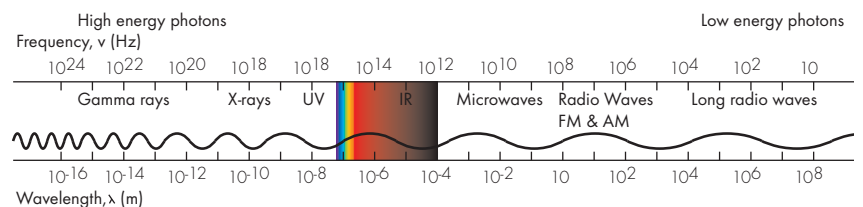

UV: Ultraviolet Radiation			VIS: Visible Radiation; Light					IR: Infrared Radiation					
UVC	UVB	UVA	Violet	Blue	Blue/Green	Green	Yellow/Green	Yellow	Orange	Red	UVA	UVB	UVC
100-280nm	280-315nm	315-400nm									800-1400nm	1400nm - 3.0µm	3.0µm - 1mm

Wave Infrared comparison

	Short Wave Infrared	Medium Wave Infrared	Long Wave Infrared
Typical source	IR Halogen Lamp	Quartz Heat Source	Resistance
Materials	Tungsten Filament welded in a quartz tube	Filament in compound of Fe-Cr-Al in a quartz tube	Filament in compound of Fe-Cr-Al in a steel tube
Radiant efficiency	92%	60%	40%
Switch on/off times	1 second	30 second	5 minutes



Dimensions (mm)

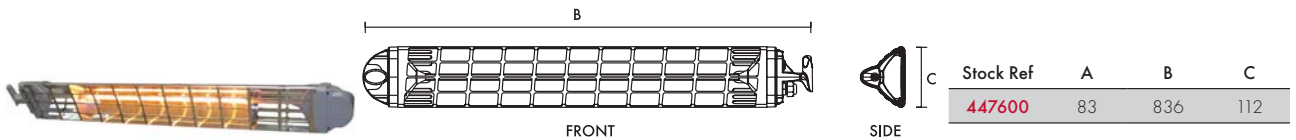

Stock Ref	A	B	C
447600	83	836	112

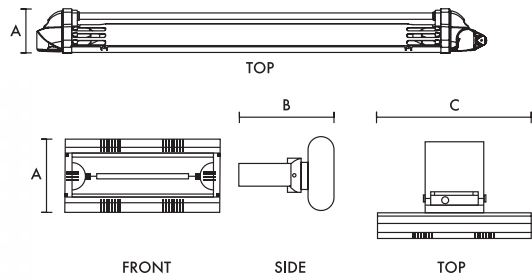

Stock Ref	A	B	C
447602	235	313	486

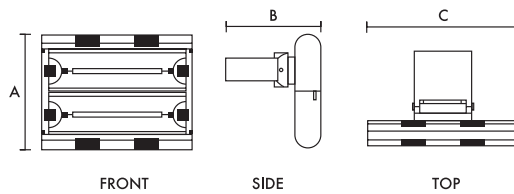

Stock Ref	A	B	C
447603	376	313	496

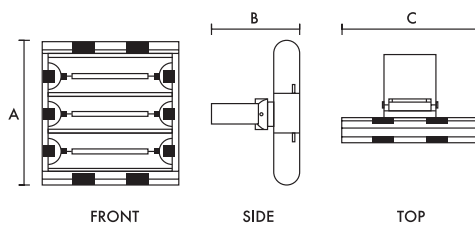

Stock Ref	A	B	C
447604	515	313	496

Technical Details

Stock Ref	Model	Weight kg	Voltage rating	Bulb	Luminous spectrum	Accessories	Output W	Amps	Heating range m ²	Replacement elements
447600	VARO 1800	1.0	230V ~ 50-60Hz	gold x1	IR-A	wall bracket	1800	8	8-10	VARO 447606
447602	VARI 2000	2.2	220-240V - 50-60Hz	gold x1	IR-A	wall bracket	2000	9	9-12	VARI 447605
447603	VARI 4000	3.0	220-240V - 50-60Hz	gold x1	IR-A	wall bracket	4000	18	12-16	VARI 447605
447604	VARI 6000	3.8	380-415V - 50-60Hz	gold x1	IR-A	wall bracket	6000	27	16-20	VARI 447605

Opal

Aluminium Radiators



Features & Benefits

- Aluminium block with innovative curved elements
- Digitally controlled thermostat
- Dynamic fluid with high thermal inertia
- Temperature setting; Comfort, Economy, Anti-Freeze
- Seven pre-set lifestyle heating schedules, including two programmable options
- Outputs from 500W - 1500W
- Safety thermal regulator
- Easy to install
- Safe, clean and easy to operate
- All radiators are powder coated externally in white (RAL 9016)
- No maintenance required
- These slim line radiators are 96mm deep
- All radiators are supplied with wall fixing brackets
- Each radiator is supplied with 0.70m length power cable
- IP24 rated

The Vent-Axia Opal range of Aluminium Radiators offers a slim stylish design with advanced digital thermostatic control giving you one of the most cost effective and energy efficient electric heating system you can have.

Popular with specifiers, contractors and home owners, the Opal range is ideal for new build and refurbishment.

Available in five sizes, our range provides a solution for any size room with outputs from 500W - 1500W.

All of the Opal Aluminium Radiators controllers are fully programmable offering closer management of energy control with resultant costs savings. This can be measured with the on-board energy monitor allowing you to see how much energy you are using to heat your room. All standard units come with all the features and controls you would expect to see on an advanced heating system.

Energy Saving Electronic Control

Accurate, fast acting control is essential for reducing temperature overrun and minimising energy consumption.

The silent operating electronic thermostat is accurate to +/- 0.5°C and acts quickly to maintain consistent temperature levels.

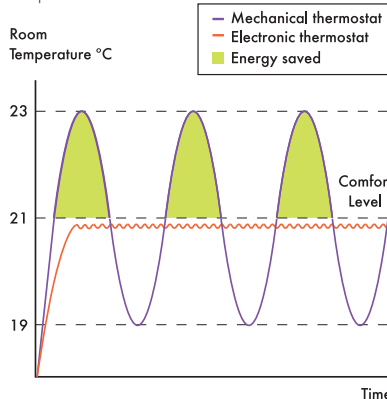

Seven Pre-set Lifestyle Heat Schedules

The heater is pre-programmed with seven plans during its manufacture, with two of them being configurable to meet your own needs. The five invariable programmes are adapted to most heating situations. The seven plans are described in the table on the right

Heating schedule PLnF is pre-programmed for when you are away from your home for a long period of time and would like to protect it against freezing. The green economy LED will flash.

Heating schedule PLUE is designed for weekends. With this plan the heater is pre-programmed to work from Monday to Thursday in the antifreeze position. From Friday through to Sunday you can configure the programme according to your own needs.

Should the pre-set schedules not meet your heating requirements, the PLCF heating plan enables you to create your own heating schedule.

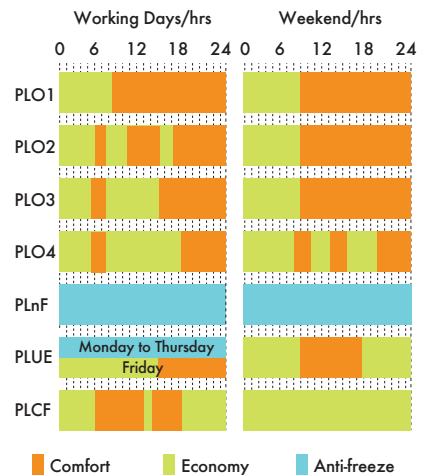

Specification

Stock Ref	Model	Weight kg	Dimensions (mm)			Output	
			H	W	D	W	Amps
448469	VAAR500 500W	11	584	460	96	500	2.3
448470	VAAR750 750W	15	584	620	96	750	3.4
448471	VAAR1000 1000W	19	584	780	96	1000	4.5
448472	VAAR1250 1250W	23	584	940	96	1250	5.7
448473	VAAR1500 1500W	27	584	1100	96	1500	6.8

Optimax® Plus Panel Heater



Features & Benefits

- Integral adjustable thermostat
- Optional integral timer model
- Frost protection setting of 5°C
- BEAB approved
- Unique quick fix wall bracket
- Colour RAL 9001
- Ideal complement to storage heaters
- Brackets for panel included
- IP24 rated

Comfort Heating

Our Optimax Plus Panel Heaters are perfect for smaller rooms such as bedrooms, studies, conservatories and loft conversions.

Vent-Axia's Panel Heaters offer a wide range of heat outputs from 750W to 2000W and every model is available with or without a timer. Vent-Axia Panel Heaters look as good as they perform. Stylish and slim, they occupy minimal wall space and are finished in an attractive white finish.

Vent-Axia Panel Heaters are wall mounted and connected to the permanent electrical supply via a fused connection switched outlet. Vent-Axia Panel Heaters are supplied with mounting brackets and one metre of cable connected to the bottom right hand side of the unit.

Adjustable Thermostat

All Vent-Axia Panel Heaters have a built-in adjustable thermostat offering a full temperature range, including a frost protection setting of 5°C.

For maximum safety there is a thermal cut-out on all models to prevent overheating should the outlet grille be accidentally covered.

Models

Manual and Timer versions available.

Model	Stock Ref
VAPH 075	439034
VAPH 075T	439038
VAPH 125	439035
VAPH 125T	439039
VAPH 150	439036
VAPH 150T	439040
VAPH 200	439037
VAPH 200T	439041

Dimensions (mm)

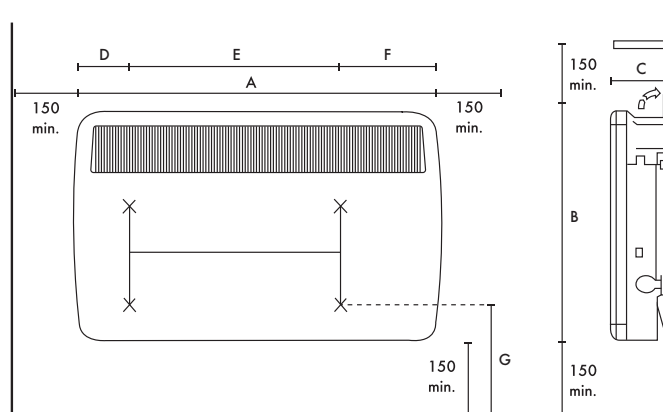

Specification

Stock Ref	Model	Output kW	Dimensions mm							Weight kg
			A	B	C	D	E	F	G	
439034 / 439038	VAPH 075/T	0.75	620	430	108	118	288	214	255	6.2
439035 / 439039	VAPH 125/T	1.25	690	430	108	118	358	214	255	6.6
439036 / 439040	VAPH 150/T	1.5	690	430	108	118	358	214	255	6.6
439037 / 439041	VAPH 200/T	2	860	430	108	118	528	214	255	8.0

220-240V-50Hz. BEAB Approved.

Optimax[®] Plus

Combination Storage Heater



Features & Benefits

- Optimised charge period offers 15% energy saving
- Reduced installation times
- Conveniently mounted controls
- Range of three heat outputs
- Colour RAL 9001
- IP20 rated
- BEAB approved

Comfort Heating

Vent-Axia Combination Storage Heaters take advantage of low tariff night-time electricity in the same way as our domestic storage heaters.

Vent-Axia Combination Heaters combine the benefit of a domestic storage heater and a convector heater in one casing. The storage heater offers comfortable heat around the clock taking advantage of low tariff electricity.

The convector heater can be switched on at any time to offer additional heat when required, or used outside the normal heating season for instant heating.

Combination Heaters require a permanent power supply for immediate convection heating when required. The storage heater section has a separate off-peak supply.

Features such as snap-on feet, simple wall fixings and quick assembly mean that new installations or replacement of existing units are completed with minimum disruption. The cable entry is located at the back of the unit on the bottom right hand side.

All models incorporate an ambient thermostat which optimises the charge to suit room conditions, typically saving an additional 15% in energy costs.

Vent-Axia Combination Heaters are slim, compact and aesthetically pleasing. Their attractive neutral finish blends in with a variety of decors.

The controls are conveniently positioned on top of the heater for ease of use. Once the optimum settings are selected, no further adjustment is necessary. A separate convector heater On/Off switch is situated on the side of the casing together with a thermostat for temperature control.

Models

Combination Heaters

Model	Stock Ref
VACSH 12A	438919
VACSH 18A	438920
VACSH 24A	438921

Dimensions (mm)

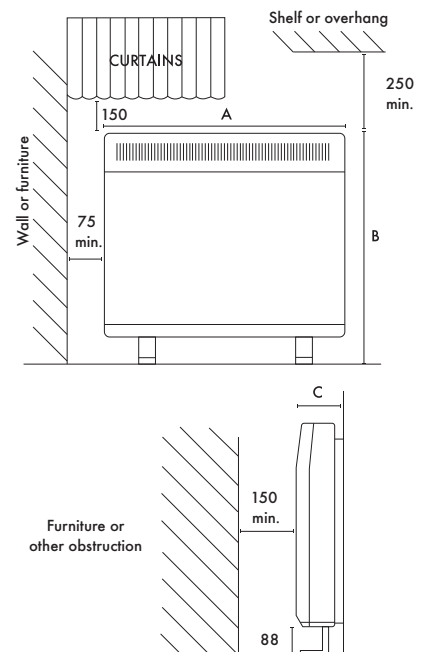

Specification

Stock Ref	Model	Input kW	Convector Heater		Dimensions mm			Weight kg	Number of bricks
			Output kW		A	B	C		
438919	VACSH 12A	1.70	1		540	730	185	79	8
438920	VACSH 18A	2.55	1.5		765	730	185	116	12
438921	VACSH 24A	3.40	2		990	730	185	152	16

220-240V-50Hz. BEAB Approved.

Optimax[®] Plus Storage Heater



Features & Benefits

- Perfect for offices and homes
- Optimised charge period offers 15% energy saving
- Reduced installation times
- Conveniently mounted controls
- Range of four heat outputs
- Colour RAL 9001
- IP20 rated
- BEAB approved

Comfort Heating

Vent-Axia Storage Heaters are often an economic alternative for new build or in existing properties, particularly where no other fuel source is available.

Vent-Axia Storage Heaters are simple to install, economical to run and virtually maintenance free. Ideal for use in living rooms, hallways and landings.

The range can be installed in bathrooms outside Zone 2, provided that the installation complies with IEE regulations.

Vent-Axia Storage Heaters offer comfortable warmth around the clock taking advantage of low-tariff electricity.

Ease of Installation

Simple to install wall fixings and quick assembly mean that new installations or replacement of existing units are completed with minimum disruption. The cable entry is located at the back of the unit on the bottom right hand side.

The automatic Optimax Plus storage heaters incorporate an ambient thermostat which optimises the charge to suit room conditions, typically saving an additional 15% in energy costs.

Vent-Axia storage heaters are slim, compact and aesthetically pleasing. Their attractive neutral finish blends in with furnishings.

The controls are conveniently positioned on top of the storage heater for ease of use. Once the optimum settings are selected, no further adjustment is necessary.

Models

Storage Heaters

Model	Stock Ref
VASH 6A	438673
VASH 12A	439359
VASH 18A	439360
VASH 24A	439361

Dimensions (mm)

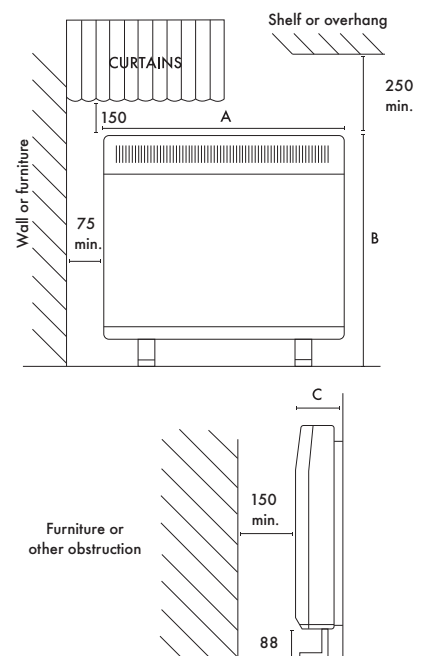

Specification

Stock Ref	Model	Input kW	Dimensions mm			Weight kg	Number of bricks
			A	B	C		
438673	VASH 6A	0.85	332	700	170	41	4
439359	VASH 12A	1.70	560	700	170	77	8
439360	VASH 18A	2.55	788	700	170	110	12
439361	VASH 24A	3.40	1016	700	170	145	16

220-240V-50Hz. BEAB Approved.

Heating Range



Plinth Heaters

Features & Benefits

- Ideal for where wall space is at a premium
- Finishes: Stainless steel, Brown or White
- Optional thermostatic control 5-30 °C
- Can be used with remote switch VARSU 436494
- Two heat settings 1kW & 2kW
- Fan only mode

Vent-Axia Plinth Heaters are designed for use in kitchens and bedrooms. They fit neatly into most types of fitted furniture, fascias, display units and false walls.

When installed in a corner with an adjacent cupboard to the right, a distance of at least 150mm must be maintained between the right hand end of the heater and the front of the adjacent cupboard door.

Vent-Axia Plinth Heaters are supplied with 1.5m of 1mm² 3 core cable, terminating on the right hand side of the unit.

Models

Thermostatic Models

Model	Stock Ref
VAPL2TC-S	459115
VAPL2TC-W	459116
VAPL2TC-B	459117

Dimensions (mm)

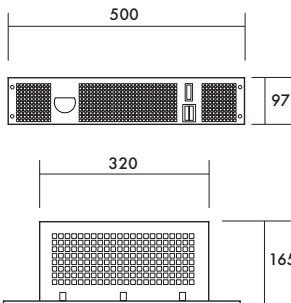

Weight: 3kg
Cut Out (WxH): 470x85mm



Warm Air Curtains

Features & Benefits

- Integral Switching for faster installation
- Three heat settings and fan only mode
- Models to suit single and double doorways
- Suitable for use as a high level fan heater

Vent-Axia Warmair Curtains provide a heated downflow of warm air in doorways of commercial premises such as shops, offices and schools.

The robust outer case is made from painted steel with an off white epoxy finish. Accommodating varying door widths is easily achieved by installing Warmair units 'side by side'.

Vent-Axia Warmair Curtains are supplied with 0.75m of 3 core cable, and mounting brackets.

Three Warmair models are available offering heat outputs & fan only :

Warmair 3 - 3 kW, 2 kW, 1 kW
Warmair 4.5 - 4.5 kW, 3 kW, 1.5 kW
Warmair 6 - 6kW, 4 kW, 2 kW

Models

Warm Air Curtains

Model	Stock Ref
Warmair 3	456343
Warmair 4.5	456344
Warmair 6	456345

Remote Switch

Remote Switch unit to control Warmair units. Switch allows for fan only & three heat settings.

Model	Stock Ref
VARSU	436494

Specification

Model	Rating kW	Dimensions mm			Weight kg
		W	H	D	
Warmair 3	3.0	650	103	210	6.1
Warmair 4.5	4.5	650	103	210	6.5
Warmair 6	6.0	900	103	210	8.7

220-240V-50Hz. BEAB Approved.



Downflow Heater

Features & Benefits

- Stylish compact design
- Two heat settings, 1kW and 2kW
- Pullcord operation
- Overheat protection
- Fan only option
- IP23 rated

The IP23 rated Downflow Heater operates via a pullcord and is suitable for use within Zone 2 of the bathroom. The Downflow Heater has two heat settings; 1kW/2kW plus a fan only option and is designed to be permanently wall mounted for use with an AC electrical supply.

Function	Indication
Off	0
Fan Only	
Fan + Heat Setting 1	1
Fan + Heat Setting 2	2

For maximum safety the heater includes a thermal cut-out feature to prevent overheating.

Models

Downflow Heater

Model	Stock Ref
VADH2	455834

Specification

Model	Rating kW	Dimensions mm			Weight kg
		W	H	D	
VADH 2	2	240	255	135	2

220-240V-50Hz.

Portable Heating



Convector Heater

Features & Benefits

- Silent operation
- Ideal for use where occasional heating is required
- Three heat outputs
- Thermostatic control
- Safety thermal cutout
- BEAB Approval

The Vent-Axia Convector Heater is ideal for use in any domestic or commercial room where extra or occasional heating is required. The heater is suitable for use in the home, offices, shops and workshops, but is not recommended for use in bathrooms.

The unit offers three heat outputs; 0.75kW, 1.25kW and 2kW, and is supplied with a thermostatic control.

The Vent-Axia Convector Heater is lightweight, portable and is supplied with a cable and plug. Stylish and versatile, the heater may be wall mounted or installed as a floor standing unit using the feet included. This gives the benefit of moving the heater to an area where you want, when you want.

For maximum safety the heater includes a thermal cut-out feature to prevent overheating.

Model

Convector Heater

Model **Stock Ref**
VACH2-TC **426250**

Specification

Model	Rating	Dimensions mm			Weight
	kW	W	H	D	kg
VACH2TC	2	530	370	110	2.3

220-240V-50Hz. BEAB Approved



Portable Fan Heater

Features & Benefits

- Thermostat control
- Fan only mode for summer cooling
- Two heat settings
- Safety cutout

The Vent-Axia Portable Fan Heater is a floor standing heater with three settings, fan only, 1kW and 2kW outputs. Variable thermostat. The unit comes complete with a 13amp plug.



Model

Portable Fan Heater

Model **Stock Ref**
VAFH2TC **426715**

Specification

Model	Rating	Dimensions mm			Weight
	kW	W	H	D	kg
VAFH2TC	2	265	130	275	1.5

Accessories & Controllers

For ventilation systems to be truly efficient it is important for them to operate only when needed. Our range of Sentinel demand ventilation systems along with our controls and sensors help respond to the exact ventilation requirements of a room at any one time. Providing airflow only when it is required and at the level that it is required ensures that only the energy that is needed is used; no more, no less.

Approved Document L now recognises the value that controls can offer and you will find Vent-Axia offer a range of solutions to ensure that you can maximise the benefit of automation wherever you chose to use it.



Controllers and Sensors

168-177



Ventilation Accessories

178-185

Vent-Axia

Accessories & Controls



Controllers & Sensors



Ecotronic Controller Surface Mounting

An electronic controller for use with all T-Series and Standard Range models to give extract/intake and speed variation. For groups of units of any one size up to a total of 400 Watts. Do not mix T-Series with Standard Range. Where a controller is used with T-Series, 5-core flexible cord is required.

- 'E' running position for optimum efficiency.
- Finger-tip sliders.
- Infinitely variable speed control.
- Double pole On/Off switching.
- Extract/intake airflow direction.
- Neon indicator.
- Sensor mode for use with suitable electromechanical switches, eg. ThermoSwitch, HumidiSwitch to give automatic fan operation.
- Adjustable minimum speed setting.
- Knockouts for recessed wiring.
- Ambient operating temperature range 0°C to +40°C.
- Dimensions: 86 x 156 x 53mm (H x W x D).
- Supply voltage 220-240V/1/50Hz.
- Maximum load: Ecotronic - 400 Watts.
- Designed to meet IP20.
- BEAB Approved.

Stock Ref
W362320



T-Series® Controller Surface Mounting

A single unit controller for use with all T-Series ventilating units. With knockouts for recessed wiring. Where a controller is used with T-Series, 5-core flexible cord is required.

- 3-speed operation. High, medium or low.
- Finger-tip sliders.
- Double pole On/Off switching.
- Extract/intake airflow direction.
- Sensor mode for use with suitable electromechanical switches, eg. ThermoSwitch, HumidiSwitch to give automatic fan operation.
- Unique shutter open/ fan Off setting.
- Neon indicator.
- Knockouts for recessed wiring.
- Ambient operating temperature range 0°C to +40°C.
- Dimensions: 86 x 156 x 53mm (H x W x D).
- Supply voltage 220-240V/1/50Hz.
- Designed to meet IP20.
- BEAB approved.

Stock Ref
W361119



TimeSpan® Controller

Adjustable timer with overrun facility for fans ventilating WCs and other small rooms.

For use with any Vent-Axia fan within maximum rating below. The fan is switched On with the light and keeps running for a pre-set period after the light is switched Off.

- Fits to any single gang box.
- Adjustable time delay 5-25 minutes.
- Ambient operating temperature range 0°C to +40°C.
- Maximum load 250W inductive.
- BEAB Approved.
- Dimensions: 87 x 87 x 33mm (H x W x D).
- Supply voltage 220-240V/1/50Hz.
- Will fit single gang box for surface mounting.

Stock Ref
563519

Surface Mounting Box

A surface mounting back box is available.

Stock Ref
410020

Registered design numbers: 1 030 207 Surface Mounting Controller, 1 030 208 Flush Fitting Controller. Patented Remote Speed Control Circuit. European Patent number EP 0180311.

Manufacturers of some fluorescent/low energy lighting systems indicate that these can interfere with other electronic/timing circuits. For reliable operation of these circuits we recommend therefore that a tungsten filament light is used.



Air Quality Sensor

Automatically reacts to the depletion of air quality, sensing unpleasant smells and toilet odours to regulate mechanically ventilated areas such as cinemas, pubs, clubs, restaurants, kitchens, toilets and conference rooms. This is not a CO₂ sensor.

The sensor switches the fan On when the air quality declines below an adjustable preset level. This is registered by the ceramic sensing head which is self-cleaning, a process which occurs every time the unit is triggered. When the atmosphere has returned to normal, the fan will continue to run for a pre-set period (adjustable between 1-25 minutes) and then switch Off.

The air quality sensor should not be used for the detection of combustible gases and is not designed for use as a smoke detector in an alarm system.

For use with various Vent-Axia fans within maximum rating below.

The Air Quality Sensor is also able to switch between trickle and boost speed on the appropriate ventilation units.

- Ambient operating temperature range 0°C to +50°C.
- Dimensions: 87 x 157 x 47mm (H x W x D).
- Maximum switched load: 2A inductive at 240V.
- Sensor consumption: 25mA at 240V.
- Supply voltage 240V/1/50Hz.

Stock Ref
563506



Electronic 1.5A Controller

Surface mounted, providing infinitely variable speed control and features an On/Off/sensor slider with neon indicator. There is an adjustable minimum speed setting. The controller is radio suppressed to BS EN 55014 and electrical connections for use with suitable external sensors are provided.

86 x 156 x 53mm (H x W x D).

Hole for wall box:
80x150x150mm (H x W x D).

Stock Ref
W300310

For flush fitting a metal wall box accessory is available.

Flush fitting box
Stock Ref
400144

Controllers & Sensors



Ambient Response Humidity Sensor

A self programming electronic On/Off wall mounted humidity sensor which reacts to any rapid increase in humidity and temperature by switching a Vent-Axia fan 'On' for rapid removal of moisture laden air in domestic bathrooms and kitchens. Can be wired into controller 'Auto' mode connections. Night time relative humidity increment setback feature suppresses nuisance tripping when the humidity level gradually rises as the temperature falls.

- Pullcord override and neon indicator.
- Changeover relay switch.
- Operating range: 30%-90%RH.
- Ambient operating temperature +5°C to +40°C.
- Dimensions: 87 x 87 x 33mm (H x W x D).
- Will fit single gang box for surface mounting.

Stock Ref
563550 240VAC 50Hz

European Patent No: 2298057

Surface Mounting Box

A surface mounting back box is available.

Stock Ref
410020



Ambient Response SELV 12 Humidity Sensor

12V Safety Extra Low Voltage version for use with VA100 SELV, Solo SELV, LuminAir SELV and HR100 SELV range.

The latest self programming electronic On/Off wall mounted humidity sensor which reacts to any rapid increase in humidity and temperature by switching a Vent-Axia fan 'On' for rapid removal of moisture laden air in domestic bathrooms and kitchens. Can be wired into controller 'Auto' mode connections. Night time relative humidity increment setback feature suppresses nuisance tripping when the humidity level gradually rises as the temperature falls.

- Pullcord override and neon indicator.
- Changeover relay switch.
- Operating range: 30%-90%RH.
- Ambient operating temperature +5°C to +40°C.
- Dimensions: 87 x 87 x 33mm (H x W x D).
- Will fit single gang box for surface mounting.

Stock Ref
563551 12VAC 50Hz

Surface Mounting Box

A surface mounting back box is available.

Stock Ref
410020



Lo-Carbon Ambient Response Humidity Sensor

Designed specifically for the Lo-Carbon product range. This self programming electronic On/Off wall mounted humidity sensor reacts to any rapid increase in humidity and temperature by switching a Vent-Axia fan 'On' for rapid removal of moisture laden air in domestic bathrooms and kitchens. Night time relative humidity increment setback feature suppresses nuisance tripping when the humidity level gradually rises as the temperature falls.

- Pullcord override and neon indicator.
- Changeover relay switch.
- Operating range: 30%-90%RH.
- Ambient operating temperature +5°C to +40°C.
- Dimensions: 87 x 87 x 33mm (H x W x D).
- Will fit single gang box for surface mounting.

Stock Ref
563552 12VDC

Surface Mounting Box

A surface mounting back box is available.

Stock Ref
410020

All of these Sensors can be wired for either On/Off or Trickle/Boost operation.

Manufacturers of some fluorescent/low energy lighting systems indicate that these can interfere with other electronic/timing circuits. For reliable operation of these circuits we recommend therefore that a tungsten filament light is used.



**Ecotronic Humidity Sensor
Surface Mounting**

An adjustable set point, solid state On/Off sensor. A pullcord provides manual override, indicated by lamp. Adjustable from 65 to 90% relative humidity. Can be wired into controller 'Auto' mode connections. Incorporates changeover switch to select low/high speed.

- Setting range 65% - 90%RH.
- Maximum switching load 1 Amp inductive.
- Pullcord override indicated by lamp.
- Ambient operating temperature 0°C to +40°C.
- Dimensions: 87 x 87 x 33mm. (H x W x D).
- Supply voltage 220-240V/1/50Hz.

Stock Ref
563532

Surface Mounting Box

A surface mounting back box is available.

Stock Ref
410020



**Ecotronic® SELV 12
Humidity Sensor**

12V Safety Extra Low Voltage version for use with VA100 SELV, Solo SELV, and LuminAir SELV range. Incorporates changeover switch to select low/high speed.

Although suitable for siting within reach of a shower or bath we recommend this model is located out of the spray zone of a bath or shower.

- Setting range 65% - 90%RH.
- Maximum switching load 5.6A @ 12V AC.
- Pullcord override indicated by lamp.
- Ambient operating temperature 0°C to +40°C.
- Dimensions: 87 x 87 x 33mm (H x W x D).
- Supply voltage 12V AC.

Stock Ref
563531

Surface Mounting Box

A surface mounting back box is available.

Stock Ref
410020



Vent-Axia HumidiSwitch

Operates Vent-Axia ventilating units on either a rise or a fall in humidity to control the damaging effects of condensation.

- Concealed adjustment.
- Setting range 20% to 80% RH.
- Ambient operating temperature 0°C to +50°C.
- Dimensions: 82 x 132 x 40mm (H x W x D).
- Rating 2A (1A inductive).
- Switching range 120-240V.
- Designed for use with controllers with 'Auto' mode facility.
- Single pole changeover contacts.

Stock Ref
563501

The Ecotronic and Ecotronic SELV 12 Sensor can be wired for either On/Off or Trickle/Boost operation.

Controllers & Sensors



7 Day TimeSwitch

For applications where regular switching is required at fixed periods or at different times on different days of the week, eg: offices, shops, pubs and restaurants.

The 7-day TimeSwitch gives twelve On or Off positions per day and can be set for 7 days. The cycle will repeat until changed.

- Analogue clock display and integral time switches for ease of setting.
- Manual override.
- Removable clear plastic cover protects TimeSwitch face.
- Volt free changeover contacts.
- Time base: 7 days.
- Shortest switching time: 2 hours.
- Maximum load: 16amp resistive (8amp inductive).
- Ambient operating temperature range -20°C to +85°C.
- Dimensions: 104 x 74 x 52mm (H x W x D).
- Supply voltage 220-240V/1/50Hz.

Stock Ref
563515



Vent-Axia ThermoSwitch

Automatically switches On fans on either a rise or fall in air temperature. The ThermoSwitch can be used with all Vent-Axia fans (via switch gear if appropriate) for the removal of warm air from buildings. It can also be used to switch On Hi-Line ceiling fans for summer cooling and to move high level warm air down to the working level during winter.

- Setting range: +6°C to +30°C.
- Two internal range limit/locking rings are included to allow setting within a limited temperature range or locking at a fixed t/o point.
- IP20 rated.
- Sealed sensing mechanism.
- Snap-action, single pole, changeover contacts.
- Mounting direct on surface only.
- Electrical connection to screw type terminals with rear or side cable entry.
- Dimensions: 80 x 104 x 36mm (H x W x D).
- Contact rating: 1.5 amp (inductive).
- 16 amps (resistive).
- Maximum voltage 250V.

Stock Ref
563502



Guardian Personnel Detector (PIR Sensor)

Suitable for controlling a range of Vent-Axia fans. Continuously monitors an area and activates when a moving body is detected.

- Supplied complete with wall mounting bracket.
- Adjustable timer overrun (5 seconds to 20 minutes).
- Supplied with lens to provide 15m (max) range, 200° detection area.
- Designed to meet IP55.
- Ambient operating temperature range -20°C to +50°C.
- Maximum load: 10 amp resistive (5 amp inductive).
- Suitable for use with fluorescent lighting up to 500W.
- Internal/External use.
- Supply voltage 220-240V/1/50Hz.

Stock Ref
563548



Vent-Axia Visionex PIR

A wall or ceiling mounted movement detector for use with any domestic Vent-Axia mains voltage product. Also suitable for use with Vent-Axia T-Series controllers on 'Auto' setting and ITC controllers on sensor mode.

- Fits any UK single gang mounting box.
- Adjustable timer overrun (5-25 minutes).
- Range of detection up to 10 metres.
- Designed to meet IP43.
- Ambient operating temperature range 0°C to +50°C.
- Maximum load: 2.5 amps/600W inductive. Not suitable for use with lighting.
- Internal use only.
- No switched live required for internal rooms and WCs.
- Double insulated.
- Volt-free contacts.
- Supply voltage 220-240V/1/50Hz.

Stock Ref
459623

Surface Mounting Box

A surface mounting back box is available.

Stock Ref
410020



Vent-Axia Visionex SELV 12 PIR

A wall or ceiling mounted movement detector for use with any domestic Vent-Axia SELV 12 product.

- Fits any UK single gang mounting box.
- Adjustable timer overrun (5-25 minutes).
- Range of detection up to 10 metres.
- Designed to meet IP43.
- Ambient operating temperature range 0°C to +50°C.
- Maximum load: 5.6 amps inductive @ 12V.
- Internal use only.
- No switched live required for internal rooms and WCs.
- Class III product.
- Volt-free contacts.
- Supply voltage 12V/1/50Hz.

Stock Ref
459624

Surface Mounting Box

A surface mounting back box is available.

Stock Ref
410020



3 Pole Isolator

Isolates Live, Neutral and Switched Live for integral timer fans. 6 amp, 3 pole isolator complying to the 3mm contact separation requirement for routine maintenance repair.

Stock Ref
563518

Surface Mounting Box

A surface mounting back box is available.

Stock Ref
410020

Controllers & Sensors



Fan Speed Adjuster

5 step speed adjuster for domestic kitchen extract fans, that can reduce the speed to 40% of its maximum performance.

91mm x 176mm x 85mm (WxHxD).

Stock Ref
458153



5 Step Auto Controller

Used in conjunction with speed controllable fans to provide 5 stepped speed without electronic motor 'hum'. Several fans can be connected to one transformer provided their combined load does not exceed the controller rating.

Single phase: 3.5 , 6.0 and 7.5amp. Rotary switch giving On/Off and five speeds.
Output voltages at 240V/1PH/50Hz 0, 90, 115, 140, 175, 240 volts.
Neon indicator. Enclosures are protected to IP54.

Dimensions	Stock Ref
230 x 168 x 118	10314103
230 x 168 x 118	10314105
284 x 240 x 132	10314107



Ventwise Controller

The award winning Ventwise controller has been designed to fully automate a ventilation system. The unit can be used on intermittent or continuous systems, switching a fan between Off and On or from trickle to boost speed. The controller saves energy by only switching when cooking is taking place or condensation is being generated. The current sensor detects when the power supply to an oven or hob is switched on. The temperature sensor detects the rise in temperature in the hot feed to a bath or shower. Suitable for 240V single phase, the Ventwise is capable of switching 2 amps or 500 Watts. Ideal for student accommodation, social and sheltered housing, the Ventwise maintains indoor air quality without the need for manual switching.

160mm x 85mm x 45mm (WxHxD).

3 sensor inputs
Stock Ref
435960

6 sensor inputs
Stock Ref
446409

Current Sensors
6m cable
Stock Ref
435956

12m cable
Stock Ref
435957

Temperature Sensors
6m cable
Stock Ref
435958

12m cable
Stock Ref
435959



Remote Delay Timer

A remote delay timer for use with all domestic products gives the option of offering a 2 minute delay before the fan starts. Once the fan has started the overrun timer is adjustable between 5-25 minutes.

Stock Ref
457986

Surface Mounting Box

A surface mounting back box is available.

Stock Ref
410020



Isolator Relay Controller

Allows fan unit to be isolated from other mains circuit when used with TIM2, Trickle/boost switch or light switch control.

Stock Ref
442030

Surface Mounting Box

A surface mounting back box is available.

Stock Ref
410020



150VA Transformer

Surface Mounting Transformer with six voltage selections for trickle settings to match dwelling volume. Provides Boost/Trickle ventilation when used with humidity sensors or a manual switch. 95 x 225 x 75mm (H x W x D).

Stock Ref
563538

Controllers & Sensors



Normal Boost Switch

A single gang switch to boost from high to low speeds on all heat recovery systems.
85 x 85 x 10mm (H x W x D).

Stock Ref
455213



VCON6

A double gang switch to boost from high to low speeds.
85 x 145 x 10mm (H x W x D).

Stock Ref
370356



Normal Boost Purge Switch

A single gang switch to operate between normal, boost and purge speeds.
85 x 85 x 10mm (H x W x D).

Stock Ref
5108454



Momentary Push Switch

Compatible with the Sentinel Kinetic range, the momentary switch boosts the unit for 30 minutes.
85 x 85 x 10mm (H x W x D).

Stock Ref
448929



LED Indicator

Compatible with the Sentinel Kinetic range, the LED indicator illuminates when the MVHR unit requires a filter check or if the unit has a fault. Supplied with 15 metres of cable.
85 x 85 x 10mm (H x W x D).

Stock Ref
448356



Normal Boost Switch - Stainless Steel

A single gang switch to operate normal/boost functions on MVHR systems. Brushed stainless steel finish.

90 x 90 x 18 (H x W x D).
Stock Ref
437320



Normal Boost Switch with Light Indicator

A single gang switch with LED illumination when in the Boost condition.
85 x 85 x 10mm (H x W x D).

Stock Ref
449060



2-Way Switch and Neons

A double gang switch to boost from high to low speeds on all heat recovery systems, incorporating neon lights to indicate speed settings. Suitable changeover relay required.
85 x 145 x 10mm (H x W x D).

Stock Ref
459746



3 Speed Controller

A three position rotary control which enables the unit to be manually switched from permanent trickle ventilation to either medium or boost speed.
85 x 85 x 25mm (H x W x D).
85 x 85 x 37mm (H x W x D); with rotary switch.

Stock Ref
563533



TIM2 Overrun Timer

The TIM2 is a remote mounting electronic overrun timer with a relay output. 2 Amp indication load maximum. Adjustable overrun 2-30 mins. Ideal for where fans are to be controlled in conjunction with a lighting circuit or activated by remote sensors.
76 x 76 x 41mm. (H x W x D).

Stock Ref
370346



HR500 Controller

Surface mounting. On/Off remote sensor mode. Heat exchange, single fan extract or twin fan extract modes. Infinitely variable speed. Minimum speed setting.

Stock Ref
W14301010

Ventilation Accessories

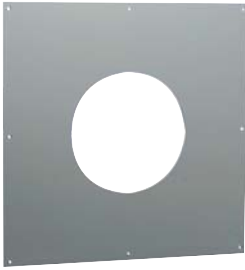

Fixing Plates

A single plate available in 300mm and 450mm square modular sizes for permanent fixing on walls or for use with other modular components.

Manufactured in high impact recyclable thermoplastic.

Unit Size	Stock Ref
6"	561136
7"	561137
9"	561139
12"	561142

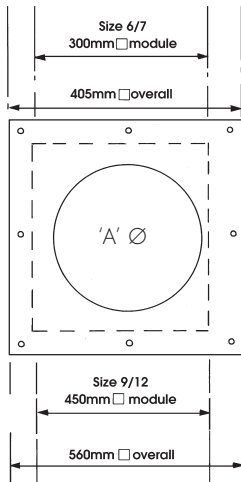

Vent-Axia fixing plate

Unit size	'A' Ø	Module Size
6"	184mm	300mm □
7"	222mm	300mm □
9"	260mm	450mm □
12"	337mm	450mm □



T-Series Adaptor Kits

Used for T-Series Window models in secondary double glazing, Roof models in secondary double glazing in exposed areas, Roof models through roofs and Darkroom models installed through either roof or walls. Adaptor kits allow units to be installed on two surfaces.

T-Series Adaptor kits consist of two Mounting plates with weather-tight seals and a set of fixing screws.

Unit Size	Stock Ref
6"	W561031
7"	W561032
9"	W561033
12"	W561034

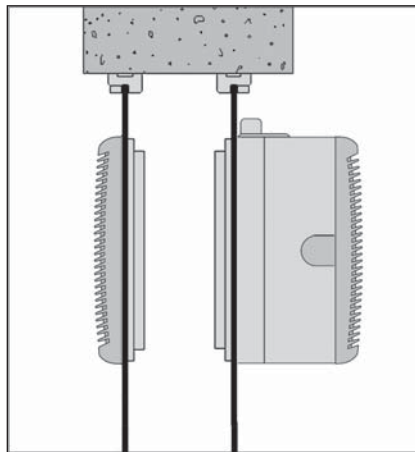

T-Series Extended Fixing Rod Sets

For use with T-Series Window and Roof models fitted through walls. Consists of a set of rods which are cut to suit the wall thickness.

Maximum thickness of wall 370mm.

Rod thread 3.5mm.

Unit Size	Stock Ref
6", 7" & 9"	568104
12"	568106

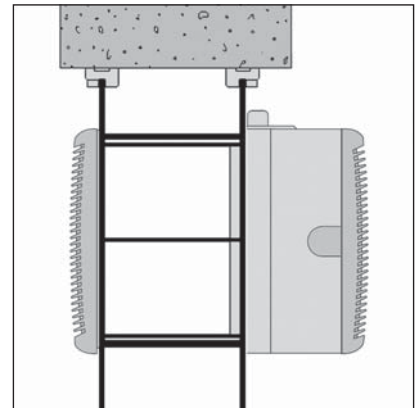



Wall Liner Section

Designed for T-Series units installed in walls thicker than 315mm, each liner section provides a maximum extension of 150mm. Wall liner section can also form a frame for Panel models in walls.

T-Series Wall Liners

Unit Size	Stock Ref
6"	460094
7"	460095
9"	460096
12"	460086



Mounting Boxes

A flanged sleeve in 300mm and 450mm square modular sizes used as an interconnecting sleeve between other modular accessories.

Mounting boxes will accept the depth of a unit and can be mounted in conjunction with a Fixing plate and Eggcrate grille for ventilation through ceilings.

Manufactured in flame retardant high impact recyclable thermoplastic.

Duct length 200mm.

Unit Size	Stock Ref
6"/7"	560236
9"/12"	560239

Unit Size	Mounting box modular size
6"/7"	300mm □
9"/12"	450mm □

Joining Bolt Set

Set of 8 nuts, bolts and washers.

Stock Ref
563000



Single Spigots

Single spigots in 300mm and 450mm square modular sizes. Used to connect Flexible ducting to Mounting boxes and other modular accessories or can be fixed directly to walls.

Manufactured in flame retardant high impact thermoplastic.

Unit Size	Nom Dia	Stock Ref
6"	175mm(B)	560637
6"/7"	225mm(B)	560639
7"	250mm(A)	560640
9"	300mm(A)	560642
9"	300mm(B)	566142
12"	400mm(B)	566146

Vent-Axia single spigot

Unit Size	'A' Ø	Module Size
6"	B 175mm	300mm
6"	B 225mm	300mm
7"	B 225mm	300mm
7"	A 250mm	300mm
9"	A 300mm	300mm
9"	B 300mm	450mm
12"	B 400mm	450mm

Ventilation Accessories



Multi-Spigot Plates

Available with 2, 3, 4 or 5 circular spigots of 100mm diameter. Multi-spigot plates are used in conjunction with 100mm Flexible ducting and other modular accessories to ventilate several small areas especially internal WCs. For use with Size 6 units only. Manufactured in flame retardant high impact recyclable thermoplastic.

Available in 300mm square modular size.

Description	Stock Ref
2-3-4 Spigots	560734
5 Spigots	560735



T-Series Direct Mount Spigots

Used to connect Flexible ducting directly to the inlet side of all T-Series models and the outlet side of T-Series Window models.

Manufactured in flame-retardant high impact recyclable thermoplastic.

Unit Size	Stock Ref
6" All models	560501
7" All models	560502
9" WW/RF	560503
9" WL/PL	560504
12" All models	560505



T-Series Darkroom Cowl Assembly

For use with all T-Series fans for Darkroom applications. Designed to give light protection.

Can also be used in other light sensitive areas such as medical, dental and veterinarian applications.

Unit Size	Stock Ref
6"	460585
7"	460586
9"	460587
12"	460588



Cone Connectors

Used in conjunction with a Size 6 *Standard Panel model to reduce the outlet spigot (175mm Ø) to 100mm Ø flexible or rigid ducting.

The Cone connector is 280mm long and incorporates a splitter for improved performance. Manufactured in flame retardant, high impact thermoplastic. Colour: Grey.

Unit Size	Stock Ref
6"	560936

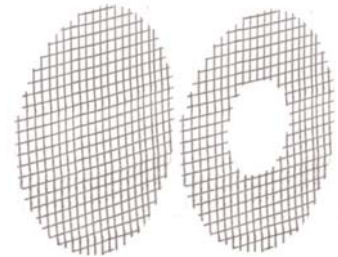
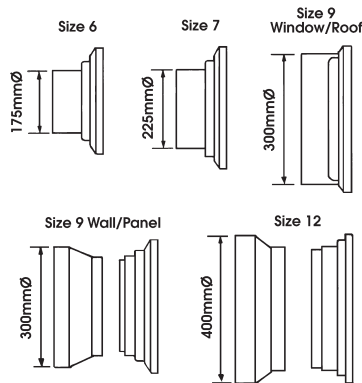

Standard Range Protective Grilles

Where Standard Range units are installed in low positions, finger guards provide extra protection to VDE, DIN 31001.

Standard Range internal grille (all models)

Unit Size	Stock Ref
6"	563106
7"	563107
9"	563109
12"	563112

Standard Range external grille (window models)

Unit Size	Stock Ref
6"	563406
7"	563407
9"	563409
12"	563412

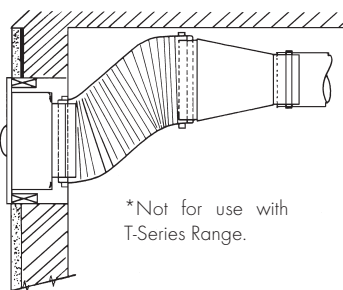



Plenum Boxes

The Plenum box allows square grilles and diffusers to connect to circular duct. Each box size has a two diameter circular spigot for maximum versatility. The box is deep enough to accommodate both a double deflection grille and opposed blade damper.

Manufactured in flame retardant high impact recyclable thermoplastic.

Size	Stock Ref	Nom. Ø
200	560601	125/150
250	560602	150/175
300	560603	200/225
300	560604	250/300
450	560605	315/400

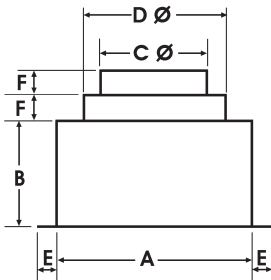

Dimensions (mm)

Stock Ref.	A	B	CØ	DØ	E	F
560601	200	130	125	150	25	25
560602	250	130	150	175	25	25
560603	300	130	200	225	25	25
560604	300	130	250	300	25	25
560605	450	130	315	400	25	25



Single Deflection Grilles

Single deflection grilles are suitable for either side wall or exposed duct applications.

The Single deflection grille has a single row of blades which permit up to 45° deflection of the air in one plane.

Satin silver finish.

Size 6/7 fits 300mm square modular size and size 9/12 fits 450mm square modular size.

Module size	Stock Ref
200mm sq	561370
250mm sq	561371
300mm sq	561372
450mm sq	561373



Double Deflection Grilles

Double deflection grilles are suitable for supply air for either side wall or exposed duct applications.

The Double deflection grille has two rows of blades set at 90° apart which permit up to 45° deflection of the air in two planes.

Satin silver finish.

Size 6/7 fits 300mm square modular size and size 9/12 fits 450mm square modular size.

Module size	Stock Ref
200mm sq	561380
250mm sq	561381
300mm sq	561382
450mm sq	561383

Ventilation Accessories



Eggcrate Grilles

Eggcrate grilles can be used for air replacement or air extract purposes.

Used underneath Roof plate assemblies with Roof models, underneath single spigots in ceilings, underneath mounting boxes and on the inside faces of walls that have units in fixed and removable wall plates on the outside of the wall.

Comprising a 13mm square by 13mm deep mesh eggcrate core housed in a frame which has a satin silver or white finish.

Size 6/7 fits 300mm square modular size and size 9/12 fits 450mm square modular size.

Size 6/7 - 785cm² free area
Size 9/12 - 1810cm² free area

200mm Sq - 340 cm²
250mm Sq - 530 cm²

Satin finish.

Module size	Stock Ref
200mm sq	561303
250mm sq	561305
300mm sq	561301
450mm sq	561302

White finish.

Module size	Stock Ref
125mm sq	560846
200mm sq	560847
250mm sq	560848
300mm sq	560849
450mm sq	560850



Opposed Blade Dampers

Opposed blade dampers are used to regulate air flow through all Vent-Axia grilles and diffusers. Key operated.

This action ensures that the downstream airflow is non-directional when the damper is in the partially closed position. Opposed blade dampers have aluminium blades and the frame is left in natural mill finish.

Can be used in conjunction with Eggcrate, Single deflection and Double deflection grilles.

Size 6/7 fits 300mm square modular size and size 9/12 fits 450mm square modular size.

Module size	Stock Ref
200mm sq	561341
250mm sq	561342
300mm sq	561343
450mm sq	561344



Filtered Inlet Grille

For ceiling, panel or glass mounting. Consists of a size 6 grille, washable filter, adaptor kit and a stepped spigot to suit 100, 125 or 150mm diameter ducting.

Grille size:	226mm x 220mm
Spigot depth:	100mm
Fixing hole diameter:	184mm

Stock Ref
W563536



4-Way Diffusers

Manufactured in polypropylene plastic. Four diffuser cassettes can be set for downward or 45° discharge in any of sixteen directional combinations. Colour: Ivory

Neck Size	Stock Ref
225mm	10546230
300mm	10546300
350mm	10546350
400mm	10546400
450mm	10546450
500mm	10546500

500mm fits ceiling grid size 600mm □, 595mm □ overall diffuser size



Neck Adaptor

Used to connect Flexible ducting directly to 4-way diffusers. Integral volume control damper for duct sizes up to 300mm.

Diffuser Duct Size	4-Way Neck Size	Stock Ref
150mm Ø	225mm	10547150
200mm Ø	225mm	10547200
250mm Ø	300mm	10547250
300mm Ø	350mm	10547300
400mm Ø	400mm	10547400
400mm Ø	450mm	10548400
400mm Ø	500mm	10548000



Window/Wall/Ceiling Termination Sets

Used to terminate Flexible ducting at windows. Can be used with the Extended fixing rod set or Fixing plates for termination at walls. Used with Flexible ducting and Worm drive clips.

Consists of a Direct mount spigot, Adaptor kit, Window grille and all screws.

Unit Size	Spigot DiaØ	Stock Ref
6	175mm	W560151
7	225mm	W560152
9	300mm	W560153
12	400mm	W560154

Other sizes

Spigot DiaØ	Stock Ref
125	W10554150
200	W10554200
250	W10554250
315	W10554315

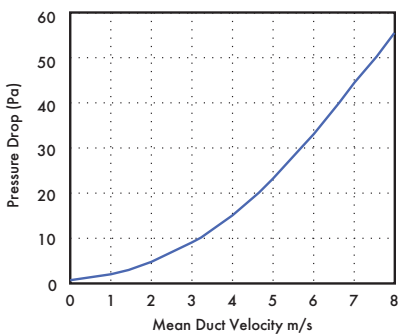

Air Replacement Non-Vision Grilles

Satin finish

Non-vision grilles consist of a single row of overlapping chevron vanes. Used as transfer grilles for doors or partitions, the overlapping vanes prevent through-vision.

Module size	Stock Ref
300mm sq	561311
450mm sq	561312

Black finish

In addition to preventing through-vision the black finish also limits light transference. Use two grilles back to back for darkroom applications.

Module size	Stock Ref
300mm sq	561321
450mm sq	561322



Fire Dampers

Available in 300mm and 450mm square modular sizes. For use with other modular accessories when a duct passes through a ceiling or wall requiring a damper to be fitted. 107mm deep.

Concertina type with 71°C fusible link, 2 hour rated.

Manufactured in stainless steel.

Size	Stock Ref
6/7	561901
9/12	561902



Roof Termination Sets

Used to terminate Flexible ducting at roofs.

Consists of: Direct mount spigot, Adaptor kit, Roof cowl, Deflector and all screws. Can be used with Roof Plate Assemblies for installation on flat roofs.

T-series units

Size	Spigot Ø	Stock Ref
6	175	560161
7	225	560162
9	300	560163
12	400	560164

Vent-Axia roof termination

Diameter	Stock Ref
100/125/150mm	10555150
200mm	10555200
250mm	10555250
315mm	10555315

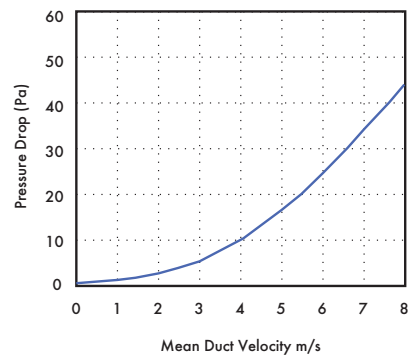

Ventilation Accessories



Air Replacement Non-Vision Door Grilles with Matching Flanges

Non-vision grilles consist of a single row of overlapping chevron vanes to prevent through-vision, supplied with matching flanges. The grille is fitted to one side of the door with the matching flange on the other side.

Suitable for door thicknesses of 19-49mm.

Available in Silver or Brown finish, in two sizes, 600 x 150 and 600 x 300mm.

Satin finish

Size	Stock Ref
600 x 150mm	561390
600 x 300mm	561391

Brown finish

Size	Stock Ref
600 x 150mm	560900
600 x 300mm	560901



Heavy Duty T-Series Wall Grilles

Tough aluminum construction for accessible public areas. Fits T-Series wall models in place of existing external grille. Finish T-Series grey.

Size	Stock Ref
6	452725
7	452726
9	452727
12	452728



External Louvres Mill

Weather resistant external louvres are suitable for air intake or discharge and for use with ducting on external walls.

The narrow blade construction has a 38mm pitch set at 45° with a depth of 41mm and an integral rain lip.

Standard 32mm wide undrilled outer flanges in aluminium have fully welded mitre corners as standard.

Size 6/7 fits 300mm square modular size and size 9/12 fits 450mm square modular size.

Size 6/7 - 345cm² free area
Size 9/12 - 824cm² free area

Satin finish

Size	Stock Ref
225mm sq	561350
300mm sq	561351
400mm sq	561355
450mm sq	561352

Brown finish

Size	Stock Ref
225mm sq	560910
300mm sq	560911
400mm sq	560912
450mm sq	560913



Louvre Grilles

Louvre grilles can be used for air replacement, for extract purposes and as an external louvre. Available in four sizes, the assembly fits over rather than into the aperture making it especially useful where there are space restrictions within the duct.

Manufactured in thermoplastic. Choice of three colours: White, Brown and Grey.

Size 6	- 190cm ² free area
Size 7	- 335cm ² free area
Size 9	- 415cm ² free area
Size 12	- 705cm ² free area

Grille Dimensions (mm)

Size	w x h
Size 6	= 310 x 303
Size 7	= 352 x 345
Size 9	= 391 x 388
Size 12	= 470 x 467

The grilles and surrounds are moulded in ABS plastic to tone in with building materials, therefore an equivalent BS or RAL colour reference cannot be given.

Unit Size	Colour	Stock Ref
6	Grey	W561431
6	Brown	561411
6	White	561421
7	Grey	W561432
7	Brown	561412
7	White	561422
9	Grey	W561433
9	Brown	561413
9	White	561423
12	Grey	W561434
12	Brown	561414
12	White	561424



Roof Plate Assemblies

Vent-Axia roof plate assemblies are manufactured in high impact recyclable thermoplastic. They consist of a strong one piece moulded plate with extended sides to assist flashing and weather protection. A separate sub-frame is provided for permanent fixing to the roof kerb. The Vent-Axia Roof model is then fitted to the plate using a suitable sealing compound between the Cowl and plate, ensuring a weather-tight seal.

Size	Stock Ref
6	560136
7	560137
9	560139
12	560142

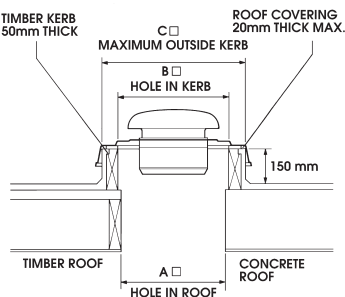

Size	A	B	C
6	300mm	335mm	465mm
7	300mm	335mm	465mm
9	450mm	490mm	615mm
12	450mm	490mm	615mm

In addition to the size 6, 7, 9 & 12 Roof Termination Sets, the Roof Plate Assemblies can also be used with the following Roof Terminations part numbers.

- 10555150 use size 6 Roof Plate Assembly
- 10555200 use size 7 Roof Plate Assembly
- 10555250 use size 9 Roof Plate Assembly
- 10555315 use size 12 Roof Plate Assembly



Joining Pieces

Used to join lengths of flexible ducting to give a long-lasting airtight connection.

Duct Size	Stock Ref
100mm Ø	561804
125mm Ø	561805
150mm Ø	561806
175mm Ø	561807
200mm Ø	561808
225mm Ø	561809
250mm Ø	561810
300mm Ø	561812
315mm Ø	561813
400mm Ø	561816



Worm Drive Clips

Stainless steel tightening band with quick-fix screwed ends for securing flexible ducting.

Max. Ø	Stock Ref
110mm	561704
215mm	561707
270mm	561710
380mm	561715
525mm	561720
660mm	561726



Standard Range Adaptor Kits

Used for Standard Range Window models in secondary double glazing, Roof models in secondary double glazing in exposed areas and Roof models through roofs.

Adaptor kits allow units to be installed on two surfaces and consist of an additional shroud and gasket, locking ring and seal. The shroud and gasket fit to the outside part of the unit, the locking ring and seal going to the inside part.

Fitting through holes in both Fixing Plates or glass, Vent-Axia's spigot and ring method of fixing allows simple installation separately to both parts.

Colour: Ivory.

Unit size	Stock Ref
6	561011
7	561012
9	561013
12	561014

Plate & Case Fans

Vent-Axia Plate and Case axial fans result from a detailed understanding of air movement within the European market. The products are designed to meet the exacting demands of both modern building services as well as the replacement market.

The fans are supplied fully assembled and ready for installation in any application together with a comprehensive range of accessories and controllers.

Our new range of VSP and VSC fans have been designed incorporating the FE2 Owllet impeller. This state of the art impeller ensures maximum efficiency and minimum noise for the application.

The bifurcated and cased axial ranges along with the KAF range are designed for reliable operation within the aggressive environments of commercial kitchens.



Sabre® Plate Mounted Sickle Fans (VSP)

188-193



Sabre® Sickle Short Case Fans (VSC)

194-201



Long Case Axial Fans (LCA)

202-231



Kitchen Axial Fans (KAF)

232-235



Bifurcated Case Axial Fans (BIFA)

236-261

Vent-Axia

Plate & Case Fans

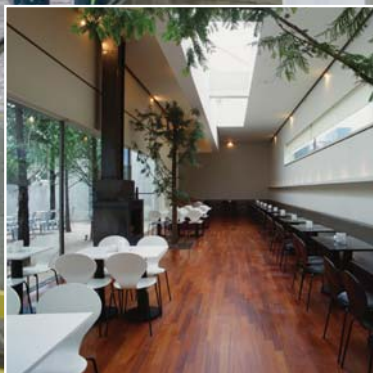

Sabre® Plate Mounted Sickle Fans (VSP)

Features and Benefits

- Swept impeller with Aerofoil blades, winglets and serrated trailing edge for optimum performance
- One shot die cast impeller, dynamically balanced for smoother operation
- Operating temperature up to 70°C
- External Rotor Motors on all models for compact efficient design
- All models speed controllable
- Guards fitted as standard on all models
- Thermal Overload Protection for motor protection
- Maintenance free sealed for life bearings
- 2 Year Guarantee

The latest generation of the Vent-Axia Sabre® Plate Mounted Sickle fans incorporate the very latest FE2 Owllet impeller offering improved performance over the previous ranges with up to 7dB(A) reduction in sound and up to 15% improvement in efficiency ensuring the best available fan performance in its class. The advanced blade design, matched to a purpose designed external rotor motor ensures unrivalled reliability and controllability.

Design and Development

Using a combination of NASA research into wing performance and winglets, coupled with a study of bird flight, has enabled the development of the best available Sickle blade profile. By matching this to a purpose designed close fitting mounting plate ensures best use of this blade technology thereby reducing noise and improving the performance in plate axial fans.

Construction

Vent-Axia Sabre® Plate Mounted Sickle fans are based on an integrated impeller and external rotor motor design, which produces a very compact unit. Together with a specially designed bell mouth inlet and mounting plate, the complete fan is lightweight and ensures an excellent performance to sound level ratio.

The mounting plate is formed from a single sheet, protected with a tough epoxy paint finish. Inlet finger guards and motor supports are manufactured from steel rod and electro welded for extra strength. Finger guards give protection to BS 848 Part 5. Manufacture is controlled to BS EN ISO 9001 Standards.

Impellers

The impellers incorporate the latest in sickle blade aerofoil technology to ensure minimum sound and maximum performance. Impellers up to 400mm diameter are moulded from a composite polymer, impellers above this size are Aluminium. The motors and impellers are factory matched, statically and dynamically balanced to ISO 1940 part 1, Quality Class G.6.3.

Motors

The external rotor motors are specifically designed and styled for this range of fan. Ball bearings are greased for life. Sizes 315 - 710 motors are protected to IP54 against dust and moisture, complying with BS EN 60529.

They have ribbed aluminium body castings for efficient cooling with Motor insulation to Class 'F' (from -40°C to + 70°C). Speed controlled sizes 450 to 710, 6 & 8 pole motors are only suitable for operating temperatures of up to 40°C.

Electrical

The Sabre® Plate Mounted Sickle fan range is available for either single phase 220-240V 50 Hz capacitor start and run or three phase 380-415V 50Hz. Motors are fitted with Thermal Overload Protection which should be wired into all controller circuits and into starter contactors to prevent motor damage due to overloading / overheating.

Speed Control

Units are suitable for speed control by either electronic, voltage reduction or frequency inverters where permissible. For optimum efficiency and controllability Vent-Axia recommend the use of the eDemand Inverter controller to give close control via sensors or manual control.

Form of Running

Plate mounted fans (ex-stock) are supplied for extract use (Form 'A' running).

Performance

The fan performance is in accordance with tests to ISO 5801.

Sound Levels

Fan sound levels are measured in a reverberant chamber in accordance with ISO 3744 Part 1. Published dB(A) figures are free field sound pressure levels at 3m with spherical propagation at a reference level of 2×10^{-5} Pa (20 micro-Pascal). The sound power level spectra figures are dB with a reference level of 10^{-12} Watts (1 pico-watt).

To ensure minimum noise levels during speed control, either an auto transformer or eDemand inverter speed control is recommended.

Accessories

A full range of accessories is available with the Sabre® Plate Mounted Sickle fans:

- Electronic speed controllers
- Auto transformer speed controllers
- eDemand inverter speed control
- D.O.L. starters
- Louvre shutter
- Discharge guard



Fan Dimensions (mm)

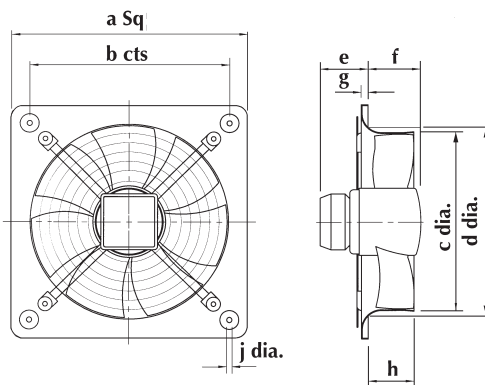

Stock Ref	Kg	A	B	C	D	E	F	G	H	J
VSP25012/14	4.2	370	320	260	264.5	78	73.4	6	50	7
VSP31514/34	6.7	430	380	349	349	78	83.9	11	63	9
VSP35514/34	7.5	485	435	390	390	78	82.9	12	68	9
VSP40014/34	8.7	549	490	412	419.8	90	91.5	12	88	9
VSP45014/34/16/36	16.2	575	535	463	480	110	143.5	14	96	11
VSP50014/34/16/36	20.1	655	615	517	528	84.5	141.5	16	104	11
VSP56014	31.8	725	675	568	589	98.3	167.5	16	119	11
VSP56034/16/36	24.2	725	675	568	589	82.5	162.5	16	119	11
VSP63034/36	37.2	805	750	643	664	111	159.5	20	130	11
VSP63016	26.7	805	750	643	664	70.5	174.5	20	130	11
VSP71016/36/38	38.6	850	810	720	763	44	201.5	20	150	14.5

Accessories Dimensions

Discharge Guard 'K' factor loss 0.25

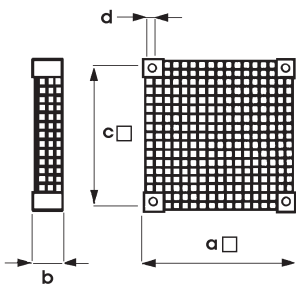

Stock Ref	a	b	c	Ød
10502325	397	64	351	8
10502375	449	64	403	8
10502450	501	64	455	8
10502525	553	64	507	8
10502630	808	150	735	8
10502800	1010	140	-	8

If a discharge guard is required with a louvre shutter the next size up discharge guard should be selected.

Louvre Shutter

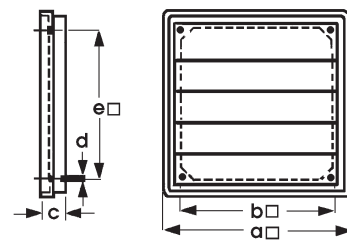

Stock Ref	a	b	c	Ød	e
LS250	294	265	25	6	230
LS315	344	276	26	6	295
LS355	398	312	26	6	329
LS400	458	365	26	6	382
LS450	499	395	31	6	432
LS500	544	444	31	6	477
LS560	605	533	31	6	533
LS630	694	627	31	6	626
LS710	790	722	43	6	722

Sabre® Plate Mounted Sickle Fans (VSP)

Performance Curves

250 to 400 dia. - Pole 2 & 4

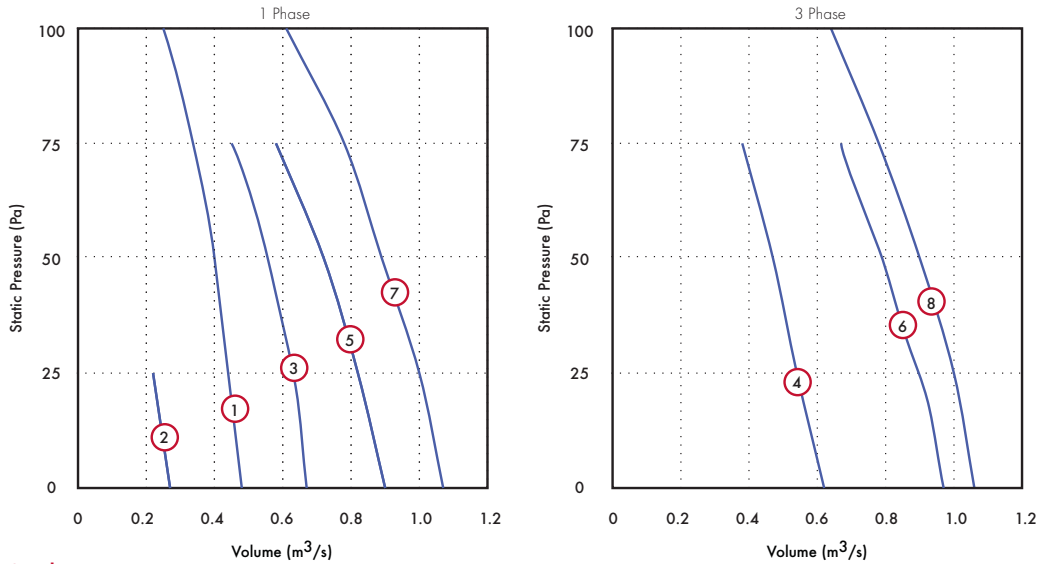

Performance Guide

Stock Ref	Supply	IP Rating	Motor kW	F.L.C Amps	S.C. Amps	Poles	rpm	Curve	Volume m³/s @ Pa					dB(A) @ 3m	
									0	25	50	75	100		
VSP25012	230/1/50	IP54	0.12	0.54	2.16	2	2160	①	Volume m³/s	0.48	0.44	0.40	0.36	0.25	50
									Power Watts	110	115	118	121	125	
VSP25014	230/1/50	IP54	0.05	0.24	0.96	4	1370	②	Volume m³/s	0.27	0.22				37
									Power Watts	46	48				
VSP31514	230/1/50	IP54	0.14	0.62	2.48	4	1360	③	Volume m³/s	0.67	0.63	0.51	0.45	45	
									Power Watts	111	118	124	130		
VSP31534	400/3/50	IP54	0.12	0.68	2.72	4	1450	④	Volume m³/s	0.62	0.54	0.47	0.38	47	
									Power Watts	105	115	117	120		
VSP35514	230/1/50	IP54	0.18	0.75	3	4	1260	⑤	Volume m³/s	0.90	0.82	0.72	0.58	46	
									Power Watts	132	141	151	162		
VSP35534	400/3/50	IP54	0.14	0.4	1.6	4	1390	⑥	Volume m³/s	0.97	0.90	0.65	0.67	48	
									Power Watts	152	168	176	178		
VSP40014	230/1/50	IP54	0.24	1.05	4.2	4	1340	⑦	Volume m³/s	1.07	1.00	0.89	0.78	0.61	46
									Power Watts	166	195	200	210	240	
VSP40034	400/3/50	IP54	0.17	0.46	1.84	4	1360	⑧	Volume m³/s	1.06	1.00	0.90	0.78	0.64	47
									Power Watts	160	170	190	205	220	

Sound Power Level Spectra dB (ref 10⁻¹² Watts)

Stock Ref	63Hz	125Hz	250Hz	500Hz	1KHz	2KHz	4KHz	8KHz	dB(A) @ 3m
VSP25012	65	70	68	66	64	66	62	55	50
VSP25014	56	63	56	54	53	53	49	41	37
VSP31514	71	70	65	60	58	59	55	47	45
VSP31534	75	71	62	60	61	62	59	51	47
VSP35514	67	70	67	64	58	60	53	45	46
VSP35534	74	66	61	63	64	63	59	53	48
VSP40014	72	73	66	62	60	59	54	48	46
VSP40034	67	67	61	60	60	59	54	48	47

Performance Curves

450 to 500 dia. - Pole 4 & 6

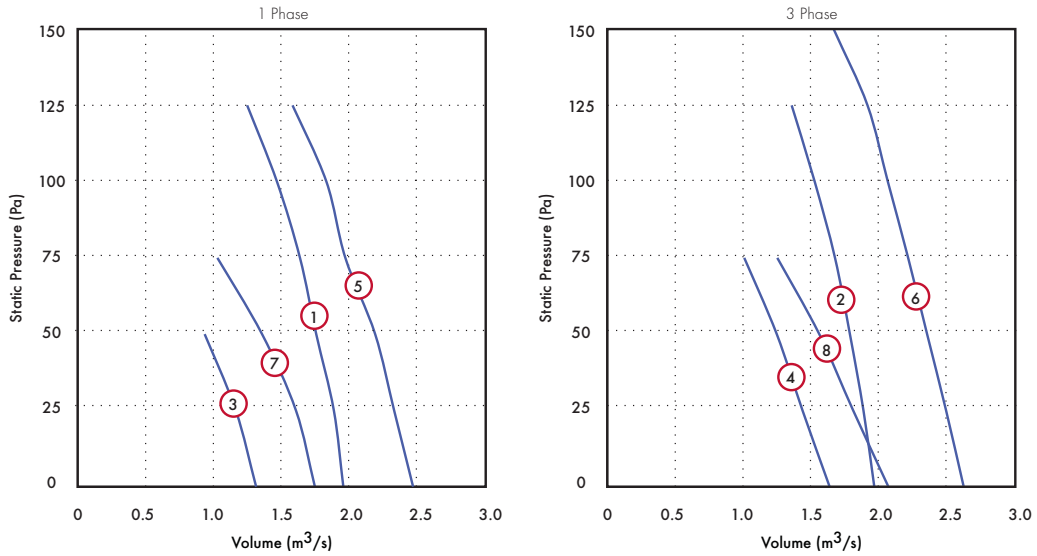

Performance Guide

Stock Ref	Supply	IP Rating	Motor kW	F.L.C Amps	S.C. Amps	Poles	rpm	Curve	Volume m³/s @ Pa							dB(A) @ 3m	
									0	25	50	75	100	125	150		
VSP45014	230/1/50	IP54	0.56	2.5	10	4	1320	①	Volume m³/s	1.96	1.89	1.76	1.64	1.47	1.25		49
									Power Watts	480	500	520	530	540	550		
VSP45034	400/3/50	IP54	0.54	1.1	4.4	4	1350	②	Volume m³/s	1.97	1.89	1.79	1.68	1.53	1.36		49
									Power Watts	440	460	480	505	520	530		
VSP45016	230/1/50	IP54	0.19	0.9	3.6	6	910	③	Volume m³/s	1.32	1.17	0.94					41
									Power Watts	165	175	180					
VSP45036	400/3/50	IP54	0.36	0.66	2.64	6	1020	④	Volume m³/s	1.64	1.44	1.25	1.01				44
									Power Watts	325	350	360	380				
VSP50014	230/1/50	IP54	0.76	3.3	13.2	4	1230	⑤	Volume m³/s	2.47	2.33	2.19	1.97	1.83	1.58		51
									Power Watts	630	660	670	690	720	740		
VSP50034	400/3/50	IP54	0.84	1.45	5.8	4	1340	⑥	Volume m³/s	2.63	2.50	2.36	2.22	2.07	1.92	1.67	52
									Power Watts	620	650	680	720	740	750	800	
VSP50016	230/1/50	IP54	0.3	1.3	5.2	6	910	⑦	Volume m³/s	1.75	1.61	1.36	1.03				44
									Power Watts	250	265	280	295				
VSP50036	400/3/50	IP54	0.54	0.96	3.84	6	940	⑧	Volume m³/s	2.07	1.81	1.56	1.25				47
									Power Watts	470	500	520	540				

Sound Power Level Spectra dB (ref 10⁻¹² Watts)

Stock Ref	63Hz	125Hz	250Hz	500Hz	1KHz	2KHz	4KHz	8KHz	dB(A) @ 3m
VSP45014	67	69	71	63	63	63	59	53	49
VSP45034	72	70	65	65	64	64	59	53	49
VSP45016	57	62	59	56	56	56	50	41	41
VSP45036	71	66	60	60	60	58	51	43	44
VSP50014	71	75	67	63	67	68	60	52	51
VSP50034	74	72	66	66	68	68	62	56	52
VSP50016	66	72	70	55	59	58	51	43	44
VSP50036	77	77	72	66	64	61	54	47	47

Sabre® Plate Mounted Sickle Fans (VSP)

Performance Curves

560 to 710 dia. - Pole 4 & 6 & 8

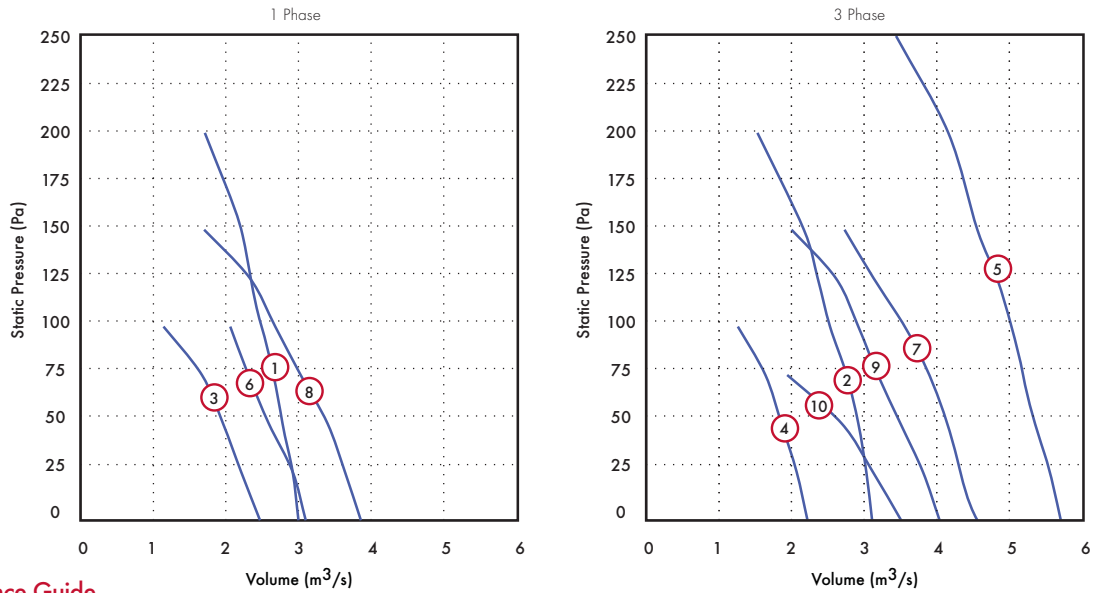

Performance Guide

Stock Ref	Supply	IP Rating	Motor kW	F.L.C Amps	S.C. Amps	Poles	rpm	Curve	Volume m³/s @ Pa								dB(A) @ 3m		
									0	25	50	75	100	125	150	200		250	
VSP56014	230/1/50	IP54	1.15	5	20	4	1330	①	Volume m³/s	3.00	2.92	2.78	2.69	2.51	2.31	2.22	1.71		62
									Power Watts	810	830	870	890	900	980	1000	1100		
VSP56034	400/3/50	IP54	1.05	2.2	8.8	4	1280	②	Volume m³/s	3.11	3.03	2.92	2.76	2.53	2.36	2.17	1.53		57
									Power Watts	742	800	840	860	910	920	940	1044		
VSP56016	230/1/50	IP54	0.46	2.2	8.8	6	930	③	Volume m³/s	2.22	2.07	1.86	1.64	1.26					50
									Power Watts	369	394	415	438	458					
VSP56036	400/3/50	IP54	0.58	1.1	4.4	6	910	④	Volume m³/s	2.47	2.21	1.96	1.67	1.14					51
									Power Watts	489	518	542	556	576					
VSP63034	400/3/50	IP54	2.4	4.6	18.4	4	1320	⑤	Volume m³/s	5.71	5.56	5.35	5.19	5.03	4.83	4.56	4.16	3.44	62
									Power Watts	2305	2350	2400	2450	2500	2540	2587	2628	2639	
VSP63016	230/1/50	IP54	0.74	3.4	13.6	6	910	⑥	Volume m³/s	3.10	2.92	2.59	2.31	2.06					52
									Power Watts	568	603	650	679	710					
VSP63036	400/3/50	IP54	1.5	2.6	10.4	6	1040	⑦	Volume m³/s	4.56	4.32	4.07	3.81	3.56	3.13	2.73			57
									Power Watts	1538	1550	1593	1610	1645	1661	1666			
VSP71016	230/1/50	IP54	0.95	4.4	17.6	6	850	⑧	Volume m³/s	3.86	3.64	3.40	3.03	2.68	2.33	1.70			52
									Power Watts	607	666	700	760	808	850	950			
VSP71036	400/3/50	IP54	0.94	1.7	6.8	6	900	⑨	Volume m³/s	4.04	3.81	3.50	3.19	2.92	2.61	2.00			49
									Power Watts	560	620	700	768	813	861	920			
VSP71038	400/3/50	IP54	0.62	1.05	4.2	8	690	⑩	Volume m³/s	3.51	3.12	2.69	1.94						45
									Power Watts	451	510	540	616						

Sound Power Level Spectra dB (ref 10⁻¹² Watts)

Stock Ref	63Hz	125Hz	250Hz	500Hz	1KHz	2KHz	4KHz	8KHz	dB(A) @ 3m
VSP56014	79	78	74	74	77	77	73	66	62
VSP56034	84	78	76	74	75	74	70	63	57
VSP56016	75	73	66	65	67	66	60	54	50
VSP56036	77	77	67	66	67	66	60	54	51
VSP63034	85	80	77	75	78	77	71	66	62
VSP63016	74	71	73	68	68	66	60	54	52
VSP63036	84	75	71	71	74	71	65	59	57
VSP71016	81	81	72	69	70	67	61	57	52
VSP71036	69	69	68	67	68	65	59	52	49
VSP71038	66	63	63	65	62	59	50	44	45

Accessories



Stock Ref	Supply	Electronic Controller*	5 Step Auto transformer	eDemand Voltage*	eDemand 1ph			D.O.L Starter	Overload
					eDemand 3ph Inverter	in 3ph out inverter	Inverter		
VSP25012	230/1/50	W10303102M	10314102	444164	-	-	444169	444744	444698
VSP25014	230/1/50	W10303102M	10314102	444164	-	-	444169	444744	444697
VSP31514	230/1/50	W10303102M	10314102	444164	-	-	444169	444744	444699
VSP31534	400/3/50	-	10314301	444166	444172	444177	-	444747	444699
VSP35514	230/1/50	W10303102M	10314102	444164	-	-	444169	444744	444699
VSP35534	400/3/50	-	10314301	444166	444172	444177	-	444747	444698
VSP40014	230/1/50	W10303102M	10314102	444164	-	-	444169	444744	444700
VSP40034	400/3/50	-	10314301	444166	444172	444177	-	444747	444698
VSP45014	230/1/50	10303103	10314103	444164	-	-	444169	444744	444702
VSP45034*	400/3/50	-	10314302	444166	444172	444177	-	444747	444700
VSP45016	230/1/50	W10303102M	10314102	444164	-	-	444169	444744	444699
VSP45036*	400/3/50	-	10314301	444166	444172	444177	-	444747	444699
VSP50014	230/1/50	10303106	10314105	444164	-	-	444169	444744	444702
VSP50034*	400/3/50	-	10314302	444166	444172	444177	-	444747	444700
VSP50016	230/1/50	W10303102M	10314102	444164	-	-	444169	444744	444700
VSP50036*	400/3/50	-	10314302	444166	444172	444177	-	444747	444700
VSP56014	230/1/50	10303106	10314105	444164	-	-	444170	444744	444703
VSP56034*	400/3/50	-	10314304	444166	444172	444177	-	444747	444702
VSP56016	230/1/50	10314103	10314103	444164	-	-	444169	444744	444702
VSP56036*	400/3/50	-	10314302	444166	444172	444177	-	444747	444700
VSP63034*	400/3/50	-	10314307	444166	444173	444177	-	444747	444703
VSP63016	230/1/50	10303106	10314105	444164	-	-	444169	444744	444702
VSP63036*	400/3/50	-	10314304	444166	444173	444177	-	444747	444702
VSP71016	230/1/50	10303106	10314105	444164	-	-	444170	444744	444703
VSP71036*	400/3/50	-	10314302	444166	444172	444177	-	444747	444701
VSP71038*	400/3/50	-	10314302	444166	444172	444177	-	444747	444700

* Electronic Voltage controllers may cause motor noise and vibration at lower speeds, transformer or Inverter recommended for noise sensitive applications

* All models are supplied with 2 speed delta/star connection motors as standard (Sizes 450 to 630 are 4/6 Pole, size 710 is 6/8 pole)

Guards: Some installations may occur where additional safety parts are needed, to ensure safety in operation. For example, the unit may be fitted at the inlet or outlet end of a ducted ventilation system, thereby exposing the impeller/motor to unguarded access. In this event, the installer must fit a safety guard complying to current regulations. These guards are available as an optional extra

Where inverters are utilised these must include Sine filters, as included within our eDemand range of inverters.

Louvre shutter		Discharge guard	
Fan Dia.	Stock Ref	Fan Dia.	Stock Ref
250	LS250	250	10502325
315	LS315	315	10502325
355	LS355	355	10502375
400	LS400	400	10502450
450	LS450	450	10502525
500	LS500	500	10502525
560	LS560	560	10502630
630	LS630	630	10502630
710	LS710	710	10502800

NOTE: If a discharge guard is required with a louvre shutter the next size up discharge guard should be selected

Sabre[®] Sickle Short Case Fans (VSC)

Features and Benefits

- Swept impeller with Aerofoil blades, winglets and serrated trailing edge for optimum performance
- One shot die cast impeller, dynamically balanced for smoother operation
- Operating temperature up to 70°C
- External Rotor Motors on all models for compact efficient design
- All models speed controllable
- Guards fitted as standard on all models
- Thermal Overload Protection for motor protection
- Maintenance free sealed for life bearings
- 2 Year Guarantee

The latest generation of the Vent-Axia Sabre[®] Sickle Short Case fans incorporate the very latest FE2 Owllet impeller offering improved performance over the previous ranges with up to 7dB(A) reduction in sound and up to 15% improvement in efficiency ensuring the best available fan performance in its class. The advanced blade design is matched to a purpose designed external rotor motor to ensure unrivalled reliability and controllability.

Design and Development

Using a combination of NASA research into wing performance and winglets, coupled with a study of bird flight has enabled the development of the best available Sickle blade profile. Matching this to a purpose designed close fitting casing ensures best use of this blade technology thereby reducing noise and improving the performance in cased axial fans.

Construction

The Sabre[®] Sickle Short Case fan range share the same case lengths as the Euroseries Cased axial range making them fully interchangeable and compatible with the full range of Vent-Axia Accessories. The strong and compact short case is constructed from rolled steel plate and protected with a tough, epoxy paint finish. Casing dimensions are to DIN 24151 and flange dimensions are to ISO 6580.

Manufacture is controlled to BS EN ISO 9001. The compact motor/impeller unit is robustly supported within the casing by electro welded and epoxy coated steel rod mounting supports for ease of installation and service access. Suitable for all outdoor weather environments.

Impellers

The impellers incorporate the latest in Sickle blade aerofoil technology to ensure minimum sound and maximum performance. Impellers up to 400mm diameter are moulded from a composite polymer, impellers above this size are Aluminium. The motors and impellers are factory matched, statically and dynamically balanced to ISO 1940 part 1, Quality Class G.6.3.

Motors

The external rotor motors are specifically designed and styled for this range of fan. Ball bearings are greased for life. Sizes 315 – 710 motors are protected to IP54 against dust and moisture, complying with BS EN 60529.

They have ribbed aluminium body castings for efficient cooling with Motor insulation to Class 'F' (from -40°C to + 70°C). Speed controlled sizes 450 to 710, 6 & 8 pole motors are only suitable for operating temperatures of up to 40°C.

Electrical

The Sabre[®] Sickle Short Case fan range is available for either single phase 220-240V 50 Hz capacitor start and run or three phase 380-415V 50Hz. Motors are fitted with Thermal Overload Protection which should be wired into all controller circuits and into starter contactors to prevent motor damage due to overloading / overheating.

Speed Control

Units are suitable for speed control by either electronic, voltage reduction or frequency inverters where permissible. For optimum efficiency and controllability Vent-Axia recommend the use of the eDemand Inverter Controller to give close control via sensors or manual control.

Form of Running

Cased mounted fans (ex-stock) are supplied for extract use (Form 'B' running).

Performance

The fan performance is in accordance with tests to ISO 5801.

Sound Levels

Fan sound levels are measured in a reverberant chamber in accordance with ISO 3744 Part 1. Published dB(A) figures are free field sound pressure levels at 3m with spherical propagation at a reference level of 2×10^{-5} Pa (20 micro-Pascal). The sound power level spectra figures are dB with a reference level of 10^{-12} Watts (1 pico-watt).

To ensure minimum noise levels during speed control, either an auto transformer or eDemand inverter speed control is recommended.

Accessories

A full range of accessories is available with the Sabre[®] Sickle Short Case fans:

- Electronic Speed Controllers
- Auto Transformer Speed Controllers
- eDemand Inverter Speed Control
- D.O.L. Starters
- Ancillary Packs
- Attenuators



Fan Dimensions (mm)

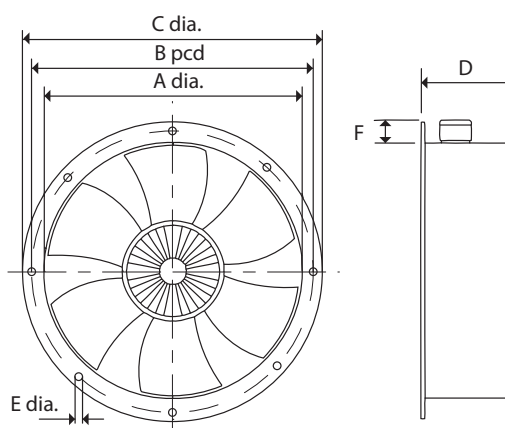

Stock Ref	Kg	A	B	C	D	E	n*	F
VSC31514	7	316	356	382	136.5	9.5	8	65
VSC31534	7	316	356	382	136.5	9.5	8	65
VSC35514	7	356	395	421	136.5	9.5	8	65
VSC35534	7.1	359	395	421	135	9.5	8	65
VSC40014	8.3	400	438	466	155	9.5	12	65
VSC40034	8.3	400	438	466	155	9.5	12	65
VSC45014	15.7	451	487	515	160	9.5	12	65
VSC45034	14.2	451	487	515	160	9.5	12	65
VSC45036	14.2	451	487	515	160	9.5	12	65
VSC50014	16.8	503	541	567	166	9.5	12	65
VSC50034	16.8	503	541	567	166	9.5	12	65
VSC50036	16.8	503	541	567	166	9.5	12	65
VSC56014	29.7	559	605	635	210	11.5	16	75
VSC56034	21.3	559	605	635	210	11.5	16	75
VSC56034	21.3	559	605	635	210	11.5	16	75
VSC63034	35.8	634	674	707	225.5	11.5	16	75
VSC63036	35.8	634	674	707	225.5	11.5	16	75
VSC71036	41.8	711	751	785	260	11.5	16	75
VSC71016	36.8	711	751	785	260	11.5	16	75
VSC71038	41.8	711	751	785	260	11.5	16	75

*n = number of holes

Sabre® Sickle Short Case Fans (VSC)

Performance Curves

315 to 400 dia. - Pole 4

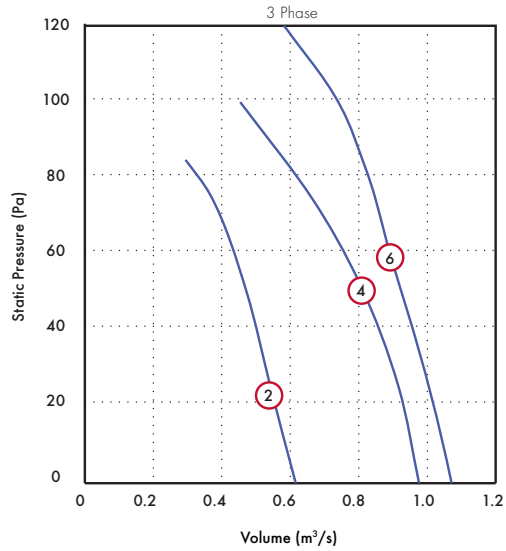
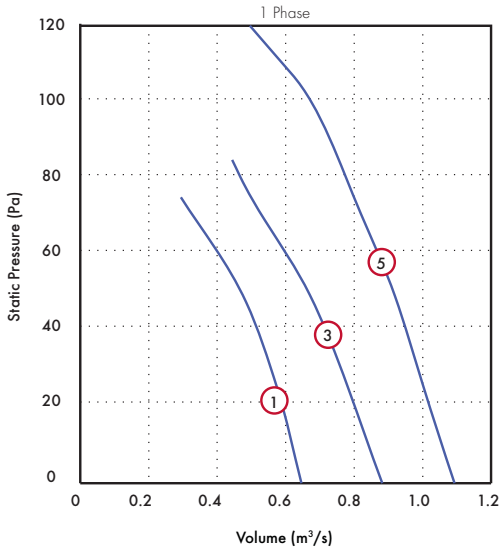

Performance Guide

Stock Ref	Supply	IP Rating	Motor kW	F.L.C Amps	S.C. Amps	Poles	rpm	Curve	Volume m³/s @ Pa					dB(A) @ 3.0m	
									0	25	50	75	100		
VSC31514	230/1/50	IP54	0.14	0.62	2.48	4	1360	1	Volume m³/s	0.65	0.58	0.47	0.29		44
									Power Watts	85	93	100	110		
VSC31534	400/3/50	IP54	0.12	0.68	2.72	4	1450	2	Volume m³/s	0.62	0.54	0.47	0.38		47
									Power Watts	105	115	117	120		
VSC35514	230/1/50	IP54	0.18	0.75	3	4	1260	3	Volume m³/s	0.88	0.78	0.67	0.50		48
									Power Watts	145	155	167	181		
VSC35534	400/3/50	IP54	0.14	0.4	1.6	4	1390	4	Volume m³/s	0.98	0.92	0.82	0.67	0.44	48
									Power Watts	155	166	174	179	186	
VSC40014	230/1/50	IP54	0.24	1.05	4.2	4	1340	5	Volume m³/s	1.09	1.00	0.92	0.79	0.67	46
									Power Watts	183	197	210	224	236	
VSC40034	400/3/50	IP54	0.17	0.46	1.84	4	1360	6	Volume m³/s	1.07	1.01	0.92	0.85	0.74	44
									Power Watts	168	184	200	214	228	

Sound Power Level Spectra dB (ref 10⁻¹² Watts)

Stock Ref	63Hz	125Hz	250Hz	500Hz	1KHz	2KHz	4KHz	8KHz	dB(A) @ 3.0m
VSC31514	71	70	65	60	58	59	55	47	44
VSC31534	75	71	62	60	61	62	59	51	47
VSC35514	67	70	67	64	58	60	53	45	48
VSC35534	74	66	61	63	64	63	59	53	48
VSC40014	72	73	66	62	60	59	54	48	46
VSC40034	67	67	61	60	60	59	54	48	44

Performance Curves

450 to 500 dia. - Pole 4 & 6

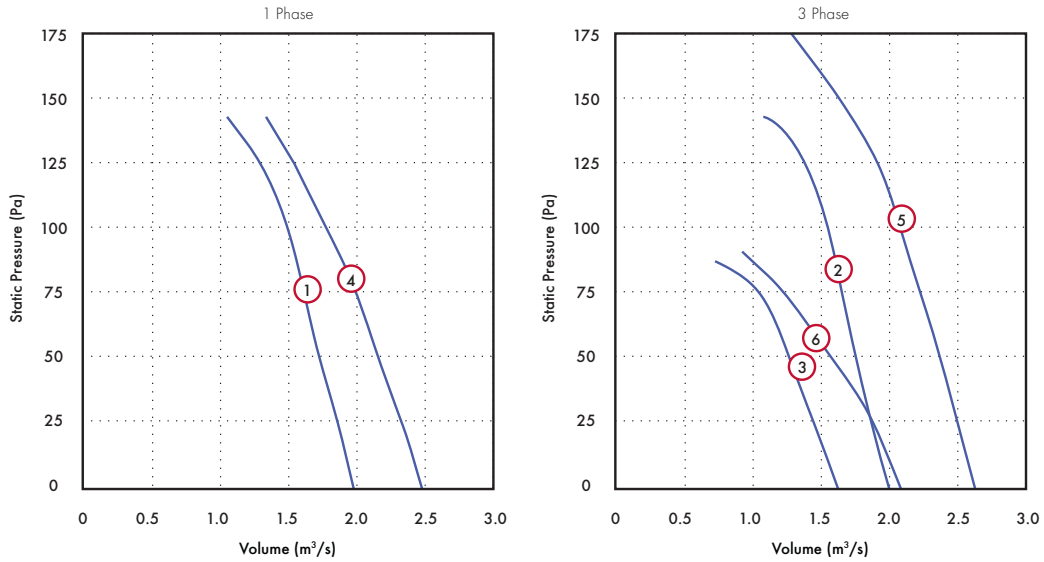

Performance Guide

Stock Ref	Supply	IP Rating	Motor kW	F.L.C Amps	S.C. Amps	Poles	rpm	Curve	Volume m³/s @ Pa							dB(A) @ 3.0m		
									0	25	50	75	100	125	150		175	
VSC45014	230/1/50	IP54	0.56	2.5	10	4	1320	1	Volume m³/s	1.98	1.86	1.72	1.58	1.50	1.31			49
									Power Watts	481	490	510	530	537	546			
VSC45034	400/3/50	IP54	0.54	1.1	4.4	4	1350	2	Volume m³/s	2.00	1.89	1.75	1.68	1.53	1.41			49
									Power Watts	446	450	485	510	523	532			
VSC45036	400/3/50	IP54	0.36	0.66	2.64	6	1020	3	Volume m³/s	1.623	1.448	1.254	1.056					44
									Power Watts	333	351	364	372					
VSC50014	230/1/50	IP54	0.76	3.3	13.2	4	1230	4	Volume m³/s	2.48	2.33	2.14	2.02	1.78	1.54			51
									Power Watts	626	649	670	696	710	740			
VSC50034	400/3/50	IP54	0.84	1.45	5.8	4	1340	5	Volume m³/s	2.63	2.50	2.38	2.22	2.08	1.91	1.63	1.28	52
									Power Watts	616	653	683	713	739	765	802	829	
VSC50036	400/3/50	IP54	0.54	0.96	3.84	6	940	6	Volume m³/s	2.08	1.89	1.57	1.25					47
									Power Watts	472	498	517	530					

Sound Power Level Spectra dB (ref 10⁻¹² Watts)

Stock Ref	63Hz	125Hz	250Hz	500Hz	1KHz	2KHz	4KHz	8KHz	dB(A) @ 3.0m
VSC45014	67	69	71	63	63	63	59	53	49
VSC45034	72	70	65	65	64	64	59	53	49
VSC45036	71	66	60	60	60	58	51	43	44
VSC50014	71	75	67	63	67	68	60	52	51
VSC50034	74	72	66	66	68	68	62	56	52
VSC50036	77	77	72	66	64	61	54	47	47

Sabre[®] Sickle Short Case Fans (VSC)

Performance Curves

560 to 630 dia. - Pole 4 & 6

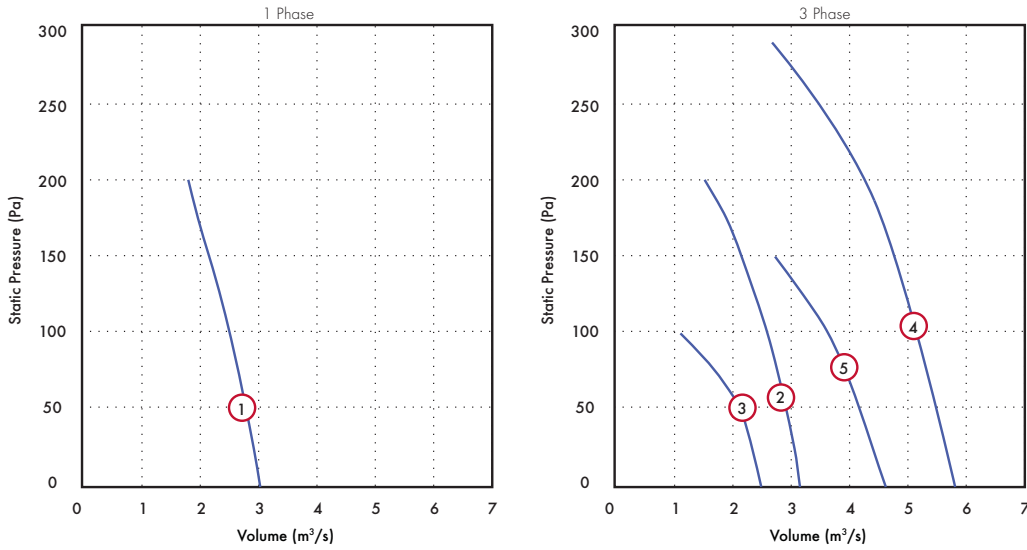

Performance Guide

Stock Ref	Supply	IP Rating	Motor kW	F.L.C Amps	S.C. Amps	Poles	rpm	Curve	Volume m ³ /s @ Pa										dB(A) @ 3.0m			
									0	25	50	75	100	125	150	175	200	225		250	275	
VSC56014	230/1/50	IP54	1.15	5	20	4	1330	①	Volume m ³ /s	3.03	2.92	2.78	2.67	2.50	2.36	2.15	1.96	1.79			62	
									Power Watts	824	850	910	946	996	1020	1055	1085	1114				
VSC56034	400/3/50	IP54	1.05	2.2	8.8	4	1280	②	Volume m ³ /s	3.15	3.06	2.89	2.76	2.59	2.39	2.14	1.89	1.52			57	
									Power Watts	742	770	830	870	910	945	975	1014	1044				
VSC56036	400/3/50	IP54	0.65	1.25	5	6	880	③	Volume m ³ /s	2.47	2.28	2.06	1.67	1.11							51	
									Power Watts	560	580	605	628	650								
VSC63034	400/3/50	IP54	2.4	4.6	18.4	4	1320	④	Volume m ³ /s	5.81	5.64	5.50	5.35	5.21	5.00	4.69	4.54	4.23	3.61	3.56	3.40	60
									Power Watts	2396	2440	2511	2550	2603	2650	2700	2735	2750	2762	2769	2759	
VSC63036	400/3/50	IP54	1.5	2.6	10.4	6	1040	⑤	Volume m ³ /s	4.62	4.39	4.17	3.91	3.63	3.21	2.72						55
									Power Watts	1608	1640	1677	1695	1722	1741	1753						

Sound Power Level Spectra dB (ref 10⁻¹² Watts)

Stock Ref	63Hz	125Hz	250Hz	500Hz	1KHz	2KHz	4KHz	8KHz	dB(A) @ 3.0m
VSC56014	79	78	74	74	77	77	73	66	62
VSC56034	84	78	76	74	75	74	70	63	57
VSC56036	77	77	67	66	67	66	60	54	51
VSC63034	85	80	77	75	78	77	71	66	60
VSC63036	84	75	71	71	74	71	65	59	55

Performance Curves

710 dia. - Pole 6 & 8

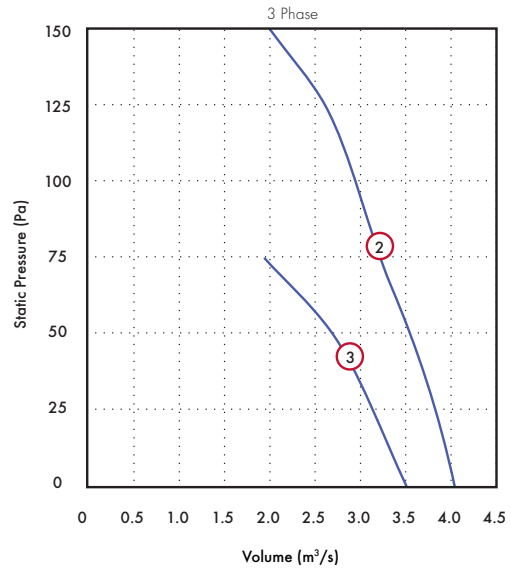
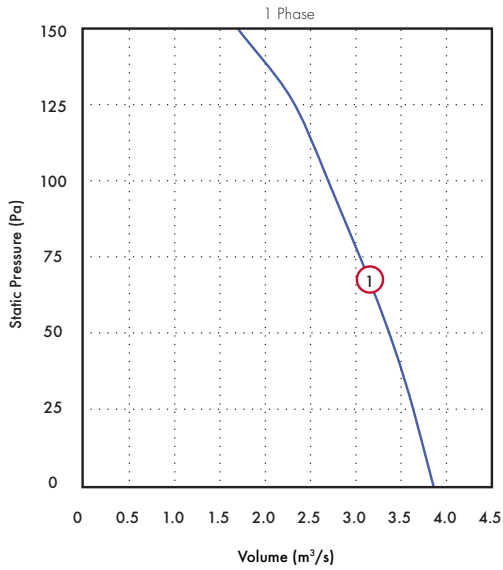

Performance Guide

Stock Ref	Supply	IP Rating	Motor kW	F.L.C Amps	S.C. Amps	Poles	rpm	Curve	Volume m³/s @ Pa							dB(A) @ 3.0m	
									0	25	50	75	100	125	150		
VSC71016	230/1/50	IP54	0.95	4.4	17.6	6	850	①	Volume m³/s	3.859	3.637	3.399	3.056	2.677	2.333	1.695	52
									Power Watts	607	666	705	750	808	850	950	
VSC71036	400/3/50	IP54	0.94	1.7	6.8	6	900	②	Volume m³/s	4.042	3.861	3.611	3.194	2.919	2.608	1.994	49
									Power Watts	560	590	670	768	813	861	931	
VSC71038	400/3/50	IP54	0.62	1.05	4.2	8	690	③	Volume m³/s	3.512	3.115	2.694	1.936				45
									Power Watts	451	510	560	615				

Sound Power Level Spectra dB (ref 10⁻¹² Watts)

Stock Ref	63Hz	125Hz	250Hz	500Hz	1KHz	2KHz	4KHz	8KHz	dB(A) @ 3.0m
VSC71016	81	81	72	69	70	67	61	57	52
VSC71036	69	69	68	67	68	65	59	52	49
VSC71038	66	63	63	65	62	59	50	44	45

Sabre® Sickle Short Case Fans (VSC)

Accessories Dimensions (mm)

Mounting Feet (Pack of 2)

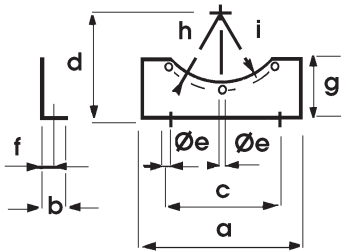

Stock Ref	a	b	c	d	Øe	f	g	h	i
MFZ315	315	40	265	200	10	20	71	178	166
MFZ355	350	40	300	225	10	20	81.5	197.5	186
MFZ400	250	40	220	250	10	20	78	219	205
MFZ450	275	40	240	275	10	20	82	243.5	230
MFZ500	315	50	280	315	1	25	100	270.5	255
MFZ560	355	50	320	355	12	25	97	302.5	285
MFZ630	400	50	360	400	12	25	108.5	337	320
MFZ710	465	50	415	450	12	25	118.5	375.5	362

Inlet Wire Guard 'K' factor loss 0.25

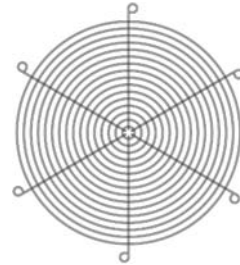

Stock Ref	Dia
WGZ315	375
WGZ355	414
WGZ400	461
WGZ450	506
WGZ500	560
WGZ560	626.5
WGZ630	695.5
WGZ710	772.5

For more information on the 'K' factor, refer to General Information Section

Anti-Vibration Mounts (Pack of 4) - All Models

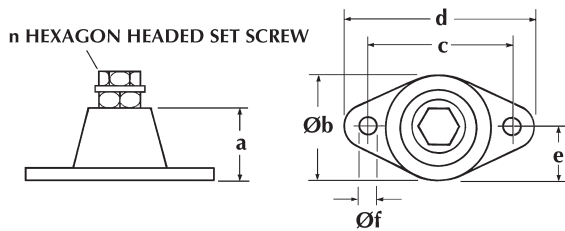

Stock Ref	a	Øb	c	d	e	Øf	n	load kg
68MP033G	27	37	54	67	18.5	7	M8	23

Coupling Flange

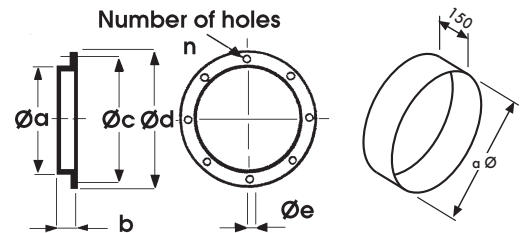

Flexible Connection

Stock Ref	Øa	b	Øc	Ød	Øe	Øf	n
CFZ315	313	40	356	382	10	319	8
CFZ355	353	40	395	421	10	359	8
CFZ400	398	45	438	466	10	404	12
CFZ450	448	45	487	515	10	454	12
CFZ500	498	45	541	567	10	504	12
CFZ560	558	45	605	635	12	564	16
CFZ630	628	45	674	707	12	634	16
CFZ710	708	50	751	785	12	714	16

Accessories



Stock Ref	Supply	Electronic Controller*	5 Step Auto Transformer	eDemand Voltage*	eDemand 1ph			D.O.L Starter	Overload
					eDemand 3ph Inverter	in 3ph out Inverter	eDemand 1Ph Inverter		
VSC31514	230/1/50	W10303102M	10314102	444164	-	-	444169	444744	444699
VSC31534	400/3/50	-	10314301	444166	444172	444177	-	444747	444699
VSC35514	230/1/50	W10303102M	10314102	444164	-	-	444169	444744	444699
VSC35534	400/3/50	-	10314301	444166	444172	444177	-	444747	444698
VSC40014	230/1/50	W10303102M	10314102	444164	-	-	444169	444744	444700
VSC40034	400/3/50	-	10314301	444166	444172	444177	-	444747	444698
VSC45014	230/1/50	10303103	10314103	444164	-	-	444169	444744	444702
VSC45034*	400/3/50	-	10314302	444166	444172	444177	-	444747	444700
VSC45036*	400/3/50	-	10314301	444166	444172	444177	-	444747	444699
VSC50014	230/1/50	10303106	10314105	444164	-	-	444169	444744	444702
VSC50034*	400/3/50	-	10314302	444166	444172	444177	-	444747	444700
VSC50036*	400/3/50	-	10314301	444166	444172	444177	-	444747	444700
VSC56014	230/1/50	10303106	10314105	444164	-	-	444170	444744	444703
VSC56034	400/3/50	-	10314304	444166	444173	444177	-	444747	444701
VSC63034*	400/3/50	-	10314304	444166	444173	444177	-	444747	444703
VSC63036*	400/3/50	-	10314304	444166	444173	444177	-	444747	444702
VSC71036*	400/3/50	-	10314302	444166	444172	444177	-	444747	444701
VSC71016	230/1/50	10303106	10314105	444164	-	-	444170	444744	444703
VSC71038*	400/3/50	-	10314302	444166	444172	444177	-	444747	444700

* Electronic Voltage controllers may cause motor noise and vibration at lower speeds, transformer or Inverter recommended for noise sensitive applications

* All models are supplied with 2 speed delta/star connection motors, as standard. (Sizes 450 to 630 are 4/6 Pole)

Guards: Some installations may occur where additional safety parts are needed, to ensure safety in operation. For example, the unit may be fitted at the inlet or outlet end of a ducted ventilation system, thereby exposing the impeller/motor to unguarded access. In this event, the installer must fit a safety guard complying to current regulations. These guards are available as an optional extra. Where inverters are utilised these must include Sine filters, as included within our eDemand range of inverters.

Fan Dia	Mounting Feet	Inlet Wire	Coupling	Axial Ancillary	Cased Axial	Cased Axial	Cased Axial
	Wire (pack of 2)	Guard	Flange	Pack	Attenuator	Attenuator Pod 1D	Pod 2D
	Stock Ref	Stock Ref	Stock Ref	Stock Ref	Stock Ref	Stock Ref	Stock Ref
315	MFZ315	WGZ315	CFZ315	APZ315	ACZ3151D	ACZ3151DP	ACZ3152DP
355	MFZ355	WGZ355	CFZ355	APZ355	ACZ3551D	ACZ3551DP	ACZ3552DP
400	MFZ400	WGZ400	CFZ400	APZ400	ACZ4001D	ACZ4001DP	ACZ4002DP
450	MFZ450	WGZ450	CFZ450	APZ450	ACZ4501D	ACZ4501DP	ACZ4502DP
500	MFZ500	WGZ500	CFZ500	APZ500	ACZ5001D	ACZ5001DP	ACZ5002DP
560	MFZ560	WGZ560	CFZ560	APZ560	ACZ5601D	ACZ5601DP	ACZ5602DP
630	MFZ630	WGZ630	CFZ630	APZ630	ACZ6301D	ACZ6301DP	ACZ6302DP
710	MFZ710	WGZ710	CFZ710	APZ710	ACZ7101D	ACZ7101DP	ACZ7102DP

Long Case Axial Fans (LCA)

Features & Benefits

- Motors protected to IP55
- Motor insulation Class 'F'
- Maximum ambient temp. 54 °C
- Speed controllable via transformer or inverter
- IP55 terminal box
- Adjustable factory set die cast aluminium impeller
- Suitable for relative humidity levels up to 95% R.H
- Manufactured to BS EN ISO 9001
- Performance tested to BS 848 parts 1, 2 and ISO 5801
- 2 Year Guarantee

The Long Case Axial range of fans incorporates manually adjustable pitch impellers which provide a comprehensive range of duties offering high performance and pressure characteristics.

Available in thirteen sizes ranging from 250 to 1250mm diameter and performances from 0.24m³/s to 36m³/s with pressure development up to 1500Pa. The casing is constructed from rolled steel plate complete with flanges and protected with a tough, galvanised finish.

The Long Case Axial Fan range has a number of accessories available which include: Axial Ancillary Pack, Attenuators, Mounting Feet, Wire Inlet Guard, Coupling Flange and Speed Controllers.

Sound Levels

All measurements of the sound that the fans generate have been taken strictly in accordance with BS 848 part 2, test method 1. Published sound power level spectra figures are dBW with a reference of 10⁻¹² Watts(1 Pico watt).

Motors

The motors are specially selected for optimum performance and efficiency. Ball bearings are greased for life and allow the fan to be installed at any angle. Suitable for continuous operation in relative humidity up to 95% Motors are protected to IP55 against dust and water jets complying with BS EN 60529. They have ribbed aluminium body castings for efficient cooling. Motor insulation is Class 'F' (from -35°C to +54°C). Star/delta starting is recommended for motor output above 7.5kW.

Axial Impellers

Impeller blades are clamped in a split cast aluminium hub, with a keywayed mild steel insert enabling positive locking of the impeller assembly to the motor shaft, this also allows manual adjustment of the pitch angle giving a wide selection of performance details.



Terminal Box

Rated to IP55, protected against dust and water jets from any angle, allowing outside applications.

Declaration of Conformity

All models are supplied with an EC Declaration of Conformity as defined by the EC Council Directive on Machinery 98/37/EC. This declares that all the models, on the basis of their design and construction in the form brought onto the market by Vent-Axia, are in accordance with the Machinery Directive.

Electrical

Single phase 220-240V 50 Hz permanent capacitor. Three phase 380-415V 50Hz. Protection of the motor must be provided by an overload current sensing device (eg. D.O.L Starter or Star/Delta starter where appropriate) or the guarantee will be invalidated. All models are available with 4 pole motors for 250 up to 1250mm diameter with additional 2 pole motors available from 250 up to 630mm diameter.

All units are manufactured to order with 10 working days delivery (uk mainland).



Fan Dimensions (mm)

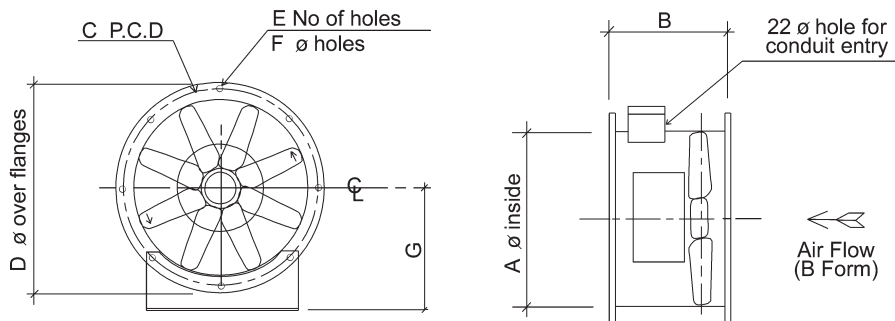

Model No.	Pole	Phase	Pitch Angle	A	B	C	D	E	F	G	Max Weight kg
LCA25	2 & 4	1 & 3	25-40	250	300	295	335	8	10	200	15
LCA31	2 & 4	1 & 3	10-38	315	420	355	385	8	10	224	23
LCA35	2 & 4	1 & 3	10-38	355	420	395	425	8	10	250	25
LCA40	2 & 4	1 & 3	10-38	400	435	450	480	8	12	280	38
LCA45	2 & 4	1 & 3	10-40	450	435	500	530	8	12	315	49
LCA50	2	3	10-31	500	565	560	590	12	12	315	86
LCA50	2	3	32-40	500	565	560	590	12	12	315	86
LCA50	4	1 & 3	10-40	500	565	560	590	12	12	315	86
LCA56	2	3	10-15	560	565	620	650	12	12	355	94
LCA56	2	3	16-24	560	565	620	650	12	12	355	94
LCA56	4	1 & 3	10-40	560	565	620	650	12	12	355	94
LCA63	2	3	10-22	630	565	690	720	12	12	400	96
LCA63	4	1	10-26	630	565	690	720	12	12	400	96
LCA63	4	3	10-40	630	565	690	720	12	12	400	96
LCA71	4	3	10-36	710	565	770	800	16	12	435	92
LCA80	4	3	10-20	800	565	860	890	16	12	480	131
LCA80	4	3	21-34	800	565	860	890	16	12	480	131
LCA90	4	3	10-26	900	565	970	1038	16	14	535	214
LCA90	4	3	28-40	900	700	970	1038	16	14	535	214
LCA100	4	3	10-22	1000	565	1070	1138	16	14	555	274
LCA100	4	3	24-32	1000	700	1070	1138	16	14	555	274
LCA100	4	3	34-40	1000	790	1070	1138	16	14	555	274
LCA125	4	3	20-34	1250	950	1320	1390	20	15	868	903

Long Case Axial Fans (LCA)

Performance Curves

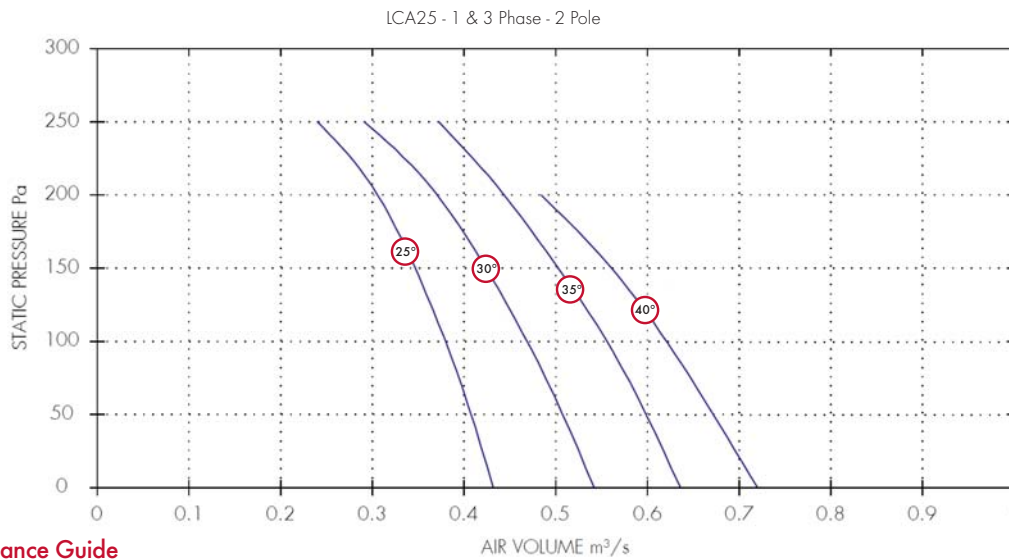

Performance Guide

Dia.	1 Phase		3 Phase		IP	Curve	m³/s at Pa					Motor	dBA @3m	
	Stock Ref	Stock Ref	Poles	rpm			Rating	Ref	0	50	100			150
250	LCA251225	LCA253225	2	2800	IP55	25°	0.43	0.41	0.38	0.35	0.31	0.24	0.37	58
250	LCA251230	LCA253230	2	2800	IP55	30°	0.54	0.51	0.47	0.42	0.37	0.29	0.37	57
250	LCA251235	LCA253235	2	2800	IP55	35°	0.64	0.6	0.56	0.5	0.44	0.37	0.37	58
250	LCA251240	LCA253240	2	2800	IP55	40°	0.72	0.67	0.62	0.56	0.48		0.37	59

Sound Power Level Spectra dB (ref 10⁻¹² Watts)

Dia.	1 Phase Stock		3 Phase		Spectrum	63	125	250	500	1k	2k	4k	8k	dBA @ 3m
	Stock Ref	Stock Ref	Poles	Spectrum										
250	LCA251225	LCA253225	2	Inlet/Outlet	73	74	82	75	73	70	67	64	58	
250	LCA251230	LCA253230	2	Inlet/Outlet	72	73	81	74	72	69	66	63	57	
250	LCA251235	LCA253235	2	Inlet/Outlet	73	74	82	75	73	70	67	64	58	
250	LCA251240	LCA253240	2	Inlet/Outlet	74	75	83	76	74	71	68	65	59	

Performance Curves

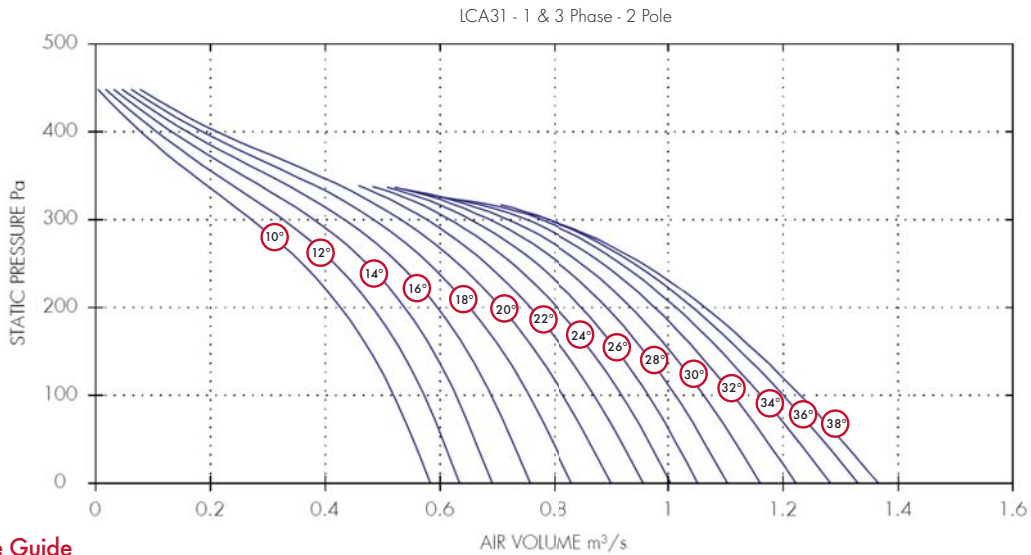

Performance Guide

Dia.	1 Phase		3 Phase		Poles	rpm	IP Rating	Curve Ref	m³/s at Pa				Motor kW	dBA @3m
	Stock Ref	Stock Ref	0	100					200	300	400			
315	LCA311210	LCA313210	2	2800	IP55	10°	0.58	0.52	0.43	0.27	0.08	0.37	65	
315	LCA311212	LCA313212	2	2800	IP55	12°	0.63	0.57	0.48	0.33	0.11	0.37	65	
315	LCA311214	LCA313214	2	2800	IP55	14°	0.69	0.63	0.54	0.38	0.13	0.37	65	
315	LCA311216	LCA313216	2	2800	IP55	16°	0.76	0.69	0.6	0.43	0.16	0.37	63	
315	LCA311218	LCA313218	2	2800	IP55	18°	0.83	0.76	0.65	0.48	0.19	0.37	61	
315	LCA311220	LCA313220	2	2800	IP55	20°	0.9	0.82	0.71	0.53	0.21	0.37	61	
315	LCA311222	LCA313222	2	2800	IP55	22°	0.96	0.87	0.76	0.58		0.37	62	
315	LCA311224	LCA313224	2	2800	IP55	24°	1	0.92	0.8	0.62		0.37	63	
315	LCA311226	LCA313226	2	2800	IP55	26°	1.05	0.97	0.85	0.65		0.55	63	
315	LCA311228	LCA313228	2	2800	IP55	28°	1.1	1.01	0.89	0.69		0.55	63	
315	LCA311230	LCA313230	2	2800	IP55	30°	1.16	1.06	0.94	0.72		0.55	64	
315	LCA311232	LCA313232	2	2800	IP55	32°	1.22	1.11	0.98	0.75		0.55	66	
315	LCA311234	LCA313234	2	2800	IP55	34°	1.28	1.16	1.01	0.78		0.75	66	
315	LCA311236	LCA313236	2	2800	IP55	36°	1.33	1.2	1.04	0.79		0.75	66	
315	LCA311238	LCA313238	2	2800	IP55	38°	1.37	1.23	1.06	0.79		0.75	66	

Sound Power Level Spectra dB (ref 10⁻¹² Watts)

Dia.	1 Phase		3 Phase		Poles	Spectrum	dB @ 3m										
	Stock Ref	Stock Ref	63	125			250	500	1k	2k	4k	8k					
315	LCA311210	LCA313210	2	Inlet/Outlet	83	82	82	79	81	80	76	68	65				
315	LCA311212	LCA313212	2	Inlet/Outlet	83	82	82	79	81	80	76	68	65				
315	LCA311214	LCA313214	2	Inlet/Outlet	83	82	82	79	81	80	76	68	65				
315	LCA311216	LCA313216	2	Inlet/Outlet	81	80	80	77	79	78	74	66	63				
315	LCA311218	LCA313218	2	Inlet/Outlet	79	78	78	75	77	76	72	64	61				
315	LCA311220	LCA313220	2	Inlet/Outlet	79	78	78	75	77	76	72	64	61				
315	LCA311222	LCA313222	2	Inlet/Outlet	80	79	79	76	78	77	73	65	62				
315	LCA311224	LCA313224	2	Inlet/Outlet	81	80	80	77	79	78	74	66	63				
315	LCA311226	LCA313226	2	Inlet/Outlet	81	80	80	77	79	78	74	66	63				
315	LCA311228	LCA313228	2	Inlet/Outlet	81	80	80	77	79	78	74	66	63				
315	LCA311230	LCA313230	2	Inlet/Outlet	82	81	81	78	80	79	75	67	64				
315	LCA311232	LCA313232	2	Inlet/Outlet	84	83	83	80	82	81	77	69	66				
315	LCA311234	LCA313234	2	Inlet/Outlet	84	83	83	80	82	81	77	69	66				
315	LCA311236	LCA313236	2	Inlet/Outlet	84	83	83	80	82	81	77	69	66				
315	LCA311238	LCA313238	2	Inlet/Outlet	84	83	83	80	82	81	77	69	66				

Long Case Axial Fans (LCA)

Performance Curves

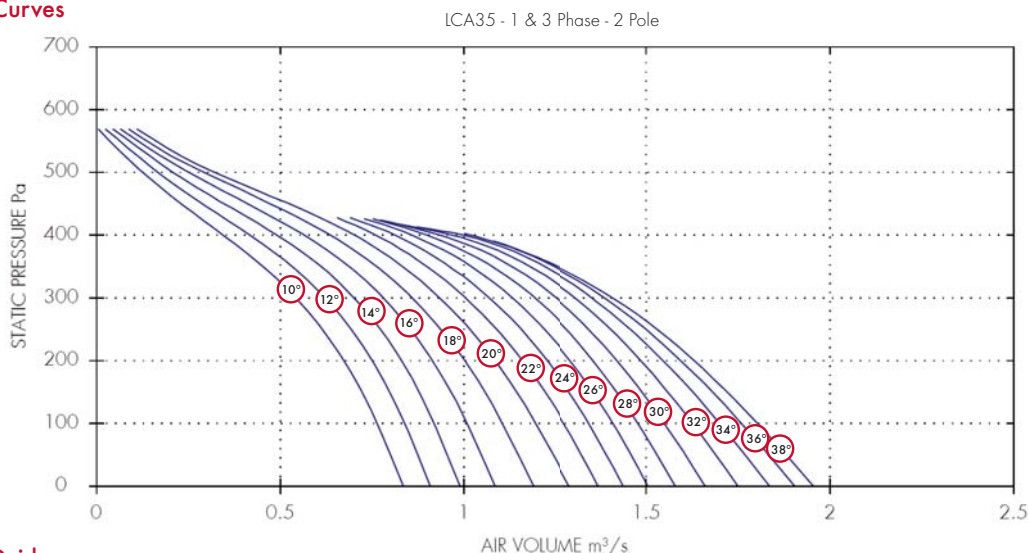

Performance Guide

Dia.	1 Phase		3 Phase		IP	Curve Ref	m³/s at Pa						Motor kW	dBa @3m
	Stock Ref	Stock Ref	Poles	rpm			Rating	0	100	200	300	400		
355	LCA351210	LCA353210	2	2800	IP55	10°	0.84	0.76	0.67	0.54	0.34	0.13	0.37	65
355	LCA351212	LCA353212	2	2800	IP55	12°	0.91	0.84	0.75	0.62	0.42	0.17	0.37	66
355	LCA351214	LCA353214	2	2800	IP55	14°	0.99	0.92	0.83	0.7	0.49	0.21	0.55	66
355	LCA351216	LCA353216	2	2800	IP55	16°	1.08	1.01	0.92	0.78	0.56	0.25	0.55	66
355	LCA351218	LCA353218	2	2800	IP55	18°	1.19	1.1	1	0.86	0.64	0.29	0.55	66
355	LCA351220	LCA353220	2	2800	IP55	20°	1.29	1.2	1.09	0.93	0.7	0.32	0.55	66
355	LCA351222	LCA353222	2	2800	IP55	22°	1.37	1.28	1.16	1	0.76		0.75	61
355	LCA351224	LCA353224	2	2800	IP55	24°	1.44	1.34	1.23	1.07	0.81		0.75	62
355	LCA351226	LCA353226	2	2800	IP55	26°	1.51	1.41	1.29	1.13	0.86		0.75	63
355	LCA351228	LCA353228	2	2800	IP55	28°	1.58	1.48	1.36	1.19	0.9		1.1	63
355	LCA351230	LCA353230	2	2800	IP55	30°	1.66	1.55	1.42	1.25	0.93		1.1	64
355	LCA351232	LCA353232	2	2800	IP55	32°	1.75	1.63	1.49	1.31	0.97		1.1	64
355	LCA351234	LCA353234	2	2800	IP55	34°	1.84	1.7	1.55	1.35	1		1.1	64
355	LCA351236	LCA353236	2	2800	IP55	36°	1.9	1.76	1.59	1.39	1.02		1.5	64
355	LCA351238	LCA353238	2	2800	IP55	38°	1.96	1.8	1.63	1.41			1.5	64

Sound Power Level Spectra dB (ref 10⁻¹² Watts)

Dia.	1 Phase		3 Phase		Spectrum	dB								dBa @ 3m
	Stock Ref	Stock Ref	Poles			63	125	250	500	1k	2k	4k	8k	
355	LCA351210	LCA353210	2	Inlet/Outlet	83	82	82	79	81	80	76	68	65	
355	LCA351212	LCA353212	2	Inlet/Outlet	84	83	83	80	82	81	77	69	66	
355	LCA351214	LCA353214	2	Inlet/Outlet	84	83	83	80	82	81	77	69	66	
355	LCA351216	LCA353216	2	Inlet/Outlet	84	83	83	80	82	81	77	69	66	
355	LCA351218	LCA353218	2	Inlet/Outlet	84	83	83	80	82	81	77	69	66	
355	LCA351220	LCA353220	2	Inlet/Outlet	84	83	83	80	82	81	77	69	66	
355	LCA351222	LCA353222	2	Inlet/Outlet	79	78	78	75	77	76	72	64	61	
355	LCA351224	LCA353224	2	Inlet/Outlet	80	79	79	76	78	77	73	65	62	
355	LCA351226	LCA353226	2	Inlet/Outlet	81	80	80	77	79	78	74	66	63	
355	LCA351228	LCA353228	2	Inlet/Outlet	81	80	80	77	79	78	74	66	63	
355	LCA351230	LCA353230	2	Inlet/Outlet	82	81	81	78	80	79	75	67	64	
355	LCA351232	LCA353232	2	Inlet/Outlet	82	81	81	78	80	79	75	67	64	
355	LCA351234	LCA353234	2	Inlet/Outlet	82	81	81	78	80	79	75	67	64	
355	LCA351236	LCA353236	2	Inlet/Outlet	82	81	81	78	80	79	75	67	64	
355	LCA351238	LCA353238	2	Inlet/Outlet	82	81	81	78	80	79	75	67	64	

Performance Curves

LCA40 - 1 & 3 Phase - 2 Pole

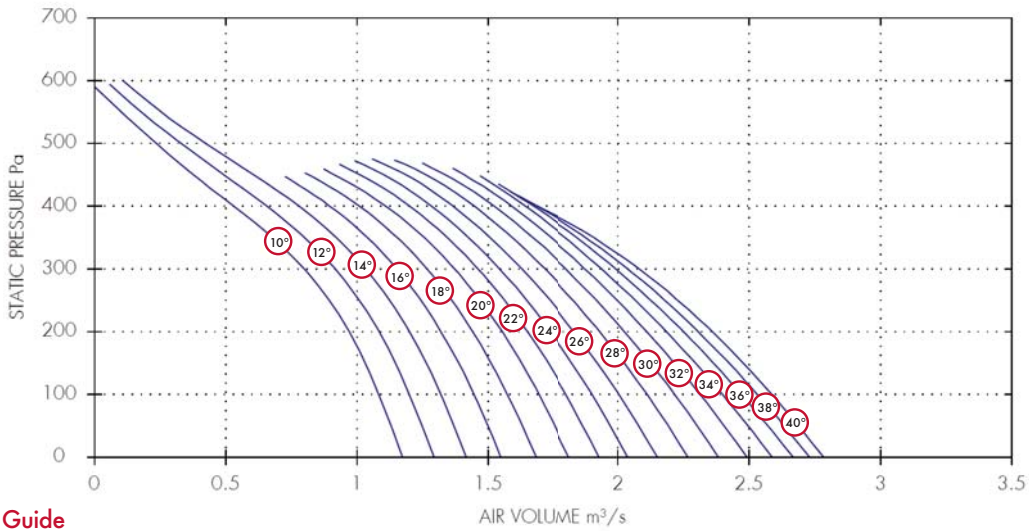

Performance Guide

Dia.	1 Phase		3 Phase		Poles	rpm	IP Rating	Curve Ref	m³/s at Pa					Motor kW	dBA @3m
	Stock Ref	Stock Ref	0	100					200	300	400	500			
400	LCA401210	LCA403210	2	2800	IP55	10°	1.17	1.08	0.97	0.8	0.53	0.23	0.55	71	
400	LCA401212	LCA403212	2	2800	IP55	12°	1.29	1.2	1.09	0.92	0.66	0.33	0.55	71	
400	LCA401214	LCA403214	2	2800	IP55	14°	1.42	1.32	1.2	1.03	0.78	0.42	0.75	71	
400	LCA401216	LCA403216	2	2800	IP55	16°	1.55	1.45	1.32	1.15	0.9		0.75	71	
400	LCA401218	LCA403218	2	2800	IP55	18°	1.68	1.57	1.44	1.27	1.01		0.75	71	
400	LCA401220	LCA403220	2	2800	IP55	20°	1.81	1.69	1.55	1.37	1.11		1.1	71	
400	LCA401222	LCA403222	2	2800	IP55	22°	1.93	1.8	1.65	1.46	1.2		1.1	66	
400	LCA401224	LCA403224	2	2800	IP55	24°	2.04	1.9	1.74	1.54	1.28		1.1	66	
400	LCA401226	LCA403226	2	2800	IP55	26°	2.15	2	1.83	1.63	1.37		1.1	67	
400	LCA401228	LCA403228	2	2800	IP55	28°	2.27	2.11	1.93	1.72	1.45		1.5	68	
400	LCA401230	LCA403230	2	2800	IP55	30°	2.38	2.22	2.03	1.8	1.52		1.5	68	
400	LCA401232	LCA403232	2	2800	IP55	32°	2.49	2.31	2.11	1.88	1.59		1.5	68	
400	-	LCA403234	2	2800	IP55	34°	2.59	2.4	2.19	1.94	1.64		2.2	67	
400	-	LCA403236	2	2800	IP55	36°	2.67	2.47	2.25	1.99	1.67		2.2	66	
400	-	LCA403238	2	2800	IP55	38°	2.73	2.53	2.31	2.04	1.69		2.2	66	
400	-	LCA403240	2	2800	IP55	40°	2.78	2.59	2.36	2.08	1.69		3	66	

Sound Power Level Spectra dB (ref 10⁻¹² Watts)

Dia.	1 Phase Stock Ref		3 Phase Stock Ref		Poles	Spectrum	dB						dBA @ 3m
	63	125	250	500			1k	2k	4k	8k			
400	LCA401210	LCA403210	2	Inlet/Outlet	89	86	89	86	87	84	81	74	71
400	LCA401212	LCA403212	2	Inlet/Outlet	89	86	89	86	87	84	81	74	71
400	LCA401214	LCA403214	2	Inlet/Outlet	89	86	89	86	87	84	81	74	71
400	LCA401216	LCA403216	2	Inlet/Outlet	89	86	89	86	87	84	81	74	71
400	LCA401218	LCA403218	2	Inlet/Outlet	89	86	89	86	87	84	81	74	71
400	LCA401220	LCA403220	2	Inlet/Outlet	89	86	89	86	87	84	81	74	71
400	LCA401222	LCA403222	2	Inlet/Outlet	84	81	84	81	82	79	76	69	66
400	LCA401224	LCA403224	2	Inlet/Outlet	84	81	84	81	82	79	76	69	66
400	LCA401226	LCA403226	2	Inlet/Outlet	85	82	85	82	83	80	77	70	67
400	LCA401228	LCA403228	2	Inlet/Outlet	86	83	86	83	84	81	78	71	68
400	LCA401230	LCA403230	2	Inlet/Outlet	86	83	86	83	84	81	78	71	68
400	LCA401232	LCA403232	2	Inlet/Outlet	86	83	86	83	84	81	78	71	68
400	-	LCA403234	2	Inlet/Outlet	85	82	85	82	83	80	77	70	67
400	-	LCA403236	2	Inlet/Outlet	84	81	84	81	82	79	76	69	66
400	-	LCA403238	2	Inlet/Outlet	84	81	84	81	82	79	76	69	66
400	-	LCA403240	2	Inlet/Outlet	84	81	84	81	82	79	76	69	66

Long Case Axial Fans (LCA)

Performance Curves

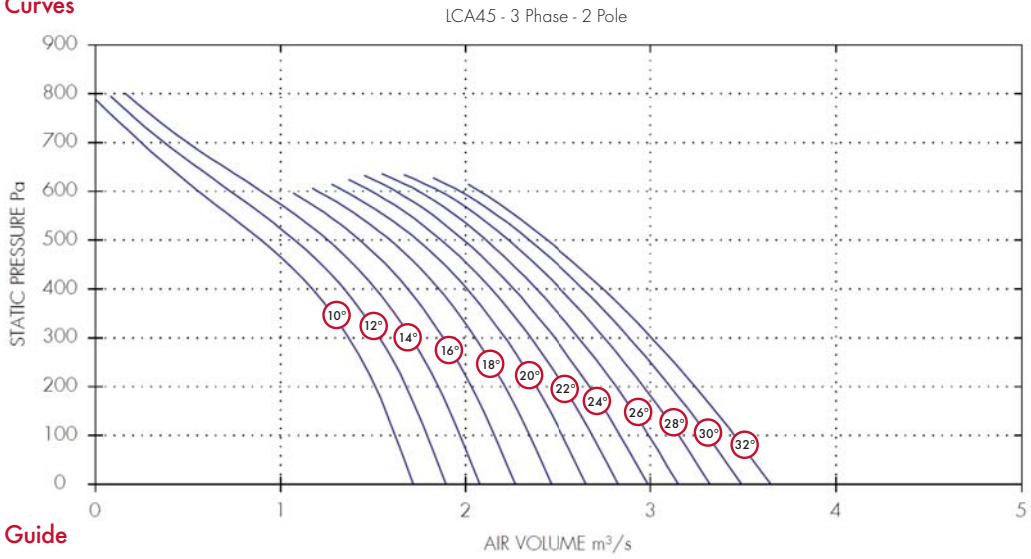

Performance Guide

Dia.	3 Phase Stock Ref	Poles	rpm	IP Rating	Curve Ref	m ³ /s at Pa								Motor kW	dBA @3m
						0	100	200	300	400	500	600	700		
450	ICA453210	2	2880	IP55	10°	1.72	1.62	1.51	1.37	1.17	0.89	0.56	0.25	1.1	74
450	ICA453212	2	2880	IP55	12°	1.89	1.79	1.68	1.54	1.34	1.08	0.73	0.37	1.1	73
450	ICA453214	2	2880	IP55	14°	2.08	1.97	1.85	1.7	1.51	1.26	0.9	0.5	1.5	72
450	ICA453216	2	2880	IP55	16°	2.27	2.16	2.03	1.88	1.69	1.43			1.5	71
450	ICA453218	2	2880	IP55	18°	2.47	2.35	2.21	2.05	1.86	1.59	1.2		1.5	70
450	ICA453220	2	2880	IP55	20°	2.65	2.53	2.38	2.21	2.01	1.74	1.35		2.2	70
450	ICA453222	2	2880	IP55	22°	2.82	2.69	2.53	2.35	2.14	1.87	1.49		2.2	70
450	ICA453224	2	2880	IP55	24°	2.99	2.84	2.67	2.48	2.26	1.99	1.62		2.2	70
450	ICA453226	2	2880	IP55	26°	3.15	2.99	2.82	2.61	2.38	2.11	1.75		2.2	70
450	ICA453228	2	2880	IP55	28°	3.32	3.15	2.96	2.75	2.51	2.23	1.86		3	70
450	ICA453230	2	2880	IP55	30°	3.49	3.31	3.11	2.89	2.64	2.35	1.97		3	70
450	ICA453232	2	2880	IP55	32°	3.65	3.45	3.24	3.01	2.74	2.44	2.08		3	70

Sound Power Level Spectra dB (ref 10⁻¹² Watts)

Dia.	3 Phase Stock Ref	Poles	Spectrum	dB @ 3m								
				63	125	250	500	1k	2k	4k	8k	
450	ICA453210	2	Inlet/Outlet	92	89	92	89	90	87	84	77	74
450	ICA453212	2	Inlet/Outlet	91	88	91	88	89	86	83	76	73
450	ICA453214	2	Inlet/Outlet	90	87	90	87	88	85	82	75	72
450	ICA453216	2	Inlet/Outlet	89	86	89	86	87	84	81	74	71
450	ICA453218	2	Inlet/Outlet	88	85	88	85	86	83	80	73	70
450	ICA453220	2	Inlet/Outlet	88	85	88	85	86	83	80	73	70
450	ICA453222	2	Inlet/Outlet	88	85	88	85	86	83	80	73	70
450	ICA453224	2	Inlet/Outlet	88	85	88	85	86	83	80	73	70
450	ICA453226	2	Inlet/Outlet	88	85	88	85	86	83	80	73	70
450	ICA453228	2	Inlet/Outlet	88	85	88	85	86	83	80	73	70
450	ICA453230	2	Inlet/Outlet	88	85	88	85	86	83	80	73	70
450	ICA453232	2	Inlet/Outlet	88	85	88	85	86	83	80	73	70

Performance Curves

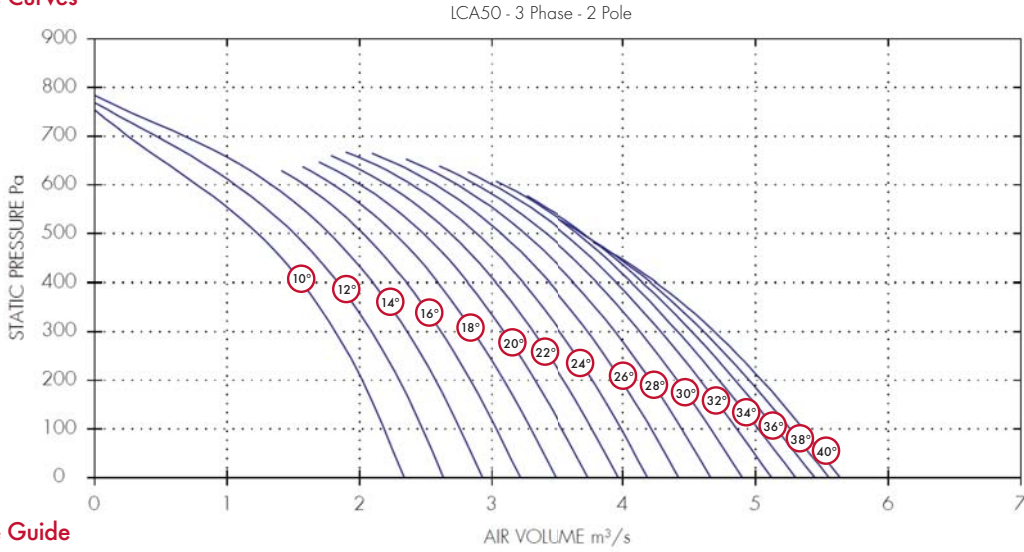

Performance Guide

Dia.	Stock Ref	Poles	rpm	IP Rating	Curve Ref	m ³ /s at Pa										Motor kW	dBA @3m
						0	100	200	300	400	500	600	700				
500	LCA503210	2	2880	IP55	10°	2.34	2.19	2.02	1.82	1.56	1.23	0.77	0.25	1.5	74		
500	LCA503212	2	2880	IP55	12°	2.64	2.48	2.3	2.09	1.83	1.51	1.06	0.46	1.5	73		
500	LCA503214	2	2880	IP55	14°	2.93	2.76	2.57	2.36	2.1	1.77	1.33	0.68	2.2	72		
500	LCA503216	2	2880	IP55	16°	3.21	3.04	2.84	2.62	2.35	2.03	1.58		2.2	71		
500	LCA503218	2	2880	IP55	18°	3.48	3.29	3.09	2.86	2.59	2.26	1.8		2.2	71		
500	LCA503220	2	2880	IP55	20°	3.73	3.54	3.33	3.09	2.82	2.48	2.01		3	71		
500	LCA503222	2	2880	IP55	22°	3.96	3.77	3.55	3.31	3.03	2.69	2.21		3	71		
500	LCA503224	2	2880	IP55	24°	4.19	3.99	3.77	3.52	3.24	2.88	2.4		3	71		
500	LCA503226	2	2880	IP55	26°	4.42	4.21	3.99	3.73	3.44	3.07	2.58		4	71		
500	LCA503228	2	2880	IP55	28°	4.66	4.45	4.21	3.94	3.63	3.25	2.74		4	72		
500	LCA503230	2	2880	IP55	30°	4.9	4.67	4.41	4.13	3.8	3.41	2.88		4	72		
500	LCA503232	2	2880	IP55	32°	5.12	4.86	4.58	4.28	3.95	3.55	3		5.5	72		
500	LCA503234	2	2880	IP55	34°	5.3	5.02	4.73	4.41	4.07	3.66	3.08		5.5	72		
500	LCA503236	2	2880	IP55	36°	5.45	5.16	4.85	4.52	4.15	3.7			5.5	72		
500	LCA503238	2	2880	IP55	38°	5.55	5.26	4.95	4.61	4.21	3.69			7.5	72		
500	LCA503240	2	2880	IP55	40°	5.64	5.36	5.05	4.69	4.25				7.5	72		

Sound Power Level Spectra dB (ref 10⁻¹² Watts)

Dia.	Stock Ref	Poles	Spectrum	dB								dBA @ 3m
				63	125	250	500	1k	2k	4k	8k	
500	LCA503210	2	Inlet/Outlet	93	84	91	91	91	87	85	78	74
500	LCA503212	2	Inlet/Outlet	92	83	90	90	90	86	84	77	73
500	LCA503214	2	Inlet/Outlet	91	82	89	89	89	85	83	76	72
500	LCA503216	2	Inlet/Outlet	90	81	88	88	88	84	82	75	71
500	LCA503218	2	Inlet/Outlet	90	81	88	88	88	84	82	75	71
500	LCA503220	2	Inlet/Outlet	90	81	88	88	88	84	82	75	71
500	LCA503222	2	Inlet/Outlet	90	81	88	88	88	84	82	75	71
500	LCA503224	2	Inlet/Outlet	90	81	88	88	88	84	82	75	71
500	LCA503226	2	Inlet/Outlet	90	81	88	88	88	84	82	75	71
500	LCA503228	2	Inlet/Outlet	91	82	89	89	89	85	83	76	72
500	LCA503230	2	Inlet/Outlet	91	82	89	89	89	85	83	76	72
500	LCA503232	2	Inlet/Outlet	91	82	89	89	89	85	83	76	72
500	LCA503234	2	Inlet/Outlet	91	82	89	89	89	85	83	76	72
500	LCA503236	2	Inlet/Outlet	91	82	89	89	89	85	83	76	72
500	LCA503238	2	Inlet/Outlet	91	82	89	89	89	85	83	76	72
500	LCA503240	2	Inlet/Outlet	91	82	89	89	89	85	83	76	72

Long Case Axial Fans (LCA)

Performance Curve

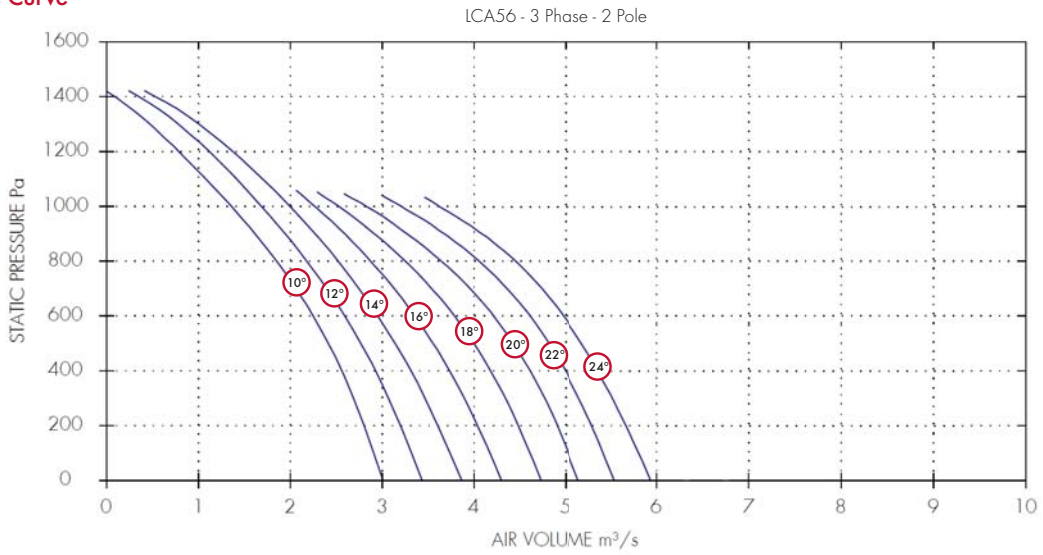

Performance Guide

Dia.	3 Phase		rpm	IP Rating	Curve Ref	m³/s at Pa								Motor kW	dBA @3m
	Stock Ref	Poles				0	200	400	600	800	1000	1200	1400		
560	LCA563210	2	2880	IP55	10°	3.01	2.8	2.56	2.25	1.85	1.36	0.79	0.09	4	79
560	LCA563212	2	2880	IP55	12°	3.44	3.2	2.93	2.59	2.18	1.69	1.11	0.35	4	79
560	LCA563214	2	2880	IP55	14°	3.87	3.61	3.31	2.95	2.52	1.99	1.37	0.53	4	79
560	LCA563216	2	2880	IP55	16°	4.3	4.04	3.73	3.36	2.88	2.27			5.5	79
560	LCA563218	2	2880	IP55	18°	4.73	4.48	4.18	3.79	3.25	2.53			5.5	79
560	LCA563220	2	2880	IP55	20°	5.15	4.91	4.61	4.21	3.65	2.83			7.5	79
560	LCA563222	2	2880	IP55	22°	5.54	5.3	5	4.61	4.05	3.21			7.5	79
560	LCA563224	2	2880	IP55	24°	5.94	5.67	5.36	4.98	4.45	3.62			7.5	79

Sound Power Level Spectra dB (ref 10⁻¹² Watts)

Dia.	3 Phase Stock Ref	Poles	Spectrum	dB @ 3m								
				63	125	250	500	1k	2k	4k	8k	
560	LCA563210	2	Inlet/Outlet	94	89	97	98	94	91	86	82	79
560	LCA563212	2	Inlet/Outlet	94	89	97	98	94	91	86	82	79
560	LCA563214	2	Inlet/Outlet	94	89	97	98	94	91	86	82	79
560	LCA563216	2	Inlet/Outlet	94	89	97	98	94	91	86	82	79
560	LCA563218	2	Inlet/Outlet	94	89	97	98	94	91	86	82	79
560	LCA563220	2	Inlet/Outlet	94	89	97	98	94	91	86	82	79
560	LCA563222	2	Inlet/Outlet	94	89	97	98	94	91	86	82	79
560	LCA563224	2	Inlet/Outlet	94	89	97	98	94	91	86	82	79
560	LCA563226	2	Inlet/Outlet	94	89	97	98	94	91	86	82	79

Performance Curve

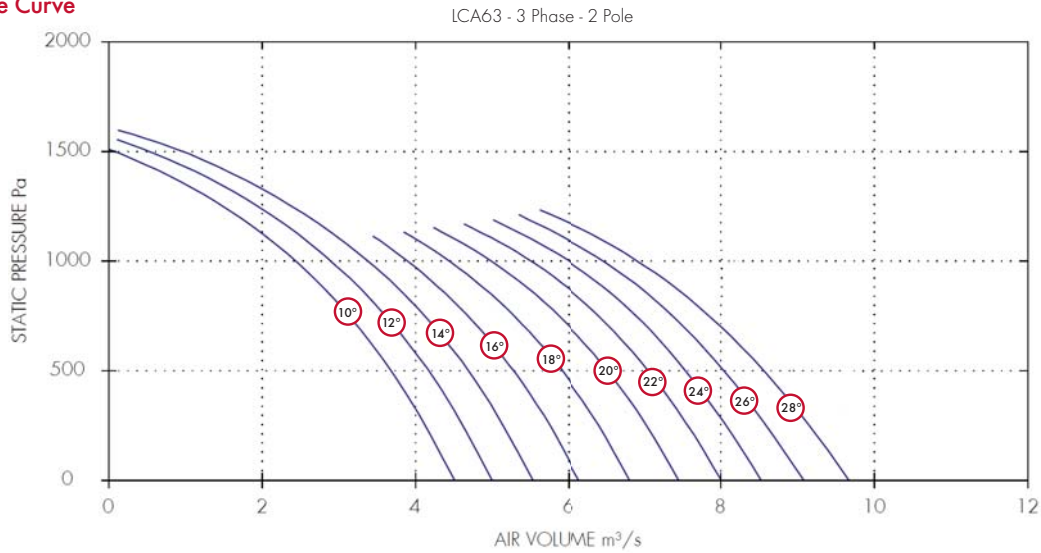

Performance Guide

Dia.	3 Phase			IP	Curve	m ³ /s at Pa								Motor	dBA @3m
	Stock Ref	Poles	rpm			Rating	Ref	0	200	400	600	800	1000		
630	LCA633210	2	2940	IP55	10°	4.51	4.2	3.87	3.47	3.01	2.44	1.7	0.72	5.5	84
630	LCA633212	2	2940	IP55	12°	5	4.7	4.36	3.96	3.48	2.9	2.16	1.17	5.5	84
630	LCA633214	2	2940	IP55	14°	5.53	5.22	4.88	4.48	3.98	3.38	2.61	1.6	7.5	84
630	LCA633216	2	2940	IP55	16°	6.15	5.84	5.48	5.06	4.54	3.89			7.5	84
630	LCA633218	2	2940	IP55	18°	6.81	6.5	6.13	5.68	5.14	4.44			11	84
630	LCA633220	2	2940	IP55	20°	7.46	7.12	6.74	6.28	5.72	4.98			11	84
630	LCA633222	2	2940	IP55	22°	8.01	7.67	7.27	6.82	6.25	5.51			11	84
630	LCA633224	2	2940	IP55	24°	8.53	8.17	7.76	7.3	6.74	6			15	84
630	LCA633226	2	2940	IP55	26°	9.08	8.7	8.27	7.79	7.22	6.47	5.41		15	84
630	LCA633228	2	2940	IP55	28°	9.67	9.26	8.81	8.3	7.69	6.92	5.85		15	84

Sound Power Level Spectra dB (ref 10⁻¹² Watts)

Dia.	Stock Ref	Poles	Spectrum	63	125	250	500	1k	2k	4k	8k	dBA @ 3m
630	LCA633210	2	Inlet/Outlet	99	94	102	103	99	96	91	87	84
630	LCA633212	2	Inlet/Outlet	99	94	102	103	99	96	91	87	84
630	LCA633214	2	Inlet/Outlet	99	94	102	103	99	96	91	87	84
630	LCA633216	2	Inlet/Outlet	99	94	102	103	99	96	91	87	84
630	LCA633218	2	Inlet/Outlet	99	94	102	103	99	96	91	87	84
630	LCA633220	2	Inlet/Outlet	99	94	102	103	99	96	91	87	84
630	LCA633222	2	Inlet/Outlet	99	94	102	103	99	96	91	87	84
630	LCA633224	2	Inlet/Outlet	99	94	102	103	99	96	91	87	84
630	LCA633226	2	Inlet/Outlet	99	94	102	103	99	96	91	87	84
630	LCA633228	2	Inlet/Outlet	99	94	102	103	99	96	91	87	84

Long Case Axial Fans (LCA)

Performance Curve

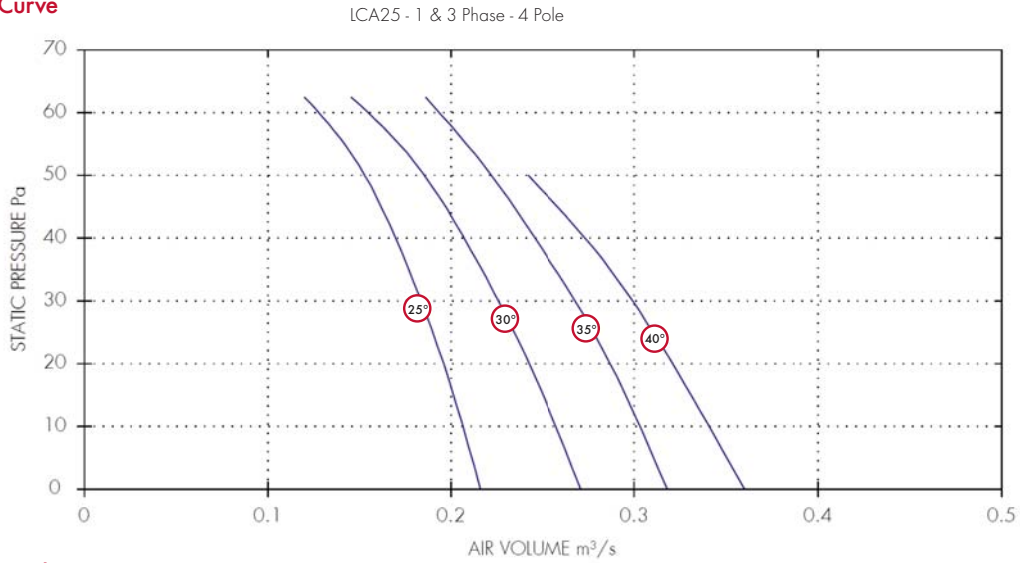

Performance Guide

Dia.	1 Phase		3 Phase		IP	Curve	m ³ /s at Pa							Motor	dBA @3m
	Stock Ref	Stock Ref	Poles	rpm			Rating	Ref	0	10	20	30	40		
250	LCA251425	LCA253425	4	1400	IP55	25°	0.22	0.21	0.2	0.18	0.17	0.15	0.13	0.25	46
250	LCA251430	LCA253430	4	1400	IP55	30°	0.27	0.26	0.24	0.23	0.21	0.19	0.15	0.25	45
250	LCA251435	LCA253435	4	1400	IP55	35°	0.32	0.3	0.29	0.27	0.25	0.22	0.19	0.25	46
250	LCA251440	LCA253440	4	1400	IP55	40°	0.36	0.34	0.32	0.3	0.27	0.24		0.25	46

Sound Power Level Spectra dB (ref 10⁻¹² Watts)

Dia.	1 Phase		3 Phase		Spectrum	dB								dBA @3m
	Stock Ref	Stock Ref	Poles	rpm		63	125	250	500	1k	2k	4k	8k	
250	LCA251425	LCA253425	4	1400	Inlet/Outlet	61	68	64	63	61	58	55	52	46
250	LCA251430	LCA253430	4	1400	Inlet/Outlet	60	67	63	62	60	57	54	51	45
250	LCA251435	LCA253435	4	1400	Inlet/Outlet	61	68	64	63	61	58	55	52	46
250	LCA251440	LCA253440	4	1400	Inlet/Outlet	61	68	64	63	61	58	55	52	46

Performance Curve

LCA31 - 1 & 3 Phase - 4 Pole

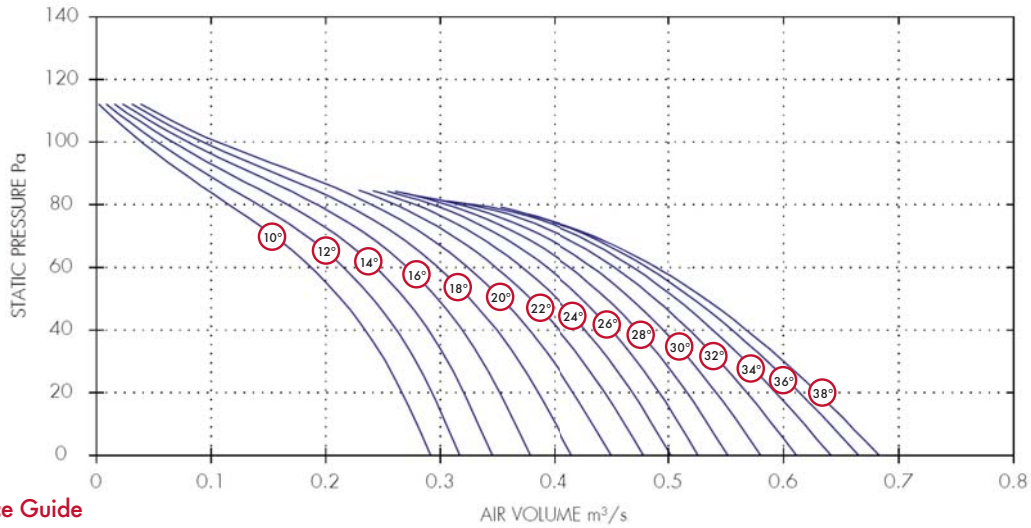

Performance Guide

Dia.	1 Phase		3 Phase		IP Rating	Curve Ref	AIR VOLUME m³/s						Motor kW	dBa @3m
	Stock Ref	Stock Ref	Poles	rpm			0	20	40	60	80	100		
315	LCA311410	LCA313410	4	1400	IP55	10°	0.29	0.27	0.23	0.19	0.12	0.04	0.25	49
315	LCA311412	LCA313412	4	1400	IP55	12°	0.32	0.29	0.26	0.22	0.14	0.05	0.25	49
315	LCA311414	LCA313414	4	1400	IP55	14°	0.35	0.32	0.29	0.24	0.17	0.07	0.25	49
315	LCA311416	LCA313416	4	1400	IP55	16°	0.38	0.35	0.32	0.27	0.19	0.08	0.25	44
315	LCA311418	LCA313418	4	1400	IP55	18°	0.42	0.39	0.35	0.3	0.22	0.09	0.25	44
315	LCA311420	LCA313420	4	1400	IP55	20°	0.45	0.42	0.38	0.32	0.24	0.11	0.25	44
315	LCA311422	LCA313422	4	1400	IP55	22°	0.48	0.45	0.4	0.35	0.26		0.25	44
315	LCA311424	LCA313424	4	1400	IP55	24°	0.5	0.47	0.43	0.37	0.28		0.25	46
315	LCA311426	LCA313426	4	1400	IP55	26°	0.53	0.49	0.45	0.39	0.29		0.25	46
315	LCA311428	LCA313428	4	1400	IP55	28°	0.55	0.52	0.47	0.41	0.31		0.25	46
315	LCA311430	LCA313430	4	1400	IP55	30°	0.58	0.54	0.5	0.43	0.32		0.25	46
315	LCA311432	LCA313432	4	1400	IP55	32°	0.61	0.57	0.52	0.45	0.32		0.25	48
315	LCA311434	LCA313434	4	1400	IP55	34°	0.64	0.59	0.54	0.47	0.33		0.25	48
315	LCA311436	LCA313436	4	1400	IP55	36°	0.67	0.61	0.56	0.48			0.25	48
315	LCA311438	LCA313438	4	1400	IP55	38°	0.68	0.63	0.57	0.49			0.25	48

Sound Power Level Spectra dB (ref 10⁻¹² Watts)

Dia.	1 Phase		3 Phase		Spectrum	dB @ 3m							
	Stock Ref	Stock Ref	Poles			63	125	250	500	1k	2k	4k	8k
315	LCA311410	LCA313410	4	Inlet/Outlet	66	69	67	64	65	63	58	48	49
315	LCA311412	LCA313412	4	Inlet/Outlet	66	69	67	64	65	63	58	48	49
315	LCA311414	LCA313414	4	Inlet/Outlet	66	69	67	64	65	63	58	48	49
315	LCA311416	LCA313416	4	Inlet/Outlet	61	64	62	59	60	58	53	43	44
315	LCA311418	LCA313418	4	Inlet/Outlet	61	64	62	59	60	58	53	43	44
315	LCA311420	LCA313420	4	Inlet/Outlet	61	64	62	59	60	58	53	43	44
315	LCA311422	LCA313422	4	Inlet/Outlet	61	64	62	59	60	58	53	43	44
315	LCA311424	LCA313424	4	Inlet/Outlet	63	66	64	61	62	60	55	45	46
315	LCA311426	LCA313426	4	Inlet/Outlet	63	66	64	61	62	60	55	45	46
315	LCA311428	LCA313428	4	Inlet/Outlet	63	66	64	61	62	60	55	45	46
315	LCA311430	LCA313430	4	Inlet/Outlet	63	66	64	61	62	60	55	45	46
315	LCA311432	LCA313432	4	Inlet/Outlet	65	68	66	63	64	62	57	47	48
315	LCA311434	LCA313434	4	Inlet/Outlet	65	68	66	63	64	62	57	47	48
315	LCA311436	LCA313436	4	Inlet/Outlet	65	68	66	63	64	62	57	47	48
315	LCA311438	LCA313438	4	Inlet/Outlet	65	68	66	63	64	62	57	47	48
315	LCA311440	LCA313440	4	Inlet/Outlet	65	68	66	63	64	62	57	47	48

Long Case Axial Fans (LCA)

Performance Curve

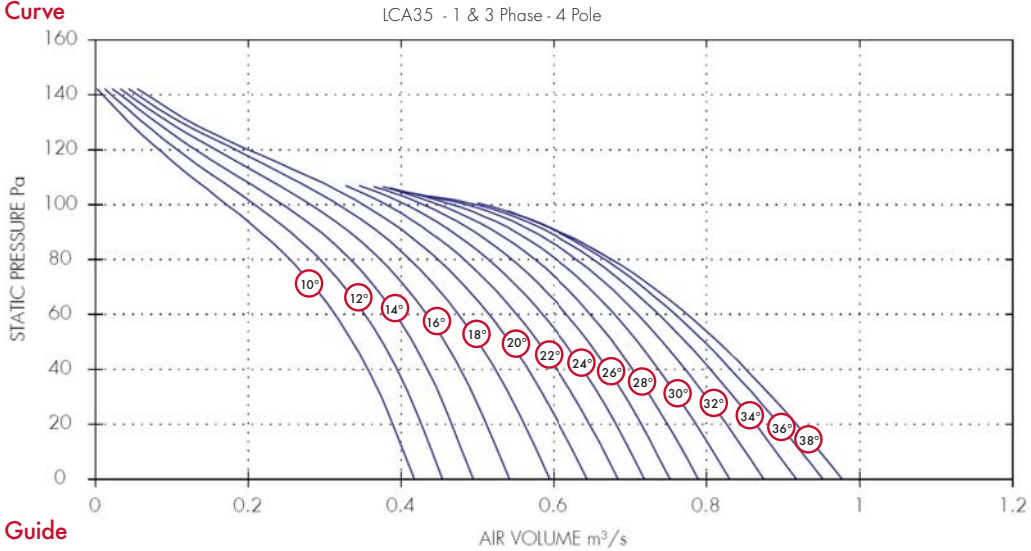

Performance Guide

Dia.	1 Phase		3 Phase		IP Rating	Curve Ref	AIR VOLUME m ³ /s								Motor kW	dBA @3m
	Stock Ref	Stock Ref	Poles	rpm			0	20	40	60	80	100	120	140		
355	LCA351410	LCA353410	4	1400	IP55	10°	0.42	0.39	0.36	0.31	0.25	0.17	0.08	0.01	0.25	50
355	LCA351412	LCA353412	4	1400	IP55	12°	0.45	0.43	0.39	0.35	0.29	0.21	0.11	0.02	0.25	50
355	LCA351414	LCA353414	4	1400	IP55	14°	0.49	0.47	0.43	0.39	0.33	0.25	0.13	0.03	0.25	50
355	LCA351416	LCA353416	4	1400	IP55	16°	0.54	0.51	0.48	0.43	0.37	0.28	0.16	0.04	0.25	50
355	LCA351418	LCA353418	4	1400	IP55	18°	0.6	0.56	0.52	0.48	0.41	0.32	0.18	0.06	0.25	50
355	LCA351420	LCA353420	4	1400	IP55	20°	0.64	0.61	0.57	0.52	0.45	0.35	0.2	0.07	0.25	50
355	LCA351422	LCA353422	4	1400	IP55	22°	0.68	0.65	0.6	0.55	0.48	0.38			0.25	45
355	LCA351424	LCA353424	4	1400	IP55	24°	0.72	0.68	0.64	0.59	0.51	0.41			0.25	45
355	LCA351426	LCA353426	4	1400	IP55	26°	0.75	0.72	0.67	0.62	0.55	0.43			0.25	46
355	LCA351428	LCA353428	4	1400	IP55	28°	0.79	0.75	0.7	0.65	0.58	0.45			0.25	47
355	LCA351430	LCA353430	4	1400	IP55	30°	0.83	0.79	0.74	0.68	0.6	0.47			0.25	47
355	LCA351432	LCA353432	4	1400	IP55	32°	0.87	0.83	0.77	0.71	0.63	0.48			0.25	48
355	LCA351434	LCA353434	4	1400	IP55	34°	0.92	0.86	0.81	0.74	0.65	0.5			0.25	48
355	LCA351436	LCA353436	4	1400	IP55	36°	0.95	0.89	0.83	0.76	0.67	0.51			0.25	48
355	LCA351438	LCA353438	4	1400	IP55	38°	0.98	0.92	0.85	0.78	0.68				0.25	48

Sound Power Level Spectra dB (ref 10⁻¹² Watts)

Dia.	1 Phase		3 Phase		Spectrum	dB @3m								
	Stock Ref	Stock Ref	Poles	rpm		63	125	250	500	1k	2k	4k	8k	
355	LCA351410	LCA353410	4	1400	Inlet/Outlet	67	70	68	65	66	64	59	49	50
355	LCA351412	LCA353412	4	1400	Inlet/Outlet	67	70	68	65	66	64	59	49	50
355	LCA351414	LCA353414	4	1400	Inlet/Outlet	67	70	68	65	66	64	59	49	50
355	LCA351416	LCA353416	4	1400	Inlet/Outlet	67	70	68	65	66	64	59	49	50
355	LCA351418	LCA353418	4	1400	Inlet/Outlet	67	70	68	65	66	64	59	49	50
355	LCA351420	LCA353420	4	1400	Inlet/Outlet	67	70	68	65	66	64	59	49	50
355	LCA351422	LCA353422	4	1400	Inlet/Outlet	62	65	63	60	61	59	54	44	45
355	LCA351424	LCA353424	4	1400	Inlet/Outlet	62	65	63	60	61	59	54	44	45
355	LCA351426	LCA353426	4	1400	Inlet/Outlet	63	66	64	61	62	60	55	45	46
355	LCA351428	LCA353428	4	1400	Inlet/Outlet	64	67	65	62	63	61	56	46	47
355	LCA351430	LCA353430	4	1400	Inlet/Outlet	64	67	65	62	63	61	56	46	47
355	LCA351432	LCA353432	4	1400	Inlet/Outlet	65	68	66	63	64	62	57	47	48
355	LCA351434	LCA353434	4	1400	Inlet/Outlet	65	68	66	63	64	62	57	47	48
355	LCA351436	LCA353436	4	1400	Inlet/Outlet	65	68	66	63	64	62	57	47	48
355	LCA351438	LCA353438	4	1400	Inlet/Outlet	65	68	66	63	64	62	57	47	48

Performance Curve

LCA40 - 1 & 3 Phase - 4 Pole

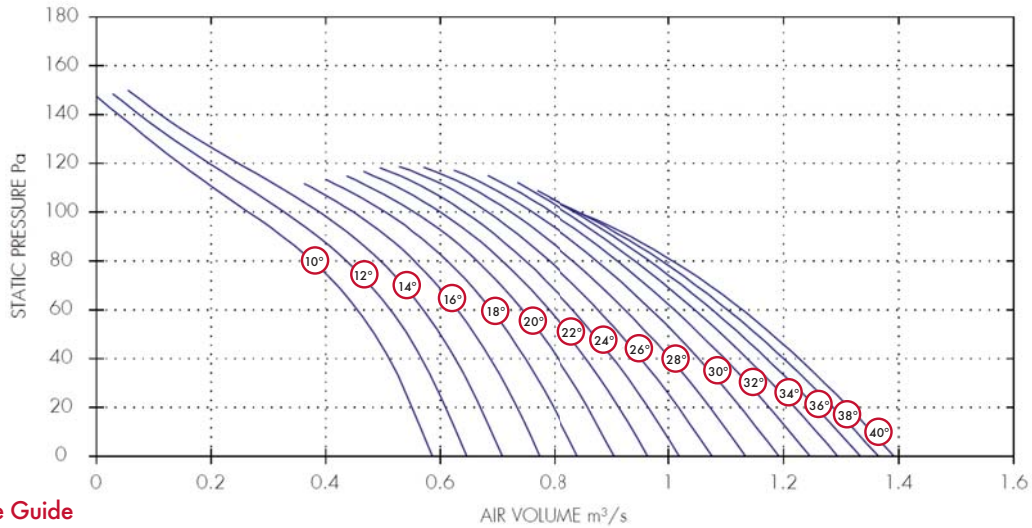

Performance Guide

Dia.	1 Phase		3 Phase		IP Rating	Curve Ref	m³/s at Pa								Motor kW	dBA @3m
	Stock Ref	Stock Ref	Poles	rpm			0	20	40	60	80	100	120	140		
400	LCA401410	LCA403410	4	1400	IP55	10°	0.59	0.55	0.51	0.46	0.38	0.27	0.15	0.04	0.25	54
400	LCA401412	LCA403412	4	1400	IP55	12°	0.65	0.61	0.57	0.51	0.44	0.33	0.2	0.08	0.25	54
400	LCA401414	LCA403414	4	1400	IP55	14°	0.71	0.67	0.63	0.57	0.5	0.39	0.25	0.11	0.25	54
400	LCA401416	LCA403416	4	1400	IP55	16°	0.77	0.73	0.69	0.63	0.56	0.45			0.25	54
400	LCA401418	LCA403418	4	1400	IP55	18°	0.84	0.8	0.75	0.69	0.61	0.5			0.25	54
400	LCA401420	LCA403420	4	1400	IP55	20°	0.91	0.86	0.81	0.74	0.66	0.55			0.25	54
400	LCA401422	LCA403422	4	1400	IP55	22°	0.96	0.91	0.86	0.79	0.71	0.6			0.25	48
400	LCA401424	LCA403424	4	1400	IP55	24°	1.02	0.97	0.9	0.83	0.75	0.64			0.25	48
400	LCA401426	LCA403426	4	1400	IP55	26°	1.08	1.02	0.95	0.88	0.79	0.68			0.25	50
400	LCA401428	LCA403428	4	1400	IP55	28°	1.13	1.07	1	0.92	0.83	0.72			0.25	51
400	LCA401430	LCA403430	4	1400	IP55	30°	1.19	1.13	1.05	0.97	0.88	0.76			0.25	52
400	LCA401432	LCA403432	4	1400	IP55	32°	1.25	1.18	1.1	1.01	0.91	0.79			0.25	52
400	LCA401434	LCA403434	4	1400	IP55	34°	1.29	1.22	1.14	1.05	0.94	0.82			0.25	51
400	LCA401436	LCA403436	4	1400	IP55	36°	1.33	1.26	1.17	1.08	0.97	0.84			0.25	51
400	LCA401438	LCA403438	4	1400	IP55	38°	1.36	1.29	1.2	1.1	0.99	0.84			0.25	50
400	LCA401440	LCA403440	4	1400	IP55	40°	1.39	1.31	1.23	1.13	1.01	0.84			0.37	50

Sound Power Level Spectra dB (ref 10⁻¹² Watts)

Dia.	1 Phase		3 Phase		Spectrum	dB @3m								
	Stock Ref	Stock Ref	Poles	rpm		63	125	250	500	1k	2k	4k	8k	
400	LCA401410	LCA403410	4	1400	Inlet/Outlet	72	74	73	69	70	67	63	54	54
400	LCA401412	LCA403412	4	1400	Inlet/Outlet	72	74	73	69	70	67	63	54	54
400	LCA401414	LCA403414	4	1400	Inlet/Outlet	72	74	73	69	70	67	63	54	54
400	LCA401416	LCA403416	4	1400	Inlet/Outlet	72	74	73	69	70	67	63	54	54
400	LCA401418	LCA403418	4	1400	Inlet/Outlet	72	74	73	69	70	67	63	54	54
400	LCA401420	LCA403420	4	1400	Inlet/Outlet	72	74	73	69	70	67	63	54	54
400	LCA401422	LCA403422	4	1400	Inlet/Outlet	66	68	67	63	64	61	57	48	48
400	LCA401424	LCA403424	4	1400	Inlet/Outlet	66	68	67	63	64	61	57	48	48
400	LCA401426	LCA403426	4	1400	Inlet/Outlet	68	70	69	65	66	63	59	50	50
400	LCA401428	LCA403428	4	1400	Inlet/Outlet	69	71	70	66	67	64	60	51	51
400	LCA401430	LCA403430	4	1400	Inlet/Outlet	70	72	71	67	68	65	61	52	52
400	LCA401432	LCA403432	4	1400	Inlet/Outlet	70	72	71	67	68	65	61	52	52
400	LCA401434	LCA403434	4	1400	Inlet/Outlet	69	71	70	66	67	64	60	51	51
400	LCA401436	LCA403436	4	1400	Inlet/Outlet	69	71	70	66	67	64	60	51	51
400	LCA401438	LCA403438	4	1400	Inlet/Outlet	68	70	69	65	66	63	59	50	50
400	LCA401440	LCA403440	4	1400	Inlet/Outlet	68	70	69	65	66	63	59	50	50

Long Case Axial Fans (LCA)

Performance Curve

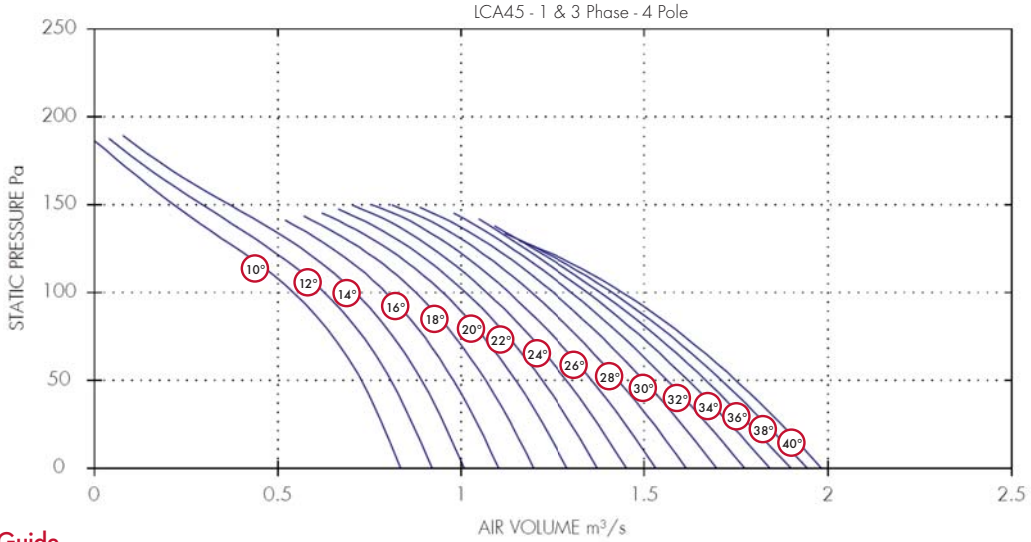

Performance Guide

Dia.	1 Phase		3 Phase		IP	Curve	m³/s at Pa					Motor	dBA @3m
	Stock Ref	Stock Ref	Poles	rpm			Rating	Ref	0	40	80		
450	LCA451410	LCA453410	4	1400	IP55	10°	0.83	0.75	0.63	0.42	0.15	0.25	59
450	LCA451412	LCA453412	4	1400	IP55	12°	0.92	0.83	0.71	0.51	0.22	0.25	59
450	LCA451414	LCA453414	4	1400	IP55	14°	1.01	0.92	0.8	0.6	0.28	0.25	59
450	LCA451416	LCA453416	4	1400	IP55	16°	1.1	1.01	0.88	0.68		0.25	59
450	LCA451418	LCA453418	4	1400	IP55	18°	1.2	1.1	0.96	0.76		0.25	54
450	LCA451420	LCA453420	4	1400	IP55	20°	1.29	1.18	1.04	0.83		0.25	55
450	LCA451422	LCA453422	4	1400	IP55	22°	1.37	1.25	1.11	0.9		0.25	54
450	LCA451424	LCA453424	4	1400	IP55	24°	1.45	1.32	1.17	0.96		0.25	54
450	LCA451426	LCA453426	4	1400	IP55	26°	1.53	1.4	1.23	1.01		0.37	54
450	LCA451428	LCA453428	4	1400	IP55	28°	1.61	1.47	1.29	1.07		0.37	54
450	LCA451430	LCA453430	4	1400	IP55	30°	1.7	1.54	1.36	1.13		0.37	54
450	LCA451432	LCA453432	4	1400	IP55	32°	1.77	1.61	1.41	1.17		0.37	54
450	LCA451434	LCA453434	4	1400	IP55	34°	1.84	1.67	1.46	1.21		0.55	54
450	LCA451436	LCA453436	4	1400	IP55	36°	1.9	1.72	1.51	1.24		0.55	54
450	LCA451438	LCA453438	4	1400	IP55	38°	1.94	1.76	1.54	1.25		0.55	54
450	LCA451440	LCA453440	4	1400	IP55	40°	1.98	1.8	1.58	1.27		0.55	54

Sound Power Level Spectra dB (ref 10⁻¹² Watts)

Dia.	1 Phase		3 Phase		Spectrum	dB								dBA @3m
	Stock Ref	Stock Ref	Poles	rpm		63	125	250	500	1k	2k	4k	8k	
450	LCA451410	LCA453410	4	1400	Inlet/Outlet	77	79	78	74	75	72	68	59	59
450	LCA451412	LCA453412	4	1400	Inlet/Outlet	77	79	78	74	75	72	68	59	59
450	LCA451414	LCA453414	4	1400	Inlet/Outlet	77	79	78	74	75	72	68	59	59
450	LCA451416	LCA453416	4	1400	Inlet/Outlet	77	79	78	74	75	72	68	59	59
450	LCA451418	LCA453418	4	1400	Inlet/Outlet	72	74	73	69	70	67	63	54	54
450	LCA451420	LCA453420	4	1400	Inlet/Outlet	73	75	74	70	71	68	64	55	55
450	LCA451422	LCA453422	4	1400	Inlet/Outlet	72	74	73	69	70	67	63	54	54
450	LCA451424	LCA453424	4	1400	Inlet/Outlet	72	74	73	69	70	67	63	54	54
450	LCA451426	LCA453426	4	1400	Inlet/Outlet	72	74	73	69	70	67	63	54	54
450	LCA451428	LCA453428	4	1400	Inlet/Outlet	72	74	73	69	70	67	63	54	54
450	LCA451430	LCA453430	4	1400	Inlet/Outlet	72	74	73	69	70	67	63	54	54
450	LCA451432	LCA453432	4	1400	Inlet/Outlet	72	74	73	69	70	67	63	54	54
450	LCA451434	LCA453434	4	1400	Inlet/Outlet	72	74	73	69	70	67	63	54	54
450	LCA451436	LCA453436	4	1400	Inlet/Outlet	72	74	73	69	70	67	63	54	54
450	LCA451438	LCA453438	4	1400	Inlet/Outlet	72	74	73	69	70	67	63	54	54
450	LCA451440	LCA453440	4	1400	Inlet/Outlet	72	74	73	69	70	67	63	54	54

Performance Curve

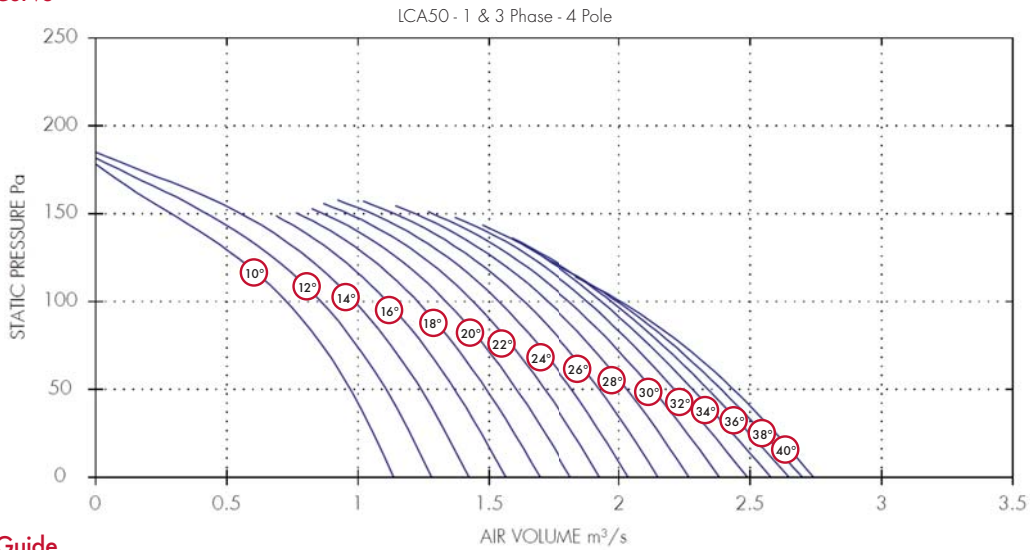

Performance Guide

Dia.	1 Phase		3 Phase		IP	Curve	m³/s at Pa					Motor kW	dBA @3m
	Stock Ref	Stock Ref	Poles	rpm			Rating	Ref	0	40	80		
500	LCA501410	LCA503410	4	1400	IP55	10°	1.14	1.01	0.84	0.58	0.18	0.25	58
500	LCA501412	LCA503412	4	1400	IP55	12°	1.28	1.15	0.97	0.72	0.3	0.25	58
500	LCA501414	LCA503414	4	1400	IP55	14°	1.42	1.28	1.1	0.85	0.42	0.25	58
500	LCA501416	LCA503416	4	1400	IP55	16°	1.56	1.41	1.22	0.97	0.5	0.25	58
500	LCA501418	LCA503418	4	1400	IP55	18°	1.69	1.53	1.34	1.09	0.6	0.25	58
500	LCA501420	LCA503420	4	1400	IP55	20°	1.82	1.65	1.45	1.19	0.7	0.37	58
500	LCA501422	LCA503422	4	1400	IP55	22°	1.93	1.76	1.56	1.29	0.8	0.37	58
500	LCA501424	LCA503424	4	1400	IP55	24°	2.04	1.87	1.66	1.39	0.9	0.37	58
500	LCA501426	LCA503426	4	1400	IP55	26°	2.15	1.97	1.76	1.48	1.0	0.37	60
500	LCA501428	LCA503428	4	1400	IP55	28°	2.27	2.08	1.86	1.56	1.1	0.55	60
500	LCA501430	LCA503430	4	1400	IP55	30°	2.38	2.18	1.95	1.64	1.2	0.55	61
500	LCA501432	LCA503432	4	1400	IP55	32°	2.49	2.27	2.02	1.71	1.3	0.55	61
500	LCA501434	LCA503434	4	1400	IP55	34°	2.58	2.34	2.08	1.76	1.4	0.55	61
500	LCA501436	LCA503436	4	1400	IP55	36°	2.65	2.4	2.13	1.78	1.5	0.75	61
500	LCA501438	LCA503438	4	1400	IP55	38°	2.7	2.46	2.17	1.77	1.6	0.75	61
500	LCA501440	LCA503440	4	1400	IP55	40°	2.74	2.5	2.2	1.7	1.7	0.75	61

Sound Power Level Spectra dB (ref 10⁻¹² Watts)

Dia.	1 Phase		3 Phase		Spectrum	dB								dBA @3m
	Stock Ref	Stock Ref	Poles	rpm		63	125	250	500	1k	2k	4k	8k	
500	LCA501410	LCA503410	4	1400	Inlet/Outlet	76	78	74	75	74	71	68	58	58
500	LCA501412	LCA503412	4	1400	Inlet/Outlet	76	78	74	75	74	71	68	58	58
500	LCA501414	LCA503414	4	1400	Inlet/Outlet	76	78	74	75	74	71	68	58	58
500	LCA501416	LCA503416	4	1400	Inlet/Outlet	76	78	74	75	74	71	68	58	58
500	LCA501418	LCA503418	4	1400	Inlet/Outlet	76	78	74	75	74	71	68	58	58
500	LCA501420	LCA503420	4	1400	Inlet/Outlet	76	78	74	75	74	71	68	58	58
500	LCA501422	LCA503422	4	1400	Inlet/Outlet	76	78	74	75	74	71	68	58	58
500	LCA501424	LCA503424	4	1400	Inlet/Outlet	76	78	74	75	74	71	68	58	58
500	LCA501426	LCA503426	4	1400	Inlet/Outlet	78	80	76	77	76	73	70	60	60
500	LCA501428	LCA503428	4	1400	Inlet/Outlet	78	80	76	77	76	73	70	60	60
500	LCA501430	LCA503430	4	1400	Inlet/Outlet	79	81	77	78	77	74	71	61	61
500	LCA501432	LCA503432	4	1400	Inlet/Outlet	79	81	77	78	77	74	71	61	61
500	LCA501434	LCA503434	4	1400	Inlet/Outlet	79	81	77	78	77	74	71	61	61
500	LCA501436	LCA503436	4	1400	Inlet/Outlet	79	81	77	78	77	74	71	61	61
500	LCA501438	LCA503438	4	1400	Inlet/Outlet	79	81	77	78	77	74	71	61	61
500	LCA501440	LCA503440	4	1400	Inlet/Outlet	79	81	77	78	77	74	71	61	61

Long Case Axial Fans (LCA)

Performance Curve

LCA56 - 1 & 3 Phase - 4 Pole

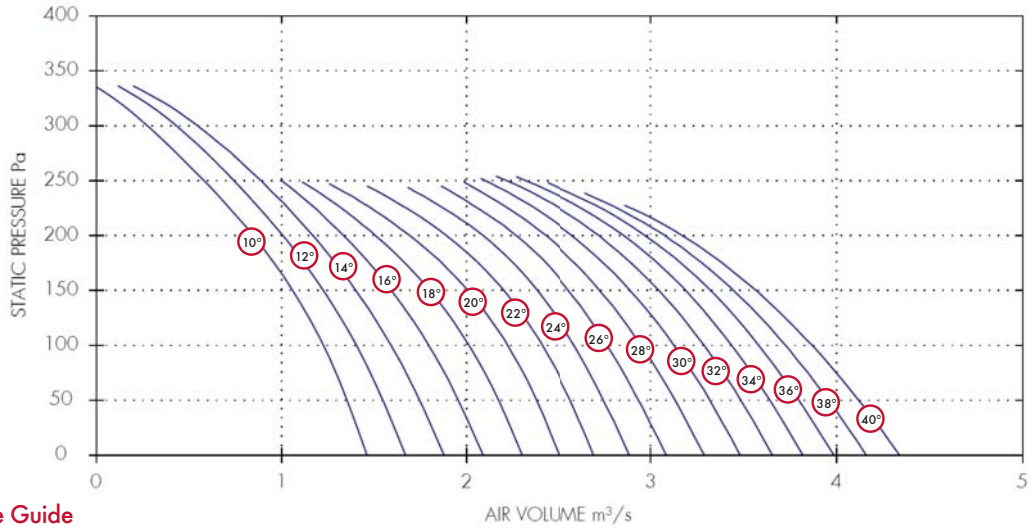

Performance Guide

Dia.	1 Phase		3 Phase		IP	Curve	m³/s at Pa							Motor	dBA
	Stock Ref	Stock Ref	Poles	rpm			Rating	Ref	0	50	100	150	200		
560	LCA561410	LCA563410	4	1400	IP55	10°	1.46	1.36	1.23	1.06	0.85	0.58	0.28	0.55	64
560	LCA561412	LCA563412	4	1400	IP55	12°	1.67	1.55	1.41	1.23	1.01	0.74	0.43	0.55	64
560	LCA561414	LCA563414	4	1400	IP55	14°	1.88	1.75	1.59	1.4	1.17	0.89	0.55	0.55	64
560	LCA561416	LCA563416	4	1400	IP55	16°	2.09	1.96	1.8	1.59	1.34			0.55	64
560	LCA561418	LCA563418	4	1400	IP55	18°	2.3	2.17	2.01	1.8	1.51			0.75	64
560	LCA561420	LCA563420	4	1400	IP55	20°	2.5	2.38	2.22	2.01	1.69			0.75	64
560	LCA561422	LCA563422	4	1400	IP55	22°	2.7	2.57	2.41	2.2	1.89			0.75	64
560	LCA561424	LCA563424	4	1400	IP55	24°	2.89	2.75	2.59	2.38	2.09			1.1	64
560	LCA561426	LCA563426	4	1400	IP55	26°	3.08	2.94	2.77	2.56	2.27			1.1	64
560	LCA561428	LCA563428	4	1400	IP55	28°	3.29	3.13	2.95	2.73	2.43			1.1	64
560	LCA561430	LCA563430	4	1400	IP55	30°	3.48	3.32	3.13	2.89	2.58	2.1		1.1	64
560	LCA561432	LCA563432	4	1400	IP55	32°	3.66	3.49	3.29	3.04	2.72	2.21		1.5	64
560	LCA561434	LCA563434	4	1400	IP55	34°	3.82	3.64	3.44	3.19	2.85	2.32		1.5	64
560	LCA561436	LCA563436	4	1400	IP55	36°	3.99	3.8	3.58	3.32	2.97			1.5	64
560	-	LCA563438	4	1400	IP55	38°	4.16	3.96	3.73	3.45	3.08			2.2	64
560	-	LCA563440	4	1400	IP55	40°	4.34	4.12	3.87	3.57	3.17			2.2	64

Sound Power Level Spectra dB (ref 10⁻¹² Watts)

Dia.	1 Phase		3 Phase		Spectrum	dB								dBA @3m
	Stock Ref	Stock Ref	Poles	rpm		63	125	250	500	1k	2k	4k	8k	
560	LCA561410	LCA563410	4	1400	Inlet/Outlet	75	75	80	81	81	77	74	64	64
560	LCA561412	LCA563412	4	1400	Inlet/Outlet	75	75	80	81	81	77	74	64	64
560	LCA561414	LCA563414	4	1400	Inlet/Outlet	75	75	80	81	81	77	74	64	64
560	LCA561416	LCA563416	4	1400	Inlet/Outlet	75	75	80	81	81	77	74	64	64
560	LCA561418	LCA563418	4	1400	Inlet/Outlet	75	75	80	81	81	77	74	64	64
560	LCA561420	LCA563420	4	1400	Inlet/Outlet	75	75	80	81	81	77	74	64	64
560	LCA561422	LCA563422	4	1400	Inlet/Outlet	75	75	80	81	81	77	74	64	64
560	LCA561424	LCA563424	4	1400	Inlet/Outlet	75	75	80	81	81	77	74	64	64
560	LCA561426	LCA563426	4	1400	Inlet/Outlet	75	75	80	81	81	77	74	64	64
560	LCA561428	LCA563428	4	1400	Inlet/Outlet	75	75	80	81	81	77	74	64	64
560	LCA561430	LCA563430	4	1400	Inlet/Outlet	75	75	80	81	81	77	74	64	64
560	LCA561432	LCA563432	4	1400	Inlet/Outlet	75	75	80	81	81	77	74	64	64
560	LCA561434	LCA563434	4	1400	Inlet/Outlet	75	75	80	81	81	77	74	64	64
560	LCA561436	LCA563436	4	1400	Inlet/Outlet	75	75	80	81	81	77	74	64	64
560	-	LCA563438	4	1400	Inlet/Outlet	75	75	80	81	81	77	74	64	64
560	-	LCA563440	4	1400	Inlet/Outlet	75	75	80	81	81	77	74	64	64

Performance Curve

LCA63 - 1 & 3 Phase - 4 Pole

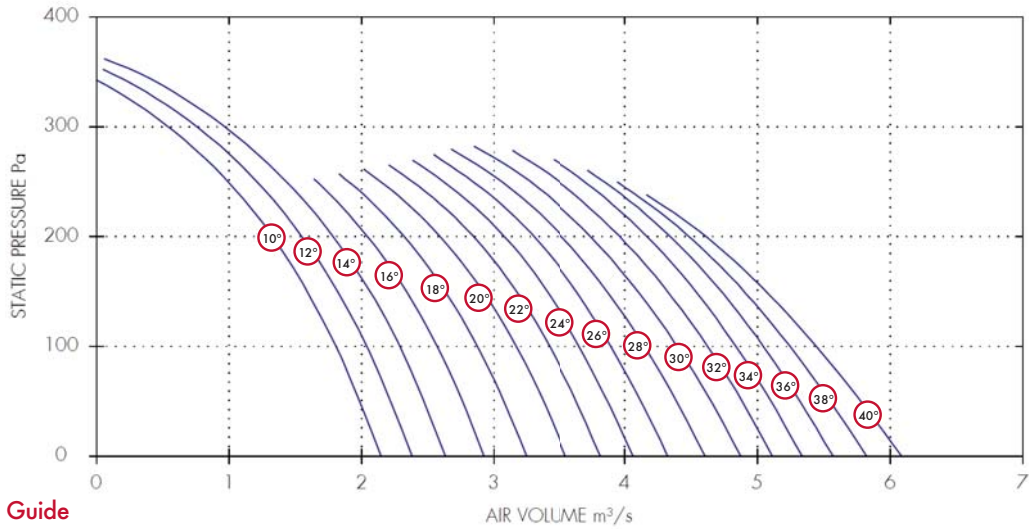

Performance Guide

Dia.	1 Phase		3 Phase		Poles	rpm	IP	Rating	Curve Ref	m³/s at Pa						Motor kW	dBA @3m
	Stock Ref	Stock Ref	0	50						100	150	200	250	300			
630	LCA631410	LCA633410	4	1400	IP55	10°	2.15	1.99	1.81	1.59	1.33	0.99	0.54	0.55	64		
630	LCA631412	LCA633412	4	1400	IP55	12°	2.38	2.22	2.04	1.82	1.55	1.21	0.76	0.75	64		
630	LCA631414	LCA633414	4	1400	IP55	14°	2.64	2.47	2.29	2.06	1.79	1.43	0.97	0.75	64		
630	LCA631416	LCA633416	4	1400	IP55	16°	2.93	2.76	2.57	2.34	2.05	1.66		1.1	64		
630	LCA631418	LCA633418	4	1400	IP55	18°	3.24	3.08	2.88	2.63	2.32	1.9		1.1	64		
630	LCA631420	LCA633420	4	1400	IP55	20°	3.55	3.37	3.17	2.92	2.59	2.14		1.1	64		
630	LCA631422	LCA633422	4	1400	IP55	22°	3.82	3.63	3.42	3.17	2.85	2.38		1.5	65		
630	LCA631424	LCA633424	4	1400	IP55	24°	4.06	3.87	3.66	3.4	3.08	2.62		1.5	65		
630	LCA631426	LCA633426	4	1400	IP55	26°	4.32	4.12	3.9	3.63	3.3	2.84		1.5	65		
630	-	LCA633428	4	1400	IP55	28°	4.61	4.39	4.15	3.87	3.52	3.06		2.2	65		
630	-	LCA633430	4	1400	IP55	30°	4.88	4.65	4.4	4.1	3.74	3.27		2.2	65		
630	-	LCA633432	4	1400	IP55	32°	5.11	4.89	4.63	4.32	3.96	3.5		2.2	65		
630	-	LCA633434	4	1400	IP55	34°	5.34	5.1	4.84	4.54	4.17	3.7		2.2	65		
630	-	LCA633436	4	1400	IP55	36°	5.57	5.32	5.04	4.73	4.34	3.84		3	65		
630	-	LCA633438	4	1400	IP55	38°	5.82	5.55	5.25	4.9	4.48			3	65		
630	-	LCA633440	4	1400	IP55	40°	6.09	5.78	5.44	5.06	4.61			3	65		

Sound Power Level Spectra dB (ref 10⁻¹² Watts)

Dia.	1 Phase		3 Phase		Poles	Spectrum	dB							dBA @3m
	Stock Ref	Stock Ref	63	125			250	500	1k	2k	4k	8k		
630	LCA631410	LCA633410	4	Inlet/Outlet	75	71	79	82	81	77	74	66	64	
630	LCA631412	LCA633412	4	Inlet/Outlet	75	71	79	82	81	77	74	66	64	
630	LCA631414	LCA633414	4	Inlet/Outlet	75	71	79	82	81	77	74	66	64	
630	LCA631416	LCA633416	4	Inlet/Outlet	75	71	79	82	81	77	74	66	64	
630	LCA631418	LCA633418	4	Inlet/Outlet	75	71	79	82	81	77	74	66	64	
630	LCA631420	LCA633420	4	Inlet/Outlet	75	71	79	82	81	77	74	66	64	
630	LCA631422	LCA633422	4	Inlet/Outlet	76	72	80	83	82	78	75	67	65	
630	LCA631424	LCA633424	4	Inlet/Outlet	76	72	80	83	82	78	75	67	65	
630	LCA631426	LCA633426	4	Inlet/Outlet	76	72	80	83	82	78	75	67	65	
630	-	LCA633428	4	Inlet/Outlet	76	72	80	83	82	78	75	67	65	
630	-	LCA633430	4	Inlet/Outlet	76	72	80	83	82	78	75	67	65	
630	-	LCA633432	4	Inlet/Outlet	76	72	80	83	82	78	75	67	65	
630	-	LCA633434	4	Inlet/Outlet	76	72	80	83	82	78	75	67	65	
630	-	LCA633436	4	Inlet/Outlet	76	72	80	83	82	78	75	67	65	
630	-	LCA633438	4	Inlet/Outlet	76	72	80	83	82	78	75	67	65	
630	-	LCA633440	4	Inlet/Outlet	76	72	80	83	82	78	75	67	65	

Long Case Axial Fans (LCA)

Performance Curve

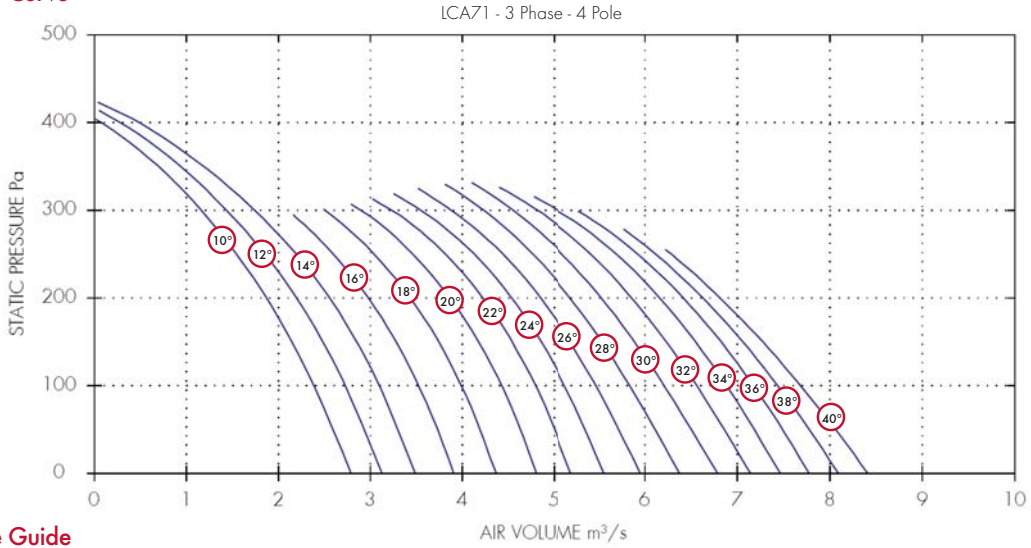

Performance Guide

Dia.	3 Phase		rpm	IP Rating	Curve Ref	m³/s at Pa					Motor kW	dBA @3m
	Stock Ref	Poles				0	100	200	300	400		
710	ICA713410	4	1420	IP55	10°	2.79	2.39	1.87	1.16	0.07	0.75	74
710	ICA713412	4	1420	IP55	12°	3.12	2.73	2.2	1.44	0.28	1.1	74
710	ICA713414	4	1420	IP55	14°	3.49	3.1	2.56	1.74	0.48	1.1	74
710	ICA713416	4	1420	IP55	16°	3.91	3.53	2.98			1.5	74
710	ICA713418	4	1420	IP55	18°	4.37	3.99	3.44	2.5		1.5	74
710	ICA713420	4	1420	IP55	20°	4.81	4.43	3.87	2.89		2.2	71
710	ICA713422	4	1420	IP55	22°	5.19	4.8	4.23	3.23		2.2	71
710	ICA713424	4	1420	IP55	24°	5.56	5.13	4.54	3.55		2.2	71
710	ICA713426	4	1420	IP55	26°	5.95	5.47	4.85	3.88		3	71
710	ICA713428	4	1420	IP55	28°	6.37	5.84	5.19	4.23		3	71
710	ICA713430	4	1420	IP55	30°	6.78	6.21	5.53	4.55		3	71
710	ICA713432	4	1420	IP55	32°	7.14	6.56	5.86	4.82		4	71
710	ICA713434	4	1420	IP55	34°	7.46	6.88	6.16	5.04		4	71
710	ICA713436	4	1420	IP55	36°	7.77	7.17	6.42			4	71
710	ICA713438	4	1420	IP55	38°	8.09	7.44	6.63			5.5	71
710	ICA713440	4	1420	IP55	40°	8.41	7.68	6.81			5.5	71

Sound Power Level Spectra dB (ref 10⁻¹² Watts)

Dia.	3 Phase		Spectrum									dBA @3m
	Stock Ref	Poles		63	125	250	500	1k	2k	4k	8k	
710	ICA713410	4	Inlet/Outlet	89	84	92	92	90	85	82	75	74
710	ICA713412	4	Inlet/Outlet	89	84	92	92	90	85	82	75	74
710	ICA713414	4	Inlet/Outlet	89	84	92	92	90	85	82	75	74
710	ICA713416	4	Inlet/Outlet	89	84	92	92	90	85	82	75	74
710	ICA713418	4	Inlet/Outlet	89	84	92	92	90	85	82	75	74
710	ICA713420	4	Inlet/Outlet	86	81	89	89	87	82	79	72	71
710	ICA713422	4	Inlet/Outlet	86	81	89	89	87	82	79	72	71
710	ICA713424	4	Inlet/Outlet	86	81	89	89	87	82	79	72	71
710	ICA713426	4	Inlet/Outlet	86	81	89	89	87	82	79	72	71
710	ICA713428	4	Inlet/Outlet	86	81	89	89	87	82	79	72	71
710	ICA713430	4	Inlet/Outlet	86	81	89	89	87	82	79	72	71
710	ICA713432	4	Inlet/Outlet	86	81	89	89	87	82	79	72	71
710	ICA713434	4	Inlet/Outlet	86	81	89	89	87	82	79	72	71
710	ICA713436	4	Inlet/Outlet	86	81	89	89	87	82	79	72	71
710	ICA713438	4	Inlet/Outlet	86	81	89	89	87	82	79	72	71
710	ICA713440	4	Inlet/Outlet	86	81	89	89	87	82	79	72	71

Performance Curve

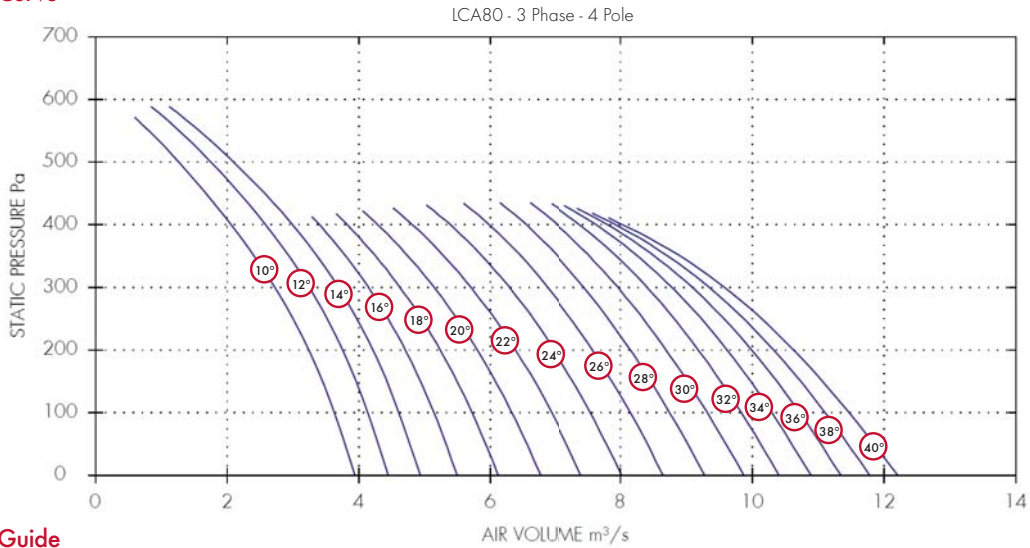

Performance Guide

Dia.	3 Phase		rpm	IP Rating	Curve Ref	m³/s at Pa						Motor kW	dBA @3m
	Stock Ref	Poles				0	100	200	300	400	500		
800	LCA803410	4	1420	IP55	10°	3.94	3.63	3.24	2.73	2.06	1.27	2.2	80
800	LCA803412	4	1440	IP55	12°	4.45	4.14	3.76	3.25	2.58	1.75	2.2	80
800	LCA803414	4	1440	IP55	14°	4.94	4.61	4.21	3.69	2.99	2.1	3	80
800	LCA803416	4	1440	IP55	16°	5.49	5.14	4.71	4.15	3.4		3	80
800	LCA803418	4	1440	IP55	18°	6.12	5.72	5.24	4.63	3.82		3	80
800	LCA803420	4	1440	IP55	20°	6.77	6.33	5.8	5.14	4.29		3	77
800	LCA803422	4	1440	IP55	22°	7.4	6.94	6.38	5.7	4.82		4	78
800	LCA803424	4	1440	IP55	24°	8.02	7.54	6.98	6.29	5.39		4	78
800	LCA803426	4	1440	IP55	26°	8.65	8.15	7.57	6.88	5.98		5.5	78
800	LCA803428	4	1440	IP55	28°	9.28	8.75	8.15	7.44	6.55		5.5	79
800	LCA803430	4	1440	IP55	30°	9.88	9.32	8.69	7.96	7.03		7.5	79
800	LCA803432	4	1440	IP55	32°	10.41	9.84	9.19	8.41	7.38		7.5	79
800	LCA803434	4	1440	IP55	34°	10.89	10.3	9.62	8.78	7.63		7.5	79
800	LCA803436	4	1440	IP55	36°	11.34	10.72	10	9.09	7.8		11	79
800	LCA803438	4	1440	IP55	38°	11.78	11.11	10.33	9.35	7.93		11	79
800	LCA803440	4	1440	IP55	40°	12.21	11.47	10.63	9.58	8.04		11	79

Sound Power Level Spectra dB (ref 10⁻¹² Watts)

Dia.	3 Phase		Spectrum	dB @3m								
	Stock Ref	Poles		63	125	250	500	1k	2k	4k	8k	
800	LCA803410	4	Inlet/Outlet	93	87	93	98	96	93	88	80	80
800	LCA803412	4	Inlet/Outlet	93	87	93	98	96	93	88	80	80
800	LCA803414	4	Inlet/Outlet	93	87	93	98	96	93	88	80	80
800	LCA803416	4	Inlet/Outlet	93	87	93	98	96	93	88	80	80
800	LCA803418	4	Inlet/Outlet	93	87	93	98	96	93	88	80	80
800	LCA803420	4	Inlet/Outlet	90	84	90	95	93	90	85	77	77
800	LCA803422	4	Inlet/Outlet	91	85	91	96	94	91	86	78	78
800	LCA803424	4	Inlet/Outlet	91	85	91	96	94	91	86	78	78
800	LCA803426	4	Inlet/Outlet	91	85	91	96	94	91	86	78	78
800	LCA803428	4	Inlet/Outlet	92	86	92	97	95	92	87	79	79
800	LCA803430	4	Inlet/Outlet	92	86	92	97	95	92	87	79	79
800	LCA803432	4	Inlet/Outlet	92	86	92	97	95	92	87	79	79
800	LCA803434	4	Inlet/Outlet	92	86	92	97	95	92	87	79	79
800	LCA803436	4	Inlet/Outlet	92	86	92	97	95	92	87	79	79
800	LCA803438	4	Inlet/Outlet	92	86	92	97	95	92	87	79	79
800	LCA803440	4	Inlet/Outlet	92	86	92	97	95	92	87	79	79

Long Case Axial Fans (LCA)

Performance Curve

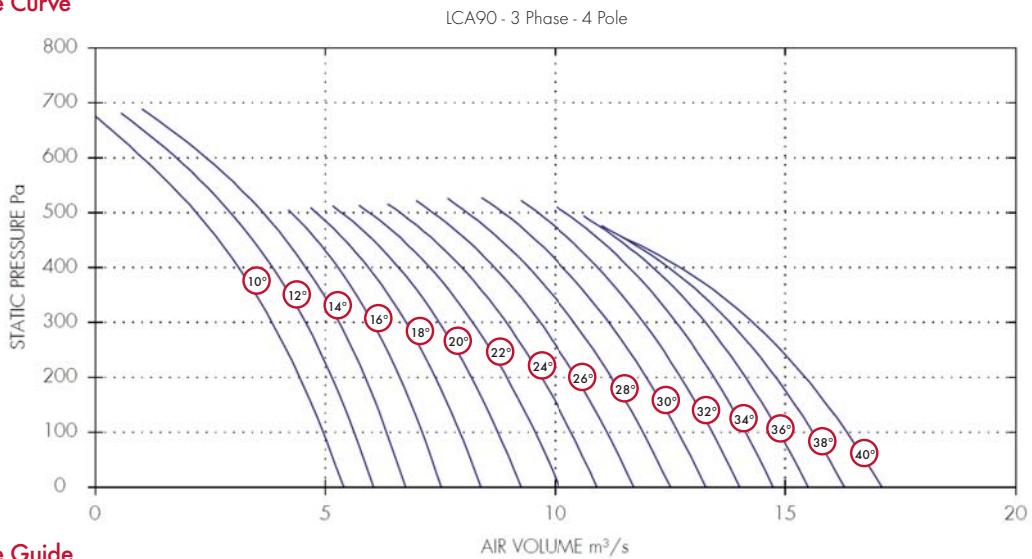

Performance Guide

Dia.	3 Phase		rpm	IP Rating	Curve Ref	m ³ /s at Pa						Motor kW	dBA @3m	
	Stock Ref	Poles				0	100	200	300	400	500			600
900	LCA903410	4	1440	IP55	10°	5.4	4.95	4.45	3.84	3.11	2.19	1.02	3	79
900	LCA903412	4	1440	IP55	12°	6.05	5.63	5.15	4.57	3.85	2.94	1.75	4	80
900	LCA903414	4	1440	IP55	14°	6.74	6.34	5.87	5.3	4.58	3.64	2.41	4	80
900	LCA903416	4	1440	IP55	16°	7.52	7.11	6.62	6.03	5.27	4.26		4	80
900	LCA903418	4	1440	IP55	18°	8.38	7.93	7.4	6.75	5.94	4.8		5.5	81
900	LCA903420	4	1440	IP55	20°	9.26	8.76	8.18	7.48	6.6	5.35		5.5	81
900	LCA903422	4	1440	IP55	22°	10.1	9.57	8.95	8.21	7.27	5.96		7.5	81
900	LCA903424	4	1440	IP55	24°	10.92	10.35	9.71	8.94	7.97	6.62		7.5	81
900	LCA903426	4	1440	IP55	26°	11.72	11.14	10.47	9.67	8.68	7.34		7.5	82
900	LCA903428	4	1440	IP55	28°	12.51	11.92	11.23	10.42	9.42	8.09		11	82
900	LCA903430	4	1440	IP55	30°	13.28	12.69	11.99	11.18	10.17	8.86		11	82
900	LCA903432	4	1440	IP55	32°	14.02	13.42	12.74	11.93	10.94	9.62		11	82
900	LCA903434	4	1440	IP55	34°	14.74	14.15	13.46	12.64	11.62	10.22		15	82
900	LCA903436	4	1440	IP55	36°	15.5	14.87	14.14	13.27	12.14			15	82
900	LCA903438	4	1440	IP55	38°	16.29	15.6	14.8	13.81	12.47			15	82
900	LCA903440	4	1440	IP55	40°	17.1	16.34	15.44	14.3	12.72			15	82

Sound Power Level Spectra dB (ref 10⁻¹² Watts)

Dia.	3 Phase		Spectrum	dB								dBA @3m
	Stock Ref	Poles		63	125	250	500	1k	2k	4k	8k	
900	LCA903410	4	Inlet/Outlet	89	83	91	97	95	92	87	79	79
900	LCA903412	4	Inlet/Outlet	90	84	92	98	96	93	88	80	80
900	LCA903414	4	Inlet/Outlet	90	84	92	98	96	93	88	80	80
900	LCA903416	4	Inlet/Outlet	90	84	92	98	96	93	88	80	80
900	LCA903418	4	Inlet/Outlet	91	85	93	99	97	94	89	81	81
900	LCA903420	4	Inlet/Outlet	91	85	93	99	97	94	89	81	81
900	LCA903422	4	Inlet/Outlet	91	85	93	99	97	94	89	81	81
900	LCA903424	4	Inlet/Outlet	91	85	93	99	97	94	89	81	81
900	LCA903426	4	Inlet/Outlet	92	86	94	100	98	95	90	82	82
900	LCA903428	4	Inlet/Outlet	92	86	94	100	98	95	90	82	82
900	LCA903430	4	Inlet/Outlet	92	86	94	100	98	95	90	82	82
900	LCA903432	4	Inlet/Outlet	92	86	94	100	98	95	90	82	82
900	LCA903434	4	Inlet/Outlet	92	86	94	100	98	95	90	82	82
900	LCA903436	4	Inlet/Outlet	92	86	94	100	98	95	90	82	82
900	LCA903438	4	Inlet/Outlet	92	86	94	100	98	95	90	82	82
900	LCA903440	4	Inlet/Outlet	92	86	94	100	98	95	90	82	82

Performance Curve

LCA100 - 3 Phase - 4 Pole

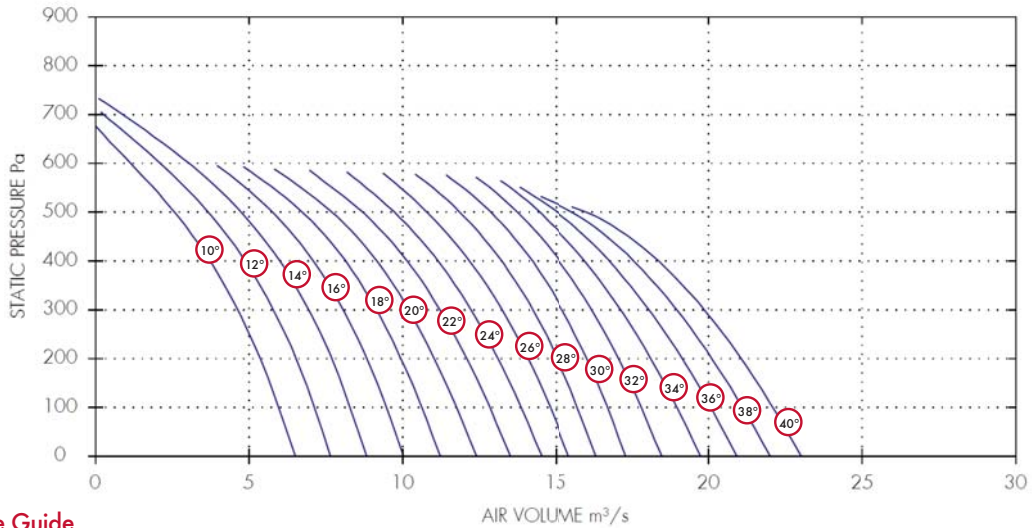

Performance Guide

Dia.	Stock Ref	Poles	rpm	IP Rating	Curve Ref	m³/s at Pa					Motor kW	dBA @3m
						0	150	300	450	600		
1000	LCA1003410	4	1440	IP55	10°	6.5	5.68	4.63	3.18	1.14	4	89
1000	LCA1003412	4	1440	IP55	12°	7.66	6.85	5.79	4.31	2.11	4	89
1000	LCA1003414	4	1440	IP55	14°	8.83	8.01	6.94	5.41	3.04	5.5	89
1000	LCA1003416	4	1440	IP55	16°	10.02	9.17	8.06	6.48		5.5	89
1000	LCA1003418	4	1440	IP55	18°	11.23	10.3	9.15	7.51		7.5	89
1000	LCA1003420	4	1440	IP55	20°	12.4	11.41	10.2	8.5		7.5	89
1000	LCA1003422	4	1440	IP55	22°	13.51	12.47	11.22	9.49		7.5	89
1000	LCA1003424	4	1440	IP55	24°	14.53	13.5	12.23	10.49		11	89
1000	LCA1003426	4	1440	IP55	26°	15.45	14.47	13.23	11.53		11	89
1000	LCA1003428	4	1440	IP55	28°	16.33	15.41	14.24	12.6		15	89
1000	LCA1003430	4	1440	IP55	30°	17.31	16.4	15.24	13.6		15	89
1000	LCA1003432	4	1440	IP55	32°	18.48	17.47	16.21	14.48		15	89
1000	LCA1003434	4	1440	IP55	34°	19.74	18.58	17.15	15.26		18.5	89
1000	LCA1003436	4	1440	IP55	36°	20.93	19.64	18.07	16		18.5	89
1000	LCA1003438	4	1440	IP55	38°	22.01	20.64	18.98	16.71		18.5	89
1000	LCA1003440	4	1440	IP55	40°	23.03	21.6	19.87	17.41		22	89

Sound Power Level Spectra dB (ref 10⁻¹² Watts)

Dia.	Stock Ref	Poles	Spectrum	dB @3m								
				63	125	250	500	1k	2k	4k	8k	
1000	LCA1003410	4	Inlet/Outlet	99	94	101	106	106	102	97	89	89
1000	LCA1003412	4	Inlet/Outlet	99	94	101	106	106	102	97	89	89
1000	LCA1003414	4	Inlet/Outlet	99	94	101	106	106	102	97	89	89
1000	LCA1003416	4	Inlet/Outlet	99	94	101	106	106	102	97	89	89
1000	LCA1003418	4	Inlet/Outlet	99	94	101	106	106	102	97	89	89
1000	LCA1003420	4	Inlet/Outlet	99	94	101	106	106	102	97	89	89
1000	LCA1003422	4	Inlet/Outlet	99	94	101	106	106	102	97	89	89
1000	LCA1003424	4	Inlet/Outlet	99	94	101	106	106	102	97	89	89
1000	LCA1003426	4	Inlet/Outlet	99	94	101	106	106	102	97	89	89
1000	LCA1003428	4	Inlet/Outlet	99	94	101	106	106	102	97	89	89
1000	LCA1003430	4	Inlet/Outlet	99	94	101	106	106	102	97	89	89
1000	LCA1003432	4	Inlet/Outlet	99	94	101	106	106	102	97	89	89
1000	LCA1003434	4	Inlet/Outlet	99	94	101	106	106	102	97	89	89
1000	LCA1003436	4	Inlet/Outlet	99	94	101	106	106	102	97	89	89
1000	LCA1003438	4	Inlet/Outlet	99	94	101	106	106	102	97	89	89
1000	LCA1003440	4	Inlet/Outlet	99	94	101	106	106	102	97	89	89

Long Case Axial Fans (LCA)

Performance Curve

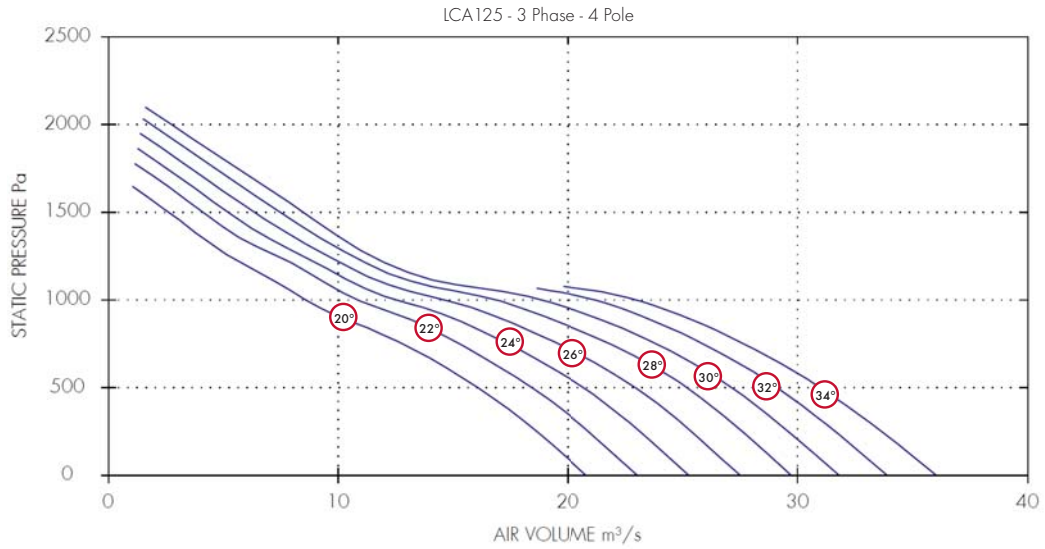

Performance Guide

Dia.	3 Phase			IP Rating	Curve Ref	m³/s at Pa								Motor kW	dBA @3m	
	Stock Ref	Poles	rpm			0	250	500	750	1000	1250	1500	1750			2000
1250	LCA1253420	4	1475	IP55	20°	20.81	18.64	16.07	12.79	8.59	5.26	2.6			22	83
1250	LCA1253422	4	1475	IP55	22°	23.03	20.92	18.43	15.28	10.86	7.33	4.1	1.46		30	84
1250	LCA1253424	4	1475	IP55	24°	25.27	23.16	20.69	17.37	12.55	8.47	5.18	2.51		30	85
1250	LCA1253426	4	1475	IP55	26°	27.51	25.39	22.96	19.57	14.61	9.54	6.33	3.58		37	86
1250	LCA1253428	4	1475	IP55	28°	29.72	27.6	25.18	21.83	16.82	10.6	7.46	4.64	1.84	37	87
1250	LCA1253430	4	1475	IP55	30°	31.81	29.62	27.15	23.86	18.86	11.45	8.46	5.62	2.71	37	87
1250	LCA1253432	4	1475	IP55	32°	33.89	31.63	29.13	25.88	21.13					45	88
1250	LCA1253434	4	1475	IP55	34°	36.01	33.63	30.98	27.66	22.97					45	88

Sound Power Level Spectra dB (ref 10⁻¹² Watts)

Dia.	3 Phase			Spectrum	dB @3m								
	Stock Ref	Poles	rpm		63	125	250	500	1k	2k	4k	8k	
1250	LCA1253420	4	1475	Inlet/Outlet	98	105	101	100	98	95	92	89	83
1250	LCA1253422	4	1475	Inlet/Outlet	99	106	102	101	99	96	93	90	84
1250	LCA1253424	4	1475	Inlet/Outlet	100	107	103	102	100	97	94	91	85
1250	LCA1253426	4	1475	Inlet/Outlet	101	108	104	103	101	98	95	92	86
1250	LCA1253428	4	1475	Inlet/Outlet	102	109	105	104	102	99	96	93	87
1250	LCA1253430	4	1475	Inlet/Outlet	102	109	105	104	102	99	96	93	87
1250	LCA1253432	4	1475	Inlet/Outlet	103	110	106	105	103	100	97	94	88
1250	LCA1253434	4	1475	Inlet/Outlet	103	110	106	105	103	100	97	94	88

Electrical Details

1 Phase 2 Pole

Stock Ref	rpm	Pitch Angle	Motor kW	S.C. Amps	F.L.C Amps	Starting Method	Starter Ref	Overload Ref	Transform Controller	*eDemand Controller		
										Voltage Control	1/3 Phase Inverter	3 Phase Inverter
LCA25	2800	25°-40°	0.37	8	2.6	D.O.L	444744	444702	-	-	-	-
LCA31	2800	10°-24°	0.37	8	2.6	D.O.L	444744	444702	-	-	-	-
LCA31	2800	26°-32°	0.55	14	3.6	D.O.L	444744	444703	-	-	-	-
LCA31	2800	34°-38°	0.75	16	4.5	D.O.L	444744	444703	-	-	-	-
LCA35	2800	10°-12°	0.55	14	3.6	D.O.L	444744	444703	-	-	-	-
LCA35	2800	22°-26°	0.75	16	4.5	D.O.L	444744	444703	-	-	-	-
LCA35	2800	28°-34°	1.1	23	6.6	D.O.L	444744	444704	-	-	-	-
LCA35	2800	36°-38°	1.5	31	8.5	D.O.L	444744	444705	-	-	-	-
LCA40	2800	10°-12°	0.55	14	3.6	D.O.L	444744	444703	-	-	-	-
LCA40	2800	14°-18°	0.75	16	4.5	D.O.L	444744	444704	-	-	-	-
LCA40	2800	20°-24°	1.1	23	6.6	D.O.L	444744	444704	-	-	-	-
LCA40	2800	26°-32°	1.5	31	8.5	D.O.L	444744	444705	-	-	-	-

*1 phase 2 pole is not speed controllable

3 Phase 2 Pole

Stock Ref	rpm	Pitch Angle	Motor kW	S.C. Amps	F.L.C Amps	Starting Method	Starter Ref	Overload Ref	Transform Controller	eDemand Controller		
										Voltage Control	1/3 Phase Inverter	3 Phase Inverter
LCA25	2800	25°-40°	0.37	5.82	0.97	D.O.L	444747	444700	-	-	444177	444172
LCA31	2800	10°-24°	0.37	5.82	0.97	D.O.L	444747	444700	-	-	444177	444172
LCA31	2800	26°-32°	0.55	8.52	1.42	D.O.L	444747	444701	-	-	444177	444172
LCA31	2800	34°-38°	0.75	10.62	1.77	D.O.L	444747	444701	-	-	444177	444172
LCA35	2800	10°-12°	0.37	5.82	0.97	D.O.L	444747	444700	-	-	444177	444172
LCA35	2800	14°-20°	0.55	8.52	1.42	D.O.L	444747	444701	-	-	444177	444172
LCA35	2800	22°-26°	0.75	10.62	1.77	D.O.L	444747	444701	-	-	444177	444172
LCA35	2800	28°-34°	1.1	15.06	2.51	D.O.L	444747	444702	-	-	444177	444173
LCA35	2800	36°-38°	1.5	19.68	3.28	D.O.L	444747	444702	-	-	444177	444173
LCA35	2800	40°	2.2	27.66	4.61	D.O.L	444747	444703	-	-	-	444174
LCA40	2800	10°-12°	0.55	8.52	1.42	D.O.L	444747	444701	-	-	444177	444172
LCA40	2800	14°-18°	0.75	10.62	1.77	D.O.L	444747	444701	-	-	444177	444172
LCA40	2800	20°-26°	1.1	15.06	2.51	D.O.L	444747	444702	-	-	444177	444173
LCA40	2800	28°-32°	1.5	19.68	3.28	D.O.L	444747	444702	-	-	444177	444173
LCA40	2800	34°-38°	2.2	27.66	4.61	D.O.L	444744	444703	-	-	-	444174
LCA40	2800	40°	3	42.2	6.03	D.O.L	444747	444704	-	-	-	444174
LCA45	2880	10°-12°	1.1	15.06	2.51	D.O.L	444747	444702	-	-	444177	444173
LCA45	2880	14°-18°	1.5	19.68	3.28	D.O.L	444747	444702	-	-	444177	444173
LCA45	2880	20°-26°	2.2	27.66	4.61	D.O.L	444747	444703	-	-	444177	444173
LCA45	2880	28°-32°	3	42.2	6.03	D.O.L	444747	444704	-	-	-	444174
LCA50	2880	10°-12°	1.5	19.68	3.28	D.O.L	444747	444702	-	-	444177	444173
LCA50	2880	14°-18°	2.2	27.66	4.61	D.O.L	444747	444703	-	-	-	444174
LCA50	2880	20°-24°	3	42.2	6.03	D.O.L	444747	444704	-	-	-	444174
LCA50	2880	26°-30°	4	59.1	7.88	D.O.L	444747	444705	-	-	-	444175
LCA50	2880	32°-36°	5.5	78.8	10.5	D.O.L	444748	444706	-	-	-	444175

Speed Controllers

Used in conjunction with speed controllable fans Vent-Axia offers a choice of speed controllers, the traditional Five-Step Auto Transformer or the Inverter Speed Controller.

The Five-Step-Auto Transformer provides five stepped speed settings without the electronic motor harmonic noise associated with all electronic or solid state type Speed Controllers.

eDemand Speed Controllers & Inverters see Accessories & Controllers Section.

Long Case Axial Fans (LCA)

Electrical Details

3 Phase 2 Pole

Stock Ref	rpm	Pitch Angle	Motor kW	S.C. Amps	F.L.C Amps	Starting Method	Starter Ref	Overload Ref	Transform Controller	eDemand Controller		
										Voltage Control	1/3 Phase Inverter	3 Phase Inverter
LCA50	2880	38°-40°	7.5	106	14.1	D.O.L	444748	444707	-	-	-	444176
LCA56	2880	10°-14°	4	59.1	7.88	D.O.L	444747	444705	-	-	-	444175
LCA56	2880	16°-18°	5.5	78.8	10.5	D.O.L	444748	444706	-	-	-	444175
LCA56	2880	20°-24°	7.5	106	14.1	D.O.L	444748	444707	-	-	-	444176
LCA63	2940	10°-12°	5.5	78.8	10.5	D.O.L	444748	444706	-	-	-	444175
LCA63	2940	14°-16°	7.5	106	14.1	D.O.L	444748	444707	-	-	-	444176
LCA63	2940	18°-22°	11	52.3	20.9	Star Delta	444843	444707	-	-	-	-
LCA63	2940	24°-28°	15	75.3	30.1	Star Delta	-	-	-	-	-	-

1 Phase 4 Pole

Stock Ref	rpm	Pitch Angle	Motor kW	S.C. Amps	F.L.C Amps	Starting Method	Starter Ref	Overload Ref	Transform Controller	eDemand Controller		
										Voltage Control	1/3 Phase Inverter	3 Phase Inverter
LCA25	1400	25°-40°	0.25	5	2	D.O.L	444744	444701	10314103	444164	-	-
LCA31	1400	10°-38°	0.25	5	2	D.O.L	444744	444701	10314103	444164	-	-
LCA35	1400	10°-38°	0.25	5	2	D.O.L	444744	444701	10314103	444164	-	-
LCA40	1400	10°-36°	0.25	5	2	D.O.L	444744	444701	10314103	444164	-	-
LCA40	1400	38°-40°	0.37	7	2.9	D.O.L	444744	444702	10314105	444164	-	-
LCA45	1400	10°-24°	0.25	5	2	D.O.L	444744	444701	10314103	444164	-	-
LCA45	1400	26°-32°	0.37	7	2.9	D.O.L	444744	444702	10314105	444164	-	-
LCA45	1400	34°-40°	0.55	11	3.9	D.O.L	444744	444703	10314105	444164	-	-
LCA50	1400	10°-18°	0.25	5	2	D.O.L	444744	444701	10314103	444164	-	-
LCA50	1400	20°-26°	0.37	7	2.9	D.O.L	444744	444702	10314105	444164	-	-
LCA50	1400	28°-34°	0.55	11	3.9	D.O.L	444744	444703	10314105	444164	-	-
LCA50	1400	36°-40°	0.75	15	5.3	D.O.L	444744	444704	10314107	444165	-	-
LCA56	1400	10°-16°	0.55	11	3.9	D.O.L	444744	444703	10314105	444164	-	-
LCA56	1400	18°-22°	0.75	15	5.3	D.O.L	444744	444704	10314107	444165	-	-
LCA56	1400	24°-30°	1.1	22	7	D.O.L	444744	444705	10314120	444165	-	-
LCA56	1400	32°-36°	1.5	32	9.3	D.O.L	444744	444706	10314120	-	-	-
LCA63	1400	10°-12°	0.55	11	3.9	D.O.L	444744	444703	10314105	444164	-	-
LCA63	1400	14°-16°	0.75	15	5.3	D.O.L	444744	444704	10314107	444165	-	-
LCA63	1400	18°-24°	1.1	22	7	D.O.L	444744	444705	10314120	444165	-	-
LCA63	1400	22°-26°	1.5	32	9.3	D.O.L	444744	444706	10314120	-	-	-

3 Phase 4 Pole

Stock Ref	rpm	Pitch Angle	Motor kW	S.C. Amps	F.L.C Amps	Starting Method	Starter Ref	Overload Ref	Transform Controller	eDemand Controller		
										Voltage Control	1/3 Phase Inverter	3 Phase Inverter
LCA25	1400	25°-40°	0.25	4.26	0.71	D.O.L	444747	444699	10314301	444166	444177	444172
LCA31	1400	10°-38°	0.25	5.04	0.84	D.O.L	444747	444699	10314301	444166	444177	444172
LCA35	1400	10°-38°	0.25	5.04	0.84	D.O.L	444747	444699	10314301	444166	444177	444172
LCA40	1400	10°-26°	0.25	5.04	0.84	D.O.L	444747	444699	10314301	444166	444177	444172
LCA40	1400	28°-38°	0.25	5.04	0.84	D.O.L	444747	444699	10314301	444166	444177	444172
LCA40	1400	40°	0.37	6.66	1.11	D.O.L	444747	444700	10314301	444166	444177	444172

Speed Controllers

Used in conjunction with speed controllable fans Vent-Axia offers a choice of speed controllers, the traditional Five-Step Auto Transformer or the Inverter Speed Controller.

The Five-Step-Auto Transformer provides five stepped speed settings without the electronic motor harmonic noise associated with all electronic or solid state type Speed Controllers.

eDemand Speed Controllers & Inverters see Accessories and Controls Section.

Electrical Details

3 Phase 4 Pole

Stock Ref	rpm	Pitch Angle	Motor kW	S.C. Amps	F.L.C Amps	Starting Method	Starter Ref	Overload Ref	Transform Controller	eDemand Controller		
										Voltage Control	1/3 Phase Inverter	3 Phase Inverter
LCA45	1400	10°24°	0.25	5.04	0.84	D.O.L	444747	444699	10314301	444166	444177	444172
LCA45	1400	26°32°	0.37	6.66	1.11	D.O.L	444747	444700	10314301	444166	444177	444172
LCA45	1400	34°40°	0.55	9.48	1.58	D.O.L	444747	444701	10314304	444166	444177	444172
LCA50	1400	10°18°	0.25	5.04	0.84	D.O.L	444747	444699	10314301	444166	444177	444172
LCA50	1400	20°26°	0.37	6.66	1.11	D.O.L	444747	444700	10314301	444166	444177	444172
LCA50	1400	28°34°	0.55	9.48	1.58	D.O.L	444747	444701	10314304	444166	444177	444172
LCA50	1400	36°40°	0.75	11.58	1.93	D.O.L	444747	444701	10314304	444166	444177	444172
LCA56	1400	10°16°	0.55	9.48	1.58	D.O.L	444747	444701	10314304	444166	444177	444172
LCA56	1400	18°22°	0.75	11.58	1.93	D.O.L	444747	444702	10314304	444166	444177	444172
LCA56	1400	24°30°	1.1	15.84	2.64	D.O.L	444747	444702	10314304	444166	444177	444173
LCA56	1400	32°36°	1.5	20.7	3.45	D.O.L	444747	444702	10314304	444166	444177	444173
LCA56	1400	38°40°	2.2	33.9	4.84	D.O.L	444747	444703	10314307	444167	-	444174
LCA63	1400	10°	0.55	9.48	1.58	D.O.L	444747	444701	10314304	444166	444177	444172
LCA63	1400	12°14°	0.75	11.58	1.93	D.O.L	444747	444701	10314304	444166	444177	444172
LCA63	1400	16°18°	1.1	15.84	2.64	D.O.L	444747	444702	10314304	444166	444177	444173
LCA63	1400	22°26°	1.5	20.7	3.45	D.O.L	444747	444702	10314307	444166	444177	444173
LCA63	1400	28°34°	2.2	33.9	4.84	D.O.L	444747	444703	10314307	444167	-	444174
LCA63	1400	36°40°	3	45.3	6.47	D.O.L	444747	444704	10314311	444167	-	444174
LCA71	1420	10°	0.75	11.58	1.93	D.O.L	444747	444701	10314304	444166	444177	444172
LCA71	1420	12°14°	1.1	15.84	2.64	D.O.L	444747	444702	10314304	444166	444177	444173
LCA71	1420	16°18°	1.5	20.7	3.45	D.O.L	444747	444702	10314304	444166	444177	444173
LCA71	1420	20°24°	2.2	33.9	4.84	D.O.L	444747	444703	10314307	444167	-	444174
LCA71	1420	26°30°	3	45.3	6.47	D.O.L	444747	444704	10314311	444167	-	444174
LCA71	1420	32°36°	4	57.8	8.26	D.O.L	444747	444705	10314311	444167	-	444175
LCA71	1420	38°40°	5.5	77	11	D.O.L	444748	444706	-	444168	-	444175
LCA80	1420	10°12°	2.2	33.9	4.84	D.O.L	444747	444703	10314307	444167	-	444174
LCA80	1440	14°20°	3	45.3	6.47	D.O.L	444747	444704	10314311	444167	-	444174
LCA80	1440	22°24°	4	57.8	8.26	D.O.L	444747	444705	10314311	444167	-	444175
LCA80	1440	26°28°	5.5	77	11	D.O.L	444748	444706	-	444168	-	444175
LCA80	1440	30°34°	7.5	102.2	14.6	D.O.L	444748	444707	-	-	-	444176
LCA80	1440	36°40°	11	52.3	20.9	Star Delta	444843	444707	-	-	-	-
LCA90	1440	10°	3	45.3	6.47	D.O.L	444747	444704	10314311	444167	-	444174
LCA90	1440	12°16°	4	57.8	8.26	D.O.L	444747	444705	10314311	444167	-	444175
LCA90	1440	18°20°	5.5	77	11	D.O.L	444748	444706	-	444168	-	444175
LCA90	1440	22°26°	7.5	102.2	14.6	D.O.L	444748	444707	-	-	-	444176
LCA90	1440	28°32°	11	52.3	20.9	Star Delta	444843	444707	-	-	-	-
LCA90	1440	34°40°	15	75.3	30.1	Star Delta	-	-	-	-	-	-
LCA100	1440	10°12°	4	57.8	8.26	D.O.L	444747	444705	10314311	444167	-	444175
LCA100	1440	14°16°	5.5	77	11	D.O.L	444748	444706	-	444168	-	444175
LCA100	1440	18°22°	7.5	102.2	14.6	D.O.L	444748	444707	-	-	-	444176
LCA100	1440	24°26°	11	52.3	20.9	Star Delta	444843	444707	-	-	-	-
LCA100	1440	28°32°	15	75.3	30.1	Star Delta	-	-	-	-	-	-
LCA100	1440	34°38°	18.5	86	34.3	Star Delta	-	-	-	-	-	-
LCA100	1440	40°	22	102	40.6	Star Delta	-	-	-	-	-	-
LCA125	1475	20°	22	102	40.6	Star Delta	-	-	-	-	-	-
LCA125	1475	22°24°	30	131	54.7	Star Delta	-	-	-	-	-	-
LCA125	1475	26°30°	37	159	66.4	Star Delta	-	-	-	-	-	-
LCA125	1475	32°34°	45	193	80.5	Star Delta	-	-	-	-	-	-

Long Case Axial Fans (LCA)

Fan Attenuator Details

An attenuator without pod offers negligible resistance to air flow, and therefore the pressure loss can be considered to be the same as that for the equivalent length of ducting.

Resistance Graph for Axial Attenuator with Pod

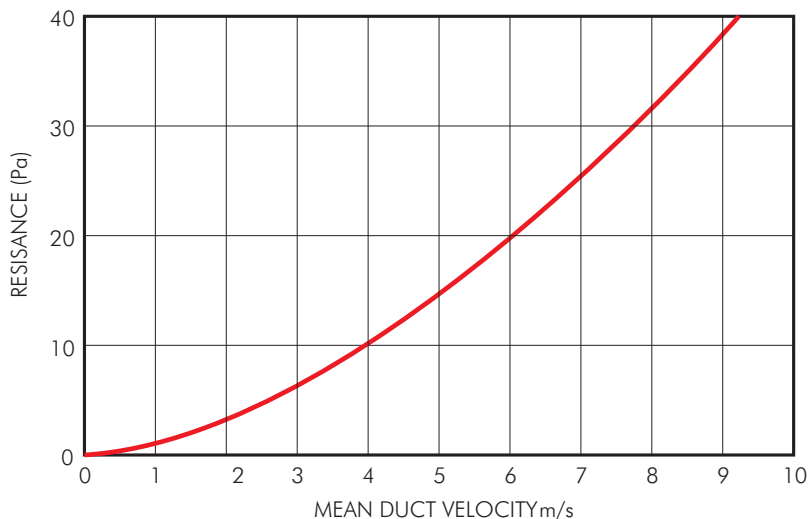

Attenuator Insertion Loss Data

Dia	Stock Ref	63	125	250	500	1k	2k	4k	8k	kg approx
250	10514250	2	3	6	11	16	11	10	6	20
315	10514315	2	3	6	11	16	11	10	6	22
355	10514355	2	3	6	12	16	11	10	6	30
400	10514400	2	3	6	13	16	12	10	6	41
450	10514450	2	4	6	14	17	12	10	6	50
500	10514500	3	4	7	14	17	14	11	7	59
560	10514560	2	4	8	15	18	14	11	7	70
630	10514630	3	4	8	16	18	14	11	7	82
710	10514710	1	2	6	9	12	10	6	2	90
800	10514800	1	2	6	9	12	10	6	2	100
900	10514900	1	2	6	9	12	10	6	2	145
1000	10514000	1	2	6	9	12	10	6	2	184
1250	105141250	1	2	6	9	12	10	6	2	150

Melinox lined attenuators are available on request

Case Axial Attenuator Fitted with Pod Insertion Losses

Dia	Stock Ref	63	125	250	500	1k	2k	4k	8k	kg approx
315	10500315	6	7	12	18	27	25	22	19	32
355	10500355	3	8	12	18	28	26	22	19	44
400	10500400	3	8	12	18	28	26	23	19	60
450	10500450	4	8	14	20	28	26	23	19	73
500	10500500	4	8	14	20	29	26	23	19	87
560	10500560	4	9	14	20	29	26	23	19	102
630	10500630	4	9	14	20	29	26	23	19	120
710	10500710	6	10	20	30	35	28	25	22	134
800	10500800	6	10	20	30	35	28	25	22	149
900	10500900	6	10	20	30	35	28	25	22	211
1000	105001000	6	10	20	30	35	28	25	22	267
1250	105001250	6	10	17	28	27	21	18	17	222

Attenuator Dimensions (mm)

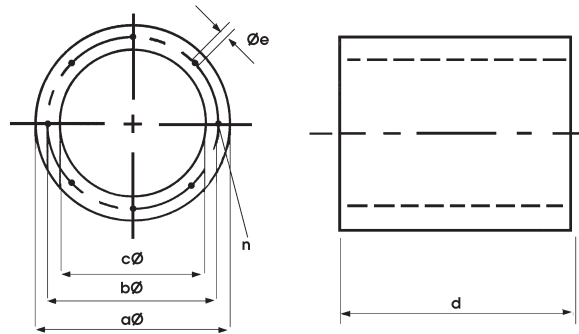

Model	Stock		a Ø	b Ø	c Ø	d	e Ø	n
	Ref							
LCA25	10514250		350	292	254	375	M8	4
LCA31	10514315		415	355	315	475	M8	8
LCA35	10514355		455	395	355	540	M8	8
LCA40	10514400		500	450	400	600	M10	8
LCA45	10514450		550	500	450	675	M10	8
LCA50	10514500		600	560	500	750	M10	12
LCA56	10514560		660	620	560	810	M10	12
LCA63	10514630		730	690	630	940	M10	12
LCA71	10514710		814	700	710	1070	M10	16
LCA80	10514800		900	860	796	1200	M10	16
LCA90	10514900		999	970	893	1350	M10	16
LCA100	105141000		1108	1070	1070	1500	M10	16
LCA125	105141250		1350	1320	1250	1875	M10	20

Long Case Axial Fans (LCA)

Accessory Dimensions (mm)

Coupling Flange

Rolled from mild steel. Dimensionally matched to fan flange and fixing holes.

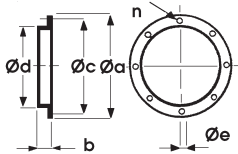

Stock Ref	a Ø	b	c Ø	d Ø	e Ø	n
10506250	335	30	295	250	10	8
10506315	385	30	355	315	10	8
10506355	425	45	395	355	10	8
10506400	480	45	450	400	12	8
10506450	530	60	500	450	12	8
10506500	590	0	560	500	12	12
10506560	650	75	620	560	12	12
10506630	720	75	690	630	12	12
10506710A	800	40	770	710	12	16
10506800A	890	40	860	800	12	16
10506900A	1038	50	970	900	14	16
105061000A	1138	50	1070	1000	14	16
105061250A	1390	83	1320	1250	15	20

Anti-Vibration Mounts

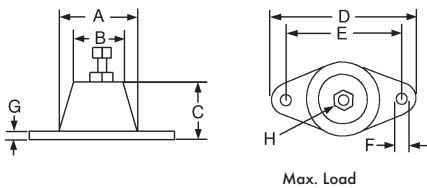

*Stock Ref	A	B	C	D	E	F	G	H	kg
68MP033G	37	26	27	67	54	7	3	M 8	23
68MP055B	37	26	27	67	54	7	3	M8	36
68MP133G	57	46	35	95	76	10.5	4	M12	91
68MP165R	57	46	35	95	76	10.5	4	M12	245

*supplied as a set of 4.

Inlet Wire Guard

'K' factor loss 0.25

Available for direct fixing to either side of the fan using flange sizing holes. Constructed to meet BS 848 Part 5.

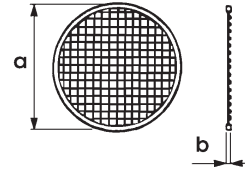

Stock Ref	a	b
10505250	330	3
10505315	380	3
10505355	420	3
10505400	475	3
10505450	525	3
10505500	595	3
10505560	655	3
10505630	725	3
10505710	784	10
10505800	870	10
10505900	970	10
105051000	1090	10
105051250	1370	10

For more information on the 'K' factor, refer to General Information Section

Mounting Feet

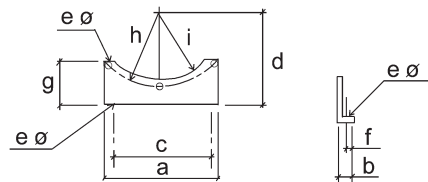

*Stock Ref	a	b	c	d	e	f	g	h	i
10503250	232	24	180	240	10	14	115	146	130
10503315	275	24	224	240	10	14	115	177.5	167
10503355	303	24	250	250	10	14	125	197.5	187
10503400	348	24	280	300	12	14	135	225	213
10503450	384	24	315	360	12	14	155	250	238
10503500	425	24	315	360	12	14	135	280	268
10503560	475	24	355	355	12	14	155	310	298
10503630	520	24	400	400	12	14	175	345	333
10503710A	710	40	610	435	13	18	240	385	365
10503800A	800	40	700	480	13	18	262	430	410
10503900A	900	40	800	535	13	18	288	485	460
105031000A	1000	40	900	580	15	18	314	535	510
105031250A	1250	80	1150	868	15	26	366	660	640

*Set of 2 feet

Accessories

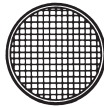
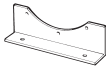

Model Ref	Mounting Feet - set of 2 Stock Ref	Inlet Wire Guard Stock Ref	Coupling Flange Stock Ref	*Ancillary Pack Stock Ref	Axial Attenuator Stock Ref	Attenuator inc. Pod Stock Ref	**Anti Vibration Mount Stock Ref
LCA25	10503250	10505250	10506250	10513250	10514250	-	68MP033G
LCA31	10503315	10505315	10506315	10513315	10514315	10500315	68MP033G
LCA35	10503355	10505355	10506355	10513355	10514355	10500355	68MP033G
LCA40	10503400	10505400	10506400	10513400	10514400	10500400	68MP033G
LCA45	10503450	10505450	10506450	10513450	10514450	10500450	68MP033G
LCA50	10503500	10505500	10506500	10513500	10514500	10500500	68MP033G
LCA56	10503560	10505560	10506560	10513560	10514560	10500560	68MP033G
LCA63	10503630	10505630	10506630	10513630	10514630	10500630	68MP033G
LCA71	10503710A	10505710	10506710A	10513710A	10514710A	10500710	68MP055B
LCA80	10503800A	10505800	10506800A	10513800A	10514800A	10500800	68MP055B
LCA90	10503900A	10505900	10506900A	10513900A	10514900A	10500900	68MP133G
LCA100	105031000A	105051000	105061000A	105131000A	105141000A	105001000	68MP133G
LCA125	105031250A	105051250	105061250A	105131250A	105141250A	105001250	68MP165R

*consists of 2 Matching Flanges, 2 Flexible Connectors, 2 Mounting Feet, 4 Anti Vibration Mounts, 4 Worm Drive Clips

Typical Installation

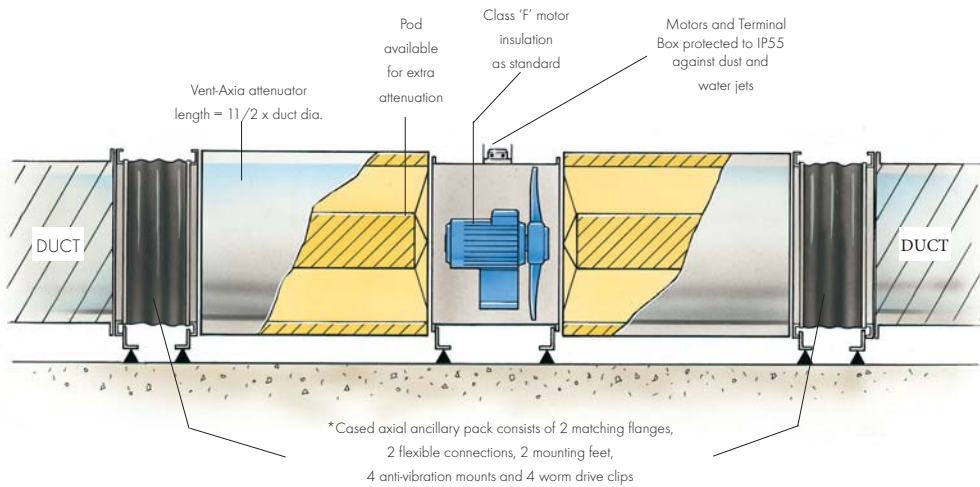

Kitchen Axial Fan (KAF)

Features & Benefits

- Fully ERP 2015 compliant
- Designed to operate at elevated temperatures (70°C max)
- All models speed controllable via matched eDemand inverter controls
- Robust motor construction for aggressive conditions
- Die cast aluminium impellers
- IP65 motor and terminal box, suitable for internal or external mounting as standard
- Motor insulation class H, suitable for induct operating temperatures of -40°C to +70°C
- Standard Thermal Overload Protection
- Maximum operating temperature indicator label
- Available from 450 to 630 diameter, Single or Three Phase
- Manufacture controlled to BS EN ISO 9001
- Performance tested to BS 848 Parts 1 & 2

The ever tightening requirement for kitchen ventilation systems with higher filtration levels and long duct runs requires a powerful and yet compact fan to provide a cost-effective controllable ventilation solution suitable for operating reliably in atmospherically aggressive installations.

A first within the H&V industry, Vent-Axia's New Kitchen Axial Fan range provides such a solution offering robustly engineered fans and motors designed and tested for operation at elevated temperatures (up to 70°C induct) whilst utilising speed control. Utilising Vent-Axia's advanced eDemand Inverter controls provides accurate and reliable control functionality whilst offering substantial running cost reductions and noise control.

Available in four sizes: 450, 500, 560 and 630mm diameter with a performance envelope from 0.65m³/s to 5.93m³/s and pressure

development of up to 600 Pa. Ensuring a compact design, the units have been constructed from a single sheet of steel, with a single 2 pole motor and axial impeller mounted within the length of the unit casing. The unit is manufactured from electro welded steel with an epoxy paint finish. Factory assembled to BS EN ISO 9001 ensuring a quiet and vibration free unit.

All sizes are protected with a tough black epoxy paint finish for those harsh environmental conditions, internally or externally. Ensuring ease of installation the motor is wired directly into a single IP65 terminal box.

Axial Impellers

The impeller is manufactured in die-cast aluminium and fitted with narrow profiled blades, which provide the maximum efficiency at the maximum airflow. Airflow is Form A to ensure maximum cooling airflow over the motor.

Motors

Specifically designed for this range of fans and the expected environmental conditions. Greased for life ball bearings with temperature resilient grease specially selected to operate at the elevated temperatures likely to be encountered in kitchen applications whilst allowing the fans to be installed at any angle. Rotors are dynamically balanced to ISO 1940 grade G6.3. Motors are protected to IP65 against dust and water jets complying with BS EN 60529. They have ribbed aluminium body castings and are mounted towards the airstream for efficient cooling. Motor insulation is Class 'H' (from -40°C to +70°C). All models are speed controllable by either voltage control or frequency inverter (see electrical section for details).

Electrical

Single phase 220-240V/50 Hz. Capacitor start and run. Three phase 380V-415V/50Hz. All motors are fitted with Standard Thermal Overload Protection (S.T.O.P), which should be wired into all controller circuits and into starter contactors.

Terminal Box

IP65 terminal box is supplied with all models with 20mm PGI entry.

Performance

The fan performance is tested and certified in accordance with BS 848 Part 1 1980.

Sound Levels

Fan sound levels, measured in a reverberant chamber in accordance with BS848 part 2 published dB(A) figures are free field sound pressure levels at 3m with spherical propagation at reference level of 2 x10⁻⁵Pa (20 micro-pascal). The sound power level spectra figures are dB with a reference level of 10-12 Watts (1 pico-watt). To ensure minimum noise levels during speed control, an auto transformer speed control is recommended.

Accessories

- eDemand Inverter speed Controllers
- Auto Transformer Speed Controllers
- Mounting Ancillary Packs
- Cased Attenuators
- Mounting Feet
- Wire Inlet Guard
- Coupling Flanges

Warranty

Standard 2 year warranty, extendable to 5 years by registration, subject to installation and maintenance in accordance with fitting and operating instructions supplied with product.

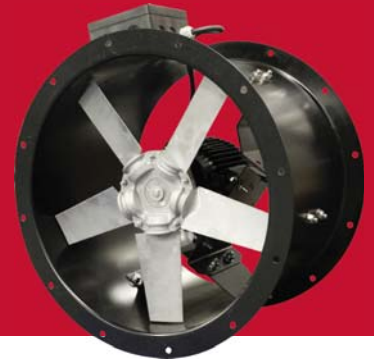

Performance Curve

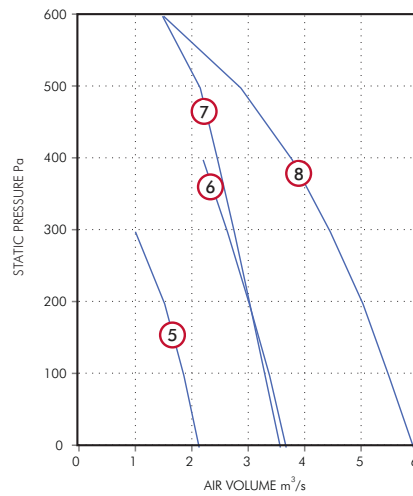
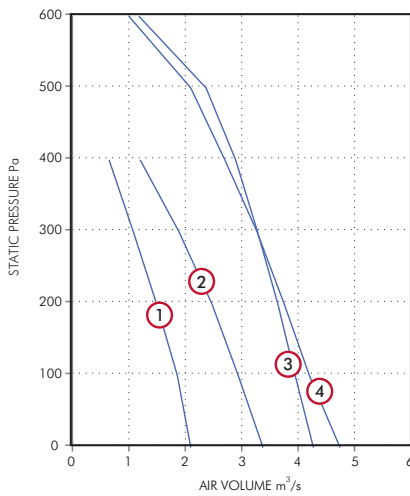

Performance Guide

Stock Ref	Speed		Performance				m³/s at Pa							Motor kW	Amps S.C.	Amps F.L.C.	
	rpm	Phase	Pole	Curve	0	50	100	150	200	300	400	500	600				
KAF45012	2850	1	2	①	2.1	2	1.86	1.69	1.49	1.08	0.65				1.1	29	6.6
KAF50012	2850	1	2	②	3.38	3.2	2.94	2.73	2.47	1.89	1.2				1.5	35	7.8
KAF56012	2800	1	2	③	4.27	4.1	3.95	3.81	3.64	3.28	2.89	2.37	1.18		2.2	66	15
KAF63012	2860	1	2	④	4.74	4.5	4.2	4	3.75	3.27	2.7	2.1	1.00		3	80	13.5
KAF45032	2830	3	2	⑤	2.13	2	1.86	1.72	1.52	1					1.1	11	2
KAF50032	2830	3	2	⑥	3.67	3.56	3.38	3.23	3.02	2.63	2.2				1.5	17	3.4
KAF56032	2760	3	2	⑦	3.57	3.45	3.3	3.16	3.03	2.75	2.46	2.15	1.48		2.2	32	4.9
KAF63032	2785	3	2	⑧	5.93	5.69	5.49	5.26	5.03	4.45	3.78	2.87	1.5		4	66	7.8

Sound Power Level Spectra dB (re 10⁻¹²Watts)

Stock Ref	Phase	Pole	125	250	500	1k	2k	4k	8k	dB(A) @ 3m
KAF45012	Inlet/Outlet	1	70	71	79	82	82	79	74	67
KAF50012	Inlet/Outlet	1	70	76	79	81	81	80	75	67
KAF56012	Inlet/Outlet	1	79	94	97	99	98	94	86	78
KAF63012	Inlet/Outlet	1	79	90	98	99	98	97	91	81
KAF45032	Inlet/Outlet	3	63	73	80	82	83	81	76	68
KAF50032	Inlet/Outlet	3	69	80	83	84	85	84	80	70
KAF56032	Inlet/Outlet	3	86	98	97	97	92	87	80	75
KAF63032	Inlet/Outlet	3	79	90	98	98	99	97	91	81

Published dB(A) figures are free field sound levels at 3m with spherical propagation at a reference level of 2x10⁻⁵ Pa. The free field sound power level spectra figure are dB with reference of 10⁻¹² Watts. To ensure minimum noise levels during speed control an auto transformer or inverter speed controller is recommended.

Kitchen Axial Fans (KAF)

Fan Dimensions (mm)

Size	Øa	b	Øc	Ød	Øe	n	kg approx
450	450	375	500	530	12	8	41
500	500	375	560	590	12	12	46
560	560	520	620	650	12	12	59
630	630	520	690	720	12	12	64

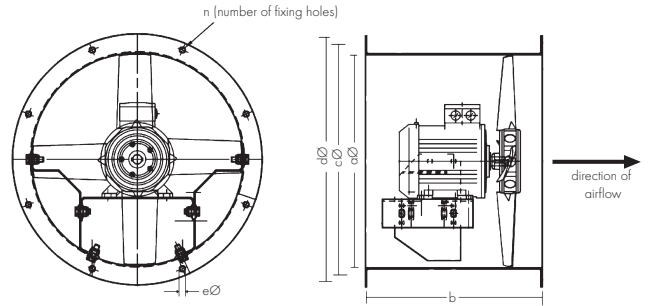

Attenuator Insertion Losses

Dia	63	125	250	500	1k	2k	4k	8k
450	2	4	6	14	17	12	10	6
500	3	4	7	14	17	14	11	7
560	3	4	8	15	18	14	11	7
630	3	4	8	16	18	14	11	7

Attenuator Fitted with Pod Insertion Losses

Dia	63	125	250	500	1k	2k	4k	8k
450	4	8	14	20	28	26	23	19
500	4	8	14	20	29	26	23	19
560	4	9	14	20	29	26	23	19
630	4	9	14	20	29	26	23	19

Accessories Dimensions (mm)

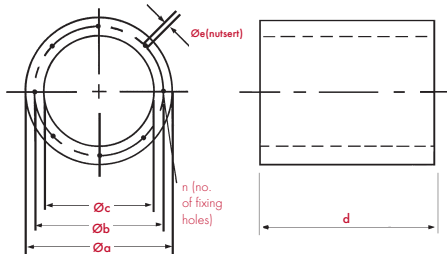

Resistance Graph For Case Attenuator Fitted With Pod

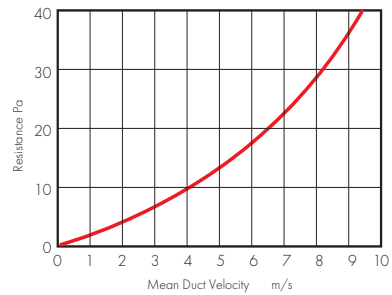

Case Axial Attenuator

Dia	Øa	bØ	Øc	d	Øe*	n	kg approx	Fitted with pod kg approx	Free area m ² without pod
450	550	500	450	675	M10	8	50	73	0.159
500	600	560	500	750	M10	12	59	87	0.196
560	660	620	560	840	M10	12	70	102	0.246
630	730	690	630	940	M10	12	82	120	0.312

*Threaded hole to take bolt

Mounting Feet

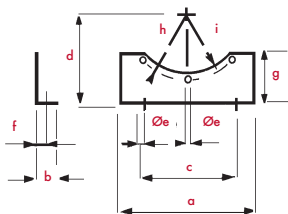

Stock Ref	a	b	c	d	Øe	f	g	h	i
10503450	384	24	315	315	12	14	155	250	238
10503500	425	24	315	315	12	14	135	280	268
10503560	475	24	355	355	12	14	155	310	298
10503630	520	24	400	400	12	14	175	345	333

Inlet Wire Guard

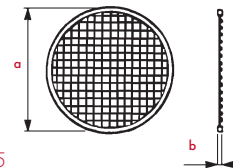

'K' factor loss 0.25

Stock Ref	Øa	b
10505450	525	3
10505500	595	3
10505560	655	3
10505630	725	3

For more information on the 'K' factor, refer to General Information Section

Accessories Dimensions (mm)

Anti-Vibration Mounts

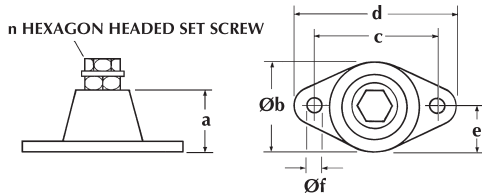

*Stock	Ref	a	Øb	c	d	e	Øf	n	Max load kg
	68MP033G	27	37	54	67	18.5	7	M8	23

* 4 required per fan

Coupling Flange

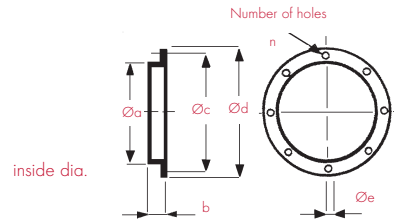

Stock	Ref No.	Øa	b	Øc	Ød	Øe	n
	10506450	450	60	500	537	12	8
	10506500	500	60	560	595	12	12
	10506560	560	75	620	655	12	12
	10506630	630	75	690	725	12	12

Accessories

Mounting

Stock Ref	Ancillary Pack *	Case Axial Attenuator			Mounting Feet	Coupling Flange	Inlet Wire Guard	Anti Vibration Mounts #
		Case Axial Attenuator	in Pod					
KAF45012	10513450	10514450	10500450	10503450	10506450	10505450	68MP033G	
KAF50012	10513500	10514500	10500500	10503500	10506500	10505500	68MP033G	
KAF56012	10513560	10514560	15000560	10503560	10506560	10505560	68MP033G	
KAF63012	10513630	10514630	10500630	10503630	10506630	10505630	68MP033G	
KAF45032	10513450	10514450	10500450	10503450	10506450	10505450	68MP033G	
KAF50032	10513500	10514500	10500500	10503500	10506500	10505500	68MP033G	
KAF56032	10513560	10514560	15000560	10503560	10506560	10505560	68MP033G	
KAF63032	10513630	10514630	10500630	10503630	10506630	10505630	68MP033G	

Manual Starter

eDemand Controls**

Stock Ref	Starter	Overload	Single Phase in 3 Phase			Voltage Control	Transformer Control
			Single Phase Inverter	Out Inverter	3 Phase Inverter		
KAF45012	444744	444705	444171	x	x	444165	10314113
KAF50012	444744	444705	444171	x	x	444165	10314113
KAF56012	444744	444707	x	x	x	x	x
KAF63012	444744	444707	x	x	x	x	x
KAF45032	444747	444702	x	444177	444172	444166	10314304
KAF50032	444747	444702	x	444177	444173	444166	10314304
KAF56032	444747	444703	x	444177	444173	x	x
KAF63032	444747	444705	x	x	444174	x	x

* Includes 4 Anti Vibration Mounts, 2 Mounting Feet, 2 Flanges and 2 Flexible Connectors

** For Manual control requires Speed Potentiometer 426332

4 required per fan

x Not suitable

Bifurcated Case Axial Fans (BIFA)

Features & Benefits

- Sizes 250 to 1000 dia
- Motors protected to IP55
- Motor insulation Class 'F'
- Maximum ambient temperature 200 °C
- Speed controllable via transformer or inverter (when the ambient air temperature is not higher than 60 °C)
- IP55 terminal box
- Suitable for relative humidity levels up to 95% R.H
- Manufactured to BS EN ISO 9001
- Performance tested to BS 848 parts 1, 2 and ISO 5801
- 2 Year Guarantee

The Bifurcated Case Axial range has been specifically developed to meet the need for an axial fan which can handle atmospheres normally detrimental to the life of the fan motor.

By isolating the motor from the system airstream, the bifurcated fan can handle a wide variety of saturated and dust-laden atmospheres, heated air and hot gases.

The range has a split airway with a direct driven motor operating in ambient air within the motor compartment. They are suitable, as standard, for handling air temperatures up to +200 °C.

The Bifurcated Case Axial Fan range has a number of accessories available which include: Axial Ancillary Pack, Attenuator, Wire Inlet Guard, Coupling Flanges, Mounting Feet, AV Mounts and Speed Controllers.

Motors

The motors are specially selected to operate within the motor compartment with the airstream in the duct system, at an elevated temperature.

Motors are of the B3 foot mounting type, totally enclosed and fan cooled. Being foot mounted the motors can, in the event of a failure, be readily interchanged with a comparable frame size from a wide range of manufacturers to cover temperatures of up to 200 °C.

Where indicated, the motor is suitable for speed control by either an inverter or a 5-step auto transformer speed controller when the ambient air temperature is not higher than 60 °C.

Electrical

Single phase 220-240V/50 Hz supply are available in two sizes 250 and 315 dia. in either 2 or 4 pole versions. Three phase 380-440V/50Hz supply are available in nine sizes 250, 315, 400, 500, 630, 710, 800, 900 and 1000 dia. in either 2 or 4 pole versions (710, 800, 900 and 1000 dia are only available as 4 pole).

Impellers and Casing

The aluminium alloy impellers are die cast and have an adjustable pitch which allows a wide range of air outputs to be selected. All the casings are manufactured in steel and hot dipped galvanised to BS EN ISO 1461 after fabrication. Motor mountings and fixings used in the assembly of the fan are zinc plated and passivated.

Form of Running

Bifurcated fans have arrows showing the direction of the impeller rotation and airflow. All models are Form B running.

Terminal Box

To IP55, protected against dust and water jets from any angle, allowing outside applications.

Performance

Tested to BS 848 Part 1 & 2. Published dB(A) figures are free field sound pressure levels at 3m with spherical propagation at a reference level of 2×10^{-5} Pa (20 micro-Pascal). The inlet and outlet sound power level spectra figures are dB with a reference of 10^{-12} Watts (1 pico-watt).

Cooling

External cooling is provided by a fan mounted at the non-drive end of the motor, protected by a cover with a grid air intake. The airflow, guided by the fan cover, is directed longitudinally on the entire periphery of the motor in the channels formed by the frame ribs.

Adequate space is provided within the motor compartment to ensure a plentiful supply of cooling air. The air within the motor compartment must not exceed 40 °C. For ambients in excess of this, please consult our Technical Services Department for further information.



Fan Dimensions (mm)

BIFA25 - BIFA50

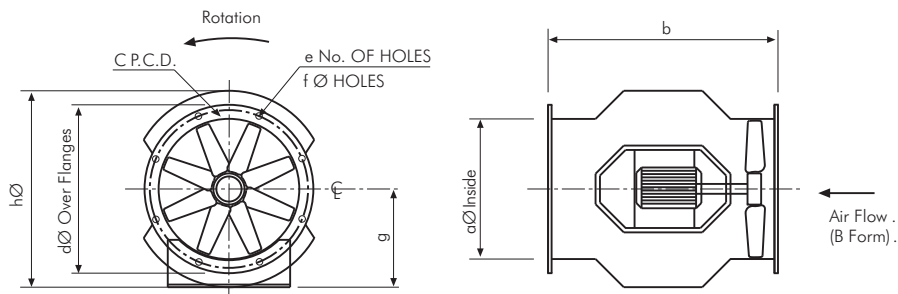

Model No.	Pole	Phase	Pitch Angle	aØ	b	c	d	e	f	g	hØ	Approx. Weight kg
BIFA25	2&4	1&3	25-40	250	535	302	328	8	10	240	452	30
BIFA31	2&4	1&3	10-38	315	535	355	385	8	10	240	452	35
BIFA40	2&4	1&3	10-38	400	625	450	480	8	10	335	585	49
BIFA45	2&4	1&3	10-40	450	625	500	535	8	12	360	650	60
BIFA50	4	1&3	10-40	500	660	560	590	12	12	360	695	66
BIFA50	2	3	10-40	500	710	560	590	12	12	360	695	87

BIFA63 - BIFA100

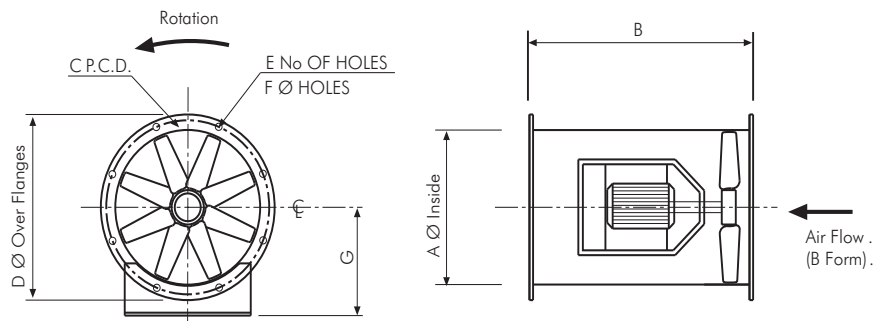

Model No.	Pole	Phase	Pitch Angle	a	b	c	d	e	f	g	Approx. Weight kg
BIFA56	2&4	3	10-40	560	800	604	644	12	12	350	80
BIFA63	2&4	3	10-40	630	790	690	728	12	12	400	106
BIFA71	4	3	10-40	710	800	754	784	16	12	435	120
BIFA80	4	3	10-40	800	880	860	890	16	12	450	155
BIFA90	4	3	10-40	900	900	970	1038	16	14	535	170
BIFA100	4	3	10-40	1000	1000	1070	1138	16	14	575	275

Bifurcated Case Axial Fans (BIFA)

Performance Curve

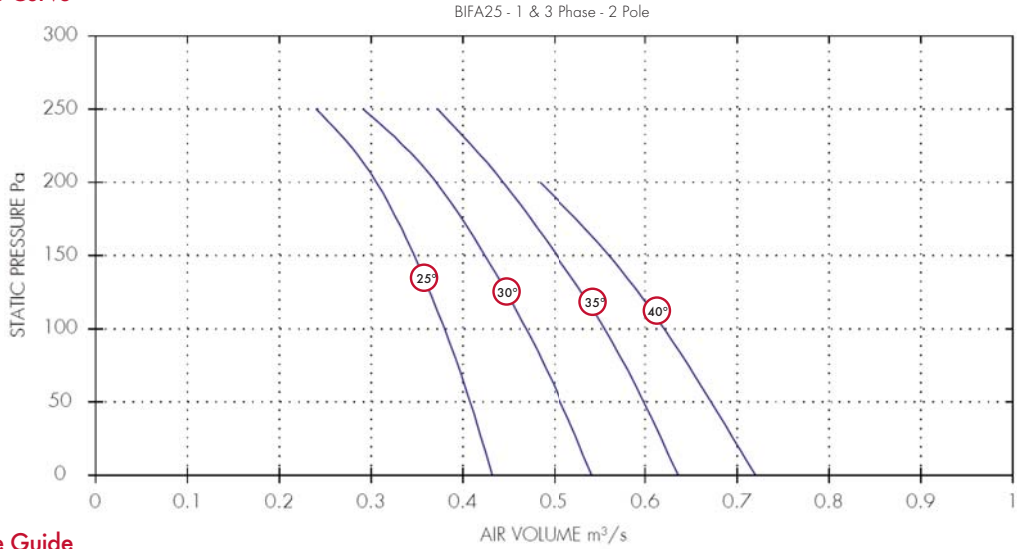

Performance Guide

Dia.	1 Phase		3 Phase		IP	Curve Ref	m³/s at Pa					Motor kW	dBA @3m	
	Stock Ref	Stock Ref	Poles	rpm			Rating	0	50	100	150			200
250	BIFA251225	BIFA253225	2	2800	IP55	25°	0.43	0.41	0.38	0.35	0.31	0.24	0.37	58
250	BIFA251230	BIFA253230	2	2800	IP55	30°	0.54	0.51	0.47	0.42	0.37	0.29	0.37	57
250	BIFA251235	BIFA253235	2	2800	IP55	35°	0.64	0.6	0.56	0.5	0.44	0.37	0.37	58
250	BIFA251240	BIFA253240	2	2800	IP55	40°	0.72	0.67	0.62	0.56	0.48		0.37	59

Sound Power Level Spectra dB (ref 10⁻¹² Watts)

Dia.	1 Phase		3 Phase		Spectrum	dB @ 3m								
	Stock Ref	Stock Ref	Poles	rpm		63	125	250	500	1k	2k	4k	8k	
250	BIFA251225	BIFA253225	2	2800	Inlet/Outlet	73	74	82	75	73	70	67	64	58
250	BIFA251230	BIFA253230	2	2800	Inlet/Outlet	72	73	81	74	72	69	66	63	57
250	BIFA251235	BIFA253235	2	2800	Inlet/Outlet	73	74	82	75	73	70	67	64	58
250	BIFA251240	BIFA253240	2	2800	Inlet/Outlet	74	75	83	76	74	71	68	65	59

Performance Curve

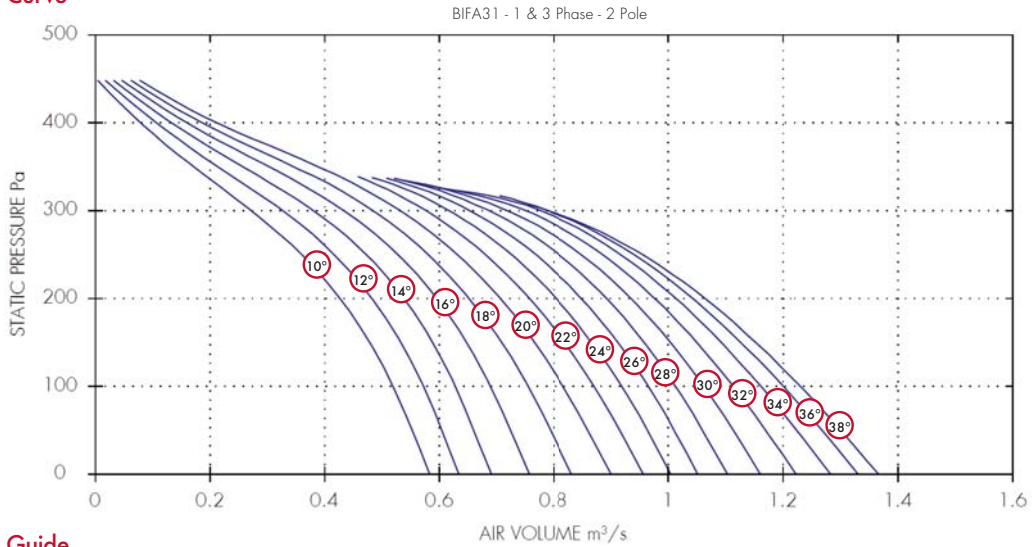

Performance Guide

Dia.	1 Phase		3 Phase		IP	Curve	m³/s at Pa					Motor	dBA
	Stock Ref	Stock Ref	Poles	rpm			Rating	Ref	0	100	200		
315	BIFA311210	BIFA313210	2	2800	IP55	10°	0.58	0.52	0.43	0.27	0.08	0.37	65
315	BIFA311212	BIFA313212	2	2800	IP55	12°	0.63	0.57	0.48	0.33	0.11	0.37	65
315	BIFA311214	BIFA313214	2	2800	IP55	14°	0.69	0.63	0.54	0.38	0.13	0.37	65
315	BIFA311216	BIFA313216	2	2800	IP55	16°	0.76	0.69	0.6	0.43	0.16	0.37	63
315	BIFA311218	BIFA313218	2	2800	IP55	18°	0.83	0.76	0.65	0.48	0.19	0.37	61
315	BIFA311220	BIFA313220	2	2800	IP55	20°	0.9	0.82	0.71	0.53	0.21	0.37	61
315	BIFA311222	BIFA313222	2	2800	IP55	22°	0.96	0.87	0.76	0.58		0.37	62
315	BIFA311224	BIFA313224	2	2800	IP55	24°	1	0.92	0.8	0.62		0.37	63
315	BIFA311226	BIFA313226	2	2800	IP55	26°	1.05	0.97	0.85	0.65		0.55	63
315	BIFA311228	BIFA313228	2	2800	IP55	28°	1.1	1.01	0.89	0.69		0.55	63
315	BIFA311230	BIFA313230	2	2800	IP55	30°	1.16	1.06	0.94	0.72		0.55	64
315	BIFA311232	BIFA313232	2	2800	IP55	32°	1.22	1.11	0.98	0.75		0.55	66
315	BIFA311234	BIFA313234	2	2800	IP55	34°	1.28	1.16	1.01	0.78		0.75	66
315	BIFA311236	BIFA313236	2	2800	IP55	36°	1.33	1.2	1.04	0.79		0.75	66
315	BIFA311238	BIFA313238	2	2800	IP55	38°	1.37	1.23	1.06	0.79		0.75	66

Sound Power Level Spectra dB (ref 10⁻¹² Watts)

Dia.	1 Phase		3 Phase		Spectrum	dB @ 3m										
	Stock Ref	Stock Ref	Poles	rpm		63	125	250	500	1k	2k	4k	8k	dBA @ 3m		
315	BIFA311210	BIFA313210	2	2800	Inlet/Outlet	83	82	82	79	81	80	76	68	65		
315	BIFA311212	BIFA313212	2	2800	Inlet/Outlet	83	82	82	79	81	80	76	68	65		
315	BIFA311214	BIFA313214	2	2800	Inlet/Outlet	83	82	82	79	81	80	76	68	65		
315	BIFA311216	BIFA313216	2	2800	Inlet/Outlet	81	80	80	77	79	78	74	66	63		
315	BIFA311218	BIFA313218	2	2800	Inlet/Outlet	79	78	78	75	77	76	72	64	61		
315	BIFA311220	BIFA313220	2	2800	Inlet/Outlet	79	78	78	75	77	76	72	64	61		
315	BIFA311222	BIFA313222	2	2800	Inlet/Outlet	80	79	79	76	78	77	73	65	62		
315	BIFA311224	BIFA313224	2	2800	Inlet/Outlet	81	80	80	77	79	78	74	66	63		
315	BIFA311226	BIFA313226	2	2800	Inlet/Outlet	81	80	80	77	79	78	74	66	63		
315	BIFA311228	BIFA313228	2	2800	Inlet/Outlet	81	80	80	77	79	78	74	66	63		
315	BIFA311230	BIFA313230	2	2800	Inlet/Outlet	82	81	81	78	80	79	75	67	64		
315	BIFA311232	BIFA313232	2	2800	Inlet/Outlet	84	83	83	80	82	81	77	69	66		
315	BIFA311234	BIFA313234	2	2800	Inlet/Outlet	84	83	83	80	82	81	77	69	66		
315	BIFA311236	BIFA313236	2	2800	Inlet/Outlet	84	83	83	80	82	81	77	69	66		
315	BIFA311238	BIFA313238	2	2800	Inlet/Outlet	84	83	83	80	82	81	77	69	66		

Bifurcated Case Axial Fans (BIFA)

Performance Curve

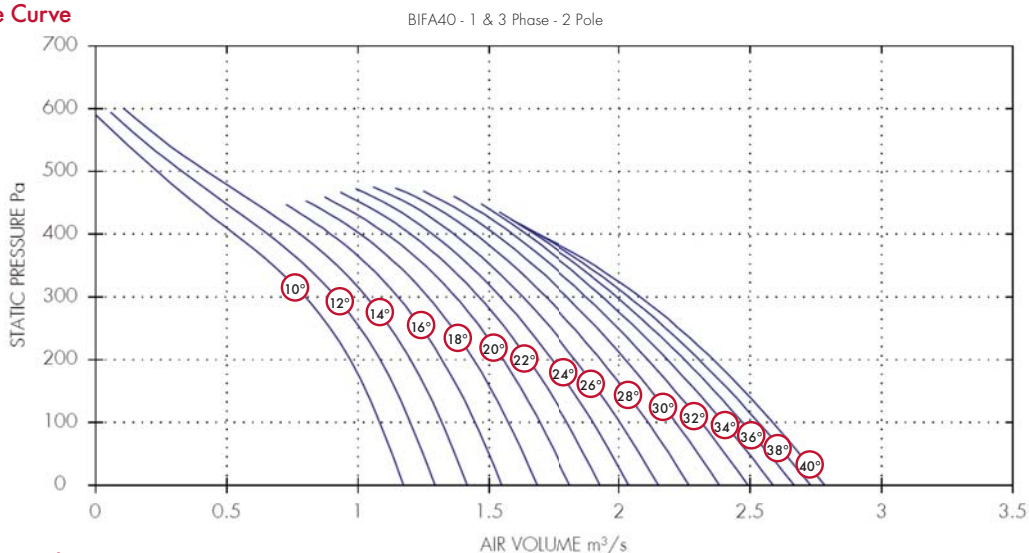

Performance Guide

Dia.	1 Phase		3 Phase		IP	Curve	m³/s at Pa						Motor	dBA @3m
	Stock Ref	Stock Ref	Poles	rpm			Rating	Ref	0	100	200	300		
400	BIFA401210	BIFA403210	2	2800	IP55	10°	1.17	1.08	0.97	0.8	0.53	0.23	0.55	71
400	BIFA401212	BIFA403212	2	2800	IP55	12°	1.29	1.2	1.09	0.92	0.66	0.33	0.55	71
400	BIFA401214	BIFA403214	2	2800	IP55	14°	1.42	1.32	1.2	1.03	0.78	0.42	0.75	71
400	BIFA401216	BIFA403216	2	2800	IP55	16°	1.55	1.45	1.32	1.15	0.9		0.75	71
400	BIFA401218	BIFA403218	2	2800	IP55	18°	1.68	1.57	1.44	1.27	1.01		0.75	71
400	BIFA401220	BIFA403220	2	2800	IP55	20°	1.81	1.69	1.55	1.37	1.11		1.1	71
400	BIFA401222	BIFA403222	2	2800	IP55	22°	1.93	1.8	1.65	1.46	1.2		1.1	66
400	BIFA401224	BIFA403224	2	2800	IP55	24°	2.04	1.9	1.74	1.54	1.28		1.1	66
400	BIFA401226	BIFA403226	2	2800	IP55	26°	2.15	2	1.83	1.63	1.37		1.1	67
400	BIFA401228	BIFA403228	2	2800	IP55	28°	2.27	2.11	1.93	1.72	1.45		1.5	68
400	BIFA401230	BIFA403230	2	2800	IP55	30°	2.38	2.22	2.03	1.8	1.52		1.5	68
400	BIFA401232	BIFA403232	2	2800	IP55	32°	2.49	2.31	2.11	1.88	1.59		1.5	68
400	-	BIFA403234	2	2800	IP55	34°	2.59	2.4	2.19	1.94	1.64		2.2	67
400	-	BIFA403236	2	2800	IP55	36°	2.67	2.47	2.25	1.99	1.67		2.2	66
400	-	BIFA403238	2	2800	IP55	38°	2.73	2.53	2.31	2.04	1.69		2.2	66
400	-	BIFA403240	2	2800	IP55	40°	2.78	2.59	2.36	2.08	1.69		3	66

Sound Power Level Spectra dB (ref 10⁻¹² Watts)

Dia.	1 Phase		3 Phase		Spectrum	dB								dBA @ 3m
	Stock Ref	Stock Ref	Poles	rpm		63	125	250	500	1k	2k	4k	8k	
400	BIFA401210	BIFA403210	2	2800	Inlet/Outlet	89	86	89	86	87	84	81	74	71
400	BIFA401212	BIFA403212	2	2800	Inlet/Outlet	89	86	89	86	87	84	81	74	71
400	BIFA401214	BIFA403214	2	2800	Inlet/Outlet	89	86	89	86	87	84	81	74	71
400	BIFA401216	BIFA403216	2	2800	Inlet/Outlet	89	86	89	86	87	84	81	74	71
400	BIFA401218	BIFA403218	2	2800	Inlet/Outlet	89	86	89	86	87	84	81	74	71
400	BIFA401220	BIFA403220	2	2800	Inlet/Outlet	89	86	89	86	87	84	81	74	71
400	BIFA401222	BIFA403222	2	2800	Inlet/Outlet	84	81	84	81	82	79	76	69	66
400	BIFA401224	BIFA403224	2	2800	Inlet/Outlet	84	81	84	81	82	79	76	69	66
400	BIFA401226	BIFA403226	2	2800	Inlet/Outlet	85	82	85	82	83	80	77	70	67
400	BIFA401228	BIFA403228	2	2800	Inlet/Outlet	86	83	86	83	84	81	78	71	68
400	BIFA401230	BIFA403230	2	2800	Inlet/Outlet	86	83	86	83	84	81	78	71	68
400	BIFA401232	BIFA403232	2	2800	Inlet/Outlet	86	83	86	83	84	81	78	71	68
400	-	BIFA403234	2	2800	Inlet/Outlet	85	82	85	82	83	80	77	70	67
400	-	BIFA403236	2	2800	Inlet/Outlet	84	81	84	81	82	79	76	69	66
400	-	BIFA403238	2	2800	Inlet/Outlet	84	81	84	81	82	79	76	69	66
400	-	BIFA403240	2	2800	Inlet/Outlet	84	81	84	81	82	79	76	69	66

Performance Curve



Performance Guide

Dia.	3 Phase			IP Rating	Curve Ref	m³/s at Pa						Motor kW	dBA @3m
	Stock Ref	Poles	rpm			0	150	300	450	600	750		
450	BIFA453210	2	2880	IP55	10°	1.72	1.57	1.37	1.04	0.56	0.11	1.1	74
450	BIFA453212	2	2880	IP55	12°	1.89	1.74	1.54	1.22	0.73	0.21	1.1	73
450	BIFA453214	2	2880	IP55	14°	2.08	1.91	1.7	1.4	0.9	0.32	1.5	72
450	BIFA453216	2	2880	IP55	16°	2.27	2.1	1.88	1.57			1.5	71
450	BIFA453218	2	2880	IP55	18°	2.47	2.28	2.05	1.74	1.2		1.5	70
450	BIFA453220	2	2880	IP55	20°	2.65	2.46	2.21	1.88	1.35		2.2	70
450	BIFA453222	2	2880	IP55	22°	2.82	2.61	2.35	2.01	1.49		2.2	70
450	BIFA453224	2	2880	IP55	24°	2.99	2.76	2.48	2.13	1.62		2.2	70
450	BIFA453226	2	2880	IP55	26°	3.15	2.91	2.61	2.25	1.75		2.2	70
450	BIFA453228	2	2880	IP55	28°	3.32	3.06	2.75	2.38	1.86		3	70
450	BIFA453230	2	2880	IP55	30°	3.49	3.21	2.89	2.5	1.97		3	70
450	BIFA453232	2	2880	IP55	32°	3.65	3.35	3.01	2.6	2.08		3	70

Sound Power Level Spectra dB (ref 10⁻¹² Watts)

Dia.	3 Phase Stock Ref	Poles	Spectrum	dB @ 3m										
				63	125	250	500	1k	2k	4k	8k	dBA @ 3m		
450	BIFA453210	2	Inlet/Outlet	92	89	92	89	90	87	84	77	74		
450	BIFA453212	2	Inlet/Outlet	91	88	91	88	89	86	83	76	73		
450	BIFA453214	2	Inlet/Outlet	90	87	90	87	88	85	82	75	72		
450	BIFA453216	2	Inlet/Outlet	89	86	89	86	87	84	81	74	71		
450	BIFA453218	2	Inlet/Outlet	88	85	88	85	86	83	80	73	70		
450	BIFA453220	2	Inlet/Outlet	88	85	88	85	86	83	80	73	70		
450	BIFA453222	2	Inlet/Outlet	88	85	88	85	86	83	80	73	70		
450	BIFA453224	2	Inlet/Outlet	88	85	88	85	86	83	80	73	70		
450	BIFA453226	2	Inlet/Outlet	88	85	88	85	86	83	80	73	70		
450	BIFA453228	2	Inlet/Outlet	88	85	88	85	86	83	80	73	70		
450	BIFA453230	2	Inlet/Outlet	88	85	88	85	86	83	80	73	70		
450	BIFA453232	2	Inlet/Outlet	88	85	88	85	86	83	80	73	70		

Bifurcated Case Axial Fans (BIFA)

Performance Curve

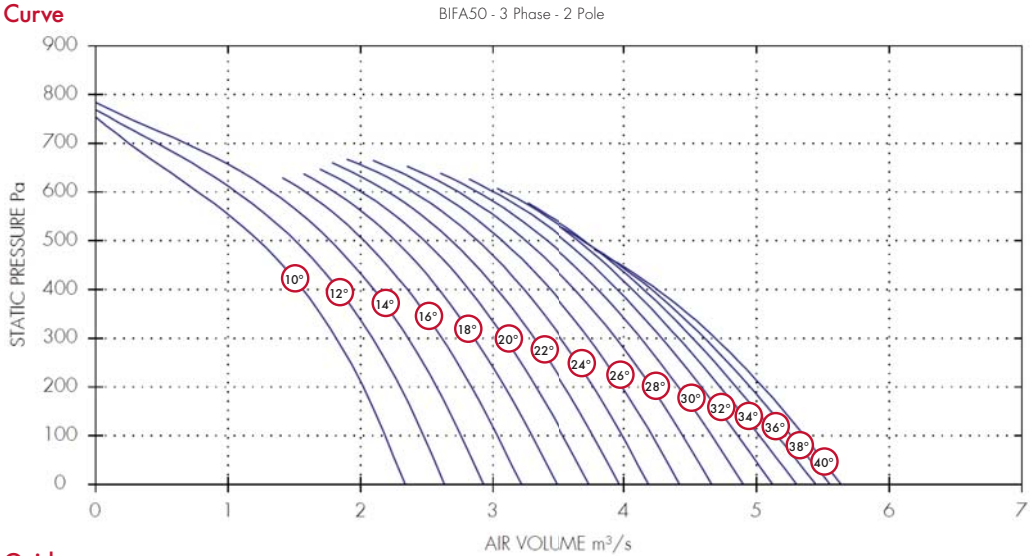

Performance Guide

Dia.	3 Phase			IP Rating	Curve Ref	m³/s at Pa						Motor kW	dBA @3m
	Stock Ref	Poles	rpm			0	150	300	450	600	750		
500	BIFA503210	2	2880	IP55	10°	2.34	2.11	1.82	1.41	0.77	0.02	1.5	74
500	BIFA503212	2	2880	IP55	12°	2.64	2.39	2.09	1.68	1.06	0.12	1.5	73
500	BIFA503214	2	2880	IP55	14°	2.93	2.67	2.36	1.95	1.33	0.26	2.2	72
500	BIFA503216	2	2880	IP55	16°	3.21	2.94	2.62	2.2	1.58		2.2	71
500	BIFA503218	2	2880	IP55	18°	3.48	3.19	2.86	2.44	1.8		2.2	71
500	BIFA503220	2	2880	IP55	20°	3.73	3.43	3.09	2.66	2.01		3	71
500	BIFA503222	2	2880	IP55	22°	3.96	3.66	3.31	2.87	2.21		3	71
500	BIFA503224	2	2880	IP55	24°	4.19	3.88	3.52	3.07	2.4		3	71
500	BIFA503226	2	2880	IP55	26°	4.42	4.11	3.73	3.26	2.58		4	71
500	BIFA503228	2	2880	IP55	28°	4.66	4.33	3.94	3.45	2.74		4	72
500	BIFA503230	2	2880	IP55	30°	4.9	4.54	4.13	3.62	2.88		4	72
500	BIFA503232	2	2880	IP55	32°	5.12	4.72	4.28	3.76	3		5.5	72
500	BIFA503234	2	2880	IP55	34°	5.3	4.88	4.41	3.87	3.08		5.5	72
500	BIFA503236	2	2880	IP55	36°	5.45	5	4.52	3.94			5.5	72
500	BIFA503238	2	2880	IP55	38°	5.55	5.11	4.61	3.97			7.5	72
500	BIFA503240	2	2880	IP55	40°	5.64	5.21	4.69	3.98			7.5	72

Sound Power Level Spectra dB (ref 10⁻¹² Watts)

Dia.	3 Phase			Spectrum	63	125	250	500	1k	2k	4k	8k	dBA @ 3m
	Stock Ref	Poles	rpm										
500	BIFA503210	2	2880	Inlet/Outlet	93	84	91	91	91	87	85	78	74
500	BIFA503212	2	2880	Inlet/Outlet	92	83	90	90	90	86	84	77	73
500	BIFA503214	2	2880	Inlet/Outlet	91	82	89	89	89	85	83	76	72
500	BIFA503216	2	2880	Inlet/Outlet	90	81	88	88	88	84	82	75	71
500	BIFA503218	2	2880	Inlet/Outlet	90	81	88	88	88	84	82	75	71
500	BIFA503220	2	2880	Inlet/Outlet	90	81	88	88	88	84	82	75	71
500	BIFA503222	2	2880	Inlet/Outlet	90	81	88	88	88	84	82	75	71
500	BIFA503224	2	2880	Inlet/Outlet	90	81	88	88	88	84	82	75	71
500	BIFA503226	2	2880	Inlet/Outlet	90	81	88	88	88	84	82	75	71
500	BIFA503228	2	2880	Inlet/Outlet	91	82	89	89	89	85	83	76	72
500	BIFA503230	2	2880	Inlet/Outlet	91	82	89	89	89	85	83	76	72
500	BIFA503232	2	2880	Inlet/Outlet	91	82	89	89	89	85	83	76	72
500	BIFA503234	2	2880	Inlet/Outlet	91	82	89	89	89	85	83	76	72
500	BIFA503236	2	2880	Inlet/Outlet	91	82	89	89	89	85	83	76	72
500	BIFA503238	2	2880	Inlet/Outlet	91	82	89	89	89	85	83	76	72
500	BIFA503240	2	2880	Inlet/Outlet	91	82	89	89	89	85	83	76	72

Performance Curve

BIFA56 - 3 Phase - 2 Pole

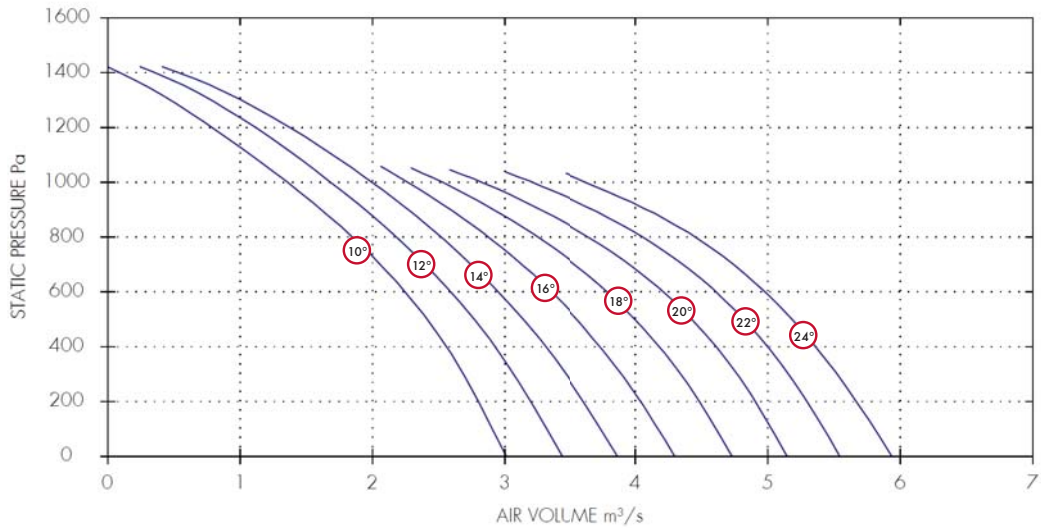

Performance Guide

3 Phase			IP	Curve	m³/s at Pa									Motor	dBa
Dia.	Stock Ref	Poles	rpm	Rating	Ref	0	200	400	600	800	1000	1200	1400	kW	@3m
560	BIFA563210	2	2880	IP55	10°	3.01	2.8	2.56	2.25	1.85	1.36	0.79	0.09	4	79
560	BIFA563212	2	2880	IP55	12°	3.44	3.2	2.93	2.59	2.18	1.69	1.11	0.35	4	79
560	BIFA563214	2	2880	IP55	14°	3.87	3.61	3.31	2.95	2.52	1.99	1.37	0.53	4	79
560	BIFA563216	2	2880	IP55	16°	4.3	4.04	3.73	3.36	2.88	2.27			5.5	79
560	BIFA563218	2	2880	IP55	18°	4.73	4.48	4.18	3.79	3.25	2.53			5.5	79
560	BIFA563220	2	2880	IP55	20°	5.15	4.91	4.61	4.21	3.65	2.83			7.5	79
560	BIFA563222	2	2880	IP55	22°	5.54	5.3	5	4.61	4.05	3.21			7.5	79
560	BIFA563224	2	2880	IP55	24°	5.94	5.67	5.36	4.98	4.45	3.62			7.5	79

Sound Power Level Spectra dB (ref 10⁻¹² Watts)

Dia.	3 Phase Stock Ref	Poles	Spectrum	63	125	250	500	1k	2k	4k	8k	dBa @ 3m
560	BIFA563210	2	Inlet/Outlet	94	89	97	98	94	91	86	82	79
560	BIFA563212	2	Inlet/Outlet	94	89	97	98	94	91	86	82	79
560	BIFA563214	2	Inlet/Outlet	94	89	97	98	94	91	86	82	79
560	BIFA563216	2	Inlet/Outlet	94	89	97	98	94	91	86	82	79
560	BIFA563218	2	Inlet/Outlet	94	89	97	98	94	91	86	82	79
560	BIFA563220	2	Inlet/Outlet	94	89	97	98	94	91	86	82	79
560	BIFA563222	2	Inlet/Outlet	94	89	97	98	94	91	86	82	79
560	BIFA563224	2	Inlet/Outlet	94	89	97	98	94	91	86	82	79

Bifurcated Case Axial Fans (BIFA)

Performance Curve

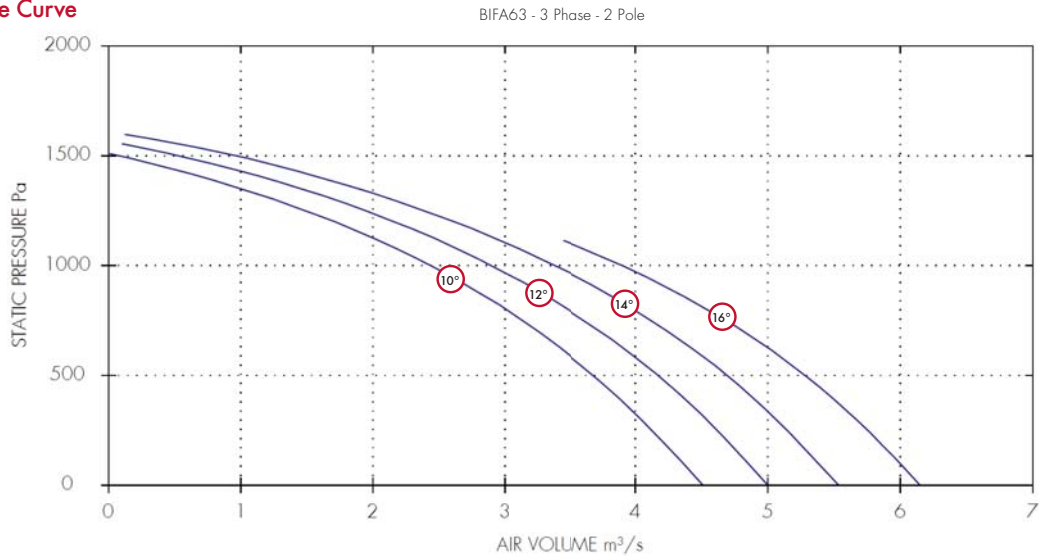

Performance Guide

Dia.	3 Phase			IP	Curve	m³/s at Pa								Motor	dBA @3m
	Stock Ref	Poles	rpm			Rating	Ref	0	200	400	600	800	1000		
630	BIFA633210	2	2940	IP55	10°	4.51	4.2	3.87	3.47	3.01	2.44	1.7	0.72	5.5	84
630	BIFA633212	2	2940	IP55	12°	5	4.7	4.36	3.96	3.48	2.9	2.16	1.17	5.5	84
630	BIFA633214	2	2940	IP55	14°	5.53	5.22	4.88	4.48	3.98	3.38	2.61	1.6	7.5	84
630	BIFA633216	2	2940	IP55	16°	6.15	5.84	5.48	5.06	4.54	3.89			7.5	84

Sound Power Level Spectra dB (ref 10⁻¹² Watts)

Dia.	3 Phase Stock Ref	Poles	Spectrum	63	125	250	500	1k	2k	4k	8k	dBA @ 3m
630	BIFA633210	2	Inlet/Outlet	99	94	102	103	99	96	91	87	84
630	BIFA633212	2	Inlet/Outlet	99	94	102	103	99	96	91	87	84
630	BIFA633214	2	Inlet/Outlet	99	94	102	103	99	96	91	87	84
630	BIFA633216	2	Inlet/Outlet	99	94	102	103	99	96	91	87	84

Performance Curve

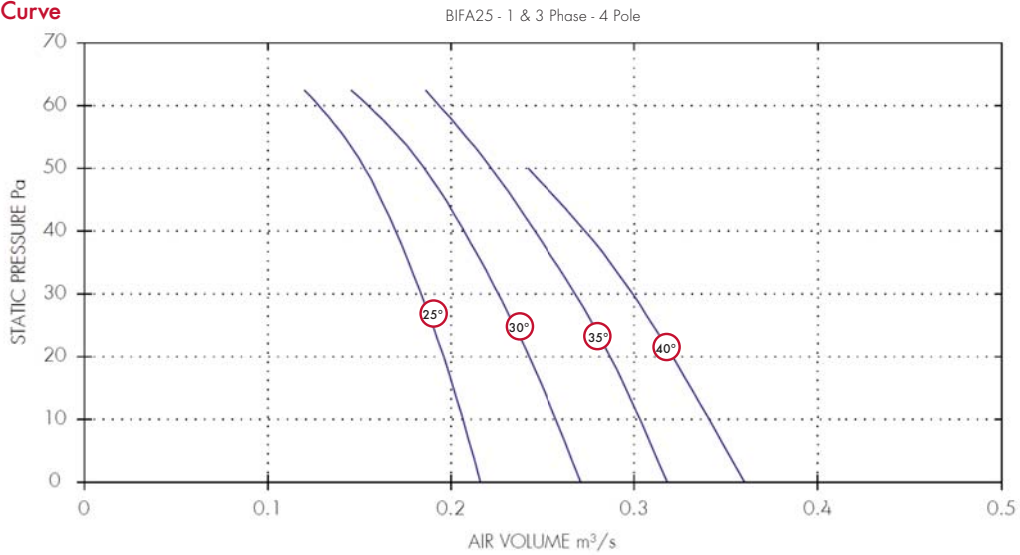

Performance Guide

Dia.	1 Phase		3 Phase		IP	Curve	m³/s at Pa							Motor	dBA @3m
	Stock Ref	Stock Ref	Poles	rpm			Rating	Ref	0	10	20	30	40		
250	BIFA251425	BIFA253425	4	1400	IP55	25°	0.22	0.21	0.2	0.18	0.17	0.15	0.13	0.25	46
250	BIFA251430	BIFA253430	4	1400	IP55	30°	0.27	0.26	0.24	0.23	0.21	0.19	0.15	0.25	45
250	BIFA251435	BIFA253435	4	1400	IP55	35°	0.32	0.3	0.29	0.27	0.25	0.22	0.19	0.25	46
250	BIFA251440	BIFA253440	4	1400	IP55	40°	0.36	0.34	0.32	0.3	0.27	0.24	0.24	0.25	46

Sound Power Level Spectra dB (ref 10⁻¹² Watts)

Dia.	1 Phase		3 Phase		Spectrum	dB								dBA @ 3m
	Stock Ref	Stock Ref	Poles	rpm		63	125	250	500	1k	2k	4k	8k	
250	BIFA251425	BIFA253425	4	1400	Inlet/Outlet	61	68	64	63	61	58	55	52	46
250	BIFA251430	BIFA253430	4	1400	Inlet/Outlet	60	67	63	62	60	57	54	51	45
250	BIFA251435	BIFA253435	4	1400	Inlet/Outlet	61	68	64	63	61	58	55	52	46
250	BIFA251440	BIFA253440	4	1400	Inlet/Outlet	61	68	64	63	61	58	55	52	46

Bifurcated Case Axial Fans (BIFA)

Performance Curve

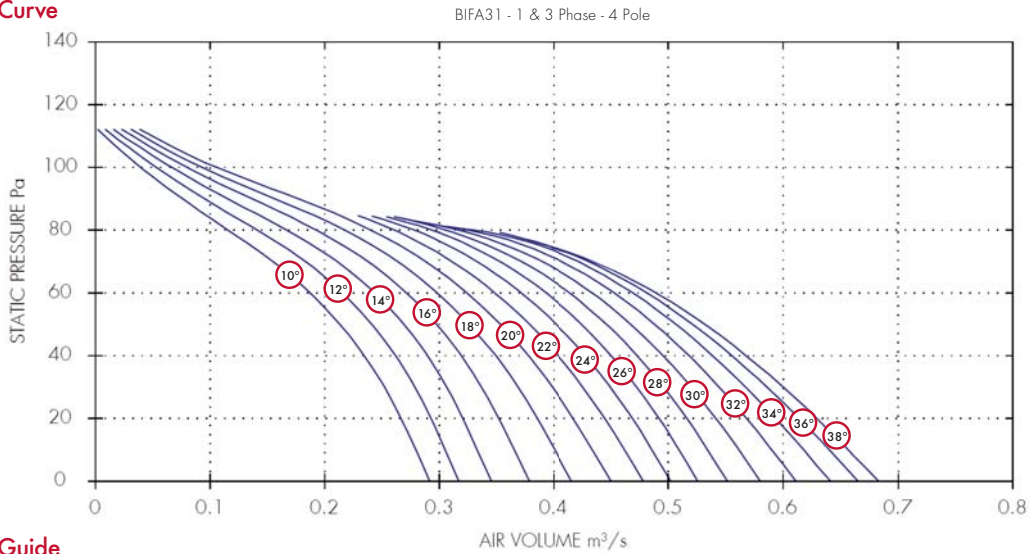

Performance Guide

Dia.	1 Phase		3 Phase		IP	Curve	m³/s at Pa						Motor	dBa
	Stock Ref	Stock Ref	Poles	rpm			Rating	Ref	0	20	40	60		
315	BIFA311410	BIFA313410	4	1400	IP55	10°	0.29	0.27	0.23	0.19	0.12	0.04	0.25	49
315	BIFA311412	BIFA313412	4	1400	IP55	12°	0.32	0.29	0.26	0.22	0.14	0.05	0.25	49
315	BIFA311414	BIFA313414	4	1400	IP55	14°	0.35	0.32	0.29	0.24	0.17	0.07	0.25	49
315	BIFA313416	BIFA313416	4	1400	IP55	16°	0.38	0.35	0.32	0.27	0.19	0.08	0.25	44
315	BIFA311418	BIFA313418	4	1400	IP55	18°	0.42	0.39	0.35	0.3	0.22	0.09	0.25	44
315	BIFA311420	BIFA313420	4	1400	IP55	20°	0.45	0.42	0.38	0.32	0.24	0.11	0.25	44
315	BIFA311422	BIFA313422	4	1400	IP55	22°	0.48	0.45	0.4	0.35	0.26		0.25	44
315	BIFA311424	BIFA313424	4	1400	IP55	24°	0.5	0.47	0.43	0.37	0.28		0.25	46
315	BIFA311426	BIFA313426	4	1400	IP55	26°	0.53	0.49	0.45	0.39	0.29		0.25	46
315	BIFA311428	BIFA313428	4	1400	IP55	28°	0.55	0.52	0.47	0.41	0.31		0.25	46
315	BIFA311430	BIFA313430	4	1400	IP55	30°	0.58	0.54	0.5	0.43	0.32		0.25	46
315	BIFA311432	BIFA313432	4	1400	IP55	32°	0.61	0.57	0.52	0.45	0.32		0.25	48
315	BIFA311434	BIFA313434	4	1400	IP55	34°	0.64	0.59	0.54	0.47	0.33		0.25	48
315	BIFA311436	BIFA313436	4	1400	IP55	36°	0.67	0.61	0.56	0.48			0.25	48
315	BIFA311438	BIFA313438	4	1400	IP55	38°	0.68	0.63	0.57	0.49			0.25	48

Sound Power Level Spectra dB (ref 10⁻¹² Watts)

Dia.	1 Phase		3 Phase		Poles	Spectrum	dB @ 3m									
	Stock Ref	Stock Ref	Stock Ref	Stock Ref			63	125	250	500	1k	2k	4k	8k	dBa @ 3m	
315	BIFA311410	BIFA313410	BIFA313410	BIFA313410	4	Inlet/Outlet	66	69	67	64	65	63	58	48	49	
315	BIFA311412	BIFA313412	BIFA313412	BIFA313412	4	Inlet/Outlet	66	69	67	64	65	63	58	48	49	
315	BIFA311414	BIFA313414	BIFA313414	BIFA313414	4	Inlet/Outlet	66	69	67	64	65	63	58	48	49	
315	BIFA313416	BIFA313416	BIFA313416	BIFA313416	4	Inlet/Outlet	61	64	62	59	60	58	53	43	44	
315	BIFA311418	BIFA313418	BIFA313418	BIFA313418	4	Inlet/Outlet	61	64	62	59	60	58	53	43	44	
315	BIFA311420	BIFA313420	BIFA313420	BIFA313420	4	Inlet/Outlet	61	64	62	59	60	58	53	43	44	
315	BIFA311422	BIFA313422	BIFA313422	BIFA313422	4	Inlet/Outlet	61	64	62	59	60	58	53	43	44	
315	BIFA311424	BIFA313424	BIFA313424	BIFA313424	4	Inlet/Outlet	63	66	64	61	62	60	55	45	46	
315	BIFA311426	BIFA313426	BIFA313426	BIFA313426	4	Inlet/Outlet	63	66	64	61	62	60	55	45	46	
315	BIFA311428	BIFA313428	BIFA313428	BIFA313428	4	Inlet/Outlet	63	66	64	61	62	60	55	45	46	
315	BIFA311430	BIFA313430	BIFA313430	BIFA313430	4	Inlet/Outlet	63	66	64	61	62	60	55	45	46	
315	BIFA311432	BIFA313432	BIFA313432	BIFA313432	4	Inlet/Outlet	65	68	66	63	64	62	57	47	48	
315	BIFA311434	BIFA313434	BIFA313434	BIFA313434	4	Inlet/Outlet	65	68	66	63	64	62	57	47	48	
315	BIFA311436	BIFA313436	BIFA313436	BIFA313436	4	Inlet/Outlet	65	68	66	63	64	62	57	47	48	
315	BIFA311438	BIFA313438	BIFA313438	BIFA313438	4	Inlet/Outlet	65	68	66	63	64	62	57	47	48	

Performance Curve

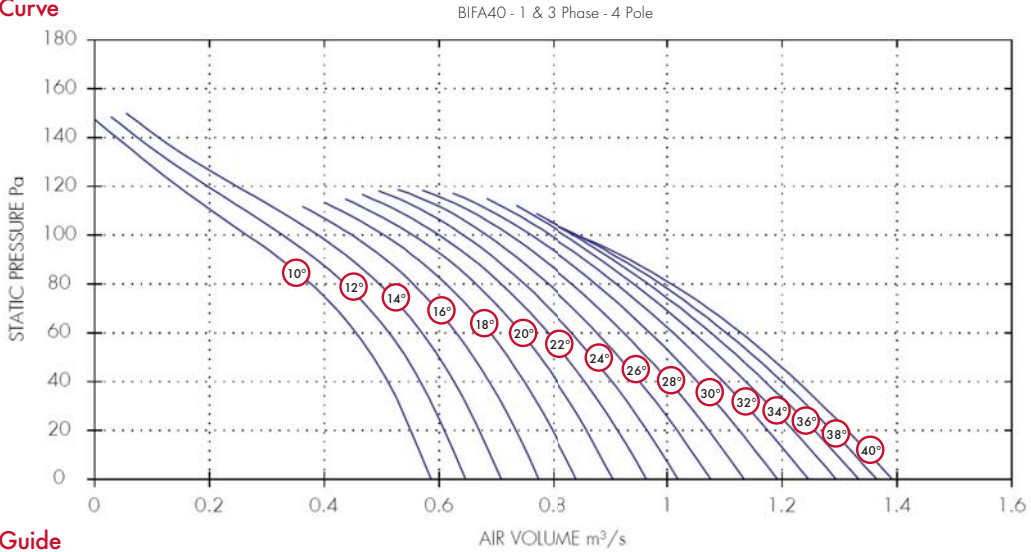

Performance Guide

Dia.	1 Phase		Poles	rpm	IP Rating	Curve Ref	m³/s at Pa								Motor kW	dBA @3m
	Stock Ref	3 Phase Stock Ref					0	20	40	60	80	100	120	140		
400	BIFA401410	BIFA403410	4	1400	IP55	10°	0.59	0.55	0.51	0.46	0.38	0.27	0.15	0.04	0.25	54
400	BIFA401412	BIFA403412	4	1400	IP55	12°	0.65	0.61	0.57	0.51	0.44	0.33	0.2	0.08	0.25	54
400	BIFA401414	BIFA403414	4	1400	IP55	14°	0.71	0.67	0.63	0.57	0.5	0.39	0.25	0.11	0.25	54
400	BIFA401416	BIFA403416	4	1400	IP55	16°	0.77	0.73	0.69	0.63	0.56	0.45			0.25	54
400	BIFA401418	BIFA403418	4	1400	IP55	18°	0.84	0.8	0.75	0.69	0.61	0.5			0.25	54
400	BIFA401420	BIFA403420	4	1400	IP55	20°	0.91	0.86	0.81	0.74	0.66	0.55			0.25	54
400	BIFA401422	BIFA403422	4	1400	IP55	22°	0.96	0.91	0.86	0.79	0.71	0.6			0.25	48
400	BIFA401424	BIFA403424	4	1400	IP55	24°	1.02	0.97	0.9	0.83	0.75	0.64			0.25	48
400	BIFA401426	BIFA403426	4	1400	IP55	26°	1.08	1.02	0.95	0.88	0.79	0.68			0.25	50
400	BIFA401428	BIFA403428	4	1400	IP55	28°	1.13	1.07	1	0.92	0.83	0.72			0.25	51
400	BIFA401430	BIFA403430	4	1400	IP55	30°	1.19	1.13	1.05	0.97	0.88	0.76			0.25	52
400	BIFA401432	BIFA403432	4	1400	IP55	32°	1.25	1.18	1.1	1.01	0.91	0.79			0.25	52
400	BIFA401434	BIFA403434	4	1400	IP55	34°	1.29	1.22	1.14	1.05	0.94	0.82			0.25	51
400	BIFA401436	BIFA403436	4	1400	IP55	36°	1.33	1.26	1.17	1.08	0.97	0.84			0.25	51
400	BIFA401438	BIFA403438	4	1400	IP55	38°	1.36	1.29	1.2	1.1	0.99	0.84			0.25	50
400	BIFA401440	BIFA403440	4	1400	IP55	40°	1.39	1.31	1.23	1.13	1.01	0.84			0.37	50

Sound Power Level Spectra dB (ref 10⁻¹² Watts)

Dia.	1 Phase		Poles	Spectrum	dB								dBA @ 3m
	Stock Ref	1 Phase Stock Ref			63	125	250	500	1k	2k	4k	8k	
400	BIFA401410	BIFA403410	4	Inlet/Outlet	72	74	73	69	70	67	63	54	54
400	BIFA401412	BIFA403412	4	Inlet/Outlet	72	74	73	69	70	67	63	54	54
400	BIFA401414	BIFA403414	4	Inlet/Outlet	72	74	73	69	70	67	63	54	54
400	BIFA401416	BIFA403416	4	Inlet/Outlet	72	74	73	69	70	67	63	54	54
400	BIFA401418	BIFA403418	4	Inlet/Outlet	72	74	73	69	70	67	63	54	54
400	BIFA401420	BIFA403420	4	Inlet/Outlet	72	74	73	69	70	67	63	54	54
400	BIFA401422	BIFA403422	4	Inlet/Outlet	66	68	67	63	64	61	57	48	48
400	BIFA401424	BIFA403424	4	Inlet/Outlet	66	68	67	63	64	61	57	48	48
400	BIFA401426	BIFA403426	4	Inlet/Outlet	68	70	69	65	66	63	59	50	50
400	BIFA401428	BIFA403428	4	Inlet/Outlet	69	71	70	66	67	64	60	51	51
400	BIFA401430	BIFA403430	4	Inlet/Outlet	70	72	71	67	68	65	61	52	52
400	BIFA401432	BIFA403432	4	Inlet/Outlet	70	72	71	67	68	65	61	52	52
400	BIFA401434	BIFA403434	4	Inlet/Outlet	69	71	70	66	67	64	60	51	51
400	BIFA401436	BIFA403436	4	Inlet/Outlet	69	71	70	66	67	64	60	51	51
400	BIFA401438	BIFA403438	4	Inlet/Outlet	68	70	69	65	66	63	59	50	50
400	BIFA401440	BIFA403440	4	Inlet/Outlet	68	70	69	65	66	63	59	50	50

Bifurcated Case Axial Fans (BIFA)

Performance Curve

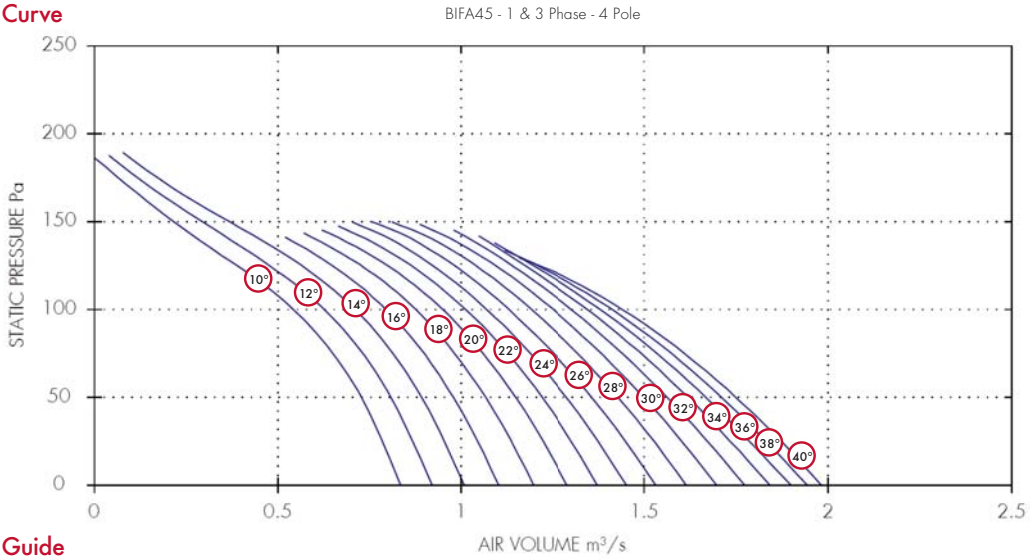

Performance Guide

Dia.	1 Phase		3 Phase		IP	Curve	AIR VOLUME m³/s					Motor	dBA @3m
	Stock Ref	Stock Ref	Poles	rpm			Rating	Ref	0	40	80		
450	BIFA451410	BIFA453410	4	1400	IP55	10°	0.83	0.75	0.63	0.42	0.15	0.25	59
450	BIFA451412	BIFA453412	4	1400	IP55	12°	0.92	0.83	0.71	0.51	0.22	0.25	59
450	BIFA451414	BIFA453414	4	1400	IP55	14°	1.01	0.92	0.8	0.6	0.28	0.25	59
450	BIFA451416	BIFA453416	4	1400	IP55	16°	1.1	1.01	0.88	0.68		0.25	59
450	BIFA451418	BIFA453418	4	1400	IP55	18°	1.2	1.1	0.96	0.76		0.25	54
450	BIFA451420	BIFA453420	4	1400	IP55	20°	1.29	1.18	1.04	0.83		0.25	55
450	BIFA451422	BIFA453422	4	1400	IP55	22°	1.37	1.25	1.11	0.9		0.25	54
450	BIFA451424	BIFA453424	4	1400	IP55	24°	1.45	1.32	1.17	0.96		0.25	54
450	BIFA451426	BIFA453426	4	1400	IP55	26°	1.53	1.4	1.23	1.01		0.37	54
450	BIFA451428	BIFA453428	4	1400	IP55	28°	1.61	1.47	1.29	1.07		0.37	54
450	BIFA451430	BIFA453430	4	1400	IP55	30°	1.7	1.54	1.36	1.13		0.37	54
450	BIFA451432	BIFA453432	4	1400	IP55	32°	1.77	1.61	1.41	1.17		0.37	54
450	BIFA451434	BIFA453434	4	1400	IP55	34°	1.84	1.67	1.46	1.21		0.55	54
450	BIFA451436	BIFA453436	4	1400	IP55	36°	1.9	1.72	1.51	1.24		0.55	54
450	BIFA451438	BIFA453438	4	1400	IP55	38°	1.94	1.76	1.54	1.25		0.55	54
450	BIFA451440	BIFA453440	4	1400	IP55	40°	1.98	1.8	1.58	1.27		0.55	54

Sound Power Level Spectra dB (ref 10⁻¹² Watts)

Dia.	1 Phase		3 Phase		Spectrum	dB @ 3m										
	Stock Ref	Stock Ref	Poles	rpm		63	125	250	500	1k	2k	4k	8k	dBA @ 3m		
450	BIFA451410	BIFA453410	4	1400	Inlet/Outlet	77	79	78	74	75	72	68	59	59		
450	BIFA451412	BIFA453412	4	1400	Inlet/Outlet	77	79	78	74	75	72	68	59	59		
450	BIFA451414	BIFA453414	4	1400	Inlet/Outlet	77	79	78	74	75	72	68	59	59		
450	BIFA451416	BIFA453416	4	1400	Inlet/Outlet	77	79	78	74	75	72	68	59	59		
450	BIFA451418	BIFA453418	4	1400	Inlet/Outlet	72	74	73	69	70	67	63	54	54		
450	BIFA451420	BIFA453420	4	1400	Inlet/Outlet	73	75	74	70	71	68	64	55	55		
450	BIFA451422	BIFA453422	4	1400	Inlet/Outlet	72	74	73	69	70	67	63	54	54		
450	BIFA451424	BIFA453424	4	1400	Inlet/Outlet	72	74	73	69	70	67	63	54	54		
450	BIFA451426	BIFA453426	4	1400	Inlet/Outlet	72	74	73	69	70	67	63	54	54		
450	BIFA451428	BIFA453428	4	1400	Inlet/Outlet	72	74	73	69	70	67	63	54	54		
450	BIFA451430	BIFA453430	4	1400	Inlet/Outlet	72	74	73	69	70	67	63	54	54		
450	BIFA451432	BIFA453432	4	1400	Inlet/Outlet	72	74	73	69	70	67	63	54	54		
450	BIFA451434	BIFA453434	4	1400	Inlet/Outlet	72	74	73	69	70	67	63	54	54		
450	BIFA451436	BIFA453436	4	1400	Inlet/Outlet	72	74	73	69	70	67	63	54	54		
450	BIFA451438	BIFA453438	4	1400	Inlet/Outlet	72	74	73	69	70	67	63	54	54		
450	BIFA451440	BIFA453440	4	1400	Inlet/Outlet	72	74	73	69	70	67	63	54	54		

Performance Curve

BIFA50 - 1 & 3 Phase - 4 Pole

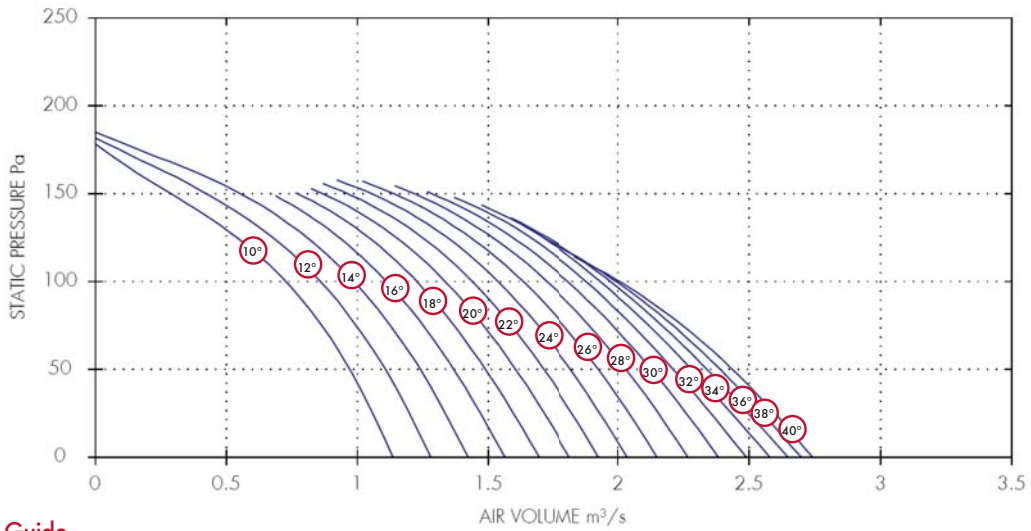

Performance Guide

Dia.	1 Phase		3 Phase		IP Rating	Curve Ref	m³/s at Pa					Motor kW	dBA @3m
	Stock Ref	Stock Ref	Poles	rpm			0	40	80	120	160		
500	BIFA501410	BIFA503410	4	1400	IP55	10°	1.14	1.01	0.84	0.58	0.18	0.25	58
500	BIFA501412	BIFA503412	4	1400	IP55	12°	1.28	1.15	0.97	0.72	0.3	0.25	58
500	BIFA501414	BIFA503414	4	1400	IP55	14°	1.42	1.28	1.1	0.85	0.42	0.25	58
500	BIFA501416	BIFA503416	4	1400	IP55	16°	1.56	1.41	1.22	0.97		0.25	58
500	BIFA501418	BIFA503418	4	1400	IP55	18°	1.69	1.53	1.34	1.09		0.25	58
500	BIFA501420	BIFA503420	4	1400	IP55	20°	1.82	1.65	1.45	1.19		0.37	58
500	BIFA501422	BIFA503422	4	1400	IP55	22°	1.93	1.76	1.56	1.29		0.37	58
500	BIFA501424	BIFA503424	4	1400	IP55	24°	2.04	1.87	1.66	1.39		0.37	58
500	BIFA501426	BIFA503426	4	1400	IP55	26°	2.15	1.97	1.76	1.48		0.37	60
500	BIFA501428	BIFA503428	4	1400	IP55	28°	2.27	2.08	1.86	1.56		0.55	60
500	BIFA501430	BIFA503430	4	1400	IP55	30°	2.38	2.18	1.95	1.64		0.55	61
500	BIFA501432	BIFA503432	4	1400	IP55	32°	2.49	2.27	2.02	1.71		0.55	61
500	BIFA501434	BIFA503434	4	1400	IP55	34°	2.58	2.34	2.08	1.76		0.55	61
500	BIFA501436	BIFA503436	4	1400	IP55	36°	2.65	2.4	2.13	1.78		0.75	61
500	BIFA501438	BIFA503438	4	1400	IP55	38°	2.7	2.46	2.17	1.77		0.75	61
500	BIFA501440	BIFA503440	4	1400	IP55	40°	2.74	2.5	2.2			0.75	61

Sound Power Level Spectra dB (ref 10⁻¹² Watts)

Dia.	1 Phase		3 Phase		Spectrum	dB @ 3m										
	Stock Ref	Stock Ref	Poles	rpm		63	125	250	500	1k	2k	4k	8k	dBA @ 3m		
500	BIFA501410	BIFA503410	4	1400	Inlet/Outlet	76	78	74	75	74	71	68	58	58		
500	BIFA501412	BIFA503412	4	1400	Inlet/Outlet	76	78	74	75	74	71	68	58	58		
500	BIFA501414	BIFA503414	4	1400	Inlet/Outlet	76	78	74	75	74	71	68	58	58		
500	BIFA501416	BIFA503416	4	1400	Inlet/Outlet	76	78	74	75	74	71	68	58	58		
500	BIFA501418	BIFA503418	4	1400	Inlet/Outlet	76	78	74	75	74	71	68	58	58		
500	BIFA501420	BIFA503420	4	1400	Inlet/Outlet	76	78	74	75	74	71	68	58	58		
500	BIFA501422	BIFA503422	4	1400	Inlet/Outlet	76	78	74	75	74	71	68	58	58		
500	BIFA501424	BIFA503424	4	1400	Inlet/Outlet	76	78	74	75	74	71	68	58	58		
500	BIFA501426	BIFA503426	4	1400	Inlet/Outlet	78	80	76	77	76	73	70	60	60		
500	BIFA501428	BIFA503428	4	1400	Inlet/Outlet	78	80	76	77	76	73	70	60	60		
500	BIFA501430	BIFA503430	4	1400	Inlet/Outlet	79	81	77	78	77	74	71	61	61		
500	BIFA501432	BIFA503432	4	1400	Inlet/Outlet	79	81	77	78	77	74	71	61	61		
500	BIFA501434	BIFA503434	4	1400	Inlet/Outlet	79	81	77	78	77	74	71	61	61		
500	BIFA501436	BIFA503436	4	1400	Inlet/Outlet	79	81	77	78	77	74	71	61	61		
500	BIFA501438	BIFA503438	4	1400	Inlet/Outlet	79	81	77	78	77	74	71	61	61		
500	BIFA501440	BIFA503440	4	1400	Inlet/Outlet	79	81	77	78	77	74	71	61	61		

Bifurcated Case Axial Fans (BIFA)

Performance Curve

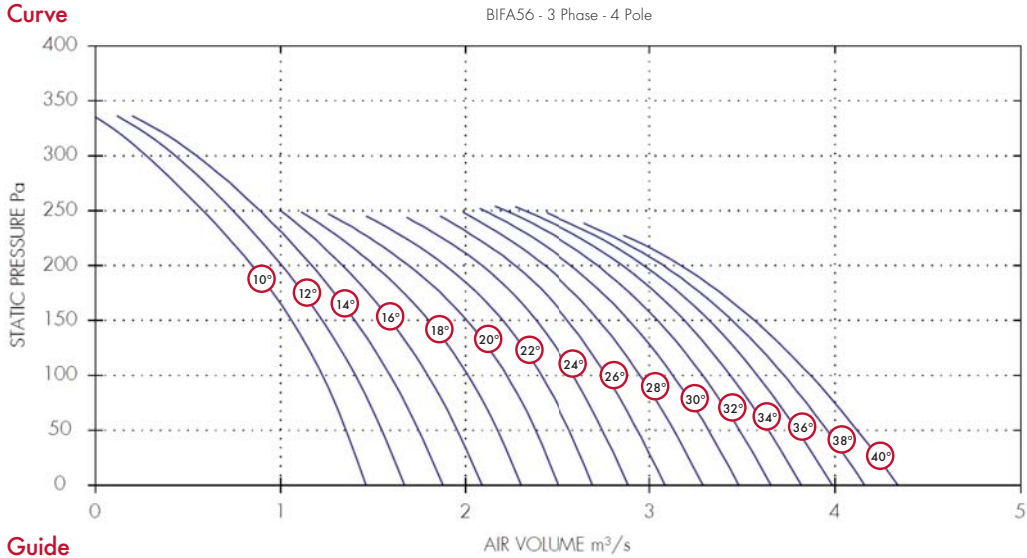

Performance Guide

Dia.	3 Phase			IP Rating	Curve Ref	m³/s at Pa							Motor kW	dBA @3m
	Stock Ref	Poles	rpm			0	50	100	150	200	250	300		
560	BIFA563410	4	1400	IP55	10°	1.46	1.36	1.23	1.06	0.85	0.58	0.28	0.55	64
560	BIFA563412	4	1400	IP55	12°	1.67	1.55	1.41	1.23	1.01	0.74	0.43	0.55	64
560	BIFA563414	4	1400	IP55	14°	1.88	1.75	1.59	1.4	1.17	0.89	0.55	0.55	64
560	BIFA563416	4	1400	IP55	16°	2.09	1.96	1.8	1.59	1.34			0.55	64
560	BIFA563418	4	1400	IP55	18°	2.3	2.17	2.01	1.8	1.51			0.75	64
560	BIFA563420	4	1400	IP55	20°	2.5	2.38	2.22	2.01	1.69			0.75	64
560	BIFA563422	4	1400	IP55	22°	2.7	2.57	2.41	2.2	1.89			0.75	64
560	BIFA563424	4	1400	IP55	24°	2.89	2.75	2.59	2.38	2.09			1.1	64
560	BIFA563426	4	1400	IP55	26°	3.08	2.94	2.77	2.56	2.27			1.1	64
560	BIFA563428	4	1400	IP55	28°	3.29	3.13	2.95	2.73	2.43			1.1	64
560	BIFA563430	4	1400	IP55	30°	3.48	3.32	3.13	2.89	2.58	2.1		1.1	64
560	BIFA563432	4	1400	IP55	32°	3.66	3.49	3.29	3.04	2.72	2.21		1.5	64
560	BIFA563434	4	1400	IP55	34°	3.82	3.64	3.44	3.19	2.85	2.32		1.5	64
560	BIFA563436	4	1400	IP55	36°	3.99	3.8	3.58	3.32	2.97			1.5	64
560	BIFA563438	4	1400	IP55	38°	4.16	3.96	3.73	3.45	3.08			2.2	64
560	BIFA563440	4	1400	IP55	40°	4.34	4.12	3.87	3.57	3.17			2.2	64

Sound Power Level Spectra dB (ref 10⁻¹² Watts)

Dia.	3 Phase			Spectrum	dB @ 3m							
	Stock Ref	Poles			63	125	250	500	1k	2k	4k	8k
560	BIFA563410	4	Inlet/Outlet	75	75	80	81	81	77	74	64	64
560	BIFA563412	4	Inlet/Outlet	75	75	80	81	81	77	74	64	64
560	BIFA563414	4	Inlet/Outlet	75	75	80	81	81	77	74	64	64
560	BIFA563416	4	Inlet/Outlet	75	75	80	81	81	77	74	64	64
560	BIFA563418	4	Inlet/Outlet	75	75	80	81	81	77	74	64	64
560	BIFA563420	4	Inlet/Outlet	75	75	80	81	81	77	74	64	64
560	BIFA563422	4	Inlet/Outlet	75	75	80	81	81	77	74	64	64
560	BIFA563424	4	Inlet/Outlet	75	75	80	81	81	77	74	64	64
560	BIFA563426	4	Inlet/Outlet	75	75	80	81	81	77	74	64	64
560	BIFA563428	4	Inlet/Outlet	75	75	80	81	81	77	74	64	64
560	BIFA563430	4	Inlet/Outlet	75	75	80	81	81	77	74	64	64
560	BIFA563432	4	Inlet/Outlet	75	75	80	81	81	77	74	64	64
560	BIFA563434	4	Inlet/Outlet	75	75	80	81	81	77	74	64	64
560	BIFA563436	4	Inlet/Outlet	75	75	80	81	81	77	74	64	64
560	BIFA563438	4	Inlet/Outlet	75	75	80	81	81	77	74	64	64
560	BIFA563440	4	Inlet/Outlet	75	75	80	81	81	77	74	64	64

Performance Curve

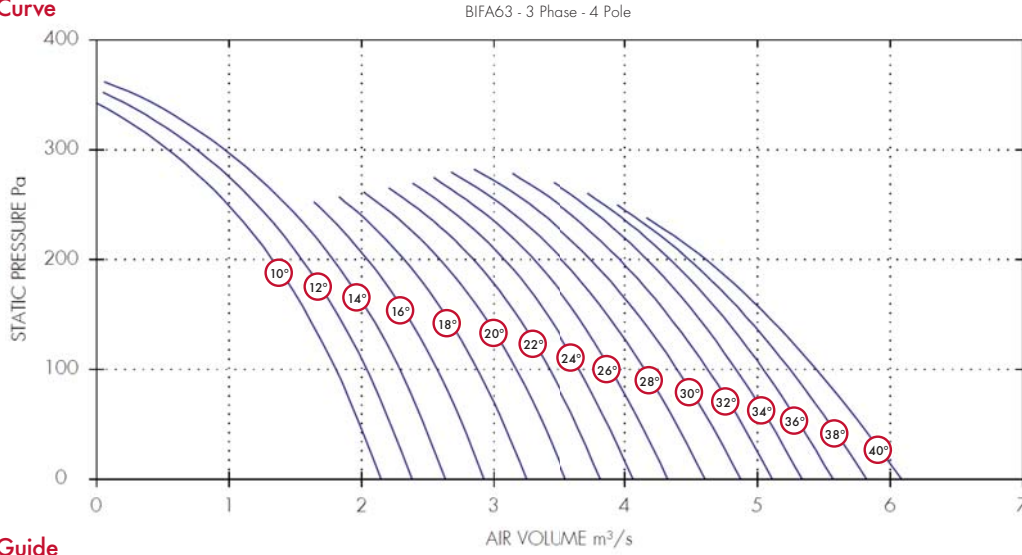

Performance Guide

Dia.	Stock Ref	Poles	rpm	IP Rating	Curve Ref	m³/s at Pa							Motor kW	dBA @3m	
						0	50	100	150	200	250	300			350
630	BIFA633410	4	1400	IP55	10°	2.15	1.99	1.81	1.59	1.33	0.99	0.54	0.55	64	
630	BIFA633412	4	1400	IP55	12°	2.38	2.22	2.04	1.82	1.55	1.21	0.76	0.09	0.75	64
630	BIFA633414	4	1400	IP55	14°	2.64	2.47	2.29	2.06	1.79	1.43	0.97	0.29	0.75	64
630	BIFA633416	4	1400	IP55	16°	2.93	2.76	2.57	2.34	2.05	1.66			1.1	64
630	BIFA633418	4	1400	IP55	18°	3.24	3.08	2.88	2.63	2.32	1.9			1.1	64
630	BIFA633420	4	1400	IP55	20°	3.55	3.37	3.17	2.92	2.59	2.14			1.1	64
630	BIFA633422	4	1400	IP55	22°	3.82	3.63	3.42	3.17	2.85	2.38			1.5	65
630	BIFA633424	4	1400	IP55	24°	4.06	3.87	3.66	3.4	3.08	2.62			1.5	65
630	BIFA633426	4	1400	IP55	26°	4.32	4.12	3.9	3.63	3.3	2.84			1.5	65
630	BIFA633428	4	1400	IP55	28°	4.61	4.39	4.15	3.87	3.52	3.06			2.2	65
630	BIFA633430	4	1400	IP55	30°	4.88	4.65	4.4	4.1	3.74	3.27			2.2	65
630	BIFA633432	4	1400	IP55	32°	5.11	4.89	4.63	4.32	3.96	3.5			2.2	65
630	BIFA633434	4	1400	IP55	34°	5.34	5.1	4.84	4.54	4.17	3.7			2.2	65
630	BIFA633436	4	1400	IP55	36°	5.57	5.32	5.04	4.73	4.34	3.84			3	65
630	BIFA633438	4	1400	IP55	38°	5.82	5.55	5.25	4.9	4.48				3	65
630	BIFA633440	4	1400	IP55	40°	6.09	5.78	5.44	5.06	4.61				3	65

Sound Power Level Spectra dB (ref 10⁻¹² Watts)

Dia.	Stock Ref	Poles	Spectrum	dB @ 3m								
				63	125	250	500	1k	2k	4k	8k	
630	BIFA633410	4	Inlet/Outlet	75	71	79	82	81	77	74	66	64
630	BIFA633412	4	Inlet/Outlet	75	71	79	82	81	77	74	66	64
630	BIFA633414	4	Inlet/Outlet	75	71	79	82	81	77	74	66	64
630	BIFA633416	4	Inlet/Outlet	75	71	79	82	81	77	74	66	64
630	BIFA633418	4	Inlet/Outlet	75	71	79	82	81	77	74	66	64
630	BIFA633420	4	Inlet/Outlet	75	71	79	82	81	77	74	66	64
630	BIFA633422	4	Inlet/Outlet	76	72	80	83	82	78	75	67	65
630	BIFA633424	4	Inlet/Outlet	76	72	80	83	82	78	75	67	65
630	BIFA633426	4	Inlet/Outlet	76	72	80	83	82	78	75	67	65
630	BIFA633428	4	Inlet/Outlet	76	72	80	83	82	78	75	67	65
630	BIFA633430	4	Inlet/Outlet	76	72	80	83	82	78	75	67	65
630	BIFA633432	4	Inlet/Outlet	76	72	80	83	82	78	75	67	65
630	BIFA633434	4	Inlet/Outlet	76	72	80	83	82	78	75	67	65
630	BIFA633436	4	Inlet/Outlet	76	72	80	83	82	78	75	67	65
630	BIFA633438	4	Inlet/Outlet	76	72	80	83	82	78	75	67	65
630	BIFA633440	4	Inlet/Outlet	76	72	80	83	82	78	75	67	65

Bifurcated Case Axial Fans (BIFA)

Performance Curve

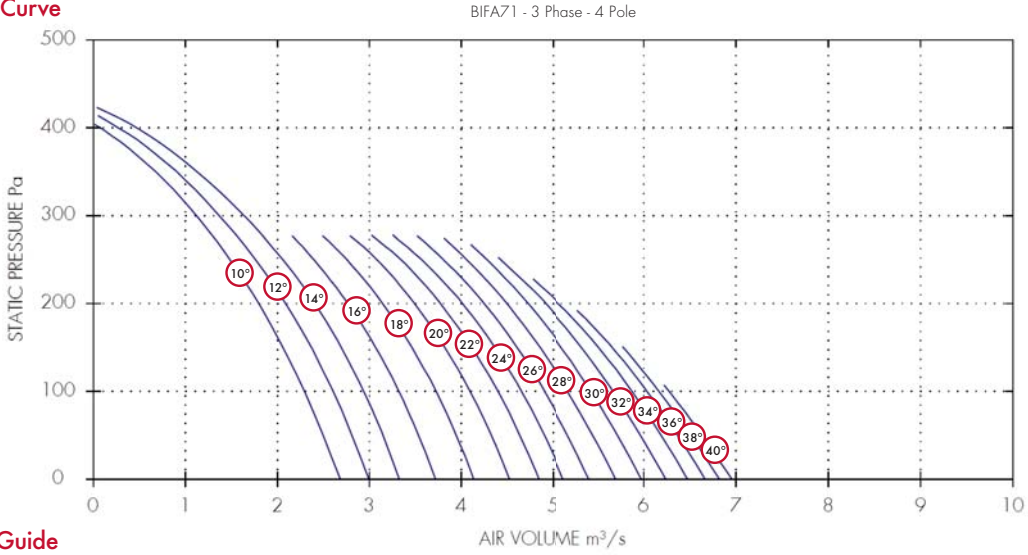

Performance Guide

Dia.	3 Phase		rpm	IP Rating	Curve Ref	m³/s at Pa										Motor kW	dBA @3m
	Stock Ref	Poles				0	50	100	150	200	250	300	350	400			
710	BIFA713410	4	1420	IP55	10°	2.68	2.5	2.3	2.06	1.8	1.49	1.12	0.68	0.07	0.75	74	
710	BIFA713412	4	1420	IP55	12°	2.99	2.81	2.61	2.37	2.09	1.76	1.37	0.9	0.27	1.1	74	
710	BIFA713414	4	1420	IP55	14°	3.33	3.15	2.94	2.7	2.41	2.06	1.64	1.13	0.47	1.1	74	
710	BIFA713416	4	1420	IP55	16°	3.72	3.53	3.32	3.07	2.77	2.4				1.5	74	
710	BIFA713418	4	1420	IP55	18°	4.14	3.95	3.73	3.46	3.15	2.76				1.5	74	
710	BIFA713420	4	1420	IP55	20°	4.53	4.33	4.1	3.82	3.49	3.08				2.2	71	
710	BIFA713422	4	1420	IP55	22°	4.84	4.64	4.4	4.12	3.77	3.34				2.2	71	
710	BIFA713424	4	1420	IP55	24°	5.12	4.9	4.66	4.36	4.01	3.57				2.2	71	
710	BIFA713426	4	1420	IP55	26°	5.4	5.17	4.91	4.61	4.25	3.81				3	71	
710	BIFA713428	4	1420	IP55	28°	5.69	5.45	5.17	4.86	4.49	4.06				3	71	
710	BIFA713430	4	1420	IP55	30°	5.98	5.71	5.43	5.1	4.73	4.28				3	71	
710	BIFA713432	4	1420	IP55	32°	6.24	5.97	5.67	5.32	4.92	4.42				4	71	
710	BIFA713434	4	1420	IP55	34°	6.47	6.19	5.87	5.51	5.07					4	71	
710	BIFA713436	4	1420	IP55	36°	6.67	6.37	6.04	5.66						4	71	
710	BIFA713438	4	1420	IP55	38°	6.82	6.51	6.17	5.78						5.5	71	
710	BIFA713440	4	1420	IP55	40°	6.96	6.63	6.28							5.5	71	

Sound Power Level Spectra dB (ref 10⁻¹² Watts)

Dia.	3 Phase		Spectrum	dB @ 3m								
	Stock Ref	Poles		63	125	250	500	1k	2k	4k	8k	
710	BIFA713410	4	Inlet/Outlet	89	84	92	92	90	85	82	75	74
710	BIFA713412	4	Inlet/Outlet	89	84	92	92	90	85	82	75	74
710	BIFA713414	4	Inlet/Outlet	89	84	92	92	90	85	82	75	74
710	BIFA713416	4	Inlet/Outlet	89	84	92	92	90	85	82	75	74
710	BIFA713418	4	Inlet/Outlet	89	84	92	92	90	85	82	75	74
710	BIFA713420	4	Inlet/Outlet	86	81	89	89	87	82	79	72	71
710	BIFA713422	4	Inlet/Outlet	86	81	89	89	87	82	79	72	71
710	BIFA713424	4	Inlet/Outlet	86	81	89	89	87	82	79	72	71
710	BIFA713426	4	Inlet/Outlet	86	81	89	89	87	82	79	72	71
710	BIFA713428	4	Inlet/Outlet	86	81	89	89	87	82	79	72	71
710	BIFA713430	4	Inlet/Outlet	86	81	89	89	87	82	79	72	71
710	BIFA713432	4	Inlet/Outlet	86	81	89	89	87	82	79	72	71
710	BIFA713434	4	Inlet/Outlet	86	81	89	89	87	82	79	72	71
710	BIFA713436	4	Inlet/Outlet	86	81	89	89	87	82	79	72	71
710	BIFA713438	4	Inlet/Outlet	86	81	89	89	87	82	79	72	71
710	BIFA713440	4	Inlet/Outlet	86	81	89	89	87	82	79	72	71

Performance Curve

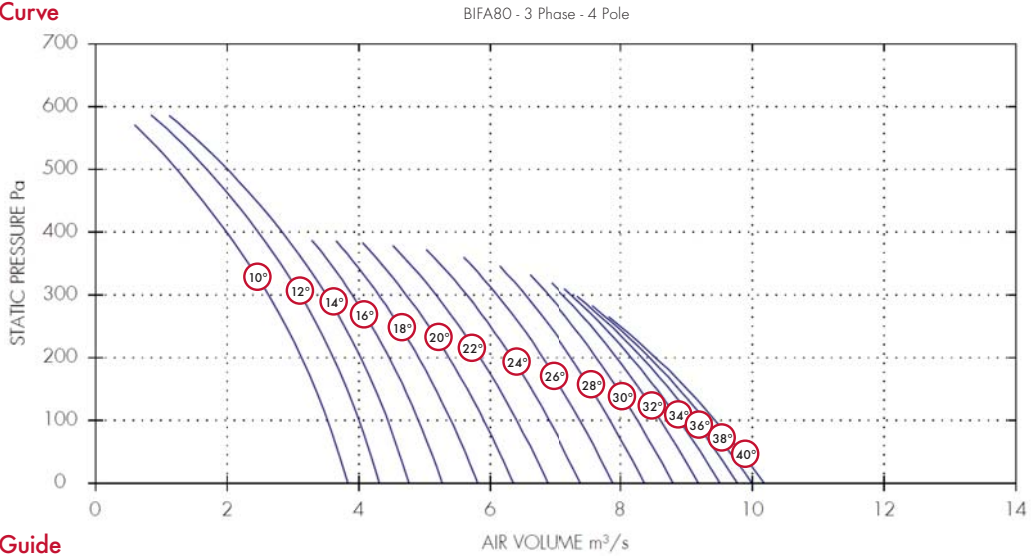

Performance Guide

Dia.	Stock Ref	Poles	rpm	IP Rating	Curve Ref	m³/s at Pa						Motor kW	dBA @3m
						0	100	200	300	400	500		
800	BIFA803410	4	1420	IP55	10°	3.84	3.53	3.13	2.63	1.99	1.24	2.2	80
800	BIFA803412	4	1440	IP55	12°	4.32	4	3.61	3.11	2.47	1.69	2.2	80
800	BIFA803414	4	1440	IP55	14°	4.76	4.44	4.03	3.51	2.84	2	3	80
800	BIFA803416	4	1440	IP55	16°	5.27	4.91	4.46	3.9			3	80
800	BIFA803418	4	1440	IP55	18°	5.81	5.4	4.91	4.3			3	80
800	BIFA803420	4	1440	IP55	20°	6.35	5.9	5.37	4.72			3	77
800	BIFA803422	4	1440	IP55	22°	6.88	6.4	5.84	5.17			4	78
800	BIFA803424	4	1440	IP55	24°	7.39	6.9	6.33	5.64			4	78
800	BIFA803426	4	1440	IP55	26°	7.89	7.38	6.8	6.1			5.5	78
800	BIFA803428	4	1440	IP55	28°	8.36	7.84	7.25	6.53			5.5	79
800	BIFA803430	4	1440	IP55	30°	8.8	8.26	7.64	6.89			7.5	79
800	BIFA803432	4	1440	IP55	32°	9.19	8.61	7.94	7.12			7.5	79
800	BIFA803434	4	1440	IP55	34°	9.51	8.9	8.17	7.25			7.5	79
800	BIFA803436	4	1440	IP55	36°	9.78	9.12	8.33				11	79
800	BIFA803438	4	1440	IP55	38°	9.99	9.29	8.44				11	79
800	BIFA803440	4	1440	IP55	40°	10.18	9.44	8.54				11	79

Sound Power Level Spectra dB (ref 10⁻¹² Watts)

Dia.	3 Phase Stock Ref	Poles	Spectrum	dB @ 3m										
				63	125	250	500	1k	2k	4k	8k	dBA @ 3m		
800	BIFA803410	4	Inlet/Outlet	93	87	93	98	96	93	88	80	80		
800	BIFA803412	4	Inlet/Outlet	93	87	93	98	96	93	88	80	80		
800	BIFA803414	4	Inlet/Outlet	93	87	93	98	96	93	88	80	80		
800	BIFA803416	4	Inlet/Outlet	93	87	93	98	96	93	88	80	80		
800	BIFA803418	4	Inlet/Outlet	93	87	93	98	96	93	88	80	80		
800	BIFA803420	4	Inlet/Outlet	90	84	90	95	93	90	85	77	77		
800	BIFA803422	4	Inlet/Outlet	91	85	91	96	94	91	86	78	78		
800	BIFA803424	4	Inlet/Outlet	91	85	91	96	94	91	86	78	78		
800	BIFA803426	4	Inlet/Outlet	91	85	91	96	94	91	86	78	78		
800	BIFA803428	4	Inlet/Outlet	92	86	92	97	95	92	87	79	79		
800	BIFA803430	4	Inlet/Outlet	92	86	92	97	95	92	87	79	79		
800	BIFA803432	4	Inlet/Outlet	92	86	92	97	95	92	87	79	79		
800	BIFA803434	4	Inlet/Outlet	92	86	92	97	95	92	87	79	79		
800	BIFA803436	4	Inlet/Outlet	92	86	92	97	95	92	87	79	79		
800	BIFA803438	4	Inlet/Outlet	92	86	92	97	95	92	87	79	79		
800	BIFA803440	4	Inlet/Outlet	92	86	92	97	95	92	87	79	79		

Bifurcated Case Axial Fans (BIFA)

Performance Curve

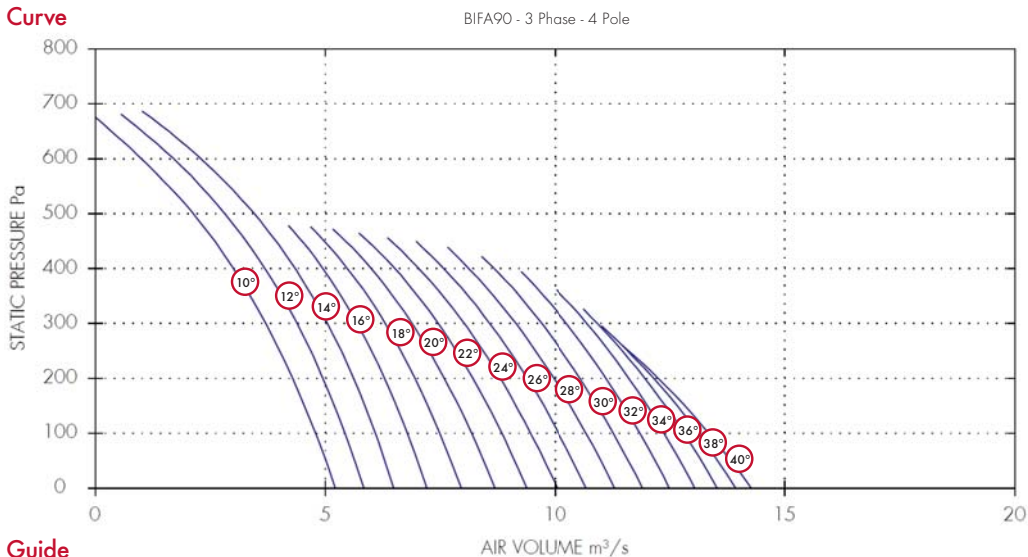

Performance Guide

Dia.	3 Phase			IP Rating	Curve Ref	m³/s at Pa							Motor kW	dBA @3m
	Stock Ref	Poles	rpm			0	100	200	300	400	500	600		
900	BIFA903410	4	1440	IP55	10°	5.22	4.79	4.29	3.71	3	2.12	1	3	79
900	BIFA903412	4	1440	IP55	12°	5.84	5.43	4.95	4.38	3.69	2.82	1.7	4	80
900	BIFA903414	4	1440	IP55	14°	6.49	6.09	5.62	5.05	4.34	3.45	2.29	4	80
900	BIFA903416	4	1440	IP55	16°	7.21	6.79	6.29	5.69	4.94			4	80
900	BIFA903418	4	1440	IP55	18°	7.96	7.49	6.95	6.3	5.49			5.5	81
900	BIFA903420	4	1440	IP55	20°	8.69	8.18	7.59	6.89	6			5.5	81
900	BIFA903422	4	1440	IP55	22°	9.39	8.84	8.21	7.46	6.51			7.5	81
900	BIFA903424	4	1440	IP55	24°	10.04	9.47	8.81	8.02	7.04			7.5	81
900	BIFA903426	4	1440	IP55	26°	10.69	10.08	9.39	8.58	7.57			7.5	82
900	BIFA903428	4	1440	IP55	28°	11.31	10.69	9.97	9.14	8.12			11	82
900	BIFA903430	4	1440	IP55	30°	11.91	11.28	10.55	9.71	8.67			11	82
900	BIFA903432	4	1440	IP55	32°	12.5	11.85	11.12	10.26				11	82
900	BIFA903434	4	1440	IP55	34°	13.05	12.39	11.62	10.7				15	82
900	BIFA903436	4	1440	IP55	36°	13.54	12.82	11.97	10.93				15	82
900	BIFA903438	4	1440	IP55	38°	13.94	13.13	12.15					15	82
900	BIFA903440	4	1440	IP55	40°	14.27	13.36	12.26					15	82

Sound Power Level Spectra dB (ref 10⁻¹² Watts)

Dia.	3 Phase			Spectrum	dB								dBA @ 3m
	Stock Ref	Poles	rpm		63	125	250	500	1k	2k	4k	8k	
900	BIFA903410	4	1440	Inlet/Outlet	89	83	91	97	95	92	87	79	79
900	BIFA903412	4	1440	Inlet/Outlet	90	84	92	98	96	93	88	80	80
900	BIFA903414	4	1440	Inlet/Outlet	90	84	92	98	96	93	88	80	80
900	BIFA903416	4	1440	Inlet/Outlet	90	84	92	98	96	93	88	80	80
900	BIFA903418	4	1440	Inlet/Outlet	91	85	93	99	97	94	89	81	81
900	BIFA903420	4	1440	Inlet/Outlet	91	85	93	99	97	94	89	81	81
900	BIFA903422	4	1440	Inlet/Outlet	91	85	93	99	97	94	89	81	81
900	BIFA903424	4	1440	Inlet/Outlet	91	85	93	99	97	94	89	81	81
900	BIFA903426	4	1440	Inlet/Outlet	92	86	94	100	98	95	90	82	82
900	BIFA903428	4	1440	Inlet/Outlet	92	86	94	100	98	95	90	82	82
900	BIFA903430	4	1440	Inlet/Outlet	92	86	94	100	98	95	90	82	82
900	BIFA903432	4	1440	Inlet/Outlet	92	86	94	100	98	95	90	82	82
900	BIFA903434	4	1440	Inlet/Outlet	92	86	94	100	98	95	90	82	82
900	BIFA903436	4	1440	Inlet/Outlet	92	86	94	100	98	95	90	82	82
900	BIFA903438	4	1440	Inlet/Outlet	92	86	94	100	98	95	90	82	82
900	BIFA903440	4	1440	Inlet/Outlet	92	86	94	100	98	95	90	82	82

Performance Curve

BIFA100 - 3 Phase - 4 Pole

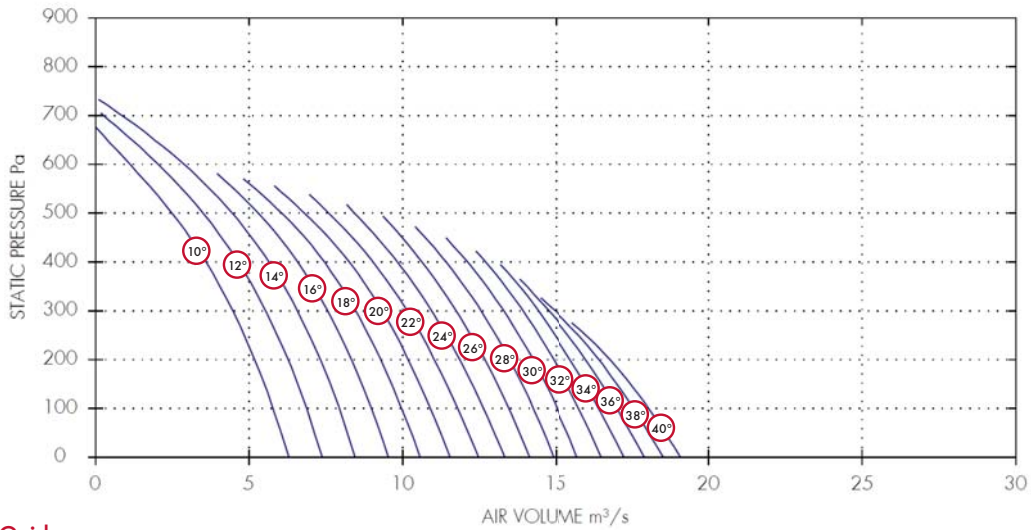

Performance Guide

Dia.	Stock Ref	3 Phase Poles	rpm	IP Rating	Curve Ref	m³/s at Pa							Motor kW	dBA @3m	
						0	100	200	300	400	500	600			700
1000	BIFA1003410	4	1440	IP55	10°	6.3	5.78	5.18	4.47	3.6	2.49	1.12	4	89	
1000	BIFA1003412	4	1440	IP55	12°	7.38	6.87	6.27	5.54	4.64	3.5	2.04	0.26	4	89
1000	BIFA1003414	4	1440	IP55	14°	8.46	7.94	7.33	6.57	5.64	4.45	2.88	0.86	5.5	89
1000	BIFA1003416	4	1440	IP55	16°	9.54	8.98	8.33	7.55	6.58	5.3			5.5	89
1000	BIFA1003418	4	1440	IP55	18°	10.57	9.97	9.29	8.47	7.45	6.06			7.5	89
1000	BIFA1003420	4	1440	IP55	20°	11.55	10.91	10.19	9.33	8.26	6.8			7.5	89
1000	BIFA1003422	4	1440	IP55	22°	12.46	11.79	11.04	10.15	9.04	7.59			7.5	89
1000	BIFA1003424	4	1440	IP55	24°	13.32	12.64	11.86	10.94	9.82	8.44			11	89
1000	BIFA1003426	4	1440	IP55	26°	14.13	13.45	12.67	11.75	10.63				11	89
1000	BIFA1003428	4	1440	IP55	28°	14.93	14.26	13.48	12.55	11.41				15	89
1000	BIFA1003430	4	1440	IP55	30°	15.73	15.05	14.25	13.29	12.11				15	89
1000	BIFA1003432	4	1440	IP55	32°	16.52	15.78	14.92	13.91	12.7				15	89
1000	BIFA1003434	4	1440	IP55	34°	17.26	16.44	15.5	14.42					18.5	89
1000	BIFA1003436	4	1440	IP55	36°	17.92	17.03	16.01	14.77					18.5	89
1000	BIFA1003438	4	1440	IP55	38°	18.53	17.57	16.44	14.97					18.5	89
1000	BIFA1003440	4	1440	IP55	40°	19.1	18.06	16.8						22	89

Sound Power Level Spectra dB (ref 10⁻¹² Watts)

Dia.	3 Phase Stock Ref	Poles	Spectrum	dB @ 3m								
				63	125	250	500	1k	2k	4k	8k	
1000	BIFA1003410	4	Inlet/Outlet	99	94	101	106	106	102	97	89	89
1000	BIFA1003412	4	Inlet/Outlet	99	94	101	106	106	102	97	89	89
1000	BIFA1003414	4	Inlet/Outlet	99	94	101	106	106	102	97	89	89
1000	BIFA1003416	4	Inlet/Outlet	99	94	101	106	106	102	97	89	89
1000	BIFA1003418	4	Inlet/Outlet	99	94	101	106	106	102	97	89	89
1000	BIFA1003420	4	Inlet/Outlet	99	94	101	106	106	102	97	89	89
1000	BIFA1003422	4	Inlet/Outlet	99	94	101	106	106	102	97	89	89
1000	BIFA1003424	4	Inlet/Outlet	99	94	101	106	106	102	97	89	89
1000	BIFA1003426	4	Inlet/Outlet	99	94	101	106	106	102	97	89	89
1000	BIFA1003428	4	Inlet/Outlet	99	94	101	106	106	102	97	89	89
1000	BIFA1003430	4	Inlet/Outlet	99	94	101	106	106	102	97	89	89
1000	BIFA1003432	4	Inlet/Outlet	99	94	101	106	106	102	97	89	89
1000	BIFA1003434	4	Inlet/Outlet	99	94	101	106	106	102	97	89	89
1000	BIFA1003436	4	Inlet/Outlet	99	94	101	106	106	102	97	89	89
1000	BIFA1003438	4	Inlet/Outlet	99	94	101	106	106	102	97	89	89
1000	BIFA1003440	4	Inlet/Outlet	99	94	101	106	106	102	97	89	89

Bifurcated Case Axial Fans (BIFA)

Electrical Details

1 Phase 2 Pole

Stock Ref	rpm	Pitch Angle	Motor kW	S.C. Amps	F.L.C Amps	Starting Method	Starter Ref	Overload Ref	Transform Controller	*eDemand Controller		
										Voltage Control	1/3 Phase Inverter	3 Phase Inverter
BIFA25	2800	25°-50°	0.37	8	2.6	D.O.L	444744	444702	-	-	-	-
BIFA31	2800	10°-24°	0.37	8	2.6	D.O.L	444744	444702	-	-	-	-
BIFA31	2800	26°-32°	0.55	14	3.6	D.O.L	444744	444703	-	-	-	-
BIFA31	2800	34°-38°	0.75	16	4.5	D.O.L	444744	444703	-	-	-	-
BIFA31	2800	40°	1.1	23	6.6	D.O.L	444744	444704	-	-	-	-
BIFA40	2800	10°-18°	0.75	16	4.5	D.O.L	444744	444703	-	-	-	-
BIFA40	2800	20°-24°	1.1	23	6.6	D.O.L	444744	444704	-	-	-	-
BIFA40	2800	26°-32°	1.5	31	8.5	D.O.L	444744	444705	-	-	-	-

* 1 phase 2 pole are not speed controllable

3 Phase 2 Pole

Stock Ref	rpm	Pitch Angle	Motor kW	S.C. Amps	F.L.C Amps	Starting Method	Starter Ref	Overload Ref	Transform Controller	eDemand Controller		
										Voltage Control	1/3 Phase Inverter	3 Phase Inverter
BIFA25	2800	25°-50°	0.37	5.82	0.97	D.O.L	444747	444700	-	-	444177	444172
BIFA31	2800	10°-24°	0.37	5.82	0.97	D.O.L	444747	444700	-	-	444177	444172
BIFA31	2800	26°-32°	0.55	8.52	1.42	D.O.L	444747	444701	-	-	444177	444172
BIFA31	2800	34°-38°	0.75	10.62	1.77	D.O.L	444747	444701	-	-	444177	444172
BIFA31	2800	40°	1.1	15.06	2.51	D.O.L	444747	444702	-	-	444177	444173
BIFA40	2800	10°-18°	0.75	10.62	1.77	D.O.L	444747	444701	-	-	444177	444172
BIFA40	2800	20°-26°	1.1	15.06	2.51	D.O.L	444747	444702	-	-	444177	444173
BIFA40	2800	28°-32°	1.5	19.68	3.28	D.O.L	444747	444702	-	-	444177	444173
BIFA40	2800	34°-38°	2.2	27.66	4.61	D.O.L	444747	444703	-	-	-	444174
BIFA40	2800	40°	3	42.2	6.03	D.O.L	444747	444704	-	-	-	444174
BIFA45	2880	10°-12°	1.1	15.06	2.51	D.O.L	444747	444702	-	-	444177	444173
BIFA45	2880	14°-18°	1.5	19.68	3.28	D.O.L	444747	444702	-	-	444177	444173
BIFA45	2880	20°-26°	2.2	27.66	4.61	D.O.L	444747	444703	-	-	-	444174
BIFA45	2880	28°-32°	3	42.2	6.03	D.O.L	444747	444704	-	-	-	444174
BIFA50	2880	10°-12°	1.5	19.68	3.28	D.O.L	444747	444702	-	-	444177	444173
BIFA50	2880	14°-18°	2.2	27.66	4.61	D.O.L	444747	444703	-	-	-	444174
BIFA50	2880	20°-24°	3	42.2	6.03	D.O.L	444747	444704	-	-	-	444174
BIFA50	2880	26°-30°	4	59.1	7.88	D.O.L	444747	444705	-	-	-	444175
BIFA50	2880	32°-36°	5.5	78.8	10.5	D.O.L	444748	444706	-	-	-	444175
BIFA50	2880	38°-40°	7.5	106	14.1	D.O.L	444748	444707	-	-	-	444176
BIFA56	2880	10°-14°	4	59.1	7.88	D.O.L	444747	444705	-	-	-	444175
BIFA56	2880	16°-18°	5.5	78.8	10.5	D.O.L	444748	444706	-	-	-	444175
BIFA56	2880	20°-24°	7.5	106	14.1	D.O.L	444748	444707	-	-	-	444176
BIFA63	2940	10°-12°	5.5	78.8	10.5	D.O.L	444748	444706	-	-	-	444175
BIFA63	2940	14°-16°	7.5	106	14.1	D.O.L	444748	444707	-	-	-	444176

1 Phase 4 Pole

Stock Ref	rpm	Pitch Angle	Motor kW	S.C. Amps	F.L.C Amps	Starting Method	Starter Ref	Overload Ref	Transform Controller	eDemand Controller		
										Voltage Control	1/3 Phase Inverter	3 Phase Inverter
BIFA25	1440	25°-50°	0.25	5	2	D.O.L	444744	444701	10314103	444164	-	-
BIFA31	1400	10°-40°	0.25	5	2	D.O.L	444744	444701	10314103	444164	-	-
BIFA40	1400	10°-40°	0.55	11	3.9	D.O.L	444744	444703	10314105	444164	-	-
BIFA45	1400	10°-40°	0.55	11	3.9	D.O.L	444744	444703	10314105	444164	-	-
BIFA50	1400	10°-34°	0.55	11	3.9	D.O.L	444744	444703	10314105	444164	-	-
BIFA50	1400	36°-40°	0.75	15	5.3	D.O.L	444744	444704	10314107	444165	-	-
ICA125	1475	32°-34°	45	193	80.5	Star Delta	-	-	-	-	-	-

Electrical Details

3 Phase 4 Pole

Stock Ref	rpm	Pitch Angle	Motor kW	S.C. Amps	F.L.C Amps	Starting Method	Starter Ref	Overload Ref	Transform Controller	eDemand Controller		
										Voltage Control	1/3 Phase Inverter	3 Phase Inverter
BIFA25	1440	25°50°	0.25	5.04	0.84	D.O.L	444747	444699	10314301	444166	444177	444172
BIFA31	1400	10°40°	0.25	5.04	0.84	D.O.L	444747	444699	10314301	444166	444177	444172
BIFA40	1400	10°40°	0.55	9.48	1.58	D.O.L	444747	444701	10314304	444166	444177	444172
BIFA45	1400	10°-40°	0.55	9.48	1.58	D.O.L	444747	444701	10314304	444166	444177	444172
BIFA50	1400	10°34°	0.55	9.48	1.58	D.O.L	444747	444701	10314304	444166	444177	444172
BIFA50	1400	36°40°	0.75	11.58	1.93	D.O.L	444747	444701	10314304	444166	444177	444172
BIFA56	1400	10°16°	0.55	9.48	1.58	D.O.L	444747	444701	10314304	444166	444177	444172
BIFA56	1400	18°22°	0.75	11.58	1.93	D.O.L	444747	444701	10314304	444166	444177	444172
BIFA56	1400	24°30°	1.1	15.84	2.64	D.O.L	444747	444702	10314304	444166	444177	444173
BIFA56	1400	32°36°	1.5	20.7	3.45	D.O.L	444747	444702	10314304	444166	444177	444173
BIFA56	1400	38°40°	2.2	33.9	4.84	D.O.L	444747	444703	10314307	444167	-	444173
BIFA63	1400	10°	0.55	9.48	1.58	D.O.L	444747	444701	10314304	444166	444177	444172
BIFA63	1400	12°14°	0.75	11.58	1.93	D.O.L	444747	444701	10314304	444166	444177	444172
BIFA63	1400	16°20°	1.1	15.84	2.64	D.O.L	444747	444702	10314304	444166	444177	444173
BIFA63	1400	22°26°	1.5	20.7	3.45	D.O.L	444747	444702	10314304	444166	444177	444173
BIFA63	1400	28°34°	2.2	33.9	4.84	D.O.L	444747	444703	10314307	444167	-	444174
BIFA63	1400	36°40°	3	45.3	6.47	D.O.L	444747	444704	10314311	444167	-	444174
BIFA71	1420	10°	0.75	11.58	1.93	D.O.L	444747	444701	10314304	444166	444177	444172
BIFA71	1420	12°14°	1.1	15.84	2.64	D.O.L	444747	444702	10314304	444166	444177	444173
BIFA71	1420	16°18°	1.5	20.7	3.45	D.O.L	444747	444702	10314304	444166	444177	444173
BIFA71	1420	20°24°	2.2	33.9	4.84	D.O.L	444747	444703	10314307	444167	-	444174
BIFA71	1420	26°30°	3	45.3	6.47	D.O.L	444747	444704	10314311	444167	-	444174
BIFA71	1420	32°36°	4	57.8	8.26	D.O.L	444747	444705	10314311	444167	-	444175
BIFA71	1420	38°40°	5.5	77	11	D.O.L	444748	444706	-	444168	-	444175
BIFA80	1420	10°12°	2.2	33.9	4.84	D.O.L	444747	444703	10314307	444167	-	444174
BIFA80	1440	14°20°	3	45.3	6.47	D.O.L	444747	444704	10314311	444167	-	444174
BIFA80	1440	22°24°	4	57.8	8.26	D.O.L	444747	444705	10314311	444167	-	444175
BIFA80	1440	26°28°	5.5	77	11	D.O.L	444748	444706	-	444168	-	444175
BIFA80	1440	30°34°	7.5	102.2	14.6	D.O.L	444748	444707	-	-	-	444176
BIFA80	1440	36°40°	11	52.3	20.9	Star Delta	444843	444707	-	-	-	-
BIFA90	1440	10°	3	45.3	6.47	D.O.L	444747	444704	10314311	444167	-	444174
BIFA90	1440	12°16°	4	57.8	8.26	D.O.L	444747	444705	10314311	444167	-	444175
BIFA90	1440	18°20°	5.5	77	11	D.O.L	444748	444706	-	444168	-	444175
BIFA90	1440	22°26°	7.5	102.2	14.6	D.O.L	444748	444707	-	-	-	444176
BIFA90	1440	28°32°	11	52.3	20.9	Star Delta	444843	444707	-	-	-	-
BIFA90	1440	34°40°	15	75.3	30.1	Star Delta	-	-	-	-	-	-
BIFA100	1440	10°12°	4	57.8	8.26	D.O.L	444747	444705	10314311	444167	-	444175
BIFA100	1440	14°16°	5.5	77	11	D.O.L	444748	444706	-	444168	-	444175
BIFA100	1440	18°22°	7.5	102.2	14.6	D.O.L	444748	444707	-	-	-	444176
BIFA100	1440	24°26°	11	52.3	20.9	Star Delta	444843	444707	-	-	-	-
BIFA100	1440	28°32°	15	75.3	30.1	Star Delta	-	-	-	-	-	-
BIFA100	1440	34°38°	18.5	86	34.3	Star Delta	-	-	-	-	-	-
BIFA100	1440	40°	22	102	40.6	Star Delta	-	-	-	-	-	-

Speed Controllers

Used in conjunction with speed controllable fans Vent-Axia offers a choice of speed controllers, the traditional Five-Step Auto Transformer or the Inverter Speed Controller.

The Five-Step-Auto Transformer provides five stepped speed settings without the electronic motor harmonic noise associated with all electronic or solid state type Speed Controllers.

eDemand Speed Controllers & Inverters see Accessories & Controls Section.

Bifurcated Case Axial Fans (BIFA)

Accessory Dimensions (mm)

Coupling Flange

Rolled from mild steel. Dimensionally matched to fan flange and fixing holes.

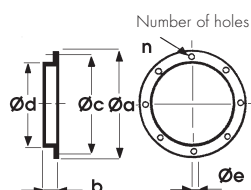

Stock Ref	a Ø	b	c Ø	d Ø	e Ø	n
10506250	327	55	292	254	10	4
10506315	385	30	355	315	10	8
10506400	480	45	450	400	12	8
10506450	530	60	500	450	12	8
10506500	590	0	560	500	12	12
10506560	650	75	620	560	12	12
10506630	720	75	690	630	12	12
10506710A	794	40	770	710	12	13
10506800A	884	40	860	800	12	13
10506900A	1100	50	970	900	14	15

*Anti-Vibration Mounts

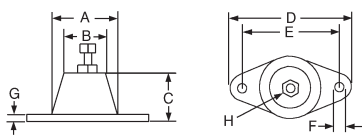

Max. Load

Stock Ref	A	B	C	D	E	F	G	H	kg
68MP033G	37	26	27	67	54	7	3	M8	23
68MP055B	37	26	27	67	54	7	3	M8	36
68MP133G	57	46	35	95	76	10.5	4	M12	91
68MP165R	57	46	35	95	76	10.5	4	M12	245

*Supplied as a set of 4

Inlet Wire Guard

'K' factor loss 0.25

Available for direct fixing to either side of the fan using flange sizing holes. Constructed to meet BS 848 Part 5.

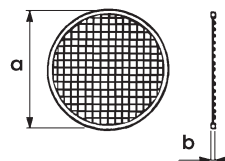

Stock Ref	a	b
10505250	245	3
10505315	380	3
10505400	475	3
10505450	525	3
10505500	595	3
10505560	655	3
10505630	725	3
10505710A	784	10
10505800A	870	10
10505900A	970	10
105051000A	1090	10

For more information on the 'K' factor, refer to General Information Section

*Mounting Feet

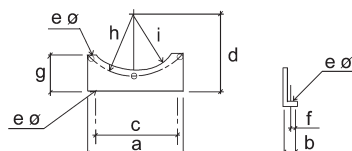

Stock Ref	a	b	c	d	e	f	g	h	i
10503250	232	24	180	240	10	14	115	146	130
10503315	275	24	224	240	10	14	115	177.5	167
10503400	348	24	280	300	12	14	135	225	213
10503450	384	24	315	360	12	14	155	250	238
10503500	425	24	315	360	12	14	135	280	268
10503560	475	24	355	355	12	14	155	310	298
10503630	520	24	400	400	12	14	175	345	333
10503710A	710	40	610	435	13	18	240	385	365
10503800A	800	40	700	480	13	18	262	430	410
10503900A	900	40	800	535	13	18	288	485	460
105031000A	1000	40	900	580	15	18	314	535	510

*Supplied as a pair

Accessories

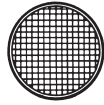
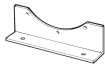

Model Ref	Mounting Feet Stock Ref	Inlet Wire Guard Stock Ref	Coupling Flange Stock Ref	Ancillary Pack* Stock Ref	Attenuator Stock Ref	Attenuator inc. Pod Stock Ref	Anti-Vibration Mount** Stock Ref
BIFA25	10503250	10505250	10506250	10513250HT	10514250	-	68MP033G
BIFA31	10503315	10505315	10506315	10513315HT	10514315	10500315	68MP033G
BIFA40	10503400	10505400	10506400	10513400HT	10514400	10500400	68MP033G
BIFA45	10503450	10505450	10506450	10513450HT	10514450	10500450	68MP033G
BIFA50	10503500	10505500	10506500	10513500HT	10514500	10500500	68MP033G
BIFA56	10503560	10505560	10506560	10513560HT	10514560	10500560	68MP033G
BIFA63	10503630	10505630	10506630	10513630HT	10514630	10500630	68MP033G
BIFA71	10503710A	10505710	10506710A	10513710HT	10514710A	10500710	68MP055B
BIFA80	10503800A	10505800	10506800A	10513800HT	10514800A	10500800	68MP055B
BIFA90	10503900A	10505900	10506900A	10513900HT	10514900A	10500900	68MP133G
BIFA100	105031000A	105051000	105061000A	105131000HT	105141000A	105001000	68MP133G

* Axial Ancillary Pack consists of 2 Matching flanges, 2 Flexible Connectors, 2 Mounting Feet, 4 Anti Vibration Mounts and 4 Worm Drive Clips

** Supplied as a set of 4

Typical Installation

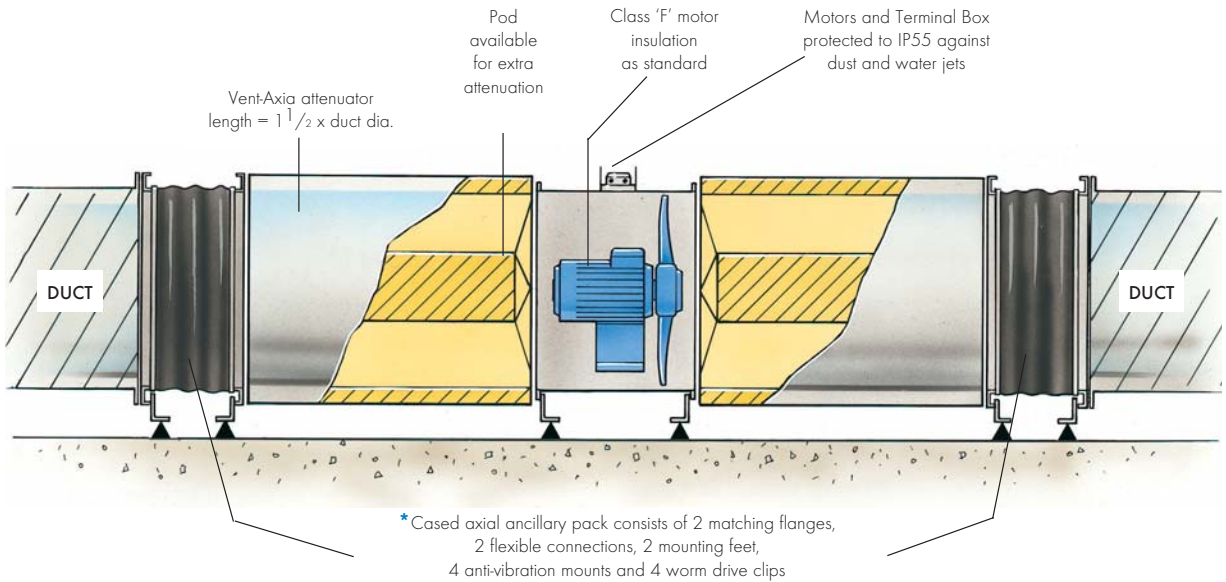

Bifurcated Case Axial Fans (BIFA)

Fan Attenuator Details

An attenuator without pod offers negligible resistance to air flow, and therefore the pressure loss can be considered to be the same as that for the equivalent length of ducting.

Resistance Graph for Axial Attenuator with Pod

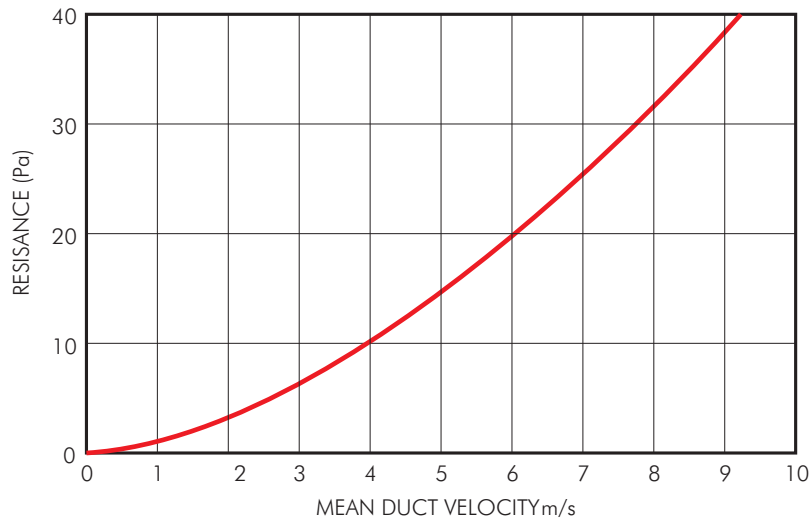

Attenuator Insertion Loss Data

Dia	Stock Ref	63	125	250	500	1k	2k	4k	8k	kg approx
250	10514250	2	3	6	11	16	11	10	6	20
315	10514315	2	3	6	11	16	11	10	6	22
355	10514355	2	3	6	12	16	11	10	6	30
400	10514400	2	3	6	13	16	12	10	6	41
450	10514450	2	4	6	14	17	12	10	6	50
500	10514500	3	4	7	14	17	14	11	7	59
560	10514560	2	4	8	15	18	14	11	7	70
630	10514630	3	4	8	16	18	14	11	7	82
710	10514710	1	2	6	9	12	10	6	2	90
800	10514800	1	2	6	9	12	10	6	2	100
900	10514900	1	2	6	9	12	10	6	2	145
1000	10514000	1	2	6	9	12	10	6	2	184

Melinex lined attenuators are available on request

Case Axial Attenuator Fitted with Pod Insertion Losses

Dia	Stock Ref	63	125	250	500	1k	2k	4k	8k	kg approx
315	10500315	6	7	12	18	27	25	22	19	32
355	10500355	3	8	12	18	28	26	22	19	44
400	10500400	3	8	12	18	28	26	23	19	60
450	10500450	4	8	14	20	28	26	23	19	73
500	10500500	4	8	14	20	29	26	23	19	87
560	10500560	4	9	14	20	29	26	23	19	102
630	10500630	4	9	14	20	29	26	23	19	120
710	10500710	6	10	20	30	35	28	25	22	134
800	10500800	6	10	20	30	35	28	25	22	149
900	10500900	6	10	20	30	35	28	25	22	211
1000	105001000	6	10	20	30	35	28	25	22	267

Attenuator Dimensions (mm)

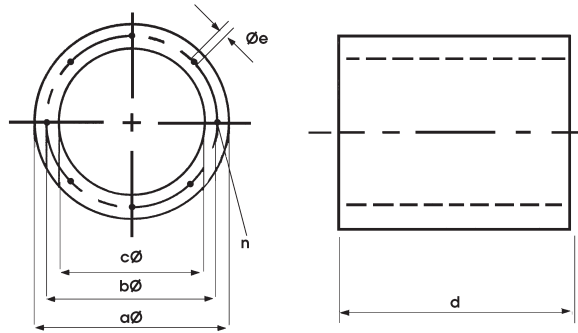

Model	Stock		$a\varnothing$	$b\varnothing$	$c\varnothing$	d	$e\varnothing$	n
	Ref							
BIFA25	10514250		350	292	254	375	M8	4
BIFA31	10514315		415	355	315	475	M8	8
BIFA35	10514355		455	395	355	540	M8	8
BIFA40	10514400		500	450	400	600	M10	8
BIFA45	10514450		550	500	450	675	M10	8
BIFA50	10514500		600	560	500	750	M10	12
BIFA56	10514560		660	620	560	810	M10	12
BIFA63	10514630		730	690	630	940	M10	12
BIFA71	10514710		814	700	710	1070	M10	16
BIFA80	10514800		900	860	796	1200	M10	16
BIFA90	10514900		999	970	893	1350	M10	16
BIFA100	105141000		1108	1070	1070	1500	M10	16
BIFA125	105141250		1350	1320	1250	1875	M10	20

In-line Fans

Vent-Axia in-line fans features both box and tube fans designed to provide controllable environmental management solutions for commercial and industrial applications.

With sizes ranging from 100mm to 710mm diameter and air volumes up to 5.63m³/s optimum performance at minimum running costs is assured.

Where noise is an issue, our ACQ range features 50mm of acoustic lining and is designed to be compact enough to fit within ceiling voids.

Designed specifically to fully comply with the new Building Regulations for Commercial Kitchens and fully tested within the the aggressive conditions observed in commercial kitchen applications the New EKF range with its EC motor out of the airstream achieves low specific fan powers (<1.0w/l/s), has a multi spigot arrangement and is suitable for 120°C in duct temperature.



Lo-Carbon Kitchen Box Fans (EKF)

264-271



Eco Mixed Flow Fans (eMF)

272-277



Powerflow In-Line Duct Fans (ACP)

278-281



EuroSeries (SDX)
In-Line Centrifugal Duct Fans

282-285



Slimpak® (SLP) In-Line Centrifugal Duct Fans

286-289



New & Improved Acoustic In-Line
Fans (ACQ)

290-293



Square Mixed Flow Fans (MFQ)

294-299

Vent-Axia

In-Line Fans



Lo-Carbon Kitchen Box Fan (EKF)

Features and Benefits

- Energy efficient EC motor
- 120°C airstream rated
- Sealed for life motor
- Flexible installation, straight through or turn through 90° as standard
- Internal or external mounting as standard
- 25mm Double skin casing
- Integral IP65 Isolator
- Simple potentiometer control
- ERP 2015 compliant
- Compliant part L 2013 SFP for requirements for kitchen ventilation systems

Vent-Axia's latest product offering in the Non Residential sector is a centrifugal box fan specifically designed for kitchen operation at elevated duct temperatures of up to 120°C. Working closely with our Engineering partner, the motor impeller arrangement has been specifically engineered to benefit from the efficiencies of an EC external rotor motor mounted out of the airstream to allow for operation at 120°C in duct temperatures.

Construction



The casing is constructed from a framed 25mm double skin with acoustic insulation to minimise unit noise. With careful thought to maximising the installation possibilities from one unit Vent-Axia have managed to create a single unit that is suitable for both internal and external mounting as standard. In addition to this the duct configuration

can be either straight blow through or turn through 90° and with the motor shaft either horizontal or vertical this enables the fan to be mounted in any orientation.

Motor

The Kitchen Box Fan range is powered by highly efficient, electronically commutated (EC) motors with permanent magnets, exceeding the minimum efficiency requirements for IE3 motors. All units are fully speed controllable via the onboard electronics utilising a 0-10V input signal. Motors and the onboard electronics are protected to IP54 as standard mounted and are out of the airstream.

The combination of an EC high efficiency motor and a high efficiency backward curved impeller ensures ERP 2015 compliance.

Impeller

A backward curved welded Aluminium impeller is mounted on an extended shaft from the EC external motor. Motor and impeller is balanced as a finished assembly to G2.5 to ensure vibration free operation. Impeller matched to inlet cone for optimum performance.

Speed Control

By utilising EC motors the EKF range has been designed for simple Demand Ventilation control facilitated by use of a 0-10V potentiometer. This low voltage controller can then be mounted within the kitchen area thereby removing the risk of overheating or damaging the control circuits.

Performance

The fan performance has been tested in accordance with ISO 5801 DIN 24163.

Sound Levels

Fan sound levels were measured in a reverberant chamber in accordance with EN ISO 3745. Published dB(A) figures are free field at a distance of 3m with hemispherical propagation at a

reference level of 2×10^{-5} . The sound power level spectra figures are dB with a reference level of 10^{12} Watts.

Electrical

Depending on unit size the EKF range is suitable for either single phase 220-240V 50Hz or three phase 380-414V 50Hz. All mains wiring is direct to the built in IP65 isolator mounted on the motor support plate providing simple and safe connection and operation.

Accessories

A full range of accessories are available for the EKF range including:

- Potentiometer speed controller (included as standard)
- Square to round duct connectors
- Flexible connectors
- Mounting support and A/V mount set
- Weather cowl
- Discharge louvre

Online Documentation

For digital catalogue information, fitting & wiring instructions and online fan selection programme visit www.vent-axia.com/ekf



Fan Dimensions (mm)

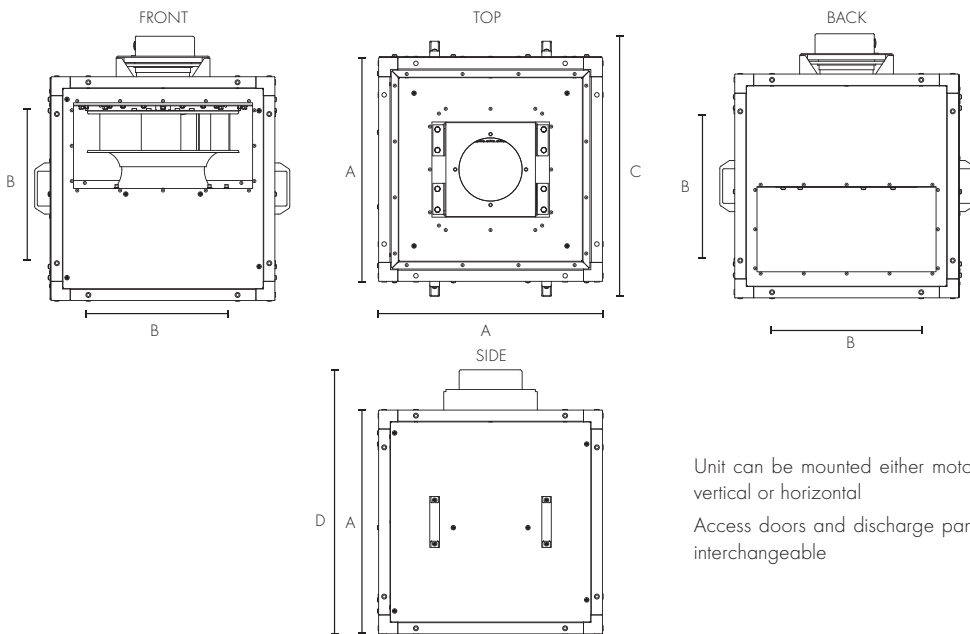

Unit can be mounted either motor shaft vertical or horizontal

Access doors and discharge panel are interchangeable

Model	A	B	C	D	Weight (kg)
EKF355E1	600	400	684	708	63
EKF400E1	700	500	784	826	81
EKF450E1	700	500	784	826	83.5
EKF450E3	700	500	784	826	83.5
EKF500E3	850	650	929	1017	130
EKF560E3	850	650	929	1017	132

Lo-Carbon Kitchen Box Fan (EKF)

Performance Curve

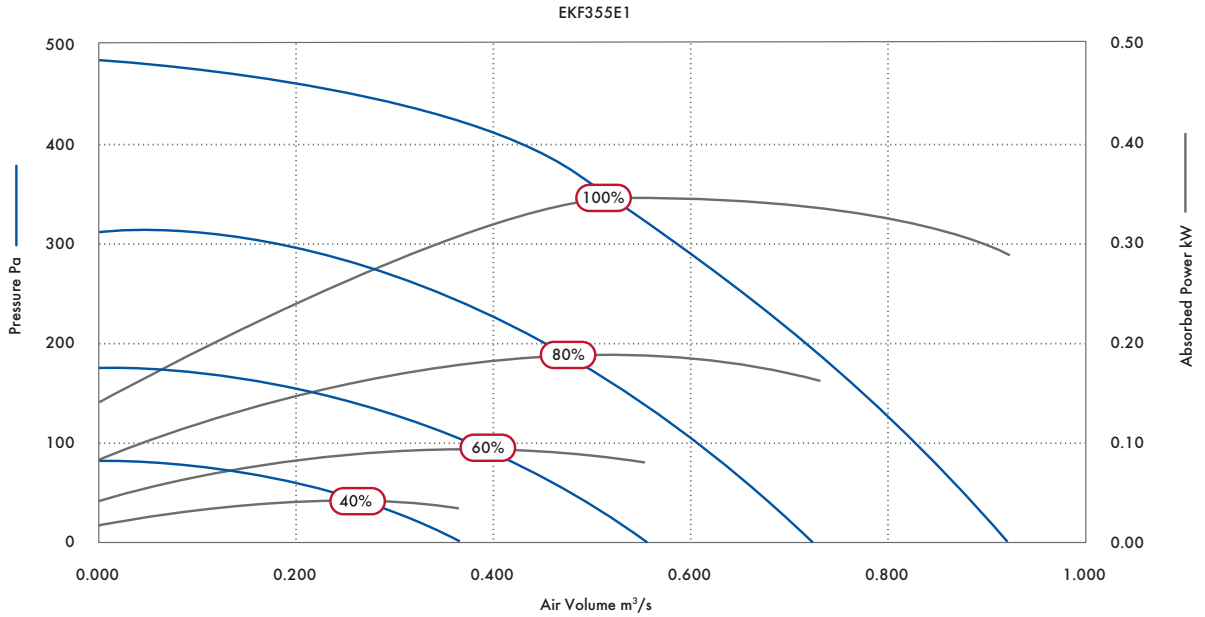

Performance Guide

Speed	Airflow, m ³ /s @ Pa											Fans F.L.C.	Supply Voltage	
	0	50	100	150	200	250	300	350	400	450				
100%	m ³ /s	0.920	0.866	0.815	0.767	0.700	0.630	0.600	0.510	0.435	0.275	1.7	220V/ 1/ 50Hz	
	kW	0.29	0.31	0.32	0.32	0.33	0.34	0.34	0.34	0.33	0.27			
	SFP	0.32	0.35	0.39	0.42	0.48	0.54	0.60	0.66	0.76	0.97			
80%	m ³ /s	0.737	0.665	0.605	0.538	0.455	0.360	0.140				1.0		
	kW	0.16	0.17	0.18	0.19	0.18	0.18	0.13						
	SFP	0.22	0.26	0.30	0.35	0.41	0.50	0.90						
60%	m ³ /s	0.554	0.475	0.375	0.230							0.7		
	kW	0.08	0.09	0.09	0.08									
	SFP	0.14	0.18	0.24	0.36									
40%	m ³ /s	0.368	0.230											0.5
	kW	0.04	0.04											
	SFP	0.095	0.172											

Sound Data

Speed	Test Mode	Octave Band Frequency SWL								SPL dB(A) @ 3m
		63	125	250	500	1K	2K	4K	8K	
100%	Intake	50	66	66	63	60	61	58	52	49
	Discharge	48	66	67	67	69	66	62	55	
	Breakout	62	71	72	64	66	58	53	47	
90%	Intake	46	62	58	57	55	55	51	46	47
	Discharge	42	61	59	61	63	60	55	48	
	Breakout	61	77	72	61	59	53	47	41	
80%	Intake	43	51	50	51	48	48	43	37	38
	Discharge	36	39	48	52	56	55	52	46	
	Breakout	58	70	62	54	48	44	37	32	
60%	Intake	40	46	45	45	40	39	33	30	29
	Discharge	34	36	44	43	40	39	35	30	
	Breakout	57	59	51	46	39	33	27	31	

ErP conform 2015, N=79.6, statA=69. 9%, VSD integrated, Integrated controller.

Performance Curve

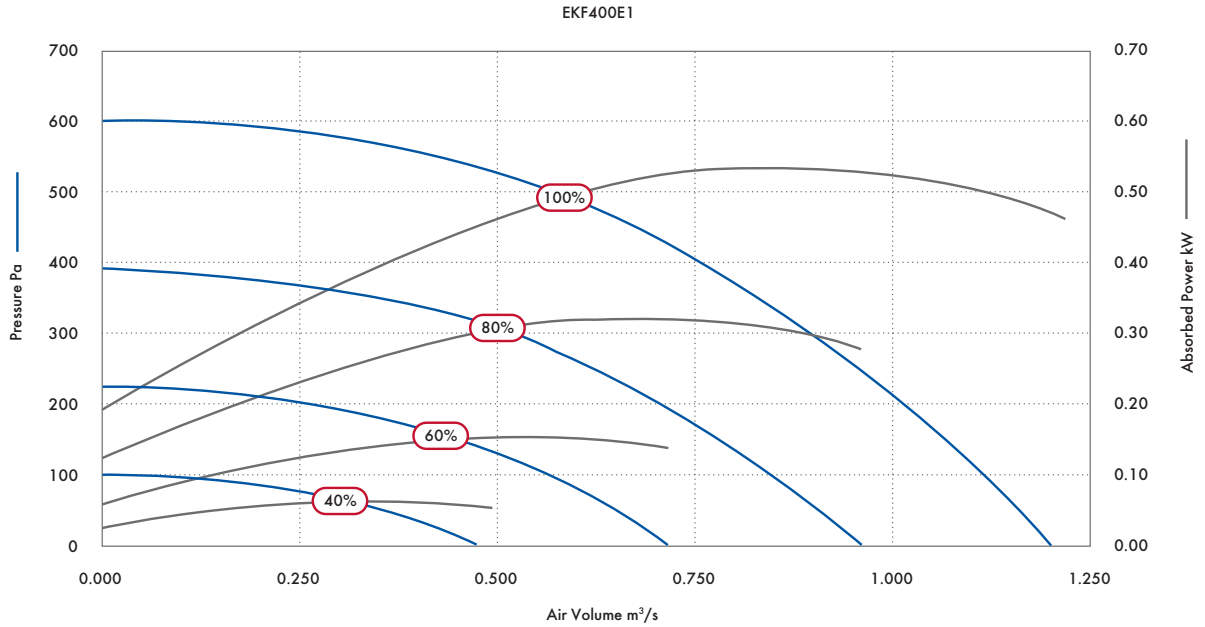

Performance Guide

Speed	Airflow, m³/s @ Pa												Fans F.L.C.	Supply Voltage	
	0	50	100	150	200	250	300	350	400	450	500	600			
100%	m³/s	1.206	1.160	1.115	1.065	1.020	0.965	0.907	0.845	0.765	0.685	0.586	0.175	3.0	220V/ 1/ 50Hz
	kW	0.53	0.55	0.56	0.58	0.59	0.60	0.61	0.61	0.60	0.59	0.56	0.33		
	SFP	0.44	0.47	0.50	0.55	0.58	0.62	0.67	0.72	0.79	0.86	0.96	1.90		
80%	m³/s	0.961	0.907	0.845	0.780	0.705	0.622	0.520	0.350					2.2	
	kW	0.28	0.30	0.31	0.32	0.32	0.32	0.31	0.26						
	SFP	0.29	0.33	0.36	0.40	0.45	0.51	0.59	0.75						
60%	m³/s	0.721	0.640	0.552	0.438	0.235							1.6		
	kW	0.13	0.14	0.15	0.14	0.12									
	SFP	0.18	0.22	0.27	0.33	0.51									
40%	m³/s	0.480	0.351	0.012										0.8	
	kW	0.06	0.05	0.03											
	SFP	0.11	0.16	2.50											

Sound Data

Speed	Test Mode	Octave Band Frequency SWL								SPL dB(A) @ 3m
		63	125	250	500	1K	2K	4K	8K	
100%	Intake	61	70	69	66	65	64	60	54	56
	Discharge	58	70	73	72	73	69	64	57	
	Breakout	69	90	94	70	67	63	57	53	
80%	Intake	54	61	60	59	59	58	54	47	49
	Discharge	50	61	65	66	67	63	58	51	
	Breakout	65	81	73	65	61	56	50	44	
60%	Intake	49	52	52	51	51	50	45	38	42
	Discharge	45	52	57	59	59	54	49	45	
	Breakout	62	75	64	57	52	46	40	34	
40%	Intake	44	47	47	44	44	43	40	33	32
	Discharge	40	46	47	45	45	43	42	35	
	Breakout	60	62	54	49	44	35	28	31	

ErP conform 2015, N=79.6, statA=69.9%, VSD integrated, Integrated controller.

Lo-Carbon Kitchen Box Fan (EKF)

Performance Curve

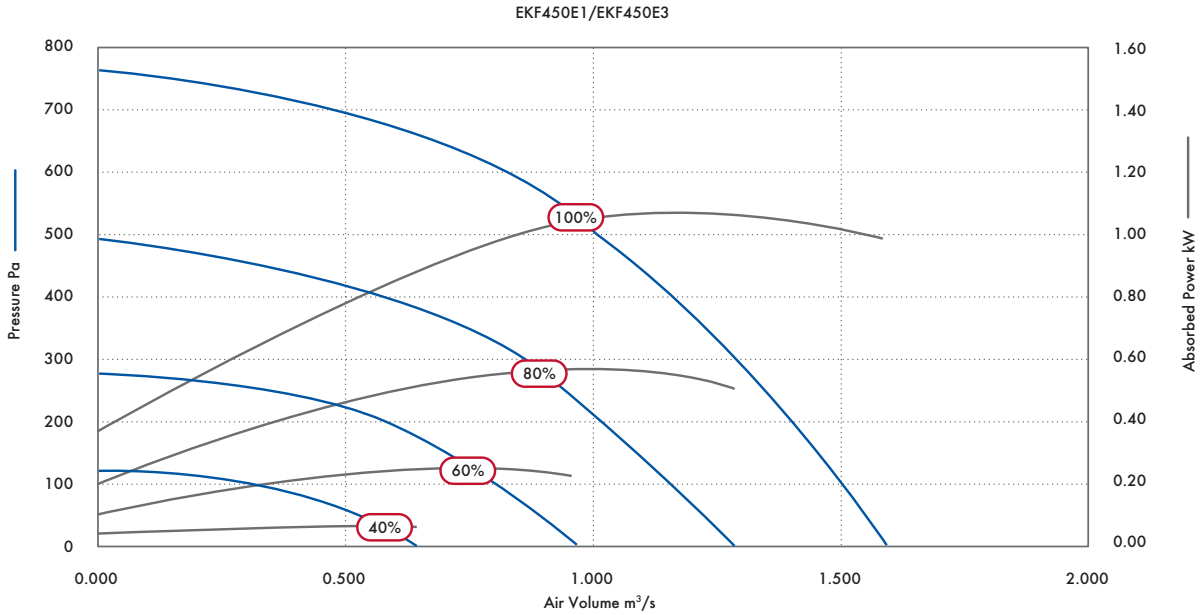

Performance Guide

Speed	Airflow, m³/s @ Pa														E1 Model		E3 Model		
	0	50	100	150	200	250	300	350	400	450	500	550	600	700	Fans F.L.C.	Supply Voltage	Fans F.L.C.	Supply Voltage	
100%	m³/s	1.602	1.555	1.505	1.458	1.408	1.356	1.290	1.220	1.160	1.092	1.012	0.925	0.840	0.462	5.2	220V/ 1/ 50Hz	1.8	400V/ 3/ 50Hz
	kW	0.99	1.01	1.03	1.04	1.05	1.07	1.07	1.07	1.06	1.05	1.03	1.00	0.76					
	SFP	0.62	0.65	0.68	0.71	0.75	0.79	0.83	0.87	0.92	0.97	1.04	1.12	1.19	1.64				
80%	m³/s	1.285	1.228	1.166	1.095	1.015	0.938	0.855	0.762	0.582						3.8	220V/ 1/ 50Hz	1.0	400V/ 3/ 50Hz
	kW	0.51	0.53	0.54	0.55	0.55	0.55	0.55	0.54	0.49									
	SFP	0.40	0.43	0.46	0.50	0.55	0.59	0.64	0.71	0.84									
60%	m³/s	0.962	0.881	0.786	0.685	0.556	0.350									2.7	220V/ 1/ 50Hz	0.8	400V/ 3/ 50Hz
	kW	0.23	0.24	0.25	0.24	0.24	0.20												
	SFP	0.24	0.27	0.31	0.35	0.43	0.58												
40%	m³/s	0.640	0.511	0.290												1.9	220V/ 1/ 50Hz	0.5	400V/ 3/ 50Hz
	kW	0.08	0.09	0.08															
	SFP	0.13	0.17	0.26															

Sound Data

Speed	Test Mode	Octave Band Frequency SWL								SPL dB(A) @ 3m
		63	125	250	500	1K	2K	4K	8K	
100%	Intake	55	70	67	68	70	70	66	60	59
	Discharge	54	70	77	77	78	75	70	63	
	Breakout	70	81	86	74	68	63	57	52	
80%	Intake	51	70	59	63	65	64	60	54	52
	Discharge	46	48	68	69	72	72	69	64	
	Breakout	71	84	76	69	63	57	50	44	
60%	Intake	50	57	53	55	58	55	50	44	45
	Discharge	36	45	56	62	64	65	60	54	
	Breakout	66	78	66	62	54	49	40	40	
40%	Intake	45	50	46	48	51	50	43	37	34
	Discharge	31	42	48	53	55	56	52	38	
	Breakout	65	66	55	52	46	37	29	32	

Three phase unit ErP conform 2015, N=79.6, statA=69.9%, VSD integrated, Integrated controller
 Single phase unit ErP conform 2015, N=76.1, statA=66.6%, VSD integrated, Integrated controller

Performance Curve

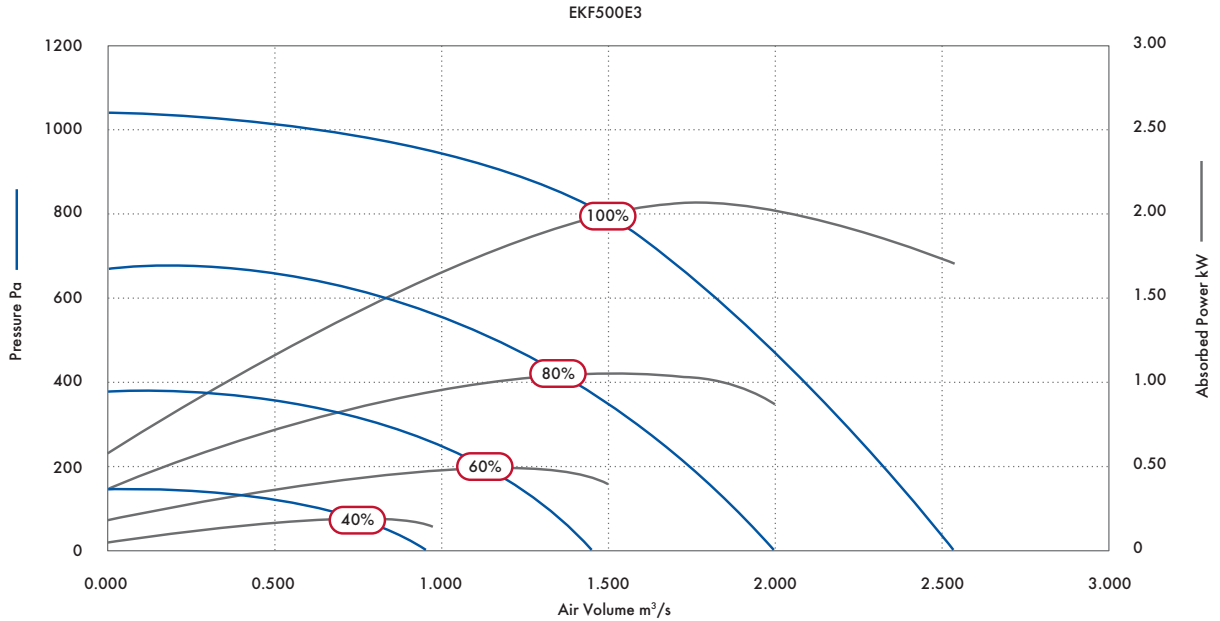

Performance Guide

Speed	Airflow, m³/s @ Pa												Fans F.L.C.	Supply Voltage
	0	100	200	300	400	500	600	700	800	900	1000			
100%	m³/s	2.543	2.450	2.320	2.190	2.075	1.935	1.835	1.700	1.458	1.250	0.539	5.5	400V/ 3/ 50Hz
	kW	1.71	1.76	1.82	1.89	1.96	2.03	2.07	2.10	2.00	1.85	1.25		
	SFP	0.67	0.72	0.78	0.86	0.95	1.05	1.13	1.23	1.37	1.53	2.29		
80%	m³/s	2.002	1.900	1.765	1.570	1.372	1.178	0.754					3.9	
	kW	0.88	1.01	1.04	1.05	1.04	1.02	0.87						
	SFP	0.44	0.53	0.59	0.67	0.76	0.82	1.16						
60%	m³/s	1.499	1.330	1.129	0.850								2.8	
	kW	0.40	0.47	0.49	0.46									
	SFP	0.26	0.35	0.43	0.54									
40%	m³/s	0.966	0.665										1.3	
	kW	0.18	0.22											
	SFP	0.19	0.33											

Sound Data

Speed	Test Mode	Octave Band Frequency SWL								SPL dB(A) @ 3m
		63	125	250	500	1K	2K	4K	8K	
100%	Intake	62	73	70	71	77	73	74	69	60
	Discharge	60	76	82	80	83	81	79	75	
	Breakout	75	82	88	73	69	68	65	59	
80%	Intake	60	66	62	66	67	67	61	56	52
	Discharge	56	67	72	74	75	71	66	60	
	Breakout	70	81	77	69	64	62	59	51	
60%	Intake	51	61	56	58	61	60	55	50	45
	Discharge	50	62	65	66	68	64	60	55	
	Breakout	66	74	70	61	57	53	49	43	
40%	Intake	46	56	51	53	50	55	50	43	35
	Discharge	43	55	56	57	59	55	51	48	
	Breakout	63	62	58	52	48	41	34	31	

ErP conform 2015, N=73.4, statA=66.9%, VSD integrated, Integrated controller.

Lo-Carbon Kitchen Box Fan (EKF)

Performance Curve

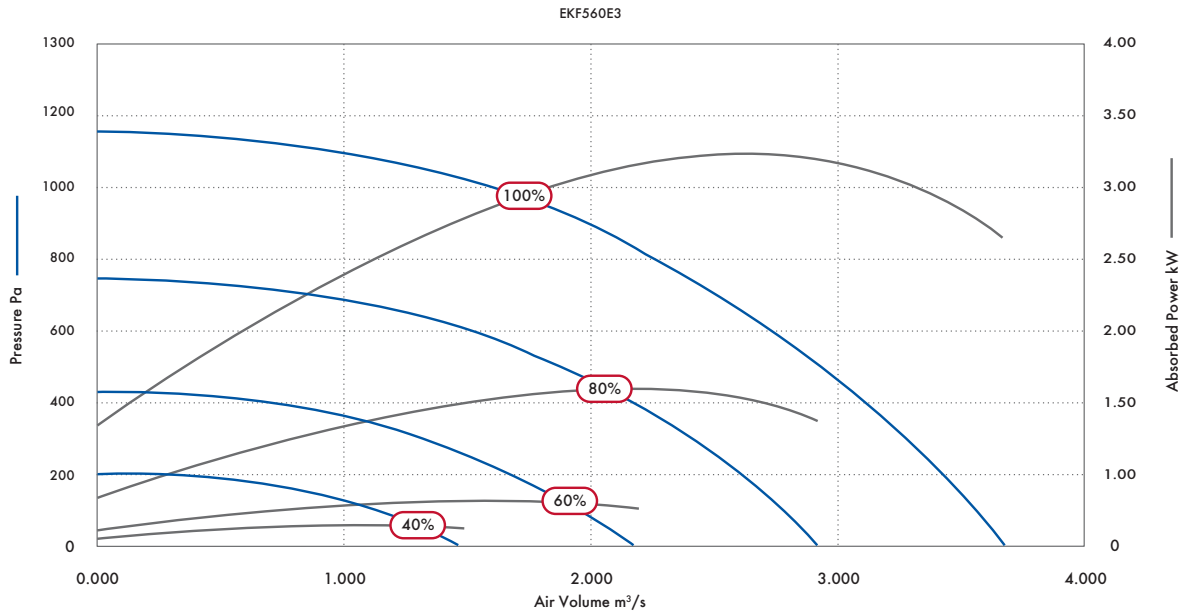

Performance Guide

Speed	Airflow, m³/s @ Pa												Fans F.L.C.	Supply Voltage	
	0	100	200	300	400	500	600	700	800	900	1000	1100			
100%	m³/s	3.693	3.570	3.440	3.310	3.135	2.940	2.725	2.507	2.278	2.004	1.650	0.930	3.6	400V/ 3/ 50Hz
	kW	2.58	2.75	2.92	3.00	3.10	3.14	3.17	3.20	3.15	3.08	2.83	2.16		
	SFP	0.70	0.77	0.85	0.91	0.99	1.07	1.16	1.27	1.38	1.54	1.72	2.32		
80%	m³/s	2.926	2.780	2.585	2.405	2.155	1.860	1.500	0.900					2.6	
	kW	1.33	1.45	1.56	1.61	1.62	1.60	1.51	1.20						
	SFP	0.45	0.52	0.60	0.67	0.75	0.86	1.01	1.33						
60%	m³/s	2.192	1.987	1.672	1.293	0.600								1.8	
	kW	0.59	0.65	0.69	0.69	0.49									
	SFP	0.27	0.33	0.42	0.53	0.81									
40%	m³/s	1.481	1.081	0.019										1.0	
	kW	0.27	0.32	0.11											
	SFP	0.18	0.30	5.74											

Sound Data

Speed	Test Mode	Octave Band Frequency SWL								SPL dB(A) @ 3m
		63	125	250	500	1K	2K	4K	8K	
100%	Intake	64	78	81	74	77	76	72	67	65
	Discharge	62	76	83	83	83	81	76	70	
	Breakout	82	87	87	81	73	70	67	62	
80%	Intake	65	78	75	72	75	74	70	64	60
	Discharge	63	77	79	81	81	79	74	67	
	Breakout	77	85	80	76	68	65	61	56	
60%	Intake	60	67	63	60	64	60	56	50	52
	Discharge	56	65	67	70	70	66	60	54	
	Breakout	73	78	72	68	62	58	52	50	
40%	Intake	53	60	56	53	57	53	49	43	44
	Discharge	48	55	57	60	60	56	51	46	
	Breakout	68	67	64	60	55	47	38	41	

ErP conform 2015, N=72.4, statA=67.8%, VSD integrated, Integrated controller.

Accessories



Unit Size	Mounting Bracket & A/V Mount Set	Flexible Connector	Square to Circular Duct Transformation Section	Discharge Cowl	Weather Roof
EKF355	EKFMF355	EKFFC355	EKFTP35-35	EKFDC355	EKFWR355
EKF400	EKFMF400	EKFFC400	EKFTP40-40	EKFDC400	EKFWR400
EKF450	EKFMF400	EKFFC400	EKFTP40-45	EKFDC400	EKFWR400
EKF500	EKFMF500	EKFFC500	EKFTP50-50	EKFDC500	EKFWR500
EKF560	EKFMF500	EKFFC500	EKFTP50-56	EKFDC500	EKFWR500

Accessories Dimensions

Mounting Bracket & A/V Mount Set

Stock Ref	A	B	C	DØ	E	F	G	HØ	I	J	K
EKFMF355	600	100	400	13	25	700	750	9	30	100	35
EKFMF400	700	100	500	13	25	800	850	9	30	100	35
EKFMF400	700	100	500	13	25	800	850	9	30	100	35
EKFMF500	850	100	650	13	25	950	1000	9	30	100	35
EKFMF500	850	100	650	13	25	950	1000	9	30	100	35

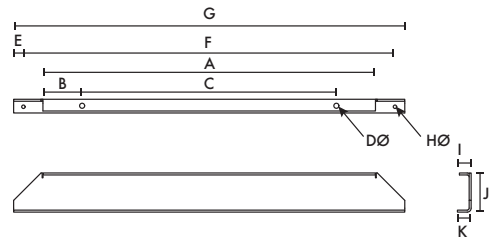

Square to Circular Duct Transformation Section

Stock Ref	A	B	C	DØ	E	F	G	H
EKFTP35-35	600	100	400	348	50	400	540	570
EKFTP40-40	700	100	500	398	50	400	640	670
EKFTP40-45	700	100	500	448	50	400	640	670
EKFTP50-50	850	100	650	498	50	400	790	820
EKFTP50-56	850	100	650	558	50	400	790	820

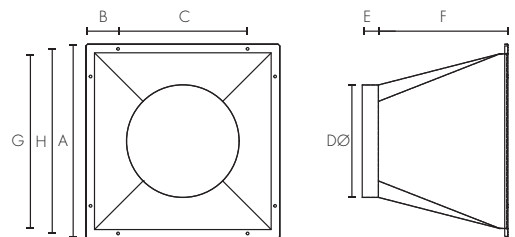

Flexible Connector

Stock Ref	A	B	C	D	EØ	F	G
EKFFC355	600	100	400	34	8	570	150
EKFFC400	700	100	500	34	8	670	150
EKFFC500	850	100	650	34	8	820	150

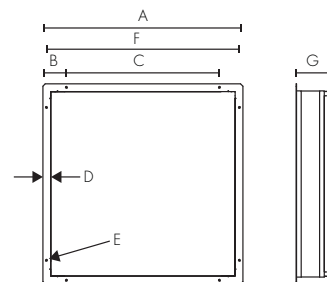

Note: weather roof and cowl dimensions on application

Eco Mixed Flow (eMF)

Features & Benefits

- **High efficiency Mixed Flow Fan with guide vanes**
- **Available in sizes 355 to 710mm dia.**
- **IP54 Fan rating (duct mounted)**
- **Operating Temperatures up to 80°C (see technical specification)**
- **Maintenance free, long life bearings**
- **All units suitable for speed control**
- **Quality Assurance to BS EN ISO 9001:1994**

Energy Saver

The 'eMF' high efficiency in-line mixed flow duct fans are designed around a high efficiency, high pressure development mixed flow impellor, offering a very compact design with high performance and low sound levels.

The in-line fan is constructed from steel and incorporates an aerodynamically designed airflow guide vane to ensure maximum performance from the unit.

All models offer minimum space requirements for installation and are designed for simple installation into duct ventilation systems via the included mounting foot. All units are suitable for vertical or horizontal mounting.

The eMF range is available in 15 models, covering sizes 355, 400, 450, 500, 560, 630 & 710mm diameter. The range shall provide a performance from 0.06m³/s to 5.63m³/s with a maximum pressure development of up to 1200 Pa.

Impellers

The impellers are aerodynamically designed high efficiency mixed flow type, manufactured from steel or polyamide. The motor and impeller is be factory matched, statically and dynamically balanced to ISO 1940, Grade G 2.5.

Motors

All sizes are protected to IP54 in accordance with BS EN 60529:1992. With motors suitable for operating temperatures up to 80°C (see technical data). The range incorporates maintenance free motors, fitted with sealed for life ball bearings, ideally suited for speed control. Single phase 230V units by auto transformer control, 3 phase 230V or 400V by frequency inverters.

Motor protection by means of a thermal contact switch incorporated within the windings is provided to prevent motor damage due to overloading/overheating.

Terminal Box

All single phase units are supplied with an IP44 terminal box as standard. All three phase units are supplied with a 2m long flying lead.

Performance

The fan performance is in accordance with tests to BS848 Part 1 1980, with the fan sound levels measured in a reverberant chamber in accordance with BS848 Part 2 1985.

Quality Assurance

Design and manufacture is in accordance with the standard for quality management systems BS EN ISO 9001:1994.

Accessories

A full range of accessories are available with the eMF in-line mixed flow duct fans such as:

- Fast Clamps
- Auto Transformer Speed Controllers
- Frequency Inverters
- D.O.L. Starters and Overloads



Fan Dimensions (mm)

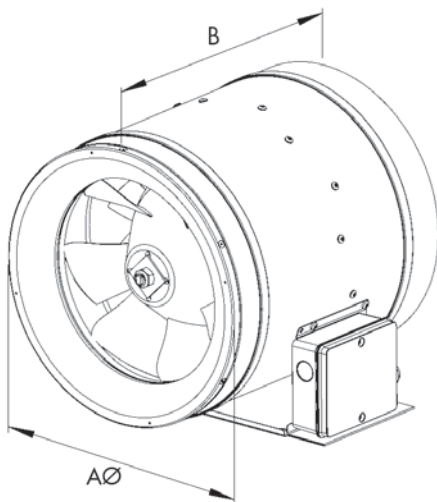

Stock Ref	AØ	B	Weight kg
EMF35514	355	396	13.5
EMF35512	354	396	17.3
EMF40014	403	417	12.8
EMF45014	453	467	18.4
EMF50014	504	515	23.2
EMF56014	564	582	38.0
EMF63014	634	655	43.1
EMF35532	354	396	17.5
EMF40034	403	417	14.8
EMF45034	453	467	18.9
EMF50034	504	515	23.6
EMF40032	403	417	20.3
EMF56034	564	582	28.0
EMF63034	634	654	39.3
EMF71034	714	732	49.0

Eco Mixed Flow (eMF)

Performance Curve

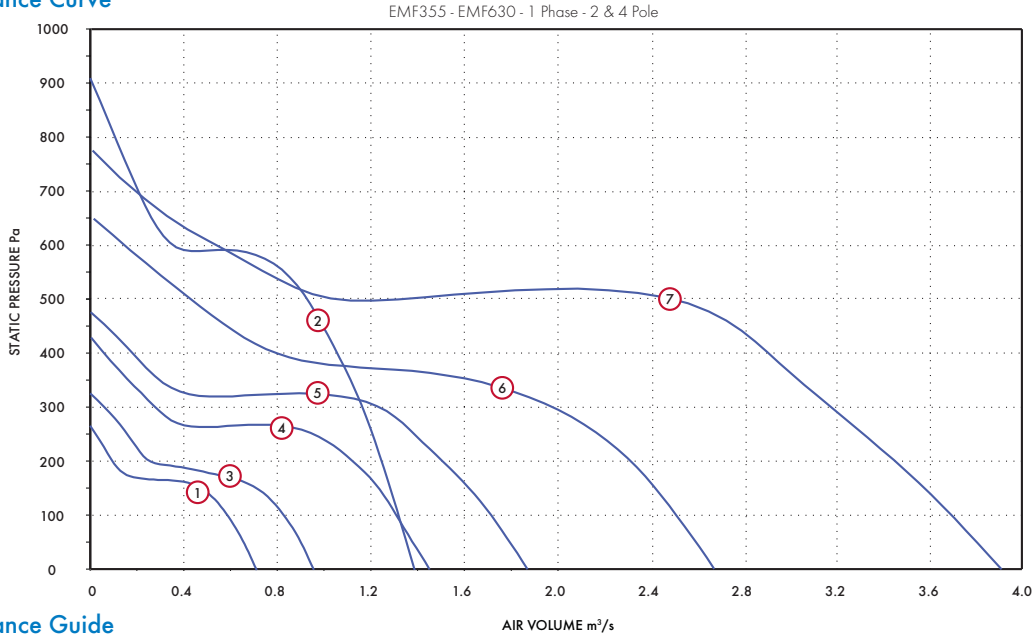

Performance Guide

Stock Ref	rpm	Max temp °C	Curve Ref	AIR VOLUME m ³ /s										Voltage	Max Watts	S.C. Amps	F.L.C. Amps
				0	100	200	300	400	500	600	700	800	900				
EMF35514	1460	45	①	0.71	0.58	0.09								230V/1/50	150	3.0	1.2
EMF35512	2850	80	②	1.39	1.32	1.24	1.16	1.05	0.92	0.35	0.20	0.10	0.01	230V/1/50	950	13.5	5.4
EMF40014	1460	80	③	0.95	0.82	0.25	0.06							230V/1/50	210	3.8	1.5
EMF45014	1450	80	④	1.45	1.31	1.12	0.28	0.06						230V/1/50	450	7.8	3.1
EMF50014	1380	80	⑤	1.87	1.71	1.50	1.25	0.18						230V/1/50	1380	9.3	3.7
EMF56014	1430	80	⑥	2.67	2.51	2.31	1.97	0.78	0.42	0.12				230V/1/50	1110	19.0	7.6
EMF63014	1410	50	⑦	3.89	3.69	3.43	3.18	2.90	2.49	0.54	0.19			230V/1/50	2140	28.5	11.4

Sound Data

Stock Ref		125	250	500	1k	2k	4k	8k	dBa @3m
EMF35512	INLET	49	72	74	79	78	77	71	40
	OUTLET	55	74	80	83	81	77	69	40
	BREAKOUT	49	56	60	61	59	58	49	40
EMF35514	INLET	51	57	61	62	63	63	48	26
	OUTLET	56	60	66	67	64	60	47	26
	BREAKOUT	42	41	43	46	43	46	29	26
EMF40014	INLET	57	60	70	68	69	64	53	35
	OUTLET	65	63	73	73	69	65	54	35
	BREAKOUT	50	46	59	59	53	52	41	35
EMF45014	INLET	64	66	69	71	74	69	57	42
	OUTLET	71	69	77	76	74	70	59	42
	BREAKOUT	57	69	67	65	61	57	43	42
EMF50014	INLET	69	69	72	73	73	69	57	41
	OUTLET	74	75	78	77	74	70	59	41
	BREAKOUT	54	66	65	64	61	59	42	41
EMF56014	INLET	72	77	79	79	78	74	63	49
	OUTLET	76	82	85	81	79	76	65	49
	BREAKOUT	70	77	75	69	68	63	52	49
EMF63014	INLET	74	78	82	82	80	78	66	50
	OUTLET	74	82	86	84	81	78	67	50
	BREAKOUT	70	74	76	72	70	65	53	50

Performance Curve

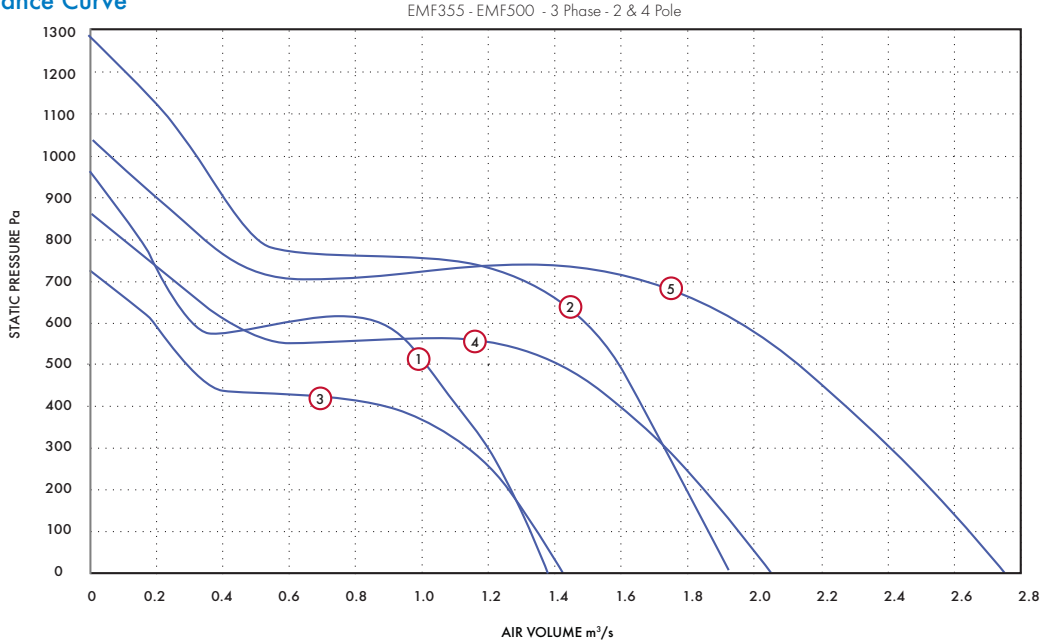

Performance Guide

Stock Ref	Max rpm	Max temp °C	Curve Ref	m³/s at Pa							Voltage	Max Watts	S.C. Amps	F.L.C. Amps
				0	200	400	600	800	1000	1200				
EMF35532	2910	60	1	1.38	1.27	1.10	0.88	0.15			230V/3/50	910	8.0	3.2
EMF40032	2930	80	2	1.92	1.85	1.66	1.49	0.51	0.32	0.11	400V/3/50	1540	8.0	3.2
EMF40034	2200	80	3	1.43	1.26	0.88	0.19				230V/3/75	650	6.8	2.7
EMF45034	2150	80	4	2.04	1.84	1.60	0.42				230V/3/70	1200	11.0	4.4
EMF50034	2060	70	5	2.75	2.53	2.27	1.96	0.34			230V/3/70	1920	17.8	7.1

Sound Data

Stock Ref		125	250	500	1K	2K	4K	8K	dBa @3m
EMF35532	INLET	52	75	77	79	78	77	74	43
	OUTLET	56	76	85	85	82	78	71	43
	BREAKOUT	52	60	66	64	60	61	53	43
EMF40032	INLET	73	88	84	84	85	82	80	55
	OUTLET	76	89	93	91	87	84	80	55
	BREAKOUT	72	88	81	75	71	69	62	55
EMF40034	INLET	68	82	77	77	77	74	66	43
	OUTLET	69	85	86	84	79	76	68	43
	BREAKOUT	59	59	68	66	62	60	51	43
EMF45034	INLET	72	84	81	79	78	77	69	46
	OUTLET	74	87	88	84	81	79	71	46
	BREAKOUT	65	69	72	68	63	62	52	46
EMF50034	INLET	61	81	82	83	81	79	72	53
	OUTLET	71	81	89	89	86	82	74	53
	BREAKOUT	77	77	79	75	70	68	61	53

Eco Mixed Flow (eMF)

Performance Curve

EMF560 - EMF710 - 3 Phase - 2 & 4 Pole

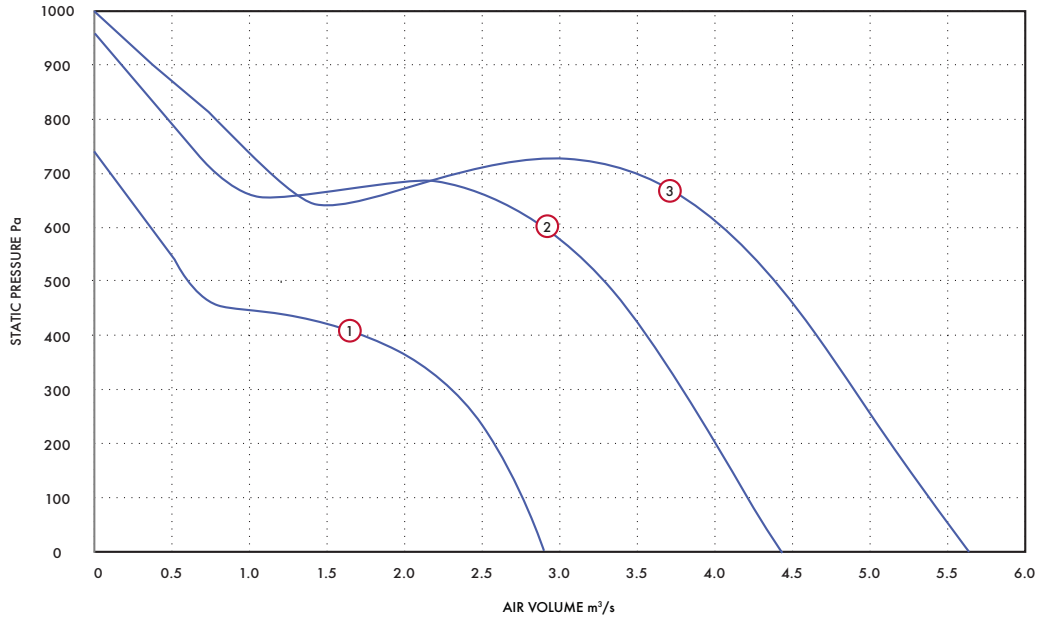

Performance Guide

Stock Ref	rpm	Max temp °C	Curve Ref	m³/s at Pa					Voltage	Max Watts	S.C. Amps	F.L.C. Amps
				0	200	400	600	800				
EMF56034	1570	80	①	2.90	2.57	1.73	0.37		400V/3/50	1360	7.0	2.8
EMF63034	1590	70	②	4.43	4.00	3.56	2.90	0.47	400V/3/50	2620	13.5	5.4
EMF71034	1440	55	③	5.63	5.13	4.66	4.05	0.78	400V/3/50	3610	19.3	7.7

Sound Data

Stock Ref		125	250	500	1K	2K	4K	8K	dBa @3m
EMF56034	INLET	72	74	78	80	78	75	63	48
	OUTLET	74	84	83	82	80	76	65	48
	BREAKOUT	59	67	74	71	68	63	51	48
EMF63034	INLET	76	77	85	83	81	80	68	51
	OUTLET	76	83	88	85	83	80	69	51
	BREAKOUT	67	69	77	73	71	66	55	51
EMF71034	INLET	74	84	85	87	83	80	69	54
	OUTLET	75	87	90	89	86	81	71	54
	BREAKOUT	68	77	78	78	74	66	58	54

Accessories



Fan			Auto Transformer	eDemand Frequency Inverter	Fast Clamp
Stock Ref	Voltage/Hz	FLC	Stock Ref	Stock Ref	Stock Ref
EMF35512	230/1/50	5.4	10314107	-	VM355
EMF35514	230/1/50	1.2	10314103	-	VM355
EMF40014	230/1/50	1.5	10314103	-	VM400
EMF45014	230/1/50	3.1	10314105	-	VM450
EMF50014	230/1/50	3.7	10314105	-	VM500
EMF56014	230/1/50	7.6	10314107	-	VM560
EMF63014	230/1/50	11.4	10314113	-	VM630
*EMF35532	230/3/50	3.2	-	444177	VM355
EMF40032	400/3/50	3.2	-	444173	VM400
*EMF40034	230/3/75	2.7	-	444177	VM400
*EMF45034	230/3/70	4.4	-	444177	VM450
*EMF50034	230/3/70	7.1	-	-	VM500
EMF56034	400/3/50	2.8	-	444173	VM560
EMF63034	400/3/50	5.4	-	444174	VM630
EMF71034	400/3/50	7.7	-	444175	VM710

*Item available to special order, please enquire.

Fans marked with a * must be operated with a single phase in three phase out inverter.

Powerflow In-Line Duct Fans (ACP)

Features & Benefits

- Tough plastic in-line range in seven models
- 50-80mm long ribbed spigots
- Flame retardant casing
- All models speed controllable
- Fitted with Standard Thermal Overload Protection (S.T.O.P.)
- Manufacture controlled to BS EN ISO 9001
- Performance tested to BS 848 Part1 & 2
- 2 Year Guarantee

Ducted Ventilation

Powerflow models provide a compact yet versatile range designed with the installer in mind, combining the acoustic benefits of a tough plastic casing with the pressure characteristics of a centrifugal fan.

A range of seven models from 100 to 315mm dia. duct sizes. The 315mm dia. model has been specifically developed for use with rigid ductwork. Air volumes from 0.059m³/s to 0.42m³/s in free air and capable of pressure development up to 550 Pa.

Typical Installation

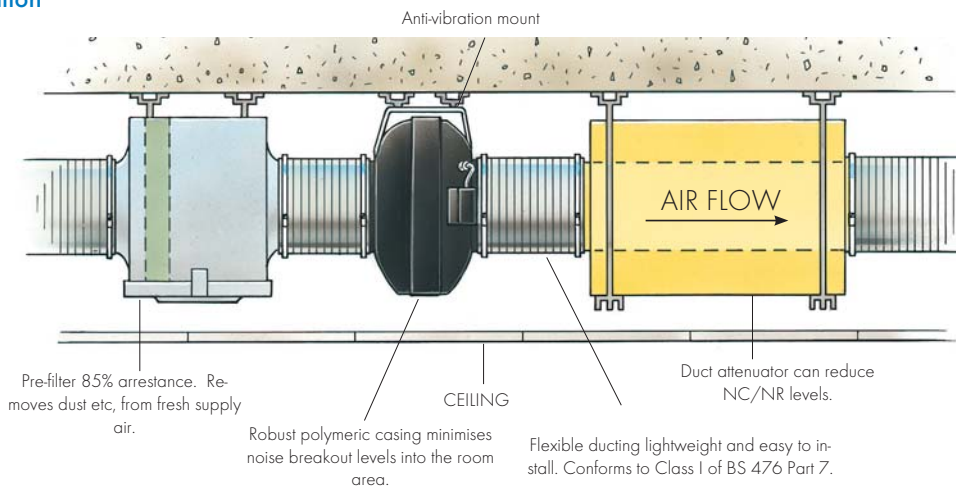

Powerflow has 50-80mm long inlet and discharge spigots allowing easy installation and fixing. The adjustable mounting foot allows the terminal box to be rotated to any angle and allows plenty of space and adjustment for screw fixing. The robust fire-retardant polymeric casing combined with internal guide vanes ensures optimum airflow management through the unit.

Electrical

Motors are 220-240V single phase 50Hz. Capacitor start and run. The terminal box is integral with the case moulding. All motors are fitted with Standard Thermal Overload Protection (S.T.O.P.).

Motor/Impellers

All models are fitted with an external rotor motor and backward curved impeller assembly for long life and reliability.

All sizes are IP44 according to BS EN 60529. Ball bearings are greased for life and designed to run at any angle. Insulation is Class 'B' (from -30°C to +40°C). Manufacture is controlled to BS EN ISO 9001.

Accessories

A full range of accessories are available with the Powerflow in-line centrifugal duct fans such as:

- Electronic Speed Controllers
- Auto Transformer Speed Controllers
- D.O.L. Starters
- Pre & Secondary Filter Cassettes
- Electric Heater Batteries
- In-Line Attenuators
- Backdraught Shutters
- Fast Clamps



Fan Dimensions (mm)

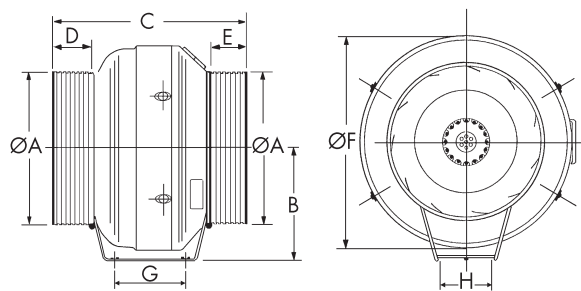

Dia	Øa	b	c	d	e	Øf	g	h	Weight kg
100*	100	146	287	52	52	254	110	270*	2.2
125*	125	146	287	60	60	254	110	270*	2.2
150*	149	175	287	52	52	301	110	270*	3.1
160*	160	175	287	52	52	301	110	270*	3.1
200	200	193	290	47	47	344	92	130	4.3
250	250	218	312	65	65	367	92	130	4.6
315	315	250	366	76	76	405	92	130	5.9

*Sizes 100, 125, 150 & 160 have a flat mounting foot

Powerflow In-Line Duct Fans (ACP)

Performance Curve

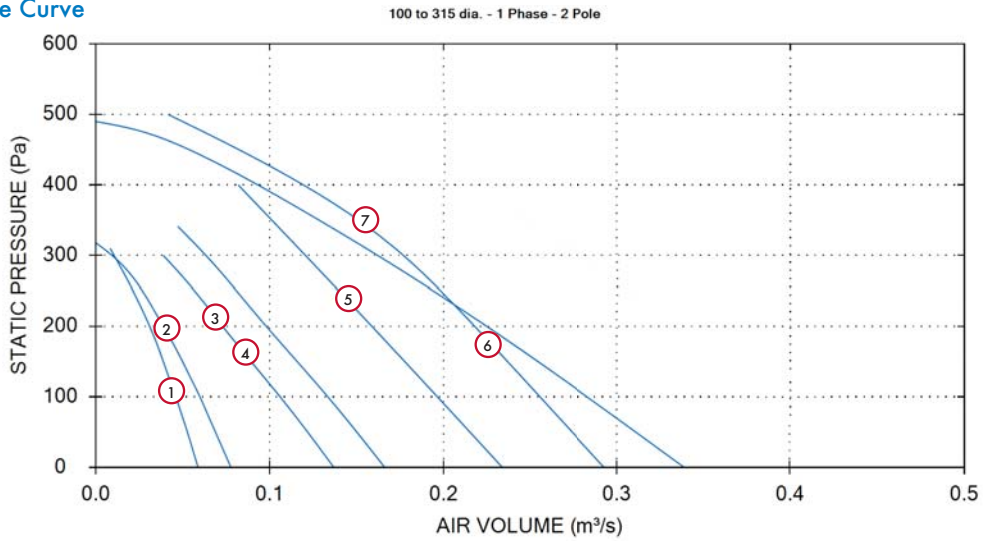

Performance Guide

Dia.	Nominal rpm	Curve Ref	m³/s at Pa								Watts	S.C. Amps	F.L.C. Amps	dB(A) @3m	
			0	50	100	150	200	250	300	350					400
100	2740	1	0.059	0.052	0.046	0.039	0.031	0.021			83	0.85	0.34	35	
125	2410	2	0.078	0.069	0.06	0.05	0.039	0.027			86	0.85	0.34	35	
150	2520	3	0.137	0.122	0.106	0.089	0.073	0.057	0.039		100	1.1	0.43	45	
160	2520	4	0.137	0.122	0.106	0.089	0.073	0.057	0.039		100	1.1	0.43	45	
200	2620	5	0.234	0.214	0.194	0.177	0.159	0.138	0.119	0.1	0.082	150	1.52	0.68	47
250	2720	6	0.29	0.27	0.25	0.234	0.216	0.197	0.177	0.156	0.124	185	1.6	0.77	48
315	2720	7	0.339	0.313	0.274	0.244	0.218	0.191	0.161	0.131	0.098	182	1.57	0.75	51

Figures are based on a 1 Phase Motor

Sound Data

Stock Ref		63	125	250	500	1K	2K	4K	8K	dB(A) @3m
ACP10012B	INLET	81	84	75	68	61	52	46	40	51
ACP10012B	OUTLET	82	84	77	68	61	52	49	43	52
ACP10012B	BREAKOUT	52	48	57	53	53	48	40	38	35
ACP12512B	INLET	80	79	76	70	61	57	51	45	51
ACP12512B	OUTLET	82	80	76	71	61	54	51	43	52
ACP12512B	BREAKOUT	52	48	57	53	53	48	40	38	35
ACP15012B	INLET	79	84	84	76	69	65	61	52	59
ACP15012B	OUTLET	78	84	83	74	69	65	60	50	58
ACP15012B	BREAKOUT	59	62	66	62	62	58	51	43	45
ACP16012B	INLET	81	81	79	76	66	61	58	49	55
ACP16012B	OUTLET	80	82	81	73	67	62	57	49	54
ACP16012B	BREAKOUT	59	62	66	62	62	58	51	43	45
ACP20012B	INLET	80	79	74	76	67	65	66	60	57
ACP20012B	OUTLET	79	79	74	71	69	69	65	59	55
ACP20012B	BREAKOUT	54	70	67	66	62	59	53	43	47
ACP25012B	INLET	84	80	74	74	69	69	67	63	57
ACP25012B	OUTLET	75	79	73	72	72	73	68	64	59
ACP25012B	BREAKOUT	60	71	70	66	65	62	55	44	48
ACP31512B	INLET	84	80	74	74	69	69	67	63	56
ACP31512B	OUTLET	75	79	73	72	72	73	68	64	59
ACP31512B	BREAKOUT	72	71	73	71	66	63	55	45	51

Accessories



Stock Ref	Electronic Controller	Auto Transformer	D.o.I. Starter & Coil	*Edemand Controller Stock Ref			↑Duct Air Heater	Filter Cassette	Bag Filter Cassette
	Stock Ref	Stock Ref	Stock Ref	Voltage Control	1/3 Phase Inverter	3 Phase Inverter	Stock Ref	Stock Ref	Stock Ref
ACP10012	W10303102M	10314103	444744 + 444697	444164	-	-	10531100T1	10532100	10533100
ACP12512	W10303102M	10314103	444744 + 444697	444164	-	-	10531125T1	10532125	10533125
ACP15012	W10303102M	10314103	444744 + 444698	444164	-	-	10531150T1	10532150	10533150
ACP16012	W10303102M	10314103	444744 + 444698	444164	-	-	-	-	-
ACP20012	W10303102M	10314103	444744 + 444699	444164	-	-	10531200T1	10532200	10533200
ACP25012	W10303102M	10314103	444744 + 444699	444164	-	-	10531250T1	10532250	10533250
ACP31512	W10303102M	10314103	444744 + 444699	444164	-	-	10531315T1	10532315	10533315

*For full range of speed controller options, see Accessories & Controllers section



Stock Ref	Duct Attenuator				Heat Exchange Unit
	300mm Stock Ref	600mm Stock Ref	900mm Stock Ref	1200mm Stock Ref	Stock Ref
ACP10012	10534100	10535100	10536100	-	-
ACP12512	10534125	10535125	10536125	-	-
ACP15012	10534150	10535150	10536150	-	-
ACP16012	-	-	-	-	-
ACP20012	-	10535200	10536200	10537200	10538290 +10577315 +10578315
ACP25012	-	10535250	10536250	10537250	10538290 +10577315 +10578315
ACP31512	-	10535315	10536315	10537315	10538290 +10577315

EuroSeries® (SDX)

In-Line Centrifugal Duct Fans



from Vent-Axia

Features & Benefits

- Available in sizes 100 to 315
- 200 and 250 sizes also available as high performance
- Motor Insulation Class B, protected to IP44
- Operating Temperatures from -25°C up to +60°C
- All units suitable for speed control
- Quality Assurance to BS EN ISO 9001:1994
- Performance tested to BS848 Part 1 1980
- 2 Year Warranty

The SDX Euroflow in-line centrifugal duct fans are designed around an efficient backward curved centrifugal impeller and external rotor motor to ensure a compact design, high performance and low sound levels.

The in-line fan casing is constructed from pressed steel and incorporates an aerodynamically designed airflow guide vane, ensuring maximum performance from the unit whilst maintaining minimum noise levels. All models are supplied with a simple mounting foot for ease of installation.

The SDX range is available in eight model sizes: 100, 125, 150, 200, 250 & 315mm diameter as standard performance and sizes 200 and 250 also available as a high performance in-line centrifugal duct fan. The range provides a performance up to 0.372m³/s with a maximum pressure development of 500 Pa.

The SDX range is suitable for the extract of clean air only. It is not suitable for extracting or transporting grinding dust, soot, explosive or other aggressive gases etc.

Impellers

The impellers are aerodynamically designed centrifugal backward curved type, manufactured by injection moulding of a polypropylene resin. The motor and impeller is factory matched, statically and dynamically balanced in two planes to ISO 1940, Grade G 6.3.

Motors

All units are fitted with motors protected to IP44, insulation Class B and are suitable for temperatures ranging from -25°C to +60°C with humidity levels of up to 95% RH ensuring reliable operation. All sizes are for a 220V/1/50Hz electrical supply and incorporate a manual reset thermal protection device.

Terminal Box

An IP54 terminal box fitted to the casing with multiple cable entry positions.

Performance

The fan performance is in accordance with tests to BS848 Part 1 1980, with the fan sound levels measured in a reverberant chamber in accordance with BS848 Part 2 1985.

Quality Assurance

Design and manufacture is in accordance with the standard for quality management systems BS EN ISO 9001:1994.

Accessories

A full range of accessories are available with the Euroflow in-line centrifugal duct fans such as:

- Electronic Speed Controllers
- Auto Transformer Speed Controllers
- D.O.L. Starter and Overload
- Pre & Secondary Filter Cassettes
- Electric Heater Batteries
- In-Line Attenuators
- Backdraught Shutters
- Fast Clamps
- Flexible Ducting
- Wall Terminals
- Roof Terminals



Dimensions (mm)

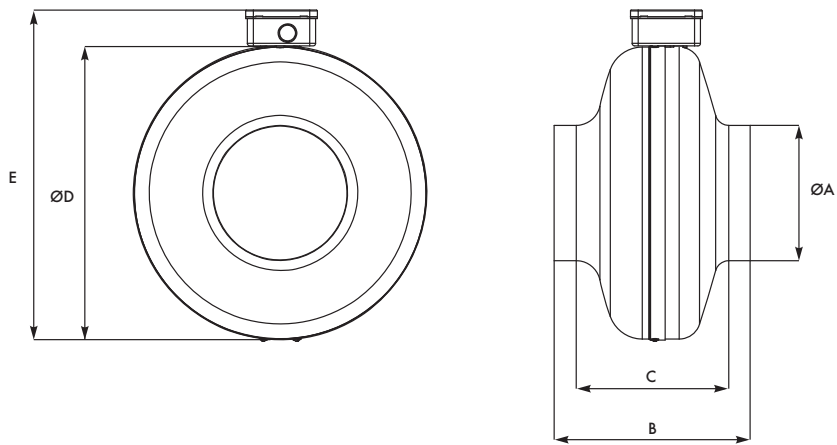

Unit Size	ØA	B	C	ØD	E	kg
SDX100	100	189	152	244	287	3
SDX125	125	182	143	243	286	3
SDX150	150	217	166	344	387	3
SDX200	200	219	167	344	387	4
SDX200H	200	231	179	344	387	4.7
SDX250	250	223	167	344	387	4
SDX250H	250	230	167	344	387	4.7
SDX315	315	243	175	402	444	5.6

Performance Curves

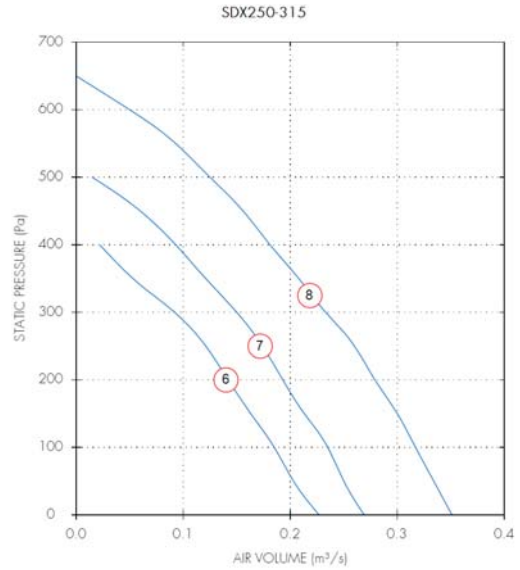
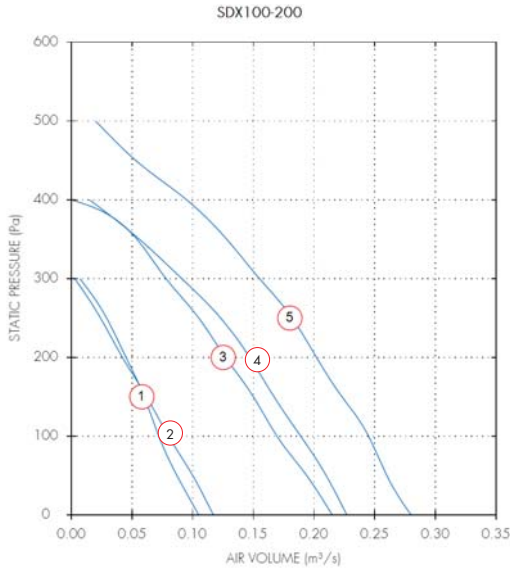

Performance Guide

Dia.	Motor Phase	Stock Ref	r.p.m	IP Rating	Curve Ref.	m³/s @ Pa								Motor kW	F.L.C Amps	dBA @ 3m
						0	100	200	300	400	500	600				
100	1	SDX100	2800	IP44	1	0.1	0.07	0.05	0.01					0.07	0.31	26
125	1	SDX125	2800	IP44	2	0.12	0.08	0.04	0					0.08	0.31	24
150	1	SDX150	2800	IP44	3	0.22	0.17	0.13	0.08	0				0.1	0.44	35
200	1	SDX200	2600	IP44	4	0.23	0.19	0.15	0.09	0.02				0.11	0.45	34
200	1	SDX200H	2660	IP44	5	0.28	0.24	0.2	0.16	0.09	0.02			0.14	0.56	38
250	1	SDX250	2600	IP44	6	0.23	0.18	0.14	0.09	0.02				0.11	0.45	31
250	1	SDX250H	2460	IP44	7	0.27	0.23	0.19	0.15	0.09	0.02			0.13	0.56	34
315	1	SDX315	2567	IP44	8	0.35	0.32	0.28	0.23	0.18	0.13	0.05		0.22	0.96	36

Sound Power Level Spectra dB (ref 10⁻¹² Watts)

Dia.	Motor Phase	Stock Ref	Spectrum	125	250	500	1k	2k	4k	8k	dBA @ 3m
100	1	SDX100	Inlet	53	58	60	66	65	58	47	49
100	1	SDX100	Outlet	54	60	61	67	66	58	48	50
100	1	SDX100	Breakout	34	58	44	55	54	47	37	39
125	1	SDX125	Inlet	50	54	63	65	64	56	47	48
125	1	SDX125	Outlet	49	53	61	64	63	55	45	47
125	1	SDX125	Breakout	28	29	45	53	52	44	35	36
150	1	SDX150	Inlet	51	66	67	71	62	61	53	52
150	1	SDX150	Outlet	52	67	68	72	64	63	50	54
150	1	SDX150	Breakout	30	49	51	60	52	50	36	41
200	1	SDX200	Inlet	46	53	62	66	63	64	54	50
200	1	SDX200	Outlet	45	54	61	68	64	65	53	51
200	1	SDX200	Breakout	22	24	41	49	53	43	40	35
200	1	SDX200H	Inlet	53	60	66	69	66	65	63	53
200	1	SDX200H	Outlet	54	62	65	70	67	67	63	54
200	1	SDX200H	Breakout	25	35	46	53	55	47	45	38
250	1	SDX250	Inlet	41	52	61	66	66	64	56	51
250	1	SDX250	Outlet	43	53	60	68	67	65	57	52
250	1	SDX250	Breakout	24	30	38	48	47	45	40	32
250	1	SDX250H	Inlet	54	62	67	69	67	67	65	54
250	1	SDX250H	Outlet	55	63	66	70	68	67	65	54
250	1	SDX250H	Breakout	33	38	47	50	48	47	46	34
315	1	SDX315	Inlet	50	59	67	68	66	65	64	52
315	1	SDX315	Outlet	51	60	66	69	67	66	65	53
315	1	SDX315	Breakout	33	38	45	48	47	45	43	32

Models & Accessories

Fan	Speed Controller		Starter (requires Overload)	Overload
Stock Ref	Stock Ref	Stock Ref	Stock Ref	Stock Ref
SDX100	SP5001	SPM5020	444744	444696
SDX125	SP5001	SPM5020	444744	444696
SDX150	SP5001	SPM5020	444744	444697
SDX200	SP5001	SPM5020	444744	444698
SDX200H	SP5001	SPM5020	444744	444699
SDX250	SP5001	SPM5020	444744	444698
SDX250H	SP5001	SPM5020	444744	444699
SDX315	SP5001	SPM5020	444744	444699

In-Line Attenuators				
Dia	300mm	600mm	900mm	1200mm
	Stock Ref	Stock Ref	Stock Ref	Stock Ref
100	83010030	83010060	83010090	-
125	83012030	83012060	83012090	-
150	83015030	83015060	83015090	-
200	-	83020060	83020090	83020120
250	-	83025060	83025090	83025120
315	-	83031060	83031090	83031120

Fan	Wall Terminal	Wall Terminal	Electric Heaters	Panel Filters
Stock Ref	Stock Ref	Stock Ref	Stock Ref	Stock Ref
100	SA100/280	SA100/80	10531100T1	QPF100A
125	SA125/280	SA125/80	10531125T1	QPF125A
150	SA150/280	SA150/80	10531150T1	QPF150A
200	SA200/280	SA200/80	10531200T1	QPF200A
250	SA250/280	SA250/80	10531250T1	QPF250A
315	SA315/280	SA315/80	10531315T1	QPF315A

Fan	Bag Filters	Roof Terminal	Louvre Shutter
Stock Ref	Stock Ref	Stock Ref	Stock Ref
100	QPFB100A	WRC100	LS250
125	QPFB125A	WB160	LS250
150	QPFB150A	WB160	LS250
200	QPFB200A	WB200	LS250
250	QPFB250A	RCZ300	LS250
315	QPFB315A	RCZ300	LS315

Slimpak® (SLP)

In-Line Centrifugal Duct Fans



Features & Benefits

- Ultra slim and compact
- Acoustically treated 'O' class rated
- 'Eco Flow' computer modelled design
- Latest external rotor motor
- Fully speed controllable
- Matching ancillaries

The Slimpak in-line acoustic fans shall be as supplied from Roof Units. Manufactured from prime quality galvanised sheet steel, ensuring a robust in-line fan for those tough site conditions. Slimpak fans are internally treated with an 'O' class rated acoustic foam, which offers the benefits of excellent low level duct bound and breakout sound levels, in addition to self extinguishing properties, zero burn role, resistant to ignition, and no toxic fumes.

Slimpak fans are suitable for circular ducting ranging in sizes 100, 125, 150, 200, 250 and 315mm with air volumes from 0.075m³/s to 0.380m³/s and pressure development of up to 550Pa.

The casing shall be specially designed to allow the unit to be mounted quickly and easily. All manufacturing progressed of the Slimpak fan units are computer designed and controlled to BS EN ISO 9001 Standards.

Impellers

The backward curved centrifugal impellers are be aerodynamically designed, utilising computer technology combining the impeller with the external rotor motor. The motor and impeller is factory matched, statically and dynamically balanced on precision machines, to DIN ISO 1940 Grade 6.3, to give quiet, vibration free running. The aerodynamic blades and motor housing are manufactured from prime quality galvanised sheet steel.

Motors

All sizes from 100 to 315 are protected to IP44 in accordance with BS EN 60529:1992. With motor insulation Class B, suitable for operating temperatures from -15°C and atmospheres up to 95% RH. The range incorporates maintenance free external rotor motors, fitted with sealed for life ball bearings.

All sizes are ideally suitable for speed control by electronic or voltage reduction. Roof Units would recommend that a voltage reduction Auto Transformer speed controller is used with all Slimpak units to ensure minimum noise levels during speed control and to eliminate any possibility of harmonic noise levels which occur when using electronic speed controllers at lower levels.

Terminal Box

An IP54 terminal box is supplied with all models with 20mm cable gland entry, ensuring suitability for external use.

Performance

The fan performance is in accordance with tests to BS848 Part 1 1980, with the fan sound levels measured in a reverberant chamber in accordance with BS848 Part 2 1985.

Quality Assurance

Design and manufacture are in accordance with the standard for quality management systems BS EN ISO 9001:1994.

Accessories

A full range of accessories are available with the Slimpak range of fans such as:

- Auto Transformer Speed Controllers
- Electronic Speed Controllers
- D.O.L. Starters
- Pre & Secondary Filter Cassettes
- Electric Heater Batteries
- Backdraught Shutters
- In-Line Attenuators
- Wall & Roof Terminals
- Fast Clamps



Dimensions (mm)

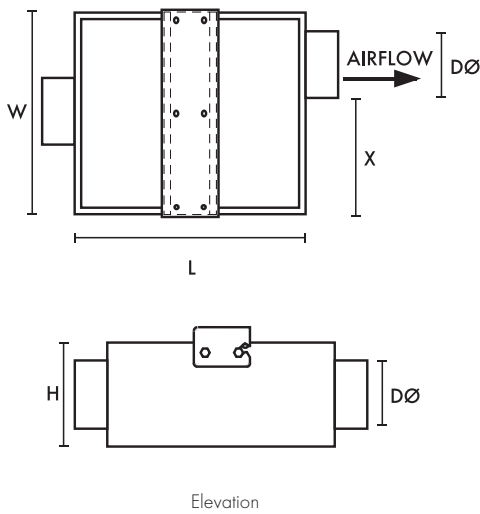

Stock Ref	L	W	H	DØ	X	Weight kg
SLP100	360	306	160	100	178	8
SLP125	360	306	160	125	165	8
SLP150	360	306	180	150	140	9
SLP200	415	360	285	200	140	13
SLP250	415	360	285	250	90	15
SLP315	450	400	350	315	65	17

Mounting Bracket (mm)

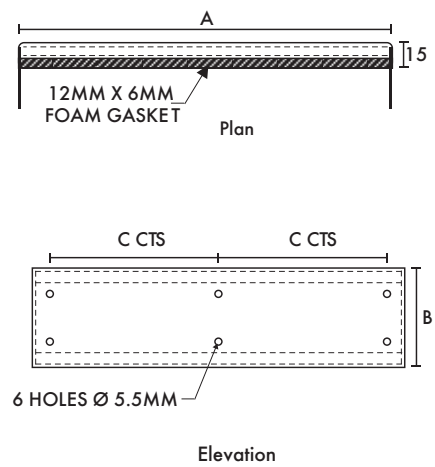

Stock Ref	A	B	C
SLP100	306	80	138
SLP125	306	80	138
SLP150	306	80	138
SLP200	360	130	165
SLP250	360	130	165
SLP315	400	180	184.5

Performance Curve

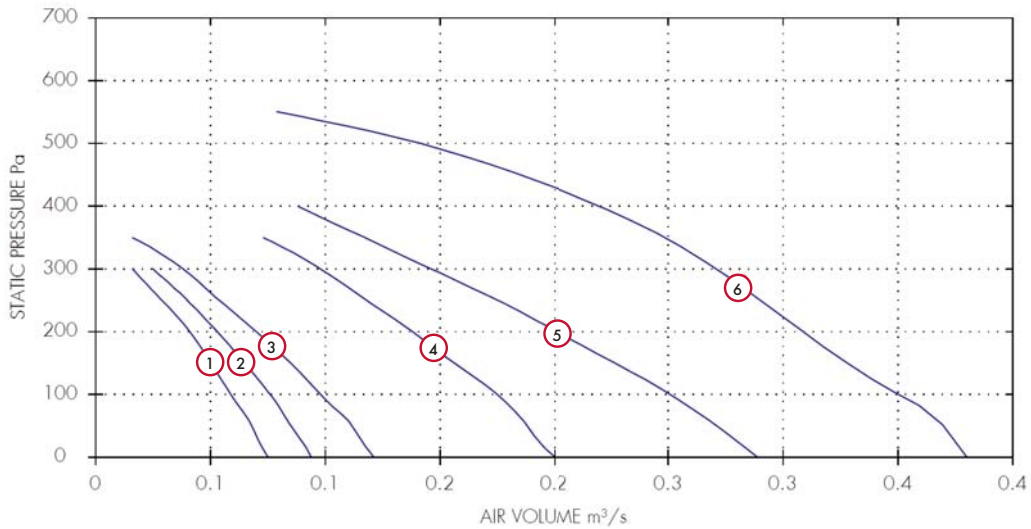

Performance Guide

Stock Ref	rpm	Phase	Curve Ref	Duty m³/s @ Pa													Amps		
				0	25	50	100	150	200	250	300	350	400	450	500	550	kW	FLC	SC
SLP100	2450	1	①	0.075	0.071	0.068	0.059	0.051	0.041	0.029	0.016	-	-	-	-	-	0.058	0.26	1.04
SLP125	2450	1	②	0.094	0.090	0.086	0.076	0.065	0.053	0.040	0.025	-	-	-	-	-	0.058	0.26	1.04
SLP150	2450	1	③	0.121	0.116	0.112	0.098	0.085	0.070	0.054	0.038	0.016	-	-	-	-	0.058	0.26	1.04
SLP200	2700	1	④	0.200	0.193	0.188	0.175	0.156	0.138	0.118	0.098	0.073	-	-	-	-	0.12	0.48	1.92
SLP250	2400	1	⑤	0.289	0.280	0.271	0.251	0.227	0.201	0.175	0.146	0.117	0.088	0.053	-	-	0.13	0.65	3.0
SLP315	2550	1	⑥	0.380	0.342	0.370	0.350	0.328	0.309	0.290	0.271	0.248	0.220	0.185	0.141	0.079	0.23	1.02	5.0

FLC = Full Load Current SC = Starting Current

Sound Power Level Spectra dB (re 10⁻¹² Watts)

Stock Ref		63Hz	125	250	500	1K	2K	4K	8K	dB(A) @ 3.0m
SLP100	inlet	60	63	56	62	51	48	41	40	40
	Outlet	61	65	57	58	56	54	50	43	41
	Breakout	51	52	53	51	42	38	34	30	30
SLP125	inlet	55	59	58	64	53	49	42	39	42
	Outlet	59	61	59	61	59	58	54	45	44
	Breakout	52	54	54	52	43	38	34	30	31
SLP150	inlet	52	58	57	64	55	52	47	42	42
	Outlet	58	60	60	63	60	59	55	47	45
	Breakout	52	53	53	52	43	38	34	30	31
SLP200	inlet	65	68	72	64	56	51	52	47	46
	Outlet	60	66	68	71	66	65	65	58	52
	Breakout	58	65	65	59	48	43	38	35	39
SLP250	inlet	74	76	75	68	58	57	55	48	50
	Outlet	62	72	74	73	72	69	68	59	56
	Breakout	61	70	68	63	54	47	43	32	43
SLP315	inlet	71	75	74	70	70	66	63	58	54
	Outlet	62	70	76	78	72	71	70	63	59
	Breakout	61	69	70	64	58	52	46	37	45

Models & Accessories

Speed Controller

Stock Ref	Speed Controller		Starter Stock Ref	Overload Stock Ref	Electric Heaters Stock Ref
	Electronic Stock Ref	Auto Transfor. Stock Ref			
SLP100	SP5001	SPM5020	444744	444699	10531100T1
SLP125	SP5001	SPM5020	444744	444699	10531125T1
SLP150	SP5001	SPM5020	444744	444699	10531150T1
SLP200	SP5001	SPM5020	444744	444699	10531200T1
SLP250	SP5001	SPM5020	444744	444700	10531250T1
SLP315	SP5001	SPM5020	444744	444702	10531315T1

Attenuators

Stock Ref	Attenuators		Discharge Stock Ref	Wall Terminal Stock Ref
	Inlet Stock Ref			
SLP100	SLSI100/1		SLSD100/1	SA100/280
SLP125	SLSI125/1		SLSD125/1	SA125/280
SLP150	SLSI150/1		SLSD150/1	SA150/280
SLP200	SLSI200/1		SLSD200/1	SA200/280
SLP250	SLSI250/1		SLSD250/1	SA250/280
SLP315	SLSI315/1		SLSD315/1	SA315/280

Stock Ref	Roof Terminal Stock Ref	Louvre Shutter Stock Ref	Flexible Connections Stock Ref	Panel Filters Stock Ref	Spare Panel Filters Stock Ref	Back Draught Shutters Stock Ref
SLP125	WB160C	LS250	FLX125	SLPF125	-	BDS125
SLP150	WB160C	LS315	FLX150	SLPF150	FILTERSSLP150	BDS150
SLP200	WB200C	LS315	FLX200	SLPF200	FILTERSSLP200	BDS200
SLP250	WB200C	LS315	FLX250	SLPF250	FILTERSSLP250	BDS250
SLP315	RCZ300	LS400	FLX315	SLPF315	FILTERSSLP315	BDS315

New & Improved Acoustic In-Line Fans (ACQ)

Features and Benefits

- Acoustically treated housing, Class 'O' rated, sandwich construction selected for maximum noise absorption
- Motors protected to IP44
- Motor insulation Class 'B'
- Maximum operating temperature 50 °C
- Standard Thermal Overload Protection
- Fully weatherproof units available
- All models speed controllable
- Manufacture controlled to BS EN 150 9001
- Performance tested to BS 848 parts 1 and 2

The ACQ fans feature an acoustic foam of dual density sandwich construction specially selected for maximum sound absorption and quiet operation. The housing is designed to be as compact as possible for concealed false ceiling applications.

Manufactured in Aluzinc sheet metal, with integral anchorage points to allow the fan to be suspended at any angle, via drop rods or anti vibration mounts, ensuring a quick and easy solution to installation of the in-line acoustic fans. The access panel is easily removed for inspection.

The full range of Acoustic fans manufactured from Aluzinc and as such are suitable for both internal and external mounting as standard.

Eleven models are available in sizes 100, 125, 150, 160, 200, 250, 315, 400 and 500, providing air volumes from 0.075m³/s to 1.609m³/s (270m³/h to 5,792 m³/h) at free air. Designed for pressures up to 550 Pa.

Motors

At the heart of the range is a proven external rotor motor and backward curved impeller selected for low noise and high efficiency impeller assembly specially selected for its performance. The assembly is dynamically balanced to ISO 1940. Motors are rated to IP44 according to BS EN 60529. Ball bearings are greased for life and allow the fan to run at any angle. Insulation is Class 'B' (from -15 °C to +50 °C).

All Acoustic fans are suitable for speed control with either an Electronic or Auto Transformer. An Auto Transformer is recommended to ensure minimum noise levels during speed control so eliminating any possibility of motor harmonic noise.

Terminal Box

An IP54 Terminal Box is supplied with all models with 20mm cable gland entry.

Sound and Performance

Tested to ISO5801. Published dB(A) figures are free field sound pressure levels at 3m with spherical propagation at a reference level of 2 x 10⁻⁵Pa (20 micro-Pascal). The inlet, outlet and breakout sound power level spectra figures are dB with a reference of 10⁻¹² Watts (1 pico-watt).

Electrical

The ACQ range is supplied with motors wound to suit a 230V/1ph/50Hz supply capacitor start and run.

Quality Assurance

Design and manufacture is in accordance with BS EN ISO 9001.



Fan Dimensions (mm)

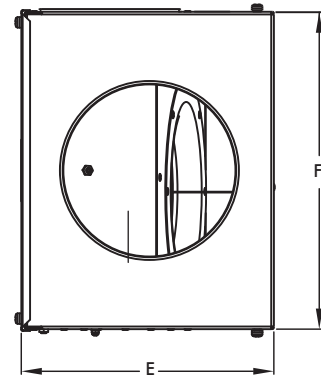
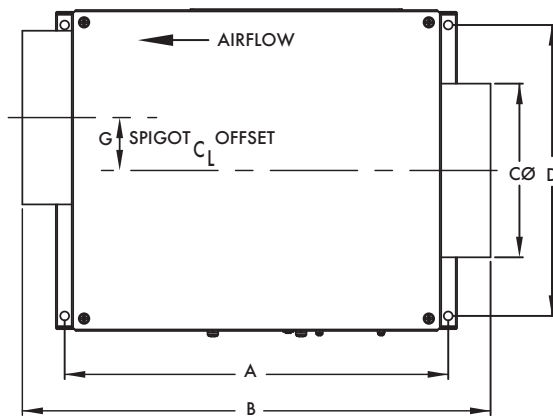

Stock Ref	A	B	CØ	D	E	F	G	Weight kg
ACQ10012D	380	443	100	275	192	306	62	8.5
ACQ12512D	380	443	125	275	192	306	62	8.5
ACQ15012D	380	443	150	275	192	306	62	8.5
ACQ16012D	380	443	160	275	192	306	62	8.5
ACQ20012D	435	531	200	330	287	360	60	12.5
ACQ25012D	435	531	250	330	287	360	35	13
ACQ31512LD	710	808	315	540	458	568	43	34
ACQ31514HD	710	808	315	540	458	568	43	36
ACQ40014D	710	808	400	540	458	568	43	36
ACQ50014D	898	996	500	735	577	765	59	55

New & Improved Acoustic In-Line Fans (ACQ)

Performance Curves

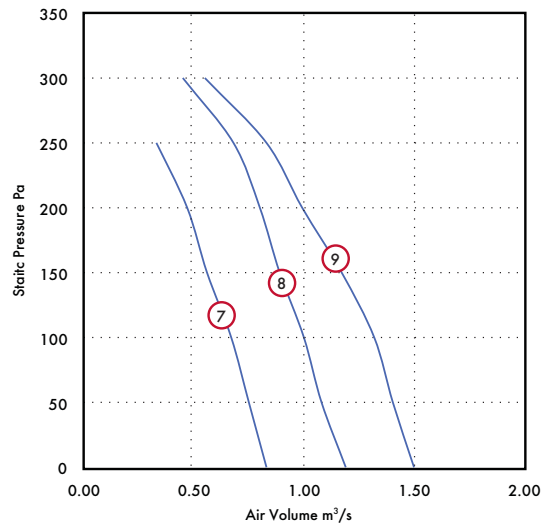
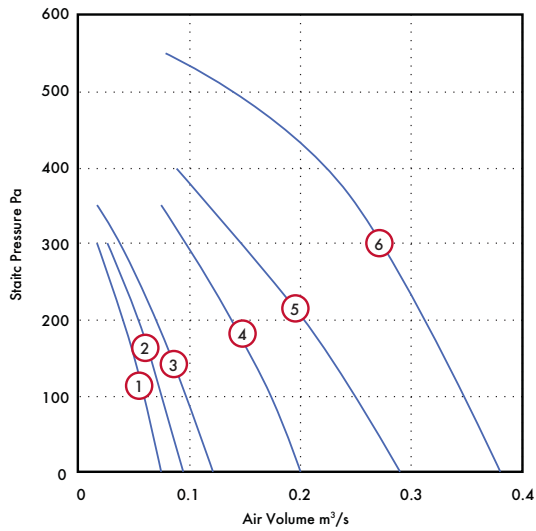

Performance Guide

	rpm	Phase	Curve Ref	Duty m ³ /s @ Pa											Amps			
				0	50	100	150	200	250	300	350	400	450	500	550	kW	FLC	SC
ACQ10012D	2450	1	1	0.075	0.068	0.059	0.051	0.041	0.029	0.016	-	-	-	-	-	0.058	0.26	1.04
ACQ12512D	2450	1	2	0.094	0.086	0.076	0.065	0.053	0.040	0.025	-	-	-	-	-	0.058	0.26	1.04
ACQ15012D	2450	1	3	0.121	0.112	0.098	0.085	0.070	0.054	0.038	0.016	-	-	-	-	0.058	0.26	1.04
ACQ16012D	2450	1	3	0.121	0.112	0.098	0.085	0.070	0.054	0.038	0.016	-	-	-	-	0.058	0.26	1.04
ACQ20012D	2700	1	4	0.200	0.188	0.175	0.156	0.138	0.118	0.098	0.073	-	-	-	-	0.12	0.48	1.92
ACQ25012D	2400	1	5	0.289	0.271	0.251	0.227	0.201	0.175	0.146	0.117	0.088	0.053	-	-	0.13	0.65	3.0
ACQ31512LD	2550	1	6	0.380	0.370	0.350	0.328	0.309	0.290	0.271	0.248	0.220	0.185	0.141	0.079	0.23	1.02	5.0
ACQ31514HD	1330	1	7	0.83	0.75	0.67	0.56	0.47	0.33	-	-	-	-	-	-	0.27	1.18	4.72
ACQ40014D	1340	1	8	1.19	1.08	1.00	0.89	0.80	0.68	0.45	-	-	-	-	-	0.47	2.33	9.32
ACQ50014D	1330	1	9	1.50	1.40	1.32	1.17	0.99	0.83	0.55	-	-	-	-	-	0.73	3.21	12.84

FLC = Full Load Current SC = Starting Current

Accessories



Size	Std Fan Stock Ref	Electronic Controller Stock Ref	Auto Transformer Stock Ref	eDemand Voltage Control Stock Ref
100	ACQ10012D	W10303102M	10314103	444164
125	ACQ12512D	W10303102M	10314103	444164
150	ACQ15012D	W10303102M	10314103	444164
160	ACQ16012D	W10303102M	10314103	444164
200	ACQ20012D	W10303102M	10314103	444164
250	ACQ25012D	W10303102M	10314103	444164
315	ACQ31512LD	W10303102M	10314103	444164
315	ACQ31514HD	10303103	10314103	444164
400	ACQ40014D	10303106	10314105	444164
500	ACQ50014D	10303106	10314105	444164



Size	* Anti-Vibration Mounts (each) Stock Ref	Duct Air Heater Stock Ref	Filter Cassette Stock Ref	Bag Filter Cassette Stock Ref	Heat Exchange Unit Stock Ref	Flexible Connections Stock Ref
100	68MP033G	10531100T1	10532100	10533100	-	FLX100
125	68MP033G	10531125T1	10532125	10533125	-	FLX125
150	68MP033G	10531150T1	10532150	10533150	-	FLX150
160	68MP033G	-	10532160A	10533160	-	FLX160
200	68MP033G	10531200T1	10532200	10533200	10538290 +10577315 +10578315	FLX200
250	68MP033G	10531250T1	10532250	10533250	10538290 +10577315 +10578315	FLX250
315	68MP033G	10531315T1	10532315	10533315	10538290 +10577315	FLX315
400	68MP033G	10531400T3	10532400	10533400	-	FLX400
500	68MP033G	10531500T3	10532500A	10533500	-	FLX500

*4 required per fan



Size	Backdraught	Fast	Duct Attenuator			
	Shutter Stock Ref	Clamp Stock Ref	300mm Stock Ref	600mm Stock Ref	900mm Stock Ref	1200mm Stock Ref
100	10542100	10540100	10534100	10535100	10536100	-
125	10542125	10540125	10534125	10535125	10536125	-
150	10542150	10540150	10534150	10535150	10536150	-
160	-	10540160	-	10535160	-	-
200	10542200	10540200	-	10535200	10536200	10537200
250	10542250	10540250	-	10535250	10536250	10537250
315	10542315	10540315	-	10535315	10536315	10537315
400	10542400	10540400	-	10535400	10536400	10537400
500	-	-	-	-	10536500	-

Square Mixed Flow Fans (MFQ)

Features & Benefits

- Motors protected to IP44
- Motor insulation Class 'B'
- Standard Thermal Overload Protection
- Ductmate flanging
- All models speed controllable
- Manufacture controlled to BS EN ISO 9001
- Performance tested to BS 848 parts 1 & 2

The Square Mixed Flow (MFQ) range has been specially designed for systems with high performance and low sound levels in mind. Ideal for commercial and industrial premises, the MFQ range places the emphasis on fast installation, reliable performance and easy access for maintenance.

The range offers almost two and a half times the pressure development of conventional axial fans and is an ideal cost effective alternative to two stage axial arrangements. The range is dimensionally compact, saving weight and installation costs.

Available in five sizes with a duty range from 0.632m³/s to 3.673m³/s (2275m³/h to 13,222m³/h), develops pressures up to 450 Pa.

Mixed Flow Impeller and Casing

The high efficiency backward curved mixed flow impeller is manufactured in a moulded Polyamide material with 30% Glass Fibre. All other sizes of impeller are constructed in aluminium. All impellers offer non-overloading characteristics and are dynamically balanced for maximum efficiency. The casing is manufactured in sheet steel with Ductmate flanges at both ends.

The full range of MFQ fans is manufactured with an Aluzinc casing suitable for both internal and external mounting as standard.

Motors

A proven external rotor motor design and advanced new design of radial mixed flow impeller assembly has been specially selected for its performance and non-overloading characteristics. The assembly is dynamically balanced to VDI 2060. The motors in this range are rated at IP44 according to BS EN 60529. Ball bearings are greased for life and are designed to run at any angle. Insulation is Class B (from -30°C to +40°C).



Electrical

Single phase 220-240V 50 Hz. Capacitor: start and run. Capacitors are located in the terminal box. Three phase 380-415V 50Hz. All motors are fitted with Standard Thermal Overload Protection (S.T.O.P.).

Performance and Sound

Tested to BS 848 Parts 1 & 2. Published dB(A) figures are free field sound pressure levels at 3m with spherical propagation at a reference level of 2×10^{-5} Pa (20 micro-Pascal). The inlet, outlet and breakout sound power level spectra figures are dB with a reference of 10^{-12} Watts (1 pico-watt).

Quality Assurance

Design and manufacture is in accordance with BS EN ISO 9001.



Fan Dimensions (mm)

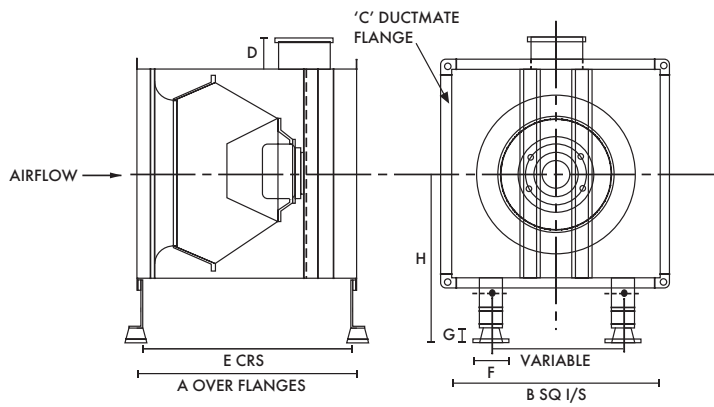

Unit	Duct Size	A	B	C	D	E	F	G	H	Weight kg
350	450 x 450	400	450	25	52	406	62	29	345	22
400	500 x 500	450	500	25	52	456	62	29	370	28
450	550 x 550	485	550	35	52	491	62	29	405	42
500	650 x 650	510	650	35	86	516	102	37	455	73
560	700 x 700	530	700	35	52	536	102	37	480	78

Square Mixed Flow Fans (MFQ)

Performance Curve

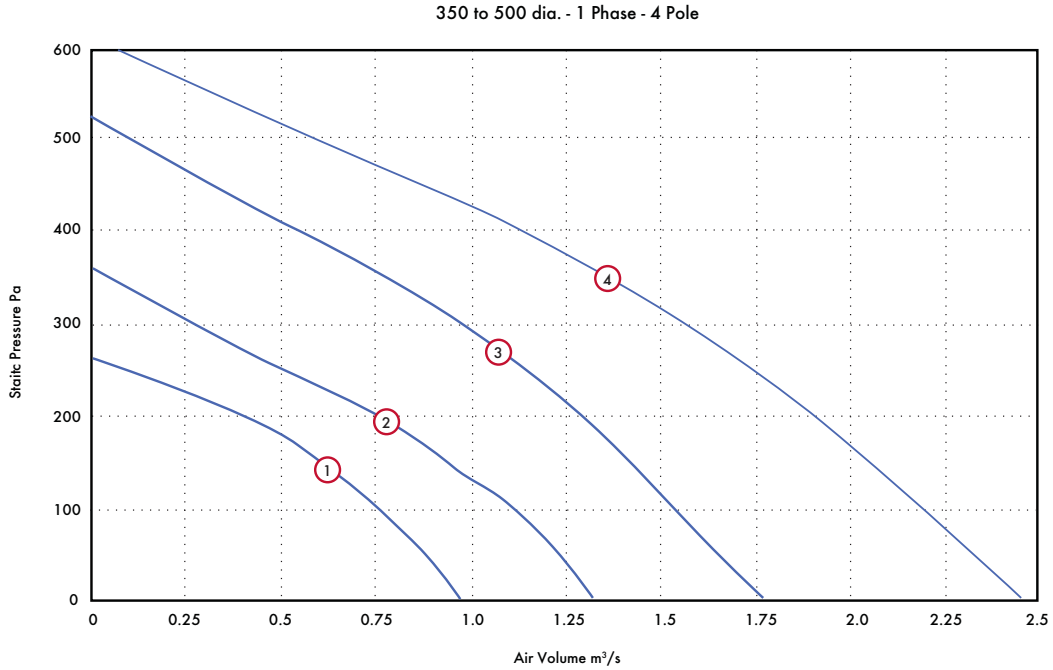

Performance Guide

Stock Ref	Motor Phase	Pole	rpm	Curve Ref	m ³ /s at Pa										Motor kW	SC Amps	FLC Amps	dBA @ 3m		
					0	50	75	100	150	200	250	300	350	400					450	
MFQ35014	1	4	1390	1	0.976	0.875	0.82	0.752	0.603	0.394							0.31	3.7	1.35	55
MFQ40014	1	4	1280	2	1.323	1.21	1.15	1.077	0.928	0.746	0.511	0.275	0.025				0.52	5.5	2.2	57
MFQ45014	1	4	1330	3	1.774	1.65	1.595	1.547	1.423	1.3	1.15	0.971	0.768	0.535	0.316		0.96	9.6	4.3	59
MFQ50014	1	4	1310	4	2.438	2.31	2.246	2.182	2.046	1.91	1.74	1.57	1.35	1.13	0.87		1.45	15	6.1	61

S.C. = STARTING CURRENT
F.L.C. = FULL LOAD CURRENT

Sound Power Level Spectra dB (re 10⁻¹² Watts)

Unit	Motor			63	125	250	500	1k	2k	4k	8k	dBA @ 3m
	Phase	Pole	Inlet/Outlet									
MFQ350	1	4	Inlet	70	74	76	72	72	70	62	54	55
MFQ350	1	4	Outlet	70	74	76	72	72	70	62	54	55
MFQ400	1	4	Inlet	71	78	79	75	74	69	68	59	57
MFQ400	1	4	Outlet	71	78	79	75	74	69	68	59	57
MFQ450	1	4	Inlet	80	82	79	76	78	73	68	60	59
MFQ450	1	4	Outlet	80	82	79	76	78	73	68	60	59
MFQ500	1	4	Inlet	83	85	81	79	80	76	71	66	61
MFQ500	1	4	Outlet	83	85	81	79	80	76	71	66	61

Performance Curve

400 to 560 dia. - 3 Phase - 4 & 6 Pole

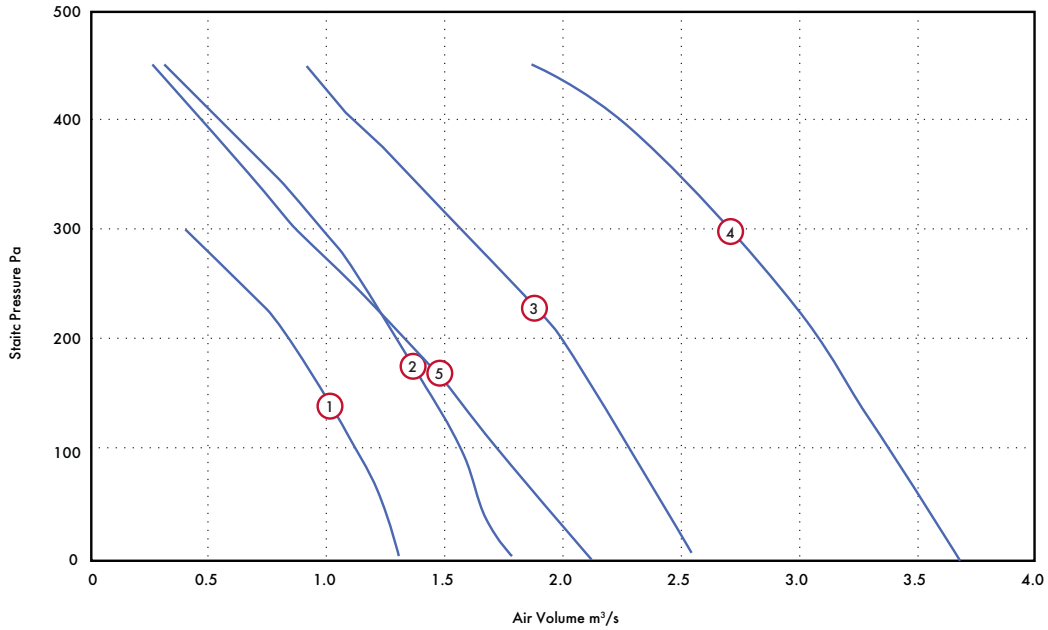

Performance Guide

Stock Ref	Motor Phase	Pole	rpm	Curve Ref	m ³ /s at Pa										Motor kW	SC Amps	FLC Amps	dBA @ 3m	
					0	50	75	100	150	200	250	300	350	400					450
MFQ40034*	3	4	1350	1	1.306	1.218	1.173	1.121	1.001	0.84	0.638	0.397				0.54	4.2	1.05	57
MFQ45034*	3	4	1330	2	1.774	1.65	1.595	1.547	1.423	1.3	1.15	0.971	0.768	0.535	0.316	0.89	5.9	1.65	59
MFQ50034*	3	4	1320	3	2.533	2.402	2.34	2.271	2.132	1.99	1.77	1.59	1.34	1.11	0.895	1.35	10	2.4	61
MFQ56034*	3	4	1350	4	3.673	3.525	3.451	3.377	3.229	3.08	2.89	2.7	2.47	2.24	1.85	2.4	20	4.3	68
MFQ56036	3	6	850	5	2.249	1.957	1.811	1.66	1.329	0.997	0.62	0.25				0.67	3.7	1.45	54

*The 3 phase, 4 pole units 400 to 500 are fitted with 2 speed pole change delta/star connection motors as standard (4/6 pole).

S.C. = STARTING CURRENT

F.L.C. = FULL LOAD CURRENT

Sound Power Level Spectra dB (re 10⁻¹² Watts)

Unit	Motor Phase	Pole	Inlet/Outlet	Motor								dBA @ 3m
				63	125	250	500	1k	2k	4k	8k	
MFQ400	3	4	Inlet	71	78	79	75	74	69	68	59	57
MFQ400	3	4	Outlet	71	78	79	75	74	69	68	59	57
MFQ450	3	4	Inlet	80	82	79	76	78	73	68	60	59
MFQ450	3	4	Outlet	80	82	79	76	78	73	68	60	59
MFQ500	3	4	Inlet	83	85	81	79	80	76	71	66	61
MFQ500	3	4	Outlet	83	85	81	79	80	76	71	66	61
MFQ560	3	4	Inlet	86	90	87	86	87	81	74	69	68
MFQ560	3	4	Outlet	86	90	87	86	87	81	74	69	68
MFQ560	3	6	Outlet	79	80	76	76	78	72	65	56	56
MFQ560	3	6	Inlet	76	75	73	73	73	65	57	49	54

Square Mixed Flow Fans (MFQ)

Accessories Dimensions (mm)

Flexible Connectors and Silencer

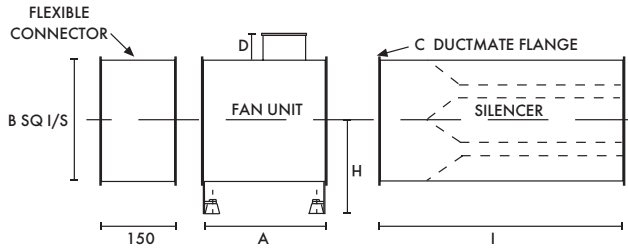

Unit	A	B	C	D	H	I	Weight	Flange
							kg	Ductmate
350	400	450	25	52	345	1200	45	25
400	450	500	25	52	370	1200	48	25
450	485	550	35	52	405	1200	55	35
500	510	650	35	86	455	1500	67	35
560	530	700	35	52	480	1500	70	35

Mount/Feet Details

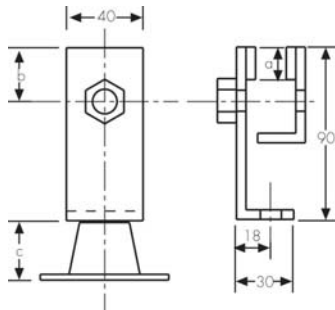

Stock Ref	a	b	c
PAVM 1	25	38	27
PAVM 2	35	38	27
PAVM 3	35	38	35

Clamp Details

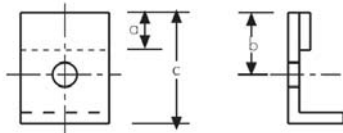

Stock Ref	a	b	c
PAVM 1	25	38	60
PAVM 2	35	38	60
PAVM 3	35	38	60

Silencer Resistance Pa

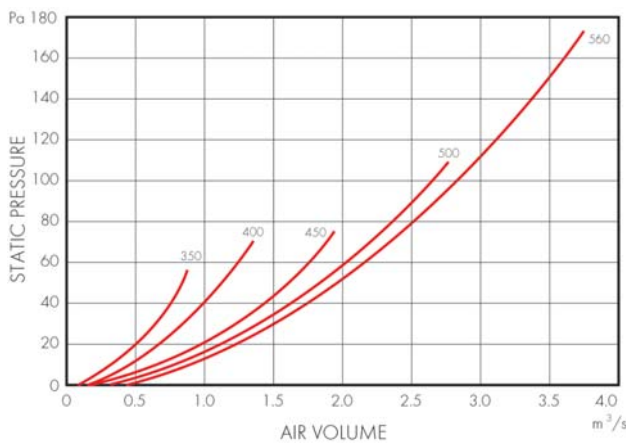

Silencer Insertion Losses

Size	63	125	250	500	1k	2k	4k	8k
350	-3	-5	-14	-27	-36	-36	-29	-24
400	-2	-4	-12	-22	-30	-30	-22	-14
450	-2	-4	-11	-17	-24	-24	-16	-8
500	-3	-6	-15	-23	-31	-31	-21	-11
560	-4	-8	-16	-24	-32	-32	-22	-12

Accessories



Standard Fan Stock Ref	Weatherproofed Fan Stock Ref	Electronic	Auto	D.O.L.		eDemand Controller		
		Controller Stock Ref	Transformer Stock Ref	Starter Stock Ref	Overload Stock Ref	Voltage Control Stock Ref	1/3 Phase Inverter Stock Ref	3 Phase Inverter Stock Ref
MFQ35014	MFQ35014WP	W10303102M	10314103	444744	444700	444164	-	-
MFQ40014	MFQ40014WP	W10303102M	10314103	444744	444702	444164	-	-
MFQ40034*	MFQ40034WP*	-	10314301	444747	444700	444166	444177	444172
MFQ45014	MFQ45014WP	10303106	10314105	444744	444703	444164	-	-
MFQ45034*	MFQ45034WP*	-	10314301	444747	444701	444166	444177	444172
MFQ50014	MFQ50014WP	10303110	10314107	444744	444704	444165	-	-
MFQ50034*	MFQ50034WP*	-	10314304	444747	444702	444166	444177	444173
MFQ56034	MFQ56034WP	-	10314307	444747	444703	444166	444177	444173
MFQ56036*	MFQ56036WP	-	10314304	444747	444701	444166	444177	444172

*For full range of speed controller options, see Accessories & Controllers section

Size	Set of Mounting	Flexible	Matching	Acoustic
	Feet & AV's	Connection	Attenuator	Jacket
	Stock Ref	Stock Ref	Stock Ref	Stock Ref
350	PAVM1	MFQFC350	MFQSS350	MFQAJ350
400	PAVM1	MFQFC400	MFQSS400	MFQAJ400
450	PAVM2	MFQFC450	MFQSS450	MFQAJ450
500	PAVM3	MFQFC500	MFQSS500	MFQAJ500
560	PAVM3	MFQFC560	MFQSS560	MFQAJ560

NOTE: The 3 phase, 4 pole Units 400 to 500 are fitted with 2 speed pole change delta/star connection motors as standard (4/6 pole).

Twin Fan

Vent-Axia twin fan range encompasses direct and belt driven models with air performance up to 3.5m³/s with circular duct from 100 to 500mm and rectangular ducts up to 1200x850mm.

As with many Vent-Axia units our Trakmaster twin fan controller range offers the end user flexibility when interfaced with a BMS. In-line with our constant drive to offer energy efficient solutions the night time setback facility reduces the fan output during low occupancy periods.



New & Improved Acoustic Twin Fans (ATQ) 302-307



Power-Line[®] (TDF) 308-311



Trakmaster Twin Fan Controller 312-313

Vent-Axia

Twin Fan

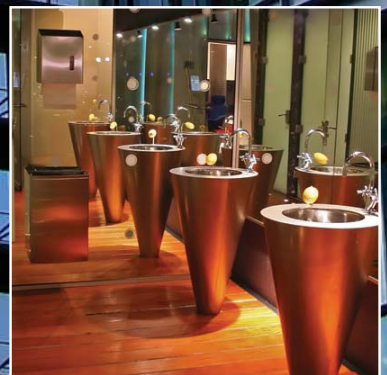
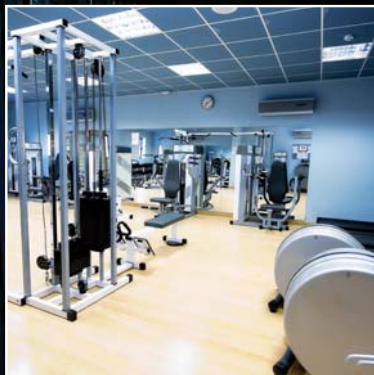
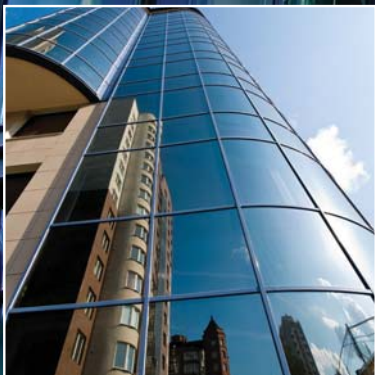

New & Improved Acoustic Twin Fans (ATQ)

Features & Benefits

- Available in sizes from 100 to 500mm dia
- Acoustically treated housing, Class 'O' rated, sandwich construction selected for maximum noise absorption
- Motors protected to IP44
- Motor insulation Class B
- Maximum operating temperature 50°C
- Standard Thermal Overload Protection
- Manufacture controlled to BS EN ISO 9001
- Performance tested to BS 848 Part 1 & 2
- 2 Year Guarantee

VentAxia ATQ fans feature an acoustic foam of dual density sandwich construction specially selected for maximum sound absorption and quiet operation. The housing is designed to be as compact as possible for concealed false ceiling applications. Manufactured in Aluzinc sheet metal, with integral anchorage points to allow the fan to be suspended horizontally via drop rods or anti vibration mounts, ensuring a quick and easy solution to installation. The access panel is easily removed for inspection. Individual gravity operated shutters prevent air from passing through the unit during shut down periods.

The full range of acoustic fans are manufactured from Aluzinc and as such are suitable for both internal and external mounting as standard.

Ten models are available in sizes 100, 125, 150, 160, 200, 250, 315, 400 and 500, providing air volumes from 0.057m³/s to 1.40m³/s (205m³/h to 5040m³/h) at free air. Designed for pressures up to 550 Pa.

Motors

At the heart of the range is a proven external rotor motor and high efficiency backward curved impeller specially selected for its performance. The assembly is dynamically balanced to ISO 1940. Motors are rated to IP44 according to BS EN 60529. Ball bearings are greased for life and allow the fan to run at any angle. Insulation is Class 'B' (from -15°C to +50°C). The size 500 utilizes an internal rotor motor with Class B insulation (from -15°C to +40°C).

All Acoustic fans are suitable for speed control, an Auto Transformer is recommended to ensure minimum noise levels during speed control so eliminating any possibility of motor harmonic noise.

Auto-changeover control is available from the Trackmaster range of controls providing autochangeover control on fan failure and duty sharing options. All controls provide BMS operation via volt free contacts and the option for remote indication.

For eDemand controls refer to Accessories & Controllers Section.

Terminal Box

An IP54 Terminal Box is supplied with all models with 20mm cable gland entry.

Performance and Sound

Tested to BS 848 Parts 1 & 2. Published dB(A) figures are free field sound pressure levels at 3m with spherical propagation at a reference level of 2×10^{-5} Pa [20 micro-Pascal]. The inlet, outlet and breakout sound power level spectra figures are dB with a reference of 10^{-12} Watts (1 pico-watt).

Electrical

The ATQ range is supplied with motors wound to suit a 230V/1ph/50Hz supply capacitor start and run.

Quality Assurance

Design and manufacture is in accordance with BS EN ISO 9001.



Typical Installation

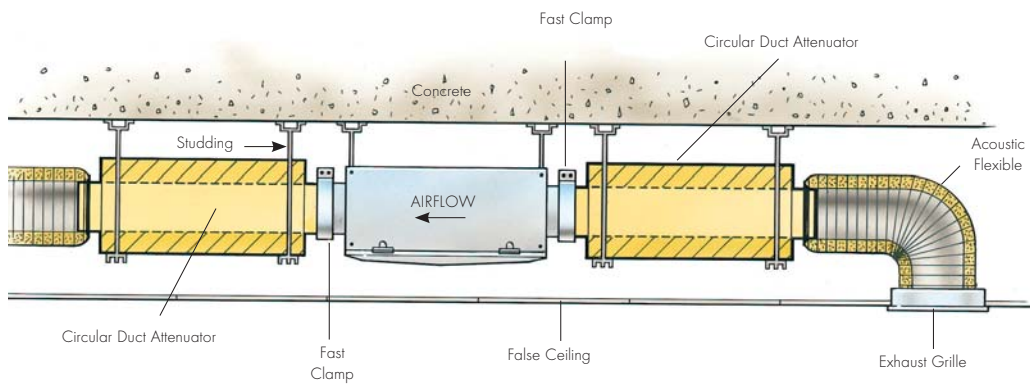

Dimensions (mm)

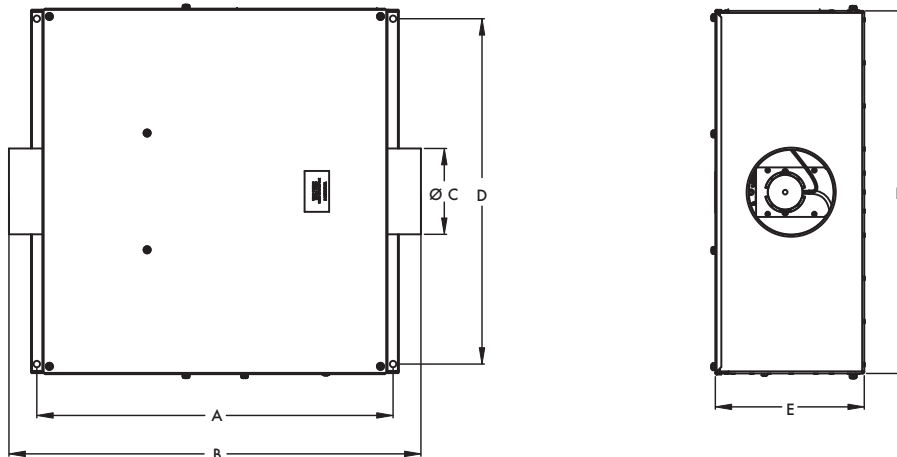

Stock Ref	Duct Diameter mm				Weight		
	A	B	ØC	D	E	F	Kg
ATQ10012D	610	705	100	591	256	622	26
ATQ12512D	610	705	125	591	256	622	26
ATQ15012D	610	705	150	591	256	622	26
ATQ16012D	610	705	160	591	256	622	26
ATQ20012D	801	896	200	703	343	734	39
ATQ25012D	925	1020	250	798	354	829	48
ATQ31512LD	1255	1353	315	1145	536	1176	88
ATQ31514HD	1255	1353	315	1145	536	1176	90
ATQ40014D	1255	1353	400	1145	536	1176	90
ATQ50014D	1492	1590	500	1533	675	1564	175

New & Improved Acoustic Twin Fans (ATQ)

Performance Curve

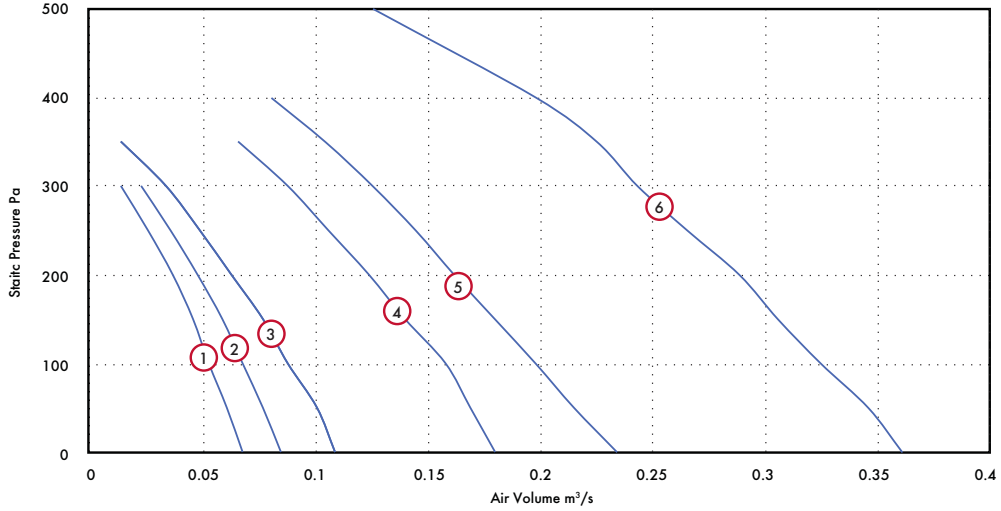

Stock Ref	rpm	Phase	Curve Ref	Duty m³/s @ Pa												Amps		
				0	50	100	150	200	250	300	350	400	450	500	kW	FLC	SC	
ATQ10012D	2450	1	1	0.068	0.061	0.053	0.046	0.037	0.026	0.014						0.058	0.26	1.04
ATQ12512D	2450	1	2	0.085	0.077	0.068	0.059	0.048	0.036	0.023						0.058	0.26	1.04
ATQ15012D	2450	1	3	0.109	0.101	0.088	0.077	0.063	0.049	0.034	0.014					0.058	0.26	1.04
ATQ16012D	2450	1	3	0.109	0.101	0.088	0.077	0.063	0.049	0.034	0.014					0.058	0.26	1.04
ATQ20012D	2700	1	4	0.180	0.169	0.158	0.140	0.124	0.106	0.088	0.066					0.12	0.48	1.92
ATQ25012D	2400	1	5	0.234	0.215	0.198	0.18	0.162	0.145	0.126	0.105	0.081				0.13	0.65	3.0
ATQ31512LD	2550	1	6	0.36	0.345	0.324	0.305	0.288	0.265	0.243	0.225	0.198	0.165	0.126		0.23	1.02	5.0

FLC = Full Load Current SC = Starting Current

Performance Curve

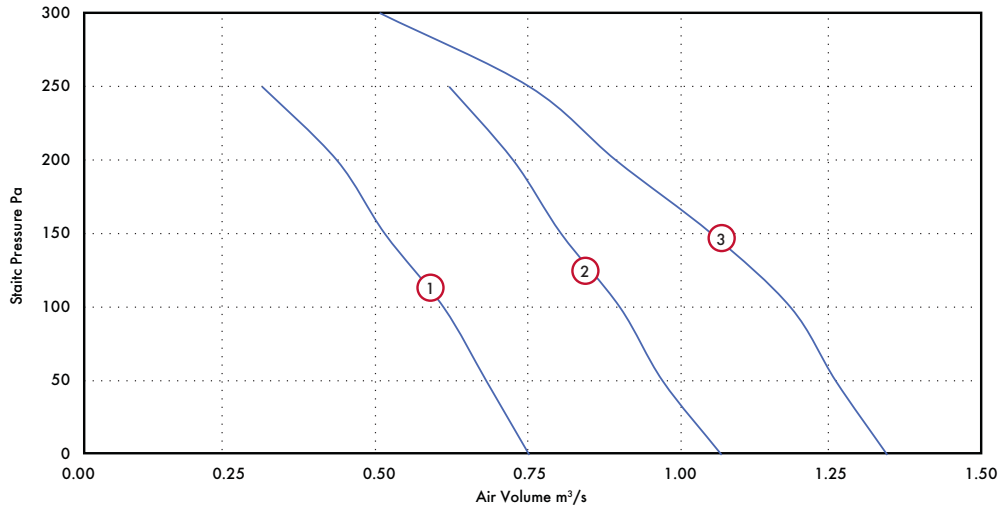

Performance Guide

Stock Ref	rpm	Phase	Curve Ref	Duty m³/s @ Pa							kW	Amps	
				0	50	100	150	200	250	300		FLC	SC
ATQ31514HD	1330	1	1	0.747	0.675	0.603	0.504	0.423	0.297	0.27	1.18	4.72	
ATQ40014D	1340	1	2	1.071	0.972	0.9	0.801	0.72	0.612	0.47	2.33	9.32	
ATQ50014D	1330	1	3	1.35	1.263	1.187	1.054	0.890	0.747	0.495	3.21	12.84	

FLC = Full Load Current SC = Starting Current

New & Improved Acoustic Twin Fans (ATQ)

Duct Attenuators Dimensions (mm)

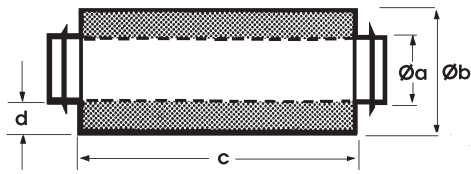

Length	Stock Ref.	Øa	Øb	c	d	kg approx
300	10534100	100	200	300	50	2.6
300	10534125	125	225	300	50	3.6
300	10534150	150	250	300	50	4
300	10534160	160	250	300	50	4
600	10535100	100	200	600	50	4
600	10535125	125	225	600	50	4.5
600	10535150	150	250	600	50	6
600	10535160	160	250	600	50	6
600	10535200	200	315	600	57.5	7.4
600	10535250	250	355	600	52.5	10.2
600	10535315	315	450	600	67.5	13
600	10535400	400	606	600	103	18.5
900	10536100	100	200	900	50	7
900	10536125	125	225	900	50	8
900	10536150	150	250	900	50	9
900	10536160	160	250	900	50	9
900	10536200	200	315	900	57.5	11
900	10536250	250	355	900	52.5	14.7
900	10536315	315	450	900	67.5	18
900	10536400	400	606	900	103	38
900	10536500	500	711	900	105.5	43
1200	10537200	200	315	1200	57.5	14
1200	10537250	250	355	1200	52.5	18.5
1200	10537315	315	450	1200	67.5	21.5
1200	10537400	400	606	1200	103	50
1200	10537500	500	711	1200	105.5	60

Duct Attenuator Insertion Losses

Stock Ref.	Length	Duct Ø	Duct							
			63	125	250	500	1k	2k	4k	8k
10534100	300	100	3	4	10	18	23	25	25	12
10534125	300	125	3	4	8	17	21	23	21	11
10534150	300	150	3	3	6	14	20	23	21	11
10534160	300	160	3	3	6	14	20	23	21	11
10535100	600	100	5	8	16	33	39	40	36	17
10535125	600	125	4	8	13	30	34	35	31	15
10535150	600	150	4	7	13	23	29	36	31	15
10535160	600	160	4	7	13	23	29	36	31	20
10535200	600	200	4	5	11	21	26	32	20	9
10535250	600	250	3	6	10	19	24	29	19	8
10535315	600	315	3	5	8	16	21	22	16	15
10535400	600	400	3	4	7	14	18	19	14	13
10536100	900	100	10	13	20	39	45	38	35	18
10536125	900	125	9	12	18	37	41	37	32	16
10536150	900	150	8	9	15	30	37	37	33	17
10536160	900	160	8	9	15	30	37	37	33	17
10536200	900	200	7	9	14	27	31	36	25	12
10536250	900	250	5	8	13	24	30	31	22	11
10536315	900	315	4	7	11	20	31	27	17	12
10536400	900	400	3	5	9	19	26	20	13	11
10536500	900	500	3	4	9	15	23	17	12	11
10537200	1200	200	10	12	17	35	40	43	27	13
10537250	1200	250	7	9	15	31	36	38	26	12
10537315	1200	315	6	8	13	23	32	30	18	11
10537400	1200	400	6	8	14	24	30	28	17	9
10537500	1200	500	5	7	13	18	26	23	15	9

Accessories



Size	Standard Fan	**ITC Man/Auto Changeover Controller	**ITC-DS 12/24hr Auto Changeover Controller
	Stock Ref.	Stock Ref.	Stock Ref.
100	ATQ10012D	10314200	10314210
125	ATQ12512D	10314200	10314210
150	ATQ15012D	10314200	10314210
160	ATQ16012D	10314200	10314210
200	ATQ20012D	10314200	10314210
250	ATQ25012D	10314200	10314210
315	ATQ31512LD	10314200	10314210
315	ATQ31514HD	10314200	10314210
400	ATQ40014D	10314200	10314210
500	ATQ50014D	10314200	10314210

**Not suitable for use with eDemand controllers. For compatible changeover panel, see Accessories and Controllers Section



Size	eDemand Auto Changeover	eDemand Voltage Controller	*Anti-Vibration Mounts	RVC Remote Visual Indicator	Remote Setback Controller	Auto Transformer
	Stock Ref.	Stock Ref.	Stock Ref.	Stock Ref.	Stock Ref.	Stock Ref.
100	444180	444164	68MP033G	10314220	10314230	10314103
125	444180	444164	68MP033G	10314220	10314230	10314103
150	444180	444164	68MP033G	10314220	10314230	10314103
160	444180	444164	68MP033G	10314220	10314230	10314103
200	444180	444164	68MP033G	10314220	10314230	10314103
250	444180	444164	68MP033G	10314220	10314230	10314103
315	444180	444164	68MP033G	10314220	10314230	10314103
400	444180	444164	68MP033G	10314220	10314230	10314105
500	444180	444164	68MP033G	10314220	10314230	10314105

*4 off required



Size	Backdraught Shutter	Fast Clamp	Duct Attenuator			
	Stock Ref.	Stock Ref.	300mm Stock Ref.	600mm Stock Ref.	900mm Stock Ref.	1200mm Stock Ref.
100	10542100	10540100	10534100	10535100	10536100	-
125	10542125	10540125	10534125	10535125	10536125	-
150	10542150	10540150	10534150	10535150	10536150	-
160	-	10540160	-	10535160	-	-
200	10542200	10540200	-	10535200	10536200	10537200
250	10542250	10540250	-	10535250	10536250	10537250
315	10542315	10540315	-	10535315	10536315	10537315
400	10542400	10540400	-	10535400	10536400	10537400
500	-	-	-	-	10536500	-

Power-Line® (TDF)

Features & Benefits

- **Direct Drive Twin Fan (Run & standby)**
- **Backward Curved Radial Impellers**
- **Performance range up to 3.5m³/s**
- **Static Pressure Development up to 500pa**
- **Speed Controllable**
- **Quality assured to BS EN ISO 9001**
- **Performance listed to BS 848 Part 1**

The TDF range are twin backward curved radial impellers (Run & Standby) designed for induct installations.

Casings

Robustly constructed from aluzinc sheet steel, fitted with propriety flanges at each end in accordance with DW142.

Impellers

Aerodynamically designed backward curved radial impeller constructed in a moulded GRP reinforced Polypropylene to suit the performance requirements.

The rotor of the external rotor motor forms the hub of the impeller. Rotors and impellers are factory matched and statically and dynamically balanced on precision machines according to VDI2060 quality class Q6.3.

Motors

Maintenance free external rotor motors with generously dimensioned sealed for life ball bearings encapsulating a high temperature lubricant. The bearings allow for the fan to be mounted at any angle.

Insulation is Class B with the enclosure IP44 according to DIN 40050. The electrical design corresponds to VDE 0530/12.84. The motors are suitable for operation in atmosphere up to 95% RH and ambients up to 40°C.

Motors are wound to suit either 240V 50HZ 1PH or 415V 50HZ 3PH electrical supply. All motors are fitted with Hot Spot protection by means of a thermal contact switch incorporated in the motor windings to prevent motor damage due to overloading. As the motors have a special torque-speed characteristic they are ideally suited for speed control by voltage reduction.

Performance

Performance figures given have been tested using installation Type 'D' in accordance with BS848 Part 1 1980 and BS848 Part 2 1985. The aerodynamic performance data being to tolerance Class 'C' as recommended by BSI C.A.M.E Scheme, Certification No CM005.

Sound Levels

Sound Levels are measured in a reverberent chamber in accordance with BS848 Part 2. Sound level measurements are taken with the fan operating at 20% of its maximum pressure development.

Published dBA figures are sound pressure levels measured at a distance of 3m with spherical sound level propagation. It is included for comparative purposes only and the real sound level experienced will depend on the acoustic characteristics of the area being served.

Quality Assurance

Design and manufacture is in accordance with Quality Assured to BS EN ISO9001



Fan Dimensions (mm)

Unit Size	A	B	C	D	E	F	G	H	J	K	L	N	Max Weight Kg
320	500	655	900	230	525	680	25	9	50	150	130	220	65
380	550	745	1015	260	585	780	35	11	50	160	130	240	75
420	625	830	1130	295	600	865	35	11	50	230	230	220	103
480	700	925	1250	325	735	960	35	11	65	230	230	300	112
520	775	1055	1385	355	810	1090	35	11	50	230	230	350	145
600	850	1200	1530	400	885	1235	35	11	55	230	230	400	180

Note: For motor removal allow D+J minimum clearance

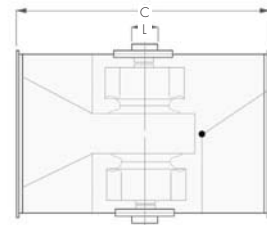
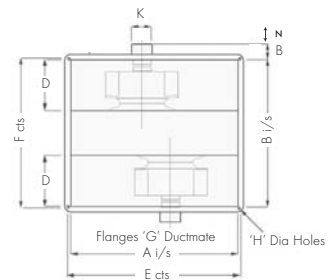

Power Line TDF Flexible Connections

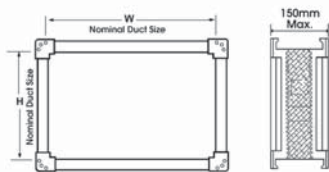

Dimensions (mm)

Unit Code	W	H	Ductmate
320	500	655	25
380	550	745	35
420	625	830	35
480	700	925	35
520	775	1055	35
600	850	1200	35

Power Line TDF Attenuators



Unit Code

RUTDS	W	L	H	Ductmate	Weight
320	500	900	655	25	30
380	550	1200	745	35	62
420	625	1200	830	35	70
480	700	1500	925	35	96
520	775	1500	1055	35	110
600	850	1800	1200	35	150

Vent-Axia Power-Line (TDF)

Performance Curve

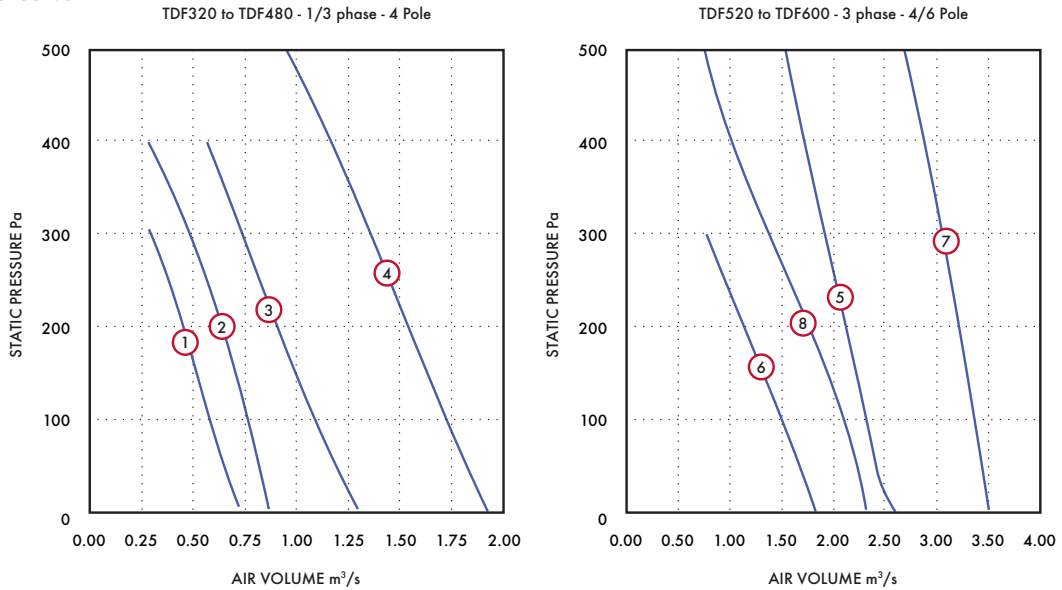

Performance Guide

Size	Phase		rpm	Curve Ref.	m ³ /s at Pa								Motor kW	S.C. Amps	F.L.C. Amps	dBA @ 3m
	Motor	Pole			0	50	100	150	200	300	400	500				
TDF32014	1	4	1375	1	0.731	0.646	0.584	0.532	0.465	0.294			0.31	1.35	3.7	58
TDF38014	1	4	1365	2	0.869	0.822	0.763	0.696	0.642	0.491	0.285		0.52	5	2.2	59
TDF38034	3	4	1365	2	0.869	0.822	0.763	0.696	0.642	0.491	0.285		0.46	2.5	0.85	59
TDF42014	1	4	1280	3	1.301	1.192	1.083	0.977	0.931	0.750	0.57		0.74	7	3.2	61
TDF42034	3	4	1280	3	1.301	1.192	1.083	0.977	0.931	0.750	0.57		0.69	3.4	1.3	61
TDF48014	1	4	1360	4	1.928	1.843	0.71	1.615	1.52	1.33	1.164	0.95	1.3	15	5.7	66
TDF48034	3	4	1360	4	1.928	1.843	0.71	1.615	1.52	1.33	1.164	0.95	1.25	9.2	2.3	66
TDF52034	3	4	1345	5	2.612	2.432	2.337	2.242	2.147	1.928	1.729	1.548	1.8	10	3.4	67
TDF52036	3	6	865	6	1.824	1.634	1.472	1.301	1.13	0.769			0.69	3.6	1.5	55
TDF60034	3	4	1425	7	3.515	3.431	3.345	3.303	3.220	3.075	2.893	2.692	4.1	29	6.8	70
TDF60036	3	6	925	8	2.33	2.21	2.107	1.858	1.719	1.404	1.016	0.76	1.2	8	2.6	56

Sound Power Level Spectra dB (re 10⁻¹² Watts)

Size	Pole	63	125	250	500	1k	2k	4k	8k	dB A @ 3m
TDF320	4	65	84	79	77	73	70	65	58	58
TDF380	4	66	84	78	79	75	71	66	59	59
TDF420	4	74	91	83	81	76	72	69	65	61
TDF480	4	76	95	88	86	81	76	76	71	66
TDF520	4	80	96	89	86	83	78	72	66	67
TDF520	6	80	81	78	80	71	62	60	52	55
TDF600	4	83	99	94	90	87	85	75	70	70
TDF600	6	84	86	80	77	73	66	61	56	56

Power-Line Silencers Type TDS

Unit Code TDS	Attenuation across Sound Spectrum H ₃							
	63	125	250	500	1K	2K	4K	8K
320	3	8	17	24	32	32	25	20
380	6	12	23	32	45	45	33	28
420	6	10	20	31	43	43	33	27
480	4	9	17	27	36	36	24	13
520	3	7	14	22	27	21	15	10
600	4	8	15	24	30	26	14	8

For sound breakout through the fan casing the above figures may be reduced by 15dB across the frequency band 125 to 8k

Accessories



Size W x H	Fan Stock Ref.	Transformer	*eDemand Controller			
		Speed Controller Stock Ref.	Auto Changeover Stock Ref.	Voltage Control Stock Ref.	1/3 Phase Inverter Stock Ref.	3 Phase Inverter Stock Ref.
500 x 655	TDF32014	10314103	444180	444164	-	-
550 x 745	TDF38014	10314103	444180	444164	-	-
550 x 745	TDF38034	10314301	444179	444166	444177	444172
625 x 830	TDF42014	10314105	444180	444164	-	-
625 x 830	TDF42034	10314304	444179	444166	444177	444172
700 x 925	TDF48014	10314107	444180	444165	-	-
700 x 925	TDF48034	10314304	444179	444166	444177	444173
775 x 1055	TDF52034	10314304	444179	444166	444177	444173
775 x 1055	TDF52036	10314304	444179	444166	444177	444172
850 x 1200	TDF60034	10314307	444179	444167	-	444175
850 x 1200	TDF60036	10314304	444179	444166	444177	444173



Size W x H	**ITC Man /Auto Ch'over Cont. Stock Ref.	**ITC-DS 12/24hr Auto Ch'over Stock Ref.	RVC Remote Visual Indicator Stock Ref.	RSC Remote Setback Cont. Stock Ref.	Weather Proof Treatment Stock Ref.
	500 x 655	10314200	10314210	10314220	10314230
550 x 745	10314200	10314210	10314220	10314230	ECP2
625 x 830	10314200	10314210	10314220	10314230	ECP3
700 x 925	10314200	10314210	10314220	10314230	ECP3
775 x 1055	10314200	10314210	10314220	10314230	ECP3
850 x 1200	10314200	10314210	10314220	10314230	ECP4



Size W x H	Mounting Feet & AVs (Set of 4) Stock Ref.	Flexible Connection Stock Ref.	Matching Attenuator Stock Ref.	Acoustic Jacket Stock Ref.	Discharge Cowl Stock Ref.	Roof Canopy Stock Ref.
	500 x 655	PAVM1	TFC320	RUTDS320	TAJ320	-
550 x 745	PAVM2	TFC380	RUTDS380	TAJ380	TDW380	TRC380
625 x 830	PAVM3	TFC420	RUTDS420	TAJ420	TDW420	TRC420
700 x 925	PAVM3	TFC480	RUTDS480	TAJ480	TDW480	TRC480
775 x 1055	PAVM3	TFC520	RUTDS520	TAJ520	TDW520	TRC520
850 x 1200	PAVM3	TFC600	RUTDS600	TAJ600	TDW600	TRC600

**Not suitable for use with eDemand controllers. For compatible changeover panel, see Accessories and Controllers Section.

Trakmaster Twin Fan Controller*

The range of intelligent Vent-Axia twin fan controllers has been designed to offer total flexibility and controlled interface with BMS (Building Management Systems) saving installation costs, and providing energy management/night setback facility.

ITC - (Trakmaster twin fan control)



Provides automatic changeover on fan failure as well as enabling a manual selection of either fan for duty sharing or test purposes. (BMS compatible via volt free contacts). This controller must have a permanent live supply. Any On/Off switching must be via the sensor connections S1 and SG terminals.

Stock Ref **10314200**

RVC - (Remote visual indicator)



Wired in conjunction with either an ITC or ITC-DS controller the RVC can be located up to 100m away using low cost ELV wiring. The compact, single gang RVC ELV (Extra Low Voltage) remote visual controller indicates status of Fan 1 and Fan 2 with status/warning lights. Push button allows Fan 1 and Fan 2 with standby (Off) to be selected.

Stock Ref **10314220**

ITC-DS - (Trakmaster twin fan control - Duty sharing)



Incorporates a timing mechanism which operates alternate fans on 12 or 24 hour intervals, thus ensuring the extended life of the fan bearings. The controller also provides automatic changeover on fan failure along with the facility for manual selection of either fan. (BMS compatible via volt free contacts). This controller

must have a permanent live supply. Any On/Off switching must be via the sensor connections S1 and SG terminals.

Stock Ref **10314210**

RSC - (Remote setback control)



The RSC multi-speed control system offers 2 speed fan versatility eg. Energy Management for night-time setback. Can be used in conjunction with Vent-Axia ITC, ITC-DS controllers using 5 step auto-transformer speed controllers for speed selection. Uses 24V output from ITC controller.

Stock Ref. **103 14 230**

Electrical ITC/ITC-D S

Maximum load: 9 amps on single or three phase.

Dimensions

ITC-DS - 103 14 210 OR ITC - 10314200

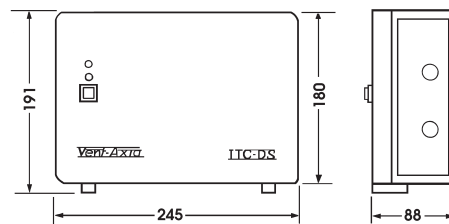

RSC - 103 14 230A

RVC - 10314220

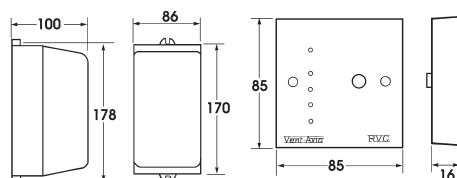

Note:
Suitable for mounting with single gang electrical box.

PLEASE NOTE: The ITC Controllers may be used in conjunction with a 5-Step Auto Transformer SPEED CONTROLLER for commissioning purposes to meet the required design criteria.

*For alternative eDemand twin fan controls see Accessories & Controllers Section



Sensors for use with ITC and ITC-DS controls

ThermoSwitch



Operates on either a fall or rise in temperature for extraction of excess heat. Range 6°C to 30°C.
Stock Ref. 563502

Ecotronic Humidistat



An electronic On/Off humidistat with concealed humidity adjustment 65-90% RH with removable pullcord override. Changeover relay switch.
Stock Ref. 563550

Air Quality Sensor



Automatically reacts to tobacco smoke, smells and toilet odours to trigger the system or switch speed.
Stock Ref. 563506

7-Day TimeSwitch



7-Day timer with analogue display. Override facility. Gives twelve On or Off positions per day.
Stock Ref. 563515

HumidiSwitch



Actuates mechanical humidistat ventilating units on either a rise or fall in humidity. Concealed adjustment. Range 20% to 80% RH.
Stock Ref. 563501

Visionex PIR Detector



Ceiling mounted movement detector. Adjustable overrun timer 5 to 25 minutes. Fits any UK single gang mounting box. Range of detection up to 10 metres. 220-240V.
Stock Ref. 459623

Connection Layout of ITC And ITC-DS Controller

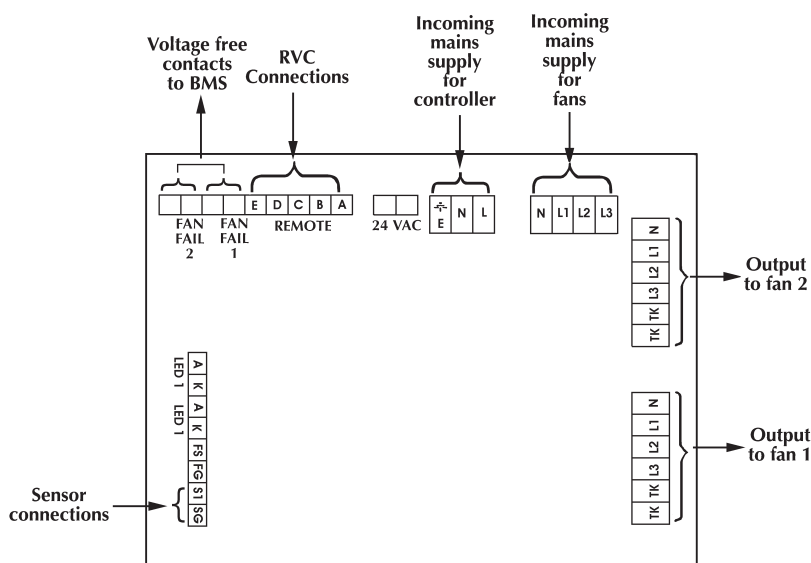

For full wiring information, refer to ITC Fitting & Wiring instructions.

Sentinel D-Box

Sentinel D-Box from Vent-Axia

Sentinel is the answer to key questions such as 'Why ventilate a room you're not using?' or 'Why over ventilate a room with only one or two occupants inside?'

Sentinel overcomes many of the issues encountered with a traditional fixed volume ventilation system that is either On or Off irrespective of the number of people in the room, risking room over ventilation, burning valuable money and a wasteful use of energy.

The Sentinel system from Vent-Axia benefits the commercial building by providing:

- Lower energy consumption than traditional systems
- Reduced losses to ventilation under part occupancy
- Longer running life
- Reduced operating costs
- Savings in lifetime maintenance costs
- Ease of installation

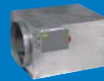

Sentinel D-Box Single Fan

320-329



Sentinel D-Box Twin Fan

330-339



Sentinel D-Box Sensors & Controls

340-341

Vent-Axia

Sentinel D-Box



Vent-Axia Sentinel D-Box Fans

Using the Vent-Axia Lo-Carbon range can reduce electrical consumption, thus reducing the overall carbon footprint.

Sentinel is a new range of ventilation systems for multi occupancy and intermittently used rooms. Using energy efficient ducted fans with intelligent sensing and control, the system meets the ventilation requirements of both new builds and refurbishment projects.

Ideal for applications where the rooms are used at different times of the day by a variable number of people, the Sentinel system will monitor occupancy, ventilation rate and air quality, and respond accordingly to maintain the atmosphere within preset limits.

Typical Applications

A network of hotel bathrooms, flats or apartments, which require ventilation, but are only used in limited periods particularly in the morning and in the evening.

School classrooms and lecture theatres which are only occupied during lesson time by a variable number of students, but when used must keep CO₂ levels within prescribed limits.

Office meeting rooms or open plan areas which

again are used periodically during the day by a variable number of staff and visitors, but when occupied must meet required airflow rates.

Automatic sensing and control runs the system according to the maximum demand requirements of the building zone, whether it be carbon dioxide levels, temperature, humidity or air quality - triggered by people entering or leaving the rooms. Common configurations include Electronic Static Pressure (ESP) controllers for constant pressure systems.

System Control

The precise control of the Sentinel system, driven by the ventilation requirements of the room at any one time, means that the system is only running to the level required, using energy when it is needed. A range of sensors are employed to determine the occupancy of the rooms and manage the system ventilation rates accordingly. This optimises the use of energy whilst meeting the legislation requirements of the building.

This compares to a 'traditional' fixed volume system, which in general is either 'ON' or 'OFF' often using energy to ventilate an empty or half occupied room, over ventilating and wasting energy.

System Overview

The Sentinel System is made up of 3 parts: EC/DC Fan Motor, Sentinel Integral Control Unit, Sensors and Controls.

The ventilation demands of the room are detected by the wall, ceiling or duct mounted Sentinel sensors/switches. These communicate with the Sentinel control unit, which in turn drives the fan to the required speed to deliver the airflow. As the ventilation is provided to the room, the sensors continuously feedback to the control unit, driving the fan motor to the exact level required in the room at any one time.

Accessories

For duct accessories refer to Ducting Section.

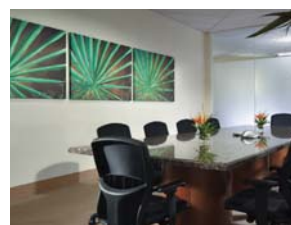
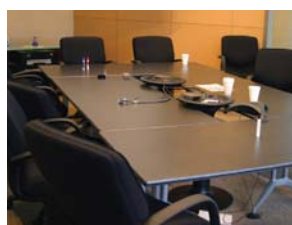



Typical network of hotel bathrooms/flats/apartments



Typical school classroom

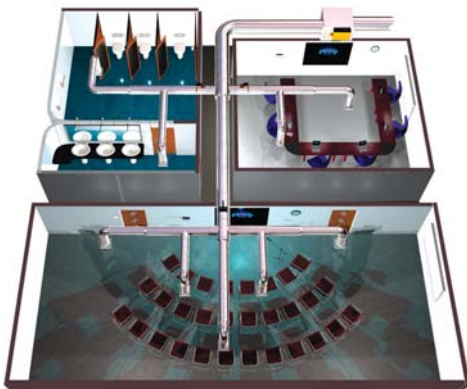

Typical office plan with conference facilities

System Technology

Sentinel demand ventilation is a closed loop controlled ventilation system. Employing a range of sensors to manage the system, demand is sensed by PIR, temperature, humidity, air quality or carbon dioxide sensors. Depending on the levels in the rooms, Sentinel's fan speed is ramped up or down to control the parameters within the required limits. If the room is unoccupied, the system switches off, saving energy and cost to the business. Available in single or twin fan configurations, twin allowing for load sharing or 'standby' for extra reliability.

EC/DC Energy Saving Fan Motor Technology

Sentinel utilises the latest EC/DC motor technology, which provides energy saving benefits even over DC motors.



This technology is also infinitely speed controllable and offers increased energy savings across the complete speed control range when compared with conventional inverter drive solutions. The result is higher efficiency, reduced noise, accurate controllability, better speed control drawing less power and as a result better overall system performance.

Sentinel can be used in a hierarchal system where maximum demand, for example temperature and/or CO₂ gives priority control of the fan speed or a constant pressure system with room mounted PIR/grilles or in-line damper control.

Vent-Axia Sentinel D-Box Fans

Highest Motor Efficiency

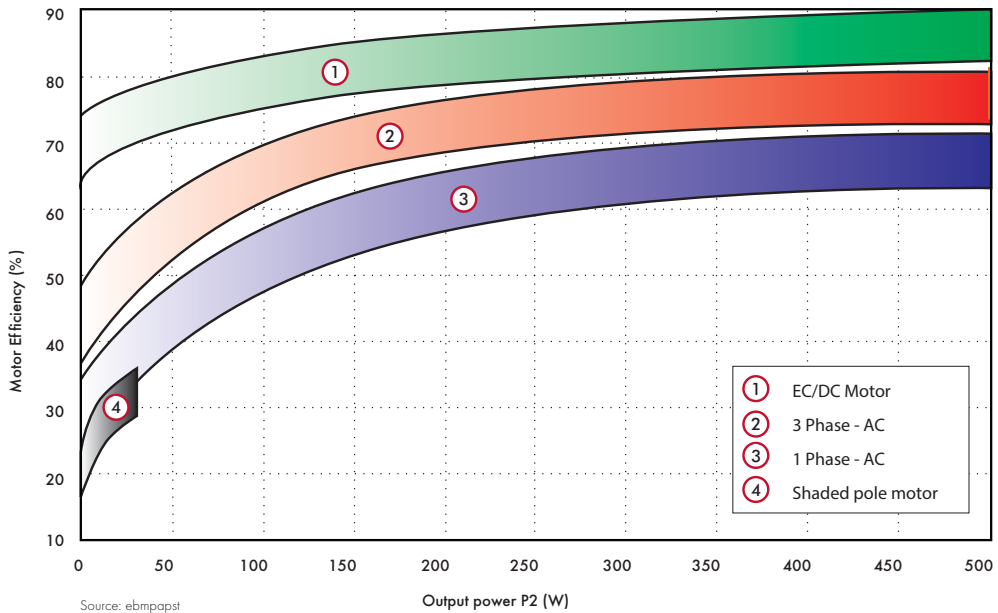

Typical EC/AC Motor Speed Control Comparison

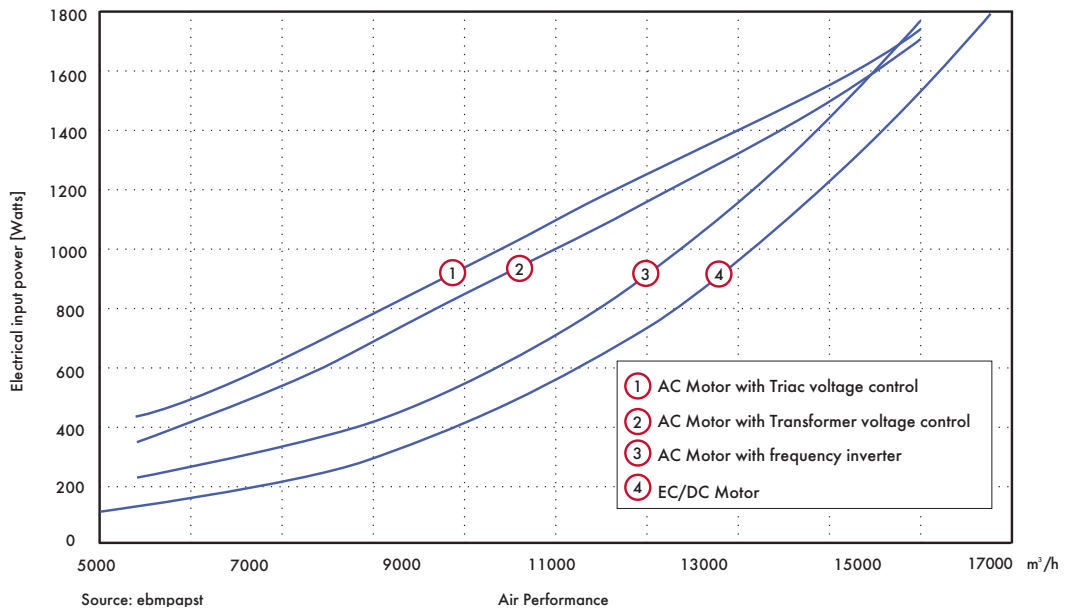

As can be seen from above motor comparisons, the EC/DC motor offers higher efficiencies when compared to AC motors, and also consumes less power under speed control, giving both the highest motor efficiency and lowest power consumption across the speed control range.

Hierarchical Control



The system is controlled by on board electronics, with an LCD display showing fan status and allowing for simple commissioning and installation, whether as a local sensor control unit or linked into a building management system.

1. Switched on/off or minimum/maximum level control

In an environment such as an office, the system is activated and runs between minimum and maximum levels by a choice of sensors.

- AQS - Air Quality Sensor
- PIR Detector
- Thermostat
- Humidistat
- Time Clock
- BMS (remote enable)

2. Hierarchical - maximum demand multi sensor input

Used with a combination of sensors, with a defined level of priorities to simultaneously control a number of atmospheric conditions

within a room, such as a meeting room.

- CO₂/Temperature - room mounted
- CO₂ - duct mounted
- Manual speed adjuster
- Building Management System (0-10V)

Constant Pressure Extract

Applied in a discreet central extract system, such as hotel bathrooms or apartment blocks, the system grilles and/or duct dampers are controlled by the presence of a person in the room or by achieving required levels of humidity. The central system will respond to the demand depending on the number of active rooms.

- PIR/Humidity Extract Grille 125mm
- PIR 12 - 70m³/h
- Humidity: 12m³/h - 30% RH
70m³/h - 75% RH
- Motorised Duct Dampers 100mm - 315mm Dia
- Built in end stop adjustment for setting minimum and maximum volume
- 24V Min/Max or 0-10V proportional control options
- Motorised Duct Dampers - Sensor Control options
- Each 24V powered extract damper can be controlled by one of the following sensors:-

Min-Max (DVDxxx/MM)

- AQS - Air Quality Sensor - Room (432953)

- PIR Detector - Room (433162)
- Thermostat - Room (563502)
- Humidistat - Room (432945)

Proportional 0-10V (DVDxxx/PC)

- Carbon Dioxide Sensor - Room (433259)
- Carbon Dioxide Sensor - Duct (433259)
- Temperature Sensor - Room (434749)

Note Local 24V power supply required to power dampers & Sensors (426526)

Controls



* Overall potential savings based on 12 hours use

Sentinel D-Box Single Fan

The Sentinel single in-line duct fans are as supplied from Vent-Axia Ltd. Manufactured from prime quality galvanised sheet steel, Sentinel fan units are internally treated with an 'O' class rated, BS476 part 6 & 7, acoustic foam, which offers the benefits of high sound absorption, good thermal insulation properties, in addition to self extinguishing properties and resistance to ignition.

Weatherproof external units incorporate controller shrouds and are coated externally with a polyurethane finish.

The casing includes an inclined inlet and bellmouth entry which directs the incoming air to the impeller with minimal turbulence. The result is better air management through the unit, less noise, higher efficiency and an increased performance.

The housing is designed to be as compact as possible for concealed false ceiling applications and Sentinel casings are specially designed to allow the unit to be mounted via its unique mounting bracket, ensuring a quick and easy solution to installation.

Impellers

All Sentinel units feature a low energy, Class 1, EC/DC external rotor motor and backward curved impeller assembly specifically chosen for performance and non-overloading characteristics. The assembly is dynamically balanced to DIN ISO 1940 Grade 6.3, duct size 500mm rated IP54, all other sizes, IP44 according to BS EN 60529. Ball bearings are greased for life. Insulation is Class 'B' (from -25°C to +60°C). All models incorporate internal electronic overload protection and soft start function.

Electrical

Every Sentinel unit is fitted with a purpose designed common PCB controller incorporating a 16-character backlit alphanumeric x 2 line display with 4 button membrane keypad for fan status and commissioning set up. The enclosure is fitted with a 4-pole 10A isolator that is suitable for fitting a locking device to prevent accidental operation.

Motors are single phase 230V +/- 10% / 50/60Hz / 1ph (size 100-400mm) or 400V +/- 10% / 50/60Hz / 3ph (size 500mm), (4 wire systems only).

24V DC power is provided from the controller for powering the matched range of Sentinel switches and sensors.

Performance/Sound

Extensively tested to BS848 parts 1 & 2. Published dB(A) figures are free field sound pressure levels at 3m with spherical propagation at reference level of 2×10^{-5} Pa. The inlet/outlet sound power level spectra figures are dB with a reference of 10^{-12} watts.

Weatherproof Typical Ordering Designation

Ordering Codes are similar to existing units with Suffix.... /WP which denotes Weatherproof finish.

Example SENT100S/CP/WP

Accessories

For duct accessories see Ducting and Fitting Section.



Fan Dimensions (mm)

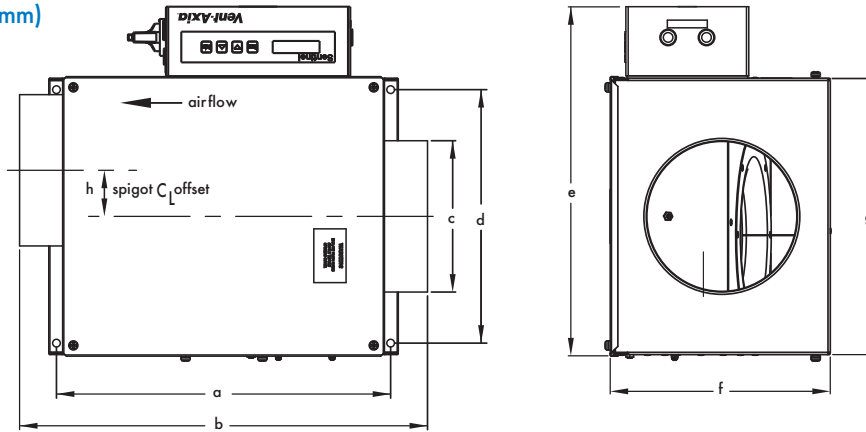

Hierarchy	Constant Pressure	a	b	c	d	e	f	g	h	Weight kg
SENT100S	SENT100S/CP	380	443	100	275	400	192	306	62	8.5
SENT125S	SENT125S/CP	380	443	125	275	400	192	306	62	8.5
SENT150S	SENT150S/CP	380	443	150	275	400	192	306	62	8.5
SENT200S	SENT200S/CP	435	531	200	330	453	287	360	60	12.5
SENT250S	SENT250S/CP	435	531	250	330	453	287	360	35	13
SENT315S	SENT315S/CP	710	808	315	540	661	458	568	43	34
SENT400S	SENT400S/CP	710	808	400	540	661	458	568	43	36
SENT500S	SENT500S/CP	898	996	500	735	858	577	765	59	55

Accessories

Hierarchy	Anti-Vibration Mounts	Duct air heater	Filter cassette	Bag filter cassette	*Duct attenuator 600mm
Model	Model	Stock Ref	Stock Ref	Stock Ref	Stock Ref
SENT100S	SENT100S/CP	68MP033G	10531100T1	10532100A	10533100
SENT125S	SENT125S/CP	68MP033G	10531125T1	10532125A	10533125
SENT150S	SENT150S/CP	68MP033G	10531150T1	10532150A	10533150
SENT200S	SENT200S/CP	68MP033G	10531200T1	10532200A	10533200
SENT250S	SENT250S/CP	68MP033G	10531250T1	10532250A	10533250
SENT315S	SENT315S/CP	68MP033G	10531315T1	10532315A	10533315
SENT400S	SENT400S/CP	68MP033G	10531400T3	10532400A	10533400
SENT500S	SENT500S/CP	68MP033G	10531500T3	10532500A	10533500

*For alternative attenuator lengths, refer to Accessories and Controllers section

Vent-Axia Sentinel D-Box Single Fan

Performance Curve

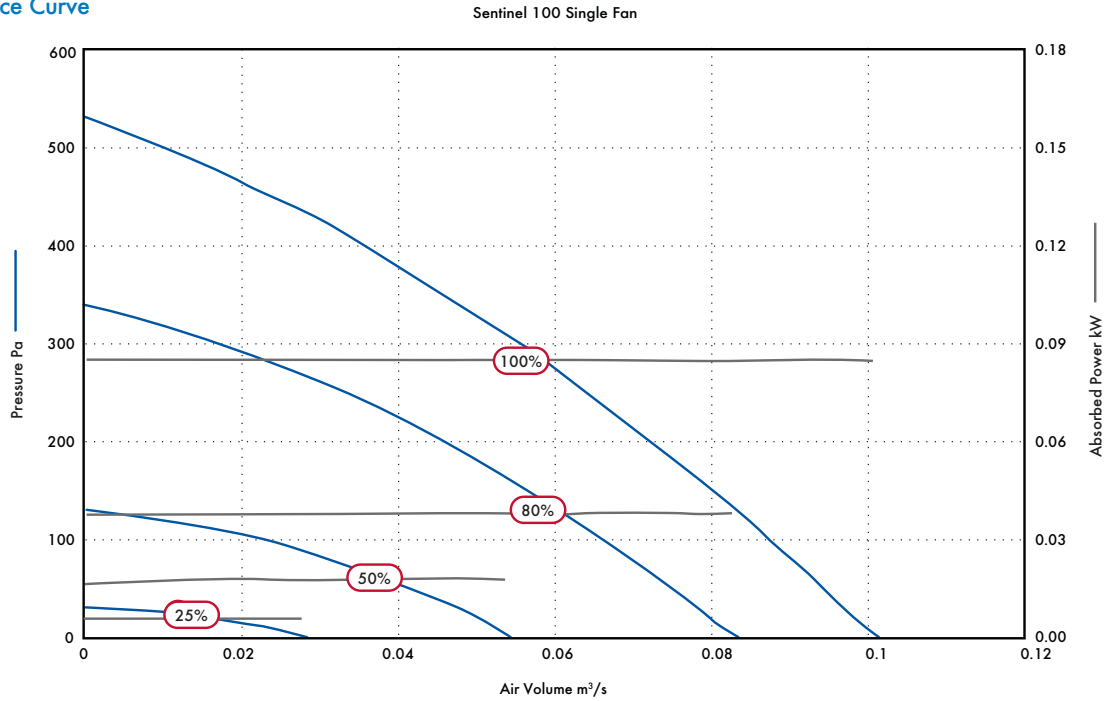

Performance Guide

Speed	Phase	Airflow, m ³ /s @ Pa											Amps F.L.C
		0	25	50	100	125	150	200	250	300	350	375	
100%	m ³ /s	0.10	0.10	0.09	0.09	0.08	0.08	0.07	0.06	0.06	0.05	0.04	
	kW	0.08	0.09	0.08	0.09	0.08	0.08	0.08	0.09	0.09	0.09	0.08	0.72
	SFP	0.84	0.88	0.90	0.98	1.01	1.06	1.18	1.33	1.52	1.85	2.07	
80%	m ³ /s	0.08	0.08	0.08	0.07	0.06	0.06	0.05	0.03	0.02			
	kW	0.04	0.04	0.04	0.04	0.04	0.04	0.04	0.04	0.04			0.5
	SFP	0.46	0.48	0.51	0.58	0.62	0.68	0.83	1.15	2.11			
50%	m ³ /s	0.05	0.05	0.04	0.02	0.01							
	kW	0.02	0.02	0.02	0.02	0.02							0.15
	SFP	0.33	0.38	0.44	0.78	2.75							
25%	m ³ /s	0.03	0.01										
	kW	0.01	0.01										0.08
	SFP	0.21	0.46										

Sound Data

Speed	Test Mode	Octave Band Frequency SWL								dB(A) @3m
		63	125	250	500	1k	2k	4k	8k	
100%	Inlet	57.2	68.7	68	70.1	59.4	53.1	47.3	41.8	42.5
	Outlet	54.9	67.7	70	70.5	68.1	64.6	57.7	49.5	49.3
	Breakout	58.7	63.8	63.3	63	54.8	51.2	46.4	42.1	42.2
80%	Inlet	52.2	63.7	63	65.1	54.3	48.1	42.3	36.8	37.5
	Outlet	50.1	62.9	65.1	65.6	63.2	59.7	52.9	44.6	44.5
	Breakout	53.8	58.9	58.5	58.2	49.9	46.4	41.5	37.2	37.3
50%	Inlet	42.2	53.7	52.9	55.1	44.3	38.1	32.3	26.8	27.5
	Outlet	39.9	52.7	54.9	55.4	53	49.5	42.7	34.4	34.3
	Breakout	43.6	48.7	48.3	48	39.7	36.2	31.4	27	27.1
25%	Inlet	27.1	38.6	37.9	40	29.2	23	17.2	11.7	12.4
	Outlet	24.8	37.6	39.9	40.4	37.9	34.5	27.6	19.4	19.2
	Breakout	28.6	33.7	33.2	32.9	24.7	21.1	16.3	11.9	12.1

Performance Curve

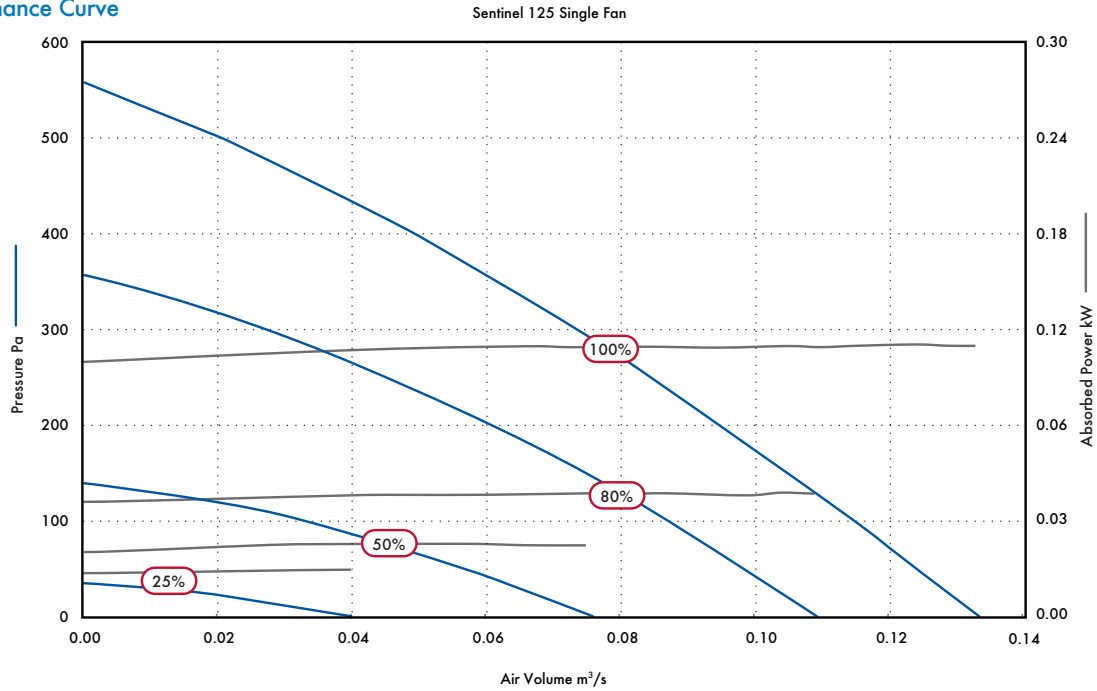

Performance Guide

Speed	Phase	Airflow, m ³ /s @ Pa													Amps F.L.C	
		0	25	50	100	125	150	200	250	300	350	375	400	450		
100%	1	m ³ /s	0.13	0.13	0.12	0.12	0.11	0.11	0.10	0.08	0.07	0.07	0.06	0.05	0.04	0.72
		kW	0.09	0.09	0.09	0.09	0.08	0.09	0.08	0.08	0.08	0.09	0.08	0.08	0.09	
		SFP	0.64	0.66	0.69	0.74	0.77	0.81	0.89	1.01	1.16	1.25	1.39	1.73	2.43	
80%	1	m ³ /s	0.11	0.10	0.10	0.09	0.08	0.08	0.06	0.05	0.03	0.02				0.51
		kW	0.04	0.04	0.04	0.04	0.04	0.04	0.04	0.04	0.04	0.04				
		SFP	0.35	0.37	0.38	0.44	0.47	0.51	0.62	0.84	1.41	2.38				
50%	1	m ³ /s	0.08	0.07	0.06	0.03	0.02									0.18
		kW	0.02	0.02	0.02	0.02	0.02									
		SFP	0.29	0.33	0.39	0.67	1.47									
25%	1	m ³ /s	0.04	0.02											0.09	
		kW	0.01	0.01												
		SFP	0.35	0.74												

Sound Data

Speed	Test Mode	Octave Band Frequency SWL									dB(A) @3m
		63	125	250	500	1k	2k	4k	8k		
100%	Inlet	57.9	68.5	68.3	70.5	62.4	57.3	50.8	45.5	44.5	
	Outlet	58.7	68.4	69.6	74.2	69.7	67.2	61.9	53.7	51.9	
	Breakout	56.3	59.2	63.4	62.8	56.5	52.1	45.2	38.2	42.3	
80%	Inlet	53.1	63.6	63.4	65.7	57.6	52.4	46	40.6	39.7	
	Outlet	53.9	63.6	64.7	69.4	64.9	62.4	57.1	48.8	47.1	
	Breakout	51.5	54.3	58.6	58	51.6	47.3	40.4	33.3	37.5	
50%	Inlet	42.9	53.4	53.3	55.5	47.4	42.2	35.8	30.4	29.5	
	Outlet	43.7	53.4	54.5	59.2	54.7	52.2	46.9	38.6	36.9	
	Breakout	41.3	44.1	48.4	47.8	41.4	37.1	30.2	23.1	27.3	
25%	Inlet	27.8	38.3	38.2	40.4	32.3	27.2	20.8	15.4	14.4	
	Outlet	28.6	38.3	39.4	44.1	39.6	37.1	31.8	23.6	21.8	
	Breakout	26.2	29.1	33.3	32.7	26.4	22	15.1	8.1	12.2	

Vent-Axia Sentinel D-Box Single Fan

Performance Curve

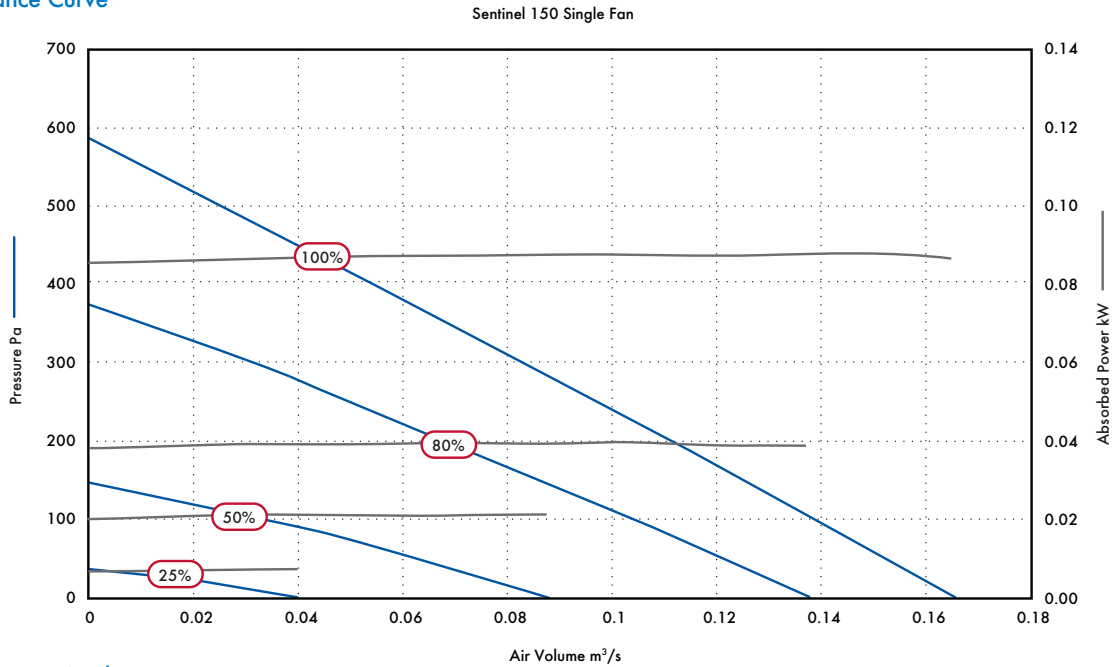

Performance Guide

Speed	Phase	Airflow, m ³ /s @ Pa												Amps F.L.C	
		0	25	50	100	125	150	200	250	300	350	375	400		
100%	1	m ³ /s	0.17	0.16	0.15	0.14	0.13	0.12	0.11	0.10	0.08	0.07	0.05	0.04	0.74
		kW	0.09	0.09	0.09	0.09	0.09	0.09	0.09	0.09	0.09	0.09	0.09	0.09	
		SFP	0.52	0.55	0.57	0.63	0.66	0.70	0.78	0.91	1.06	1.28	1.61	2.23	
80%	1	m ³ /s	0.14	0.13	0.12	0.10	0.10	0.09	0.07	0.05	0.03	0.01			0.48
		kW	0.04	0.04	0.04	0.04	0.04	0.04	0.04	0.04	0.04	0.04			
		SFP	0.28	0.30	0.32	0.38	0.41	0.45	0.57	0.78	1.26	3.55			
50%	1	m ³ /s	0.09	0.08	0.06	0.03	0.02								0.16
		kW	0.02	0.02	0.02	0.02	0.02								
		SFP	0.24	0.28	0.33	0.64	1.31								
25%	1	m ³ /s	0.04	0.02											0.08
		kW	0.01	0.01											
		SFP	0.18	0.47											

Sound Data

Speed	Test Mode	Octave Band Frequency SWL								dB(A) @3m
		63	125	250	500	1k	2k	4k	8k	
100%	Inlet	60	71.5	74	75.2	66.6	61.5	53.6	50	49.8
100%	Outlet	60.2	71.5	73.8	73.8	73.1	70.4	64.6	57.4	55
100%	Breakout	55.8	58.3	62.8	63.9	58	54.4	47	39.6	43.5
80%	Inlet	55.1	66.7	69.1	70.3	61.8	56.7	48.8	45.2	45
80%	Outlet	55.3	66.7	68.9	68.9	68.3	65.6	57.3	52.5	50.1
80%	Breakout	50.9	53.5	57.9	59.1	53.1	49.6	42.2	34.7	38.6
50%	Inlet	44.9	56.4	58.9	60.1	51.5	46.5	38.6	35	34.8
50%	Outlet	45.1	56.5	58.7	58.7	58.1	55.3	47.1	42.3	39.9
50%	Breakout	40.7	43.3	47.7	48.9	42.9	39.4	31.9	24.5	28.4
25%	Inlet	29.9	41.4	43.9	45.1	36.5	31.4	23.6	20	19.7
25%	Outlet	30.1	41.4	43.7	43.7	43.1	40.3	32.1	27.3	24.9
25%	Breakout	25.7	28.2	32.7	33.8	27.9	24.3	16.9	9.4	13.4

Performance Curve

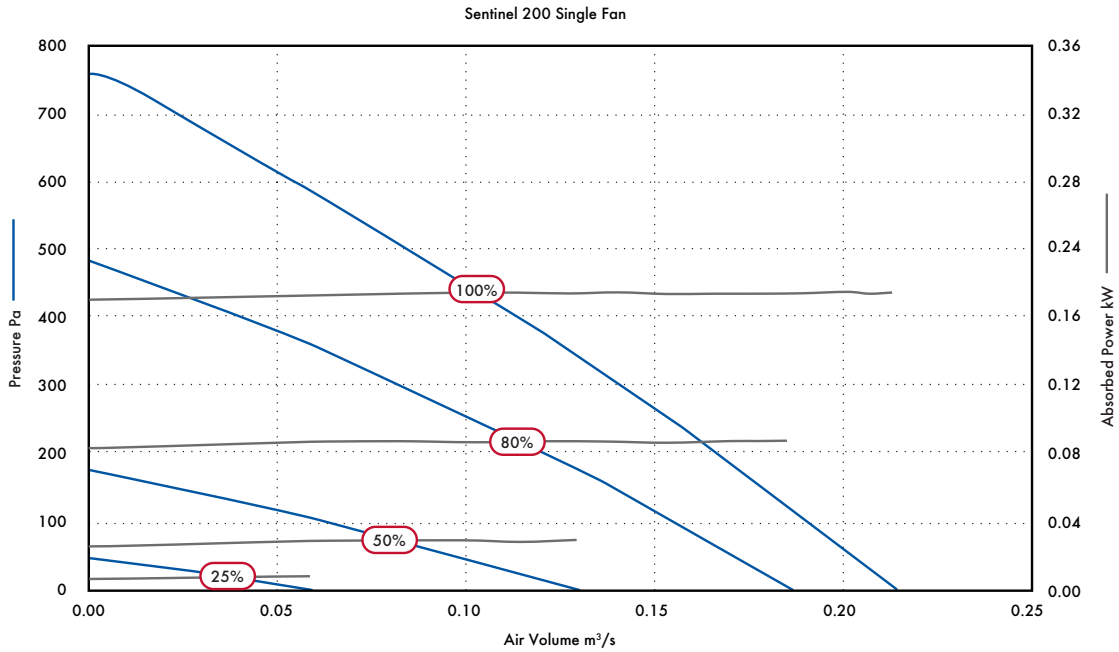

Performance Guide

Speed	Phase	Airflow, m ³ /s @ Pa													Amps F.L.C
		0	25	50	100	150	200	250	300	350	400	450	500		
100%	1	m ³ /s	0.21	0.21	0.20	0.19	0.18	0.17	0.15	0.14	0.13	0.11	0.10	0.09	0.72
		kW	0.17	0.17	0.17	0.17	0.17	0.17	0.17	0.17	0.17	0.17	0.17	0.17	
		SFP	0.81	0.83	0.86	0.91	0.97	1.04	1.12	1.23	1.35	1.52	1.75	2.04	
80%	1	m ³ /s	0.19	0.18	0.17	0.15	0.14	0.12	0.10	0.08	0.06	0.04			0.5
		kW	0.09	0.09	0.09	0.09	0.09	0.09	0.09	0.09	0.09	0.09	0.09		
		SFP	0.47	0.49	0.51	0.56	0.63	0.72	0.84	1.05	1.38	2.12			
50%	1	m ³ /s	0.13	0.12	0.10	0.06	0.02								0.16
		kW	0.03	0.03	0.03	0.03	0.03								
		SFP	0.23	0.25	0.30	0.46	1.27								
25%	1	m ³ /s	0.06	0.03											0.08
		kW	0.01	0.01											
		SFP	0.15	0.28											

Sound Data

Speed	Test Mode	Octave Band Frequency SWL								dB(A) @3m
		63	125	250	500	1k	2k	4k	8k	
100%	Inlet	65.4	74.3	75.1	76.2	70.9	65.2	63.7	57	52.9
100%	Outlet	66.2	74.4	73.7	81.2	78.5	79.2	74.9	68	62.9
100%	Breakout	63.5	61.9	63.3	68.7	63.1	63.3	55.2	41.7	49
80%	Inlet	60.6	69.4	70.3	71.3	66	60.4	58.9	52.2	48.1
80%	Outlet	61.3	69.5	68.8	76.3	73.7	74.4	70.1	63.2	58
80%	Breakout	58.6	57.1	58.4	63.8	58.2	58.4	50.3	36.9	44.2
50%	Inlet	50.4	59.2	60.1	61.1	55.8	50.2	48.7	42	37.9
50%	Outlet	53.4	60.9	68	64.5	60.7	59.6	56.1	47.7	46.6
50%	Breakout	49.6	48.2	56	51.8	44.7	42.9	34.5	30.7	32.4
25%	Inlet	35.3	44.2	45	46.1	40.8	35.1	33.7	27	22.8
25%	Outlet	36.1	44.3	43.6	51.1	48.4	49.1	44.8	37.9	32.8
25%	Breakout	33.4	31.8	33.2	38.6	33	33.2	25.1	11.6	19

Vent-Axia Sentinel D-Box Single Fan

Performance Curve

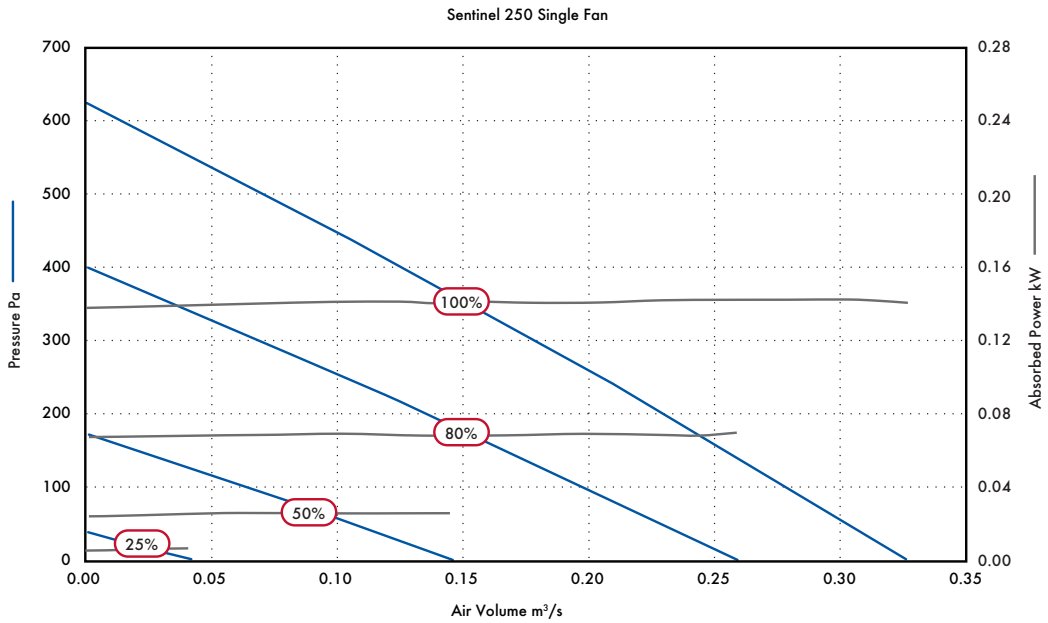

Performance Guide

Speed	Phase	Airflow, m³/s @ Pa													Amps F.L.C	
		0	25	50	100	150	200	250	300	350	375	400	450	500		
100%	1	m³/s	0.33	0.32	0.30	0.28	0.25	0.23	0.20	0.18	0.15	0.14	0.13	0.10	0.07	1.38
		kW	0.14	0.14	0.14	0.14	0.14	0.14	0.14	0.14	0.14	0.14	0.14	0.14	0.14	
		SFP	0.43	0.45	0.47	0.51	0.56	0.62	0.69	0.79	0.93	1.01	1.13	1.44	2.01	
80%	1	m³/s	0.26	0.24	0.23	0.20	0.17	0.13	0.10	0.07	0.03					1
		kW	0.07	0.07	0.07	0.07	0.07	0.07	0.07	0.07	0.07					
		SFP	0.27	0.28	0.30	0.35	0.41	0.51	0.68	1.01	2.03					
50%	1	m³/s	0.15	0.12	0.10	0.06	0.02									0.2
		kW	0.03	0.03	0.03	0.03	0.03									
		SFP	0.18	0.21	0.25	0.43	1.53									
25%	1	m³/s	0.04	0.02												0.07
		kW	0.01	0.01												
		SFP	0.17	0.47												

Sound Data

Speed	Test Mode	Octave Band Frequency SWL								dB(A) @3m
		63	125	250	500	1k	2k	4k	8k	
100%	Inlet	66.7	73.4	73.5	79	69.6	64.6	62	58.8	54.1
100%	Outlet	69	72.9	73.6	78.2	75.5	76.2	70.8	66.7	60.1
100%	Breakout	63.3	64.7	65.8	69.9	64.1	63.3	52.8	43.3	49.9
80%	Inlet	61.8	68.6	68.7	74.1	64.8	59.8	57.2	53.9	49.3
80%	Outlet	64.1	68	68.8	73.3	70.7	71.4	66	61.9	55.2
80%	Breakout	58.5	59.8	61	65.1	59.3	58.5	48	38.4	45
50%	Inlet	51.8	58.5	58.6	64	54.7	49.7	47.1	43.8	39.2
50%	Outlet	50.5	59.2	65.3	59.1	56.2	57.7	55.1	41.4	43.3
50%	Breakout	48.5	51.4	59.8	50.7	45.6	44.7	37.1	31.1	33.9
25%	Inlet	36.6	43.3	43.4	48.9	39.6	34.5	31.9	28.6	24
25%	Outlet	38.9	42.8	43.5	48.1	45.4	46.1	40.7	36.6	30
25%	Breakout	33.2	34.6	35.7	39.8	34	33.2	22.7	13.2	19.8

Performance Curve

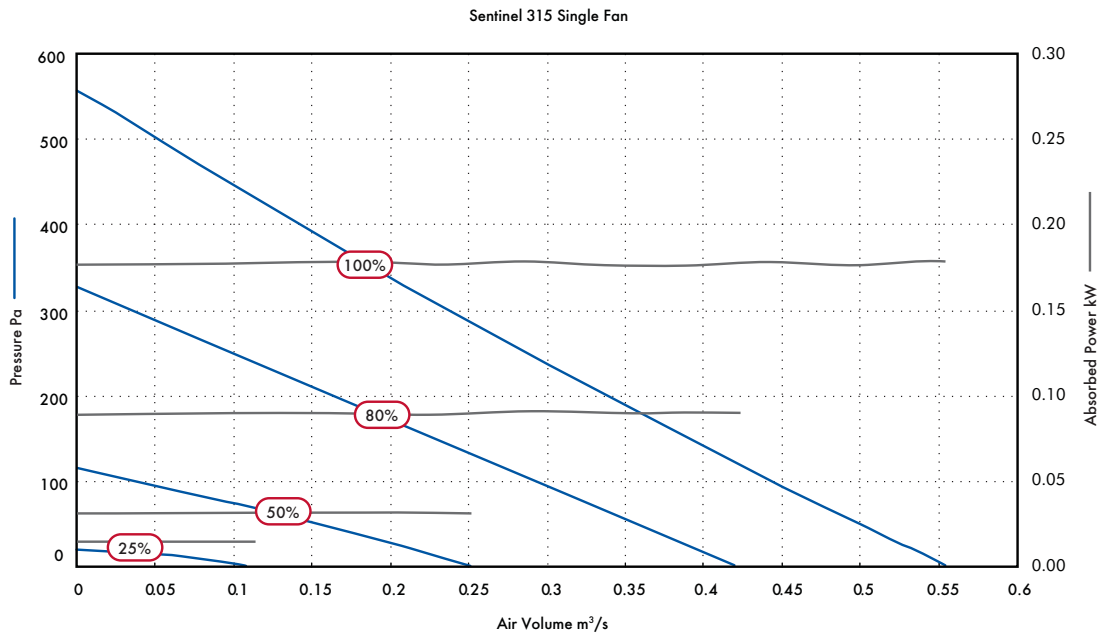

Performance Guide

Speed	Phase	Airflow, m ³ /s @ Pa													Amps F.L.C	
		0	25	50	100	125	150	200	250	300	350	375	400	450		
100%	1	m ³ /s	0.56	0.53	0.50	0.44	0.39	0.34	0.29	0.24	0.21	0.19	0.14	0.10	0.07	1.36
		kW	0.18	0.18	0.17	0.18	0.18	0.18	0.18	0.18	0.18	0.18	0.18	0.18	0.18	
		SFP	0.32	0.34	0.35	0.40	0.45	0.52	0.62	0.74	0.83	0.94	1.25	1.84	2.39	
80%	1	m ³ /s	0.43	0.39	0.36	0.29	0.23	0.16	0.10	0.04						0.50
		kW	0.09	0.09	0.09	0.09	0.09	0.09	0.09	0.09						
		SFP	0.21	0.23	0.25	0.31	0.39	0.55	0.90	2.47						
50%	1	m ³ /s	0.25	0.21	0.15	0.04										0.19
		kW	0.03	0.03	0.03	0.03										
		SFP	0.12	0.15	0.20	0.83										
25%	1	m ³ /s	0.12													0.08
		kW	0.01													
		SFP	0.12													

Sound Data

Speed	Test Mode	Octave Band Frequency SWL								dB(A) @3m
		63	125	250	500	1k	2k	4k	8k	
100%	Inlet	67.1	74.6	77.5	73.8	66.2	62.8	58.1	53.6	51
100%	Outlet	70.6	75.3	78.9	78.7	76.8	76.4	69.2	63.9	60.5
100%	Breakout	62.8	66.5	69.2	64	58.9	56	47.5	37.9	45.3
80%	Inlet	62.2	69.7	72.7	68.9	61.4	57.9	53.3	48.7	46.1
80%	Outlet	65.7	70.5	74.1	73.9	71.9	71.6	64.4	59.1	55.7
80%	Breakout	57.9	61.6	64.4	59.2	54.1	51.1	42.6	33.1	40.5
50%	Inlet	52	59.5	62.4	58.6	51.1	47.7	43	38.4	35.8
50%	Outlet	55.6	66	66.7	59.2	57.9	58.3	50	38.6	43.8
50%	Breakout	51.4	55.2	55.2	46.1	41.8	36.8	28.4	31.2	29.6
25%	Inlet	37	44.5	47.5	43.7	36.1	32.7	28	23.5	20.9
25%	Outlet	40.4	45.2	48.8	48.6	46.7	46.3	39.1	33.8	30.5
25%	Breakout	32.7	36.4	39.1	33.9	28.8	25.9	17.4	7.8	15.3

Vent-Axia Sentinel D-Box Single Fan

Performance Curve

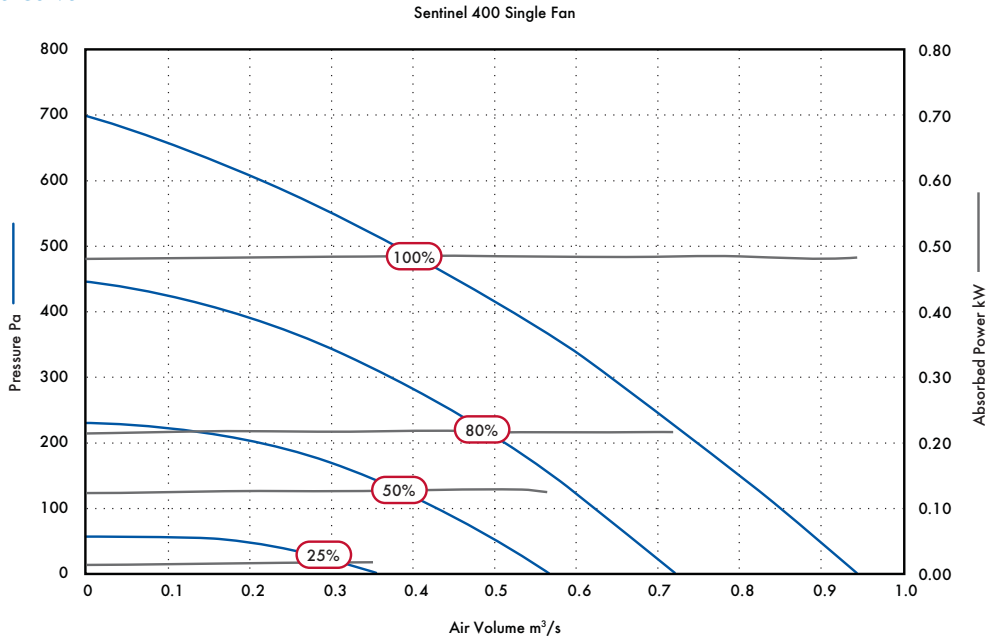

Performance Guide

Speed	Phase	Airflow, m ³ /s @ Pa																	Amps F.L.C	
		0	25	50	100	150	200	225	250	300	350	400	425	450	500	550	600			
100%	1	m ³ /s	0.95	0.92	0.90	0.85	0.80	0.75	0.72	0.70	0.64	0.58	0.52	0.49	0.45	0.38	0.30	0.21	2.47	
		kW	0.48	0.48	0.49	0.49	0.48	0.48	0.49	0.48	0.49	0.48	0.48	0.48	0.48	0.48	0.48	0.48		
		SFP	0.51	0.52	0.54	0.57	0.60	0.64	0.67	0.69	0.76	0.83	0.93	0.99	1.07	1.27	1.60	2.26		
80%	1	m ³ /s	0.72	0.70	0.67	0.62	0.57	0.51	0.48	0.45	0.37	0.29	0.17	0.10						1.80
		kW	0.22	0.22	0.22	0.22	0.22	0.22	0.22	0.22	0.22	0.22	0.22	0.22						
		SFP	0.30	0.31	0.32	0.35	0.38	0.43	0.45	0.49	0.58	0.76	1.25	2.21						
50%	1	m ³ /s	0.57	0.54	0.50	0.43	0.34	0.21	0.09											0.59
		kW	0.12	0.13	0.13	0.13	0.13	0.13	0.13											
		SFP	0.22	0.24	0.25	0.30	0.37	0.59	1.43											
25%	1	m ³ /s	0.35	0.29	0.18															0.13
		kW	0.02	0.02	0.02															
		SFP	0.05	0.06	0.10															

Sound Data

Speed	Test Mode	Octave Band Frequency SWL								dB(A) @3m
		63	125	250	500	1k	2k	4k	8k	
100%	Inlet	78	86.2	86.7	74.6	69.9	66.3	60.9	53.1	57.1
100%	Outlet	77.7	87	92.3	80.5	79.4	75.6	70.3	62.8	64.3
100%	Breakout	76.8	84.9	84.8	78.9	74	68.5	60.6	51.9	65.3
80%	Inlet	72	80	79.9	74.1	69.2	63.7	55.7	47.1	55.5
80%	Outlet	72.8	82.2	87.5	75.6	74.6	70.8	65.4	58	59.4
80%	Breakout	73.2	81.4	81.9	69.7	65.1	61.5	56	48.3	52.2
50%	Inlet	61.8	69.8	69.7	63.9	59	53.5	45.5	36.9	45.3
50%	Outlet	62.6	72	77.3	65.4	64.4	60.6	55.2	47.8	49.1
50%	Breakout	62.9	71.2	71.7	59.5	54.9	51.2	45.8	38.1	42
25%	Inlet	46.8	54.8	54.7	48.8	44	38.4	30.5	21.8	30.3
25%	Outlet	47.6	56.9	62.3	50.4	49.4	45.5	40.2	32.7	34.3
25%	Breakout	47.9	56.2	56.7	44.5	39.8	36.2	30.8	23.1	27

Performance Curve

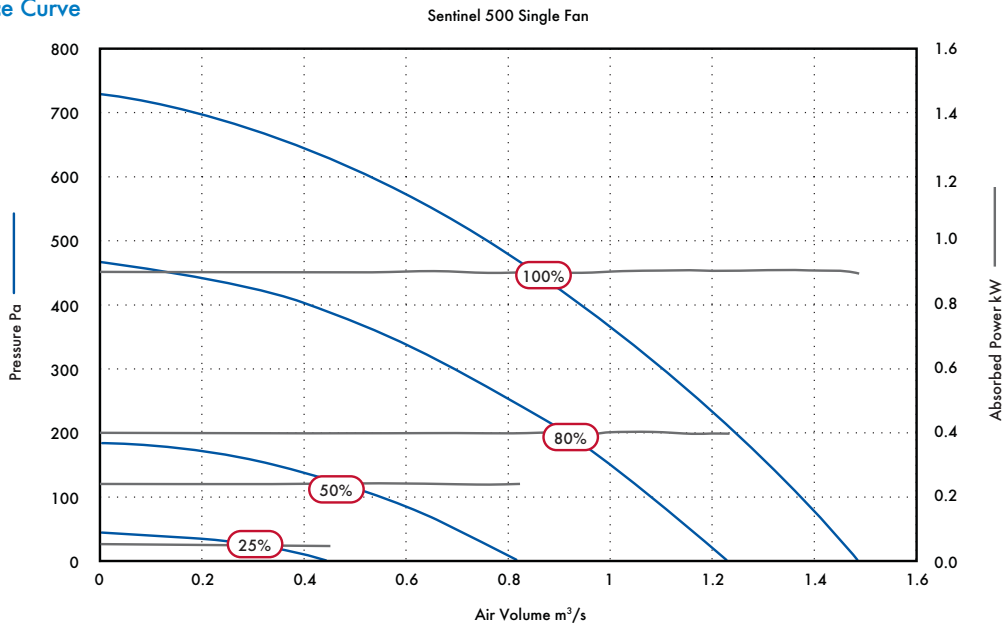

Performance Guide

Speed	Phase	Airflow, m ³ /s @ Pa																Amps F.L.C		
		0	25	50	100	150	175	200	250	300	350	400	450	500	550	600	650			
100%	3	m ³ /s	1.49	1.46	1.43	1.37	1.31	1.28	1.24	1.17	1.10	1.02	0.94	0.86	0.76	0.65	0.53	0.38	2.10	
		kW	0.89	0.91	0.90	0.90	0.90	0.89	0.89	0.90	0.90	0.90	0.90	0.90	0.90	0.90	0.90	0.90		0.90
		SFP	0.60	0.62	0.63	0.66	0.69	0.70	0.72	0.77	0.82	0.88	0.95	1.05	1.18	1.38	1.69	2.34		
80%	3	m ³ /s	1.23	1.20	1.16	1.08	1.00	0.95	0.91	0.81	0.70	0.57	0.40	0.16						1.60
		kW	0.39	0.40	0.39	0.40	0.40	0.39	0.40	0.40	0.40	0.40	0.40	0.39						
		SFP	0.32	0.33	0.34	0.37	0.40	0.41	0.44	0.49	0.57	0.70	0.98	2.48						
50%	3	m ³ /s	0.82	0.76	0.70	0.55	0.34	0.15											0.67	
		kW	0.24	0.24	0.24	0.24	0.24	0.24												
		SFP	0.29	0.31	0.34	0.44	0.71	1.61												
25%	3	m ³ /s	0.45	0.31															0.23	
		kW	0.04	0.05																
		SFP	0.1	0.15																

Sound Data

Speed	Test Mode	Octave Band Frequency SWL								dB(A) @3m
		63	125	250	500	1k	2k	4k	8k	
100%	Inlet	81.1	95.1	86.7	79.6	71.2	67.2	61.2	62.5	60.3
100%	Outlet	81.6	92.9	88	84.9	81.5	76	70.4	69.9	65.7
100%	Breakout	78.4	88.8	84.8	81.7	75.3	67.8	59.7	55.4	61.9
80%	Inlet	76.3	90.3	81.9	74.8	66.4	62.4	56.4	57.7	55.5
80%	Outlet	76.8	88.1	83.2	80.1	76.7	71.2	65.6	65.1	60.9
80%	Breakout	73.6	84	79.9	76.8	70.5	62.9	54.8	50.6	57
50%	Inlet	66.1	80.1	71.7	64.6	56.2	52.2	46.2	47.5	45.3
50%	Outlet	66.6	77.9	73	69.9	66.5	61	55.4	54.9	50.7
50%	Breakout	63.4	73.8	69.7	66.6	60.3	52.7	44.6	40.4	46.8
25%	Inlet	51	65	56.6	49.5	41.1	37.1	31.1	32.4	30.2
25%	Outlet	51.6	62.8	57.9	54.8	51.4	45.9	40.3	39.8	35.6
25%	Breakout	48.3	58.8	54.7	51.6	45.2	37.6	29.6	25.3	31.8

Sentinel D-Box Twin Fan

Features and Benefits

- **Duct Sizes 100 – 500mm**
- **Performance - Airflow 0.01 to 1.2m³/s, Pressure up to 650Pa**
- **Sentinel demand ventilation fan controller with lockable isolator**
- **Latest energy saving EC/DC motors**
- **Internal or external models (IPX2 or IPX5)**
- **Manufactured controlled to BS EN ISO 9001**
- **Performance tested to BS848 Part 1 & 2**

The Sentinel twin in-line duct fans are as supplied from Vent-Axia Ltd. Manufactured from prime quality galvanised sheet steel, Sentinel fan units are internally treated with an 'O' class rated, BS476 part 6 & 7, acoustic foam, which offers the benefits of high sound absorption, good thermal insulation properties in addition to self extinguishing properties and resistant to ignition.

Weatherproof external units incorporate controller shrouds and are coated externally with a polyurethane finish.

The housing is designed to be as compact as possible for concealed false ceiling applications and Sentinel casings are specially designed to allow the unit to be mounted via its unique mounting bracket, ensuring a quick and easy solution to installation.

The unit is suitable for ceiling or floor mounting, non-return dampers can be easily rotated on site to suit.

Impellers

All Sentinel units feature a low energy, Class 1, EC/DC external rotor motor and backward curved impeller assembly specifically chosen for performance and non-overloading characteristics. The assembly is dynamically balanced to DIN ISO 1940 Grade 6.3, duct size 500mm rated IP54, all other sizes, IP44 according to BS EN 60529. Ball bearings are greased for life. Insulation is Class 'B' (from -25°C to +60°C).

All models incorporate internal electronic overload protection and soft start function.

Electrical

Every Sentinel unit is fitted with a purpose designed common PCB controller incorporating a 16-character backlit alphanumeric x 2 line display with 4 button membrane keypad for fan status & commissioning set up. The enclosure is fitted with a 4-pole 10A isolator that is suitable for fitting a locking device to prevent accidental operation.

The twin unit controller features automatic 6hr duty/share and run/standby in the event of motor failure.

Motors are single phase 230V +/- 10% / 50/60Hz / 1ph (size 100-400mm) or 400V +/- 10% / 50/60Hz / 3ph (size 500mm), (4 wire systems only).

24V DC power is provided from the controller for powering the matched range of Sentinel switches and sensors.

Performance/Sound

Extensively tested to BS848 parts 1 & 2. Published dB(A) figures are free field sound pressure levels at 3m with spherical propagation at reference level of 2x10⁻⁵ Pa. The inlet/outlet sound power level spectra figures are dB with a reference of 10⁻¹² watts.

Weatherproof Typical Ordering Designation

Ordering Codes are similar to existing units with Suffix... /WP which denotes Weatherproof finish.

Example SENT100T/CP/WP

Accessories

For duct accessories see Ducting and Fitting Section.



Fan Dimensions (mm)

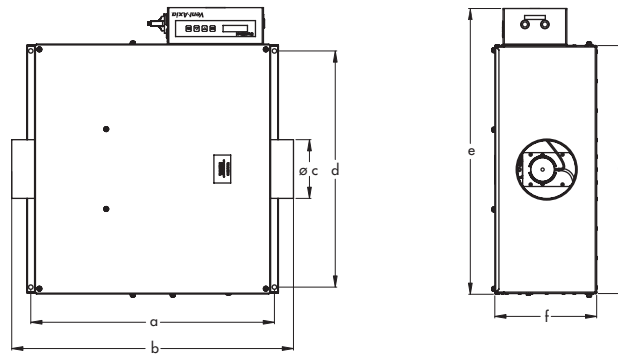

Hierarchy	Constant	Duct Diameter mm							Weight
Model	Pressure Model	a	b	c	d	e	f	g	Kg
SENT100T	SENT100T/CP	610	705	100	591	717	256	622	26
SENT125T	SENT125T/CP	610	705	125	591	717	256	622	26
SENT150T	SENT150T/CP	610	705	150	591	717	256	622	26
SENT200T	SENT200T/CP	801	896	200	703	830	343	734	39
SENT250T	SENT250T/CP	925	1020	250	798	925	354	829	48
SENT315T	SENT315T/CP	1255	1353	315	1145	1272	536	1176	88
SENT400T	SENT400T/CP	1255	1353	400	1145	1272	536	1176	90
SENT500T	SENT500T/CP	1492	1590	500	1533	1661	675	1564	175

Accessories

Hierarchy	Model	Anti-Vibration				*Duct	
		Mounts	Duct air heater	Filter cassette	Bag filter cassette	attenuator 600mm	
Model	Model	Stock Ref.	Stock Ref.	Stock Ref.	Stock Ref.	Stock Ref.	
SENT100T	SENT100T/CP	68MP033G	10531100T1	10532100A	10533100	10535100	
SENT125T	SENT125T/CP	68MP033G	10531125T1	10532125A	10533125	10535125	
SENT150T	SENT150T/CP	68MP033G	10531150T1	10532150A	10533150	10535150	
SENT200T	SENT200T/CP	68MP033G	10531200T1	10532200A	10533200	10535200	
SENT250T	SENT250T/CP	68MP033G	10531250T1	10532250A	10533250	10535250	
SENT315T	SENT315T/CP	68MP033G	10531315T1	10532315A	10533315	10535315	
SENT400T	SENT400T/CP	68MP033G	10531400T3	10532400A	10533400	10535400	
SENT500T	SENT500T/CP	68MP133G	10531500T3	10532500A	10533500	10536500*	

*For alternative attenuator lengths, refer to Accessories and Controllers section

Vent-Axia Sentinel D-Box Twin Fan

Performance Curve

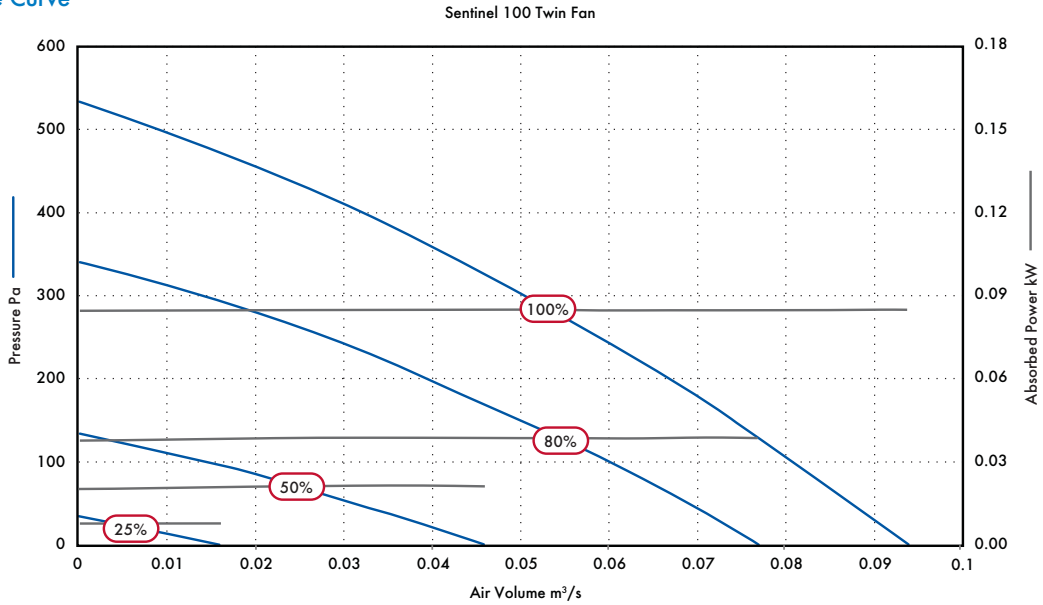

Performance Guide

Speed	Phase	Airflow, m ³ /s @ Pa											Amps F.L.C	
		0	25	50	75	100	125	150	200	250	300	350		
100%	1	m ³ /s	0.09	0.09	0.09	0.08	0.08	0.08	0.07	0.07	0.06	0.05	0.04	0.69
		kW	0.08	0.08	0.08	0.08	0.08	0.08	0.08	0.08	0.08	0.08	0.08	
		SFP	0.90	0.93	0.97	1.01	1.04	1.10	1.14	1.26	1.43	1.66	2.01	
80%	1	m ³ /s	0.08	0.07	0.07	0.06	0.06	0.06	0.05	0.04	0.03	0.01	0.5	
		kW	0.04	0.04	0.04	0.04	0.04	0.04	0.04	0.04	0.04	0.04		
		SFP	0.50	0.53	0.56	0.60	0.64	0.70	0.77	0.99	1.43	2.75		
50%	1	m ³ /s	0.05	0.04	0.03	0.02	0.01						0.16	
		kW	0.02	0.02	0.02	0.02	0.02							
		SFP	0.46	0.55	0.69	0.92	1.52							
25%	1	m ³ /s	0.02										0.08	
		kW	0.01											
		SFP	0.49											

Sound Data

Speed	Test Mode	Octave Band Frequency SWL								dB(A) @3m
		63	125	250	500	1k	2k	4k	8k	
100%	Inlet	54.7	61.5	61.3	60.5	51.1	47.2	40.5	36.6	34.2
100%	Outlet	58.6	63.8	58.4	57.3	53.8	55.5	49.1	41.3	38.4
100%	Breakout	58.4	64	62.6	55.7	45.7	42.7	39.4	37.6	37
80%	Inlet	49.8	56.6	56.5	55.7	46.3	42.4	35.7	31.7	29.4
80%	Outlet	53.7	58.9	53.5	52.5	48.9	50.6	44.3	36.4	33.6
80%	Breakout	53.5	59.2	57.8	50.8	40.9	37.9	34.5	32.7	32.2
50%	Inlet	39.6	46.4	46.3	45.5	36.1	32.1	25.5	21.5	19.1
50%	Outlet	43.5	48.7	43.3	42.3	38.7	40.4	34.1	26.2	23.3
50%	Breakout	43.3	49	47.6	40.6	30.7	27.6	24.3	22.5	22
25%	Inlet	24.5	31.3	31.2	30.4	21	17.1	10.4	6.5	19.7
25%	Outlet	28.4	33.6	28.2	27.2	23.6	25.3	19	11.1	14.9
25%	Breakout	28.2	33.9	32.5	25.5	15.6	12.6	9.2	7.4	20.4

Performance Curve

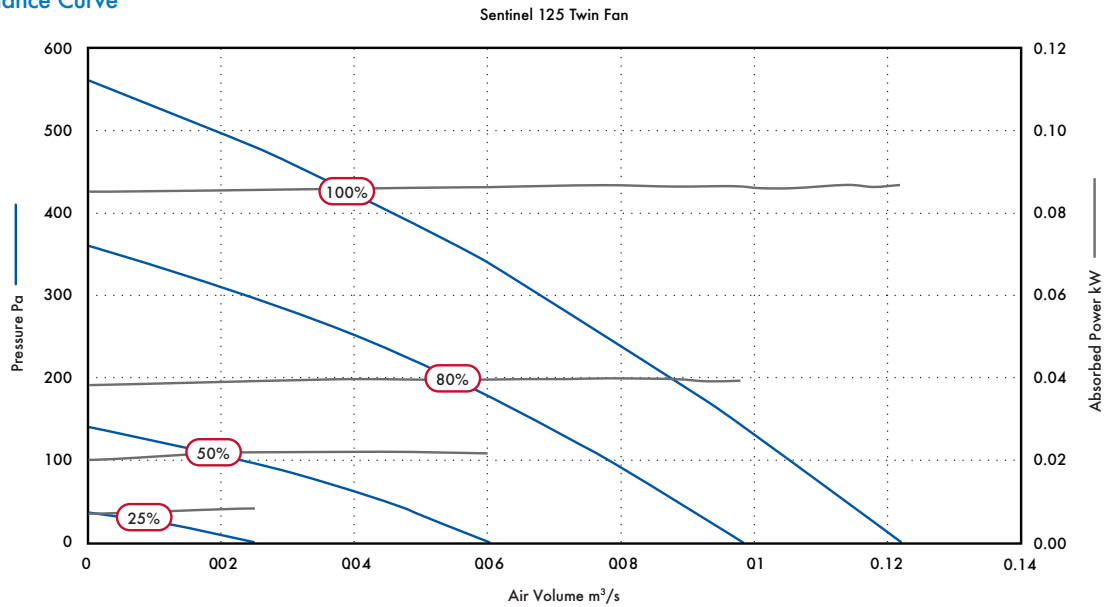

Performance Guide

Speed	Phase	Airflow, m³/s @ Pa											Amps F.L.C	
		0	25	50	100	125	150	200	250	300	350	400		
100%	1	m³/s	0.12	0.12	0.11	0.11	0.10	0.10	0.09	0.08	0.07	0.06	0.05	0.72
		kW	0.09	0.09	0.09	0.09	0.09	0.09	0.09	0.09	0.09	0.09	0.09	
		SFP	0.71	0.73	0.76	0.81	0.85	0.89	0.98	1.11	1.27	1.51	1.88	
80%	1	m³/s	0.10	0.09	0.09	0.08	0.07	0.07	0.05	0.04	0.02			0.51
		kW	0.04	0.04	0.04	0.04	0.04	0.04	0.04	0.04	0.04			
		SFP	0.40	0.42	0.45	0.51	0.55	0.60	0.73	0.99	1.64			
50%	1	m³/s	0.06	0.05	0.04	0.02	0.01							0.18
		kW	0.02	0.02	0.02	0.02	0.02							
		SFP	0.36	0.42	0.50	0.95	2.19							
25%	1	m³/s	0.03	0.01										0.09
		kW	0.01	0.01										
		SFP	0.33	0.92										

Sound Data

Speed	Test Mode	Octave Band Frequency SWL								dB(A) @3m
		63	125	250	500	1k	2k	4k	8k	
100%	Inlet	62.6	64	66.6	64.1	54	49.7	40.8	38.4	37.3
100%	Outlet	61.9	65.7	63.5	62.4	58.4	60.4	53.7	47.3	43.3
100%	Breakout	69.7	61.5	62.4	56	47.2	45.2	38.3	33.8	37.2
80%	Inlet	57.8	59.1	61.8	59.2	49.2	44.8	36	33.6	32.5
80%	Outlet	57.1	60.8	58.7	57.5	53.5	55.5	48.9	42.4	38.4
80%	Breakout	64.8	56.7	57.6	51.2	42.4	40.4	33.4	28.9	32.4
50%	Inlet	47.6	48.9	51.6	49	39	34.6	25.8	23.4	22.3
50%	Outlet	46.9	50.6	48.5	47.4	43.3	45.3	38.7	32.2	28.2
50%	Breakout	54.6	46.5	47.4	41	32.2	30.2	23.2	18.7	23.2
25%	Inlet	32.5	33.9	36.5	34	23.9	19.6	10.7	8.3	18.8
25%	Outlet	31.8	35.6	33.4	32.3	28.3	30.3	23.6	17.2	14.5
25%	Breakout	39.6	31.4	32.3	25.9	17.1	15.1	8.2	3.7	22.3

Vent-Axia Sentinel D-Box Twin Fan

Performance Curve

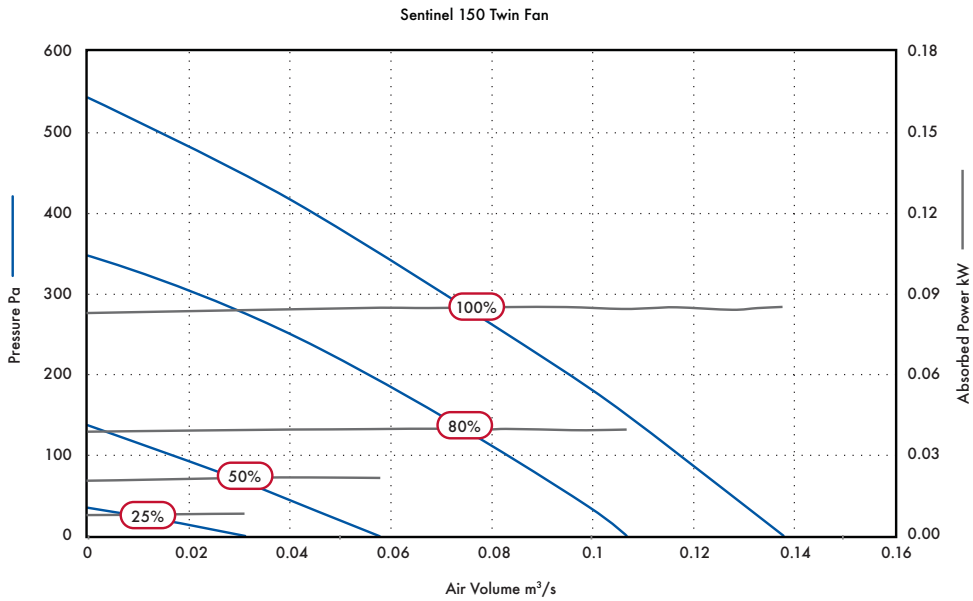

Performance Guide

Speed	Phase	Airflow, m ³ /s @ Pa												Amps F.L.C	
		0	25	50	100	125	150	200	250	300	325	350	400		
100%	1	m ³ /s	0.14	0.13	0.13	0.12	0.11	0.11	0.10	0.08	0.07	0.07	0.06	0.04	0.71
		kW	0.09	0.09	0.08	0.09	0.09	0.08	0.09	0.09	0.09	0.09	0.09	0.08	
		SFP	0.62	0.64	0.66	0.73	0.76	0.80	0.90	1.03	1.20	1.31	1.47	1.93	
80%	1	m ³ /s	0.11	0.10	0.10	0.08	0.08	0.07	0.06	0.04	0.02				0.48
		kW	0.04	0.04	0.04	0.04	0.04	0.04	0.04	0.04	0.04				
		SFP	0.37	0.39	0.41	0.48	0.51	0.57	0.71	0.99	1.89				
50%	1	m ³ /s	0.06	0.05	0.04	0.02									0.17
		kW	0.02	0.02	0.02	0.02									
		SFP	0.37	0.45	0.57	1.35									
25%	1	m ³ /s	0.03	0.01											0.08
		kW	0.01	0.01											
		SFP	0.26	0.73											

Sound Data

Speed	Test Mode	Octave Band Frequency SWL								dB(A) @3m
		63	125	250	500	1k	2k	4k	8k	
100%	Inlet	58.6	65.9	68.1	65.8	54.1	50.6	42.9	41.5	39.7
100%	Outlet	59.3	68.7	66.8	63.5	60	61.9	56	49.5	45.2
100%	Breakout	66	62	61.9	59.8	50.8	48.4	40.2	37.1	39.2
80%	Inlet	53.7	61.1	63.2	61	49.2	45.8	38.1	36.7	33.8
80%	Outlet	54.5	63.8	62	58.7	55.2	57.1	51.1	44.7	40.4
80%	Breakout	61.1	57.2	57	55	45.9	43.6	35.3	32.3	34.4
50%	Inlet	43.5	50.9	53	50.8	39	35.6	27.8	26.5	24.6
50%	Outlet	44.3	53.6	51.8	48.5	45	46.9	40.9	34.5	30.1
50%	Breakout	50.9	47	46.8	44.8	35.7	33.4	25.1	22.1	24.2
25%	Inlet	28.5	35.8	38	35.7	24	20.6	12.8	11.4	17.2
25%	Outlet	29.2	38.6	36.7	33.5	30	31.8	25.9	19.4	15.1
25%	Breakout	35.9	32	31.8	29.7	20.7	18.3	10.1	7	19.6

Performance Curve

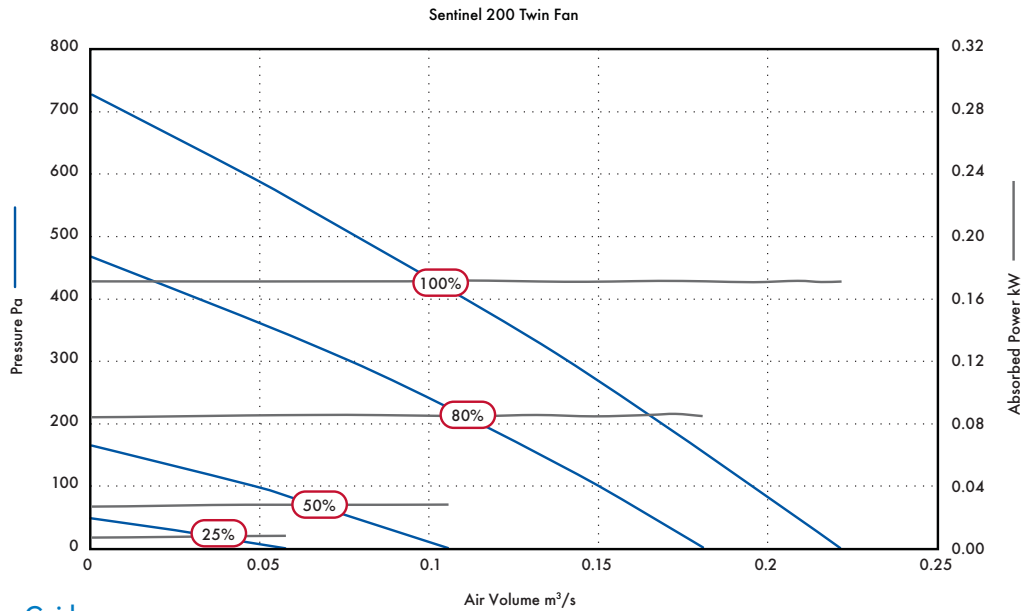

Performance Guide

Speed	Phase	Airflow, m ³ /s @ Pa													Amps F.L.C
		0	25	50	100	150	200	250	300	350	400	450	500		
100%	1	m ³ /s	0.22	0.22	0.21	0.20	0.18	0.17	0.15	0.14	0.13	0.11	0.09	0.08	1.4
		kW	0.17	0.17	0.17	0.17	0.17	0.17	0.17	0.17	0.17	0.17	0.17	0.17	
		SFP	0.77	0.79	0.82	0.87	0.94	1.02	1.11	1.22	1.37	1.56	1.82	2.17	
80%	1	m ³ /s	0.18	0.17	0.17	0.15	0.13	0.12	0.10	0.08	0.06	0.03			1.07
		kW	0.09	0.09	0.09	0.08	0.09	0.09	0.09	0.09	0.09	0.09			
		SFP	0.47	0.50	0.52	0.57	0.65	0.74	0.89	1.13	1.53	2.60			
50%	1	m ³ /s	0.11	0.09	0.08	0.05	0.01								0.2
		kW	0.03	0.03	0.03	0.03	0.03								
		SFP	0.27	0.31	0.37	0.62	2.58								
25%	1	m ³ /s	0.06	0.03											0.09
		kW	0.01	0.01											
		SFP	0.15	0.3											

Sound Data

Speed	Test Mode	Octave Band Frequency SWL								dB(A) @3m
		63	125	250	500	1k	2k	4k	8k	
100%	Inlet	60.6	71.5	66.8	70.7	64.1	57.3	53.2	49	46
100%	Outlet	63.3	74.7	66.6	80.4	70.2	68.6	64.6	58	55
100%	Breakout	66	69	63.2	66.3	57.4	52.6	45.5	37	44.7
80%	Inlet	55.8	66.7	61.9	65.8	59.3	52.5	48.4	44.2	41.1
80%	Outlet	58.4	69.8	61.7	75.6	65.4	63.7	59.8	53.2	50.3
80%	Breakout	61.2	64.2	58.4	61.4	52.5	47.8	40.6	32.1	39.9
50%	Inlet	45.6	56.5	51.7	55.6	49.1	42.2	38.2	34	30.9
50%	Outlet	48.2	59.6	51.5	65.3	55.2	53.5	49.6	43	40.1
50%	Breakout	51	54	48.2	51.2	42.3	37.6	30.4	21.9	29.7
25%	Inlet	30.5	41.4	36.7	40.6	34	27.2	23.1	18.9	15.9
25%	Outlet	33.2	44.6	36.5	50.3	40.1	38.5	34.5	27.9	25
25%	Breakout	36	38.9	33.2	36.2	27.3	22.6	15.4	6.9	19.2

Vent-Axia Sentinel D-Box Twin Fan

Performance Curve

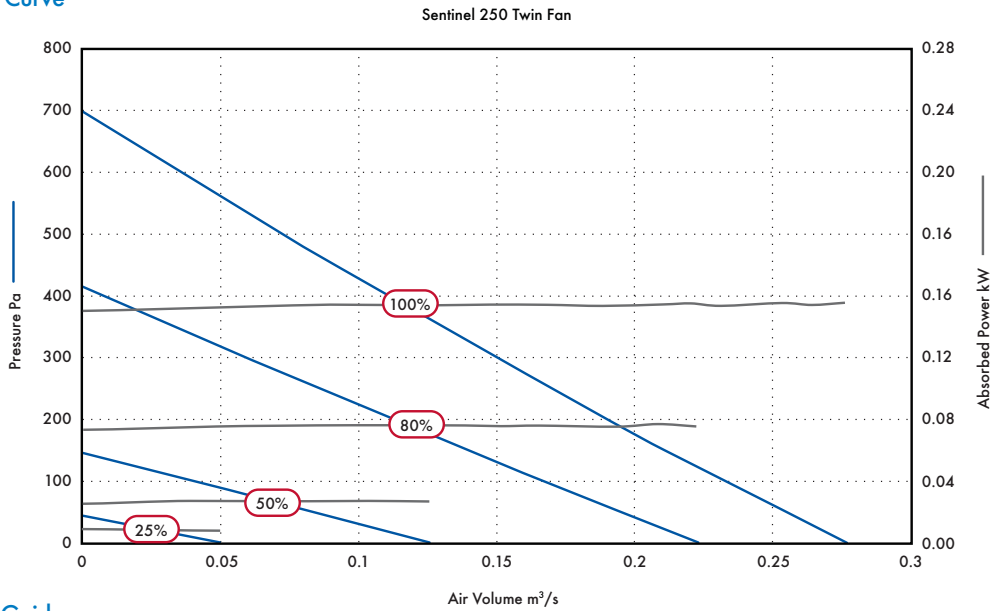

Performance Guide

Speed	Phase	Airflow, m ³ /s @ Pa													Amps F.L.C	
		0	25	50	100	125	150	200	250	300	350	400	450	500		
100%	1	m ³ /s	0.28	0.27	0.25	0.23	0.22	0.21	0.19	0.17	0.15	0.13	0.11	0.09	0.07	1.4
		kW	0.16	0.15	0.15	0.15	0.15	0.15	0.15	0.15	0.15	0.15	0.15	0.15	0.15	
		SFP	0.56	0.58	0.61	0.66	0.70	0.73	0.81	0.91	1.04	1.19	1.41	1.71	2.17	
80%	1	m ³ /s	0.22	0.21	0.19	0.17	0.15	0.14	0.11	0.09	0.06	0.03				0.92
		kW	0.08	0.08	0.08	0.08	0.08	0.08	0.08	0.08	0.08	0.08				
		SFP	0.34	0.37	0.39	0.46	0.50	0.55	0.69	0.90	1.29	2.31				
50%	1	m ³ /s	0.13	0.10	0.08	0.04	0.02									0.2
		kW	0.03	0.03	0.03	0.03	0.03									
		SFP	0.22	0.27	0.34	0.72	1.65									
25%	1	m ³ /s	0.05	0.02											0.09	
		kW	0.01	0.01												
		SFP	0.18	0.43												

Sound Data

Speed	Test Mode	Octave Band Frequency SWL								dB(A) @3m
		63	125	250	500	1k	2k	4k	8k	
100%	Inlet	61.7	70.5	62.2	70.9	60.2	51.8	51.2	47.8	45.1
100%	Outlet	63.9	74.3	63.6	76.2	67.5	66.2	60.9	55.9	52.4
100%	Breakout	66.7	66.8	62.3	67.8	56.3	52.3	44.2	39.9	45.4
80%	Inlet	56.9	65.7	57.3	66	55.4	46.9	46.3	43	40.2
80%	Outlet	59.1	69.5	58.8	71.3	62.6	61.4	56	51.1	47.6
80%	Breakout	61.8	62	57.4	62.9	51.4	47.5	39.3	35	40.5
50%	Inlet	46.8	55.6	47.3	56	45.3	36.8	36.2	32.9	30.1
50%	Outlet	49	59.4	48.7	61.2	52.5	51.3	46	41	37.5
50%	Breakout	51.7	51.9	47.4	52.8	41.4	37.4	29.2	25	30.4
25%	Inlet	31.6	40.4	32.1	40.8	30.1	21.6	21	17.7	16.7
25%	Outlet	33.8	44.2	33.5	46.1	37.3	36.1	30.8	25.8	22.3
25%	Breakout	36.6	36.7	32.2	37.6	26.2	22.2	14.1	9.8	18.3

Performance Curve

Sentinel 315 Twin Fan

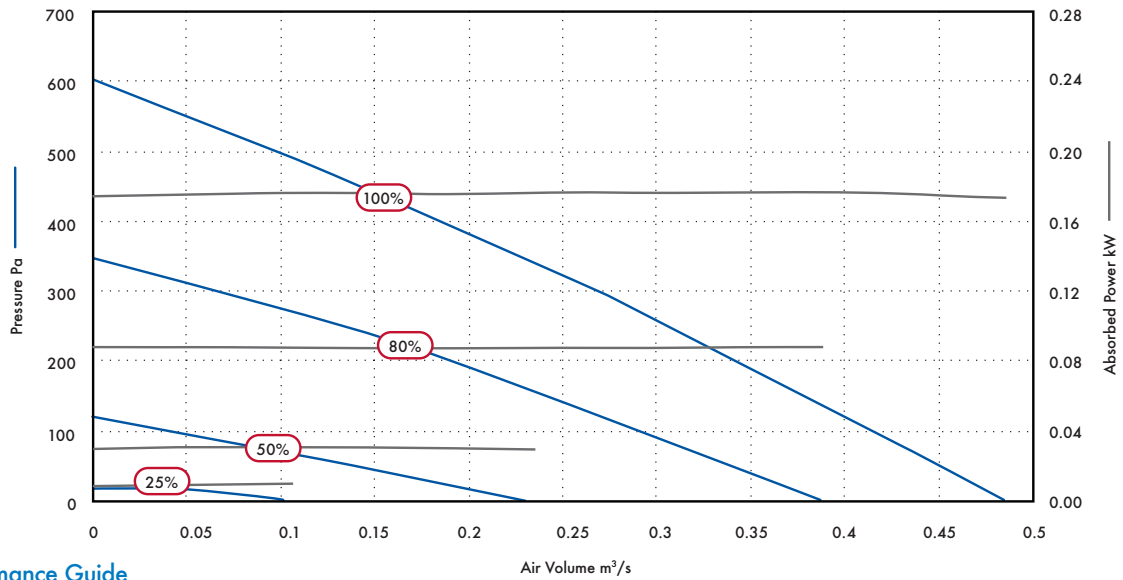

Performance Guide

Speed	Phase	Airflow, m³/s @ Pa														Amps F.L.C	
		0	50	100	150	200	250	300	325	350	400	450	500	525			
100%	1	m³/s	0.49	0.45	0.42	0.38	0.34	0.31	0.27	0.25	0.23	0.19	0.14	0.10	0.08	1.40	
		kW	0.17	0.18	0.18	0.18	0.18	0.18	0.18	0.18	0.18	0.18	0.18	0.18	0.18		
		SFP	0.36	0.39	0.43	0.46	0.51	0.58	0.66	0.71	0.78	0.95	1.24	1.81	2.36		
80%	1	m³/s	0.39	0.34	0.30	0.25	0.19	0.13	0.07	0.04						0.60	
		kW	0.09	0.09	0.09	0.09	0.09	0.09	0.09	0.09							
		SFP	0.23	0.26	0.30	0.36	0.46	0.66	1.27	2.47							
50%	1	m³/s	0.23	0.14	0.04											0.20	
		kW	0.03	0.03	0.03												
		SFP	0.13	0.22	0.77												
25%	1	m³/s	0.11														0.09
		kW	0.01														
		SFP	0.13														

Sound Data

Speed	Test Mode	Octave Band Frequency SWL								dB(A) @3m
		63	125	250	500	1k	2k	4k	8k	
100%	Inlet	64.4	70	65.8	64.6	58.6	50.3	47.4	44.6	41.5
100%	Outlet	65.7	72	64.5	71.9	64.7	64.2	58.1	51.9	49.7
100%	Breakout	68	65.9	64	60.1	53.3	48.9	41.3	34.1	40.5
80%	Inlet	59.6	65.1	61	59.7	53.7	45.4	42.5	39.7	36.7
80%	Outlet	60.8	67.2	59.7	67.1	59.9	59.3	53.2	47.1	44.9
80%	Breakout	63.1	61.1	59.2	55.2	48.4	44	36.5	29.3	35.7
50%	Inlet	49.3	54.9	50.7	49.5	43.5	35.2	32.3	29.5	26.4
50%	Outlet	50.6	56.9	49.4	56.8	49.6	49.1	43	36.8	34.6
50%	Breakout	52.8	50.8	48.9	45	38.2	33.7	26.2	19	25.4
25%	Inlet	34.3	39.9	35.7	34.5	28.5	20.2	17.3	14.5	14.8
25%	Outlet	35.6	42	34.4	41.8	34.6	34.1	28	21.8	19.6
25%	Breakout	37.9	35.8	33.9	30	23.2	18.8	11.2	4	20.4

Vent-Axia Sentinel D-Box Twin Fan

Performance Curve

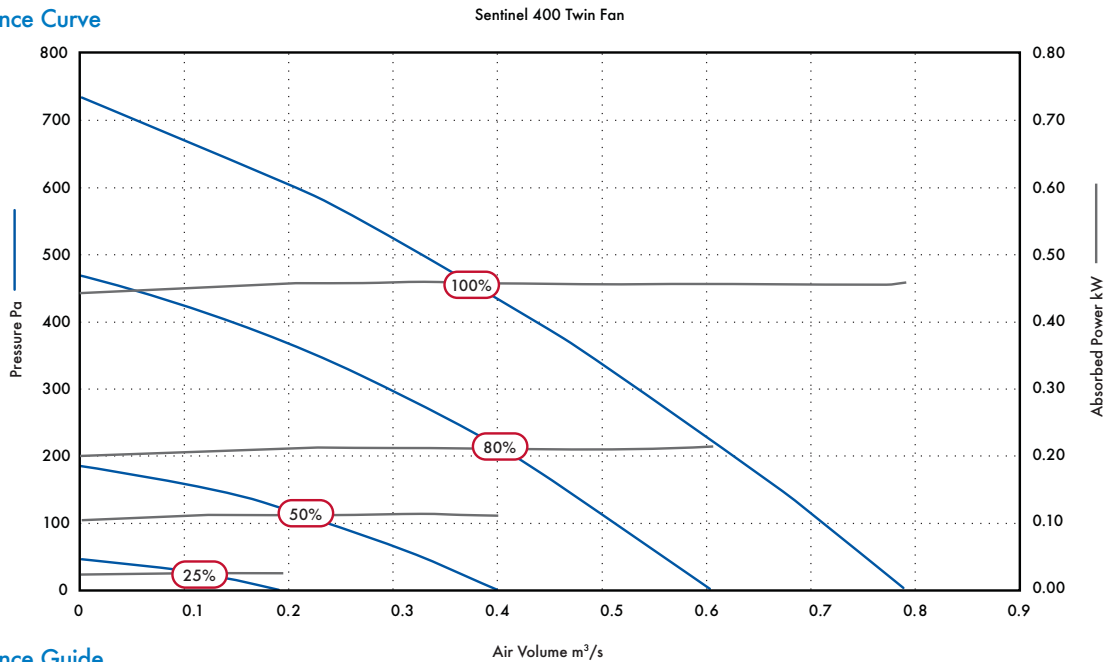

Performance Guide

Speed	Phase	Airflow, m ³ /s @ Pa																Amps F.L.C
		0	25	50	100	125	150	200	250	300	350	400	450	500	550	600		
100%	1	m ³ /s	0.79	0.77	0.75	0.71	0.67	0.65	0.63	0.58	0.54	0.49	0.44	0.38	0.33	0.27	0.21	2.86
		kW	0.46	0.45	0.46	0.46	0.45	0.46	0.46	0.46	0.46	0.46	0.46	0.46	0.46	0.46	0.46	
		SFP	0.58	0.59	0.61	0.64	0.68	0.71	0.73	0.79	0.85	0.94	1.05	1.19	1.40	1.70	2.23	
80%	1	m ³ /s	0.61	0.58	0.56	0.52	0.47	0.44	0.41	0.36	0.30	0.23	0.15					2.02
		kW	0.21	0.21	0.21	0.21	0.21	0.21	0.21	0.21	0.21	0.21	0.21					
		SFP	0.35	0.36	0.37	0.41	0.45	0.48	0.50	0.59	0.71	0.93	1.43					
50%	1	m ³ /s	0.40	0.36	0.33	0.24	0.12											0.77
		kW	0.11	0.11	0.11	0.11	0.11											
		SFP	0.27	0.30	0.34	0.46	0.90											
25%	1	m ³ /s	0.19	0.11														0.19
		kW	0.02	0.02														
		SFP	0.11	0.19														

Sound Data

Speed	Test Mode	Octave Band Frequency SWL								dB(A) @3m
		63	125	250	500	1k	2k	4k	8k	
100%	Inlet	73	82.9	75.8	69.4	63	55.9	53.6	49.8	49.2
100%	Outlet	75.5	83.8	79.5	78.5	74.7	71	64.8	57.3	58.7
100%	Breakout	77.6	80.7	80.5	72.8	66.6	60.4	50.9	41.7	54.7
80%	Inlet	68.2	78.1	71	64.6	58.2	51.1	48.8	44.9	44.3
80%	Outlet	70.6	78.9	74.6	73.7	69.9	66.1	59.9	52.4	53.6
80%	Breakout	72.7	75.9	75.6	68	61.7	55.5	46.1	36.9	49.9
50%	Inlet	58	67.9	60.7	54.4	47.9	40.9	38.6	34.7	34.1
50%	Outlet	60.4	68.7	64.4	63.5	59.7	55.9	49.7	42.2	43.6
50%	Breakout	62.5	65.6	65.4	57.8	51.5	45.3	35.9	26.7	39.7
25%	Inlet	42.9	52.9	45.7	39.4	32.9	25.8	23.6	19.7	19.1
25%	Outlet	45.4	53.7	49.4	48.4	44.6	40.9	34.7	27.2	28.6
25%	Breakout	47.5	50.6	50.4	42.8	36.5	30.3	20.8	11.6	24.9

Performance Curve

Sentinel 500 Twin Fan

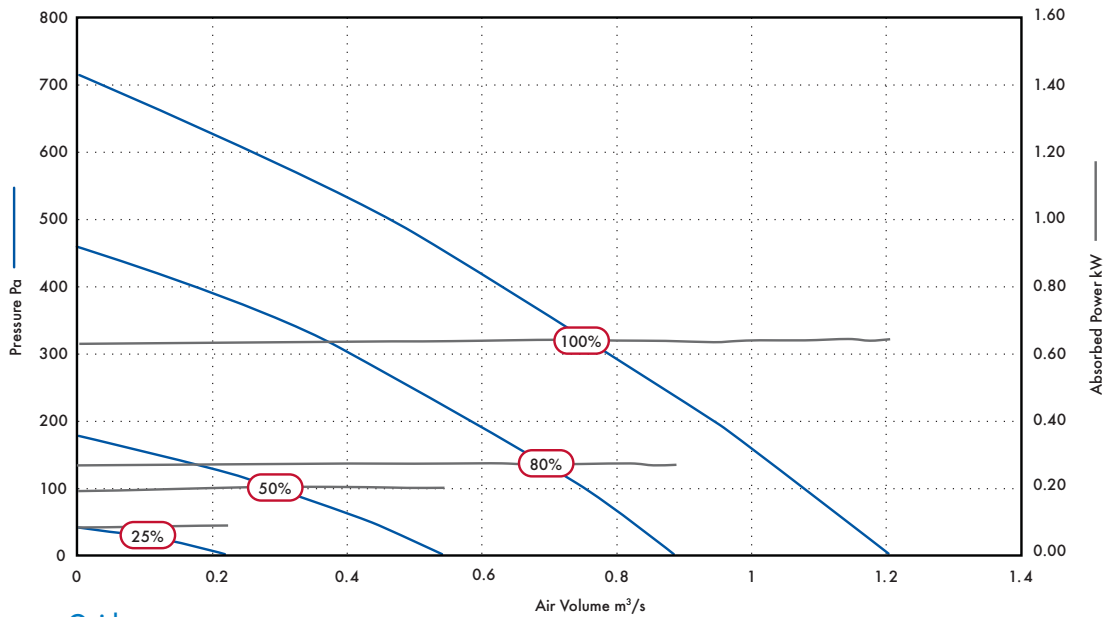

Performance Guide

Speed	Phase	Airflow, m³/s @ Pa															Amps F.L.C
		0	25	50	100	150	175	200	250	300	350	400	450	500	550		
100%		m³/s	1.20	1.17	1.14	1.08	1.01	0.98	0.94	0.87	0.80	0.72	0.64	0.56	0.47	0.37	2.1
	kW	0.65	0.65	0.65	0.65	0.65	0.64	0.64	0.64	0.65	0.65	0.65	0.64	0.64	0.65		
	SFP	0.54	0.55	0.57	0.60	0.64	0.66	0.68	0.74	0.81	0.90	1.01	1.16	1.38	1.74		
80%		m³/s	0.89	0.85	0.82	0.75	0.67	0.63	0.59	0.50	0.40	0.30	0.17				1.6
	kW	0.27	0.26	0.27	0.27	0.27	0.27	0.27	0.27	0.27	0.27	0.27					
	SFP	0.30	0.31	0.33	0.36	0.40	0.43	0.46	0.54	0.67	0.91	1.55					
50%		m³/s	0.54	0.49	0.43	0.30	0.13										0.67
	kW	0.20	0.20	0.20	0.20	0.20											
	SFP	0.36	0.40	0.46	0.67	1.53											
25%		m³/s	0.22	0.12											0.39		
	kW	0.08	0.08														
	SFP	0.36	0.71														

Sound Data

Speed	Test Mode	Octave Band Frequency SWL								dB(A) @3m
		63	125	250	500	1k	2k	4k	8k	
100%	Inlet	74.9	86.2	77.4	72.7	62.3	56.4	52.6	52.5	52.1
100%	Outlet	78.6	85.1	84.5	78	74.3	69	63.5	58.5	59.2
100%	Breakout	68.5	63.6	60.3	54.5	47.6	41.1	30.4	30.9	35.8
80%	Inlet	70	81.4	72.6	67.9	57.4	51.6	47.7	47.7	47.3
80%	Outlet	73.7	80.3	79.6	73.2	69.4	64.2	58.7	53.6	54.3
80%	Breakout	63.6	58.8	55.4	49.7	42.7	36.3	25.6	26.1	31
50%	Inlet	59.8	71.2	62.4	57.7	47.2	41.4	37.5	37.5	37.1
50%	Outlet	63.5	70.1	69.4	63	59.2	54	48.5	43.4	44.1
50%	Breakout	53.4	48.6	45.2	39.5	32.5	26.1	15.4	15.9	21.4
25%	Inlet	44.8	56.1	47.3	42.6	32.1	26.3	22.5	22.4	22
25%	Outlet	48.5	55	54.3	47.9	44.2	38.9	33.4	28.4	29

Sentinel D-Box Sensors & Controls

Ambient Response Humidity Sensor*



Humidity Sensor control is fixed at 72 - 75%RH. Incorporates a night time 'set back' function to avoid nuisance tripping as the humidity level rises

when the air cools. An integral pullcord provides a manual override function if required. Can be wired for either On/Off or Trickle Boost operation. Pullcord override and neon indicator. Changeover relay switch. Operating range: 30% - 90%RH. Ambient operating temperature +5°C to +40°C. 24V DC SELV. Dimensions: 87 x 87 x 33mm (H x W x D). Will fit single gang box for surface mounting.

Stock Ref

432945

Ecotronic Humidity Sensor*



Humidity Control is automatic and can be set to switch between 65 and 90%RH. An integral pullcord provides a manual override function

if required. Can be wired for either ON/OFF or Trickle Boost operation. Set Point adjustable. Maximum switching load 1 amp inductive. Pullcord override indicator. Ambient operating temperature 0°C to +40°C. Dimensions: 87 x 87 x 33mm (H x W x D). Supply voltage 24V DC SELV.

Humidity sensors should be sited approx. 100mm below ceiling level and not above cupboards, refer to siting details in fitting and wiring instructions supplied with product.

Stock Ref

432949

Vent-Axia ThermoSwitch®



Automatically switches on fans on either a rise or fall in air temperature. Can be used for Trickle/ Boost operation on either

intake or extract systems. Setting range: +6°C to +30°C. Two internal range limit/locking rings are included to allow setting within a limited temperature range or locking at a fixed set-point. IP20 rated. Sealed sensing mechanism. Mounting direct on surface only. Dimensions: 80 x 104 x 36mm (H x W x D). Volt free switch connection to Sentinel.

Stock Ref

563502

Air Quality Sensor (AQS)*



Automatically reacts to the deterioration of air quality, sensing tobacco smoke, smells and toilet odours to

regulate mechanically ventilated areas, such as cinemas, pubs, clubs, restaurants, kitchens, toilets and conference rooms.

The sensor switches when the air quality declines below an adjustable preset level. This is registered by a self-cleaning ceramic sensing head. The air quality sensor should not be used for the detection of combustible gases. Ambient operating temperature range 0°C to +50°C. MIN - MAX mode or direct Damper control. Dimensions: 87 x 157 x 47mm (H x W x D) Surface mounted. 1 - 25 min O/R timer. Supply voltage 24V DC SELV.

Stock Ref

432953

Vent-Axia Visionex PIR*



A wall or ceiling person presence detector for use with Sentinel. Can be used in MIN - MAX mode or for direct damper control.

Fits any UK single gang mounting box. Adjustable timer overrun (5-25 minutes). Range of detection up to 10 metres. Designed to meet IP43. Ambient operating temperature range 0°C to +50°C. Supply voltage 24V DC SELV.

Stock Ref

433162

7 Day TimeSwitch



For applications where regular switching is required at fixed periods or at different times on different days of the week, eg: offices, shops, pubs and restaurants.

The 7 Day TimeSwitch gives twelve On or Off positions per day and can be set for 7 days. The cycle will repeat until changed. Volt free switch connection to Sentinel.

Analogue clock display and integral time switches for ease of setting. Manual override. Removable clear plastic cover protects timeswitch face. Time base: 7 days. Shortest switching time: 2 hours. Ambient operating temperature range -20°C to +85°C. Dimensions: 104 x 74 x 52mm (H x W x D). Supply voltage 220-240V/1/50Hz.

Stock Ref

563515

* PLEASE NOTE: These sensors/controls are unique to Sentinel and CANNOT be used with any other product.



Remote Speed Control*



Provides infinitely variable Sentinel fan speed control between the 2 set points in Proportional mode. This control does NOT provide an ON/OFF switching facility.

Manual control. Located remotely. 24V DC SELV. Ambient operating temperature -5°C to +40°C. Dimensions: 84 x 84 x 30mm (H x W x D). Will fit single gang box for surface mounting.

Stock Ref **426332**

CO₂ Duct Probe



High CO₂ levels promote increased fatigue and reduced concentration. This sensor monitors CO₂ levels in extract ducts from conference areas, offices,

theatres etc. With Sentinel in Proportional control mode, air extraction rate tracks the CO₂ level to improve indoor air quality.

24V DC SELV. 0 - 2000ppm CO₂ working range. Auto-calibrating NDIR absorption sensor. Stable drift compensation. Adjustable probe length. MAX. IP Rating 65.

Stock Ref **433259**

CO₂ + Temp Room Sensor*



HVAC temperature and carbon dioxide room sensor for ventilation control of residential areas, office areas and classrooms. Used with

Sentinel in Proportional control mode. Sensor will monitor both CO₂ and temperature levels between the set points, the air extraction rate following the higher of the 2 outputs.

24V DC SELV. 0 - 2000ppm CO₂ working range. 0 - 50°C working range. Auto-calibrating NDIR CO₂ absorption sensor. Thin film platinum temperature sensor for high accuracy. Dimensions: 100 x 84 x 25mm (H x W x D).

Stock Ref **433257**

Remote Fan Status Indicator*



This Remote Display unit will indicate the running status and condition of the fan or fans. Can be used in all Sentinel operating modes for fan mounting.

24V DC SELV. Directly connects into the SCU. Used for single and twin fan mounting. Ambient operating temperature -5°C to +50°C. Dimensions: 86 x 86 x 28mm (H x W x D).

Stock Ref **433816**

Constant Press System Accessories PIR Grille*



PIR grille is on extract grille with an integral flap damper. Suitable for bathrooms and WC's. The PIR function fully opens the damper when a person.

presence is detected. The opening time is fixed at 20 mins. Spigot size is 125mm.

12V AC SELV unit using the main transformer unit

supplied. Integral PIR person presence sensor controlling damper. Auto-humidity control damper response at all times. 100° viewing angle. Temperature range 0 - 50°C. Size: 158 x 150 x 35mm (H x W x D). MAX airflow 70m³/hr @100 Pa.

Stock Ref **434184**

Dampers*



Two types available:

- MM type - opening shut/MIN to open/MAX controlled by switches and
- PC type - opening proportionally when controlled by sensors.

Duct sizes available: 100, 125, 150, 200, 250 and 315. Industry standard actuators.

Typical ordering designation: DVD size MM or PC

Power Supply*



For those situations where a separate 24V DC SELV supply source is required. 24W output capacity. See Fitting & Wiring instructions for connection details.

Stock Ref **433193**

Sentinel Totus² D-ERV

Following on from the highly successful award winning Sentinel demand ventilation system, Vent-Axia has taken the next step by incorporating the Sentinel demand control philosophy with a state of the art high efficiency heat recovery cell to create the Sentinel Totus² D-ERV, Demand Energy Recovery Ventilation System.

Sentinel Totus² D-ERV incorporates the same 'Sentinel' high efficiency EC/DC backward curved motors/impellers, Sentinel Demand Controlled ventilation strategies and a market leading high efficiency counterflow heat recovery cell which achieves up to 90% energy recovery.

The Energy recovery capabilities are independently tested and rated to EN308.

Sentinel provides a solution to the common problem of 'Why ventilate a room you're not using?' or 'Why over ventilate a room with only one or two occupants inside?'

Sentinel overcomes many of the issues encountered with a traditional fixed volume ventilation system that is either ON or OFF irrespective of the number of people in the room, risking over ventilation, burning valuable money and is a wasteful use of energy.



Sentinel Totus² D-ERV

354-359

Vent-Axia

Sentinel Totus² D-ERV





Welcome to the world of Sentinel Demand Energy Recovery Ventilation

Sentinel Totus² Demand Energy Recovery Ventilation (D-ERV) is a new heat recovery demand ventilation system designed to meet modern building management control principles. It responds to the exact ventilation requirements of a room at any one time providing airflow only when it is required and to the level that is required, therefore using only the energy that is needed; no more no less, whilst recovering maximum energy from the extracted air and transferring it to the fresh supply air. This overcomes many of the issues encountered with a traditional fixed volume ventilation system that is either ON or OFF irrespective of the occupancy of the room, risking over ventilation, burning valuable money and is a wasteful use of energy. There is an additional benefit to this demand controlled lower speed running, one of reduced noise intrusion, something that in today's society is becoming more important to end users.

Vent-Axia's dedicated HEVAC team offers:

- ✓ Practical advice on HEVAC selection and installation
- ✓ Guidance on solutions to meet legislation requirements
- ✓ Project management and site deliveries
- ✓ After sales support and maintenance information

The need to recover energy

The high efficiency cell incorporated within the Totus² range achieves a market leading 90% efficiency (EN308 independently tested). This enables Sentinel Totus² to recover a third more energy than a 70% efficient device. This high efficiency means that heating and cooling loads associated with 'extract to waste' type systems can be reduced by up to 25% in both heating and cooling seasons. This high efficiency also means that expensive after heaters, often required in lower efficiency heat recovery devices, are now not required.

The need to save costs

Rising fuel prices are placing an increasing burden on organisations as they seek to reduce consumption. Sentinel Totus² D-ERV features:

- ✓ High efficiency heat exchanger - up to 90% energy recovery offering savings of up to 25% on heating and cooling loads
- ✓ Integral automatic summer bypass - providing free cooling during summer
- ✓ Single skin construction with 95kg/m³ thermal and acoustic foam insulation (Maxi unit double skinned)
- ✓ Low stand by power only 0.6W
- ✓ Energy efficient EC/DC motors - 1/3 less energy lost to heat than a conventional AC motor
- ✓ ERP 2015 compliant fans

The need for system integration

With the drive towards 'whole building cost' philosophy maintenance schedules and costs are all now essential elements of the project in addition to the initial capital costs. Sentinel Totus² D-ERV incorporates a number of integrated features to offer maximum flexibility during design, build and operation including:

- ✓ Air conditioning interlock - to optimise energy recovery
- ✓ Heating system interlock - summer bypass optimisation
- ✓ Interfaces for BMS control and monitoring
- ✓ EC/DC motors with lower maintenance requirements and longer service life
- ✓ Aluzinc casing - suitable for external installations as standard
- ✓ Optional cowl for roof mounting
- ✓ Integral condensate pump - reduces installation costs and space requirements
- ✓ In-built automatic frost protection - prevents heat exchanger freezing at very low temperatures
- ✓ Ability to utilise the frost heaters as top up heat removing the need for additional duct mounted heaters
- ✓ In-built backlit LCD user control interface which can be remotely mounted to suit site requirements
- ✓ Night time purge facility to reduce overheat during warm summer periods

The need for better health

Removal of pollutants, such as moisture, carbon dioxide and external fumes are all important factors in maintaining indoor air quality. Studies within schools have demonstrated that maintaining lower carbon dioxide levels helps create a better learning environment.

- ✓ Hierarchical control maintains CO₂ levels within levels described in Building Bulletin 101
- ✓ Low sound levels meet requirements of Building Design
- ✓ Automatic 100% summer bypass providing free summer cooling
- ✓ Demand control optimising indoor air quality
- ✓ Closed loop control system ensures maximum comfort levels at minimum energy levels

The need to meet legislation

The Energy Performance of Buildings directive is implemented through the UK building regulations. Sentinel Totus² is fully compliant with both Part F and L requirements.

- ✓ Meets the requirement of the Building Services Compliance Guide minimum specific fan power requirements.
- ✓ Market leading 90% heat exchange efficiency independently tested to EN 308
- ✓ Meets carbon footprint reduction targets
- ✓ Lowest Specific Fan Power figures of any high efficiency D-ERV product



Sentinel Totus² D-ERV

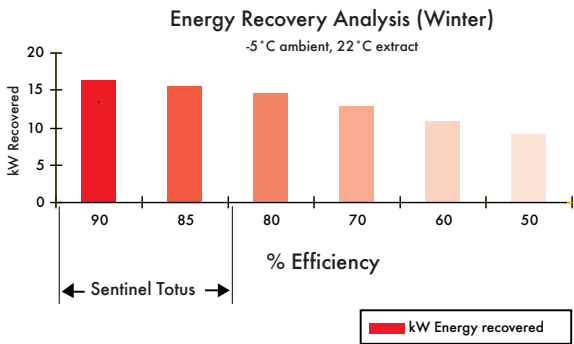

Airflow m ³ /s	Efficiency %	kW Heat recovered	Supply temp °C
0.555	90	16.51	19.3
	85	15.59	18.0
	80	14.67	16.6
	70	12.84	13.9
	60	11.00	11.2
	50	9.17	8.5

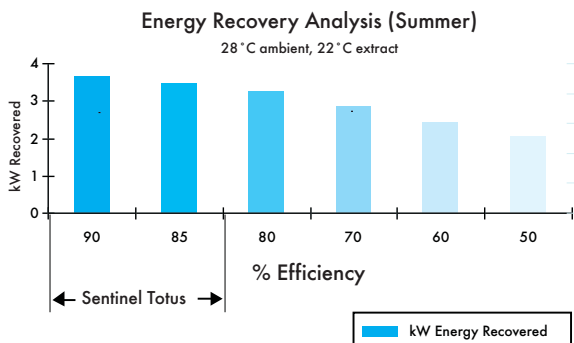

Airflow m ³ /s	Efficiency %	kW Cool Recovered	Supply temp °C
0.555	90	3.67	22.6
	85	3.46	22.9
	80	3.26	23.2
	70	2.85	23.8
	60	2.45	24.4
	50	2.04	25.0

The need for energy recovery

Rising fuel prices are placing an increased burden on organisations as they seek to reduce consumption.

Sentinel Totus² D-ERV incorporates a number of market leading technologies and control strategies to take commercial heat recovery ventilation to the next level and further reduce energy consumption and waste.

- ✓ **Sentinel demand ventilation control** - matching air quality with low power consumption using high efficiency, low energy EC/DC motor technology
- ✓ **Energy saving control functions** -
 - i. Automatic summer bypass - provides free cooling during summer
 - ii. Low standby power - 0.6 Watts
 - iii. Night time purge facility - reducing air conditioning start up loads
- ✓ **System interfaces** - to optimise interface with environmental control systems
 - i. Air conditioning interlock - to maximise energy recovery opportunities
 - ii. Heating system interlock - to optimise summer bypass functionality
 - iii. BMS interfaces - control and monitoring
- ✓ **High efficiency energy recovery cell**
 - i. Up to 90% energy recovery - reducing associated heating and cooling loads by up to 25%
 - ii. High efficiency eliminates the need for re-heaters eg. typically at -5°C ambient, 22°C room conditions the supply air temperature is maintained above 19°C

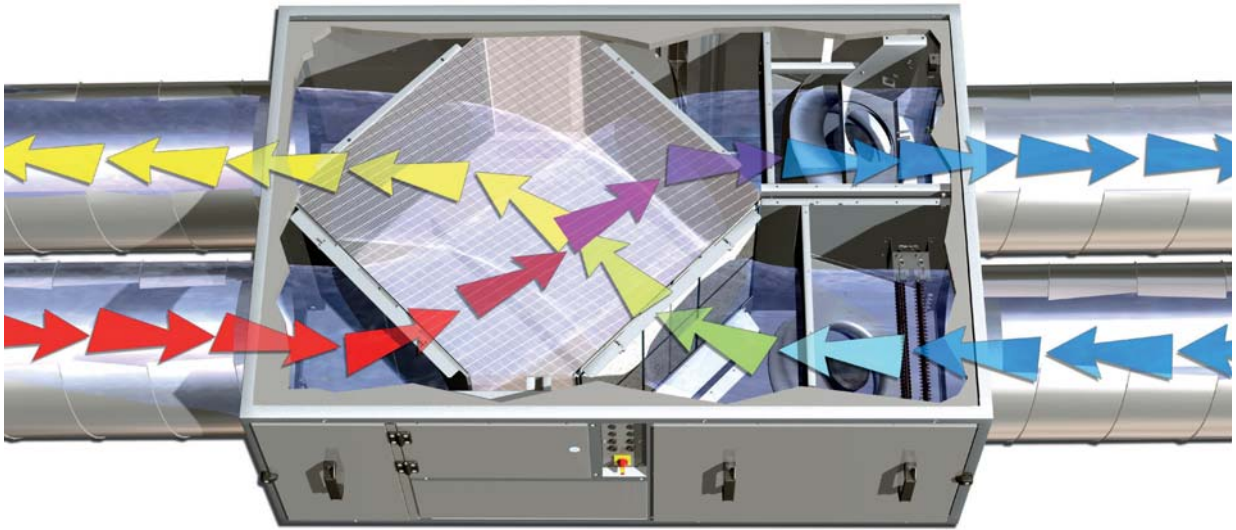

The Sentinel Totus² D-ERV units incorporate a brand new market leading counterflow heat exchanger.

The Sentinel Totus² D-ERV range has been independently tested to EN 308 to achieve energy savings of up to 90% and higher in the case of condensation.

The plate heat exchanger is a true counterflow device, incorporating a special plate edge seal, to enhance air tightness and stability, eliminating the transfer of odours or humidity and ensuring the highest efficiency levels.

The aluminium construction makes it insensitive to frost and heat damage and tolerant to pressure imbalance conditions, unlike equivalent paper or plastic variants.

This high efficiency energy recovery ventilation system also includes further functions to reduce energy usage and maintain high levels of indoor air quality.

- ✓ High efficiency EC/DC motors and backward curved impellers with 'Sentinel' demand control logic to optimise IAQ, whilst using the minimum amount of energy
- ✓ Built-in automatic 100% summer bypass, to take advantage of free cooling opportunities (with air conditioning interlock)
- ✓ Heating system interlock to ensure free cooling is optimised
- ✓ Low standby power 0.6 Watts (PIR actuation)
- ✓ Night time purge facility to reduce overhear during the operational day and reduce air conditioning start up loads



Sentinel Totus² Mini/Midi D-ERV Unit



Sentinel Totus² Maxi D-ERV Unit

Sentinel Totus² D-ERV

EC/DC energy saving fan motor benefits

- ✓ Higher efficiency at full speed - at 50% reduction in motor speed gives an 88% reduction in power usage
- ✓ Continuous speed control across the full operating range giving an increased tolerance to high and low pressure
- ✓ ERP 2015 compliant fans
- ✓ Low noise compared to a step control motor
- ✓ Power input lost as heat is reduced by 1/3 compared to a conventional AC motor
- ✓ Lower maintenance requirements and longer service life

Highest Motor Efficiency

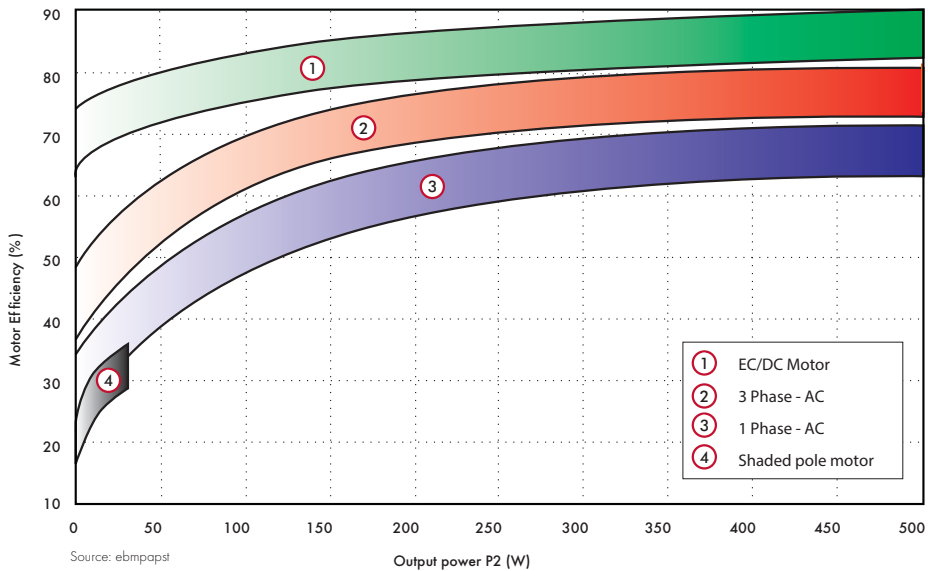

Typical EC/AC Motor Speed Control Comparison

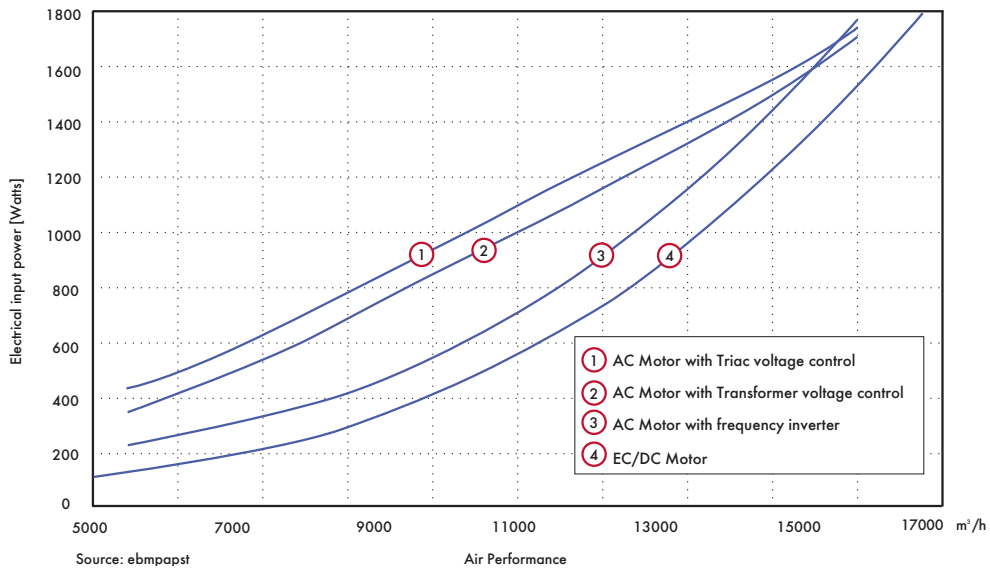

As can be seen from above motor comparisons, the EC/DC motor offers higher efficiencies when compared to AC motors, and also consumes less power under speed control, giving both the highest motor efficiency and lowest power consumption across the speed control range.

Demand control



Precise control of the Sentinel Totus² D-ERV system, driven by the ventilation requirements of the room at any one time, means that the system is only running to the level required, using energy when it is needed. A range of sensors are employed to determine the occupancy of the rooms, and manage the system ventilation rates accordingly. This optimises the use of energy whilst meeting the legislation requirements of the building.

This compares to a 'traditional' fixed volume system, which in general is either 'ON' or 'OFF' often using energy to ventilate an empty or half occupied room, over ventilating and wasting energy.

System overview

The Sentinel Totus² D-ERV system is made up of 4 elements:

- ✓ Up to 90% energy recovery (EN 308)
- ✓ Low energy EC/DC motors
- ✓ Sentinel Totus² D-ERV, Demand Energy Recovery control
- ✓ Sensors and Controls

The ventilation demands of the room are detected by the wall or ceiling mounted Sentinel Totus² D-ERV sensors/switches. These communicate with the Sentinel Totus² D-ERV unit, which in turn drives the fan to the required speed to deliver the airflow. As the ventilation is provided to the room, the sensors continuously feedback to the control unit, driving the fan motor to the exact level required in the room at any one time.

Hierarchical control

The system is controlled by on board electronics, with an LCD display showing fan status and allowing for simple commissioning and installation, whether as a local sensor control unit or linked into a building management system. The LCD display unit can be remotely mounted if required.

1. Switched on/off or minimum/maximum level control. In an environment such as an office, the system is activated and runs between minimum and maximum levels by a choice of sensors:

- PIR Detector
- Thermostat
- Humidistat
- BMS (remote enable)

2. Hierarchical - maximum demand multi sensor input used with a combination of sensors, with a defined level of priorities to simultaneously control a number of atmospheric conditions within a room, such as a meeting room:

- CO₂/temperature - room mounted
- CO₂ - duct mounted
- Building Management System (0-10V)

Constant pressure extract

Applied in a discreet central extract system, such as hotel bathrooms or apartment blocks, the system grilles and/or duct dampers are controlled by the presence of a person in the room or by achieving required levels of humidity. The central system will respond to the demand depending on the number of active rooms.

- PIR/Humidity Extract Grille 125mm
- PIR 12 - 70m³/h
- Humidity: 12m³/h - 30% RH
70m³/h - 75% RH
- Motorised Duct Dampers 100mm - 315mm Dia

Built in end stop adjustment for setting minimum and maximum volume.

24V Min/Max or 0-10V proportional control options. Motorised Duct Dampers - Sensor Control options

Each 24V powered extract damper can be controlled by one of the following sensors:-

Min-Max (DVDxxx/MM)

- AQS- Air Quality Sensor - Room (432953)
- PIR Detector - Room (433162)
- Thermostat - Room (563502B)
- Humidistat - Room (432945)

Proportional 0-10V (DVDxxx/PC)

- Carbon Dioxide Sensor - Room (433257)
- Carbon Dioxide Sensor - Duct (433259)

Note Local 24V power supply required to power Dampers & Sensors.

Sentinel Totus² D-ERV Units



Mini/Midi fan unit



Maxi fan unit

System technology

Sentinel Totus² D-ERV is a closed loop controlled ventilation system. Employing a range of sensors to manage the system, demand is sensed by PIR, temperature, humidity, air quality or carbon dioxide sensors. Depending on the levels in the rooms, Sentinel Totus² D-ERV's fan speed is ramped up or down to control the parameters within the required limits. If the room is unoccupied, the system switches off, saving energy and cost to the business.

The unit standby power consumption is only 0.6 Watts.

The EC/DC energy saving fan motor technology



- ✓ Compliant to ERP 2015, future proofed fan and motor assemblies
- ✓ Higher efficiency at full speed - at 50% reduction in motor speed gives an 87.5% reduction in power usage
- ✓ Continuous speed control across the full operating range giving an increased tolerance to high and low pressure
- ✓ Low noise compared to a step control motor
- ✓ Power input lost as heat is reduced by 1/3 compared to a conventional AC motor
- ✓ Lower maintenance requirements and longer service life

The Sentinel Totus² D-ERV units are manufactured from Aluzinc sheet and are suitable for internal or external mounting as standard.

Sentinel Totus² D-ERV utilises the latest EC/DC motor technology, which provides energy saving benefits even over DC motors.

This technology is also infinitely speed controllable and offers increased energy savings across the complete speed control range when compared with conventional inverter drive solutions. The result is higher efficiency, reduced noise, accurate controllability, better speed control drawing less power and as a result better overall system performance. Volume reduction also increases energy recovery efficiency beyond the published figures.

Sentinel Totus² D-ERV can be used in a hierarchical system where maximum demand, for example temperature and/or CO₂ gives priority control of the fan speed or a constant pressure system with room mounted PIR/grilles or in-line damper control.

Heart of EC/DC motor

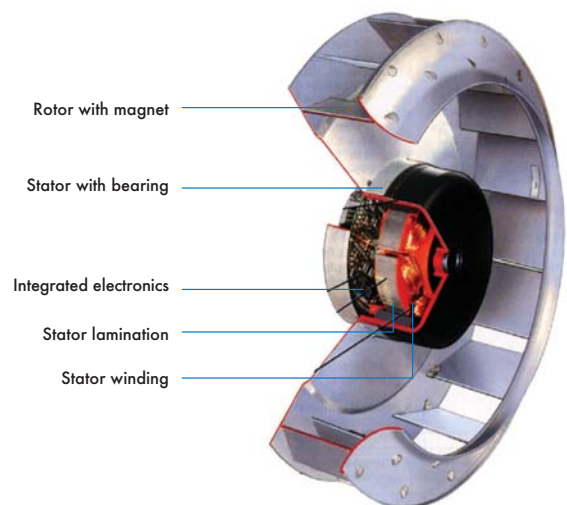

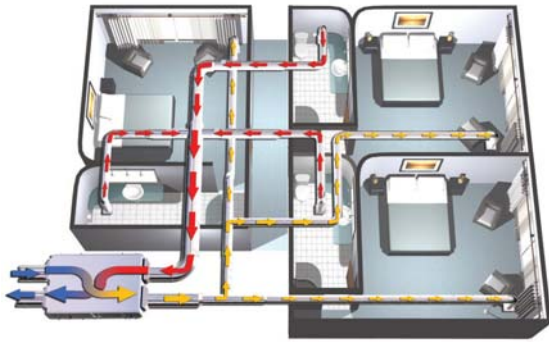

Typical network of hotel bathrooms/flats/apartments

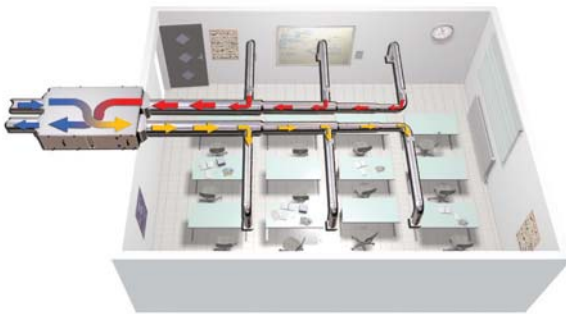

Typical school classroom



Mini/Midi fan unit



Maxi fan unit

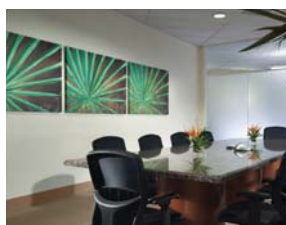

Sentinel Totus² D-ERV is a new range of energy recovery ventilation systems for multi occupancy and variable demand rooms. Using energy efficient EC/DC fans, 90% heat recovery with intelligent sensing and control, the system meets the ventilation requirements of both new builds and refurbishment projects.

Ideal for applications where the rooms are used at different times of the day by a variable number of people, the Sentinel Totus² D-ERV system will monitor occupancy, ventilation rate and air quality, and respond accordingly to maintain the atmosphere within preset limits, recovering up to 90% of extracted energy.

Typical applications include:

- ✓ A network of hotel bathrooms, flats or apartments which require ventilation but are only used for limited periods particularly in the morning and evening
- ✓ School classrooms and lecture theatres which are only occupied during lesson time by a variable number of students, but when used must keep CO₂ levels within prescribed limits
- ✓ Office meeting rooms or open plan areas which again are used periodically during the day by a variable number of staff and visitors, but when occupied must meet required airflow rates

Automatic sensing and control runs the system according to the maximum demand requirements of the building zone, whether it be carbon dioxide levels, temperature, humidity or air quality - triggered by people entering or leaving the rooms. Common configurations include Electronic Static Pressure (ESP) controllers for constant pressure systems.

Sentinel Totus² D-ERV

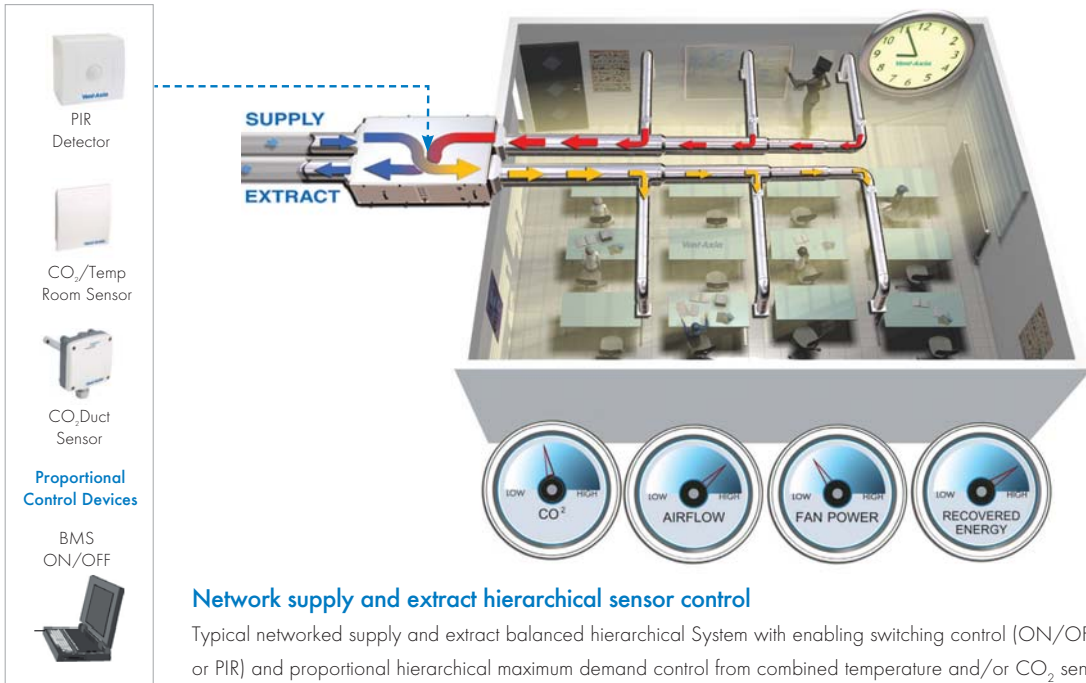

Central extract controlled system - hotels or apartments

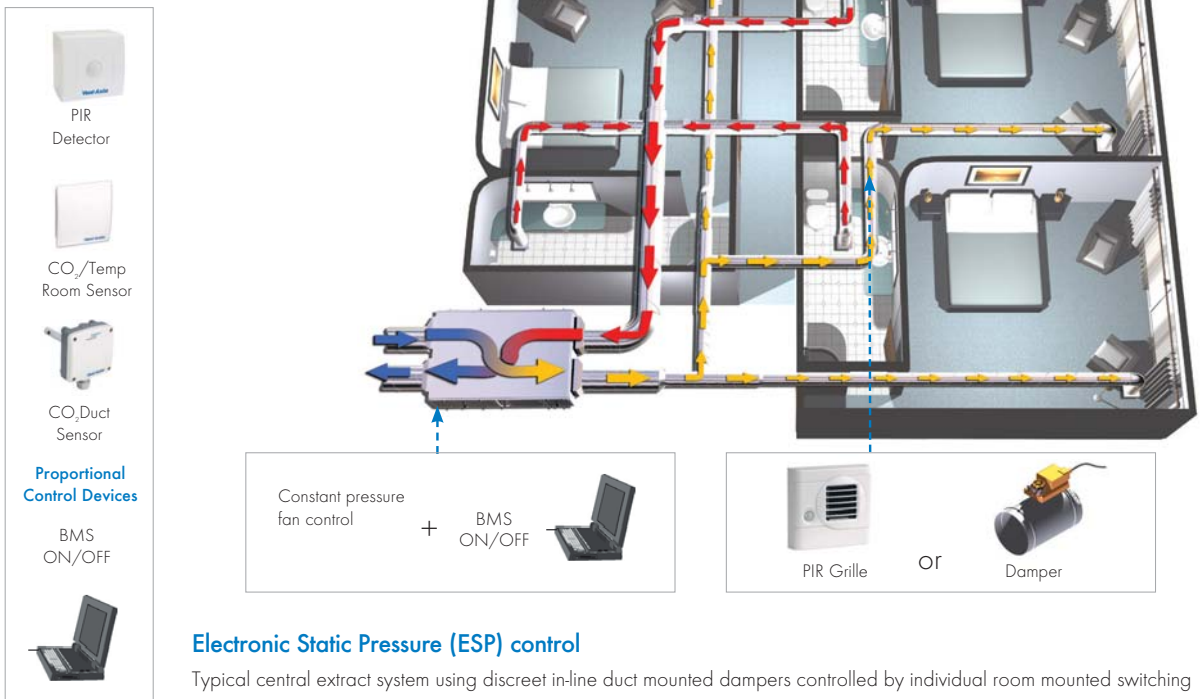

Operation

The supply and extract ventilation unit shall be as Sentinel Totus² D-ERV, as manufactured by Vent-Axia and shall be sized as indicated on the drawings and shall be in accordance with the particular specification.

Supply air to the room shall be pre-heated by the extract air via the integrated aluminium counterflow heat recovery cell. The Sentinel Totus² D-ERV unit shall automatically vary the ventilation rate via EC/DC motors as it receives signals from one of the optional interconnected sensors. When a signal is received, the fans shall either vary their speed proportionally or on a trickle and boost principle.

The unit shall have the facility to commission the supply and extract fans individually via in-built minimum and maximum speed adjustment. The fans themselves shall have infinitely variable speed control.

Unit specification

The unit shall be manufactured with a frameless construction, and incorporate single skinned Aluzinc panels (Maxi unit double skinned) with a high thermal and acoustic efficiency internal insulating foam. The unit shall be suitable for internal or external mounting as standard.

The unit shall have a high efficiency aluminium counterflow heat exchanger, supply and extract filters, automatic summer bypass on 100% of airflow, integral minimum and maximum infinitely variable speed controls with fascia mounted failure indication.

The unit shall have low energy, high efficiency EC/DC fan/motor assemblies with sealed for life bearings. The impellers shall be high efficiency backward curved centrifugal type fully compliant with ERP 2015.

The unit shall have a heat exchanger cell with a thermal efficiency of up to 90% when tested to EN 308. This shall be protected by G4 grade synthetic filters on supply and extract. Complete with a condensate drip tray, internal condensate pump and drain connection.

The unit shall incorporate 2 stage electric frost heaters to protect the cell from freezing under low ambient conditions. The frost heaters shall be programmable to allow operation as a 'top up' heating source, without the need for additional duct mounted heaters.

The unit shall be constructed with removable top and bottom access panels, or side panels for the Maxi unit allowing full maintenance access.

The removable panels shall provide access to the following:

- ✓ Supply or extract fan
- ✓ Supply and extract filter
- ✓ Heat exchanger
- ✓ Frost heater

Within a separate side access section access shall be provided for wiring termination and set-up/commissioning. The backlit LCD user interface therein shall be within a separate viewing and access panel allowing commissioning without the need to access the wiring section. This controller can be demounted for remote installation if required.

Units shall be as manufactured by Vent-Axia Ltd.

Standard controls

All Sentinel Totus² D-ERV units shall incorporate the following functions integrally mounted, pre-wired and factory fitted by the manufacturer:

- ✓ Integral infinitely variable fan speed control on supply and extract
- ✓ Integral min/max ventilation control/set point
- ✓ Integral BMS interfaces - control and status indication
- ✓ Cooling and heating interlocks (summer/winter)
- ✓ 0-10V speed adjustment
- ✓ Integral on/off or trickle boost function from remote switch, e.g. PIR occupancy detector
- ✓ Automatic frost protection by in-built electric frost heaters
- ✓ User settable night time purge function to purge the room automatically over night to reduce morning start up loads within the space during hot summer periods
- ✓ The unit shall be controlled by the 'Sentinel' control devices (enablers and sensors) as detailed in the schedule or on the drawings

Frost protection and control

The control for the in-built electric frost coils shall be 2 stage fully integrated and automatic and will ensure the energy recovery cell does not freeze up under low ambient conditions. The frost protection system will switch in each of the 2 stages as required when ambient temperature falls below 0°C.

Sentinel Totus² D-ERV

Features and Benefits

- 3 unit sizes covering 500-2000m³/h
- Sentinel demand ventilation control
- Low energy EC/DC motors
- Internal or external mounting IPX4
- Up to 90% energy recovery cell
- Independently Tested to EN 308
- Proportional or constant pressure control
- Performance tested to BS848 Parts 1 & 2
- Manufacture controlled to BS EN ISO 9001

Mini and Midi Models are manufactured with a frameless construction from single skinned Aluzinc panels, internally lined with 90kg/m³ high efficiency acoustic and thermally insulating foam (fire retardant to BS476 Part 7 Class 1 & Part 6 Class O). Aluzinc panels allow for all units to be mounted either internally or externally as standard (IPX4). An optional inlet cowl is available for roof mounting applications if required.

Maxi units are manufactured with an aluminium frame construction with double skinned Aluzinc panels fitted with 60kg/m³ thermal acoustic insulation.

The casing includes an inclined inlet and bellmouth entry which directs the incoming air to the impeller with minimal turbulence. The result is better air management through the unit, less noise, higher efficiency and an increased performance.

The housing is designed to be as compact as possible for concealed false ceiling applications and Sentinel Totus² D-ERV, Demand Energy Recovery casings incorporate top and bottom access panels for maintenance (note Maxi unit is side access). Access panels are sized to enable single man maintenance.

Impellers

All Sentinel Totus² D-ERV units feature low energy, Class 1, EC/DC external rotor motor and backward curved impeller assemblies specifically chosen for performance and non-overloading characteristics. The assembly is dynamically balanced to DIN ISO 1940 Grade 6.3. Ball bearings are greased for life. Insulation is Class 'B' (from -25°C to +60°C). All models incorporate internal electronic overload protection and soft start function.

Filters

All Sentinel Totus² D-ERV units are complete as standard with G4 replaceable synthetic filters, complete with filter change warning. High grade F6 filters are available as an option.

Performance/Sound

Extensively tested to BS848 parts 1 & 2. Published dB(A) figures are free field sound pressure levels at 3m with spherical propagation at reference level of 2×10^{-5} Pa. The inlet/outlet sound power level spectra figures are dB with a reference of 10^{-12} watts.

Electrical

Every Sentinel Totus² D-ERV unit is fitted with integrated controls and a purpose designed common user interface controller incorporating a 16 character backlit alpha numerical 2 line display with 4 button membrane keypad for fan status and commissioning set up. As standard this is mounted behind a removable perspex viewing pane allowing commissioning without accessing the wiring compartment. The user interface can be removed and remotely fixed if required. The unit also incorporates an isolator that is suitable for fitting a locking device to prevent accidental operation.

Motors are single phase 230V +/- 10% / 50/60Hz / 1ph.

24V DC power is provided from the unit for powering the matched range of Sentinel Demand Ventilation switches and sensors.

Models

Sensor Control

Model	Stock Ref
Mini	TOTUS2MINI
Midi	TOTUS2MIDI
Maxi	TOTUS2MAXI

Constant Pressure

Model	Stock Ref
Mini/CP	TOTUS2MINI/CP
Midi/CP	TOTUS2MIDI/CP
Maxi/CP	TOTUS2MAXI/CP



Fan Dimensions (mm)

Model	a	b	c	d	e	f	g	h	i	j
Mini	1800	1910	-	970	900	450	350	-	55	70
Midi	1900	2020	400	1320	1250	538	350	250	60	70
Maxi	1800	1924	-	1212	1130	530	660	-	60	-

Sentinel Totus² Mini/ Midi

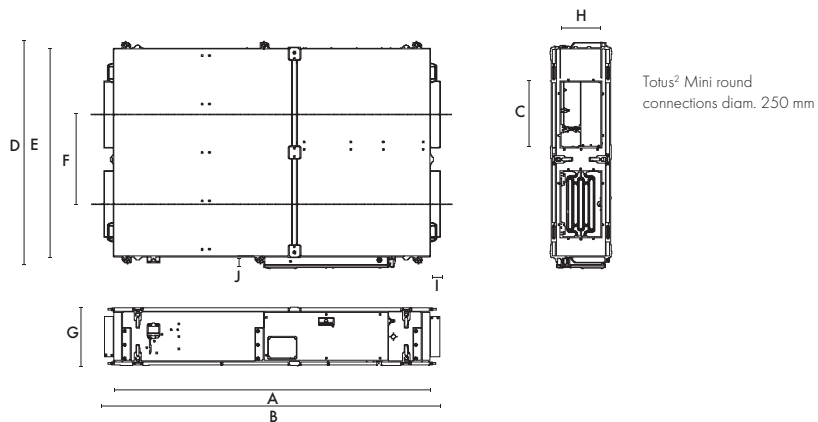

Sentinel Totus² Maxi

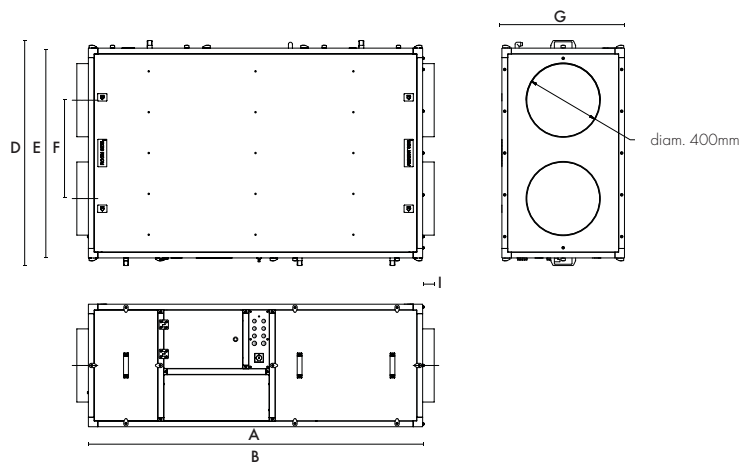

Sentinel Totus² D-ERV - Mini Model

Performance Curve

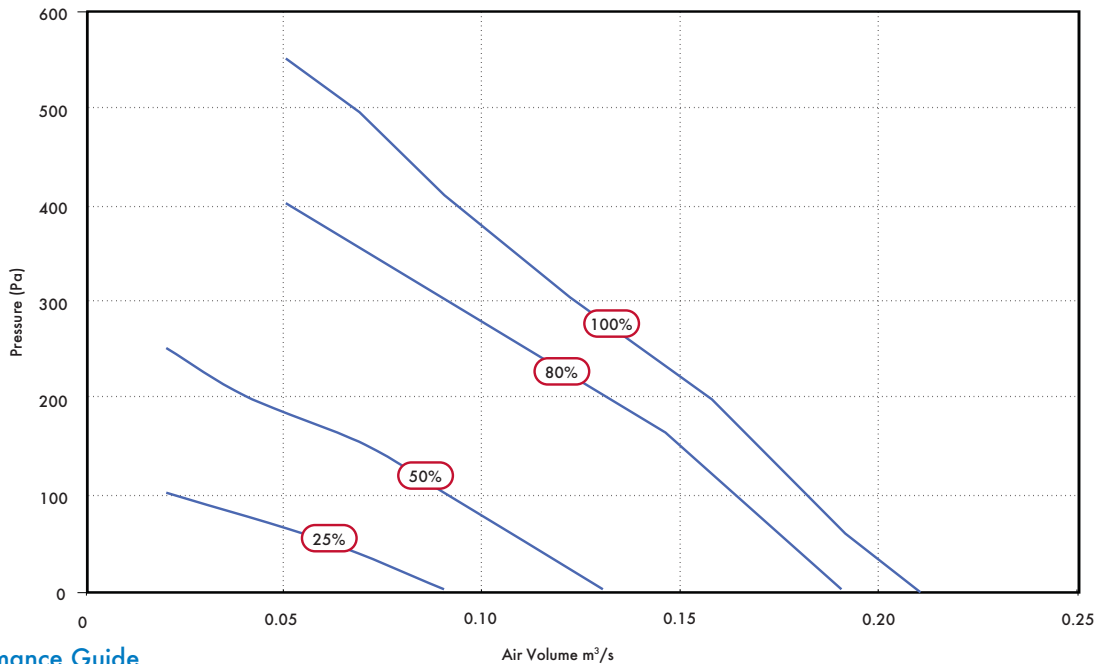

Performance Guide

Speed	Airflow, m ³ /s @ Pa													Fans F.L.C.	Supply Voltage	Frost Heater	Unit Rated Current	
	0	50	100	150	200	250	300	350	400	450	500	550						
100%	m ³ /s	0.21	0.19	0.18	0.17	0.16	0.14	0.12	0.11	0.09	0.08	0.07	0.05	2.5	230V/ 1/ 50Hz	2KW	12A	
	Watts	334	337	337	337	336	333	332	337	332	335	329	335					
	SFP	1.59	1.77	1.87	1.98	2.10	2.38	2.77	3.06	3.69	4.19	4.70	6.70					
80%	m ³ /s	0.19	0.18	0.16	0.15	0.13	0.11	0.09	0.07	0.05				1.85				
	Watts	263	262	265	268	266	263	259	254	245								
	SFP	1.38	1.46	1.66	1.79	2.05	2.39	2.88	3.63	4.90								
50%	m ³ /s	0.13	0.11	0.09	0.07	0.04	0.02							0.8				
	Watts	110	112	111	109	105	96											
	SFP	0.85	1.02	1.23	1.56	2.63	4.80											
25%	m ³ /s	0.09	0.06	0.02														0.35
	Watts	46	46	41														
	SFP	0.51	0.77	2.05														

Performance Data from Lab Report Ref LR5100

Sound Data

Speed	Test Mode	Octave Band Frequency SWL								Breakout dB(A) @ 3m
		63	125	250	500	1K	2K	4K	8K	
100%	Intake	58	65	69	54	53	54	48	46	33
	Supply	55	59	55	50	49	53	37	36	
	Discharge	59	68	74	66	63	67	55	57	
	Exhaust	55	60	63	52	50	55	37	36	
	Breakout	55	53	55	47	43	46	33	31	
80%	Intake	58	63	69	54	53	52	45	45	31
	Supply	53	58	55	46	48	50	34	33	
	Discharge	59	67	74	64	62	65	53	55	
	Exhaust	55	59	60	50	48	52	34	34	
	Breakout	53	52	53	44	42	44	31	30	
50%	Intake	54	58	64	49	47	42	35	36	25
	Supply	49	53	53	39	40	38	26	29	
	Discharge	54	62	69	56	55	53	43	43	
	Exhaust	50	54	56	41	41	39	25	29	
	Breakout	50	48	49	38	35	33	24	27	
25%	Intake	47	52	48	39	37	30	26	29	17
	Supply	48	48	38	33	31	27	22	28	
	Discharge	49	59	51	48	44	41	30	30	
	Exhaust	48	50	39	34	31	28	23	29	
	Breakout	44	45	33	32	28	25	23	26	

Sentinel Totus² D-ERV - Midi Model

Performance Curve

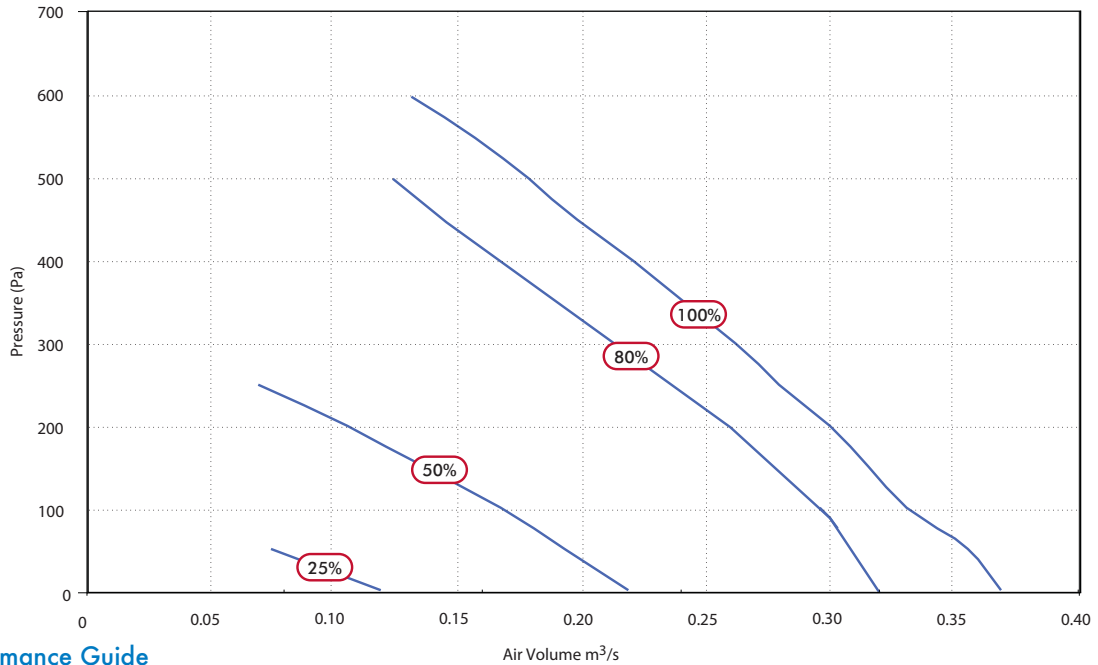

Performance Guide

Speed	Airflow, m ³ /s @ Pa													Fans F.L.C.	Supply Voltage	Frost Heater	Unit Rated Current		
	0	50	100	150	200	250	300	350	400	450	500	550	600						
100%	m ³ /s	0.37	0.35	0.33	0.31	0.30	0.28	0.26	0.24	0.22	0.20	0.18	0.16	0.13	3.0	230V/ 1/ 50Hz	2kW	12A	
	Watts	628	626	627	630	627	627	623	618	612	598	585	573	548					
	SFP	1.71	1.77	1.91	2.01	2.1	2.26	2.4	2.58	2.79	3.05	3.31	3.7	4.22					
80%	m ³ /s	0.37	0.31	0.29	0.28	0.26	0.24	0.21	0.19	0.17	0.14	0.12				2.5	230V/ 1/ 50Hz	2kW	12A
	Watts	500	501	503	503	501	497	491	483	474	458	445							
	SFP	1.37	1.6	1.71	1.81	1.93	2.11	2.29	2.54	2.79	3.29	3.71							
50%	m ³ /s	0.22	0.19	0.17	0.14	0.10	0.07							1.0	230V/ 1/ 50Hz	2kW	12A		
	Watts	198	198	197	193	185	174												
	SFP	0.91	1.04	1.19	1.43	1.78	2.56												
25%	m ³ /s	0.12	0.07											0.5	230V/ 1/ 50Hz	2kW	12A		
	Watts	72	71																
	SFP	0.62	0.97																

Performance Data from Lab Report Ref LR5100

Sound Data

Speed	Test Mode	Octave Band Frequency SWL								Breakout dB(A) @ 3m
		63	125	250	500	1K	2K	4K	8K	
100%	Intake	66	70	75	60	57	52	50	45	37
	Supply	61	62	65	54	52	46	42	41	
	Discharge	67	80	81	74	68	64	60	54	
	Exhaust	59	68	69	58	52	49	41	39	
	Breakout	61	62	63	51	46	42	37	37	
80%	Intake	64	68	72	57	53	49	45	42	34
	Supply	58	61	60	52	49	43	38	39	
	Discharge	66	79	80	73	65	62	57	50	
	Exhaust	58	67	68	54	48	44	37	38	
	Breakout	58	60	58	48	43	40	35	36	
50%	Intake	59	64	57	46	45	40	35	32	25
	Supply	54	56	48	42	40	34	30	31	
	Discharge	62	71	65	62	56	53	46	41	
	Exhaust	53	65	53	45	41	37	32	38	
	Breakout	55	56	44	38	35	31	26	27	
25%	Intake	58	53	46	37	37	29	25	29	18
	Supply	49	46	40	33	32	25	23	30	
	Discharge	56	56	53	49	44	39	31	30	
	Exhaust	50	48	43	35	31	26	23	29	
	Breakout	48	46	35	29	27	24	22	28	

Sentinel Totus² D-ERV - Maxi Model

Performance Curve

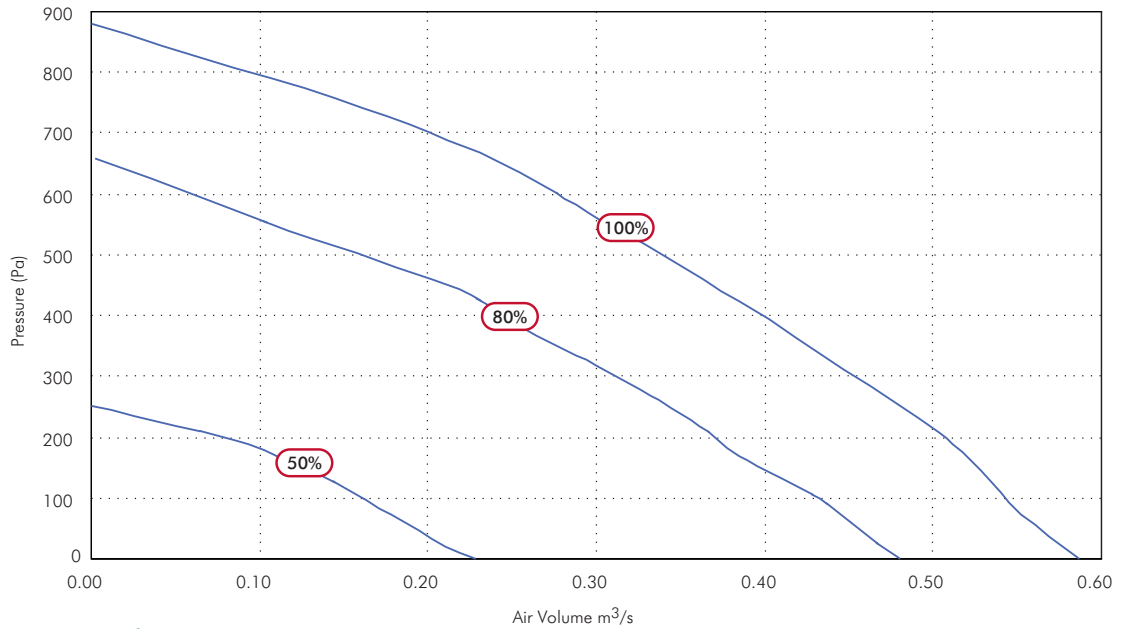

Performance Guide

Speed	Airflow, m ³ /s @ Pa												Fans F.L.C.	Supply Voltage	Frost Heater	Unit Current		
	0	50	100	150	200	250	300	350	400	450	500	550					600	
100%	m ³ /s	0.587	0.58	0.54	0.52	0.51	0.48	0.43	0.415	0.4	0.365	0.34	0.31	0.268	5	230V/ 1/ 50Hz	4KW	20A
	SFP	1.73	1.75	1.88	1.95	1.99	2.11	2.36	2.44	2.53	2.78	2.98	3.27	3.78				
80%	m ³ /s	0.48	0.46	0.43	0.4	0.38	0.345	0.315	0.28	0.24	0.22	0.16			3	230V/ 1/ 50Hz	4KW	20A
	SFP	1.31	1.37	1.46	1.57	1.66	1.82	3	2.25	2.62	2.86	3.93						
50%	m ³ /s	0.228	0.19	0.16	0.125	0.07									1	230V/ 1/ 50Hz	4KW	20A
	SFP	0.82	0.99	1.17	1.5	2.67												

Sound Data

Speed	Test Mode	Octave Band Frequency SWL								Breakout dB(A) @3m
		63	125	250	500	1k	2k	4k	8k	
100%	Intake	67	72	75	72	73	71	68	62	41
	Supply	62	65	75	66	65	61	53	46	
	Discharge	67	70	83	72	75	73	70	65	
	Extract	62	64	74	63	60	54	44	39	
	Breakout	66	67	70	53	48	49	41	39	
80%	Intake	64	71	79	70	69	68	65	58	40
	Supply	60	64	77	63	62	57	49	43	
	Discharge	65	69	82	69	72	70	67	59	
	Extract	59	63	75	60	57	51	42	38	
	Breakout	64	63	68	50	53	44	38	36	
50%	Intake	56	68	57	57	57	53	49	40	30
	Supply	52	66	57	51	50	44	35	31	
	Discharge	56	64	61	56	59	57	50	41	
	Extract	52	62	52	46	43	37	28	28	
	Breakout	54	62	52	41	39	38	34	32	
25%	Intake	48	47	40	37	35	29	23	29	20
	Supply	46	43	39	33	31	25	23	29	
	Discharge	46	45	42	40	41	34	25	29	
	Extract	48	41	37	31	26	23	23	29	
	Breakout	46	44	40	32	30	28	26	30	

CO₂ + Temp Room Sensor *



HVAC temperature and carbon dioxide room sensor for proportional ventilation control. Sensor will monitor both CO₂ and temperature levels between the set points, the air flow rate following the higher of the 2 outputs.

24V DC SELV. 0 - 2000ppm CO₂ working range. 0 - 50°C working range. Auto-calibrating NDIR CO₂ absorption sensor. Dimensions: 100 x 84 x 25mm (H x W x D).

Stock Ref **433257**

CO₂ Duct Probe



Sensor monitors CO₂ level in extract ducts from conference areas, offices, theatres etc. In proportional control mode, air flow rate tracks the CO₂ level to improve indoor air quality.

24V DC SELV. 0 - 2000ppm CO₂ working range. Auto-calibrating NDIR absorption sensor. Adjustable probe length. MAX. IP Rating 65. Dimensions: 80 x 80 x 38mm (H x W x D).

Stock Ref **433259**

Vent-Axia PIR *



A wall or ceiling mounted presence detector for use with Sentinel Totus² D-ERV. Can be used in MIN - MAX mode or for direct damper control.

Fits any UK single gang mounting box. Adjustable timer overrun (5-25 minutes). Range of detection up to 10 metres. Designed to meet IP43. Ambient operating temperature range 0°C to +50°C. Supply voltage 24V DC SELV. Dimensions: 87 x 87 x 40mm (H x W x D).

Stock Ref **433162**

Vent-Axia ThermoSwitch®



Automatically switches on fans on either a rise or fall in air temperature.

Used for Trickle/ Boost operation. Setting range: +6°C to +30°C. IP20 rated. Sealed sensing mechanism. Mounting direct on surface only. Dimensions: 80 x 104 x 36mm (H x W x D). Volt free switch connection to Sentinel Totus² D-ERV, Demand Energy Recovery.

Stock Ref **563502**

Power Supply *



For those situations where a separate 24V DC SELV supply source is required to power duct dampers. 24W output capacity. See F & W for connection details.

Stock Ref **433193**

F6 Filter



Replacement filter to grade F6. Replaces standard G4 filter

Model	Stock Ref
Mini	445852
Midi	407882
Maxi	445946

PIR Grille *



PIR grille is on extract grille with an integral flap damper. Suitable for bathrooms and WCs. The PIR function fully opens the damper when a person presence is detected. The opening time is fixed at 20 mins. Spigot size is 125mm.

12V AC SELV unit using the main transformer unit supplied. Integral PIR person presence sensor controlling damper. Auto-humidity control damper response at all times. 100° viewing angle. Temperature range 0 - 50°C. Dimensions: 158 x 150 x 35mm (H x W x D). MAX airflow 70m³/hr @100 Pa.

Stock Ref **434184**

Dampers *



Two types available:

- a) MM type - opening shut/MIN to open/MAX controlled by switches and
- b) PC type - opening proportionally when controlled by sensors.

Duct sizes available: 100, 125, 150, 200, 250 and 315. Industry standard actuators.

Typical ordering designation: DVD size MM or PC

Inlet Cowl



For these situations where there is no ducted inlet or extract and the unit is roof mounted. Offers weather protection to ensuring air paths do not recirculate.

Model	Stock Ref
Mini	445832
Midi	446591
Maxi	441366

Midi Duct Transformation Piece



To convert rectangular duct spigot to 315mm dia circular ducting

Stock Ref: **449645**

Duct Mounted LPHW Coils

Top up heating LPHW coils to suit the duct connection size for each Totus. Sized to give 18 to 25°C temperature rise at maximum airflow with water 80/60 as standard. For full details contact Technical Support.

Model	Stock Ref
Mini	449642
Midi	449643
Maxi	449644

* PLEASE NOTE: These sensors/controls are unique to Sentinel Totus² D-ERV and CANNOT be used with any other product.

Roof Fans

With one of the widest ranges of roof mounted fans Vent-Axia can provide a solution to any consultant's ventilation requirement whether in public, commercial or industrial applications. The architects need for an aesthetically pleasing low profile cowl are also provided for.

The latest generation of the Vent-Axia Sabre® Sickle fan assisted roof cowls incorporate the very latest FE2 Owllett impeller plate axial fans offering improved performance over the previous ranges with up to 7dB(A) reduction in sound and up to 15% improvement in efficiency ensuring the best available fan performance in its class. The advanced blade design is matched to a purpose designed external rotor motor to ensure unrivalled reliability and controllability.

Optional integral backdraught shutters limit heat loss from the building when the unit is off.



Sabre® Sickle fan assisted roof cowl (VSR) 362-369



Mixed Flow Roof Fans (RMH) 370-375



Lo-Carbon Energy Saver MX Roof Fans (MX) 376-379

Vent-Axia

Roof Fans



Sabre[®] Sickle Fan assisted Roof cowls (VSR)

Features and Benefits

- Swept impeller with Aerofoil blades, winglets and serrated trailing edge for optimum performance
- Fully assembled cowl, separate plate axial fan
- Optional backdraught shutters and birdguard
- Moulded from recyclable polymeric material
- One shot die cast aluminium impeller dynamically balanced for smooth operation
- All sizes resistant to UV light
- All models speed controllable
- Thermal Overload Protection for motor protection
- Operating temperature up to 70°C
- 2 Year Guarantee
- Designed for Data centre and warehouse cooling applications

The latest generation of the Vent-Axia Sabre[®] Sickle Fan assisted roof cowls incorporate the very latest FE2 Owllett plate axial fans supplied separate to the cowl offering improved performance over the previous ranges with up to 7dB(A) reduction in sound and up to 15% improvement in efficiency ensuring the best available fan performance in its class. The advanced blade design is matched to a purpose designed external rotor motor to ensure unrivalled reliability and controllability.

All cowl and roof mounting plates are moulded from specially formulated polymeric materials, which are high impact resistant and provide a rigid profile against strong winds and are resistant to UV light. Standard Colour BS00A05. Alternative colours are available on request.

Suitable for flat or inclined roofs (max. angle 30°). Sabre[®] Sickle Fan assisted roof cowls are designed for either kerb or purlin box mounting. All sizes are fitted with inlet wire guards, giving protection to BS 848 part 5. Bird guards are available as optional accessories.

Design and Development

Using a combination of NASA research into wing performance and winglets, coupled with a study of bird flight has enabled the development of the best available Sickle blade profile. Matching this to a purpose designed close fitting casing ensures best use of this blade technology thereby reducing noise and improving the performance in cased axial fans.

Impellers

The impellers incorporate the latest in Sickle blade aerofoil technology to ensure minimum sound and maximum performance. The motors and impellers are factory matched, statically and dynamically balanced to ISO 1940 part 1, Quality Class G.6.3.

Motors

The external rotor motors are specifically designed and styled for this range of fan. Ball bearings are greased for life. Sizes 315 - 710 motors are protected to IP54 against dust and moisture complying with BS EN 60529.

They have ribbed aluminium body castings for efficient cooling with Motor insulation to Class 'F' (from -40°C to + 70°C). Speed controlled sizes 450 to 710, 6 & 8 pole motors are only suitable for operating temperatures of up to 40°C.

Electrical

The Sabre[®] Sickle Fan assisted roof cowls range is available for either single phase 220-240V 50 Hz capacitor start and run or three phase 380-415V 50Hz. Motors are fitted with Thermal Overload Protection which should be wired into all controller circuits and into starter contacts to prevent motor damage due to overloading / overheating.

Speed Control

Units are suitable for speed control by either electronic, voltage reduction or frequency inverters where permissible. For optimum efficiency and controllability Vent-Axia recommend the use of the eDemand Inverter controller to give close control via sensors or manual control.

Terminal Box

An IP54 terminal box is supplied with all models with M20 x 1.5mm gland entry offering protection against dust and water.

Performance

The fan performance is in accordance with tests to ISO 5801.

Sound Levels

Fan sound levels are measured in a reverberant chamber in accordance with ISO 3744 Part 1. Published dB(A) figures are free field sound pressure levels at 3m with spherical propagation at a reference level of 2×10^{-5} Pa (20 micro-Pascal). The sound power level spectra figures are dB with a reference level of 10^{-12} Watts (1 pico-watt).

To ensure minimum noise levels during speed control, either an auto transformer or eDemand inverter speed control is recommended.

Packing

Sabre[®] Sickle Fan assisted roof cowls consist of two elements, a boxed cowl assembly and a plate mounted fan. Fan & cowl are supplied separately to assist with transportation and are quickly assembled on site.

Accessories

A full range of accessories is available for the Sabre[®] Sickle Fan assisted roof cowls:

- Electronic Speed Controllers
- Auto Transformer Speed Controllers
- eDemand Inverter Speed Control
- D.O.L. Starters
- Purlin Boxes
- Backdraught Shutters
- Bird Guards
- Roof Attenuators



Fan Dimensions (mm)

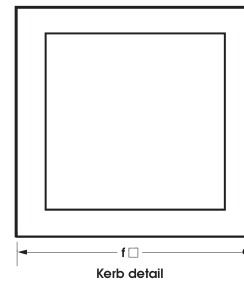
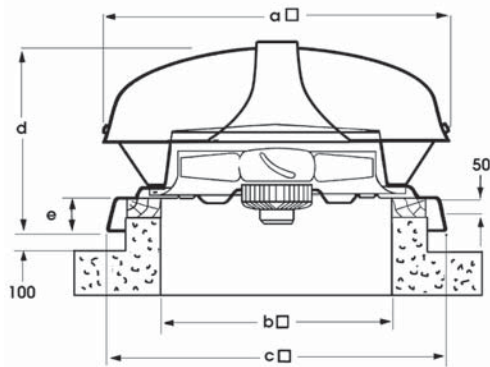

Dia	a	b	c	d	e	f	Kg max Kerb detail
250	700	475	737	411	97	675	11.7
315	700	475	737	411	97	675	12.8
355	700	475	737	411	97	675	13.8
400	800	575	830	466	97	775	19.2
450	800	575	830	466	97	775	24.8
500	950	715	1000	579	100	915	30.3
560	950	715	1000	579	100	915	37
630	1230	840	1100	731	105	1040	64
710	1230	840	1100	731	105	1040	50

Sabre Sickle Fan assisted roof cowls (VSR)

Performance Curve

250 - 355 dia. - 2 & 4 Pole

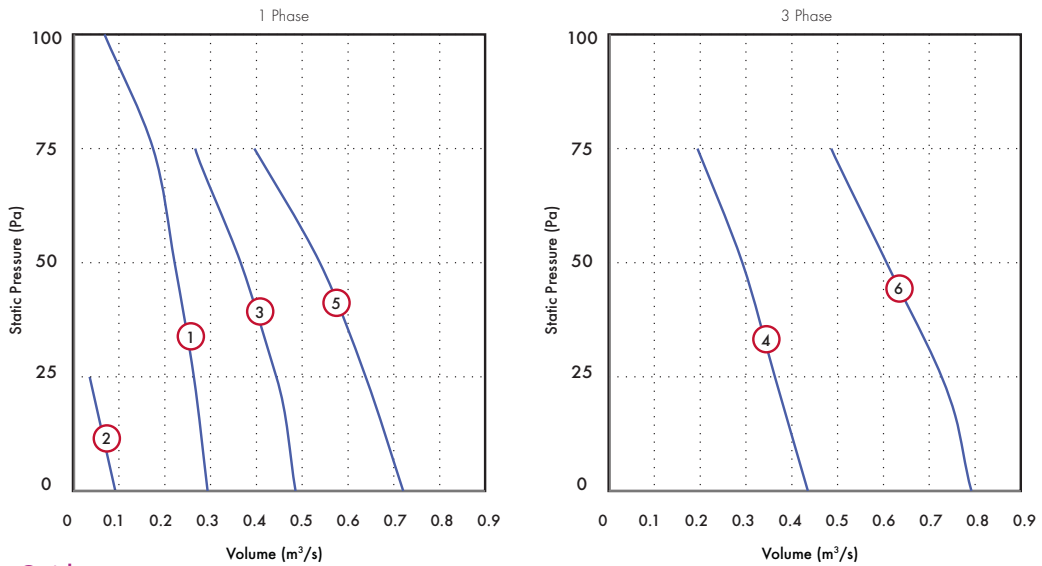

Performance Guide

Stock Ref	Supply	IP Rating	Motor kW	F.L.C Amps	S.C. Amps	Poles	rpm	Curve	Volume m³/s @ Pa					dB(A) @ 3.0m	
									0	25	50	75	100		
VSR25012	230/1/50	IP54	0.12	0.54	2.16	2	2160	1	Volume m³/s	0.29	0.26	0.22	0.18	0.07	50
								Power Watts	110	115	118	121	125		
VSR25014	230/1/50	IP54	0.05	0.24	0.96	4	1370	2	Volume m³/s	0.09	0.04				37
								Power Watts	46	48					
VSR31514	230/1/50	IP54	0.14	0.62	2.48	4	1360	3	Volume m³/s	0.49	0.44	0.37	0.27		45
								Power Watts	111	118	124	130			
VSR31534	400/3/50	IP54	0.12	0.68	2.72	4	1450	4	Volume m³/s	0.44	0.36	0.29	0.19		47
								Power Watts	105	115	117	120			
VSR35514	230/1/50	IP54	0.18	0.75	3	4	1260	5	Volume m³/s	0.72	0.64	0.54	0.40		46
								Power Watts	132	141	151	162			
VSR35534	400/3/50	IP54	0.14	0.4	1.6	4	1390	6	Volume m³/s	0.79	0.72	0.61	0.49		48
								Power Watts	152	168	176	178			

Sound Power Level Spectra dB (ref 10⁻¹² Watts)

Stock Ref	63Hz	125Hz	250Hz	500Hz	1KHz	2KHz	4KHz	8KHz	dB(A) @ 3.0m
VSR25012	65	70	68	66	64	66	62	55	50
VSR25014	56	63	56	54	53	53	49	41	37
VSR31514	71	70	65	60	58	59	55	47	45
VSR31534	75	71	62	60	61	62	59	51	47
VSR35514	67	70	67	64	58	60	53	45	46
VSR35534	74	66	61	63	64	63	59	53	48

Performance Curve

400 - 450 dia. - 4 & 6 Pole

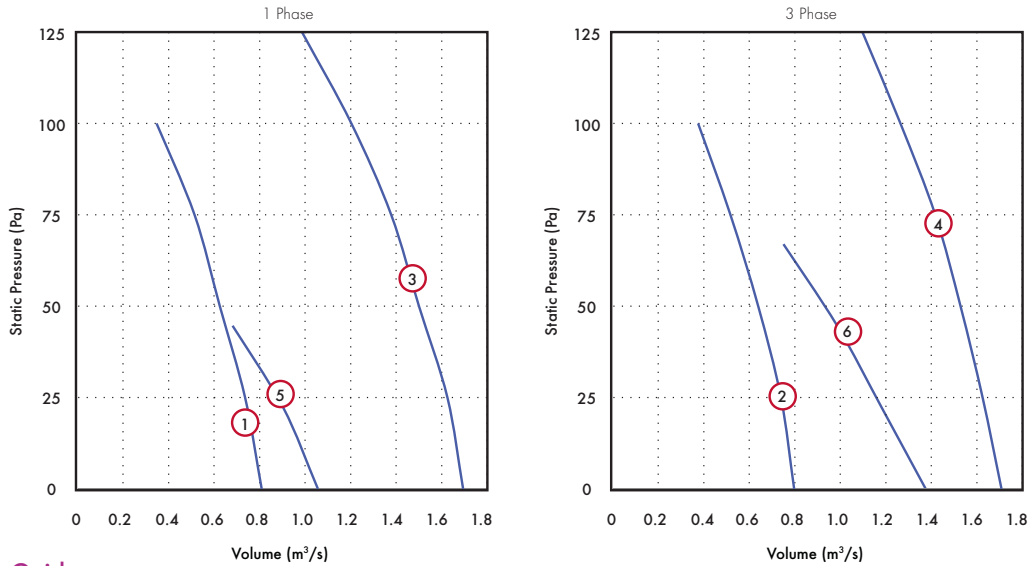

Performance Guide

Stock Ref	Supply	IP	Motor Rating	kW	F.L.C. Amps	S.C. Amps	Poles	rpm	Curve	Volume m³/s @ Pa						dB(A) @ 3.0m
										0	25	50	75	100	125	
VSR40014	230/1/50	IP54	0.24	1.05	4.2	4	1340	1	Volume m³/s	0.81	0.74	0.63	0.51	0.35		46
									Power Watts	166	195	200	210	240		
VSR40034	400/3/50	IP54	0.17	0.46	1.84	4	1360	2	Volume m³/s	0.80	0.74	0.64	0.52	0.38		47
									Power Watts	160	170	190	205	220		
VSR45014	230/1/50	IP54	0.56	2.5	10	4	1320	3	Volume m³/s	1.69	1.63	1.50	1.38	1.20	0.99	49
									Power Watts	480	500	520	530	540	550	
VSR45034	400/3/50	IP54	0.54	1.1	4.4	4	1350	4	Volume m³/s	1.71	1.63	1.53	1.42	1.26	1.10	49
									Power Watts	440	460	480	505	520	530	
VSR45016	230/1/50	IP54	0.19	0.9	3.6	6	910	5	Volume m³/s	1.06	0.90	0.68				41
									Power Watts	165	175	180				
VSR45036	400/3/50	IP54	0.36	0.66	2.64	6	1020	6	Volume m³/s	1.38	1.18	0.99	0.75			44
									Power Watts	325	350	360	380			

Sound Power Level Spectra dB (ref 10⁻¹² Watts)

Stock Ref	63Hz	125Hz	250Hz	500Hz	1KHz	2KHz	4KHz	8KHz	dB(A) @ 3.0m
VSR40014	72	73	66	62	60	59	54	48	46
VSR40034	67	67	61	60	60	59	54	48	47
VSR45014	67	69	71	63	63	63	59	53	49
VSR45034	72	70	65	65	64	64	59	53	49
VSR45016	57	62	59	56	56	56	50	41	41
VSR45036	71	66	60	60	60	58	51	43	44

Sabre Sickle Fan assisted roof cowls (VSR)

Performance Curve

500 - 560 dia. - 4 & 6 Pole

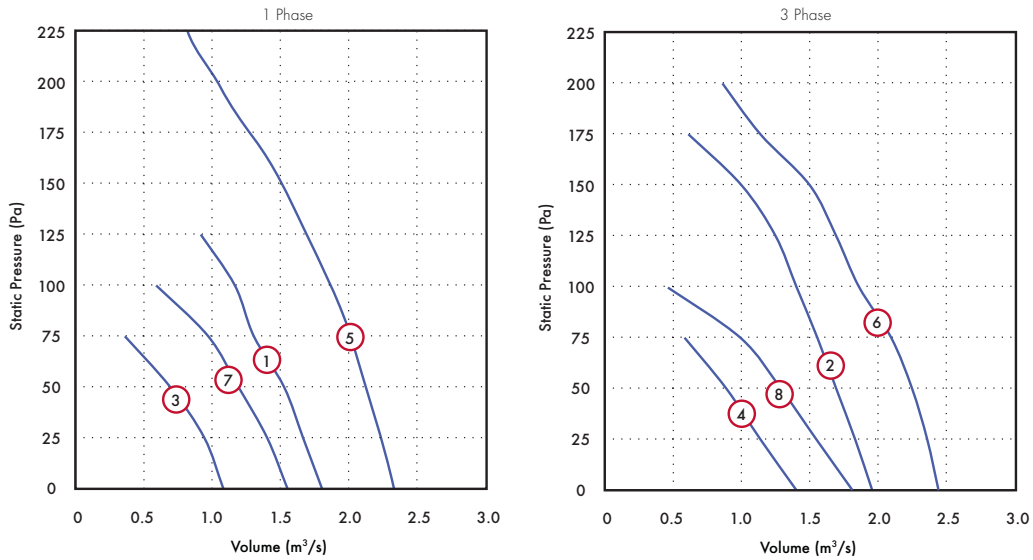

Performance Guide

Stock Ref	Supply	IP	Motor Rating	F.L.C. kW	S.C. Amps	Poles	rpm	Curve	Volume m³/s @ Pa										dB(A) @ 3.0m				
									0	25	50	75	100	125	150	175	200	225					
VSR50014	230/1/50	IP54	0.76	3.3	13.2	4	1230	1	Volume m³/s	1.81	1.67	1.53	1.31	1.17	0.92						51		
									Power Watts	630	660	670	690	720	740								
VSR50034	400/3/50	IP54	0.84	1.45	5.8	4	1340	2	Volume m³/s	1.96	1.83	1.70	1.56	1.40	1.25	1.00	0.61				52		
									Power Watts	620	650	680	720	740	750	800	825						
VSR50016	230/1/50	IP54	0.3	1.3	5.2	6	910	3	Volume m³/s	1.08	0.94	0.69	0.36									44	
									Power Watts	250	265	280	295										
VSR50036	400/3/50	IP54	0.54	0.96	3.84	6	940	4	Volume m³/s	1.40	1.14	0.89	0.58									47	
									Power Watts	470	500	520	540										
VSR56014	230/1/50	IP54	1.15	5	20	4	1330	5	Volume m³/s	2.33	2.25	2.11	2.03	1.87	1.67	1.56	1.28	1.04	0.80			62	
									Power Watts	810	830	870	890	900	980	1000	1050	1100	1110				
VSR56034	400/3/50	IP54	1.05	2.2	8.8	4	1280	6	Volume m³/s	2.44	2.36	2.25	2.10	1.86	1.69	1.50	1.14	0.86				57	
									Power Watts	742	800	840	860	910	920	940	1014	1044					
VSR56016	230/1/50	IP54	0.46	2.2	8.8	6	930	7	Volume m³/s	1.55	1.40	1.19	0.97	0.59									50
									Power Watts	369	394	415	438	458									
VSR56036	400/3/50	IP54	0.58	1.1	4.4	6	910	8	Volume m³/s	1.81	1.55	1.29	1.00	0.47									51
									Power Watts	489	518	542	556	576									

Sound Power Level Spectra dB (ref 10⁻¹² Watts)

Stock Ref	63Hz	125Hz	250Hz	500Hz	1KHz	2KHz	4KHz	8KHz	dB(A) @ 3.0m
VSR50014	71	75	67	63	67	68	60	52	51
VSR50034	74	72	66	66	68	68	62	56	52
VSR50016	66	72	70	55	59	58	51	43	44
VSR50036	77	77	72	66	64	61	54	47	47
VSR56014	79	78	74	74	77	77	73	66	62
VSR56034	84	78	76	74	75	74	70	63	57
VSR56016	75	73	66	65	67	66	60	54	50
VSR56036	77	77	67	66	67	66	60	54	51

Performance Curve

630 - 710 dia. - 4 & 6 & 8 Pole

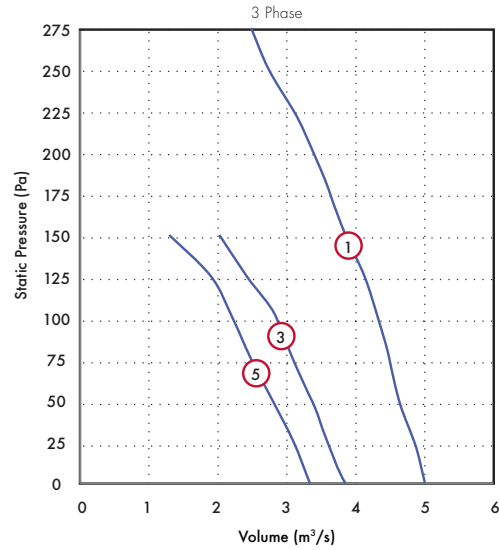
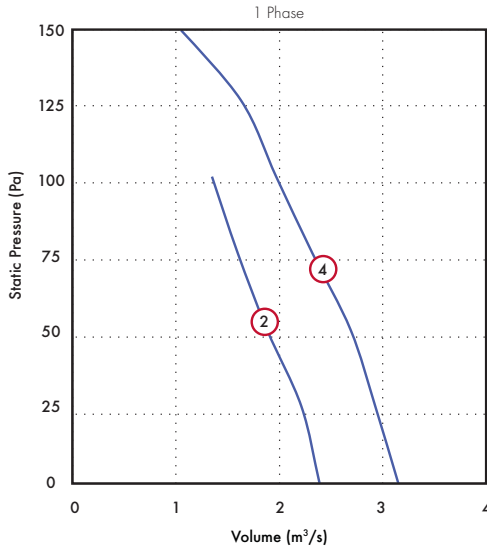

Performance Guide

Stock Ref	Supply	IP Rating	Motor kW	F.L.C Amps	S.C. Amps	Poles	rpm	Curve	Volume m³/s @ Pa										dB(A) @ 3.0m				
									0	25	50	75	100	125	150	175	200	225		250	275		
VSR63034	400/3/50	IP54	2.4	4.6	18.4	4	1320	1	Volume m³/s	5.00	4.85	4.62	4.49	4.32	4.13	3.85	3.63	3.40	3.10	2.74	2.48	62	
									Power Watts	2305	2350	2400	2450	2500	2540	2587	2600	2628	2630	2639	2659		
VSR63016	230/1/50	IP54	0.74	3.4	13.6	6	910	2	Volume m³/s	2.39	2.21	1.88	1.60	1.35								52	
									Power Watts	568	603	650	679	710									
VSR63036	400/3/50	IP54	1.5	2.6	10.4	6	1040	3	Volume m³/s	3.85	3.55	3.36	3.10	2.85	2.42	2.02						57	
									Power Watts	1538	1550	1593	1610	1645	1661	1666							
VSR71016	230/1/50	IP54	0.95	4.4	17.6	6	850	4	Volume m³/s	3.15	2.93	2.69	2.32	1.97	1.63	0.99						52	
									Power Watts	607	666	700	760	808	850	950							
VSR71036	400/3/50	IP54	0.94	1.7	6.8	6	900	5	Volume m³/s	3.33	3.10	2.79	2.48	2.21	1.90	1.29						49	
									Power Watts	560	620	700	768	813	861	920							

Sound Power Level Spectra dB (ref 10⁻¹² Watts)

Stock Ref	63Hz	125Hz	250Hz	500Hz	1KHz	2KHz	4KHz	8KHz	dB(A) @ 3.0m
VSR63034	85	80	77	75	78	77	71	66	62
VSR63016	74	71	73	68	68	66	60	54	52
VSR63036	84	75	71	71	74	71	65	59	57
VSR71016	81	81	72	69	70	67	61	57	52
VSR71036	69	69	68	67	68	65	59	52	49

Sabre Sickle Fan assisted roof cowls (VSR)

Pressure Drop for Roof Cowl only

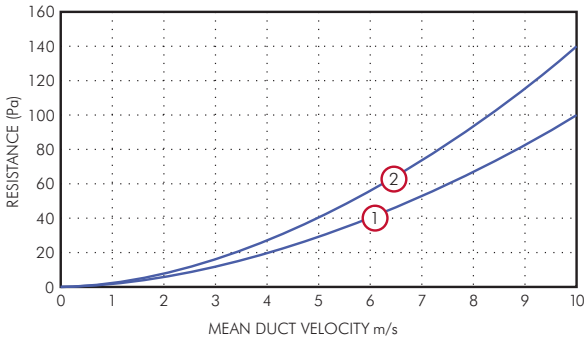

Stock Ref	Free area m ²	Resistance curve	Cowl only weight kg
RCZ300	0.099	1	7.5
RCZ400	0.159	2	9
RCZ500	0.246	2	13
RCZ630	0.396	3	19

Roof Attenuators

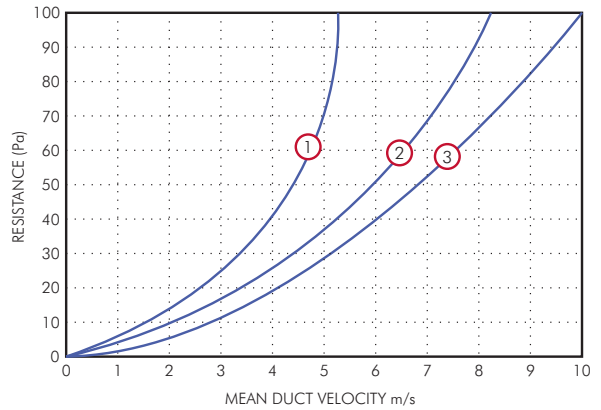
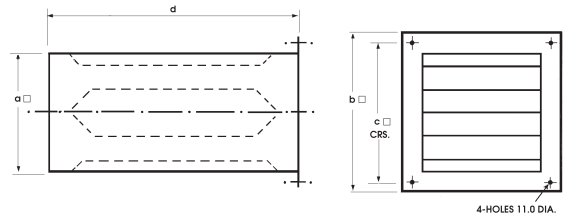

Stock Ref	a	b	c	d	Kg approx	Free area m ²	Resistance curve
RAZ300600	455	535	505	600	18	0.156	1
RAZ400600	555	635	605	600	22	0.245	2
RAZ500600	635	790	745	600	31	0.416	2
RAZ600600	770	935	890	600	44	0.616	3
RAZ300900	455	535	505	900	21	0.156	1
RAZ400900	555	635	605	900	28	0.245	2
RAZ500900	635	790	745	900	39	0.416	2
RAZ600900	770	935	890	900	52	0.616	3
RAZ3001200	455	535	505	1200	25	0.156	1
RAZ4001200	555	635	605	1200	35	0.245	2
RAZ5001200	635	790	745	1200	48	0.416	2
RAZ6001200	770	935	890	1200	61	0.616	2

* Recommended maximum duty velocity 10m/s

Vertical Backdraught Shutters

Size	Percentage reduction in performance at 4 pole speeds
315	7%
355	12%
400	10%
450	*3%
500	*4%
560	*6%
630	*3%
710	*7%

* For 6 and 8 pole fans, reduce percentages by ratio of fan speeds.

Purlin Box

(Manufactured from 1.5mm pre-galv. mild steel)

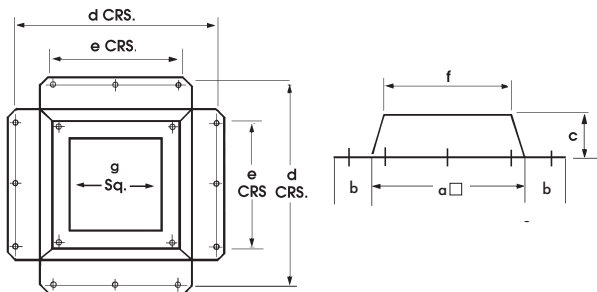

Size	a	b	c	d	e	f	g
250/315/355	625	90	240	765	400	590	460
400/450	725	90	240	865	500	705	565
500	890	70	250	990	650	864	640
560	890	70	250	990	650	864	700
630	1030	75	250	1140	760	985	775
710	1030	75	250	1140	760	985	840

Typical Installation

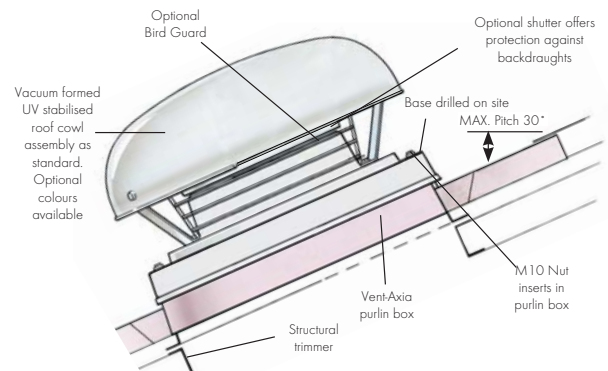

Accessories



Stock Ref	Supply	Electronic Controller	5 Step Auto Transformer	D.O.L Starter	Overload	eDemand** Voltage	
						Control*	Inverter
VSR25012	230/1/50	W10303102M	10314102	444744	444698	444164	-
VSR25014	230/1/50	W10303102M	10314102	444744	444697	444164	-
VSR31514	230/1/50	W10303102M	10314102	444744	444699	444164	-
VSR31534	400/3/50	-	10314301	444747	444699	444166	444172
VSR35514	230/1/50	W10303102M	10314102	444744	444699	444164	-
VSR35534	400/3/50	-	10314301	444747	444698	444166	444172
VSR40014	230/1/50	W10303102M	10314102	444744	444700	444164	-
VSR40034	400/3/50	-	10314301	444747	444698	444166	444172
VSR45014	230/1/50	10303103	10314103	444744	444702	444164	-
VSR45034*	400/3/50	-	10314302	444747	444700	444166	444172
VSR45016	230/1/50	W10303102M	10314102	444744	444699	444164	-
VSR45036*	400/3/50	-	10314301	444747	444699	444166	444172
VSR50014	230/1/50	10303106	10314105	444744	444702	444164	-
VSR50034*	400/3/50	-	10314302	444747	444700	444166	444172
VSR50016	230/1/50	W10303102M	10314102	444744	444700	444164	-
VSR50036*	400/3/50	-	10314302	444747	444700	444166	444172
VSR56014	230/1/50	10303106	10314105	444744	444703	444164	-
VSR56034*	400/3/50	-	10314304	444747	444702	444166	444172
VSR56016	230/1/50	10314103	10314103	444744	444702	444164	-
VSR56036*	400/3/50	-	10314302	444747	444700	444166	444172
VSR63034	400/3/50	-	10314307	444747	444703	444166	444173
VSR63016	230/1/50	10303106	10314105	444744	444702	444164	-
VSR63036*	400/3/50	-	10314304	444747	444702	444166	444173
VSR71016	230/1/50	10303106	10314105	444744	444703	444164	-
VSR71036*	400/3/50	-	10314302	444747	444701	444166	444172

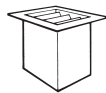

Roof Attenuator



Purlin



Shutter

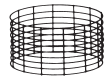

Bird

Model Ref	Roof Attenuator			Purlin Boxes Stock Ref	Shutter Stock Ref	Bird Guard Stock Ref
	600mm Stock Ref	900mm Stock Ref	1200mm Stock Ref			
VSR250	RAZ300600	RAZ300900	RAZ3001200	PBZ300	RSZ300	BGZ300
VSR315	RAZ300600	RAZ300900	RAZ3001200	PBZ300	RSZ300	BGZ300
VSR355	RAZ300600	RAZ300900	RAZ3001200	PBZ300	RSZ300	BGZ300
VSR400	RAZ400600	RAZ400900	RAZ4001200	PBZ400	RSZ400	BGZ400
VSR450	RAZ400600	RAZ400900	RAZ4001200	PBZ400	RSZ400	BGZ400
VSR500	RAZ500600	RAZ500900	RAZ5001200	PBZ500	RSZ500	BGZ500
VSR560	RAZ500600	RAZ500900	RAZ5001200	PBZ560	RSZ500	BGZ500
VSR630	RAZ600600	RAZ600900	RAZ6001200	PBZ630	RSZ630	BGZ630
VSR710	RAZ600600	RAZ600900	RAZ6001200	PBZ710	RSZ630	BGZ630

** For full range of speed controller options, see Accessories & Controllers Section.

* Three phase models are supplied with 2 speed delta/star connection motors, as standard. (Sizes 450 to 630 are 4/6 Pole, 710 are 6/8 pole).

When low noise levels are required on all other models a 5 step auto transformer speed controller is recommended.

Optional coloured Cowls and Bases available on request.

Mixed Flow Roof Fans (RMH)

Features and Benefits

- Motors protected to IP44
- Motor insulation Class 'B'
- Maximum operating temperature 40 °C
- Standard Thermal Overload Protection IP65
- P65 service isolator
- Guard included as standard
- All models speed controllable
- Performance tested to BS 848 parts 1 & 2
- Manufacture controlled to BS EN ISO 9001
- 2 Year Guarantee

Specially designed for use when medium pressure characteristics are required, the Vent-Axia Mixed Flow Roof range is delivered on-site fully assembled and ready for installation. To meet COSHH requirements, a service isolator is fitted and pre-wired as standard. Equally suitable for flat or inclined roofs, the range is suitable for kerb or purlin box mounting and boasts a wide range of accessories to suit many different industrial applications. There are five sizes available with duties ranging from 0.606m³/s to 3.63m³/s (2182m³/h to 13068m³/h) with pressure development available up to 600 Pa.

The mounting plate is moulded with a fixed integral bellmouth to ensure optimum efficiency and precise alignment. The weather-cowl is also moulded to produce a smooth, internal surface and a tough, stable UV resistant finish. Colour: BS 10A07. Alternative colours available on request.

Vent-Axia mixed flow roof fans are designed for either kerb or inclined fixing (maximum angle 30°).

Electrical

Single phase 220-240V 50 Hz. Capacitor start and run. Three phase 380-415V 50Hz. A service isolator switch is provided for local isolation and the enclosure is protected to IP65 according to BS EN 60529. All motors are fitted with Standard Thermal Overload Protection (S.T.O.P.), which for three phase fans should be wired into all controller circuits and into starter contactors. Most models are available with 4 and 6 pole motors.

Motors

The Mixed Flow roof range features a proven external rotor motor and backward curved mixed flow glass reinforced polyamide impeller selected for performance and non-overloading characteristics. The assembly is dynamically balanced to VDI 2060. The motors in this range are rated IP44 according to BS EN 60529. Ball



bearings are greased for life and are designed to run at any angle. Insulation is Class 'B' (from -30°C to +40°C). Manufacture is controlled to BS EN ISO 9001 standards.

Sound Levels

Published dB(A) figures are free field sound pressure levels at 3m with spherical propagation at a reference level of 2 x 10⁻⁵Pa (20 micro-Pascal). The sound power level spectra figures are dB with a reference level of 10⁻¹² Watts (1 pico-watt).

Performance

Tested to BS 848 Parts 1 & 2.

Accessories

Purlin boxes

Available in sizes to suit all models and should be used to support the fan in conjunction with a soaker flange sheet.

Roof attenuators

Available in all sizes to cover the range of Mixed Flow Roof fans in three lengths: 600, 900 or 1200mm according to the attenuation required.

Shutters

Robust construction, designed to fit beneath the fan using the fittings provided. Airflow operated, manual or motorised shutter. A minimum distance of half the attenuator width is required between an airflow shutter and a roof attenuator for satisfactory operation.



Fan Dimensions (mm)

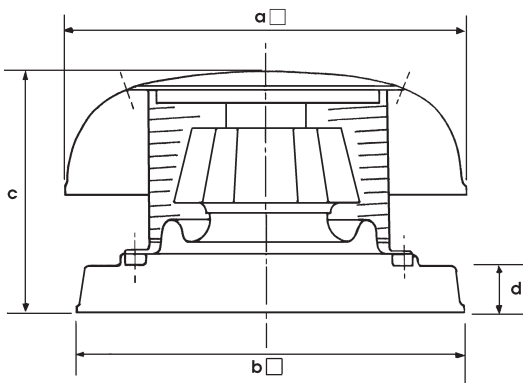

Fan size	a □	b □	c	d	Weight Kg
250	500	500	280	90	16
315	700	680	410	83	16
355 / 400	800	780	480	83	24/27
450	950	930	575	103	45
500 / 560	1230	1055	630	103	48 / 64

Details for Purlin Mounting

(Manufactured from 1.5mm pre-galv. mild steel).

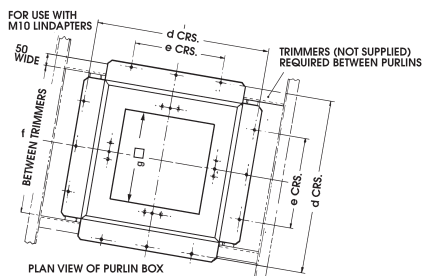
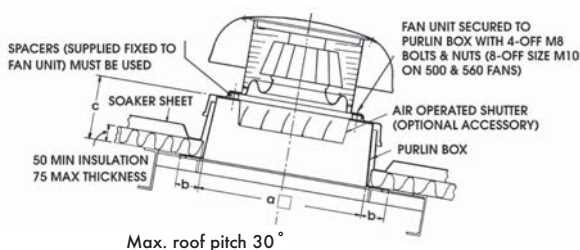

Fan size	a □	b	c	d	e	f	g □
315	625	90	240	765	400	653	400
355 / 400	725	90	240	865	500	753	500
450	890	70	250	990	650	878	650
500 / 560	1030	75	250	1140	760	1028	790

Details for Kerb Mounting

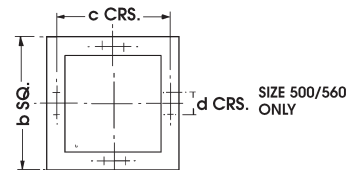
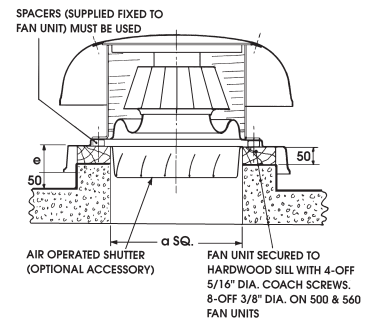

Fan size	a □	b □	c	d	e
250	500	500	280	90	16
315	700	680	410	83	16
355 / 400	500	700	570	-	83
450	650	850	690	-	103
500 / 560	790	990	842	100	103

Mixed Flow Roof Fans (RMH)

Performance Curve

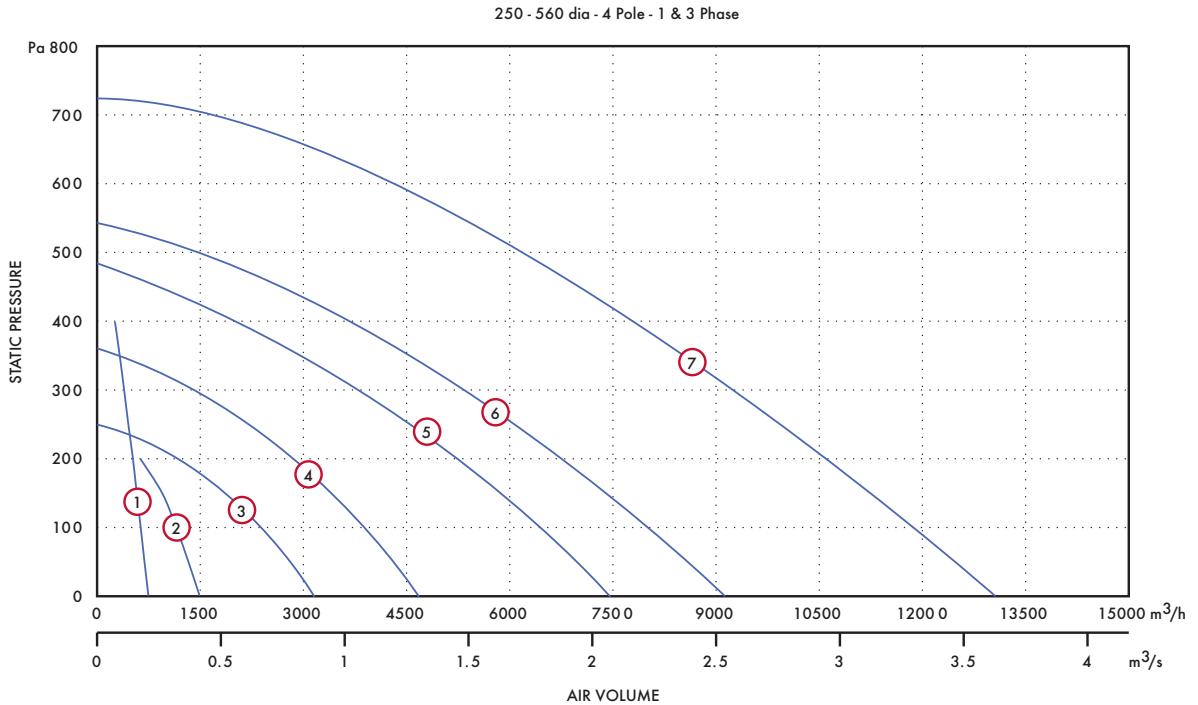

Performance Guide

Dia.	Phase	Stock Model	Ref.	Pole	rpm	Curve Ref.	m³/s at Pa							Motor kW	S.C. Amps	F.L.C. Amps	dBA @ 3m		
							0	50	100	150	200	250	300					350	400
250	1	RMH25012		2	2720	1	0.248	0.229	0.211	0.192	0.174	0.152	0.132	0.111	0.088	0.16	2.1	0.7	62
315	1	RMH31514		4	1400	2	0.493	0.439	0.381	0.314	0.21					0.17	1.4	0.8	52
355	1	RMH35514		4	1410	3	0.868	0.77	0.652	0.51	0.333					0.31	4	1.45	56
400	1	RMH40014		4	1340	4	1.297	1.187	1.069	0.947	0.795	0.595	0.365			0.52	6	2.4	58
400	3	RMH40034		4	1340	4	1.297	1.187	1.069	0.947	0.795	0.595	0.365			0.54	4.2	1.05	58
450	1	RMH45014		4	1380	5	2.053	1.916	1.77	1.618	1.451	1.256	1.045	0.82	0.57	0.96	10.5	4.7	64
450	3	RMH45034		4	1380	5	2.053	1.916	1.77	1.618	1.451	1.256	1.045	0.82	0.57	0.89	5.9	1.65	64
500	1	RMH50014		4	1370	6	2.508	2.35	2.18	2.023	1.83	1.64	1.435	1.22	0.99	1.45	16	6.6	69
500	3	RMH50034		4	1370	6	2.508	2.18	2.023	1.83	1.64	1.435	1.22	0.99		1.35	10	2.4	69
560	3	RMH56034		4	1380	7	3.631	3.458	3.305	3.13	3	2.817	2.589	2.45	2.24	2.4	22	4.7	70

Sound Power Level Spectra dB (re 10⁻¹²Watts)

Diameter	Pole	63	125	250	500	1k	2k	4k	8k
250	2	69	75	80	78	76	74	73	66
315	4	64	75	77	70	60	63	63	51
355	4	65	68	75	73	73	70	59	53
400	4	66	73	79	77	73	72	68	61
450	4	71	76	84	83	83	80	77	65
500	4	73	82	87	84	84	82	76	68
560	4	75	83	90	87	85	85	82	73

Performance Curve

355 - 560 dia - 6 Pole - 1 & 3 Phase

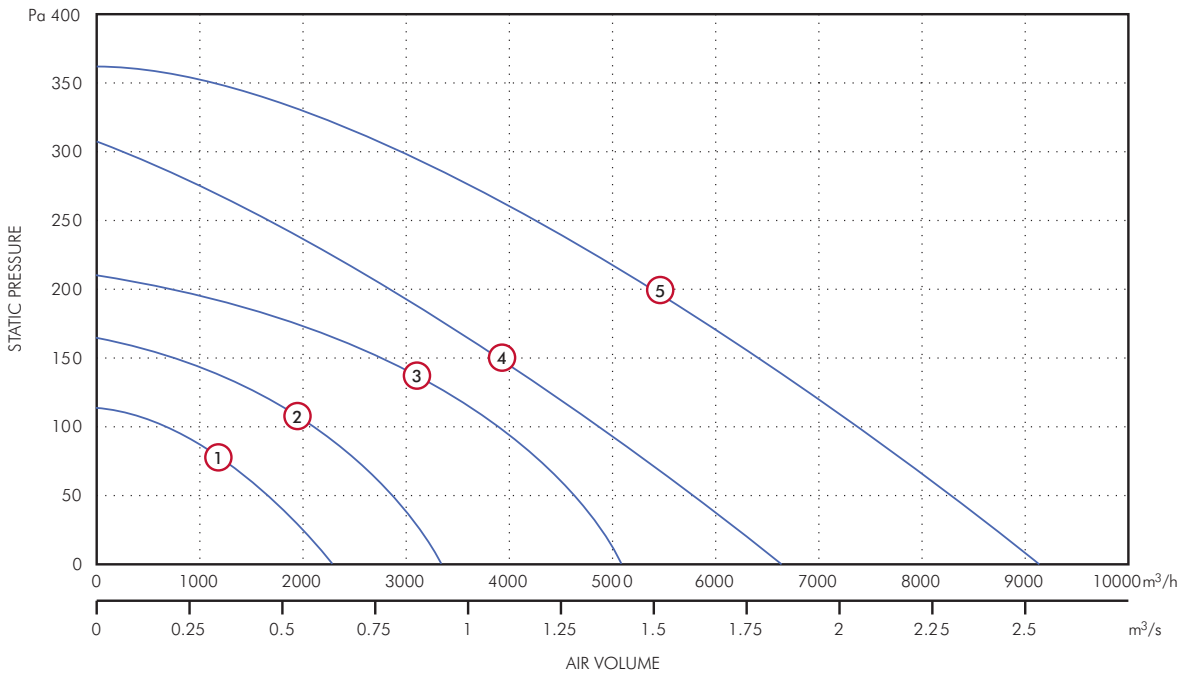

Performance Guide

Dia.	Phase	Stock Model	Pole	rpm	Curve Ref.	m³/s at Pa						Motor kW	S.C. Amps	F.L.C. Amps	dBA @ 3m
						0	25	50	100	150	200				
355	1	RMH35516	6	920	1	0.606	0.55	0.466	0.16			0.09	1.1	0.44	47
355	3	RMH35536	6	920	1	0.606	0.55	0.466	0.16			0.1	0.57	0.25	47
400	3	RMH40036	6	910	2	0.919	0.863	0.794	0.588	0.204		0.39	1.4	0.67	49
450	1	RMH45016	6	920	3	1.417	1.35	1.288	1.067	0.728	0.149	0.4	5.1	2.3	55
450	3	RMH45036	6	920	3	1.417	1.35	1.288	1.067	0.728	0.149	0.59	2	0.96	55
500	1	RMH50016	6	910	4	1.831	1.716	1.6	1.34	1.047	0.731	0.43	4.1	2.1	60
500	3	RMH50036	6	910	4	1.831	1.716	1.6	1.34	1.047	0.731	0.88	4.4	1.45	60
560	1	RMH56016	6	870	5	2.556	2.425	2.324	2.074	1.821	1.541	0.68	7.1	3.3	61
560	3	RMH56036	6	870	5	2.556	2.425	2.324	2.074	1.821	1.541	0.67	4.1	1.55	61

Sound Power Level Spectra dB (re 10⁻¹²Watts)

Diameter	Pole	63	125	250	500	1k	2k	4k	8k
355	6	59	60	66	63	63	61	50	46
400	6	60	63	69	77	64	62	59	52
450	6	65	67	75	73	72	70	68	55
500	6	67	73	77	75	75	72	67	59
560	6	68	73	80	78	76	75	73	64

Mixed Flow Roof Fans (RMH)

Accessories Dimensions (mm)

Roof Attenuators

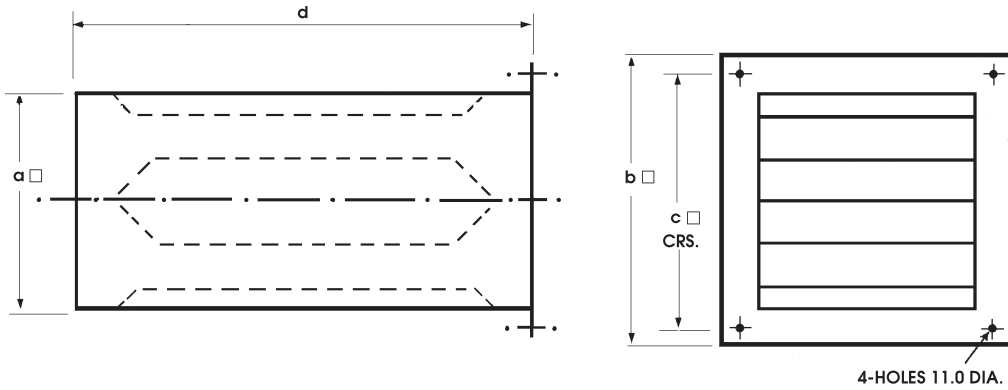

Stock Ref.	a □	b □	c □	d	kg approx	Face Area m ²	Curve Ref
10520315	395	495	445	600	18	0.156	②
10520400	495	595	545	600	22	0.245	①
10520500	645	745	695	600	31	0.416	①
10520630	785	885	835	600	44	0.616	②
10521315	395	495	445	900	21	0.156	②
10521400	495	595	545	900	28	0.245	①
10521500	645	745	695	900	39	0.416	①
10521630	785	885	835	900	52	0.616	②
10522315	395	495	445	1200	25	0.156	②
10522400	495	595	545	1200	35	0.245	①
10522500	645	745	695	1200	48	0.416	①
10522630	785	885	835	1200	61	0.616	②

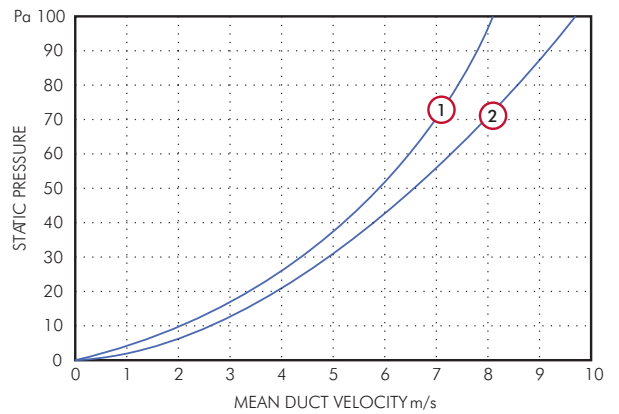

Roof Attenuator, Insertion Losses

Stock Ref..	Length mm	63	125	250	500	1k	2k	4k	8k
105 20 315	600	2	4	9	16	20	22	18	14
105 20 400	600	2	4	8	15	18	20	17	13
105 20 500	600	2	4	9	16	20	22	18	14
105 20 630	600	2	4	8	15	18	20	17	13
105 21 315	900	3	6	13	22	30	31	22	17
105 21 400	900	2	6	12	20	25	27	20	16
105 21 500	900	3	6	13	22	30	31	22	17
105 21 630	900	2	6	12	20	25	27	20	16
105 22 315	1200	4	9	16	28	34	35	23	19
105 22 400	1200	4	8	15	26	32	33	21	18
105 22 500	1200	4	9	16	28	34	35	23	19
105 22 630	1200	4	8	15	26	32	33	21	18

Accessories



Fan	Electronic Controller	Auto Transformer	Starter	Overload	Voltage Control	*eDemand Controller 1/3 Phase Inverter	3 Phase Inverter
Stock Ref.	Stock Ref.	Stock Ref.	Stock Ref.	Stock Ref.	Stock Ref.	Stock Ref.	Stock Ref.
RMH25012	W10303102M	10314103	444744	444699	444164	-	-
RMH31514	W10303102M	10314103	444744	444699	444164	-	-
RMH35514	W10303102M	10314103	444744	444701	444164	-	-
RMH35516	W10303102M	10314103	444744	444698	444164	-	-
RMH35536	-	10314301	444747	444697	444166	444177	444172
RMH40014	10303103	10314103	444744	444702	444164	-	-
RMH40034	-	10314301	444747	444700	444166	444177	444172
RMH40036	-	10314301	444747	444699	444166	444177	444172
RMH45014	10303106	10314105	444744	444703	444164	-	-
RMH45034	-	10314304	444747	444701	444166	444177	444172
RMH45016	10303103	10314103	444744	444702	444164	-	-
RMH45036	-	10314301	444747	444700	444166	444177	444172
RMH50014	10303110	10314107	444744	444702	444165	-	-
RMH50034	-	10314304	444747	444702	444166	444177	444173
RMH50016	W10303102M	10314103	444744	444701	444164	-	-
RMH50036	-	10314304	444747	444701	444166	444177	444172
RMH56034	-	10314307	444747	444703	444166	-	444173
RMH56016	10303106	10314105	444744	444702	444164	-	-
RMH56036	-	10314304	444744	444702	444166	444177	444172

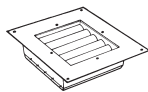

Air Operated Shutters †



Roof Attenuators

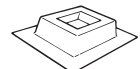

Purlin Boxes

Size	Stock Ref.	600mm † Stock Ref.	900mm † Stock Ref.	1200mm † Stock Ref.	Stock Ref.
315	10517315	10520315	10521315	10522315	10516315
355	10517315	10520315	10521315	10522315	10516315
400	10517400	10520400A	10521400	10522400	10516400
450	10517400	10520400A	10521400	10522400	10516400
500	-	10520500	10521500	10522500	10516500
560	-	10520500	10521500	10522500	10516500
630	-	10520630	10521630	10522630	10516630

† Air Operated Shutters and manual/motorisable Shutters are not suitable for use in combination with Roof Attenuators. Special manual/motorisable Shutters can be fitted to the bottom of the Roof Attenuator - Supplied by others

* For full range of speed controller options, see Accessories & Controllers Section

Lo-Carbon Energy Saver MX Roof Fans (MX)

Features and Benefits

- Reduces your carbon footprint
- Three stylish diagonal discharge models
- 70% energy savings
- Customised performance from 2200m³/h to 6700m³/h
- Can be remotely monitored
- Designed for easy inspection access for cleaning, maintenance or servicing
- Long life DC motor

The Lo-Carbon MX Roof Range offers longer life, lower maintenance and energy savings to a variety of commercial and industrial applications. Three stylish diagonal discharge models MX10, MX20 and MX30 offer customised performances up to 5,500m³/h.

The units are moulded in tough recyclable material, fully UV stabilised and are suitable for arduous external conditions. The design features a mixed flow impeller with the motor out of the airstream and a slanted diagonal discharge pattern which creates an upwardly spiralling discharge pattern. Suitable for horizontal mounting only (max. of 3° from horizontal).

Motors

At the heart of the range is the latest Lo-Carbon energy saver DC technology, eliminating the need for expensive transformer controllers to achieve customised duties. Due to the Lo-Carbon DC design, the motors run cooler, prolonging the life of the bearings and motor lubricants. The motor is integral to the mixed flow impeller and is designed for ambient duct temperatures up to +80°C.

MX motors are up to 80% efficient in converting energy into rotation, providing large energy savings throughout the speed range. They are also precisely controllable, typically offering energy savings of 40-60% compared with AC equivalents.

On Board Control

The electronics in the Lo-Carbon MX range offer the possibility of setting any working point/speed whenever required without a controller. The standard unit is ready to connect to a single phase electrical supply. However, an ideal working point can be set either at the factory or on site to suit a system duty. If the system resistance or volume requirement changes, the fan duty can be re-programmed to meet this new performance on site. Traditional AC products are tied to 4, 6 and 8 pole models and costly transformers - the Lo-Carbon MX is simply set up at the desired speed and, if required, can be controlled using inexpensive switches connected by four core low voltage wire. The Lo-Carbon DC system can be controlled down to much lower speeds than AC motors providing very quiet performance when required.

Maintenance

Vent-Axia Lo-Carbon MX units have a built in fault diagnosis system. An installation of several units can be interconnected using simple two core wire to form a BUS network for flexible remote maintenance monitoring tailored to meet your needs. Vent-Axia MX maintenance software is available, the installation can be used on a laptop/PC. Alternatively a hand held diagnostics/programmer is available for on site use. Lo-Carbon MX units have their own encoded signature, allowing ease of identification and full performance history access.

Vent-Axia's Lo-Carbon MX range is designed for easy inspection access for cleaning. Four screws secure the main cover. Disconnect the internal mains plug and four bolts release the chassis holding the fan/motor assembly and the electronic module.

The Lo-Carbon MX range is constructed from fully recyclable plastics. The diagonal vortex discharge pattern throws air and sound upwards and away from the roof surface.

Lo-Carbon MX Sectional View

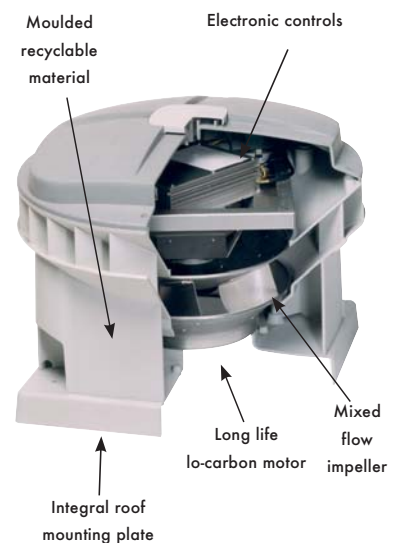



Performance

MX 10/10

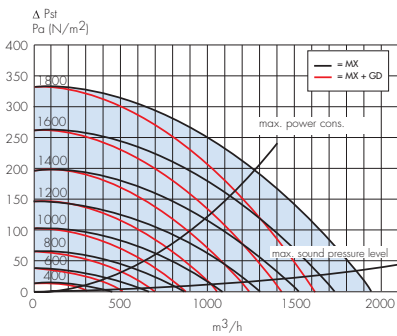

MX 10/10 - Stock Ref No: 45 46 12

max. 2000 rpm/2200 m³/h

Speed rpm	Current A	Power Watts	del. dB(A)	Sound level	
				intake dB(A)	intake* dB(A)
1800	0.76	174	57	72	63
1600	0.55	125	54	70	61
1400	0.39	87	50	66	58
1200	0.26	60	46	63	55
1000	0.17	39	41	58	51
800	0.12	27	36	56	49
600	0.09	19	30	49	42
400	0.07	12	24	41	35

* with GD silencer

max. 2000 rpm/2200 m³/h

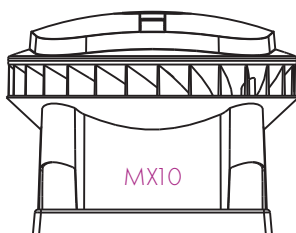

MX 20/10

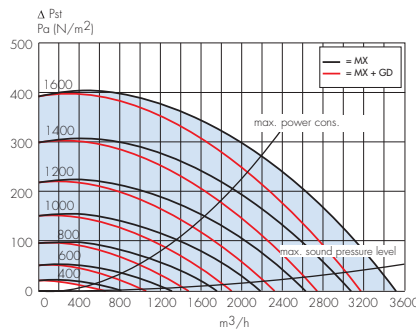

MX 20/10 - Stock Ref No: 45 46 13

max. 1600 rpm/3600 m³/h

Speed rpm	Current A	Power Watts	del. dB(A)	Sound level	
				intake dB(A)	intake* dB(A)
1600	1.8	409	62	77	64
1400	1.16	266	58	74	62
1200	0.73	169	53	69	57
1000	0.44	100	48	65	54
800	0.25	57	42	59	49
600	0.14	31	36	55	45
400	0.09	17	28	48	39

* with GD silencer

max. 1600 rpm/3600 m³/h

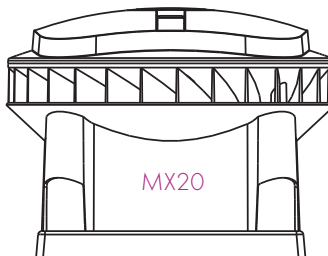

MX 30/20

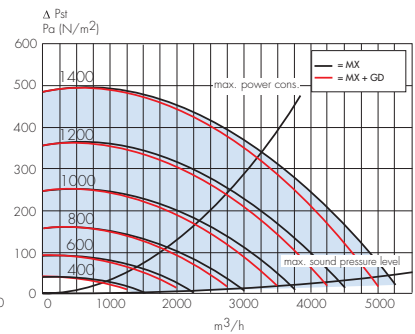

MX 30/20 - Stock Ref No: 45 46 14

max. 1500 rpm/6700 m³/h

Speed rpm	Current A	Power Watts	del. dB(A)	Sound level	
				intake dB(A)	intake* dB(A)
1200	1.9	433	60	75	65
1000	1.1	250	56	71	61
800	0.59	135	50	66	56
600	0.28	64	43	60	50
400	0.11	24	34	51	42

* with GD silencer

max. 1500 rpm/6700 m³/h

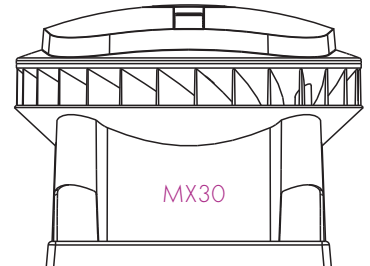

Lo-Carbon Energy Saver MX Roof Fans (MX)

Fan Dimensions (mm)

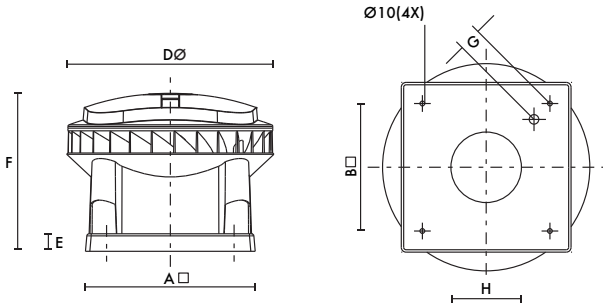

Model	MX10/10	MX20/10	MX30/20
A □	460	580	665
B □	330	450	535
D Ø	575	708	863
E	60	60	60
F	473	540	601
G	44	48	64
H	196	241	302

Upstand Dimensions

Model	A □	B □	C □
MX 10/10	275	375	330
MX 20/10	400	500	450
MX 30/20	485	585	535

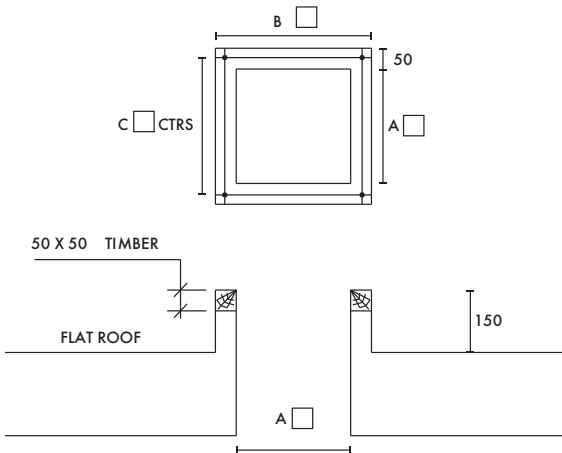

LTG Temperature Sensitive Speed Controller

LTG
DIMENSIONAL
DETAILS

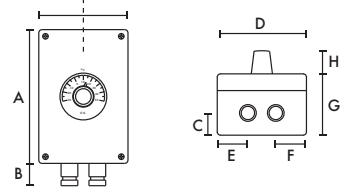

VG 31 Multi Unit Controller

VG 31
DIMENSIONAL
DETAILS

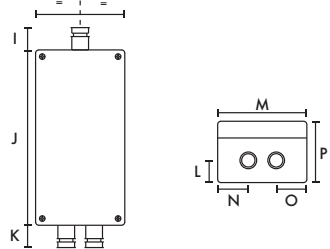

The LTG is an air temperature sensitive speed controller, which can be set between 20°C and 50°C. The controller is suitable for controlling up to 5 MX units when used in conjunction with a VG31 Multi Unit Controller.

The fan will run at a minimum speed, until the air temperature reaches the set point on the controller. When the set point is reached the controller will gradually increase the speed of the fan until the fan has reached its maximum speed. The fan speed gradient (min/max bandwidth), can be set from between 0.5°C and 10°C by adjusting a potentiometer within the controller housing. A probe fixed within the fan housing measures the air temperature.

A	120
B	28
C	28
D	80
E	27.5
F	27.5
G	60
H	20
I	20
J	180
K	20
L	20
M	80
N	27.5
O	27.5
P	60

Lo-Carbon MX Roof Range Alternative Management Controls

Easy to monitor and maintain

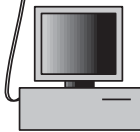
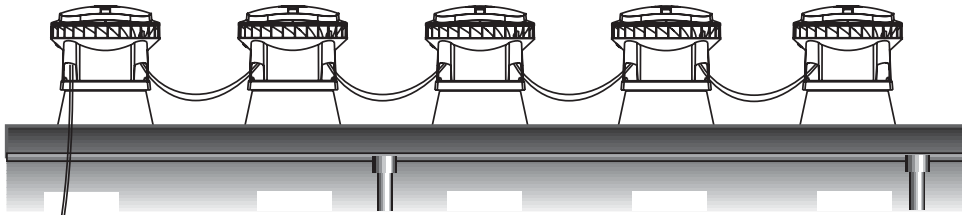

BMS OR REMOTE LOCATION - CONNECT UP TO 31 UNITS

NOTE: Please enquire as to the compatibility of an existing or proposed BMS. A BMS programme is available on request.

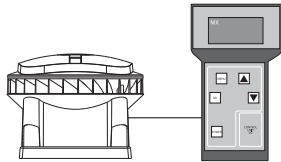

HAND HELD PROGRAMMER
(Available upon request)

PC SOFTWARE
(Available if required)

Lo-Carbon MX Roof Range Fan Controls



SAG 0-2

2-step controller step 1 and 2 are separately adjustable

Stock Ref
454616



SAG 0-5

5-step controller adjustable maximum capacity

Stock Ref
454617



SAG 0-M

Infinitely variable controller adjustable maximum capacity

Stock Ref
454618

Accessories

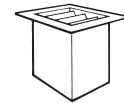

DNG 31

LTG

Roof Attenuators

Model Ref.	SAG 0-2 Stock Ref.	SAG 0-5 Stock Ref.	SAG 0-M Stock Ref.	DNG 31 2 Speed Stock Ref.	LTG Temperature Stock Ref.	600mm Stock Ref.	900mm Stock Ref.	1200mm Stock Ref.
MX 10/10	454616	454617	454618	456930	456931	-	-	-
MX 20/10	454616	454617	454618	456930	456931	10520315	10521315	10522315
MX 30/20	454616	454617	454618	456930	456931	-	-	-

Air Handling

Vent-Axia's existing range of Slimline, Mini Slim and Mini Direct AHU's have been re-designed to comply with today's more rigorous regulations. Now supplied with energy efficient EC motors, integral speed control and, where electric heating is included, integral electric heating controls. Casings are of a double skinned construction with a Pentapost aluminium frame, Aluzinc panels and 60kg/m³ acoustic insulation.

The Slimline range is for internal mounting and consists of 2 base models with either Electric or LPHW heating, both with top or bottom access. The Mini Direct range is for internal or external mounting and consists of 5 base models with either electric or LPHW heating and side access. Both ranges can be inverted to allow connections from either left or right as standard.



Slimline Range (SL)

382-385



D1 to D6 Mini Direct Range

386-389

Specification

	Slimline	MiniDirect
Construction	Double Skin	Double Skin
Drive	EC Direct drive	EC Direct Drive
Impellers	Backward Curved Centrifugal	
Access	Top or Bottom	Left or Right
External	-	✓
Internal	Floor	✓
	Suspended	✓
Heating	LPHW	✓
	Electric	✓
Dampers	Optional	Optional
Filtration Bag	M5	M5
Attenuators	Optional	Optional
Controls	Integral	Integral

Airflow Range

Model	Airflow Range m ³ /s	
Slimline	0.05	0.92
MiniDirect	0.05	2.25

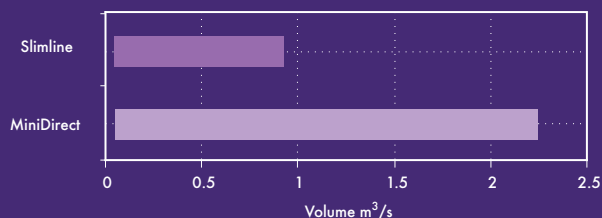

Vent-Axia

Air Handling

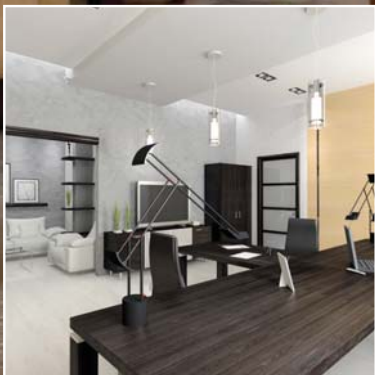

Slimline Range (SL)

Features & Benefits

- Performance range up to 0.92m³/s
- Speed control included
- EC Backward curved fans
- Anodised aluminium pentapost frame
- Double skinned Aluzinc panels
- Low profile direct drive units
- 2 Year guarantee

Low profile direct drive Air Handling

Unit - Duties from 0.05m³/s to 0.92m³/s

Updated to incorporate modern energy efficient EC motors these units are designed specifically for applications with limited available height such as ceiling voids. Access can be from above or below with heater and motor connections on the left or right hand side.

The casing comprises of an AA25 anodised aluminium frame with high density glass reinforced nylon corners and double skinned Aluzinc panels enclosing 25mm of 60kg/m³ mineral fibre insulation. All panels are retained by proprietary fasteners. All panels are sealed by a purpose designed leak seal gasket fully retained into the aluminium framework.

Specification

Direct driven backward curved centrifugal fans with energy efficient EC motors statically and dynamically balanced to G6.3 for smooth long life operation. All motors incorporate EC motor controls to provide fully variable speed control.

Motors and control electronics are protected to IP44 as a minimum and suitable for operating in ambient conditions of 40°C and up to 95% RH. Electrical supply is 230/1/50 for all units.

Standard units contain either an electric heater battery or LPHW heater battery (specified at time of order) and an M5 filter. Units are suitable for internal mounting only.

Electric heating units include a simple heater control enabling the off coil temperature to be set and either adjusted by external or internal controls (external controls at additional cost). LPHW heating controls are by others.

Flexible Connectors

The Flexible Connectors are manufactured from Revertex JPT 20 with ductmate flanges to DW142.

Bag Filters

Bag Filters are manufactured from fire retardant synthetic material with galvanised steel frames. The filter grade is M5.

L.P.H.W. Heater Batteries

L.P.H.W. Heater Batteries are constructed from copper tube, mechanically bonded to aluminium fins with the complete assembly housed in a galvanised steel casing. The coil headers and return bends are totally enclosed within the air handling unit casing. Flow and return connections are located on the same side of the unit and have male B.S.P. thread. L.P.H.W. Heater Batteries are pressure tested under water to 250p.s.i.

Electric Heater Batteries

Electric Heater Battery elements are constructed from Nichrome 5 spiral resistance wire surrounded by magnesium oxide powder and sheathed in stainless steel. The elements are carried on a galvanised steel frame. All electric heaters incorporate a thermal cut out device. Electrical connections are via a flush mounted terminal box on the outside of the air handling unit casing.



Unit Dimensions (mm)

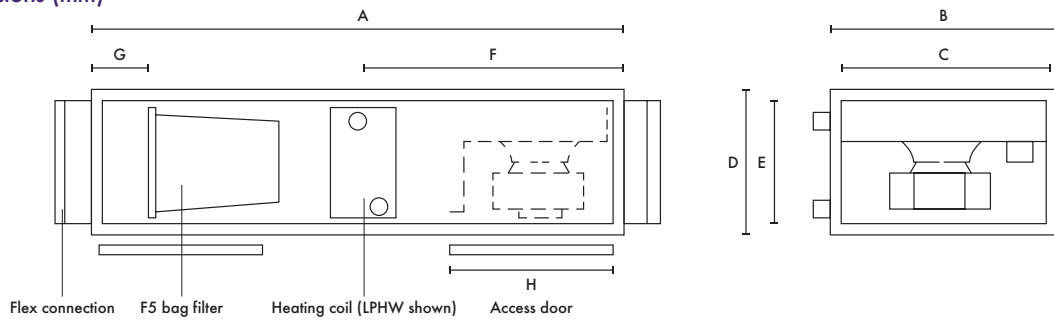

Unit Ref	A	B	C	D	E	F	G	H
SL6-22	1560	660	600	360	300	758	220	480
SL8-31	1560	810	750	360	300	758	220	480

Electrical / Heating Data

	Fan Supply	Speed	Max Fan Input kW	Heater Supply	Max Heater KW (Electric)	Heater Current Amps	LPHW Heater max Flow l/s	Temperature Rise at Max Airflow
SL6-22	230/1/50	3220	230	230/1/50	9	34	5.8	22
SL8-31	230/1/50	2600	450	400/3/50	18	25	12.9	22

Slimline Range (SL)

Performance Curve

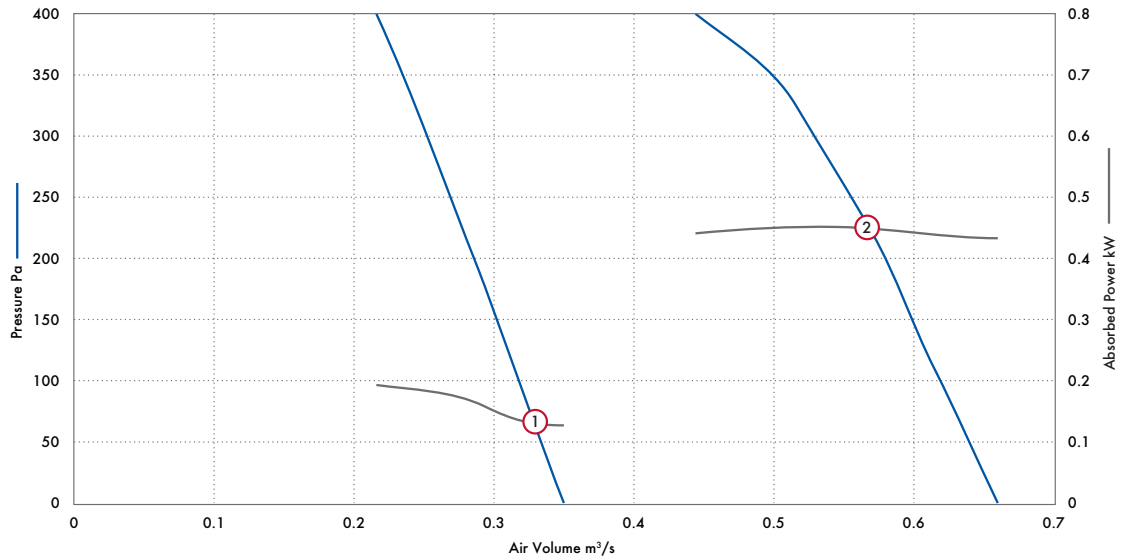

Performance Guide

Model	Curve Ref	Airflow, m ³ /s @ Pa									
		0	50	100	150	200	250	300	350	400	
SL6-22	①	m ³ /s	0.350	0.332	0.317	0.300	0.286	0.266	0.255	0.236	0.216
		kW	0.13	0.13	0.14	0.15	0.17	0.18	0.18	0.19	0.19
		SFP	0.36	0.39	0.43	0.49	0.59	0.66	0.71	0.79	0.89
SL8-31	②	m ³ /s	0.660	0.639	0.619	0.597	0.580	0.555	0.528	0.500	0.444
		kW	0.43	0.43	0.44	0.45	0.45	0.45	0.45	0.45	0.44
		SFP	0.66	0.68	0.71	0.75	0.77	0.81	0.86	0.91	0.99

Sound Data

Model		dBW re 10 ⁻¹² W								dBA @ 3.0m
		63	125	250	500	1k	2k	4k	8k	
SL6-22	Inlet	64	59	69	62	59	54	52	48	35
	Outlet	66	61	73	65	65	63	57	55	
	Breakout	58	53	57	35	35	30	24	24	
SL8-31	Inlet	62	65	70	69	60	63	59	56	40
	Outlet	65	68	73	72	69	66	62	59	
	Breakout	57	60	57	42	39	33	29	26	

Silencer Dimensions (mm)

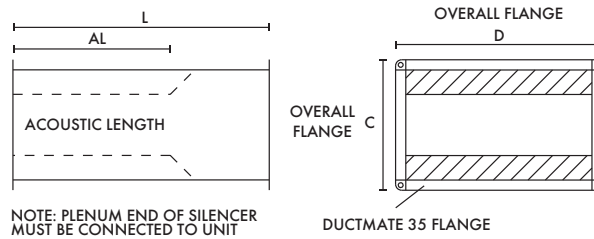

Unit Size	Dimensions in mm				Approx Wgt kg
	L	AL	C	D	
SL6-22	1500	1200	360	660	33
	1800	1500	360	660	39
	1200	900	360	810	37
SL8-31	1500	1200	360	810	42
	1800	1500	360	810	48

Silencer resistance (Pa) standard length silencer

Unit Size	0.1	0.15	0.2	0.25	0.3	0.35	0.4	0.45	0.5	0.55	0.6	0.65	0.7	0.8	0.9	1.0
SL6-22	2	4	7	11	16	22	29	37	-	-	-	-	-	-	-	-
SL8-31	1.5	3	5	8	11	15	19	24	30	36	43	51	59	77	97	120

Insertion loss for standard silencers

Unit Size	Length mm	Octave band mid frequency Hz								
		63	125	250	500	1k	2k	4k	8k	
SL6-22	1200	-5	-9	-17	-28	-37	-37	-29	-24	
	1500	-7	-12	-25	-35	-50	-50	-38	-30	
	1800	-8	-15	-28	-42	-50	-50	-46	-34	
SL8-31	1200	-5	-9	-17	-28	-37	-37	-29	-24	
	1500	-7	-12	-25	-35	-50	-50	-38	-30	
	1800	-8	-15	-28	-42	-50	-50	-46	-34	

Damper Dimensions (mm)

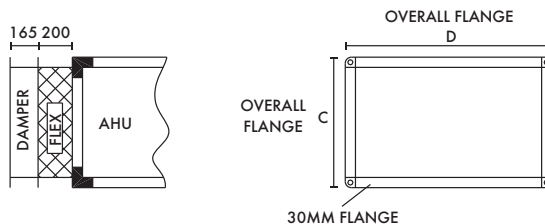

Dampers are supplied with extended spindles - suitable for motorisation as standard.

Unit Size	Inlet Damper		Dim in mm		Approx Wgt kg
	Stock Ref		C	D	
SL6-22	57CD-66		360	660	6
SL8-31	57CD-81		360	810	7

D1 to D6 Mini Direct Range

Features & Benefits

- Performance range up to 2.25m³/s
- Motor Insulation Class B minimum
- Standard Thermal Overload Protection (S.T.O.P.)
- Anodised Aluminium pentapost frame
- Double skinned panels
- Compact direct drive units
- Internal standard
- Optional external unit
- 1 Year Guarantee

Mini Direct Drive Units

Updated to incorporate modern energy efficient EC motors these simple Direct Drive Air Handling Units have a neat and compact design. Access can be on the left or right hand side. Units can be internal or external mounting (external specified at time of order).

Mini Direct Drive Unit - Duties from

0.05m³/s to 2.25m³/s

A compact and economical range of units with directly driven backward curved EC centrifugal fans. There are five standard unit sizes. All units the fans incorporate speed control via the EC motor for added flexibility. The standard unit consists of a 100mm M5 panel filter, LPHW or electric heating, direct drive centrifugal fan and flexible connectors.

The casing comprises of anodised aluminium frame with high density glass reinforced nylon corners and double skinned Aluzinc panels enclosing 25mm of 60kg/m³ mineral fibre insulation. All panels are retained by proprietary fixings and sealed by a purpose designed gasket fully retained into the aluminium framework

Suitable for internal mounting as standard. Models suitable for external mounting, inlet weather cowl are available to order.

Specification

Direct driven backward curved centrifugal fans with energy efficient EC motors statically and dynamically balanced to G6.3 for smooth long life operation. All motors incorporate EC motor controls to provide fully variable speed control.

Motors and control electronics are protected to IP44 as a minimum and suitable for operating in ambient conditions of 40°C and up to 95% RH. Electrical supply is 230/1/50 for all units.

Standard units contain either an electric heater battery or LPHW heater battery (specified at time of order) and an M5 filter. Units are suitable for internal or external mounting with side access.

Electric heating units include a simple heater control enabling the off coil temperature to be set an either adjusted by external or internal controls (external controls controls at additional cost). LPHW heating controls are by others.

Flexible Connectors

The Flexible Connectors are manufactured from Revertex JPT 20 with ductmate flanges to DW142.

Bag Filters

Bag Filters are manufactured from fire retardant synthetic material with galvanised steel frames. The filter grade is M5.

L.P.H.W. Heater Batteries

L.P.H.W. Heater Batteries are constructed from copper tube, mechanically bonded to aluminium fins with the complete assembly housed in a galvanised steel casing. The coil headers and return bends are totally enclosed within the air handling unit casing. Flow and return connections are located on the same side of the unit and have male B.S.P. thread. L.P.H.W. Heater Batteries are pressure tested under water to 250 p.s.i.

Electric Heater Batteries

Electric Heater Battery elements are constructed from Nichrome 5 spiral resistance wire surrounded by magnesium oxide powder and sheathed in stainless steel. The elements are carried on a galvanised steel frame. All electric heaters incorporate a thermal cut out device. Electrical connections are via a flush mounted terminal box on the outside of the air handling unit casing.



Fan Dimensions (mm)

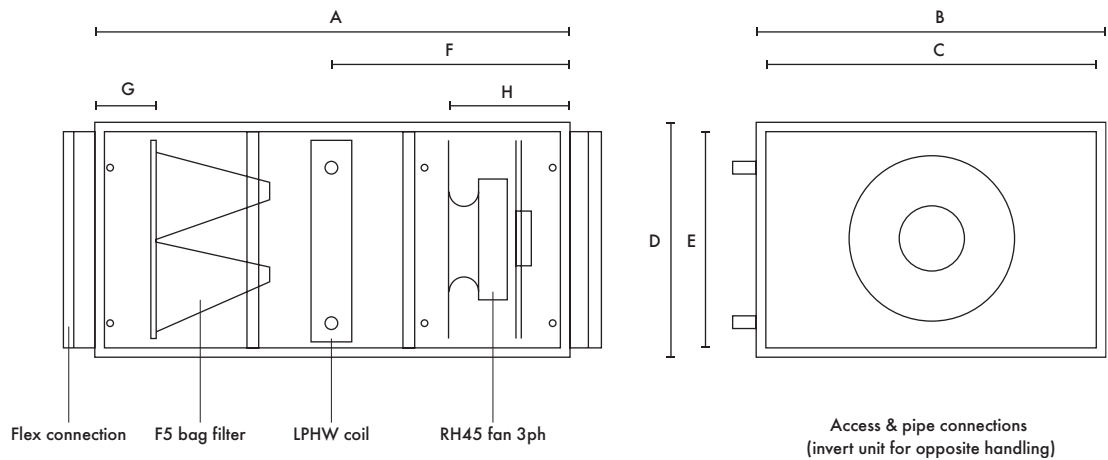

Unit Size	A	B	C	D	E	F	G	H
D1-22	1560	660	600	360	300	758	220	n/a
D3-35	1560	660	600	520	460	780	220	300
D4-31	1560	660	600	720	660	780	220	300
D5-35	1710	960	900	720	660	850	220	450
D6-45	1710	1260	1200	720	660	850	220	450

Electrical / Heating Data

	Fan Supply	Speed	Max Fan Input kW	Heater Supply	Max Heater KW (Electric)	Heater Current Amps	LPHW Heater max Flow l/s	Temperature Rise at Max Airflow
D1-22	230/1/50	3220	230	230/1/50	9	34	5.8	22
D3-31	230/1/50	2600	450	400/3/50	12	17	8.6	22
D4-31	230/1/50	2600	430	400/3/50	18	25	12.9	22
D5-35	230/1/50	2460	1090	400/3/50	27	38	19.4	22
D6-45	230/1/50	2080	2360	400/3/50	45	63	32.4	22

D1 to D6 Mini Direct Drive Range

Performance Curve

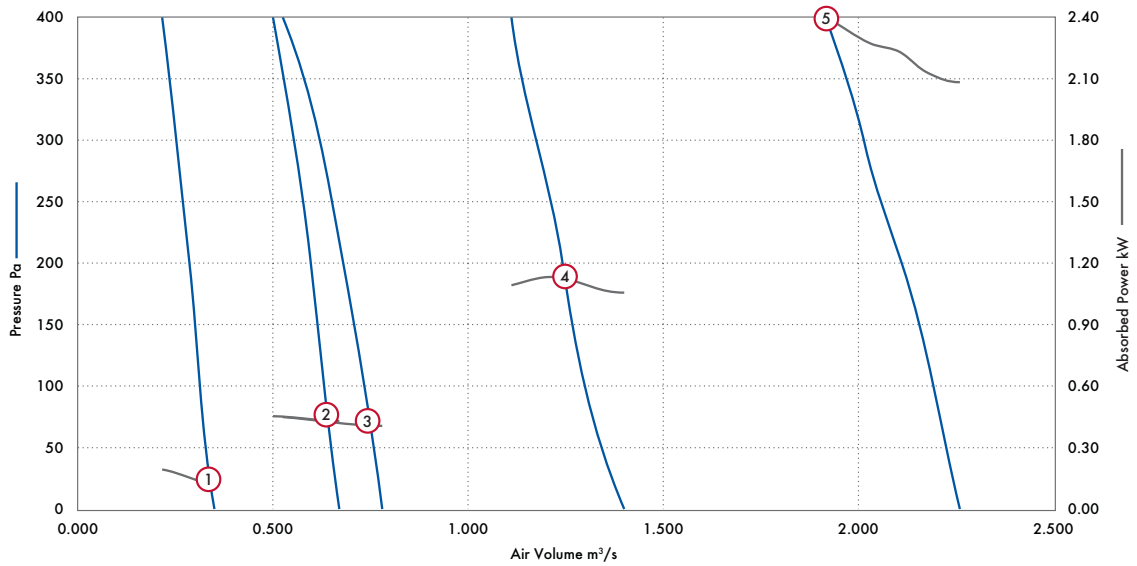

Performance Guide

Model	Curve Ref	Airflow, m³/s @ Pa									
		0	50	100	150	200	250	300	350	400	
D1-22	①	m³/s	0.350	0.322	0.317	0.300	0.286	0.266	0.255	0.236	0.216
		kW	0.13	0.13	0.14	0.15	0.17	0.18	0.18	0.19	0.19
		SFP	0.36	0.39	0.43	0.49	0.59	0.66	0.71	0.79	0.89
D3-31	②	m³/s	0.670	0.647	0.639	0.619	0.597	0.580	0.555	0.528	0.500
		kW	0.43	0.43	0.43	0.44	0.45	0.45	0.45	0.45	0.45
		SFP	0.64	0.66	0.68	0.71	0.75	0.77	0.81	0.86	0.91
D4-31	③	m³/s	0.780	0.760	0.736	0.711	0.680	0.653	0.630	0.589	0.525
		kW	0.41	0.41	0.42	0.42	0.42	0.43	0.44	0.44	0.45
		SFP	0.52	0.53	0.57	0.59	0.62	0.66	0.70	0.75	0.86
D5-35	④	m³/s	1.400	1.333	1.294	1.264	1.242	1.216	1.183	1.130	1.111
		kW	1.06	1.06	1.09	1.11	1.13	1.14	1.13	1.10	1.09
		SFP	0.75	0.79	0.84	0.88	0.91	0.93	0.96	0.97	0.98
D6-45	⑤	m³/s	2.260	2.222	2.194	2.152	2.111	2.050	2.014	1.972	1.916
		kW	2.08	2.08	2.12	2.14	2.23	2.26	2.29	2.35	2.40
		SFP	0.92	0.94	0.97	0.99	1.05	1.10	1.14	1.19	1.25

Sound Data

Model		dBW re 10 ¹² W								dBA @ 3.0m
		63	125	250	500	1000	2000	4000	8000	
D1-22	Inlet	64	59	69	62	59	54	52	48	35
	Outlet	66	61	73	65	65	63	57	55	
	Breakout	58	53	57	35	35	30	24	24	
D3-31	Inlet	62	65	70	69	60	63	59	56	40
	Outlet	65	68	73	72	69	66	62	59	
	Breakout	57	60	57	42	39	33	29	26	
D4-31	Inlet	62	65	70	69	60	63	59	56	40
	Outlet	65	68	73	72	69	66	62	59	
	Breakout	57	60	57	42	39	33	29	26	
D5-35	Inlet	73	75	77	79	74	68	67	61	50
	Outlet	73	76	81	82	83	79	73	66	
	Breakout	67	70	65	50	53	46	50	35	
D6-45	Inlet	77	80	82	82	77	76	73	66	50
	Outlet	73	76	81	82	83	79	73	66	
	Breakout	67	70	65	50	53	46	40	35	

Silencer Dimensions (mm)

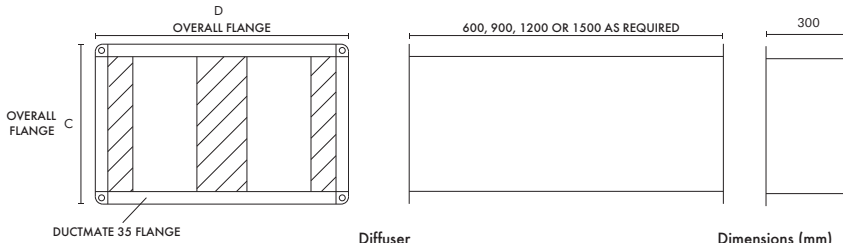

Outlet Diffusers for Connection to Silencer

This item is essential when connecting a silencer directly to the discharge side of a fan section. The flanges at either end match the AHU and silencer dimension.

Unit Size	Diffuser Stock Ref	Dimensions (mm) C	Dimensions (mm) D	Approx Wgt kg
D1	54BC1	360	660	18
D3	54BC3	520	660	32
D4	54BC4	720	660	40
D5	54BC5	720	960	46
D6	54BC6	720	1260	50

Insertion loss for standard silencers

Unit Size	Octave band mid frequency Hz								Length mm
	63	125	250	500	1k	2k	4k	8k	
D1	-4	-6	-12	-20	-27	-27	-20	-16	600
D3	-5	-9	-17	-28	-37	-37	-29	-24	900
D4	-5	-9	-17	-28	-37	-37	-29	-24	900
D5	-5	-9	-17	-28	-37	-37	-29	-24	900
D6	-5	-9	-17	-28	-37	-37	-29	-24	900

N.B. For data on other silencer lengths please enquire

Standard length silencer resistance (Pa)

Unit Size	Pressure Drop (Pa) Air Volume m³/sec															
	0.1	0.2	0.3	0.4	0.5	0.6	0.7	0.8	0.9	1	1.2	1.4	1.6	1.8	2	2.4
D1	2	8	18	-	-	-	-	-	-	-	-	-	-	-	-	-
D3	1	4	8	14	21	31	41	54	-	-	-	-	-	-	-	-
D4	1	2	4	7	10	15	20	26	32	40	58	-	-	-	-	-
D5	1	1	2	4	5	7	10	13	16	20	29	39	51	65	80	-
D6	1	1	2	2	3	5	6	8	10	12	18	24	31	29	48	70

Inlet Damper Dimensions (mm)

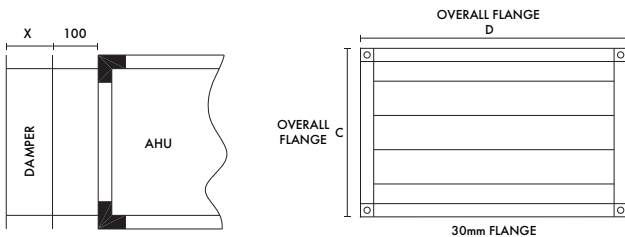

Dampers are supplied with extended spindles suitable for motorisation as standard. When using a damper, a rigid connector will be required.

Unit Size	Inlet Damper			Dimensions (mm)			Approx Wgt kg
	Stock Ref.	Rigid Connector Stock Ref	Flexible Connector Stock Ref.	C	D	X	
D1	57CD-66	54MC1	68FC-1	360	660	165	6
D3	57CD-3	54MC3	68FC-3	520	660	165	7
D4	57CD-4	54MC4	68FC-4	720	660	165	9
D5	57CD-5	54MC5	68FC-5	720	960	165	12
D6	57CD-6	54MC6	68FC-6	720	1260	165	25

Accessories & Controllers - Non Residential

Whether you are looking for ducting, controllers or accessories this is the section where you can find the details.

Within each product area you can find product specific accessories, here you can find common items which fit a range of fans.

This simple easy to use reference section provides you with all the details you need to complete the selection and specification of your project.



eDemand Controllers

392-397



Air Duct Heater

398



Speed Controllers & Accessories

399-411

Vent-Axia

Accessories & Controls



eDemand Controllers

Electronic voltage controller



Features & Benefits

- Demand ventilation control for A/C speed controllable fans
- Quick start-up by pre-programmed modes
- IP54 Rated
- Total motor protection using thermistor connection
- LCD multi function display
- Menu language – English, German, French, Italian
- 2 x analogue input for sensors (0-10V – separate power supply required, 0-20mA)
- CO₂ Control
- Temperature control
- Constant pressure control
- Manual remote speed adjuster (0-20 mA)
- Min/Max speed limitation - Volume range set point adjustment
- 2 x Programmable relay output - Fault Condition, master slave
- Programmable 2x Digital inputs – On/Off, external fault, manual speed control
- RS485 Modbus interface
- Master/Slave capability via 0-10V output

Equipment/Function

- Mains switch with by-pass function
- Pin protection, to save user settings
- Quick start up by pre-programmed modes
- Max environmental conditions 40 Deg C, 85% Humidity no condensation
- Readout events memory (checking Fault log)

Technical

Line voltage 1~ 230V (-15% / + 10%) 50/60 Hz

Line Voltage 3~208V - 415V (-10%/+6%), 50/60 Hz

Stock Ref	444164	444165	444166	444167	444168
Voltage	1 Phase	1 Phase	3 Phase	3 Phase	3 Phase
Rated current / A	6	10	5	10	15
Max. line fuse / A	10	16	10	16	20
Max. heat dissip. /W	20	40	25	50	70
Weight / kg	1.4	2.4	2.4	2.8	4.8

Interference emissions EN 61000-6-3 (unshielded motor cable)

Interference immunity EN 61000-6-2

For suitability check relevant fan accessory section

Dimensions (mm)

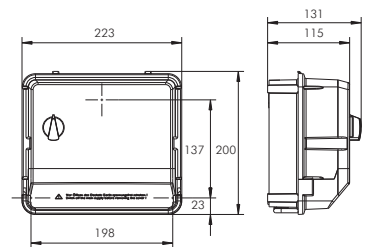

1 Phase 6 Amp

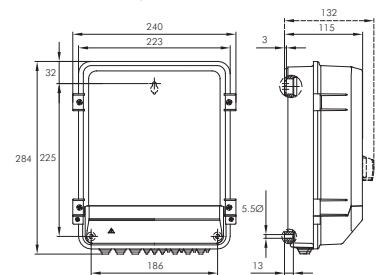

1 Phase 10 Amp

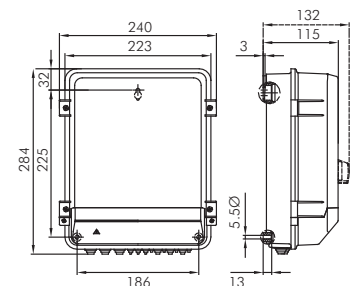

3 Phase 5/10 /15 Amp

eDemand Controllers

Frequency Inverter 1~ to 3~



Features & Benefits

- Demand ventilation control for A/C speed controllable Fans
- Quick start-up by pre-programmed modes
- IP54 Rated
- Total motor protection using thermistor connection
- LCD multi function display
- Menu language - English, German, French, Italian
- 2 x analogue input for sensors (0-10V - separate power supply required, 0-20mA)
- CO₂ Control
- Temperature control
- Constant pressure control
- Manual remote speed adjuster (0-20 mA)
- Min/Max speed limitation - Volume range set point adjustment
- 2 x Programmable relay output - Fault Condition, master slave
- Programmable 2x Digital inputs - On/Off, external fault, manual speed control
- RS485 Modbus Interface
- Master/Slave capability via 0-10V output

Equipment/Function

- Pin protection, to save user settings
- Quick start up by pre-programmed modes
- Integrated SINEFILTER
- Max environmental conditions 40 Deg C, 85% Humidity no condensation
- Readout events memory (checking Fault log)
- Speed control of fans without additional (electromagnetic) motor noise
- Parallel operation of fans, no risk of motor damage (screened motor cables are not required)
- Active power factor adjustment for sinusoidal input current
- Integrated process controller (PID free programmable)

Technical

Line voltage 1~ 208 ... 277 V (-10 % / +10 %), 50/60 Hz

Output voltage 3~ 230V (max. 250V) for 3~ motors in Δ connection

Stock Ref	444177
Voltage	1 Phase
Rated current / A	5
Max. line fuse / A	10
Max. heat dissip. /W	205
Weight / kg	6.6

Max output frequency 100 Hz

Clock frequency 16 Hz

Interference emissions EN 61000-6-3 (unshielded motor cable)

Interference immunity EN 61000-6-2

For suitability check relevant fan accessory section

Dimensions (mm)

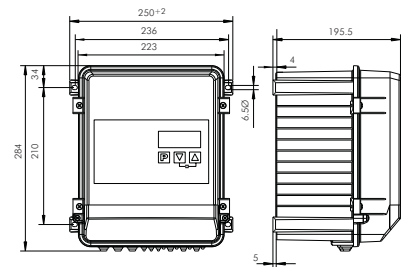

1 Phase 5 Amp

eDemand Controllers

Frequency Inverter 3~



Features & Benefits

- Demand ventilation control for A/C speed controllable Fans
- Quick start-up by pre-programmed modes
- IP54 Rated
- Total motor protection using thermistor connection
- LCD multi function display
- Menu language - English, German, French, Italian
- 2 x analogue input for sensors (0-10V - separate power supply required, 0-20mA)
- CO₂ Control
- Temperature control
- Constant pressure control
- Manual remote speed adjuster (0-20 mA)
- Min/Max speed limitation - Volume range set point adjustment
- 2 x Programmable relay output - Fault Condition, master slave
- Programmable 2x Digital inputs - On/Off, external fault, manual speed control
- RS485 Modbus interface
- Master/Slave capability via 0-10V output

Equipment/Function

- Pin protection, to save user settings
- Quick start up by pre-programmed modes
- Integrated SINEFILTER
- Max environmental conditions 40 Deg C, 85% Humidity no condensation
- Readout events memory (checking Fault log)
- Speed control of fans without additional (electromagnetic) motor noise
- Integrated SINEFILTER between phase to phase & phase to ground
- Parallel operation of fans, no risk of motor damage (screened motor cables are not required)
- Active power factor adjustment for sinusoidal input current
- Integrated process controller (PID free programmable)

Technical

Line voltage 3 ~ 208...480 V (-15 % / +10 %),
50/60 Hz

Stock Ref	444172	444173	444174	444175	444176
Rated current / A	2.5	5	8	14	18
Max. line fuse / A	6	10	10	16	20
Max. heat dissip. /W	50	100	150	310	400
Weight / kg	3.3	7.2	7.9	8.7	9.1

Max output frequency 100 Hz
 Clock frequency 16 Hz
 Interference emissions EN 61000-6-3 (unshielded motor cable)
 Interference immunity EN 61000-6-2
 For suitability check relevant fan accessory section

Dimensions (mm)

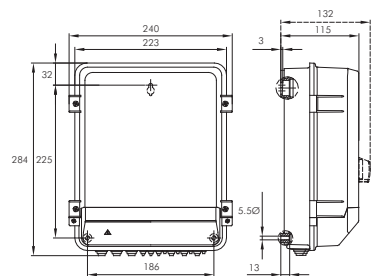

2.5 Amps

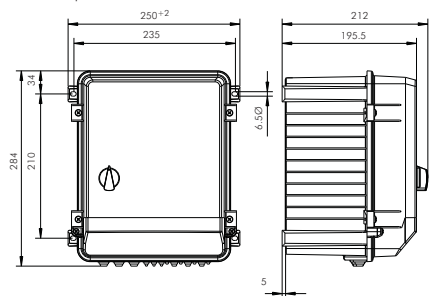

5/8/14/18 Amps

eDemand Controllers Frequency Inverter 1~



Features & Benefits

- Demand ventilation control for A/C speed controllable Fans
- Quick start-up by pre-programmed modes
- IP54 Rated
- Total motor protection using thermistor connection
- LCD multi function display
- Menu language - English, German, French, Italian
- 2 x analogue input for sensors (0-10V - separate power supply required, 0-20mA)
- CO₂ Control
- Temperature control
- Constant pressure control
- Manual remote speed adjuster (0-20 mA)
- Min/Max speed limitation - Volume range set point adjustment
- 2 x Programmable relay output - Fault Condition, master slave
- Programmable 2x Digital inputs - On/Off, external fault, manual speed control
- RS485 Modbus interface
- Master/Slave capability via 0-10V output

Equipment/Function

- Pin protection, to save user settings
- Quick start up by pre-programmed modes
- Integrated SINEFILTER
- Max environmental conditions 35 Deg C, 85% Humidity no condensation
- Readout events memory (checking Fault log)
- Speed control of fans without additional (electromagnetic) motor noise
- Parallel operation of fans, no risk of motor damage (screened motor cables are not required)
- Active power factor adjustment for sinusoidal input current
- Integrated process controller (PID free programmable)

Technical

Line voltage 1~ 208 ... 277 V (-10 % / +10 %), 50/60 Hz

Stock Ref	444169	444170	444171
Voltage	1 Phase	1 Phase	1 Phase
Rated current / A	4	6	10
Input rated Current/ A	3.85	5.85	-
Max. line fuse / A	6	10	16
Max. heat dissip. /W	57	102	130
Weight / kg	3.4	5.7	6.8

Max output frequency 100 Hz

Clock frequency 16 Hz

Interference emissions EN 61000-6-3 (unshielded motor cable)

Interference immunity EN 61000-6-2

For suitability check relevant fan accessory section

Dimensions (mm)

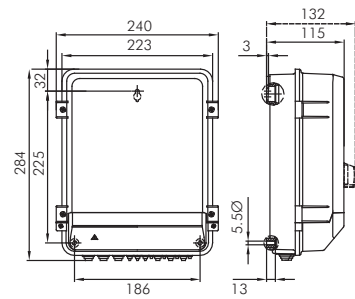

4 Amps

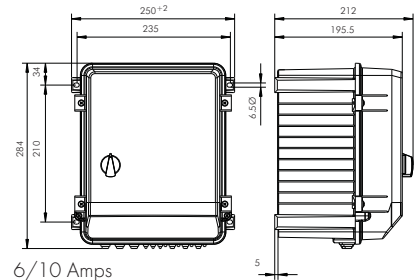

6/10 Amps

eDemand Auto Changeover Panels

Features & Benefits

- IP54 Enclosure
- eDemand compatible
- Single & Three Phase models
- Adjustable duty/share timer
- Automatic changeover (Fan Fail)
- Fan failure alarm contacts

Offering Demand Ventilation control for the wide range of standard AC speed controllable Twin fans, these new changeover panels have been designed to complement the new range of eDemand Controllers and are fully compatible.

Speed control input is suitable for use with the following eDemand Controller ranges:

- Single & Three Phase electronic speed controllers
- Single & Three Phase inverters
- Single to Three Phase inverter

Models

Model	Stock Ref
Three Phase 16 Amp	444179
Single Phase 10 Amp	444180
Single Phase 20 Amp	444181

Dimensions (mm)

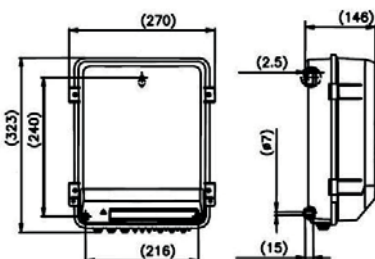

Connection Diagrams

Single Phase Inverters for 444169, 444170 & 444171

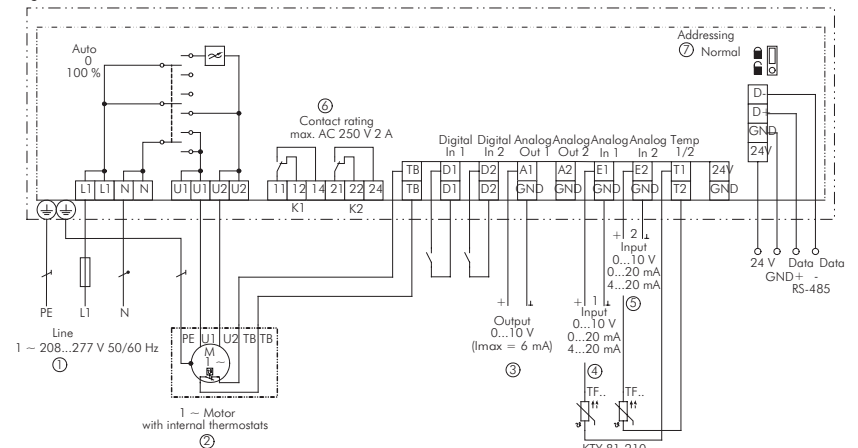

- 1 Line 1 ~ 208...277 V, 50/60 Hz
- 2 1 ~ Motor with internal thermostats
- 3 Output 0...10 V ($I_{max} = 6$ mA)
- 4 Input 1: 0...10 V, 0...20 mA, 4...20 mA, TF.. (KTY81-210), PT1000
- 5 Input 2: 0...10 V, 0...20 mA, 4...20 mA, TF.. (KTY81-210), PT1000
- 6 Contact rating max. 2A / 250 V AC
- 7 Addressing, normal lock closed

Three Phase Inverters for 444172, 444173, 444174, 444175 & 444176

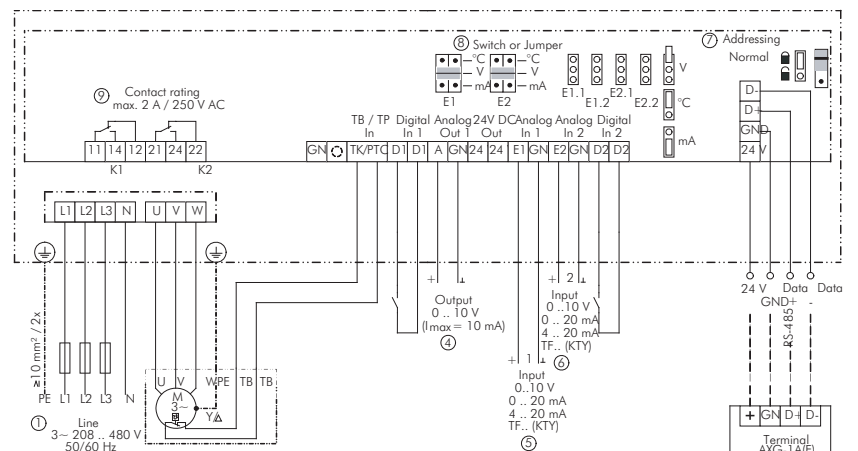

- 1 Line 3 ~ 208...480 V, 50/60 Hz
- 2 Only in special version suitable for IT network!
- 3 ~ Motor with internal thermostats
- 4 Output 0...10 V ($I_{max} = 10$ mA)
- 5 Input 1: 0...10 V, 0...20 mA, 4...20 mA, TF.. (KTY)
- 6 Input 2: 0...10 V, 0...20 mA, 4...20 mA, TF.. (KTY)
- 7 Addressing, normal lock closed
- 8 Switch or jumper depending on version

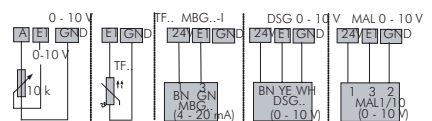



Connection Diagrams

Single Phase Electronic for 444164 & 444165

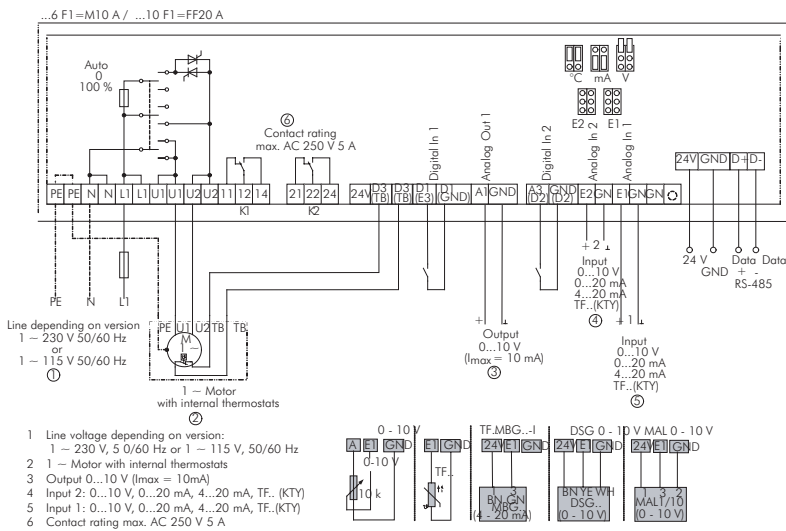

Three Phase Electronic for 444166, 444167 & 444168

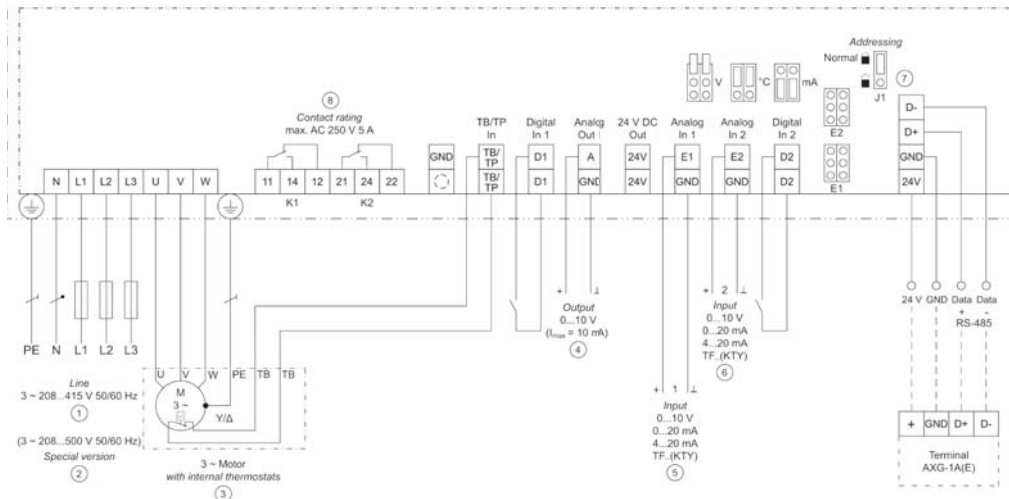

AirTrack Heaters



Features & Benefits

- Supply and extract fan outputs
- Combined temperature and airflow sensor
- Run on timer
- Solid state switching - no mechanical switching breakdown
- Indicators for control status
- High temperature limit and manual reset

The Vent-Axia range of sheathed element air duct heaters with built in control system provide a safe method of air heating which is economical to install and operate.

Construction

Circular Duct Air Heaters comprise of electric resistance elements, mounted in a pre-galvanised steel casing. Elements consist of a nickel/chromium resistance wire, spirally wound, insulated by compacted magnesium oxide powder and fitted within a stainless steel tube. The ends of each element are sealed with silicone rubber. Elements are return bent and mounted in the terminal box with airtight fixing glands.

Standard terminal boxes are made from pre-galvanised sheet steel, 25mm conduit holes and earth stud are provided. The terminal boxes conform to IP30.

Every heater is fitted with a high temperature safety cut out operating at 120°C complete with push button manual reset.

Available in 100, 125, 150, 200, 250, 315, 400 and 500mm diameter sizes. The air velocity across the heater elements must be greater than 2m/s and installed a minimum distance of one metre from the exhaust outlet of the fan unit.

Mounting

Heaters can be mounted in any position, vertical or horizontal. Care should be taken to ensure the cut out remains operational.

Controls

The Vent-Axia range of duct heaters with built-in controls are designed to be cost effective and space saving whilst maintaining the features normally associated with larger control panels.

Duct Air Heater Resistance Graph

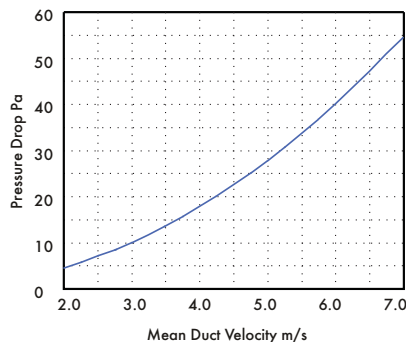

Dimensions (mm)

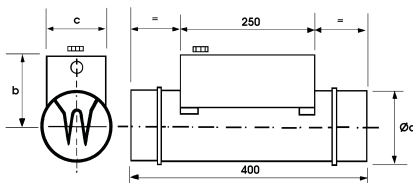

Stock Ref	Øa	b	c	kg
10531100T1	100	160	117	3
10531125T1	125	160	117	3.8
10531150T1	150	160	117	4
10531200T1	200	160	117	6
10531250T1	250	160	117	7.5
10531315T1	315	160	117	8.2
10531315T3	315	160	117	8.5
10531400T3	400	160	117	9.2
10531500T3	500	160	117	10

Duct Air Temperature Rise

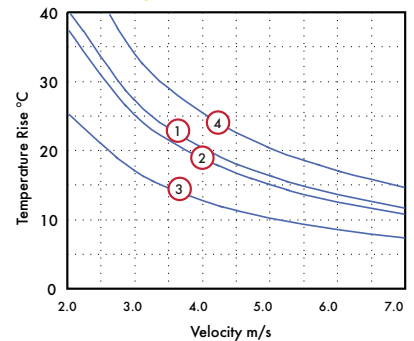

- ① 10531125T1 (1.25kW)
- ② 10531100T1 (0.75kW)
- ③ 10531200T1 (2kW)
- ④ 10531200T1 (4kW)

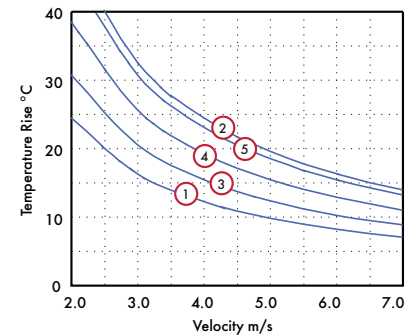

- ① 10531250T1 (3kW)
- ② 10531250T1 (6kW)
- ③ 10531315T1 (4kW)
- ④ 10531315T1 (8kW)
- ⑤ 10531315T3 (9kW)

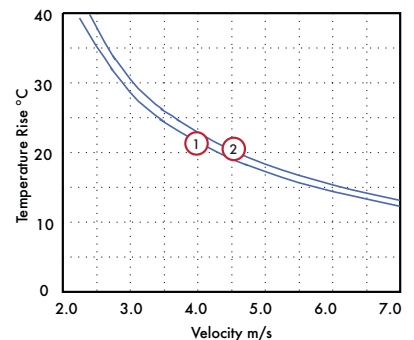

- ① 10531400T3 (12kW)
- ② 10531500T3 (21kW)

RSC ELV Speed Selector (Extra Low Voltage)



Features & Benefits

- Stand alone two speed remote control of any industrial Vent-Axia speed controllable fan
- Maximum rating 9 amp, 1 phase or 3 phase
- Remote control via Vent-Axia sensors or relay in the BMS system
- Night setback facility - saves energy
- Extra low voltage wiring between controller and remote sensor
- Enclosure protected to IP65

Speed Selector

The RSC ELV (Extra Low Voltage) two speed selector has been especially developed for use with Industrial products to offer energy saving on all ventilation systems. Typically, ventilation systems are designed to cope with periods of peak demand, extracting expensively heated and conditioned air even through periods of low occupancy. Vent-Axia's Two Speed Selector works by switching the power source between mains supply and a speed controller enabling reduction in the volume of air extracted during periods of low demand. The selection of power can be achieved by a Vent-Axia sensor or timer with volt free contacts or via a relay from the BMS (Building Management System). Connections between the RSC and the sensor are Extra Low Voltage.

The RSC ELV two speed selector comprises of three modules, the RSC controller (103 14 230A) an electronic or 5-step auto-transformer appropriately rated to suit the fan and a Vent-Axia compatible sensor.

The two speed changeover of the RSC ELV 24 is controlled by Vent-Axia compatible auto sensors utilising Extra Low Voltage wiring.

With up to five speeds being available selected from a 5-step auto transformer controller.

Electrical

9 Amp maximum rating on single phase 220V-240V/1/50Hz and three phase 380-415V/3/50Hz.

Dimensions

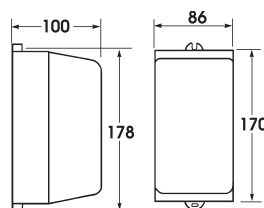

Models

RSC ELV Speed Selector (Extra Low Voltage)

Stock Ref
10314230

Compatible Auto Sensors



ThermoSwitch

Operates on either a fall or rise in temperature for extraction of excess heat. Range 6°C to 30°C.

Stock Ref
563502



7-Day TimeSwitch

7-Day timer with analogue display. Override facility. Gives twelve On or Off positions per day.

Stock Ref
563515



Ecotronic Humidistat

An electronic On/Off humidistat with concealed humidity adjustment 65-90% RH with pullcord override. Neon indicator. Changeover relay switch.

Stock Ref
563550



HumidiSwitch

Actuates ventilating units on either a rise or fall in humidity. Range 20% to 80% RH.

Stock Ref
563501



Air Quality Sensor

Automatically reacts to tobacco smoke, smells and toilet odours to trigger the system or switch to high speed.

Stock Ref
563506



Visionex PIR Detector

Ceiling mounted movement detector. Adjustable overrun timer 5 to 25 minutes. Fits any UK single gang mounting box. Range of detection up to 10 metres. 220-240V

Stock Ref
459623

Duct Attenuators



Duct Attenuators

Easily installed, the duct attenuator is used in the system to absorb sound. Available in 100, 125, 150, 200, 250, 315 and 400mm diameter sizes. Manufactured in galvanised sheet metal with 50mm Rockwool sound absorption material. Maximum operating temp. 100°C.

Dimensions

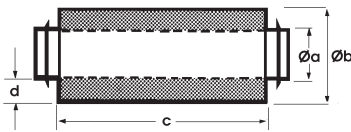

Stock Ref	Øa	Øb	c	d	kg
10534100	100	200	300	50	2.4
10534125	125	225	300	50	2.6
10534150	150	250	300	50	4.1
10535100	100	200	600	50	2.9
10535125	125	225	600	50	4.5
10535150	150	250	600	50	5.8
10535200	200	315	600	57.5	7
10535250	250	355	600	52.5	8.6
10535315	315	450	600	67.5	9.8
10535400	400	630	600	115	18
10536100	100	200	900	50	6.6
10536125	125	225	900	50	7.6
10536150	150	250	900	50	9
10536200	200	315	900	57.5	10
10536250	250	355	900	52.5	12.2
10536315	315	450	900	67.5	15
10536400	400	630	900	115	21
10537200	200	315	1200	57.5	14
10537250	250	355	1200	52.5	18
10537315	315	450	1200	67.5	21
10537400	400	630	1200	115	27

Resistance Graph

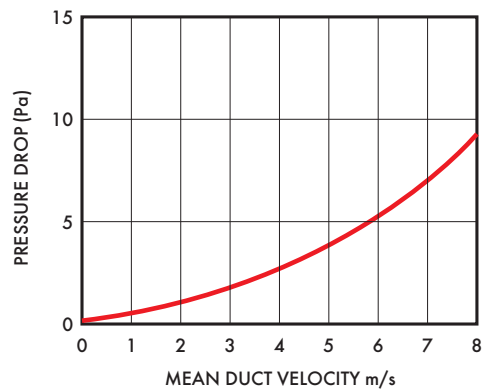

Duct Attenuator Insertion Losses

Stock Ref	Length	Duct Ø	63	125	250	500	1k	2k	4k	8k
10534100	300	100	3	4	10	18	23	25	25	12
10534125	300	125	3	4	8	17	21	23	21	11
10534150	300	150	3	3	6	14	20	23	21	11
10535100	600	100	5	8	16	33	39	40	36	17
10535125	600	125	4	8	13	30	34	35	31	15
10535150	600	150	4	7	13	23	29	36	31	15
10535200	600	200	4	5	11	21	26	32	20	9
10535250	600	250	3	6	10	19	24	29	19	8
10535315	600	315	3	5	8	16	21	22	16	15
10535400	600	400	3	4	7	14	18	19	14	13
10536100	900	100	10	13	20	39	45	38	35	18
10536125	900	125	9	12	18	37	41	37	32	16
10536150	900	150	8	9	15	30	37	37	33	17
10536200	900	200	7	9	14	27	31	36	25	12
10536250	900	250	5	8	13	24	30	31	22	11
10536315	900	315	4	7	11	20	31	27	17	12
10536400	900	400	4	6	9	18	26	24	16	11
10537200	1200	200	10	12	17	35	40	43	27	13
10537250	1200	250	7	9	15	31	36	38	26	12
10537315	1200	315	6	8	13	23	32	30	18	11
10537400	1200	400	5	8	12	20	29	27	17	9

Heat Exchange Unit



Heat Exchange Unit

A 'stand alone' heat exchange module which will transfer up to 70% of the outgoing heat to incoming air. Polymeric construction with spigots to suit 200, 250 and 315mm flexible ductwork. Module accessible for routine cleaning. Condensate outlet provided. Ideal for use in air conditioned environments. The Heat Exchanger works at the same high efficiency, automatically keeping a cool room cool.

By transferring heat from the extracted stale air, fresh pre-heated air is supplied to the room from outside, maintaining oxygen levels and preventing stuffiness. Maximum operating temperature 0°C to 70°C. (Weight 9kg)

Typical Installation

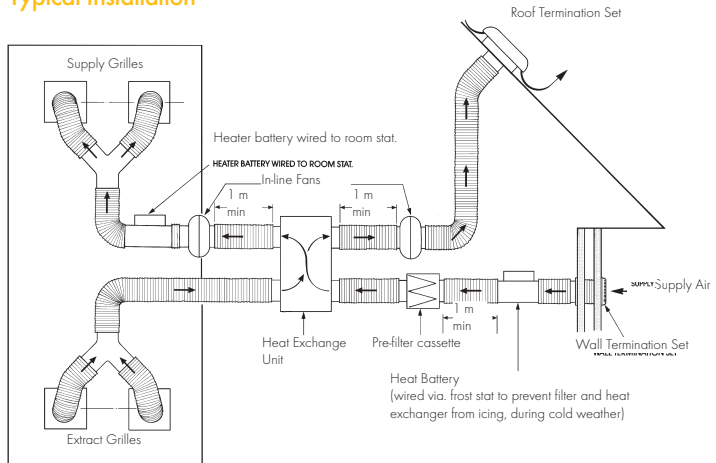

Dimensions

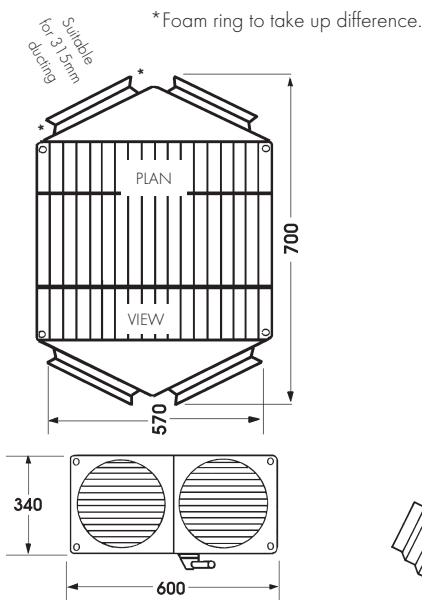

Heat Exchange Resistance Graph

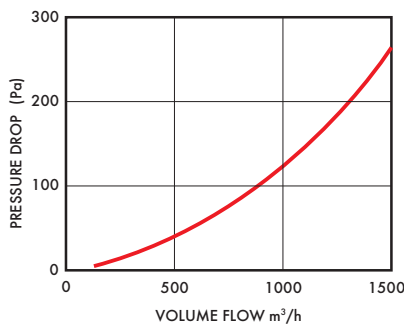

Thermal Efficiency Graph

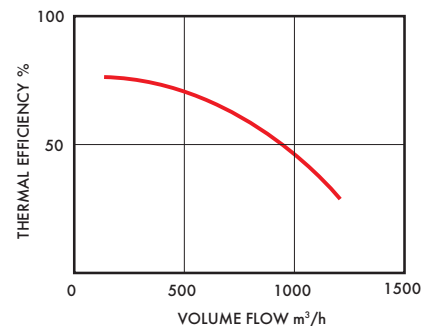

WARNING

Both airflows to be subjected to the same conditions (ie. negative or positive pressure)
Maximum differential pressure must not exceed 150Pa.

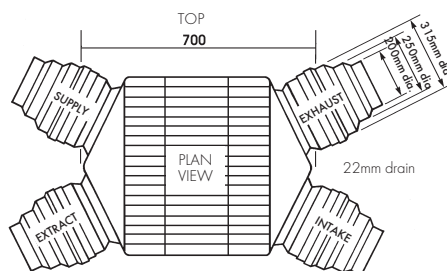

Vent-Axia heat exchange unit

Dia.	Stock Ref	Weight
315mm	10538290 + 10577315	9 kg

Vent-Axia heat exchange unit

Dia.	Stock Ref
200mm	10538290 + 10577315 + 10578315
250mm	10538290 + 10577315 + 10578315

Accessories



Electronic Controllers

The 2.5 amp controller provides electronic motor speed control. On/Off with neon indicator, infinitely variable speed slider control, minimum speed presettable and optional sensor mode. Connections for use with external sensors are provided.

3 and 6 amp electronic controllers provide infinitely variable speed control from preset minimum to maximum. Features an On/Off switch with neon indicator and speed control knob. Built in 'Hard Start' auto maximum speed for a few seconds.

10 amp electronic controller provides infinitely variable speed control from preset minimum to maximum and feature On/Off Override switch for maximum speed. Neon indicator and built-in 'Hard Start' auto-maximum speed for a few seconds.

For ambient temperatures between 30-40°C the controller rating must be reduced by 2% for every 1°C above 30°C, eg. reduce by 10% at 35°C.

Stock Ref	Max. amps	Dimensions (mm) W x H x D	Weight kg
W10303102M	2.5	156 x 86 x 53	0.4
10303103	3	150 x 90 x 65	0.5
10303106	6	150 x 90 x 65	0.5
10303110	10	167 x 220 x 130	1.3

Five Step Auto Transformers

Used in conjunction with speed controllable fans to provide 5 stepped speed without electronic motor 'hum and vibration'. Several fans can be connected to one transformer provided their combined load does not exceed the controller rating.

Single phase: 2.0, 3.5, 6.0, 7.5, 9.0 and 14 amp.
Three phase: 1.0, 2.0, 4.0, 7.0 and 14 amp.
Rotary switch giving On/Off and five speeds.
Output voltages at 240V/1PH/50Hz
0, 65, 110, 135, 170 and 240 volts.
Output voltages at 415V/3PH/50Hz
0, 65, 110, 175, 285, 415 volts.
Neon indicator. Three phase units complete with terminals for remote on/off switch.

Multi-unit Speed Control

When more than one fan is required to be controlled by one Auto Transformer, then the total combined FLC of all the fan units must not exceed 90% of the controllers maximum rating and not more than 2 x the total SC. The TKs must be wired in series. Fans without TKs or in-built S.T.O.P must not be wired in multiples.

Single Phase

Stock Ref	Max Peak Load Current	Dimensions (mm) H x W x D	Weight kg
10314103*	3.5	230 x 168 x 118	4.6
10314105*	6.0	230 x 166 x 118	5.0
10314107*	7.5	284 x 240 x 132	6.2
10314113*	14.0	316 x 270 x 168	16.5

*IP54 enclosures

Three Phase

Stock Ref	Max Peak Load Current	Dimensions (mm) H x W x D	Weight kg
10314301*	1.0 amps	284 x 240 x 132	4.7
10314304†	4.0 amps	316 x 270 x 168	12.9
10314307†	7.0 amps	324 x 270 x 168	15.6
10314311†	14.0 amps	295 x 400 x 170	30.0

*IP54 enclosure †IP21 enclosure

Direct on-line starters

Suitable for all models. Push button Start/Stop. 240V contactor coil for single phase applications and three phase supplies where a neutral is present. 415V contactor coil for three phase supplies where a neutral is not present or required.

Protection is given by an overload relay which is selected to match the load of the fan.

Enclosures are protected to IP65.

Overloads

Stock Ref	DOL Rating (Amps)	Star Delta Rating (Amps)
444696	0.16-0.25	-
444697	0.25-0.4	-
444698	0.4-0.63	-
444699	0.63-1.0	-
444700	1.0-1.6	-
444701	1.6-2.25	2.7-4.3
444702	2.5-4.0	4.3-6.9
444703	4.0-6.0	6.9-10
444704	5.5-8.0	9.5-13.8
444705	7-10	12-17
444706	10-13	17-22
444707	13-18	22-31
444708	18-25	31-43
444709	23-32	39-55

DOL & Star Delta Starters

Stock Ref	Phase	DOL Rating (Amps)	Star Delta Rating (Amps)
444744	1	12	-
444745	1	25	-
444746	1	32	-
444747	3	12	-
444748	3	25	-
444749	3	32	-
444750	3	50	-
444842	-	-	21
444843	-	-	30



Backdraught Shutters

Duct sleeve manufactured from galvanised steel. The circular butterfly shutter is fitted with a return spring for positive closing.

Available in 100, 125, 150, 200, 250, and 315mm diameter sizes.

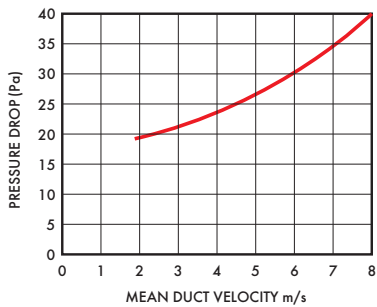

Dimensions

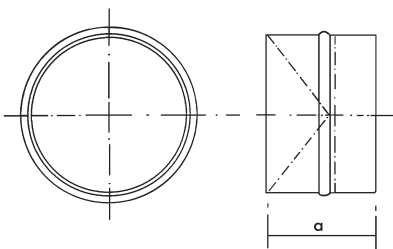

Stock Ref	Dia	a
10542100	100mm	88mm
10542125	125mm	88mm
10542150	150mm	88mm
10542200	200mm	88mm
10542250	250mm	128mm
10542315	315mm	128mm



Fast Clamps

Used to connect rigid ductwork to Airtrak fans. The clamp is manufactured from galvanised steel and features a thick neoprene rubber pad which is fixed on the inside. The clamp acts effectively as a vibration absorber and a noise suppressor. The fast clamp is tightened by two quick release bolts. Available in 100,125, 150, 200, 315 and 400mm diameter sizes.

Max. operating temperature 150°C.

Dimensions

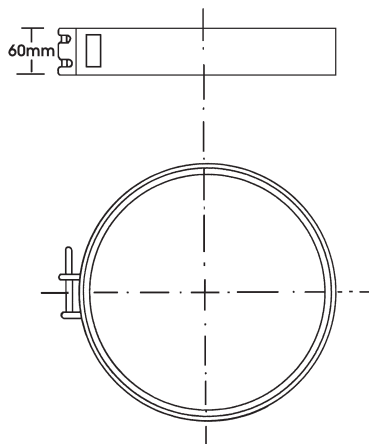

Stock Ref	Dia
10540125	100mm
10540125	125mm
10540150	150mm
10540200	200mm
10540250	250mm
10540315	315mm

Accessories



Bag Filter Cassettes

Bag filter cassettes are available in a range of seven sizes. The synthetic filter medium is to EU5 Eurovent 4/5 94% arrestance. The housing is galvanised sheet metal with spigots fitted with integral seals. Quick release catches allow easy access to the bag filter. Replacement bag filters are available.

Resistance Graph

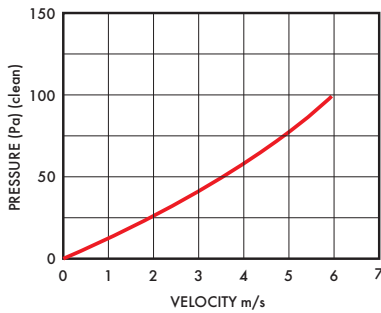

Stock Ref	Dia	Spare filter
10533100	100mm	10557150
10533125	125mm	10557150
10533150	150mm	10557150
10533200	200mm	10557200
10533250	250mm	10557250
10533315	315mm	10557315
10533400	400mm	10557400
10533500	500mm	10557500

Dimensions

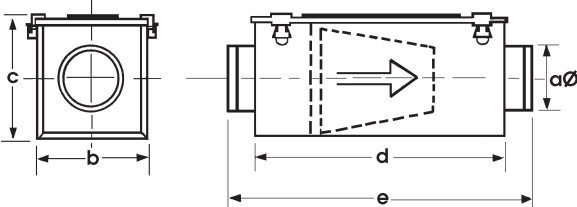

Stock Ref	Øa	b	c	d	e	kgs
10533100	100	200	203	450	540	4
10533125	125	200	203	450	540	4
10533150	150	200	203	450	540	4
10533200	200	245	248	450	560	5
10533250	250	295	298	500	620	7
10533315	315	345	348	550	670	8.5
10533400	400	445	448	650	770	12
10533500	500	600	600	650	770	12



Pre-Filter Cassettes

Pre-filter cassettes are available in a range of seven sizes and are tested to EU3 (Eurovent 4/5) 85% arrestance. Housing is in galvanised sheet metal. Spigots are fitted with integral seals. Quick release catches allow access to the filter medium. Replacement pre-filters are available.

Resistance Graph

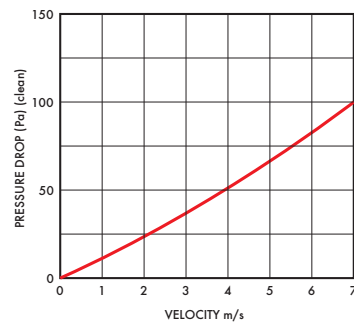

Dimensions

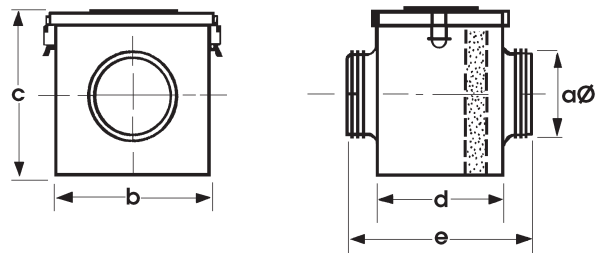

Stock Ref	Øa	b	c	d	e	kg
10532100	100	205	170	120	227	2
10532125	125	215	205	140	252	2
10532150	150	265	235	155	267	3
10532200	200	315	275	180	302	3.5
10532250	250	365	325	230	352	5.5
10532315	315	425	390	330	452	7
10532400	400	515	495	455	487	10.5

Diameter	Pre-filter cassettes	
	Stock Ref	Spare filter Stock Ref
100mm	10532100	10556100
125mm	10532125	10556125
150mm	10532150	10556150
200mm	10532200	10556200
250mm	10532250	10556250
315mm	10532315	10556315
400mm	10532400	10556400



Joining Pieces

Used to join lengths of flexible ducting to give a long-lasting airtight connection. Manufactured from galvanized steel. Available in 100, 125, 150, 200, 315 and 400mm diameter sizes.

Stock Ref	Dia
561804	100mm
561805	125mm
561806	150mm
561808	200mm
561810	250mm
561813	315mm



Worm Drive clips

Stainless steel bands used for securing flexible ducting. Available to fit 100, 125, 150, 200, 250, 315, 355, 400, 450, 500, 560 and 630mm diameter sizes.

Stock Ref	Dia
561704	100mm
561707	125mm
561707	150mm
561710	200mm
561710	250mm
561715	315mm
561715	355mm
561720	400mm
561720	450mm
561720	500mm
561726	560mm
561726	630mm

Accessories



Louvred Shutters

A range of twelve sizes of shutter with gravity return flaps to protect against backdraughts. The frame is manufactured from high impact polystyrene and the louvres from P.V.C. All components are UV stabilised.

Resistance Graph

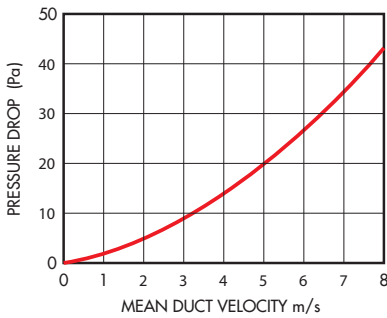

3-Way Splitter

For dividing a ventilation system, providing ducting to multiple supply or extract grilles using only a single fan source. Manufactured from high impact polymeric material with a maximum operating temperature of +50°C.

Resistance Graph

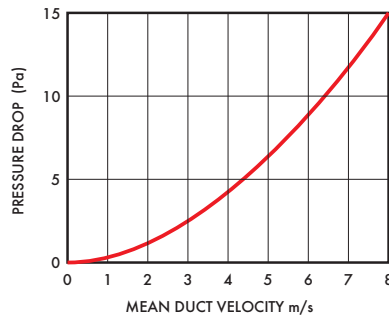

Duct 'Y' Piece

For dividing a ventilation system, providing ducting to multiple supply or extract grilles using only a single fan source. Available in fire retardant ABS.

Vent-Axia Duct Y Piece

2 x	Into 1 x	Stock Ref
100	100	452081
100	150	452082
125	125	455211
125	150	455212
150	150	452083
150	200	452084
200	200	452085
200	250	452078
250	250	452076
250	300	452079

Dimensions

Typical Installation

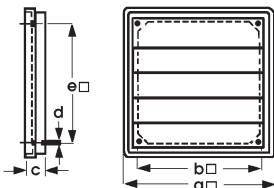

Stock Ref	Dia.	a	*b	c	Ød	e
LS100	100mm	139	100	15	4	95
LS125	125mm	160	135	15	5	110
LS150	150mm	180	155	20	5	130
LS200	200mm	242	205	20	5	182
LS250	250mm	294	265	25	5	230
LS315	315mm	360	310	27	5	295
LS355	355mm	411	349	27	5	329
LS400	400mm	456	409	27	5	382
LS450	450mm	505	458	27	5	432
LS500	500mm	560	508	27	5	477
LS560	560mm	605	565	31	5	533
LS630	630mm	696	657	31	5	626

* Fixing hole

Dimensions

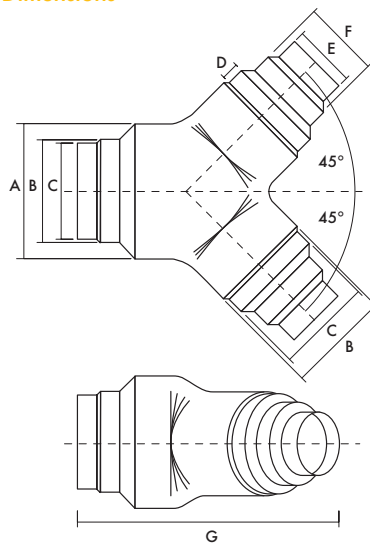

Stock Ref	A Ø	B Ø	C Ø	D	E Ø	F Ø	G
10551250	-	250	200	45	150	-	500
10553400	400	315	300	45	200	250	625



Wall or Window Termination Sets

Used to terminate flexible ducting at walls utilising worm drive clips. Flexible wall sleeve and fixing rods can be cut to suit varying wall thicknesses up to 360mm.

Consists of: Direct mount spigot, grille, flexible wall sleeve and all fixings.

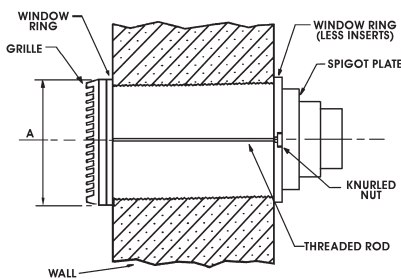
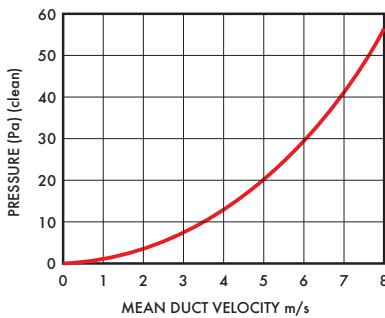

Spigot Dia.	Grille Size 'A' H x W	Hole required in		Stock Ref
		wall Ø	window Ø	
100mm	220 x 226	210	184	W10554150
125mm	220 x 226	210	184	W10554150
150mm	220 x 226	210	184	W10554150
200mm	258 x 265	240	222	W10554200
250mm	302 x 304	290	260	W10554250
315mm	378 x 381	370	337	W10554315

Roof Termination Sets

Used to terminate flexible ducting at roofs utilising worm drive clips.

Consists of: Direct mount spigot, adaptor kit, roof cowl, deflector and all screws.

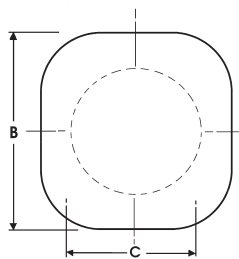
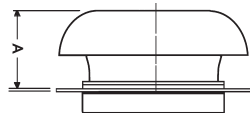
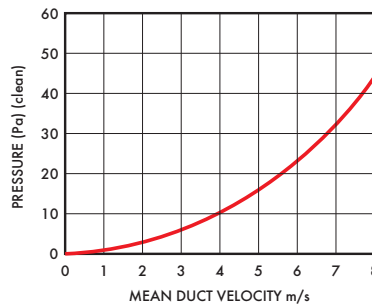

Dia.	a	b	cØ	Stock Ref
100mm	100	285	184	10555150
125mm	100	285	184	10555150
150mm	100	285	184	10555150
200mm	136	400	222	10555200
250mm	136	400	260	10555250
315mm	171	500	337	10555315

Roof plate assembly

Termination Set	Roof Plate Assembly
10555150	560136
10555200	560137
10555250	560139
10555315	560142

Louvred Grilles

Louvred grilles can be used for air replacement for extract purposes and as an external louver. Available in four sizes, the assembly fits over, rather than into the aperture making it especially useful where there are space restrictions within the duct.

Manufactured in thermoplastic. Choice of three colours: Ivory, Brown or Grey.

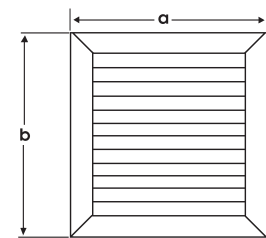
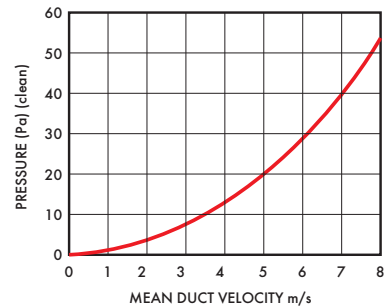

Stock Ref	Colour	hole size	Louvred grilles	
			a	b
W561431	Grey	230mm	310	303
561421	Ivory	230mm	310	303
561411	Brown	230mm	310	303
W561432	Grey	270mm	351	344
561422	Ivory	270mm	351	344
561412	Brown	270mm	351	344
W561433	Grey	300mm	391	388
561423	Ivory	300mm	391	388
561413	Brown	300mm	391	388
W561434	Grey	380mm	470	467
561424	Ivory	380mm	470	467
561414	Brown	380mm	470	467

Accessories



Circular Supply & Exhaust Diffusers

Manufactured from powder coated steel. Suitable for supplying or exhausting air and can be fitted directly to the duct or in the ceiling. Available in 100, 125, 150, and 200mm diameter sizes.

Dimensions

100, 125 dia

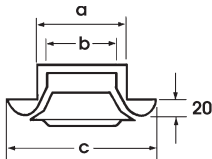

150, 200 dia

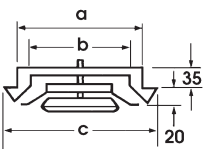

Dia.	Stock Ref	a	b	c	Weight	
					valve	frame
100mm	10543100	100	80	150	150	90
125mm	10543125	125	96	158	160	130
150mm	10543150	150	115	195	230	150
200mm	10544200	200	163	210	340	180

Circular Exhaust Diffusers

Dia.	Stock Ref	a	b	c	g	Weight	
						valve	frame
100mm	10544100	100	70	143	115	90	
125mm	10544125	125	96	158	150	130	
150mm	10544150	150	115	195	200	150	
200mm	10544200	200	163	210	340	180	

Supply Diffusers Curves

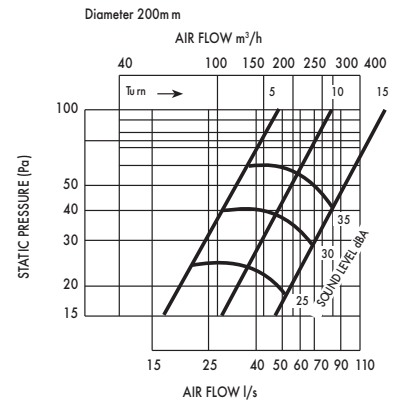
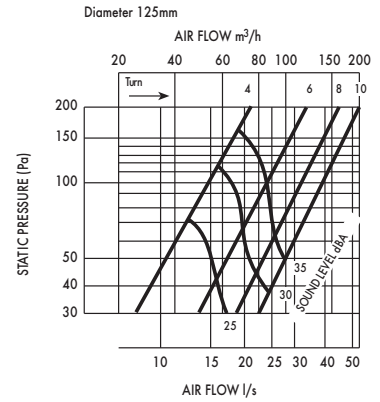
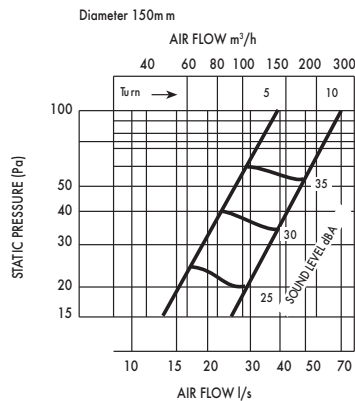
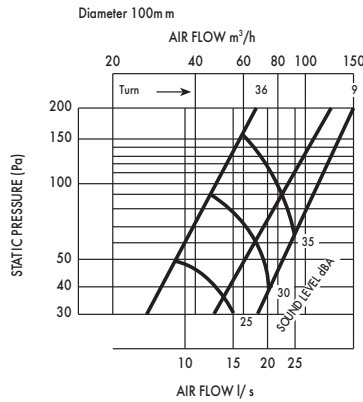

eg. 100mm diameter supply diffuser. Design 15l/s flow
3 turns ~ 30-35 dBA ~ 130Pa
6 turns ~ 25-30 dBA ~ 40Pa

Exhaust Diffusers Curves

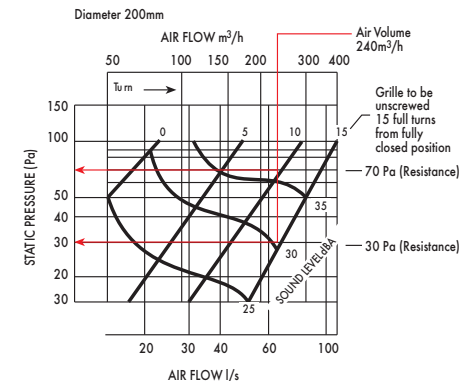
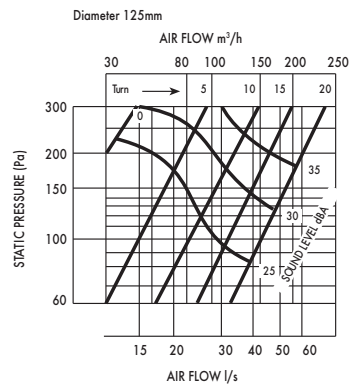
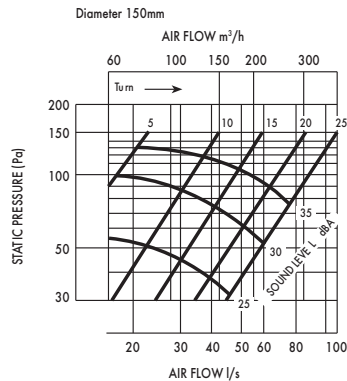
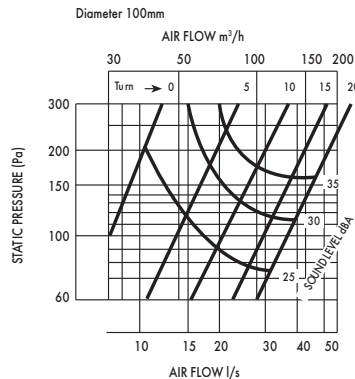



Plenum Boxes

The Plenum box allows square grilles and diffusers to connect to circular duct. Each box size has a two diameter circular spigot for maximum versatility. The box is deep enough to accommodate both a double deflection grille and opposed blade damper.

Manufactured in flame retardant high impact recyclable thermoplastic.

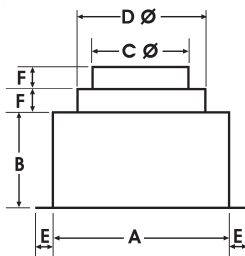

Stock Ref	A	B	C Ø	D Ø	E	F
560601	200	130	125	150	25	25
560602	250	130	150	175	25	25
560603	300	130	200	225	25	25
560604	300	130	250	300	25	25
560605	450	130	315	400	25	25



Single Deflection Grilles

Suitable for either sidewall or exposed duct applications. A single row of blades permits up to 45° deflection of the air in one plane. Satin silver finish.

Size 6/7 fits 300mm square modular size and size 9/12 fits 450mm square modular size.

Unit size	Module size	Stock Ref
Size 6/7	300 mm □	561372
Size 9/12	450 mm □	561373
Also available in the following sizes:-		
	200mm □	561370
	250mm □	561371



Eggcrate Grilles - Satin silver & white finish

Eggcrate grilles can be used for air replacement or air extract purposes.

Used underneath Roof Plate Assemblies with roof models, underneath single spigots in ceilings, underneath mounting boxes and on the inside faces of walls that have units in Fixed and Removable wall plates on the outside of the wall.

Comprising a 13mm square by 13mm deep mesh eggcrate core housed in a frame which has a satin silver or white finish.

Size 6/7 fits 300mm square modular size and size 9/12 fits 450mm square modular size.

Size 6/7 - 785cm² free area
Size 9/12 - 1810cm² free area

Eggcrate grilles satin silver finish

Unit size	Module size	Stock Ref
Size 6/7	300 mm □	561301
Size 9/12	450 mm □	561302
Also available in the following sizes:-		
	200mm □	561303
	250mm □	561305

Eggcrate grilles white finish

Unit size	Module size	Stock Ref
Size 6/7	300 mm □	560849
Size 9/12	450 mm □	560850
Also available in the following sizes:-		
	125mm □	560846
	200mm □	560847

Accessories



4-Way Diffusers

Manufactured in light polypropylene plastic. With four diffuser cassettes which can be set for downward or 45 degree discharge in any of sixteen directional combinations.

Stock Ref	Neck Size	Colour
10546230	225mm <input type="checkbox"/>	Ivory
10546300	300mm <input type="checkbox"/>	Ivory
10546350	350mm <input type="checkbox"/>	Ivory
10546400	400mm <input type="checkbox"/>	Ivory
10546450	450mm <input type="checkbox"/>	Ivory
10546500	500mm* <input type="checkbox"/>	Ivory

* Fits ceiling grid size 595mm

Dimensions (mm)

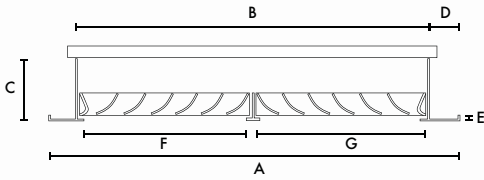

Stock Ref	a <input type="checkbox"/>	b <input type="checkbox"/>	c	d	e	f <input type="checkbox"/>	g <input type="checkbox"/>
10546230	265	224	60	20	5	102	112
10546300	335	292	60	22	5	136	140
10546350	390	345	60	22	5	162	168
10546400	440	395	75	22	8	183	190
10546450	490	459	75	22	8	208	215
10546500	595	495	70	50	10	236	240

Diffuser		Neck Adaptor	
Stock Ref		Stock Ref	Duct Ø
10546230	OR	10547150	150
10546230	OR	10547200	200
10546300		10547250	250
10546350		10547300	300
10546400		10547400	400
10546450		10548400	400
10546500		10548000	315/400

Performance

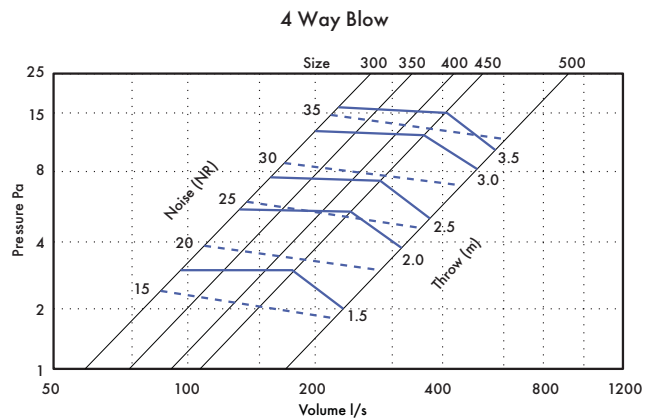
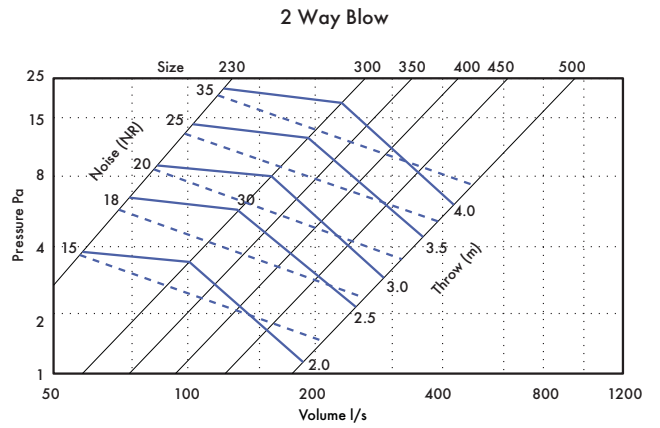
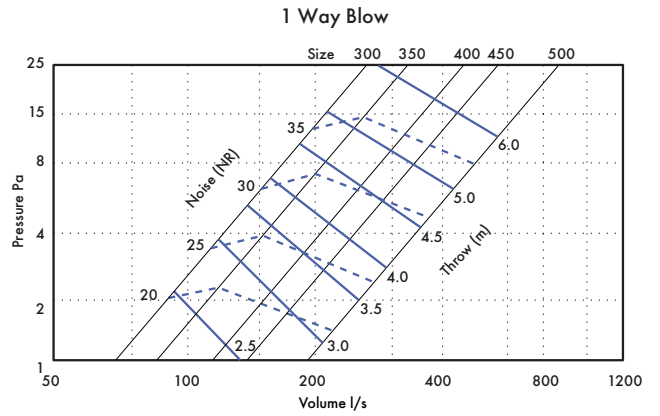

Optional Air Flow Direction

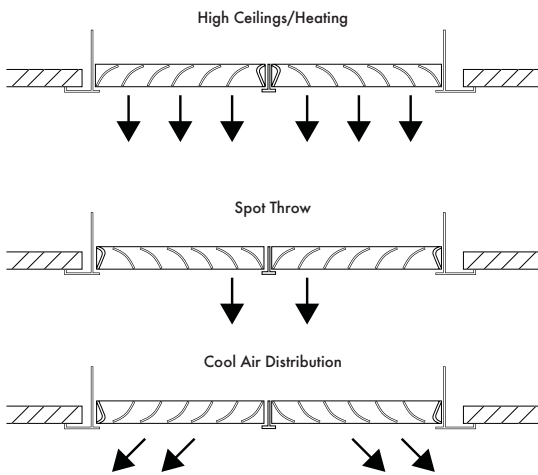
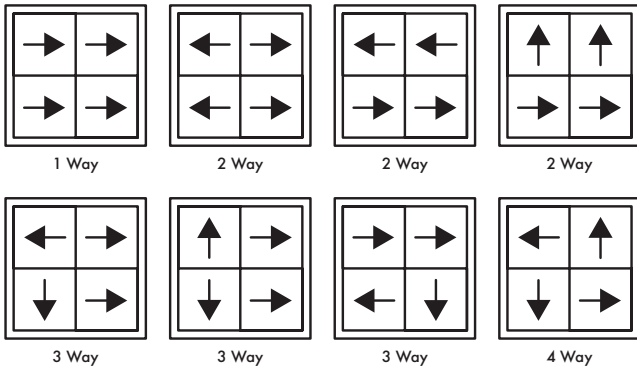

Mounting Types

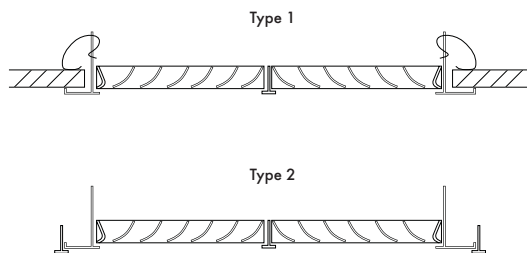

Neck Adaptors

Used to connect flexible ducting directly to 4-way diffusers for intake/extract applications.

Stock Ref	4 - way diffuser size	Duct Ø
10547150	225mm	150mm
10547200	225mm	200mm
10547250	300mm	250mm
10547300	350mm	315mm
10547400	400mm	400mm
10548400	450mm	400mm
10548000	500mm	315/400mm

Dimensions (mm)

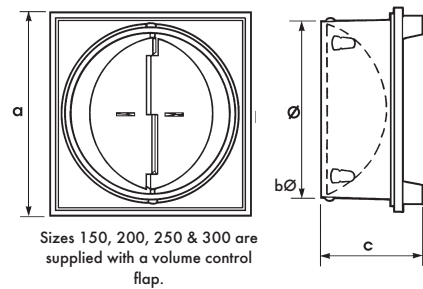

Stock Ref	Duct Dia.	a	Øb	c
10547150	150	235	145	115
10547200	200	235	195	115
10547250	250	305	245	115
10547300	300/315	355	295	110
10547400	400	407	400	90
10548400	400	459	400	92
10548000	315/400	500	315/400	168 max