

B.E.G. LUXOMAT®



▪ www.beg-luxomat.com ▪



OUTDOOR AND INDOOR MOTION DETECTORS



| Energy savings

| Security

| Comfort

The outdoor motion detector RC-plus next – The premium class

- Energy saving by courtesy of follow up accommodation
- Additional cover clips also ensure stepless adjustment of the detection area
- Modern sensors for a better quality of detection by walking towards
- Easy installation with plug-in socket



Smartphone with B.E.G. App and IR-RC-Adapter



UP TO 4 DIFFERENT COLOURS

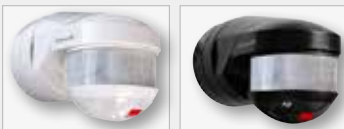

white black



brown Silver

SOCKET COMPATIBLE TO PREVIOUS

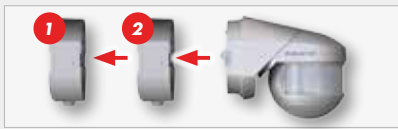

1) RC-plus or Vario base
2) RC-plus next retaining ring

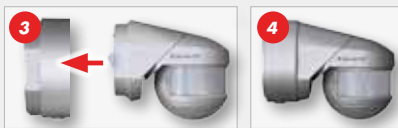

3) RC-plus or Vario base with retaining ring
4) Base complete

TYPES OF MOUNTING



Wall mounting



Ceiling mounting



Corner mounting with socket base



Adjustable sensor head lens



Blinds and coverage



One-handed plug-in base mounting

Concealed controller for lag time, range and Lux values

Cable entry from above, below or behind

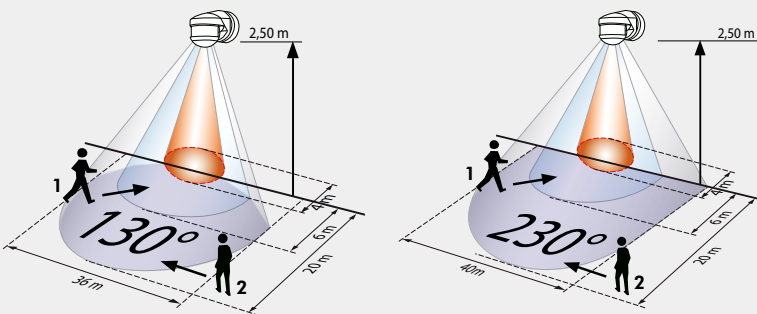

- 1 ■ Walking towards
- 2 ■ Walking across
- Anti-creep protection

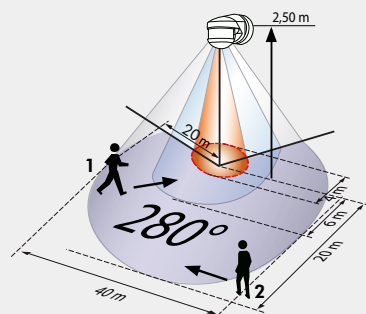

Product	Colour	B.E.G.
RC-plus next 130	white	97001
RC-plus next 230	white	97002
RC-plus next 280	white	97003
IR-RC	grey	92000
IR-RC-Mini	grey	92090
RC-plus next 230 KNX	white	97052
IR-RC-Adapter for B.E.G. Remote Control App	black	92726



LC-plus 280
Spherical head adjustable

LC-Click-N 140/200
360° anti creep protection

LC-Mini 120/180
Spherical head adjustable in two levels

Smartphone with
B.E.G. App and
IR-RC-Adapter

- Electronic micro processor controlled motion detector with 360°-anti-creep for a gapless monitoring
- Adjustment light level and time setting by screwdriver or potentiometers at the bottom of the detector ball.
- Wall mounting or outdoor mounting with special socket (included)
- 16 m detection

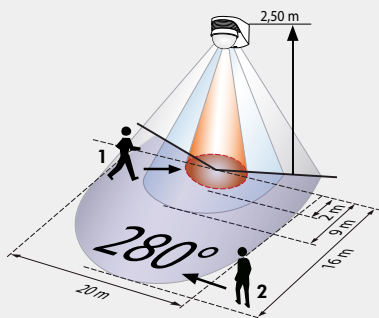

- 1 ■ Walking towards
- 2 ■ Walking across
- Anti-creep protection

- Range of detection 140° and 200° plus 360° anti-creep protection
- Fits on every 60mm FM-holder box resp. hides the whole holder box
- Easy installation with plug-in socket
- 12 m detection

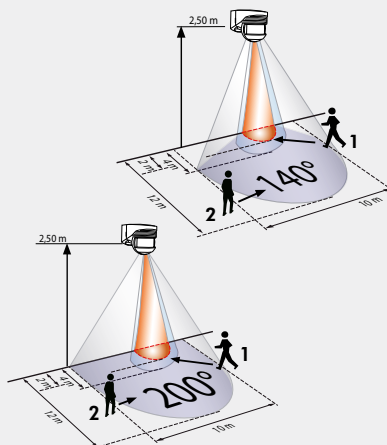

- 1 ■ Walking towards
- 2 ■ Walking across
- Anti-creep protection

- Range of detection 120° and 180°
- The detection area can be altered by blinds, which are included. The blinds can be clipped-on and moved to stop unwanted detection.
- Adjustment light level and time setting by screwdriver or potentiometers at the bottom of the detector ball.
- 10 m detection

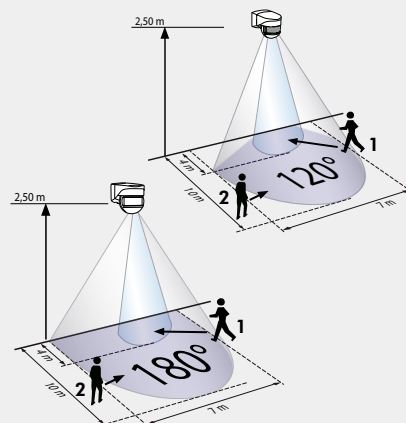

- 1 ■ Walking towards
- 2 ■ Walking across

Product	Colour	B.E.G.
LC-plus 280	white	91008
LC-plus 280	black	91028
IR-LC-Mini	grey	92093
IR-LC-plus	grey	92095
IR-RC-Adapter for B.E.G. Remote Control App	black	92726

Product	Colour	B.E.G.
LC-Click-N 140	white	91001
LC-Click-N 140	black	91021
LC-Click-N 200	white	91002
LC-Click-N 200	black	91022

Product	Colour	B.E.G.
LC-Mini 120	white	91051
LC-Mini 120	black	91071
LC-Mini 180	white	91052
LC-Mini 180	black	91072

A special solution to integrate the SMARTHOME radio system!

- Remote controllable ceiling-mounted motion detectors PD3N-1C in surface-mount and ceiling-mount version with circular detection area
- Switching for all types of light fixtures by high performance relay
- Optical system, designed for highest sensitivity
- Also available in 2 channel acoustic, and wireless versions

PD3N-2C
Detects smallest movements

PD3N-1C-SM
Separate wiring base to speed installation

PD3N-1C (Acoustic)
Picks up on movement and then sound

Smartphone with B.E.G. App and IR-RC-Adapter



TYPES OF MOUNTING

SPECIALS



Surface mounted Flush ceiling mounted



Blinds and coverage

Hidden potentiometers for follow-up time, range and lux value

PD3N -XC (-Micro) -SM SM: Surface mounting
-FC FC: Flush-ceiling mounting

Product type Numbers of channels with acoustic sensor

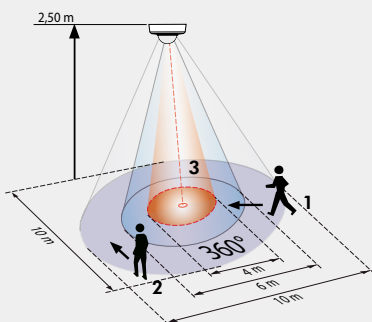
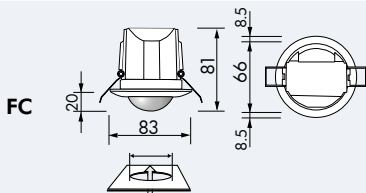
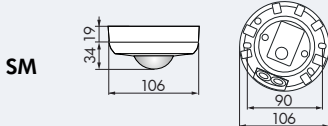

- 1 ■ Walking towards
- 2 ■ Walking across
- 3 ■ Small movements

Product	Colour	B.E.G.
PD3N-1C-SM	white	92190
PD3N-1C-FC	white	92196
PD3N-1C-SM Micro	white	92219
PD3N-1C-FC Micro	white	92184
PD3N-2C-FC	white	92198
IR-PD3N	grey	92105
IR-PD-Mini	grey	92159
IR-RC-Adapter for B.E.G. Remote Control App	black	92726

- 230V~ ±10%
- 360°
- across Ø 10.00 m
towards Ø 6.00 m
- SM = IP44; FC = IP23 / Class II / CE
- SM Ø 106 x H 53 mm
FC Ø 83 x H 81 mm
- 25°C to +50°C
- Housing UV- and shock-resistant polycarbonate
- IR-PD3N, IR-PD-Mini
- Channel 1 (Control the lighting)**
2300W, cosφ = 1;
1150VA, cosφ = 0.5
- 30 sec. - 30 min. or impulse
- 10 - 2000 Lux

PD4N-1C
High performance relay for electronic ballasts

PD4N-1C-C
Ideal for monitoring corridors.
With 20m reach and detection.



Smartphone with B.E.G. App and IR-RC-Adapter



- Remote controllable ceiling-mounted motion detectors for mounting large areas with a 24 m detection zone.
- Switching for all types of light fixtures by high performance relay
- Optical system, designed for highest sensitivity

- Remote controllable ceiling-mounted motion detectors PD4N-1C-C in surface-mount and ceiling-mount version with narrow detection area ideal for corridors

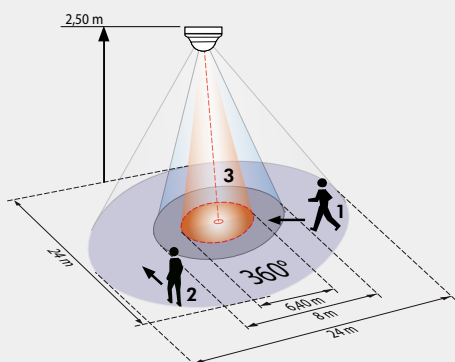

- 1 ■ Walking towards
- 2 ■ Walking across
- 3 ■ Small movements

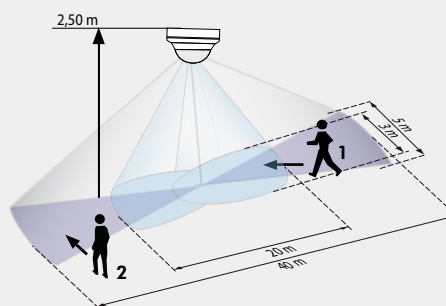

- 1 ■ Walking towards
- 2 ■ Walking across

Product	Colour	B.E.G.
PD4N-1C-SM	white	92144
PD4N-1C-FC	white	92149
IR-PD3N	grey	92105
IR-PD-Mini	grey	92159
IR-RC-Adapter for B.E.G. Remote Control App	black	92726

Product	Colour	B.E.G.
PD4N-1C-C-SM	white	92270
PD4N-1C-C-FC	white	92274
IR-PD3N	grey	92105
IR-PD-Mini	grey	92159
IR-RC-Adapter for B.E.G. Remote Control App	black	92726

**Light only when needed –
Motion detectors for more energy efficiency in buildings**

- In spite of small dimensions it switches all types of light fixtures using high performance relay with in-rush current limitation especially for electronic ballasts.
- Mini-motion detector PD9 Special version for installation into ceilings or directly built into light fittings
- GH version provides 6 m detection at 10 m height.

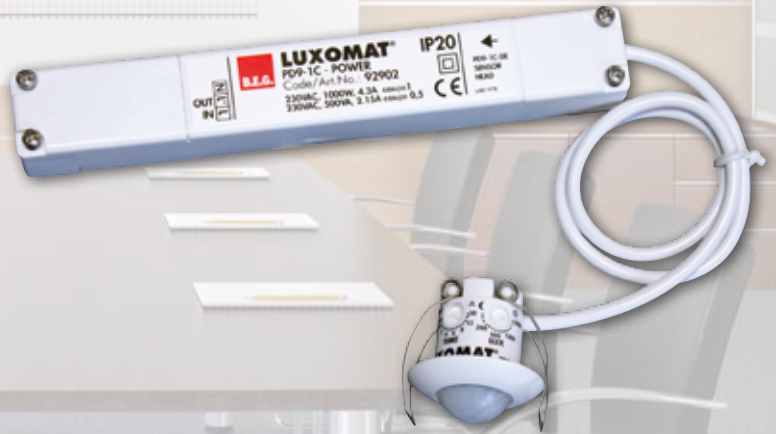

PD9-1C-FAMILY

SPECIALS



PD9-DIGI-FC



PD9-1C-FC

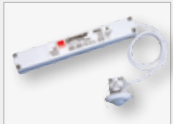

PD9-1C-GH-FC



Extreme small dimension

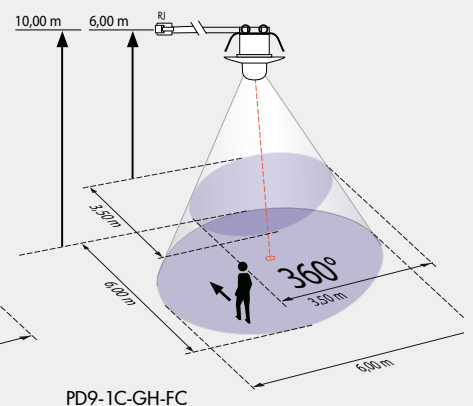
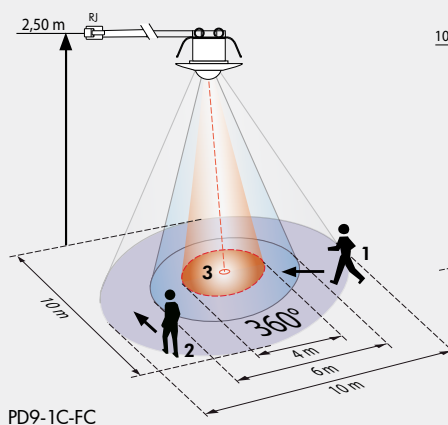
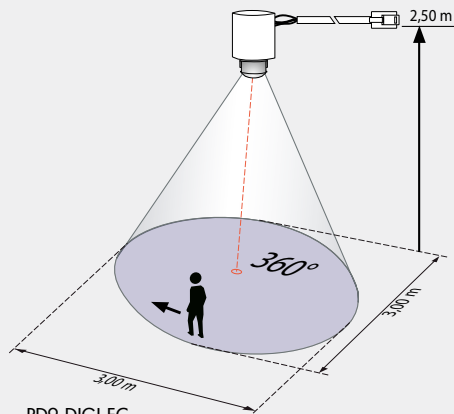
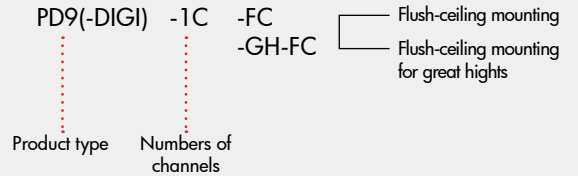

- 1 ■ Walking towards
- 2 ■ Walking across
- 3 ■ Small movements

Product	Colour	B.E.G.
PD9-DIGI-FC	white	92917
PD9-1C-FC	white	92902
PD9-1C-GH-FC	white	92934

HF-motion detector

- 360° resp. 160° detection area depending of the kind of installation for ceiling or wall
- HF technology: 5.8GHz – reacts to the smallest motion, independently of temperature
- Range, twilight value and follow up time are adjustable with potentiometer
- Extremely short activation time

HF-MD1
Invisible light switching



HF-MD2
Surface mounted



- Installation in light fittings, dry lining boxes or behind wall or ceiling coverings with sufficient light detection for the light sensor
- Especially for uses without direct contact (can also detect through walls)

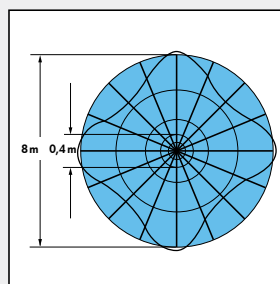
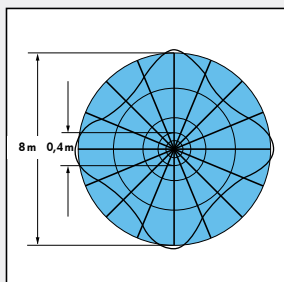
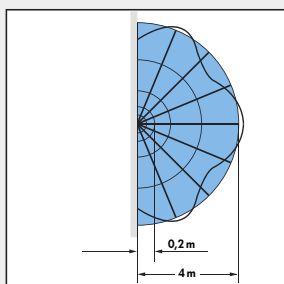

- Walking across or towards
The range depends on size and speed of the object.

Product	Colour	B.E.G.
HF-MD1	white	94401
HF-MD2	white	94402
HF-H-MD1 Standard	white	94431

Energy saving made easy – using B.E.G. occupancy detectors

- Remote controllable occupancy detector for inside use PD2 and PD4-M-1C as Master version for surface/false ceiling with circular detection area
- One channel to switch the lighting (potential-free)
- The connection of a unlimited number of Slaves for reasonable extension is possible!
- Optical system, designed for highest sensitivity
- Constantly measures high values to provide greatest efficiency
- Possible to add switch for automatic (presence) and semi-automatic (absence) control



Smartphone with B.E.G. App and IR-RC-Adapter



TYPES OF MOUNTING

SPECIALS



Blinds and coverage

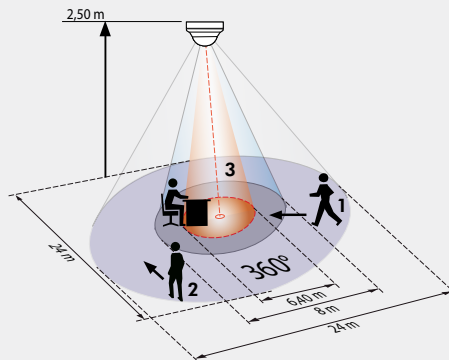
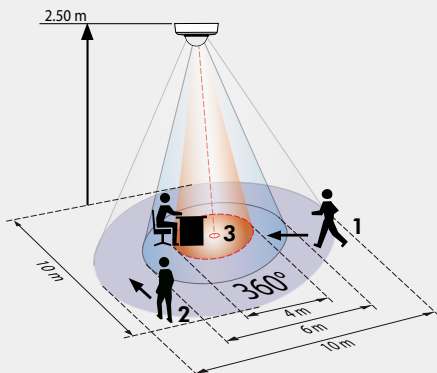
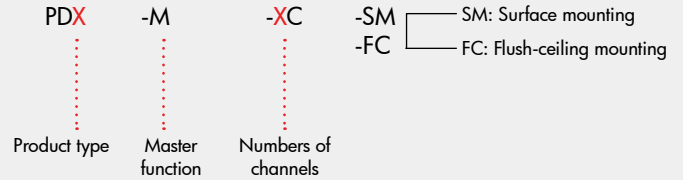

- 1 ■ Walking towards
- 2 ■ Walking across
- 3 ■ Seated activity

Product	Colour	B.E.G.
PD2-M-1C-SM	white	92550
PD2-M-1C-FC	white	92565
PD4-M-1C-SM	white	92580
PD4-M-1C-FC	white	92585
IR-PD-1C	grey	92520
IR-PD-Mini	grey	92159
IR-RC-Adapter for B.E.G. Remote Control App	black	92726

Indoor 140-L
Night light, orientation light
and push button in one device



Indoor 180-R
Acoustic-light – The first light switch
that can hear and see



- Wall-mounted occupancy detector with integrated switch
- One channel for switching light (either main light or orientation light)
- Integrated downlight with orientation and night light function
- Manual operation available with integrated switch
- Detection area can be extended with additional Indoor 140-L units
- Indoor 140-L can be used as master or slave device

- Combined motion detector and acoustic sensor as wall switch Indoor 180-R/-3W/2W with 180° detection area
- The detection area can be altered by using the included blinds at the bottom of the detector (3 wire)
- Relay version in 3-conductor or in 2-conductor engineering for inductive, capacitive and ohmic loads (2 wire)
- Acoustic sensor is adjustable to stop fake re-triggering
- Fits a 16 mm back box

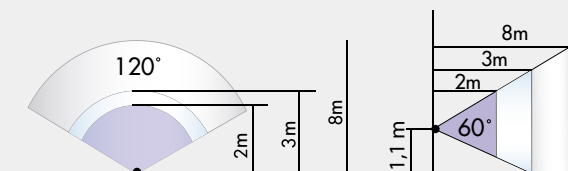

- Walking across
- Walking towards
- Seated activity

Product	Colour	B.E.G.
Indoor 140-L	white	94327

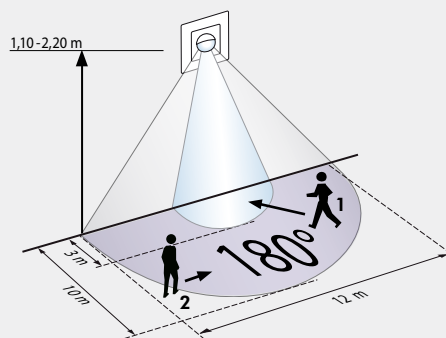

- 1 ■ Walking towards
- 2 ■ Walking across

Product	Colour	B.E.G.
Indoor 180-R, fully fitted	RAL9010	92610
Indoor 180-R-2W, fully fitted	RAL9010	92615

**Set new standards with DALI/DSI
occupancy detectors**

- Remote controllable group occupancy detector as Master version for surface and false ceiling mounting with DALI-interface and with circular detection area
- Integrated light sensor for automatic constant light control
- Many programmes adjustable with the remote control IR-PD-DALI or the **B.E.G. Remote Control App**
- Switch-over between DSI and DALI via remote control
- Control of up to 50 ballasts
- Orientation lighting can be set between 5 - 60 min., on or off
- 100h burn in function



Smartphone with B.E.G. App and IR-RC-Adapter



TYPES OF MOUNTING

SPECIALS

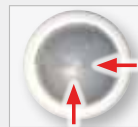

Hidden potentiometers for follow-up time, range and lux value

Blinds and coverage

PDX — Product type
 -M — Master function
 -DALI/DSI — DALI/DSI version
 -SM — SM: Surface mounting
 -FC — FC: Flush-ceiling mounting

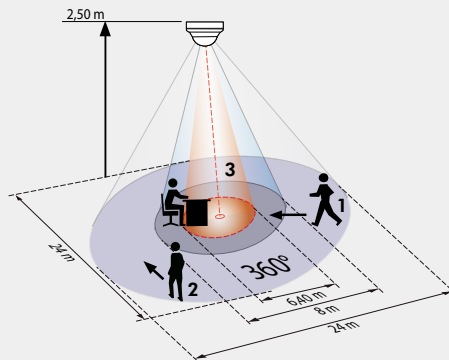
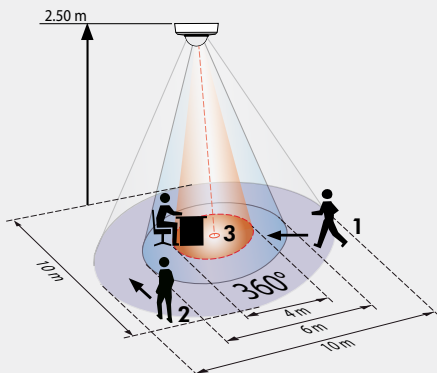

- 1 ■ Walking towards
- 2 ■ Walking across
- 3 ■ Seated activity

Product	Colour	B.E.G.
PD2-M-DALI/DSI-SM	white	92280
PD2-M-DALI/DSI-FC	white	92258
PD4-M-DALI/DSI-SM	white	92279
PD4-M-DALI/DSI-FC	white	92275
IR-PD-DALI	grey	92094
IR-PD-DALI-Mini	grey	92112
IR-RC-Adapter for B.E.G. Remote Control App	black	92726



- Remotely controllable CdS-FC photocell for ceiling installation
 - Adjustable deactivation delay with self-learning deactivation and twilight value
 - Extra flat form – only 6mm high
 - Ideal for entrance areas, staircases, offices and training facilities
 - Also available as DALI/DSI version
- Remotely controllable CdS-T-SM for surface installation inside or not
 - IP54
 - Built in calendar function to set different times for weekends to days of the week
 - Forced off (F) to turn connected lights off between 1 A.M. and 6 A.M.
- CdS-SM photocell for automatically switching lighting
 - Light value and activation/deactivation delay may be set from the outside using the potentiometer
 - LED setting aid (no delay)
 - Activation and deactivation delay with self-learning deactivation-light value
 - Integrated automatic function (10 Lux / 40 sec. activation / 120 sec. deactivation delay)

Product	Colour	B.E.G.
CdS-FC	white	92249
IR-CdS-FP	grey	92396
CdS-DALI/DSI-1C-SM	white	92563
CdS-DALI/DSI-1C-FC	white	92562
IR-CdS-DALI	white	92577
IR-RC-Adapter for B.E.G. Remote Control App	black	92726

Product	Colour	B.E.G.
CdS-T-SM	white	92367
IR-CdS-T	grey	92367
IR-RC-Adapter for B.E.G. Remote Control App	black	92726

Product	Colour	B.E.G.
CdS-SM	white	92369



OVERVIEW OF **B.E.G.** MOTION DETECTOR:



Motion detector for outdoor use



Ceiling-mounted-motion detector for indoor use

B.E.G. Brück Electronic GmbH
Gerberstr. 30 ▪ D-51789 Lindlar
Tel: +49 (0) 2266.90 121-0
Fax: +49 (0) 2266.90 121-50
E-Mail: info@beg.de
Internet: www.beg-luxomat.com

B.E.G. (UK) Ltd.
Q West, Great West Road
Brentford, Middlesex, TW8 0GP
Tel: +44 (0) 870.850 54 12
Fax: +44 (0) 870.850 54 13
E-Mail: info@beguk.co.uk
Internet: www.beg-luxomat.com

Marlin Electrical Ltd
10 Vesey Place
Glenageary, Co. Dublin
Tel: +353 (0) 12 80 72 05
Fax: +353 (0) 12 80 77 76
Internet: www.beg-luxomat.com