



**JCC** | a **LEVITON**  
company

## About Us

Leviton is a world leader in diversified electrical technologies and the largest privately owned manufacturer of electrical wiring equipment in North America.

Leviton products help customers create sustainable and intelligent environments through their electrical wiring devices, network and data centre connectivity solutions, lighting energy management systems, and security and automation applications.

Operating in over 80 countries and with a portfolio of more than 25,000 products, Leviton are at the forefront of global developments in building technology and are uniquely positioned to support JCC in developing cutting edge LED innovation.

Leviton acquired JCC in 2013 to enhance JCC's position as the UK market leader in LED lighting and strengthen our shared vision to ensure accessibility to the benefits of the latest LED technology.

Established in 1989, JCC are market leaders in the development of cutting edge LED lighting technology.

We are driven by our passion to create innovative LED lighting solutions. This ensures that our customers can take advantage of the benefits that the latest LED technology can provide for both domestic, commercial and industrial applications.

We believe that LED lighting is the most effective way that homes and businesses can tackle rising energy costs and the global need to reduce CO<sub>2</sub> consumption.

LED technology provides us with the opportunity to readdress traditional lighting and create innovative solutions that can improve installation times, enrich our homes, increase productivity within the workplace and enhance safety across all environments.





# Welcome to Catalogue 32

2019 marks the 30th anniversary since JCC was established. Our brand is a reflection of our continued commitment to deliver the latest, high quality lighting fixtures to our customers with a key focus on service and availability.

Catalogue 32 introduces over 400 new product codes including control ready variants across all of our commercial product ranges.

To support our latest introductions, we have invested in a new dedicated production facility at our head office in West Sussex which opened in spring 2019. This ensures that we are positioned to offer the widest range of products as lighting technology continues to evolve.

---

Please contact us for further information and advice on any of the products within our catalogue. To find your local JCC sales representative please see inside back cover.

**CUSTOMER SERVICES:** +44 (0)1243 838999 | [customer.services@jcc.co.uk](mailto:customer.services@jcc.co.uk)

**TECHNICAL SUPPORT:** [technical.support@jcc.co.uk](mailto:technical.support@jcc.co.uk)



# Contents

Fire-rated Downlights	14	Undershelf & Cabinet	250
Downlights	28	Bulkheads	256
LED Panels	64	Exterior LED Wall & Post Lights	284
Commercial Linear LED	88	Floodlights	316
Battens & Weatherproofs	108	Bollards	340
Highbay and Lowbay	150	Recessed Ground Wall & Spike Lights	360
Emergency	174	Lanterns	378
Interior Pendants	186	Controls & Sensors	392
Spotlights & Track Systems	196	Technical	398
LED Strip	226	Index	414

# NEW

## Products & upgrades

A quick reference to the exciting new products and upgrades in Catalogue 32

### Toughbay™ Retrofit p.154

- ✓ Integrated 3 hour maintained emergency options
- ✓ 60°, 90° and 120° beam angle available in all sizes
- ✓ 4000K available in 150W version

Toughbay™ Retrofit range has been expanded to feature emergency variants as well as 60°, 90°, and 120° beam angle options in all sizes. 4000K colour temperature is now available in the 150W version.



### Remote Emergency Pack p.176

- ✓ Automatic self-test function
- ✓ Universal panel and downlight conversion
- ✓ Plug and play DC connectors

All panels and downlights are now suitable for use with self test emergency pack. The new universal plug and play emergency pack features a push-fit terminal block and screw-less cable restraint providing a simple installation.



## OxfordLED™ p.100

- ✓ Enhanced light uniformity
- ✓ Improved LED efficiency, now up to 135lpcW
- ✓ Increased lumen output

OxfordLED™ features an upgraded polycarbonate diffuser which provides improved light uniformity as well as increasing the energy efficiency up to 135lmW.

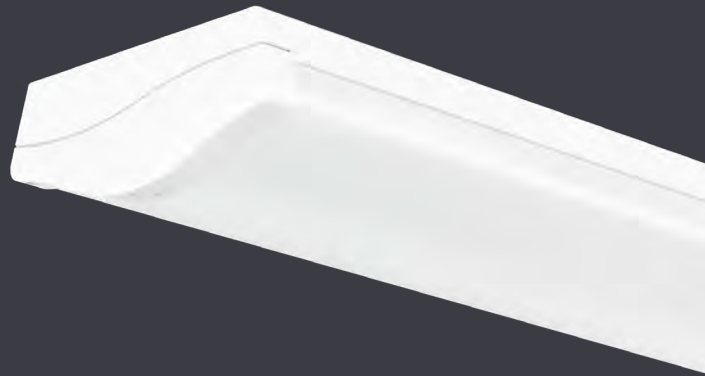

## Skytile® p.64

- ✓ UGR <19 as standard
- ✓ 5 year extended warranty incl. 2 year on site support
- ✓ DALI, DSI and 1-10V dimmable options available

Skytile® now includes our latest introduction which features a UGR <19 diffuser as standard in all sizes (600x600mm, 1200x300mm and 1200x600mm) and comes with a 5 year extended warranty including 2 year on site support.



## Skytile® TP(a) p.76

- ✓ TP(a) rated diffuser
- ✓ UGR <19 as standard
- ✓ 5 Year extended warranty

Skytile® TP(a) 600x600 is available in 4000K and 5700K colour temperatures with a UGR <19 PET self extinguishing diffuser as standard, providing complete peace of mind in all applications.

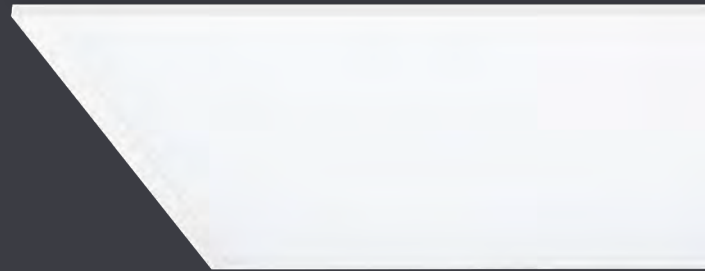

## LED Strip p.226

- ✔ New 4.8W, 6500K and RGBW options
- ✔ Online configurator calculates driver requirements
- ✔ RGBW with wireless IR remote control

The expanded range of LED strip is now available in both 5m and 50m reels as well as customisable lengths using the online LED Strip Configurator. RGBW LED Strip can be wirelessly programmed using the IR wireless remote.



## RadiaLED® Optimum CCT p.261

- ✔ Colour temperature selectable in 3000K and 4000K
- ✔ Detachable white rim now included as standard
- ✔ Increased efficiency and lumen output

RadiaLED® Optimum CCT provides new 3000K and 4000K switchable feature. All RadiaLED® Optimum products are now supplied with detachable white rim as standard.



## Toughflood™ Asymmetric p.326

- ✔ Asymmetric beam angle
- ✔ 5 Year extended warranty
- ✔ Comprehensive range from 80W to 200W

The asymmetric beam angle created from the micro lenses provides complete control of light distribution and reduces unwanted light spill. Toughflood™ is available in 80W, 100W, 150W and 200W variants.







# NEW

## DALI & 1-10V Dimmable

A comprehensive range of DALI or 1-10V dimmable variants are available in all sizes and wattages with our full commercial product ranges.

### DALI & 1-10V Downlights

From p.14



V50™



V50™ Tilt



Nebula™



Nebula™ Darklight



Nebula High Output



Coral LED™



Commercial Downlight



Commercial Gimbal Downlight

### DALI & 1-10V LED Panels

From p.64



Skytile®



Skytile® TP(a)



Skytile® Direct/Indirect



Skytile® Base



Skytile® Linear 1200x600



Skytile® Linear 1200x300

## **DALI & 1-10V** Commercial Linear LED

From p.88



Skytile® Surface



OxfordLED™



Line of Light

## **DALI & 1-10V** Battens & Weatherproofs

From p.108



Skypack™ Quick Release



Skypack™



ToughLED™ Weatherproof



ToughLED™ High Output

## **1-10V** Industrial Highbays

From p.150



Toughbay™ Circular



Toughbay™ Retrofit



Toughbay™ Linear

## **1-10V** LED Strip

From p.226



4.8W LED Strip



9.6W LED Strip



14.4W LED Strip

## **DALI & 1-10V** Bulkheads

From p.256



RadiaLED® Optimum



RadiaLED® Optimum CCT



RadiaLED® Style



RadiaLED® Utility

# Introducing our LED Strip light service



## Tailored to suit your needs

The new LED Strip light service offers a custom solution through your preferred wholesaler. Use our online configurator to build your kit, then simply provide the order summary to your wholesaler along with your customer's address, and we will deliver everything you need directly to site.

Offering a range of different options, including low, standard and high output LED Strip; 2700K, 3000K, 4000K, 6500K & RGBW colour temperatures, IP20 & IP65 protection and profiles to suit all applications.



### CUSTOM SERVICE

Our custom service provides tailor made LED Strip kits complete with all accessories and drivers, ordered via your wholesaler and delivered direct to site.



### SIMPLE ONLINE CONFIGURATOR

Our configurator takes the hassle out of ordering LED Strip by automatically working out exactly what driver, strip and components you require, reducing wastage and saving you money.



### VARIETY OF OPTIONS

Available in four outputs, five colour temperatures including RGBW, IP20 and IP65, with three aluminium profile options.



### FAST TURNAROUND

Your LED Strip light order will be delivered direct to site shortly after the order has been placed with JCC by your chosen wholesaler.

## Quick and easy three step process



1. SIMPLE ONLINE CONFIGURATOR



2. ORDER VIA YOUR WHOLESALER



3. DELIVERED DIRECTLY TO SITE

See p.246 for more information



## Simple online configurator

### **AUTOMATICALLY CALCULATE YOUR REQUIREMENTS**

Our quick and easy online configurator tool has been created to reduce the challenges associated with ordering LED Strip.

The step-by-step process, combined with the intuitive design, makes it easy to specify your LED Strip lighting requirements whilst automatically calculating the most economical driver available for your configuration. See p.246 for more information.

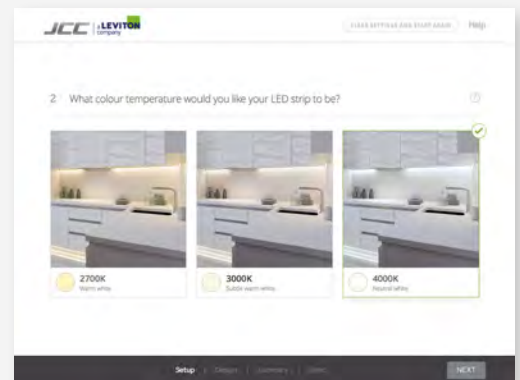

Build your layout online using our  
step-by-step online configurator

[jcc.co.uk/ledstrip](http://jcc.co.uk/ledstrip)

# Quality, reliability and service

## State-of-the-art testing facilities

We have continued to invest in our state-of-the-art in-house testing facility which allows us to fully test key aspects of our products performance from thermal characteristics, electrical safety, detailed harmonics, live switching and photometry. This ensures that our products always meet the highest standards expected by our valued customers.

## Quality and reliability

Quality is at the heart of everything we do and underpins our brand. Every new product that we launch goes through rigorous in-house and independent 3rd party testing to ensure full compliance to the required approvals and standards.

## Lighting design service

Our team of lighting designers are on hand to support you with your next lighting project. As experts in the JCC product portfolio and with their extensive knowledge of all sectors and applications, they can produce detailed calculations and drawings in accordance with CIBSE, BS 5499 and BS 5266-1 guidelines and standards.

## New dedicated production facility

In Spring 2019 we opened our new dedicated production facility at our Head Office in West Sussex. This investment ensures that we can offer the highest level of service on conversions and strengthen the breadth of variants offered within our full product portfolio.







# Fire-rated Downlights

V50™	16
V50™ Tilt	19
V50™ Accessories	20
Twist & Lock	24
Showerlight	25



V50™

# Ultra shallow, colour selectable LED downlight



SELECTABLE  
COLOUR TEMP.



ULTRA LOW  
PROFILE DESIGN



INTERCHANGEABLE  
ALUMINIUM BEZELS



## Ultra low profile design suitable for shallow ceiling voids

V50's low profile design enables the fitting to be installed in applications with a shallow 50mm ceiling void. The V50 airflow cap can be removed to further reduce the product height.



## Selectable colour temperature from below the ceiling

V50 features a simple switch that allows users to choose between either 3000K or 4000K colour temperature from below the ceiling. The switch is covered by a silicone gasket that ensures IP65 protection is maintained.

# V50™

## Colour selectable fire-rated LED downlight

- Selectable colour temperature from beneath the ceiling
- Die-cast aluminium bezels
- Fully fire rated for 30, 60 and 90 minute ceilings
- Available as a complete fixture or without bezel (JC1001/NB)

∨ JC1001/CH



∨ JC1001/WH



∨ JC1001/BN



∨ JC1006/BR\*\*



∨ JC1006/BLK\*\*



RATING



CLASS 2



CLASS 1 (EM)



COL. SWITCH



CRI: RA



WARRANTY\*



DIMMABLE



BEAM

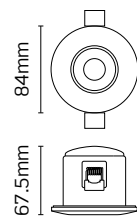

Cut out: Ø70mm

CODE	DESCRIPTION	COL TEMP.	DIM.	WATT	LUMENS	LPCW
JC1001/NB	V50 without bezel	3000K & 4000K	Yes	7.5W	600/650	80/87
JC1001/BN	V50 with brushed nickel bezel	3000K & 4000K	Yes	7.5W	600/650	80/87
JC1001/CH	V50 with chrome bezel	3000K & 4000K	Yes	7.5W	600/650	80/87
JC1001/WH	V50 with white bezel	3000K & 4000K	Yes	7.5W	600/650	80/87
JC1001/3B	V50 with BN,CH and White bezels	3000K & 4000K	Yes	7.5W	600/650	80/87
JC1001/BNEM	V50 emergency with brushed nickel bezel	3000K & 4000K	Yes	7.5W	600/650	80/87
JC1001/CHEM	V50 emergency with chrome bezel	3000K & 4000K	Yes	7.5W	600/650	80/87
JC1001/WHEM	V50 emergency with white bezel	3000K & 4000K	Yes	7.5W	600/650	80/87
JC1001/NBDALI	V50 DALI/1-10V without bezel	3000K & 4000K	Yes	7.5W	600/650	80/87
JC1006*	Separate bezel for V50 (add suffix)	-	-	-	-	-

\*For Black add /BLK suffix, for Brushed Brass add /BR suffix, for Brushed Nickel add /BN suffix, for Chrome add /CH suffix, for White add /WH suffix. \*\*Bezel only to be used with JC1001/NB.

**Body:** Steel. **Lens:** Polycarbonate. **Bezel:** Aluminium. | **Accessories:** Converter plate (p.20), Concealer ring (p.21)

\*Extended warranty requires online registration. Terms and conditions apply.

# V50™ Tilt

Colour selectable fire-rated LED downlight with 20° tilt

- Colour temperature switch located on the driver
- Die-cast aluminium bezels
- Fully fire rated for 30, 60 and 90 minute ceilings
- 350° rotatable and 20° tiltable

∨ JC1002/CH



∨ JC1002/BN



∨ JC1002/WH

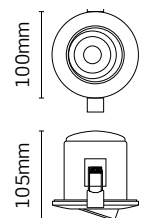

Cut out: Ø85mm

 IP 20	 CLASS 2	 COL. SWITCH	 CRI: RA	 WARRANTY*	 DIMMABLE	 BEAM
---	---	---	---	---	--	--

CODE	DESCRIPTION	COL TEMP.	DIM.	WATT	LUMENS	LPCW
JC1002/BN	V50 Tilt with brushed nickel bezel	3000K & 4000K	Yes	7.5W	600/650	80/87
JC1002/CH	V50 Tilt with chrome bezel	3000K & 4000K	Yes	7.5W	600/650	80/87
JC1002/WH	V50 Tilt with white bezel	3000K & 4000K	Yes	7.5W	600/650	80/87

\*For DALI/1-10V dimmable options see index or contact JCC customer services on 01243 838999

**Body:** Steel. **Lens:** Polycarbonate. **Bezel:** Aluminium. | **Accessories:** Converter plate (p.20)

\*Extended warranty requires online registration. Terms and conditions apply.

# V50™ Converter Plate

## Fire-rated converter plate for V50 & V50 Tilt

- Allows for the retrofit of V50 and V50 Tilt units where larger downlights were previously installed
- Fully fire rated for 30, 60 and 90 minute ceilings
- Suitable for all ceiling types for cut outs 80-120mm in diameter

✓ JC1003/CH



✓ JC1003/BN



✓ JC1003/WH

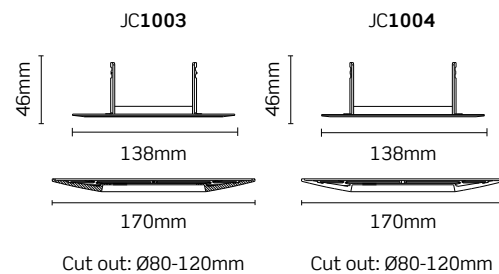

RATING\*\*



RATING\*



GUARANTEE



B. NICKEL



CHROME



WHITE

**CODE**

**DESCRIPTION**

JC1003\* Converter plate for standard V50 (luminaire not included)

JC1004\*\* Converter plate for V50 Tilt (luminaire not included)

For Brushed Nickel add /BN suffix, for Chrome add /CH suffix, for White add /WH suffix.

**Body:** Steel. **Bezel:** Aluminium.

# V50™ Concealer Ring

Available for V50

- Covers ceiling cut outs damaged from previous fittings
- For use with ceiling cut outs 80-105mm in diameter
- Ideal for installing V50 into suspended ceilings
- Does not maintain fire rating

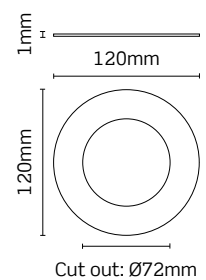

RATING



GUARANTEE



WHITE

**CODE**

**DESCRIPTION**

JC1005

Concealer ring for standard V50 - 5 pack (luminaire not included)

**Body:** Steel. | (Does not maintain fire rating)







# Twist & Lock

## Fire-rated twist and lock mains downlight

- Press-fit terminal with loop in/loop out

∨ JC94113WH



∨ JC94114CH

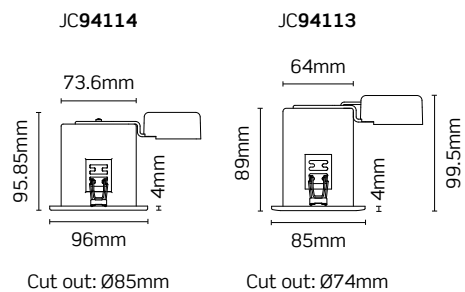

RATING  
 CLASS 2  
 GUARANTEE  
 WHITE  
 CHROME  
 B. NICKEL

CODE	DESCRIPTION	LAMP
JC94113	Fire-rated Twist & Lock	GU10 50W Max
JC94114	Fire-rated 15° tiltable Twist & Lock	GU10 50W Max

For Brushed Nickel add **BN** suffix, for Chrome add **CH** suffix, for White add **WH** suffix. Lamp not supplied.

**Body:** Steel. **Bezel:** Aluminium.

# Showerlight

## Fire-rated IP65 downlight

- Press-fit terminal with loop in/loop out

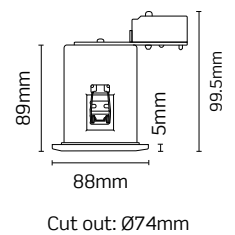

CODE	DESCRIPTION	LAMP
JC94110	Fire-rated Enclosed IP65 Downlight	GU10 50W Max
For Brushed Nickel add <b>BN</b> suffix, for Chrome add <b>CH</b> suffix, for White add <b>WH</b> suffix. Lamp not supplied.		
<b>Body:</b> Steel. <b>Lens:</b> Glass. <b>Bezel:</b> Aluminium.		







# Downlights

Nebula™	30
Nebula™ Darklight	35
Nebula™ High Output	38
Nebula™ High Output Tilt	41
Coral LED™	44
Coral LED™ Rims	47
Commercial Downlight	48
Commercial Gimbal Downlight	49
Skydisc™ PC IP65	50
Skydisc™ PC IP20	54
Surface Downlight	58
Surface High Output	62

## Nebula™ Range

# Contemporary & discrete architectural downlights



### Nebula™ Downlight

---

Slim profile available in standard IP44 (IP65 with gasket). High performance CREE LED COB and five year extended warranty ensures complete peace of mind during the lifetime of the product. Triac and DALI dimming variants available across the range.

**Available in 8W, 12W and 15W variants.**



### Nebula™ Darklight

---

Recessed, tiltable LED module with discreet die-cast aluminium bezel creates a low glare lighting effect for any commercial and residential application. 8W, 12W and 15W LED modules with Triac and DALI dimming variants available across the range.

**Available in 8W, 12W and 15W variants.**





# Nebula™ 8W

## Slim bezel LED downlight

- Slim profile die-cast aluminium bezel
- IP65 gasket available (JC95131)
- Triac, DALI and 1-10V dimmable options available

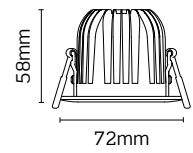

Cut out: Ø64mm











CODE	DESCRIPTION	COL TEMP.	DIM.	WATT	LUMENS	LPCW
JC95101	Nebula LED Downlight	3000K	No	8W	600	75
JC95101DIM	Nebula LED Downlight Triac	3000K	Yes	8W	600	75
JC95101DALI	Nebula LED Downlight DALI/1-10V	3000K	Yes	8W	600	75
JC95102	Nebula LED Downlight	4000K	No	8W	650	81
JC95102DIM	Nebula LED Downlight Triac	4000K	Yes	8W	650	81
JC95102DALI	Nebula LED Downlight DALI/1-10V	4000K	Yes	8W	650	81
JC95131	IP65 gasket 5pcs (8W only)	-	-	-	-	-

For emergency versions add **EM** suffix.

**Body:** Aluminium. **Lens:** Glass. **Bezel:** Die-cast aluminium.

\*Extended warranty requires online registration. Terms and conditions apply.

# Nebula™ 12W

## Slim bezel LED downlight

- Slim profile die-cast aluminium bezel
- IP65 gasket available (JC95130)
- Triac, DALI and 1-10V dimmable options available

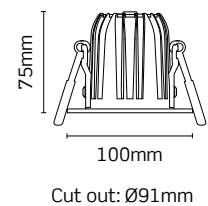











CODE	DESCRIPTION	COL TEMP.	DIM.	WATT	LUMENS	LPCW
JC95111	Nebula LED Downlight	3000K	No	12W	900	75
JC95111DIM	Nebula LED Downlight Triac	3000K	Yes	12W	900	75
JC95111DALI	Nebula LED Downlight 60° DALI/1-10V	3000K	Yes	12W	900	75
JC95112	Nebula LED Downlight	4000K	No	12W	1000	83
JC95112DIM	Nebula LED Downlight Triac	4000K	Yes	12W	1000	83
JC95112DALI	Nebula LED Downlight DALI/1-10V	4000K	Yes	12W	1000	83
JC95130	IP65 gasket 5pcs (12W & 15W only)	-	-	-	-	-

For emergency versions add **EM** suffix.

**Body:** Aluminium. **Lens:** Glass. **Bezel:** Die-cast aluminium.

\*Extended warranty requires online registration. Terms and conditions apply.

# Nebula™ 15W

## Slim bezel LED downlight

- Slim profile die-cast aluminium bezel
- IP65 gasket available
- Triac, DALI and 1-10V dimmable options available

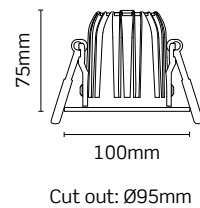

RATING



CLASS 2



CLASS 1 (EM)



80



WARRANTY\*



EM OPTIONS



DIM OPTIONS



BEAM



WHITE

CODE	DESCRIPTION	COL TEMP.	DIM.	WATT	LUMENS	LPCW
JC95121	Nebula LED Downlight	3000K	No	15W	1200	80
JC95121DIM	Nebula LED Downlight Triac	3000K	Yes	15W	1200	80
JC95121DALI	Nebula LED Downlight DALI/1-10V	3000K	Yes	15W	1200	80
JC95122	Nebula LED Downlight	4000K	No	15W	1350	90
JC95122DIM	Nebula LED Downlight Triac	4000K	Yes	15W	1350	90
JC95122DALI	Nebula LED Downlight DALI/1-10V	4000K	Yes	15W	1350	90
JC95130	IP65 gasket 5pcs (12W & 15W only)	-	-	-	-	-

For emergency versions add **EM** suffix.

**Body:** Aluminium. **Lens:** Glass. **Bezel:** Die-cast aluminium.

\*Extended warranty requires online registration. Terms and conditions apply.

# Nebula™ Darklight 8W

## Slim bezel tiltable LED downlight

- Discreet recessed darklight LED module
- 35° tiltable
- Triac, DALI and 1-10V dimmable options available

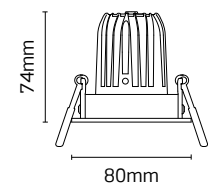

Cut out: Ø75mm

 **RATING**  
  **CLASS 2**  
  **CLASS 1 (EM)**  
  **CRI: RA**  
  **WARRANTY\***  
  **EM OPTIONS**  
  **DIM OPTIONS**  
  **BEAM**  
  **WHITE**

CODE	DESCRIPTION	COL TEMP.	DIM.	WATT	LUMENS	LPCW
JC95201	Nebula Darklight	3000K	No	8W	525	66
JC95201DIM	Nebula Darklight Triac	3000K	Yes	8W	525	66
JC95201DALI	Nebula Darklight DALI/1-10V	3000K	Yes	8W	525	66
JC95202	Nebula Darklight	4000K	No	8W	575	72
JC95202DIM	Nebula Darklight Triac	4000K	Yes	8W	575	72
JC95202DALI	Nebula Darklight DALI/1-10V	4000K	Yes	8W	575	72

For emergency versions add **EM** suffix.

**Body:** Aluminium. **Lens:** Glass. **Bezel:** Die-cast aluminium.

\*Extended warranty requires online registration. Terms and conditions apply.

# Nebula™ Darklight 12W

## Slim bezel tiltable LED downlight

- Discreet recessed darklight LED module
- 35° tiltable
- Triac, DALI and 1-10V dimmable options available

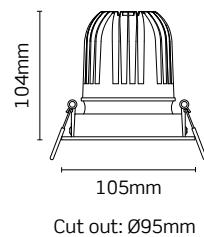

RATING



CLASS 2



CLASS 1 (EM)



CRI: RA



WARRANTY\*



EM OPTIONS



DIM OPTIONS



BEAM



WHITE

CODE	DESCRIPTION	COL TEMP.	DIM.	WATT	LUMENS	LPCW
JC95211	Nebula Darklight	3000K	No	12W	800	67
JC95211DIM	Nebula Darklight Triac	3000K	Yes	12W	800	67
JC95211DALI	Nebula Darklight DALI/1-10V	3000K	Yes	12W	800	67
JC95212	Nebula Darklight	4000K	No	12W	850	71
JC95212DIM	Nebula Darklight Triac	4000K	Yes	12W	850	71
JC95212DALI	Nebula Darklight DALI/1-10V	4000K	Yes	12W	850	71

For emergency versions add **EM** suffix.

**Body:** Aluminium. **Lens:** Glass. **Bezel:** Die-cast aluminium.

\*Extended warranty requires online registration. Terms and conditions apply.

# Nebula™ Darklight 15W

## Slim bezel tiltable LED downlight

- Discreet recessed darklight LED module
- 35° tiltable
- Triac, DALI and 1-10V dimmable options available

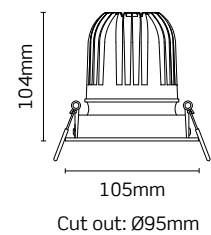

 **RATING**  
  **CLASS 2**  
  **CLASS 1 (EM)**  
  **CRI: RA**  
  **WARRANTY\***  
  **EM OPTIONS**  
  **DIM OPTIONS**  
  **BEAM**  
  **WHITE**

CODE	DESCRIPTION	COL TEMP.	DIM.	WATT	LUMENS	LPCW
JC95221	Nebula Darklight	3000K	No	15W	1050	70
JC95221DIM	Nebula Darklight Triac	3000K	Yes	15W	1050	70
JC95221DALI	Nebula Darklight DALI/1-10V	3000K	Yes	15W	1050	70
JC95222	Nebula Darklight	4000K	No	15W	1100	73
JC95222DIM	Nebula Darklight Triac	4000K	Yes	15W	1100	73
JC95222DALI	Nebula Darklight DALI/1-10V	4000K	Yes	15W	1100	73

For emergency versions add **EM** suffix.

**Body:** Aluminium. **Lens:** Glass. **Bezel:** Die-cast aluminium.

\*Extended warranty requires online registration. Terms and conditions apply.

# Nebula™ High Output 8W

## Low profile LED downlight

- Triac, DALI and 1-10V dimmable options available
- Slim profile bezel for discreet installations

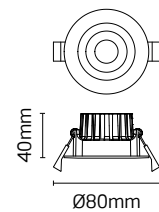

Cut out: Ø68-75mm



RATING



CLASS 2



CRI: RA



WARRANTY\*



EM OPTIONS



BEAM



DIMMABLE



WHITE

CODE	DESCRIPTION	COL TEMP.	DIM.	WATT	LUMENS	LPCW
JC95301	Slim Bezel LED Downlight Triac	3000K	Yes	8W	770	97
JC95301DALI	Slim Bezel LED Downlight DALI/1-10V	3000K	Yes	8W	770	97
JC95302	Slim Bezel LED Downlight Triac	4000K	Yes	8W	840	105
JC95302DALI	Slim Bezel LED Downlight DALI/1-10V	4000K	Yes	8W	840	105
JCEM001	Remote Emergency Pack	-	-	-	-	-
JCEM001ST	Remote Emergency Pack Self Test	-	-	-	-	-

Body: Aluminium. Lens: Polycarbonate. Bezel: Aluminium.

\*Extended warranty requires online registration. Terms and conditions apply.



# Nebula™ High Output 10W

## Low profile LED downlight

- Triac, DALI and 1-10V dimmable options available
- Slim profile bezel for discreet installations









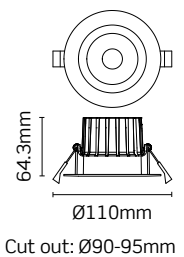

CODE	DESCRIPTION	COL TEMP.	DIM.	WATT	LUMENS	LPCW
JC95303	Slim Bezel LED Downlight Triac	3000K	Yes	10W	820	82
JC95303DALI	Slim Bezel LED Downlight DALI/1-10V	3000K	Yes	10W	820	82
JC95304	Slim Bezel LED Downlight Triac	4000K	Yes	10W	890	89
JC95304DALI	Slim Bezel LED Downlight DALI/1-10V	4000K	Yes	10W	890	89
JCEM001	Remote Emergency Pack	-	-	-	-	-
JCEM001ST	Remote Emergency Pack Self Test	-	-	-	-	-

**Body:** Aluminium. **Lens:** Polycarbonate. **Bezel:** Aluminium.

\*Extended warranty requires online registration. Terms and conditions apply.

# Nebula™ High Output 13W

## Low profile LED downlight

- Triac, DALI and 1-10V dimmable options available
- Slim profile bezel for discreet installations

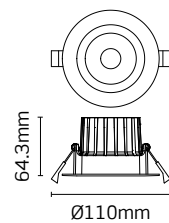

Cut out: Ø90-95mm



RATING



CLASS 2



CRI: RA



WARRANTY\*



EM OPTIONS



BEAM



DIM OPTIONS



WHITE

CODE	DESCRIPTION	COL TEMP.	DIM.	WATT	LUMENS	LPCW
JC95305	Slim Bezel LED Downlight Triac	3000K	Yes	13W	950	73
JC95305DALI	Slim Bezel LED Downlight DALI/1-10V	3000K	Yes	13W	950	73
JC95306	Slim Bezel LED Downlight Triac	4000K	Yes	13W	1200	92
JC95306DALI	Slim Bezel LED Downlight DALI/1-10V	4000K	Yes	13W	1200	92
JCEM001	Remote Emergency Pack	-	-	-	-	-
JCEM001ST	Remote Emergency Pack Self Test	-	-	-	-	-

**Body:** Aluminium. **Lens:** Polycarbonate. **Bezel:** Aluminium.

\*Extended warranty requires online registration. Terms and conditions apply.

# Nebula™ High Output Tilt 8W

Low profile, tiltable LED downlight

- 30° tiltable
- Triac, DALI and 1-10V dimmable options available
- Slim profile bezel for discreet installations

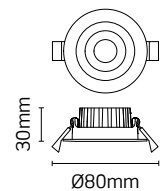

Cut out: Ø90-95mm









CODE	DESCRIPTION	COL TEMP.	DIM.	WATT	LUMENS	LPCW
JC95401	Slim Bezel LED Downlight Tilt Triac	3000K	Yes	8W	770	97
JC95401DALI	Slim Bezel LED Downlight Tilt DALI/1-10V	3000K	Yes	8W	770	97
JC95402	Slim Bezel LED Downlight Tilt Triac	4000K	Yes	8W	840	105
JC95402DALI	Slim Bezel LED Downlight Tilt DALI/1-10V	4000K	Yes	8W	840	105

Body: Aluminium. Lens: Polycarbonate. Bezel: Aluminium.

\*Extended warranty requires online registration. Terms and conditions apply.

# Nebula™ High Output Tilt 10W

Low profile, tiltable LED downlight

- Slim profile bezel for discreet installations
- 30° tiltable
- Triac, DALI and 1-10V dimmable options available

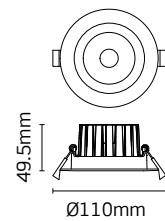

Cut out: Ø90-95mm



RATING



CLASS 2



CRI: RA



WARRANTY\*



BEAM



DIMMABLE



WHITE

CODE	DESCRIPTION	COL TEMP.	DIM.	WATT	LUMENS	LPCW
JC95403	Slim Bezel LED Downlight Tilt Triac	3000K	Yes	10W	820	82
JC95403DALI	Slim Bezel LED Downlight Tilt DALI/1-10V	3000K	Yes	10W	820	82
JC95404	Slim Bezel LED Downlight Tilt Triac	4000K	Yes	10W	890	89
JC95404DALI	Slim Bezel LED Downlight Tilt DALI/1-10V	4000K	Yes	10W	890	89

**Body:** Aluminium. **Lens:** Polycarbonate. **Bezel:** Aluminium.

\*Extended warranty requires online registration. Terms and conditions apply.

# Nebula™ High Output Tilt 13W

Low profile, tiltable LED downlight

- Slim profile bezel for discreet installations
- 30° tiltable
- Triac, DALI and 1-10V dimmable options available

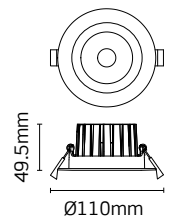

Cut out: Ø90-95mm



RATING



CLASS 2



CRI: RA



WARRANTY\*



BEAM



DIM OPTIONS



WHITE

CODE	DESCRIPTION	COL TEMP.	DIM.	WATT	LUMENS	LPCW
JC95505	Slim Bezel LED Downlight Tilt Triac	3000K	Yes	13W	950	73
JC95505DALI	Slim Bezel LED Downlight Tilt DALI/1-10V	3000K	Yes	13W	950	73
JC95606	Slim Bezel LED Downlight Tilt Triac	4000K	Yes	13W	1200	92
JC95606DALI	Slim Bezel LED Downlight Tilt DALI/1-10V	4000K	Yes	13W	1200	92

Body: Aluminium. Lens: Polycarbonate. Bezel: Aluminium.

\*Extended warranty requires online registration. Terms and conditions apply.

# Coral LED™ 16W

Direct replacement for 2x18W CFL

- Rim and dropped glass accessories available, see page 47
- DALI, DSI and 1-10V dimming options available

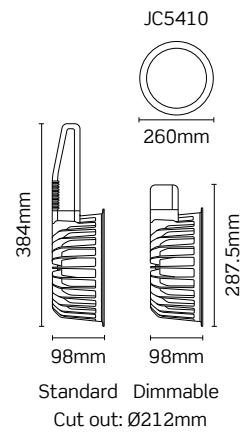

RATING  
 CLASS 2  
 CLASS 1 (EM)  
 CRI: RA  
 WARRANTY\*  
 EM OPTIONS  
 DIM OPTIONS

CODE	DESCRIPTION	COL TEMP.	DIM.	WATT	LUMENS	LPCW
JC5421	Coral LED	4000K	No	16W	1600	100
JC5421DALI	Coral LED DALI	4000K	Yes	16W	1600	100
JC5421DSI	Coral LED DSI	4000K	Yes	16W	1600	100
JC5421/1-10V	Coral LED 1-10V	4000K	Yes	16W	1600	100
JC5421EM	Coral LED emergency	4000K	No	16W	1600	100
JC5421EMDALI	Coral LED DALI emergency	4000K	Yes	16W	1600	100
JC5421EMDSI	Coral LED DSI emergency	4000K	Yes	16W	1600	100
JC5421EM/1-10V	Coral LED 1-10V emergency	4000K	Yes	16W	1600	100
JC5410	Coral LED Concealer ring	-	-	-	-	-

Body: Aluminium. Lens: Polycarbonate. | Rim not included.

\*Extended warranty requires online registration. Terms and conditions apply.

# Coral LED™ 24W

Direct replacement for 2x26W CFL

- Rim and dropped glass accessories available, see page 47
- DALI, DSI and 1-10V dimming options available

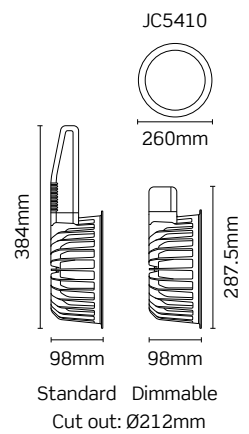

RATING  
 CLASS 2  
 CLASS 1 (EM)  
 CRI: RA  
 WARRANTY\*  
 EM OPTIONS  
 DIM OPTIONS

CODE	DESCRIPTION	COL TEMP.	DIM.	WATT	LUMENS	LPCW
JC5420	Coral LED	4000K	No	24W	2200	92
JC5420DALI	Coral LED DALI	4000K	Yes	24W	2200	92
JC5420DSI	Coral LED DSI	4000K	Yes	24W	2200	92
JC5420/1-10V	Coral LED 1-10V	4000K	Yes	24W	2200	92
JC5420EM	Coral LED emergency	4000K	No	24W	2200	92
JC5420EMDALI	Coral LED DALI emergency	4000K	Yes	24W	2200	92
JC5420EMDSI	Coral LED DSI emergency	4000K	Yes	24W	2200	92
JC5420EM/1-10V	Coral LED 1-10V emergency	4000K	Yes	24W	2200	92
JC5410	Coral LED Concealer ring	-	-	-	-	-

Body: Aluminium. Lens: Polycarbonate. | Rim not included.

\*Extended warranty requires online registration. Terms and conditions apply.

# Coral LED™ 32W

Direct replacement for 2x32W CFL

- Rim and dropped glass accessories available, see page 47
- DALI, DSI and 1-10V dimming options available

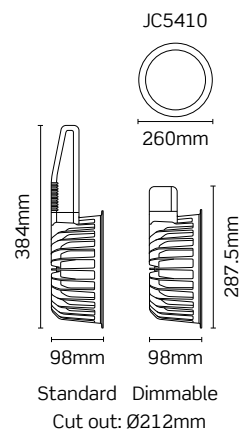

RATING  
 CLASS 2  
 CLASS 1 (EM)  
 CRI: RA  
 WARRANTY\*  
 EM OPTIONS  
 DIM OPTIONS

CODE	DESCRIPTION	COL TEMP.	DIM.	WATT	LUMENS	LPCW
JC5422	Coral LED	4000K	No	32W	2800	88
JC5422DALI	Coral LED DALI	4000K	Yes	32W	2800	88
JC5422DSI	Coral LED DSI	4000K	Yes	32W	2800	88
JC5422/1-10V	Coral LED 1-10V	4000K	Yes	32W	2800	88
JC5422EM	Coral LED emergency	4000K	No	32W	2800	88
JC5422EMDALI	Coral LED DALI emergency	4000K	Yes	32W	2800	88
JC5422EMDSI	Coral LED DSI emergency	4000K	Yes	32W	2800	88
JC5422EM/1-10V	Coral LED 1-10V emergency	4000K	Yes	32W	2800	88
JC5410	Coral LED Concealer ring	-	-	-	-	-

Body: Aluminium. Lens: Polycarbonate. | Rim not included.

\*Extended warranty requires online registration. Terms and conditions apply.



# Coral LED™ Rims

Rim accessories to complement the Coral LED range

- IP65 rim attachment available (JC5368)



JC5052 N, JC5054,  
JC5060, JC5368,

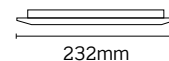

JC5110

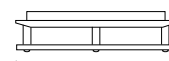

JC5118

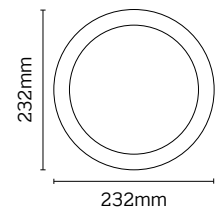
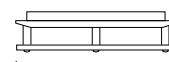

RATING



RATING



CHROME



WHITE

**CODE**

**DESCRIPTION**

JC5052 N	IP20 white aluminium rim
JC5110	IP20 white rim with dropped glass
JC5118	IP20 white rim with halo dropped glass
JC5054	IP20 chrome aluminium rim
JC5060	IP20 white aluminium rim c/w frosted glass
JC5368	IP65 rim attachment white rim/clear glass









Rim: Aluminium / Glass.

# Commercial Downlight

## High performance commercial LED downlight

- Available in two sizes 145mm and 190mm diameter
- DALI and 1-10V dimming options available



 **RATING**   
  **CLASS 2**   
  **DIM OPTIONS**  
 **CRI: RA**   
  **WARRANTY\***   
  **EM OPTIONS**   
  **BEAM**   
  **WHITE**

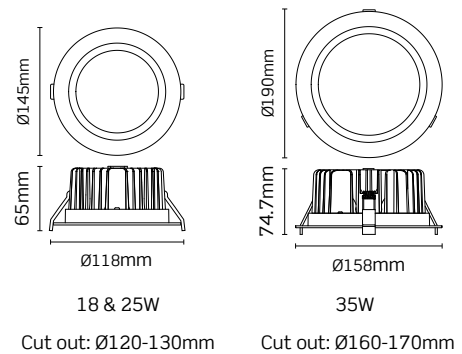

CODE	DESCRIPTION	COL TEMP.	DIM.	WATT	LUMENS	LPCW
JC54300	Commercial Downlight	4000K	No	18W	1960	109
JC54300DIM	Commercial Downlight DALI/1-10V	4000K	Yes	18W	1960	109
JC54301	Commercial Downlight	4000K	No	25W	2700	108
JC54301DIM	Commercial Downlight DALI/1-10V	4000K	Yes	25W	2700	108
JC54302	Commercial Downlight	4000K	No	35W	3960	113
JC54302DIM	Commercial Downlight DALI/1-10V	4000K	Yes	35W	3960	113
JCEM001	Remote Emergency Pack	-	-	-	-	-
JCEM001ST	Remote Emergency Pack Self Test	-	-	-	-	-

**Body:** Aluminium. **Lens:** Polycarbonate. **Bezel:** Aluminium.

\*Extended warranty requires online registration. Terms and conditions apply.

# Commercial Gimbal Downlight

## High performance retail LED downlight

- 360° rotatable and 30° tiltable
- Available in 24°, 45° and 60° beam angle options
- DALI and 1-10V dimming options available

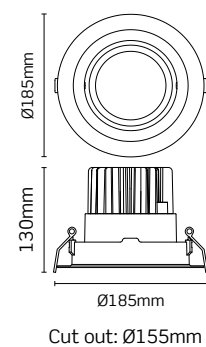









RATING CLASS 2 DIM OPTIONS CRI: RA WARRANTY\* BEAM OPTIONS WHITE

CODE	DESCRIPTION	COL TEMP.	DIM.	WATT	LUMENS	LPCW
JC54303	Commercial Gimbal Downlight 24° beam	4000K	No	35W	3000	86
JC54303DIM	Commercial Gimbal Downlight 24° beam DALI/1-10V	4000K	Yes	35W	3000	86
JC54304	Commercial Gimbal Downlight 45° beam	4000K	No	35W	3000	86
JC54304DIM	Commercial Gimbal Downlight 45° beam DALI/1-10V	4000K	Yes	35W	3000	86
JC54305	Commercial Gimbal Downlight 60° beam	4000K	No	35W	3000	86
JC54305DIM	Commercial Gimbal Downlight 60° beam DALI/1-10V	4000K	Yes	35W	3000	86

**Body:** Aluminium. **Lens:** Clear Acrylic. **Bezel:** Aluminium.

Produced to order, contact JCC customer services on **01243 838999**.

\*Extended warranty requires online registration. Terms and conditions apply.

# Skydisc™ PC IP65 7W

Dimmable, slim commercial downlight

- Triac dimmable as standard

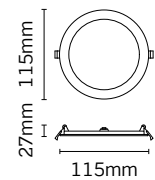

Cut out: Ø100-110mm



RATING



CLASS 2



CRI: RA



WARRANTY\*



BEAM



EM OPTIONS



DIMMABLE



WHITE

CODE	DESCRIPTION	COL TEMP.	DIM.	WATT	LUMENS	LPCW
JC72501	Skydisc PC IP65 Triac	4000K	Yes	7W	650	93
JC72505	Skydisc PC IP65 Triac	4700K	Yes	7W	650	93
JC73505	Skydisc PC IP65 Triac	5700K	Yes	7W	650	93
JCEM001	Remote Emergency Pack	-	-	-	-	-
JCEM001ST	Remote Emergency Pack Self Test	-	-	-	-	-

**Body:** Thermal Plastic. **Diffuser:** Polycarbonate. **Bezel:** Polycarbonate.

\*Extended warranty requires online registration. Terms and conditions apply.

# Skydisc™ PC IP65 13W

Dimmable, slim commercial downlight

- Triac dimmable as standard

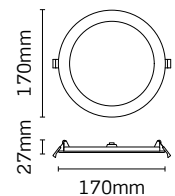

Cut out: Ø150-160mm









CODE	DESCRIPTION	COL TEMP.	DIM.	WATT	LUMENS	LPCW
JC72502	Skydisc PC IP65 Triac	4000K	Yes	13W	1300	100
JC72506	Skydisc PC IP65 Triac	4700K	Yes	13W	1300	100
JC73506	Skydisc PC IP65 Triac	5700K	Yes	13W	1300	100
JCEM001	Remote Emergency Pack	-	-	-	-	-
JCEM001ST	Remote Emergency Pack Self Test	-	-	-	-	-

**Body:** Thermal Plastic. **Diffuser:** Polycarbonate. **Bezel:** Polycarbonate.

\*Extended warranty requires online registration. Terms and conditions apply.

# Skydisc™ PC IP65 17W

Dimmable, slim commercial downlight

- Triac dimmable as standard



RATING



CLASS 2



CRI: RA



WARRANTY\*



BEAM



EM OPTIONS



DIMMABLE



WHITE

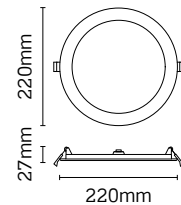

Cut out: Ø200-210mm

CODE	DESCRIPTION	COL TEMP.	DIM.	WATT	LUMENS	LPCW
JC72503	Skydisc PC IP65 Triac	4000K	Yes	17W	1700	100
JC72507	Skydisc PC IP65 Triac	4700K	Yes	17W	1700	100
JC73507	Skydisc PC IP65 Triac	5700K	Yes	17W	1700	100
JCEM001	Remote Emergency Pack	-	-	-	-	-

**Body:** Thermal Plastic. **Diffuser:** Polycarbonate. **Bezel:** Polycarbonate.

Not suitable for use with JCEM001ST.

\*Extended warranty requires online registration. Terms and conditions apply.

# Skydisc™ PC IP65 23W

Dimmable, slim commercial downlight

- Triac dimmable as standard









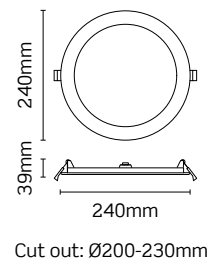

CODE	DESCRIPTION	COL TEMP.	DIM.	WATT	LUMENS	LPCW
JC72504	Skydisc PC IP65 Triac	4000K	Yes	23W	2100	91
JC72508	Skydisc PC IP65 Triac	4700K	Yes	23W	2100	91
JC73508	Skydisc PC IP65 Triac	5700K	Yes	23W	2100	91
JCEM001	Remote Emergency Pack	-	-	-	-	-

**Body:** Thermal Plastic. **Diffuser:** Polycarbonate. **Bezel:** Polycarbonate.

Not suitable for use with JCEM001ST.

\*Extended warranty requires online registration. Terms and conditions apply.

# Skydisc™ PC IP20 10W

IP20 commercial downlight

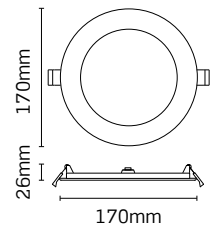

RATING



CLASS 2



CRI: RA



WARRANTY\*



BEAM



EM OPTIONS



WHITE

Cut out: Ø150-160mm

CODE	DESCRIPTION	COL TEMP.	DIM.	WATT	LUMENS	LPCW
JC72401	Skydisc PC IP20	4000K	No	10W	770	77
JC72404	Skydisc PC IP20	4700K	No	10W	770	77
JC73404	Skydisc PC IP20	5700K	No	10W	770	77
JCEM001	Remote Emergency Pack	-	-	-	-	-
JCEM001ST	Remote Emergency Pack Self Test	-	-	-	-	-

**Body:** Polycarbonate. **Diffuser:** Polycarbonate. **Bezel:** Polycarbonate.

\*Extended warranty requires online registration. Terms and conditions apply.



# Skydisc™ PC IP20 16W

IP20 commercial downlight

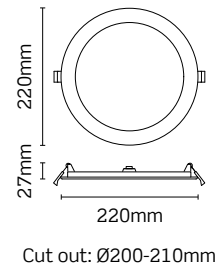









RATING CLASS 2 CRI: RA WARRANTY\* BEAM EM OPTIONS WHITE

CODE	DESCRIPTION	COL TEMP.	DIM.	WATT	LUMENS	LPCW
JC72402	Skydisc PC IP20	4000K	No	16W	1300	81
JC72405	Skydisc PC IP20	4700K	No	16W	1300	81
JC73405	Skydisc PC IP20	5700K	No	16W	1300	81
JCEM001	Remote Emergency Pack	-	-	-	-	-
JCEM001ST	Remote Emergency Pack Self Test	-	-	-	-	-

**Body:** Polycarbonate. **Diffuser:** Polycarbonate. **Bezel:** Polycarbonate.

\*Extended warranty requires online registration. Terms and conditions apply.

# Skydisc™ PC IP20 22W

IP20 commercial downlight

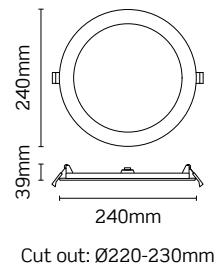









CODE	DESCRIPTION	COL TEMP.	DIM.	WATT	LUMENS	LPCW
JC72403	Skydisc PC IP20	4000K	No	22W	1750	80
JC72406	Skydisc PC IP20	4700K	No	22W	1750	80
JC73406	Skydisc PC IP20	5700K	No	22W	1750	80
JCEM001	Remote Emergency Pack	-	-	-	-	-

**Body:** Polycarbonate. **Diffuser:** Polycarbonate. **Bezel:** Polycarbonate.

Not suitable for use with JCEM001ST.

\*Extended warranty requires online registration. Terms and conditions apply.



# Surface Downlight 10W

Cylindrical surface mounted LED downlight

- Triac dimmable as standard



RATING



CLASS 1



CRI: RA



WARRANTY\*



BEAM



DIMMABLE



BLACK



WHITE

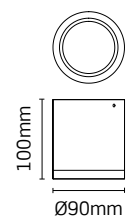

CODE	DESCRIPTION	COL TEMP.	DIM.	WATT	LUMENS	LPCW
JC84301	Surface Downlight Triac	3000K	Yes	10W	800	80
JC84300	Surface Downlight Triac	4000K	Yes	10W	950	95

For Black add **BLK** suffix, for White add **WH** suffix.

**Body:** Aluminium. **Lens:** Glass.

\*Extended warranty requires online registration. Terms and conditions apply.

# Surface Downlight 25W

Cylindrical surface mounted LED downlight

- Triac dimmable as standard



RATING



CLASS 1



CRI: RA



WARRANTY\*



BEAM



DIMMABLE



BLACK



WHITE

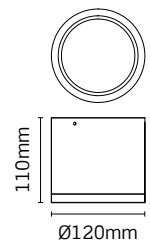

CODE	DESCRIPTION	COL TEMP.	DIM.	WATT	LUMENS	LPCW
JC84303	Surface Downlight Triac	3000K	Yes	25W	2540	102
JC84302	Surface Downlight Triac	4000K	Yes	25W	2910	116

For Black add **BLK** suffix, for White add **WH** suffix.

**Body:** Aluminium. **Lens:** Glass.

\*Extended warranty requires online registration. Terms and conditions apply.

# Surface Downlight 35W

Cylindrical surface mounted LED downlight

- Triac dimmable as standard



^ Black version available

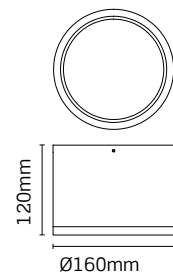

RATING



CLASS 1



CRI: RA



WARRANTY\*



BEAM



DIMMABLE



BLACK



WHITE

CODE	DESCRIPTION	COL TEMP.	DIM.	WATT	LUMENS	LPCW
JC84305	Surface Downlight Triac	3000K	Yes	35W	3370	96
JC84304	Surface Downlight Triac	4000K	Yes	35W	3720	106

For Black add **BLK** suffix, for White add **WH** suffix.

**Body:** Aluminium. **Lens:** Glass.

\*Extended warranty requires online registration. Terms and conditions apply.



# Surface High Output 25W

High output cylindrical surface mounted LED downlight



Black version available

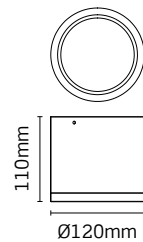

RATING



CLASS 1



CRI: RA



WARRANTY\*



BEAM OPTIONS



BLACK



WHITE

CODE	DESCRIPTION	COL TEMP.	DIM.	WATT	LUMENS	LPCW
JC84306	Surface Downlight 24° beam	3000K	No	25W	2750	110
JC84307	Surface Downlight 45° beam	3000K	No	25W	2750	110
JC84308	Surface Downlight 60° beam	3000K	No	25W	2750	110
JC84309	Surface Downlight 24° beam	4000K	No	25W	3025	121
JC84310	Surface Downlight 45° beam	4000K	No	25W	3025	121
JC84311	Surface Downlight 60° beam	4000K	No	25W	3025	121

For Black add **BLK** suffix, for White add **WH** suffix.

**Body:** Aluminium. **Lens:** Glass.

Produced to order, contact JCC customer services on **01243 838999**.

\*Extended warranty requires online registration. Terms and conditions apply.



# Surface High Output 35W

High output cylindrical surface mounted LED downlight



^ Black version available









RATING CLASS 1 CRI: RA WARRANTY\* BEAM OPTIONS BLACK WHITE

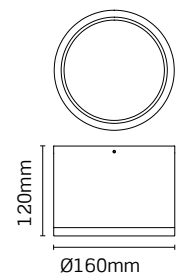

CODE	DESCRIPTION	COL TEMP.	DIM.	WATT	LUMENS	LPCW
JC84312	Surface Downlight 24° beam	3000K	No	35W	3850	110
JC84313	Surface Downlight 45° beam	3000K	No	35W	3850	110
JC84314	Surface Downlight 60° beam	3000K	No	35W	3850	110
JC84315	Surface Downlight 24° beam	4000K	No	35W	4200	120
JC84316	Surface Downlight 45° beam	4000K	No	35W	4200	120
JC84317	Surface Downlight 60° beam	4000K	No	35W	4200	120

For Black add **BLK** suffix, for White add **WH** suffix.

**Body:** Aluminium. **Lens:** Glass.

Produced to order, contact JCC customer services on **01243 838999**.

\*Extended warranty requires online registration. Terms and conditions apply.



# LED Panels

Skytile®	66
Skytile® Linear	70
Skytile® TP(a)	76
Skytile® Sense	80
Skytile® Base	82
Skytile® Direct/Indirect	84
Skytile® Mount box	86
Skytile® Suspension Kit	87

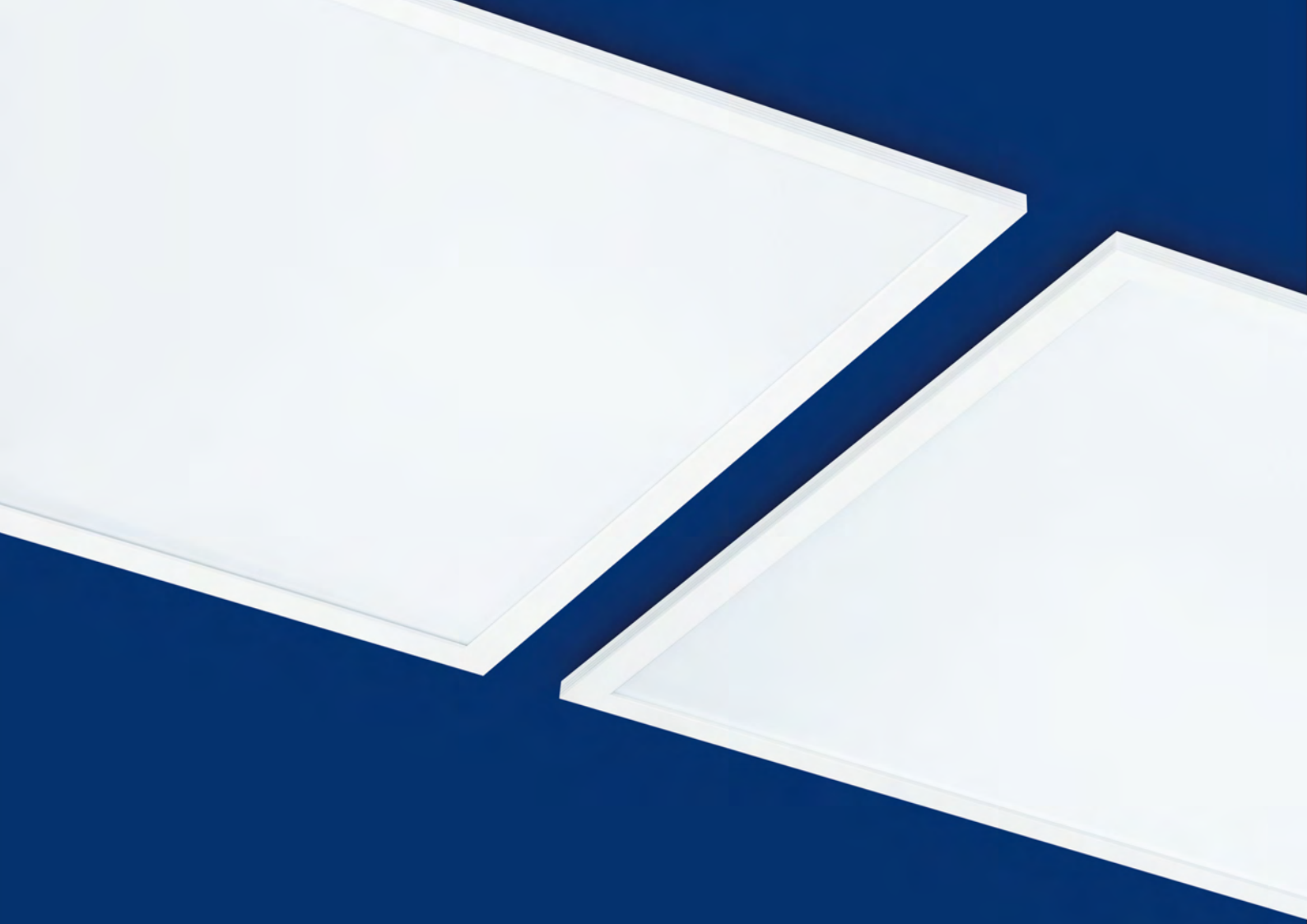

Skytile®

# Introducing the next generation of Skytile® LED flat panels



5YR EXT.  
INC. 2YR ON-SITE



UGR <19  
COMPLIANT



IP44  
RATED

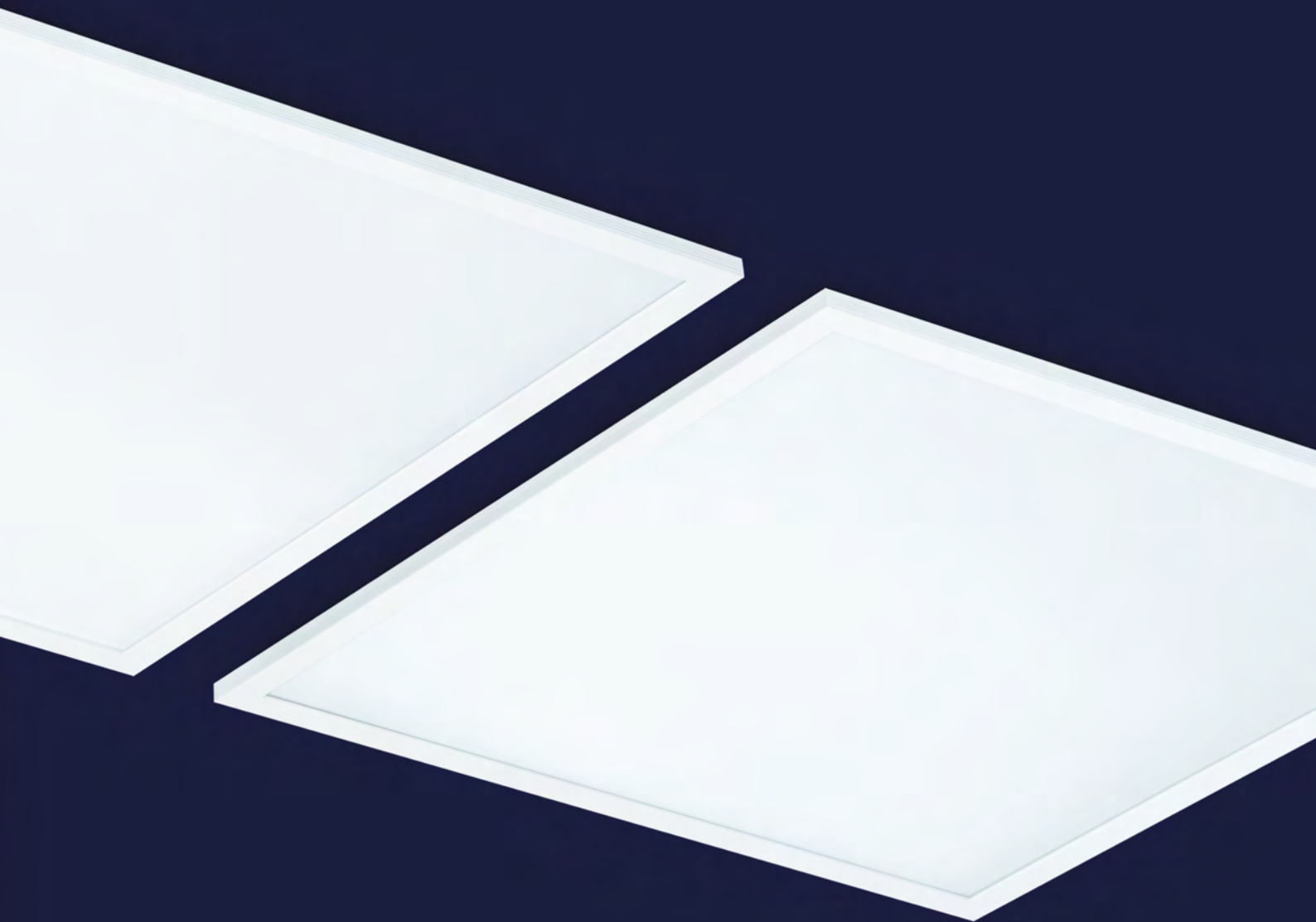

## High efficiency with UGR <19 as standard

The new additions to our market leading Skytile range features a low glare diffuser as standard that supports UGR <19 compliance when mounted at 2.8m ceiling heights. The Skytile brand has become synonymous with delivering the highest quality LED flat panel construction coupled with outstanding energy efficiency of up to 100 lpcW across the range.

# Skytile® 600 x 600

NEW

## High performance low glare LED panel

- 5 year extended warranty, including 2 year on-site support
- DALI, DSI and 1-10V dimmable options available
- Self test emergency pack available (JCEM001ST)
- Designed to comply with BS EN 12464-1 lighting of work places



RATING



CLASS 2



CRI: RA



WARRANTY\*



ON-SITE



EM OPTIONS



DIM OPTIONS



&lt;19



WHITE

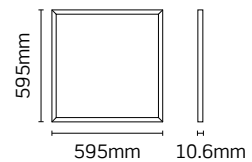

CODE	DESCRIPTION	COL TEMP.	DIM	WATT	LUMENS	LPCW
JC080001	Skytile	3000K	No	30W	3000	100
JC080004	Skytile DALI	3000K	Yes	30W	3000	100
JC080007	Skytile 1-10V	3000K	Yes	30W	3000	100
JC080010	Skytile DSI	3000K	Yes	30W	3000	100
JC080002	Skytile	4000K	No	30W	3000	100
JC080005	Skytile DALI	4000K	Yes	30W	3000	100
JC080008	Skytile 1-10V	4000K	Yes	30W	3000	100
JC080011	Skytile DSI	4000K	Yes	30W	3000	100
JC080003	Skytile	5700K	No	30W	3000	100
JC080006	Skytile DALI	5700K	Yes	30W	3000	100
JC080009	Skytile 1-10V	5700K	Yes	30W	3000	100
JC080012	Skytile DSI	5700K	Yes	30W	3000	100
JCEM001	Remote Emergency Pack	-	-	-	-	-
JCEM001ST	Remote Emergency Pack Self-Test	-	-	-	-	-
JC71311	4 wire suspension kit (1.5m)	-	-	-	-	-
JC71262	600 x 600mm Surface mount box	-	-	-	-	-

**Body:** Aluminium. **Diffuser:** Opal TP(b) Polystyrene.



# Skytile<sup>®</sup> Linear 1200 x 300



## High performance low glare LED panel

- 5 year extended warranty, including 2 year on-site support
- DALI, DSI and 1-10V dimmable options available
- Self test emergency pack available (JCEM001ST)
- Designed to comply with BS EN 12464-1 lighting of work places

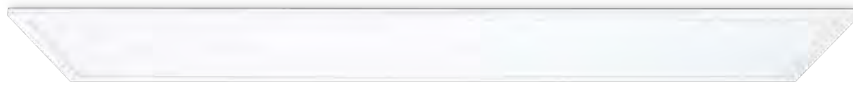
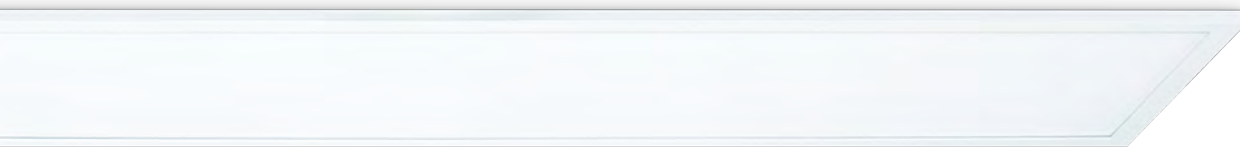

RATING



CLASS 2



CRI: RA



WARRANTY\*



ON-SITE



EM OPTIONS



DIM OPTIONS



&lt;19



WHITE

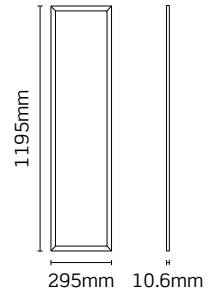

CODE	DESCRIPTION	COL TEMP.	DIM	WATT	LUMENS	LPCW
JC080013	Skytile Linear	4000K	No	30W	3000	100
JC080015	Skytile Linear DALI	4000K	Yes	30W	3000	100
JC080017	Skytile Linear 1-10V	4000K	Yes	30W	3000	100
JC080019	Skytile Linear DSI	4000K	Yes	30W	3000	100
JC080014	Skytile Linear	5700K	No	30W	3000	100
JC080016	Skytile Linear DALI	5700K	Yes	30W	3000	100
JC080018	Skytile Linear 1-10V	5700K	Yes	30W	3000	100
JC080020	Skytile Linear DSI	5700K	Yes	30W	3000	100
JCEM001	Remote Emergency Pack	-	-	-	-	-
JCEM001ST	Remote Emergency Pack self test	-	-	-	-	-
JC71311	4 wire suspension kit (1.5m)	-	-	-	-	-
JC71299	1200 x 300mm Surface mount box	-	-	-	-	-

**Body:** Aluminium. **Diffuser:** TP(b) polystyrene.



# Skytile<sup>®</sup> Linear 1200 x 600



## High performance low glare LED panel

- 5 year extended warranty, including 2 year on-site support
- DALI, DSI and 1-10V dimmable options available
- Self test emergency pack available (JCEM001ST)
- Designed to comply with BS EN 12464-1 lighting of work places

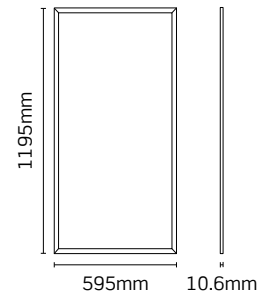
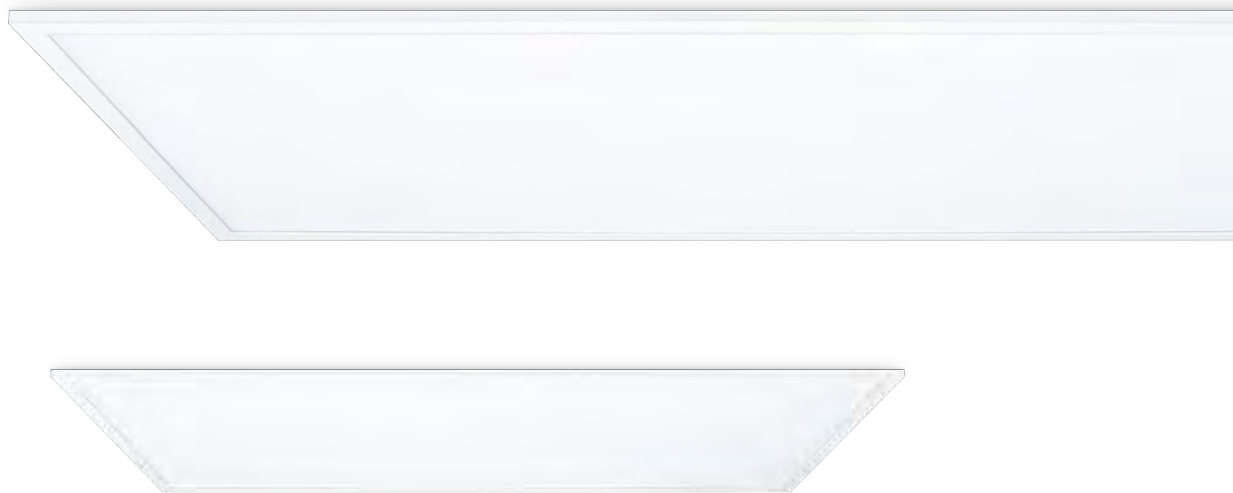

RATING IP 44    
 CLASS 2    
 CRI: RA 80    
 WARRANTY\* 5yr    
 ON-SITE 2yr    
 EM OPTIONS    
 DIM OPTIONS    
 UGR <19    
 WH WHITE

CODE	DESCRIPTION	COL TEMP.	DIM	WATT	LUMENS	LPCW
JC080021	Skytile Linear	4000K	No	48W	4800	100
JC080023	Skytile Linear DALI	4000K	Yes	48W	4800	100
JC080025	Skytile Linear 1-10V	4000K	Yes	48W	4800	100
JC080027	Skytile Linear DSI	4000K	Yes	48W	4800	100
JC080022	Skytile Linear	5700K	No	48W	4800	100
JC080024	Skytile Linear DALI	5700K	Yes	48W	4800	100
JC080026	Skytile Linear 1-10V	5700K	Yes	48W	4800	100
JC080028	Skytile Linear DSI	5700K	Yes	48W	4800	100
JCEM001	Remote Emergency Pack	-	-	-	-	-
JCEM001ST	Remote Emergency Pack self test	-	-	-	-	-
JC71312	6 wire suspension kit (1.5m)	-	-	-	-	-
JC71295	1200 x 600mm Surface mount box	-	-	-	-	-

Body: Aluminium. Diffuser: TP(b) polystyrene.

\*Extended warranty requires online registration. 2 year warranty on batteries for emergency variants. Terms and conditions apply.

# Skytile® 28W

## High performance LED 28W panel

- 7 year extended warranty, including 2 year on-site support
- Up to 107 lumens per circuit Watt
- DALI, DSI and 1-10V dimmable options available
- Self test emergency pack available (JCEM001ST)

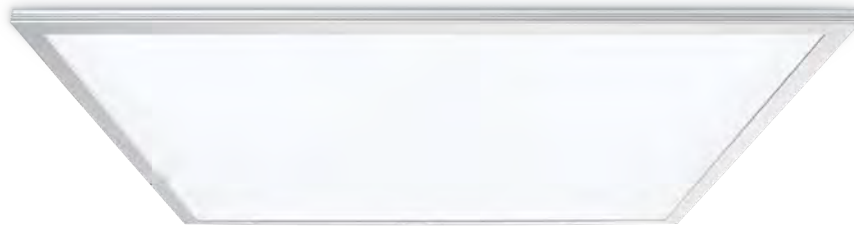

RATING



CLASS 2



CRI: RA



WARRANTY\*



ON-SITE



EM OPTIONS



DIM OPTIONS



SILVER



WHITE

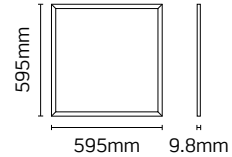

CODE	DESCRIPTION	COL TEMP.	DIM.	WATT	LUMENS	LPCW
JC71351	Skytile	3000K	No	28W	2700	96
JC71351DALI	Skytile DALI	3000K	Yes	28W	2700	96
JC71351DSI	Skytile DSI	3000K	Yes	28W	2700	96
JC71351/1-10V	Skytile 1-10V	3000K	Yes	28W	2700	96
JC71355	Skytile	4000K	No	28W	3000	107
JC71355DALI	Skytile DALI	4000K	Yes	28W	3000	107
JC71355DSI	Skytile DSI	4000K	Yes	28W	3000	107
JC71355/1-10V	Skytile 1-10V	4000K	Yes	28W	3000	107
JC71276	Skytile	4700K	No	28W	3000	107
JC71276DALI	Skytile DALI	4700K	Yes	28W	3000	107
JC71276DSI	Skytile DSI	4700K	Yes	28W	3000	107
JC71276/1-10V	Skytile 1-10V	4700K	Yes	28W	3000	107
JCEM001	Remote Emergency Pack	-	-	-	-	-
JCEM001ST	Remote Emergency Pack self test	-	-	-	-	-
SPR0579	Armstrong oracle T-Clip Bracket	-	-	-	-	-
JC71311	4 wire suspension kit (1.5m)	-	-	-	-	-
JC71262	600 x 600mm Surface mount box	-	-	-	-	-

For White add **WH** suffix (available for 4700K options only).

**Body:** Aluminium. **Diffuser:** Opal Polycarbonate.

# Skytile® 36W

## High performance LED 36W flat panel

- 7 year extended warranty, including 2 year on-site support
- Up to 106 lumens per circuit Watt
- Ideal for ceiling heights over 2.8m
- DALI, DSI and 1-10V dimmable options available
- Self test emergency pack available (JCEM001ST)

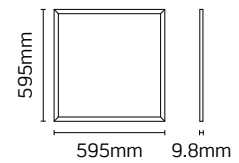

CODE	DESCRIPTION	COL TEMP.	DIM.	WATT	LUMENS	LPCW
JC71353	Skytile	3000K	No	36W	3500	97
JC71353DALI	Skytile DALI	3000K	Yes	36W	3500	97
JC71353DSI	Skytile DSI	3000K	Yes	36W	3500	97
JC71353/1-10V	Skytile 1-10V	3000K	Yes	36W	3500	97
JC71357	Skytile	4000K	No	36W	3800	106
JC71357DALI	Skytile DALI	4000K	Yes	36W	3800	106
JC71357DSI	Skytile DSI	4000K	Yes	36W	3800	106
JC71357/1-10V	Skytile 1-10V	4000K	Yes	36W	3800	106
JC71277	Skytile	4700K	No	36W	3800	106
JC71277DALI	Skytile DALI	4700K	Yes	36W	3800	106
JC71277DSI	Skytile DSI	4700K	Yes	36W	3800	106
JC71277/1-10V	Skytile 1-10V	4700K	Yes	36W	3800	106
JCEM001	Remote Emergency Pack	-	-	-	-	-
JCEM001ST	Remote Emergency Pack self test	-	-	-	-	-
SPR0579	Armstrong oracle T-Clip Bracket	-	-	-	-	-
JC71311	4 wire suspension kit (1.5m)	-	-	-	-	-
JC71262	600 x 600mm Surface mount box	-	-	-	-	-

Body: Aluminium. Diffuser: Opal Polycarbonate.

\*Extended warranty requires online registration. 2 year warranty on batteries for emergency variants. Terms and conditions apply.

# Skytile® Linear 36W 1200 x 300

## High performance linear LED panel

- 7 year extended warranty, including 2 year on-site support
- Up to 100 lumens per circuit Watt
- DALI, DSI and 1-10V dimmable options available
- Self test emergency pack available (JCEM001ST)

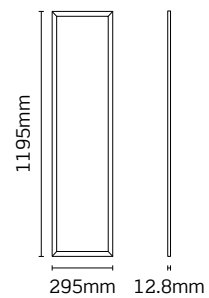
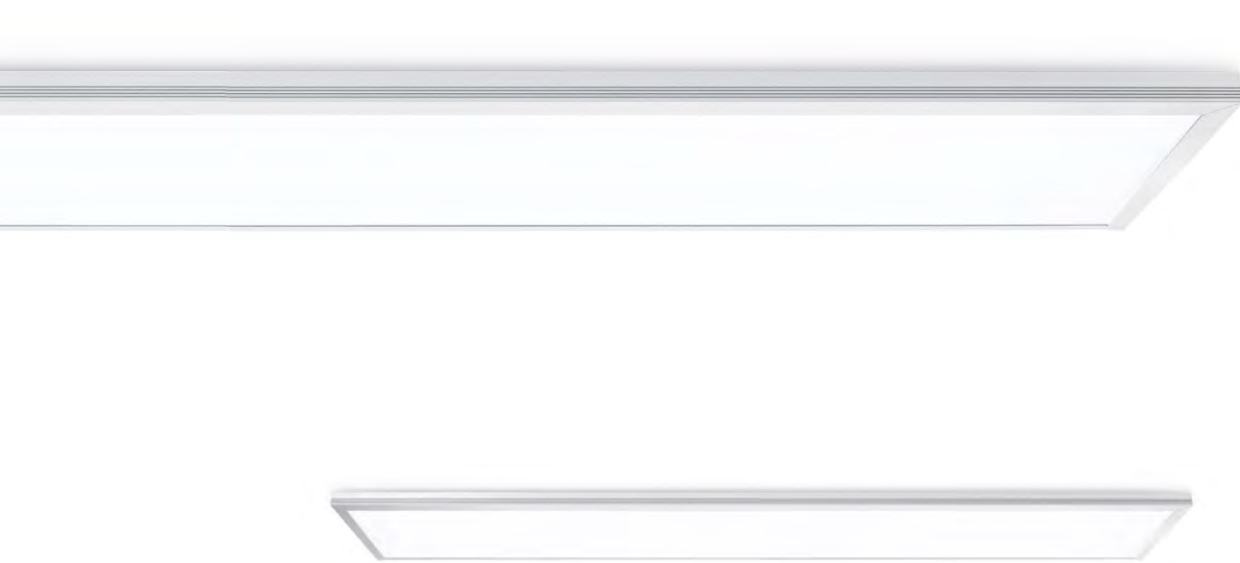

RATING



CLASS 2



CRI: RA



WARRANTY\*



ON-SITE



EM OPTIONS



DIM OPTIONS



WHITE

CODE	DESCRIPTION	COL TEMP.	DIM.	WATT	LUMENS	LPCW
JC71359	Skytile Linear	4700K	No	36W	3600	100
JC71359/DALI	Skytile Linear DALI	4700K	Yes	36W	3600	100
JC71359/DSI	Skytile Linear DSI	4700K	Yes	36W	3600	100
JC71359/1-10V	Skytile Linear 1-10V	4700K	Yes	36W	3600	100
JCEM001	Remote Emergency Pack	-	-	-	-	-
JCEM001ST	Remote Emergency Pack Self-Test	-	-	-	-	-
JC71311	4 wire suspension kit (1.5m)	-	-	-	-	-
JC71299	1200 x 300mm Surface mount box	-	-	-	-	-





**Body:** Aluminium. **Diffuser:** Opal Polycarbonate.

# Skytile<sup>®</sup> Linear 44W 1200 x 600

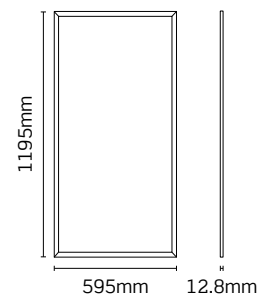
## High performance linear LED panel

- 7 year extended warranty, including 2 year on-site support
- Up to 100 lumens per circuit Watt
- DALI, DSI and 1-10V dimmable options available
- Self test emergency pack available (JCEM001ST)



 **RATING**    
  **CLASS 2**    
  **CRI: RA**    
  **WARRANTY\***    
  **ON-SITE**    
  **EM OPTIONS**    
  **DIM OPTIONS**    
  **WHITE**

CODE	DESCRIPTION	COL TEMP.	DIM.	WATT	LUMENS	LPCW
JC71361	Skytile Linear	4700K	No	44W	4400	100
JC71361/DALI	Skytile Linear DALI	4700K	Yes	44W	4400	100
JC71361/DSI	Skytile Linear DSI	4700K	Yes	44W	4400	100
JC71361/1-10V	Skytile Linear 1-10V	4700K	Yes	44W	4400	100
JCEM001	Remote Emergency Pack	-	-	-	-	-
JCEM001ST	Remote Emergency Pack Self-Test	-	-	-	-	-
JC71312	6 wire suspension kit (1.5m)	-	-	-	-	-
JC71295	1200 x 600mm Surface mount box	-	-	-	-	-

**Body:** Aluminium. **Diffuser:** Opal Polycarbonate.

\*Extended warranty requires online registration. 2 year warranty on batteries for emergency variants. Terms and conditions apply.

## Skytile® TP(a)

# TP(a) rated LED panel for placement without restriction



5YR EXT.  
WARRANTY



0.8MM SELF EXTINGUISHING  
TP(a) DIFFUSER



UGR < 19  
COMPLIANT

Skytile® TP(a) incorporates a 0.8mm TP(a) rated diffuser. This allows Skytile® TP(a) to be used in all applications without restriction, giving installers complete peace of mind. The specially engineered diffuser meets UGR < 19 requirements when used in standard 2.8m ceiling heights and delivers outstanding efficiency of 100 lpcW.





# Skytile® TP(a)

NEW

## High performance LED flat panel with thermoplastic diffuser

- Meets TP(a) requirements, suitable for all applications
- Assists with sub UGR19 when mounted at standard 2.8m ceiling height
- Designed to comply with BS EN 12464-1 lighting of workspace
- DALI, DSI and 1-10V dimmable options available
- Self test emergency pack available (JCEM001ST)

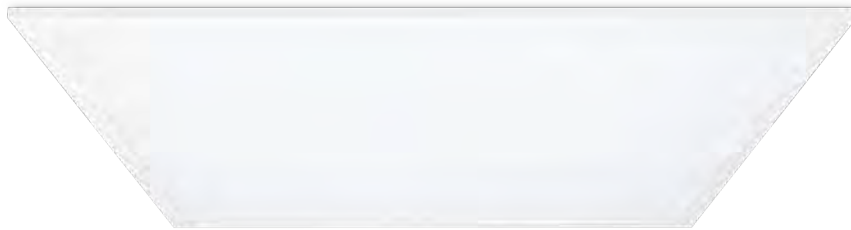

RATING



CLASS 2



CRI: RA



WARRANTY\*



EM OPTIONS



DIM OPTIONS



&lt;19



WHITE

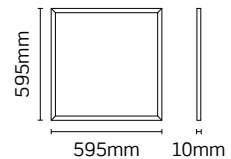

CODE	DESCRIPTION	COL TEMP.	DIM	WATT	LUMENS	LPCW
JC080029	Skytile TP(a)	4000K	No	30W	3000	100
JC080031	Skytile TP(a) DALI	4000K	Yes	30W	3000	100
JC080033	Skytile TP(a) 1-10V	4000K	Yes	30W	3000	100
JC080035	Skytile TP(a) DSI	4000K	Yes	30W	3000	100
JC080030	Skytile TP(a)	5700K	No	30W	3000	100
JC080032	Skytile TP(a) DALI	5700K	Yes	30W	3000	100
JC080034	Skytile TP(a) 1-10V	5700K	Yes	30W	3000	100
JC080036	Skytile TP(a) DSI	5700K	Yes	30W	3000	100
JCEM001	Remote Emergency Pack	-	-	-	-	-
JCEM001ST	Remote Emergency Pack Self-Test	-	-	-	-	-
JC080045	Skytile TP(a) suspension kit	-	-	-	-	-
JC71262	Skytile 600 x 600 surface mount box	-	-	-	-	-

**Body:** Aluminium. **Diffuser:** Opal TP(a) Polyethylene terephthalate.





# Skytile® Sense Presence Detection

LED panel with integrated microwave presence detection

- Microwave step-dimmable to 10%, 25% and 50% levels
- Sensors can be wired in synchronised banks for seamless office integration
- Variable LED hold time and standby period
- Achieve up to 50% energy saving against a standard panel



RATING



CLASS 2



CRI: RA



WARRANTY\*



ON-SITE



SENSING



EM OPTIONS



SILVER

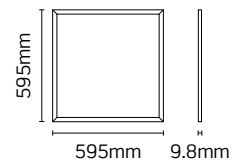

CODE	DESCRIPTION	COL TEMP.	DIM.	WATT	LUMENS	LPCW
JC71276PD	Skytile Sense Presence Detection	4700K	No	28W	3000	107
JC71355PD	Skytile Sense Presence Detection	4000K	No	28W	3000	107
JCEM001	Remote Emergency Pack	-	-	-	-	-
JCEM001ST	Remote Emergency Pack Self-Test	-	-	-	-	-
JC71311	4 wire suspension kit (1.5m)	-	-	-	-	-
JC71262	600 x 600mm Surface mount box	-	-	-	-	-

**Body:** Aluminium. **Diffuser:** Opal Polycarbonate.

\*Extended warranty requires online registration. Terms and conditions apply.

# Skytile<sup>®</sup> Sense Daylight Harvesting

LED panel with integrated microwave daylight harvesting

- Intelligently adapts light level to fluctuations in natural daylight
- Achieve up to an additional 60% energy saving against standard panel
- No need for additional wiring on commissioning



RATING



CLASS 2



CRI: RA



WARRANTY\*



ON-SITE



SENSING



EM OPTIONS



SILVER

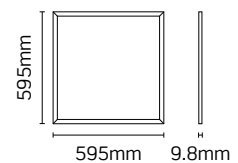

CODE	DESCRIPTION	COL TEMP.	DIM.	WATT	LUMENS	LPCW
JC71276DH	Skytile Sense Daylight Harvesting	4700K	No	28W	3000	107
JC71355DH	Skytile Sense Daylight Harvesting	4000K	No	28W	3000	107
JCEM001	Remote Emergency Pack	-	-	-	-	-
JCEM001ST	Remote Emergency Pack Self-Test	-	-	-	-	-
JC71311	4 wire suspension kit (1.5m)	-	-	-	-	-
JC71262	600 x 600mm Surface mount box	-	-	-	-	-

**Body:** Aluminium. **Diffuser:** Opal Polycarbonate.

\*Extended warranty requires online registration. Terms and conditions apply.

# Skytile® Base

## Direct fluorescent replacement

- DALI and 1-10V dimmable options available
- Self test emergency pack available (JCEM001ST)

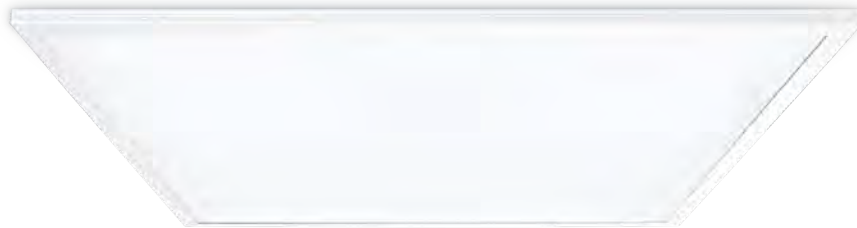









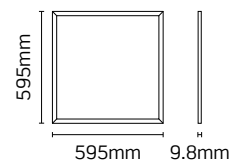

CODE	DESCRIPTION	COL TEMP.	DIM.	WATT	LUMENS	LPCW
JC71676	Skytile Base	4200K	No	32W	2800	88
JC71676DALI	Skytile Base DALI / 1-10V	4200K	No	32W	2800	88
JCEM001	Remote Emergency Pack	-	-	-	-	-
JCEM001ST	Remote Emergency Pack Self-Test	-	-	-	-	-
JC71311	4 wire suspension kit (1.5m)	-	-	-	-	-
JC71262	600 x 600mm Surface mount box	-	-	-	-	-
SPR0579	Armstrong oracle T-Clip Bracket	-	-	-	-	-

**Body:** Aluminium. **Diffuser:** Opal Polycarbonate.

\*Extended warranty requires online registration. 2 year warranty on batteries for emergency variants. Terms and conditions apply.



# Skytile® Direct/Indirect

## Architectural direct/indirect luminaire

- Assists with sub UGR19 when mounted at standard 2.8m ceiling height
- DALI, DSI and 1-10V dimmable options available
- Self test emergency pack available

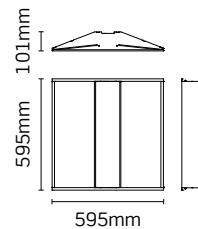

RATING



CLASS 2



CRI: RA



WARRANTY\*



EM OPTIONS



DIM OPTIONS



<19



WHITE

CODE	DESCRIPTION	COL TEMP.	DIM.	WATT	LUMENS	LPCW
JC71376	Skytile Direct/Indirect	4000K	No	35W	3400	97
JC71376DALI	Skytile Direct/Indirect DALI	4000K	Yes	35W	3400	97
JC71376DSI	Skytile Direct/Indirect DSI	4000K	Yes	35W	3400	97
JC71376/1-10V	Skytile Direct/Indirect 1-10V	4000K	Yes	35W	3400	97
JCEM001	Remote Emergency Pack	-	-	-	-	-
JCEM001ST	Remote Emergency Pack Self-Test	-	-	-	-	-

Body: Steel. Diffuser: Polycarbonate.

\*Extended warranty requires online registration. Terms and conditions apply.



# Skytile® Surface Mount Box

Suitable for installation on solid ceilings

- Standard and linear variants available
- Suitable for emergency versions

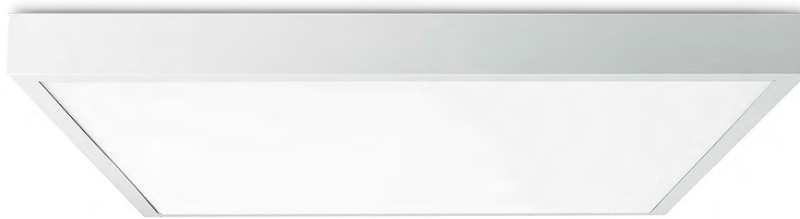

WHITE



GUARANTEE

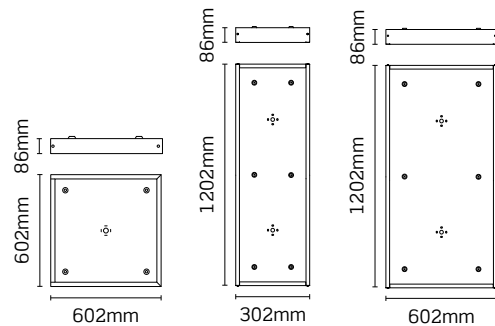

CODE	DESCRIPTION
JC71262	600 x 600mm Surface mount box
JC71295	1200 x 600mm Surface mount box
JC71299	1200 x 300mm Surface mount box

**Body:** Pressed Steel.



# Skytile® Suspension Kit

## Suspension cables for Skytile® LED panels

- Supplied with 1.5m suspension cable
- Collar locking mechanism to adjust mounting heights
- For both ceiling and cable tray mounting

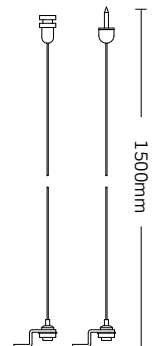

2yr

GUARANTEE

### CODE

### DESCRIPTION

JC71311	4 wire suspension kit (1.5m) suitable for 600 x 600 & 1200 x 300
JC71312	6 wire suspension kit (1.5m) suitable for 1200 x 600
JC080045	2 wire 'Y' Skytile TP(a) suspension kit

**Cable:** Steel.



# Commercial Linear LED

Skytile® Surface	90
OxfordLED™	100
Line of Light	102

## Skytile® Surface

Unique slide and lock design for easy installation



EASY  
INSTALLATION



MICROWAVE  
SENSING



DIMMABLE  
VARIANTS



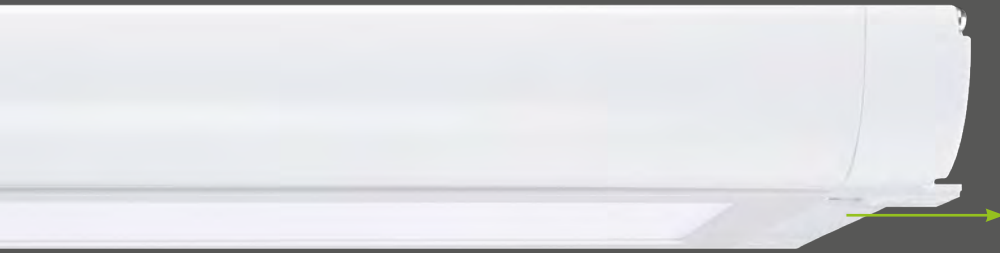

## Secure Locking Caps

Skytile Surface has been designed to ensure a quick and easy installation. Slide the secure locking caps from both sides of the fitting to release the inner LED panel.

## Hinged LED Panel

Once unlocked, the hinged pivot mechanism allows the panel to be carefully manoeuvred with ease for a faster, simpler installation.

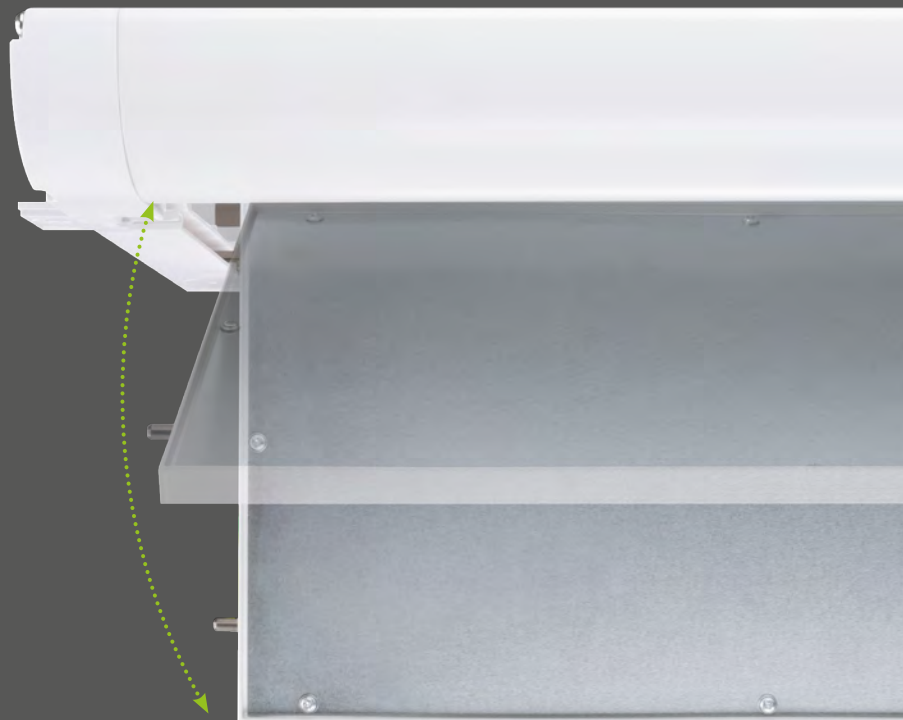

**4FT - 1200X300**

Microwave\*, DALI, DSI and 1-10V dimming variants available.



**5FT - 1500X300**

Microwave\*, DALI, DSI and 1-10V dimming variants available.



**6FT - 1800X300**

Microwave\*, DALI, DSI and 1-10V dimming variants available.

\*Microwave versions 100mm longer than other variants

# Skytile® Surface 4ft

## Direct 2x36W T8 replacement

- Conduit entry points at both ends
- DALI, 1-10V and DSI dimmable options available
- Rear BESA plate mounting option

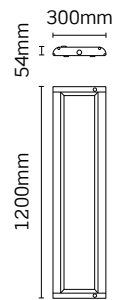
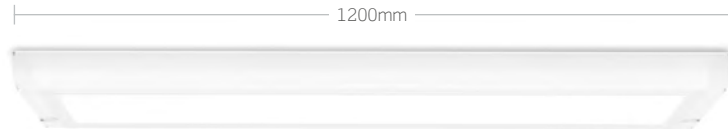

 RATING  
 CLASS 1  
 CRI: RA  
 WARRANTY\*  
 BEAM  
 EM OPTIONS  
 DIM OPTIONS  
 WHITE

CODE	DESCRIPTION	COL TEMP.	DIM.	WATT	LUMENS	LPCW
JC72305	Skytile Surface	4000K	No	49W	4200	86
JC72305EM	Skytile Surface emergency	4000K	No	49W	4200	86
JC72305DALI	Skytile Surface DALI	4000K	Yes	49W	4200	86
JC72305EMDALI	Skytile Surface DALI emergency	4000K	Yes	49W	4200	86
JC72305DSI	Skytile Surface DSI	4000K	Yes	49W	4200	86
JC72305EMDSI	Skytile Surface DSI emergency	4000K	Yes	49W	4200	86
JC72305/1-10V	Skytile Surface 1-10V	4000K	Yes	49W	4200	86
JC72305EM/1-10V	Skytile Surface 1-10V emergency	4000K	Yes	49W	4200	86
JC72301	Skytile Surface	4700K	No	49W	4200	86
JC72301EM	Skytile Surface emergency	4700K	No	49W	4200	86
JC72301DALI	Skytile Surface DALI	4700K	Yes	49W	4200	86
JC72301EMDALI	Skytile Surface DALI emergency	4700K	Yes	49W	4200	86
JC72301DSI	Skytile Surface DSI	4700K	Yes	49W	4200	86
JC72301EMDSI	Skytile Surface DSI emergency	4700K	Yes	49W	4200	86
JC72301/1-10V	Skytile Surface 1-10V	4700K	Yes	49W	4200	86
JC72301EM/1-10V	Skytile Surface 1-10V emergency	4700K	Yes	49W	4200	86
JC73301	Skytile Surface	5700K	No	49W	4200	86
JC73301EM	Skytile Surface emergency	5700K	No	49W	4200	86
JC73301DALI	Skytile Surface DALI	5700K	Yes	49W	4200	86
JC73301EMDALI	Skytile Surface DALI emergency	5700K	Yes	49W	4200	86
JC73301DSI	Skytile Surface DSI	5700K	Yes	49W	4200	86
JC73301EMDSI	Skytile Surface DSI emergency	5700K	Yes	49W	4200	86
JC73301/1-10V	Skytile Surface 1-10V	5700K	Yes	49W	4200	86
JC73301EM/1-10V	Skytile Surface 1-10V emergency	5700K	Yes	49W	4200	86
JC71311	Skytile Surface suspension kit (1.5m)	-	-	-	-	-

Body: Aluminium. End caps: Polycarbonate. Diffuser: Polystyrene.

\*Extended warranty requires online registration. 2 year warranty on batteries for emergency variants. Terms and conditions apply.

# Skytile® Surface 4ft Microwave Sense

## Direct 2x36W T8 replacement

- Conduit entry points available
- Rear BESA plate mounting option
- Microwave dimming with corridor function

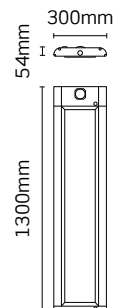
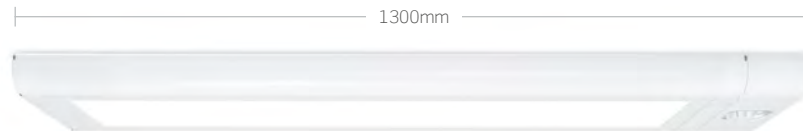

 **RATING**   
  **CLASS 1**   
  **CRI: RA**   
  **WARRANTY\***   
  **BEAM**   
  **EM OPTIONS**   
  **SENSING**   
  **WHITE**

CODE	DESCRIPTION	COL TEMP.	DIM.	WATT	LUMENS	LPCW
JC72305MW	Skytile Surface microwave on/off	4000K	No	49W	4200	86
JC72305EMMW	Skytile Surface microwave on/off emergency	4000K	No	49W	4200	86
JC72305SD	Skytile Surface microwave step dim	4000K	-	49W	4200	86
JC72305EMSD	Skytile Surface microwave step dim emergency	4000K	-	49W	4200	86
JC72301MW	Skytile Surface microwave on/off	4700K	No	49W	4200	86
JC72301EMMW	Skytile Surface microwave on/off emergency	4700K	No	49W	4200	86
JC72301SD	Skytile Surface microwave step dim	4700K	-	49W	4200	86
JC72301EMSD	Skytile Surface microwave step dim emergency	4700K	-	49W	4200	86
JC73301MW	Skytile Surface microwave on/off	5700K	No	49W	4200	86
JC73301EMMW	Skytile Surface microwave on/off emergency	5700K	No	49W	4200	86
JC73301SD	Skytile Surface microwave step dim	5700K	-	49W	4200	86
JC73301EMSD	Skytile Surface microwave step dim emergency	5700K	-	49W	4200	86
JC71311	Skytile Surface suspension kit (1.5m)	-	-	-	-	-

**Body:** Aluminium. **End caps:** Polycarbonate. **Diffuser:** Polystyrene.

\*Extended warranty requires online registration. 2 year warranty on batteries for emergency variants. Terms and conditions apply.

# Skytile® Surface 5ft

## Direct 2x58W T8 replacement

- Conduit entry points at both ends
- DALI, 1-10V and DSI dimmable options available
- Rear BESA plate mounting option

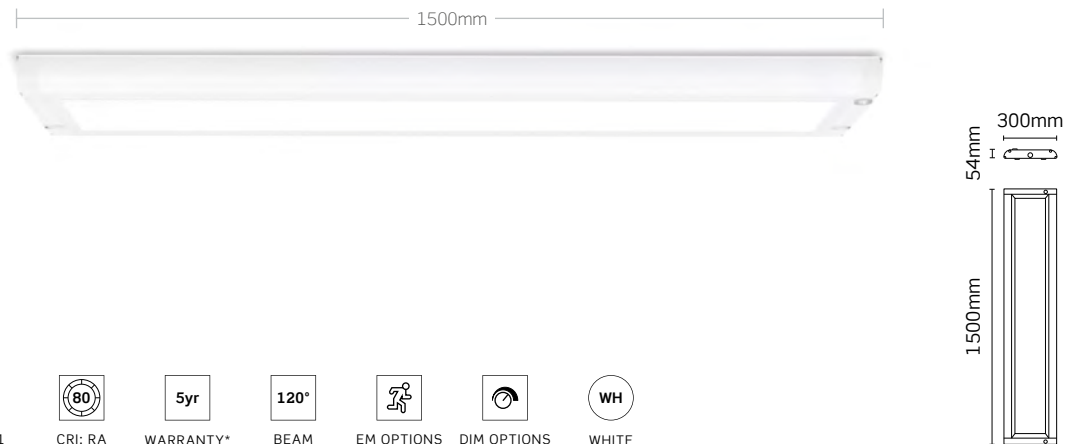

CODE	DESCRIPTION	COL TEMP.	DIM.	WATT	LUMENS	LPCW
JC72306	Skytile Surface	4000K	No	60W	5100	85
JC72306EM	Skytile Surface emergency	4000K	No	60W	5100	85
JC72306DALI	Skytile Surface DALI	4000K	Yes	60W	5100	85
JC72306EMDALI	Skytile Surface DALI emergency	4000K	Yes	60W	5100	85
JC72306DSI	Skytile Surface DSI	4000K	Yes	60W	5100	85
JC72306EMDSI	Skytile Surface DSI emergency	4000K	Yes	60W	5100	85
JC72306/1-10V	Skytile Surface 1-10V	4000K	Yes	60W	5100	85
JC72306EM/1-10V	Skytile Surface 1-10V emergency	4000K	Yes	60W	5100	85
JC72302	Skytile Surface	4700K	No	60W	5100	85
JC72302EM	Skytile Surface emergency	4700K	No	60W	5100	85
JC72302DALI	Skytile Surface DALI	4700K	Yes	60W	5100	85
JC72302EMDALI	Skytile Surface DALI emergency	4700K	Yes	60W	5100	85
JC72302DSI	Skytile Surface DSI	4700K	Yes	60W	5100	85
JC72302EMDSI	Skytile Surface DSI emergency	4700K	Yes	60W	5100	85
JC72302/1-10V	Skytile Surface 1-10V	4700K	Yes	60W	5100	85
JC72302EM/1-10V	Skytile Surface 1-10V emergency	4700K	Yes	60W	5100	85
JC73302	Skytile Surface	5700K	No	60W	5100	85
JC73302EM	Skytile Surface emergency	5700K	No	60W	5100	85
JC73302DALI	Skytile Surface DALI	5700K	Yes	60W	5100	85
JC73302EMDALI	Skytile Surface DALI emergency	5700K	Yes	60W	5100	85
JC73302DSI	Skytile Surface DSI	5700K	Yes	60W	5100	85
JC73302EMDSI	Skytile Surface DSI emergency	5700K	Yes	60W	5100	85
JC73302/1-10V	Skytile Surface 1-10V	5700K	Yes	60W	5100	85
JC73302EM/1-10V	Skytile Surface 1-10V emergency	5700K	Yes	60W	5100	85
JC71311	Skytile Surface suspension kit (1.5m)	-	-	-	-	-

Body: Aluminium. End caps: Polycarbonate. Diffuser: Polystyrene.

\*Extended warranty requires online registration. 2 year warranty on batteries for emergency variants. Terms and conditions apply.



# Skytile® Surface 5ft Microwave Sense

## Direct 2x58W T8 replacement

- Conduit entry points available
- Rear BESA plate mounting option
- Microwave dimming with corridor function

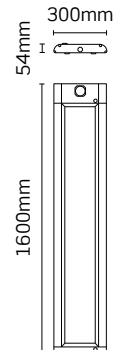
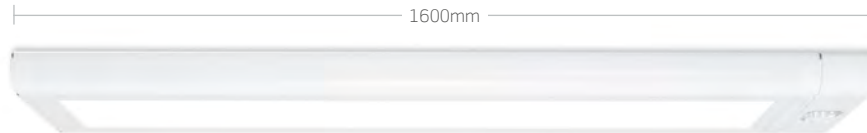

 **RATING**  
  **CLASS 1**  
  **CRI: RA**  
  **WARRANTY\***  
  **BEAM**  
  **EM OPTIONS**  
  **SENSING**  
  **WHITE**

CODE	DESCRIPTION	COL TEMP.	DIM.	WATT	LUMENS	LPCW
JC72306MW	Skytile Surface microwave on/off	4000K	No	60W	5100	85
JC72306EMMW	Skytile Surface microwave on/off emergency	4000K	No	60W	5100	85
JC72306SD	Skytile Surface microwave step dim	4000K	-	60W	5100	85
JC72306EMSD	Skytile Surface microwave step dim emergency	4000K	-	60W	5100	85
JC72302MW	Skytile Surface microwave on/off	4700K	No	60W	5100	85
JC72302EMMW	Skytile Surface microwave on/off emergency	4700K	No	60W	5100	85
JC72302SD	Skytile Surface microwave step dim	4700K	-	60W	5100	85
JC72302EMSD	Skytile Surface microwave step dim emergency	4700K	-	60W	5100	85
JC73302MW	Skytile Surface microwave on/off	5700K	No	60W	5100	85
JC73302EMMW	Skytile Surface microwave on/off emergency	5700K	No	60W	5100	85
JC73302SD	Skytile Surface microwave step dim	5700K	-	60W	5100	85
JC73302EMSD	Skytile Surface microwave step dim emergency	5700K	-	60W	5100	85
JC71311	Skytile Surface suspension kit (1.5m)	-	-	-	-	-

**Body:** Aluminium. **End caps:** Polycarbonate. **Diffuser:** Polystyrene.

\*Extended warranty requires online registration. 2 year warranty on batteries for emergency variants. Terms and conditions apply.

# Skytile® Surface 5ft High Output

## Direct 2x70W T8 replacement

- Conduit entry points at both ends
- DALI, 1-10V and DSI dimmable options available
- Rear BESA plate mounting option

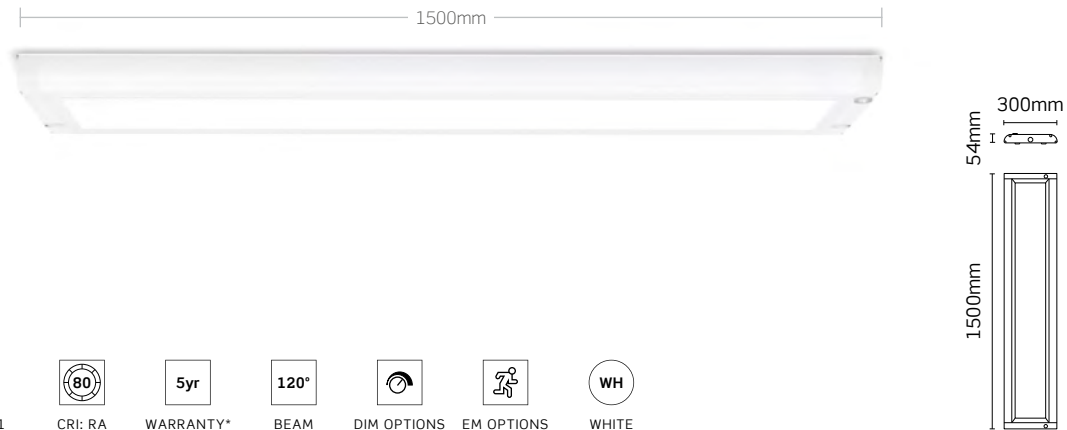

CODE	DESCRIPTION	COL TEMP.	DIM.	WATT	LUMENS	LPCW
JC72307	Skytile Surface	4000K	No	80W	6400	80
JC72307EM	Skytile Surface emergency	4000K	No	80W	6400	80
JC72307DALI	Skytile Surface DALI	4000K	Yes	80W	6400	80
JC72307EMDALI	Skytile Surface DALI emergency	4000K	Yes	80W	6400	80
JC72307DSI	Skytile Surface DSI	4000K	Yes	80W	6400	80
JC72307EMDSI	Skytile Surface DSI emergency	4000K	Yes	80W	6400	80
JC72307/1-10V	Skytile Surface 1-10V	4000K	Yes	80W	6400	80
JC72307EM/1-10V	Skytile Surface 1-10V emergency	4000K	Yes	80W	6400	80
JC72303	Skytile Surface	4700K	No	80W	6400	80
JC72303EM	Skytile Surface emergency	4700K	No	80W	6400	80
JC72303DALI	Skytile Surface DALI	4700K	Yes	80W	6400	80
JC72303EMDALI	Skytile Surface DALI emergency	4700K	Yes	80W	6400	80
JC72303DSI	Skytile Surface DSI	4700K	Yes	80W	6400	80
JC72303EMDSI	Skytile Surface DSI emergency	4700K	Yes	80W	6400	80
JC72303/1-10V	Skytile Surface 1-10V	4700K	Yes	80W	6400	80
JC72303EM/1-10V	Skytile Surface 1-10V emergency	4700K	Yes	80W	6400	80
JC73303	Skytile Surface	5700K	No	80W	6400	80
JC73303EM	Skytile Surface emergency	5700K	No	80W	6400	80
JC73303DALI	Skytile Surface DALI	5700K	Yes	80W	6400	80
JC73303EMDALI	Skytile Surface DALI emergency	5700K	Yes	80W	6400	80
JC73303DSI	Skytile Surface DSI	5700K	Yes	80W	6400	80
JC73303EMDSI	Skytile Surface DSI emergency	5700K	Yes	80W	6400	80
JC73303/1-10V	Skytile Surface 1-10V	5700K	Yes	80W	6400	80
JC73303EM/1-10V	Skytile Surface 1-10V emergency	5700K	Yes	80W	6400	80
JC71311	Skytile Surface suspension kit (1.5m)	-	-	-	-	-

**Body:** Aluminium. **End caps:** Polycarbonate. **Diffuser:** Polystyrene.

\*Extended warranty requires online registration. 2 year warranty on batteries for emergency variants. Terms and conditions apply.

# Skytile® Surface 5ft High Output Microwave Sense

Direct 2x70W T8 replacement

- Conduit entry points available
- Rear BESA plate mounting option
- Microwave dimming with corridor function

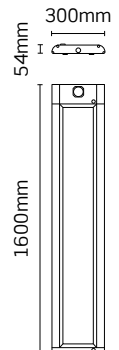
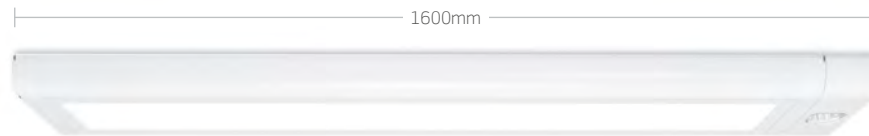

 **RATING**    
  **CLASS 1**    
  **CRI: RA**    
  **WARRANTY\***    
  **BEAM**    
  **EM OPTIONS**    
  **SENSING**    
  **WHITE**

CODE	DESCRIPTION	COL TEMP.	DIM.	WATT	LUMENS	LPCW
JC72307MW	Skytile Surface microwave on/off	4000K	No	80W	6400	80
JC72307EMMW	Skytile Surface microwave on/off emergency	4000K	No	80W	6400	80
JC72307SD	Skytile Surface microwave step dim	4000K	-	80W	6400	80
JC72307EMSD	Skytile Surface microwave step dim emergency	4000K	-	80W	6400	80
JC72303MW	Skytile Surface microwave on/off	4700K	No	80W	6400	80
JC72303EMMW	Skytile Surface microwave on/off emergency	4700K	No	80W	6400	80
JC72303SD	Skytile Surface microwave step dim	4700K	-	80W	6400	80
JC72303EMSD	Skytile Surface microwave step dim emergency	4700K	-	80W	6400	80
JC73303MW	Skytile Surface microwave on/off	5700K	No	80W	6400	80
JC73303EMMW	Skytile Surface microwave on/off emergency	5700K	No	80W	6400	80
JC73303SD	Skytile Surface microwave step dim	5700K	-	80W	6400	80
JC73303EMSD	Skytile Surface microwave step dim emergency	5700K	-	80W	6400	80
JC71311	Skytile Surface suspension kit (1.5m)	-	-	-	-	-

**Body:** Aluminium. **End caps:** Polycarbonate. **Diffuser:** Polystyrene.

\*Extended warranty requires online registration. 2 year warranty on batteries for emergency variants. Terms and conditions apply.

# Skytile® Surface 6ft

## Direct 2x80W T5 replacement

- Conduit entry points at both ends
- DALI, 1-10V and DSI dimmable options available
- Rear BESA plate mounting option

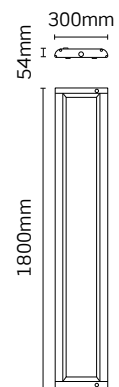
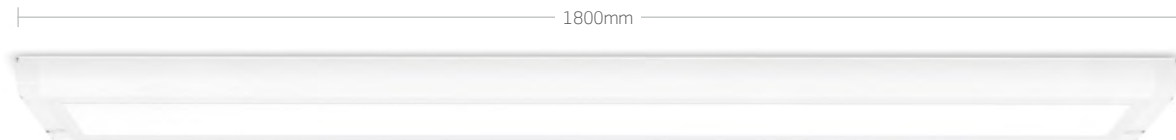

							
RATING	CLASS 1	CRI: RA	WARRANTY*	BEAM	EM OPTIONS	DIM OPTIONS	WHITE

CODE	DESCRIPTION	COL TEMP.	DIM.	WATT	LUMENS	LPCW
JC72304	Skytile Surface	4700K	No	100W	7300	73
JC72304EM	Skytile Surface emergency	4700K	No	100W	7300	73
JC73304	Skytile Surface	5700K	No	100W	7300	73
JC73304EM	Skytile Surface emergency	5700K	No	100W	7300	73
JC71311	Skytile Surface suspension kit (1.5m)	-	-	-	-	-

**Body:** Aluminium. **End caps:** Polycarbonate. **Diffuser:** Polystyrene.

\*Extended warranty requires online registration. 2 year warranty on batteries for emergency variants. Terms and conditions apply.

# Skytile® Surface 6ft Microwave Sense

Direct 2x80W T5 replacement

- Conduit entry points available
- Rear BESA plate mounting option
- Microwave dimming with corridor function

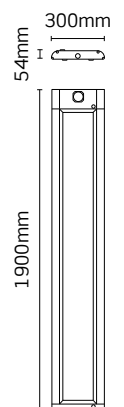
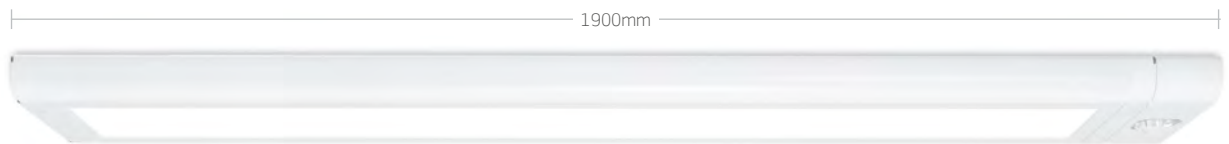







RATING CLASS 1 CRI: RA WARRANTY\* BEAM EM OPTIONS SENSING WHITE

CODE	DESCRIPTION	COL TEMP.	DIM.	WATT	LUMENS	LPCW
JC72304MW	Skytile Surface microwave on/off	4700K	No	100W	7300	73
JC72304EMMW	Skytile Surface microwave on/off emergency	4700K	No	100W	7300	73
JC73304MW	Skytile Surface microwave on/off	5700K	No	100W	7300	73
JC73304EMMW	Skytile Surface microwave on/off emergency	5700K	No	100W	7300	73
JC71311	Skytile Surface suspension kit (1.5m)	-	-	-	-	-

**Body:** Aluminium. **End caps:** Polycarbonate. **Diffuser:** Polystyrene.

\*Extended warranty requires online registration. 2 year warranty on batteries for emergency variants. Terms and conditions apply.

# OxfordLED™ 4ft



## The 36W T8 fluorescent retrofit

- New white opal diffuser
- Improved lumen output and efficiency
- Hinged design for simple installation
- DALI and 1-10V dimmable available



RATING  
 CLASS 1  
 CRI: RA  
 WARRANTY\*  
 EM OPTIONS  
 DIM OPTIONS  
 WHITE

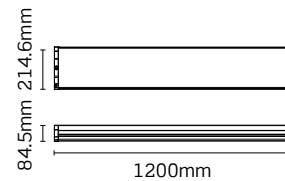

CODE	DESCRIPTION	COL TEMP.	DIM.	WATT	LUMENS	LPCW
JC030001	OxfordLED 4ft Single	4000K	No	20W	2700	135
JC030011	OxfordLED 4ft Single DALI/1-10V	4000K	Yes	20W	2700	135
JC030002	OxfordLED 4ft Single emergency	4000K	No	22W	2700	123
JC030012	OxfordLED 4ft Single DALI/1-10V emergency	4000K	Yes	22W	2700	123
JC030003	OxfordLED 4ft Twin	4000K	No	40W	4400	110
JC030013	OxfordLED 4ft Twin DALI/1-10V	4000K	Yes	40W	4400	110
JC030004	OxfordLED 4ft Twin emergency	4000K	No	42W	4400	105
JC030014	OxfordLED 4ft Twin DALI/1-10V emergency	4000K	Yes	42W	4400	105

**Body:** Steel. **Diffuser:** Polycarbonate.

\*Extended warranty requires online registration. 2 year warranty on batteries for emergency variants. Terms and conditions apply.

# OxfordLED™ 5ft



## The 58W T8 fluorescent retrofit

- New white opal diffuser
- Improved lumen output and efficiency
- Hinged design for simple installation
- DALI and 1-10V dimmable available



RATING  
 CLASS 1  
 CRI: RA  
 WARRANTY\*  
 EM OPTIONS  
 DIM OPTIONS  
 WHITE

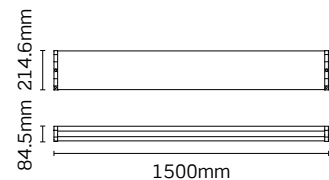

CODE	DESCRIPTION	COL TEMP.	DIM.	WATT	LUMENS	LPCW
JC030005	OxfordLED 5ft Single	4000K	No	30W	3500	116
JC030015	OxfordLED 5ft Single DALI/1-10V	4000K	Yes	30W	3500	116
JC030006	OxfordLED 5ft Single emergency	4000K	No	32W	3500	109
JC030016	OxfordLED 5ft Single DALI/1-10V emergency	4000K	Yes	32W	3500	109
JC030007	OxfordLED 5ft Twin	4000K	No	60W	6400	107
JC030017	OxfordLED 5ft Twin DALI	4000K	Yes	60W	6400	107
JC030027	OxfordLED 5ft Twin 1-10V	4000K	Yes	60W	6400	107
JC030008	OxfordLED 5ft Twin emergency	4000K	No	62W	6400	103
JC030018	OxfordLED 5ft Twin DALI emergency	4000K	Yes	62W	6400	103
JC030028	OxfordLED 5ft Twin 1-10V emergency	4000K	Yes	62W	6400	103
JC030009	OxfordLED 5ft Twin High Output	4000K	No	80W	8400	105
JC030019	OxfordLED 5ft Twin High Output DALI	4000K	Yes	80W	8400	105
JC030029	OxfordLED 5ft Twin High Output 1-10V	4000K	Yes	80W	8400	105
JC030010	OxfordLED 5ft Twin High Output emergency	4000K	No	82W	8400	102
JC030020	OxfordLED 5ft Twin High Output DALI emergency	4000K	Yes	82W	8400	102
JC030030	OxfordLED 5ft Twin High Output 1-10V emergency	4000K	Yes	82W	8400	102

**Body:** Steel. **Diffuser:** Polycarbonate.

\*Extended warranty requires online registration. 2 year warranty on batteries for emergency variants. Terms and conditions apply.



## Line of Light

The optimum blend of  
form and function



PLUG AND PLAY  
INSTALLATION



INTEGRATED 3  
HOUR EMERGENCY



DALI DIMMING  
AVAILABLE





## Continuous line of light

With a polycarbonate diffuser and seamless aluminium profile, Line of Light creates a professional linear lighting solution suitable for any commercial project. The innovative plug and play connectors are integrated within each luminaire and corner accessory. This allows for a seamless lighting solution and ultra fast installation.

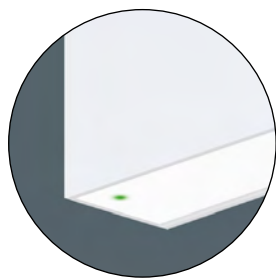

## Integrated emergency

1200mm and 1500mm luminaires are available as standard with an integrated 3 hour emergency pack, using lithium-ion low self discharge batteries.

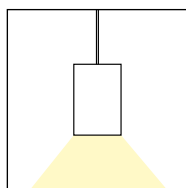

### SUSPENDED

Line of Light suspension kit (JC770/1/SUS) includes two suspension cables in 3m lengths.

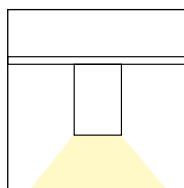

### SURFACE MOUNTED

Two brackets are supplied as standard with each luminaire for surface mounting.

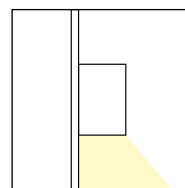

### WALL MOUNTED

Line of Light wall mounting kit (JC770/1/WALL) includes two bracket units to surface mount the luminaire.

# Line of Light Direct

## Direct only light fittings

- Linkable plug and play lighting solution
- DALI dimmable options available
- Available in white finish and 4000K LED
- Integrated emergency versions available
- Suspension kit and wall mount kit available

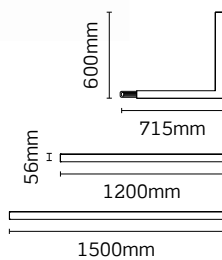

RATING



CLASS 1



CRI: RA



WARRANTY\*



EM OPTIONS



DIM OPTIONS



WHITE



84mm

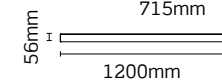

1200mm

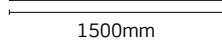

1500mm

CODE	DESCRIPTION	COL TEMP.	DIM.	WATT	LUMENS	LPCW
JC773S/4/4K/ND/WH	Line of Light Direct 1200mm start	4000K	No	26W	2600	100
JC773S/5/4K/ND/WH	Line of Light Direct 1500mm start	4000K	No	35W	3500	100
JC773/4/4K/ND/WH	Line of Light Direct 1200mm middle/end	4000K	No	26W	2600	100
JC773/5/4K/ND/WH	Line of Light Direct 1500mm middle/end	4000K	No	35W	3500	100
JC774/2/4K/ND/WH	Line of Light Direct corner (L)	4000K	No	26W	2600	100
JC770/1/SUS	Line of Light suspension kit (pack of 2)	-	-	-	-	-
JC770/1/WALL	Line of Light wall mounting kit (pack of 2)	-	-	-	-	-

For **emergency** replace **ND/WH** with **NDEM/WH**, for **DALI** replace **ND/WH** with **DALI**, for **DALI emergency** replace **ND/WH** with **DALIEM**. (**Emergency** only available in straight lengths).

**Body:** Aluminium. **Diffuser:** Polycarbonate.

# Line of Light Direct/Indirect

## Direct/Indirect light fittings

- 65% downwards light output, 35% upwards light output
- Linkable plug and play lighting solution
- DALI dimmable options available
- Available in white finish and 4000K LED
- Integrated emergency versions available
- Suspension kit and wall mount kit available



✓ JC771S/4/4K/ND/WH

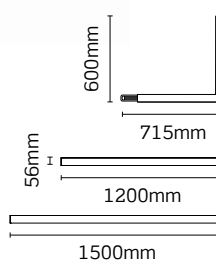

RATING  
 CLASS 1  
 CRI: RA  
 WARRANTY\*  
 EM OPTIONS  
 DIM OPTIONS  
 WHITE

CODE	DESCRIPTION	COL TEMP.	DIM.	WATT	LUMENS	LPCW
JC771S/4/4K/ND/WH	Line of Light Dir/Indir. 1200mm start	4000K	No	40W	4000	100
JC771S/5/4K/ND/WH	Line of Light Dir/Indir. 1500mm start	4000K	No	50W	5000	100
JC771/4/4K/ND/WH	Line of Light Dir/Indir. 1200mm middle/end	4000K	No	40W	4000	100
JC771/5/4K/ND/WH	Line of Light Dir/Indir. 1500mm middle/end	4000K	No	50W	5000	100
JC772/2/4K/ND/WH	Line of Light Dir/Indir. corner (L)	4000K	No	40W	4000	100
JC770/1/SUS	Line of Light suspension kit (pack of 2)	-	-	-	-	-
JC770/1/WALL	Line of Light wall mounting kit (pack of 2)	-	-	-	-	-

For **emergency** replace **ND/WH** with **NDEM/WH**, for **DALI** replace **ND/WH** with **DALI**, for **DALI emergency** replace **ND/WH** with **DALIEM**. (Emergency only available in straight lengths).

**Body:** Aluminium. **Diffuser:** Polycarbonate.

\*Extended warranty requires online registration. 2 year warranty on batteries for emergency variants. Terms and conditions apply.







# Battens & Weatherproofs

Skypack™ Quick Release	110
Skypack™	118
Skypack™ High Output	122
ToughLED™ Weatherproof	132
ToughLED™ High Output	144



## Skypack™ Quick Release

Intelligently designed for  
the fastest installation



DALI DIMMABLE  
OPTIONS



EMERGENCY  
VERSIONS AVAILABLE



HIGHLY EFFICIENT  
120 LPCW





## Intelligent quick release design with suspended LED tray

Skypack Quick Release uses an innovative dual button mechanism which makes installation quick and simple. The side buttons release the full LED tray for easy access to the mounting points and wiring connections.



### 4FT OPTION

Standard and emergency variants available.



### 5FT OPTION

Standard and emergency variants available.



### 6FT OPTION

Standard and emergency variants available.

# Skypack™ Quick Release 4ft Single

Intelligent press release design for a simple installation

- Conduit entry points at both ends
- Suitable for central BESA mounting
- DALI and 1-10V dimming available
- Press-fit terminals with loop-in/loop-out











RATING CLASS 1 CRI: RA WARRANTY\* EM OPTIONS DIM OPTIONS WHITE

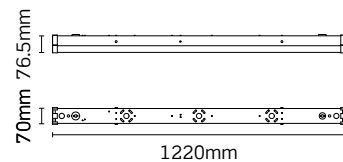

CODE	DESCRIPTION	COL TEMP.	DIM.	WATT	LUMENS	LPCW
JC71741	Skypack QR 4ft single	4000K	No	23W	2760	120
JC71741DALI	Skypack QR 4ft single DALI	4000K	Yes	23W	2760	120
JC71741/1-10V	Skypack QR 4ft single 1-10V	4000K	Yes	23W	2760	120
JC71741EM	Skypack QR 4ft single emergency	4000K	No	25W	2760	110
JC71741EMDALI	Skypack QR 4ft single DALI emergency	4000K	Yes	25W	2760	110
JC71741EM/1-10V	Skypack QR 4ft single 1-10V emergency	4000K	Yes	25W	2760	110

**Body:** Steel. **Diffuser:** Polycarbonate.

\*Extended warranty requires online registration. 2 year warranty on batteries for emergency variants. Terms and conditions apply.

# Skypack™ Quick Release 4ft Twin

Intelligent press release design for a simple installation

- Conduit entry points at both ends
- Suitable for central BESA mounting
- DALI and 1-10V dimming available
- Press-fit terminals with loop-in/loop-out



 RATING  
 CLASS 1  
 CRI: RA  
 WARRANTY\*  
 EM OPTIONS  
 DIM OPTIONS  
 WHITE

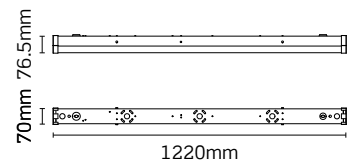

CODE	DESCRIPTION	COL TEMP.	DIM.	WATT	LUMENS	LPCW
JC71742	Skypack QR 4ft twin	4000K	No	40W	4800	120
JC71742DALI	Skypack QR 4ft twin DALI	4000K	Yes	40W	4800	120
JC71742/1-10V	Skypack QR 4ft twin 1-10V	4000K	Yes	40W	4800	120
JC71742EM	Skypack QR 4ft twin emergency	4000K	No	42W	4800	114
JC71742EMDALI	Skypack QR 4ft twin DALI emergency	4000K	Yes	42W	4800	114
JC71742EM/1-10V	Skypack QR 4ft twin 1-10V emergency	4000K	Yes	42W	4800	114

**Body:** Steel. **Diffuser:** Polycarbonate.

\*Extended warranty requires online registration. 2 year warranty on batteries for emergency variants. Terms and conditions apply.

# Skypack™ Quick Release 5ft Single

Intelligent press release design for a simple installation

- Conduit entry points at both ends
- Suitable for central BESA mounting
- DALI and 1-10V dimming available
- Press-fit terminals with loop-in/loop-out











RATING CLASS 1 CRI: RA WARRANTY\* EM OPTIONS DIM OPTIONS WHITE

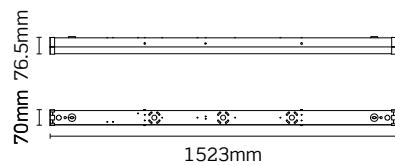

CODE	DESCRIPTION	COL TEMP.	DIM.	WATT	LUMENS	LPCW
JC71743	Skypack QR 5ft single	4000K	No	37W	4440	120
JC71743DALI	Skypack QR 5ft single DALI	4000K	Yes	37W	4440	120
JC71743/1-10V	Skypack QR 5ft single 1-10V	4000K	Yes	37W	4440	120
JC71743EM	Skypack QR 5ft single emergency	4000K	No	39W	4440	113
JC71743EMDALI	Skypack QR 5ft single DALI emergency	4000K	Yes	39W	4440	113
JC71743EM/1-10V	Skypack QR 5ft single 1-10V emergency	4000K	Yes	39W	4440	113

**Body:** Steel. **Diffuser:** Polycarbonate.

\*Extended warranty requires online registration. 2 year warranty on batteries for emergency variants. Terms and conditions apply.

# Skypack™ Quick Release 5ft Twin

Intelligent press release design for a simple installation

- Conduit entry points at both ends
- Suitable for central BESA mounting
- DALI and 1-10V dimming available
- Press-fit terminals with loop-in/loop-out



 RATING  
 CLASS 1  
 CRI: RA  
 WARRANTY\*  
 EM OPTIONS  
 DIM OPTIONS  
 WHITE

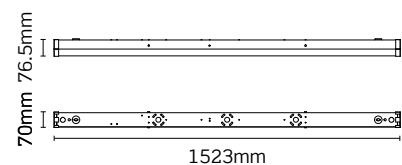

CODE	DESCRIPTION	COL TEMP.	DIM.	WATT	LUMENS	LPCW
JC71744	Skypack QR 5ft twin	4000K	No	60W	7200	120
JC71744DALI	Skypack QR 5ft twin DALI	4000K	Yes	60W	7200	120
JC71744/1-10V	Skypack QR 5ft twin 1-10V	4000K	Yes	60W	7200	120
JC71744EM	Skypack QR 5ft twin emergency	4000K	No	62W	7200	116
JC71744EMDALI	Skypack QR 5ft twin DALI emergency	4000K	Yes	62W	7200	116
JC71744EM/1-10V	Skypack QR 5ft twin 1-10V emergency	4000K	Yes	62W	7200	116

**Body:** Steel. **Diffuser:** Polycarbonate.

\*Extended warranty requires online registration. 2 year warranty on batteries for emergency variants. Terms and conditions apply.

# Skypack™ Quick Release 6ft Single



Intelligent press release design for a simple installation

- Conduit entry points at both ends
- Suitable for central BESA mounting
- DALI and 1-10V dimming available
- Press-fit terminals with loop-in/loop-out



RATING  
 CLASS 1  
 CRI: RA  
 WARRANTY\*  
 EM OPTIONS  
 DIM OPTIONS  
 WHITE

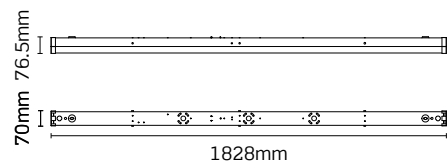

CODE	DESCRIPTION	COL TEMP.	DIM.	WATT	LUMENS	LPCW
JC71745	Skypack QR 6ft single	4000K	No	54W	6480	120
JC71745DALI	Skypack QR 6ft single DALI	4000K	Yes	54W	6480	120
JC71745/1-10V	Skypack QR 6ft single 1-10V	4000K	Yes	54W	6480	120
JC71745EM	Skypack QR 6ft single emergency	4000K	No	56W	6480	115
JC71745EMDALI	Skypack QR 6ft single DALI emergency	4000K	Yes	56W	6480	115
JC71745EM/1-10V	Skypack QR 6ft single 1-10V emergency	4000K	Yes	56W	6480	115

Body: Steel. Diffuser: Polycarbonate.

\*Extended warranty requires online registration. 2 year warranty on batteries for emergency variants. Terms and conditions apply.

# Skypack™ Quick Release 6ft Twin



Intelligent press release design for a simple installation

- Conduit entry points at both ends
- Suitable for central BESA mounting
- DALI and 1-10V dimming available
- Press-fit terminals with loop-in/loop-out



RATING  
 CLASS 1  
 CRI: RA  
 WARRANTY\*  
 EM OPTIONS  
 DIM OPTIONS  
 WHITE

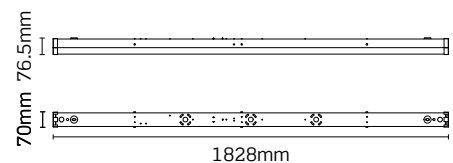

CODE	DESCRIPTION	COL TEMP.	DIM.	WATT	LUMENS	LPCW
JC71746	Skypack QR 6ft twin	4000K	No	82W	9800	120
JC71746DALI	Skypack QR 6ft twin DALI	4000K	Yes	82W	9800	120
JC71746/1-10V	Skypack QR 6ft twin 1-10V	4000K	Yes	82W	9800	120
JC71746EM	Skypack QR 6ft twin emergency	4000K	No	84W	9800	120
JC71746EMDALI	Skypack QR 6ft twin DALI emergency	4000K	Yes	84W	9800	120
JC71746EM/1-10V	Skypack QR 6ft twin 1-10V emergency	4000K	Yes	84W	9800	120

**Body:** Steel. **Diffuser:** Polycarbonate.

\*Extended warranty requires online registration. 2 year warranty on batteries for emergency variants. Terms and conditions apply.

# Skypack™ 4ft Single

## Direct 1x36W T8 fluorescent replacement

- Conduit entry points at both ends
- Suitable for BESA mounting
- DALI and 1-10V dimming available
- Microwave on/off sensing available
- Press-fit terminals with loop-in/loop-out

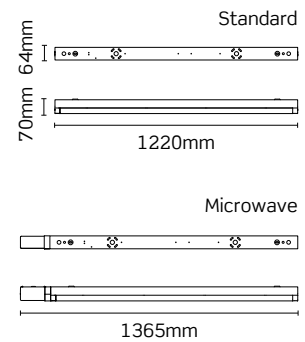

RATING



CLASS 1



CRI: RA



WARRANTY\*



SENSING



EM OPTIONS



DIM OPTIONS



WHITE

CODE	DESCRIPTION	COL TEM	DIM.	WATT	LUMENS	LPCW
JC71701	Skypack 4ft single	4000K	No	20W	2500	125
JC71701MW	Skypack 4ft single microwave on/off	4000K	No	20W	2500	125
JC71701DALI	Skypack 4ft single DALI	4000K	Yes	20W	2500	125
JC71701/1-10V	Skypack 4ft single 1-10V	4000K	Yes	20W	2500	125
JC71701EM	Skypack 4ft single emergency	4000K	No	20W	2500	125
JC71701MWEM	Skypack 4ft single microwave on/off emergency	4000K	No	20W	2500	125
JC71701EMDALI	Skypack 4ft single DALI emergency	4000K	Yes	20W	2500	125
JC71701EM/1-10V	Skypack 4ft single 1-10V emergency	4000K	Yes	20W	2500	125
JC71730	Skypack in-line cont. connector	-	-	-	-	-

Body: Steel. Diffuser: Opal Polycarbonate.

\*Extended warranty requires online registration. 2 year warranty on batteries for emergency variants. Terms and conditions apply.



# Skypack™ 4ft Twin

## Direct 2x36W T8 fluorescent replacement

- Conduit entry points at both ends
- Suitable for BESA mounting
- DALI and 1-10V dimming available
- Microwave on/off sensing available
- Press-fit terminals with loop-in/loop-out

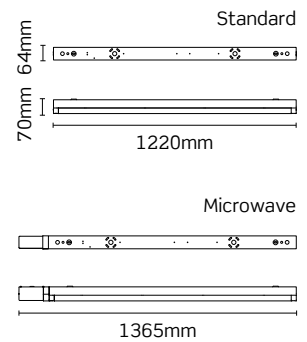

 RATING  
 CLASS 1  
 CRI: RA  
 WARRANTY\*  
 SENSING  
 EM OPTIONS  
 DIM OPTIONS  
 WHITE

CODE	DESCRIPTION	COL TEM	DIM.	WATT	LUMENS	LPCW
JC71703	Skypack 4ft twin	4000K	No	40W	5100	128
JC71703MW	Skypack 4ft twin microwave on/off	4000K	No	40W	5100	128
JC71703DALI	Skypack 4ft twin DALI	4000K	Yes	40W	5100	128
JC71703/1-10V	Skypack 4ft twin 1-10V	4000K	Yes	40W	5100	128
JC71703EM	Skypack 4ft twin emergency	4000K	No	40W	5100	128
JC71703MWEM	Skypack 4ft twin microwave on/off emergency	4000K	No	40W	5100	128
JC71703EMDALI	Skypack 4ft twin DALI emergency	4000K	Yes	40W	5100	128
JC71703EM/1-10V	Skypack 4ft twin 1-10V emergency	4000K	Yes	40W	5100	128
JC71730	Skypack in-line cont. connector	-	-	-	-	-

**Body:** Steel. **Diffuser:** Opal Polycarbonate.

\*Extended warranty requires online registration. 2 year warranty on batteries for emergency variants. Terms and conditions apply.

# Skypack™ 5ft Single

## Direct 1x58W T8 fluorescent replacement

- Conduit entry points at both ends
- Suitable for BESA mounting
- DALI and 1-10V dimming available
- Microwave on/off sensing available
- Press-fit terminals with loop-in/loop-out

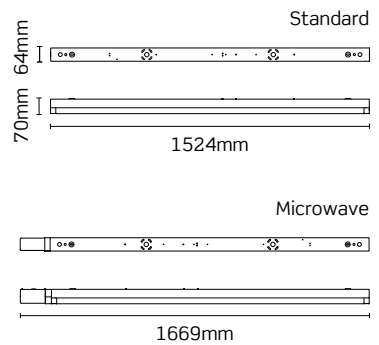

RATING



CLASS 1



CRI: RA



WARRANTY\*



DIM OPTIONS



SENSING



EM OPTIONS



WHITE

CODE	DESCRIPTION	COL TEMP.	DIM.	WATT	LUMENS	LPCW
JC71705	Skypack 5ft single	4000K	No	30W	3700	124
JC71705MW	Skypack 5ft single microwave on/off	4000K	No	30W	3700	124
JC71705SD	Skypack 5ft single microwave step dim	4000K	-	30W	3700	124
JC71705DALI	Skypack 5ft single DALI	4000K	Yes	30W	3700	124
JC71705/1-10V	Skypack 5ft single 1-10V	4000K	Yes	30W	3700	124
JC71705EM	Skypack 5ft single emergency	4000K	No	30W	3700	124
JC71705MWEM	Skypack 5ft single microwave on/off emergency	4000K	No	30W	3700	124
JC71705EMSD	Skypack 5ft single microwave step dim emergency	4000K	-	30W	3700	124
JC71705EMDALI	Skypack 5ft single DALI emergency	4000K	Yes	30W	3700	124
JC71705EM/1-10V	Skypack 5ft single 1-10V emergency	4000K	Yes	30W	3700	124
JC71730	Skypack In-line cont. connector	-	-	-	-	-

**Body:** Steel. **Diffuser:** Opal Polycarbonate.

\*Extended warranty requires online registration. 2 year warranty on batteries for emergency variants. Terms and conditions apply.

# Skypack™ 5ft Twin

## Direct 2x58W T8 fluorescent replacement

- Conduit entry points at both ends
- Suitable for BESA mounting
- DALI and 1-10V dimming available
- Microwave on/off sensing available
- Press-fit terminals with loop-in/loop-out

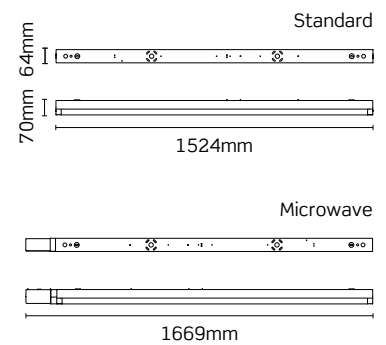

 **RATING**    
  **CLASS 1**    
  **CRI: RA**    
  **WARRANTY\***    
  **DIM OPTIONS**    
  **SENSING**    
  **EM OPTIONS**    
  **WHITE**

CODE	DESCRIPTION	COL TEMP.	DIM.	WATT	LUMENS	LPCW
JC71707	Skypack 5ft twin	4000K	No	60W	7300	122
JC71707MW	Skypack 5ft twin microwave on/off	4000K	No	60W	7300	122
JC71707SD	Skypack 5ft twin microwave step dim	4000K	-	60W	7300	122
JC71707DALI	Skypack 5ft twin DALI	4000K	Yes	60W	7300	122
JC71707/1-10V	Skypack 5ft twin 1-10V	4000K	Yes	60W	7300	122
JC71707EM	Skypack 5ft twin emerg.	4000K	No	60W	7300	122
JC71707MWEM	Skypack 5ft twin microwave on/off emergency	4000K	No	60W	7300	122
JC71707EMSD	Skypack 5ft twin microwave step dim emergency	4000K	-	60W	7300	122
JC71707EMDALI	Skypack 5ft twin DALI emergency	4000K	Yes	60W	7300	122
JC71707EM/1-10V	Skypack 5ft twin 1-10V emergency	4000K	Yes	60W	7300	122
JC71730	Skypack In-line cont. connector	-	-	-	-	-

**Body:** Steel. **Diffuser:** Opal Polycarbonate.

\*Extended warranty requires online registration. 2 year warranty on batteries for emergency variants. Terms and conditions apply.

# Skypack™ High Output 4ft Single

Outperforms traditional fluorescent battens

- Conduit entry points at both ends
- Suitable for BESA mounting
- DALI and 1-10V dimming available
- Microwave on/off and step dimmable sensing options
- Press-fit terminals with loop-in/loop-out

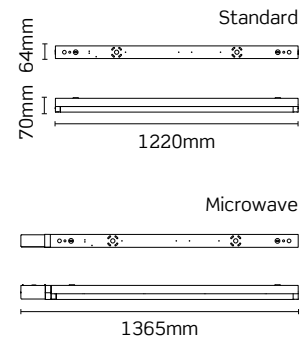

 **RATING**    
  **CLASS 1**    
  **CRI: RA**    
  **WARRANTY\***    
  **DIM OPTIONS**    
  **SENSING**    
  **EM OPTIONS**    
  **WHITE**

CODE	DESCRIPTION	COL TEMP.	DIM.	WATT	LUMENS	LPCW
JC71702	Skypack 4ft single	4000K	No	30W	4000	133
JC71702MW	Skypack 4ft single microwave on/off	4000K	No	30W	4000	133
JC71702SD	Skypack 4ft single microwave step dim	4000K	-	30W	4000	133
JC71702DALI	Skypack 4ft single DALI	4000K	Yes	30W	4000	133
JC71702/1-10V	Skypack 4ft single 1-10V	4000K	Yes	30W	4000	133
JC71702EM	Skypack 4ft single emergency	4000K	No	30W	4000	133
JC71702MWEM	Skypack 4ft single microwave on/off emergency	4000K	No	30W	4000	133
JC71702EMSD	Skypack 4ft single microwave step dim emergency	4000K	-	30W	4000	133
JC71702EMDALI	Skypack 4ft single DALI emergency	4000K	Yes	30W	4000	133
JC71702EM/1-10V	Skypack 4ft single 1-10V emergency	4000K	Yes	30W	4000	133
JC71730	Skypack 4ft In-line cont. connector	-	-	-	-	-

**Body:** Steel. **Diffuser:** Opal Polycarbonate.

\*Extended warranty requires online registration. 2 year warranty on batteries for emergency variants. Terms and conditions apply.

# Skypack™ High Output 4ft Twin

Outperforms traditional fluorescent battens

- Conduit entry points at both ends
- Suitable for BESA mounting
- DALI and 1-10V dimming available
- Microwave on/off sensing available
- Press-fit terminals with loop-in/loop-out

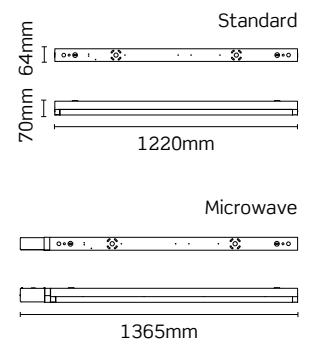









CODE	DESCRIPTION	COL TEMP.	DIM.	WATT	LUMENS	LPCW
JC71704	Skypack 4ft twin	4000K	No	55W	7600	138
JC71704MW	Skypack 4ft twin microwave on/off	4000K	No	55W	7600	138
JC71704SD	Skypack 4ft twin microwave step dim	4000K	-	55W	7600	138
JC71704DALI	Skypack 4ft twin DALI	4000K	Yes	55W	7600	138
JC71704/1-10V	Skypack 4ft twin 1-10V	4000K	Yes	55W	7600	138
JC71704EM	Skypack 4ft twin emergency	4000K	No	55W	7600	138
JC71704EMDALI	Skypack 4ft twin DALI emergency	4000K	Yes	55W	7600	138
JC71704EM/1-10V	Skypack 4ft twin 1-10V emergency	4000K	Yes	55W	7600	138
JC71704MWEM	Skypack 4ft twin microwave on/off emergency	4000K	No	55W	7600	138
JC71704EMSD	Skypack 4ft twin microwave step dim emergency	4000K	-	55W	7600	138
JC71730	Skypack 4ft In-line cont. connector	-	-	-	-	-

Body: Steel. Diffuser: Opal Polycarbonate.

\*Extended warranty requires online registration. 2 year warranty on batteries for emergency variants. Terms and conditions apply.

# Skypack™ High Output 5ft Single

## Outperforms traditional fluorescent battens

- Conduit entry points at both ends
- Suitable for BESA mounting
- DALI and 1-10V dimming available
- Microwave on/off sensing available
- Press-fit terminals with loop-in/loop-out

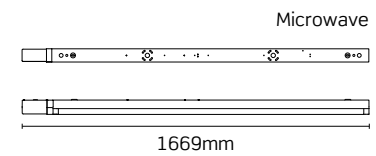
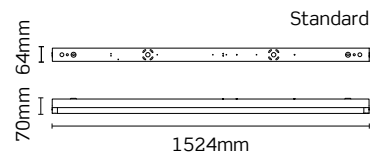

RATING



CLASS 1



CRI: RA



WARRANTY\*



DIM OPTIONS



SENSING



EM OPTIONS



WHITE

CODE	DESCRIPTION	COL TEMP.	DIM.	WATT	LUMENS	LPCW
JC71706	Skypack 5ft single	4000K	No	45W	6000	132
JC71706MW	Skypack 5ft single microwave on/off	4000K	No	45W	6000	132
JC71706DALI	Skypack 5ft single DALI	4000K	Yes	45W	6000	132
JC71706/1-10V	Skypack 5ft single 1-10V	4000K	Yes	45W	6000	132
JC71706EM	Skypack 5ft single emergency	4000K	No	45W	6000	132
JC71706MWEM	Skypack 5ft single microwave on/off emergency	4000K	No	45W	6000	132
JC71706EMDALI	Skypack 5ft single DALI emergency	4000K	Yes	45W	6000	132
JC71706EM/1-10V	Skypack 5ft single 1-10V emergency	4000K	Yes	45W	6000	132
JC71730	Skypack 5ft In-line cont. connector	-	-	-	-	-

Body: Steel. Diffuser: Opal Polycarbonate.

\*Extended warranty requires online registration. 2 year warranty on batteries for emergency variants. Terms and conditions apply.

# Skypack™ High Output 5ft Twin

Outperforms traditional fluorescent battens

- Conduit entry points at both ends
- Suitable for BESA mounting
- DALI and 1-10V dimming available
- Microwave on/off sensing available
- Press-fit terminals with loop-in/loop-out

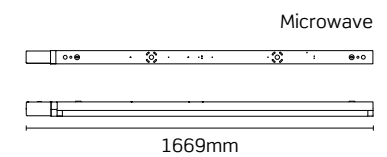
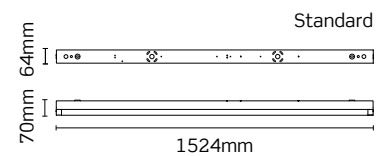

 **RATING**   
  **CLASS 1**   
  **CRI: RA**   
  **WARRANTY\***   
  **DIM OPTIONS**   
  **SENSING**   
  **EM OPTIONS**   
  **WHITE**

CODE	DESCRIPTION	COL TEMP.	DIM.	WATT	LUMENS	LPCW
JC71708	Skypack 5ft twin	4000K	No	75W	10,000	133
JC71708MW	Skypack 5ft twin microwave on/off	4000K	No	75W	10,000	133
JC71708DALI	Skypack 5ft twin DALI	4000K	Yes	75W	10,000	133
JC71708/1-10V	Skypack 5ft twin 1-10V	4000K	Yes	75W	10,000	133
JC71708EM	Skypack 5ft twin emergency	4000K	No	75W	10,000	133
JC71708MWEM	Skypack 5ft twin microwave on/off emergency	4000K	No	75W	10,000	133
JC71708EMDALI	Skypack 5ft twin DALI emergency	4000K	Yes	75W	10,000	133
JC71708EM/1-10V	Skypack 5ft twin 1-10V emergency	4000K	Yes	75W	10,000	133
JC71730	Skypack 5ft In-line cont. connector	-	-	-	-	-

**Body:** Steel. **Diffuser:** Opal Polycarbonate.









\*Extended warranty requires online registration. 2 year warranty on batteries for emergency variants. Terms and conditions apply.

# Skypack™ High Output 6ft Single

## Outperforms traditional fluorescent battens

- Conduit entry points at both ends
- Suitable for BESA mounting
- DALI and 1-10V dimming available
- Microwave on/off and step dimmable sensing options
- Press-fit terminals with loop-in/loop-out



 RATING	 CLASS 1	 CRI: RA	 WARRANTY*
 SENSING	 EM OPTIONS	 DIM OPTIONS	 WHITE

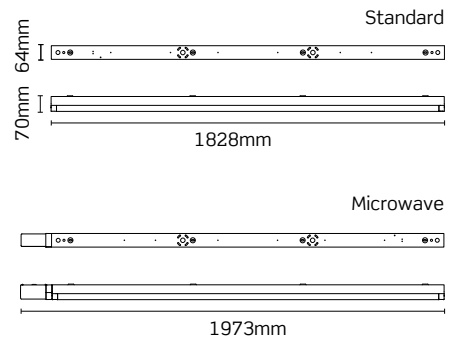

CODE	DESCRIPTION	COL TEMP.	DIM.	WATT	LUMENS	LPCW
JC71709	Skypack 6ft single	4000K	No	53W	6400	120
JC71709MW	Skypack 6ft single microwave on/off	4000K	No	53W	6400	120
JC71709SD	Skypack 6ft single microwave step dim	4000K	-	53W	6400	120
JC71709DALI	Skypack 6ft single DALI	4000K	Yes	53W	6400	120
JC71709/1-10V	Skypack 6ft single 1-10V	4000K	Yes	53W	6400	120
JC71709EM	Skypack 6ft single emergency	4000K	No	53W	6400	120
JC71709MWEM	Skypack 6ft single microwave on/off emergency	4000K	No	53W	6400	120
JC71709EMSD	Skypack 6ft single microwave step dim emergency	4000K	-	53W	6400	120
JC71709EMDALI	Skypack 6ft single DALI emergency	4000K	Yes	53W	6400	120
JC71709EM/1-10V	Skypack 6ft single 1-10V emergency	4000K	Yes	53W	6400	120
JC71730	Skypack 6ft in-line cont. connector	-	-	-	-	-

**Body:** Steel. **Diffuser:** Opal Polycarbonate.

\*Extended warranty requires online registration. 2 year warranty on batteries for emergency variants. Terms and conditions apply.











# Skypack™ High Output 6ft Twin

Outperforms traditional fluorescent battens

- Conduit entry points at both ends
- Suitable for BESA mounting
- DALI and 1-10V dimming available
- Microwave on/off sensing available
- Press-fit terminals with loop-in/loop-out



 RATING	 CLASS 1	 CRI: RA	 WARRANTY*
 SENSING	 EM OPTIONS	 DIM OPTIONS	 WHITE

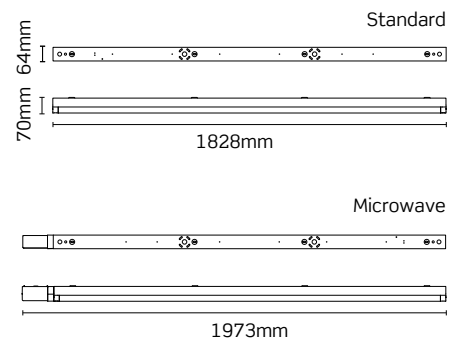

CODE	DESCRIPTION	COL TEMP.	DIM.	WATT	LUMENS	LPCW
JC71710	Skypack 6ft twin	4000K	No	90W	10,800	120
JC71710MW	Skypack 6ft twin microwave on/off	4000K	No	90W	10,800	120
JC71710DALI	Skypack 6ft twin DALI	4000K	Yes	90W	10,800	120
JC71710/1-10V	Skypack 6ft twin 1-10V	4000K	Yes	90W	10,800	120
JC71710EM	Skypack 6ft twin emergency	4000K	No	90W	10,800	120
JC71710MWEM	Skypack 6ft twin microwave on/off emergency	4000K	No	90W	10,800	120
JC71710EMDALI	Skypack 6ft twin DALI emergency	4000K	Yes	90W	10,800	120
JC71710EM/1-10V	Skypack 6ft twin 1-10V emergency	4000K	Yes	90W	10,800	120
JC71730	Skypack 6ft in-line cont. connector	-	-	-	-	-

**Body:** Steel. **Diffuser:** Opal Polycarbonate.

\*Extended warranty requires online registration. 2 year warranty on batteries for emergency variants. Terms and conditions apply.



6  
7  
8  
9



4

3

5

9

## ToughLED™ Range

Long lasting performance for  
the toughest environments



## ToughLED™ Weatherproof

---

ToughLED Weatherproof offers a variety of lumen outputs along with two diffuser options. With internal microwave sensors available this fitting allows for further energy savings in addition to the products high efficiency performance.

Available in 4ft, 5ft and 6ft variants.



3YR EXT.  
WARRANTY



IP65  
PROTECTION



## ToughLED™ High Output

---

Featuring a higher lumen performance this product is suitable for installation in locations that require a greater light output. ToughLED High Output offers a polycarbonate diffuser and body providing a robust exterior required for multiple applications.

**Available in 5ft and 6ft variants.**



5YR EXT.  
WARRANTY



UP TO  
10,800 LUMENS

# ToughLED™ Weatherproof 4ft Single White Opal

## High efficiency IP65 LED Batten

- Conduit entry points at both ends
- Internal microwave sensing options available
- DALI and 1-10V dimming available
- Suitable for food preparation areas



CODE	DESCRIPTION	COL TEMP.	DIM.	WATT	LUMENS
JC71553WOP	Weatherproof 4ft single	4000K	No	18W	2050
JC71553MW/WOP	Weatherproof 4ft single microwave on/off	4000K	No	18W	2050
JC71553WOPDALI	Weatherproof 4ft single DALI	4000K	Yes	18W	2050
JC71553WOP/1-10V	Weatherproof 4ft single 1-10V	4000K	Yes	18W	2050
JC71553EM/WOP	Weatherproof 4ft single emergency	4000K	No	18W	2050
JC71553MWEM/WOP	Weatherproof 4ft single microwave on/off emergency	4000K	No	18W	2050
JC71553EM/WOPDALI	Weatherproof 4ft single DALI emergency	4000K	Yes	18W	2050
JC71553EM/WOP/1-10V	Weatherproof 4ft single 1-10V emergency	4000K	Yes	18W	2050

**Body:** ABS. **Diffuser:** Polycarbonate.

# ToughLED™ Weatherproof 4ft Single Frosted

## High efficiency IP65 LED Batten

- Conduit entry points at both ends
- Internal microwave sensing options available
- DALI and 1-10V dimming available
- Suitable for food preparation areas



RATING IP 65    
 CLASS 1    
 CRI: RA    
 WARRANTY\* 3yr    
 DIM OPTIONS    
 BEAM 120°    
 SENSING    
 EM OPTIONS    
 GREY    
 85mm height, 80mm width, 1270mm length

CODE	DESCRIPTION	COL TEMP.	DIM.	WATT	LUMENS
JC71553FR	Weatherproof 4ft single	4000K	No	18W	2300
JC71553MW/FR	Weatherproof 4ft single microwave on/off	4000K	No	18W	2300
JC71553FRDALI	Weatherproof 4ft single DALI	4000K	Yes	18W	2300
JC71553FR/1-10V	Weatherproof 4ft single 1-10V	4000K	Yes	18W	2300
JC71553EM/FR	Weatherproof 4ft single emergency	4000K	No	18W	2300
JC71553MWEM/FR	Weatherproof 4ft single microwave on/off emergency	4000K	No	18W	2300
JC71553EM/FRDALI	Weatherproof 4ft single DALI emergency	4000K	Yes	18W	2300
JC71553EM/FR/1-10V	Weatherproof 4ft single 1-10V emergency	4000K	Yes	18W	2300

**Body:** ABS. **Diffuser:** Polycarbonate.

\*Extended warranty requires online registration. 2 year warranty on batteries for emergency variants. Terms and conditions apply.

# ToughLED™ Weatherproof 4ft Twin White Opal

## High efficiency IP65 LED Batten

- Conduit entry points at both ends
- Internal microwave sensing options available
- DALI and 1-10V dimming available
- Suitable for food preparation areas



RATING	CLASS 1	CRI: RA	WARRANTY*	DIM OPTIONS	BEAM	SENSING	EM OPTIONS	GREY	

CODE	DESCRIPTION	COL TEMP.	DIM.	WATT	LUMENS
JC71554WOP	Weatherproof 4ft twin	4000K	No	37W	4300
JC71554MW/WOP	Weatherproof 4ft twin microwave on/off	4000K	No	37W	4300
JC71554WOPDALI	Weatherproof 4ft twin DALI	4000K	Yes	37W	4300
JC71554WOP/1-10V	Weatherproof 4ft twin 1-10V	4000K	Yes	37W	4300
JC71554EM/WOP	Weatherproof 4ft twin emergency	4000K	No	37W	4300
JC71554MWEM/WOP	Weatherproof 4ft twin microwave on/off emergency	4000K	No	37W	4300
JC71554EM/WOPDALI	Weatherproof 4ft twin DALI emergency	4000K	Yes	37W	4300
JC71554EM/WOP/1-10V	Weatherproof 4ft twin 1-10V emergency	4000K	Yes	37W	4300

Body: ABS. Diffuser: Polycarbonate.

\*Extended warranty requires online registration. 2 year warranty on batteries for emergency variants. Terms and conditions apply.



# ToughLED™ Weatherproof 4ft Twin Frosted

## High efficiency IP65 LED Batten

- Conduit entry points at both ends
- Internal microwave sensing options available
- DALI and 1-10V dimming available
- Suitable for food preparation areas



IP 65
CLASS 1
CRI: RA 80
WARRANTY\* 3yr
DIM OPTIONS
BEAM 120°
SENSING
EM OPTIONS
GRY
118mm
80mm
1270mm

CODE	DESCRIPTION	COL TEMP.	DIM.	WATT	LUMENS
JC71554FR	Weatherproof 4ft twin	4000K	No	37W	4700
JC71554MW/FR	Weatherproof 4ft twin microwave on/off	4000K	No	37W	4700
JC71554FRDALI	Weatherproof 4ft twin DALI	4000K	Yes	37W	4700
JC71554FR/1-10V	Weatherproof 4ft twin 1-10V	4000K	Yes	37W	4700
JC71554EM/FR	Weatherproof 4ft twin emergency	4000K	No	37W	4700
JC71554MWEM/FR	Weatherproof 4ft twin microwave on/off emergency	4000K	No	37W	4700
JC71554EM/FRDALI	Weatherproof 4ft twin DALI emergency	4000K	Yes	37W	4700
JC71554EM/FR/1-10V	Weatherproof 4ft twin 1-10V emergency	4000K	Yes	37W	4700

Body: ABS. Diffuser: Polycarbonate.

\*Extended warranty requires online registration. 2 year warranty on batteries for emergency variants. Terms and conditions apply.



# ToughLED™ Weatherproof 5ft Single White Opal

## High efficiency IP65 LED Batten

- Conduit entry points at both ends
- Internal microwave sensing options available
- DALI and 1-10V dimming available
- Suitable for food preparation areas

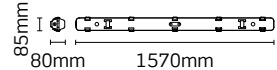

✓ JC71555WOP

									
RATING	CLASS 1	CRI: RA	WARRANTY*	DIM OPTIONS	BEAM	SENSING	EM OPTIONS	GREY	

CODE	DESCRIPTION	COL TEMP.	DIM.	WATT	LUMENS
JC71555WOP	Weatherproof 5ft single	4000K	No	27W	3200
JC71555MW/WOP	Weatherproof 5ft single microwave on/off	4000K	No	27W	3200
JC71555WOPDALI	Weatherproof 5ft single DALI	4000K	Yes	27W	3200
JC71555WOP/1-10V	Weatherproof 5ft single 1-10V	4000K	Yes	27W	3200
JC71555EM/WOP	Weatherproof 5ft single emergency	4000K	No	27W	3200
JC71555MWEM/WOP	Weatherproof 5ft single microwave on/off emergency	4000K	No	27W	3200
JC71555EM/WOPDALI	Weatherproof 5ft single DALI emergency	4000K	Yes	27W	3200
JC71555EM/WOP/1-10V	Weatherproof 5ft single 1-10V emergency	4000K	Yes	27W	3200

Body: ABS. Diffuser: Polycarbonate.

\*Extended warranty requires online registration. 2 year warranty on batteries for emergency variants. Terms and conditions apply.

# ToughLED™ Weatherproof 5ft Single Frosted

## High efficiency IP65 LED Batten

- Conduit entry points at both ends
- Internal microwave sensing options available
- DALI and 1-10V dimming available
- Suitable for food preparation areas



 RATING	 CLASS 1	 CRI: RA	 WARRANTY*	 DIM OPTIONS	 BEAM	 SENSING	 EM OPTIONS	 GREY	
--	---	---	---	---	--	---	---	--	---

CODE	DESCRIPTION	COL TEMP.	DIM.	WATT	LUMENS
JC71555FR	Weatherproof 5ft single	4000K	No	27W	3400
JC71555MW/FR	Weatherproof 5ft single microwave on/off	4000K	No	27W	3400
JC71555FRDALI	Weatherproof 5ft single DALI	4000K	Yes	27W	3400
JC71555FR/1-10V	Weatherproof 5ft single 1-10V	4000K	Yes	27W	3400
JC71555EM/FR	Weatherproof 5ft single emergency	4000K	No	27W	3400
JC71555MWEM/FR	Weatherproof 5ft single microwave on/off emergency	4000K	No	27W	3400
JC71555EM/FRDALI	Weatherproof 5ft single DALI emergency	4000K	Yes	27W	3400
JC71555EM/FR/1-10V	Weatherproof 5ft single 1-10V emergency	4000K	Yes	27W	3400

Body: ABS. Diffuser: Polycarbonate.









\*Extended warranty requires online registration. 2 year warranty on batteries for emergency variants. Terms and conditions apply.

# ToughLED™ Weatherproof 5ft Twin White Opal

## High efficiency IP65 LED Batten

- Conduit entry points at both ends
- Internal microwave sensing options available
- DALI and 1-10V dimming available
- Suitable for food preparation areas

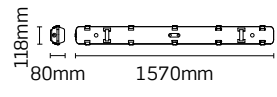

CODE	DESCRIPTION	COL TEMP.	DIM.	WATT	LUMENS
JC71556WOP	Weatherproof 5ft twin	4000K	No	57W	6150
JC71556MW/WOP	Weatherproof 5ft twin microwave on/off	4000K	No	57W	6150
JC71556WOPDALI	Weatherproof 5ft twin DALI	4000K	Yes	57W	6150
JC71556WOP/1-10V	Weatherproof 5ft twin 1-10V	4000K	Yes	57W	6150
JC71556EM/WOP	Weatherproof 5ft twin emergency	4000K	No	57W	6150
JC71556MWEM/WOP	Weatherproof 5ft twin microwave on/off emergency	4000K	No	57W	6150
JC71556EM/WOPDALI	Weatherproof 5ft twin DALI emergency	4000K	Yes	57W	6150
JC71556EM/WOP/1-10V	Weatherproof 5ft twin /1-10V emergency	4000K	Yes	57W	6150

Body: ABS. Diffuser: Polycarbonate.

\*Extended warranty requires online registration. 2 year warranty on batteries for emergency variants. Terms and conditions apply.

# ToughLED™ Weatherproof 5ft Twin Frosted

## High efficiency IP65 LED Batten

- Conduit entry points at both ends
- Internal microwave sensing options available
- DALI and 1-10V dimming available
- Suitable for food preparation areas



RATING	CLASS 1	CRI: RA	WARRANTY*	DIM OPTIONS	BEAM	SENSING	EM OPTIONS	GREY	

CODE	DESCRIPTION	COL TEMP.	DIM.	WATT	LUMENS
JC71556FR	Weatherproof 5ft twin	4000K	No	57W	7000
JC71556MW/FR	Weatherproof 5ft twin microwave on/off	4000K	No	57W	7000
JC71556FRDALI	Weatherproof 5ft twin DALI	4000K	Yes	57W	7000
JC71556FR/1-10V	Weatherproof 5ft twin 1-10V	4000K	Yes	57W	7000
JC71556EM/FR	Weatherproof 5ft twin emergency	4000K	No	57W	7000
JC71556MWEM/FR	Weatherproof 5ft twin microwave on/off emergency	4000K	No	57W	7000
JC71556EM/FRDALI	Weatherproof 5ft twin DALI emergency	4000K	Yes	57W	7000
JC71556EM/FR/1-10V	Weatherproof 5ft twin /1-10V emergency	4000K	Yes	57W	7000

Body: ABS. Diffuser: Polycarbonate.

\*Extended warranty requires online registration. 2 year warranty on batteries for emergency variants. Terms and conditions apply.

# ToughLED™ Weatherproof 6ft Single White Opal

## High efficiency IP65 LED Batten

- Conduit entry points at both ends
- Internal microwave sensing options available
- DALI and 1-10V dimming available
- Suitable for food preparation areas



CODE	DESCRIPTION	COL TEMP.	DIM.	WATT	LUMENS
JC71557WOP	Weatherproof 6ft single	4000K	No	35W	3800
JC71557MW/WOP	Weatherproof 6ft single microwave on/off	4000K	No	35W	3800
JC71557WOPDALI	Weatherproof 6ft single DALI	4000K	Yes	35W	3800
JC71557WOP/1-10V	Weatherproof 6ft single 1-10V	4000K	Yes	35W	3800
JC71557EM/WOP	Weatherproof 6ft single emergency	4000K	No	35W	3800
JC71557MWEM/WOP	Weatherproof 6ft single microwave on/off emergency	4000K	No	35W	3800
JC71557EM/WOPDALI	Weatherproof 6ft single DALI emergency	4000K	Yes	35W	3800
JC71557EM/WOP/1-10V	Weatherproof 6ft single 1-10V emergency	4000K	Yes	35W	3800

**Body:** ABS. **Diffuser:** Polycarbonate.

# ToughLED™ Weatherproof 6ft Single Frosted

## High efficiency IP65 LED Batten

- Conduit entry points at both ends
- Internal microwave sensing options available
- DALI and 1-10V dimming available
- Suitable for food preparation areas



∨ JC71557FR

									
RATING	CLASS 1	CRI: RA	WARRANTY*	DIM OPTIONS	BEAM	SENSING	EM OPTIONS	GREY	

CODE	DESCRIPTION	COL TEMP.	DIM.	WATT	LUMENS
JC71557FR	Weatherproof 6ft single	4000K	No	35W	4300
JC71557MW/FR	Weatherproof 6ft single microwave on/off	4000K	No	35W	4300
JC71557FRDALI	Weatherproof 6ft single DALI	4000K	Yes	35W	4300
JC71557FR/1-10V	Weatherproof 6ft single 1-10V	4000K	Yes	35W	4300
JC71557EM/FR	Weatherproof 6ft single emergency	4000K	No	35W	4300
JC71557MWEM/FR	Weatherproof 6ft single microwave on/off emergency	4000K	No	35W	4300
JC71557EM/FRDALI	Weatherproof 6ft single DALI emergency	4000K	Yes	35W	4300
JC71557EM/FR/1-10V	Weatherproof 6ft single 1-10V emergency	4000K	Yes	35W	4300

Body: ABS. Diffuser: Polycarbonate.

\*Extended warranty requires online registration. 2 year warranty on batteries for emergency variants. Terms and conditions apply.

# ToughLED™ Weatherproof 6ft Twin White Opal

## High efficiency IP65 LED Batten

- Conduit entry points at both ends
- Internal microwave sensing options available
- DALI and 1-10V dimming available
- Suitable for food preparation areas



✓ JC71558WOP

RATING	CLASS 1	CRI: RA	WARRANTY*	DIM OPTIONS	BEAM	SENSING	EM OPTIONS	GREY	

CODE	DESCRIPTION	COL TEMP.	DIM.	WATT	LUMENS
JC71558WOP	Weatherproof 6ft twin	4000K	No	70W	7100
JC71558MW/WOP	Weatherproof 6ft twin microwave on/off	4000K	No	70W	7100
JC71558WOPDALI	Weatherproof 6ft twin DALI	4000K	Yes	70W	7100
JC71558WOP/1-10V	Weatherproof 6ft twin 1-10V	4000K	Yes	70W	7100
JC71558EM/WOP	Weatherproof 6ft twin emergency	4000K	No	70W	7100
JC71558MWEM/WOP	Weatherproof 6ft twin microwave on/off emergency	4000K	No	70W	7100
JC71558EM/WOPDALI	Weatherproof 6ft twin DALI emergency	4000K	Yes	70W	7100
JC71558EM/WOP/1-10V	Weatherproof 6ft twin 1-10V emergency	4000K	Yes	70W	7100

**Body:** ABS. **Diffuser:** Polycarbonate.

\*Extended warranty requires online registration. 2 year warranty on batteries for emergency variants. Terms and conditions apply.



# ToughLED™ Weatherproof 6ft Twin Frosted

## High efficiency IP65 LED Batten

- Conduit entry points at both ends
- Internal microwave sensing options available
- DALI and 1-10V dimming available
- Suitable for food preparation areas













RATING CLASS 1 CRI: RA WARRANTY\* DIM OPTIONS BEAM SENSING EM OPTIONS GREY 118mm 80mm 1870mm

CODE	DESCRIPTION	COL TEMP.	DIM.	WATT	LUMENS
JC71558FR	Weatherproof 6ft twin	4000K	No	70W	8600
JC71558MW/FR	Weatherproof 6ft twin microwave on/off	4000K	No	70W	8600
JC71558FRDALI	Weatherproof 6ft twin DALI	4000K	Yes	70W	8600
JC71558FR/1-10V	Weatherproof 6ft twin 1-10V	4000K	Yes	70W	8600
JC71558EM/FR	Weatherproof 6ft twin emergency	4000K	No	70W	8600
JC71558MWEM/FR	Weatherproof 6ft twin microwave on/off emergency	4000K	No	70W	8600
JC71558EM/FRDALI	Weatherproof 6ft twin DALI emergency	4000K	Yes	70W	8600
JC71558EM/FR/1-10V	Weatherproof 6ft twin 1-10V emergency	4000K	Yes	70W	8600

Body: ABS. Diffuser: Polycarbonate.

\*Extended warranty requires online registration. 2 year warranty on batteries for emergency variants. Terms and conditions apply.

# ToughLED™ High Output 5ft Single

Outperforms traditional fluorescent weatherproof

- Conduit entry points at both ends
- DALI and 1-10V dimming available
- Suitable for food preparation areas



∨ JC71501

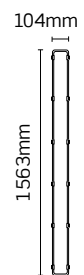

RATING   
 CLASS 2   
 CLASS 1 (EM)   
 CRI: RA   
 WARRANTY\*   
 DIM OPTIONS   
 SENSING   
 EM OPTIONS   
 RATING   
 GREY

CODE	DESCRIPTION	COL TEMP.	DIM.	WATT	LUMENS	LPCW
JC71501	ToughLED 5ft single	4000K	No	49W	4500	92
JC71501DALI	ToughLED 5ft single DALI	4000K	Yes	49W	4500	92
JC71501DSI	ToughLED 5ft single DSI	4000K	Yes	49W	4500	92
JC71501/1-10V	ToughLED 5ft single 1-10V	4000K	Yes	49W	4500	92
JC71509	ToughLED 5ft single microwave on/off	4000K	No	49W	4500	92
JC71509SD	ToughLED 5ft single microwave step dim	4000K	-	49W	4500	92
JC71505	ToughLED 5ft single emergency	4000K	No	49W	4500	92
JC71505DALI	ToughLED 5ft single emergency DALI	4000K	Yes	49W	4500	92
JC71505DSI	ToughLED 5ft single emergency DSI	4000K	Yes	49W	4500	92
JC71505/1-10V	ToughLED 5ft single emergency 1-10V	4000K	Yes	49W	4500	92
JC71525	ToughLED 1.5m suspension kit (single)	-	-	-	-	-

**Body:** Polycarbonate. **Diffuser:** Polycarbonate.

\*Extended warranty requires online registration. 2 year warranty on batteries for emergency variants. Terms and conditions apply.

# ToughLED™ High Output 5ft Twin

Outperforms traditional fluorescent weatherproof

- Conduit entry points at both ends
- DALI and 1-10V dimming available
- Suitable for food preparation areas

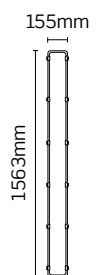











RATING CLASS 2 CLASS 1 (EM) CRI: RA WARRANTY\* DIM OPTIONS SENSING EM OPTIONS RATING GREY

CODE	DESCRIPTION	COL TEMP.	DIM.	WATT	LUMENS	LPCW
JC71503	ToughLED 5ft twin	4000K	No	98W	9000	92
JC71503DALI	ToughLED 5ft twin DALI	4000K	Yes	98W	9000	92
JC71503DSI	ToughLED 5ft twin DSI	4000K	Yes	98W	9000	92
JC71503/1-10V	ToughLED 5ft twin 1-10V	4000K	Yes	98W	9000	92
JC71511	ToughLED 5ft twin microwave on/off	4000K	No	98W	9000	92
JC71511SD	ToughLED 5ft twin microwave step dim	4000K	-	98W	9000	92
JC71507	ToughLED 5ft twin emergency	4000K	No	98W	9000	92
JC71507DALI	ToughLED 5ft twin emergency DALI	4000K	Yes	98W	9000	92
JC71507DSI	ToughLED 5ft twin emergency DSI	4000K	Yes	98W	9000	92
JC71507/1-10V	ToughLED 5ft twin emergency 1-10V	4000K	Yes	98W	9000	92
JC71526	ToughLED 1.5m suspension kit (twin)	-	-	-	-	-

Body: Polycarbonate. Diffuser: Polycarbonate.

\*Extended warranty requires online registration. 2 year warranty on batteries for emergency variants. Terms and conditions apply.

# ToughLED™ High Output 6ft Single

Outperforms traditional fluorescent weatherproof

- Conduit entry points at both ends
- DALI and 1-10V dimming available
- Suitable for food preparation areas

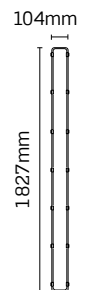

RATING	CLASS 2	CLASS 1 (EM)	CRI: RA	WARRANTY*	DIM OPTIONS	SENSING	EM OPTIONS	RATING	GREY

CODE	DESCRIPTION	COL TEMP.	DIM.	WATT	LUMENS	LPCW
JC71502	ToughLED 6ft single	4000K	No	59W	5400	92
JC71510	ToughLED 6ft single microwave on/off	4000K	No	59W	5400	92
JC71506	ToughLED 6ft single emergency	4000K	No	59W	5400	92
JC71525	ToughLED 1.5m suspension kit (single)	-	-	-	-	-

**Body:** Polycarbonate. **Diffuser:** Polycarbonate.

\*Extended warranty requires online registration. 2 year warranty on batteries for emergency variants. Terms and conditions apply.

# ToughLED™ High Output 6ft Twin

Outperforms traditional fluorescent weatherproof

- Conduit entry points at both ends
- DALI and 1-10V dimming available
- Suitable for food preparation areas



✓ JC71504

RATING

CLASS 2

CLASS 1 (EM)

CRI: RA

WARRANTY\*

DIM OPTIONS

SENSING

EM OPTIONS

RATING

GREY

CODE	DESCRIPTION	COL TEMP.	DIM.	WATT	LUMENS	LPCW
JC71504	ToughLED 6ft twin	4000K	No	118W	10,800	92
JC71512	ToughLED 6ft twin microwave on/off	4000K	No	118W	10,800	92
JC71508	ToughLED 6ft twin emergency	4000K	No	118W	10,800	92
JC71526	ToughLED 1.5m suspension kit (twin)	-	-	-	-	-

**Body:** Polycarbonate. **Diffuser:** Polycarbonate.

\*Extended warranty requires online registration. 2 year warranty on batteries for emergency variants. Terms and conditions apply.



U  
8B



U  
8C





# Highbay & Lowbay

Toughbay™ Retrofit	154
Toughbay™ Circular	156
Toughbay™ Circular Accessories	163
Toughbay™ Linear	166



## Toughbay™ Range

Durability that delivers  
outstanding energy efficiency



IP65  
PROTECTION



MULTIPLE BEAM  
OPTIONS



EMERGENCY  
OPTIONS



## Toughbay™ Retrofit

---

A versatile highbay, offering multiple beam angle options, emergency and microwaveable dimming variants and easy to install 1m flex.

**Available in 100W, 150W and 200W variants.**

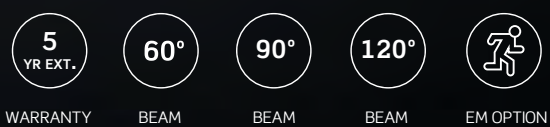

## Toughbay™ Circular

---

Available in three wattage options, Toughbay Circular comes with a 5 year warranty including 2 year on-site support, providing complete peace of mind.

**Available in 100W, 180W and 230W variants.**

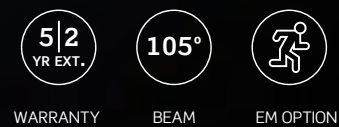

# Toughbay™ Retrofit 100W



## 150W HID replacement

- Available in 60°, 90° and 120° beam angle options
- 1-10V dimmable as standard
- Comes pre-wired with 1m flex
- Emergency options available



RATING  
 CLASS 1  
 CRI: RA  
 WARRANTY\*  
 DIM. OPTIONS  
 BEAM OPTIONS  
 BLACK

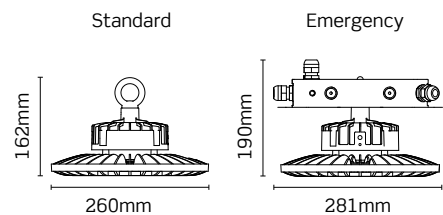

CODE	DESCRIPTION	COL TEMP.	DIM.	WATT	LUMENS	LPCW
JC040001	Toughbay Retrofit 60°	5700K	Yes	100W	12,300	123
JC040002	Toughbay Retrofit 60° emergency	5700K	Yes	100W	12,300	123
JC040005	Toughbay Retrofit 90°	5700K	Yes	100W	12,300	123
JC040006	Toughbay Retrofit 90° emergency	5700K	Yes	100W	12,300	123
JC040025	Toughbay Retrofit 120°	5700K	Yes	100W	12,300	123
JC040026	Toughbay Retrofit 120° emergency	5700K	Yes	100W	12,300	123
JC040049	Mount bracket for 100W & 150W Toughbay Retrofit	-	-	-	-	-

**Body:** Aluminium. **Lens:** Polycarbonate. **Bracket:** Steel.

JC040049 mount bracket not suitable for use with emergency or microwave versions.

\*Extended warranty requires online registration. 2 year warranty on batteries for emergency variants. Terms and conditions apply.

# Toughbay™ Retrofit 100W MW Step dim



## 150W HID replacement

- Available in 60°, 90° and 120° beam angle options
- 1-10V microwave step dimmable
- Comes complete with IP65 junction box
- Emergency options available
- Remote control available



RATING    
 CLASS 1    
 CRI: RA    
 WARRANTY\*    
 BEAM OPTIONS    
 BLACK

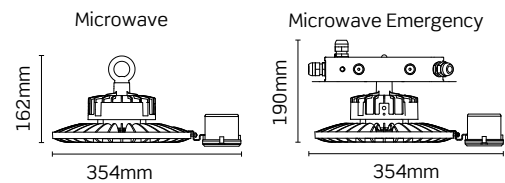

CODE	DESCRIPTION	COL TEMP.	DIM.	WATT	LUMENS	LPCW
JC040003	Toughbay Retrofit 60° microwave step dim	5700K	-	100W	12,300	123
JC040004	Toughbay Retrofit 60° microwave step dim emergency	5700K	-	100W	12,300	123
JC040007	Toughbay Retrofit 90° microwave step dim	5700K	-	100W	12,300	123
JC040008	Toughbay Retrofit 90° microwave step dim emergency	5700K	-	100W	12,300	123
JC040027	Toughbay Retrofit 120° microwave step dim	5700K	-	100W	12,300	123
JC040028	Toughbay Retrofit 120° microwave step dim emergency	5700K	-	100W	12,300	123
LEV71805	Toughbay microwave remote control	-	-	-	-	-

**Body:** Aluminium. **Lens:** Polycarbonate. **Bracket:** Steel.

\*Extended warranty requires online registration. 2 year warranty on batteries for emergency variants. Terms and conditions apply.

# Toughbay™ Retrofit 150W



## 250W HID replacement

- Available in 60°, 90° and 120° beam angle options
- 1-10V dimmable as standard
- Comes pre-wired with 1m flex
- Emergency options available
- 4000K and 5700K options



RATING  
 CLASS 1  
 CRI: RA  
 WARRANTY\*  
 DIM. OPTIONS  
 BEAM OPTIONS  
 BLACK

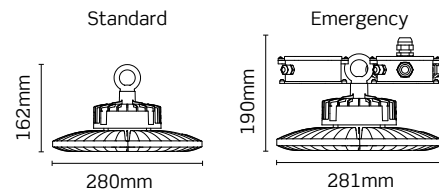

CODE	DESCRIPTION	COL TEMP.	DIM.	WATT	LUMENS	LPCW
JC040051	Toughbay Retrofit 60°	4000K	Yes	150W	18,400	123
JC040052	Toughbay Retrofit 60° emergency	4000K	Yes	150W	18,400	123
JC040055	Toughbay Retrofit 90°	4000K	Yes	150W	18,400	123
JC040056	Toughbay Retrofit 90° emergency	4000K	Yes	150W	18,400	123
JC040037	Toughbay Retrofit 120°	4000K	Yes	150W	18,400	123
JC040038	Toughbay Retrofit 120° emergency	4000K	Yes	150W	18,400	123
JC040009	Toughbay Retrofit 60°	5700K	Yes	150W	18,400	123
JC040010	Toughbay Retrofit 60° emergency	5700K	Yes	150W	18,400	123
JC040013	Toughbay Retrofit 90°	5700K	Yes	150W	18,400	123
JC040014	Toughbay Retrofit 90° emergency	5700K	Yes	150W	18,400	123
JC040029	Toughbay Retrofit 120°	5700K	Yes	150W	18,400	123
JC040030	Toughbay Retrofit 120° emergency	5700K	Yes	150W	18,400	123
JC040049	Mount bracket for 100W & 150W Toughbay Retrofit	-	-	-	-	-

**Body:** Aluminium. **Lens:** Polycarbonate. **Bracket:** Steel.

JC040049 mount bracket not suitable for use with emergency or microwave versions.

\*Extended warranty requires online registration. 2 year warranty on batteries for emergency variants. Terms and conditions apply.

# Toughbay™ Retrofit 150W MW Step dim



## 250W HID replacement

- Available in 60°, 90° and 120° beam angle options
- 1-10V microwave step dimmable
- Comes complete with IP65 junction box
- Emergency options available
- 4000K and 5700K options
- Remote control available



RATING  
 CLASS 1  
 CRI: RA  
 WARRANTY\*  
 BEAM OPTIONS  
 BLACK

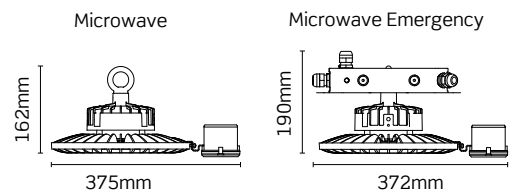

CODE	DESCRIPTION	COL TEMP.	DIM.	WATT	LUMENS	LPCW
JC040053	Toughbay Retrofit 60° microwave step dim	4000K	-	150W	18,400	123
JC040054	Toughbay Retrofit 60° microwave step dim emergency	4000K	-	150W	18,400	123
JC040057	Toughbay Retrofit 90° microwave step dim	4000K	-	150W	18,400	123
JC040058	Toughbay Retrofit 90° microwave step dim emergency	4000K	-	150W	18,400	123
JC040039	Toughbay Retrofit 120° microwave step dim	4000K	-	150W	18,400	123
JC040040	Toughbay Retrofit 120° microwave step dim emergency	4000K	-	150W	18,400	123
JC040011	Toughbay Retrofit 60° microwave step dim	5700K	-	150W	18,400	123
JC040012	Toughbay Retrofit 60° microwave step dim emergency	5700K	-	150W	18,400	123
JC040015	Toughbay Retrofit 90° microwave step dim	5700K	-	150W	18,400	123
JC040016	Toughbay Retrofit 90° microwave step dim emergency	5700K	-	150W	18,400	123
JC040031	Toughbay Retrofit 120° microwave step dim	5700K	-	150W	18,400	123
JC040032	Toughbay Retrofit 120° microwave step dim emergency	5700K	-	150W	18,400	123
LEV71805	Toughbay microwave remote control	-	-	-	-	-

**Body:** Aluminium. **Lens:** Polycarbonate. **Bracket:** Steel.

\*Extended warranty requires online registration. 2 year warranty on batteries for emergency variants. Terms and conditions apply.

# Toughbay™ Retrofit 200W



## 400W HID replacement

- Available in 60°, 90° and 120° beam angle options
- 1-10V dimmable as standard
- Comes pre-wired with 1m flex
- Emergency options available



RATING	CLASS 1	CRI: RA	WARRANTY*	DIM. OPTIONS	BEAM OPTIONS	BLACK	162mm 320mm	205mm 320mm

CODE	DESCRIPTION	COL TEMP.	DIM.	WATT	LUMENS	LPCW
JC040017	Toughbay Retrofit 60°	5700K	Yes	200W	24,500	123
JC040018	Toughbay Retrofit 60° emergency	5700K	Yes	200W	24,500	123
JC040021	Toughbay Retrofit 90°	5700K	Yes	200W	24,500	123
JC040022	Toughbay Retrofit 90° emergency	5700K	Yes	200W	24,500	123
JC040033	Toughbay Retrofit 120°	5700K	Yes	200W	24,500	123
JC040034	Toughbay Retrofit 120° emergency	5700K	Yes	200W	24,500	123
JC040050	Mount bracket for 200W Toughbay Retrofit	-	-	-	-	-

**Body:** Aluminium. **Lens:** Polycarbonate. **Bracket:** Steel.

JC040050 mount bracket not suitable for use with emergency or microwave versions.

\*Extended warranty requires online registration. 2 year warranty on batteries for emergency variants. Terms and conditions apply.



# Toughbay™ Retrofit 200W MW Step dim



## 400W HID replacement

- Available in 60°, 90° and 120° beam angle options
- 1-10V microwave step dimmable
- Comes complete with IP65 junction box
- Emergency options available
- Remote control available



RATING IP 65
 CLASS 1
 CRI: RA
 WARRANTY\* 5yr
 BEAM OPTIONS
 BLACK

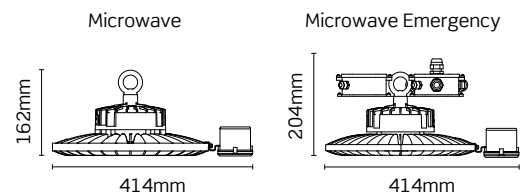

CODE	DESCRIPTION	COL TEMP.	DIM.	WATT	LUMENS	LPCW
JC040019	Toughbay Retrofit 60° microwave step dim	5700K	-	200W	24,500	123
JC040020	Toughbay Retrofit 60° microwave step dim emergency	5700K	-	200W	24,500	123
JC040023	Toughbay Retrofit 90° microwave step dim	5700K	-	200W	24,500	123
JC040024	Toughbay Retrofit 90° microwave step dim emergency	5700K	-	200W	24,500	123
JC040035	Toughbay Retrofit 120° microwave step dim	5700K	-	200W	24,500	123
JC040036	Toughbay Retrofit 120° microwave step dim emergency	5700K	-	200W	24,500	123
LEV71805	Toughbay microwave remote control	-	-	-	-	-

**Body:** Aluminium. **Lens:** Polycarbonate. **Bracket:** Steel.

\*Extended warranty requires online registration. 2 year warranty on batteries for emergency variants. Terms and conditions apply.

# Toughbay™ Circular 100W

## 150W HID replacement

- 5 year extended warranty, including 2 year on-site support
- 1-10V dimmable as standard
- Black and white finish options
- Emergency option available

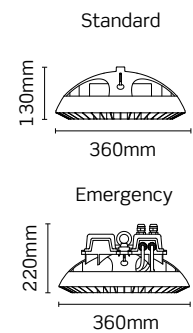

 <b>IP65</b>	 <b>CLASS 1</b>	 <b>80</b>	 <b>5yr</b>	 <b>2yr</b>			 <b>105°</b>	 <b>BLK</b>	 <b>WH</b>
<small>RATING</small>	<small>CLASS 1</small>	<small>CRI: RA</small>	<small>WARRANTY*</small>	<small>ON-SITE</small>	<small>DIM. OPTIONS</small>	<small>EM OPTION</small>	<small>BEAM</small>	<small>BLACK</small>	<small>WHITE</small>

CODE	DESCRIPTION	COL TEMP.	DIM.	WATT	LUMENS	LPCW
JC71810BLK	Toughbay Circular black	5700K	Yes	100W	10,600	106
JC71810WH	Toughbay Circular white	5700K	Yes	100W	10,600	106
JC71810BLKEM	Toughbay Circular emergency black	5700K	Yes	100W	10,600	106
JC71810WHEM	Toughbay Circular emergency white	5700K	Yes	100W	10,600	106

**Body:** Aluminium. **Lens:** Polycarbonate.

\*Extended warranty requires online registration. 2 year warranty on batteries for emergency variants. Terms and conditions apply.

# Toughbay™ Circular 180W

## 250W HID replacement

- 5 year extended warranty, including 2 year on-site support
- 1-10V dimmable as standard
- Emergency option available

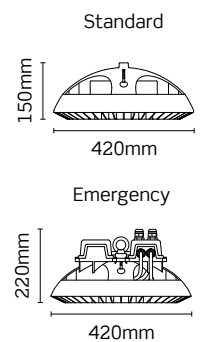

RATING	CLASS 1	CRI: RA	WARRANTY*	ON-SITE	DIM. OPTIONS	EM OPTION	BEAM	BLACK

CODE	DESCRIPTION	COL TEMP.	DIM.	WATT	LUMENS	LPCW
JC71811BLK	Toughbay Circular	5700K	Yes	180W	19,700	110
JC71811BLKEM	Toughbay Circular emergency	5700K	Yes	180W	19,700	110

**Body:** Aluminium. **Lens:** Polycarbonate.

\*Extended warranty requires online registration. 2 year warranty on batteries for emergency variants. Terms and conditions apply.

# Toughbay™ Circular 230W

## 400W HID replacement

- 5 year extended warranty, including 2 year on-site support
- 1-10V dimmable as standard
- Emergency option available

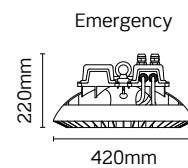
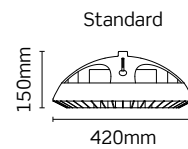

RATING



CLASS 1



CRI: RA



WARRANTY\*



ON-SITE



DIMMABLE



EM OPTION



BEAM



BLACK

CODE	DESCRIPTION	COL TEMP.	DIM.	WATT	LUMENS	LPCW
JC71812BLK	Toughbay Circular	5700K	Yes	230W	23,700	103
JC71812BLKEM	Toughbay Circular emergency	5700K	Yes	230W	23,700	103

**Body:** Aluminium. **Lens:** Polycarbonate.

\*Extended warranty requires online registration. 2 year warranty on batteries for emergency variants. Terms and conditions apply.

# Toughbay™ Circular Accessories

Accessories for JC71810, JC71811 & JC71812

∨ JC71854BLK



∨ JC71855BLK  
(Fitting not included)



∨ JC71851



RATING\*



GUARANTEE



BLACK



WHITE

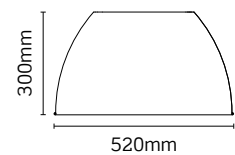

CODE	DESCRIPTION	FINISH
JC71854PR	Toughbay Circular 60° beam reflector (JC71810 only)	Prismatic
JC71854BLK	Toughbay Circular 60° beam reflector (JC71810 only)	Black
JC71852BLK	Toughbay Circular 60° beam reflector (JC71811/JC71812 only)	Black
JC71856	Toughbay Circular surface mounting bracket (JC71810 only) white	White
JC71855	Toughbay Circular surface mounting bracket (JC71810 only) black	Black
JC71850	Toughbay Circular surface mounting bracket (JC71811/JC71812 only)	Black
JC71851	Toughbay Circular waterproof IP67 connector	Black

Body: Steel.



OLYMPUS  
Twin Pack

DENNIS

ELITE 6

A&W

ADUR & WORTHING  
WASTE SERVICES

A&W

ADUR & WORTHING  
WASTE SERVICES



CRANES

8t  
CRANE

OLYMPUS  
Job-Pak

KONECRANES

KONECRANES

VNI7 DPV



## Toughbay™ Linear

Engineered for aisle and  
racking applications



7YR EXT.  
WARRANTY



MULTIPLE BEAM  
OPTIONS



MICROWAVE SENSING  
OPTIONS





## Ultra durable construction with multiple beam angle options

Toughbay Linear is available in a wide range of beam angle options, designed specifically to enhance illumination in aisle and racking applications. Featuring an operating temperature of -30 to +60 and a 7 year warranty, Toughbay Linear delivers maximum performance with the highest quality construction.



### 50° BEAM

Narrow open area  
50 degree beam angle.

### 80° BEAM

Wide open area  
80 degree beam angle.

### 30x60° BEAM







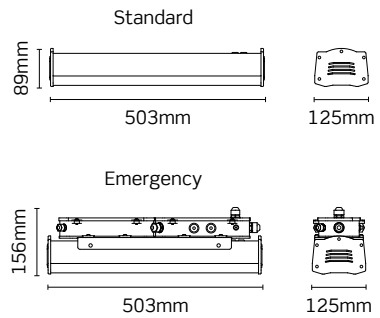

Asymmetric 30 x 60 degree beam  
angle for walkways and racking.

# Toughbay™ Linear 100W

Designed for aisle and racking applications

- 7 year extended warranty
- 1-10V dimmable as standard
- Emergency options available



 RATING	 CLASS 1	 CRI: RA	 WARRANTY*	 DIM. OPTIONS
 EM OPTIONS	 SENSING	 BEAM OPTIONS	 BLACK	

CODE	DESCRIPTION	COL TEMP.	DIM.	WATT	LUMENS	LPCW
JC71931/30X60	Toughbay Linear 30° x 60° 1-10V dimmable	5700K	Yes	100W	14,000	140
JC71931/30X60EM	Toughbay Linear 30° x 60° 1-10V dimmable emergency	5700K	Yes	100W	14,000	140
JC71931/50	Toughbay Linear 50° 1-10V dimmable	5700K	Yes	100W	14,000	140
JC71931/50EM	Toughbay Linear 50° 1-10V dimmable emergency	5700K	Yes	100W	14,000	140
JC71931/80	Toughbay Linear 80° 1-10V dimmable	5700K	Yes	100W	14,000	140
JC71931/80EM	Toughbay Linear 80° 1-10V dimmable emergency	5700K	Yes	100W	14,000	140

**Body:** Aluminium. **Lens:** Polycarbonate.

\*Extended warranty requires online registration. 2 year warranty on batteries for emergency variants. Terms and conditions apply.

# Toughbay™ Linear 100W MW Step Dim

Designed for aisle and racking applications

- 7 year extended warranty
- 1-10V microwave step dimmable
- Emergency options available
- Remote control available

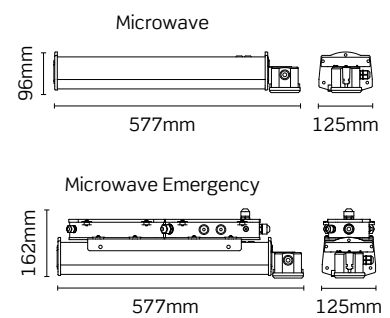

IP 65 RATING	CLASS 1	CRI: RA	7yr WARRANTY*	DIM. OPTIONS
EM OPTIONS	SENSING	BEAM OPTIONS	BLACK	

CODE	DESCRIPTION	COL TEMP.	DIM.	WATT	LUMENS	LPCW
JC71931/30X60MW	Toughbay Linear 30° x 60° microwave step dim	5700K	-	100W	14,000	140
JC71931/30X60MWEM	Toughbay Linear 30° x 60° microwave step dim em.	5700K	-	100W	14,000	140
JC71931/50MW	Toughbay Linear 50° microwave step dim	5700K	-	100W	14,000	140
JC71931/50MWEM	Toughbay Linear 50° microwave step dim em.	5700K	-	100W	14,000	140
JC71931/80MW	Toughbay Linear 80° microwave step dim	5700K	-	100W	14,000	140
JC71931/80MWEM	Toughbay Linear 80° microwave step dim em.	5700K	-	100W	14,000	140
LEV71805	Toughbay microwave remote control	-	-	-	-	-

**Body:** Aluminium. **Lens:** Polycarbonate.









\*Extended warranty requires online registration. 2 year warranty on batteries for emergency variants. Terms and conditions apply.

# Toughbay™ Linear 150W

Designed for aisle and racking applications

- 7 year extended warranty
- 1-10V dimmable as standard
- Emergency options available



 RATING	 CLASS 1	 CRI: RA	 WARRANTY*	 DIMMABLE
 EM OPTIONS	 SENSING	 BEAM OPTIONS	 BLACK	

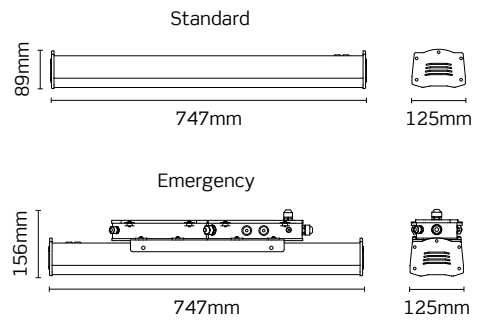

CODE	DESCRIPTION	COL TEMP.	DIM.	WATT	LUMENS	LPCW
JC71932/30X60	Toughbay Linear 30°x 60° 1-10V dimmable	5700K	Yes	150W	21,000	140
JC71932/30X60EM	Toughbay Linear 30°x 60° 1-10V dimmable emergency	5700K	Yes	150W	21,000	140
JC71932/50	Toughbay Linear 50° 1-10V dimmable	5700K	Yes	150W	21,000	140
JC71932/50EM	Toughbay Linear 50° 1-10V dimmable emergency	5700K	Yes	150W	21,000	140
JC71932/80	Toughbay Linear 80° 1-10V dimmable	5700K	Yes	150W	21,000	140
JC71932/80EM	Toughbay Linear 80° 1-10V dimmable emergency	5700K	Yes	150W	21,000	140

**Body:** Aluminium. **Lens:** Polycarbonate.









\*Extended warranty requires online registration. 2 year warranty on batteries for emergency variants. Terms and conditions apply.

# Toughbay™ Linear 150W MW Step Dim

Designed for aisle and racking applications

- 7 year extended warranty
- 1-10V microwave step dimmable
- Emergency options available
- Remote control available



 RATING	 CLASS 1	 CRI: RA	 WARRANTY*
 EM OPTIONS	 SENSING	 BEAM OPTIONS	 BLACK

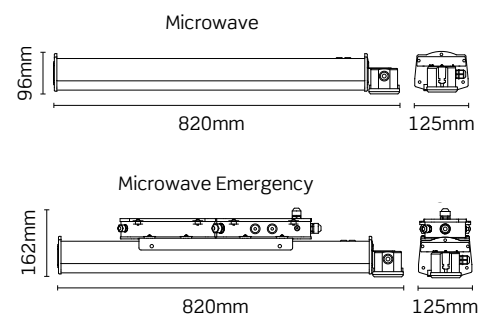

CODE	DESCRIPTION	COL TEMP.	DIM.	WATT	LUMENS	LPCW
JC71932/30X60MW	Toughbay Linear 30° x 60° microwave step dim	5700K	-	150W	21,000	140
JC71932/30X60MWEM	Toughbay Linear 30° x 60° microwave step dim em.	5700K	-	150W	21,000	140
JC71932/50MW	Toughbay Linear 50° microwave step dim	5700K	-	150W	21,000	140
JC71932/50MWEM	Toughbay Linear 50° microwave step dim em.	5700K	-	150W	21,000	140
JC71932/80MW	Toughbay Linear 80° microwave step dim	5700K	-	150W	21,000	140
JC71932/80MWEM	Toughbay Linear 80° microwave step dim em.	5700K	-	150W	21,000	140
LEV71805	Toughbay microwave remote control	-	-	-	-	-

Body: Aluminium. Lens: Polycarbonate.









\*Extended warranty requires online registration. 2 year warranty on batteries for emergency variants. Terms and conditions apply.

# Toughbay™ Linear 200W

Designed for aisle and racking applications

- 7 year extended warranty
- 1-10V dimmable as standard
- Emergency options available



 RATING	 CLASS 1	 CRI: RA	 WARRANTY*	 DIMMABLE
 EM OPTIONS	 SENSING	 BEAM OPTIONS	 BLACK	

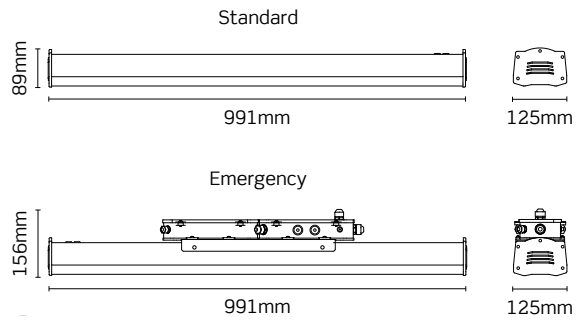

CODE	DESCRIPTION	COL TEMP.	DIM.	WATT	LUMENS	LPCW
JC71933/30X60	Toughbay Linear 30°x60° 1-10V dimmable	5700K	Yes	200W	28,000	140
JC71933/30X60EM	Toughbay Linear 30°x60° 1-10V dimmable emergency	5700K	Yes	200W	28,000	140
JC71933/50	Toughbay Linear 50° 1-10V dimmable	5700K	Yes	200W	28,000	140
JC71933/50EM	Toughbay Linear 50° 1-10V dimmable emergency	5700K	Yes	200W	28,000	140
JC71933/80	Toughbay Linear 80° 1-10V dimmable	5700K	Yes	200W	28,000	140
JC71933/80EM	Toughbay Linear 80° 1-10V dimmable emergency	5700K	Yes	200W	28,000	140

**Body:** Aluminium. **Lens:** Polycarbonate.









\*Extended warranty requires online registration. 2 year warranty on batteries for emergency variants. Terms and conditions apply.

# Toughbay™ Linear 200W MW Step Dim

Designed for aisle and racking applications

- 7 year extended warranty
- 1-10V microwave step dimmable
- Emergency options available
- Remote control available



 RATING	 CLASS 1	 CRI: RA	 WARRANTY*
 EM OPTIONS	 SENSING	 BEAM OPTIONS	 BLACK

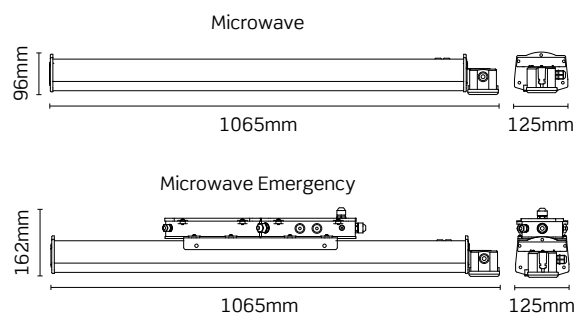

CODE	DESCRIPTION	COL TEMP.	DIM.	WATT	LUMENS	LPCW
JC71933/30X60MW	Toughbay Linear 30°x60° microwave dimming	5700K	-	200W	28,000	140
JC71933/30X60MWEM	Toughbay Linear 30x60° microwave dimming em.	5700K	-	200W	28,000	140
JC71933/50MW	Toughbay Linear 50° microwave dimming	5700K	-	200W	28,000	140
JC71933/50MWEM	Toughbay Linear 50° microwave dimming em.	5700K	-	200W	28,000	140
JC71933/80MW	Toughbay Linear 80° microwave dimming	5700K	-	200W	28,000	140
JC71933/80MWEM	Toughbay Linear 80° microwave dimming em.	5700K	-	200W	28,000	140
LEV71805	Toughbay microwave remote control	-	-	-	-	-

Body: Aluminium. Lens: Polycarbonate.

\*Extended warranty requires online registration. 2 year warranty on batteries for emergency variants. Terms and conditions apply.





# Emergency

Remote Emergency Pack	176
IP65 Exit Bulkhead	178
Exit Box	179
Exit Blade	180
Twin Spot	182
Emergency LED Downlight	184
Surface LED Downlight	185

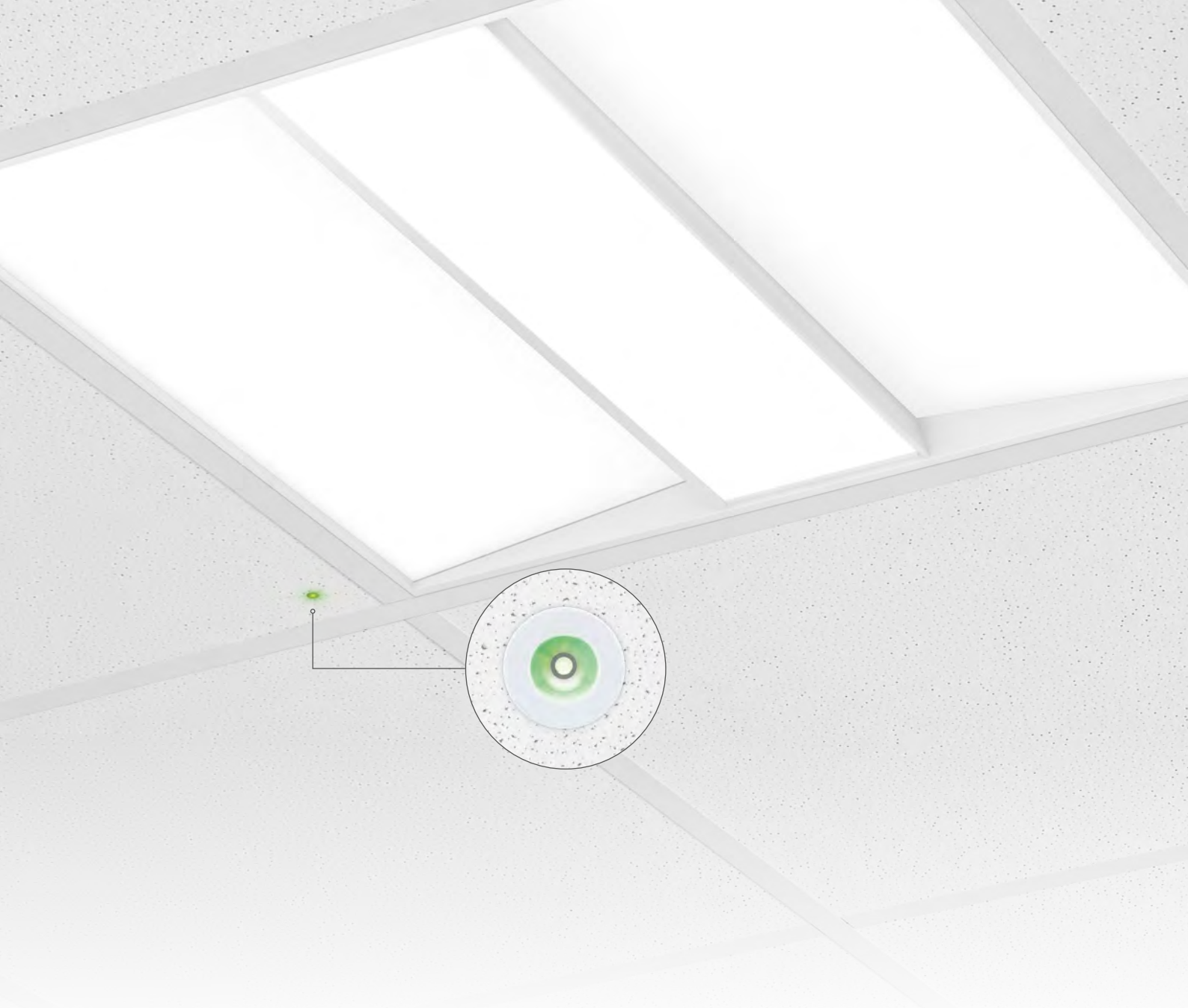

## **Remote Emergency Pack Self-Test**

# Automated testing for assurance of safety

JCC 's Emergency Remote Packs are designed to comply with the requirements of UK law and the relevant industry national and international standards. Both the Self-test and standard remote packs ensure that emergency lighting systems comply with the recommendations of BS5266-1: Code of Practice for the Emergency Lighting.

The weekly, monthly and annual testing for emergency lighting must be undertaken at times of least risk and in accordance with EN 50172:2004. JCC's self-test remote pack supports Facilities Managers with this requirement by automatically carrying out the required tests and highlighting any issues via the LED indicator. The indicator will flash red when any of these tests have failed, quickly highlighting any issues that can then be resolved straight away.

# Remote Emergency Pack

Emergency pack for selected JCC downlight products

- Class II with earth provision for continuous wiring requirements
- Push fit loop in/loop out connections
- Plug and play molex DC connectors



RATING



CLASS 2



WARRANTY\*

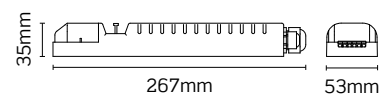

CODE	DESCRIPTION	VOLTAGE	WATT
JCEM001	Remote Emergency Pack	6 - 80V DC	50W Max
JCEM001ST	Remote Emergency Pack Self-Test	6 - 60V DC	50W Max

**Body:** Polycarbonate.

\*Extended warranty requires online registration. 2 year warranty on batteries for emergency variants. Terms and conditions apply.

# IP65 Exit Bulkhead

Direct 8W T5 retrofit LED exit bulkhead



20M VIEWING DISTANCE



RATING



CLASS 1



CRI: RA



WARRANTY\*



WHITE

JC50321

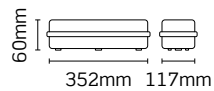

JC50313

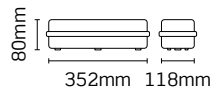

CODE	DESCRIPTION	COL TEMP.	WATT	LUMENS DC	LUMENS AC
JC50321	Exit bulkhead	6000K	4.5W	120	122
JC50313	Self test exit bulkhead	6000K	7W	200	400

**Body:** Polycarbonate. **Diffuser:** Polycarbonate.

\*Extended warranty requires online registration. 2 year warranty on batteries for emergency variants. Terms and conditions apply.

# Exit Box

Direct 8W T5 retrofit LED exit box

✓ JC50303 (SHOWN WITH JC50304)  
36M VIEWING DISTANCE



✓ JC50322 (SHOWN WITH JC50329)  
34M VIEWING DISTANCE



RATING



CLASS 1



CRI: RA  
(JC50303)



CRI: RA  
(JC50322)



WARRANTY\*



WHITE

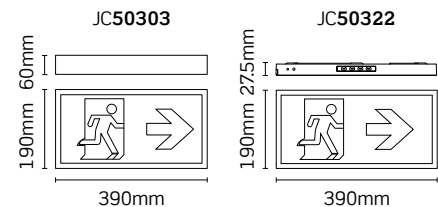

CODE	DESCRIPTION	COL TEMP.	WATT	LUMENS DC	LUMENS AC
JC50303	Exit Box with down arrow**	6000K	5.7W	49	95
JC50304	Left & right running legend for JC50303	-	-	-	-
JC50314	Up running legend for JC50303	-	-	-	-
JC50322	Self Test Exit Box	6000K	3W	16	15
JC50329	Left/Right/Up legend for JC50322	-	-	-	-

**Body:** Painted Steel (JC50303) Polycarbonate (JC50322) Acrylic (Running Man Legend). **Diffuser:** Polycarbonate.

\*\* Running man legend kits bought separately

\*Extended warranty requires online registration. 2 year warranty on batteries for emergency variants. Terms and conditions apply.

# Exit Blade

## Contemporary LED exit wall blade

∨ JC50302  
35M VIEWING DISTANCE



∨ JC50323  
35M VIEWING DISTANCE



∨ JC50326  
35M VIEWING DISTANCE



JC50302

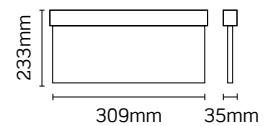

JC50323

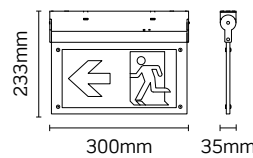

JC50326

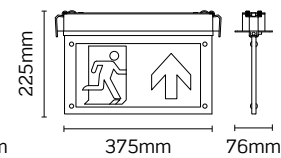

RATING



CLASS 1



CLASS 2\*



CRI: RA



WARRANTY\*



WHITE

CODE	DESCRIPTION	COL TEMP.	WATT	LUMENS DC	LUMENS AC
JC50302	Exit Blade**	6000K	3W	50	50
JC50323*	Exit Blade Self Test**	6000K	3W	25	25
JC50326*	Exit Blade Recessed**	6000K	3W	40	40
JC50308	Arrow left & right legend	-	-	-	-
JC50310	Arrow down legend (x2)	-	-	-	-
JC50311	Arrow up legend (x2)	-	-	-	-

\*\* Running man legend kits bought separately

**Body:** Polycarbonate. **Lens:** Polycarbonate.

\*Extended warranty requires online registration. 2 year warranty on batteries for emergency variants. Terms and conditions apply.

# Suspended Exit Blade

Contemporary LED exit wall blade

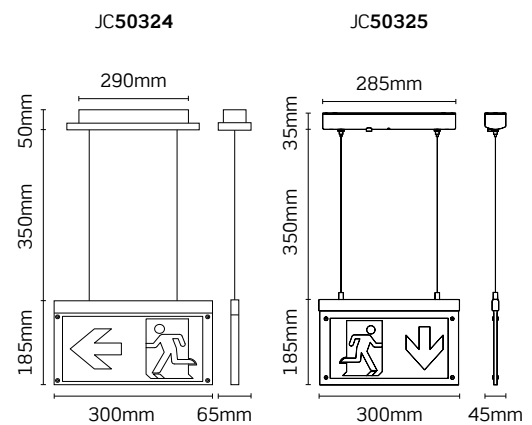

 RATING  
 CLASS 2  
 CRI: RA  
 WARRANTY\*  
 WHITE

CODE	DESCRIPTION	COL TEMP.	WATT	LUMENS DC	LUMENS AC
JC50324	Exit Blade recessed suspended**	6000K	3W	40	40
JC50325	Exit Blade surface suspended**	6000K	3W	25	25
JC50308	Arrow left & right legend	-	-	-	-
JC50310	Arrow down legend (x2)	-	-	-	-
JC50311	Arrow up legend (x2)	-	-	-	-

\*\* Running man legend kits bought separately

**Body:** Polycarbonate. **Lens:** Polycarbonate.

\*Extended warranty requires online registration. 2 year warranty on batteries for emergency variants. Terms and conditions apply.

# Twin Spot

IP65 emergency LED twin spot (Non maintained)



RATING



CLASS 1



CRI: RA  
(JC50305)



CRI: RA  
(JC50328)



WARRANTY\*



WHITE

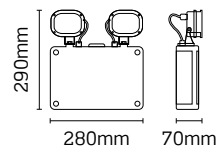

CODE	DESCRIPTION	COL TEMP.	WATT	LUMENS	LPCW
JC50305	IP65 Twin Spot	6000K	2x3W	470	78
JC50328	IP65 Twin Spot Self-test	6000K	2x6W	700	58

**Body:** Polycarbonate. **Lens:** Polycarbonate.

\*Extended warranty requires online registration. 2 year warranty on batteries for emergency variants. Terms and conditions apply.



# Twin Spot

IP20 emergency LED twin spot (Non maintained)









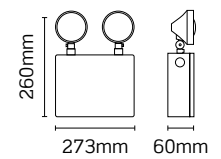

CODE	DESCRIPTION	COL TEMP.	WATT	LUMENS	LPCW
JC50327	IP20 Twin Spot	6000K	2x2.5W	300	60

**Body:** Polycarbonate. **Lens:** Polycarbonate.

\*Extended warranty requires online registration. 2 year warranty on batteries for emergency variants. Terms and conditions apply.

# Emergency LED Downlight

Recessed 3W remote LED downlight (Non maintained)



RATING



CLASS 2



CRI: RA



WARRANTY\*



BEAM



WHITE



42.5mm



21mm

CODE	DESCRIPTION	COL TEMP.	WATT	LUMENS	LPCW
JC50306	Emergency LED Downlight	6000K	3W	103	34

**Body:** Polycarbonate. **Lens:** Polycarbonate.

\*Extended warranty requires online registration. 2 year warranty on batteries for emergency variants. Terms and conditions apply.

# Surface LED Downlight

Surface mount emergency 3W LED downlight (Non maintained)



RATING



CLASS 2



CRI: RA



WARRANTY\*



WHITE

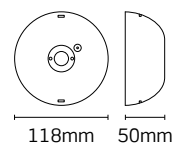

CODE	DESCRIPTION	COL TEMP.	WATT	LUMENS	LPCW
JC50307	Surface LED Downlight	6000K	3W	103	34

**Body:** Polycarbonate. **Lens:** Polycarbonate.

\*Extended warranty requires online registration. 2 year warranty on batteries for emergency variants. Terms and conditions apply.



# Interior Pendants

Architectural Pendant	188
Architectural Pendant High Output	193
Dome Pendant	194
Ring Pendant	195

# Architectural Pendant 10W

## Dimmable interior LED pendant

- Pre wired with three core cable and a braided outer sleeving
- Triac dimmable as standard

∨ JC84210BLK



∨ JC84211WH

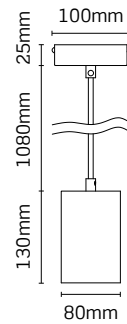

RATING



CLASS 1



CRI: RA



WARRANTY\*



BEAM



DIM OPTIONS



BLACK



WHITE

CODE	DESCRIPTION	COL TEMP.	DIM.	WATT	LUMENS	LPCW
JC84210	Architectural LED Pendant	3000K	Yes	10W	870	87
JC84211	Architectural LED Pendant	4000K	Yes	10W	910	91

For Black add **BLK** suffix, for White add **WH** suffix.

**Body:** Aluminium. **Lens:** Glass.

\*Extended warranty requires online registration. Terms and conditions apply.

# Architectural Pendant 18W

## Dimmable interior LED pendant

- Pre wired with three core cable and a braided outer sleeving
- Triac dimmable as standard

∨ JC84212BLK



∨ JC84213WH

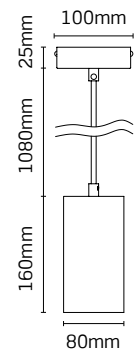

RATING



CLASS 1



CRI: RA



WARRANTY\*



BEAM



DIM OPTIONS



BLACK



WHITE

CODE	DESCRIPTION	COL TEMP.	DIM.	WATT	LUMENS	LPCW
JC84212	Architectural LED Pendant	3000K	Yes	18W	1500	83
JC84213	Architectural LED Pendant	4000K	Yes	18W	1600	89

For Black add **BLK** suffix, for White add **WH** suffix.

**Body:** Aluminium. **Lens:** Glass.

\*Extended warranty requires online registration. Terms and conditions apply.







# Architectural Pendant 25W

## Dimmable interior LED pendant

- Pre wired with three core cable and a braided outer sleeving
- Triac dimmable as standard

∨ JC84214BLK



∨ JC84215WH

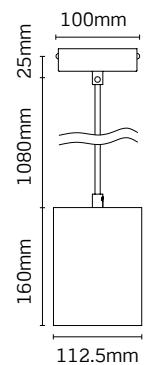

RATING



CLASS 1



CRI: RA



WARRANTY\*



BEAM



DIM OPTIONS



BLACK



WHITE

CODE	DESCRIPTION	COL TEMP.	DIM.	WATT	LUMENS	LPCW
JC84214	Architectural LED Pendant	3000K	Yes	25W	1950	78
JC84215	Architectural LED Pendant	4000K	Yes	25W	2000	80

For Black add **BLK** suffix, for White add **WH** suffix.

**Body:** Aluminium. **Lens:** Glass.

\*Extended warranty requires online registration. Terms and conditions apply.

# Architectural Pendant High Output 25W

## High output interior LED Pendant

- Pre wired with three core cable and a braided outer sleeving

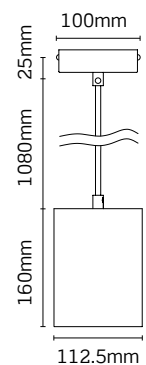

 RATING  
 CLASS 1  
 CRI: RA  
 WARRANTY\*  
 BEAM OPTIONS  
 BLACK  
 WHITE

CODE	DESCRIPTION	COL TEMP.	DIM.	WATT	LUMENS	LPCW
JC84216	High output LED pendant 24°	3000K	No	25W	2700	108
JC84217	High output LED pendant 36°	3000K	No	25W	2700	108
JC84218	High output LED pendant 24°	4000K	No	25W	2800	112
JC84219	High output LED pendant 36°	4000K	No	25W	2800	112

For Black add **BLK** suffix, for White add **WH** suffix.

**Body:** Aluminium. **Lens:** Glass.

Products available to order, contact JCC customer services on **01243 838999**.

\*Extended warranty requires online registration. Terms and conditions apply.

# Dome Pendant

Architectural retail LED pendant

∨ JC71860BLK



∨ JC71861WH

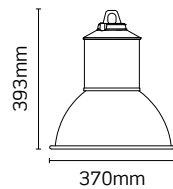
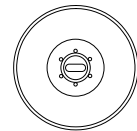

RATING



CLASS 1



CRI: RA



WARRANTY\*



BEAM



BLACK



WHITE

CODE	DESCRIPTION	COL TEMP.	DIM.	WATT	LUMENS	LPCW
JC71860	LED Dome Pendant	3000K	No	30W	3500	117
JC71861	LED Dome Pendant	4000K	No	30W	3800	127

For Black add **BLK** suffix, for White add **WH** suffix.

**Body:** Aluminium. **Diffuser:** Polycarbonate.

\*Extended warranty requires online registration. Terms and conditions apply.

# Ring Pendant

## Decorative interior LED lighting

- Surface mount option available, see pages 280-281
- Triac dimmable as standard

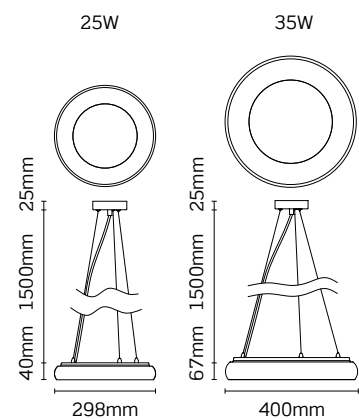
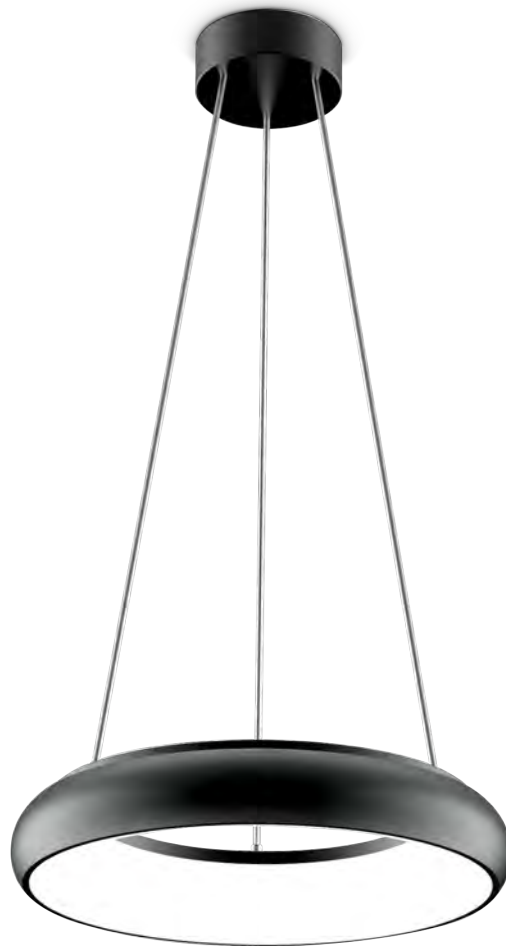







RATING CLASS 1 CRI: RA WARRANTY\* BEAM BLACK

CODE	DESCRIPTION	COL TEMP.	DIM.	WATT	LUMENS	LPCW
JC96401	LED Ring Pendant	3000K	Yes	25W	2130	85
JC96403	LED Ring Pendant	3000K	Yes	35W	2900	83
JC96400	LED Ring Pendant	4000K	Yes	25W	2190	88
JC96402	LED Ring Pendant	4000K	Yes	35W	3160	90

**Body:** Aluminium. **Diffuser:** Polycarbonate.

\*Extended warranty requires online registration. Terms and conditions apply.



# Spotlights & Track Systems

Retail Light Box	198	Starspot™ Global Track	213
Starscoop™ Linear	201	Starspot™ 500 Surface	214
Starscoop™	202	Aztek	216
Starscoop™ High Output	204	Spot Track Kit	219
Starspot™ 600	208	Sigma Spotlight	220
Starspot™ 1000	210	Standard Spotlight	221
Starspot™ 1500	211	Single Circuit Track	222
Starspot™ 3000	212	Three Circuit Track	224

# Retail Light Box

## High output retail spotlights

- Available in 15°, 24° and 36° beam angle options

∨ JC66011WH



∨ JC66011BLK



RATING



CLASS 2



CRI: RA



WARRANTY\*



BEAM OPTIONS



BLACK



WHITE

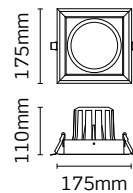

CODE	DESCRIPTION	COL TEMP.	DIM.	WATT	LUMENS	LPCW
JC66011	Retail Light Box Single 15° beam	3000K	No	35W	3840	110
JC66012	Retail Light Box Single 24° beam	3000K	No	35W	3840	110
JC66013	Retail Light Box Single 36° beam	3000K	No	35W	3840	110
JC66014	Retail Light Box Single 15° beam	4000K	No	35W	4100	117
JC66015	Retail Light Box Single 24° beam	4000K	No	35W	4100	117
JC66016	Retail Light Box Single 36° beam	4000K	No	35W	4100	117
JCEM001	JCC Emergency Remote Pack	-	-	-	-	-
JCEM001ST	JCC Emergency Remote Pack Self-Test	-	-	-	-	-

For Black add **BLK** suffix, for White add **WH** suffix.

**Body:** Aluminium. **Lens:** Polycarbonate.

Products available to order, contact JCC customer services on **01243 838999**.

\*Extended warranty requires online registration. Terms and conditions apply.



# Retail Light Box

## High output retail spotlights

- Available in 15°, 24° and 36° beam angle options

∨ JC66021WH



∨ JC66021BLK



RATING



CLASS 2



CRI: RA



WARRANTY\*



BEAM OPTIONS



BLACK



WHITE

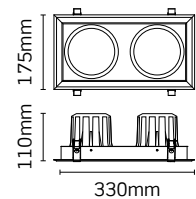

CODE	DESCRIPTION	COL TEMP.	DIM.	WATT	LUMENS	LPCW
JC66021	Retail Light Box Twin 15° beam	3000K	No	2x35W	2x3840	2x110
JC66022	Retail Light Box Twin 24° beam	3000K	No	2x35W	2x3840	2x110
JC66023	Retail Light Box Twin 36° beam	3000K	No	2x35W	2x3840	2x110
JC66024	Retail Light Box Twin 15° beam	4000K	No	2x35W	2x4100	2x117
JC66025	Retail Light Box Twin 24° beam	4000K	No	2x35W	2x4100	2x117
JC66026	Retail Light Box Twin 36° beam	4000K	No	2x35W	2x4100	2x117
JCEM001	JCC Emergency Remote Pack	-	-	-	-	-
JCEM001ST	JCC Emergency Remote Pack Self-Test	-	-	-	-	-

For Black add **BLK** suffix, for White add **WH** suffix.

**Body:** Aluminium. **Lens:** Polycarbonate.

Products available to order, contact JCC customer services on **01243 838999**.

\*Extended warranty requires online registration. Terms and conditions apply.

# Retail Light Box

## High output retail spotlights

- Available in 15°, 24° and 36° beam angle options

∨ JC66031WH



∨ JC66031BLK











RATING CLASS 2 CRI: RA WARRANTY\* BEAM OPTIONS BLACK WHITE

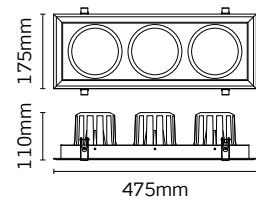

CODE	DESCRIPTION	COL TEMP.	DIM.	WATT	LUMENS	LPCW
JC66031	Retail Light Box Triple 15° beam	3000K	No	3x35W	3x3840	3x110
JC66032	Retail Light Box Triple 24° beam	3000K	No	3x35W	3x3840	3x110
JC66033	Retail Light Box Triple 36° beam	3000K	No	3x35W	3x3840	3x110
JC66034	Retail Light Box Triple 15° beam	4000K	No	3x35W	3x4100	3x117
JC66035	Retail Light Box Triple 24° beam	4000K	No	3x35W	3x4100	3x117
JC66036	Retail Light Box Triple 36° beam	4000K	No	3x35W	3x4100	3x117
JCEM001	JCC Emergency Remote Pack	-	-	-	-	-
JCEM001ST	JCC Emergency Remote Pack Self-Test	-	-	-	-	-

For Black add **BLK** suffix, for White add **WH** suffix.

**Body:** Aluminium. **Lens:** Polycarbonate.

Products available to order, contact JCC customer services on **01243 838999**.

\*Extended warranty requires online registration. Terms and conditions apply.

# Starscoop™ Linear

High output retail scoop light

- 45° tiltable LED module
- Durable die-cast aluminium construction

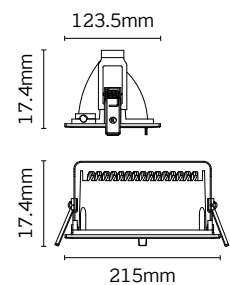

						
RATING	CLASS 2	CRI: RA	WARRANTY*	BEAM	EM OPTIONS	WHITE

CODE	DESCRIPTION	COL TEMP.	DIM.	WATT	LUMENS	LPCW
JC47440WH	Starscoop Linear	4000K	No	40W	4050	101
JCEM001	JCC Emergency Remote Pack	-	-	-	-	-
JCEM001ST	JCC Emergency Remote Pack Self-Test	-	-	-	-	-

Body: Aluminium. Lens: Glass.

\*Extended warranty requires online registration. Terms and conditions apply.

# Starscoop™ 20W

## Commercial LED display light

- 350° rotatable and 35° tiltable

✓ JC47441WH



✓ JC47441BLK

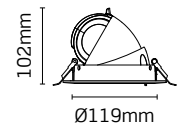
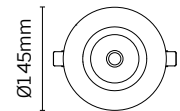

Cut out: Ø120-130mm



RATING



CLASS 2



CRI: RA



WARRANTY\*



BEAM



EM OPTIONS



BLACK



WHITE

CODE	DESCRIPTION	COL TEMP.	DIM.	WATT	LUMENS	LPCW
JC47441	Starscoop	4000K	No	20W	2020	101
JCEM001	JCC Emergency Remote Pack	-	-	-	-	-
JCEM001ST	JCC Emergency Remote Pack Self-Test	-	-	-	-	-

For Black add **BLK** suffix, for White add **WH** suffix.

**Body:** Aluminium. **Lens:** Glass.

\*Extended warranty requires online registration. Terms and conditions apply.

# Starscoop™ 35W

## Commercial LED display light

- 350° rotatable and 35° tiltable

∨ JC47442WH



∨ JC47442BLK

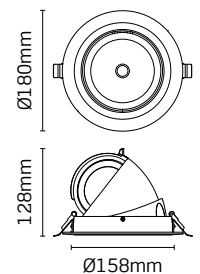

Cut out: Ø165-170mm



RATING



CLASS 2



CRI: RA



WARRANTY\*



BEAM



EM OPTIONS



BLACK



WHITE

CODE	DESCRIPTION	COL TEMP.	DIM.	WATT	LUMENS	LPCW
JC47442	Starscoop	4000K	No	35W	3400	97
JCEM001	JCC Emergency Remote Pack	-	-	-	-	-
JCEM001ST	JCC Emergency Remote Pack Self-Test	-	-	-	-	-

For Black add **BLK** suffix, for White add **WH** suffix.

**Body:** Aluminium. **Lens:** Glass.

\*Extended warranty requires online registration. Terms and conditions apply.

# Starscoop™ High Output

High performance 20W commercial LED display light

∨ JC47443WH



∨ JC47443BLK

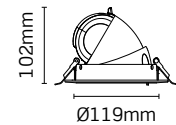
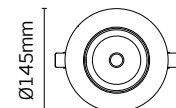

Cut out: Ø120-130mm



RATING



CLASS 2



CRI: RA



WARRANTY\*



BEAM OPTIONS



EM OPTIONS



BLACK



WHITE

CODE	DESCRIPTION	COL TEMP.	DIM.	WATT	LUMENS	LPCW
JC47443	Starscoop 24° beam	3000K	No	20W	2230	112
JC47444	Starscoop 45° beam	3000K	No	20W	2230	112
JC47445	Starscoop 60° beam	3000K	No	20W	2230	112
JC47446	Starscoop 24° beam	4000K	No	20W	2330	117
JC47447	Starscoop 45° beam	4000K	No	20W	2330	117
JC47448	Starscoop 60° beam	4000K	No	20W	2330	117
JCEM001	JCC Emergency Remote Pack	-	-	-	-	-
JCEM001ST	JCC Emergency Remote Pack Self-Test	-	-	-	-	-

For Black add **BLK** suffix, for White add **WH** suffix.

**Body:** Aluminium. **Lens:** Glass.

Products available to order, contact JCC customer services on **01243 838999**.

\*Extended warranty requires online registration. Terms and conditions apply.

# Starscoop™ High Output

High performance 35W commercial LED display light

∨ JC47449WH



∨ JC47449BLK

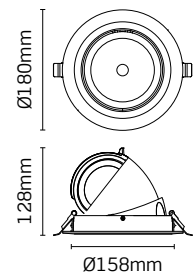

Cut out: Ø165-170mm









RATING CLASS 2 CRI: RA WARRANTY\* BEAM OPTIONS EM OPTIONS BLACK WHITE

CODE	DESCRIPTION	COL TEMP.	DIM.	WATT	LUMENS	LPCW
JC47449	Starscoop 24° beam	3000K	No	35W	3780	108
JC47450	Starscoop 45° beam	3000K	No	35W	3780	108
JC47451	Starscoop 60° beam	3000K	No	35W	3780	108
JC47452	Starscoop 24° beam	4000K	No	35W	4000	114
JC47453	Starscoop 45° beam	4000K	No	35W	4000	114
JC47454	Starscoop 60° beam	4000K	No	35W	4000	114
JCEM001	JCC Emergency Remote Pack	-	-	-	-	-
JCEM001ST	JCC Emergency Remote Pack Self-Test	-	-	-	-	-

For Black add **BLK** suffix, for White add **WH** suffix.

**Body:** Aluminium. **Lens:** Glass.

Products available to order, contact JCC customer services on **01243 838999**.

\*Extended warranty requires online registration. Terms and conditions apply.







# Starspot™ 600

High performance LED spotlights

- Triac dimmable as standard

∨ JC14222WH



∨ JC14222BLK



RATING



CLASS 1



CRI: RA



WARRANTY\*



BEAM



DIM. OPTIONS



BLACK



WHITE

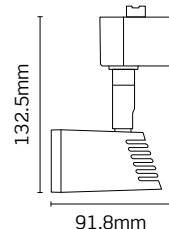

CODE	DESCRIPTION	COL TEMP.	DIM.	WATT	LUMENS	LPCW
JC14222	Starspot 600	3000K	Yes	7W	580	83
JC14223	Starspot 600	4000K	Yes	7W	600	86

For Black add **BLK** suffix, for White add **WH** suffix.

**Body:** Aluminium. **Lens:** Polycarbonate.

\*Extended warranty requires online registration. Terms and conditions apply.

# Starspot™ 600 Track Kit

High performance LED spotlights

- Triac dimmable as standard

∨ JC14225WH



∨ JC14225BLK



RATING



CLASS 1



CRI: RA



WARRANTY\*



BEAM



DIM. OPTIONS



BLACK



WHITE

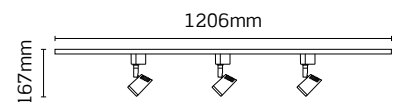

CODE	DESCRIPTION	COL TEMP.	DIM.	WATT	LUMENS	LPCW
JC14224	Starspot 600 Track Kit	3000K	Yes	3x7W	3x580	3x83
JC14225	Starspot 600 Track Kit	4000K	Yes	3x7W	3x600	3x86

For Black add **BLK** suffix, for White add **WH** suffix.

**Body:** Aluminium. **Lens:** Polycarbonate. | Track kit includes: 3 x Starspot 600 spotlights, 1120mm track section and 86mm live end.

\*Extended warranty requires online registration. Terms and conditions apply.

# Starspot™ 1000

High performance LED spotlights

∨ JC14154WH



∨ JC14154BLK



RATING



CLASS 1



CRI: RA



WARRANTY\*



BEAM



BLACK



WHITE

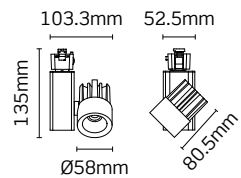

CODE	DESCRIPTION	COL TEMP.	DIM.	WATT	LUMENS	LPCW
JC14154	Starspot 1000 40° beam angle	3000K	No	15W	900	60
JC14155	Starspot 1000 40° beam angle	4000K	No	15W	1000	67

For Black add **BLK** suffix, for White add **WH** suffix.

**Body:** Aluminium. **Lens:** Polycarbonate. | Method of fix: Fixed to Single Circuit Track of Three Circuit with JC88118.

\*Extended warranty requires online registration. Terms and conditions apply.

# Starspot™ 1500

High performance LED spotlights

∨ JC14157WH



∨ JC14157BLK



RATING



CLASS 1



CRI: RA



WARRANTY\*



BEAM



BLACK



WHITE

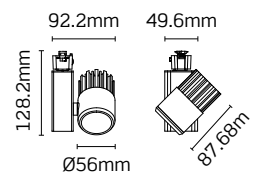

CODE	DESCRIPTION	COL TEMP.	DIM.	WATT	LUMENS	LPCW
JC14157	Starspot 1500 40° beam angle	3000K	No	20W	1300	65
JC14156	Starspot 1500 40° beam angle	4000K	No	20W	1500	75

For Black add **BLK** suffix, for White add **WH** suffix.

**Body:** Aluminium. **Lens:** Polycarbonate. | Method of fix: Fixed to Single Circuit Track of Three Circuit with JC88118.

\*Extended warranty requires online registration. Terms and conditions apply.

# Starspot™ 3000

High performance LED spotlights

∨ JC14204BLK



∨ JC14204WH



RATING



CLASS 1



CRI: RA



WARRANTY\*



BEAM OPTIONS



BLACK



WHITE

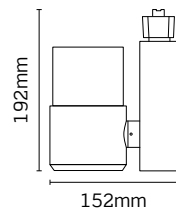

CODE	DESCRIPTION	COL TEMP.	DIM.	WATT	LUMENS	LPCW
JC14204	Starspot 3000 15° beam	3000K	No	34W	2800	82
JC14200	Starspot 3000 38° beam	3000K	No	34W	2800	82
JC14205	Starspot 3000 15° beam	4000K	No	34W	3000	88
JC14201	Starspot 3000 38° beam	4000K	No	34W	3000	88

For Black add **BLK** suffix, for White add **WH** suffix.

**Body:** Aluminium. **Lens:** Polycarbonate. | Method of fix: Fixed to Single Circuit Track of Three Circuit with JC88118.

\*Extended warranty requires online registration. Terms and conditions apply.

# Starspot™ Global Track

## Retrofit global track spotlight

∨ JC14300

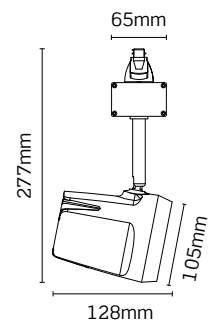

 RATING  
 CLASS 1  
 CRI: RA  
 WARRANTY\*  
 BEAM OPTIONS  
 BLACK  
 WHITE

CODE	DESCRIPTION	COL TEMP.	DIM.	WATT	LUMENS	LPCW
JC14300	Global Track Fitting 15° beam	3000K	No	35W	3200	91
JC14301	Global Track Fitting 24° beam	3000K	No	35W	3200	91
JC14302	Global Track Fitting 36° beam	3000K	No	35W	3200	91
JC14303	Global Track Fitting 15° beam	4000K	No	35W	3370	96
JC14304	Global Track Fitting 24° beam	4000K	No	35W	3370	96
JC14305	Global Track Fitting 36° beam	4000K	No	35W	3370	96

For Black add **BLK** suffix, for White add **WH** suffix.

**Body:** Aluminium. **Lens:** Polycarbonate. | Only for use with global track systems. Not compatible with JCC Single or Three Circuit Track.

Products available to order, contact JCC customer services on **01243 838999**.

\*Extended warranty requires online registration. Terms and conditions apply.

# Starspot™ 500 Surface Single

High performance LED surface mounted spotlights

- 350° rotatable and 90° tiltable

∨ JC14159WH

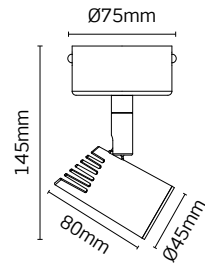

					
RATING	CLASS 1	CRI: RA	WARRANTY*	BEAM	WHITE

CODE	DESCRIPTION	COL TEMP.	DIM.	WATT	LUMENS	LPCW
JC14159WH	Starspot 500 Surface	3000K	No	7W	450	64
JC14158WH	Starspot 500 Surface	4000K	No	7W	480	69

**Body:** Aluminium. **Lens:** Polycarbonate.

\*Extended warranty requires online registration. Terms and conditions apply.



# Starspot™ 500 Surface Triple

High performance LED surface mounted spotlights

- 350° rotatable and 90° tiltable

∨ JC14162WH



∨ JC14106WH

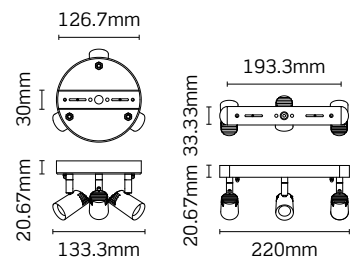

RATING CLASS 1 CRI: RA WARRANTY\* BEAM SATIN CHROME WHITE

CODE	DESCRIPTION	COL TEMP.	DIM.	WATT	LUMENS	LPCW
JC14163	Starspot 500 Surface Triple Plate	3000K	No	3 x 7W	3 x 450	3 x 64
JC14161	Starspot 500 Surface Triple Bar	3000K	No	3 x 7W	3 x 450	3 x 64
JC14162	Starspot 500 Surface Triple Plate	4000K	No	3 x 7W	3 x 480	3 x 69
JC14160	Starspot 500 Surface Triple Bar	4000K	No	3 x 7W	3 x 480	3 x 69

For Satin Chrome add **SCH** suffix, for White add **WH** suffix.

**Body:** Aluminium. **Lens:** Polycarbonate.

\*Extended warranty requires online registration. Terms and conditions apply.

# Aztek

## GU10 mains track spotlights

- 350° rotatable and 180° tiltable

∨ JC14102



∨ JC14104

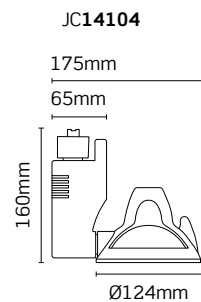
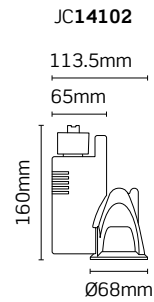

RATING



CLASS 1



GUARANTEE



WHITE

CODE	DESCRIPTION	LAMP
JC14102WH	Aztek Mains Track Spotlight	50W Max
JC14104WH	Aztek Mains Track HiSpot	HiSpot ES111 75W Max

Body: Aluminium. | Method of Fix: Fixed to Single Circuit Track with JC88118. | Lamp not supplied.

# Aztek Low Voltage

Low voltage spotlights with integral transformer

- 350° rotatable and 180° tiltable

∨ JC14108BLK



∨ JC14109WH

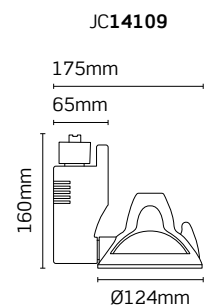
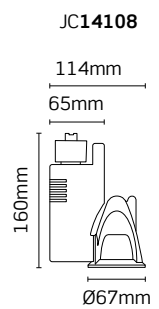

RATING



CLASS 1



GUARANTEE



BLACK



WHITE

CODE	DESCRIPTION	LAMP
JC14108	Aztek Low Voltage	MR16 50W
JC14109	Aztek Low Voltage	AR111 50W

For Black add **BLK** suffix, for White add **WH** suffix.

**Body:** Aluminium. | Method of Fix: Fixed to Single Circuit Track with JC88118. | Lamp not supplied.

# Aztek CDM-T

Spotlights for G12 ceramic metal halide lamps

- 350° rotatable and 180° tiltable

∨ JC14112WH

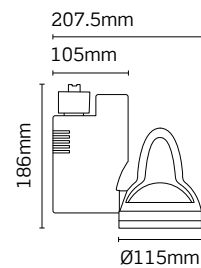

RATING



CLASS 1



GUARANTEE



WHITE

**CODE**

**DESCRIPTION**

**LAMP**

JC14112WH

Aztek CDM-T

CDM-T 35W

**Body:** Aluminium. | Lamp not supplied.

# Spot Track Kit

Track kit with four spotlights

∨ JC14048WH



∨ JC142048BLK



RATING



CLASS 1



GUARANTEE



BLACK



WHITE

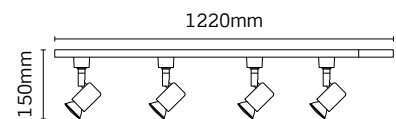

CODE	DESCRIPTION	LAMP
JC14048	Spot Track Kit	GU10 x 4 Max

For Black add **BLK** suffix, for White add **WH** suffix.

**Body:** Steel. | Lamp not supplied.

# Sigma Spotlight

GU10 track fitting

∨ JC14044BLK

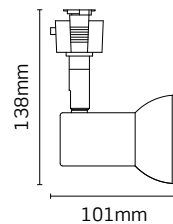

RATING



CLASS 1



GUARANTEE



BLACK



WHITE

CODE	DESCRIPTION	LAMP
JC14044	Sigma Spotlight	QPAR16 50W

For Black add **BLK** suffix, for White add **WH** suffix.

**Body:** Steel. | **Method of Fix:** Fixed to Single Circuit Track with JC88118. | **Lamp** not supplied.

# Standard Spotlight

GU10 standard track fitting

∨ JC14032WH



∨ JC14032BLK



∨ JC14032SIL



RATING



CLASS 1



GUARANTEE



BLACK



SILVER



WHITE

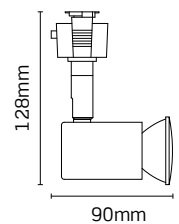

CODE	DESCRIPTION	LAMP
JC14032	Standard Spotlight	QPAR16 50W Max

For Black add **BLK** suffix, for Silver add **SIL** suffix, for White add **WH** suffix.

**Body:** Steel. | **Method of Fix:** Fixed to Single Circuit Track with JC88118. | **Lamp** not supplied.

# Single Circuit Track

Single circuit track with range of accessories

- Compatible with all JCC Single Circuit spotlights
- Track can be cut to required length

∨ JC14001WH (510MM)



∨ JC14002BLK (1120MM)



RATING



CLASS 1



GUARANTEE



BLACK



WHITE

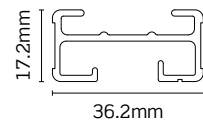

CODE	DESCRIPTION
JC14001	Single Circuit Track 510mm track section
JC14002	Single Circuit Track 1120mm track section
JC14003	Single Circuit Track 2340mm track section

For Black add **BLK** suffix, for White add **WH** suffix.

**Body:** Steel. | Supplied with end caps (3mm).



# Single Circuit Track Accessories

Accessories & connections for single circuit track



CODE	DESCRIPTION
JC14004	Track connector with power
JC14005	Adjustable right angle (L) & straight connector with power feed
JC14006	T connector
JC14007	4 way connector
JC14008	Power feed for track centre
JC14009	Power feed at track end with conduit entry
JC14010	Flexible connector
JC14011	Adapter to suspend pendants from track (5amp max)
JC14012	Adapter to provide power from track to pendants etc (1m flex - 5amp max)
JC14013	Power feed at track end
JC14070	Surface adapter for mainline fittings
JC14093	Suspension kit for suspended ceilings (3m)
JC14094	Wire suspension kit (3m)

For Black add **BLK** suffix, for White add **WH** suffix.

**Body:** Aluminium. **Cover:** Polycarbonate.

# Three Circuit Track

Three circuit flexible track system fittings



∨ JC88103BLK



∨ JC88103WH



RATING



CLASS 1



GUARANTEE



BLACK



WHITE

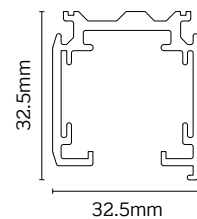

CODE	DESCRIPTION
JC88103	3m track section

For Black add **BLK** suffix, for White add **WH** suffix.

**Body:** Aluminium. | Suitable for use with Three Circuit Track adapter JC88118.

# Three Circuit Track Accessories

Three circuit flexible track system fittings

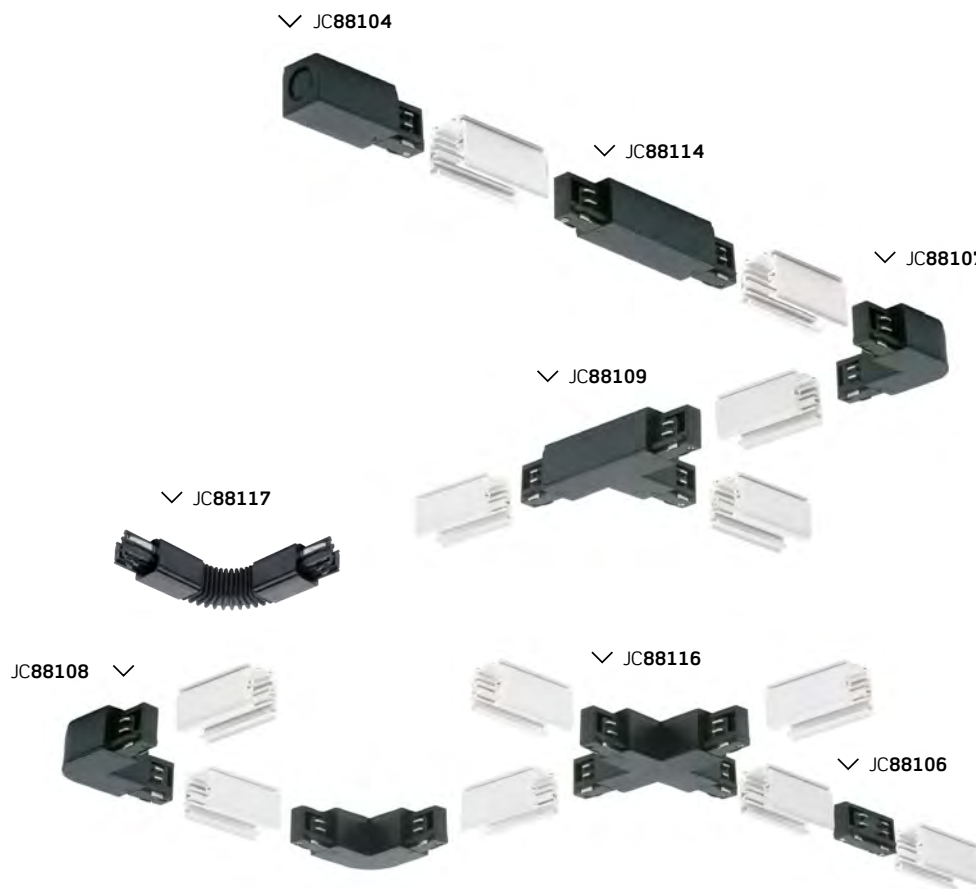

CODE	DESCRIPTION
JC88104	Power feed - right
JC88105	Power feed - left
JC88106	Concealed track connector
JC88107	L connector - right sided earth
JC88108	L connector - left sided earth
JC88109	T connector - right sided earth
JC88110	T connector - left sided earth
JC88112	End cap
JC88113	Ceiling bracket connector*
JC88114	Track connector with power feed
JC88115	Wire suspension kit* 1.5m
JC88116	Crossover connector
JC88117	Flexible elbow connector
JC88118	Three circuit track adapter (10amp max)

For Black add **BLK** suffix, for White add **WH** suffix. \*Only available in White (**WH**) (one per fitting)

**Body:** Aluminium



^ Convert any single circuit spotlight into a three circuit option by ordering track adapter, **JC88118** (one per fitting).



# LED Strip

5m LED Strip Reel IP20	232
5m LED Strip Reel IP65	233
50m LED Strip Reel IP20	234
50m LED Strip Reel IP65	235
5m RGBW LED Strip Reel IP20	238
5m RGBW LED Strip Reel IP65	239
50m RGBW LED Strip Reel IP20	240
50m RGBW LED Strip Reel IP65	241
Aluminium Profile	242
LED Strip Drivers & Controllers	243
LED Strip Connectors & Accessories	244
LED Strip Corners	245
LED Strip light service	248





## LED Strip

# Customisable LED Strip to suit all applications



VARIETY OF  
OPTIONS



CUSTOM SERVICE  
VIA CONFIGURATOR



5M AND 50M  
REEL OPTIONS

Our LED Strip provides the most flexible lighting solution to enhance your application and bring illumination to new and creative spaces. The range includes 2700K, 3000K, 4000K and 6500K colour temperature options in both IP20 and IP65 variants, as well as RGBW. Single colour LED Strip uses 120 LEDs per meter and 50mm cut points to ensure smooth and uniform light distribution with complete accuracy to your installation.

## LED Strip

# Options to suit all applications

### Light output options



#### 4.8W PER METER

For domestic installations that require accent lighting and back lighting around mirrors and under cabinets.



#### 9.6W PER METER

Ideal for domestic applications that require greater accent lighting such as living rooms and bedrooms.



#### 14.4W PER METER

High output LED strip creates functional lighting from higher ceilings, pelmets and corridors.

### Colour temperature options



#### 2700K ULTRA WARM WHITE

Create a warming environment that compliments wooden flooring and kitchen cabinets.



#### 3000K WARM WHITE

Perfect for domestic applications to create a warm and comfortable living environment.



#### 4000K NEUTRAL WHITE

Ideal for kitchen and bathroom applications and replacing traditional fluorescent colour temperatures.



#### 6500K DAYLIGHT

Ultra cool white LEDs for commercial, retail and display applications to create a sleek modern effect.



#### RGBW (RED, GREEN, BLUE & WHITE)

Select or blend red, green, blue and white to create up to 16 colours using the wireless IR remote control.



## IP ratings

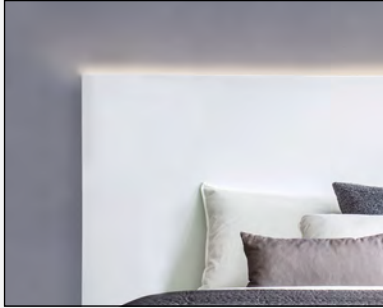

### IP20 - DRY AREAS

LED tape for applications not requiring protection from dust and moisture, such as bedrooms and living rooms.



### IP65 - WET AREAS

Protected from dust and moisture ideal for bathroom, kitchen and outdoor applications.

## Aluminium extrusions



### RECESSED

Recessed aluminium profile provides seamless LED integration.



### SURFACE

Surface mounted aluminium profile and clips for ease of installation.



### CORNER

90° corner profile for ceiling edging, stairway lighting and floor uplighting.

## Dimming options



### DIMMABLE (TRIAC)

Triac mains dimming is typically the most common dimming method in domestic applications.



### DIMMABLE (1-10V)

1-10V dimming provides smoother dimming and is often used in commercial applications.



### NON-DIMMABLE

Non dimmable IP20 drivers available for applications that do not require any form of dimming.

# 5m LED Strip Reel IP20

**NEW**

## LED Strip lighting

- Continuous 5m reel of LED strip
- 120 LEDs per metre for an even light distribution
- Cut to required length at 50mm cut points ensuring a more accurate installation
- Available with triac dimmable, 1-10V dimmable and non-dimmable 24V drivers see page 243
- Aluminium profile options see page 242



RATING

CLASS 3

CRI: RA

WARRANTY\*

DIM. OPTIONS

24V

4.8W &amp; 9.6W Strip

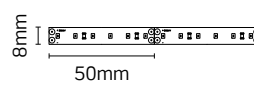

14.4W Strip

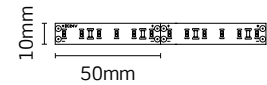

CODE	DESCRIPTION	COL TEMP.	DIM.**	WATT	LUMENS†	LPCW
JC121358	4.8W per meter LED strip 5m reel IP20	2700K	Yes	4.8W	480	100
JC121268	4.8W per meter LED strip 5m reel IP20	3000K	Yes	4.8W	480	100
JC121269	4.8W per meter LED strip 5m reel IP20	4000K	Yes	4.8W	480	100
JC121270	4.8W per meter LED strip 5m reel IP20	6500K	Yes	4.8W	480	100
JC121271	9.6W per meter LED strip 5m reel IP20	2700K	Yes	9.6W	960	100
JC121272	9.6W per meter LED strip 5m reel IP20	3000K	Yes	9.6W	960	100
JC121273	9.6W per meter LED strip 5m reel IP20	4000K	Yes	9.6W	960	100
JC121274	9.6W per meter LED strip 5m reel IP20	6500K	Yes	9.6W	960	100
JC121275	14.4W per meter LED strip 5m reel IP20	2700K	Yes	14.4W	1440	100
JC121276	14.4W per meter LED strip 5m reel IP20	3000K	Yes	14.4W	1440	100
JC121277	14.4W per meter LED strip 5m reel IP20	4000K	Yes	14.4W	1440	100
JC121278	14.4W per meter LED strip 5m reel IP20	6500K	Yes	14.4W	1440	100

\*\*All strip dimmable with correct driver see page 243 (sold separately). | †Lumens stated are per metre.

# 5m LED Strip Reel IP65



## IP Rated LED Strip lighting

- Continuous 5m reel of LED strip
- 120 LEDs per metre for an even light distribution
- Cut to required length at 50mm cut points ensuring a more accurate installation
- Available with triac dimmable, 1-10V dimmable and non-dimmable 24V drivers see page 243
- Aluminium profile options see page 242

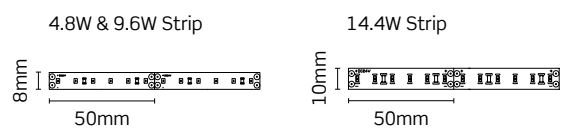

CODE	DESCRIPTION	COL TEMP.	DIM.**	WATT	LUMENS <sup>+</sup>	LPCW
JC121283	4.8W per meter LED strip 5m reel IP65	2700K	Yes	4.8W	480	100
JC121284	4.8W per meter LED strip 5m reel IP65	3000K	Yes	4.8W	480	100
JC121285	4.8W per meter LED strip 5m reel IP65	4000K	Yes	4.8W	480	100
JC121286	4.8W per meter LED strip 5m reel IP65	6500K	Yes	4.8W	480	100
JC121287	9.6W per meter LED strip 5m reel IP65	2700K	Yes	9.6W	960	100
JC121288	9.6W per meter LED strip 5m reel IP65	3000K	Yes	9.6W	960	100
JC121289	9.6W per meter LED strip 5m reel IP65	4000K	Yes	9.6W	960	100
JC121290	9.6W per meter LED strip 5m reel IP65	6500K	Yes	9.6W	960	100
JC121291	14.4W per meter LED strip 5m reel IP65	2700K	Yes	14.4W	1440	100
JC121292	14.4W per meter LED strip 5m reel IP65	3000K	Yes	14.4W	1440	100
JC121293	14.4W per meter LED strip 5m reel IP65	4000K	Yes	14.4W	1440	100
JC121294	14.4W per meter LED strip 5m reel IP65	6500K	Yes	14.4W	1440	100

\*\*All strip dimmable with correct driver see page 243 (sold separately). | <sup>+</sup>Lumens stated are per metre.

\*Extended warranty requires online registration. Terms and conditions apply.

# 50m LED Strip Reel IP20

**NEW**

## LED Strip lighting

- Continuous 50m reel of LED strip
- 120 LEDs per metre for an even light distribution
- Cut to required length at 50mm cut points ensuring a more accurate installation
- Available with triac dimmable, 1-10V dimmable and non-dimmable 24V drivers see page 243
- Aluminium profile options see page 242

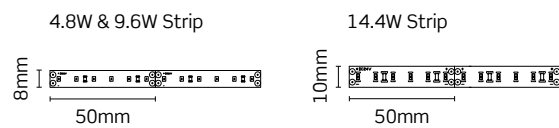

CODE	DESCRIPTION	COL TEMP.	DIM.**	WATT	LUMENS <sup>†</sup>	LPCW
JC121299	4.8W per meter LED strip 50m reel IP20	2700K	Yes	4.8W	480	100
JC121300	4.8W per meter LED strip 50m reel IP20	3000K	Yes	4.8W	480	100
JC121301	4.8W per meter LED strip 50m reel IP20	4000K	Yes	4.8W	480	100
JC121302	4.8W per meter LED strip 50m reel IP20	6500K	Yes	4.8W	480	100
JC121303	9.6W per meter LED strip 50m reel IP20	2700K	Yes	9.6W	960	100
JC121304	9.6W per meter LED strip 50m reel IP20	3000K	Yes	9.6W	960	100
JC121305	9.6W per meter LED strip 50m reel IP20	4000K	Yes	9.6W	960	100
JC121306	9.6W per meter LED strip 50m reel IP20	6500K	Yes	9.6W	960	100
JC121307	14.4W per meter LED strip 50m reel IP20	2700K	Yes	14.4W	1440	100
JC121308	14.4W per meter LED strip 50m reel IP20	3000K	Yes	14.4W	1440	100
JC121309	14.4W per meter LED strip 50m reel IP20	4000K	Yes	14.4W	1440	100
JC121310	14.4W per meter LED strip 50m reel IP20	6500K	Yes	14.4W	1440	100

\*\*All strip dimmable with correct driver see page 243 (sold separately). | <sup>†</sup>Lumens stated are per metre.

# 50m LED Strip Reel IP65



## IP Rated LED Strip lighting

- Continuous 50m reel of LED strip
- 120 LEDs per metre for an even light distribution
- Cut to required length at 50mm cut points ensuring a more accurate installation
- Available with triac dimmable, 1-10V dimmable and non-dimmable 24V drivers see page 243
- Aluminium profile options see page 242

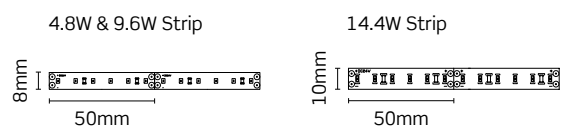

CODE	DESCRIPTION	COL TEMP.	DIM.**	WATT	LUMENS <sup>†</sup>	LPCW
JC121315	4.8W per meter LED strip 50m reel IP65	2700K	Yes	4.8W	480	100
JC121316	4.8W per meter LED strip 50m reel IP65	3000K	Yes	4.8W	480	100
JC121317	4.8W per meter LED strip 50m reel IP65	4000K	Yes	4.8W	480	100
JC121318	4.8W per meter LED strip 50m reel IP65	6500K	Yes	4.8W	480	100
JC121319	9.6W per meter LED strip 50m reel IP65	2700K	Yes	9.6W	960	100
JC121320	9.6W per meter LED strip 50m reel IP65	3000K	Yes	9.6W	960	100
JC121321	9.6W per meter LED strip 50m reel IP65	4000K	Yes	9.6W	960	100
JC121322	9.6W per meter LED strip 50m reel IP65	6500K	Yes	9.6W	960	100
JC121323	14.4W per meter LED strip 50m reel IP65	2700K	Yes	14.4W	1440	100
JC121324	14.4W per meter LED strip 50m reel IP65	3000K	Yes	14.4W	1440	100
JC121325	14.4W per meter LED strip 50m reel IP65	4000K	Yes	14.4W	1440	100
JC121326	14.4W per meter LED strip 50m reel IP65	6500K	Yes	14.4W	1440	100

\*\*All strip dimmable with correct driver see page 243 (sold separately) | <sup>†</sup>Lumens stated are per metre.

\*Extended warranty requires online registration. Terms and conditions apply.





RESERVED

BANDIE  
FRANCE

# 5m RGBW LED Strip Reel IP20



## Colour changing LED Strip lighting

- Red, green, blue and white combine to create 16 different colour options
- White options available in warm white (3000K) and neutral white (4000K)
- Continuous 5m reel of LED strip
- Cut to required length at 100mm cut points ensuring a more accurate installation
- 24V driver and RGBW IR controller required see page 243
- Aluminium profile options see page 242



∧ JC121331 24V RGBW receiver & remote



RATING



CLASS 3



CRI: RA



WARRANTY\*



DIM. OPTIONS



24V



10mm



100mm

CODE	DESCRIPTION	COL TEMP.	DIM.**	WATT	LUMENS	LPCW
JC121279	7.2W per meter LED strip 5m reel IP20 RGB-WW	RGBW (3000K)	Yes	7.2W	-	-
JC121280	7.2W per meter LED strip 5m reel IP20 RGBW-NW	RGBW (4000K)	Yes	7.2W	-	-
JC121281	14.4W per meter LED strip 5m reel IP20 RGB-WW	RGBW (3000K)	Yes	14.4W	-	-
JC121282	14.4W per meter LED strip 5m reel IP20 RGB-NW	RGBW (4000K)	Yes	14.4W	-	-

\*\*All RGBW strip dimmable with RGBW IR controller see page 243 (sold separately).

\*Extended warranty requires online registration. Terms and conditions apply.



# 5m RGBW LED Strip Reel IP65



## Colour changing IP Rated LED Strip lighting

- Red, green, blue and white combine to create 16 different colour options
- White options available in warm white (3000K) and neutral white (4000K)
- Continuous 5m reel of LED strip
- Cut to required length at 100mm cut points ensuring a more accurate installation
- 24V driver and RGBW IR controller required see page 243
- Aluminium profile options see page 242



∧ JC121331 24V RGBW receiver & remote

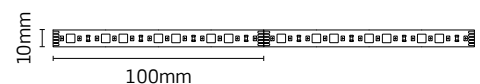

CODE	DESCRIPTION	COL TEMP.	DIM.**	WATT	LUMENS	LPCW
JC121295	7.2W per meter LED strip 5m reel IP65 RGB-WW	RGBW (3000K)	Yes	7.2W	-	-
JC121296	7.2W per meter LED strip 5m reel IP65 RGBW-NW	RGBW (4000K)	Yes	7.2W	-	-
JC121297	14.4W per meter LED strip 5m reel IP65 RGBW-WW	RGBW (3000K)	Yes	14.4W	-	-
JC121298	14.4W per meter LED strip 5m reel IP65 RGBW-NW	RGBW (4000K)	Yes	14.4W	-	-

\*\*All RGBW strip dimmable with RGBW IR controller see page 243 (sold separately).

\*Extended warranty requires online registration. Terms and conditions apply.

# 50m RGBW LED Strip Reel IP20



## Colour changing LED Strip lighting

- Red, green, blue and white combine to create 16 different colour options
- White options available in warm white (3000K) and neutral white (4000K)
- Continuous 50m reel of LED strip
- Cut to required length at 100mm cut points ensuring a more accurate installation
- 24V driver and RGBW IR controller required see page 243
- Aluminium profile options see page 242



∧ JC121331 24V RGBW receiver & remote

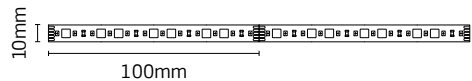

CODE	DESCRIPTION	COL TEMP.	DIM.**	WATT	LUMENS	LPCW
JC121311	7.2W per meter LED strip 50m reel IP20 RGB-WW	RGBW (3000K)	Yes	7.2W	-	-
JC121312	7.2W per meter LED strip 50m reel IP20 RGB-NW	RGBW (4000K)	Yes	7.2W	-	-
JC121313	14.4W per meter LED strip 50m reel IP20 RGB-WW	RGBW (3000K)	Yes	14.4W	-	-
JC121314	14.4W per meter LED strip 50m reel IP20 RGB-NW	RGBW (4000K)	Yes	14.4W	-	-

\*\*All RGBW strip dimmable with RGBW IR controller see page 243 (sold separately).

\*Extended warranty requires online registration. Terms and conditions apply.

# 50m RGBW LED Strip Reel IP65



## Colour changing IP Rated LED Strip lighting

- Red, green, blue and white combine to create 16 different colour options
- White options available in warm white (3000K) and neutral white (4000K)
- Continuous 50m reel of LED strip
- Cut to required length at 100mm cut points ensuring a more accurate installation
- 24V driver and RGBW IR controller required see page 243
- Aluminium profile options see page 242



^ JC121331 24V RGBW receiver & remote

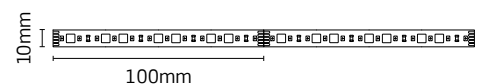

CODE	DESCRIPTION	COL TEMP.	DIM.**	WATT	LUMENS	LPCW
JC121327	7.2W per meter LED strip 50m reel IP65 RGB-WW	RGBW (3000K)	Yes	7.2W	-	-
JC121328	7.2W per meter LED strip 50m reel IP65 RGB-NW	RGBW (4000K)	Yes	7.2W	-	-
JC121329	14.4W per meter LED strip 50m reel IP65 RGB-WW	RGBW (3000K)	Yes	14.4W	-	-
JC121330	14.4W per meter LED strip 50m reel IP65 RGB-NW	RGBW (4000K)	Yes	14.4W	-	-

\*\*All RGBW strip dimmable with RGBW IR controller see page 243 (sold separately).

\*Extended warranty requires online registration. Terms and conditions apply.

# Aluminium Profile

For use with all LED Strip products

- Surface, recessed and corner profiles available
- Provided with two polycarbonate end caps as standard
- Available in 2m lengths



RATING



WARRANTY\*



SILVER

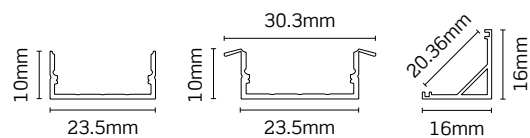

CODE	DESCRIPTION
JC121265	2m surface mount profile
JC121266	2m recessed aluminium profile
JC121267	2m corner surface mount profile

**Body:** Aluminium. **Diffuser:** Polycarbonate.

\*Extended warranty requires online registration. Terms and conditions apply.

# LED Strip Drivers & Controllers

Drivers and controllers for LED Strip products



JC121331 ^



^ BC020003



^ BC020006



RATING



RATING



WARRANTY\*

CODE	DESCRIPTION	WATT	DIM	IP
BC020008	Non-dimmable 24V driver	30W	No	20
BC020006	Non-dimmable 24V driver	75W	No	20
BC020007	Non-dimmable 24V driver	180W	No	20
BC020003	1-10V dimmable 24V driver	50W	Yes	65
BC020004	1-10V dimmable 24V driver	75W	Yes	65
BC020005	1-10V dimmable 24V driver	150W	Yes	65
BC020001	Triac dimmable 24V driver	75W	Yes	20
JC121331	24V RGBW receiver and remote	-	-	-

\*Extended warranty requires online registration. Terms and conditions apply.

# LED Strip Connectors & Accessories

For use with all LED Strip products



RATING



RATING

CODE	COMPONENT	FOR USE WITH	DESCRIPTION	PACK QTY.
JC121349	DC cable	Single colour	2m DC cable	1
JC121350	DC cable	RGBW	2m DC cable	1
JC83213	Pre-wired connector	Single colour	Strip-to-cable connector with 15cm cable and clip	6
JC83215	Pre-wired connector	Single colour	Strip-to-strip connector with 15cm cable and clip	5
JC121352	Pre-wired connector	Single colour	10mm clips with 0.5m cable	10
JC121354	Pre-wired connector	RGBW	10mm clips with 0.5m cable	10
JC121356	Pre-wired connector	RGBW	5-pin connector with 0.5m cable and clip	2
JC83214	Strip-to-strip	Single colour	Corner connector	5
JC83216	Strip-to-strip	Single colour	Connector with heat shrink	10
JC020019	Strip-to-strip	Single colour (only 9.6W)	8mm clips	10
JC020027	Strip-to-strip	Single colour (only 4.8W & 14.4W)	10mm clips	10
JC121353	Strip-to-strip	RGBW	10mm clips	10
JC020020	Strip-to-cable	Single colour (only 9.6W)	8mm clips	10
JC020028	Strip-to-cable	Single colour (only 4.8W & 14.4W)	10mm clips	10
JC83217	Retaining clips	All LED Strip	PCB retaining clips	10
JC83218	Retaining clips	DC cable	DC cable retating clips	10
JC121348	IP65 seal connector	All LED Strip	30mm heat shrink	5
JC121357	IP65 seal connector	All LED Strip	IP65 silicone glue (50ml) with IP end caps	1

All connectors are IP20 as standard, for IP65 use JC121348 30mm heat shrink and JC121357 IP65 silicone glue at each connection point.

# LED Strip Corners

Corner pieces for use with all LED Strip products

- Corner pieces in all colour temperatures to ensure seamless illumination



^ JC121336

CODE	DESCRIPTION	COL TEMP.
JC121332	4.8W Corner left/right pack	2700K
JC121333	4.8W Corner left/right pack	3000K
JC121334	4.8W Corner left/right pack	4000K
JC121335	4.8W Corner left/right pack	6500K
JC121336	9.6W Corner left/right pack	2700K
JC121337	9.6W Corner left/right pack	3000K
JC121338	9.6W Corner left/right pack	4000K
JC121339	9.6W Corner left/right pack	6500K
JC121340	14.4W Corner left/right pack	2700K
JC121341	14.4W Corner left/right pack	3000K
JC121342	14.4W Corner left/right pack	4000K
JC121343	14.4W Corner left/right pack	6500K
JC121344	RGB-WW 7.2W left/right pack	RGBW 3000K
JC121345	RGB-NW 7.2W left/right pack	RGBW 4000K
JC121346	RGB-WW 14.4W left/right pack	RGBW 3000K
JC121347	RGB-NW 14.4W left/right pack	RGBW 4000K

# Tailor made LED Strip lighting



## Introducing our LED Strip light service

The new LED Strip light service offers a custom solution through your preferred wholesaler. Use our online configurator to build your kit, then simply provide the order summary to your wholesaler along with your customer's address, and we will deliver everything you need directly to site.

Offering a range of different options, including low, standard and high output LED Strip; 2700K, 3000K, 4000K, 6500K colour temperatures alongside RGBW options, IP20 & IP65 protection and profiles to suit all applications.



### CUSTOM SERVICE

Our custom service provides tailor made LED Strip kits complete with all accessories and drivers, ordered via your wholesaler and delivered direct to site.



### SIMPLE ONLINE CONFIGURATOR

Our configurator takes the hassle out of ordering LED Strip by automatically working out exactly what driver, strip and components you require, reducing wastage and saving you money.



### VARIETY OF OPTIONS

Available in four outputs, five colour temperatures including RGBW, IP20 and IP65, with three aluminium profile options.



### FAST TURNAROUND

Your LED Strip light order will be delivered direct to site shortly after the order has been placed with JCC by your chosen wholesaler.

## Quick and easy three step process



### 1. SIMPLE ONLINE CONFIGURATOR

Input your LED Strip requirements online to generate an order summary to provide to your chosen wholesaler.



### 2. ORDER VIA YOUR WHOLESALER

From your order summary, your preferred wholesaler will order all components required.



### 3. DELIVERED DIRECTLY TO SITE

Provide your wholesaler with a preferred delivery address and we will send your components direct to site.





# Simple online configurator

## Automatically calculate your requirements

Our quick and easy online configurator tool has been created to simplify building your strip light project.

The step-by-step process, combined with the intuitive design, makes it easy to specify your LED Strip requirements whilst automatically calculating the most economical driver available for your configuration. Offering a range of different options, including low, standard and high output LED Strip; 2700K, 3000K, 4000K, 6500K colour temperatures alongside RGBW options, IP20 & IP65 protection and profiles to suit all applications.



### Configure

Choose the components you require for your design, including output, IP rating, colour temperature, dimmability and profile options.



### Design

Enter your LED Strip and DC cable measurements for our configurator to automatically generate a summary of components to provide to your chosen wholesaler in person or via email.



### Deliver

From receipt of your order summary, your chosen wholesaler will order all necessary components directly from JCC. Provide your wholesaler with a preferred delivery address and we will send your components direct to site.

Build your layout online using our step-by-step configurator

[jcc.co.uk/ledstrip](http://jcc.co.uk/ledstrip)



9:00

**JCC** | a **LEVITON**  
company

Help

2.1 What would your next  
piece of tape be?

Enter length to the  
nearest 5cm

**145** | cm

1

2  
ABC

3  
DEF

4  
GHI

5  
JKL

6  
MNO

7  
PQRS

8  
TUV

9  
WXYZ

0





# Undershelf & Cabinet

LED Undercabinet

252

---

T5 Undershelf

253

# LED Undercabinet

## Direct replacement for T5 fluorescent

- Three link leads available in 250mm, 500mm and 1000mm lengths
- End to end connection available
- On/off switch on each luminaire
- Supplied as standard with 1000mm mains cable

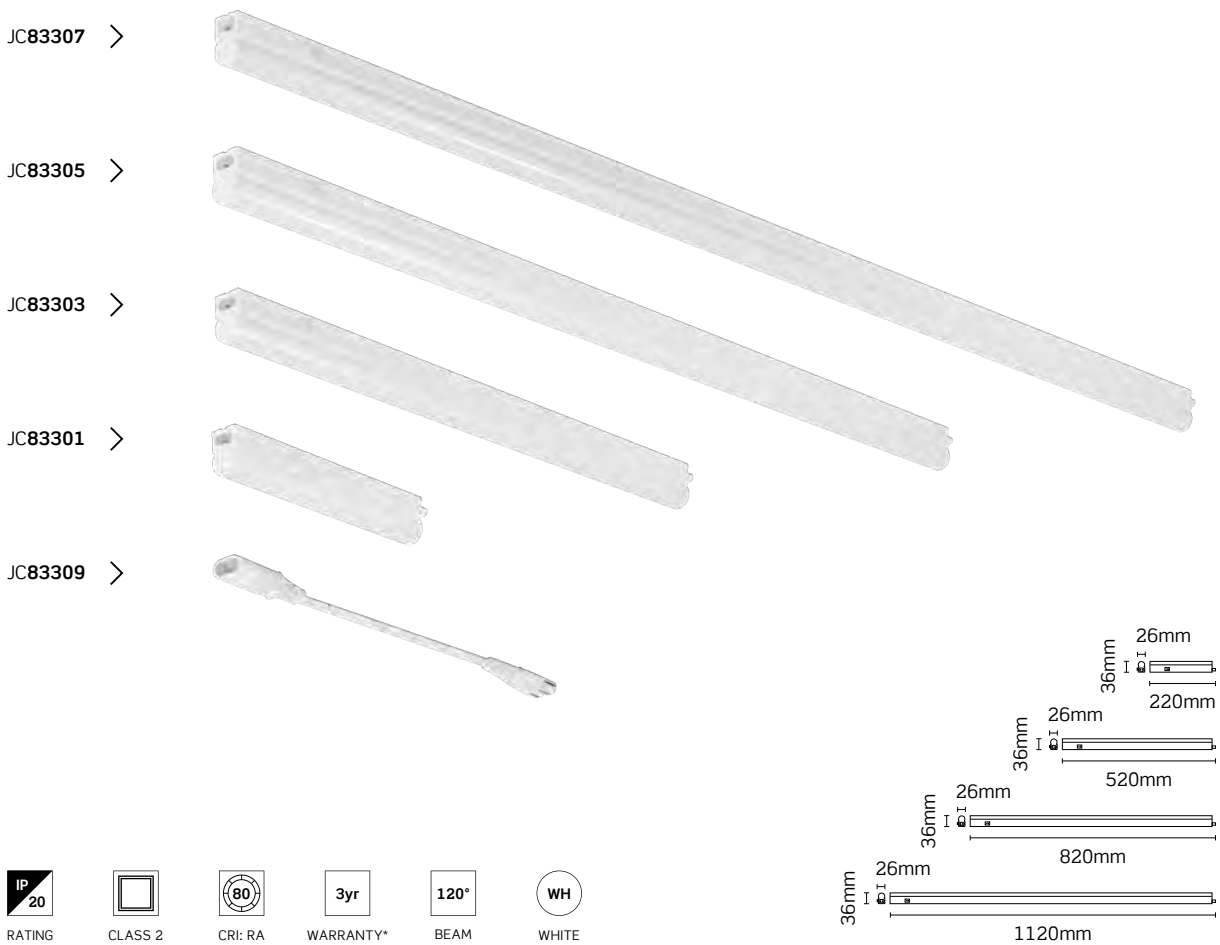







RATING CLASS 2 CRI: RA WARRANTY\* BEAM WHITE

CODE	DESCRIPTION	COL TEMP.	DIM.	WATT	LUMENS	LPCW
JC83302	220mm Undercabinet LED Batten	3000K	No	3W	300	100
JC83304	520mm Undercabinet LED Batten	3000K	No	8W	820	103
JC83306	820mm Undercabinet LED Batten	3000K	No	12W	1370	114
JC83308	1120mm Undercabinet LED Batten	3000K	No	15W	1650	110
JC83301	220mm Undercabinet LED Batten	4000K	No	3W	320	107
JC83303	520mm Undercabinet LED Batten	4000K	No	8W	920	115
JC83305	820mm Undercabinet LED Batten	4000K	No	12W	1480	123
JC83307	1120mm Undercabinet LED Batten	4000K	No	15W	1750	117
JC83309	LED Undercabinet Link Lead: 250mm	-	-	-	-	-
JC83310	LED Undercabinet Link Lead: 500mm	-	-	-	-	-
JC83311	LED Undercabinet Link Lead: 1000mm	-	-	-	-	-

**Body:** Polycarbonate. **Diffuser:** Polycarbonate. **Clips:** Polycarbonate.

\*Extended warranty requires online registration. Terms and conditions apply.

# T5 Undershef

Low energy, linkable fluorescent striplight

- On/off switch on each luminaire

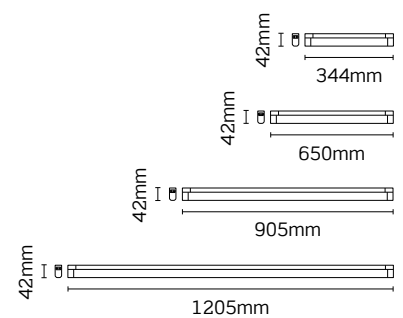

 RATING  
 CLASS 2  
 CRI: RA  
 GUARANTEE  
 WHITE

CODE	DESCRIPTION	LAMP
JC83020	T5 8W Fluorescent Striplight (344mm)	8W
JC83021	T5 14W Fluorescent Striplight (650mm)	14W
JC83022	T5 21W Fluorescent Striplight (905mm)	21W
JC83023	T5 28W Fluorescent Striplight (1205mm)	28W
JC83024	T5 250mm Link Lead	-
JC83025	T5 500mm Link Lead	-
JC83026	T5 1000mm Link Lead	-

Body: PVC. Diffuser: Polycarbonate. | Lamp included.









# Bulkheads

RadiaLED® Optimum	260
RadiaLED® Utility	268
RadiaLED® Style	272
RadiaLED® Slim	275
RadiaLED® Vogue	278
Ring Bulkhead	280
NiteLED™ Wall Sphere	282
Astra Wall Lights	283

## Bulkheads Range

Unique RadiaLED® LED array ensures smooth light uniformity, with no LED hotspots

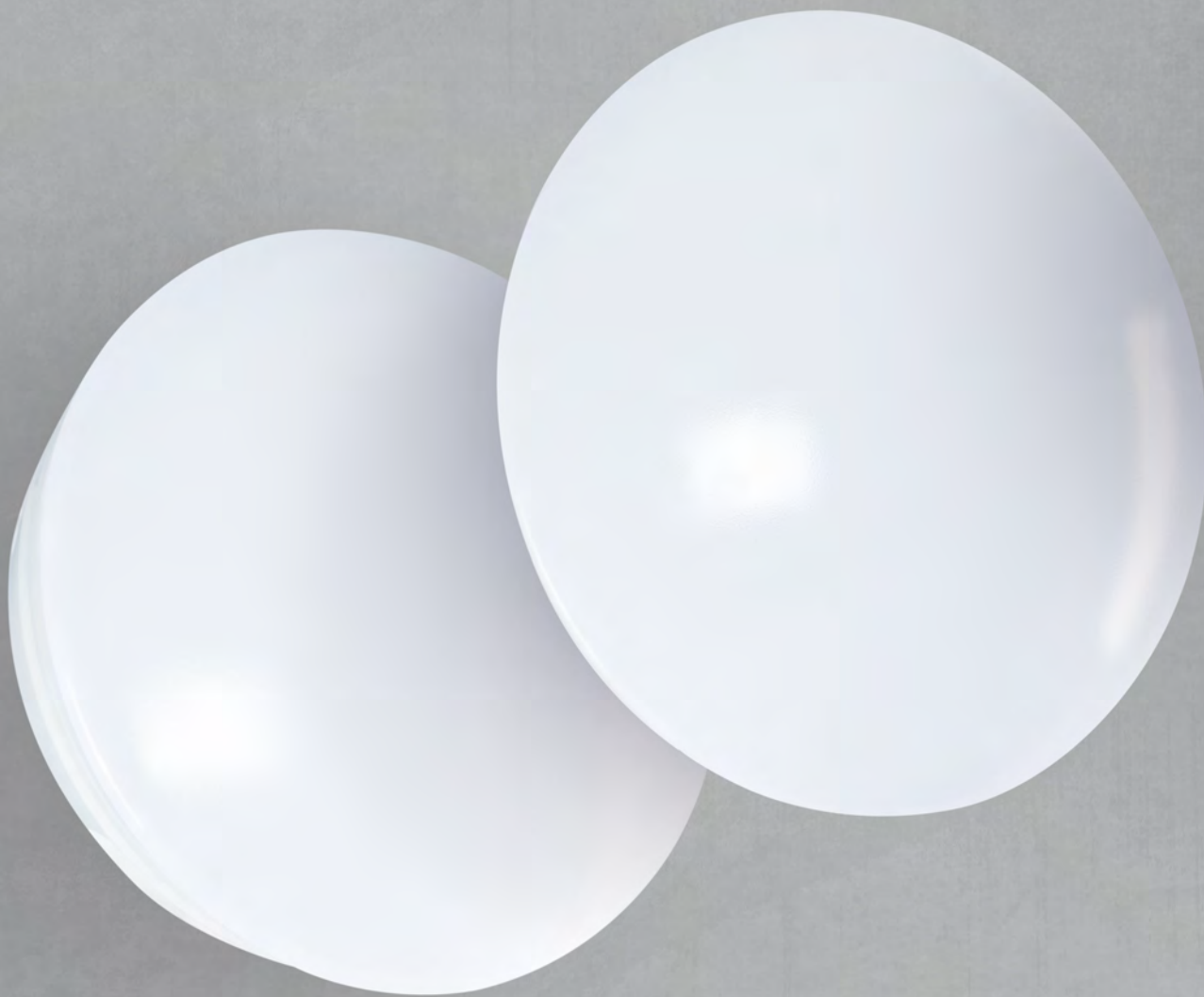

### RadiaLED® Style

---

RadiaLED Style is the ideal solution for corridor and stairwell applications that require a contemporary looking fitting.

**Available in 12W, 14W and 30W variants.**



WARRANTY



IP44



2900 LUMENS

### RadiaLED® Slim

---

RadiaLED Slim is a more discreet alternative to the Style. With the shallow body construction and opal diffuser, Slim ensures a smooth and seamless appearance.

**Available in 12W, 18W and 32W variants.**



WARRANTY



IP44



2900 LUMENS



## RadiaLED® Optimum

---

RadiaLED Optimum offers a wide range of rim options with a colour switchable variant, ensuring suitability for a variety of installations.

**Available in 8W, 12W and 18W variants.**



WARRANTY



IP65



CCT SWITCH

## RadiaLED® Utility

---

At the forefront of functionality, RadiaLED Utility provides IP65 protection against the elements making it suitable for interior and exterior installations.

**Available in 12W and 21W variants.**



WARRANTY



IP65













IK09

# RadiaLED® Optimum 8W

## Ultra durable, stylish LED bulkhead

- Comes with white rim as standard, multiple rim options available, see page 266
- Improved lumen output and efficiency
- Ultra durable IK09 impact rating
- Dusk to dawn on/off photocell options available
- DALI and 1-10V dimmable now available
- Microwave dimming with corridor function available

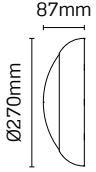

CODE	DESCRIPTION	COL TEMP.	DIM.	WATT	LUMENS	LPCW
JC070001	RadiaLED Optimum	4000K	No	8W	750	94
JC070002	RadiaLED Optimum photocell on/off	4000K	No	8W	750	94
JC070003	RadiaLED Optimum microwave step dim	4000K	-	8W	750	94
JC070004	RadiaLED Optimum emergency	4000K	No	8W	750	94
JC070005	RadiaLED Optimum photocell on/off emergency	4000K	No	8W	750	94
JC070006	RadiaLED Optimum microwave step dim emergency	4000K	-	8W	750	94
JC070051	RadiaLED Optimum DALI/1-10V	4000K	Yes	8W	750	94
JC070052	RadiaLED Optimum DALI/1-10V emergency	4000K	Yes	8W	750	94

**Body:** Polycarbonate. **Diffuser:** Polycarbonate. | Includes white rim as standard. | Twin conduit entry points.

\*Extended warranty requires online registration. 2 year warranty on batteries for emergency variants. Terms and conditions apply.

# RadiaLED<sup>®</sup> Optimum CCT 8W



Colour switchable 3000K & 4000K with multiple rim options

- Colour temperature switch accessible without the need to remove LED tray
- Comes with white rim as standard, multiple rim options available, see page 266
- Ultra durable IK09 impact rating
- Dusk to dawn on/off photocell options available
- DALI and 1-10V dimmable options
- Microwave dimming with corridor function available



RATING  
 CLASS 2  
 CLASS 1 (EM)  
 COL. SWITCH  
 CRI: RA  
 WARRANTY\*  
 RATING  
 SENSING  
 DIM OPTIONS  
 EM OPTIONS  
 WHITE

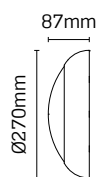

CODE	DESCRIPTION	COL TEMP.	DIM.	WATT	LUMENS	LPCW
JC070019	RadiaLED Optimum CCT	3000K & 4000K	No	8W	750	94
JC070020	RadiaLED Optimum CCT photocell on/off	3000K & 4000K	No	8W	750	94
JC070021	RadiaLED Optimum CCT microwave step dim	3000K & 4000K	-	8W	750	94
JC070022	RadiaLED Optimum CCT emergency	3000K & 4000K	No	8W	750	94
JC070023	RadiaLED Optimum CCT photocell on/off emergency	3000K & 4000K	No	8W	750	94
JC070024	RadiaLED Optimum CCT microwave step dim emergency	3000K & 4000K	-	8W	750	94
JC070057	RadiaLED Optimum CCT DALI/1-10V	3000K & 4000K	Yes	8W	750	94
JC070058	RadiaLED Optimum CCT DALI/1-10V emergency	3000K & 4000K	Yes	8W	750	94

**Body:** Polycarbonate. **Diffuser:** Polycarbonate. | Includes white rim as standard. | Twin conduit entry points.

\*Extended warranty requires online registration. 2 year warranty on batteries for emergency variants. Terms and conditions apply.

# RadiaLED® Optimum 12W

## Ultra durable, stylish LED bulkhead

- Comes with white rim as standard, multiple rim options available, see page 266
- Improved lumen output and efficiency
- Ultra durable IK09 impact rating
- Dusk to dawn on/off photocell options available
- DALI and 1-10V dimmable now available
- Microwave dimming with corridor function available

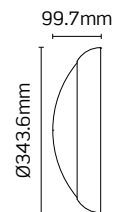











CODE	DESCRIPTION	COL TEMP.	DIM.	WATT	LUMENS	LPCW
JC070007	RadiaLED Optimum	4000K	No	12W	1300	108
JC070008	RadiaLED Optimum photocell on/off	4000K	No	12W	1300	108
JC070009	RadiaLED Optimum microwave step dim	4000K	-	12W	1300	108
JC070010	RadiaLED Optimum emergency	4000K	No	12W	1300	108
JC070011	RadiaLED Optimum photocell on/off emergency	4000K	No	12W	1300	108
JC070012	RadiaLED Optimum microwave step dim emergency	4000K	-	12W	1300	108
JC070053	RadiaLED Optimum DALI/1-10V	4000K	Yes	12W	1300	108
JC070054	RadiaLED Optimum DALI/1-10V emergency	4000K	Yes	12W	1300	108

**Body:** Polycarbonate. **Diffuser:** Polycarbonate. | Includes white rim as standard. | Twin conduit entry points.

\*Extended warranty requires online registration. 2 year warranty on batteries for emergency variants. Terms and conditions apply.



# RadiaLED® Optimum CCT 12W



Colour switchable 3000K & 4000K with multiple rim options

- Colour temperature switch accessible without the need to remove LED tray
- Comes with white rim as standard, multiple rim options available, see page 266
- Ultra durable IK09 impact rating
- Dusk to dawn on/off photocell options available
- DALI and 1-10V dimmable options
- Microwave dimming with corridor function available

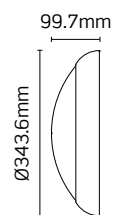

RATING  
 CLASS 2  
 CLASS 1 (EM)  
 COL. SWITCH  
 CRI: RA  
 WARRANTY\*  
 RATING  
 SENSING  
 DIM OPTIONS  
 EM OPTIONS  
 WHITE

CODE	DESCRIPTION	COL TEMP.	DIM.	WATT	LUMENS	LPCW
JC070025	RadiaLED Optimum CCT	3000K & 4000K	No	12W	1300	108
JC070026	RadiaLED Optimum CCT photocell on/off	3000K & 4000K	No	12W	1300	108
JC070027	RadiaLED Optimum CCT microwave step dim	3000K & 4000K	Yes	12W	1300	108
JC070028	RadiaLED Optimum CCT emergency	3000K & 4000K	No	12W	1300	108
JC070029	RadiaLED Optimum CCT photocell on/off emergency	3000K & 4000K	Yes	12W	1300	108
JC070030	RadiaLED Optimum CCT microwave step dim emergency	3000K & 4000K	Yes	12W	1300	108
JC070059	RadiaLED Optimum CCT DALI/1-10V	3000K & 4000K	Yes	12W	1300	108
JC070060	RadiaLED Optimum CCT DALI/1-10V emergency	3000K & 4000K	Yes	12W	1300	108

**Body:** Polycarbonate. **Diffuser:** Polycarbonate. | Includes white rim as standard. | Twin conduit entry points.

\*Extended warranty requires online registration. 2 year warranty on batteries for emergency variants. Terms and conditions apply.

# RadiaLED® Optimum 18W

## Ultra durable, stylish LED bulkhead

- Comes with white rim as standard, multiple rim options available, see page 266
- Improved lumen output and efficiency
- Ultra durable IK09 impact rating
- Dusk to dawn on/off photocell options available
- DALI and 1-10V dimmable now available
- Microwave dimming with corridor function available

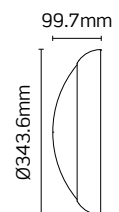

 RATING  
  CLASS 2  
  CLASS 1 (EM)  
  CRI: RA  
  WARRANTY\*  
  RATING  
  SENSING  
  DIM OPTIONS  
  EM OPTIONS  
  WHITE

CODE	DESCRIPTION	COL TEMP.	DIM.	WATT	LUMENS	LPCW
JC070013	RadiaLED Optimum	4000K	No	18W	1900	106
JC070014	RadiaLED Optimum photocell on/off	4000K	No	18W	1900	106
JC070015	RadiaLED Optimum microwave step dim	4000K	Yes	18W	1900	106
JC070016	RadiaLED Optimum emergency	4000K	No	18W	1900	106
JC070017	RadiaLED Optimum photocell on/off emergency	4000K	No	18W	1900	106
JC070018	RadiaLED Optimum microwave step dim emergency	4000K	Yes	18W	1900	106
JC070055	RadiaLED Optimum DALI/1-10V	4000K	Yes	18W	1900	106
JC070056	RadiaLED Optimum DALI/1-10V emergency	4000K	Yes	18W	1900	106

**Body:** Polycarbonate. **Diffuser:** Polycarbonate. | Includes white rim as standard. | Twin conduit entry points.

\*Extended warranty requires online registration. 2 year warranty on batteries for emergency variants. Terms and conditions apply.

# RadiaLED<sup>®</sup> Optimum CCT 18W



Colour switchable 3000K & 4000K with multiple rim options

- Colour temperature switch accessible without the need to remove LED tray
- Comes with white rim as standard, multiple rim options available, see page 266
- Ultra durable IK09 impact rating
- Dusk to dawn on/off photocell options available
- DALI and 1-10V dimmable options
- Microwave dimming with corridor function available

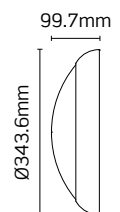

RATING  
 CLASS 2  
 CLASS 1 (EM)  
 COL. SWITCH  
 CRI: RA  
 WARRANTY\*  
 RATING  
 SENSING  
 DIM OPTIONS  
 EM OPTIONS  
 WHITE

CODE	DESCRIPTION	COL TEMP.	DIM.	WATT	LUMENS	LPCW
JC070031	RadiaLED Optimum CCT	3000K & 4000K	No	18W	1900	106
JC070032	RadiaLED Optimum CCT photocell on/off	3000K & 4000K	No	18W	1900	106
JC070033	RadiaLED Optimum CCT microwave step dim	3000K & 4000K	Yes	18W	1900	106
JC070034	RadiaLED Optimum CCT emergency	3000K & 4000K	No	18W	1900	106
JC070035	RadiaLED Optimum CCT photocell on/off emergency	3000K & 4000K	No	18W	1900	106
JC070036	RadiaLED Optimum CCT microwave step dim emergency	3000K & 4000K	Yes	18W	1900	106
JC070061	RadiaLED Optimum CCT DALI/1-10V	3000K & 4000K	Yes	18W	1900	106
JC070062	RadiaLED Optimum CCT DALI/1-10V emergency	3000K & 4000K	Yes	18W	1900	106

**Body:** Polycarbonate. **Diffuser:** Polycarbonate. | Includes white rim as standard. | Twin conduit entry points.

\*Extended warranty requires online registration. 2 year warranty on batteries for emergency variants. Terms and conditions apply.

# RadiaLED® Optimum Rims

Rim accessories to complement RadiaLED Optimum

✓ BLACK



✓ CHROME



✓ SATIN CHROME



✓ BLACK NICKEL



✓ ANTIQUE BRASS



✓ SATIN SILVER



✓ BLACK EYELID



RATING



GUARANTEE



BLACK



CHROME



SATIN CHROME



BLK NICKEL



ANTIQUE BRASS



SATIN SILVER

CODE	DESCRIPTION	FINISH
JC23330BLK	RadiaLED Optimum 8W rim	Black
JC23330CH	RadiaLED Optimum 8W rim	Chrome
JC23330SCH	RadiaLED Optimum 8W rim	Satin Chrome
JC23330BLN	RadiaLED Optimum 8W rim	Black Nickel
JC23330AB	RadiaLED Optimum 8W rim	Antique Brass
JC23330SAS	RadiaLED Optimum 8W rim	Satin Silver
JC23330EYE	RadiaLED Optimum 8W rim	Black Eyelid
JC23340BLK	RadiaLED Optimum 12/18W rim	Black
JC23340CH	RadiaLED Optimum 12/18W rim	Chrome
JC23340SCH	RadiaLED Optimum 12/18W rim	Satin Chrome
JC23340BLN	RadiaLED Optimum 12/18W rim	Black Nickel
JC23340AB	RadiaLED Optimum 12/18W rim	Antique Brass
JC23340SAS	RadiaLED Optimum 12/18W rim	Satin Silver
JC23340EYE	RadiaLED Optimum 12/18W rim	Black Eyelid

Body: Polycarbonate.



# RadiaLED® Utility 12W White Opal

Ultra durable, amenity LED bulkheads

- IP65 protection against dust and moisture
- Photocell and microwave sensing options available
- DALI and 1-10V dimmable options available

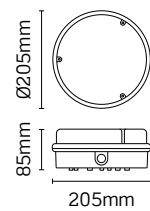

RATING



CLASS 1



CRI: RA



WARRANTY\*



SENSING



DIM OPTIONS



EM OPTIONS



WHITE

CODE	DESCRIPTION	COL TEMP.	DIM.	WATT	LUMENS (OPAL)
JC23401WOP	RadiaLED Utility	4000K	No	12W	700
JC23401EMWOP	RadiaLED Utility emergency	4000K	No	12W	700
JC23401DIMWOP	RadiaLED Utility DALI/1-10V	4000K	Yes	12W	700
JC23401EMDIMWOP	RadiaLED Utility DALI/1-10V emergency	4000K	Yes	12W	700
JC23411WOP	RadiaLED Utility microwave on/off	4000K	No	12W	700
JC23411EMWOP	RadiaLED Utility microwave on/off emergency	4000K	No	12W	700
JC23421WOP	RadiaLED Utility microwave step dim	4000K	-	12W	700
JC23431WOP	RadiaLED Utility on/off photocell	4000K	No	12W	700
JC23431EMWOP	RadiaLED Utility on/off photocell emergency	4000K	No	12W	700

Body: Polycarbonate. Diffuser: Polycarbonate.

\*Extended warranty requires online registration. 2 year warranty on batteries for emergency variants. Terms and conditions apply.

# RadiaLED® Utility 12W Prismatic

Ultra durable, amenity LED bulkheads

- IP65 protection against dust and moisture
- Photocell and microwave sensing options available
- DALI and 1-10V dimmable options available

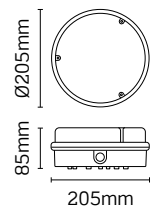

RATING



CLASS 1



CRI: RA



WARRANTY\*



SENSING



DIM OPTIONS



EM OPTIONS



WHITE

CODE	DESCRIPTION	COL TEMP.	DIM.	WATT	LUMENS (PRISMATIC)
JC23401WPR	RadiaLED Utility	4000K	No	12W	1150
JC23401EMWPR	RadiaLED Utility emergency	4000K	No	12W	1150
JC23401DIMWPR	RadiaLED Utility DALI/1-10V	4000K	Yes	12W	1150
JC23401EMDIMWPR	RadiaLED Utility DALI/1-10V emergency	4000K	Yes	12W	1150
JC23411WPR	RadiaLED Utility microwave on/off	4000K	No	12W	1150
JC23411EMWPR	RadiaLED Utility microwave on/off emergency	4000K	No	12W	1150
JC23421WPR	RadiaLED Utility microwave step dim	4000K	-	12W	1150
JC23431WPR	RadiaLED Utility on/off photocell	4000K	No	12W	1150
JC23431EMWPR	RadiaLED Utility on/off photocell emergency	4000K	No	12W	1150

Body: Polycarbonate. Diffuser: Polycarbonate.

\*Extended warranty requires online registration. 2 year warranty on batteries for emergency variants. Terms and conditions apply.

# RadiaLED® Utility 21W White Opal

Ultra durable, amenity LED bulkheads

- IP65 protection against dust and moisture
- Photocell and microwave sensing options available
- DALI and 1-10V dimmable options available

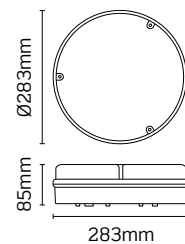

RATING



CLASS 1



CRI: RA



WARRANTY\*



SENSING



DIM OPTIONS



EM OPTIONS



WHITE

CODE	DESCRIPTION	COL TEMP.	DIM.	WATT	LUMENS (OPAL)
JC23402WOP	RadiaLED Utility	4000K	No	21W	1350
JC23402EMWOP	RadiaLED Utility emergency	4000K	No	21W	1350
JC23402DIMWOP	RadiaLED Utility DALI/1-10V	4000K	Yes	21W	1350
JC23402EMDIMWOP	RadiaLED Utility DALI/1-10V emergency	4000K	Yes	21W	1350
JC23412WOP	RadiaLED Utility microwave on/off	4000K	No	21W	1350
JC23412EMWOP	RadiaLED Utility microwave on/off emergency	4000K	No	21W	1350
JC23422WOP	RadiaLED Utility microwave step dim	4000K	-	21W	1350
JC23422EMWOP	RadiaLED Utility microwave step dim emergency	4000K	-	21W	1350
JC23432WOP	RadiaLED Utility on/off photocell	4000K	No	21W	1350
JC23432EMWOP	RadiaLED Utility on/off photocell emergency	4000K	No	21W	1350

Body: Polycarbonate. Diffuser: Polycarbonate.

\*Extended warranty requires online registration. 2 year warranty on batteries for emergency variants. Terms and conditions apply.



# RadiaLED® Utility 21W Prismatic

Ultra durable, amenity LED bulkheads

- IP65 protection against dust and moisture
- Photocell and microwave sensing options available
- DALI and 1-10V dimmable options available

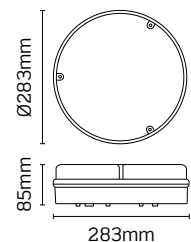

 **RATING**    
  **CLASS 1**    
  **CRI: RA**    
  **WARRANTY\***    
  **SENSING**    
  **DIM OPTIONS**    
  **EM OPTIONS**    
  **WHITE**

CODE	DESCRIPTION	COL TEMP.	DIM.	WATT	LUMENS (PRISMATIC)
JC23402WPR	RadiaLED Utility	4000K	No	21W	2000
JC23402EMWPR	RadiaLED Utility emergency	4000K	No	21W	2000
JC23402DIMWPR	RadiaLED Utility DALI/1-10V	4000K	Yes	21W	2000
JC23402EMDIMWPR	RadiaLED Utility DALI/1-10V emergency	4000K	Yes	21W	2000
JC23412WPR	RadiaLED Utility microwave on/off	4000K	No	21W	2000
JC23412EMWPR	RadiaLED Utility microwave on/off emergency	4000K	No	21W	2000
JC23422WPR	RadiaLED Utility microwave step dim	4000K	-	21W	2000
JC23422EMWPR	RadiaLED Utility microwave step dim emergency	4000K	-	21W	2000
JC23432WPR	RadiaLED Utility on/off photocell	4000K	No	21W	2000
JC23432EMWPR	RadiaLED Utility on/off photocell emergency	4000K	No	21W	2000

**Body:** Polycarbonate. **Diffuser:** Polycarbonate.

\*Extended warranty requires online registration. 2 year warranty on batteries for emergency variants. Terms and conditions apply.

# RadiaLED® Style 12W

High performance LED wall & ceiling light

- 16W CFL replacement
- Ultra durable IK09 impact rating
- IP44 protection against dust and moisture
- DALI and 1-10V dimmable options available

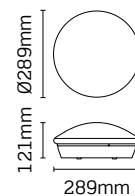

RATING



CLASS 1



CRI: RA



WARRANTY\*



RATING



SENSING



DIM OPTIONS



EM OPTIONS



WHITE

CODE	DESCRIPTION	COL TEMP.	DIM.	WATT	LUMENS	LPCW
JC234201	RadiaLED Style	4000K	No	12W	1025	85
JC234201MW	RadiaLED Style microwave on/off sensor	4000K	No	12W	1025	85
JC234201DIM	RadiaLED Style DALI/1-10V	4000K	Yes	12W	1025	85
JC234201EM	RadiaLED Style emergency	4000K	No	12W	1025	85
JC234201EMDIM	RadiaLED Style DALI/1-10V emergency	4000K	Yes	12W	1025	85
JC234201EM/MW	RadiaLED Style microwave on/off sensor emergency	4000K	No	12W	1025	85

Body: Steel. Diffuser: Polycarbonate.

\*Extended warranty requires online registration. 2 year warranty on batteries for emergency variants. Terms and conditions apply.

# RadiaLED® Style 14W

## High performance LED wall & ceiling light

- 28W CFL replacement
- Ultra durable IK09 impact rating
- IP44 protection against dust and moisture
- DALI and 1-10V dimmable options available

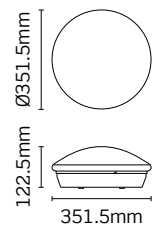

 RATING	 CLASS 1	 CRI: RA	 WARRANTY*	 RATING	 SENSING	 DIM OPTIONS	 EM OPTIONS	 WHITE
--	---	---	---	--	---	---	---	---

CODE	DESCRIPTION	COL TEMP.	DIM.	WATT	LUMENS	LPCW
JC234202	RadiaLED Style	4000K	No	14W	1250	89
JC234202MW	RadiaLED Style microwave on/off sensor	4000K	No	14W	1250	89
JC234202DIM	RadiaLED Style DALI/1-10V	4000K	Yes	14W	1250	89
JC234202EM	RadiaLED Style emergency	4000K	No	14W	1250	89
JC234202EMDIM	RadiaLED Style DALI/1-10V emergency	4000K	Yes	14W	1250	89
JC234202EM/MW	RadiaLED Style microwave on/off sensor emergency	4000K	No	14W	1250	89

**Body:** Steel. **Diffuser:** Polycarbonate.

\*Extended warranty requires online registration. 2 year warranty on batteries for emergency variants. Terms and conditions apply.

# RadiaLED® Style 30W

## High performance LED wall & ceiling light

- Outperforms traditional 38W CFL
- Ultra durable IK09 impact rating
- IP44 protection against dust and moisture
- DALI and 1-10V dimmable options available

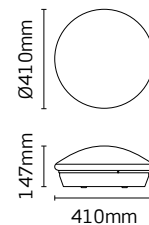

RATING



CLASS 1



CRI: RA



WARRANTY\*



SENSING



DIM OPTIONS



EM OPTIONS



RATING



WHITE

CODE	DESCRIPTION	COL TEMP.	DIM.	WATT	LUMENS	LPCW
JC234203	RadiaLED Style	4000K	No	30W	2900	97
JC234203MW	RadiaLED Style microwave on/off sensor	4000K	No	30W	2900	97
JC234203DIM	RadiaLED Style DALI/1-10V	4000K	Yes	30W	2900	97
JC234203EM	RadiaLED Style emergency	4000K	No	30W	2900	97
JC234203EMDIM	RadiaLED Style DALI/1-10V emergency	4000K	Yes	30W	2900	97
JC234203EM/MW	RadiaLED Style microwave on/off sensor emergency	4000K	No	30W	2900	97

**Body:** Steel. **Diffuser:** Polycarbonate.





\*Extended warranty requires online registration. 2 year warranty on batteries for emergency variants. Terms and conditions apply.

# RadiaLED® Slim 12W

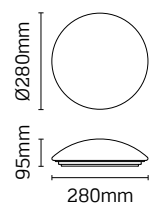
High performance, slim profile LED wall light

- 16W CFL replacement
- IP44 protection against dust and moisture



				
RATING	CLASS 1	CRI: RA	WARRANTY*	WHITE

CODE	DESCRIPTION	COL TEMP.	DIM.	WATT	LUMENS	LPCW
JC24240	RadiaLED Slim	4000K	No	12W	1050	88

**Body:** Steel. **Diffuser:** Polycarbonate.

\*Extended warranty requires online registration. Terms and conditions apply.

# RadiaLED® Slim 18W

High performance, slim profile LED wall light

- 28W CFL replacement
- IP44 protection against dust and moisture

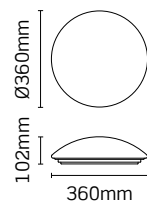

RATING



CLASS 1



CRI: RA



WARRANTY\*



EM OPTIONS



WHITE

CODE	DESCRIPTION	COL TEMP.	DIM.	WATT	LUMENS	LPCW
JC24241	RadiaLED Slim	4000K	No	18W	1500	83
JC24241EM	RadiaLED Slim emergency	4000K	No	18W	1500	83

**Body:** Steel. **Diffuser:** Polycarbonate.

\*Extended warranty requires online registration. 2 year warranty on batteries for emergency variants. Terms and conditions apply.

# RadiaLED® Slim 32W

High performance, slim profile LED wall light

- 38W CFL replacement
- IP44 protection against dust and moisture









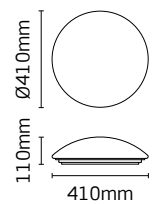

RATING CLASS 1 CRI: RA WARRANTY\* EM OPTIONS WHITE



CODE	DESCRIPTION	COL TEMP.	DIM.	WATT	LUMENS	LPCW
JC24242	RadiaLED Slim	4000K	No	32W	2900	91
JC24242EM	RadiaLED Slim emergency	4000K	No	32W	2900	91

**Body:** Steel. **Diffuser:** Polycarbonate.

\*Extended warranty requires online registration. 2 year warranty on batteries for emergency variants. Terms and conditions apply.

# RadiaLED® Vogue 23W

Decorative LED wall and ceiling light

- Unique design reflects light to create a halo effect around the fitting

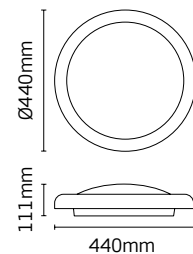

RATING



CLASS 1



CRI: RA



WARRANTY\*



SENSING



EM OPTIONS



CHROME



WHITE

CODE	DESCRIPTION	COL TEMP.	DIM.	WATT	LUMENS	LPCW
JC96311	RadiaLED Vogue	4000K	No	23W	1215	53
JC96312	RadiaLED Vogue emergency	4000K	No	23W	1215	53

For Chrome add **CH** suffix, for White add **WH** suffix.

**Body:** Polycarbonate. **Diffuser:** Polycarbonate.

\*Extended warranty requires online registration. 2 year warranty on batteries for emergency variants. Terms and conditions apply.



# RadiaLED® Vogue 32W

Decorative LED wall and ceiling light

- Unique design reflects light to create a halo effect around the fitting

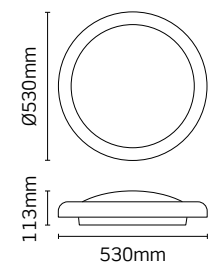









CODE	DESCRIPTION	COL TEMP.	DIM.	WATT	LUMENS	LPCW
JC96313	RadiaLED Vogue	4000K	No	36W	2080	58
JC96317	RadiaLED Vogue microwave on/off sensor	4000K	No	36W	2080	58
JC96314	RadiaLED Vogue emergency	4000K	No	36W	2080	58

For Chrome add **CH** suffix, for White add **WH** suffix.

**Body:** Polycarbonate. **Diffuser:** Polycarbonate.

\*Extended warranty requires online registration. 2 year warranty on batteries for emergency variants. Terms and conditions apply.

# Ring Bulkhead 25W

Decorative surface mounted ring bulkhead



^ Matching pendant available: JC96400 (see p 195).

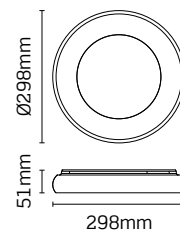

-  RATING
-  CLASS 1
-  CRI: RA
-  WARRANTY\*
-  BEAM
-  TRIAC
-  BLACK

CODE	DESCRIPTION	COL TEMP.	DIM.	WATT	LUMENS	LPCW
JC96404	Ring bulkhead	4000K	Yes	25W	2190	88
JC96405	Ring bulkhead	3000K	Yes	25W	2130	85

**Body:** Aluminium. **Diffuser:** Polycarbonate. | Comes complete with mounting bracket.

\*Extended warranty requires online registration. Terms and conditions apply.

# Ring Bulkhead 35W

Decorative surface mounted ring bulkhead



^ Matching pendant available:  
JC96400 (see p 195).

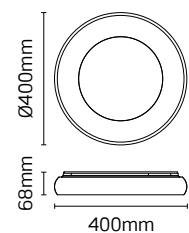

-  RATING
-  CLASS 1
-  CRI: RA
-  WARRANTY\*
-  BEAM
-  TRIAC
-  BLACK

CODE	DESCRIPTION	COL TEMP.	DIM.	WATT	LUMENS	LPCW
JC96406	Ring bulkhead	4000K	Yes	35W	3160	90
JC96407	Ring bulkhead	3000K	Yes	35W	2900	83

**Body:** Aluminium. **Diffuser:** Polycarbonate. | Comes complete with mounting bracket.

\*Extended warranty requires online registration. Terms and conditions apply.

# NiteLED™ Wall Sphere

Ultra durable exterior LED lighting

- 16W CFL replacement

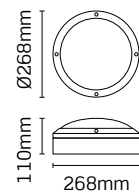

RATING



CLASS 1



CRI: RA



GUARANTEE



ANTHRACITE

CODE	DESCRIPTION	COL TEMP.	DIM.	WATT	LUMENS	LPCW
JC39418	NiteLED Wall Sphere	4000K	No	10W	600	60

**Body:** Aluminium. **Diffuser:** Polycarbonate.

# Astra Wall Lights

IP65 weatherproof LED bulkhead

- Available in clear and red diffuser options

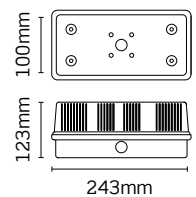

CODE	DESCRIPTION	LAMP
JC40007CL	Astra Wall Light - clear diffuser	42W (GLS) Max
JC40007RD	Astra Wall Light - red diffuser	42W (GLS) Max

Body: Pressed Steel. Diffuser: Polycarbonate. | Lamp not included.



# Exterior LED Wall & Post Lights

Linear Wall	288
Cylindrical Up/Down Wall Light	292
Surface Mounted Downlight	293
Rectangular Wall Light	294
Up/Down Light Box	296
Up/Down Wall Light	297
Round Up/Down Wall Light	298
Louvred Wall Light	302
Wall Light	303
Wall Spot	304
Directional Spotlight	306
NiteLED™ Exterior Wall Light Range	308
NiteLED™ Dome Wall Lights	314





## Exterior Wall Range

# Architectural exterior wall luminaires



MATCHING 3000K  
COLOUR TEMP.



CONSISTENT  
ANTHRACITE FINISH



DIE-CAST ALUMINIUM  
CONSTRUCTION

### EXTERIOR WALL RANGE

---



Linear Wall Lights  
p.288



Cylindrical Up/Down  
Wall Lights  
p.292



Surface Mounted  
Downlight  
p.293



Rectangular Wall Light  
p.295



Up/Down Light Box  
p.296



Up/Down Lights  
p.297



Wall Light  
p.299



Louvred Wall Light  
p.302



Wall Light  
p.303



Wall Spot  
p.304



Directional Spotlight  
p.306



Directional Spotlight  
p.307

# Linear Wall

## Architectural exterior LED lighting

- Durable die-cast aluminium construction
- Single direction downward wall wash in anthracite
- IP65 weather resistant
- Matching 3000K colour temperature and finish to the Architectural Exterior range

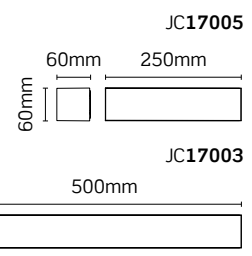

RATING	CLASS 1	CRI: RA	WARRANTY*	BEAM	ANTHRACITE

CODE	DESCRIPTION	COL TEMP.	DIM.	WATT	LUMENS	LPCW
JC17003	Linear Wall Large Single Direction	3000K	No	18W	1100	61
JC17005	Linear Wall Small Single Direction	3000K	No	9W	550	61

**Body:** Die-cast aluminium. **Diffuser:** Glass.

\*Extended warranty requires online registration. Terms and conditions apply.

# Linear Wall Mini

## Architectural exterior LED lighting

- Durable die-cast aluminium construction
- Single direction downward wall wash in anthracite
- IP65 weather resistant
- Matching 3000K colour temperature and finish to the Architectural Exterior range

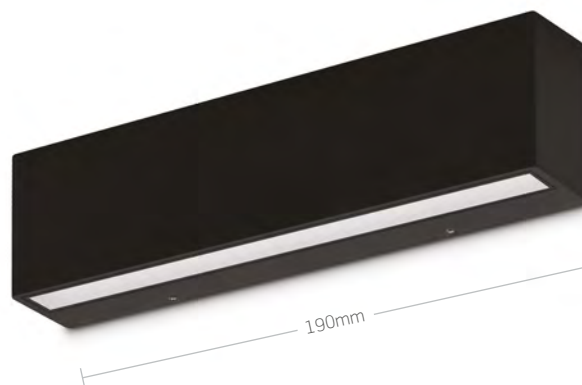





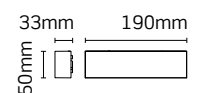

CODE	DESCRIPTION	COL TEMP.	DIM.	WATT	LUMENS	LPCW
JC17006	Linear Wall Mini Single Direction	3000K	No	7W	220	31

**Body:** Die-cast aluminium. **Diffuser:** Glass.

\*Extended warranty requires online registration. Terms and conditions apply.

# Linear Wall Up/Down

## Architectural exterior LED lighting

- Durable die-cast aluminium construction
- Up/down wall wash
- IP65 weather resistant
- Matching 3000K colour temperature and finish to the Architectural Exterior range

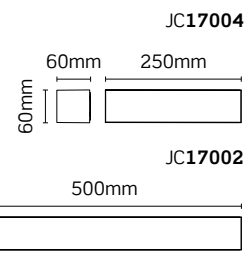

RATING	CLASS 1	CRI: RA	WARRANTY*	BEAM	ANTHRACITE

CODE	DESCRIPTION	COL TEMP.	DIM.	WATT	LUMENS	LPCW
JC17002	Linear Wall Up/Down Large	3000K	No	36W	2100	58
JC17004	Linear Wall Up/Down Small	3000K	No	18W	1000	56

**Body:** Die-cast aluminium. **Diffuser:** Glass.

\*Extended warranty requires online registration. Terms and conditions apply.



# Cylindrical Up/Down Wall Light

## Architectural exterior LED lighting

- Durable die-cast aluminium construction
- Surface mountable up/down wall light
- IP54 protection against dust and moisture
- Matching 3000K colour temperature and finish to the Architectural Exterior range



RATING  
 CLASS 1  
 CRI: RA  
 WARRANTY\*  
 BEAM OPTIONS  
 ANTHRACITE

CODE	DESCRIPTION	COL TEMP.	DIM.	WATT	LUMENS	LPCW
JC17015	Cylindrical Up/down 44° beam angle	3000K	No	8W	400	50
JC17016	Cylindrical Up/down 18° beam angle	3000K	No	14W	800	57

**Body:** Die-cast aluminium. **Lens:** Glass.

\*Extended warranty requires online registration. Terms and conditions apply.

# Surface Mounted Downlight

## Architectural exterior LED lighting

- Durable die-cast aluminium construction
- Surface mountable up/down downlight
- IP54 protection against dust and moisture
- Matching 3000K colour temperature and finish to the Architectural Exterior range
- Narrow 18° beam angle

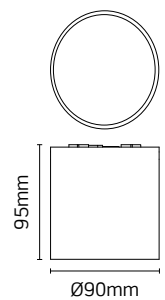







RATING CLASS 1 CRI: RA WARRANTY\* BEAM ANTHRACITE

CODE	DESCRIPTION	COL TEMP.	DIM.	WATT	LUMENS	LPCW
JC17001	Surface Mounted Downlight beam angle	3000K	No	7W	520	74

**Body:** Die-cast aluminium. **Lens:** Glass.

\*Extended warranty requires online registration. Terms and conditions apply.

# Rectangular Up/Down Wall Light

## Architectural exterior LED lighting

- Two directional light output
- Durable die-cast aluminium construction
- IP54 protection against dust and moisture
- Matching 3000K colour temperature and finish to the Architectural Exterior range









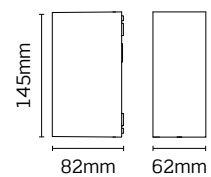

RATING CLASS 1 CRI: RA WARRANTY\* BEAM ANTHRACITE



CODE	DESCRIPTION	COL TEMP.	DIM.	WATT	LUMENS	LPCW
JC17011	Rectangular Up/Down Wall Light	3000K	No	14W	1000	71

**Body:** Die-cast aluminium. **Lens:** Glass.

\*Extended warranty requires online registration. Terms and conditions apply.



# Rectangular Wall Light

## Architectural exterior LED lighting

- Single direction light output
- Durable die-cast aluminium construction
- IP54 protection against dust and moisture
- Matching 3000K colour temperature and finish to the Architectural Exterior range

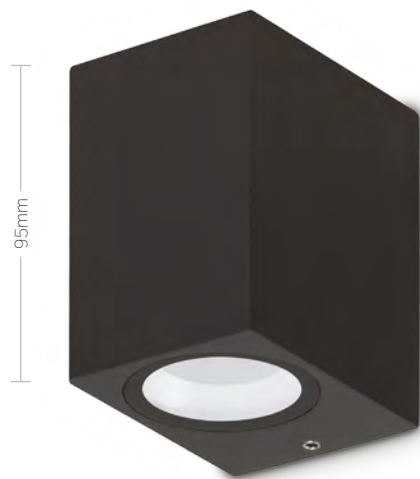







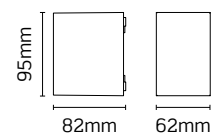

RATING CLASS 1 CRI: RA WARRANTY\* BEAM ANTHRACITE



CODE	DESCRIPTION	COL TEMP.	DIM.	WATT	LUMENS	LPCW
JC17012	Rectangular Single Direction Wall Light	3000K	No	7W	550	78

**Body:** Die-cast aluminium. **Lens:** Glass.

\*Extended warranty requires online registration. Terms and conditions apply.

# Up/Down Light Box

## Architectural exterior LED lighting

- Durable die-cast aluminium construction
- Surface mountable up/down wall light
- IP54 protection against dust and moisture
- Matching 3000K colour temperature and finish to the Architectural Exterior range











RATING CLASS 1 CRI: RA WARRANTY\* BEAM ANTHRACITE WHITE

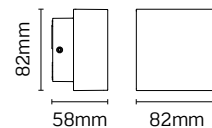

CODE	DESCRIPTION	COL TEMP.	DIM.	WATT	LUMENS	LPCW
JC17010	Up/Down Box	3000K	No	5W	160	32

For Anthracite add **BLK** suffix, for White add **WH** suffix.

**Body:** Die-cast aluminium. **Lens:** Polycarbonate.

\*Extended warranty requires online registration. Terms and conditions apply.

# Up/Down Wall Light

## Architectural exterior lighting

- Durable die-cast aluminium construction
- Surface mountable up down wall light
- LED wall light with matching finish to the Architectural Exterior range

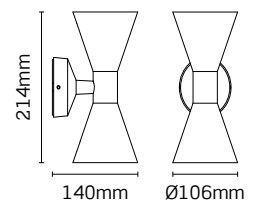

RATING



CLASS 1



WARRANTY\*



ANTHRACITE

**CODE**

**DESCRIPTION**

**WATT**

JC17035

Up/Down Wall Light

2 x 5W GU10 LED Max

**Body:** Die-cast aluminium. **Lens:** Glass. | Lamps not included.

\*Extended warranty requires online registration. Terms and conditions apply.

# Round Up/Down Wall Light

## Architectural exterior LED lighting

- Durable die-cast aluminium construction
- IP65 ingress protection
- Matching 3000K colour temperature and finish to the Architectural Exterior range

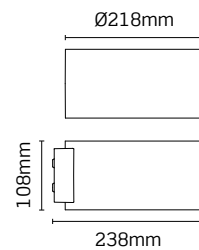

					
RATING	CLASS 1	CRI: RA	WARRANTY*	BEAM	ANTHRACITE

CODE	DESCRIPTION	COL TEMP.	DIM.	WATT	LUMENS	LPCW
JC17014	Round Up/Down	3000K	No	30W	1700	57

**Body:** Die-cast aluminium. **Lens:** Glass.

\*Extended warranty requires online registration. Terms and conditions apply.

# Up/Down Wall Light

## Architectural exterior LED lighting

- Durable die-cast aluminium construction
- IP65 ingress protection
- Matching 3000K colour temperature and finish to the Architectural Exterior range

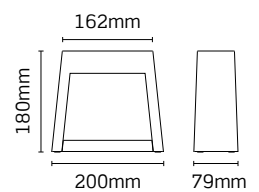
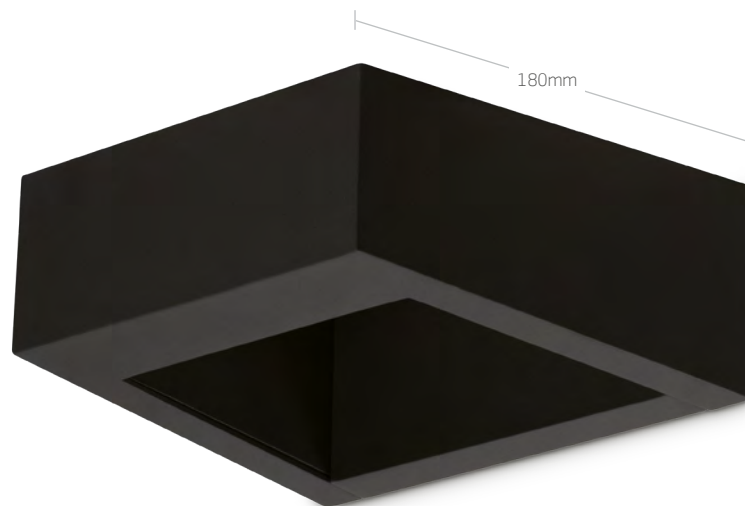

 RATING	 CLASS 1	 CRI: RA	 WARRANTY*	 BEAM	 RATING	 ANTHRACITE
---	--	--	--	---	---	---

CODE	DESCRIPTION	COL TEMP.	DIM.	WATT	LUMENS	LPCW
JC17017	Up/Down Wall Light	3000K	No	18W	600	33

**Body:** Die-cast aluminium. **Diffuser:** Polycarbonate.

\*Extended warranty requires online registration. Terms and conditions apply.





# Louvred Wall Light

## Architectural exterior LED lighting

- Durable die-cast aluminium construction
- IP54 protection against dust and moisture
- Matching 3000K colour temperature and finish to the Architectural Exterior range
- Matching bollard available see page 342

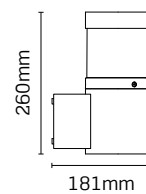

RATING



CLASS 1



CRI: RA



WARRANTY\*



BEAM



ANTHRACITE

CODE	DESCRIPTION	COL TEMP.	DIM.	WATT	LUMENS	LPCW
JC17046	Louvred Wall Light	3000K	No	15W	400	27

**Body:** Die-cast aluminium. **Diffuser:** Polycarbonate.

\*Extended warranty requires online registration. Terms and conditions apply.



# Wall Light

## Architectural exterior LED lighting

- Durable die-cast aluminium construction
- IP54 protection against dust and moisture
- Matching 3000K colour temperature and finish to the Architectural Exterior range
- Matching bollard available see page 345

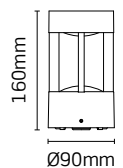
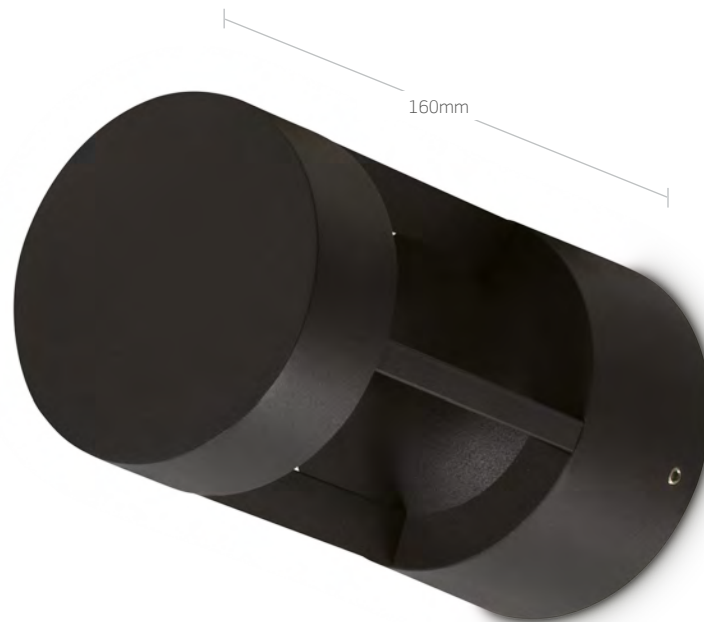

IP 54 CLASS 1 CRI: RA (80) 3yr 40° BLK  
RATING CLASS 1 CRI: RA WARRANTY\* BEAM ANTHRACITE

CODE	DESCRIPTION	COL TEMP.	DIM.	WATT	LUMENS	LPCW
JC17019	Wall Light	3000K	No	7W	500	71

**Body:** Die-cast aluminium. **Diffuser:** Polycarbonate.

\*Extended warranty requires online registration. Terms and conditions apply.

# Wall Spot Short Arm

## Architectural exterior LED lighting

- Durable die-cast aluminium construction
- IP65 protection weather resistant
- Matching 3000K colour temperature and finish to the Architectural Exterior range



					
RATING	CLASS 1	CRI: RA	WARRANTY*	BEAM	ANTHRACITE

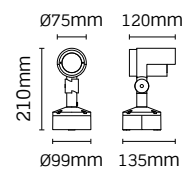

CODE	DESCRIPTION	COL TEMP.	DIM.	WATT	LUMENS	LPCW
JC17043	Wall Spot Short Arm	3000K	No	10W	750	75

**Body:** Die-cast aluminium. **Lens:** Polycarbonate.

\*Extended warranty requires online registration. Terms and conditions apply.

# Wall Spot Long Arm

## Architectural exterior LED lighting

- Durable die-cast aluminium construction
- IP65 protection weather resistant
- Matching 3000K colour temperature and finish to the Architectural Exterior range

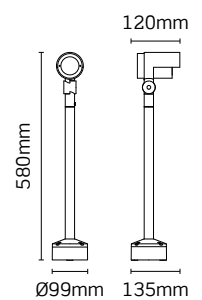

 RATING	 CLASS 1	 CRI: RA	 WARRANTY*	 BEAM	 ANTHRACITE
---	--	--	--	---	---

CODE	DESCRIPTION	COL TEMP.	DIM.	WATT	LUMENS	LPCW
JC17042	Wall Spot Long Arm	3000K	No	10W	750	75

**Body:** Die-cast aluminium. **Lens:** Polycarbonate.

\*Extended warranty requires online registration. Terms and conditions apply.

# Directional Spotlight 36W

## Architectural exterior LED lighting

- Durable die-cast aluminium housing
- Tiltable 120° LED module
- Wide 120° beam angle
- Matching 3000K colour temperature and finish to the Architectural Exterior range

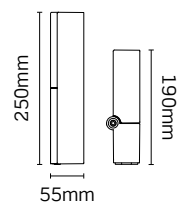

RATING



CLASS 1



CRI: RA



WARRANTY\*



BEAM



ANTHRACITE

CODE	DESCRIPTION	COL TEMP.	DIM.	WATT	LUMENS	LPCW
JC17023	Directional Spotlight 120° beam angle	3000K	No	36W	2000	56

**Body:** Die-cast aluminium. **Diffuser:** Glass.

\*Extended warranty requires online registration. Terms and conditions apply.

# Directional Spotlight 16W

## Architectural exterior LED lighting

- Durable die-cast aluminium housing
- Tiltable 120° LED module
- Narrow 28° beam angle
- Matching 3000K colour temperature and finish to the Architectural Exterior range

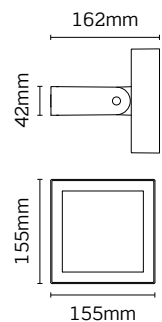

					
RATING	CLASS 1	CRI: RA	WARRANTY*	BEAM	ANTHRACITE

CODE	DESCRIPTION	COL TEMP.	DIM.	WATT	LUMENS	LPCW
JC17024	Directional Spotlight 28° beam angle	3000K	No	16W	1000	63

**Body:** Die-cast aluminium. **Diffuser:** Glass.

\*Extended warranty requires online registration. Terms and conditions apply.

# NiteLED™ Wall Curve

Low wattage LED exterior lighting



RATING



CLASS 1



CRI: RA



GUARANTEE



ANTHRACITE

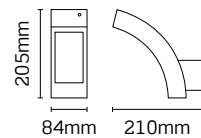





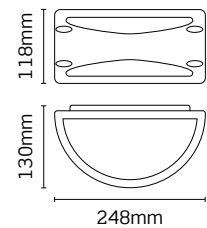

CODE	DESCRIPTION	COL TEMP.	DIM.	WATT	LUMENS	LPCW
JC39409	NiteLED Wall Curve	4000K	No	5W	350	70

**Body:** Aluminium. **Diffuser:** Polycarbonate.

# NiteLED™ Up/Down Wall Crescent

Low wattage LED exterior lighting



-  IP 54  
RATING
-  CLASS 1
-  CRI: RA 80
-  2yr  
GUARANTEE
-  BLK  
ANTHRACITE

CODE	DESCRIPTION	COL TEMP.	DIM.	WATT	LUMENS	LPCW
JC39416	NiteLED Up/Down Wall Crescent	4000K	No	8.5W	300	35

**Body:** Aluminium. **Diffuser:** Polycarbonate.









# NiteLED™ Wall Wedge

Low wattage LED exterior lighting



RATING CLASS 1 CRI: RA GUARANTEE ANTHRACITE

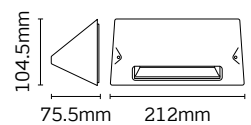

CODE	DESCRIPTION	COL TEMP.	DIM.	WATT	LUMENS	LPCW
JC39406	NiteLED Wall Wedge	4000K	No	3W	150	50

**Body:** Aluminium. **Lens:** Polycarbonate.

# NiteLED™ Wall Arc

Low wattage LED exterior lighting



RATING



CLASS 1



CRI: RA



GUARANTEE



ANTHRACITE

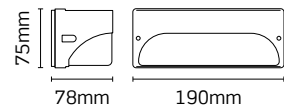





CODE	DESCRIPTION	COL TEMP.	DIM.	WATT	LUMENS	LPCW
JC39407	NiteLED Wall Arc	4000K	No	3W	150	50

Body: Aluminium. Lens: Polycarbonate.

# NiteLED™ Quarter Sphere

High efficiency LED exterior lighting



RATING CLASS 1 CRI: RA GUARANTEE ANTHRACITE

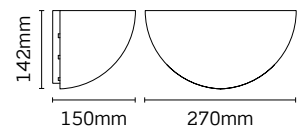

CODE	DESCRIPTION	COL TEMP.	DIM.	WATT	LUMENS	LPCW
JC39408	NiteLED Quarter Sphere	4000K	No	10.5W	900	86

**Body:** Aluminium. **Diffuser:** Polycarbonate.

# NiteLED™ Dome Wall Lights

Low wattage LED exterior lighting

✓ JC39429SS



✓ JC39429BLK

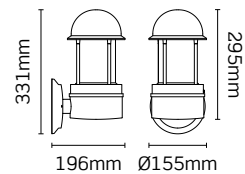

RATING



CLASS 1



CRI: RA



GUARANTEE



BLACK



STAINLESS STEEL

CODE	DESCRIPTION	COL TEMP.	DIM.	WATT	LUMENS	LPCW
JC39429	NiteLED Dome Wall Light - Plain	4000K	No	8.5W	200	24

For Black add **BLK** suffix, for Stainless Steel add **SS** suffix.

**Body:** Aluminium or Stainless Steel. **Lens:** Polycarbonate.

# NiteLED™ Dome Wall Lights

Low wattage LED exterior lighting

∨ JC39428SS



∨ JC39428BLK

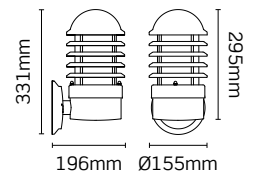

- RATING
- CLASS 1
- CRI: RA
- GUARANTEE
- BLACK
- STAINLESS STEEL

CODE	DESCRIPTION	COL TEMP.	DIM.	WATT	LUMENS	LPCW
JC39428	NiteLED Dome Wall Light - Louvred	4000K	No	8.5W	200	24

For Black add **BLK** suffix, for Stainless Steel add **SS** suffix.

**Body:** Aluminium or Stainless Steel. **Lens:** Polycarbonate.



# Floodlights

LED Floodlight	318
Toughflood™ Asymmetric	326
Toughflood™ High Output	332

# LED Floodlight 10W

High performance domestic floodlight

- Supplied pre-wired with 800mm flex



RATING



CLASS 1



CRI: RA



WARRANTY\*



BEAM



BLACK



WHITE

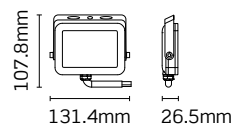

CODE	DESCRIPTION	COL TEMP.	DIM.	WATT	LUMENS	LPCW
JC45200	LED Floodlight	4000K	No	10W	1000	100

For Black add **BLK** suffix, for White add **WH** suffix.

**Body:** Aluminium. **Lens:** Toughened Glass. **Bracket:** Galvanised Steel.

\*Extended warranty requires online registration. Terms and conditions apply.



# LED Floodlight 10W PIR

High performance domestic floodlight

- Supplied pre-wired with 800mm flex



						
RATING	CLASS 1	CRI: RA	WARRANTY*	BEAM	BLACK	WHITE

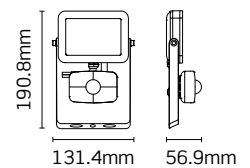

CODE	DESCRIPTION	COL TEMP.	DIM.	WATT	LUMENS	LPCW
JC45201	LED Floodlight with PIR	4000K	No	10W	1000	100

For Black add **BLK** suffix, for White add **WH** suffix.

**Body:** Aluminium. **Lens:** Toughened Glass. **Bracket:** Galvanised Steel.

\*Extended warranty requires online registration. Terms and conditions apply.

# LED Floodlight 20W

High performance domestic floodlight

- Supplied pre-wired with 800mm flex



RATING



CLASS 1



CRI: RA



WARRANTY\*



BEAM



BLACK



WHITE

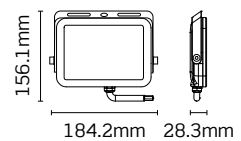

CODE	DESCRIPTION	COL TEMP.	DIM.	WATT	LUMENS	LPCW
JC45202	LED Floodlight	4000K	No	20W	2100	105

For Black add **BLK** suffix, for White add **WH** suffix.

**Body:** Aluminium. **Lens:** Toughened Glass. **Bracket:** Galvanised Steel.

\*Extended warranty requires online registration. Terms and conditions apply.

# LED Floodlight 20W PIR

High performance domestic floodlight

- Supplied pre-wired with 800mm flex

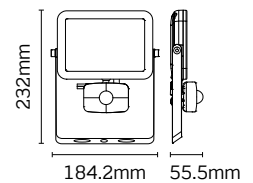

RATING



CLASS 1



CRI: RA



WARRANTY\*



BEAM



BLACK



WHITE

CODE	DESCRIPTION	COL TEMP.	DIM.	WATT	LUMENS	LPCW
JC45203	LED Floodlight with PIR	4000K	No	20W	2100	105

For Black add **BLK** suffix, for White add **WH** suffix.

**Body:** Aluminium. **Lens:** Toughened Glass. **Bracket:** Galvanised Steel.

\*Extended warranty requires online registration. Terms and conditions apply.

# LED Floodlight 30W

High performance domestic floodlight

- Supplied pre-wired with 800mm flex



RATING



CLASS 1



CRI: RA



WARRANTY\*



BEAM



BLACK



WHITE

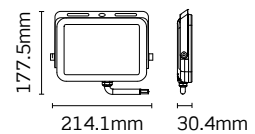

CODE	DESCRIPTION	COL TEMP.	DIM.	WATT	LUMENS	LPCW
JC45204	LED Floodlight	4000K	No	30W	2800	93

For Black add **BLK** suffix, for White add **WH** suffix.

**Body:** Aluminium. **Lens:** Toughened Glass. **Bracket:** Galvanised Steel.

\*Extended warranty requires online registration. Terms and conditions apply.

# LED Floodlight 30W PIR

High performance domestic floodlight

- Supplied pre-wired with 800mm flex



RATING



CLASS 1



CRI: RA



WARRANTY\*



BEAM



BLACK



WHITE

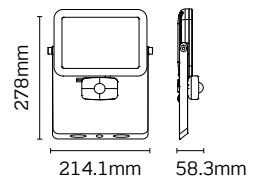

CODE	DESCRIPTION	COL TEMP.	DIM.	WATT	LUMENS	LPCW
JC45205	LED Floodlight with PIR	4000K	No	30W	2800	93

For Black add **BLK** suffix, for White add **WH** suffix.

**Body:** Aluminium. **Lens:** Toughened Glass. **Bracket:** Galvanised Steel.

\*Extended warranty requires online registration. Terms and conditions apply.

# LED Floodlight 50W

High performance domestic floodlight

- Supplied pre-wired with 800mm flex



RATING



CLASS 1



CRI: RA



WARRANTY\*



BEAM



BLACK



WHITE

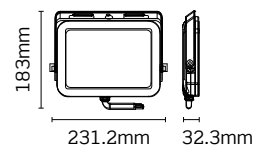

CODE	DESCRIPTION	COL TEMP.	DIM.	WATT	LUMENS	LPCW
JC45206	LED Floodlight	4000K	No	50W	4500	90

For Black add **BLK** suffix, for White add **WH** suffix.

**Body:** Aluminium. **Lens:** Toughened Glass. **Bracket:** Galvanised Steel.

\*Extended warranty requires online registration. Terms and conditions apply.

# LED Floodlight 50W PIR

High performance domestic floodlight

- Supplied pre-wired with 800mm flex

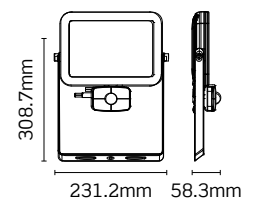

						
RATING	CLASS 1	CRI: RA	WARRANTY*	BEAM	BLACK	WHITE

CODE	DESCRIPTION	COL TEMP.	DIM.	WATT	LUMENS	LPCW
JC45207	LED Floodlight with PIR	4000K	No	50W	4500	90

For Black add **BLK** suffix, for White add **WH** suffix.

**Body:** Aluminium. **Lens:** Toughened Glass. **Bracket:** Galvanised Steel.

\*Extended warranty requires online registration. Terms and conditions apply.

## Toughflood™ Asymmetric

Maximum performance,  
maximum control

5  
YR EXT.

5YR EXT.  
WARRANTY

60°

60° ASYMMETRIC  
LENS

180°

180° TILTABLE  
BRACKET

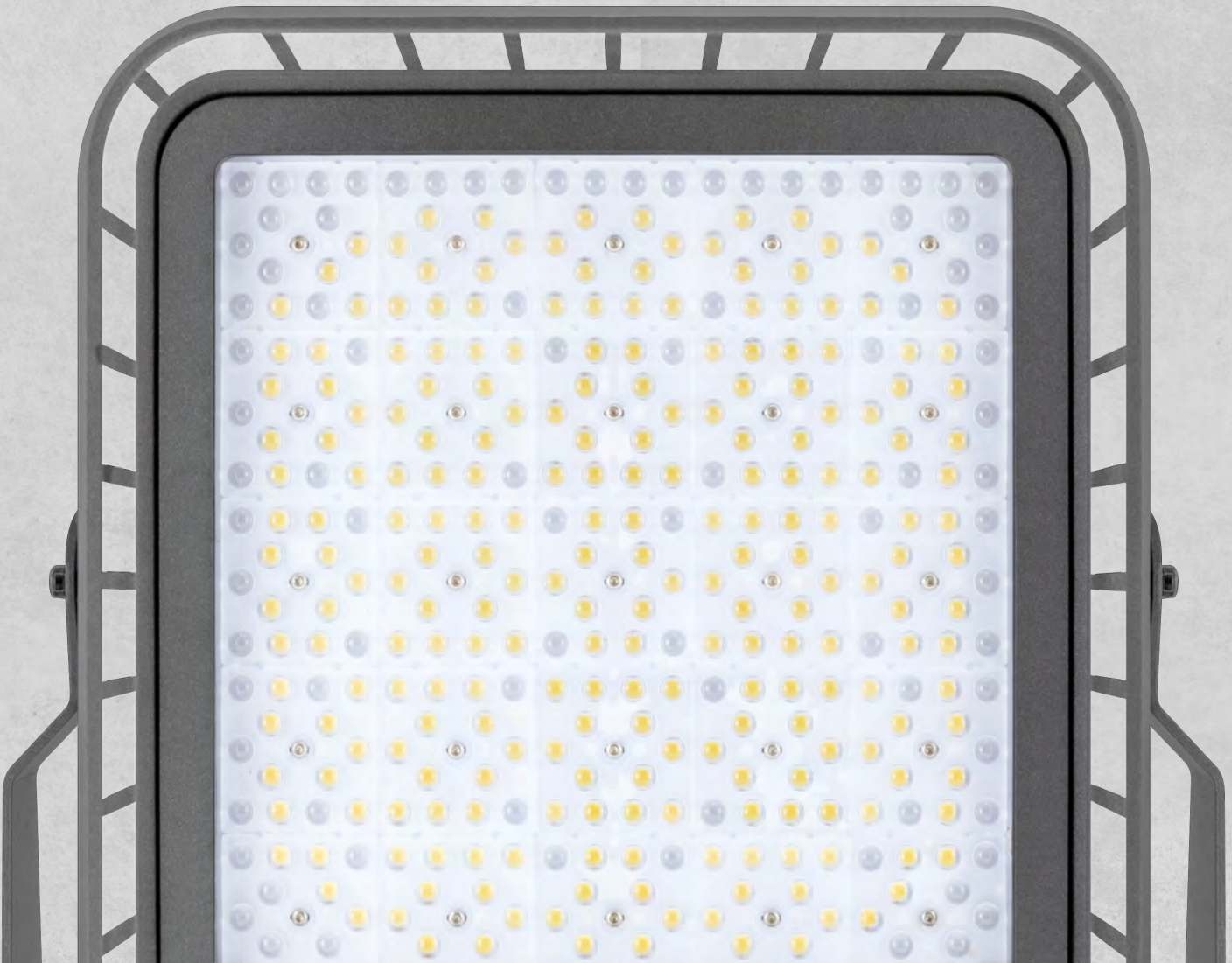



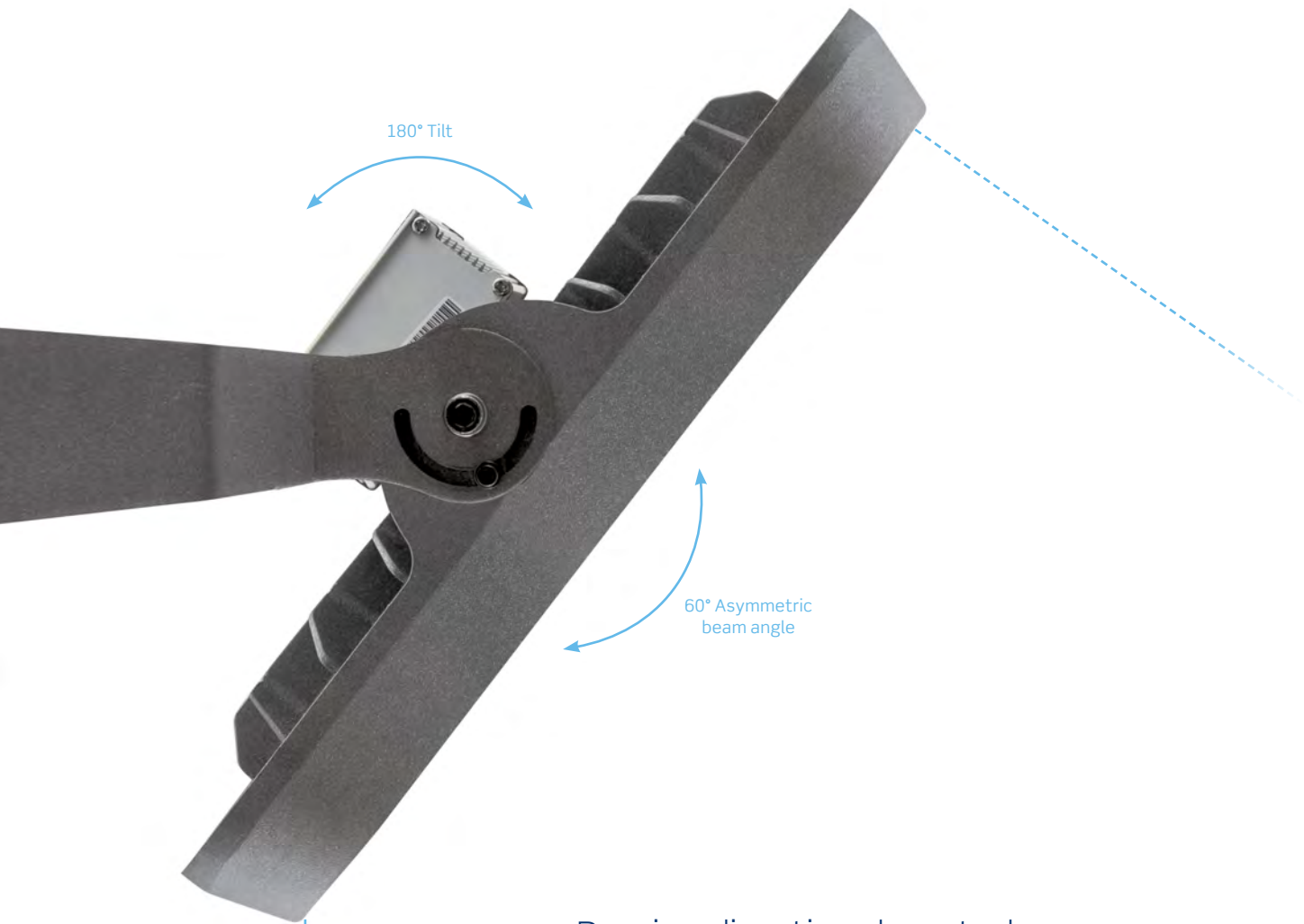

## Precise directional control

Toughflood Asymmetric has been engineered with complete control in mind. The asymmetric lenses control the light and direct it towards the ground. This ensures that all light is used efficiently and minimises light pollution. The 180° tiltable bracket provides further control, allowing the installer to position the fitting to light the specified area.



**80W & 100W**  
9,200 lumens  
150W HID equivalent



**150W**  
17,000 lumens  
250W HID equivalent



**200W**  
24,000 lumens  
400W HID equivalent

# Toughflood™ Asymmetric 80W



High output commercial LED floodlight

- Asymmetric lens design ensures complete control of light direction
- Instant start-up for use with occupancy sensors
- Ideal for mounting heights of up to 6m

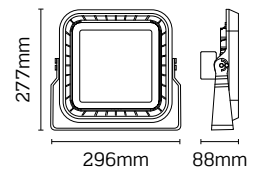

RATING	CLASS 1	CRI: RA	WARRANTY*	BEAM	RATING	GREY

CODE	DESCRIPTION	COL TEMP.	DIM.	WATT	LUMENS	LPCW
JC050001	Toughflood Asymmetric	4000K	No	80W	9200	115

**Body:** Aluminium. **Diffuser:** Toughened Glass. **Bracket:** Galvanised Steel.

\*Extended warranty requires online registration. Terms and conditions apply.

# Toughflood™ Asymmetric 100W



## High output commercial LED floodlight

- Asymmetric lens design ensures complete control of light direction
- Instant start-up for use with occupancy sensors
- Ideal for mounting heights of up to 6m



RATING	CLASS 1	CRI: RA	WARRANTY*	BEAM	RATING	GREY

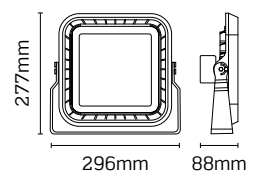

CODE	DESCRIPTION	COL TEMP.	DIM.	WATT	LUMENS	LPCW
JC050002	Toughflood Asymmetric	4000K	No	100W	11400	114

**Body:** Aluminium. **Diffuser:** Toughened Glass. **Bracket:** Galvanised Steel.

\*Extended warranty requires online registration. Terms and conditions apply.

# Toughflood™ Asymmetric 150W



High output commercial LED floodlight

- Asymmetric lens design ensures complete control of light direction
- Instant start-up for use with occupancy sensors
- Ideal for mounting heights of up to 8m



RATING	CLASS 1	CRI: RA	WARRANTY*	BEAM	RATING	GREY

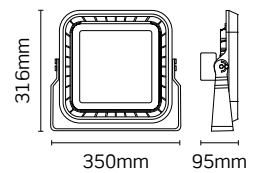

CODE	DESCRIPTION	COL TEMP.	DIM.	WATT	LUMENS	LPCW
JC050003	Toughflood Asymmetric	4000K	No	150W	17000	113

**Body:** Aluminium. **Diffuser:** Toughened Glass. **Bracket:** Galvanised Steel.

\*Extended warranty requires online registration. Terms and conditions apply.

# Toughflood™ Asymmetric 200W



## High output commercial LED floodlight

- Asymmetric lens design ensures complete control of light direction
- Instant start-up for use with occupancy sensors
- Ideal for mounting heights of up to 10m



RATING	CLASS 1	CRI: RA	WARRANTY*	BEAM	RATING	GREY

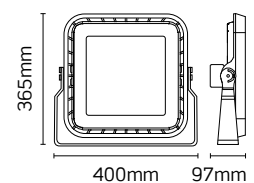

CODE	DESCRIPTION	COL TEMP.	DIM.	WATT	LUMENS	LPCW
JC050004	Toughflood Asymmetric	4000K	No	200W	24000	120

**Body:** Aluminium. **Diffuser:** Toughened Glass. **Bracket:** Galvanised Steel.

\*Extended warranty requires online registration. Terms and conditions apply.

Toughflood™ High Output

Where durability  
meets performance



DURABLE  
CONSTRUCTION



IP66  
PROTECTION



HIGHLY EFFICIENT  
140 LPCW



## Precise directional control

Indicators on both the mounting bracket and each individual linear module ensure that a precise distribution can be achieved during installation.

The mounting bracket allows for 180° angle adjustment in 30° increments.

Further 24° adjustments can be made on each linear module up to 144°.



## Optics system

A wide range of lenses providing further flexibility and control are available on all variants.

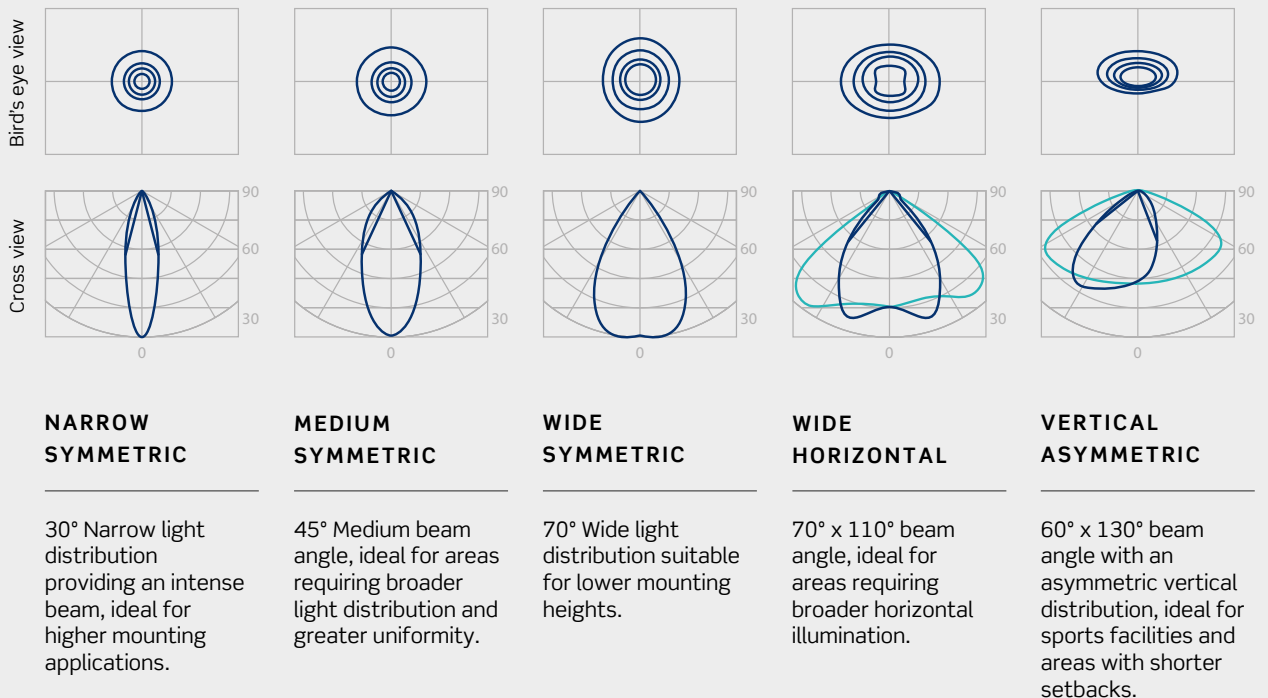

# Toughflood™ High Output 100W & 150W

Ultra efficient 100W & 150W directional floodlight



RATING



CLASS 1



CRI: RA

5yr

WARRANTY\*



RATING



BLACK

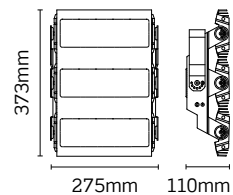
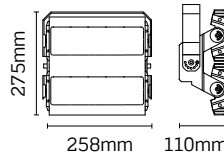

CODE	DESCRIPTION	COL TEMP.	DIM.	WATT	LUMENS	LPCW
JC45220/30	Toughflood 30° Symmetric	4000K	No	100W	14,200	142
JC45220/45	Toughflood 45° Symmetric	4000K	No	100W	14,100	141
JC45220/70	Toughflood 70° Symmetric	4000K	No	100W	14,100	141
JC45220/711	Toughflood 70x110° Symmetric	4000K	No	100W	14,200	142
JC45220/613	Toughflood 60x130° Asymmetric	4000K	No	100W	14,200	142
JC45221/30	Toughflood 30° Symmetric	4000K	No	150W	21,000	140
JC45221/45	Toughflood 45° Symmetric	4000K	No	150W	21,100	141
JC45221/70	Toughflood 70° Symmetric	4000K	No	150W	21,100	141
JC45221/711	Toughflood 70x110° Symmetric	4000K	No	150W	21,000	140
JC45221/613	Toughflood 60x130° Asymmetric	4000K	No	150W	21,300	142

**Body:** Aluminium. **Lens:** Polycarbonate. **Bracket:** Galvanised Steel.

Produced to order, contact JCC customer services on **01243 838999**.





# Toughflood™ High Output 200W

Ultra efficient 200W directional floodlight



RATING



CLASS 1



CRI: RA



WARRANTY\*



RATING



BLACK

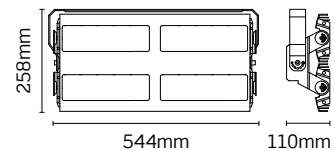

CODE	DESCRIPTION	COL TEMP.	DIM.	WATT	LUMENS	LPCW
JC45222/30	Toughflood 30° Symmetric	4000K	No	200W	28,100	141
JC45222/45	Toughflood 45° Symmetric	4000K	No	200W	28,100	141
JC45222/70	Toughflood 70° Symmetric	4000K	No	200W	28,100	141
JC45222/711	Toughflood 70x110° Symmetric	4000K	No	200W	28,400	142
JC45222/613	Toughflood 60x130° Asymmetric	4000K	No	200W	28,500	143

**Body:** Aluminium. **Lens:** Polycarbonate. **Bracket:** Galvanised Steel.

Produced to order, contact JCC customer services on **01243 838999**.

\*Extended warranty requires online registration. Terms and conditions apply.

# Toughflood™ High Output 300W

Ultra efficient 300W directional floodlight

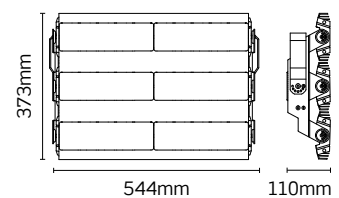

CODE	DESCRIPTION	COL TEMP.	DIM.	WATT	LUMENS	LPCW
JC45223/30	Toughflood 30° Symmetric	4000K	No	300W	42,000	140
JC45223/45	Toughflood 45° Symmetric	4000K	No	300W	42,100	140
JC45223/70	Toughflood 70° Symmetric	4000K	No	300W	42,100	140
JC45223/711	Toughflood 70x110° Symmetric	4000K	No	300W	42,200	141
JC45223/613	Toughflood 60x130° Asymmetric	4000K	No	300W	42,300	141

**Body:** Aluminium. **Lens:** Polycarbonate. **Bracket:** Galvanised Steel.

Produced to order, contact JCC customer services on **01243 838999**.

\*Extended warranty requires online registration. Terms and conditions apply.

# Toughflood™ High Output 450W

Ultra efficient 450W directional floodlight



RATING



CLASS 1



CRI: RA



WARRANTY\*



RATING



BLACK

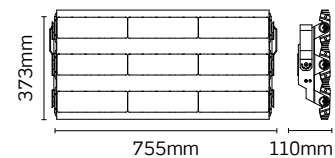

CODE	DESCRIPTION	COL TEMP.	DIM.	WATT	LUMENS	LPCW
JC45224/30	Toughflood 30° Symmetric	4000K	No	450W	63,100	140
JC45224/45	Toughflood 45° Symmetric	4000K	No	450W	63,000	140
JC45224/70	Toughflood 70° Symmetric	4000K	No	450W	63,100	140
JC45224/711	Toughflood 70x110° Symmetric	4000K	No	450W	63,300	141
JC45224/613	Toughflood 60x130° Asymmetric	4000K	No	450W	63,700	142

**Body:** Aluminium. **Lens:** Polycarbonate. **Bracket:** Galvanised Steel.

Produced to order, contact JCC customer services on **01243 838999**.

\*Extended warranty requires online registration. Terms and conditions apply.

# Toughflood™ High Output 600W

Ultra efficient 600W directional floodlight



RATING



CLASS 1



CRI: RA



WARRANTY\*



RATING



BLACK

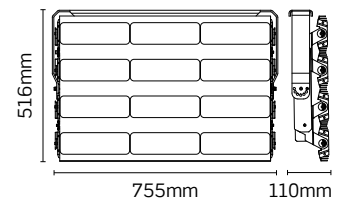

CODE	DESCRIPTION	COL TEMP.	DIM.	WATT	LUMENS	LPCW
JC45225/30	Toughflood 30° Symmetric	4000K	No	600W	84,100	140
JC45225/45	Toughflood 45° Symmetric	4000K	No	600W	84,100	140
JC45225/70	Toughflood 70° Symmetric	4000K	No	600W	84,200	140
JC45225/711	Toughflood 70x110° Symmetric	4000K	No	600W	84,700	141
JC45225/613	Toughflood 60x130° Asymmetric	4000K	No	600W	84,700	141

**Body:** Aluminium. **Lens:** Polycarbonate. **Bracket:** Galvanised Steel.

Produced to order, contact JCC customer services on **01243 838999**.

\*Extended warranty requires online registration. Terms and conditions apply.



# Bollards

Louvred Bollard	342
Square Bollard	343
Round Bollard	345
Directional Slim Bollard	348
Decorative Square Bollard	349
Directional Round Bollard	351
Tapered Bollard	352
NiteLED™ Round Bollard	354
NiteLED™ Square Bollard	355
NiteLED™ Dome Bollard	356

# Louvred Bollard

## Architectural exterior LED lighting

- Matching 3000K LED colour temperature and finish to the Architectural Exterior range
- Supplied with L-bolts for installation



**IP 54**   
 **CLASS 1**   
 **80**   
 **3yr**   
 **82°**   
 **BLK**  
 RATING    CLASS 1    CRI: RA    WARRANTY\*    BEAM    ANTHRACITE

CODE	DESCRIPTION	COL TEMP.	DIM.	WATT	LUMENS	LPCW
JC17047	Louvred Bollard Short	3000K	No	15W	400	27
JC17048	Louvred Bollard Tall	3000K	No	15W	400	27

**Body:** Die-cast Aluminium. **Diffuser:** Polycarbonate.

\*Extended warranty requires online registration. Terms and conditions apply.



# Square Bollard

## Architectural exterior LED lighting

- Matching 3000K LED colour temperature and finish to the Architectural Exterior range
- Supplied with L-bolts for installation



CODE	DESCRIPTION	COL TEMP.	DIM.	WATT	LUMENS	LPCW
JC17032	Square Bollard Short	3000K	No	15W	500	33
JC17033	Square Bollard Tall	3000K	No	15W	500	33

**Body:** Die-cast Aluminium. **Diffuser:** Polycarbonate.

\*Extended warranty requires online registration. Terms and conditions apply.

# Square Bollard

## Architectural exterior LED lighting

- Matching 3000K LED colour temperature and finish to the Architectural Exterior range
- Supplied with L-bolts for installation

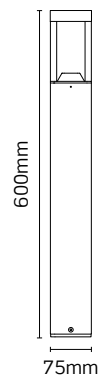

RATING



CLASS 1



CRI: RA



WARRANTY\*



BEAM



ANTHRACITE

CODE	DESCRIPTION	COL TEMP.	DIM.	WATT	LUMENS	LPCW
JC17022	Square Bollard	3000K	No	7W	450	64

**Body:** Die-cast Aluminium. **Diffuser:** Glass.

\*Extended warranty requires online registration. Terms and conditions apply.

# Round Bollard

## Architectural exterior LED lighting

- Matching 3000K LED colour temperature and finish to the Architectural Exterior range
- Supplied with L-bolts for installation



CODE	DESCRIPTION	COL TEMP.	DIM.	WATT	LUMENS	LPCW
JC17020	Round Bollard Short	3000K	No	7W	450	64
JC17021	Round Bollard Tall	3000K	No	7W	450	64

**Body:** Die-cast Aluminium. **Diffuser:** Glass.

\*Extended warranty requires online registration. Terms and conditions apply.





# Directional Slim Bollard

## Architectural exterior LED lighting

- Matching 3000K LED colour temperature and finish to the Architectural Exterior range
- Supplied with L-bolts for installation

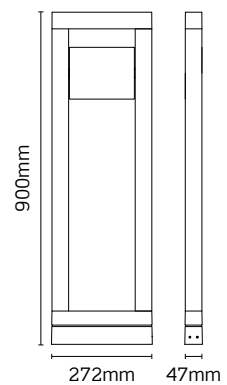

RATING



CLASS 1



CRI: RA



WARRANTY\*



BEAM



ANTHRACITE

CODE	DESCRIPTION	COL TEMP.	DIM.	WATT	LUMENS	LPCW
JC17031	Directional Slim Bollard	3000K	No	16W	1100	69

**Body:** Die-cast Aluminium. **Diffuser:** Glass.

\*Extended warranty requires online registration. Terms and conditions apply.

# Decorative Square Bollard

## Architectural exterior LED lighting

- Matching 3000K LED colour temperature and finish to the Architectural Exterior range

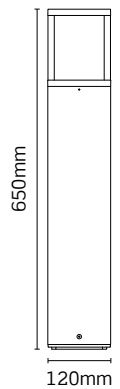
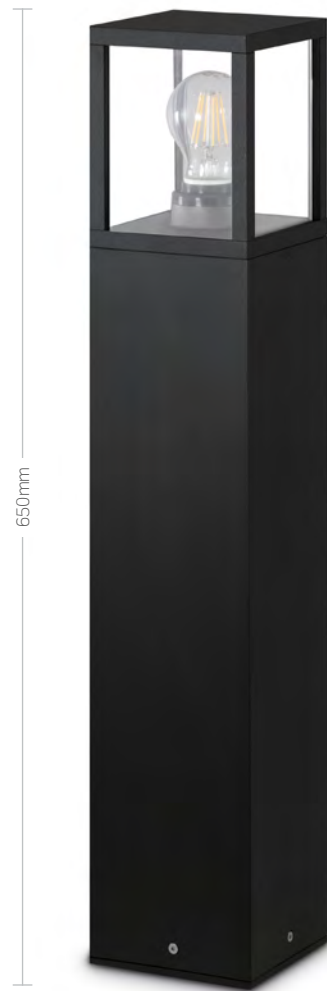

RATING



CLASS 1



WARRANTY\*



ANTHRACITE



WHITE

CODE	DESCRIPTION	LAMP (NOT SUPPLIED)
JC17040	Decorative Square Bollard	E27 Halogen or LED lamp 15W Max

For Anthracite add **BLK** suffix, for White add **WH** suffix.

**Body:** Die-cast Aluminium. **Diffuser:** Polycarbonate.

\*Extended warranty requires online registration. Terms and conditions apply.





# Directional Round Bollard

## Architectural exterior LED lighting

- Matching 3000K LED colour temperature and finish to the Architectural Exterior range
- 300° directional LED module

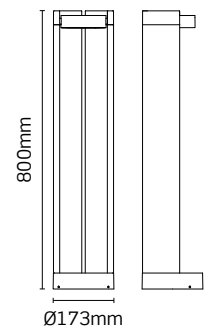







RATING CLASS 1 CRI: RA WARRANTY\* ANTHRACITE

CODE	DESCRIPTION	COL TEMP.	DIM.	WATT	LUMENS	LPCW
JC17041	Directional Round Bollard	3000K	No	15W	500	33

**Body:** Aluminium. **Diffuser:** Glass.

\*Extended warranty requires online registration. Terms and conditions apply.

# Tapered Bollard

## Architectural exterior LED lighting

- Matching 3000K LED colour temperature and finish to the Architectural Exterior range

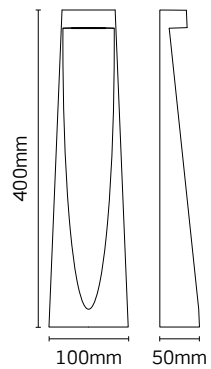

RATING



CLASS 1



CRI: RA



WARRANTY\*



BEAM



ANTHRACITE

CODE	DESCRIPTION	COL TEMP.	DIM.	WATT	LUMENS	LPCW
JC17018	Tapered Bollard	3000K	No	7W	300	43

**Body:** Aluminium. **Diffuser:** Polycarbonate.

\*Extended warranty requires online registration. Terms and conditions apply.



# NiteLED™ Round Bollard

Low wattage LED exterior lighting

- Root mounting kit available (JC39412)

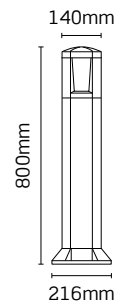

RATING



CLASS 1



CRI: RA



GUARANTEE



ANTHRACITE

CODE	DESCRIPTION	COL TEMP.	DIM.	WATT	LUMENS	LPCW
JC39404	NiteLED Round Bollard	4000K	No	6W	300	50
JC39412	Root mounting kit (Round Bollard)	-	-	-	-	-

**Body:** Die-cast Aluminium. **Diffuser:** Polycarbonate.

# NiteLED™ Square Bollard

Low wattage LED exterior lighting

- Root mounting kit available (JC39413)

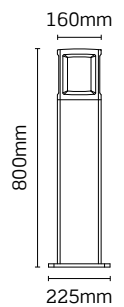

				
RATING	CLASS 1	CRI: RA	GUARANTEE	ANTHRACITE

CODE	DESCRIPTION	COL TEMP.	DIM.	WATT	LUMENS	LPCW
JC39405	NiteLED Square Bollard	4000K	No	6W	300	50
JC39413	Root mounting kit (Square Bollard)	-	-	-	-	-

**Body:** Die-cast Aluminium. **Diffuser:** Polycarbonate.

# NiteLED™ Dome Bollard

Low wattage LED exterior lighting

- Root mounting kit available (JC39224)
- Matching wall light available, see page 314



CODE	DESCRIPTION	COL TEMP.	DIM.	WATT	LUMENS	LPCW
JC39425BLK	Short Dome Bollard (475mm)	4000K	No	8.5W	200	24
JC39426BLK	Medium Dome Bollard (775mm)	4000K	No	8.5W	200	24
JC39427BLK	Tall Dome Bollard (1275mm)	4000K	No	8.5W	200	24
JC39224	Root mounting kit	-	-	-	-	-

Body: Aluminium. Diffuser: Polycarbonate.

# NiteLED™ Dome Bollard

## Low wattage LED exterior lighting

- Root mounting kit available (JC39224)
- Matching wall light available, see page 315

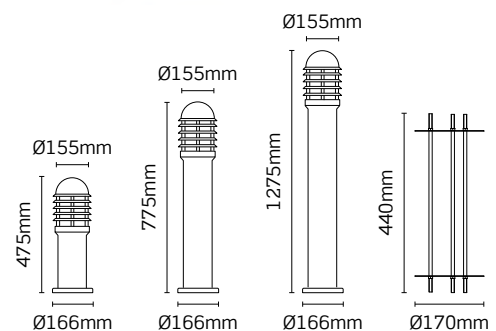

CODE	DESCRIPTION	COL TEMP.	DIM.	WATT	LUMENS	LPCW
JC39422BLK	Short Louvred Bollard (475mm)	4000K	No	8.5W	200	24
JC39423BLK	Medium Louvred Bollard (775mm)	4000K	No	8.5W	200	24
JC39424BLK	Tall Louvred Bollard (1275mm)	4000K	No	8.5W	200	24
JC39224	Root mounting kit	-	-	-	-	-

Body: Aluminium. Diffuser: Polycarbonate.

# NiteLED™ Dome Bollard

Low wattage LED exterior lighting

- Root mounting kit available (JC39224)
- Matching wall light available, see page 314



 **RATING** IP 44  
 **CLASS 1**  
 **CRI: RA** 80  
 **GUARANTEE** 2yr  
 **STAINLESS STEEL** SS

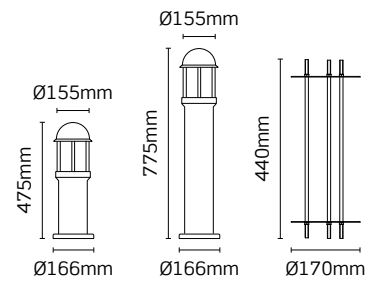

CODE	DESCRIPTION	COL TEMP.	DIM.	WATT	LUMENS	LPCW
JC39425SS	Short Dome Bollard (475mm)	4000K	No	8.5W	200	24
JC39426SS	Medium Dome Bollard (775mm)	4000K	No	8.5W	200	24
JC39224	Root mounting kit	-	-	-	-	-

**Body:** 316 Stainless Steel. **Diffuser:** Polycarbonate.



# NiteLED™ Dome Bollard

Low wattage LED exterior lighting

- Root mounting kit available (JC39224)
- Matching wall light available, see page 315



 **RATING** IP 44  
 **CLASS 1**  
 **CRI: RA** 80  
 **GUARANTEE** 2yr  
 **STAINLESS STEEL** SS

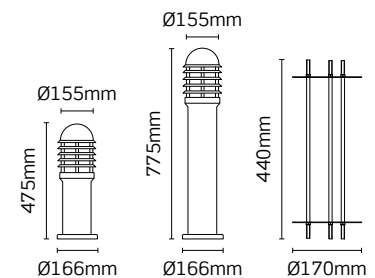

CODE	DESCRIPTION	COL TEMP.	DIM.	WATT	LUMENS	LPCW
JC39422SS	Short Louvred Bollard (475mm)	4000K	No	8.5W	200	24
JC39423SS	Medium Louvred Bollard (775mm)	4000K	No	8.5W	200	24
JC39224	Root mounting kit	-	-	-	-	-

**Body:** 316 Stainless Steel. **Diffuser:** Polycarbonate.



# Recessed Ground & Spike Lights

Inground LED	362
NiteLED™ Walkover	364
Inground Single Direction	366
Inground Twin Direction	367
Inground Quad Direction	368
Inground Spike	370
Inground Spike Spotlight	371
Elegenti LED Step Light	376
Charon Deck Lights	377

# Inground LED

## High performance stainless steel inground LED

- High quality stainless steel construction
- 500kg static weight limit
- Supplied pre-wired with 900mm flex
- IP67 protection against dust and the effects of immersion



125mm

					
RATING	CLASS 1	CRI: RA	WARRANTY*	BEAM	STAINLESS STEEL

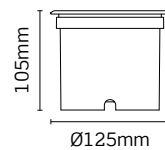

CODE	DESCRIPTION	COL TEMP.	DIM.	WATT	LUMENS	LPCW
JC17029	IP67 Inground walkover	3000K	No	7W	600	86

**Body:** Aluminium. **Diffuser:** Glass. **Bezel:** Stainless Steel.

\*Extended warranty requires online registration. Terms and conditions apply.

# Inground LED

## High output stainless steel inground LED

- High quality stainless steel construction
- 500kg static weight limit
- Supplied pre-wired with 900mm flex
- IP67 protection against dust and the effects of immersion



240mm

					
RATING	CLASS 1	CRI: RA	WARRANTY*	BEAM	STAINLESS STEEL

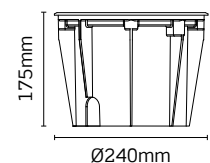

CODE	DESCRIPTION	COL TEMP.	DIM.	WATT	LUMENS	LPCW
JC17034	IP67 Inground walkover	3000K	No	24W	1800	75

**Body:** Aluminium. **Diffuser:** Glass. **Bezel:** Stainless Steel.

\*Extended warranty requires online registration. Terms and conditions apply.

# NiteLED™ Walkover

## Stainless steel inground LED accent light

- High quality stainless steel construction
- Supplied pre-wired with 850mm flex
- IP67 protection against dust and the effects of immersion



119mm

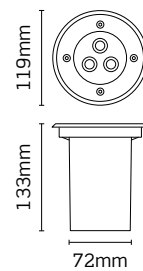

					
RATING	CLASS 1	CRI: RA	GUARANTEE	BEAM	STAINLESS STEEL

CODE	DESCRIPTION	COL TEMP.	WATT	DIM.	LUMENS	LPCW
JC39415	NiteLED Walkover	4000K	3W	No	180	60

**Body:** Aluminium. **Diffuser:** Clear Glass. **Bezel:** Stainless Steel.

# NiteLED™ Walkover

## Stainless steel inground LED accent light

- High quality stainless steel construction
- Supplied pre-wired with 850mm flex
- IP67 protection against dust and the effects of immersion



149mm

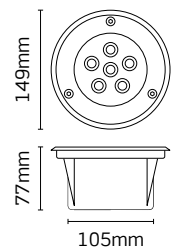

					
RATING	CLASS 1	CRI: RA	GUARANTEE	BEAM	STAINLESS STEEL

CODE	DESCRIPTION	COL TEMP.	WATT	DIM.	LUMENS	LPCW
JC39414	NiteLED Walkover	4000K	6W	No	360	60

**Body:** Aluminium. **Diffuser:** Clear Glass. **Bezel:** Stainless Steel.

# Inground Single Direction

## Single directional recessed accent light

- Durable die-cast aluminium construction
- IP67 protection against dust and moisture
- Supplied pre-wired with 900mm flex

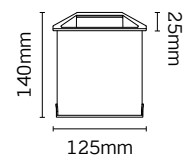
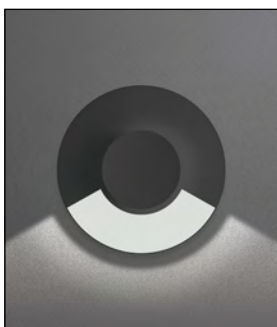







RATING CLASS 1 CRI: RA WARRANTY\* BEAM ANTHRACITE

CODE	DESCRIPTION	COL TEMP.	DIM.	WATT	LUMENS
JC17026	Inground Single Direction	3000K	No	7W	100

Body: Aluminium. Diffuser: Glass.

\*Extended warranty requires online registration. Terms and conditions apply.



# Inground Twin Direction

## Twin directional recessed accent light

- Durable die-cast aluminium construction
- IP67 protection against dust and moisture
- Supplied pre-wired with 900mm flex

125mm

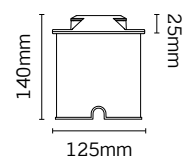







RATING CLASS 1 CRI: RA WARRANTY\* BEAM ANTHRACITE

CODE	DESCRIPTION	COL TEMP.	DIM.	WATT	LUMENS
JC17027	Inground Twin Direction	3000K	No	7W	150

**Body:** Aluminium. **Diffuser:** Glass.

\*Extended warranty requires online registration. Terms and conditions apply.

# Inground Quad Direction

## Quad directional recessed accent light

- Durable die-cast aluminium construction
- IP67 protection against dust and moisture
- Supplied pre-wired with 900mm flex

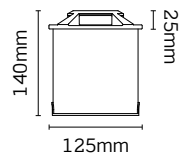

					
RATING	CLASS 1	CRI: RA	WARRANTY*	BEAM	ANTHRACITE

CODE	DESCRIPTION	COL TEMP.	DIM.	WATT	LUMENS
JC17028	Inground Quad-Direction	3000K	No	7W	200

Body: Aluminium. Diffuser: Glass.

\*Extended warranty requires online registration. Terms and conditions apply.



# Inground Spike

## Wide beam architectural inground LED spike

- Durable die-cast aluminium construction
- IP65 protection against dust and moisture
- Supplied pre-wired with 900mm flex
- Wide 95° beam angle

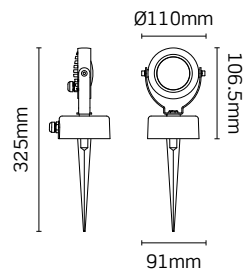

					
RATING	CLASS 1	CRI: RA	WARRANTY*	BEAM	ANTHRACITE

CODE	DESCRIPTION	COL TEMP.	DIM.	WATT	LUMENS	LPCW
JC17025	Inground spike	3000K	No	7W	600	86

Body: Aluminium. Diffuser: Glass.

\*Extended warranty requires online registration. Terms and conditions apply.

# Inground Spike Spotlight

Narrow beam architectural inground LED spike

- Durable die-cast aluminium construction
- IP65 protection against dust and moisture
- Supplied pre-wired with 900mm flex
- Narrow 45° beam angle



175mm

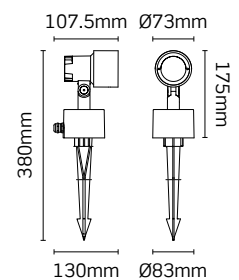

 IP 65	 CLASS 1	 CRI: RA	 WARRANTY*	 BEAM	 ANTHRACITE
---	---	---	---	--	--

CODE	DESCRIPTION	COL TEMP.	DIM.	WATT	LUMENS	LPCW
JC17030	Inground Spike Spotlight	3000K	No	15W	650	43

Body: Aluminium. Diffuser: Glass.

\*Extended warranty requires online registration. Terms and conditions apply.





# Inground Spike Spotlight

Short architectural inground LED spike spotlight

- Durable die-cast aluminium construction
- IP65 protection against dust and moisture
- Supplied pre-wired with 900mm flex
- Narrow 41° beam angle

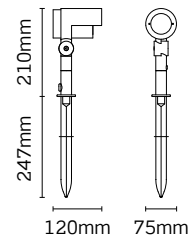

					
RATING	CLASS 1	CRI: RA	WARRANTY*	BEAM	ANTHRACITE

CODE	DESCRIPTION	COL TEMP.	WATT	DIM	LUMENS	LPCW
JC17044	Inground Spike Spotlight short	3000K	10W	No	750	75

**Body:** Aluminium. **Lens:** Polycarbonate.

\*Extended warranty requires online registration. Terms and conditions apply.



# Inground Spike Spotlight

## Tall architectural inground LED spike

- Durable die-cast aluminium construction
- IP65 protection against dust and moisture
- Supplied pre-wired with 900mm flex
- Narrow 41° beam angle

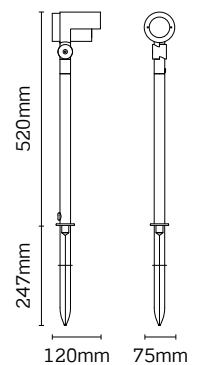







RATING CLASS 1 CRI: RA WARRANTY\* BEAM ANTHRACITE

CODE	DESCRIPTION	COL TEMP.	WATT	DIM	LUMENS	LPCW
JC17045	Inground Spike Spotlight tall	3000K	10W	No	750	75

**Body:** Aluminium. **Lens:** Polycarbonate.

\*Extended warranty requires online registration. Terms and conditions apply.

# Elegenti LED Step Light

Recessed step light for pathway lighting

- IP68 protection against water ingress
- Supplied with integral driver
- Comes complete with recessed wall box



146mm



RATING



CLASS 2



CRI: RA



GUARANTEE



STAINLESS STEEL

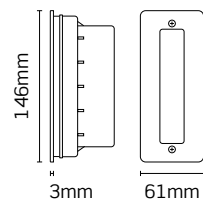

CODE	DESCRIPTION	COL TEMP.	WATT	DIM	LUMENS
JC71115	Elegenti LED step light	6000K	1.5W	No	45

**Body:** Polycarbonate. **Lens:** Clear Acrylic. **Cover:** Stainless Steel.

# Charon Deck Lights

## LED deck lighting kit

- Supplied as kits with 5 head per kit
- Comes complete pre-wired with plug, driver and cable

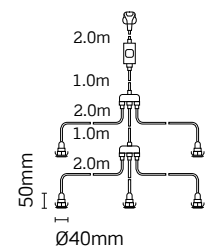

				
RATING	CLASS 2	CRI: RA	GUARANTEE	BR. ALUMINIUM

Cut out: Ø35mm

CODE	DESCRIPTION	COL TEMP.	WATT (PER HEAD)	LUMENS
JC71054	Charon Deck Lights (5 head kit)	6000K	0.5W	15

Body: Aluminium. Lens: Clear Glass.



# Lanterns

Montella™ Lanterns	380
Montella™ Half Wall Lanterns	381
LED Lantern Top Arm	382
LED Lantern Bottom Arm	383
LED Lantern Post Top	384
Frosted Glazed Lantern	385
Glazed Lantern	388
Glazed Lantern Mini	389
Glazed Post Light	390

# Montella™ Lanterns

## Traditional wall lanterns

- Discreet integrated PIR with manual override function available

∨ JC32011BLK



∨ JC32012WH



JC32010/12

JC32011

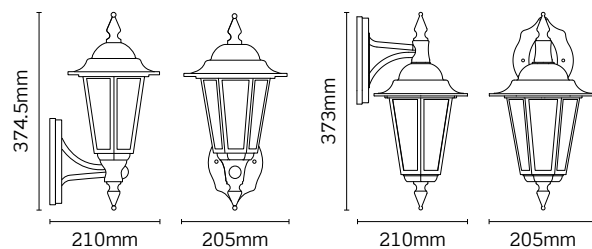

RATING



CLASS 2



GUARANTEE



SENSING



BLACK



WHITE

CODE	DESCRIPTION	LAMP
JC32010	Montella lantern bottom arm	ES E27 42W Max
JC32011	Montella lantern top arm	ES E27 42W Max
JC32012	Montella lantern bottom arm with PIR	ES E27 42W Max

For Black add **BLK** suffix, for White add **WH** suffix.

**Body:** Polycarbonate. **Diffuser:** Polycarbonate. | Lamp not supplied.

# Montella™ Half Wall Lanterns

## Traditional wall lanterns

- Discreet integrated PIR with manual override function available



JC32015

JC32017

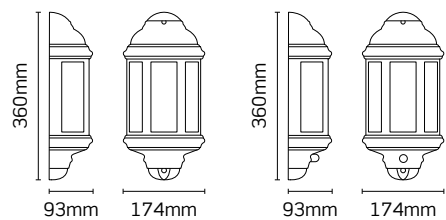

RATING



CLASS 2



GUARANTEE



SENSING



BLACK



WHITE

CODE	DESCRIPTION	LAMP
JC32015	Montella half wall lantern	ES E27 42W Max
JC32017	Montella half wall lantern with PIR	ES E27 42W Max

For Black add **BLK** suffix, for White add **WH** suffix.

**Body:** Polycarbonate. **Diffuser:** Polycarbonate. | Lamp not supplied.

# LED Lantern Top Arm

Contemporary LED wall lantern

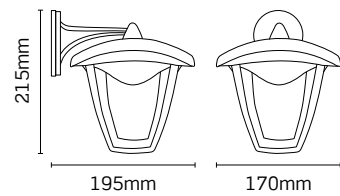

RATING



CLASS 1



CRI: RA



GUARANTEE



BLACK

CODE	DESCRIPTION	COL TEMP.	DIM.	WATT	LUMENS	LPCW
JC39433	Top Arm LED Lantern	4000K	No	7.5W	290	41

**Body:** Aluminium. **Lens:** Polycarbonate.



# LED Lantern Bottom Arm

Contemporary LED wall lantern

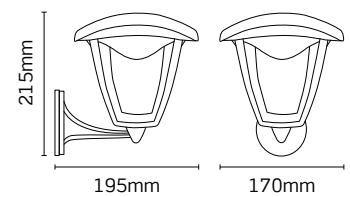

-   
RATING
-   
CLASS 1
-   
CRI: RA
-   
GUARANTEE
-   
SENSING
-   
BLACK

CODE	DESCRIPTION	COL TEMP.	DIM.	WATT	LUMENS	LPCW
JC39431	Bottom Arm LED Lantern	4000K	No	7.5W	290	41
JC39432	Bottom Arm LED Lantern with PIR	4000K	No	7.5W	290	41

**Body:** Aluminium. **Lens:** Polycarbonate.

# LED Lantern Post Top

Contemporary LED post top lantern

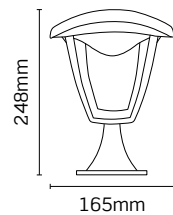

RATING



CLASS 1



CRI: RA



GUARANTEE



BLACK

CODE	DESCRIPTION	COL TEMP.	DIM.	WATT	LUMENS	LPCW
JC39434	Post Top Cast LED Lantern	4000K	No	7.5W	290	41



Body: Aluminium. Lens: Polycarbonate.

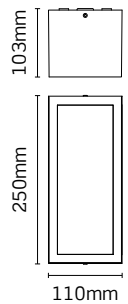

# Frosted Glazed Lantern

Architectural exterior LED lighting

- Matching 3000K LED colour temperature and finish to the Architectural Exterior range



RATING CLASS 1 CRI: RA WARRANTY\* ANTHRACITE

CODE	DESCRIPTION	COL TEMP.	DIM.	WATT	LUMENS	LPCW
JC17008	Frosted Glazed Lantern	3000K	No	18W	700	39

**Body:** Aluminium. **Diffuser:** Glass.

\*Extended warranty requires online registration. Terms and conditions apply.





# Glazed Lantern

Architectural exterior LED lighting

- Rubber gasket to maintain IP54 rating

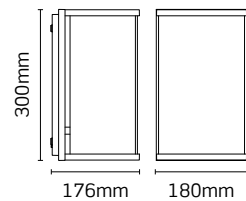

RATING



CLASS 1



WARRANTY\*



ANTHRACITE



WHITE

**CODE**

**DESCRIPTION**

**LAMP**

JC17007

Glazed Lantern

ES E27 15W LED Max

For Anthracite add **BLK** suffix, for White add **WH** suffix.

**Body:** Aluminium. **Diffuser:** Glass. | Lamp not supplied.

\*Extended warranty requires online registration. Terms and conditions apply.

# Glazed Lantern Mini

Architectural exterior LED lighting

- Rubber gasket to maintain IP54 rating



					
RATING	CLASS 1	WARRANTY*	SENSING	ANTHRACITE	WHITE

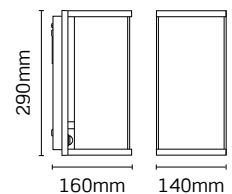

CODE	DESCRIPTION	LAMP
JC17036	Glazed Lantern Mini with PIR	ES E27 15W LED Max
JC17037	Glazed Lantern Mini	ES E27 15W LED Max

For Anthracite add **BLK** suffix, for White add **WH** suffix.

**Body:** Aluminium. **Diffuser:** Glass. | Lamp not supplied.

\*Extended warranty requires online registration. Terms and conditions apply.

# Glazed Post Light

Architectural exterior LED lighting

- Rubber gasket to maintain IP54 rating

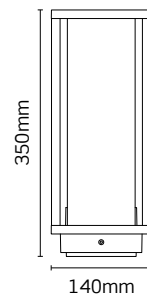

RATING



CLASS 1



WARRANTY\*



ANTHRACITE



WHITE

CODE	DESCRIPTION	LAMP
JC17038	Glazed Post Light	ES E27 15W LED Max

For Anthracite add **BLK** suffix, for White add **WH** suffix.

**Body:** Aluminium. **Diffuser:** Glass. | Lamp not supplied.

\*Extended warranty requires online registration. Terms and conditions apply.



# Glazed Post Light

Architectural exterior LED lighting

- Rubber gasket to maintain IP54 rating

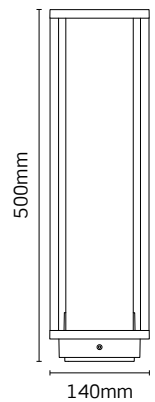

				
RATING	CLASS 1	WARRANTY*	ANTHRACITE	WHITE

CODE	DESCRIPTION	LAMP
JC17039	Glazed Post Light	ES E27 15W LED Max

For Anthracite add **BLK** suffix, for White add **WH** suffix.

**Body:** Aluminium. **Diffuser:** Glass. | Lamp not supplied.

\*Extended warranty requires online registration. Terms and conditions apply.



# Controls & Sensors

Toughbay™ Retrofit Dimming Sensor	394
Toughbay™ Linear Dimming Sensor	395
Toughbay™ Microwave Remote	396
PIR Detector	397

# Toughbay™ Retrofit Dimming Sensor

## 1-10V step dimming microwave sensor

- Remote control (LEV71805) available to programme microwave sensor settings
- 60°, 90° and 120° beam angle options and emergency versions available

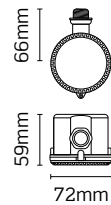

RATING



WARRANTY\*



EM OPTIONS



SENSING



BEAM OPTIONS

CODE	DESCRIPTION	COL TEMP.	WATT	LUMENS	LPCW
JC040003	Toughbay Retrofit 60° microwave step dim	5700K	100W	12,300	123
JC040004	Toughbay Retrofit 60° microwave step dim emergency	5700K	100W	12,300	123
JC040007	Toughbay Retrofit 90° microwave step dim	5700K	100W	12,300	123
JC040008	Toughbay Retrofit 90° microwave step dim emergency	5700K	100W	12,300	123
JC040027	Toughbay Retrofit 120° microwave step dim	5700K	100W	12,300	123
JC040028	Toughbay Retrofit 120° microwave step dim emergency	5700K	100W	12,300	123
JC040053	Toughbay Retrofit 60° microwave step dim	4000K	150W	18,400	123
JC040054	Toughbay Retrofit 60° microwave step dim emergency	4000K	150W	18,400	123
JC040057	Toughbay Retrofit 90° microwave step dim	4000K	150W	18,400	123
JC040058	Toughbay Retrofit 90° microwave step dim emergency	4000K	150W	18,400	123
JC040039	Toughbay Retrofit 120° microwave step dim	4000K	150W	18,400	123
JC040040	Toughbay Retrofit 120° microwave step dim emergency	4000K	150W	18,400	123
JC040011	Toughbay Retrofit 60° microwave step dim	5700K	150W	18,400	123
JC040012	Toughbay Retrofit 60° microwave step dim emergency	5700K	150W	18,400	123
JC040015	Toughbay Retrofit 90° microwave step dim	5700K	150W	18,400	123
JC040016	Toughbay Retrofit 90° microwave step dim emergency	5700K	150W	18,400	123
JC040031	Toughbay Retrofit 120° microwave step dim	5700K	150W	18,400	123
JC040032	Toughbay Retrofit 120° microwave step dim emergency	5700K	150W	18,400	123
JC040019	Toughbay Retrofit 60° microwave step dim	5700K	200W	24,500	123
JC040020	Toughbay Retrofit 60° microwave step dim emergency	5700K	200W	24,500	123
JC040023	Toughbay Retrofit 90° microwave step dim	5700K	200W	24,500	123
JC040024	Toughbay Retrofit 90° microwave step dim emergency	5700K	200W	24,500	123
JC040035	Toughbay Retrofit 120° microwave step dim	5700K	200W	24,500	123
JC040036	Toughbay Retrofit 120° microwave step dim emergency	5700K	-	-	-
LEV71805	Toughbay Microwave Remote	-	-	-	-

**Body:** Aluminium. **Lens:** Polycarbonate. **Sensor:** Polycarbonate.

# Toughbay™ Linear Dimming Sensor

## 1-10V step dimming microwave sensor

- Remote control (LEV71805) available to programme microwave sensor settings
- 50°, 80° and 30° x 60° beam angles available
- Emergency versions available



 **IP 65**  
 RATING

 **5yr**  
 WARRANTY\*

 **EM OPTIONS**

 **SENSING**

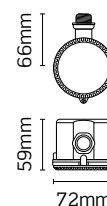

CODE	DESCRIPTION	COL TEMP.	WATT	LUMENS	LPCW
JC71931/30X60MW	Toughbay Linear 30° x 60° microwave step dim	5700K	100W	14,000	140
JC71931/30X60MWEM	Toughbay Linear 30° x 60° microwave step dim emergency	5700K	100W	14,000	140
JC71931/50MW	Toughbay Linear 50° microwave step dim	5700K	100W	14,000	140
JC71931/50MWEM	Toughbay Linear 50° microwave step dim emergency	5700K	100W	14,000	140
JC71931/80MW	Toughbay Linear 80° microwave step dim	5700K	100W	14,000	140
JC71931/80MWEM	Toughbay Linear 80° microwave step dim emergency	5700K	100W	14,000	140
JC71932/30X60MW	Toughbay Linear 30° x 60° microwave step dim	5700K	150W	21,000	140
JC71932/30X60MWEM	Toughbay Linear 30° x 60° microwave step dim emergency	5700K	150W	21,000	140
JC71932/50MW	Toughbay Linear 50° microwave step dim	5700K	150W	21,000	140
JC71932/50MWEM	Toughbay Linear 50° microwave step dim emergency	5700K	150W	21,000	140
JC71932/80MW	Toughbay Linear 80° microwave step dim	5700K	150W	21,000	140
JC71932/80MWEM	Toughbay Linear 80° microwave step dim emergency	5700K	150W	21,000	140
JC71933/30X60MW	Toughbay Linear 30°x60° microwave step dim	5700K	200W	28,000	140
JC71933/30X60MWEM	Toughbay Linear 30x60° microwave step dim emergency	5700K	200W	28,000	140
JC71933/50MW	Toughbay Linear 50° microwave step dim	5700K	200W	28,000	140
JC71933/50MWEM	Toughbay Linear 50° microwave step dim emergency	5700K	200W	28,000	140
JC71933/80MW	Toughbay Linear 80° microwave step dim	5700K	200W	28,000	140
JC71933/80MWEM	Toughbay Linear 80° microwave step dim emergency	5700K	200W	28,000	140
LEV71805	Toughbay Microwave Remote	-	-	-	-

Body: Aluminium. Lens: Polycarbonate. Sensor: Polycarbonate.

\*Extended warranty requires online registration. Terms and conditions apply.

# Toughbay™ Microwave Remote

## 1-10V step dimming microwave sensor remote

- Quick and simple programming of microwave sensor settings
- For use with Toughbay Retrofit and Toughbay Linear

**RESET**

Reset microwave sensor to dip switch settings.

**AUTO MODE**

Return to settings before on/off selected.

**DETECTION AREA**

Variable microwave sensitivity depending on mounting height and required area of detection.

**QUICK SETTING**

4 default settings available. Suitable for different applications and mounting heights (see website for more details).

**HOLD TIME**

The length of time the luminaire remains at full brightness before dimming or turning off.

**STAND-BY DIM LEVEL**

Minimum brightness the luminaire remains at after no movement is detected.

**STAND-BY PERIOD**

Length of time the luminaire remains at the dimmed brightness before turning off.

**DAYLIGHT SENSOR**

Select ambient natural light level that is required before the luminaire is switched on with microwave detection.

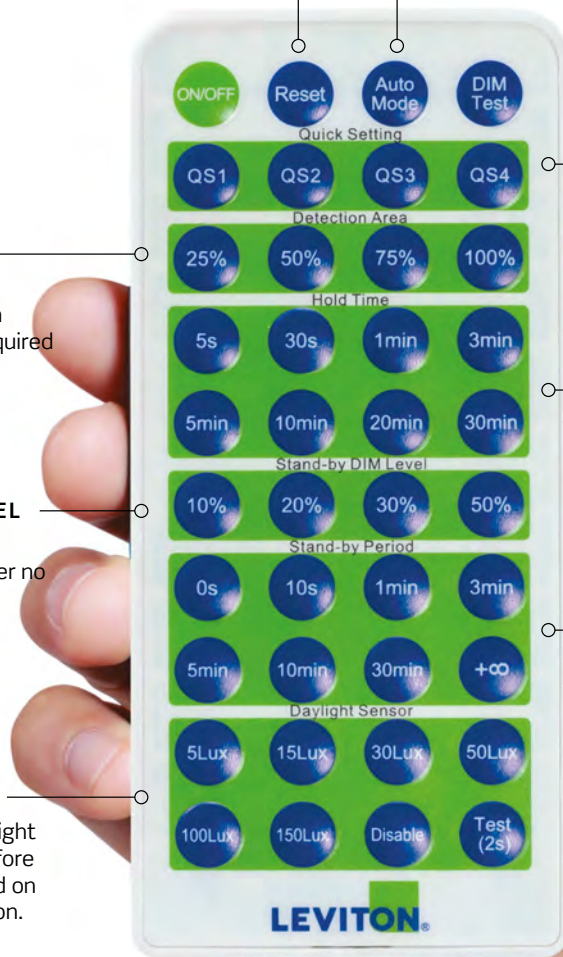

CODE	DESCRIPTION
LEV71805	Toughbay Microwave Remote

**Body:** Polycarbonate.

# PIR Detector

## External PIR detection sensor

- Manual override PIR sensor feature
- Compatible with both LED and Halogen
- Available in black and white

∨ LEV68003



∧ Also available in black finish:  
LEV68003



RATING



GUARANTEE



BLACK



WHITE

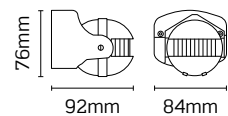

CODE	DESCRIPTION	DETECTION RANGE	HOLD TIME	ANGLE OF VIEW
LEV68003	IP44 PIR	12m	10 secs to 4 mins	180°

For Black add **BLK** suffix, for White add **WH** suffix.

**Body:** Polycarbonate.





# Technical

Lighting explained	400
Building lighting basics	402
IP Ratings	405
2014 Build regulations	406
Emergency lighting	407
Controlling lighting	408
Components of lighting control systems	410
Communication protocols	412

## Lighting education

# Lighting explained

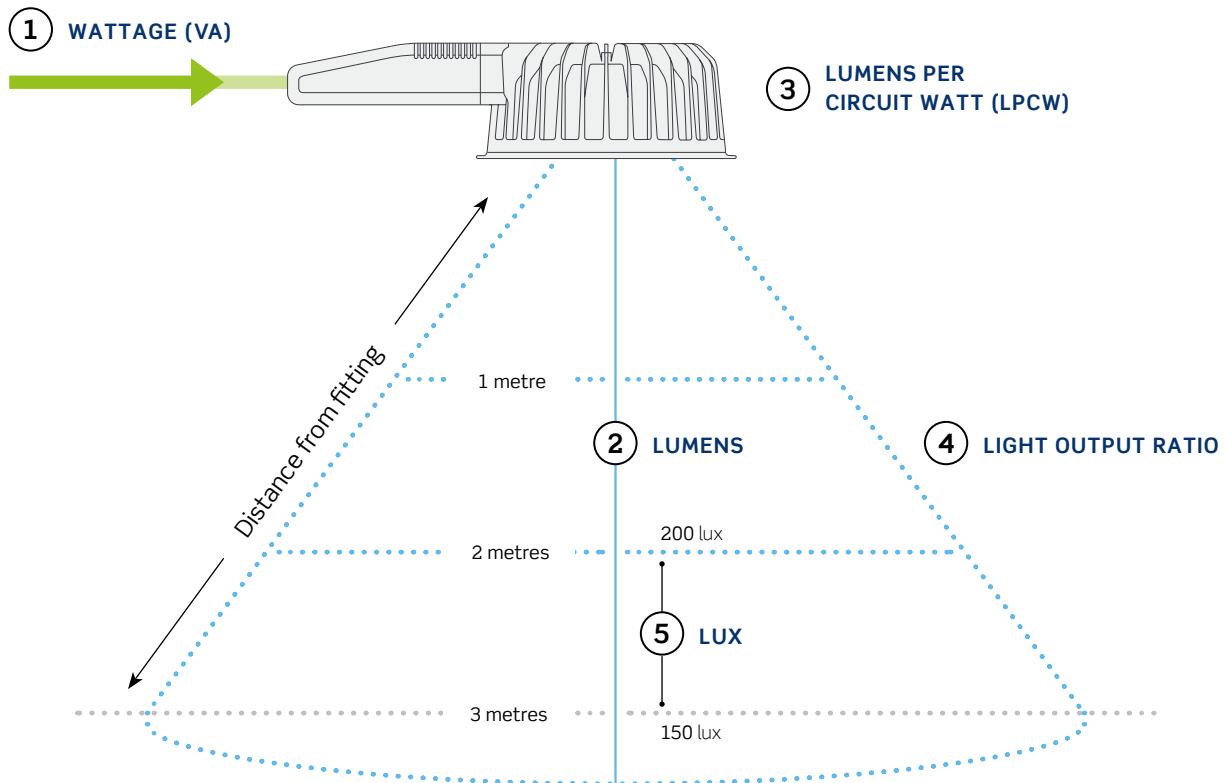

## A guide to commonly used terms within lighting

### 1. WATTAGE (VA)

A measure of power or the rate of energy consumption by an electrical device when it is in operation, calculated by multiplying the voltage at which an appliance operates by the current it draws (Watts = Volts X Amperes).

### 2. LUMENS

A lumen is a unit of measurement that is used to express how much illumination a source of light provides.

### 3. LUMENS PER CIRCUIT WATT (LPCW)

A calculation of the efficiency of a fitting.  
Lumens (3000) ÷ Wattage (50W) = 60 LpcW

### 4. LIGHT OUTPUT RATIO (LOR)

This is a measure of the efficiency of the fitting and is a ratio of the lumens leaving the light source and the lumens that finally leave the fitting.

### 5. LUX

A measure of the intensity of light as seen by the human eye and measured by luminous flux per unit area. One lux is equal to one lumen per square metre.

### MORE INFORMATION AT [JCC.CO.UK](http://JCC.CO.UK)

For further information on lighting principles and common industry terminology, visit: [jcc.co.uk/lighting-explained](http://jcc.co.uk/lighting-explained)

## Common lighting industry terms

Terminology used within the lighting industry, including Colour Rendering Index (CRI), IP Ratings and L70 Lumen Depreciation.

### COLOUR RENDERING INDEX (CRI)

A measure of the ability of a light source to reproduce the colours of various objects. A light source with a CRI of 100 (Ra) would be perfect and balanced in terms of colour reproduction, shading and contrast.

### LUMEN DEPRECIATION (L70)

Lumen depreciation values reflect the overall performance of a light source through its life. All light sources suffer from lumen depreciation, which can be accelerated by poor thermal conditions, over voltage or incorrect application. L70 is the operating time (hours) until the LED lumen output is depreciated to 70% of its initial lumens.

### IP RATINGS

Ingress Protection (IP) is a value given to products that have particular protection against dust and/or moisture. The IP number is split, the first digit represents the level of protection against dust particles while the second digit represents the protection against moisture. For example IP00 has no protection against dust or moisture whilst a product with IP68 is dust tight and submersible up to 2m (see page 403 for more information).

### LENI (LIGHT ENERGY NUMERIC INDICATOR)

LENI is a measurement of the buildings energy performance in energy usage per sq/m. For more information, visit [www.thelia.org.uk](http://www.thelia.org.uk)

## Understanding colour temperature

The colour temperature of a light source is measured in degrees Kelvin. Below is a Kelvin temperature scale with examples of how colour temperature is used within different lighting applications.

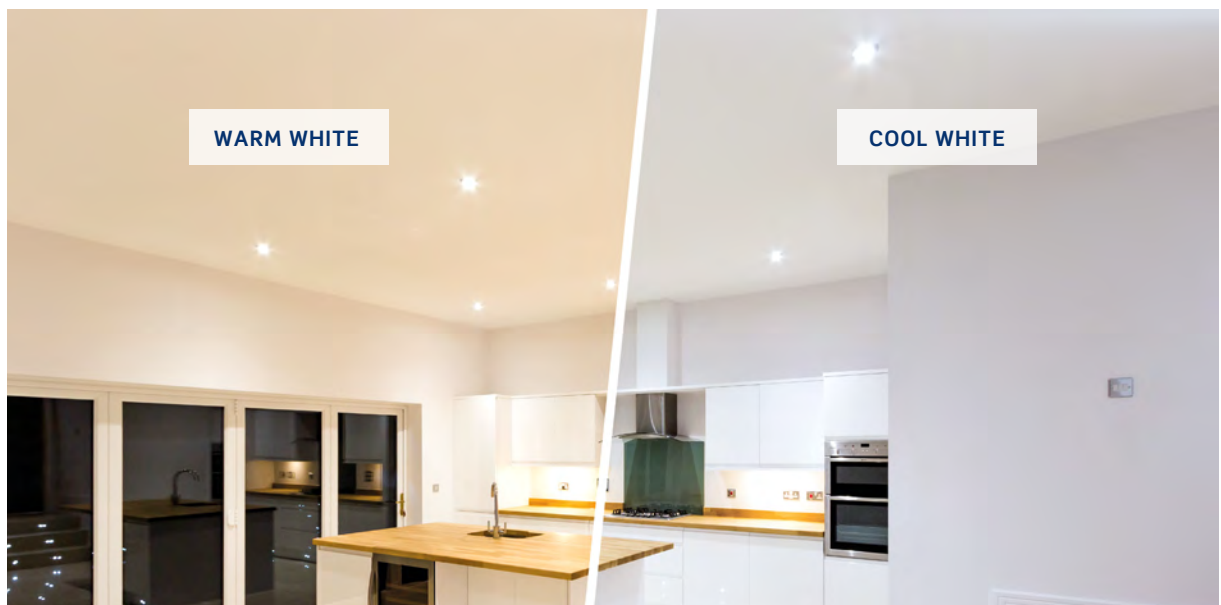
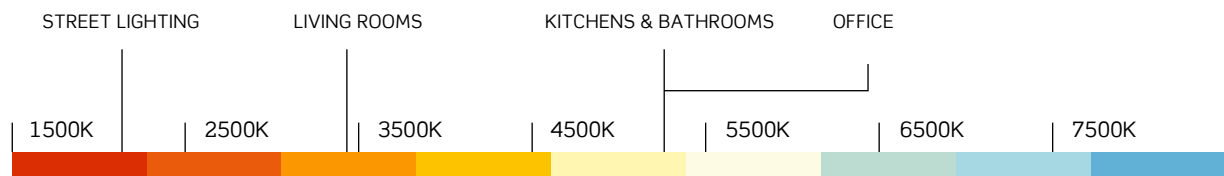

## Lighting education

# Building lighting basics

## Key factors to consider when lighting a building

It's important to understand who will be using the area and what will be the layout. The following is a simple checklist:

### WHAT IS THE PRIMARY USE OF THE AREA?

The level of light required will depend upon the tasks performed within the area. See CIBSE guidelines below.

### WHAT COLOURS ARE USED WITHIN THE DECOR?

Dark walls, flooring and furniture can absorb up to 80% of the light.

### HOW MUCH NATURAL DAYLIGHT ENTERS THE AREA?

Windows, exterior doors and skylights impact the level of light within an environment. To maintain constant light levels the area may require lighting control such as daylight harvesting (see page 409).

### WHAT LEVEL OF MAINTENANCE DOES THE AREA RECEIVE?

Without regular cleaning, the light output of all light fittings is reduced. Non-LED fittings require lamps to be replaced dependant upon lamp technology.

### IS THE CEILING SUSPENDED OR SOLID?

Light fittings are often designed for a specific ceiling type. The ceiling within your application may dictate the relevant fittings required.

### IS THERE ELECTRICAL PROVISION FOR WALL MOUNTED LIGHTS?

If lighting new areas where fittings do not replace previous lighting, chasing wiring into the wall may be necessary.

### WHICH REGULATIONS ARE APPLICABLE?

The 2014 Building Regulations stipulate key attributes that are required for fittings used within certain areas (see page 406).

### ARE THERE ENVIRONMENTAL CONSIDERATIONS?

Older lamp technologies such as CDM can considerably add to ambient room temperatures. Areas with heightened levels of dust, dirt and water may require an IP rating (see page 405).

## CIBSE recommended light levels

The table below is a guide to assist with calculating a lighting scheme. Please note these are just a guide and a professional lighting design may be required.

AREA TYPE	RECOMMENDED LUX LEVELS
Public areas with dark surroundings	10 - 50 Lux
Simple orientation for short visits	100 - 150 Lux
Warehouse racking	150 Lux
Warehouses, homes, theatres	150 - 200 Lux
Brighter areas such as bathrooms	150 - 200 Lux
Simple office work and classrooms	300 - 500 Lux
Normal office work with computers	300 - 500 Lux
Supermarkets and workshops	500 - 1000 Lux

## How to add interest to lighting

Good lighting design recognises the need for depth of view. Both ambient and accent lighting should be used, whilst combining colour temperatures to create a more comfortable working environment.



### AMBIENT LIGHTING

This is the general lighting within an area and typically contributes 80% of the overall lighting level.

Skytile is a good example of product designed for ambient lighting.



### ACCENT LIGHTING

Adds interest and depth to a design and should compliment but not conflict with the ambient lighting. This can include wall washing, the subtle use of colour, up lighting and spotlighting.

LED Strip and V50 are excellent for accent lighting.



### MIXING WARM & COOL

Coloured lighting within a design can affect the atmosphere created. The ambient lighting can be a cooler temperature to add a more commercial feel. Supplement with warm white as accent lighting to create a more dynamic environment.



## Typical areas within commercial applications

### 1. MEETING & BOARDROOM

The main lighting should be focused on the table areas. Remember to allow control of lighting near screens and displays. Use accent lighting to provide depth, and consider lighting pictures and other features.

### 2. OFFICE AREA

Try to allow for flexible use of the space so that desks can be repositioned. The lighting on desks should be greater than general movement areas. Consider the opportunity to use natural daylight, this may require lighting control for daylight harvesting. Adequately light emergency escape routes (see page 407).

### 3. RECEPTION

The reception area can provide a first impression of the business. The ambient and accent lighting should be varied to provide a dynamic feel.

### 4. STAIRWELLS

Primarily focus on safety by ensuring good light levels. Also consider the emergency requirements for emergency escape.

### 5. BASEMENT

Natural light and external views are unavailable and therefore it's vital to create depth of design by mixing accent and ambient light with variations in colour temperature.

### 6. SHOWROOM

The primary focus should be on the products being displayed. Track lighting can provide flexibility for changes of use (see StarSpot pages 208-213). Good CRI (see page 401) is important to ensure that colours are displayed correctly, LED lighting can have good and consistent CRI. Also consider the reliability of the lighting, a long L70 (see page 401) is important or the products will become dimly lit over time as product performance deteriorates.

### 7. EXTERIOR

Consider the security requirements and the safe passage of people when entering and leaving the building. Good exterior lighting can dramatically change the look of a building so consider both lighting the area around the building and the elevations of the entrance area and side walls.



## Lighting education

# IP Ratings

Explanation of IP numbers for degree of protection:

- |   |  |   |  |
|---|--|---|--|
| 0 | Non-protected                                      | 0 | Non-protected  |
| 1 | Protected against solid objects greater than 50mm  | 1 | Protected against dripping water                       |
| 2 | Protected against solid objects greater than 12mm  | 2 | Protected against dripping water when tilted up to 15° |
| 3 | Protected against solid objects greater than 2.5mm | 3 | Protected against spraying water                       |
| 4 | Protected against solid objects greater than 1.0mm | 4 | Protected against splashing water                      |
| 5 | Dust - Protected                                   | 5 | Protected against water jets                           |
| 6 | Dust - Tight                                       | 6 | Protected against heavy seas                           |
|   |  | 7 | Protected against the effects of immersion             |
|   |  | 8 | Protected against submersion                           |

Example **IP6X**

Example **IPX5**

## Lighting education

# 2014 Building Regulations

The Building Regulations are government standards that have been put in place to provide contractors with a guide denoting the health and safety requirements for all aspects of construction and building renovations.

## Part L - Efficiency

### Domestic

#### MINIMUM LIGHT FITTING PERFORMANCE

**Internal lighting** - At least 75% of all the light fittings in the main dwelling spaces (excluding infrequently accessed spaces used for storage) must have light fittings with an efficacy greater than 45 lpcW and total light output greater than 400 lumens.

Light fittings of less than 5 circuit Watts, are excluded from the calculation.

**External lighting** - Either:

Light fitting and lamps of greater than 100 Watts must be automatically controlled to switch off after the area becomes unoccupied and automatically controlled to switch off when daylight is sufficient.

Or:

If the light fittings are better than 45 lpcW then they should be automatically controlled, so as to switch off when daylight is sufficient and can be manually controllable.

### Non-Domestic/Commercial

#### MINIMUM LIGHT FITTING PERFORMANCE

General lighting in office and industrial – 60 lumens per circuit Watt.

**Display lighting** – 22 lumens per circuit Watt

## Part B - Fire Safety

Building Regulations Part B is focused on Fire safety, providing suitable protection for people to escape buildings with the time gained by having provisions in place. Fire rated luminaires are one of these provisions which are designed to slow down the spread of fire between floors.

## Part C - Resistance to Contaminants & Moisture

Building Regulations Part C aims to prevent condensation and drafts from penetrating the ceiling cut out around a luminaire. Part C products prevent condensation from passing through the fitting.

## Part E - Resistance to Sound

Building Regulations Part E is most commonly required for buildings such as flats, and is aimed to prevent sound from travelling between floors via the ceiling cut out for the luminaire. Products that are Part E compliant are also known as being acoustic rated.



## Lighting education

# Emergency Lighting

## What is an emergency light fitting?

Emergency light fittings include a battery as a backup power source that is continuously charged.

Emergency light fittings can tell when the power has failed and immediately switch to using the backup battery.

The battery needs to power the light fitting for a minimum of 3 hours. To conserve power, the light output from the fitting is reduced, often to 10% of the normal light output.

### MAINTAINED FITTING

Will operate as a normal light fitting and be controlled with all the other lights in the area, however when the power fails the maintained emergency fitting will continue to operate but, at a lower light level.

### NON-MAINTAINED FITTING

Usually switched off, with its batteries being continuously charged and a green LED showing fully charged. When the power fails the fitting switches on using its battery supply. Non-maintained fittings are not part of the general lighting but are fittings such as emergency exit signs. All JCC emergency light fittings can operate as a maintained and non-maintained light.

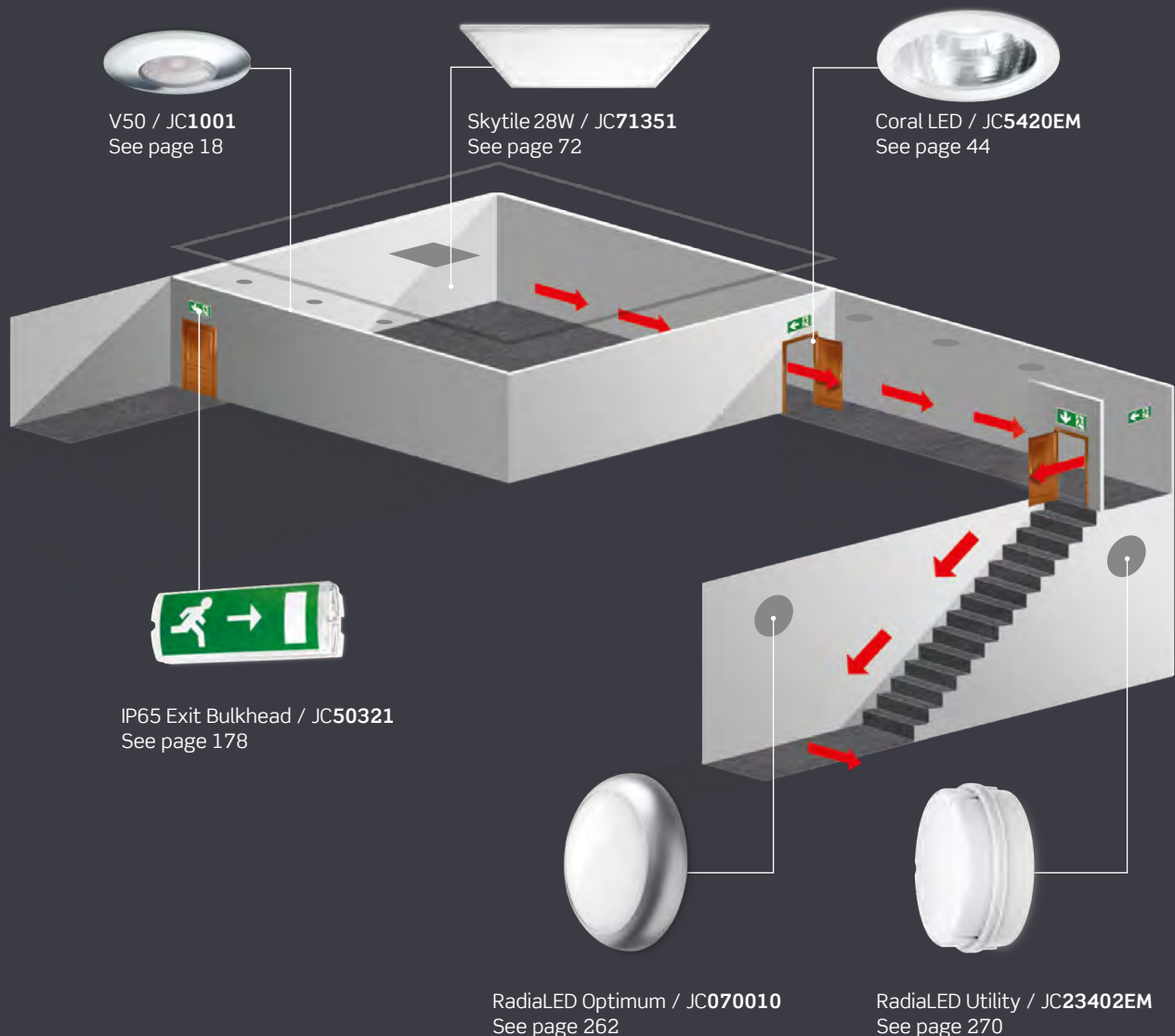

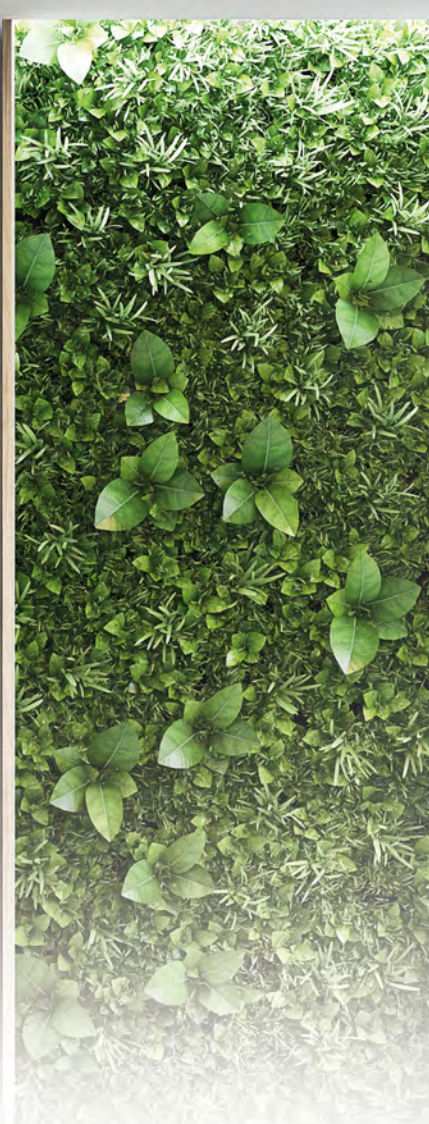

## Lighting education

# Controlling Lighting

### Why control lighting?

Switching to LED from traditional lighting technology, such as halogen or fluorescent, can provide up to 90% energy savings. However, LED lighting can provide other benefits, such as instantly controlling on/off without deterioration in the fittings operating life. These benefits are suitable for lighting control and allow for significantly improved energy savings and a better lit environment.

### Additional 50% energy saving

The government recognises the benefit of lighting control and is starting to introduce regulations that focus on improving the energy efficiency of a complete building. The introduction of Building Regulations Part L (2013) is an example of this change and introduces the concept of a Lighting Energy Numeric Indicator (LENI) that calculates the energy usage of a building per metre<sup>2</sup>.

## What are the types of lighting control?

Good lighting control systems should adjust the lighting to compensate for changes in daylight levels and the usage of the area. The main types of control are:

### 1. ABSENCE DETECTION

Manual on, auto off. Typically this type of control assists with cost savings by ensuring lighting is only used for a certain period of time before turning itself off automatically. The light can then be turned back on manually when required.

### 2. PRESENCE DETECTION

Auto on, auto off. With presence detection installed, the lighting will automatically turn on when the sensor detects movement, depending on chosen settings the lighting will automatically turn off/dim to a lower light level when no movement is detected after the set period of time.

### 3. DAYLIGHT COMPENSATION

Manual on, auto off. One of the more environmentally friendly and efficient ways of controlling lighting is using natural daylight. Lighting controls can be designed to assess how much daylight fills the room and adjusts the light output from the fitting to maintain a certain lux level throughout the day and night.

### 1. ABSENCE DETECTION

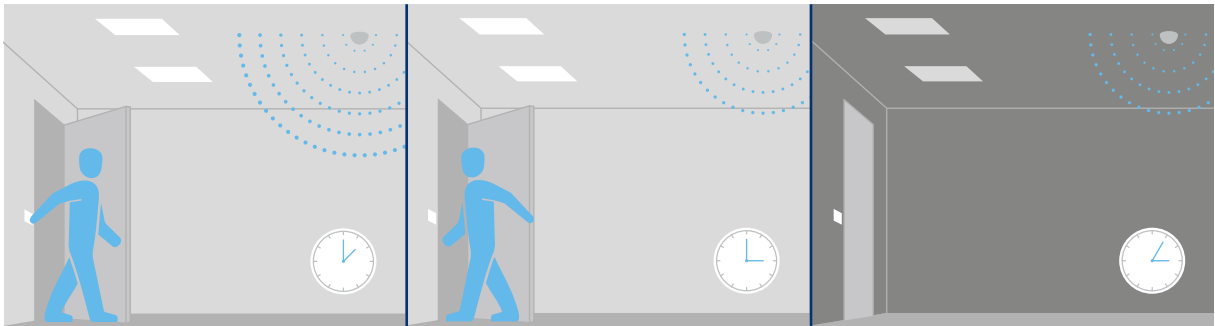

Lighting is switched on using a time switch or detection from an occupancy sensor.

Lighting stays on using a timer.

Lighting is automatically switched off after a specified period of time.

### 2. PRESENCE DETECTION

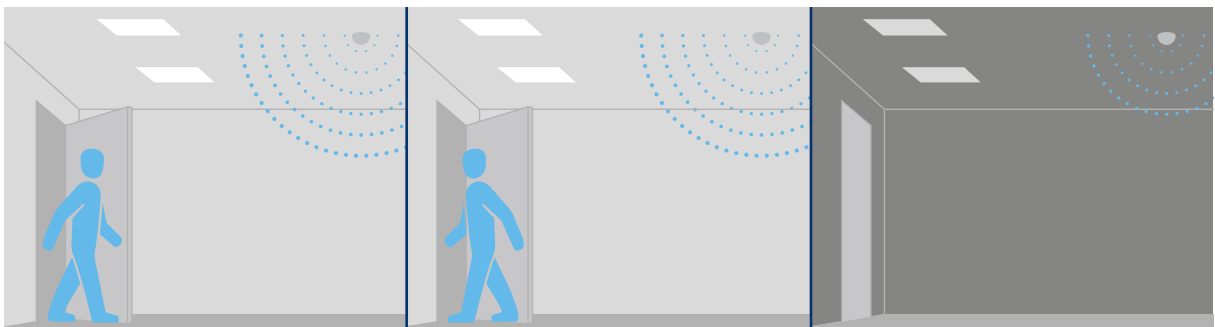

The lighting is switched on after detection by an occupancy sensor.

Sensor detects any further activity.

Lighting is switched off when the sensor doesn't detect any further activity.



## Detectors

Detectors provide the lighting control system with information on its environment; has the light level changed or are there people in the area? Multi-sensor technologies can be combined into a single detector or operate separately. The primary sensor types are:

### PIR

Identifies people by looking for changes in the heat pattern, heat is always generated by people.

### MICROWAVE

A transmitter sends out microwaves that bounce off people and are received back at the sensor. These detectors can be more robust than a PIR but travel through walls and can cause unplanned detection.

### ULTRASONIC

Operate on the Doppler principle by emitting ultrasonic high-frequency sound waves into the room and then monitoring the variations of that signal as they return to a microphone within the sensor.

### PHOTOCELL

The power to the LED fitting can be changed but only in fixed incremental amounts. This is useful when limited illumination is required for safety or security.



## Transmission options

Detectors provide the lighting control system with information on its environment; has the light level changed or are there people in the area? Multi-sensor technologies can be combined into a single detector or operate separately. The primary sensor types are:

### MAINS POWER

Simple to install as it only requires a mains supply cable and is used for applications that use limited power such as domestic lighting. Phase dimming uses this form of transmission.

### SEPARATE CONTROL WIRE

Used to control most commercial applications where the power usage is greater. Allows the transmission of 1-10 Volt, DALI, and DSI directly to the light fittings.

### WIRELESS TRANSMISSION

Used to transmit a digital signal and doesn't require a separate control wire, however wireless links can suffer interference and are limited in range particularly where walls and metal objects exist. ZigBee is an example standard that allows meshing to increase range and reliability.

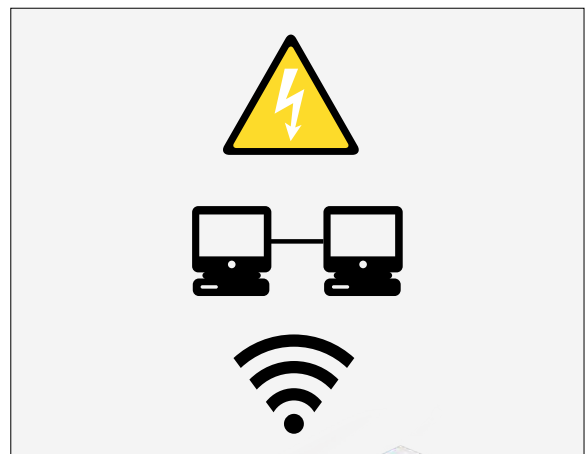

## Lighting education

# Communication protocols

### PHASE DIMMING

Uses the mains alternating current (AC) to reduce power to the light fitting by cutting out sections of the AC supply. Phase dimming was designed for traditional lighting technology and is common in lower power domestic lighting but is unsuitable for commercial applications.

The supply can be cut from:

- The front of the AC wave (leading edge dimming) and/or
- The back edge (trailing edge dimming)

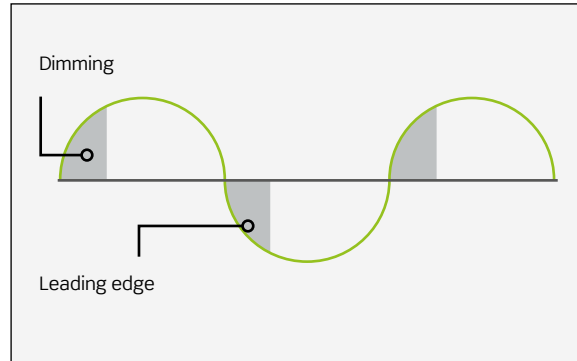

### 1-10V VOLT ANALOGUE

Uses a separate control wire to notify the driver that the power to the LEDs should be changed. The separate control signal is a direct current (DC) and can be adjusted from 1 up to 10 volts, the voltage level is interpreted by the driver to set the LED power.

This method of control is a low current system (typically 1mA) meaning it can be run along relatively thin cables with little voltage drop and depending on dimmer manufacturer recommendations, allows for up to 50 LED dimmable drivers on one wall mounted dimmer.

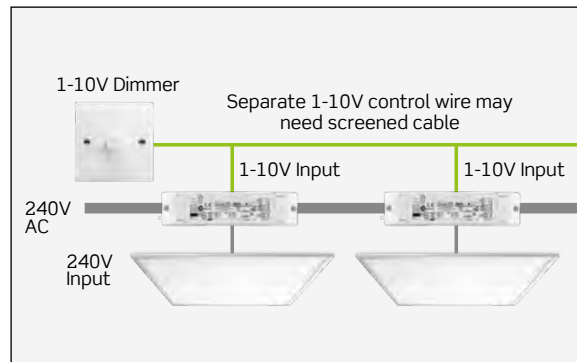

### DALI (DIGITAL ADDRESSABLE LIGHTING INTERFACE)

This is a digital communications protocol that was developed for the lighting industry. A separate control wire or BUS is used to send digital information to light fittings and allows the individual light fittings and sensors to communicate with an advanced lighting control system.

Although DALI is a standard protocol beware of mixing components between manufacturers without first testing. Along with the correct LED driver the DALI system requires additional control equipment including DALI BUS controllers, power supplies, sensors and user interfaces.

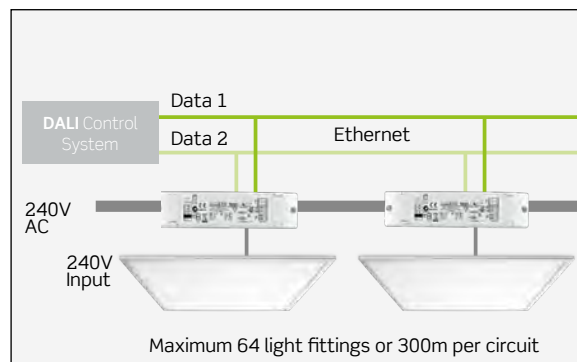







# Index

BC020001 - JC080012	416-417
JC080013 - JC14225	418-419
JC14300 - JC45220/45	420-421
JC45220/613 - JC71312	422-423
JC71351 - JC71702SD	424-425
JC71703 - JC71933/30X60MWEM	426-427
JC71933/30X60MWEM - JC83217	428-429
JC83218 - SPR0579	430-431

## Codes BC020001 - JC040036

Code	Section	Page	Code	Section	Page
BC020001	LED Strip	243	JC040007	Controls & Sensors	394
BC020003	LED Strip	243	JC040008	Highbay & Lowbay	155
BC020004	LED Strip	243	JC040008	Controls & Sensors	394
BC020005	LED Strip	243	JC040009	Highbay & Lowbay	156
BC020006	LED Strip	243	JC040010	Highbay & Lowbay	156
BC020007	LED Strip	243	JC040011	Highbay & Lowbay	157
BC020008	LED Strip	243	JC040011	Controls & Sensors	394
JC020019	LED Strip	244	JC040012	Highbay & Lowbay	157
JC020020	LED Strip	244	JC040012	Controls & Sensors	394
JC020027	LED Strip	244	JC040013	Highbay & Lowbay	156
JC020028	LED Strip	244	JC040014	Highbay & Lowbay	156
JC030001	Commercial Linear LED	100	JC040015	Highbay & Lowbay	157
JC030002	Commercial Linear LED	100	JC040015	Controls & Sensors	394
JC030003	Commercial Linear LED	100	JC040016	Highbay & Lowbay	157
JC030004	Commercial Linear LED	100	JC040016	Controls & Sensors	394
JC030005	Commercial Linear LED	101	JC040017	Highbay & Lowbay	158
JC030006	Commercial Linear LED	101	JC040018	Highbay & Lowbay	158
JC030007	Commercial Linear LED	101	JC040019	Highbay & Lowbay	159
JC030008	Commercial Linear LED	101	JC040019	Controls & Sensors	394
JC030009	Commercial Linear LED	101	JC040020	Highbay & Lowbay	159
JC030010	Commercial Linear LED	101	JC040020	Controls & Sensors	394
JC030011	Commercial Linear LED	100	JC040021	Highbay & Lowbay	158
JC030012	Commercial Linear LED	100	JC040022	Highbay & Lowbay	158
JC030013	Commercial Linear LED	100	JC040023	Highbay & Lowbay	159
JC030014	Commercial Linear LED	100	JC040023	Controls & Sensors	394
JC030015	Commercial Linear LED	101	JC040024	Highbay & Lowbay	159
JC030016	Commercial Linear LED	101	JC040024	Controls & Sensors	394
JC030017	Commercial Linear LED	101	JC040025	Highbay & Lowbay	154
JC030018	Commercial Linear LED	101	JC040026	Highbay & Lowbay	154
JC030019	Commercial Linear LED	101	JC040027	Highbay & Lowbay	155
JC030020	Commercial Linear LED	101	JC040027	Controls & Sensors	394
JC030027	Commercial Linear LED	101	JC040028	Highbay & Lowbay	155
JC030028	Commercial Linear LED	101	JC040028	Controls & Sensors	394
JC030029	Commercial Linear LED	101	JC040029	Highbay & Lowbay	156
JC030030	Commercial Linear LED	101	JC040030	Highbay & Lowbay	156
JC040001	Highbay & Lowbay	154	JC040031	Highbay & Lowbay	157
JC040002	Highbay & Lowbay	154	JC040031	Controls & Sensors	394
JC040003	Highbay & Lowbay	155	JC040032	Highbay & Lowbay	157
JC040003	Controls & Sensors	394	JC040032	Controls & Sensors	394
JC040004	Highbay & Lowbay	155	JC040033	Highbay & Lowbay	158
JC040004	Controls & Sensors	394	JC040034	Highbay & Lowbay	158
JC040005	Highbay & Lowbay	154	JC040035	Highbay & Lowbay	159
JC040006	Highbay & Lowbay	154	JC040035	Controls & Sensors	394
JC040007	Highbay & Lowbay	155	JC040036	Highbay & Lowbay	159

## Codes JC040036 - JC080012

Code	Section	Page	Code	Section	Page
JC040036	Controls & Sensors	394	JC070016	Bulkheads	264
JC040037	Highbay & Lowbay	156	JC070017	Bulkheads	264
JC040038	Highbay & Lowbay	156	JC070018	Bulkheads	264
JC040039	Highbay & Lowbay	157	JC070019	Bulkheads	261
JC040039	Controls & Sensors	394	JC070020	Bulkheads	261
JC040040	Highbay & Lowbay	157	JC070021	Bulkheads	261
JC040040	Controls & Sensors	394	JC070022	Bulkheads	261
JC040049	Highbay & Lowbay	154	JC070023	Bulkheads	261
JC040049	Highbay & Lowbay	155	JC070024	Bulkheads	261
JC040049	Highbay & Lowbay	156	JC070025	Bulkheads	263
JC040049	Highbay & Lowbay	157	JC070026	Bulkheads	263
JC040050	Highbay & Lowbay	158	JC070027	Bulkheads	263
JC040050	Highbay & Lowbay	159	JC070028	Bulkheads	263
JC040051	Highbay & Lowbay	156	JC070029	Bulkheads	263
JC040052	Highbay & Lowbay	156	JC070030	Bulkheads	263
JC040053	Highbay & Lowbay	157	JC070031	Bulkheads	265
JC040053	Controls & Sensors	394	JC070032	Bulkheads	265
JC040054	Highbay & Lowbay	157	JC070033	Bulkheads	265
JC040054	Controls & Sensors	394	JC070034	Bulkheads	265
JC040055	Highbay & Lowbay	156	JC070035	Bulkheads	265
JC040056	Highbay & Lowbay	156	JC070036	Bulkheads	265
JC040057	Highbay & Lowbay	157	JC070051	Bulkheads	260
JC040057	Controls & Sensors	394	JC070052	Bulkheads	260
JC040058	Highbay & Lowbay	157	JC070053	Bulkheads	262
JC040058	Controls & Sensors	394	JC070055	Bulkheads	264
JC050001	Floodlights	328	JC070056	Bulkheads	264
JC050002	Floodlights	329	JC070057	Bulkheads	261
JC050003	Floodlights	330	JC070058	Bulkheads	261
JC050004	Floodlights	331	JC070059	Bulkheads	263
JC070001	Bulkheads	260	JC070060	Bulkheads	263
JC070002	Bulkheads	260	JC070061	Bulkheads	265
JC070003	Bulkheads	260	JC070062	Bulkheads	265
JC070004	Bulkheads	260	JC080001	LED Panels	68
JC070005	Bulkheads	260	JC080002	LED Panels	68
JC070006	Bulkheads	260	JC080003	LED Panels	68
JC070007	Bulkheads	262	JC080004	LED Panels	68
JC070008	Bulkheads	262	JC080005	LED Panels	68
JC070009	Bulkheads	262	JC080006	LED Panels	68
JC070010	Bulkheads	262	JC080007	LED Panels	68
JC070011	Bulkheads	262	JC080008	LED Panels	68
JC070012	Bulkheads	262	JC080009	LED Panels	68
JC070013	Bulkheads	264	JC080010	LED Panels	68
JC070014	Bulkheads	264	JC080011	LED Panels	68
JC070015	Bulkheads	264	JC080012	LED Panels	68

## Codes JC080013 - JC121310

Code	Section	Page	Code	Section	Page
JC080013	LED Panels	70	JC121267	LED Strip	242
JC080014	LED Panels	70	JC121268	LED Strip	232
JC080015	LED Panels	70	JC121269	LED Strip	232
JC080016	LED Panels	70	JC121270	LED Strip	232
JC080017	LED Panels	70	JC121271	LED Strip	232
JC080018	LED Panels	70	JC121272	LED Strip	232
JC080019	LED Panels	70	JC121273	LED Strip	232
JC080020	LED Panels	70	JC121274	LED Strip	232
JC080021	LED Panels	71	JC121275	LED Strip	232
JC080022	LED Panels	71	JC121276	LED Strip	232
JC080023	LED Panels	71	JC121277	LED Strip	232
JC080024	LED Panels	71	JC121278	LED Strip	232
JC080025	LED Panels	71	JC121279	LED Strip	238
JC080026	LED Panels	71	JC121280	LED Strip	238
JC080027	LED Panels	71	JC121281	LED Strip	238
JC080028	LED Panels	71	JC121282	LED Strip	238
JC080029	LED Panels	78	JC121283	LED Strip	233
JC080030	LED Panels	78	JC121284	LED Strip	233
JC080031	LED Panels	78	JC121285	LED Strip	233
JC080032	LED Panels	78	JC121286	LED Strip	233
JC080033	LED Panels	78	JC121287	LED Strip	233
JC080034	LED Panels	78	JC121288	LED Strip	233
JC080035	LED Panels	78	JC121289	LED Strip	233
JC080036	LED Panels	78	JC121290	LED Strip	233
JC080045	LED Panels	78	JC121291	LED Strip	233
JC080045	LED Panels	87	JC121292	LED Strip	233
JC1001/3B	Fire-rated Downlights	18	JC121293	LED Strip	233
JC1001/BN	Fire-rated Downlights	18	JC121294	LED Strip	233
JC1001/BNEM	Fire-rated Downlights	18	JC121295	LED Strip	239
JC1001/CH	Fire-rated Downlights	18	JC121296	LED Strip	239
JC1001/CHEM	Fire-rated Downlights	18	JC121297	LED Strip	239
JC1001/NB	Fire-rated Downlights	18	JC121298	LED Strip	239
JC1001/NBDALI	Fire-rated Downlights	18	JC121299	LED Strip	234
JC1001/WH	Fire-rated Downlights	18	JC121300	LED Strip	234
JC1001/WHEM	Fire-rated Downlights	18	JC121301	LED Strip	234
JC1002/BN	Fire-rated Downlights	19	JC121302	LED Strip	234
JC1002/CH	Fire-rated Downlights	19	JC121303	LED Strip	234
JC1002/WH	Fire-rated Downlights	19	JC121304	LED Strip	234
JC1003	Fire-rated Downlights	20	JC121305	LED Strip	234
JC1004	Fire-rated Downlights	20	JC121306	LED Strip	234
JC1005	Fire-rated Downlights	21	JC121307	LED Strip	234
JC1006	Fire-rated Downlights	18	JC121308	LED Strip	234
JC121265	LED Strip	242	JC121309	LED Strip	234
JC121266	LED Strip	242	JC121310	LED Strip	234

## Codes JC121311 - JC14225

Code	Section	Page	Code	Section	Page
JC121311	LED Strip	240	JC121357	LED Strip	244
JC121312	LED Strip	240	JC121358	LED Strip	232
JC121313	LED Strip	240	JC14001	Spotlights & Track Systems	222
JC121314	LED Strip	240	JC14002	Spotlights & Track Systems	222
JC121315	LED Strip	235	JC14003	Spotlights & Track Systems	222
JC121316	LED Strip	235	JC14004	Spotlights & Track Systems	223
JC121317	LED Strip	235	JC14005	Spotlights & Track Systems	223
JC121318	LED Strip	235	JC14006	Spotlights & Track Systems	223
JC121319	LED Strip	235	JC14007	Spotlights & Track Systems	223
JC121320	LED Strip	235	JC14008	Spotlights & Track Systems	223
JC121321	LED Strip	235	JC14009	Spotlights & Track Systems	223
JC121322	LED Strip	235	JC14010	Spotlights & Track Systems	223
JC121323	LED Strip	235	JC14011	Spotlights & Track Systems	223
JC121324	LED Strip	235	JC14012	Spotlights & Track Systems	223
JC121325	LED Strip	235	JC14013	Spotlights & Track Systems	223
JC121326	LED Strip	235	JC14032	Spotlights & Track Systems	221
JC121327	LED Strip	241	JC14044	Spotlights & Track Systems	220
JC121328	LED Strip	241	JC14048	Spotlights & Track Systems	219
JC121329	LED Strip	241	JC14070	Spotlights & Track Systems	223
JC121330	LED Strip	241	JC14093	Spotlights & Track Systems	223
JC121331	LED Strip	243	JC14094	Spotlights & Track Systems	223
JC121332	LED Strip	245	JC14102WH	Spotlights & Track Systems	216
JC121333	LED Strip	245	JC14104WH	Spotlights & Track Systems	216
JC121334	LED Strip	245	JC14108	Spotlights & Track Systems	217
JC121335	LED Strip	245	JC14109	Spotlights & Track Systems	217
JC121336	LED Strip	245	JC14112WH	Spotlights & Track Systems	218
JC121337	LED Strip	245	JC14154	Spotlights & Track Systems	210
JC121338	LED Strip	245	JC14155	Spotlights & Track Systems	210
JC121339	LED Strip	245	JC14156	Spotlights & Track Systems	211
JC121340	LED Strip	245	JC14157	Spotlights & Track Systems	211
JC121341	LED Strip	245	JC14158WH	Spotlights & Track Systems	214
JC121342	LED Strip	245	JC14159WH	Spotlights & Track Systems	214
JC121343	LED Strip	245	JC14160	Spotlights & Track Systems	215
JC121344	LED Strip	245	JC14161	Spotlights & Track Systems	215
JC121345	LED Strip	245	JC14162	Spotlights & Track Systems	215
JC121346	LED Strip	245	JC14163	Spotlights & Track Systems	215
JC121347	LED Strip	245	JC14200	Spotlights & Track Systems	212
JC121348	LED Strip	244	JC14201	Spotlights & Track Systems	212
JC121349	LED Strip	244	JC14204	Spotlights & Track Systems	212
JC121350	LED Strip	244	JC14205	Spotlights & Track Systems	212
JC121352	LED Strip	244	JC14222	Spotlights & Track Systems	208
JC121353	LED Strip	244	JC14223	Spotlights & Track Systems	208
JC121354	LED Strip	244	JC14224	Spotlights & Track Systems	209
JC121356	LED Strip	244	JC14225	Spotlights & Track Systems	209

## Codes JC14300 - JC23412EMWPR

Code	Section	Page	Code	Section	Page
JC14300	Spotlights & Track Systems	213	JC17041	Bollards	351
JC14301	Spotlights & Track Systems	213	JC17042	Exterior LED Wall & Post Lights	305
JC14302	Spotlights & Track Systems	213	JC17043	Exterior LED Wall & Post Lights	304
JC14303	Spotlights & Track Systems	213	JC17044	Recessed Ground & Spike Lights	374
JC14304	Spotlights & Track Systems	213	JC17045	Recessed Ground & Spike Lights	375
JC14305	Spotlights & Track Systems	213	JC17046	Exterior LED Wall & Post Lights	302
JC17001	Exterior LED Wall & Post Lights	293	JC17047	Bollards	342
JC17002	Exterior LED Wall & Post Lights	290	JC17048	Bollards	342
JC17003	Exterior LED Wall & Post Lights	288	JC23330AB	Bulkheads	266
JC17004	Exterior LED Wall & Post Lights	290	JC23330BLK	Bulkheads	266
JC17005	Exterior LED Wall & Post Lights	288	JC23330BLN	Bulkheads	266
JC17006	Exterior LED Wall & Post Lights	289	JC23330CH	Bulkheads	266
JC17007	Lanterns	388	JC23330EYE	Bulkheads	266
JC17008	Lanterns	385	JC23330SAS	Bulkheads	266
JC17010	Exterior LED Wall & Post Lights	296	JC23330SCH	Bulkheads	266
JC17011	Exterior LED Wall & Post Lights	294	JC23340AB	Bulkheads	266
JC17012	Exterior LED Wall & Post Lights	295	JC23340BLK	Bulkheads	266
JC17014	Exterior LED Wall & Post Lights	298	JC23340BLN	Bulkheads	266
JC17015	Exterior LED Wall & Post Lights	292	JC23340CH	Bulkheads	266
JC17016	Exterior LED Wall & Post Lights	292	JC23340EYE	Bulkheads	266
JC17017	Exterior LED Wall & Post Lights	299	JC23340SAS	Bulkheads	266
JC17018	Bollards	352	JC23340SCH	Bulkheads	266
JC17019	Exterior LED Wall & Post Lights	303	JC23401DIMWOP	Bulkheads	268
JC17020	Bollards	345	JC23401DIMWPR	Bulkheads	269
JC17021	Bollards	345	JC23401EMDIMWOP	Bulkheads	268
JC17022	Bollards	344	JC23401EMDIMWPR	Bulkheads	269
JC17023	Exterior LED Wall & Post Lights	306	JC23401EMWOP	Bulkheads	268
JC17024	Exterior LED Wall & Post Lights	307	JC23401EMWPR	Bulkheads	269
JC17025	Recessed Ground & Spike Lights	370	JC23401WOP	Bulkheads	268
JC17026	Recessed Ground & Spike Lights	366	JC23401WPR	Bulkheads	269
JC17027	Recessed Ground & Spike Lights	367	JC23402DIMWOP	Bulkheads	270
JC17028	Recessed Ground & Spike Lights	368	JC23402DIMWPR	Bulkheads	271
JC17029	Recessed Ground & Spike Lights	362	JC23402EMDIMWOP	Bulkheads	270
JC17030	Recessed Ground & Spike Lights	371	JC23402EMDIMWPR	Bulkheads	271
JC17031	Bollards	348	JC23402EMWOP	Bulkheads	270
JC17032	Bollards	343	JC23402EMWPR	Bulkheads	271
JC17033	Bollards	343	JC23402WOP	Bulkheads	270
JC17034	Recessed Ground & Spike Lights	363	JC23402WPR	Bulkheads	271
JC17035	Exterior LED Wall & Post Lights	297	JC23411EMWOP	Bulkheads	268
JC17036	Lanterns	389	JC23411EMWPR	Bulkheads	269
JC17037	Lanterns	389	JC23411WOP	Bulkheads	268
JC17038	Lanterns	390	JC23411WPR	Bulkheads	269
JC17039	Lanterns	391	JC23412EMWOP	Bulkheads	270
JC17040	Bollards	349	JC23412EMWPR	Bulkheads	271

## Codes JC23412WOP - JC45220/45

Code	Section	Page	Code	Section	Page
JC23412WOP	Bulkheads	270	JC39224	Bollards	356
JC23412WPR	Bulkheads	271	JC39224	Bollards	357
JC234201	Bulkheads	272	JC39224	Bollards	358
JC234201DIM	Bulkheads	272	JC39224	Bollards	359
JC234201EM	Bulkheads	272	JC39404	Bollards	354
JC234201EM/MW	Bulkheads	272	JC39405	Bollards	355
JC234201EMDIM	Bulkheads	272	JC39406	Exterior LED Wall & Post Lights	311
JC234201MW	Bulkheads	272	JC39407	Exterior LED Wall & Post Lights	312
JC234202	Bulkheads	273	JC39408	Exterior LED Wall & Post Lights	313
JC234202DIM	Bulkheads	273	JC39409	Exterior LED Wall & Post Lights	308
JC234202EM	Bulkheads	273	JC39412	Bollards	354
JC234202EM/MW	Bulkheads	273	JC39413	Bollards	355
JC234202EMDIM	Bulkheads	273	JC39414	Recessed Ground & Spike Lights	365
JC234202MW	Bulkheads	273	JC39415	Recessed Ground & Spike Lights	364
JC234203	Bulkheads	274	JC39416	Exterior LED Wall & Post Lights	309
JC234203DIM	Bulkheads	274	JC39418	Bulkheads	282
JC234203EM	Bulkheads	274	JC39422BLK	Bollards	357
JC234203EM/MW	Bulkheads	274	JC39422SS	Bollards	359
JC234203EMDIM	Bulkheads	274	JC39423BLK	Bollards	357
JC234203MW	Bulkheads	274	JC39423SS	Bollards	359
JC23421WOP	Bulkheads	268	JC39424BLK	Bollards	357
JC23421WPR	Bulkheads	269	JC39425BLK	Bollards	356
JC23422EMWOP	Bulkheads	270	JC39425SS	Bollards	358
JC23422EMWPR	Bulkheads	271	JC39426BLK	Bollards	356
JC23422WOP	Bulkheads	270	JC39426SS	Bollards	358
JC23422WPR	Bulkheads	271	JC39427BLK	Bollards	356
JC23431EMWOP	Bulkheads	268	JC39428	Exterior LED Wall & Post Lights	315
JC23431EMWPR	Bulkheads	269	JC39429	Exterior LED Wall & Post Lights	314
JC23431WOP	Bulkheads	268	JC39431	Lanterns	383
JC23431WPR	Bulkheads	269	JC39432	Lanterns	383
JC23432EMWOP	Bulkheads	270	JC39433	Lanterns	382
JC23432EMWPR	Bulkheads	271	JC39434	Lanterns	384
JC23432WOP	Bulkheads	270	JC40007CL	Bulkheads	283
JC23432WPR	Bulkheads	271	JC40007RD	Bulkheads	283
JC24240	Bulkheads	275	JC45200	Floodlights	318
JC24241	Bulkheads	276	JC45201	Floodlights	319
JC24241EM	Bulkheads	276	JC45202	Floodlights	320
JC24242	Bulkheads	277	JC45203	Floodlights	321
JC24242EM	Bulkheads	277	JC45204	Floodlights	322
JC32010	Lanterns	380	JC45205	Floodlights	323
JC32011	Lanterns	380	JC45206	Floodlights	324
JC32012	Lanterns	380	JC45207	Floodlights	325
JC32015	Lanterns	381	JC45220/30	Floodlights	334
JC32017	Lanterns	381	JC45220/45	Floodlights	334

## Codes JC45220/613 - JC5421EM

Code	Section	Page	Code	Section	Page
JC45220/613	Floodlights	334	JC50303	Emergency	179
JC45220/70	Floodlights	334	JC50304	Emergency	179
JC45220/711	Floodlights	334	JC50305	Emergency	182
JC45221/30	Floodlights	334	JC50306	Emergency	184
JC45221/45	Floodlights	334	JC50307	Emergency	185
JC45221/613	Floodlights	334	JC50308	Emergency	180
JC45221/70	Floodlights	334	JC50308	Emergency	181
JC45221/711	Floodlights	334	JC50310	Emergency	180
JC45222/30	Floodlights	336	JC50310	Emergency	181
JC45222/45	Floodlights	336	JC50311	Emergency	180
JC45222/613	Floodlights	336	JC50311	Emergency	181
JC45222/70	Floodlights	336	JC50313	Emergency	178
JC45222/711	Floodlights	336	JC50314	Emergency	179
JC45223/30	Floodlights	337	JC50321	Emergency	178
JC45223/45	Floodlights	337	JC50322	Emergency	179
JC45223/613	Floodlights	337	JC50323	Emergency	180
JC45223/70	Floodlights	337	JC50324	Emergency	181
JC45223/711	Floodlights	337	JC50325	Emergency	181
JC45224/30	Floodlights	338	JC50326	Emergency	180
JC45224/45	Floodlights	338	JC50327	Emergency	183
JC45224/613	Floodlights	338	JC50328	Emergency	182
JC45224/70	Floodlights	338	JC50329	Emergency	179
JC45224/711	Floodlights	338	JC5052 N	Downlights	47
JC45225/30	Floodlights	339	JC5054	Downlights	47
JC45225/45	Floodlights	339	JC5060	Downlights	47
JC45225/613	Floodlights	339	JC5110	Downlights	47
JC45225/70	Floodlights	339	JC5118	Downlights	47
JC45225/711	Floodlights	339	JC5368	Downlights	47
JC47440WH	Spotlights & Track Systems	201	JC5410	Downlights	44
JC47441	Spotlights & Track Systems	202	JC5410	Downlights	45
JC47442	Spotlights & Track Systems	203	JC5410	Downlights	46
JC47443	Spotlights & Track Systems	204	JC5420	Downlights	45
JC47444	Spotlights & Track Systems	204	JC5420/1-10V	Downlights	45
JC47445	Spotlights & Track Systems	204	JC5420DALI	Downlights	45
JC47446	Spotlights & Track Systems	204	JC5420DSI	Downlights	45
JC47447	Spotlights & Track Systems	204	JC5420EM	Downlights	45
JC47448	Spotlights & Track Systems	204	JC5420EM/1-10V	Downlights	45
JC47449	Spotlights & Track Systems	205	JC5420EMDALI	Downlights	45
JC47450	Spotlights & Track Systems	205	JC5420EMDSI	Downlights	45
JC47451	Spotlights & Track Systems	205	JC5421	Downlights	44
JC47452	Spotlights & Track Systems	205	JC5421/1-10V	Downlights	44
JC47453	Spotlights & Track Systems	205	JC5421DALI	Downlights	44
JC47454	Spotlights & Track Systems	205	JC5421DSI	Downlights	44
JC50302	Emergency	180	JC5421EM	Downlights	44



## Codes JC5421EM/1-10V - JC71312

Code	Section	Page	Code	Section	Page
JC5421EM/1-10V	Downlights	44	JC71262	LED Panels	72
JC5421EMDALI	Downlights	44	JC71262	LED Panels	73
JC5421EMDSI	Downlights	44	JC71262	LED Panels	78
JC5422	Downlights	46	JC71262	LED Panels	80
JC5422/1-10V	Downlights	46	JC71262	LED Panels	81
JC5422DALI	Downlights	46	JC71262	LED Panels	82
JC5422DSI	Downlights	46	JC71262	LED Panels	84
JC5422EM	Downlights	46	JC71262	LED Panels	86
JC5422EM/1-10V	Downlights	46	JC71276	LED Panels	72
JC5422EMDALI	Downlights	46	JC71276/1-10V	LED Panels	72
JC5422EMDSI	Downlights	46	JC71276DALI	LED Panels	72
JC54300	Downlights	48	JC71276DH	LED Panels	81
JC54300DIM	Downlights	48	JC71276DSI	LED Panels	72
JC54301	Downlights	48	JC71276PD	LED Panels	80
JC54301DIM	Downlights	48	JC71277	LED Panels	73
JC54302	Downlights	48	JC71277/1-10V	LED Panels	73
JC54302DIM	Downlights	48	JC71277DALI	LED Panels	73
JC54303	Downlights	49	JC71277DSI	LED Panels	73
JC54303DIM	Downlights	49	JC71295	LED Panels	71
JC54304	Downlights	49	JC71295	LED Panels	75
JC54304DIM	Downlights	49	JC71295	LED Panels	86
JC54305	Downlights	49	JC71299	LED Panels	70
JC54305DIM	Downlights	49	JC71299	LED Panels	74
JC66011	Spotlights & Track Systems	198	JC71299	LED Panels	86
JC66012	Spotlights & Track Systems	198	JC71311	LED Panels	68
JC66013	Spotlights & Track Systems	198	JC71311	LED Panels	70
JC66014	Spotlights & Track Systems	198	JC71311	LED Panels	72
JC66015	Spotlights & Track Systems	198	JC71311	LED Panels	73
JC66016	Spotlights & Track Systems	198	JC71311	LED Panels	74
JC66021	Spotlights & Track Systems	199	JC71311	LED Panels	80
JC66022	Spotlights & Track Systems	199	JC71311	LED Panels	81
JC66023	Spotlights & Track Systems	199	JC71311	LED Panels	82
JC66024	Spotlights & Track Systems	199	JC71311	LED Panels	87
JC66025	Spotlights & Track Systems	199	JC71311	Commercial Linear LED	92
JC66026	Spotlights & Track Systems	199	JC71311	Commercial Linear LED	93
JC66031	Spotlights & Track Systems	200	JC71311	Commercial Linear LED	94
JC66032	Spotlights & Track Systems	200	JC71311	Commercial Linear LED	95
JC66033	Spotlights & Track Systems	200	JC71311	Commercial Linear LED	96
JC66034	Spotlights & Track Systems	200	JC71311	Commercial Linear LED	97
JC66035	Spotlights & Track Systems	200	JC71311	Commercial Linear LED	98
JC66036	Spotlights & Track Systems	200	JC71311	Commercial Linear LED	99
JC71054	Recessed Ground & Spike Lights	377	JC71312	LED Panels	71
JC71115	Recessed Ground & Spike Lights	376	JC71312	LED Panels	75
JC71262	LED Panels	68	JC71312	LED Panels	87

## Codes JC71351 - JC71554MWEM/FR

Code	Section	Page	Code	Section	Page
JC71351	LED Panels	72	JC71506	Battens & Weatherproofs	146
JC71351/1-10V	LED Panels	72	JC71507	Battens & Weatherproofs	145
JC71351DALI	LED Panels	72	JC71507/1-10V	Battens & Weatherproofs	145
JC71351DSI	LED Panels	72	JC71507DALI	Battens & Weatherproofs	145
JC71353	LED Panels	73	JC71507DSI	Battens & Weatherproofs	145
JC71353/1-10V	LED Panels	73	JC71508	Battens & Weatherproofs	147
JC71353DALI	LED Panels	73	JC71509	Battens & Weatherproofs	144
JC71353DSI	LED Panels	73	JC71509SD	Battens & Weatherproofs	144
JC71355	LED Panels	72	JC71510	Battens & Weatherproofs	146
JC71355/1-10V	LED Panels	72	JC71511	Battens & Weatherproofs	145
JC71355DALI	LED Panels	72	JC71511SD	Battens & Weatherproofs	145
JC71355DH	LED Panels	81	JC71512	Battens & Weatherproofs	147
JC71355DSI	LED Panels	72	JC71525	Battens & Weatherproofs	144
JC71355PD	LED Panels	80	JC71525	Battens & Weatherproofs	146
JC71357	LED Panels	73	JC71526	Battens & Weatherproofs	145
JC71357/1-10V	LED Panels	73	JC71526	Battens & Weatherproofs	147
JC71357DALI	LED Panels	73	JC71553EM/FR	Battens & Weatherproofs	133
JC71357DSI	LED Panels	73	JC71553EM/FR/1-10V	Battens & Weatherproofs	133
JC71359	LED Panels	74	JC71553EM/FRDALI	Battens & Weatherproofs	133
JC71359/1-10V	LED Panels	74	JC71553EM/WOP	Battens & Weatherproofs	132
JC71359/DALI	LED Panels	74	JC71553EM/WOP/1-10V	Battens & Weatherproofs	132
JC71359/DSI	LED Panels	74	JC71553EM/WOPDALI	Battens & Weatherproofs	132
JC71361	LED Panels	75	JC71553FR	Battens & Weatherproofs	133
JC71361/1-10V	LED Panels	75	JC71553FR/1-10V	Battens & Weatherproofs	133
JC71361/DALI	LED Panels	75	JC71553FRDALI	Battens & Weatherproofs	133
JC71361/DSI	LED Panels	75	JC71553MW/FR	Battens & Weatherproofs	133
JC71376	LED Panels	84	JC71553MW/WOP	Battens & Weatherproofs	132
JC71376/1-10V	LED Panels	84	JC71553MWEM/FR	Battens & Weatherproofs	133
JC71376DALI	LED Panels	84	JC71553MWEM/WOP	Battens & Weatherproofs	132
JC71376DSI	LED Panels	84	JC71553WOP	Battens & Weatherproofs	132
JC71501	Battens & Weatherproofs	144	JC71553WOP/1-10V	Battens & Weatherproofs	132
JC71501/1-10V	Battens & Weatherproofs	144	JC71553WOPDALI	Battens & Weatherproofs	132
JC71501DALI	Battens & Weatherproofs	144	JC71554EM/FR	Battens & Weatherproofs	135
JC71501DSI	Battens & Weatherproofs	144	JC71554EM/FR/1-10V	Battens & Weatherproofs	135
JC71502	Battens & Weatherproofs	146	JC71554EM/FRDALI	Battens & Weatherproofs	135
JC71503	Battens & Weatherproofs	145	JC71554EM/WOP	Battens & Weatherproofs	134
JC71503/1-10V	Battens & Weatherproofs	145	JC71554EM/WOP/1-10V	Battens & Weatherproofs	134
JC71503DALI	Battens & Weatherproofs	145	JC71554EM/WOPDALI	Battens & Weatherproofs	134
JC71503DSI	Battens & Weatherproofs	145	JC71554FR	Battens & Weatherproofs	135
JC71504	Battens & Weatherproofs	147	JC71554FR/1-10V	Battens & Weatherproofs	135
JC71505	Battens & Weatherproofs	144	JC71554FRDALI	Battens & Weatherproofs	135
JC71505/1-10V	Battens & Weatherproofs	144	JC71554MW/FR	Battens & Weatherproofs	135
JC71505DALI	Battens & Weatherproofs	144	JC71554MW/WOP	Battens & Weatherproofs	134
JC71505DSI	Battens & Weatherproofs	144	JC71554MWEM/FR	Battens & Weatherproofs	135

## Codes JC71554MWEM/WOP - JC71702SD

Code	Section	Page	Code	Section	Page
JC71554MWEM/WOP	Battens & Weatherproofs	134	JC71557FRDALI	Battens & Weatherproofs	141
JC71554WOP	Battens & Weatherproofs	134	JC71557MW/FR	Battens & Weatherproofs	141
JC71554WOP/1-10V	Battens & Weatherproofs	134	JC71557MW/WOP	Battens & Weatherproofs	140
JC71554WOPDALI	Battens & Weatherproofs	134	JC71557MWEM/FR	Battens & Weatherproofs	141
JC71555EM/FR	Battens & Weatherproofs	137	JC71557MWEM/WOP	Battens & Weatherproofs	140
JC71555EM/FR/1-10V	Battens & Weatherproofs	137	JC71557WOP	Battens & Weatherproofs	140
JC71555EM/FRDALI	Battens & Weatherproofs	137	JC71557WOP/1-10V	Battens & Weatherproofs	140
JC71555EM/WOP	Battens & Weatherproofs	136	JC71557WOPDALI	Battens & Weatherproofs	140
JC71555EM/WOP/1-10V	Battens & Weatherproofs	136	JC71558EM/FR	Battens & Weatherproofs	143
JC71555EM/WOPDALI	Battens & Weatherproofs	136	JC71558EM/FR/1-10V	Battens & Weatherproofs	143
JC71555FR	Battens & Weatherproofs	137	JC71558EM/FRDALI	Battens & Weatherproofs	143
JC71555FR/1-10V	Battens & Weatherproofs	137	JC71558EM/WOP	Battens & Weatherproofs	142
JC71555FRDALI	Battens & Weatherproofs	137	JC71558EM/WOP/1-10V	Battens & Weatherproofs	142
JC71555MW/FR	Battens & Weatherproofs	137	JC71558EM/WOPDALI	Battens & Weatherproofs	142
JC71555MW/WOP	Battens & Weatherproofs	136	JC71558FR	Battens & Weatherproofs	143
JC71555MWEM/FR	Battens & Weatherproofs	137	JC71558FR/1-10V	Battens & Weatherproofs	143
JC71555MWEM/WOP	Battens & Weatherproofs	136	JC71558FRDALI	Battens & Weatherproofs	143
JC71555WOP	Battens & Weatherproofs	136	JC71558MW/FR	Battens & Weatherproofs	143
JC71555WOP/1-10V	Battens & Weatherproofs	136	JC71558MW/WOP	Battens & Weatherproofs	142
JC71555WOPDALI	Battens & Weatherproofs	136	JC71558MWEM/FR	Battens & Weatherproofs	143
JC71556EM/FR	Battens & Weatherproofs	139	JC71558MWEM/WOP	Battens & Weatherproofs	142
JC71556EM/FR/1-10V	Battens & Weatherproofs	139	JC71558WOP	Battens & Weatherproofs	142
JC71556EM/FRDALI	Battens & Weatherproofs	139	JC71558WOP/1-10V	Battens & Weatherproofs	142
JC71556EM/WOP	Battens & Weatherproofs	138	JC71558WOPDALI	Battens & Weatherproofs	142
JC71556EM/WOP/1-10V	Battens & Weatherproofs	138	JC71676	LED Panels	82
JC71556EM/WOPDALI	Battens & Weatherproofs	138	JC71676DALI	LED Panels	82
JC71556FR	Battens & Weatherproofs	139	JC71701	Battens & Weatherproofs	118
JC71556FR/1-10V	Battens & Weatherproofs	139	JC71701/1-10V	Battens & Weatherproofs	118
JC71556FRDALI	Battens & Weatherproofs	139	JC71701DALI	Battens & Weatherproofs	118
JC71556MW/FR	Battens & Weatherproofs	139	JC71701EM	Battens & Weatherproofs	118
JC71556MW/WOP	Battens & Weatherproofs	138	JC71701EM/1-10V	Battens & Weatherproofs	118
JC71556MWEM/FR	Battens & Weatherproofs	139	JC71701EMDALI	Battens & Weatherproofs	118
JC71556MWEM/WOP	Battens & Weatherproofs	138	JC71701MW	Battens & Weatherproofs	118
JC71556WOP	Battens & Weatherproofs	138	JC71701MWEM	Battens & Weatherproofs	118
JC71556WOP/1-10V	Battens & Weatherproofs	138	JC71702	Battens & Weatherproofs	122
JC71556WOPDALI	Battens & Weatherproofs	138	JC71702/1-10V	Battens & Weatherproofs	122
JC71557EM/FR	Battens & Weatherproofs	141	JC71702DALI	Battens & Weatherproofs	122
JC71557EM/FR/1-10V	Battens & Weatherproofs	141	JC71702EM	Battens & Weatherproofs	122
JC71557EM/FRDALI	Battens & Weatherproofs	141	JC71702EM/1-10V	Battens & Weatherproofs	122
JC71557EM/WOP	Battens & Weatherproofs	140	JC71702EMDALI	Battens & Weatherproofs	122
JC71557EM/WOP/1-10V	Battens & Weatherproofs	140	JC71702EMSD	Battens & Weatherproofs	122
JC71557EM/WOPDALI	Battens & Weatherproofs	140	JC71702MW	Battens & Weatherproofs	122
JC71557FR	Battens & Weatherproofs	141	JC71702MWEM	Battens & Weatherproofs	122
JC71557FR/1-10V	Battens & Weatherproofs	141	JC71702SD	Battens & Weatherproofs	122

## Codes JC71703 - JC71741EMDALI

Code	Section	Page	Code	Section	Page
JC71703	Battens & Weatherproofs	119	JC71707MWEM	Battens & Weatherproofs	121
JC71703/1-10V	Battens & Weatherproofs	119	JC71707SD	Battens & Weatherproofs	121
JC71703DALI	Battens & Weatherproofs	119	JC71708	Battens & Weatherproofs	125
JC71703EM	Battens & Weatherproofs	119	JC71708/1-10V	Battens & Weatherproofs	125
JC71703EM/1-10V	Battens & Weatherproofs	119	JC71708DALI	Battens & Weatherproofs	125
JC71703EMDALI	Battens & Weatherproofs	119	JC71708EM	Battens & Weatherproofs	125
JC71703MW	Battens & Weatherproofs	119	JC71708EM/1-10V	Battens & Weatherproofs	125
JC71703MWEM	Battens & Weatherproofs	119	JC71708EMDALI	Battens & Weatherproofs	125
JC71704	Battens & Weatherproofs	123	JC71708MW	Battens & Weatherproofs	125
JC71704/1-10V	Battens & Weatherproofs	123	JC71708MWEM	Battens & Weatherproofs	125
JC71704DALI	Battens & Weatherproofs	123	JC71709	Battens & Weatherproofs	126
JC71704EM	Battens & Weatherproofs	123	JC71709/1-10V	Battens & Weatherproofs	126
JC71704EM/1-10V	Battens & Weatherproofs	123	JC71709DALI	Battens & Weatherproofs	126
JC71704EMDALI	Battens & Weatherproofs	123	JC71709EM	Battens & Weatherproofs	126
JC71704EMSD	Battens & Weatherproofs	123	JC71709EM/1-10V	Battens & Weatherproofs	126
JC71704MW	Battens & Weatherproofs	123	JC71709EMDALI	Battens & Weatherproofs	126
JC71704MWEM	Battens & Weatherproofs	123	JC71709EMSD	Battens & Weatherproofs	126
JC71704SD	Battens & Weatherproofs	123	JC71709MW	Battens & Weatherproofs	126
JC71705	Battens & Weatherproofs	120	JC71709MWEM	Battens & Weatherproofs	126
JC71705/1-10V	Battens & Weatherproofs	120	JC71709SD	Battens & Weatherproofs	126
JC71705DALI	Battens & Weatherproofs	120	JC71710	Battens & Weatherproofs	127
JC71705EM	Battens & Weatherproofs	120	JC71710/1-10V	Battens & Weatherproofs	127
JC71705EM/1-10V	Battens & Weatherproofs	120	JC71710DALI	Battens & Weatherproofs	127
JC71705EMDALI	Battens & Weatherproofs	120	JC71710EM	Battens & Weatherproofs	127
JC71705EMSD	Battens & Weatherproofs	120	JC71710EM/1-10V	Battens & Weatherproofs	127
JC71705MW	Battens & Weatherproofs	120	JC71710EMDALI	Battens & Weatherproofs	127
JC71705MWEM	Battens & Weatherproofs	120	JC71710MW	Battens & Weatherproofs	127
JC71705SD	Battens & Weatherproofs	120	JC71710MWEM	Battens & Weatherproofs	127
JC71706	Battens & Weatherproofs	124	JC71730	Battens & Weatherproofs	118
JC71706/1-10V	Battens & Weatherproofs	124	JC71730	Battens & Weatherproofs	119
JC71706DALI	Battens & Weatherproofs	124	JC71730	Battens & Weatherproofs	120
JC71706EM	Battens & Weatherproofs	124	JC71730	Battens & Weatherproofs	121
JC71706EM/1-10V	Battens & Weatherproofs	124	JC71730	Battens & Weatherproofs	122
JC71706EMDALI	Battens & Weatherproofs	124	JC71730	Battens & Weatherproofs	123
JC71706MW	Battens & Weatherproofs	124	JC71730	Battens & Weatherproofs	124
JC71706MWEM	Battens & Weatherproofs	124	JC71730	Battens & Weatherproofs	125
JC71707	Battens & Weatherproofs	121	JC71730	Battens & Weatherproofs	126
JC71707/1-10V	Battens & Weatherproofs	121	JC71730	Battens & Weatherproofs	127
JC71707DALI	Battens & Weatherproofs	121	JC71741	Battens & Weatherproofs	112
JC71707EM	Battens & Weatherproofs	121	JC71741/1-10V	Battens & Weatherproofs	112
JC71707EM/1-10V	Battens & Weatherproofs	121	JC71741DALI	Battens & Weatherproofs	112
JC71707EMDALI	Battens & Weatherproofs	121	JC71741EM	Battens & Weatherproofs	112
JC71707EMSD	Battens & Weatherproofs	121	JC71741EM/1-10V	Battens & Weatherproofs	112
JC71707MW	Battens & Weatherproofs	121	JC71741EMDALI	Battens & Weatherproofs	112

## Codes JC71742 - JC71933/30X60MWEM

Code	Section	Page	Code	Section	Page
JC71742	Battens & Weatherproofs	113	JC71856	Highbay & Lowbay	163
JC71742/1-10V	Battens & Weatherproofs	113	JC71860	Interior Pendants	194
JC71742DALI	Battens & Weatherproofs	113	JC71861	Interior Pendants	194
JC71742EM	Battens & Weatherproofs	113	JC71931/30X60	Highbay & Lowbay	168
JC71742EM/1-10V	Battens & Weatherproofs	113	JC71931/30X60EM	Highbay & Lowbay	168
JC71742EMDALI	Battens & Weatherproofs	113	JC71931/30X60MW	Highbay & Lowbay	169
JC71743	Battens & Weatherproofs	114	JC71931/30X60MW	Controls & Sensors	395
JC71743/1-10V	Battens & Weatherproofs	114	JC71931/30X60MWEM	Highbay & Lowbay	169
JC71743DALI	Battens & Weatherproofs	114	JC71931/30X60MWEM	Controls & Sensors	395
JC71743EM	Battens & Weatherproofs	114	JC71931/50	Highbay & Lowbay	168
JC71743EM/1-10V	Battens & Weatherproofs	114	JC71931/50EM	Highbay & Lowbay	168
JC71743EMDALI	Battens & Weatherproofs	114	JC71931/50MW	Highbay & Lowbay	169
JC71744	Battens & Weatherproofs	115	JC71931/50MW	Controls & Sensors	395
JC71744/1-10V	Battens & Weatherproofs	115	JC71931/50MWEM	Highbay & Lowbay	169
JC71744DALI	Battens & Weatherproofs	115	JC71931/50MWEM	Controls & Sensors	395
JC71744EM	Battens & Weatherproofs	115	JC71931/80	Highbay & Lowbay	168
JC71744EM/1-10V	Battens & Weatherproofs	115	JC71931/80EM	Highbay & Lowbay	168
JC71744EMDALI	Battens & Weatherproofs	115	JC71931/80MW	Highbay & Lowbay	169
JC71745	Battens & Weatherproofs	116	JC71931/80MW	Controls & Sensors	395
JC71745/1-10V	Battens & Weatherproofs	116	JC71931/80MWEM	Highbay & Lowbay	169
JC71745DALI	Battens & Weatherproofs	116	JC71931/80MWEM	Controls & Sensors	395
JC71745EM	Battens & Weatherproofs	116	JC71932/30X60	Highbay & Lowbay	170
JC71745EM/1-10V	Battens & Weatherproofs	116	JC71932/30X60EM	Highbay & Lowbay	170
JC71745EMDALI	Battens & Weatherproofs	116	JC71932/30X60MW	Highbay & Lowbay	171
JC71746	Battens & Weatherproofs	117	JC71932/30X60MW	Controls & Sensors	395
JC71746/1-10V	Battens & Weatherproofs	117	JC71932/30X60MWEM	Highbay & Lowbay	171
JC71746DALI	Battens & Weatherproofs	117	JC71932/30X60MWEM	Controls & Sensors	395
JC71746EM	Battens & Weatherproofs	117	JC71932/50	Highbay & Lowbay	170
JC71746EM/1-10V	Battens & Weatherproofs	117	JC71932/50EM	Highbay & Lowbay	170
JC71746EMDALI	Battens & Weatherproofs	117	JC71932/50MW	Highbay & Lowbay	171
JC71810BLK	Highbay & Lowbay	160	JC71932/50MW	Controls & Sensors	395
JC71810BLKEM	Highbay & Lowbay	160	JC71932/50MWEM	Highbay & Lowbay	171
JC71810WH	Highbay & Lowbay	160	JC71932/50MWEM	Controls & Sensors	395
JC71810WHEM	Highbay & Lowbay	160	JC71932/80	Highbay & Lowbay	170
JC71811BLK	Highbay & Lowbay	161	JC71932/80EM	Highbay & Lowbay	170
JC71811BLKEM	Highbay & Lowbay	161	JC71932/80MW	Highbay & Lowbay	171
JC71812BLK	Highbay & Lowbay	162	JC71932/80MW	Controls & Sensors	395
JC71812BLKEM	Highbay & Lowbay	162	JC71932/80MWEM	Highbay & Lowbay	171
JC71850	Highbay & Lowbay	163	JC71932/80MWEM	Controls & Sensors	395
JC71851	Highbay & Lowbay	163	JC71933/30X60	Highbay & Lowbay	172
JC71852BLK	Highbay & Lowbay	163	JC71933/30X60EM	Highbay & Lowbay	172
JC71854BLK	Highbay & Lowbay	163	JC71933/30X60MW	Highbay & Lowbay	173
JC71854PR	Highbay & Lowbay	163	JC71933/30X60MW	Controls & Sensors	395
JC71855	Highbay & Lowbay	163	JC71933/30X60MWEM	Highbay & Lowbay	173

## Codes JC71933/30X60MWEM - JC72307MW

Code	Section	Page	Code	Section	Page
JC71933/30X60MWEM	Controls & Sensors	395	JC72303EMDSI	Commercial Linear LED	96
JC71933/50	Highbay & Lowbay	172	JC72303EMMW	Commercial Linear LED	97
JC71933/50EM	Highbay & Lowbay	172	JC72303EMSD	Commercial Linear LED	97
JC71933/50MW	Highbay & Lowbay	173	JC72303MW	Commercial Linear LED	97
JC71933/50MW	Controls & Sensors	395	JC72303SD	Commercial Linear LED	97
JC71933/50MWEM	Highbay & Lowbay	173	JC72304	Commercial Linear LED	98
JC71933/50MWEM	Controls & Sensors	395	JC72304EM	Commercial Linear LED	98
JC71933/80	Highbay & Lowbay	172	JC72304EMMW	Commercial Linear LED	99
JC71933/80EM	Highbay & Lowbay	172	JC72304MW	Commercial Linear LED	99
JC71933/80MW	Highbay & Lowbay	173	JC72305	Commercial Linear LED	92
JC71933/80MW	Controls & Sensors	395	JC72305/1-10V	Commercial Linear LED	92
JC71933/80MWEM	Highbay & Lowbay	173	JC72305DALI	Commercial Linear LED	92
JC71933/80MWEM	Controls & Sensors	395	JC72305DSI	Commercial Linear LED	92
JC72301	Commercial Linear LED	92	JC72305EM	Commercial Linear LED	92
JC72301/1-10V	Commercial Linear LED	92	JC72305EM/1-10V	Commercial Linear LED	92
JC72301DALI	Commercial Linear LED	92	JC72305EMDALI	Commercial Linear LED	92
JC72301DSI	Commercial Linear LED	92	JC72305EMDSI	Commercial Linear LED	92
JC72301EM	Commercial Linear LED	92	JC72305EMMW	Commercial Linear LED	93
JC72301EM/1-10V	Commercial Linear LED	92	JC72305EMMW	Commercial Linear LED	93
JC72301EMDALI	Commercial Linear LED	92	JC72305MW	Commercial Linear LED	93
JC72301EMDSI	Commercial Linear LED	92	JC72305SD	Commercial Linear LED	93
JC72301EMMW	Commercial Linear LED	93	JC72306	Commercial Linear LED	94
JC72301EMSD	Commercial Linear LED	93	JC72306/1-10V	Commercial Linear LED	94
JC72301MW	Commercial Linear LED	93	JC72306DALI	Commercial Linear LED	94
JC72301SD	Commercial Linear LED	93	JC72306DSI	Commercial Linear LED	94
JC72302	Commercial Linear LED	94	JC72306EM	Commercial Linear LED	94
JC72302/1-10V	Commercial Linear LED	94	JC72306EM/1-10V	Commercial Linear LED	94
JC72302DALI	Commercial Linear LED	94	JC72306EMDALI	Commercial Linear LED	94
JC72302DSI	Commercial Linear LED	94	JC72306EMDSI	Commercial Linear LED	94
JC72302EM	Commercial Linear LED	94	JC72306EMMW	Commercial Linear LED	95
JC72302EM/1-10V	Commercial Linear LED	94	JC72306EMSD	Commercial Linear LED	95
JC72302EMDALI	Commercial Linear LED	94	JC72306MW	Commercial Linear LED	95
JC72302EMDSI	Commercial Linear LED	94	JC72306SD	Commercial Linear LED	95
JC72302EMMW	Commercial Linear LED	95	JC72307	Commercial Linear LED	96
JC72302EMSD	Commercial Linear LED	95	JC72307/1-10V	Commercial Linear LED	96
JC72302MW	Commercial Linear LED	95	JC72307DALI	Commercial Linear LED	96
JC72302SD	Commercial Linear LED	95	JC72307DSI	Commercial Linear LED	96
JC72303	Commercial Linear LED	96	JC72307EM	Commercial Linear LED	96
JC72303/1-10V	Commercial Linear LED	96	JC72307EM/1-10V	Commercial Linear LED	96
JC72303DALI	Commercial Linear LED	96	JC72307EMDALI	Commercial Linear LED	96
JC72303DSI	Commercial Linear LED	96	JC72307EMDSI	Commercial Linear LED	96
JC72303EM	Commercial Linear LED	96	JC72307EMMW	Commercial Linear LED	97
JC72303EM/1-10V	Commercial Linear LED	96	JC72307EMSD	Commercial Linear LED	97
JC72303EMDALI	Commercial Linear LED	96	JC72307MW	Commercial Linear LED	97

## Codes JC72307SD - JC83217

Code	Section	Page	Code	Section	Page
JC72307SD	Commercial Linear LED	97	JC73303EM/1-10V	Commercial Linear LED	96
JC72401	Downlights	54	JC73303EMDALI	Commercial Linear LED	96
JC72402	Downlights	55	JC73303EMDSI	Commercial Linear LED	96
JC72403	Downlights	56	JC73303EMMW	Commercial Linear LED	97
JC72404	Downlights	54	JC73303EMSD	Commercial Linear LED	97
JC72405	Downlights	55	JC73303MW	Commercial Linear LED	97
JC72406	Downlights	56	JC73303SD	Commercial Linear LED	97
JC72501	Downlights	50	JC73304	Commercial Linear LED	98
JC72502	Downlights	51	JC73304EM	Commercial Linear LED	98
JC72503	Downlights	52	JC73304EMMW	Commercial Linear LED	99
JC72504	Downlights	53	JC73304MW	Commercial Linear LED	99
JC72505	Downlights	50	JC73404	Downlights	54
JC72506	Downlights	51	JC73405	Downlights	55
JC72507	Downlights	52	JC73406	Downlights	56
JC72508	Downlights	53	JC73505	Downlights	50
JC73301	Commercial Linear LED	92	JC73506	Downlights	51
JC73301/1-10V	Commercial Linear LED	92	JC73507	Downlights	52
JC73301DALI	Commercial Linear LED	92	JC73508	Downlights	53
JC73301DSI	Commercial Linear LED	92	JC770/1/SUS	Commercial Linear LED	104
JC73301EM	Commercial Linear LED	92	JC770/1/SUS	Commercial Linear LED	105
JC73301EM/1-10V	Commercial Linear LED	92	JC770/1/WALL	Commercial Linear LED	104
JC73301EMDALI	Commercial Linear LED	92	JC770/1/WALL	Commercial Linear LED	105
JC73301EMDSI	Commercial Linear LED	92	JC771/4/4K/ND/WH	Commercial Linear LED	105
JC73301EMMW	Commercial Linear LED	93	JC771/5/4K/ND/WH	Commercial Linear LED	105
JC73301EMSD	Commercial Linear LED	93	JC771S/4/4K/ND/WH	Commercial Linear LED	105
JC73301MW	Commercial Linear LED	93	JC771S/5/4K/ND/WH	Commercial Linear LED	105
JC73301SD	Commercial Linear LED	93	JC772/2/4K/ND/WH	Commercial Linear LED	105
JC73302	Commercial Linear LED	94	JC773/4/4K/ND/WH	Commercial Linear LED	104
JC73302/1-10V	Commercial Linear LED	94	JC773/5/4K/ND/WH	Commercial Linear LED	104
JC73302DALI	Commercial Linear LED	94	JC773S/4/4K/ND/WH	Commercial Linear LED	104
JC73302DSI	Commercial Linear LED	94	JC773S/5/4K/ND/WH	Commercial Linear LED	104
JC73302EM	Commercial Linear LED	94	JC774/2/4K/ND/WH	Commercial Linear LED	104
JC73302EM/1-10V	Commercial Linear LED	94	JC83020	Undershelf & Cabinet	253
JC73302EMDALI	Commercial Linear LED	94	JC83021	Undershelf & Cabinet	253
JC73302EMDSI	Commercial Linear LED	94	JC83022	Undershelf & Cabinet	253
JC73302EMMW	Commercial Linear LED	95	JC83023	Undershelf & Cabinet	253
JC73302EMSD	Commercial Linear LED	95	JC83024	Undershelf & Cabinet	253
JC73302MW	Commercial Linear LED	95	JC83025	Undershelf & Cabinet	253
JC73302SD	Commercial Linear LED	95	JC83026	Undershelf & Cabinet	253
JC73303	Commercial Linear LED	96	JC83213	LED Strip	244
JC73303/1-10V	Commercial Linear LED	96	JC83214	LED Strip	244
JC73303DALI	Commercial Linear LED	96	JC83215	LED Strip	244
JC73303DSI	Commercial Linear LED	96	JC83216	LED Strip	244
JC73303EM	Commercial Linear LED	96	JC83217	LED Strip	244

## Codes JC83218 - JC95211DIM

Code	Section	Page	Code	Section	Page
JC83218	LED Strip	244	JC88107	Spotlights & Track Systems	225
JC83301	Undershelf & Cabinet	252	JC88108	Spotlights & Track Systems	225
JC83302	Undershelf & Cabinet	252	JC88109	Spotlights & Track Systems	225
JC83303	Undershelf & Cabinet	252	JC88110	Spotlights & Track Systems	225
JC83304	Undershelf & Cabinet	252	JC88112	Spotlights & Track Systems	225
JC83305	Undershelf & Cabinet	252	JC88113	Spotlights & Track Systems	225
JC83306	Undershelf & Cabinet	252	JC88114	Spotlights & Track Systems	225
JC83307	Undershelf & Cabinet	252	JC88115	Spotlights & Track Systems	225
JC83308	Undershelf & Cabinet	252	JC88116	Spotlights & Track Systems	225
JC83309	Undershelf & Cabinet	252	JC88117	Spotlights & Track Systems	225
JC83310	Undershelf & Cabinet	252	JC88118	Spotlights & Track Systems	225
JC83311	Undershelf & Cabinet	252	JC94110	Fire-rated Downlights	25
JC84210	Interior Pendants	188	JC94113	Fire-rated Downlights	24
JC84211	Interior Pendants	188	JC94114	Fire-rated Downlights	24
JC84212	Interior Pendants	189	JC95101	Downlights	32
JC84213	Interior Pendants	189	JC95101DALI	Downlights	32
JC84214	Interior Pendants	192	JC95101DIM	Downlights	32
JC84215	Interior Pendants	192	JC95102	Downlights	32
JC84216	Interior Pendants	193	JC95102DALI	Downlights	32
JC84217	Interior Pendants	193	JC95102DIM	Downlights	32
JC84218	Interior Pendants	193	JC95111	Downlights	33
JC84219	Interior Pendants	193	JC95111DALI	Downlights	33
JC84300	Downlights	58	JC95111DIM	Downlights	33
JC84301	Downlights	58	JC95112	Downlights	33
JC84302	Downlights	59	JC95112DALI	Downlights	33
JC84303	Downlights	59	JC95112DIM	Downlights	33
JC84304	Downlights	60	JC95121	Downlights	34
JC84305	Downlights	60	JC95121DALI	Downlights	34
JC84306	Downlights	62	JC95121DIM	Downlights	34
JC84307	Downlights	62	JC95122	Downlights	34
JC84308	Downlights	62	JC95122DALI	Downlights	34
JC84309	Downlights	62	JC95122DIM	Downlights	34
JC84310	Downlights	62	JC95130	Downlights	33
JC84311	Downlights	62	JC95130	Downlights	34
JC84312	Downlights	63	JC95131	Downlights	32
JC84313	Downlights	63	JC95201	Downlights	35
JC84314	Downlights	63	JC95201DALI	Downlights	35
JC84315	Downlights	63	JC95201DIM	Downlights	35
JC84316	Downlights	63	JC95202	Downlights	35
JC84317	Downlights	63	JC95202DALI	Downlights	35
JC88103	Spotlights & Track Systems	224	JC95202DIM	Downlights	35
JC88104	Spotlights & Track Systems	225	JC95211	Downlights	36
JC88105	Spotlights & Track Systems	225	JC95211DALI	Downlights	36
JC88106	Spotlights & Track Systems	225	JC95211DIM	Downlights	36



## Codes JC95212 - SPR0579

Code	Section	Page	Code	Section	Page
JC95212	Downlights	36	JC96406	Bulkheads	281
JC95212DALI	Downlights	36	JC96407	Bulkheads	281
JC95212DIM	Downlights	36	JCEM001	Emergency	177
JC95221	Downlights	37	JCEM001ST	Emergency	177
JC95221DALI	Downlights	37	LEV68003	Controls & Sensors	397
JC95221DIM	Downlights	37	LEV71805	Highbay & Lowbay	155
JC95222	Downlights	37	LEV71805	Highbay & Lowbay	157
JC95222DALI	Downlights	37	LEV71805	Highbay & Lowbay	159
JC95222DIM	Downlights	37	LEV71805	Highbay & Lowbay	169
JC95301	Downlights	38	LEV71805	Highbay & Lowbay	171
JC95301DALI	Downlights	38	LEV71805	Highbay & Lowbay	173
JC95302	Downlights	38	LEV71805	Controls & Sensors	394
JC95302DALI	Downlights	38	LEV71805	Controls & Sensors	395
JC95303	Downlights	39	LEV71805	Controls & Sensors	396
JC95303DALI	Downlights	39	SPR0579	LED Panels	72
JC95304	Downlights	39	SPR0579	LED Panels	73
JC95304DALI	Downlights	39	SPR0579	LED Panels	82
JC95305	Downlights	40			
JC95305DALI	Downlights	40			
JC95306	Downlights	40			
JC95306DALI	Downlights	40			
JC95401	Downlights	41			
JC95401DALI	Downlights	41			
JC95402	Downlights	41			
JC95402DALI	Downlights	41			
JC95403	Downlights	42			
JC95403DALI	Downlights	42			
JC95404	Downlights	42			
JC95404DALI	Downlights	42			
JC95505	Downlights	43			
JC95505DALI	Downlights	43			
JC95606	Downlights	43			
JC95606DALI	Downlights	43			
JC96311	Bulkheads	278			
JC96312	Bulkheads	278			
JC96313	Bulkheads	279			
JC96314	Bulkheads	279			
JC96317	Bulkheads	279			
JC96400	Interior Pendants	195			
JC96401	Interior Pendants	195			
JC96402	Interior Pendants	195			
JC96403	Interior Pendants	195			
JC96404	Bulkheads	280			
JC96405	Bulkheads	280			



# Who to Contact

**DAN GOLDING**  
National Sales Manager  
TEL: 07803 237307  
Nationwide

**IAN TUCKER**  
National Specification Manager  
TEL: 07825 065605  
Nationwide



## Regional Sales Manager North

TEL: 07789 866298



## Regional Sales Manager South

TEL: 07713 641939

## Area Sales Managers



**ELECTRICAL AND ALLIED  
DISTRIBUTORS LTD**  
TEL: 02890 326822  
Postcodes: All Ireland



**JOSH PERRIN**  
TEL: 07717 894248  
Postcodes: BS, TA, EX, TQ, PL, TR,  
BA, DT, SP



**STEVIE MURDIE**  
TEL: 07766 814430  
Postcodes: ZE, KW, IV, HS, AB, PH,  
DD, PA, FK, KY, EH, ML, DG, KA, G,TD



**DANIELLE TUCK**  
TEL: 07710 109131  
Postcodes: BH, RG, SO, PO



**DES TULLY**  
TEL: 07740 065526  
Postcodes: NE, CA, LA, FY, PR, BB, BD,  
HG, YO, HU, TS, DL, SR, DH



**CAMERON COLE**  
TEL: 07867 455258  
Postcodes: NN, MK, OX, HP, LU,  
AL, SL, UB, W, TW, SW, KT, SM



**RYAN HOWARD**  
TEL: 07741 667666  
Postcodes: DE, IM, WN, L, WA, M,  
SK, CW, CH, LL, ST, SY, TF



**CLIVE DU-PREEZ**  
TEL: 07880 384420  
Postcodes: CM, WD, EN, HA, NW,  
N, E, IG, RM, SS, DA, SE, WC, EC



**LUCY WILSON**  
TEL: 07880 194396  
Postcodes: LS, HX, HD, WF, S, OL,  
BL, DN



**VICTORIA FOSTER**  
TEL: 07551 158488  
Postcodes: NR, IP, CB, CO, SG



**YVETTE DOWNING**  
TEL: 07917 506880  
Postcodes: WS, WV, DY, B, CV

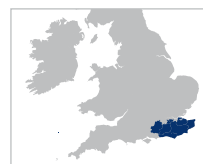

**YAZMIN HILLS**  
TEL: 07551 158489  
Postcodes: CR, BR, GU, RH, BN, TN,  
ME, CT



**RICKY CHEVIS**  
TEL: 07710 109141  
Postcodes: LN, NG, LE, PE



**GARETH THOMAS**  
TEL: 07500 805482  
Postcodes: SA, LD, HR, WR, GL, NP,  
CF, SN



**JCC Lighting Products Ltd**

Innovation Centre, Beeding Close, Southern Cross Trading Estate,  
Bognor Regis, West Sussex, PO22 9TS

**Web** [www.jcc.co.uk](http://www.jcc.co.uk)

**Sales tel** 01243 838999 **Sales orders** [sales@jcc.co.uk](mailto:sales@jcc.co.uk)

**Sales fax** 01243 838998 **Enquiries** [customer.services@jcc.co.uk](mailto:customer.services@jcc.co.uk)