

# Solar Product Range

---



Brighter **Solutions**

IMO is at the forefront of control component technology specifically developed for the renewable energy market and in particular solar energy. Whether meeting the demands of safe and efficient DC switching or delivering tracking solutions that help to maximise solar energy conversion rates, you can be sure that IMO products have been developed to meet the highest technical and commercial standards.

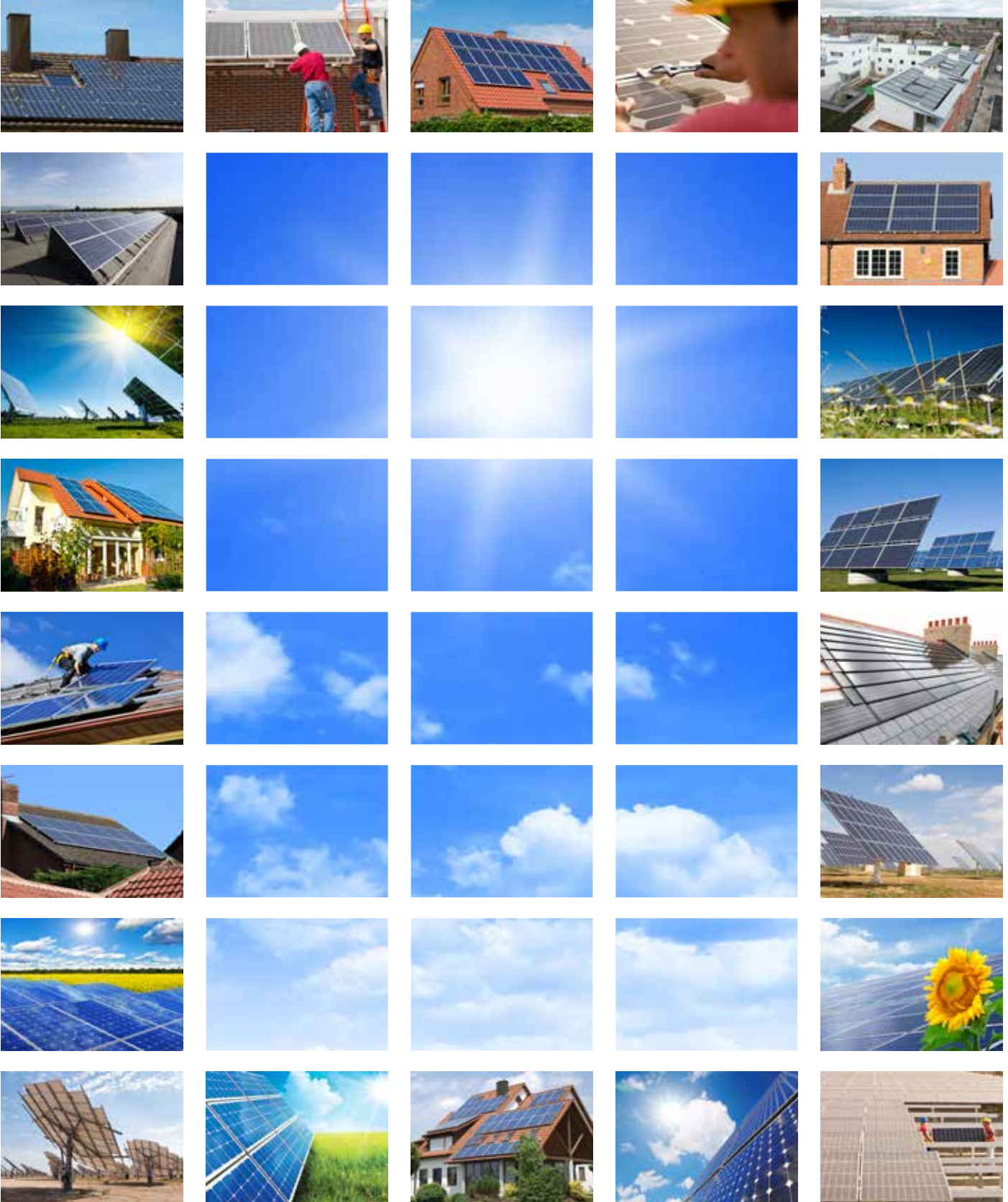

# Contents

	Page
<b>IMO Solar Guide</b>	<b>4</b>
<b>DC Isolators</b>	<b>16</b>
<b>Lever Actuator</b>	
Panel Mounting Switch	18
Base Mounting Switch	19
Single Hole Mounting Switch	20
Distribution Board Switch	21
<b>Lever Actuator Lockable</b>	
Single Hole Mounting Switch	22
Distribution Board Switch	23
<b>Rotary Actuator Lockable</b>	
Panel Mounting Switch	24
Base Mounting Switch	25
Enclosed Switch	26
<b>Technical Data</b>	<b>27</b>
<b>Dimensions</b>	<b>35</b>
<b>AC Isolators</b>	<b>39</b>
<b>DC Contactors</b>	<b>40</b>
<b>Solar Connectors</b>	<b>44</b>
<b>DIN Terminals</b>	<b>45</b>
<b>Distribution Boxes</b>	<b>46</b>
<b>Solar Relays</b>	<b>47</b>
<b>Solar Cube (Solar Tracker)</b>	<b>48</b>
<b>Certifications</b>	<b>50</b>

# IMO Solar Guide - Abbreviations



<b>AC</b>	Alternating Current
<b>DC</b>	Direct Current
<b><math>I_e</math></b>	Rated Operational Current
<b>IMO</b>	IMO Precision Controls
<b><math>I_{sc}</math></b>	Short-Circuit Current
<b><math>I_{th}</math></b>	Thermal Current
<b>MPPT</b>	Maximum Power Point Tracking
<b>PV</b>	Photovoltaic
<b><math>V_{oc}</math></b>	Open-Circuit Voltage

## References

<b>BS 7671</b>	Requirements for Electrical Installations
<b>EN 60364-7-712</b>	Low-voltage electrical installations. Part 7-712: Requirements for special installations or locations. Photovoltaic (PV) power systems
<b>EN 60529</b>	Specification for degrees of protection provided by enclosures (IP code)
<b>EN 60947-1</b>	Low-voltage switchgear and controlgear. Part 1: General rules
<b>EN 60947-3</b>	Low-voltage switchgear and controlgear. Part 3: Switches, disconnectors, switch-disconnectors and fuse-combination units
<b>IEC EN 61215</b>	Crystalline silicon terrestrial photovoltaic (PV) modules – Design qualification and type approval
<b>IEC EN 61646</b>	Thin-film terrestrial photovoltaic (PV) modules - Design qualification and type approval
<b>Nema 250</b>	Enclosures for Electrical Equipment (1000 Volts Maximum)
<b>UL 94</b>	Standard for Tests for Flammability of Plastic Materials for Parts in Devices and Appliances
<b>UL 508</b>	Industrial Control Equipment
<b>UL 508i</b>	Manual Disconnect Switches intended for use in Photovoltaic Systems
<b>DTI/Pub URN 06/1972</b>	Photovoltaics in Buildings, Guide to the installation of PV systems 2nd Edition

## Guide to Installation of PV Systems – 3rd Edition

### Other Relevant References

<b>G83/1-1</b>	Recommendations for Connection of Small-scale Embedded Generators (Up to 16A per Phase) in Parallel with Public Low-Voltage Distribution Networks
<b>G59/2</b>	Recommendations for the Connection of Generating Plant to the Distribution Systems of Licensed Distribution Network Operators
<b>NFPA70 2014</b>	National Electrical Code



# What is a PV System?

A Photovoltaic (PV) power system primarily converts sunlight directly into electricity using a photovoltaic cell array. The conversion of the solar radiation into electric current is carried out using the photoelectric effect found when some semiconductors that are suitably “doped” generate electricity when exposed to solar radiation.

As an individual PV-cell gives a relatively low output, a number of PV-cells are connected in series to supply higher voltages and connected in parallel in order to offer higher current capability. These cell arrays are referred to as PV-panels, and a number of interconnected panels are referred to as PV-strings. If there is a requirement for increased capacity then a larger system can be constructed whereby the PV-strings are connected in parallel to form a PV-array that gives a DC output current equivalent to the sum of all the PV-string outputs.

The main advantages of photovoltaic (PV) electricity generation are as follows:

- no fossil fuel usage and subsequent emission of pollution
- no nuclear fuel usage and disposal or storage of radioactive materials
- local distributed generation where needed
- installed system reliability and extended life
- reduced operating and maintenance costs
- ease of upgrading and replacement if necessary due to modularity of installation

When considering PV panels it is important to ensure that the units comply with all relevant standards for both electrical performance and for building requirements. It is recommended that, where possible, they comply with either IEC 61215 or IEC 61646, depending upon the structure of the cells. Once chosen the panels should be mounted in a location that maximises their exposure to sunlight for as long as possible and limits the possibility of shading, or future potential shading.

An inverter should be chosen to match the overall power capacity of the PV array, and like the arrays, it should operate as efficiently as possible. When considering the inverter, one using a Maximum Power Point Tracking (MPPT) system is preferential as this is a technique that grid connected inverters use to get the maximum possible power from one or more photovoltaic devices.

Where the PV installation is tied into the domestic grid system then the rules and procedures designated in G83 should be referred to and followed by a competent installer who is associated with a suitable accreditation scheme such as MCS.

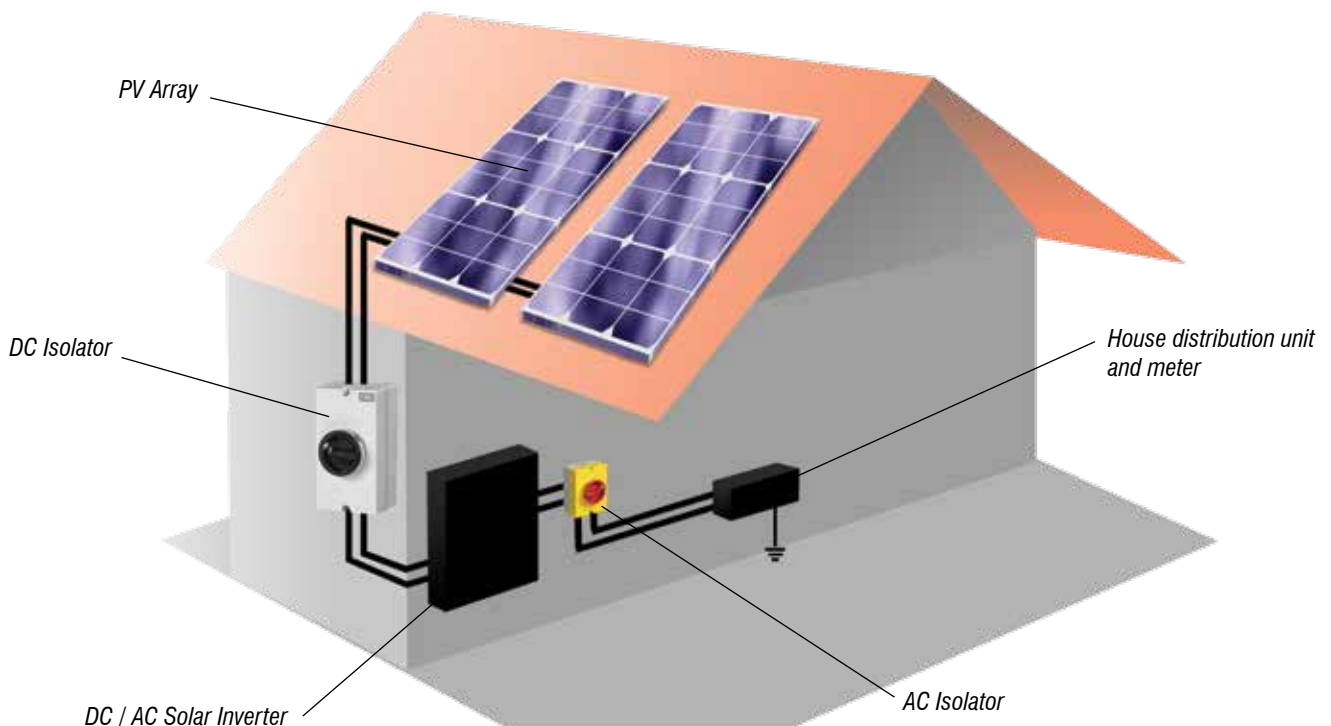

# AC vs DC Safe Switching

As any electrician is aware the nature of DC switching has to be considered with care because on disconnection an arc can occur that is more arduous than that produced with an AC load because there is no zero point on DC. The nature of this arc means that design considerations have to be made within the switch in order to quench this phenomenon; that not only includes significant contact gaps with high speed of operation, but also thermal transmissive materials.

What must be considered is that any AC isolator is predominantly designed with materials chosen such that the load will be AC. This means that the load supply will be a 50/60Hz sine wave, whether it be 230VAC or 400VAC, etc. When switching AC it should be remembered that the nature of the load supply will always pass through 0VAC twice in every cycle and therefore although loads can be arduous in type the supply is self-extinguishing. By that we mean that even if the isolator switches at peak load and an arc is formed between contacts, the action of the supply reducing to 0V means that the load will tend to zero and the arc will be extinguished.

DC load, on the other hand, is always there and unless the load becomes zero, the power being pulled through the contacts will always be the same. So if the load is 500VDC 25A it will be 500V 25A now, in 1s, in 1min, in 1hour – that is constant. In this case, unlike the AC above if you switch “OFF” on load you will also be switching “ON” on load; DC does not go through a 0V level unless there is system supply failure (or some other fault).

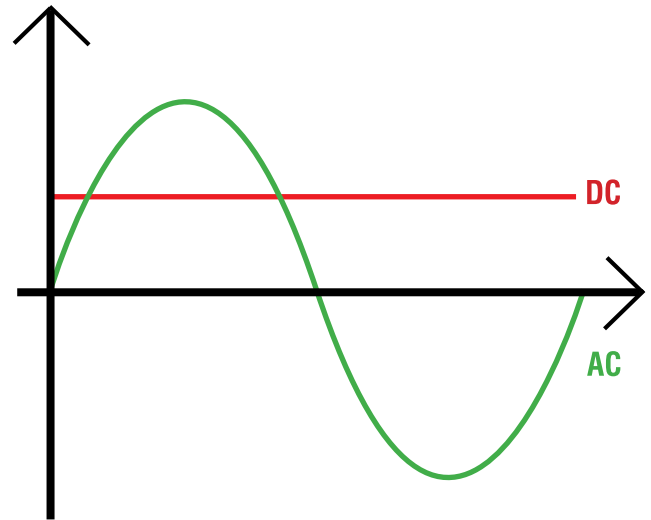

So if switching a loaded DC circuit, especially at the high voltages that can be found in PV installations (up to 1000V or more), current will continue to flow over the opening contact gap due to the partial breakdown of the air between the contacts. This phenomenon is viewed as an arc between the contacts and it will only stop when the distance between the contacts, and so the air gap, becomes large enough to prevent the continued electrical breakdown.

In order to replicate in DC, the self-extinguishing nature of AC, then switching OFF the load should occur quickly and in a switch that is designed with a contact system that allows enough distance to break the DC arc and dissipate the arc energy present during such a switching operation. Therefore, in order to perform such switching safely a fast operating switch-disconnector is necessary.

## What is a Switch and what is a Switch-Disconnecter?

We are all familiar with a switch. In its basic form we all know it as having one or more sets of electrical contacts that are connected to a load and manually operated to either close or open the contacts in order to make them conducting or non-conducting.

However, there is a European standard covering switches and switch-disconnectors which is EN 60947-3, and in this document there are definitions of industrial switches.

A **switch** is a mechanical switching device used for making and breaking current in an electrical circuit within certain operational conditions.

A **disconnecter** is a mechanical switching device used for carrying current in an electrical circuit under normal conditions and for providing off-load isolation, therefore it is only intended to be used for isolation once the current flow is negligible or has been interrupted by another device.

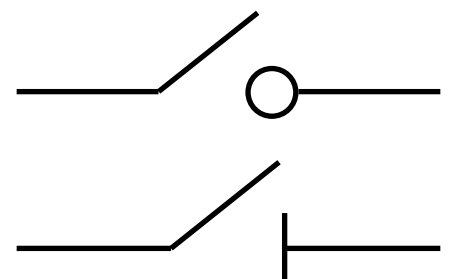

A **switch-disconnector** is a mechanical switching device that meets the requirements for utilisation as both a switch and a disconnector, so it can be used to make and break current whilst also giving on-load isolation.

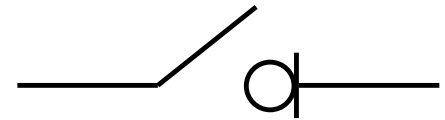

Electrical installations, whether it be residential or industrial, normally follow a set of regulations in order to ensure a safe living or working environment. In the UK these rules are specified in the IET wiring regulations BS 7671. Within these regulations Chapter 53 Section 537 covers the requirement for Isolation and Switching, whilst Section 712 contains specific requirements relating to the installation of PV power supply systems including those with AC modules.

If a switch is not rated or classified as a disconnector or switch-disconnector then BS 7671 does not allow for its use in an electrical circuit as safety isolation switch.

EN 60947-3 is listed in BS 7671 Table 53.2 as an appropriate standard covering product isolation, emergency switching and functional switching; and as IMO designs and manufactures its range of switch-disconnectors (more commonly referred to as isolators) to this European Standard our range of Solar Isolators therefore meet the requirements stipulated under BS 7671.

## Utilisation Categories

Utilisation Categories as are covered in European Standard EN 60947-1 and define an equipment's intended application. The list of both AC and DC categories for low-voltage switchgear and controlgear are stated in EN 60947-1 Annex A along with the relevant product standards.

Manufacturers of both switchgear and controlgear should include in their technical product data all the operational ratings for the utilisation categories for which a product is designed and as such this should remove the confusion for users and designers in their selection of the correct product.

If we consider PV installations where there are requirements for switchgear being used on both the DC and AC side then the system falls typically within two categories below (for which the relevant standard is EN 60947-3)

AC-21 – Switching of resistive loads, including moderate overloads

AC-22 – Switching of mixed resistive and inductive loads, including moderate overloads

DC-21 – Switching of resistive loads, including moderate overloads

DC-22 – Switching of mixed resistive and inductive loads, including moderate overloads

Compliance to the EN60947-3 utilisation categories involves the products completing a number of tests, these include the “Making and Breaking Capacity” (section 7.2.4.1) and “Operational Performance” (section 7.2.4.2). Verification of the rated making and breaking capacities are stated by reference to the rated operational voltage and rated operational current according to Table 3 (see extract below).

Utilisation categories	Rated operational categories	Making			Breaking			Number of operating cycles
		$I/I_e$	$U/U_e$	L/R ms	$I_c/I_e$	$U_r/U_e$	L/R ms	
DC-20A - DC-20B	All values	-	-	-	-	-	-	-
DC-21A - DC-21B	All values	1,5	1,05	1	1,5	1,05	1	5
DC-22A - DC-22B	All values	4	1,05	2,5	4	1,05	2,5	5
DC-23A - DC-23B	All values	4	1,05	15	4	1,05	15	5

$I$ =making current     $I_c$ =breaking current     $I_e$ =rated operational current  
 $U$ =applied voltage     $U_e$ =rated operational voltage     $U_r$ =operational frequency or d.c recovery voltage

The designation of utilisation categories is completed by the suffix A or B according to whether the intended application requires frequent or infrequent operation and such operational performance is verified by the product completing the tests as detailed in EN60947-3 Table 4 (see extract below) based upon the test parameters from Table 5 (extract after).

Rated operational current $I_e$	Number of operating cycles per hour	Number of operating cycles					
		AC and DC A categories			AC and DC B categories		
		Without current	With current	Total	Without current	With current	Total
$0 < I_e \leq 100$	120	8,500	1,500	10,000	1,700	300	2,000
$100 < I_e \leq 315$	120	7,000	1,000	8,000	1,400	200	1,600
$315 < I_e \leq 630$	60	4,000	100	5,000	8,700	200	1,000
$630 < I_e \leq 2,500$	20	2,500	500	3,000	500	100	600
$2,500 < I_e$	10	1,500	500	2,000	300	100	400

Utilisation categories	Rated operational categories	Making			Breaking		
		$I/I_e$	$U/U_e$	L/R ms	$I_c/I_e$	$U_r/U_e$	L/R ms
DC-21A - DC-21B	All Values	1	1	1	1	1	1
DC-22A - DC-22B	All Values	1	1	2	1	1	2
DC-23A - DC-23B	All Values	1	1	7,5	1	1	7,5

$I$  = making current     $I_c$  = breaking current     $I_e$  = rated operational current  
 $U$  = applied voltage     $U_e$  = rated operational voltage     $U_r$  = operational frequency or d.c recovery voltage

Table entries identified by being highlighted in yellow, are those relevant to the IMO Solar Isolators.

Utilisation categories with the suffix B are appropriate for devices which, due to design or application, are only intended for infrequent operation. This could apply, for example, to disconnectors or switch-disconnectors normally operated to provide isolation for maintenance work, and this is the situation for many isolators used in DC applications.

The IMO Solar Isolators have also been tested for switching operations appropriate for category A which allows them to be used in areas where more frequent operation is required; or applications where an extended operational lifetime would be necessary.

## PV Installation Isolation

PV installations consist of the DC side, the Inverter and the AC side with isolation required for both the PV-array to the inverter and for the AC supply from the load, particularly where the system is connected to the Distributed Network, this is a stipulation in G83/1. In some instances the "Guide to Installation of PV Systems" allows inverter and DC string isolation to be provided by the same device, for example the PV plug and socket connectors, but this is only deemed suitable for smaller systems and the connectors must be labelled appropriately. Generally IMO would always recommend the use of a suitably rated DC isolator.

## DC Isolator Selection

BS 7671 states that a method of isolation must be provided on the DC side of a PV installation and this can be provided by a switch-disconnector as classified under EN 60947-3 this is also covered by "Guide to the installation of PV systems". The Guide also stipulates that the switch must isolate all live conductors (typically double pole to isolate PV array positive and negative conductors).

BS 7671 specifies that isolators that are in compliance with EN 60947-3 are appropriate for use in PV systems





The isolator rating must consider the maximum voltage and current of the PV string being switched and these parameters then adjusted in accordance with the safety factors stipulated in current standards. This should then be the minimum required rating of the isolator.

$$\begin{aligned} \text{Voltage} &= N_s \times V_{oc} \times 1.15 \\ \text{Current} &= N_p \times I_{sc} \times 1.25 \end{aligned}$$

$N_s$  - Number of panels connected in series  
 $N_p$  - Number of strings connected in parallel  
 $V_{oc}$  - Open-Circuit Voltage (from module manufacturer's data)  
 $I_{sc}$  - Short-Circuit Current (from module manufacturer's data)

The isolator should also be suitable for use in the appropriate application which in PV installations is normally considered to be either DC-21A, DC-21B, DC-22A or DC-22B. Normally isolation of the DC supply from the inverter would not be a regular occurrence and therefore generally ratings for DC-21B or DC-22B would, as a minimum, be necessary; although category A types (as previously covered in Utilisation Categories) would be advantageous due to their capability of a higher number of switching operations, and therefore a longer guaranteed life.

## AC Isolator Selection

AC Isolators are used in both stand-alone grid or network distributed systems.

If connected to the distributed network then G83/1 stipulates the PV system must be connected directly to an isolation switch that is wired so as to isolate both the live and neutral conductors, capable of being secured in the "OFF" position and in an accessible location within the installation.

In a stand-alone system IMO recommend that a lockable OFF isolation switch is similarly used within the installation.

BS 7671 specifies that isolators that are in compliance with EN 60947-3 are appropriate for use in PV systems.

Unlike a DC isolator that is required to switch both the positive and negative conductors, an AC isolator should be chosen with regards to the supply being single phase, which is typically found in domestic installations or three phase, which is typical for commercial or industrial installations. Ideally for single phase a 2pole isolator should be used to switch the live and neutral line (earth constantly connected) whilst a 4pole isolator would be used to switch the 3 voltage lines and neutral (earth constantly connected).

The isolator rating should be based on the inverter output which is normally specified per phase, that is line to neutral, and for example maybe shown as 20A at 230VAC; if this output is from a three phase unit then the AC isolator must be rated to for the line-to-line voltage which would typically be 415VAC.

With both AC and DC isolators the ambient temperature of the environment in which the switch is mounted must be considered as most industrial switches are nominally rated for use in 35°C. However, if the isolator is to be used in an area where solar activity is prevalent, thereby making more efficient use of the installation and greater yield, or in an enclosed space such as a loft or that of an inverter enclosure, then an isolator capable of handling the elevated temperatures should be selected.

All IMO Solar Isolators are capable of being installed in areas where high ambient temperatures of up to +45°C can be found. In installations of higher temperatures, our open style product can be used up to +65°C, however, you should ensure safe operating conditions and correct mounting of the product.



## Why use an IMO Solar Isolator?

IMO Precision Controls offers a range of True DC Isolators specifically designed for use in Solar PV installations in accordance with EN 60364-7-712. The IMO design incorporates a user independent switching action so as the handle is moved it interacts with a spring mechanism which, upon reaching a set point, causes the contacts to “SNAP” over thereby ensuring a very fast break/make action. This mechanism means that the disconnection of the load circuits and suppression of the arc, produced by a constant DC load, is normally extinguished in a maximum of 5ms using the specific pole suppression chambers incorporated within the design.

Many alternative solutions, particularly those based upon an AC isolator designs which use bridge contacts, have been modified and rated for DC operation. These types of product have a switching speed that is directly linked to operator speed therefore, slow operation of the handle results in slow contact separation of the contacts which can produce arcing times of 100ms or more. Also in these switches the contact surface is also the surface upon which arcs tend to form; therefore, any surface damage or sooting caused by the arcing is likely to have a detrimental effect on the isolator’s contact resistance and its longevity.

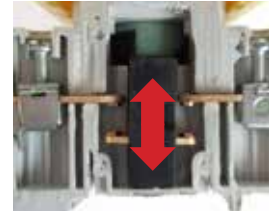

The IMO DC Isolator range is offered in a number of configurations all rated for installation and use as switch-disconnects and all with options allowing for “LOCKABLE OFF” operation. Although able to offer the industry standard two position 90° handle operation from LOCKABLE OFF-ON, IMO have also introduced a **SAFE-LOCK**

patented handle that allows for three rotational positions relating to ON-OFF-LOCK. The facility offered by this design gives a LOCK position that is removed from the OFF setting ensuring the handle can be placed in its own unique position when locked. When this design is used within the IMO enclosed Solar Isolators it ensures that engineering access can only be attained to the enclosure when the handle is in the OFF position; whilst the “LOCK” position ensures secure power isolation combined with non-access to the enclosure (when the isolator block is secured with supplied screws) and thereby significantly reducing the risks of tampering when maintenance/repair is carried out on equipment in-line after the isolator, **SAFE-LOCK**. Once any work has been undertaken the locking mechanism can then be removed from the handle and the isolator returned to its normal operational mode.



IMO Solar Isolators use a rotary “knife contact” mechanism so when the unit is operated the handle movement gives a double make/break per contact set. As DC load switching creates arcing the design is such that this only occurs on the corners of the switching parts meaning that the main contact is made on an area where no arcing has occurred. The rotary contact mechanism methodology used in the IMO Solar Isolators means that, when the isolator is operated, a self-cleaning action occurs on the arcing points and contact surfaces thereby producing good high vibration resistant contact integrity, with reduced contact resistance. This IMO contact system ensures that power loss per pole is kept as low as possible and consistent over the life of the product unlike conventional style isolators where entrapment of contaminants, and then subsequent compression on lateral operation, can lead to variable and increasing contact resistance and hence per pole losses.

As indicated in the section about **Utilisation Categories**, the IMO product is satisfactory for use in installations classified as either DC-21A, DC-21B or DC-22A, and so suitable for a high number of “off load” operations (without current) and also a high number of operating cycles “on load” (with current).

A further advantage of the IMO contact mechanism is that, in the event of the supply to earth failure, the high short circuit current pulls the contacts together thereby giving a high short circuit withstand current of up to 2400A (product dependent).

PV residential installations are typically 1000VDC however, IMO Solar Isolators already have the capability to operate up to 1500VDC.



In the move towards safer installations of PV systems, whether it be in a domestic or industrial environment, consideration has to often be given to the materials and the risk of fire hazard that they pose. Ratings referred to under the UL 94 category are deemed generally acceptable for compliance with this requirement as this cover tests for flammability of polymeric materials used for parts in devices and appliances. Although there are 12 flame classifications specified in UL 94, there are 6 which relate to materials commonly used in manufacturing enclosures, structural parts and insulators found in consumer electronic products. These are 5VA, 5VB, V-0, V-1, V-2 and HB.

It is because of this that the IMO Solar Isolator range is constructed of materials that significantly reduce the risk of a fire hazard and in particular our enclosed installation style products for which the main plastic enclosure is rated at UL 94V-0 and the handles are UL 94V-2 rated. The classification criteria for each of these ratings is found in of the UL 94 Table 8.1 (see extract below).

Criteria conditions	V-0	V-1	V-2
Afterflame time for each individual specimen t1 or t2	≤10s	≤10s	≤30s
Total afterflame time for any condition set (t1 plus t2 for the 5 specimens	≤50s	≤250s	≤250s
Afterflame puts afterglow time for each individual specimen after the second flame application (t2+t3)	≤30s	≤60s	≤60s
Afterflame or afterglow of any specimen up to the holding clamp	No	No	No
Cotton indicator ignited by flaming particles or drops	No	No	Yes

The installation requirements and environments of PV systems can vary significantly and the IMO Solar Isolator has been designed such that it can offer a wide range of configurations depending upon the users' requirement. Also the IMO Solar Isolator range includes models that, when mounted in accordance with their respective instructions and with the appropriate IMO handle, offer suitable protection up to IP66 (EN 60529) and NEMA 3R (Nema 250, UL508).

With the advent of more worldwide installations and the requirements laid down in many country's national wiring publications for the use of DC switches in PV installations, the IMO Solar Isolators have also been assessed and tested under the latest UL standard UL508i which has been specifically written to cover the use of "Manual Disconnect Switches intended for use in Photovoltaic Systems".

This UL508i standard specifically covers switches rated up to 1500 V that are intended for use in an ambient temperatures of -20°C to +60°C, and that are suitable for use on the load side of PV branch protection devices.

In order to comply with this standard the IMO DC Isolators has to pass an overload test, at +60°C, of 50 cycles at 200% of rated current; followed by an endurance test of 6000 cycles (6 cycles/min) at rated load (Ith) and a further 4000 cycles with no current.

The IMO DC Isolator has successfully attained certification under the UL508i standard and as such is suitable for use as a disconnection method for the isolation of the output of DC PV array where it is to be connected to a DC/AC inverter.

# Examples of Typical PV Installations

## Single String System – 3kW Output Single Phase

Consider two potential configurations for a typical 3kW system which would supply 13A at 230VAC:

### System 1

Inverter: Input: 600VDC ( $V_{OC}$ ), 16A ( $I_{DC}$ ), 32A ( $I_{DC\ max}$ ) Output - 230VAC ( $V_{AC}$ ), 13A ( $I_{AC}$ ), 17.2A ( $I_{AC\ max}$ )  
 Solar Panel: 64.9V ( $V_{OC}$ ), 6.46A ( $I_{SC}$ ), 5.98A ( $I_{mpp}$ ), 327Wp ( $P_{nom}$ )  
 No. of panels: 8  
 Calculation:  $V = 8 \times 64.9 \times 1.15 = 597.08V$   $I = 6.46 \times 1.25 = 8.08A$

For this configuration, the IMO SI16-PEL64R-2 rated at 16A for 700VDC is suitable for the DC switch and the PE69-3020 rated at 20A is suitable for the AC switch.

### System 2

Inverter: Input: 750VDC ( $V_{OC}$ ), 15A ( $I_{DC}$ ), 28A ( $I_{DC\ max}$ ) Output - 230VAC ( $V_{AC}$ ), 13A ( $I_{AC}$ ), 16A ( $I_{AC\ max}$ )  
 Solar Panel: 64.9V ( $V_{OC}$ ), 6.46A ( $I_{SC}$ ), 5.98A ( $I_{mpp}$ ), 327Wp ( $P_{nom}$ )  
 No. of panels: 10  
 Calculation:  $V = 10 \times 64.9 \times 1.15 = 746.35V$   $I = 6.46 \times 1.25 = 8.08A$

For this configuration, the IMO SI25-PEL64R-2 rated at 16A for 900VDC is suitable for the DC switch and the PE69-3020 rated at 20A is suitable for the AC switch.

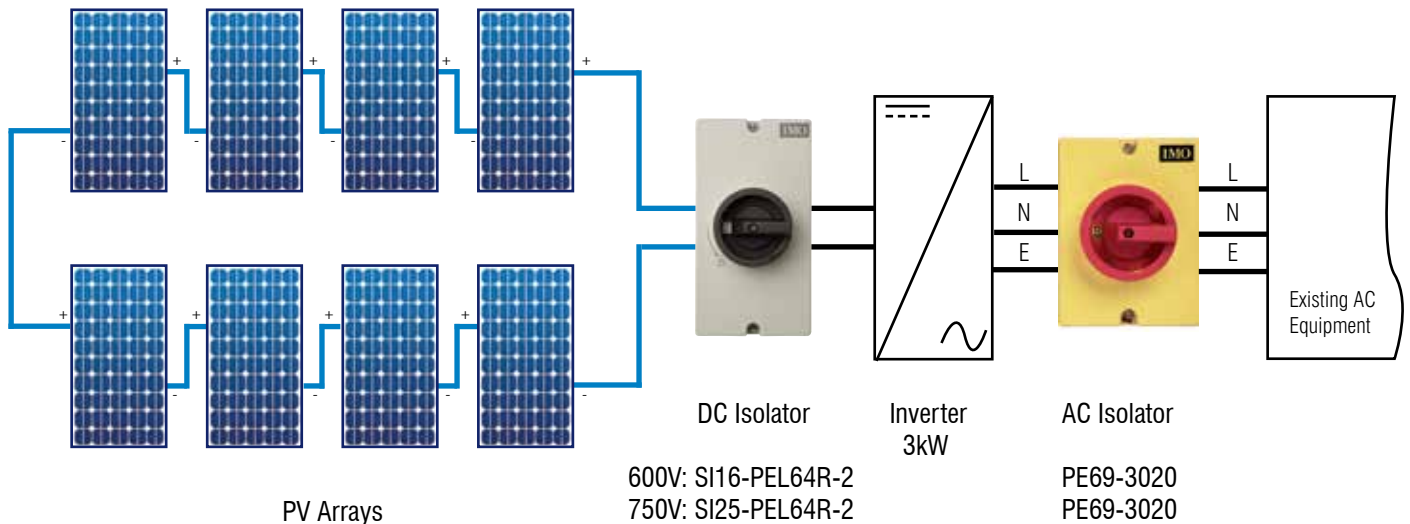

### Dual String System – 5kW Output Single Phase

Consider a typical 5kW system which would supply 22A at 230VAC:

Inverter: Input (per string): 600VDC ( $V_{OC}$ ), 18A ( $I_{DC}$ ), 36A ( $I_{DC\ max}$ ) Output - 230VAC ( $V_{AC}$ ), 25A ( $I_{AC\ max}$ )  
 Solar Panel: 64.9V ( $V_{OC}$ ), 6.46A ( $I_{SC}$ ), 5.98A ( $I_{mpp}$ ), 327Wp ( $P_{nom}$ )  
 No. of panels: 8 per string  
 Calculation:  $V = 8 \times 64.9 \times 1.15 = 597.08V$      $I = 6.46 \times 1.25 = 8.08A$

For this configuration, each string is to be switched at these levels so the IMO SI16-PEL64R-4 rated at 16A for 700VDC per string is suitable for the DC switch and the PE69-3025 rated at 25A is suitable for the AC switch.

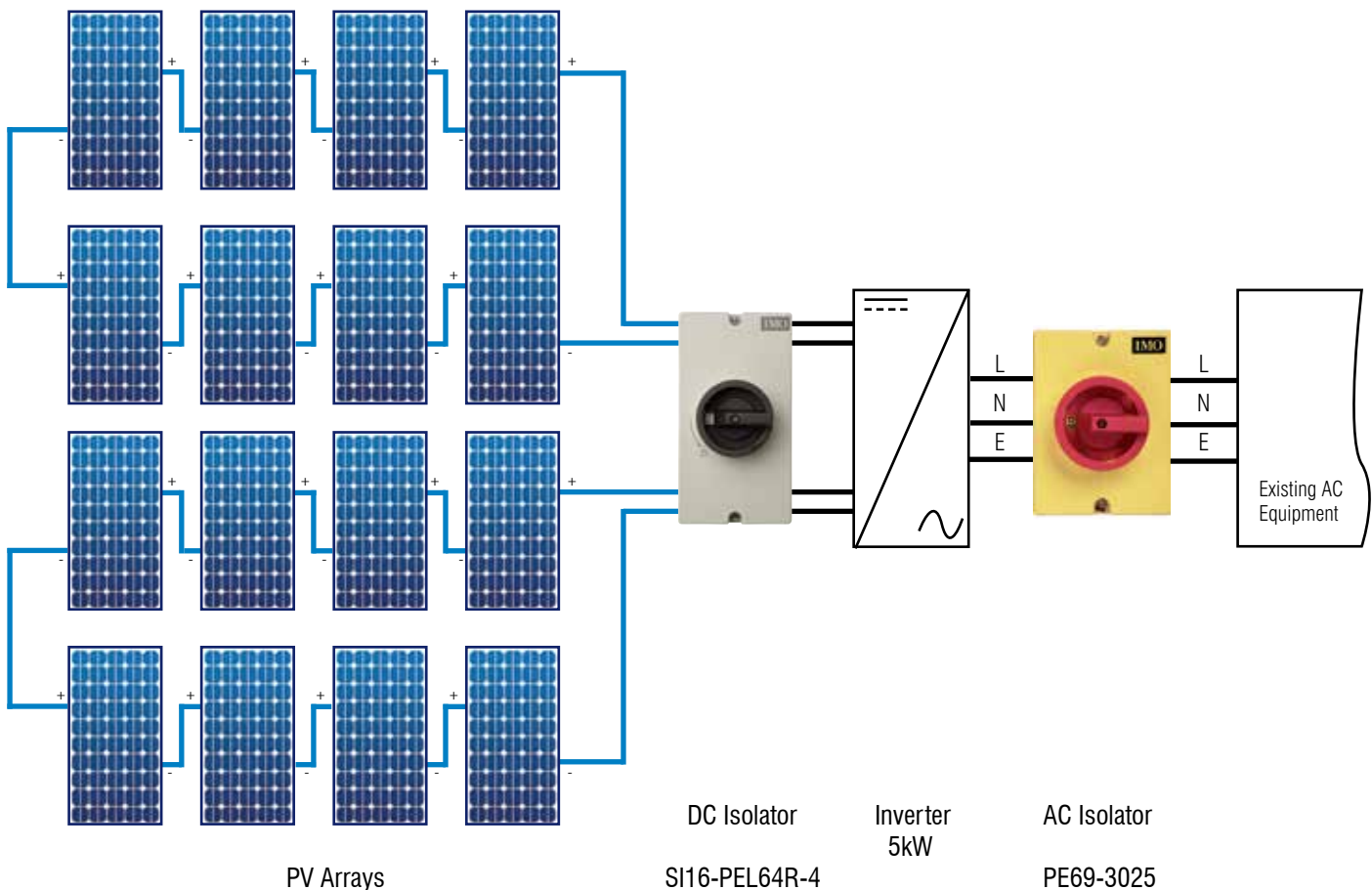

### High Voltage Multi-string System – 12.5kW Output Three Phase

Inverter: Input (per string): 900VDC ( $V_{OC}$ ), 18A ( $I_{DC}$ ), 36A ( $I_{DC\ max}$ ) Output - 400VAC ( $V_{AC}$ ), 20A ( $I_{AC\ max}$ )  
 Solar Panel: 64.9V ( $V_{OC}$ ), 6.46A ( $I_{SC}$ ), 5.98A ( $I_{mpp}$ ), 327Wp ( $P_{nom}$ )  
 No. of panels: 12 per string  
 Calculation:  $V = 12 \times 64.9 \times 1.15 = 895.62V$      $I = 6.46 \times 1.25 = 8.08A$

For this system there are several options to consider. If each string is to be switched individually then the SI25-PEL64R-2 rated at 11A for 1000VDC is suitable for the DC switch. If there is a requirement to isolate the strings as pairs then the SI25-PEL64R-4 is suitable. If all strings are to be isolated using one DC isolator then the IMO SI25-PEL64R-8 is suitable. The PE69-3025 rated at 25A is suitable for the AC switch in each case.

Alternatively, if the requirement is to still have the capability of isolating each string individually whilst retaining a single housing unit, then an IMO distribution box populated with SI25-DBL-2 is suitable. These devices use the same switch block as the SI25-PEL64R-2 so have the same rating of 11A at 1000VDC.



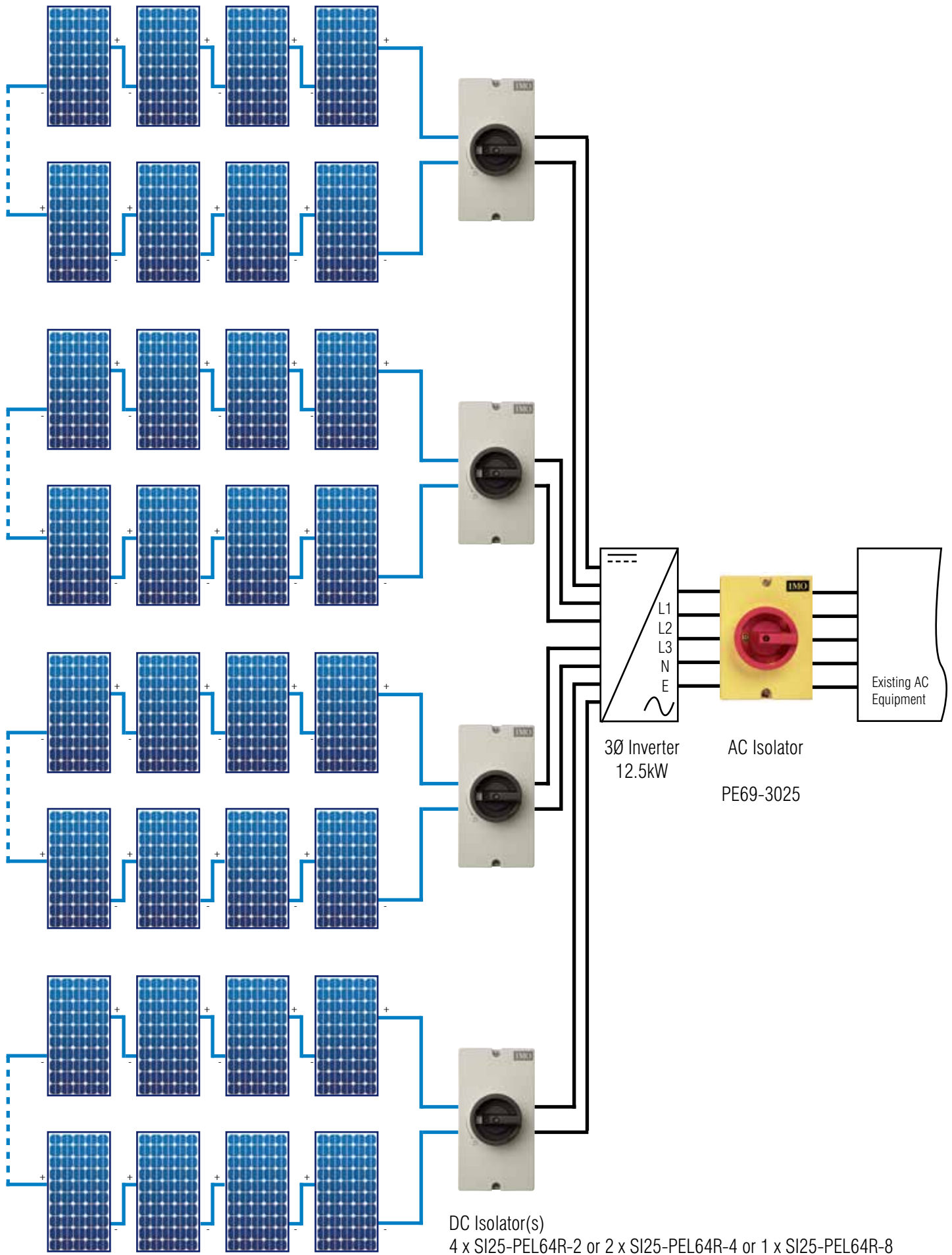



# Over Two Million Installed Units - ZERO FAILURES

In solar installation, the DC isolator is like a vehicle air-bag. You never know it really works until you need it. So it's good to know that the IMO SI has now surpassed two million installed units without a single recorded failure.

Not surprising considering the product carries all the most important approvals including UL508i, TUV (IEC 60947-1 & IEC 60947-3), CE and CCC. In fact, the IMO SI solar isolator has been tested by some of the most rigorous examiners and OEM manufacturers in the world, passing with flying colours every single time.

As ever, the SI range has a guaranteed arc suppression time of under 5mS, in built arc cooling chambers, operator independent switching mechanism and Safe-Lock handle, making it one of the safest DC isolators available, no matter who uses it or how slowly they operate it.

**Why take a risk on safety? Insist on TRUE DC, contact us for a quotation and see why the IMO SI TRUE DC Isolator is the sensible choice for the PV installer.**

*Keep Solar Safe*



This document is meant as a guide and IMO Precision Controls shall not be liable in any event whatsoever for any indirect, special or consequential damages, arising out of the use of the products covered by this document at any time or howsoever caused by the goods. IMO Precision Controls excludes any warranty, condition or statement, express or implied, statutory or otherwise, as to quality, merchantability, or fitness of the goods for any particular purpose.

# DC Isolators

	Lever Actuator				Lever Actuator Lockable		Rotary Actuator Lockable		
	Panel Mounting	Base mounting w. door coupling	Single hole mounting Ø22.5mm	Modular switch	Single hole mounting Ø22.5mm	Modular switch	Panel Mounting	Base mounting w. door coupling	Plastic Enclosure
<b>SI16</b>	..PM64..	..BMDC64..	..SHM..	..DB..	..SHML..	..DBL..	..PM64R..	..BMDC64R..	..PEL64R..
<b>SI25</b>	..PM64..	..BMDC64..	..SHM..	..DB..	..SHML..	..DBL..	..PM64R..	..BMDC64R..	..PEL64R..
<b>SI32</b>	..PM64..	..BMDC64..	..SHM..	..DB..	..SHML..	..DBL..	..PM64R..	..BMDC64R..	..PEL64R..
<b>SI40</b>	..PM64..	..BMDC64..	-	..DB..	-	..DBL..	..PM64R..	..BMDC64R..	..PEL64R..
<b>SI55</b>	..PM64..	..BMDC64..	-	..DB..	-	..DBL..	..PM64R..	..BMDC64R..	..PEL64R..

## Technical Data for DC according to IEC 60947-3

Type		DC21A/B								DC22B			
		500V	600V	700V	800V	900V	1000V	1200V	1500V	500V	600V	800V	1000V
2 poles in series 	<b>SI16 ..</b>	16A	16A	16A	16A	13A	9A	6A	3A	7A	5.5A	2A	1A
	<b>SI25 ..</b>	25A	25A	23A	20A	16A	11A	8A	4A	8A	6A	2.5A	1.5A
	<b>SI32 ..</b>	32A	32A	27A	23A	20A	13A	10A	5A	9A	6.5A	3A	2A
	<b>SI40 ..</b>	40A	40A	35A	30A	25A	20A	15A	10A	-	-	-	-
	<b>SI55 ..</b>	55A	55A	55A	45A	35A	25A	20A	15A	-	-	-	-
2 poles in series + 2 parallel 	<b>SI16 ..</b>	29A	29A	16A	16A	13A	9A	6A	3A	-	-	-	-
	<b>SI25 ..</b>	45A	45A	23A	20A	16A	11A	8A	4A	-	-	-	-
	<b>SI32 ..</b>	58A	50A	27A	23A	20A	13A	10A	5A	-	-	-	-
	<b>SI40 ..</b>	72A	64A	35A	30A	25A	20A	15A	10A	-	-	-	-
	<b>SI55 ..</b>	85A	80A	55A	45A	35A	25A	20A	15A	-	-	-	-
4 poles in series 	<b>SI16 ..</b>	16A	16A	16A	16A	16A	16A	16A	16A	16A	16A	11.5A	8A
	<b>SI25 ..</b>	25A	25A	25A	25A	25A	25A	25A	20A	25A	25A	12A	9A
	<b>SI32 ..</b>	32A	32A	32A	32A	32A	32A	32A	23A	32A	27.5A	12.5A	10A
	<b>SI40 ..</b>	40A	40A	40A	40A	40A	40A	40A	30A	-	-	-	-
	<b>SI55 ..</b>	55A	55A	55A	55A	55A	55A	55A	40A	-	-	-	-
4 poles in series + 2 parallel 	<b>SI16 ..</b>	29A	29A	29A	29A	29A	29A	29A	16A	-	-	-	-
	<b>SI25 ..</b>	45A	45A	45A	45A	45A	45A	45A	20A	-	-	-	-
	<b>SI32 ..</b>	58A	58A	58A	58A	58A	58A	50A	23A	-	-	-	-

DC21B Switching of DC-resistive loads including moderate overloads, Time constant  $L/R \leq 1\text{ms}$

DC22B Switching of DC-resistive and inductive loads including moderate overloads, Time constant  $L/R \leq 2.5\text{ms}$  (e.g. shunt motors)

# Switching Configurations

Type	2-pole	2-pole 4 parallel poles	4-pole	2-pole 4 poles in series Input on top Output bottom	2-pole 4 poles in series Input and Output bottom	2-pole 4 poles in series Input and Output on top
<b>SI16</b>	2	2H	4	4S	4T	4B
<b>SI25</b>	2	2H	4	4S	4T	4B
<b>SI32</b>	2	2H	4	4S	4T	4B
<b>SI40</b>	2	2H	4	4S	4T	4B
<b>SI55</b>	2	2H	4	4S	4T	4B
Contacts Wiring Diagram						
Switching example						

Type	6-pole	2-pole 6 parallel poles	8-pole	2-pole 8 parallel poles
<b>SI16</b>	6	3H	8	4H
<b>SI25</b>	6	3H	8	4H
<b>SI32</b>	6	3H	8	4H
<b>SI40</b>	-	-	-	-
<b>SI55</b>	-	-	-	-
Contacts Wiring Diagram				
Switching example				

## Insulated Jumper for series and parallel switching of contacts

Type	Jumper	Pack	Weight
<b>SI16, SI25, SI32</b>	<b>SIV-B1</b>	100	6.6g/pc.
<b>SI40, SI55</b>	<b>SIV-B2</b>	100	9.64g/pc.



# Lever Actuator Switch - Panel Mounting

- Panel Mounting, IP66
- Escutcheon Plate 64mm<sup>2</sup>
- NEMA Type 3R Handle
- IP20 Body



DC21A IEC60947-3				UL Ratings UL508I				Poles in series	No. of Strings	Weight Kg/pcs.	Part Number	Contact Configuration
600V	800V	1000V	1500V	350V	500V	600V	1000V					
16A	16A	9A	3A	16A	16A	16A	-	2	1	0.20	SI16 PM64 2	
25A	20A	11A	4A	20A	20A	20A	-	2	1	0.20	SI25 PM64 2	
32A	23A	13A	5A	25A	25A	25A	-	2	1	0.20	SI32 PM64 2	
40A	30A	20A	6A	40A	40A	40A	16A	2	1	0.41	SI40 PM64 2	
55A	45A	25A	8A	55A	55A	55A	20A	2	1	0.41	SI55 PM64 2	
29A	16A	9A	3A	29A	29A	21A	-	2	1	0.25	SI16 PM64 2H	
45A	20A	11A	4A	45A	38A	23A	-	2	1	0.25	SI25 PM64 2H	
50A	23A	13A	5A	58A	40A	25A	-	2	1	0.25	SI32 PM64 2H	
64A	30A	20A	6A	72A	53A	42A	22A	2	1	0.54	SI40 PM64 2H	
80A	45A	25A	8A	85A	66A	55A	25A	2	1	0.54	SI55 PM64 2H	
16A	16A	9A	3A	16A	16A	16A	-	2	2	0.23	SI16 PM64 4	
25A	20A	11A	4A	20A	20A	20A	-	2	2	0.23	SI25 PM64 4	
32A	23A	13A	5A	25A	25A	25A	-	2	2	0.23	SI32 PM64 4	
40A	30A	20A	6A	40A	40A	40A	16A	2	2	0.52	SI40 PM64 4	
55A	45A	25A	8A	55A	55A	55A	20A	2	2	0.52	SI55 PM64 4	
16A	16A	16A	16A	16A	16A	16A	-	4	1	0.24	SI16 PM64 4S	
25A	25A	25A	20A	25A	25A	25A	-	4	1	0.24	SI25 PM64 4S	
32A	32A	32A	23A	32A	32A	32A	-	4	1	0.24	SI32 PM64 4S	
40A	40A	40A	30A	40A	40A	40A	40A	4	1	0.52	SI40 PM64 4S	
55A	55A	55A	40A	55A	55A	55A	55A	4	1	0.52	SI55 PM64 4S	
16A	16A	9A	3A	16A	16A	16A	-	2	3	0.36	SI16 PM64 6	
25A	20A	11A	4A	20A	20A	20A	-	2	3	0.36	SI25 PM64 6	
32A	23A	13A	5A	25A	25A	25A	-	2	3	0.36	SI32 PM64 6	
16A	16A	9A	3A	16A	16A	16A	-	2	4	0.41	SI16 PM64 8	
25A	20A	11A	4A	20A	20A	20A	-	2	4	0.41	SI25 PM64 8	
32A	23A	13A	5A	25A	25A	25A	-	2	4	0.41	SI32 PM64 8	
29A	29A	29A	16A	29A	29A	29A	-	4	1	0.46	SI16 PM64 4H	
45A	45A	45A*	20A	45A	45A	45A	-	4	1	0.46	SI25 PM64 4H	
58A	58A*	58A*	23A	58A	58A	50A	-	4	1	0.46	SI32 PM64 4H	

4T / 4B configuration also available. For ratings refer to 4S configuration. (See page 17)

\* DC21B



# Lever Actuator Switch - Base Mounting, Door Clutch

- Base Mounting, Door Clutch, IP66
- Five point fixing handle mount
- Escutcheon Plate 64mm<sup>2</sup>
- NEMA Type 3R Handle
- IP20 Body



DC21A IEC60947-3				UL Ratings UL508I				Poles in series	No. of Strings	Weight Kg/pcs.	Part Number	Contact Configuration
600V	800V	1000V	1500V	350V	500V	600V	1000V					
16A	16A	9A	3A	16A	16A	16A	-	2	1	0.22	<b>SI16 BMDC64 2</b>	
25A	20A	11A	4A	20A	20A	20A	-	2	1	0.22	<b>SI25 BMDC64 2</b>	
32A	23A	13A	5A	25A	25A	25A	-	2	1	0.22	<b>SI32 BMDC64 2</b>	
40A	30A	20A	10A	40A	40A	40A	16A	2	1	0.51	<b>SI40 BMDC64 2</b>	
55A	45A	25A	15A	55A	55A	55A	20A	2	1	0.51	<b>SI55 BMDC64 2</b>	
29A	16A	9A	3A	29A	29A	21A	-	2	1	0.27	<b>SI16 BMDC64 2H</b>	
45A	20A	11A	4A	45A	38A	23A	-	2	1	0.27	<b>SI25 BMDC64 2H</b>	
50A	23A	13A	5A	58A	40A	25A	-	2	1	0.27	<b>SI32 BMDC64 2H</b>	
64A	30A	20A	6A	72A	53A	42A	22A	2	1	0.55	<b>SI40 BMDC64 2H</b>	
80A	45A	25A	8A	85A	66A	55A	25A	2	1	0.55	<b>SI55 BMDC64 2H</b>	
16A	16A	9A	3A	16A	16A	16A	-	2	2	0.25	<b>SI16 BMDC64 4</b>	
25A	20A	11A	4A	20A	20A	20A	-	2	2	0.25	<b>SI25 BMDC64 4</b>	
32A	23A	13A	5A	25A	25A	25A	-	2	2	0.25	<b>SI32 BMDC64 4</b>	
40A	30A	20A	6A	40A	40A	40A	16A	2	2	0.56	<b>SI40 BMDC64 4</b>	
55A	45A	25A	8A	55A	55A	55A	20A	2	2	0.56	<b>SI55 BMDC64 4</b>	
16A	16A	16A	16A	16A	16A	16A	-	4	1	0.26	<b>SI16 BMDC64 4S</b>	
25A	25A	25A	20A	25A	25A	25A	-	4	1	0.26	<b>SI25 BMDC64 4S</b>	
32A	32A	32A	23A	32A	32A	32A	-	4	1	0.26	<b>SI32 BMDC64 4S</b>	
40A	40A	40A	30A	40A	40A	40A	40A	4	1	0.58	<b>SI40 BMDC64 4S</b>	
55A	55A	55A	40A	55A	55A	55A	55A	4	1	0.58	<b>SI55 BMDC64 4S</b>	
16A	16A	9A	3A	16A	16A	16A	-	2	3	0.38	<b>SI16 BMDC64 6</b>	
25A	20A	11A	4A	20A	20A	20A	-	2	3	0.38	<b>SI25 BMDC64 6</b>	
32A	23A	13A	5A	25A	25A	25A	-	2	3	0.38	<b>SI32 BMDC64 6</b>	
16A	16A	9A	3A	16A	16A	16A	-	2	4	0.43	<b>SI16 BMDC64 8</b>	
25A	20A	11A	4A	20A	20A	20A	-	2	4	0.43	<b>SI25 BMDC64 8</b>	
32A	23A	13A	5A	25A	25A	25A	-	2	4	0.43	<b>SI32 BMDC64 8</b>	
29A	29A	29A	16A	29A	29A	29A	-	4	1	0.48	<b>SI16 BMDC64 4H</b>	
45A	45A	45A*	20A	45A	45A	45A	-	4	1	0.48	<b>SI25 BMDC64 4H</b>	
58A	58A*	58A*	23A	58A	58A	50A	-	4	1	0.48	<b>SI32 BMDC64 4H</b>	

4T / 4B configuration also available. For ratings refer to 4S configuration. (See page 17)

\* DC21B

# Lever Actuator Switch - Single Hole Mounting

- Single Hole Mounting Ø22mm, IP66
- Escutcheon Plate 48mm<sup>2</sup>
- NEMA Type 3R Handle
- IP20 Body



DC21A IEC60947-3				UL Ratings UL508I				Poles in series	No. of Strings	Weight Kg/pcs.	Part Number	Contact Configuration
600V	800V	1000V	1500V	350V	500V	600V	1000V					
16A	16A	9A	3A	16A	16A	16A	-	2	1	0.21	SI16 SHM 2	
25A	20A	11A	4A	20A	20A	20A	-	2	1	0.21	SI25 SHM 2	
32A	23A	13A	5A	25A	25A	25A	-	2	1	0.21	SI32 SHM 2	
29A	16A	9A	3A	29A	29A	21A	-	2	1	0.26	SI16 SHM 2H	
45A	20A	11A	4A	45A	38A	23A	-	2	1	0.26	SI25 SHM 2H	
50A	23A	13A	5A	58A	40A	25A	-	2	1	0.26	SI32 SHM 2H	
16A	16A	9A	3A	16A	16A	16A	-	2	2	0.23	SI16 SHM 4	
25A	20A	11A	4A	20A	20A	20A	-	2	2	0.23	SI25 SHM 4	
32A	23A	13A	5A	25A	25A	25A	-	2	2	0.23	SI32 SHM 4	
16A	16A	16A	16A	16A	16A	16A	-	4	1	0.25	SI16 SHM 4S	
25A	25A	25A	20A	25A	25A	25A	-	4	1	0.25	SI25 SHM 4S	
32A	32A	32A	23A	32A	32A	32A	-	4	1	0.25	SI32 SHM 4S	
16A	16A	16A	16A	16A	16A	16A	-	4	1	0.25	SI16 SHM 4T	
25A	25A	25A	20A	25A	25A	25A	-	4	1	0.25	SI25 SHM 4T	
32A	32A	32A	23A	32A	32A	32A	-	4	1	0.25	SI32 SHM 4T	
16A	16A	16A	16A	16A	16A	16A	-	4	1	0.25	SI16 SHM 4B	
25A	25A	25A	20A	25A	25A	25A	-	4	1	0.25	SI25 SHM 4B	
32A	32A	32A	23A	32A	32A	32A	-	4	1	0.25	SI32 SHM 4B	
16A	16A	9A	3A	16A	16A	16A	-	2	3	0.38	SI16 SHM 6	
25A	20A	11A	4A	20A	20A	20A	-	2	3	0.38	SI25 SHM 6	
32A	23A	13A	5A	25A	25A	25A	-	2	3	0.38	SI32 SHM 6	
16A	16A	9A	3A	16A	16A	16A	-	2	4	0.43	SI16 SHM 8	
25A	20A	11A	4A	20A	20A	20A	-	2	4	0.43	SI25 SHM 8	
32A	23A	13A	5A	25A	25A	25A	-	2	4	0.43	SI32 SHM 8	
29A	29A	29A	16A	29A	29A	29A	-	4	1	0.48	SI16 SHM 4H	
45A	45A	45A*	20A	45A	45A	45A	-	4	1	0.48	SI25 SHM 4H	
58A	58A*	58A*	23A	58A	58A	50A	-	4	1	0.48	SI32 SHM 4H	

4T / 4B configuration also available. For ratings refer to 4S configuration. (See page 17)

\* DC21B

# Lever Actuator Switch for Distribution Board

- For Distribution Boards, IP40
- NEMA Type 1 Handle
- IP20 Body



DC21A IEC60947-3				UL Ratings UL508I				Poles in series	No. of Strings	Weight Kg./pcs.	Part Number	Contact Configuration
600V	800V	1000V	1500V	350V	500V	600V	1000V					
16A	16A	9A	3A	16A	16A	16A	-	2	1	0.19	SI16 DB 2	
25A	20A	11A	4A	20A	20A	20A	-	2	1	0.19	SI25 DB 2	
32A	23A	13A	5A	25A	25A	25A	-	2	1	0.19	SI32 DB 2	
40A	30A	20A	10A	40A	40A	40A	16A	2	1	0.41	SI40 DB 2	
55A	45A	25A	15A	55A	55A	55A	20A	2	1	0.41	SI55 DB 2	
29A	16A	9A	3A	29A	29A	21A	-	2	1	0.24	SI16 DB 2H	
45A	20A	11A	4A	45A	38A	23A	-	2	1	0.24	SI25 DB 2H	
50A	23A	13A	5A	58A	40A	25A	-	2	1	0.24	SI32 DB 2H	
64A	30A	20A	6A	72A	53A	42A	22A	2	1	0.52	SI40 DB 2H	
80A	45A	25A	8A	85A	66A	55A	25A	2	1	0.52	SI55 DB 2H	
16A	16A	9A	3A	16A	16A	16A	-	2	2	0.22	SI16 DB 4	
25A	20A	11A	4A	20A	20A	20A	-	2	2	0.22	SI25 DB 4	
32A	23A	13A	5A	25A	25A	25A	-	2	2	0.22	SI32 DB 4	
40A	30A	20A	6A	40A	40A	40A	16A	2	2	0.45	SI40 DB 4	
55A	45A	25A	8A	55A	55A	55A	20A	2	2	0.45	SI55 DB 4	
16A	16A	16A	16A	16A	16A	16A	-	4	1	0.23	SI16 DB 4S	
25A	25A	25A	20A	25A	25A	25A	-	4	1	0.23	SI25 DB 4S	
32A	32A	32A	23A	32A	32A	32A	-	4	1	0.23	SI32 DB 4S	
40A	40A	40A	30A	40A	40A	40A	40A	4	1	0.49	SI40 DB 4S	
55A	55A	55A	40A	55A	55A	55A	55A	4	1	0.49	SI55 DB 4S	
16A	16A	9A	3A	16A	16A	16A	-	2	3	0.35	SI16 DB 6	
25A	20A	11A	4A	20A	20A	20A	-	2	3	0.35	SI25 DB 6	
32A	23A	13A	5A	25A	25A	25A	-	2	3	0.35	SI32 DB 6	
16A	16A	9A	3A	16A	16A	16A	-	2	4	0.40	SI16 DB 8	
25A	20A	11A	4A	20A	20A	20A	-	2	4	0.40	SI25 DB 8	
32A	23A	13A	5A	25A	25A	25A	-	2	4	0.40	SI32 DB 8	
29A	29A	29A	16A	29A	29A	29A	-	4	1	0.43	SI16 DB 4H	
45A	45A	45A*	20A	45A	45A	45A	-	4	1	0.43	SI25 DB 4H	
58A	58A*	58A*	23A	58A	58A	50A	-	4	1	0.43	SI32 DB 4H	

4T / 4B configuration also available. For ratings refer to 4S configuration. (See page 17)

\* DC21B

# Lever Actuator Switch - Lockable Off

- Lever Actuator Switch
- Lockable Off
- Single Hole Mounting Ø22mm, IP66
- Escutcheon plate 48mm<sup>2</sup> (other options available)
- NEMA Type 3R Handle
- IP20 Body



DC21A IEC60947-3				UL Ratings UL508I				Poles in series	No. of Strings	Weight Kg/pcs.	Part Number	Contact Configuration
600V	800V	1000V	1500V	350V	500V	600V	1000V					
16A	16A	9A	3A	16A	16A	16A	-	2	1	0.21	SI16 SHML 2	
25A	20A	11A	4A	20A	20A	20A	-	2	1	0.21	SI25 SHML 2	
32A	23A	13A	5A	25A	25A	25A	-	2	1	0.21	SI32 SHML 2	
29A	16A	9A	3A	29A	29A	21A	-	2	1	0.27	SI16 SHML 2H	
45A	20A	11A	4A	45A	38A	23A	-	2	1	0.27	SI25 SHML 2H	
50A	23A	13A	5A	58A	40A	25A	-	2	1	0.27	SI32 SHML 2H	
16A	16A	9A	3A	16A	16A	16A	-	2	2	0.24	SI16 SHML 4	
25A	20A	11A	4A	20A	20A	20A	-	2	2	0.24	SI25 SHML 4	
32A	23A	13A	5A	25A	25A	25A	-	2	2	0.24	SI32 SHML 4	
16A	16A	16A	16A	16A	16A	16A	-	4	1	0.25	SI16 SHML 4S	
25A	25A	25A	20A	25A	25A	25A	-	4	1	0.25	SI25 SHML 4S	
32A	32A	32A	23A	32A	32A	32A	-	4	1	0.25	SI32 SHML 4S	
16A	16A	16A	16A	16A	16A	16A	-	4	1	0.25	SI16 SHML 4T	
25A	25A	25A	20A	25A	25A	25A	-	4	1	0.25	SI25 SHML 4T	
32A	32A	32A	23A	32A	32A	32A	-	4	1	0.25	SI32 SHML 4T	
16A	16A	16A	16A	16A	16A	16A	-	4	1	0.25	SI16 SHML 4B	
25A	25A	25A	20A	25A	25A	25A	-	4	1	0.25	SI25 SHML 4B	
32A	32A	32A	23A	32A	32A	32A	-	4	1	0.25	SI32 SHML 4B	
16A	16A	9A	3A	16A	16A	16A	-	2	3	0.39	SI16 SHML 6	
25A	20A	11A	4A	20A	20A	20A	-	2	3	0.39	SI25 SHML 6	
32A	23A	13A	5A	25A	25A	25A	-	2	3	0.39	SI32 SHML 6	
16A	16A	9A	3A	16A	16A	16A	-	2	4	0.44	SI16 SHML 8	
25A	20A	11A	4A	20A	20A	20A	-	2	4	0.44	SI25 SHML 8	
32A	23A	13A	5A	25A	25A	25A	-	2	4	0.44	SI32 SHML 8	
29A	29A	29A	16A	29A	29A	29A	-	4	1	0.49	SI16 SHML 4H	
45A	45A	45A*	20A	45A	45A	45A	-	4	1	0.49	SI25 SHML 4H	
58A	58A*	58A*	23A	58A	58A	50A	-	4	1	0.49	SI32 SHML 4H	

4T / 4B configuration also available. For ratings refer to 4S configuration. (See page 17)

\* DC21B

# Lever Actuator Switch - Lockable Off for Distribution Boards

- Lockable Off
- For Distribution Boards, IP40
- Low Height Handle Also Available
- NEMA Type 1 Handle
- IP20 Body



DC21A IEC60947-3				UL Ratings UL508I				Poles in series	No. of Strings	Weight Kg/pcs.	Part Number	Contact Configuration
600V	800V	1000V	1500V	350V	500V	600V	1000V					
16A	16A	9A	3A	16A	16A	16A	-	2	1	0.19	SI16 DBL 2	
25A	20A	11A	4A	20A	20A	20A	-	2	1	0.19	SI25 DBL 2	
32A	23A	13A	5A	25A	25A	25A	-	2	1	0.19	SI32 DBL 2	
40A	30A	20A	6A	40A	40A	40A	16A	2	1	0.40	SI40 DBL 2	
55A	45A	25A	8A	55A	55A	55A	20A	2	1	0.40	SI55 DBL 2	
29A	16A	9A	3A	29A	29A	21A	-	2	1	0.25	SI16 DBL 2H	
45A	20A	11A	4A	45A	38A	23A	-	2	1	0.25	SI25 DBL 2H	
50A	23A	13A	5A	58A	40A	25A	-	2	1	0.25	SI32 DBL 2H	
64A	30A	20A	6A	72A	53A	42A	22A	2	1	0.54	SI40 DBL 2H	
80A	45A	25A	8A	85A	66A	55A	25A	2	1	0.54	SI55 DBL 2H	
16A	16A	9A	3A	16A	16A	16A	-	2	2	0.22	SI16 DBL 4	
25A	20A	11A	4A	20A	20A	20A	-	2	2	0.22	SI25 DBL 4	
32A	23A	13A	5A	25A	25A	25A	-	2	2	0.22	SI32 DBL 4	
40A	30A	20A	6A	40A	40A	40A	16A	2	2	0.47	SI40 DBL 4	
55A	45A	25A	8A	55A	55A	55A	20A	2	2	0.47	SI55 DBL 4	
16A	16A	16A	16A	16A	16A	16A	-	4	1	0.23	SI16 DBL 4S	
25A	25A	25A	20A	25A	25A	25A	-	4	1	0.23	SI25 DBL 4S	
32A	32A	32A	23A	32A	32A	32A	-	4	1	0.23	SI32 DBL 4S	
40A	40A	40A	30A	40A	40A	40A	40A	4	1	0.50	SI40 DBL 4S	
55A	55A	55A	40A	55A	55A	55A	55A	4	1	0.50	SI55 DBL 4S	
16A	16A	9A	3A	16A	16A	16A	-	2	3	0.36	SI16 DBL 6	
25A	20A	11A	4A	20A	20A	20A	-	2	3	0.36	SI25 DBL 6	
32A	23A	13A	5A	25A	25A	25A	-	2	3	0.36	SI32 DBL 6	
16A	16A	9A	3A	16A	16A	16A	-	2	4	0.41	SI16 DBL 8	
25A	20A	11A	4A	20A	20A	20A	-	2	4	0.41	SI25 DBL 8	
32A	23A	13A	5A	25A	25A	25A	-	2	4	0.41	SI32 DBL 8	
29A	29A	29A	16A	29A	29A	29A	-	4	1	0.46	SI16 DBL 4H	
45A	45A	45A	20A	45A	45A	45A	-	4	1	0.46	SI25 DBL 4H	
58A	58A	58A	23A	58A	58A	50A	-	4	1	0.46	SI32 DBL 4H	

4T / 4B configuration also available. For ratings refer to 4S configuration. (See page 17)

\* DC21B



# Rotary Actuator Switch - Lockable Off

- Rotary Actuator Switch
- Lockable Off
- Panel Mounting, IP66
- Rotary Handle 64mm<sup>2</sup>
- NEMA Type 3R Handle
- IP20 Body



DC21A IEC60947-3				UL Ratings UL508I				Poles in series	No. of Strings	Weight Kg/pcs.	Part Number	Contact Configuration
600V	800V	1000V	1500V	350V	500V	600V	1000V					
16A	16A	9A	3A	16A	16A	16A	-	2	1	0.21	SI16 PM64R 2	
25A	20A	11A	4A	20A	20A	20A	-	2	1	0.21	SI25 PM64R 2	
32A	23A	13A	5A	25A	25A	25A	-	2	1	0.21	SI32 PM64R 2	
40A	30A	20A	6A	40A	40A	40A	16A	2	1	0.43	SI40 PM64R 2	
55A	45A	25A	8A	55A	55A	55A	20A	2	1	0.43	SI55 PM64R 2	
29A	16A	9A	3A	29A	29A	21A	-	2	1	0.26	SI16 PM64R 2H	
45A	20A	11A	4A	45A	38A	23A	-	2	1	0.26	SI25 PM64R 2H	
50A	23A	13A	5A	58A	40A	25A	-	2	1	0.26	SI32 PM64R 2H	
64A	30A	20A	6A	72A	53A	42A	22A	2	1	0.57	SI40 PM64R 2H	
80A	45A	25A	8A	85A	66A	55A	25A	2	1	0.57	SI55 PM64R 2H	
16A	16A	9A	3A	16A	16A	16A	-	2	2	0.24	SI16 PM64R 4	
25A	20A	11A	4A	20A	20A	20A	-	2	2	0.24	SI25 PM64R 4	
32A	23A	13A	5A	25A	25A	25A	-	2	2	0.24	SI32 PM64R 4	
40A	30A	20A	6A	40A	40A	40A	16A	2	2	0.50	SI40 PM64R 4	
55A	45A	25A	8A	55A	55A	55A	20A	2	2	0.50	SI55 PM64R 4	
16A	16A	16A	16A	16A	16A	16A	-	4	1	0.25	SI16 PM64R 4S	
25A	25A	25A	20A	25A	25A	25A	-	4	1	0.25	SI25 PM64R 4S	
32A	32A	32A	23A	32A	32A	32A	-	4	1	0.25	SI32 PM64R 4S	
40A	40A	40A	30A	40A	40A	40A	40A	4	1	0.53	SI40 PM64R 4S	
55A	55A	55A	40A	55A	55A	55A	55A	4	1	0.53	SI55 PM64R 4S	
16A	16A	9A	3A	16A	16A	16A	-	2	3	0.37	SI16 PM64R 6	
25A	20A	11A	4A	20A	20A	20A	-	2	3	0.37	SI25 PM64R 6	
32A	23A	13A	5A	25A	25A	25A	-	2	3	0.37	SI32 PM64R 6	
16A	16A	9A	3A	16A	16A	16A	-	2	4	0.42	SI16 PM64R 8	
25A	20A	11A	4A	20A	20A	20A	-	2	4	0.42	SI25 PM64R 8	
32A	23A	13A	5A	25A	25A	25A	-	2	4	0.42	SI32 PM64R 8	
29A	29A	29A	16A	29A	29A	29A	-	4	1	0.47	SI16 PM64R 4H	
45A	45A	45A*	20A	45A	45A	45A	-	4	1	0.47	SI25 PM64R 4H	
58A	58A*	58A*	23A	58A	58A	50A	-	4	1	0.47	SI32 PM64R 4H	

4T / 4B configuration also available. For ratings refer to 4S configuration. (See page 17)

\* DC21B

# Rotary Actuator Switch - Lockable Off

- Lockable Off
- Base Mounting, Door Clutch, IP66
- Five Point Fixing, Handle Mount
- Rotary Handle 64mm<sup>2</sup>
- NEMA Type 3R Handle
- IP20 Body



DC21A IEC60947-3				UL Ratings UL508I				Poles in series	No. of Strings	Weight Kg/pcs.	Part Number	Contact Configuration
600V	800V	1000V	1500V	350V	500V	600V	1000V					
16A	16A	9A	3A	16A	16A	16A	-	2	1	0.23	SI16 BMDC64R 2	
25A	20A	11A	4A	20A	20A	20A	-	2	1	0.23	SI25 BMDC64R 2	
32A	23A	13A	5A	25A	25A	25A	-	2	1	0.23	SI32 BMDC64R 2	
40A	30A	20A	6A	40A	40A	40A	16A	2	1	0.51	SI40 BMDC64R 2	
55A	45A	25A	8A	55A	55A	55A	20A	2	1	0.51	SI55 BMDC64R 2	
29A	16A	9A	3A	29A	29A	21A	-	2	1	0.28	SI16 BMDC64R 2H	
45A	20A	11A	4A	45A	38A	23A	-	2	1	0.28	SI25 BMDC64R 2H	
50A	23A	13A	5A	58A	40A	25A	-	2	1	0.28	SI32 BMDC64R 2H	
64A	30A	20A	6A	72A	53A	42A	22A	2	1	0.65	SI40 BMDC64R 2H	
80A	45A	25A	8A	85A	66A	55A	25A	2	1	0.65	SI55 BMDC64R 2H	
16A	16A	9A	3A	16A	16A	16A	-	2	2	0.26	SI16 BMDC64R 4	
25A	20A	11A	4A	20A	20A	20A	-	2	2	0.26	SI25 BMDC64R 4	
32A	23A	13A	5A	25A	25A	25A	-	2	2	0.26	SI32 BMDC64R 4	
40A	30A	20A	6A	40A	40A	40A	16A	2	2	0.58	SI40 BMDC64R 4	
55A	45A	25A	8A	55A	55A	55A	20A	2	2	0.58	SI55 BMDC64R 4	
16A	16A	16A	16A	16A	16A	16A	-	4	1	0.27	SI16 BMDC64R 4S	
25A	25A	25A	20A	25A	25A	25A	-	4	1	0.27	SI25 BMDC64R 4S	
32A	32A	32A	23A	32A	32A	32A	-	4	1	0.27	SI32 BMDC64R 4S	
40A	40A	40A	30A	40A	40A	40A	40A	4	1	0.62	SI40 BMDC64R 4S	
55A	55A	55A	40A	55A	55A	55A	55A	4	1	0.62	SI55 BMDC64R 4S	
16A	16A	9A	3A	16A	16A	16A	-	2	3	0.39	SI16 BMDC64R 6	
25A	20A	11A	4A	20A	20A	20A	-	2	3	0.39	SI25 BMDC64R 6	
32A	23A	13A	5A	25A	25A	25A	-	2	3	0.39	SI32 BMDC64R 6	
16A	16A	9A	3A	16A	16A	16A	-	2	4	0.44	SI16 BMDC64R 8	
25A	20A	11A	4A	20A	20A	20A	-	2	4	0.44	SI25 BMDC64R 8	
32A	23A	13A	5A	25A	25A	25A	-	2	4	0.44	SI32 BMDC64R 8	
29A	29A	29A	16A	29A	29A	29A	-	4	1	0.49	SI16 BMDC64R 4H	
45A	45A	45A*	20A	45A	45A	45A	-	4	1	0.49	SI25 BMDC64R 4H	
58A	58A*	58A*	23A	58A	58A	50A	-	4	1	0.49	SI32 BMDC64R 4H	

4T / 4B configuration also available. For ratings refer to 4S configuration. (See page 17)

\* DC21B

# Rotary Actuator Switch - Lockable Off in Plastic Enclosure

- Rotary Actuator Switch
- Lockable Off - Safe-Lock
- Self-Extinguishing Plastic Enclosure
- M25 Cable Gland Entry Option
- NEMA Type 3R
- IP66



DC21A IEC60947-3				UL Ratings UL508I				Poles in series	No. of Strings	Weight Kg/pcs.	Part Number	Contact Configuration
600V	800V	1000V	1500V	350V	500V	600V	1000V					
16A	16A	9A	3A	16A	16A	16A	-	2	1	0.43	<b>SI16 PEL64R 2</b>	
25A	20A	11A	4A	20A	20A	20A	-	2	1	0.43	<b>SI25 PEL64R 2</b>	
32A	23A	13A	5A	25A	25A	25A	-	2	1	0.43	<b>SI32 PEL64R 2</b>	
40A	30A	20A	6A	40A	40A	40A	16A	2	1	1.59	<b>SI40 PEL64R 2</b>	
55A	45A	25A	8A	55A	55A	55A	20A	2	1	1.59	<b>SI55 PEL64R 2</b>	
29A	16A	9A	3A	29A	29A	21A	-	2	1	0.49	<b>SI16 PEL64R 2H</b>	
45A	20A	11A	4A	45A	38A	23A	-	2	1	0.49	<b>SI25 PEL64R 2H</b>	
50A	23A	13A	5A	58A	40A	25A	-	2	1	0.49	<b>SI32 PEL64R 2H</b>	
64A	30A	20A	6A	72A	53A	42A	22A	2	1	1.74	<b>SI40 PEL64R 2H</b>	
80A	45A	25A	8A	85A	66A	55A	25A	2	1	1.74	<b>SI55 PEL64R 2H</b>	
16A	16A	9A	3A	16A	16A	16A	-	2	2	0.46	<b>SI16 PEL64R 4</b>	
25A	20A	11A	4A	20A	20A	20A	-	2	2	0.46	<b>SI25 PEL64R 4</b>	
32A	23A	13A	5A	25A	25A	25A	-	2	2	0.46	<b>SI32 PEL64R 4</b>	
40A	30A	20A	6A	40A	40A	40A	16A	2	2	1.67	<b>SI40 PEL64R 4</b>	
55A	45A	25A	8A	55A	55A	55A	20A	2	2	1.67	<b>SI55 PEL64R 4</b>	
16A	16A	16A	16A	16A	16A	16A	-	4	1	0.47	<b>SI16 PEL64R 4S</b>	
25A	25A	25A	20A	25A	25A	25A	-	4	1	0.47	<b>SI25 PEL64R 4S</b>	
32A	32A	32A	23A	32A	32A	32A	-	4	1	0.47	<b>SI32 PEL64R 4S</b>	
40A	40A	40A	30A	40A	40A	40A	40A	4	1	1.70	<b>SI40 PEL64R 4S</b>	
55A	55A	55A	40A	55A	55A	55A	55A	4	1	1.70	<b>SI55 PEL64R 4S</b>	
16A	16A	9A	3A	16A	16A	16A	-	2	3	1.53	<b>SI16 PEL64R 6</b>	
25A	20A	11A	4A	20A	20A	20A	-	2	3	1.53	<b>SI25 PEL64R 6</b>	
32A	23A	13A	5A	25A	25A	25A	-	2	3	1.53	<b>SI32 PEL64R 6</b>	
16A	16A	9A	3A	16A	16A	16A	-	2	4	1.58	<b>SI16 PEL64R 8</b>	
25A	20A	11A	4A	20A	20A	20A	-	2	4	1.58	<b>SI25 PEL64R 8</b>	
32A	23A	13A	5A	25A	25A	25A	-	2	4	1.58	<b>SI32 PEL64R 8</b>	
29A	29A	29A	16A	29A	29A	29A	-	4	1	1.63	<b>SI16 PEL64R 4H</b>	
45A	45A	45A*	20A	45A	45A	45A	-	4	1	1.63	<b>SI25 PEL64R 4H</b>	
58A	58A*	58A*	23A	58A	58A	50A	-	4	1	1.63	<b>SI32 PEL64R 4H</b>	

4T / 4B configuration also available. For ratings refer to 4S configuration. (See page 17)

\* DC21B

# Technical Data

Data according to IEC 60947-3, VDE 0660, GB14048.3

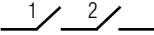
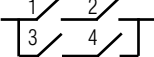
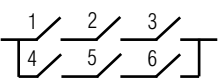
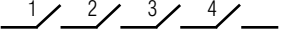
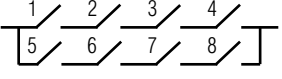
Main Contacts		Type	SI16	SI25	SI32	SI40	SI55		
Rated thermal current $I_{th}$		A	16	25	32	40	55		
Rated insulation voltage $U_i^{1)}$		V	1000	1000	1000	1500	1500		
Rated insulation voltage $U_i^{2)}$		V	1500	1500	1500	-	-		
Distance of contacts (per pole)		mm	8	8	8	-	-		
<b>Rated operational current <math>I_e</math></b>									
<b>DC21A &amp; DC21B</b>	1 pole 1 	300V	A	16	23	27	40	55	
		400V	A	12	14	16	30	40	
		500V	A	9	11	13	19	25	
		600V	A	6	8	10	15	20	
		700V	A	4.5	6	7.5	10	15	
		800V	A	3	4	5	8	10	
<b>DC21B</b>	2 poles in series 2 	500V	A	16	25	32	40	55	
		600V	A	16	25	32	40	55	
		700V	A	16	23	27	35	55	
		800V	A	16	20	23	30	45	
		850V	A	-	-	25	-	-	
		900V	A	13	16	20	25	35	
		1000V	A	9	11	13	20	32	
		1200V	A	6	8	10	10	15	
		1500V	A	3	4	5	6	8	
		2 poles in series + 2 poles parallel 2H 	500V	A	29	45	58	72	85
			600V	A	29	45	50	64	80
			700V	A	16	23	27	35	55
800V	A		16	20	23	30	45		
900V	A		13	16	20	25	35		
1000V	A		9	11	13	20	25		
3 poles in series + 2 poles parallel 3H 	500V	A	29	45	58	-	-		
	600V	A	29	45	50	-	-		
	700V	A	29	38	45	-	-		
	800V	A	29	38	45	-	-		
	900V	A	29	38	45	-	-		
	1000V	A	29	38	45	-	-		
4 poles in series 4S 	500V	A	16	25	32	40	55		
	600V	A	16	25	32	40	55		
	700V	A	16	25	32	40	55		
	800V	A	16	25	32	40	55		
	900V	A	16	25	32	40	55		
	1000V	A	16	25	32	40	55		
4 poles in series + 2 poles parallel 4H 	500V	A	29	45	58	-	-		
	600V	A	29	45	58	-	-		
	700V	A	29	45	58	-	-		
	800V	A	29	45	58	-	-		
	900V	A	29	45	58	-	-		
	1000V	A	29	45	58	-	-		
<b>Rated operational current <math>I_e</math></b>									
	AC21B	2, 4	$U_e$ max. 440V	A	16	25	32	40	55
	2H		$U_e$ max. 440V	A	29	45	58	72	85

1) Suitable at overvoltage category I to III, pollution degree 3 (standard-industry):  $U_{imp} = 8kV$ .

2) Suitable at overvoltage category I to III, pollution degree 2 (min.IP55):  $U_{imp} = 8kV$ .

# Technical Data continued

Data according to IEC 60947-3, VDE 0660, GB14048.3

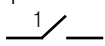
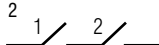
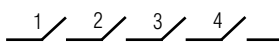
Main Contacts		Type	SI16	SI25	SI32	SI40	SI55
<b>DC22B</b> L/R = 2.5ms	1 pole 	500V A	1	1.25	1.5	x	2.5
		600V A	0.5	0.75	1	x	2
		800V A	0.3	0.4	0.5	x	1.5
		1000V A	0.15	0.2	0.25	x	1
		1200V A	-	-	-	x	x
		1500V A	-	-	-	x	x
	2 poles in series 	500V A	7	8	9	x	x
		600V A	5.5	6	6.5	x	x
		800V A	2	2.5	3	x	x
		1000V A	1	1.5	2	x	x
		1200V A	-	-	-	x	x
		1500V A	-	-	-	x	x
	4 poles in series 4S 	500V A	16	25	32	x	x
		600V A	16	25	27.5	x	x
		800V A	11.5	12	12.5	x	x
		1000V A	8	9	10	x	x
		1200V A	-	-	-	x	x
		1500V A	-	-	-	x	x
<b>Rated conditional short-circuit current</b>		kA <sub>eff</sub>	5	5	5	10	10
Max. fuse size		gL (gG)	40	63	80	125	160
Mechanical Life		x10 <sup>3</sup>	10	10	10	10	10
Rated short-time withstand current (1s)	I <sub>cw</sub>	2, 4, 6, 8 A	800	900	1000	A2, A4: 1200	A2, A4: 1400
		2H, 3H, 4H A	1300	1500	1700	A2+2: 2000	A2+2: 2400
Short circuit making capacity	I <sub>cw</sub>	2, 4, 6, 8 A	800	900	1000	A2, A4: 1200	A2, A4: 1400
		2H, 3H, 4H A	1300	1500	1700	A2+2: 2000	A2+2: 2400
<b>Maximum cable cross sections</b> (including jumper LSV-B1)							
solid or stranded		mm <sup>2</sup>	4 - 16	4 - 16	4 - 16	2.5 - 25	2.5 - 25
flexible		mm <sup>2</sup>	4 - 10	4 - 10	4 - 10	4 - 16	4 - 16
flexible (+ multicore cable end)		mm <sup>2</sup>	4 - 10	4 - 10	4 - 10	2.5 - 16	2.5 - 16
Size of terminal screw			M4 Pz2	M4 Pz2	M4 Pz2	M5 Pz2	M5 Pz2
Tightening torque		Nm	1.2 - 1.8	1.2 - 1.8	1.2 - 1.8	2.5 - 2.8	2.5 - 2.8
2 cables per clamp without jumper LSV-B1 / LSV-B2							
solid or stranded		mm <sup>2</sup>	16+(1.5-2.5)/10+(1.5-6)/6+(1.5-10)/4+(1.5-10)			16+(1.5-2.5)/10+(1.5-10)/6+(1.5-10)/4+(1.5-10)	
flexible & flexible + multicore cable end		mm <sup>2</sup>	16+(1.5-2.5)/10+(1.5-4)/6+(1.5-6)			16+(1.5-6)/10+(1.5-10)/6+(1.5-16)/4+(1.5-16)	
stranded		AWG	8+(16-12)/10+(16-10)/12+(16-8)/14+(16-8)			3+(18-10)/4+(18-10)/6+(18-8)/8+(18-8)	
solid		AWG	10+(16-12)/12+(16-10)/14+(16-10)			10+(16-10)/12+(16-10)/14+(16-10)/12+(16-10)/14+(16-10)	
<b>Maximum ambient temperature</b>							
Operation	All types except PEL64R				-40 to +65		
	PEL64R type				-40 to +45		
Storage					-50 to +70		
<b>Power loss per switch at I<sub>e,max</sub> DC21B</b>							
2		W	0.8	2	3	4	6
4		W	1.6	4	6	8	12
6		W	2.4	6	9	12	18
8		W	3.2	8	12	16	24
2H		W	0.4	1	1.5	2	3
3H		W	0.6	1.5	2.25	3	4.5
4H		W	0.8	2	3	4	6

x - In Test



# Technical Data continued

Data according to UL508i File E362605 and UL508 File E146487, Category no.: NRNT2, NRNT8

Main Contacts	Type	S116	S125	S132	S140	S155		
Ampere-Rating "General Use" 1 pole 1	DC							
	350V A	4	5	6	7.1	10		
	500V A	4	5	6	5.7	7		
	600V A	4	5	6	5	5.8		
	700V A	-	-	-	3.9	5		
	800V A	-	-	-	3.2	4.4		
	900V A	-	-	-	2.5	3.5		
	1000V A	-	-	-	1.5	2		
	2 poles in series 2	350V A	16	20	25	40	55	
		500V A	16	20	25	40	55	
600V A		16	20	25	40	55		
700V A		-	-	-	32	46		
800V A		-	-	-	26	37		
900V A		-	-	-	20	28		
1000V A		-	-	-	16	20		
2 poles in series + 2 poles parallel 2H		350V A	29	45	58	72	85	
		400V A				67	79	
		500V A	29	38	40	53	66	
	600V A	21	23	25	42	55		
	700V A	-	-	-	35	47		
	800V A	-	-	-	30	40		
	900V A	-	-	-	26	32		
	1000V A	-	-	-	22	25		
	4 poles in series 4S	350V A	16	25	32	40	55	
		500V A	16	25	32	40	55	
600V A		16	25	32	40	55		
700V A		-	-	-	40	55		
800V A		-	-	-	40	55		
900V A		-	-	-	40	55		
1000V A		-	-	-	40	55		
3 poles in series + 2 poles parallel 3H		350V A	29	45	58	-	-	
		500V A	29	38	50	-	-	
		600V A	21	38	45	-	-	
	4 poles in series + 2 poles parallel 4H	350V A	29	45	58	-	-	
		500V A	29	45	58	-	-	
		600V A	29	45	50	-	-	
		AC Rating "General Use" 2 poles in series 	600V A	16	25	32	x	x
			277V A	-	-	50	x	x
		3 poles parallel	3x480V A	-	-	32	-	-
		Fuse size (RK5) Industrial Control Switch 5kA / 600V 5kA / 1000V	A	40	60	80	-	-
A			-	-	-	90	125	
<b>Maximum cable cross sections</b> (including jumper SIV-B1/B2)		solid or stranded	AWG	12 - 10	12 - 10	12 - 10	16 - 10	16 - 10
		flexible	AWG	12 - 6	12 - 6	12 - 6	14 - 4	14 - 4
	flexible (+ multicore cable end)	AWG	12 - 6	12 - 6	12 - 6			
	Size of terminal screw		M4 Pz2	M4 Pz2	M4 Pz2	M5 Pz2	M5 Pz2	
Tightening torque	lb.inch	9 - 16	9 - 16	9 - 16	22 - 25	22 - 25		

x - In Test

Approvals	Country	RoHS	USA, UL508i	US, Canada, UL508	Europe CE	TUV Rheinland	GOST Russia	IEC CB Europe
S116		✓	✓	✓	✓	✓	✓	✓
S125		✓	✓	✓	✓	✓	✓	✓
S132		✓	✓	✓	✓	✓	✓	✓
S140		✓	✓	✓	✓	Pending	Pending	Pending
S155		✓	✓	✓	✓	Pending	Pending	Pending

# Technical Data continued

Switch SI16 2/4 poles all types except PEL64R

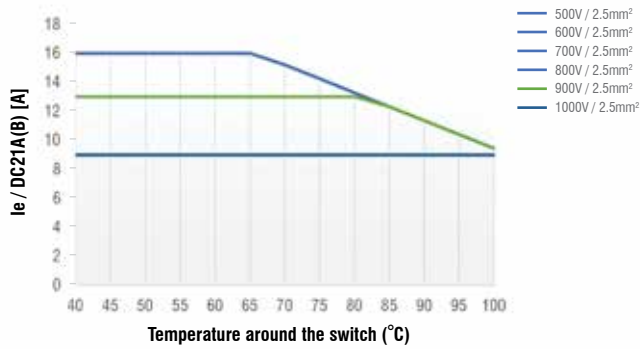

Switch SI16 2H all types except PEL64R

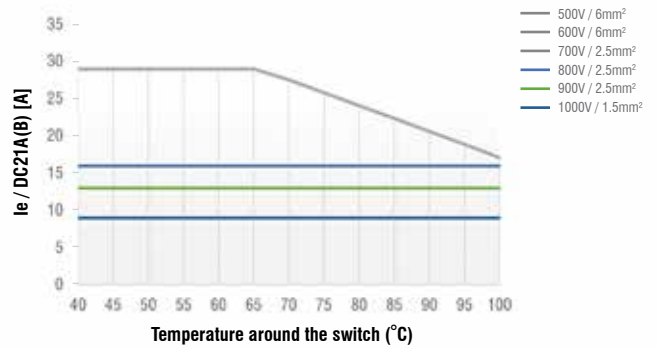

Switch SI16 4S all types except PEL64R

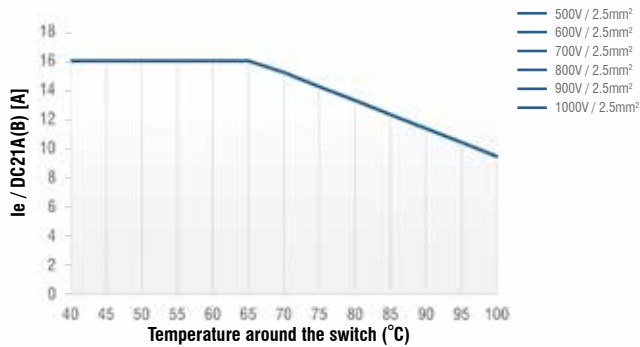

Switch SI16 4H all types except PEL64R

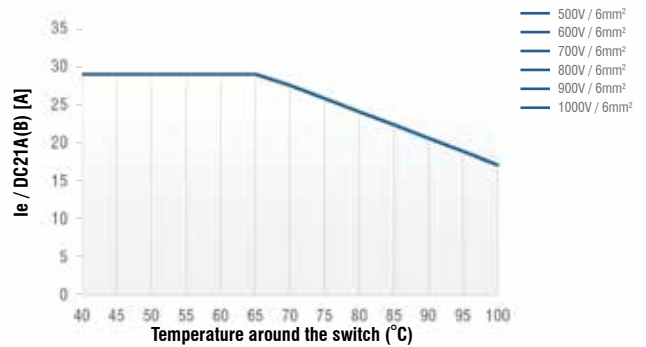

Switch SI16 2/4 poles PEL64R type

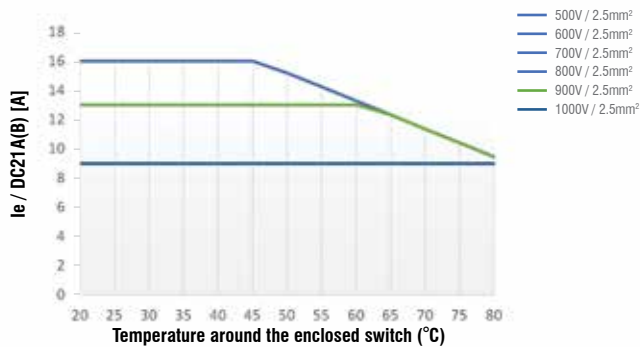

Switch SI16 2H PEL64R type

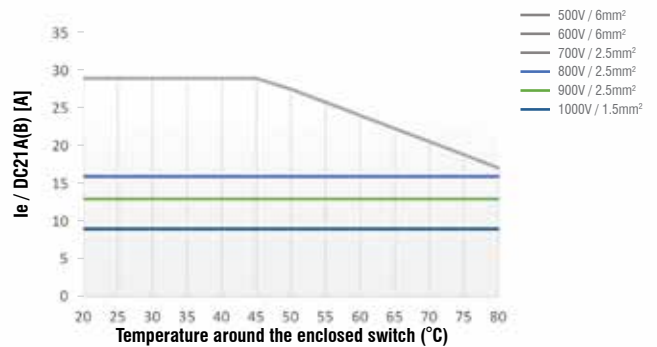

Switch SI16 4S PEL64R type

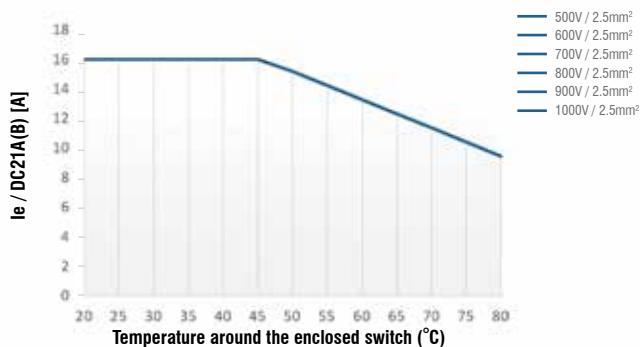

Switch SI16 4H PEL64R type

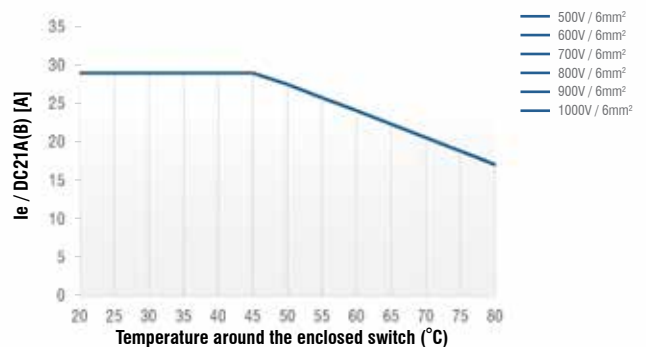

# Technical Data continued

**Switch SI25 2/4 poles all types except PEL64R**

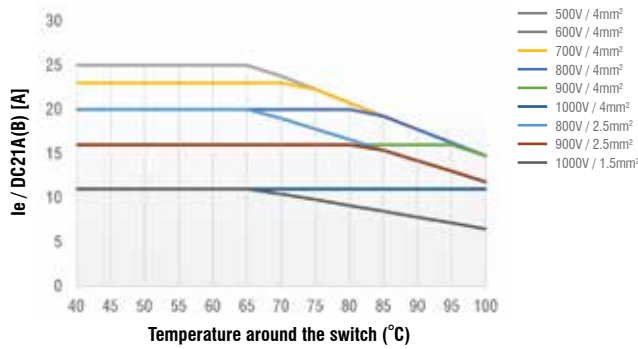

**Switch SI25 2H all types except PEL64R**

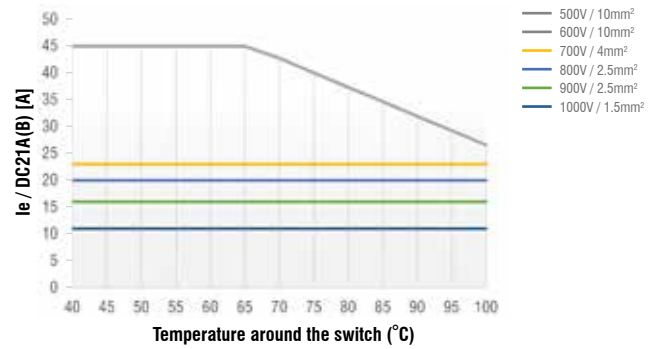

**Switch SI25 4S all types except PEL64R**

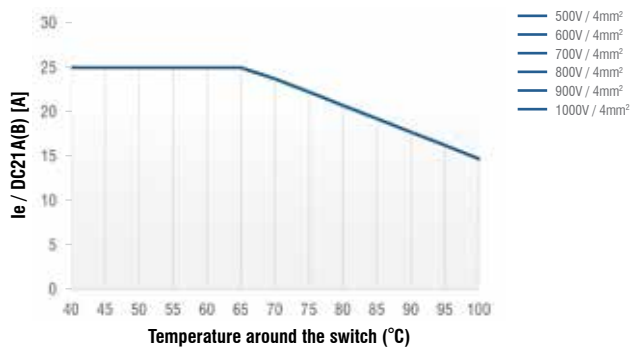

**Switch SI25 4H all types except PEL64R**

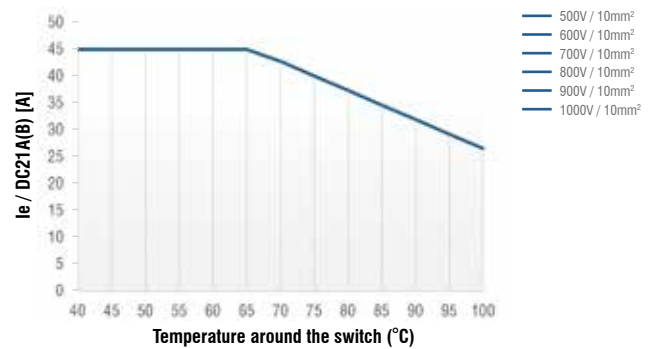

**Switch SI25 2/4 poles PEL64R type**

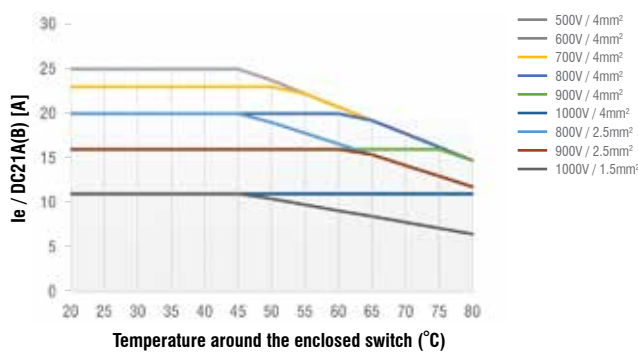

**Switch SI25 2H PEL64R type**

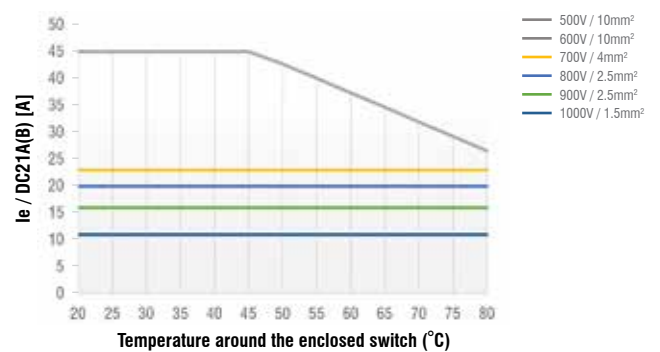

**Switch SI25 4S PEL64R type**

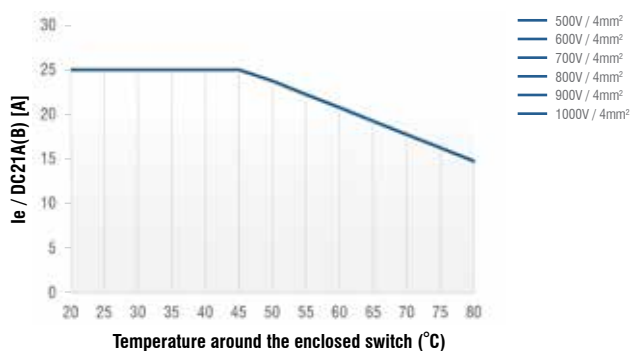

**Switch SI25 4H PEL64R type**

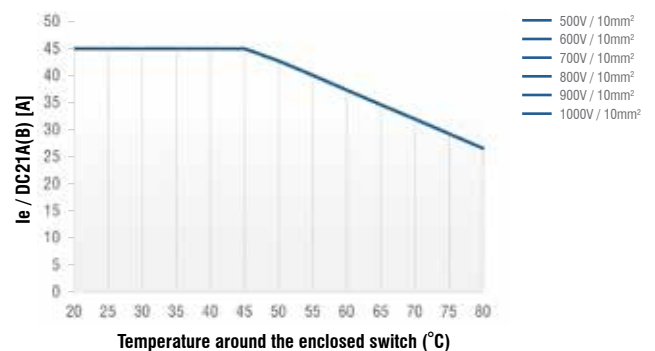

# Technical Data continued

Switch SI32 2/4 poles all types except PEL64R

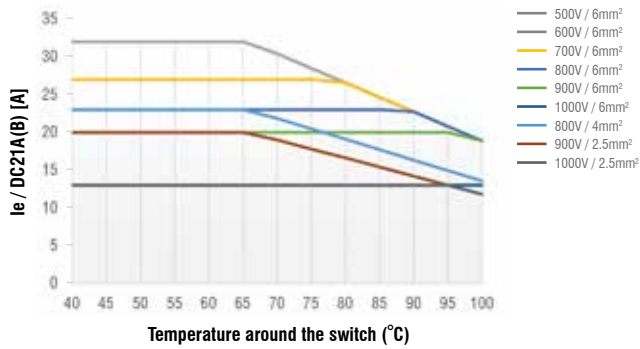

Switch SI32 2H all types except PEL64R

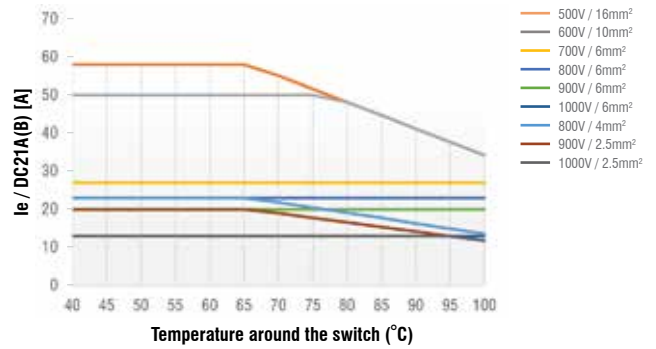

Switch SI32 4S all types except PEL64R

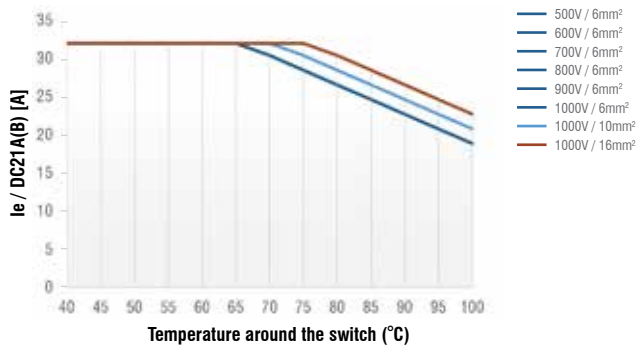

Switch SI32 4H all types except PEL64R

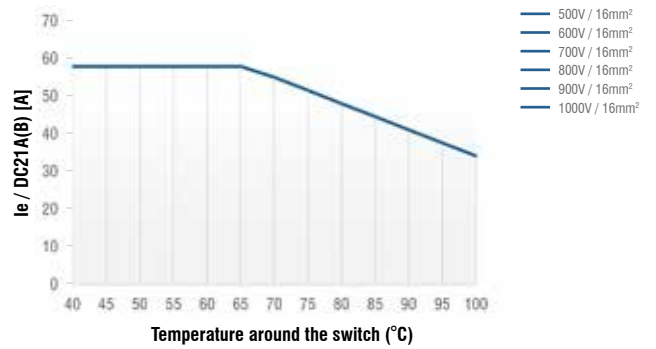

Switch SI32 2/4 PEL64R type

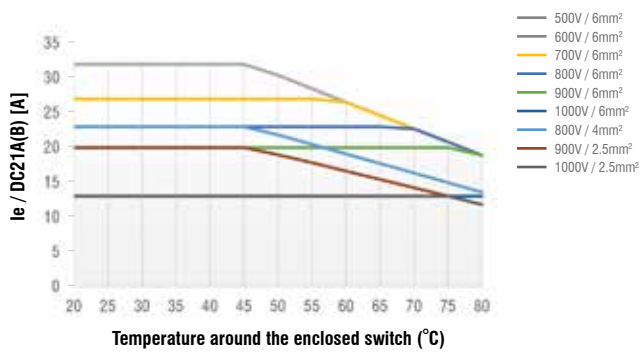

Switch SI32 2H PEL64R type

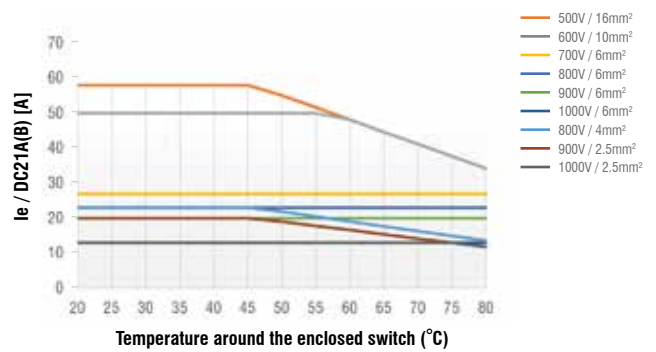

Switch SI32 4S PEL64R type

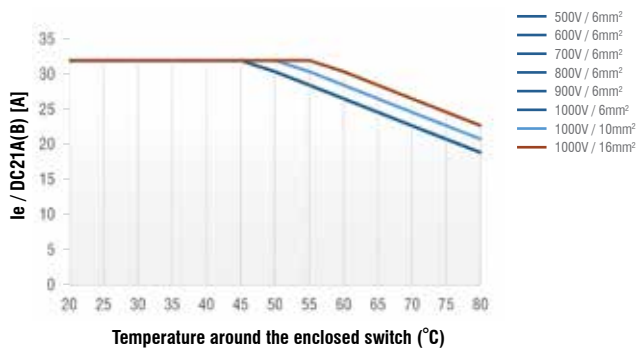

Switch SI32 4H PEL64R type

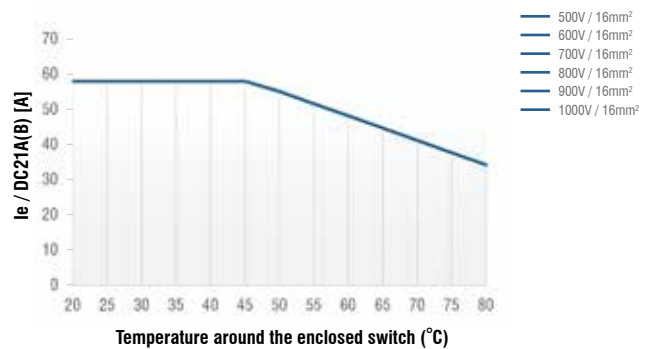

# Technical Data continued

**Switch SI40 2/4 poles all types except PEL64R**

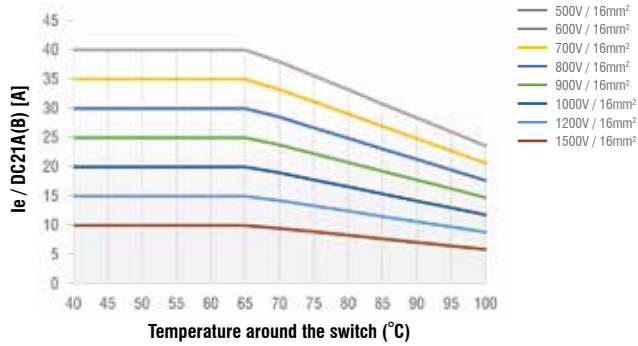

**Switch SI40 2H all types except PEL64R**

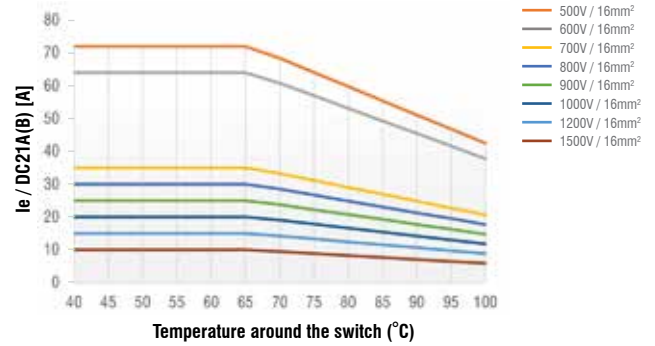

**Switch SI40 4S all types except PEL64R**

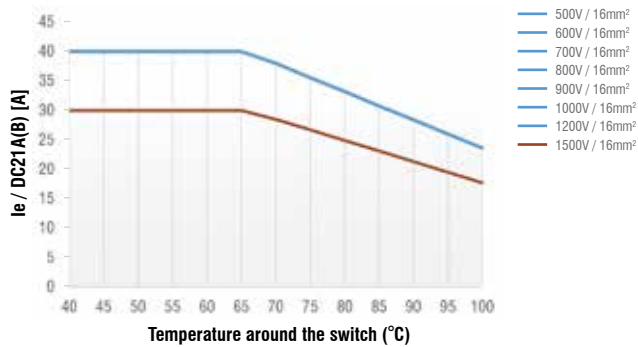

**Switch SI40 2/4 poles PEL64R type**

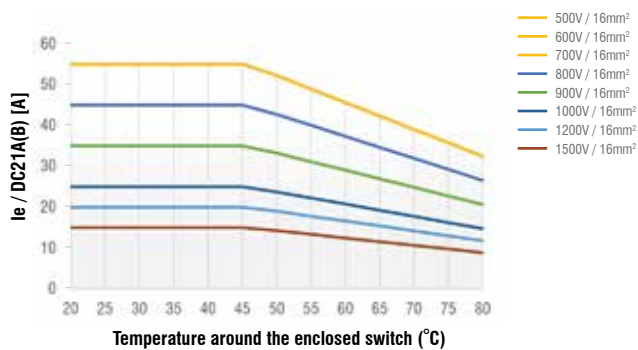

**Switch SI40 2H PEL64R type**

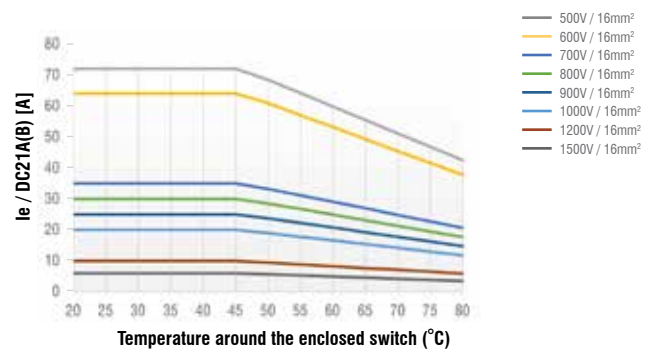

**Switch SI40 4S PEL64R type**

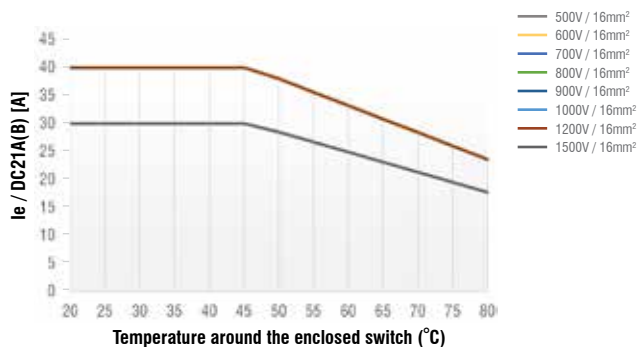



# Technical Data continued

Switch SI55 2/4 poles all types except PEL64R

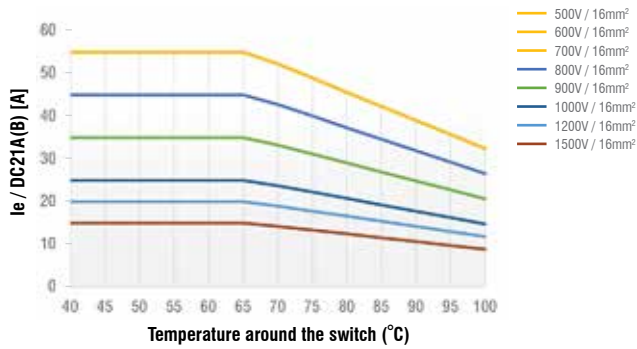

Switch SI55 2H all types except PEL64R

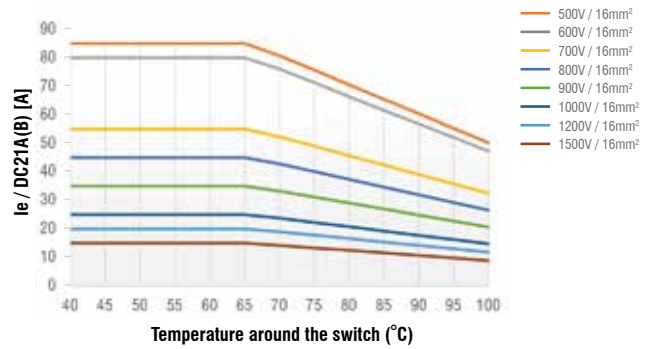

Switch SI55 4S all types except PEL64R

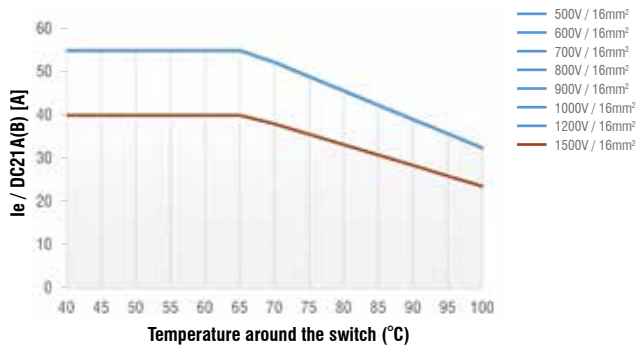

Switch SI55 2/4 poles PEL64R type

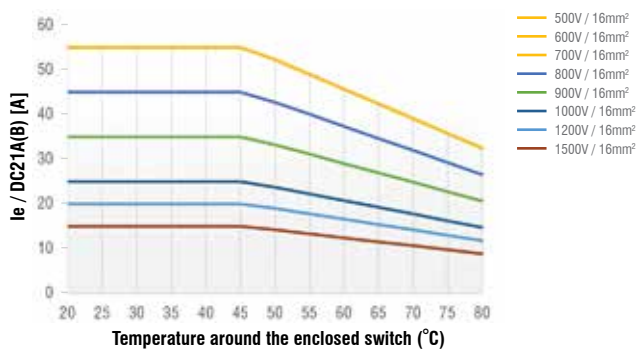

Switch SI55 2H PEL64R type

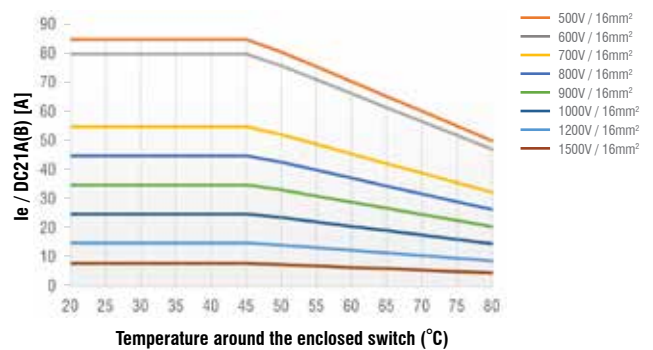

Switch SI55 4S PEL64R type

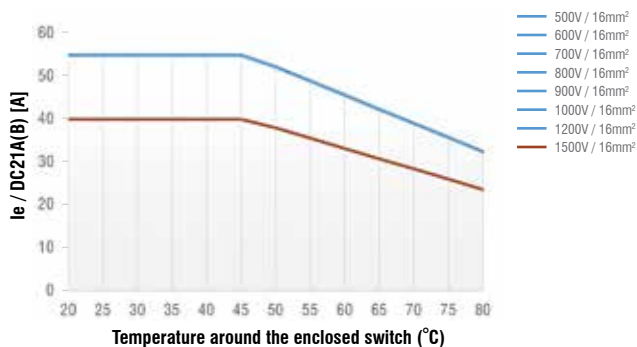

# Dimensions

**SI16PM / SI25PM / SI32PM**  
2

2H, 4

**SI + X "Y"**  
Extended Switch Shaft

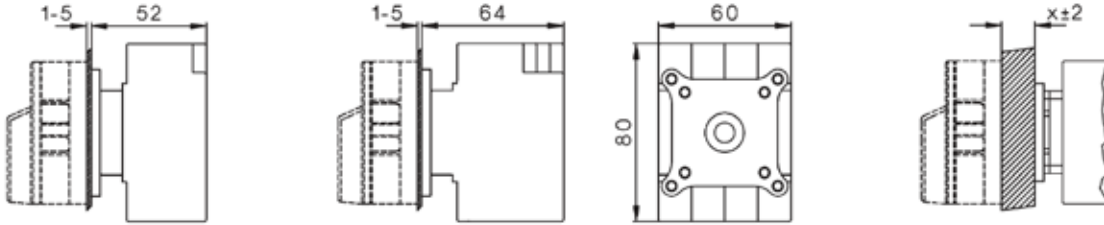

**SI16PM / SI25PM / SI32PM**  
6, 8, 4H

**SI40PM / SI55PM**  
2, 2H, 4

Mounting Hole

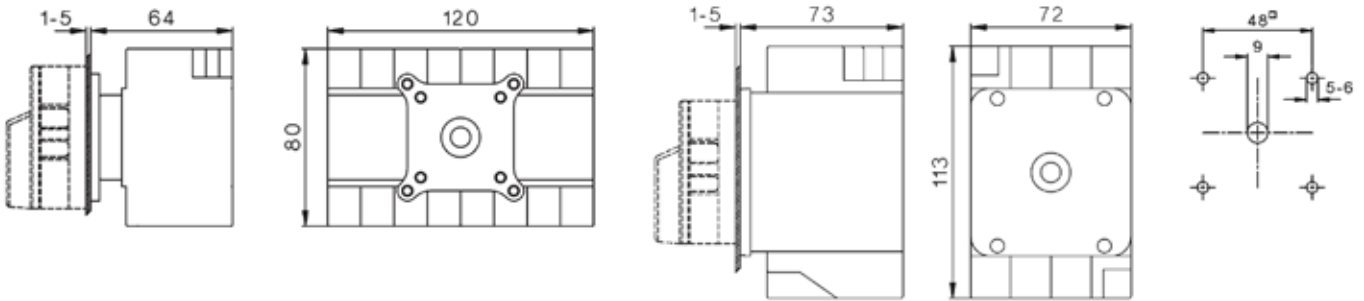

**Escutcheon Plate 64**  
Lever

Lockable Lever

Lockable Rotary

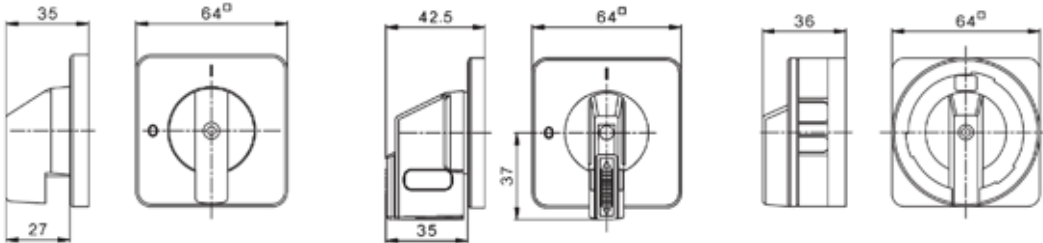

**SI16SHM(L) / SI25SHM(L) / SI32SHM(L)**  
2

2H, 4

Mounting Hole

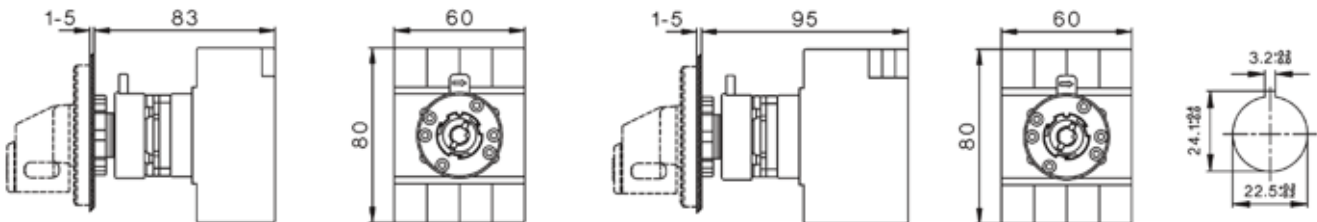

**Escutcheon Plate 48**  
Lever Handle

Lockable Lever

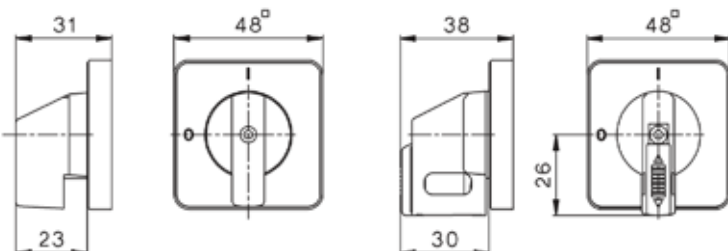

# Dimensions continued

## SI16SHM(L) / SI25SHM(L) / SI32SHM(L) 6, 8, 4H

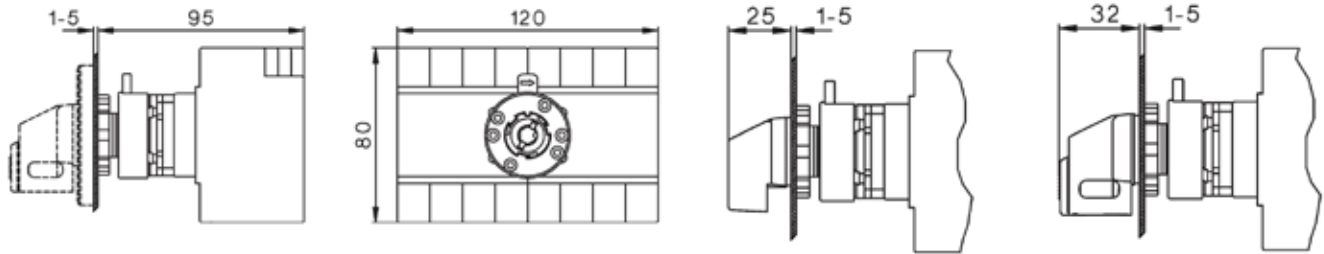

## SI16BMDL / SI25BMDL / SI32BMDL 2H, 4

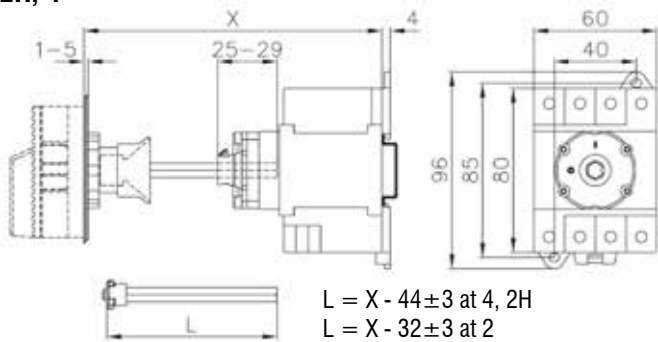

delivered with: 2H, 4  
 $X_{max.} = 194$ ,  $L = 150$   
 $(X_{min.} = 89)$

delivered with: 2  
 $X_{max.} = 182$ ,  $L = 150$   
 $(X_{min.} = 77)$

Greater X-Dimensions on request

$L = X - 44 \pm 3$  at 4, 2H  
 $L = X - 32 \pm 3$  at 2

## SI16BMDL / SI25BMDL / SI32BMDL 6, 8, 4H

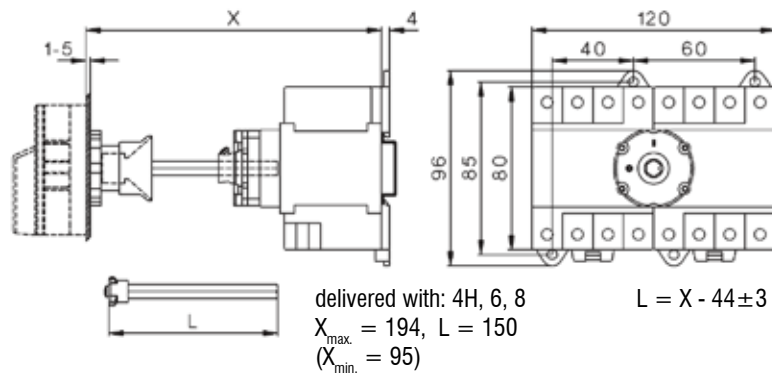

Mounting Hole

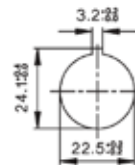

delivered with: 4H, 6, 8  
 $X_{max.} = 194$ ,  $L = 150$   
 $(X_{min.} = 95)$

$L = X - 44 \pm 3$

## SI40BMDL / SI55BMDL 2, 2H, 4

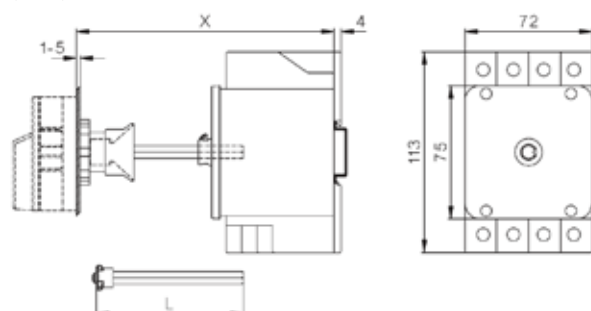

delivered with: 2, 2H, 4  
 $X_{max.} = 194$ ,  $L = 133$   
 $(X_{min.} = 103)$

$L = X - 61 \pm 3$

## Dimensions continued

SI16DB(L) / SI25DB(L) / SI32DB(L)  
2

2H, 4

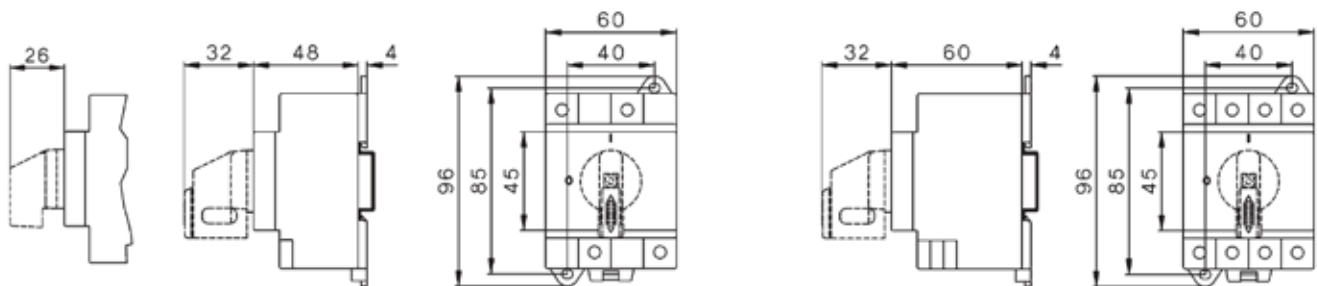

SI40DB(L) / SI55DB(L)  
2, 2H, 4

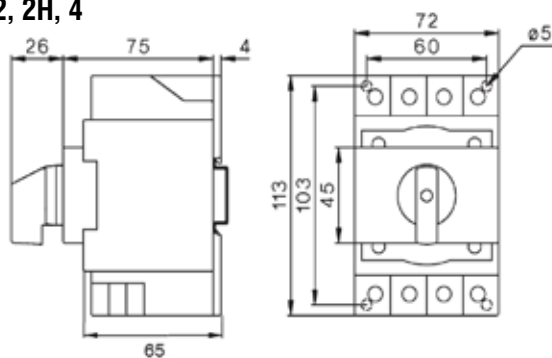

SI16DB(L) / SI25DB(L) / SI32DB(L)  
6, 8, 4H

SI.. DBL with low height handle  
2-LH

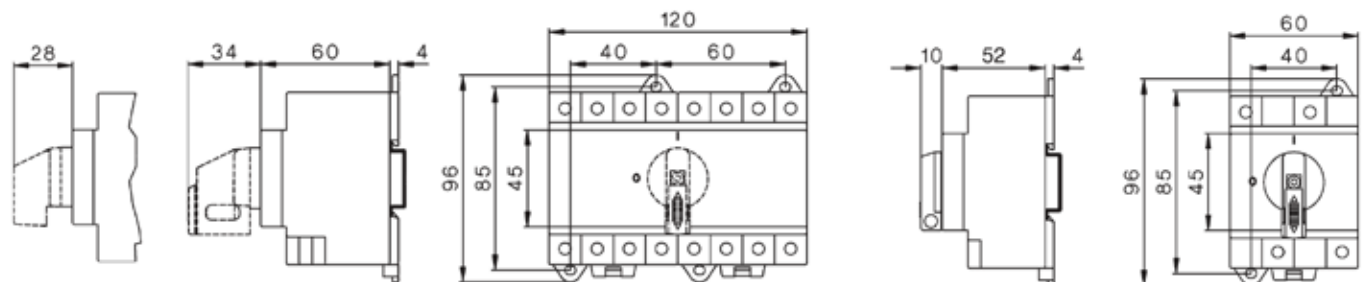

SI16DBL / SI25DBL / SI32DBL with low height handle  
2H-LH, 4-LH

4H-LH, 6-LH, 8-LH

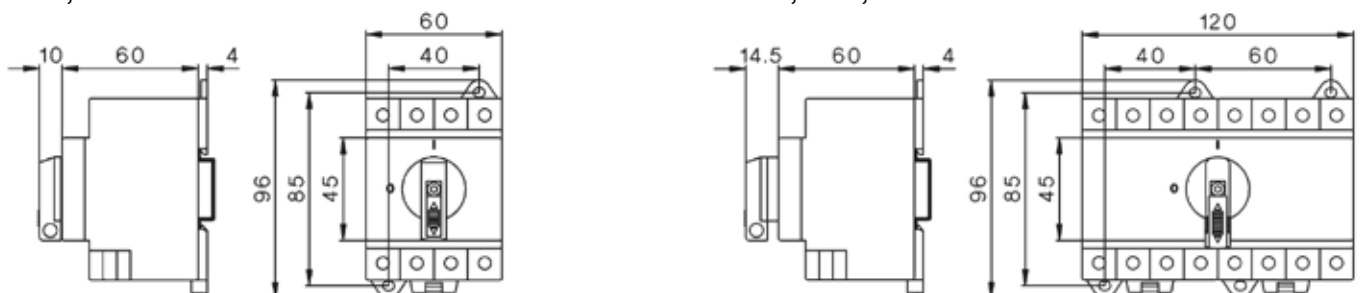

# Dimensions continued

**SI16PEL / SI25PEL / SI32PEL**  
2, 2H, 4

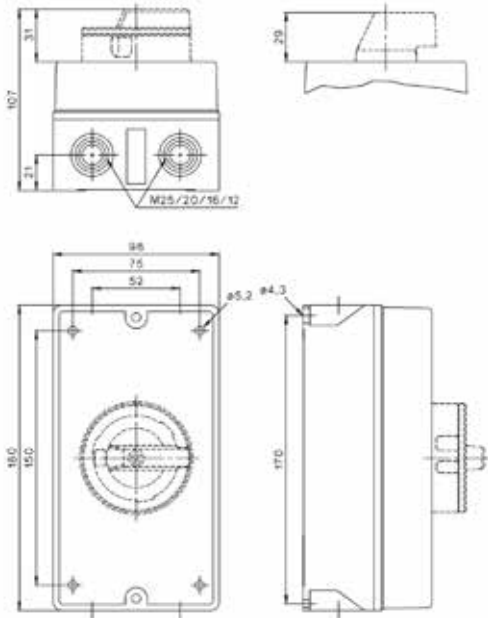

**SI16PEL / SI25PEL / SI32PEL**  
2, 2H, 4 + M25

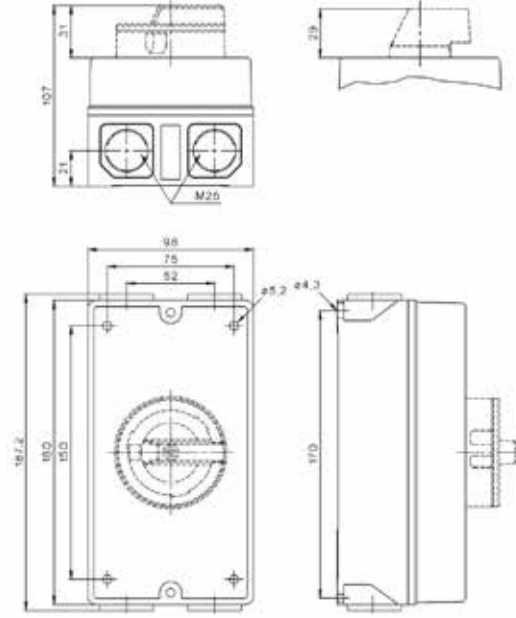

**SI16PEL / SI25PEL / SI32PEL**  
6, 8, 3H, 4H

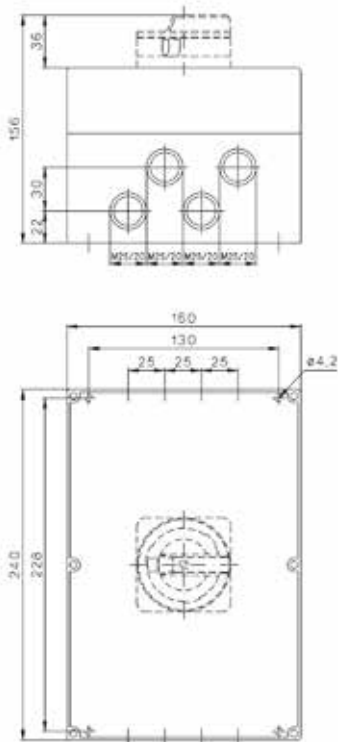

**SI40PEL / SI55PEL**  
2, 2H, 4

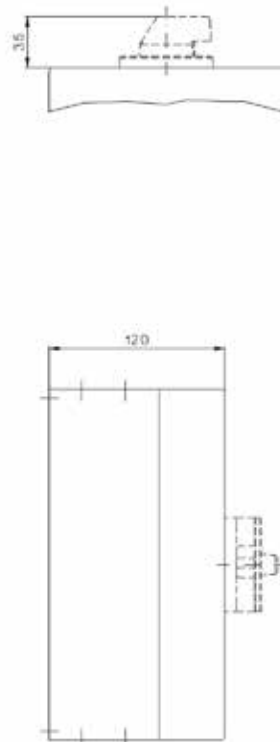

# Enclosed AC Isolator - PE69

- 3, 4, 6 and 8 pole versions available
- On load 20A - 100A
- Red/Yellow
- 3 Padlock positions
- IP65
- IP66 taller enclosure available
- Aux. Contacts available



Part number	Number of poles	Rating @ 3~400V			
		AC21/Amps	AC3/kW	AC23/Amps	AC23/kW
PE69-3020	3	20	5.5	16	7.5
PE69-3025	3	25	7.5	20	10
PE69-3032	3	32	11	25	12.5
PE69-3040	3	40	15	32	16
PE69-3063	3	63	18.5	45	22
PE69-3080	3	80	18.5	45	22
PE69-30100	3	100	30	72	37
PE69-4020	4	20	5.5	16	7.5
PE69-4025	4	25	7.5	20	10
PE69-4032	4	32	11	25	12.5
PE69-4040	4	40	15	32	16
PE69-4063	4	63	18.5	45	22
PE69-4080	4	80	18.5	45	22
PE69-40100	4	100	30	72	37
PE69-6020	6	20	5.5	16	7.5
PE69-6025	6	25	7.5	20	10
PE69-6032	6	32	11	25	12.5
PE69-6060	6	40	15	32	16
PE69-6063	6	63	18.5	45	22
PE69-6080	6	80	18.5	45	22
PE69-8020	8	20	5.5	16	7.5
PE69-8025	8	25	7.5	20	10
PE69-8032	8	32	11	25	12.5
PE69-8080	8	40	15	32	16
PE69-8063	8	63	18.5	45	22
PE69-8080	8	80	18.5	45	22

## Dimensions (mm)

Type	Pole	A	B	C	D1	E	F	H
PE69..20-40	3, 4	130	98	121	2x25,5/20,5	75	100	77
PE69..63-100	3, 4	200	120	-	40,5/32,5 + 16,5	95	165	86
PE69..20-40	6	200	120	-	40,5/32,5 + 16,5	95	165	86
PE69..20-40	8	240	160	-	40,5/32,5	130	228	120
PE69..63-80	6, 8	240	160	-	40,5/32,5	130	228	120

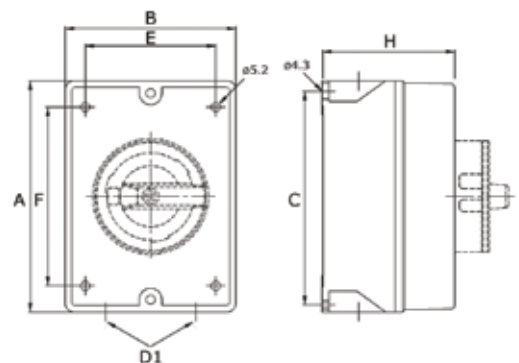



# Rapid Shutdown Solutions

In most Photovoltaic-installations, the DC switch is either integrated in the DC/AC-inverter or installed next to it, so the DC wires between solar-panels and inverter are continuously under voltage. In case of a fire, these wires need to be switched off as close as possible to the Photovoltaic panels and the fire brigade needs easy access to this switch off device.

For this purpose, IMO contactors for DC switching, used as a fire protection defeat device, can switch off the Photovoltaic-installation with an Emergency-Stop button. Alternatively, the contactor coil can be wired to the AC mains (grid) so that DC disconnection is achieved upon shutdown of the AC grid supply.

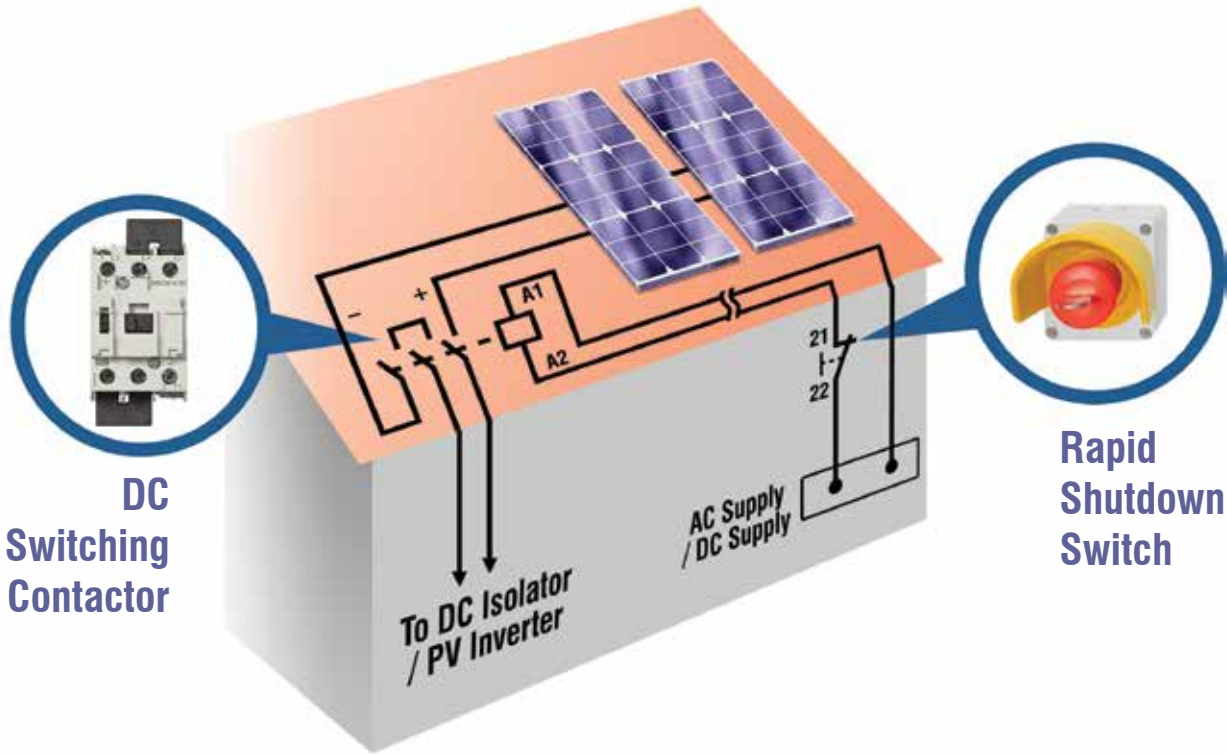

## Ordering Codes & Options

600VDC Rated

**MDC 20 - S-00 - 24AC**

Current Rating

20A	<b>20</b>
48A	<b>48</b>
80A	<b>80</b>
100A	<b>100</b>

Coil Voltage

24AC	<b>24AC</b>
110AC	<b>110AC</b>
230AC	<b>230AC</b>
400AC	<b>400AC</b>
24DC	<b>24DC</b>

1000VDC Rated

**MPV 12 - S-00 - 24AC**

Current Rating

12A	<b>12</b>
30A	<b>30</b>
60A	<b>60</b>
80A	<b>80</b>
100A	<b>100</b>
150A	<b>150</b>
200A	<b>200</b>
240A	<b>240</b>
300A	<b>300</b>
400A	<b>400</b>
450A	<b>450</b>

Coil Voltage

24AC	<b>24AC</b>
110AC	<b>110AC</b>
230AC	<b>230AC</b>
400AC	<b>400AC</b>
24DC	<b>24DC</b>

# AC Operated

Rated Operational Current DC1			Part Number	Additional Aux. Contacts	Pack pcs.	AC Coil	DC Coil	Wiring Diagram
600V	1000V	1200V				Weight kg / pc	Weight kg / pc	
20A	-	-	MDC20-S-00(10*)	2 MCAA11***	1	0.45	0.5	
48A	-	-	MDC48-S-00(10*)	+1 MCAT..	1	0.45	0.5	
80A**	35A	-	MDC80-S-00	2 MCAA11	1	1.17	1.17	
100A	-	-	MDC100-S-00	+1 MCAT..	1	1.8	1.8	
12A	12A	6A	MPV12-S-00(10*)	2 MCAA11*** +1 MCAT..	1	0.8	0.85	
30A	30A	-	MPV30-S-00(10*)	2 MCAA11***	1	0.9	0.95	
60A	60A	-	MPV60-S-00(10*)	+1 MCAT..	1	0.9	0.95	
80A**	80A	-	MPV80-S-00	2 MCAA11	1	1.35	1.35	
100A	100A	-	MPV100-S-00	+1 MCAT..	1	2.3	2.3	
150A	150A	-	MPV150-S-00	2 MCAA11	1	5	5	
200A	200A	-	MPV200-S-00	+1 MCAT..	1	5	5	
240A	240A	-	MPV240-S-00	2 MCAA11	1	5	5	
300A	300A	-	MPV300-S-00	2 MCAA11	1	7.5	7.5	
400A	400A	-	MPV400-S-00	+1 MCAT..	1	7.5	7.5	
450A	450A	-	MPV450-S-00	2 MCAA11 +1 MCAT..	1	7.5	7.5	

\* DC coil version comes with one NO aux. contact

\*\* UL Pending

\*\*\* DC coil version only one MCAA11



## Auxiliary Contact Blocks for contactors MDC-.. & MPV-..

Rated Operational Current			For Contactors	Type	Pack pcs.	Weight kg / pc.	Wiring Diagram
AC15 230V A	AC15 400V A	AC1 690V A					
3	2	10	MDC / MPV-.. Front	MCAT11	1	0.04	
3	2	10	MDC / MPV-.. Front	MCAT22	1	0.05	
3	2	10	MDC / MPV-.. Side	MCAA11	1	0.05	



## Accessories

Type	Pack pcs.	Weight kg / pc.	Wiring diagram	
Fire Brigade-Emergency stop Key operated button Ø40mm, according to EN418, unlock by key	BG10P44S3-11-SK	1	0.22	



# Technical Data

Data according to IEC 60947-3, VDE 0660

Type		MDC 20..	MDC 48..	MDC 80..	MDC 100..	MPV 12..	MPV 30..	MPV 60..	MPV 80..	MPV 100..	MPV 150..	MPV 200..	MPV 240..	MPV 300..	MPV 400..	MPV 450..
Rated insulation voltage	V=	600	600	1000	600	1200	1000	1000	1000	1000	1000	1000	1000	1000	1000	1000
U <sub>imp</sub>	kV	8	8	8	8	8	8	8	8	8	8	8	8	8	8	8
Poles in Series		3	3	3	3	8	6	6	4	4	3	3	3	3	3	3
DC1 600V dc I <sub>b</sub>	A	20	48	80	100	12	30	60	80	100	150	200	240	300	400	450
DC1 1000V dc I <sub>b</sub>	A	-	-	35	100	12	30	60	80	100	150	200	240	300	400	450
DC1 1200V dc I <sub>b</sub>	A	-	-	-	-	6	-	-	-	-	-	-	-	-	-	-
Main poles resistance	mOhm	2.5	2.3		3	13	8.5	8.5		4	1.5	1.5	1.5	0.85	0.85	0.85
Mechanical life	10 <sup>6</sup>	10		10		10		10		10		10		8		8
Protection degree		IP20		IP20		IP20		IP20		IP20		IP20		IP00		IP00
														IP20 w. terminal lug.		IP20 w. terminal lug.
Weight	kg	0.45		1.17	1.8		0.9		1.35	2.3		5				7.5
Main poles																
Cable cross-sections	mm <sup>2</sup>	2 x 1.5 - 10		2.5-35	4 - 35 +4-50	2x 1.5- 2.5	2 x 1.5-10		2.5-35	4-35 +4-50	busbar 18 x 4 screw M8			busbar 25 x 6 screw M10		
Tightening torque	Nm	2.3		5	8	1.4	2.3		5	8	17			35		
Mounting		DIN-rail or Screw			Screw	DIN-rail or Screw				Screw						
Operating coil range	U <sub>c</sub>	0.85 - 1.1														
<b>Power consumption of coils</b>																
AC	Inrush	VA	90		250		200		250		350		360			
	Hold	VA/W	9 / 4		18 / 6.3		18 / 8		18 / 6.3		5 / 5		5 / 5			
DC	Inrush	W	120		230		230		230		350		360			
	Hold	W	2		4		4		4		5		5			
<b>Switching time at voltage</b>																
Make time	ms	10 - 25		15 - 50		10 - 25		15 - 50		30 - 60		40 - 60				
Release time	ms	6 - 18		30 - 80		6 - 18		30 - 80		30 - 60		40 - 60				
<b>Maximum Ambient Temperature</b>																
Operation	°C	-25 to +40 (+70) <sup>(1)</sup>														
Storage	°C	-25 to +70														

<sup>1)</sup> > 40° ... 1% / °C de-rating (eg. at 60°C 20% de-rating)

## Dimensions (mm)

MDC20-S-00, MDC48-S-00

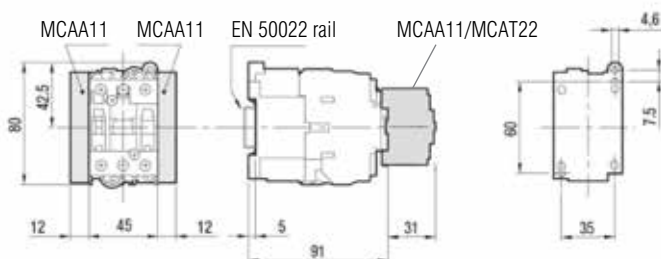

MDC20-S-10, MDC48-S-10 (DC Coil)



MDC80-S-00

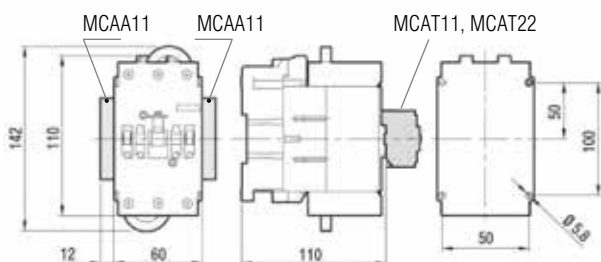

MDC100-S-00

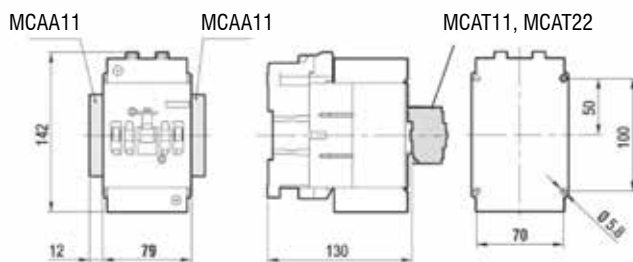

MPV12-S-00

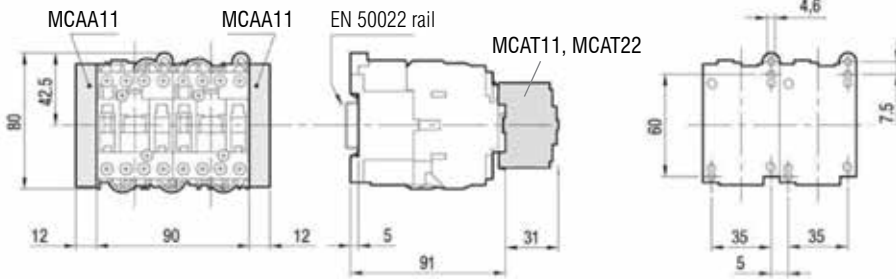

MPV12-S-10 (DC Coil)

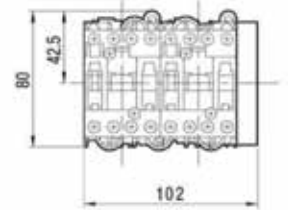

MPV30-S-00, MPV60-S-00

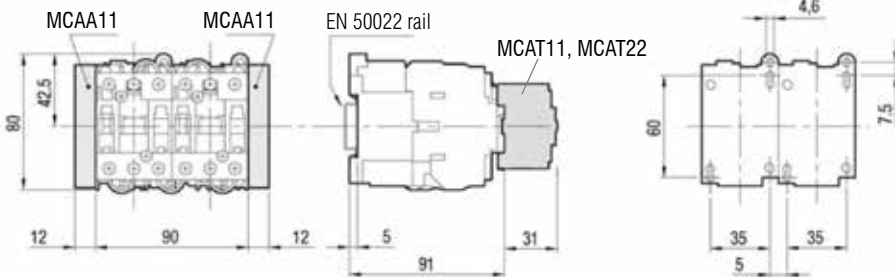

MPV30-S-10, MPV60-S-10 (DC Coil)

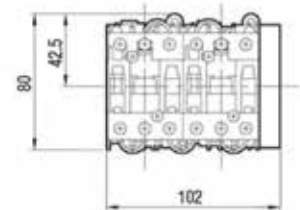

MPV80-S-00

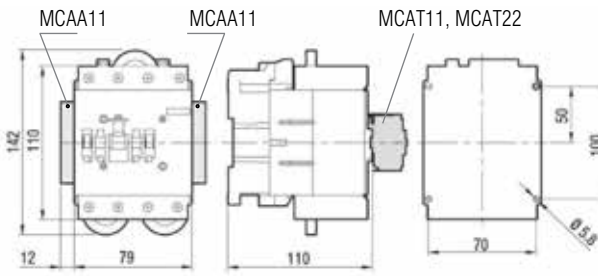

MPV100-S-00

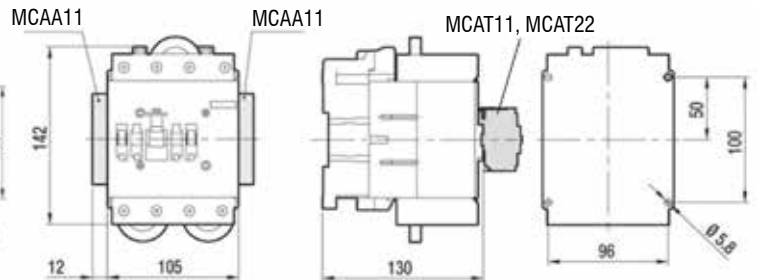

MPV150-S-00, MPV200-S-00, MPV240-S-00

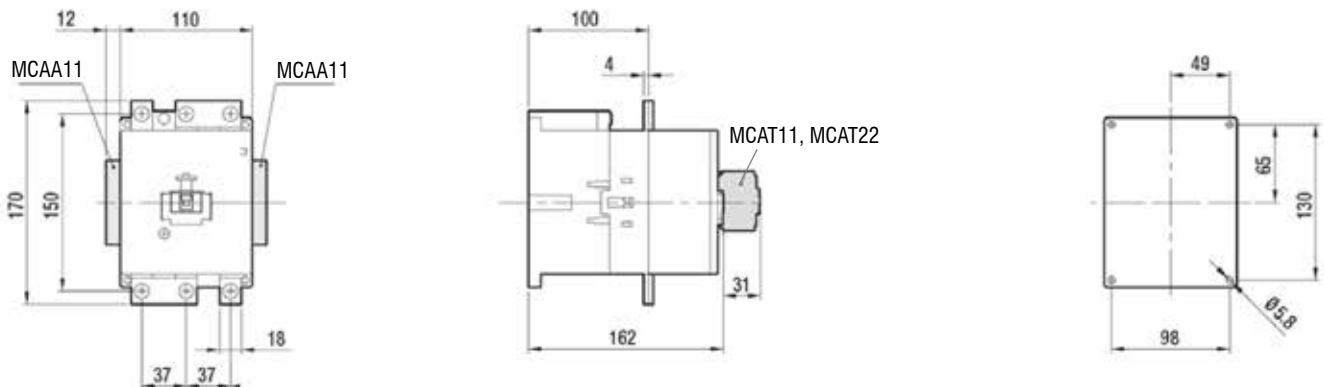

MPV300-S-00, MPV400-S-00, MPV450-S-00

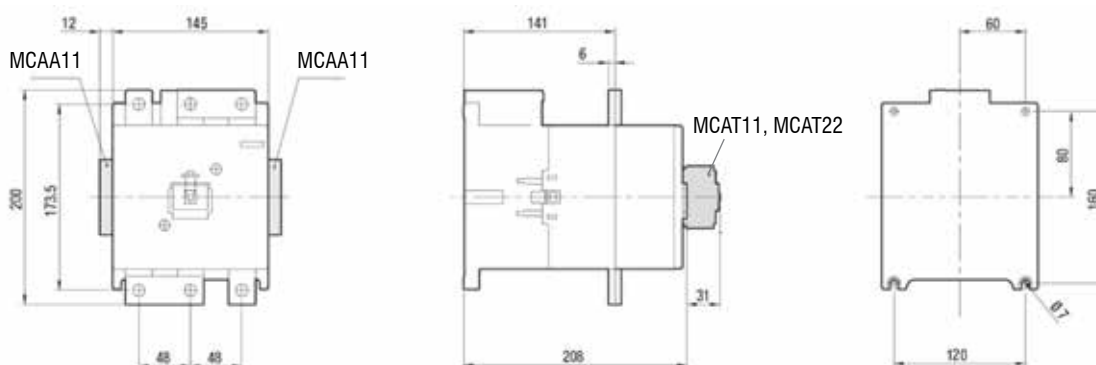

# Solar Connectors

Mobile connectors are used to connect PV panels in series. They also link lengths of cabling and allow connection to Branch and Panel connectors.

Branch connectors are used to link multiple strings together allowing, for example, a 2 pole (single string) DC isolator to switch both strings at the same time.

Panel connectors mount on solar string boxes, enclosed DC isolators and any other enclosed DC switching device allowing easy connection to the rest of the PV system.

- 1000V DC 30A Rated
- For 2.5-4-6mm<sup>2</sup> Cables
- Secure Easy Clip & Release System
- IP67 Protection
- UL94-5VA Fire Protection
- Class 2 Protection
- Operating Temperature: -40°C ~ +85°C

Part Number	Description	Pack Quantity
SIC-M-4M*	Male mobile connector	100
SIC-M-4F*	Female mobile connector	100
SIC-P-4M	Male panel connector	100
SIC-P-4F	Female panel connector	100
SIC-B-4PAIR	1xMFF + 1xFMM branch connectors	1 Pair
SIC-I-4M	Male connector metal insert (spare)	100
SIC-I-4F	Female connector metal insert (spare)	100

\* TUV Approved

## Dimensions

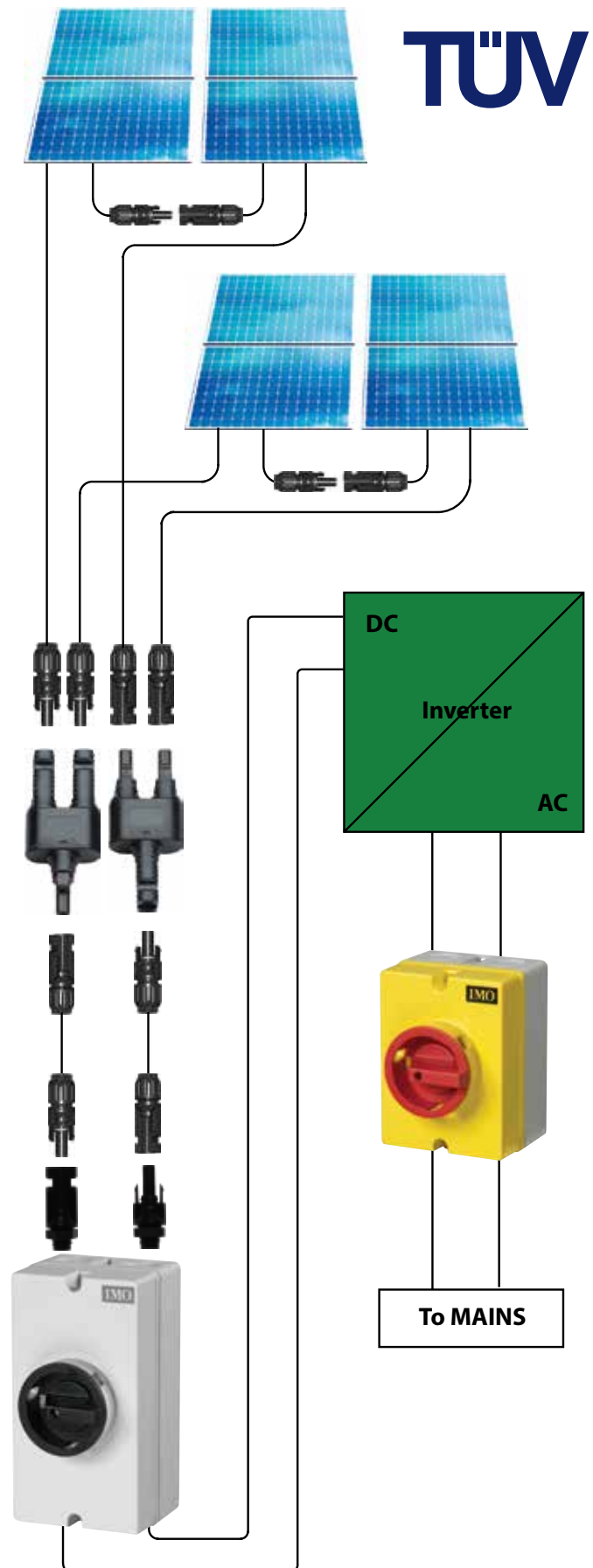
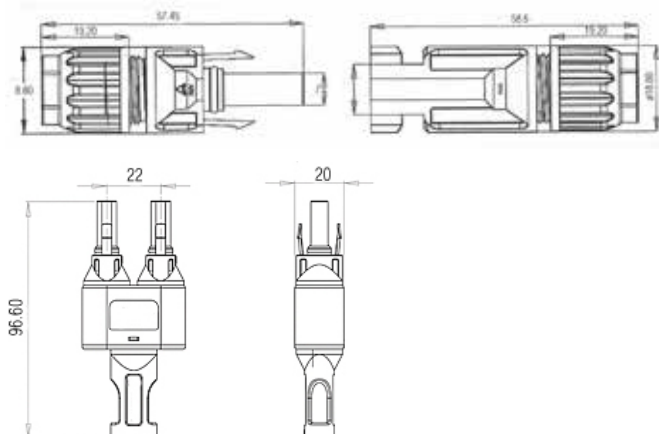

**TUV**

# DIN Rail Terminals

- 1000V Rated up to 232A
- Up to 95mm<sup>2</sup> wiring capacity
- UL94-V0 Materials
- Various colours available
- Labelling options
- UR/cUR approved (E244285)

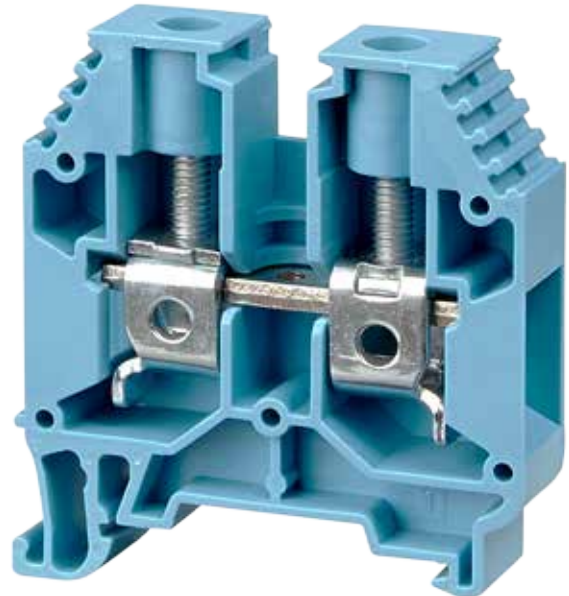

General Product Information	ER16V	ER35PV	ER50V	ER70V	ER70PV
Insulating material	PA 66	PA 66	PA 66	PA 66	PA 66
Inflammability class acc. to UL 94	V0	V0	V0	V0	V0
<b>Dimensions</b>					
Width	12 mm	16 mm	20 mm	22 mm	22 mm
Length	50 mm	52.8 mm	80 mm	74.0 mm	80.0 mm
Height (MR 35x7,5)	55.5mm	58.7 mm	84.7mm	67.5 mm	88.7 mm
<b>IEC Technical Data</b>					
Nominal Voltage	1000 V	1000 V	1000 V	750 V	1000 V
Nominal Current	76 A	115 A	150 A	192 A	232 A
Wire Cross Section	16 mm <sup>2</sup>	35 mm <sup>2</sup>	50 mm <sup>2</sup>	70 mm <sup>2</sup>	70 mm <sup>2</sup>
<b>UR / cUR Technical Data</b>					
Nominal Voltage	1000 V	1000 V	1000 V	1000 V	1000 V
Nominal Current	85 A	115 A	150 A	175 A	175 A
Wire Cross Section	12 - 4 AWG	12-2 AWG	6-1/0 AWG	6-2/0 AWG	6-2/0 AWG
<b>Connection Data</b>					
Minimum solid strand cross section	2.5 mm <sup>2</sup>	1.5 mm <sup>2</sup>	16 mm <sup>2</sup>	10 mm <sup>2</sup>	25 mm <sup>2</sup>
Maximum solid Strand cross section	25 mm <sup>2</sup>	35 mm <sup>2</sup>	70 mm <sup>2</sup>	70 mm <sup>2</sup>	95 mm <sup>2</sup>
Minimum fine Strand cross section	4 mm <sup>2</sup>	1.5 mm <sup>2</sup>	16 mm <sup>2</sup>	16 mm <sup>2</sup>	35 mm <sup>2</sup>
Maximum fine strand cross section	25 mm <sup>2</sup>	35 mm <sup>2</sup>	50 mm <sup>2</sup>	70 mm <sup>2</sup>	95 mm <sup>2</sup>
AWG Conductor Range	12 - 4	12-2	6 - 1/0	6 - 2/0	6 - 2/0
Connection Type	screw (1,0x5,5)	screw (1.2x6,5)	hexagonal socket screw S5 (DIN 6911)	hexagonal socket screw S6 (DIN 6911)	hexagonal socket screw S6 (DIN 6911)
Insulation Stripping length	16 mm	18 mm	24 mm	24 mm	24 mm
Tightening torque	1,2 - 2,0 Nm	2,5 - 3,5 Nm	6,0 - 10 Nm	6,0 - 12 Nm	6,0 - 12 Nm



# Distribution Boxes

- 4 to 36 poles
- High thermal stability - ASA plastic
- Transparent door
- UV stabilized
- IP65 rating - Inside / Outside use
- Earth & neutral bars included
- Suitable for Photovoltaic applications
- Optional Key Lock (E-Lock)



## Technical Data

Protection class	IP65	Temperature range	-25°C to 60°C
Isolation class	II	Colour	RAL 7035
Impact kit	IK07	IEC capability	60670-25

Type	Description	Number of terminals PE/N	Dimensions H x W x D (mm)
E-04W	4 Module Enclosure	4/4	200 x 127 x 120
E-08W	8 Module Enclosure	8/8	200 x 200 x 120
E-12W	12 Module Enclosure	10/10	258 x 318 x 142
E-24W	24 Module Enclosure	13/13	383 x 318 x 142
E-36W	36 Module Enclosure	13/13	507 x 318 x 142

Type	Cable Entries
E-04W	4 x M20 4 x M25/M32
E-08W	8 x M20 6 x M25 /M32
E-12W	12 x M20 10 x M25/M32 4 x M32/M40 2 x side knockout 90 x 37mm
E-24W	12 x M20 10 x M25/M32 4 x M32/M40 4 x side knockout 90 x 37mm
E-36W	12 x M20 10 x M25/M32 4 x M32/M40 6 x side knockout 90 x 37mm

### Step 1 - Select your box:



### Step 2 - Select your isolator:





### Step 3 - Select your accessories:



# Solar Relays



Model	DYA	PHY	PEY
			
Features	<ul style="list-style-type: none"> <li>- High voltage direct current relay</li> <li>- 10A, 20A, 40A, 80A, 120A, 200A, 300A switch capability</li> <li>- 10A, 20A, 40A: No specific polarity requirements for connection</li> <li>- Switching power up to 750kW</li> <li>- 2.5kV dielectric strength (between coil &amp; contacts)</li> </ul>	<ul style="list-style-type: none"> <li>- 30A switching capability</li> <li>- 4kV dielectric strength</li> <li>- Class F insulation</li> <li>- 3.00mm contact gap</li> </ul>	<ul style="list-style-type: none"> <li>- 30A switching capability</li> <li>- 4kV dielectric strength</li> <li>- Class F insulation</li> <li>- 3.0mm contact gap</li> </ul>
Contact Form	1A	1A, 2A	1A, 2A
Contact Material	Alloy	AgSnO <sub>2</sub>	AgSnO <sub>2</sub>
Max. Switching Voltage	750VDC	277VAC	277VAC
Max. Switching Power	30-750kW	8310VA / 6925VA	8310VA / 6925VA
Rated Load (Resistive Load)	10A 450VDC - 300A 450VDC	1A: 30A 240VAC/30A 277VAC 2A: 25A 240VAC/25A 277VAC	1A: 30A 240VAC/30A 277VAC 2A: 25A 240VAC/25A 277VAC
Rated Voltage	12, 24VDC	6 to 220/240VAC, 3 to 200VDC	6 to 220/240VAC, 3 to 200VDC
Ambient Temperature	-40°C to + 85°C	-55°C to + 70°C	-55°C to + 70°C
Mechanical Life (min.)	2 x 10 <sup>5</sup> ops	1 x 10 <sup>7</sup> ops	1 x 10 <sup>7</sup> ops
Electric Life (min.)	Product Dependant	1 x 10 <sup>5</sup> ops	1 x 10 <sup>5</sup> ops
Terminal Type	QC, Screw	PCB, QC	Screw

Model	PRW	PRR	PQY
			
Features	<ul style="list-style-type: none"> <li>- 31A switching capability</li> <li>- Applicable to inverter used for photovoltaic power generation systems</li> <li>- Ideal for UPS</li> <li>- 1.5mm contact gap</li> <li>- Clearance between contact &amp; coil is greater than 6.4mm</li> <li>- Creepage distance &gt; 8mm</li> </ul>	<ul style="list-style-type: none"> <li>- 10A switching capability</li> <li>- 5kV dielectric strength</li> <li>- 1.5mm contact gap</li> <li>- Sealed and dust protected versions available</li> </ul>	<ul style="list-style-type: none"> <li>- 10A switching capability</li> <li>- 1.5kV dielectric strength</li> <li>- 2.00mm contact gap</li> <li>- Plug-in and PCB versions available</li> </ul>
Contact Form	1A	2A	2C
Contact Material	AgSnO <sub>2</sub>	AgSnO <sub>2</sub>	AgCe
Max. Switching Voltage	277VAC	30VDC / 250VAC	30VDC / 250VAC
Max. Switching Power	7750VA	240W / 2500VA	300W / 2500VA
Rated Load (Resistive Load)	Resistive: 26A 250VAC Inductive: 31A 250VAC	10A 250VAC / 8A 30VDC	10A 30VDC / 250VAC
Rated Voltage	9 to 24VDC	3 to 60VDC	6 to 240VAC, 5 to 220VDC
Ambient Temperature	-40°C to + 85°C	-40°C to + 85°C	-40°C to + 70°C
Mechanical Life (min.)	1 x 10 <sup>6</sup> ops	5 x 10 <sup>5</sup> ops	1 x 10 <sup>7</sup> ops
Electric Life (min.)	3 x 10 <sup>4</sup> ops	1 x 10 <sup>5</sup> ops	1 x 10 <sup>5</sup> ops
Terminal Type	PCB, QC	PCB	PCB, QC

# Solar Cube

## Precision Solar Tracking & Management

The IMO Solar Cube has been developed as a ground breaking, easy to set up solar tracking and measurement controller with the flexibility to adapt to any installation.

The Solar Cube is an off the shelf controller designed for use on either one or two axis solar panel installations to track the sun's movement and provide optimum panel (or array) positioning. The sun's position is calculated using the local time and date comparing this with the longitude and latitude location of the solar array. From this data the Solar Cube calculates the 'zenith angle' and the 'azimuth angle', which together exactly specify the position of the sun in the sky to within 0.01°.

To position the array the Solar Cube uses feedback from an electronic compass device connected via RS232 or RS485 which then activates the solar array's actuators until the correct position is reached. The compass is mounted directly on the array frame to give accurate positioning information.

With the option of GPS positioning or manual inputting of the array's location, the Solar Cube is easy to setup anywhere in the world. The Solar Cube is a competitive solution for controlling each array or it can be configured to control up to 4 arrays from one controller providing additional savings. Options for feedback and control from a single control station or via a web server are also available.

Solar Cube also offers data logging facilities using its own internal Micro SD card. Power output can be logged continually to produce daily, monthly and yearly figures. Revenues can be calculated along with CO<sub>2</sub> reduction figures.



## Solar Cube Key Features

- 3.5" Monochrome Touch Screen
- 5 Pre-programmed function keys
- Built-in sun positioning algorithm
- 3D Compass input for accurate positioning
- Automatic location and clock updates with GPS
- MicroSD card for data logging
- Password security for all settings
- Error based adjustment with configurable error values for each axis
- Configurable minimum and maximum adjustment angles
- Configurable safety cut-out system
- Configurable twilight settings (returns to morning position automatically)
- Single Axis supports Azimuth or Zenith tracking
- Supports custom inverter serial communications
- GPRS and Ethernet Remote Access options available
- Emergency Stop input
- Manual Jog function
- Manual Override key
- Optional Ice and Wind Sensor inputs
- Four motor outputs (For 2 Axis Control)
- Limit Switch inputs for safety cut out
- Optional Washer Control output
- Analog input for power output measurement (CT Connection)
- Optional analog input for light level sensing
- IP65 (NEMA4) CE, cUL, UL
- 10-30VDC supply

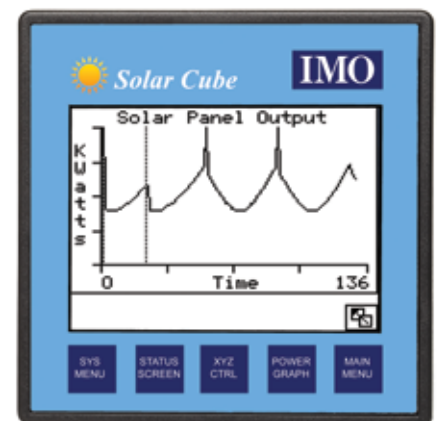
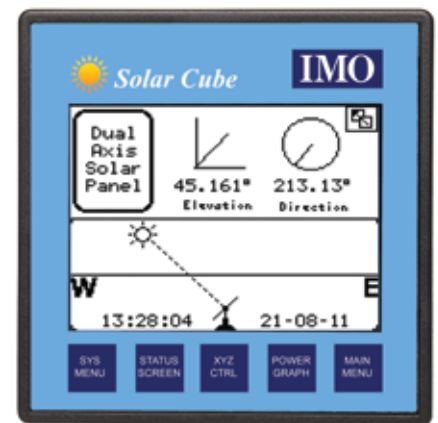
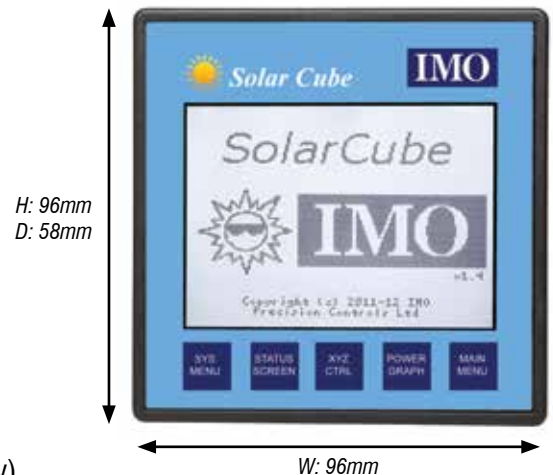

## Solar Cube Data Logging

- Total kWh produced to date
- Total kWh produced today
- Current Power Output graph (kW against time)
- Yesterday's Power Output graph
- Yield Values for last 31 days (kWh against days)
- Yield Values for last 12 months (kWh against months)
- Specific Annual Yield

## Part Numbers

### Single Array

Part Number	Description
SOLARCUBE-1A	Single Array Solar Tracker, 1 or 2 axis configurable
COMPASS-485	3D Positional Compass
OEM GPS RECEIVER	RS232 GPS Receiver

### Four Array

Part Number	Description
SOLARCUBE-4A	Four Array Solar Tracker, 1 or 2 axis configurable
SMT-CD-R20-V3 (x3)	Slave Array I/O Repeater
COMPASS-485 (x4)	3D Positional Compass
OEM GPS RECEIVER	RS232 GPS Receiver

Note: Above configuration can be used for each group of 4 Arrays. Where a large number of Arrays need linking a Master Control option is available, call IMO for details.



# Certifications



**UL508i  
Certificate**



**cUR  
Certificate**



**UR  
Certificate**



**GOST  
Certificate**



**IEC  
Certificate**



**TUV  
Certificate**



# Also Available From IMO

AC Variable Speed Drives  
0.37-710kW (0.5-950HP)

A solution for every application

AC Variable Speed Drives

iDrive2  
AC Variable Speed General Purpose Drives  
0.4 - 2.2kW

Affordable drives evolved

iDrive2 Low-Cost Drives

Miniature Circuit Breakers

Bridging the gap

Miniature Circuit Breakers

Panel Product Range

Click on a better solution

Panel Product Range

Relays  
Relais  
Relè  
Реле

A solution for every application

Relays

Terminal Blocks

Connecting to the Future

PCB Terminal Blocks

DIN Rail Push-Fit Terminals  
Rail DIN Borniers Enfilable  
Barra DIN Morsetti ad Inserzione Rapida  
DIN-Рейка Клеммы Быстрого Зажима

Stay on the right track

Pushfit Terminals

Solar Cube  
Precision Solar Tracking & Measurement

Solar Cube

iView HMI

HMI solutions you can view

iView Advanced HMI

Automation Product Range

Solutions with you in mind

Automation Product Range

i3 Intelligent Control Station

Think inside the box

i3 Intelligent Control Station

Push Buttons

Pushing the boundaries

Push Buttons (Online Only)



## IMO Worldwide Offices

### IMO Precision Controls Limited

1000 North Circular Road  
Staples Corner  
London NW2 7JP  
United Kingdom

Tel: 020 8452 6444  
Fax: 020 8450 2274  
Email: imo@imopc.com  
Web: www.imopc.com

### IMO Jeambrun Automation SAS

Centre D'Affaires Rocroy  
30, Rue de Rocroy  
94100 Saint-Maur-Des-Fosses  
France

Tel: 0800 912 712 (n° gratuit)  
Fax: 0145 134 737  
Email: imo-fr@imopc.com  
Web: www.imojeambrun.fr

### IMO Automazione

Via Ponte alle Mosse, 61  
50144 Firenze (FI)  
Italia

Tel: 800 930 872 (toll free)  
Fax: 8000 452 6445  
Email: imo-it@imopc.com  
Web: www.imopc.it

### IMO Canada

Unit 32 - B - North  
18 Stratheam Avenue, Brampton  
Ontario L6T 4Y2  
Canada

Tel: 905 799 9237 (local)  
Fax: 905 799 0450  
Email: imo-ca@imopc.com  
Web: www.imopc.com

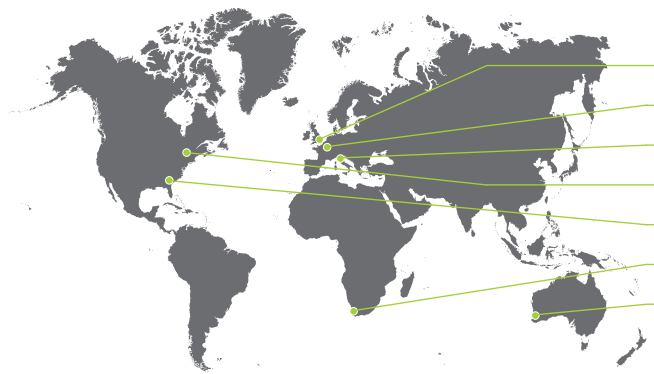

-  IMO UK
-  IMO Jeambrun
-  IMO Automazione
-  IMO Canada
-  IMO Automation
-  IMO South Africa
-  IMO Pacific

### IMO Automation LLC

101 Colony Park Drive, Suite 300  
Cumming  
Georgia 30040  
USA

Tel: 404 476 8810  
Fax: 404 476 8811  
Email: imo-usa@imopc.com  
Web: www.imoautomation.com

### IMO South Africa (Pty) Ltd

G16 Centurion Business Park  
Montague Gardens  
Cape Town 7441  
South Africa

Tel: 021 551 1787  
Fax: 021 555 0676  
Email: info@imopc.co.za  
Web: www.imopc.co.za

### IMO Pacific Pty Ltd

1/6 Dillington Pass  
Landsdale  
Perth WA 6065  
Australia

Tel: 08 9302 5246 (local)  
Fax: 08 9303 9908  
Email: sales@imopacific.com.au  
Web: www.imopacific.com.au