

TE'S CROMPTON INSTRUMENTS ANALOGUE METERS

Table of contents

I. DIN panel meters



An extensive range of 48, 72, 96 and 144 mm DIN style panel meters. Short-scale ammeters, voltmeters and frequency meters incorporate slide-in dials and terminal covers. Long-scale meters are also available. Meters for power or energy contain in-built transducers and can be customised to suit many different system configurations and ranges. UL, CSA and Marine Approved.

6



Chapter 1

II. Saxon series panel meters



A range of 2 1/2" and 3 1/2" surface mount panel meters utilising pivot and jewel mechanisms and offering IP54 protection. The range offers iron vane and moving coil AC and DC ammeters and voltmeters, elapsed time and frequency meters. UL and CSA Approved.

36



Chapter 2

III. Fiesta series panel meters

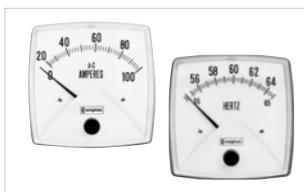

A robust range of short-scale 3 1/2" surface mount panel meter offering IP55 protection and featuring wide-view contoured windows. The range offers iron vane and moving coil AC and DC ammeters and voltmeters, elapsed time and frequency meters. UL and CSA Approved.

42



Chapter 3

IV. Challenger series panel meters

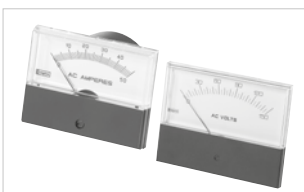

A range of 1 1/2", 2 1/2", 3 1/2" and 4 1/2" analogue panel meters. The Challenger analogue panel meters feature a detachable lower fascia plate, which allows either surface or window mounting. Meters use a high torque pivot and jewel movement. UL and CSA Approved.

48



Chapter 4

V. ANSI switchboard meters



56

High quality range of switchboard instruments with Class 1 accuracy and which complies with American ANSI-C39.1 (1981) specifications. Available in 4 1/2" case size, the rugged design characteristics meet the needs of the most demanding environmental applications.



VI. Meter relay panel meters



80

Series 239 meter relays combine a highly accurate indicator with High and Low set point relays. The relays can operate alarm and control devices when the monitored signal value moves outside the chosen set point limits shown by adjustable red index pointers.

VII. Sealed and ruggedised panel meters



86

Designed to comply with industrial, marine and military specifications, these 240° and 90° scale meters are resistant to extreme shock, vibration, temperature, dirt and humidity. The range offers a wide range of bezel sizes fitted with toughened glass.

VIII. Instrument selector switches



92

Panel mounted selector switches offer a 7-position voltmeter switch and a 4-position ammeter switch for reading line-to-line or line-to-neutral voltage and phase current.

Should you need more details about product codes, please check the product builder sheets on the website www.crompton-instruments.com/analogue.html





Chapter I DIN panel meters

Short scale.....	6
Long scale.....	14
Dual voltmeter and frequency meter.....	18
Power meters.....	19
LED synchroscope.....	23
Elapsed time meters.....	24
Phase sequence indicators and phase angle meters.....	25

DIN panel meters

FEATURES

- A range of the most popular short-scale measuring instruments in 4 case sizes
- Shock resistant sprung pivot and jewel movement
- Terminal covers supplied as standard
- EMC hard frequency meters are fully EMC and LVD compliant
- 1/4" 'fast on' terminals available

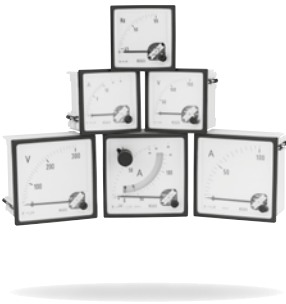

APPLICATIONS

- Switchgear
- Distribution systems
- Generator sets
- Control panels
- Energy management
- Building management
- Utility power monitoring
- Process control
- Motor control

APPROVALS



- E242, E243 & E244 models
- Short scale 90°
- Moving Coil DC & Moving Coil Rectified AC meters



- E242, E243 & E244 models
- Short scale 90°
- Moving Iron & Moving Coil meters

BENEFITS

- Low cost
- Local indication
- Ease of installation
- Minimal training
- Low maintenance
- Customised options and features

A range of 48, 72, 96 and 144 mm DIN style panel meters measuring all electrical parameters and featuring moving coil or moving iron movements. All meters incorporate slide-in dials and terminal covers as standard. A range of customised options is available.

MOVEMENTS

MOVING COIL METER

Centre cored, self shielding moving coil movement, using pivots, hairsprings and sprung jewels. Seven variations have been designed in movement ranges: all intermediate ranges are achieved by shunting the next lowest range. All DC voltmeters are 1000 ohms per volt, rectified product run at 900 ohms per volt, millivolt meters use the 5 milliamp movement.

MOVING IRON METER

Clapper type repulsion design using pivots, hairsprings and jewel movements. The bottom jewel is oil filled to provide damping while the top is sprung for resilience. All voltmeters are manufactured with external voltage dropper resistors to substantially reduce the self heating effects.

FREQUENCY METER

Meter uses a 100 microamp 4000 ohm movement driven by an EMC hard frequency conversion circuit.

DIALS, SCALES AND POINTERS

Standard dials are white matt with black printed scales and bar knife-edge pointers. Black dials with white or yellow scales and pointers are also available. Interchangeable slide-in dials are used on the E242, E243, E244 and E246 90° moving iron, moving coil and frequency meter models.

General options include red supplementary pointers, red indexes (quadrant scales), red, green or blue lines, bands or segments, finely spaced divisions, multi-scales, special scales and captions to customer's requirements. 24V Bulb illumination available on E244 Moving Coil & Moving Coil Rectified Meters.

SPECIFICATIONS

Type of instrument	Moving iron for current and voltage	Moving coil for current and voltage	Moving coil with rectifiers for current and voltage	Moving coil with built-in transducer for frequency measurement	Maximum demand indicators	Combined MD with moving iron movement
Format	48 x 48 mm 72 x 72 mm 96 x 96 mm 144 x 144 mm	48 x 48 mm 72 x 72 mm 96 x 96 mm 144 x 144 mm	48 x 48 mm 72 x 72 mm 96 x 96 mm 144 x 144 mm	48 x 48 mm (short scale only) 72 x 72 mm (short scale only) 96 x 96 mm 144 x 144 mm	72 x 72 mm 96 x 96 mm	96 x 96 mm
Movement type	Sprung pivot jewel with silicon oil damping	Sprung pivot jewel with eddy current damping	Sprung pivot jewel with eddy current damping	Sprung pivot jewel with eddy current damping	Sprung pivot jewel with silicon oil damping	Sprung pivot jewel with silicon oil damping
Burden	0.5 VA-15 A then 0.8 VA voltmeters 4.5 VA	See type specific specifications	See type specific specifications	See type specific specifications	2.5 VA	3 VA
Accuracy	1.5% to DIN43780	1.5% to DIN43780	1.5% to DIN43780	0.5% to DIN43780	3%	3% on MDI 1.5% ammeter
Input type	AC current or voltage	DC current or voltage	AC current or voltage	AC voltage	AC current	AC current
Measuring range (short scale)	6-600 V 100 mA-100 A 48 mm only up to 40 A	50 mV-600 V 100 µA-40 A, 48 mm only 25 A	15-600 V 1m A-100 mA and 1 A & 5 A	57.7 V - 500V 45/55Hz 45/65Hz 55/65Hz 360/440Hz 380/420Hz	0-1/1.2 A or 0-5/6 A 8, 15 or 20 minute delays	1-6 A 8, 15 or 20 minute delays 0-5 A/6 A instantaneous
Measuring range (long scale)	N/A	50 mV-600 V 100 µA-40 A 48 mm only 20 A	15-600 V 10 mA-15 A	57.7 V - 500V 45/55Hz 45/65Hz 55/65Hz 360/440Hz 380/420Hz	N/A	N/A
Dielectric voltage withstand test	3 kV AC	3 kV AC	3 kV AC	3 kV AC	3 kV AC	3 kV AC

DIN panel meters - short scale

DIN16257 SYMBOL MEANING FOR CALIBRATION POSITION

VERTICAL



HORIZONTAL



INCLINED

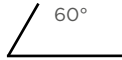

Inclination of dial surface.
Required orientation must always be stated when ordering if other than vertical mounting is required.

GENERAL SPECIFICATIONS

Performance	BS EN60051
Measuring ranges	DIN43701
Accuracy overload	BS EN60051
Dimensions	DIN43700
Scale marking generally to	DIN43802
Magnetic influence	BS EN60051
Safety	BS EN61010-1
Terminals	Clamp strap M4 for up to 25 A. Clamp strap M8 for over 25 A 1/4" spade terminals available for models E243 and E244
Humidity range	Up to 95% RH (non condensing)
Test voltage @50Hz	3 kV RMS for 1 minute
Ammeter ranges	1.0/1.2/1.5/2.5/5/6 and decade multiples thereof
Overload AC current	x 1.2 continuous x 10 for 5 seconds
AC voltage and frequency	x 1.2 continuous x 2 for 5 seconds
Standard calibration	23°C. Calibration at other temperatures available on request
Operating temperature	-20°C to +60°C
Damping time	Less than 3 seconds
Enclosure code	IP52 as standard IP54 on request
Case and base	Grade UL94V0
Case	Dimensions and panel cut out conform to IEC473, DIN43700. Case made from glass filled polycarbonate self-extinguishing and non drip in accordance with UL94V-O
Bezel	Slim-line DIN43802, black as standard
Bezel window	Standard sheet glass, with zero adjusters where appropriate. Non reflecting glass or polycarbonate shatterproof windows are available
Installation	Installations in switchboard panel or mosaic arrangement on equipment or machine with a panel thickness of up to 40 mm in a horizontal or vertical plane
Fixing on panel	Swivel captive fasteners, which can be fixed at either corner
Mounting position	Normal vertical mounting or as indicated on the scale in accordance with DIN16257. A deviation of $\pm 15^\circ$ is permissible
Insulation group	Insulation resistance more than $5\Omega @ 500 \text{ V}$
Environmental	Measurement category III IEC 1010-1 Pollution degree 2 IEC 1010-1 Electrical rating 600 V RMS (920 V peak)
Approvals	EMC, LVD, Lloyds and UL

DIMENSIONS

Moving coil measuring range		Moving iron measuring range	
6 - 60 A	C=67 mm	0 - 30 A	C=64 mm
>60 A	C=78 mm	>30 A	C=67 mm

MAX. PANEL THICKNESS = 40 MM

D	A	B
48 x 48	45 x 45	4
72 x 72	68 x 68	4
96 x 96	92 x 92	4
144 x 144	138 x 138	4

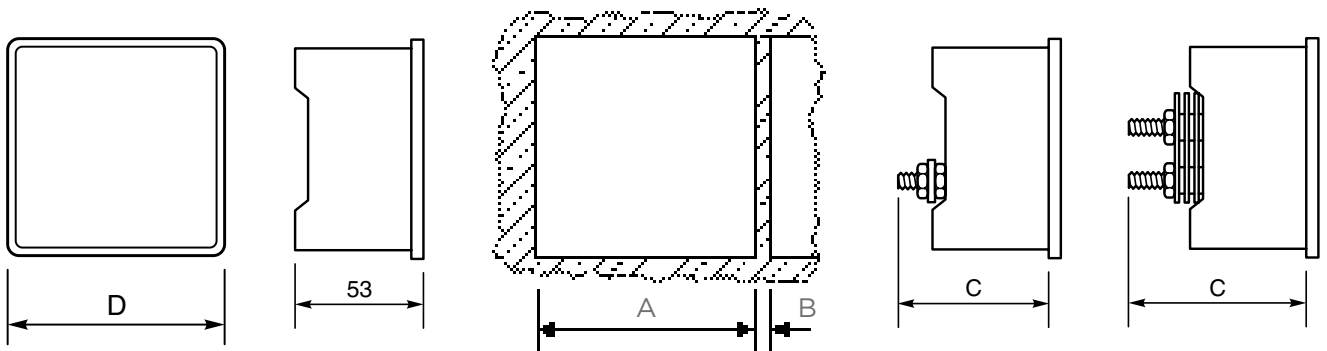

Short scale moving iron AC ammeters and voltmeters



Designed to measure AC current or voltage, these meters indicate true RMS values and are substantially independent of system waveform. Scales are calibrated down to 20%, and ammeters can have overload scales of x2, x3, x5 or x6 for motor start duty. Ammeters can be supplied for use with -/1 A or -/5 A current transformers, whilst voltmeters can be scaled for use with voltage transformers. Meters can be used to measure DC at reduced accuracy.

PRODUCT CODES

Bezel size mm	48	72	96	144
Scale length mm	42	65	94	145
AC ammeter	E242-75A	E243-02A	E244-02A	E246-02A
x2 overload ammeter	E242-752A	E243-022A	E244-022A	-
x3 overload ammeter	E242-753A	E243-023A	E244-023A	-
x5 overload ammeter	E242-755A	E243-025A	E244-025A	-
x6 overload ammeter	E242-756A	E243-026A	E244-026A	-
AC voltmeter	E242-75V	E243-02V	E244-02V	E246-02V

SPECIFICATIONS

Accuracy	Class 1.5
Frequency	50, 60 Hz, (400 Hz on request)
Burden at 50 Hz	Ammeters: 0.5 VA Voltmeters: Up to 4.5 VA maximum
Ratings	Ammeters: 0.5-100 A AC direct connected (40 A for E242-75 A and E246-02 A) Maximum system voltage 600 V AC Low load/high middle, maximum 10 A
Voltmeters	6-600 V

CONNECTIONS

AC ammeter

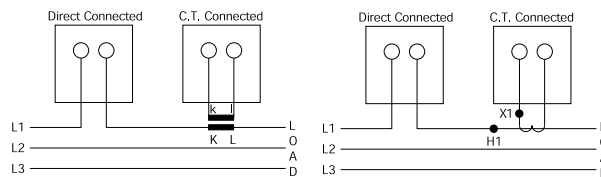

AC VOLTMETER

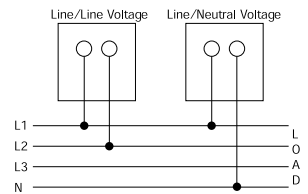

Frequency meters



Frequency meters use an integral electronic converter and a moving coil indicator. These easy to read meters have accuracy Class 0.5.

PRODUCT CODES

Bezel size mm	48	72	96
Scale length mm	42	65	94
Product codes	E242-41S	E243-41S	E244-41S

SPECIFICATIONS

Ratings	100 - 125 V AC 200 - 250 V AC 380 - 440 V AC* 500 V AC*
Frequency	0.5%: 45/55 Hz, 55/65 Hz, 45/65 Hz, 360/440 Hz
Burden	4 VA maximum

CONNECTIONS

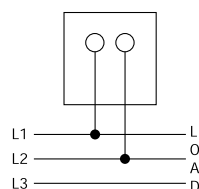

Short scale maximum demand indicators



The thermal/time characteristics of MDI meters monitor the most economic use of cable, fusegear and transformers. The directly heated bimetal element indicates mean RMS current over 8, 15, or 20 minutes, and a red slave pointer shows the highest value reached. The reset knob is wire sealable. Scales are calibrated to match the CT primary plus 20% overload. End values are selected from: 1.2, 1.8, 2.4, 3, 3.6, 4.8, 6, 7.2, 9 amps and their multiples of 10 and 100.

PRODUCT CODES

Bezel size mm	72	96
Scale length mm*	65	94
Product codes		
8 minute time lag		
without limiting CT for use with 5 A CT	E243-16B	E244-16B
15 minute time lag		
without limiting CT for use with 5 A CT	E243-16A	E244-16A
20 minute time lag		
without limiting CT for use with 5 A CT	E243-16J	E244-16J

* Scaled 0/100/120% of CT primary value.

SPECIFICATIONS

Accuracy	Class 3
Options	5 A for use with separate CT 5/5 A saturating CT 1/5 A saturating CT
Burden at 50 Hz	MDI - 2.5 VA, CT - 2 VA
Overload withstand	Standard: 5 x FL for 5 seconds, 10 x FL for 1 second. With saturating CT: 10 x FL for 3 seconds, 20 x FL for 1 second
Frequency	50/60 Hz

CONNECTIONS

Maximum demand indicators

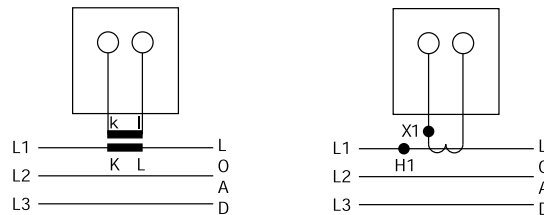

Combined AC ammeter and maximum demand indicators



Where measurement of instantaneous and maximum demand currents are required, these instruments combine both movements in one case. The meter can also replace an existing AC ammeter. Meets the same specifications listed above.

PRODUCT CODES

Bezel size mm	72	96
Scale length mm*	65	94
Product codes		
8 minute time lag		
without limiting CT for use with 5 A CT 3 VA	-	E244-16Q
15 minute time lag		
without limiting CT for use with 5 A CT 3 VA	E243-16C	E244-16C
with limiting CT		E244-16F
20 minute time lag		
without limiting CT for use with 5 A CT 3 VA	-	E244-16H

SPECIFICATIONS

Accuracy	Moving iron ammeter: Class 1.5 MDI: Class 3
Burden at 50 Hz	MI - 0.5 VA, MDI - 2.5 VA saturating CT - 2 VA

Short scale moving coil DC meters



Moving coil meters are suitable for all DC systems. The linear scale is calibrated down to zero and the accuracy maintained down to 10%. High currents are measured with separate shunts and suitably scaled indicators. Suppressed, centre and offset zero models are available.

PRODUCT CODES

Bezel size mm	48	72	96	144
Scale length mm	42	65	94	145
Product codes				
Ammeters	E242-89A	E243-01A	E244-01A	E246-01A
Ammeters suppressed zero	E242-89R	E243-01R	E244-01R	E246-01R
Ammeters centre zero	E242-89C	E243-01C	E244-01C	E246-01C
Voltmeters	E242-89V	E243-01V	E244-01V	E246-01V
Voltmeters suppressed zero	E242-89S	E243-01S	E244-01S	E246-01S
Voltmeters centre zero	E242-89N	E243-01N	E244-01N	E246-01N

SPECIFICATIONS

Accuracy	Class 1.5
Ratings	Ammeters: 100 μ A-25 A 4/20 mA suppressed zero 40 A for model E242, E243 and E244 up to 100 A Voltmeters: 50 mV-600 V 1/5 V suppressed zero 50, 60, 75, 100, 150 mV for use with shunts
Impedance	Ammeters: 75 mV internal shunt above 60mA Voltmeters: 1000 Ω /V above 1 V

CONNECTIONS

DC voltmeter

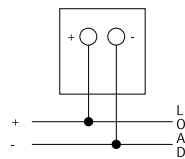

DC ammeter

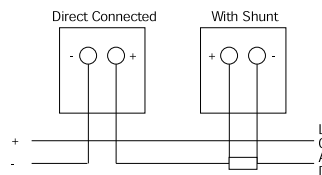

Short scale rectified AC ammeters and voltmeters



For high frequency or linear full scale AC measurements, these instruments measure average values of sinusoidal waveforms and are scaled in RMS values.

The high quality silicon bridge rectifier gives a linear scale down to near zero, where some compression occurs.

PRODUCT CODES

Bezel size mm	48	72	96	144
Scale length mm	42	65	94	145
Product codes				
Ammeters	E242-89B	E243-01B	E244-01B	E246-01B
Voltmeters	E242-89W	E243-01W	E244-01W	E246-01W

SPECIFICATIONS

Accuracy	1.5% ES
Ratings	Ammeters: 250 μ A-1 A AC Over 1 A via CTs
Voltmeters	15 - 600 V AC direct connected. Models available for use with VTs
Frequency	50/60 Hz, (Single frequencies 25 Hz - 1 kHz on request)

CONNECTIONS

AC ammeter

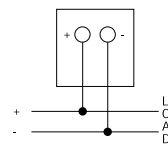

AC voltmeter

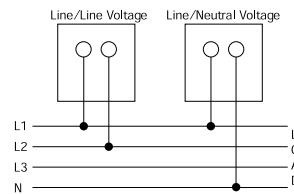

Short scale process indicators



Meters are used to check process functions locally or remotely at centralised controls. These moving coil instruments offer a wide variety of electrical and mechanical readouts and are operated by transducer, tachogenerator, thermocouple, resistance bulb or other DC analogue signals. Suppressed, centre and offset zero models are available on request.

PRODUCT CODES

Bezel size mm	48	72	96	144
Scale length mm	42	65	94	145
Product codes				
AC current	E242-89A	E243-01A	E244-01A	E246-01A
AC voltage	E242-89V	E243-01V	E244-01V	E246-0 V
Phase angle	-	E243-014	E244-014	-
Watts	-	E243-015	E244-015	-
VAR	-	E243-016	E244-016	-
VA	-	E243-017	E244-017	-

SPECIFICATIONS

Accuracy	Class 1.5
Ratings	1, 2, 5, 10, 20 mA 4/20 mA suppressed zero

CONNECTIONS

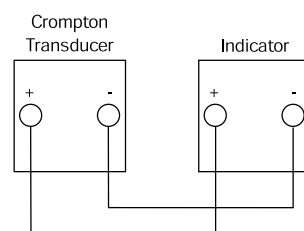

AC ammeters and voltmeters with selector switch

FEATURES

- Integral selector switch
- True RMS measurement
- Scaled for customer VT or CT primary values
- DIN 72 and DIN 96 models
- Terminal cover as standard
- Shock resistant sprung pivot and jewel movement
- x2 overload ammeters



APPLICATIONS

- Switchgear
- Distribution systems
- Generator sets
- Control panels
- Energy management
- Building management

APPROVALS

- IEC61010-1B2001, EMC and LVD

BENEFITS

- Space and time saving
- Competitive cost
- Local indication
- Ease of installation
- Low maintenance
- Customised options and features

These 96 mm and 72 mm units offer Class 1.5 true RMS measurement of three-phase AC voltage or current with various switch notation options. The integral selector switch eliminates the necessity for a separate selector switch, saving valuable panel space and providing installation benefits. These robust moving iron meters incorporate a clapper type repulsion design which utilises a pivot, hairspring and jewel movement. The bottom jewel is oil filled to provide damping while the top is sprung for resilience. Voltmeters are manufactured with internal voltage dropper resistors.

PRODUCT CODES - AC AMMETERS WITH SELECTOR SWITCH

Code	Case size	Full scale deflection	Switch notation
E243-02E-G-LS**-C7-AMP3	72 mm	0/5 A AC	OFF L1 L2 L3
E244-02E-G-LS**-C7-AMP3	96 mm	0/5 A AC	OFF L1 L2 L3
E243-022E-G-LS**-C7-AMP3	72 mm	0/5/10 A AC	OFF L1 L2 L3
E244-022E-G-LS**-C7-AMP3	96 mm	0/5/10 A AC	OFF L1 L2 L3
E243-02E-G-LA**-C7-AMP3	72 mm	0/1 A AC	OFF L1 L2 L3
E244-02E-G-LA**-C7-AMP3	96 mm	0/1 A AC	OFF L1 L2 L3
E243-022E-G-LA**-C7-AMP3	72 mm	0/1/2 A AC	OFF L1 L2 L3
E244-022E-G-LA**-C7-AMP3	96 mm	0/1/2 A AC	OFF L1 L2 L3

**Insert applicable CT primary value.

PRODUCT CODES - AC VOLTMETERS WITH SELECTOR SWITCH

Code	Case size	Full scale deflection	Switch notation	3-phase
E243-02Q-G-PM**-C7-SW6	72 mm	0/120 V AC	OFF L1L2 L2L3 L3L1	3W
E243-02Q-G-PZ**-C7-SW6	72 mm	0/150 V AC	OFF L1L2 L2L3 L3L1	3W
E243-02Q-G-PZ-PZ-C7-SW6	72 mm	0/150 V AC	OFF L1L2 L2L3 L3L1	3W
E243-02Q-G-RX-RX-C7-SW6	72 mm	0/300 V AC	OFF L1L2 L2L3 L3L1	3W
E243-02Q-G-SF-SF-C7-SW3	72 mm	0/500 V AC	L1L3 L1L2 L2L3 L3N L2N L1N	4W
E243-02Q-G-SJ-SJ-C7-SW3	72 mm	0/600 V AC	L1L3 L1L2 L2L3 L3N L2N L1N	4W
E244-02Q-G-PZ**-C7-SW6	96 mm	0/150 V AC	OFF L1L2 L2L3 L3L1	3W
E244-02Q-G-PZ-PZ-C7-SW6	96 mm	0/150 V AC	OFF L1L2 L2L3 L3L1	3W
E244-02Q-G-RX-RX-C7-SW6	96 mm	0/300 V AC	OFF L1L2 L2L3 L3L1	3W
E244-02Q-G-SF-SF-C7-SW3	96 mm	0/500 V AC	L1L3 L1L2 L2L3 L3N L2N L1N	4W
E244-02Q-G-SF-SF-C7-SW3	96 mm	0/600 V AC	L1L3 L1L2 L2L3 L3N L2N L1N	4W

**Insert applicable VT primary and secondary value, e.g. 15 kV/110 V.

PRODUCT CODES - OPTIONS

Description
Non reflecting glass window
Red supplementary pointer, externally adjustable
Red index mark (triangle)

Please state any required options at time of ordering.

CONNECTIONS

AC ammeter with selector switch

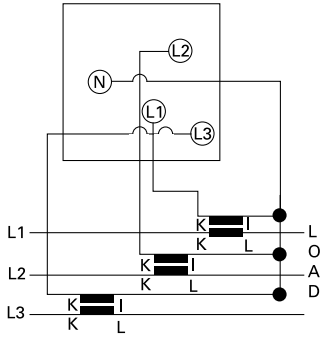

AC voltmeters 3-phase 3-wire

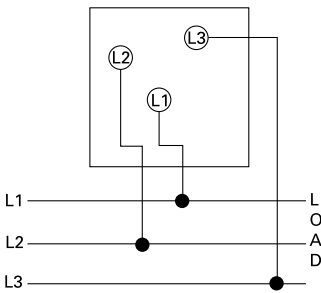

AC voltmeters 3-phase 4-wire

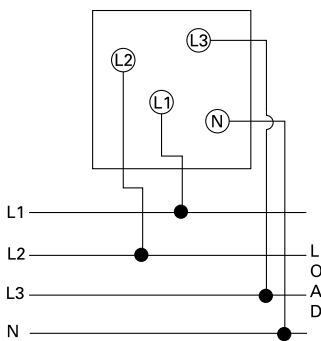

GENERAL SPECIFICATIONS

Accuracy	1.5% of full scale deflection (FSD)
Input rating	Ammeter: 1 A, 5 A 1/2 A or 5/10 A moving iron, direct connected Voltmeter: 120, 300, 500 and 600 V AC
Frequency	50, 60 Hz (400 Hz on request)
Burden at 50 Hz	Ammeters: 0.5 VA Voltmeters: 4-5 VA max
Overload ammeter	2 x In continuous for 2 minutes, 4 x In for 1 minute
Overload voltmeter	1.2 x continuous 2 x for 5 seconds
Movement	Moving iron shock resistant sprung pivot and jewel
Scale length	DIN72: 54 mm DIN96: 97 mm
Enclosure style	Panel mount to DIN42700
Enclosure material	Grade UL94 VO
Bezel style	Black matt DIN43802
Window	Standard sheet glass
Terminals	M4 captive screw clamp
Fixing	2 corner fixing clamps with tensioning thumb screws
Mounting position	Vertical mount to DIN16257, inclination of dial surface $\pm 15\%$
Damping time	Less than 3 seconds
Compliant with	IEC61010-1B2001, CAT III 600V, EMC and LVD
Operating temperature	-20°C to +55°C
Storage temperature	-40°C to +75°C
Calibration temperature	23°C
Relative humidity	95% (non condensing)
Dimensions	96DIN: 96 mm high x 96 mm wide x 63 mm deep 72DIN: 72 mm high x 72 mm wide x 63 mm deep
Panel cut out	DIN96: 92 mm x 92 mm DIN72: 68 mm x 68 mm
IP protection	IP40
Weight	E243-02E 275 g E243-02Q 300 g E244-02E 360 g E244-02Q 390 g

DIMENSIONS

72DIN models

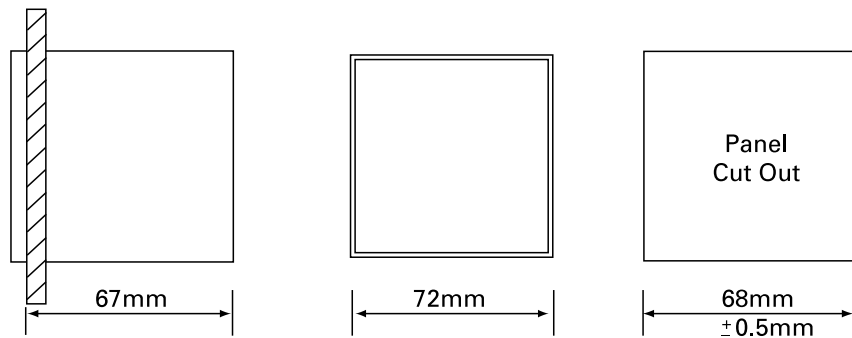

96DIN models

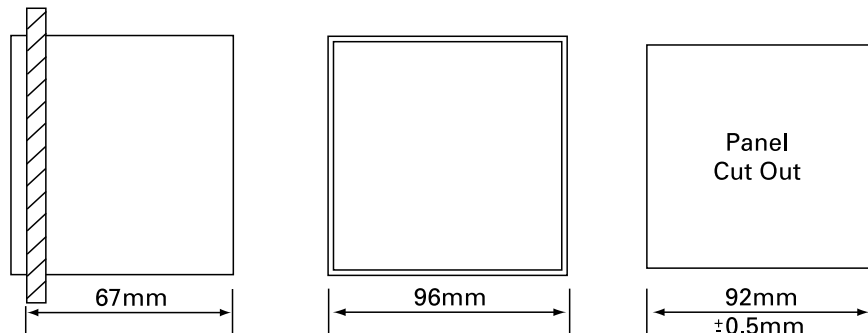

DIN panel meters - long scale

FEATURES

- DIN 48, 72, 96 and 144mm case sizes
- Slide in dials
- Shock resistant sprung pivot & jewel movement
- Terminal covers supplied as standard
- EMC hard frequency meter are fully EMC and LVD compliant



APPLICATIONS

- Switchgear
- Distribution systems
- Generator sets
- Control panels
- Energy management
- Building management
- Utility power monitoring
- Process control
- Motor control

DIN16257 SYMBOL MEANING FOR CALIBRATION POSITION

VERTICAL



HORIZONTAL

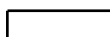

INCLINED

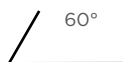

Inclination of dial surface.

Required orientation must always be stated when ordering if other than vertical mounting is required.

APPROVALS

- EMC
- LVD

BENEFITS

- Local indication
- Ease of installation
- Minimal training
- Low maintenance
- Customised options and features

MOVING COIL METER

Centre cored, self shielding moving coil movement, using pivots, hairsprings and sprung jewels. Seven variations have been designed in movement ranges: all intermediate ranges are achieved by shunting the next lowest range. All DC voltmeters are 1000 ohms per volt, rectified product run at 900 ohms per volt. Millivolt meters use the 5 milliamp movement.

FREQUENCY METER

Meter uses a 100 microamps 4000 ohm movement driven by an EMC hard frequency conversion circuit.

DIALS, SCALES AND POINTERS

Standard dials are white matt with black printed scales and bar knife-edge pointers. Black dials with white or yellow scales and pointers are also available. Interchangeable slide-in dials are used on the E243 and E244 240° moving coil and frequency meter models.

Standard options include red supplementary pointers, and non-reflecting glass.

Other options available on request.

GENERAL SPECIFICATIONS

Performance	BS EN60051
Measuring ranges	DIN43701
Accuracy overload	BS EN60051
Dimensions	DIN43700 see detail on following page
Scale marking generally to	DIN43802
Magnetic influence	BS EN60051
Safety	BS EN61010-1
Terminals	Clamp strap M4 for up to 25A. Clamp strap M8 for over 25A
Humidity range	Up to 75% RH (non condensing)
Test voltage @50Hz	3kV RMS for 1 minute
Overload AC current	x 1.2 continuous, or x 10 for 5 seconds max
AC voltage and frequency	x 1.2 continuous, or x 2 for 5 seconds max
Standard calibration	23°C. Calibration at other temperatures available on request
Operating temperature	-10°C to +55°C
Damping time	Less than 3 seconds
Enclosure code	IP52 as standard IP54 on request
Case and base	Grade UL94V0 (Lexan 500R)
Case	Dimensions and panel cut out conform to IEC473, DIN43700. Case made from glass filled polycarbonate self-extinguishing and non drip in accordance with UL94 V-O.
Mounting position	Normal vertical mounting or as indicated on the scale in accordance with DIN16257. A deviation of ±15° is permissible
Bezel	Slim-line DIN43802, black as standard
Bezel window	Standard sheet glass, with zero adjusters where appropriate. Non reflecting glass windows are available
Installation	Installations in switchboard panel or mosaic arrangement on equipment or machine with a panel thickness of up to 40 mm in a horizontal or vertical plane
Fixing on panel	Swivel captive fasteners, which can be fixed at either corner
Insulation group	Insulation resistance more than 5 MΩ@ 500 V
Environmental	Measurement category III IEC 61010-1 Pollution degree 2 IEC 1010-1 Electrical rating 600 V RMS (920 V peak)
Approvals	EMC, LVD

ENVIRONMENTAL CONDITIONS

Climatic suitability	climatic class 3 according to VDE/VDI 3540
Operating temperature	-10 - + 55 °C
Storage temperature	-25 - + 65 °C
Relative humidity	≤75% annual average, noncondensing
Shock resistance	15g _n for pulse duration 11 ms
Vibration resistance	10-55-10Hz for ampli. 0.15mm (1.5 g at 50Hz)

Long scale rectified AC ammeter and voltmeter

FEATURES

- Measures AC current or voltage
- CT connected ammeters
- Direct and VT connected voltmeters
- Linear scaling
- Glass filled polycarbonate housing (UL 94-V-0)
- Knife edge pointer.
- Easily replaceable glass and bezel
- 240° long scale version



APPLICATIONS

- Control/switchgear panels & machinery consoles

CONSTRUCTION

- Polycarbonate, flame retardant & drip proof case as per UL 94 V-0
- Front facia - Glass
- Panel fixing - mounting clamp

APPROVALS

- CE marked
- UKCA

BENEFITS

- Easy to operate
- Exchangeable dial
- Low consumption
- Terminal cover included

PRODUCT CODES

Bezel size (mm)	DIN 48	DIN 72	DIN 96	DIN 144
Scale length (mm)	70	106	142	230
AC ammeter rectified 240°	E242-05B	E243-05B	E244-05B	E246-05B
AC voltmeter rectified 240°	E242-05W	E243-05W	E244-05W	E246-05W
AC ammeter rectified 240° x6 overload	-	E243-056B	E244-056B	-

GENERAL SPECIFICATION

Accuracy class	1.5 IEC 51/ DIN EN 60051
Maximum continuous overload	1.2 times rated voltage / current
Maximum short duration overload	2 times, 5 Sec max:1 overload 10 times, 0.5 Sec max:9 overload
Measured quantity	AC voltage or current
Encloses codes	IP52 - case IP00-terminals with out backcover IP20 for terminals with backcover
Insulation class	Group A according to VDE 0110
Rated insulation voltage	660 V
Proof voltage testing	2 kV
Installation category	300 VCAT III
Insulation resistance	> 50 Mohm at 500 V d.c
Ambient temperature	IEC 51/ DIN EN 60051
Position of use	Vertical $\pm 5^\circ$
Frequency	40.5 - 71.5 Hz
External magnetic field	At 0.4 kA/m
Impedance	Voltmeters: 900 ohm/V Ammeters: 75mV internal shunt

DIMENSIONS

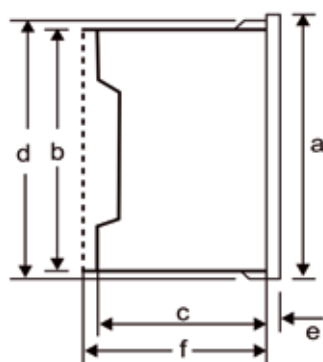

Front dimensions mm	48 x 48	72 x 72	96 x 96	144 x 144
Bezel (a) mm	48	72	96	144
Case (b) mm	43.5	66	90	136
Depth (c) mm	53	53	53	53
Depth (d) mm	44.5	67.5	91.5	137.5
Depth (e) mm	5.5	5.5	5.5	5.5
Depth with back cover (f) mm	64	64	64	64
Cutout size mm	45 ± 0.6	68 ± 0.7	92 ± 0.8	138 ± 0.1
Weight Kg	0.13	0.25	0.30	0.43

CONNECTION DIAGRAMS

AC voltage

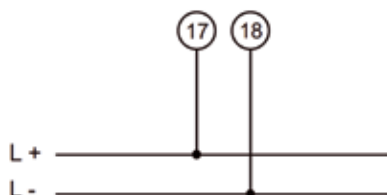

AC current

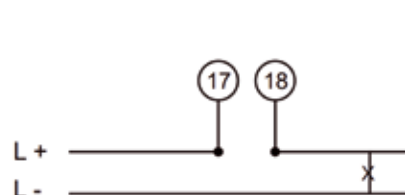

Long scale DC ammeter and voltmeter

FEATURES

- Measures DC current or voltage
- Direct and shunt connected ammeters
- Direct connected voltmeters
- Live zero ammeters and voltmeters
- Centre zero ammeters and voltmeters
- Linear scaling
- 240° long scale version



APPLICATIONS

- Control/switchgear panels & machinery consoles

CONSTRUCTION

- Polycarbonate, flame retardant & drip proof case as per UL 94 V-0
- Front fascia - Glass
- Panel fixing - mounting clamp

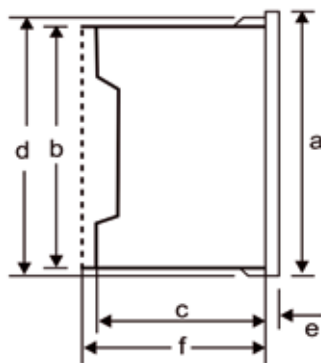

APPROVALS

- CE marked
- UKCA

BENEFITS

- Easy to operate
- Exchangeable dial
- Terminal cover included

PRODUCT CODES

Bezel size (mm)	DIN 48	DIN 72	DIN 96	DIN 144
Scale length (mm)	48	106	142	230
DC ammeter 240°	E242-05A	E243-05A	E244-05A	E246-05A
DC voltmeter 240°	E242-05V	E243-05V	E244-05V	E246-05V
DC ammeter 240° live zero	E242-05R	E243-05R	E244-05R	E246-05R
DC voltmeter 240° live zero	E242-05S	E243-05S	E244-05S	E246-05S
DC ammeter 240° centre zero	E242-05C	E243-05C	E244-05C	E246-05C
DC voltmeter 240° centre zero	E242-05N	E243-05N	E244-05N	E246-05N

GENERAL SPECIFICATION

Accuracy class	1.5 IEC 51/ DIN EN 60051
Maximum continuous overload	1.2 times rated voltage / current
Maximum short duration overload - Ammeters	10 times for 5 sec : 1 overload 10 times for 0.5 sec : 9 overloads
Maximum short duration overload - Voltmeters	2 times for 5 sec : 1 overload 2 times for 0.5 sec : 9 overloads
Measured quantity	DC voltage or current
Encloses codes	IP52 - case IP00-terminals with out backcover IP20 for terminals with backcover
Insulation class	Group A according to VDE 0110
Rated insulation voltage	1000 V
Proof voltage testing	3 kV
Installation category	600 VCAT III
Insulation resistance	> 50 Mohm at 500 V d.c
Ambient temperature	0 - 50°C
Position of use	Vertical ±5°
Frequency	40.5 - 71.5 Hz
External magnetic field	0.5mT
Impedance	Voltmeters: 900 ohm/V Ammeters: 75mV internal shunt

DIMENSIONS

	48 x 48	72 x 72	96 x 96	144 x 144
Front dimensions mm	48 x 48	72 x 72	96 x 96	144 x 144
Bezel (a) mm	48	72	96	144
Case (b) mm	43.5	66	90	136
Depth (c) mm	53	53	53	53
Depth (d) mm	44.5	67.5	91.5	137.5
Depth (e) mm	5.5	5.5	5.5	5.5
Depth with back cover (f)mm	64	64	64	64
Cutout size mm	45 ^{+0.6}	68 ^{+0.7}	92 ^{+0.8}	138 ^{+0.1}
Weight Kg	0.13	0.25	0.30	0.43

CONNECTION DIAGRAMS

DC voltage

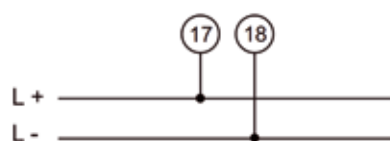

DC current

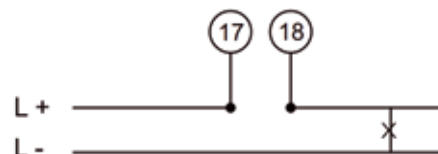

Long scale frequency meters

FEATURES

- Measures AC frequencies
- Pointer type available as 240° long scale version
- Direct or VT connected

APPROVALS

- CE marked
- UKCA

BENEFITS

- Easy to operate
- High visibility
- Terminal cover included



APPLICATIONS

- AC switchgears, panels and distribution boards
- Control board
- Generator sets

CONSTRUCTION

- Polycarbonate, flame retardant & drip proof case as per UL 94 V-0
- Front facia - Antiglare glass
- Panel fixing - mounting clamp

PRODUCT CODES

Bezel size (mm)	DIN 96	DIN 144
Scale length (mm)	142	230
Frequency meter 240°	E244-41L	E246-41L

GENERAL SPECIFICATION

Accuracy class	0.5 IEC 51/ DIN EN 60051	0.5 IEC 51/ DIN EN 60051
Maximum continuous overload	1.2 times rated voltage	
Maximum short duration overload	2 times rated voltage, 5 Sec:1 overload 2 times rated voltage, 0.5 Sec:9 overload	
Measured quantity	Frequency	
Enclosures codes	IP52 - case IPO0- terminals	
Insulation class	Group A according to VDE 0110	
Rated insulation voltage	660 V	
Proof voltage testing	2 kV	
Installation category	300 VCAT III	
Insulation resistance	> 50 Mohm at 500 V d.c	
Ambient temperature	0 - 50°	
Position of use	Nominal position ±5	
Voltage	Rated voltage ±15%	
External magnetic field	At 0.4 kA/m	

DIMENSIONS

Front dimensions mm	96 x 96	144 x 144
Bezel (a) mm	96	144
Case (b) mm	90	136
Depth (c) mm	53	53
Depth (d) mm	91.5	137.5
Depth (e) mm	5.5	5.5
Depth with back cover (f) mm	64	64
Cutout size mm	92 ^{+0.8}	138 ^{+0.1}
Weight Kg	0.45	0.60

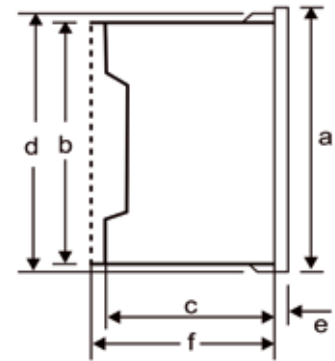

CONNECTION DIAGRAM

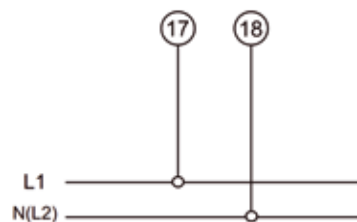

Dual voltmeter and frequency meter

FEATURES

- Measures AC frequencies of two independent systems
- Pointer type dual voltmeter and frequency meter with two independent 90° short scale movements
- Direct or VT connected

APPROVALS

- CE marked
- UKCA

BENEFITS

- Easy to operate
- High visibility
- Easy installation
- Terminal cover included



PRODUCT CODES

Bezel size (mm)	96
Voltmeter meter 2 x 90°	E244-80L
Frequency meter 2 x 90°	E244-41D

GENERAL SPECIFICATION

	VOLTMETER	FREQUENCY METER
Accuracy class	1.5 IEC 51/ DIN EN 60051	0.5 DIN EN 60051
Maximum continuous overload	1.2 times rated voltage	1.2 times rated voltage
Maximum short duration overload	2 times for 5 Sec: 1 overload 2 timesfor 0.5 sec: 9 overloads	2 times rated input voltage, 5 sec
Measured quantity	AC voltage	Frequency
Encloses codes	IP52 - case IP00-terminals with out backcover IP20 for terminals with backcover	
Insulation class	Group A according to VDE 0110	
Rated insulation voltage	1000V	660V
Proof voltage testing	2kV	
Installation category	300V CAT III	
Insulation resistance	> 50 Mohm at 500 V d.c	
Ambient temperature	0 - 50°	
Position of use	Vertical ±5°	Nominal position ±5°
External magnetic field	At 0.4 kA/m	0.5 mT
Impedance Voltmeters	900 ohm/V	Rated voltage ±20%

APPLICATIONS

- AC switchgears, panels and distribution boards
- Control board
- Generator sets

CONSTRUCTION

- Polycarbonate, flame retardant & drip proof case as per UL 94 V-0
- Front facia - Glass
- Installation with swivel screws

DIMENSIONS

	VOLTMETER	FREQUENCY METER
Front dimensions mm	96 x 96	96 x 96
Bezel (a) mm	96	96
Case (b) mm	90	90
Depth (c) mm	53	53
Depth (d) mm	91.5	91.5
Depth (e) mm	5.5	5.5
Depth (f) mm	64	64
Cutout size mm	92 ^{+0.8}	92 ^{+0.8}
Weight Kg	0.3	0.2

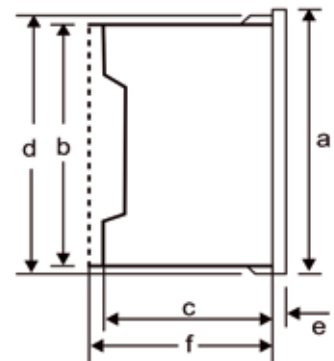

CONNECTION DIAGRAM

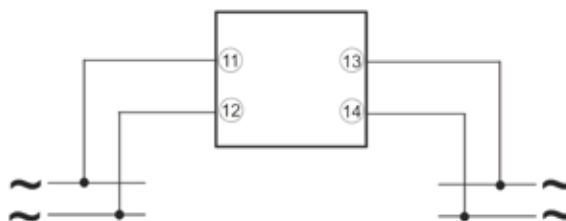

Power factor meters

FEATURES

- Indicates Power factor of electrical systems
- Several voltage ranges available

APPROVALS

- CE marked
- UKCA

BENEFITS

- Easy to operate
- High visibility
- Terminal cover included
- Low self consumption
- Internal power supply from voltage input



PRODUCT CODES

Bezel size (mm)	DIN 96	DIN 96	DIN 96	DIN 96	DIN 96
Scale length (mm)	97	97	97	97	97
Power factor meter 90°	E244-420 single-phase	E244-421 3P/3W balanced	E244-42C 3P/4W balanced	E244-423 3P/3W unbalanced	E244-424 3P/4W unbalanced
Bezel size (mm)	DIN 96	DIN 96	DIN 96	DIN 96	DIN 96
Scale Length (mm)	142	142	142	142	142
Power factor meter 240°	E244-135 single-phase	E244-136 3P/3W balanced	E244-13D 3P/4W balanced	E244-138 3P/3W unbalanced	E244-139 3P/4W unbalanced

Accuracy class	1.5 IEC 51/ DIN EN 60051
Maximum continuous overload	1.2 times rated voltage / current
Maximum short duration overload 90°	10 times rated current for for 0.5 sec, 9 overloads 10 times rated current for 5 Sec, 1 overload
Maximum short duration overload 240°	2 times for 5 sec : 1 overload 2 times for 0.5 sec : 9 overloads
Voltage circuit	2 times rated current for for 0.5 sec, 9 overloads 2 times rated current for 5 Sec, 1 overload
Measured quantity	Power factor
Encloses codes	IP52 - case IP00 - terminals
Insulation class	Group A according to VDE 0110
Rated insulation voltage	660 V
Proof voltage testing	2 kV
Installation category	300 VCAT III
Insulation resistance	> 50 Mohm at 500 V DC
Ambient temperature	0 - 50°
Position of use	Nominal position + 5°
Voltage	Rated voltage ±15%
Current	20 to 120% of rated current
Frequency	49-51 Hz for single phase 45-65 Hz for 3 phase
External magnetic field	At 0.4 kA/m

APPLICATIONS

- AC switchgears, panels and distribution boards
- Control boards
- Generator sets

CONSTRUCTION

- Polycarbonate, flame retardant & drip proof case as per UL 94 V-0
- Front facia - Glass
- Installation with mounting clamps

DIMENSIONS

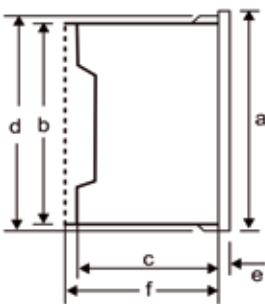

Front dims mm	96 x 96
Bezel (a) mm	96
Case (b) mm	90
Depth (c) mm	106
Depth (d) mm	91.5
Depth (e) mm	5.5
Cutout size mm	92 ^{+0.8}
Weight Kg	0.68

CONNECTION DIAGRAMS

Single phase

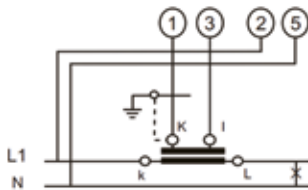

3-phase 3 wire balanced load

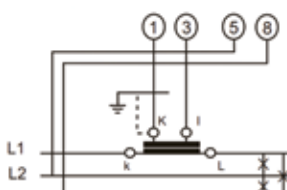

3-phase 4 wire balanced load

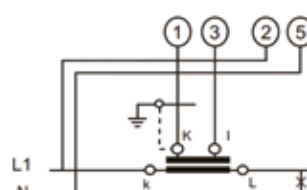

3-phase 3 wire unbalanced load

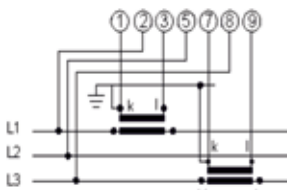

3-phase 4 wire unbalanced load

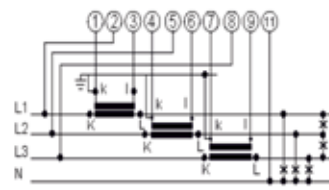

Power wattmeters

FEATURES

- Indicates active power of electrical systems
- Several voltage ranges available



APPLICATIONS

- AC switchgears, panels and distribution boards
- Control boards
- Generator sets

CONSTRUCTION

- Polycarbonate, flame retardant & drip proof case as per UL 94 V-0
- Front facia - Antiglare glass
- Panel fixing - mounting clamp

APPROVALS

- CE marked
- UKCA

BENEFITS

- Easy to operate
- High visibility
- Terminal cover included
- Low self consumption
- Internal power supply from voltage input

PRODUCT CODES

Bezel size (mm)	DIN 96	DIN 96	DIN 96	DIN 96	DIN 96
Scale length (mm)	97	97	97	97	97
Wattmeter 90°	E244-210 single-phase	E244-211 3P/3W balanced	E244-21C 3P/4W balanced	E244-213 3P/3W unbalanced	E244-214 3P/4W unbalanced
Bezel size (mm)	DIN 96	DIN 96	DIN 96	DIN 96	DIN 96
Scale length (mm)	142	142	142	142	142
Wattmeter 240°	E244-215 single-phase	E244-216 3P/3W balanced	E244-21D 3P/4W balanced	E244-218 3P/3W unbalanced	E244-219 3P/4W unbalanced

GENERAL SPECIFICATION

Wattmeter	90°	240°
Accuracy class	1.5 IEC 51/ DIN EN 60051	
Maximum continuous overload	1.2 times rated voltage	
Maximum short duration overload	2 times rated voltage, 5 Sec max, 10 times rated current, 5 Sec max	2 times for 5 sec : 1 overload 2 times for 0.5 sec : 9 overloads
Measured quantity	Active / Reactive Power	
Encloses codes	IP52 - case IPO0- terminals	
Insulation class	Group A according to VDE 0110	
Rated insulation voltage	660 V	
Proof voltage testing	2 kV	
Installation category	300 VCAT III	
Insulation resistance	> 50 Mohm at 500 V d.c	
Ambient temperature	10 - 37°C	0- 50°C
Position of use	Nominal position +50	Nominal position + 5°
Voltage	Rated voltage +15%	
External magnetic field	At 0.4 kA/m than 6% of fiducial value (not as a percentage class index)	At 0.4 kA/m

DIMENSIONS

	90°	240°
Front dims mm	96 x 96	96 x 96
Bezel (a) mm	96	96
Case (b) mm	90	90
Depth (c) mm	106	106
Depth (d) mm	91.5	91.5
Depth (e) mm	5.5	5.5
Cutout size mm	92 ^{+0.8}	92 ^{+0.8}
Weight Kg	0.65-0.75	0.73-0.85

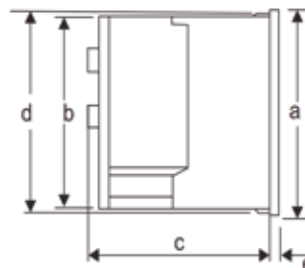

CONNECTION DIAGRAMS

SEE PAGE 22

Power varimeters

FEATURES

- Indicates reactive power of electrical systems
- Several voltage ranges available



APPROVALS

- CE marked
- UKCA

BENEFITS

- Easy to operate
- High visibility
- Terminal cover included
- Low self consumption
- Internal power supply from voltage input

PRODUCT CODES

Bezel size (mm)	96	96	96	96	96
Scale Length (mm)	97	97	97	97	97
Varmeter 90°	E244-310 single-phase	E244-311 3P/3W balanced	E244-31C 3P/4W balanced	E244-313 3P/3W unbalanced	E244-314 3P/4W unbalanced
Bezel size (mm)	96	96	96	96	96
Scale length (mm)	142	142	142	142	142
Varmeter 240°	E244-315 single-phase	E244-316 3P/3W balanced	E244-31D 3P/4W balanced	E244-318 3P/3W unbalanced	E244-319 3P/4W unbalanced

GENERAL SPECIFICATION

Varmeter	90°	240°
Accuracy class	1.5 IEC 51/ DIN EN 60051	
Maximum continuous overload	1.2 times rated voltage	
Maximum short duration overload	2 times rated voltage, 5 Sec max, 10 times rated current, 5 Sec max	2 times for 5 sec : 1 overload 2 times for 0.5 sec : 9 overloads
Measured quantity	Active / Reactive Power	
Enclosures codes	IP52 - case IPO0- terminals	
Insulation class	Group A according to VDE 0110	
Rated insulation voltage	660 V	
Proof voltage testing	2 kV	
Installation category	300 VCAT III	
Insulation resistance	> 50 Mohm at 500 V d.c	
Ambient temperature	10 - 37°C	0- 50°C
Position of use	Nominal position +50	Nominal position + 5°
Voltage	Rated voltage +15%	
External magnetic field	At 0.4 kA/m than 6% of fiducial value (not as a percentage class index)	At 0.4 kA/m

APPLICATIONS

- AC switchgears, panels and distribution boards
- Control boards
- Generator sets

CONSTRUCTION

- Polycarbonate, flame retardant & drip proof case as per UL 94 V-0
- Front fascia - Antiglare glass
- Panel fixing - mounting clamp

DIMENSIONS

	90°	240°
Front dims mm	96 x 96	96 x 96
Bezel (a) mm	96	96
Case (b) mm	90	90
Depth (c) mm	106	106
Depth (d) mm	91.5	91.5
Depth (e) mm	5.5	5.5
Cutout size mm	92 ^{+0.8}	92 ^{+0.8}
Weight Kg	0.65-0.75	0.73-0.85

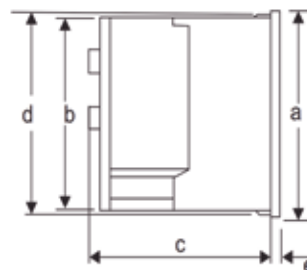

CONNECTION DIAGRAMS

SEE PAGE 22

Power wattmeters

CONNECTION DIAGRAMS

Single phase

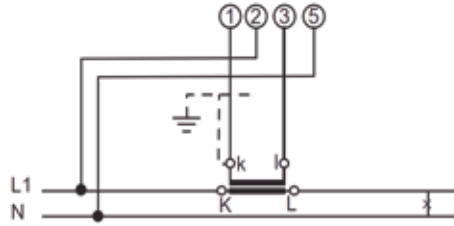

Three phase, three-wire AC Supply with balanced load

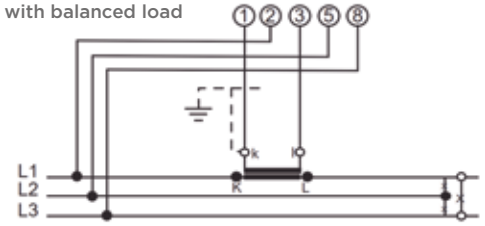

Three phase, four-wire AC Supply with balanced load

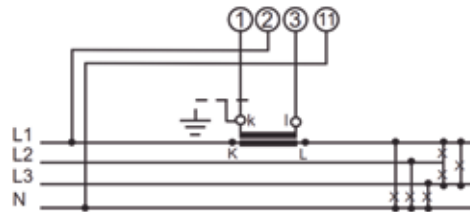

Three phase, three-wire AC Supply with unbalanced load

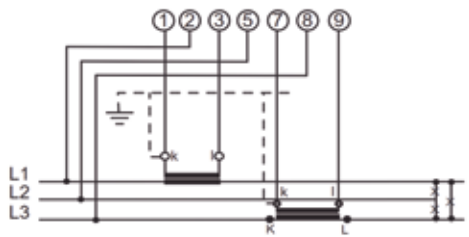

Three phase, four-wire AC Supply with unbalanced load

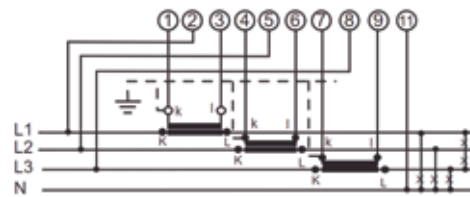

Power varmeters

CONNECTION DIAGRAMS

Single phase

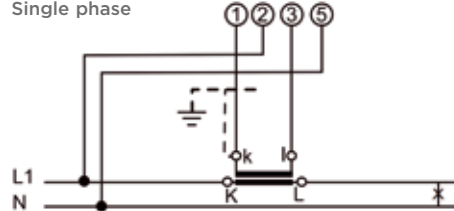

3-phase 3 wire balanced load

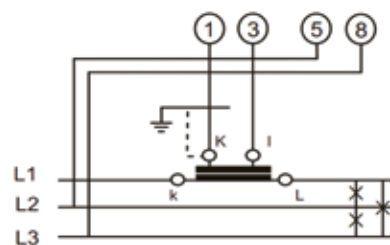

3-phase 4 wire balanced load

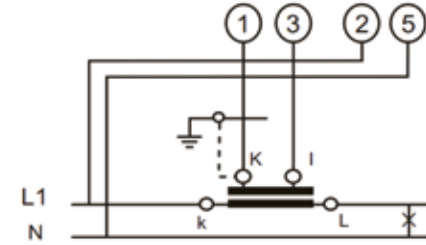

3-phase 3 wire unbalanced load

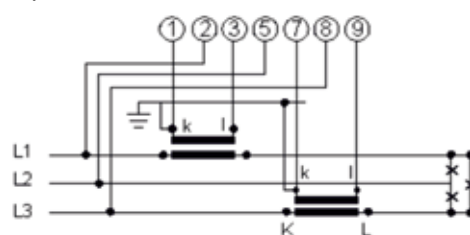

3-phase 4 wire unbalanced load

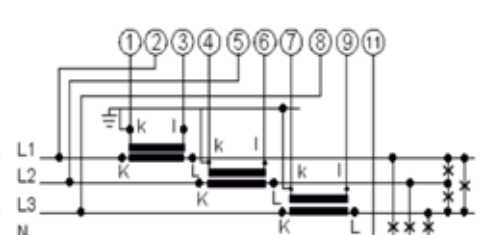

LED Synchroscope

FEATURES

- Clear synchronising indication
- Relay output for remote indication



APPLICATIONS

- Switchgear panels

APPROVALS

- IEC 61010

360° LED SYNCHROSCOPE

LED Synchrosopes measure and display the frequency difference of two power sources. Monitoring the display allows the user to connect two synchronized power systems.

The LED indication gives real-time feedback on the synchronisation state. When the synchronised state is achieved, the indicator stays in the synchronising position.

The LED indication gives real-time feedback on the synchronisation state with relay output for systems integration. Dead bus monitoring is also available, as an option, combined with the Voltage and phase monitoring.

SPECIFICATIONS

Nominal Voltage	±10% of range
Nominal Frequency	45 / 65 Hz
Operating Position	Panel Mounted (Vertical)
Accuracy	1%
Overload	1.2x range max, continuous, 2x for 5 secs
Relay Output Type	Single Pole changeover
Relay Output Rating	250 V, 5 A AC resistive
Operating Temperature	-20°C to +45°C (-4°F to 113°F)
Storage Temperature	-30°C to +70°C (-22°F to 158°F)
Humidity	95% RH (non-condensing)
Pull-in Frequency	56 Hz
Drop Out Frequency	55 Hz
Insulation Between Circuits	2.2 kV
Insulation to Case	4 kV
Overvoltage Category	III
Pollution Degree	II
Enclosure Integrity	UL94-V0
Enclosure Style	DIN 96
Case Material	Polycarbonate
Ingress Protection	IP54 (with gasket)
Electrical Connections	Cage clamp, Plug / Socket
Mounting	Snap-in
Weight	200g

Product codes	Voltage	Operation
244-14HG-L-01	100/120 V (110 V nominal)	Synchro check relay, Voltage Difference and Dead Bus
244-14HG-M-01	220/240 V (230 V nominal)	
244-14HG-H-01	380/480 V (430 V nominal)	
244-14GG-J-01	62/76 V (69.3 V nominal)	Synchro check relay, and Voltage Difference
244-14GG-L-01	100/120 V (110 V nominal)	
244-14GG-M-01	220/240 V (230 V nominal)	
244-14GG-H-01	380/480 V (430 V nominal)	

DIMENSIONS

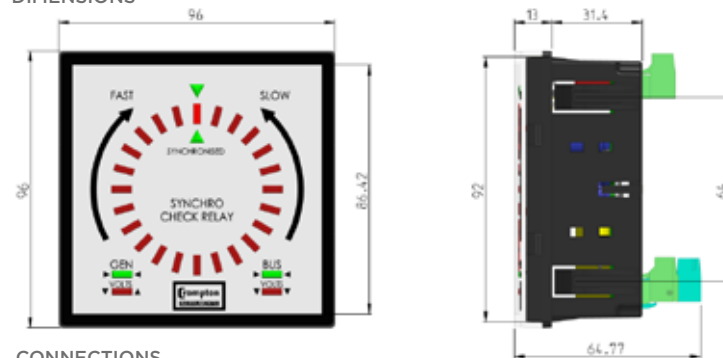

CONNECTIONS

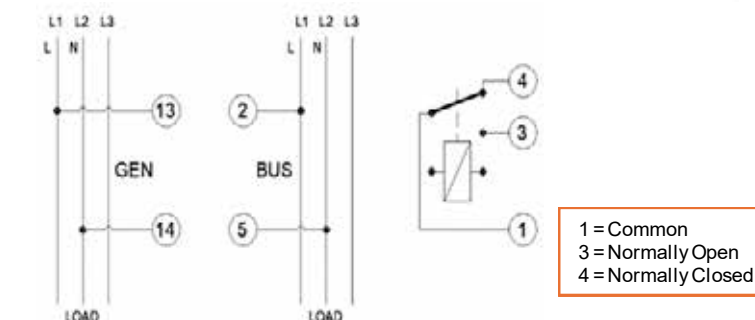

Elapsed time meters (hours run meters)



Elapsed time meters (ETM) or hours-run meters monitor “ON/RUN” time of plant and equipment, allowing the user to effectively control production efficiency, cost estimation and service period monitoring for preventative maintenance. Time is measured in increments of 0.01h up to 99999.99 hours after which the meter automatically resets to zero. Meters are non-resettable before this time to prevent accidental resetting.

SPECIFICATIONS

AC	
Display	99999.99
Voltage	100-125 V AC 200-250 V AC 380-440 V AC
Frequency	50 or 60 Hz
Operating temperature	-25°C to +80°C
IP Protection	IP52
Burden	1 VA (100-125 V AC) 2 VA (200-250 V AC) 3.5 VA (380-440 V AC)
DC	
Display	99999.99
Voltage	12-36 V DC 10-80 V DC 110 V DC
Operating temperature	-20°C to +70°C
IP Protection	IP52
Burden	0.5 VA (12 - 36 V AC) 1 VA (10-80 V AC) 1.5 VA (110 V AC) 0.5 VA (6 - 30 V) 1 VA (36 - 80 V)

Bezel size product codes	48 mm	72 mm	96 mm
100-125 V AC 50 Hz	M242-155-G-PL-ZH-C5	M243-155-G-PL-ZH-C5	M244-155-G-PL-ZH-C5
200-250 V AC 50 Hz	M242-155-G-RN-ZH-C5	M243-155-G-RN-ZH-C5	M244-155-G-RN-ZH-C5
380-440 V AC 50 Hz	M242-155-G-RY-ZH-C5	M243-155-G-RY-ZH-C5	M244-155-G-RY-ZH-C5
100-125 V AC 60 Hz	M242-156-G-PL-ZH-C6	M243-156-G-PL-ZH-C6	M244-156-G-PL-ZH-C6
200-250 V AC 60 Hz	M242-156-G-RN-ZH-C6	M243-156-G-RN-ZH-C6	M244-156-G-RN-ZH-C6
380-440 V AC 60 Hz	M242-156-G-RY-ZH-C6	M243-156-G-RY-ZH-C6	M244-156-G-RY-ZH-C6
6-30 V DC	-	M243-157-G-BU-ZH-DC	M244-157-G-BU-ZH-DC
12-36 V DC	M242-157-G-BU-ZH-DC	-	-
10-80 V DC	-	M243-157-G-NR-ZH-DC	M244-157-G-NR-ZH-DC
36-80 V DC	M242-157-G-NR-ZH-DC	-	-
110 V DC	M242-157-G-PM-ZH-DC	M243-157-G-PM-ZH-DC	M244-157-G-PM-ZH-DC

Elapsed time/hours
run meters AC

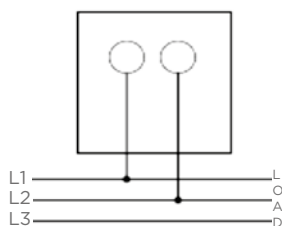

Elapsed time/hours
run meters DC

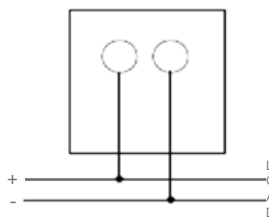

Phase sequence indicators



Electronic phase sequence indicators ensure correct phase rotation and the presence of all 3-phase supplies. Incorrect or loss of phase can cause serious damage in a wide range of electrical machines. Ship-to-shore supplies, mobile generators and remote installations are particularly vulnerable to this problem.

PRODUCT CODES

Bezel size mm	DIN 72	Voltage	Frequency	DIN 96	Voltage	Frequency
Phase sequence indicator	E243-12PG-P3C7	151-300V	50-60Hz	E244-12PG-P2C7	100-150V	50-60Hz
	E243-12PG-P4C7	301-500V	50-60Hz	E244-12PG-P3C7	151-300V	50-60Hz
	E243-12PG-P3C4	151-300V	400Hz	E244-12PG-P4C7	301-500V	50-60Hz
	E243-12PG-P4C4	301-500V	400Hz	E244-12PG-P2C4	100-150V	400Hz
	-	-	-	E244-12PG-P3C4	151-300V	400Hz
	-	-	-	E244-12PG-P4C4	301-500V	400Hz

GENERAL SPECIFICATION

Max system voltage	600V
Frequency	50/60 Hz and 400Hz
Burden	2.5 VA/phase

CONNECTIONS

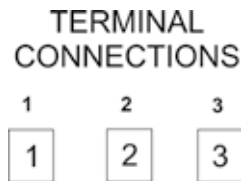

DIMENSIONS

DIN 72

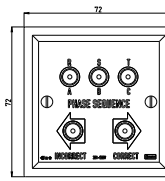

DIN 96

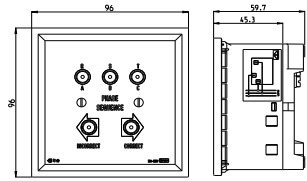

Phase angle meters

Phase angle meters indicate the phase displacement between current and voltage. They are used in applications where the phase angle must be monitored, for example with tariffs having VAR penalties, or to optimise generator power delivery.

PRODUCT CODES - SHORT-SCALE MODELS

DIMENSIONS

Bezel size mm	72	96
Scale length mm	65	94
Product codes		
3-phase 3/4-wire balanced load	E243-42A	E244-42A

SPECIFICATIONS

Accuracy	Class 1.5
Ratings	Current: 1 A or 5 A for CTs Voltage: 110 V, 240 V, 380 V & 400 V for VT use
Frequency	50 Hz, 60 Hz
Burden at 50 Hz	Current: 1 VA Voltage: 3 VA per phase
Current range	20-120%

CONNECTIONS

3-phase, 3/4-wire balanced systems

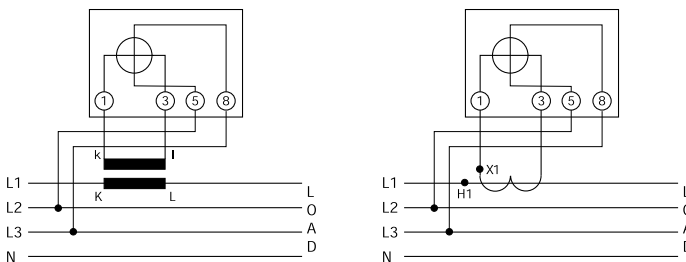





Chapter 2 Saxon series panel indicators

Saxon series panel indicators.....	36
AC ammeter.....	37
AC voltmeter.....	37
Milliammeters.....	37
DC voltmeter.....	38
DC ammeter.....	38
Frequency meter.....	38
Elapsed time meter.....	39

Saxon series panel indicators

FEATURES

- Three compact case sizes
- Withstands high levels of shock, vibration, dirt and humidity
- Pivot and jewel mechanisms

APPROVALS

- UL approved file no. E203000
- CSA



BENEFITS

- Complies with ANSI C39.1 (IEC 51)
- IP54 (NEMA 3) protection
- Instruments comply with BS EN61010-1 and meet IEC414 (BS5458)
- Pass dielectric test (2600 V for 1min)

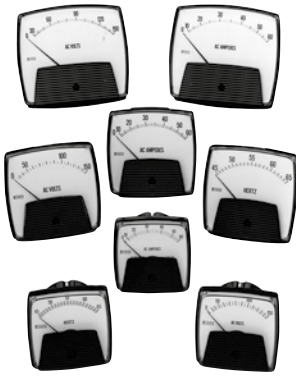

A range of 2½" and 3½" surface mount panel meters utilising pivot and jewel mechanisms and offering IP54 protection. The range includes iron vane and moving coil AC and DC ammeters and voltmeters and frequency meters designed to perform in demanding environments.

SPECIFICATIONS - FREQUENCY METERS

Accuracy	0.15 = 60 Hz, 1.25 = 400 Hz, 0.15 = 50 Hz, 0.25 = 55 Hz
Voltage	110/130 V, 200/250 V
Frequency	50 Hz or 60 Hz
Burden	4 VA Maximum

SPECIFICATIONS - MOVING IRON AC AMMETER AND VOLTMETER

Accuracy	±1.5%
Rating	Ammeters: 1 - 30 A Volts: 50 V - 600 V
Overload	Ammeters: x1.2 continuous, x10 for 5 seconds Volts: x1.2 continuous, x2 for 5 seconds
Burden	Ammeters: 0.5 VA Volts: 4.5 VA maximum

SPECIFICATIONS - MOVING COIL DC AMMETER AND VOLTMETER

Accuracy	±1.5%
Rating	Ammeters: 1 - 30 A Volts: 10 V - 600 V
Operating temperature	-20°C to +60°C (-4°F to +140°F)
Storage temperature	-30°C to +70°C (-22°F to +158°F)

APPLICATIONS

- Switchgear
- Distribution systems
- Generator sets
- Control panels
- Energy management
- Building management
- Utility power monitoring
- Process control
- Motor control

DIMENSIONS

Specify number of fixing studs when ordering 2½" and 3½" meters.

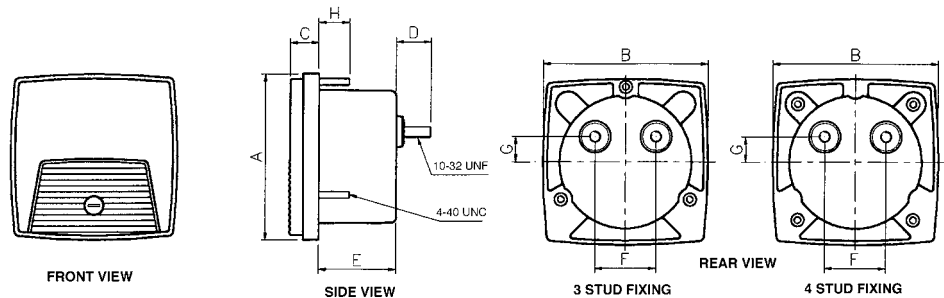

AC ammeter



PRODUCT CODES - AC AMMETER TRUE RMS READING (ACCURACY $\pm 2\%$ ES)

Rating	Scaling	Cat. no.
5 A	0-5 A	(01*)-75AA-LSLC-C7-B*
10 A	0-10 A	(01*)-75AA-MTMT-C7-B*
15 A	0-15 A	(01*)-75AA-NDND-C7-B*
20 A	0-20 A	(01*)-75AA-NGNG-C7-B*
30 A	0-30 A	(01*)-75AA-NLNL-C7-B*
1 A	Transformer rated	(01*)-75AA-LA**-C7-B*
5 A	Transformer rated	(01*)-75AA-LS**-C7-B*

AC voltmeter



PRODUCT CODES - AC VOLTMETER TRUE RMS READING (ACCURACY $\pm 2\%$ ES)

Rating	Scaling	Cat. no.
150 V	0-150 V	(01*)-75VA-PZPZ-C7-B*
300 V	0-300 V	(01*)-75VA-RXRXC7-B*
600 V	0-600 V	(01*)-75VA-SJSJC7-B*
150 V	Transformer rated	(01*)-75VA-PZ**-C7-B*

Milliammeters



PRODUCT CODES - MILLIAMMETERS SUPPRESSED ZERO (ACCURACY $\pm 2\%$ ES)

Rating	Scaling	Cat. no.
4-20 mA	To suit requirements	(01*)-01RA-HG**-B*
		**Specify scale value

DC voltmeter



PRODUCT CODES - DC VOLTMETERS SENSITIVITY 1000Ω/VOLT (ACCURACY ±2% ES)

Rating	Scaling	Cat. no.
0-15 V	0-15 V	(01*)-01VA-NDND-B*
0-30 V	0-30 V	(01*)-01VA-NLNL-B*
0-50 V	0-50 V	(01*)-01VA-NTNT-B*
0-150 V	0-150 V	(01*)-01VA-PZPZ-B*
0-300 V	0-300 V	(01*)-01VA-RXRX-B*
0-600 V	0-600 V	(01*)-01VA-SJSJ-B*

DC ammeter



PRODUCT CODES - DC AMMETER (ACCURACY ±2% ES)

Rating	Scaling	Cat. no.
0-1 mA	To suit requirements	(01*)-01AA-FA**-B*
0-5 mA	0-5 mA	(01*)-01AA-FXFX-B*
0-10 mA	0-10 mA	(01*)-01AA-GZGZ-B*
0-20 mA	0-20 mA	(01*)-01AA-HFHF-B*
0-50 mA	0-50 mA	(01*)-01AA-HYHY-B*
0-100 mA	0-100 mA	(01*)-01AA-JRJR-B*
0-200 mA	0-200 mA	(01*)-01AA-KAKA-B*
0-500 mA	0-500 mA	(01*)-01AA-KMKM-B*
0-1 A 0-1A	(01*)-01AA-LALA-B*	
0-2 A 0-2 A	(01*)-01AA-LELE-B*	
0-5 A 0-5 A	(01*)-01AA-LSLS-B*	
0-10 A	0-10 A	(01*)-01AA-MTMT-B*
0-50 mV	To suit	(01*)-01AA-EC**-B*

Frequency meter



PRODUCT CODES - FREQUENCY METERS 120V, SELF CONTAINED

Rating	Scaling	Cat. no.
50 Hz	45-55 Hz	(01*)-41SA-PNAG-AG-B*
55 Hz	45-65 Hz	(01*)-41SA-PNAJ-AJ-B*
60 Hz	55-65 Hz	(01*)-41SA-PNAN-AN-B*

Elapsed time meter



PRODUCT CODES - ELAPSED TIME METERS 99999.99 HOURS, NON-RESETTABLE

Rating	Scaling	Cat. no.
110/130 V, 50 Hz	-	(01*)-155A-PNZH-C5-B*
200/250 V, 50 Hz	-	(01*)-155A-RNZH-C5-B*
480 V, 50 Hz	-	(01*)-155A-SEZH-C5-B*
110/130 V, 60 Hz	-	(01*)-156A-PNZH-C6-B*
200/250 V, 60 Hz	-	(01*)-156A-RNZH-C6-B*
480 V, 60 Hz	-	(01*)-156A-SEZH-C6-B*

To denote the required case size, replace the 01* in the catalogue number with 012 or 013, for 2½" or 3½" respectively.

To denote the required stud fixing configuration, replace B* with B2 (2 stud), B3 (3 stud) or B4 (4 stud).

PANEL CUT-OUT

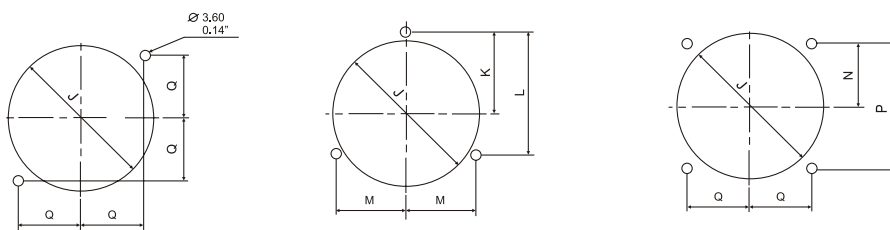

	A	B	C	D	E	F	G	H	J	K	L	M	N	P	Q
2½ mm	68.6	68.6	11.8	14.6	32.0	25.4	10.4	12.7	55.9	31.0	46.5	26.9	23.9	47.8	23.9
inch	2.70	2.70	0.46	0.57	1.26	1.00	0.41	0.50	2.20	1.22	1.83	1.06	0.94	1.88	0.94
3½ mm	88.9	88.9	11.8	14.6	36.0	25.4	10.4	12.7	69.9	40.2	60.3	34.8	28.5	57.0	28.5
inch	3.5	3.5	0.46	0.57	1.42	1.00	0.41	0.50	2.75	1.58	2.37	1.37	1.12	2.24	1.12
4½ mm	112.0	123.2	12.7	16.3	30.5	28.4	0.38	12.7	70.9				51.6	90.4	50.8
inch	4.41	4.85	0.50	0.64	1.20	1.12	0.41	0.50	2.78				2.03	3.56	2.00





Chapter 3 016 series fiesta panel indicators

016 series fiesta panel indicators.....	42
AC ammeter short-scale.....	43
AC overload ammeter.....	43
AC voltmeter.....	43
DC ammeter.....	44
DC voltmeter.....	44
Frequency meter.....	44
Elapsed time meter.....	45
Transducer indicators.....	45

O16 series fiesta panel indicators



A robust range of short-scale 3 1/2" surface mount panel meters offering IP55 protection and featuring a wide view contoured window. The Fiesta range includes iron vane and moving coil AC and DC ammeters and voltmeters, elapsed time and frequency meters and is ideally suited for demanding environments. Options include panel gasket.

SPECIFICATIONS - IRON VANE AC AMMETER AND VOLTMETER

Accuracy	Ammeters 2%
Ratings	Short-scale 1 - 80 A
Voltmeters	50 V - 600 V
Overload	Ammeters: x1.2 continuous, 10 x for 5 seconds
Voltmeters	x1.2 for 2 hours, 2 x for 5 seconds
Burden	Ammeters: 0.5 VA; 1.5 VA
Voltmeters	4.5 VA maximum
Operating temperature	-20°C to +65°C (-4°F to +149°F)
Storage temperature	-30°C to +70°C (-22°F to +158°F)

SPECIFICATIONS - MOVING COIL DC AMMETER AND VOLTMETER

Accuracy	1.5
Ratings	Ammeters: 100 µA to 30 A
Voltmeters	50 mV - 600 V
Overload	Ammeters: x1.2 continuous, 10 x for 5 seconds
Voltmeters	x1.2 continuous, 2 x for 5 seconds
Impedance	Voltmeters: 1000 ohms per nominal volt
Operating temperature	-20°C to +65°C (-4°F to +149°F)
Storage temperature	-30°C to +70°C (-22°F to +158°F)

SPECIFICATIONS - ELAPSED TIME METER AND FREQUENCY METERS

Voltage	100/125 V, 200/250 V or 480 V AC
Frequency	50 Hz or 60 Hz
Burden	4 VA maximum
Operating temperature	-20°C to +65°C (-4°F to +149°F)
Storage temperature	-30°C to +70°C (-22°F to +158°F)

DIMENSIONS

Instrument	Dim X inches	Dim X mm
MC. INSTS	1/4"-28 UNF	18.0
MI voltmeter and AMM up to 59 A	1/4"-28 UNF	18.0
MI ammeter 60 A and over	5/16"-24 UNF	23.0

CONNECTIONS

Ammeter DC
direct connected
(max rating 30 A)

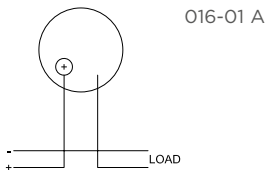

Ammeter AC

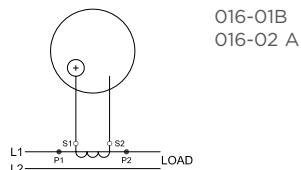

Voltmeter DC
direct connected
(max rating 800 A)

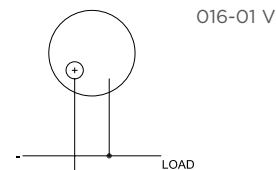

Voltmeter AC/
frequency meter
V.T. Operated

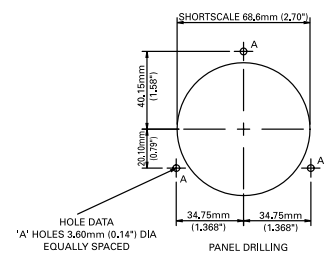
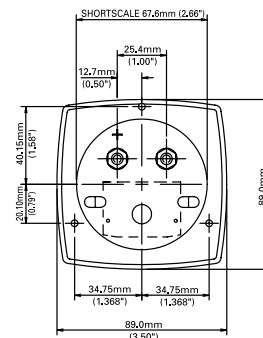
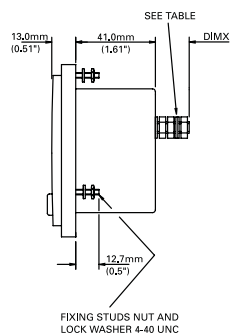
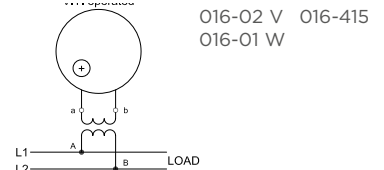

AC ammeter short-scale



PRODUCT CODES - TRUE RMS READING, SELF CONTAINED 50/60 HZ

Rating	Scaling	Cat. no.
5 A	0-5 A	•016-02A*-LSLS-C7
10 A	0-10 A	•016-02A*-MTMT-C7
15 A	0-15 A	•016-02A*-NDND-C7
20 A	0-20 A	•016-02A*-NGNG-C7
30 A	0-30 A	•016-02A*-NLNL-C7
5 A	Transformer rated	•016-02A*-LS**-C7

PRODUCT CODES - MOVING COIL RECTIFIED

1mA - 1 A	To suit	•016-01B*-
-----------	---------	------------

AC overload ammeter



PRODUCT CODES - TRUE RMS READING, SELF CONTAINED 50/60 HZ

Rating	Scaling	Cat. no.
5 A	0-5-30 A	•016-022*-LSLS-C7
10 A	0-10-60 A	•016-022*-MTMT-C7
15 A	0-15-90 A	•016-022*-NDND-C7
20 A	0-20-120 A	•016-022*-NGNG-C7
30 A	0-30-180 A	•016-022*-NLNL-C7
5 A	Transformer rated	•016-022*-LS**-C7

Rating	Scaling	Cat. no.
5 A	0-5-30 A	•016-023*-LSLS-C7
10 A	0-10-60 A	•016-023*-MTMT-C7
15 A	0-15-90 A	•016-023*-NDND-C7
20 A	0-20-120 A	•016-023*-NGNG-C7
30 A	0-30-180 A	•016-023*-NLNL-C7
5 A	Transformer rated	•016-023*-LS**-C7

Rating	Scaling	Cat. no.
5 A	0-5-30 A	•016-026*-LSLS-C7
10 A	0-10-60 A	•016-026*-MTMT-C7
15 A	0-15-90 A	•016-026*-NDND-C7
20 A	0-20-120 A	•016-026*-NGNG-C7
30 A	0-30-180 A	•016-026*-NLNL-C7
5 A	Transformer rated	•016-026*-LS**-C7

AC voltmeter



PRODUCT CODES - TRUE RMS READING

Rating	Scaling	Cat. no.
150V	0-150V	•016-02V*-PZPZ-C7
300V	0-300V	•016-02V*-RXRX-C7
600V	0-600V	•016-02V*-SJSJ-C7
150V	Transformer rated	•016-02V*-PZ**-C7

PRODUCT CODES - MOVING COIL RECTIFIED

50-600 V	To suit	•016-01W*-
----------	---------	------------

DC ammeter



PRODUCT CODES - DC AMMETER

Rating	Scaling	Cat. no.
0-50 mV	To suit	•016-01A*-EC**
0-1 mA	To suit	•016-01A*-FA**
0-5 mA	To suit	•016-01A*-FX**
0-10 mA	To suit	•016-01A*-HA**
0-20 mA	To suit	•016-01A*-HF**

SUPPRESSED ZERO

PRODUCT CODES - MILLIAMMETERS - NO ZERO SET UNLESS SPECIFIED

Rating	Scaling	Cat. no.
4/20 mA	To suit	•016-01RA*-HG**

PRODUCT CODES - VOLTMETER - NO ZERO SET UNLESS SPECIFIED

Rating	Scaling	Cat. no.
1-5 V	To suit	016-01SA-LM**

** Customer must state required scaling at time of ordering.

DC voltmeter



PRODUCT CODES - SENSITIVITY 1000 Ω/V

Rating	Scaling	Cat. no.
0-15 V	0-15 V	•016-01V*-NDND
0-30 V	0-30 V	•016-01V*-NLNL
0-50 V	0-50 V	•016-01V*-NTNT
0-150 V	0-150 V	•016-01V*-PZPZ
0-300 V	0-300 V	•016-01V*-RXRX
0-600 V	0-600 V	•016-01V*-SJSJ

Frequency meter



PRODUCT CODES - 120 V, SELF CONTAINED

Rating	Scaling	Cat. no. standard case
50 Hz centre frequency, -0.15 accuracy	45-55 Hz	•016-41S*-PNAG-AG
55 Hz centre frequency, -0.25 accuracy	45-65 Hz	•016-41S*-PNAJ-AJ
60 Hz centre frequency, -0.15 accuracy	55-65 Hz	•016-41S*-PNAN-AN
400 Hz centre frequency, -1.25 accuracy	360-440 Hz	•016-41S*-PNBI-BI

Elapsed time meter



PRODUCT CODES - 99999.99 HOURS, NON-RESETTABLE

Rating	Scaling	Cat. no. standard case
110/130 V, 50 Hz	-	•016-155*-PNZH-C5
200/250 V, 50 Hz	-	•016-155*-RNZH-C5
480 V, 50 Hz	-	•016-155*-SEZH-C5
110/130 V, 60 Hz	-	•016-156*-PNZH-C6
200/250 V, 60 Hz	-	•016-156*-RNZH-C6
480 V, 60 Hz	-	•016-156*-SEZH-C6

Transducer indicators



PRODUCT CODES - DC MILLIAMP RATED

Rating	Scaling	Cat. no. standard case
Speed	To suit	016-012A
Frequency	To suit	016-013A
Phase angle	To suit	016-014A
Watts	To suit	016-015A
VArS	To suit	016-016A
VA	To suit	016-017A

** Customer must state required scaling at time of ordering.

- UL approved





Chapter 4 Challenger analogue panel meters

Challenger analogue panel meters.....48

Challenger analogue panel meters

FEATURES

- Measurement and indication of AC amps, volts, frequency and DC signals
- Surface or window mounting
- Rear zero adjuster on moving coil meters
- High torque pivot and jewel movement
- True RMS measurement meters
- AC and DC inputs
- Up to 40 A DC direct connected
- Up to 50 A AC direct connected



APPLICATIONS

- Marine panels
- Switchgear
- Distribution systems
- Control panels
- Embedded generation
- Energy management
- Building management
- Utility power monitoring
- Process control
- Motor monitoring

APPROVALS

- ANSI C39.1 1981
- IEC 51
- UL3111-1
- EMC
- LVD
- UL CSA



The Challenger range of analogue panel meters offers accurate measurement and indication of most electrical and electronic parameters in industry standard 1½", 2½", 3½" and 4½" case sizes. This innovative design features a detachable lower fascia plate, which allows the flexibility of either surface or window mounting. The fascia is simply unclipped to achieve the completely flush panel appearance of rear of panel window mounting.

AC moving coil rectified meters provide 1.5% accuracy of the full scale value and feature a rear zero adjuster screw for tamperproof installation. AC moving iron meters also provide 1.5% high accuracy and true RMS measurement.

OPERATION

The meters utilise a traditional pivot and jewel movement, incorporating specially hardened steel pivots and a spring loaded jewel. Ideally suited for all applications, including the most demanding conditions.

MOVING COIL METERS

These meters offer a centre cored, self-shielding moving coil movement using pivots, hairsprings and sprung jewels. Variations in movement are limited by design. All DC voltmeters are 1000 ohms per Volt, moving coil rectified products run at 900 ohms per Volt. Millivolt meters use a 5 milliamps/50 mV movement.

MOVING IRON METERS

This clapper type repulsion design utilises a pivot, hairspring and jewel movement. The bottom jewel is oil filled to provide damping while the top is sprung for resilience. All voltmeters are manufactured with internal voltage dropper resistors.

FREQUENCY METERS

Frequency meters utilise a 1mA/35 ohm DC moving coil movement driven by an EMC hard frequency conversion circuit.

DIALS, POINTERS AND SCALES

Dials are interchangeable between the Challenger meters for inputs within the published specifications of the meter. Options for non standard customised dials are available upon request.

CURRENT TRANSFORMERS AND SHUNTS

Our extensive range of current transformers provides accurate measurement of AC current and ratio matching to a consistent 5 or 1 amp secondary current, proportional to the primary current.

Our range of shunts ensures a DC millivolt signal exactly proportional to the system current for driving ammeters, providing accurate measurement of DC current up to 12000 A, with secondary inputs of, 50, 60, 75 or 100 mV DC to match the Challenger input.

BENEFITS

- AC moving iron and moving coil mechanisms
- Reduced inventory
- 4 ANSI standard case sizes
- Detachable lower fascia plate
- Easy to modify for distributors
- Through holes for back of panel mounting

Challenger analogue panel meters

SPECIFICATIONS

Accuracy	
DC ammeters and voltmeters	1.5% 0-100% of full scale deflection
AC ammeters and voltmeters	Moving iron: 1.5% 10-100% of full scale deflection Moving coil: 1.5% 10-100% of full scale deflection
Frequency meters	0.5% of end scale value
Input ratings	
DC moving coil ammeters	100 μ A - 30 A DC. (Model 361: 10 A max)
DC moving coil voltmeters	50 mV - 600 V DC
DC moving coil centre zero ammeters	+/-50 mA to +/-30 A DC. (Model 361: 10 A max)
DC moving coil centre zero voltmeter	+/-50 mV to +/-600 V DC. Standard 1 k ohm/volt
DC moving coil suppressed zero ammeters	4/20 mA DC
DC moving coil suppressed zero voltmeters	1/5, 8/16, 16/32 or 12/24 V DC
AC moving coil ammeters	100 μ A - 750 mA AC
AC moving coil voltmeters	50 - 600 V AC. Standard 900 ohms/volt
AC moving iron ammeters	1 - 50 A AC (Model 361: non applicable)
AC moving iron voltmeters	50 - 600 V AC (Model 361: non applicable)
Frequency	100/130 V, 200/250 V, 360/440 V, 50 Hz, 60 Hz or 400 Hz (Model 361: non applicable)
Burden	Ammeter: 0.5 VA Voltmeter: 4.5 VA
Frequency	4 VA
Overload	1.2 continuous x 10 for 0.5 seconds
Enclosure	
Movement	High torque pivot and jewel moving coil and moving iron
Scale balance	Within 1% of scale length
Relative humidity	25% - 80% nominal range of use
Operating temperature	0°C to +40°C (-32°F to +104°F)
Storage temperature	-20°C +55°C (-4°F to +131°F)
Case and lower mask	Black matt case UL94V. Polycarbonate cover
Window	Shatterproof polycarbonate
Surface mounting	4 corner studs
Rear of panel mounting	2 through hole mounts (Model 361: facility pending)
Compliant with	
UL and CSA	File no: E203000
Performance	ANSI C39.1 1981 and IEC 51
Scaling	ANSI C39.1 1981
Safety	IEC61010-1 (LVD) and BS EN61326:1998 (EMC)
Vibration	ANSI C39.1 1981 cl. 5.13

CONNECTIONS

DC amps - self contained

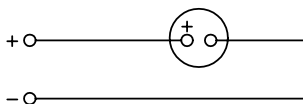

DC amps - for use with external shunt

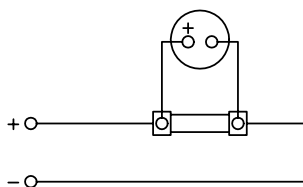

DC volts

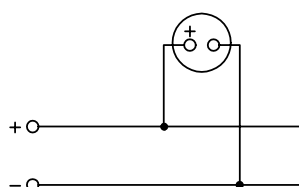

AC amps - self contained

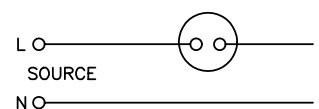

AC amps - For use with current transformer

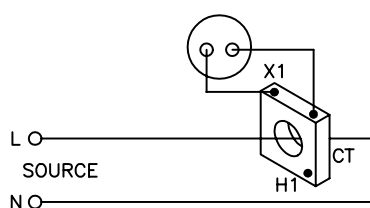

AC volts

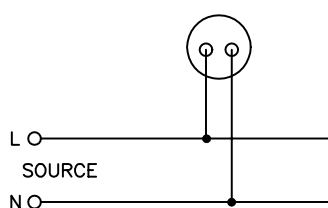

Frequency meter

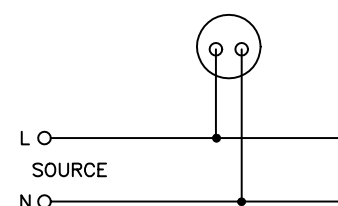

AC ammeter

MODEL 362 (2 1/2")

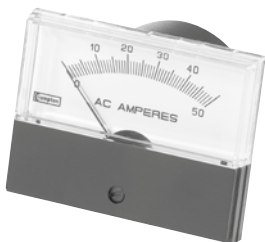

PRODUCT CODES - AC AMMETER TRUE RMS READING (ACCURACY ±2% ES)

Rating	Scaling	Cat. no.
5 A	0-5 A	(36*)-02AA-LSLS-C7
10 A	0-10 A	(36*)-02AA-MTMT-C7
15 A	0-15 A	(36*)-02AA-NDND-C7
20 A	0-20 A	(36*)-02AA-NGNG-C7
30 A	0-30 A	(36*)-02AA-NLNL-C7
1 A	Transformer rated	(36*)-02AA-LA**-C7
5 A	Transformer rated	(36*)-02AA-LS**-C7

AC voltmeter

MODEL 362 (2 1/2")



PRODUCT CODES - AC VOLTMETER TRUE RMS READING (ACCURACY ±2% ES)

Rating	Scaling	Cat. no.
150 V	0-150 V	(36*)-02VA-PZPZ-C7
300 V	0-300 V	(36*)-02VA-RXRX-C7
600 V	0-600 V	(36*)-02VA-SJSJ-C7
150 V	Transformer rated	(36*)-02VA-PZ**-C7

Milliammeters

MODEL 361 (1 1/2")



PRODUCT CODES - MILLIAMMETERS SUPPRESSED ZERO (ACCURACY ±2% ES)

Rating	Scaling	Cat. no.
4-20 mA	To suit requirements	(36*)-01RA-HG**
		**Specify scale value

DC voltmeter

MODEL 364 (4 1/2")



PRODUCT CODES - DC VOLTMETERS SENSITIVITY 1000Ω/VOLT (ACCURACY ±2% ES)

Rating	Scaling	Cat. no.
0-15 V	0-15 V	(36*)-01VA-NDND
0-30 V	0-30 V	(36*)-01VA-NLNL
0-50 V	0-50 V	(36*)-01VA-NTNT
0-150 V	0-150 V	(36*)-01VA-PZPZ
0-300 V	0-300 V	(36*)-01VA-RXR X
0-600 V	0-600 V	(36*)-01VA-SJSJ

DC ammeter



PRODUCT CODES - DC AMMETER (ACCURACY ±2% ES)

Rating	Scaling	Cat. no.
0-1 mA	To suit requirements	(36*)-01AA-FA**
0-5 mA	0-5 mA	(36*)-01AA-FXFX
0-10 mA	0-10 mA	(36*)-01AA-GZGZ
0-20 mA	0-20 mA	(36*)-01AA-HFHF
0-50 mA	0-50 mA	(36*)-01AA-HYHY
0-100 mA	0-100 mA	(36*)-01AA-JRJR
0-200 mA	0-200 mA	(36*)-01AA-KAKA
0-500 mA	0-500 mA	(36*)-01AA-KMKM
0-1 A	0-1A	(36*)-01AA-LALA
0-2 A	0-2 A	(36*)-01AA-LELE
0-5 A	0-5 A	(36*)-01AA-LSLS
0-10 A	0-10 A	(36*)-01AA-MTMT
0-50 mV	To suit	(36*)-01AA-EC**

Frequency meter

MODEL 363 (3 1/2")



PRODUCT CODES - FREQUENCY METERS 120V, SELF CONTAINED

Rating	Scaling	Cat. no.
50 Hz	45-55 Hz	(36*)-41SA-PNAG-AG
55 Hz	45-65 Hz	(36*)-41SA-PNAJ-AJ
60 Hz	55-65 Hz	(36*)-41SA-PNAN-AN

Challenger analogue panel meters

MODEL 361 (1½")



DIMENSIONS - SURFACE MOUNT

Model 361

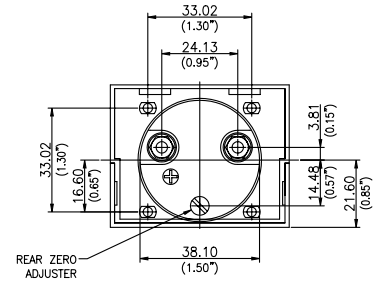
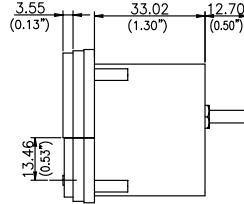
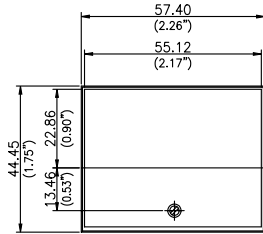

MODEL 362 (2½")



Model 362

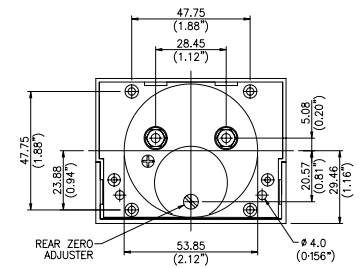
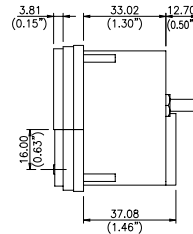
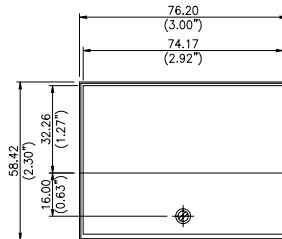

MODEL 363 (3½")



Model 363

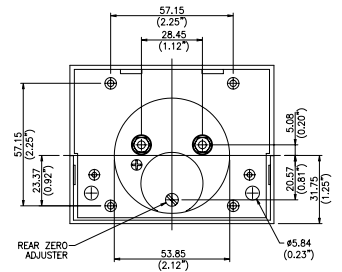
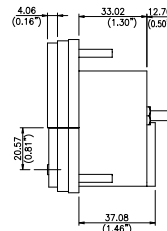
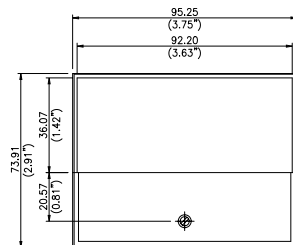

MODEL 364 (4½")



Model 364

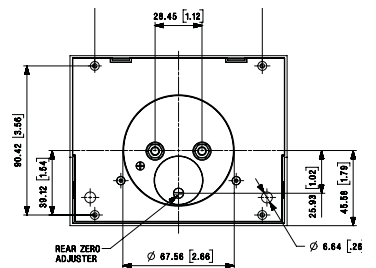
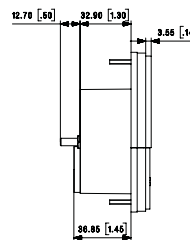
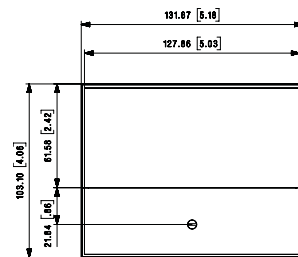

Challenger analogue panel meters

Model 361
surface mount cut-out

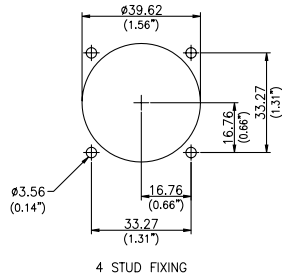

Window mount cut-out

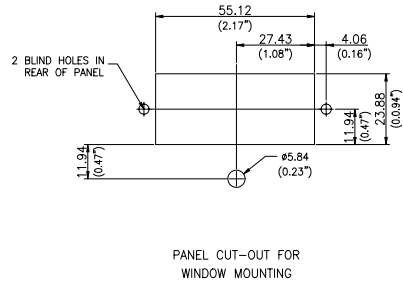

Model 362
surface mount cut-out

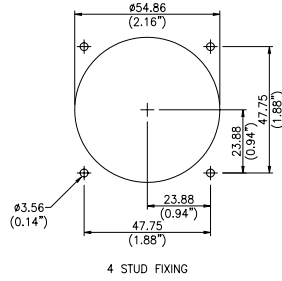

Window mount cut-out

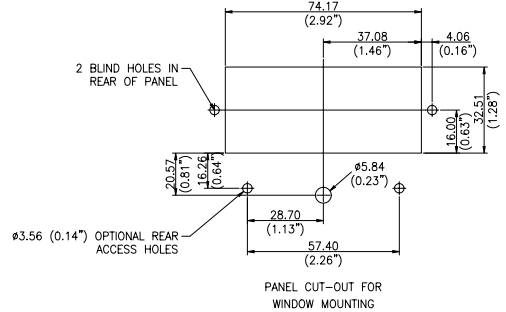

Model 363
surface mount cut-out

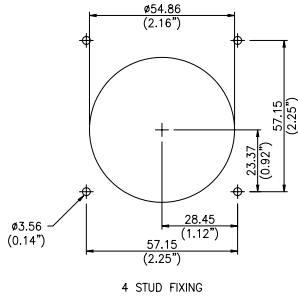

Window mount cut-out

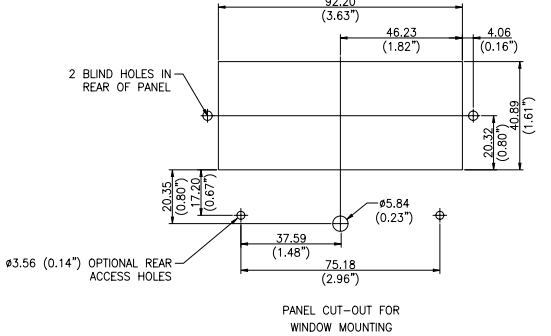

Model 364
surface mount cut-out

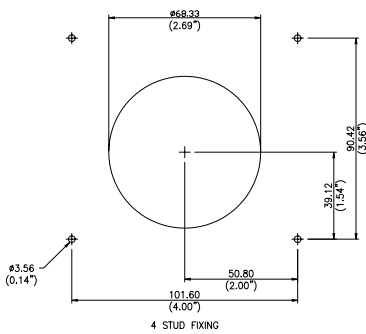

Window mount cut-out

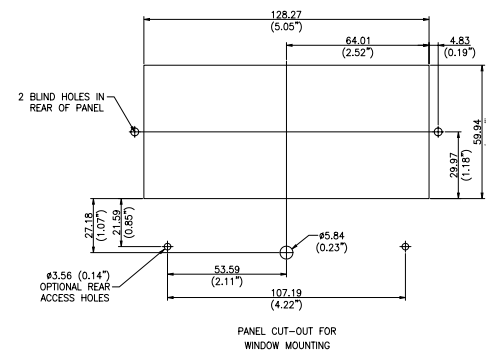





Chapter 5 ANSI switchboard meters

007 switchboard meters.....	56
ANSI switchboard meters.....	57
AC and DC ammeters, voltmeters and frequency meters.....	59
RMS reading AC ammeters.....	60
DC ammeters.....	62
DC voltmeters.....	63
Frequency meters.....	63
AC wattmeters and VArmeters.....	64
AC wattmeters.....	65
Wattmeter VArmeter scale selector guide.....	66
AC VArmeters.....	68
DC transducer indicators.....	68
007 synchroscope.....	69
Elapsed time meters.....	70
AC phase sequence, phase failure indicators.....	70
AC power factor meter.....	71
LED digital analogue combination.....	72
Switchboard meter options	77

007 switchboard meters

FEATURES

- Low profile
- Class 1 accuracy
- Optional panel gasket
- Reliability
- Long scale 240°

APPROVALS

- UL approved file no. E203000



BENEFITS

- Enhanced safety
- Reinforced insulation
- ANSI C39.1



The Crompton Instruments compact ANSI switchboard meter offers Class 1 accuracy metering performance packed in a low profile, depth saving case. The 007 switchboard meters are a direct drop-in replacement for our legacy switchboard products.

The compact case also offers a lightweight, heavy duty polycarbonate case which is electrically safe. The 4½ inch meter complies with ANSI-C39.1 specifications.

PRODUCT CODES

Model	Function
007-05FA	AC rms reading ammeter, linear scale, left zero
007-05GA	AC rms reading voltmeter, linear scale, left zero
007-05VA	DC voltmeter, left zero
007-05AA	DC milliammeter/millivoltmeter, left zero
007-05CA	DC milliammeter/millivoltmeter, centre zero
007-05RA	DC milliammeter, suppressed zero (4/20 mA etc)
007-055A	DC transducer indicator, scaled watts
007-056A	DC transducer indicator, scaled var
007-41LA	AC frequency meter
007-05BA	AC rectified ammeter
007-05PA	DC voltmeter, centre zero
007-05NA	DC voltmeter, centre zero
007-05ZA	DC voltmeter, expanded scale
007-05DA	DC ammeter, offset zero
007-05WA	AC rectified voltmeter
007-05YA	AC voltmeter, expanded scale

APPLICATIONS

- Switchgear
- Distribution systems
- Energy management
- Process control
- Building management

PRODUCT CODE AND ORDERING INFORMATION EXAMPLE

007-05GA-PZPZ-C7

RMS compensated Switchboard meter.

HOW TO ORDER

To order an equivalent for a 077, AB40 Or DB40 type meter, order exactly the same code, except replace 077 with 007.

E.g: 077-05FA-LSPK-C7 is 0-5A electrical scale, 0-100A dial AC ammeter, 50-60Hz. 007-05FA-LSPK-C7 provides identical specification in compact body style

DIMENSIONS

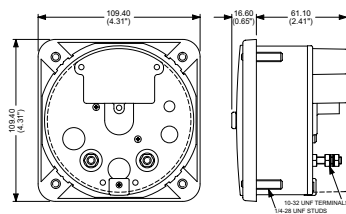

PANEL CUT OUT

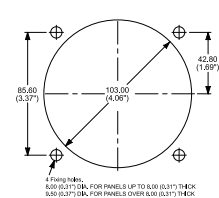

ANSI switchboard meters

FEATURES

- Rugged pivot and jewel movement
- Class 1 accuracy

APPROVALS

- c-UL UL listed
- E203000
- CE marked



BENEFITS

- Meets all the requirements of ANSI-C39.1 (1981)
- Parallax error-free platform dials
- Bump, shock and vibration proof
- Customised options and features



High quality range of switchboard instruments with Class 1 accuracy and which complies with American ANSI-C39.1 (1981) specifications. Available in 41/2" case size, the rugged design characteristics meet the needs of the most demanding environmental applications. This extensive range of analogue and digital/analogue meters utilises high shock and provides 1% accuracy for all RMS AC and DC ranges. The range offers various customised options and features.

DESCRIPTION

Our Switchboard Meter series offers two case types; models 007 and 078.

Model 078 is high shock hermetically sealed and all models have heavy gauge pressed steel cases. Mounting is by four integral studs. Model 078 has a die-cast bezel and a projecting moulded toughened glass window, which incorporates a gas tight zero adjuster.

Model 007 is a one piece flame retardant polycarbonate moulding with a black matte finished bezel area, and a specially contoured window to minimise reflection from adjacent light sources.

Scales are 240° moving iron and 250° moving coil with parallax error-free platform dials. Standard dials are white matte with black printed scales and bar knife-edge pointers.

APPLICATIONS

- Switchgear
- Distribution systems
- Generator sets
- Control panels
- Energy management
- Building management
- Utility power monitoring
- Process control
- Motor control

SPECIFICATIONS

Performance	ANSI C39.1 (1981)
Accuracy	Class 1
Terminals	10 - 32 UNF terminals
Response time	Approximately 2.5 seconds to full scale (007 and 078)
Dielectric voltage	Withstand test 2.3 kV for 1 minute
Standard calibration	23°C
Operating temperature	0°C to +60°C. Model 078: -40°C to +70°C
Storage temperature	-10°C to +50°C
Extreme temperature range	-20°C to +65°C
Enclosure integrity	Model 007 to IP54 (NEMA 3S) splash proof, IP55 (NEMA 4) hoseproof is an optional extra Model 078 to IP67 (NEMA 6 and 6P)
Fixing on panel	4 integral 1/4 -28 UNF fixing studs
Certifications	c-UL-us, CE

DIMENSIONS (IN INCHES)

Model	Panel Cutout			Rear View		Side View		
	Dia	A	B	C	D	E	F	G
007 (Amps, Volts & Freq.)	4.06	3.37	1.69	4.31	0.65	2.41	-	4.05
007 Others	4.06	3.37	1.69	4.31	0.65	-	0.91	4.05
078	4.06	3.37	1.69	4.31	0.63	-	0.91	4.05

Dimension E on 007 others and 078 products varies with measured parameter.

See product code on following page.

Dimension F on 078 (Amps, Volts & Freq.) products is included with dimension E.

1-4 Fixing holes Ø 8mm. 2-1/4-28 UNF fixing studs. 3-10-32 UNF terminals.

007 POWER AND 078

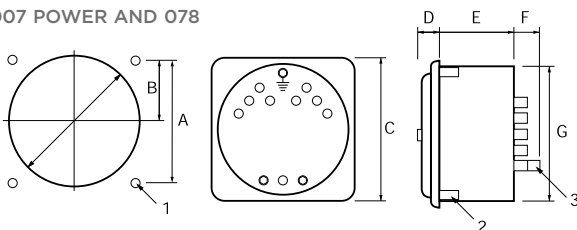

007 AMPS | VOLTS | FREQUENCY ONLY

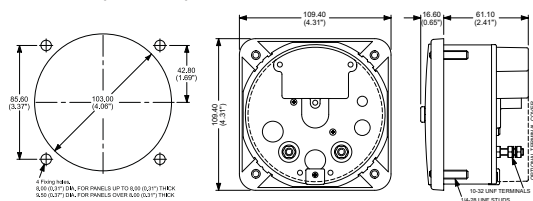

ANSI switchboard meters

Type of instrument	Ranges	Dimension E		Product code
		007	078	
AC rectified ammeter	1 - 30 A	56	86	007/078-05B
AC rectified voltmeter	30 - 800 V	56	86	007/078-05W
AC voltmeter expanded scale	110 - 130 V	86	86	007/078-05Y
AC RMS ammeter	1 - 30 A	56	86	007/078-05F
AC RMS voltmeter	150 - 750 V	56	86	007/078-05G
Elapsed time meter (99999.99)	50 or 60 Hz / 100 - 440 V* and DC	56	56	007/078-155/156/077-151
Frequency meter	50, 60	86	86	007/078-41L
AC wattmeter or VARmeter	0.2 - 10 A/100 - 440 V*	132	132	007/078-21 or 31
LED synchroscope only	63.5 - 480 V****	86	-	077-14A
LED synchroscope and Synchro check relay	63.5 - 480 V****	86	-	077-14 L/G/D/U
Phase sequence indicator	100 - 150, 151 - 300, 301 - 500 V	56	-	077-12P
Transducer operated indicator	1, 5, 10, 20, or 4/20 mA	56	56	007/078-05
DC ammeter moving coil	200 μ A - 30 A 56	56	56	007/078-05A
DC voltmeter moving coil	50 mV - 600 V 56	56	56	007/078-05V
240° phase angle power factor	1 or 5 A, 100 - 400 V, 50, 60	132	132	007/078-42
DIGI/Analogue AC ammeter	1 mA - 10 A	86	-	007-DIB
DIGI/Analogue AC voltmeter	200 mV - 600 V	86	-	007-DIW
DIGI/Analogue DC ammeter	1m A - 1 A	86	-	007-DIA
DIGI/Analogue DC voltmeter	20 mV - 600 V	86	-	007-DIV
DIGI/Analogue transducer indicator	DC mA	86	-	007-DIT
DIGI/Analogue tachometer	AC or DC rated	86	-	007-DI2

* 100-440V = (100/125, 200/250, 380/440).

**100-440V = (100/125, 200/250, 380/440). Frequencies 45/55, 55/65, 45/65, 46/54, 50/70, 58/62, 56/64.

****Nominal voltage to be specified.

AC and DC ammeters, voltmeters and frequency meters

FEATURES

- 250° linear scale
- True RMS converting circuit
- RMS compensated rectifier
- Wide selection of AC and DC inputs

APPROVALS

- c-UL UL listed
- E203000



This range of self contained, pivot and jewel moving iron meters feature 250° linear scale. AC instruments are available with true RMS converting circuit or RMS compensated rectifier. While types of frequency meters can be damaged by transient supply voltage spike, Crompton Instruments 007-41 frequency meters can withstand, without damage, 10 successive transient spikes of 1250 volts. The range offers c-UL-us certification.

SPECIFICATIONS - GENERAL

Manufactured in accordance with American National Standards ANSI C39.1, (1981)

Accuracy	±1% full scale at 23°C (73°F)
Scales arc	250° full scale deflection
Scale length	007 and 078: 175.2 mm (6.9")
Scale plate	2 piece, platform type
Response time	007 and 078: Approximately 2.5 seconds to full scale
Operating temperature	0 to 40°C (32 to 104°F)
Storage temperature	-10 to +50°C (14 to 122°F)
Extreme temperature range	-20° to +65°C (-4° to 149°F)
Terminals	Standard 10-32 UNF stud. M5 screw clamp is optional
Dielectric withstand	2300 V AC for 1 minute between electrical circuit and case
Overshoot	33% maximum
Enclosure code	007: IP54, optional IP55 and 078: IP67A
Certification	c-UL-us

SPECIFICATIONS - AMMETERS AND VOLTMETERS

Overload rating	AC ammeters - 2 x continuous, 50 x for 1 second AC voltmeters and frequency meters - 1.2 x continuous DC ammeters - 2 x continuous 10 x for 1 second DC voltmeters - 1.2 x continuous
Frequency range	AC calibration 50/60Hz ±20%

SPECIFICATIONS - FREQUENCY METERS

Response time	3 seconds maximum
External temperature influence	0.6 times accuracy maximum with ±10°C from reference temperature
External field influence	2.0 times accuracy maximum with 0.5m T field
Acceptable input harmonic influence	up to 30% distortion

Maximum Frequency - Hz	Centre Scale - Hz	Error in Hz
45-55	50	0.15
46-54	50	0.15
45-65	55	0.25
50-70	60	0.25
55-65	60	0.15
56-64	60	0.15

FIG. AA 007-05/007-41

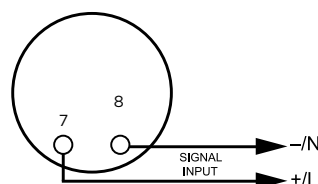

RMS reading AC ammeters

AC AMMETER



PRODUCT CODES – SELF CONTAINED 40/70HZ - ACCURACY $\pm 1\%$, 60HZ***

Rating	Scaling*	4 1/2" square flange	
		Std. case catalogue number	Std. case hi-shock catalogue number
1A	0-1A	•007-05FA-LALA-C7	078-05FJ-LALA-C6
1.5A	0-1.5A	•007-05FA-LCLC-C7	078-05FJ-LCLC-C6
2A	0-2A	•007-05FA-LELE-C7	078-05FJ-LELE-C6
3A	0-3A	•007-05FA-LJLJ-C7	078-05FJ-LJLJ-C6
5A	0-5A	•007-05FA-LSLS-C7	078-05FJ-LSLS-C6
7.5A	0-7.5A	•007-05FA-MFMF-C7	078-05FJ-MFMF-C6
10A	0-10A	•007-05FA-MTMT-C7	078-05FJ-MTMT-C6
15A	0-15A	•007-05FA-NDND-C7	078-05FJ-NDND-C6
20A	0-20A	•007-05FA-NGNG-C7	078-05FJ-NGNG-C6
30A	0-30A	•007-05FA-NLNL-C7	078-05FJ-NLNL-C6

For AC rectified non-RMS compensated meter, please replace the -05F in the product code with -05B.

PRODUCT CODES – TRANSFORMER RATED 40/70HZ - BURDEN 0.3VA***

Rating	Scaling*	4 1/2" square flange	
		Std. case catalogue number	Std. case hi-shock catalogue number
5A	0-10A	•007-05FA-LSMT-C7	078-05FJ-LSMT-C6
5A	0-15A	•007-05FA-LSND-C7	078-05FJ-LSND-C6
5A	0-20A	•007-05FA-LSNG-C7	078-05FJ-LSNG-C6
5A	0-25A	•007-05FA-LSNJ-C7	078-05FJ-LSNJ-C6
5A	0-30A	•007-05FA-LSNL-C7	078-05FJ-LSNL-C6
5A	0-40A	•007-05FA-LSNP-C7	078-05FJ-LSNP-C6
5A	0-50A	•007-05FA-LSNT-C7	078-05FJ-LSNT-C6
5A	0-75A	•007-05FA-LSPB-C7	078-05FJ-LSPB-C6
5A	0-100A	•007-05FA-LSPK-C7	078-05FJ-LSPK-C6
5A	0-150A	•007-05FA-LSPZ-C7	078-05FJ-LSPZ-C6
5A	0-200A	•007-05FA-LSRL-C7	078-05FJ-LSRL-C6
5A	0-250A	•007-05FA-LSRS-C7	078-05FJ-LSRS-C6
5A	0-300A	•007-05FA-LSRX-C7	078-05FJ-LSRX-C6
5A	0-400A	•007-05FA-LSSC-C7	078-05FJ-LSSC-C6
5A	0-500A	•007-05FA-LSSF-C7	078-05FJ-LSSF-C6
5A	0-600A	•007-05FA-LSSJ-C7	078-05FJ-LSSJ-C6
5A	0-800A	•007-05FA-LSSN-C7	078-05FJ-LSSN-C6
5A	0-1000A	•007-05FA-LSSS-C7	078-05FJ-LSSS-C6
5A	0-1200A	•007-05FA-LSSU-C7	078-05FJ-LSSU-C6
5A	0-1500A	•007-05FA-LSTC-C7	078-05FJ-LSTC-C6
5A	0-1600A	•007-05FA-LSTE-C7	078-05FJ-LSTE-C6
5A	0-2000A	•007-05FA-LSTM-C7	078-05FJ-LSTM-C6
5A	0-2500A	•007-05FA-LSTU-C7	078-05FJ-LSTU-C6
5A	0-3000A	•007-05FA-LSUA-C7	078-05FJ-LSUA-C6
5A	0-4000A	•007-05FA-LSUE-C7	078-05FJ-LSUE-C6
5A	0-5000A	•007-05FA-LSUJ-C7	078-05FJ-LSUJ-C6
5A	0-6000A	•007-05FA-LSUP-C7	078-05FJ-LSUP-C6
5A	0-7000A	•007-05FA-LSUS-C7	078-05FJ-LSUS-C6
5A	0-8000A	•007-05FA-LSUW-C7	078-05FJ-LSUW-C6

For AC rectified non-RMS compensated meter, please replace the -05F in the product code with -05B.

* Other scales are available.

*** For case types 007/078 use 10-32 UNF terminals.

• c-UL-us certified.

RMS reading AC voltmeters

AC VOLTMETER



PRODUCT CODES – SELF CONTAINED 50/60HZ ± 20% - ACCURACY ±1%***

Rating	Scaling*	4 1/2" square flange	
		Std. case catalogue number	Std. case hi-shock catalogue number
150V	0-150V	•007-05GA-PZPZ-C7	078-05GJ-PZPZ-C6
250V	0-250V	•007-05GA-RSRS-C7	078-05GJ-RSRS-C6
300V	0-300V	•007-05GA-RXRX-C7	078-05GJ-RXRX-C6
500V	0-500V	•007-05GA-SFSF-C7	078-05GJ-SFSF-C6
600V	0-600V	•007-05GA-SJSJ-C7	078-05GJ-SJSJ-C6
750V	0-750V	007-05GA-SMSM-C7	078-05GJ-SMSM-C6

For AC rectified non-RMS compensated meter, please replace the -05G in the product code with -05W.

PRODUCT CODES – TRANSFORMER RATED 50/60HZ - ACCURACY ±1% 0.8VA @ 150V***

Rating	Scaling*	4 1/2" square flange	
		Std. case catalogue number	Std. case hi-shock catalogue number
150V	0-300V	•007-05GA-PZRX-C7	078-05GJ-PZRX-C6
150V	0-600V	•007-05GA-PZSJ-C7	078-05GJ-PZSJ-C6
150V	0-750V	•007-05GA-PZSM-C7	078-05GJ-PZSM-C6
150V	0-3000V	•007-05GA-PZUA-C7	078-05GJ-PZUA-C6
150V	0-5250V	•007-05GA-PZUL-C7	078-05GJ-PZUL-C6
150V	0-6000V	•007-05GA-PZUP-C7	078-05GJ-PZUP-C6
150V	0-9000V	•007-05GA-PZUY-C7	078-05GJ-PZUY-C6
150V	0-15kV	•007-05GA-PZWC-C7	078-05GJ-PZWC-C6
150V	0-18kV	•007-05GA-PZWD-C7	078-05GJ-PZWD-C6
150V	0-45kV	•007-05GA-PZWJ-C7	078-05GJ-PZWJ-C6
250V	0-600V	•007-05GA-RSSJ-C7	078-05GJ-RSSJ-C6

For AC rectified non-RMS compensated meter, please replace the -05G in the product code with -05W.

PRODUCT CODES – EXPANDED SCALE - MOVING COIL ZENER DIODE *** ACCURACY ±0.3% OF MID-SCALE VALUE SELF CONTAINED, 20-1000HZ

Rating	Scaling*	4 1/2" square flange	
		Std. case catalogue number	Std. case hi-shock catalogue number
110-130V	110-130V	007-05YA-PNPN-C6	078-05YJ-PNPN-C6
110-130V	To suit PT	007-05YA-PN**-C6	078-05YJ-PN**-C6

* Other scales are available.

** Scaling information provided at time of order.

*** For case types 007/078 use 10-32 UNF terminals.

• c-UL-us listed.

AC VOLTMETER -
EXPANDED SCALE

DC ammeters



PRODUCT CODES – SELF CONTAINED - ACCURACY $\pm 1\%$ ***

Rating	Scaling*	4 1/2" square flange	
		Std. case catalogue number	Std. case hi-shock catalogue number
0-200 μ A	0-200 μ A	•007-05AA-EAEA	078-05AJ-EAEA
0-300 μ A	0-300 μ A	•007-05AA-EEEE	078-05AJ-EEEE
0-500 μ A	0-500 μ A	•007-05AA-EMEM	078-05AJ-EMEM
0-800 μ A	0-800 μ A	•007-05AA-EWEW	078-05AJ-EWEW
0-1mA	0-1mA	•007-05AA-FAFA	078-05AJ-FAFA
0-2mA	0-2mA	•007-05AA-FGFG	078-05AJ-FGFG
0-5mA	0-5mA	•007-05AA-FXFX	078-05AJ-FXFX
0-10mA	0-10mA	•007-05AA-HAHA	078-05AJ-HAHA
0-20mA	0-20mA	•007-05AA-HFHF	078-05AJ-HFHF
0-30mA	0-30mA	•007-05AA-HMHM	078-05AJ-HMHM
0-50mA	0-50mA	•007-05AA-HXHY	078-05AJ-HXHY
0-100mA	0-100mA	•007-05AA-JRJR	078-05AJ-JRJR
0-200mA	0-200mA	•007-05AA-KAKA	078-05AJ-KAKA
0-300mA	0-300mA	•007-05AA-KGKG	078-05AJ-KGKG
0-500mA	0-500mA	•007-05AA-KMKM	078-05AJ-KMKM
0-800mA	0-800mA	•007-05AA-KWKW	078-05AJ-KWKW
0-1A	0-1A	•007-05AA-LALA	078-05AJ-LALA
0-5A	0-5A	•007-05AA-LSLS	078-05AJ-LSLS
0-10A	0-10A	•007-05AA-MTMT	078-05AJ-MTMT
0-15A	0-15A	•007-05AA-NDND	078-05AJ-NDND
0-20A	0-20A	•007-05AA-NGNG	078-05AJ-NGNG
0-30A	0-30A	•007-05AA-NLNL	078-05AJ-NLNL



PRODUCT CODES – MILLIMETERS – SUPPRESSED ZERO, NO ZERO ADJUST UNLESS SPECIFIED

Rating	Scaling*	4 1/2" square flange	
		Std. case catalogue number	Std. case hi-shock catalogue number
1/5mA	To Suit	•007-05RA-GM**	078-05RJ-GM**
4/20mA	To Suit	•007-05RA-HG**	078-05RJ-HG**
10/50mA	To Suit	•007-05RA-HZ**	078-05RJ-HZ**

PRODUCT CODES – SHUNT RATED – ACCURACY $\pm 1\%$ ***

Rating	Scaling*	4 1/2" square flange	
		Std. case catalogue number	Std. case hi-shock catalogue number
50mV	To suit shunt rating	•007-05AA-EY**	078-05AJ-EY**
50-0-50mV		•007-05CA-GB**	078-05CJ-GB**
100mV		•007-05AA-GB**	078-05AJ-GB**
100-0-100mV		•007-05CA-GM**	078-05CJ-GM**

PRODUCT CODES – ZERO LEFT FOR USE WITH 50 MV SHUNTS AND 0.05 OHM SHUNT LEADS***AND ****

Rating	Scaling*	4 1/2" square flange	
		Std. case catalogue number	Std. case hi-shock catalogue number
50mV	0-15A	•007-05AA-EYND	078-05AJ-EYND
50mV	0-20A	•007-05AA-EYNG	078-05AJ-EYNG
50mV	0-30A	•007-05AA-EYNL	078-05AJ-EYNL
50mV	0-40A	•007-05AA-EYNP	078-05AJ-EYNP
50mV	0-75A	•007-05AA-EYPB	078-05AJ-EYPB
50mV	0-100A	•007-05AA-EYPK	078-05AJ-EYPK
50mV	0-150A	•007-05AA-EYPZ	078-05AJ-EYPZ
50mV	0-200A	•007-05AA-EYRL	078-05AJ-EYRL
50mV	0-300A	•007-05AA-EYRX	078-05AJ-EYRX
50mV	0-400A	•007-05AA-EYSC	078-05AJ-EYSC
50mV	0-500A	•007-05AA-EYSF	078-05AJ-EYSF
50mV	0-750A	•007-05AA-EYSM	078-05AJ-EYSM
50mV	0-1000A	•007-05AA-EYSS	078-05AJ-EYSS
50mV	0-1200A	•007-05AA-EYSU	078-05AJ-EYSU
50mV	0-1500A	•007-05AA-EYTC	078-05AJ-EYTC
50mV	0-2000A	•007-05AA-EYTM	078-05AJ-EYTM
50mV	0-3000A	•007-05AA-EYUA	078-05AJ-EYUA

- c-UL-us certified.
Specify shunt lead resistance value if in excess of 0.05 ohms for calibration purposes.
DC shunt rated ammeters have thermistor circuit ambient temperature compensation.
Separate shunt and shunt leads are not included.
- * Other scales are available.
- ** Specify scale required.
- *** Other mV ratings and scale options available upon request.
- **** For case types 007/078 use 10-32 UNF terminals.

DC voltmeters



PRODUCT CODES - SENSITIVITY 1000 OHMS / VOLT - ACCURACY $\pm 1\%$ ***

Rating	Scaling*	4 1/2" square flange	
		Std. case catalogue number	Std. case hi-shock catalogue number
500MV-800V	To suit	•007-05VA-**	078-05VJ-**
0-15V	0-15V	•007-05VA-NDND	078-05VJ-NDND
0-30V	0-30V	•007-05VA-NLNL	078-05VJ-NLNL
0-50V	0-50V	•007-05VA-NTNT	078-05VJ-NTNT
0-75V	0-75V	•007-05VA-PBPB	078-05VJ-PBPB
0-150V	0-150V	•007-05VA-PZPZ	078-05VJ-PZPZ
0-300V	0-300V	•007-05VA-RXR X	078-05VJ-RXR X
0-400V	0-400V	•007-05VA-SCSC	078-05VJ-SCSC
0-500V	0-500V	•007-05VA-SFSF	078-05VJ-SFSF
0-600V	0-600V	•007-05VA-SJSJ	078-05VJ-SJSJ
0-750V	0-750V	007-05VA-SMSM	078-05VJ-SMSM
0-800V	0-800V	007-05VA-SNSN	078-05VJ-SNSN

PRODUCT CODES - ZERO CENTRE - SENSITIVITY 2000 OHMS / VOLT ACCURACY $\pm 1\%$ ***

Rating	Scaling*	4 1/2" square flange	
		Std. case catalogue number	Std. case hi-shock catalogue number
150-0-150V	150-0-150V	•007-05NA-RXR X	078-05NJ-RXR X
300-0-300V	300-0-300V	•007-05NA-SJSJ	078-05NJ-SJSJ
500-0-500V	500-0-500V	•007-05NA-SSSS	078-05NJ-SSSS
600-0-600V	600-0-600V	•007-05NA-SUSU	078-05NJ-SUSU

Frequency meters



PRODUCT CODES - 120V SELF CONTAINED***

Rating	Scaling*	4 1/2" square flange	
		Std. case catalogue number	Std. case hi-shock catalogue number
50Hz +/-0.15	45-55Hz	•007-41LA-PNAG-AG	078-41LJ-PNAG-AG
50Hz +/-0.15	46-54Hz	•007-41LA-PNAH-AH	078-41LJ-PNAH-AH
50Hz +/-0.25	45-65Hz	•007-41LA-PNAJ-AJ	078-41LJ-PNAJ-AJ
60Hz +/-0.25	50-70Hz	•007-41LA-PNAL-AL	078-41LJ-PNAL-AL
60Hz +/-0.15	55-65Hz	•007-41LA-PNAN-AN	078-41LJ-PNAN-AN
60Hz +/-0.15	56-64Hz	•007-41LA-PNAO-AO	078-41LJ-PNAO-AO
60Hz +/-0.08	58-62Hz	•007-41LA-PNAT-AT	078-41LJ-PNAT-AT

For alternative voltage rating 200-250V, use code RN instead of PN.

For alternative voltage rating 380-480V, case types 007/078 use code SE instead of PN.

10-32 UNF terminals.

* Other scales are available.

** Specify scale required.

*** For case types 007/078 use 10-32 UNF terminals.

• c-UL-us certified.

AC wattmeters and VArmeters



The Crompton Instruments Switchboard series of AC Wattmeters and VArmeters incorporate a DC moving coil, pivot and jewel indicator with a micro-circuit watt transducer PCB to read power on single or three phase systems with optional transformer isolation. The most frequently selected wattmeter scale marking for common current and voltage transformers are listed on the following pages. In addition, these instruments may be supplied with zero-left or centre-zero scale.

SCALING

Wattmeter and VArmeter current circuits should have equal carrying capacity because they are frequently connected in series. This means that the sum of the left and right end-scale values of the VArmeters should be equal to or greater than the full scale value of the Wattmeter (or have higher end-scale values if the instruments are centre or offset-zero). Instruments measuring 10,000 kilowatts and over are marked in megawatts. Centre-zero or offset-zero Watt and VArmeters are marked "IN" for left deflection and "OUT" for right deflection. On ordering, Wattmeter and VArmeter scales will be calculate, the nearest preferred scale will be offered from the charts on the following pages. Custom scales are available but at an extra cost.

CALIBRATION

For full load value of Watts or VA, assuming unity power factor:

1-phase 2-wire Watts = amps x volts

3-phase 3-wire Watts = amps x line-to-line volts x $\sqrt{3}$

3-phase 4-wire Watts = amps x line-to-neutral volts x 3

Minimum scale values are obtained by multiplying resultant Watts, using the above formula x 0.7 and selecting next higher standard scale.

For maximum scale value, multiply x 1.3 and select the next lowest standard.

If scale calculates to an exact listed value, use this value rather than the next higher or lower value.

Note: When ordering Wattmeters and VArmeters, please specify CT ratio, VT ratio and required scale.

SPECIFICATIONS

Burden per element	Current circuit: 2VA Voltage Circuit: 1VA
Accuracy	Class 1.0
Ambient range	0° to ± 60° (32° to 104°F) std. calibration 20°C (68°F)
Ambient influence	0.05% per 1°C maximum
Overloads-current	10 x rating for 5 seconds, 1.2 x continuously
Voltage influence	2 x rating for 5 seconds, 1.2 x continuously voltage Accuracy maintained, 80 - 110% rated voltage
Power factor influence	Accuracy maintained, 0.1 lag to 0.1 lead
Enclosure code	007 IP54 optional IP55 078 IP67
Response time	007 and 078 approximately 2.5 seconds
Dielectric withstand	Live parts to case including panel 2600V RMS for 1 minute

AC wattmeters



PRODUCT CODES - 1-ELEMENT, TRANSFORMER RATED, 50/60HZ
 INTEGRAL TRANSDUCER - ACCURACY 1.0%, 50/60HZ

Measured System		Scaling	4 1/2" square flange			
Phases	Wires		Std. case catalogue number	Std. case hi-shock catalogue number		
1	2	5	120V	To suit	•007-215A-QQ**-C7	078-215J-QQ**-C6
1	2	5	240V	To suit	007-215A-QS**-C7	078-215J-QS**-C6

For connection diagram refer to Figure A1

PRODUCT CODES - 2 -ELEMENT, TRANSFORMER RATED, 50/60HZ
 TAUT BAND INTEGRAL TRANSDUCER - ACCURACY 1.0%, 50/60HZ

Measured System		Scaling	4 1/2" square flange			
Phases	Wires		Std. case catalogue number	Std. case hi-shock catalogue number		
3	3	5	120V	To suit	•007-218A-QQ**-C7	078-218J-QQ**-C6
3	3	5	208V	To suit	•007-218A-QR**-C7	078-218J-QR**-C6
3	3	5	240V	To suit	•007-218A-QS**-C7	078-218J-QS**-C6
3	3	5	380V	To suit	•007-218A-QX**-C7	078-218J-QX**-C6
3	3	5	480V	To suit	•007-218A-QT**-C7	078-218J-QT**-C6

For connection diagram refer to Figure A2

PRODUCT CODES - 2 1/2 - ELEMENT, TRANSFORMER RATED, 50/60HZ
 TAUT BAND INTEGRAL TRANSDUCER - ACCURACY 1.0%, 50/60HZ

Measured System		Scaling	4 1/2" square flange			
Phases	Wires		Std. case catalogue number	Std. case hi-shock catalogue number		
3	4	5	69V	To suit	•007-219A-QL-C7**	078-219J-QL**-C6
3	4	5	120V	To suit	•007-219A-QQ-C7**	078-219J-QQ**-C6
3	4	5	277V	To suit	•007-219A-QY-C7**	078-219J-QY**-C6
3	4	5	346V	To suit	•007-219A-QZ-C7**	078-219J-QZ**-C6

For connection diagram refer to Figure A3

- * Other scales are available.
- ** Specify CT (Current Transformer) and VT (Voltage Transformer) ratios if used and preferred scale at time of ordering.
- c-UL-us certified.

Fig. A1
 Models 007-215, 078-215
 Wattmeter single phase

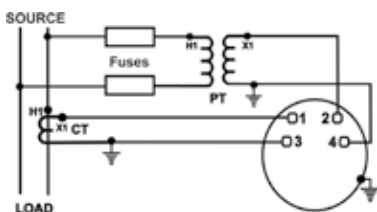

Fig. A2
 Models 007-218, 078-218
 Wattmeter 3-phase 3-wire unbalanced load

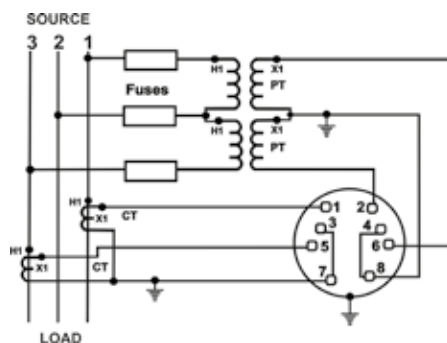
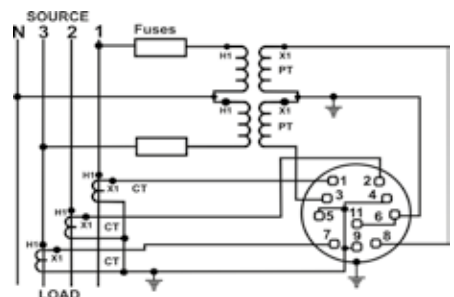

Fig. A3
 Models 007-219, 078-219
 Wattmeter 3-phase 4-wire unbalanced load



Wattmeter | VArmeter scale selector guide

		120	208	240	480	600	2400	3600	4200	4800	6000	7200	8400
Primary potential transformer voltage system		(1:1)	(1.73:1)	(2:1)	(4:1)	(5:1)	(20:1)	(30:1)	(35:1)	(40:1)	(50:1)	(60:1)	(70:1)
3-phase 3-wire (L-L) system voltage		120	208	240	480	600	2400	3600	4200	4800	6000	7200	8400
3-phase 4-wire (L-N) current transformer		69	120	139	277	347	1390	2100	2400	2770	3500	4160	4800
RATIO 25/5 (5:1)	Normal Max. Min.	5KW 6 3	10KW 10 5	10KW 12 6	20KW 25 12.5	25KW 30 15	100KW 120 60	150KW 200 100	175KW 200 100	200KW 250 125	250KW 300 150	300KW 400 200	350KW 450 225
RATIO 50/5 (10:1)	Normal Max. Min.	10KW 12 6	20KW 20 10	20KW 25 12.5	40KW 50 25	50KW 60 30	200KW 250 125	300KW 400 200	350KW 450 250	400KW 500 250	500KW 600 300	600KW 800 400	700KW 900 450
RATIO 75/5 (15:1)	Normal Max. Min.	15KW 20 10	25KW 30 15	30KW 40 20	60KW 80 40	75KW 100 50	300KW 400 200	500KW 700 350	600KW 800 400	700KW 900 450	800KW 1000 500	1000KW 1200 600	1200KW 1500 750
RATIO 100/5 (20:1)	Normal Max. Min.	20KW 25 12.5	30KW 40 20	40KW 50 25	75KW 100 50	100KW 120 60	400KW 500 250	600KW 800 400	700KW 900 450	800KW 1000 500	1000KW 1200 600	1200KW 1500 750	1200KW 100 750
RATIO 150/5 (30:1)	Normal Max. Min.	30KW 40 20	50KW 70 35	50KW 75 35	100KW 150 75	150KW 200 100	600KW 800 400	800KW 1200 600	1000KW 1200 600	1200KW 1500 750	1500KW 2000 1000	1800KW 2400 1000	2000KW 2500 1250
RATIO 200/5 (40:1)	Normal Max. Min.	40KW 50 25	75KW 80 40	75KW 100 50	150KW 200 100	200KW 250 125	800KW 1000 500	1200KW 1500 750	1200KW 1500 750	1500KW 2000 1000	2000KW 2500 1250	2500KW 3000 1500	3000KW 3500 1750
RATIO 300/5 (60:1)	Normal Max. Min.	70KW 75 35	100KW 120 60	100KW 150 75	200KW 300 150	300KW 400 200	1200KW 1500 750	1500KW 2000 1000	2000KW 2500 1250	2500KW 4000 2000	3000KW 4000 2000	3500KW 4000 2000	4500KW 5000 2500
RATIO 400/5 (80:1)	Normal Max. Min.	75KW 100 50	125KW 150 75	150KW 200 100	300KW 400 200	400KW 500 250	1500KW 2000 1000	2500KW 3000 1500	3000KW 3600 1800	3000KW 4000 2000	4000KW 5000 2500	5000KW 6000 3000	6000KW 7000 3500
RATIO 600/5 (120:1)	Normal Max. Min.	125KW 150 75	200KW 250 125	200KW 300 150	450KW 600 300	600KW 800 400	2000KW 3000 1500	3000KW 4000 2000	4000KW 5000 2500	5000KW 6000 3000	6000KW 8000 4000	7500KW 8000 4000	8000KW 10MW 5000KW
RATIO 800/5 (160:1)	Normal Max. Min.	150KW 200 100	250KW 350 175	300KW 400 200	600KW 800 400	800KW 1000 500	3000KW 4000 2000	5000KW 6000 3000	6000KW 7500 3000	6000KW 8000 4000	8000KW 10MW 5000KW	10MW 12 6000KW	12MW 15 7500KW
RATIO 1000/5 (200:1)	Normal Max. Min.	200KW 250 125	350KW 450 225	400KW 500 250	800KW 1000 500	1000KW 1200 600	4000KW 5000 2500	6000KW 8000 4000	6000KW 8000 4000	8000KW 10MW 5000KW	10MW 12 6000KW	12MW 15 7500KW	15MW 18 10
RATIO 1200/5 (240:1)	Normal Max. Min.	250KW 300 150	400KW 500 250	500KW 600 300	1000KW 1200 600	1200KW 1500 750	5000KW 6000 3000	7000KW 8000 4000	8000KW 10MW 5000KW	10MW 12 6000KW	12MW 15 7500KW	15MW 18 10	10MW 20 10
RATIO 1500/5 (300:1)	Normal Max. Min.	300KW 400 200	500KW 700 350	600KW 750 375	1200KW 1500 1000	1500KW 2000 1000	6000KW 8000 4000	10MW 12 6000KW	10MW 12 6000KW	12MW 15 7500KW	15MW 20 10	20MW 20 10	20MW 25 12.5
RATIO 2000/5 (400:1)	Normal Max. Min.	400KW 500 250	750KW 800 400	800KW 1000 500	1600KW 2000 750	2000KW 2500 1250	8000KW 10MW 5000	12MW 15 7500KW	12MW 15 7500KW	15MW 20 10	20MW 25 12.5	25MW 30 15	30MW 35 20
RATIO 3000/5 (600:1)	Normal Max. Min.	750KW 800 400	1000KW 1200 600	1200KW 1500 750	2000KW 3000 1500	3000KW 4000 2000	12MW 15 7500KW	18MW 20 10	20MW 25 12.5	25MW 30 15	30MW 40 20	35MW 40 20	40MW 50 25
RATIO 4000/5 (800:1)	Normal Max. Min.	800KW 1000 500	1200KW 1500 750	1500KW 2000 1000	3000KW 4000 2000	4000KW 5000 2500	15MW 20 10	20MW 30 15	25MW 30 15	30MW 40 20	40MW 50 25	50MW 60 30	50MW 75 40
RATIO 5000/5 (1000:1)	Normal Max. Min.	1000KW 1250 500	1500KW 2000 1000	2000KW 2500 1250	4000KW 5000 2500	5000KW 6000 3000	20MW 25 12.5	30MW 40 20	20MW 25 12.5	40MW 50 25	50MW 60 30	60MW 80 40	75MW 80 40
RATIO 6000/5 (1200:1)	Normal Max. Min.	1200KW 1500 750	2000KW 2500 1250	2500KW 3000 1500	5000KW 6000 3000	6000KW 8000 4000	25MW 30 15	35MW 40 20	40MW 50 25	50MW 60 30	60MW 80 40	60MW 80 40	80MW 100 50

Wattmeter | VArmeter scale selector guide

Primary potential transformer voltage system		12kV	14.4kV	24kV	34.5kV	38kV	46kV	92kV	115kV	138kV	345kV	765kV
		(100:1)	(120:1)	(200:1)	(300:1)	(330:1)	(400:1)	(800:1)	(1000:1)	(1200:1)	(3000:1)	(6000:1)
3-phase 3-wire (L-L) system voltage		12KV	14.4kV	24kV	34.5kV	38kV	46kV	92kV	115kV	138kV	345kV	765kV
3-phase 4-wire (L-N) current transformer		6900	8300	13.8KV	20kV	22kV	26.5kV	53kV	66kV	80kV	200kV	440kV
RATIO 25/5 (5:1)	Normal	500KW	600KW	1000KW	1500KW	1500KW	1500KW	3000KW	5000KW	6000KW	15MW	30MW
	Max. Min.	650 325	800 400	1200 600	1500 750	2000 1000	2500 1250	200 100	200 100	250 125	300 150	400 200
RATIO 50/5 (10:1)	Normal	1000KW	1200KW	2000KW	3000KW	3000KW	3500KW	8000KW	10MW	12MW	30MW	60MW
	Max. Min.	1200 600	1500 750	2500 1250	3500 1750	4000 2000	5000 2500	10MW 5000KW	12 6000KW	15 7500KW	35 15	80 40
RATIO 75/5 (15:1)	Normal	1500KW	1800KW	3000KW	4000KW	5000KW	5000KW	10MW	15MW	15MW	45MW	100MW
	Max. Min.	2000 1000	2000 1000	4000 2000	5000 2500	6000 3000	7500 3000	15 7500KW	20 7500KW	20 10	50 25	125 50
RATIO 100/5 (20:1)	Normal	2000KW	2500KW	4000KW	6000KW	6000KW	7500KW	15MW	20MW	25MW	60MW	125MW
	Max. Min.	2500 1250	3000 1500	5000 2500	7500 3000	8000 4000	10MW 5000KW	20 10	25 12.5	30 15	70 35	150 75
RATIO 150/5 (30:1)	Normal	3000KW	3500KW	6000KW	10MW	10MW	10MW	20MW	30MW	35MW	90MW	200MW
	Max. Min.	4000 2000	4000 2000	4000 2000	10 5000KW	12 6000KW	15 7500KW	30 15	35 15	40 20	100 50	250 100
RATIO 200/5 (40:1)	Normal	4000KW	4500KW	8000KW	12MW	12MW	15MW	30MW	35MW	50MW	100MW	250MW
	Max. Min.	5000 2500	6000 3000	8000 2500	15 7500KW	15 7500KW	20 10	40 20	50 25	60 30	150 75	300 150
RATIO 300/5 (60:1)	Normal	6000KW	7000KW	12MW	18MW	18MW	20MW	45MW	60MW	75MW	150MW	400MW
	Max. Min.	8000 4000	8000 4000	15 7.5	20 10	25 12.5	30 15	60 30	75 30	80 40	200 100	500 250
RATIO 400/5 (80:1)	Normal	8000KW	10MW	15MW	24MW	25MW	30MW	60MW	80MW	100MW	200MW	500MW
	Max. Min.	10MW 5000KW	12 6000KW	20 10	30 15	30 15	40 20	80 40	100 50	120 60	300 150	600 300
RATIO 600/5 (120:1)	Normal	12MW	15MW	25MW	35MW	40MW	45MW	90MW	100MW	150MW	350MW	800KW
	Max. Min.	15 7500KW	18 10	30 15	40 20	50 25	60 30	120 60	150 75	180 75	450 225	1000 500
RATIO 800/5 (160:1)	Normal	15MW	20MW	30MW	50MW	50MW	60MW	120MW	150MW	200MW	500MW	1000MW
	Max. Min.	20 10	25 12.5	40 20	60 30	60 30	80 40	150 75	200 100	200 100	600 300	1200 600
RATIO 1000/5 (200:1)	Normal	20MW	25MW	40MW	50MW	60MW	75MW	150MW	200MW	250MW	600MW	1200MW
	Max. Min.	25 12.5	30 15	50 25	60 30	80 40	100 50	200 100	250 125	300 150	750 300	1500 750
RATIO 1200/5 (240:1)	Normal	25MW	30MW	50MW	60MW	80MW	100MW	175MW	250MW	300MW	750MW	1500MW
	Max. Min.	30 15	35 20	60 30	80 40	100 50	120 60	200 100	300 150	350 175	900 450	2000 1000
RATIO 1500/5 (300:1)	Normal	30MW	35MW	60MW	75MW	100MW	120MW	250MW	300MW	350MW	900MW	2000MW
	Max. Min.	40 20	40 20	80 40	100 50	120 60	150 75	300 150	350 175	450 225	1000 500	2500 1250
RATIO 2000/5 (400:1)	Normal	40MW	50MW	80MW	100MW	120MW	150MW	300MW	400MW	500MW	1000MW	2500MW
	Max. Min.	50 25	60 30	100 50	150 75	150 75	200 100	400 200	500 250	600 300	1500 750	3000 1500
RATIO 3000/5 (600:1)	Normal	60MW	75MW	100MW	150MW	200MW	200MW	400MW	600MW	700MW	1500MW	3500MW
	Max. Min.	80 40	80 40	150 75	200 100	250 125	300 150	500 250	750 350	900 450	2000 1000	5000 2500
RATIO 4000/5 (800:1)	Normal	80MW	100MW	150MW	200MW	250MW	300MW	500MW	800MW	1000MW	2000MW	500MW
	Max. Min.	100 50	125 60	200 100	300 150	300 150	400 200	800 400	1000 500	1200 600	3000 1500	6000 3000
RATIO 5000/5 (1000:1)	Normal	100MW	125MW	200MW	250MW	300MW	400MW	750MW	1000MW	1200MW	3000MW	3000MW
	Max. Min.	120 60	150 75	250 125	300 150	400 200	500 250	1000 500	1200 600	1500 750	3500 1750	8000 4000
RATIO 6000/5 (1200:1)	Normal	120MW	150MW	250MW	350KW	400MW	450MW	1000MW	1200MW	1500MW	3500MW	8000MW
	Max. Min.	150 75	175 80	300 150	400 200	500 250	600 300	1200 600	1500 750	1750 800	4000 2000	10000 5000

AC VArmeters



PRODUCT CODES - ELEMENT, TRANSFORMER RATED, 50/60HZ
INTEGRAL TRANSDUCER - ACCURACY 1.0%, 50/60HZ

Measured System				Scaling	4 1/2" square flange	
Phases	Wires	Amperes 1VA max. burden	Volts 1 VA max. burden		Std. case catalogue number	Std. case hi-shock catalogue number
3	3	5	120V	To suit	•007-31LA-QQ**-C7	078-31LJ-QQ**-C6
3	3	5	208V	To suit	•007-31LA-QR**-C7	078-31LJ-QR**-C6
3	3	5	240V	To suit	•007-31LA-QS**-C7	078-31LJ-QS**-C6
3	3	5	380V	To suit	•007-31LA-QX**-C7	078-31LJ-QX**-C6
3	3	5	480V	To suit	•007-31LA-QT**-C7	078-31LJ-QT**-C6

For connection diagram refer to Figure D1

PRODUCT CODES - 2 1/2-ELEMENT, TRANSFORMER RATED, 50/60HZ
TAUT BAND INTEGRAL TRANSDUCER - ACCURACY 1.0%, 50/60HZ

Measured System				Scaling	4 1/2" square flange	
Phases	Wires	Amperes 1VA max. burden	Volts 1 VA max. burden		Std. case catalogue number	Std. case hi-shock catalogue number
3	4	5	120V	To suit	•007-31UA-QQ**-C7	078-31UJ-QQ**-C6
3	4	5	208V	To suit	•007-31UA-QR**-C7	078-31UJ-QR**-C6
3	4	5	480V	To suit	•007-31UA-QT**-C7	078-31UJ-QT**-C6

For connection diagram refer to Figure D1

- * Other scales are available.
- ** Specify CT (Current Transformer) and VT (Voltage Transformer) ratios if used and preferred scale at time of ordering.
- c-UL-us certified.

DC transducer indicators



PRODUCT CODES

Rating	Scaling*	4 1/2" square flange	
		Std. case catalogue number	Std. case hi-shock catalogue number
Watts 1mA	To suit	•007-055A-FA**	078-055J-FA**
VARs 1mA	To suit	•007-056A-FA**	078-056J-FA**
Frequency 1mA	To suit	•007-053A-FA**	078-053J-FA**
Power factor 1mA	To suit	•007-054A-FA**	078-054J-FA**
AC amps 1mA	To suit	•007-05AA-FA**	078-05AJ-FA**
AC volts 1mA	To suit	•007-05VA-FA**	078-05VJ-FA**
Speed 1mA	To suit	•007-052A-FA**	078-052J-FA**
VA 1mA	To suit	•007-057A-FA**	078-057J-FA**

Fig. D1 Models 007-31L, 078-31L VArmeter
3-phase 3-wire unbalanced load

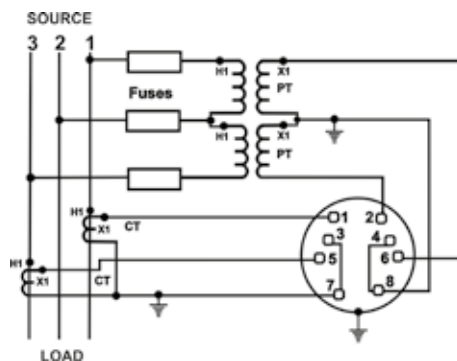

- * Case types 007/078 use 10-32 UNF terminals.
- ** Specify scale. Input: 1mA DC for 4/20mA change "FA" to "HG".
- c-UL-us certified.

For use with the following transducers: Watts, Vars, Frequency, Power Factor, AC amperes, AC volts and temperature.

007 ANSI Rotary synchroscope

FEATURES

- 2.5 degrees accuracy
- Enhanced safety
- ANSI C39.1
- Reliable

APPROVALS

- c-UL UL listed
- File number E203000



BENEFITS

- Enhanced safety



The Crompton Instruments ANSI Rotary Synchrosopes measure and display the frequency difference between two power sources. Monitoring the display allows the user to connect two synchronized power systems together.

The rotary design gives real-time feedback on the synchronization state, ensuring a safe and reliable synchronization.

When the synchronization state is achieved, the indicator stays in the synchronizing position. The ANSI Rotary Synchroscope complies with UL Approved E203000 and ANSI C39.1 standards.

PRODUCT CODES

Model	Voltage Range (L-N)	Frequency
007-145A-PRAE-C7-FP	120 V	50 / 60 Hertz

APPLICATIONS

- Switchgear Panels
- Power Plants

SPECIFICATIONS

Nominal Voltage	120 V AC
Nominal Frequency	50 or 60 Hertz (specify)
Operating Position	On vertical panel unless otherwise specified at time of order
Accuracy	2.5 degrees
Overshoot	33% maximum
Response Time	3 seconds maximum for 180° deflection
Sensitivity at Synchronization	3 degrees (electrical phase) maximum
Operating Temperature	-20°C to +45°C (-4°F to 13°F)
Storage Temperature	-30°C to +70°C (-22°F to 158°F)
Humidity	95% RH (non-condensing)
Ingress Protection	IP54 (NEMA 35) to Front Panel (with Panel Gasket)
Insulation between Circuits	1.5 kV
Insulation to Case	3 kV
Overtoltage Category	II
Pollutions Degree	III
Enclosure Integrity	2
Enclosure Style	4.5" round barrel
Case Material Polycarbonate	UL94-V0
Electrical Connections	10/32" UNF (Fixing kits supplied)
Mounting Studs	1/4" UNF (Fixing kits supplied)
Dimensions in mm	109.4 x 109.4 x 101
Weight	500g
Standards	UL Approved E203000 and ANSI C39.1
Country of Origin	USA

PANEL CUT OUT

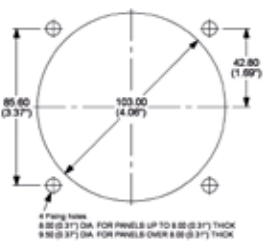
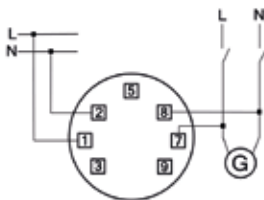

DIMENSIONS

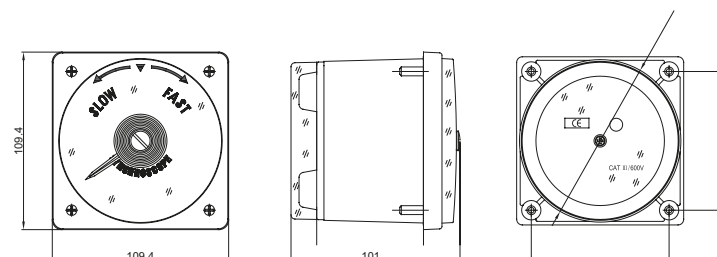

Elapsed time meters



PRODUCT CODES – 99,999.99 HOURS, NON RESET, BURDEN 2.5VA 50 OR 60HZ
Synchronous motor running time meter with a non-resettable indicator.

Rating	4 1/2" square flange	
	Std. case catalogue number	Std. case hi-shock catalogue number
110/130 V 50 Hz	•007-155A-PNZH-C5	078-155J-PNZH-C5
200/250 V 50 Hz	•007-155A-RNZH-C5	078-155J-RNZH-C5
480 V 50 Hz	•007-155A-SEZH-C5	078-155J-SEZH-C5
110/130 V 60 Hz	•007-156A-PNZH-C6	078-156J-PNZH-C6
200/250 V 60 Hz	•007-156A-RNZH-C6	078-156J-RNZH-C6
480 V 60 Hz	•007-156A-SEZH-C6	078-156J-SEZH-C6
12/24/40/110 V DC	007-151A-**-ZH-DC	Not Available

AC phase sequence, phase failure indicators



PRODUCT CODES – NEON BULB TYPE, BURDEN 2.5VA

Two neon bulbs for phase sequence indication:

first marked the caption "correct 1-2-3", the second marked "incorrect 3-2-1".

Three neon bulbs for phase failure indication - first marked 1, second marked 2, third marked 3.

Rating	4 1/2" square flange	
	Std. case catalogue number	Std. case hi-shock catalogue number
100/150 V 50/60 Hz	007-12PA-P2C7	077-12PA-P2C7
151/300 V 50/60 Hz	007-12PA-P3C7	077-12PA-P3C7
301/500 V 50/60 Hz	007-12PA-P4C7	077-12PA-P4C7
100-150V 400Hz	007-12PA-P2C4	077-12PA-P2C4
151-300V 400Hz	007-12PA-P3C4	077-12PA-P3C4
301-500V 400Hz	007-12PA-P4C4	077-12PA-P4C4

DIMENSIONS 007

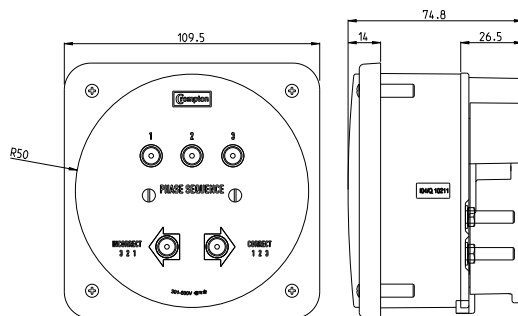

CONNECTIONS

TERMINAL CONNECTIONS



DIMENSIONS 077

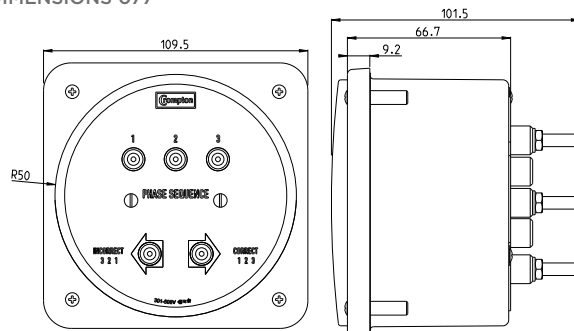

PANEL CUT OUT

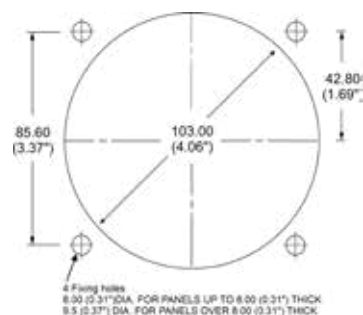

AC power factor meter



SPECIFICATIONS

Ratings, self-contained	Current windings 5 A. Voltage windings minimum 50 V, maximum 600 V
Accuracy	Balanced load: Class 1
Overshoot	33%
External temperature influence	0.5% fid minimum
External field influence	0.5% fid maximum
Frequency range	50 Hz or 60 Hz standard, 25-400 Hz optional (Specify)
Frequency influence	Single phase instruments, 59 to 61 Hz 1.0% fid maximum polyphase instruments $\pm 10\%$ deviation from 69 Hz: 1.0%
Overload capacity: 25% indefinitely	Current coils 1000% momentarily, 100% for 15 minutes Voltage circuits 25% indefinitely
Burdens	Each current circuit, 1.5VA approximately Each voltage circuit 1 VA approximately Measuring systems 077-427-3 or 4-wire
Ranges available	Lag 0.5-1 - 0.5 lead power factor Lag 0.2-1 - 0.8 lead power factor

Fig. E Models 007-425, 078-425J electronic phase angle meter single phase

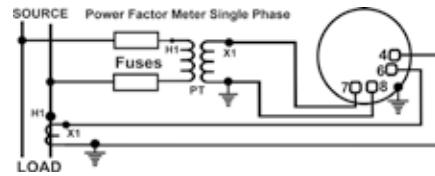
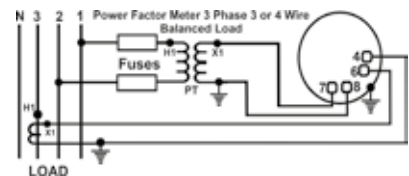

Fig. F Models 007-427, 078-427J electronic phase angle meter 3-phase, 3- or 4-wire balanced load



PRODUCT CODES - BALANCED LOAD - ACCURACY $\pm 1\%$

Phases	Wires	Amperes	1VA max. burden	Volts	1 VA max. burden	Scaling	4 1/2" square flange	
							Std. case catalogue number	Std. case hi-shock catalogue number
1	2	5	120V			0.5-1-0.5	•007-425A-QQAD-C6	078-425J-QQAD-C6
1	2	5	240V			0.5-1-0.5	•007-425A-QSAD-C6	078-427J-QSAD-C6
3	3/4	5	120V			0.5-1-0.5	•007-427A-QQAD-C6	078-427J-QQAD-C6
3	3/4	5	208V			0.5-1-0.5	•007-427A-QRAD-C6	078-427J-QRAD-C6
3	3/4	5	240V			0.5-1-0.5	•007-427A-QSAD-C6	078-427J-QSAD-C6
3	3/4	5	480V			0.5-1-0.5	•007-427A-QTAD-C6	078-427J-QTAD-C6

Instruments may be used on loads down to 20% of current and between 90% and 110% of voltage rating.

For connection diagrams refer to Fig. E and F.

• c-UL-us certified.



LED digital | analogue combination

FEATURES

- Rugged shock and vibration resistant pivot and jewel design
- High accuracy LED display
- Wide selection of AC and DC inputs
- Maximum trend indication visibility
- Input isolation
- External decimal point selection option
- Interchangeable with 4 1/2" switchboard meters



APPLICATIONS

- Switchgear
- Distribution systems
- Generator sets
- Control panels
- Energy management
- Building management
- Utility power monitoring
- Process control
- Motor control

APPROVALS

- c-UL UL listed
- E203000
- CE marked



BENEFITS

- Cost effective
- Meets all the requirement of ANSI-C39.1 (1981)
- IP54 (NEMA 3) protection
- Optional IP55 (NEMA 4) gasket
- Bump, shock and vibration proof
- Customised option and features

Crompton Instruments model 007-DI features a combination of the traditional 250° 4 1/2" switchboard indicator with the trend indication plus the benefits of wide angle LED visibility. This rugged shock and vibration resistant design provides precision accuracy and instantaneous reading via the bright in-dial mounted 3 1/2" digit LED display.

DESCRIPTION

Model 007-DI digital analogue indicators are ideal for all applications where moving pointer instruments are preferable to indicate trend with the simultaneous display of a high visibility precision LED readout for increased user interface.

The 007-DI is interchangeable with other analogue and digital instruments designed to directly mount in to a standard ANSI-C39. 4 1/2" switchboard cut-out. Available in side, centre, or off-set zero versions, the 007-DI can accept AC and DC current and voltage inputs as well as a wide range of transducer outputs, making it suitable for a variety of other applications including low-load current, temperature, speed, Watt/VARs, percent and level.

SPECIFICATIONS

Inputs	DC Voltage: 100 mV-600 V (1 MΩ input impedance as standard) DC Current: 1 mA-1 A, 4 to 20 mA (Voltage drop 200 mV nominal) External shunt operation (50mV and 100mV) AC Voltage: 200 mV-600 V (1 kΩ /voltage) AC Current: 1 mA-999 mA (Using internal shunt, voltage drop 200mV nominal) 1 A, 2 A, 5 A and 10 A using internal current transformer
Common mode rejection	=>80 dB @ 50/60 Hz
Overload	Voltage: x 1.2 continuous. x 1.5 for 10 seconds Current using internal CT: x 1.2 continuous. x 10 for 10 seconds
External power requirement	Standard: 120 and 240 V ±15% Optional: 480 V ±15% AC 40-60 Hz
Burden	3 VA @ 60 Hz
DC	Standard: 12, 24, 48, 110 and 125 V ±15%
Display analogue	Long-scale moving coil. 250° deflection. Scale length 6.8" Response time less than 2.5 seconds
Display options	Centre or offset zero. Scale plate in colors other than white Colored lines or segments on scale
Digital display	3 1/2 digit red LED. 7 segment (7.6 mm, 0.3" high). Right hand decimal points. Polarity indication: positive / none. Negative / horizontal bar " - ". Update time (standard): 1 per second
Accuracy - analogue	DC and AC ±1% of FSD (calibrated at 25°C)
Accuracy - digital	DC: ±0.05% of reading ±1 count ±100 ppm of reading / °C max AC current: 0-1 Amp ±0.1% reading ±3 counts ±150 ppm of reading / °C AC current: 0-10 amps ±0.1% reading ±10 counts ±150 ppm of reading / °C (maximum) AC voltage: ±0.1% of reading ±3 counts ±150 ppm of reading / °C (max) Zero ±1 count ±0.2 counts/°C (maximum), DC offset scale only. Warm-up time: 1 minute
Long term stability	±2 counts
Calibration check	Recommended 12 monthly intervals
Enclosure code	IP54 (optional IP55 using panel gasket)
Operational temperature	0 to 60°C (32° - 140° F)
Storage temperature	-20° to 60°C (-4° - 140° F)
Humidity	Up to 90% relative @ 55° C. Tests to BS2011 part 2DA
Isolation test voltage	2 kV RMS 60 Hz for 1 minute
Interference rejection	To IEEE STD472, ANSI C37 90A, SEN 361503, IEC 255-4

LED digital | analogue combination

AC VOLTMETER



- * Other scalings are available.
- ** Specify power supply voltage according to power supply codes table located on page 73.
- *** Case types 007 use 10-32 UNF terminals.

PRODUCT CODES - 99,999.99 HOURS, NON RESET, BURDEN 2.5VA 50 OR 60HZ

Digital accuracy $\pm 0.1\%$ ± 3 counts, analogue accuracy $\pm 1\%$

Rating	Scaling*	Catalogue number
200mV	0-200mV	007-DIWA-KAKA-C6-**
250mV	0-250mV	007-DIWA-KDKD-C6-**
500mV	0-500mV	007-DIWA-KMKM-C6-**
1V	0-1V	007-DIWA-LALA-C6-**
5V	0-5V	007-DIWA-LSLS-C6-**
10V	0-10V	007-DIWA-MTMT-C6-**
15V	0-15V	007-DIWA-NDND-C6-**
30V	0-30V	007-DIWA-NLNL-C6-**
150V	0-150V	007-DIWA-PZPZ-C6-**
250V	0-250V	007-DIWA-RSRS-C6-**
300V	0-300V	007-DIWA-RXRX-C6-**
500V	0-500V	007-DIWA-SFSF-C6-**
600V	0-600V	007-DIWA-SJSJ-C6-**

For connection diagrams, refer to Figure H.

PRODUCT CODES - AC VOLTMETERS TRANSFORMER RATED (40/70HZ)***

Rating	Scaling*	Catalogue number
150V	0-300V	007-DIWA-PZRX-C6-**
150V	0-600V	007-DIWA-PZSJ-C6-**
150V	0-750V	007-DIWA-PZSM-C6-**
150V	0-3000V	007-DIWA-PZUA-C6-**
143V	0-5000V	007-DIWA-PTUJ-C6-**
150V	0-5250V	007-DIWA-PZUL-C6-**
150V	0-6000V	007-DIWA-PZUP-C6-**
150V	0-9000V	007-DIWA-PZUY-C6-**
150V	0-15kV	007-DIWA-PZWC-C6-**
150V	0-18kV	007-DIWA-PZWD-C6-**
150V	0-45kV	007-DIWA-PZWJ-C6-**
150V	0-60kV	007-DIWA-PZWL-C6-**

For connection diagrams, refer to Figure H.

Fig. G Models 007-DA2, 007-DAA
LCD digital/analogue meter

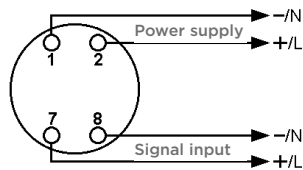
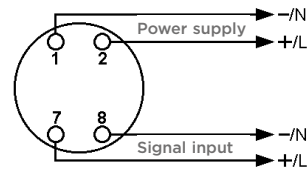

Fig. H Models 007-DI2, 007-DIA
007-DIB, 007-DIC, 007-DIN,
007-DIT, 007-DIV, 007-DIW
LED digital/analogue meter



LED digital | analogue combination

AC AMMETER



- * Other scalings are available.
- ** Specify power supply voltage according to power supply codes table located on page 73.
- *** Case types 007 use 10-32 UNF terminals.

PRODUCT CODES - AC AMMETERS - DIRECT READING (40/70HZ)***

Rating	Scaling*	Catalogue number
1A	0-1A	007-DIBA-LALA-C6-**
1.5A	0-1.5A	007-DIBA-LCLC-C6-**
2A	0-2A	007-DIBA-LELE-C6-**
3A	0-3A	007-DIBA-LJLJ-C6-**
5A	0-5A	007-DIBA-LSLS-C6-**
8A	0-8A	007-DIBA-MJMJ-C6-**
10A	0-10A	007-DIBA-MTMT-C6-**

For connection diagrams, refer to Figure I.

FIG. I MODELS 007-DI2, 007-DIA
007-DIB, 007-DIC, 007-DIN,
007-DIT, 007-DIV, 007-DIW
LED DIGITAL/ANALOGUE METER

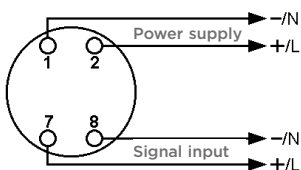

PRODUCT CODES - NEON BULB TYPE, BURDEN 2.5VA

Two neon bulbs for phase sequence indication - first marked the caption "correct 1-2-3", the second marked "incorrect 3-2-1". Three neon bulbs for phase failure indication - first marked 1, second marked 2, third marked 3.

PRODUCT CODES - AC AMMETERS TRANSFORMER RATED (40/70HZ)

Digital accuracy $\pm 0.1\%$ ± 1 counts, analogue accuracy $\pm 1\%$

Rating	Scaling*	Catalogue number
5A	0-15A	007-DIBA-LSND-C6-**
5A	0-20A	007-DIBA-LSNG-C6-**
5A	0-25A	007-DIBA-LSNJ-C6-**
5A	0-30A	007-DIBA-LSNL-C6-**
5A	0-40A	007-DIBA-LSNP-C6-**
5A	0-50A	007-DIBA-LSNT-C6-**
5A	0-60A	007-DIBA-LSNW-C6-**
5A	0-75A	007-DIBA-LSPB-C6-**
5A	0-80A	007-DIBA-LSPD-C6-**
5A	0-100A	007-DIBA-LSPK-C6-**
5A	0-150A	007-DIBA-LSPZ-C6-**
5A	0-200A	007-DIBA-LSRL-C6-**
5A	0-250A	007-DIBA-LSRS-C6-**
5A	0-300A	007-DIBA-LSRX-C6-**
5A	0-400A	007-DIBA-LSSC-C6-**
5A	0-500A	007-DIBA-LSSF-C6-**
5A	0-600A	007-DIBA-LSSJ-C6-**
5A	0-750A	007-DIBA-LSSM-C6-**
5A	0-800A	007-DIBA-LSSN-C6-**
5A	0-1000A	007-DIBA-LSSS-C6-**
5A	0-1200A	007-DIBA-LSSU-C6-**
5A	0-1500A	007-DIBA-LSTC-C6-**

For connection diagrams, refer to Figure J.

FIG. J MODELS 007-DI2, 007-DIA
007-DIB, 007-DIC, 007-DIN,
007-DIT, 007-DIV, 007-DIW
LED DIGITAL/ANALOGUE METER

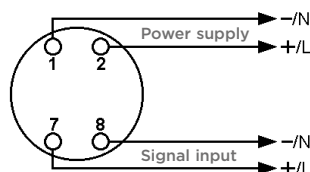

- * Other scalings are available.
- ** Specify power supply voltage, according to power supply codes table located on page 73.

LED digital | analogue combination

DC VOLTMETER



PRODUCT CODES - DC VOLTMETERS - DIRECT READING

Digital accuracy $\pm 0.5\%$ ± 1 counts, analogue accuracy $\pm 1\%$

Rating	Scaling*	Catalogue number
200mV	0-200mV	007-DIVA-KAKA-**
250mV	0-250mV	007-DIVA-KDKD-**
500mV	0-500mV	007-DIVA-KMKM-**
1V	0-1V	007-DIVA-LALA-**
5V	0-5V	007-DIVA-LSLS-**
10V	0-10V	007-DIVA-MTMT-**
15V	0-15V	007-DIVA-NDND-**
30V	0-30V	007-DIVA-NLNL-**
50V	0-50V	007-DIVA-NTNT-**
75V	0-75V	007-DIVA-PBPB-**
80V	0-80V	007-DIVA-PDPD-**
150V	0-150V	007-DIVA-PZPZ-**
300V	0-300V	007-DIVA-RXR-**
400V	0-400V	007-DIVA-SCSC-**
500V	0-500V	007-DIVA-SFSF-**
600V	0-600V	007-DIVA-SJSJ-**
150-0-150V	150-0-150V	007-DINA-RXR-**
300-0-300V	300-0-300V	007-DINA-SJSJ-**
600-0-600V	600-0-600V	007-DINA-SUSU-**

For connection diagrams, refer to Figure K.

FIG. K MODELS 007-DI2, 007-DIA
007-DIB, 007-DIC, 007-DIN,
007-DIT, 007-DIV, 007-DIW
LED DIGITAL/ANALOGUE METER

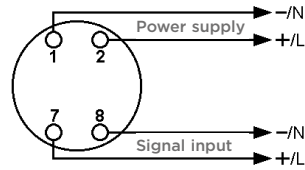

* Other scalings are available.

** Specify power supply voltage, according to power supply codes table located on page 73.

LED digital | analogue combination

DC AMMETER



- * Other scalings are available.
- ** Specify power supply voltage, according to power supply codes table located on page 73.

FIG. L MODELS 007-DI2, 007-DIA, 007-DIB, 007-DIC, 007-DIN, 007-DIT, 007-DIV, 007-DIW
LED DIGITAL/ANALOGUE METER

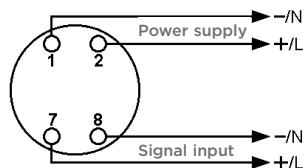

PRODUCT CODES – DC AMMETERS - SHUNT RATED

Digital accuracy $\pm 0.5\%$ ± 1 counts, analogue accuracy $\pm 1\%$

Rating	Scaling*	Catalogue number
100-0-100mV	Scaled to suit standard shunt ratings	007-DICA-GM**-**
100-0-100mV-2-0-2mA		007-DICA-FM**-**

For connection diagram, refer to Figure L.

PRODUCT CODES – DC AMMETERS - SUPPRESSED ZERO

Digital accuracy $\pm 0.5\%$ ± 1 counts, analogue accuracy $\pm 1\%$

Rating	Scaling*	Catalogue number
1-5mA	Scaled to suit standard shunt ratings	007-DIAA-GM**-**
4-20mA		007-DIAA-HG**-**
10-50mA		007-DIAA-HZ**-**

For connection diagram, refer to Figure L.

PRODUCT CODES – DC AMMETERS - DIRECT READING

Digital accuracy $\pm 0.5\%$ ± 1 counts, analogue accuracy $\pm 1\%$

Rating	Scaling*	Catalogue number
1mA	0-1mA	007-DIAA-FAFA-**
2mA	0-2mA	007-DIAA-FGFG-**
5mA	0-5mA	007-DIAA-FXFY-**
10mA	0-10mA	007-DIAA-GZGZ-**
20mA	0-20mA	007-DIAA-HFHF-**
30mA	0-30mA	007-DIAA-HMHM-**
50mA	0-50mA	007-DIAA-HYHY-**
100mA	0-100mA	007-DIAA-JRJR-**
200mA	0-200mA	007-DIAA-KAKA-**
300mA	0-300mA	007-DIAA-KGKG-**
500mA	0-500mA	007-DIAA-KMKM-**
800mA	0-800mA	007-DIAA-KWKW-**
1A	0-1A	007-DIAA-LALA-**

For connection diagram, refer to Figure L.

Switchboard meter options

PRODUCT CODES - POWER SUPPLY

Power Supplies	
A2 - 12 - 48V DC	NR - 48V DC
A5-120 - 250V AC/DC	MU - 12V DC

SCALE - OPTIONS

Options	Option code
Red or colored line or mark (specify position)	SL
Colored zones or segments (specify limits and color(s))	SZ
Customer user logo imprinted on dial	SM

CONSTRUCTION - OPTIONS

Options	Option code
Anti-glare window	BR
Polychloroprene panel gasket	MG

The suffix option code is added at the end of the complete part number.





Chapter 6

Meter relay panel meters

239 Meter relay panel meters.....	80
007 Meter relay switchboard meters.....	81

239 Meter relay panel meters

FEATURES

- Class 1.5 Accuracy
- Stable electronic switching circuit does not use lamps, photocells, inductors or capacitors
- Isolated input signal
- Control function continues if the indicator becomes damaged
- Rugged, shock and vibration resistant design
- LED relay status indicators



APPLICATIONS

- Liquid level control
- Load shedding
- Power factor correction
- High & Low alarms
- Shutdown
- Frequency monitoring
- Temperature indication and control

DIMENSIONS

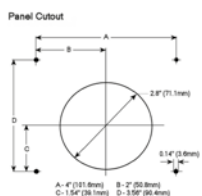
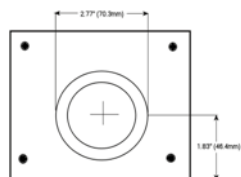
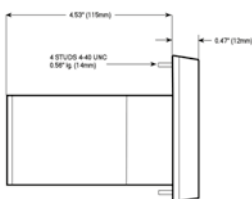
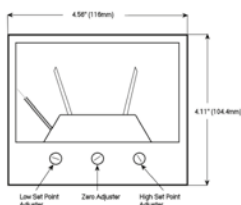

Series 239 meter relays combine a highly accurate indicator with High and Low set point relays. The relays can operate alarm and control devices when the monitored signal value moves outside the chosen set point limits shown by adjustable red index pointers. A single compact case houses the unit which requires only the input signal and power supply thus saving space and installation time.

PRODUCT CODES

Model	No. Relays & Setpoints	Function
239-300A	One relay, two setpoints	Upscale de-energised, downscale energised
239-301A	One relay, one setpoint	Upscale energised, downscale de-energised
239-302A	Two relays, two setpoints	Mid band de-energised, outside band energised
239-303A	Two relays, two setpoints	Both upscale energised, downscale de-energised
239-304A	Two relays, two setpoints	High and low midband energised, outside band de-energised - no time delay
239-305A	Two relays, two setpoints	Both upscale de-energised, downscale energised
239-307A	One relay, one setpoint	Upscale de-energised, downscale energised
239-30RA	Two relays, two setpoints	Midband de-energised, outside band energised - operates from 2, 3 or 4 wire RTD
239-30TA	Two relays, two setpoints	Midband de-energised, outside band energised - operates from thermocouple input

SPECIFICATIONS

Adjustments	
Front panel	Set-point potentiometer(s)
Rear panel	Delay potentiometer(s)
Measuring Inputs	
AC Voltage	10 V to 600 V RMS (Sensitivity 1 Kohm/V to 100 Kohm/V) max 2.5 Mohm
AC Current	1 mA to 15 A RMS (20mV drop)
DC Voltage	10 mV to 600 V RMS (Sensitivity 1 Kohm/V to 100 Kohm/V)
DC Current	100 uA to 15 A (20 mV drop) Centre zero option up to 15/015 amps
Max continuous input voltage	1.2x rating (600 V max.)
Max continuous input current	1.2x nominal (15 A max.)
Max short duration input current	6x nominal for 6 sec. (30 A max.)
Freq. monitoring	50 to 60 Hz +/-10%
Burden	<0.5 VA
Damping Time	1 second
4" Scale	100 deg. Deflection
Panel Material	Ferrous or non-ferrous
Dielectric Test	2600 V RMS for 1 min.
Auxiliary Supply Burden	<1.5 W
Enclosure	
Flammability	UL94V1
Terminal capacities	1 to 4 mm ² solid or stranded conductors
Accuracy	
Indicator accuracy	Class 1.5
Set-point range	98% of scale
Set-point accuracy	1% of range
Set-point hysteresis	2% of range
Trip repeatability	0.5% of range
Relay trip-time	<1 second
Time delay	0-20 seconds, adjustable by potentiometer on rear panel. Option: 0-10 sec & 0-40 sec.
Indication	Single red LED, per set-point, to indicate trip condition
Outputs	
Relays	DPCO contacts rated 5 A @ 250 V AC; 5 A @ 30 V DC. Resistive electrical life >100,000 operations @ 5 A, 250 V AC Contact class IIB (IEC 60255-0-20)
Relay logic	Configurable to energise or de-energise on trip
Environmental & Mechanical	
Ambient temperature reference range	+15 deg C to +30 deg C
nominal range of use	0 deg C to +60 deg C
Storage temperature	-20 deg C to +70 deg C
Relative humidity	<90%, non condensing
Shock	15g/6ms (EN 60068-2-27)
Bumping	40g/6ms (EN 60058-2-29)
Vibration	10-300Hz (EN 60068-2-6)
Protection Class	Terminals to IP20
BS EN 60529)	Enclosure to IP50

Series 007 switchboard analogue meter relays

FEATURES

- Indicator Class 1.5 Accuracy
- Stable electronic switching circuit does not use lamps, photocells, inductors or capacitors
- Isolated input signal
- Control function continues if the indicator becomes damaged
- Rugged, shock and vibration resistant design
- LED relay status indicators



APPLICATIONS

- Level control
- Load shedding
- Power factor correction
- High & Low alarms
- Shutdown
- Overload alarm
- Temperature indication and control

Series 007 Meter Relays combine a highly accurate indicator with High and Low set point relays. The relays can operate alarm and control devices when the monitored signal value moves outside the chosen set point limits shown by adjustable red index pointers.

A single compact case houses the unit which requires only the input signal and power supply thus saving space and installation time.

ACCESSORIES

The following optional accessories are also available for the 239 Meter Relay:

- Relay latching
- External reset switch
- Finger knob setpoint adjusters
- Hysteresis
- Panel mounting gasket

PRODUCT CODES

Model	No. Relays & Setpoints	Function
007-300A	One relay, two setpoints	Upscale de-energised, down scale energised
007-301A	One relay, one setpoint	Upscale energised, downscale de-energised
007-302A	Two relays, two setpoints	Mid band de-energised, outside band energised
007-303A	Two relays, two setpoints	Both upscale energised, downscale de-energised
007-304A	Two relays, two setpoints	High and low midband energised, outside band de-energised - no time delay
007-305A	Two relays, two setpoints	Both upscale de-energised, downscale energised
007-307A	One relay, one setpoint	Upscale de-energised, downscale energised
007-30RA	Two relays, two setpoints	Midband de-energised, outside band energised - operates from 2, 3 or 4 wire RTD
007-30TA	Two relays, two setpoints	Midband de-energised, outside band energised - operates from thermocouple input

For complete ordering codes, including input, scaling and auxiliary ratings, please consult your sales representative.

DIMENSIONS

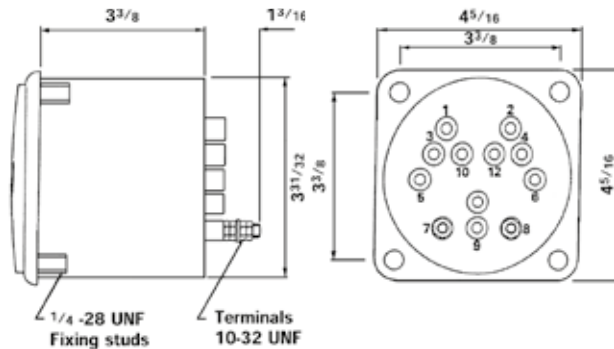

CONNECTIONS

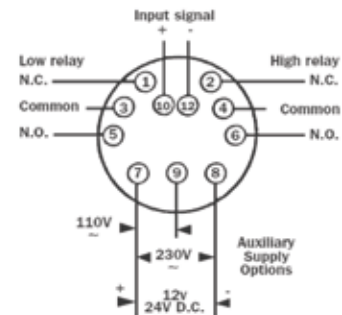
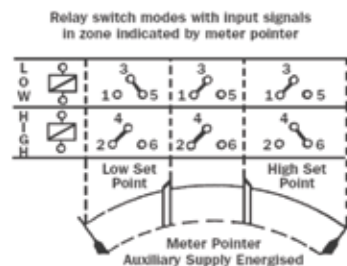





Chapter 7 Sealed and ruggedised panel indicators

Sealed and ruggedised panel indicators.....86

Sealed and ruggedised panel indicators

FEATURES

- Designed specifically for stringent industrial, marine and military specifications
- An extensive range of high accuracy measuring instruments in 3 case sizes
- Rugged Hi-Q taut-band suspension
- Bump, shock and vibration proof



APPLICATIONS

- Switchgear
- Distribution systems
- Generator sets
- Control panels
- Utility power monitoring
- Process control
- Motor control
- Marine
- Military

APPROVALS

- DEF STAN 66.7

BENEFITS

- Complies with BS EN60051 (IEC51)
- IP67 (NEMA 6 and 6P) protection
- Dial illumination option
- Parallax error-free platform dials for 078/087. Optional for 083/084

078/080/087 SERIES 240° SCALE

The Crompton Instruments 078/080/087 series of heavy duty sealed instruments are designed to comply with the most stringent industrial, marine and military specifications.

This metal cased range offers bezel sizes of 57 mm, 83 mm and 110 mm all fitted with toughened glass. Indicators comply with Ministry of Defence specification DEF STAN 66.7. and operate efficiently in the most adverse environments where extreme conditions of shock, vibration, dirt, humidity and temperature variation are present.

DESCRIPTION

Indicators have metal cases with bezel sizes of 50 x 57 mm (083), 83 mm Ø (084) and 110 mm x 100 mm (078/087). All indicators are fitted with toughened glass windows. The standard black matt finish can be replaced with options ranging from light admiralty grey to BS3181C No:697. To prevent fogging, all indicators have been dried, evacuated and filled with dry nitrogen during manufacturing. The case interior retains a constant pressure of at least 94kPa above the exterior with leakage not above the equivalent of 1.33 Pa ml/s of air. Except on model 083, panel sealing gaskets are standard equipment.

Standard instrument dials are finished in acrylic white matt with black printing and a parallel pointer. Scales form a true arc with zero on the left hand-side. Options include dial illumination, a centre, off-set or suppressed zero, colour index lines, bands, zones or segments, a black dial with white printing, and customer logo.

SPECIFICATIONS

Performance	BS EN60051 (IEC51) DEF STAN 66-7 on request (087 only)
Accuracy	Refer to Product Range table
Scaling	BS89, BS3693 or DEF STAN 66-7 and 66-9
Dielectric test	2kV RMS to BS EN61010-1
Overloads	x 1.2 rated current for 2 hours x 10 rated current for 5 seconds x 1.2 rated voltage for 2 hours x 2 rated voltage for 5 seconds
Enclosure code	IP67 (NEMA 6 and 6P)
Case	Black matt metal filled with dry nitrogen
Bezel	Black matt metal. Optional admiralty grey No. 697
Bezel window	Toughened glass
Operating temperature	-40°C to +70°C (-40°F to +158°F)
Storage temperature	-55°C to +85°C (-67°F to +185°F)
Standard calibration	23°C (73°F)
Approvals	EMC and LVD DEF 66.7

Sealed and ruggedised panel indicators

078/080/087 SERIES 240° SCALE

PRODUCT RANGE

Type of instrument	Ranges	Accuracy class	Burden VA	Case code depth behind the bezel				Product code
				57	59	86	86	
DC ammeter shunt operated	50, 60, 75, 100, 150 mV	2.5	See T118***	57	-	-	-	083-05A
DC ammeter shunt operated	50, 60, 75, 100, 150 mV	1.5	See T118***	-	59	-	-	084-05A
DC ammeter shunt operated	50, 60, 75, 100, 150 mV	1.5	See T118***	-	-	86	-	078-05A
DC ammeter shunt operated	50, 60, 75, 100, 150 mV	1.5	See T118***	-	-	-	86	087-11A
DC ammeter	200 µA-30 A	2.5	See T118***	57	-	-	-	083-05A
DC ammeter	200 µA-30 A	1.5	See T118***	-	59	-	-	084-05A
DC ammeter	200 µA-30 A	1.0	See T118***	-	-	86	-	078-05A
DC ammeter	200 µA-30 A	1.0	See T118***	-	-	-	86	087-11A
DC ammeter suppressed zero	4/20 mA	2.5	See T118***	57	-	-	-	083-05R
DC ammeter suppressed zero	4/20 mA	1.5	See T118***	-	59	-	-	084-05R
DC ammeter suppressed zero	4/20 mA	1.5	See T118***	-	-	86	-	078-05R
DC ammeter suppressed zero	4/20 mA	1.5	See T118***	-	-	-	86	087-11R
DC voltmeter	50 mV-600 V	2.5	See T118***	57	-	-	-	083-05V
DC voltmeter	50 mV-600 V	1.5	See T118***	-	59	-	-	084-05V
DC voltmeter	50 mV-800 V	1.5	See T118***	-	-	86	-	078-05V
DC voltmeter	50 mV-800 V	1.0	See T118***	-	-	-	86	087-11V
DC voltmeter suppressed zero	1/5 V	1.5	See T118***	-	-	86	-	078-05S
DC voltmeter suppressed zero	1/5 V	1.5	See T118***	-	-	-	86	087-11S
AC rectified ammeter	200 µA-1 A	2.5	See T118***	57	-	-	-	083-05B
AC rectified ammeter	200 µA-1 A	2.5	See T118***	-	59	-	-	084-05B
AC rectified ammeter	200 µA-30 A	1.5	See T118***	-	-	86	-	078-05B
AC rectified ammeter	200 µA-30 A	1.5	See T118***	-	-	-	86	087-11B
AC rectified voltmeter	15 - 600 V 25 Hz/3 kHz	2.5	See T118***	57	-	-	-	083-05W
AC rectified voltmeter	15 - 600 V 25 Hz/3 kHz	2.5	See T118***	-	59	-	-	084-05W
AC rectified voltmeter	15 - 600 V 25 Hz/3 kHz	1.5	See T118***	-	-	86	-	078-05W
AC rectified voltmeter	15 - 600 V 25 Hz/3 kHz	1.5	See T118***	-	-	-	86	087-11W
Elapsed time meter	50 or 60 Hz, 100-400 V*			57	-	-	-	083-155 or 156
Elapsed time meter	12, 24 V DC			57	-	-	-	083-151
Elapsed time meter	50 or 60 Hz, 100-400 V*			-	59	-	-	084-155 or 156
Elapsed time meter	12, 24 V DC			-	59	-	-	084-151
Elapsed time meter	50 or 60 Hz, 100-400 V*			-	-	86	-	078-155 or 156
Frequency meter	50/60/400 Hz 100-440 V*	0.5%	4	57	-	-	-	083-41S
Frequency meter	50/60/400 Hz 100-440 V*	0.5%	4	-	59	-	-	084-41S/089-41S
Frequency meter	50/60/400 Hz 100-440 V*	0.5%	4	-	-	86	86	078/087-41L
Temperature indicator	RTD	1.5	See T118***	-	-	86	-	078-45 R
Wattmeter or Varmeter	0.2 - 10 A/100-440 V*	Balanced	Current	-	-	132	132	078/087-21 or 31
Transducer operated indicator	1, 5, 10, 20 or 4/20 mA	1.0	See T118***	57	-	-	-	083-05
Transducer operated indicator	1, 5, 10, 20 or 4/20 mA	1.0	See T118***	-	59	-	-	084-05
Transducer operated indicator	1, 5, 10, 20 or 4/20 mA	1.0	See T118***	-	-	86	-	078-05
Transducer operated indicator	1, 5, 10, 20 or 4/20 mA	1.0	See T118***	-	-	-	86	087-11

* 100 - 440 V = (100/125, 200/250, 380/440).

*** The T118 technical sheet is available on request.

Sealed and ruggedised panel indicators



O80 SERIES 90° SCALE

A range of metal case, sealed instruments for industrial and military applications involving extreme shock, vibration, temperature, dirt and humidity. Bezel sizes 57 mm, 83 mm comply with Ministry of Defence specification DEF STAN 66-7 or DEF STAN 66-9 for all standard ratings.

DESCRIPTION

Two bezel sizes of 57 x 57 mm (O83) and 83 mm Ø (O84), with barrel diameters of 53 mm (O83) and 67 mm (O84) and toughened glass windows are used throughout the series. To avoid fogging they are dried, evacuated and filled with dry nitrogen. Panel sealing gaskets are provided as standard with the exception of Model O83. Models O83 and O84 have steel cases with fixing holes in the flange. Sealed zero adjusters are provided. Standard instrument dials are finished in a white matt with black printing and parallel pointer. The scales form a true arc with zero on the left.

OPTIONS

Available options include dial illumination, a centre, off-set or suppressed zero, colour index lines, bands, zones or segments, a black dial with white printing and customer logo. Instruments operated by separate transducers indicate watts, VAR, frequency, phase angle, current, voltage and other physical/mechanical parameters are also available. Illumination options as follows:

Models O83/O84: Edge, white or red bulb, 12 or 24 V, illumination.

SPECIFICATIONS

Performance	BS EN60051 (IEC51). DEF STAN 66-7 and 66.9 on request (O84 only)
Accuracy	Class 2.5 frequency meter 0.5% of mid frequency
Scaling	To BS89, BS3693 or DEF STAN 66-7 and 66-9
Dielectric test @ 50 Hz	2 kV RMS; <50 V 500 V RMS All for 1 minute
Overloads	x1.2 rated current or voltage for 2 hours. x 10 rated current for 5 seconds. x2 rated voltage for 5 seconds
Burden	AC ammeter: 1 VA maximum. AC voltmeter: 3 VA maximum
Frequency meter	4 VA maximum
Elapsed time meter	2.5 VA maximum
Enclosure code	IP67 (NEMA 6 and 6P)
Case	Black matt metal filled with dry nitrogen
Bezel	Black matt metal
Bezel window	Toughened glass
Operating temperature	-40°C to +70°C (-45F to +158°F)
Standard calibration	23°C (73°F)
Approvals	EMC and LVD. DEF 66.7 and 66.9

PRODUCT RANGE

Type of instrument	Ranges	Accuracy class	Burden VA	Depth	Diameter Dimension	Product code
AC ammeter moving iron	1 - 30 A	2.5	1.0	37.6	53	O83-75A
AC ammeter moving iron	1 -30 A	2.5	1.0	38	67	O84-75A
AC voltmeter moving iron	5 - 300 V	2.5	3.0	37.6	53	O83-75V
AC voltmeter moving iron	5 - 300 V	2.5	3.0	38	67	O84-75V
DC ammeter shunt operated	50, 60, 75, 100, 150 mV	2.5	1.0	33.6	53	O83-80A
DC ammeter shunt operated	50, 60, 75, 100, 150 mV	2.5	1.0	33.5	67	O84-80A
DC ammeter	50 µA-30 A	2.5	1.0	33.6	53	O83-80A
DC ammeter	50 µA-30 A	2.5	1.0	33.5	67	O84-80A
DC ammeter suppressed zero	4/20 mA	2.5	1.0	33.6	53	O83-80R
DC ammeter suppressed zero	4/20 mA	2.5	1.0	33.5	67	O84-80R
DC voltmeter	50 mV-300 V, 1000 Ω/V	2.5	2.0	33.6	53	O83-80V
DC voltmeter	50 mV-300 V	2.5	2.0	33.5	67	O84-80V
DC voltmeter suppressed zero	1/5 V	2.5	2.0	33.5	67	O84-80S
AC rectified ammeter	100 µA-500 mA.25 Hz/3 kHz	2.5	3.0	33.6	53	O83-80B
AC rectified ammeter	100 µA-500 mA.25 Hz/3 kHz	2.5	3.0	33.5	67	O84-80B
AC rectified voltmeter	15 - 600 V, 900 Ω/V	2.5	3.0	33.6	53	O83-80W
AC rectified voltmeter	15 - 600 V	2.5	3.0	33.5	67	O84-80W
Elapsed time meter (99999.9)	12 or 24 V DC	2.5	3.0	33	53 / 67	O82/O83/O84-151
Elapsed time meter (99999.9)	50 Hz/100-440 V*	2.5	2.5	33	53 / 67	O83/O84-155
Elapsed time meter (99999.9)	60 Hz/100-440 V*	2.5	2.5	33	53 / 67	O83/O84-156
Frequency meter	50 or 60 or 400 Hz/100-440 V*	2.5	4.0	33.6	53	O83-41S
Frequency meter	50 or 60 or 400 Hz/100-440 V*	2.5	4.0	33.5	67	O84-41S
Transducer indicator speed	1, 5, 10, 20, and 4/20 mA	2.5	1.0	33.5	67	O84-802
Transducer indicator frequency	1, 5, 10, 20, and 4/20 mA	2.5	1.0	33.5	67	O84-803
Transducer indicator phase angle	1, 5, 10, 20, and 4/20 mA	2.5	1.0	33.5	67	O84-804
Transducer indicator watts	1, 5, 10, 20, and 4/20 mA	2.5	1.0	33.5	67	O84-805
Transducer indicator VARs	1, 5, 10, 20, and 4/20 mA	2.5	1.0	33.5	67	O84-806
Transducer indicator VA	1, 5, 10, 20, and 4/20 mA	2.5	1.0	33.5	67	O84-807

*100-440V - (100/125 or 200/250 or 380/440).

Sealed and ruggedised panel indicators



DIMENSIONS Model 083

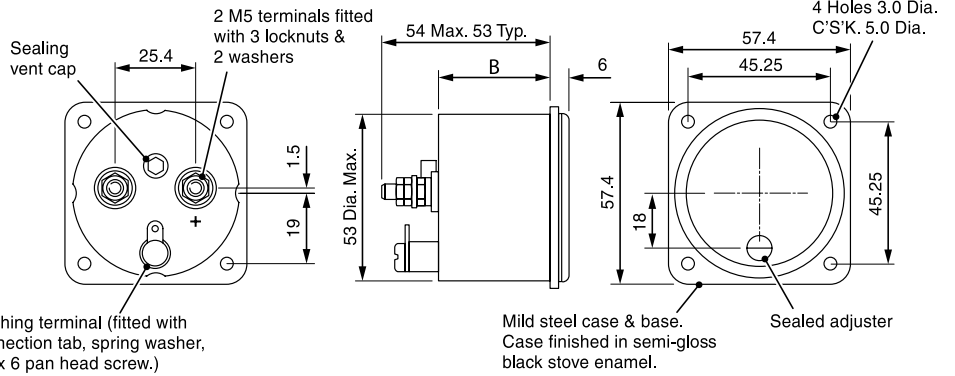

	B
083-80	33.6
083-75	37.6



Model 084

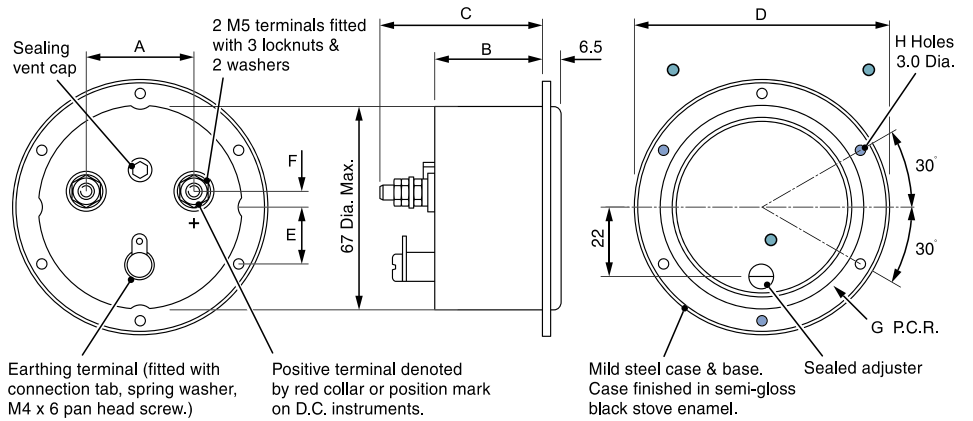

*When fitted with terminal shunt for ranges above 20 amps.

	A	B	C	D	E	F	G	H
084-80	35	33.5	59	82.5	20	5	36.5	6 off
084-75	35	38	64	82.5	20	5	36.5	6 off

Panel Cut out 68.3ø - Holes 3.8ø
These ● holes on 084 only.





Chapter 8 Instrument selector switches

Instrument selector switches.....92

Instrument selector switches

FEATURES

- Compact size
- Reliable design
- Multi pole



APPROVALS

- IEC EN 60947-3
- VDE 0660 part 107

BENEFITS

- Cost effective
- Easy to install
- High protection class

Panel mounted selector switches offer a 7-position voltmeter switch and a 4-position ammeter switch for reading line-to-line or line-to-neutral voltage and phase current.

Each switch is supplied with both numbered and coloured annotation.

APPLICATIONS

- ON-OFF Switches
- Change over Switches
- Multi-step Switches
- Volt-Ammeter Switches
- Selector Switches
- Mains Switching
- Coolant Pumps

Description		Current Rating		
		6A	10A	16A
Ammeter Selector Switch 5 Position Line Current with OFF with Neutral		SWA-5P-6A ✓	SWA-5P-10A ✓	SWA-5P-16A ✓
Ammeter Selector Switch 4 Position Line Current with OFF		SWA-4P-6A ✓	SWA-4P-10A ✓	SWA-4P-16A ✓
Voltmeter Selector Switch 4 Position Voltage between Phases with OFF		SWV-4P-6A-LL ✓	SWV-4P-10A-LL ✓	SWV-4P-16A-LL ✓
Voltmeter Selector Switch 7 Position Voltage between Phases & Individual Phase to Neutral with OFF		SWV-7P-6A ✓	SWV-7P-10A ✓	SWV-7P-16A ✓
Voltmeter Selector Switch 4 Position Phase to Neutral Voltages with OFF		SWV-4P-6A-LN ✓	SWV-4P-10A-LN ✓	SWV-4P-16A-LN ✓

Rotary cam switches dimensional details

Type	A	B	C (max)	D	M1	M2	M3	R	S	W1	W2
Cam 6A	29	9.7	4	32	36	4	8	48	48	13	7
Cam 10A	29	9.5	4	43	36	4	7	60	48	19	5
Cam 16A	29	9.5	4	43	36	4	7	60	48	19	5

DIMENSIONS

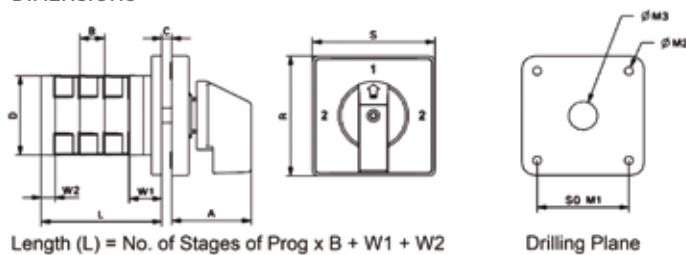

Product coding system

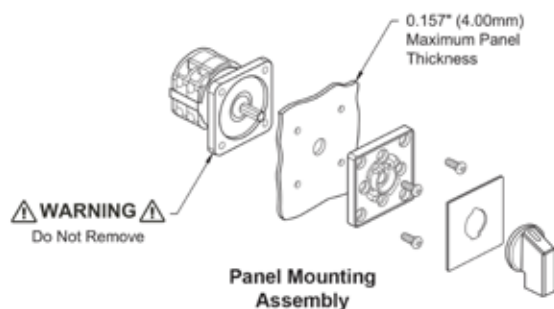

TE Connectivity Ltd. is a \$13 billion global technology and manufacturing leader creating a safer, sustainable, productive, and connected future. For more than 75 years, our connectivity and sensor solutions, proven in the harshest environments, have enabled advancements in transportation, industrial applications, medical technology, energy, data communications, and the home. With 78,000 employees, including more than 7,000 engineers, working alongside customers in nearly 150 countries, TE ensures that EVERY CONNECTION COUNTS. - www.TE.com.

Generation

- Conventional Power
- Nuclear Power
- Wind/Solar
- Hydro-electric

Transmission & Distribution

- Substation
- Underground
- Overhead
- Street Lighting

Industry

- Mining
- Petrochemical
- Railway
- Shipbuilding

WHEREVER ELECTRICITY FLOWS, YOU'LL FIND TE ENERGY



crompton-instruments.com

FOR MORE INFORMATION:

TE Technical Support Centres

- USA: +1 800 327 6996
- UK: +44 1376 509 401
- Australia: +61 1300 656 090
- Singapore: +65 6590 5151
- Hong Kong: +852 2790 9609

te.com/energy

© 2018 TE Connectivity Ltd. family of companies. All Rights Reserved. EPP-2042-03/19

TE Connectivity, the TE connectivity (logo) and Crompton Instruments are trademarks of the TE Connectivity Ltd. family of companies. Other logos, product and Company names mentioned herein may be trademarks of their respective owners. While TE has made every reasonable effort to ensure the accuracy of the information in this brochure, TE does not guarantee that it is error-free, nor does TE make any other representation, warranty or guarantee that the information is accurate, correct, reliable or current. TE reserves the right to make any adjustments to the information contained herein at any time without notice. TE expressly disclaims all implied warranties regarding the information contained herein, including, but not limited to, any implied warranties of merchantability or fitness for a particular purpose. The dimensions in this brochure are for reference purposes only and are subject to change without notice. Specifications are subject to change without notice. Consult TE for the latest dimensions and design specifications.

