

EN54-13 COMPLIANT CONVENTIONAL FIRE ALARM SOLUTIONS

from C-TEC



interface boards

control panels

visual alarm devices

heat detectors

fault monitoring modules

smoke detectors

manual call points

multi-sensors



You're safe with C-TEC



CFP 2-8 CONVENTIONAL FIRE ALARM PANELS TO EN54-2, 4 & 13

CFP 2-8 ZONE CONVENTIONAL FIRE ALARM PANEL

- ▶ Certified to EN54-2 and 4 (LPCB) and 13 (BSI)
- ▶ 2, 4 or 8 zone circuits
- ▶ Four conventional sounder circuits (can be converted into two EN54-13 compliant sounder circuits using a BF354 interface board and two BF355 fault monitoring modules, see below)
- ▶ Intuitive user-friendly interface with colour-coded buttons and combined keypad/keyschwitch entry to access level 2
- ▶ Integral 1.5A EN54-4/A2 compliant switch mode PSU
- ▶ Wide range of engineering functions including zone test, coincidence, zone delay and non-latching zones
- ▶ Two relays (Fire & Fault) and two open-collector outputs (Remote and Reset)
- ▶ 'Class change' and alert inputs
- ▶ Space for two x 12V 3.2Ah VRLA batteries
- ▶ Attractive flush or surface mountable plastic lid and enclosure - no bezel required
- ▶ Expansion connections provided for up to eight two-wire repeaters (one CFP761 network driver card required per system)
- ▶ Measures 380mm (W) x 235mm (H) x 96mm (D). 1.75 KG weight.
- ▶ English, Dutch and German language variants, as detailed:-



CFP702-4	CFP 2 zone conventional fire panel to EN54-2/4/13, keypad/keyschwitch entry (English version)
CFP704-4	CFP 4 zone conventional fire panel to EN54-2/4/13, keypad/keyschwitch entry (English version)
CFP708-4	CFP 8 zone conventional fire panel to EN54-2/4/13, keypad/keyschwitch entry (English version)

EN54-13 INTERFACE MODULES TO EN54-13

BF354 EN54-13 INTERFACE BOARD

- ▶ Certified to EN54 Part 13 (BSI)
- ▶ Fits inside a CFP fire panel to provide two EN54-13 monitored sounder circuits
- ▶ Monitored for partial and full open or short circuit faults when used in conjunction with a BF355 fault monitoring module (one BF355 required per sounder circuit)
- ▶ 20VDC min to 27VDC max Alarm voltage
- ▶ Each circuit fused at 400mA

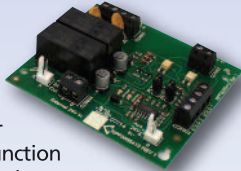

BF355 FAULT MONITORING MODULE

- ▶ Certified to EN54 Part 13 (BSI)
- ▶ Detects resistances down to 10 ohms
- ▶ Can be fitted inside or alongside the last device on a sounder circuit
- ▶ Measures 50mm x 26mm x 5mm with 100mm tails
- ▶ One required per BF354 interface board sounder circuit
- ▶ Note the CFP's zone circuits are monitored to EN54-13 without the need for any additional interface boards

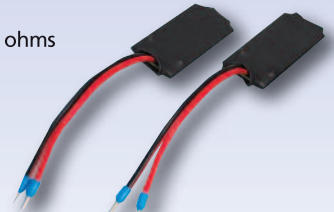

MANUAL CALL POINTS TO EN54-11 & 13

BF370FR MANUAL CALL POINT

- ▶ Certified to EN54 Part 11 (LPCB) and 13 (BSI)
- ▶ 'Universal' design combines a number of functions into one package, simplifying selection and reducing stock variants
- ▶ Choice of glass or plastic elements
- ▶ Quick visible alarm indication
- ▶ Changeover contacts
- ▶ IP24 rated
- ▶ Supplied with surface mounting back box



BF370S MANUAL CALL POINT

- ▶ Certified to EN54 Part 11 (LPCB) & 13 (BSI)
- ▶ Smooth-action resettable element mimics feel of breaking glass
- ▶ Red LED 'alarm ring' illuminates call point face upon activation
- ▶ Reset and back box removal tool included
- ▶ IP42
- ▶ Photoluminescent operating window remains visible for up to 5 mins
- ▶ Yellow and black physical alarm flag
- ▶ Supplied with a 'Not in Use' label
- ▶ Optional transparent hinged cover protects against vandalism and accidental activation



ActiV FIRE DETECTORS TO EN54-5, 7 & 13 (AS INDICATED)

C4416
OPTICAL SMOKE DETECTOR

- ▶ Certified to EN54-7 (Intertek) & 13 (BSI)
- ▶ Uses an infrared light source & photodiode to detect smoke
- ▶ Typically used in escape routes, living areas, bedrooms & other enclosed spaces
- ▶ Particularly effective at detecting slow burning fires such as those caused by overheated electrical wiring or smouldering materials



C4403A2 60°C STANDARD
TEMPERATURE HEAT DETECTOR

- ▶ Certified to EN54-5 (Intertek) & 13 (BSI)
- ▶ Class/Type: A2 (Static)
- ▶ Application temp: 25°C typical, 50°C max
- ▶ Static response temp: 54°C min. 65°C max.
- ▶ Generates an alarm condition when it detects a temperature of between 54°C and 65°C



C4403B 75°C HIGH
TEMPERATURE HEAT DETECTOR

- ▶ Certified to EN54-5 (Intertek) & 13 (BSI)
- ▶ Class/Type: B (Static)
- ▶ Application temp: 40°C typ., 65°C max.
- ▶ Static response temp: 69°C min. 85°C max.
- ▶ Generates an alarm condition when it detects a temperature of between 69°C and 85°C



C4403A1R RATE OF RISE
HEAT DETECTOR

- ▶ Certified to EN54-5 (Intertek) & 13 (BSI)
- ▶ Class/Type: A1R (Rate of Rise/Static)
- ▶ Application temp: 25°C typical, 50°C max.
- ▶ Static response temp: 54°C min. 65°C max.
- ▶ Generates an alarm condition when it detects a sudden rise in temperature or if it detects a static temperature of between 54°C & 65°C



C4414 MULTI-SENSOR
FIRE DETECTOR

- ▶ Certified to EN54-5 & 7 (Intertek) & 13 (BSI)
- ▶ Incorporates a smoke and a heat sensor which, as well as operating independently, combine to produce a sensitive response to freely burning fires. For example, when a rise in heat is detected, the level at which the detector responds to smoke is reduced. This smoke + heat analysis makes it ideal for detecting a wide range of fires whilst reducing false alarms
- ▶ Max.static response of heat element is 65°C



C4408D
DETECTOR BASE c/w DIODE

- ▶ Compatible with all ActiV fire detectors
- ▶ Integrated head-base locking mechanism, removal tool & ID tag
- ▶ Connections for an optional remote LED
- ▶ Can be ceiling mounted in any orientation due to the 360° viewing angle of the LED indicator strips on all ActiV detectors
- ▶ Can form part of a detector/base sounder combination using a BF341C/CR/3 base sounder (detailed below)



SOUNDERS & VADs TO EN54-3, 23 & 13 (AS INDICATED)

BF440CF/1
SOLISTA LX WALL VAD

- ▶ Certified to EN54-23 (AFNOR) and 13 (BSI)
- ▶ W-2.4-7.5 rated (can switch to 2.4-2.5 if required)
- ▶ 10-25mA alarm current depending on setting



BF441CF/3
SOLISTA LX CEILING VAD

- ▶ Certified to EN54-23 (AFNOR) and 13 (BSI)
- ▶ C-3-7.5 rated (can switch to C-3-2.5 if required)
- ▶ 10-25mA alarm current depending on setting



BF433CF/5
RoLPLX WALL SOUNDER VAD

- ▶ Certified to EN54-3 and 23 (AFNOR) and 13 (BSI)
- ▶ W-2.4-7.5 rated (can switch to W-2.4-2.5 if required)
- ▶ 102dB(A) sound output
- ▶ 22-37mA alarm current



BF433CF/7 SYMPHONI LX
WALL SOUNDER/VAD

- ▶ Certified to EN54-3 and 23 (AFNOR/VDS) and 13 (BSI)
- ▶ W-2.4-7.5 rated (can switch to W-2.4-2.5 if required)
- ▶ 100dB(A) sound output
- ▶ 15-30mA alarm current



BF341C/CR/3
BASE SOUNDER

- ▶ Certified to EN54-3 (BRE) and 13 (BSI)
- ▶ 32 tones and 88-93dB(A) sound output (selectable)
- ▶ 6-12mA alarm current
- ▶ Compatible with C4408D



BF430CF/16
ASKARI BEDHEAD SOUNDER

- ▶ Certified to EN54-3 (BRE) and 13 (BSI)
- ▶ 32 tones
- ▶ 18mA alarm current
- ▶ Up to 97dB(A) sound output



BF430CF/11
ROLP WALL SOUNDER

- ▶ Certified to EN54-3 (BRE) and 13 (BSI)
- ▶ 32 Tones
- ▶ 12mA alarm current
- ▶ Up to 102dB(A) sound output



BF340CF/18
SYMPHONI WALL SOUNDER

- ▶ Certified to EN54-3 (BRE/vdS) and 13 (BSI)
- ▶ 32 Tones
- ▶ 5mA alarm current
- ▶ Up to 100dB(A) sound output



WHAT IS EN 54-13?

- ▶ EN54-13's full title is EN 54-13 2005 (Fire Detection and Fire Alarm Systems, Compatibility assessment of system components). It calls for fire alarm system components to be tested as a system to ensure full functionality and compatibility
- ▶ Although not yet a mandated standard that can be used as a basis for CE marking, EN54-13 is demanded in some European territories by installation standards such as NEN2535 (Netherlands) and NBN S21.100 (Belgium).
- ▶ The standard specifies the minimum functions to be performed by CIE (fire panels) and system components such as detectors, call points and sounders. It also specifies the requirements for network systems.
- ▶ In particular, EN54-13 extends the monitoring requirements for transmission paths beyond those specified in individual EN54 product standards, requiring partial or 'creeping' open or short circuit faults to be flagged as a fault condition before devices become inoperable.

C-TEC'S EN54-13 SOLUTION

C-TEC's EN54-13 conventional fire alarm solution centres around our award-winning CFP 2-8 zone conventional fire panel and our new BF354 interface board and BF355 fault monitoring modules. When used in conjunction with our ActiV fire detectors and wide range of sounders, VADs and call points, installers can rest-assured the system they are installing is fully compliant with the system compatibility requirements of EN54-13 and is certified as such by the BSI.



A TYPICAL CFP EN54-13 COMPLIANT CONVENTIONAL FIRE ALARM SYSTEM

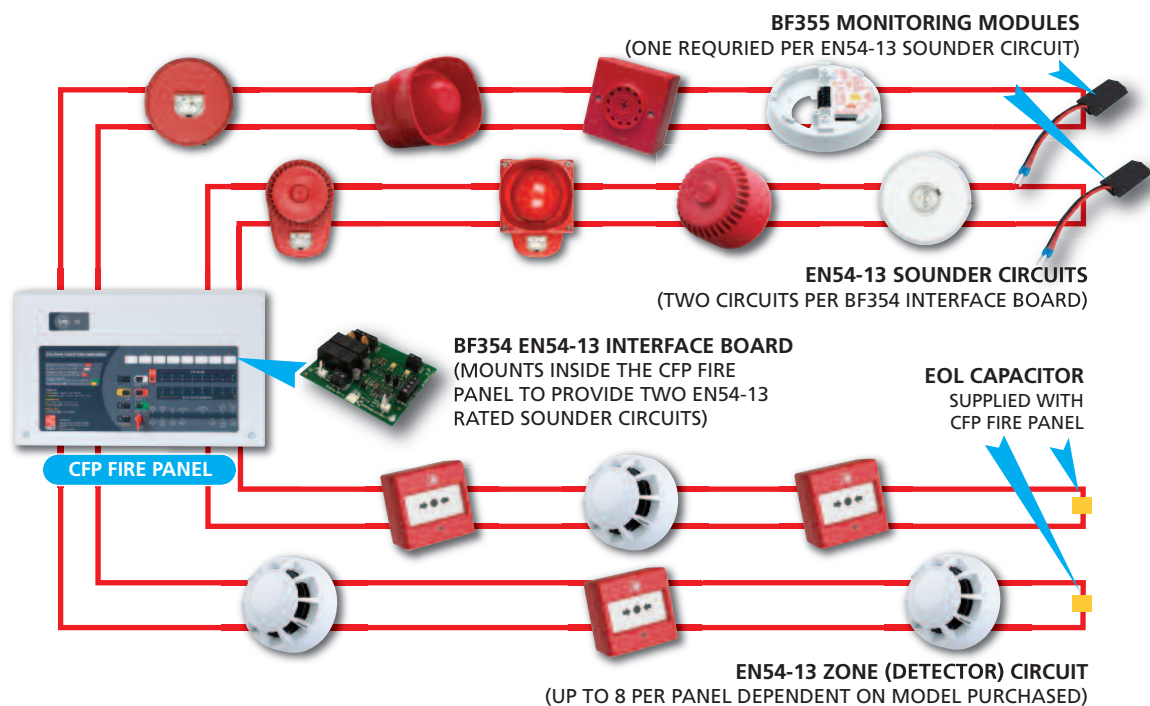

You're safe with C-TEC