

PRODUCT SELECTION GUIDE

# Electrification UK

## Contractor handbook



---

**ABB's Electrification Business Area is a global leader in electrical products and solutions, operating in more than 100 countries, with over 200 manufacturing sites. Our 50,000+ employees are dedicated to delivering safe, smart and sustainable electrification. With ABB Ability™ enabled digital solutions at its core, our portfolio protects, connects and optimises the flow of electrical energy for smarter electricity distribution for utilities, industry, buildings, infrastructure and mobility.**



---

# Table of contents

<b>004–017</b>	<b>1. Introduction</b>
<b>018–037</b>	<b>2. Residential wiring accessories</b>
<b>038–071</b>	<b>3. Smart home - Designed to make your life simpler</b>
<b>072–075</b>	<b>4. EV charging - Terra AC Wallbox</b>
<b>076–081</b>	<b>5. Residential distribution boards</b>
<b>082–115</b>	<b>6. Commercial distribution boards</b>
<b>116–138</b>	<b>7. Commercial panel boards</b>
<b>139–164</b>	<b>8. Enclosed switching products</b>
<b>165–169</b>	<b>9. Enclosed switches</b>
<b>170–243</b>	<b>10. Cable management products</b>
<b>254–265</b>	<b>11. Energy and Lighting management</b>
<b>266–283</b>	<b>12. Furse® - Earthing, lightning and surge protection</b>
<b>284–300</b>	<b>13. Commercial / Industrial enclosures</b>
<b>301–305</b>	<b>14. Enclosed control products</b>
<b>306–325</b>	<b>15. Metering and monitoring</b>
<b>326–338</b>	<b>16. Electronic relays and controls</b>
<b>339–354</b>	<b>17. Motor Control and protection</b>
<b>355–361</b>	<b>18. Jokab safety products</b>

# A safer, more reliable flow of electricity



"We make our customers more successful by identifying the challenges they face and creating opportunities through intelligent solutions to improve insight and efficiency into power distribution."

To meet the needs of this changing world, ABB's Electrification business is dedicated to developing pioneering technologies that, from the substation to the point of consumption, create a safer, smarter, more sustainable electrical flow – for everyone.

With a broad range of market-leading products and solutions, a global sales network and customised support, ABB provides flexibility that improves energy performance, whatever the requirements. Our trusted, high-quality products are intelligent and cloud-based, enabling them to control and protect power more effectively.

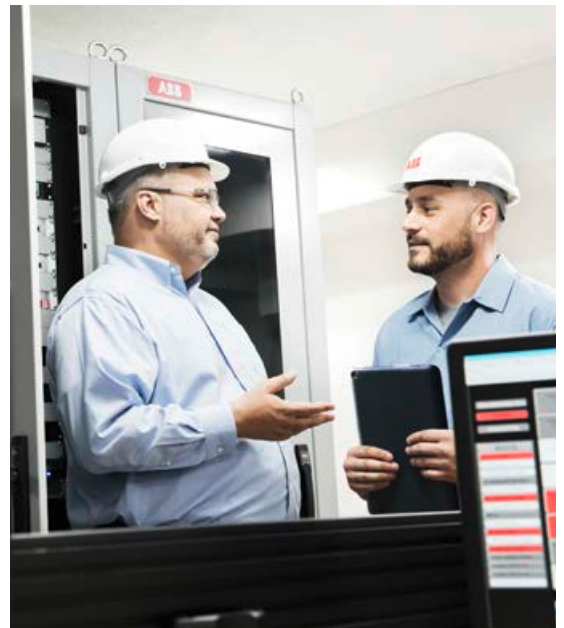

Buildings



Data Centres



EV Charging



Marine



Oil &amp; Gas



Rail



Food &amp; Beverage



Manufacturing



Solar



Wind



# Digital services

## Simplified business solutions

By digitalising our services, we are easing the transformation for our customers from traditional office based operations, towards a digitalised future, enabling a more efficient pro-active work environment.

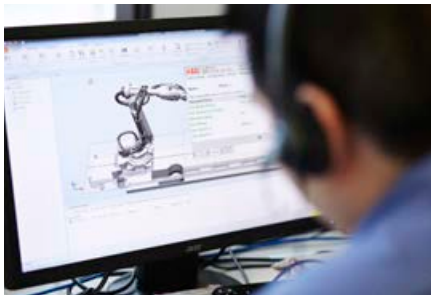

### E-Configure

With e-Configure, customers can completely integrate the ordering process, selecting, configuring and ordering their products more quickly and simply.

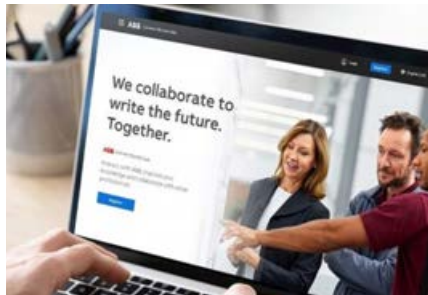

### ABB Connect Partner Hub

Join our dynamic, online platform that connects customers directly with key professionals, such as system integrators, and ABB Ability™ digital solutions and services.



### Building Information Modeling

ABB BIM objects are just one click away. Find them stored along with supporting documentation in our download centre or via selected third party repositories.



### ABB eFinder

ABB eFinder is a quick & easy way of sourcing and buying ABB Electrification components online. Just type in your product ID or product code, and eFinder will show you the list of distributor web shops and the approved distributors in your area.



### ABB EasyOrder

Exclusively available for ABB Electrification customers and partners, ABB EasyOrder is loaded with useful features including real-time information on pricing, stock and delivery, smart suggestions for accessories and instant access to technical data.







# Smarter mobility

## Electric vehicle infrastructure solutions

As an innovator in EV infrastructure solutions, ABB is laying the foundations in the UK for a future of smarter, reliable, and emission-free mobility, accessible by everyone, everywhere.

Whether you're a home owner wanting to travel emission free, an out-of-town retailer looking to offer charging points for customers or looking to build en-route fast charging stations, ABB's future-proof charging technology with unrivalled connectivity offers a sustainable option for EV charging.

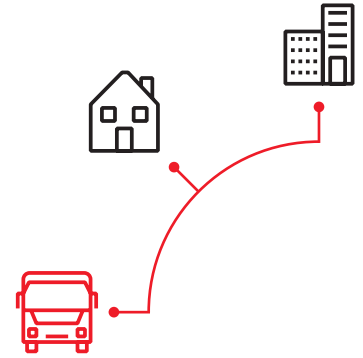

### Charging systems for every application

#### DC fast-charging

Terra DC fast chargers. The most widely used EV fast chargers in the market, ideal for urban applications, retail and refuelling stations.

- Compact footprint
- Maximised revenue generation
- Future ready



#### DC wallbox

The Terra DC wallbox is a future-proof investment supporting current and future EVs with high voltage charging, applicable to a wide variety of use cases, in an ultra-compact footprint, that is safe and reliable, for residential use too.

- Intelligent design: compact, convenient, connected
- Future-proof: ROI maximised
- Safety: built-in protection



#### High power fast-charging

Terra HP charge post is a modular 175-350kW high power charger ideally suited for highway corridor and EV fleet operations.

- Customisable branding
- Premium user experience



#### AC wallbox

Terra AC wallbox provides tailored, intelligent and networked charging solutions for any business, home or location.

- High value
- Futureproof flexibility
- Safety and protection



Scan the QR code to learn more



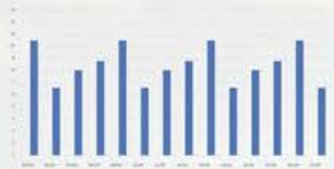



---

# ABB Ability™ Energy Manager

## Sustainability and energy efficiency

ABB Ability™ Energy Manager is the digital solution to monitor and optimise your energy consumption and CO<sub>2</sub> footprint, giving the chance to make faster and better decisions based on data insights.

---

### What is ABB Ability™ Energy Manager?



**Energy management**  
tool for small to large size sites -  
including segment specific features  
(Building, Datacentres)



**Energy and Asset Manager**  
Innovative cloud-based or on-premise  
platform and ready-to-use solution



**Cost efficient solution**  
with add-on and premium services,  
including upgrade to ABB Ability™



**Pre-engineered functionalities**  
ensure on-site commissioning in less  
than 1 day



---

Scan the QR code  
to unlock your  
**FREE TRIAL**



# ABB Electrification business

## Service facilities

The ABB Electrification Service facility in Coleshill demonstrates our commitment to customer experience, enabling faster response for investigation, repair and refurbishment of ABB's Electrification portfolio.

Your business efficiency depends on your choices. ABB's service agreements let you focus on what you do best, while your power distribution system runs smoothly. With your equipment performance optimised, your cost control improved, it's your way towards less unplanned downtime and easier maintenance budgeting.

Here are some examples of the service choice you can make:



### Delivered maintenance services

This is the essential maintenance to prolong the lifetime of your assets. We take precise maintenance actions, including providing genuine ABB parts in preventive maintenance kits.



### Self maintenance services

We provide you with access to proprietary resources that allow you to manage your own maintenance. Resources include online troubleshooting tools, manuals and equipment histories.

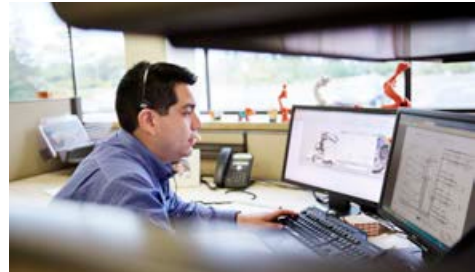

### Technical support

Expert help is only a phone call away. This solution is for all technical telephone assistance and rapid troubleshooting advice.



### On-site response time

For those times when you need help, and you need it now. One phone call and an expert will be on-site within the time agreed.



### Skills development services

Your investments improve performances when effectively used on a day-to-day basis. We share our expertise to elevate your operators' skills to maximise your investment.



Our centralised service facilities, located at Coleshill, Birmingham allow ABB to provide a faster and more efficient turnaround on maintenance, investigation and repair of electrical vehicle charging stations, solar inverters, low- and medium-voltage circuit breakers, low-voltage panels and other electrical apparatus including uninterruptible power supply (UPS) systems.

Located directly opposite, our dedicated assembly site covers approximately 2,000 sq.m of warehouse space, and is used to pre-assemble and store our sub-distribution products, adding further added value from ABB services including all the testing facilities. Our centralised service facility produces both standard and custom variants of:



Assembled plastic and metal switches



Enclosed ATS panels



Assembled panel boards



Assembled distribution boards







# Product Training & CPD Seminars

## What courses and training are available?

We offer training in the following areas, among others:

- Products and systems
- Commissioning and user training
- Service and maintenance training
- Design and dimensioning
- Customer-specific tailored courses

ABB offer a wide range of free product training and support, providing informed decision making for your electrical installation needs.

With ABB Electrification Business you don't just have access to the most comprehensive range of Low and Medium Voltage products available - providing unlimited compatibility solutions - we also offer industry-leading support services.

These include structured training and seminars to help our customers develop a greater knowledge and understanding of their industry's legislation and standards - essential for making informed project specification decisions.

Our CPD seminars and training aim to:

- provide critical and relevant facts on changes in industry legislation
- address the impact of these changes on your business
- provide guidance on effective methodologies to simplify implementation
- address ways of reducing overall labour and maintenance costs



## CPD Seminars and training

Selectivity & Coordination with Power Circuit Breakers

Selecting Circuit Breakers Using Software Based Sources

Advanced Circuit Protection In Buildings and Infrastructure

Protection Against Electric Shock & Thermal Effects According to BS 7671 18th Edition

Autotransfer Switching Equipment - Life Safety Transfer Switching

LV Switchboard Design to BS EN 61439

Electronic Power Breaker Trip Units

Energy Management and Asset Management

EV Charging

Lightning Protection Standards; IEC / BS EN 62305

Surge Protection to BS EN 62305 / BS 7671 18th edition

## Product training

### Lighting

ICEL risk assessment

Introduction to metering

KNX Introduction

LV Protection & control

ICEL risk assessment

### Earthing & lightning protection overview

Earthing & lightning protection

Overvoltage protection to BS 7671

Lightning protection - Earthing

Lightning Protection - Surge Protection

New standards in lightning protection - Understanding BS EN 62305:2006

17th Edition first amendment - Surge protection

### Other

Understanding hazardous areas - LFH Conduit

Energy saving with variable speed drives

ABB i-bus KNX

ABB-free@home®

## Lunch & learn (technical seminars)

E-Max 2 MCCB

The new ATS

Discrimination study workshop

Fuse vs Fuseless

Introduction to circuit breakers

Zone selectivity

DOC software

Power quality

ABB breakers - A technical comparison

Directional, Differential and Zone Protection

Communications capabilities with ABB breakers

ABB Metering capability

MV Grid connection, MV switchgear and transformer offering

\* For a full list of all training courses we offer visit our website: [new.abb.com/low-voltage/service/training](http://new.abb.com/low-voltage/service/training)  
Where requested, we can tailor a course, provide an informal briefing or supply specific training on our product lines.

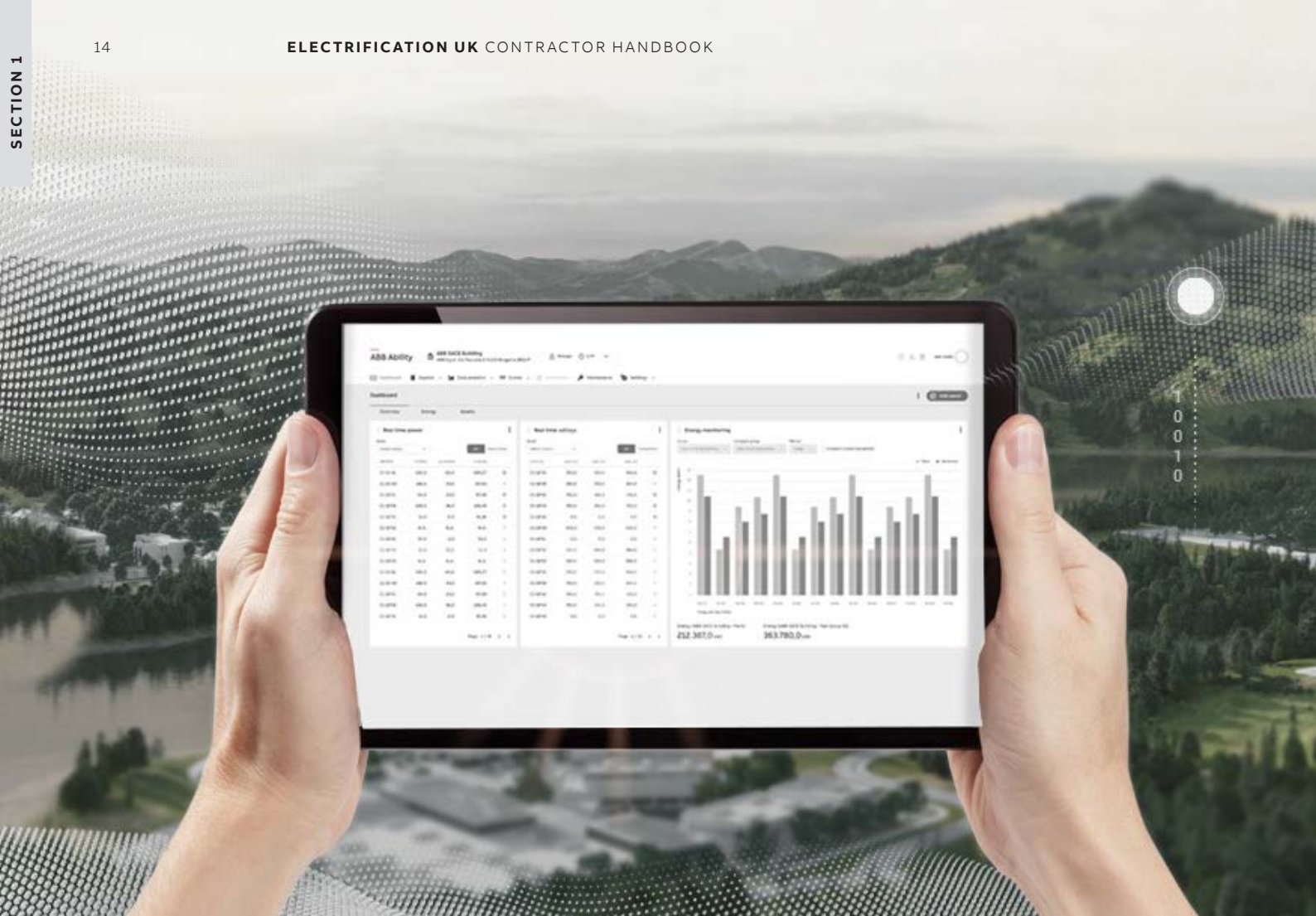

# ABB Ability™ Digital Solutions

for safer, smarter and  
more sustainable  
electrification

ABB Ability™ solutions deliver a safer, smarter, more sustainable electrical infrastructure by providing data-driven insights that enable you to reduce costs, increase comfort, and drive efficiency.

With our solutions, you can unlock the full potential of your equipment by quickly and easily adding innovative new features and functionality.

Our digital transformation solutions for Smart buildings, E-Mobility, Data Centre, Food & beverage, Chemicals, oil and gas and many other transform the way you work by:

- Empowering better decisions with data and Improving reliability
- Increasing flexibility and Reducing cost
- Optimising comfort and Improving ROI (return of investment)

#### ABB Ability™ Energy and Asset Manager

ABB Ability™ Energy and Asset Manager provides application-specific asset and energy management. Users can view and analyse data on facility performance and manage assets to optimise energy consumption in real time and improve overall site efficiency. This SaaS assist conformity to assessments like ISO 50001, LEED, CIBSE TM39, BREEAM.

With instant access, anytime, anywhere the new solution is suitable for small and midsize factories, shopping malls or data centres, and could save customers up to 30% on their energy bills and up to 40% on maintenance costs.

**Dashboard of ABB Ability™ Energy and Asset Manager**



ABB is also delivering the future of electrification with **digital twin** solutions. In the near term, we'll be using digital twin solutions to integrate operations with the installation and commissioning of our products, ensuring our customers don't lose the connection between our pre- and post-sales support.





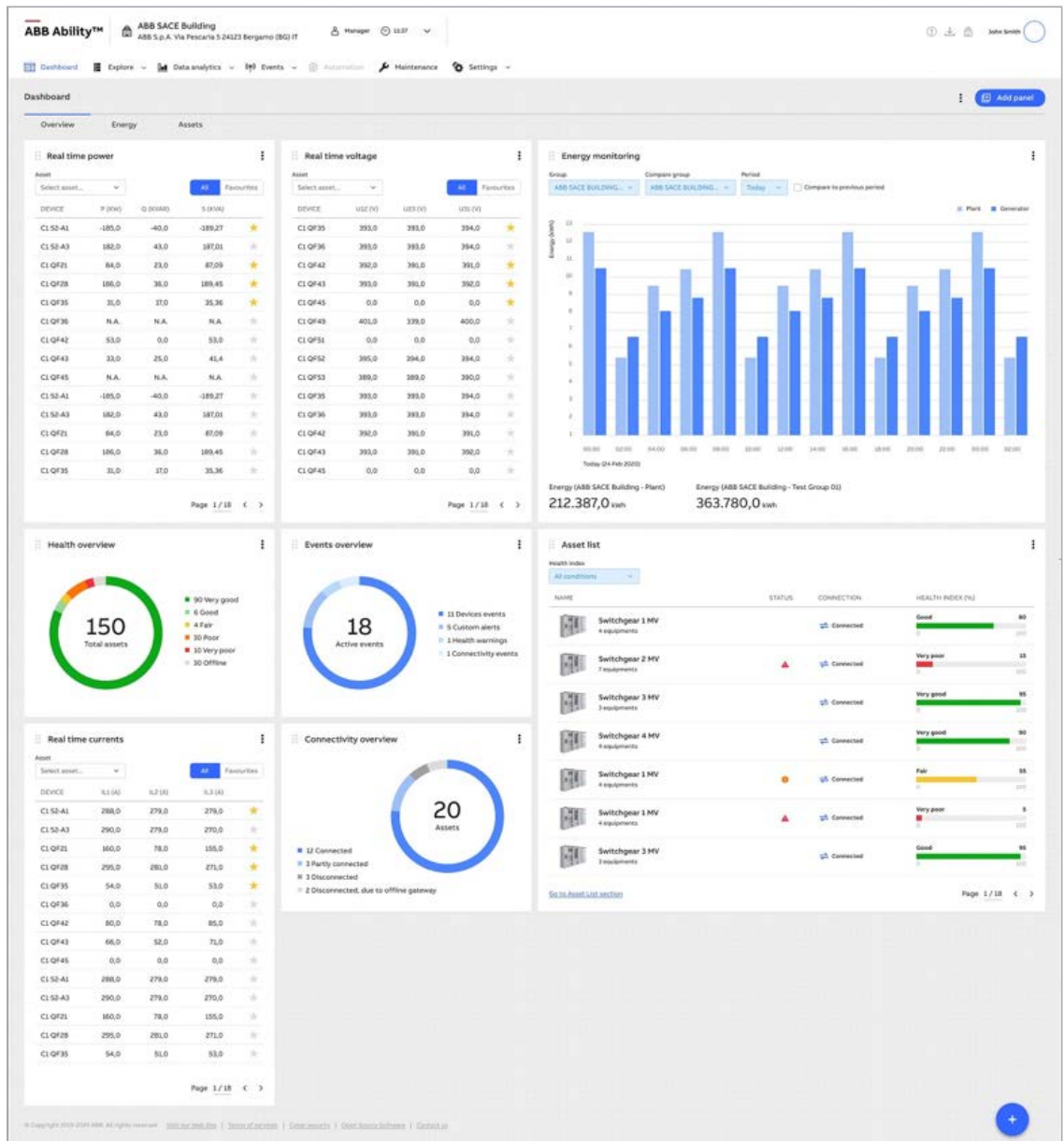

# How to use this book

## Quick guide to ordering products

**Section header**

This is the product group title

**Product image**

Helping you to find the correct product at a glance

ESB INSTALLATION CONTACTORS – ORDER CODES 107

**ESB installation contactors**  
Order Codes



The ESB25..N installation contactors are used to control single and three-phases loads up to 25 A and can be operated by AC or DC voltages. These contactors are made for use in household applications as well as in industrial environment. ESB25..N series is providing the following benefits:

- Hum-free operation, low power consumption and integrated overvoltage protection.
- Various contact combinations and accessories are available.

**ESB25..N installation contactors - 25 A, AC-1/AC-7a, AC/DC operated**

Main contacts	Width in number of modular spacings	Rated control circuit voltage <sup>(1)</sup> VAC/DC	Pkg qty	Weight (1 pc.) kg	Type	Order Code
<b>Single packaging</b>						
	2	24	1	0.245	ESB25-40N-01	1SAE231111R0140
	2	230 ... 240	1	0.235	ESB25-40N-06	1SAE231111R0640
	2	24	1	0.245	ESB25-04N-01	1SAE231111R0104
	2	230 ... 240	1	0.235	ESB25-04N-06	1SAE231111R0604
	2	24	1	0.245	ESB25-22N-01	1SAE231111R0122
	2	230 ... 240	1	0.235	ESB25-22N-06	1SAE231111R0622
	2	24	1	0.245	ESB25-31N-01	1SAE231111R0131
	2	230 ... 240	1	0.235	ESB25-31N-06	1SAE231111R0631
	2	24	1	0.245	ESB25-13N-01	1SAE231111R0113
	2	230 ... 240	1	0.235	ESB25-13N-06	1SAE231111R0613

<sup>(1)</sup> Other control voltages: see voltage code table and contact ABB for availability of products.

**Description**

Item specific product description

**Order Code**

When placing an order this is the number to quote

**ABB EasyOrder** bolservices.it.abb.com  
**Phone** 0333 999 9900  
**Email** LV.Enquiries@gb.abb.com  
**Web** new.abb.com/low-voltage

24/7  
 Monday - Friday: (GMT) 9am - 5pm  
 24/7







---

# Residential wiring accessories

<b>020</b>	<b>Millenium switches and sockets</b>
<b>026</b>	<b>Inora switches and sockets</b>
<b>031</b>	<b>Zenit switches and sockets</b>



For more detailed product information, please refer to our online technical brochures available at:  
[new.abb.com/low-voltage/support/documentation](http://new.abb.com/low-voltage/support/documentation)

or contact our sales team via email [LV.enquiries@gb.abb.com](mailto:LV.enquiries@gb.abb.com)

or call 0333 999 9933

---

**MILLENIUM WIRING ACCESSORIES**

The Millennium series offers control, functionality and convenience that will always fit the desired look and feel of the building.



# Millenium Switches

Millenium offers high quality complete sets. Each unique reference contains mechanism, frame and mounting plate; making easier the ordering, handling and installation. A reliable and complete collection with all functionality at first sight.

Millenium offers a wide and elegant choice of finishes in stainless steel AISI 304 material: from the Brush Stainless Steel, to the soft new touch given by the Silk Black, and the luxury of the sophisticated gold finishes, Matt Gold and Antique Gold.



## 1 Gang switch rocker

	Description	Technical data	Order Code
	1 gang 1 way switch	10 AX	AM10120-ST
	1 gang 2 way switch	10 AX	AM10520-ST
	Intermediate switch	10 AX	AM11920-ST
	1 gang 1 way switch	20 AX	AM11020-ST
	1 gang 2 way switch	20 AX	AM11520-ST

## Premium switch rocker

	Description	Technical data	Order Code
	1 gang 1 way switch	10 AX	AM10144-ST
	1 gang 2 way switch	10 AX	AM10544-ST
	Intermediate switch	10 AX	AM11944-ST
	1 gang 1 way switch	20 AX	AM11044-ST
	1 gang 2 way switch	20 AX	AM11544-ST
	1 gang 1 way push button switch	10 A	AM443044-ST

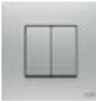
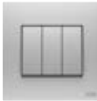
## 2, 3 and 4 gang switches

	Description	Technical data	Order Code
	2 gang 1 way switch	10 A	AM10244-ST
	2 gang 2 way switch	10 AX	AM10644-ST
	2 gang 2 way switch	16 AX	AM111644-ST
	3 gang 2 way switch	16 AX	AM112153-ST
	4 gang 2 way switch	10 AX	AM119188-ST
	4 gang 2 way switch	16 AX	AM119588-ST

- 01 ST - Stainless Steel.
- 02 SB - Silk Black.
- 03 MG - Matt Gold.
- 04 AG - Antique Gold.
- 05 WG - White Glass.
- 06 BG - Black Glass.

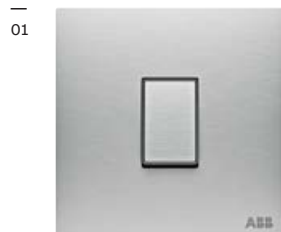









# Millenium

## Socket outlets

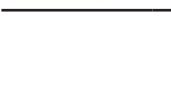
### Socket outlets

	Description	Technical data	Order Code
	BS single pole switched socket outlet	13A SP dual earth terminals	AM23386-ST
		with child safety shutter system.	AM23386-SB
			AM23386-MG
			AM23386-AG
	BS double pole switched socket outlet	13A DP dual earth terminals	AM23786-ST
		with child safety shutter system.	AM23786-SB
			AM23786-MG
			AM23786-AG
	BS double pole switched socket outlet with led	13A SP dual earth terminals and LED with child safety shutter system.	AM23486-ST
			AM23486-SB
			AM23486-MG
			AM23486-AG
	2 Gang BS double pole switched socket outlet	13A DP dual earth terminals and LED with child safety shutter system.	AM23886-ST
			AM23886-SB
			AM23886-MG
			AM23886-AG
	2 Gang BS double pole switched socket outlet with led.	13A DP dual earth terminals and LED with child safety shutter system.	AM239147-ST
			AM239147-SB
			AM239147-MG
			AM239147-AG
	2 Gang BS double pole switched socket outlet.	5A DP round pin switched socket outlet.	AM240147-ST
			AM240147-SB
			AM240147-MG
			AM240147-AG
	2 Gang BS double pole switched socket outlet.		AM22186-ST
			AM22186-SB
			AM22186-MG
			AM22186-AG

- 01 ST - Stainless Steel.
- 02 SB - Silk Black.
- 03 MG - Matt Gold.
- 04 AG - Antique Gold.
- 05 WG - White Glass.
- 06 BG - Black Glass.

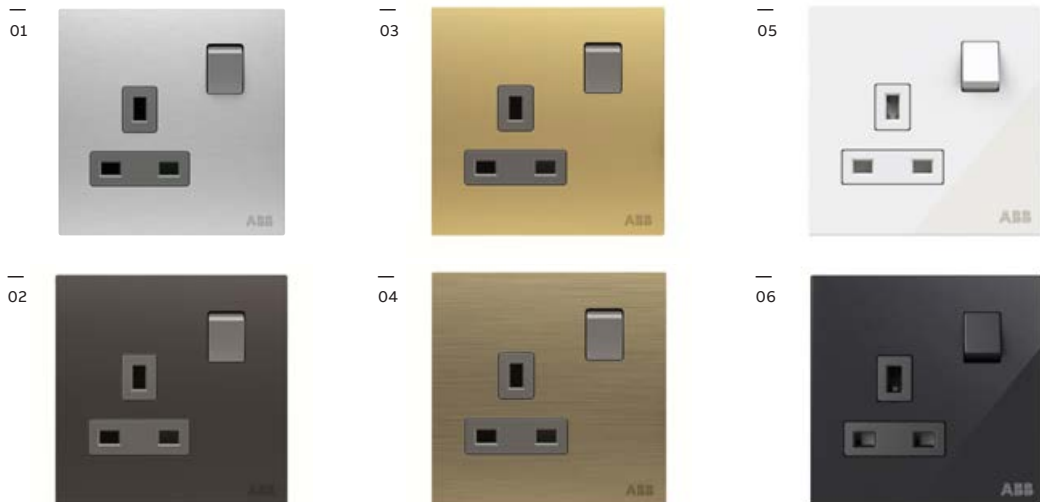

## Millenium

### USB sockets

#### USB Sockets

	Description	Technical data	Order Code
	1 Gang telephone outlet RJ11	13A SP 1 gang USB Charger Type A Charger output 10.5W	AM23586-ST
			AM23586-SB
			AM23586-MG
			AM23586-AG

#### USB Sockets

	Description	Technical data	Order Code
	BS single pole switched socket outlet	13A SP 2 gang USB Charger Type A Charger output 13W	AM235147-ST
			AM235147-SB
			AM235147-MG
			AM235147-AG



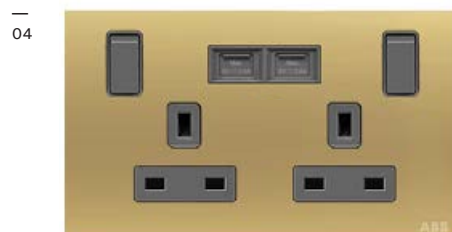
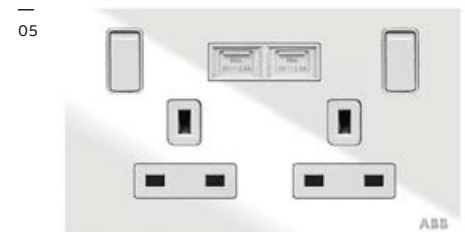





- 01 ST - Stainless Steel.
- 02 SB - Silk Black.
- 03 MG - Matt Gold.
- 04 AG - Antique Gold.
- 05 WG - White Glass.
- 06 BG - Black Glass.



# Millenium

## Telecommunication & audio

### Telecommunications & audio

	Description	Technical data	Order Code
	1 Gang telephone outlet RJ11	4 pole UTP	AM32144-ST
			AM32144-SB
			AM32144-MG
			AM32144-AG
	1 Gang telephone outlet BT master, RJ11/RJ12	4 pole UTP	AM30544-ST
			AM30544-SB
			AM30544-MG
			AM30544-AG
	1 Gang telephone outlet BT secondary, outlet RJ11/RJ12	6 pole UTP	AM30644-ST
			AM30644-SB
			AM30644-MG
			AM30644-AG
	1 Gang computer outlet RJ45 Cat 5e UTP	8 pole UTP	AM33144-ST
			AM33144-SB
			AM33144-MG
			AM33144-AG
	1 Gang computer outlet RJ45 Cat 6 UTP	8 pole UTP	AM33344-ST
			AM33344-SB
			AM33344-MG
			AM33344-AG
	RJ45 single adapter	For connectors type Keystone, AMP, Brand-Rex, Openet-ICS, THT Leviton, Krone	AM33544-ST
			AM33544-SB
			AM33544-MG
			AM33544-AG
	2 Gang computer outlet RJ45 Cat 5e UTP	8 pole UTP	AM33244-ST
			AM33244-SB
			AM33244-MG
			AM33244-AG
	RJ45 double adapter	For connectors type Keystone, AMP, Brand-Rex, Openet-ICS, THT Leviton, Krone	AM33444-ST
			AM33444-SB
			AM33444-MG
			AM33444-AG

- 01 ST - Stainless Steel.
- 02 SB - Silk Black.
- 03 MG - Matt Gold.
- 04 AG - Antique Gold.
- 05 WG - White Glass.
- 06 BG - Black Glass.









# Millenium

## Telecommunication & audio

### Telecommunications & audio

	Description	Technical data	Order Code
	1 Gang TV outlet	Dead-end-feeder isolated. For technical data see below	AM30144-ST
			AM30144-SB
			AM30144-MG
			AM30144-AG
	SAT outlet	F type isolated dead-end-feeder. For technical data see below	AM30344-ST
			AM30344-SB
			AM30344-MG
			AM30344-AG
	SAT Twin outlet	F type isolated dead-end-feeder. For technical data see below	AM32344-ST
			AM32344-SB
			AM32344-MG
			AM32344-AG

### Telecommunications & audio

	Description	Technical data	Order Code
	Audio outlet, 2 terminals L & R	2 terminals	AM34144-ST
			AM34144-SB
			AM34144-MG
			AM34144-AG
	Flex outlet	20A	AM55044-ST
			AM55044-SB
			AM55044-MG
			AM55044-AG

- 01 ST - Stainless Steel.
- 02 SB - Silk Black.
- 03 MG - Matt Gold.
- 04 AG - Antique Gold.
- 05 WG - White Glass.
- 06 BG - Black Glass.



# Inora

## Simplicity for timeless design



Inora's simple and elegant design perfectly complements the interior of any residential or commercial building. With its functional simplicity it creates a timeless aesthetic. Available in four colours.

- 01 White
- 02 Classic grey - G
- 03 Starry black - 885
- 04 Royal gold - PG

01

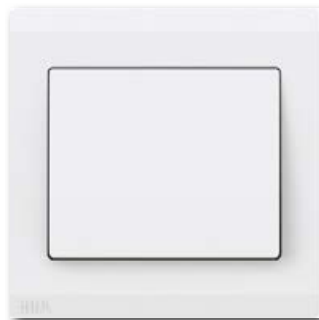

02



03



04



**Inora**  
Switches

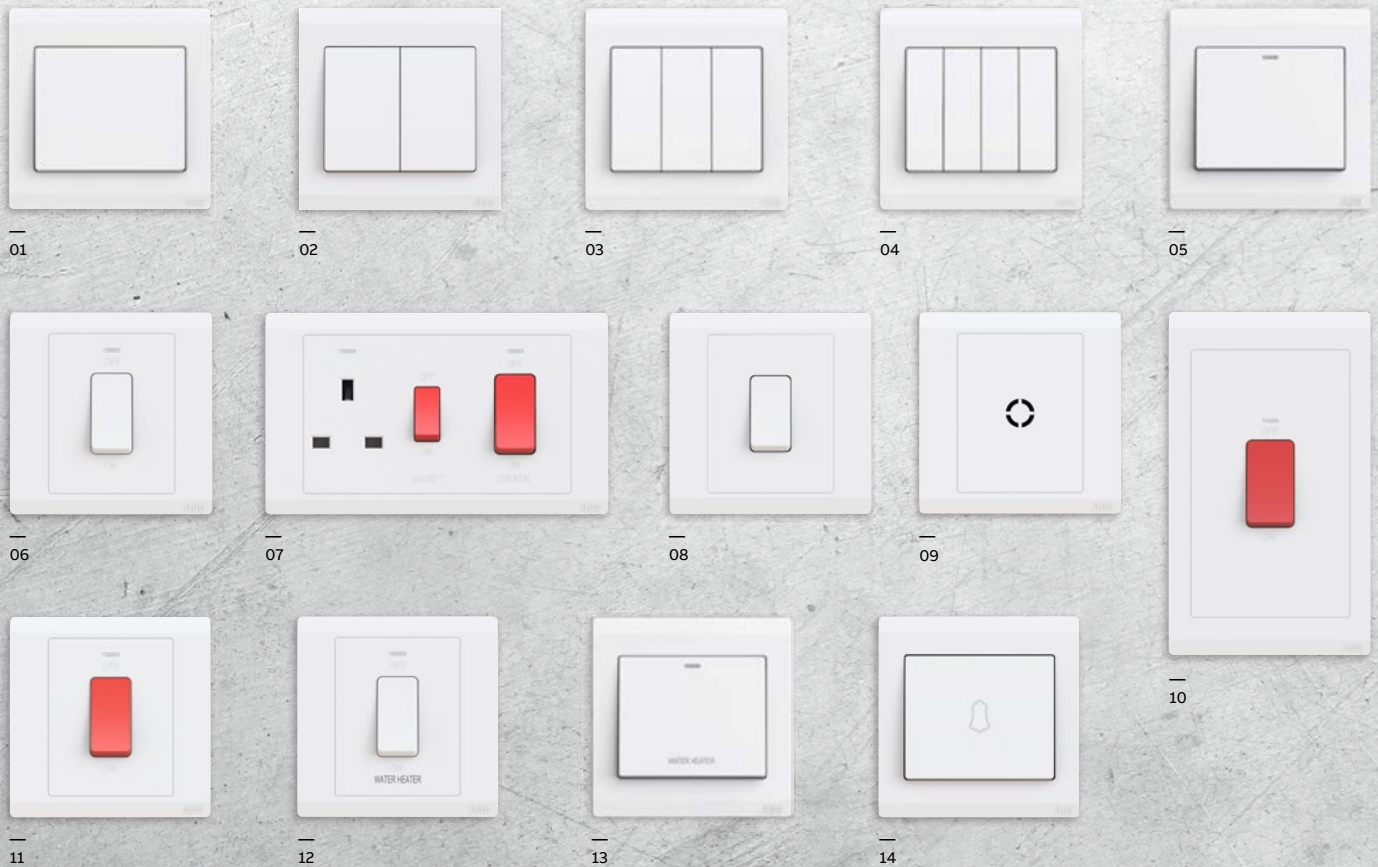

See product picture	Order Code	Type	Description	Technical Data	Flush-mounted Box Dimension
<b>Switches</b>					
01	2TCZ171001R0030	BL101	1 Gang 1 Way 10AX SWITCH	10AX	35mm
02	2TCZ171003R0030	BL102	2 Gang 1 Way 10AX SWITCH	10AX	35mm
03	2TCZ171005R0030	BL103	3 Gang 1 Way 10AX SWITCH	10AX	35mm
04	2TCZ171007R0030	BL104	4 Gang 1 Way 10AX SWITCH	10AX	35mm
01	2TCZ171002R0030	BL105	1 Gang 2 Way 10AX SWITCH	10AX	35mm
02	2TCZ171004R0030	BL106	2 Gang 2 Way 10AX SWITCH	10AX	35mm
03	2TCZ171006R0030	BL107	3 Gang 2 Way 10AX SWITCH	10AX	35mm
04	2TCZ171008R0030	BL108	4 Gang 2 Way 10AX SWITCH	10AX	35mm
01	2TCZ171095R0070	BL110	1 Gang 1 Way 20AX SWITCH	20AX	35mm
05	2TCZ171096R0070	BL111	1 Gang 1 Way 20AX DP SWITCH WITH LED	20AX	35mm
06	2TCZ171020R0070	BL111S	1 Gang 1 Way 20AX DP SWITCH WITH ILLUMINATION	20AX	35mm
01	2TCZ171097R0070	BL112	1 Gang 2 Way 20AX SWITCH	20AX	35mm
02	2TCZ171016R0070	BL114	2 Gang 1 Way 20AX SWITCH	20AX	35mm
02	2TCZ171017R0070	BL115	2 Gang 2 Way 20AX SWITCH	20AX	35mm
07	2TCZ171015R0090	BL118	2 Gang 1Way 45A DP SWITCH & 13A SWITCH SOCKET WITH ILLUMINATION	45A/13A	35mm
01	2TCZ171009R0030	BL119*	1 Gang INTERMEDIATE 10AX SWITCH	10AX	35mm
08	2TCZ171021R0030	BL119S	1 Gang INTERMEDIATE 10AX SWITCH	10AX	35mm
09	2TCZ171099R0070	BL120	20A FLEX OUTLET	20A	35mm
10	2TCZ171019R0090	BL143	1 Gang 45A DP SWITCH WITH ILLUMINATION (6X3)	45A	35mm
12	2TCZ171012R0075	BL171WH	1 Gang 1 Way 20AX DP SW WITH ILLUMINATION- MARKED WATER HEATER	20A	35mm
11	2TCZ171013R0090	BL176	1 Gang 1 Way 32A DP SWITCH WITH ILLUMINATION	32A	35mm
11	2TCZ171098R0090	BL179	1 Gang 1 Way 45A DP SWITCH WITH ILLUMINATION	45A	35mm
13	2TCZ171014R0070	BL180WH	1 Gang 1 Way 20AX DP SWITCH WITH LED, MARKED WATER HEATER	20AX	35mm
14	2TCZ171011R0030	BL429	1 Gang 1 Way 10A PUSH SWITCH- MARKED BELL	10A	35mm
01	2TCZ171010R0030	BL430	1 Gang 1 Way 10A PUSH SWITCH	10A	35mm

Notes: \* Available in Q4, 2022



## Inora

### Socket outlets

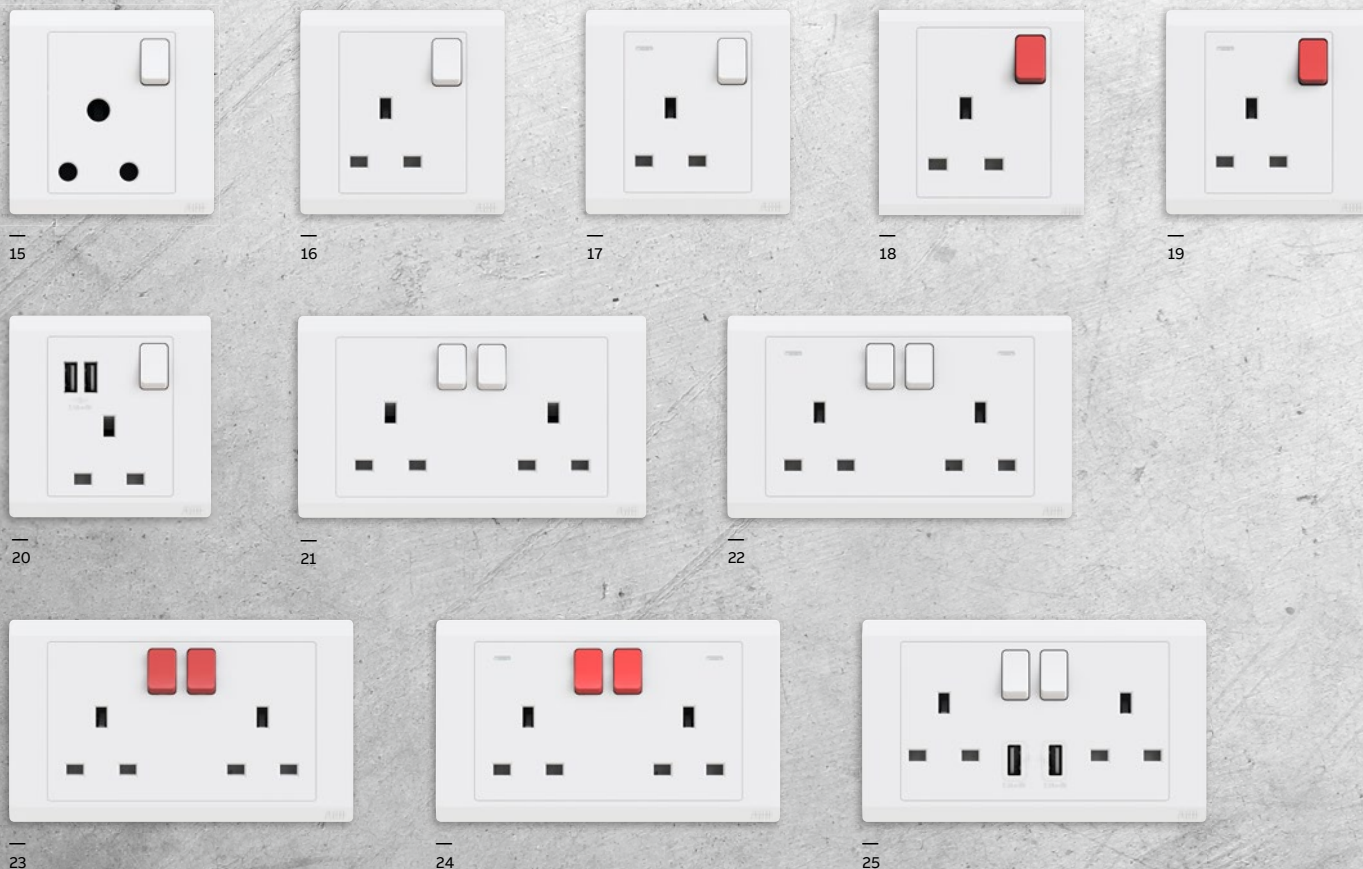

See product picture	Order Code	Type	Description	Technical Data	Flush-mounted Box Dimension
<b>Socket</b>					
15	2TCZ172012R0050	BL209	1 Gang 15A SWITCHED SOCKET SP	15A	35mm
19	2TCZ172020R0040	BL213	1 Gang 13A SWITCHED SOCKET SP WITH RED ROCKER & ILLUMINATION	13A	35mm
18	2TCZ172019R0040	BL214	1 Gang 13A SWITCHED SOCKET SP WITH RED ROCKER	13A	35mm
23	2TCZ172021R0040	BL215	2 Gang 13A SWITCHED SOCKET SP WITH RED ROCKER	13A	35mm
16	2TCZ172001R0040	BL224	1 Gang 13A SWITCHED SOCKET SP	13A	35mm
21	2TCZ172010R0040	BL227	2 Gang 13A SWITCHED SOCKET SP	13A	35mm
17	2TCZ172002R0040	BL229	1 Gang 13A SWITCHED SOCKET SP WITH ILLUMINATION	13A	35mm
22	2TCZ172011R0040	BL230	2 Gang 13A SWITCHED SOCKET SP WITH ILLUMINATION	13A	35mm
24	2TCZ172094R0040	BL236	2 Gang 13A SWITCHED SOCKET SP WITH RED ROCKER & ILLUMINATION	13A	35mm
16	2TCZ172095R0040	BL237	1 Gang 13A SWITCHED SOCKET DP	13A	35mm
17	2TCZ172096R0040	BL238	1 Gang 13A SWITCHED SOCKET DP WITH ILLUMINATION	13A	35mm
21	2TCZ172097R0040	BL239	2 Gang 13A SWITCHED SOCKET DP	13A	35mm
22	2TCZ172098R0040	BL240	2 Gang 13A SWITCHED SOCKET DP WITH ILLUMINATION	13A	35mm
20	2TCZ172016R0040	BL261	1 Gang BS SWITCHED SOCKET DP WITH USB,TYPEA*2	13A	47mm
25	2TCZ172017R0040	BL262	2 Gang BS SWITCHED SOCKET DP WITH USB,TYPEA*2	13A	47mm

## Inora

### Data outlets

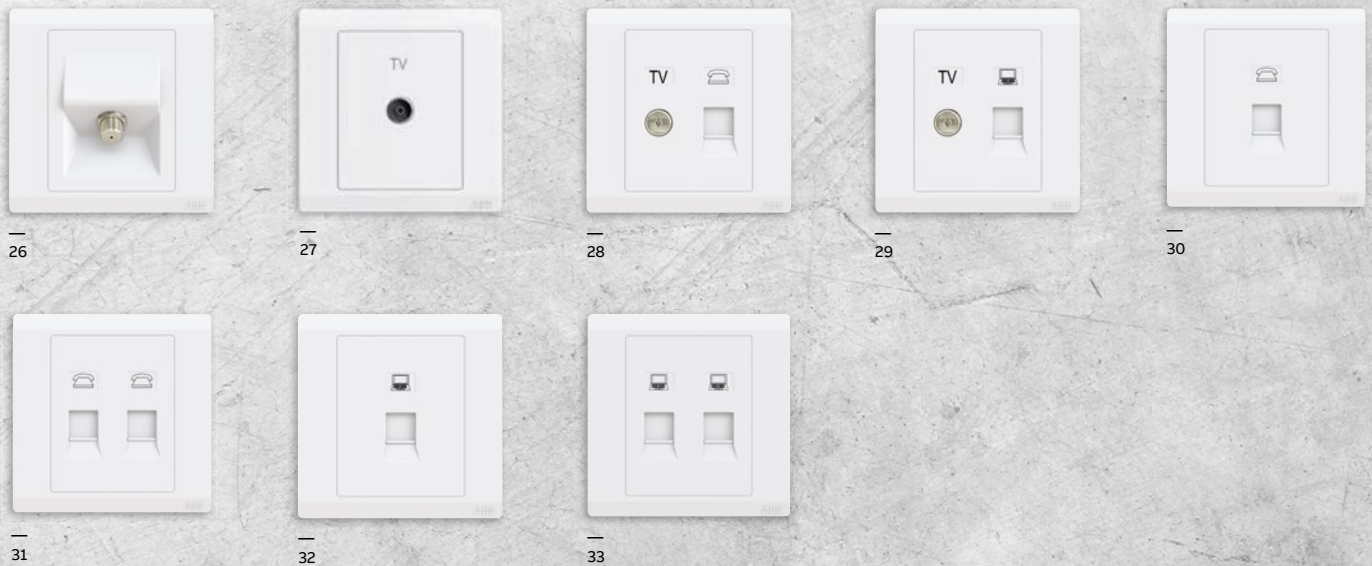

See product picture	Order Code	Type	Description	Technical Data	Flush-mounted Box Dimension
<b>Data outlets</b>					
27	2TCZ173001R0010	BL301	1 Gang TV OUTLET, DEAD-END LINE	DEAD-END LINE	35mm
26	2TCZ173099R0010	BL308	1 Gang SAT OUTLET- 45 DEGREE	F-type	35mm
33	2TCZ173019R0010	BL317	2 Gang DATA OUTLET RJ45 CAT.6a	RJ45 Cat.6a	35mm
32	2TCZ173020R0010	BL318	1 Gang DATA OUTLET RJ45 CAT.6a	RJ45 Cat.6a	35mm
30	2TCZ173006R0010	BL321	1 Gang TELEPHONE OUTLET RJ11	RJ11	35mm
31	2TCZ173012R0010	BL322	2 Gang TELEPHONE OUTLET RJ11	RJ11	35mm
28	2TCZ173010R0010	BL324	2 Gang TV/ TELEPHONE OUTLET	5-1000MHz RJ11	35mm
29	2TCZ173016R0010	BL325	2 Gang TV/ DATA OUTLET RJ45 CAT.5e	5-1000MHz RJ45 Cat.5e	35mm
33	2TCZ173014R0010	BL329	2 Gang DATA OUTLET RJ45 CAT.6	RJ45 Cat.6	35mm
32	2TCZ173007R0010	BL331	1 Gang DATA OUTLET RJ45 CAT.5e	RJ45 Cat.5e	35mm
32	2TCZ173017R0010	BL331-H	1 Gang DATA OUTLET HOUSING	-	35mm
33	2TCZ173013R0010	BL332	2 Gang DATA OUTLET RJ45 CAT.5e	RJ45 Cat.5e	35mm
33	2TCZ173018R0010	BL332-H	2 Gang DATA OUTLET HOUSING	-	35mm
32	2TCZ173008R0010	BL333	1 Gang DATA OUTLET RJ45 CAT.6	RJ45 Cat.6	35mm



## Inora

### Function control / FCU & Flex outlets / Accessories



See product picture	Order Code	Type	Description	Technical Data	Flush-mounted Box Dimension
<b>Function control</b>					
37	2TCZ174002R0010	BL401	SHAVER SOCKET	"Input: 230V, 50 Hz/60 Hz Outlet: 115 V/230 V, 20 VA"	47mm
35	2TCZ174003R0010	BL405*	LED DIMMER	3-150VA	35mm
34	2TCZ174001R0010	BL412	ROTARY DIMMER	25-500VA	35mm
36	2TCZ174009R0010	BL422	FAN REGULATOR	25-500VA	35mm
<b>FCU &amp; Flex outlets</b>					
38	2TCZ175003R0040	BL506	1 Gang 13A UNSWITCHED FUSED CONNECTION UNIT	13A250V~	35mm
40	2TCZ175004R0040	BL507	1 Gang 13A SWITCHED FUSED CONNECTION UNIT WITH ILLUMINATION	13A250V~	35mm
39	2TCZ175099R0040	BL508	1 Gang 13A SWITCHED FUSED CONNECTION UNIT	13A250V~	35mm
41	2TCZ175006R0090	BL590	FLEX OUTLET 45A	45A250V~	35mm
<b>Accessories</b>					
42	2TCZ175001R0010	BL504	1 Gang BLANK PLATE	-	35 mm
43	2TCZ175002R0010	BL505	2 Gang BLANK PLATE	-	35 mm

Notes: \* Available in Q4, 2022



# Zenit British Standard

## Switch to endless possibilities

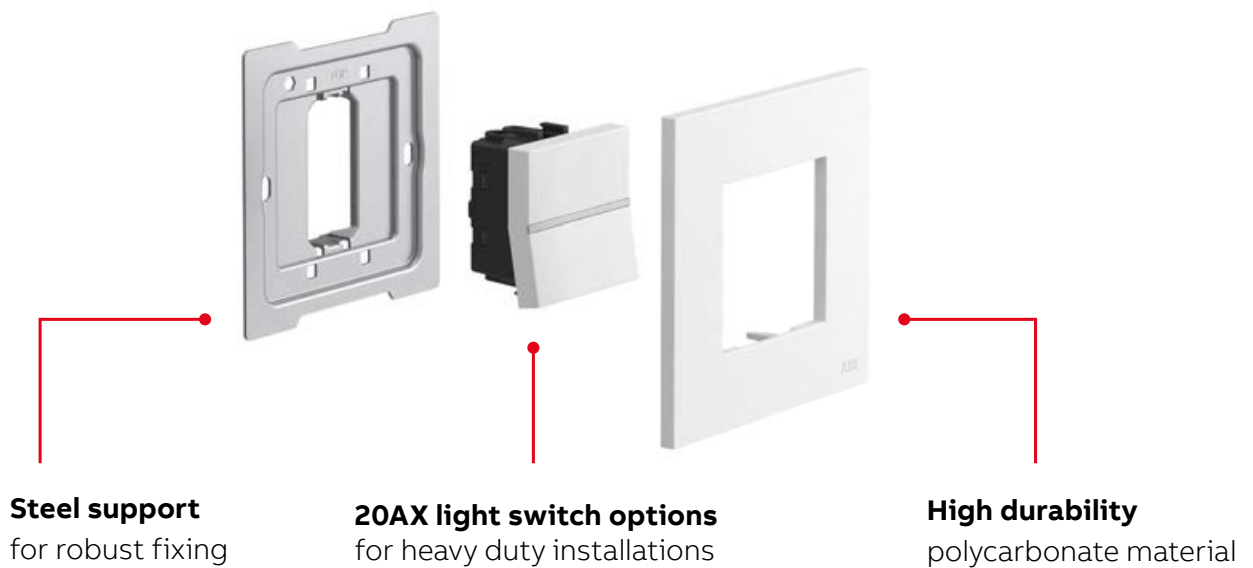
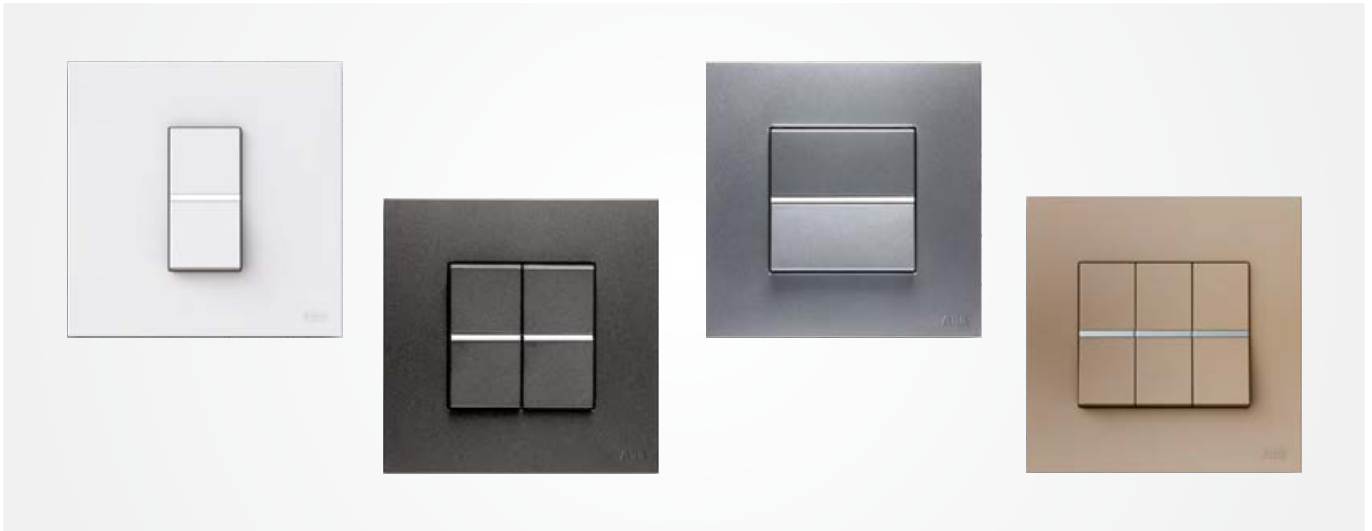

### Robust materials

Metal supports for the switches and socket outlets guarantee a strong bond to the wall.

A blend of certified (1) ABS and polycarbonate materials is used for the inner functional components.

High durability polycarbonate is used for rockers or frames to produce a wear-proof product with outstanding aesthetics.

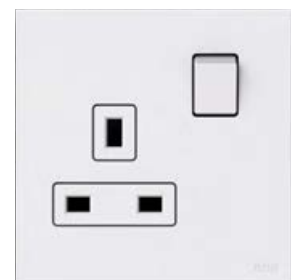

## Zenit

### 1-gang switches and push buttons | Small rocker size (22 x 44 mm)

Product	Article-No.	Order-No.	Pack/Qty
---------	-------------	-----------	----------



**Switch 1-gang, 1-way, SP 10AX,  
Small size w / frame**  
Rated voltage: 250 Vac  
Rated current: 10AX  
Function size: 22x44 mm  
Includes frame and metal support

White	<b>AM21010 BL</b>	2CLA210109B1101	1
-------	-------------------	-----------------	---



**Switch 1-gang, 2-way, SP 10AX,  
Small size w / frame**  
Rated voltage: 250 Vac  
Rated current: 10AX  
Function size: 22x44 mm  
Includes frame and metal support

White	<b>AM21020 BL</b>	2CLA210209B1101	1
-------	-------------------	-----------------	---



**Switch 1-gang Intermediate, SP 10AX,  
Small size w / frame**  
Rated voltage: 250 Vac  
Rated current: 10AX  
Function size: 22x44 mm  
Includes frame and metal support

White	<b>AM21100 BL</b>	2CLA211009B1101	1
-------	-------------------	-----------------	---



**Switch 1-gang, 1-way, SP 20AX,  
Small size w / frame**  
Rated voltage: 250 Vac  
Rated current: 20AX  
Function size: 22x44 mm  
Includes frame and metal support

White	<b>AM21011 BL</b>	2CLA210119B1101	1
-------	-------------------	-----------------	---

Product	Article-No.	Order-No.	Pack/Qty
---------	-------------	-----------	----------



**Switch 1-gang, 2-way, SP 20AX,  
Small size w / frame**  
Rated voltage: 250 Vac  
Rated current: 20AX  
Function size: 22x44 mm  
Includes frame and metal support

White	<b>AM21021 BL</b>	2CLA210219B1101	1
-------	-------------------	-----------------	---



**Switch 1-gang, 1-way, DP 20AX,  
Small size with  
LED w / frame**  
Rated voltage: 250 Vac  
Rated current: 20AX  
Function size: 22x44 mm  
LED indicator and ON sign  
Includes frame and metal support

White	<b>AM21013 BL</b>	2CLA210139B1101	1
-------	-------------------	-----------------	---



**Push button 1-gang, 1-way, SP 10AX,  
Small size w / frame**  
Rated voltage: 250 Vac  
Rated current: 10AX  
Function size: 22x44 mm  
Includes frame and metal support

White	<b>AM21040 BL</b>	2CLA210409B1101	1
-------	-------------------	-----------------	---





**Push button 1-gang, 1-way, SP 10AX,  
Small size with Bell w / frame**  
Rated voltage: 250 Vac  
Rated current: 10AX  
Function size: 22x44 mm  
LED indicator and bell sign  
Includes frame and metal support

White	<b>AM21044 BL</b>	2CLA210449B1101	1
-------	-------------------	-----------------	---

## Zenit

1-gang switches and push buttons | Small rocker size (22x44 mm)

Product	Article-No.	Order-No.	Pack/Qty
	<b>Switch 2-gang, 1-way, SP 10AX, Small size w / frame</b> Rated voltage: 250 Vac Rated current: 10AX Function size: 44 x 44 mm Includes frame and metal support		
White	<b>AM22110 BL</b>	2CLA221109B1101	1

Product	Article-No.	Order-No.	Pack/Qty
	<b>Switch 3-gang, 2-way, SP 10AX, Triple size w / frame</b> Rated voltage: 250 Vac Rated current: 10AX Function size: 53 x 44 mm Includes frame and metal support		
White	<b>AM23020 BL</b>	2CLA230209B1101	1

## Zenit

Push-button | Premium size (44x44 mm)

Product	Article-No.	Order-No.	Pack/Qty
	<b>Push-button 1-gang, 1-way, SP premium 10A</b> Rated voltage: 250 Vac Rated current: 10A Premium size rocker		
White	<b>AM22040 BL</b>	2CLA220409B1101	1

	<b>Switch 1-gang, 1-way, SP premium w / bell</b> Rated voltage: 250 Vac Rated current: 10A Bell symbol indicator LED Premium size rocker		
White	<b>AM22044 BL</b>	2CLA220449B1101	1



## Zenit

### Switches | Premium size (44 x 44 mm)

Product	Article-No.	Order-No.	Pack/Qty
---------	-------------	-----------	----------



**Switch 1-gang, 1-way,  
SP premium 10AX**  
Rated voltage: 250 Vac  
Rated current: 10AX  
Premium size rocker

White	<b>AM22010 BL</b>	2CLA220109B1101	1
-------	-------------------	-----------------	---



**Switch 1-gang, 2-way,  
SP premium 10AX**  
Rated voltage: 250 Vac  
Rated current: 10AX  
Premium size rocker

White	<b>AM22100 BL</b>	2CLA221009B1101	1
-------	-------------------	-----------------	---



**Switch 1-gang, intermediate,  
SP premium 10AX**  
Rated voltage: 250 Vac  
Rated current: 10AX  
Premium size rocker

White	<b>AM22100 BL</b>	2CLA221009B1101	1
-------	-------------------	-----------------	---



**Switch 1-gang, 1-way,  
SP premium 20AX**  
Rated voltage: 250 Vac  
Rated current: 20AX  
Premium size rocker

White	<b>AM22011 BL</b>	2CLA220119B1101	1
-------	-------------------	-----------------	---

Product	Article-No.	Order-No.	Pack/Qty
---------	-------------	-----------	----------



**Switch 1-gang, 2-way, SP 20AX,  
Premium size w / frame**  
Rated voltage: 250 Vac  
Rated current: 20AX  
Function size: 44 x 44 mm  
Includes frame and metal support

White	<b>AM22021 BL</b>	2CLA220219B1101	1
-------	-------------------	-----------------	---



**Switch 1-gang, 1-way, DP 20AX,  
Premium size with LED w / frame**  
Rated voltage: 250 Vac  
Rated current: 20AX  
Function size: 44 x 44 mm  
LED indicator and ON sign  
Includes frame and metal support

White	<b>AM22013 BL</b>	2CLA220139B1101	1
-------	-------------------	-----------------	---



**Switch 1-gang, 1-way, DP 32A,  
Premium size w / frame**  
Rated voltage: 250 Vac  
Rated current: 32A  
Function size: 44 x 44 mm  
Includes frame and metal support with twin-earth

White	<b>AM22018 BL</b>	2CLA220189B1101	1
-------	-------------------	-----------------	---



**Switch 1-gang, 1-way,  
DP premium 45A**  
Rated voltage: 250 Vac  
Rated current: 45A  
Status indicator LED  
Premium size rocker

White	<b>AM22014 BL</b>	2CLA220149B1101	1
-------	-------------------	-----------------	---



**Switch 1-gang, 1-way,  
DP premium 45A**  
Rated voltage: 250 Vac  
Rated current: 45A  
Status indicator LED  
Premium size rocker  
Large frame (147 x 86 mm)

# Zenit

## Socket outlets

Product	Article-No.	Order-No.	Pack/Qty
---------	-------------	-----------	----------



### BS Single socket outlet 13A, DP switched

Rated voltage: 250 Vac  
 Rated current: 13A  
 Double pole switch  
 Includes child safety shutter  
 Includes frame and metal support with twin earth

White	AM22373 BL	2CLA223739B1101	1
Silver	AM22373 PL	2CLA223739B1301	1
Anthracite	AM22373 AN	2CLA223739B1801	1
Champagne	AM22373 CV	2CLA223739B1901	1

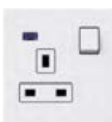

### BS Single socket outlet 13A, DP switched w / LED

Rated voltage: 250 Vac  
 Rated current: 13A  
 Double pole switch  
 LED indicator  
 Includes child safety shutter  
 Includes frame and metal support with twin earth

White	AM22374 BL	2CLA223749B1101	1
Silver	AM22374 PL	2CLA223749B1301	1
Anthracite	AM22374 AN	2CLA223749B1801	1
Champagne	AM22374 CV	2CLA223749B1901	1



### BS Single socket outlet 13A, with USB-Charger Type-C, DP switch

Rated voltage: 250 Vac  
 Rated current: 13A  
 Double pole switch  
 USB-C 18 W. with Advanced Charging  
 Includes child safety shutter  
 Includes frame and metal support with twin earth

White	AM22379 BL	2CLA223799B1101	1
Silver	AM22379 PL	2CLA223799B1301	1
Anthracite	AM22379 AN	2CLA223799B1801	1
Champagne	AM22379 CV	2CLA223799B1901	1

Product	Article-No.	Order-No.	Pack/Qty
---------	-------------	-----------	----------



### BS Double socket outlet 13A, DP switched

Rated voltage: 250 Vac  
 Rated current: 13A  
 Double pole switch  
 Includes child safety shutter  
 Includes frame and metal support with twin earth

White	AM24371 BL	2CLA243719B1101	1
Silver	AM24371 PL	2CLA243719B1301	1
Anthracite	AM24371 AN	2CLA243719B1801	1
Champagne	AM24371 CV	2CLA243719B1901	1



### BS Double socket outlet 13A, DP switched w / LED

Rated voltage: 250 Vac  
 Rated current: 13A  
 Double pole switch  
 LED indicator  
 Includes child safety shutter  
 Includes frame and metal support with twin earth

White	AM24372 BL	2CLA243729B1101	1
Silver	AM24372 PL	2CLA243729B1301	1
Anthracite	AM24372 AN	2CLA243729B1801	1
Champagne	AM24372 CV	2CLA243729B1901	1



### BS Double socket outlet 13A, with USB-Charger Type-C+A, DP switch

Rated voltage: 250 Vac  
 Rated current: 13A  
 Double pole switch  
 USB-C 18 W. with Advanced Charging  
 USB-A 18 W. (shared)  
 Includes child safety shutter  
 Includes frame and metal support with twin earth

White	AM24379 BL	2CLA243799B1101	1
Silver	AM24379 PL	2CLA243799B1301	1
Anthracite	AM24379 AN	2CLA243799B1801	1
Champagne	AM24379 CV	2CLA243799B1901	1



### BS Cooker control unit 13A, DP sw. 45A

Rated voltage: 250 Vac  
 Rated current (socket): 13A  
 Rated current (switch): 45A  
 LED indicator  
 Includes frame and metal support and twin earth

White	AM24374 BL	2CLA243749B1101	1
Silver	AM24374 PL	2CLA243749B1301	1
Anthracite	AM24374 AN	2CLA243749B1801	1
Champagne	AM24374 CV	2CLA243749B1901	1

## Zenit

### Socket outlets

Product	Article-No.	Order-No.	Pack/Qty
---------	-------------	-----------	----------



#### Universal socket outlet 13A, DP switched

Rated voltage: 250 Vac  
 Rated current: 13A  
 Double pole switch  
 Includes child safety shutter  
 Includes frame and metal support with twin earth

White	AM22391 BL	2CLA223919B1101	1
Silver	AM22391 PL	2CLA223919B1301	1
Anthracite	AM22391 AN	2CLA223919B1801	1
Champagne	AM22391 CV	2CLA223919B1901	1



#### Round-pin Single socket outlet 15A, DP switched w/LED

Rated voltage: 250 Vac  
 Rated current: 15A  
 Double pole switch  
 LED indicator  
 Includes child safety shutter  
 Includes frame and metal support with twin earth

White	AM22377 BL	2CLA223779B1101	1
Silver	AM22377 PL	2CLA223779B1301	1
Anthracite	AM22377 AN	2CLA223779B1801	1
Champagne	AM22377 CV	2CLA223779B1901	1



#### Round-pin socket outlet 5A, DP switched

Rated voltage: 250 Vac  
 Rated current: 5A  
 Double pole switch  
 Includes child safety shutter  
 Includes frame and metal support with twin earth

White	AM22375 BL	2CLA223759B1101	1
Silver	AM22375 PL	2CLA223759B1301	1
Anthracite	AM22375 AN	2CLA223759B1801	1
Champagne	AM22375 CV	2CLA223759B1901	1



#### Shaver socket outlet

Input: 250 Vac / 20VA  
 Outputs: 115V and 230V  
 Size: 150 x 90 x 54 mm  
 Compatible with box model:  
 803.2

White	AM28030 BL	2CLA280309B1101	1
Silver	AM28030 PL	2CLA280309B1301	1
Anthracite	AM28030 AN	2CLA280309B1801	1
Champagne	AM28030 CV	2CLA280309B1901	1

### Fuse connection unit

Product	Article-No.	Order-No.	Pack/Qty
---------	-------------	-----------	----------



#### Fuse connector unit 13A, w/flex outlet w/LED

Rated voltage: 250 Vac  
 Rated current: 13A  
 LED indicator  
 Fuse breaking capacity: 6kA 264 Vac 50HN  
 Fuse size: Ø 6.3x25 mm  
 Includes frame and metal support

White	AM23085 BL	2CLA230859B1101	1
Silver	AM23085 PL	2CLA230859B1301	1
Anthracite	AM23085 AN	2CLA230859B1801	1
Champagne	AM23085 CV	2CLA230859B1901	1



#### Fuse connector unit 13A, Switched w/flex outlet w/LED

Rated voltage: 250 Vac  
 Rated current: 13A  
 LED indicator  
 Includes manual switch  
 Fuse breaking capacity: 6kA 264 Vac 50HN  
 Fuse size: Ø 6.3x25 mm  
 Includes frame and metal support

White	AM23082 BL	2CLA230829B1101	1
Silver	AM23082 PL	2CLA230829B1301	1
Anthracite	AM23082 AN	2CLA230829B1801	1
Champagne	AM23082 CV	2CLA230829B1901	1



## Zenit

### Complete sets

Product ID	Model	Color option	Switches and push buttons	Function size (mm)
2CLA210109B1101	AM21010	BL	Switch 1-gang, 1-way, SP 10AX, small size w / frame	22x44
2CLA210209B1101	AM21020	BL	Switch 1-gang, 2-way, SP 10AX, small size w / frame	22x44
2CLA211009B1101	AM21100	BL	Switch 1-gang Intermediate, SP 10AX, small size w / frame	22x44
2CLA210119B1101	AM21011	BL	Switch 1-gang, 1-way, SP 20AX, small size w / frame	22x44
2CLA210219B1101	AM21021	BL	Switch 1-gang, 2-way, SP 20AX, small size w / frame	22x44
2CLA210139B1101	AM21013	BL	Switch 1-gang, 1-way, DP 20AX, small size with LED w / frame	22x44
2CLA210409B1101	AM21040	BL	Push button 1-gang, 1-way, SP 10AX, small size w / frame	22x44
2CLA210449B1101	AM21044	BL	Push button 1-gang, 1-way, SP 10AX, small size with Bell w / frame	22x44
2CLA221109B1101	AM22110	BL	Switch 2-gang, 1-way, SP 10AX, small size w / frame	44x44
2CLA230209B1101	AM23020	BL	Switch 3-gang, 2-way, SP 10AX, triple size w / frame	53x44
2CLA220109B1101	AM22010	BL	Switch 1-gang, 1-way, SP 10AX, premium size w / frame	44x44
2CLA220209B1101	AM22020	BL	Switch 1-gang, 2-way, SP 10AX, premium size w / frame	44x44
2CLA221009B1101	AM22100	BL	Switch 1-gang Intermediate, SP 10AX, premium size w / frame	44x44
2CLA220119B1101	AM22011	BL	Switch 1-gang, 1-way, SP 20AX, premium size w / frame	44x44
2CLA220219B1101	AM22021	BL	Switch 1-gang, 2-way, SP 20AX, premium size w / frame	44x44
2CLA220139B1101	AM22013	BL	Switch 1-gang, 1-way, DP 20AX, premium size with LED w / frame	44x44
2CLA220189B1101	AM22018	BL	Switch 1-gang, 1-way, DP 32AX, premium size w / frame	44x44
2CLA220149B1101	AM22014	BL	Switch 1-gang, 1-way, DP 45AX, premium size with LED -RJ w / frame	44x44
2CLA220169B1101	AM22016	BL	Switch 1-gang, 1-way, DP 45AX, premium size with LED -RJ w / long	44x44
2CLA220409B1101	AM22040	BL	Push button 1-gang, 1-way, SP 10AX, premium size w / frame	44x44
2CLA220449B1101	AM22044	BL	Push button 1-gang, 1-way, SP 10AX, premium size with bell w / frame	44x44

Product ID	Model	Color option	Socket outlets
2CLA223739B1101	AM22373	BL, PL, AN, CV	BS Single socket outlet 13A, DP switched
2CLA223749B1101	AM22374	BL, PL, AN, CV	BS Single socket outlet 13A, DP switched w / LED
2CLA223799B1101	AM22379	BL, PL, AN, CV	BS Single socket outlet 13A, with USB-charger type-C, DP switch
2CLA243719B1101	AM24371	BL, PL, AN, CV	BS Double socket outlet 13A, DP switched
2CLA243729B1101	AM24372	BL, PL, AN, CV	BS Double socket outlet 13A, DP switched w / LED
2CLA243799B1101	AM24379	BL, PL, AN, CV	BS Double socket outlet 13A, with USB-Charger Type-C+A, DP switch
2CLA223919B1101	AM22391	BL, PL, AN, CV	Universal socket outlet 13A, DP switched
2CLA243749B1101	AM24374	BL, PL, AN, CV	BS Cooker control unit 13A, DP sw. 45A.
2CLA223779B1101	AM22377	BL, PL, AN, CV	BS Single socket outlet 15A round-pin, DP switched w / LED
2CLA223759B1101	AM22375	BL, PL, AN, CV	BS Single socket outlet 5A round-pin, DP switched
2CLA280309B1101	AM28030	BL, PL, AN, CV	Shaver socket outlet
2CLA230859B1101	AM23085	BL, PL, AN, CV	Fuse connector unit 13A, w / flex outlet w / LED
2CLA230829B1101	AM23082	BL, PL, AN, CV	Fuse connector unit 13A, switched w / flex outlet w / LED

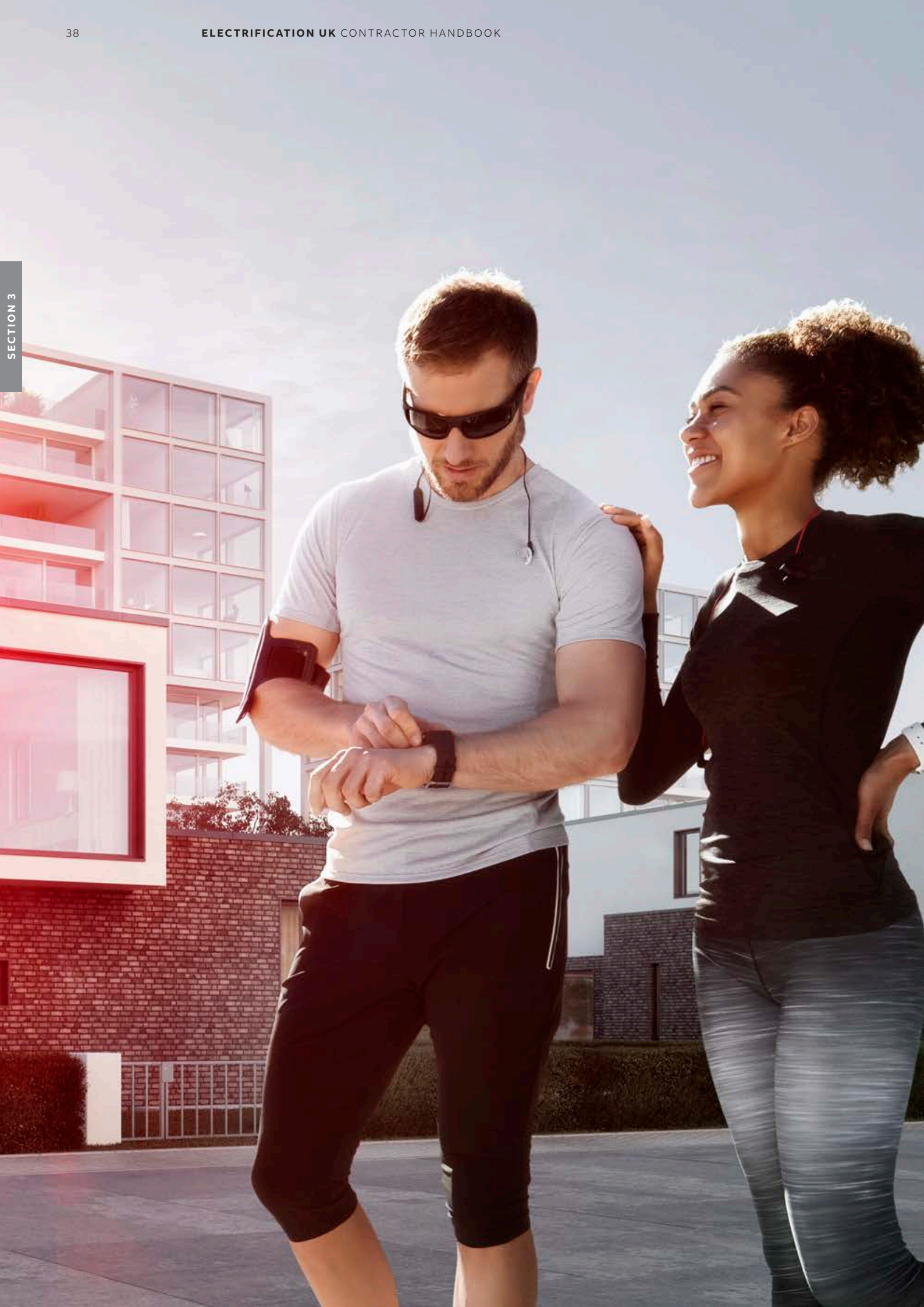

---

# Smart home - Designed to make your life simpler

- 040      **ABB-free@home®**
- 042      **The range**
- 068      **ABB IP Door entry systems**



For more detailed product information, please refer to our online technical brochures available at: [new.abb.com/low-voltage/support/documentation](http://new.abb.com/low-voltage/support/documentation)

or contact our sales team via email [LV.enquiries@gb.abb.com](mailto:LV.enquiries@gb.abb.com)

or call 0333 999 9933





# ABB-free@home®

## The Smart Home

Now easier than ever. Only a few components are needed to install ABB-free@home® for direct activation of lights, HVAC, blind control and more. The entire system only requires a bus cable, the sensor/actuator unit, a power supply and a System Access Point

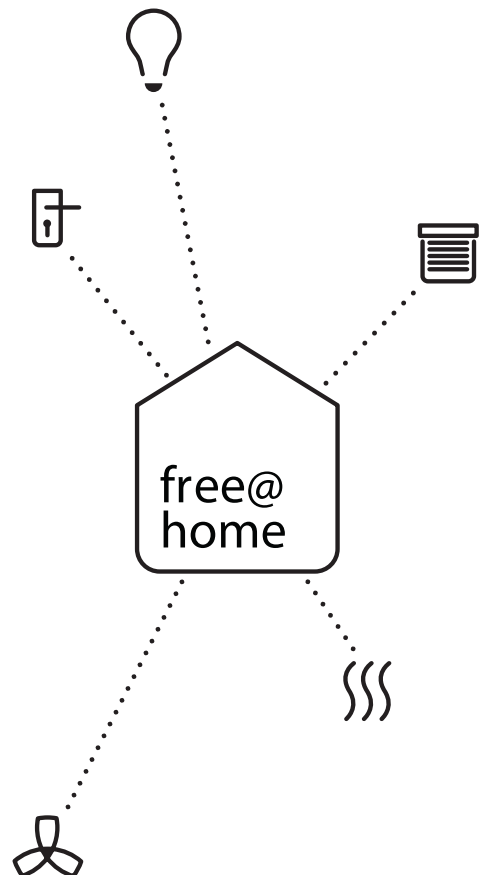

## One smart Home one app



### Central distribution board with rail-mounting actuator

The installation of central rail-mounting actuators in the consumer unit makes the installation of the sensors even easier – as only the bus line is located in the flush-mounted box. With this method, the costs for each channel can be reduced.

### Sensor/actuator unit for decentralised control

All in one. With the sensor/actuator unit, both the sensor and actuator are located in a single device to save space. The basic function of the unit is pre-configured, which makes programming the basic function unnecessary – but possible if required. The 230-volt line is wired as usual.

### Wired communication

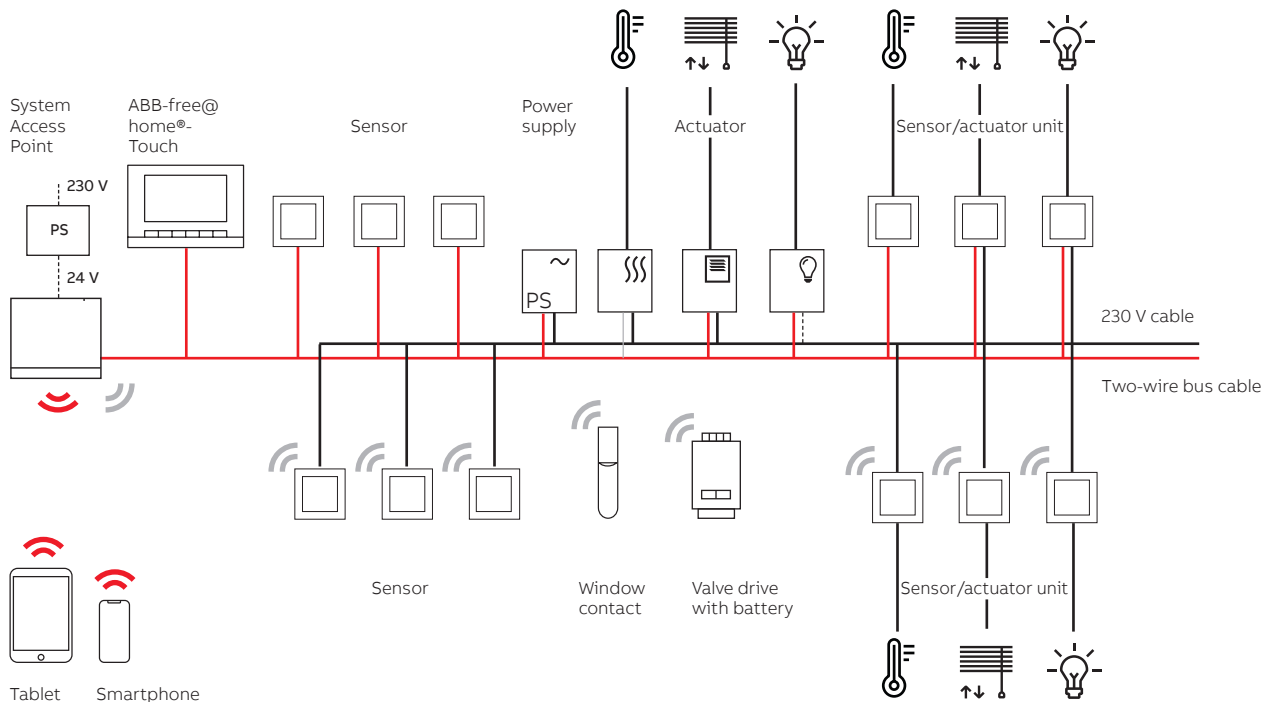

### Wireless communication

## ABB-free@home® - The range

Modularity makes everything possible



### System Access Point 2.0

Article no.	SAP/S.3
Description	For commissioning and remote control of the ABB-free@home® system. With integrated ABB-free@home® wireless antenna. With integrated ABB-free@home® bus connection. Allows the execution of astro and time programs. Commissioning and remote control is executed via web interface or app. No additional commissioning software is required. Easy commissioning with WLAN ad-hoc mode. Connection to the home network via WLAN client mode or via CAT cable.
Dimensions (H x W x D)	107 mm x 109 mm x 30 mm
Technical data	Display elements: LED for status display Nominal voltage: 230 V~ Rated frequency: 50 Hz/60 Hz Protection type of device: IP 20



### ABB-free@homeTouch 7"

Article no.	DP4-T-1
Description	For use as remote sensor.
Dimensions (H x W x D)	Cable length: 4 m
Technical data	Line type: H03 VV-F Type: NTC 10 kohm



### ABB-free@homeTouch 4.3"

Article no.	black: DP4-1-625 white: DP4-1-611
Description	For the central control of up to 16 configurable ABB-free@home® functions. For the display of configurable system messages. A configurable primary function can be triggered with a multi-touch gesture. Capacitive touch screen with closed glass surface. With integrated room temperature controller and temperature sensor. In connection with temperature sensor DP4-T-1 the integrated room temperature controller can be fitted with a remote sensor. Suitable as room temperature controller extension unit (up to 8).
Dimensions (H x W x D)	104 mm x 143 mm x 53 mm
Technical data	Display size: 10.9 cm (4.3") Display resolution: 480 x 854 Mounting height: 8 mm Display elements: 1 LCD display Bus voltage: 24 V~ Protection class (Device): IP 30



### Installation box, FM

Article no.	DP4-F
Description	For flush-mounted und hollow-wall installation of the ABB-free@homeTouch 4.3" DP4-1-6XX. Windproof.
Dimensions (H x W x D)	82 mm x 123 mm x 50 mm
Technical data	Mounting depth: 50 mm





---

**ABB SmartTouch® 10"**

Article no.	white / stainless: ST/U10.1.1-811 black / stainless: ST/U10.1.1-825 white / graphite: ST/U10.2.1-811 black / graphite: ST/U10.2.1-825 white / satin gold: ST/U10.3.1-811 black / satin gold: ST/U10.3.1-825 white / rose gold: ST/U10.4.1-811 black / rose gold: ST/U10.4.1-825
Description	<p>Freely programmable Touch panel featuring a 10-inch IPS screen with 1280*800 resolution that combines smart home automation and door communication in one device for residential applications, hotels, and commercial buildings. ABB SmartTouch® 10" offers home control and monitoring of the ABB-free@home®, or ABB i-bus®KNX system and the fully integrated functions of ABB-Welcome.</p> <p>Control, observe and manage your entire installation on one device: Switching - Dimming - Slider - Blind - RGBW control element - Step switch - Scene switch - Display element - Audio control element - RTC control element - VRV control element and display different values such as energy consumption and production. With scene function, logic functions, presence simulation and time programs.</p> <p>ABB SmartTouch® 10" can also be used as an end device for communication with the ABB-Welcome outdoor stations, and as part of the ABB-Welcome door communication system.</p>
Dimensions (H x W x D)	180.2 mm x 254.6 mm x 17.5 mm
Functions	<p>ABB i-bus®KNX: A total of 450 control elements are displayed on a maximum of 25 pages.</p> <p>ABB-free@home®: Twisted pair connection provides a single dashboard page with a maximum of 18 controls. Alternatively, for additional control, connection via wi-fi delivers the same amount of control and features as the ABB-free@home® Next app.</p> <p>80 fault and alarm messages          30 logic functions          30 timers          Presence simulation for 20 participants          10 scene actuators (in total 100 scenes are possible to store) 3 object RTCs          Equipped with a hearing loop for coupling the audio signal into hearing aids          A single page can have up to 18 touch surfaces</p>
Technical data	<p>External power supply: 20-32 VDC (SELV) or via the ABB-Welcome system controller.</p> <p>Display size: 25,4 cm (10")          Display resolution: 1280*800          Display screen: IPS display          Flush or Surface mounted.          Can also be mounted on a desktop stand.</p> <p>The flat design slim real metal frame sits almost flush with the wall (14 mm) and is available in 4 colors (stainless steel, graphite, gold and rose gold) and black or white glass.</p>

---



---

**IP Touch 7"**

---

Article no.	AN +LAN Version-White: 2TMA130050W0068 LAN + WIF Version-White: 2TMA130050W0066 LAN +LAN Version-Black: 2TMA130050B0068 LAN + WIF Version-Black: 2TMA130050B0066
-------------	---

---



---

**IP Touch 10"**

---

Article no.	LAN +LAN Version-White: 2TMA130050W0060 LAN + WIF Version-White: 2TMA130050W0058 LAN +LAN Version-Black: 2TMA130050B0060 LAN + WIF Version- Black: 2TMA130050B0058
-------------	---

---

Description	IP touch with cyber security boot & storage function. Supporting the systems door communication ABB-Welcome, ABB i-bus® KNX and ABB-free@home®. Connectable via LAN or WiFi, power supply via direct DC or PoE. Can be mounted surface or flush. With integrated room temperature controller and temperature sensor.
-------------	--

During the conversation a picture of the visitor can be taken and stored in the picture memory. For door calls during absence three pictures of the visitor are automatically stored in the picture memory. Different bell sounds are adjustable for door and floor ringing; five polyphone bell sounds are available. Individual bell sounds (can be integrated via SD card). SD card slot for extension of the picture memory. Equipped with a hearing loop (T-Loop) for coupling the audio signal into hearing aids. Capacitive HD display with glass surface, resolution 7" with 1024 x 600 and 10" with 1280 x 800.

Dimensions (H x W x D)	198.5 mm x 149.6 mm x 36 mm
---------------------------	-----------------------------

---

**Sensor/Switch actuator (1 contact)**

Article no. 2 Button: SSA-F-1.1.PB.1  
4 Button: SSA-F-2.1.PB.1

Description For switching 230 V~ devices. With 1 integrated switch actuator. Switching function is available pre-configured.

Dimensions (H × W × D) 44 mm × 44 mm × 40.9 mm

Technical data Outputs: 1× normally open contact, potential free  
Suitable for: resistive  
Rated current: 10 A  
Rated power: 2300 W  
Suitable for: capacitive  
Rated current: 10 AX  
Protection class of device: IP 20  
Mounting depth: 31.5 mm

**Sensor/Switch actuator 2/2gang (2 contacts)**

4 Button: SSA-F-2.1.PB.1

Description For switching 230 V~ devices. With 1 integrated switch actuator. Switching function is available pre-configured. Use with ABB-free@home® 4 fold push buttons.

Dimensions 44 mm × 44 mm × 40.9 mm

Technical data Outputs: 2× normally open contact, potential free  
Suitable for: resistive  
Rated current: 10 A  
Rated power: 2 x 1200 W  
Suitable for: capacitive  
Rated current: 10 AX  
Protection class of device: IP 20  
Mounting depth: 31.5 mm

**Sensor/Dim actuator (1 dimming channel)**

Article no. 2 Button: SBA-F-1.1.PB.1  
4 Button: SBA-F-2.1.PB.1

Description For dimming 230 V~ loads. With integrated universal dimming actuator for controlling different lamps. The dimming function is available pre-configured.

Dimensions (H × W × D) 44 mm × 44 mm × 40.9 mm

Technical data Outputs: 1× dimming channel  
Suitable for: 230 V incandescent lamps and low-voltage halogen lamps with conventional transformers or electronic transformers  
Rated power: 10–180 W/VA  
Suitable for: LEDi and energy-saving bulbs  
Rated power: 2–80 W/VA  
Protection class of device: IP 20  
Mounting depth: 31.5 mm

**Sensor/Blind actuator**

2 Button: SBA-F-1.1.PB.1  
4 Button: SBA-F-2.1.PB.1

Description For controlling blind and awning motors. With integrated blind actuator. Blind function is available pre-configured.

Dimensions 44 mm × 44 mm × 40.9 mm

Technical data Outputs: 1× Change-over contacts/normally open contact, potential-bound  
Rated power: 920 VA  
Rated current: 4 A  
Suitable for: Operating mode blind  
Protection class of device: IP 20  
Mounting depth: 31.5 mm





#### Room Temperature Controller

Article no.	RTC-F-1.PB
Description	Room temperature control function for controlling commercially available valve drives or analogue valve drives (continuous controllers). With display of set-value temperature. Only to be used with ABB-free@home® Zenit cover plates for room thermostat.
Dimensions (H x W x D)	44 mm x 44 mm x 29.4 mm
Technical data	Display elements: LCD Display showing operation modes Protection class of device: IP 20 Mounting depth: 17.9 mm



#### Room Temperature Controller

Article no.	RTC-F-2.1-1.PB-WL
Description	Room temperature control function for controlling commercially available valve drives or analogue valve drives (continuous controllers). With display of set-value temperature. Only to be used with ABB-free@home® Zenit cover plates for room thermostat.
Dimensions (H x W x D)	44 mm x 44 mm x 29.4 mm
Technical data	Display elements: LCD Display showing operation modes Protection class of device: IP 20 Mounting depth: 17.9 mm



#### Sensor unit 1gang

Article no.	2 button: SU-F-1.0.PB.1 4 button: SU-F-2.0.PB.1
Description	For sending switching, dimming and blind commands to an ABB-free@home® actuator.
Dimensions (H x W x D)	44 mm x 44 mm x 23.5 mm
Technical data	Control element: Switch contacts top/ bottom Display elements: LED as light for orientation or display of switching state Protection class of device: IP 20 Mounting depth: 14.1 mm



#### Movement detector + 1 actuator

Article no.	MSA-F-1.1.PB.1
Description	With select lens for detection with animal access. Including an integrated actuator for switching 230 V~ devices. To be used with ABB-free@home® Zenit cover plates for movement detector.
Dimensions (H x W x D)	44 mm x 44 mm x 47 mm
Technical data	Outputs: 1x normally open contact, potential free Suitable for: resistive Rated current: 10 A Rated power: 2300 W Suitable for: capacitive Rated current: 10 AX Detection range: frontal 6m, lateral 3m Detection angle: 180° Brightness limit value: 1 – 500 lux Protection class of device: IP 20 Mounting depth: 31.5 mm



### Movement detector

Article no.	MD-F-1.0.PB.1
Description	With select lens for detection with animal access. For automatic switching of ABB-free@home® actuators dependent on movement and brightness. To be used with ABB-free@home® Zenit cover plates for movement detector.
Dimensions (H × W × D)	44 mm × 44 mm × 29.6 mm
Technical data	Detection range: frontal 6 m, lateral 3 m Detection angle: 180° Brightness limit value: 1 – 500 lux Protection class of device: IP 20 Mounting depth: 14.1 mm



### Sensor/Switch actuator, wireless (1 contact)

2 Button: SSA-F-1.1.PB.1-WL 4 Button: SSA-F-2.1.PB.1-WL
For switching 230 V~ devices. With integrated actuator. Switching function is available pre-configured.
44 mm × 44 mm × 40.9 mm
Outputs: 1× normally open contact, potential free Suitable for: resistive Rated current: 10 A Rated power: 2300 W Suitable for: capacitive Rated current: 10 AX Protection class of device: IP 20 Mounting depth: 31.5 mm



### Sensor/Switch actuator, wireless (2 contact)

Article no.	4 Button: SSA-F-2.2.PB.1-WL
Description	For switching 230 V~ devices. With integrated actuator. Switching function is available pre-configured. To be used with ABB-free@home® Zenit cover plates for 4 fold push buttons.
Dimensions (H × W × D)	44 mm × 44 mm × 40.9 mm
Technical data	Outputs: 2× normally open contact, potential free Suitable for: resistive Rated current: 10 A Rated power: 2 × 1200 W Suitable for: capacitive Rated current: 10 AX Protection class of device: IP 20 Mounting depth: 31.5 mm



### Sensor/Dim actuator 1/1gang, wireless

2 Button: SSA-F-1.1.PB.1-WL
For dimming 230 V~ loads. With integrated universal dimming actuator for controlling different lamps. The dimming function is available pre-configured. To be used with ABB-free@home® Zenit cover plates for 2 fold push buttons.
44 mm × 44 mm × 40.9 mm
Outputs: 1× dimming channel Suitable for: 230 V incandescent lamps and low-voltage halogen lamps with conventional transformers or electronic transformers Rated power: 10–180 W/VA Suitable for: LEDi and energy-saving bulbs Rated power: 2–80 W/VA Protection class of device: IP 20 Mounting depth: 31.5 mm



wireless

**Sensor/Dim actuator 2/1gang, wireless**

Article no. 4 Button: SDA-F-2.1.PB.1-WL

Description For dimming 230 V~ loads. With integrated universal dimming actuator for controlling different lamps. The dimming function is available pre-configured. To be used with ABB-free@home® Zenit cover plates for 4 fold push buttons.

Dimensions (H×W×D) 44 mm × 44 mm × 40.9 mm

Technical data Outputs: 1× dimming channel  
Suitable for: 230 V incandescent lamps and low-voltage halogen lamps with conventional transformers or electronic transformers  
Rated power: 10–180 W/VA  
Suitable for: LEDi and energy-saving bulbs  
Rated power: 2–80 W/VA  
Protection class of device: IP 20  
Mounting depth: 31.5 mm



wireless



wireless

**Sensor/Blind actuator 1/1gang, wireless**Article no. 2 Button: SBA-F-2.1.PB.1-WL  
4 Button: SBA-F-1.1.PB.1-WL

Description For controlling blind and awning motors. With integrated blind actuator. Blind function is available pre-configured. To be used in combination with ABB-free@home® Zenit cover plates for 4 fold push buttons.

Dimensions 44 mm × 44 mm × 40.9 mm

Technical data Outputs: 1× Change-over contacts/normally open contact, potential bound  
Rated power: 920 VA  
Rated current: 4 A  
Suitable for: Operating mode blind  
Protection class of device: IP 20  
Mounting depth: 31.5 mm



wireless

**Room Thermostat, wireless**

Article no. RTC-F-1.PB-WL

Description Room temperature control function for controlling commercially available valve drives or analogue valve drives (continuous controllers) in connection with HA-M-0.6.1, HA-M-0.12.1, FCA-M-2.3.1. With display of set-value temperature. To be used with ABB-free@home® Zenit cover plates for room temperature controller.

Dimensions (H×W×D) 44 mm × 44 mm × 29.4 mm

Technical data Display elements: LCD Display showing operation modes  
Protection class of device: IP 20  
Mounting depth: 17.9 mm



wireless

**Sensor unit, wireless (4 Button)**

Article no. 4 Button: SU-F-2.0.PB.1-WL

Description For sending switching, dimming and blind command to an ABB-free@home® actuator. To be used with ABB-free@home® Zenit cover plates for 4 fold push buttons.

Dimensions 44 mm × 44 mm × 23.5 mm

Technical data Control element: Switch contacts top/bottom  
Display elements: LED for orientation or switch state display  
Protection class of device: IP 20  
Mounting depth: 14.1 mm





Wireless

---

**Movement detector + 1 actuator, wireless**

---

Article no.	MSA-F-1.1.1-WL
Description	With select lens for detection with animal access. Including an integrated actuator for switching 230 V~ devices. To be used with ABB-free@home® Zenit cover plates for movement detector.
Dimensions (H × W × D)	44 mm × 44 mm × 47 mm
Technical data	<p>Outputs: 1× normally open contact, potential free</p> <p>Suitable for: resistive</p> <p>Rated current: 10 A</p> <p>Rated power: 2300 W</p> <p>Suitable for: capacitive</p> <p>Rated current: 10 AX</p> <p>Detection range: frontal 6 m, lateral 3 m</p> <p>Detection angle: 180°</p> <p>Brightness limit value: 1 – 500 lux</p> <p>Protection class of device: IP 20</p> <p>Mounting depth: 31.5 mm</p>

---

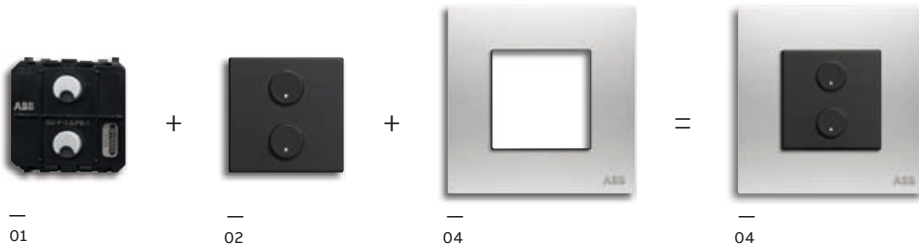

- 01 Switch actuator.
- 02 Rocker, 2 fold push buttons.
- 03 Frame.
- 04 ABB-free@home® Switch Sensor 1/2gang KNX.



- 05 ABB-free@home® 1/2gang switches.
- 06 ABB-free@home® Room temperature controller.
- 07 ABB-free@home® Movement detector.
- 08 ABB-free@home® 2/4gang switches.

Colour options for frames and cover plates  
Millenium

Colour	Code (c)	Colour	Code (c)
anthracite	AN	matt gold	MG
antique gold	AG	silk black	SB
brushed stainless steel	ST		

Available symbols for push buttons

Symbol	Code (i)	Colour	Code (i)
No symbol		Scene	S
Light	L	Dimmer	D
Blind	B		



<b>Cover plate for 2 fold push buttons inc. neutral symbols</b>	
Article no.	SR-2-N2 <b>c</b>
Description	As cover for ABB-free@home® 1gang switches of Zenit VDE and NEMA ranges.
Dimensions (H x W x D)	44 mm x 44 mm
Colours <b>(c)</b>	AN, BL, CV, PL



<b>Cover plate for 4 fold push buttons inc. neutral symbols</b>	
Article no.	SR-4-N2 <b>c</b>
Description	As cover for ABB-free@home® 2gang switches of Zenit VDE and NEMA ranges.
Dimensions (H x W x D)	44 mm x 44 mm
Colours <b>(c)</b>	AN, BL, CV, PL



<b>Icon for Zenit Rockers</b>	
Article no.	Icons (white): SB <b>i</b> -N2BL Icons (grey): SB <b>i</b> -N2GR
Description	Interchangeable icons for Zenit rockers, available with several icon designs <b>(i)</b> in 2 colors, grey (GR) and white (BL).
Dimensions (H x W x D)	44 mm x 44 mm
Symbols <b>(i)</b>	L, B, S, D



<b>Cover plate for movement detector</b>	
Article no.	CP-MD-N2 <b>c</b>
Description	As cover for ABB-free@home® movement detector of Zenit VDE and NEMA ranges.
Dimensions (H x W x D)	44 mm x 44 mm
Colours <b>(c)</b>	AN, BL, CV, PL



<b>Cover plate for room temperature controller</b>	
Article no.	N2372.1 <b>c</b>
Description	As frame for ABB-free@home® sensors and rockers of Zenit NEMA range
Dimensions (H x W x D)	122 mm x 90 mm
Colours <b>(c)</b>	AN, OX, CV, PZ, PL, BL, CB, CN, WG



<b>Cover plate for room temperature controller</b>	
Article no.	CP-RTC-N2 <b>c</b>
Description	As cover for ABB-free@home® room thermostat RTC-F-1.PB.
Dimensions (H x W x D)	44 mm x 44 mm
Colours <b>(c)</b>	AN, BL, CV, PL



<b>Square Frame, VDE</b>	
Article no.	N2271 <b>c</b>
Description	As frame for ABB-free@home® sensors and rockers of Zenit VDE range.
Dimensions (H x W x D)	90 mm x 90 mm
Colours <b>(c)</b>	AN, OX, BL



**Cover plate for 2 fold push buttons incl neutral symbols**

Article no.	2 Button: SR-2-AMAN 4 Button: SR-4-AMAN
Description	As cover for ABB-free@home® 1/2gang switches of Millenium Range.
Dimensions (H x W x D)	44 mm x 44 mm



**Cover Plate for Movement Detector**

Article no.	CP-MD-AMAN
Description	As cover for ABB-free@home® movement detector of Millenium Range.
Dimensions (H x W x D)	44 mm x 44 mm



**Cover Plate for Room Temperature Controller**

Article no.	CP-RTC-AMAN
Description	As cover for ABB-free@home® room thermostat RTC-F-1.PB.
Dimensions (H x W x D)	44 mm x 44 mm



**Square Frame, Millenium**

Article no.	AMD5144- <b>c</b>
Description	As frame for ABB-free@home® sensors and rockers of Millenium Range, includes mounting frame: AMD5053.
Dimensions (H x W x D)	86 mm x 86 mm
Colours ( <b>c</b> )	AG, MG, SB, ST
Symbols ( <b>i</b> )	



**Icon for Millenium Rockers**

Article no.	SBi-AMAN
Description	Interchangeable icons for Millenium rockers, available with several icon design options ( <b>i</b> ) in colour anthracite.
Colours ( <b>c</b> )	AN
Symbols ( <b>i</b> )	L, , S, D





---

**Sensor/Switch actuator (1 contact)**

---

Article no. 2 Button: SSA-F-1.1.PB.1-WL  
4 Button: SSA-F-2.1.PB.1-WL

Description For switching 230 V~ devices. With 1 integrated switch actuator. Switching function is available pre-configured.

Dimensions (H × W × D) 44 mm × 44 mm × 40.9 mm

Technical data Outputs: 1× normally open contact, potential free  
Suitable for: resistive  
Rated current: 10 A  
Rated power: 2300 W  
Suitable for: capacitive  
Rated current: 10 AX  
Protection class of device: IP 20  
Mounting depth: 31.5 mm



---

**Sensor/Switch actuator 2/2gang**

---

4 Button: SSA-F-2.1.PB.1

Description For switching 230 V~ devices. With 1 integrated switch actuator. Switching function is available pre-configured. Use with ABB-free@home® 4 fold push buttons.

Dimensions (H × W × D) 44 mm × 44 mm × 40.9 mm

Technical data Outputs: 2× normally open contact, potential free  
Suitable for: resistive  
Rated current: 10 A  
Rated power: 2300 W  
Suitable for: capacitive  
Rated current: 10 AX  
Protection class of device: IP 20  
Mounting depth: 31.5 mm



---

**Sensor/Dim actuator (1 contact)**

---

Article no. 2 Button: SDA-F-1.1.PB.1  
4 Button: SDA-F-2.1.PB.1

Description For dimming 230 V~ loads. With integrated universal dimming actuator for controlling different lamps. The dimming function is available pre-configured.

Dimensions (H × W × D) 44 mm × 44 mm × 40.9 mm

Technical data Outputs: 1× dimming channel  
Suitable for: 230 V incandescent lamps and low-voltage halogen lamps with conventional transformers or electronic transformers  
Rated power: 10–180 W/VA  
Suitable for: LEDi and energy-saving bulbs  
Rated power: 2–80 W/VA  
Protection class of device: IP 20  
Mounting depth: 31.5 mm



---

**Sensor/Blind actuator 1/1gang**

---

2 Button: SBA-F-1.1.PB.1

Description For controlling blind and awning motors. With integrated blind actuator. Blind function is available pre-configured. To be used with ABB-free@home® 2 fold push buttons.

Dimensions (H × W × D) 44 mm × 44 mm × 40.9 mm

Technical data Outputs: 1× Change-over contacts/normally open contact, potential-bound  
Rated power: 920 VA  
Rated current: 4 A  
Suitable for: Operating mode blind  
Protection class of device: IP 20  
Mounting depth: 31.5 mm



#### Sensor/Blind actuator

Article no. 2 Button: SBA-F-1.1.PB.1  
4 Button: SBA-F-2.1.PB.1

Description For controlling blind and awning motors. With integrated blind actuator. Blind function is available pre-configured.

Dimensions (H x W x D) 44 mm x 44 mm x 40.9 mm

Technical data Outputs: 1x Change-over contacts/normally open contact, potential-bound  
Rated power: 920 VA  
Rated current: 4 A  
Suitable for: Operating mode blind  
Protection class of device: IP 20  
Mounting depth: 31.5 mm



#### Room temperature controller

RTC-F-1.PB

Room temperature control function for controlling commercially available valve drives or analogue valve drives (continuous controllers). With display of set-value temperature. Only to be used with ABB-free@home® Zenit cover plates for room thermostat.

44 mm x 44 mm x 29.4 mm

Display elements: LCD Display showing operation modes  
Protection class of device: IP 20  
Mounting depth: 17.9 mm



#### Room temperature controller

Article no. RTC-F-2.1-1.PB-WL

Description Room temperature control function for controlling commercially available valve drives or analogue valve drives (continuous controllers). With display of set-value temperature. Only to be used with ABB-free@home® Zenit cover plates for room thermostat.

Dimensions (H x W x D) 44 mm x 44 mm x 29.4 mm

Technical data Display elements: LCD Display showing operation modes  
Protection class of device: IP 20  
Mounting depth: 17.9 mm



#### Sensor unit

2 button: SU-F-1.0.PB.1  
4 Button: SU-F-2.0.PB.1

For sending switching, dimming and blind commands to an ABB-free@home® actuator. To be used with ABB-free@home® 4 fold push buttons.

44 mm x 44 mm x 23.5 mm

Control element: Switch contacts top/ bottom  
Display elements: LED as light for orientation or display of switching state  
Protection class of device: IP 20  
Mounting depth: 14.1 mm



<b>Movement detector + 1 actuator</b>	
Article no.	MSA-F-1.1.PB.1
Description	With select lens for detection with animal access. Including an integrated actuator for switching 230 V~ devices. To be used with ABB-free@home® Zenit cover plates for movement detector.
Dimensions (H × W × D)	44 mm × 44 mm × 47 mm
Technical data	Outputs: 1× normally open contact, potential free Suitable for: resistive Rated current: 10 A Rated power: 2300 W Suitable for: capacitive Rated current: 10 AX Detection range: frontal 6 m, lateral 3 m Detection angle: 180° Brightness limit value: 1 – 500 lux Protection class of device: IP 20 Mounting depth: 31.5 mm



<b>Movement detector</b>	
Article no.	MD-F-1.0.PB.1
Description	With select lens for detection with animal access. For automatic switching of ABB-free@home® actuators dependent on movement and brightness. To be used with ABB-free@home® Zenit cover plates for movement detector.
Dimensions (H × W × D)	44 mm × 44 mm × 29.6 mm
Technical data	Detection range: frontal 6 m, lateral 3 m Detection angle: 180° Brightness limit value: 1 – 500 lux Protection class of device: IP 20 Mounting depth: 14.1 mm



wireless



wireless

<b>Sensor/Switch actuator 1/1gang, wireless (1 contact)</b>	
Article no.	2 Button: SSA-F-1.1.PB.1-WL 4 Button: SSA-F-2.1.PB.1-WL
Description	For switching 230 V~ devices. With integrated actuator. Switching function is available pre-configured.
Dimensions (H × W × D)	44 mm × 44 mm × 40.9 mm
Technical data	Outputs: 1× normally open contact, potential free Suitable for: resistive Rated current: 10 A Rated power: 2300 W Suitable for: capacitive Rated current: 10 AX Protection class of device: IP 20 Mounting depth: 31.5 mm



wireless

<b>Sensor/Switch actuator 2/2gang, wireless</b>	
Article no.	4 Button: SSA-F-2.2.PB.1-WL
Description	For switching 230 V~ devices. With integrated actuator. Switching function is available pre-configured. To be used with ABB-free@home® Zenit cover plates for 4 fold push buttons.
Dimensions (H × W × D)	44 mm × 44 mm × 40.9 mm
Technical data	Outputs: 2× normally open contact, potential free Suitable for: resistive Rated current: 10 A Rated power: 2 x 1200 W Suitable for: capacitive Rated current: 10 AX Protection class of device: IP 20 Mounting depth: 31.5 mm



wireless

**Sensor/Dim actuator 1/1gang, wireless**

Article no. 2 Button: SDA-F-1.1.PB.1-WL

**Description** For dimming 230 V~ loads. With integrated universal dimming actuator for controlling different lamps. The dimming function is available pre-configured. To be used with ABB-free@home® Zenit cover plates for 2 fold push buttons.

**Dimensions (H × W × D)** 44 mm × 44 mm × 40.9 mm

**Technical data** Outputs: 1× dimming channel  
Suitable for: 230 V incandescent lamps and low-voltage halogen lamps with conventional transformers or electronic transformers  
Rated power: 10–180 W/VA  
Suitable for: LEDi and energy-saving bulbs  
Rated power: 2–80 W/VA  
Protection class of device: IP 20  
Mounting depth: 31.5 mm



wireless

**Sensor/Dim actuator 2/1gang, wireless**

SDA-F-2.1.PB.1-WL

For dimming 230 V~ loads. With integrated universal dimming actuator for controlling different lamps. The dimming function is available pre-configured. To be used with ABB-free@home® Zenit cover plates for 4 fold push buttons.

44 mm × 44 mm × 40.9 mm

Outputs: 1× dimming channel  
Suitable for: 230 V incandescent lamps and low-voltage halogen lamps with conventional transformers or electronic transformers  
Rated power: 10–180 W/VA  
Suitable for: LEDi and energy-saving bulbs  
Rated power: 2–80 W/VA  
Protection class of device: IP 20  
Mounting depth: 31.5 mm



wireless



wireless

**Sensor/Blind actuator, wireless (1 contact)**Article no. 2 Button: SBA-F-1.1.PB.1-WL  
2 Button: SBA-F-2.1.PB.1-WL

**Description** For controlling blind and awning motors. With integrated blind actuator. Blind function is available pre-configured.

**Dimensions (H × W × D)** 44 mm × 44 mm × 40.9 mm

**Technical data** Outputs: 1× Change-over contacts/normally open contact,potential-bound  
Rated power: 920 VA  
Rated current: 4 A  
Suitable for: Operating mode blind  
Protection class of device: IP 20  
Mounting depth: 31.5 mm



wireless

**Room Thermostat, wireless**

RTC-F-1.PB-WL

Room temperature control function for controlling commercially available valve drives or analogue valve drives (continuous controllers) in connection with HA-M-0.6.1, HA-M-0.12.1, FCA-M-2.3.1. With display of set-value temperature. To be used with ABB-free@home® Zenit cover.

44 mm × 44 mm × 29.4 mm

Display elements: LCD Display showing operation modes  
Protection class of device: IP 20  
Mounting depth: 17.9 mm



**Sensor unit, wireless**

Article no. 2 Button: SU-F-1.0.PB.1-WL  
4 Button: SU-F-2.0.PB.1-WL

Description For sending switching, dimming and blind command to an ABB-free@home® actuator.

Dimensions (H × W × D) 44 mm × 44 mm × 23.5 mm

Technical data Control element: Switch contacts top/bottom  
Display elements: LED for orientation or switch state display  
Protection class of device: IP 20  
Mounting depth: 14.1 mm

**Movement detector + 1 actuator, wireless**

MSA-F-1.1.1-WL

Description With select lens for detection with animal access. Including an integrated actuator for switching 230 V~ devices. To be used with ABB-free@home® Zenit cover plates for movement detector.

Dimensions 44 mm × 44 mm × 47 mm

Technical data Outputs: 1× normally open contact, potential free  
Suitable for: resistive  
Rated current: 10 A  
Rated power: 2300 W  
Suitable for: capacitive  
Rated current: 10 AX  
Detection range: frontal 6 m, lateral 3 m  
Detection angle: 180°  
Brightness limit value: 1 – 500 lux  
Protection class of device: IP 20  
Mounting depth: 31.5 mm



## ABB-free@home® | ABB Tenton®

Measure, monitor, and control the air quality in your home.

With ABB-free@home®, you have all you need to make your home secure and comfortable, all via one simple system.

Nowadays, we are more aware of the importance of maintaining good health and general well-being, as well as reducing pollutants and promoting sustainability. That's why we've introduced ABB Tenton® for ABB-free@home®. Working seamlessly with ABB-free@home® ecosystem, it ensures your home's overall air quality will be as you want it to be at all times – giving you even more control and peace of mind.

### Measurement and control across four key areas

The unique ABB Tenton® Indoor Air Quality (IAQ) system gives you the comprehensive information you need:

- **Temperature** – measure and control the temperature so it's always just right
- **Humidity** – measure humidity levels for a healthy living environment.
- **Carbon dioxide** – monitor CO<sub>2</sub> levels for safety and overall comfort
- **Volatile organic compounds (VOC)** – check pollutant levels to ensure well-being

In each case, you'll have all the data at your fingertips – and you'll be automatically notified if any of these elements exceeds the set level or designated air quality. You'll then be able to adjust heating, air conditioning, and ventilation as required.

### How it works

- Sensors capture Information and summarise it into an easy-to-understand air quality index, displayed on the unit.
- If levels exceed set thresholds, then you're sent notifications automatically.
- Everything is viewable and adjustable on the device or via your ABB-free@home® app.
- Individually monitor levels in rooms throughout your home, wherever you are.
- Integrate seamlessly with ABB-free@home® functions, so you can operate lighting, heating, aircon, blinds, and more.

### How to get started

- It's simple to set up – a professional electrician can install everything, with no need for special installers or system integrators.
- The clean, elegant design has flexible options for flush or surface mounting, and comes in a choice of colors to match your interior.
- You can also customize the function and control elements, using our online labeling tool to display text and symbols in the ways you want.



SECTION 3



**Control unit**

Article no. 8 button: SB-F-8.0.1-84  
12 Button: SB-F-12.0.1-84

Technical data Inputs: 4  
Polling voltage: 20 V~  
Protection type of device: IP 20

Colours White Matt, Silver, Black, White



**Control unit with temperature control**

Article no. 6 button: SBR-F-6.0.1-84  
8 button: SBR-F-10.0.1-84

Technical data Inputs: 4  
Polling voltage: 20 V~  
Protection type of device: IP 20

Colours White Matt, Silver, Black, White

**Control unit with temperature control and air quality**

6 Button: SBC-F-6.0.1-84  
8 Button: SBC-F-10.0.1-84

Inputs: 4  
Polling voltage: 20 V~  
Protection type of device: IP 20

White Matt, Silver, Black, White



### Fan coil actuator, MDRC

Article no.	FCA-M-2.3.1
Description	For controlling blower convectors. Supports 2-pipe and 4-pipe system for heating and cooling. The fan speed levels can be switched using a changeover or step switch function. Three contacts for switching a three-stage fan. Two contacts for activating the heating and cooling valves. With two binary inputs for connecting dewpoint and condensation contacts. The scanning voltage is provided by the device. The bus connection is provided via the enclosed bus terminal.
Dimensions (H × W × D)	90 mm × 108 mm × 64 mm
Technical data	Supports 24 V and 230 V valves Outputs: 3x Normally open contact, potential free Suitable for: AC3 Rated current: 6 A Output voltage: 230 V~ Protection type of device: IP 20 Module width: 6 MW



### Power supply

Article no.	PS-M-64.1.1
Description	Power supply with integrated choke. Fast diagnosis due to LED display for operational readiness and errors.
Dimensions (H × W × D)	90 mm × 72 mm × 64 mm
Technical data	Display element: operating/overload LED Nominal voltage: 230 V~, +10%/-15% Secondary: 30 V, +2 V/-2 V Rated frequency: 50 Hz/60 Hz Outputs: 1 Nominal current: 640 mA Protection type of device: IP 20 Module width: 4 MW



### Binary input 4gang

Article no.	BI-M-4.0.1
Description	Records 10 to 230 V AC/DC signals via 4 channels. The information of the signal evaluation can be used for activating ABB-free@home® actuators or for recording status information.
Dimensions (H × W × D)	90 mm × 36 mm × 64 mm
Technical data	Inputs: 4 Protection type of device: IP 20 Module width: 2 MW



### Switch Actuator, 4-fold, 16 A, MDRC

Article no.	SA-M-4.16.2.2
Description	For switching 4 independent 127 V~/230 V~ loads. Each contact has a manual operation function independent of auxiliary voltage for additionally displaying the contact setting. The bus can be connected via enclosed terminal block.
Dimensions (H × W × D)	90 mm × 70 mm × 63.5 mm
Technical data	Outputs: 4 Maximum switching current: 16 A Maximum switching power: 2500 W Mounting type: DIN rail Number of inputs: Analog (0 ... 10 V / 4 ... 20 mA) Analog, 0 No unit Number of LEDs: 1 Rated current: 16 A Output voltage: 230 V AC Protection class (Device): IP20 Module width: 4 MW





---

**Switch Actuator, 8-fold 16 A, MDRC**

---

Article no. SA-M-8.16.2.2

**Description** For switching 8 independent 127 V~/230 V~ loads. Each contact has a manual operation function independent of auxiliary voltage for additionally displaying the contact setting. The bus can be connected via enclosed terminal block.

**Dimensions (H × W × D)** 90 mm × 140 mm × 63.5 mm

**Technical data**  
 Outputs: 8  
 Maximum switching current: 16A  
 Maximum switching power: 2500 W  
 Mounting type: DIN rail  
 Number of inputs: Analog (0 ... 10 V / 4 ... 20 mA)  
 Analog, 0 No unit  
 Number of LEDs: 1  
 Rated current: 16 A  
 Output voltage: 230 V AC  
 Protection class (Device): IP20  
 Module width: 8 MW



---

**Switch Actuator, 12-fold 16 A, MDRC**

---

Article no. SA-M-12.16.2.2

**Description** For switching 12 independent 127 V~/230 V~ loads. Each contact has a manual operation function independent of auxiliary voltage for additionally displaying the contact setting. The bus can be connected via enclosed terminal block.

**Dimensions (H × W × D)** 90 mm × 210 mm × 63.5 mm

**Technical data**  
 Outputs: 12  
 Maximum switching current: 16A  
 Maximum switching power: 2500 W  
 Mounting type: DIN rail  
 Number of inputs: Analog (0 ... 10 V / 4 ... 20 mA)  
 Analog 0 No unit  
 Number of LEDs: 1  
 Rated current: 16 A  
 Output voltage: 230 V AC  
 Protection class (Device): IP20  
 Module width: 12 MW



---

**Switch actuator 8gang**

---

Article no. SA-M-8.8.1

**Description** The binary inputs can be used as an interface for convenient operation of ABB-free@home® systems via potential free push buttons or for reading technical binary signals. The switching outputs can be switched independently as a function of other sensors connected to the bus.

**Dimensions (H × W × D)** 90 mm × 144 mm × 64 mm

**Technical data**  
 Inputs: 8  
 Polling voltage: 32 V  
 Max. cable length: ≤100m  
 Outputs: 8  
 Suitable for: AC1  
 Rated current: 6 A, at cos φ 0.8  
 Output voltage: 230 V~  
 Suitable for: AC3  
 Rated current: 6 A, at cos φ 0.45  
 Protection class of device: IP 20  
 Module width: 8 MW

**Blind Actuator, 4-fold, 230 V, MDRC**

Article no. BA-M-4.230.1.1

Description For controlling 4 independent blind or roller shutter drives. The outputs are inversely blocked. The bus can be connected via enclosed terminal block

Dimensions (H x W x D) 90 mm x 70 mm x 63.5 mm

Technical data  
 Outputs: 4  
 Maximum switching current: 6A  
 Maximum switching power: 1200 W  
 Mounting type: DIN rail  
 Number of inputs; Analog (0 ... 10 V / 4 ... 20 mA)  
 Analog 0 No unit  
 Number of LEDs: 1  
 Rated current: 6 A  
 Output voltage: 230 V AC  
 Protection class (Device): IP20  
 Module width: 4 MW

**Blind Actuator, 8-fold 230 V, MDRC**

Article no. BA-M-8.230.1.1

Description For controlling 8 independent blind or roller shutter drives. The bus can be connected via enclosed terminal block.

Dimensions 90 mm x 140 mm x 63.5 mm

Technical data  
 Outputs: 8  
 Maximum switching current: 6A  
 Maximum switching power: 1200 W  
 Mounting type: DIN rail  
 Number of inputs; Analog (0 ... 10 V / 4 ... 20 mA)  
 Analog 0 No unit  
 Number of LEDs: 1  
 Rated current: 6 A  
 Output voltage: 230 V AC  
 Protection class (Device): IP20  
 Module width: 8 MW

**Dimming actuator, 4gang**

Article no. DA/M.4.210.2.1

Description Multichannel universal dimming actuator optimised for dimming retrofit LED lamps (LEDi). Also suitable for dimming incandescent lamps, low-voltage halogen lights with conventional or electronic transformers, 230 V halogen lamps and dimmable energy-saving halogen lamps. Automatic load detection (can be deactivated). Separate N-connection per channel. Parallel connection of the outputs possible to increase the output power. Outputs can be connected in parallel in any configuration. Minimum load: 2 W.

Dimensions (H x W x D) 90 mm x 108 mm x 64 mm

Technical data  
 Rated voltage: 110 - 230 V~, +10 % / -10 %  
 Rated frequency: 50 Hz - 60 Hz  
 Outputs: 4x dimming channel  
 Rated power: 2 - 210 W/VA  
 Protection class (Device): IP 20  
 Temperature range (Device): -5 °C to 45 °C  
 Mounting depth: 68 mm  
 Module width: 6 MW

**Dimming actuator, 6gang**

Article no. DA/M.6.210.2.1

Description Multichannel universal dimming actuator optimised for dimming retrofit LED lamps (LEDi). Also suitable for dimming incandescent lamps, low-voltage halogen lights with conventional or electronic transformers, 230 V halogen lamps and dimmable energy-saving halogen lamps. Automatic load detection (can be deactivated). Separate N-connection per channel. Parallel connection of the outputs possible to increase the output power. Outputs can be connected in parallel in any configuration. Minimum load: 2 W.

Dimensions 90 mm x 144 mm x 64 mm

Technical data  
 Rated voltage: 110 - 230 V~, +10 % / -10 %  
 Rated frequency: 50 Hz - 60 Hz  
 Outputs: 6x dimming channel  
 Rated power: 2 - 210 W/VA  
 Protection class (Device): IP 20  
 Temperature range (Device): -5 °C to 45 °C  
 Mounting depth: 68 mm  
 Module width: 8 MW

**DALI Gateway, MDRC**

Article no.	HA-M-0.12.1
Description	The device is used to interface between DALI and ABB-free@home® installations and incorporates the DALI power supply. One DALI output for up to 16 DALI Slaves.
Dimensions (H × W × D)	90 mm × 72 mm × 64 mm
Technical data	Bus voltage: 24 V Rated voltage: 100 – 240 V~ Rated frequency: 50 Hz, 60 Hz DALI outputs: 1 Protection class (device): IP 20

**Dimming actuator, 4gang, 315W**

Article no.	DA/M.4.315.2.1
Description	Multichannel universal dimming actuator optimised for dimming retrofit LED lamps (LEDi). Also suitable for dimming incandescent lamps, low-voltage halogen lights with conventional or electronic transformers, 230 V halogen lamps and dimmable energy-saving halogen lamps. Automatic load detection (can be deactivated). Separate N-connection per channel. Parallel connection of the outputs possible to increase the output power. Outputs can be connected in parallel in groups. Minimum load: 2 W.
Dimensions (H × W × D)	90 mm × 144 mm × 182 mm
Technical data	Bus voltage: 24 V Rated voltage: 230 V~ Rated frequency: 50 Hz / 60 Hz Outputs: 4 dimming channel Rated output: 10 - 315 W/VA Rated output: 2 - 80 W/VA Protection class (device): IP 20 Temperature range (device): -5 °C - 45 °C Storage temperature range: -20 °C - 70 °C Module width: 8 Division units: 8

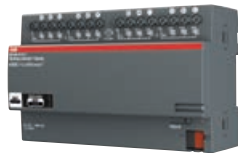
**Heating actuator 12gang**

Article no.	HA-M-0.12.1
Description	For controlling thermoelectric actuating drives in heating/cooling systems. The outputs are protected against short-circuit and overload.
Dimensions (H × W × D)	90 mm × 144 mm × 64 mm
Technical data	Outputs: 12 Type of load: resistive Nominal current: 160 mA Protection type of device: IP 20 Module width: 8 MW

**Heating actuator 6gang**

Article no.	HA-M-0.6.1
Description	For controlling thermoelectric actuating drives in heating/cooling systems. The outputs are protected against short-circuit and overload.
Dimensions (H × W × D)	90 mm × 72 mm × 64 mm
Technical data	Outputs: 6 Type of load: resistive Nominal current: 160 mA Protection type of device: IP 20 Module width: 4 MW



<b>Weather station</b>	
Article no.	WS-1
Description	For recording and transmitting of brightness, temperature, wind speed and rain. Weather data can be linked with actuators to automatically control functions. Weather data can be visualized in the ABB-free@home® web interface and the ABB-free@home® app. Wind speed measuring range 2 - 30 m/s. The bus can be connected via enclosed terminal block.
Dimensions (H × W × D)	108 mm × 121 mm × 227 mm
Technical data	Rated voltage: 110 V~ - 230 V~ Rated frequency: 50 Hz - 60 Hz Bus voltage: 24 V~ Inputs: 4 Protection class (Device): IP 44 Temperature range (Device): -20 °C to 55 °C Brightness limit value: 1 Lux - 100000 Lux

<b>USB Interface, MDRC</b>	
Article no.	USB-M-1.1
Description	USB Interface for the creation of a central twisted pair line in multi-dwelling applications, e.g. a Central Weather Station in an apartment building.
Dimensions (H × W × D)	90 mm × 36 mm × 64.5 mm
Technical data	Supply voltage: 5 V DC via USB Type B connector Bus voltage: 24 V (bus connection terminal) Protection class (Device): IP 20 Temperature range (Device): -5 °C to 45 °C Module width: 2 MW



<b>Movement detector + 1 actuator, wireless</b>																							
Article no.	MSA-F-1.1.1-c-WL																						
Description	With select lens for detection with animal access. Communication with the ABB-free@home® system is carried out wireless. For automatic switching of ABB-free@home® actuators dependent on movement and brightness. Switch- off delay of the actuator can be programmed via the web interface of the System Access Point. For switching 127 V~/230 V~ consumers.																						
Dimensions (H × W × D)	71 mm × 71 mm × 53 mm																						
Technical data	<table border="0"> <tr> <td>Outputs: 1x Normally open contact, potential free</td> <td>Detection range: frontal: 6 m, lateral: 3 m</td> </tr> <tr> <td>Suitable for: ohmic</td> <td>Detection angle: 180 °</td> </tr> <tr> <td>Rated current: 10 A</td> <td>Brightness limit value: 1 Lux - 500</td> </tr> <tr> <td>Output voltage: 230 V~</td> <td>Lux Mounting height: 1.1 m - 1.3 m</td> </tr> <tr> <td>Rated power: 2300 W</td> <td>Protection class of device: IP 20</td> </tr> <tr> <td>Suitable for: capacitive</td> <td>Mounting depth: 32 mm</td> </tr> <tr> <td>Rated current: 10 AX</td> <td>Position for installation: vertical</td> </tr> <tr> <td>Rated power: 2300 VA</td> <td></td> </tr> <tr> <td>Suitable for: inductive</td> <td></td> </tr> <tr> <td>Rated current: 10 AX</td> <td></td> </tr> <tr> <td>Rated power: 2300 VA</td> <td></td> </tr> </table>	Outputs: 1x Normally open contact, potential free	Detection range: frontal: 6 m, lateral: 3 m	Suitable for: ohmic	Detection angle: 180 °	Rated current: 10 A	Brightness limit value: 1 Lux - 500	Output voltage: 230 V~	Lux Mounting height: 1.1 m - 1.3 m	Rated power: 2300 W	Protection class of device: IP 20	Suitable for: capacitive	Mounting depth: 32 mm	Rated current: 10 AX	Position for installation: vertical	Rated power: 2300 VA		Suitable for: inductive		Rated current: 10 AX		Rated power: 2300 VA	
Outputs: 1x Normally open contact, potential free	Detection range: frontal: 6 m, lateral: 3 m																						
Suitable for: ohmic	Detection angle: 180 °																						
Rated current: 10 A	Brightness limit value: 1 Lux - 500																						
Output voltage: 230 V~	Lux Mounting height: 1.1 m - 1.3 m																						
Rated power: 2300 W	Protection class of device: IP 20																						
Suitable for: capacitive	Mounting depth: 32 mm																						
Rated current: 10 AX	Position for installation: vertical																						
Rated power: 2300 VA																							
Suitable for: inductive																							
Rated current: 10 AX																							
Rated power: 2300 VA																							
(c)	81, 82, 83, 84, 803, 840, 866, 884, 885																						





**External Antenna**

Article no. SAP-1-WL

Description To be used in combination with System Access Point SAP-S-2 and SAP/S.3. Transmits the wireless signal outside, in case the internal antenna of the System Access Point is shielded. With magnetic foot.

Dimensions (H x W x D) cable lengths: 1.5 m

Technical data



**Basic ABB-free@home® radiator thermostat, wireless**

Article no. HA-S-1-WL

Description For temperature regulation of water-bearing heaters. With integrated temperature sensor, controller and actuating drive. Local operation for the switchover between comfort mode and Off. No wire laying required. Communication with the ABB-free@home® system is carried out wireless. Setpoint adjustment via the ABB-free@home® app or a ABB-free@home® extension unit. Integrated "Window open" detection or can be linked with WBI-S-X-W.

Dimensions 63 mm x 48 mm x 84 mm

Technical data With lime protection function. With frost protection function. Noiseless running. Installation with sleeve nut M 30 x 1.5 Fits many popular valve bases (e.g. Braukmann, Heimeier, Honeywell, Junkers, MNG). The adapters for Danfoss RAV, Danfoss RA and Danfoss RAVL are included in the scope of supply. Adapters for additional valves are available as accessories. Battery included in scope supply. Battery type: 2 x AA Protection class (Device): IP 20



**Valve adapter Herz**

Article no. AC-HA-1

Description Metal adapter for installation radiator thermostat. (HA-S-X-WL). For valve bodies Herz M 28 x 1,5.



**Valve adapter Comap**

Article no. AC-HA-2

Description Metal adapter for installation radiator thermostat. (6256/X-WL). For valve bodies Comap M 28 x 1,5.



### Valve adapter Herz

Article no.	AC-HA-3
Description	Metal adapter for installation radiator thermostat. (HA-S-X-WL). For valve bodies Orkli M 28 x 1,0.



### ABB-free@home window sensor, wireless

Article no.	studio white matt: WBI-S-1-64-WL basalt black: WBI-S-1-65-WL stainless steel: WBI-S-1-66-WL
Description	For monitoring and transmission of the current window handle position (window open, closed, tilted). The status can be visualised on the ABB-free@home panel and in the ABB-free@home app. The window sensor is installed between the available window handle and the window frame. Existing window handle is used. Suitable for window handle: 7 mm square fastener, 43 mm attachment screw separation, lifter dia. 10 and 12 mm, max. mounting plate size 34 x 77 mm (WxH). No wire laying required. Mounting accessories (square extension, screws, adapter for cams) for the window sensor are included in scope of delivery.
Dimensions (H x W x D)	168 mm x 38 mm x 13 mm
Technical data	Battery included in scope supply. Battery type: CR2 Notification in case of low battery capacity in the ABB-free@home app. Protection class (Device): IP 43



### ABB-free@home universal detector, wireless

Article no.	studio white matt: BI-S-1-64-WL basalt black: BI-S-1-65-WL
Description	For monitoring and transmission of the state (open, closed) of dormer windows, skylights, doors and gates. Additional connection option for an external, potential-free sensor (choice of normally closed or normally open contact). The status can be visualized on the ABB-free@home panel and in the ABB-free@home app. Isolated evaluation and monitoring of channels. The universal detector and the magnets are fixed with adhesive film or screws. Accessories (adhesive foil, screws, magnet) included in delivery.
Dimensions (H x W x D)	118 mm x 30 mm x 22 mm
Technical data	Battery type: CR2 Notification in case of low battery capacity in the ABB-free@home app. External sensor max. wire length: 5 m External sensor terminal connection diameter: 0.14...0.5 mm <sup>2</sup> (single wire) Protection class (Device): IP 43

**Binary input 2gang**

Article no. BI-F-2.0.1

**Description** Conventional push-buttons or auxiliary contacts can be connected to 2 channels. The information of the contact enquiry can be used for activating ABB-free@home® actuators or for recording status information. The contact polling voltage is made available from the binary input itself. Extension of the connecting cables possible by a maximum of 10 m. Flush-mounted device for installation in a 60 mm device box or distribution box.

**Dimensions (H × W × D)** 39 mm × 40 mm × 12 mm

**Technical data** Inputs: 2  
Polling voltage: 20 V–  
Protection type of device: IP 20

**Binary input 4gang**

Article no. BI-F-4.0.1

**Description** Conventional push-buttons or auxiliary contacts can be connected to 4 channels. The information of the contact enquiry can be used for activating ABB-free@home® actuators or for recording status information. The contact polling voltage is made available from the binary input itself. Extension of the connecting cables possible by a maximum of 10 m. Flush-mounted device for installation in a 60 mm device box or distribution box.

**Dimensions (H × W × D)** 39 mm × 40 mm × 12 mm

**Technical data** Inputs: 4  
Polling voltage: 20 V–  
Protection type of device: IP 20

**Split Unit Gateway, FM**

Article no. SUG-F-1.1

**Description** The device is used to interface between the ABB-free@home® system and many manufacturers' air conditioners, so-called split units. The device converts the ABB-free@home® telegrams into infrared commands and transmits them to the split unit. The transmitter of the supplied cable is bonded directly onto the split unit's receiver. The split unit then no longer receives the commands from a remote control. Instead, it can be operated via any ABB-free@home® sensors. The model of the split unit can be selected during commissioning. Auxiliary voltage is not required.

**Dimensions (H × W × D)** 39 mm × 40 mm × 12 mm

**Technical data** Outputs: 1  
Bus voltage: 24 V  
Protection class (device): IP 20

# ABB IP Door Entry Systems

## Systems fully connected

Door communication, access control and home & building automation. ABB offers a complete range of smart products with all possibilities at your fingertips.

### Fully connected

- Easily expandable system
- One programming software for all types of building
- Supports multiple outdoor call stations
- Indoor touch panels to see/speak and answer
- Free App control available for all platforms

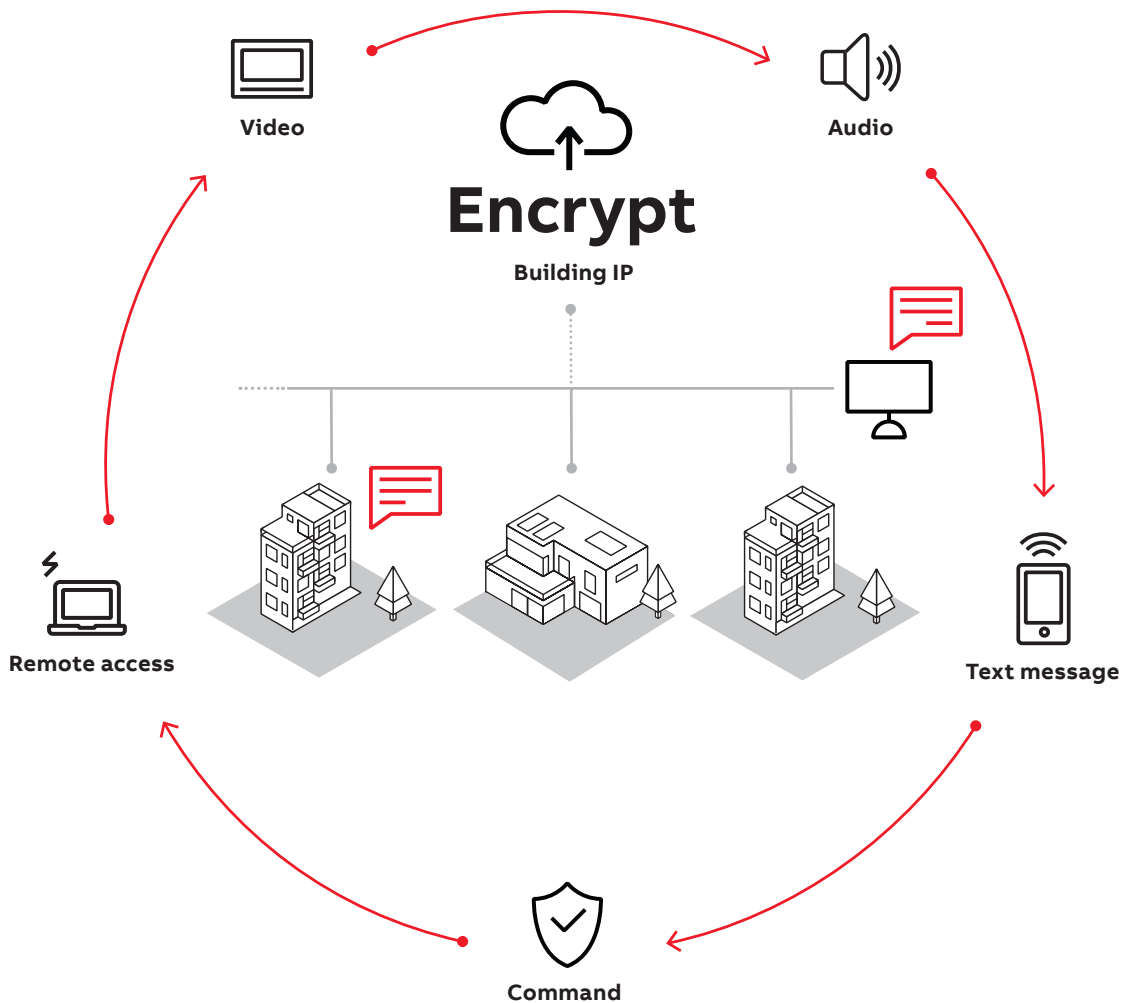

## Customisable or prebuilt outdoor call stations



Display  
IC/DC module



Keypad  
module



Round 1  
pushbutton



Round 1 pushbutton  
with card reader



Round 2  
pushbutton



Round 2 pushbutton  
with card reader



Round 3  
pushbutton



Round 3 pushbutton  
with card reader



Bar 3 row  
pushbutton



Bar 4 row  
pushbutton



HD video  
streaming (720P)  
with 130° angle

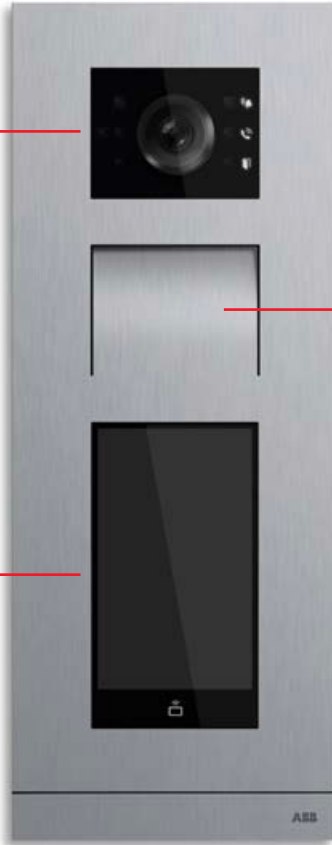

Audio module



Intuitive operable  
touchscreen  
& virtual keypad  
integrated

01 **Video Keypad**  
outdoor station,  
stainless steel

02 **Video** outdoor  
station, touch 5",  
stainless steel

03 **Video pushbutton**  
outdoor station,  
stainless steel

04 **Mini** outdoor station,  
aluminium alloy

05 **2nd confirmed**  
outdoor station,  
aluminium alloy



01



02



03



04



05



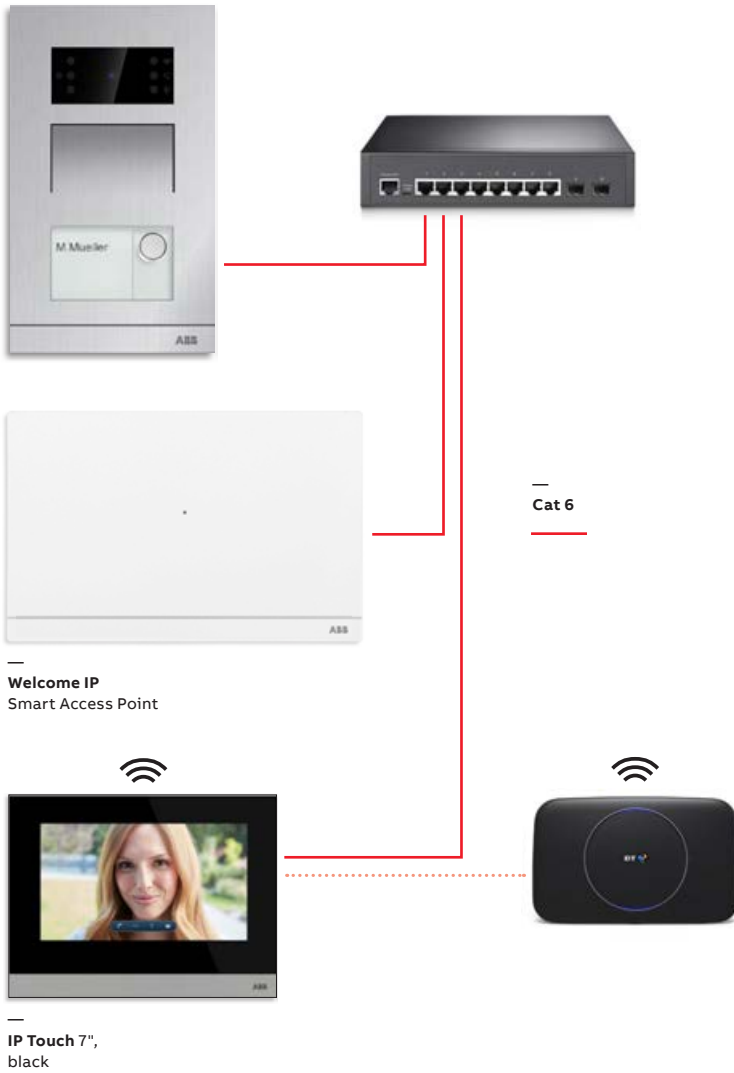

Welcome IP  
Smart Access Point

IP Touch 7",  
black

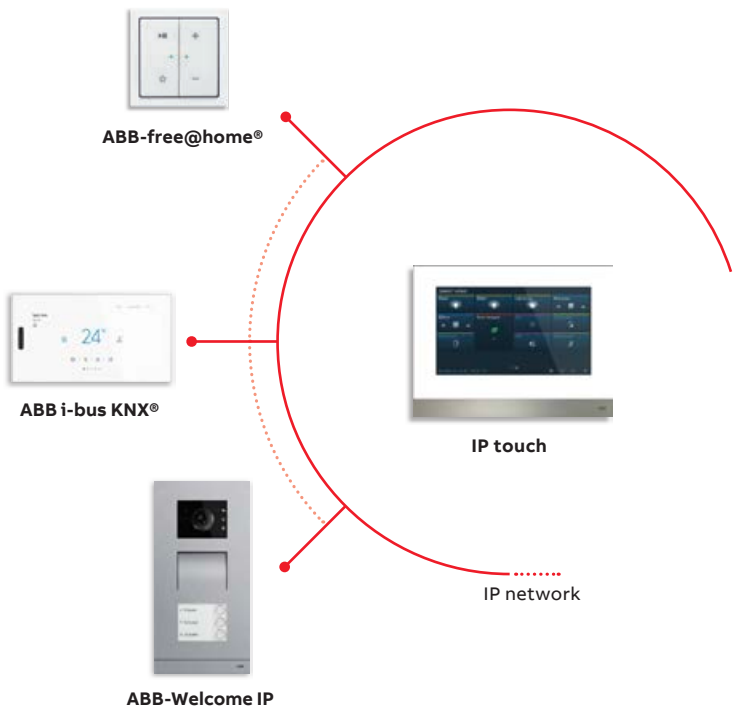

## One topology to suit all types of building

### Answer door calls away from home

Bring the door communication of your ABB Welcome IP system to your iOS or Android smart phone. Don't miss any visitor on your door anymore. With the ABB Welcome IP App all the calls from your outdoor station will be redirected to your smartphone or tablet.

### Example bill of materials

1. Outdoor Station (Aluminium finish) - 1-Call button (2TMA130010A0009)
2. Smart Access Point (2TMA400260W0008)
3. 7" Touch Screen (White) - LAN/LAN Communication (2TMA130050W0065)

## Control your lighting / heating / blinds and your door entry in one system

- Communicates directly to ABB's home automation system
- Communicates directly to ABB's commercial building automation system
- Can operate as a standalone system

## Touch screens to act as the central control



Touch screen control



22mm for 7"

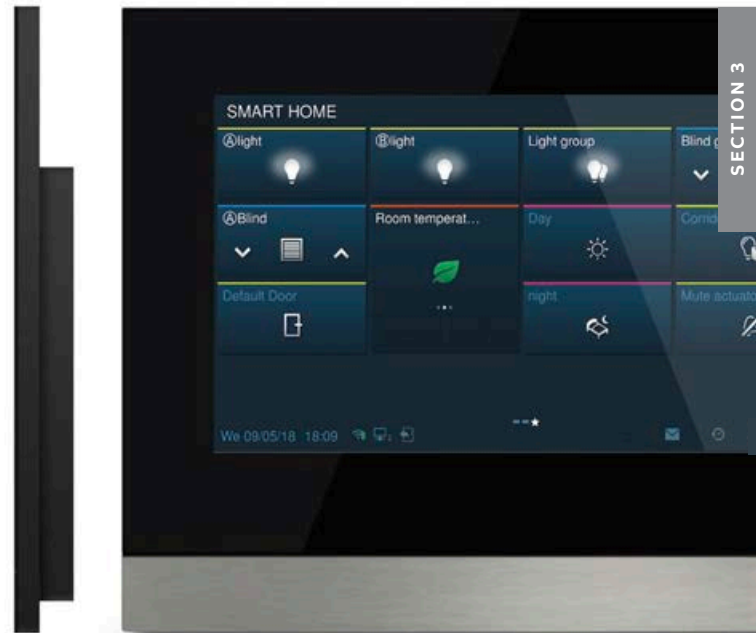

SECTION 3

### With high resolution display

- Intuitive GUI on sliding screen
- Selection of installation box options\* ensure easy installation on all kinds of walls
- Induction loop for hearing aid
- Only 7.8 mm depth when flush mounted
- Both LAN and Wi-Fi version to connect to home network

\*Available in 7" and 10" version in black or white finish.

01

01 IP Touch 7", white







For more detailed product information, please refer to our online technical brochures available at: [new.abb.com/low-voltage/support/documentation](https://new.abb.com/low-voltage/support/documentation)

or contact our sales team via email [LV.enquiries@gb.abb.com](mailto:LV.enquiries@gb.abb.com)

or call 0333 999 9933

# Terra AC wallbox

## To serve a growing market



### Reducing cost of EVs

EVs will be cheaper than internal combustion engine (ICE) alternatives by the mid-to-late 2020s in almost every market

### Global EV sales

Electric vehicles will represent 57% of global passenger car sales by 2040

### Passenger EV sales

Passenger EV sales will rise to 28 million in 2030 and 56 million by 2040

Terra AC wallbox provides tailored, intelligent and networked charging solutions for any business, home or location.

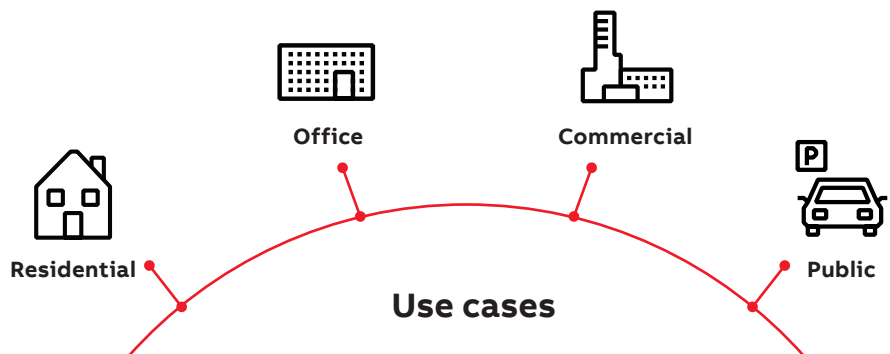

#### At home

From private homes to multi-tenant homes and residential communities

#### At work

From small offices to large offices, business parks and complexes

#### Commercial locations

From hotels to sports institutions and shopping centres

#### While parking

While on the street or in a car park



source: <https://about.bnef.com/electric-vehicle-outlook/#toc-viewreport>

# Smarter charging

## IEC portfolio

AC charger for electric vehicles, type 2

Power supply network: 220 ... 240 V single phase and 380 ... 415 V three phase, 50 / 60 Hz

	Rated power (kW)	Max. current (A)	Socket outlet or connector type	Other features	Type	Order Code	Weight Pkg (1pce) (kg)
	7.4	32	Socket, type 2	–	Terra AC W7-T-0	ABB6AGC081278	3
			Socket, type 2	RFID	Terra AC W7-T-R-0	ABB6AGC085382	3
			Socket, type 2	RFID, 4G	Terra AC W7-T-R-C-0	ABB6AGC085383	3
<b>Single phase with display and MID certification</b>							
	7.4	32	Socket, type 2	RFID, 4G, daisy-chain ethernet	Terra AC W7-T-RD-MC-0	ABB6AGC082174	3
	22	32	Socket, type 2	–	Terra AC W22-T-0	ABB6AGC081279	3
			Socket, type 2	RFID	Terra AC W22-T-R-0	ABB6AGC082152	3
			Socket, type 2	RFID, 4G	Terra AC W22-T-R-C-0	ABB6AGC082153	3
<b>Three phase with display and MID certification</b>							
	22	32	Socket, type 2	RFID, daisy-chain ethernet	Terra AC W22-T-RD-M-0	ABB6AGC081280	3
			Socket, type 2	RFID, 4G, daisy-chain ethernet	Terra AC W22-T-RD-MC-0	ABB6AGC081281	3

## Terra AC wallbox accessories

Description	Current (A)	Type	Order Code	Weight Pkg (1pce) (kg)
<b>Pedestal</b>				
For floor standing installation				
Metal pedestal for 1 charger, free-standing	–	TAC pedestal single	ABB6AGC085345	9.12
Metal pedestal for 2 chargers, back to back free-standing	–	TAC pedestal back to back	ABB6AGC085684	11
<b>RFID card (MIFARE)</b>				
RFID cards with ABB logo, pack of 5	–	SER-abbRFIDtags	ABB6AGC082175	0.07
RFID cards, blank, pack of 5	–	SER-blankRFIDtags	ABB6AGC082176	0.07
<b>Charge cables</b>				
Length: 7 m				
Cables with 2 connectors of same or different types				
<b>Single phase</b>				
Type 2 to type 2	32	TAC-cable T2-T2 7m1P32A	ABB6AGC082535	2.95
Type 2 to type 1	32	TAC-cable T2-T1 7m1P32A	ABB6AGC082539	3.77
<b>Three phase</b>				
Type 2 to type 2	32	TAC-cable T2-T2 7m3P32A	ABB6AGC082537	4.18
<b>Warranty</b>				
Total warranty time of 4 years (standard warranty 3 years + 1 years)		TAC extended warranty 4 yr	ABB6AGC084054	–
Total warranty time of 5 years (standard warranty 3 years + 2 years)		TAC extended warranty 5 yr	ABB6AGC084055	–



## Terra AC wallbox

### Technical specification

Product information	
Charging type	Mode 3 charging, level 2
Input/output power rating and current	IEC ratings: Single phase up to 7.4 kW / 32 A Three phase up to 22 kW / 32 A
Input/output voltage	UL ratings up to 7.7 kW / 32 A Single phase: 110 ... 240 V Three phase: 380 ... 415 V, 50 / 60 Hz
Network type	TT, TN
Socket outlet or connector type	Type 2 socket with or without shutter Type 1 or type 2 cable. Cable can be wrapped around the charger
Protection	Overcurrent, overvoltage, undervoltage, ground fault including DC residual current protection, integrated surge protection
Overvoltage category	III
Energy metering	Revenue grade energy meter Class B (+/- 1%) , MID certification on display variants only
Mobile communication with nano SIM socket	EU: GSM, 4G, LTE, WCDMA US: 4G, LTE, WCDMA
Available configurable contacts	1 input, 1 output
User interface	
Connectivity	Wifi, Ethernet (RJ45), Bluetooth, RS485, 4G / 3G
User authentication	ABB RFID card (1 included) or ChargerSync™ app and portal
User interface	TerraConfig app or portal for setup, ChargerSync™ app or portal for use
Communication protocols	OCPP 1.6 and RS485 for energy meter connection
Status indication	5 LED's
Configuration	
Software update	OCPP 1.6, ABB web portal or App
Control and configuration	ABB web portal or App
General characteristics	
IP and IK rating	IP54, IK10 (IK8+ for operating temperature from -35 to -30 °C)
NEMA enclosure type	NEMA 3
Operating altitude	2000 m
Operating temperature range	-35...+50 °C (derating may apply)
Storage temperature range	-40...+80 °C
Mounting	Wall or floor using a pedestal
Dimensions	H x W x D 320 x 195 x 110 mm H x W x D 12.60 x 7.68 x 4.33 inches
Certification and standards	
Safety standards	IEC/EN 61851-1, EN 62311, EN 62479, IEC/EN 62955 TuV listed conforming to UL 2594, UL 2231-1, UL 2231-2, UL 1998, CSA C22.2. NO.280
Codes and standards	IEC 61851-21-2, EN 61000-6-1, EN 61000-6-2, EN 61000-6-3, EN 61000-6-4, EN 61000-3-2, EN 61000-3-3, EN 61000-3-11, EN 61000-3-12 CE RED- WLAN / RFID / E-UTRA: EN 300 328 V2.1.1, EN 300 330 V2.1.1, EN 301 908-1 V11.1.2, EN 301 908-13 EN 50470-1, EN 50470-3 FCC Part 15 Class B ENERGY STAR
Certification	CE, CB, MID, UL
Warranty	36 months

## Smarter by design

### Fully compliant with UK smart charging legislation

- The ChargerSync app allows streamlined charger configuration
- Ready for integration with advanced smart building energy system
- Simple software updates via the App makes the charger future-ready

## With the user in mind

- Enables users to authenticate their charger via the App or RFID card. Configuration is easily done via the App or ABB web portal
- Sends charging status via the App
- Provides information about the status of chargers (availability, number of sessions, energy delivery)





---

# Residential distribution boards

<b>078</b>	<b>Protecta Home - Consumer units</b>
<b>080</b>	<b>MCB miniature circuit breakers</b>
<b>080</b>	<b>RCBO residential circuit breakers</b>
<b>081</b>	<b>Arc Fault Detection Devices (AFDD)</b>
<b>081</b>	<b>Accessories</b>



For more detailed product information, please refer to our online technical brochures available at:  
[new.abb.com/low-voltage/support/documentation](http://new.abb.com/low-voltage/support/documentation)

or contact our sales team via email [LV.enquiries@gb.abb.com](mailto:LV.enquiries@gb.abb.com)

or call 0333 999 9933



## Protecta Home - Consumer units

### Steel enclosures



#### Steel Enclosure to BS EN 61439-3

- Supplied factory fitted with switch disconnector and/or RCD, specification as table. Unit comes complete with shrouded busbar, earth and neutral bars and installation instructions
- Colour RAL7035 Steel
- Adaptable split load versions

#### Steel enclosure to BS EN 61439-3

Type	Description	Nominal dimensions (mm)				Order Code
		Mods	H	W	D	
Main Switch - 100A	Protecta Home CU MS 100A 2way	2	250	190	105	EPH-S10002
	Protecta Home CU MS 100A 4way	4	250	190	105	EPH-S10004
	Protecta Home CU MS 100A 8way	8	250	270	105	EPH-S10008
	Protecta Home CU MS 100A 10way	10	250	290	105	EPH-S10010
	Protecta Home CU MS 100A 12way	12	250	330	105	EPH-S10012
	Protecta Home CU MS 100A 16way	16	250	380	105	EPH-S10016
	Protecta Home CU MS 100A 20way	20	250	450	105	EPH-S10020
	Protecta Home CU MS 100A 22way	22	250	490	105	EPH-S10022
Main Switch - 63A	Protecta Home CU MS 63A 2way	2	250	190	105	EPH-S60002
	Protecta Home CU MS 63A 4way	4	250	190	105	EPH-S60004
	Protecta Home CU MS 63A 8way	8	250	270	105	EPH-S60008
	Protecta Home CU MS 63A 10way	10	250	290	105	EPH-S60010
	Protecta Home CU MS 63A 12way	12	250	330	105	EPH-S60012
	Protecta Home CU MS 63A 16way	16	250	380	105	EPH-S60016
	Protecta Home CU MS 63A 20way	20	250	450	105	EPH-S60020
	Protecta Home CU MS 63A 22way	22	250	490	105	EPH-S60022
RCCB Switch - 63A	Protecta Home CU RCCB 63A 2way	2	250	190	105	EPH-S66102
	Protecta Home CU RCCB 63A 4way	4	250	190	105	EPH-S66104
	Protecta Home CU RCCB 63A 8way	8	250	270	105	EPH-S66108
	Protecta Home CU RCCB 63A 10way	10	250	290	105	EPH-S66110
	Protecta Home CU RCCB 63A 12way	12	250	330	105	EPH-S66112
	Protecta Home CU RCCB 63A 16way	16	250	380	105	EPH-S66116
	Protecta Home CU RCCB 63A 20way	20	250	450	105	EPH-S66120
	Protecta Home CU RCCB 63A 22way	22	250	490	105	EPH-S66122
RCCB Switch - 100A	Protecta Home CU RCCB 100A 2way	2	250	190	105	EPH-S11102
	Protecta Home CU RCCB 100A 4way	4	250	190	105	EPH-S11104
	Protecta Home CU RCCB 100A 8way	8	250	270	105	EPH-S11108
	Protecta Home CU RCCB 100A 10way	10	250	290	105	EPH-S11110
	Protecta Home CU RCCB 100A 12way	12	250	330	105	EPH-S11112
	Protecta Home CU RCCB 100A 16way	16	250	380	105	EPH-S11116
	Protecta Home CU RCCB 100A 20way	20	250	450	105	EPH-S11120
	Protecta Home CU RCCB 100A 22way	22	250	490	105	EPH-S11122
Main Switch - 100A + 2 x 100A RCCB	Protecta Home CU SL 100A/100A 8way	8	250	330	105	EPH-S11208
	Protecta Home CU SL 100A/100A 12way	12	250	380	105	EPH-S11212
	Protecta Home CU SL 100A/100A 16way	16	250	450	105	EPH-S11216
	Protecta Home CU SL 100A/100A 18way	18	250	490	105	EPH-S11218

**Note:** RCCB Split Consumer units have a variable split arrangement.

## Protecta Home - Consumer units

### Steel enclosures

Type	Description	Nominal dimensions (mm)				Order Code
		Mods	H	W	D	
Main Switch - 63A + 2 x 63A RCCB	Protecta Home CU SL 63A/63A 8way	8	250	330	105	EPH-S66208
	Protecta Home CU SL 63A/63A 12way	12	250	380	105	EPH-S66212
	Protecta Home CU SL 63A/63A 16way	16	250	450	105	EPH-S66216
	Protecta Home CU SL 63A/63A 18way	18	250	490	105	EPH-S66218
Main Switch - 100A + 2 x 63A RCCB	Protecta Home CU SL 100A/63A 8way	8	250	330	105	EPH-S16208
	Protecta Home CU SL 100A/63A 12way	12	250	380	105	EPH-S16212
	Protecta Home CU SL 100A/63A 16way	16	250	450	105	EPH-S16216
	Protecta Home CU SL 100A/63A 18way	18	250	490	105	EPH-S16218
Main Switch - 100A + 1 x 80A RCCB + 1 x 63A RCCB	Protecta Home CU SL 100A/80A/63A 8way	8	250	330	105	EPH-S17208
	Protecta Home CU SL 100A/80A/63A 12way	12	250	380	105	EPH-S17212
	Protecta Home CU SL 100A/80A/63A 16way	16	250	450	105	EPH-S17216
	Protecta Home CU SL 100A/80A/63A 18way	18	250	490	105	EPH-S17218
Main Switch - 100A + 3x100A RCCB	Protecta Home CU SSL 100A 16way	16	250	490	105	EPH-S11316
	Protecta Home CU SSL 100A 20way	20	500	330	105	EPH-S11320
Main Switch - 63A + 3x63A RCCB	Protecta Home CU TSL 100A 16way	16	250	490	105	EPH-S66316
	Protecta Home CU TSL 100A 20way	20	500	330	105	EPH-S66320
Main Switch - 100A + 2 x 100A RCCB Split MCB/AFDD	Protecta Home CU AMSL 100A 8way	12	250	380	105	EPH-11244-AM
	Protecta Home CU AMSL 100A 12way	18	250	490	105	EPH-11266-AM
Main Switch - 63A + 2 x 63A RCCB Split MCB/AFDD	Protecta Home CU AMSL 63A 8way	12	250	380	105	EPH-66244-AM
	Protecta Home CU AMSL 63A 12way	18	250	490	105	EPH-66266-AM
Main Switch - 100A + 2 x 100A RCCB AFDD	Protect Home CU AFSL 100A 9way	18	250	490	105	EPH-S11209-AF
	Protect Home CU AFSL 100A 11way	22	500	330	105	EPH-S11211-AF
	Protect Home CU AFSL 100A 15way	30	500	380	105	EPH-S11215-AF
	Protect Home CU AFSL 100A 19way	38	500	450	105	EPH-S11219-AF
Main Switch - 63A + 2 x 63A RCCB AFDD	Protect Home CU AFSL 63A 9way	18	250	490	105	EPH-S66209-AF
	Protect Home CU AFSL 63A 11way	22	500	330	105	EPH-S66211-AF
	Protect Home CU AFSL 63A 15way	30	500	380	105	EPH-S66215-AF
	Protect Home CU AFSL 63A 19way	38	500	450	105	EPH-S66219-AF

Note: RCCB Split Consumer units have a variable split arrangement.

#### Add on kits

Type	Description	Nominal dimensions (mm)				Order Code
		Mods	H	W	D	
Add on kits	100A Direct Conn Pulse/Modbus Meter	2	N/A	N/A	N/A	EPH-METER1
	100A Direct Conn Pulse/Mbus Meter	2	N/A	N/A	N/A	EPH-METER2
	High Integrity Neutral x2 MCB/RCBO	N/A	N/A	N/A	N/A	EPH-H.I
	Surge Protection Type 2 6kA	2	N/A	N/A	N/A	EPH-SURGE



## Protecta Home - Consumer units

### Order Codes

#### SH201 MCBs - 1Pole

	Breaking capacity kA	Rating Amps	Type B Order Code	Type C Order Code
	6	6	SH201-B6	SH201-C6
	6	10	SH201-B10	SH201-C10
	6	16	SH201-B16	SH201-C16
	6	20	SH201-B20	SH201-C20
	6	25	SH201-B25	SH201-C25
	6	32	SH201-B32	SH201-C32
	6	40	SH201-B40	SH201-C40
	6	50	SH201-B50	SH201-C50
	6	63	SH201-B63	SH201-C63

#### DSE201 - Type A RCBO

	Breaking capacity kA	Rating Amps	Sensitivity	Type B Order Code	Type C Order Code
	6	6	30mA	DSE201-B6 A30	DSE201-C6 A30
	6	10	30mA	DSE201-B10 A30	DSE201-C10 A30
	6	16	30mA	DSE201-B16 A30	DSE201-C16 A30
	6	20	30mA	DSE201-B20 A30	DSE201-C20 A30
	6	25	30mA	DSE201-B25 A30	DSE201-C25 A30
	6	32	30mA	DSE201-B32 A30	DSE201-C32 A30
	6	40	30mA	DSE201-B40 A30	DSE201-C40 A30
	6	50	30mA	DSE201-B50 A30	DSE201-C50 A30

#### SH202 MCBs - 2 Pole - To be used with AFDD Consumer Units

	Breaking capacity kA	Rating Amps	Type B Order Code	Type C Order Code
	6	6	SH202-B6	SH202-C6
	6	10	SH202-B10	SH202-C10
	6	16	SH202-B16	SH202-C16
	6	20	SH202-B20	SH202-C20
	6	25	SH202-B25	SH202-C25
	6	32	SH202-B32	SH202-C32
	6	40	SH202-B40	SH202-C40
	6	50	SH202-B50	SH202-C50
	6	63	SH202-B63	SH202-C63

## Protecta Home - Consumer units

### Order Codes

#### S-ARC1, 6 kA

Number of poles	Characteristics	Rated current	Bbn	Ordering details	Weight	Pkg	Order Code
		$I_n$ A	8012542 EAN	Type	1 pcs kg	qty pce	
1P+N	B	6	750130	S-ARC1 B6	0.180	1	2CSA255901R9065
		10	178132	S-ARC1 B10	0.180	1	2CSA255901R9105
		13	750031	S-ARC1 B13	0.180	1	2CSA255901R9135
		16	178033	S-ARC1 B16	0.180	1	2CSA255901R9165
		20	749936	S-ARC1 B20	0.180	1	2CSA255901R9205
		25	341116	S-ARC1 B25	0.180	1	2CSA255901R9255
		32	341017	S-ARC1 B32	0.180	1	2CSA255901R9325
1P+N	C	40	340812	S-ARC1 B40	0.180	1	2CSA255901R9405
		6	177937	S-ARC1 C6	0.180	1	2CSA255901R9064
		10	749837	S-ARC1 C10	0.180	1	2CSA255901R9104
		13	500735	S-ARC1 C13	0.180	1	2CSA255901R9134
		16	886136	S-ARC1 C16	0.180	1	2CSA255901R9164
		20	175438	S-ARC1 C20	0.180	1	2CSA255901R9204
		25	374114	S-ARC1 C25	0.180	1	2CSA255901R9254
		32	374015	S-ARC1 C32	0.180	1	2CSA255901R9324
		40	373919	S-ARC1 C40	0.180	1	2CSA255901R9404

#### DS-ARC1, 6 kA

Number of poles	Rated residual current $I_{\Delta n}$ mA	Charac-teristics	Rated current	Bbn	Ordering details	Weight	Pkg	Order Code
			$I_n$ A	8012542 EAN	Type	1 pcs kg	qty pce	
1P+N	30	B	6	736516	DS-ARC1 B6 A30	0.240	1	2CSA255103R1065
			10	735618	DS-ARC1 B10 A30	0.240	1	2CSA255103R1105
			13	736417	DS-ARC1 B13 A30	0.240	1	2CSA255103R1135
			16	735519	DS-ARC1 B16 A30	0.240	1	2CSA255103R1165
			20	736318	DS-ARC1 B20 A30	0.240	1	2CSA255103R1205
1P+N	30	C	6	736110	DS-ARC1 C6 A30	0.240	1	2CSA255103R1064
			10	735212	DS-ARC1 C10 A30	0.240	1	2CSA255103R1104
			13	748311	DS-ARC1 C13 A30	0.240	1	2CSA255103R1134
			16	611110	DS-ARC1 C16 A30	0.240	1	2CSA255103R1164
			20	735113	DS-ARC1 C20 A30	0.240	1	2CSA255103R1204

#### Accessories

Description	Order Code
MCB padlock adaptor 3mm hasp	SA1
Padlock with 2 keys	SA2
Spare 19 Module Busbar	PS 1/19/30
MCB Blank module RAL7035	EPP-BP1
Blanking Plate 12 Mod	SZ-BP1
Insulating Cover for Busbar 5pcs	SZ-BSK



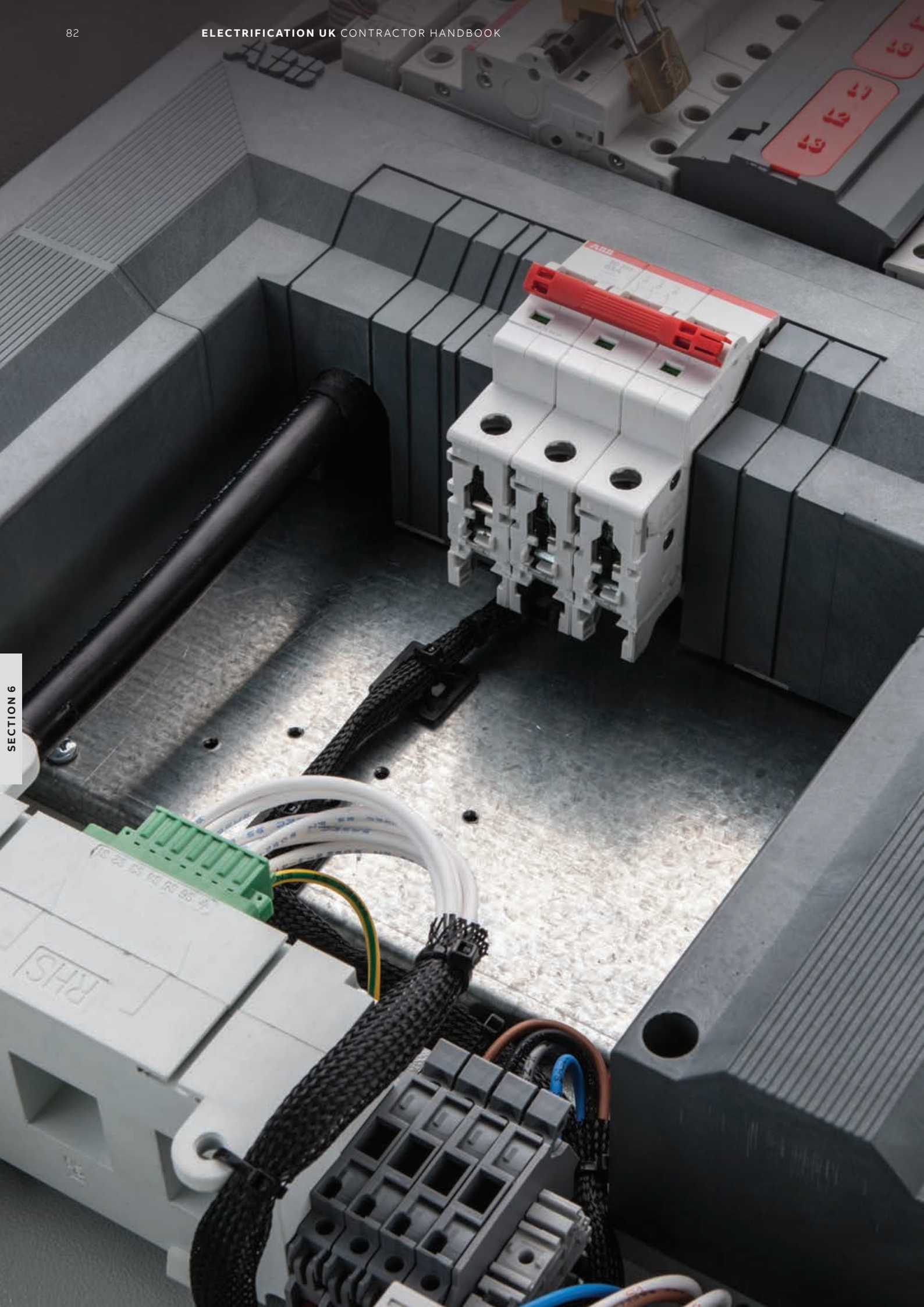

---

# Commercial distribution boards

<b>084</b>	<b>Protecta Plus distribution boards</b>
<b>098</b>	<b>MCB miniature circuit breakers</b>
<b>100</b>	<b>RCBO residential circuit breakers</b>
<b>102</b>	<b>Arc Fault Detection Devices (AFDD)</b>
<b>103</b>	<b>RCCB F200 series residual current circuit breakers</b>
<b>104</b>	<b>Metering</b>
<b>106</b>	<b>ESB installation contactors</b>
<b>111</b>	<b>DBT Timer digital time switches</b>
<b>113</b>	<b>T Line modular twilight switches</b>
<b>115</b>	<b>Modular sockets</b>



For more detailed product information, please refer to our online technical brochures available at:  
[new.abb.com/low-voltage/support/documentation](http://new.abb.com/low-voltage/support/documentation)

or contact our sales team via email [LV.enquiries@gb.abb.com](mailto:LV.enquiries@gb.abb.com)

or call 0333 999 9933



# Protecta Plus

## General features of the series

With the Protecta Plus system, ABB has developed a new and versatile series of MCB distribution boards which can be expanded over time. The wide internal accessibility ensures a quick and easy approach to the electrical components assembly. The neutral and earth bars positioned on the inner sides of the distribution board are completely isolated to ensure better safety for users.

### Main construction features

- Structure in epoxy coated metal sheets, 1 mm, textured finish
- Wall installation for indoor environments
- Degree of protection - IP43 with door, IP30 without door
- Mechanical resistance: IK07
- Busbar rating: 250A
- Number of ways: 4, 8, 12, 16, 20, 24
- Maximum ambient temperature +35 °C
- Compliance with IEC BS EN 61439 1-2
- Simple wiring of all cabinets, both horizontally and vertically
- Easy internal accessibility that facilitates all the wiring operations and maintenance
- Prepackaged standardised kits for specific applications (e.g. surge protection, metering)

### A comprehensive range

The range consists of distribution boards for wall mounting in six heights from 590 mm to 1360mm, 450 mm width and depth starting from 125 mm, ensuring the development of multiple solutions. Protecta Plus system is easy to design, quick to assemble and reliable to apply.

### Ease of wiring

With the new mounting concept, Protecta Plus offers great levels of flexibility and accessibility for installation and wiring. The internal module can be easily removed allowing the wiring of different equipment outside the distribution board. This solution allows for an easier installation with more rapid production times.

### Maximum accessibility

Thanks to the particularly large opening angle of the door, Protecta Plus offers the possibility to have optimal access to the distribution board, especially in case of maintenance. The reversible doors can be installed with right or left opening.



A series of rational solutions developed to achieve a complete range of capabilities and functions with a single type of distribution board to meet different installation requirements, whilst simplifying the work of the installer.

**Simplified series connection**

The distribution boards can be combined side-by-side through pre-cut cable conduit holes large enough for the passage of wiring harnesses.

**Range**

depth: 125 mm;  
width: 450 mm;  
6 heights: 590, 730, 870, 1050, 1220, 1360 mm.

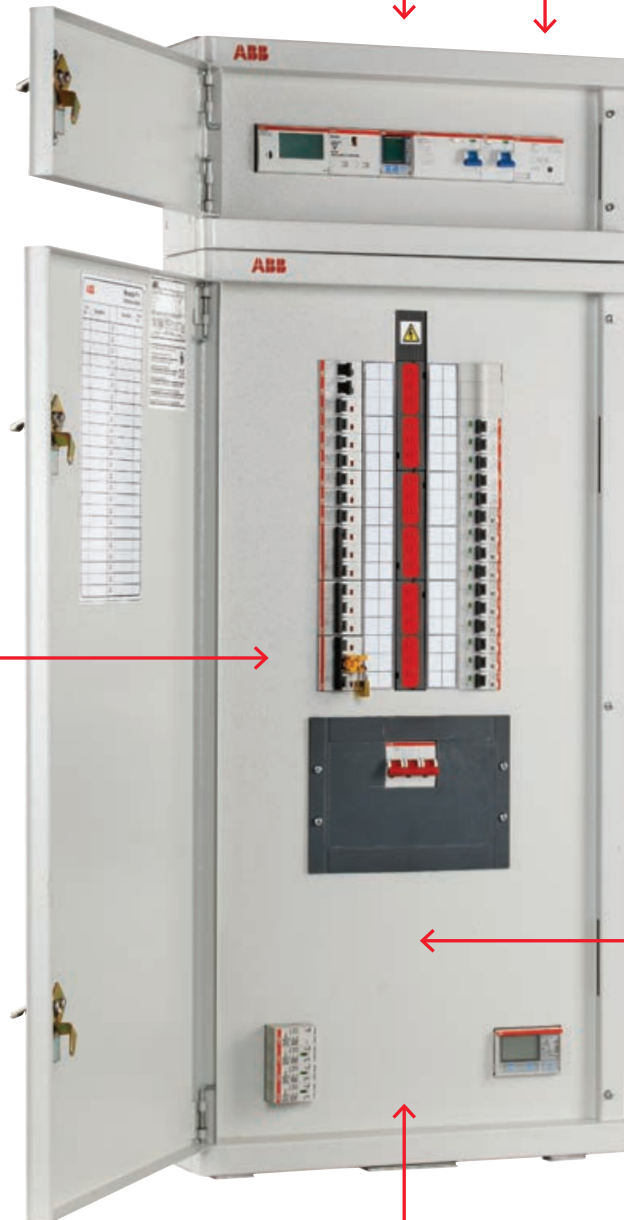

**Ergonomics and design**

The design of this series is characterised by special features, such as rounded edges for a more efficient ergonomic look.

**High output capacity**

Primary branch capacity up to 100A.

**Complete protection**

Designed to ensure maximum protection and efficiency, through the provision for the installation of surge protection devices.

**Flexible mounting**

The PAN assembly system can easily be removed from the bottom distribution board.

# Protecta Plus

## The details make the difference

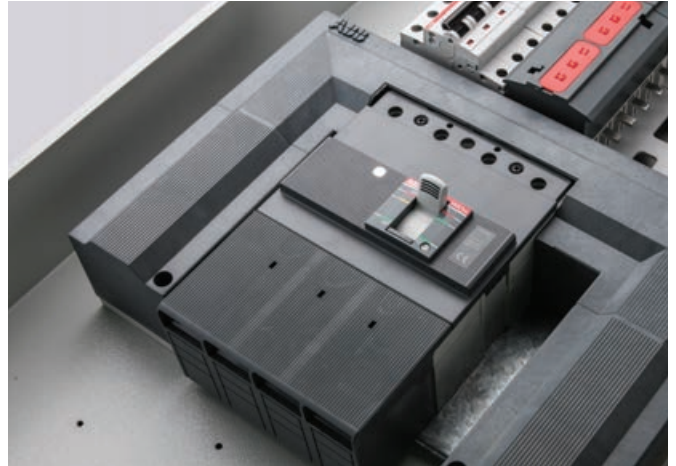

### Board width

Protecta Plus has been designed with a width of 450 mm, this combined with the reduced RCBO height of 115 mm gives the installer ample cable room either side of the board.

### One Solution

All Protecta Plus boards come as standard with 250A main bars. This gives the user a full range from 125A 3P through to 250A 4P incoming options.

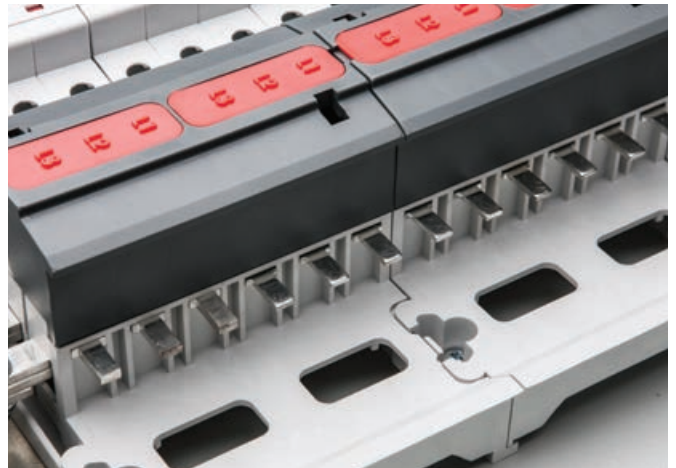
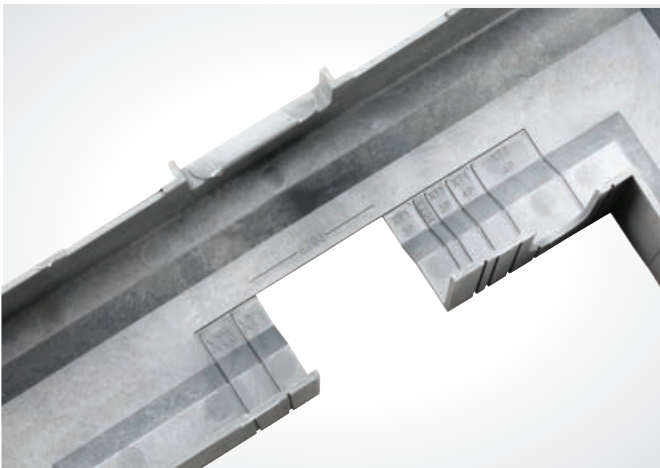

### Incoming shroud

The shroud comes ready to accept a 125A 3P incoming devices. The easy break technology and clear indication on the rear allows the user to modify the shroud dependant upon requirements up to 250A 4P.

### 100A Outgoing ways

The first two 3P outgoing ways are fitted with 3 mm branch copper to allow for 100A MCBs to be fitted. This allows for a maximum of **2 x 100A 3P** or **6 x 100A 1P** MCBs per board removing the need to move up to high performance boards or panel boards.



**Full MCB blank**

To aid installation and safety a custom MCB blank has been developed specifically for Protecta Plus.



**Clean earth**

Earth bars are fitted with removable links allowing the boards to be configured for 50/100% clean earth.

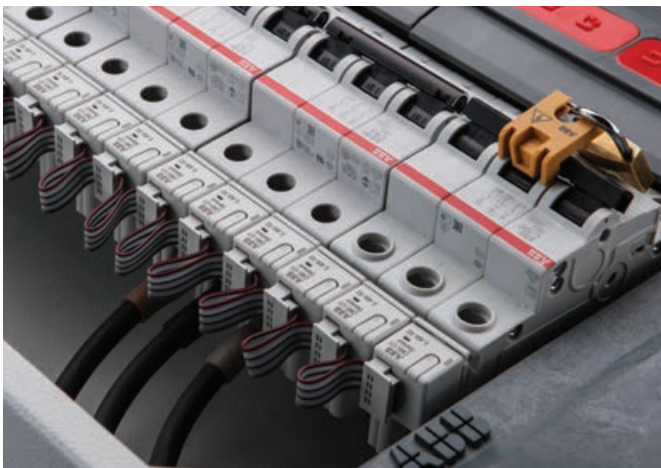

**Padlocking facilities**

All outgoing devices on Protecta Plus can be padlocked in on/off position for increased safety.

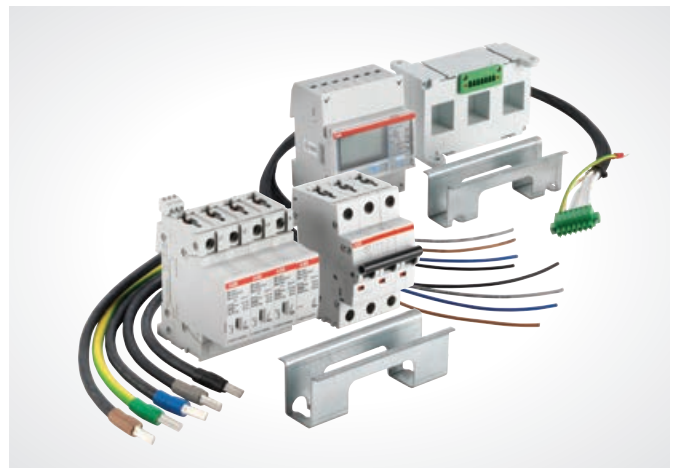

**Metering and surge protection**

Available in kit form to fit all Protecta Plus TPN boards. The boards have been designed to house these integrally.



# Protecta Plus

## Order process



Protecta Plus DB



Vertical split-load board



Horizontal split-load board



Incoming kit



2 x Distribution boards

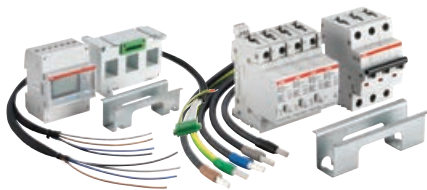

Meter/surge kits (optional)



Surge kits (optional)

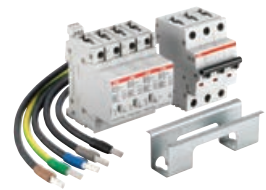

Surge kits (optional)



MCB/RCBO/Blanks



Accessories



## Protecta Plus

### Order Codes



**Pack contents: Type A Distribution board**

- Distribution board
- Factory fitted 100A switch disconnecter
- RAL7035 textured finish

**MCB Distribution board - Type A**

Description	Dimensions (mm) H x W x D	Order Code
Protecta Plus DB 2way SP, inc 100A isolator	250 x 190 x 125	EPP-W102
Protecta Plus DB 4way SP, inc 100A isolator	250 x 190 x 125	EPP-W104
Protecta Plus DB 8way SP, inc 100A isolator	250 x 260 x 125	EPP-W108
Protecta Plus DB 12way SP, inc 100A isolator	250 x 330 x 125	EPP-W112
Protecta Plus DB 16way SP, inc 100A isolator	250 x 400 x 125	EPP-W116
Protecta Plus DB 20way SP, inc 100A isolator	250 x 470 x 125	EPP-W120



**Pack contents**

- Enclosure
- Factory fitted 100A switch disconnecter
- 2x MID, Modbus ( RS485 ) & pulse meters

**MCB Distribution board - Type A Split Metered**

Description	No. of outgoing ways	Dimensions (mm) H x W x D	Order Code
Single Phase Power & Lighting 14+12	14+12 SP	590 x 450 x 125	EPP-SSL1412-1002P
Single Phase Power & Lighting 6+6	6+6 SP	250 x 470 x 125	EPP-SSL66-1002P

\* M-Bus available on request.

## Protecta Plus

### Order Codes



#### Pack contents: Type B Distribution board

- 250A Busbar
- RAL7035 textured finish
- Door Closing Latch

#### MCB distribution board - Type B

Description	Dimensions (mm) H x W x D	Order Code
Protecta Plus DB 4 Way 250A - TPN	590 x 450 x 125	EPP-W304
Protecta Plus DB 8 Way 250A - TPN	730 x 450 x 125	EPP-W308
Protecta Plus DB 12 Way 250A - TPN	870 x 450 x 125	EPP-W312
Protecta Plus DB 16 Way 250A - TPN	1050 x 450 x 125	EPP-W316
Protecta Plus DB 20 Way 250A - TPN	1220 x 450 x 125	EPP-W320
Protecta Plus DB 24 Way 250A - TPN	1360 x 450 x 125	EPP-W324



#### Pack contents: Horizontal split load kit

- 2 x MID, Modbus ( RS485 ) & Pulse Meters
- Associated CTs
- Incoming isolators
- Internal cables
- **Requires 2 x MCB distribution board - Type B**

Please note as these kits allow for 4 to 24way boards cutting and crimping of cables is required.

#### Horizontal split load kit

Description	Dimensions (mm) H x W x D	Order Code
125A 3P Horizontal split load kit - 2 x Meters	400 x 900 x 125	EPP-HSL-1253P
125A 4P Horizontal split load kit - 2 x Meters	400 x 900 x 125	EPP-HSL-1254P
160A 3P Horizontal split load kit - 2 x Meters	400 x 900 x 125	EPP-HSL-1603P
160A 4P Horizontal split load kit - 2 x Meters	400 x 900 x 125	EPP-HSL-1604P
250A 3P Horizontal split load kit - 2 x Meters	600 x 900 x 125	EPP-HSL-2503P
250A 4P Horizontal split load kit - 2 x Meters	600 x 900 x 125	EPP-HSL-2504P

# Protecta Plus

## Order Codes



### Pack contents: Incoming kit

- Copper connection kit and fittings
- Incoming device
- Cover plate
- Instruction leaflet

### Standard Cable Capacity:

125A Isolator	50mm <sup>2</sup>
160A Isolator	70mm <sup>2</sup>
250A Isolator	95mm <sup>2</sup>

See MCCB Accessories for extended terminals for larger cable requirements on page 97.

### Incoming connection kit

Description	Rating (A)	No. of Poles	Order Code
125A 3P Switch Incoming Kit	125	TP	EPP-1253P
125A 4P Switch Incoming Kit	125	TPSN	EPP-1254P
160A 3P Switch Incoming Kit XT1	160	TP	EPP-1603P
160A 4P Switch Incoming Kit XT1	160	TPSN	EPP-1604P
250A 3P Switch Incoming Kit XT3	250	TP	EPP-2503P
250A 4P Switch Incoming Kit XT3	250	TPSN	EPP-2504P
125A 3P MCCB 36kA Th/Mag Inc Kit XT1	125	TP	EPP-1253PMCCB
125A 4P MCCB 36kA Th/Mag Inc Kit XT1	125	TPSN	EPP-1254PMCCB
160A 3P MCCB 36kA Th/Mag Inc Kit XT1	160	TP	EPP-1603PMCCB
160A 4P MCCB 36kA Th/Mag Inc Kit XT1	160	TPSN	EPP-1604PMCCB
250A 3P MCCB 36kA Th/Mag Inc Kit XT3	250	TP	EPP-2503PMCCB
250A 4P MCCB 36kA Th/Mag Inc Kit XT3	250	TPSN	EPP-2504PMCCB
100A 4P RCD Incoming Kit (to be ordered with RCCB Rating below)	100	TPSN	EPP-KIT-RCD
F200 A type RCCB - 30mA	100	TPSN	F204A-100/0.03
F200 A type RCCB - 100mA	100	TPSN	F204A-100/0.1
F200 A type RCCB - 300mA	100	TPSN	F204A-100/0.3
F200 A type RCCB - 300mA (time delay)	100	TPSN	F204AS-100/0.3
125A Single Phase Kit ( to be used with EPP-1254P)	125	SPSN	EPP-KIT-1251P
250A Single Phase Kit ( to be used with EPP-2504P)	250	SPSN	EPP-KIT-2501P
250A Direct Connection Kit	250	TP	EPP-KIT-DIRECT
EPP-ATS125 125A OTM-C21D (Std. 50mm2)	125	TP	EPP-ATS125
<b>MCCB Accessories</b>			
160A XT1 3P Front Extended Terminals (EF) - Set of 3			1SDA066865R1
160A XT1 4P Front Extended Terminals (EF) - Set of 4			1SDA066866R1
250A XT3 3P Front Extended Terminals (EF) - Set of 3			1SDA066873R1
250A XT3 4P Front Extended Terminals (EF) - Set of 4			1SDA066874R1

## Protecta Plus

### Order Codes



#### Pack contents: Vertical split load boards

- 1x Isolator
- Meters are MID, Modbus (RS485) & pulse output
- Associated CTs
- Incoming terminals
- Internal cables
- **Units supplied with Main Isolator & meters pre-configured to internal C.T sizing**
- Outgoing devices to be ordered separately

#### Standard Cable Capacity:

125A Isolator	50mm <sup>2</sup>
160A Isolator	70mm <sup>2</sup>
250A Isolator	95mm <sup>2</sup>

See MCCB Accessories for extended terminals for larger cable requirements.

#### Vertical Split Load Distribution Boards

Rating of Main Isolator	No. of outgoing ways (TPN) Split variants	No. of meters	Dimensions mm (H x W x D)	Order Code
125A TPN	8 + 4	2	1090 x 450 x 125	EPP-VSL84-1253P
125A TPN	8 + 8	2	1270 x 450 x 125	EPP-VSL88-1253P
125A TPN	12 + 8	2	1440 x 450 x 125	EPP-VSL128-1253P
125A TPN	12 + 12	2	1580 x 450 x 125	EPP-VSL1212-1253P
125A TPN	16 + 8	2	1580 x 450 x 125	EPP-VSL168-1253P
125A TPN	8 + 4 + 4	3	1380 x 450 x 125	EPP-VSL844-1253P
125A TPN	12 + 8 + 4	3	1690 x 450 x 125	EPP-VSL1284-1253P
160A TPN	8 + 4	2	1090 x 450 x 125	EPP-VSL84-1603P
160A TPN	8 + 8	2	1270 x 450 x 125	EPP-VSL88-1603P
160A TPN	12 + 8	2	1440 x 450 x 125	EPP-VSL128-1603P
160A TPN	12 + 12	2	1580 x 450 x 125	EPP-VSL1212-1603P
160A TPN	16 + 8	2	1580 x 450 x 125	EPP-VSL168-1603P
160A TPN	8 + 4 + 4	3	1380 x 450 x 125	EPP-VSL844-1603P
160A TPN	12 + 8 + 4	3	1690 x 450 x 125	EPP-VSL1284-1603P
250A TPN	8 + 4	2	1090 x 450 x 125	EPP-VSL84-2503P
250A TPN	8 + 8	2	1270 x 450 x 125	EPP-VSL88-2503P
250A TPN	12 + 8	2	1440 x 450 x 125	EPP-VSL128-2503P
250A TPN	12 + 12	2	1580 x 450 x 125	EPP-VSL1212-2503P
250A TPN	16 + 8	2	1580 x 450 x 125	EPP-VSL168-2503P
250A TPN	8 + 4 + 4	3	1380 x 450 x 125	EPP-VSL844-2503P
250A TPN	12 + 8 + 4	3	1690 x 450 x 125	EPP-VSL1284-2503P

\* 4pole variants available - change end part code to 4P.

\* Please ensure RCBO lead lengths are considered for top section of DBs (12+12, 16+8, 8+4+4 & 12+8+4).



## Protecta Plus

### Order Codes

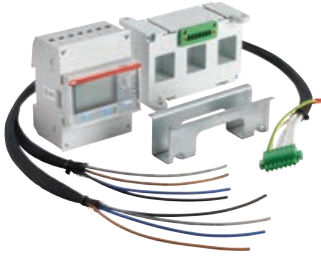

**Pack contents: Incoming metering**

- 1 x Meter
- 1 x C.T Block
- 1 x Wiring Loom & DIN support
- Instruction leaflet

Please note as these kits allow for 4 to 24way boards cutting and crimping of cables is required.

**Incoming metering**

Description	Order Code
100A MID Incoming Meter c/w Pulse & RS485 to be used with Type A DBs only - Direct Connection	EPP-METMOD100SPN
125A MID Approved c/w pulse output	EPP-METMOD125A
125A MID Approved c/w pulse output & Modbus ( RS485 )	EPP-METMOD125B
125A MID Approved c/w pulse output, Modbus ( RS485 ) Imp / Exp	EPP-METMOD125C
160A MID Approved c/w pulse output	EPP-METMOD160A
160A MID Approved c/w pulse output & Modbus ( RS485 )	EPP-METMOD160B
160A MID Approved c/w pulse output, Modbus ( RS485 ) Imp / Exp	EPP-METMOD160C
250A MID Approved c/w pulse output	EPP-METMOD250A
250A MID Approved c/w pulse output & Modbus ( RS485 )	EPP-METMOD250B
250A MID Approved c/w pulse output, Modbus ( RS485 ) Imp / Exp	EPP-METMOD250C

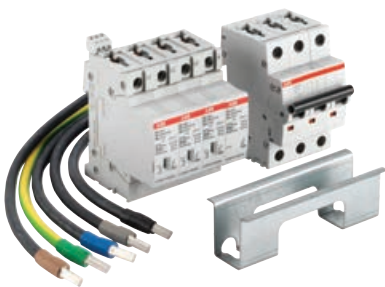

**Pack contents: Surge protection**

- 1 x Surge unit
- 1 x MCB
- 1 x Wiring Loom & DIN support
- Instruction leaflet

Please note as these kits allow for 4 to 24way boards cutting and crimping of cables is required.

**Surge protection**

Description	No. of Poles	Order Code
Type 2 Surge Protection - including 63A 1P MCB	SPN	EPP-FURSE-SPN
Type 1+2 surge protection - including 63A 3P MCB	TPN	EPP-SOULET1-2
Type 2+3 surge protection - including 63A 3P MCB	TPN	EPP-SOULE

## Protecta Plus

### Circuit Monitoring System - CMS Order Codes



#### Pack contents: Top / Bottom Extension - Control Unit

- 1x Control unit
- 1x Incoming CTs & fuses
- 1 x 5m Ribbon Cable
- 1x pack of (35pcs) sensor connectors
- RJ45 connection

- The CMS consists of a control unit and sensors, allowing easy monitoring of the individual circuits
- Control unit which manages up to 96 sensors
- Support of several communication protocols: Modbus RTU, Modbus TCP/IP, SNMP v1/v2 and v3 encrypted
- Easy access for data collection (online and historical values) and quick data export provided by the integrated web server
- Notification of alarms via e-mail and FTP server

#### Top / Bottom Extension - Control Unit

Description	Dimensions (mm) H x W x D	Order Code
CMS Distribution Board Incomer / Outgoing Control Unit (125A)	200 x 450 x 125	EPP-CMS125
CMS Distribution Board Incomer / Outgoing Control Unit (160A)	200 x 450 x 125	EPP-CMS160
CMS Distribution Board Incomer / Outgoing Control Unit (250A)	200 x 450 x 125	EPP-CMS250

#### Open core sensors Open-core sensors 18 mm

Description	Order Code
80A (MCBs)	CMS-120PS
40A (MCBs)	CMS-121PS
20A (MCBs)	CMS-122PS

#### Open core sensors Open-core sensors 18 mm for DIN rail mounting (universally usable)

Description	Order Code
80A (RCBOs)	CMS-120DR
40A (RCBOs)	CMS-121DR
20A (RCBOs)	CMS-122DR

## Accessories

Description	Order code
Cable 5m	CMS-802
Sensor connectors ( 35pcs )	CMS-820

## Protecta Plus

### Order Codes



**Pack contents: Contactor control**

- 3P contactor
- Control circuit & fuse protection
- Instruction leaflet

**Contactor Control**

Description	Dimensions (mm) H x W x D	Order Code
125A AC1 rated 3P Contactor	400 x 450 x 250	EPP-CON125
160A AC1 rated 3P Contactor	400 x 450 x 250	EPP-CON160
250A AC1 rated 3P Contactor	400 x 450 x 250	EPP-CON250



**Pack contents: Top extension boxes**

- Fixings
- DIN rail / mounting plate
- RAL7035 textured finish

**Extension boxes**

Type	No. of modules	Dimensions (mm) H x W x D	Order Code
Hinged door with 1 DIN rail	16	200 x 450 x 130	EPP-R1016
Hinged door with 2 DIN rail	32	400 x 450 x 130	EPP-R2032
Plain extension box 200mm		200 x 450 x 130	EPP-EB20
Plain extension box 400mm		400 x 450 x 130	EPP-EB40

## Protecta Plus

### Order Codes



#### Pack contents: Row type boards

- Fixings
- DIN rail / mounting plate
- RAL7035 textured finish

#### Row type extension boxes

No. of modules	No. of rows	Sided width	Dimensions (mm) H x W x D	Order Code
36	2	4way DB	590 x 450 x 125	EPP-R2036
54	3	8way DB	730 x 450 x 125	EPP-R3054
72	4	12way DB	870 x 450 x 125	EPP-R4072
90	5	16way DB	1050 x 450 x 125	EPP-R5090
108	6	20way DB	1220 x 450 x 125	EPP-R6108
126	7	24way DB	1360 x 450 x 125	EPP-R7126

#### Additional N/PE for side extension boxes

Description	Order Code
Protecta Plus - Row Type N-Bar 9	EPP-N-09
Protecta Plus - Row Type N-Bar 13	EPP-N-13
Protecta Plus - Row Type N-Bar 17	EPP-N-17
Protecta Plus - Row Type N-Bar 21	EPP-N-21
Protecta Plus - Row Type E-Bar 9	EPP-PE-09
Protecta Plus - Row Type E-Bar 13	EPP-PE-13
Protecta Plus - Row Type E-Bar 17	EPP-PE-17
Protecta Plus - Row Type E-Bar 21	EPP-PE-21

#### Terminal cover

Description	Order Code
Protecta Plus - Top Shroud	EPP-TC
Protecta Plus Mains TS - 4 Way	EPP-MTCO4
Protecta Plus Mains TS - 8 Way	EPP-MTCO8
Protecta Plus Mains TS - 12 Way	EPP-MTC12
Protecta Plus Mains TS - 16 Way	EPP-MTC16
Protecta Plus Mains TS - 20 Way	EPP-MTC20
Protecta Plus Mains TS - 24 Way	EPP-MTC24



## Protecta Plus

### Order Codes

#### Labels for outgoing circuits

	No. of ways	Order Code
	4	EPP-LKIT-04
	8	EPP-LKIT-08
	12	EPP-LKIT-12
	16	EPP-LKIT-16
	24	EPP-LKIT-24

#### Replacement doors

Description	Order Code
Protecta Plus Solid Door - 4 ways / 2 rows	EPP-ST-04
Protecta Plus Solid Door - 8 ways / 3 rows	EPP-ST-08
Protecta Plus Solid Door - 12 ways / 4 rows	EPP-ST-12
Protecta Plus Solid Door - 16 ways / 4 rows	EPP-ST-16
Protecta Plus Solid Door - 20 ways / 5 rows	EPP-ST-20
Protecta Plus Solid Door - 24 ways / 6 rows	EPP-ST-24

## MCCB Accessories

	Description	Order Code
	MCB Blank	EPP-E91
	Blanking Strip 12 Mods	SZ-BP1
	Inner Isolator Terminal Shroud	EPP-ITS
	Top Mount TPN DB Earth Bar	EPP-DME
	Lock and Key	EPP-LK KEY
	Side by Side Connection Kit	EPP-KIT JOIN
	MCB Padlock Adaptor	SA 1
	MCB Padlock C/W 2 X Keys	SA 2
	DB / Trunking adaptor	EPP-TRADT
	Protecta Plus - Glandplate Plain	EPP-GP-B



## MCB - S 200 M series

### Order Codes

#### S 200 series M B

	Rated current in A	Rated current in kA		Order Code
		IEC/EN 60898-1 IEC/EN 60947-2		
			1 Pole	3 Pole
	6	10kA/15kA	S201M-B6	S203M-B6
	10	10kA/15kA	S201M-B10	S203M-B10
	13	10kA/15kA	S201M-B13	S203M-B13
	16	10kA/15kA	S201M-B16	S203M-B16
	20	10kA/15kA	S201M-B20	S203M-B20
	25	10kA/15kA	S201M-B25	S203M-B25
	32	10kA/15kA	S201M-B32	S203M-B32
	40	10kA/15kA	S201M-B40	S203M-B40
	50	10kA/15kA	S201M-B50	S203M-B50
	63	10kA/15kA	S201M-B63	S203M-B63
	80	6kA	S201-B80	S203-B80
	100	6kA	S201-B100	S203-B100

#### S 200 series M C

	Rated current in A	Rated current in kA		Order Code
		IEC/EN 60898-1 IEC/EN 60947-2		
			1 Pole	3 Pole
	6	10kA/15kA	S201M-C6	S203M-C6
	10	10kA/15kA	S201M-C10	S203M-C10
	13	10kA/15kA	S201M-C13	S203M-C13
	16	10kA/15kA	S201M-C16	S203M-C16
	20	10kA/15kA	S201M-C20	S203M-C20
	25	10kA/15kA	S201M-C25	S203M-C25
	32	10kA/15kA	S201M-C32	S203M-C32
	40	10kA/15kA	S201M-C40	S203M-C40
	50	10kA/15kA	S201M-C50	S203M-C50
	63	10kA/15kA	S201M-C63	S203M-C63
	80	6kA	S201-C80	S203-C80
	100	6kA	S201-C100	S203-C100

#### S 200 series M D

	Rated current in A	Rated current in kA		Order Code
		IEC/EN 60898-1 IEC/EN 60947-2		
			1 Pole	3 Pole
	6	10kA/15kA	S201M-D6	S203M-D6
	10	10kA/15kA	S201M-D10	S203M-D10
	13	10kA/15kA	S201M-D13	S203M-D13
	16	10kA/15kA	S201M-D16	S203M-D16
	20	10kA/15kA	S201M-D20	S203M-D20
	25	10kA/15kA	S201M-D25	S203M-D25
	32	10kA/15kA	S201M-D32	S203M-D32
	40	10kA/15kA	S201M-D40	S203M-D40
	50	10kA/15kA	S201M-D50	S203M-D50
	63	10kA/15kA	S201M-D63	S203M-D63

## MCB - S 300 P series

### Order Codes

#### S 300 series P B

	Rated current in A	Rated current in kA		Order Code
		IEC/EN 60898-1		
		IEC/EN 60947-2	1 Pole	
	6	25kA	S301P-B6	S303P-B6
	10	25kA	S301P-B10	S303P-B10
	13	25kA	S301P-B13	S303P-B13
	16	25kA	S301P-B16	S303P-B16
	20	25kA	S301P-B20	S303P-B20
	25	25kA	S301P-B25	S303P-B25
	32	25kA	S301P-B32	S303P-B32
	40	25kA	S301P-B40	S303P-B40
	50	25kA	S301P-B50	S303P-B50
	63	25kA	S301P-B63	S303P-B63

#### S 300 series P C

	Rated current in A	Rated current in kA		Order Code
		IEC/EN 60898-1		
		IEC/EN 60947-2	1 Pole	
	6	25kA	S301P-C6	S303P-C6
	10	25kA	S301P-C10	S303P-C10
	13	25kA	S301P-C13	S303P-C13
	16	25kA	S301P-C16	S303P-C16
	20	25kA	S301P-C20	S303P-C20
	25	25kA	S301P-C25	S303P-C25
	32	25kA	S301P-C32	S303P-C32
	40	25kA	S301P-C40	S303P-C40
	50	25kA	S301P-C50	S303P-C50
	63	25kA	S301P-C63	S303P-C63

#### S 300 series P D

	Rated current in A	Rated current in kA		Order Code
		IEC/EN 60898-1		
		IEC/EN 60947-2	1 Pole	
	6	25kA	S301P-D6	S303P-D6
	10	25kA	S301P-D10	S303P-D10
	13	25kA	S301P-D13	S303P-D13
	16	25kA	S301P-D16	S303P-D16
	20	25kA	S301P-D20	S303P-D20
	25	25kA	S301P-D25	S303P-D25
	32	25kA	S301P-D32	S303P-D32
	40	25kA	S301P-D40	S303P-D40
	50	25kA	S301P-D50	S303P-D50
	63	25kA	S301P-D63	S303P-D63

# RCBO DSE201 M - Type A

## Order Codes

### DSE201 M - Type A



Rated residual current $I_{\Delta n}$ [mA]	Rated current in A	Rated current in kA		Order Code	
				B Characteristic	C Characteristic
10	6	10kA/15kA		DSE201 M B6 A10	DSE201 M C6 A10
	10	10kA/15kA		DSE201 M B10 A10	DSE201 M C10 A10
	16	10kA/15kA		DSE201 M B16 A10	DSE201 M C16 A10
	20	10kA/15kA		DSE201 M B20 A10	DSE201 M C20 A10
	25	10kA/15kA		DSE201 M B25 A10	DSE201 M C25 A10
	32	10kA/15kA		DSE201 M B32 A10	DSE201 M C32 A10
	40	10kA/15kA		DSE201 M B40 A10	DSE201 M C40 A10
	50	10kA		DSE201 M B50 A10	DSE201 M C50 A10
30	6	10kA/15kA		DSE201 M B6 A30	DSE201 M C6 A30
	10	10kA/15kA		DSE201 M B10 A30	DSE201 M C10 A30
	16	10kA/15kA		DSE201 M B16 A30	DSE201 M C16 A30
	20	10kA/15kA		DSE201 M B20 A30	DSE201 M C20 A30
	25	10kA/15kA		DSE201 M B25 A30	DSE201 M C25 A30
	32	10kA/15kA		DSE201 M B32 A30	DSE201 M C32 A30
	40	10kA/15kA		DSE201 M B40 A30	DSE201 M C40 A30
	50	10kA		DSE201 M B50 A30	DSE201 M C50 A30
100	6	10kA/15kA			DSE201 M C6 A100
	10	10kA/15kA			DSE201 M C10 A100
	16	10kA/15kA			DSE201 M C16 A100
	20	10kA/15kA			DSE201 M C20 A100
	25	10kA/15kA			DSE201 M C25 A100
	32	10kA/15kA			DSE201 M C32 A100
	40	10kA/15kA			DSE201 M C40 A100
	50	10kA			DSE201 M C50 A100
300	6	10kA/15kA			DSE201 M C6 A300
	10	10kA/15kA			DSE201 M C10 A300
	16	10kA/15kA			DSE201 M C16 A300
	20	10kA/15kA			DSE201 M C20 A300
	25	10kA/15kA			DSE201 M C25 A300
	32	10kA/15kA			DSE201 M C32 A300
	40	10kA/15kA			DSE201 M C40 A300
	50	10kA			DSE201 M C50 A300

## RCBO DSE203N M

### Order Codes



#### DSE203N M: 3P+N eRCBO

**Function:** protection and control of the circuits against overloads and short-circuits; protection against the effects of sinusoidal alternating and direct pulsating earth fault currents; protection against indirect contact and additional protection against direct contact ( $I_{\Delta n} = 30 \text{ mA}$ ). The neutral is unswitched. Voltage dependent RCBO.

**Applications:** residential, commercial, industrial

**Standard:** IEC 61009-1; IEC 61009-2-2; AS/NZS 61009.1

Alternative Sensitivity of 10mA,100mA and 300mA are available on request

#### DSE203N M: 3P+N eRCBO

N. Poles	Breaking capacity	Type	Sensitivity $I_{\Delta n}$ mA	Tripping Char.	Rated Current $I_n$ A	Order Code	
3+N	10 kA	A	30	B	6	DSE203N M B6 A30	
					10	DSE203N M B10 A30	
					13	DSE203N M B13 A30	
					16	DSE203N M B16 A30	
					20	DSE203N M B20 A30	
					25	DSE203N M B25 A30	
					32	DSE203N M B32 A30	
					40	DSE203N M B40 A30	
					50	DSE203N M B50 A30	
					63	DSE203N M B63 A30	
					C	6	DSE203N M C6 A30
						10	DSE203N M C10 A30
				13		DSE203N M C13 A30	
				16		DSE203N M C16 A30	
				20		DSE203N M C20 A30	
				25		DSE203N M C25 A30	
				32		DSE203N M C32 A30	
				40		DSE203N M C40 A30	
				50		DSE203N M C50 A30	
				63		DSE203N M C63 A30	

## S-ARC1 M, 10 kA & DS-ARC1 M

### Order Codes

#### S-ARC1 M, 10 kA - MCB + AFDD ( 2module)

	Number of poles	Rated residual current $I_{\Delta n}$ mA	Characteristics	Rated current	
				$I_n$ A	Order Code
	1P+N	30	B	6	S-ARC1 M B6
				10	S-ARC1 M B10
				13	S-ARC1 M B13
				16	S-ARC1 M B16
				20	S-ARC1 M B20
				25	S-ARC1 M B25
				32	S-ARC1 M B32
				40	S-ARC1 M B40
1P+N	30	C	6	S-ARC1 M C6	
			10	S-ARC1 M C10	
			13	S-ARC1 M C13	
			16	S-ARC1 M C16	
			20	S-ARC1 M C20	
			25	S-ARC1 M C25	
			32	S-ARC1 M C32	
			40	S-ARC1 M C40	

#### DS-ARC1 M, 10 kA - RCBO + AFDD ( 3module)

	Number of poles	Rated residual current $I_{\Delta n}$ mA	Characteristics	Rated current				
				$I_n$ A	Order Code			
	1P+N	30	B	6	DS-ARC1 M B6 A30			
				10	DS-ARC1 M B10 A30			
				13	DS-ARC1 M B13 A30			
				16	DS-ARC1 M B16 A30			
				20	DS-ARC1 M B20 A30			
				1P+N	30	C	6	DS-ARC1 M C6 A30
							10	DS-ARC1 M C10 A30
							13	DS-ARC1 M C13 A30
16	DS-ARC1 M C16 A30							
				20	DS-ARC1 M C20 A30			



## RCCB F 200 series A type

### Order Codes

#### F 200 A type - F202



Number of poles	Rated residual current I <sub>Δn</sub> [mA]	Rated current in A	Order Code	
2	10	16	F202A-16/0.01	
		25	F202A-25/0.01	
		25	F202A-25/0.03	
		40	F202A-40/0.03	
		63	F202A-63/0.03	
		80	F202A-80/0.03	
	100	100	F202A-100/0.03	
		25	25	F202A-25/0.1
			40	F202A-40/0.1
			63	F202A-63/0.1
			80	F202A-80/0.1
			100	F202A-100/0.1
300	25		25	F202A-25/0.3
		40	F202A-40/0.3	
		63	F202A-63/0.3	
		80	F202A-80/0.3	
		100	F202A-100/0.3	
		500	25	25
40	F202A-40/0.5			
63	F202A-63/0.5			
80	F202A-80/0.5			
100	F202A-100/0.5			

#### F 200 A type - F204



Number of poles	Rated residual current I <sub>Δn</sub> [mA]	Rated current in A	Order Code	
4	30	25	F204A-25/0.03	
		40	F204A-40/0.03	
		63	F204A-63/0.03	
		80	F204A-80/0.03	
		100	F204A-100/0.03	
		100	25	25
	40			F204A-40/0.1
	63			F204A-63/0.1
	80			F204A-80/0.1
	100			F204A-100/0.1
	300			25
		40	F204A-40/0.3	
63		F204A-63/0.3		
80		F204A-80/0.3		
100		F204A-100/0.3		
500		25	25	
	40		F204A-40/0.5	
	63		F204A-63/0.5	
	80		F204A-80/0.5	
	100		F204A-100/0.5	

## Metering EQ series - direct connection

### Order Codes

#### A series - A41

80A SPN 4mod	Description	Order Code
	Pulse output	A41 111 - 100
	Pulse output, RS-485	A41 112 - 100
	Pulse output, M-Bus	A41 113 - 100
	2 output, 2 input, RS-485	A41 312 - 100
	2 output, 2 input, M-Bus	A41 313 - 100

#### A series - A43

80A TPN 7mod	Description	Order Code
	Pulse output	A43 111 - 100
	Pulse output, RS-485	A43 112 - 100
	Pulse output, M-Bus	A43 113 - 100
	2 output, 2 input, RS-485	A43 312 - 100
	2 output, 2 input, M-Bus	A43 313 - 100

#### B series - B21

65A SPN 2mod	Description	Order Code
	Pulse output	B21 111 - 100
	Pulse output, RS-485	B21 112 - 100
	Pulse output, M-Bus	B21 113 - 100
	2 output, 2 input, RS-485	B21 312 - 100
	2 output, 2 input, M-Bus	B21 313 - 100

#### B series - B23

65A TPN 4mod	Description	Order Code
	Pulse output	B23 111 - 100
	Pulse output, RS-485	B23 112 - 100
	Pulse output, M-Bus	B23 113 - 100
	2 output, 2 input, RS-485	B23 312 - 100
	2 output, 2 input, M-Bus	B23 313 - 100

---

## Metering C series - Direct connection

### Order Codes

---

#### C series - C11

40A SPN 1Mod	Description	Order Code
	Pulse output	C11 110-101

---

#### C series - C13

40A TPN 3 Mod	Description	Order Code
	Pulse output	C13 110-101

## ESB installation contactors

### Order Codes



ESB20..N

1SBCT01052V0000

The ESB20..N installation contactors are used to control single-phase loads up to 20 A and can be operated by AC or DC voltages. These contactors are made for use in household applications as well as in industrial environment.

ESB20..N series is providing the following benefits:

- Hum-free operation, low power consumption and integrated overvoltage protection.
- Various contact combinations and accessories are available.

#### ESB20..N installation contactors - 20 A, AC-1 /AC-7a, AC/DC operated

Main contacts	Width in number of modular spacings	Rated control circuit voltage <sup>(1)</sup> VAC/DC	Pkg qty	Weight (1 pc.) kg	Type	Order Code
<b>Single packaging</b>						
	1	24	1	0.14	ESB20-20N-01	1SBE121111R0120
	1	230	1	0.14	ESB20-20N-06	1SBE121111R0620
	1	24	1	0.14	ESB20-02N-01	1SBE121111R0102
	1	230	1	0.14	ESB20-02N-06	1SBE121111R0602
	1	24	1	0.14	ESB20-11N-01	1SBE121111R0111
	1	230	1	0.14	ESB20-11N-06	1SBE121111R0611

<sup>(1)</sup> Other control voltages: see voltage code table and contact ABB for availability of products.

# ESB installation contactors

## Order Codes



ESB25..N

2CDC22100V00017

The ESB25..N installation contactors are used to control single and three-phases loads up to 25 A and can be operated by AC or DC voltages. These contactors are made for use in household applications as well as in industrial environment. ESB25..N series is providing the following benefits:

- Hum-free operation, low power consumption and integrated overvoltage protection.
- Various contact combinations and accessories are available.

### ESB25..N installation contactors - 25 A, AC-1/AC-7a, AC/DC operated

Main contacts	Width in number of modular spacings	Rated control circuit voltage <sup>(1)</sup> VAC/DC	Pkg qty	Weight (1 pc.) kg	Type	Order Code
<b>Single packaging</b>						
	2	24	1	0.245	ESB25-40N-01	1SAE231111R0140
		230 ... 240	1	0.235	ESB25-40N-06	1SAE231111R0640
	2	24	1	0.245	ESB25-04N-01	1SAE231111R0104
		230 ... 240	1	0.235	ESB25-04N-06	1SAE231111R0604
	2	24	1	0.245	ESB25-22N-01	1SAE231111R0122
		230 ... 240	1	0.235	ESB25-22N-06	1SAE231111R0622
	2	24	1	0.245	ESB25-31N-01	1SAE231111R0131
		230 ... 240	1	0.235	ESB25-31N-06	1SAE231111R0631
	2	24	1	0.245	ESB25-13N-01	1SAE231111R0113
		230 ... 240	1	0.235	ESB25-13N-06	1SAE231111R0613

<sup>(1)</sup> Other control voltages: see voltage code table and contact ABB for availability of products.



## ESB installation contactors

### Order Codes



ZCDC22108V0007

ESB40..N

The ESB40..N installation contactors are used to control single and three-phases loads up to 40 A and can be operated by AC or DC voltages. These contactors are made for use in household applications as well as in industrial environment. ESB40..N series is providing the following benefits:

- Hum-free operation, low power consumption and integrated overvoltage protection.
- Various contact combinations and accessories are available.

#### ESB40..N installation contactors - 40 A, AC-1/AC-7a, AC/DC operated

Main contacts	Width in number of modular spacings	Rated control circuit voltage <sup>(1)</sup> VAC/DC	Pkg qty	Weight (1 pc.) kg	Type	Order Code
<b>Single packaging</b>						
	3	24	1	0.405	ESB40-40N-01	1SAE341111R0140
		230	1	0.405	ESB40-40N-06	1SAE341111R0640
	3	24	1	0.405	ESB40-22N-01	1SAE341111R0122
		230	1	0.405	ESB40-22N-06	1SAE341111R0622
	3	24	1	0.405	ESB40-31N-01	1SAE341111R0131
		230	1	0.405	ESB40-31N-06	1SAE341111R0631
	3	24	1	0.385	ESB40-30N-01	1SAE341111R0130
		230	1	0.385	ESB40-30N-06	1SAE341111R0630
	3	24	1	0.370	ESB40-20N-01	1SAE341111R0120
		230	1	0.370	ESB40-20N-06	1SAE341111R0620

<sup>(1)</sup> Other control voltages: see voltage code table and contact ABB for availability of products.

# ESB installation contactors

## Order Codes



2CDC221009V0017

ESB63..N

The ESB63..N installation contactors are used to control single and three-phases loads up to 63 A and can be operated by AC or DC voltages. These contactors are made for use in household applications as well as in industrial environment. ESB63..N series is providing the following benefits:

- Hum-free operation, low power consumption and integrated overvoltage protection.
- Various contact combinations and accessories are available.

**ESB63..N installation contactors - 63 A, AC-1/AC-7a, AC/DC operated**

Main contacts	Width in number of modular spacings	Rated control circuit voltage <sup>(1)</sup> VAC/DC	Pkg qty	Weight (1 pc.) kg	Type	Order Code
<b>Single packaging</b>						
	3	24	1	0.405	ESB63-40N-01	1SAE351111R0140
		230	1	0.405	ESB63-40N-06	1SAE351111R0640
	3	230	1	0.405	ESB63-31N-06	1SAE351111R0631
	3	230	1	0.385	ESB63-30N-06	1SAE351111R0630
	3	24	1	0.37	ESB63-20N-01	1SAE351111R0120
		230	1	0.37	ESB63-20N-06	1SAE351111R0620

<sup>(1)</sup> Other control voltages: see voltage code table and contact ABB for availability of products.

## ESB installation contactors

### Order Codes



ESB100-20N

2CD22100V0017



ESB100-40N

2CD22101V0017

The ESB100..N installation contactors are used to control single and three-phases loads up to 100 A and can be operated by AC or DC voltages.

These contactors are made for use in household applications as well as in industrial environment. ESB100..N series is providing the following benefits:

- Hum-free operation, low power consumption and integrated overvoltage protection.
- Various contact combinations and accessories are available.

#### ESB100..N installation contactors - 100 A, AC-1/AC-7a, AC/DC operated

Main contacts	Width in number of modular spacings	Rated control circuit voltage <sup>(1)</sup> VAC/DC	Pkg qty	Weight (1 pc.) kg	Type	Order Code
<b>Single packaging</b>						
	6	24	1	0.810	ESB100-40N-01	1SAE661111R0140
		230	1	0.810	ESB100-40N-06	1SAE661111R0640
	3	24	1	0.405	ESB100-20N-01	1SAE361111R0120
		230	1	0.405	ESB100-20N-06	1SAE361111R0620

<sup>(1)</sup> Other control voltages: see voltage code table and contact ABB for availability of products.

## DBT Timer digital time switches

### Order Codes



DY365

#### DBT Timer digital time switches

The unique design, with white backlight LCD display, and extreme ease of use with only four buttons, make DBT Timer ideal to automate the installation functions. The possibility to configure all digital devices via DBT Timer APP and Bluetooth connection makes the configuration and installation time even shorter. DBT Timer digital time switches are equipped with large capacity internal battery to maintain operation without power supply in order to avoid the risk of program loss and to maintain the time settings in case of power failure, respective of its duration. DBT Timer digital time switches are equipped with various functions such as the impulse, cycle, random and holiday function.

#### Digital yearly time switch - DY365

DY365 is the digital yearly time switch with 2 channels from DBT Timer range. Thanks to the two extension channel units DY365 4CE and DY365 2CE, DY365 is able to control up to 8 channels. DY365 can be coupled with DY GPS antenna to allow synchronization received from the Global Positioning System or with DY DCF77 antenna that allows an automatic synchronization of the digital time switch with the Frankfurt DCF77 time signal.



DW1

#### Digital weekly time switch - DW

DW1 and DW2 are weekly digital time switches with 1 and 2 channels, respectively. They allow exclusion of the normal weekly program in every week with the same mode.



DWA1

#### Digital weekly astronomical time switch - DWA

The astronomical switches DWA1 and DWA2, respectively, with 1 and 2 channels, automatically control lighting circuits depending on the time of sunrise and sunset, greatly increasing energy efficiency. The programming is in fact based on a mathematical algorithm able to calculate the time of the rising and setting of the sun in a certain location for each day of the year. Once powered the device, simply insert date, time, geographical coordinates and time zone so that it is ready to work. These settings can also be automatically defined using the DBT Timer APP. The installation of astronomical digital time switches is particularly useful when using a twilight switch with external sensor is not recommended because it may be subject to malfunctions caused by air pollution, excessive brightness or vandalism. DWA1 and DWA2 are also indicated for the control of public lighting, shop windows of shops, neon signs, monuments, facades, illuminated fountains, ...



DWTL1

#### Digital weekly twilight time switch - DWTL1

DWTL1 is digital time switch with astronomical function and external luminosity probe DWS indicated for the management of the lighting system, luminous signs. Digital weekly twilight switch with 1 channel allows the exclusion of the weekly programming. DWTL1 can be configured as astronomical with probe switch which initial configuration requires the activation of the load from sunset to sunrise and during the daytime hours in case of low light. Also, it can be used as programmable twilight switch in which activation of the load occurs when the probe detects a low light condition in case that daily or weekly programming requires it.

Version	Order details		Weight	Pack
	Type code	Order code	1 piece	unit
			kg	pc.
Yearly time switch, 2 channels	DY365	2CSM221201R1000	0.250	1
Weekly time switch, 1 channel	DW1	2CSM222531R1000	0.129	1
Weekly time switch, 2 channels	DW2	2CSM222521R1000	0.152	1
Weekly astronomical time switch, 1 channel	DWA1	2CSM222511R1000	0.129	1
Weekly astronomical time switch, 2 channels	DWA2	2CSM222501R1000	0.152	1
Weekly twilight time switch, 1 channel	DWTL1	2CSM222491R1000	0.160	1

## DBT Timer digital time switches

### Order Codes



DY DCF77



DY GPS



DY365 2CE



DY365 4CE



DWS

#### Accessories for DBT Timer digital time switches

The DY365 2CE and DY365 4CE are extension channel units with 2 and 4 outputs relays. They are respectively coupled to the DY365 in order to expand number of contacts managed from 2 to maximum 8.

DY DCF77 antenna, used in conjunction with the device, enables it to be automatically synchronized with the official DCF77 Frankfurt time signal, broadcast via long wave radio. DY GPS antenna is available to ensure good coverage around the world in any weather condition. This antenna uses the synchronization from the Global Positioning System and provides more precise values than terrestrial transmissions.

DWS is external probe for light intensity which is coupled with digital weekly twilight switch, DWTL1.

Version	Order details		Weight	Pack
	Type code	Order code	1 piece	unit
			kg	pc.
DCF77 antenna	DY DCF77	2CSM250421R1000	0.100	1
GPS antenna	DY GPS	2CSM250411R1000	0.080	1
2 channel extension	DY365 2CE	2CSM221191R1000	0.185	1
4 channel extension	DY365 4CE	2CSM221181R1000	0.486	1
DWS external sensor	DWS	2CSM222481R1000	0.021	1



## TL Line twilight switches

### Order Codes



TL1

#### TL Line modular twilight switches

TL1 twilight switch allows to switch ON and switch OFF lighting devices according to a scheduled level of the ambient light. It is used in combination with an external sensor to detect if the ambient light is higher or lower than the set level . A switching delay prevents them from operating unnecessarily when the light intensity suddenly changes (e.g. lightning, moving vehicles, etc.). The TL1 twilight switch 1 channel is preset with a 10 LUX from factory and it is equipped with 2 signalling LEDs that indicate the setpoint value and display the status of the contact . The operating instructions are printed on the side of the product.

Brightness range	Order details		Weight	Pack
	Type code	Order code	1 piece	unit
lx			kg	pc.
2:200	TL1	2CSM229921R1341	0.155	1



TLs

#### Accessories for TL Line modular twilight switches

The external sensor TLs is supplied in the same package of the switch, TL1, but it's also available separately as spare part. The upper part of the external case (with screw locking), made up of thermoplastic material, bears up against ultraviolet rays to guarantee an homogeneous diffusion of the daylight internally. The sensor is also equipped with a cable gland.

	Order details		Weight	Pack
	Type code	Order code	1 piece	unit
External sensor	TLs	2CSM229931R1341	0.008	1

## TL Line twilight switches

### Order Codes



TL1 Pole

Technical features		
		TL1 POLE
Rated supply voltage	[V]	110 ÷ 230 AC
Contact type		1NO polarized
Incandescent lamps $\cos\phi$ 1	[W]	1000
Fluorescent lamps $\cos\phi$ 0.8	[W]	300
Fluorescent- duo/electronic lamps	[W]	300
LED lamps	[W]	100
Rated frequency	[Hz]	50/60
Switching delay ON	[s]	25+ -10%
Switching delay OFF	[s]	35+ -10%
Brightness range (with tolerance of $\pm 20\%$ )	[lx]	2...200
Protection degree twilight switch		IP54
Protection degree sensor		IP54
Operating temperature twilight switch	[°C]	-40...+70
Operating temperature sensor	[°C]	-40...+70
Storage temperature twilight switch	[°C]	-50...+80
Storage temperature sensor	[°C]	-50...+80
Power consumption	[W]	0.25 W $\cos\phi$ 0.35 (idle) 0.8 W $\cos\phi$ 0.4 (active)
Max terminal cross section	[mm <sup>2</sup> ]	6
Terminals		loss-proof screw
Screw Type		PZ1
Tightening torque: terminals	[Nm]	1.2
screw sensor	[Nm]	1.2
Mounting		Pole/wall mounted
Switching status indication/ brightness range		red/green LEDs
Max wiring length		100
Modules		
Reference standards		EN 60669-1 EN 60662-2-1 EN60730-1

### TL1 Pole mounting twilight switch

The TL1 Pole version is designed for installation on the pole/wall, with photocell inputs and integrated cabling including cable gland seals to ensure a high protection degree. Thanks also to the high quality, TL1 Pole provides excellent resistance to atmospheric agents and a long service life. TL1 Pole is also internally equipped with a preset sensor of 10 LUX. The sensor is extractable from the base and allows an easy and efficient maintenance without needing further wiring. TL1 Pole is the ideal solution to manage the external light systems such as the public ones, more precisely, in cases where there is a need of controlling the lighting of public or private roads, gardens, courtyards at the decline of solar radiation during twilight.

Brightness range	Order details		Weight 1 piece	Pack unit
	Type code	Order code		
lx			kg	pc.
2:200	TL1 Pole	2CSM229911R1341	0.135	1

## Modular sockets

### Order Codes

#### British standard modular sockets

				Order details	
	Colour	Modules	Type	Order Code	
	Grey	3	M1363	2CSM259343R0721	
	Grey with light	3	M1363-L	2CSM258163R0721	



## E 90 fuse switch disconnectors

### Order Codes

E 90 series fuse switch disconnectors are designed for switching circuits under load, providing protection against short circuits and overloads. The case is made of self-extinguishing thermoplastic material resistant to high temperatures (all materials are UL listed) while the contact clips are in silver plated copper. E 90 fuse switch disconnectors can be sealed or

padlocked to ensure operator safety during maintenance. Versions with blown fuse indicator allow to check whether the fuse is still working correctly or not. For easy and quick installation E 90 range is totally compatible with connecting bars, terminals and caps of S 200 MCBs. Thanks to cURus approval, they can be installed in UL certified machines.

#### E 90 fuse switch disconnectors for 10.3 x 38 mm fuses (AC-22B)

				Order details	
	Number of poles	Rated current In	Modules	Type	Order Code
	1	32	1	E 91/32	2CSM200923R1801
	1	32	1	E 91/32s	2CSM202483R1801
	3	32	3	E 93/32	2CSM204753R1801
	3	32	3	E 93/32s	2CSM202063R1801
					

s: version with blown fuse indicator light.  
Fuses not included.



SECTION 7

---

# Commercial panelboards

<b>118</b>	<b>Protecta Power</b>
<b>123</b>	<b>400A Panelboard &amp; Incoming Devices</b>
<b>125</b>	<b>800A Panelboard &amp; Incoming Devices</b>
<b>127</b>	<b>Protecta Power outgoing MCCBs</b>
<b>134</b>	<b>MCCB Accessories</b>
<b>135</b>	<b>Protecta Power Side Cableways</b>
<b>136</b>	<b>Protecta Power Metering</b>
<b>137</b>	<b>Protecta Power Surge</b>
<b>138</b>	<b>Protecta Power Accessories</b>



For more detailed product information, please refer to our online technical brochures available at: [new.abb.com/low-voltage/support/documentation](https://new.abb.com/low-voltage/support/documentation)

or contact our sales team via email [LV.enquiries@gb.abb.com](mailto:LV.enquiries@gb.abb.com)

or call 0333 999 9933



# Protecta Power

## General features of the series

Protecta Power is a versatile solution that can be seamlessly installed in a wide range of applications. With its reliable and safe power distribution, it provides exceptional performance and a peace of mind in any environment.

### Applications

- Commercial Buildings
- Mixed Residential/Multi-Dwelling
- Industrial / Transportation
- Institutional Buildings

### Main construction features

- Structure in epoxy coated metal sheets, 1.5 mm, textured finish
- Busbar rating: 800A
- Short Circuit Withstand 50kA for 1s
- RAL 7035
- Form 3b type 2 as standard
- Form 4 type 2 & 6 Group mounted with 4 pole incoming breaker and individual dis-connectable neutral links adjacent to 3P outgoing breakers or utilisation of 4 pole breakers. Outgoing terminals shrouds should be used.
- Wall / Free standing installation for indoor environments
- Degree of protection - IP43 with door, IP30 without door
- Mechanical resistance: IK07
- Busbar rating: 800A
- Number of ways: 8, 12, 18
- Maximum ambient temperature +35 °C
- Compliance with IEC BS EN 61439 1-2
- Simple wiring of all cabinets, both horizontally and vertically
- Easy internal accessibility that facilitates all the wiring operations and maintenance
- Prepackaged standardized kits for specific applications (e.g. surge protection, metering)

### Flexible Outgoing

allows to mix various Tmax XT breakers up to 630A providing a customizable and adaptable solution for power distribution, allowing installer to easily adjust and modify the system as their needs change.

### Pluggable Breaker

convenient and efficient solution enabling quick and easy installation and replacement of breakers without the need for special tools or equipment leading to time saving and costs reduction

### Generous Wiring Space

allows for easy installation and maintenance, providing ample room for cables and wiring which results in reduced installation time and costs, as well as improved system reliability and uptime.

**Various Incoming Options**

Compatible with a variety of breakers 3 & 4 poles up to 800A, allowing businesses to select the most suitable option for their specific needs

**Range**

depth: 300 mm;  
width: 1000 mm;  
3 heights: 1400,  
1700, 2000 mm.

**Ergonomics  
and design**

removable doors and  
side gland plates for  
ease of access

**Integration**

of ABB's latest Metering  
and surge solutions



# Protecta Power

## Enhanced mechanical segregation

With enhanced mechanical segregation between busbars, functional units and terminals Protecta Power promotes ease of use while meeting the requirements of Form 4, types 2 and 6 under the BS EN 61439 standard.



### Outgoing Device Selection

#### Key

- 1  A1 - 1P, 30mm (w)
- 2  XT1 - 3P, 80mm (w)
- 3  XT2 - 3P, 90mm (w)
- 4  XT4 - 3P, 110mm (w)
- 5  XT5 - 3P, 140mm (w)
- 6  Neutral Link A1, XT1, XT2 & XT4, 30 mm (w)
- 7  Neutral Link - XT5, 50 mm (w)
- 8  XT1 - 4P, 110 mm (w)
- 9  XT2 - 4P or 3P + Neutral Link, 120 mm (w)
- 10  XT4 - 4P or 3P + Neutral Link, 140 mm (w)
- 11  XT5 - 4P or 3P + Neutral Link, 190 mm (w)

#### 8 way - Panelboard 440mm Left & Right

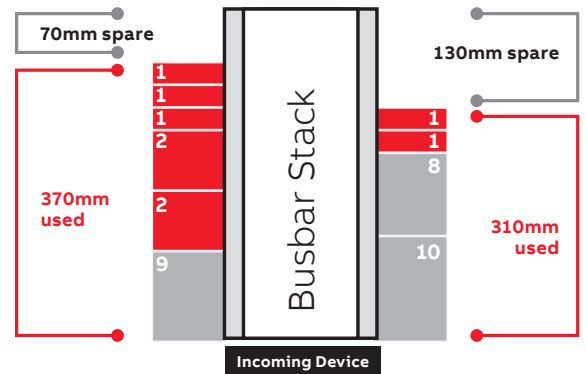

#### 12 way - Panelboard 720mm Left & Right

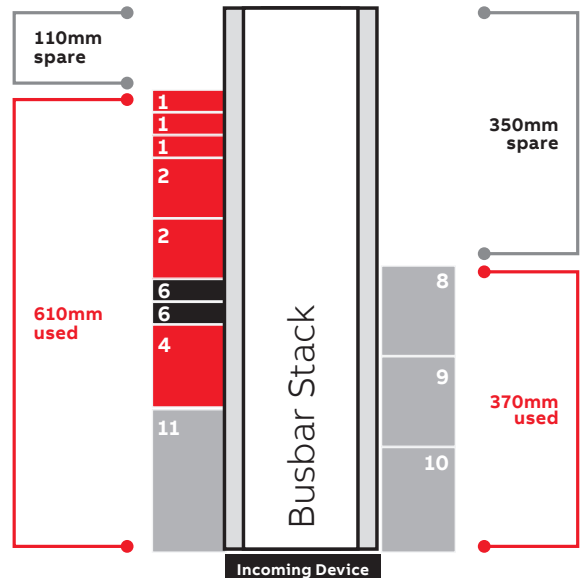

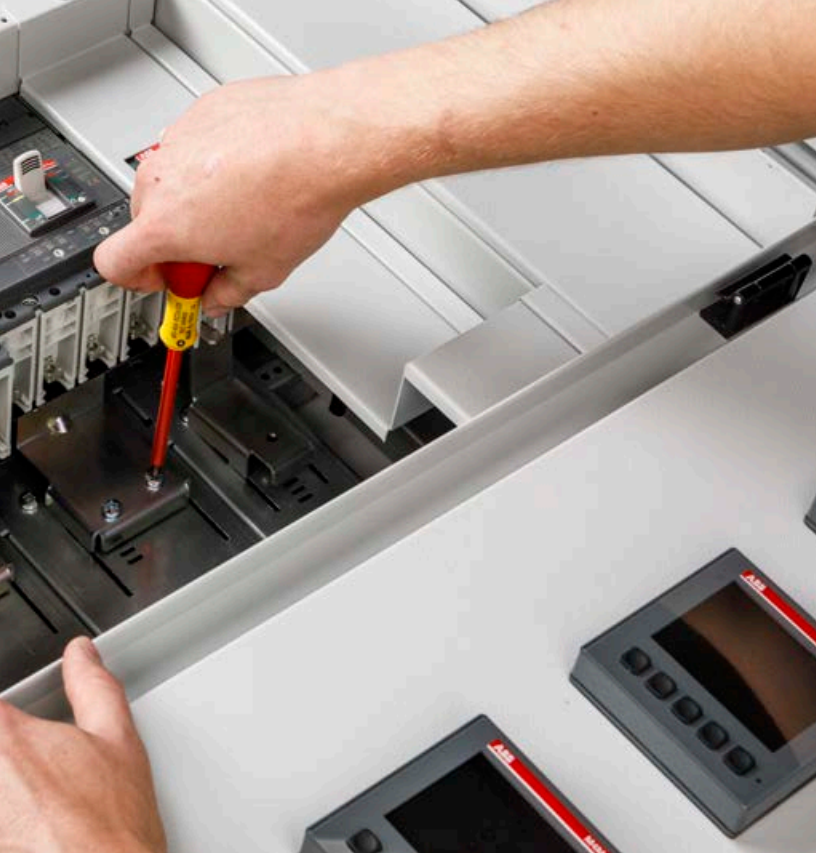

### Custom options

You can choose and customise the layout of your outgoing devices - utilising the busbar stack lengths available 440mm, 720mm and 1000mm and populating it with the MCCB frame size to suit the application.

### MCCB Devices available:

- A1 - upto 125A Thermal Magnetic
- XT1 - upto 160A Thermal Magnetic
- XT2 - upto 160A Thermal Magnetic / Electronic Trip
- XT4 - upto 250A Thermal Magnetic / Electronic Trip
- XT5 - upto 630A Thermal Magnetic / Electronic Trip

### 18 way - Panelboard 1000mm Left & Right

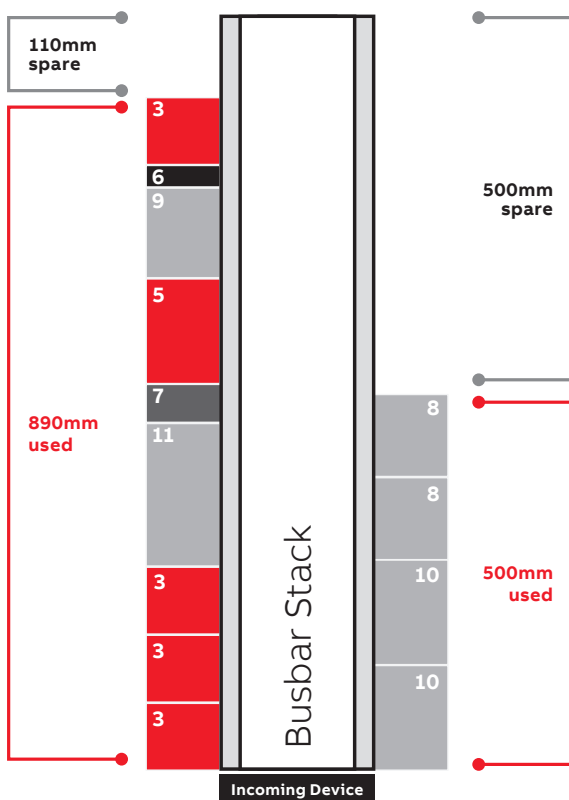

# Protecta Power

## Order process



Panelboard enclosure

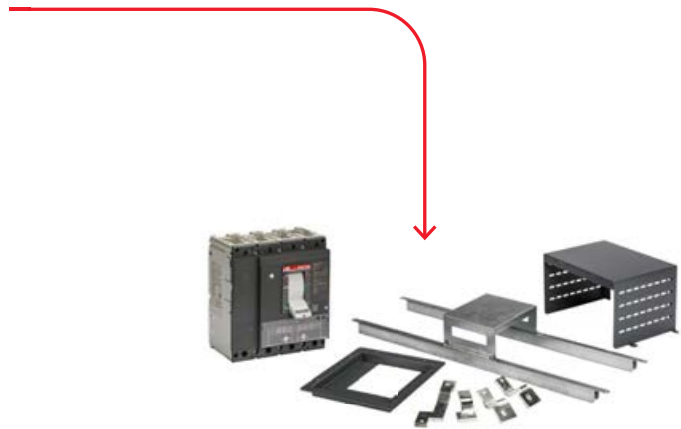

Incoming kit



MCCBs



Accessories

SECTION 7



## Protecta Power

### Order Codes



Main Enclosure 400A Panelboard

Description	No. Of Ways	Busbar Rating	Dimensions (mm) H x W x D	Order Code
400A Busbar Panelboard	8	400	1400 x 1000 x 300	EPX-PB408
400A Busbar Panelboard	12	400	1700 x 1000 x 300	EPX-PB412
400A Busbar Panelboard	18	400	2000 x 1000 x 300	EPX-PB418



**Pack contents:**

- Incoming device
- XT4 Max cable capacity = 150mm<sup>2</sup>
- XT5 Max cable capacity = 185mm<sup>2</sup>

Front extended terminals available for lug connectivity, see page 91.

400A Panelboard - Incoming Devices - Non Auto Switch Disconnecter

Description	Device Rating	No. of Poles	Order Code
Switch Disconnecter - XT4	250A	3P	EPX-2503SD
Switch Disconnecter - XT4	250A	4P	EPX-2504SD
Switch Disconnecter - XT5	400A	3P	EPX-4003SD
Switch Disconnecter - XT5	400A	4P	EPX-4004SD

## Protecta Power

### Order Codes



#### Pack contents:

Incoming device

- XT4 Max cable capacity = 150mm<sup>2</sup>
- XT5 Max cable capacity = 185mm<sup>2</sup>

Front extended terminals available for lug connectivity, see page 91.

#### MCCB Incoming Devices

Description	Device Rating	No. of Poles	Order Code
TMA MCCB - XT4	250A	3P	EPX-2503MCCB
TMA MCCB - XT4	250A	4P	EPX-2504MCCB
TMA MCCB - XT5	400A	3P	EPX-4003MCCB
TMA MCCB - XT5	400A	4P	EPX-4004MCCB
Electronic MCCB - XT4	250A	3P	EPX-2503-E1-MCCB
Electronic MCCB - XT4	250A	4P	EPX-2504-E1-MCCB
Electronic MCCB - XT5	400A	3P	EPX-4003-E1-MCCB
Electronic MCCB - XT5	400A	4P	EPX-4004-E1-MCCB

\* EKIP LS/I Electronic Trip MCCBs as standard.



#### Pack contents:

- Incomer support bracket
- Shrouding
- Busbar connectivity

#### Incoming Connection Kits

Description	Current Rating	No. of Poles	Order Code
XT4 Connection Kit	250	3P	EPX-2503CK
XT4 Connection Kit	250	4P	EPX-2504CK
XT5 Connection Kit	400	3P	EPX-4003CK
XT5 Connection Kit	400	4P	EPX-4004CK
Direct Connection Kit	400	4P	EPX-400DC

## Protecta Power

### Order Codes



Main Enclosure 800A Panelboard

Description	No. Of Ways	Busbar Rating	Dimensions (mm) H x W x D	Order Code
800A Busbar Panelboard	8	800	1400 x 1000 x 300	EPX-PB808
800A Busbar Panelboard	12	800	1700 x 1000 x 300	EPX-PB812
800A Busbar Panelboard	18	800	2000 x 1000 x 300	EPX-PB818



800A Panelboard - Incoming Devices - Non Auto Switch Disconnecter

**Pack contents:**

- Incoming device
- XT5 Max cable capacity = 185mm<sup>2</sup>
- XT6 Max cable capacity = 2x120mm<sup>2</sup>

Front extended terminals available for lug connectivity, see page 91.

Description	Device Rating	No. of Poles	Order Code
Switch Disconnecter - XT5	630A	3P	EPX-6303SD
Switch Disconnecter - XT5	630A	4P	EPX-6304SD
Switch Disconnecter - XT6	800A	3P	EPX-8003SD
Switch Disconnecter - XT6	800A	4P	EPX-8004SD

## Protecta Power

### Order Codes



#### Pack contents:

Incoming device

- XT5 Max cable capacity = 185mm<sup>2</sup>
- XT6 Max cable capacity = 2x120mm<sup>2</sup>

Front extended terminals available for lug connectivity, see page 91.

#### MCCB Incoming Devices

Description	Device Rating	No. of Poles	Order Code
TMA MCCB - XT5	630A	3P	EPX-6303MCCB
TMA MCCB - XT5	630A	4P	EPX-6304MCCB
TMA MCCB - XT6	800A	3P	EPX-8003MCCB
TMA MCCB - XT6	800A	4P	EPX-8004MCCB
Electronic MCCB - XT5	630A	3P	EPX-6303-E1-MCCB
Electronic MCCB - XT5	630A	4P	EPX-6304-E1-MCCB
Electronic MCCB - XT6	800A	3P	EPX-8003-E1-MCCB
Electronic MCCB - XT6	800A	4P	EPX-8004-E1-MCCB

\* EKIP LS/I Electronic Trip MCCBs as standard.



#### Pack contents:

- Incomer support bracket
- Shrouding
- Busbar connectivity

#### Incoming Connection Kits

Description	Current Rating	No. of Poles	Order Code
XT5 Connection Kit	630A	3P	EPX-6303CK
XT5 Connection Kit	630A	4P	EPX-6304CK
XT6 Connection Kit	800A	3P	EPX-8003CK
XT6 Connection Kit	800A	4P	EPX-8004CK
Direct Connection Kit	800A	4P	EPX-800DC

## Protecta Power Order Codes



**Pack contents:**

- MCCB Base Plate and Cover required with each outgoing device - to be ordered separately

### Outgoing MCCB Base Plate and Cover

Description	Order Code
Outgoing MCCB Base Plate and Cover A1 1P	EPX-BPCA1-1P
Outgoing MCCB Base Plate and Cover A1 (1P+N)	EPX-BPCA1 -1P+N
Outgoing MCCB Base Plate and Cover XT1 3P	EPX-BPCXT1 -3P
Outgoing MCCB Base Plate and Cover XT2 3P	EPX-BPCXT2 -3P
Outgoing MCCB Base Plate and Cover XT4 3P	EPX-BPCXT4 -3P
Outgoing MCCB Base Plate and Cover XT5 3P	EPX-BPCXT5 -3P
Outgoing MCCB Base Plate and Cover XT1 4P	EPX-BPCXT1 -4P
Outgoing MCCB Base Plate and Cover XT2 4P	EPX-BPCXT2 -4P
Outgoing MCCB Base Plate and Cover XT4 4P	EPX-BPCXT4 -4P
Outgoing MCCB Base Plate and Cover XT5 4P	EPX-BPCXT5 -4P

\* MCCB Base Plate and Cover required with each outgoing device.

**Max Cable capacity**

- A1 SP = 50mm<sup>2</sup>
- XT1 = 70mm<sup>2</sup>
- XT2 = 95mm<sup>2</sup>
- XT4 = 150mm<sup>2</sup>
- XT5 = 185mm<sup>2</sup>

Front extended terminals available for lug connectivity, see page 91.

**TMA**

- Thermal Trip adjustment 0.7 to 1 x I<sub>n</sub>
- Magnetic Trip Adjustment 5 to 10 x I<sub>n</sub>

**Electronic Trip Unit**

- Adjustable trip overloads 0.4 to 1 x I<sub>n</sub>
- Delayed short circuit 1 to 10 x I<sub>n</sub>

### 1-Pole Devices - A1 25kA - Thermal-magnetic

	Rated current in A	Order Code		
		A1 - 1P - L1	A1 - 1P - L2	A1 - 1P - L3
	16A 1P 18kA MCCB	EPX-A1B-016L1	EPX-A1B-016L2	EPX-A1B-016L3
	20A 1P 25kA MCCB	EPX-A1C-020L1	EPX-A1C-020L2	EPX-A1C-020L3
	25A 1P 25kA MCCB	EPX-A1C-025L1	EPX-A1C-025L2	EPX-A1C-025L3
	32A 1P 25kA MCCB	EPX-A1C-032L1	EPX-A1C-032L2	EPX-A1C-032L3
	40A 1P 25kA MCCB	EPX-A1C-040L1	EPX-A1C-040L2	EPX-A1C-040L3
	50A 1P 25kA MCCB	EPX-A1C-050L1	EPX-A1C-050L2	EPX-A1C-050L3
	63A 1P 25kA MCCB	EPX-A1C-063L1	EPX-A1C-063L2	EPX-A1C-063L3
	80A 1P 25kA MCCB	EPX-A1C-080L1	EPX-A1C-080L2	EPX-A1C-080L3
	100A 1P 25kA MCCB	EPX-A1C-100L1	EPX-A1C-100L2	EPX-A1C-100L3
	125A 1P 25kA MCCB	EPX-A1C-125L1	EPX-A1C-125L2	EPX-A1C-125L3



## Protecta Power

### Order Codes

#### 3-Pole Devices - 36kA - Thermal-magnetic

	Rated current in A				Order Code
		XT1 - 3-Pole (80mm)	XT2 - 3-Pole (90mm)	XT4 - 3-Pole (110mm)	XT5 - 3-Pole (140mm)
	16A 3P 36kA MCCB	EPX-XT1N-TM0163	EPX-XT2N-TM0163	EPX-XT4N-TM0163	-
	20A 3P 36kA MCCB	EPX-XT1N-TM0203	EPX-XT2N-TM0203	EPX-XT4N-TM0203	-
	25A 3P 36kA MCCB	EPX-XT1N-TM0253	EPX-XT2N-TM0253	EPX-XT4N-TM0253	-
	32A 3P 36kA MCCB	EPX-XT1N-TM0323	EPX-XT2N-TM0323	EPX-XT4N-TM0323	-
	40A 3P 36kA MCCB	EPX-XT1N-TM0403	EPX-XT2N-TM0403	EPX-XT4N-TM0403	-
	50A 3P 36kA MCCB	EPX-XT1N-TM0503	EPX-XT2N-TM0503	EPX-XT4N-TM0503	-
	63A 3P 36kA MCCB	EPX-XT1N-TM0633	EPX-XT2N-TM0633	EPX-XT4N-TM0633	-
	80A 3P 36kA MCCB	EPX-XT1N-TM0803	EPX-XT2N-TM0803	EPX-XT4N-TM0803	-
	100A 3P 36kA MCCB	EPX-XT1N-TM1003	EPX-XT2N-TM1003	EPX-XT4N-TM1003	-
	125A 3P 36kA MCCB	EPX-XT1N-TM1253	EPX-XT2N-TM1253	EPX-XT4N-TM1253	-
	160A 3P 36kA MCCB	EPX-XT1N-TM1603	EPX-XT2N-TM1603	EPX-XT4N-TM1603	-
	200A 3P 36kA MCCB	-	-	EPX-XT4N-TM2003	-
	250A 3P 36kA MCCB	-	-	EPX-XT4N-TM2503	-
	320A 3P 36kA MCCB	-	-	-	EPX-XT5N-TM3203
	400A 3P 36kA MCCB	-	-	-	EPX-XT5N-TM4003
	630A 3P 36kA MCCB	-	-	-	EPX-XT5N-TM6303

For XT5 outgoing devices, consider a side cableway extension box for larger cables.

#### 4-Pole Devices - 36kA - Thermal-magnetic

	Rated current in A				Order Code
		XT1 - 4-Pole (90mm)	XT2 - 4-Pole (110mm)	XT4 - 4-Pole (140mm)	XT5 - 4-Pole (190mm)
	16A 4P 36kA MCCB	EPX-XT1N-TM0164	EPX-XT2N-TM0164	EPX-XT4N-TM0164	-
	20A 4P 36kA MCCB	EPX-XT1N-TM0204	EPX-XT2N-TM0204	EPX-XT4N-TM0204	-
	25A 4P 36kA MCCB	EPX-XT1N-TM0254	EPX-XT2N-TM0254	EPX-XT4N-TM0254	-
	32A 4P 36kA MCCB	EPX-XT1N-TM0324	EPX-XT2N-TM0324	EPX-XT4N-TM0324	-
	40A 4P 36kA MCCB	EPX-XT1N-TM0404	EPX-XT2N-TM0404	EPX-XT4N-TM0404	-
	50A 4P 36kA MCCB	EPX-XT1N-TM0504	EPX-XT2N-TM0504	EPX-XT4N-TM0504	-
	63A 4P 36kA MCCB	EPX-XT1N-TM0634	EPX-XT2N-TM0634	EPX-XT4N-TM0634	-
	80A 4P 36kA MCCB	EPX-XT1N-TM0804	EPX-XT2N-TM0804	EPX-XT4N-TM0804	-
	100A 4P 36kA MCCB	EPX-XT1N-TM1004	EPX-XT2N-TM1004	EPX-XT4N-TM1004	-
	125A 4P 36kA MCCB	EPX-XT1N-TM1254	EPX-XT2N-TM1254	EPX-XT4N-TM1254	-
	160A 4P 36kA MCCB	EPX-XT1N-TM1604	EPX-XT2N-TM1604	EPX-XT4N-TM1604	-
	200A 4P 36kA MCCB	-	-	EPX-XT4N-TM2004	-
	250A 4P 36kA MCCB	-	-	EPX-XT4N-TM2504	-
	320A 4P 36kA MCCB	-	-	-	EPX-XT5N-TM3204
	400A 4P 36kA MCCB	-	-	-	EPX-XT5N-TM4004
	630A 4P 36kA MCCB	-	-	-	EPX-XT5N-TM6304

For XT5 outgoing devices, consider a side cableway extension box for larger cables.

# Protecta Power

## Order Codes

### Features

- Electronic Trip MCCBs
- Overload Protection (L)
- Short Circuit Protection with Delayed Trip (S)
- Instantaneous Short Circuit Protection (I)
- EKIP LS/I = L Protection then you choose between S or I protection
- EKIP LSI = All three LS and I characteristics included for adjustability
- EKIP Touch / Hi Touch available on request

### 3-Pole Devices - 36kA - Electronic Trip - LS/I

	Rated current in A	Order Code		
		XT2 - 3-Pole (90mm)	XT4 - 3-Pole (110mm)	XT5 - 3-Pole (140mm)
	25A 3P 36kA MCCB - (Ekip) - LS/I	EPX-XT2N-E1-0253	-	-
	40A 3P 36kA MCCB - (Ekip) - LS/I	-	EPX-XT4N-E1-0403	-
	63A 3P 36kA MCCB - (Ekip) - LS/I	EPX-XT2N-E1-0633	EPX-XT4N-E1-0633	-
	100A 3P 36kA MCCB - (Ekip) - LS/I	EPX-XT2N-E1-1003	EPX-XT4N-E1-1003	-
	160A 3P 36kA MCCB - (Ekip) - LS/I	EPX-XT2N-E1-1603	EPX-XT4N-E1-1603	-
	250A 3P 36kA MCCB - (Ekip) - LS/I	-	EPX-XT4N-E1-2503	EPX-XT5N-E1-2503
	320A 3P 36kA MCCB - (Ekip) - LS/I	-	-	EPX-XT5N-E1-3203
	400A 3P 36kA MCCB - (Ekip) - LS/I	-	-	EPX-XT5N-E1-4003
	630A 3P 36kA MCCB - (Ekip) - LS/I	-	-	EPX-XT5N-E1-6303

For XT5 outgoing devices, consider a side cableway extension box for larger cables.

### 4-Pole Devices - 36kA- Electronic Trip - LS/I

	Rated current in A	Order Code		
		XT2 - 4-Pole (120mm)	XT4 - 4-Pole (140mm)	XT5 - 4-Pole (190mm)
	25A 4P 36kA MCCB - (Ekip) - LS/I	EPX-XT2N-E1-0254	-	-
	40A 4P 36kA MCCB - (Ekip) - LS/I	-	EPX-XT4N-E1-0404	-
	63A 4P 36kA MCCB - (Ekip) - LS/I	EPX-XT2N-E1-0634	EPX-XT4N-E1-0634	-
	100A 4P 36kA MCCB - (Ekip) - LS/I	EPX-XT2N-E1-1004	EPX-XT4N-E1-1004	-
	160A 4P 36kA MCCB - (Ekip) - LS/I	EPX-XT2N-E1-1604	EPX-XT4N-E1-1604	-
	250A 4P 36kA MCCB - (Ekip) - LS/I	-	EPX-XT4N-E1-2504	EPX-XT5N-E1-2504
	320A 4P 36kA MCCB - (Ekip) - LS/I	-	-	EPX-XT5N-E1-3204
	400A 4P 36kA MCCB - (Ekip) - LS/I	-	-	EPX-XT5N-E1-4004
	630A 4P 36kA MCCB - (Ekip) - LS/I	-	-	EPX-XT5N-E1-6304

For XT5 outgoing devices, consider a side cableway extension box for larger cables.

## Protecta Power

### Order Codes

#### Features

- Electronic Trip MCCBs
- Overload Protection (L)
- Short Circuit Protection with Delayed Trip (S)
- Instantaneous Short Circuit Protection (I)
- EKIP LS/I = L Protection then you choose between S or I protection
- EKIP LSI = All three LS and I characteristics included for adjustability
- EKIP Touch / Hi Touch available on request

#### 3-Pole Devices - 36kA- Electronic Trip - LSI

	Rated current in A	Order Code		
		XT2 - 3-Pole (90mm)	XT4 - 3-Pole (110mm)	XT5 - 3-Pole (140mm)
	25A 3P 36kA MCCB - (Ekip) - LSI	EPX-XT2N-E2-0253	–	–
	40A 3P 36kA MCCB - (Ekip) - LSI	–	EPX-XT4N-E2-0403	–
	63A 3P 36kA MCCB - (Ekip) - LSI	EPX-XT2N-E2-0633	EPX-XT4N-E2-0633	–
	100A 3P 36kA MCCB - (Ekip) - LSI	EPX-XT2N-E2-1003	EPX-XT4N-E2-1003	–
	160A 3P 36kA MCCB - (Ekip) - LSI	EPX-XT2N-E2-1603	EPX-XT4N-E2-1603	–
	250A 3P 36kA MCCB - (Ekip) - LSI	–	EPX-XT4N-E2-2503	EPX-XT5N-E2-2503
	320A 3P 36kA MCCB - (Ekip) - LSI	–	–	EPX-XT5N-E2-3203
	400A 3P 36kA MCCB - (Ekip) - LSI	–	–	EPX-XT5N-E2-4003
	630A 3P 36kA MCCB - (Ekip) - LSI	–	–	EPX-XT5N-E2-6303

For XT5 outgoing devices, consider a side cableway extension box for larger cables.

#### 4-Pole Devices - 36kA- Electronic Trip - LSI

	Rated current in A	Order Code		
		XT2 - 4-Pole (120mm)	XT4 - 4-Pole (140mm)	XT5 - 4-Pole (190mm)
	25A 4P 36kA MCCB - (Ekip) - LSI	EPX-XT2N-E2-0254	–	–
	40A 4P 36kA MCCB - (Ekip) - LSI	–	EPX-XT4N-E2-0404	–
	63A 4P 36kA MCCB - (Ekip) - LSI	EPX-XT2N-E2-0634	EPX-XT4N-E2-0634	–
	100A 4P 36kA MCCB - (Ekip) - LSI	EPX-XT2N-E2-1004	EPX-XT4N-E2-1004	–
	160A 4P 36kA MCCB - (Ekip) - LSI	EPX-XT2N-E2-1604	EPX-XT4N-E2-1604	–
	250A 4P 36kA MCCB - (Ekip) - LSI	–	EPX-XT4N-E2-2504	EPX-XT5N-E2-2504
	320A 4P 36kA MCCB - (Ekip) - LSI	–	–	EPX-XT5N-E2-3204
	400A 4P 36kA MCCB - (Ekip) - LSI	–	–	EPX-XT5N-E2-4004
	630A 4P 36kA MCCB - (Ekip) - LSI	–	–	EPX-XT5N-E2-6304

For XT5 outgoing devices, consider a side cableway extension box for larger cables.

# Protecta Power

## Order Codes

### 3-Pole Devices - 50kA - Thermal-magnetic

	Rated current in A	Order Code			
		XT1S - 3-Pole (80mm)	XT2S - 3-Pole (90mm)	XT4S - 3-Pole (110mm)	XT5S - 3-Pole (140mm)
	16A 3P 50kA MCCB	EPX-XT1S-TM0163	EPX-XT2S-TM0163	EPX-XT4S-TM0163	-
	20A 3P 50kA MCCB	EPX-XT1S-TM0203	EPX-XT2S-TM0203	EPX-XT4S-TM0203	-
	25A 3P 50kA MCCB	EPX-XT1S-TM0253	EPX-XT2S-TM0253	EPX-XT4S-TM0253	-
	32A 3P 50kA MCCB	EPX-XT1S-TM0323	EPX-XT2S-TM0323	EPX-XT4S-TM0323	-
	40A 3P 50kA MCCB	EPX-XT1S-TM0403	EPX-XT2S-TM0403	EPX-XT4S-TM0403	-
	50A 3P 50kA MCCB	EPX-XT1S-TM0503	EPX-XT2S-TM0503	EPX-XT4S-TM0503	-
	63A 3P 50kA MCCB	EPX-XT1S-TM0633	EPX-XT2S-TM0633	EPX-XT4S-TM0633	-
	80A 3P 50kA MCCB	EPX-XT1S-TM0803	EPX-XT2S-TM0803	EPX-XT4S-TM0803	-
	100A 3P 50kA MCCB	EPX-XT1S-TM1003	EPX-XT2S-TM1003	EPX-XT4S-TM1003	-
	125A 3P 50kA MCCB	EPX-XT1S-TM1253	EPX-XT2S-TM1253	EPX-XT4S-TM1253	-
	160A 3P 50kA MCCB	EPX-XT1S-TM1603	EPX-XT2S-TM1603	EPX-XT4S-TM1603	-
	200A 3P 50kA MCCB	-	-	EPX-XT4S-TM2003	-
	250A 3P 50kA MCCB	-	-	EPX-XT4S-TM2503	-
	320A 3P 50kA MCCB	-	-	-	EPX-XT5S-TM3203
	400A 3P 50kA MCCB	-	-	-	EPX-XT5S-TM4003
	630A 3P 50kA MCCB	-	-	-	EPX-XT5S-TM6303

For XT5 outgoing devices, consider a side cableway extension box for larger cables.

### 4-Pole Devices - 50kA- Thermal-magnetic

	Rated current in A	Order Code			
		XT1S - 4-Pole (110mm)	XT2S - 4-Pole (120mm)	XT4S - 4-Pole (140mm)	XT5S - 4-Pole (190mm)
	16A 4P 50kA MCCB	EPX-XT1S-TM0164	EPX-XT2S-TM0164	EPX-XT4S-TM0164	-
	20A 4P 50kA MCCB	EPX-XT1S-TM0204	EPX-XT2S-TM0204	EPX-XT4S-TM0204	-
	25A 4P 50kA MCCB	EPX-XT1S-TM0254	EPX-XT2S-TM0254	EPX-XT4S-TM0254	-
	32A 4P 50kA MCCB	EPX-XT1S-TM0324	EPX-XT2S-TM0324	EPX-XT4S-TM0324	-
	40A 4P 50kA MCCB	EPX-XT1S-TM0404	EPX-XT2S-TM0404	EPX-XT4S-TM0404	-
	50A 4P 50kA MCCB	EPX-XT1S-TM0504	EPX-XT2S-TM0504	EPX-XT4S-TM0504	-
	63A 4P 50kA MCCB	EPX-XT1S-TM0634	EPX-XT2S-TM0634	EPX-XT4S-TM0634	-
	80A 4P 50kA MCCB	EPX-XT1S-TM0804	EPX-XT2S-TM0804	EPX-XT4S-TM0804	-
	100A 4P 50kA MCCB	EPX-XT1S-TM1004	EPX-XT2S-TM1004	EPX-XT4S-TM1004	-
	125A 4P 50kA MCCB	EPX-XT1S-TM1254	EPX-XT2S-TM1254	EPX-XT4S-TM1254	-
	160A 4P 50kA MCCB	EPX-XT1S-TM1604	EPX-XT2S-TM1604	EPX-XT4S-TM1604	-
	200A 4P 50kA MCCB	-	-	EPX-XT4S-TM2004	-
	250A 4P 50kA MCCB	-	-	EPX-XT4S-TM2504	-
	320A 4P 50kA MCCB	-	-	-	EPX-XT5S-TM3204
	400A 4P 50kA MCCB	-	-	-	EPX-XT5S-TM4004
	630A 4P 50kA MCCB	-	-	-	EPX-XT5S-TM6304

For XT5 outgoing devices, consider a side cableway extension box for larger cables.

## Protecta Power

### Order Codes

#### Features

- Electronic Trip MCCBs
- Overload Protection (L)
- Short Circuit Protection with Delayed Trip (S)
- Instantaneous Short Circuit Protection (I)
- EKIP LS/I = L Protection then you choose between S or I protection
- EKIP LSI = All three LS and I characteristics included for adjustability
- EKIP Touch / Hi Touch available on request

#### 3-Pole Devices - 50kA - Electronic Trip - LS/I

	Rated current in A	Order Code		
		XT2S - 3-Pole (90mm)	XT4S - 3-Pole (110mm)	XT5S - 3-Pole (140mm)
	25A 3P 50kA MCCB - (Ekip) - LS/I	EPX-XT2S-E1-0253	-	-
	40A 3P 50kA MCCB - (Ekip) - LS/I	-	EPX-XT4S-E1-0403	-
	63A 3P 50kA MCCB - (Ekip) - LS/I	EPX-XT2S-E1-0633	EPX-XT4S-E1-0633	-
	100A 3P 50kA MCCB - (Ekip) - LS/I	EPX-XT2S-E1-1003	EPX-XT4S-E1-1003	-
	160A 3P 50kA MCCB - (Ekip) - LS/I	EPX-XT2S-E1-1603	EPX-XT4S-E1-1603	-
	250A 3P 50kA MCCB - (Ekip) - LS/I	-	EPX-XT4S-E1-2503	EPX-XT5S-E1-2503
	320A 3P 50kA MCCB - (Ekip) - LS/I	-	-	EPX-XT5S-E1-3203
	400A 3P 50kA MCCB - (Ekip) - LS/I	-	-	EPX-XT5S-E1-4003
	630A 3P 50kA MCCB - (Ekip) - LS/I	-	-	EPX-XT5S-E1-6303

For XT5 outgoing devices, consider a side cableway extension box for larger cables.

#### 4-Pole Devices - 50kA - Electronic Trip - LS/I

	Rated current in A	Order Code		
		XT2S - 4-Pole (120mm)	XT4S - 4-Pole (140mm)	XT5S - 4-Pole (190mm)
	25A 4P 50kA MCCB - (Ekip) - LS/I	EPX-XT2S-E1-0254	-	-
	40A 4P 50kA MCCB - (Ekip) - LS/I	-	EPX-XT4S-E1-0404	-
	63A 4P 50kA MCCB - (Ekip) - LS/I	EPX-XT2S-E1-0634	EPX-XT4S-E1-0634	-
	100A 4P 50kA MCCB - (Ekip) - LS/I	EPX-XT2S-E1-1004	EPX-XT4S-E1-1004	-
	160A 4P 50kA MCCB - (Ekip) - LS/I	EPX-XT2S-E1-1604	EPX-XT4S-E1-1604	-
	250A 4P 50kA MCCB - (Ekip) - LS/I	-	EPX-XT4S-E1-2504	EPX-XT5S-E1-2504
	320A 4P 50kA MCCB - (Ekip) - LS/I	-	-	EPX-XT5S-E1-3204
	400A 4P 50kA MCCB - (Ekip) - LS/I	-	-	EPX-XT5S-E1-4004
	630A 4P 50kA MCCB - (Ekip) - LS/I	-	-	EPX-XT5S-E1-6304

For XT5 outgoing devices, consider a side cableway extension box for larger cables.



## Protecta Power

### Order Codes

**Features**

- Electronic Trip MCCBs
- Overload Protection (L)
- Short Circuit Protection with Delayed Trip (S)
- Instantaneous Short Circuit Protection (I)
- EKIP LS/I = L Protection then you choose between S or I protection
- EKIP LSI = All three LS and I characteristics included for adjustability
- EKIP Touch / Hi Touch available on request

**3-Pole Devices - 50kA - Electronic Trip - LSI**

	Rated current in A	Order Code		
		XT2S - 3-Pole (90mm)	XT4S - 3-Pole (110mm)	XT5S - 3-Pole (140mm)
	25A 3P 50kA MCCB - (Ekip) - LSI	EPX-XT2S-E2-0253	-	-
	40A 3P 50kA MCCB - (Ekip) - LSI	-	EPX-XT4S-E2-0403	-
	63A 3P 50kA MCCB - (Ekip) - LSI	EPX-XT2S-E2-0633	EPX-XT4S-E2-0633	-
	100A 3P 50kA MCCB - (Ekip) - LSI	EPX-XT2S-E2-1003	EPX-XT4S-E2-1003	-
	160A 3P 50kA MCCB - (Ekip) - LSI	EPX-XT2S-E2-1603	EPX-XT4S-E2-1603	-
	250A 3P 50kA MCCB - (Ekip) - LSI	-	EPX-XT4S-E2-2503	EPX-XT5S-E2-2503
	320A 3P 50kA MCCB - (Ekip) - LSI	-	-	EPX-XT5S-E2-3203
	400A 3P 50kA MCCB - (Ekip) - LSI	-	-	EPX-XT5S-E2-4003
	630A 3P 50kA MCCB - (Ekip) - LSI	-	-	EPX-XT5S-E2-6303

For XT5 outgoing devices, consider a side cableway extension box for larger cables.

**4-Pole Devices - 50kA - Electronic Trip - LSI**



	Rated current in A	Order Code		
		XT2S - 4-Pole (120mm)	XT4S - 4-Pole (140mm)	XT5S - 4-Pole (190mm)
	25A 4P 50kA MCCB - (Ekip) - LSI	EPX-XT2S-E2-0254	-	-
	40A 4P 50kA MCCB - (Ekip) - LSI	-	EPX-XT4S-E2-0404	-
	63A 4P 50kA MCCB - (Ekip) - LSI	EPX-XT2S-E2-0634	EPX-XT4S-E2-0634	-
	100A 4P 50kA MCCB - (Ekip) - LSI	EPX-XT2S-E2-1004	EPX-XT4S-E2-1004	-
	160A 4P 50kA MCCB - (Ekip) - LSI	EPX-XT2S-E2-1604	EPX-XT4S-E2-1604	-
	250A 4P 50kA MCCB - (Ekip) - LSI	-	EPX-XT4S-E2-2504	EPX-XT5S-E2-2504
	320A 4P 50kA MCCB - (Ekip) - LSI	-	-	EPX-XT5S-E2-3204
	400A 4P 50kA MCCB - (Ekip) - LSI	-	-	EPX-XT5S-E2-4004
	630A 4P 50kA MCCB - (Ekip) - LSI	-	-	EPX-XT5S-E2-6304

For XT5 outgoing devices, consider a side cableway extension box for larger cables.

## Protecta Power

### Order Codes

#### Terminals for circuit-breaker

	Size	Type	Order Code	
			pcs (1/2 kit for 3p)	pcs (1/2 kit for 4p)
 <p>— Front extended terminal - EF</p>	XT1	F Front terminals	1SDA066849R1	1SDA066850R1
	XT1	EF Extended front terminals	1SDA066865R1	1SDA066866R1
	XT1	FC CuAl terminals for CuAl cables 1x1.5...70mm <sup>2</sup>	1SDA067151R1	1SDA067152R1
	XT2	F Front terminals	1SDA066853R1	1SDA066854R1
	XT2	EF Extended front terminals	1SDA066869R1	1SDA066870R1
	XT2	FC CuAl terminals for CuAl cables 1x1...95mm <sup>2</sup>	1SDA067163R1	1SDA067164R1
	XT4	F Front terminals	1SDA066861R1	1SDA066862R1
	XT4	EF Extended front terminals	1SDA066877R1	1SDA066878R1
	XT4	FC CuAl terminals for CuAl cables 1x1...150mm <sup>2</sup>	1SDA067191R1	1SDA067192R1
	XT4	ES Extended spread front terminals	1SDA066901R1	1SDA066902R1
 <p>— Front extended spread terminal - ES</p>	XT5	F Front terminals	1SDA104730R1	1SDA104731R1
	XT5	EF Extended front terminals	1SDA104734R1	1SDA104735R1
	XT5	XT5 FC CuAl 1x35...185mm <sup>2</sup>	1SDA104746R1	1SDA104747R1
	XT5	ES Extended spread front terminals	1SDA104738R1	1SDA104739R1
	XT6	F Front terminals	1SDA104732R1	1SDA104733R1
 <p>— FCCuAl internal terminal</p>	XT6	EF Extended front terminals 800A	1SDA104736R1	1SDA104737R1
	XT6	XT6 ES Extended spread front terminals Upper	1SDA104740R1	1SDA104741R1
	XT6	XT6 ES Extended spread front terminals Lower	1SDA113127R1	1SDA104741R1

#### Insulating terminal covers

	Size	Type	Order Code	
			3 poles	4 poles
	XT1	HTC High terminal covers	1SDA066664R1	1SDA066665R1
	XT2	HTC High terminal covers	1SDA066666R1	1SDA066667R1
	XT3	HTC High terminal covers	1SDA066668R1	1SDA066669R1
	XT4	HTC High terminal covers	1SDA066670R1	1SDA066671R1
	XT5	HTC High terminal covers	1SDA105025R1	1SDA105026R1
	XT6	HTC High terminal covers	1SDA105027R1	1SDA105028R1

# Protecta Power

## Order Codes

### Outgoing Neutral Links

	Description	Order Code
	A1 / XT1 Neutral Link, to be used with 1P MCCB - Outgoing Device	EPX-NLA1XT1
	XT2 Neutral Link, to be used with 3P MCCB - Outgoing Device	EPX-NLXT2
	XT4 Neutral Link, to be used with 3P MCCB - Outgoing Device	EPX-NLXT4
	XT5 Neutral Link, to be used with 3P MCCB - Outgoing Device	EPX-NLXT5

Group mounted Form 4 Type 2/6, Neutral link for outgoing section to be used with 1Pole and 3Pole MCCBs.

### Blanking plates for unused ways

	Description	Order Code
	Cover blank Size 10	EPX-CB010
	Cover blank Size 20	EPX-CB020
	Cover blank Size 30	EPX-CB030
	Cover blank Size 40	EPX-CB040
	Cover blank Size 50	EPX-CB050
	Cover blank Size 100	EPX-CB100
	Cover blank Size 150	EPX-CB150
	Cover blank Size 200	EPX-CB200

Blanking plates to be used for filling un-used ways / space in outgoing section.

### Cableway Extension Boxes

	Description	Dimension (mm) H x W	No. of Meter Knock-outs	Order Code
	Side extension box to fit 8 way	1400 x 300	N/A	EPX-SIDECABLE-08
	Side extension box to fit 12 way	1700 x 300	N/A	EPX-SIDECABLE-12
	Side extension box to fit 18 way	2000 x 300	N/A	EPX-SIDECABLE-18
	Side extension box with Metering provision to fit 8 way	1400 x 300	4	EPX-SIDECABLE-08M
	Side extension box with Metering provision to fit 12 way	1700 x 300	7	EPX-SIDECABLE-12M
	Side extension box with Metering provision to fit 18 way	2000 x 300	10	EPX-SIDECABLE-18M
	Top / Bottom Extension box	300 x 1000	N/A	EPX-EXT1000
	Corner Box	300 x 300	N/A	EPX-EXT300

## Protecta Power

### Order Codes



#### Pack contents:

- Meter, Fixing brackets,
- CT and terminals.
- Requires a Side extension box
- with Metering provision - to be ordered separately

### Outgoing Meter Kits

Description	Meter Type	Order Code
125A Outgoing Metering Kits - Single Phase	M4M Pulse / Modbus	EPX-METER125-SP
125A Outgoing Metering Kits - Single Phase	M4M Pulse / Modbus & MID	EPX-METER125MID-SP
125A Outgoing Metering Kits - 3 Phase	M4M Pulse / Modbus	EPX-METER125-TP
160-250A Outgoing Metering Kits - 3phase	M4M Pulse / Modbus	EPX-METER250-TP
400A Outgoing Metering Kits - 3 Phase	M4M Pulse / Modbus	EPX-METER400-TP
630A Outgoing Metering Kits - 3 Phase	M4M Pulse / Modbus	EPX-METER630-TP
125A Outgoing Metering Kits	M4M Pulse / Modbus & MID	EPX-METER125MID-TP
160-250A Outgoing Metering Kits	M4M Pulse / Modbus & MID	EPX-METER250MID-TP
400A Outgoing Metering Kits	M4M Pulse / Modbus & MID	EPX-METER400MID-TP
630A Outgoing Metering Kits - 3 Phase	M4M Pulse / Modbus & MID	EPX-METER630MID-TP
Unused meter - blanks		EV1136



#### Pack contents:

- Top / Bottom extension box,
- Meter, Fixing brackets,
- CT and terminals

### Incoming Meter Kits

Description	Dimension (mm) H x W	Order Code
250A Incomer Meter Kit - M4M Pulse / Modbus	300 x 1000	EPX-ICMETER250
400A Incomer Meter Kit - M4M Pulse / Modbus	300 x 1000	EPX-ICMETER400
630A Incomer Meter Kit - M4M Pulse / Modbus	300 x 1000	EPX-ICMETER630
800A Incomer Meter Kit - M4M Pulse / Modbus	300 x 1000	EPX-ICMETER800
250A Incomer Meter Kit - M4M Pulse / Modbus & MID	300 x 1000	EPX-ICMETER250MID
400A Incomer Meter Kit - M4M Pulse / Modbus & MID	300 x 1000	EPX-ICMETER400MID
630A Incomer Meter Kit - M4M Pulse / Modbus & MID	300 x 1000	EPX-ICMETER630MID
800A Incomer Meter Kit - M4M Pulse / Modbus & MID	300 x 1000	EPX-ICMETER800MID

## Protecta Power

### Order Codes



**Pack contents:**

- Surge unit
- Connection cables
- Din rail
- Protective "MCCB" and "Outgoing MCCB Base Plate and Cover" must be ordered separately. To be fitted into board taking an outgoing way to feed SPD.

#### Surge Protection Kits

Description	Dimension (mm) H x W	Order Code
Surge Protection Kits type 1-2	300 x 1000	EPX-SURGE-T12
Surge Protection Kits type 1,2 & 3	300 x 1000	EPX-SURGE-T123

#### Residual current devices - 4 poles



Size	Type	Order Code
XT2	XT2 RC Sel	1SDA067126R1
XT4	XT4 RC Sel	1SDA067131R1
XT5	XT5 RC Sel <sup>(1)</sup>	1SDA105131R1

(1) This can also be mounted on a three-poles circuit-breaker.  
For XT5 outgoing devices, consider a side cableway extension box for larger cables.



## Protecta Power Accessories

### Accessories



Description	Order Code
Plain Door H1400 x W1000 (8way PB)	EPX-PD08
Plain Door H1700 x W1000 (12way PB)	EPX-PD12
Plain Door H2000 x W1000 (18way PB)	EPX-PD18
Side Extension Plain Door H1400 x W300 (8way PB)	EPX-SED08
Side Extension Plain Door H1700 x W300 (12way PB)	EPX-SED12
Side Extension Plain Door H2000 x W300 (18way PB)	EPX-SED18
Side Extension Metered Door H1400 x W300 (8way PB)	EPX-SED08M
Side Extension Metered Door H1700 x W300 (12way PB)	EPX-SED12M
Side Extension Metered Door H2000 x W300 (18way PB)	EPX-SED18M
Enclosure Top/ Bottom gland	EPX-TG1000
Corner gland	EPX-CG300
Plain Side gland H1400 x D300 (8way PB)	EPX-SG08
Plain Side gland H1700 x D300 (12way PB)	EPX-SG12
Plain Side gland H2000 x D300 (18way PB)	EPX-SG18
Vented Side gland H1400 x D300 (8way PB)	EPX-VSG08
Vented Side gland H1700 x D300 (12way PB)	EPX-VSG12
Vented Side gland H2000 x D300 (18way PB)	EPX-VSG18
Plinth - RAL 7012	EPX-PL1000
Side Extension box Plinth - RAL 7012	EPX-PL300
Wall mounting kit	EPX-WM-KIT
Lifting bolt with accessories	EPX-LIFT
Double Lifting bolt with accessories	EPX-LIFT2
Standard lock solution	EPX-PBLOCK
Lock L handle	EPX-PBLOCK-L
Lock T handle	EPX-PBLOCK-T
Door Hinge	EPX-DH001
Extension/Neutral Kit 2x08W	EPX-EX-N08
Extension/Neutral Kit 2x12W	EPX-EX-N12
Extension/Neutral Kit 2x18W	EPX-EX-N18
Extension Earth Kit 2x08W	EPX-EX-E08

---

# Enclosed switching products

<b>140</b>	<b>Introducing enclosed automatic transfer switches</b>
<b>144</b>	<b>Plug &amp; play</b>
<b>146</b>	<b>Enclosed ATS</b>
<b>150</b>	<b>ATS accessories</b>
<b>154</b>	<b>TruONE</b>
<b>158</b>	<b>Technical data</b>
<b>163</b>	<b>TruONE accessories</b>



For more detailed product information, please refer to our online technical brochures available at: [new.abb.com/low-voltage/support/documentation](http://new.abb.com/low-voltage/support/documentation)

or contact our sales team via email [LV.enquiries@gb.abb.com](mailto:LV.enquiries@gb.abb.com)

or call 0333 999 9933

# Enclosed automatic transfer switches

## General specification

For ATS versions up to 125A the handle is a direct mounted type, and it can be padlocked in the “0” position with three padlocks with a 5 ... 6 mm hasp. It is possible to operate the switch with the manual handle in case of emergency, regardless of the position of switch and without any supply power.

### Technical specifications according to IEC 60947-3 and IEC 60947-6-1

- |                                    |                  |
|------------------------------------|------------------|
| • Type of equipment                | ATSE             |
| • Class of equipment               | PC               |
| • Rated operational voltage,       | $U_e$ Max. 415 V |
| • Rated impulse withstand voltage, | $U_{imp}$ 6 kV   |
| • Rated frequency                  | 50 - 60 Hz       |

### Bypass Requirement

In order to comply with BS8519 which states “Where the availability of the life safety and fire-fighting equipment is conditional to the occupation of the building, a bypass arrangement should be incorporated to enable the changeover device to be maintained without loss of service from the critical plant”.

The bypass switches consist of the following;

### Single or mains bypass

Operate isolators to give a seamless transfer to the primary supply bypassing the ATS. The front of the panel should indicate that the ATS has been bypassed and is safe to carry out maintenance.

### Dual Bypass

Operate isolators and change over switches to give a seamless transfer to bypass the ATS and to select either the primary supply or secondary supply.



# The one ATS with all these advantages



## Easy to Install

Reduces installation time by up to 80%.

Why waste time piecing together an ATS from multiple components and as many as 20 connection wires, not to mention the time spent testing? TruONE® is the first automatic transfer switch to put it all together, including the controller with detachable HMI. It can be installed with a single wire using standard enclosures.



## Safety and Protection

Reduces risk of operator injury.

TruONE® enables emergency manual operation — even under load — without opening the panel door when the HMI is mounted to the ATS frame. The HMI can be detached from the frame for door mounting, offering more flexibility for the panel designer. Best of all, regardless of the HMI installation method, there's no need for connecting dangerous line voltages to the door, so the risk of operator injury due to equipment malfunction is reduced.



## Optimum Interface

Simplifies connectivity.

TruONE® features cloud-based connectivity through the ABB Ability™ Electrical Distribution Control System (EDCS). ABB Ability simplifies implementation and use of TruONE® in coordination with other ABB devices, ensuring one common user interface and one common software environment. Market-leading modular connectivity with seven communication protocols ensures easy installation and connectivity now and far into the future.

# Even more advantages



## Speed Up Your Project

Now you can speed up your project even more, thanks to TruONE® automatic commissioning capabilities. Pre-made configuration files can be uploaded from your PC to TruONE®, minimising the risk of human error and reducing programming time by 80%.



## Continuous Operation

TruONE® features predictive maintenance, self-diagnostics and customer-replaceable critical modules to simplify service and significantly reduce downtime and service costs. Say goodbye to blinking lights and stopping motors. TruONE® provides a fast in-phase open transition of power, ensuring unnoticed generator use during business hours.



## Energy Efficiency

Full compatibility with ABB Ability™ EDCS allows data processing from the site's electrical equipment to deliver analysis and make recommendations for optimising the electrical system's performance. This allows remote monitoring of plants, energy consumption and costs at a glance, making implementation of energy management strategies easier and faster.



## Optimised Logistics

TruONE® features a wide voltage range from 200 to 480 Vac (with +/-20% tolerance), reducing the need to stock multiple SKUs, reducing inventory and saving space in the warehouse.

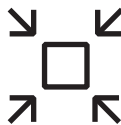

## Space Saving

TruONE® features plug-in factory and field-mount accessorising, so you don't need extra space inside the panel. Even in the case of specialised customer needs, you can use standard cabinets.





# Architecture

## Truly plug & play

**Embedded solution with Ekip Com Hub**  
 Emax 2 equipped with the new Ekip Com Hub establishes the cloud connection for the whole switchboard.

This dedicated cartridge-type communication module just needs to be inserted into the terminal box and connected to the internet.



ABB showcases a further evolution in the low-voltage distribution business, setting a new benchmark in terms of simplicity and performance.

ABB Ability™ Electrical Distribution Control System enables the collection of relevant information from the ABB devices installed in the low-voltage power distribution system.

These devices can be connected, plug & play, to the cloud-computing platform by sharing data either with Emax 2 (equipped with Ekip Com Hub) or with Ekip E-Hub via Modbus RS-485, Modbus TCP and Ekip Link.

Family	Device
ACB	Emax 2 (*)
ACB	New Emax (*)
MCCB	Tmax T (*)
MCCB	Tmax XT (*)
Metering device	M2M
Metering device	CMS 700
Fusegear	Slimline XR ITS 2
Signalling module for digital inputs (e.g. for MCCBs)	Ekip Signalling Modbus TCP
Digital Meters/Sensor	Pulse meter (**)
Analog Meters/Sensor	Analog meter (**)
Arc guard	TVOC-2
And many others to come...	

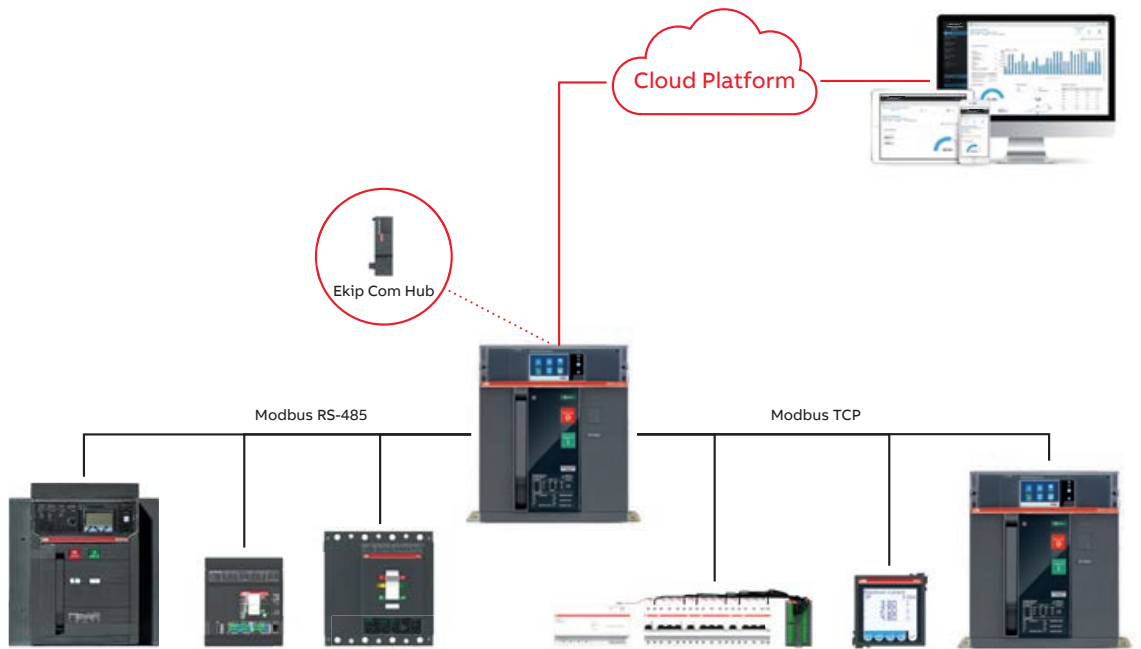
**External solution with Ekip E-Hub**

The Ekip E-Hub module can be mounted on DIN rail to collect data throughout the system. Moreover, it is possible to connect sensors for

environmental parameters (temperature, water, gas) via both analog and digital I/O. Modules for Wi-Fi or GPRS connection are provided as optional features.

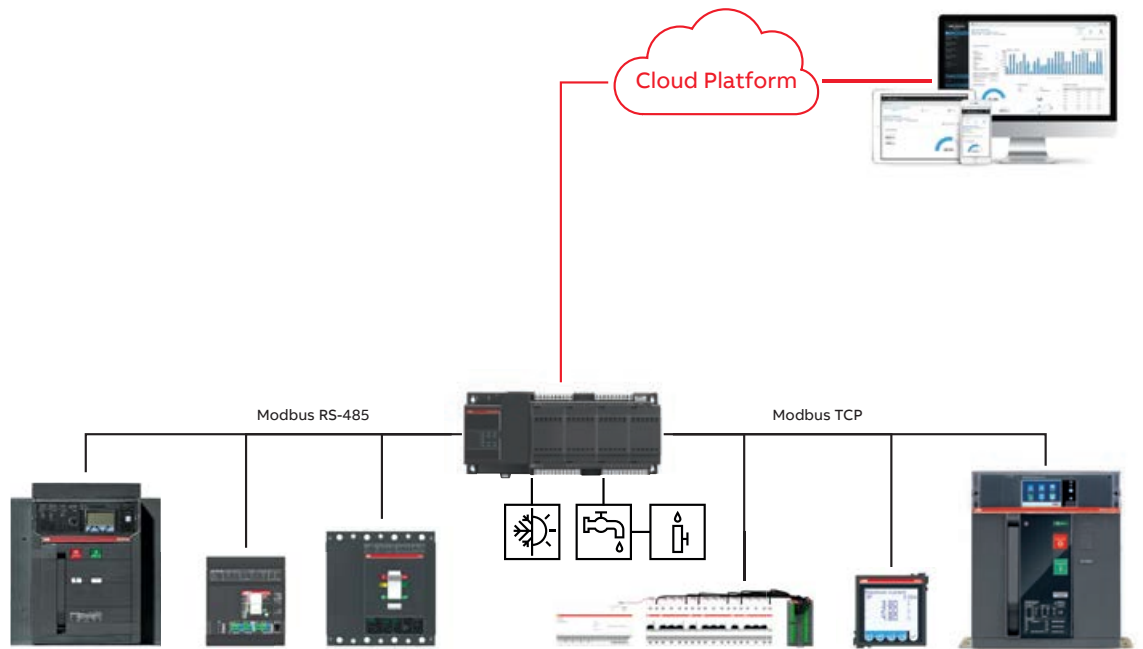

INFORMATION												COMMUNICATION
State	Current	Voltage	Power	Energy	Power Factor	Alarms	Maintenance & Diagnostics	Power Quality	Load management	Environmental parameters	General Info	Protocol
•	•	•	•	•	•	•	•	•	•		•	Modbus RS-485, Modbus TCP, Ekip Link
•	•	•	•	•	•	•	•				•	Modbus RS-485
•	•	•	•	•	•	•	•				•	Modbus RS-485
	•	•	•	•	•			•			•	Modbus RS-485, Modbus TCP
	•	•	•	•	•						•	Modbus RS-485, Modbus TCP
•	•	•	•	•	•	•	•				•	Modbus RS-485
•											•	Modbus TCP
										•	•	Digital I/O
										•	•	Analog I/O
•						•					•	Modbus RS-485

\* Provided the product with dedicated accessories for communication and metering functions

\*\* only with Ekip E-Hub module

## Reliable in extreme conditions

You can be sure TruONE® exceeds standard requirements for performance and reliability to bring you dependable operation in even the most challenging electrical, mechanical and environmental conditions.



TruONE® is the only ATS to guarantee safe and reliable operation during dramatic variations in temperature (-25–+70°C) and voltage (200–480 Vac with +/-20% tolerance), and it's tolerant of vibrations (acc. IEC 60068-2-6) and shocks (acc. IEC 60068-2-27). TruONE® also has true short-circuit resilience, able to take the hit and remain fully operational after exposure to even the most dangerous phenomena.

Site conditions can change due to unexpected situations, but the performance of TruONE® does not.

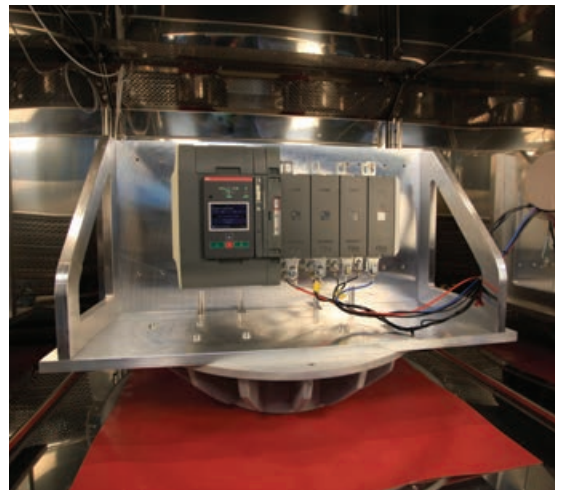

Testing for vibrations, shocks and a wide temperature range.

### Enclosure

#### IP65 SR2 Sheet steel enclosures

The SR2 enclosures come from years in building the experience IP65 metal structures (in accordance with the IEC 60529 Standard), together with the innovative new production process used for construction patented by ABB.

Conforming to EN 62208 standard for low voltage switchgear and controlgear assemblies and allow realisation of electrical equipment conforming to

IEC 60204-1 standard "Safety of machinery", electrical equipment of machines and of the EN 60439-1 Standard and the new EN 61439-1-2 standard "Low voltage protection switchgear and controlgear for assemblies". The degree of protection, in accordance with the IEC 60529 standard "Degrees of protection of enclosures (IP Code)", is IP65.



## Enclosed ATS

### Order Codes



Mimic panel on front door for easy identification.



#### Features and benefits:

- I-O-II –operation with stable OFF position between positions I and II
- HMI can be mounted on the door upon request, please add -H to Part no. (e.g. OTOne40E4L3SBSR-H)

#### I-O-II Delayed transition - Open style operation

Description	Enclosure Size (mm)	Order Code
40A 4 pole ATS with OMD300 controller	600 x 600 x 250	OTA40E4C3SR
63A 4 pole ATS with OMD300 controller	600 x 600 x 250	OTA63E4C3SR
125A 4 pole ATS with OMD300 controller	600 x 600 x 250	OTA125E4C3SR
40A 4 pole ATS with OMD800 controller	600 x 600 x 250	OTA40E4C8SR
63A 4 pole ATS with OMD800 controller	600 x 600 x 250	OTA63E4C8SR
125A 4 pole ATS with OMD800 controller	600 x 600 x 250	OTA125E4C8SR

#### Delayed transition – Open style, Level 2 DIP controls

Bottom entry - Source 1 and Source 2 connections on bottom, load connections on top

Description	Enclosure Size (mm)	Order Code
160A 4 pole ATS with level 2 controller	600 x 600 x 250	OTOne160E4L2SR
250A 4 pole ATS with level 2 controller	600 x 600 x 250	OTOne250E4L2SR
400A 4 pole ATS with level 2 controller	800 x 600 x 300	OTOne400E4L2SR
630A 4 pole ATS with level 2 controller	1000 x 800 x 400	OTOne630E4L2SR
800A 4 pole ATS with level 2 controller	1000 x 800 x 400	OTOne800E4L2SR
1000A 4 pole ATS with level 2 controller	1400 x 800 x 500	OTOne1000E4L2SR
1250A 4 pole ATS with level 2 controller	1400 x 800 x 500	OTOne1250E4L2SR
1600A 4 pole ATS with level 2 controller	1400 x 800 x 500	OTOne1600E4L2SR

#### Delayed transition – Open style, Level 3 LCD controls

Bottom entry - Source 1 and Source 2 connections on bottom, load connections on top

Communication modules to be ordered separately.

Description	Enclosure Size (mm)	Order Code
160A 4 pole ATS with level 3 controller	600 x 600 x 250	OTOne160E4L3SR
250A 4 pole ATS with level 3 controller	600 x 600 x 250	OTOne250E4L3SR
400A 4 pole ATS with level 3 controller	800 x 600 x 300	OTOne400E4L3AM
630A 4 pole ATS with level 3 controller	1000 x 800 x 400	OTOne630E4L3AM
800A 4 pole ATS with level 3 controller	1000 x 800 x 400	OTOne800E4L3AM
1000A 4 pole ATS with level 3 controller	1400 x 800 x 500	OTOne1000E4L3AM
1250A 4 pole ATS with level 3 controller	1400 x 800 x 500	OTOne1250E4L3AM
1600A 4 pole ATS with level 3 controller	1400 x 800 x 500	OTOne1600E4L3SAM



## Ordering Information

### Enclosed ATS single and dual bypass

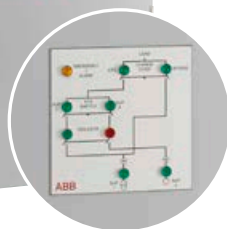

Mimic panel on front door for easy identification.

#### Features and benefits:

- I-O-II –operation with stable OFF position between positions I and II
- HMI can be mounted on the door upon request, please add -H to Part no. (e.g. OTOne40E4L3SBSR-H)



#### Delayed transition – I-O-II Level 3 LCD controller

Description	Enclosure Size (mm)	Order Code
40A 4 pole level 3 controller ATS, single bypass	1000 x 800 x 300	OTOne40E4L3SBSR
63A 4 pole level 3 controller ATS, single bypass	1000 x 800 x 300	OTOne63E4L3SBSR
100A 4 pole level 3 controller ATS, single bypass	1000 x 800 x 300	OTOne100E4L3SBSR
160A 4 pole level 3 controller ATS, single bypass	1200 x 1000 x 400	OTOne160E4L3SBSR
250A 4 pole level 3 controller ATS, single bypass	1200 x 1000 x 400	OTOne250E4L3SBSR
400A 4 pole level 3 controller ATS, single bypass	1200 x 1000 x 400	OTOne400E4L3SBAM
630A 4 pole level 3 controller ATS, single bypass	1600 x 1200 x 600	OTOne630E4L3SBAM
800A 4 pole level 3 controller ATS, single bypass	1600 x 1200 x 600	OTOne800E4L3DBAM

Description	Enclosure Size (mm)	Order Code
40A 4 pole level 3 controller ATS, dual bypass	1000 x 800 x 300	OTOne40E4L3DBSR
63A 4 pole level 3 controller ATS, dual bypass	1000 x 800 x 300	OTOne63E4L3DBSR
100A 4 pole level 3 controller ATS, dual bypass	1000 x 800 x 300	OTOne100E4L3DBSR
160A 4 pole level 3 controller ATS, dual bypass	1200 x 1000 x 400	OTOne160E4L3DBSR
250A 4 pole level 3 controller ATS, dual bypass	1200 x 1000 x 400	OTOne250E4L3SBSR
400A 4 pole level 3 controller ATS, dual bypass	1200 x 1000 x 400	OTOne400E4L3DBAM
630A 4 pole level 3 controller ATS, dual bypass	1600 x 1200 x 600	OTOne630E4L3DBAM
800A 4 pole level 3 controller ATS, dual bypass	1600 x 1200 x 600	OTOne800E4L3DBAM

## Ordering Information

Enclosed ATS with overlapping neutral with no bypass, single bypass and dual bypass

### Features and benefits:

- I-II operation without stable OFF position
- Delivery includes handle for manual operation
- HMI can be mounted on the door upon request, please add -H to Part no. (e.g. OTOne40E4L3SBSR-H)

**Open transition – Open style, Level 3 LCD controller with overlapping neutral. I-II Operation**  
Bottom entry - Source 1 and Source 2 connections on bottom, load connections on top

Description	Enclosure Size (mm)	Order Code
60A 4 pole with TruOne level 3 controller & overlapping neutral	600 x 600 x 250	OTOne60E4L3OLNSR
100A 4 pole with TruOne level 3 controller & overlapping neutral	600 x 600 x 250	OTOne100E4L3OLNSR
160A 4 pole with TruOne level 3 controller & overlapping neutral	600 x 600 x 250	OTOne160E4L3OLNSR
200A 4 pole with TruOne level 3 controller & overlapping neutral	600 x 600 x 250	OTOne200E4L3OLNSR
250A 4 pole with TruOne level 3 controller & overlapping neutral	600 x 600 x 250	OTOne250E4L3OLNSR
400A 4 pole with TruOne level 3 controller & overlapping neutral	800 x 600 x 300	OTOne400E4L3OLNSR
630A 4 pole with TruOne level 3 controller & overlapping neutral	1000 x 800 x 400	OTOne630E4L3OLNSR
800A 4 pole with TruOne level 3 controller & overlapping neutral	1000 x 800 x 400	OTOne800E4L3OLNSR

Description	Enclosure Size (mm)	Order Code
60A 4 pole with TruOne level 3 controller & overlapping neutral	1000 x 800 x 300	OTOne60E4L3OLNSBSR
100A 4 pole with TruOne level 3 controller & overlapping neutral	1000 x 800 x 300	OTOne100E4L3OLNSBSR
160A 4 pole with TruOne level 3 controller & overlapping neutral	1000 x 800 x 300	OTOne160E4L3OLNSBSR
200A 4 pole with TruOne level 3 controller & overlapping neutral	1200 x 1000 x 400	OTOne200E4L3OLNSBSR
250A 4 pole with TruOne level 3 controller & overlapping neutral	1200 x 1000 x 400	OTOne250E4L3OLNSBSR
400A 4 pole with TruOne level 3 controller & overlapping neutral	1200 x 1000 x 400	OTOne400E4L3OLNSBAM
630A 4 pole with TruOne level 3 controller & overlapping neutral	1600 x 1200 x 600	OTOne630E4L3OLNSBAM
800A 4 pole with TruOne level 3 controller & overlapping neutral	1600 x 1200 x 600	OTOne800E4L3OLNSBAM

Description	Enclosure Size (mm)	Order Code
60A 4 pole with TruOne level 3 controller & overlapping neutral	1000 x 800 x 300	OTOne60E4L3OLNDBSR
100A 4 pole with TruOne level 3 controller & overlapping neutral	1000 x 800 x 300	OTOne100E4L3OLNDBSR
160A 4 pole with TruOne level 3 controller & overlapping neutral	1000 x 800 x 300	OTOne160E4L3OLNDBSR
200A 4 pole with TruOne level 3 controller & overlapping neutral	1200 x 1000 x 400	OTOne200E4L3OLNDBSR
250A 4 pole with TruOne level 3 controller & overlapping neutral	1200 x 1000 x 400	OTOne250E4L3OLNDBSR
400A 4 pole with TruOne level 3 controller & overlapping neutral	1200 x 1000 x 400	OTOne400E4L3OLNDBAM
630A 4 pole with TruOne level 3 controller & overlapping neutral	1600 x 1200 x 600	OTOne630E4L3OLNDBAM
800A 4 pole with TruOne level 3 controller & overlapping neutral	1600 x 1200 x 600	OTOne800E4L3OLNDBAM

## Accessories

### Automatic transfer switches



OXEA1

#### Auxiliary power supply module

The OXEA1 auxiliary power supply module is used for: a) connecting connectivity modules (signalling and communication) to the switch b) powering the ATS controller and connectivity modules from auxiliary 12-24 Vdc power supply, to keep them operational during power failures. A 12-24 Vdc power supply is not required when line power is available but it is necessary to keep the modules operational during power failures.

Suitable for switches	Aux voltage	Type	Weight/unit kg	Order Code
OX30...1600	12-24Vdc	OXEA1	0.04	1SCA148926R1001

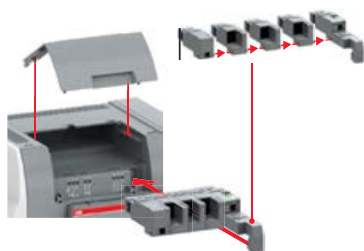

#### Connectivity modules

The connectivity modules are used in combination with OXEA1 auxiliary power supply module to enable communication capabilities (Ekip Com modules) and increase the number of digital inputs and outputs (Ekip Signalling modules). The maximum number of additional modules depends on the TruONE switch size: IEC 200-400 Amps and UL 30-260 Amps can fit three additional modules and IEC 500-1600 Amps and UL 400-1200 Amps can fit four additional modules. These modules are available with TruONE Level 3 and Level 4 controllers.



EKIP COM

#### Communication modules for Level 3 and Level 4 controllers

The Ekip Com modules enable TruONE to be integrated in an industrial communication network for remote supervision and control of the switch. Several Ekip Com modules can be installed at the same time, thereby enabling connection to communication systems that use different protocols. The Ekip Com modules for Modbus RTU, Profibus-DP and DeviceNet contain a terminating resistor and DIP switch for optional activation to terminate the serial network or bus. The Profibus-DP module also contains a polarisation resistor and DIP switch for its activation.

Suitable for switches	Protocol	Type	Weight/unit kg	Order Code
OX30...1600	Modbus RTU	Ekip Com Modbus RTU-OX	0.2	1SDA104051R1
OX30...1600	Modbus TCP	Ekip Com Modbus TCP-OX	0.2	1SDA104052R1
OX30...1600	Profibus DP	Ekip Com Profibus	0.2	1SDA074152R1
OX30...1600	Profinet	Ekip Com Profinet	0.2	1SDA074153R1
OX30...1600	EtherNet/IP	Ekip Com EtherNet / IP	0.2	1SDA074155R1
OX30...1600	DeviceNet	Ekip Com DeviceNet	0.2	1SDA074154R1

## Accessories

### Automatic transfer switches



EKIP 2K SIGNALLING

The Ekip 2K Signalling modules add two input and two output contacts for controlling and remote signalling. They can be programmed with the HMI unit's display or with the Ekip Connect software. Three versions of the Ekip 2K Signalling modules are available: Ekip 2K-1, Ekip 2K-2, Ekip 2K-3. Simultaneous usage of same types is not possible.

#### Signalling modules for Level 3 and Level 4 controllers

Suitable for switches	No. of DI/DO	DI/DO numbering	Type	Weight/unit kg	Order Code
OX30...1600	2/2	11,12/11,12	Ekip Signalling 2K-1-OX	0.2	1SDA104053R1
OX30...1600	2/2	21,22/21,22	Ekip Signalling 2K-2-OX	0.2	1SDA104054R1
OX30...1600	2/2	31,32/31,32	Ekip Signalling 2K-3-OX	0.2	1SDA104055R1



EKIP PROGRAMMING

The Ekip Programming module is used for programming TruONE via USB to a PC using the Ekip Connect software that can be downloaded online. It enables both online (line power available) and offline (no line power available) programming. Available for TruONE Level 3 and Level 4 controllers.

#### Ekip programming module

Suitable for switches	Type	Weight/unit kg	Order Code
OX30...1600	Ekip Programming	0.2	1SDA076154R1



EKIP COM HUB

Ekip Com Hub is a communication module for cloud-based connectivity through the ABB Ability™ Electrical Distribution Control System (EDCS). TruONE equipped with Ekip Com Hub can establish the connection to ABB Ability for the whole low-voltage power distribution panel. This dedicated cartridge-type communication module just needs to be inserted into the TruONE and connected to the internet. For further information related to ABB Ability and Electrical Distribution Control System, please visit the dedicated website <https://new.abb.com/low-voltage/launches/abb-ability-edcs>. Available for TruONE Level 3 and Level 4 controllers.

#### Ekip com hub

Suitable for switches	Type	Weight/unit kg	Order Code
OX30...1600	Ekip Programming	0.2	1SDA076154R1

## Accessories

### Automatic transfer switches



OXEB\_

#### Phase barriers

Grey plastic barriers for maintaining 1" clearance between the phases without terminal shrouds. Snap-on mounting. Included as standard for the LOAD side terminals with IEC 500-1600 Amps and UL 400-1200 Amps.

Suitable for switches	No. of poles	Units/type [pcs]	Type	Weight/unit kg	Order Code
OX30...1600	3	4	OXEB1600/4	0.5	1SCA150201R1001
OX30...1600	4	6	OXEB1600/6	0.7	1SCA150202R1001

Note: Phase barriers cannot be used together with terminal shrouds.



OXEW1600\_

#### Wide blade kit

This is required for IEC 1000-1600 A and UL 800-1200 A switches on the LOAD side terminals, when wiring is done with four cables and using mechanical compression lugs.

Suitable for switches	No. of poles	Units/type [pcs]	Type	Weight/unit kg	Order Code
IEC 1000-1600 Amps	3	6	OXEW1600/3	1.38	1SCA150204R1001
UL 800-1200 Amps	4	8	OXEW1600/4	1.83	1SCA150205R1001

Note: These codes are only for spare part purposes as the items are already included in the standard delivery.



OXEC21

#### Wide blade kit

IP54 padlockable transparent cover, providing protection against accidental contact.

Suitable for switches	Type	Weight/unit kg	Order Code
OX30...1600	OXEC21	0.18	1SCA147308R1001

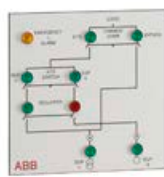

#### Mimic panels (Single/Dual Bypass)

Description	Dimensions (mm)	Order Code
Mimic Panel for Dual ByPass ATS	200 x 200 x 80	01MimicDB
Mimic Panel for Single ByPass ATS	200 x 200 x 80	01MimicSB

Note: Other options available upon request.



## Accessories

### Automatic transfer switches



OA1G01AU

**Auxiliary contacts**

Mounting on the right side of the switch: Max. 4 auxiliary contact blocks / Source 1 and Source 2 position indication (totally 8 blocks). Types \_AU have gold plated contacts for harsh environments and low operating voltages. Simultaneous action with the main contacts, IP20.

Suitable for switches	Contact functions	Installation side	Delivery batch [pcs]	Type	Weight/unit kg	Order Code
OX30...1600	1NO	Right	10	OA1G10	0.03	1SCA022353R4970
OX30...1600	1NC	Right	10	OA3G01	0.03	1SCA022456R7410
OX30...1600	1NO	Right	10	OA1G10AU	0.03	1SCA022436R7910
OX30...1600	1NC	Right	10	OA3G01AU	0.03	1SCA022819R5260



OA1G10

**Auxiliary contacts** - Technical data for auxiliary contacts according to IEC 60947-5-1, for OA1G\_, OA3G\_

AC15				DC12		DC13	
Ue/[V]	Ie/[A]	Ue/[V]	Ie/[A]	P/[W]	Ie/[A]	P/[W]	
230	6	24	10	240	2	50	
400	4	72	4	290	0.8	60	
415	4	125	2	250	0.55	70	
690	2	250	0.55	140	0.27	70	
		440	0.1	44			



OA3G01

**Auxiliary contacts** - Function table for auxiliary contacts / Source 1 position (max. 2+2)

Switch position	Main contacts	OA1G10 NO	OA3G01 NC
I	closed	closed	open
0	open	open	closed
II	closed	open	closed



OA3G01AU

**Auxiliary contacts** - Function table for auxiliary contacts / Source 2 position (max. 2+2)

Switch position	Main contacts	OA1G10 NO	OA3G01 NC
I	closed	open	closed
0	open	open	closed
II	closed	closed	open

## TruONE™ Part no. key

Example key and product description:

**OXB1000E3S4Q54B**

ABB TruONE™ automatic transfer switch, delayed transition, 1000 amperes, IEC, 3 phase + Neutral (3ph, 4 wire), Level 4 controls, 200–480 VAC voltage area, enclosed style IP54 – bottom in/bottom out.

<b>ABB TruONE™ ATS</b>
<b>OX</b>
<b>ATS type</b>
<b>A</b> Open transition I - II (without stable OFF position for load disconnection)
<b>B</b> Delayed transition I - O - II (with stable OFF position for load disconnection)
<b>ATS size</b>
30, 60, 100, 125, 160, 200, 250, 260, 315, 400, 500, 600, 630, 800, 1000, 1200, 1250, 1600
<b>Standard</b>
<b>E</b> IEC
<b>U</b> UL
<b>Phase poles</b>
<b>1</b> 1-pole
<b>2</b> 2-pole
<b>3</b> 3-pole
<b>Neutral</b>
<b>S</b> Switched Neutral
<b>O</b> Overlapping Neutral
<b>X</b> None
<b>Controller</b>
<b>2</b> Level 2 controls (DIP)
<b>3</b> Level 3 controls (LCD)
<b>4</b> Level 4 controls (Touch)
<b>Voltage code</b>
<b>Q</b> 200–480 VAC
<b>Enclosure rating</b>
<b>54</b> IP54 (IEC)
_ (blank) Open style, no enclosure
<b>Cabling direction</b>
Open style, no enclosure
<b>B</b> Bottom entry (sources on bottom, load on top)
<b>T</b> Top entry (sources on the top, load on the bottom)
Enclosed style
<b>B</b> Bottom in / Bottom out
<b>D</b> Bottom in / Top out
<b>Note:</b> Contact ABB for more details on the available versions.

—  
01 Open style ATS  
UL 30-200 A  
IEC 200-250 A



01

—  
02 Open style ATS  
UL 260 A  
IEC 315-400 A



02

—  
03 Open style ATS  
UL 400-600 A  
IEC 500-800 A



03

—  
04 Open style ATS  
UL 800-1200 A  
IEC 1000-1600 A



04

—  
05 Enclosed style ATS  
IEC 200-1600 A



05

—  
**Targeted product performance**

ATS Frame Size	30-400 A	260-800 A	800-1600 A
IEC 60947-6-1, GB 14048-11: AC-33B	200-400 A	630-800 A	1000-1600 A
GB 14048-11: AC-33iA	30-200 A	260-600 A	800-1200 A
UL1008: Emergency systems—total system load	30-200 A	260-600 A	800-1200 A
I <sub>cc</sub> (rated conditional short-circuit current)	100 kA	100 kA	100 kA
I <sub>cw</sub> (rated short-time withstand current)/Short-time current ratings, 100ms	18-30 kA	42 kA	50 kA
I <sub>cw</sub> (rated short-time withstand current)/Short-time current ratings, 500ms		30 kA	50 kA
Withstand and Close-on ratings (any breaker) 480V	42 kA	50 kA	85 kA
Withstand and Close-on ratings, with current limiting fuses	200 kA	200 kA	200 kA

## TruONE™ feature comparison

Main features in the table below. Consult ABB for more information.



### Feature comparison

	Level 2 controls	Level 3 controls	Level 4 controls
Ampere sizes available	IEC: 200-1600 A UL: 30-1200 A	IEC: 200-1600 A UL: 30-1200 A	IEC: 200-1600 A UL: 30-1200 A
Rated voltage	200-480Vac	200-480Vac	200-480Vac
Rated frequency	50 / 60 Hz	50 / 60 Hz	50 / 60 Hz
Phase system	Single and Three	Single and Three	Single and Three
Number of poles	2, 3 and 4	2, 3 and 4	3 and 4
<b>Neutral configuration</b>			
Switched	Yes	Yes	Yes
Overlapping	No	Yes	Yes
<b>Product type</b>			
Open transition (I-II)	Yes	Yes	Yes
Delayed transition (I-O-II)	Yes	Yes	Yes
<b>Voltage and frequency settings</b>			
Pick up Voltage Source 1	Fixed 2% above drop out	81...99%, 101...119%	81...99%, 101...119%
Drop out Voltage Source 1	+/-5, 10, 15, 20%	80...98%, 102...120%	80...98%, 102...120%
Pick up Voltage Source 2	Fixed 2% above drop out	81...99%, 101...119%	81...99%, 101...119%
Drop out Voltage Source 2	+/-5, 10, 15, 20%	80...98%, 102...120%	80...98%, 102...120%
Pick up Frequency Source 1	Fixed 1% above drop out	80,5...99,5%, 100,5...119,5%	80,5...99,5%, 100,5...119,5%
Drop out Frequency Source 1	+/-5, 10 %	80...99%, 101...120%	80...99%, 101...120%
Pick up Frequency Source 2	Fixed 1% above drop out	80,5...99,5%, 100,5...119,5%	80,5...99,5%, 100,5...119,5%
Drop out Frequency Source 2	+/-5, 10 %	80...99%, 101...120%	80...99%, 101...120%
<b>Time delay settings</b>			
Override momentary Source 1 Outage, sec	0, 1, 2, 3, 4, 5, 10, 15, 20, 25, 30	0...60	0...60
Transfer from Source 1 to Source 2, sec	Fixed 2 seconds	0...3600	0...3600
Override momentary Source 2 Outage, sec	Fixed 1,5 seconds	0...60	0...60
Transfer from Source 2 to Source 1, min	0, 1, 2, 3, 4, 5, 10, 15, 20, 25, 30	0...120	0...120
Generator stop delay, min	30 secs or 4 mins	0...60	0...60
Center-OFF delay, sec	0 or 4	0...300	0...300
Pre-transfer delay S1 to S2, sec	No	0...60	0...60
Post-transfer delay S1 to S2, sec	No	0...60	0...60
Pre-transfer delay S2 to S1, sec	No	0...60	0...60
Post-transfer delay S2 to S1, sec	No	0...60	0...60
Load shed delay, sec	No	0...60	0...60
<b>Source failure detections</b>			
No voltage	Yes	Yes	Yes
Undervoltage	Yes	Yes	Yes
Overvoltage	Yes	Yes	Yes
Phase missing	Yes	Yes	Yes
Voltage unbalance	Yes	Yes	Yes
Invalid frequency	Yes	Yes	Yes
Incorrect phase sequence	Yes	Yes	Yes

## TruONE™ feature comparison

Main features in the table below. Consult ABB for more information.



### Feature comparison

	Level 2 controls	Level 3 controls	Level 4 controls
<b>Features</b>			
Controls	DIP + keys	LCD + keys	Touch + keys
LED indications for ATS, S1 and S2 status	Yes	Yes	Yes
Open transition - Standard digital inputs/outputs	0 / 1	1 / 1	2 / 1
Delayed transition - Standard digital inputs/outputs	1 / 1	2 / 1	3 / 1
Programmable digital inputs/outputs	No	Yes	Yes
Auto config (voltage, frequency, phase system)	Yes	Yes	Yes
Source priority	Source 1, No priority	Source 1/2, No priority	Source 1/2, No priority
Manual re-transfer	Yes	Yes	Yes
In-phase monitor	Yes	Yes	Yes
Genset exercising: on-load, off-load	Yes	Yes	Yes
In-built power meter module	No	No	Yes
Load shedding	No	Yes	Yes
Real time clock	No	Yes	Yes
Event log	No	Yes	Yes
Predictive maintenance	No	No	Yes
<b>Field-mount accessories</b>			
Auxiliary contacts for position indication	Yes	Yes	Yes
Digital input/output modules	No	Yes	Yes
12-24 Vdc aux supply module for controller	No	Yes	Yes
Communication modules	No	Yes	Yes
<b>Connectivity</b>			
Modbus RS485	No	Yes	Yes
Modbus/TCP	No	Yes	Yes
Profibus DP	No	Yes	Yes
ProfiNet	No	Yes	Yes
DeviceNet	No	Yes	Yes
Ethernet IP	No	Yes	Yes
IEC 61850	No	Yes	Yes
Monitoring via ABB Ability™: EDCS	No	Yes	Yes
<b>Enclosures</b>			
Open style	Yes	Yes	Yes
IP54	No	Yes	Yes
<b>For applications</b>			
Mains - Mains	Yes	Yes	Yes
Mains - Generator	Yes	Yes	Yes



## Technical data

### OTM\_C\_D products overview



#### OTM\_C20D

For Network/Network application.

Fixed version with pre-defined delay times and voltage thresholds.

#### Fixed version

Number of poles	Rated current (A)	Rated voltage (V)	Voltage sensing	Type	Order Code	Weight (kg)
2	63	230:220-240	Top in	OTM63F2C20D230C	1SCA151421R1001	1.75
2	125	230:220-240	Top in	OTM125F2C20D230C	1SCA151417R1001	1.75
3	63	400:380-415	Top in	OTM63F3C20D400C	1SCA151423R1001	1.75
3	125	400:380-415	Top in	OTM125F3C20D400C	1SCA151419R1001	1.75
4	40	400:380-415	Top in	OTM40F4C20D400C	1SCA151252R1001	2.00
4	63	400:380-415	Top in	OTM63F4C20D400C	1SCA151254R1001	2.00
4	125	400:380-415	Top in	OTM125F4C20D400C	1SCA151250R1001	2.00



#### OTM\_C21D

For Network/Network and Network/Genset applications.

Adjustable version with configurable transfer and back-switching delays.

Adjustable over and under-voltage thresholds.

#### Adjustable version

Number of poles	Rated current (A)	Rated voltage (V)	Voltage sensing	Type	Order Code	Weight (kg)
2	63	230:220-240	Top in	OTM63F2C21D230C	1SCA151422R1001	1.75
2	125	230:220-240	Top in	OTM125F2C21D230C	1SCA151418R1001	1.75
3	63	400:380-415	Top in	OTM63F3C21D400C	1SCA151424R1001	1.75
3	125	400:380-415	Top in	OTM125F3C21D400C	1SCA151420R1001	1.75
4	40	400:380-415	Top in	OTM40F4C21D400C	1SCA151253R1001	2.00
4	63	400:380-415	Top in	OTM63F4C21D400C	1SCA151255R1001	2.00
4	125	400:380-415	Top in	OTM125F4C21D400C	1SCA151251R1001	2.00
4	40	400:380-415	Bottom in	OTM40F4CB21D400C	1SCA150580R1001	2.00
4	63	400:380-415	Bottom in	OTM63F4CB21D400C	1SCA150586R1001	2.00
4	125	400:380-415	Bottom in	OTM125F4CB21D400C	1SCA150574R1001	2.00

## Technical data

### Compact automatic transfer switches

#### Automatic transfer switches functionality

OTM_C_D products overview	OTM_C20D_	OTM_C21D_
<b>Features</b>	x	x
Rated operational voltage Ue	154 V AC - 480 V AC +/- 20% + N	
Rated frequency	50 / 60 Hz +/- 10%	
Voltage sensing precision	5%	
Frequency sensing precision	1%	
Rated impulse withstand voltage, Uimp	6 kV	
Overvoltage category	III	
Pollution degree	2	
Protection rating for the front panel	IP20	
Operating temperature	- 20...+ 60 °C	
Transportation and storage temperature	- 25...+ 80 °C	
Altitude	Max. 2000m	
Humidity With condensation	5 %...98 %	
Humidity Without condensation	5 %...90 %	
<b>Operation Types</b>		
Manual operation with handle	x	x
Local operation with front panel keypad		x
Automatic transfer switching equipment (ATSE)	x	x
<b>Applications</b>		
Transfer between two Transformers	x	x
Transfer between a Transformers and a generator		x
<b>Operation modes</b>		
Automatic transfer and back-switching operation	x	x
Automatic transfer and manual back-switching operation	x	x
<b>Source failure detections</b>		
No voltage	x	x
Undervoltage	Fixed 0.7Ue	0.7-0.95 Ue
Overvoltage	Fixed 1.3Ue	1.05-1.3 Ue
Phase missing	x	x
Voltage unbalance		x
Invalid frequency		x
<b>Configuration</b>		
By DIP switches	x	x
By rotary switches		x
Two power status display	x	x
Two switches status display	x	x
Auto status display	x	x
Alarm display	x	x

## Technical data

### Compact automatic transfer switches

#### Automatic transfer switches functionality

OTM_C_D products overview	OTM_C20D_	OTM_C21D_
<b>Time delays</b>		
Delay on transfer <sup>3)</sup>		0-30s
Back-switching delay		0-900s
Generator stop delay		30s,400s
<b>Signals input and output</b>		
Emergency Off with 24VDC signal input	x	x
Test signal input		x
Switch position signal	With Auxiliary contacts	Without Auxiliary contact
Alarm output signal		x

<sup>3)</sup> Overvoltage and undervoltage conditions

## Compact ATS

### Easy use and installation

01 Easy manual operation with the handle in case of emergency.

02 DIN- rail mounting.

03 Base mounting with screws.



## Technical data

### Compact automatic transfer switches OTM40...125\_

#### Compact automatic transfer switches

Data according to IEC 60947-3				Switch size		
				OTM40_	OTM63_	OTM125_
Rated insulation voltage and rated operational voltage AC20/DC20	Pollution degree 3	V	800	800	800	
Dielectric strength	50 Hz 1min.	kV	6	6	6	
Rated impulse withstand voltage		kV	8	8	8	
Rated thermal current and rated operational current AC20/DC20	/ ambient 40°C	In open air	A	40	63	125
	/ ambient 40°C	In enclosure	A	40	63	125
	/ ambient 60°C	In enclosure	A	32	50	100
..with minimum conductor cross section	Cu	mm <sup>2</sup>	10	16	50	
Rated operational current, AC-21A	up to 500 V	A	40	63	125	
	690 V	A	40	63	125	
Rated operational current, AC-22A	up to 500 V	A	40	63	125	
	690 V	A	40	63	125	
Rated operational current, AC-23A	up to 415 V	A	40	63	90	
	500 V	A	40	60	70	
	690 V	A	40	40	50	
Rated operational current / poles in series, DC-21A	up to 48 V	A	40/1	63/1	125/1	
	110 V	A	40/2	63/2	125/2	
	220 V	A	40/4	63/4	100/4	
Rated operational current / poles in series, DC-22A	up to 48 V	A	40/1	63/1	125/1	
	110 V	A	40/2	63/2	125/2	
	220 V	A	40/4	63/4	80/4	
Rated operational current / poles in series, DC-23A	up to 48 V	A	40/1	63/1	125/1	
	110 V	A	40/2	63/2	125/2	
	220 V	A	40/4	63/4	63/4	
Rated operational power, AC-23A <sup>1)</sup>	230 V	kW	7.5	15	22	
The kW-ratings are accurate for 3-phase 1500 R.P.M. standard asynchronous motors	400 V	kW	18.5	30	45	
	415 V	kW	18.5	30	45	
	500 V	kW	22	37	45	
	690 V	kW	37	37	45	
Rated breaking capacity in category AC-23	up to 415 V	A	320	504	720	
	500 V	A	320	480	560	
	690 V	A	320	320	400	
Rated conditional short-circuit current I <sub>p</sub> (r.m.s.) and corresponding max. allowed cut-off current i <sub>c</sub> (peak) value.	I <sub>p</sub> (r.m.s.) 50 kA, 415 V	i <sub>c</sub> (peak)	kA	16.5	16.5	16.5
	Max. OFA_ fuse size	gG/aM	A/A	125/125	125/125	125/125
The cut-off current i <sub>c</sub> refers to values listed by fuse manufacturers (single phase test acc. to IEC60269).	I <sub>p</sub> (r.m.s.) 18 kA, 690 V	i <sub>c</sub> (peak)	kA	11	11	11
	Max. OFA_ fuse size	gG	A	125	125	125
	I <sub>p</sub> (r.m.s.) 50 kA, 690 V	i <sub>c</sub> (peak)	kA	10	10	10
	Max. OFA_ fuse size	gG/aM	A/A	63/63	63/63	63/63
Rated short-time withstand current	I <sub>cw</sub> (r.m.s.)	690 V 1s	kA	2.5	2.5	2.5
Rated short-time making capacity <sup>2)</sup>	I <sub>cm</sub> (peak)	690 V	kA	3.6	3.6	3.6
Power loss / pole	With rated current		W	1.6	2.8	6.3
Mechanical endurance	Number of oper. cycles <sup>3)</sup>		Cycles	10 000	10 000	10 000
Cable size	Cu-wire size suitable for terminal clamps		mm <sup>2</sup>	2.5-25/2x2.5-16	10-70	10-70
			AWG	14-4/2x14-6	8-00	8-00
Terminal tightening torque	Counter torque required		Nm	6	6	6
			Nm	5	5	5
Operating torque	Typical for 3-pole switches		Nm	5	5	5
Weight without accessories	3-pole switch		kg	1.75	1.75	1.75

## Technical data

### Compact automatic transfer switches OTM40...125\_

#### Compact automatic transfer switches

Data according to IEC 60947-6-1				Switch size		
				OTM40_	OTM63_	OTM125_
Class of equipment				PC	PC	PC
Rated short-time withstand current	l <sub>cw</sub> (r.m.s.)	690 V 0.1s	kA	5	5	5
Conditional short-circuit current	I <sub>cc</sub> (r.m.s.)	415 V	kA	50	50	50
Corresponding fuse rating	gG/aM fuse	415 V	A	125	125	125
Rated operational current, AC-31B		up to 415 V	A	40	63	125
Rated operational current, AC-32B		up to 415 V	A	40	63	125

<sup>1)</sup> These values are given for guidance and may vary according to the motor manufacturer.  
<sup>2)</sup> Short circuit duration > 50ms, without fuse protection.  
<sup>3)</sup> Operating cycle: O - I - O - II - O.

## Compact ATS

### Dimensional drawings

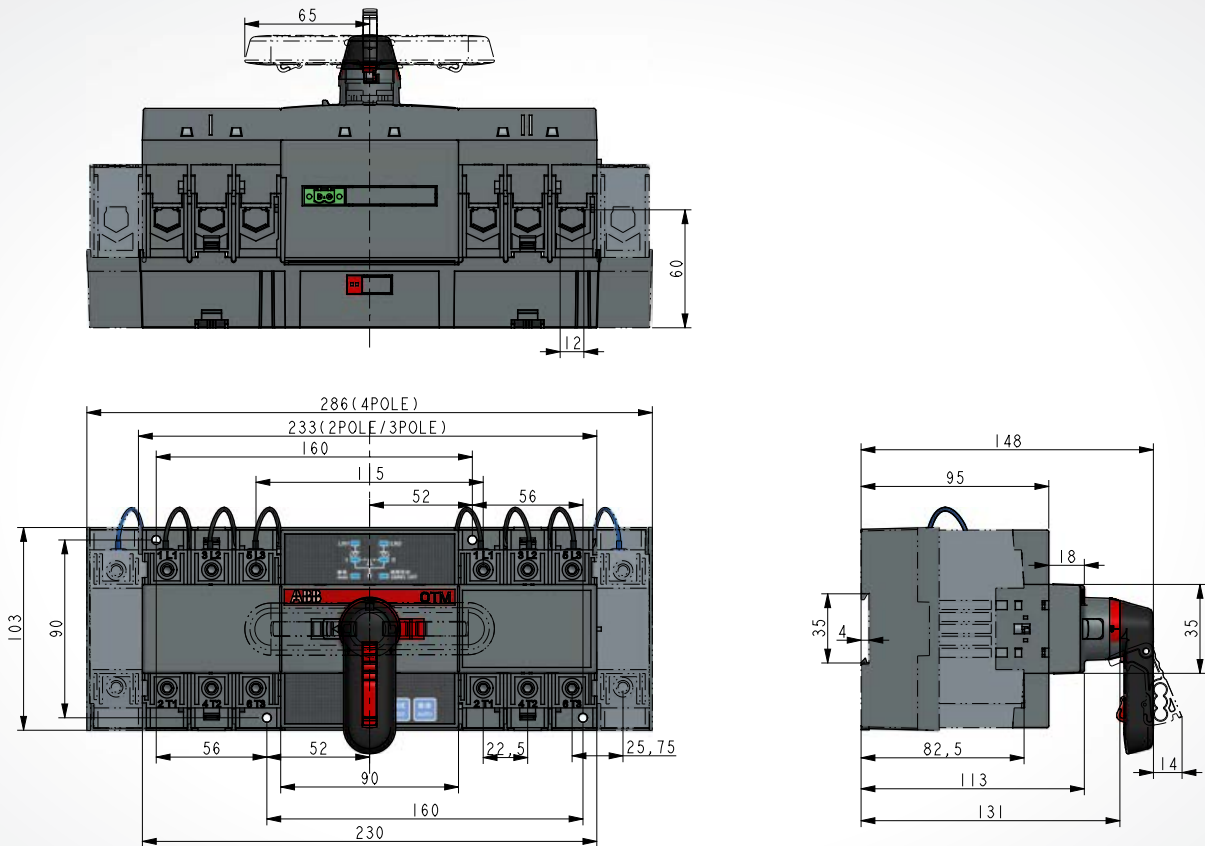

## Accessories

### Order Codes

#### Handles, direct mounting

Plastic I - O - II handle

Suitable for switches	Colour	Installation side	Type	Order Code	Units/type (pcs)	Weight/unit (kg)
OTM40...125F_CM	Black	Shaft incl.	OHB65D6CM	1SCA022807R9430	1	0.12



#### Handle storage clip

The handle can be stored in the handle storage clip OTVS0. The handle storage clip can be fixed to a panel frame using the included adhesive tape.

Suitable for switches	Type	Order Code	Units/type (pcs)	Weight/unit (kg)
OTM40...125F_CM	OTVS0	1SCA117524R1001	1	0.02



OA1G01  
OA7G10

OA1G10  
OA8G01

#### Auxiliary contacts

Snap-on mounting to the switch, IP 20, max. 2 blocks/ side.  $I_{th} = 16 A$ , suitable for cable cross sections max.  $2 \times 2.5 \text{ mm}^2$ . Simultaneous action with the main contacts. The type and ordering number is for one piece.

Suitable for switches	Contact function	Installation side	Type	Order Code	Units/type (pcs)	Weight/unit (kg)
OTM40...125F_CM	1NO	Right	OA1G10	1SCA022353R4970	1	0.03
OTM40...125F_CM	1NC	Right	OA8G01	1SCA022744R2240	1	0.03
OTM40...125F_CM	1NO	Left	OA7G10	1SCA022673R1140	1	0.03
OTM40...125F_CM	1NC	Left	OA1G01	1SCA022353R4890	1	0.03



## Accessories

### Order Codes



OTS\_T3



OTS\_T1

### Terminal shrouds

Transparent plastic, snap-on mounting to the switches, IP20. The full shrouding of a 3-pole change-over switch is achieved with four 3-pole shrouds.\*

Suitable for switches	Type	Order Code	Units/type (pcs)	Weight/unit (kg)
<b>For three pole switches</b>				
OTM40...125F_CM	OTS125T3	1SCA022379R9680	1	0.03
<b>For fourth pole</b>				
OTPS60FP, OTPS125FP	OTS125T1	1SCA022379R9760	1	0.03



OZXT1



OZXT2...3



OZXT6

### Terminal clamp sets

Suitable for switches	Contact function	Type	Order Code	Units/type (pcs)	Weight/unit (kg)
<b>Terminal clamp sets for Al- and Cu-cables insulated versions</b>					
OTM40...125F_CM	16...50 Al / 2.5...50 Cu	OZXT1	1SCA022469R6310	3	0.06
OTM63...125F_CM	16...120 Al/Cu	OZXT2	1SCA022620R7200	3	0.21
OTM63...125F_CM	2x(16...50) Al/Cu	OZXT3	1SCA022639R0720	3	0.21
<b>Including 0.75...2.5 mm<sup>2</sup> voltage sensing connection. Voltage sensing wires are not included in the delivery</b>					
OTM40...125F_CM	16...50 Al/2.5...50 Cu	OZXT6	1SCA122537R1001	3	0.06
<b>Terminal clamp sets for Al- and Cu-cables</b>					
OTM40...125F_CM	10...70 Al/Cu	OZXL1	1SCA022439R6770	3	0.14



OMZC\_

### Parallel connection kits

Finger protected connection bars for parallel connection of the upper or lower terminals. The bars accept additional cables, the maximum size is stated below.

Suitable for switches	Cable crosssection (mm <sup>2</sup> )	Type	Order Code	Units/type (pcs)	Weight/unit (kg)
OTM40F3CM_	2.5...25/2x2.5...16	OMZC03	1SCA121324R1001	1	0.5
OTM40F4CM_	2.5...25/2x2.5...16	OMZC04	1SCA121325R1001	1	0.65
OTM40...125F3CM_	10...70	OMZC03	1SCA117037R1001	1	0.5
OTM40...125F4CM_	10...70	OMZC04	1SCA117038R1001	1	0.65

\* Terminal shrouds can also be mounted on parallel connection kits.

---

# Enclosed switches

- 166**      **Loadbreak and safety switches**
- 169**      **Switch fuses**



For more detailed product information, please refer to our online technical brochures available at: [new.abb.com/low-voltage/support/documentation](http://new.abb.com/low-voltage/support/documentation)

or contact our sales team via email [LV.enquiries@gb.abb.com](mailto:LV.enquiries@gb.abb.com)

or call 0333 999 9933

# Enclosed switches

## Switch solutions - Functionality and features

Enclosed switches are designed and used as main switches for applications, which need to be isolated from the network. The range includes front operated and side operated switch disconnectors, switch fuses and changeover switches enclosed in plastic, steel sheet or stainless steel sheet and aluminium enclosures. They are rated for utilisation categories including disconnecting as well as making and breaking the load. In addition the switch fuses equipped with fuse links protects the application and the cables from overload currents and short circuits.

### Plastic enclosures

The plastic enclosures are most suitable for locations with high chemical and moisture requirements. In addition they are light and easy to install and handle.

### Steel sheet enclosures

The steel sheet enclosures are hot dip galvanised and the surface is polyester powder painted. The enclosures are durable and robust for various environments.

### Stainless steel sheet enclosures

The stainless steel sheet enclosures are made of AISI 304 stainless steel. They are used particularly in the food and beverage industry and in locations where high hygiene is required. The smooth surface does not require any painting and is easy to clean.

### Aluminium alloy enclosures

Aluminium enclosures have very good impact strength and protection against UV light. They are suitable both for indoor and outdoor use in medium to heavy-duty applications.

### Safety for personnel – reliable position indication

- Padlocking in the OFF-position with one, three or six (with the shackle L6) padlocks against unintentional start-up.
- The handle cannot be padlocked in the OFF-position if one of the contacts is not in the OFF-position.
- The cover cannot be removed if the handle is padlocked.
- Door interlock in the ON-position.
- Arc proof, short circuit durability function: Expander washers in aluminium enclosures with  $I_e > 160$  A and door locking release in large metal sheet enclosures type MSC.
- Door interlock defeatable with rectangular and pistol type handles.



## Switchgear - Loadbreak and safety switches

IP65 Double insulated enclosure



### Load Break Switches 3 - 4 pole 9...37kW

- IP65 three and four-pole switch disconnectors suitable for load break switching or isolation
- Polycarbonate enclosure. IEC 60947-3

Polycarbonate enclosure 9kW ... 11kW 3 pole

Rating@415v			Dimensions (mm)			Order Code
1th A	AC22	kW	H	W	D	
32	25	9	125	100	107	S37K5N-A
40	40	11				S315KN-A
Polycarbonate enclosure 9kW ... 37kW 4 pole						
32	25	9	125	100	107	S47K5N-A
40	40	11				S415KN-A
63	63	22	170	140	108	S418KN-A
80	80	37				S426KN-A



- IP65 rated
- Grey plastic enclosure
- Standard handle - Red/Yellow (padlockable in the off position)
- Cable entries top and bottom
- All OTP16 (excluding 3p) /25/32 all have 25/20mm reducers

Polycarbonate enclosure 9kW ... 37kW 4 pole

Rating@415v				No. Poles	Dimensions (mm)			Order Code
1th A	AC22	AC23	kW		H	W	D	
25	16	16	7.5	3 + solid neutral	150	130	60	OTP16BA3M
				4				OTP16BA4M
				6				OTP16BA6M
32	25	20	9	3 + solid neutral	150	130	60	OTP25BA3M
				4				OTP25BA4M
				6				OTP25BA6M
40	40	23	11	3 + neutral	150	130	60	OTP32BA3M
				4				OTP32BA4M
				6				OTP32BA6M
63	63	45	22	3 + solid neutral	200	145	90	OTP45BA3M
				4				OTP45BA4M
				6				OTP45BA6M
80	80	75	37	3 + solid neutral	200	145	90	OTP63BA3M
				4				OTP63BA4M
				6				OTP63BA6M
125	125	90	45	3 + solid neutral	400	200	140	OTP125BA3U
				4				OTP125BA4U
				6				OTP125BA6U
Safety switches 3 pole 16...40 amps								
25	16	16	7.5	3	150	130	60	OTP16B3M
32	25	20	9	3	150	130	60	OTP16B3M
40	40	23	11	3	150	130	60	OTP32B3U

## Switchgear - Loadbreak switches

IP65 Steel enclosure



- IP65 rated (not suitable for external installation)
- Powder coated textured finish (RAL 7035)
- All 3 pole switches include detachable neutral link (OT160 solid link)
- Hinged lid complete with lock
- Padlockable pistol grip handle as standard
- Removable gland plates fitted top and bottom (see below for knockout configurations)
- Spreader boxes available see below

Load break switches 3 - 4 pole 9...37kW

Rating@415v			Dimensions (mm)			No. Poles	Order Code
1 <sup>th</sup> A	AC22	AC23	H	W	D		
32	25	20	300	200	150	3 + solid neutral	OT20TPN-A
						4	OT20FP-A
40	40	23	300	200	150	3 + solid neutral	OT32TPN-A
						4	OT32FP-A
80	80	75	300	300	150	3 + solid neutral	OT63TPN-A
						4	OT63FP-A
115	100	80	400	300	150	3 + solid neutral	OT100TPN-A
						4	OT100FP-A
125	125	90	400	300	150	3 + solid neutral	OT125TPN-A
						4	OT125FP-A
160	160	135	500	400	200	3 + solid neutral	OT160TPN-A
						4	OT160FP-A
200	200	200	500	400	200	3 + solid neutral	OT200TPN-A
						4	OT200FP-A
315	315	315	500	400	200	3 + solid neutral	OT315TPN-A
						4	OT400FP-A
500	500	500	500	400	200	3 + solid neutral	OT400TPN-A
						4	OT400TPN-A
630	630	630	600	400	250	3 + solid neutral	OT630TPN-A
						4	OT630FP-A
800	800	800	600	400	250	3 + solid neutral	OT800TPN-A
						4	OT800TPN-A

Spreader boxes

	Spreader box	Spreader box gasket
	Order Code	Order Code
<b>Suitable for Loadbreak Switches</b>		
OT20, OT32, OT63, OT100, OT125	Not Required	Not Required
OT160, OT200, OT315, OT400	SRN5420K	GZ4020
OT630, OT800	SRN6425K	GZ4025
Wall Mounting Brackets (Pack of 4)	-	AA1206
<b>Auxiliary Contacts</b>		
1 N/O	OA1G10	OA1G10
1 N/C - only for OT20-125_	OA1G01	OA1G01
1 N/C - only for OT200 and above	OA3G01	OA3G01
1 N/O - 1 N/C - OT20-125 and OT160 only	OA2G11	OA2G11

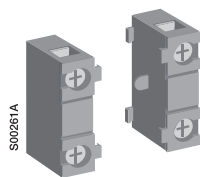

S00261A

## Switchgear - Switch fuses

### IP65 Steel enclosure

- IP65 rated (not suitable for external installation)
- Powder coated textured finish (RAL 7035)
- All switches are supplied with fuses and removable gland plates
- All 3 pole switches include detachable neutral link (OT160 solid link)
- Switch Fuses are internally rated IP20 on incoming terminals up to 63A
- Hinged lid complete with lock
- Padlockable pistol grip handle as standard
- Switch Fuses 100A are supplied with incoming terminal shrouds (NOT FITTED) to allow customer connections
- Spreader boxes available see below

#### 3 - 4 pole 20 ... 800A

	AC23 [kW]				Dimensions (mm)			No. Poles	Fuse Type	Order Code
	1 <sup>st</sup> A	400V	500V	690V	H	W	D			
	20	7.5	11	15	300	300	150	3+detach neutral 4	A1	OS20TPN-A OS20FP-A
	32	15	18	25	300	300	150	3+detach neutral 4	A2	OS32TPN-A OS32FP-A
	63	30	37	55	400	300	150	3+detach neutral 4	A2/A3	OS63TPN-A OS63FP-A
	100	55	55	90	400	300	150	3+detach neutral 4	A2/A3	OS100TPN-A OS100FP-A
	125	55	75	110	400	300	150	3+detach neutral 4	A2/A3	OS125TPN-A OS125FP-A
	160	75	90	132	500	400	200	3 + solid neutral 4	A3/A4	OS160TPN-A OS160FP-A
	200	110	132	200	600	400	250	3+detach neutral 4	B1/B2	OS200TPN-A OS200FP-A
	315	160	220	220	600	400	250	3+detach neutral 4	B1/B4	OS315TPN-A OS315FP-A
	400	220	280	400	600	400	250	3+detach neutral 4	B1/B4	OS400TPN-A OS400FP-A
	630	355	450	560	600	600	300	3+detach neutral 4	C1/C2	OS630TPN-A OS630FP-A
800	450	560	710	600	800	300	3+detach neutral 4	C1/C2	OS800TPN-A OS800FP-A	

Note: OT630 & OT800 TPN/FP products are made to order and are non-stock items.

#### Spreader boxes

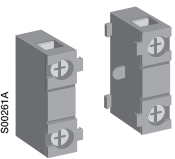
	Suitable for Loadbreak Switches	Spreader box		Spreader box gasket	
		Order Code	Order Code	Order Code	Order Code
	OS20 - OS125	Not Required	-	Not Required	Not Required
	OS160	SRN5420K	SRN5420K	GZ4020	GZ4020
	OS200 - OS400	SRN6425K	SRN6425K	GZ4025	GZ4025
	OS630 - OS800	SRN8530K	SRN8530K	GZ6030	GZ6030
	Wall Mounting Brackets (Pack of 4)	-	-	AA1206	AA1206
<b>Auxiliary Contacts</b>					
	1 N/O			OA1G10	OA1G10
	1 N/C			OA1G01	OA1G01
	1 N/O - 1 N/C			OA3G01	OA3G01
	1 x CO contact - only for products OS20_/OS32_			OA2G11	OA2G11







---

# Cable management products

<b>172</b>	<b>Adaptaflex® Flexible Cable Protection - Introduction</b>
<b>175</b>	<b>Adaptaflex - Convenience packs</b>
<b>176</b>	<b>Adaptaflex - Metallic flexible conduit systems</b>
<b>185</b>	<b>Adaptaflex - Non-metallic flexible conduit systems</b>
<b>195</b>	<b>Industrial cable glands</b>
<b>217</b>	<b>Hazardous area cable glands</b>
<b>240</b>	<b>Ty-Rap® Cable ties</b>
<b>243</b>	<b>Ty-Met™ Stainless steel cable ties</b>
<b>245</b>	<b>Ty-Fast® Cable ties</b>
<b>251</b>	<b>E-Klips® Spring Steel Fasteners</b>



For more detailed product information, please refer to our online technical brochures available at: [new.abb.com/low-voltage/support/documentation](http://new.abb.com/low-voltage/support/documentation)

or contact our sales team via email [LV.enquiries@gb.abb.com](mailto:LV.enquiries@gb.abb.com)

or call 0333 999 9933

# Adaptaflex® Flexible Cable Protection

## Company overview

Established in 1972, Adaptaflex® flexible conduit systems are used to protect critical power and data cabling.

Adaptaflex® Flexible Cable Protection is part of ABB Installation Products with their conduit solutions found in applications all over the world. Combining innovative design with dedicated manufacture it offers customers one of the world's broadest ranges of cable protection products and solutions. With a choice of over 6000 products the range covers metallic and non-metallic flexible conduit systems for the protection of critical power and data cable.

The system solutions from Adaptaflex need to perform in a wide variety of environments, from high temperature to freezing conditions. The products are designed and tested to withstand constant vibrations, water ingress and offer corrosion and chemical resistance. Products are available in many different materials, including halogen free, low smoke and low toxicity materials.

An extensive range of engineered solutions are designed to withstand the rigours of some of the most technically-demanding markets. So whatever your project involves, our experience will provide the answer, helping you to specify the correct flexible conduit system.

### Markets and industries

Adaptaflex flexible conduit systems are used to protect critical power and data cabling throughout a wide range of markets including:

- Commercial contracting
- Machine & automation
- Rail/Infrastructure
- Marine
- Mechanical
- Security/CCTV
- Data cabling/Data centres
- Critical power
- Renewable energy
- Food & Beverage
- Construction

Our products are designed and engineered to meet a variety of market application requirements, providing product innovation that saves installation and component costs, improves quality and delivers integrity in the end product.



# Quality approvals and third party testing

## Quality approvals

The company's commitment to independent testing across a wide range of applications has led to an impressive range of certifications and quality approvals:

- BSI Kitemark
- BS EN ISO14001 Environmental standard
- IEC 61386 Conduit standard covering the performance characteristics of flexible conduits
- ISO 60529 IP69 Rated, standard with its Adaptalok range of non metallic fittings
- Offer non-metallic conduit that is fully compliant to the new dual listed UL 1696 standard. Required for any equipment destined for export to the USA and Canada

### Industry standards

As one of the world's leading flexible conduit system manufacturers, Adaptaflex has achieved many international approvals, for our manufacturing as well as our product ranges.

Adaptaflex are able to use our experience and knowledge to ensure safety and quality levels are maintained now and in the future.

### BSI Kitemark

Adaptaflex manufacture to third party accreditation through the BSI Kitemark scheme. The Kitemark is one of the world's premier symbols of trust, integrity and quality. Manufacturers with the Kitemark are an elite club of some of the world's best companies being annually tested to ensure continued compliance. Having the Kitemark associated with our products illustrates that we have satisfied the most rigorous of quality processes.

### ISO9001 Quality standard

Adaptaflex conform to ISO 9001:2000, the internationally recognised standard for Quality Management Systems. This standard reflects the procedures and management processes throughout the whole of the company.

### ISO14001 and ISO45001 Environmental standard

Controlling the impact of manufacturing activities on the environment is a major challenge. Again Adaptaflex lead the way by being the first conduit manufacturer to comply with this Standard.

### Customer support

All our products are backed up by a full technical support team, sales teams, customer care team and in-house marketing specialists. All dedicated teams working together to ensure that you have the best support in the market place.

[cmg.conduitsystems@abb.com](mailto:cmg.conduitsystems@abb.com)  
for technical support.

## Third party testing & approvals

### IEC61386 Performance classification standard

Adaptaflex has achieved third party accreditation to the IEC61386 Standard from the British Standards Institution (BSI). IEC61386 conformance guarantees that products meet performance specifications for fatigue life, operating temperature, non-flame propagation, IP ratings amongst other criteria.



## Flexible conduit systems

### Quick selection guide

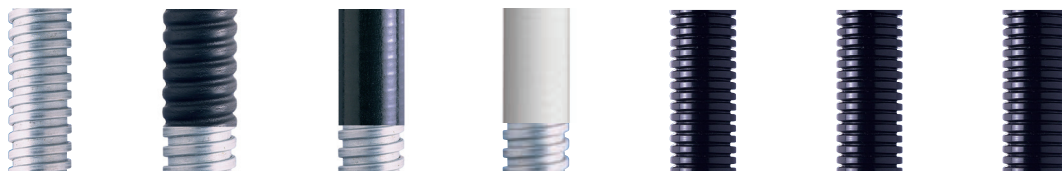

Type	Metallic conduit				Non-metallic conduit		
	Corrugated Metallic	Corrugated Metallic	Smooth Liquid-Tight Metallic	Anti-microbial Liquid Tight Metallic	Corrugated Plastic	Corrugated Plastic	Corrugated Plastic
Series	S	SP	SPL	SAM	PP	PR	PA
Usage	Heavy weight conduit for commercial building, light industrial or outdoor applications	Heavy-duty industrial, confined space and moving applications	Heavy-duty industrial, marine, extreme condition and hazardous explosive area applications	Food, Beverage, Pharmaceutical, Hygienic and high temperature applications	Medium weight conduit for commercial building, light industrial or outdoor applications	Standard weight conduit for construction, transport and rail infrastructures.	Commercial building, light industrial or outdoor applications
Core material	Galvanised Steel	Galvanised Steel	Galvanised Steel	Galvanised or Stainless Steel	Polypropylene	Modified nylon PA6	Nylon PA6
Jacket material	None	PVC	PVC	Thermoplastic	None	None	None
IP rating	Up to IP40	Up to IP65	Up to IP69	Up to IP69	Up to IP66	Up to IP69	Up to IP69
Temperature range	-50 to +300	-25 to +70	-20 to +105	-30 to +150	-20 to +90	-40 to +120	-40 to +120
Flexibility	High	High	Medium	Medium	High	High	High
Mechanical strength	Very High?	Very High	Very High	Very High	Low	Medium	Medium
UV Resistance	Very High	Very High	Very High	High	Medium	Very High	Very High
Zero Halogen	No	No	No	Yes	Yes	Yes	Yes
Self Extinguishing	Yes	Yes	Yes	Yes	No	Yes	Yes

- This book contains an overview of conduit and fittings from the ABB adaptaflex range.  
 - Several more Conduit ranges available including Stainless Steel, Low fire hazard, Braided EMI screening, Food & Beverage specific, Accessories, etc.  
 - Please contact our office or visit <http://new.abb.com/low-voltage/products/conduit-fittings/adaptaflex>.

## Convenience packs

### Professional installer conduit systems

#### LFH Convenience



Part no.	Type	Conduit/fitting diameter (mm)	One-piece conduit fittings	Locknuts	IP rating
CP-AF20A	10m Black Type PA LFH Nylon 6, 20mm diameter	20	10	10	IP66
CP-AF25A	10m Black Type PA LFH Nylon 6, 25mm diameter	25	10	10	IP66

Convenience pack / Nylon Conduit with Adaptalok One-Piece, Fast Fit, Push & Twist Fittings.  
Materials: Polyamide Nylon 6 / Colour: Black (BL).



#### Polypropylene Convenience



Part no.	Type	Conduit/fitting diameter (mm)	One-piece conduit fittings	Locknuts	IP rating
CP-AF20BS-PP	10m Grey Type PP Polypropylene conduit, 20mm diameter	20	10	10	IP54
CP-AF25BS-PP	10m Grey Type PP Polypropylene conduit, 25mm diameter	25	10	10	IP54

Convenience Pack / Type PP Polypropylene Conduit with One-Piece, Fast Fit, Push & Twist Fittings.  
Materials: PP Polypropylene / Colour: Grey (GR).

#### Retail / Office Convenience



Part no.	Type	Conduit/fitting diameter (mm)	One-piece conduit fittings	Locknuts	IP rating
CP-AF20BS	10m Grey Type KF PVCu, 20mm diameter	20	10	10	IP66
CP-AF25BS	10m Grey Type KF PVCu, 20mm diameter	25	10	10	IP66
CP-KF20BS	10m White Type KF PVCu, 25mm diameter	20	10	10	IP66
CP-KF25BS	10m White Type KF PVCu, 25mm diameter	25	10	10	IP66

Convenience Pack / Self-Extinguishing PVC Conduit & One-Piece Fittings & Locknuts.  
Materials: PVC Pliable / Colour: White (W).



## Anti-microbial metallic conduit systems

### SAMHL series - Smooth anti-microbial liquid-tight conduit

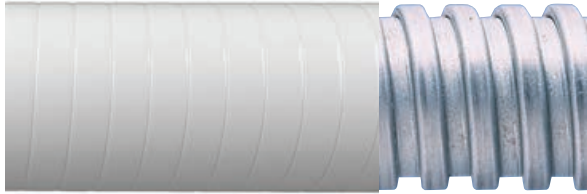

Anti-microbial liquid tight high temperature covered steel flexible conduit. Suitable for indoor splash zone areas or food processing equipment. The biocidal coating attacks bacteria that comes into contact with it, including MRSA, E.coli, etc eliminating 99% in 2 hours.

#### Features



- **Type SAMHL** - Galvanised steel core string packed with Anti-microbial protection incorporated into a FDA, EC and FSA compliant DuPont Hytrel® thermoplastic jacket
- **Type SSAMHL** - Stainless steel string with Anti-microbial protection incorporated into a FDA, EC and FSA compliant DuPont Hytrel® thermoplastic jacket
- IP40 – IP69 rated
- Temperature range up to -50°C to +130°C
- Approvals: CE, BS EN 61386-1,-23, NSF 14159-1-2014 & NSF 169-2009

#### Type SAMHL and SSAMHL - Anti-microbial liquid tight conduit



Part no.		Conduit size (mm)	Diameter Dimensions (mm)			Coil lengths	
Galvanised Steel Core	Stainless Steel Core		Outside	Inside	Bend radius	Galvanised Steel Core	Stainless Steel Core
SAMHL16/25M	SSAMHL16/25M	16	17.8mm	12.5mm	50mm	25	25
SAMHL20/25M	SSAMHL20/25M	20	21.1mm	15.9mm	80mm	25	25
SAMHL25/25M	SSAMHL25/25M	25	26.4mm	21.0mm	110mm	25	25
SAMHL32/25M	SSAMHL32/25M	32	33.1mm	26.7mm	144mm	25	25
SAMHL40/25M	SSAMHL40/25M	40	41.8mm	35.4mm	180mm	25	25
SAMHL50/25M	SSAMHL50/25M	50	47.5mm	40.4mm	240mm	25	25
SAMHL63/25M	SSAMHL63/25M	63	59.7mm	51.6mm	345mm	25	25

Note: Conduit is fully cleanable and will maintain full ingress protection under normal wet cleaning conditions with associated fittings.

#### Type SAMHL

Approvals	IP rating	Appropriate fitting	Temperature range	UV resistance
   NSF 14159-1-2014 NSF 169-2009	For use with: Type SPL, SSPL and SAM		Static applications: -50°C to +130°C	-
	IP66	Type M, C45 & C90	Moving applications: -5°C to +150°C	
	IP67	Type A, B, M, C45 & C90	<b>Flexibility &amp; fatigue life</b>	
	IP68	Type M, C45 & C90 (10 bar 30mins)	High flexibility - High fatigue life	
	IP69	Type M, C45 & C90	<b>Fire Performance &amp; EMI Screen</b>	
			Self extinguishing	

#### Type SSAMHL

Approvals	IP rating	Appropriate fitting	Temperature range	UV resistance
   NSF 14159-1-2014 NSF 169-2009	For use with: Type SPL, SSPL and SAM		Static applications: -50°C to +130°C	-
	IP66	Type M, C45 & C90	Moving applications: -5°C to +150°C	
	IP67	Type A, B, M, C45 & C90		
	IP68	Type M, C45 & C90 (10 bar 30mins)		
	IP69	Type M, C45 & C90		

## Anti-microbial metallic conduit systems

### Type SAM for SAMHL series conduit



Single piece, liquid tight, high temperature Stainless Steel fitting suitable for indoor splash zone areas or food processing equipment



**Features**

- Unique single piece design
- 316 Stainless Steel
- Face seal materials adhere to FDA (Food and Drug Administration) and European Food Contact regulations
- IP67, IP68 & IP69 protection
- Approvals CE, BS EN 61386-1,-23, NSF14159-1-2014, NSF169-2009, UL514b
- Multiple thread type Metric/NPT

**Fittings for SAMHL series conduit**

METRIC Part no.	Conduit size		Nominal Dimensions						
	METRIC (mm)	US (NPT)	B	C	D	E	F	G	Weight (g)
SPL16/M16/SAM	16	3/8"	7.0	32.8	30.0	31.9	14.0	10.5	9.98
SPL20/M20/SAM	20	1/2"	10.0	35.6	32.0	35.0	18.0	14.5	11.34
SPL25/M25/SAM	25	3/4"	14.0	43.0	38.0	41.0	23.0	18.3	16.78
SPL32/M32/SAM	32	1"	15.0	51.5	45.0	49.0	30.0	24.1	29.94
SPL40/M40/SAM	40	1 1/4"	16.0	53.3	57.0	61.5	38.0	32.7	39.92
SPL50/M50/SAM	50	1 1/2"	18.0	60.2	64.0	69.0	48.0	37.7	45.36
SPL63/M63/SAM	63	2"	20.0	71.4	80.0	87.0	61.0	49.0	52.16

Note: Parts are maintenance free, face seal can be replaced if damaged. Parts are fully cleanable and will maintain full ingress protection under normal wet cleaning conditions.

Approvals	IP rating	Temperature range	UV resistance
  NSF 14159-1-2014 NSF 169-2009   UL514b File No. E60625	<b>For use with:</b> All liquidtight conduit <b>IP66</b> Yes <b>IP68</b> Yes (10 bar 30mins) <b>IP69</b> Yes	Static applications: -50°C to +130°C Moving applications: -5°C to +150°C <b>Flexibility &amp; fatigue life</b> High flexibility - High fatigue life <b>Fire Performance &amp; EMI Screen</b> Self extinguishing	-

## Metallic conduit systems



### Type LFH-SPL & SPL - Adaptasteel

- Low fire hazard performance covered steel flexible conduit
- Material: Low fire hazard jacket covered galvanised steel
- Colour: Black (BL) only

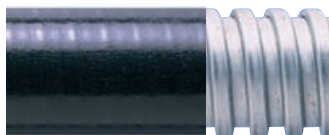
#### Type LFH-SPL - Adaptasteel

	Part no.	Nominal Conduit Size	Outside Diameter	US Conduit Size	Inside Diameter	Min. Bend Radius	Reel Length
	LFH- SPL16	16mm	17.0mm	3/8"	13.0mm	50mm	10, 25m
	LFH- SPL20	20mm	21.5mm	1/2"	16.9mm	80mm	10, 25m
	LFH- SPL25	25mm	26.0mm	3/4"	21.4mm	110mm	10, 25m
	LFH- SPL32	32mm	34.0mm	1"	28.1mm	145mm	10, 25m
	LFH- SPL40	40mm	44.5mm	1 1/4"	37.7mm	180mm	10m

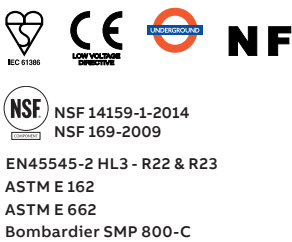
To order quote Order Code, colour & reel length, e.g. LFH-SPL16/BL/25M.

Approvals	IP rating	Appropriate fitting	Temperature range	UV resistance
	For use with: Type SPL, SSPL and SAM		Static applications: -20°C to +90°C	High
	IP66	Type M, C45 & C90	Moving applications: -5°C to +105°C	
	IP67	Type A, B, M, C45 & C90	<b>Flexibility &amp; fatigue life</b>	
	IP68	Type M, C45 & C90 (10 bar 30mins)	Medium flexibility – Medium fatigue life	
	IP69	Type M, C45 & C90	<b>Fire performance &amp; EMI screen</b>	
			Self extinguishing	
			Halogen free	

- Liquid tight oil resistant covered steel flexible conduit
- Material: PVC covered galvanised steel
- Colour: Black (BL), Grey (GR), Orange (OR)

#### Type SPL - Adaptasteel

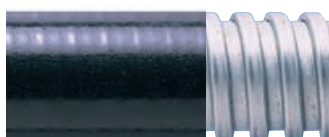
	Part no.	Nominal Conduit Size	Outside Diameter	US Conduit Size	Inside Diameter	Min. Bend Radius	Reel Length
	SPL12	12mm	14.2mm	5/16"	10.0mm	45mm	10, 25, 50m
	SPL16	16mm	17.8mm	3/8"	12.5mm	50mm	10, 25, 50m
	SPL20	20mm	21.1mm	1/2"	15.9mm	80mm	10, 25, 50m
	SPL25	25mm	26.4mm	3/4"	21.0mm	110mm	10, 25, 50m
	SPL32	32mm	33.1mm	1"	26.7mm	145mm	10, 25m
	SPL40	40mm	41.8mm	1 1/4"	35.4mm	180mm	10, 25m

To order quote Order Code, colour & reel length, e.g. SPL12/BL/50M.

Approvals	IP rating	Appropriate fitting	Temperature range	UV resistance
	For use with: Type SPL, SSPL and SAM		Static applications: -20°C to +105°C	Very high
	IP66	Type M, C45 & C90	Moving applications: -5°C to +105°C	
	IP67	Type A, B, M, C45 & C90	<b>Flexibility &amp; fatigue life</b>	
	IP68	Type M, C45 & C90 (10 bar 30mins)	Medium flexibility – Medium fatigue life	
	IP69	Type M, C45 & C90	<b>Fire performance &amp; EMI screen</b>	
			Self extinguishing	

## Metallic conduit systems

### Type A, B, M & U coupler - Adaptasteel

- **Type M** Straight fitting – Fixed external male thread
- **Type B** Straight fitting – Swivel external male thread
- **Type C90** Combined fitting and elbow
- For insertion into threaded entries & knockouts using a locknut (order locknuts separately)
- Materials: Nickel plated brass
- **Coupler** for coupling separate lengths of SPL conduit
- Materials: Nickel Plated Brass, Co-Polyester Seals

#### Type M - Adaptasteel

Part no.	Nominal conduit size	US conduit size	Thread
<b>Metric thread</b>			
SPL10/M12/M	10mm	3/4"	M12
SPL10/M16/M	10mm	3/4"	M16
SPL12/M16/M	12mm	5/16"	M16
SPL16/M16/M	16mm	3/8"	M16
SPL16/M20/M	16mm	3/8"	M20
SPL20/M20/M	20mm	1/2"	M20
SPL25/M25/M	25mm	3/4"	M25
SPL32/M32/M	32mm	1"	M32
SPL40/M40/M	40mm	1 1/4"	M40
SPL50/M50/M	50mm	1 1/2"	M50
SPL63/M63/M	63mm	2"	M63
<b>PG thread</b>			
SPL10/PG7/M	10mm	3/4"	PG7
SPL12/PG9/M	12mm	5/16"	PG9
SPL16/PG11/M	16mm	3/8"	PG11
SPL16/PG13/M	16mm	3/8"	PG13,5
SPL20/PG16/M	20mm	1/2"	PG16
SPL25/PG21/M	25mm	3/4"	PG21
SPL32/PG29/M	32mm	1"	PG29
SPL40/PG36/M	40mm	1 1/4"	PG36
SPL50/PG42/M	50mm	1 1/2"	PG42
SPL63/PG48/M	63mm	2"	PG48
<b>NPT thread</b>			
SPL16/038/M	16mm	3/8"	3/8
SPL20/050/M	20mm	1/2"	1/2
SPL25/075/M	25mm	3/4"	3/4
SPL32/100/M	32mm	1"	1
SPL40/125/M	40mm	1 1/4"	1 1/4
SPL50/150/M	50mm	1 1/2"	1 1/2
SPL63/200/M	63mm	2"	2



#### Type B - Adaptasteel

Part no.	Nominal Conduit Size	US Conduit Size	Metric Thread
SPL16/M16/B	16mm	3/8"	M16
SPL16/M20/B	16mm	3/8"	M20
SPL20/M20/B	20mm	1/2"	M20
SPL25/M25/B	25mm	3/4"	M25
SPL32/M32/B	32mm	1"	M32



#### Type C90 - Adaptasteel

Part no.	Nominal Conduit Size	Metric Thread
SPL16/M16/C90*	16mm	M16
SPL16/M20/C90*	16mm	M20
SPL20/M20/C90*	20mm	M20
SPL25/M25/C90*	25mm	M25
SPL32/M32/C90*	32mm	M32



\* These parts are not UL listed.

#### Type U coupler - Adaptasteel

Part no.	Nominal Conduit Size	US Conduit Size	Bore
SPL16/U/M	16mm	3/8"	M20
SPL20/U/M	20mm	1/2"	M25
SPL25/U/M	25mm	3/4"	M32
SPL32/U/M	32mm	1"	
SPL40/U/M	40mm	1 1/4"	
SPL50/U/M	50mm	1 1/2"	
SPL63/U/M	63mm	2"	



#### Approvals



#### IP rating

For use with: All liquidtight conduit

IP66	Yes
IP67	Yes
IP68	Yes (10 bar 30 mins)
IP69	Yes

#### Temperature range

Static applications: -65°C to +150°C  
 Moving applications: -45°C to +150°C

#### UV resistance

-

#### Fitting characteristics

This applies to the Type U coupler only



## Metallic conduit systems





### Type LFH-SP & SP - Adaptasteel

- Liquid resistant enhanced low fire hazard covered steel flexible conduit
- Material: Polyolefin covered galvanised steel
- Colour: Black (BL) only

#### Type LFH-SP - Adaptasteel

	Part no.	Nominal Conduit Size	Outside Diameter	Inside Diameter	Min. Bend Radius	Reel Length
	LFH- SP12	12mm	14.0mm	10.3mm	30mm	25, 50m
	LFH- SP16	16mm	17.0mm	13.0mm	35mm	10, 25, 50m
	LFH- SP20	20mm	21.5mm	16.9mm	45mm	10, 25, 50m
	LFH- SP25	25mm	26.0mm	21.4mm	55mm	10, 25, 50m
	LFH- SP32	32mm	34.0mm	28.1mm	60mm	10, 25m
	LFH- SP40	40mm	44.5mm	37.7mm	80mm	10, 25m

To order quote Order Code, colour & reel length, e.g. LFH-SP16/BL/50M.



Approvals	IP rating	Appropriate fitting	Temperature range	UV resistance	Fire Performance & EMI Screen
   	For use with: Type SP		Static applications: -25°C to +90°C	High	Self extinguishing Halogen free
	IP54	Type SP - Type A, B, C, E & F	Moving applications: -5°C to +105°C		
	IP65	Type SP - Type M & C90	<b>Flexibility &amp; fatigue life</b> High flexibility - Medium fatigue life		
EN45545-2 HL3 - R22 & R23					

- Liquid resistant general purpose covered steel flexible conduit
- Material: PVC covered galvanised steel
- Colour: Black, Grey and Orange

#### Type SP - Adaptasteel

	Part no.	Nominal Conduit Size	Outside Diameter	Inside Diameter	Min. Bend Radius	Reel Length
	SP10	10mm	10.0mm	6.8mm	25mm	25, 50m
	SP12	12mm	14.0mm	10.3mm	30mm	25, 50m
	SP16	16mm	17.0mm	13.0mm	35mm	10, 25, 50m
	SP20	20mm	21.5mm	16.9mm	45mm	10, 25, 50m
	SP25	25mm	26.0mm	21.4mm	55mm	10, 25, 50m
	SP32	32mm	34.0mm	28.1mm	60mm	10, 25m
	SP40	40mm	44.5mm	37.7mm	80mm	10, 25m
	SP50	50mm	55.0mm	48.4mm	90mm	10, 25m
	SP63	63mm	64.5mm	57.5mm	115mm	10m
	SP75	75mm	79.0mm	70.0mm	150mm	10m

To order quote Order Code colour & reel length, e.g. SP12/BL/25M.









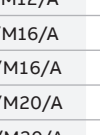

Approvals	IP rating	Appropriate fitting	Temperature range	UV resistance
 	For use with: Type SP		Static applications: -25°C to +70°C	Very high
	IP54	Type SP - Type A, B, C, E & F	Moving applications: -5°C to +90°C	
	IP65	Type SP - Type M & C90	<b>Flexibility &amp; fatigue life</b> High flexibility - Medium fatigue life	<b>Fire Performance &amp; EMI Screen</b> Self extinguishing

## Metallic conduit systems

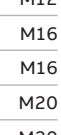
Type A, B, & C90 - Adaptasteel

- **Type A / M** - Straight fitting - fixed external male thread
- For insertion into knockouts using a locknut
- **Type B** - Straight fitting - Fixed external male thread
- For insertion into threaded entries & knockouts using a locknut
- **Type F** - Straight swivel fitting - For external threads and other fittings
- Material: Nickel Plated Brass

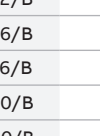





### Type A - Adaptasteel

	Part no.	Nominal Conduit Size	Metric Thread
	SP10/M12/A	10mm	M12
	SP12/M16/A	12mm	M16
	SP16/M16/A	16mm	M16
	SP16/M20/A	16mm	M20
	SP20/M20/A	20mm	M20
	SP25/M25/A	25mm	M25
	SP32/M32/A	32mm	M32
	SP40/M40/A	40mm	M40
	SP50/M50/A	50mm	M50
	SP63/M63/A	63mm	M63
	SP75/M75/A	75mm	M75

Approvals	IP Rating	Appropriate Conduit
		
	For use with: Type SP / SN / LFH-SP	
	IP54	Yes

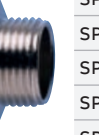
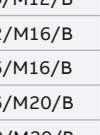
Temperature Range
Static Applications: -50°C to +300°C
Moving Applications: -45°C to +250°C

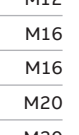





### Type B - Adaptasteel

	Part no.	Nominal Conduit Size	Metric Thread
	SP10/M12/B	10mm	M12
	SP12/M16/B	12mm	M16
	SP16/M16/B	16mm	M16
	SP16/M20/B	16mm	M20
	SP20/M20/B	20mm	M20
	SP25/M25/B	25mm	M25
	SP32/M32/B	32mm	M32
	SP40/M40/B	40mm	M40
	SP50/M50/B	50mm	M50

Approvals	IP Rating	Appropriate Conduit
		
	For use with: Type / SN / LFH-SP	
	IP54	Yes

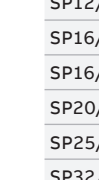
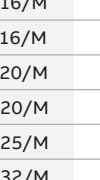
Temperature Range
Static Applications: -50°C to +300°C
Moving Applications: -45°C to +250°C

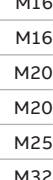

### Type M - Adaptasteel

	Part no.	Nominal Conduit Size	Metric Thread
	SP12/M16/M	12mm	M16
	SP16/M16/M	16mm	M16
	SP16/M20/M	16mm	M20
	SP20/M20/M	20mm	M20
	SP25/M25/M	25mm	M25
	SP32/M32/M	32mm	M32
	SP40/M40/M	40mm	M40
	SP50/M50/M	50mm	M50

Approvals	IP Rating	Appropriate Conduit
		
	For use with: Type SP / SN / LFH-SP	
	IP65	Yes

Temperature Range	Fitting Characteristics
Static Applications: -50°C to +150°C	
Moving Applications: -45°C to +150°C	

### Type F - Adaptasteel

	Part no.	Nominal Conduit Size	Metric Thread
	SP20/M20/F	20mm	M20
	SP25/M25/F	25mm	M25
	SP32/M32/F	32mm	M32

Approvals	IP Rating	Appropriate Conduit
		
	For use with: Type SP / SN / LFH-SP	
	IP54	Yes

Temperature Range
Static Applications: -50°C to +300°C
Moving Applications: -45°C to +250°C



## Metallic conduit systems



### Type S & SS - Adaptasteel

- Inherent low fire hazard steel conduit
- Material: Stainless steel 316 - corrosion resistant

#### Type SS - Adaptasteel

	Part no.	Nominal Conduit Size	Outside Diameter	Inside Diameter	Min. Bend Radius	Reel Length
	SS10	10mm	9.0mm	6.8mm	25mm	25, 50m
	SS12	12mm	13.0mm	10.3mm	30mm	10, 25, 50m
	SS16	16mm	16.0mm	13.0mm	35mm	10, 25, 50m
	SS20	20mm	20.5mm	16.9mm	45mm	10, 25, 50m
	SS25	25mm	25.0mm	21.4mm	55mm	10, 25, 50m
	SS32	32mm	32.0mm	28.1mm	60mm	10, 25m

To order quote Order Code & reel length, e.g. SS12/25M.



Approvals	IP rating	Appropriate fitting	Temperature range	UV resistance	Fire Performance & EMI Screen
	For use with: Type S		Static applications: -50°C to +350°C	Very high	
	IP40	Type S - Type A, B, F & C	Moving applications: -45°C to +250°C		
			<b>Flexibility &amp; fatigue life</b>		
			High flexibility - High fatigue life		

- Inherent low fire hazard steel conduit
- Material: Galvanised steel - general purpose

#### Type S - Adaptasteel

	Part no.	Nominal Conduit Size	Outside Diameter	Inside Diameter	Min. Bend Radius	Reel Length
	S10	10mm	9.1mm	7.0mm	25mm	25, 50m
	S12	12mm	13.0mm	10.3mm	30mm	10, 25, 50m
	S16	16mm	16.0mm	13.0mm	35mm	10, 25, 50m
	S20	20mm	20.5mm	16.9mm	45mm	10, 25, 50m
	S25	25mm	25.0mm	21.4mm	55mm	10, 25, 50m
	S32	32mm	32.0mm	28.1mm	60mm	10, 25m
	S40	40mm	42.5mm	37.7mm	80mm	10, 25m
	S50	50mm	53.0mm	48.4mm	90mm	10, 25m
	S63	63mm	62.5mm	57.5mm	115mm	10m
	S75	75mm	77.0mm	70.0mm	150mm	10m

To order quote Order Code & reel length, e.g. S12/25M.

Approvals	IP rating	Appropriate fitting	Temperature range	UV resistance	Fire Performance & EMI Screen
	For use with: Type S		Static applications: -50°C to +300°C	Very high	
	IP40	Type S - Type A, B, F & C	Moving applications: -45°C to +250°C		
			<b>Flexibility &amp; fatigue life</b>		
			High flexibility - High fatigue life		

## Metallic conduit systems

### Type A, B, C & F - Adaptasteel

- **Type A** - Straight fitting - fixed external male thread
- For insertion into knockouts using a locknut
- Order locknuts separately
- Material: Nickel Plated Brass
- **Type B** - Straight fitting - swivel external male thread
- For insertion into threaded entries & knockouts using a locknut (order locknuts separately)
- Material: Nickel Plated Brass

#### Type A - Adaptasteel

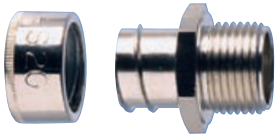
	Part no.	Nominal Conduit Size	Metric Thread
	S10/M12/A	10mm	M12
	S12/M16/A	12mm	M16
	S16/M16/A	16mm	M16
	S16/M20/A	16mm	M20
	S20/M20/A	20mm	M20
	S25/M25/A	25mm	M25
	S32/M32/A	32mm	M32
	S40/M40/A	40mm	M40
	S50/M50/A	50mm	M50
	S63/M63/A	63mm	M63
	S75/M75/A	75mm	M75

#### Type B - Adaptasteel

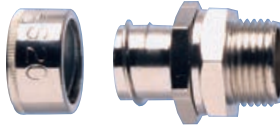
	Part no.	Nominal Conduit Size	Metric Thread
	S10/M12/B	10mm	M12
	S12/M16/B	12mm	M16
	S16/M16/B	16mm	M16
	S16/M20/B	16mm	M20
	S20/M20/B	20mm	M20
	S25/M25/B	25mm	M25
	S32/M32/B	32mm	M32
	S40/M40/B	40mm	M40
	S50/M50/B	50mm	M50

Approvals	IP Rating	Appropriate Conduit
	For use with: Type S / SS	
	IP40	Yes

Temperature Range	Fitting Characteristics
Static Applications: -50°C to +300°C	
Moving Applications: -45°C to +250°C	

- Smooth entry bush
- For locking conduit into plain holes in enclosures
- Materials: Nickel Plated Brass

- Straight fitting - swivel external male thread

#### Type C - Adaptasteel

	Part no.	Nominal Conduit Size	Hole Size
	S10/9/C	10mm	9mm
	S12/12/C	12mm	12mm
	S16/16/C	16mm	16mm
	S20/20/C	20mm	20mm
	S25/25/C	25mm	25mm
	S32/32/C	32mm	32mm
	S40/40/C	40mm	40mm
	S50/51/C	50mm	50mm
	S63/61/C	63mm	63mm
	S75/75/C	75mm	75mm

#### Type F - Adaptasteel

	Part no.	Nominal Conduit Size	Metric Thread
	S20/M20/F	20mm	M20
	S25/M25/F	25mm	M25
	S32/M32/F	32mm	M32

Approvals	IP Rating	Appropriate Conduit
	For use with: Type S / SS	
	IP40	Yes

Approvals	IP Rating	Appropriate Conduit
	For use with: Type S / SS	
	IP40	Yes

Temperature Range
Static Applications: -50°C to +300°C
Moving Applications: -45°C to +250°C

Temperature Range
Static Applications: -50°C to +300°C

# Metallic conduit systems

## Accessories

### Stainless steel locknut

Female threaded locknut / Materials: 316 stainless steel

Part no.	Thread size	Nominal dimensions (mm)		
		A	B	C
<b>Metric</b>				
LNSS/M16	M16 x 1.5	3.0	20.0	21.1
LNSS/M20	M20 x 1.5	3.5	24.0	26.6
LNSS/M25	M25 x 1.5	4.0	30.0	33.2
LNSS/M32	M32 x 1.5	5.0	36.0	39.9
LNSS/M40	M40 x 1.5	5.0	47.2	52.3
LNSS/M50	M50 x 1.5	5.0	60.3	66.5
LNSS/M63	M63 x 1.5	6.0	69.8	77.6
<b>NPSL</b>				
LNSS/038	3/8"	3.0	20.0	21.1
LNSS/050	1/2"	3.0	27.0	30.0
LNSS/075	3/4"	3.5	30.0	33.2
LNSS/100	1"	5.0	38.0	42.0
LNSS/125	1 1/4"	5.5	52.0	57.5
LNSS/150	1 1/2"	6.0	60.0	66.5
LNSS/200	2"	7.0	69.8	77.0

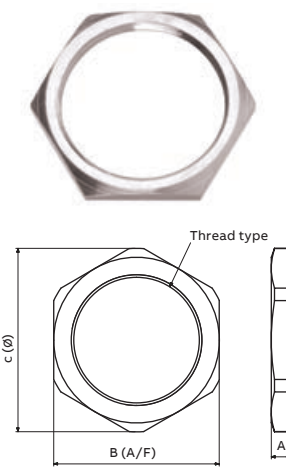

### Enlargers, Reducers, Converters

Materials: Nickel Plated Brass

External thread	Internal thread						
	To M10	To M12	To M16	To M20	To M25	To M32	To M40
M16	- B/M16-M12/R	-	- B/M16-M20/E	-	-	-	-
M20	B/M20-M10/R	B/M20-M12/R	B/M20-M16/R	- B/M20-M25/E	-	-	-
M25	-	-	- B/M25-M20/R	-	- B/M25-M32/E	-	-
M32	-	-	-	- B/M32-M25/R	-	-	-
M40	-	-	-	-	- B/M40-M32/R	-	-
M50	-	-	-	-	-	- B/M50-M40/R	-

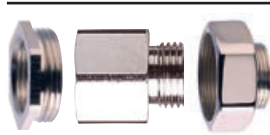

### Type P

P-clip conduit support / Materials: Plated Steel construction with PVC Insert

Plated steel Part no.	Nominal conduit size (mm)
PCLIP/10	10
PCLIP/12	12
PCLIP/16	16
PCLIP/20	20
PCLIP/25	25
PCLIP/32	32
PCLIP/40	40
PCLIP/50	50
PCLIP/63	63
PCLIP/75	75



### Female Coupler

Brass internal female coupler / Materials: Nickel plated brass

Part no.	Metric thread	Part no.	Metric thread
B/M16/C	M16	B/M40/C	M40
B/M20/C	M20	B/M50/C	M50
B/M25/C	M25	B/M63/C	M63
B/M32/C	M32	B/M75/C	M75



### Conduit cutting tool

Order Code	Features
CUT-VICE	Cut-vice offers the ability to produce a clean cut for conduit sizes 16mm to 40mm.



Place the conduit along the vice body and tighten the clamp. Holding the conduit and integral handle together, insert a hacksaw blade into the guide and cut. For braided conduit, wrap adhesive tape around the cutting point to secure braid. Remove tape after cutting.

## Non-metallic conduit systems

### Type PR & PA

#### Type PR

Standard weight conduit / Materials: Modified polyamide (nylon) 6 / Colour: Black (BL) only

Part no.	Nominal conduit size (mm)	NW conduit size (mm)	Conduit pitch	Outside diameter (mm)	Inside diameter (mm)	Minimum bend radius (mm)	Reel length (m)
PRFS13/BL/50M	10	7.5	Fine	10.0	6.2	20	50
PRFS16/BL/50M	13	10	Fine	13.0	9.9	30	50
PRFS21/BL/50M	16	13	Fine	15.8	11.7	35	50
PRCS21/BL/50M	21	17	Fine	21.2	16.6	40	50
PRCS28/BL/50M	28	23	Coarse	28.5	21.7	50	50
PRCS34/BL/50M	34	29	Coarse	34.5	27.7	60	50
PRCS42/BL/25M	42	36	Coarse	42.5	35.5	65	25
PRCS54/BL/25M	54	48	Coarse	54.5	46.6	75	25

If interested in different coil lengths, do not hesitate to inquire.

#### Approvals



EN45545-2 HL3 - R22 & R23

#### IP rating

#### Appropriate fitting

For use with: PC / ATS / Adaptalok AL / Adaptaseal / Adaptaring

IP40 Adaptaring

IP66 PC, ATS, Adaptalok AL, Adaptaseal

IP67 PC, ATS, Adaptalok AL + ALS Seal, Adaptaseal

IP68 PC, ATS, Adaptalok AL + ALS Seal, Adaptaseal

IP69 PC, ATS, Adaptalok AL + ALS Seal, Adaptaseal

#### Temperature range

Static applications: -40°C to +120°C

Moving applications: -5°C to +120°C

#### Flexibility & fatigue life

High flexibility - Medium fatigue life

#### Fire performance & EMI screen

Self extinguishing

Halogen free

#### UV resistance

Very high



#### Type PA - H

Heavy weight conduit / Materials: Polyamide (nylon) 6 / Colour: Black (BL), Grey (GR)

Part no.	Nominal conduit size (mm)	NW conduit size (mm)	Conduit pitch	Outside diameter (mm)	Inside diameter (mm)	Minimum bend radius (mm)	Reel length (m)
PAFH13/BL/50M*	13	10	Fine	13.0	9.0	35	50
PAFH16/BL/50M	16	13	Fine	15.8	11.3	45	50
PACH21/BL/50M	21	17	Coarse	21.2	14.5	60	50
PACH28/BL/50M	28	23	Coarse	28.5	21.3	70	50
PACH34/BL/25M	34	29	Coarse	34.5	26.8	75	50
PACH42/BL/25M	42	36	Coarse	42.5	34.6	90	25
PACH54/BL/25M	54	48	Coarse	54.5	46.0	95	25

For grey color version state "GR" instead of "BL" in Part no. If interested in different coil lengths, do not hesitate to inquire.

\*These parts are not covered by the UR certification.

#### Approvals



EN45545- HL2

#### IP rating

#### Appropriate fitting

For use with: Type PC / ATS / Adaptalok AL / Adaptaseal / Adaptaring

IP40 Adaptaring

IP66 PC, ATS, Adaptalok AL, Adaptaseal

IP67 PC, ATS, Adaptalok AL + ALS Seal, Adaptaseal

IP68 PC, ATS, Adaptalok AL + ALS Seal, Adaptaseal

#### Temperature range

Static applications: -40°C to +120°C

Moving applications: -5°C to +120°C

#### Flexibility & fatigue life

High flexibility - High fatigue life

#### Fire performance & EMI screen

Self extinguishing

Halogen free

#### UV resistance

Very high



## Non-metallic conduit systems

### Type PA & PA-Slit

#### Type PA - S

Standard weight conduit / Materials: Polyamide (nylon) 6 / Colour: Black (BL), Grey (GR)

Part no.	Nominal conduit size (mm)	NW conduit size	Conduit pitch	Outside diameter (mm)	Inside diameter (mm)	Minimum bend radius (mm)	Reel length (m)
PAFS10/BL/50M*	10	7.5	Fine	10.0	6.5	15	50
PAFS13/BL/50M*	13	10	Fine	13.0	9.6	25	50
PAFS16/BL/50M	16	13	Fine	15.8	11.8	35	50
PAFS21/BL/50M	21	17	Fine	21.2	16.5	45	50
PAFS28/BL/50M	28	23	Fine	28.5	22.6	50	50
PACS28/BL/50M	28	23	Coarse	28.5	21.7	50	50
PAFS34/BL/50M	34	29	Fine	34.5	28.8	60	50
PACS34/BL/50M	34	29	Coarse	34.5	27.7	60	50
PACS42/BL/25M	42	36	Coarse	42.5	35.2	65	25
PACS48/BL/25M	48	42	Coarse	48.2	40.9	70	25
PACS54/BL/25M	54	48	Coarse	54.5	46.5	75	25
PACS80/BL/10M	80	70	Coarse	79.3	67.0	160	10
PACS106/BL/10M	106	95	Coarse	106.0	91.5	210	10

For grey color version state "GR" instead of "BL" in Part no. If interested in different coil lengths, do not hesitate to inquire.  
\*These parts are not covered by the UR certification.

#### Approvals



EN45545- HL2

#### IP rating

#### Appropriate fitting

For use with: Type PC / ATS / Adaptalok AL / Adaptaseal / Adaptaring

IP40	Adaptaring & Jumbo
IP65	Adaptalok AL Jumbo + SK Seal
IP66	PC, ATS, Adaptalok AL, Adaptaseal
IP67	PC, ATS, Adaptalok AL + ALS Seal, Adaptaseal
IP68	PC, ATS, Adaptalok AL + ALS Seal, Adaptaseal
IP69	PC, ATS, Adaptalok AL + ALS Seal, Adaptaseal

#### Temperature range

Static applications: -40°C to +120°C

Moving applications: -25°C to +150°C

#### Flexibility & fatigue life

High flexibility – High fatigue life

#### Fire performance & EMI screen

Self extinguishing

Halogen free



Very high

#### Type PA-Slit

Slit conduit / Materials: Polyamide (nylon) 6 / Colour: Black (BL) only

Part no.	Nominal conduit size (mm)	NW conduit size	Conduit pitch	Outside diameter (mm)	Inside diameter (mm)	Minimum bend radius (mm)	Reel length (m)
PAFL13-S/BL/50M	13	10	Fine	13.0	10.0	25	50
PAFL16-S/BL/50M	16	13	Fine	15.8	11.9	35	50
PAFL21-S/BL/50M	21	17	Fine	21.2	16.8	45	50
PACL28-S/BL/50M	28	23	Coarse	28.5	22.2	50	50
PACL34-S/BL/50M	34	29	Coarse	34.5	27.9	60	50
PACL42-S/BL/25M	42	36	Coarse	42.5	35.2	65	25
PACL54-S/BL/25M	54	48	Coarse	54.5	46.9	75	25

If interested in different coil lengths, do not hesitate to inquire.

#### Approvals



#### IP rating

#### Appropriate fitting

N/A

#### Temperature range

Static applications: -40°C to +120°C

Moving applications: -5°C to +120°C

#### Flexibility & fatigue life

High flexibility – High fatigue life

#### Fire performance & EMI screen

Self extinguishing

Halogen free

Very high

## Non-metallic conduit systems

### Type A, C90 & 45 - Adaptalok ATSTM

- Straight, 45° and 90° fittings available - fixed external male thread
- For insertion into knockouts using a locknut
- Locknut supplied with metric thread
- Materials: Polyamide (Nylon) 66 / TPE
- Colours: Black (BL), Grey (GR) / Yellow (Y) Elastomer

#### Type A - Adaptalok ATSTM

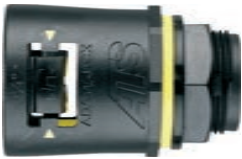
	Part no.	Nominal Conduit Size	Metric Thread
	AT13/M16/A	13mm	M16
	AT16/M16/A	16mm	M16
	AT16/M20/A	16mm	M20
	AT21/M20/A	21mm	M20
	AT21/M25/A	21mm	M25
	AT28/M25/A	28mm	M25
	AT28/M32/A	28mm	M32
	AT34/M32/A	34mm	M32
	AT34/M40/A	34mm	M40
	AT42/M40/A	42mm	M40
	AT42/M50/A	42mm	M50
	AT48/M50/A	48mm	M50
	AT54/M50/A	54mm	M50
	AT54/M63/A	54mm	M63

To order quote Order Code, body colour & Elastomer colour, e.g. AT21/M20/A/BLY.

#### Type 45 - Adaptalok ATSTM

	Part no.	Nominal Conduit Size	Metric Thread
	AT13/M16/45	13mm	M16
	AT16/M16/45	16mm	M16
	AT16/M20/45	16mm	M20
	AT21/M20/45	21mm	M20
	AT28/M25/45	28mm	M25
	AT34/M32/45	34mm	M32
	AT42/M40/45	42mm	M40
	AT48/M50/45	48mm	M50
	AT54/M50/45	54mm	M50

To order quote Order Code, body colour & Elastomer colour, e.g. AT54/M50/45/BLY.

#### Type C90 - Adaptalok ATSTM

	Part no.	Nominal Conduit Size	Metric Thread
	AT13/M16/C90	13mm	M16
	AT16/M16/C90	16mm	M16
	AT16/M20/C90	16mm	M20
	AT21/M20/C90	21mm	M20
	AT28/M25/C90	28mm	M25
	AT34/M32/C90	34mm	M32
	AT42/M40/C90	42mm	M40
	AT48/M50/C90	48mm	M50
	AT54/M50/C90	54mm	M50
	AT54/M63/C90	54mm	M63

To order quote Order Code, body colour & Elastomer colour, e.g. AT21/M20/C90/BLY.

#### Approvals



#### IP rating

For use with: Type PA / PR / PADL / PF

IP rating	Appropriate conduit
IP40	Yes
IP65	Yes
IP68	Yes 4 bar 30mins with Heavy Weight Conduits 2 bar 30mins with Standard Weight Conduits
IP69	Yes

#### Temperature Range

Static Applications: -50°C to +120°C

Moving Applications: -45°C to +120°C



## Non-metallic conduit systems

### Type SA, CS90 & S45 - Adaptalok ATSTM

- Straight, 45° and 90° fittings available - metal swivel external male thread
- For insertion into threaded entries & knockouts
- Order locknuts separately
- Materials: Polyamide (Nylon) 66, Nickel plated Brass thread/TPE
- Colours: Black (BL), Grey (GR) / Yellow (Y), Blue (B) Elastomer

#### Type SA - Adaptalok ATSTM

	Part no.	Nominal Conduit Size	Metric Thread
	AT13/M16/SA	13mm	M16
	AT16/M16/SA	16mm	M16
	AT21/M20/SA	21mm	M20
	AT28/M25/SA	28mm	M25
	AT34/M32/SA	34mm	M32
	AT42/M40/SA	42mm	M40
	AT48/M50/SA	48mm	M50
	AT54/M50/SA	54mm	M50
	AT54/M63/SA	54mm	M63

To order quote Order Code, body colour & Elastomer colour, e.g. AT16/M16/SA/BLB.

#### Type S45 - Adaptalok ATSTM

	Part no.	Nominal Conduit Size	Metric Thread
	AT13/M16/S45	13mm	M16
	AT16/M16/S45	16mm	M16
	AT21/M20/S45	21mm	M20
	AT28/M25/S45	28mm	M25
	AT34/M32/S45	34mm	M32
	AT42/M40/S45	42mm	M40
	AT48/M50/S45	48mm	M50
	AT54/M50/S45	54mm	M50
	AT54/M63/S45	54mm	M63

To order quote Order Code, body colour & Elastomer colour, e.g. AT54/M63/S45/BLB.

#### Type CS90 - Adaptalok ATSTM

	Part no.	Nominal Conduit Size	Metric Thread
	AT13/M16/CS90	13mm	M16
	AT16/M16/CS90	16mm	M16
	AT21/M20/CS90	21mm	M20
	AT28/M25/CS90	28mm	M25
	AT34/M32/CS90	34mm	M32
	AT42/M40/CS90	42mm	M40
	AT48/M50/CS90	48mm	M50
	AT54/M50/CS90	54mm	M50
	AT54/M63/CS90	54mm	M63

To order quote Order Code, body colour & Elastomer colour, e.g. AT16/M16/SA/BLB.

Approvals	Blue Elastomer version only	IP rating	Appropriate conduit
		For use with: Type PA / PR / PADL / PF	
		IP40	Yes
		IP65	Yes
		IP68	Yes
		4 bar 30mins with Heavy Weight Conduits	
		2 bar 30mins with Standard Weight Conduits	
		IP69	Yes
Temperature Range		Fitting Characteristics	
Static Applications: -50°C to +120°C			
Moving Applications: -45°C to +120°C			



## Non-metallic conduit systems

### Type A, C90 & 45 - Adaptalok

- Straight, 45° and 90° fittings available - fixed external male thread
- For insertion into knockouts using a locknut
- Locknut supplied with metric thread only
- Materials: Polyamide (Nylon) 66
- Colours: Black (BL), Grey (GR)

#### Type A - Adaptalok

	Part no.	Nominal Conduit Size	Metric Thread
	AL10/M12/A	10mm	M16
	AL13/M16/A	13mm	M16
	AL13/M20/A	13mm	M20
	AL16/M16/A	16mm	M16
	AL16/M20/A	16mm	M20
	AL21/M20/A	21mm	M20
	AL21/M25/A	21mm	M25
	AL28/M25/A	28mm	M25
	AL28/M32/A	28mm	M32
	AL34/M32/A	34mm	M32
	AL34/M40/A	34mm	M40
	AL42/M40/A	42mm	M40
	AL42/M50/A	42mm	M50
	AL54/M50/A	54mm	M50
	AL54/M63/A	54mm	M63

#### Type C90 - Adaptalok

	Part no.	Nominal Conduit Size	Metric Thread
	AL10/M12/C90*	10mm	M12
	AL13/M16/C90*	13mm	M16
	AL16/M16/C90	16mm	M16
	AL16/M20/C90	16mm	M20
	AL21/M20/C90	21mm	M20
	AL28/M25/C90	28mm	M25
	AL34/M32/C90	34mm	M32
	AL42/M40/C90	42mm	M40
	AL54/M50/C90	54mm	M50
	AL54/M63/C90	54mm	M63

\*These parts are not covered by the RU certification.

#### Type 45 - Adaptalok

	Part no.	Nominal Conduit Size	Metric Thread
	AL13/M16/45*	13mm	M16
	AL16/M16/45	16mm	M16
	AL16/M20/45	16mm	M20
	AL21/M20/45	21mm	M20
	AL28/M25/45	28mm	M25
	AL34/M32/45	34mm	M32
	AL42/M50/45	42mm	M40
	AL54/M50/45	54mm	M50
	AL54/M63/45	54mm	M63

#### Approvals



#### IP rating

IP rating	Appropriate conduit
For use with: Type PA / CP / PR / PF	
IP66	Yes
IP67	Yes + ALS Seal
IP68	Yes + ALS Seal
IP69	Yes + ALS Seal

#### Temperature Range

Static Applications: -50°C to +120°C  
 Moving Applications: -45°C to +120°C

#### Fitting Characteristics



To order quote Order Code & body colour, e.g. AL21/M20/45/BL.

\*These parts are not covered by the RU certification.

## Non-metallic conduit systems

### Type A & C90 - Adaptalok

- Straight, 45° and 90° fittings available - swivel external male thread
- For insertion into knockouts using a locknut
- Locknut supplied with metric thread only
- Materials: Polyamide (Nylon) 66
- Colours: Black (BL), Grey (GR)

#### Type SA - Adaptalok

	Part no.	Nominal Conduit Size	Metric Thread
	AL13/M16/SA*	13mm	M16
	AL16/M16/SA	16mm	M16
	AL21/M20/SA	16mm	M20
	AL28/M25/SA	28mm	M25
	AL34/M32/SA	34mm	M32
	AL42/M40/SA	42mm	M40
	AL54/M50/SA	54mm	M50
	AL54/M63/SA	54mm	M63

#### Type CS90 - Adaptalok

	Part no.	Nominal Conduit Size	Metric Thread
	AL13/M16/CS90*	13mm	M16
	AL16/M16/CS90	16mm	M16
	AL21/M20/CS90	21mm	M20
	AL28/M25/CS90	28mm	M25
	AL34/M32/CS90	34mm	M32
	AL42/M40/CS90	42mm	M40
	AL54/M50/CS90	54mm	M50
	AL54/M63/CS90	54mm	M63

To order quote Order Code & body colour, e.g. AL13/M16/CS90/BL. NPT also available.  
\*These parts are not covered by the RU certification.

#### Type S45 - Adaptalok

	Part no.	Nominal Conduit Size	Metric Thread
	AL13/M16/S45*	13mm	M16
	AL16/M16/S45	16mm	M16
	AL21/M20/S45	21mm	M20
	AL28/M25/S45	28mm	M25
	AL34/M32/S45	34mm	M32
	AL42/M40/S45	42mm	M40
	AL54/M50/S45	54mm	M50
	AL54/M63/S45	54mm	M63

#### Approvals



NF

#### IP rating

For use with: Type PA / PI / CP / PR / PF

IP rating	Appropriate conduit
IP66	Yes
IP67	Yes + ALS Seal
IP68	Yes + ALS Seal
IP69	Yes + ALS Seal

#### Temperature Range

Static Applications: -50°C to +120°C

Moving Applications: -45°C to +120°C

To order quote Order Code & body colour, e.g. AL21/M20/45/BL.  
\*These parts are not covered by the RU certification.

## Non-metallic conduit systems

Type KF PVCu conduits, Type KFA & Coupler - Korifit

Type KF

Lightweight, Standard weight & Medium weight conduit /  
Materials: PVCu / Colour: Grey (GR), White (W), Black (BL)

Part no.	Nominal conduit size (mm)	NW conduit size (mm)	Conduit pitch	Outside diameter (mm)	Inside diameter (mm)	Min. bend radius (mm)	Reel length (m)
<b>Lightweight conduit - Grey (GR)</b>							
KFL16/50M	16	13	Fine	15.8	12.1	25	50
KFL20/50M	20	17	Fine	19.8	14.5	30	50
KFL25/50M	25	22	Fine	24.8	19.9	40	50
<b>Standard weight conduit - White (W)</b>							
KFS16/W/50M	16	13	Fine	15.8	11.9	25	50
KFS20/W/50M	20	17	Fine	19.8	14.3	30	50
KFS25/W/50M	25	22	Fine	24.8	19.7	40	50
<b>Medium weight conduit - Black (BL)</b>							
KFM16/50M	16	13	Fine	15.8	11.9	25	50
KFM20/50M	20	17	Fine	19.8	14.3	30	50
KFM25/50M	25	22	Fine	24.8	19.7	40	50

**Approvals**



**IP rating**

For use with: Korifit KC & KF

IP40

**Appropriate fitting**

Korifit KC

IP65

Korifit KC

**Temperature range**

Static applications: -5°C to +60°C

Moving applications: -5°C to +60°C

**UV resistance**

High

**Flexibility & fatigue life**

Pliable - Low fatigue life

**Fire performance & EMI screen**

Self extinguishing

Type KFA - Korifit

Straight fitting - fixed external male thread /  
Materials: Polyamide (Nylon) 66 /  
Colours: Black (BL), Grey (GR) or White (W)

Part no.	Nominal Conduit Size	Metric Thread
KF16/M16/A	16mm	M16
KF16/M20/A	16mm	M20
KF20/M20/A	20mm	M20
KF25/M25/A	25mm	M25

To order quote Order Code & body colour, e.g. KF16/M16/A/BL.

Coupler - Korifit

Straight one piece coupler /  
Materials: Polyamide (Nylon) 66 /  
Colour: White (W) only

Part no.	Nominal Conduit Size	NW Conduit Size
KF2020	20mm	17

To order quote Order Code & body colour, e.g. KF2020/W.

**Approvals**



**IP rating**

For use with: Korifit Type KF

IP65

**Appropriate conduit**

Yes

**Temperature range**

Static applications: -5°C to +60°C

Moving applications: -5°C to +60°C

**Fitting characteristics**



## Non-metallic conduit systems

### Type KC/A, KC/C90 - Korifit

- Straight fitting - fixed external male thread
- For insertion into threaded entries & knockouts
- Locknut supplied
- Materials: Polyamide (Nylon) 66
- Colours: Black, Grey or White

- 90° Elbow fitting - fixed external male thread
- For insertion into knockouts
- Locknut supplied
- Materials: Polyamide (Nylon) 66
- Colour: Black only

#### Type KC/A - Korifit





	Part no.	Nominal Conduit Size	Metric Thread
	KC16/M16/A	16mm	M16
	KC16/M20/A	16mm	M20
	KC20/M20/A	20mm	M20
	KC25/M25/A	20mm	M25

To order quote Order Code & body colour, e.g. KC16/M16/A/BL.

#### Type KC/C90 - Korifit

	Part no.	Nominal Conduit Size	Metric Thread
	KC16/M16/C90	16mm	M16
	KC20/M20/C90	20mm	M20
	KC25/M25/C90	25mm	M25

To order quote Order Code & body colour, e.g. KC16/M16/C90/BL.

Approvals	IP rating	Appropriate conduit	Temperature range	Fitting characteristics
  	IP40	Yes	Static applications: -5°C to +60°C Moving applications: -5°C to +60°C	

## Non-metallic conduit systems

### Accessories

- Inspection T-piece
- Material: Polyamide (Nylon) 66
- Colour: Black (BL) only

#### Type T



Part no.	Nominal conduit size (mm)
ASF10X3/T/BL	10
ASF13X3/T/BL	13
ASF16X3/T/BL	16
ASF21X3/T/BL	21
ASC21X3/T/BL	21
ASF28X3/T/BL	28
ASC28X3/T/BL	28
ASF34X3/T/BL	34
ASC34X3/T/BL	34

For connection to corrugated flexible conduit.

#### Approvals



#### IP rating

#### Appropriate conduit

#### Temperature range

For use with: Type PA / CP / PR / PF

Static applications: -50°C to +120°C

IP66 Yes

Moving applications: -45°C to +120°C

IP67 Yes

#### Type AC

Conduit clips with integral lid / Material: Polyamide (nylon)66, impact modified Nylon - ST version only / Colour: Black (BL), Grey (GR)



Part no.	Colour		Impact Modified (Black only)	Nominal Conduit Size
	Black	Grey		
ACB10		ACG10	-	10mm
ACB13		ACG13	ACB13/ST	13mm
ACB16		ACG16	ACB16/ST	16mm
ACB21V2		ACG21V2	ACB21V2/ST	21mm
ACB28		ACG28	ACB28/ST	28mm
ACB34		ACG34	ACB34/ST	34mm
ACB42V2		ACG42V2	ACB42V2/ST	42mm
ACB54V2		ACG54V2	ACB54V2/ST	54mm

#### Type LNP

Nylon Locknuts / Material: Polyamide (nylon) 6 / Colour: Black (BL), Grey (GR)



Part no.	Colour		Metric Thread
	Black	Grey	
LNPB/M12	-		M12
LNPB/M16		LNPG/M16	M16
LNPB/M20		LNPG/M20	M20
LNPB/M25		LNPG/M25	M25
LNPB/M32		LNPG/M32	M32
LNPB/M40		LNPG/M40	M40
LNPB/M50		LNPG/M50	M50
LNPB/M63		LNPG/M63	M63

#### Kwikcut

#### Kwikcut cutting tool

Part no.  
KWIKCUT

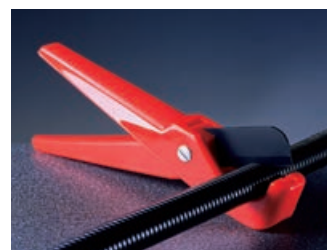

Kwikcut is the ideal cutting tool for non-metallic conduits (PA, PF, PR, PADL, CP, KFL, KFS, KFM, PP, XF & PK) up to 32mm.

Place the conduit between the cutting blade and lower support, squeeze the handles and rotate the conduit for a clean, easy cut. Spare blades are available.



## Non-metallic conduit systems



### Accessories

- Reducing kit
- Materials: Polyamide (Nylon) 66 & neoprene rubber
- Colour: Black (BL) only

#### Type RK

	Nominal conduit size (mm)	Conduit pitch	Part no.				
			Reducing to conduit size 10	Reducing to conduit size 13	Reducing to conduit size 16	Reducing to conduit size 21	Reducing to conduit size 28
	10	Fine	-	-	-	-	-
	13	Fine	RK13-10	-	-	-	-
	16	Fine	RK16-10	RK16-13	-	-	-
	21	Fine	RK21-10	RK21-13	RK21-16	-	-
	21	Coarse	RK21-10	RK21-13	RK21-16	-	-
	28	Fine	-	RK28-13	RK28-16	RK28-21	-
	28	Coarse	-	RK28-13	RK28-16	RK28-21	-
	34	Fine	-	-	-	RK34-21	RK34-28
	34	Coarse	-	-	-	RK34-21	RK34-28

For connection to a reduced conduit size.

Approvals	IP rating	Appropriate conduit	Temperature range
  	For use with: Type PA / CP / PR / PF		Static applications: -40°C to +120°C
	IP66	Yes	Moving applications: -5°C to +120°C
	IP67	Yes	
	IP68	Yes (2 bar 30mins)	
	IP69	Yes	

#### End sleeves

Materials: Polyamide (nylon) 6 / Colour: Black (BL) only

	Part no.	Nominal conduit size (mm)
	GZ9	13
	GZ11	16
	GZ13	21
	GZ21	28
	GZ29	34
	GZ36	42

For sealing cables to non-metallic conduit

#### Removal tool for Adaptalok fittings

Materials: Polyamide (nylon) 6 / Colour: Black (BL) only

	Part no.	Adaptalok fitting size (mm)
	AL13RT	13
	AL16RT	16
	AL21RT	21
	AL28RT	28
	AL34RT	34
	AL42RT	42
	AL54RT	54

To provide easy removal of Adaptalok & ATS Fittings.

---

# Industrial Cable glands

Supported by global certifications and our commitment to quality and research, ABB offers industrial cable glands for a broad array of applications anywhere you need them.

With varieties designed to withstand wet or dry locations, indoor or outdoor use and corrosive conditions, ABB offers a general purpose industrial gland to meet your need. Backed by thorough testing, ABB glands meet or exceed regulatory and certification standards, no matter where on the globe you need to use them.

Cable glands provide sealed entry into enclosures, motors, panels or any other device, limiting the ingress of water and dust. Regardless of the configuration, ABB's high quality standards help to extend system life and minimise downtime.

Available in stainless steel, nickel-plated brass, aluminum or nylon, our cable glands are available in a variety of thread types, shapes and hole configurations. Self-grounding varieties are available, along with a full array of accessories.

---

ABB industrial cable glands can be installed anywhere. Supported by global certifications and type approvals, we have a solution for most applications.



## Cable glands for industrial applications

### Selection guide



— Selection guide

Type	Rail Specific applications					
	NPG	NCG	BCG	RNCG	RBCG	RBSG
<b>General</b>						
Commercial Building	•	•	-	-	-	-
Residential Building	•	•	-	•	•	•
Industrial MRO	-	•	•	-	-	-
Low Ingress	-	•	•	-	-	-
<b>OEM</b>						
General Applications	•	•	•	-	-	-
Industrial Machinery	-	-	-	-	-	-
Commercial Machinery	-	-	-	-	-	-
Panel Building	•	•	•	-	-	-
Lighting	-	•	-	-	-	-
<b>Rail</b>						
Traction - Exterior	-	-	•	•	•	•
Traction - Interior	-	•	-	•	•	•
Infrastructure - Exterior	-	-	•	•	•	•
Infrastructure - Interior	-	•	-	•	•	•
<b>Automation</b>						
Robotics	•	•	•	-	-	-
Control systems	•	-	•	-	-	-
Enclosures and Motors	•	•	•	-	-	-
<b>Marine</b>						
General Applications	-	•	-	-	-	-
Outdoor Applications	-	•	-	-	-	-
Passenger/Crew Areas	-	•	-	-	-	-
<b>Oil and Gas</b>						
IEC standards	-	-	-	-	-	-
NEC Standards	-	-	-	-	-	-
<b>Other</b>						
Solar	•	•	•	-	-	-
Food and Beverage	-	-	-	-	-	-
Chemical Plants	-	-	-	-	-	-
Data Centres	-	-	•	-	-	-
Waste Water Management	-	-	-	-	-	-

**Other cable gland ranges are available** for other types of industries and applications. Please contact us to find out more.



# NPG Quick-Connect™

## Cable glands



ABB's latest cable gland offering, the NPG Quick-Connect™, allows for fast and effective fitting without access to the inside of an enclosure, greatly speeding installation. The speed and ease of installation makes the NPG ideal for panel builders and volume installers of all types. NPG Quick-Connect™ is a single-piece, corrosion resistant nylon gland suitable for non-armoured, portable and tray cable types. When installed, the NPG achieves ingress protection of IP66 or IP68 (5 bar 30 mins).

### Quick-Connect™ - NPG Series - Nylon cable gland

<b>Approvals &amp; certifications</b>		<b>Conformity</b> Conforms to:
		EN 62444
		UL514B (see table for details)
		CSA C22.2 No 18.3
<b>Temperature range</b>		
Normal Use: -20°C to +100°C (-4°F to +212°F)		
Short Term: -30°C to +150°C (-22°F to +302°F)		
<b>IP Rating</b>	<b>Material</b>	
IP66	Halogen free nylon (PA6) construction	
IP68 (5-Bar 30 mins)	Available in black, grey and light grey	
	Chloroprene seals	

Under normal use, NPG Quick-Connect™ glands are rated to perform from -20°C to 100°C (-4°F to 212°F), but in shorter bursts can withstand -30°C to 150°C (-22°F to 302°F).

### Dimensions

Metric thread Part no.	Metric thread	Cable size		Hole size		Nominal dimensions (mm/in)				
		Min. (mm/in)	Max. (mm/in)	Min. (mm/in)	Max. (mm/in)	A Min	B Min	C Min	W1	W2
NPG-M161x (cURus)	M16	5.0	10.0	16.2	16.4	9.0	42.5	26.5	22.0	22.0
		0.197	0.394	0.638	0.646	0.354	1.673	1.043	0.866	0.866
NPG-M201x (cURus)	M20	6.0	12.0	20.2	20.4	9.0	41.5	30.3	24.0	24.0
		0.236	0.472	0.795	0.803	0.354	1.634	1.193	0.945	0.945
NPG-M202x (cURus)	M20	7.0	13.0	20.2	20.4	9.0	41.5	30.3	25.0	25.0
		0.276	0.512	0.795	0.803	0.354	1.634	1.193	0.984	0.984
NPG-M251x (cURus)	M25	11.0	17.0	25.2	25.4	9.0	43.5	36.3	29.0	29.0
		0.433	0.669	0.992	1.000	0.354	1.713	1.429	1.142	1.142
NPG-M321x (cURus)	M32	15.0	21.0	32.2	32.4	9.0	49.5	43.2	36.0	36.0
		0.591	0.827	1.268	1.276	0.354	1.949	1.701	1.417	1.417

NPT thread Part no.	NPT thread	Cable size		Hole size		Nominal dimensions (mm/in)				
		Min. (mm/in)	Max. (mm/in)	Min. (mm/in)	Max. (mm/in)	A Min	B Min	C Min	W1	W2
NPG-0381x	3/8"	5.0	10.0	17.65	18.85	10.0	41.2	26.5	22.0	22.0
		0.197	0.394	0.695	0.742	0.394	1.673	1.043	0.866	0.866
NPG-0501x	1/2"	6.0	12.0	21.84	23.01	10.0	39.2	30.5	24.0	24.0
		0.236	0.472	0.860	0.906	0.394	1.543	1.201	0.945	0.945
NPG-0502x	1/2"	10.0	14.0	21.84	23.01	10.0	39.8	30.5	27.0	27.0
		0.394	0.551	0.860	0.906	0.394	1.689	1.201	1.063	1.063
NPG-0751x	3/4"	13.0	18.0	27.78	28.98	10.0	41.9	39.0	33.0	33.0
		0.512	0.709	1.094	1.141	0.394	1.650	1.535	1.299	1.299
NPG-1001x	1"	18.0	25.0	34.51	35.71	10.0	50.1	47.5	42.0	42.0
		0.709	0.984	1.359	1.406	1.972	1.972	1.870	1.654	1.654

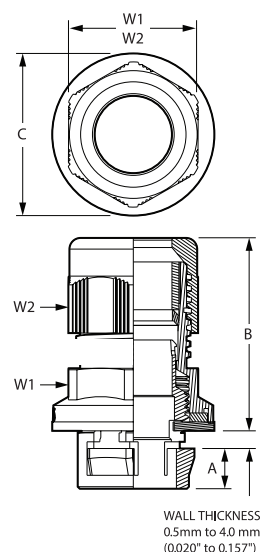

**Note for colour:** x in part number - B-Black (RAL 9001), G-Grey (RAL 7001), LG-Light grey (RAL 7035). M40 Metric Thread available on request.

# Nylon cable glands for general purpose use

## NCG Series



**Features and benefits:**

- Low profile cable glands
- Wide cable clamping range
- Corrosion resistant

**NCG Series - Nylon cable glands**

Approvals & certifications	Conformity	Temperature range
	Conforms to:	
	EN 62444	Normal Use: -20°C to +100°C (-4°F to +212°F)
	UL514B (see table for details)	Short Term: -30°C to +150°C (-22°F to +302°F)
	CSA C22.2 No 18.3	
		Material
IP Rating		Halogen free nylon construction Chloroprene seals Available in black, grey and light grey
IP66		
IP68 (5-Bar 30 mins)		
NEMA 4		

**Dimensions**

Metric thread	Part no.	Metric thread	Cable range		Nominal dimensions (mm/in)				
			Min. (mm/in)	Max. (mm/in)	A Min	B Min	C Min	W1	W2
	NCG-M121x	M12x1.5	2.0	5.0	8.0	23.0	16.9	15.0	15.0
			0.079	0.197	0.315	0.906	0.665	0.591	0.591
	NCG-M122x (cURus)	M12x1.5	3.0	6.5	8.0	23.0	16.9	15.0	15.0
			0.118	0.256	0.315	0.906	0.665	0.591	0.591
	NCG-M161x	M16x1.5	2.0	6.0	8.0	26.5	21.9	19.0	19.0
			0.079	0.236	0.315	1.043	0.862	0.748	0.748
	NCG-M161x-L	M16x1.5	2.0	6.0	15.0	26.5	21.9	19.0	19.0
			0.079	0.236	0.591	1.043	0.862	0.748	0.748
	NCG-M162x (cURus)	M16x1.5	4.0	8.0	8.0	26.5	21.9	19.0	19.0
			0.157	0.315	0.315	1.043	0.862	0.748	0.748
	NCG-M162x-L	M16x1.5	4.0	8.0	15.0	26.5	21.9	19.0	19.0
			0.157	0.315	0.591	1.043	0.862	0.748	0.748
	NCG-M163x (cURus)	M16x1.5	5.0	10.0	10.0	30.0	25.0	22.0	22.0
			0.197	0.394	0.394	1.181	0.984	0.866	0.866
	NCG-M163x-L (cURus)	M16x1.5	5.0	10.0	15.0	30.0	25.0	22.0	22.0
			0.157	0.315	0.591	1.043	0.862	0.748	0.748
NCG-M201x	M20x1.5	5.0	9.0	10.0	30.0	27.0	24.0	24.0	
		0.197	0.354	0.394	1.043	1.063	0.945	0.945	
NCG-M201x-L	M20x1.5	5.0	9.0	15.0	30.0	27.0	24.0	24.0	
		0.197	0.354	0.591	1.043	1.063	0.945	0.945	

Note for colour: x in part number - B-Black (RAL 9001), G-Grey (RAL 7001), LG-Light grey (RAL 7035).



## Nylon cable glands for general purpose use

### NCG Series

#### Dimensions

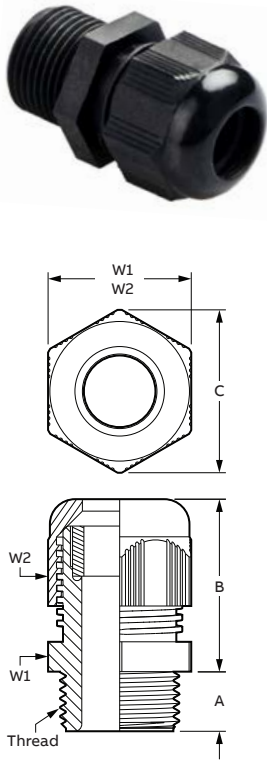
Metric thread	Part no.	Metric thread	Cable range		Nominal dimensions (mm/in)				
			Min. (mm/in)	Max. (mm/in)	A Min	B Min	C Min	W1	W2
	NCG-M202x (cULus)	M20x1.5	6.0	12.0	10.0	30.0	27.0	24.0	24.0
			0.236	0.472	0.394	1.181	1.063	0.945	0.945
	NCG-M202x-L (cULus)	M20x1.5	6.0	12.0	15.0	30.0	27.0	24.0	24.0
			0.236	0.472	0.591	1.181	1.063	0.945	0.945
	NCG-M203x (cULus)	M20x1.5	10.0	14.0	10.0	33.5	31.0	27.0	27.0
			0.394	0.551	0.394	1.319	1.22	1.063	1.063
	NCG-M203x-L (cULus)	M20x1.5	10.0	14.0	15.0	33.5	31.0	27.0	27.0
			0.394	0.551	0.591	1.319	1.22	1.063	1.063
	NCG-M251x	M25x1.5	9.0	16.0	10.0	38.0	38.0	33.0	33.0
			0.354	0.63	0.394	1.496	1.496	1.299	1.299
	NCG-M251x-L	M25x1.5	9.0	16.0	15.0	38.0	38.0	33.0	33.0
			0.354	0.63	0.591	1.496	1.496	1.299	1.299
	NCG-M252x (cULus)	M25x1.5	11.0	17.0	8.0	38.0	32.5	29.0	29.0
			0.433	0.669	0.315	1.496	1.28	1.142	1.142
	NCG-M252x-L	M25x1.5	11.0	17.0	15.0	36.0	32.5	29.0	29.0
			0.433	0.669	0.591	1.417	1.28	1.142	1.142
	NCG-M253x (cULus)	M25x1.5	13.0	18.0	10.0	38.0	38.0	33.0	33.0
			0.512	0.709	0.394	1.496	1.496	1.299	1.299
	NCG-M253x-L	M25x1.5	13.0	18.0	15.0	38.0	38.0	33.0	33.0
			0.512	0.709	0.591	1.496	1.496	1.299	1.299
NCG-M321x	M32x1.5	11.0	15.0	10.0	42.5	41.0	36.0	36.0	
		0.433	0.591	0.394	1.673	1.614	1.417	1.417	
NCG-M321x-L	M32x1.5	11.0	15.0	15.0	42.5	36.0	36.0	36.0	
		0.433	0.591	0.591	1.673	1.417	1.417	1.417	
NCG-M322x (cULus)	M32x1.5	15.0	21.0	10.0	42.5	41.0	36.0	36.0	
		0.591	0.827	0.394	1.673	1.614	1.417	1.417	
NCG-M322x-L	M32x1.5	15.0	21.0	15.0	42.5	41.0	36.0	36.0	
		0.591	0.827	0.591	1.673	1.614	1.417	1.417	
NCG-M323x (cULus)	M32x1.5	18.0	25.0	15.0	42.0	47.3	42.0	42.0	
		0.709	0.984	0.591	1.654	1.862	1.654	1.654	
NCG-M401x	M40x1.5	16.0	23.0	10.0	47.5	52.4	46.0	46.0	
		0.63	0.906	0.394	1.870	2.063	1.811	1.811	
NCG-M401x-L	M40x1.5	16.0	23.0	18.0	47.5	52.4	46.0	46.0	
		0.63	0.906	0.709	1.870	2.063	1.811	1.811	
NCG-M402x (cULus)	M40x1.5	19.0	28.0	10.0	47.5	52.4	46.0	46.0	
		0.748	1.102	0.394	1.870	2.063	1.811	1.811	
NCG-M402x-L	M40x1.5	19.0	28.0	18.0	47.5	52.4	46.0	46.0	
		0.748	1.102	0.709	1.870	2.063	1.811	1.811	
NCG-M403x (cULus)	M40x1.5	22.0	32.0	18.0	52.0	60.0	53.0	53.0	
		0.866	1.26	0.709	2.047	2.362	2.087	2.087	
NCG-M501x	M50x1.5	25.0	31.0	18.0	53.5	67.8	60.0	60.0	
		0.984	1.22	0.709	2.106	2.669	2.362	2.362	
NCG-M502x (cULus)	M50x1.5	30.0	38.0	18.0	53.5	67.8	60.0	60.0	
		1.181	1.496	0.709	2.106	2.669	2.362	2.362	
NCG-M631x	M63x1.5	29.0	35.0	18.0	53.0	72.9	65.0	65.0	
		1.142	1.378	0.709	2.087	2.870	2.559	2.559	
NCG-M632x (cULus)	M63x1.5	34.0	44.0	18.0	53.0	72.9	65.0	65.0	
		1.339	1.732	0.709	2.087	2.87	2.559	2.559	
NCG-M751x (cULus)	M75x1.5	48.0	55.0	25.0	55.0	89.0	75.0	80.0	
		1.89	2.165	0.984	2.165	3.504	2.953	3.15	

Note for colour: x in part number - B-Black (RAL 9001), G-Grey (RAL 7001), LG-Light grey (RAL 7035).

## Nylon cable glands for industrial applications

### NCG Series

#### Dimensions

NPT thread	Part no.	NPT thread	Cable range		Nominal dimensions (mm/in)				
			Min. (mm/in)	Max. (mm/in)	A Min	B Min	C Min	W1	W2
	NCG-0381x	3/8"	3.0	7.0	15.0	30.0	25.0	22.0	22.0
			0.118	0.276	0.591	1.181	0.984	0.866	0.866
	NCG-0382x (cULus)	3/8"	5.0	10.0	15.0	30.0	25.0	22.0	22.0
			0.197	0.394	0.591	1.181	0.984	0.866	0.866
	NCG-0501x	1/2"	5.0	9.0	15.0	30.0	27.0	24.0	24.0
			0.197	0.354	0.591	1.181	1.063	0.945	0.945
	NCG-0502x (cULus)	1/2"	6.0	12.0	15.0	30.0	27.0	24.0	24.0
			0.236	0.472	0.591	1.181	1.063	0.945	0.945
	NCG-0503x (cULus)	1/2"	10.0	14.0	11.0	33.5	30.9	27.0	27.0
			0.394	0.551	0.433	1.319	1.217	1.063	1.063
	NCG-0504x	1/2"	9.0	16.0	15.0	38.0	38.0	33.0	33.0
			0.354	0.63	0.591	1.496	1.496	1.299	1.299
	NCG-0505x	1/2"	13.0	18.0	15.0	38.0	38.0	33.0	33.0
			0.512	0.709	0.591	1.496	1.496	1.299	1.299
	NCG-0751x	3/4"	9.0	16.0	15.0	38.0	38.0	33.0	33.0
			0.354	0.63	0.591	1.496	1.496	1.299	1.299
	NCG-0752x (cULus)	3/4"	13.0	18.0	15.0	38.0	38.0	33.0	33.0
			0.512	0.709	0.591	1.496	1.496	1.299	1.299
	NCG-1001x	1"	12.0	20.0	18.0	42.0	47.3	42.0	42.0
			0.472	0.787	0.709	1.654	1.862	1.654	1.654
	NCG-1002x (cULus)	1"	18.0	25.0	18.0	42.0	47.3	42.0	42.0
			0.709	0.984	0.709	1.654	1.862	1.654	1.654



## Nylon cable glands for industrial applications

### NCG Series

#### Dimensions

PG thread	Part no.	PG thread	Cable range		Nominal dimensions (mm/in)				
			Min. (mm/in)	Max. (mm/in)	A Min	B Min	C Min	W1	W2
	NCG-PG71x (cULus)	PG07	3.0	6.5	8.0	23.0	16.9	15.0	15.0
			0.118	0.256	0.315	0.906	0.665	0.591	0.591
	NCG-PG91x (cULus)	PG09	4.0	8.0	8.0	26.5	21.9	19.0	19.0
			0.157	0.315	0.315	1.043	0.862	0.748	0.748
	NCG-PG111x	PG11	3.0	7.0	8.0	29.0	25.0	22.0	22.0
			0.118	0.276	0.315	1.142	0.984	0.866	0.866
	NCG-PG112x (cULus)	PG11	5.0	10.0	8.0	29.0	25.0	22.0	22.0
			0.197	0.394	0.315	1.142	0.984	0.866	0.866
	NCG-PG131x (cULus)	PG13	6.0	12.0	10.0	29.0	27.0	24.0	24.0
			0.236	0.472	0.394	1.142	1.063	0.945	0.945
	NCG-PG161x (cULus)	PG16	10.0	14.0	10.0	33.5	30.9	27.0	27.0
			0.394	0.551	0.394	1.319	1.217	1.063	1.063
	NCG-PG211x (cULus)	PG21	13.0	18.0	11.0	37.0	38.0	33.0	33.0
			0.512	0.709	0.433	1.457	1.496	1.299	1.299
NCG-PG291x (cULus)	PG29	18.0	25.0	11.0	42.0	47.3	42.0	42.0	
		0.709	0.984	0.433	1.654	1.862	1.654	1.654	
NCG-PG361x (cULus)	PG36	22.0	32.0	13.0	52.0	60.0	53.0	53.0	
		0.866	1.26	0.512	2.047	2.362	2.087	2.087	
NCG-PG421x (cULus)	PG42	30.0	38.0	13.0	53.5	67.8	60.0	60.0	
		1.181	1.496	0.512	2.106	2.669	2.362	2.362	
NCG-PG481x (cULus)	PG48	34.0	44.0	14.0	53.5	72.9	65.0	65.0	
		1.339	1.732	0.551	2.106	2.87	2.559	2.559	

Note for colour: x in part number - B-Black (RAL 9001), G-Grey (RAL 7001), LG-Light grey (RAL 7035).

#### Dimensions

GAS thread	Part no.	GAS thread	Cable range		Nominal dimensions (mm/in)				
			Min. (mm/in)	Max. (mm/in)	A Min	B Min	C Min	W1	W2
	NCG-G0251x	1/4"	3.0	6.5	10.0	23.0	16.9	15.0	15.0
			0.118	0.256	0.394	0.906	0.665	0.591	0.591
	NCG-G0381x	3/8"	5.0	10.0	11.0	30.0	25.0	22.0	22.0
			0.197	0.394	0.433	1.181	0.984	0.866	0.866
	NCG-G0501x	1/2"	6.0	12.0	10.0	30.0	27.0	24.0	24.0
			0.236	0.472	0.394	1.181	1.063	0.945	0.945
	NCG-G0502x	1/2"	10.0	14.0	11.0	30.0	30.9	27.0	27.0
			0.394	0.551	0.433	1.181	1.217	1.063	1.063
	NCG-G0751x	3/4"	13.0	18.0	12.0	38.0	38.0	33.0	33.0
			0.512	0.709	0.472	1.496	1.496	1.299	1.299
	NCG-G1001x	1"	18.0	25.0	13.0	42.0	47.3	42.0	42.0
			0.709	0.984	0.512	1.654	1.862	1.654	1.654

Note for colour: x in part number - B-Black (RAL 9001), G-Grey (RAL 7001), LG-Light grey (RAL 7035).

## Brass cable glands (general purpose)





### BCG Series



#### Features and benefits:

- Low profile cable glands
- Wide cable clamping range
- Good corrosion resistance

#### BCG Series - Brass cable glands

Approvals & certifications	Conformity Conforms to:	Temperature range
   	EN 62444	Normal use: -20°C to +100°C (-4°F to +212°F)
	UL514B	Short Term: -30°C to +150°C (-22°F to +302°F)
		IP Rating
		IP66
		IP68 (5-Bar 30 mins)
		NEMA 4
		Material
		Nickel plated brass construction
		Chloroprene seals

#### Dimensions

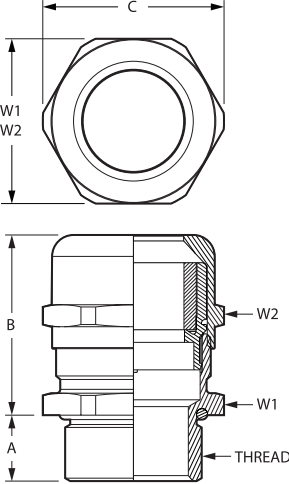
Metric thread	Part no.	Metric thread	Cable size		Nominal dimensions (mm/in)				
			Min. (mm/in)	Max. (mm/in)	A Min	B Min	C Min	W1	W2
	BCG-M121	M12x1.5	2.0	5.0	6.0	22.0	15.5	14.0	14.0
			0.079	0.197	0.236	0.866	0.610	0.551	0.551
	BCG-M122 (cURus)	M12x1.5	3.0	6.5	6.0	22.0	15.5	14.0	14.0
			0.118	0.256	0.236	0.866	0.610	0.551	0.551
	BCG-M122-L	M12x1.5	3.0	6.5	12.0	22.0	15.5	14.0	14.0
			0.118	0.256	0.472	0.866	0.610	0.551	0.551
	BCG-M161	M16x1.5	2.0	6.0	7.0	23.0	20.0	18.0	17.0
			0.079	0.236	0.276	0.906	0.787	0.709	0.669
	BCG-M161-L	M16x1.5	2.0	6.0	12.0	23.0	20.0	18.0	17.0
			0.079	0.236	0.472	0.906	0.787	0.709	0.669
	BCG-M162 (cURus)	M16x1.5	4.0	8.0	7.0	23.0	20.0	18.0	17.0
			0.157	0.315	0.276	0.906	0.787	0.709	0.669
BCG-M162-L	M16x1.5	4.0	8.0	12.0	23.0	20.0	18.0	17.0	
		0.157	0.315	0.472	0.906	0.787	0.709	0.669	
BCG-M163 (cURus)	M16x1.5	5.0	10.0	7.0	28.5	22.0	20.0	20.0	
		0.197	0.394	0.276	1.122	0.866	0.787	0.787	
BCG-M163-L (cURus)	M16x1.5	5.0	10.0	12.0	28.5	22.0	20.0	20.0	
		0.197	0.394	0.472	1.122	0.866	0.787	0.787	
BCG-M201	M20x1.5	5.0	9.0	8.0	26.0	24.5	22.0	22.0	
		0.197	0.354	0.315	1.024	0.965	0.866	0.866	
BCG-M201-L	M20x1.5	5.0	9.0	12.0	26.0	24.5	22.0	22.0	
		0.197	0.354	0.472	1.024	0.965	0.866	0.866	
BCG-M202 (cULus)	M20x1.5	6.0	12.0	8.0	26.5	24.5	22.0	22.0	
		0.236	0.472	0.315	1.043	0.965	0.866	0.866	

## Brass cable glands (general purpose)

### BCG Series

#### Dimensions

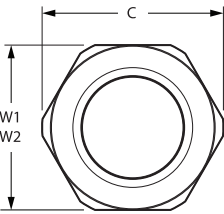
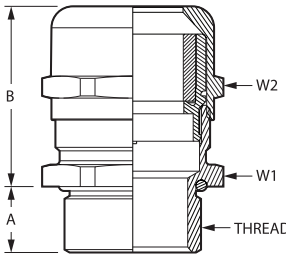
Metric thread	Part no.	Metric thread	Cable range		Nominal dimensions (mm/in)				
			Min. (mm/in)	Max. (mm/in)	A Min	B Min	C Min	W1	W2
	BCG-M202-L (cULus)	M20x1.5	6.0	12.0	12.0	26.0	24.5	22.0	22.0
			0.236	0.472	0.472	1.024	0.965	0.866	0.866
	BCG-M203 (cULus)	M20x1.5	10.0	14.0	8.0	28.0	26.8	24.0	24.0
			0.394	0.551	0.315	1.102	1.055	0.945	0.945
	BCG-M203-L	M20x1.5	10.0	14.0	12.0	28.0	26.8	24.0	24.0
			0.394	0.551	0.472	1.102	1.055	0.945	0.945
	BCG-M251	M25x1.5	7.0	12.0	8.0	28.0	29.8	27.0	24.0
			0.276	0.472	0.315	1.102	1.173	1.063	0.945
	BCG-M251-L	M25x1.5	7.0	12.0	12.0	28.0	29.8	27.0	24.0
			0.276	0.472	0.472	1.102	1.173	1.063	0.945
	BCG-M252	M25x1.5	9.0	16.0	8.0	33.0	33.0	30.0	30.0
			0.354	0.630	0.315	1.299	1.299	1.181	1.181
	BCG-M252-L	M25x1.5	9.0	16.0	12.0	33.0	33.0	30.0	30.0
			0.354	0.630	0.472	1.299	1.299	1.181	1.181
	BCG-M253 (cULus)	M25x1.5	10.0	14.0	8.0	28.0	29.8	27.0	24.0
			0.394	0.551	0.315	1.102	1.173	1.063	0.945
	BCG-M253-L	M25x1.5	10.0	14.0	12.0	28.0	29.8	27.0	24.0
			0.394	0.551	0.472	1.102	1.173	1.063	0.945
	BCG-M254 (cULus)	M25x1.5	13.0	18.0	8.0	33.0	32.0	30.0	30.0
			0.512	0.709	0.315	1.299	1.260	1.181	1.181
	BCG-M254-L	M25x1.5	13.0	18.0	12.0	33.0	32.0	30.0	30.0
			0.512	0.709	0.472	1.299	1.260	1.181	1.181
	BCG-M321	M32x1.5	9.0	16.0	9.0	33.0	37.5	34.0	30.0
			0.354	0.630	0.354	1.299	1.476	1.339	1.181
	BCG-M321-L	M32x1.5	9.0	16.0	15.0	33.0	37.5	34.0	30.0
			0.354	0.630	0.591	1.299	1.476	1.339	1.181
	BCG-M322	M32x1.5	12.0	20.0	9.0	44.0	44.5	40.0	40.0
			0.472	0.787	0.354	1.732	1.752	1.575	1.575
	BCG-M322-L	M32x1.5	12.0	20.0	15.0	44.0	44.5	40.0	40.0
			0.472	0.787	0.591	1.732	1.752	1.575	1.575
	BCG-M323 (cULus)	M32x1.5	13.0	18.0	9.0	33.0	37.5	34.0	30.0
			0.512	0.709	0.354	1.299	1.476	1.339	1.181
	BCG-M323-L	M32x1.5	13.0	18.0	15.0	33.0	37.5	34.0	30.0
			0.512	0.709	0.591	1.299	1.476	1.339	1.181
	BCG-M324 (cULus)	M32x1.5	15.0	21.0	8.0	36.0	37.0	34.0	34.0
			0.591	0.827	0.315	1.417	1.457	1.339	1.339
	BCG-M324-L (cULus)	M32x1.5	15.0	21.0	15.0	36.0	37.0	34.0	34.0
			0.591	0.827	0.591	1.417	1.457	1.339	1.339
	BCG-M325 (cULus)	M32x1.5	18.0	25.0	9.0	44.0	44.5	40.0	40.0
			0.709	0.984	0.354	1.732	1.752	1.575	1.575
	BCG-M325-L	M32x1.5	18.0	25.0	15.0	44.0	44.5	40.0	40.0
			0.709	0.984	0.591	1.732	1.752	1.575	1.575
	BCG-M401	M40x1.5	12.0	20.0	9.0	38.5	48.5	43.0	40.0
			0.472	0.787	0.354	1.516	1.909	1.693	1.575
	BCG-M401-L	M40x1.5	12.0	20.0	15.0	38.5	48.5	43.0	40.0
			0.472	0.787	0.591	1.516	1.909	1.693	1.575
	BCG-M402	M40x1.5	16.0	23.0	9.0	43.5	48.4	43.0	43.0
			0.630	0.906	0.354	1.713	1.906	1.693	1.693

## Brass cable glands (general purpose)

### BCG Series

#### Dimensions

Metric thread	Part no.	Metric thread	Cable size		Nominal dimensions (mm/in)				
			Min. (mm/in)	Max. (mm/in)	A Min	B Min	C Min	W1	W2
	BCG-M403 (cULus)	M40x1.5	19.0	28.0	9.0	43.5	48.4	43.0	43.0
			0.748	1.102	0.354	1.713	1.906	1.693	1.693
	BCG-M403-L (cULus)	M40x1.5	19.0	28.0	15.0	43.5	48.4	43.0	43.0
			0.748	1.102	0.591	1.713	1.906	1.693	1.693
	BCG-M404 (cULus)	M40x1.5	22.0	32.0	9.0	52.5	55.5	50.0	50.0
			0.866	1.260	0.354	2.067	2.185	1.969	1.969
	BCG-M404-L (cULus)	M40x1.5	22.0	32.0	15.0	52.5	55.5	50.0	50.0
			0.866	1.260	0.591	2.067	2.185	1.969	1.969
	BCG-M501 (cULus)	M50x1.5	20.0	26.0	9.0	48.0	61.0	55.0	50.0
			0.787	1.024	0.354	1.890	2.402	2.165	1.969
	BCG-M502 (cULus)	M50x1.5	22.0	32.0	9.0	48.0	61.0	55.0	50.0
			0.866	1.260	0.354	1.890	2.402	2.165	1.969
	BCG-M502-L (cULus)	M50x1.5	22.0	32.0	15.0	48.0	61.0	55.0	50.0
			0.866	1.260	0.591	1.890	2.402	2.165	1.969
	BCG-M503 (cULus)	M50x1.5	27.0	38.0	9.0	52.0	64.0	58.0	58.0
			1.063	1.496	0.354	2.047	2.520	2.283	2.283
	BCG-M503-L (cULus)	M50x1.5	27.0	38.0	15.0	52.0	64.0	58.0	58.0
			1.063	1.496	0.591	2.047	2.520	2.283	2.283
	BCG-M504 (cULus)	M50x1.5	34.0	44.0	9.0	52.8	75.0	68.0	64.0
			1.339	1.732	0.354	2.079	2.953	2.677	2.520
BCG-M504-L (cULus)	M50x1.5	34.0	44.0	15.0	52.8	75.0	68.0	64.0	
		1.339	1.732	0.591	2.079	2.953	2.677	2.520	
BCG-M631 (cULus)	M63x1.5	29.0	35.0	10.0	54.0	75.0	68.0	64.0	
		1.142	1.378	0.394	2.126	2.953	2.677	2.520	
BCG-M631-L (cULus)	M63x1.5	29.0	35.0	18.0	54.0	75.0	68.0	64.0	
		1.142	1.378	0.709	2.126	2.953	2.677	2.520	
BCG-M632 (cULus)	M63x1.5	34.0	44.0	10.0	54.0	75.0	68.0	64.0	
		1.339	1.732	0.394	2.126	2.953	2.677	2.520	
BCG-M632-L (cULus)	M63x1.5	34.0	44.0	18.0	53.0	75.0	68.0	64.0	
		1.339	1.732	0.709	2.087	2.953	2.677	2.520	
BCG-M633 (cULus)	M63x1.5	37.0	53.0	10.0	51.0	83.0	75.0	75.0	
		1.457	2.087	0.394	2.008	3.268	2.953	2.953	
BCG-M633-L (cULus)	M63x1.5	37.0	53.0	18.0	51.0	83.0	75.0	75.0	
		1.457	2.087	0.709	2.008	3.268	2.953	2.953	



## Brass cable glands (general purpose)

### BCG Series

#### Dimensions

NPT thread	Part no.	NPT thread	Cable size		Nominal dimensions (mm/in)				
			Min. (mm/in)	Max. (mm/in)	A Min	B Min	C Min	W1	W2
	BCG-0381	3/8" NPT	2.0	6.0	11.5	23.0	21.0	19.0	17.0
			0.079	0.236	0.453	0.906	0.827	0.748	0.669
	BCG-0382	3/8" NPT	5.0	10.0	11.5	29.5	22.0	20.0	20.0
			0.197	0.394	0.453	1.161	0.866	0.787	0.787
	BCG-0501	1/2" NPT	5.0	9.0	13.0	25.5	24.5	22.0	22.0
			0.197	0.354	0.512	1.004	0.965	0.866	0.866
	BCG-0502 (cULus)	1/2" NPT	6.0	12.0	13.0	25.5	24.5	22.0	22.0
			0.236	0.472	0.512	1.004	0.965	0.866	0.866
	BCG-0503	1/2" NPT	10.0	14.0	13.0	28.0	26.8	24.0	24.0
			0.394	0.551	0.512	1.102	1.055	0.945	0.945
	BCG-0752 (cULus)	3/4" NPT	13.0	18.0	13.0	36.0	33.0	30.0	30.0
			0.512	0.709	0.512	1.417	1.299	1.181	1.181
BCG-1002 (cULus)	1" NPT	18.0	25.0	13.0	43.0	48.5	43.0	40.0	
		0.709	0.984	0.512	1.693	1.909	1.693	1.575	

#### Dimensions

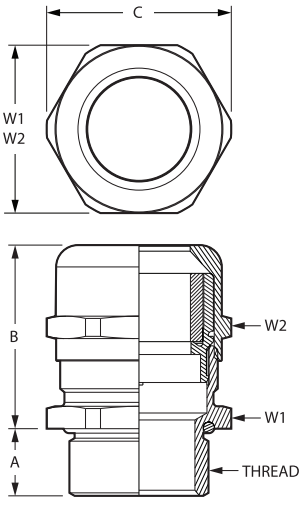
PG thread	Part no.	PG thread	Cable range		Nominal dimensions (mm/in)				
			Min. (mm/in)	Max. (mm/in)	A Min	B Min	C Min	W1	W2
	BCG-PG71	PG07	2.0	5.0	6.0	22.0	15.5	14.0	14.0
			0.079	0.197	0.236	0.866	0.610	0.551	0.551
	BCG-PG71-L	PG07	2.0	5.0	10.0	22.0	15.5	14.0	14.0
			0.079	0.197	0.394	0.866	0.610	0.551	0.551
	BCG-PG72 (cURus)	PG07	3.0	6.5	6.0	22.0	15.5	14.0	14.0
			0.118	0.256	0.236	0.866	0.610	0.551	0.551
	BCG-PG72-L (cURus)	PG07	3.0	6.5	10.0	22.0	15.5	14.0	14.0
			0.118	0.256	0.394	0.866	0.610	0.551	0.551
	BCG-PG91	PG09	2.0	6.0	6.0	23.5	18.9	17.0	17.0
			0.079	0.236	0.236	0.925	0.744	0.669	0.669
	BCG-PG91-L	PG09	2.0	6.0	10.0	23.5	18.9	17.0	17.0
			0.079	0.236	0.394	0.925	0.744	0.669	0.669
BCG-PG92 (cURus)	PG09	4.0	8.0	6.0	23.5	18.9	17.0	17.0	
		0.157	0.315	0.236	0.925	0.744	0.669	0.669	
BCG-PG92-L (cURus)	PG09	4.0	8.0	10.0	23.5	18.9	17.0	17.0	
		0.157	0.315	0.394	0.925	0.744	0.669	0.669	
BCG-PG112 (cURus)	PG11	5.0	10.0	6.0	26.0	22.0	20.0	20.0	
		0.197	0.394	0.236	1.024	0.866	0.787	0.787	
BCG-PG112-L (cURus)	PG11	5.0	10.0	10.0	26.0	22.0	20.0	20.0	
		0.197	0.394	0.394	1.024	0.866	0.787	0.787	
BCG-PG132 (cULus)	PG13.5	6.0	12.0	6.5	24.5	24.5	22.0	22.0	
		0.236	0.472	0.256	0.965	0.965	0.866	0.866	
BCG-PG132-L (cULus)	PG13.5	6.0	12.0	10.0	24.5	24.5	22.0	22.0	
		0.236	0.472	0.394	0.965	0.965	0.866	0.866	
BCG-PG161	PG16	7.0	12.0	6.5	28.0	26.5	24.0	24.0	
		0.276	0.472	0.256	1.102	1.043	0.945	0.945	

## Brass cable glands (general purpose)

### BCG Series

#### Dimensions

PG thread	Part no.	PG thread	Cable size		Nominal dimensions (mm/in)				
			Min. (mm/in)	Max. (mm/in)	A Min	B Min	C Min	W1	W2
	BCG-PG162 (cULus)	PG16	10.0	14.0	6.5	28.0	26.5	24.0	24.0
			0.394	0.551	0.256	1.102	1.043	0.945	0.945
	BCG-PG162-L (cULus)	PG16	10.0	14.0	10.0	28.0	26.5	24.0	24.0
			0.394	0.551	0.394	1.102	1.043	0.945	0.945
	BCG-PG211	PG21	9.0	16.0	7.2	33.0	33.0	30.0	30.0
			0.354	0.630	0.283	1.299	1.299	1.181	1.181
	BCG-PG212 (cULus)	PG21	13.0	18.0	7.2	33.0	33.0	30.0	30.0
			0.512	0.709	0.283	1.299	1.299	1.181	1.181
	BCG-PG212-L (cULus)	PG21	13.0	18.0	12.0	33.0	33.0	30.0	30.0
			0.512	0.709	0.472	1.299	1.299	1.181	1.181
	BCG-PG291	PG29	12.0	20.0	8.0	38.5	44.5	40.0	40.0
			0.472	0.787	0.315	1.516	1.752	1.575	1.575
	BCG-PG292 (cULus)	PG29	18.0	25.0	8.0	38.5	44.5	40.0	40.0
			0.709	0.984	0.315	1.516	1.752	1.575	1.575
	BCG-PG292-L (cULus)	PG29	18.0	25.0	12.0	38.5	44.5	40.0	40.0
			0.709	0.984	0.472	1.516	1.752	1.575	1.575
	BCG-PG362 (cULus)	PG36	22.0	32.0	9.0	48.0	55.5	50.0	50.0
			0.866	1.260	0.354	1.890	2.185	1.969	1.969
	BCG-PG362-L (cULus)	PG36	22.0	32.0	14.0	48.0	55.5	50.0	50.0
			0.866	1.260	0.551	1.890	2.185	1.969	1.969
	BCG-PG481	PG48	29.0	35.0	14.0	52.5	70.0	64.0	64.0
			1.142	1.378	0.551	2.067	2.756	2.520	2.520
	BCG-PG481-L	PG48	29.0	35.0	18.0	52.5	70.0	64.0	64.0
			1.142	1.378	0.709	2.067	2.756	2.520	2.520

# Rail Specific Cable glands

ABB cable glands comply to the latest European safety standard EN45545 and achieve the highest fire performance HL3 rating for both interior and exterior locations, suitable for rail vehicle and infrastructure usage.

This range of cable glands can be installed anywhere where low smoke and toxicity combined with wide temperature characteristics, versatile cable clamping and resistance to oils and chemicals may be required.

For more than 30 years we have worked with the foremost manufacturers and suppliers of public transportation systems throughout the world. We understand not just the standards that you need to work to, but also the industry issues that you face including your customer service delivery expectations.

Our systems perform in a wide variety of environments from high temperature to freezing subzero conditions, as well as withstanding constant vibrations, water ingress, offer corrosion resistance. They are also available in halogen free, low smoke and low toxicity materials. If your project involves rail stations, infrastructure, signalling, tunnels, surveillance or data and information systems, our experience can help you.

#### Product examples

- RBCG Series - Rail Brass Cable Glands
- RNCG Series - Rail Nylon Cable Glands
- RBSG Series - Rail Stackable Nickel Plated Brass



# Nylon cable glands - Rail specific EN45545

## RNCG Series



**Features and benefits:**

- EN45545-2 Compliant HL3 for R22 and R23 usage
- Lightweight nylon construction
- Large capacity sealing range
- Corrosion resistant

**RNCG Series - Nylon cable glands**

Approvals & certifications	Conformity Conforms to:	Temperature range
	EN 45545-2, HL3 (R22 and R23)	Normal use: -40°C to +100°C (-40°F to +212°F)
	EN 62444	Short Term: -40°C to +120°C (-40°F to +248°F)
		IP Rating
		IP66
		IP68 (5-Bar 30 mins)
		IP69
		Material
		All materials EN 45545-2 compliant to HL3 for category R22 and R23 use
		Low smoke zero halogen EPDM seals
		Fire
		EN 45545-2 HL3
		Low smoke zero halogen nylon body and cap

**Dimensions**

Metric thread	Part no.	Metric thread	Cable range		Nominal dimensions (mm/in)				
			Min. (mm/in)	Max. (mm/in)	A Min	B Min	C Min	W1	W2
	RNCG-M122	M12x1.5	3.0 0.118	6.5 0.256	8.0 0.315	23.0 0.906	16.9 0.665	15.0 0.591	15.0 0.591
	RNCG-M163-S	M16x1.5	4.0 0.157	8.0 0.315	8.0 0.315	26.5 1.043	21.9 0.862	19.0 0.748	19.0 0.748
	RNCG-M163	M16x1.5	4.0 0.157	8.0 0.315	10.0 0.394	26.5 1.043	21.9 0.862	19.0 0.748	19.0 0.748
	RNCG-M164	M16x1.5	5.0 0.197	10.0 0.394	10.0 0.394	30.0 1.181	25.0 0.984	22.0 0.866	22.0 0.866
	RNCG-M164-L	M16x1.5	5.0 0.197	10.0 0.394	15.0 0.591	30.0 1.181	25.0 0.984	22.0 0.866	22.0 0.866
	RNCG-M202	M20x1.5	6.0 0.236	12.0 0.472	10.0 0.394	30.0 1.181	27.0 1.063	24.0 1.945	24.0 1.945
	RNCG-M202x-L	M20x1.5	6.0 0.236	12.0 0.472	15.0 0.591	30.0 1.181	27.0 1.063	24.0 1.945	24.0 1.945
	RNCG-M205	M20x1.5	10.0 0.394	14.0 0.551	10.0 0.394	33.5 1.319	31.0 1.22	27.0 1.063	27.0 1.063
	RNCG-M205-L	M20x1.5	10.0 0.394	14.0 0.551	15.0 0.591	33.5 1.319	31.0 1.22	27.0 1.063	27.0 1.063
	RNCG-M254	M25x1.5	13.0 0.512	18.0 0.709	10.0 0.394	38.0 1.496	38.0 1.496	33.0 1.299	33.0 1.299

## Nylon cable glands - Rail specific EN45545

### RNCG Series

#### Dimensions

Metric thread	Part no.	Metric thread	Cable range		Nominal dimensions (mm/in)				
			Min. (mm/in)	Max. (mm/in)	A Min	B Min	C Min	W1	W2
	RNCG-M254-L	M25x1.5	13.0	18.0	18.0	38.0	38.0	33.0	33.0
			0.512	0.709	0.709	1.496	1.496	1.299	1.299
	RNCG-M324-L	M32x1.5	18.0	25.0	15.0	42.0	47.3	42.0	42.0
			0.709	0.984	0.591	1.654	1.862	1.654	1.654
	RNCG-M404x	M40x1.5	22.0	32.0	18.0	52.0	60.0	53.0	53.0
			0.866	1.26	0.709	2.047	2.362	2.087	2.087

## Brass cable glands - Rail specific EN45545

### RBCG Series



#### Features and benefits:

- EN45545-2 Compliant HL3 for R22 and R23 usage
- Robust metallic construction
- Large capacity sealing range

#### RBCG Series - Brass cable glands

Approvals & certifications	Conformity Conforms to:	Temperature range
CE	EN 45545-2, HL3 (R22 and R23)	Normal use: -40°C to +100°C (-40°F to +212°F)
	EN 62444	Short Term: -40°C to +120°C (-40°F to +248°F)
		IP Rating
		IP66
		IP68 (5-Bar 30 mins)
		IP69
		Material
		All materials EN 45545-2 compliant to HL3 for category R22 and R23 use
		Nickel plated brass body and cap
		Fire
		Low smoke zero halogen EPDM seals
		Low smoke zero halogen nylon body and cap
		EN 45545-2 HL3

#### Dimensions

Metric thread	Part no.	Metric thread	Cable range		Nominal dimensions (mm/in)				
			Min. (mm/in)	Max. (mm/in)	A Min	B Min	C Min	W1	W2
	RBCG-M122	M12x1.5	3.0	6.5	12.0	22.0	15.5	14.0	14.0
	RBCG-M122-S	M12x1.5	3.0	6.5	6.0	22.0	15.5	14.0	14.0
	RBCG-M163	M16x1.5	4.0	8.0	12.0	23.0	20.0	18.0	17.0
	RBCG-M163-S	M16x1.5	4.0	8.0	7.0	23.0	20.0	18.0	17.0
	RBCG-M164	M16x1.5	5.0	10.0	12.0	28.5	22.0	20.0	20.0
	RBCG-M164-S	M16x1.5	5.0	10.0	7.0	28.5	22.0	20.0	20.0
	RBCG-M202	M20x1.5	6.0	12.0	12.0	26.0	24.5	22.0	22.0
	RBCG-M204	M20x1.5	10.0	14.0	12.0	28.0	26.8	24.0	24.0
	RBCG-M204-S	M20x1.5	10.0	14.0	8.0	28.0	26.8	24.0	24.0
			0.394	0.551	0.315	1.102	1.055	0.945	0.945



## Brass cable glands - Rail specific EN45545

### RBCG Series

#### Dimensions

Metric thread	Part no.	Metric thread	Cable range		Nominal dimensions (mm/in)				
			Min. (mm/in)	Max. (mm/in)	A Min	B Min	C Min	W1	W2
	RBCG-M254	M25x1.5	13.0	18.0	12.0	33.0	33.0	30.0	30.0
			0.512	0.709	0.709	1.299	1.299	1.181	1.181
	RBCG-M254-S	M25x1.5	13.0	18.0	8.0	33.0	33.0	30.0	30.0
			0.512	0.709	0.315	1.299	1.299	1.181	1.181
	RBCG-M325	M32x1.5	18.0	25.0	15.0	44.0	44.5	40.0	40.0
			0.709	0.984	0.591	1.732	1.752	1.575	1.575
	RBCG-M325-S	M32x1.5	18.0	25.0	9.0	44.0	44.5	40.0	40.0
			0.709	0.984	0.354	1.732	1.752	1.575	1.575
	RBCG-M405	M40x1.5	22.0	32.0	15.0	52.5	55.5	50.0	50.0
			0.866	1.26	0.591	2.067	2.185	1.185	1.969
	RBCG-M404x	M40x1.5	22.0	32.0	9.0	52.5	55.5	50.0	50.0
			0.866	1.26	0.354	2.067	2.185	1.185	1.185

## Stackable brass cable glands- Rail specific EN45545

### RBSG Series







#### Features and benefits:

- EN45545-2 Compliant HL3 for R22 and R23 usage
- Robust metallic construction
- Multiple seal bushings for wide clamping range

#### RBSG Series - Brass cable glands

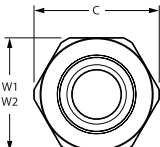
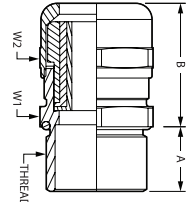
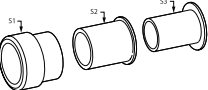
Approvals & certifications	Conformity	Temperature range
	Conforms to:	Normal use: -50°C to +125°C (-40°F to +257°F)
	EN 45545-2, HL3 (R22 and R23)	Short Term: -50°C to +140°C (-40°F to +284°F)
	EN 62444	
IP Rating		Material
IP66		All materials EN 45545-2 compliant to HL3 for category R22 and R23 use
IP68 (5-Bar 30 mins)		
IP69		
		Nickel plated brass body and cap
Fire		
		EN 45545-2 HL3

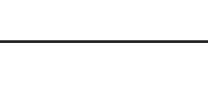
#### Dimensions

Metric thread	Part no.	Metric thread	Cable range (mm/in)				Seals range (mm/in)				Nominal dimensions (mm/in)				
			Min.	Max.	S1	S2	S3	A Min	B Min	C Min	W1	W2			
	RBSG-M201	M20x1.5	4.0	12.0	9.0	12.0	6.0	9.0	4.0	6.0	9.0	27.0	24.5	22.0	22.0
			0.157	0.472	0.354	0.472	0.236	0.354	0.157	0.236	0.354	1.063	0.965	0.866	0.866
	RBSG-M202	M20x1.5	10.0	16.0	14.5	16.0	12.0	14.5	10.0	12.0	9.0	30.0	31.0	28.0	28.0
			0.394	0.630	0.571	0.630	0.472	0.571	0.394	0.472	0.354	1.181	1.220	1.102	1.102
	RBSG-M251	M25x1.5	4.0	12.0	9.0	12.0	6.0	9.0	4.0	6.0	9.0	27.0	31.0	28.0	22.0
			0.157	0.472	0.354	0.472	0.236	0.354	0.157	0.236	0.354	1.063	1.220	1.102	0.866
	RBSG-M252	M25x1.5	10.0	18.0	14.5	18.0	12.0	14.5	10.0	12.0	9.0	30.5	31.0	28.0	28.0
			0.394	0.709	0.571	0.709	0.472	0.571	0.394	0.472	0.354	1.201	1.220	1.102	1.102
	RBSG-M321	M32x1.5	10.0	18.0	14.5	18.0	12.0	14.5	10.0	12.0	9.0	30.5	39.0	35.0	28.0
			0.394	0.709	0.571	0.709	0.472	0.571	0.394	0.472	0.354	1.201	1.535	1.378	1.102
	RBSG-M322	M32x1.5	14.0	24.0	20.0	24.0	17.0	20.0	14.0	17.0	9.0	33.0	39.0	35.0	35.0
			0.551	0.945	0.787	0.945	0.669	0.787	0.551	0.669	0.354	1.299	1.535	1.378	1.378
	RBSG-M323	M32x1.5	22.0	28.0	27.0	28.0	24.0	27.0	22.0	24.0	9.0	41.0	49.5	45.0	45.0
			0.866	1.102	1.063	1.102	0.945	1.063	0.866	0.945	0.354	1.614	1.949	1.772	1.772
	RBSG-M401	M40x1.5	14.0	24.0	20.0	24.0	17.0	20.0	14.0	17.0	9.0	33.0	50.0	45.0	35.0
			0.551	0.945	0.787	0.945	0.669	0.787	0.551	0.669	0.354	1.299	1.969	1.772	1.378
	RBSG-M402	M40x1.5	22.0	32.0	27.0	32.0	24.0	27.0	22.0	24.0	9.0	40.5	49.5	45.0	45.0
			0.866	1.260	1.063	1.260	0.945	1.063	0.866	0.945	0.354	1.594	1.949	1.772	1.772
	RBSG-M501	M50x1.5	26.0	35.0	31.0	35.0	28.0	31.0	26.0	28.0	9.0	43.5	61.0	55.0	50.0
			1.024	1.378	1.220	1.378	1.102	1.220	1.024	1.102	0.354	1.713	2.402	2.165	1.969
	RBSG-M502	M50x1.5	35.0	44.0	41.0	44.0	38.0	41.0	35.0	38.0	9.0	43.0	70.0	64.0	64.0
			1.378	1.732	1.614	1.732	1.496	1.614	1.378	1.496	0.354	1.693	2.756	2.520	2.520

# Food and Beverage

## Cable glands

Hygienic, corrosion-resistant cable glands from ABB provide rigorous, dependable electrical connections for food processing machinery and preparation stations.

— 01 Food processing - Explosion proof (Dust).

— 02 Beverage manufacture - Explosion proof (Vapour).

Along with other products in the ABB electrical connection portfolio, ABB's high quality cable glands can help extend the life of electrical systems in a food and beverage plant's challenging environments while reducing system changeover and downtimes. With high ingress protection ratings and corrosion-resistant stainless steel or nylon construction, ABB glands can withstand a plant's toughest challenges, even in areas that require frequent washdowns.

Products that are particularly attractive to food and beverage processors include the NSF approved FSCG stainless steel gland series, allowing the safe termination of cables into equipment, and the NSF approved FSEM stainless steel EMC gland series, where grounding continuity for a shielded cable is required. Both are IP rated to IP69.

01



02



# Stainless steel cable glands - NSF approved food and beverage cable glands



## FSCG Series



### Features and benefits:

- Smooth hygienic external casing
- One piece, fully enclosed
- Suitable for splash zones
- Corrosion resistant

### FSCG Series - NSF approved cable glands

Approvals & certifications		Conformity	Temperature range	
 	Conforms to:		Normal use: -20°C to +100°C (-40°F to +212°F)	
	NSF - 169-2012		Short Term: -40°C to +150°C (-40°F to +302°F)	
		UL514B / CSA C22.2 No 18.3		
			IP Rating	Material
			IP66	Stainless Steel construction
			IP68 (5-Bar 30 mins)	FDA Compliant EPDM Seals
			IP69 (Steam cleaning)	

### Dimensions

Metric thread Part no.	Metric thread	Cable range		Nominal dimensions (mm/in)					
		Min. (mm/in)	Max. (mm/in)	A Min	B Min	C Min	D Min	W1	W2
FSCG-M121	M12x1.5	3.0	6.5	6.0	21.3	15.6	16.5	14.0	10.0
		0.118	0.256	0.236	0.839	0.614	0.650	0.551	0.394
FSCG-M161	M16x1.5	5.0	10.0	7.0	23.1	20.2	21.0	18.0	14.0
		0.197	0.394	0.276	0.909	0.795	0.827	0.709	0.551
FSCG-M201	M20x1.5	6.0	12.0	10.0	26.7	24.1	26.4	22.0	18.0
		0.236	0.472	0.394	1.051	0.949	1.039	0.866	0.709
FSCG-M251	M25x1.5	12.0	17.0	14.0	29.1	30.1	33.0	28.0	23.0
		0.472	0.669	0.551	1.146	1.185	1.299	1.102	0.906

NPT thread Part no.	NPT thread	Cable range		Nominal dimensions (mm/in)					
		Min. (mm/in)	Max. (mm/in)	A Min	B Min	C Min	D Min	W1	W2
FSCG-0381	3/8"	3.0	6.5	15.26	21.2	20.2	26.5	18.0	14.0
		0.118	0.256	0.601	0.835	0.795	1.043	0.709	0.551
FSCG-0382	3/8"	5.0	10.0	15.26	23.7	24.1	26.5	22.0	14.0
		0.197	0.394	0.601	0.933	0.949	1.043	0.866	0.551
FSCG-0501	1/2"	6.0	12.0	19.85	28.0	30.1	26.5	28.0	18.0
		0.236	0.472	0.781	1.102	1.185	1.043	1.102	0.709
FSCG-0751	3/4"	12.0	17.0	20.15	31.6	38.0	39.0	35.0	23.0
		0.472	0.669	0.793	1.244	1.496	1.535	1.378	0.906



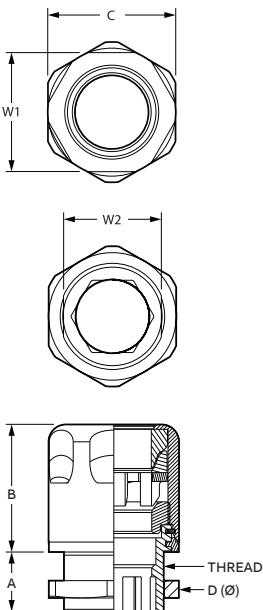

## Stainless steel cable glands - EMC NSF approved food and beverage cable glands FSEM Series



### Features and benefits:

- Smooth hygienic external casing
- One piece, fully enclosed
- Internal continuity contacts
- Corrosion resistant
- Extended radial contact with the shielding for improved EMI protection

### FSEM Series - NSF approved cable glands

Approvals & certifications	Conformity Conforms to:	Temperature range
 	NSF - 169-2012	Normal use: -20°C to +100°C (-8°F to +212°F)
	UL514B / CSA C22.2 No 18.3	Short Term: -40°C to +150°C (-40°F to +302°F)
	IP Rating	Material
	IP66	Stainless Steel construction
	IP67	FDA Compliant EPDM Seals
	IP68 (5-Bar 30 mins)	
	IP69 (Steam Cleaning)	

### Dimensions

Metric thread Part no.	Metric thread	Cable range		Nominal dimensions (mm/in)					
		Min. (mm/in)	Max. (mm/in)	A Min	B Min	C Min	D Min	W1	W2
FSEM-M161	M16x1.5	5.0	10.0	7.0	28.1	20.2	21.0	18.0	14.0
		0.197	0.394	0.276	1.106	0.795	0.827	0.709	0.551
FSEM-M201	M20x1.5	6.0	12.0	10.0	32.7	24.1	26.5	22.0	18.0
		0.236	0.472	0.394	1.287	0.949	1.043	0.866	0.709
FSEM-M251	M25x1.5	12.0	17.0	14.0	37.9	30.1	33.0	28.0	23.0
		0.472	0.669	0.551	1.492	1.185	1.299	1.102	0.906

NPT thread Part no.	NPT thread	Cable range		Nominal dimensions (mm/in)					
		Min. (mm/in)	Max. (mm/in)	A Min	B Min	C Min	D Min	W1	W2
FSEM-0381	3/8"	5.0	10.0	15.26	28.6	24.1	26.5	22.0	14.0
		0.197	0.394	0.601	1.126	0.949	1.043	0.866	0.551
FSEM-0501	1/2"	6.0	12.0	19.85	33.2	30.1	26.5	28.0	18.0
		0.236	0.472	0.781	1.307	1.185	1.043	1.102	0.709
FSEM-0751	3/4"	12.0	17.0	20.15	39.1	38.0	39.0	35.0	23.0
		0.472	0.669	0.793	1.539	1.496	1.535	1.378	0.906



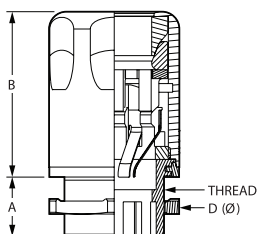
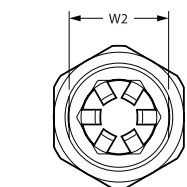
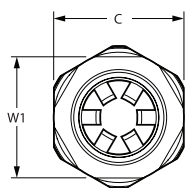

# Hazardous area Cable glands

ABB products protect critical data and power cables in hazardous areas onshore and offshore.

Whether it is data cables from a gas detector or the cable protection on a power transmission unit, ABB hazardous area cable glands are designed and manufactured to meet the demands of rigorous and arduous operating environments in addition to ATEX and IECEx standards.

ABB's hazardous area cable glands are suitable for use with a range of cable types on applications such as:

- Skids
- Control boxes
- Motors
- Lighting

## Product examples

Cable type	Standard gland	Barrier gland
Non armoured	EXCG (Non-metallic)	C4 Series
	C2 Series	
	ISR (Mechanical grip)	
Wire armoured	C1 Series (Double compression)	C5 Series
MC armoured	ST	STX
	STE (High range)	
EMC	C6 Series	
Flat	C2F Series (Heat trace)	
	C6F Series (Heat trace)	





## Cable glands for hazardous areas

### Selection guide

#### Selection guide



Type	Non-armoured cable types				Armoured cable types	
	EXCG	C2/C2F	C6/C6F	C4	C1	C5
<b>General</b>						
Commercial Building	-	-	-	-	-	-
Residential Building	-	-	-	-	-	-
Industrial MRO	-	-	-	-	•	-
Low Ingress	-	-	-	-	-	-
<b>OEM</b>						
General Applications	•	-	-	-	-	-
Industrial Machinery	•	•	-	-	•	-
Commercial Machinery	-	-	-	-	-	-
Panel Building	•	•	-	-	-	-
Lighting	•	•	-	-	-	-
<b>Rail</b>						
Traction - Exterior	-	-	-	-	-	-
Traction - Interior	-	-	-	-	-	-
Infrastructure - Exterior	-	-	-	-	-	-
Infrastructure - Interior	-	-	-	-	-	-
<b>Automation</b>						
Robotics	-	•	•	-	-	-
Control systems	-	•	•	-	-	-
Enclosures and Motors	-	•	•	-	-	-
<b>Marine</b>						
General Applications	•	•	•	•	•	•
Outdoor Applications	•	•	•	•	•	•
Passenger/Crew Areas	•	•	•	•	•	•
<b>Oil and Gas</b>						
IEC standards	•	•	•	•	•	•
NEC Standards	-	•	•	-	•	-
<b>Other</b>						
Solar	-	-	-	-	-	-
Food and Beverage	-	•	-	-	•	-
Chemical Plants	-	•	•	-	•	-
Data Centres	-	-	•	-	-	-
Waste Water Management	-	•	•	•	•	•

**Other cable gland ranges are available** for other types of industries and applications. Please contact us to find out more.



## Ex e Nylon cable glands for hazardous areas





### EXCG Series



#### Features and benefits:

- Increased safety Ex e
- Suitable for use in Zone 1, 2, 21 and 22
- For use with non-armoured circular cable types
- Can be used for Ex ia intrinsically safe, with blue cap

#### EXCG Series - Nylon cable glands

Approvals & certifications		Conformity	Temperature range	
   		Conforms to: EN/IEC: 60079-0, 60079-7, 60079-34, 62444 ATEX:IMQ_03 ATEX016X REV03 IECEx: IECEx IMQ 13.0005X Ⓢ II 2 GD, Ex e IIC Gb, Ex tb IIIC Db	Operating range: -40°C to +80°C	
			IP Rating	Material
			IP66	Nylon
			IP68	

#### Dimensions

Metric thread	Part no.	Metric thread	Cable range		Nominal dimensions (mm/in)			
			Min. (mm/in)	Max. (mm/in)	A Min	B Min	W1	W2
	EXCGM20S	M20	6.0	12.0	10.0	40.0	24.0	24.0
			0.236	0.472	0.393	1.574	0.944	0.944
	EXCGM20SL	M20	6.0	12.0	15.0	45.0	24.0	24.0
			0.236	0.472	0.590	1.771	0.944	0.944
	EXCGM20M	M20	10.0	14.0	10.0	42.0	27.0	27.0
			0.393	0.551	0.393	1.653	1.062	1.062
	EXCGM20ML	M20	10.0	14.0	15.0	50.0	27.0	27.0
			0.393	0.551	0.590	1.968	1.062	1.062
	EXCGM25S	M25	13.0	18.0	10.0	47.0	33.0	33.0
			0.511	0.708	0.393	1.850	1.299	1.299
	EXCGM25SL	M25	13.0	18.0	15.0	50.0	33.0	33.0
			0.511	0.708	0.590	1.968	1.299	1.299
	EXCGM25M	M25	11.0	17.0	8.0	42.5	29.0	29.0
			0.433	0.669	0.314	1.673	1.141	1.141
	EXCGM32S	M32	15.0	21.0	10.0	50.0	36.0	36.0
			0.590	0.826	0.393	1.968	1.417	1.417
	EXCGM32M	M32	18.0	25.0	15.0	68.0	42.0	42.0
			0.708	0.984	0.590	2.677	1.653	1.653
	EXCGM40S	M40	19.0	28.0	10.0	55.0	46.0	46.0
			0.748	1.102	0.393	2.165	1.811	1.811
	EXCGM40M	M40	22.0	32.0	18.0	68.0	53.0	53.0
			0.866	1.259	0.708	2.677	2.086	2.086
	EXCGM50S	M50	30.0	38.0	18.0	73.0	60.0	60.0
			1.181	1.496	0.708	2.874	2.362	2.362
	EXCGM63S	M63	34.0	44.0	18.0	74.0	65.0	65.0
			1.338	1.732	0.708	2.913	2.559	2.559

# Ex d e Non-armoured cable glands for hazardous areas

## C2 Series



### Features and benefits:

- Flameproof Ex d and Increased safety Ex e
- Suitable for use in Zone 1, 2, 21 and 22
- For use with non-armoured circular cable types
- Wide cable range
- Deluge proof

Available in kit form with locknut, earth tag, sealing washer and dust shroud, add 'K' suffix.

### C2 Series - Ex d e single compression cable glands

Approvals & certifications	Conformity	Temperature range					
	EN/IECEX: 60079-0, 60079-1, 60079-7, 60079-34, 62444 UL514B, UL2225 ATEX:IMQ_03 ATEX016X REV03 IECEX: IECEX IMQ 14.0005X EACEX: RU C-GB.AA87.B.00198 CNEX: CNEX15.1696X DNV: TAE00000Y3 UL: E477121 © II 2 GD, Ex d e IIC Gb, Ex tb IIIC Db Class 1 Zone 1 AEx e IIC	Operating range: -40°C to +100°C (-40°F to +212°F)					
		<table border="1"> <thead> <tr> <th>IP Rating</th> <th>Material</th> </tr> </thead> <tbody> <tr> <td>IP66</td> <td>Nickel plated brass</td> </tr> <tr> <td>IP68 (5-Bar 30 mins)</td> <td>Stainless steel 316</td> </tr> </tbody> </table>	IP Rating	Material	IP66	Nickel plated brass	IP68 (5-Bar 30 mins)
IP Rating	Material						
IP66	Nickel plated brass						
IP68 (5-Bar 30 mins)	Stainless steel 316						

### Dimensions

Metric thread	Part no.	Metric thread	Cable range Ø		Nominal dimensions (mm/in)				
			Min. (mm/in)	Max. (mm/in)	A Min	B Min	C Min	W1	W2
	EXN03MMC2	M16x1.5	4.0 0.157	12.0 0.472	16.0 0.63	31.0 1.22	24.0 0.945	22.0 0.866	22.0 0.866
	EXN04MSC2	M20x1.5	3.0 0.118	9.0 0.354	16.0 0.63	27.0 1.063	24.0 0.945	22.0 0.866	20.0 0.787
	EXN04MMC2	M20x1.5	4.0 0.157	12.0 0.472	16.0 0.63	27.0 1.063	24.0 0.945	22.0 0.866	22.0 0.866
	EXN04MLC2	M20x1.5	10.0 0.394	16.0 0.63	16.0 0.63	30.0 1.181	31.0 1.22	28.0 1.102	28.0 1.102
	EXN05MMC2	M25x1.5	10.0 0.394	18.0 0.709	16.0 0.63	30.5 1.201	31.0 1.22	28.0 1.102	28.0 1.102
	EXN05MLC2	M25x1.5	14.0 0.551	20.0 0.787	16.0 0.63	34.0 1.339	39.0 1.535	35.0 1.378	35.0 1.378
	EXN06MMC2	M32x1.5	14.0 0.551	24.0 0.945	16.0 0.63	33.0 1.299	39.0 1.535	35.0 1.378	35.0 1.378
	EXN06MLC2	M32x1.5	22.0 0.866	28.0 1.102	16.0 0.63	41.0 1.614	50.0 1.969	45.0 1.772	45.0 1.772
	EXN07MMC2	M40x1.5	22.0 0.866	32.0 1.26	18.0 0.709	41.0 1.614	50.0 1.969	45.0 1.772	45.0 1.772

## Ex d e Non-armoured cable glands for hazardous areas

### C2 Series

#### Dimensions

Metric thread	Part no.	Metric thread	Cable range Ø		Nominal dimensions (mm/in)				
			Inner Min. (mm/in)	Outer Max. (mm/in)	A Min	B Min	C Min	W1	W2
	EXN07MLC2	M40x1.5	26.0	34.0	18.0	44.0	55.5	50.0	50.0
			1.024	1.339	0.709	1.732	2.185	1.969	1.969
	EXN08MSC2	M50x1.5	26.0	35.0	18.0	44.0	61.0	55.0	50.0
			1.024	1.378	0.709	1.732	2.402	2.165	1.969
	EXN08MMC2	M50x1.5	35.0	44.0	18.0	43.0	70.0	64.0	64.0
			1.378	1.732	0.709	1.693	2.756	2.52	2.52
	EXN09MSC2	M63x1.5	35.0	45.0	18.0	43.0	75.0	68.0	64.0
			1.378	1.772	0.709	1.693	2.953	2.677	2.52
	EXN09MMC2	M63x1.5	46.0	56.0	18.0	52.5	89.0	75.0	80.0
			1.811	2.205	0.709	2.067	3.504	2.953	3.15
	EXN10MSC2	M75x1.5	46.0	62.0	20.0	52.0	89.0	80.0	80.0
			1.811	2.441	0.787	2.047	3.504	3.15	3.15
	EXN10MMC2	M75x1.5	60.0	69.0	20.0	55.0	105.0	95.0	95.0
			2.362	2.717	0.787	2.165	4.134	3.74	3.74
	EXN11MSC2	M90x1.5	60.0	75.0	20.0	55.0	105.0	95.0	95.0
			2.362	2.953	0.787	2.165	4.134	3.74	3.74
	EXN11MMC2	M90x1.5	75.0	82.0	20.0	55.0	117.0	105.0	105.0
			2.953	3.228	0.787	2.165	4.606	4.134	4.134

# Ex d e Non-armoured cable glands for hazardous areas

## C2 Series

### Dimensions

NPT thread	Part no.	NPT thread	Cable range Ø		Nominal dimensions (mm/in)				
			Min. (mm/in)	Max. (mm/in)	A Min	B Min	C Min	W1	W2
	EXN03AMC2	3/8"	4.0	12.0	16.0	31.0	24.0	22.0	22.0
			0.157	0.472	0.63	1.22	0.945	0.866	0.866
	EXN04ASC2	1/2"	3.0	9.0	16.0	27.0	24.0	22.0	20.0
			0.118	0.354	0.63	1.063	0.945	0.866	0.787
	EXN04AMC2	1/2"	4.0	12.0	16.0	27.0	24.0	22.0	22.0
			0.157	0.472	0.63	1.063	0.945	0.866	0.866
	EXN04ALC2	1/2"	10.0	16.0	16.0	30.0	31.0	28.0	28.0
			0.394	0.63	0.63	1.181	1.22	1.102	1.102
	EXN05AMC2	3/4"	10.0	18.0	16.0	30.5	31.0	28.0	28.0
			0.394	0.709	0.63	1.201	1.22	1.102	1.102
	EXN05ALC2	3/4"	14.0	20.0	16.0	34.0	39.0	35.0	35.0
			0.551	0.787	0.63	1.339	1.535	1.378	1.378
	EXN06AMC2	1"	14.0	24.0	20.0	33.0	39.0	35.0	35.0
			0.551	0.945	0.787	1.299	1.535	1.378	1.378
	EXN06ALC2	1"	22.0	28.0	20.0	41.0	50.0	45.0	45.0
			0.866	1.102	0.787	1.614	1.969	1.772	1.772
	EXN07AMC2	1 1/4"	22.0	32.0	20.0	41.0	50.0	45.0	45.0
			0.866	1.26	0.787	1.614	1.969	1.772	1.772
	EXN07ALC2	1 1/4"	26.0	34.0	20.0	44.0	55.5	50.0	50.0
			1.0	1.3	0.8	1.7	2.2	2.0	2.0
EXN08ASC2	1 1/2"	26.0	35.0	20.0	44.0	61.0	55.0	50.0	
		1.0	1.4	0.8	1.7	2.4	2.2	2.0	
EXN08AMC2	1 1/2"	35.0	44.0	20.0	43.0	70.0	64.0	64.0	
		1.4	1.7	0.8	1.7	2.8	2.5	2.5	
EXN09ASC2	2"	35.0	45.0	20.0	43.0	75.0	68.0	64.0	
		1.4	1.8	0.8	1.7	3.0	2.7	2.5	
EXN09AMC2	2"	46.0	56.0	20.0	52.5	89.0	75.0	80.0	
		1.8	2.2	0.8	2.1	3.5	3.0	3.2	
EXN10ASC2	2 1/2"	46.0	62.0	21.0	52.0	89.0	80.0	80.0	
		1.8	2.4	0.8	2.0	3.5	3.2	3.2	
EXN10AMC2	2 1/2"	60.0	69.0	21.0	55.0	105.0	95.0	95.0	
		2.4	2.7	0.8	2.2	4.1	3.7	3.7	
EXN11ASC2	3"	60.0	75.0	21.0	55.0	105.0	95.0	95.0	
		2.4	3.0	0.8	2.2	4.1	3.7	3.7	
EXN11AMC2	3"	75.0	82.0	21.0	55.0	117.0	105.0	105.0	
		3.0	3.2	0.8	2.2	4.6	4.1	4.1	



## Ex d e EMC cable glands for hazardous areas





### C6 Series



#### Features and benefits:

- Flameproof Ex d and Increased safety Ex e
- Suitable for use in Zone 1, 2, 21 and 22
- For use with shielded circular cable types
- EMC contact to maintain shielding continuity
- Wide cable range
- Deluge proof

#### C6 Series - Ex d e single compression cable glands

Approvals & certifications		Conformity	Temperature range	
   	Conforms to:		Operating range: -60°C to +100°C (-76°C to +212°C)	
	EN/IECEx: 60079-0, 60079-1, 60079-7, 60079-34, 62444			
	ATEX:IMQ_03 ATEX016X REV03			
	IECEx: IECEx IMQ 14.0005X		IP Rating	
	DNV: TAE00000Y3		IP66	
	Ⓜ II 2 GD, Ex d e IIC Gb, Ex tb IIIC Db		Material	
				Nickel plated brass
				Stainless steel 316

#### Dimensions

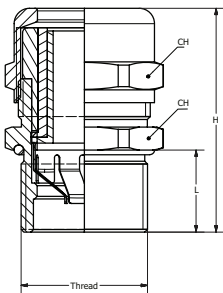
Metric thread	Part no.	Metric thread	Cable range Ø		Nominal dimensions (mm/in)				
			Min. (mm/in)	Max. (mm/in)	A Min	B Min	C Min	W1	W2
	EXN03MSC6	M16x1.5	4.0	8.0	16.0	28.5	22.0	20.0	20.0
			0.157	0.315	0.63	1.122	0.866	0.787	0.787
	EXN03MMC6	M16x1.5	4.0	8.0	16.0	28.5	24.5	22.0	22.0
			0.157	0.315	0.63	1.122	0.965	0.866	0.866
	EXN04MMC6	M20x1.5	4.0	12.0	18.0	27.0	24.5	22.0	22.0
			0.157	0.472	0.709	1.063	0.965	0.866	0.866
	EXN05MMC6	M25x1.5	10.0	18.0	16.0	30.5	31.0	28.0	28.0
			0.394	0.709	0.63	1.201	1.22	1.102	1.102
	EXN06MMC6	M32x1.5	14.0	24.0	19.0	33.0	39.0	35.0	35.0
			0.551	0.945	0.748	1.299	1.535	1.378	1.378
	EXN07MMC6	M40x1.5	22.0	32.0	20.0	40.5	49.5	45.0	45.0
			0.866	1.26	0.787	1.594	1.949	1.772	1.772
	EXN08MMC6	M50x1.5	26.0	35.0	20.0	43.5	61.0	55.0	50.0
			1.024	1.378	0.787	1.713	2.402	2.165	1.969
	EXN09MMC6	M63x1.5	35.0	45.0	20.0	43.5	70.0	68.0	64.0
			1.378	1.772	0.787	1.713	2.756	2.677	2.52

#### Sealing Combination

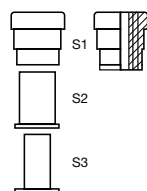

## Ex d e EMC cable glands for hazardous areas

### C6 Series

#### Dimensions

NPT thread	Part no.	NPT thread	Cable range Ø		Nominal dimensions (mm/in)				
			Min. (mm/in)	Max. (mm/in)	A Min	B Min	C Min	W1	W2
	EXN03ASC6	3/8"	4.0	8.0	16.0	28.5	22.0	20.0	20.0
			0.157	0.315	0.63	1.122	0.866	0.787	0.787
	EXN03AMC6	3/8"	4.0	8.0	18.0	28.5	24.5	22.0	22.0
			0.157	0.315	0.709	1.122	0.965	0.866	0.866
	EXN04AMC6	1/2"	4.0	12.0	18.0	27.0	24.5	22.0	22.0
			0.157	0.472	0.709	1.063	0.965	0.866	0.866
	EXN05AMC6	3/4"	10.0	18.0	20.0	30.5	31.0	28.0	28.0
			0.394	0.709	0.787	1.201	1.22	1.102	1.102
	EXN06AMC6	3/4"	14.0	24.0	20.0	33.0	39.0	35.0	35.0
			0.551	0.945	0.787	1.299	1.535	1.378	1.378
	EXN07AMC6	1"	22.0	32.0	20.0	40.5	49.5	45.0	45.0
			0.866	1.26	0.787	1.594	1.949	1.772	1.772
EXN08AMC6	1 1/4"	26.0	35.0	20.0	43.5	61.0	55.0	50.0	
		1.024	1.378	0.787	1.713	2.402	2.165	1.969	
EXN09AMC6	1 1/2"	35.0	45.0	20.0	43.5	70.0	68.0	64.0	
		1.378	1.772	0.787	1.713	2.756	2.677	2.52	

## Ex d e Non-armoured barrier cable glands for hazardous areas

### C4 Series



#### Features and benefits:

- Flameproof Ex d and Increased safety Ex e
- Suitable for use in Zone 1, 2, 21 and 22
- For use with all non-armoured cable types
- Epoxy compound barrier

#### C4 Series - Ex d e armoured cable glands

#### Approvals & certifications



#### Conformity

Conforms to:  
EN/IECEX: 60079-0, 60079-1,  
60079-7, 60079-34, 62444

ATEX:IMQ\_03 ATEX016X REV03

IECEX: IECEX CES 14.0013X

DNV: TAE00000Y3

TAE00000Y3

Ⓜ II 2 GD, Ex d e IIC Gb, Ex tb IIIC Db

#### Temperature range

Operating range: -60°C to +100°C (-76°F to +212°F)

#### IP Rating

IP66

#### Material

Nickel plated brass

Stainless steel 316

#### Dimensions

Metric thread	Part no.	Cable range Ø		Nominal dimensions (mm/in)						
		Metric thread	Min. (mm/in)	Max. (mm/in)	A Min	B Min	C Min	W1	W2	W3
	EXN04MC4	M20x1.5	8.5	16.0	16.0	62.0	33.0	30.0	30.0	29.0
			0.335	0.630	0.630	2.440	1.299	1.181	1.181	1.142
	EXN05MC4	M25x1.5	16.0	21.0	16.0	62.8	37.0	34.0	34.0	34.0
			0.630	0.827	0.630	2.472	1.456	1.338	1.338	1.338
	EXN06MC4	M32x1.5	16.0	26.0	16.0	68.5	45.0	42.0	42.0	40.0
			0.630	1.024	0.630	2.460	1.771	1.653	1.653	1.574
	EXN07MC4	M40x1.5	29.0	41.0	16.0	75.1	66.0	50.0	60.0	60.0
			1.142	1.614	0.630	2.956	2.598	1.968	2.362	2.362
	EXN08MC4	M50x1.5	33.0	48.0	16.0	82.7	77.0	60.0	70.0	75.0
		1.299	1.890	0.630	3.255	3.031	2.362	2.755	2.952	
EXN09MC4	M63x1.5	36.0	52.0	16.0	96.0	77.0	70.0	70.0	74.0	
		1.417	2.047	0.630	3.779	3.031	2.755	2.755	2.913	

EXN for nickel plated.

## Ex d e Non-armoured barrier cable glands for hazardous areas

### C4 Series

#### Dimensions

NPT thread	Part no.	Cable range Ø			Nominal dimensions (mm/in)					
		NPT thread	Min. (mm/in)	Max. (mm/in)	A Min	B Min	C Min	W1	W2	W3
	EXN04AC4	1/2"	8.5	16.0	21.0	62.0	33.0	30.0	30.0	30.0
			0.335	0.630	0.826	2.440	1.299	1.181	1.181	1.181
	EXN05AC4	3/4"	16.0	21.0	21.0	62.8	37.0	34.0	34.0	34.0
			0.630	0.827	0.826	2.472	1.456	1.338	1.338	1.338
	EXN06AC4	1"	16.0	26.0	26.0	68.5	45.0	42.0	42.0	40.0
			0.630	1.024	1.023	2.460	1.771	1.653	1.653	1.574
	EXN07AC4	1 1/4"	29.0	41.0	28.0	75.1	66.0	50.0	60.0	60.0
			1.142	1.614	1.102	2.956	2.598	1.968	2.362	2.362
	EXN08AC4	1 1/2"	33.0	48.0	28.0	82.7	77.0	60.0	70.0	75.0
			1.299	1.890	1.102	3.255	3.031	2.362	2.755	2.952
	EXN09AC4	2"	36.0	52.0	28.0	96.0	77.0	70.0	70.0	74.0
			1.417	2.047	1.102	3.779	3.031	2.755	2.755	2.913



EXN for nickel plated.

## Ex d e Armoured cable glands for hazardous areas

### C1 Series



#### Features and benefits:

- Flameproof Ex d and Increased safety Ex e
- Suitable for use in Zone 1, 2, 21 and 22
- For use with Wire, braid or tape armoured cable types

Available in kit form with locknut, earth tag, sealing washer and dust shroud, add 'K' suffix.

#### C1 Series - Ex d e single compression cable glands

Approvals & certifications		Conformity	Temperature range
	Conforms to: EN/IECEX: 60079-0, 60079-1, 60079-7, 60079-34, 62444 UL514B, UL2225 ATEX:IMQ_03 ATEX016X REV03 IECEX: IECEX CES 13.0014X UL: E477121 Ⓢ II 2 GD, Ex d e IIC Gb, Ex tb IIIC Db Class 1 Zone 1 AEx e IIC		Operating range: -40°C to +100°C (-40°F to +212°F)
	IP Rating	Material	
	IP66	Nickel plated brass and	
	IP68 (5-Bar 30 mins)	Stainless steel 316	

#### Dimensions

Metric thread	Part no.	Metric thread	Cable range Ø		Nominal dimensions (mm/in)					
			Inner Min. (mm/in)	Outer Max. (mm/in)	A Min	B Min	C Min	W1	W2	W3
	EXN03MSC1	M16x1.5	3.0 - 8.5	6.0 - 12.0	16.0	47.5	29.0	22.0	26.0	26.0
			0.118 - 0.335	0.236 - 0.472	0.63	1.87	1.142	0.866	1.024	1.024
	EXN03MMC1	M16x1.5	6.0 - 12.0	8.5 - 16.0	16.0	50.0	31.5	25.0	29.0	29.0
			0.236 - 0.472	0.335 - 0.630	0.63	1.969	1.24	0.984	1.142	1.142
	EXN04MSC1	M20x1.5	3.0 - 8.5	6.0 - 12.0	16.0	47.5	29.0	24.0	26.0	26.0
			0.118 - 0.335	0.236 - 0.472	0.63	1.87	1.142	0.945	1.024	1.024
	EXN04MMC1	M20x1.5	6.0 - 12.0	8.5 - 16.0	16.0	47.0	31.5	25.0	29.0	29.0
			0.236 - 0.472	0.335 - 0.630	0.63	1.929	1.24	0.984	1.142	1.142
	EXN04MLC1	M20x1.5	12.0 - 14.5	16.0 - 20.0	16.0	52.0	35.0	28.0	30.0	32.0
			0.472 - 0.571	0.630 - 0.787	0.63	2.047	1.378	1.102	1.181	1.26
	EXN05MSC1	M25x1.5	6.0 - 12.0	8.5 - 16.0	18.0	50.5	31.5	29.0	29.0	29.0
			0.236 - 0.472	0.335 - 0.630	0.709	1.988	1.24	1.142	1.142	1.142
EXN05MMC1	M25x1.5	12.0 - 16.0	16.0 - 21.0	18.0	54.5	37.0	32.0	34.0	34.0	
		0.472 - 0.630	0.630 - 0.827	0.709	2.146	1.457	1.26	1.339	1.339	
EXN05MLC1	M25x1.5	12.0 - 20.0	16.0 - 26.0	18.0	60.5	44.0	36.0	40.0	40.0	
		0.472 - 0.787	0.630 - 1.024	0.709	2.382	1.732	1.417	1.575	1.575	
EXN06MSC1	M32x1.5	12.0 - 20.0	16.0 - 26.0	18.0	62.0	44.0	40.0	40.0	40.0	
		0.472 - 0.787	0.630 - 1.024	0.709	2.441	1.732	1.575	1.575	1.575	

# Ex d e Armoured cable glands for hazardous areas

## C1 Series

### Dimensions



Metric thread	Part no.	Metric thread	Cable range Ø		Nominal dimensions (mm/in)					
			Inner Min. (mm/in)	Outer Max. (mm/in)	A Min	B Min	C Min	W1	W2	W3
	EXN06MMC1	M32x1.5	15.0 - 26.0	20.0 - 33.0	18.0	78.5	57.0	48.0	52.0	52.0
			0.591 - 1.024	0.787 - 1.299	0.709	3.091	2.244	1.89	2.047	2.047
	EXN07MSC1	M40x1.5	15.0 - 26.0	20.0 - 33.0	18.0	78.5	57.0	48.0	52.0	52.0
			0.591 - 1.024	0.787 - 1.299	0.709	3.091	2.244	1.89	2.047	2.047
	EXN07MMC1	M40x1.5	20.0 - 32.0	29.0 - 41.0	18.0	89.5	66.0	55.0	60.0	60.0
			0.787 - 1.260	1.142 - 1.614	0.709	3.524	2.598	2.165	2.362	2.362
	EXN08MSC1	M50x1.5	22.0 - 35.0	33.0 - 48.0	18.0	96.5	82.0	60.0	70.0	75.0
			0.866 - 1.378	1.299 - 1.890	0.709	3.799	3.228	2.362	2.756	2.953
	EXN08MMC1	M50x1.5	27.0 - 41.0	36.0 - 52.0	18.0	100.0	83.0	70.0	70.0	74.0
			1.063 - 1.614	1.417 - 2.047	0.709	3.937	3.268	2.756	2.756	2.913
	EXN09MSC1	M63x1.5	35.0 - 45.0	43.0 - 57.0	20.0	106.0	89.5	75.0	80.0	80.0
			1.378 - 1.772	1.693 - 2.244	0.787	4.173	3.524	2.953	3.15	3.15
	EXN09MMC1	M63x1.5	40.0 - 52.0	47.0 - 60.0	20.0	108.0	94.0	85.0	85.0	85.0
			1.575 - 2.047	1.850 - 2.362	0.787	4.252	3.701	3.346	3.346	3.346
	EXN10MSC1	M75x1.5	40.0 - 52.0	47.0 - 60.0	20.0	107.0	94.0	85.0	85.0	85.0
			1.575 - 2.047	1.850 - 2.362	0.787	4.252	3.701	3.346	3.346	3.346
	EXN10MMC1	M75x1.5	45.0 - 60.0	54.0 - 70.0	20.0	125.0	110.5	90.0	95.0	100.0
			1.772 - 2.362	2.126 - 2.756	0.787	4.921	4.35	3.543	3.74	3.937
	EXN11MSC1	M90x1.5	45.0 - 60.0	54.0 - 70.0	20.0	124.0	110.5	95.0	95.0	100.0
			1.772 - 2.362	2.126 - 2.756	0.787	4.882	4.35	3.74	3.74	3.937
	EXN11MMC1	M90x1.5	60.0 - 72.0	63.0 - 80.0	20.0	154.0	127.0	110.0	115.0	115.0
			2.362 - 2.835	2.480 - 3.150	0.787	6.063	5.000	4.331	4.528	4.528
	EXN12MSC1	M110x2.0	45.0 - 60.0	54.0 - 70.0	20.0	124.0	110.5	120.0	95.0	100.0
			1.772 - 2.362	2.126 - 2.756	0.787	4.882	4.35	4.724	3.74	3.937
	EXN12MMC1	M110x2.0	60.0 - 72.0	63.0 - 80.0	20.0	154.0	127.0	120.0	115.0	115.0
			2.362 - 2.835	2.480 - 3.150	0.787	6.063	5.000	4.724	4.528	4.528

### Dimensions

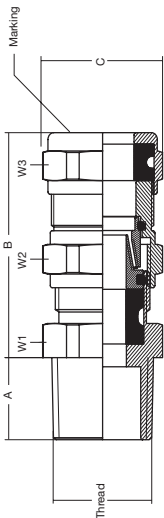

NPT thread	Part no.	NPT thread	Cable range Ø		Nominal dimensions (mm/in)					
			Inner Min. (mm/in)	Outer Max. (mm/in)	A Min	B Min	C Min	W1	W2	W3
	EXN03ASC1	3/8"	3.0 - 8.5	6.0 - 12.0	16.0	47.5	29.0	22.0	26.0	26.0
			0.118 - 0.335	0.236 - 0.472	0.63	1.87	1.142	0.866	1.024	1.024
	EXN03AMC1	3/8"	6.0 - 12.0	8.5 - 16.0	16.0	50.0	31.5	25.0	29.0	29.0
			0.236 - 0.472	0.335 - 0.630	0.63	1.969	1.24	0.984	1.142	1.142
	EXN04ASC1	1/2"	3.0 - 8.5	6.0 - 12.0	16.0	47.5	29.0	24.0	26.0	26.0
			0.118 - 0.335	0.236 - 0.472	0.63	1.87	1.142	0.945	1.024	1.024
	EXN04AMC1	1/2"	6.0 - 12.0	8.5 - 16.0	16.0	49.0	31.5	25.0	29.0	29.0
			0.236 - 0.472	0.335 - 0.630	0.63	1.929	1.24	0.984	1.142	1.142
	EXN04ALC1	1/2"	12.0 - 14.5	16.0 - 20.0	16.0	52.0	35.0	28.0	30.0	32.0
			0.472 - 0.571	0.630 - 0.787	0.63	2.047	1.378	1.102	1.181	1.26
	EXN05ASC1	3/4"	6.0 - 12.0	8.5 - 16.0	18.0	50.5	31.5	29.0	29.0	29.0
			0.236 - 0.472	0.335 - 0.630	0.709	1.988	1.24	1.142	1.142	1.142
	EXN05AMC1	3/4"	12.0 - 16.0	16.0 - 21.0	18.0	54.5	37.0	32.0	34.0	34
			0.472 - 0.630	0.630 - 0.827	0.709	2.146	1.457	1.26	1.339	1.339
	EXN05ALC1	3/4"	12.0 - 20.0	16.0 - 26.0	18.0	60.5	44.0	36.0	40.0	40.0
			0.472 - 0.787	0.630 - 1.024	0.709	2.382	1.732	1.417	1.575	1.575
	EXN06ASC1	1"	12.0 - 20.0	16.0 - 26.0	18.0	62.0	44.0	40.0	40.0	40.0
			0.472 - 0.787	0.630 - 1.024	0.709	2.441	1.732	1.575	1.575	1.575



## Ex d e Armoured cable glands for hazardous areas

### C1 Series

#### Dimensions

NPT thread	Part no.	NPT thread	Cable range Ø		Nominal dimensions (mm/in)					
			Inner Min. (mm/in)	Outer Max. (mm/in)	A Min	B Min	C Min	W1	W2	W3
	EXN06AMC1	1"	20.0 - 32.0	29.0 - 41.0	18.0	89.5	66.0	55.0	60.0	60.0
			0.787 - 1.260	1.142 - 1.614	0.709	3.524	2.598	2.165	2.362	2.362
	EXN07ASC1	1 1/4"	22.0 - 35.0	33.0 - 48.0	21.0	96.5	82.0	60.0	70.0	75.0
			0.866 - 1.378	1.299 - 1.890	0.827	3.799	3.228	2.362	2.756	2.953
	EXN07AMC1	1 1/4"	27.0 - 41.0	36.0 - 52.0	21.0	100.0	83.0	70.0	70.0	74.0
			1.063 - 1.614	1.417 - 2.047	0.827	3.937	3.268	2.756	2.756	2.913
	EXN08ASC1	1 1/2"	35.0 - 45.0	43.0 - 57.0	21.0	106.0	89.5	75.0	80.0	80.0
			1.378 - 1.772	1.693 - 2.244	0.827	4.173	3.524	2.953	3.15	3.15
	EXN08AMC1	1 1/2"	40.0 - 52.0	47.0 - 60.0	21.0	108.0	94.0	85.0	85.0	85.0
			1.575 - 2.047	1.850 - 2.362	0.827	4.252	3.701	3.346	3.346	3.346
	EXN09ASC1	2"	40.0 - 52.0	47.0 - 60.0	21.0	108.0	94.0	85.0	85.0	85.0
			1.575 - 2.047	1.850 - 2.362	0.827	4.252	3.701	3.346	3.346	3.346
	EXN09AMC1	2"	45.0 - 60.0	54.0 - 70.0	21.0	125.0	110.5	90.0	95.0	100.0
			1.772 - 2.362	2.126 - 2.756	0.827	4.921	4.35	3.543	3.74	3.937
	EXN10ASC1	2 1/2"	45.0 - 60.0	54.0 - 70.0	21.0	124.0	110.5	95.0	95.0	100.0
			1.772 - 2.362	2.126 - 2.756	0.827	4.882	4.35	3.74	3.74	3.937
	EXN10AMC1	2 1/2"	60.0 - 72.0	63.0 - 80.0	21.0	154.0	127.0	110.0	115.0	115.0
			2.362 - 2.835	2.480 - 3.150	0.827	6.063	5.000	4.331	4.528	4.528
	EXN11ASC1	3"	45.0 - 60.0	54.0 - 70.0	21.0	124.0	110.5	120.0	95.0	100.0
			1.772 - 2.362	2.126 - 2.756	0.827	4.882	4.350	4.724	3.74	3.937
	EXN11AMC1	3"	60.0 - 72.0	63.0 - 80.0	21.0	154.0	127.0	120.0	115.0	115.0
			2.362 - 2.835	2.480 - 3.150	0.8	6.1	5.0	4.7	4.5	4.528
	EXN12ASC1	3 1/2"	45.0 - 60.0	54.0 - 70.0	21.0	124.0	110.5	120.0	95	100.0
			1.772 - 2.362	2.126 - 2.756	0.787	4.882	4.35	4.724	3.74	3.937
	EXN12AMC1	3 1/2"	60.0 - 72.0	63.0 - 80.0	21.0	154.0	127.0	120.0	115.0	115.0
			2.362 - 2.835	2.480 - 3.150	0.787	6.063	5	4.724	4.528	4.528

## Ex d e Armoured barrier cable glands for hazardous areas

### C5 Series



**Features and benefits:**

- Flameproof Ex d and Increased safety Ex e
- Suitable for use in Zone 1, 2, 21 and 22
- For use with Wire, braid or tape armoured cable types
- Epoxy compound barrier

C5 Series - Ex d e armoured cable glands

Approvals & certifications		Conformity	Temperature range	
	Conforms to:		Operating range: -60°C to +100°C (-76°F to +212°F)	
	EN/IECEX: 60079-0, 60079-1, 60079-7, 60079-34, 62444		<b>IP Rating</b> IP66	<b>Material</b> Brass, Nickel plated brass and Stainless steel 316
	ATEX:IMQ_03 ATEX016X REV03			
IECEX: IECEX CES 14.0013X				
© II 2 GD, Ex d e IIC Gb, Ex tb IIIC Db				

**Dimensions**

Metric thread	Part no.	Metric thread	Cable range Ø		Nominal dimensions (mm/in)						
			Min. (mm/in)	Max. (mm/in)	A Min	B Min	C Min	W1	W2	W3	
	EXN04MC5	M20x1.5	8.5	16.0	16.0	70.0	33.0	30.0	30.0	29.0	
	EXN05MC5	M25x1.5	16.0	21.0	16.0	72.1	37.0	34.0	34.0	34.0	
	EXN06MC5	M32x1.5	16.0	26.0	16.0	76.0	45.0	42.0	42.0	40.0	
	EXN07MC5	M40x1.5	29.0	41.0	16.0	83.4	66.0	50.0	60.0	60.0	
	EXN08MC5	M50x1.5	33.0	48.0	16.0	96.6	77.0	60.0	70.0	75.0	
	EXN09MC5	M63x1.5	36.0	52.0	16.0	109.5	77.0	70.0	70.0	74.0	
	EXN04AC5	1/2"	8.5	16.0	16.0	70.0	33.0	30.0	30.0	30.0	
	EXN05AC5	3/4"	16.0	21.0	16.0	72.1	37.0	34.0	34.0	34.0	
	EXN06AC5	1"	16.0	26.0	16.0	76.0	45.0	42.0	42.0	40.0	
	EXN07AC5	1 1/4"	29.0	41.0	16.0	83.4	66.0	50.0	60.0	60.0	
	EXN08AC5	1 1/2"	33.0	48.0	16.0	96.6	77.0	60.0	70.0	75.0	
	EXN09AC5	2"	36.0	52.0	16.0	109.5	77.0	70.0	70.0	74.0	
				1.417	2.047	0.630	4.311	3.031	2.755	2.755	2.913

EXN for nickel plated.

## Jacketed metal-clad cable fittings for hazardous locations

### ST Series



**Features and benefits:**

- Excellent pullout strength
- Robust metallic construction
- Quick and easy installation without disassembly
- “Pop-on” fitting (no disassembly) saves installer time
- Provides grounding continuity of cable armour
- Splined gland and gripping features for ease of installation

**ST Series - Jacketed metal-clad cable glands**

Approvals & certifications	Conformity Conforms to:	Temperature range							
	CSA C22.2 60079-0, C22.2 60079-7, C22.2 No.18.3, C22.2 No.25, C22.2 No.94, C22.2 No. 174, UL2279, UL514B, UL50	- 40 to +90°C (-40°F to +194°F)							
	c-CSA-us Certificate: 1105555 File 23086	<table border="1"> <thead> <tr> <th>IP Rating</th> <th>Material</th> </tr> </thead> <tbody> <tr> <td>Type 4X</td> <td>Copper free aluminium</td> </tr> <tr> <td></td> <td>Zinc plated steel</td> </tr> <tr> <td></td> <td>Stainless steel</td> </tr> </tbody> </table>	IP Rating	Material	Type 4X	Copper free aluminium		Zinc plated steel	
IP Rating	Material								
Type 4X	Copper free aluminium								
	Zinc plated steel								
	Stainless steel								
	Class I Div1 ABCD Class II Div1 EFG Class III Div1 (Refer to CEC)								
	Ex e II								
	UL File: E38947								
	Class I, Zone 1, AEx e II								
	Suitable for Class I Div2, Class II Div2 and Class III Div2								

**Dimensions**

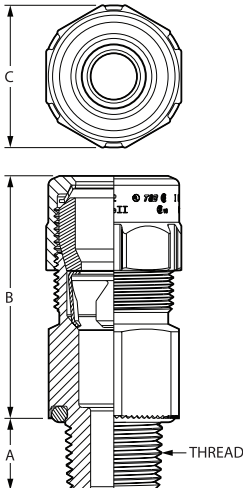
NPT thread	Part no.	NPT thread	Cable range over jacket		Cable range over armour		Nominal dimensions (mm/in)		
			Min. (mm/in)	Max. (mm/in)	Min. (mm/in)	Max. (mm/in)	A Min	B Min	C Min
	ST038-461S*	3/8"	8.74	13.59	6.20	11.05	11.68	51.31	25.27
			0.344	0.535	0.244	0.435	0.460	2.020	0.995
	ST050-462	1/2"	13.34	16.51	10.54	14.48	15.75	51.31	34.13
			0.525	0.650	0.415	0.570	0.620	2.020	1.344
	ST050-464	1/2"	15.24	19.30	12.45	17.27	15.75	51.31	34.13
			0.600	0.760	0.490	0.680	0.620	2.020	1.344
	ST050-465	1/2"	18.42	22.48	15.62	20.45	15.75	54.10	42.07
			0.725	0.885	0.615	0.805	0.620	2.130	1.656
	ST050-466	1/2"	20.96	25.02	18.16	22.99	15.75	54.10	42.07
			0.825	0.985	0.715	0.905	0.620	2.130	1.656
	ST075-467	3/4"	22.35	27.05	19.56	25.02	16.00	62.23	53.18
			0.880	1.065	0.770	0.985	0.630	2.450	2.094
	ST075-468	3/4"	26.04	30.61	23.24	28.58	16.00	62.23	53.18
			1.025	1.205	0.915	1.125	0.630	2.450	2.094
	ST100-469	1"	30.15	34.93	27.36	32.89	19.94	66.04	61.91
		1.187	1.375	1.077	1.295	0.785	2.600	2.438	
ST125-470	1 1/4"	34.29	41.28	31.50	39.24	20.57	83.31	76.20	
		1.350	1.625	1.240	1.545	0.810	3.280	3.000	

# Jacketed metal-clad cable fittings for hazardous locations

## ST Series

### Dimensions



NPT thread	Part no.	NPT thread	Cable range over jacket		Cable range over armour		Nominal dimensions (mm/in)		
			Min. (mm/in)	Max. (mm/in)	Min. (mm/in)	Max. (mm/in)	A Min	B Min	C Min
	ST125-550	1 1/4"	38.10	41.28	35.31	39.24	20.57	83.31	76.20
			1.500	1.625	1.390	1.545	0.810	3.280	3.000
	ST125-471	1/2"	40.64	47.63	37.85	45.59	20.57	83.31	76.20
			1.600	1.875	1.490	1.795	0.810	3.280	3.000
	ST150-472	1/2"	43.18	49.91	40.39	47.88	20.96	91.95	87.31
			1.700	1.965	1.590	1.885	0.825	3.620	3.438
	ST150-473	1/2"	48.26	55.55	45.47	53.52	20.96	91.95	87.31
			1.900	2.187	1.790	2.107	0.825	3.620	3.438
	ST200-551	1/2"	48.26	55.55	45.47	53.52	21.84	92.46	96.84
			1.900	2.187	1.790	2.107	0.860	3.640	3.813
	ST200-474	3/4"	53.34	60.33	50.55	57.91	21.84	92.46	96.84
			2.100	2.375	1.990	2.280	0.860	3.640	3.813
	ST200-475	3/4"	58.42	65.15	55.63	63.12	21.84	92.46	106.36
			2.300	2.565	2.190	2.485	0.860	3.640	4.188
	ST200-476	3/4"	63.50	69.85	60.71	67.46	21.84	92.46	106.36
			2.500	2.750	2.390	2.656	0.860	3.640	4.188
	ST250-477	3/4"	60.45	67.06	56.90	65.02	32.51	119.38	121.44
			2.380	2.640	2.240	2.560	1.280	4.700	4.781
	ST250-478	3/4"	65.53	72.14	61.98	69.85	32.51	119.38	121.44
			2.580	2.840	2.440	2.750	1.280	4.700	4.781
	ST300-479	3/4"	70.87	77.72	67.06	75.44	34.04	119.38	129.38
			2.790	3.060	2.640	2.970	1.340	4.700	5.094
	ST300-480	3/4"	76.20	83.06	72.90	81.03	34.04	121.67	139.70
			3.000	3.270	2.870	3.190	1.340	4.790	5.500
	ST300-481	3/4"	81.53	88.39	77.27	86.11	34.04	121.67	139.70
			3.210	3.480	3.042	3.390	1.340	4.790	5.500
	ST350-482	3/4"	86.87	93.73	83.06	91.19	35.31	121.67	153.19
			3.420	3.690	3.270	3.590	1.390	4.790	6.031
	ST350-483	3/4"	91.69	98.30	87.38	95.76	35.31	121.67	153.19
			3.610	3.870	3.440	3.770	1.390	4.790	6.031
	ST400-484	1"	96.77	102.36	91.44	99.82	36.58	122.94	166.69
			3.810	4.030	3.600	3.930	1.440	4.840	6.563
	ST400-485	1 1/4"	100.71	106.30	95.38	103.25	36.58	122.94	166.69
			3.965	4.185	3.755	4.065	1.440	4.840	6.563
	ST400-486	1 1/4"	104.65	110.24	99.31	107.19	36.58	122.94	166.69
			4.120	4.340	3.910	4.220	1.440	4.840	6.563

## Jacketed metal-clad cable fittings for ordinary locations



### STE Series



#### Features and benefits:

- Excellent pullout strength
- Robust metallic construction
- Quick and easy installation without disassembly
- Extended clamping range taking
- Provides grounding continuity of cable armour

#### STE Series - Jacketed metal-clad cable glands

Approvals & certifications	Conformity Conforms to:	Temperature range
 	CSA C22.2 60079-0, C22.2 60079-7, C22.2 No.18.3, C22.2 No.25, C22.2 No.94, C22.2 No. 174, UL2279, UL514B, UL50 c-CSA-us Certificate: 1105555 File 23086	- 40°C to +90°C (-40°F to +194°F)
	Class I Div1 ABCD Class II Div1 EFG Class III Div1 (Refer to CEC)	<b>IP Rating</b> Type 4X
	Ex e II UL File: E38947 Class I, Zone 1, AEx e II Suitable for Class I Div2, Class II Div2 and Class III Div2	

#### Dimensions

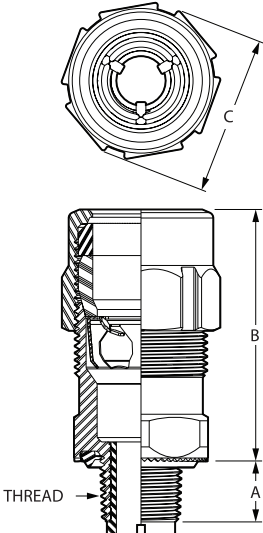
NPT thread	Part no.	NPT thread	Cable range over jacket		Cable range over armour		Nominal dimensions (mm/in)		
			Min. (mm/in)	Max. (mm/in)	Min. (mm/in)	Max. (mm/in)	A Min	B Min	C Min
	STE050 DATA	1/2"	12.70	17.78	10.41	15.49	15.75	53.34	34.54
			0.500	0.700	0.410	0.610	0.620	2.100	1.360
	STE050	1/2"	15.24	25.02	13.21	22.73	15.75	64.01	41.40
			0.600	0.985	0.520	0.895	0.620	2.520	1.630
	STE075	3/4"	21.84	30.61	19.81	28.58	16.00	72.14	52.83
			0.860	1.205	0.780	1.125	0.630	2.840	2.080
	STE100	1"	24.13	34.93	22.10	32.89	19.94	76.71	58.42
			0.950	1.375	0.870	1.295	0.785	3.020	2.300
	STE125	1 1/4"	29.21	41.28	25.15	37.21	20.57	101.85	71.63
			1.150	1.625	0.990	1.465	0.810	4.010	2.820
	STE150	1 1/2"	36.58	49.91	32.51	45.85	20.96	108.97	82.55
			1.440	1.965	1.280	1.805	0.825	4.290	3.250
	STE200	2"	46.36	60.33	42.29	56.26	21.84	104.65	91.44
			1.825	2.375	1.665	2.215	0.860	4.120	3.600
	STE250	2 1/2"	57.53	72.14	53.47	68.07	32.51	144.02	120.65
			2.265	2.840	2.105	2.680	1.280	5.670	4.750
	STE300	3"	67.82	83.06	64.64	79.88	33.66	146.81	137.16
			2.670	3.270	2.545	3.145	1.325	5.780	5.400
	STE350	3 1/2"	81.79	98.30	78.49	92.46	35.31	145.80	149.86
			3.220	3.870	3.090	3.640	1.390	5.740	5.900
	STE400	4"	93.09	110.24	90.17	107.32	35.31	147.07	162.56
			3.665	4.340	3.550	4.225	1.390	5.790	6.400

# Star Teck Extreme® Director™ for ordinary applications

## STED Series



**Features and benefits:**

- Excellent pullout strength
- Robust metallic construction
- Quick and easy installation without disassembly
- Extended clamping range taking
- Provides grounding continuity of cable armour

**STED Series - Jacketed metal-clad cable glands**

Approvals & certifications	Conformity	Temperature range							
	Conforms to: CSA C22.2 60079-0, C22.2 60079-7, C22.2 No.18.3, C22.2 No.25, C22.2 No.94, C22.2 No. 174, UL2279, UL514B, UL50 c-CSA-us Certificate: 1105555 File 23086 Class I Div1 ABCD Class II Div1 EFG Class III Div1 (Refer to CEC) Ex e II UL File: E38947 Class I, Zone 1, AEx e II Suitable for Class I Div 2, Class II Div 2 and Class III Div 2	- 40°C to +90°C (-40°F to +194°F)							
		<table border="1"> <thead> <tr> <th>IP Rating</th> <th>Material</th> </tr> </thead> <tbody> <tr> <td>Type 4X</td> <td>Copper free aluminium</td> </tr> <tr> <td></td> <td>Zinc plated steel</td> </tr> <tr> <td></td> <td>Stainless steel</td> </tr> </tbody> </table>	IP Rating	Material	Type 4X	Copper free aluminium		Zinc plated steel	
IP Rating	Material								
Type 4X	Copper free aluminium								
	Zinc plated steel								
	Stainless steel								

**Dimensions**

NPT thread Part no.	NPT thread	Cable range over jacket		Cable range over armour		Nominal dimensions (mm/in)					
		Min. (mm/in)	Max. (mm/in)	Min. (mm/in)	Max. (mm/in)	A Min	B Min	C Min	D Min	E Min	F Min
STED050	1/2"	15.24	22.48	13.21	20.19	17.46	136.53	49.21	20.64	96.84	63.50
		0.600	0.885	0.520	0.795	0.688	5.375	1.938	0.813	3.813	2.500
STED075	3/4"	21.84	30.61	19.81	28.58	17.46	168.40	63.50	26.99	101.60	76.20
		0.860	1.205	0.780	1.125	0.688	6.630	2.500	1.063	4.000	3.000

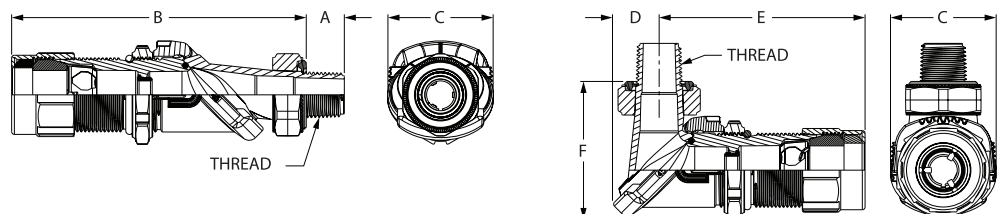



# Star Teck XP® jacketed metal-clad cable fittings for hazardous locations



## STX Series



### Features and benefits:

- Excellent solution for hazardous location
- Excellent pullout strength
- Robust metallic construction
- Quick and easy installation without disassembly
- Provides grounding continuity of cable armour
- Splined gland and gripping features for ease of installation

### STX Series - Jacketed metal-clad cable glands

Approvals & certifications	Conformity Conforms to:	Temperature range
 	CSA C22.2 No.18.3, C22.2 No.25, C22.2 No.30, C22.2 No. 174, UL2225, UL514B	- 40°C to +90°C (-40°F to +194°F)
	CSA Certificate: 1310604 File 23086	
	Class I Div1 ABCD Class II Div1 EFG Class III Div1	
	UL: E82038	
	Class I Div1 ABCD Class II Div1 EFG Class III Div1	
		<b>IP Rating</b>
		Type 4 / 4X
		<b>Material</b>
		Copper free aluminium
		Zinc plated steel
		PVC coating available for both

### Dimensions

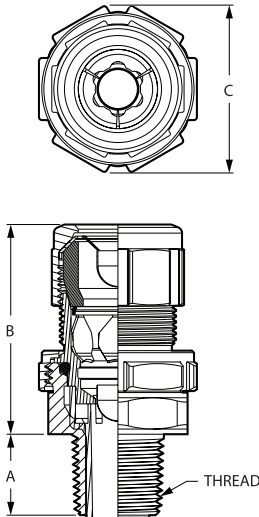
NPT thread	Part no.	NPT thread	Cable range over jacket		Cable range over armour		Nominal dimensions (mm/in)		
			Min. (mm/in)	Max. (mm/in)	Min. (mm/in)	Max. (mm/in)	A Min	B Min	C Min
	STX050-462	1/2"	13.34	16.51	10.54	14.48	20.07	63.50	41.40
			0.525	0.650	0.415	0.570	0.790	2.500	1.630
	STX050-464	1/2"	15.24	19.30	12.45	17.27	20.07	63.50	41.40
			0.600	0.760	0.490	0.680	0.790	2.500	1.630
	STX075-465	3/4"	18.42	22.48	15.62	20.45	20.07	66.55	46.23
			0.725	0.885	0.615	0.805	0.790	2.620	1.820
	STX075-466	3/4"	20.96	25.02	18.16	22.99	20.07	66.55	46.23
			0.825	0.985	0.715	0.905	0.790	2.620	1.820
	STX100-467	1"	22.35	27.05	19.56	25.02	25.02	71.88	61.98
			0.880	1.065	0.770	0.985	0.985	2.830	2.440
	STX100-468	1"	26.04	30.61	23.24	28.58	25.02	71.88	61.98
			1.025	1.205	0.915	1.125	0.985	2.830	2.440
	STX125-469	1 1/4"	30.15	34.93	27.36	32.89	25.65	77.47	64.01
			1.187	1.375	1.077	1.295	1.010	3.050	2.520
	STX150-470	1 1/2"	34.29	41.28	31.50	39.24	26.16	95.50	83.31
			1.350	1.625	1.240	1.545	1.030	3.760	3.280
	STX150-550	1 1/2"	38.10	41.28	35.31	39.24	26.16	95.50	83.31
			1.500	1.625	1.390	1.545	1.030	3.760	3.280
	STX150-471	1 1/2"	40.64	47.63	37.85	45.59	26.16	95.50	83.31
			1.600	1.875	1.490	1.795	1.030	3.760	3.280
	STX200-472	2"	43.18	49.91	40.39	47.88	26.92	102.87	92.46
			1.700	1.965	1.590	1.885	1.060	4.050	3.640
	STX200-473	2"	48.26	55.55	45.47	53.52	26.92	102.87	92.46
			1.900	2.187	1.790	2.107	1.060	4.050	3.640

## Star Teck XP® for hazardous locations

### STX Series

#### Dimensions

NPT thread	Part no.	NPT thread	Cable range over jacket		Cable range over armour		Nominal dimensions (mm/in)		
			Min. (mm/in)	Max. (mm/in)	Min. (mm/in)	Max. (mm/in)	A Min	B Min	C Min
	STX200-474	2"	53.34	60.33	50.55	57.91	26.92	105.41	102.87
			2.100	2.375	1.990	2.280	1.060	4.150	4.050
	STX250-475	2 1/2"	58.42	65.15	55.63	63.12	40.13	109.47	115.32
			2.300	2.565	2.190	2.485	1.580	4.310	4.540
	STX250-476	2 1/2"	63.50	69.85	60.71	67.46	40.13	109.47	115.32
			2.500	2.750	2.390	2.656	1.580	4.310	4.540
	STX300-478	3"	65.53	72.14	61.98	69.85	41.66	143.26	125.22
			2.580	2.840	2.440	2.750	1.640	5.640	4.930
	STX300-479	3"	70.87	77.72	67.06	75.44	41.66	147.32	133.35
			2.790	3.060	2.640	2.970	1.640	5.800	5.250
	STX350-480	3 1/2"	76.20	83.06	72.90	81.03	42.93	160.53	147.07
			3.000	3.270	2.870	3.190	1.690	6.320	5.790
	STX350-481	3 1/2"	81.53	88.39	77.27	86.11	42.93	160.53	147.07
			3.210	3.480	3.042	3.390	1.690	6.320	5.790
	STX400-482	4"	86.87	93.73	83.06	91.19	44.20	168.40	157.23
			3.420	3.690	3.270	3.590	1.740	6.630	6.190
	STX400-483	4"	91.69	98.30	87.38	95.76	44.20	168.40	157.23
			3.610	3.870	3.440	3.770	1.740	6.630	6.190
	STX400-484	4"	96.77	102.36	91.44	99.82	44.20	180.09	175.26
			3.810	4.030	3.600	3.930	1.740	7.090	6.900
	STX400-485	4"	100.71	106.30	95.38	103.25	44.20	180.09	175.26
			3.965	4.185	3.755	4.065	1.740	7.090	6.900



# Star Teck XP® jacketed metal-clad cable fittings for hazardous locations



## STEX Series



**Features and benefits:**

- Excellent solution for hazardous location
- Excellent pullout strength
- Robust metallic construction
- Quick and easy installation without disassembly
- Provides grounding continuity of cable armour
- Splined gland and gripping features for ease of installation

**STEX Series - Jacketed metal-clad cable glands**

Approvals & certifications	Conformity Conforms to:	Temperature range
 	CSA C22.2 No.18.3, C22.2 No.25, C22.2 No.30, C22.2 No. 174, UL2225, UL514B	- 40°C to +90°C (-40°F to +194°F)
	CSA Certificate: 1310604 File 23086	
	Class I Div1 ABCD Class II Div1 EFG Class III Div1	
	UL File: E82038	
	Class I Div1 ABCD Class II Div1 EFG Class III Div1	
		<b>IP Rating</b>
		Type 4 / 4X
		<b>Material</b>
		Copper free aluminium
		Zinc plated steel
		PVC coating available for both

**Dimensions**

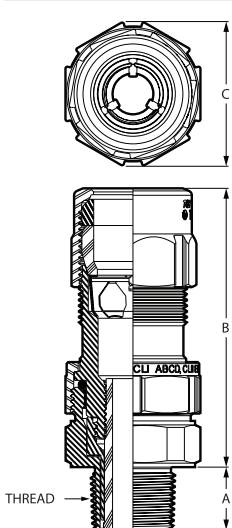
NPT thread	Part no.	NPT thread	Cable range over jacket		Cable range over armour		Nominal dimensions (mm/in)		
			Min. (mm/in)	Max. (mm/in)	Min. (mm/in)	Max. (mm/in)	A Min	B Min	C Min
	STEX075	3/4"	15.24	25.02	13.21	22.73	20.07	86.36	46.23
	STEX100	1"	0.600	0.985	0.520	0.895	0.790	3.400	1.820
	STEX125	1 1/4"	24.13	34.93	22.10	32.89	25.65	99.57	64.01
	STEX150	1 1/2"	29.21	41.28	25.15	37.21	26.16	127.51	83.31
	STEX200	2"	1.150	1.625	0.990	1.465	1.030	5.020	3.280
	STEX250	2 1/2"	36.58	49.91	32.51	45.85	26.92	130.05	92.46
	STEX300	3"	1.440	1.965	1.280	1.805	1.060	5.120	3.640
	STEX350	3 1/2"	46.36	60.33	42.29	56.26	40.13	131.32	115.32
	STEX400	4"	1.825	2.375	1.665	2.215	1.580	5.170	4.540
			57.53	72.14	53.47	68.07	41.66	167.89	125.22
			2.265	2.840	2.105	2.680	1.640	6.610	4.930
			67.82	83.06	64.64	79.88	42.93	187.45	147.07
		2.670	3.270	2.545	3.145	1.690	7.380	5.790	
		81.79	98.30	78.49	92.46	44.20	194.31	157.23	
		3.220	3.870	3.090	3.640	1.740	7.650	6.190	







## Ty-Rap® high performance cable ties

### Nylon detectable cable ties



#### Characteristics

The Ty-Rap® detectable cable ties from ABB incorporate a unique compound (patent pending) detectable by X-ray equipment and metal detectors. Bright blue color enhances visual detection. Recommended for applications in food, pharmaceutical and other contamination-sensitive industries using detection systems, where cable tie installation residuals (cut tails) are permitted in the finished product.

- Engineered to provide the highest detectability in metal detectors by size
- Specially formulated metallic particles provide high reflection in X-ray equipment
- Bright blue color for an easy visual detection
- Help achieve the HACCP EU-Directive
- Available in 6 different sizes in convenient small bags
- Mounting bases available

#### Technical information

- Material - Molding: Polyamide 6.6
- Material - Locking barb: 316 grade stainless steel
- Temperature range: -60°C to +85°C
- Min. Installation Temp.: -20°C
- Color: Bright blue
- Flammability rating: UL 94 HB
- Other properties: UV-resistant, halogen free, silicone free

#### Detectable cable ties



Product code	GID No.	Color	Material	Bundle ø from ... to [mm]	Length L [mm]	Width W [mm]	Min. tensile strength [N]	Quantity [pieces]
<b>Detectable Polyamide 6.6</b>								
TY523MR-NDT	7TCG009330R0027	Blue	Polyamide 6.6	2 - 16	93	2,3	80	100
TY524MR-NDT	7TCG009330R0028	Blue	Polyamide 6.6	2 - 35	140	3,6	160	100
TY525MR-NDT	7TCG009330R0026	Blue	Polyamide 6.6	3,5 - 45	186	4,6	200	100
TY5253M-NDT	7TAG009660R0071	Blue	Polyamide 6.6	3,5 - 76	295	4,7	220	100
TY528MR-NDT	7TCG009330R0025	Blue	Polyamide 6.6	3,5 - 102	361	4,8	220	100
TY527MR-NDT	7TCG009330R0029	Blue	Polyamide 6.6	6 - 102	345	6,9	540	50

Some approvals may not be applicable to all product codes.

#### Tooling



##### ERG50

For use with 2,4mm to 4,8mm (50N to 220N) cable ties.



##### ERG120

For use with 4,8mm to 7,6mm (180N to 540N) cable ties.

#### Dimensions

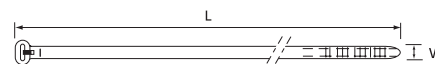

# Ty-Rap® High Performance Cable Ties

## Product code structure

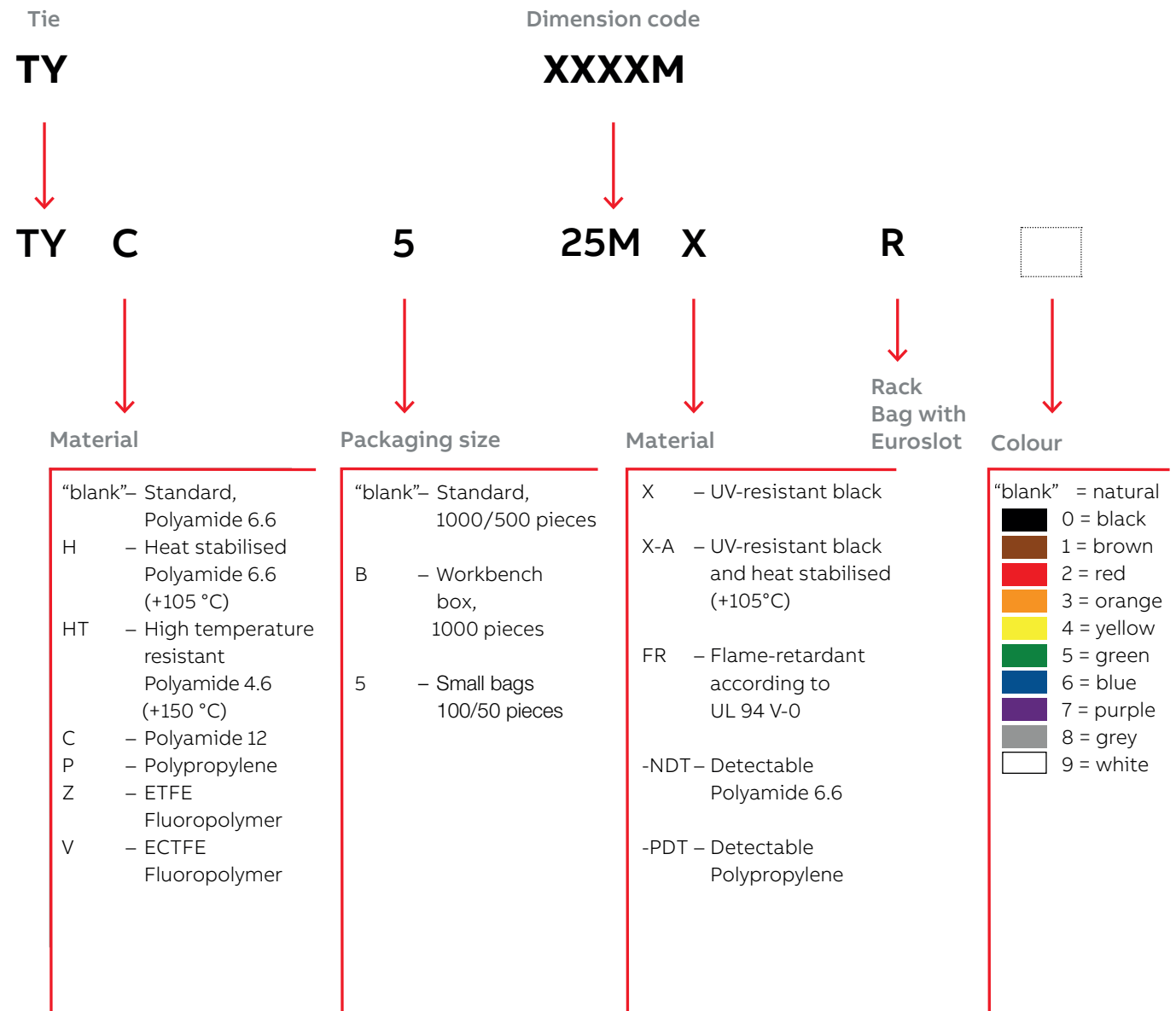

Note: Nylon (Polyamide) is inherently susceptible to environmental conditions. Ty-Rap® cable ties are moisturised to optimum performance levels at machine-side and should be stored in cool dry areas out of direct sunlight. Cable ties are packaged in plastic bags to contain moisture and should remain sealed until ready for use.



## Polyamide 6.6 cable ties - UV-resistant black - Euroslot packaging

### Ty-Rap® High Performance Cable Ties

01 Ty-Rap® High Performance Cable Ties

#### Characteristics

- UV-resistant version, especially recommended for outdoor applications
- Black version (2% carbon for military specifications)
- Packaging in small polythene bags with Euroslot, ideal for display and point-of-sales promotion (rack)
- Several lengths and 6 typical widths with a tensile strength up to 780N, to cover the most demanding applications
- Very convenient for small series production: 100 pieces (for cable ties from 2.4 mm to 4.8 mm width) or 50 pieces (for cable ties 6.9 mm width and above)

#### Technical Information

- Material - Moulding: Polyamide 6.6
- Material - Locking barb: 316 grade stainless steel
- Temperature range: -40°C to +105°C
- Colour: See colour chart below
- Flammability rating: UL 94 V-2
- Other properties: Halogen free, Silicone free

Order Code	MIL Spec.	Length [mm]	Width [mm]	Thickness [mm]	Bundle ø from ... to [mm]	Min. tensile strength [N]	Quantity [pieces]	Tooling
TY5232MR	MS-3367-4	92	2.4	1.0	2 - 16	80	100	
TY5232MR	-	203	2.4	1.0	2 - 50	80	100	
TY5234M*	-	356	2.4	1.0	2 - 102	80	100	
TY524MR	MS-3367-5	140	3.6	1.1	2 - 29	180	100	ERG50 WT193A
TY5242MR	-	204	3.6	1.1	2 - 50	180	100	
TY526MR	-	284	3.6	1.1	2 - 76	130	100	
TY5244MR	-	368	3.6	1.1	2 - 103	130	100	
TY525MR	MS-3367-1	186	4.8	1.3	3.5 - 45	220	100	ERG50
TY5253MR	MS-3367-7	295	4.8	1.3	3.5 - 78	220	100	ERG120
TY528MR	MS-3367-2	361	4.8	1.4	3.5 - 102	220	100	WT193A
TY5271MR	-	150	7.6	1.5	6 - 31	540	50	
TY5272MR	-	223	6.9	1.6	6 - 50	540	50	
TY527MR	MS-3367-3	340	6.9	1.6	6 - 90	540	50	
TY5275M*	-	457	6.9	1.6	6 - 127	540	50	ERG120
TY5277M*	-	617	6.9	1.6	6 - 177	540	50	L-500-EU
TY529M*	MS-3367-6	771	6.9	1.6	6 - 229	540	50	

\*Product References TY5234M, TY5275M, TY5277M and TY529M have no Euroslot.

01



For cable ties in a specific colour, replace \* in the Product Reference by the colour code:

0 = black, 1 = brown, 2 = red, 3 = orange, 4 = yellow, 5 = green, 6 = blue, 7 = purple, 8 = grey and 9 = white



For example: TY23M-1 defines a brown TY23M cable tie. Contact your Sales Office for product availability.

\*\* For smaller quantities, the figure "5" needs to be added to the Order Code immediately after "TY" - example: TY523M-2 is the same as TY23M-2 but in bags of 100

\*\* Some approvals may not be applicable to all the Product References. Contact your Sales Office for approvals limitations.

# Ty-Met™ Stainless steel cable ties

## Ball-Lock type – Standard widths, uncoated

01 Stainless steel cable ties

### Characteristics

The ball-lock type stainless steel ties from ABB are self-locking and require no time consuming crimping or folding operations

- Strong self-locking mechanism (stainless steel ball), with low insertion force
- Fast, easy and reliable installation
- Standard widths (4,6mm & 7,9mm, suitable for most applications, indoor and outdoor)
- Uncoated version, suitable for high temperature environments
- 2 grades of non-magnetic stainless steel: 304 grade for standard applications and 316 grade (marine grade) for extra corrosion resistance

- Applications: installation of cables and pipes in extreme conditions and hazardous areas, such as: petrochemical and food processing industries, power stations, mining, shipbuilding, offshore and other aggressive environments

### Technical information

- Material: A. 304 grade non-magnetic stainless steel; B. 316 grade non-magnetic stainless steel
- Temperature range: -60°C to +300°C
- Color: Metallic
- Extremely high flame and UV resistance
- Strap thickness: 0,26mm

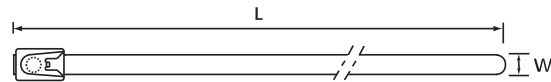

\*\* Some approvals may not be applicable to all the Product References. Contact your Sales Office for approvals limitations.

Product Ref. Stainless steel 304	Product Ref. Stainless steel 316	Length (L) [mm]	Width (W) [mm]	Material thickness [mm]	Bundle ø from ... to [mm]	Min. tensile strength [N]	Quantity [pieces]	Tooling
YLS-4.6-100A	YLS-4.6-100B	100	4.6	0.26	20-25	778	100	
YLS-4.6-125A	YLS-4.6-125B	125	4.6	0.26	20-25	778	100	
YLS-4.6-150A	YLS-4.6-150B	150	4.6	0.26	20-35	778	100	
YLS-4.6-200A	YLS-4.6-200B	200	4.6	0.26	20-50	778	100	
YLS-4.6-300A	YLS-4.6-300B	300	4.6	0.26	20-83	778	100	
YLS-4.6-360A	YLS-4.6-360B	360	4.6	0.26	20-100	778	100	
YLS-4.6-520A	YLS-4.6-520B	520	4.6	0.26	20-150	778	100	
YLS-4.6-680A	YLS-4.6-680B	680	4.6	0.26	20-200	778	100	
YLS-4.6-840A	YLS-4.6-840B	840	4.6	0.26	20-250	778	100	
YLS-4.6-1000A	YLS-4.6-1000B	1000	4.6	0.26	20-300	778	100	
YLS-4.6-1200A	YLS-4.6-1200B	1200	4.6	0.26	20-365	778	100	
YLS-4.6-1400A	YLS-4.6-1400B	1400	4.6	0.26	20-425	778	100	CT3
YLS-7.9-100A	YLS-7.9-100B	100	7.9	0.26	20-20	1112	100	CT6
YLS-7.9-125A	YLS-7.9-125B	125	7.9	0.26	20-22	1112	100	
YLS-7.9-150A	YLS-7.9-150B	150	7.9	0.26	20-35	1112	100	
YLS-7.9-200A	YLS-7.9-200B	200	7.9	0.26	20-50	1112	100	
YLS-7.9-300A	YLS-7.9-300B	300	7.9	0.26	20-83	1112	100	
YLS-7.9-360A	YLS-7.9-360B	360	7.9	0.26	20-100	1112	100	
YLS-7.9-520A	YLS-7.9-5200B	520	7.9	0.26	20-150	1112	100	
YLS-7.9-680A	YLS-7.9-680B	680	7.9	0.26	20-200	1112	100	
YLS-7.9-840A	YLS-7.9-840B	840	7.9	0.26	20-250	1112	100	
YLS-7.9-1000A	YLS-7.9-1000B	1000	7.9	0.26	20-300	1112	100	
YLS-7.9-1200A	YLS-7.9-1200B	1200	7.9	0.26	20-365	1112	100	
YLS-7.9-1400A	YLS-7.9-1400B	1400	7.9	0.26	20-425	1112	100	

## Ty-Met™ Standard cable ties

### Stainless steel cable ties

01 Stainless steel cable ties

#### Characteristics

The Ball-Lock Type stainless steel ties from ABB are self-locking, requiring no time consuming crimping or folding operations.

- Strong self-locking mechanism (stainless steel ball), with low insertion force
- Fast, easy and reliable installation
- Heavy-duty version (12 mm & 16 mm of width), for extreme applications, indoor and outdoor
- Uncoated version, suitable for high temperature environments
- Corrosion resistant 316 grade stainless steel (marine grade) for high mechanical and chemical durability

- Applications: installation of cables and pipes in extreme conditions and hazardous areas, such as: petrochemical and food processing industries, power stations, mining, shipbuilding, offshore and other aggressive environments

#### Technical Information

- Material: 316 grade non-magnetic stainless steel
- Temperature range: -80°C to +300°C
- Colour: Metallic
- Flammability rating: Absolutely fireproof
- Other properties: UV-resistant



01

Order Code	Length [mm]	Width [mm]	Material thickness [mm]	Bundle ø from ... to [mm]	Min. tensile strength [N]	Quantity [pieces]	Tooling
YLS-12-200B	200	12.0	0.32	25-50	2670	50	
YLS-12-300B	300	12.0	0.32	25-83	2670	50	
YLS-12-360B	360	12.0	0.32	25-100	2670	50	
YLS-12-440B	440	12.0	0.32	25-125	2670	50	
YLS-12-520B	520	12.0	0.32	25-150	2670	50	
YLS-12-600B	600	12.0	0.32	25-175	2670	50	CT3
YLS-12-680B	680	12.0	0.32	25-200	2670	50	CT7
YLS-12-760B	760	12.0	0.32	25-225	2670	50	
YLS-12-840B	840	12.0	0.32	25-250	2670	50	
YLS-12-1000B	1000	12.0	0.32	25-300	2670	25	
YLS-12-1200B	1200	12.0	0.32	25-365	2670	25	
YLS-12-1400B	1400	12.0	0.32	25-425	2670	25	
YLS-16-200B	200	16.0	0.32	40-50	3110	50	
YLS-16-300B	300	16.0	0.32	40-80	3110	50	
YLS-16-360B	360	16.0	0.32	40-100	3110	50	
YLS-16-440B	440	16.0	0.32	40-125	3110	50	
YLS-16-520B	520	16.0	0.32	40-150	3110	50	
YLS-16-600B	600	16.0	0.32	40-185	3110	50	
LS-16-680B	680	16.0	0.32	40-200	3110	50	CT7
YLS-16-760B	760	16.0	0.32	40-225	3110	50	
YLS-16-840B	840	16.0	0.32	40-250	3110	50	
YLS-16-1000B	1000	16.0	0.32	40-300	3110	25	
YLS-16-1200B	1200	16.0	0.32	40-365	3110	25	
YLS-16-1400B	1400	16.0	0.32	40-425	3110	25	

# Ty-Fast® plastic cable ties

ABB offers a complete range of all plastic cable ties to fasten cables in the most demanding applications.

## Ty-Fast® all plastic ties

The all-plastic cable ties are available in lengths from 100mm to 1220mm and widths from 2,5mm to 12,2mm, offering a loop tensile strength up to 1200 N. These cable ties will satisfy bundling requirements up to 375,5mm. Made of halogen and silicone free Polyamide 6,6, Ty-Fast® cable ties are available in natural and black UV-resistant and heat stabilized material.

Ty-Fast® cable ties meet shipbuilding classification such as DNV-GL, Lloyd's Register of Shipping, Bureau Veritas. Ty-Fast® cable ties have a CE declaration, supported by compliance to the low voltage directive and EN/IEC 62275. On top the Ty-Fast® range is also compliant to UL 62275.

State-of-the-art robotic and raw material handling equipment assures product and material integrity throughout the manufacturing process.

The integrally formed polyamide pawl combines low insertion and high locking strength.

The low profile head significantly reduces the potential for snagging during installation.

Quick and easy pull through increases productivity, reduces operator fatigue.

Tail with finger grip design that helps operator grasp and pull ties snugly.

Sure grip tab keeps the tail from popping out while being treated, then holds it securely for final tightening by hand or tool.



**Ty-Fast® cable ties for demanding applications**  
An all-in one solution:  
UV resistant and with enhanced temperature range.



## All plastic cable ties

Ty-Fast® product code structure

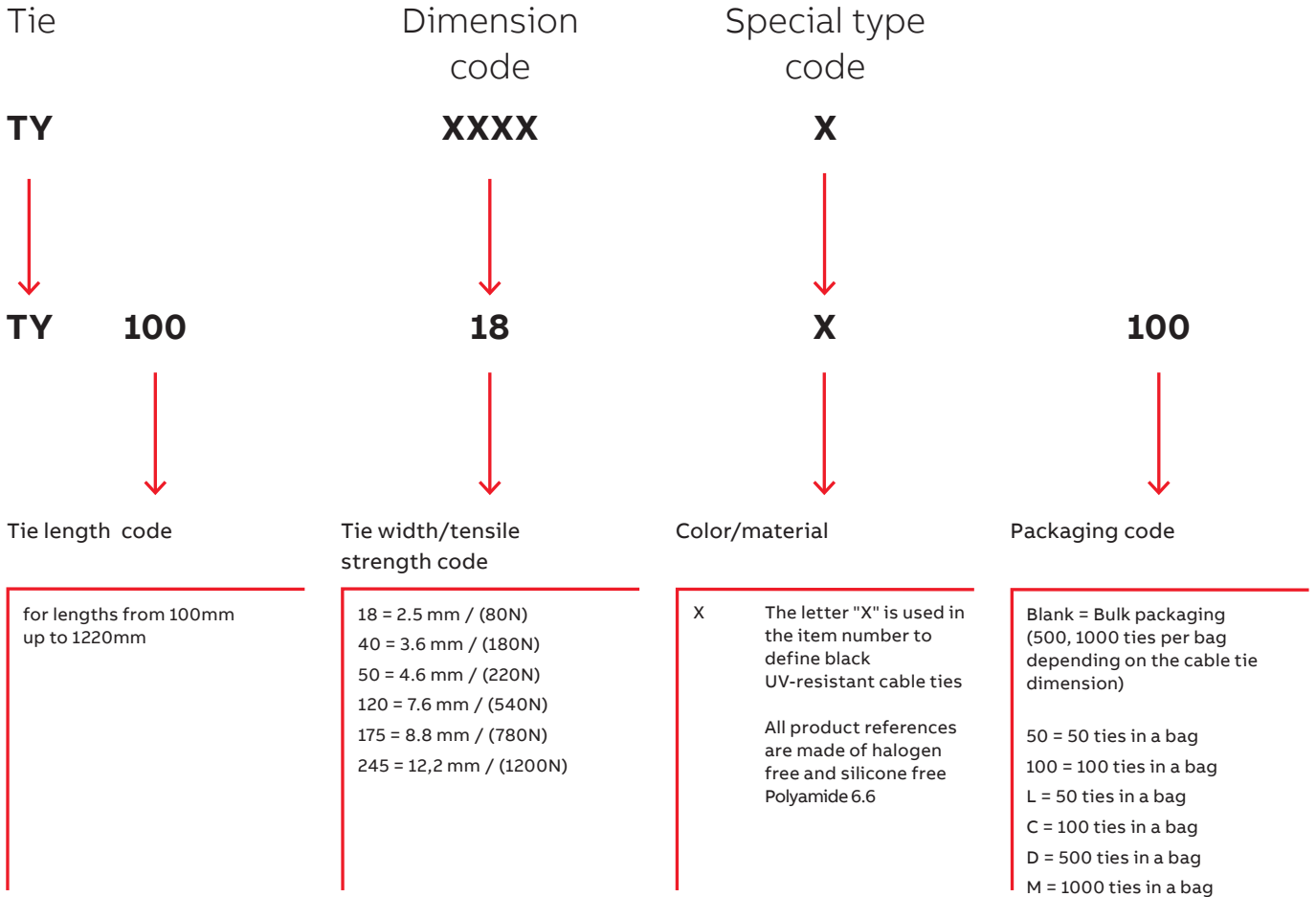

Note: Nylon (Polyamide 6.6) is inherently susceptible to environmental conditions. Ty-Fast® cable ties are moisturised to optimum performance levels at machine-side and should be stored in cool dry areas out of direct sunlight. Cable ties are packaged in plastic bags to contain moisture and should remain sealed until ready for use.

### Easy handling

The turned up tail makes orientation and handling easy, even in blind installations or tight locations.

### Easy installation

The specially designed thin tail with grips makes installing the ties easy, even when wearing gloves.



The **integrally formed pawl** combines low insertion and high locking strength.

## Ty-Fast® cable ties

Natural - Distribution packaging



### Characteristics

- Suitable for indoor applications
- Material: Polyamide 6.6
- Color: Natural
- Halogen and silicone free
- Packaging: 50 pieces or 100 pieces per bag

### Technical features

- Length: from 100mm to 1220mm
- Tensile strength: from 80N to 1200N
- Bundle diameter: from 1.5mm to 375.5mm
- Operating temperature: -40°C to 85°C
- Minimum installation temperature: -20°C
- Flammability rating: UL 94V-2

Natural - Distribution packaging



Product code	GID No.	Bundle ø from ... to [mm]	Length L [mm]	Width W [mm]	Min. tensile strength [N]	Quantity [pieces]
<b>Standard pack size</b>						
TY100-18-C	7TCG054360R0420	1,5 - 20,5	100	2,5	80	100
TY125-18-C	7TCG054360R0422	1,5 - 36,5	150	2,5	80	100
TY200-18-C	7TCG054360R0424	1,5 - 52,5	200	2,5	80	100
TY125-40-100*	7TAG054360R0125	1,5 - 32	143	3,6	180	100
TY200-40-C	7TCG054360R0426	2,0 - 52,5	203	3,5	180	100
TY300-40-100	7TCG054360R0241	1,5 - 76	290	3,6	180	100
TY400-40-100	7TAG054360R0312	6,35 - 102	370	3,6	180	100
TY175-50-100	7TAG054360R0157	3,17 - 44	188	4,8	220	100
TY225-50-100	7TCG054360R0231	3,17 - 57	228	4,8	220	100
TY300-50-100	7TAG054360R0260	3,17 - 76	304	4,8	220	100
TY400-50-100	7TAG054360R0316	3,17 - 102	366	4,8	220	100
TY450-50-C	7TCG054290R0033	3,0 - 122,5	430	4,8	222	100
TY200-120-C	7TCG054360R0428	6,0 - 56	220	7,5	550	100
TY400-120-100	7TCG054360R0284	15 - 102	374	7,6	540	100
TY450-120-L	7TCG054410R0023	6,0 - 130,5	450	7,5	550	50
TY600-120-L	7TCG054410R0024	6,0 - 181,5	610	7,5	550	50
TY800-120-L	7TCG054410R0025	6,0 - 226	750	7,5	550	50
TY600-175-L	7TCG054530R0025	7,0 - 181,5	610	8,8	800	50
TY900-175-L	7TCG054510R0009	7,0 - 280	920	8,8	800	50
TY1000-175-L	7TCG054520R0005	7,0 - 295	1020	8,8	800	50
TY1200-175-L	7TCG054520R0006	7,0 - 375,5	1220	8,8	800	50
TY500-245-L**	7TCG054510R0010	9,0 - 156	530	12,2	1200	50
TY720-245-L**	7TCG054510R0011	9,0 - 216	730	12,2	1200	50
TY1050-245-L**	7TCG054510R0012	9,0 - 323	1030	12,2	1200	50

\* Operating temperature: -30°C to +85°C.

\*\* Minimum installation temperature: -10°C.

### Tooling



**ERG50**  
For use with 2,4mm to 4,8mm (80N to 220N) cable ties.



**ERG120**  
For use with 4.8mm to 7,6mm (220N to 540N) cable ties.



**WT3D**  
For use with 7.6mm to 12.7mm (540N to 1200N) cable ties.

### Dimensions

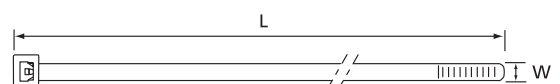



## Ty-Fast® cable ties

Natural - OEM packaging



### Characteristics

- Suitable for indoor applications
- Material: Polyamide 6.6
- Color: Natural
- Halogen and silicone free
- Packaging: 500 pieces or 1000 pieces per bag

### Technical features

- Length: from 100mm to 430mm
- Tensile strength: from 80N to 540N
- Bundle diameter: from 1.5mm to 122.5mm
- Operating temperature: -40°C to 85°C
- Minimum installation temperature: -20°C
- Flammability rating: UL 94V-2

Natural - OEM packaging



Product code	GID No.	Bundle ø from ... to [mm]	Length L [mm]	Width W [mm]	Min. tensile strength [N]	Quantity [pieces]
<b>Bulk pack size</b>						
TY100-18-M	7TCG054360R0421	1,5 - 20,5	100	2,5	80	1000
TY125-18-M	7TCG054360R0423	1,5 - 36,5	150	2,5	80	1000
TY200-18-M	7TCG054360R0425	1,5 - 52,5	200	2,5	80	1000
TY125-40*	7TAG054360R0123	1,5 - 32	143	3,6	180	1000
TY200-40-M	7TCG054360R0427	2,0 - 52,5	203	3,5	180	1000
TY300-40	7TCG054360R0240	1,5 - 76	290	3,6	180	1000
TY400-40	7TAG054360R0311	6,35 - 102	370	3,6	180	1000
TY175-50	7TAG054360R0153	3,17 - 44	188	4,8	220	1000
TY225-50	7TCG054360R0230	3,17 - 57	228	4,8	220	1000
TY300-50	7TAG054360R0259	3,17 - 76	304	4,8	220	1000
TY400-50	7TAG054360R0315	3,17 - 102	366	4,8	220	1000
TY450-50-D	7TCG054290R0037	3,0 - 122,5	430	4,8	222	500
TY200-120-D	7TCG054360R0429	6,0 - 56	220	7,5	550	500
TY400-120	7TAG054360R0282	15 - 124	374	7,6	540	500

\* Operating temperature: -30°C to +85°C.

### Tooling



**ERG50**  
For use with 2,4mm to 4,8mm (80N to 220N) cable ties.



**ERG120**  
For use with 4,8mm to 7,6mm (220N to 540N) cable ties.



**WT3D**  
For use with 7.6mm to 12.7mm (540N to 1200N) cable ties.

### Dimensions

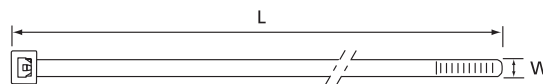

## Ty-Fast® cable ties

Black UV-resistant and heat stabilized - Distribution packaging



### Characteristics

- Suitable for indoor and outdoor applications
- Heat stabilised + UV-resistant, for outdoor applications that also require a resistance to high temperature +115°C
- Material Polyamide 6.6
- Color: black
- Halogen and silicone free
- Packaging: 50 pieces or 100 pieces per bag

### Technical information

- Length: from 100mm to 1220mm
- Tensile strength: from 80N to 120N
- Bundle diameter: from 1.5mm to 375.5mm
- Operating temperature: -40°C to 115°C
- All items without suffix L, C, M and D have a maximum operating temperature of 105°C
- Minimum installation temperature: -20°C
- Flammability rating: UL 94V-2

Black UV-resistant and heat stabilized



Product code	GID No.	Bundle ø from ... to [mm]	Length L [mm]	Width W [mm]	Min. tensile strength [N]	Quantity [pieces]
<b>Standard pack size</b>						
TY100-18X-C	7TCG054360R0430	1,5 - 20,5	100	2,5	80	100
TY125-18X-C	7TCG054360R0432	3,0 - 36,5	150	2,5	80	100
TY200-18X-C	7TCG054360R0434	3,0 - 52,5	200	2,5	80	100
TY125-40X-100*	7TAG054360R0142	1,5 - 32	143	3,6	180	100
TY200-40X-C	7TCG054360R0436	3,0 - 52,5	203	3,5	180	100
TY300-40X-100	7TCG054360R0257	1,5 - 76	290	3,6	180	100
TY400-40X-100	7TAG054360R0314	6,35 - 102	370	3,6	180	100
TY175-50X-100	7TAG054360R0179	3,17 - 44	188	4,8	220	100
TY225-50X-100	7TCG054360R0237	3,17 - 57	228	4,8	220	100
TY300-50X-100	7TAG054360R0279	3,17 - 76	304	4,8	220	100
TY400-50X-100	7TAG054360R0337	3,17 - 102	366	4,8	220	100
TY450-50X-C	7TCG054290R0035	3,0 - 122,5	430	4,8	222	100
TY200-120X-C	7TCG054360R0438	6,0 - 56	220	7,5	550	100
TY400-120X-100	7TCG054360R0308	15 - 102	374	7,6	540	100
TY450-120X-L	7TCG054410R0026	6,0 - 130,5	450	7,5	550	50
TY600-120X-L	7TCG054410R0027	6,0 - 181,5	610	7,5	550	50
TY800-120X-L	7TCG054410R0028	6,0 - 226	750	7,5	550	50
TY600-175X-L	7TCG054530R0026	9,0 - 181,5	610	8,8	800	50
TY900-175X-L	7TCG054510R0013	9,0 - 280	920	8,8	800	50
TY1000-175X-L	7TCG054520R0007	9,0 - 295	1020	8,8	800	50
TY1200-175X-L	7TCG054520R0008	9,0 - 375,5	1220	8,8	800	50
TY500-245X-L	7TCG054510R0014	9,0 - 156	530	12,2	1200	50
TY720-245X-L	7TCG054510R0015	9,0 - 216	730	12,2	1200	50
TY1050-245X-L	7TCG054510R0016	9,0 - 323	1030	12,2	1200	50

\* Operating temperature: -30°C to +105°C.

### Tooling



**ERG50**  
For use with 2,4mm to 4,8mm (80N to 220N) cable ties.



**ERG120**  
For use with 4,8mm to 7,6mm (220N to 540N) cable ties.



**WT3D**  
For use with 7,6mm to 12,7mm (540N to 1200N) cable ties.

### Dimensions

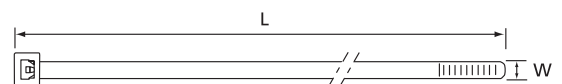

## Ty-Fast® cable ties

Black UV-resistant and heat stabilized - OEM packaging



### Characteristics

- Suitable for indoor and outdoor applications
- Heat stabilised + UV-resistant, for outdoor applications that also require a resistance to high temperature +115°C
- Material Polyamide 6.6
- Color: black
- Halogen and silicone free
- Packaging: 500 pieces or 1000 pieces per bag

### Technical features

- Length: from 100mm to 430mm
- Tensile strength: from 80N to 540N
- Bundle diameter: from 1.5mm to 122.5mm
- Operating temperature: -40°C to 115°C
- All items without suffix L, C, M and D have a maximum operating temperature of 105°C
- Minimum installation temperature: -20°C
- Flammability rating: UL 94V-2

Black UV-resistant and heat stabilized



Product code	GID No.	Bundle ø from ... to [mm]	Length L [mm]	Width W [mm]	Min. tensile strength [N]	Quantity [pieces]
<b>Bulk pack size</b>						
TY100-18X-M	7TCG054360R0431	1,5 - 20,5	100	2,5	80	1000
TY125-18X-M	7TCG054360R0433	3,0 - 36,5	150	2,5	80	1000
TY200-18X-M	7TCG054360R0435	3,0 - 52,5	200	2,5	80	1000
TY125-40X*	7TAG054360R0141	1,5 - 32	140	3,6	180	1000
TY200-40X-M	7TCG054360R0437	3,0 - 52,5	203	3,5	180	1000
TY300-40X	7TCG054360R0256	1,5 - 76	290	3,6	180	1000
TY400-40X	7TAG054360R0313	6,35 - 102	370	3,6	180	1000
TY175-50X	7TAG054360R0178	3,17 - 44	188	4,8	220	1000
TY225-50X	7TCG054360R0236	3,17 - 57	228	4,8	220	1000
TY300-50X	7TAG054360R0278	3,17 - 76	304	4,8	220	1000
TY400-50X	7TAG054360R0336	3,17 - 102	370	4,8	220	1000
TY450-50X-D	7TCG054290R0038	3,0 - 122,5	430	4,8	222	500
TY200-120X-D	7TCG054360R0439	6,0 - 56	220	7,5	550	500
TY400-120X	7TAG054360R0307	15 - 124	374	7,6	540	500

\* Operating temperature: -30°C to +105°C.

### Tooling



**ERG50**  
For use with 2,4mm to 4,8mm (80N to 220N) cable ties.



**ERG120**  
For use with 4,8mm to 7,6mm (220N to 540N) cable ties.



**WT3D**  
For use with 7,6mm to 12,7mm (540N to 1200N) cable ties.

### Dimensions

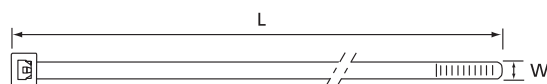

## E-Klips® mechanical and electrical fixings

### Key products

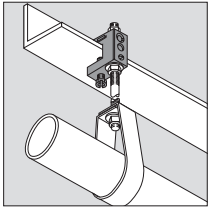

Girder clamps for threaded rod

Part Code	ABB Order Code	Quantity (pieces)
PPFH-65	7TCA084030R1720	25
PPFH-107	7TCA084030R1719	25

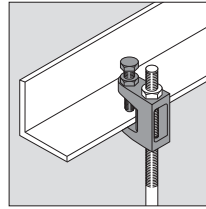

Girder clamps for threaded rod

Part Code	ABB Order Code	Quantity (pieces)
FC-11	7TCA084220R0153	25
FC-10T	7TCA084220R0152	25

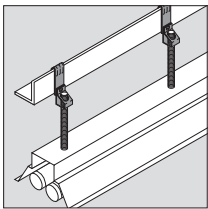

Purlin clips for threaded rod

Part Code	ABB Order Code	Quantity (pieces)
AV155-AM8T	7TCA084030R0754	25
AV155-AM10T	7TCA084030R0742	25

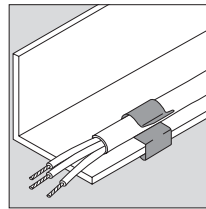

Girder clips for single cables

Part Code	ABB Order Code	Quantity (pieces)
PPECS-89	7TCA084030R1714	25
PPECS-1011	7TCA084030R1710	25
PPECS-1214	7TCA084030R1711	25
PPECS-1519	7TCA084030R1712	25
PPECS-2024	7TCA084030R1713	25
PPECM-89	7TCA084030R1709	25
PPECM-1011	7TCA084030R1705	25
PPECM-1214	7TCA084030R1706	25
PPECM-1519	7TCA084030R1707	25
PPECM-2024	7TCA084030R1708	25
PPECL-89	7TCA084030R1704	25
PPECL-1011	7TCA084030R1700	25
PPECL-1214	7TCA084030R1701	25
PPECL-1519	7TCA084030R1702	25
PPECL-2024	7TCA084030R1703	25

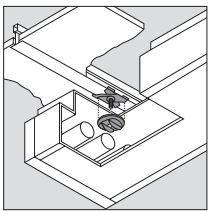

Suspended ceiling clips

Part Code	ABB Order Code	Quantity (pieces)
PPJHX-16S	7TCA084030R1721	25

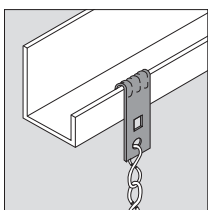

Purlin clips for chain or wire

Part Code	ABB Order Code	Quantity (pieces)
PPAV-155	7TCA084030R1699	25

# Girder clips

## Key products

### Girder clips for conduit

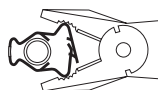
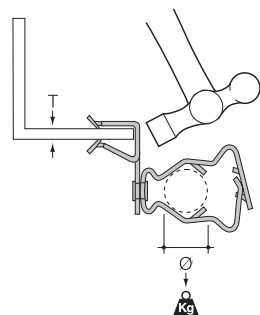
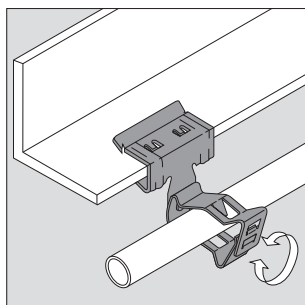

Part Code	ABB Order Code	T (mm)	Ø (mm)	PG type	Load rating (kg)	Material finishes	Quantity (pieces)
AH153-GM1219	7TCA084030R1133	1.5-3	12-19	7/9/11	12	F8+	25
AH153-GM1926	7TCA084030R1135	1.5-3	19-26	13.5/16	12	F8+	25
AH153-GM2632	7TCA084030R1138	1.5-3	26-32	21	12	F8+	25
AH153-GM3240	7TCA084030R1140	1.5-3	32-40	29	12	F8+	25
AH153-GM4047	7TCA084030R1142	1.5-3	40-47	36	12	F8+	25
AH153-GM4757	7TCA084030R1144	1.5-3	47-57	36/42	12	F8+	25
AH38-GM1219	7TCA084030R1163	3-8	12-19	7/9/11	12	F8+	25
AH38-GM1926	7TCA084030R1165	3-8	19-26	13.5/16	12	F8+	25
AH38-GM2632	7TCA084030R1168	3-8	26-32	21	12	F8+	25
AH38-GM3240	7TCA084030R1170	3-8	32-40	29	12	F8+	25
AH38-GM4047	7TCA084030R1172	3-8	40-47	36	12	F8+	25
AH38-GM4757	7TCA084030R1174	3-8	47-57	36/42	12	F8+	25
AH814-GM1219	7TCA084030R1105	8-14	12-19	7/9/11	12	F8+	25
AH814-GM1926	7TCA084030R1107	8-14	19-26	13.5/16	12	F8+	25
AH814-GM2632	7TCA084030R1109	8-14	26-32	21	12	F8+	25
AH814-GM3240	7TCA084030R1111	8-14	32-40	29	12	F8+	25
AH814-GM4047	7TCA084030R1113	8-14	40-47	36	12	F8+	25
AH814-GM4757	7TCA084030R1115	8-14	47-57	36/42	12	F8+	25
AH1420-GM1219	7TCA084030R0487	14-20	12-19	7/9/11	12	F8+	25
AH1420-GM1926	7TCA084030R0489	14-20	19-26	13.5/16	12	F8+	25
AH1420-GM2632	7TCA084030R0493	14-20	26-32	21	12	F8+	25
AH1420-GM3240	7TCA084030R0495	14-20	32-40	29	12	F8+	25
AH1420-GM4047	7TCA084030R0497	14-20	40-47	36	12	F8+	25
AH1420-GM4757	7TCA084030R0499	14-20	47-57	36/42	12	F8+	25

### Girder clips for chain wire

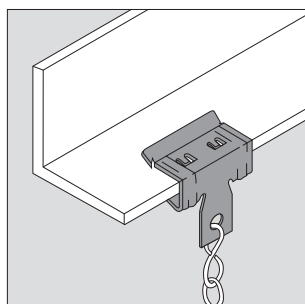

Part no.	ABB Order Code	T (mm)	Ø (mm)	A (mm)	B (mm)	Load rating (kg)	Material finishes	Quantity (pieces)
AH-153	7TCA084030R0448	1.5-3	6.5	16	12.5	72	F8+	100
AH-38	7TCA084030R0452	3-8	6.5	18	20.3	90	F8+	100
AH-814	7TCA084030R0457	8-14	6.5	26	20.3	90	F8+	100
AH-1420	7TCA084030R0443	14-20	6.5	30	26.6	90	F8+	100

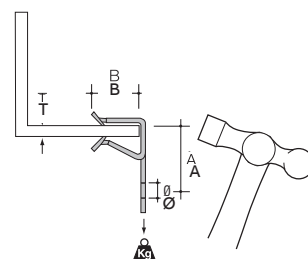

## Girder clips and rod

### Key products

#### Girder clips for conduit box

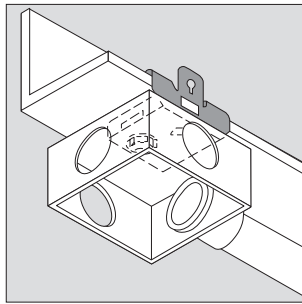

Part no.	ABB Order Code	T (mm)	Ø (mm)	A (mm)	B (mm)	C (mm)	Load rating (kg)	Material finishes	Quantity (pieces)
EH-38	7TCA084030R1091	3-8	7	-	7.5	33	45	F8+	100
EH-814	7TCA084030R1098	8-14	7	-	7.5	33	45	F8+	100
EH-1420	7TCA084030R1085	14-20	7	-	7.5	33	45	F8+	100
EH-38S	7TCA084030R1095	3-8	-	M6x10	7.5	33	45	F8+	100
EH-814S	7TCA084030R1102	8-14	-	M6x10	7.5	33	45	F8+	100
EH-1420S	7TCA084030R1088	14-20	-	M6x10	7.5	33	45	F8+	100

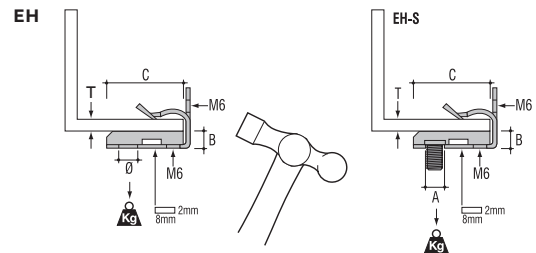

#### Purlin clamp for threaded rod

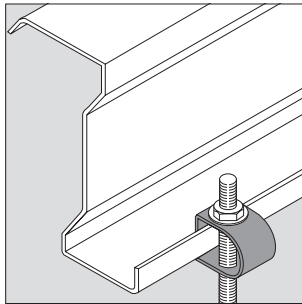

Part no.	ABB Order Code	T (mm)	Ø (mm)	A (mm)	B (mm)	Load rating (kg)	Material finishes	Quantity (pieces)
PD	7TCA084220R0299	≤4	12	15	85	40	F2	50

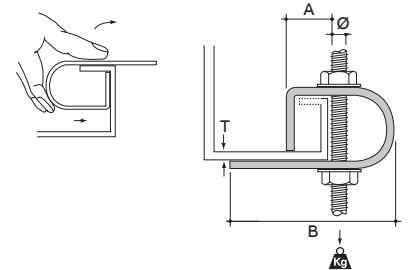

#### Fastening clips for threaded rod

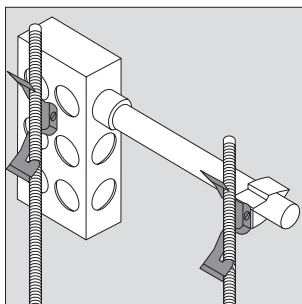

Part no.	ABB Order Code	ØA (mm)	Load rating (kg)	Material finishes	Quantity (pieces)
FM-313T	7TCA084030R1270	M6/M8/M10	10	F8+	100
FM-320T	7TCA084030R1274	M6/M8/M10	10	F8+	100

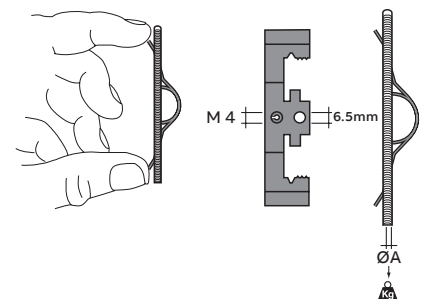



---

# Energy and lighting management

255	Busch-Jaeger presence detectors
264	Busch-Watchdog outdoor



---

For more detailed product information, please refer to our online technical brochures available at: [new.abb.com/low-voltage/support/documentation](http://new.abb.com/low-voltage/support/documentation)

or contact our sales team via email [LV.enquiries@gb.abb.com](mailto:LV.enquiries@gb.abb.com)

or call 0333 999 9933

# Overview

## Presence detectors

### Presence detectors 230 V

Compact devices for almost every application.



### Busch-Watchdog Presence tech

Versatile due to modular construction.



### Busch-Watchdog Presence tech BasicLINE

For small offices, toilets, pass-through areas and dedicated applications.



### Busch-Presence detectors KNX

Expertise always works. Almost unnoticed.



## Technical data

### Presence detectors 230 V



NEW



NEW

Products	Busch-Presence detector Compact, relay	Busch-Presence detector Universal, relay
Article number	6819/60-24-500 6819/60-183-500	6819/30-24-500 6819/30-183-500
Device type	Master <sup>1)</sup>	Master <sup>1)</sup>
Half- / automatic / comfort automatic mode	yes / yes / -	yes / yes / -
Detection range:		
Mounting height	2.5 m / 3 m / 4 m	2.5 m / 3 m / 4 m
sitting	5 m / 6.5 m / -	8 m / 10 m / -
walking (lateral / diagonal)	6.5 m / 8 m / 10.5 m	10 m / 12 m / 16 m
walking (frontal)	4.5 m / 6 m / 7 m	7 m / 8 m / 10 m
Sensitivity adjustment	-	-
Number of channels	1	1
<b>Load<sup>2)</sup>:</b>		
LEDi	200 VA	200 VA
LEDs with converter	200 VA	200 VA
Incandescent lamps	2300 W	2300 W
HV halogen lamps	2300 W	2300 W
LV halogen lamps with electr. transformer	2300 VA	2300 VA
Fluorescent lamps	2300 VA	2300 VA
Electr. fan engines	-	-
Inrush current max.:	165 A / 20 ms // 350 A / 200 µs	165 A / 20 ms // 350 A / 200 µs
2-stage power-off (EN15232)	-	-
PIR / individually activated	4 / -	4 / -
2 light bands / HVAC / backboard light	- / - / -	- / - / -
Intern brightness sensor	yes	yes
Remote controllable	yes, via IR service-remote control 6843	yes, via IR service-remote control 6843
False ceilings via spring brackets	yes	yes
Surface mounted	-	-
Flush-mounting	-	-
Mounting depth (fm box / ceiling mount):	- / 49 mm	- / 49 mm
Mounting Dimensions:	Ø 68 mm	Ø 68 mm
Visible height:	23 mm	23 mm
Protection class (sensor / actuator)	IP 40	IP 40

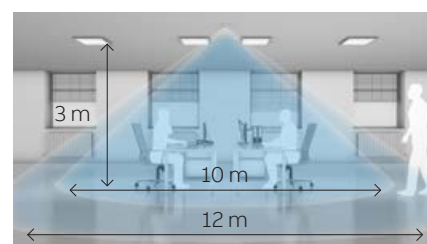
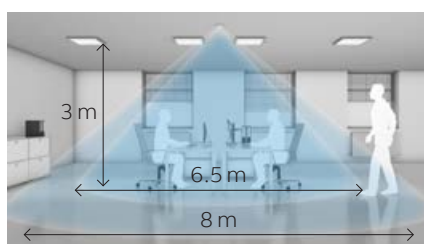

- 1 Lateral approach to the detector.
- 2 Diagonal approach to the detector.
- 3 Lateral approach to the detector.
- 4 Frontal approach to the detector.

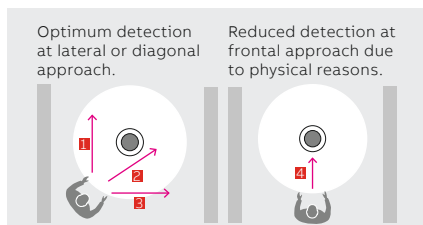

#### Technical details

The Busch-Presence detectors consist of two parts lens and 4 PIR sensors. The maximum detection range depends on the mounting site and ambient conditions.



NEW



NEW



NEW

Busch-Presence detector Compact, e-contact	Busch-Presence detector Universal, e-contact	Busch-Presence detector Corridor, relay
6817/62-24-500	6817/32-24-500	6819/50-24-500
6817/62-183-500	6817/32-183-500	6819/50-183-500
Master <sup>1)</sup>	Master <sup>1)</sup>	Master <sup>1)</sup>
yes / yes / -	yes / yes / -	yes / yes / -
2.5 m / 3 m / 4 m	2.5 m / 3 m / 4 m	2.5 m / 3 m / 4 m
5 m / 6.5 m / -	8 m / 10 m / -	- / - / -
6.5 m / 8 m / 10.5 m	10 m / 12 m / 16 m	24 m x 2.5 m / 24 m x 3 m / 24 m x 3 m
4.5 m / 6 m / 7 m	7 m / 8 m / 10 m	14 m x 2.5 m / 14 m x 3 m / 14 m x 3 m
-	-	-
1	1	1
3 - 200 VA	3 - 200 VA	200 VA
3 - 200 VA	3 - 200 VA	200 VA
3 - 200 W	3 - 200 W	2300 W
3 - 200 W	3 - 200 W	2300 W
3 - 200 VA	3 - 200 VA	2300 VA
3 - 200 VA	3 - 200 VA	2300 VA
-	-	-
165 A / 20 ms // 350 A / 200 µs	165 A / 20 ms // 350 A / 200 µs	165 A / 20 ms // 350 A / 200 µs
-	-	-
4 / -	4 / -	4 / -
- / - / -	- / - / -	- / - / -
yes	yes	yes
yes, via IR service-remote control 6843	yes, via IR service-remote control 6843	yes, via IR service-remote control 6843
yes	yes	yes
-	-	-
-	-	-
- / 36 mm	- / 36 mm	- / 49 mm
Ø 68 mm	Ø 68 mm	Ø 68 mm
23 mm	23 mm	27 mm
IP 40	IP 40	IP 40

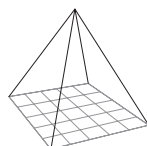
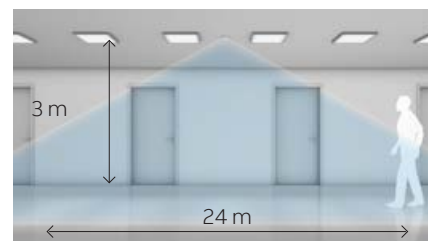
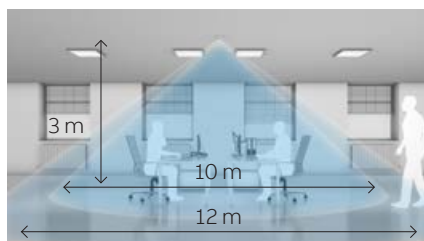
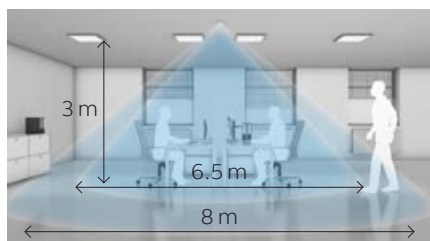

— Detection system of conventional movement detectors

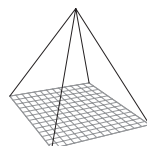

— Busch-Presence detection system

**There is no better way.**

The detection system consisting of four sensors and mirrors is far superior to conventional movement sensors. Even the smallest movement is reliably detected and triggers a response.

<sup>1)</sup> Slave version available.

<sup>2)</sup> at 230 V~ main voltage.

## Technical data

### Presence detectors 230 V



NEW



NEW

Products	Busch-Presence detector Universal BT, relay	Busch-Presence detector Universal BT, e-contact
Article number	6819/31-24-500 6819/31-183-500	6819/33-24-500 6819/33-183-500
Device type	Master <sup>1)</sup>	Master <sup>1)</sup>
Half- / automatic / comfort automatic mode	yes / yes / yes	yes / yes / yes
Detection range:		
Mounting height	2.5 m / 3 m / 4 m	2.5 m / 3 m / 4 m
sitting	8 m / 10 m / -	8 m / 10 m / -
walking (lateral / diagonal)	10 m / 12 m / 16 m	10 m / 12 m / 16 m
walking (frontal)	7 m / 8 m / 10 m	7 m / 8 m / 10 m
Sensitivity adjustment	yes	yes
Number of channels	1	1
<b>Load<sup>2)</sup>:</b>		
LEDi	200 VA	3 - 200 VA
LEDs with converter	200 VA	3 - 200 VA
Incandescent lamps	2300 W	3 - 200 W
HV halogen lamps	2300 W	3 - 200 W
LV halogen lamps with electr. transformer	2300 VA	3 - 200 VA
Fluorescent lamps	2300 VA	3 - 200 VA
Electr. fan engines	-	-
Inrush current max.:	165 A / 20 ms // 350 A / 200 µs	165 A / 20 ms // 350 A / 200 µs
2-stage power-off (EN15232)	-	-
PIR / individually activated	4 / 4	4 / 4
2 light bands / HVAC / backboard light	- / - / -	- / - / -
Intern brightness sensor	yes	yes
Remote controlable	yes, Smartphone APP via Bluetooth	yes, Smartphone APP via Bluetooth
False ceilings via spring brackets	yes	yes
Surface mounted	-	-
Flush-mounting	-	-
Mounting depth (fm box / ceiling mount):	- / 49 mm	- / 36 mm
Mounting Dimensions:	Ø 68 mm	Ø 68 mm
Visible height:	23 mm	23 mm
Protection class (sensor / actuator)	IP 40	IP 40

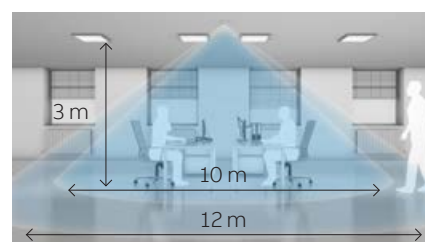
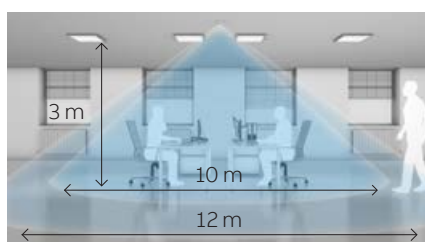



NEW



NEW



NEW

Busch-Presence detector Corridor BT, relay	Busch-Presence detector Universal BT, e-contact with sealing ring	Busch-Presence detector Universal BT, DALI
6819/51-24-500	6817/93-24-500	6819/35-24-500
6819/51-183-500	6817/93-183-500	6819/35-183-500
Master <sup>1)</sup>	Master <sup>1)</sup>	Master <sup>1)</sup>
yes / yes / yes	yes / yes / yes	yes / yes / yes
2.5 m / 3 m / 4 m	2.5 m / 3 m / 4 m	2.5 m / 3 m / 4 m
- / - / -	8 m / 10 m / -	8 m / 10 m / -
24 m x 2.5 m / 30 m x 3 m / 30 m x 3 m	10 m / 12 m / 16 m	10 m / 12 m / 16 m
18 m x 2.5 m / 20 m x 3 m / 20 m x 3 m	7 m / 8 m / 10 m	7 m / 8 m / 10 m
yes	yes	yes
1	1	2
200 VA	3 - 200 VA	200 VA
200 VA	3 - 200 VA	200 VA
2300 W	3 - 200 W	1380 W
2300 W	3 - 200 W	1380 W
2300 VA	3 - 200 VA	1380 VA
2300 VA	3 - 200 VA	1380 VA
-	-	1380 VA
165 A / 20 ms // 350 A / 200 µs	165 A / 20 ms // 350 A / 200 µs	165 A / 20 ms // 350 A / 200 µs
-	-	yes
4 / 4	4 / 4	4 / 4
- / - / -	- / - / -	- / yes / yes
yes	yes	yes
yes, Smartphone APP via Bluetooth	yes, Smartphone APP via Bluetooth	yes, Smartphone APP via Bluetooth
yes	yes	yes
-	-	-
-	-	-
- / 49 mm	- / 36 mm	- / 60 mm
Ø 68 mm	Ø 68 mm	Ø 68 mm
27 mm	23 mm	23 mm
IP 40	IP 41	IP 40

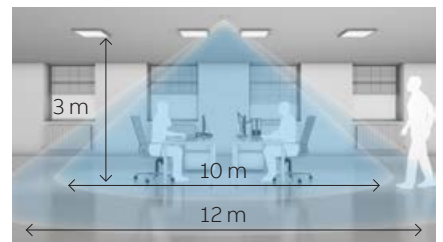
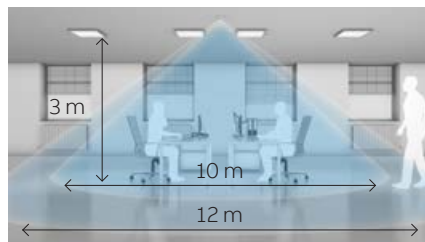
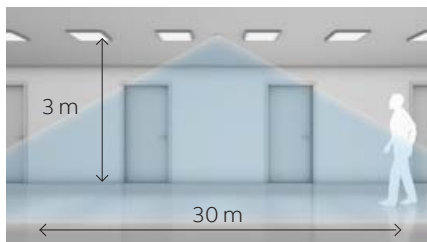

<sup>1)</sup> Slave version available.

<sup>2)</sup> at 230 V~ main voltage.



## Technical data

### Presence detectors 230 V



NEW

Products	Busch-Presence detector Corridor BT, DALI
Article number	6819/55-24-500 6819/55-183-500
Device type	Master <sup>1)</sup>
Half- / automatic / comfort automatic mode	yes / yes / yes
Detection range:	
Mounting height	2.5 m / 3 m / 4 m
sitting	- / - / -
walking (lateral / diagonal)	24 m x 2,5 m / 30 m x 3 m / 30 m x 3 m
walking (frontal)	18 m x 2,5 m / 20 m x 3 m / 20 m x 3 m
Sensitivity adjustment	yes
Number of channels	2
<b>Load<sup>2)</sup>:</b>	
LEDi	200 VA
LEDs with converter	200 VA
Incandescent lamps	1380 W
HV halogen lamps	1380 W
LV halogen lamps with electr. transformer	1380 VA
Fluorescent lamps	1380 VA
Electr. engines	1380 VA
Inrush current max.:	165 A / 20 ms // 350 A / 200 µs
2-stage power-off (EN152321)	yes
PIR / individually activated	4 / 4
2 light bands / HVAC / backboard light	- / yes / yes
Intern brightness sensor	yes
Remote controlable	yes, Smartphone APP via Bluetooth
False ceilings via spring brackets	yes
Surface mounted	-
Flush-mounting	-
Mounting depth (fm box / ceiling mount):	- / 60 mm
Mounting Dimensions:	Ø 68 mm
Visible height:	27 mm
Protection class (sensor / actuator)	IP 40

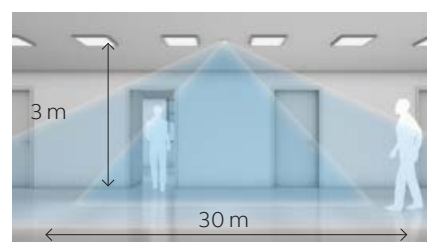



Busch-Watchdog Presence tech BasicLINE mini	Busch-Watchdog Presence tech BasicLINE	Busch-Watchdog Presence tech BasicLINE Corridor
6811 EB-500	6814 U-500	6818 U-500
Single device	Single device	Single device
- / yes / -	yes / yes / -	- / yes / -
2.5 m / 3 m / 4 m	2.5 m / 3 m / 4 m	2.5 m / 3 m / 4 m
3 m / 3.5 m / -	4 m / 4.5 m / -	4 m / 4.5 m / -
5 m / 6 m / 8 m	7 m / 8 m / 10 m	24 m / 20 m / -
ns	4 m / 3 m / 2 m	ns
yes	-	-
1	1	1
200 VA	200 VA	200 VA
200 VA	200 VA	200 VA
2000 W	2000 W	2000 W
1000 W	1000 W	1000 W
2000 VA	2000 VA	2000 VA
1000 VA	1000 VA	1000 VA
-	-	-
80 A / 20 ms	80 A / 20 ms	80 A / 20 ms
-	-	-
1 / -	1 / -	4 / -
- / - / -	- / - / -	- / - / -
yes	yes	yes
-	-	yes, via IR service-remote control 6843
yes	yes	yes
-	-	yes
-	yes	yes
180 mm	28 mm / 41 mm	18 mm / 48 mm
32 mm	65 mm	64 mm
10 mm	31 mm	57 mm
IP 40 / IP 20	IP 40	IP 40 / IP 54 <sup>3)</sup>

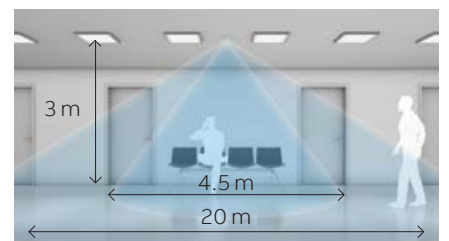
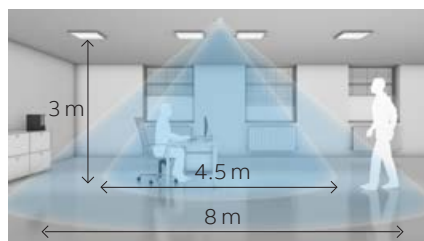
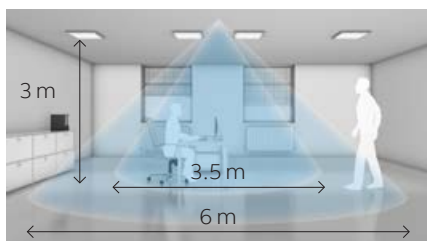

<sup>1)</sup> Slave version available.  
<sup>2)</sup> at 230 V~ main voltage.  
<sup>3)</sup> only with surface mount box.

## Technical data

### Presence detectors 230 V



Products	Busch-Watchdog Presence tech	Busch-Watchdog Presence tech
Article number	6813-101-500 & 6401 U-102-500 6813-183-101-500 & 6401 U-102-500	6813-101-500 & 6402 U-500 6813-183-101-500 & 6402 U-500
Device type	Master <sup>1)</sup>	Master <sup>1)</sup>
Half- / automatic / comfort automatic mode	- / yes / -	- / yes / -
Detection range:		
Mounting height	2.5 m / 3 m / 4 m	2.5 m / 3 m / 4 m
sitting	8 m / 10 m / -	8 m / 10 m / -
walking (lateral / diagonal)	10 m / 12 m / 16 m	10 m / 12 m / 16 m
walking (frontal)	6 m / 7 m / 9 m	6 m / 7 m / 9 m
Sensitivity adjustment	-	-
Number of channels	1	2
<b>Load<sup>2)</sup>:</b>		
LEDi	200 VA	200 VA
LEDs with converter	200 VA	200 VA
Incandescent lamps	2300 W	2300 W
HV halogen lamps	2300 W	2300 W
LV halogen lamps with electr. transformer	2300 VA	2300 VA
Fluorescent lamps	2300 VA	2300 VA
Electr. engines	-	-
Inrush current max.:	80 A / 20 ms	80 A / 20 ms
2-stage power-off (EN152321)	-	-
PIR / individually activated	4 / -	4 / -
2 light bands / HVAC / backboard light	- / - / -	- / yes / -
Intern brightness sensor	yes	yes
Remote controlable	yes, via IR remote control 6010-25	yes, via IR remote control 6010-25
False ceilings via spring brackets	-	-
Surface mounted	yes	yes
Flush-mounting	yes	yes
Mounting depth (fm box / ceiling mount):	32 mm / -	32 mm / -
Mounting Dimensions:	-	-
Visible height:	51 mm	51 mm
Protection class (sensor / actuator)	IP 20	IP 20

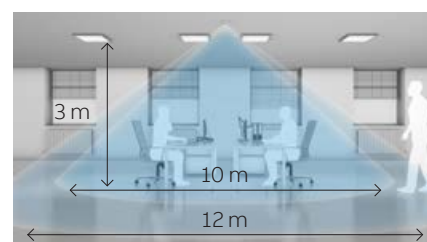
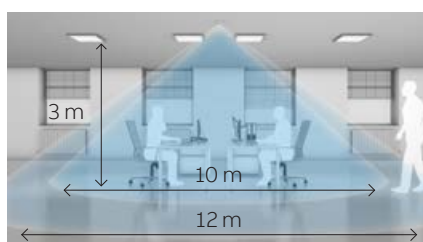



Busch-Watchdog Presence tech DualLINE	Busch-Watchdog Presence tech DualLINE
6813/11-24-500 & 6402 U-500 6813/11-183-500 & 6402 U-500	6813/11-24-500 & 6550 U-101-500 6813/11-183-500 & 6550 U-101-500
Master <sup>1)</sup>	Master <sup>1)</sup>
yes / yes / -	yes / yes / -
2.5 m / 3 m / 4 m	2.5 m / 3 m / 4 m
8 m / 10 m / -	8 m / 10 m / -
10 m / 12 m / 16 m	10 m / 12 m / 16 m
6 m / 7 m / 9 m	6 m / 7 m / 9 m
-	-
2	1
200 VA	-
200 VA	200 VA
2300 W	-
2300 W	-
2300 VA	-
2300 VA	700 VA
-	-
80 A / 20 ms	-
-	-
4 / -	4 / -
yes / - / -	- / - / -
yes	yes
yes, via IR remote control	yes, via IR remote control
6010-25	6010-25
-	-
yes	yes
yes	yes
32 mm / -	32 mm / -
-	-
51 mm	51 mm
IP 20	IP 20

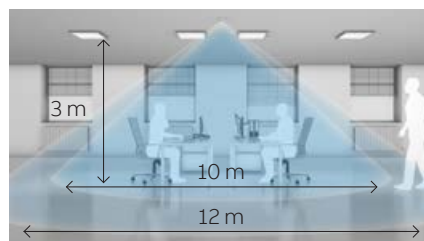
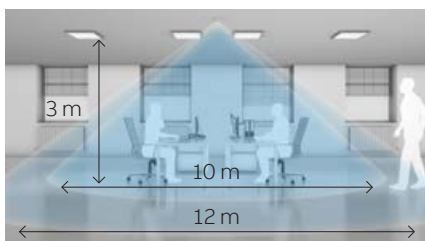

<sup>1)</sup> Slave version available.  
<sup>2)</sup> at 230 V~ main voltage.

## Technical data

### Busch-Watchdog outdoor



Products	Busch-Watchdog 70 MasterLINE	Busch-Watchdog 110 MasterLINE	Busch-Watchdog 220 MasterLINE	Busch-Watchdog 280 MasterLINE
Article number	6854 AGM-xxx-500	6855 AGM-xxx-500	6847 AGM-xxx-500, 6847 / 8 AGM-204-500, 6847 / 11 AGM-xxx-500	6867 AGM-xxx-500
Device type	-	-	220°	280°
Detection levels	4	4	4	4
Creep zone protection in the detection range	•	•	•	•
Coverage <sup>3</sup>	12 m frontal, 4 m lateral	12 m frontal, 4 m lateral	16 m frontal, 16 m lateral	16 m frontal, 16 m lateral
LED detection check	•	•	•	•
Light activation via break switch	•	•	•	•
Switching outputs	1 x non-isolated	1 x non-isolated	1 x non-isolated	1 x non-isolated
Back field detection	-	-	•	•
Remote operation via IR remote control, 6841-101-500	-	•	•	•
Remote parameterisable IR service remote control, 6842-101-500	-	•	•	•
Presence simulation via IR remote control	-	•	•	•
Continuous light switching (4 hours) via IR remote control	-	•	•	•
Continuous Off (4 hours) via IR remote control	•	•	•	-
Tripping delay	1 / 3 / 5 minutes	10 s to 30 minutes	10 s to 30 minutes	10 s to 30 minutes
Recommended mounting method	Screw-type terminals	Screw-type terminals	Wago screw terminals	Wago screw terminals
Twilight sensor	3 / 15 lux / ∞ (daytime operation)	3 lux / ∞ (daytime operation)	0.5 – 300 lux / ∞ (daytime operation)	0.5 – 300 lux / ∞ (daytime operation)
Mounting height	2.50 m	2.50 m	2.50 m	2.50 m
Dimensions (H x W x D)	100 x 125 x 33 mm	100 x 125 x 33 mm	115 x 125 x 141 mm	115 x 125 x 141 mm
Any type of loads	•	•	•	•
Suitable for wall and ceiling installation <sup>2</sup>	• / -	• / -	• / •	•
Additional functions	-	-	--	-

<sup>1</sup>) Depending on the switch actuator used.

<sup>2</sup>) The use of the corner adapter 6868-xxx-500 may depend on the mounting location.

<sup>3</sup>) Mounting height of 2.50 m.



<b>Busch-Watchdog 220 MasterLINE premium</b>	<b>Busch-Watchdog 220 WaveLINE</b>	<b>Busch-Watchdog 220 MasterLINE select</b>	<b>Busch-Watchdog 220 MasterLINE KNX</b>	<b>Busch-Watchdog 220 MasterLINE KNX premium</b>
6848 AGM-xxx-500	6747 AGM-xxx-500	6847 AGS-xxx-500	6179/01-xxx-500	6179/02-xxx-500
220°	220°	220°	220°	220°
4	4	1	4	4
-	•	•	•	•
16 m frontal, 16 m lateral	16 m frontal, 16 m lateral	16 m frontal, 16 m lateral	16 m frontal, 16 m lateral	16 m frontal, 16 m lateral
•	-	•	-	-
•	-	•	KNX	KNX
1 x non-isolated 1 x floating	- <sup>1</sup>	1 x non-isolated	2 movement channels	4 movement channels
•	•	-	•	•
•	-	•	-	With 6179-500
•	-	•	-	-
•	-	•	-	-
•	-	•	-	-
•	-	•	•	•
10 s to 30 minutes	10 s to 30 minutes <sup>1</sup>	10 s to 30 minutes	10 s to 18 hours	10 s to 18 hours
Wago screw terminals	Integrated battery compartment	Wago screw terminals	KNX screwless terminals	KNX screwless terminals
0.5 – 300 lux/ ∞ (daytime operation)	0.5 – 300 lux/ ∞ (daytime operation)	0.5 – 300 lux/ ∞ (daytime operation)	1 – 1,000 lux	1 – 80,000 lux
2.50 m	2.50 m	1.10 m – 1.50 m or 2.50 m	2.50 m	2.50 m
115 × 125 × 141 mm	115 × 125 × 141 mm	115 × 125 × 141 mm	115 × 125 × 141 mm	115 × 125 × 141 mm
•	-	•	-	-
•	•	•	•	•
-	-	-	3 x Twilight threshold	3 × Twilight /brightness threshold 3 × Temperature threshold 10 × Logic functions



---

# Furse® - Earthing, lightning and surge protection

<b>267</b>	<b>Introduction</b>
<b>268</b>	<b>Conductors</b>
<b>271</b>	<b>Earth bonds and clamps</b>
<b>273</b>	<b>Earth electrodes</b>
<b>275</b>	<b>Earth bars</b>
<b>277</b>	<b>Electronic systems protection - Surge Protective Devices (SPDs)</b>



For more detailed product information, please refer to our online technical brochures available at: [new.abb.com/low-voltage/support/documentation](http://new.abb.com/low-voltage/support/documentation)

or contact our sales team via email [LV.enquiries@gb.abb.com](mailto:LV.enquiries@gb.abb.com)

or call 0333 999 9933

# Introduction

## Lightning protection standard IEC/BS EN 62305

Within the field of lightning protection, developing a thorough understanding of IEC/BS EN 62305 is fundamental to ensure the design and implementation of safe systems against risk from lightning.

—  
\* We hope you find this guide useful and should you require assistance or advice, please do not hesitate to contact ABB.

This guide has been developed therefore to improve understanding of lightning protection and to help industry professionals, including M&E engineers, lightning protection designers and contractors, to navigate through the principles of IEC/BS EN 62305 in a practical and pragmatic manner, considering the diverse and often complicated recommendations therein.

In conjunction with our other Furse technical material, such as CPD accredited seminars and risk assessment software, this guide is presented with the following aims:

- To briefly explain the theory and phenomenon of lightning
- To précis, and simplify where possible the four parts of IEC/BS EN 62305
- To provide an introduction to the transient overvoltage protection requirements defined within IEC60364 / BS 7671
- To outline the importance of lightning protection component performance to IEC 62561, which follows on from former product standard, BS EN 50164

All standards are open to individual interpretation. This guide therefore reflects Furse's own views on good practice and it is not the intention that these views replace, in any way, the recommendations contained in the IEC/BS EN 62305 series, but rather to be read in conjunction with the standard.

### Development of the lightning protection standard

The International Electrotechnical Commission (IEC) is the body responsible for the recommendations and maintenance of IEC 62305, through its technical committee, TC 81. This committee includes many member countries including the UK. Additionally, the UK, as part of the European Union, is one of the 28 countries with membership of CEN (Comité Européen de Normalisation), which focuses on ensuring harmonisation of design and application standards throughout its member states.

**The electrical arm of CEN is CENELEC (CLC)**, and it is this committee which is responsible for compiling and producing standards relevant to lightning protection. In 2006, a four-part suite of standards on lightning protection was compiled by CENELEC under the reference number 62305 series.

The UK's **British Standards Institution (BSI)** adopted this CENELEC standard as its own British Standard (with minor amendments), and introduced BS EN 62305 in August 2006. A second edition of each of the four parts of BS EN 62305 was introduced in 2011/2012.

British Standard, BS EN 62305, is a national standard developed from the international standard, IEC 62305 in agreement with TC/81 and CENELEC. This approach has been followed by many other countries worldwide, which have introduced their own national standards, and therefore the content of this guide shall be equally of interest to those working in the lightning protection industry in those countries.

### Scope of IEC/BS EN 62305

IEC/BS EN 62305 considers lightning protection in much greater depth and detail than historic standards, such as BS 6651. Additionally, in two key areas, Part 2: Risk management and Part 4: Electrical and electronic systems within structures, it is radically different:

- **Part 2:** presents risk management in much greater detail and complexity and defines a single risk assessment process for protection against physical damage to structures, life hazard, and protection of electronic systems
- **Part 4:** is now a key part of the core IEC/BS EN 62305 standard with implementation driven by Part 2

# Conductors

Bare conductors, hard drawn and tinned conductors

## Bare copper tape

	Part no.	Conductor size (mm)
	TC005	12.5 x 1.5
	TC010	12.5 x 3
	TC015	20 x 1.5
	TC020	20 x 3
	TC020/100	20 x 3
	TC026-FU	25 x 2
	TC030	25 x 3
	TC030/50	25 x 3
	TC030-UL	1" x 1/8"
	TC035	25 x 4
	TC040	25 x 6
	TC042	30 x 3
	TC044	30 x 4
	TC043-FU	30 x 5
	TC045	31 x 3
	TC048	31.5 x 4
	TC050	31 x 6
	TC055	38 x 3
	TC060-FU	38 x 5
	TC065	38 x 6
	TC067	40 x 3
	TC066	40 x 4
	TC071	40 x 5
	TC068	40 x 6
	TC070	50 x 3
	TC075	50 x 4
	TC078	50 x 5
	TC080	50 x 6
	TC090	50 x 7
	TC092	50 x 8
TC093	75 x 6	
TC094	50 x 10	
TC096	60 x 10	
TC098	80 x 6	
TC099	100 x 6	

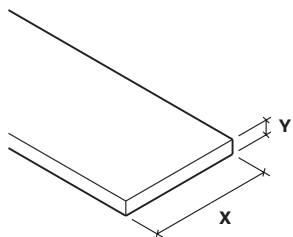

## Bare aluminium tape

	Part no.	Conductor size (mm)
	TA005	12.5 x 1.5
	TA020	20 x 3
	TA030	25 x 3
	TA040	30 x 3
	TA042	25 x 6
	TA068	40 x 6
	TA080	50 x 6

## Bare stranded copper cable

Part no.	Cross sectional area (mm <sup>2</sup> )
<b>Soft drawn stranded copper cable</b>	
CB016	16
CB025	25
CB035	35
CB050-FU	50
CB070	70
CB095	95
CB120-FU	120
CB150-FU	150
CB185	185
CB240	240
CB300-FU	300
CB400-FU	400
<b>Hard drawn stranded copper cable</b>	
CB071	70



## Bare & tinned solid circular

Part no.	Diameter (mm)
<b>Copper conductor</b>	
CD035	Ø 8
<b>Aluminium conductor</b>	
CD080	Ø 8
<b>Tinned copper conductor</b>	
CD235	Ø 8

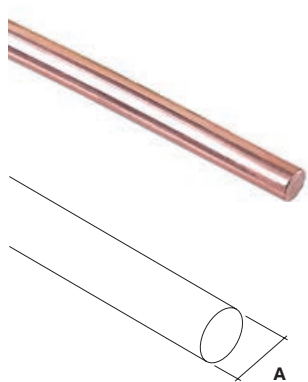

## Hard drawn copper bar

Part no.	Overall nominal size (mm)
BA205	25 x 3
BA210	25 x 6
BA225	38 x 6
BA230	50 x 6
BA235	50 x 10
BA240	75 x 6
BA250-FU	100 x 6



## Conductors

### PVC and LSOH covered conductors

#### PVC covered copper tape



Part no.	Conductor size (mm)	Colour range
TC100-FU	12.5 x 1.5	Black
TC105-FU	25 x 3	Black
TC105/50	25 x 3	Black
TC110	25 x 3	Green
TC110/50	25 x 3	Green
TC115-FU	25 x 3	Grey
TC115/50	25 x 3	Grey
TC116-FU	25 x 3	Dark grey
TC116/25	25 x 3	Dark grey
TC120-FU	25 x 3	Stone
TC120/50	25 x 3	Stone
TC125-FU	25 x 3	White
TC125/50	25 x 3	White
TC130	25 x 3	Brown
TC130/50	25 x 3	Brown
TC140-FU	25 x 6	Green
TC145	50 x 6	Green

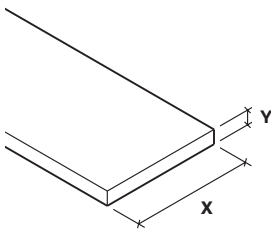

#### PVC covered aluminium tape



Part no.	Conductor size (mm)	Colour range
TA105	25 x 3	Black
TA110	25 x 3	Green
TA115	25 x 3	Grey
TA120	25 x 3	Stone
TA125	25 x 3	White
TA130	25 x 3	Brown
TA140	25 x 6	Green

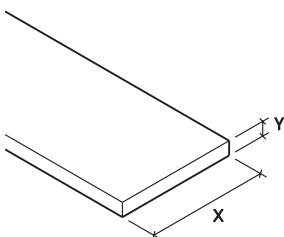

#### Green & yellow PVC covered copper tape



Part no.	Conductor size (mm)
TC111-FU	25 x 3
TC111/50	25 x 3

#### Green LSOH covered copper tape

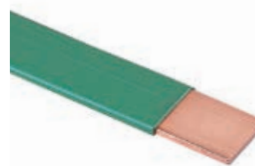

Part no.	Conductor size (mm)
TC910	25 x 3
TC910/50	25 x 3
TC940	25 x 6
TC980	50 x 6

#### Green & yellow PVC insulated stranded copper cable



Part no.	Cross-sectional area (mm <sup>2</sup> )
CC016	16
CC025	25
CC035	35
CC050	50
CC070	70
CC095	95
CC120-FU	120
CC150-FU	150
CC185	185
CC240	240
CC300	300
CC400-FU	400

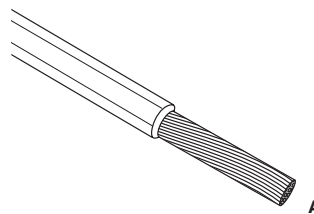

# Conductor network

## Conductor clips & clamps

### Tape clip

Part no.	Conductor width (mm)	Conductor thickness (mm)
<b>For use with bare copper</b>		
CP205	20	3
CP210	25	3-4
CP220	25	5-6
CP230	30-32	3-4
CP235	30-32	5-6.5
CP240	38-40	3-4
CP245	38-40	5-6.5
CP255	50	3-4
CP260	50	5-6.5
<b>For use with PVC covered copper</b>		
CP215	25	3-4
CP225	25	6
CP265	50	6
<b>For use with lead covered copper</b>		
CP305	25	3
<b>For use with bare aluminium</b>		
CP105	20	3
CP110	25	3-4
CP125	50	6
<b>For use with PVC covered aluminium</b>		
CP115	25	3
CP130	50	6



### Pressed tape clip

Part no.	Conductor size (mm)
<b>For use with bare copper</b>	
CP510	20 x 3
CP515	25 x 3
<b>For use with bare aluminium</b>	
CP405	20 x 3
CP410	25 x 3
CP415	25 x 6
<b>For use with PVC covered tape</b>	
CP517	25 x 3



### Non-metallic tape clip

Part no.	Conductor size (mm)	Colour
<b>For use with bare tape</b>		
CP005	20 x 3	Brown
CP010	20 x 3	Grey
CP015	25 x 3	Brown
CP020	25 x 3	Grey
CP065	50 x 6	Brown
<b>For use with PVC covered tape</b>		
CP025	25 x 3	Brown
CP030	25 x 3	Black
CP033	25 x 3	Dark grey
CP035	25 x 3	Green
CP040	25 x 3	Grey
CP045	25 x 3	Stone
CP050	25 x 3	White



### Square tape clamp

Part no.	Conductor size (mm)	Conductor material
CT105-H	25 x 3	Copper
CT110-H	25 x 6	Copper
CT115-H	50 x 6	Copper
CT005-H	25 x 3	Aluminium
CT010	25 x 6	Aluminium

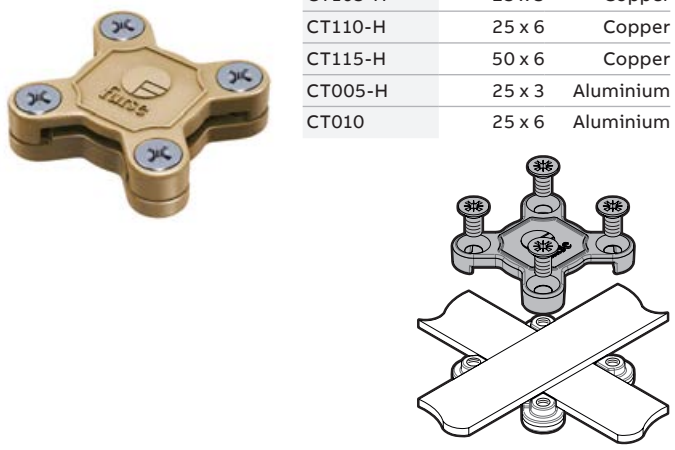

### Cable to tape square clamp

Part no.	Conductor size	Conductor material
CT125-FU	25 x 3 mm to 50 mm <sup>2</sup>	Copper
CT130-FU	25 x 3 mm to 70 mm <sup>2</sup>	Copper
CT135-FU	25 x 3 mm to 95 mm <sup>2</sup>	Copper

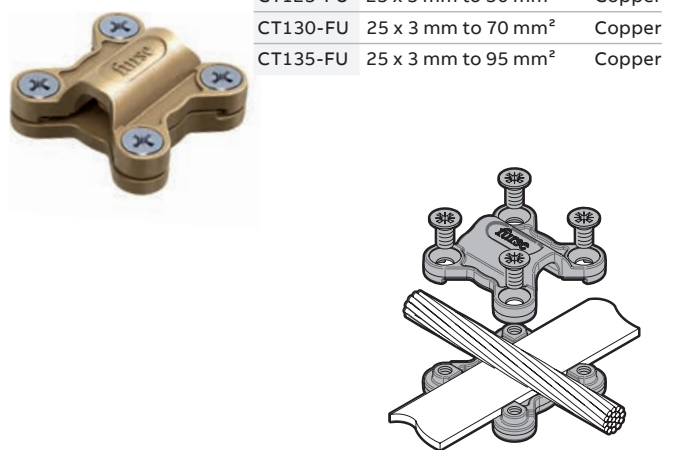

## Conductor network

### Conductor clamps

#### Crossover tape clamp

Part no. Conductor	Conductor size (mm)	Conductor material
CX105-H	25 x 3	Copper
CX005-H	25 x 3	Aluminium

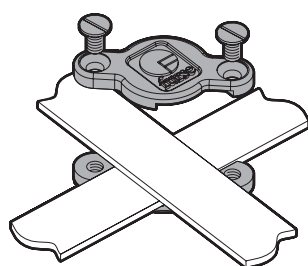

#### Test / Junction clamp

Part no.	Conductor size (mm)	Conductor material
CN105-H	26 x 8	Copper
CN005	26 x 8	Aluminium

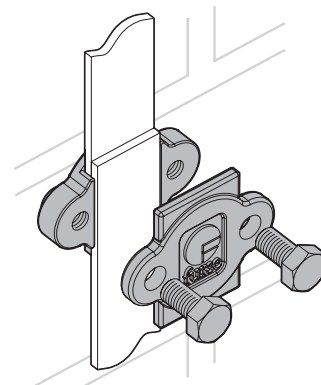

## Earth bonds and clamps

### Mechanical clamps

#### Rod to tape clamp (type A)

Part no.	Nominal rod diameter		Max. conductor (mm)
	(in)	(mm)	
CR105	Ø ½	Ø 12.7	26 x 12
	Ø ½	Ø 16	26 x 12
	Ø ¾	Ø 20	26 x 10
CR108	Ø ⅝	Ø 16	30 x 2
	Ø ¾	Ø 20	30 x 2
CR110	Ø ⅝	Ø 16	40 x 12
CR115	Ø ⅝	Ø 16	51 x 8
CR125	Ø ¾	Ø 20	51 x 12
CR130	Ø ½	Ø 12.7	26 x 20
	Ø ⅝	Ø 16	26 x 18
	Ø ¾	Ø 20	26 x 10
	Ø 1	Ø 25	26 x 10

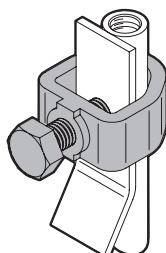

#### Rod to cable clamp (type G)

Part no.	Nominal rod diameter		Max. conductor (mm²)
	(in)	(mm²)	
CR505	Ø ⅜	Ø 9.5	6-35
CR510-FU	Ø ½	Ø 12.7	16-50
CR515	Ø ⅝	Ø 16	16-70
CR520	Ø ¾	Ø 20	35-95
CR525	Ø 1	Ø 25	70-150

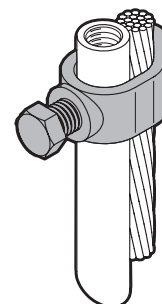



# Earth bonds and clamps

## Mechanical clamps

### 'U' bolt rod clamp (type E)

Part no.	Nominal rod/rebar diameter (mm)	Tape width (mm)
CR305	Ø 14 - 25	-
CR320	Ø 14 - 25	25
CR325	Ø 26 - 40	-
CR326	Ø 26 - 40	25
CR330	Ø 41 - 50	-

### 'U' bolt rod clamp (type GUV)

Part no.	Nominal rod/rebar diameter (mm)	Conductor range (mm <sup>2</sup> )
CR700	Ø 12 - 20	16-70
CR705	Ø 12 - 20	70-150
CR710	Ø 25	16-70
CR740	Ø 12 - 27	185-300
CR750	Ø 25	70-150
CR750	Ø 25	150-300

### Rod to cable clamp (type B)

Part no.	Nominal rod diameter		Rod type
	(in)	(mm)	
CR205	Ø 3/8	Ø 9.5	Copperbond
CR215	Ø 5/8	Ø 16	Copperbond
CR220	Ø 5/8	Ø 15	Solid copper
CR225	Ø 3/4	Ø 20	Copperbond
CR230	Ø 3/4	Ø 20	Solid copper

### B bond

Part no.	Max tape width (mm)	Conductor material
BN105	26	Copper
BN005	26	Aluminium
BN113	31	Copper
BN114	40	Copper
BN117	50	Copper

## Earth electrodes

### Earth rod and earth rod seal

#### Threaded copperbond earth rod



Part no.	Nominal diameter (in)	Length (mm)
RB105	Ø ½	1,200
RB110	Ø ½	1,500
RB115	Ø ½	1,800
RB125	Ø ½	2,400
RB205-FU	Ø 5/8	1,200
RB210	Ø 5/8	1,500
RB215	Ø 5/8	1,800
RB220-FU	Ø 5/8	2,100
RB225	Ø 5/8	2,400
RB235	Ø 5/8	3,000
RB305	Ø ¾	1,200
RB310	Ø ¾	1,500
RB315	Ø ¾	1,800
RB320-FU	Ø ¾	2,100
RB325	Ø ¾	2,400
RB335	Ø ¾	3,000

#### Fittings (threaded)



Part no.	Type
CG170	½" Coupling
CG270	5/8" Coupling
CG370	¾" Coupling
ST100	½" Driving stud
ST200	5/8" Driving stud
ST300	¾" Driving stud

#### Earth rod seal



Part no.	Type
<b>Earth rod seal assembly</b>	
ES300	Earth rod seal and membrane seal
<b>Earth rod seal pack</b>	
ES300-12	Seal pack for ½" (Ø 12.7 mm) Copperbond rod
ES300-58	Seal pack for 5/8" (Ø 14.2 mm) Copperbond rod
ES300-34	Seal pack for ¾" (Ø 17.2 mm) Copperbond rod
ES300-15	Seal pack for Ø 15 mm solid copper rod
ES300-16	Seal pack for Ø 16 mm stainless steel rod
ES300-20	Seal pack for Ø 20 mm solid copper rod
<b>Earth rod seal tube</b>	
ES310-03	Seal tube, 300 mm length
ES310-05	Seal tube, 500 mm length
ES310-10	Seal tube, 1,000 mm length
ES310-15	Seal tube, 1,500 mm length
ES310-20	Seal tube, 2,000 mm length
ES310-30	Seal tube, 3,000 mm length
<b>Accessory spanner set</b>	
ES320	Membrane seal torque spanner set

## Earth electrodes

Inspection pits, plate, lattice, backfill materials

### FurseCEM® conductive aggregate

Order Code	Description	Weight (kg)
CM035	FurseCEM®	25kg
CM040	FurseCEM® Premix*	25kg
CM045	FurseCEM® Low Density	25kg
CM050	FurseCEM® Low Density Premix*	25kg



### Concrete inspection pit

Order Code	Description
PT005	Concrete inspection pit
Accessories	
PT006	5 hole earth bar
PT007	7 hole earth bar



### Bentonite moisture retaining clay

Order Code	Description	Weight (kg)
CM015	Bentonite powder	25kg
CM020	Bentonite granules	25kg



### Earth plate (solid copper)

Order Code	Size (mm)
PE005	600 x 600 x 1.5
PE015	900 x 900 x 1.5
PE010	600 x 600 x 3
PE020	900 x 900 x 3



### Lightweight inspection pit

Order Code	Description
PT205	Lightweight inspection pit with grey polymer lid
PT004	5 hole earth bar
Accessories for polymer lid	
AK005	6 mm Allen key
Accessories for concrete lid	
JH100	M8 x 100 mm long mild steel 'J' bolt lifting hook
AS100	M8 x 60 stainless steel Allen caphead screw (2 per lid)



### Earth mat (lattice copper)

Order Code	Size (mm)
PE110	600 x 600 x 3
PE120	900 x 900 x 3



# Earth bonds and clamps

## Earth bars

### Earth bar

Part no.	Description	Length (mm)
<b>Copper earth bar</b>		
LK245-6	6 way	400
LK245-8	8 way	500
LK245-10	10 way	650
LK245-12	12 way	750
LK245-14	14 way	850
LK245-16	16 way	950
LK245-18	18 way	1,050
LK245-20	20 way	1,200
LK245-22	22 way	1,300
LK245-24	24 way	1,400
LK245-26	26 way	1,500
LK245-28	28 way	1,650
LK245-30	30 way	1,750
<b>Tinned copper earth bar</b>		
LK245-6-T	6 way	400
LK245-8-T	8 way	500
LK245-10-T	10 way	650
LK245-12-T	12 way	750
LK245-14-T	14 way	850
LK245-16-T	16 way	950
LK245-18-T	18 way	1,050
LK245-20-T	20 way	1,200
LK245-22-T	22 way	1,300
LK245-24-T	24 way	1,400
LK245-26-T	26 way	1,500
LK245-28-T	28 way	1,650
LK245-30-T	30 way	1,750
<b>Earth Bar with stainless steel fixings</b>		
<b>Copper earth bar</b>		
LK245-6SS	6 way	400
LK245-8SS	8 way	500
LK245-10SS	10 way	650
LK245-12SS	12 way	750
<b>Tinned copper earth bar</b>		
LK245-6TSS	6 way	400
LK245-8TSS	8 way	500
LK245-10TSS	10 way	650
LK245-12TSS	12 way	750

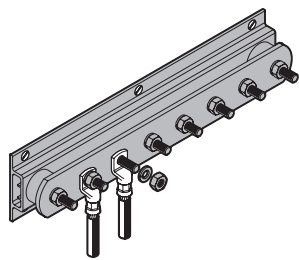

### Earth bar with single disconnecting link

Part no.	Description	Length (mm)
<b>Copper earth bar</b>		
LK243-6	6 way	475
LK243-8	8 way	575
LK243-10	10 way	725
LK243-12	12 way	825
LK243-14	14 way	925
LK243-16	16 way	1,025
LK243-18	18 way	1,125
LK243-20	20 way	1,275
LK243-22	22 way	1,375
LK243-24	24 way	1,475
LK243-26	26 way	1,575
LK243-28	28 way	1,725
LK243-30	30 way	1,825
<b>Tinned copper earth bar</b>		
LK243-6-T	6 way	475
LK243-8-T	8 way	575
LK243-10-T	10 way	725
LK243-12-T	12 way	825
LK243-14-T	14 way	925
LK243-16-T	16 way	1,025
LK243-18-T	18 way	1,125
LK243-20-T	20 way	1,275
LK243-22-T	22 way	1,375
LK243-24-T	24 way	1,475
LK243-26-T	26 way	1,575
LK243-28-T	28 way	1,725
LK243-30-T	30 way	1,825
<b>Earth Bar with stainless steel fixings and single disconnecting link</b>		
<b>Copper earth bar</b>		
LK243-6SS	6 way	475
LK243-8SS	8 way	575
LK243-10SS	10 way	725
LK243-12SS	12 way	825
<b>Tinned copper earth bar</b>		
LK243-6TSS	6 way	475
LK243-8TSS	8 way	575
LK243-10TSS	10 way	725
LK243-12TSS	12 way	825

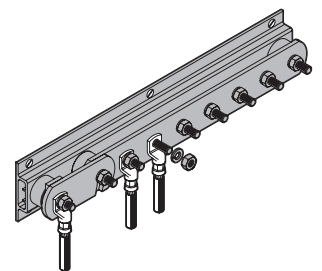

# Earth bonds and clamps

## Earth bars

### Earth bar with twin disconnecting link

Part no.	Description	Length (mm)
<b>Copper earth bar</b>		
LK207-6	6 way	550
LK207-8	8 way	650
LK207-10	10 way	800
LK207-12	12 way	900
LK207-14	14 way	1,000
LK207-16	16 way	1,100
LK207-18	18 way	1,200
LK207-20	20 way	1,350
LK207-22	22 way	1,450
LK207-24	24 way	1,550
LK207-26	26 way	1,650
LK207-28	28 way	1,800
LK207-30	30 way	1,900
<b>Tinned copper earth bar</b>		
LK207-6-T	6 way	550
LK207-8-T	8 way	650
LK207-10-T	10 way	800
LK207-12-T	12 way	900
LK207-14-T	14 way	1,000
LK207-16-T	16 way	1,100
LK207-18-T	18 way	1,200
LK207-20-T	20 way	1,350
LK207-22-T	22 way	1,450
LK207-24-T	24 way	1,550
LK207-26-T	26 way	1,650
LK207-28-T	28 way	1,800
LK207-30-T	30 way	1,900
<b>Earth Bar with stainless steel fixings and twin disconnecting links</b>		
<b>Copper earth bar</b>		
LK207-6SS	8 way	550
LK207-8SS	10 way	650
LK207-10SS	12 way	800
LK207-12SS	14 way	900
<b>Tinned copper earth bar</b>		
LK207-6TSS	6 way	550
LK207-8TSS	8 way	650
LK207-10TSS	10 way	800
LK207-12TSS	12 way	900

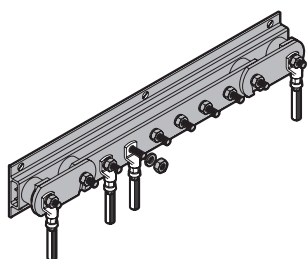

### Earth bar accessories

Part no.	Description
<b>Copper earth bar</b>	
LK004	Swan-neck link
LK205	Disconnecting link
<b>Tinned copper earth bar</b>	
LK004-T	Swan-neck link
LK205-T	Disconnecting link

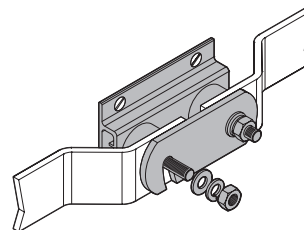
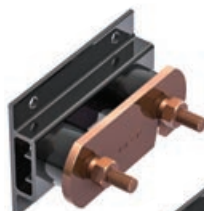





## Electronic systems protection

### Surge protection devices (SPDs) for mains power supplies

#### Mains supplies - equipotential bonding

	Part no.	Description
	ESP 415T1/25/TNS	ESP Type 1 power SPD for 3 Phase 400V, 25kA 10/350, 4 modes
	ESP 415T1/25/TNC	ESP Type 1 power SPD for 3 Phase 400V, 25kA 10/350, 3 modes
	ESP 415T1/25/TT	ESP Type 1 power SPD for 3 Phase 400V, 25kA (L-N) + 100kA (N-E) 10/350, 3+1 modes
	ESP 415T1/12.5/TNS	ESP Type 1 power SPD for 3 Phase 400V, 12.5kA 10/350, 4 modes
	ESP 415T1/12.5/TNC	ESP Type 1 power SPD for 3 Phase 400V, 12.5kA 10/350, 3 modes
	ESP 415T1/12.5/TT	ESP Type 1 power SPD for 3 Phase 400V, 12.5kA (L-N) + 50kA (N-E) 10/350, 3+1 modes
	ESP 240T1/25/TNS	ESP Type 1 power SPD for 1 Phase 400V, 25kA 10/350, 2 modes
	ESP 240T1/25/TNC	ESP Type 1 power SPD for 1 Phase 400V, 25kA 10/350, 1 mode
	ESP 240T1/25/TT	ESP Type 1 power SPD for 1 Phase 400V, 25kA (L-N) + 100kA (N-E) 10/350, 1+1 modes
	ESP 415T2/50/TNS	ESP Type 2 power SPD for 3 Phase 400V, 50kA 8/20, 4 modes
	ESP 415T2/50/TNC	ESP Type 2 power SPD for 3 Phase 400V, 50kA 8/20, 3 modes
	ESP 415T2/50/TT	ESP Type 2 power SPD for 3 Phase 400V, 50kA (L-N) + 65kA (N-E) 8/20, 3+1 modes
	ESP 240T2/50/TNS	ESP Type 2 power SPD for 1 Phase 400V, 50kA 8/20, 2 modes
	ESP 240T2/50/TNC	ESP Type 2 power SPD for 1 Phase 400V, 50kA 8/20, 1 mode
	ESP 240T2/50/TT	ESP Type 2 power SPD for 1 Phase 400V, 50kA (L-N) + 65kA (N-E) 8/20, 1+1 modes

#### Mains supplies - DIN housing

	Part no.	Description
	ESP 240 D1	Enhanced Type 1+2+3 Full Mode power SPD for 240V Single Phase supplies, Din Rail mounted
	ESP 415 D1	Enhanced Type 1+2+3 Full Mode power SPD for 415V 3 Phase supplies, Din Rail mounted
	<b>Supplied with remote indication display</b>	
	ESP 415 D1R	Enhanced Type 1+2+3 Full Mode power SPD for 3 Phase 415V supplies, LED status indication on remote display, Din Rail mounting
	ESP RLA HD-4	4 Metre display lead for ESP D1R Series

#### Mains supplies (extra high maximum surge currents)

	Part no.	Description
	ESP 415 M2	Enhanced Type 1+2+3 Full Mode power SPD for 3 Phase 415V supplies, high surge current rating
	ESP 415 M4	Enhanced Type 1+2+3 Full Mode power SPD for 3 Phase 415V supplies, very high surge current rating

#### Mains supplies & power distribution system

	Part no.	Description
	ESP 240 M1	Enhanced Type 1+2+3 power SPD for 240V Single Phase supplies
	ESP 415 M1	Enhanced Type 1+2+3 power SPD for 415V 3 Phase supplies

#### Sub-distribution board

	Part no.	Description
	ESP 240CD40	Compact Type 2+3 SPD for 240V Single Phase supplies
	ESP 415CD40	Compact Type 2+3 SPD for 415V Single Phase supplies

#### Mains protectors for specific systems

	Part no.	Description
	ESP 240CDT2/40/TT	Compact Type 2 SPD for 240V residential consumer units
	ESP 415CDT2/40/TT	Compact Type 2 SPD for 415V residential consumer units



## Electronic systems protection

### Surge protection devices (SPDs) for mains power supplies

#### Mains supplies - with remote display indication



Part no.	Description
ESP 415 M1R	Enhanced Type 1+2+3 power SPD for 3 Phase 415V supplies, with remote indication display
ESP 415 M2R	Enhanced Type 1+2+3 power SPD for 3 Phase 415V supplies, 12.5KA 10/350, with remote indication display
ESP 415 M4R	Enhanced Type 1+2+3 power SPD for 3 Phase 415V supplies, 25KA 10/350, with remote indication display
ESP RLA-4	4 Metre display lead for ESP M1R, M2R and M4R Series

#### Mains supplies & fused connections up to 10 amps or up to 32 amps



Part no.	Description
<b>Protectors rated at 10 amps or less</b>	
ESP 240D-10A	Enhanced mains SPD for 240V supplies up to 10A, with LED status indication
ESP 240DS-10A	Enhanced mains SPD for 240V supplies up to 10A, with LED status indication and remote signal contact
<b>Protectors rated at 32 amps or less</b>	
ESP 240D-32A	Enhanced mains SPD for 240V supplies up to 32A, with LED status indication
ESP 240DS-32A	Enhanced mains SPD for 240V supplies up to 32A, with LED status indication and remote signal contact

#### Mains supplies & fused connections up to 5 amps or up to 16 amps



Part no.	Description
<b>Protectors rated at 5 amps or less</b>	
ESP 240-5A	Enhanced mains SPD for 240V supplies up to 5A
ESP 240-5A/BX	Enhanced mains SPD for 240V supplies up to 5A, IP66 enclosure
<b>Protectors rated at 16 amps or less</b>	
ESP 240-16A	Enhanced mains SPD for 240V supplies up to 16A
ESP 240-16A/BX	Enhanced mains SPD for 240V supplies up to 16A, IP66 enclosure
ESP 240T3/SKT	Type 3 mains SPD for supplies up to 16A for installation behind socket outlets

#### Plug-in SPD for mains power supplies, with telephone and computer line protection options



Part no.	Description
ESP MC/19BK	Brackets and fixings for mounting ESP MC SPD Series To 19" racks
ESP MC	Plug-in power SPD with filtering for 220-240V systems up to 13A with UK plug
ESP MC/TN/RJ11	Plug-in power SPD with filtering for 220-240V systems up to 13A with UK plug and data SPD for telecom systems with RJ11 connection
ESP MC/Cat-5e	Plug-in power SPD with filtering for 220-240V systems up to 13A with UK plug and data SPD for Cat-5E computer systems with RJ45 connection

## Electronic systems protection

Surge protection devices (SPDs) for data, signal and telephone lines

### Twisted pair data communication & signal lines (lower in-line resistance, higher current and higher bandwidth)

	Part no.	Description
	ESP 06E	Data SPD for 2-Wire signal lines up to 6V, 1.25A
	ESP 15E	Data SPD for 2-Wire signal lines up to 15V, 1.25A
	ESP 30E	Data SPD for 2-Wire signal lines up to 30V, 1.25A
	ESP 50E	Data SPD for 2-Wire signal lines up to 50V, 1.25A
	ESP 110E	Data SPD for 2-Wire signal lines up to 110V, 1.25A

### Twisted pair data communication, signal & telecom lines - slim line, with removable protection module

	Part no.	Description	
	ESP SLTN	Data SPD for 2-Wire telephone lines up to 296V (ringing voltage)	
	<b>Slim line protectors with removable protection module, LED status indication and isolated screen</b>		
	ESP SL06L/I	Data SPD for 2-Wire signal lines up to 6V, 750mA	
	ESP SL15L/I	Data SPD for 2-Wire signal lines up to 15V, 750mA	
	ESP SL30L/I	Data SPD for 2-Wire signal lines up to 30V, 750mA	
	ESP SL50L/I	Data SPD for 2-Wire signal lines up to 50V, 750mA	
	ESP SL110L/I	Data SPD for 2-Wire signal lines up to 110V, 750mA	
	<b>Slim line SPD for 4-20mA current loops with removable protection module, LED status indication and isolated screen</b>		
	ESP SL30L/4-20/I	Data SPD for 4-20mA signal lines up to 30V, 75mA	

### High density data, signal & telephone lines (/PT fast fit Push Terminal option)

	Part no.	Description
	ESP 06Q or ESP 06Q/PT	Data SPD for 8-Wire (4 pairs) 6V signal lines space saving design
	ESP 15Q or ESP 15Q/PT	Data SPD for 8-Wire (4 pairs) 15V signal lines space saving design
	ESP 30Q or ESP 30Q/PT	Data SPD for 8-Wire (4 pairs) 30V signal lines space saving design
	ESP 50Q or ESP 50Q/PT	Data SPD for 8-Wire (4 pairs) 50V signal lines space saving design
	ESP 110Q or ESP 110Q/PT	Data SPD for 8-Wire (4 pairs) 110V signal lines space saving design
	ESP 180Q or ESP 180Q/PT	Data SPD for 8-Wire (4 pairs) 180V signal lines space saving
	ESP TNQ or ESP TNQ/PT	Data SPD for 4 twisted pair phone lines with a maximum (ringing) voltage of 296 volts

### Three wire RTD applications

	Part no.	Description
	ESP RTD	Data SPD for three 3-Wire RTD systems
	ESP SL RTD	Slim Line Data SPD for 3-Wire RTD systems
	ESP RTDQ	Data SPD for three of 3-Wire RTD systems space saving design

### RS485 & Fieldbus applications

	Part no.	Description
	ESP RS485	Data SPD for RS485 signalling systems
	ESP SL RS485	Slim Line Data SPD for RS485 signal lines
	ESP RS485Q	Data SPD for 8-Wire (4 pairs) RS485 signal lines space saving design
	ESP RS485Q/PT	

## Electronic systems protection

### Surge protection devices (SPDs) for computer and telephone lines

#### Plug-in protectors for telephone & ISDN lines

	Part no.	Description
	ESP TN/JP	Data SPD for telephone line with BT UK connection
	ESP TN/RJ11-6/6	Data SPD for 6-Wire telephone line with RJ11 connection
	ESP ISDN/RJ45-8/8	Data SPD for 8-Wire ISDN telephone line, RJ45 connector
	ESP MC/TN/RJ11 Series	Power + Data SPD - UK 3 Pin plug sockets and RJ11 connection

#### PSTN & ISDN telephone lines with LSA-PLUS connections

	Part no.	Description
	ESP KE10	Earth connection bar for up to 10 of ESP KT1 data SPDs for LSA-PLUS PBX systems
	ESP KT1	Data SPD for one LSA-PLUS PBX phone line, use with ESP KE10 earth bar
	ESP K10T1	Data SPD for 10 LSA-PLUS PBX telephone lines

#### Computer networks up to Cat-6 cabling & PoE+

	Part no.	Description
	ESP Cat-6	Data SPD for Cat-6 1000 Base T computer networks, RJ45 connector
	ESP Cat-6/PoE	Data SPD for Cat-6 1000 Base T computer networks with Power over Ethernet, RJ45 connector
	ESP MC/Cat-5 Series	Power + Data SPD - UK 3 Pin plug sockets and RJ45 connection

## Electronic systems protection

### Surge protection devices (SPDs) for specific systems

#### Mains supplies - wind turbine (WT) power distribution systems



Part no.	Description
ESP 690/25/WT	Type 1+2 power SPD for wind turbine systems, 25kA 10/350
ESP 690/12.5/WT	Type 1+2 power SPD for wind turbine systems, 12.5kA 10/350
ESP CE7	Connection and earthing bar for use with 3 of ESP 690/12.5/WT protectors for TNC systems
ESP CE9	Connection and earthing bar for use with 4 of ESP 690/12.5/WT protectors for TNS systems
ESP CE10	Connection and earthing bar for use with 3 of ESP 690/25/WT protectors for TNC systems
ESP CE13	Connection and earthing bar for use with 4 of ESP 690/25/WT protectors for TNS systems

#### DC photo-voltaic (PV) power distribution systems



Part no.	Description
ESP DC1100T1/12.5	Type 1+2 power SPD for 1100Vdc PV supplies, 12.5kA 10/350 surge current rating
ESP DC1500T1/12.5	Type 1+2 power SPD for 1500Vdc PV supplies, 12.5kA 10/350 surge current rating
ESP DC1100T2/40	Type 2 power SPD for 1100Vdc PV supplies, 40kA 8/20 surge current rating
ESP DC1500T2/30	Type 2 power SPD for 1500Vdc PV supplies, 40kA 8/20 surge current rating

#### Coaxial cable TV (CATV) systems



Part no.	Description
ESP CATV/F	Data SPD for Cable TV 5-860Mhz with F Type connector
ESP TV/F	Data SPD for TV 5-860Mhz with F Type connector
ESP TV/EURO	Data SPD for TV 5-860Mhz with Euro-TV connector
ESP MATV/F	Data SPD for main antenna TV MATV 5-2450Mhz with F Type connector
ESP SMATV/F	Data SPD for satellite main antenna TV SMATV 860-2450Mhz with F Type connector

#### Coaxial RF systems (for frequencies between DC and up to 3.5 GHz)



Part no.	Description
ESP RF/N	ESP RF Series data SPD, N bulkhead female (LINE) / N male (CLEAN) connectors
ESP RF/DIN	ESP RF Series data SPD, 7/16 DIN bulkhead female (LINE) / 7/16 DIN male (CLEAN) connectors
ESP RF/BNC	ESP RF Series data SPD, BNC bulkhead female (LINE) / BNC male (CLEAN) connectors
ESP RF/TNC	ESP RF Series Data SPD, TNC bulkhead female (LINE) / TNC male (CLEAN) connectors
ESP RF/SMA	ESP RF Series Data SPD, SMA bulkhead female (LINE) / SMA male (CLEAN) connectors

#### Closed circuit TV video lines



Part no.	Description
ESP CCTV/B	Data SPD for CCTV systems with BNC connection for Coax cable
ESP CCTV/T	Data SPD for CCTV systems with twisted pair cables

## Electronic systems protection

### Accessories

#### Weatherproof enclosures

Part no.	Description
WBX 2/G	IP66 Enclosure for 2 single stud ESP D/E/H data SPDs or ESP TN telecom SPD, grey lid
WBX 3	IP67 Enclosure for 3 single stud data SPDs or ESP Single Phase M1 mains SPD, clear lid
WBX 3/G	IP67 Enclosure for 3 single stud data SPDs, grey lid
WBX 4	IP66 Enclosure for ESP 415 M1, ESP 208 M1 or ESP 480 M1 or 4 single stud ESP data/telecom
WBX 4/GS	IP66 Enclosure for 4 single stud ESP data/telecom SPDs using CME4 earth bar, grey lid, security screws
WBX 8	IP66 Enclosure for 8 single stud ESP data/telecom SPDs using CME8 earth bar, grey lid
WBX 8/GS	IP66 Enclosure for 8 single stud ESP data/telecom SPDs using CME8 earth bar, grey lid, security screws
WBX 16/2/G	IP56 Enclosure for 1 or 2 CME16 earth bars for mounting and enclosing up to
WBX D4	IP65 Enclosure for 72mm DIN (4TE)
WBX D8	IP65 Enclosure for 144mm DIN (8TE)
WBX M2	IP67 Enclosure for ESP 415 M2 or ESP 480 M2, clear lid
WBX M4	IP67 Enclosure for ESP 415 M2 or ESP 480 M2, clear lid
WBX SLQ	IP66 Enclosure for up to 15 of ESP SL Series, or up to 6 of ESP Q Series, clear lid
WBX SLQ/G	IP66 Enclosure for up to 15 of ESP SL Series, or up to 6 of ESP Q Series, grey lid

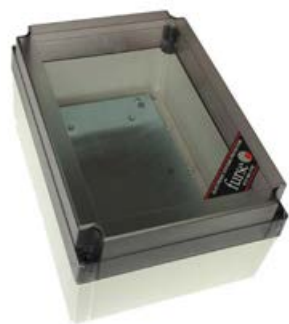

#### Metallic enclosures

Part no.	MBX D4	MBX D8
<b>Dimensions (mm)</b>		
Length: – External	268	268
Width: – External	134	208
Depth: – External	104	104
Fixing centres (mm):	201 x 66.5 (3 holes)	201 x 137
IP Rating:	IP20	IP20
Temperature range:	-40 to +80°C	-40 to +80°C
Product available width:	73.5mm (4TE)	146mm (8TE)



#### Combined mounting & earthing kits

Part no.	Description
CME 4	4 Hole combined mounting earthing kit
CME 8	8 Hole combined mounting earthing kit
CME 16	16 Hole combined mounting earthing kit
CME 32	32 Hole combined mounting earthing kit









---

# Commercial/ Industrial enclosures

<b>285</b>	<b>IP65 SR2 enclosures</b>
<b>287</b>	<b>IP66 SRX enclosures</b>
<b>289</b>	<b>IP66 Gemini enclosures</b>
<b>291</b>	<b>Mistral 65 double insulated enclosures</b>
<b>294</b>	<b>ARIA universal polyester enclosures</b>
<b>296</b>	<b>APO polyester boxes</b>
<b>298</b>	<b>Europa series IP44, IP55 and IP65 thermoplastic enclosures</b>
<b>300</b>	<b>Europa series IP65 polycarbonate enclosures</b>



For more detailed product information, please refer to our online technical brochures available at: [new.abb.com/low-voltage/support/documentation](http://new.abb.com/low-voltage/support/documentation)

or contact our sales team via email [LV.enquiries@gb.abb.com](mailto:LV.enquiries@gb.abb.com)

or call 0333 999 9933

## SR2 Enclosures

IP65 Sheet steel enclosures





### Rapid selection table

Overall Dimensions			Enclosures with blind door + back plate		Kit for automation			Kit for distribution			
Height mm	Width mm	Depth mm	Enclosures with blind door + back plate	with glazed door*	Blind counter door	Back plate	No. vertical mod. H=185mm	No. DIN mod. per row	Total modules	DIN Supports	
300	200	150	SRN3215K								
	300		SRN3315K								
	400		SRN3415K								
400	300	150	SRN4315K								
	300		SRN4320K								
	400	200	SRN4420K								
	600		SRN4620K								
500	300	200	SRN5320K								
	400		SRN5420K	SRN5420VK*	KC5040K	PF5040	2	14	28	KD5040K	
	500		SRN5520K								
	400		SRN5425K	SRN5425VK*	KC5040K	PF5040	2	14	28	KD5040K	
	400		SRN6420K	SRN6420VK*	KC6040K	PF6040	3	14	42	KD6040K	
600	500	200	SRN6520K								
	600		SRN6620K								
	400		SRN6425K	SRN6425VK*	KC6040K	PF6040	3	14	42	KD6040K	
	500		SRN6520K								
	600		SRN6625K								
	600		SRN6630K								
700	500	200	SRN7520K	SRN7520VK*	KC7050K	PF7050					
	500		SRN7525K	SRN7525VK*	KC7050K	PF7050					
800	600	250	SRN8625K	SRN8625VK*	KC8060K	PF8060	4	25	100	KD8060K	
	600		SRN8630K	SRN8630VK*	KC8060K	PF8060	4	25	100	KD8060K	
	800		SRN8830K								
1000	600	300	SRN10625K	SRN10625VK*	KC1060K	PF1060	5	25	125	KD1060K	
	600		SRN10630K	SRN10630VK*	KC1060K	PF1060	5	25	125	KD1060K	
	800		SRN10830K	SRN10830VK*	KC1080K	PF1080	5	36	180	KD1080K	
1200	600	300	SRN12630K	SRN12630VK*	KC1260K	PF1260	6	25	150	KD1260K	
	800		SRN12830K	SRN12830VK*	KC1280K	PF1280	6	36	216	KD1280K	
	800		SRN12840K								

\* No mounting plate included.



### Technical characteristics

Conformity with Standard	IEC 62208, IEC 61439-1-2	
Degree of protection	IP65 (IEC 60529), UL Listed: UL 508A, NEMA: Types 1, 3R, 12	
Degree of mechanical strength	IK10 blind door IK09 glazed door (IEC 62262)	
Certifications	 	
Type of material	Metallic	
Paint colour	RAL7035 (orange peel)	
Installation site	Indoors	
Fixing method	floor/wall	
Normal service conditions - ambient temperature	from -5 to +40°C	
Operating climate	constant	23°C/83% - 40°C/93%
(t°/Ur%)	variable	23°C/98% - 40°C/98%

## SR2 Enclosures

IP65 Sheet steel enclosures

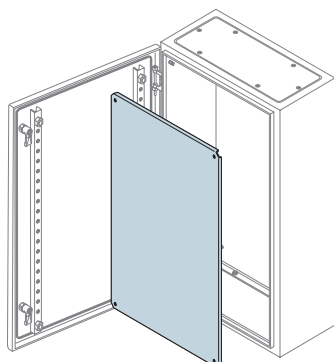

Blind internal mounting plate

Dimensions (mm)		
H	W	Order Code
300	200	PF3020
300	300	PF3030
300	400	PF3040
400	300	PF4030
400	400	PF4040
400	600	PF4060
500	300	PF5030
500	400	PF5040
600	400	PF6040
600	600	PF6060
700	500	PF7050
800	600	PF8060
800	800	PF8080
1000	600	PF1060
1000	800	PF1080
1200	600	PF1260
1200	800	PF1280

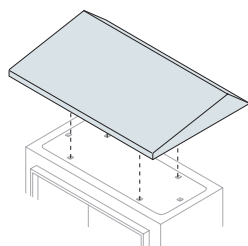

Spray protection roof

Dimensions (mm)		
W	D	Order Code
200	150	TT2015K
300	150	TT3015K
400	150	TT4015K
300	200	TT3020K
400	200	TT4020K
500	200	TT5020K
600	200	TT6020K
400	250	TT4025K
500	250	TT5025K
600	250	TT6025K
600	300	TT6030K
800	300	TT8030K

ZA4020

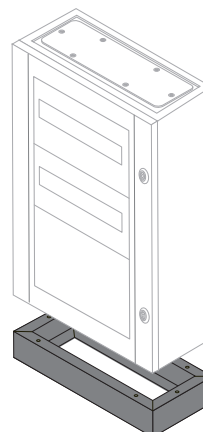

GZ4020



Accessories for stacking

Dimensions (mm)		
W	D	Order Code
<b>IP65 gasket</b>		
400	200	GZ4020
	250	GZ4025
600	200	GZ6020
	250	GZ6025
	300	GZ6030
800	300	GZ8030

Plinth

Dimensions (mm)			
W	D	H	Order Code
400	200	100	ZA4020
	250	100	ZA4025
600	250	100	ZA6025
	300	100	ZA6030
800	300	100	ZA8030

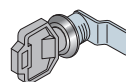

AA8001



AA8002

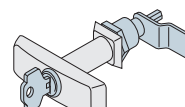

AA8003

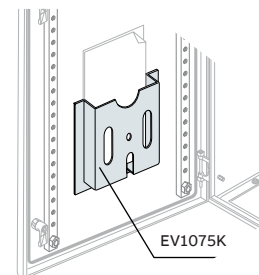

EV1075K

Enclosure accessories

Description	Order Code
Document pocket	EV1075K
N.4 wall mounting brackets	AA1206
Double tongue 7mm lock with DIN 5mm plastic key	AA8001
Lock with Yale insert & key	AA8002
T handle with Yale insert and key	AA8003
Replacement hinge kit	AA1204

## SRX Enclosures

IP66 Stainless steel enclosures



Rapid selection table

Overall Dimensions			Enclosures	Kit for automation	Kit for distribution Supports for mounting modular panels					
Height mm	Width mm	Depth mm	Enclosures with blind door + back plate	with glazed door*	Blind counter door	Back plate	No. vertical mod. H=185mm	No. DIN mod. per row	Total modules	DIN Supports
300	200	150	SRN3215X			PF3020				
	400	150	SRN3415X			PF3040				
400	300	150	SRN4315X							
		200	SRN4320X		KC4030X	PF4030				
	400	200	SRN4420X			PF4040				
	600	200	SRN4620X			PF4060				
500	400	200	SRN5420X	SRN5420VX*	KC5040X	PF5040	2	14	28	KD5040X
	500	200	SRN5520X			PF5050				
600	400	200	SRN6420X	SRN6420VX*	KC6040X	PF6040	3	14	42	KD6040X
		300	SRN6620X			PF6060				
	600	300	SRN6630X							
700	500	250	SRN7525X	SRN7525VX*	KC7050X	PF7050				
		200	SRN8620X					25	100	
	800	600	250	SRN8625VX*	KC8060X	PF8060	4	25	100	KD8060X
800	300	SRN8630X						25	100	
		800	300	SRN8830X			PF8080			
	1000	800	300	SRN10830X	SRN10830VX*	KC1080X	PF1080	5	36	180
1200	600	300	SRN12630X			PF1260				
	800	300	SRN12830X			PF1280				

\* No mounting plate included.



### Technical characteristics

Conforms to	CEI EN 62208, IEC 61439-1-2
Degree of protection	IP66 (CEI EN 60529), UL Listed: UL 508A, NEMA: Types 1, 3R, 4, 4X, 12
Degree of mechanical protection	IK10 blind door IK09 glazed door (IEC 62262)
Certifications	
Type of material	AISI 304
Installation site	Indoors/outdoors
Fixing method	floor/wall
Normal service conditions - ambient temperature	from -5 to +55°C

## SRX Enclosures

### IP66 Stainless steel enclosures

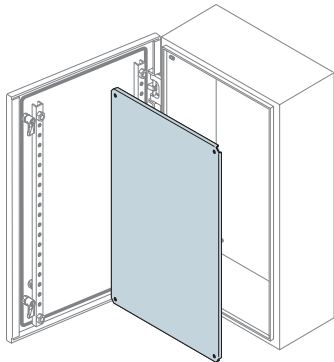

#### Opaque internal mounting plate

20/10 thick galvanised sheet metal internal plate, complete with fixing with small parts supplied. Depth-adjustable using a special spacer kit (to be ordered separately).

#### Opaque internal mounting plate

##### Dimensions (mm)

H	W	Order Code
300	200	PF3020
300	400	PF3040
400	300	PF4030
400	400	PF4040
400	600	PF4060
500	400	PF5040
500	500	PF5050
600	400	PF6040
600	600	PF6060
700	500	PF7050
800	600	PF8060
800	800	PF8080
1000	800	PF1080
1200	600	PF1260
1200	800	PF1280

#### Enclosure accessories

##### Description

##### Order Code

Document pocket	EV1075K
Wall mounting brackets (4 off)	AA1206
Double tongue 7mm lock with DIN 55mm plastic key	AA8001
Lock with Yale insert & key	AA8002
T handle with Yale insert and key	AA8003

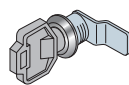
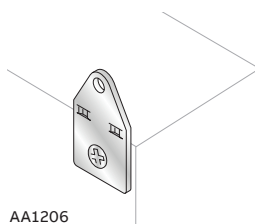
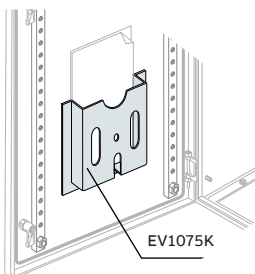

AA8001

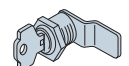

AA8002

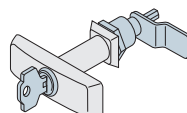

AA8003

# Gemini enclosures

## IP66 thermoplastic enclosures



- Made of thermoplastic material, to which the co-injection moulding technique gives the same mechanical characteristics as polyester
- Extremely sturdy, with its rigid covering and expanded internal core
- IP66, IP30 with the door open afford a very high resistance to chemical and atmospheric agents
- Guarantees excellent performances even in severe operating conditions

### Rapid selection table

Size	No. of vertical mod. H=150mm	No. of DIN modules installable	External Dimensions			Internal Dimensions			Complete switchboard door			Door		
			(H) mm	(W) mm	(D) mm	(H) mm	(W) mm	(D) mm	Transparent	Opaque	Box only	Transparent	Opaque	Uprights
1	2	24 (12x2)	400	335	210	300	250	180	1SL0211A00	1SL0201A00	1SL0221A00	1SL0241A00	1SL0231A00	1SL0283A00
2	3	54 (18x3)	550	460	260	450	375	230	1SL0212A00	1SL0202A00	1SL0222A00	1SL0242A00	1SL0232A00	1SL0284A00
3	4	72 (18x4)	700	460	260	600	375	230	1SL0213A00	1SL0203A00	1SL0223A00	1SL0243A00	1SL0233A00	1SL0285A00
4	4	96 (24x4)	700	590	260	600	500	230	1SL0214A00	1SL0204A00	1SL0224A00	1SL0244A00	1SL0234A00	1SL0285A00
5	5	120 (24x5)	855	590	360	750	500	330	1SL0215A00	1SL0205A00	1SL0225A00	1SL0245A00	1SL0235A00	1SL0286A00
6	6	216 (36x6)	1005	840	360	900	750	330	1SL0216A00	1SL0206A00	1SL0226A00	1SL0246A00	1SL0236A00	1SL0287A00

### Sizes available

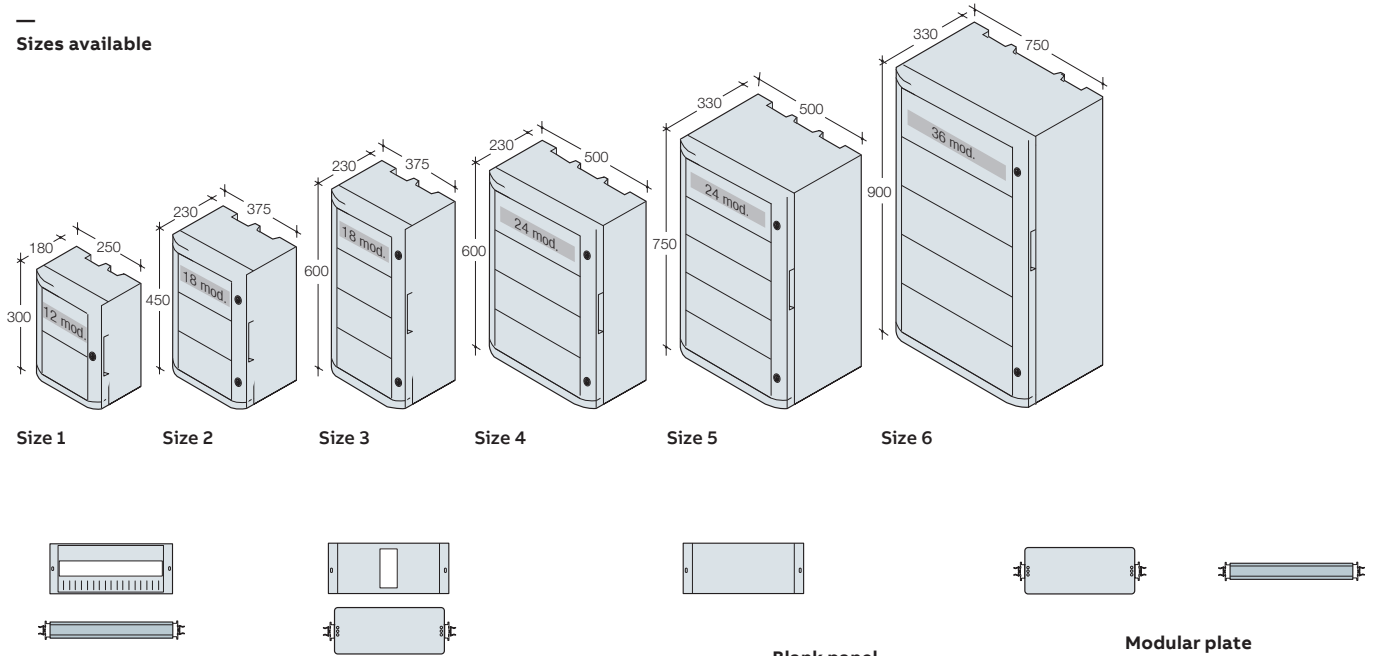

Size	DIN rail kit DIN rail+drilled panel		Kit for XTmax plate+drilled panel		Blank panel			Modular plate		Blank panel
	1 mod. H=150mm	1+1/2 mod. H=225mm	1 mod. H=150mm	2 mod. H=300mm	1/2 mod. H=75mm	1 mod. H=150mm	2 mod. H=300mm	1 mod. H=150mm	2 mod. H=300mm	DIN rail
1	1SL0307A00	-	-	-	1SL0318A00	1SL0324A00	1SL0330A00	1SL0296A00	-	1SL0290A00
2	1SL0308A00	1SL0313A00	1SL0373A00	1SL0376A00	1SL0319A00	1SL0325A00	1SL0331A00	1SL0297A00	1SL0302A00	1SL0291A00
3	1SL0308A00	1SL0313A00	1SL0373A00	1SL0376A00	1SL0319A00	1SL0325A00	1SL0331A00	1SL0297A00	1SL0302A00	1SL0291A00
4	1SL0309A00	1SL0314A00	1SL0374A00	1SL0377A00	1SL0320A00	1SL0326A00	1SL0332A00	1SL0298A00	1SL0303A00	1SL0292A00
5	1SL0309A00	1SL0314A00	1SL0374A00	1SL0377A00	1SL0320A00	1SL0326A00	1SL0332A00	1SL0298A00	1SL0303A00	1SL0292A00
6	1SL0310A00	1SL0315A00	1SL0375A00	1SL0378A00	1SL0321A00	1SL0327A00	1SL0333A00	1SL0299A00	1SL0304A00	1SL0293A00



## Gemini switchboards

### Assembly kits

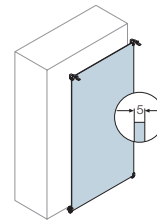
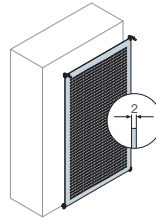
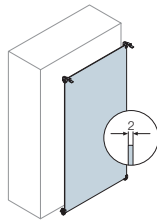

#### Base plates

Size	Blank metal	Drilled metal	Insulating material
1	1SL0259A00	1SL0259A00	1SL0275A00
2	1SL0260A00	1SL0260A00	1SL0276A00
3	1SL0261A00	1SL0261A00	1SL0277A00
4	1SL0262A00	1SL0262A00	1SL0278A00
5	1SL0263A00	1SL0263A00	1SL0279A00
6	1SL0264A00	1SL0264A00	1SL0280A00

#### Locks

	Description	Order Code
	Lock with Yale Typed key	1SL0340A00
	Lock with triangular impression	1SL0341A00
	Lock with square impression	1SL0339A00
	Wall mounting brackets	1SL0342A00

#### Specifications

	Specifications
Protection	IP66 (IEC EN 60529) Class II insulation
Strength	Thermoplastic material moulded in co-injection Resistance to abnormal heat and fire up to a temperature of 750 °C (IEC EN 60695-2-11) IK10 (IEC EN 50102) degree of resistance to impacts Protection against chemical and atmospheric agents (water, saline solutions, acids, basic agents, mineral oils, UV rays) Operating temperature -25 °C ÷ +100 °C
Performance	Rated service voltage up to 1000 V Rated insulating DC voltage up to 1000 V Rated insulating AC voltage up to 1500 V
Flexibility of use	6 sizes from 335x400x210 mm to 840x1005x360 mm (WxHxD, external dimensions) DIN 24 to 216 modules
Installation	Snap-on mounting of all components in compliance with safety Standards
Quality and environment	Compliance with CEI EN 62208 international reference Standard, qualification for the requirements of CEI EN 61439-1 Standard, IMQ mark according to EN 62208 Standard. 100% recyclable EN 60068-2-52 resistance to marine environments EN60068-2-5 resistance direct sun exposure UL Listed: UL508A, UL50, UL50E Nema: Types 1, 3R, 4, 4X, 12

# Mistral 65

## A versatile range suitable for every application

Efficiency, safety, integration: the new Mistral 65 series rests on the strengths which have consolidated ABB's image over the years for its expertise and reliability in the area of products for protection, control, monitoring, measurement, safety and energy efficiency.



### Designed for harsh environments

- The Mistral 65 consumer units come with IP65 protection degree, providing a dust-tight resistance (6) and jetting water resistance (5)
- Mechanical strength of Mistral 65 consumer units are IK09 (10joule) and IK08 for the precut parts
- Transparent or opaque doors which open up to 180°, and a choice of between 4 and 72 modules

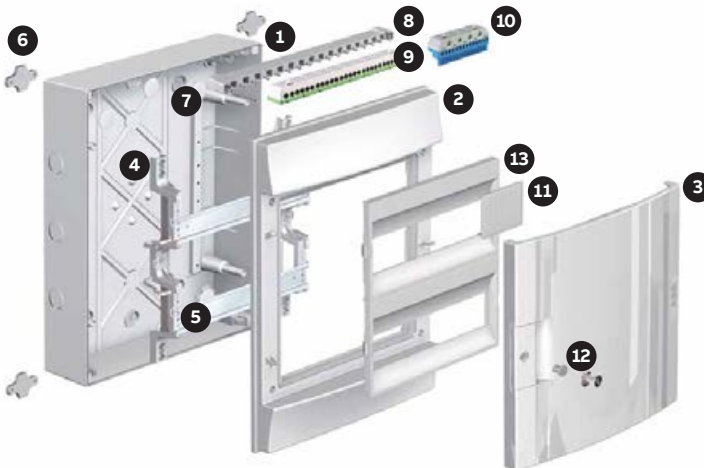
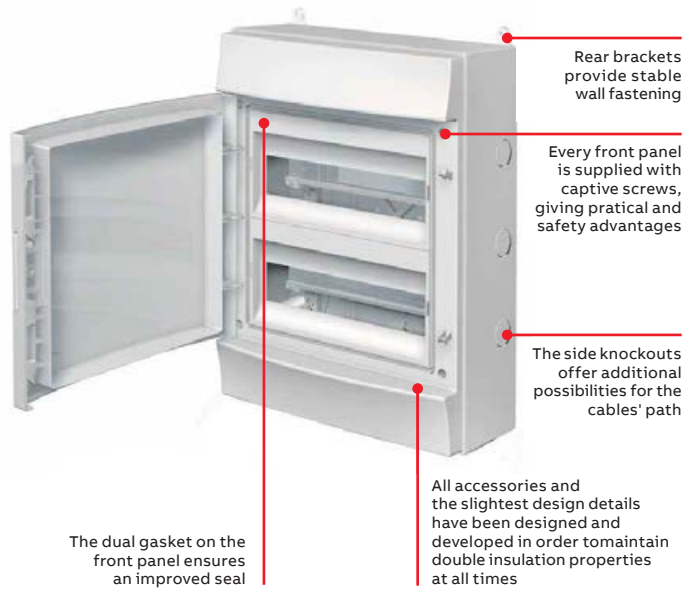
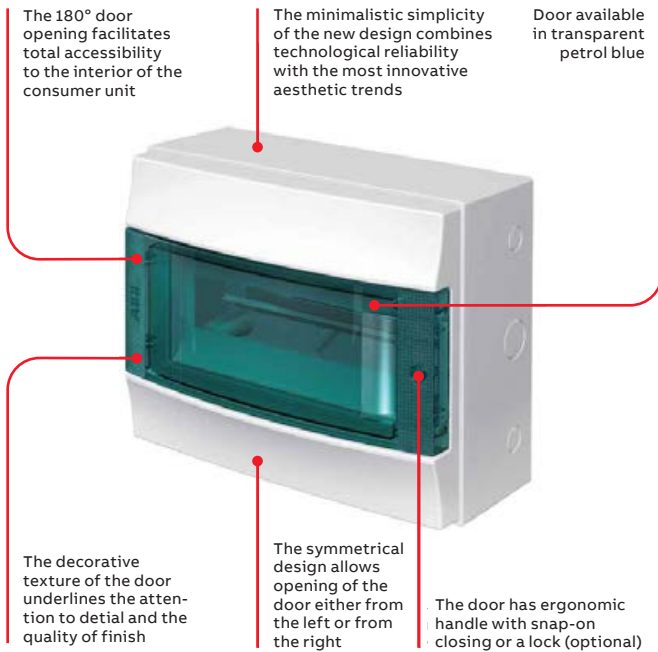

- 1. Box for wall mounting
- 2. Reversible front panel
- 3. RAL 7035 opaque door
- 4. Fixed support for DIN rail
- 5. DIN rail
- 6. Wall fastening brackets
- 7. Plugs, protection class II
- 8. Terminal block carriers
- 9. Terminal blocks with screw coupling
- 10. Terminal blocks with screwless coupling
- 11. Module cover
- 12. Finish or closure elements (lock and key optional)
- 13. Reversible panels



- 1. Box for wall mounting
- 2. Metal plate
- 3. Reversible front panel
- 4. Inner door
- 5. RAL 7035 opaque door

# Mistral 65

Double insulated enclosures

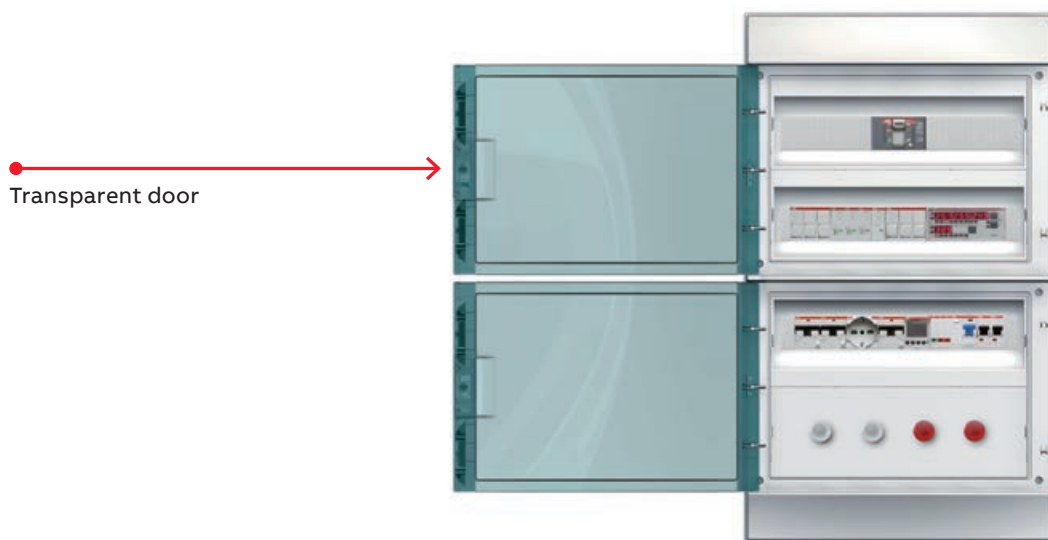

## Enclosure with transparent door

	Rows	Dimensions (mm)			Order Code
		Width	Height	Depth	
650 Transparent door 4M	1	152	202	117	1SL1200A00
650 Transparent door 8M	1	232	250	154	1SL1201A00
650 Transparent door 12M	1	320	250	155	1SL1202A00
650 Transparent door 18M	1	430	250	155	1SL1203A00
650 Transparent door 24M	2	320	435	155	1SL1204A00
650 Transparent door 36M 2F	2	430	435	155	1SL1205A00
650 Transparent door 36M 3F	3	320	600	155	1SL1206A00
650 Transparent door 48M	4	320	735	155	1SL1207A00
650 Transparent door 54M	3	430	600	155	1SL1208A00
650 Transparent door 72M	4	430	735	155	1SL1209A00

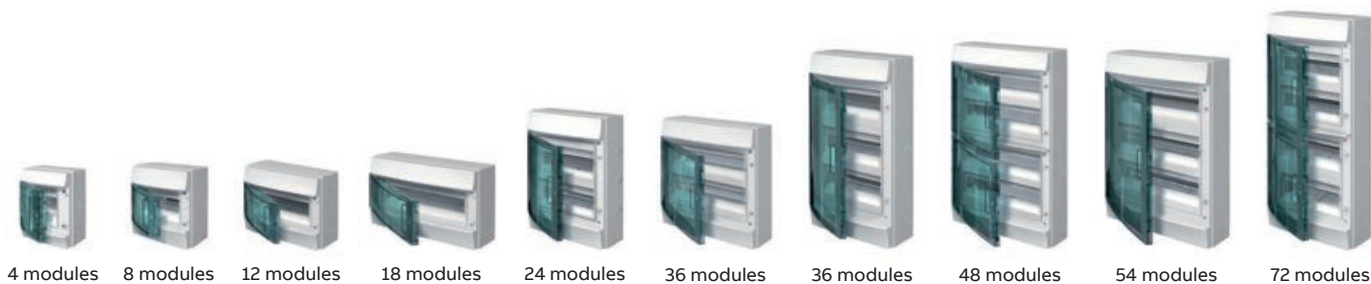

4 modules    8 modules    12 modules    18 modules    24 modules    36 modules    36 modules    48 modules    54 modules    72 modules

# Mistral 65

## Double insulated enclosures

### Accessories

		Order Code
	Wall fixing brackets (4 pcs) MISTRAL65	1SL1927A00
	Lock with key MISTRAL65	1SL1931A00
	Cable gland Ø 16	1SL1935A00
	Cable gland Ø 20	1SL1936A00
	Cable gland Ø 25	1SL1937A00
	Cable gland Ø 32	1SL1938A00
	Metal base plate 12M Mistral65	1SL1920A00
	Metal base plate 2x12M Mistral65	1SL1921A00
	Metal base plate 18M Mistral65	1SL1922A00
	Metal base plate 2x18M Mistral65	1SL1923A00
	Central blind panel 12M Mistral65	1SL1945A00
	Blind panel 12M Mistral65	1SL1946A00
	Central blind panel 18M Mistral65	1SL1947A00
Blind panel 18M Mistral65	1SL1948A00	

### Terminal blocks

		Order Code	
	Terminal block N 3*16mm <sup>2</sup> +3*6mm <sup>2</sup>	A	1SPE007715F0731
	Terminal block N 5*16mm <sup>2</sup> +6*6mm <sup>2</sup>	B	1SPE007715F0732
	Terminal block N 7*16mm <sup>2</sup> +9*6mm <sup>2</sup>	C	1SPE007715F0733
	Terminal block N 9*16mm <sup>2</sup> +12*6mm <sup>2</sup>	D	1SPE007715F0734
	Terminal block N 11*16mm <sup>2</sup> +15*6mm <sup>2</sup>	E	1SPE007715F0735
	Terminal block PE 3*16mm <sup>2</sup> +3*6mm <sup>2</sup>	A	1SPE007715F0741
	Terminal block PE 5*16mm <sup>2</sup> +6*6mm <sup>2</sup>	B	1SPE007715F0742
	Terminal block PE 7*16mm <sup>2</sup> +9*6mm <sup>2</sup>	C	1SPE007715F0743
	Terminal block PE 9*16mm <sup>2</sup> +12*6mm <sup>2</sup>	D	1SPE007715F0744
	Terminal block PE 11*16mm <sup>2</sup> +15*6mm <sup>2</sup>	E	1SPE007715F0745
	Terminal carrier, 8 modules		1SPE007715F0751
	Terminal carrier, 12 modules		1SPE007715F0752
	Terminal carrier, 18 modules		1SPE007715F0753

### Terminal Carrier

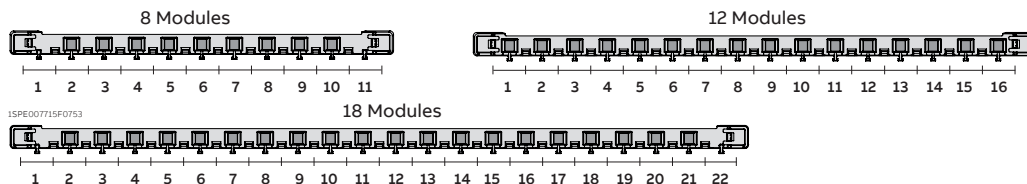

### Terminal Blocks

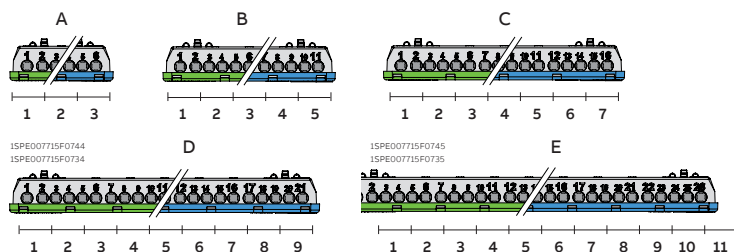

## ARIA

### Universal polyester enclosures





#### Specifications

- Seven different types.
- Enclosures made from light grey polyester (RAL 7035), hot press moulded, GRP.
- The enclosure is equipped with 4 threaded rods and 4 nuts for securing a mounting plate or frame and is equipped as standard with a double-bit key lock.
- Maximum protection for the user and equipment thanks to its total insulation and IP66 protection rating in accordance with EN/IEC 62208 (IP54 for enclosures with inspection windows).
- IK08 protection rating against external mechanical impacts in accordance with EN/IEC 62208 (IK07 for cabinets with windows).
- Polyester boxes can resist temperatures of up to 70°C under continuous operation and peak temperatures of up to 130 °C.
- Self-extinguishing polyester, halogen-free.
- Insulation voltage  $U_i = 1000\text{VAC}$  and  $1500\text{VDC}$ .
- Standard: EN/IEC 61439-2, EN/IEC 60529, EN/IEC 62262, EN/IEC 62208.
- IP66 versions UL / CSA certified.

#### Rapid selection table

Type	External dimensions (mm)			Enclosure (no mounting plate)		Mounting plate
	H	W	D	IP54	IP66	2mm Galv. steel mounting plate
				Transparent door	Opaque door	
ARIA 32	315	215	170	–	4TBA831025C0100	4TBA831026C0100
ARIA 43	415	315	170	4TBA831815C0100	4TBA831036C0100	4TBA831037C0100
ARIA 54	515	415	230	4TBA831129C0100	4TBA831052C0100	4TBA831053C0100
ARIA 64	615	415	230	4TBA831130C0100	4TBA831065C0100	4TBA831066C0100
ARIA 75	735	535	270	4TBA831131C0100	4TBA831081C0100	4TBA831082C0100
ARIA 86	835	635	300	4TBA831132C0100	4TBA831098C0100	4TBA831099C0100
ARIA 108	1035	835	300	4TBA831133C0100	4TBA831112C0100	4TBA831113C0100

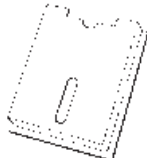
#### Accessories

Type	Description	Order Code
	Document Pocket A5	4TBP832000C0100
	Stainless Steel grade 304 wall mounting brackets (4 off)	4TBA831000C0100
	Polyamide wall mounting brackets (4 off)	4TBA831001C0100

# ARIA

## Universal polyester enclosures



1. Monobloc base
2. Detachable door, left-hand or right-hand opening
3. No water stagnation on the seal
4. Mounting point in the door
5. Front plate:
  - polyester RAL 7035
  - hinged
  - detachable
  - stand-alone
  - sealable
  - quick installation
6. Interchangeable cylinders
7. Mounting frame:
  - removable
  - perforated
  - reinforced DIN rails
8. Integral hinges 180° pivoting door
9. Mounting plate:
  - metal
  - pertinax
  - perforated
10. Mounts directly onto the wall or via external mounting lugs made from stainless or synthetic material



Rapid selection table

Type	Rows / Modules		Internal system		Internal system full cover plate options		
	Rows	Total modules	Mounting frame	Solid front	DIN slots	Plate for individual modular plates	
ARIA 32	2	12	4TBA831030C0100	4TBA831028C0100	4TBA831029C0100	-	
ARIA 43	2	24	4TBA831041C0100	4TBA831039C0100	4TBA831040C0100	4TBA831790C0100	
ARIA 54	3	54	4TBA831057C0100	4TBA831055C0100	4TBA831056C0100	4TBA831791C0100	
ARIA 64	3	54	4TBA831070C0100	4TBA831068C0100	4TBA831069C0100	4TBA831792C0100	
ARIA 75	4	88	4TBA831086C0100	4TBA831084C0100	4TBA831085C0100	4TBA831793C0100	
ARIA 86	4	96	4TBA831103C0100	4TBA831101C0100	4TBA831102C0100	4TBA831794C0100	
ARIA 108	5	108	4TBA831117C0100	4TBA831115C0100	4TBA831116C0100	4TBA831795C0100	

Type	Number of Individual Modular Plates Possible		Individual modular plates	
	Rows / No. of Plates	Modules per plate	Solid modular plate (no slots)	Slotted modular plate
ARIA 32	-	-	-	-
ARIA 43	2	12	4TBA831797C0100	4TBA831796C0100
ARIA 54	3	18	4TBA831799C0100	4TBA831798C0100
ARIA 64	3	18	4TBA831801C0100	4TBA831800C0100
ARIA 75	4	22	4TBA831803C0100	4TBA831802C0100
ARIA 86	8	12	4TBA831797C0100	4TBA831796C0100
ARIA 108	10	18	4TBA831801C0100	4TBA831800C0100





# APO

## Polyester boxes



### Specifications

- The range comprises nine different sizes with 300 and 185 mm modules.
- The base is fabricated from polyester, hot press moulded and reinforced with glass fiber, dyed in mass RAL 7035 light grey color. It is equipped with M4 inserts (Dodge-type) for attaching a mounting plate or a frame.
- The cover may be fabricated from transparent polycarbonate or hot press moulded polyester, reinforced with glass fiber, dyed in mass RAL 7035 light gray color.
- Maximum protection for the user and equipment thanks to its total insulation and IP67 protection rating in accordance with EN/IEC 60529.



Type	APO 31	APO 41
------	--------	--------

### Rapid selection table

Type	External dimensions (mm)			Enclosure	
	H	W	D	IP67 Solid polyester cover with securing screws	IP67 Transparent polycarbonate cover with securing screws
APO 1	186	151	140	4TBO856048C0100	4TBO856057C0100
APO 31	302	186	175	4TBO856049C0100	4TBO856058C0100
APO 41	302	302	175	4TBO856050C0100	4TBO856059C0100
APO 71	370	300	175	4TBO856051C0100	4TBO856060C0100
APO 51	488	302	175	4TBO856052C0100	4TBO856061C0100
APO 81	558	302	175	4TBO856053C0100	4TBO856062C0100
APO 61	602	302	175	4TBO856054C0100	4TBO856063C0100
APO 11	602	372	175	4TBO856055C0100	4TBO856064C0100
APO 12	603	603	175	4TBO856056C0100	4TBO856065C0100

### Accessories

Type	Description	Order Code
	Stainless Steel grade 304 wall mounting brackets (4 off)	4TBO852025C0100
	Glass Fiber-reinforced Polyamide wall mounting brackets (4 off)	4TBO851266C0100

- IK08 protection rating against external mechanical impacts in accordance with EN/IEC 62208.
- Each box, which is a multiple of a smaller one, also has a variety of the mounting points of the smaller box. These points have non-threaded holes for embedded M4 inserts.
- The base also includes four to six non-threaded holes for embedded M6 inserts.
- The box may be wall-mounted or on a pedestal.
- Material is simple to work with using conventional tools such as drills, mills, saws, etc.
- Polyester boxes can resist temperatures of up to 70°C under continuous operation and peak temperatures of up to 130°C. The transparent polycarbonate covers can resist operating temperatures of up to 120°C.
- Insulation voltage  $U_i = 1000VAC$  and  $1500VDC$ .
- Standard: EN/IEC 62208.
- APO enclosures are UL Listed, in accordance with the UL Standard 508. They are also CSA certified.

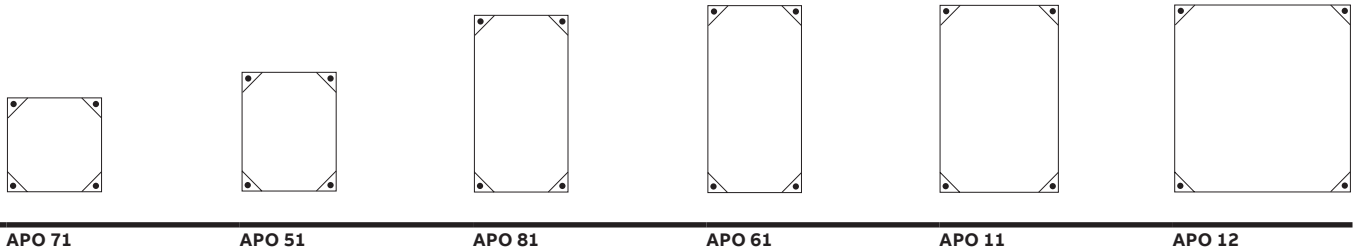

IP67 Transparent polycarbonate pivoting cover with clip-in buttons	Enclosure	Mounting plate	Depth extender
	IP55 Solid hinged cover with securing screws	2mm Galv. steel mounting plate	Depth extension frame
-	4TBO856071C0100	4TBO851191C0100	4TBO856040C0100*
4TBO856066C0100	4TBO856072C0100	4TBO851188C0100	4TBO856041C0100*
4TBO856067C0100	4TBO856073C0100	4TBO851279C0100	4TBO856042C0100*
4TBO856068C0100	4TBO856074C0100	4TBO851185C0100	4TBO856043C0100*
4TBO856069C0100	4TBO856075C0100	4TBO852095C0100	-
-	4TBO856076C0100	4TBO851171C0100	4TBO856044C0100**
4TBO856070C0100	4TBO856077C0100	4TBO851287C0100	4TBO856045C0100**
-	4TBO856078C0100	4TBO851292C0100	4TBO856046C0100**
-	4TBO856079C0100	4TBO852178C0100	4TBO856047C0100**

\*35mm / \*\*60mm.

## Europa series





Junction boxes IP44, IP55 & IP65 in thermoplastic



### Technical characteristics

- Protection degree: IP44 for press-on lid boxes with cable glands, IP55 for screw-on lid boxes with cable glands, IP65 for screw-on lid box with smooth sides.
- Shock resistant: IK07 for IP44 boxes, IK08 for IP55 and IP65 boxes.
- IP44 and IP55 boxes with press-on lids in thermoplastic material, self-extinguishing in compliance with UL 94 HB Standard and resistant to abnormal heat and fire up to 650°C (glow wire flammability index) in compliance with IEC 60695-2-11 Standard.
- IP65 boxes with screw-on lids in halogen free thermoplastic material, self-extinguishing in compliance with UL 94 HB Standard and resistant to abnormal heat and fire up to 650°C (glow wire flammability index) in compliance with IEC 60695-2-11 Standard.
- Installation temperature from -25°C to +60°C; Resistant to heat: ball thermopressure up to +85°C for IP44, IP55 and IP65 junction boxes.
- Boxes with protection degree IP55 and IP65 are composed of a patented lid produced in a single pressing phase together with its seal.
- All junction boxes made in compliance with IEC 60670-1 and IEC 60670-22 Standards.

### IP44, IP55 & IP65 Thermoplastic boxes







Description	Dimensions (mm)			Order Code
	H x W x D	650° C	960° C	
 IP 44 boxes	Ø60 - H35	00800	1SL0900A00	
	Ø80 - H40	00802	1SL0901A00	
	65 x 65 x 32	00808	1SL0902A00	
	80 x 80 x 40	00810	1SL0903A00	
 IP 55 waterproof boxes with plastic 1/4 turn screws	100 x 100 x 50	1SL0816A00	1SL0916A00	
	105 x 70 x 50	1SL0820A00	–	
	100 x 100 x 80	1SL0821A00	1SL0921A00	
	153 x 110 x 66	1SL0822A00	1SL0922A00	
	160 x 135 x 77	1SL0824A00*	1SL0924A00*	
	220 x 170 x 80	1SL0826A00*	1SL0926A00*	
 IP 65 waterproof boxes with plastic 1/4 turn screws	310 x 240 x 110	1SL0828A00*	1SL0928A00*	
	100 x 100 x 50	1SL0846A00	1SL0946A00	
	105 x 70 x 50	1SL0850A00	–	
	100 x 100 x 80	1SL0851A00	1SL0951A00	
	153 x 110 x 66	1SL0852A00	1SL0952A00	
	160 x 137 x 77	1SL0854A00*	1SL0954A00*	
 IP 65 waterproof boxes with plastic 1/4 turn screws c/w Transparent Lid	220 x 170 x 80	1SL0856A00*	1SL0956A00*	
	310 x 240 x 110	1SL0858A00*	1SL0958A00*	
	153 x 110 x 66	1SL0872A00	–	
	160 x 135 x 77	1SL0874A00	–	
	220 x 170 x 80	1SL0876A00	–	
310 x 240 x 110	1SL0878A00	–		

\* Can be wall-mounted using wall brackets code 12858.

## Europa series

Junction boxes IP44, IP55 & IP65 in thermoplastic

### IP44, IP55 & IP65 Thermoplastic boxes

	Description	Dimensions (mm)			Order Code	
		H x W x D	650° C	960° C	650° C	960° C
	IP 55 waterproof boxes with steel screws	100 x 100 x 50	00816	–		
		105 x 70 x 50	00820	–		
		100 x 100 x 80	00821	–		
		153 x 110 x 66	00822	–		
	IP 65 waterproof boxes with steel screws	100 x 100 x 50	00846	–		
		105 x 70 x 50	00850	–		
		100 x 100 x 80	00851	–		
		153 x 110 x 66	00852	–		
	IP 65 waterproof boxes with plastic 1/4 turn screws	151 x 110 x 66	00 872	–		
	IP 55 waterproof boxes with plastic 1/4 turn screws	160 x 135 x 150	1SL0830A00	–		
		220 x 170 x 150	1SL0832A00	–		
		310 x 240 x 160	1SL0834A00	–		
	IP 65 waterproof boxes with plastic 1/4 turn screws	160 x 135 x 150	1SL0860A00	1SL0960A00		
		220 x 170 x 150	1SL0862A00	1SL0962A00		
		310 x 240 x 160	1SL0864A00	1SL0964A00		
	IP 65 waterproof boxes with plastic 1/4 turn screws	160 x 135 x 150	1SL0880A00*	–		
		220 x 170 x 150	1SL0882A00*	–		
		310 x 240 x 160	1SL0884A00*	–		
	Metal base plates for boxes with dimensions:	160 x 135 x 77	00900	–		
		220 x 170 x 80	00902	–		
		310 x 240 x 110	00904	–		

\* Can be wall-mounted using wall brackets code 12858.

## Europa series

### Junction boxes IP65 in polycarbonate



#### Technical characteristics

- Protection degree IP 65.
- Insulation class II.
- Self-extinguishing and resistant to abnormal heat and fire up to 960 °C (glow wire test) in compliance with IEC 60695-2-11 Standard.
- Installation temperature from -25 °C to +60 °C.
- Shock resistance 20 Joules (IK 10).
- High resistance to UV rays.
- Boxes code 12808, 12812, 12814, 12816 and 12818 fitted with one rigid and one bi-material flange for facilitated input of conduits and cables.
- Junction boxes produced in compliance with CEI 23-49 (1996) + V1 + V2, CB certificate IEC 60670-24 Standards.

#### IP65 Polycarbonate enclosure

		Size (mm): H x W x D	Order Code
		220 x 140 x 140	12804
		220 x 205 x 140	12808
		220 x 275 x 140	12812
		370 x 275 x 140	12814
		570 x 275 x 140	12816
		570 x 380 x 140	12818

#### Mounting plates

Type	For Enclosure Type	Order Code	
	Aluminium plated metal	12804	12842
		12808	12844
		12812	12845
		12814	12846
		12816	12847
		12818	12848
	Insulated	12808	12834
		12812	12835
		12814	12836
		12816	12837
		12818	12838

#### Wall mounting brackets

	Order Code
	12858

#### DIN rails

For enclosure type	Order Code	
	12804	12852
	12808	12854
	12812 - 12814 - 12816	12855
	12818	12856

---

# Enclosed control products

<b>302</b>	<b>Direct-on-line starters</b>
<b>303</b>	<b>Star delta starters</b>
<b>304</b>	<b>Push button stations</b>
<b>305</b>	<b>Heating and lighting contactors</b>



For more detailed product information, please refer to our online technical brochures available at: [new.abb.com/low-voltage/support/documentation](http://new.abb.com/low-voltage/support/documentation)

or contact our sales team via email [LV.enquiries@gb.abb.com](mailto:LV.enquiries@gb.abb.com)

or call 0333 999 9933



## Direct-on-line starters

IP66 plastic - IP55 metal enclosure

Direct on line IP66 plastic enclosure 400v up to 7.5kW (supplied without overload)

	Three Phase 400V [AC3]		Single Phase 230V [AC3]		Dimensions (mm)			Part no.	Order Code
	KW	hp	KW	hp	H	W	D		
 DL205P	<b>100-250v coil</b>								
	5.5	7.5	1.5	2.0	230	106	127	DL205P	1TVC230050P5699
	7.5	10.0	2.2	3.0				DL207P	1TVC230070P5699
	<b>250-500v coil</b>								
5.5	7.5			230	106	127	DL405P	1TVC400050P5699	
7.5	10.0						DL407P	1TVC400070P5699	

Direct on line IP55 metal enclosure 400v up to 7.5kW (supplied without overload)

	Three Phase 400V [AC3]		Single Phase 230V [AC3]		Dimensions (mm)			Part no.	Order Code
	KW	hp	KW	hp	H	W	D		
 DL205S	<b>100-250v coil</b>								
	5.5	7.5	1.5	2.0	184	184	165	DL205S	1TVC230050S5699
	7.5	10.0	2.2	3.0				DL207S	1TVC230070S5699
	<b>250-500v coil</b>								
5.5	7.5			184	184	165	DL405S	1TVC400050S5699	
7.5	10.0						DL407S	1TVC400070S5699	

Direct on line with Isolator IP55 metal enclosure 400v up to 7.5kW (supplied without overload)

	Three Phase 400V [AC3]		Single Phase 230V [AC3]		Dimensions (mm)			Part no.	Order Code
	KW	hp	KW	hp	H	W	D		
 DI205S	<b>100-250v coil</b>								
	5.5	7.5	1.5	2.0	184	184	180	DI205S	1TVC230051S5699
	7.5	10.0	2.2	3.0				DI207S	1TVC230071S5699
	<b>250-500v coil</b>								
5.5	7.5			184	184	180	DI405S	1TVC400051S5699	
7.5	10.0						DI407S	1TVC400071S5699	

Direct on line Reversing IP55 metal enclosure 400v up to 7.5kW (supplied without overload)

	Three Phase 400V [AC3]		Single Phase 230V [AC3]		Dimensions (mm)			Part no.	Order Code
	KW	hp	KW	hp	H	W	D		
 DR207S	<b>100-250v coil</b>								
	7.5	10.0	2.2	3.0	184	184	165	DR207S	1TVC230072S5699
	<b>250-500v coil</b>								
7.5	10.0			184	184	165	DR407S	1TVC400072S5699	

Note: Overload supplied separately

## Star delta starters IP55 metal enclosure



SD2155

### Star-Delta IP65 metal Enclosure 400V up to 22kW

- Star-Delta starters in metal enclosure IEC 947-4-1.
- All three phase star delta starters, are complete with push buttons, and 100-250v or 250-500v coils.
- Overload for standard motor duty must be purchased separately

### Star-Delta IP55 metal enclosure 400V up to 22kW (supplied without overload)

	Three Phase 400V [AC3]		Dimensions (mm)			Part no.	Order Code
	KW	hp	H	W	D		
	<b>100-250v coil</b>						
	15	20.0	184	284	165	SD215S	1TVC230153S5699
	22.0	30.0	305	284	175	SD222S	1TVC230223S5699
	<b>250-500v coil</b>						
	15	20.0	184	284	165	SD415S	1TVC400153S5699
	22.0	30.0	305	284	175	SD422S	1TVC400223S5699

### Star-Delta with Isolator IP55 metal enclosure 400V up to 22kW (supplied without overload)

	Three Phase 400V [AC3]		Dimensions (mm)			Part no.	Order Code
	KW	hp	H	W	D		
	<b>100-250v coil</b>						
	15	20.0	184	284	180	SI215S	1TVC230154S5699
	22.0	30.0	305	284	190	SI222S	1TVC230224S5699
	<b>250-500v coil</b>						
	15	20.0	184	284	180	SI415S	1TVC400154S5699
	22.0	30.0	305	284	190	SI422S	1TVC400224S5699

**Note:** All Direct on Line and Star Delta starters are supplied without overload fitted. Select TF42 overload based on motor rating from page 352.

## Push button stations

### Plastic IP65 enclosures

- IP65 thermoplastic control station complete with actuator, contact blocks and legend plate. Supplied fully assembled. Other variations are available on request.

#### One gang push buttons

	Description	Dimensions (mm)			Part no.	Order Code
		H	W	D		
	1 Way Start/Green	75	101	74	1GO	1TVC11000P3101
	1 Way Stop/Red				1RC	1TVC101000P3102

#### Emergency stops

	Description	Dimensions (mm)			Part no.	Order Code
		H	W	D		
	Emergency stop 30mm (twist release) - to IEC60947-5-5	75	101	92	1RSC	1TVC101000P3203
	Emergency stop 40mm (twist release) - to IEC60947-5-5	75	101	107	1RSC-EN	1TVC101000P3204
	Emergency stop 60mm (twist release) - to IEC60947-5-5	75	101	107	1RMSC50	1TVC101000P3205
	Emergency stop 40mm (with key release) - to IEC60947-5-5	75	101	122	1RMSKC	1TVC101000P3206

#### Selector switches

	Description	Dimensions (mm)			Part no.	Order Code
		H	W	D		
	Two-position switch	75	101	74	1H2O-I	1TVC110000P3107
	Two-position key switch (key removable both positions)				1K2O-I	1TVC110000P3108
	Three position switch				1H3I-O-II	1TVC110100P3109
	Three position key switch (key removable in all positions)				1K3I-O-II	1TVC110100P3110

#### Two gang push buttons

	Description	Dimensions (mm)			Part no.	Order Code
		H	W	D		
	Start/Green and Stop/Red	75	141	79	2GORC	1TVC211000P3111
	Start/Green and Red/Emergency Stop 40mm (twist release) to IEC60947-5-5	75	141	107		1TVC211000P3112

#### Terminal box in enclosures

	Description	No of Terms	[A] 1th	Dimensions (mm)			Part no.	Order Code
				H	W	D		
	Terminal box 2.5mm IP55 plastic enclosure	5	24	118	163	72	5TERM2.5	1TVC151800S2349
		10	24				10TERM2.5	1TVC151800S2347
	Terminal box 4mm IP55 plastic enclosure	5	32				5TERM4	1TVC151800S2350
		10	32				10TERM4	1TVC151800S2348

## Push button stations

Plastic IP65 enclosures

### Stainless enclosures

Description	Dimensions (mm)			Part no.	Order Code
	H	W	D		
 Emergency Stop 40mm (stay-put) - to EN418	100	140	100	1RSC-ENSS	1TVC100000P5015
1 Gang empty enclosure	91	91	55	01.001001.SS1	01.001001.SS1
2 Gang empty enclosure	152	91	55	01.001002.SS2	01.001002.SS2
3 Gang empty enclosure	207	91	55	01.001003.SS3	01.001003.SS3

## Heating and lighting

IP65 plastic - IP55 metal enclosure

### Three & four pole heating & lighting contactors IP65 plastic enclosure

Heating AC1 Amps	Amps per pole Fluorescent Mercury	Amps per Pole Tungsten	Main Poles	Part no.	
<b>100-250v coil (Including neutral terminal strip)</b>					
25	16	16	4	HL025P	1TVC230025P5604
45	30	32	4	HL045P	1TVC230045P5604



HL025P

### Three & four pole heating & lighting contactors IP55 metal enclosure

Heating AC1 Amps	Amps per pole Fluorescent Mercury	Amps per Pole Tungsten	Main Poles	Part no.	
<b>100-250v coil (Including neutral terminal strip)</b>					
25	16	16	4	HL025S	1TVC230025S5604
45	30	32	4	HL045S	1TVC230045S5604
70	40	16	3	HL063S	1TVC230063S5603
100	70	32	3	HL100S	1TVC230100S5603



HL025S

### Dimensions

Enclosure	Height (mm)	Width (mm)	Depth (mm)	Part no.	Order Code
Plastic	230	106	127	HL025P - HL045P	
Metal	180	185	145	HL025S - HL100S	

---

# Metering and monitoring

<b>307</b>	<b>Energy meters</b>
<b>316</b>	<b>Network analyzers</b>
<b>319</b>	<b>Circuit monitoring systems</b>
<b>324</b>	<b>Data loggers</b>



---

For more detailed product information, please refer to our online technical brochures available at: [new.abb.com/low-voltage/support/documentation](http://new.abb.com/low-voltage/support/documentation)

or contact our sales team via email [LV.enquiries@gb.abb.com](mailto:LV.enquiries@gb.abb.com)

or call 0333 999 9933

# Energy meters

## The details make the difference

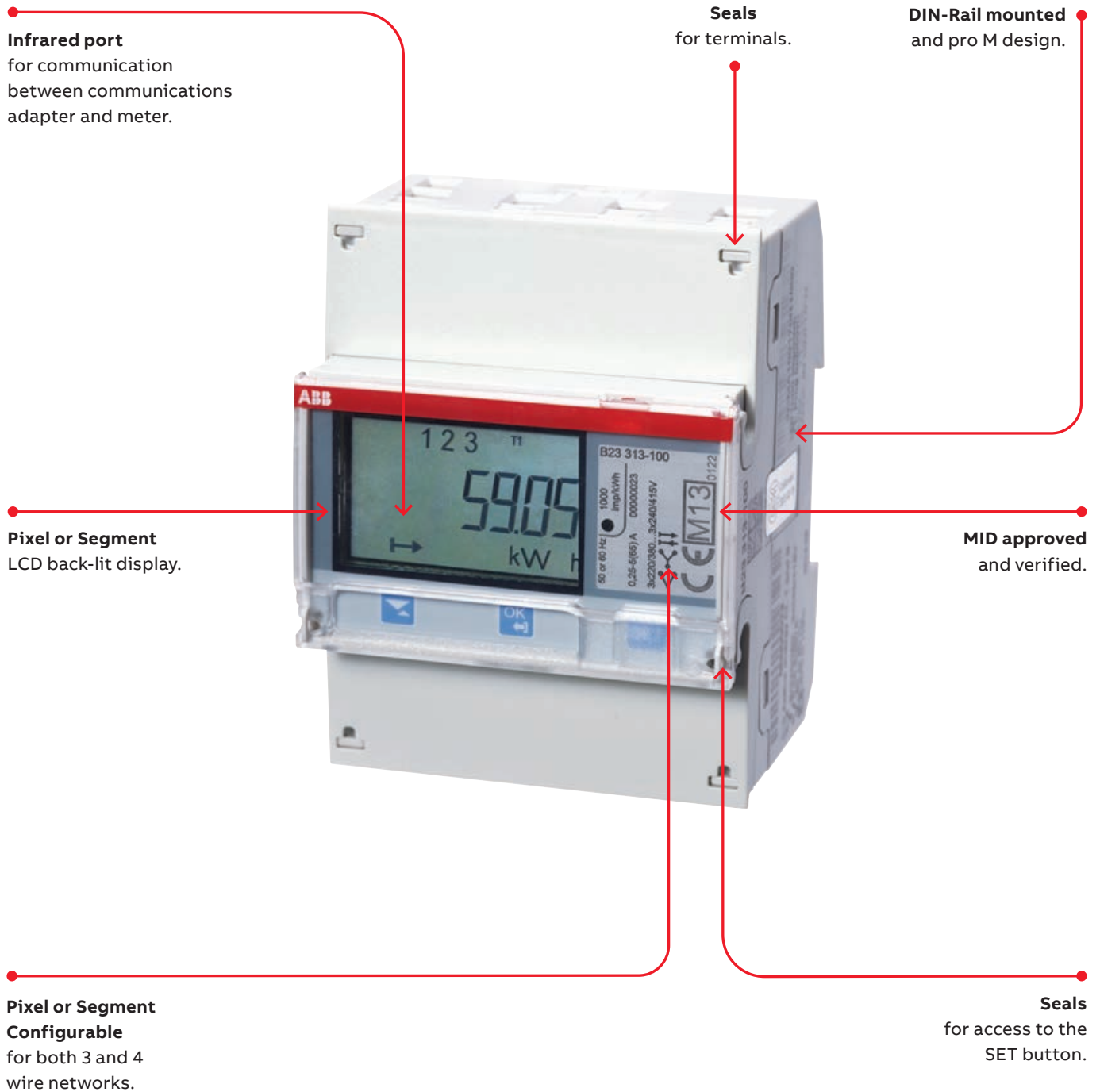



## Energy meters A series

### Order Codes



A41

Direct connected energy meter up to 80 A. Verified and approved according to MID. IEC approval. Instrument values. Alarm function. Communication - Infrared (M-Bus). Optional - Communication with M-Bus, RS-485 Modbus, RS-485 EQ bus.

#### Energy meters single phase electricity meter, 2 DIN with IR port, 80 A

##### Class B (Cl. 1) with functionality level Steel. Active energy.

Description	Bbn	Type	Order Code	Pkg	Weight
	7392696			qty	(1 pc.)
EAN					
kg (lb)					
57.7...288 V AC, Pulse output	705547	A41 111 - 100	2CMA170554R1000	1	0.230
57.7...288 V AC, Pulse output, RS-485	705004	A41 112 - 100	2CMA170500R1000	1	0.230
57.7...288 V AC, Pulse output, M-Bus	002400	A41 113 - 100	2CMA100240R1000	1	0.230

##### Class 1 (Reactive Class 2) with functionality level Silver.

Active and reactive energy, import/export, tariffs 1-4, tariff control via inputs and communication.

Description	Bbn	Type	Order Code	Pkg	Weight
	7392696			qty	(1 pc.)
EAN					
kg (lb)					
57.7...288 V AC, 2 output, 2 input, RS-485	705035	A41 312 - 100	2CMA170503R1000	1	0.230
57.7...288 V AC, 2 output, 2 input, M-Bus	705042	A41 313 - 100	2CMA170504R1000	1	0.230

##### Class B (Cl. 1) (Reactive Cl. 2) with functionality level Gold. Active and reactive energy, import/export, tariffs 1-4, tariff controlled via inputs, communication or clock, previous values, max and min demand.

Description	Bbn	Type	Order Code	Pkg	Weight
	7392696			qty	(1 pc.)
EAN					
kg (lb)					
57.7...288 V AC, 2 output, 2 input, RS-485	705059	A41 412 - 100	2CMA170505R1000	1	0.230 (0.230)

## Energy meters A series

### Order Codes



A42

Transformer CTVT connected energy meter up to 6 A. Verified and approved according to MID. IEC approval. Voltage V - 57...288 V AC. Instrument values. Alarm function. Communication - Infrared (M-Bus). Optional - Communication with M-Bus, RS-485 Modbus, RS-485 EQ bus.

#### Energy meters single phase electricity meter, 4 DIN with IR port, 6 A

##### Class B (Cl. 1) with functionality level Steel. Active energy.

Description	Bbn	Type	Order Code	Pkg	Weight
	7392696			qty	(1 pc.)
	EAN				kg (lb)
57.7...288 V AC, Pulse output	705554	A42 111 - 100	2CMA170555R1000	1	0.200
57.7...288 V AC, Pulse output, RS-485	705103	A42 112 - 100	2CMA170510R1000	1	0.200
57.7...288 V AC, Pulse output, M-Bus	002424	A42 113 - 100	2CMA100242R1000	1	0.200

##### Class B (Cl. 1) (Reactive Cl. 2) with functionality level Silver. Active and reactive energy, import/export, tariffs 1-4, tariff control via inputs and communication.

Description	Bbn	Type	Order Code	Pkg	Weight
	7392696			qty	(1 pc.)
	EAN				kg (lb)
57.7...288 V AC, 2 output, 2 input, RS-485	705127	A42 312 - 100	2CMA170512R1000	1	0.200

##### Class C (Cl. 0.5 S) (Reactive Cl. 2) with functionality level Platinum. Active and reactive energy, import/export, tariffs 1-4, tariff controlled via inputs, communication or clock, previous values, max and min demand, advanced load profiles, harmonics and THD. Versions for 16.7, 50 or 60 Hz.

Description	Bbn	Type	Order Code	Pkg	Weight
	7392696			qty	(1 pc.)
	EAN				kg (lb)
57.7...288 V AC, Configurable 4 I/O channels, RS-485	002387	A42 552 - 100	2CMA100238R1000	1	0.200
100...288 V AC, Configurable 4 I/O RS-485 channels, RS-485 16.7*, 50 or 60 Hz	705189	A42 552 - 120	2CMA100518R1000	1	0.200
100...288 V AC, Configurable 4 I/O channels, M-Bus 16.7*, 50 or 60 Hz	705196	A42 552 - 120	2CMA100519R1000	1	0.200

\* The meters are not tested and approved for placement on rolling stock.

## Energy meters A series

### Order Codes



A43

Direct connected energy meter up to 80 A. Verified and approved according to MID. IEC approval. 2- and 3-element metering. Instrument values. Alarm function. Communication - Infrared (M-Bus). Optional - Communication with M-Bus, RS-485 Modbus, RS-485 EQ bus.

#### Energy meters three phase electricity meter, 7 DIN with IR port, 80 A

##### Class B (Cl. 1) with functionality level Steel. Active energy.

Description	Bbn	Type	Order Code	Pkg	Weight
	7392696			qty	(1 pc.)
	EAN				kg (lb)
3 x 57.7/100...288/500 V AC, Pulse output	705202	A43 111 - 100	2CMA170520R1000	1	0.440
3 x 57.7/100...288/500 V AC, Pulse output, RS-485	002448	A43 112 - 100	2CMA100244R1000	1	0.440
3 x 57.7/100...288/500 V AC, Pulse output, M-Bus	002455	A43 113 - 100	2CMA100245R1000	1	0.440

##### Class B (Cl. 1) (Reactive Cl. 2) with functionality level Bronze. Active and reactive energy, import/export.

Description	Bbn	Type	Order Code	Pkg	Weight
	7392696			qty	(1 pc.)
	EAN				kg (lb)
3 x 57.7/100...288/500 V AC, Pulse output, RS-485	705226	A43 212 - 100	2CMA170522R1000	1	0.440
3 x 57.7/100...288/500 V AC, Pulse output, M-Bus	705233	A43 213 - 100	2CMA170523R1000	1	0.440

##### Class B (Cl. 1) (Reactive Cl. 2) with functionality level Silver. Active and reactive energy, import/export, tariffs 1-4, tariff control via inputs and communication.

Description	Bbn	Type	Order Code	Pkg	Weight
	7392696			qty	(1 pc.)
	EAN				kg (lb)
3 x 57.7/100...288/500 V AC, 2 output, 2 input, RS-485	705257	A43 312 - 100	2CMA170505R1000	1	0.440
3 x 57.7/100...288/500 V AC, 2 output, 2 input, M-Bus	705264	A43 313 - 100	2CMA170526R1000	1	0.440

##### Class B (Cl. 1) (Reactive Cl. 2) with functionality level Platinum. Active and reactive energy, import/export, tariffs 1-4, tariff controlled via inputs, communication or clock, previous values, max and min demand, advanced load profiles, harmonics and THD.

Description	Bbn	Type	Order Code	Pkg	Weight
	7392696			qty	(1 pc.)
	EAN				kg (lb)
3 x 57.7/100...288/500 V AC, Configurable 4 I/O channels, RS-485	705318	A43 512 - 100	2CMA170531R1000	1	0.440
3 x 57.7/100...288/500 V AC, Configurable 4 I/O channels, M-Bus	705325	A43 513 - 100	2CMA170532R1000	1	0.440

## Energy meters A series

### Order Codes



A44

Transformer CTVT connected energy meter up to 6 A. Verified and approved according to MID. IEC approval. 2- and 3-element metering. Instrument values. Alarm function. Communication - Infrared (M-Bus). Optional - Communication with M-Bus, RS-485 Modbus, RS-485 EQ bus.

#### Energy meters three phase electricity meter, 7 DIN with IR port, 6 A

##### Class B (Cl. 1) with functionality level Steel. Active energy.

Description	Bbn	Type	Order Code	Pkg	Weight
	7392696			qty	(1 pc.)
	EAN				kg (lb)
3 x 57.7/100...288/500 V AC, Pulse output	705332	A44 111 - 100	2CMA170533R1000	1	0.350
3 x 57.7/100...288/500 V AC, Pulse output, RS-485	002486	A44 112 - 100	2CMA100248R1000	1	0.350
3 x 57.7/100...288/500 V AC, Pulse output, M-Bus	002493	A44 113 - 100	2CMA100249R1000	1	0.350

##### Class B (Cl. 1) (Reactive Cl. 2) with functionality level Bronze. Active and reactive energy, import/export.

Description	Bbn	Type	Order Code	Pkg	Weight
	7392696			qty	(1 pc.)
	EAN				kg (lb)
3 x 57.7/100...288/500 V AC, Pulse output	000130	A44 211 - 100	2CMA100013R1000	1	0.350
3 x 57.7/100...288/500 V AC, Pulse output, RS-485	705349	A44 212 - 100	2CMA170534R1000	1	0.350
3 x 57.7/100...288/500 V AC, Pulse output, M-Bus	705356	A44 213 - 100	2CMA170535R1000	1	0.350

##### Class B (Cl. 1) (Reactive Cl. 2) with functionality level Silver. Active and reactive energy, import/export, tariffs 1-4, tariff control via inputs and communication.

Description	Bbn	Type	Order Code	Pkg	Weight
	7392696			qty	(1 pc.)
	EAN				kg (lb)
3 x 57.7/100...288/500 V AC, 2 output, 2 input	705363	A44 311 - 100	2CMA170536R1000	1	0.350

##### Class C (Cl. 0.5 S) (Reactive Cl. 2) with functionality level Silver. Active and reactive energy, import/export, tariffs 1-4, tariff control via inputs and communication.

Description	Bbn	Type	Order Code	Pkg	Weight
	7392696			qty	(1 pc.)
	EAN				kg (lb)
3 x 57.7/100...288/500 V AC, 2 output, 2 input, RS-485	705370	A44 352 - 100	2CMA170537R1000	1	0.350
3 x 57.7/100...288/500 V AC, 2 output, 2 input, M-Bus	705387	A44 353 - 100	2CMA170538R1000	1	0.350

## Energy meters A series

### Order Codes

—  
**Class C (Cl. 0.5 S) (Reactive Cl. 2) with functionality level Gold. Active and reactive energy, import/export, tariffs 1-4, tariff controlled via inputs, communication or clock, previous values, max and min demand.**

Description	Bbn 7392696 EAN	Type	Order Code	Pkg qty	Weight (1 pc.) kg (lb)
3 x 57.7/100...288/500 V AC, 2 output, 2 input, RS-485	705400	A44 452 - 100	2CMA170540R1000	1	0.350

—  
**Class C (Cl. 0.5 S) (Reactive Cl. 2) with functionality level Platinum. Active and reactive energy, import/export, tariffs 1-4, tariff controlled via inputs, communication or clock, previous values, max and min demand, advanced load profiles, harmonics and THD.**

Description	Bbn 7392696 EAN	Type	Order Code	Pkg qty	Weight (1 pc.) kg (lb)
3 x 57.7/100...288/500 V AC, Configurable 4 I/O channels, RS-485	705455	A44 552 - 100	2CMA170545R1000	1	0.350
3 x 57.7/100...288/500 V AC, Configurable 4 I/O channels, M-Bus	705462	A44 553 - 100	2CMA170546R1000	1	0.350
3 x 57.7/100...400/690 V AC, 1 input + 1 output, RS-485	705493	A44 552 - 110	2CMA170549R1000	1	0.350
3 x 57.7/100...400/690 V AC, 1 input + 1 output, M-Bus	705486	A44 553 - 110	2CMA170548R1000	1	0.350

## Energy meters B series

### Order Codes



B21

Direct connected energy meter up to 65 A. Verified and approved according to MID. IEC approval. Instrument values. Alarm function. - Communication - Infrared (M-Bus). Optional - Communication with M-Bus, RS-485 Modbus, RS-485 EQ bus.

#### Energy meters single phase electricity meter, 2 DIN with IR port, 65 A

For direct connection up to 65 A. Class B (Cl. 1) with functionality level Steel. Active energy.

Description	Bbn	Type	Order Code	Pkg	Weight
	7392696			qty	(1 pc.)
	EAN				kg (lb)
1 x 230 V AC, Pulse output	001496	B21 111 - 100	2CMA100149R1000	1	0.140
1 x 230 V AC, Pulse output, RS-485	001502	B21 112 - 100	2CMA100150R1000	1	0.150
1 x 230 V AC, Pulse output, M-Bus	001519	B21 113 - 100	2CMA100151R1000	1	0.150

For direct connection up to 65 A. Class B (Cl. 1) (Reactive Cl. 2) with functionality level Silver.

Active and reactive energy, import/export, tariffs 1-4, tariff controll via inputs and communication.

Description	Bbn	Type	Order Code	Pkg	Weight
	7392696			qty	(1 pc.)
	EAN				kg (lb)
1 x 230 V AC, 2 output, 2 input	001540	B21 311 - 100	2CMA100154R1000	1	0.140
1 x 230 V AC, 2 output, 2 input, input, RS-485	001557	B21 312 - 100	2CMA100155R1000	1	0.150
1 x 230 V AC, 2 output, 2 input, M-Bus	001564	B21 313 - 100	2CMA100156R1000	1	0.150



## Energy meters B series

### Order Codes



B23

Direct connected energy meter up to 65 A. Verified and approved according to MID. IEC approval. 2- and 3-element metering. Instrument values. Alarm function. Communication - Infrared (M-Bus). Optional - Communication with M-Bus, RS-485 Modbus, RS-485 EQ bus.

#### Energy meters three phase electricity meter, 4 DIN with IR port, 65 A

##### Class B (Cl. 1) with functionality level Steel. Active energy.

Description	Bbn	Type	Order Code	Pkg	Weight
	7392696			qty	(1 pc.)
	EAN				kg (lb)
3 x 230/400 V AC, Pulse output	001632	B23 111 - 100	2CMA100163R1000	1	0.310
3 x 230/400 V AC, Pulse output, RS-485	001649	B23 112 - 100	2CMA100164R1000	1	0.320
3 x 230/400 V AC, Pulse output, M-Bus	001656	B23 113 - 100	2CMA100165R1000	1	0.330

##### Class B (Cl. 1) (Reactive Cl. 2) with functionality level Bronze. Active and reactive energy, import/export.

Description	Bbn	Type	Order Code	Pkg	Weight
	7392696			qty	(1 pc.)
	EAN				kg (lb)
3 x 230/400 V AC, Pulse output, RS-485	001663	B23 212 - 100	2CMA100166R1000	1	0.320

##### Class C (Cl. 0.5 S) (Reactive Cl. 2) with functionality level Silver.

Active and reactive energy, import/export, tariffs 1-4, tariff control via inputs and communication.

Description	Bbn	Type	Order Code	Pkg	Weight
	7392696			qty	(1 pc.)
	EAN				kg (lb)
3 x 230/400 V AC, 2 output, 2 input	001687	B23 311 - 100	2CMA100168R1000	1	0.330
3 x 230/400 V AC, 2 output, 2 input, RS-485	001694	B23 311 - 100	2CMA100169R1000	1	0.340
3 x 230/400 V AC, 2 output, 2 input, M-Bus	001700	B23 313 - 100	2CMA100170R1000	1	0.350

## Energy meters B series

### Order Codes



B24

Transformer CT connected energy meter up to 6 A. Verified and approved according to MID. IEC approval. 2- and 3-element metering. Instrument values. Alarm function. Communication - Infrared (M-Bus). Optional - Communication with M-Bus, RS-485 Modbus, RS-485 EQ bus.

#### Energy meters three phase electricity meter, 4 DIN with IR port, 6 A

##### Class B (Cl. 1) with functionality level Steel. Active energy.

Description	Bbn	Type	Order Code	Pkg	Weight
	7392696			qty	(1 pc.)
	EAN				kg (lb)
3 x 230/400 V AC, Pulse output	001779	B24 111 - 100	2CMA100177R1000	1	0.250
3 x 230/400 V AC, Pulse output, RS-485	001786	B24 112 - 100	2CMA100178R1000	1	0.250
3 x 230/400 V AC, Pulse output, M-Bus	001793	B24 113 - 100	2CMA100179R1000	1	0.270

##### Class B (Cl. 1) (Reactive Cl. 2) with functionality level Bronze. Active and reactive energy, import/export.

Description	Bbn	Type	Order Code	Pkg	Weight
	7392696			qty	(1 pc.)
	EAN				kg (lb)
3 x 230/400 V AC, Pulse output, RS-485	001809	B24 212 - 100	2CMA100180R1000	1	0.250

##### Class C (Cl. 0.5 S) (Reactive Cl. 2) with functionality level Silver.

Active and reactive energy, import/export, tariffs 1-4, tariff control via inputs and communication.

Description	Bbn	Type	Order Code	Pkg	Weight
	7392696			qty	(1 pc.)
	EAN				kg (lb)
3 x 230/400 V AC, 2 output, 2 input, RS-485	001694	B24 352 - 100	2CMA100183R1000	1	0.270
3 x 230/400 V AC, 2 output, 2 input, M-Bus	001700	B24 353 - 100	2CMA100184R1000	1	0.290

# M4M Network analysers

## Accurate electrical measuring and power monitoring.

Simple in every aspect, M4M enables accurate energy efficiency evaluations and perfectly fits the ABB solution for monitoring, optimisation and control of electrical system.

### Accurate measurement

Class 0,5 measurement according to IEC 61557-12 and advanced power quality functionalities, including historical measurements.

### Option for MID Approval

Class C accuracy in accordance with 2014/32/EU for billing applications.

### Clear visualisation

Color display and App-structured menu for advanced graphic visualisation.

### Full communication

ABB Ability™ native network analyzers with complete communication protocols and I/O options for integration in any system.

### Smart commissioning

Bluetooth module for easy configuration through EPiC Mobile App unique commissioning tool.

### Intuitive access

Simplified access to the device via touch screen display or 5 pushbuttons keypad.

### Easy to install

Fast one-hand mounting and comfortable installation with clips in only 57 mm depth inside the panel.

### Fast wiring

All-removable terminals and one tool process to speed up the wiring activities.



## Network analysers

### M4M series



M4M 20

M4M 20 is ABB’s network analyser range that provides complete and accurate electrical parameters monitoring and basic power quality analysis. Equipped with graphic color display for advanced visualisation of the measured parameters and Bluetooth® module for smart commissioning.

#### M4M 20 Network analyser

Communication protocol	I/O	Bbn 8012542 EAN	Type	Order Code	Pkg qty	Weight (1 pc.) kg (lb)
BLE	2 Digital out.	511519	M4M 20	2CSG251151R4051	1	0.400
BLE, Modbus RTU	2 Digital out.	511410	M4M 20 Modbus	2CSG251141R4051	1	0.400
BLE, Modbus TCP/IP	2 Digital out.	044710	M4M 20 Ethernet	2CSG204471R4051	1	0.400
BLE, Profibus DP-V0	2 Digital out.	511311	M4M 20 Profibus	2CSG251131R4051	1	0.400
BLE, BACnet/IP	2 Digital out.	368311	M4M 20 Bacnet	2CSG236831R4051	1	0.400
BLE, Modbus RTU	2 Progr. I/O, 2 Digital out., 2 Analogue out.	511618	M4M 20 I/O	2CSG251161R4051	1	0.400
<b>MID</b> BLE, Modbus RTU	2 Digital out.	390558	M4M 20-M MODBUS	2CSG239055R4051	1	0.400
<b>MID</b> BLE, Modbus TCP/IP	2 Digital out.	390657	M4M 20-M ETHERNET	2CSG239065R4051	1	0.400



M4M 20 - ROGOWSKI VERSION

M4M 20 is also available as compatible with ABB’s R4M Rogowski coils for current measurement, increasing the flexibility of network analysers offer and allowing retrofit in any existing installations. M4M 20 Rogowski together with R4M Rogowski coils ensures the integration of basic power quality metering in any existing system with 0 downtime.

#### M4M 20 Network analyser - Rogowski version

Communication protocol	I/O	Bbn 8012542 EAN	Type	Order Code	Pkg qty	Weight (1 pc.) kg (lb)
BLE, Modbus RTU	2 Digital Outputs	070818	M4M 20 Rogowski	2CSG207081R4051	1	0.400

## Network analysers

### M4M series



M4M 30

M4M 30 is ABB's network analyser range that allows complete power quality analysis and energy efficiency evaluations. Equipped with touchscreen color display for simplified access to the device and with Bluetooth® module for smart commissioning.

#### M4M 20 Network analyser

Communication protocol	I/O	Bbn 8012542 EAN	Type	Order Code	Pkg qty	Weight (1 pc.) kg (lb)
BLE, Modbus RTU	4 Progr. I/O	747611	M4M 30 Modbus	2CSG274761R4051	1	0.400
BLE, Modbus TCP/IP	4 Progr. I/O	746812	M4M 30 Ethernet	2CSG274681R4051	1	0.400
BLE, Profibus DP-V0	4 Progr. I/O	367918	M4M 30 Profibus	2CSG236791R4051	1	0.400
BLE, BACnet/IP	4 Progr. I/O	024514	M4M 30 Bacnet	2CSG202451R4051	1	0.400
BLE, Modbus RTU	6 Progr. I/O, 2 Analogue out.	024712	M4M 30 I/O	2CSG202471R4051	1	0.400
MID BLE, Modbus RTU	4 programmable I/O	390350	M4M 30-M MODBUS	2CSG239035R4051	1	0.400
MID BLE, Modbus TCP/IP	4 programmable I/O	390459	M4M 30-M ETHERNET	2CSG239045R4051	1	0.400



M4M 30 - ROGOWSKI VERSION

M4M 30 is also available as compatible with ABB's R4M Rogowski coils for current measurement, increasing the flexibility of network analysers and allowing retrofit in any existing installations. M4M 30 Rogowski together with R4M coils ensure integration of complete PQ analysis in any existing system with 0 downtime.

#### M4M 20 Network analyser - Rogowski version

Communication protocol	I/O	Bbn 8012542 EAN	Type	Order Code	Pkg qty	Weight (1 pc.) kg (lb)
BLE, Modbus RTU	4 Progr. I/O	024613	M4M 30 Rogowski	2CSG202461R4051	1	0.400



R4M

M4M 30 is also available as compatible with ABB's R4M Rogowski coils for current measurement, increasing the flexibility of network analysers and allowing retrofit in any existing installations. M4M 30 Rogowski together with R4M coils ensure integration of complete PQ analysis in any existing system with 0 downtime.

#### R4M Rogowski coils

Diameter (mm)	Bbn 8012542 EAN	Type	Order Code	Pkg qty	Weight (1 pc.) kg (lb)
80	021605	R4M-80	2CSG202160R1101	1	0.150
200	021506	R4M-200	2CSG202150R1101	1	0.250

# Circuit monitoring systems

## System pro M compact® InSite

Connected solutions for sub distribution.

System pro M compact® InSite is a range of connected devices to support energy and asset management in electrical distribution.

The solution delivers highest data security standards (encrypted SNMP V3 and SSL certificate) as well as continuous upgrades thanks to regular firmware updates. Central to the System pro M® InSite range is the SCU100 control unit, that has been specifically developed to allow users to better manage energy and assets in sub distribution boards. It can gather data from up to 16 energy and power meters, as well current sensors for branch measurement.

ABB's ready-made, pre-assembled InSite kit packages are designed to make sub and final electrical distribution smarter with minimal effort. Any size of installation in commercial or industrial application can easily be upgraded,

reducing installation and configuration time to nearly zero, and in turn, minimize costly operational downtime.

To enable monitoring and control of the complete energy distribution system, the range is completed with a flexible choice of input and output modules, which can be easily connected to ABB's System pro M compact® accessories of MCBs and RCDs, as well as other DIN-Rail products with digital inputs or outputs. They can also be connected to pulse meters – such as gas or water – to collect utilities consumption.

Based on a wide set of data, available functionalities range from simple monitoring of the installation to analysis of historical data, customized alarms and implementation of automated actions to reduce energy consumption, identify potential risks and ensure operational continuity.

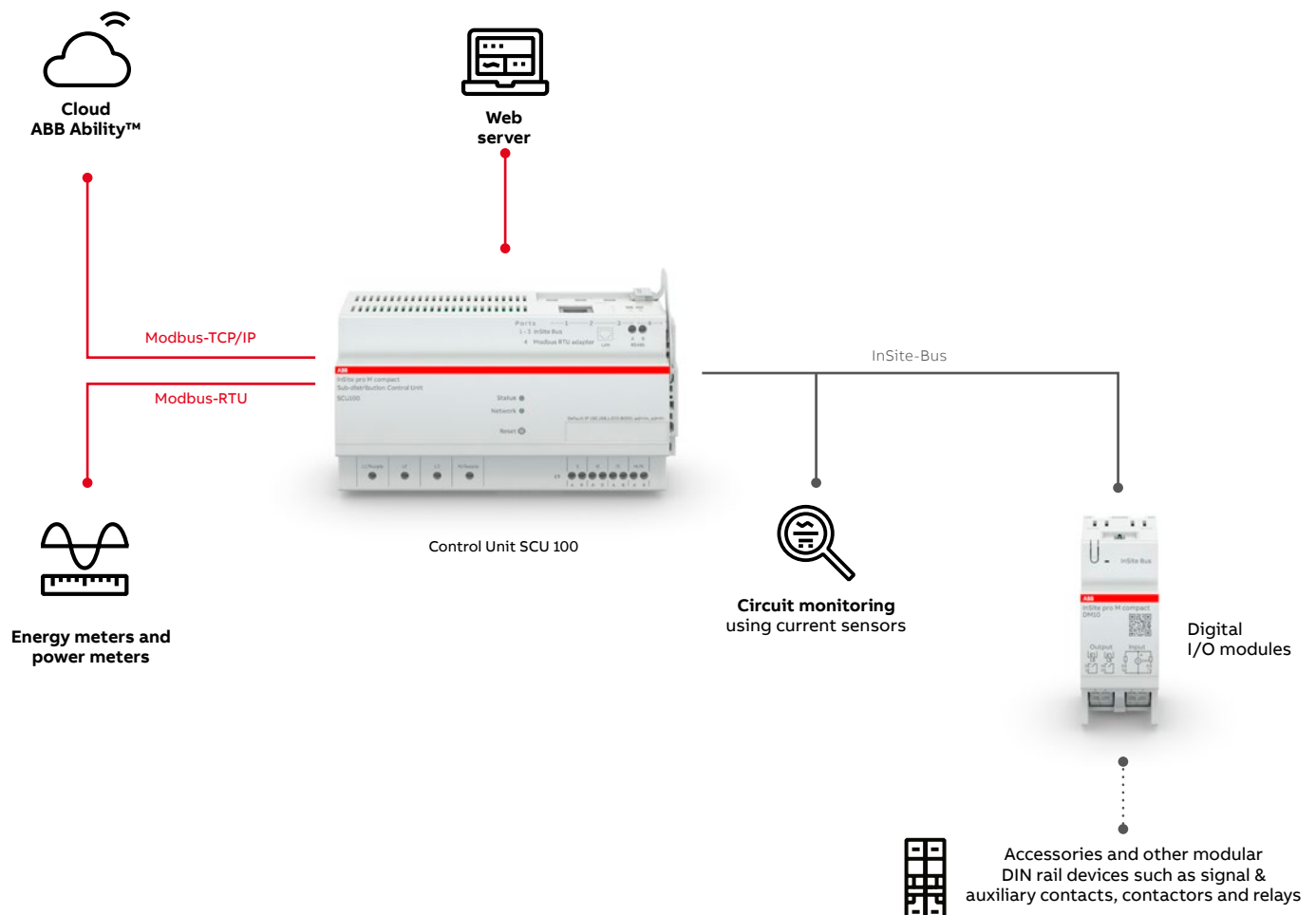



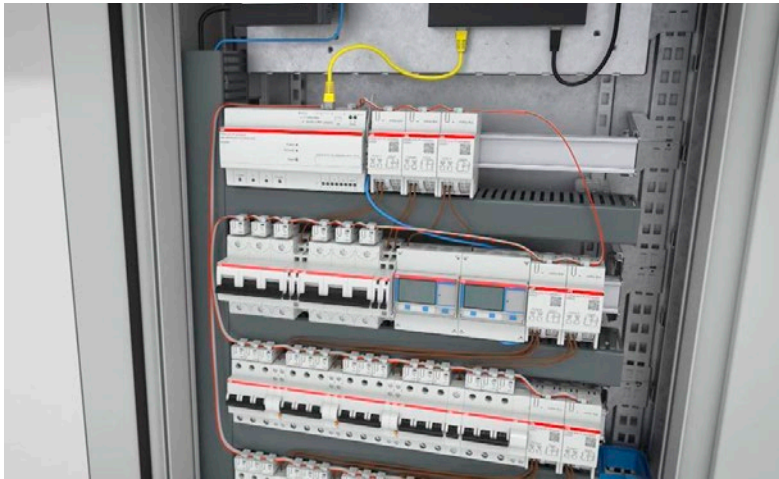

**What to include in the panel:**

- 1 Control Unit
- 2 Digital I/O modules
- 3 Current sensors
- 4 Flat cable

**1 Control Unit  
SCU 100**

Single access point in the sub distribution board, data aggregator and collector from field devices

4<sup>th</sup> port for Modbus RTU to enable connection of meters

Firmware upgrade to communicate with:

- Classic accessories connected through I/O modules
- Sensors, energy and power meters in Modbus RTU
- Current sensors

Modbus TCP/IP and RTU to communicate to supervision system, enabling remote availability of collected data

LEDs for visual understanding of correct /uncorrect installation and functioning

Internal power supply to enable communication and correct functioning of sensors and I/O modules

**2 Digital Input/Output modules  
DM00, DM10, DM11**

- Connect in the connectivity system classic accessories from existing and future ABB ranges and 3rd party ranges.
- Compatibility with water/gas/heat meters with pulse outputs
- Input to receive data from hard wired connecte devices (accessories, meters)
- Output to act on connected accessories

Connection to InSite bus via same type of connectors as existing sensors

Assignment of ID address via dedicated button and analogous procedure as for sensors

No external power supply to enable communication and correct functioning

Visual indication of correct installation and functioning

Screwless terminals to ease installation procedure

## System pro M compact® InSite

### Circuit Monitoring System (CMS)



#### SCU100

The SCU100 is capable of collecting measurements and information from up to 16 energy and power meters, in addition to 96 current sensors and digital channels, all simultaneously. It calculates the energy and number of operations at single line level and compares stored values by period or by device.

Remotely monitoring of the system is made possible by a digital communication that supports different protocols: Modbus RTU, TCP or SNMP v1 and v2 and the encrypted v3.

Its built-in web server offers intuitive access to the measured data, the configuration settings and the system parameters, providing one unique interface for both operations and commissioning process. The two interfaces – LAN (TCP/IP or Modbus TCP) and RS485 (Modbus RTU) – guarantee straightforward integration into any IT infrastructure. What's more, the data can be read out by means of an encrypted SNMP protocol.

The Sub-distribution Control Unit SCU100 has been specifically developed to meet requirements of energy and asset monitoring and control in sub-distribution panelboards. In a framework where energy efficiency and operations continuity are becoming crucial, SCU100 offers the possibility to reduce wastes and identify risky situations promptly.



#### Digital Input and Output modules – DM11, DM00, DM10

The range of digital Input and Output Modules consists of 3 devices to adapt to quantity and type of installed products: Input Module DM11, Output Module DM00 and Input/Output Module DM10.

They can be connected to System pro M compact® accessories of MCBs and RCDs, but also to other DIN-Rail products with a digital input or output and to pulse meters (e.g. water, gas meters). They can read contact status, activate or deactivate lines and collect utilities consumptions.

ABB ranges compatible with I/O Modules are:

Molded Case Circuit Breaker	
Tmax XT	
Molded Case Circuit Breaker	Residual Current Devices
S 200	RCCBs – F 200
SN 201	RCD-blocks – DDA 200, DDA 800
S200 80-100A	RCBOs – DS 201, DS 202, DS 203, DS 200, DS800
S 750 DR	eRCBOs – DSE, DSN
S 700	
S 800	

## System pro M compact® InSite

### CMS sensor components

#### Sensor mounting methods



**System pro M,  
SMISSLINE**

**S800**

**DIN rail**

**Cable tie**

for all LS, FI & FI-LS  
with twin terminals

for all S800 devices  
with cage terminals

universally usable

universally usable

#### Open-core sensors

AC accuracy\*  $\leq \pm 1.0\%$

The laying method  
influences the accuracy.



#### 18-mm overall width

CMS-120xx (80A)

CMS-200SB

CMS-200DR

CMS-200CA

CMS-121xx (40A)

CMS-201SB

CMS-201DR

CMS-201CA

CMS-122xx (20A)

CMS-202SB

CMS-202DR

CMS-202CA

\* All accuracy specifications refer to the relevant full scale value and apply to 25°C.

#### CMS sensor components

Description	GTIN 7612271 EAN	Type	Order Code	Pkg qty	Weight of 1 unit (kg)
Sub-distribution Control Unit	508104	SCU100	2CCG000242R0001	1	0.329
Digital Input Module	508135	DM11	2CCG000245R0001	1	0.075
Digital Output Module	508142	DM00	2CCG000246R0001	1	0.085
Digital Input and Output Module	508159	DM10	2CCG000247R0001	1	0.080
Flat cable 5m	508111	INS105	2CCG000243R0001	1	0.046
Connector set (35pcs)	508128	INS135	2CCG000244R0001	35	0.024

**Solid core sensors**

AC accuracy\* ≤ ±0.5%



**18-mm overall width**

CMS-100xx (80A)	CMS-100PS	CMS-100SB	CMS-100DR	CMS-100CA
CMS-101xx (40A)	CMS-101PS	CMS-101SB	CMS-101DR	CMS-101CA
CMS-102xx (20A)	CMS-102PS	CMS-102SB	CMS-102DR	CMS-102CA



**25-mm overall width**

CMS-200xx (80A)	CMS-200SB	CMS-200DR	CMS-200CA
CMS-201xx (40A)	CMS-201SB	CMS-201DR	CMS-201CA
CMS-202xx (20A)	CMS-202SB	CMS-202DR	CMS-202CA

\* All accuracy specifications refer to the relevant full scale value and apply to 25°C.



**Accessories**

The Sub-distribution Control Unit needs a flat cable to gather information from current sensors and digital I/O modules. The flat cable should be a 4-pin cable, flexible in length. Devices can be placed at customizable distances required by the specific application.

# Data loggers ABB EQmatic

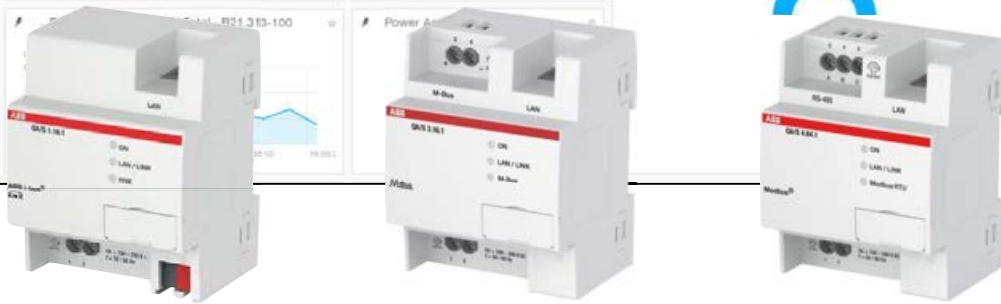
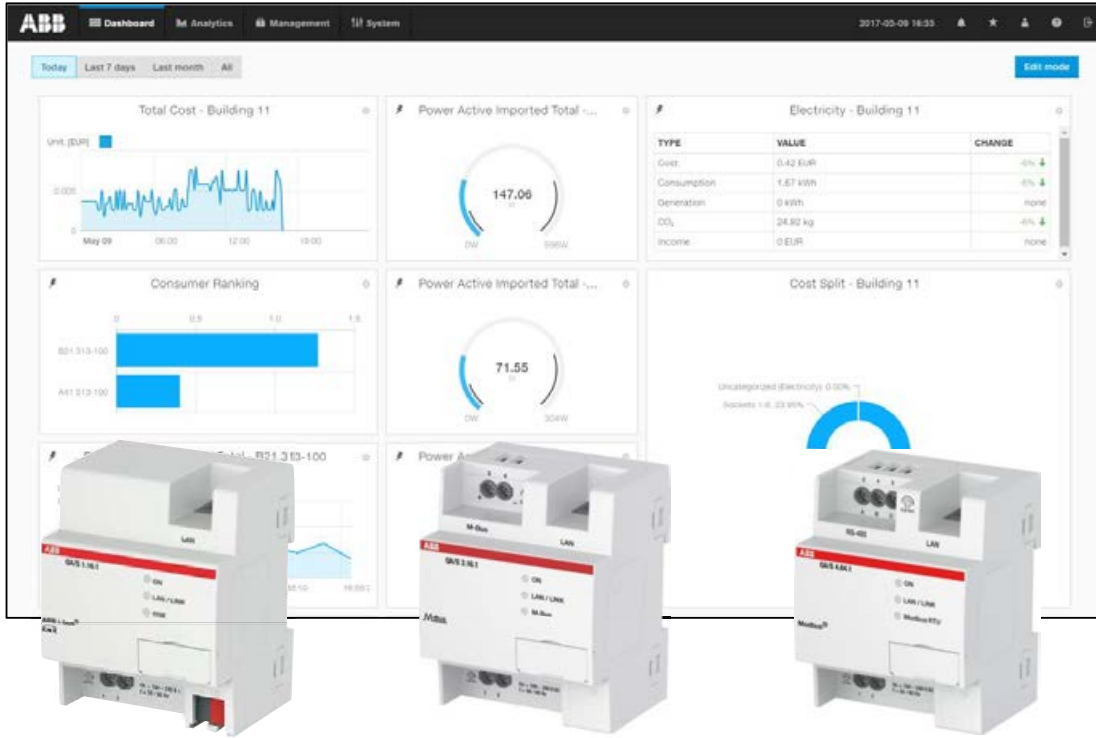

 **Transparency** (cost & consumption)

 **Improve** energy efficiency

 **Sustainability**

 **Reduce** costs

 **Fulfil** regulations (e.g. ISO 50001)

## Architecture

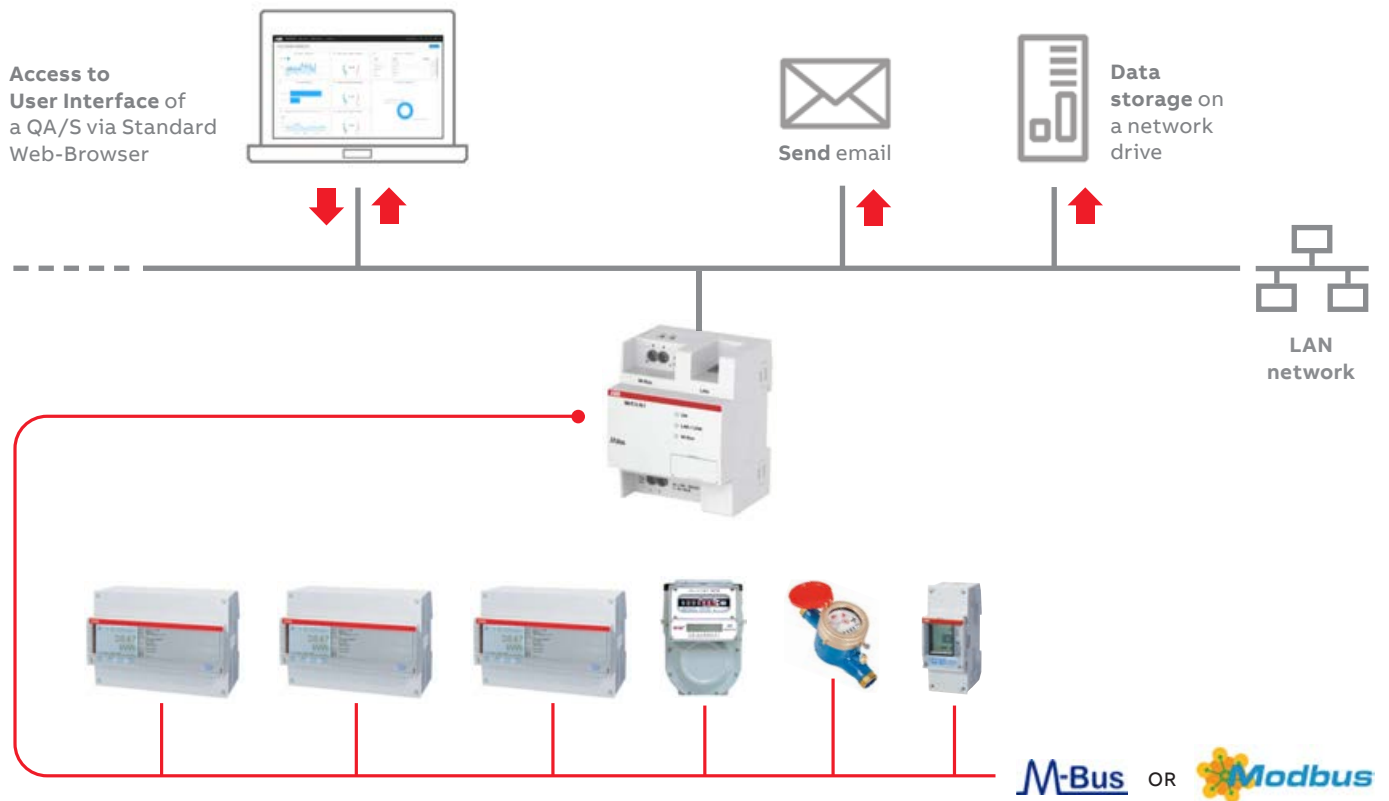

## ABB EQmatic Order Codes



QA/S 3.16.1



QA/S 3.64.1

Compact and web-based stand-alone devices for energy management applications. For monitoring, logging, displaying and analyzing consumption data of up to 16 or 64 electricity, gas, water or heat meters via M-Bus. Automatic detection for ABB Energy meters (A/B-Series). Access to the device via embedded web browser. The user interface provides graphical analysis functions, e.g. dashboard, historical data, instantaneous values, benchmark functions, cost allocation according to consumer groups and more.

### Energy Analyzer, M-Bus, MDRC

**Class B (Cl. 1) with functionality level Steel. Active energy.**

Description	EAN	Type	Order Code	Pkg	Weight
				qty	(1 pc.) kg (lb)
64 Devices	4016779997768	QA/S 3.64.1	2CDG110227R0011	1	0.150
16 Devices	–	QA/S 3.16.1	2CDG110226R0011	1	0.150



---

# Electronic relays and controls

<b>327</b>	<b>Monitoring relays - Three phase</b>
<b>331</b>	<b>Timers</b>
<b>332</b>	<b>Power supplies</b>
<b>334</b>	<b>Pluggable interface relays and optocouplers</b>



---

For more detailed product information, please refer to our online technical brochures available at: [new.abb.com/low-voltage/support/documentation](http://new.abb.com/low-voltage/support/documentation)

or contact our sales team via email [LV.enquiries@gb.abb.com](mailto:LV.enquiries@gb.abb.com)

or call 0333 999 9933

## Measuring and monitoring relays

### Assortment overview

#### Single-phase current and voltage monitoring

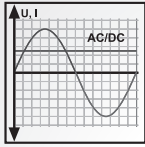

##### Current monitoring

- Monitoring of motor current consumption
- Monitoring of lighting installations and heating circuits
- Monitoring of transportation equipment overload
- Monitoring of locking devices, electromechanical brake gear and locked rotors

##### Voltage monitoring

- Speed monitoring of DC motors
- Monitoring of battery voltages and other supply networks

Please contact us for more information.

#### Three-phase monitoring

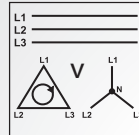

- Voltage monitoring of mobile three-phase equipment
- Protection of personnel and installations against phase reversal
- Monitoring of the supply voltage of machines and installations
- Protection of equipment against damage caused by unstable supply voltage
- Switching to emergency or auxiliary supply
- Protection of motors against damage caused by unbalanced phase voltages and phase loss

See “Ordering details - Singlefunctional” on page 329 or “Ordering details - Multifunctional” on page 330.

#### Grid feeding monitoring relays

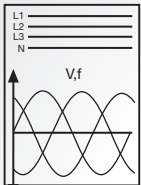

The CM-UFx range monitors all voltage and frequency parameters in a grid and ensures the safe feeding of decentral produced electrical energy into the grid.

- Monitoring of the voltage with up to 2 thresholds for over- and undervoltage
- Monitoring of the frequency with up to 2 thresholds for over- and underfrequency
- ROCOF (rate of change of frequency) and vector shift detection
- In compliance with several local standards

Please contact us for more information.

#### Insulation monitoring

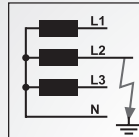

- Monitoring of electrically isolated supply mains for insulation resistance failure
- Detection of initial faults
- Protection against earth faults

Please contact us for more information.

## Measuring and monitoring relays

### Assortment overview

#### Thermistor motor protection

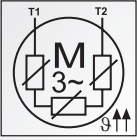

CM-MSE and CM-MSS provide full protection of motors with integrated PTC resistor sensors.

- Protection of motors against thermal overload, e. g. caused by insufficient cooling, heavy load starting conditions, undersized motors, etc.

Please contact us for more information.

#### Temperature monitoring

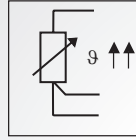

Acquisition, messaging and regulation of temperatures of solid, liquid and gaseous media in processes and machines.

- Motor and system protection
- Control panel temperature monitoring
- Frost monitoring
- Temperature limits for process variables, e.g. in the packing or electroplating industry
- Control of systems and machines like heating, air-conditioning and ventilation systems, solar collectors, heat pumps or hot water supply systems
- Monitoring of servomotors with KTY sensors
- Bearing and gear oil monitoring
- Coolant monitoring

Please contact us for more information.

#### Liquid level monitoring and control

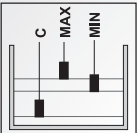

- Protection of pumps against dry running
- Protection against container overflow
- Control of liquid levels
- Detection of leaks
- Control of mixing ratios

Please contact us for more information.





## Timers

### Order Codes – CT-D range



The CT-D range in MDRC design with a width of only 17.5 mm fits into all domestic installation and distribution panels. The CT-D range represents a link between industry and the installation types. For maximum flexibility in operation. The devices offer 4 or 7 time ranges from 0.05 seconds up to 100 hours. Their wide input range allows the use in applications worldwide.

#### Ordering details - CT-D range

Timing function	Rated control supply voltage	Time ranges	Control input	Output	Type	Order Code	Weight (1 pce) kg (lb)
Multi <sup>1)</sup>	24-240 V AC / 24-48 V DC	7 (0.05 s - 100 h)	■	1 c/o	CT-MFD.12	1SVR500020R0000	0.060 (0.132)
Multi <sup>1)</sup>	12-240 V AC/DC	7 (0.05 s - 100 h)	■	2 c/o	CT-MFD.12	1SVR500020R1100	0.065 (0.143)
ON-delay	24-240 V AC / 24-48 V DC	7 (0.05 s - 100 h)		1 c/o	CT-ERD.12	1SVR500100R0000	0.060 (0.132)
OFF-delay	24-240 V AC / 24-48 V DC	7 (0.05 s - 100 h)	■	1 c/o	CT-AHD.12	1SVR500110R0000	0.060 (0.132)
Impulse--ON	24-240 V AC / 24-48 V DC	7 (0.05 s - 100 h)		1 c/o	CT-VWD.12	1SVR500130R0000	0.060 (0.132)
Flasher starting with ON	24-240 V AC / 24-48 V DC	7 (0.05 s - 100 h)		1 c/o	CT-EBD.12	1SVR500150R0000	0.060 (0.132)
Pulse generator	24-240 V AC / 24-48 V DC	2 x 7 (0.05 s - 100 h)	■	1 c/o	CT-TGD.12	1SVR500160R0000	0.060 (0.132)
Star Delta changeover	24-240 V AC / 24-48 V DC	4 (0.05 s - 10 min)		2 c/o	CT-SAD.22	1SVR500210R0100	0.065 (0.143)



## Power Supplies

### Order Codes – CP-D & CP-E range



The CP-D of modular power supply units in MDRC design (modular DIN rail components) is ideally suited for installation in distribution panels. This range offers devices with output voltages of 12 V DC and 24 V DC at output currents of 0.42 A to 4.2 A. Thanks to their high thermal efficiency, these power supplies have very low power and heat dissipation and can be operated without forced cooling. All power supply units in the CP-D range are approved according to all relevant international standards.

#### Ordering details - CP-D range

Input voltage range	Rated output voltage / current	Type	Order Code	Weight (1 pce) kg (lb)
90-264 V AC / 120-375 V DC	12 V DC / 0.83 A	CP-D 12/0.83	1SVR427041R1000	0.06 (0.13)
90-264 V AC / 120-375 V DC	12 V DC / 2.1 A	CP-D 12/2.1	1SVR427043R1200	0.19 (0.41)
90-264 V AC / 120-375 V DC	24 V DC / 0.42 A	CP-D 24/0.42	1SVR427041R0000	0.06 (0.13)
90-264 V AC / 120-375 V DC	24 V DC / 1.3 A	CP-D 24/1.3	1SVR427043R0100	0.19 (0.41)
90-264 V AC / 120-375 V DC	24 V DC / 2.5 A	CP-D 24/2.5	1SVR427044R0200	0.25 (0.56)
90-264 V AC / 120-375 V DC	24 V DC / 4.2 A	CP-D 24/4.2	1SVR427045R0400	0.32 (0.71)

This range offers types with output voltages from 5 V DC to 48 V DC at output currents of 0.625 A to 20 A. With their high thermal efficiency of up to 90%, these power supplies have very low power and heat dissipation and can be operated without forced cooling. The functionality has been enhanced while the number of different types has been considerably reduced. Of course, all power supplies of the CP-E range are approved in accordance with all relevant international standards.

#### Ordering details - CP-E range

Input voltage range function	Rated output voltage / current	Type	Order Code	Weight (1 pce) kg (lb)
90-264 V AC / 120-375 V DC	24 V DC / 0.75 A	CP-E.24 / 0.75 A	1SVR427030R0000	0.15 (0.33)
90-264 V AC / 90-375 V DC	24 V DC / 1.25 A	CP-E.24 / 1.25 A	1SVR427032R1000	0.29 (0.64)
90-264 V AC / 90-375 V DC	24 V DC / 2.5 A	CP-E.24 / 2.5 A	1SVR427032R0000	0.36 (0.79)



CP-E.24 / 2.5 A

1SVR427032R0000



CP-E.24 / 5A

1SVR427034R0000

Input voltage range function	Rated output voltage / current	Type	Order Code	Weight (1 pce) kg (lb)
90-132 V AC, 180-264 V AC / 210-375 V DC	24 V DC / 5	CP-E.24 / 5A	1SVR427034R0000	1.0 (2.20)
90-132 V AC, 180-264 V AC / 210-375 V DC	24 V DC / 10 A	CP-E.24 / 10 A	1SVR427035R0000	1.36 (3.01)
90-264 V AC / 120-375 V DC	24 V DC / 20 A	CP-E.24 / 20 A	1SVR427036R0000	1.90 (4.18)

SECTION 16

## Power Supplies

### Order Codes – CP-S.1 & CP-T range



ABB's new generation of CP-S.1 power supplies for machine building applications deliver high efficiency, high reliability and a minimised footprint. This advanced range of power supplies has an integrated 150% power reserve functionality for up to 5 s and operate at an efficiency of up to 94%. They come equipped with overheat protection and active power factor correction, combined with a broad AC and DC input voltage and extensive worldwide approvals. Make the all-new CP-S.1 power supplies your preferred choice for professional DC applications. UL listing as well as marine approvals complete the assortment offering.

#### Ordering details - CP-S.1 range

Description	Rated input voltage	Rated output voltage	Output power	Order Code
CP-S.1 24/3.0	100-240 V AC, 100-250 V DC	3.0 A	72 W	1SVR427054R0000
CP-S.1 24/5.0		5.0 A	120 W	1SVR427055R0000
CP-S.1 24/10.0		10.0 A	240 W	1SVR427056R0000
CP-S.1 24/20.0		20.0 A	480 W	1SVR427057R0000
CP-S.1 24/40.0	110-240 V AC, 110-250 V DC	40.0 A	960 W	1SVR427054R2000
CP-C.1-A-RU	10-56 V DC	2 x 20 A or 1 x 40 A	-	1SVR427056R2000



CP-T 24/5.0

2CDC 271.043 50009

In terms of design and functionality, the CP-T range perfectly supplements the existing products and extends the range appropriately. The devices can be supplied with a three-phase voltage as well as with two-phase mains. Here, ABB offers power supply units with 24 V DC and 48 V DC outputs with 5 A, 10 A, 20 A and 40 A and efficiency of up to 93%.

As in the case of all products, they are designed for an ambient temperature of up to 70°C. All products can be supplied within an AC supply voltage range between 340 to 575 V AC and a DC supply voltage range between 480 to 820 V DC.

#### Ordering details - CP-T range

Input voltage range	Rated output voltage / current	Type	Order Code	Weight (1 pce) kg (lb)
340-575 V AC / 480-820 V DC	24 V DC / 5 A	CP-T 24/5.0	1SVR427054R0000	0.80 (1.77)
340-575 V AC / 480-820 V DC	24 V DC / 10 A	CP-T 24/10.0	1SVR427055R0000	1.05 (2.31)
340-575 V AC / 480-820 V DC	24 V DC / 20 A	CP-T 24/20.0	1SVR427056R0000	1.75 (3.86)
340-575 V AC / 480-820 V DC	24 V DC / 40 A	CP-T 24/40.0	1SVR427057R0000	3.20 (7.05)
340-575 V AC / 480-820 V DC	48 V DC / 5 A	CP-T 48/5.0	1SVR427054R2000	1.05 (2.31)
340-575 V AC / 480-820 V DC	48 V DC / 10 A	CP-T 48/10.0	1SVR427055R2000	1.75 (3.86)
340-575 V AC / 480-820 V DC	48 V DC / 20 A	CP-T 48/20.0	1SVR427056R2000	3.40 (7.50)



CP-T 24/10.0, CP-T 48/5.0

2CDC 271.045 50009



CP-T 24/20.0, CP-T 48/10.0

2CDC 271.047 50009

## Pluggable interface relays and optocouplers

### Order Codes – CR-S range



CR-S Interface relay

2CDC 291.005.50014



CR-S Optocoupler

2CDC 291.003.50016



CR-S Interface relay

2CDC 291.005.50014

The slim pluggable interface relays and optocouplers of the CR-S Range may be used for electrical isolation, amplification and signal matching. The CR-S relays are 6.2 mm wide and therefore allow for the switching high currents on a small footprint.

#### Ordering details - CR-S range pluggable interface relays

Rated control supply voltage	Outputs	Contact ratings	Type	Order Code	Pkg qty	Weight (1 pc.) kg (lb)
5 V DC	1 c/o (SPDT) standard contacts	250 V, 6 A	CR-S005VDC1R	1SVR405501R1010	10	0.005 (0.011)
12 V DC			CR-S012VDC1R	1SVR405501R2010		
24 V DC			CR-S024VDC1R	1SVR405501R3010		
48 V DC			CR-S048VDC1R	1SVR405501R4010		
60 V DC			CR-S060VDC1R	1SVR405501R5010		
5 V DC	1 c/o (SPDT) gold plated contacts	12 V, 250 mA (3W) <sup>1)</sup>	CR-S005VDC1RG	1SVR405501R1020	10	0.005 (0.011)
12 V DC			CR-S012VDC1RG	1SVR405501R2020		
24 V DC			CR-S024VDC1RG	1SVR405501R3020		
48 V DC			CR-S048VDC1RG	1SVR405501R4020		
60 V DC			CR-S060VDC1RG	1SVR405501R5020		

#### Ordering details - CR-S range pluggable optocouplers

Rated control supply voltage	Outputs	Type	Order Code	Pkg qty	Weight (1 pc.) kg (lb)
24 V DC	Transistor, 100 mA - 48 V DC	CR-S024VDC1TRA	1SVR405510R3050	10	0.004 (0.009)
	MOS-FET, 2 A - 24 V DC	CR-S024VDC1MOS	1SVR405510R3060		
	Triac, 2 A - 240 V AC	CR-S024VDC1TRI	1SVR405510R3070		

#### Ordering details - CR-S range sockets

Rated control supply voltage	Connection type	Type	Order Code	Pkg qty	Weight (1 pc.) kg (lb)
6-24 V DC	Screw	CR-S006/024VDC1SS	1SVR405521R1100	10	0.025 (0.055)
	Spring	CR-S006/024VDC1SZ	1SVR405521R1200		
12-24 V AC/DC	Screw	CR-S012/024VADC1SS	1SVR405521R3100	10	0.025 (0.055)
	Spring	CR-S012/024VADC1SZ	1SVR405521R3200		
48-60 V AC/DC	Screw	CR-S048/060VADC1SS	1SVR405521R5100	10	0.025 (0.055)
	Spring	CR-S048/060VADC1SZ	1SVR405521R5200		
110-125 V AC/DC	Screw	CR-S110/125VADC1SS	1SVR405521R6100	10	0.025 (0.055)
	Spring	CR-S110/125VADC1SZ	1SVR405521R6200		
220-240 V AC/DC	Screw	CR-S220/240VADC1SS	1SVR405521R7100	10	0.025 (0.055)
	Spring	CR-S220/240VADC1SZ	1SVR405521R7200		

#### Ordering details - CR-S range accessories

Version	Type	Order Code	Pkg qty	Weight (1 pc.) kg (lb)
Jumper bar 20 pole, blue colour	CR-SJB20-BLUE	1SVR405598R0700	10	0.008 (0.018)
Jumper bar 20 pole, red colour	CR-SJB20-RED	1SVR405598R0800		
Jumper bar 20 pole, black colour	CR-SJB20-BLACK	1SVR405598R0900		
Separator	CR-SSEP	1SVR405599R0000	10	0.012

# Pluggable interface relays and optocouplers

## Order Codes – CR-P range



2CDC291.045.F000.4

CR-P relay



2CDC291.006.S0016

CR-P optocoupler



2CDC291.006.F0011

CR-PLS



2CDC291.004.F0007

CR-PJ



2CDC291.088.F0004

CR-PLSX relay

The CR-P range offers the highest current switching in an IP67 rated relay housing. This range comprises of pluggable interface relays and optocouplers offered in 10 different control supply voltages. Additionally, gold plated contacts are available for applications where sensitive signals are to be switched. The CR-P range also includes complete versions consisting of a relay, socket, holder and functional module.

### Ordering details - CR-P range relays

Rated control supply voltage	Outputs	Contact ratings	Type	Order Code	Pkg	Weight (1 pc.)
					qty	kg (lb)
12 V DC	1 c/o (SPDT)	250 V, 16 A	CR-P012DC1	1SVR405600R4000	10	0.014 (0.031)
24 V DC			CR-P024DC1	1SVR405600R1000		
48 V DC			CR-P048DC1	1SVR405600R6000		
110 V DC			CR-P110DC1	1SVR405600R8000		
24 V AC			CR-P024AC1	1SVR405600R0000		
48 V AC			CR-P048AC1	1SVR405600R5000		
110 V AC			CR-P110AC1	1SVR405600R7000		
120 V AC			CR-P120AC1	1SVR405600R2000		
230 V AC			CR-P230AC1	1SVR405600R3000		
12 V DC			2 c/o (SPDT)	250 V, 8 A		
24 V DC	CR-P024DC2	1SVR405601R1000				
48 V DC	CR-P048DC2	1SVR405601R6000				
110 V DC	CR-P110DC2	1SVR405601R8000				
12 V AC	CR-P012AC2	1SVR405601R0200				
24 V AC	CR-P024AC2	1SVR405601R0000				
48 V AC	CR-P048AC2	1SVR405601R5000				
110 V AC	CR-P110AC2	1SVR405601R7000				
120 V AC	CR-P120AC2	1SVR405601R2000				
230 V AC	CR-P230AC2	1SVR405601R3000				

### Ordering details - CR-P range pluggable optocouplers

Rated control supply voltage (Us)	Outputs	Type	Order Code	Pkg	Weight (1 pc.)
				qty	kg (lb)
10-32 V DC	MOS-FET, 5 A - 35 V DC	CR-P024MOS1	1SVR405610R4060	10	0.011 (0.618)
	Triac, 3 A - 275 V AC	CR-P024TRI1	1SVR405610R4070		

### Ordering details - Accessories

Version	Connection terminal	Type	Order Code	Pkg	Weight (1 pc.)
				qty	kg (lb)
Logical socket with protective separation	screw	CR-PLS	1SVR405650R0000	10	0.045 (0.099)
Logical socket	screw	CR-PLSx	1SVR405650R0100		
	spring	CR-PLC	1SVR405650R0200		0.042 (0.093)
Standard socket	screw	CR-PSS	1SVR405650R1000		0.038 (0.084)
Plastic holder for socket		CR-PH	1SVR405659R0000	10	0.002 (0.004)
Metal holder		CR-PH1	1SVR405659R0100		
Jumper bar for sockets with screw connection		CR-PJ	1SVR405658R5000		0.018 (0.040)
Marker		CR-PM	1SVR405658R0000	10	0.0002 (0.0004)

## Pluggable interface relays and optocouplers

### Order Codes – CR-M range



CR-M

2CDC291.002.F0015

The CR-M range offers the possibility of switching up to 4 different circuits with a single relay. The integrated LED and test button allow for easy testing and commissioning. This range of relays are available at a wide range of different coil voltages and are accompanied by a wide variety of functional modules. The CR-M range also includes complete versions consisting of a relay, socket, holder and functional module.

#### Ordering details - CR-M range without LED

Rated control supply voltage	Outputs	Contact ratings	Type	Order Code	Pkg	Weight (1 pc.)				
					qty	kg (lb)				
12 V DC	2 c/o (SPDT)	250 V, 12 A	CR-M012DC2	1SVR405611R4000	10	0.033 (0.073)				
24 V DC			CR-M024DC2	1SVR405611R1000						
48 V DC			CR-M048DC2	1SVR405611R6000						
60 V DC			CR-M060DC2	1SVR405611R4200						
110 V DC			CR-M110DC2	1SVR405611R8000						
125 V DC			CR-M125DC2	1SVR405611R8200						
220 V DC			CR-M220DC2	1SVR405611R9000						
24 V AC			CR-M024AC2	1SVR405611R0000						
48 V AC			CR-M048AC2	1SVR405611R5000						
110 V AC			CR-M110AC2	1SVR405611R7000						
120 V AC			CR-M120AC2	1SVR405611R2000						
230 V AC			CR-M230AC2	1SVR405611R3000						
12 V DC			3 c/o (SPDT)	250 V, 10 A			CR-M012DC3	1SVR405612R4000	10	0.033 (0.073)
24 V DC							CR-M024DC3	1SVR405612R1000		
48 V DC	CR-M048DC3	1SVR405612R6000								
60 V DC	CR-M060DC3	1SVR405612R4200								
110 V DC	CR-M110DC3	1SVR405612R8000								
125 V DC	CR-M125DC3	1SVR405612R8200								
220 V DC	CR-M220DC3	1SVR405612R9000								
24 V AC	CR-M024AC3	1SVR405612R0000								
48 V AC	CR-M048AC3	1SVR405612R5000								
60 V AC	CR-M060AC3	1SVR405612R5200								
110 V AC	CR-M110AC3	1SVR405612R7000								
120 V AC	CR-M120AC3	1SVR405612R2000								
230 V AC	CR-M230AC3	1SVR405612R3000								
12 V DC	4 c/o (SPDT)	250 V, 6 A			CR-M012DC4	1SVR405613R4000	10	0.033 (0.073)		
24 V DC			CR-M024DC4	1SVR405613R1000						
48 V DC			CR-M048DC4	1SVR405613R6000						
60 V DC			CR-M060DC4	1SVR405613R4200						
110 V DC			CR-M110DC4	1SVR405613R8000						
125 V DC			CR-M125DC4	1SVR405613R8200						
220 V DC			CR-M220DC4	1SVR405613R9000						
24 V AC			CR-M024AC4	1SVR405613R0000						
48 V AC			CR-M048AC4	1SVR405613R5000						
110 V AC			CR-M110AC4	1SVR405613R7000						
120 V AC			CR-M120AC4	1SVR405613R2000						
230 V AC			CR-M230AC4	1SVR405613R3000						

## Pluggable interface relays and optocouplers

### Order Codes – CR-M range



CR-M

2CDC291.002.F0015

#### Ordering details - CR-M range with LED

Rated control supply voltage	Outputs	Contact ratings	Type	Order Code	Pkg	Weight
					qty	(1 pc.) kg (lb)
12 V DC	2 c/o (SPDT)	250 V, 12 A	CR-M012DC2L	1SVR405611R4100	10	0.033 (0.073)
24 V DC			CR-M024DC2L	1SVR405611R1100		
48 V DC			CR-M048DC2L	1SVR405611R6100		
60 V DC			CR-M060DC2L	1SVR405611R4300		
110 V DC			CR-M110DC2L	1SVR405611R8100		
125 V DC			CR-M125DC2L	1SVR405611R8300		
220 V DC			CR-M220DC2L	1SVR405611R9100		
12 V AC			CR-M012AC2L	1SVR405611R0300		
24 V AC			CR-M024AC2L	1SVR405611R0100		
48 V AC			CR-M048AC2L	1SVR405611R5100		
110 V AC			CR-M110AC2L	1SVR405611R7100		
120 V AC			CR-M120AC2L	1SVR405611R2100		
230 V AC			CR-M230AC2L	1SVR405611R3100		
12 V DC			3 c/o (SPDT)	250 V, 10 A		
24 V DC	CR-M024DC3L	1SVR405612R1100				
48 V DC	CR-M048DC3L	1SVR405612R6100				
60 V DC	CR-M060DC3L	1SVR405612R4300				
110 V DC	CR-M110DC3L	1SVR405612R8100				
125 V DC	CR-M125DC3L	1SVR405612R8300				
220 V DC	CR-M220DC3L	1SVR405612R9100				
12 V AC	CR-M012AC3L	1SVR405612R0300				
24 V AC	CR-M024AC3L	1SVR405612R0100				
48 V AC	CR-M048AC3L	1SVR405612R5100				
110 V AC	CR-M110AC3L	1SVR405612R7100				
120 V AC	CR-M120AC3L	1SVR405612R2100				
230 V AC	CR-M230AC3L	1SVR405612R3100				
12 V DC	4 c/o (SPDT)	250 V, 6 A			CR-M012DC4L	1SVR405613R4100
24 V DC			CR-M024DC4L	1SVR405613R1100		
48 V DC			CR-M048DC4L	1SVR405613R6100		
60 V DC			CR-M060DC4L	1SVR405613R4300		
110 V DC			CR-M110DC4L	1SVR405613R8100		
125 V DC			CR-M125DC4L	1SVR405613R8300		
220 V DC			CR-M220DC4L	1SVR405613R9100		
12 V AC			CR-M012AC4L	1SVR405613R0300		
24 V AC			CR-M024AC4L	1SVR405613R0100		
48 V AC			CR-M048AC4L	1SVR405613R5100		
110 V AC			CR-M110AC4L	1SVR405613R7100		
120 V AC			CR-M120AC4L	1SVR405613R2100		
230 V AC			CR-M230AC4L	1SVR405613R3100		



## Pluggable interface relays and optocouplers

### Ordering details – CR-M range



CR-M4SS

2CDC291.009 F0011



CR-MJ

2CDC291.005 F0007

#### Ordering details - Accessories

Version	Connection terminal	Type	Order Code	Pkg	Weight
				qty	(1 pc.) kg (lb)
Logical socket for 2 c/o	screw	CR-M2LS	1SVR405651R1100	10	0.055 (0.121)
Logical socket for 3 c/o		CR-M3LS	1SVR405651R2100		0.062 (0.137)
Logical socket for 2/4 c/o		CR-M4LS	1SVR405651R3100		0.066 (0.146)
Logical socket for 2 c/o	spring	CR-M2LC	1SVR405651R1200	10	0.065 (0.143)
Logical socket for 2/4 c/o		CR-M4LC	1SVR405651R3200		0.066 (0.146)
Standard socket for 2 c/o	screw	CR-M2SS	1SVR405651R1000	10	0.066 (0.146)
Standard socket for 3 c/o		CR-M3SS	1SVR405651R2000		0.068 (0.150)
Standard socket for 2/4 c/o		CR-M4SS	1SVR405651R3000		0.070 (0.154)
Standard socket for 2 c/o	fork type	CR-M2SF	1SVR405651R1300	10	0.040 (0.088)
Standard socket for 2/4 c/o		CR-M4SF	1SVR405651R3300		0.048 (0.106)
Plastic holder		CR-MH	1SVR405659R1000	10	0.003 (0.007)
Metal holder		CR-MH1	1SVR405659R1100	10	0.0005 (0.001)
Jumper bar for sockets with screw connection		CR-MJ	1SVR405658R6000	10	0.029 (0.064)
Marker		CR-MM	1SVR405658R1000	10	0.0005 (0.001)
Plug for test button replacement		CR-MP	1SVR405658R2000	100	0.001 (0.002)

---

# Motor control and protection

340	Push buttons
341	Emergency stops, enclosures heavy duty push buttons
342	Standard and double push buttons
343	Emergency, stops and Selector switches
344	Key switches & pilot lights
345	Contacts, lamp blocks and accessories
346	3-pole contactor overview
348	AF09 ... AF38 3 pole contactors
349	AF40 ... AF96 3 pole contactors
352	Overload protection
353	Limit switches



For more detailed product information, please refer to our online technical brochures available at: [new.abb.com/low-voltage/support/documentation](https://new.abb.com/low-voltage/support/documentation)

or contact our sales team via email [LV.enquiries@gb.abb.com](mailto:LV.enquiries@gb.abb.com)

or call 0333 999 9933

# Pilot devices - compact 22mm

## Push buttons

Push buttons black plastic bezel

**Order example:**  
 EX1: Type CP1-10 ■ -10, to order colour red replace ■ with R: CP1-10 R-10  
 EX2: Order Code 1SFA619100R101 □  
 To order red replace □ with 1: 1SFA619100R1011

**Colour Codes**

	Red	Green	Yellow	Blue	White	Black	Grey	Clear
Type ■	R	G	Y	L	W	B	U	c
Order Code □	1	2	3	4	5	6	7	8

Type	Contacts		Part no.	Order Code
	N/O	N/C		
Flush momentary	1	-	CP1-10 ■ -10	1SFA619100R101 □
	2	-	CP1-10 ■ -20	1SFA619100R102 □
	-	1	CP1-10 ■ -01	1SFA619100R104 □
	-	2	CP1-10 ■ -02	1SFA619100R105 □
	1	1	CP1-10 ■ -11	1SFA619100R107 □
Flush maintained	1	-	CP2-10 ■ -10	1SFA619101R101 □
	2	-	CP2-10 ■ -20	1SFA619101R102 □
	-	1	CP2-10 ■ -01	1SFA619101R104 □
	-	2	CP2-10 ■ -02	1SFA619101R105 □
	1	1	CP2-10 ■ -11	1SFA619101R107 □
Extended momentary	1	-	CP3-10 ■ -10	1SFA619102R101 □
	2	-	CP3-10 ■ -20	1SFA619102R102 □
	-	1	CP3-10 ■ -01	1SFA619102R104 □
	-	2	CP3-10 ■ -02	1SFA619102R105 □
	1	1	CP3-10 ■ -11	1SFA619102R107 □
Extended maintained	1	-	CP4-10 ■ -10	1SFA619103R101 □
	2	-	CP4-10 ■ -20	1SFA619103R102 □
	-	1	CP4-10 ■ -01	1SFA619103R104 □
	-	2	CP4-10 ■ -02	1SFA619103R105 □
	1	1	CP4-10 ■ -11	1SFA619103R107 □

Push buttons chrome metal bezel

Type	Contacts		Part no.	Order Code
	N/O	N/C		
Flush momentary	1	-	CP1-30 ■ -10	1SFA619100R301 □
	2	-	CP1-30 ■ -20	1SFA619100R302 □
	-	1	CP1-30 ■ -01	1SFA619100R304 □
	-	2	CP1-30 ■ -02	1SFA619100R305 □
	1	1	CP1-30 ■ -11	1SFA619100R307 □
Flush maintained	1	-	CP2-30 ■ -10	1SFA619101R301 □
	2	-	CP2-30 ■ -20	1SFA619101R302 □
	-	1	CP2-30 ■ -01	1SFA619101R304 □
	-	2	CP2-30 ■ -02	1SFA619101R305 □
	1	1	CP2-30 ■ -11	1SFA619101R307 □
Extended momentary	1	-	CP3-30 ■ -10	1SFA619102R301 □
	2	-	CP3-30 ■ -20	1SFA619102R302 □
	-	1	CP3-30 ■ -01	1SFA619102R304 □
	-	2	CP3-30 ■ -02	1SFA619102R305 □
	1	1	CP3-30 ■ -11	1SFA619102R307 □
Extended maintained	1	-	CP4-30 ■ -10	1SFA619103R301 □
	2	-	CP4-30 ■ -20	1SFA619103R302 □
	-	1	CP4-30 ■ -01	1SFA619103R304 □
	-	2	CP4-30 ■ -02	1SFA619103R305 □
	1	1	CP4-30 ■ -11	1SFA619103R307 □

SECTION 17

## Pilot devices - compact 22mm

Emergency stops, enclosures and LED's

### Emergency stop buttons

Type	Contacts		Part no.	Order Code
	N/O	N/C		
 30mm Twist Release Red	0	1	CE3T-10R-01	1SFA619500R1041
	0	2	CE3T-10R-02	1SFA619500R1051
	1	1	CE3T-10R-11	1SFA619500R1071
40mm Twist Release Red	0	1	CE4T-10R-01	1SFA619550R1041
	0	2	CE4T-10R-02	1SFA619550R1051
	1	1	CE4T-10R-11	1SFA619550R1071
40mm Key Release Red	0	2	CE4K-10R-02	1SFA619552R1051
	1	1	CE4K-10R-11	1SFA619552R1071

### Enclosures

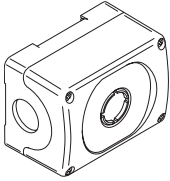
Type	Part no.	Order Code
 Enclosure 1 hole - yellow	CEPY1-0	1SFA619821R1000
Enclosed E-Stop (twist release 2NO + 2NC)	CEPY1-1001	1SFA619821R1001
Enclosed E-Stop with shroud (twist release)	CEPY1-2001	1SFA619821R2001
E-Stop shroud for compact enclosure	CA1-8053	1SFA619920R8053

### Compact LED pilot lights

Colour	Part no.	Order Code
<b>Rated voltage 24 V AC/DC</b>		
Red	CL2-502R	1SFA619403R5021
Green	CL2-502G	1SFA619403R5022
Yellow	CL2-502Y	1SFA619403R5022
Blue	CL2-502L	1SFA619403R5024
Clear	CL2-502C	1SFA619403R5028
<b>Rated voltage 110-130 V AC</b>		
Red	CL2-513R	1SFA619403R5131
Green	CL2-513G	1SFA619403R5132
Yellow	CL2-513Y	1SFA619403R5133
<b>Rated voltage 110-130 V DC</b>		
Red	CL2-515R	1SFA619403R5151
Green	CL2-515G	1SFA619403R5152
Yellow	CL2-515Y	1SFA619403R5153
<b>Rated voltage 220 V DC</b>		
Red	CL2-520R	1SFA619403R5201
Green	CL2-520G	1SFA619403R5202
Yellow	CL2-520Y	1SFA619403R5203
<b>Rated voltage 230 V AC</b>		
Red	CL2-523R	1SFA619403R5231
Green	CL2-523G	1SFA619403R5232
Yellow	CL2-523Y	1SFA619403R5233
Blue	CL2-523L	1SFA619403R5234
Clear	CL2-523C	1SFA619403R5238
<b>Rated voltage 380-415 V AC</b>		
Red	CL2-542R	1SFA619403R5421
Green	CL2-542G	1SFA619403R5422

## Pilot devices - modular 22mm

### Push buttons

#### Standard push buttons black plastic bezel



Type			Part no.	Order Code
Flush	Momentary	Non illuminated	MP1-10 ■	1SFA611100R100 □
	Maintained		MP2-10 ■	1SFA611101R100 □
	Momentary	Illuminated	MP1-11 ■	1SFA611101R110 □
	Maintained		MP2-11 ■	1SFA611101R110 □
Extended	Momentary	Non illuminated	MP3-10 ■	1SFA611102R100 □
	Maintained		MP4-10 ■	1SFA611103R100 □
	Momentary	Illuminated	MP3-11 ■	1SFA611102R110 □
	Maintained		MP4-11 ■	1SFA611103R110 □

#### Standard push buttons chrome plastic bezel



Type			Part no.	Order Code
Flush	Momentary	Non illuminated	MP1-20 ■	1SFA611100R200 □
	Maintained		MP2-20 ■	1SFA611101R200 □
	Momentary	Illuminated	MP1-21 ■	1SFA611100R210 □
	Maintained		MP2-21 ■	1SFA611101R210 □
Extended	Momentary	Non illuminated	MP3-20 ■	1SFA611102R200 □
	Maintained		MP4-20 ■	1SFA611103R200 □
	Momentary	Illuminated	MP3-21 ■	1SFA611102R210 □
	Maintained		MP4-21 ■	1SFA611103R210 □

#### Standard push buttons metal bezel



Type			Part no.	Order Code
Flush	Momentary	Non illuminated	MP1-30 ■	1SFA611100R300 □
	Maintained		MP2-30 ■	1SFA611101R300 □
	Momentary	Illuminated	MP1-31 ■	1SFA611100R310 □
	Maintained		MP2-31 ■	1SFA611101R310 □
Extended	Momentary	Non illuminated	MP3-30 ■	1SFA611102R300 □
	Maintained		MP4-30 ■	1SFA611103R300 □
	Momentary	Illuminated	MP3-31 ■	1SFA611102R310 □
	Maintained		MP4-31 ■	1SFA611103R310 □

Select your colour by replacing with a digit from the chart below

#### How to order standard operators:

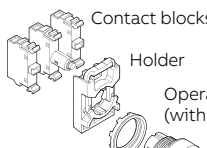
- Non-illuminated operator + holder + contact block(s)
  - Illuminated operator + holder + contact block(s) + lamp block
- 

#### Color codes

Description	Type	Order Code
Red	R	1
Green	G	2
Yellow	Y	3
Blue	L	4
White	W	5
Black	B	6
Grey	U	7
Clear	C	8

#### Contact blocks including holder with 3 blocks

Description	Type	Order Code
1 NO	MCBH-10	1SFA611605R1101
1 NC	MCBH-01	1SFA611605R1110
2 NC	MCBH-02	1SFA611605R1120
2 NO	MCBH-20	1SFA611605R1102
1 NO+1 NC	MCBH-11	1SFA611605R1111
1 NO+2 NC	MCBH-12	1SFA611605R1121
<b>Contact blocks</b>		
1 NO	MCB-10	1SFA611610R1001
1 NC	MCB-01	1SFA611610R1010
<b>Separate holder for 3 blocks</b>		
Holder	MCBH-00	1SFA611605R1100



#### Ordering example:

- Ex 1: Type CP1-10 ■ -10, to order color red replace ■ with R: CP1-10 R-10
- Ex 2: Order code 1SFA619100R101 □, to order color red replace □ with 1: 1SFA619100R1011



## Pilot devices - modular 22mm

### Emergency stops and selector switches



#### Emergency stops

Type	Part no.	Order Code
 30mm Red Non illuminated	Twist release	MPET3-10R
	Pull release	MPEP3-10R
	Key release	MPEK3-11R
 40mm Red Non illuminated	Twist release	MPET4-10R
	Pull release	MPEP4-10R
	Key release	MPEK4-11R
40mm Red Illuminated	Twist release	MPMT3-11R
	Pull release	MPMP3-11R
60mm Red Illuminated	Twist release	MPMT4-11R
	Pull release	MPMP4-11R

#### Selector switches black plastic bezel

Type	Part no.	Order Code
 Two position BC  Two position AC  Two position spring return CB	Black	Short handle
	M2SS1-10B	1SFA611200R1006
	M2SS2-10B	1SFA611201R1006
Two position BC Two position AC Two position spring return CB	Black	Long handle
	M2SS4-10B	1SFA611203R1006
	M2SS5-10B	1SFA611204R1006
Three position ABC Three position spring return A to B - C to B Three position stay put A, spring return C to B Three position stay put C, spring return A to B	Black	Short handle
	M3SS2-10B	1SFA611211R1006
	M3SS3-10B	1SFA611212R1006
Three position ABC Three position spring return A to B - C to B Three position stay put A, spring return C to B Three position stay put C, spring return A to B	Black	Long handle
	M3SS4-10B	1SFA611213R1006
	M3SS5-10B	1SFA611214R1006
Three position stay put A, spring return C to B Three position stay put C, spring return A to B	Black	
	M3SS6-10B	1SFA611215R1006
	M3SS8-10B	1SFA611217R1006

#### Selector switches chrome metal bezel

Type	Part no.	Order Code
 Two position BC  Two position AC  Two position spring return CB	Black	Short handle
	M2SS1-30B	1SFA611200R3006
	M2SS2-30B	1SFA611201R3006
Two position BC Two position AC Two position spring return CB	Black	Long handle
	M2SS4-30B	1SFA611203R3006
	M2SS5-30B	1SFA611204R3006
Three position ABC Three position spring return A to B - C to B Three position stay put A, spring return C to B Three position stay put C, spring return A to B	Black	Short handle
	M3SS1-30B	1SFA611210R3006
	M3SS2-30B	1SFA611211R3006
Three position stay put A, spring return C to B Three position stay put C, spring return A to B Three position ABC Three position spring return A to B - C to B Three position stay put A, spring return C to B Three position stay put C, spring return A to B	Black	Long handle
	M3SS3-30B	1SFA611212R3006
	M3SS4-30B	1SFA611213R3006
Three position spring return A to B - C to B Three position stay put A, spring return C to B Three position stay put C, spring return A to B	Black	
	M3SS5-30B	1SFA611214R3006
	M3SS6-30B	1SFA611215R3006
Three position stay put C, spring return A to B	Black	M3SS8-30B
		1SFA611217R3006



## Pilot devices - modular 22mm

### Key switches, pilot lights

#### Key switches black plastic bezel

Type	Part no.	Order Code
Two position Key release in BC positions	71/Ronis 455 Maintained	M2SSK1-101 1SFA611280R1001
	72/Ronis 421 BC	M2SSK1-102 1SFA611280R1002
	73/Ronis 3433-E	M2SSK1-103 1SFA611280R1003
Two position Key release in B positions	71/Ronis 455	M2SSK2-101 1SFA611281R1001
	72/Ronis 421	M2SSK2-102 1SFA611281R1002
	73/Ronis 3433-E	M2SSK2-103 1SFA611281R1003
Two position	71/Ronis 455 Momentary	M2SSK3-101 1SFA611282R1001
	72/Ronis 421 BC	M2SSK3-102 1SFA611282R1002
	73/Ronis 3433-E	M2SSK3-103 1SFA611282R1003
Three position	71/Ronis 455 Maintained	M3SSK1-101 1SFA611283R1001
	72/Ronis 421 ABC	M3SSK1-102 1SFA611283R1002
	73/Ronis 3433-E	M3SSK1-103 1SFA611283R1003

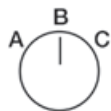

#### Key switches chrome metal bezel

Type	Part no.	Order Code
Two position Key release in BC positions	71/Ronis 455 Maintained	M2SSK1-301 1SFA611280R3001
	72/Ronis 421 BC	M2SSK1-302 1SFA611280R3002
	73/Ronis 3433-E	M2SSK1-303 1SFA611280R3003
Two position Key release in B positions	71/Ronis 455	M2SSK2-301 1SFA611281R3001
	72/Ronis 421	M2SSK2-302 1SFA611281R3002
	73/Ronis 3433-E	M2SSK2-303 1SFA611281R3003
Two position	71/Ronis 455 Momentary	M2SSK3-301 1SFA611282R3001
	72/Ronis 421 BC	M2SSK3-302 1SFA611282R3002
	73/Ronis 3433-E	M2SSK3-303 1SFA611282R3003
Three position	71/Ronis 455 Maintained	M3SSK1-301 1SFA611283R3001
	72/Ronis 421 ABC	M3SSK1-302 1SFA611283R3002
	73/Ronis 3433-E	M3SSK1-303 1SFA611283R3003

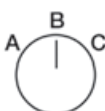

#### Pilot lights





	Part no.	Order Code
Red	ML-100 R	1SFA611400R1001
Green	ML-100 G	1SFA611400R1002
Yellow	ML-100 Y	1SFA611400R1003
Blue	ML-100 B	1SFA611400R1004
White	ML-100 W	1SFA611400R1005
Clear	ML-100 C	1SFA611400R1008
Light diffusing lens	KA1-8005	1SFA616920R8005



## Pilot devices - modular 22mm

### Contacts, lamp blocks and accessories

#### Contacts and lampblocks

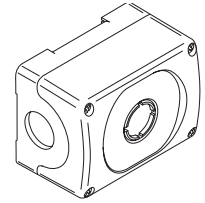
	Part no.	Order Code
<b>Separate holder</b>		
	Holder for 3 blocks	MCBH-00 1SFA611605R1100
	Holder for 5 blocks	MCBH-50 1SFA611601R1100
<b>Contact blocks</b>		
	1 NO	MCB-10 1SFA611610R1001
	1 NC	MCB-01 1SFA611610R1010
	2 NC	MCB-20 1SFA611610R1020
	2 NC	MCB-02 1SFA611610R1002
	1 NO + 1 NC	MCB-11 1SFA611610R1011
<b>Contact blocks with 3-holder included</b>		
	1 NO	MCBH-10 1SFA611605R1101
	1 NC	MCBH-01 1SFA611605R1110
	2 NO	MCBH-20 1SFA611605R1102
	2 NC	MCBH-02 1SFA611605R1120
	1 NO + 1 NC double contacts	MCBH-11 1SFA611605R1111
	2 NO + 1 NC double contacts	MCBH-21 1SFA611605R1112
<b>Legend plate holders</b>		
	Holder black	KA1-8120 1SFA616920R8120
	Inserts without text	KA1-8121 1SFA616920R8121
	Legend plate holder for plastic enclosures	MA6-1060 1SFA611930R1060
	Inserts without text for plastic enclosures	MA6-1061 1SFA611930R1061
<b>General accessories</b>		
	Shroud	MA1-8053 1SFA611920R8053
	Mounting tool	MA1-8015 1SFA611920R8015
	Membrane of silicone flush button	KA1-8052 1SFA616920R8052
	Blanking plug	MA1-8130 1SFA611920R8130
	Spacer	- SK615516-1
	Spacer for emergency stop	KA1-8045 1SFA616920R8045
	<b>Empty enclosures</b>	
	Empty Grey Enclosure - 1 Seat	1SFA611811R1000
	Empty Grey Enclosure - 2 Seat	1SFA611812R1000
	Empty Grey Enclosure - 3 Seat	1SFA611813R1000
	Empty Grey Enclosure - 4 Seat	1SFA611814R1000
	Empty Yellow Enclosure - 1 Seat	1SFA611821R1000
<b>Contact blocks for enclosures</b>		
	1 NO	1SFA611610R2001
	1 NC	1SFA611610R2010
	2 NO	1SFA611610R2002
	2 NC	1SFA611610R2020
	1 NO + 1 NC	1SFA611610R2011

## 3-pole contactor overview

### Contactors for motor control and power switching



IEC (1)	AC-3 Rated operational power	≤ 60 °C (2), 400 V	kW	4	5.5	7.5	11	15	18.5	18.5	22	30	37	45
UL/CSA	3-phase motor rating	480 V	hp	5	7.5	10	15	20	25	30	40	50	60	60
AC / DC Control supply			Type	AF09	AF12	AF16	AF26	AF30	AF38	AF40	AF52	AF65	AF80	AF96
AC Control supply			Type	AF09	AF12	AF16	AF26	AF30	AF38	AF40	AF52	AF65	AF80	AF96
DC Control supply			Type	AF09	AF12	AF16	AF26	AF30	AF38	AF40	AF52	AF65	AF80	AF96
IEC	AC-3 Rated operational current	≤ 60 °C (2), 400 V	A	9	12	18	26	32	38	40	53	65	80	96
	AC-1 Rated operational current	≤ 40 °C, 690 V	A	25	28	30	45	50	50	70	100	105	125	130
UL/CSA	General use rating	600 V	A	25	28	30	45	50	50	60	80	90	105	115
NEMA	NEMA Size			00	0	-	1	-	-	2	-	-	3	-

### Main accessories

Auxiliary contact blocks	Front mounting	CA4-10 (1 x N.O.) CA4-01 (1 x N.C.)
	Side mounting	CAL4-11 (1 x N.O. + 1 x N.C.)
Timers	Electronic	TEF4-ON TEF4-OFF
Interlocking units <sup>(3)</sup>	Mechanical	VM4
	Mechanical / Electrical	VEM4
Connection sets	For reversing contactors	BER16-4
Surge suppressors	Varistor (AC/DC)	BER38-4
	RC type (AC)	BER65-4
	Transil diode (DC)	BER96-4

### Overload relays

Thermal relays		Class 10 (Class 10A for TF140, TA200DU)	TF42 (0.10...38 A)	TF65 (22...67 A)	TF96 (40...96 A)
Electronic relays		Class 10E, 20E, 30E	EF19 (0.10...18.9 A)	EF19 (0.10...18.9 A) EF45 (9...45 A)	EF65 (20...70 A) EF96 (36...100 A)

### Manual motor starters

	Thermal / magnetic protection Class 10	MS116 (0.10...32 A) lcs up to 50 kA for class 10 A	MS450 (28...50 A) lcs up to 50 kA
		MS132 (0.10...32 A) lcs up to 100 kA	MO495 (63...100 A) lcs up to 50 kA
			MS497 (22...100 A) lcs up to 100 kA
	Magnetic only types	MO132 (0.16...32 A) lcs up to 100 kA	MO496 (32...100 A) lcs up to 100 kA
Accessories	For contactor mounting	BEA16-4	BER38-4



55	75	75	90	110	132	160	200	200	250	315	400	-	475	560	-	-
75	100	100	125	150	200	250	300	350	400	500	600	-	800	900	-	-
AF116	AF116	AF146	AF190	AF205	AF265	AF305	AF370	AF400	AF460	AF580	AF750	AF1250	AF1350	AF1650	AF2050	AF2650
AF116	AF140	AF146	AF190	AF205	AF265	AF305	AF370	AF400	AF460	AF580	AF750	AF1250	AF1350	AF1650	AF2050	AF2650
AF116	AF140	AF146	AF190	AF205	AF265	AF305	AF370	AF400	AF460	AF580	AF750	AF1250	AF1350	AF1650	AF2050	AF2650
116	140	146	190	205	265	305	370	400	460	580	750	-	860	1050	-	-
160	200	225	275	350	400	500	600	600	700	800	1050	1260	1350	1650	2050	2650
160	200	200	250	300	350	400	520	550	650	750	900	1210	1350	1650	2100	2700
-	4	-	-	-	5	-	-	-	6	-	7	-	-	8	-	-

CAL19-11 (1 x N.O. + 1 x N.C.)

CAL18-11 (1 x N.O. + 1 x N.C.)

VM19 (for same size contactors)

VM750H VM750V

TEF4-ON TEF4-OFF

VM1650H

BER140-4

BER205-4

BER370-4

BEM460-30

BEM750-30

Built-in surge protection

TF140DU  
(66...142 A) ≤ 55 °C

TA200DU  
(66...200 A) ≤ 55 °C

EF146  
(54...150 A)

EF205  
(63...210 A)

EF370  
(115...380 A)

EF460  
(150...500 A)

EF750  
(250...800 A)

E1250DU  
(375...1250 A)

Short-circuit protection devices



Push-in spring motor devices



With the new complete **Push-in Spring motor** starting solution, one push is all you need for extremely fast wiring. No tool is required, so you can save up to 50% wiring time with Push-in Spring compared to conventional spring solutions. And the connections are just as reliable. So for speed, ease and reliability, just push it.

**Faster than ever installation**

Imagine a motor starting solution that's twice as fast to install. With Push-in Spring, you no longer need to imagine – it's a reality. Push-in mode allows you to insert both ferruled and rigid cables without the need to use any tools, boosting your productivity like never before.



## AF09 ... AF38 3 pole contactors

4 to 18.5kW AC/DC operated

AF09 ... AF38 contactors are mainly used for controlling 3-phase motors and power circuits up to 690 V AC and 220 V DC. These contactors are of the block type design with 3 main poles.

- Control circuit: AC or DC operated with electronic coil interface accepting a wide control voltage range (e.g. 100...250 V AC and DC), only 4 control voltage ranges covering 24...500V 50/60 Hz and 20...500 V DC

- Can manage large control voltage variations
- Reduced panel energy consumption
- Very distinct closing and opening
- Built-in surge suppression
- Add-on auxiliary contact blocks for front or side mounting and a wide range of accessories

	IEC		UL/CSA		Rated control circuit voltage		Auxiliary contacts fitted		Part no. <sup>(1)</sup>	Order Code	
	Rated operational power 400 V AC-3 kW	current ≤ 40 °C AC-1 A	3-phase motor rating 480 V hp	General use rating 600 V AC A	Uc min. ... V 50/60 Hz	Uc max. V DC					
							1	0			
	4	25	5	25	24...60	20...60	1	0	AF09-30-10-11	1SBL137001R1110	
							0	1	AF09-30-01-11	1SBL137001R1101	
					48...130	48...130	1	0	AF09-30-10-12	1SBL137001R1210	
							0	1	AF09-30-01-12	1SBL137001R1201	
					100...250	100...250	1	0	AF09-30-10-13	1SBL137001R1310	
							0	1	AF09-30-01-13	1SBL137001R1301	
					250...500	250...500	1	0	AF09-30-10-14	1SBL137001R1410	
							0	1	AF09-30-01-14	1SBL137001R1401	
	AF09-30-10	5.5	28	7.5	28	24...60	20...60	1	0	AF12-30-10-11	1SBL157001R1110
								0	1	AF12-30-01-11	1SBL157001R1101
					48...130	48...130	1	0	AF12-30-10-12	1SBL157001R1210	
							0	1	AF12-30-01-12	1SBL157001R1201	
					100...250	100...250	1	0	AF12-30-10-13	1SBL157001R1310	
							0	1	AF12-30-01-13	1SBL157001R1301	
					250...500	250...500	1	0	AF12-30-10-14	1SBL157001R1410	
							0	1	AF12-30-01-14	1SBL157001R1401	
		7.5	30	10	30	24...60	20...60	1	0	AF16-30-10-11	1SBL177001R1110
								0	1	AF16-30-01-11	1SBL177001R1101
					48...130	48...130	1	0	AF16-30-10-12	1SBL177001R1210	
							0	1	AF16-30-01-12	1SBL177001R1201	
					100...250	100...250	1	0	AF16-30-10-13	1SBL177001R1310	
							0	1	AF16-30-01-13	1SBL177001R1301	
					250...500	250...500	1	0	AF16-30-10-14	1SBL177001R1410	
							0	1	AF16-30-01-14	1SBL177001R1401	
	AF26-30-00	11	45	15	45	24...60	20...60	0	0	AF26-30-00-11	1SBL237001R1100
								0	0	AF26-30-00-12	1SBL237001R1100
0								0	AF26-30-00-13	1SBL237001R1300	
0								0	AF26-30-00-14	1SBL237001R1400	
	15	50	20	50	24...60	20...60	0	0	AF30-30-00-11	1SBL277001R1100	
							0	0	AF30-30-00-12	1SBL277001R1200	
							0	0	AF30-30-00-13	1SBL277001R1300	
							0	0	AF30-30-00-14	1SBL277001R1400	
	18.5	50	25	50	24...60	20...60	0	0	AF38-30-00-11	1SBL297001R1100	
							0	0	AF38-30-00-12	1SBL297001R1200	
							0	0	AF38-30-00-13	1SBL297001R1300	
							0	0	AF38-30-00-14	1SBL297001R1400	

<sup>1)</sup> For other auxiliary contacts arrangements, please contact your ABB local sales organization.





## AF40 ... AF96 3 pole contactors

18.5 to 45kW AC/DC operated

AF40 ... AF96 contactors are mainly used for controlling 3-phase motors and power circuits up to 690 V AC and 220 V DC. These contactors are of the block type design with 3 main poles.

- Control circuit: AC or DC operated with electronic coil interface accepting a wide control voltage range (e.g. 100...250 V AC and DC), only 4 control voltage ranges covering 24...500V 50/60 Hz and 20...500 V DC

- Can manage large control voltage variations
- Reduced panel energy consumption
- Very distinct closing and opening
- Built-in surge suppression
- Add-on auxiliary contact blocks for front or side mounting and a wide range of accessories

	IEC		UL/CSA		Rated control circuit voltage		Auxiliary contacts fitted		Part no. <sup>(1)</sup>	Order Code
	Rated operational power 400 V AC-3 kW	current ≤ 40 °C AC-1 A	3-phase motor rating 480 V hp	General use rating 600 V AC A	Uc min. ... V 50/60 Hz	Uc max. V DC				
										
	18.5	70	30	60	24...60	–	0	0	AF40-30-00-41	1SBL347001R4100
					24...60	20...60	0	0	AF40-30-00-11	1SBL347001R1100
					48...130	48...130	0	0	AF40-30-00-12	1SBL347001R1200
					100...250	100...250	0	0	AF40-30-00-13	1SBL347001R1300
					250...500	250...500	0	0	AF40-30-00-14	1SBL347001R1400
AF40-30-00	22	100	40	80	24...60	–	0	0	AF52-30-00-41	1SBL367001R4100
					24...60	20...60	0	0	AF52-30-00-11	1SBL367001R1100
					48...130	48...130	0	0	AF52-30-00-12	1SBL367001R1200
					100...250	100...250	0	0	AF52-30-00-13	1SBL367001R1300
					250...500	250...500	0	0	AF52-30-00-14	1SBL367001R1400
	30	105	50	90	24...60	–	0	0	AF65-30-00-41	1SBL387001R4100
					24...60	20...60	0	0	AF65-30-00-11	1SBL387001R1100
					48...130	48...130	0	0	AF65-30-00-12	1SBL387001R1200
					100...250	100...250	0	0	AF65-30-00-13	1SBL387001R1300
					250...500	250...500	0	0	AF65-30-00-14	1SBL387001R1400
AF80-30-00	37	125	60	105	24...60	–	0	0	AF80-30-00-41	1SBL397001R4100
					24...60	20...60	0	0	AF80-30-00-11	1SBL397001R1100
					48...130	48...130	0	0	AF80-30-00-12	1SBL397001R1200
					100...250	100...250	0	0	AF80-30-00-13	1SBL397001R1300
					250...500	250...500	0	0	AF80-30-00-14	1SBL397001R1400
	45	130	60	155	24...60	–	0	0	AF96-30-00-41	1SBL407001R4100
					24...60	20...60	0	0	AF96-30-00-11	1SBL407001R1100
					48...130	48...130	0	0	AF96-30-00-12	1SBL407001R1200
					100...250	100...250	0	0	AF96-30-00-13	1SBL407001R1300
					250...500	250...500	0	0	AF96-30-00-14	1SBL407001R1400

<sup>1)</sup> For other auxiliary contacts arrangements, please contact your ABB local sales organisation.

\*\* Note: larger sizes and 4 pole versions available - contact us for further information.



# AF09 ... AF96 3 pole contactors

## Main accessories

### Contactor and main accessories (other accessories available)

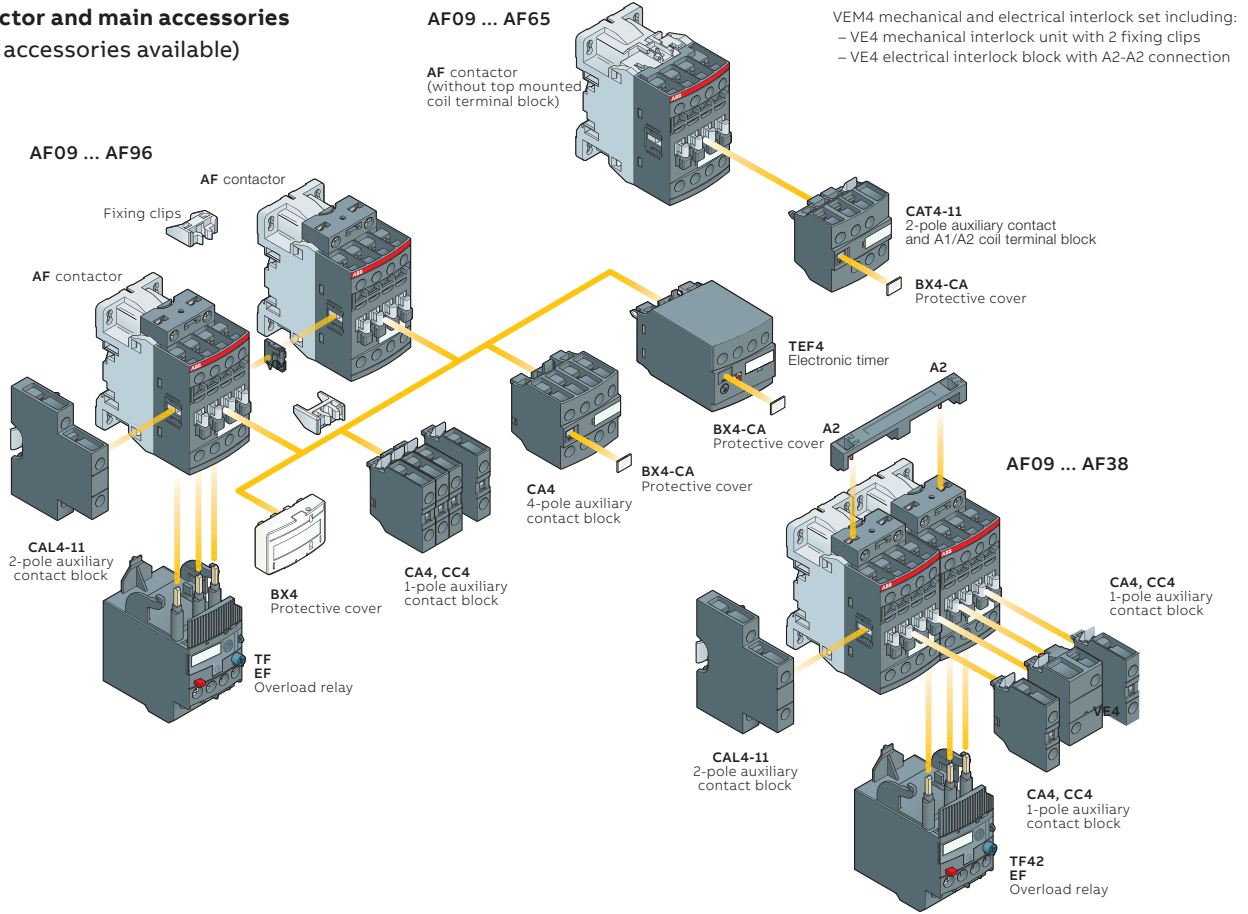

### Main accessory fitting details

Many configurations of accessories are possible depending on whether these are front-mounted or side-mounted.

Contactor types	Main poles				Built-in auxiliary contacts				Front-mounted accessories			Side-mounted accessories	
	Main poles		Built-in auxiliary contacts		Auxiliary contact blocks		Electronic timer	Electrical & mechanical interlock set (between 2 contactors)	Auxiliary contact blocks		Left side	Right side	
	1-pole CA4	1-pole CC4	2-pole CAT4-11	4-pole CA4	TEF4	VEM4	Left side	Right side	2-pole CAL4-11				
Max. N.C. built-in and add-on N.C. auxiliary contacts: 4 N.C. max. on positions 1, 2, 3, 4 and 3 N.C. max. on positions 1 ±30°, 5													
AF09 ... AF16	3	0	0	1	4 max. or	1 or	1 or	1	- +	1	-		
AF09 ... AF16	3	0	1	0	2 max. or	1	- or	1	- +	1 +	1		
AF26 ... AF38	3	0	0	0	3 max.	-	-	- +	1 +	1 or	1		
Max. add-on N.C. auxiliary contacts: 6 N.C. max. on positions 1, 1 ±30°, 2, 3, 4, 5													
AF40 ... AF65	3	0	0	0	4 max. or	1	1	1	- +	1 +	1		
AF80, AF96	3	0	0	0	4 max.	-	1	1	- +	1 +	1		









### Overload relays fitting details (1)

Contactor types	Thermal overload relays	Electronic overload relays
AF09 ... AF38	TF42 (0.10...38 A)	EF19 (0.10...19 A)
AF26 ... AF38	TF42 (0.10...38 A)	EF45 (9...45 A)
AF40 ... AF65	TF65 (22...67 A)	EF65 (20...70 A)
AF80, AF96	TF96 (40...96 A)	EF96 (36...100 A)

SECTION 17

## AF09 ... AF96 3 pole contactors

### Main accessories

		Auxiliary contacts					
		   			Part no. <sup>(1)</sup>	Order Code	
For contactors							
<b>Front-mounted instantaneous auxiliary contact blocks</b>							
 CA4-10  CAL4-11	AF09 ... AF38	1	0	-	-	CA4-10	1SBN010110R1010
		1	0	-	-	CA4-10-T	1SBN010110T1010
		0	1	-	-	CA4-01	1SBN010110R1001
		0	1	-	-	CA4-01-T	1SBN010110T1001
	AF09 ... AF16...-30-10	2	2	-	-	CA4-22M	1SBN010140R1122
	AF26 ... AF96...-30-00	2	2	-	-	CA4-22E	1SBN010140R1022
	AF09 ... AF16...-30-01	2	2	-	-	CA4-22U	1SBN010140R1322
<b>Front-mounted auxiliary contact blocks with N.O. leading contact and N.C. lagging contact</b>							
	AF09 ... AF96	-	-	1	0	CC4-10	1SBN010111R1010
		-	-	0	1	CC4-01	1SBN010111R1001
<b>Side-mounted instantaneous auxiliary contact blocks</b>							
	AF09 ... AF96	1	1	-	-	CAL4-11	1SBN010120R1011
		1	1	-	-	CAL4-11-T	1SBN010120T1011
<b>Front-mounted instantaneous auxiliary contact and A1/A2 coil terminal blocks</b>							
	AF09 ... AF16...-30-10	1	1	-	-	CAT4-11M	1SBN010151R1111
	AF26 ... AF65...-30-00	1	1	-	-	CAT4-11E	1SBN010151R1011
	AF09 ... AF16...-30-01	1	1	-	-	CAT4-11U	1SBN010151R1311
Note: CAT4 not suitable for AF..Z contactors with DC control voltage 12...20 V DC.							
<b>Mechanical interlock unit</b>							
	AF09 ... AF38			VM4		1SBN030105T1000	
	AF40 ... AF96			VM96-4		1SBN033405T1000	
Note: VM4 and VM96-4 include 2 fixing clips (BB4) to maintain together both contactors.							
<b>Mechanical and electrical interlock set</b>							
	AF09 ... AF16 AF26 ... AF38	0	2	-	-	VEM4	1SBN030111R1000
Note: - VEM4 includes a VM4 mechanical interlock unit with 2 fixing clips (BB4), a VE4 electrical interlock block. VE4 block must be used with A2-A2 connection to respect the electrical connection diagram. - VEM4 not suitable for AF..Z contactors with DC control voltage 12...20 V DC.							
		Time delay range selected by switch	Auxiliary contacts				
			Delay type	 			
For contactors					Part no. <sup>(1)</sup>	Order Code	
<b>Electronic timers</b>							
	AF09 ... AF96	0.1...1 s 1...10 s 10...100 s	ON-delay	-	-	TEF4-ON	1SBN020112R1000
			OFF-delay	-	-	TEF4-OFF	1SBN020114R1000
Note: Rated control circuit voltage U <sub>c</sub> 24...240 V 50/60 Hz or DC.							
<b>Connecting links with manual motor starters</b>							
	AF09 ... AF16	with	MS116-0.16 ... MS116-25, MS132-0.16 ... MS132-25	BEA16-4		1SBN081306T1000	
	AF26 ... AF38	with	MS116-0.16 ... MS116-16, MS132-0.16 ... MS132-10	BEA26-4		1SBN082306T1000	
		with	MS116-20 ... MS116-32, MS132-12 ... MS132-32	BEA38-4		1SBN082306T2000	
<b>Connection sets for reversing contactors</b>							
	AF09 ... AF16			BER16-4		1SBN081311R1000	
	AF26 ... AF38			BER38-4		1SBN082311R1000	
	AF40 ... AF65			BER65-4		1SBN083411R1000	
	AF80 ... AF96			BER96-4		1SBN083911R1000	
<b>Mechanical interlock unit</b>							
	AF09 ... AF16	With or without VM4		BEY16-4		1SBN081313R2000	
	AF26 ... AF38	With or without VM4		BEY38-4		1SBN082713R2000	
	AF40 ... AF65	With or without VM96-4		BEY65-4		1SBN083413R2000	
	AF80 ... AF96	With or without VM96-4		BEY96-4		1SBN083913R2000	

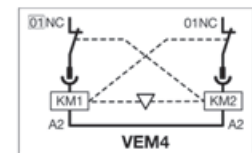

TEF4-ON



BEA16-4



BER16-4

<sup>1)</sup> For more information, refer to main catalogue "Accessories" section.

## Overload protection Selection



TF42

### TF42

The TF42 thermal overload relays are economic electromechanical protection devices for the main circuit. They offer reliable protection for motors in the event of overload or phase failure. The devices have trip class 10.

The thermal overload relays are three pole relays with bimetal tripping elements. The motor current flows through the bimetal tripping elements and heats them directly and indirectly. In case of an overload (over current), the bimetal elements bent as a result of the heating. This leads to a release of the relay and a change of the contacts switching position (95-96 / 97-98).

- Manual or automatic reset selectable
- Phase loss sensitive acc. to IEC/EN 60947-4-1
- TEST and STOP function – Trip indication on the front
- Temperature compensation
- Suitable for three- and single-phase applications

### TF42 0.10 to 38.0A

Setting range A	Short-circuit protective device	Trip class	Part no.
0.10 ... 0.13	0.5 A, fuse type T7.5	10	TF42-0.13
0.13 ... 0.17	1.0 A, fuse type T	10	TF42-0.17
0.17 ... 0.23	1.0 A, fuse type T	10	TF42-0.23
0.23 ... 0.31	1.0 A, fuse type T	10	TF42-0.31
0.31 ... 0.41	2.0 A, fuse type gG	10	TF42-0.41
0.41 ... 0.55	2.0 A, fuse type gG	10	TF42-0.55
0.55 ... 0.74	4.0 A, fuse type gG	10	TF42-0.74
0.74 ... 1.00	6.0 A, fuse type gG	10	TF42-1.0
1.00 ... 1.30	6.0 A, fuse type gG	10	TF42-1.3
1.30 ... 1.70	10.0 A, fuse type gG	10	TF42-1.7
1.70 ... 2.30	10.0 A, fuse type gG	10	TF42-2.3
2.30 ... 3.10	10.0 A, fuse type gG	10	TF42-3.1
3.10 ... 4.20	20.0 A, fuse type gG	10	TF42-4.2
4.20 ... 5.70	20.0 A, fuse type gG	10	TF42-5.7
5.70 ... 7.60	35.0 A, fuse type gG	10	TF42-7.6
7.60 ... 10.0	35.0 A, fuse type gG	10	TF42-10
10.0 ... 13.0	40.0 A, fuse type gG	10	TF42-13
13.0 ... 16.0	40.0 A, fuse type gG	10	TF42-16
16.0 ... 20.0	63.0 A, fuse type gG	10	TF42-20
20.0 ... 24.0	63.0 A, fuse type gG	10	TF42-24
24.0 ... 29.0	63.0 A, fuse type gG	10	TF42-29
29.0 ... 35.0	80.0 A, fuse type gG	10	TF42-35
35.0 ... 38.0/40.0	80.0 A, fuse type gG	10	TF42-38

**Note:**

The overload in star delta starters should be fitted in the Delta loop, therefore overload rating equal to FLC x by 0.58\*

### Overload calculation for Star Delta starters

Motor FLC	Delta Loop Setting
5	2.9
6	3.5
7	4.0
8	4.6
9	5.2
10	5.8
12	7.0
14	8.1
16	9.3
18	10.4
20	11.6
25	14.5
30	17.4
35	20.3
40	23.2
45	26.1
50	29.0
55	32.0

## Limit switches

Trustworthy detection devices



Using limit switches is the easiest way to convert mechanical movements in to electrical signals. They combine different types of actuators, casings and contacts and are perfectly suited to a large variety of applications, whatever the environment.



—  
Reliable in  
extreme  
conditions

### Ready for anything

Limit switches are designed to operate in the most difficult environments. A high degree of protection up to IP66 and the positive contact opening, guarantees reliable operation.



—  
Continuous  
operation

### Keep your installation running 24h a day

Limit switches secures your uptime. Their high mechanical durability can handle up to 10 million operations with contacts that are mechanically linked to actuators.



—  
Global  
availability

### Wherever you are

Easy product selection from our core offering that covers most applications. Thanks to global certification, our products can be used everywhere to ensure your peace of mind.

## Main applications

### Sustainability of detection for a wide variety of applications

Material handling equipment (cranes, ramps, elevators...) Escalators, parking barriers and automatic doors Machine tools and manufacturing lines.







## Limit switches

A simple core range selection covering 80% of the applications...







11 13 41 51 91





Width 30 mm - Plastic casing - Double insulation □ - IP65

Head type	Cable inlet	Type	Order Code
 11 Plain plunger steel	Iso 16	LS32P11B11	1SBV010311R1211
	Iso 20	LS33P11B11	1SBV012211R1211
	1/2" NPT	LS35P11B11	1SBV012111R1211
 13 Roller plunger plastic	Iso 16	LS32P13B11	1SBV010313R1211
	Iso 20	LS33P13B11	1SBV012213R1211
	1/2" NPT	LS35P13B11	1SBV012113R1211
 41 Roller lever plastic	Iso 16	LS32P41B11	1SBV010341R1211
	Iso 20	LS33P41B11	1SBV012241R1211
	1/2" NPT	LS35P41B11	1SBV012141R1211
 51 Adjustable roller lever plastic	Iso 16	LS32P51B11	1SBV010351R1211
	Iso 20	LS33P51B11	1SBV012251R1211
	1/2" NPT	LS35P51B11	1SBV012151R1211
 91 Flexible rod steel	Iso 16	LS32P91B11	1SBV010391R1211
	Iso 20	LS33P91B11	1SBV012291R1211
	1/2" NPT	LS35P91B11	1SBV012191R1211





Metal casing - IP66

Head type	Cable inlet	Type	Order Code
 11 Plain plunger steel	Iso 16	LS32M11B11	1SBV011911R1211
	Iso 20	LS33M11B11	1SBV013811R1211
	1/2" NPT	LS35M11B11	1SBV013711R1211
 13 Roller plunger plastic	Iso 16	LS32M12B11	1SBV011912R1211
	Iso 20	LS33M12B11	1SBV013812R1211
	1/2" NPT	LS35M12B11	1SBV013712R1211
 41 Roller lever plastic	Iso 16	LS32M41B11	1SBV011941R1211
	Iso 20	LS33M41B11	1SBV013841R1211
	1/2" NPT	LS35M41B11	1SBV013741R1211
 51 Adjustable roller lever plastic	Iso 16	LS32M51B11	1SBV011951R1211
	Iso 20	LS33M51B11	1SBV013851R1211
	1/2" NPT	LS35M51B11	1SBV013751R1211
 91 Flexible rod steel	Iso 16	LS32M91B11	1SBV011991R1211
	Iso 20	LS33M91B11	1SBV013891R1211
	1/2" NPT	LS35M91B11	1SBV013791R1211

Width 40 mm - Plastic casing - Double insulation □ - IP65

Head type	Cable inlet	Type	Order Code
 11 Plain plunger steel	Iso 20	LS43P11B11	1SBV010711R1211
	1/2" NPT	LS45P11B11	1SBV012411R1211
 13 Roller plunger steel	Iso 20	LS43P13B11	1SBV010713R1211
	1/2" NPT	LS45P13B11	1SBV012413R1211
 41 Roller lever plastic	Iso 20	LS43P41B11	1SBV010741R1211
	1/2" NPT	LS45P41B11	1SBV012441R1211
 51 Adjustable roller lever plastic	Iso 20	LS43P51B11	1SBV010751R1211
	1/2" NPT	LS45P51B11	1SBV012451R1211
 91 Flexible rod steel	Iso 20	LS43P91B11	1SBV010791R1211
	1/2" NPT	LS45P91B11	1SBV012491R1211

Metal casing - IP66

Head type	Cable inlet	Type	Order Code
 11 Plain plunger steel	Iso 20	LS43M11B11	1SBV011611R1211
	1/2" NPT	LS45M11B11	1SBV013111R1211
 13 Roller plunger steel	Iso 20	LS43M13B11	1SBV011613R1211
	1/2" NPT	LS45M13B11	1SBV013113R1211
 41 Roller lever plastic	Iso 20	LS43M41B11	1SBV011641R1211
	1/2" NPT	LS45M41B11	1SBV013141R1211
 51 Adjustable roller lever plastic	Iso 20	LS43M51B11	1SBV011651R1211
	1/2" NPT	LS45M51B11	1SBV013151R1211
 91 Flexible rod steel	Iso 20	LS43M91B11	1SBV011691R1211
	1/2" NPT	LS45M91B11	1SBV013191R1211

**Cable inlet:**

ISO 16 (standard version) equivalent to Pg11 – Cable diameter: 4.5 mm ... 10 mm (according to cable gland manufacturer).

ISO 20 (standard version) equivalent to Pg13.5 – Cable diameter: 7 mm ... 14 mm (according to cable gland manufacturer).

Technical data	Plastic casing	Metal casing
<b>Rated operational characteristics</b>	AC-15: Ue = 400 V, Ie = 4 A ; A600 DC-13: Ue = 250 V, Ie = 0,27 A ; Q600	AC-15: Ue = 400 V, Ie = 4 A ; A300 DC-13: Ue = 250 V, Ie = 0,27 A ; Q300
<b>Casing material</b>	UL-V0 thermoplastic	30 mm casing: zinc alloy / 40 mm casing: aluminium alloy
<b>Contact types</b>	1 N.O. + 1 N.C., snap action	
<b>I<sub>the</sub> conventional enclosed thermal current</b>	10 A	
<b>Screw terminals with cable clamp</b>	M3.5 - Screwdriver type: Pozidriv 2	

---

# Jokab safety products

<b>356</b>	<b>Our range of safety products</b>
<b>358</b>	<b>Sentry safety relays</b>
<b>359</b>	<b>Eden safety sensors</b>
<b>360</b>	<b>Magne – Magnetic lock</b>
<b>361</b>	<b>Smile emergency stop buttons</b>



For more detailed product information, please refer to our online technical brochures available at: [new.abb.com/low-voltage/support/documentation](http://new.abb.com/low-voltage/support/documentation)

or contact our sales team via email [LV.enquiries@gb.abb.com](mailto:LV.enquiries@gb.abb.com)

or call 0333 999 9933



# Our range of safety products







ABB can deliver all of the above safety solutions (including output devices such as contactors and frequency converters) together with automation solutions such as robotics, motors, drives and PLCs.

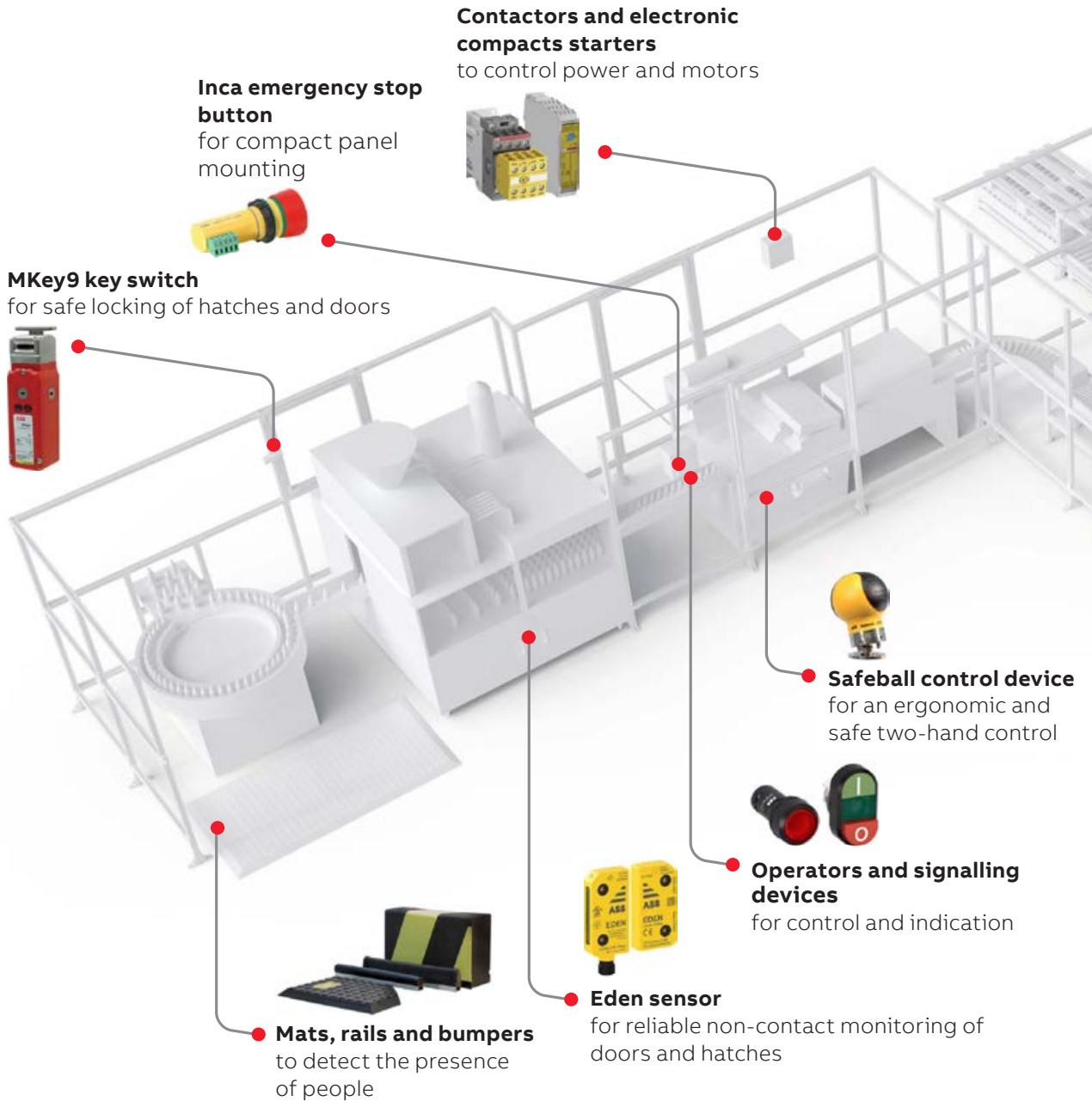
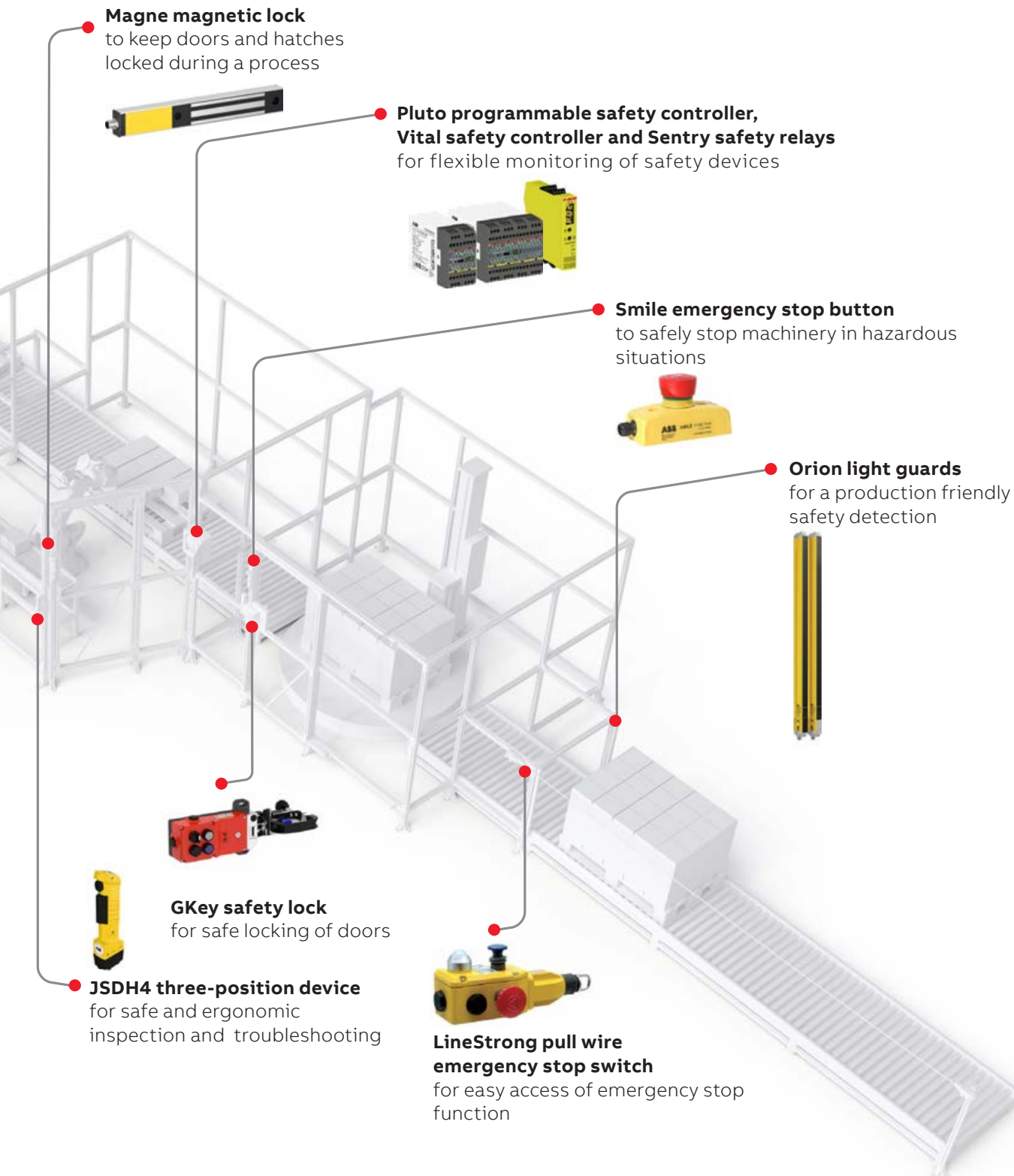

# Sentry – Safety Relays

## Order Codes

	Expansion	Safety devices	Test/Reset	Safety relay outputs	Timer function	Feature	Power supply	Type	Order Code
 <p>BSR10</p> <p>2TLCT209V0201</p>	Expansion of safety controller outputs	1 channel	Manual reset (all models have auto reset) Start/Test	3 NO + 1 NC	Off-delay 0.5 s	Configurable with display	85-265 VAC / 120-375 VDC +24 VDC	BSR10	2TLA010040R0000
		2 channels with equivalent contacts		4 NO	Off-delay 1.5 s				
		2 channels with antivalent contacts		2 NO + 2 delayed/delayable NO	Advanced timer functions 0 – 999 s <sup>d)</sup>				
		OSSD outputs / PNP outputs		4 NO + 1 NC					
		Contact mats, bumpers and safety edges <sup>c)</sup>							
		Two-hand devices							
 <p>SSR32</p> <p>2TLCT206AV0201</p>									
		a)	• b)	•			•	BSR23 <sup>e)</sup>	2TLA010041R0600
		a)	• b)	•	•		•	SSR10	2TLA010050R0000
		a)				•		SSR10M	2TLA010050R0100
		•	• • •	•	•		•	SSR20	2TLA010051R0000
		•	•	•	•		•	SSR20M	2TLA010051R0100
				•	•	•	•	SSR32	2TLA010052R0400
				•	•	•	•	SSR42	2TLA010053R0400
		•	• • •	•	•	•	•	TSR10	2TLA010060R0000
		•	• • •	•	•	•	•	TSR20	2TLA010061R0000
 <p>USR10</p> <p>2TLCT209V0201</p>									
		•	•	•	•	•	•	TSR20M	2TLA010061R0100
		•	• • • • •	•	•	• • • •	•	USR10	2TLA010070R0000
		•	• • • • •	•	•	• • • •	•	USR22	2TLA010070R0400

a) These models can also be used for expansion of Pluto safe transistor outputs (-24 VDC)  
 b) No monitoring of two-channel fault, i.e. max Category 3 without fault exclusion.  
 c) The safety relay detects a short-circuit, not a change in resistance.  
 d) Off-delay, On-delay, Time bypass or Time reset.  
 e) BSR23 must be monitored by another device in order to reach higher than Category 1/PL c according to EN ISO 13849-1, for example a safety relay, a safety PLC or an Orion light guard (EDM function).

## Eden – Non-contact safety Sensors

### Order Codes

#### Adam

Type of safety controller	StatusBus	Info signal	Local reset	Series connection	Connector male	Type	Order Code
OSSD compatible (incl. Pluto and Sentry)		x			M12-5	Adam OSSD-Info M12-5	2TLA020051R5400
		x		x	M12-8	Adam OSSD-Info M12-8	2TLA020051R5700



2TLC00045W0201

Adam OSSD-info M12-5

#### Eva

Compatible Adam	Code description	Code level	Type	Order Code
Adam DYN and OSSD	General code. (Eva is interchangeable)	Low level	Eva General code	2TLA020046R0800
	Unique code. (Prevents defeat/fraud)	High level	Eva Unique code	2TLA020046R0900



2TLC00063V0201

Eva General code

## Cables and connectors

#### Cable with connectors

Connector	Female/male	Length	Special feature	Type	Order Code	
M12-C61	M12-5 *	Female	3 m		M12-C31	2TLA020056R0500
			6 m		M12-C61	2TLA020056R0000
		Harsh environment, halogen free	10 m		M12-C101	2TLA020056R1000
			20 m		M12-C101HE	2TLA020056R8100
					M12-C201	2TLA020056R1400
					M12-C0312	2TLA020056R5800
M12-C61HE	Female + male	0.06 m		M12-C00612	2TLA020056R6300	
		1 m		M12-C112	2TLA020056R2000	
		3 m		M12-C312	2TLA020056R2100	
		6 m		M12-C612	2TLA020056R2200	
		10 m		M12-C1012	2TLA020056R2300	



2TLC17955F0201



2TLC00063R0201

## Magne – Magnetic lock

### Order Codes

#### Ordering details

For a complete Magne lock both door part and frame parts are necessary. Magne 4 also requires a separate Eva sensor.

	Safe interlocking with integrated Adam	Safety signal	Extra function	Connector	Type	Order Code
 2TLC00070V020L	No	–	–	M12-5 male	Magne 3X M12-5	2TLA042022R2700
	Yes	OSSD	"Locked" and "Closed" information outputs	M12-8 male	Magne 4 OSSD-Info	2TLA042022R4600

Magne 3



Magne 4

#### Door part

Description	Type	Order Code
Anchor plate with permanent magnet. Delivered with cellular rubber.	Magne Anchor 32B	2TLA042023R0400
Anchor plate without permanent magnet. Delivered with cellular rubber.	Magne Anchor 32A	2TLA042023R1300

#### Eva sensor for Magne 4 models

Compatible Adam	Code description	Code level	Type	Order Code
Adam DYN and OSSD	General code. (Eva is interchangeable)	Low level	Eva General code	2TLA020046R0800
	Unique code. (Prevents defeat/fraud)	High level	Eva Unique code	2TLA020046R0900

## Smile emergency stop buttons

### Order Codes

#### Smile stop button

	Connection type	Feature	Type	Order Code
 <small>2TLC1218FF0201</small>	1 x M12-5 male	Status LED	Smile 11 EA	2TLA030051R0000
	2 x M12-5 male	Status LED	Smile 12 EA	2TLA030051R0200

Smile 12 EA

## Smile safety stop buttons

### Order Codes

#### Smile safety stop button

	Type of safety signal	Connection type	Feature	Type	Order Code
 <small>2TLC1219BF0201</small>	2 NC	1 x M12-5	Status LED	Smile 11 SA	2TLA030051R0900
	* Can be adapted to DYNlink with Tina				

Smile 11 SA

## Smile reset buttons

### Order Codes

#### Smile reset button

	Type of contact	Intended use	Connectors	Type	Order Code
 <small>2TLC127018V0201</small>	1 NO	Most reset applications	M12-5 male	Smile 11 RA	2TLA030053R0000
	* See Pluto hardware manual for more information about the light button function				

Smile 11 RA



**Additional information**

We reserve the right to make technical changes or modify the contents of this document without prior notice. With regard to purchase orders, the agreed particulars shall prevail. ABB AG does not accept any responsibility whatsoever for potential errors or possible lack of information in this document.

We reserve all rights in this document and in the subject matter and illustrations contained therein. Any reproduction, disclosure to third parties or utilisation of its contents – in whole or in parts – is forbidden without prior written consent of ABB AG.





---

**ABB Limited**

Electrification Business Area  
Tower Court  
Foleshill Enterprise Park  
Courtaulds Way  
Coventry CV6 5NX  
Tel: +44 (0) 333 999 9900  
E-Mail: LV.Enquiries@gb.abb.com  
Twitter: @ABBUKEP

**[go.abb/electrification](https://go.abb/electrification)**