



Wiring Accessories

Product Catalogue

www.schneider-electric.co.uk

Life Is On | **Schneider**
Electric



Get **rewards** for your purchases with the Electrician Partner Programme

The Electrician Partner Programme is a **free scheme** for owners and employees of electrical contracting businesses of **up to 10 employees**.

- **Over 6,500** qualifying products
- **Exchange points** for holidays, supermarket vouchers and home entertainment

Start earning your rewards at:

schneider-electric.co.uk/electricianpartner

Rewards are only available to approved partners of the Electrician Partner Programme. Proof of purchase is required for rewards to be processed.





Flexible **Cable Management** systems to support with your next project

Perimeter Trunking

Stylish design with increased functionality such as flexible bends and great cable capacity. Every length and accessory is manufactured in the UK.

Bench Trunking

Bench mounted power distribution for laboratories, workshops and industrial manufacturing applications.

Power Poles, Posts & Desk Solutions

Robust and stylish design, offering flexible power distribution solutions in open plan office spaces.

Industrial Cable Support

Cable containment for harsh and corrosive environments.

Find out more at:

schneider-electric.co.uk





Electrical Cable Fixings and Materials to help you get your next job done!

From wall plugs to screws; anchors to cable reels; power tool accessories to LED work lights, forty years has seen the Thorsman, JoJo and Tower product ranges grow from a handful of products to the extensive range we see today.

18th Edition Fire-Resistant Supports

From cable clips to masonry screws, a comprehensive range of fixings to help you comply with the 18th Edition of the Wiring Regulations.



Sealants and Adhesives

Advanced suite of high-specification sealants, adhesives, caulk, expanding foams and super glue.

LED Site Lighting

All products in the range are equipped with the latest LED technology to offer better energy efficiency.



Find out more at:

schneider-electric.co.uk



Innovative Circuit Protection solutions for residential and commercial applications

Low Voltage Electrical Distribution

With demands for reliability, enhanced safety, cost reduction and connectivity ever increasing, Acti 9 Isobar P distribution boards have enabled this evolution and offered new levels of performance.

KQ distribution boards provide plug-on circuit protection for commercial applications with an encapsulated busbar assembly.

Low Voltage Electrical Distribution

With a conventional busbar assembly at an affordable price point, Easy9 covers all of your circuit protection needs in residential applications.

For improved installation time and increased levels of safety, the plug-on busbar assembly of Resi9 helps you to satisfy specification requirements.

Find out more at:

schneider-electric.co.uk



Contents

- **Section 1 Page 52**
Ultimate
Ultimate Screwless, Ultimate Flat Plate, Ultimate Low Profile, Ultimate Slimline

- **Section 2 Page 156**
Lisse Screwless Deco
Lisse Curved Screwless Decorative

- **Section 3 Page 174**
Lisse
Lisse Curved White Moulded

- **Section 4 Page 196**
Exclusive
Exclusive Square Edge White Moulded, Exclusive Metal Clad

- **Section 5 Page 222**
T2 Ceiling Accessories
Ceiling accessories, back boxes

- **Section 6 Page 232**
Weatherproof
IP55, IP66, Kavacha

- **Section 7 Page 244**
56 Series
Industrial switchgear

- **Section 8 Page 256**
Occupancy & Presence detection
ARGUS presence detector system, Stand-alone detectors, KNX, Clipsal C-Bus

- **Section 9 Page 276**
Desk Units
IDU - In-Desk Units, FDU - Flush Desk Units, PTU - Pop Up Tower Units, ODU - On-Desk Units,
UDU - Under Desk Units & Select Custom Modules

- **Section 10 Page 286**
Technical
Information

- **Section 11 Page 301**
Product Index

Ultimate Screwless



Ultimate Flat Plate



Ultimate Low Profile



Ultimate Slimline



Lisse Screwless Deco



Lisse Curved White Moulded



Exclusive Square Edge White Moulded



Exclusive Metal Clad



Ceiling accessories



Back boxes



IP55



IP66



Kavacha



Industrial switchgear



ARGUS Presence Detector system



Stand-Alone Occupancy sensors



KNX



Clipsal C-Bus





Desk units



Ultimate Screwless Flat Plate

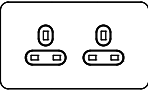
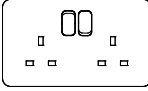





Selection Table

Product type	Description	Stainless Steel with White interior	Stainless Steel with Black interior	Polished Chrome with White Interior	Polished Chrome with Black Interior
Unswitched sockets 	13A 1 gang unswitched	GU3450WSS	GU3450BSS	GU3450WPC	GU3450BPC
	13A 2 gang unswitched	GU3460WSS	GU3460BSS	GU3460WPC	GU3460BPC
Switched sockets 	13A 1 gang SP switched	GU3410WSS	GU3410BSS	GU3410WPC	GU3410BPC
	13A 1 gang DP	GU3410DWSS	GU3410DBSS	GU3410DWPC	GU3410DBPC
	13A 1 gang DP with neon	GU3411DWSS	GU3411DBSS	GU3411DWPC	GU3411DBPC
	13A 2 gang SP switched	GU3420WSS	GU3420BSS	GU3420WPC	GU3420BPC
	13A 2 gang switched with neons	GU3421DWSS	GU3421DBSS		
	13A 2 gang DP switched	GU3420DWSS	GU3420DBSS	GU3420DWPC	GU3420DBPC
	13A 2 gang DP switched with outboard rockers	GU3431WSS	GU3431BSS		GU3431BPC
	13A 2 gang DP switched with red outboard neon rockers	GU3434WSS	GU3434BSS	GU3434WPC	
Round pin sockets	2A unswitched	GU3470WSS	GU3470BSS	GU3470WPC	GU3470BPC
	5A unswitched	GU3480WSS	GU3480BSS	GU3480WPC	GU3480BPC
	15A switched	GU3490WSS	GU3490BSS	GU3490WPC	GU3490BPC
USB Sockets & Shelves 	13A 1 gang DP switched with 2 x ports 2.1A shared USB	GGBGU34102USBAWSS	GGBGU34102USBABSS	GGBGU34102USBAWPC	GGBGU34102USBABPC
	1 gang shelf	GGBGUSHF1GS	GGBGUSHF1GBS	GGBGUSHF1GS	GGBGUSHF1GBS
	13A 2 gang DP switched with 2 x ports 2.1A shared USB	GGBGU34202USBWSS	GGBGU34202USBBSS	GGBGU34202USBWPC	GGBGU34202USBBPC
	13A 2 gang DP switched with 2 x ports 4A shared USB - coming soon	GGBGU3424DWSS	GGBGU3424DBSS	GGBGU3424DWPC	GGBGU3424DBPC
	2 gang shelf	GGBGUSHF2GS	GGBGUSHF2GBS	GGBGUSHF2GS	GGBGUSHF2GBS
Bedside light with USB	1 gang bedside light with 2.1A USB port		GGBGU1412BUBSS		GGBGU1412BUBPC
Light switches 	1 gang 2 way	GU1412WSS	GU1412BSS	GU1412WPC	GU1412BPC
	1 gang retractive	GU1412RWSS	GU1412RBSS	GU1412RWPC	GU1412RBPC
	2 gang 2 way	GU1422WSS	GU1422BSS	GU1422WPC	GU1422BPC
	3 gang 2 way	GU1432WSS	GU1432BSS	GU1432WPC	GU1432BPC
	4 gang 2 way	GU1442WSS	GU1442BSS	GU1442WPC	GU1442BPC
	6 gang 2 way	GU1462WSS	GU1462BSS	GU1462WPC	GU1462BPC
	1 gang intermediate	GU1414WSS	GU1414BSS	GU1414WPC	GU1414BPC
	3 pole fan isolator	GU1413WSS	GU1413BSS	GU1413WPC	GU1413BPC
	1 gang glow in the dark frame	GU1400F	GU1400F	GU1400F	GU1400F
Toggle switches	1 gang 2 way	GU1412TSS	GU1412TSS	GU1412TPC	GU1412TPC
	2 gang 2 way	GU1422TSS	GU1422TSS	GU1422TPC	GU1422TPC
	3 gang 2 way	GU1432TSS	GU1432TSS	GU1432TPC	GU1432TPC
	4 gang 2 way	GU1442TSS	GU1442TSS	GU1442TPC	GU1442TPC
	1 gang intermediate	GU1414TSS	GU1414TSS	GU1414TPC	GU1414TPC
Hotel key card switch	32A SP with 30 second time delay	GU1412KWSS	GU1412KBSS	GU1412KWPC	GU1412KBPC

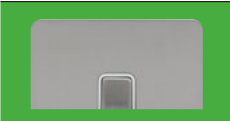
	 Polished Brass with White interior	 Polished Brass with Black interior	 Pearl Nickel with White interior	 Black Nickel with Black interior	 Painted White with White interior	 Transparent with White interior
		GU3450BPB	GU3450WPN	GU3450BBN	GU3450WPW	
GU3460WPB	GU3460BPB	GU3460WPN	GU3460BBN	GU3460WPW		
GU3410WPB	GU3410BPB	GU3410WPN	GU3410BBN	GU3410WPW	GGBGU3410CLR	
GU3410DWPB	GU3410DBPB	GU3410DWPN	GU3410DBBN	GU3410DWPW		
	GU3411DBPB	GU3411DWPN	GU3411DBBN	GU3411DWPW		
GU3420WPB	GU3420BPB	GU3420WPN	GU3420BBN	GU3420WPW	GGBGU3420CLR	
GU3421DWPB		GU3421DWPN		GU3421DWPW		
GU3420DWPB	GU3420DBPB	GU3420DWPN	GU3420DBBN	GU3420DWPW		
			GU3431BBN	GU3431WPW		
GU3470WPB	GU3470BPB	GU3470WPN	GU3470BBN	GU3470WPW		
GU3480WPB	GU3480BPB	GU3480WPN	GU3480BBN	GU3480WPW		
	GU3490BPB	GU3490WPN		GU3490WPW		
GGBGU34102USBAWPB	GGBGU34102USBABPB	GGBGU34102USBAWPN	GGBGU34102USBABBN	GGBGU34102USBAWPW		
GGBGUSHF1GS	GGBGUSHF1GBS	GGBGUSHF1GS	GGBGUSHF1GBS	GGBGUSHF1GS	GGBGUSHF1GS	
GGBGU34202USBWPB	GGBGU34202USBBPB	GGBGU34202USBWPN	GGBGU34202USBBBN	GGBGU34202USBWPW		
GGBGU3424DWPB	GGBGU3424DBPB	GGBGU3424DWPN	GGBGU3424DBBN	GGBGU3424DWPW		
GGBGUSHF2GS	GGBGUSHF2GBS	GGBGUSHF2GS	GGBGUSHF2GBS	GGBGUSHF2GS	GGBGUSHF2GS	
	GGBGU1412BUBPB		GGBGU1412BUBBN			
GU1412WPB	GU1412BPB	GU1412WPN	GU1412BBN	GU1412WPW	GGBGU1412CLR	
GU1412RWPB	GU1412RBPB	GU1412RWPN	GU1412RBBN	GU1412RWPW		
GU1422WPB	GU1422BPB	GU1422WPN	GU1422BBN	GU1422WPW	GGBGU1422CLR	
GU1432WPB	GU1432BPB	GU1432WPN	GU1432BBN	GU1432WPW	GU1432CLR	
GU1442WPB	GU1442BPB	GU1442WPN	GU1442BBN	GU1442WPW		
	GU1462BPB	GU1462WPN	GU1462BBN	GU1462WPW		
GU1414WPB	GU1414BPB	GU1414WPN	GU1414BBN	GU1414WPW		
GU1413WPB	GU1413BPB	GU1413WPN	GU1413BBN	GU1413WPW		
GU1400F	GU1400F	GU1400F	GU1400F	GU1400F	GU1400F	
GU1412TPB	GU1412TPB	GU1412TPN	GU1412TBN	GU1412TPW		
GU1422TPB	GU1422TPB	GU1422TPN	GU1422TBN	GU1422TPW		
GU1432TPB	GU1432TPB	GU1432TPN	GU1432TBN	GU1432TPW		
GU1442TPB	GU1442TPB	GU1442TPN	GU1442TBN	GU1442TPW		
GU1414TPB	GU1414TPB			GU1414TPW		
GU1412KWPB	GU1412KBPB	GU1412KWPN	GU1412KBBN	GU1412KWPW		

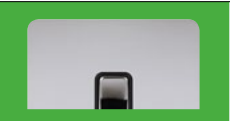
Ultimate Screwless Flat Plate

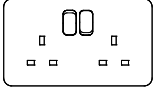
Selection Table

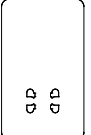
					
Product type	Description	Stainless Steel with White interior	Stainless Steel with Black interior	Polished Chrome with White Interior	Polished Chrome with Black Interior
Dimmer switches 	1 gang 2 way 400W/VA mains & low voltage	GU6412CSS	GU6412CSS	GU6412CPC	GU6412CPC
	1 gang 2 way 100W/VA LED	GU6412LSS	GU6412LSS	GU6412LPC	GU6412LPC
	1 gang 2 way 300W/VA electronic	GU6412EWSS	GU6412EBSS	GU6412EWPC	
	1 gang 2 way 300W/VA IR electronic	GU6412RWSS		GU6412RWPC	GU6412RBPC
	1 channel IR remote control	GU6000RC1R	GU6000RC1R	GU6000RC1R	GU6000RC1R
	2 gang 2 way 250W/VA mains & low voltage	GU6422CSS	GU6422CSS	GU6422CPC	GU6422CPC
	2 gang 2 way 100W/VA LED	GU6422LSS	GU6422LSS	GU6422LPC	GU6422LPC
	2 gang 2 way 200W/VA electronic	GU6422EWSS	GU6422EBSS		GU6422EBPC
	3 gang 2 way 250W/VA mains & low voltage	GU6432CSS	GU6432CSS	GU6432CPC	GU6432CPC
	3 gang 2 way 75W/VA LED	GU6432LSS	GU6432LSS	GU6432LPC	GU6432LPC
	4 gang 2 way 250W/VA mains & low voltage	GU6442CSS	GU6442CSS	GU6442CPC	GU6442CPC
	4 gang 2 way 75W/VA LED	GU6442LSS	GU6442LSS	GU6442LPC	GU6442LPC
PIR plate switches	1 gang 1 way with override		GUPA1411BSS		
	1 gang 1 way		GUP1411BSS		
Control switches 	20AX DP	GU2410WSS	GU2410BSS	GU2410WPC	GU2410BPC
	20AX DP with neon	GU2411WSS	GU2411BSS	GU2411WPC	GU2411BPC
	20AX DP with flex outlet	GU2413WSS	GU2413BSS	GU2413WPC	GU2413BPC
	20AX DP with flex outlet & neon	GU2414WSS	GU2414BSS	GU2414WPC	GU2414BPC
	20AX DP with neon, flex outlet & printed 'Water Heater'	GU2414WHWSS			GU2414WHBPC
	32A DP with neon	GU4431WSS	GU4431BSS	GU4431WPC	GU4431BPC
High current switches 	50A 2 gang DP switch with neon	GU4421WSS	GU4421BSS	GU4421WPC	GU4421BPC
	45A DP cooker control unit with 13A socket & neon	GU4401WSS	GU4401BSS	GU4401WPC	GU4401BPC
Fused connection units 	13A unswitched FCU	GU5400WSS	GU5400BSS	GU5400WPC	GU5400BPC
	13A unswitched with flex outlet	GU5403WSS	GU5403BSS	GU5403WPC	GU5403BPC
	13A DP switched	GU5410WSS	GU5410BSS	GU5410WPC	GU5410BPC
	13A DP switched with neon	GU5411WSS	GU5411BSS	GU5411WPC	GU5411BPC
	13A DP switched with flex outlet	GU5413WSS	GU5413BSS	GU5413WPC	GU5413BPC
	13A DP switched with flex outlet & neon	GU5414WSS	GU5414BSS	GU5414WPC	GU5414BPC
Shaver sockets 	115/230V dual voltage	GU7490WSS	GU7490BSS	GU7490WPC	GU7490BPC





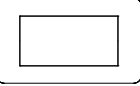

					
GU6412CPB	GU6412CPB	GU6412CPN	GU6412CBN	GU6412CPW	GGBGU6412CLR
GU6412LPB	GU6412LPB	GU6412LPN	GU6412LBN	GU6412LPW	
GU6412EWPB			GU6412EBBN	GU6412EWPW	
		GU6412RWPN	GU6412RBBN	GU6412RWPW	
GU6000RC1R	GU6000RC1R	GU6000RC1R	GU6000RC1R	GU6000RC1R	
GU6422CPB	GU6422CPB	GU6422CPN	GU6422CBN	GU6422CPW	GGBGU6422CLR
GU6422LPB	GU6422LPB	GU6422LPN	GU6422LBN	GU6422LPW	
GU6422EWPB	GU6422EBPB	GU6422EWPN	GU6422EBBN	GU6422EWPW	
GU6432CPB	GU6432CPB	GU6432CPN	GU6432CBN	GU6432CPW	
		GU6432LPN	GU6432LBN	GU6432LPW	
GU6442CPB	GU6442CPB	GU6442CPN	GU6442CBN	GU6442CPW	
GU6442LPB	GU6442LPB	GU6442LPN	GU6442LBN	GU6442LPW	
	GU2410BPB	GU2410WPN	GU2410BBN	GU2410WPW	
GU2411WPB	GU2411BPB	GU2411WPN	GU2411BBN	GU2411WPW	
GU2413WPB	GU2413BPB	GU2413WPN	GU2413BBN	GU2413WPW	
	GU2414BPB	GU2414WPN	GU2414BBN	GU2414WPW	
	GU2414WHBPB		GU2414WHBBN	GU2414WHWPW	
GU4431WPB	GU4431BPB	GU4431WPN	GU4431BBN	GU4431WPW	
GU4421WPB	GU4421BPB	GU4421WPN	GU4421BBN	GU4421WPW	
GU4401WPB	GU4401BPB	GU4401WPN	GU4401BBN	GU4401WPW	
GU5400WPB	GU5400BPB	GU5400WPN	GU5400BBN	GU5400WPW	
	GU5403BPB	GU5403WPN	GU5403BBN	GU5403WPW	
GU5410WPB	GU5410BPB	GU5410WPN	GU5410BBN	GU5410WPW	
GU5411WPB	GU5411BPB	GU5411WPN	GU5411BBN	GU5411WPW	
GU5413WPB	GU5413BPB	GU5413WPN	GU5413BBN	GU5413WPW	
	GU5414BPB	GU5414WPN	GU5414BBN	GU5414WPW	
GU7490WPB	GU7490BPB	GU7490WPN	GU7490BBN	GU7490WPW	

Ultimate Screwless Flat Plate

Selection Table



Product type	Description	Stainless Steel with White interior	Stainless Steel with Black interior	Polished Chrome with White Interior	Polished Chrome with Black Interior
USB, Data, TV & Telephone outlets 	2 x USB charger outlets 3.1A shared	GGBGU7032USBAWSS	GGBGU7032USBABSS	GGBGU7032USBAWPC	GGBGU7032USBABPC
	RJ11	GU7451WSS	GU7451BSS	GU7451WPC	GU7451BPC
	BT master	GU7461WSS	GU7461BSS	GU7461WPC	GU7461BPC
	BT secondary	GU7462WSS	GU7462BSS	GU7462WPC	GU7462BPC
	Single RJ45 CAT 5e	GU7471WSS	GU7471BSS	GU7471WPC	GU7471BPC
	Single TV-R co-axial	GU7410WSS	GU7410BSS	GU7410WPC	GU7410BPC
	Twin TV-R co-axial	GU7420WSS	GU7420BSS	GU7420WPC	GU7420BPC
	Single satellite	GU7430WSS	GU7430BSS	GU7430WPC	GU7430BPC
	Media plate: 4 x 13A socket & 4 x 50x50mm euro module cut-out	GU34204DMPWSS	GU34204DMPBSS	GU34204DMPWPC	GU34204DMPWPC
	Media plate mounting box 160 x 270 x 47mm	GGBSB4724M	GGBSB4724M	GGBSB4724M	GGBSB4724M
	Media plate: 2 x 13A socket & 2 x 50x50mm euro module cut-out	GU34202DMPWSS	GU34202DMPBSS	GU34202DMPWPC	GU34202DMPWPC
	Media plate mounting box 76 x 270 x 47mm	GGBSB4722M	GGBSB4722M	GGBSB4722M	GGBSB4722M
Euro plates & modules 	1 gang 50 x 25mm	GU8450SS	GU8450SS	GU8450PC	GU8450PC
	1 gang 50 x 50mm	GU8460SS	GU8460SS	GU8460PC	GU8460PC
	2 gang 50 x 100mm	GU8480SS	GU8480SS	GU8480PC	GU8480PC
	2 x RCA socket - 25 x 50mm	GUE7000W	GUE7000B	GUE7000W	GUE7000B
	2 x Loudspeaker socket - 25 x 50mm	GUE7001W		GUE7001W	
	TV/Radio (diplexed) - 50 x 50mm	GUE7010W	GUE7010B	GUE7010W	GUE7010B
	Single IEC coax (female) - 25 x 50mm	GUE7011W	GUE7011B	GUE7011W	GUE7011B
	Single IEC coax (male) - 25 x 50mm	GUE7012W	GUE7012B	GUE7012W	GUE7012B
	HDMI 50 x 50mm	GUE7020W	GUE7020B	GUE7020W	GUE7020B
	Single F - 25 x 50mm	GUE7030W	GUE7030B	GUE7030W	GUE7030B
	TV/Sat diplexer 50 x 50mm				GUE7040B
	RJ11 modem - 25 x 50mm	GUE7051W	GUE7051B	GUE7051W	GUE7051B
	Telephone (BT master) - 25 x 50mm	GUE7061W	GUE7061B	GUE7061W	GUE7061B
	Telephone (BT slave) - 25 x 50mm	GUE7062WK	GUE7062BK	GUE7062WK	GUE7062BK
	CAT5E - 25 x 50mm	GUE7071W	GUE7071B	GUE7071W	GUE7071B
	RJ45 CAT 6 - 25 x 50mm	GUE7072W	GUE7072B	GUE7072W	GUE7072B
	USB charger single 5V 1A 25 x 50mm	GUE7073W	GUE7073B	GUE7073W	GUE7073B
	USB charger twin 2 x 1A 50 x 50mm	GUE7074W	GUE7074B	GUE7074W	GUE7074B
	USB charger single 5V 2.1A 25 x 50mm	GUE7021W	GUE7021B	GUE7021W	GUE7021B
	USB charger twin 2 x 3.1A 50 x 50mm	GUE7031W	GUE7031B	GUE7031W	GUE7031B
	TV/Radio/Sat1 - (triplexed) 50 x 50mm	GUE7081W	GUE7081B	GUE7081W	GUE7081B
	TV/Radio/Sat1/Sat2 - (quadplexer) 50 x 50mm	GUE7082W	GUE7082B	GUE7082W	GUE7082B
	Brush outlet 50 x 50mm	GUE7076W	GUE7076B	GUE7076W	GUE7076B
	5A round pin socket 50 x 50mm	GUE7077W	GUE7077B	GUE7077W	GUE7077B
	Blank 25 x 50mm	GUE8010W	GUE8010B	GUE8010W	GUE8010B







					
Polished Brass with White interior	Polished Brass with Black interior	Pearl Nickel with White interior	Black Nickel with Black interior	Painted White with White interior	Transparent with White interior
GGBGU7032USBAWPB	GGBGU7032USBABPB	GGBGU7032USBAWPN	GGBGU7032USBABBN	GGBGU7032USBAWPW	
GU7451WPB	GU7451BPB	GU7451WPN	GU7451BBN	GU7451WPW	
GU7461WPB	GU7461BPB	GU7461WPN	GU7461BBN	GU7461WPW	
GU7462WPB	GU7462BPB	GU7462WPN	GU7462BBN	GU7462WPW	
GU7471WPB	GU7471BPB	GU7471WPN	GU7471BBN	GU7471WPW	
GU7410WPB	GU7410BPB	GU7410WPN	GU7410BBN	GU7410WPW	
GU7420WPB		GU7420WPN	GU7420BBN	GU7420WPW	
			GU7430BBN	GU7430WPW	
		GU34204DMPWPN	GU34204DMPBBN	GU34204DMPWPW	
		GGBSB4724M	GGBSB4724M	GGBSB4724M	
		GU34202DMPWPN	GU34202DMPBBN	GU34202DMPWPW	
		GGBSB4722M	GGBSB4722M	GGBSB4722M	
GU8450PB	GU8450PB	GU8450PN	GU8450BN	GU8450PW	
GU8460PB	GU8460PB	GU8460PN	GU8460BN	GU8460PW	
GU8480PB	GU8480PB	GU8480PN	GU8480BN	GU8480PW	
GUE7000W	GUE7000B	GUE7000W	GUE7000B	GUE7000W	
GUE7001W		GUE7001W		GUE7001W	
GUE7010W	GUE7010B	GUE7010W	GUE7010B	GUE7010W	
GUE7011W	GUE7011B	GUE7011W	GUE7011B	GUE7011W	
GUE7012W	GUE7012B	GUE7012W	GUE7012B	GUE7012W	
GUE7020W	GUE7020B	GUE7020W	GUE7020B	GUE7020W	
GUE7030W	GUE7030B	GUE7030W	GUE7030B	GUE7030W	
	GUE7040B		GUE7040B		
GUE7051W	GUE7051B	GUE7051W	GUE7051B	GUE7051W	
GUE7061W	GUE7061B	GUE7061W	GUE7061B	GUE7061W	
GUE7062WK	GUE7062BK	GUE7062WK	GUE7062BK	GUE7062WK	
GUE7071W	GUE7071B	GUE7071W	GUE7071B	GUE7071W	
GUE7072W	GUE7072B	GUE7072W	GUE7072B	GUE7072W	
GUE7073W	GUE7073B	GUE7073W	GUE7073B	GUE7073W	
GUE7074W	GUE7074B	GUE7074W	GUE7074B	GUE7074W	
GUE7021W	GUE7021B	GUE7021W	GUE7021B	GUE7021W	
GUE7031W	GUE7031B	GUE7031W	GUE7031B	GUE7031W	
GUE7081W	GUE7081B	GUE7081W	GUE7081B	GUE7081W	
GUE7082W	GUE7082B	GUE7082W	GUE7082B	GUE7082W	
GUE7076W	GUE7076B	GUE7076W	GUE7076B	GUE7076W	
GUE7077W	GUE7077B	GUE7077W	GUE7077B	GUE7077W	
GUE8010W	GUE8010B	GUE8010W	GUE8010B	GUE8010W	

Ultimate Screwless Flat Plate

Selection Table



Product type	Description	Stainless Steel with White interior	Stainless Steel with Black interior	Polished Chrome with White Interior	Polished Chrome with Black Interior
Grid plates 	1 gang 88 x 88mm	GUGS01GSS	GUGS01GSS	GUGS01GMS	GUGS01GMS
	2 gang 88 x 88mm	GUGS02GSS	GUGS02GSS	GUGS02GMS	GUGS02GMS
	76 x 76 x 42mm mounting box	GBG01	GBG01	GBG01	GBG01
	3 gang 88 x 148mm	GUGS03GSS	GUGS03GSS	GUGS03GMS	GUGS03GMS
	4 gang 88 x 148mm	GUGS04GSS	GUGS04GSS	GUGS04GMS	GUGS04GMS
	136 x 76 x 42mm mounting box	GBG02	GBG02	GBG02	GBG02
	6 gang 156 x 156mm	GUGS06GSS	GUGS06GSS	GUGS06GMS	GUGS06GMS
	8 gang 156 x 156mm	GUGS08GSS	GUGS08GSS	GUGS08GMS	GUGS08GMS
	136 x 136 x 42mm mounting box	GBG03	GBG03	GBG03	GBG03
	9 gang 216 x 156mm	GUGS09GSS	GUGS09GSS	GUGS09GMS	GUGS09GMS
	12 gang 216 x 156mm	GUGS12GSS	GUGS12GSS	GUGS12GMS	GUGS12GMS
	193 x 133 x 42mm mounting box	GBG04F	GBG04F	GBG04F	GBG04F
	18 gang 398 x 156mm	GUGS18GSS	GUGS18GSS	GUGS18GMS	GUGS18GMS
	24 gang 398 x 156mm	GUGS24GSS	GUGS24GSS	GUGS24GMS	GUGS24GMS
	374 x 133 x 42mm mounting box	GBG06F	GBG06F	GBG06F	GBG06F
	Grid modules (fully assembled) 	10A 2 way retractive switch	GUG102RWSS	GUG102RBSS	GUG102RWMS
2 way retractive & centre off switch		GUG202OCWSS	GUG202OCBSS	GUG202OCWMS	GUG202OCBMS
10AX toggle		GUG102TWSS	GUG102TBSS	GUG102TWMS	GUG102TBMS
10AX intermediate toggle		GUG101TWSS	GUG101TBSS	GUG101TWMS	GUG101TBMS
100W LED electronic dimmer		GGBGUGEMDIMLWSS	GGBGUGEMDIMLBSS	GGBGUGEMDIMLWPC	GGBGUGEMDIMLBPC
300W/VA universal multiway electronic touch dimmer		GUGEMDIMWSS16	GUGEMDIMBSS16	GUGEMDIMWMS16	
300W/VA universal multiway electronic touch dimmer controlled with infra-red remote		GUGEMRDIMW16	GUGEMRDIMB16	GUGEMRDIMW16	GUGEMRDIMB16
1 channel IR remote control		GU6000RC1R	GU6000RC1R	GU6000RC1R	GU6000RC1R
50mA 2 way & multiway retractive electronic dimmer		GUGEMWWSS	GUGEMWBSS	GUGEMWWMS	GUGEMWBMS
20AX 2 way key switch		GUG202KWSS	GUG202KBSS	GUG202KWMS	GUG202KBMS
20AX key switch printed TEST EMG LTG		GUG202KELWSS	GUG202KELBSS	GUG202KELWMS	GUG202KELBMS
20AX DP key switch		GUG20DPKWSS	GUG20DPKBSS	GUG20DPKWMS	GUG20DPKBMS
BT master		GUGTELMWSS	GUGTELMBSS	GUGTELMWMS	GUGTELMBMS
BT secondary		GUGTELSWSS	GUGTELSBSS	GUGTELSWMS	GUGTELSBMS
RJ11			GUGRJ11BSS		
RJ45 CAT 5e		GUGRJ45WSS		GUGRJ45WMS	GUGRJ45BMS
TV/FM coaxial		GUGCOWSS	GUGCOBSS		GUGCOBMS
Satellite "F" Type		GUGSATWSS	GUGSATBSS		GUGSATBMS
13A fuse carrier		GUG13FCUWSS	GUG13FCUBSS	GUG13FCUWMS	GUG13FCUBMS
Green indicator		GUGINDWG	GUGINDBG	GUGINDWG	GUGINDBG
Red indicator		GUGINDWR	GUGINDBR	GUGINDWR	GUGINDBR
Orange indicator		GUGINDWO	GUGINDBO	GUGINDWO	GUGINDBO
Flex outlet (10mm diameter)		GUG16COWSS	GUG16COBSS	GUG16COWMS	GUG16COBMS
Blank		GUGBWSS	GUGBBSS	GUGBWMS	GUGBBMS





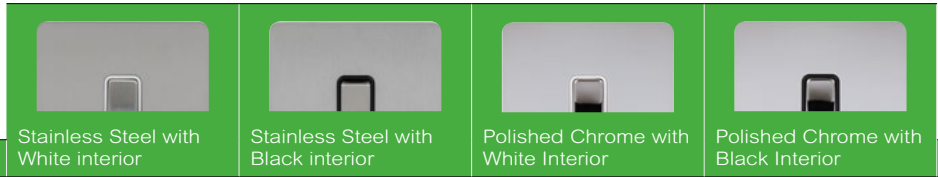

					
GUGS01GPB	GUGS01GPB	GUGS01GPN	GUGS01GBN	GUGS01GPW	
GUGS02GPB	GUGS02GPB	GUGS02GPN	GUGS02GBN	GUGS02GPW	
GBG01	GBG01	GBG01	GBG01	GBG01	
GUGS03GPB	GUGS03GPB	GUGS03GPN	GUGS03GBN	GUGS03GPW	
GUGS04GPB	GUGS04GPB	GUGS04GPN	GUGS04GBN	GUGS04GPW	
GBG02	GBG02	GBG02	GBG02	GBG02	
GUGS06GPB	GUGS06GPB	GUGS06GPN	GUGS06GBN	GUGS06GPW	
GUGS08GPB	GUGS08GPB	GUGS08GPN	GUGS08GBN	GUGS08GPW	
GBG03	GBG03	GBG03	GBG03	GBG03	
GUGS09GPB	GUGS09GPB	GUGS09GPN	GUGS09GBN	GUGS09GPW	
GUGS12GPB	GUGS12GPB	GUGS12GPN	GUGS12GBN	GUGS12GPW	
GBG04F	GBG04F	GBG04F	GBG04F	GBG04F	
GUGS18GPB	GUGS18GPB	GUGS18GPN	GUGS18GBN	GUGS18GPW	
GUGS24GPB	GUGS24GPB	GUGS24GPN	GUGS24GBN	GUGS24GPW	
GBG06F	GBG06F	GBG06F	GBG06F	GBG06F	
GUG102RWPB	GUG102RBPB	GUG102RWPB	GUG102RBBN	GUG102RWPW	
GUG202OCWPB	GUG202OCBPB	GUG202OCWPN	GUG202OCBBN	GUG202OCWPW	
	GUG102TBPB	GUG102TWPB	GUG102TBBN	GUG102TWPW	
	GUG10ITBPB	GUG10ITWPN	GUG10ITBBN	GUG10ITWPW	
	GGBGUGEMDIMLBPB	GGBGUGEMDIMLWPN	GGBGUGEMDIMLBBN	GGBGUGEMDIMLWPW	
			GUGEMDIMBBN16	GUGEMDIMWPN16	
GUGEMRDIMW16	GUGEMRDIMB16	GUGEMRDIMW16	GUGEMRDIMB16	GUGEMRDIMW16	
GU6000RC1R	GU6000RC1R	GU6000RC1R	GU6000RC1R	GU6000RC1R	
		GUGEMWWPN	GUGEMWBBN	GUGEMWWPW	
	GUG202KBPB	GUG202KWPB	GUG202KBBN	GUG202KWPW	
		GUG202KELWPN	GUG202KELBBN	GUG202KELWPW	
		GUG20DPKWPN	GUG20DPKBBN	GUG20DPKWPN	
		GUGTELMWPN	GUGTELMBBN	GUGTELMWPW	
	GUGTELSBPB	GUGTELSWPN	GUGTELSBBN	GUGTELSWPW	
				GUGRJ11WPW	
	GUGRJ45BPB		GUGRJ45BBN	GUGRJ45WPW	
		GUGCOWPN		GUGCOWPW	
	GUGSATBPB	GUGSATWPN	GUGSATBBN	GUGSATWPW	
GUG13FCUWPB	GUG13FCUBBPB	GUG13FCUWPN	GUG13FCUBBN	GUG13FCUWPW	
GUGINDWG	GUGINDBG	GUGINDWG	GUGINDBG	GUGINDWG	
GUGINDWR	GUGINDBR	GUGINDWR	GUGINDBR	GUGINDWR	
GUGINDWO	GUGINDBO	GUGINDWO	GUGINDBO	GUGINDWO	
	GUG16COBPB	GUG16COWPN	GUG16COBBN	GUG16COWPW	
	GUGBBPB	GUGBWPN	GUGBBBN	GUGBWPW	

Ultimate Screwless Flat Plate

Selection Table





Product type	Description	Stainless Steel with White interior	Stainless Steel with Black interior	Polished Chrome with White Interior	Polished Chrome with Black Interior
Grid modules (module & rocker cap separate) 	10AX 1 way	GUG101MW	GUG101MB	GUG101MW	GUG101MB
	10AX 2 way	GUG102MW	GUG102MB	GUG102MW	GUG102MB
	10AX intermediate	GUG101MW	GUG101MB	GUG101MW	GUG101MB
	20AX 1 way	GUG201MW	GUG201MB	GUG201MW	GUG201MB
	20AX 2 way centre off	GUG2020MW	GUG2020MB	GUG2020MW	GUG2020MB
	20AX 2 way	GUG202MW	GUG202MB	GUG202MW	GUG202MB
	20AX DP	GUG20DPMW	GUG20DPMB	GUG20DPMW	GUG20DPMB
	Plain rocker cap	GUGRSS	GUGRSS	GUGRMS	GUGRMS
	Rocker cap printed Cooker Hood	GUGRCHSS	GUGRCHSS	GUGRCHMS	GUGRCHMS
	Rocker cap printed Dishwasher	GUGRDWSS	GUGRDWSS	GUGRDWMS	GUGRDWMS
	Rocker cap printed Extractor Fan	GUGREFSS	GUGREFSS	GUGREFMS	GUGREFMS
	Rocker cap printed Fan	GUGRFASS	GUGRFASS	GUGRFAMS	GUGRFAMS
	Rocker cap printed Fridge Freezer	GUGRFRFZSS	GUGRFRFZSS	GUGRFRFZMS	GUGRFRFZMS
	Rocker cap printed Fridge	GUGRFRSS	GUGRFRSS	GUGRFRMS	GUGRFRMS
	Rocker cap printed Freezer	GUGRFZSS	GUGRFZSS	GUGRFZMS	GUGRFZMS
	Rocker cap printed Hob	GUGRHOSS	GUGRHOSS	GUGRHOMS	GUGRHOMS
	Rocker cap printed Heater	GUGRHESS	GUGRHESS	GUGRHEMS	GUGRHEMS
	Rocker cap printed Microwave	GUGRMWSS	GUGRMWSS	GUGRMWMS	GUGRMWMS
	Rocker cap printed Oven	GUGROVSS	GUGROVSS	GUGROVMS	GUGROVMS
	Rocker cap printed Tumble Dryer	GUGRTDSS	GUGRTDSS	GUGRTDMS	GUGRTDMS
Rocker cap printed Boiler	GUGRBOSS	GUGRBOSS	GUGRBOMS	GUGRBOMS	
Rocker cap printed Washing Machine	GUGRWMSS	GUGRWMSS	GUGRWMMS	GUGRWMMS	
Rocker cap printed Waste Disposal	GUGRDWSS	GUGRDWSS	GUGRDWMS	GUGRDWMS	
Rocker cap printed Washer Dryer	GUGRDWYSS	GUGRDWYSS	GUGRDWYMS	GUGRDWYMS	
Blank plates 	1 gang blank plate	GU8410SS	GU8410SS	GU8410PC	GU8410PC
	2 gang blank plate	GU8420SS	GU8420SS	GU8420PC	GU8420PC
Mounting boxes	1 gang 16mm deep	SB161	SB161	SB161	SB161
	1 gang 25mm deep	SB251	SB251	SB251	SB251
	2 gang 25mm deep	SB252	SB252	SB252	SB252
	1 gang 35mm deep	SB351	SB351	SB351	SB351
	2 gang 35mm deep	SB352	SB352	SB352	SB352
	1 gang 47mm deep	SB471	SB471	SB471	SB471
	2 gang 47mm deep	SB472	SB472	SB472	SB472
Spares	M3.5 x 25mm screws	3746130	3746130	3746130	3746130
	M3.5 x 50mm screws	USCREW50SS	USCREW50SS	USCREW50SS	USCREW50SS
	1 gang clear gasket for Ultimate Screwless Fkat Plate	GU1401F	GU1401F	GU1401F	GU1401F
	1 gang white gasket for Ultimate Screwless Fkat Plate	GU1401FW		GU1401FW	

					
GUG101MW	GUG101MB	GUG101MW	GUG101MB	GUG101MW	
GUG102MW	GUG102MB	GUG102MW	GUG102MB	GUG102MW	
GUG101MW	GUG101MB	GUG101MW	GUG101MB	GUG101MW	
GUG201MW	GUG201MB	GUG201MW	GUG201MB	GUG201MW	
GUG202MW	GUG202MB	GUG202MW	GUG202MB	GUG202MW	
GUG202MW	GUG202MB	GUG202MW	GUG202MB	GUG202MW	
GUG20DPMW	GUG20DPMB	GUG20DPMW	GUG20DPMB	GUG20DPMW	
GUGRPB	GUGRPB	GUGRPN	GUGRBN	GUGRPW	
		GUGRCHPN	GUGRCHBN	GUGRCHPW	
GUGRDWPB	GUGRDWPB	GUGRDWPN	GUGRDWBN	GUGRDWPW	
GUGREFPB	GUGREFPB	GUGREFPN	GUGREFBN	GUGREFPW	
GUGRFAPB	GUGRFAPB	GUGRFAPN	GUGRFABN	GUGRFAPW	
GUGRFRFZPB	GUGRFRFZPB	GUGRFRFZPN	GUGRFRFZBN	GUGRFRFZPW	
GUGRFRPB	GUGRFRPB	GUGRFRPN	GUGRFRBN	GUGRFRPW	
GUGRFZPB	GUGRFZPB	GUGRFZPN	GUGRFZBN	GUGRFZPW	
		GUGRHOPN	GUGRHOBN	GUGRHOPW	
		GUGRHEPN	GUGRHEBN	GUGRHEPW	
GUGRMWPB	GUGRMWPB	GUGRMWPN	GUGRMWBN	GUGRMWPW	
		GUGROVPN	GUGROVBN	GUGROVPW	
GUGRTDPB	GUGRTDPB	GUGRTDPN	GUGRTDBN	GUGRTDPW	
		GUGRBOPN	GUGRBOBN	GUGRBOPW	
GUGRWMPB	GUGRWMPB	GUGRWMPN	GUGRWMBN	GUGRWMPW	
		GUGRWDPN	GUGRWDBN	GUGRWDPW	
		GUGRWDYPN	GUGRWDYBN	GUGRWDYPW	
GU8410PB	GU8410PB	GU8410PN	GU8410BN	GU8410PW	
GU8420PB	GU8420PB	GU8420PN	GU8420BN	GU8420PW	
SB161	SB161	SB161	SB161	SB161	
SB251	SB251	SB251	SB251	SB251	
SB252	SB252	SB252	SB252	SB252	
SB351	SB351	SB351	SB351	SB351	
SB352	SB352	SB352	SB352	SB352	
SB471	SB471	SB471	SB471	SB471	
SB472	SB472	SB472	SB472	SB472	
3746130	3746130	3746130	3746130	3746130	3746130
USCREW50SS	USCREW50SS	USCREW50SS	USCREW50SS	USCREW50SS	USCREW50SS
GU1401F	GU1401F	GU1401F	GU1401F	GU1401F	
GU1401FW		GU1401FW		GU1401FW	

Ultimate Flat Plate

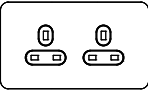
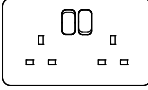
Selection Table







Product type	Description	Stainless Steel with White interior	Stainless Steel with Black interior	Polished Chrome with White Interior
Unswitched sockets 	13A 1 gang unswitched	GU3250WSS	GU3250BSS	GU3250WPC
	13A 2 gang unswitched	GU3260WSS	GU3260BSS	
Switched sockets 	13A 1 gang SP switched	GU3210WSS	GU3210BSS	GU3210WPC
	13A 1 gang DP	GU3210DWSS	GU3210DBSS	GU3210DWPC
	13A 2 gang SP switched	GU3220WSS	GU3220BSS	GU3220WPC
	13A 2 gang DP switched	GU3220DWSS	GU3220DBSS	GU3220DWPC
	13A 2 gang DP switched with outboard rockers	GU3231WSS	GU3231BSS	GU3231WPC
	13A 2 gang DP switched with red outboard neon rockers	GU3234WSS		
	1 gang shelf	GGBGUSHF1GS	GGBGUSHF1GBS	GGBGUSHF1GS
	2 gang shelf	GGBGUSHF2GS	GGBGUSHF2GBS	GGBGUSHF2GS
Round pin sockets	2A unswitched	GU3270WSS	GU3270BSS	GU3270WPC
	5A unswitched	GU3280WSS	GU3280BSS	GU3280WPC
	15A switched	GU3290WSS	GU3290BSS	
Floor sockets	13A 1 gang unswitched	GU3251WSS		
	13A 2 gang unswitched	GU3252WSS		
Light switches 	1 gang 2 way	GU1212WSS	GU1212BSS	GU1212WPC
	1 gang retractive	GU1212RWSS	GU1212RBSS	GU1212RWPC
	2 gang 2 way	GU1222WSS	GU1222BSS	GU1222WPC
	3 gang 2 way	GU1232WSS	GU1232BSS	GU1232WPC
	4 gang 2 way	GU1242WSS	GU1242BSS	GU1242WPC
	6 gang 2 way	GU1262WSS	GU1262BSS	GU1262WPC
	1 gang intermediate	GU1214WSS	GU1214BSS	GU1214WPC
	3 pole fan isolator	GU1213WSS	GU1213BSS	GU1213WPC
Toggle switches	1 gang 2 way	GU1212TSS	GU1212TSS	GU1212TPC
	2 gang 2 way	GU1222TSS	GU1222TSS	GU1222TPC
	3 gang 2 way	GU1232TSS	GU1232TSS	GU1232TPC
	4 gang 2 way	GU1242TSS	GU1242TSS	GU1242TPC
Dimmer switches 	1 gang 2 way 400W/VA mains & low voltage	GU6212CSS	GU6212CSS	GU6212CPC
	1 gang 2 way 100W/VA LED	GU6212LSS	GU6212LSS	GU6212LPC
	1 gang 2 way 300W/VA electronic		GU6212EBSS	GU6212EWPC
	1 gang 2 way 300W/VA IR electronic	GU6212RWSS	GU6212RBSS	
	1 channel IR remote control	GU6000RC1R	GU6000RC1R	GU6000RC1R
	2 gang 2 way 250W/VA mains & low voltage	GU6222CSS	GU6222CSS	GU6222CPC
	2 gang 2 way 100W/VA LED	GU6222LSS	GU6222LSS	GU6222LPC
	2 gang 2 way 200W/VA electronic		GU6222EBSS	
	3 gang 2 way 250W/VA mains & low voltage	GU6232CSS	GU6232CSS	GU6232CPC
	3 gang 2 way 75W/VA LED	GU6232LSS	GU6232LSS	GU6232LPC
	4 gang 2 way 250W/VA mains & low voltage	GU6242CSS	GU6242CSS	GU6242CPC
	4 gang 2 way 75W/VA LED	GU6242LSS	GU6242LSS	GU6242LPC

					
Polished Chrome with Black Interior	Polished Brass with White interior	Polished Brass with Black interior	Pearl Nickel with White interior	Black Nickel with Black interior	Painted White with White interior
GU3250BPC		GU3250BPB	GU3250WPN	GU3250BBN	GU3250WPW
GU3260BPC	GU3260WPB		GU3260WPN	GU3260BBN	GU3260WPW
GU3210BPC	GU3210WPB	GU3210BPB	GU3210WPN	GU3210BBN	GU3210WPW
GU3210DBPC	GU3210DWPB	GU3210DBPB	GU3210DWPN	GU3210DBBN	GU3210DWPW
GU3220BPC	GU3220WPB	GU3220BPB	GU3220WPN	GU3220BBN	GU3220WPW
GU3220DBPC	GU3220DWPB	GU3220DBPB	GU3220DWPN	GU3220DBBN	GU3220DWPW
GU3231BPC				GU3231BBN	
GGBGUSHF1GBS	GGBGUSHF1GS	GGBGUSHF1GBS	GGBGUSHF1GS	GGBGUSHF1GBS	GGBGUSHF1GS
GGBGUSHF2GBS	GGBGUSHF2GS	GGBGUSHF2GBS	GGBGUSHF2GS	GGBGUSHF2GBS	GGBGUSHF2GS
GU3270BPC	GU3270WPB	GU3270BPB	GU3270WPN	GU3270BBN	GU3270WPW
GU3280BPC	GU3280WPB	GU3280BPB	GU3280WPN	GU3280BBN	GU3280WPW
				GU3290BBN	GU3290WPW
	GU3252WPB				
GU1212BPC	GU1212WPB	GU1212BPB	GU1212WPN	GU1212BBN	GU1212WPW
GU1212RBPC		GU1212RBPB	GU1212RWPN	GU1212RBBN	GU1212RWPW
GU1222BPC	GU1222WPB	GU1222BPB	GU1222WPN	GU1222BBN	GU1222WPW
GU1232BPC	GU1232WPB	GU1232BPB	GU1232WPN	GU1232BBN	GU1232WPW
GU1242BPC	GU1242WPB	GU1242BPB	GU1242WPN	GU1242BBN	GU1242WPW
GU1262BPC		GU1262BPB	GU1262WPN	GU1262BBN	GU1262WPW
GU1214BPC	GU1214WPB	GU1214BPB	GU1214WPN	GU1214BBN	GU1214WPW
GU1213BPC	GU1213WPB	GU1213BPB	GU1213WPN	GU1213BBN	GU1213WPW
GU1212TPC	GU1212TPB	GU1212TPB	GU1212TPN	GU1212TBN	GU1212TPW
GU1222TPC	GU1222TPB	GU1222TPB	GU1222TPN	GU1222TBN	GU1222TPW
GU1232TPC	GU1232TPB	GU1232TPB	GU1232TPN	GU1232TBN	GU1232TPW
GU1242TPC	GU1242TPB	GU1242TPB	GU1242TPN		GU1242TPW
GU6212CPC	GU6212CPB	GU6212CPB	GU6212CPN	GU6212CBN	GU6212CPW
GU6212LPC	GU6212LPB	GU6212LPB	GU6212LPN	GU6212LBN	GU6212LPW
				GU6212EBBN	
GU6212RBPC					GU6212RWPW
GU6000RC1R	GU6000RC1R	GU6000RC1R	GU6000RC1R	GU6000RC1R	GU6000RC1R
GU6222CPC	GU6222CPB	GU6222CPB	GU6222CPN	GU6222CBN	GU6222CPW
GU6222LPC	GU6222LPB	GU6222LPB	GU6222LPN	GU6222LBN	GU6222LPW
GU6222EBPC	GU6222EWPB		GU6222EWPN	GU6222EBBN	
GU6232CPC	GU6232CPB	GU6232CPB	GU6232CPN	GU6232CBN	GU6232CPW
GU6232LPC				GU6232LBN	GU6232LPW
GU6242CPC	GU6242CPB	GU6242CPB	GU6242CPN	GU6242CBN	GU6242CPW
GU6242LPC					GU6242LPW

Ultimate Flat Plate

Selection Table

Product type	Description	Stainless Steel with White interior	Stainless Steel with Black interior	Polished Chrome with White Interior
Control switches 	20AX DP	GU2210WSS	GU2210BSS	GU2210WPC
	20AX DP with neon	GU2211WSS	GU2211BSS	GU2211WPC
	20AX DP with flex outlet	GU2213WSS	GU2213BSS	GU2213WPC
	20AX DP with flex outlet & neon	GU2214WSS	GU2214BSS	GU2214WPC
	20AX DP with neon, flex outlet & printed 'Water Heater'	GU2214WHWSS	GU2214WHBSS	
	32A DP with neon	GU4231WSS	GU4231BSS	GU4231WPC
	50A 2 gang DP switch with neon	GU4221WSS	GU4221BSS	GU4221WPC
	45A DP cooker control unit with 13A socket & neon	GU4201WSS	GU4201BSS	GU4201WPC
Fused connection units 	13A unswitched FCU	GU5200WSS	GU5200BSS	GU5200WPC
	13A unswitched with flex outlet	GU5203WSS	GU5203BSS	GU5203WPC
	13A DP switched	GU5210WSS	GU5210BSS	GU5210WPC
	13A DP switched with neon	GU5211WSS	GU5211BSS	GU5211WPC
	13A DP switched with flex outlet	GU5213WSS	GU5213BSS	GU5213WPC
	13A DP switched with flex outlet & neon	GU5214WSS	GU5214BSS	GU5214WPC
Shaver sockets 	115/230V dual voltage	GU7290WSS	GU7290BSS	GU7290WPC
USB, Data, TV & Telephone outlets 	BT master	GU7261WSS	GU7261BSS	GU7261WPC
	BT secondary	GU7262WSS	GU7262BSS	GU7262WPC
	Single RJ11	GU7251WSS	GU7251BSS	GU7251WPC
	Single RJ45 CAT 5e		GU7271BSS	GU7271WPC
	Single TV-R co-axial	GU7210WSS	GU7210BSS	GU7210WPC
	Twin TV-R co-axial			
	Single satellite	GU7230WSS	GU7230BSS	GU7230WPC
	Media plate: 4 x 13A socket & 4 x 50x50mm euro module cut-out	GU32204DMPWSS	GU32204DMPBSS	GU32204DMPWPC
	Media plate mounting box 160 x 270 x 47mm	GGBSB4724M	GGBSB4724M	GGBSB4724M
	Media plate: 2 x 13A socket & 2 x 50x50mm euro module cut-out	GU32202DMPWSS	GU32202DMPBSS	GU32202DMPWPC
	Media plate mounting box 76 x 270 x 47mm	GGBSB4722M	GGBSB4722M	GGBSB4722M
Euro plates & modules 	1 gang 50 x 25mm	GU8250SS	GU8250SS	GU8250PC
	1 gang 50 x 50mm	GU8260SS	GU8260SS	GU8260PC
	2 gang 50 x 100mm	GU8280SS	GU8280SS	GU8280PC
	2 x RCA socket - 25 x 50mm	GUE7000W	GUE7000B	GUE7000W
	2 x Loudspeaker socket - 25 x 50mm	GUE7001W		GUE7001W
	TV/Radio (diplexed) - 50 x 50mm	GUE7010W	GUE7010B	GUE7010W
	Single IEC coax (female) - 25 x 50mm	GUE7011W	GUE7011B	GUE7011W
	Single IEC coax (male) - 25 x 50mm	GUE7012W	GUE7012B	GUE7012W
	HDMI 50 x 50mm	GUE7020W	GUE7020B	GUE7020W
	Single F - 25 x 50mm	GUE7030W	GUE7030B	GUE7030W
	TV/Sat diplexer 50 x 50mm		GUE7040B	
	RJ11 modem - 25 x 50mm	GUE7051W	GUE7051B	GUE7051W
	Telephone (BT master) - 25 x 50mm	GUE7061W	GUE7061B	GUE7061W
	Telephone (BT slave) - 25 x 50mm	GUE7062WK	GUE7062BK	GUE7062WK
	CAT5E - 25 x 50mm	GUE7071W	GUE7071B	GUE7071W







					
GU2210BPC		GU2210BPB	GU2210WPN	GU2210BBN	GU2210WPW
GU2211BPC	GU2211WPB	GU2211BPB	GU2211WPN	GU2211BBN	GU2211WPW
GU2213BPC		GU2213BPB		GU2213BBN	GU2213WPW
		GU2214BPB	GU2214WPN	GU2214BBN	GU2214WPW
		GU2214WHBPB		GU2214WHBBN	GU2214WHWPW
GU4231BPC	GU4231WPB		GU4231WPN	GU4231BBN	GU4231WPW
GU4221BPC	GU4221WPB	GU4221BPB	GU4221WPN	GU4221BBN	GU4221WPW
GU4201BPC			GU4201WPN	GU4201BBN	GU4201WPW
GU5200BPC	GU5200WPB	GU5200BPB	GU5200WPN	GU5200BBN	GU5200WPW
GU5203BPC		GU5203BPB	GU5203WPN	GU5203BBN	GU5203WPW
GU5210BPC		GU5210BPB	GU5210WPN	GU5210BBN	GU5210WPW
GU5211BPC		GU5211BPB	GU5211WPN	GU5211BBN	GU5211WPW
GU5213BPC		GU5213BPB	GU5213WPN	GU5213BBN	GU5213WPW
GU5214BPC	GU5214WPB		GU5214WPN	GU5214BBN	GU5214WPW
GU7290BPC	GU7290WPB	GU7290BPB	GU7290WPN	GU7290BBN	GU7290WPW
GU7261BPC		GU7261BPB	GU7261WPN	GU7261BBN	GU7261WPW
GU7262BPC	GU7262WPB	GU7262BPB	GU7262WPN	GU7262BBN	GU7262WPW
GU7251BPC	GU7251WPB	GU7251BPB	GU7251WPN	GU7251BBN	GU7251WPW
GU7271BPC	GU7271WPB	GU7271BPB	GU7271WPN	GU7271BBN	GU7271WPW
		GU7210BPB	GU7210WPN	GU7210BBN	GU7210WPW
GU7220BPC	GU7220WPB	GU7220BPB		GU7220BBN	GU7220WPW
GU7230BPC			GU7230WPN		GU7230WPW
GU32204DMPWPC		GU32204DMPBPB		GU32204DMPBBN	GU32204DMPWPW
GGBSB4724M	GGBSB4724M	GGBSB4724M	GGBSB4724M	GGBSB4724M	GGBSB4724M
GU32202DMPWPC				GU32202DMPBBN	GU32202DMPWPW
GGBSB4722M	GGBSB4722M	GGBSB4722M	GGBSB4722M	GGBSB4722M	GGBSB4722M
GU8250PC	GU8250PB	GU8250PB	GU8250PN	GU8250BN	GU8250PW
GU8260PC	GU8260PB	GU8260PB	GU8260PN	GU8260BN	GU8260PW
GU8280PC	GU8280PB	GU8280PB	GU8280PN	GU8280BN	GU8280PW
GUE7000B	GUE7000W	GUE7000B	GUE7000W	GUE7000B	GUE7000W
	GUE7001W		GUE7001W		GUE7001W
GUE7010B	GUE7010W	GUE7010B	GUE7010W	GUE7010B	GUE7010W
GUE7011B	GUE7011W	GUE7011B	GUE7011W	GUE7011B	GUE7011W
GUE7012B	GUE7012W	GUE7012B	GUE7012W	GUE7012B	GUE7012W
GUE7020B	GUE7020W	GUE7020B	GUE7020W	GUE7020B	GUE7020W
GUE7030B	GUE7030W	GUE7030B	GUE7030W	GUE7030B	GUE7030W
GUE7040B		GUE7040B		GUE7040B	
GUE7051B	GUE7051W	GUE7051B	GUE7051W	GUE7051B	GUE7051W
GUE7061B	GUE7061W	GUE7061B	GUE7061W	GUE7061B	GUE7061W
GUE7062BK	GUE7062WK	GUE7062BK	GUE7062WK	GUE7062BK	GUE7062WK
GUE7071B	GUE7071W	GUE7071B	GUE7071W	GUE7071B	GUE7071W

Ultimate Flat Plate

Selection Table





Product type	Description	Stainless Steel with White interior	Stainless Steel with Black interior	Polished Chrome with White Interior
Euro plates & modules 	RJ45 CAT 6 - 25 x 50mm	GUE7072W	GUE7072B	GUE7072W
	USB charger single 5V 1A 25 x 50mm	GUE7073W	GUE7073B	GUE7073W
	USB charger twin 2 x 1A 50 x 50mm	GUE7074W	GUE7074B	GUE7074W
	USB charger single 5V 2.1A 25 x 50mm	GUE7021W	GUE7021B	GUE7021W
	USB charger twin 2 x 3.1A 50 x 50mm	GUE7031W	GUE7031B	GUE7031W
	TV/Radio/Sat1 - (triplexed) 50 x 50mm	GUE7081W	GUE7081B	GUE7081W
	TV/Radio/Sat1/Sat2 - (quadplexer) 50 x 50mm	GUE7082W	GUE7082B	GUE7082W
	Brush outlet 50 x 50mm	GUE7076W	GUE7076B	GUE7076W
	5A round pin socket 50 x 50mm	GUE7077W	GUE7077B	GUE7077W
	Blank 25 x 50mm	GUE8010W	GUE8010B	GUE8010W
Grid plates 	1 gang 88 x 88mm	GUG01GSS	GUG01GSS	GUG01GMS
	2 gang 88 x 88mm	GUG02GSS	GUG02GSS	GUG02GMS
	76 x 76 x 42mm mounting box	GBG01	GBG01	GBG01
	3 gang 88 x 148mm	GUG03GSS	GUG03GSS	GUG03GMS
	4 gang 88 x 148mm	GUG04GSS	GUG04GSS	GUG04GMS
	136 x 76 x 42mm mounting box	GBG02	GBG02	GBG02
	6 gang 156 x 156mm	GUG06GSS	GUG06GSS	GUG06GMS
	8 gang 156 x 156mm	GUG08GSS	GUG08GSS	GUG08GMS
	136 x 136 x 42mm mounting box	GBG03	GBG03	GBG03
	9 gang 216 x 156mm	GUG09GSS	GUG09GSS	GUG09GMS
	12 gang 216 x 156mm	GUG12GSS	GUG12GSS	GUG12GMS
	193 x 133 x 42mm mounting box	GBG04F	GBG04F	GBG04F
	18 gang 398 x 156mm	GUG18GSS	GUG18GSS	GUG18GMS
	24 gang 398 x 156mm	GUG24GSS	GUG24GSS	GUG24GMS
	374 x 133 x 42mm mounting box	GBG06F	GBG06F	GBG06F
Grid modules (fully assembled) 	10A 2 way retractive switch	GUG102RWSS	GUG102RBSS	GUG102RWMS
	2 way retractive & centre off switch	GUG202OCWSS	GUG202OCBSS	GUG202OCWMS
	10AX toggle	GUG102TWSS	GUG102TBSS	GUG102TWMS
	10AX intermediate toggle	GUG101TWSS	GUG101TBSS	GUG101TWMS
	100W LED electronic dimmer	GGBGUGEMDIMLWSS	GGBGUGEMDIMLBSS	GGBGUGEMDIMLWPC
	300W/VA universal multiway electronic touch dimmer	GUGEMDIMWSS16		GUGEMDIMWMS16
	300W/VA universal multiway electronic touch dimmer controlled with infr-red remote	GUGEMRDIMW16	GUGEMRDIMB16	GUGEMRDIMW16
	1 channel IR remote control	GU6000RC1R	GU6000RC1R	GU6000RC1R
	50mA 2 way & multiway retractive electronic dimmer	GUGEMWWSS	GUGEMWBSS	GUGEMWWMS
	20AX 2 way key switch	GUG202KWSS	GUG202KBSS	GUG202KWMS
	20AX key switch printed TEST EMG LTG	GUG202KELWSS	GUG202KELBSS	GUG202KELWMS
	20AX DP key switch	GUG20DPKWSS	GUG20DPKBSS	GUG20DPKWMS
	BT master	GUGTELMWSS	GUGTELMBSS	GUGTELMWMS
	BT secondary	GUGTELSWSS	GUGTELSBSS	GUGTELSWMS
	RJ11	GUGRJ11WSS	GUGRJ11BSS	
	RJ45 CAT 5e		GUGRJ45BSS	GUGRJ45WMS
	TV/FM coaxial	GUGCOWSS		
	Satellite "F" Type	GUGSATWSS	GUGSATBSS	
	13A fuse carrier	GUG13FCUWSS	GUG13FCUBSS	GUG13FCUWMS
	Green indicator	GUGINDWG	GUGINDBG	GUGINDWG
	Red indicator	GUGINDWR	GUGINDBR	GUGINDWR

					
Polished Chrome with Black Interior	Polished Brass with White interior	Polished Brass with Black interior	Pearl Nickel with White interior	Black Nickel with Black interior	Painted White with White interior
GUE7072B	GUE7072W	GUE7072B	GUE7072W	GUE7072B	GUE7072W
GUE7073B	GUE7073W	GUE7073B	GUE7073W	GUE7073B	GUE7073W
GUE7074B	GUE7074W	GUE7074B	GUE7074W	GUE7074B	GUE7074W
GUE7021B	GUE7021W	GUE7021B	GUE7021W	GUE7021B	GUE7021W
GUE7031B	GUE7031W	GUE7031B	GUE7031W	GUE7031B	GUE7031W
GUE7081B	GUE7081W	GUE7081B	GUE7081W	GUE7081B	GUE7081W
GUE7082B	GUE7082W	GUE7082B	GUE7082W	GUE7082B	GUE7082W
GUE7076B	GUE7076W	GUE7076B	GUE7076W	GUE7076B	GUE7076W
GUE7077B	GUE7077W	GUE7077B	GUE7077W	GUE7077B	GUE7077W
GUE8010B	GUE8010W	GUE8010B	GUE8010W	GUE8010B	GUE8010W
GUG01GMS	GUG01GPB	GUG01GPB	GUG01GPN	GUG01GBN	GUG01GPW
GUG02GMS	GUG02GPB	GUG02GPB	GUG02GPN	GUG02GBN	GUG02GPW
GBG01	GBG01	GBG01	GBG01	GBG01	GBG01
GUG03GMS	GUG03GPB	GUG03GPB	GUG03GPN	GUG03GBN	GUG03GPW
GUG04GMS	GUG04GPB	GUG04GPB	GUG04GPN	GUG04GBN	GUG04GPW
GBG02	GBG02	GBG02	GBG02	GBG02	GBG02
GUG06GMS	GUG06GPB	GUG06GPB	GUG06GPN	GUG06GBN	GUG06GPW
GUG08GMS	GUG08GPB	GUG08GPB	GUG08GPN	GUG08GBN	GUG08GPW
GBG03	GBG03	GBG03	GBG03	GBG03	GBG03
GUG09GMS	GUG09GPB	GUG09GPB	GUG09GPN	GUG09GBN	GUG09GPW
GUG12GMS	GUG12GPB	GUG12GPB	GUG12GPN	GUG12GBN	GUG12GPW
GBG04F	GBG04F	GBG04F	GBG04F	GBG04F	GBG04F
GUG18GMS	GUG18GPB	GUG18GPB	GUG18GPN	GUG18GBN	GUG18GPW
GUG24GMS	GUG24GPB	GUG24GPB	GUG24GPN	GUG24GBN	GUG24GPW
GBG06F	GBG06F	GBG06F	GBG06F	GBG06F	GBG06F
GUG102RBMS	GUG102RWPB	GUG102RBPB	GUG102RWPN	GUG102RBBN	GUG102RWPW
GUG202OCBMS	GUG202OCWPB	GUG202OCBPB	GUG202OCWPN	GUG202OCBBN	GUG202OCWPW
GUG102TBMS		GUG102TBPB	GUG102TWPN	GUG102TBBN	GUG102TWPW
GUG101TBMS		GUG101TBPB	GUG101TWPN	GUG101TBBN	GUG101TWPW
GGBGUGEMDIMLBPC		GGBGUGEMDIMLBPB	GGBGUGEMDIMLWPN	GGBGUGEMDIMLBBN	GGBGUGEMDIMLWPW
GUGEMDIMBMS16		GUGEMDIMBPB16		GUGEMDIMBBN16	GUGEMDIMWPW16
GUGEMRDIMB16	GUGEMRDIMW16	GUGEMRDIMB16	GUGEMRDIMW16	GUGEMRDIMB16	GUGEMRDIMW16
GU6000RC1R	GU6000RC1R	GU6000RC1R	GU6000RC1R	GU6000RC1R	GU6000RC1R
GUGEMWBMS			GUGEMWWPN	GUGEMWBBN	GUGEMWWPW
GUG202KBMS		GUG202KBPB	GUG202KWPN	GUG202KBBN	GUG202KWPW
GUG202KELBMS		GUG202KELBPB	GUG202KELWPN	GUG202KELBBN	GUG202KELWPW
GUG20DPKBMS		GUG20DPKBPB	GUG20DPKWPN	GUG20DPKBBN	GUG20DPKWPW
GUGTELMBMS		GUGTELMBPB	GUGTELMWPN	GUGTELMBBN	GUGTELMWPW
GUGTELSBMS	GUGTELSWPB	GUGTELSBPB	GUGTELSWPN	GUGTELSBBN	GUGTELSWPW
				GUGRJ11BBN	GUGRJ11WPW
GUGRJ45BMS			GUGRJ45WPN	GUGRJ45BBN	GUGRJ45WPW
GUGCOBMS				GUGCOBBN	GUGCOWPW
GUGSATBMS			GUGSATWPN	GUGSATBBN	GUGSATWPW
GUG13FCUBMS	GUG13FCUWPB	GUG13FCUBPB	GUG13FCUWPN	GUG13FCUBBN	GUG13FCUWPW
GUGINDBG	GUGINDWG	GUGINDBG	GUGINDWG	GUGINDBG	GUGINDWG
GUGINDBR	GUGINDWR	GUGINDBR	GUGINDWR	GUGINDBR	GUGINDWR

Ultimate Flat Plate

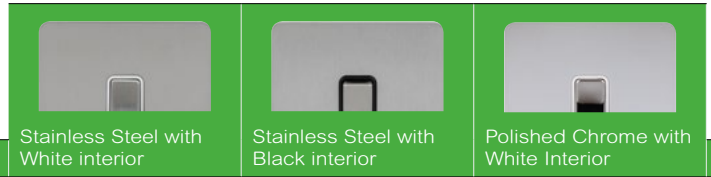
Selection Table







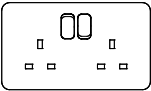

Product type	Description	Stainless Steel with White interior	Stainless Steel with Black interior	Polished Chrome with White Interior
Grid modules (module & rocker cap separate) 	Orange indicator	GUGINDWO	GUGINDBO	GUGINDWO
	Flex outlet (10mm diameter)	GUG16COWSS	GUG16COBSS	GUG16COWMS
	Blank	GUGBWSS	GUGBBSS	GUGBWMS
	10AX 1 way	GUG101MW	GUG101MB	GUG101MW
	10AX 2 way	GUG102MW	GUG102MB	GUG102MW
	10AX intermediate	GUG10IMW	GUG10IMB	GUG10IMW
	20AX 1 way	GUG201MW	GUG201MB	GUG201MW
	20AX 2 way centre off	GUG202MW	GUG202MB	GUG202MW
	20AX 2 way	GUG202MW	GUG202MB	GUG202MW
	20AX DP	GUG20DPMW	GUG20DPMB	GUG20DPMW
	Plain rocker cap	GUGRSS	GUGRSS	GUGRMS
	Rocker cap printed Cooker Hood	GUGRCHSS	GUGRCHSS	GUGRCHMS
	Rocker cap printed Dishwasher	GUGRDWSS	GUGRDWSS	GUGRDWMS
	Rocker cap printed Extractor Fan	GUGREFSS	GUGREFSS	GUGREFMS
	Rocker cap printed Fan	GUGRFASS	GUGRFASS	GUGRFAMS
	Rocker cap printed Fridge Freezer	GUGRFRFZSS	GUGRFRFZSS	GUGRFRFZMS
	Rocker cap printed Fridge	GUGRFRSS	GUGRFRSS	GUGRFRMS
	Rocker cap printed Freezer	GUGRFZSS	GUGRFZSS	GUGRFZMS
	Rocker cap printed Hob	GUGRHOSS	GUGRHOSS	GUGRHOMS
	Rocker cap printed Heater	GUGRHESS	GUGRHESS	GUGRHEMS
	Rocker cap printed Microwave	GUGRMWSS	GUGRMWSS	GUGRMWMS
	Rocker cap printed Oven	GUGROVSS	GUGROVSS	GUGROVMS
	Rocker cap printed Tumble Dryer	GUGRTDSS	GUGRTDSS	GUGRTDMS
Rocker cap printed Boiler	GUGRBOSS	GUGRBOSS	GUGRBOMS	
Rocker cap printed Washing Machine	GUGRWMSS	GUGRWMSS	GUGRWMMS	
Rocker cap printed Waste Disposal	GUGRDWSS	GUGRDWSS	GUGRDWMS	
Rocker cap printed Washer Dryer	GUGRDWYSS	GUGRDWYSS	GUGRDWYMS	
Blank plates 	1 gang blank plate	GU8210SS	GU8210SS	GU8210PC
	2 gang blank plate	GU8220SS	GU8220SS	GU8220PC
Mounting boxes	1 gang 16mm deep	SB161	SB161	SB161
	1 gang 25mm deep	SB251	SB251	SB251
	2 gang 25mm deep	SB252	SB252	SB252
	1 gang 35mm deep	SB351	SB351	SB351
	2 gang 35mm deep	SB352	SB352	SB352
	1 gang 47mm deep	SB471	SB471	SB471
	2 gang 47mm deep	SB472	SB472	SB472
	Spares	M3.5 x 25mm screws	3746130	3746130
M3.5 x 50mm screws		USCREW50SS	USCREW50SS	USCREW50SS

					
Polished Chrome with Black Interior	Polished Brass with White interior	Polished Brass with Black interior	Pearl Nickel with White interior	Black Nickel with Black interior	Painted White with White interior
GUGINDBO	GUGINDWO	GUGINDBO	GUGINDWO	GUGINDBO	GUGINDWO
GUG16COBMS		GUG16COBPB	GUG16COWPN	GUG16COBBN	GUG16COWPW
GUGBBMS		GUGBBPB	GUGBWPN	GUGBBBN	GUGBWPW
GUG101MB	GUG101MW	GUG101MB	GUG101MW	GUG101MB	GUG101MW
GUG102MB	GUG102MW	GUG102MB	GUG102MW	GUG102MB	GUG102MW
GUG101MB	GUG101MW	GUG101MB	GUG101MW	GUG101MB	GUG101MW
GUG201MB	GUG201MW	GUG201MB	GUG201MW	GUG201MB	GUG201MW
GUG2020MB	GUG2020MW	GUG2020MB	GUG2020MW	GUG2020MB	GUG2020MW
GUG202MB	GUG202MW	GUG202MB	GUG202MW	GUG202MB	GUG202MW
GUG20DPMB	GUG20DPMW	GUG20DPMB	GUG20DPMW	GUG20DPMB	GUG20DPMW
GUGRMS	GUGRPB	GUGRPB	GUGRPN	GUGRBN	GUGRPW
GUGRCHMS	GUGRCHPB	GUGRCHPB	GUGRCHPN	GUGRCHBN	GUGRCHPW
GUGRDWMS	GUGRDWPB	GUGRDWPB	GUGRDWPN	GUGRDWBN	GUGRDWPW
GUGREFMS	GUGREFPB	GUGREFPB	GUGREFPN	GUGREFBN	GUGREFPW
GUGRFAMS	GUGRFAPB	GUGRFAPB	GUGRFAPN	GUGRFABN	GUGRFAPW
GUGRFRFZMS	GUGRFRFZPB	GUGRFRFZPB	GUGRFRFZPN	GUGRFRFZBN	GUGRFRFZPW
GUGRFRMS	GUGRFRPB	GUGRFRPB	GUGRFRPN	GUGRFRBN	GUGRFRPW
GUGRFZMS	GUGRFZPB	GUGRFZPB	GUGRFZPN	GUGRFZBN	GUGRFZPW
GUGRHOMS	GUGRHOPB	GUGRHOPB	GUGRHOPN	GUGRHOBN	GUGRHOPW
GUGRHEMS			GUGRHEPN	GUGRHEBN	GUGRHEPW
GUGRMWMS	GUGRMWPB	GUGRMWPB	GUGRMWPN	GUGRMWBN	GUGRMWPW
GUGROVMS	GUGROVPB	GUGROVPB	GUGROVPN	GUGROVBN	GUGROVPW
GUGRTDMS	GUGRTDPB	GUGRTDPB	GUGRTDPN	GUGRTDBN	GUGRTDPW
GUGRBOMS	GUGRBOPB	GUGRBOPB	GUGRBOPN	GUGRBOBN	GUGRBOPW
GUGRWMS	GUGRWMPB	GUGRWMPB	GUGRWMPN	GUGRWMBN	GUGRWMPW
GUGRDMS	GUGRDWPB	GUGRDWPB	GUGRDWPN	GUGRDWBN	GUGRDWPW
GUGRDYMS			GUGRDYPN	GUGRDYBN	GUGRDYPW
GU8210PC	GU8210PB	GU8210PB	GU8210PN	GU8210BN	GU8210PW
GU8220PC	GU8220PB	GU8220PB	GU8220PN	GU8220BN	GU8220PW
SB161	SB161	SB161	SB161	SB161	SB161
SB251	SB251	SB251	SB251	SB251	SB251
SB252	SB252	SB252	SB252	SB252	SB252
SB351	SB351	SB351	SB351	SB351	SB351
SB352	SB352	SB352	SB352	SB352	SB352
SB471	SB471	SB471	SB471	SB471	SB471
SB472	SB472	SB472	SB472	SB472	SB472
3746130	3746130	3746130	3746130	3746130	3746130
USCREW50SS	USCREW50SS	USCREW50SS	USCREW50SS	USCREW50SS	USCREW50SS

Ultimate Low Profile

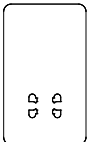
Selection Table

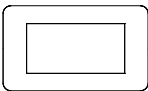



Product type	Description
Switched sockets 	13A 1 gang SP switched
	13A 2 gang SP switched
	13A 2 gang DP switched with outboard rockers
	13A 2 gang switched 2 USB ports 2.1A shared
	1 gang shelf
	2 gang shelf
Round pin sockets	5A unswitched
Light switches 	1 gang 2 way
	2 gang 2 way
	3 gang 2 way
	4 gang 2 way
	1 gang intermediate
	3 pole fan isolator
Dimmer switches 	1 gang 2 way 400W/VA mains & low voltage
	2 gang 2 way 250W/VA mains & low voltage
	3 gang 2 way 250W/VA mains & low voltage
Control switches 	20AX DP with neon
	20AX DP with flex outlet
	50A 2 gang DP switch with neon
	45A DP cooker control unit with 13A socket & neon
Fused connection units 	13A unswitched FCU
	13A DP switched
	13A DP switched with neon
	13A DP switched with flex outlet & neon
Shaver sockets 	115/230V dual voltage
USB, Data, TV & Telephone outlets 	BT master
	BT secondary
	Single TV-R co-axial
Euro plates & modules 	1 gang 50 x 25mm
	1 gang 50 x 50mm
	2 gang 50 x 100mm
	2 x RCA socket - 25 x 50mm
	2 x Loudspeaker socket - 25 x 50mm
	TV/Radio (diplexed) - 50 x 50mm
	Single IEC coax (female) - 25 x 50mm

	 Brushed Chrome with White Interior	 Brushed Chrome with Black interior	 Polished Chrome with White Interior	 Polished Chrome with Black Interior
GU3510WBC	GU3510BBC	GU3510WPC	GU3510BPC	
GU3520WBC	GU3520BBC	GU3520WPC	GU3520BPC	
GU3530WBC	GU3530BBC	GU3530WPC	GU3530BPC	
GGBGU35202USBWBC	GGBGU35202USBBBC	GGBGU35202USBWPC		
GGBGUSHF1GS	GGBGUSHF1GBS	GGBGUSHF1GS	GGBGUSHF1GBS	
GGBGUSHF2GS	GGBGUSHF2GBS	GGBGUSHF2GS	GGBGUSHF2GBS	
GU3580WBC	GU3580BBC	GU3580WPC	GU3580BPC	
GU1512WBC	GU1512BBC	GU1512WPC	GU1512BPC	
GU1522WBC	GU1522BBC	GU1522WPC	GU1522BPC	
GU1532WBC	GU1532BBC	GU1532WPC	GU1532BPC	
GU1542WBC	GU1542BBC	GU1542WPC	GU1542BPC	
GU1514WBC	GU1514BBC	GU1514WPC	GU1514BPC	
GU1513WBC	GU1513BBC	GU1513WPC	GU1513BPC	
GU6512CBC	GU6512CBC	GU6512CPC	GU6512CPC	
GU6522CBC	GU6522CBC	GU6522CPC	GU6522CPC	
GU6532CBC	GU6532CBC	GU6532CPC	GU6532CPC	
GU2511WBC	GU2511BBC	GU2511WPC	GU2511BPC	
GU2513WBC	GU2513BBC	GU2513WPC	GU2513BPC	
GU4521WBC	GU4521BBC	GU4521WPC	GU4521BPC	
GU4501WBC	GU4501BBC	GU4501WPC	GU4501BPC	
GU5500WBC	GU5500BBC	GU5500WPC	GU5500BPC	
GU5510WBC	GU5510BBC	GU5510WPC	GU5510BPC	
GU5511WBC	GU5511BBC	GU5511WPC	GU5511BPC	
GU5514WBC	GU5514BBC	GU5514WPC	GU5514BPC	
GU7590WBC	GU7590BBC	GU7590WPC	GU7590BPC	
GU7561WBC	GU7561BBC	GU7561WPC	GU7561BPC	
GU7562WBC	GU7562BBC	GU7562WPC	GU7562BPC	
GU7510WBC	GU7510BBC	GU7510WPC		
GU8550BC	GU8550BC	GU8550PC	GU8550PC	
GU8560BC	GU8560BC	GU8560PC	GU8560PC	
GU8580BC	GU8580BC	GU8580PC	GU8580PC	
GUE7000W	GUE7000B	GUE7000W	GUE7000B	
GUE7001W		GUE7001W		
GUE7010W	GUE7010B	GUE7010W	GUE7010B	
GUE7011W	GUE7011B	GUE7011W	GUE7011B	

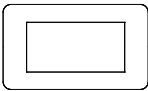
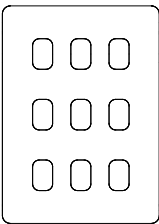
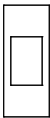
Ultimate Low Profile



Selection Table

Product type	Description
Euro plates & modules 	Single IEC coax (male) - 25 x 50mm
	HDMI 50 x 50mm
	Single F - 25 x 50mm
	TV/Sat diplexer 50 x 50mm
	RJ11 modem - 25 x 50mm
	Telephone (BT master) - 25 x 50mm
	Telephone (BT slave) - 25 x 50mm
	CAT5E - 25 x 50mm
	RJ45 CAT 6 - 25 x 50mm
	USB charger single 5V 1A 25 x 50mm
	USB charger twin 2 x 1A 50 x 50mm
	USB charger single 5V 2.1A 25 x 50mm
	USB charger twin 2 x 3.1A 50 x 50mm
	TV/Radio/Sat1 - (triplexed) 50 x 50mm
	TV/Radio/Sat1/Sat2 - (quadplexer) 50 x 50mm
	Brush outlet 50 x 50mm
	5A round pin socket 50 x 50mm
	Blank 25 x 50mm
Grid plates 	1 gang 88 x 88mm
	2 gang 88 x 88mm
	76 x 76 x 42mm mounting box
	3 gang 88 x 148mm
	4 gang 88 x 148mm
	136 x 76 x 42mm mounting box
	6 gang 156 x 156mm
	8 gang 156 x 156mm
	136 x 136 x 42mm mounting box
Grid modules (fully assembled) 	10A 2 way retractive switch
	2 way retractive & centre off switch
	10AX toggle
	10AX intermediate toggle
	100W LED electronic dimmer
	300W/VA universal multiway electronic touch dimmer
	300W/VA universal multiway electronic touch dimmer controlled with infra-red remote
	1 channel IR remote control
	50mA 2 way & multiway retractive electronic dimmer
	20AX 2 way key switch
	20AX key switch printed TEST EMG LTG
	20AX DP key switch
	BT master
	BT secondary
	RJ11
	RJ45 CAT 5e
	TV/FM coaxial
	Satellite "F" Type

	 Brushed Chrome with White Interior	 Brushed Chrome with Black interior	 Polished Chrome with White Interior	 Polished Chrome with Black Interior
GUE7012W		GUE7012B	GUE7012W	GUE7012B
GUE7020W		GUE7020B	GUE7020W	GUE7020B
GUE7030W		GUE7030B	GUE7030W	GUE7030B
GUE7040W		GUE7040B	GUE7040W	GUE7040B
GUE7051W		GUE7051B	GUE7051W	GUE7051B
GUE7061W		GUE7061B	GUE7061W	GUE7061B
GUE7062WK		GUE7062BK	GUE7062WK	GUE7062BK
GUE7071W		GUE7071B	GUE7071W	GUE7071B
GUE7072W		GUE7072B	GUE7072W	GUE7072B
GUE7073W		GUE7073B	GUE7073W	GUE7073B
GUE7074W		GUE7074B	GUE7074W	GUE7074B
GUE7021W		GUE7021B	GUE7021W	GUE7021B
GUE7031W		GUE7031B	GUE7031W	GUE7031B
GUE7081W		GUE7081B	GUE7081W	GUE7081B
GUE7082W		GUE7082B	GUE7082W	GUE7082B
GUE7076W		GUE7076B	GUE7076W	GUE7076B
GUE7077W		GUE7077B	GUE7077W	GUE7077B
GUE8010W		GUE8010B	GUE8010W	GUE8010B
GUGL01BC		GUGL01BC	GUGL01PC	GUGL01PC
GUGL02BC		GUGL02BC	GUGL02PC	GUGL02PC
GBG01		GBG01	GBG01	GBG01
GUGL03BC		GUGL03BC	GUGL03PC	GUGL03PC
GUGL04BC		GUGL04BC	GUGL04PC	GUGL04PC
GBG02		GBG02	GBG02	GBG02
GUGL06BC		GUGL06BC	GUGL06PC	GUGL06PC
GUGL08BC		GUGL08BC	GUGL08PC	GUGL08PC
GBG03		GBG03	GBG03	GBG03
GUG102RWPW		GUG102RBLK	GUG102RWMS	GUG102RBMS
GUG202OCWPW		GUG202OCBLK	GUG202OCWMS	GUG202OCBMS
GUG102TWPW			GUG102TWMS	GUG102TBMS
GUG10ITWPW			GUG10ITWMS	GUG10ITBMS
GGBGUGEMDIMLWPW			GGBGUGEMDIMLWPC	GGBGUGEMDIMLBPC
GUGEMDIMWPW16			GUGEMDIMWMS16	GUGEMDIMBMS16
GUGEMRDIMW16		GUGEMRDIMB16	GUGEMRDIMW16	GUGEMRDIMB16
GU6000RC1R		GU6000RC1R	GU6000RC1R	GU6000RC1R
GUGEMWWPW			GUGEMWWMS	GUGEMWBMS
GUG202KWPW		GUG202KBLK	GUG202KWMS	GUG202KBMS
GUG202KELWPW		GUG202KELBLK	GUG202KELWMS	GUG202KELBMS
GUG20DPKWPW		GUG20DPKBLK	GUG20DPKWMS	GUG20DPKBMS
GUGTELMWPW		GUGTELMBLK	GUGTELMWMS	GUGTELMBMS
GUGTELSWPW		GUGTELSBLK	GUGTELSWMS	GUGTELSBMS
GUGRJ11WPW		GUGRJ11BLK		
GUGRJ45WPW		GUGRJ45BLK	GUGRJ45WMS	GUGRJ45BMS
GUGCOWPW		GUGCOBLK	GUGCOWPW	GUGCOBMS
GUGSATWPW				GUGSATBMS

Ultimate Low Profile

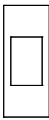
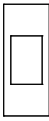
Selection Table





Product type	Description
Grid modules (fully assembled) 	13A fuse carrier
	Green indicator
	Red indicator
	Orange indicator
	Flex outlet (10mm diameter)
	Blank
Grid modules (module & rocker cap separate) 	10AX 1 way
	10AX 2 way
	10AX intermediate
	20AX 1 way
	20AX 2 way centre off
	20AX 2 way
	20AX DP
	Plain rocker cap
	Rocker cap printed Cooker Hood
	Rocker cap printed Dishwasher
	Rocker cap printed Extractor Fan
	Rocker cap printed Fan
	Rocker cap printed Fridge Freezer
	Rocker cap printed Fridge
	Rocker cap printed Freezer
	Rocker cap printed Hob
	Rocker cap printed Heater
	Rocker cap printed Microwave
	Rocker cap printed Oven
	Rocker cap printed Tumble Dryer
	Rocker cap printed Boiler
	Rocker cap printed Washing Machine
Rocker cap printed Waste Disposal	
Rocker cap printed Washer Dryer	
Blank plates 	1 gang blank plate
	2 gang blank plate
Mounting boxes	1 gang 16mm deep
	1 gang 25mm deep
	2 gang 25mm deep
	1 gang 35mm deep
	2 gang 35mm deep
	1 gang 47mm deep
	2 gang 47mm deep
Spares	M3.5 x 25mm screws
	M3.5 x 50mm screws

	 Brushed Chrome with White Interior	 Brushed Chrome with Black Interior	 Polished Chrome with White Interior	 Polished Chrome with Black Interior
GUG13FCUWPW	GUG13FCUWPW	GUG13FCUBLK	GUG13FCUWMS	GUG13FCUBMS
GUGINDWG	GUGINDWG	GUGINDBG	GUGINDWG	GUGINDBG
GUGINDWR	GUGINDWR	GUGINDBR	GUGINDWR	GUGINDBR
GUGINDWO	GUGINDWO	GUGINDBO	GUGINDWO	GUGINDBO
GUG16COWPW	GUG16COWPW	GUG16COBLK	GUG16COWMS	GUG16COBMS
GUGBWPW	GUGBWPW	GUGBBLK	GUGBWMS	GUGBBMS
GUG101MW	GUG101MW	GUG101MB	GUG101MW	GUG101MB
GUG102MW	GUG102MW	GUG102MB	GUG102MW	GUG102MB
GUG10IMW	GUG10IMW	GUG10IMB	GUG10IMW	GUG10IMB
GUG201MW	GUG201MW	GUG201MB	GUG201MW	GUG201MB
GUG202MW	GUG202MW	GUG202MB	GUG202MW	GUG202MB
GUG202MW	GUG202MW	GUG202MB	GUG202MW	GUG202MB
GUG20DPMW	GUG20DPMW	GUG20DPMB	GUG20DPMW	GUG20DPMB
GUGRPW	GUGRPW	GUGRBLK	GUGRMS	GUGRMS
GUGRCHPW	GUGRCHPW	GUGRCHBLK	GUGRCHMS	GUGRCHMS
GUGRDWPW	GUGRDWPW	GUGRDWBLK	GUGRDWMS	GUGRDWMS
GUGREFPW	GUGREFPW	GUGREFBLK	GUGREFMS	GUGREFMS
GUGRFAPW	GUGRFAPW	GUGRFABLK	GUGRFAMS	GUGRFAMS
GUGRFRFZPW	GUGRFRFZPW	GUGRFRFZBLK	GUGRFRFZMS	GUGRFRFZMS
GUGRFRPW	GUGRFRPW	GUGRFRBLK	GUGRFRMS	GUGRFRMS
GUGRFZPW	GUGRFZPW	GUGRFZBLK	GUGRFZMS	GUGRFZMS
GUGRHOPW	GUGRHOPW	GUGRHOBK	GUGRHOMS	GUGRHOMS
GUGRHEPW	GUGRHEPW	GUGRHEBLK	GUGRHEMS	GUGRHEMS
GUGRMWPW	GUGRMWPW	GUGRMWBLK	GUGRMWMS	GUGRMWMS
GUGROVPW	GUGROVPW	GUGROVBLK	GUGROVMS	GUGROVMS
GUGRTDPW	GUGRTDPW	GUGRTDBLK	GUGRTDMS	GUGRTDMS
GUGRBOPW	GUGRBOPW	GUGRBOBLK	GUGRBOMS	GUGRBOMS
GUGRWMPW	GUGRWMPW	GUGRWMBLK	GUGRWMS	GUGRWMS
GUGRWDPW	GUGRWDPW	GUGRWDBLK	GUGRWDMS	GUGRWDMS
GUGRWDYPW	GUGRWDYPW	GUGRWDYBLK	GUGRWDYMS	GUGRWDYMS
GU8510BC	GU8510BC	GU8510BC	GU8510PC	GU8510PC
GU8520BC	GU8520BC	GU8520BC	GU8520PC	GU8520PC
SB161	SB161	SB161	SB161	SB161
SB251	SB251	SB251	SB251	SB251
SB252	SB252	SB252	SB252	SB252
SB351	SB351	SB351	SB351	SB351
SB352	SB352	SB352	SB352	SB352
SB471	SB471	SB471	SB471	SB471
SB472	SB472	SB472	SB472	SB472
3746130	3746130	3746130	3746130	3746130
USCREW50SS	USCREW50SS	USCREW50SS	USCREW50SS	USCREW50SS

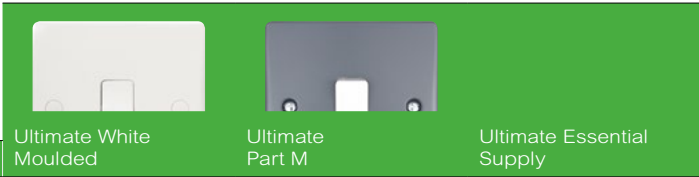

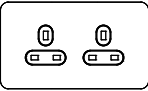
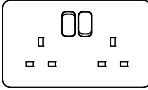

Ultimate White Moulded

Selection Table

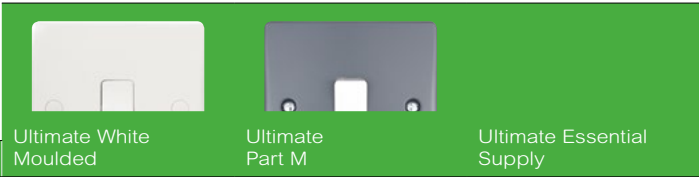

Product type	Description	Ultimate White Moulded	Ultimate Part M	Ultimate Essential Supply
Unswitched sockets 	13A 1 gang unswitched	GU3050		
	13A 2 gang unswitched	GU3060		GU3060RD
Switched sockets 	13A 1 gang SP switched	GU3010		
	13A 1 gang SP switched with neon	GU3011		
	13A 1 gang DP	GU3010D	GU3010DGY	GU3010DRD
	13A 2 gang SP switched	GU3020		
	13A 2 gang switched with neons	GU3021		
	13A 2 gang DP switched	GU3020D		
	13A 2 gang DP switched with outboard rockers	GU3030	GU3030GY	GU3030RD
	13A 2 gang DP switched clean earth with outboard rockers	GU3031		
	13A 2 gang DP switched clean earth with red outboard neon rockers	GU3032		
	13A 2 gang DP switched non-standard clean earth with outboard rockers	GU3033		
Round pin sockets	2A unswitched	GU3070		
	5A unswitched	GU3080		
	15A switched	GU3090		
	15A switched with neon	GU3091		
USB Sockets & Shelves 	13A 1 gang DP switched with 2 x ports 2.1A shared USB	GGBGU30102USBAS		
	1 gang shelf	GGBGUSHF1GS		
	13A 2 gang DP switched with 2 x ports 2.1A shared USB	GGBGU30202USBRP		
	13A 2 gang DP switched with 2 x ports 4A shared USB - coming soon	GGBGU3024D		
Light switches 	1 gang 1 way	GU1011		
	1 gang 2 way	GU1012	GU1012GY	
	1 gang 2 way wide rocker	GRWH1012	GRWH1012GY	
	1 gang retractive	GU1012R		
	1 gang retractive printed press	GU1012RP		
	1 gang retractive printed bell symbol	GU1012RB		
	2 gang 2 way	GU1022		
Light switches 	2 gang 2 way wide rocker	GRWH1022	GRWH1022GY	
	3 gang 2 way	GU1032		
	3 gang 2 way wide rocker	GRWH1032A	GRWH1032GY	
	4 gang 2 way	GU1042		
	6 gang 2 way	GU1062		
	1 gang intermediate	GU1014	GU1014GY	
	1 gang intermediate wide rocker	GRWH1014	GRWH1014GY	
3 pole fan isolator	GU1013			

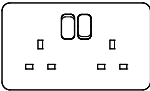



Product type	Description	Ultimate White Moulded	Ultimate Part M	Ultimate Essential Supply
Architrave switches	1 gang 2 way	GU1012A		
	2 gang 2 way	GU1022A		
Dimmer switches 	1 gang 2 way 400W/VA mains & low voltage	GU6012C		
	1 gang 2 way 100W/VA LED	GU6012L		
	2 gang 2 way 250W/VA mains & low voltage	GU6022C		
	2 gang 2 way 100W/VA LED	GU6022L		
	3 gang 2 way 250W/VA mains & low voltage	GU6032C		
	3 gang 2 way 75W/VA LED	GU6032L		
	4 gang 2 way 250W/VA mains & low voltage	GU6042C		
	4 gang 2 way 75W/VA LED	GU6042L		
Control switches 	20AX DP	GU2010	GU2010GY	
	20AX DP with neon	GU2011		
	20AX DP with neon engraved oven	GU2011OV		
	20AX DP with neon engraved tumble dryer	GU2011TR		
	20AX DP with flex outlet	GU2013		
	20AX DP with flex outlet & neon	GU2014		
	20AX DP with neon, flex outlet & printed 'Water Heater'	GU2014WH		
	32A DP with neon	GU4031		
	25A side entry flex outlet	GU2033		
	20A front entry flex outlet	GU2003		
High current switches 	50A 1 gang DP switch	GU4010		
	50A 1 gang DP switch with neon	GU4011		
	50A 2 gang DP switch	GU4020	GU4020GY	
	50A 2 gang DP switch with neon	GU4021		
	45A DP cooker control unit with 13A socket	GU4000	GU4000GY	
	45A DP cooker control unit with 13A socket & neon	GU4001		
	Cooker connection unit	GU4050		
Fused connection units 	13A unswitched FCU	GU5000		
	13A unswitched engraved security	GU5000SS		
	13A unswitched engraved towel rail	GU5000TR		
	13A unswitched with flex outlet	GU5003		
	13A unswitched with flex outlet & neon	GU5004		
	13A DP switched	GU5010	GU5010GY	
	13A DP switched engraved boiler black text	GU5010BO		
	13A DP switched engraved fridge	GU5010FR		
	13A DP switched engraved fridge freezer	GU5010FFZ		
	13A DP switched engraved fan	GU5010FA		
	13A DP switched engraved washing machine	GU5010WM		
	13A DP switched engraved cooker hood	GU5010CH		

Ultimate White Moulded

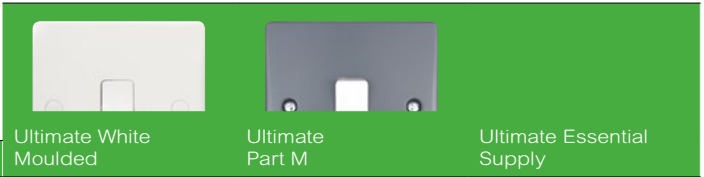
Selection Table

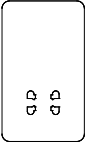

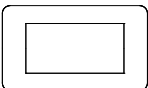
Product type	Description	Ultimate White Moulded	Ultimate Part M	Ultimate Essential Supply
Fused connection units 	13A DP switched engraved tumble dryer	GU5010TD		
	13A DP switched engraved dishwasher	GU5010DW		
	13A DP switched engraved extractor fan	GU5010EF		
	13A DP switched engraved hob	GU5010HO		
	13A DP switched engraved heater	GU5010HT		
	13A DP switched with neon	GU5011	GU5011GY	
	13A DP switched engraved boiler black text	GU5011BO		
	13A DP switched engraved fridge	GU5011FR		
	13A DP switched engraved fridge freezer	GU5011FFZ		
	13A DP switched engraved fan	GU5011FA		
	13A DP switched engraved washing machine	GU5011WM		
	13A DP switched engraved cooker hood	GU5011CH		
	13A DP switched engraved tumble dryer	GU5011TD		
	13A DP switched engraved dishwasher	GU5011DW		
	13A DP switched engraved heater	GU5011HT		
	13A DP switched engraved microwave	GU5011MW		
	13A DP switched with flex outlet	GU5013		
	13A DP switched with flex outlet & neon	GU5014		
	3A unswitched	GU50003		
	3A unswitched with flex outlet	GU50033		
Shaver sockets 	115/230V dual voltage	GU7090	GU7090GY	
USB, Data, TV & Telephone outlets 	RJ11	GU7051		
	BT master	GU7061		
	BT secondary	GU7062		
	Single RJ45 CAT 5e	GU7071		
	Twin RJ45 CAT 5e	GU7072		
	Single TV-R co-axial	GU7010		
	Twin TV-R co-axial	GU7020		
	Single satellite	GU7030		
	Twin satellite	GU7040		
	Diplex TV-R/DAB	GU7021		
	Triplex TV-R/DAB & SAT	GU7081		
Euro plates & modules 	1 gang 50 x 25mm	GU8050	GU8050GY	
	1 gang 50 x 50mm	GU8060	GU8060GY	
	2 gang 50 x 100mm	GU8080	GU8080GY	
	2 x RCA socket - 25 x 50mm	GUE7000W	GUE7000W	
	2 x Loudspeaker socket - 25 x 50mm	GUE7001W	GUE7001W	
	TV/Radio (diplexed) - 50 x 50mm	GUE7010W	GUE7010W	



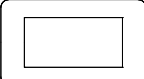
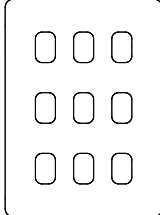
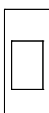

Product type	Description	Ultimate White Moulded	Ultimate Part M	Ultimate Essential Supply
Euro plates & modules 	Single IEC coax (female) - 25 x 50mm	GUE7011W	GUE7011W	
	Single IEC coax (male) - 25 x 50mm	GUE7012W	GUE7012W	
	HDMI 50 x 50mm	GUE7020W	GUE7020W	
	Single F - 25 x 50mm	GUE7030W	GUE7030W	
	TV/Sat diplexer 50 x 50mm	GUE7040W	GUE7040W	
	RJ11 modem - 25 x 50mm	GUE7051W	GUE7051W	
	Telephone (BT master) - 25 x 50mm	GUE7061W	GUE7061W	
	Telephone (BT slave) - 25 x 50mm	GUE7062WK	GUE7062WK	
	CAT5E - 25 x 50mm	GUE7071W	GUE7071W	
	RJ45 CAT 6 - 25 x 50mm	GUE7072W	GUE7072W	
	USB charger single 5V 1A 25 x 50mm	GUE7073W	GUE7073W	
	USB charger twin 2 x 1A 50 x 50mm	GUE7074W	GUE7074W	
	USB charger single 5V 2.1A 25 x 50mm	GUE7021W	GUE7021W	
	USB charger twin 2 x 3.1A 50 x 50mm	GUE7031W	GUE7031W	
	TV/Radio/Sat1 - (tripleplexed) 50 x 50mm	GUE7081W	GUE7081W	
	TV/Radio/Sat1/Sat2 - (quadplexer) 50 x 50mm	GUE7082W	GUE7082W	
	Brush outlet 50 x 50mm	GUE7076W	GUE7076W	
	5A round pin socket 50 x 50mm	GUE7077W	GUE7077W	
	Blank 25 x 50mm	GUE8010W	GUE8010W	
	Grid plates 	1 gang 88 x 88mm	GUG01G	GUG01GGY
2 gang 88 x 88mm		GUG02G	GUG02GGY	
76 x 76 x 42mm mounting box		GBG01	GBG01	
3 gang 88 x 148mm		GUG03G	GUG03GGY	
4 gang 88 x 148mm		GUG04G	GUG04GGY	
136 x 76 x 42mm mounting box		GBG02	GBG02	
6 gang 156 x 156mm		GUG06G	GUG06GGY	
8 gang 156 x 156mm		GUG08G	GUG08GGY	
136 x 136 x 42mm mounting box		GBG03	GBG03	
9 gang 216 x 156mm		GUG09G		
12 gang 216 x 156mm		GUG12G		
193 x 133 x 42mm mounting box		GBG04F		
18 gang 398 x 156mm		GUG18G		
24 gang 398 x 156mm		GUG24G		
374 x 133 x 42mm mounting box		GBG06F		
Grid modules (fully assembled) 	10AX 1 way	GUG101W	GUG101W	
	10AX 2 way	GUG102W	GUG102W	
	10AX intermediate	GUG10IW	GUG10IW	
	20AX 1 way	GUG201W	GUG201W	
	20AX 2 way centre off	GUG2020W	GUG2020W	
	20AX 2 way	GUG202W	GUG202W	
	20AX DP	GUG20DPW	GUG20DPW	
	20AX DP printed microwave	GUG20DPMWW	GUG20DPMWW	
	20AX DP printed cooker hood	GUG20DPCHW	GUG20DPCHW	
	20AX DP printed dishwasher	GUG20DPDWW	GUG20DPDWW	
	20AX DP printed freezer	GUG20DPFZW	GUG20DPFZW	

Ultimate White Moulded

Selection Table







Product type	Description	Ultimate White Moulded	Ultimate Part M	Ultimate Essential Supply
Grid modules (fully assembled) 	20AX DP printed washing machine	GUG20DPWMW	GUG20DPWMW	
	20AX DP printed tumble dryer	GUG20DPTDW	GUG20DPTDW	
	20AX DP printed heater	GUG20DPHTW	GUG20DPHTW	
	20AX DP printed washer dryer	GUG20DPWDYW	GUG20DPWDYW	
	20AX DP printed oven	GUG20DPOVW	GUG20DPOVW	
	20AX DP printed boiler	GUG20DPBOW	GUG20DPBOW	
	20AX DP printed waste disposal	GUG20DPWDW	GUG20DPWDW	
	20AX DP printed extractor fan	GUG20DPEFW	GUG20DPEFW	
	20AX DP printed fan	GUG20DPFAW	GUG20DPFAW	
	20AX DP printed fridge freezer	GUG20DPFFZW	GUG20DPFFZW	
	20AX DP printed fridge	GUG20DPFRW	GUG20DPFRW	
	20AX DP printed hob	GUG20DPHOW	GUG20DPHOW	
	10A 2 way retractive switch	GUG102RW	GUG102RW	
	2 way retractive & centre off switch	GUG202OCW	GUG202OCW	
	100W LED electronic dimmer	GGBGUGEMDIMLWPW	GGBGUGEMDIMLWPW	
	20AX 2 way key switch	GUG202KWPW	GUG202KWPW	
	20AX key switch printed TEST EMG LTG	GUG202KELWPW	GUG202KELWPW	
	20AX DP key switch printed TEST EMG LTG	GUG20DPKELWPW	GUG20DPKELWPW	
	20AX DP key switch	GUG20DPKWPW	GUG20DPKWPW	
	BT master	GUGTELMWPW	GUGTELMWPW	
	BT secondary	GUGTELSWPW	GUGTELSWPW	
	RJ11	GUGRJ11WPW	GUGRJ11WPW	
	RJ45 CAT 5e	GUGRJ45WPW	GUGRJ45WPW	
	TV/FM coaxial	GUGCOWPW	GUGCOWPW	
	Satellite "F" Type	GUGSATWPW	GUGSATWPW	
	13A fuse carrier	GUG13FCUWPW	GUG13FCUWPW	
	Green indicator	GUGINDWG	GUGINDWG	
	Red indicator	GUGINDWR	GUGINDWR	
	Orange indicator	GUGINDWO	GUGINDWO	
	Flex outlet (10mm diameter)	GUG16COWPW	GUG16COWPW	
Blank	GUGBW	GUGBW		
Blank plates 	1 gang blank plate	GU8010		
	2 gang blank plate	GU8020		
Surface pattresses	1 gang architrave 16mm deep	GPAT1G16A	GPAT1G16A	GPAT1G16A
	2 gang architrave 16mm deep	GPAT2G16A	GPAT2G16A	GPAT2G16A
	1 gang 16mm deep	GU9116	GU9116	GU9116
	1 gang 25mm deep	GU9125	GU9125	GU9125
	2 gang 25mm deep	GU9225	GU9225	GU9225
	2 gang 25mm deep dual	GU9D25	GU9D25	GU9D25
	1 gang 35mm deep	GU9135	GU9135	GU9135
	2 gang 35mm deep	GU9235	GU9235	GU9235
	1 gang 47mm deep	GU9147	GU9147	GU9147
	2 gang 47mm deep	GU9247	GU9247	GU9247

				
Product type	Description	Ultimate White Moulded	Ultimate Part M	Ultimate Essential Supply
Mounting boxes	1 gang 16mm deep	SB161	SB161	
	1 gang 25mm deep	SB251	SB251	
	2 gang 25mm deep	SB252	SB252	
	1 gang 35mm deep	SB351	SB351	
	2 gang 35mm deep	SB352	SB352	
	1 gang 47mm deep	SB471	SB471	
	2 gang 47mm deep	SB472	SB472	
Spares	M3.5 x 25mm screws	3746130	3746130	3746130
	M3.5 x 50mm screws	USCREW50SS	USCREW50SS	USCREW50SS
	Ceiling pull cord		GPULLGY	GPULLRD

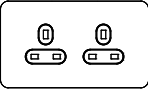
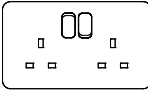
Lisse Screwless Deco





Selection Table

Product type	Description
Unswitched sockets 	13A 2 gang unswitched
Switched sockets 	13A 1 gang SP switched
	13A 1 gang DP
	13A 1 gang DP with neon
	13A non-standard plug top
	13A non-standard socket
	13A 1 gang lockable socket
	13A 2 gang SP switched
	13A 2 gang switched with neons
	13A 2 gang DP switched
Round pin sockets	2A unswitched
	5A unswitched
	5A switched
	15A switched
	16A 1 gang unswitched schuko
USB Sockets & Shelves 	13A 1 gang DP switched with 2 x ports 2.1A shared USB
	1 gang shelf
	13A 2 gang DP switched with 2 x ports 2.1A shared USB
	2 gang shelf
Light switches 	1 gang 2 way
	1 gang 2 way wide rocker
	1 gang retractive
	2 gang 2 way
	2 gang 2 way wide rocker
	3 gang 2 way
	3 gang 2 way wide rocker
	Hook accessory
	Clip accessory
	4 gang 2 way
	1 gang intermediate
	1 gang intermediate wide rocker
	3 pole fan isolator
	Dimmer switches 
1 gang 2 way 400W/VA mains & low voltage	
1 gang 2 way 100W/VA LED	
2 gang 2 way 250W/VA mains & low voltage	
2 gang 2 way 100W/VA LED	
3 gang 2 way 250W/VA mains & low voltage	
4 gang 2 way 250W/VA mains & low voltage	
Control switches 	20AX DP
	20AX DP with LED
	20AX DP with LED, flex outlet & printed 'Water Heater'

					
Stainless Steel with White interior	Stainless Steel with Black interior	Polished Chrome with White interior	Polished Chrome with Black interior	Satin Brass with Black interior	Mocha Bronze with Black interior
GGBL3060WSSS	GGBL3060BSSS	GGBL3060WPCS	GGBL3060BPCS	GGBL3060BSBS	GGBL3060BMBS
GGBL3010WSSS	GGBL3010BSSS	GGBL3010WPCS	GGBL3010BPC	GGBL3010BSBS	GGBL3010BMBS
GGBL3010DWSSS	GGBL3010DBSSS	GGBL3010DWPCS	GGBL3010DBPC	GGBL3010DBSBS	GGBL3010DBMBS
GGBL3011DWSS	GGBL3011DBSS	GGBL3011DWPC	GGBL3011DBPC	GGBL3011DBSB	
GGBLTOP13ANS	GGBLTOP13ANS	GGBLTOP13ANS	GGBLTOP13ANS	GGBLTOP13ANS	GGBLTOP13ANS
GGBL3050NSWSSS	GGBL3050NSBSSS	GGBL3050NSWPCS	GGBL3050NSBPCS	GGBL3050NSBSBS	GGBL3050NSBMBS
GGBL3060LWSS	GGBL3060LBSS	GGBL3060LWPC	GGBL3060LBPC	GGBL3060LBSB	GGBL3060LBMB
GGBL3020WSSS	GGBL3020BSSS	GGBL3020WPCS	GGBL3020BPC	GGBL3020BSBS	GGBL3020BMBS
GGBL3021DWSS	GGBL3021DBSS	GGBL3021DWPC	GGBL3021DBPC	GGBL3021DBSB	GGBL3021DBMB
GGBL3020DWSSS	GGBL3020DBSSS	GGBL3020DWPCS	GGBL3020DBPC	GGBL3020DBSBS	GGBL3020DBMBS
GGBL3070WSS	GGBL3070BSS	GGBL3070WPC	GGBL3070BPC	GGBL3070BSB	
GGBL3080WSS	GGBL3080BSS	GGBL3080WPC	GGBL3080BPC	GGBL3080BSB	GGBL3080BMB
GGBL3081WSS	GGBL3081BSS	GGBL3081WPC	GGBL3081BPC	GGBL3081BSB	GGBL3081BMB
GGBL3090WSSS	GGBL3090BSSS	GGBL3090WPCS		GGBL3090BSBS	GGBL3090BMBS
GGBL3016A1WSS	GGBL3016A1BSS	GGBL3016A1WPC		GGBL3016A1BSB	GGBL3016A1BMB
GGBL30102USBAWSSS	GGBL30102USBABSSS	GGBL30102USBAWPCS	GGBL30102USBABPCS	GGBL30102USBABSBS	GGBL30102USBABMBS
GGBLSHF1GS	GGBLSHF1GBS	GGBLSHF1GS	GGBLSHF1GBS	GGBLSHF1GBS	GGBLSHF1GBS
GGBL30202USBAWSSS	GGBL30202USBABSSS	GGBL30202USBAWPCS	GGBL30202USBABPCS	GGBL30202USBABSBS	GGBL30202USBABMBS
GGBLSHF2GS	GGBLSHF2GBS	GGBLSHF2GS	GGBLSHF2GBS	GGBLSHF2GBS	GGBLSHF2GBS
GGBL1012WSSS	GGBL1012BSSS	GGBL1012WPCS	GGBL1012BPC	GGBL1012BSBS	GGBL1012BMBS
GGBL1012WWSS	GGBL1012WBSS	GGBL1012WWPC		GGBL1012WBSB	GGBL1012WBMB
GGBL1012RWSSS	GGBL1012RBSSS	GGBL1012RWPCS	GGBL1012RBPCS	GGBL1012RBSBS	GGBL1012RBMBS
GGBL1022WSSS	GGBL1022BSSS	GGBL1022WPCS	GGBL1022BPC	GGBL1022BSBS	GGBL1022BMBS
GGBL1022WWSS	GGBL1022WBSS	GGBL1022WWPC		GGBL1022WBSB	GGBL1022WBMB
GGBL1032WSSS	GGBL1032BSSS	GGBL1032WPCS	GGBL1032BPC	GGBL1032BSBS	GGBL1032BMBS
GGBL1032WWSS	GGBL1032WBSS	GGBL1032WWPC		GGBL1032WBSB	GGBL1032WBMB
GGBLH1GS	GGBLH1GSBS	GGBLH1GS	GGBLH1GSBS	GGBLH1GSBS	GGBLH1GSBS
GGBLC1GS	GGBLC1GBS	GGBLC1GS	GGBLC1GBS	GGBLC1GBS	GGBLC1GBS
GGBL1042WSSS	GGBL1042BSSS	GGBL1042WPCS		GGBL1042BSBS	GGBL1042BMBS
GGBL1014WSSS	GGBL1014BSSS	GGBL1014WPCS	GGBL1014BPC	GGBL1014BSBS	GGBL1014BMBS
GGBL1014WWSS	GGBL1014WBSS	GGBL1014WWPC	GGBL1014WBPC	GGBL1014WBSB	GGBL1014WBMB
GGBL1013WSSS	GGBL1013BSSS	GGBL1013WPCS	GGBL1013BPC	GGBL1013BSBS	GGBL1013BMBS
GGBL6011CSSS	GGBL6011CSBS	GGBL6011CPCS	GGBL6011CPCS	GGBL6011CSBS	GGBL6011CMBS
GGBL6012CSSS	GGBL6012CSBS	GGBL6012CPCS	GGBL6012CPCS	GGBL6012CSBS	GGBL6012CMBS
GGBL6012LSSS	GGBL6012LSBS	GGBL6012LPCS	GGBL6012LPCS	GGBL6012LSBS	GGBL6012LMBS
GGBL6022CSSS	GGBL6022CSBS	GGBL6022CPCS	GGBL6022CPCS	GGBL6022CSBS	GGBL6022CMBS
GGBL6022LSSS	GGBL6022LSBS	GGBL6022LPCS	GGBL6022LPCS	GGBL6022LSBS	GGBL6022LMBS
GGBL6032CSSS	GGBL6032CSBS	GGBL6032CPCS	GGBL6032CPCS	GGBL6032CSBS	GGBL6032CMBS
GGBL6042CSSS	GGBL6042CSBS	GGBL6042CPCS	GGBL6042CPCS	GGBL6042CSBS	GGBL6042CMBS
GGBL2010WSSS	GGBL2010BSSS	GGBL2010WPCS	GGBL2010BPCS	GGBL2010BSBS	GGBL2010BMBS
GGBL2011WSSS	GGBL2011BSSS	GGBL2011WPCS	GGBL2011BPC	GGBL2011BSBS	GGBL2011BMBS
GGBL2014WHWSS	GGBL2014WHBSS	GGBL2014WHWPC	GGBL2014WHBPC	GGBL2014WHBSB	GGBL2014WHBMB

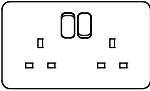
Lisse Screwless Deco

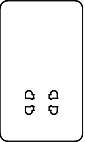
Selection Table

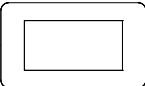



Product type	Description
High current switches 	50A 1 gang DP switch with LED
	50A 2 gang DP switch with LED
	45A DP cooker control unit with 13A socket & LED
Fused connection units 	13A unswitched FCU
	13A unswitched with flex outlet
	13A DP switched
	13A DP switched with LED
	13A DP switched with flex outlet
Shaver sockets 	115/230V dual voltage
USB, Data, TV & Telephone outlets 	2 x USB charger outlets 3.1A shared
	RJ11
	BT master
	BT secondary
	Single RJ45 CAT 5e
	Twin RJ45 CAT 5e
	Single RJ45 CAT 6
	Twin RJ45 CAT 6
	Single TV-R co-axial
	Diplex TV-R/DAB
	Satellite "F" Type
	Quadplex TV-R/DAB & 2 x SAT
	Quadplex RJ45 CAT 5 & TV return
	Quadplex RJ45 CAT 5 & RJ12
	Quadplex BT secondary & TV return
	Triplex TV-R/DAB & SAT
	Triplex TV-R/DAB & RJ45 CAT 6 UTP
	Media plate: 4 x 13A socket, 2 x 50x50mm euro mod cut-out, Quad, BT Sec & TV return
Media plate mounting box 160 x 270 x 47mm	
Euro plates & modules 	1 gang 50 x 25mm
	1 gang 50 x 50mm
	2 gang 50 x 100mm
	2 x RCA socket - 25 x 50mm
	2 x Loudspeaker socket - 25 x 50mm
	TV/Radio (diplexed) - 50 x 50mm
	Single IEC coax (female) - 25 x 50mm
	Single IEC coax (male) - 25 x 50mm
	HDMI 50 x 50mm
	Single F - 25 x 50mm
	TV/Sat diplexer 50 x 50mm

					
Stainless Steel with White interior	Stainless Steel with Black interior	Polished Chrome with White interior	Polished Chrome with Black interior	Satin Brass with Black interior	Mocha Bronze with Black interior
GGBL4011WSS	GGBL4011BSS	GGBL4011WPC	GGBL4011BPC	GGBL4011BSB	GGBL4011BMB
GGBL4021WSSS	GGBL4021BSSS	GGBL4021WPCS	GGBL4021BPC	GGBL4021BSBS	GGBL4021BMBS
GGBL4001WSSS	GGBL4001BSSS	GGBL4001WPCS	GGBL4001BPC	GGBL4001BSBS	GGBL4001BMBS
GGBL5000WSSS	GGBL5000BSSS	GGBL5000WPCS	GGBL5000BPC	GGBL5000BSBS	GGBL5000BMBS
GGBL5003WSSS	GGBL5003BSSS	GGBL5003WPCS			GGBL5003BMBS
GGBL5010WSSS	GGBL5010BSSS	GGBL5010WPCS	GGBL5010BPC	GGBL5010BSBS	GGBL5010BMBS
GGBL5011WSS	GGBL5011BSS	GGBL5011WPC	GGBL5011BPC	GGBL5011BSB	GGBL5011BMB
GGBL5013WSS	GGBL5013BSS	GGBL5013WPC	GGBL5013BPC	GGBL5013BSB	GGBL5013BMB
GGBL7090WSSS	GGBL7090BSSS	GGBL7090WPCS	GGBL7090BPCS	GGBL7090BSBS	GGBL7090BMBS
GGBL70042WSSS	GGBL70042BSSS	GGBL70042WPCS	GGBL70042BPCS	GGBL70042BSBS	GGBL70042BMBS
GGBL7051WSSS	GGBL7051BSSS	GGBL7051WPCS	GGBL7051BPC	GGBL7051BSBS	GGBL7051BMBS
GGBL7061WSSS	GGBL7061BSSS	GGBL7061WPCS	GGBL7061BPC	GGBL7061BSBS	GGBL7061BMBS
GGBL7062WSSS	GGBL7062BSSS	GGBL7062WPCS	GGBL7062BPC	GGBL7062BSBS	GGBL7062BMBS
GGBL7071C5WSSS	GGBL7071C5BSSS	GGBL7071C5WPCS	GGBL7071C5BPCS	GGBL7071C5BSBS	GGBL7071C5BMBS
GGBL7072C5WSSS	GGBL7072C5BSSS	GGBL7072C5WPCS	GGBL7072C5BPCS	GGBL7072C5BSBS	GGBL7072C5BMBS
GGBL7071C6WSSS	GGBL7071C6BSSS	GGBL7071C6WPCS	GGBL7071C6BPCS	GGBL7071C6BSBS	GGBL7071C6BMBS
GGBL7072C6WSSS	GGBL7072C6BSSS	GGBL7072C6WPCS	GGBL7072C6BPCS	GGBL7072C6BSBS	GGBL7072C6BMBS
GGBL7010WSSS	GGBL7010BSSS	GGBL7010WPCS	GGBL7010BPC	GGBL7010BSBS	GGBL7010BMBS
GGBL7020WSSS	GGBL7020BSSS	GGBL7020WPCS	GGBL7020BPCS	GGBL7020BSBS	GGBL7020BMBS
GGBL7030WSSS	GGBL7030BSSS	GGBL7030WPCS	GGBL7030BPCS	GGBL7030BSBS	GGBL7030BMBS
GGBL7074WSSS	GGBL7074BSSS	GGBL7074WPCS	GGBL7074BPCS	GGBL7074BSBS	GGBL7074BMBS
GGBL707445510WSSS	GGBL707445510BSSS	GGBL707445510WPCS	GGBL707445510BPCS	GGBL707445510BSBS	GGBL707445510BMBS
GGBL707445511WSSS	GGBL707445511BSSS	GGBL707445511WPCS	GGBL707445511BPCS	GGBL707445511BSBS	GGBL707445511BMBS
GGBL70746110WSSS	GGBL70746110BSSS	GGBL70746110WPCS	GGBL70746110BPCS	GGBL70746110BSBS	GGBL70746110BMBS
GGBL7081WSSS	GGBL7081BSSS	GGBL7081WPCS	GGBL7081BPCS	GGBL7081BSBS	GGBL7081BMBS
GGBL7081456WSSS	GGBL7081456BSSS	GGBL7081456WPCS	GGBL7081456BPCS	GGBL7081456BSBS	GGBL7081456BMBS
GGBL3020D4MPWSS	GGBL3020D4MPBSS	GGBL3020D4MPWPC	GGBL3020D4MPBPC	GGBL3020D4MPBSB	GGBL3020D4MPBMB
GGBSB4724M	GGBSB4724M	GGBSB4724M	GGBSB4724M	GGBSB4724M	GGBSB4724M
GGBL8050SS	GGBL8050SS	GGBL8050PC	GGBL8050PC	GGBL8050SB	GGBL8050MB
GGBL8060SS	GGBL8060SS	GGBL8060PC	GGBL8060PC	GGBL8060SB	GGBL8060MB
GGBL8080SS	GGBL8080SS	GGBL8080PC	GGBL8080PC	GGBL8080SB	GGBL8080MB
GUE7000W	GUE7000B	GUE7000W	GUE7000B	GUE7000B	GUE7000B
GUE7001W		GUE7001W			
GUE7010W	GUE7010B	GUE7010W	GUE7010B	GUE7010B	GUE7010B
GUE7011W	GUE7011B	GUE7011W	GUE7011B	GUE7011B	GUE7011B
GUE7012W	GUE7012B	GUE7012W	GUE7012B	GUE7012B	GUE7012B
GUE7020W	GUE7020B	GUE7020W	GUE7020B	GUE7020B	GUE7020B
GUE7030W	GUE7030B	GUE7030W	GUE7030B	GUE7030B	GUE7030B
GUE7040W	GUE7040B	GUE7040W	GUE7040B	GUE7040B	GUE7040B

Lisse Screwless Deco

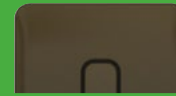

Selection Table

Product type	Description
Euro plates & modules 	RJ11 modem - 25 x 50mm
	Telephone (BT master) - 25 x 50mm
	Telephone (BT slave) - 25 x 50mm
	CAT5E - 25 x 50mm
	RJ45 CAT 6 - 25 x 50mm
	USB charger single 5V 1A 25 x 50mm
	USB charger twin 2 x 1A 50 x 50mm
	USB charger single 5V 2.1A 25 x 50mm
	USB charger twin 2 x 3.1A 50 x 50mm
	TV/Radio/Sat1 - (triplexed) 50 x 50mm
	TV/Radio/Sat1/Sat2 - (quadplexer) 50 x 50mm
	Brush outlet
	Blank 25 x 50mm
Grid plates 	1 gang 88 x 88mm
	2 gang 88 x 88mm
	76 x 76 x 42mm mounting box
	3 gang 88 x 148mm
	4 gang 88 x 148mm
	136 x 76 x 42mm mounting box
	6 gang 156 x 156mm
	8 gang 156 x 156mm
	136 x 136 x 42mm mounting box
	9 gang 216 x 156mm
	12 gang 216 x 156mm
	193 x 133 x 42mm mounting box
	Grid modules (fully assembled) 
2 way retractive & centre off switch	
100W LED rotary dimmer	
20AX double-pole switch with neon	
20AX 2 way key switch	
20AX DP key switch printed TEST EMG LTG	
20AX DP key switch	
13A fuse carrier	
Green indicator	
Red indicator	
Orange indicator	
1A USB charger	
Blank	
Grid modules (module & rocker cap separate) 	10AX 2 way
	10AX intermediate
	20AX 1 way
	20AX 2 way centre off
	20AX 2 way
	20AX DP
	Plain rocker cap
	Rocker cap printed Cooker Hood
	Rocker cap printed Dishwasher

					
GUE7051W	GUE7051B	GUE7051W	GUE7051B	GUE7051B	GUE7051B
GUE7061W	GUE7061B	GUE7061W	GUE7061B	GUE7061B	GUE7061B
GUE7062WK	GUE7062BK	GUE7062WK	GUE7062BK	GUE7062BK	GUE7062BK
GUE7071W	GUE7071B	GUE7071W	GUE7071B	GUE7071B	GUE7071B
GUE7072W	GUE7072B	GUE7072W	GUE7072B	GUE7072B	GUE7072B
GUE7073W	GUE7073B	GUE7073W	GUE7073B	GUE7073B	GUE7073B
GUE7074W	GUE7074B	GUE7074W	GUE7074B	GUE7074B	GUE7074B
GUE7021W	GUE7021B	GUE7021W	GUE7021B	GUE7021B	GUE7021B
GUE7031W	GUE7031B	GUE7031W	GUE7031B	GUE7031B	GUE7031B
GUE7081W	GUE7081B	GUE7081W	GUE7081B	GUE7081B	GUE7081B
GUE7082W	GUE7082B	GUE7082W	GUE7082B	GUE7082B	GUE7082B
GUE7076W	GUE7076B	GUE7076W	GUE7076B	GUE7076B	GUE7076B
GUE8010W	GUE8010B	GUE8010W	GUE8010B	GUE8010B	GUE8010B
GGBL01GWSS	GGBL01GBSS	GGBL01GWPC	GGBL01GBPC	GGBL01GBSB	GGBL01GBMB
GGBL02GWSS	GGBL02GBSS	GGBL02GWPC	GGBL02GBPC	GGBL02GBSB	GGBL02GBMB
GBG01	GBG01	GBG01	GBG01	GBG01	GBG01
GGBL03GWSS	GGBL03GBSS	GGBL03GWPC	GGBL03GBPC	GGBL03GBSB	GGBL03GBMB
GGBL04GWSS	GGBL04GBSS	GGBL04GWPC	GGBL04GBPC	GGBL04GBSB	GGBL04GBMB
GBG02	GBG02	GBG02	GBG02	GBG02	GBG02
GGBL06GWSS	GGBL06GBSS	GGBL06GWPC	GGBL06GBPC	GGBL06GBSB	GGBL06GBMB
GGBL08GWSS	GGBL08GBSS	GGBL08GWPC	GGBL08GBPC	GGBL08GBSB	GGBL08GBMB
GBG03	GBG03	GBG03	GBG03	GBG03	GBG03
GGBL09GWSS	GGBL09GBSS	GGBL09GWPC	GGBL09GBPC	GGBL09GBSB	GGBL09GBMB
GGBL12GBSS	GGBL12GBSS	GGBL12GWPC	GGBL12GBPC	GGBL12GBSB	GGBL12GBMB
GBG04F	GBG04F	GBG04F	GBG04F	GBG04F	GBG04F
GGBL102RSS	GGBL102RSS	GGBL102RPC	GGBL102RPC	GGBL102RSB	GGBL102RMB
GGBL202OCSS	GGBL202OCSS	GGBL202OCPC	GGBL202OCPC	GGBL202OC SB	GGBL202OCMB
GGBLGRDIMLSS	GGBLGRDIMLSS	GGBLGRDIMLPC	GGBLGRDIMLPC	GGBLGRDIMLSB	GGBLGRDIMLMB
GGBLG2011SS	GGBLG2011SS	GGBLG2011PC	GGBLG2011PC		GGBLG2011MB
GGBL202KSS	GGBL202KSS	GGBL202KPC	GGBL202KPC		GGBL202KMB
GGBL20DPKELSS	GGBL20DPKELSS	GGBL20DPKELPC	GGBL20DPKELPC		GGBL20DPKELMB
GGBL20DPKSS	GGBL20DPKSS	GGBL20DPKPC	GGBL20DPKPC	GGBL20DPKSB	GGBL20DPKMB
GGBL13FCUWSS	GGBL13FCUBSS	GGBL13FCUWPC	GGBL13FCUBPC	GGBL13FCUBSB	GGBL13FCUBMB
GGBLINDWG		GGBLINDWG			
GGBLINDWR		GGBLINDWR			
GGBLINDWO		GGBLINDWO			
GGBLE7014	GGBLE7004B	GGBLE7014	GGBLE7004B	GGBLE7004B	GGBLE7004B
GGBLBSS	GGBLBSS	GGBLBPC	GGBLBPC	GGBLB SB	GGBLBMB
GGBL102M	GGBL102M	GGBL102M	GGBL102M	GGBL102M	GGBL102M
GGBL10IM	GGBL10IM	GGBL10IM	GGBL10IM	GGBL10IM	GGBL10IM
GGBL201M	GGBL201M	GGBL201M	GGBL201M	GGBL201M	GGBL201M
GGBL2020M	GGBL2020M	GGBL2020M	GGBL2020M	GGBL2020M	GGBL2020M
GGBL202M	GGBL202M	GGBL202M	GGBL202M	GGBL202M	GGBL202M
GGBL20DPM	GGBL20DPM	GGBL20DPM	GGBL20DPM	GGBL20DPM	GGBL20DPM
GGBLRSS	GGBLRSS	GGBLRPC	GGBLRPC	GGBLR SB	GGBLRMB
GGBLRCHSS	GGBLRCHSS	GGBLRCHPC	GGBLRCHPC	GGBLRCH SB	GGBLRCHMB
GGBLRDWSS	GGBLRDWSS	GGBLRDWPC	GGBLRDWPC	GGBLRDW SB	GGBLRDWMB

Lisse Screwless Deco

Selection Table

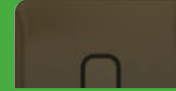

Product type	Description	
Grid modules (module & rocker cap separate) 	Rocker cap printed Extractor Fan	
	Rocker cap printed Fan	
	Rocker cap printed Fridge Freezer	
	Rocker cap printed Fridge	
	Rocker cap printed Freezer	
	Rocker cap printed Hob	
	Rocker cap printed Heater	
	Rocker cap printed Microwave	
	Rocker cap printed Oven	
	Rocker cap printed Tumble Dryer	
	Rocker cap printed Boiler	
	Rocker cap printed MVHR	
	Rocker cap printed Washing Machine	
	Blank plates 	1 gang blank plate
2 gang blank plate		
Mounting boxes	1 gang 16mm deep	
	1 gang 25mm deep	
	2 gang 25mm deep	
	1 gang 35mm deep	
	2 gang 35mm deep	
	1 gang 47mm deep	
	2 gang 47mm deep	
Spares	M3.5 x 25mm screws	
	M3.5 x 50mm screws	
	1 gang spacer frame	
	2 gang spacer frame	
	Grid insert	
	Grid insert for USB module	
LED indicator module		

					
GGBLREFSS	GGBLREFSS	GGBLREFPC	GGBLREFPC	GGBLREFSB	GGBLREFMB
GGBLRFASS	GGBLRFASS	GGBLRFAPC	GGBLRFAPC	GGBLRFASB	GGBLRFAMB
GGBLRFFZSS	GGBLRFFZSS	GGBLRFFZPC	GGBLRFFZPC	GGBLRFFZSB	GGBLRFFZMB
GGBLRFSS	GGBLRFSS	GGBLRFPC	GGBLRFPC	GGBLRFBSB	GGBLRFBSB
GGBLRFZSS	GGBLRFZSS	GGBLRFZPC	GGBLRFZPC	GGBLRFZSB	GGBLRFZMB
GGBLRHOSS	GGBLRHOSS	GGBLRHOPC	GGBLRHOPC	GGBLRHOSB	GGBLRHOMB
GGBLRHTSS	GGBLRHTSS	GGBLRHTPC	GGBLRHTPC	GGBLRHTSB	GGBLRHTMB
GGBLRMWSS	GGBLRMWSS	GGBLRMWPC	GGBLRMWPC	GGBLRMWBSB	GGBLRMWBSB
GGBLROVSS	GGBLROVSS	GGBLROVPC	GGBLROVPC	GGBLROVSB	GGBLROVMB
GGBLRTDSS	GGBLRTDSS	GGBLRTDPC	GGBLRTDPC	GGBLRTDSB	GGBLRTDMB
GGBLRBOSS	GGBLRBOSS	GGBLRBOPC	GGBLRBOPC	GGBLRBOSB	GGBLRBOMB
GGBLRMVHRSS	GGBLRMVHRSS	GGBLRMVHRPC	GGBLRMVHRPC	GGBLRMVHRBSB	GGBLRMVHRBSB
GGBLRWMSS	GGBLRWMSS	GGBLRWMPC	GGBLRWMPC	GGBLRWMSB	GGBLRWMSB
GGBL8010SSS	GGBL8010SSS	GGBL8010PCS	GGBL8010PCS	GGBL8010SBS	GGBL8010MBS
GGBL8020SSS	GGBL8020SSS	GGBL8020PCS	GGBL8020PCS	GGBL8020SBS	GGBL8020MBS
SB161	SB161	SB161	SB161	SB161	SB161
SB251	SB251	SB251	SB251	SB251	SB251
SB252	SB252	SB252	SB252	SB252	SB252
SB351	SB351	SB351	SB351	SB351	SB351
SB352	SB352	SB352	SB352	SB352	SB352
SB471	SB471	SB471	SB471	SB471	SB471
SB472	SB472	SB472	SB472	SB472	SB472
3746130	3746130	3746130	3746130	3746130	3746130
USCREW50SS	USCREW50SS	USCREW50SS	USCREW50SS	USCREW50SS	USCREW50SS
GGBLSPC1S	GGBLSPC1BS	GGBLSPC1S	GGBLSPC1BS	GGBLSPC1BS	GGBLSPC1BS
GGBLSPC2S	GGBLSPC2BS	GGBLSPC2S	GGBLSPC2BS	GGBLSPC2BS	GGBLSPC2BS
GGBLSR7004W	GGBLSR7004B	GGBLSR7004W	GGBLSR7004B	GGBLSR7004B	GGBLSR7004B
GGBLSRU7004W	GGBLSRU7004B	GGBLSRU7004W	GGBLSRU7004B	GGBLSRU7004B	GGBLSRU7004B
GGBLSIND	GGBLSIND	GGBLSIND	GGBLSIND	GGBLSIND	GGBLSIND

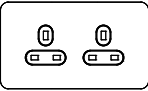
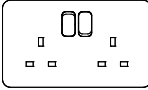

Lisse White Moulded

Selection Table



Product type	Description	
Unswitched sockets 	13A 1 gang unswitched	GGBL3050S
	13A 2 gang unswitched	GGBL3060S
Switched sockets 	13A 1 gang SP switched	GGBL3010S
	13A 1 gang DP	GGBL3010DS
	13A 1 gang SP switched non-standard	GGBL3050NS
	13A non-standard plug top	GGBLTOP13ANS
	13A 1 gang lockable socket	GGBL3060L
	13A 2 gang SP switched	GGBL3020S
	13A 2 gang DP switched	GGBL3020DS
	13A 2 gang DP switched with outboard rockers	GGBL3030S
	13A 1 to 2 gang switched converter socket	GGBL30212DS
Round pin sockets	2A unswitched	GGBL3070
	5A unswitched	GGBL3080
	5A switched	GGBL3081
	15A switched	GGBL3090S
	16A 1 gang unswitched schuko	GGBL3016A1
USB Sockets & Shelves 	13A 1 gang DP switched with 2 x ports 2.1A shared USB	GGBL30102USBAS
	1 gang shelf	GGBLSHF1GS
	13A 2 gang DP switched with 2 x ports 2.1A shared USB	GGBL30202USBAS
	2 gang shelf	GGBLSHF2GS
Light switches 	1 gang 1 way	GGBL1011S
	1 gang 2 way	GGBL1012S
	1 gang 2 way wide rocker	GGBL1012WS
	1 gang retractive	GGBL1012RS
	1 gang retractive printed press	GGBL1012RPS
	1 gang retractive printed bell symbol	GGBL1012RBS
	2 gang 2 way	GGBL1022S
	2 gang 2 way wide rocker	GGBL1022WS
	3 gang 2 way	GGBL1032S
	3 gang 2 way wide rocker	GGBL1032WS
	Hook accessory	GGBLH1GS
	Clip accessory	GGBLC1GS
	4 gang 2 way	GGBL1042S
	1 gang intermediate	GGBL1014S
	1 gang intermediate wide rocker	GGBL1014WS
	3 pole fan isolator	GGBL1013S
	2 gang 1 gang 2 way switch & 3 pole isolator	GGBL10131L
	2 gang 3 pole isolator & 1 gang 2 way switch	GGBL10131R
Architrave switches	10AX 1 gang 2 way	GGBL1012AS
	1 gang 2 way & 16mm pattress	GGBL1012116AS
	1 gang 2 way retractive printed press	GGBL1012ARP
	2 gang 2 way	GGBL1022A



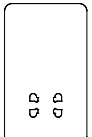

Product type	Description	
Dimmer switches 	1 gang 1 way 250W mains & low voltage	GGBL6011CS
	1 gang 2 way 400W/VA mains & low voltage	GGBL6012CS
	1 gang 2 way 100W/VA LED	GGBL6012LS
	1 gang 2 way 1-10V 6A	GGBL6012V4S
	2 gang 2 way 250W/VA mains & low voltage	GGBL6022CS
	2 gang 2 way 100W/VA LED	GGBL6022LS
	2 gang 2 way 1-10V 6A	GGBL6022V4S
	3 gang 2 way 250W/VA mains & low voltage	GGBL6032CS
	3 gang 2 way 1-10V 6A	GGBL6032V4S
	4 gang 2 way 250W/VA mains & low voltage	GGBL6042CS
	4 gang 2 way 1-10V 6A	GGBL6042V4S
	Control switches 	20AX DP
20AX DP with LED		GGBL2011S
20AX DP with LED, flex outlet & printed 'Water Heater'		GGBL2014WH
20AX DP lockable		GGBL2010LS
20A DP sink bath with neon		GGBL2022IMR
32A DP with LED		GGBL4031
25A side entry flex outlet		GGBL2033S
50A 1 gang DP switch with LED		GGBL4011S
50A 1 gang DP switch with LED engraved Oven		GGBL4011OVS
50A 1 gang DP switch with LED engraved Microwave		GGBL4011MWS
50A 2 gang DP switch with LED		GGBL4021S
50A 2 gang DP switch with LED printed shower		GGBL4021SHW
45A DP cooker control unit with 13A socket & LED		GGBL4001S
Cooker connection unit		GGBL4050S
Fused connection units 		13A unswitched FCU
	13A unswitched engraved alarm	GGBL5000AL
	13A DP switched	GGBL5010
	13A DP switched engraved boiler black text	GGBL5010BO
	13A DP switched engraved boiler red text	GGBL5010BOR
	13A DP switched engraved central heating	GGBL5010CER
	13A DP switched engraved fridge	GGBL5010FRR
	13A DP switched engraved fridge freezer	GGBL5010FFR
	13A DP switched engraved fan	GGBL5010FAR
	13A DP switched engraved washing machine	GGBL5010WMR
	13A DP switched engraved cooker hood	GGBL5010CHR
	13A DP switched engraved tumble dryer	GGBL5010TDR
	13A DP switched with LED	GGBL5011
	13A DP switched with flex outlet	GGBL5013S
	Shaver sockets 	115/230V dual voltage

Lisse White Moulded

Selection Table



Product type	Description	
USB, Data, TV & Telephone outlets 	2 x USB charger outlets 3.1A shared	GGBL70043
	RJ11	GGBL7051S
	BT master	GGBL7061S
	BT secondary	GGBL7062S
	Single RJ45 CAT 5e	GGBL7071C5S
	Twin RJ45 CAT 5e	GGBL7072C5S
	Single RJ45 CAT 6	GGBL7071C6S
	Twin RJ45 CAT 6	GGBL7072C6S
	Single TV-R co-axial	GGBL7010S
	Diplex TV-R/DAB	GGBL7020S
	Satellite "F" Type	GGBL7030S
	Quadplex TV-R/DAB & 2 x SAT	GGBL7074S
	Quadplex RJ45 CAT 5 & TV return	GGBL707445510S
	Quadplex RJ45 CAT 5 & RJ12	GGBL707445511S
	Quadplex BT secondary & TV return	GGBL70746110S
	Triplex TV-R/DAB & SAT	GGBL7081S
	Triplex TV-R/DAB & RJ45 CAT 6 UTP	GGBL7081456S
	Media plate: 4 x 13A socket, 2 x 50x50mm euro mod cut-out, Quad, BT Sec & TV return	GGBL3020D4MP
	Media plate mounting box 160 x 270 x 47mm	GGBSB4724M
	Euro plates & modules 	1 gang 50 x 25mm
1 gang 50 x 50mm		GGBL8060
2 gang 50 x 100mm		GGBL8080
2 x RCA socket - 25 x 50mm		GUE7000W
2 x Loudspeaker socket - 25 x 50mm		GUE7001W
TV/Radio (diplexed) - 50 x 50mm		GUE7010W
Single IEC coax (female) - 25 x 50mm		GUE7011W
Single IEC coax (male) - 25 x 50mm		GUE7012W
HDMI 50 x 50mm		GUE7020W
Single F - 25 x 50mm		GUE7030W
TV/Sat diplexer 50 x 50mm		GUE7040W
RJ11 modem - 25 x 50mm		GUE7051W
Telephone (BT master) - 25 x 50mm		GUE7061W
Telephone (BT slave) - 25 x 50mm		GUE7062WK
CAT5E - 25 x 50mm		GUE7071W
RJ45 CAT 6 - 25 x 50mm		GUE7072W
USB charger single 5V 1A 25 x 50mm		GUE7073W
USB charger twin 2 x 1A 50 x 50mm		GUE7074W
USB charger single 5V 2.1A 25 x 50mm		GUE7021W
USB charger twin 2 x 3.1A 50 x 50mm		GUE7031W
TV/Radio/Sat1 - (triplexed) 50 x 50mm		GUE7081W
TV/Radio/Sat1/Sat2 - (quadplexer) 50 x 50mm		GUE7082W
Brush outlet		GUE7076W
Blank 25 x 50mm		GUE8010W



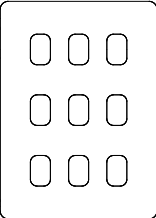
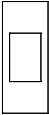

Product type	Description		
Grid plates 	1 gang 88 x 88mm	GGBL01G	
	2 gang 88 x 88mm	GGBL02G	
	76 x 76 x 42mm mounting box	GBG01	
	3 gang 88 x 148mm	GGBL03G	
	4 gang 88 x 148mm	GGBL04G	
	136 x 76 x 42mm mounting box	GBG02	
	6 gang 156 x 156mm	GGBL06G	
	8 gang 156 x 156mm	GGBL08G	
	136 x 136 x 42mm mounting box	GBG03	
	9 gang 216 x 156mm	GGBL09G	
	12 gang 216 x 156mm	GGBL12G	
	193 x 133 x 42mm mounting box	GBG04F	
	Grid modules (fully assembled) 	10AX 2 way	GGBL102W
		10AX intermediate	GGBL10IW
20AX 1 way		GGBL201W	
20AX 2 way centre off		GGBL202OCW	
20AX 2 way		GGBL202W	
20AX DP		GGBL20DPW	
20AX DP printed microwave		GGBL20DPMWW	
20AX DP printed cooker hood		GGBL20DPCHW	
20AX DP printed dishwasher		GGBL20DPDWW	
20AX DP printed freezer		GGBL20DPFZW	
20AX DP printed washing machine		GGBL20DPWMW	
20AX DP printed tumble dryer		GGBL20DPTDW	
20AX DP printed heater		GGBL20DPHTW	
20AX DP printed washer dryer		GGBL20DPW	
20AX DP printed oven		GGBL20DPOVW	
20AX DP printed boiler		GGBL20DPWBO	
20AX DP printed boost		GGBL20DPWBOT	
20AX DP printed waste disposal		GGBL20DPW	
20AX DP printed extractor fan		GGBL20DPEFW	
20AX DP printed fan		GGBL20DPFAW	
20AX DP printed fridge freezer		GGBL20DPFFZW	
20AX DP printed fridge		GGBL20DPFRW	
20AX DP printed hob		GGBL20DPHOW	
20AX DP printed wine cooler		GGBL20DPWWCL	
10A 2 way retractive switch		GGBL102RW	
2 way retractive & centre off switch		GGBL202OCW	
100W LED rotary dimmer		GGBLGRDIMLW	
20AX double-pole switch with neon		GGBLG2011	
20AX 2 way key switch		GGBL202KEPWPW	
20AX key switch printed TEST EMG LTG		GGBL202KEPWPWEL	
20AX DP key switch printed TEST EMG LTG		GGBL20DPKWPWEL	

Lisse White Moulded

Selection Table



Product type	Description	
Grid modules (fully assembled) 	20AX DP key switch	GGBL20DPKWPP
	13A fuse carrier	GGBL13FCUWPP
	Green indicator	GGBLINDWG
	Red indicator	GGBLINDWR
	Orange indicator	GGBLINDWO
	1A USB charger	GGBLE7004
	Blank	GGBLBW
	Blank plates 	1 gang blank plate
2 gang blank plate		GGBL8020S
Surface pattresses	1 gang architrave 16mm deep	GGBL9116A
	2 gang architrave 16mm deep	GGBL9216A
	1 gang 16mm deep	GGBL9116S
	1 gang 25mm deep	GGBL9125S
	2 gang 25mm deep	GGBL9225S
	2 gang 25mm deep dual	GGBL9D25S
	1 gang 47mm deep	GGBL9147S
	2 gang 47mm deep	GGBL9247S
Mounting boxes	1 gang 16mm deep	SB161
	1 gang 25mm deep	SB251
	2 gang 25mm deep	SB252
	1 gang 35mm deep	SB351
	2 gang 35mm deep	SB352
	1 gang 47mm deep	SB471
	2 gang 47mm deep	SB472
	Spares	M3.5 x 25mm screws
M3.5 x 50mm screws		USCREW50SS
1 gang spacer frame		GGBLSPC1S
2 gang spacer frame		GGBLSPC2S
LED indicator module		GGBLSIND

Ultimate



A family of styles brought together by design

From the understated design of Slimline White Moulded to chic Screwless Flat Plate, Ultimate wiring accessories provide sophisticated styles to suit all interiors.

Packed with innovative technical features and time saving installation benefits, Ultimate wiring accessories are an essential compliment for every installation.



Screwless Flat Plate:

Indulge in ultimate luxury with seamless lines and no visible screws. Combining fashion and functionality, the Ultimate Screwless Flat Plate range provides the perfect solution for customers looking for a cutting edge modern design with the latest installation features and benefits.



Flat Plate:

Add that special touch to any interior – Ultimate Flat Plate combines superior engineering with 1.5mm ultra slim, ultra chic flat plate design. The comprehensive array of finishes ensures that you will always find the perfect compliment to your design.

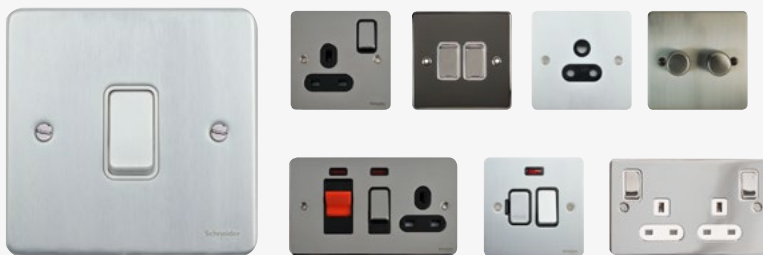

Low Profile:

Ultimate Low Profile offers a contemporary and refreshing twist on traditional designs with its softly curved edge and quality metal finishes. With its forgiving 5mm plate depth to accommodate uneven wall surfaces, it is also an ideal solution for remodel and renovation projects.



Slimline White Moulded:

Offering a stylish, modern alternative, Ultimate Slimline White Moulded meets the highest specification to enhance any installation with a full compliment of Part M and Essential Supply solutions.

Unparalleled Design Quality

Ultra slim construction: Minimal back projection for an easy fit into standard mounting boxes.

Comprehensive product range: Wide choice of devices to satisfy installation requirements.

Contemporary aesthetics: Sleek finish with screw cap covers and tactile switch action with rounded rockers.

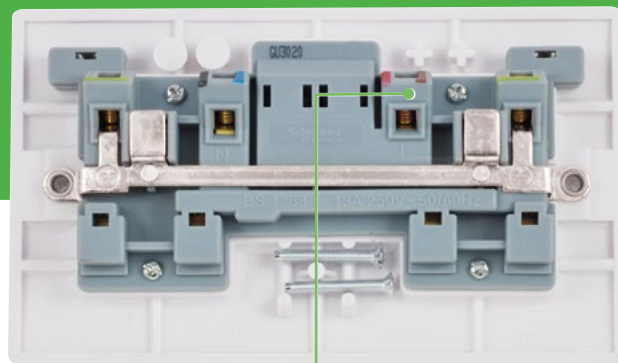
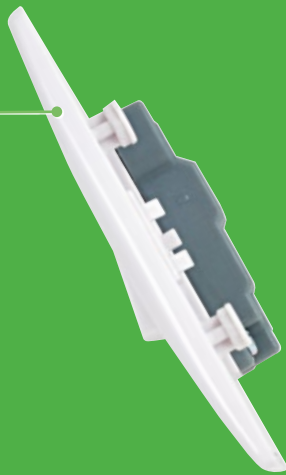

Ease of installation: Colour-coded, in-line and angled socket terminals for clear visibility.

Easier Ordering

Whether you are interested in Ultimate Slimline, Screwless Flat Plate, Flat Plate or Low Profile, simplify your ordering experience with a common part reference framework across the entire ULTIMATE range - saving you time and avoiding hassle.

- 1 Plate switches
- 2 20AX switches & flex outlets
- 3 Sockets
- 4 50A switches & 45A control units
- 5 Fused connection units
- 6 Dimmers
- 7 Shaver sockets & data communication
- 8 Blank plates

switched
unswitched
number of gangs
number of ways

- SS Stainless Steel
- PC Polished Chrome
- PW Painted White
- PN Pearl Nickel
- BN Black Nickel
- CLR Transparent
- BK Piano Black
- WH Gloss White

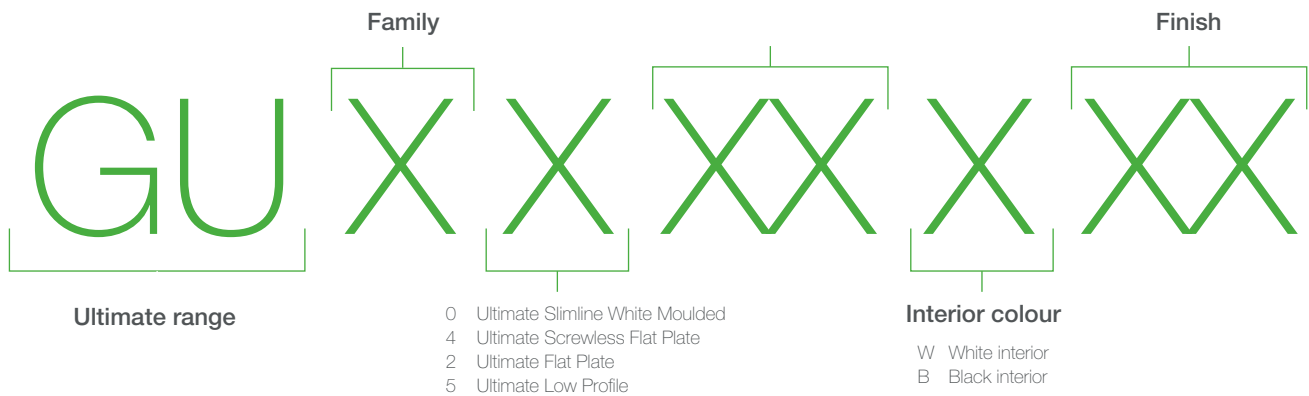

Grid Solutions

The comprehensive ULTIMATE grid system has been specially designed to bring beauty and style to commercial and residential spaces.

With a vast array of modules to choose from, including data and communications, ULTIMATE grid can provide the ideal solution for highly technical specifications.

Simple as 1, 2, 3...



Fit installation box and mounting grid. Pull through cables, cut and strip to length.

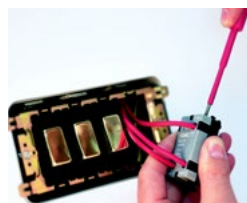

Terminate each cable to the appropriate switch (clear terminal markings).



Once wired, the modules, simply but securely, clip into the mounting grid.



Finally after decorating, fit the cover plate.



Front plates are available in a variety of finishes.

Rocker Printing and Engraving

From hob to wine cooler, the ULTIMATE range offer both printing and engraving options for a truly tailored wiring solution. Custom options available.



Ultimate Screwless Flat Plate



Solutions for today and tomorrow

The rapid expansion of entertainment and communication devices requires an ever increasing diversity of wiring accessories to power, access and control the technology people use everyday.

Choosing ULTIMATE accessories not only provides all of the functions needed in the modern home but a choice of styles and finishes to match to the mood and use of every room.



USB Solution

This contemporary range now comes with a USB charging solution, offering a simple solution to a modern day issue.



Let creativity reign with the Ultimate Screwless Transparent range.

Whether matching a favourite wallpaper to create a seamless, unblemished design, or inserting a unique family photo, your customers can pick and choose the perfect image to fit their accessories.

To create their own personal design, homeowners can download the Schneider Electric Home Touch app which is available for Apple iOS and Android platforms from the App and Google Play stores.

Specification Highlights

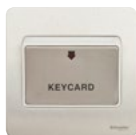

Dedicated Key Card Switch to support your specification project requirements.



Glow in the dark frame for easier accessory identification in the night hours. Wire free – simply clip in place at standard profile thickness



50A rated plate switches for switching appliances with higher current ratings, such as heaters, cookers and commercial refrigerating units.



16AX switch rating across all plate switches offers a future-proofed lighting solution to accommodate increased load requirements and fluorescent lighting demands.



Tamperproof front plates clip securely in to the mounting frames to add safety and protection. (Requires use of a tool for removal BS 7671).



Colour coded in-line terminals as well as a colour balanced back moulding makes terminals easily identifiable during installation, particularly in lower light levels.

Ultimate Screwless Flat Plate

The Ultimate Screwless Flat Plate range provides one of the most comprehensive choices of beautifully crafted, sophisticated fittings on the market. With only a mere 1.5mm front plate depth, this cutting edge screwless design blends seamlessly onto wall surfaces.

The wide selection of finish choices within the range will ensure that you always find your perfect match. Choose from Stainless Steel, Polished Chrome, Pearl Nickel, Black Nickel, Painted White, Polished Brass, Gloss White, Piano Black, or Transparent.

Independent mechanical & electrical connection for enhanced safety.

Ultra slim profile: 1.5mm plate thickness provides a design-led alternative to traditional accessories.

Large footprint: Provides extra strength and reduces the need for additional decorating.

A choice of 12 finish combinations.

Tamperproof front plates with a 4 point front plate secure connection.

In-line angled terminals for easy access during installation.

Plated earth straps provide corrosion free life.

Two sets of fixing screws to accommodate differing mounting box depths.

Finish Selection

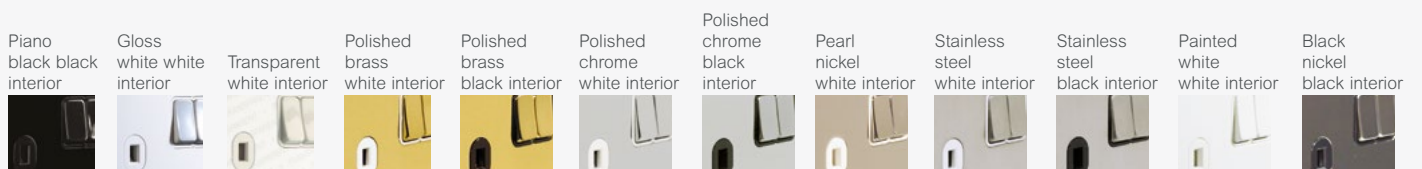

Made-to-order finishes

A high quality range of Screwless Flat Plate available in bespoke made-to-order finishes to match your project needs.

Part code structure:

- 1 Plate switches
 - 2 20AX switches & flex outlets
 - 3 Sockets
 - 4 50A switches & 45A control units
 - 5 Fused connection units
 - 6 Dimmers
 - 7 Shaver sockets & data communication
 - 8 Blank plates
- switched
- unswitched
- number of gangs
- number of ways
- DB Dark Bronze
 - JB Jet Black
 - AB Antique Brass
 - BW Bright White

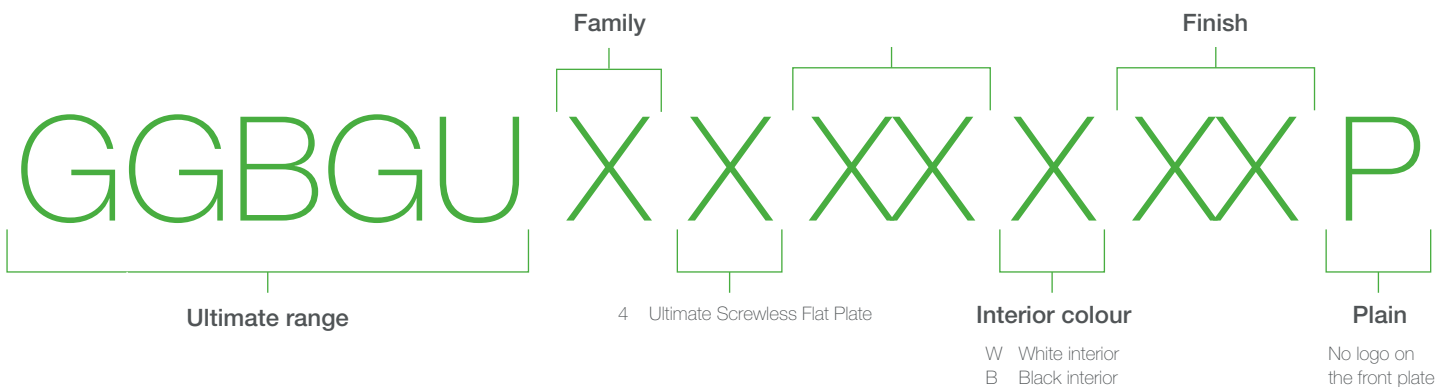

Finishes:



Dark Bronze (DB)

Designed to enhance the historic period elegance of your setting



Jet Black (JB)

Elegant matt black brings understated class to your room design



Antique Brass (AB)

A timelessly elegant finish, blending the classic and the contemporary for a superb effect

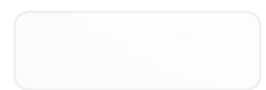

Bright White (BW)

Our super white finish will suit any design scheme you choose



Made-to-order finishes are subject to minimum order quantities and extended lead times. Please contact **0870 608 8608** and select **option 2** to obtain a quotation.

Socket outlets

13A 1 gang unswitched



GU3450BSS

Product code	Description	Pack qty
GU3450*SS	Stainless steel	1
GU3450*PC	Polished chrome	1
GU3450WPW	Painted white with white interior	1
GU3450WPN	Pearl nickel with white interior	1
GU3450BBN	Black nickel with black interior	1
GU3450BPB	Polished brass with black interior	1

- **Standard of compliance:** BS 1363 (13A)
- **Mounting box:** Minimum 25mm deep
- **Fixing screws:** M3.5 x 25mm and 30mm
- **Plate dimensions:** 88 x 88mm (1 gang) 88 x 148mm (2 gang)

13A 2 gang unswitched



GU3460BSS

Product code	Description	Pack qty
GU3460*SS	Stainless steel	1
GU3460*PC	Polished chrome	1
GU3460WPW	Painted white with white interior	1
GU3460WPN	Pearl nickel with white interior	1
GU3460BBN	Black nickel with black interior	1
GU3460*PB	Polished brass	1

13A 1 gang single-pole switched



GU3410BSS

Product code	Description	Pack qty
GU3410*SS	Stainless steel	1
GU3410*PC	Polished chrome	1
GU3410WPW	Painted white with white interior	1
GU3410WPN	Pearl nickel with white interior	1
GU3410BBN	Black nickel with black interior	1
GU3410*PB	Polished brass	1
GGBGU3410CLR	Transparent with white interior	1

13A 1 gang double-pole switched



GU3410DBSS

Product code	Description	Pack qty
GU3410D*SS	Stainless steel	1
GU3410D*PC	Polished chrome	1
GU3410DWPW	Painted white with white interior	1
GU3410DWPN	Pearl nickel with white interior	1
GU3410DBBN	Black nickel with black interior	1
GU3410D*PB	Polished brass	1

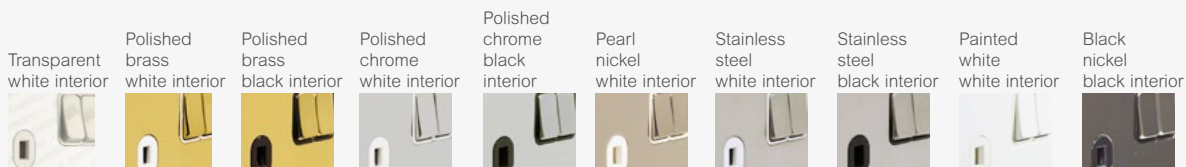

Socket outlets continued

13A 1 gang double-pole switched with neon



GU3411DBSS

Product code	Description	Pack qty
GU3411D*SS	Stainless steel	1
GU3411D*PC	Polished chrome	1
GU3411DWPW	Painted white with white interior	1
GU3411DWPN	Pearl nickel with white interior	1
GU3411DBBN	Black nickel with black interior	1
GU3411DBPB	Polished brass with black interior	1

- **Standard of compliance:**
BS 1363 (13A)
- **Mounting box:**
Minimum 25mm deep
- **Fixing screws:**
M3.5 x 25mm and 30mm
- **Plate dimensions:**
88 x 148mm (2 gang)

13A 2 gang single-pole switched



GU3420BSS

Product code	Description	Pack qty
GU3420*SS	Stainless steel	1
GU3420*PC	Polished chrome	1
GU3420WPW	Painted white with white interior	1
GU3420WPN	Pearl nickel with white interior	1
GU3420BBN	Black nickel with black interior	1
GU3420*PB	Polished brass	1
GGBGU3420CLR	Transparent with white interior	1

- **Standard of compliance:**
BS 1363 (13A)
- **Mounting box:**
Minimum 25mm deep
- **Fixing screws:**
M3.5 x 25mm and 30mm
- **Plate dimensions:**
88 x 148mm (2 gang)

13A 2 gang double-pole switched



GU3420DBSS

Product code	Description	Pack qty
GU3420D*SS	Stainless steel	1
GU3420D*PC	Polished chrome	1
GU3420DWPW	Painted white with white interior	1
GU3420DWPN	Pearl nickel with white interior	1
GU3420DBBN	Black nickel with black interior	1
GU3420*PB	Polished brass	1

13A 2 gang double-pole switched with neons



GU3421DBSS

Product code	Description	Pack qty
GU3421D*SS	Stainless steel	1
GU3421DWPW	Painted white with white interior	1
GU3421DWPN	Pearl nickel with white interior	1
GU3421DBBN	Black nickel with black interior	1
GU3421DWPB	Polished brass with white interior	1

13A 2 gang double-pole switched with clean earth & outboard rockers



GU3431BSS

Product code	Description	Pack qty
GU3431*SS	Stainless steel	1
GU3431BPC	Polished chrome with black interior	1
GU3431WPW	Painted white with white interior	1
GU3431BBN	Black nickel with black interior	1

Socket outlets continued

13A 2 gang double-pole switched with clean earth & red neon outboard rockers



GU3434BSS

Product code	Description	Pack qty
GU3434*SS	Stainless steel	1
GU3434WPC	Polished chrome with white interior	1

13A 1 gang DP switched with 2 x USB ports 2.1A shared



GGBGU34102USBABSS

Product code	Description	Pack qty
GGBGU34102USBA*SS	Stainless steel	1
GGBGU34102USBA*PC	Polished chrome	1
GGBGU34102USBAWPC	Painted white with white interior	1
GGBGU34102USBAWPN	Pearl nickel with white interior	1
GGBGU34102USBABBN	Black nickel with black interior	1
GGBGU34102USBA*PB	Polished brass	1

13A 2 gang DP switched with 2 x USB ports 2.1A shared



GGBGU34202USBBPC

Product code	Description	Pack qty
GGBGU34202USB*PC	Polished chrome	1
GGBGU34202USB*SS	Stainless steel	1
GGBGU34202USBWPW	Painted white with white interior	1
GGBGU34202USB*PB	Polished brass	1
GGBGU34202USBWPN	Pearl nickel with white interior	1
GGBGU34202USBBBN	Black nickel with black interior	1

- **Mounting box:** 35mm without spacer or 25mm with spacer

(Spacer supplied with product, not available separately)

13A 2 gang DP switched with 2 x USB ports 4A shared



GGBGU34242USBBPC

Product code	Description	Pack qty
GGBGU3424D*SS	Stainless steel	1
GGBGU3424D*PC	Polished chrome	1
GGBGU3424DWPW	Painted white with white interior	1
GGBGU3424DWPN	Pearl nickel with white interior	1
GGBGU3424DBBN	Black nickel with black interior	1
GGBGU3424D*PB	Polished brass	1

- **Mounting box:** 35mm without spacer or 25mm with spacer

(Spacer supplied with product, not available separately)

Shelf frames for socket outlets



GGBGUSHF1GS

Product code	Description	Pack qty
GGBGUSHF1GS	1 gang white	1
GGBGUSHF1GBS	1 gang black	1
GGBGUSHF2GS	2 gang white	1
GGBGUSHF2GBS	2 gang black	1

Socket outlets continued

2A unswitched round pin



GU3470BSS

Product code	Description	Pack qty
GU3470*SS	Stainless steel	1
GU3470*PC	Polished chrome	1
GU3470WPW	Painted white with white interior	1
GU3470WPN	Pearl nickel with white interior	1
GU3470BBN	Black nickel with black interior	1
GU3470*PB	Polished brass	1

- **Standard of compliance:**
BS 546
- **Mounting box:**
Minimum 25mm deep
- **Fixing screws:**
M3.5 x 25mm and 30mm
- **Plate dimensions:**
88 x 88mm

5A unswitched round pin



GU3480BSS

Product code	Description	Pack qty
GU3480*SS	Stainless steel	1
GU3480*PC	Polished chrome	1
GU3480WPW	Painted white with white interior	1
GU3480WPN	Pearl nickel with white interior	1
GU3480BBN	Black nickel with black interior	1
GU3480*PB	Polished brass	1

15A switched round pin



GU3490BSS

Product code	Description	Pack qty
GU3490*SS	Stainless steel	1
GU3490*PC	Polished chrome	1
GU3490WPW	Painted white with white interior	1
GU3490WPN	Pearl nickel with white interior	1
GU3490BPB	Polished brass with black interior	1

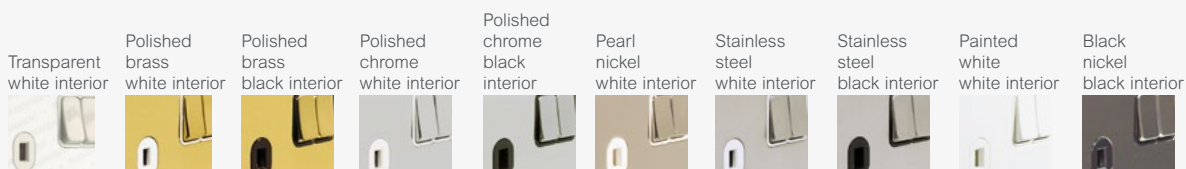

Media plates

In-line with 1 x 2 gang double-pole sockets & 2 x 2 module euro



GU34202DMPBSS

Product code	Description	Pack qty
GU34202DMP*SS	Stainless steel	1
GU34202DMP*PC	Polished chrome	1
GU34202DMPWPW	Painted white with white interior	1
GU34202DMPWPN	Pearl nickel with white interior	1
GU34202DMPBBN	Black nickel with black interior	1
GGBSB4722M	In-line back box	1

- **Standard of compliance:**
BS 5733
BS 1363-2
- **Fixing screws:**
M3.5 x 25mm and 30mm
- **Mounting box:**
47mm deep
- **Plate dimensions:**
296 x 86mm (in-line)
296 x 176mm (stacked)

Stacked with 2 x 2 gang double-pole socket outlets & 4 x 2 module euro



GU34204DMPBSS

Product code	Description	Pack qty
GU34204DMP*SS	Stainless steel	1
GU34204DMP*PC	Polished chrome	1
GU34204DMPWPW	Painted white with white interior	1
GU34204DMPWPN	Pearl nickel with white interior	1
GU34204DMPBBN	Black nickel with black interior	1
GGBSB4724M	Stacked back box	1

- Euro modules plates compatible with Schneider Electric euro modules.
- **Note:**
Modules from other suppliers may not be compatible, it is advised to check suitability.

Bedside lamp with USB

Bedside lamp with 2.1A USB port



GGBGU1412BUBSS

Product code	Description	Pack qty
GGBGU1412BUBSS	Stainless steel with black interior	1
GGBGU1412BUBPC	Polished chrome with black interior	1
GGBGU1412BUBBN	Black nickel with black interior	1
GGBGU1412BUBPB	Polished brass with black interior	1

- **Standard of compliance:**
- **Rates Voltage:**
220-240V
- **Frequency:**
50/60 HZ (+/- 3 HZ)
- **Input current:**
0.2A Max
- **USB port:**
5V 2.1A Max
- **Lamp wattage:**
2W Max

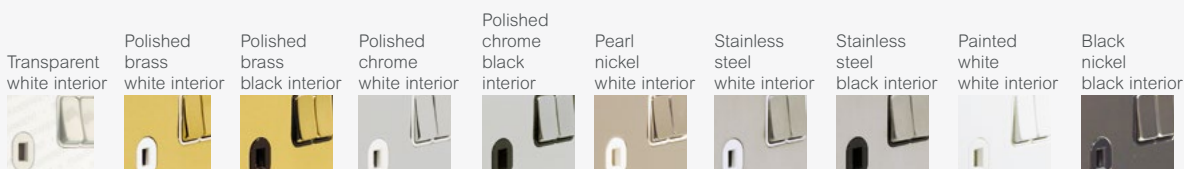

Plate switches

16AX 1 gang 2 way



GU1412BSS

Product code	Description	Pack qty
GU1412*SS	Stainless steel	1
GU1412*PC	Polished chrome	1
GU1412WPPW	Painted white with white interior	1
GU1412WPN	Pearl nickel with white interior	1
GU1412BBN	Black nickel with black interior	1
GU1412*PB	Polished brass	1
GGBGU1412CLR	Transparent with white interior	1
GU1400F	1 gang glow in the dark frame	10

- **Standard of compliance:**
BS EN 60669-1
- **Mounting box:**
16mm deep
(1-2 gang)
- **Fixing screws:**
M3.5 x 25mm and
30mm
- **Plate dimensions:**
88 x 88mm (1-3 gang)



16AX 1 gang intermediate



GU1414BSS

Product code	Description	Pack qty
GU1414*SS	Stainless steel	1
GU1414*PC	Polished chrome	1
GU1414WPPW	Painted white with white interior	1
GU1414WPN	Pearl nickel with white interior	1
GU1414BBN	Black nickel with black interior	1
GU1414*PB	Polished brass	1

- **Technical notes:**
The glow in the dark frame discreetly signposts the profile of the switch and aids switch location.

16A 1 gang 2 way retractive



GU1412RBSS

Product code	Description	Pack qty
GU1412R*SS	Stainless steel	1
GU1412R*PC	Polished chrome	1
GU1412RWPW	Painted white with white interior	1
GU1412RWPN	Pearl nickel with white interior	1
GU1412RBBN	Black nickel with black interior	1
GU1412R*PB	Polished brass	1

Plate switches continued

16AX 2 gang 2 way



GU1422BSS

Product code	Description	Pack qty
GU1422*SS	Stainless steel	1
GU1422*PC	Polished chrome	1
GU1422WPW	Painted white with white interior	1
GU1422WPN	Pearl nickel with white interior	1
GU1422BBN	Black nickel with black interior	1
GU1422*PB	Polished brass	1
GGBGU1422CLR	Transparent with white interior	1

16AX 3 gang 2 way



GU1432BSS

Product code	Description	Pack qty
GU1432*SS	Stainless steel	1
GU1432*PC	Polished chrome	1
GU1432WPW	Painted white with white interior	1
GU1432WPN	Pearl nickel with white interior	1
GU1432BBN	Black nickel with black interior	1
GU1432*PB	Polished brass	1
GU1432CLR	Transparent with white interior	1

16AX 4 gang 2 way



GU1442BSS

Product code	Description	Pack qty
GU1442*SS	Stainless steel	1
GU1442*PC	Polished chrome	1
GU1442WPW	Painted white with white interior	1
GU1442WPN	Pearl nickel with white interior	1
GU1442BBN	Black nickel with black interior	1
GU1442*PB	Polished brass	1

16AX 6 gang 2 way



GU1462BSS

Product code	Description	Pack qty
GU1462*SS	Stainless steel	1
GU1462*PC	Polished chrome	1
GU1462WPW	Painted white with white interior	1
GU1462WPN	Pearl nickel with white interior	1
GU1462BBN	Black nickel with black interior	1
GU1462BPB	Polished brass with black interior	1

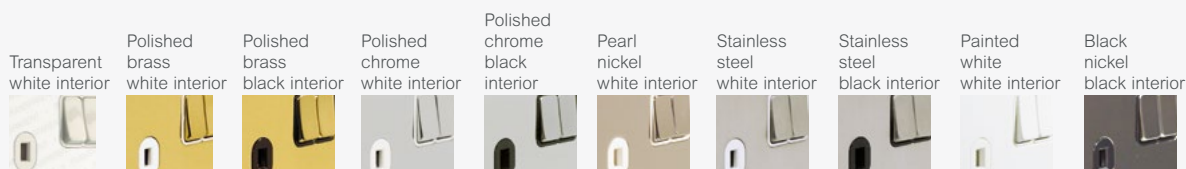

Plate switches continued

10A triple pole isolator



GU1413BSS

Product code	Description	Pack qty
GU1413*SS	Stainless steel	1
GU1413*PC	Polished chrome	1
GU1413WPW	Painted white with white interior	1
GU1413WPN	Pearl nickel with white interior	1
GU1413BBN	Black nickel with black interior	1
GU1413*PB	Polished brass	1

- **Standard of compliance:**
BS EN 60669-1
BS EN 60947-3
(GU1413***)
- **Mounting box:**
16mm deep (1-2 gang)
25mm deep (3-6 gang)
- **Fixing screws:**
M3.5 x 25mm and
30mm
- **Plate dimensions:**
88 x 88mm (1-3 gang),
88 x 148mm (4-6 gang)

PIR plate switches

1 gang 1way PIR with override



GUPA1411BSS

Product code	Description	Pack qty
GUPA1411BSS	Stainless steel with black interior	1

- **Standard of compliance:**
BS EN 60669-2-1
- **Mounting box:**
16mm deep
- **Fixing screws:**
M3.5 x 25mm and
30mm
- **Plate dimensions:**
88 x 88mm
- **Technical Notes:**
Operating distance =
6M at 45° horizontal.

1 gang 1 way PIR



GUP1411BSS

Product code	Description	Pack qty
GUP1411BSS	Stainless steel with black interior	1

- Time setting: 15 sec -
30 mins.
10 - 2000 Lux.
2 wire connection.

Toggle switches

16AX 1 gang 2 way



GU1412TSS

Product code	Description	Pack qty
GU1412TSS	Stainless steel	1
GU1412TPC	Polished chrome	1
GU1412TPW	Painted white	1
GU1412TPN	Pearl nickel	1
GU1412TBN	Black nickel	1
GU1412TPB	Polished brass	1

- **Standard of compliance:** BS EN 60669-1
- **Mounting box:** 16mm deep (1-2 gang)
- **Fixing screws:** M3.5 x 25mm and 30mm
- **Plate dimensions:** 88 x 88mm (1-3 gang)

16AX 1 gang intermediate



GU1414TSS

Product code	Description	Pack qty
GU1414TSS	Stainless steel	1
GU1414TPC	Polished chrome	1
GU1414TPW	Painted white	1
GU1414TPB	Polished brass	1

16AX 2 gang 2 way



GU1422TSS

Product code	Description	Pack qty
GU1422TSS	Stainless steel	1
GU1422TPC	Polished chrome	1
GU1422TPW	Painted white	1
GU1422TPN	Pearl nickel	1
GU1422TBN	Black nickel	1
GU1422TPB	Polished brass	1

16AX 3 gang 2 way



GU1432TSS

Product code	Description	Pack qty
GU1432TSS	Stainless steel	1
GU1432TPC	Polished chrome	1
GU1432TPW	Painted white	1
GU1432TPN	Pearl nickel	1
GU1432TBN	Black nickel	1
GU1432TPB	Polished brass	1

- **Standard of compliance:** BS EN 60669-1
- **Mounting box:** 35mm deep (3 gang)
25mm deep (4 gang)
- **Fixing screws:** M3.5 x 25mm and 30mm
- **Plate dimensions:** 88 x 88mm (3 gang)
88 x 148mm (4 gang)

16AX 4 gang 2 way



GU1442TSS

Product code	Description	Pack qty
GU1442TSS	Stainless steel	1
GU1442TPC	Polished chrome	1
GU1442TPW	Painted white	1
GU1442TPN	Pearl nickel	1
GU1442TBN	Black nickel	1
GU1442TPB	Polished brass	1

Key card switch

32A single-pole key card switch with 30 second time delay



GU1412KBSS

Product code	Description	Pack qty
GU1412K*SS	Stainless steel	1
GU1412K*PC	Polished chrome	1
GU1412KWPW	Painted white with white interior	1
GU1412KWPN	Pearl nickel with white interior	1
GU1412KBBN	Black nickel with black interior	1
GU1412K*PB	Polished brass	1

- **Standard of compliance:**
BS EN 60669-1
- **Mounting box:**
47mm deep
- **Fixing screws:**
M3.5 x 25mm and 30mm
- **Plate dimensions:**
88 x 88mm
- **Technical Notes:**
Non reader type, accepts any card (not supplied). Requires L&N connection. Will accept cards up to 85 x 53mm.

Dimmer switches

1 gang 2 way 400W/VA mains & low voltage



GU6412CSS

Product code	Description	Pack qty
GU6412CSS	Stainless steel	1
GU6412CPC	Polished chrome	1
GU6412CPW	Painted white	1
GU6412CPN	Pearl nickel	1
GU6412CBN	Black nickel	1
GU6412CPB	Polished brass	1
GGBGU6412CLR	Transparent	1

- **Standard of compliance:**
BS EN 669-2-1
- **Mounting box:**
25mm deep (1-2 gang)
35mm deep (3-4 gang)
- **Fixing screws:**
M3.5 x 25mm and 30mm
- **Plate dimensions:**
88 x 88mm (1-2 gang)
88 x 148mm (3-4 gang)
- **Technical notes:**
All dimmers not suitable with CFL lighting.

2 gang 2 way 250W/VA mains & low voltage



GU6422CSS

Product code	Description	Pack qty
GU6422CSS	Stainless steel	1
GU6422CPC	Polished chrome	1
GU6422CPW	Painted white	1
GU6422CPN	Pearl nickel	1
GU6422CBN	Black nickel	1
GU6422CPB	Polished brass	1
GGBGU6422CLR	Transparent	1

- Mains & low voltage and electronic dimmers not suitable for use with LED lamps.
- Mains & low voltage dimmers - leading edge control.
- LED dimmers - trailing edge control.

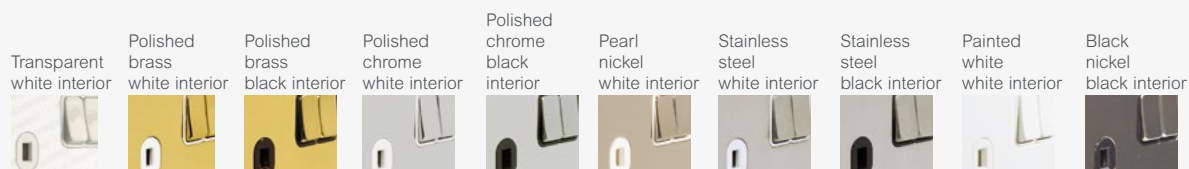

Dimmer switches continued

3 gang 2 way 250W/VA mains & low voltage



GU6432CSS

Product code	Description	Pack qty
GU6432CSS	Stainless steel	1
GU6432CPC	Polished chrome	1
GU6432CPW	Painted white	1
GU6432CPN	Pearl nickel	1
GU6432CBN	Black nickel	1
GU6432CPB	Polished brass	1

4 gang 2 way 250W/VA mains & low voltage

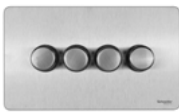

GU6442CSS

Product code	Description	Pack qty
GU6442CSS	Stainless steel	1
GU6442CPC	Polished chrome	1
GU6442CPW	Painted white	1
GU6442CPN	Pearl nickel	1
GU6442CBN	Black nickel	1
GU6442CPB	Polished brass	1

1 gang 2 way 100W/VA LED



GU6412LSS

Product code	Description	Pack qty
GU6412LSS	Stainless steel	1
GU6412LPC	Polished chrome	1
GU6412LPW	Painted white	1
GU6412LPN	Pearl nickel	1
GU6412LBN	Black nickel	1
GU6412LPB	Polished brass	1

2 gang 2 way 100W/VA LED



GU6422LSS

Product code	Description	Pack qty
GU6422LSS	Stainless steel	1
GU6422LPC	Polished chrome	1
GU6422LPW	Painted white	1
GU6422LPN	Pearl nickel	1
GU6422LBN	Black nickel	1
GU6422LPB	Polished brass	1

3 gang 2 way 75W/VA LED



GU6432LSS

Product code	Description	Pack qty
GU6432LSS	Stainless steel	1
GU6432LPC	Polished chrome	1
GU6432LPW	Painted white	1
GU6432LPN	Pearl nickel	1
GU6432LBN	Black nickel	1

- **Standard of compliance:** BS EN 669-2-1
- **Mounting box:** 25mm deep (1-2 gang) 35mm deep (3-4 gang)
- **Fixing screws:** M3.5 x 25mm and 30mm
- **Plate dimensions:** 88 x 88mm (1-2 gang) 88 x 148mm (3-4 gang)
- **Technical notes:** All dimmers not suitable with CFL lighting.

Mains & low voltage and electronic dimmers not suitable for use with LED lamps.

Mains & low voltage dimmers - leading edge control.

LED dimmers - trailing edge control.

Dimmer technical information can be found in the technical data section towards the back of the catalogue.

- **Note:** Retractive switches are required for Multi-Way Operation when using LED dimmers.

Dimmer switches continued

4 gang 2 way 75W/VA LED

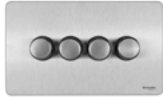

GU6442LSS

Product code	Description	Pack qty
GU6442LSS	Stainless steel	1
GU6442LPC	Polished chrome	1
GU6442LPW	Painted white	1
GU6442LPN	Pearl nickel	1
GU6442LBN	Black nickel	1
GU6442LPB	Polished brass with black interior	1

1 gang 2 way 300W/VA electronic



GU6412EBSS

Product code	Description	Pack qty
GU6412E*SS	Stainless steel	1
GU6412EWPC	Polished chrome with white interior	1
GU6412EWPW	Painted white with white interior	1
GU6412EWPN	Pearl nickel with white interior	1
GU6412EBBN	Black nickel with black interior	1
GU6412EWPB	Polished brass with white interior	1

2 gang 2 way 200W/VA electronic



GU6422EBSS

Product code	Description	Pack qty
GU6422E*SS	Stainless steel	1
GU6422EBPC	Polished chrome with black interior	1
GU6422EWPW	Painted white with white interior	1
GU6422EWPN	Pearl nickel with white interior	1
GU6422EBBN	Black nickel with black interior	1
GU6422E*PB	Polished brass	1

1 gang 2 way 300W/VA IR electronic



GU6412RBSS

Product code	Description	Pack qty
GU6412R*SS	Stainless steel	1
GU6412R*PC	Polished chrome	1
GU6412RWPW	Painted white with white interior	1
GU6412RWPN	Pearl nickel with white interior	1
GU6412RBBN	Black nickel with black interior	1
GU6000RC1R	1 channel IR remote control	1

- **Standard of compliance:** 60669-2-1
- **Mounting box:** Minimum 25mm
- **Fixing screws:** M3.5 x 25mm and 30mm
- **Plate dimensions:** 88 x 88mm (1-2 gang)
88 x 148mm (3-4 gang)
- **Technical notes:** IR remote unit requires remote control.
- All dimmers can be installed on 2 way and multiway circuits.
- For 2 way operating remote, switch must be changed for retractive switch.
- Electronic dimmers not suitable for use with CFL and LED lamps of any type.

Dimmer technical information can be found in the technical data section towards the back of this catalogue.

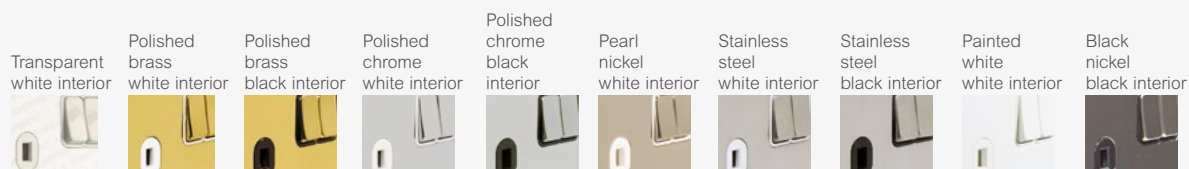

Control switches

20AX double-pole 1 gang



GU2410BSS

Product code	Description	Pack qty
GU2410*SS	Stainless steel	1
GU2410*PC	Polished chrome	1
GU2410WPW	Painted white with white interior	1
GU2410WPN	Pearl nickel with white interior	1
GU2410BBN	Black nickel with black interior	1
GU2410BPB	Polished brass with black interior	1

- **Standard of compliance:** BS EN 60669-1
- **Mounting box:** 35mm deep
- **Fixing screws:** M3.5 x 25mm and 30mm
- **Plate dimensions:** 88 x 88mm

20AX double-pole 1 gang with neon



GU2411BSS

Product code	Description	Pack qty
GU2411*SS	Stainless steel	1
GU2411*PC	Polished chrome	1
GU2411WPW	Painted white with white interior	1
GU2411WPN	Pearl nickel with white interior	1
GU2411BBN	Black nickel with black interior	1
GU2411*PB	Polished brass	1

20AX double-pole 1 gang with flex outlet



GU2413BSS

Product code	Description	Pack qty
GU2413*SS	Stainless steel	1
GU2413*PC	Polished chrome	1
GU2413WPW	Painted white with white interior	1
GU2413WPN	Pearl nickel with white interior	1
GU2413BBN	Black nickel with black interior	1
GU2413*PB	Polished brass	1

20AX double-pole 1 gang with neon & flex outlet



GU2414BSS

Product code	Description	Pack qty
GU2414*SS	Stainless steel	1
GU2414*PC	Polished chrome	1
GU2414WPW	Painted white with white interior	1
GU2414WPN	Pearl nickel with white interior	1
GU2414BBN	Black nickel with black interior	1
GU2414BPB	Polished brass with black interior	1

- **Standard of compliance:** BS EN 60669-1 (switches)
- **Mounting box:** 35mm deep
- **Fixing screws:** M3.5 x 25mm and 30mm
- **Plate dimensions:** 88 x 88mm

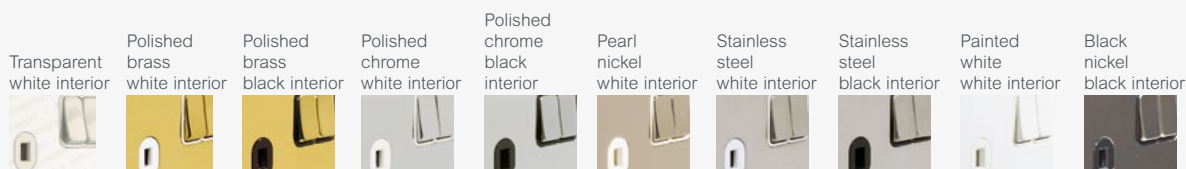

Control switches continued

20AX double-pole 1 gang with neon & flex outlet printed water heater



GU2414WHBSS

Product code	Description	Pack qty
GU2412WHWSS	Stainless steel with white interior	1
GU2412WHBPC	Polished chrome with black interior	1
GU2414WHWPW	Painted white with white interior	1
GU2414WHBBN	Black nickel with black interior	1
GU2414WHBPB	Polished brass with black interior	1

32A double-pole 1 gang with neon



GU4431BSS

Product code	Description	Pack qty
GU4431*SS	Stainless steel	1
GU4431*PC	Polished chrome	1
GU4431WPW	Painted white with white interior	1
GU4431WPN	Pearl nickel with white interior	1
GU4431BBN	Black nickel with black interior	1
GU4431*PB	Polished brass	1

Fused connection units

13A unswitched



GU5400BSS

Product code	Description	Pack qty
GU5400*SS	Stainless steel	1
GU5400*PC	Polished chrome	1
GU5400WPW	Painted white with white interior	1
GU5400WPN	Pearl nickel with white interior	1
GU5400BBN	Black nickel with black interior	1
GU5400*PB	Polished brass	1

- **Standard of compliance:**
BS 1363
- **Mounting box:**
25mm deep (unswitched)
- **Fixing screws:**
M3.5 x 25mm and 30mm
- **Plate dimensions:**
88 x 88mm

13A unswitched with flex outlet



GU5403BSS

Product code	Description	Pack qty
GU5403*SS	Stainless steel	1
GU5403*PC	Polished chrome	1
GU5403WPW	Painted white with white interior	1
GU5403WPN	Pearl nickel with white interior	1
GU5403BBN	Black nickel with black interior	1
GU5403BPB	Polished brass with black interior	1

Fused connection units continued

13A double-pole switched



GU5410BSS

Product code	Description	Pack qty
GU5410*SS	Stainless steel	1
GU5410*PC	Polished chrome	1
GU5410WPW	Painted white with white interior	1
GU5410WPN	Pearl nickel with white interior	1
GU5410BBN	Black nickel with black interior	1
GU5410*PB	Polished brass	1

- **Standard of compliance:** BS 1363
- **Mounting box:** 35mm deep (switched)
- **Fixing screws:** M3.5 x 25mm and 30mm
- **Plate dimensions:** 88 x 88mm

13A double-pole switched with neon



GU5411BSS

Product code	Description	Pack qty
GU5411*SS	Stainless steel	1
GU5411*PC	Polished chrome	1
GU5411WPW	Painted white with white interior	1
GU5411WPN	Pearl nickel with white interior	1
GU5411BBN	Black nickel with black interior	1
GU5411*PB	Polished brass	1

13A double-pole switched with flex outlet



GU5413BSS

Product code	Description	Pack qty
GU5413*SS	Stainless steel	1
GU5413*PC	Polished chrome	1
GU5413WPW	Painted white with white interior	1
GU5413WPN	Pearl nickel with white interior	1
GU5413BBN	Black nickel with black interior	1
GU5413*PB	Polished brass	1

13A double-pole switched with neon and flex outlet



GU5414BSS

Product code	Description	Pack qty
GU5414*SS	Stainless steel	1
GU5414*PC	Polished chrome	1
GU5414WPW	Painted white with white interior	1
GU5414WPN	Pearl nickel with white interior	1
GU5414BBN	Black nickel with black interior	1
GU5414BPB	Polished brass with black interior	1

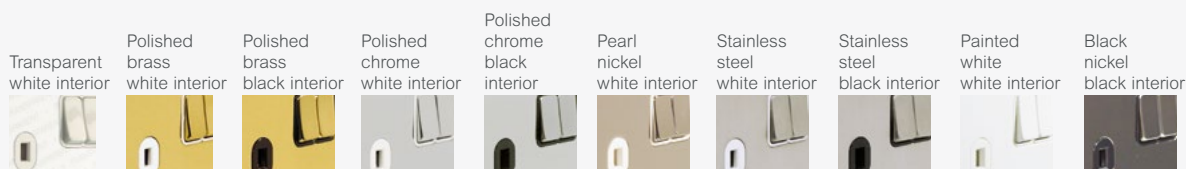

High current switches

50A 2 gang double-pole switches



GU4421BSS

Product code	Description	Pack qty
GU4421*SS	Stainless steel	1
GU4421*PC	Polished chrome	1
GU4421WPW	Painted white with white interior	1
GU4421WPN	Pearl nickel with white interior	1
GU4421BBN	Black nickel with black interior	1
GU4421*PB	Polished brass	1

- **Standard of compliance:** BS EN 60669-1
- **Mounting box:** 47mm deep
- **Fixing screws:** M3.5 x 25mm and 30mm
- **Plate dimensions:** 148 x 88mm

45A double-pole cooker control unit with 13A switched socket & neons



GU4401WSS

Product code	Description	Pack qty
GU4401*SS	Stainless steel	1
GU4401*PC	Polished chrome	1
GU4401WPW	Painted white with white interior	1
GU4401WPN	Pearl nickel with white interior	1
GU4401BBN	Black nickel with black interior	1
GU4401*PB	Polished Brass	1

- **Standard of compliance:** BS 4177
- **Mounting box:** 47mm deep
- **Fixing screws:** M3.5 x 25mm and 30mm
- **Plate dimensions:** 88 x 148mm

Shaver socket

115/230V dual voltage



GU7490BSS

Product code	Description	Pack qty
GU7490*SS	Stainless steel	1
GU7490*PC	Polished chrome	1
GU7490WPW	Painted white with white interior	1
GU7490WPN	Pearl nickel with white interior	1
GU7490BBN	Black nickel with black interior	1
GU7490*PB	Polished Brass	1

- **Standard of compliance:** BS EN 61558-2-5
- **Mounting box:** 47mm deep
- **Fixing screws:** M3.5 x 25mm and 30mm
- **Plate dimensions:** 148 x 88mm
- **Technical notes:** Unique design allows perfect fit to 47mm box.

Telephone, USB & data outlets

Single RJ11



GU7451BSS

Product code	Description	Pack qty
GU7451*SS	Stainless steel	1
GU7451*PC	Polished chrome	1
GU7451WPW	Painted white with white interior	1
GU7451WPN	Pearl nickel with white interior	1
GU7451BBN	Black nickel with black interior	1
GU7451*PB	Polished Brass	1

- **Standard of compliance:**
BS EN 41003
- **Mounting box:**
Minimum 25mm deep
- **Fixing screws:**
M3.5 x 25mm and 30mm
- **Plate dimensions:**
88 x 88mm
- **Technical notes:**
Refer to Euro plates & modules section for combined telephone & data solutions.

Master BT telephone



GU7461BSS

Product code	Description	Pack qty
GU7461*SS	Stainless steel	1
GU7461*PC	Polished chrome	1
GU7461WPW	Painted white with white interior	1
GU7461WPN	Pearl nickel with white interior	1
GU7461BBN	Black nickel with black interior	1
GU7461*PB	Polished Brass	1

Secondary BT telephone



GU7462BSS

Product code	Description	Pack qty
GU7462*SS	Stainless steel	1
GU7462*PC	Polished chrome	1
GU7462WPW	Painted white with white interior	1
GU7462WPN	Pearl nickel with white interior	1
GU7462BBN	Black nickel with black interior	1
GU7462*PB	Polished Brass	1

RJ45 CAT5e



GU7471BSS

Product code	Description	Pack qty
GU7471*SS	Stainless steel	1
GU7471*PC	Polished chrome	1
GU7471WPW	Painted white with white interior	1
GU7471WPN	Pearl nickel with white interior	1
GU7471BBN	Black nickel with black interior	1
GU7471*PB	Polished brass	1

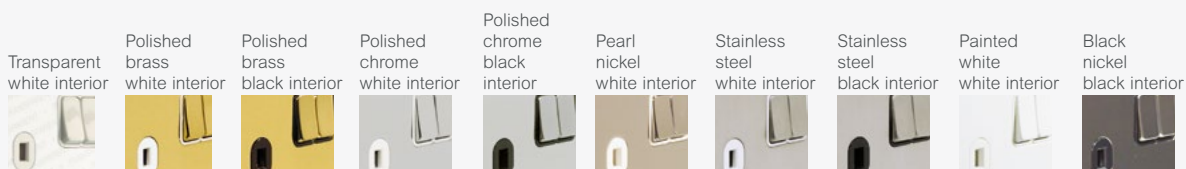

Telephone, USB & data outlets continued

USB charger outlet with 2 x ports 3.1A shared



GGBGU7032USBAWSS

Product code	Description	Pack qty
GGBGU7032USBA*SS	Stainless steel	1
GGBGU7032USBA*PC	Polished chrome	1
GGBGU7032USBAWPW	Painted white with white interior	1
GGBGU7032USBAWPN	Pearl nickel with white interior	1
GGBGU7032USBABBN	Black nickel with black interior	1
GGBGU7032USBA*PB	Polished brass	1

TV outlets / Coaxial sockets

TV/FM



GU7410BSS

Product code	Description	Pack qty
GU7410*SS	Stainless steel	1
GU7410*PC	Polished chrome	1
GU7410WPW	Painted white with white interior	1
GU7410WPN	Pearl nickel with white interior	1
GU7410BBN	Black nickel with black interior	1
GU7410BPB	Polished brass with black interior	1

- **Standard of compliance:** BS 3041 (where applicable).
- **Mounting box:** 25mm deep
- **Fixing screws:** M3.5 x 25mm and 30mm
- **Plate dimensions:** 88 x 88mm
- **Technical notes:** Products are direct connection and are not suitable for common connection.

Twin TV/FM



GU7420BSS

Product code	Description	Pack qty
GU7420*SS	Stainless steel	1
GU7420*PC	Polished chrome	1
GU7420WPW	Painted white with white interior	1
GU7420WPN	Pearl nickel with white interior	1
GU7420BBN	Black nickel with black interior	1

Single Satellite



GU7430BSS

Product code	Description	Pack qty
GU7430*SS	Stainless steel	1
GU7430*PC	Polished chrome	1
GU7430WPW	Painted white with white interior	1
GU7430WPN	Pearl nickel with white interior	1
GU7430BBN	Black nickel with black interior	1
GU7430BPB	Polished brass with black interior	1

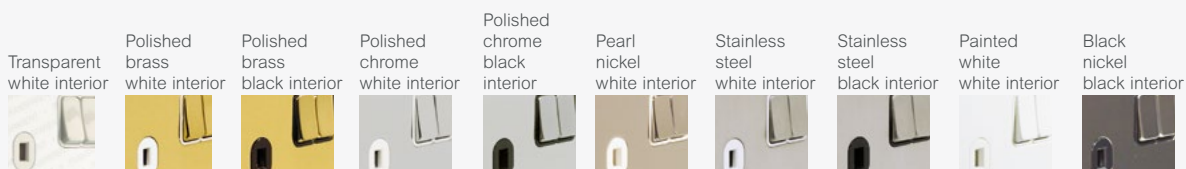

Euro modular plates & modules

1 gang euro plate, 1 module 25 x 50mm



GU8450SS

Product code	Description	Pack qty
GU8450SS	Stainless steel	1
GU8450PC	Polished chrome	1
GU8450PW	Painted white	1
GU8450PN	Pearl nickel	1
GU8450BN	Black nickel	1
GU8450PB	Polished brass	1

- **Mounting box:** Refer to module for appropriate mounting box depth.
- **Plate dimensions:** 88 x 88mm (1 gang)
- **Technical notes:** Mounting grid supplied with euro plate.

1 gang euro plate, 2 module 50 x 50mm



GU8460SS

Product code	Description	Pack qty
GU8460SS	Stainless steel	1
GU8460PC	Polished chrome	1
GU8460PW	Painted white	1
GU8460PN	Pearl nickel	1
GU8460BN	Black nickel	1
GU8460PB	Polished brass	1

- **Mounting box:** Refer to module for appropriate mounting box depth.
- **Plate dimensions:** 88 x 88mm (1 gang)
88 x 148mm (2 gang)
- **Technical notes:** Mounting grid supplied with euro plate.

2 gang euro plate, 4 module 100 x 50mm



GU8480SS

Product code	Description	Pack qty
GU8480SS	Stainless steel	1
GU8480PC	Polished chrome	1
GU8480PW	Painted white	1
GU8480PN	Pearl nickel	1
GU8480BN	Black nickel	1
GU8480PB	Polished brass	1

- Euro modules plates compatible with Schneider Electric euro modules.
- **Notes:** modules from other suppliers may not be compatible, it is advised to check suitability.

25 x 50mm euro modules



GUE7073B



GUE7072W



GUE7061B



VDIB1771XB12

Product code	Description	Pack qty
GUE7011*	Single IEC coax (female)	1
GUE7012*	25 x 50mm euro modules IEC coax (male)	1
GUE7030*	Single F type sat	1
GUE7061*	BT master telephone	1
GUE7062*K	BT secondary telephone	1
GUE7071*	RJ45 CAT5e (not screened)	1
GUE7072*	RJ45 CAT5 (not screened)	1
GUE7073*	Single USB charger 1A 5Vdc	1
GUE7021*	Single USB charger 2.1A	1
GUE7051*	RJ11 modem	1
GUE7091W	Actassi module carrier for VDIB1771XB12	8
VDIB1771XB12	Actassi S-One Connector RJ45 CAT6A shielded	12
GUE7000*	2 x Phono socket	1
GUE7001*	2 x Loudspeaker socket	1
GUE8010*	Blank module	5

- **Mounting box:** 25mm deep (25 x 50mm modules)
- **Euro module dimensions:** 25 x 50mm (single)

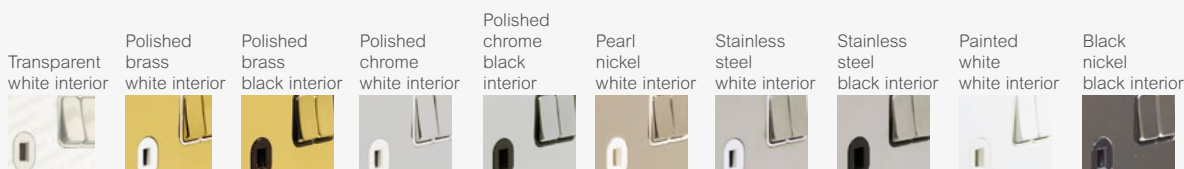

Euro modular plates & modules continued

50 x 50mm euro modules



Product code	Description	Pack qty
GUE7010*	TV/FM diplexer	1
GUE7040*	TV/Sat diplexer	1
GUE7074*	Twin USB charger 2 x 1A 5Vdc	1
GUE7031*	Twin USB charger 2 x 3.1A	1
GUE7081*	TV/FM/Sat triplexer	1
GUE7082*	TV/FM/Sat1/Sat2 quadplexer	1
GUE7020*	HDMI	1
GUE7078*	American power socket**	1
GUE7076*	Brush outlet**	1
GUE7077*	5A round pin socket**	1

- **Mounting box:**
35mm deep (25 x 50mm modules)
- **Euro module dimensions:**
50 x 50mm (double)
- ****Made-to-order products**
Subject to minimum order quantities and extended lead time. Contact 0870 608 8 608 for a quotation.

Blank plates & accessories

1 gang

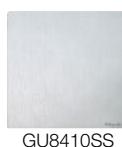

Product code	Description	Pack qty
GU8410SS	Stainless steel	1
GU8410PC	Polished chrome	1
GU8410PW	Painted white	1
GU8410PN	Pearl nickel	1
GU8410BN	Black nickel	1
GU8410PB	Polished brass	1

- **Standard of compliance:**
BS 5733
- **Fixing screws:**
M3.5 x 25mm and 30mm
- **Plate dimensions:**
88 x 88mm (1 gang)
88 x 148mm (2 gang)

2 gang



Product code	Description	Pack qty
GU8420SS	Stainless steel	1
GU8420PC	Polished chrome	1
GU8420PW	Painted white	1
GU8420PN	Pearl nickel	1
GU8420BN	Black nickel	1
GU8420PB	Polished brass	1

Spares



Product code	Description	Pack qty
GU1401F	1 gang Gasket frame - clear	1
GU1402F	2 gang Gasket frame - clear	1
3746130	M3.5 x 25mm raised head machine screws	100
USCREW50**	M3.5 x 50mm screws	100

Blank plates & accessories continued

KNX 1 gang frame



GU8434SS

Product code	Description	Pack qty
GU8434BN	Black nickel	1
GU8434PB	Polished brass	1
GU8434PC	Polished chrome	1
GU8434PN	Pearl nickel	1
GU8434PW	Painted white	1
GU8434SS	Stainless steel	1

The new KNX Multitouch Pro and KNX Push-button Pro user interfaces are the perfect addition to a modern KNX installation. Combining with the eConfigure KNX Lite, it gives you total control over all aspects of your automation installations. Perfect for increasing your project opportunities & thereby growing your business.

Please refer to full product information in the KNX section of this catalogue

Grid plates

1 gang 88 x 88mm



GUGS01GSS

Product code	Description	Pack qty
GUGS01GSS	Stainless steel	1
GUGS01GMS	Mirror steel	1
GUGS01GPW	Painted white	1
GUGS01GPN	Pearl nickel	1
GUGS01GBN	Black nickel	1
GUGS01GPB	Polished brass	1
GBG01	76 x 76 x 42mm back box	1

- **Mounting box:** 42mm deep
- **Technical notes:** All grid plates are supplied with the appropriate number of mounting frames.
Mirror steel used for polished chrome grid plates & modules.

2 gang 88 x 88mm



GUGS02GSS

Product code	Description	Pack qty
GUGS02GSS	Stainless steel	1
GUGS02GMS	Mirror steel	1
GUGS02GPW	Painted white	1
GUGS02GPN	Pearl nickel	1
GUGS02GBN	Black nickel	1
GUGS02GPB	Polished brass	1
GBG01	76 x 76 x 42mm back box	1

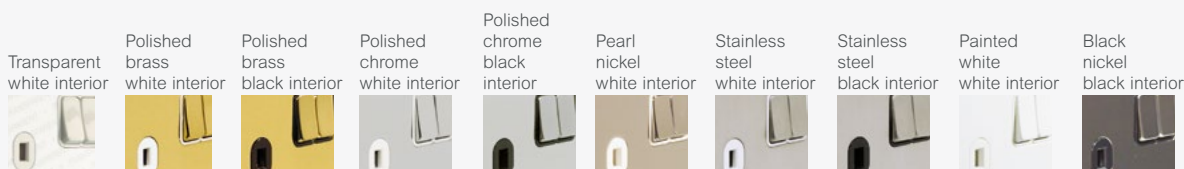

Grid plates continued

3 gang 88 x 148mm



GUGS03GSS

Product code	Description	Pack qty
GUGS03GSS	Stainless steel	1
GUGS03GMS	Mirror steel	1
GUGS03GPW	Painted white	1
GUGS03GPN	Pearl nickel	1
GUGS03GBN	Black nickel	1
GUGS03GPB	Polished brass	1
GBG02	136 x 76 x 42mm back box	1

- **Mounting box:**
42mm deep
- **Technical notes:**
All grid plates are supplied with the appropriate number of mounting frames.
- **Fixing Centres -**
1 Gang = 60.3mm
2 Gang = 120.6mm

Mirror steel used for polished chrome grid plates & modules.

4 gang 88 x 148mm



GUGS04GSS

Product code	Description	Pack qty
GUGS04GSS	Stainless steel	1
GUGS04GMS	Mirror steel	1
GUGS04GPW	Painted white	1
GUGS04GPN	Pearl nickel	1
GUGS04GBN	Black nickel	1
GUGS04GPB	Polished brass	1
GBG02	136 x 76 x 42mm back box	1

6 gang 156 x 156mm



GUGS06SS

Product code	Description	Pack qty
GUGS06GSS	Stainless steel	1
GUGS06GMS	Mirror steel	1
GUGS06GPW	Painted white	1
GUGS06GPN	Pearl nickel	1
GUGS06GBN	Black nickel	1
GUGS06GPB	Polished brass	1
GBG03	136 x 136 x 42mm back box	1

8 gang 156 x 156mm



GUGS08GSS

Product code	Description	Pack qty
GUGS08GSS	Stainless steel	1
GUGS08GMS	Mirror steel	1
GUGS08GPW	Painted white	1
GUGS08GPN	Pearl nickel	1
GUGS08GBN	Black nickel	1
GUGS08GPB	Polished brass	1
GBG03	136 x 136 x 42mm back box	1

Grid plates continued

9 gang 216 x 156mm

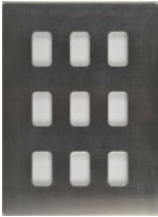

GUGS09GSS

Product code	Description	Pack qty
GUGS09GSS	Stainless steel	1
GUGS09GMS	Mirror steel	1
GUGS09GPW	Painted white	1
GUGS09GPN	Pearl nickel	1
GUGS09GBN	Black nickel	1
GUGS09GPB	Polished brass	1
GBG04F	193 x 133 x 42mm back box	1

- **Mounting box:**
42mm deep
 - **Technical notes:**
All grid plates are supplied with the appropriate number of mounting frames.
- Mirror steel used for polished chrome grid plates & modules.

12 gang 216 x 156mm

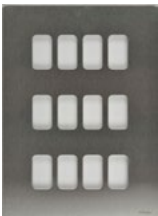

GUGS12GSS

Product code	Description	Pack qty
GUGS12GSS	Stainless steel	1
GUGS12GMS	Mirror steel	1
GUGS12GPW	Painted white	1
GUGS12GPN	Pearl nickel	1
GUGS12GBN	Black nickel	1
GUGS12GPB	Polished brass	1
GBG04F	193 x 133 x 42mm back box	1

18 gang 398 x 156mm



GUGS18GSS

Product code	Description	Pack qty
GUGS18GSS	Stainless steel	1
GUGS18GMS	Mirror steel	1
GUGS18GPW	Painted white	1
GUGS18GPN	Pearl nickel	1
GUGS18GBN	Black nickel	1
GUGS18GPB	Polished brass	1
GBG06F	374 x 133 x 42mm back box	1

24 gang 398 x 156mm



GUGS24GSS

Product code	Description	Pack qty
GUGS24GSS	Stainless steel	1
GUGS24GMS	Mirror steel	1
GUGS24GPW	Painted white	1
GUGS24GPN	Pearl nickel	1
GUGS24GBN	Black nickel	1
GUGS24GPB	Polished brass	1
GBG06F	374 x 133 x 42mm back box	1

Customisable switch grid modules

10AX metal switch module components (white or black surrounds)



GUG102MB GUG101MW

Product code	Description	Pack qty
GUG101M*	10AX 1 way SP	1
GUG102M*	10AX 2 way SP	1
GUG101M*	10AX intermediate SP	1

20AX metal switch module components (white or black surrounds)



GUG2020MB GUG20DPMW

Product code	Description	Pack qty
GUG201M*	20AX 1 way SP	1
GUG2020M*	20AX 2 way and centre off	1
GUG202M*	20AX 2 way SP	1
GUG20DPM*	20AX DP	1

- **Standard of compliance:** BS EN 60669-1
- **Mounting box:** 42mm deep
- **Technical notes:** 10AX & 20AX metal switch module components available in black or white.
- Clear terminal marking printed onto grey switch module component back mouldings ensures easy identification.
- Pre-printed rocker caps.
- Easy assembly.

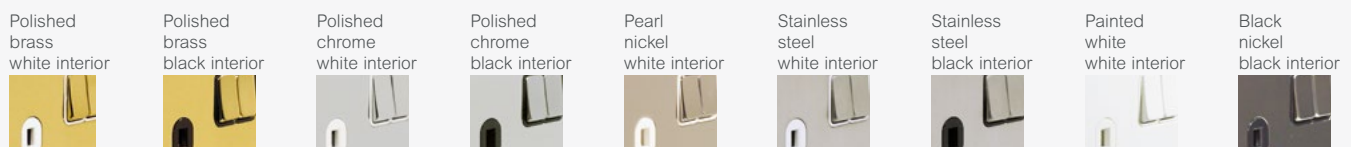
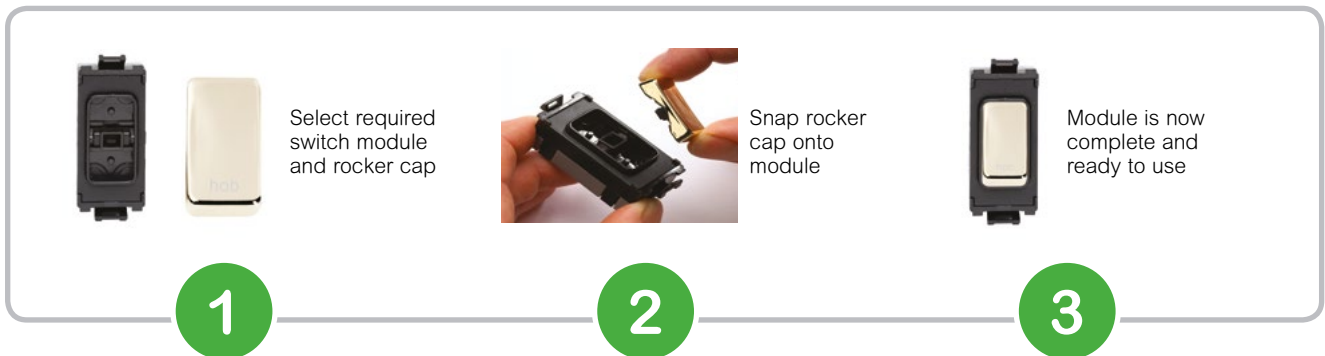

Plain and printed rocker caps for component modules



	Stainless Steel	Mirror Steel	Polished Brass	Pearl Nickel	Painted White	Black Nickel	Painted Black
Plain rocker cap	GUGRSS	GUGRMS	GUGRPB	GUGRPN	GUGRPW	GUGRBN	GUGRBLK
Rocker cap printed boiler	GUGRBOSS	GUGRBOMS		GUGRBOPN	GUGRBOPW	GUGRBOBN	GUGRBOBLK
Rocker cap printed cooker hood	GUGRCHSS	GUGRCHMS		GUGRCHPN	GUGRCHPW	GUGRCHBN	GUGRCHBLK
Rocker cap printed dish washer	GUGRDWSS	GUGRDWMS	GUGRDWPB	GUGRDWPN	GUGRDWPW	GUGRDWBN	GUGRDWBK
Rocker cap printed extractor fan	GUGREFSS	GUGREFMS	GUGREFPB	GUGREFPN	GUGREFPW	GUGREFBN	GUGREFBLK
Rocker cap printed fridge	GUGRFRSS	GUGRFRMS	GUGRFRPB	GUGRFRPN	GUGRFRPW	GUGRFRBN	GUGRFRBLK
Rocker cap printed fan	GUGRFASS	GUGRFAMS	GUGRFAPB	GUGRFAPN	GUGRFAPW	GUGRFABN	GUGRFABLK
Rocker cap printed freezer	GUGRFZSS	GUGRFZMS	GUGRFZPB	GUGRFZPN	GUGRFZPW	GUGRFZBN	GUGRFZBLK
Rocker cap printed fridge/freezer	GUGRFRFZSS	GUGRFRFZMS	GUGRFRFZPB	GUGRFRFZPN	GUGRFRFZPW	GUGRFRFZBN	GUGRFRFZBLK
Rocker cap printed hob	GUGRHOSS	GUGRHOMS		GUGRHOPN	GUGRHOPW	GUGRHOBN	GUGRHOBLK
Rocker cap printed heater	GUGRHESS	GUGRHEMS		GUGRHEPN	GUGRHEPW	GUGRHEBN	GUGRHEBLK
Rocker cap printed microwave	GUGRMWSS	GUGRMWMS	GUGRMWPB	GUGRMWPN	GUGRMWPW	GUGRMWBN	GUGRMWBLK
Rocker cap printed oven	GUGROVSS	GUGROVMS		GUGROVPN	GUGROVPW	GUGROVBN	GUGROVBLK
Rocker cap printed tumble dryer	GUGRTDSS	GUGRTDMS	GUGRTDPB	GUGRTDPN	GUGRTDPW	GUGRTDBN	GUGRTDBLK
Rocker cap printed washer dryer	GUGRWDYSS	GUGRWDYMS		GUGRWDYPN	GUGRWDYPW	GUGRWDYBN	GUGRWDYBLK
Rocker cap printed waste disposal	GUGRWDSS	GUGRWDMS		GUGRWDPN	GUGRWDPW	GUGRWDNB	GUGRWDNBK
Rocker cap printed washing machine	GUGRWMSS	GUGRWMMS	GUGRWMPB	GUGRWMPN	GUGRWMPW	GUGRWMBN	GUGRWMBLK

Retractive & toggle switch grid modules

6A 2 way retractive and centre off



GUG202OCBSS

Product code	Description	Pack qty
GUG202OC*SS	Stainless steel	1
GUG202OC*MS	Mirror steel	1
GUG202OCWPW	Painted white with white interior	1
GUG202OCWPN	Pearl nickel with white interior	1
GUG202OCBBN	Black nickel with black interior	1
GUG202OC*PB	Polished brass	1

- **Standard of compliance:** BS EN 60669-1
- **Mounting box:** 42mm deep
- **Technical notes:** Mirror steel used for polished chrome grid plates & modules.

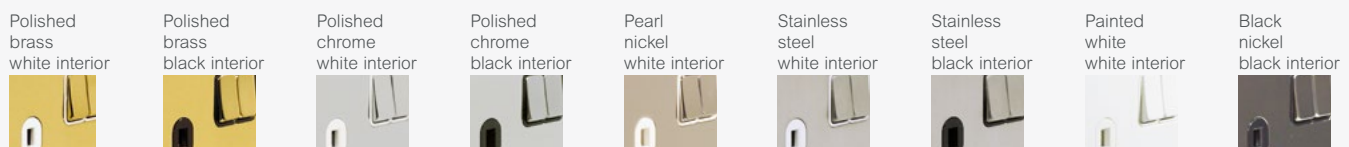

Retractive & toggle switch grid modules continued

10A 2 way retractive single-pole



GUG102RBSS

Product code	Description	Pack qty
GUG102R*SS	Stainless steel	1
GUG102R*MS	Mirror steel	1
GUG102RWPW	Painted white with white interior	1
GUG102RWPN	Pearl nickel with white interior	1
GUG102RBBN	Black nickel with black interior	1
GUG102R*PB	Polished brass	1

- **Standard of compliance:**
BS EN 60669-1
- **Mounting box:**
42mm deep
- **Technical notes:**
Mirror steel used for polished chrome grid plates & modules.

10AX way single-pole toggle



GUG102TBSS

Product code	Description	Pack qty
GUG102T*SS	Stainless steel	1
GUG102T*MS	Mirror steel	1
GUG102TWPW	Painted white with white interior	1
GUG102TWPN	Pearl nickel with white interior	1
GUG102TBBN	Black nickel with black interior	1
GUG102TBPB	Polished brass with black interior	1

10AX intermediate toggle



GUG10ITBSS

Product code	Description	Pack qty
GUG10IT*SS	Stainless steel	1
GUG10IT*MS	Mirror steel	1
GUG10ITWPW	Painted white with white interior	1
GUG10ITWPN	Pearl nickel with white interior	1
GUG10ITBBN	Black nickel with black interior	1
GUG10ITBPB	Polished brass with black interior	1

Key switch grid modules

20AX 1 way key operated double-pole



GUG20DPKBSS

Product code	Description	Pack qty
GUG20DPK*SS	Stainless steel	1
GUG20DPK*MS	Mirror steel	1
GUG20DPKWPW	Painted white with white interior	1
GUG20DPKWPN	Pearl nickel with white interior	1
GUG20DPKBBN	Black nickel with black interior	1
GUGKSK	Spare key for SW module	1

- **Standard of compliance:** BS EN 60669-1
- **Mounting box:** 42mm deep
- **Technical notes:** Mirror steel used for polished chrome grid plates & modules.

20AX 2 way key operated



GUG202KBSS

Product code	Description	Pack qty
GUG202K*SS	Stainless steel	1
GUG202K*MS	Mirror steel	1
GUG202KWPW	Painted white with white interior	1
GUG202KWPN	Pearl nickel with white interior	1
GUG202KBBN	Black nickel with black interior	1
GUG202KBPB	Polished brass with black interior	1
GUGKSK	Spare key for SW module	1

20AX 2 way key operated printed red TEST EMG LTG



GUG202KELBSS



GUGKSK

Product code	Description	Pack qty
GUG202KEL*SS	Stainless steel	1
GUG202KEL*MS	Mirror steel	1
GUG202KELWPW	Painted white with white interior	1
GUG202KELWPN	Pearl nickel with white interior	1
GUG202KELBBN	Black nickel with black interior	1
GUGKSK	Spare key for SW module	1

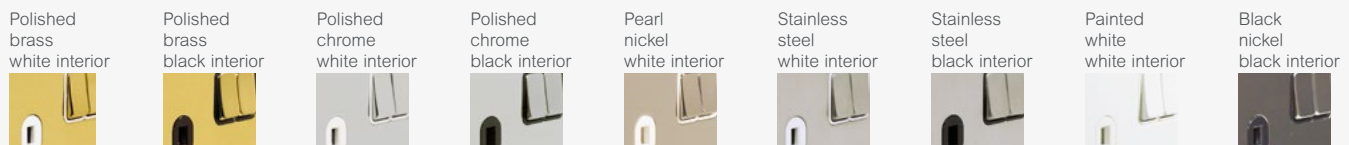

Telephone grid modules

BT master telephone



GUGTELMBSS

Product code	Description	Pack qty
GUGTELM*SS	Stainless steel	1
GUGTELM*MS	Mirror steel	1
GUGTELMWPW	Painted white with white interior	1
GUGTELMWPN	Pearl nickel with white interior	1
GUGTELMBBN	Black nickel with black interior	1

- **Standard of compliance:** BS EN 3041 (where applicable)
- **Mounting box:** 42mm deep
- **Technical notes:** Mirror steel used for polished chrome grid plates & modules.

BT secondary telephone



GUGTELSBSS

Product code	Description	Pack qty
GUGTELS*SS	Stainless steel	1
GUGTELS*MS	Mirror steel	1
GUGTELSWPW	Painted white with white interior	1
GUGTELSWPN	Pearl nickel with white interior	1
GUGTELSBBN	Black nickel with black interior	1
GUGTELSBPB	Polished brass with black interior	1

RJ11 telephone



GUGRJ11BSS

Product code	Description	Pack qty
GUGRJ11BSS	Stainless steel with black interior	1
GUGRJ11WPW	Painted white with white interior	1

Data & TV grid modules

RJ45 CAT5e



GUGRJ45BSS

Product code	Description	Pack qty
GUGRJ45WSS	Stainless steel with white interior	1
GUGRJ45*MS	Mirror steel	1
GUGRJ45WPW	Painted white with white interior	1
GUGRJ45BBN	Black nickel with black interior	1
GUGRJ45BPB	Polished brass with black interior	1

- **Standard of compliance:** BS EN 3041 (where applicable)
- **Mounting box:** 42mm deep
- **Technical notes:** Mirror steel used for polished chrome grid plates & modules.

Direct coaxial TV



GUGCOBSS

Product code	Description	Pack qty
GUGCO*SS	Stainless steel	1
GUGCPBMS	Mirror steel with black interior	1
GUGCOWPW	Painted white with white interior	1
GUGCOWPN	Pearl nickel with white interior	1
GUGCOBBN	Black nickel with black interior	1

F type satellite



GUGSATBSS

Product code	Description	Pack qty
GUGSAT*SS	Stainless steel	1
GUGSATBMS	Mirror steel with black interior	1
GUGSATWPW	Painted white with white interior	1
GUGSATWPN	Pearl nickel with white interior	1
GUGSATBBN	Black nickel with black interior	1
GUGSATBPB	Polished brass with black interior	1

Electronic dimmer grid modules

300W/VA universal multiway touch dimmer module



GUGEMDIMWPW16

Product code	Description	Pack qty
GUGEMDIM*SS16	Stainless steel	1
GUGEMDIMWPW16	Painted white with white interior	1
GUGEMDIMBBN16	Black nickel with black interior	1
GUGEMDIMWMS16	Mirror steel with white interior	1

- **Mounting box:**
42mm deep
- **Technical notes:**
Min load 60W/50VA.

300W/VA universal multiway touch dimmer module with infra red remote option



GUGEMRDIMB16

Product code	Description	Pack qty
GUGEMRDIMW16	White moulded	1
GUGEMRDIMB16	Black moulded	1
GU6000RC1R	1 channel IR remote control	1

- Electronic modules are capable of 2 way or multiway dimming.
- Not compatible with moulded grid plates.
- Modules will require derating when used in multi-gang applications.

LED electronic grid dimmer



GGBGUGEMDIMLBPC

Product code	Description	Pack qty
GGBGUGEMDIMLBPB	Polished brass with black interior	1
GGBGUGEMDIML*PC	Polished chrome	1
GGBGUGEMDIMLWPN	Pearl nickel with white interior	1
GGBGUGEMDIML*SS	Stainless steel	1
GGBGUGEMDIMLWPW	Painted white with white interior	1
GGBGUGEMDIMLBBN	Black nickel with black interior	1

- **Standard of compliance:**
BS EN 60669-2-1.
- **Technical notes:**
Not suitable with compact fluorescent (CFL) or motor loads.
- Trailing edge control. Retractive switches are required for 2 way configurations.

50mA 2 way & multiway retractive switch module



GUGEMWWPN

Product code	Description	Pack qty
GUGEMW*SS	Stainless steel	1
GUGEMW*MS	Mirror steel	1
GUGEMWWPW	Painted white with white interior	1
GUGEMWWPN	Pearl nickel with white interior	1
GUGEMWBBN	Black nickel with black interior	1

- Retractive switch for use with electronic dimmers only.

Fuse carrier, flex outlet & blank grid modules

13A fuse carrier



GUG13FCUBSS

Product code	Description	Pack qty
GUG13FCU*SS	Stainless steel	1
GUG13FCU*MS	Mirror steel	1
GUG13FCUWPW	Painted white with white interior	1
GUG13FCUWPN	Pearl nickel with white interior	1
GUG13FCUBBN	Black nickel with black interior	1
GUG13FCU*PB	Polished brass	1

- **Standard of compliance:**
BS 1363 (fuse carrier)
BS 5733
- **Mounting box:**
42mm deep
- **Technical notes:**
Full metal surround on all modules.
Modules are completely interchangeable.

Mirror steel used for polished chrome grid plates & modules.

Flex outlet up to 10mm diameter



GUG16COBSS

Product code	Description	Pack qty
GUG16CO*SS	Stainless steel	1
GUG16COBMS	Mirror steel with black interior	1
GUG16COWPW	Painted white with white interior	1
GUG16COWPN	Pearl nickel with white interior	1
GUG16COBBN	Black nickel with black interior	1
GUG16CO*PB	Polished brass	1

Blank



GUGBBSS

Product code	Description	Pack qty
GUGB*SS	Stainless steel	1
GUGB*MS	Mirror steel	1
GUGBWPW	Painted white with white interior	1
GUGBWPN	Pearl nickel with white interior	1
GUGBBBN	Black nickel with black interior	1
GUGBBPB	Polished brass with black interior	1
GUGB*	Moulded plastic (black or white)	1

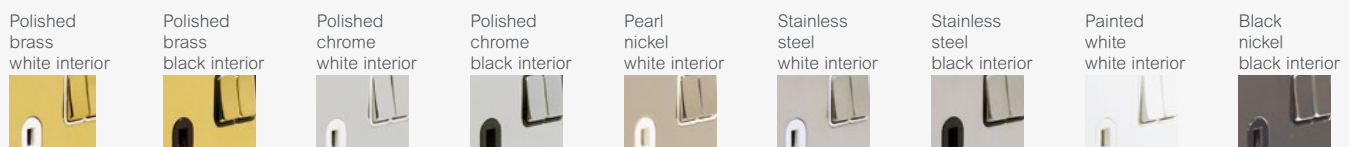

Indicator modules

White surround



Product code	Description	Pack qty
GUGINDWG	Green indicator	1
GUGINDWR	Red indicator	1
GUGINDWO	Orange indicator	1

- **Standard of compliance:** BS 5733
- **Technical notes:** 240V

Black surround



Product code	Description	Pack qty
GUGINDBG	Green indicator	1
GUGINDBR	Red indicator	1
GUGINDBO	Orange indicator	1

Flush galvanised steel boxes

16mm deep



SB161

Product code	Description	Pack qty
SB161	1 gang	20

- **Standard of compliance:** BS4662
- **Technical notes:** Supplied with earth terminal and screw.

25mm deep

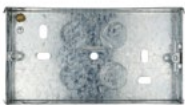

SB252

Product code	Description	Pack qty
SB251	1 gang	10
SB252	2 gang	10

Supplied with fixed and adjustable lugs.

Fitted with selection of 20mm knockouts in sides and back.

35mm deep



SB351

Product code	Description	Pack qty
SB351	1 gang	10
SB352	2 gang	5

47mm deep



SB472

Product code	Description	Pack qty
SB471	1 gang	10
SB472	2 gang	4

A photograph of two young women sitting in a kitchen, laughing joyfully. The woman on the left is wearing a black and white striped long-sleeved shirt and holding a wine glass with white wine. The woman on the right is wearing a red top and also holding a wine glass with white wine. In the background, there is a stainless steel range hood and a window with green foliage outside. A solid green horizontal band is overlaid across the middle of the image, containing the text.

Ultimate Flat Plate

Ultimate Flat Plate

Combining superior engineering with urban style, Ultimate Flat Plate utilises the aesthetics and functions of the ULTIMATE range, with an ultra slim 1.5mm thick front plate. With complementary finishes numerous aspects to make installation easier, Flat Plate is a firm favourite of consumers and electrical contractors alike.

Available in a choice of six high quality finishes with black or white interior options – coordinating these accessories has never been easier.

Colour matched screws with eyelets for seamless colour consistency.

Choice of 6 finishes & multiple interior options to compliment virtually all décor - traditional or contemporary.

1.5mm plate thickness together with large footprint provides extra strength and reduces the need for additional decorating.

Curved metal capped Rockers for a stylish look & easier operation.

Flat headed screws ensures flat profile across plate when fitted.

Two sets of secured fitting screws supplied to reduce risk of loss during installation. Long and short screws offer flexibility during installation.

A pre-fitted, close cell foam gasket aids installation on uneven walls, in addition to providing moisture protection. Foam gasket is pre-fitted to save time.

Colour coded in-line terminals as well as a colour balanced back moulding makes terminals easily identifiable during installation, particularly in lower light levels.

Specification Highlights:



13A floor sockets offer additional flexibility and easier power accessibility for residential and commercial floor plans.



Outboard sockets provide a practical solution for improved visibility and ease of operation.



Control energy access and improve public safety in communal areas with non standard sockets,



A complete range of 2A, 5A, and 15A round pin socket outlets to support bespoke lighting designs.

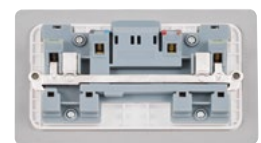

Twin earth terminals on 2 gang sockets enable installation in areas requiring high integrity earthing.

Socket outlets

13A 1 gang unswitched



GU3250WPC

Product code	Description	Pack qty
GU3250*SS	Stainless steel	1
GU3250*PC	Polished chrome	1
GU3250WPW	Painted white with white interior	1
GU3250WPN	Pearl nickel with white interior	1
GU3250BBN	Black nickel with black interior	1
GU3250BPB	Polished brass with black insert	1

- **Standard of compliance:**
BS 1363 (13A)
- **Mounting box:**
Minimum 25mm deep
- **Fixing screws:**
M3.5 x 25mm and 30mm
- **Plate dimensions:**
88 x 88mm (1 gang)
88 x 148mm (2 gang)
- **Technical notes:**
All 2 gang sockets supplied with twin earth terminals as standard. To aid flush installation, 35mm steel boxes are recommended (BS7671).

13A 2 gang unswitched



GU3260WPC

Product code	Description	Pack qty
GU3260*SS	Stainless steel	1
GU3460BPC	Polished chrome with black interior	1
GU3260WPW	Painted white with white interior	1
GU3260WPN	Pearl nickel with white interior	1
GU3260BBN	Black nickel with black interior	1
GU3260WPB	Polished brass with white interior	1

13A 1 gang single-pole switched



GU3210WPC

Product code	Description	Pack qty
GU3210*SS	Stainless steel	1
GU3210*PC	Polished chrome	1
GU3210WPW	Painted white with white interior	1
GU3210WPN	Pearl nickel with white interior	1
GU3210BBN	Black nickel with black interior	1
GU3210BPB	Polished brass with black insert	1

13A 1 gang double-pole switched



GU3210DWPC

Product code	Description	Pack qty
GU3210D*SS	Stainless steel	1
GU3210D*PC	Polished chrome	1
GU3210DWPW	Painted white with white interior	1
GU3210DWPN	Pearl nickel with white interior	1
GU3210DBBN	Black nickel with black interior	1
GU3210DBPB	Polished brass with black insert	1

13A 2 gang single-pole switched



GU3220WPC

Product code	Description	Pack qty
GU3220*SS	Stainless steel	1
GU3220*PC	Polished chrome	1
GU3220WPW	Painted white with white interior	1
GU3220WPN	Pearl nickel with white interior	1
GU3220BBN	Black nickel with black interior	1
GU3220BPB	Polished brass with black insert	1

Socket outlets continued

13A 2 gang double-pole switched

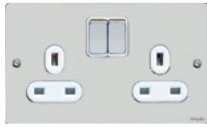

GU3220DWPC

Product code	Description	Pack qty
GU3220D*SS	Stainless steel	1
GU3220D*PC	Polished chrome	1
GU3220DWPW	Painted white with white interior	1
GU3220DWPN	Pearl nickel with white interior	1
GU3220DBBN	Black nickel with black interior	1
GU3220DBPB	Polished brass with black insert	1

- **Standard of compliance:** BS 1363 (13A)
- **Mounting box:** Minimum 25mm deep
- **Fixing screws:** M3.5 x 25mm and 30mm
- **Plate dimensions:** 88 x 88mm (1 gang)
88 x 148mm (2 gang)
- **Technical notes:** All 2 gang sockets supplied with twin earth terminals as standard. To aid flush installation, 35mm steel boxes are recommended (BS7671).
- Floor socket interiors are manufactured from high impact thermoplastic for strength.

13A 2 gang double-pole switched with clean earth & outboard rockers



GU3231WPC

Product code	Description	Pack qty
GU3231*SS	Stainless steel	1
GU3231*PC	Polished chrome	1
GU3231BBN	Black nickel	1

13A 2 gang double-pole switched with clean earth & outboard rockers



GU3234WPC

Product code	Description	Pack qty
GU3234WSS	Stainless steel with white interior	1

Shelf frames for socket outlets



GGBGUSHF1GS

Product code	Description	Pack qty
GGBGUSHF1GS	1 gang white	1
GGBGUSHF1GBS	1 gang black	1
GGBGUSHF2GS	2 gang white	1
GGBGUSHF2GBS	2 gang black	1

13A 1 gang unswitched floor socket



GU3251WSS

Product code	Description	Pack qty
GU3251WSS	Stainless steel with white interior	1

13A 2 gang unswitched floor socket



GU3252WSS

Product code	Description	Pack qty
GU3252WSS	Stainless steel with white interior	1
GU3252WPB	Polished brass with white insert	1

Polished brass white interior



Polished brass black interior

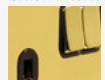

Polished chrome white interior



Polished chrome black interior



Pearl nickel white interior



Stainless steel white interior



Stainless steel black interior



Painted white white interior



Black nickel black interior



Socket outlets continued



GU3270WPC

Product code	Description	Pack qty
GU3270*SS	Stainless steel	1
GU3270*PC	Polished chrome	1
GU3270*PW	Painted white with white interior	1
GU3270WPN	Pearl nickel with white interior	1
GU3270BBN	Black nickel with black interior	1
GU3270*PB	Polished brass	1

- **Standard of compliance:** BS 546 (round pin)
- **Mounting box:** Minimum 25mm deep
- **Fixing screws:** M3.5 x 25mm and 30mm
- **Plate dimensions:** 88 x 88mm (1 gang)

5A unswitched round pin



GU3280WPC

Product code	Description	Pack qty
GU3280*SS	Stainless steel	1
GU3280*PC	Polished chrome	1
GU3280*PW	Painted white with white interior	1
GU3280WPN	Pearl nickel with white interior	1
GU3280BBN	Black nickel with black interior	1
GU3280*PB	Polished brass	1

15A switched round pin



GU3290WPC

Product code	Description	Pack qty
GU3290*SS	Stainless steel	1
GU3290WPW	Painted white with white interior	1
GU3290BBN	Black nickel with black interior	1

Media plates

In-line with 2 gang double-pole socket outlets & 2 x 2 module euro



GU32202DMPWPC

Product code	Description	Pack qty
GU32202DMP*SS	Stainless steel	1
GU32202DMP*PC	Polished chrome	1
GU32202DMPWPW	Painted white with white interior	1
GU32202DMPBBN	Black nickel with black interior	1
GGBSB4722M	In-line back box	1

- **Standard of compliance:** BS 5733 BS 1363-2
- **Mounting box:** 47mm deep
- **Fixing screws:** M3.5 x 25mm and 30mm
- **Plate dimensions:** 296 x 88mm (in-line) 296 x 176mm (stacked)

Stacked with 2 x 2 gang double-pole socket outlets & 4 x 2 module euro



GU32204DMPWPC

Product code	Description	Pack qty
GU32204DMP*SS	Stainless steel	1
GU32204DMP*PC	Polished chrome	1
GU32204DMPWPW	Painted white with white interior	1
GU32204DMPBBN	Black nickel with black interior	1
GU32204DMPBPB	Polished brass with black insert	1
GGBSB4724M	Stacked back box	1

Plate switches

16AX 1 gang 2 way



GU1212WPC

Product code	Description	Pack qty
GU1212*SS	Stainless steel	1
GU1212*PC	Polished chrome	1
GU1212*PW	Painted white with white interior	1
GU1212WPN	Pearl nickel with white interior	1
GU1212BBN	Black nickel with black interior	1
GU1212*PB	Polished brass	1

- **Standard of compliance:**
BS EN 60669-1
- **Mounting box:**
16mm deep (1-2 gang)
25mm deep (3-6 gang)
- **Fixing screws:**
M3.5 x 25mm and 30mm
- **Plate dimensions:**
88 x 88mm (1-3 gang),
88 x 148mm (4-6 gang)

16AX 1 gang intermediate



GU1214WPC

Product code	Description	Pack qty
GU1214*SS	Stainless steel	1
GU1214*PC	Polished chrome	1
GU1214*PW	Painted white with white interior	1
GU1214WPN	Pearl nickel with white interior	1
GU1214BBN	Black nickel with black interior	1
GU1214*PB	Polished brass	1

16A 1 gang 2 way retractive



GU1212RWPC

Product code	Description	Pack qty
GU1212R*SS	Stainless steel	1
GU1212R*PC	Polished chrome	1
GU1212RWPW	Painted white with white interior	1
GU1212RWPN	Pearl nickel with white interior	1
GU1212RBBN	Black nickel with black interior	1
GU1212RBPB	Polished brass with black insert	1

16AX 2 gang 2 way



GU1222WPC

Product code	Description	Pack qty
GU1222*SS	Stainless steel	1
GU1222*PC	Polished chrome	1
GU1222WPW	Painted white with white interior	1
GU1222WPN	Pearl nickel with white interior	1
GU1222BBN	Black nickel with black interior	1
GU1222*PB	Polished brass	1

16AX 3 gang 2 way



GU1232WPC

Product code	Description	Pack qty
GU1232*SS	Stainless steel	1
GU1232*PC	Polished chrome	1
GU1232*PW	Painted white with white interior	1
GU1232WPN	Pearl nickel with white interior	1
GU1232BBN	Black nickel with black interior	1
GU1232*PB	Polished brass	1

Polished brass
white interior



Polished brass
black interior

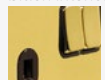

Polished chrome
white interior



Polished chrome
black interior



Pearl nickel
white interior



Stainless steel
white interior



Stainless steel
black interior



Painted white
white interior



Black nickel
black interior



Plate switches continued

16AX 4 gang 2 way



GU1242WPC

Product code	Description	Pack qty
GU1242*SS	Stainless steel	1
GU1242*PC	Polished chrome	1
GU1242*PW	Painted white with white interior	1
GU1242WPN	Pearl nickel with white interior	1
GU1242BBN	Black nickel with black interior	1
GU1242*PB	Polished brass	1

16AX 6 gang 2 way



GU1262WPC

Product code	Description	Pack qty
GU1262*SS	Stainless steel	1
GU1262*PC	Polished chrome	1
GU1262*PW	Painted white with white interior	1
GU1262WPN	Pearl nickel with white interior	1
GU1262BBN	Black nickel with black interior	1
GU1262BPB	Polished brass with black insert	1

10A triple pole isolator



GU1213WPC

Product code	Description	Pack qty
GU1213*SS	Stainless steel	1
GU1213*PC	Polished chrome	1
GU1213WPW	Painted white with white interior	1
GU1213WPN	Pearl nickel with white interior	1
GU1213BBN	Black nickel with black interior	1
GU1213*PB	Polished brass	1

- **Standard of compliance:**
BS EN 60669-1
BS EN 60947-3
(GU1213***)
- **Mounting box:**
16mm deep (1-2 gang)
25mm deep (3-6 gang)
- **Fixing screws:**
M3.5 x 25mm and
30mm
- **Plate dimensions:**
88 x 88mm (1-3 gang),
88 x 148mm (4-6 gang)

Toggle switches

16AX 1 gang 2 way



GU1212TPB

Product code	Description	Pack qty
GU1212TSS	Stainless steel	1
GU1212TPC	Polished chrome	1
GU1212TPW	Painted white	1
GU1212TPN	Pearl nickel	1
GU1212TBN	Black nickel	1
GU1212TPB	Polished brass	1

- **Standard of compliance:**
BS EN 60669-1
- **Mounting box:**
16mm deep (1-2 gang)
25mm deep (3-4 gang)
- **Fixing screws:**
M3.5 x 25mm and
30mm
- **Plate dimensions:**
88 x 88mm (1-3 gang)
88 x 148mm (4 gang)

16AX 2 gang 2 way



GU1222TPC

Product code	Description	Pack qty
GU1222TSS	Stainless steel	1
GU1222TPC	Polished chrome	1
GU1222TPW	Painted white	1
GU1222TPN	Pearl nickel	1
GU1222TBN	Black nickel	1
GU1222TPB	Polished brass	1

Toggle switches continued

16AX 3 gang 2 way



GU1232TPC

Product code	Description	Pack qty
GU1232TSS	Stainless steel	1
GU1232TPC	Polished chrome	1
GU1232TPW	Painted white	1
GU1232TPN	Pearl nickel	1
GU1232TBN	Black nickel	1
GU1232TPB	Polished brass	1

- **Standard of compliance:** BS EN 60669-1
- **Mounting box:** 25mm deep (3-4 gang)
- **Fixing screws:** M3.5 x 25mm and 30mm
- **Plate dimensions:** 88 x 88mm (1-3 gang) 88 x 148mm (4 gang)

16AX 4 gang 2 way



GU1242TPB

Product code	Description	Pack qty
GU1242TSS	Stainless steel	1
GU1242TPC	Polished chrome	1
GU1242TPW	Painted white	1
GU1242TPN	Pearl nickel	1
GU1242TPB	Polished brass	1

Dimmer switches

1 gang 2 way 400W/VA mains & low voltage



GU6212PC

Product code	Description	Pack qty
GU6212CSS	Stainless steel	1
GU6212CPC	Polished chrome	1
GU6212CPW	Painted white	1
GU6212CPN	Pearl nickel	1
GU6212CBN	Black nickel	1
GU6212CPB	Polished brass	1

- **Standard of compliance:** BS EN 60669-2-1
- **Mounting box:** 25mm deep (1-2 gang) 35mm deep (3-4 gang)
- **Fixing screws:** M3.5 x 25mm and 30mm
- **Plate dimensions:** 88 x 88mm (1-2 gang) 88 x 148mm (3-4 gang)

2 gang 2 way 250W/VA mains & low voltage



GU6222CPC

Product code	Description	Pack qty
GU6222CSS	Stainless steel	1
GU6222CPC	Polished chrome	1
GU6222CPW	Painted white	1
GU6222CPN	Pearl nickel	1
GU6222CBN	Black nickel	1
GU6222CPB	Polished brass	1

- **Technical notes:** All dimmers not suitable with CFL lighting.
- Mains & low voltage and electronic dimmers not suitable for use with LED lamps.
- Mains & low voltage dimmers - leading edge control.
- LED dimmers - trailing edge control.

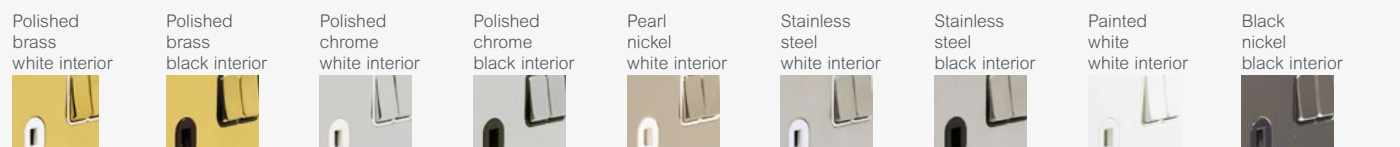

Dimmer switches continued

3 gang 2 way 250W/VA mains & low voltage



GU6232CPC

Product code	Description	Pack qty
GU6232CSS	Stainless steel	1
GU6232CPC	Polished chrome	1
GU6232CPW	Painted white	1
GU6232CPN	Pearl nickel	1
GU6232CBN	Black nickel	1
GU6232CPB	Polished brass	1

4 gang 2 way 250W/VA mains & low voltage



GU6242CPC

Product code	Description	Pack qty
GU6242CSS	Stainless steel	1
GU6242CPC	Polished chrome	1
GU6242CPW	Painted white	1
GU6242CPN	Pearl nickel	1
GU6242CBN	Black nickel	1
GU6242CPB	Polished brass	1

1 gang 2 way 100W/VA LED



GU6212LPC

Product code	Description	Pack qty
GU6212LSS	Stainless steel	1
GU6212LPC	Polished chrome	1
GU6212LPW	Painted white	1
GU6212LPN	Pearl nickel	1
GU6212LBN	Black nickel	1
GU6212LPB	Polished brass	1

2 gang 2 way 100W/VA LED



GU6222LPC

Product code	Description	Pack qty
GU6222LSS	Stainless steel	1
GU6222LPC	Polished chrome	1
GU6222LPW	Painted white	1
GU6222LPN	Pearl nickel	1
GU6222LBN	Black nickel	1
GU6222LPB	Polished brass	1

3 gang 2 way 75W/VA LED



GU6232LPC

Product code	Description	Pack qty
GU6232LSS	Stainless steel	1
GU6232LPC	Polished chrome	1
GU6232LPW	Painted white	1
GU6232LBN	Black nickel	1

- **Standard of compliance:**
BS EN 60669-2-1
- **Mounting box:**
25mm deep (1-2 gang)
35mm deep (3-4 gang)
- **Fixing screws:**
M3.5 x 25mm and 30mm
- **Plate dimensions:**
88 x 88mm (1-2 gang)
88 x 148mm (3-4 gang)
- **Technical notes:**
All dimmers not suitable with CFL lighting.

Mains & low voltage and electronic dimmers not suitable for use with LED lamps.

Mains & low voltage dimmers - leading edge control.

LED dimmers - trailing edge control.

Dimmer technical information can be found in the technical data section towards the back of this catalogue.

- **Notes:**
Retractive switches are required for Multi-Way Operation when using LED dimmers.

Dimmer switches continued

4 gang 2 way 75W/VA LED



GU6242LPC

Product code	Description	Pack qty
GU6242LSS	Stainless steel	1
GU6242LPC	Polished chrome	1
GU6242LPW	Painted white	1

1 gang 2 way 300W/VA electronic



GU6212EWPC

Product code	Description	Pack qty
GU6212EBSS	Stainless steel with black interior	1
GU6212EWPC	Polished chrome with white interior	1
GU6212EBBN	Black nickel with black interior	1

2 gang 2 way 200W/VA electronic



GU6222EWPC

Product code	Description	Pack qty
GU6222EBSS	Stainless steel with black interior	1
GU6222EBPC	Polished chrome with black interior	1
GU6222EWPN	Pearl nickel with white interior	1
GU6222EBBN	Black nickel with black interior	1
GU6222EWPB	Polished brass with white insert	1

1 gang 2 way 300W/VA IR electronic



GU6212RWPC

Product code	Description	Pack qty
GU6212R*SS	Stainless steel	1
GU6212RBPC	Polished chrome with black interior	1
GU6212RWPW	Painted white with white interior	1
GU6000RC1R	1 channel IR remote control	1

- **Standard of compliance:** BS EN 60669-2-1
- **Mounting box:** 16mm deep (1-2 gang)
35mm deep (3-4 gang)
- **Fixing screws:** M3.5 x 25mm and 30mm
- **Plate dimensions:** 88 x 88mm (1-2 gang)
88 x 148mm (3-4 gang)
- **Technical notes:** All dimmers not suitable with CFL lighting.

Mains & low voltage and electronic dimmers not suitable for use with LED lamps.

Mains & low voltage dimmers - leading edge control.

LED dimmers - trailing edge control.

Dimmer technical information can be found in the technical data section towards the back of this catalogue.

- **Notes:** Retractive switches are required for Multi-Way Operation when using LED dimmers.

Polished brass white interior



Polished brass black interior



Polished chrome white interior



Polished chrome black interior



Pearl nickel white interior



Stainless steel white interior



Stainless steel black interior



Painted white white interior



Black nickel black interior



Control switches

20AX double-pole 1 gang



GU2210WPC

Product code	Description	Pack qty
GU2210*SS	Stainless steel	1
GU2210*PC	Polished chrome	1
GU2210WPW	Painted white with white interior	1
GU2210WPN	Pearl nickel with white interior	1
GU2210BBN	Black nickel with black interior	1
GU2210BPB	Polished brass with black insert	1

- **Standard of compliance:** BS EN 60669-1 (switches)
- **Mounting box:** 35mm deep
- **Fixing screws:** M3.5 x 25mm and 30mm
- **Plate dimensions:** 88 x 88mm

20AX double-pole 1 gang with neon



GU2211WPC

Product code	Description	Pack qty
GU2211*SS	Stainless steel	1
GU2211*PC	Polished chrome	1
GU2211WPW	Painted white with white interior	1
GU2211WPN	Pearl nickel with white interior	1
GU2211BBN	Black nickel with black interior	1
GU2211*PB	Polished brass	1

20AX double-pole 1 gang with flex outlet



GU2213WPC

Product code	Description	Pack qty
GU2213*SS	Stainless steel	1
GU2213*PC	Polished chrome	1
GU2213WPW	Painted white with white interior	1
GU2213BBN	Black nickel with black interior	1
GU2213BPB	Polished brass with black insert	1

20AX double-pole 1 gang with neon & flex outlet



GU2214WPC

Product code	Description	Pack qty
GU2214*SS	Stainless steel	1
GU2214WPC	Polished chrome with white interior	1
GU2214WPW	Painted white with white interior	1
GU2214WPN	Pearl nickel with white interior	1
GU2214BBN	Black nickel with black interior	1
GU2214BPB	Polished brass with black insert	1

20AX double-pole 1 gang with neon & flex outlet printed water heater



GU2214WHWPC

Product code	Description	Pack qty
GU2214WH*SS	Stainless steel	1
GU2214WHWPW	Painted white with white interior	1
GU2214WHBBN	Black nickel with black interior	1
GU2214WHBPB	Polished brass with black insert	1

Control switches continued

32A double-pole 1 gang with neon



GU4231WPC

Product code	Description	Pack qty
GU4231*SS	Stainless steel	1
GU4231*PC	Polished chrome	1
GU4231WPW	Painted white with white interior	1
GU4231WPN	Pearl nickel with white interior	1
GU4231BBN	Black nickel with black interior	1
GU4231WPB	Polished brass with white insert	1

Fused connection units

13A unswitched



GU5200WPC

Product code	Description	Pack qty
GU5200*SS	Stainless steel	1
GU5200*PC	Polished chrome	1
GU5200WPW	Painted white with white interior	1
GU5200WPN	Pearl nickel with white interior	1
GU5200BBN	Black nickel with black interior	1
GU5200*PB	Polished brass	1

- **Standard of compliance:** BS 1363
- **Mounting box:** 25mm deep (unswitched) 35mm deep (switched)
- **Fixing screws:** M3.5 x 25mm and 30mm
- **Plate dimensions:** 88 x 88mm

13A unswitched with flex outlet



GU5203WPC

Product code	Description	Pack qty
GU5203*SS	Stainless steel	1
GU5203*PC	Polished chrome	1
GU5203WPW	Painted white with white interior	1
GU5203WPN	Pearl nickel with white interior	1
GU5203BBN	Black nickel with black interior	1
GU5203BPB	Polished brass with black insert	1

13A double-pole switched



GU5210WPC

Product code	Description	Pack qty
GU5210*SS	Stainless steel	1
GU5210*PC	Polished chrome	1
GU5210WPW	Painted white with white interior	1
GU5210WPN	Pearl nickel with white interior	1
GU5210BBN	Black nickel with black interior	1
GU5210BPB	Polished brass with black insert	1

Polished brass white interior



Polished brass black interior



Polished chrome white interior



Polished chrome black interior



Pearl nickel white interior



Stainless steel white interior



Stainless steel black interior



Painted white white interior



Black nickel black interior



Fused connection units continued

13A double-pole switched with neon



GU5211WPC

Product code	Description	Pack qty
GU5211*SS	Stainless steel	1
GU5211*PC	Polished chrome	1
GU5211WPW	Painted white with white interior	1
GU5211WPN	Pearl nickel with white interior	1
GU5211BBN	Black nickel with black interior	1
GU5211BPB	Polished brass with black insert	1

- **Standard of compliance:**
BS 1363
- **Mounting box:**
25mm deep (unswitched)
35mm deep (switched)
- **Fixing screws:**
M3.5 x 25mm and 30mm
- **Plate dimensions:**
88 x 88mm

13A double-pole switched with flex outlet



GU5213WPC

Product code	Description	Pack qty
GU5213*SS	Stainless steel	1
GU5213*PC	Polished chrome	1
GU5213WPW	Painted white with white interior	1
GU5213WPN	Pearl nickel with white interior	1
GU5213BBN	Black nickel with black interior	1
GU5213 BPB	Polished brass with black insert	1

13A double-pole switched with neon & flex outlet



GU5214WPC

Product code	Description	Pack qty
GU5214*SS	Stainless steel	1
GU5214*PC	Polished chrome	1
GU5214WPW	Painted white with white interior	1
GU5214WPN	Pearl nickel with white interior	1
GU5214BBN	Black nickel with black interior	1
GU5214*PB	Polished brass with white insert	1

High current switches

50A 2 gang double-pole switches with neon



GU4221WPC

Product code	Description	Pack qty
GU4221*SS	Stainless steel	1
GU4221*PC	Polished chrome	1
GU4221WPW	Painted white with white interior	1
GU4221WPN	Pearl nickel with white interior	1
GU4221BBN	Black nickel with black interior	1
GU4221*PB	Polished brass	1

- **Standard of compliance:** BS EN 60669-1 (switches) BS 4177 (cooker control units)

- **Mounting box:** 47mm deep

- **Fixing screws:** M3.5 x 25mm and 30mm

- **Plate dimensions:** 148 x 88mm (switches), 88 x 148mm (cooker control units).

45A double-pole cooker control unit with 13A switched socket & neons



GU4201WPC

Product code	Description	Pack qty
GU4201*SS	Stainless steel	1
GU4201*PC	Polished chrome	1
GU4201WPW	Painted white with white interior	1
GU4201WPN	Pearl nickel with white interior	1
GU4201BBN	Black nickel with black interior	1

Shaver socket

115/230V dual voltage



GU7290WPC

Product code	Description	Pack qty
GU7290*SS	Stainless steel	1
GU7290*PC	Polished chrome	1
GU7290WPW	Painted white with white interior	1
GU7290WPN	Pearl nickel with white interior	1
GU7290BBN	Black nickel with black interior	1
GU7290*PB	Polished brass	1

- **Standard of compliance:** BS EN 61558-2-5

- **Mounting box:** 47mm deep

- **Fixing screws:** M3.5 x 25mm and 30mm

- **Plate dimensions:** 148 x 88mm

- **Technical notes:** Unique design allows perfect fit to 47mm box.

Telephone outlets

Single RJ11



GU7251WPC

Product code	Description	Pack qty
GU7251*SS	Stainless steel	1
GU7251WPC	Polished chrome with white interior	1
GU7251WPW	Painted white with white interior	1
GU7251WPN	Pearl nickel with white interior	1
GU7251BBN	Black nickel with black interior	1
GU7251*PB	Polished brass	1

- **Standard of compliance:** BS EN 41003
- **Mounting box:** Minimum 25mm deep
- GU7251***: minimum 35mm deep
- **Fixing screws:** M3.5 x 25mm and 30mm
- **Plate dimensions:** 88 x 88mm
- **Technical notes:** Refer to euro plates and modules section for combined telephone & data solutions.

Master BT telephone



GU7261WPC

Product code	Description	Pack qty
GU7261*SS	Stainless steel	1
GU7261*PC	Polished chrome	1
GU7261WPW	Painted white with white interior	1
GU7261WPN	Pearl nickel with white interior	1
GU7261BBN	Black nickel with black interior	1
GU7261BPB	Polished brass with black insert	1

Secondary BT telephone



GU7262WPC

Product code	Description	Pack qty
GU7262*SS	Stainless steel	1
GU7262*PC	Polished chrome	1
GU7262WPW	Painted white with white interior	1
GU7262WPN	Pearl nickel with white interior	1
GU7262BBN	Black nickel with black interior	1
GU7262*PB	Polished brass	1

Data outlets

RJ45 CAT5e



GU7271WPC

Product code	Description	Pack qty
GU7271*SS	Stainless steel	1
GU7271*PC	Polished chrome	1
GU7271WPW	Painted white with white interior	1
GU7271WPN	Pearl nickel with white interior	1
GU7271BBN	Black nickel with black interior	1
GU7271*PB	Polished brass	1

- **Standard of compliance:** BS EN 41003
- **Mounting box:** Minimum 25mm deep
- **Fixing screws:** M3.5 x 25mm and 30mm
- **Plate dimensions:** 88 x 88mm
- **Technical notes:** Refer to euro plates and modules section for combined telephone & data solutions.

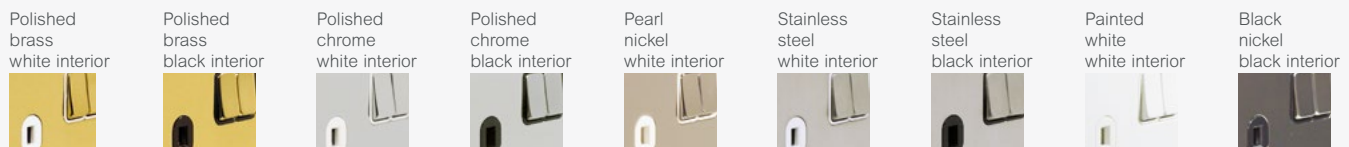

TV outlets / Coaxial sockets

Single TV/FM



GU7210WPC

Product code	Description	Pack qty
GU7210*SS	Stainless steel	1
GU7210WPC	Polished chrome with white interior	1
GU7210WPW	Painted white with white interior	1
GU7210WPN	Pearl nickel with white interior	1
GU7210BBN	Black nickel with black interior	1
GU7210BPB	Polished brass with black interior	1

Twin TV/FM



GU7220WPC

Product code	Description	Pack qty
GU7220BPC	Polished chrome with black interior	1
GU7220WPW	Painted white with white interior	1
GU7220BBN	Black nickel with black interior	1
GU7220*PB	Polished brass	1

Single Satellite



GU7230WPC

Product code	Description	Pack qty
GU7230*SS	Stainless steel	1
GU7230*PC	Polished chrome	1
GU7230WPW	Painted white with white interior	1
GU7230WPN	Pearl nickel with white interior	1

- **Standard of compliance:** BS 3041 (where applicable)
- **Mounting box:** 35mm deep
- **Fixing screws:** M3.5 x 25mm and 30mm
- **Plate dimensions:** 88 x 88mm
- **Technical notes:** Products are direct connection and are not suitable for common connection.

Euro modular plates & modules

1 gang euro plate, 1 module 25 x 50mm



GU8250PC

Product code	Description	Pack qty
GU8250SS	Stainless steel	1
GU8250PC	Polished chrome	1
GU8250PW	Painted white	1
GU8250PN	Pearl nickel	1
GU8250BN	Black nickel	1
GU8250PB	Polished brass	1

- **Mounting box:** Refer to module for appropriate mounting box depth
- **Plate dimensions:** 88 x 88mm (1 gang)
- **Technical notes:** Mounting grid supplied with euro plate.
- Euro modules plates compatible with Schneider Electric euro modules.
- **Note:** modules from other suppliers may not be compatible, it is advised to check suitability.

1 gang euro plate, 2 module 50 x 50mm



GU8260PC

Product code	Description	Pack qty
GU8260SS	Stainless steel	1
GU8260PC	Polished chrome	1
GU8260PW	Painted white	1
GU8260PN	Pearl nickel	1
GU8260BN	Black nickel	1
GU8260PB	Polished brass	1

2 gang euro plate, 4 module 100 x 50mm



GU8280PC

Product code	Description	Pack qty
GU8280SS	Stainless steel	1
GU8280PC	Polished chrome	1
GU8280PW	Painted white	1
GU8280PN	Pearl nickel	1
GU8280BN	Black nickel	1
GU8280PB	Polished brass	1

- **Mounting box:** Refer to module for appropriate mounting box depth
- **Plate dimensions:** 88 x 148mm (2 gang)
- **Technical notes:** Mounting grid supplied with euro plate.
- Euro modules plates compatible with Schneider Electric euro modules.
- **Note:** modules from other suppliers may not be compatible, it is advised to check suitability.

Polished brass white interior



Polished brass black interior



Polished chrome white interior



Polished chrome black interior



Pearl nickel white interior



Stainless steel white interior



Stainless steel black interior



Painted white white interior



Black nickel black interior



Euro modular plates & modules continued

25 x 50mm euro modules



GUE7073B GUE7072W



GUE7061B



VDIB1771XB12

Product code	Description	Pack qty
GUE7011*	Single IEC coax (female)	1
GUE7012*	25 x 50mm euro modules IEC coax (male)	1
GUE7030*	Single F type sat	1
GUE7061*	BT master telephone	1
GUE7062*K	BT secondary telephone	1
GUE7071*	RJ45 CAT5e (not screened)	1
GUE7072*	RJ45 CAT5 (not screened)	1
GUE7073*	Single USB charger 1A 5Vdc	1
GUE7021*	Single USB charger 2.1A	1
GUE7051*	RJ11 modem	1
GUE7091W	Actassi module carrier for VDIB1771XB12	8
VDIB1771XB12	Actassi S-One Connector RJ45 CAT6A shielded	12
GUE7000*	2 x Phono socket	1
GUE7001*	2 x Loudspeaker socket	1
GUE8010*	Blank module	5

- **Mounting box:**
25mm deep (25 x 50mm modules)
- **Euro module dimensions:**
25 x 50mm (single)

50 x 50mm euro modules



GUE7020B GUE7081W



GUE7010B

Product code	Description	Pack qty
GUE7010*	TV/FM diplexer	1
GUE7040*	TV/Sat diplexer	1
GUE7074*	Twin USB charger 2 x 1A 5Vdc	1
GUE7031*	Twin USB charger 2 x 3.1A	1
GUE7081*	TV/FM/Sat triplexer	1
GUE7082*	TV/FM/Sat1/Sat2 quadplexer	1
GUE7020*	HDMI	1
GUE7078*	American power socket**	1
GUE7076*	Brush outlet**	1
GUE7077*	5A round pin socket**	1

- **Mounting box:**
35mm deep (25 x 50mm modules)
- **Euro module dimensions:**
50 x 50mm (double)
- ****Made-to-order products**
Subject to minimum order quantities and extended lead time. Contact 0870 608 8 608 for a quotation.

Blank plates & accessories

1 gang



GU8210PC

Product code	Description	Pack qty
GU8210SS	Stainless steel	1
GU8210PC	Polished chrome	1
GU8210PW	Painted white	1
GU8210PN	Pearl nickel	1
GU8210BN	Black nickel	1
GU8210PB	Polished brass	1

- **Standard of compliance:** BS 5733
- **Fixing screws:** M3.5 x 25mm and 30mm
- **Plate dimensions:** 88 x 88mm (1 gang)
88 x 148mm (2 gang)

2 gang



GU8220PC

Product code	Description	Pack qty
GU8220SS	Stainless steel	1
GU8220PC	Polished chrome	1
GU8220PW	Painted white	1
GU8220PN	Pearl nickel	1
GU8220BN	Black nickel	1
GU8220PB	Polished brass	1

Spares

Product code	Description	Pack qty
3746130	M3.5 x 25mm raised head machine screws	100
USCREW50**	M3.5 x 50mm screws	100

Grid plates

1 gang 88 x 88mm



GUG01GSS

Product code	Description	Pack qty
GUG01GSS	Stainless steel	1
GUG01GMS	Mirror steel	1
GUG01GPW	Painted white	1
GUG01GPN	Pearl nickel	1
GUG01GBN	Black nickel	1
GUG01GPB	Polished brass	1
GBG01	76 x 76 x 42mm back box	1

- **Mounting box:** 42mm deep
- **Technical notes:** All grid plates are supplied with the appropriate number of mounting frames.
Mirror steel used for polished chrome grid plates & modules.

2 gang 88 x 88mm



GUG02GMS

Product code	Description	Pack qty
GUG02GSS	Stainless steel	1
GUG02GMS	Mirror steel	1
GUG02GPW	Painted white	1
GUG02GPN	Pearl nickel	1
GUG02GBN	Black nickel	1
GUG02GPB	Polished brass	1
GBG01	76 x 76 x 42mm back box	1

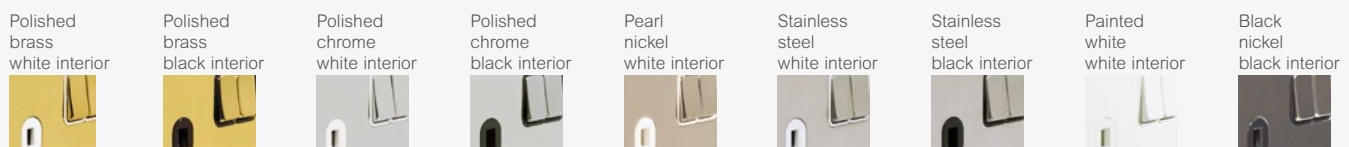

Grid plates continued

3 gang 88 x 148mm



GUG03GMS

Product code	Description	Pack qty
GUG03GSS	Stainless steel	1
GUG03GMS	Mirror steel	1
GUG03GPW	Painted white	1
GUG03GPN	Pearl nickel	1
GUG03GBN	Black nickel	1
GUG03GPB	Polished brass	1
GBG02	136 x 76 x 42mm back box	1

- **Mounting box:**
42mm deep

- **Technical notes:**
All grid plates are supplied with the appropriate number of mounting frames.

Mirror steel used for polished chrome grid plates & modules.

4 gang 88 x 148mm



GUG04GMS

Product code	Description	Pack qty
GUG04GSS	Stainless steel	1
GUG04GMS	Mirror steel	1
GUG04GPW	Painted white	1
GUG04GPN	Pearl nickel	1
GUG04GBN	Black nickel	1
GUG04GPB	Polished brass	1
GBG02	136 x 76 x 42mm back box	1

6 gang 156 x 156mm



GUG06GMS

Product code	Description	Pack qty
GUG06GSS	Stainless steel	1
GUG06GMS	Mirror steel	1
GUG06GPW	Painted white	1
GUG06GPN	Pearl nickel	1
GUG06GBN	Black nickel	1
GUG06GPB	Polished brass	1
GBG03	136 x 136 x 42mm back box	1

8 gang 156 x 156mm



GUG08GMS

Product code	Description	Pack qty
GUG08GSS	Stainless steel	1
GUG08GMS	Mirror steel	1
GUG08GPW	Painted white	1
GUG08GPN	Pearl nickel	1
GUG08GBN	Black nickel	1
GUG08GPB	Polished brass	1
GBG03	136 x 136 x 42mm back box	1

9 gang 216 x 156mm



GUG09GMS

Product code	Description	Pack qty
GUG09GSS	Stainless steel	1
GUG09GMS	Mirror steel	1
GUG09GPW	Painted white	1
GUG09GPN	Pearl nickel	1
GUG09GBN	Black nickel	1
GUG09GPB	Polished brass	1
GBG04F	193 x 133 x 42mm back box	1

Grid plates continued

12 gang 216 x 156mm



GUG12GMS

Product code	Description	Pack qty
GUG12GSS	Stainless steel	1
GUG12GMS	Mirror steel	1
GUG12GPW	Painted white	1
GUG12GPN	Pearl nickel	1
GUG12GBN	Black nickel	1
GUG12GPB	Polished brass	1
GBG04F	193 x 133 x 42mm back box	1

- **Mounting box:**
42mm deep
- **Technical notes:**
All grid plates are supplied with the appropriate number of mounting frames.

Mirror steel used for polished chrome grid plates & modules.

18 gang 398 x 156mm



GUG18GMS

Product code	Description	Pack qty
GUG18GSS	Stainless steel	1
GUG18GMS	Mirror steel	1
GUG18GPW	Painted white	1
GUG18GPN	Pearl nickel	1
GUG18GBN	Black nickel	1
GUG18GPB	Polished brass	1
GBG06F	374 x 133 x 42mm back box	1

24 gang 398 x 156mm



GUG24GMS

Product code	Description	Pack qty
GUG24GSS	Stainless steel	1
GUG24GMS	Mirror steel	1
GUG24GPW	Painted white	1
GUG24GPN	Pearl nickel	1
GUG24GBN	Black nickel	1
GUG24GPB	Polished brass	1
GBG06F	374 x 133 x 42mm back box	1

Customisable switch grid modules

10AX metal switch module components (white or black surrounds)



GUG102MB GUG101MW

Product code	Description	Pack qty
GUG101M*	10AX 1 way SP	1
GUG102M*	10AX 2 way SP	1
GUG101M*	10AX intermediate SP	1

20AX metal switch module components (white or black surrounds)



GUG2020MB GUG20DPMW

Product code	Description	Pack qty
GUG201M*	20AX 1 way SP	1
GUG2020M*	20AX 2 way and centre off	1
GUG202M*	20AX 2 way SP	1
GUG20DPM*	20AX DP	1

- **Standard of compliance:** BS EN 60669-1
- **Mounting box:** 42mm deep
- **Technical notes:** 10AX & 20AX metal switch module components available in black or white.
- Clear terminal marking printed onto grey switch module component back mouldings ensures easy identification.
- Pre-printed rocker caps.
- Easy assembly.

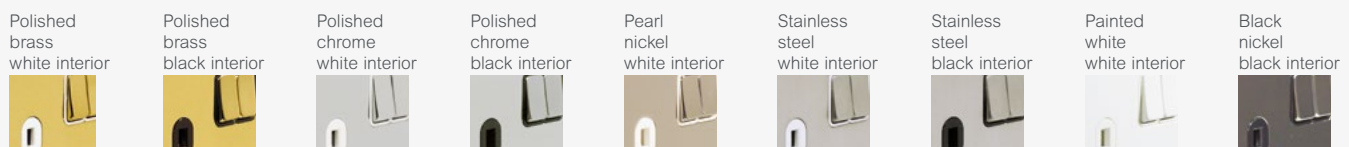
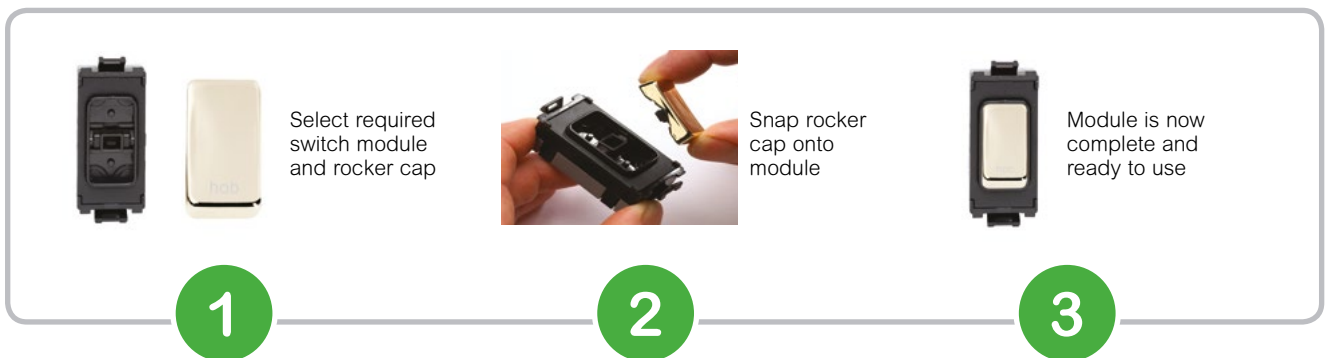

Plain and printed rocker caps for component modules



	Stainless Steel	Mirror Steel	Polished Brass	Pearl Nickel	Painted White	Black Nickel	Painted Black
Plain rocker cap	GUGRSS	GUGRMS	GUGRPB	GUGRPN	GUGRPW	GUGRBN	GUGRBLK
Rocker cap printed boiler	GUGRBOSS	GUGRBOMS		GUGRBOPN	GUGRBOPW	GUGRBOBN	GUGRBOBLK
Rocker cap printed cooker hood	GUGRCHSS	GUGRCHMS		GUGRCHPN	GUGRCHPW	GUGRCHBN	GUGRCHBLK
Rocker cap printed dish washer	GUGRDWSS	GUGRDWMS	GUGRDWPB	GUGRDWPN	GUGRDWPW	GUGRDWBN	GUGRDWBK
Rocker cap printed extractor fan	GUGREFSS	GUGREFMS	GUGREFPB	GUGREFPN	GUGREFPW	GUGREFBN	GUGREFBLK
Rocker cap printed fridge	GUGRFRSS	GUGRFRMS	GUGRFRPB	GUGRFRPN	GUGRFRPW	GUGRFRBN	GUGRFRBLK
Rocker cap printed fan	GUGRFASS	GUGRFAMS	GUGRFAPB	GUGRFAPN	GUGRFAPW	GUGRFABN	GUGRFABLK
Rocker cap printed freezer	GUGRFZSS	GUGRFZMS	GUGRFZPB	GUGRFZPN	GUGRFZPW	GUGRFZBN	GUGRFZBLK
Rocker cap printed fridge/freezer	GUGRFRFZSS	GUGRFRFZMS	GUGRFRFZPB	GUGRFRFZPN	GUGRFRFZPW	GUGRFRFZBN	GUGRFRFZBLK
Rocker cap printed hob	GUGRHOSS	GUGRHOMS		GUGRHOPN	GUGRHOPW	GUGRHOBN	GUGRHOBK
Rocker cap printed heater	GUGRHESS	GUGRHEMS		GUGRHEPN	GUGRHEPW	GUGRHEBN	GUGRHEBK
Rocker cap printed microwave	GUGRMWSS	GUGRMWMS	GUGRMWPB	GUGRMWPN	GUGRMWPW	GUGRMWBN	GUGRMWBK
Rocker cap printed oven	GUGROVSS	GUGROVMS		GUGROVPN	GUGROVPW	GUGROVBN	GUGROVBK
Rocker cap printed tumble dryer	GUGRTDSS	GUGRTDMS	GUGRTDPB	GUGRTDPN	GUGRTDPW	GUGRTDBN	GUGRTDBK
Rocker cap printed washer dryer	GUGRWDYSS	GUGRWDYMS		GUGRWDYPN	GUGRWDYPW	GUGRWDYBN	GUGRWDYBK
Rocker cap printed waste disposal	GUGRWDSS	GUGRWDMS		GUGRWDPN	GUGRWDPW	GUGRWDNB	GUGRWDNBK
Rocker cap printed washing machine	GUGRWMSS	GUGRWMMS	GUGRWMPB	GUGRWMPN	GUGRWMPW	GUGRWMBN	GUGRWMBK

Retractive & toggle switch grid modules

6A 2 way retractive and centre off



GUG202OCBSS

Product code	Description	Pack qty
GUG202OC*SS	Stainless steel	1
GUG202OC*MS	Mirror steel	1
GUG202OCWPW	Painted white with white interior	1
GUG202OCWPN	Pearl nickel with white interior	1
GUG202OCBBN	Black nickel with black interior	1
GUG202OC*PB	Polished brass	1

- **Standard of compliance:** BS EN 60669-1
- **Mounting box:** 42mm deep
- **Technical notes:** Mirror steel used for polished chrome grid plates & modules.

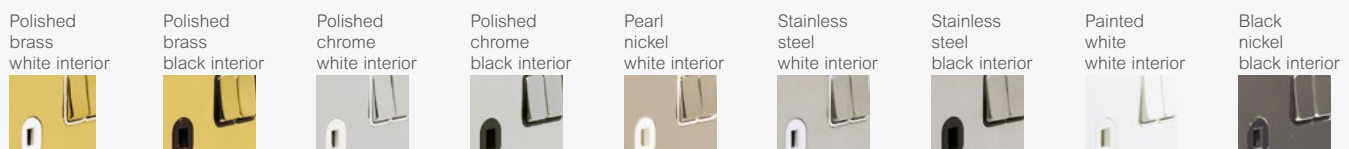

Retractive & toggle switch grid modules continued

10A 2 way retractive single-pole



GUG102RBSS

Product code	Description	Pack qty
GUG102R*SS	Stainless steel	1
GUG102R*MS	Mirror steel	1
GUG102RWPW	Painted white with white interior	1
GUG102RWPN	Pearl nickel with white interior	1
GUG102RBBN	Black nickel with black interior	1
GUG102R*PB	Polished brass	1

- **Standard of compliance:**
BS EN 60669-1
- **Mounting box:**
42mm deep
- **Technical notes:**
Mirror steel used for polished chrome grid plates & modules.

10AX way single-pole toggle



GUG102TBSS

Product code	Description	Pack qty
GUG102T*SS	Stainless steel	1
GUG102T*MS	Mirror steel	1
GUG102TWPW	Painted white with white interior	1
GUG102TWPN	Pearl nickel with white interior	1
GUG102TBBN	Black nickel with black interior	1
GUG102TBPB	Polished brass with black interior	1

10AX intermediate toggle



GUG101TBSS

Product code	Description	Pack qty
GUG101T*SS	Stainless steel	1
GUG101T*MS	Mirror steel	1
GUG101TWPW	Painted white with white interior	1
GUG101TWPN	Pearl nickel with white interior	1
GUG101TBBN	Black nickel with black interior	1
GUG101TBPB	Polished brass with black interior	1

Key switch grid modules

20AX 1 way key operated double-pole



GUG20DPKBSS

Product code	Description	Pack qty
GUG20DPK*SS	Stainless steel	1
GUG20DPK*MS	Mirror steel	1
GUG20DPKWPW	Painted white with white interior	1
GUG20DPKWPN	Pearl nickel with white interior	1
GUG20DPKBBN	Black nickel with black interior	1
GUGKSK	Spare key for SW module	1

- **Standard of compliance:** BS EN 60669-1
- **Mounting box:** 42mm deep
- **Technical notes:** Mirror steel used for polished chrome grid plates & modules.

20AX 2 way key operated



GUG202KBSS

Product code	Description	Pack qty
GUG202K*SS	Stainless steel	1
GUG202K*MS	Mirror steel	1
GUG202KWPW	Painted white with white interior	1
GUG202KWPN	Pearl nickel with white interior	1
GUG202KBBN	Black nickel with black interior	1
GUG202KBPB	Polished brass with black interior	1
GUGKSK	Spare key for SW module	1

20AX 2 way key operated printed red TEST EMG LTG



GUG202KELBSS



GUGKSK

Product code	Description	Pack qty
GUG202KEL*SS	Stainless steel	1
GUG202KEL*MS	Mirror steel	1
GUG202KELWPW	Painted white with white interior	1
GUG202KELWPN	Pearl nickel with white interior	1
GUG202KELBBN	Black nickel with black interior	1
GUGKSK	Spare key for SW module	1

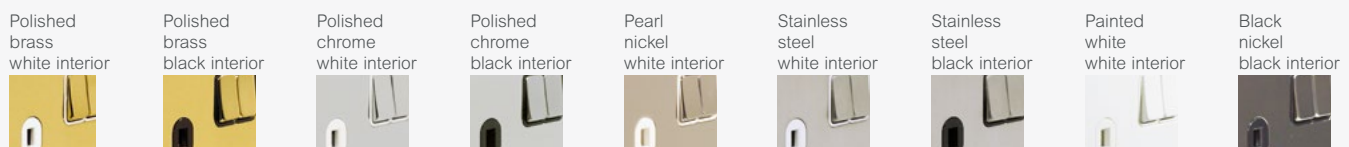

Telephone grid modules

BT master telephone



GUGTELMBSS

Product code	Description	Pack qty
GUGTELM*SS	Stainless steel	1
GUGTELM*MS	Mirror steel	1
GUGTELMWPW	Painted white with white interior	1
GUGTELMWPN	Pearl nickel with white interior	1
GUGTELMBBN	Black nickel with black interior	1

- **Standard of compliance:** BS EN 3041 (where applicable)
- **Mounting box:** 42mm deep
- **Technical notes:** Mirror steel used for polished chrome grid plates & modules.

BT secondary telephone



GUGTELSBSS

Product code	Description	Pack qty
GUGTELS*SS	Stainless steel	1
GUGTELS*MS	Mirror steel	1
GUGTELSWPW	Painted white with white interior	1
GUGTELSWPN	Pearl nickel with white interior	1
GUGTELSBBN	Black nickel with black interior	1
GUGTELSBPB	Polished brass with black interior	1

RJ11 telephone



GUGRJ11BSS

Product code	Description	Pack qty
GUGRJ11BSS	Stainless steel with black interior	1
GUGRJ11WPW	Painted white with white interior	1

Data & TV grid modules

RJ45 CAT5e



GUGRJ45BSS

Product code	Description	Pack qty
GUGRJ45WSS	Stainless steel with white interior	1
GUGRJ45*MS	Mirror steel	1
GUGRJ45WPW	Painted white with white interior	1
GUGRJ45BBN	Black nickel with black interior	1
GUGRJ45BPB	Polished brass with black interior	1

- **Standard of compliance:** BS EN 3041 (where applicable)
- **Mounting box:** 42mm deep
- **Technical notes:** Mirror steel used for polished chrome grid plates & modules.

Direct coaxial TV



GUGCOBSS

Product code	Description	Pack qty
GUGCO*SS	Stainless steel	1
GUGCPBMS	Mirror steel with black interior	1
GUGCOWPW	Painted white with white interior	1
GUGCOWPN	Pearl nickel with white interior	1
GUGCOBBN	Black nickel with black interior	1

F type satellite



GUGSATBSS

Product code	Description	Pack qty
GUGSAT*SS	Stainless steel	1
GUGSATBMS	Mirror steel with black interior	1
GUGSATWPW	Painted white with white interior	1
GUGSATWPN	Pearl nickel with white interior	1
GUGSATBBN	Black nickel with black interior	1
GUGSATBPB	Polished brass with black interior	1

Electronic dimmer grid modules

300W/VA universal multiway touch dimmer module



GUGEMDIMWPW16

Product code	Description	Pack qty
GUGEMDIM*SS16	Stainless steel	1
GUGEMDIMWPW16	Painted white with white interior	1
GUGEMDIMBBN16	Black nickel with black interior	1
GUGEMDIMWMS16	Mirror steel with white interior	1

- **Mounting box:**
42mm deep
- **Technical notes:**
Min load 60W/50VA.

300W/VA universal multiway touch dimmer module with infra red remote option



GUGEMRDIMB16

Product code	Description	Pack qty
GUGEMRDIMW16	White moulded	1
GUGEMRDIMB16	Black moulded	1
GU6000RC1R	1 channel IR remote control	1

- Electronic modules are capable of 2 way or multiway dimming.
- Not compatible with moulded grid plates.
- Modules will require derating when used in multi-gang applications.

LED electronic grid dimmer



GGBGUGEMDIMLBPC

Product code	Description	Pack qty
GGBGUGEMDIMLBPB	Polished brass with black interior	1
GGBGUGEMDIML*PC	Polished chrome	1
GGBGUGEMDIMLWPN	Pearl nickel with white interior	1
GGBGUGEMDIML*SS	Stainless steel	1
GGBGUGEMDIMLWPW	Painted white with white interior	1
GGBGUGEMDIMLBBN	Black nickel with black interior	1

- **Standard of compliance:**
BS EN 60669-2-1.
- **Technical notes:**
Not suitable with compact fluorescent (CFL) or motor loads.
- Trailing edge control. Retractive switches are required for 2 way configurations.

50mA 2 way & multiway retractive switch module



GUGEMWWPN

Product code	Description	Pack qty
GUGEMW*SS	Stainless steel	1
GUGEMW*MS	Mirror steel	1
GUGEMWWPW	Painted white with white interior	1
GUGEMWWPN	Pearl nickel with white interior	1
GUGEMWBBN	Black nickel with black interior	1

- Retractive switch for use with electronic dimmers only.

Fuse carrier, flex outlet & blank grid modules

13A fuse carrier



GUG13FCUBSS

Product code	Description	Pack qty
GUG13FCU*SS	Stainless steel	1
GUG13FCU*MS	Mirror steel	1
GUG13FCUWPPW	Painted white with white interior	1
GUG13FCUWPN	Pearl nickel with white interior	1
GUG13FCUBBN	Black nickel with black interior	1
GUG13FCU*PB	Polished brass	1

- **Standard of compliance:**
BS 1363 (fuse carrier)
BS 5733
- **Mounting box:**
42mm deep
- **Technical notes:**
Full metal surround on all modules.
Modules are completely interchangeable.

Mirror steel used for polished chrome grid plates & modules.

Flex outlet up to 10mm diameter



GUG16COBSS

Product code	Description	Pack qty
GUG16CO*SS	Stainless steel	1
GUG16COBMS	Mirror steel with black interior	1
GUG16COWPW	Painted white with white interior	1
GUG16COWPN	Pearl nickel with white interior	1
GUG16COBBN	Black nickel with black interior	1
GUG16CO*PB	Polished brass	1

Blank



GUGBBSS

Product code	Description	Pack qty
GUGB*SS	Stainless steel	1
GUGB*MS	Mirror steel	1
GUGBWPW	Painted white with white interior	1
GUGBWPN	Pearl nickel with white interior	1
GUGBBBN	Black nickel with black interior	1
GUGBBPB	Polished brass with black interior	1
GUGB*	Moulded plastic (black or white)	1

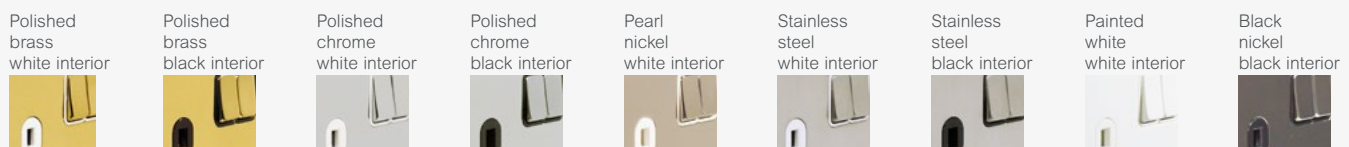

Indicator modules

White surround



Product code	Description	Pack qty
GUGINDWG	Green indicator	1
GUGINDWR	Red indicator	1
GUGINDWO	Orange indicator	1

- **Standard of compliance:** BS 5733
- **Technical notes:** 240V

Black surround



Product code	Description	Pack qty
GUGINDBG	Green indicator	1
GUGINDBR	Red indicator	1
GUGINDBO	Orange indicator	1

Flush galvanised steel boxes

16mm deep



SB161

Product code	Description	Pack qty
SB161	1 gang	20

- **Standard of compliance:** BS4662
- **Technical notes:** Supplied with earth terminal and screw.

25mm deep

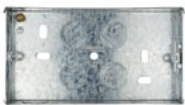

SB252

Product code	Description	Pack qty
SB251	1 gang	10
SB252	2 gang	10

Supplied with fixed and adjustable lugs.

Fitted with selection of 20mm knockouts in sides and back.

35mm deep



SB351

Product code	Description	Pack qty
SB351	1 gang	10
SB352	2 gang	5

47mm deep



SB472

Product code	Description	Pack qty
SB471	1 gang	10
SB472	2 gang	4

Ultimate Low Profile

An ideal upgrade solution for remodel and renovation projects, Ultimate Low Profile offers a contemporary and refreshing twist on traditional designs with its softly curved edge and quality metal finishes.

The forgiving 5mm plate depth provides generous wiring space and is useful when presented with uneven wall surfaces.

5mm raised edge offers easy installation access for new developments and remodel projects.

Consistent profiles throughout the range allow accessories to be mounted adjacently.

Colour-matched flat headed screws and eyelets add a finished touch, while limiting the amount of tools needed for installation.

Large plate footprint provides extra strength and reduces the need for additional decorating.

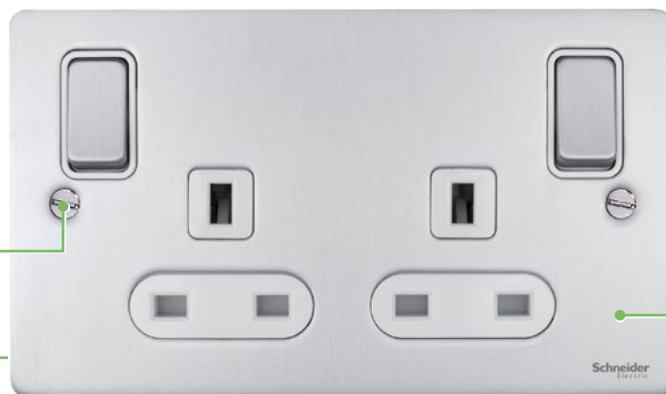

Colour coded socket terminals and printed terminal numbering ensure that cable installation is simple and straight forward.

Long and short screws supplied with all low profile accessories for installation adjacently.

Plated earth straps prevent corrosion, while inline angled terminals offer easy cable access during installation.

Specification Highlights:



16AX switch rating across all plate switches offers a future-proofed lighting solution to accommodate increased load requirements & fluorescent lighting demands.



50A rated plate switches for switching appliances with higher current ratings, such as heaters, cookers and commercial refrigerating units.



Choose from a wide range of printed rocker caps to meet your customer requirements, with bespoke options available.



Socket outlets

13A 1 gang single-pole switched



GU3510BBC

Product code	Description	Pack qty
GU3510*BC	Brushed chrome	1
GU3510*PC	Polished chrome	1

13A 2 gang single-pole switched



GU3520BBC

Product code	Description	Pack qty
GU3520*BC	Brushed chrome	1
GU3520*PC	Polished chrome	1

13A 2 gang switched USB socket



GGBGU35202USBBBC

Product code	Description	Pack qty
GGBGU35202USBWPC	Polished chrome	1
GGBGU35202USB*BC	Brushed chrome	1

13A 2 gang double-pole switched with outboard rockers



GU3530BBC

Product code	Description	Pack qty
GU3530*BC	Brushed chrome	1
GU3530*PC	Polished chrome	1

5A unswitched round pin



GU3580BBC

Product code	Description	Pack qty
GU3580*BC	Brushed chrome	1
GU3580*PC	Polished chrome	1

Shelf frames for socket outlets



GGBGUSHF1GS

Product code	Description	Pack qty
GGBGUSHF1GS	1 gang white	1
GGBGUSHF1GBS	1 gang black	1
GGBGUSHF2GS	2 gang white	1
GGBGUSHF2GBS	2 gang black	1

- **Standard of compliance:**
BS 1363 (13A)
BS 546 (round pin)
- **Mounting box:**
Minimum 25mm deep
- **Fixing screws:**
M3.5 x 25mm and 30mm
- **Plate dimensions:**
88 x 88mm (1 gang)
88 x 148mm (2 gang)
- **Technical notes:**
All 2 gang sockets supplied with twin earth terminals as standard.

Polished chrome white interior



Polished chrome black interior



Brushed chrome white interior



Brushed chrome black interior



Plate switches

16AX 1 gang 2 way



GU1512BBC

Product code	Description	Pack qty
GU1512*BC	Brushed chrome	1
GU1512*PC	Polished chrome	1

16AX 1 gang intermediate



GU1514BBC

Product code	Description	Pack qty
GU1514*BC	Brushed chrome	1
GU1514*PC	Polished chrome	1

16AX 2 gang 2 way



GU1522BBC

Product code	Description	Pack qty
GU1522*BC	Brushed chrome	1
GU1522*PC	Polished chrome	1

16AX 3 gang 2 way



GU1532BBC

Product code	Description	Pack qty
GU1532*BC	Brushed chrome	1
GU1532*PC	Polished chrome	1

16AX 4 gang 2 way



GU1542BBC

Product code	Description	Pack qty
GU1542*BC	Brushed chrome	1
GU1542*PC	Polished chrome	1

10A triple pole isolator



GU1513BBC

Product code	Description	Pack qty
GU1513*BC	Brushed chrome	1
GU1513*PC	Polished chrome	1

- **Standard of compliance:**
BS EN 60669-1
- **Mounting box:**
16mm deep (1-2 gang)
- **Fixing screws:**
M3.5 x 25mm and 30mm
- **Plate dimensions:**
88 x 88mm (1-3 gang)

- **Standard of compliance:**
BS EN 60669-1
BS EN 60947-3 (GU1513***)
- **Mounting box:**
25mm deep (3-4 gang)
- **Fixing screws:**
M3.5 x 25mm and 30mm
- **Plate dimensions:**
88 x 88mm (1-3 gang),
88 x 148mm (4 gang)

Dimmer switches

1 gang 2 way 400W/VA mains & low voltage



GU6512CBC

Product code	Description	Pack qty
GU6512CBC	Brushed chrome	1
GU6512CPC	Polished chrome	1

2 gang 2 way 250W/VA mains & low voltage



GU6522CBC

Product code	Description	Pack qty
GU6522CBC	Brushed chrome	1
GU6522CPC	Polished chrome	1

3 gang 2 way 250W/VA mains & low voltage



GU6532CBC

Product code	Description	Pack qty
GU6532CBC	Brushed chrome	1
GU6532CPC	Polished chrome	1

- **Standard of compliance:**
BS EN 60669-2-1
- **Mounting box:**
25mm deep (1-2 gang)
35mm deep (3 gang)
- **Fixing screws:**
M3.5 x 25mm and 30mm
- **Plate dimensions:**
88 x 88mm (1-2 gang)
88 x 148mm (3 gang)
- **Technical notes:**
All dimmers not suitable with CFL lighting.

Mains & low voltage and electronic dimmers not suitable for use with LED lamps.

Mains & low voltage dimmers - leading edge control.

Control switches

20AX double-pole 1 gang with neon



GU2511BBC

Product code	Description	Pack qty
GU2511*BC	Brushed chrome	1
GU2511*PC	Polished chrome	1

20AX double-pole 1 gang with flex outlet



GU2513BBC

Product code	Description	Pack qty
GU2513*BC	Brushed chrome	1
GU2513*PC	Polished chrome	1

- **Standard of compliance:**
BS EN 60669-1
- **Mounting box:**
35mm deep
- **Fixing screws:**
M3.5 x 25mm and 30mm
- **Plate dimensions:**
88 x 88mm

Fused connection units

13A unswitched



GU5500BBC

Product code	Description	Pack qty
GU5500*BC	Brushed chrome	1
GU5500*PC	Polished chrome	1

13A double-pole switched



GU5510BBC

Product code	Description	Pack qty
GU5510*BC	Brushed chrome	1
GU5510*PC	Polished chrome	1

13A double-pole switched with neon



GU5511BBC

Product code	Description	Pack qty
GU5511*BC	Brushed chrome	1
GU5511*PC	Polished chrome	1

13A double-pole switched with neon & flex outlet



GU5514BBC

Product code	Description	Pack qty
GU5514*BC	Brushed chrome	1
GU5514*PC	Polished chrome	1

- **Standard of compliance:** BS 1363
- **Mounting box:** 25mm deep (unswitched) 35mm deep (switched)
- **Fixing screws:** M3.5 x 25mm and 30mm
- **Plate dimensions:** 88 x 88mm

High current switches

50A 2 gang double-pole switches with neon



GU4521BBC

Product code	Description	Pack qty
GU4521*BC	Brushed chrome	1
GU4521*PC	Polished chrome	1

45A double-pole cooker control unit with 13A switched socket & neons



GU4501BBC

Product code	Description	Pack qty
GU4501*BC	Brushed chrome	1
GU4501*PC	Polished chrome	1

- **Standard of compliance:** BS EN 60669-1 (switches) BS 4177 (cooker control units).
- **Mounting box:** 47mm deep
- **Fixing screws:** M3.5 x 25mm and 30mm
- **Plate dimensions:** 148 x 88mm (switches), 88 x 148mm (cooker control units)

Shaver socket

115/230V dual voltage



GU7590BBC

Product code	Description	Pack qty
GU7590*BC	Brushed chrome	1
GU7590*PC	Polished chrome	1

- **Standard of compliance:** BS EN 61558-2-5
- **Mounting box:** 47mm deep
- **Fixing screws:** M3.5 x 25mm and 30mm
- **Plate dimensions:** 148 x 88mm
- **Technical notes:** Unique design allows perfect fit to 47mm box.

Telephone outlets

Master BT telephone



GU7561BBC

Product code	Description	Pack qty
GU7561*BC	Brushed chrome	1
GU7561*PC	Polished chrome	1

- **Standard of compliance:** BS EN 41003
- **Mounting box:** Minimum 25mm deep
- **Fixing screws:** M3.5 x 25mm and 30mm
- **Plate dimensions:** 88 x 88mm
- **Technical notes:** Refer to euro plate & modules section for combined telephone & data solutions.

Secondary BT telephone



GU7562BBC

Product code	Description	Pack qty
GU7562*BC	Brushed chrome	1
GU7562*PC	Polished chrome	1

TV outlets / Coaxial sockets

Single TV/FM



GU7510BBC

Product code	Description	Pack qty
GU7510*BC	Brushed chrome	1
GU7510*PC	Polished chrome	1

- **Standard of compliance:** BS 3041 (where applicable)
- **Mounting box:** 25mm deep
- **Fixing screws:** M3.5 x 25mm and 30mm
- **Plate dimensions:** 88 x 88mm
- **Technical notes:** Products are direct connection and not suitable for common connection.

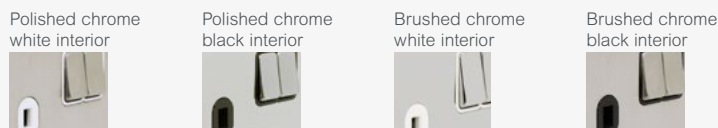

Euro modular plates & modules

1 gang euro plate, 1 module 25 x 50mm



GU8550PC

Product code	Description	Pack qty
GU8550BC	Brushed chrome	1
GU8550PC	Polished chrome	1

1 gang euro plate, 2 module 50 x 50mm



GU8560PC

Product code	Description	Pack qty
GU8560BC	Brushed chrome	1
GU8560PC	Polished chrome	1

2 gang euro plate, 4 module 100 x 50mm



GU8580BC

Product code	Description	Pack qty
GU8580BC	Brushed chrome	1
GU8580PC	Polished chrome	1

- **Mounting box:** Refer to module for appropriate mounting box depth.
- **Plate dimensions:** 88 x 88mm (1 gang)
88 x 148mm (2 gang)
- **Technical notes:** Mounting grid supplied with euro plate.
- Euro modules plates compatible with Schneider Electric euro modules.
- **Note:** modules from other suppliers may not be compatible, it is advised to check suitability.

Polished chrome
white interior



Polished chrome
black interior



Brushed chrome
white interior



Brushed chrome
black interior



Euro modular plates & modules continued

25 x 50mm euro modules



Product code	Description	Pack qty
GUE7011*	Single IEC coax (female)	1
GUE7012*	25 x 50mm euro modules IEC coax (male)	1
GUE7030*	Single F type sat	1
GUE7061*	BT master telephone	1
GUE7062*K	BT secondary telephone	1
GUE7071*	RJ45 CAT5e (not screened)	1
GUE7072*	RJ45 CAT5 (not screened)	1
GUE7073*	Single USB charger 1A 5Vdc	1
GUE7021*	Single USB charger 2.1A	1
GUE7051*	RJ11 modem	1
GUE7091W	Actassi module carrier for VDIB1771XB12	8
VDIB1771XB12	Actassi S-One Connector RJ45 CAT6A shielded	12
GUE7000*	2 x Phono socket	1
GUE7001*	2 x Loudspeaker socket	1
GUE8010*	Blank module	5

- **Mounting box:**
25mm deep (25 x 50mm modules)
- **Euro module dimensions:**
25 x 50mm (single)

50 x 50mm euro modules



Product code	Description	Pack qty
GUE7010*	TV/FM diplexer	1
GUE7040*	TV/Sat diplexer	1
GUE7074*	Twin USB charger 2 x 1A 5Vdc	1
GUE7031*	Twin USB charger 2 x 3.1A	1
GUE7081*	TV/FM/Sat triplexer	1
GUE7082*	TV/FM/Sat1/Sat2 quadplexer	1
GUE7020*	HDMI	1
GUE7078*	American power socket**	1
GUE7076*	Brush outlet**	1
GUE7077*	5A round pin socket**	1

- **Mounting box:**
35mm deep (25 x 50mm modules)
- **Euro module dimensions:**
50 x 50mm (double)
- ****Made-to-order products**
Subject to minimum order quantities and extended lead time. Contact 0870 608 8608 for a quotation.

Blank plates & accessories

1 gang



GU8510BC

Product code	Description	Pack qty
GU8510BC	Brushed chrome	1
GU8510PC	Polished chrome	1

2 gang



GU8520BC

Product code	Description	Pack qty
GU8520BC	Brushed chrome	1
GU8520PC	Polished chrome	1

Spares

Product code	Description	Pack qty
3746130	M3.5 x 25mm raised head machine screws	100
USCREW50SS	M3.5 x 50mm screws	100

- **Standard of compliance:**
BS 5733
- **Fixing screws:**
M3.5 x 25mm and 30mm
- **Plate dimensions:**
88 x 88mm (1 gang),
88 x 148mm (2 gang)

Grid plates

1 gang 88 x 88mm



GUGL01BC

Product code	Description	Pack qty
GUGL01BC	Brushed chrome	1
GUGL01PC	Polished chrome	1
GBG01	76 x 76 x 42mm back box	1

2 gang 88 x 88mm



GUGL02BC

Product code	Description	Pack qty
GUGL02BC	Brushed chrome	1
GUGL02PC	Polished chrome	1
GBG01	76 x 76 x 42mm back box	1

3 gang 88 x 148mm



GUGL03BC

Product code	Description	Pack qty
GUGL03BC	Brushed chrome	1
GUGL03PC	Polished chrome	1
GBG02	136 x 76 x 42mm back box	1

4 gang 88 x 148mm



GUGL04BC

Product code	Description	Pack qty
GUGL04BC	Brushed chrome	1
GUGL04PC	Polished chrome	1
GBG02	136 x 76 x 42mm back box	1

6 gang 156 x 156mm



GUGL06BC

Product code	Description	Pack qty
GUGL06BC	Brushed chrome	1
GUGL06PC	Polished chrome	1
GBG03	136 x 136 x 42mm back box	1

8 gang 156 x 156mm



GUGL08BC

Product code	Description	Pack qty
GUGL08BC	Brushed chrome	1
GUGL08PC	Polished chrome	1
GBG03	136 x 136 x 42mm back box	1

- **Mounting box:**
42mm deep
- **Technical notes:**
All grid plates are supplied with the appropriate number of mounting frames.

Polished chrome
white interior



Polished chrome
black interior



Brushed chrome
white interior



Brushed chrome
black interior



Customisable switch grid modules

10AX metal switch module components (white or black surrounds)



GUG102MB GUG101MW

Product code	Description	Pack qty
GUG101M*	10AX 1 way SP	1
GUG102M*	10AX 2 way SP	1
GUG10IM*	10AX intermediate SP	1

20AX metal switch module components (white or black surrounds)



GUG2020MB GUG20DPMW

Product code	Description	Pack qty
GUG201M*	20AX 1 way SP	1
GUG2020M*	20AX 2 way and centre off SP	1
GUG202M*	20AX 2 way SP	1
GUG20DPM*	20AX DP	1

- **Standard of compliance:** BS EN 60669-1
- **Mounting box:** 42mm deep
- **Technical notes:** 10AX & 20AX metal switch module components available in black or white.
- Clear terminal marking printed onto grey switch module component back mouldings ensures easy identification.
- Pre-printed rocker caps.
- Easy assembly.

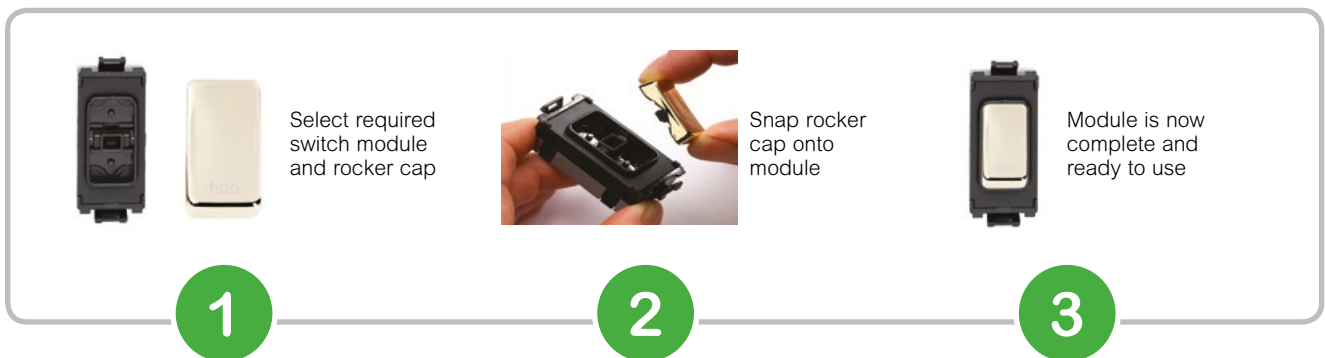

Plain and printed rocker caps for component modules



	Mirror Steel	Painted White	Painted Black	Pack qty
Plain rocker cap	GUGRMS	GUGRPW	GUGRBLK	6
Rocker cap printed boiler	GUGRBOMS	GUGRBOPW	GUGRBOBLK	6
Rocker cap printed cooker hood	GUGRCHMS	GUGRCHPW	GUGRCHBLK	6
Rocker cap printed dish washer	GUGRDWMS	GUGRDWPW	GUGRDWBLK	6
Rocker cap printed extractor fan	GUGREFMS	GUGREFPW	GUGREFBLK	6
Rocker cap printed fridge	GUGRFRMS	GUGRFRPW	GUGRFRBLK	6
Rocker cap printed fan	GUGRFAMS	GUGRFAPW	GUGRFABLK	6
Rocker cap printed freezer	GUGRFZMS	GUGRFZPW	GUGRFZBLK	6
Rocker cap printed fridge/freezer	GUGRFRFZMS	GUGRFRFZPW	GUGRFRFZBLK	6
Rocker cap printed hob	GUGRHOMS	GUGRHOPW	GUGRHOBK	6
Rocker cap printed heater	GUGRHEMS	GUGRHEPW	GUGRHEBLK	6
Rocker cap printed microwave	GUGRMWMS	GUGRMWPW	GUGRMWBLK	6
Rocker cap printed oven	GUGROVMS	GUGROVPW	GUGROVBLK	6
Rocker cap printed tumble dryer	GUGRTDMS	GUGRTDPW	GUGRTDBLK	6
Rocker cap printed washer dryer	GUGRWDYMS	GUGRWDYPW	GUGRWDYBLK	6
Rocker cap printed waste disposal	GUGRWDMS	GUGRWDPW	GUGRWDK	6
Rocker cap printed washing machine	GUGRWMMS	GUGRWMPW	GUGRWMBLK	6

Retractive & toggle switch grid modules

6A 2 way retractive and centre off



GUG202OCBLK

Product code	Description	Pack qty
GUG202OC*MS	Mirror Steel	1
GUG202OCBLK	Painted black with black interior	1
GUG202OCWPW	Painted white with white interior	1

- **Standard of compliance:** BS EN 60669-1
- **Mounting box:** 42mm deep
- **Technical notes:** Mirror steel used for polished chrome grid modules.

10A 2 way retractive single-pole



GUG102RBLK

Product code	Description	Pack qty
GUG102R*MS	Mirror Steel	1
GUG102RBLK	Painted black with black interior	1
GUG102RWPW	Painted white with white interior	1

Retractive & toggle switch grid modules continued

10AX 2 way single-pole toggle



GUG102TWPW

Product code	Description	Pack qty
GUG102T*MS	Mirror Steel	1
GUG102TWPW	Painted white with white interior	1

- **Standard of compliance:** BS EN 60669-1
- **Mounting box:** 42mm deep
- **Technical notes:** Mirror steel used for polished chrome grid modules.

10AX intermediate toggle



GUG101TWPW

Product code	Description	Pack qty
GUG101T*MS	Mirror Steel	1
GUG101TWPW	Painted white with white interior	1

Key switch grid modules

20AX 1 way double-pole key operated



GUG20DPKBLK

Product code	Description	Pack qty
GUG20DPK*MS	Mirror Steel	1
GUG20DPKBLK	Painted black with black interior	1
GUG20DPKWPW	Painted white with white interior	1
GUGKSK	Spare key for SW module	1

- **Standard of compliance:** BS EN 60669-1
- **Mounting box:** 42mm deep
- **Technical notes:** Mirror steel used for polished chrome grid modules.

20AX 2 way key operated



GUG202KBLK

Product code	Description	Pack qty
GUG202K*MS	Mirror Steel	1
GUG202KBLK	Painted black with black interior	1
GUG202KWPW	Painted white with white interior	1
GUGKSK	Spare key for SW module	1

20AX 2 way key operated printed red TEST EMG LTG



GUG202KELBLK

Product code	Description	Pack qty
GUG202KEL*MS	Mirror Steel	1
GUG202KELBLK	Painted black with black interior	1
GUG202KELWPW	Painted white with white interior	1
GUGKSK	Spare key for SW module	1



GUGKSK

Telephone grid modules

BT master telephone



GUGTEMLBLK

Product code	Description	Pack qty
GUGTELM*MS	Mirror Steel	1
GUGTEMLBLK	Painted black with black interior	1
GUGTELMWPW	Painted white with white interior	1

- **Standard of compliance:** BS EN 3041 (where applicable)
- **Mounting box:** 42mm deep
- **Technical notes:** Mirror steel used for polished chrome grid modules.

BT secondary telephone



GUGTELSBLK

Product code	Description	Pack qty
GUGTELS*MS	Mirror Steel	1
GUGTELSBLK	Painted black with black interior	1
GUGTELSWPW	Painted white with white interior	1

RJ11 telephone



GUGRJ11BLK

Product code	Description	Pack qty
GUGRJ11*MS	Mirror Steel	1
GUGRJ11BLK	Painted black with black interior	1
GUGRJ11WPW	Painted white with white interior	1

Data & TV grid modules

RJ45 CAT5e



GUGRJ45BLK

Product code	Description	Pack qty
GUGRJ45*MS	Mirror Steel	1
GUGRJ45BLK	Painted black with black interior	1
GUGRJ45WPW	Painted white with white interior	1

- **Standard of compliance:** BS EN 3041 (where applicable)
- **Mounting box:** 42mm deep
- **Technical notes:** Mirror steel used for polished chrome grid modules.

Direct coaxial TV



GUGCOBLK

Product code	Description	Pack qty
GUGCO*MS	Mirror Steel	1
GUGCOBLK	Painted black with black interior	1
GUGCOWPW	Painted white with white interior	1

F type satellite



GUGSATWPW

Product code	Description	Pack qty
GUGSAT*MS	Mirror Steel	1
GUGSATWPW	Painted white with white interior	1

Polished chrome white interior



Polished chrome black interior



Brushed chrome white interior



Brushed chrome black interior



Electronic dimmer grid modules

300W/VA universal multiway touch dimmer module



GUGEMDIMWPW16

Product code	Description	Pack qty
GUGEMDIMWPW16	Painted white with white interior	1
GGBGUGEMDIMLWPW	Painted white with white interior	1
GGBGUGEMDIMLWPC	Polished chrome with white interior	1

- **Mounting box:**
42mm deep
- **Technical notes:**
Min load 60W/50VA.

LED Electronic grid dimmer



GGBGUGEMDIMLBPB

Product code	Description	Pack qty
GGBGUGEMDIMLBPB	Polished brass with black interior	1
GGBGUGEMDIML*PC	Polished chrome	1
GGBGUGEMDIMLWPN	Pearl nickel with white interior	1
GGBGUGEMDIML*SS	Stainless steel	1
GGBGUGEMDIMLWPW	Painted white with white interior	1
GGBGUGEMDIMLBBN	Black nickel with black interior	1

300W/VA universal multiway touch dimmer module with infra red remote option



GUGEMRDIMB16

Product code	Description	Pack qty
GUGEMRDIMB16	Black moulded	1
GUGEMRDIMW16	White moulded	1
GU6000RC1R	1 channel IR remote control	1

- Electronic modules are capable of 2 way or multiway dimming.
- Retractive switch for use with electronic dimmers only.
- Not compatible with moulded grid plates.
- Modules will require derating when used in multi-gang applications.

50mA 2 way & multiway retractive switch module



GUGEMWWPW

Product code	Description	Pack qty
GUGSAT*MS	Mirror Steel	1
GUGSATWPW	Painted white with white interior	1

Fuse carrier, flex outlet & blank grid modules

13A fuse carrier



GUG13FCUBLK

Product code	Description	Pack qty
GUG13FCU*MS	Mirror Steel	1
GUG13FCUBLK	Painted black with black interior	1
GUG13FCUWPW	Painted white with white interior	1

Flex outlet up to 10mm diameter



GUG16COBLK

Product code	Description	Pack qty
GUG16CO*MS	Mirror Steel	1
GUG16COBLK	Painted black with black interior	1
GUG16COWPW	Painted white with white interior	1

Blank



GUGBB

Product code	Description	Pack qty
GUGB*MS	Mirror Steel	1
GUGBBLK	Painted black with black interior	1
GUGBWPW	Painted white with white interior	1

- **Standard of compliance:**
BS 1363 (fuse carrier)
BS 5733
- **Mounting box:**
42mm deep
- **Technical notes:**
Full metal surround on all modules.

Modules are completely interchangeable.

Mirror steel used for polished chrome grid modules.

Indicator modules

White surround



Product code	Description	Pack qty
GUGINDWG	Green indicator	1
GUGINDWR	Red indicator	1
GUGINDWO	Orange indicator	1

- **Standard of compliance:**
BS 5733
- **Mounting box:**
42mm deep
- **Technical notes:**
240V

Black surround



Product code	Description	Pack qty
GUGINDBG	Green indicator	1
GUGINDBR	Red indicator	1
GUGINDBO	Orange indicator	1

Flush galvanised steel boxes

16mm deep



SB161

Product code	Description	Pack qty
SB161	1 gang	20

25mm deep

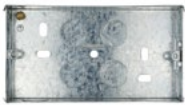

SB252

Product code	Description	Pack qty
SB251	1 gang	10
SB252	2 gang	10

35mm deep



SB351

Product code	Description	Pack qty
SB351	1 gang	10
SB352	2 gang	5

47mm deep



SB472

Product code	Description	Pack qty
SB471	1 gang	10
SB472	2 gang	4

- **Standard of compliance:** BS4662

- **Technical notes:** Supplied with earth terminal and screw.

Supplied with fixed and adjustable lugs.

Fitted with selection of 20mm knockouts in sides and back.

Ultimate Slimline White Moulded

True to its name, the Ultimate Slimline range offers one of the most slender, elegantly crafted white moulded accessory ranges on the market today.

And this premium design isn't just skin deep – turn the product over to see tailored features that will make installation faster and easier. A vast compliment of Part M, Essential Supply, and wide rocker options will ensure that you are always prepared for the precise needs of your customers.

Elegantly curved rockers for more refined style.

With the average home now containing a multitude of smart phones, tablets and other devices, there can often be issues of cable mess and a lack of available plug sockets. Our USB solutions directly help in solving this problem.

Ultra slim construction with minimal back projection for an easy installation onto standard flush mounting boxes (including 16mm).

Consistent styling throughout, as all Slimline products share same profile, from switches to cooker control units.

Individually bagged product ensures products are kept in perfect condition right up until installation.

Screw cap covers provided to hide fixing screws and create a smoother line. Two sets supplied with all moulded products.

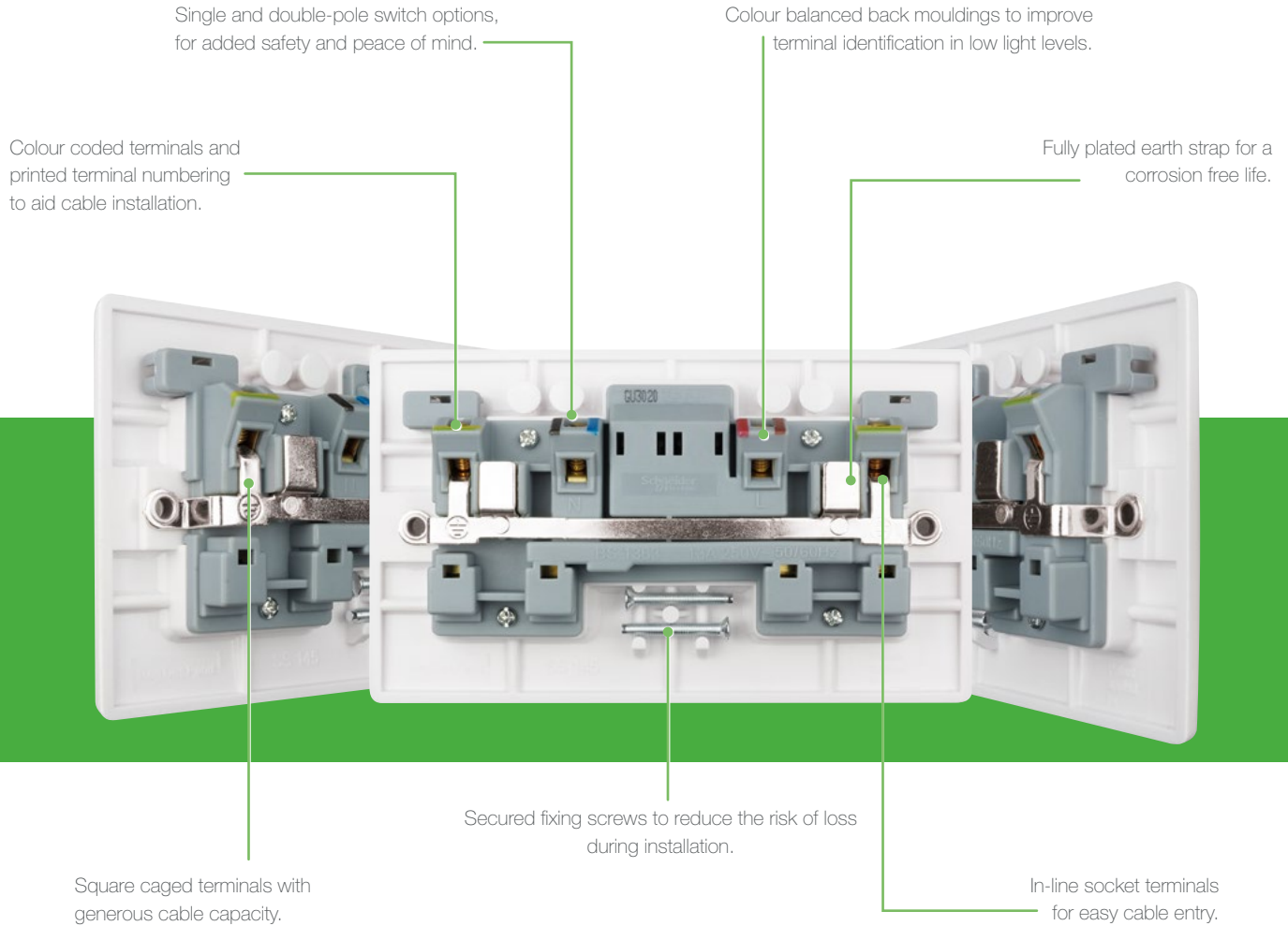

Specification Highlights



LED dimming solutions tested with leading lamp manufacturers and future-proofed switch ratings of 16AX, to satisfy all lighting demands.



50A rated plate switches for switching appliances with higher current ratings, such as heaters, cookers and commercial refrigerating units.



Twin earth terminals on 2 gang sockets enable installation in areas requiring high integrity earthing.



Unique integral locking facility on isolator for enhanced safety.



Comprehensive Part M compliant solution including socket outlets with outboard rockers, wide rocker switches, and grey faceplates.



Colour coded in-line terminals as well as a colour balanced back moulding makes terminals easily identifiable during installation, particularly in lower light levels.

Socket outlets

13A unswitched socket outlets



GU3050



GU3060

Product code	Description	Pack qty
GU3050	1 gang	10
GU3060	2 gang	5
GU3060RD	2 gang - red	5

13A switched socket outlets



GU3011



GU3020,
GU3020D

Product code	Description	Pack qty
GU3010	1 gang single-pole	10
GU3011	1 gang single-pole with neon	10
GU3010D	1 gang double-pole	10
GU3010DGY	1 gang double-pole - grey	10
GU3010DRD	1 gang double-pole - red	10
GU3020	2 gang single-pole	5
GU3021	2 gang single-pole with neons	5
GU3020D	2 gang double-pole	5

13A switched with outboard rockers socket outlets



GU3033



GU3030GY



GU3030RD

Product code	Description	Pack qty
GU3030	2 gang double-pole	5
GU3030GY	2 gang double-pole - grey	5
GU3030RD	2 gang double-pole - red	5
GU3031	2 gang double-pole with clean earth	5
GU3033	2 gang double-pole, non-standard with clean earth	5

13A switched with red neon outboard rockers socket outlets



GU3032



GU3034

Product code	Description	Pack qty
GU3032	2 gang double-pole with clean earth	5
GU3034	2 gang double-pole, non-standard with clean earth	5

- **Standard of compliance:**
BS 1363 (13A)
BS 546 (round pin)
- **Mounting box:**
Minimum 25mm deep
- **Fixing screws:**
M3.5 x 30mm
- **Plate dimensions:**
86 x 86mm
(1 gang)
86 x 146mm
(2 gang)



- **Note:** All 2 gang sockets include twin earth terminals as standard, enabling high integrity earthing. To aid flush installation, 35mm steel boxes are recommended.

Socket outlets continued

Switched USB socket outlets



GGBGU30202USBRP

Product code	Description	Pack qty
GGBGU30102USBAS	1 gang with 2x USB chargers 2.1A shared	10
GGBGU30202USBRP	2 gang with 2x USB chargers 2.1A shared	10
GGBGU3024D	2 gang with 2x USB chargers 4A shared	1

- **Mounting box:**
Minimum 35mm deep

Round pin socket outlets



GU3080 GU3090



GU3091

Product code	Description	Pack qty
GU3070	2A unswitched	10
GU3080	5A unswitched	10
GU3090	15A switched	10
GU3091	15A switched with neon	10

- **Standard of compliance:**
BS 546
- **Mounting box:**
Minimum 25mm deep
- **Fixing screws:**
M3.5 x 30mm
- **Plate dimensions:**
86 x 86mm

Shelf frames for socket outlets



GGBGUSHF1GS

Product code	Description	Pack qty
GGBGUSHF1GS	1 gang	1
GGBGUSHF2GS	2 gang	1

Plate switches

16AX 1 gang plate switches



GU1011, GU1012, GU1014 GU1012GY, GU1014GY

Product code	Description	Pack qty
GU1011	1 way	10
GU1012	2 way	10
GU1012GY	2 way - grey	10
GU1014	Intermediate	10
GU1014GY	Intermediate - grey	10

- **Standard of compliance:**
BS EN 60669-1
- **Mounting box:**
16mm deep (1-2 gang)
25mm deep (3-6 gang)
- **Fixing screws:**
M3.5 x 18mm
- **Plate dimensions:**
86 x 86mm (1-3 gang standard rocker)
86 x 146mm (4-6 gang standard rocker)

16A 1 gang retractive plate switches



GU1012RGY GU1012RP



GU1012RB

Product code	Description	Pack qty
GU1012R	2 way	10
GU1012RGY	2 way - grey	10
GU1012RP	2 way printed with press	10
GU1012RB	2 way printed with a bell symbol	10

16AX multi gang plate switches



GU1022 GU1022GY



GU1032

Product code	Description	Pack qty
GU1022	2 gang 2 way	10
GU1022GY	2 gang 2 way - grey	10
GU1032	3 gang 2 way	10
GU1032GY	3 gang 2 way - grey	10
GU1042	4 gang 2 way	5
GU1062	6 gang 2 way	5



Part M
Comprehensive Part M compliant solution including socket outlets with outboard rockers, wide rocker switches and grey faceplates.

Plate switches continued

10A triple pole isolator



GU1013

Product code	Description	Pack qty
GU1013	10A triple pole isolator	10

1 gang wide rocker



GRWH1012, GRWH1014



GRWH1012GY, GRWH1014GY

Product code	Description	Pack qty
GRWH1012	16AX 1 gang 2 way	10
GRWH1012GY	16AX 1 gang 2 way - grey	10
GRWH1014	10AX 1 gang intermediate	10
GRWH1014GY	10AX 1 gang intermediate - grey	10

16AX multi gang wide rocker



GRWH1032A



GRWH1022GY

Product code	Description	Pack qty
GRWH1022	2 gang 2 way	10
GRWH1022GY	2 gang 2 way - grey	10
GRWH1032A	3 gang 2 way	10
GRWH1032GY	3 gang 2 way - grey	10

10AX architrave



GU1012A



GU1022A

Product code	Description	Pack qty
GU1012A	1 gang 2 way	10
GU1022A	2 gang 2 way	10

Ceiling pull cords



GPULLGY



GPULLRD

Product code	Description	Pack qty
GPULLGY	1.5m with single bangle - grey	10
GPULLRD	1.5m with twin bangle - red	10

- **Standard of compliance:**
BS EN 60669-1
BS EN 60947-3
(GU1013)
- **Mounting box:**
16mm deep
(GU1013 and architrave)
25mm deep (wide rocker)
- **Fixing screws:**
M3.5 x 18mm
(GU1013 and architrave), M3.5 x 25mm (wide rocker)
- **Plate dimensions:**
86 x 86mm
(GU1013)
- 87 x 87mm (wide rocker)
- 33 x 86mm (1 gang architrave)
- 33 x 148mm (2 gang architrave)
- **Technical notes:**
Ceiling switches are sold separately to GPULLGY & GPULLRD.

Dimmer switches

Mains & low voltage

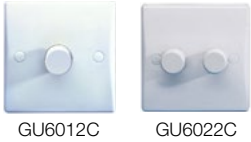

Product code	Description	Pack qty
GU6012C	1 gang 2 way 400W/VA	1
GU6022C	2 gang 2 way 250W/VA	1
GU6032C	3 gang 2 way 250W/VA	1
GU6042C	4 gang 2 way 250W/VA	1

LED



Product code	Description	Pack qty
GU6012L	1 gang 2 way 100W/VA	1
GU6022L	2 gang 2 way 100W/VA	1
GU6032L	3 gang 2 way 75W/VA	1
GU6042L	4 gang 2 way 75W/VA	1

- **Standard of compliance:** BS EN 60669-2-1
- **Mounting box:** 25mm deep
- **Fixing screws:** M3.5 x 30mm
- **Plate dimensions:** 86 x 86mm (1 gang)
86 x 146mm (2 gang)
- Leading edge control.

- **Standard of compliance:** BS EN 60669-2-1
- **Mounting box:** 25mm deep
- **Fixing screws:** M3.5 x 30mm
- **Plate dimensions:** 88 x 88mm (1 gang)
88 x 148mm (2 gang)
- Trailing edge control.

Dimmer technical information can be found in the technical data section towards the back of this catalogue.

- **Note:** 1 and 2 gang dimmer switches include spacing frame for mounting in plaster depth 16mm boxes.

Control switches & flex outlet plates

20AX DP 1 gang switched



Product code	Description	Pack qty
GU2010	20AX DP 1 gang switched	10
GU2010GY	20AX DP 1 gang switched - grey	10
GU2011	20AX DP 1 gang switched with neon	10
GU2011OV	20AX DP 1 gang switched with neon engraved OVEN	10
GU2011TR	20AX DP 1 gang switched with neon engraved TUMBLE DRIER	10

- **Standard of compliance:** BS EN 60669-1
- **Mounting box:** 25mm deep
- **Fixing screws:** M3.5 x 30mm
- **Plate dimensions:** 86 x 86mm

20AX DP 1 gang switched with flex outlet



Product code	Description	Pack qty
GU2013	20AX DP 1 gang switched with flex outlet	10
GU2014	20AX DP 1 gang switched with flex outlet and neon	10
GU2014WH	20AX DP 1 gang switched with flex outlet and neon engraved water heater	10

Control switches & flex outlet plates continued

32A DP 1 gang switched



GU4031

Product code	Description	Pack qty
GU4031	32A DP 1 gang switched with neon	10

- **Standard of compliance:**
BS EN 60669-1 (GU4031)
BS 5733 (flex outlet plates)
- **Mounting box:**
25mm deep
- **Fixing screws:**
M3.5 x 30mm
- **Plate dimensions:**
86 x 86mm

Flex outlet plates



GU2033



GU2003

Product code	Description	Pack qty
GU2033	25A side entry	10
GU2003	20A front entry	10

Fused connection units

13A unswitched



GU5000



GU5000MW



GU5000RD



GU5003TR

Product code	Description	Pack qty
GU5000	13A unswitched	10
GU5000SS	13A unswitched engraved security	10
GU5000TR	13A unswitched engraved towel rail	10
GU5003	13A unswitched with flex outlet	10
GU5004	13A unswitched with neon & flex outlet	10

- **Standard of compliance:**
BS 1363
- **Mounting box:**
25mm deep
- **Fixing screws:**
M3.5 x 30mm
- **Plate dimensions:**
86 x 86mm

3A unswitched



GU50003



GU50033

Product code	Description	Pack qty
GU50003	3A unswitched	10
GU50033	3A unswitched with flex outlet	10

- **Standard of compliance:**
BS 1363
- **Mounting box:**
25mm deep
- **Fixing screws:**
M3.5 x 30mm
- **Plate dimensions:**
86 x 86mm

Fused connection units continued

13A DP switched



GU5010



GU5010GY



GU5010CH

Product code	Description	Pack qty
GU5010	13A DP switched	10
GU5010GY	13A DP switched - grey	10
GU5010BO	13A DP switched engraved boiler	10
GU5010CH	13A DP switched engraved cooker hood	10
GU5010DW	13A DP switched engraved dish washer	10
GU5010EF	13A DP switched engraved extractor fan	10
GU5010FA	13A DP switched engraved fan	10
GU5010FR	13A DP switched engraved fridge	10
GU5010FFZ	13A DP switched engraved fridge/freezer	10
GU5010HO	13A DP switched engraved hob	10
GU5010HT	13A DP switched engraved heater	10
GU5010WM	13A DP switched engraved washing machine	10

- **Standard of compliance:** BS 1363
- **Mounting box:** 25mm deep
- **Fixing screws:** M3.5 x 30mm
- **Plate dimensions:** 86 x 86mm

13A DP switched with neon



GU5011



GU5011GY



GU5011FFZ

Product code	Description	Pack qty
GU5011	13A DP switched with neon	10
GU5011GY	13A DP switched with neon - grey	10
GU5011BO	13A DP switched with neon engraved boiler	10
GU5011CH	13A DP switched with neon engraved cooker hood	10
GU5011DW	13A DP switched with neon engraved dish washer	10
GU5011FA	13A DP switched with neon engraved fan	10
GU5011FR	13A DP switched with neon engraved fridge	10
GU5011FFZ	13A DP switched with neon engraved fridge/freezer	10
GU5011HT	13A DP switched with neon engraved heater	10
GU5011MW	13A DP switched with neon engraved microwave	10
GU5011TD	13A DP switched with neon engraved tumble dryer	10
GU5011WM	13A DP switched with neon engraved washing machine	10

- **Standard of compliance:** BS 1363
- **Mounting box:** 25mm deep
- **Fixing screws:** M3.5 x 30mm
- **Plate dimensions:** 86 x 86mm

13A DP switched with flex outlet



GU5013



GU5014

Product code	Description	Pack qty
GU5013	13A DP switched with flex outlet	10
GU5014	13A DP switched with flex outlet and neon	10

- **Standard of compliance:** BS 1363
- **Mounting box:** 25mm deep
- **Fixing screws:** M3.5 x 30mm
- **Plate dimensions:** 86 x 86mm

High current switches

50A DP switches



GU4011



GU4020

Product code	Description	Pack qty
GU4010	50A 1 gang DP switch	10
GU4011	50A 1 gang DP switch with neon	10
GU4020	50A 2 gang DP switch	5
GU4020GY	50A 2 gang DP switch - grey	5
GU4021	50A 2 gang DP switch with neon	5

- **Standard of compliance:** BS EN 60669-1 (50A DP switches) BS 4177 (cooker control units)
- **Mounting box:** 47mm deep
- **Fixing screws:** M3.5 x 30mm
- **Plate dimensions:** 86 x 86mm (1 gang) 146 x 86mm (2 gang)

45A cooker control unit with 13A switched socket



GU4001

Product code	Description	Pack qty
GU4000	45A cooker control unit with 13A switched socket	5
GU4000GY	45A cooker control unit with 13A switched socket grey	5
GU4001	45A cooker control unit with 13A switched socket with neons	5

Cooker connection unit



GU4050

Product code	Description	Pack qty
GU4050	Cooker connection unit	10

Shaver socket

115/230V dual voltage



GU7090

Product code	Description	Pack qty
GU7090	115/230V dual voltage	1
GU7090GY	115/230V dual voltage grey	1

- **Standard of compliance:** BS EN 61558-2-5
- **Mounting box:** 47mm deep
- **Fixing screws:** M3.5 x 30mm
- **Plate dimensions:** 146 x 86mm (2 gang)

Telephone outlets

Single outlet



GU7051



GU7061, GU7062

Product code	Description	Pack qty
GU7051	RJ11	10
GU7061	BT master	10
GU7062	BT secondary	10

- **Standard of compliance:** BS EN 41003
- **Mounting box:** 25mm deep
- **Fixing screws:** M3.5 x 30mm
- **Plate dimensions:** 86 x 86mm

Data outlets

RJ45 CAT5e outlets



Product code	Description	Pack qty
GU7071	Single	10
GU7072	Twin	10

- **Standard of compliance:** BS EN 41003
- **Mounting box:** 25mm deep (GU7071) 35mm deep (GU7072 and GU7074)
- **Fixing screws:** M3.5 x 30mm
- **Plate dimensions:** 86 x 86mm (single and twin) 86 x 146mm (quad)

TV outlets

Coaxial sockets



Product code	Description	Pack qty
GU7010	Single TV/FM	10
GU7020	Twin TV/FM	10
GU7030	Single satellite	10
GU7040	Twin satellite	5

- **Standard of compliance:** BS 3041 (where applicable)
- **Mounting box:** 25mm deep
- **Fixing screws:** M3.5 x 30mm
- **Plate dimensions:** 86 x 86mm

Screened coaxial sockets



Product code	Description	Pack qty
GU7021	Diplex TV/F	10
GU7081	Triplex TV/FM/SAT	10

Blank plates & accessories

Blank plates & accessories



Product code	Description	Pack qty
GU8010	1 gang blank plate	10
GU8020	2 gang blank plate	10
GUMSCO	White moulded screw cap covers	100
USCREW50SS	M3.5 x 50mm screws	100
3746130	M3.5 x 25mm raised head machine screws	100

- **Standard of compliance:** BS EN 5733
- **Fixing screws:** M3.5 x 30mm
- **Plate dimensions:** 86 x 86mm (1 gang) 86 x 146mm (2 gang)

Grid plates

88 x 88mm



Product code	Description	Pack qty
GUG01G	1 gang 88 x 88mm	1
GUG01GGY	1 gang 88 x 88mm - grey	1
GUG02G	2 gang 88 x 88mm	1
GUG02GGY	2 gang 88 x 88mm - grey	1
GBG01	76 x 76 x 42mm flush mounted back box	1

88 x 148mm



Product code	Description	Pack qty
GUG03G	3 gang 88 x 148mm	1
GUG03GGY	3 gang 88 x 148mm - grey	1
GUG04G	4 gang 88 x 148mm	1
GUG04GGY	4 gang 88 x 148mm - grey	1
GBG02	136 x 76 x 42mm flush mounted back box	1

156 x 156mm

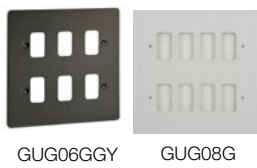

Product code	Description	Pack qty
GUG06G	6 gang 156 x 156mm	1
GUG06GGY	6 gang 156 x 156mm - grey	1
GUG08G	8 gang 156 x 156mm	1
GUG08GGY	8 gang 156 x 156mm - grey	1
GBG03	136 x 136 x 42mm flush mounted back box	1

216 x 156mm



Product code	Description	Pack qty
GUG09G	9 gang 216 x 156mm	1
GUG12G	12 gang 216 x 156mm	1
GBG04F	193 x 133 x 42mm flush mounted back box	1

Grid plates continued

398 x 156mm

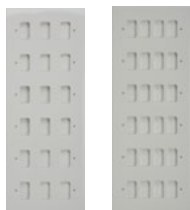

GUG18G GUG24G

Product code	Description	Pack qty
GUG18G	18 gang 398 x 156mm	1
GUG24G	24 gang 398 x 156mm	1
GBG06F	374 x 133 x 42mm flush mounted back box	1

White moulded grid modules

Switch modules



Switch modules



GUG102W

Product code	Description	Pack qty
GUG101W	10AX 1 way switch module	1
GUG102W	10AX 2 way switch module	1
GUG10IW	10AX intermediate switch module	1
GUG201W	20AX 1 way switch module	1
GUG202W	20AX 2 way switch module	1
GUG20DPW	20AX DP switch module	1

• **Standard of compliance:**
BS EN 60669-1

20AX DP printed switch modules



GUG20DPMWW



GUG20DPHTW



GUG20DPHOW

Product code	Description	Pack qty
GUG20DPMWW	20AX DP switch module printed microwave	1
GUG20DPCHW	20AX DP switch module printed cooker hood	1
GUG20DPDWW	20AX DP switch module printed dishwasher	1
GUG20DPFZW	20AX DP switch module printed freezer	1
GUG20DPWMW	20AX DP switch module printed washing machine	1
GUG20DPTDW	20AX DP switch module printed tumble dryer	1
GUG20DPHTW	20AX DP switch module printed heater	1
GUG20DPWDYW	20AX DP switch module printed washer dryer	1
GUG20DPOVW	20AX DP switch module printed oven	1
GUG20DPBOW	20AX DP switch module printed boiler	1
GUG20DPWDW	20AX DP switch module printed waste disposal	1
GUG20DPEFW	20AX DP switch module printed extractor fan	1
GUG20DPFAW	20AX DP switch module printed fan	1
GUG20DPFFZW	20AX DP switch module printed fridge freezer	1
GUG20DPFRW	20AX DP switch module printed fridge	1
GUG20DPHOW	20AX DP switch module printed hob	1

LED Electronic dimmer module



GGBGUGEMDIMLWPW

Product code	Description	Pack qty
GGBGUGEMDIMLWPW	100W LED electronic dimmer	1

White moulded grid modules continued

On/Off Retractive switch modules



GUG202OCW,
GUG102RW,
GUG2020W

Product code	Description	Pack qty
GUG202OCW	10AX 2 way & centre off retractive switch module	1
GUG102RW	10A 2 way retractive switch module	1
GUG2020W	20AX 2 way on & off switch module	1

• **Standard of compliance:**
BS EN 60669-1

Blank & indicator modules



GUGBW



GUGINDWG



GUGINDWO

Product code	Description	Pack qty
GUGBW	Blank module	1
GUGINDWG	Green indicator module	1
GUGINDWR	Red indicator module	1
GUGINDWO	Orange indicator module	1

• **Standard of compliance:**
BS EN 60669-1
(blank module)
BS 5733
(indicator modules)

White painted metal grid modules

Key switch modules



GUG20DPKWPW, GUG202KELWPW
GUG202KWPW

Product code	Description	Pack qty
GUG20DPKWPW	20AX DP	1
GUG20DPKELWPW	20AX DP printed TEST EMG LTG	1
GUG202KWPW	20AX 2 way	1
GUG202KELWPW	20AX 2 way printed TEST EMG LTG	1
GUGKSK	Spare key for SW module	1

• **Standard of compliance:**
BS EN 60669-1

Communication modules



GUGTELMWPW,
GUGTELSWPW



GUGRJ45WPW



GUGCOWPW

Product code	Description	Pack qty
GUGTELMWPW	BT master	1
GUGTELSWPW	BT secondary	1
GUGRJ11WPW	RJ11	1
GUGRJ45WPW	RJ45 CAT5e	1
GUGCOWPW	TV/FM coaxial	1
GUGSATWPW	Satellite	1

• **Standard of compliance:**
BS EN 41003
BS EN 3041
(where applicable)

Fused connection unit & flex outlet



GUG13FCUWPW



GUG16COWPW

Product code	Description	Pack qty
GUG13FCUWPW	13A fused connection unit	1
GUG16COWPW	Flex outlet (10mm diameter)	1

Euro modular plates & modules

Euro plates



GU8060



GU8080

Product code	Description	Pack qty
GU8050	1 gang 1 module	10
GU8050GY	1 gang 1 module - grey	1
GU8060	1 gang 2 module	10
GU8060GY	1 gang 2 module - grey	1
GU8080	2 gang 4 module	5
GU8080GY	2 gang 4 module - grey	1

- **Dimensions:**
86 x 86mm (1-2 module),
86 x 146mm (4 module)
- Refer to module for appropriate mounting box depth.
- Euro modules plates compatible with Schneider Electric euro modules.
- **Note:** modules from other suppliers may not be compatible, it is advised to check suitability.

25 x 50mm euro modules



GUE7011W



GUE7061W



GUE7071W



VDIB1771XB12

Product code	Description	Pack qty
GUE7011W	Single IEC coax (female)	1
GUE7012W	25 x 50mm euro modules IEC coax (male)	1
GUE7021W	Single USB charger 2.1A shared	1
GUE7030W	Single F type sat	1
GUE7061W	BT master telephone	1
GUE7062WK	BT secondary telephone	1
GUE7071W	RJ45 CAT5e (not screened)	1
GUE7072W	RJ45 CAT5 (not screened)	1
GUE7073W	Single USB charger 1A 5Vdc	1
GUE7021W	Single USB charger 2.1A shared	1
GUE7051W	RJ11 modem	1
GUE7091W	Actassi module carrier for VDIB1771XB12	8
VDIB1771XB12	Actassi S-One Connector RJ45 CAT6A shielded	12
GUE7000W	2 x Phono socket	1
GUE7001W	2 x Loudspeaker socket	1
GUE8010W	Blank module	5

- **Dimensions:**
25 x 50mm
- **Mounting box:**
25mm deep
- GUE7091W[^]* compatible with VDIB1771XB12 Actassi S-One Connector RJ45

50 x 50mm euro modules



GUE7010W



GUE7081W



GUE7020W

Product code	Description	Pack qty
GUE7010W	TV/FM diplexer	1
GUE7031W	Twin USB charger 3.1A shared	1
GUE7074W	Twin USB charger 2 x 1A 5Vdc	1
GUE7081W	TV/FM/Sat triplexer	1
GUE7082W	TV/FM/Sat1/Sat2 quadplexer	1
GUE7020W	HDMI	1
GUE7078W	American power socket**	1
GUE7076W	Brush outlet**	1
GUE7077W	5A round pin socket**	1

- **Dimensions:**
50 x 50mm
- **Mounting box:**
25mm deep
- **MTO products for projects only, leadtime to be confirmed at time of ordering.

Surface pattresses

1 gang



GU9116

Product code	Description	Pack qty
GU9116	1 gang 16mm	10
GU9125	1 gang 25mm	10
GU9135	1 gang 35mm	10
GU9147	1 gang 47mm	10

- **Standard of compliance:** BS 5733
- **Technical notes:** All supplied complete with earth terminals.

2 gang



GU9225



GU9235

Product code	Description	Pack qty
GU9225	2 gang 25mm	5
GU9D25	2 gang Dual 25mm	5
GU9235	2 gang 35mm	5
GU9247	2 gang 47mm	5

- **Standard of compliance:** BS 5733
- **Technical notes:** All supplied complete with earth terminals.

Architrave



GPAT1G16A

Product code	Description	Pack qty
GPAT1G16A	Architrave 1 gang 16mm	10
GPAT2G16A	Architrave 2 gang 16mm	10

- **Standard of compliance:** BS 5733
- **Technical notes:** All supplied complete with earth terminals.

Flush galvanised steel boxes

16mm deep



SB161

Product code	Description	Pack qty
SB161	1 gang	20

25mm deep

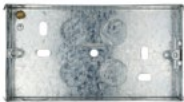

SB252

Product code	Description	Pack qty
SB251	1 gang	10
SB252	2 gang	10

35mm deep



SB351

Product code	Description	Pack qty
SB351	1 gang	10
SB352	2 gang	5

47mm deep



SB472

Product code	Description	Pack qty
SB471	1 gang	10
SB472	2 gang	4

Spares

Product code	Description	Pack qty
3746130	M3.5 x 25mm screws	100
USCREW50SS	M3.5 x 50mm screws	100

- **Standard of compliance:** BS 4662

- **Technical notes:** Supplied with earth terminal and screw.

Supplied with fixed and adjustable lugs.

Fitted with selection of 20mm knockouts in sides and back.



Lisse Screwless Deco



Curves in all the right places...

Now in an elegant decorative finish.

The smooth, modern lines of Lisse Screwless Deco offer an understated elegance to compliment today's interiors.

Whatever your taste, you can express your personal sense of style in the home down to the finest detail through the comprehensive range of finishes Lisse Screwless Deco has to offer.



- Ideally suited for new construction and refurbishment projects.
- Future-proofed to cater for the latest demands in consumer technology.
- Painting and decorating made easy by the unique screwless design and clipping system.
- Cleverly designed to ensure that product ordering is simple and efficient, with many time and space saving solutions.
- Crafted with your customer in mind, adding bespoke solutions to make a lasting impact.

Simple by design for home and business

Removable screwless cover and reliable clip-in system make painting & decorating easier.

Insert around the rocker enhances the rocker shape.

Gently rounded metal rockers to compliment the curved profile.

LED power indicator which provides a robust, efficient and long lasting solution.

Large plate footprint provides extra strength and reduces the need for additional decorating.

Available in a range of 4 stocked and 3 made-to-order metal finishes.

GGBL3021DBSS

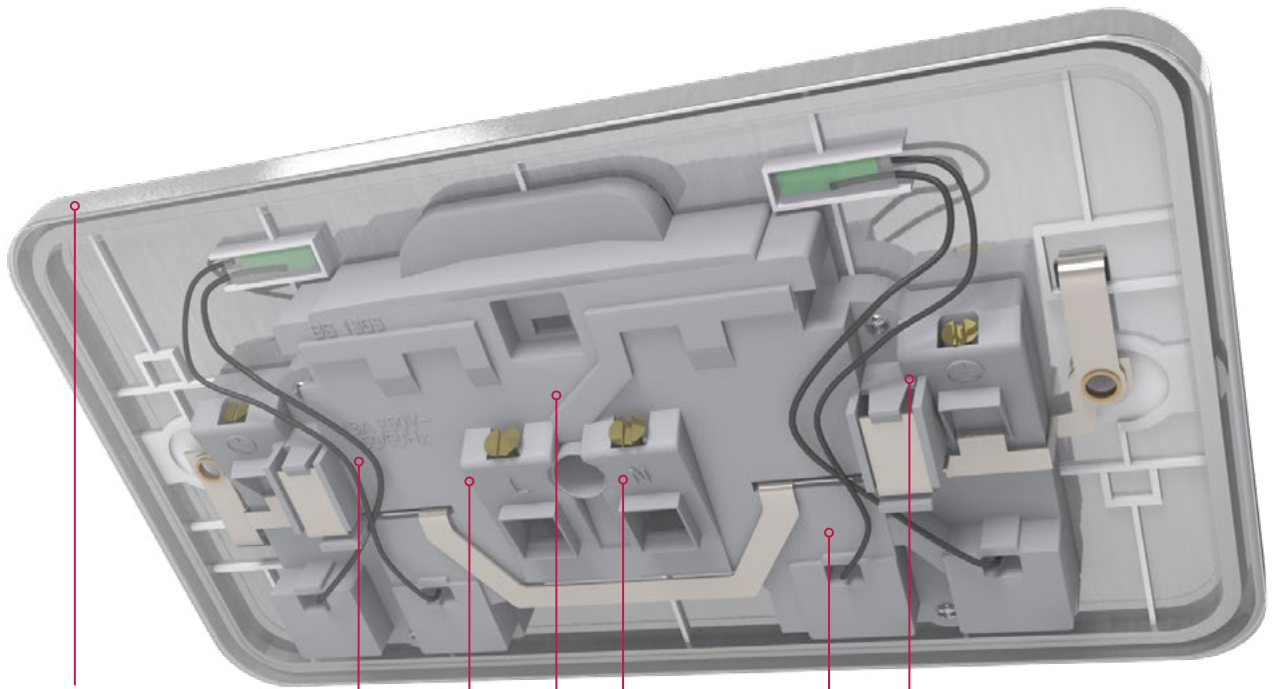

7mm raised edge profile offers easy installation for new builds and retrofits.

Angled terminals for easier access.

Backed out and captive screw terminals to allow for positive drive and speed of installation.

Minimum back projection frees up space in the back box for cabling.

Twin earth terminals on all 2 gang 13A socket outlets, for high integrity earthing.

Light grey back moulding colour for easier terminal identification.

Cable markings on all products with a moulded template to check the wire length.

Easy to understand part codes

Simple ideas...

Provide your customers the style and performance that they are looking for, whilst enjoying easier ordering with the Lisse Screwless Deco range. Part codes follow a standard, straight forward methodology to save you time.

Part code structure:

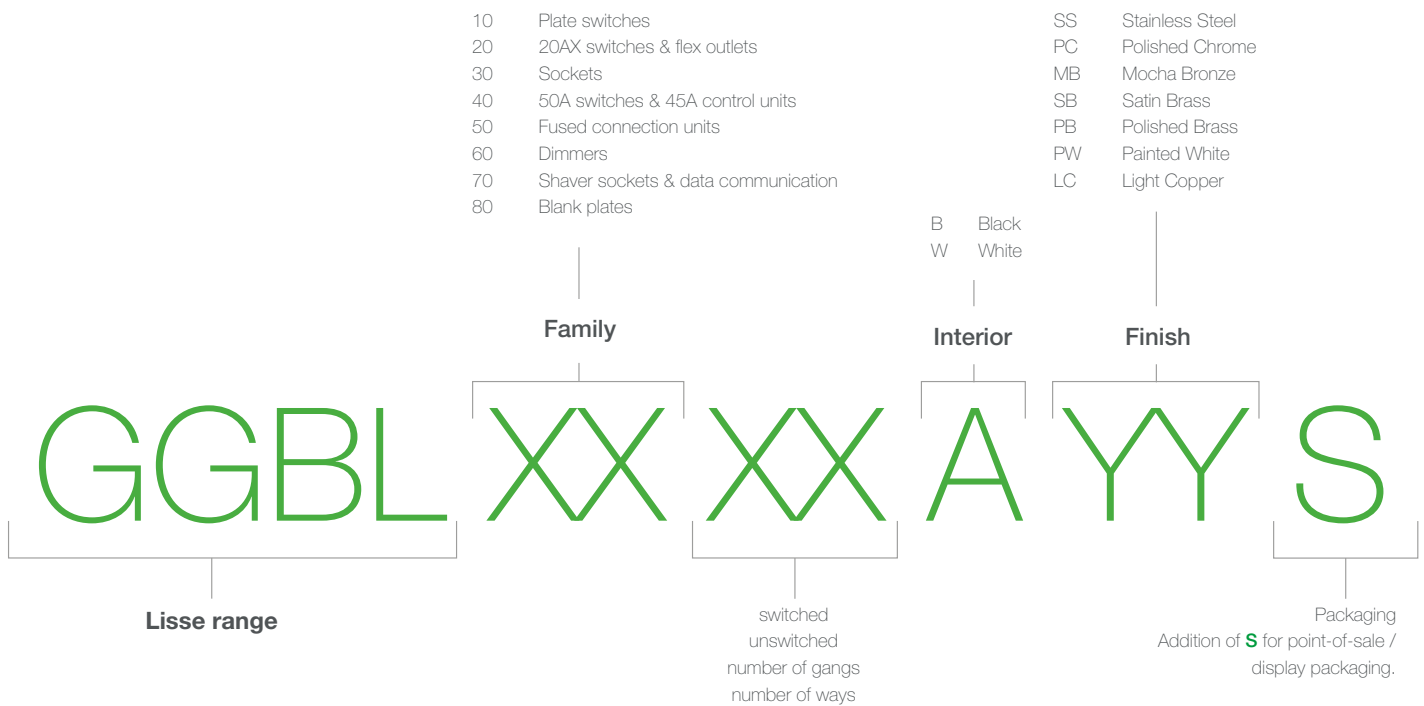

Clear, useful packaging

Lisse packaging is offered in both point-of-sale and wholesale options, depending on your needs. Each option offers clear product information and descriptions, helping to minimise errors when preparing orders.



Point of Sale / shelf-ready box and display packaging

- Clear descriptions, highlights and pictograms to inform and aid purchasing decisions.
- Shelf-ready box as a ready-to-sell merchandised unit.
- Product reference easily identifiable.
- Unobstructed view of front and back of product.
- Simply add **S** suffix to wholesale reference.









Wholesale packaging

- Optimal dimensions for standard shelves to optimise use of shelf space.
- Securely packaged to prevent movement inside the box.
- Large, visible labels.
- Easy to read in environments with low light levels.

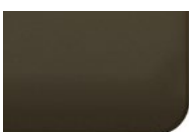
Options and availability

Finishes, configurations, packaging options and stock availability

Finishes		Inserts	Packaging option	Stock availability
Stainless Steel (SS)		WHITE	Wholesale packaging	MTS
			Shelf ready box & display packaged	MTS
		BLACK	Wholesale packaging	MTS
			Shelf ready box & display packaged	MTS
Polished Chrome (PC)		WHITE	Wholesale packaging	MTS
			Shelf ready box & display packaged	MTS
		BLACK	Wholesale packaging	MTS
			-	-
Satin Brass (SB)		WHITE	Wholesale packaging	MTO
			-	-
		BLACK	Wholesale packaging	MTS
			Shelf ready box & display packaged	MTS
Mocha Bronze (MB)		WHITE	-	-
			-	-
		BLACK	Wholesale packaging	MTS
			Shelf ready box & display packaged	MTS
Painted White (PW)		WHITE	Wholesale packaging	MTO
			-	-
		BLACK	-	-
			-	-
Polished Brass (PB)		WHITE	Wholesale packaging	MTO
			-	-
		BLACK	Wholesale packaging	MTO
			-	-
Light Copper (LC)		WHITE	Wholesale packaging	MTO
			-	-
		BLACK	-	-
			-	-

MTO = made to order | MTS = made to stock



Stainless Steel



Polished Chrome



Mocha Bronze



Satin Brass



Polished Brass
*Made to order



Painted White
*Made to order



Light Copper
*Made to order

Socket outlets

13A 1 gang switched



GGBL3010BSS

Product code	Description	Pack qty
GGBL3010***	Single-pole	1
GGBL3010***S	Single-pole (Display packaged)	6
GGBL3010D***	Double-pole	1
GGBL3010D***S	Double-pole (Display packaged)	6
GGBL3011D***	Double-pole with LED indicator	1
GGBL3050NS***S	Single-pole (Non-standard earth) (Display packaged)	6

- **Standard of compliance:** BS 1363-2
- **Mounting box:** Minimum 25mm deep
- **Fixing screws:** M3.5 x 25mm
- **Plate dimensions:** 87 x 87mm

13A 2 gang unswitched



GGBL3060BSS

Product code	Description	Pack qty
GGBL3060***S	2 gang - 13A (Display packaged)	7

13A 2 gang switched with inboard rockers



GGBL3020BSS

Product code	Description	Pack qty
GGBL3020***	Single-pole	1
GGBL3020***S	Single-pole (Display packaged)	6
GGBL3020D***	Double-pole	1
GGBL3020D***S	Double-pole (Display packaged)	6
GGBL3021D***	Double-pole with LED indicator	1

- **Standard of compliance:** BS 1363-2
- **Mounting box:** Minimum 25mm deep
- **Fixing screws:** M3.5 x 30mm
- **Plate dimensions:** 87 x 148mm

Lockable



GGBL3060LBSS

Product code	Description	Pack qty
GGBL3060L***	1 gang 13A Double-pole	1

- **Standard of compliance:** BS 1363-2
- **Mounting box:** Minimum 35mm deep
- **Fixing screws:** M3.5 x 25mm
- **Plate dimensions:** 87 x 148mm

Round pin



GGBL3070BSS

Product code	Description	Pack qty
GGBL3070***	2A unswitched	1
GGBL3080***	5A unswitched	1
GGBL3081***	5A switched	1
GGBL3090***S	15A switched (Display packaged)	5

- **Standard of compliance:** BS 546
- **Mounting box:** Minimum 25mm deep
- **Fixing screws:** M3.5 x 25mm
- **Plate dimensions:** 87 x 87mm

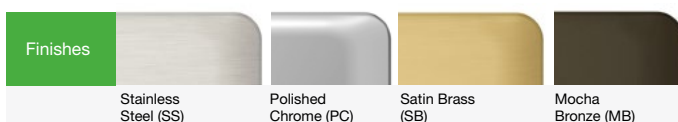

*** = Code for finish option: B or W for interior colour, followed by SS, PC, MB, SB, PB, PW or LC.

Socket outlets continued

Schuko



GGBL3016A1BSS

Product code	Description	Pack qty
GGBL3016A1***	1 gang 16A unswitched	1

- **Standard of compliance:** IEC 60884-1
- **Mounting box:** 47mm deep
- **Fixing screws:** M3.5 x 25mm
- **Plate dimensions:** 87 x 87mm
- **Not for UK use**

USB sockets 13A single-pole – 2.1A total



GGBL30202USBABSSS + GGBLSHF2GBS

Product code	Description	Pack qty
GGBL30102USBA***S	1 gang - 2xUSB (Display packaged)	1
GGBL30202USBA***S	2 gang – 2xUSB (Display packaged)	1
GGBLSHF2GS	2 gang surround with shelf – white (Display packaged)	10
GGBLSHF2GBS	2 gang surround with shelf - black (Display packaged)	10
GGBLSHF1GS	1 gang surround with shelf – white (Display packaged)	10
GGBLSHF1GBS	1 gang surround with shelf – black (Display packaged)	10

- **Standard of compliance:** BS 1363-2 / BS EN 60950-1 / WEEE : EU-directive 2002/95/EC.
- WEEE directive 2002/96/EC.
- **Mounting box:** Minimum 35 mm for GGBL30102USBAxxx (supplied with spacer for 25 mm installation).
- Minimum 25 mm for GGBL30202USBAxxx.
- **Charging capacity:** 5 VDC - 2.1 A, compatible with USB 2.0 devices.

- **Smart chip recognizes and optimizes the charging requirements of individual devices**
- **Electronically protected against over voltages and short circuits on either USB outlet (CAT3)**
- **Energy efficient, stand-by power limitation:** 0.5 W (comply with ErP Directive)

Plate switches

10AX 1 gang



GGBL1012BSS

Product code	Description	Pack qty
GGBL1012***	2 way	1
GGBL1012***S	2 way (Display packaged)	7
GGBL1014***	Intermediate	1
GGBL1014***S	Intermediate (Display packaged)	7

- **Standard of compliance:** BS EN 60669-1
- **Mounting box:** 16mm deep (1-2 gang) 25mm deep (3-4 gang)
- **Fixing screws:** M3.5 x 18mm
- **Plate dimensions:** 87 x 87mm (1-3 gang) 87 x 148 mm (4 gang)

10A 1 gang retractive



GGBL1012RBSSS

Product code	Description	Pack qty
GGBL1012R***S	2 way (Display packaged)	7

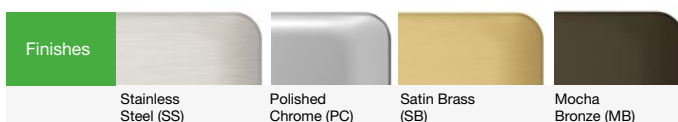

*** = Code for finish option: B or W for interior colour, followed by SS, PC, MB, SB, PB, PW or LC.

Plate switches continued

10AX 2 & 3 gang



GGBL1022BSS



GGBL1032BSS

Product code	Description	Pack qty
GGBL1022***	2 gang 2 way	1
GGBL1022***S	2 gang 2 way (Display packaged)	7
GGBL1032***	3 gang 2 way	1
GGBL1032***S	3 gang 2 way (Display packaged)	7

- **Standard of compliance:**
BS EN 60669-1
- **Mounting box:**
16mm deep (1-2 gang)
25mm deep (3-6 gang)
- **Fixing screws:**
M3.5 x 18mm
- **Plate dimensions:**
87 x 87 mm (1-3 gang)
87 x 148 mm (4 gang)
- **Compatibility:**
Compatible with GGBLILLS.

10AX 4 gang



GGBL1042BSS

Product code	Description	Pack qty
GGBL1042***	4 gang 2 way	1
GGBL1042***S	4 gang 2 way (Display packaged)	7

10A triple pole isolators



GGBL1013BSS

Product code	Description	Pack qty
GGBL1013***	1 gang triple-pole isolator	1
GGBL1013***S	1 gang triple-pole isolator (Display packaged)	7

- **Standard of compliance:**
BS EN 60947-3
- **Mounting box:**
25mm deep
- **Fixing screws:**
M3.5 x 18mm
- **Plate dimensions:**
87 x 87 mm

10AX 1 gang wide rocker



GGBL1012WSS

Product code	Description	Pack qty
GGBL1012W***	2 way	1
GGBL1014W***	intermediate	1

- **Standard of compliance:**
BS EN 60669-1
- **Mounting box:**
16mm deep (1-2 gang)
25mm (3-6 gang)
- **Fixing screws:**
M3.5 x 18mm
- **Plate dimensions:**
87 x 87 mm

10AX 2 & 3 gang wide rocker



GGBL1022WBSS



GGBL1032WWPC

Product code	Description	Pack qty
GGBL1022W***	2 gang	1
GGBL1032W***	3 gang	1

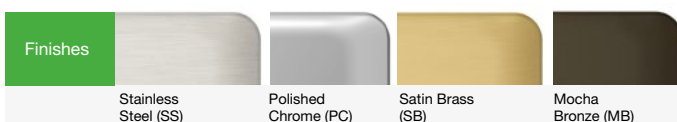

*** = Code for finish option:
B or W for interior colour,
followed by SS, PC, MB,
SB, PB, PW or LC.

Dimmer switches

Mains & low voltage



GGBL6011C**S



GGBL6022C**S

Product code	Description	Pack qty
GGBL6011C**S	1 gang 1 way - 250W - mains (Display packaged)	1
GGBL6012C**S	1 gang 2 way - 400W/VA (Display packaged)	1
GGBL6022C**S	2 gang 2 way - 250W/VA (Display packaged)	1
GGBL6032C**S	3 gang 2 way - 250W/VA (Display packaged)	1
GGBL6042C**S	4 gang 2 way - 250W/VA (Display packaged)	1

- **Standard of compliance:**
BS EN 60669-2-1
- **Mounting box:**
16mm deep
(GGBL6011Cxxx)
25mm deep
- **Fixing screws:**
M3.5 x 25mm
- **Plate dimensions:**
87 x 87mm (1-2 gang)
87 x 148.5mm (3-4 gang)
- **Technical notes:**
Leading edge control (LED Dimmer)
Trailing edge control.

LED Dimmers



GGBL6012L**S

Product code	Description	Pack qty
GGBL6012L**S	1 gang 2 way LED - 100W/VA (Display packaged)	1
GGBL6022L**S	2 gang 2 way LED - 100W/VA (Display packaged)	1

For information regarding 2W & multiway operation and general technical information please refer to the technical section at the back of this catalogue.

Control switches & flex outlet plates

20AX DP 1 gang



GGBL2010B**S

Product code	Description	Pack qty
GGBL2010**S	1 gang (Display packaged)	7
GGBL2011**	1 gang LED Indicator	1
GGBL2011**S	1 gang LED Indicator (Display packaged)	7
GGBL2014WH**	1 gang Flex Outlet & LED Indicator marked 'Water Heater'	1

- **Standard of compliance:**
BS EN 60669-1
- **Mounting box:**
25mm deep
- **Plate dimensions:**
87 x 87mm (1 gang)

Fused connection units

13A unswitched



GGBL5000BSS

Product code	Description	Pack qty
GGBL5000***	Unswitched FCU - 13A	1
GGBL5000***S	Unswitched FCU - 13A (Display packaged)	7
GGBL5003***	Unswitched FCU - Flex Outlet	1
GGBL5003***S	Unswitched FCU - Flex Outlet (Display packaged)	7

- **Standard of compliance:** BS 1363
- **Mounting box:** 25mm deep
- **Fixing screws:** M3.5 x 25mm
- **Plate dimensions:** 87 x 87mm

13A DP switched



GGBL5010BSS

Product code	Description	Pack qty
GGBL5010***	Switched FCU	1
GGBL5010***S	Switched FCU (Display packaged)	6
GGBL5011***	Switched FCU with LED Indicator	1
GGBL5013***	Switched FCU with Flex Outlet and LED indicator	1

High current switches

50A DP switches with LED indicator



GGBL4021BSS

Product code	Description	Pack qty
GGBL4011***	1 gang	1
GGBL4021***	2 gang	1
GGBL4021***S	2 gang (Display packaged)	6

- **Standard of compliance:** BS EN 60669-1 (Cooker control) BS 4177
- **Mounting box:** 47mm deep
- **Fixing screws:** M3.5 x 30mm
- **Plate dimensions:** 87 x 87mm (1 gang)
87 x 148mm (2 gang)

45A cooker control unit with 13A switched socket



GGBL4001BSS

Product code	Description	Pack qty
GGBL4001***	Cooker control unit with LED Indicator	1
GGBL4001***S	Cooker control unit with LED Indicator (Display packaged)	6

Shaver socket

115/230V dual voltage



GGBL7090BSSS

Product code	Description	Pack qty
GGBL7090***S	115/230V dual voltage	1

- **Standard of compliance:** BS EN 61558-2-5
- **Mounting box:** 47mm deep
- **Fixing screws:** M3.5 x 30mm
- **Plate dimensions:** 148 x 87mm

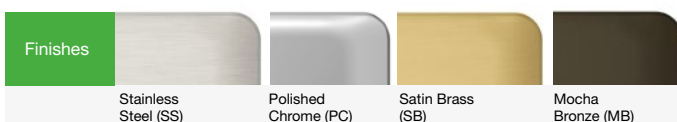

*** = Code for finish option: B or W for interior colour, followed by SS, PC, MB, SB, PB, PW or LC.

Telephone, USB & data outlets

USB charger outlet



GGBL70042BSSS

Product code	Description	Pack qty
GGBL70042***S	1gang 2xUSB – 3.1A total (Display packaged)	1

- **Charging capacity** : 5 VDC - 3.1 A, compatible with USB 2.0 devices
- **Smart chip recognizes and optimizes the charging requirements of individual devices**
- **Electronically protected against over voltages and short circuits on either USB outlet (CAT3)**
- **Energy efficient, stand-by power limitation** : 0.5 W (comply with ErP Directive)

- **Standard of compliance:**
BS EN 60950-1 / WEEE : EU-directive 2002/95/EC, WEEE directive 2002/96/EC.
- **Mounting box:**
35mm deep
- **Fixing screws:**
M3.5 x 25mm
- **Plate dimensions:**
87 x 87mm

Telephone



GGBL7061BSS

Product code	Description	Pack qty
GGBL7051***S	RJ12 (Display packaged)	1
GGBL7061***	BT Master – single	1
GGBL7061***S	BT Master – single (Display packaged)	7
GGBL7062***	BT Secondary – single	1
GGBL7062***S	BT Secondary – single (Display packaged)	7

- **Standard of compliance:**
BS EN 41003
- **Mounting box:**
25mm deep
- **Fixing screws:**
M3.5 x 18mm
- **Plate dimensions:**
87 x 87mm

RJ45 CAT5e UTP



GGBL7071C5BSS

Product code	Description	Pack qty
GGBL7071C5***S	RJ45 Cat 5e - single (Display packaged)	1
GGBL7072C5***S	RJ45 Cat 5e -twin (Display packaged)	1

- **Standard of compliance:**
ANSI/TIA-568-C.2
- **Mounting box:**
25mm deep
- **Fixing screws:**
M3.5 x 18mm
- **Plate dimensions:**
87 x 87mm

RJ45 CAT6 UTP



GGBL7072C6BSSS

Product code	Description	Pack qty
GGBL7071C6***S	RJ45 Cat 6 - single (Display packaged)	1
GGBL7072C6***S	RJ45 Cat 6 – twin (Display packaged)	1

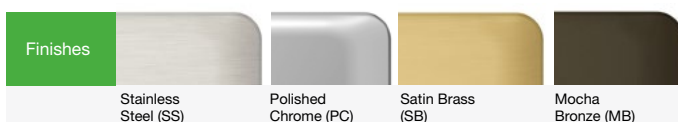

*** = Code for finish option:
B or W for interior colour,
followed by SS, PC, MB,
SB, PB, PW or LC.

TV outlets

Coaxial sockets



Product code	Description	Pack qty
GGBL7010***	TV/FM – Single	1
GGBL7010***S	TV/FM – Single (Display packaged)	7
GGBL7020***S	TV-R/DAB – Diplex (Display packaged)	1
GGBL7030***S	Satellite "F" Type (Display packaged)	1

- **Mounting box:**
25mm for GGBL7010xxx and GGBL7030xxx
- 35mm for GGBL7020xxx
- **Fixing screws:**
M3.5 x 18 mm for GGBL7010xxx and GGBL7030xxx
- M3.5 x 25 mm for GGBL7020xxx
- **Plate dimensions:**
87 x 87mm

Combination plates

Quadplex combination



Product code	Description	Pack qty
GGBL707445510***S	Quadplex RJ45 Cat5e & TV Return (Display packaged)	1
GGBL707445511***S	Quadplex RJ45 Cat5e & RJ12 (Display packaged)	1
GGBL70746110***S	TV/FM/2xSAT & Telephone & TV Return - Quadplex BT Secondary & TV Return (Display packaged)	1
GGBL7074***S	Quadplex TV-R/DAB & 2xSAT (Display packaged)	1

- **Standard of compliance:**
BS EN 5733 for GGBL7074***S
- ANSI/TIA-568-C.2 for GGBL70744551***S
- **Mounting box:**
35mm deep
- **Fixing screws:**
M3.5 x 25mm
- **Plate dimensions:**
87 x 87mm (1 gang)
87 x 148.5mm (2 gang)
- RJ45 Cat5e & RJ12 BT secondary and TV coaxial return.

Triplex combination



Product code	Description	Pack qty
GGBL7081456***S	Triplex TV-R/DAB & RJ45 Cat6 (Display packaged)	1
GGBL7081***S	Triplex TV-R/DAB & SAT (Display packaged)	1

- **Standard of compliance:**
BS5733
- **Mounting box:**
Dimension: 160 x 270 x 47 mm depth
- **Plate dimensions:**
174 x 295 mm
- Euro modules plates compatible with Schneider Electric euro modules.
- **Note:** modules from other suppliers may not be compatible, it is advised to check suitability.

Socket & media combination plate



Product code	Description	Pack qty
GGBL3020D4MP***	2x2 gang 13A socket, 2x2 module euro outlets, quadplex, BT secondary & TV return	1
GGBSB4724M	Stacked back box	1

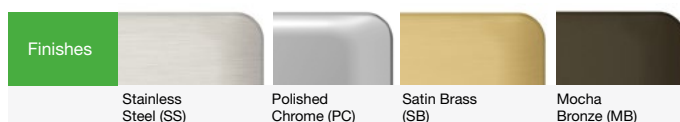

*** = Code for finish option:
B or W for interior colour,
followed by SS, PC, MB,
SB, PB, PW or LC.

Frames, blank plates & accessories

Frames, surrounds & spacers



Product code	Description	Pack qty
GGBLC1GBS	1G surround with clip - Black (Display packaged)	10
GGBLC1GS	1G surround with clip - White (Display packaged)	10
GGBLH1GSBS	1G surround with hook - Black (Display packaged)	10
GGBLH1GS	1G surround with hook - White (Display packaged)	10
GGBLSHF2GBS	2G surround with shelf - Black (Display packaged)	10
GGBLSHF2GS	2G surround with shelf - White (Display packaged)	10
GGBLSHF1GBS	1G surround with shelf - Black (Display packaged)	10
GGBLSHF1GS	1G surround with shelf - White (Display packaged)	10
GGBLSPC1BS	1G spacer - Black (Display packaged)	20
GGBLSPC1S	1G spacer - White (Display packaged)	10
GGBLSPC2BS	2G spacer - Black (Display packaged)	20
GGBLSPC2S	2G spacer - White (Display packaged)	10

- **Standard of compliance:** BS EN 5733
- **Plate dimensions:** 87 x 87mm (1 gang)
87 x 148.5mm (2 gang)

Blank plates & accessories



Product code	Description	Pack qty
GGBL8010**	1 gang	1
GGBL8010**S	1 gang (Display packaged)	10
GGBL8020**	2 gang	1
GGBL8020**S	2 gang (Display packaged)	10
GGBLSIND	Red LED indicators	5
USCREW50**	M3.5 x 50mm screws	100
GGBLILLS	1G Illumination surround	1

- **Standard of compliance:** BS EN 5733
- **Fixing screws:** M3.5 x 18mm (blank plates only)
- **Plate dimensions:** 87 x 87mm (1 gang)
87 x 148.5mm (2 gang)

Grid plates

88 x 88mm



Product code	Description	Pack qty
GGBL01G***	1 module - Incl. Mounting Grid	1
GGBL02G***	2 module - Incl. Mounting Grid	1
GBG01	76x76x42mm flush mounted back box	1

- **Mounting box:** 42mm deep
- **Fixing screws:** M3.5 x 30mm

88 x 148mm



Product code	Description	Pack qty
GGBL03G***	3 module - Incl. Mounting Grid	1
GGBL04G***	4 module - Incl. Mounting Grid	1
GBG02	136x76x42mm flush mounted back box	1

156 x 156mm



Product code	Description	Pack qty
GGBL06G***	6 module - Incl. Mounting Grid	1
GGBL08G***	8 module - Incl. Mounting Grid	1
GBG03	136x136x42mm flush mounted back box	1

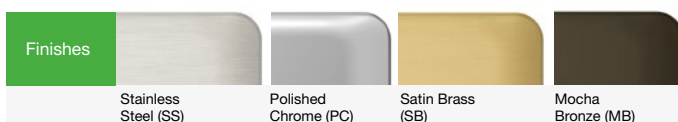

*** = Code for finish option: B or W for interior colour, followed by SS, PC, MB, SB, PB, PW or LC.

Grid plates continued

216x156mm

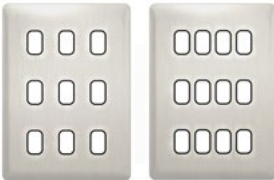

GGBL09GBSS GGBL12GBSS

Product code	Description	Pack qty
GGBL09G***	9 module - Incl. Mounting Grid	1
GGBL12G***	12 module - Incl. Mounting Grid	1
GBG04F	193x133x42mm flush mounted back box	1

- **Mounting box:**
42mm deep
- **Fixing screws:**
M3.5 x 30mm

Grid Modules

Switch modules



GGBL2020M GGBLG2011SS

Product code	Description	Pack qty
GGBL102M	10AX - 2 way (component module - add rocker cap)	6
GGBL10IM	10AX - Intermediate (component module - add rocker cap)	6
GGBL201M	20AX - 1 way (component module - add rocker cap)	6
GGBL2020M	20AX - 2 way Centre Off (component module - add rocker cap)	6
GGBL202M	20AX - 2 way (component module - add rocker cap)	6
GGBL20DPM	20AX Double-pole (component module - add rocker cap)	6
GGBLG2011**	20AX Double-pole with LED indicator	6

- **Standard of compliance:**
BS EN 60669-1
(switch modules)
BS 5733
(indicator modules)
BS EN 41003 (fused connection units).
- **Mounting box:**
42mm deep

Plain and printed rocker caps for component modules



GGBLRSS

Product code	Description	Pack qty
GGBLR**	Plain cap cover	6
GGBLRCH**	Rocker cap printed cooker hood	6
GGBLRDW**	Rocker cap printed dish washer	6
GGBLREF**	Rocker cap printed extractor fan	6
GGBLRFA**	Rocker cap printed fan	6
GGBLRFFZ**	Rocker cap printed Fridge/freezer	6
GGBLRFR**	Rocker cap printed Fridge	6
GGBLRFZ**	Rocker cap printed Freezer	6
GGBLRHO**	Rocker cap printed Hob	6
GGBLRHT**	Rocker cap printed Heater	6
GGBLRMW**	Rocker cap printed Microwave	6
GGBLROV**	Rocker cap printed Oven	6
GGBLRTD**	Rocker cap printed Tumble dryer	6
GGBLRBO**	Rocker cap printed Boiler	6
GGBLRBOT**	Rocker cap printed Boost	6
GGBLRMVHR**	Rocker cap printed MVHR	6
GGBLRWM**	Rocker cap printed Washing machine	6
GGBLRWCL**	Rocker cap printed Wine cooler	6

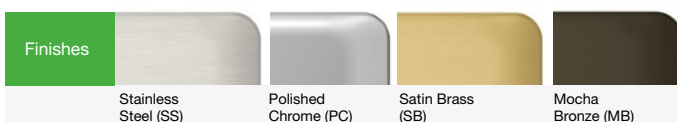

*** = Code for finish option:
B or W for interior colour,
followed by SS, PC, MB,
SB, PB, PW or LC.

Grid Modules continued

Retractive switch modules



GGBL102RSS

Product code	Description	Pack qty
GGBL102R**	2 way Retractive - 10A	6
GGBL202OC**	2 way Retractive Centre Off - 10A	6

- **Standard of compliance:** BS EN 60669-1

Key switch modules



GGBL20DPKELSS

Product code	Description	Pack qty
GGBL202K**	20AX – 2 way	6
GGBL20DPKEL**	20AX Double-pole printed Test Emg Ltg	6
GGBL20DPK**	20AX Double-pole	6
GUGKSK	Spare key for SW module	1

Fused connection unit, USB charger & blank modules



GGBL13FCUBSS



GGBLE7004B

Product code	Description	Pack qty
GGBL13FCU***	13A fused connection unit	6
GGBLB**	Blank Module	6
GGBLE7004B	USB charger Grid Module – 1x USB (1A) – Black	6
GGBLE7014	USB Grid Module – 1xUSB (1A) - White	1

- **Standard of compliance:** BS 5733 (FCU and blank module), BS EN 60950-1 (USB charger)

20A Double-pole Sink Bath Switch with Neon



GGBL2022IMRSS

Product code	Description	Pack qty
GGBL2022IMR**	20A DP Dual Control Bath-Sink / LED	1

- **Standard of compliance:** BS EN 60669-1

LED dimmer



GGBLGRDIMLSS

Product code	Description	Pack qty
GGBLGRDIML**	LED grid dimmer	1

- **Mounting box:** 35mm deep
- **Fixing screws:** M3.5 x 30mm
- **Plate dimensions:** 87 x 87mm (1 gang)
87 x 148.5mm (2 gang)

Indicator Modules



GGBLINDWG



GGBLINDWR

Product code	Description	Pack qty
GGBLINDWG	Green indicator	1
GGBLINDWR	Red indicator	1
GGBLINDWO	Orange indicator	1

Grid inserts (spare)



GGBLSR7004W

Product code	Description	Pack qty
GGBLSRU7004W	USB grid insert - White (spare part for GGBLE7004 or GGBLE7014 only)	1
GGBLSRU7004B	USB grid insert - Black (spare part for GGBLE7004B only)	1
GGBLSR7004W	Grid insert - White (generic)	20
GGBLSR7004B	Grid insert - Black (generic)	20

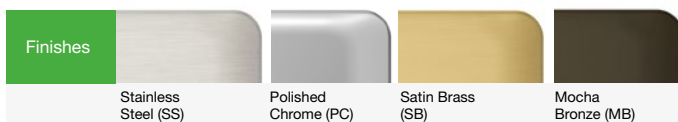

*** = Code for finish option: B or W for interior colour, followed by SS, PC, MB, SB, PB, PW or LC.

Euro plates & modules

Euro plates



GGBL8050SS GGBL8080SS

Product code	Description	Pack qty
GGBL8050**	1 gang - 1 module	1
GGBL8060**	1 gang - 2 module	1
GGBL8080**	2 gang - 4 module	1

- Euro modules plates compatible with Schneider Electric euro modules.
- **Note:** modules from other suppliers may not be compatible, it is advised to check suitability.

25 x 50mm euro modules



GUE7073B GUE7072W



GUE7061B



VDIB1771XB12

Product code	Description	Pack qty
GUE7011*	Single IEC coax (female)	1
GUE7012*	25 x 50mm euro modules IEC coax (male)	1
GUE7030*	Single F type sat	1
GUE7061*	BT master telephone	1
GUE7062*K	BT secondary telephone	1
GUE7071*	RJ45 CAT5e (not screened)	1
GUE7072*	RJ45 CAT5 (not screened)	1
GUE7073*	Single USB charger 1A 5Vdc	1
GUE7021*	Single USB charger 2.1A	1
GUE7051*	RJ11 modem	1
GUE7091W	Actassi module carrier for VDIB1771XB12	8
VDIB1771XB12	Actassi S-One Connector RJ45 CAT6A shielded	12
GUE7000*	2 x Phono socket	1
GUE7001*	2 x Loudspeaker socket	1
GUE8010*	Blank module	5

- **Mounting box:** 25mm deep (25 x 50mm modules)
- **Euro module dimensions:** 25 x 50mm (single)

50 x 50mm euro modules



GUE7020B GUE7081W



GUE7010B

Product code	Description	Pack qty
GUE7010*	TV/FM diplexer	1
GUE7040*	TV/Sat diplexer	1
GUE7074*	Twin USB charger 2 x 1A 5Vdc	1
GUE7031*	Twin USB charger 2 x 3.1A	1
GUE7081*	TV/FM/Sat triplexer	1
GUE7082*	TV/FM/Sat1/Sat2 quadplexer	1
GUE7020*	HDMI	1
GUE7078*	American power socket**	1
GUE7076*	Brush outlet**	1
GUE7077*	5A round pin socket**	1

- **Mounting box:** 35mm deep (25 x 50mm modules)
- **Euro module dimensions:** 50 x 50mm (double)
- ****Made-to-order products**
Subject to minimum order quantities and extended lead time. Contact 0870 608 8 608 for a quotation.

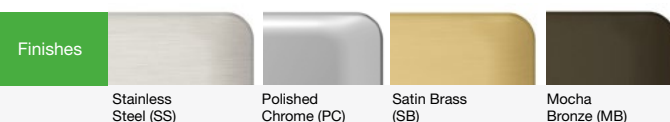

Finishes

Stainless Steel (SS)

Polished Chrome (PC)

Satin Brass (SB)

Mocha Bronze (MB)

*** = Code for finish option: B or W for interior colour, followed by SS, PC, MB, SB, PB, PW or LC.

Flush galvanised steel boxes

16mm deep



SB161

Product code	Description	Pack qty
SB161	1 gang	20

25mm deep



SB252

Product code	Description	Pack qty
SB251	1 gang	10
SB252	2 gang	10

35mm deep



SB351

Product code	Description	Pack qty
SB351	1 gang	10
SB352	2 gang	5

47mm deep



SB472

Product code	Description	Pack qty
SB471	1 gang	10
SB472	2 gang	4

- **Standard of compliance:**
BS 4662

- **Technical notes:**
Supplied with earth terminal and screw.

Supplied with fixed and adjustable lugs.

Fitted with selection of 20mm knockouts in sides and back.



Lisse

Curves in all the right places...

The Lisse White Moulded range of wiring accessories offers the perfect blend of style and performance.

You no longer have to choose between convenience and efficiency, or compromise on appearance to get the most innovative features. Lisse is packed with a vast array of technical features, providing a high level of quality, reliability and value you can count on.



- Ideally suited for new construction and refurbishment projects.
- Future-proofed to cater for the latest demands in consumer technology.
- Made from durable, high quality urea with antimicrobial properties.
- Cleverly designed to ensure that product ordering is simple and efficient, with many time and space saving solutions.
- Crafted with your customer in mind, adding bespoke solutions to make a lasting impact.

Quality as standard...

The smooth, modern lines of Lisse offer an understated elegance to compliment today's interiors.

Not only that - every attention to detail has been paid to the design and construction of this elegant white moulded range, built to make your installation faster, smoother, simpler.

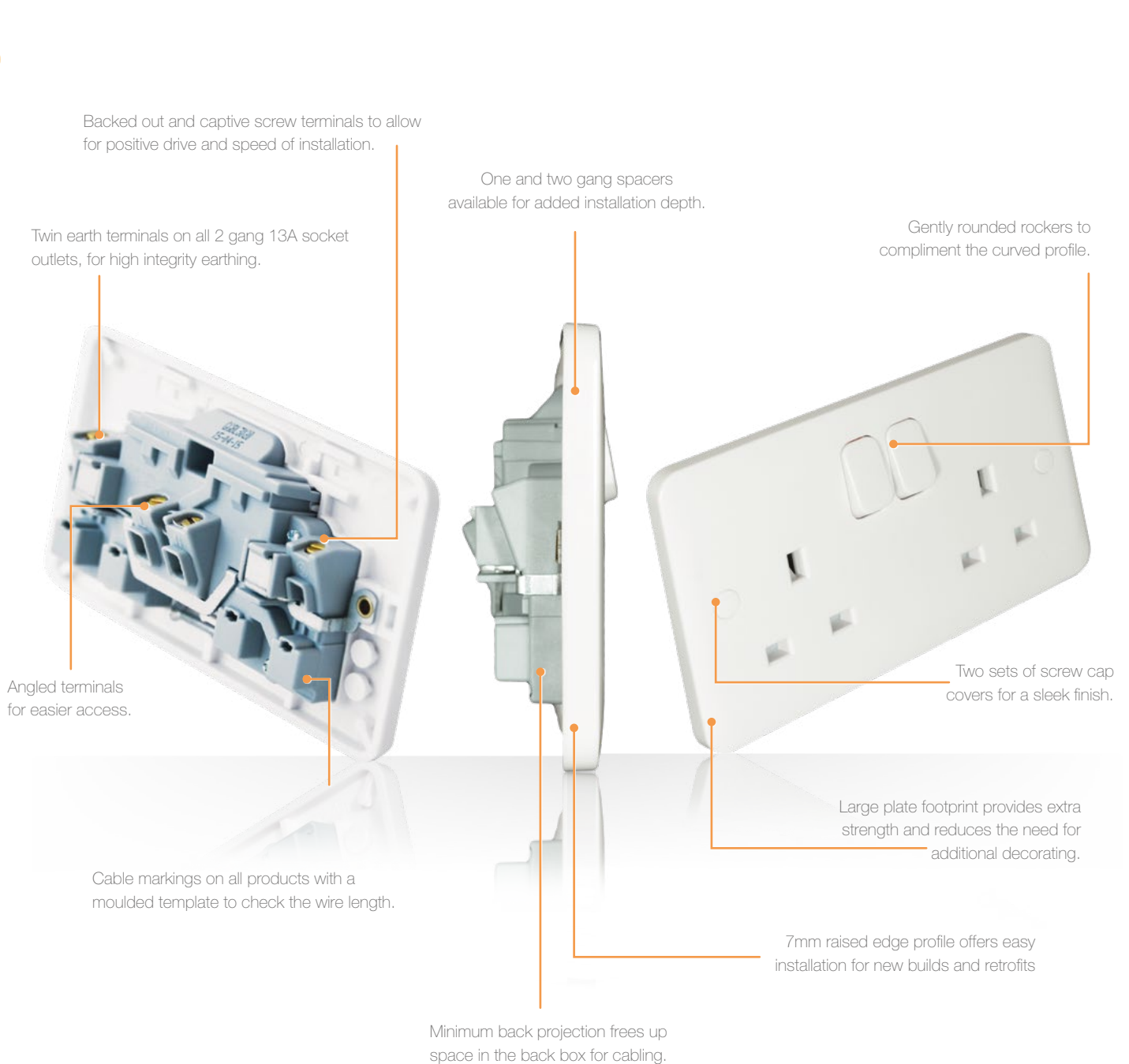

Backed out and captive screw terminals to allow for positive drive and speed of installation.

Twin earth terminals on all 2 gang 13A socket outlets, for high integrity earthing.

Angled terminals for easier access.

Cable markings on all products with a moulded template to check the wire length.

One and two gang spacers available for added installation depth.

Minimum back projection frees up space in the back box for cabling.

Gently rounded rockers to compliment the curved profile.

Two sets of screw cap covers for a sleek finish.

Large plate footprint provides extra strength and reduces the need for additional decorating.

7mm raised edge profile offers easy installation for new builds and retrofits

Tailored to meet your needs...

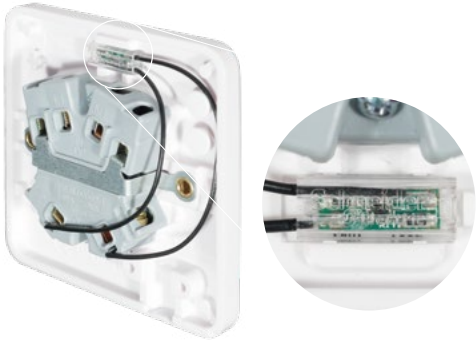

Lisse has been cleverly designed to ensure that product ordering is simple and efficient, with many time and space saving solutions. What does this mean for you? Faster ordering, fewer part references and greater installation flexibility.



Clever Illumination

Enjoy the subtle but elegant illumination provided by Lisse LED indicators. This optional feature shines through the front plate moulding when additional power indication is needed. Installation couldn't be easier, as the LED indicators are simply clipped in to place via a purpose-built holding space on the back of the front plate and leverage dedicated push terminals for cabling.



Flexible Frames

Optional Flex outlet frames offer the additional cabling depth you need on site, without having to hold stock variations of the same product. Simply clip in to place with your standard FCU or control switch to install. One and two gang spacers are also available to provide the perfect solution for remodels and retrofits when extra installation depth is needed.



Fully Antimicrobial

Lisse wiring devices can be used seamlessly with the Ultimate or Cableline anti-microbial 3 compartment trunking systems, to provide a high level of resistance to MRSA, E-Coli, Salmonella and Klebsiella Pneumoniae.

For every application

With such a comprehensive product range, Lisse White Moulded allows you to find everything that you need to meet the demands of today's modern installations.

Flexible Grid Solutions

Available in 1 to 8 gang with accompanying modules. Installation is made easy with its slot headed screw design, and ordering is simplified as mounting frames are supplied with each grid front plate.



Added Safety & Security

The Lisse lockable socket or switch is ideal for communal areas in order to prevent injury risks and unauthorised energy usage.



Stay Connected

Help customers stay connected to their TVs, game consoles, computers, and sound systems with Lisse. Choose from a full range of multimedia connectors, USB charging solutions, and combination plates.



Dimming Genius

Enjoy a comprehensive selection of dimming solutions with Lisse White Moulded, from mains & low voltage compatibility through to LED, as well as the addition of 1-10V 6A control.



Easy Conversions

The Lisse converta socket is an ideal retrofit solution when mounting box space is limited. Allows single to double socket conversion without the need for additional cabling or chasing.





Socket outlets

13A unswitched



GGBL3050



GGBL3060

Product code	Description	Pack qty
GGBL3050	1 gang	10
GGBL3050S	1 gang - display packaged	10
GGBL3060	2 gang	5
GGBL3060S	2 gang - display packaged	5

- **Standard of compliance:** BS 1363 (13A)
- **Mounting box:** Minimum 25mm deep
- **Fixing screws:** M3.5 x 25mm
- **Plate dimensions:** 87 x 87mm (1 gang)
87 x 148.5mm (2 gang)
- **Technical notes:**
 - ✔ Product compatible with LED indicator GGBLSIND.

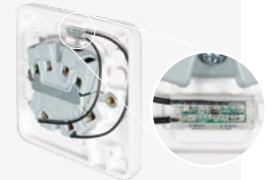

13A 1 gang switched



GGBL3010



GGBL3050NS



GGBLTOP13ANS

Product code	Description	Pack qty
GGBL3010	Single-pole ✔	10
GGBL3010S	Single-pole - display packaged ✔	10
GGBL3010D	Double-pole ✔	10
GGBL3010DS	Double-pole - display packaged ✔	10
GGBL3050NS	Single-pole non-standard - display packaged ✔	10
GGBLTOP13ANS	Non-standard plug top - display packaged ✔	20

13A 2 gang switched with inboard rockers

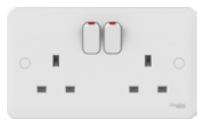

GGBL3020D

Product code	Description	Pack qty
GGBL3020	Single-pole ✔	5
GGBL3020S	Single-pole - display packaged ✔	5
GGBL3020DS	Double-pole - display packaged ✔	5
GGBL3020D	Double-pole ✔	5

13A 2 gang with outboard rockers



GGBL3030



GGBL30212DS

Product code	Description	Pack qty
GGBL3030	Double-pole ✔	5
GGBL3030S	Double-pole - display packaged ✔	5
GGBL30212DS	1 to 2 gang converta - display packaged ✔	5

Lockable



GGBL3060L

Product code	Description	Pack qty
GGBL3060L	1 gang double-pole	5

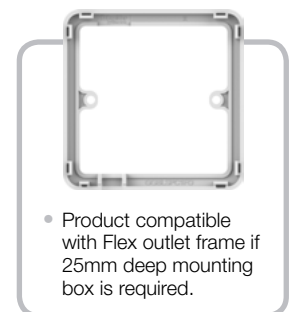

- Product compatible with Flex outlet frame if 25mm deep mounting box is required.

Socket outlets continued

Round pin



GGBL3070 GGBL3080



GGBL3090

Product code	Description	Pack qty
GGBL3070	2A unswitched	10
GGBL3080	5A unswitched	10
GGBL3081	5A switched	10
GGBL3090	15A switched	10
GGBL3090S	15A switched - display packaged	10

- **Standard of compliance:**
BS 546 (round pin)
BS 5733
BS EN 60950
- **Mounting box:**
Minimum 25mm deep
- **Fixing screws:**
M3.5 x 25mm
- **Plate dimensions:**
87 x 87mm (1 gang)

Schuko



GGBL3016A1

Product code	Description	Pack qty
GGBL3016A1	16A 1 gang unswitched*	10

Product compatible with LED indicator GGBLSIND.

* Not for UK use

USB Sockets



GGBL30202USBAS

Product code	Description	Pack qty
GGBL30102USBAS	1 gang SP switched socket outlet with 2x USB	5
GGBL30202USBAS	2 gang SP switched socket outlet with 2 x USB	5

- **Mounting box:**
25mm back box dependent on wiring configuration.

Plate switches

10AX 1 gang



GGBL1012

Product code	Description	Pack qty
GGBL1011	1 way	10
GGBL1011S	1 way - display packaged	10
GGBL1012	2 way	10
GGBL1012S	2 way - display packaged	10
GGBL1014	Intermediate	10
GGBL1014S	Intermediate - display packaged	10

- **Standard of compliance:**
BS EN 60669-1
- **Mounting box:**
16mm deep (1-2 gang)
25mm deep (3 gang)
- **Fixing screws:**
M3.5 x 18mm
- **Plate dimensions:**
87 x 87mm (1-3 gang)

10A 1 gang retractive



GGBL1012RP GGBL1012RB

Product code	Description	Pack qty
GGBL1012R	1 gang	10
GGBL1012RS	1 gang - display packaged	10
GGBL1012RP	1 gang printed with press	10
GGBL1012RPS	1 gang printed with press - display packaged	10
GGBL1012RB	1 gang 2 way printed with bell symbol	10
GGBL1012RBS	1 gang printed with bell symbol - display packaged	10

10AX 2 & 3 gang



GGBL1022 GGBL1032

Product code	Description	Pack qty
GGBL1022	2 gang 2 way	10
GGBL1022S	2 gang 2 way - display packaged	10
GGBL1032	3 gang 2 way	10
GGBL1032S	3 gang 2 way - display packaged	10

Plate switches continued

10AX 4 gang



GGBL1042

Product code	Description	Pack qty
GGBL1042	4 gang 2 way	5
GGBL1042S	4 gang 2 way - display packaged	5

10A triple pole isolators & 10AX



GGBL1013

GGBL10131L



GGBL10131R

Product code	Description	Pack qty
GGBL1013	Triple pole isolator	10
GGBL1013S	Triple pole isolator - display packaged	10
GGBL10131L	Isolator & 10AX 1 gang 2 way switch	5
GGBL10131R	1 gang 2 way switch & 10A isolator	5

- **Standard of compliance:**
BS EN 60669-1
BS EN 60947-3
(GGBL1013,
GGBL10131L,
GGBL10131R)
- **Mounting box:**
16mm deep (1-2 gang)
25mm deep (3-6 gang)
- **Fixing screws:**
M3.5 x 18mm
- **Plate dimensions:**
87 x 148.5mm (4 gang)
87 x 87mm (wide
rockers)
33 x 87mm
(1 gang architrave)
33 x 148.5mm
(2 gang architrave)

10AX 1 gang wide rocker

GGBL1012W
& GGBL1014

Product code	Description	Pack qty
GGBL1012W	2 way	10
GGBL1012WS	2 way - display packaged	10
GGBL1014W	Intermediate	10
GGBL1014WS	Intermediate - display packaged	10

10AX 2 & 3 gang wide rocker



GGBL1022W

GGBL1032W

Product code	Description	Pack qty
GGBL1022W	2 gang 2 way	10
GGBL1022WS	2 gang 2 way - display packaged	10
GGBL1032W	3 gang 2 way	10
GGBL1032WS	3 gang 2 way - display packaged	10

10AX architrave



GGBL1012ARP

Product code	Description	Pack qty
GGBL1012A	1 gang 2 way	10
GGBL1012AS	1 gang 2 way - display packaged	10
GGBL1012116AS	1 gang 2 way & 16mm pattress - display packaged	10
GGBL1012ARP	1 gang 2 way retractive printed press	10
GGBL1022A	2 gang 2 way	10

Dimmer switches

Mains & low voltage



GGBL6012CS

Product code	Description	Pack qty
GGBL6011CS	250W 1 gang 1 way mains - display packaged	5
GGBL6012CS	400W/VA 1 gang 2 way - display packaged	5
GGBL6022CS	250W/VA 2 gang 2 way - display packaged	5
GGBL6032CS	250W/VA 3 gang 2 way - display packaged	5
GGBL6042CS	250W/VA 4 gang 2 way mains & low voltage - display packaged	5

1-10V 6A fluorescent & dimmable ballast



GGBL6022V4S

Product code	Description	Pack qty
GGBL6012V4S	1 gang 2 way - display packaged	5
GGBL6022V4S	2 gang 2 way - display packaged	5
GGBL6032V4S	3 gang 2 way - display packaged	5
GGBL6042V4S	4 gang 2 way - display packaged	5

LED



GGBL6012LS GGBL6022LS

Product code	Description	Pack qty
GGBL6012LS	100W/VA 1 gang 2 way - display packaged	5
GGBL6022LS	100W/VA 2 gang 2 way - display packaged	5

- **Standard of compliance:** BS EN 60669-2-1
 - **Mounting box:** 16mm deep (GGBL6011CS) 25mm deep
 - **Fixing screws:** M3.5 x 18mm (GGBL6011CS) M3.5 x 25mm
 - **Plate dimensions:** 87 x 87mm (1-2 gang) 87 x 148.5mm (3-4 gang)
 - **Technical notes:** Mains & low voltage dimmers: leading edge control. LED Dimmers: trailing edge control.
- Dimmer technical information can be found in the technical data section towards the back of this catalogue.
- **Note:** retractive switches are required for Multi-Way Operation when using LED dimmers.

Control switches & flex outlet plates

20AX DP 1 gang switched



GGBL2010



GGBL2010LS

Product code	Description	Pack qty
GGBL2010	1 gang	10
GGBL2010LS	Lockable - display packaged	5

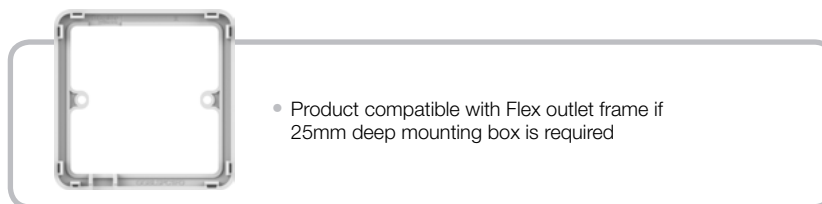

- **Standard of compliance:** BS EN 60669-1 (switches)
- **Mounting box:** 25mm deep
- **Fixing screws:** M3.5 x 25mm
- **Plate dimensions:** 87 x 87mm (1 gang)
- **Technical notes:**
 - Product compatible with LED indicator GGBLSIND.
 - Custom engraving available upon request.

20AX DP 1 gang switched with LED indicator & flex



GGBL2011

Product code	Description	Pack qty
GGBL2011	1 gang	10
GGBL2011S	1 gang - display packaged	10
GGBL2014WH	1 gang with flex outlet frame engraved water heater	10

- **Standard of compliance:** BS EN 60669-1 (switches) BS 5733 (flex outlet plates)
- **Mounting box:** 25mm deep
- **Fixing screws:** M3.5 x 25mm
- **Plate dimensions:** 87 x 87mm

Control switches & flex outlet plates continued

20A DP Sink Bath Switch with Neon



GGBL2022IMR

Product code	Description	Pack qty
GGBL2022IMR	20A DP Sink Bath Switch with Neon	10

- **Standard of compliance:**
BS EN 60669-1 (switches)
BS 5733 (flex outlet plates)
- **Mounting box:**
25mm deep
- **Fixing screws:**
M3.5 x 25mm
- **Plate dimensions:**
87 x 87mm

32A DP 1 gang switched



GGBL4031

Product code	Description	Pack qty
GGBL4031	DP 1 gang with LED indicator	10

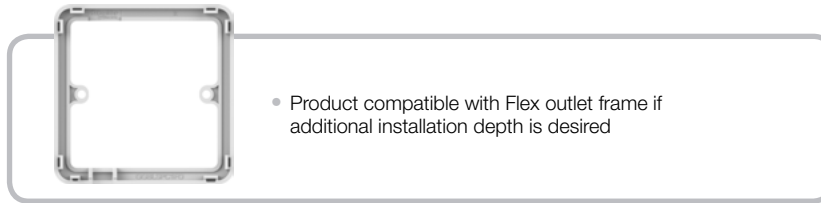

- **Mounting box:**
25mm deep (dependant on cable size)

Flex outlet plates



GGBL2033,
GGBL2033S

Product code	Description	Pack qty
GGBL2033	25A side entry	10
GGBL2033S	25A side entry - display packaged	10

- Custom engravings available upon request.

Fused connection units

13A unswitched



GGBL5000

Product code	Description	Pack qty
GGBL5000	13A unswitched ⓘ	10
GGBL5000S	13A unswitched - display packaged ⓘ	10
GGBL5000AL	13A Unswitched FCU / Printed / ALARM	10

- **Standard of compliance:**
BS 1363
- **Mounting box:**
25mm deep
- **Fixing screws:**
M3.5 x 25mm
- **Plate dimensions:**
87 x 87mm
- **Technical notes:**
ⓘ Product compatible with LED indicator GGBLSIND.
- Custom engravings available upon request.

13A DP switched



GGBL5010

Product code	Description	Pack qty
GGBL5010	13A DP switched ⓘ	10
GGBL5011	13A DP switched with LED indicator	10
GGBL5013S	13A DP switched with flex outlet frame - display packaged ⓘ	10

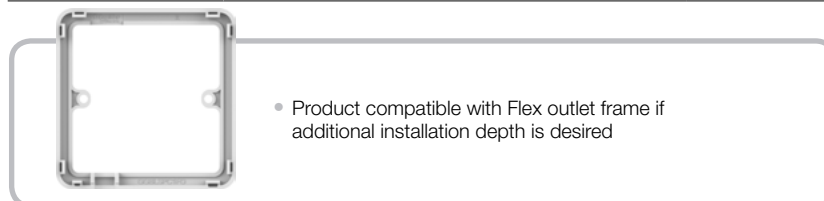

Fused connection units continued

13A DP switched FCU / red engraving



GGBL5010FFR

Product code	Description	Pack qty
GGBL5010BOR	13A DP switched FCU - Boiler	10
GGBL5010CER	13A DP switched FCU - Central heating	10
GGBL5010FRR	13A DP switched FCU - Fridge	10
GGBL5010FFR	13A DP switched FCU - Freezer	10
GGBL5010FAR	13A DP switched FCU- Fan	10
GGBL5010WMMR	13A DP switched FCU - Washing machine	10
GGBL5010CHR	13A DP switched FCU - Cooker hood	10
GGBL5010TDR	13A DP switched FCU - Tumble dryer	10

- **Standard of compliance:**
BS EN 61558-2-5
- **Mounting box:**
47mm deep
- **Fixing screws:**
M3.5 x 30mm
- **Plate dimensions:**
148.5 x 87mm

13A DP switched FCU printed

Product code	Description	Pack qty
GGBL5010BO	13A DP Switched FCU / printed / boiler	10

- **Standard of compliance:**
BS EN 61558-2-5
- **Mounting box:**
47mm deep
- **Fixing screws:**
M3.5 x 30mm
- **Plate dimensions:**
148.5 x 87mm

High current switches

50A DP switches with LED indicator



GGBL4011



GGBL4021

Product code	Description	Pack qty
GGBL4011	1 gang	5
GGBL4011S	1 gang - display packaged	10
GGBL4021	2 gang	5
GGBL4021S	2 gang - display packaged	5
GGBL4021SHW	50A 2 Gang DP Switch / Printed / SHOWER	5
GGBL4011OVW	1G 50A DP Switch / Printed / OVEN	5
GGBL4011MWW	1G 50A DP Switch / Printed / MICROWAVE	5

- **Standard of compliance:**
BS EN 60669-1 (switches)
BS 4177 (cooker control units)
- **Mounting box:**
47mm deep
- **Fixing screws:**
M3.5 x 30mm
- **Plate dimensions:**
87 x 87mm (1 gang)
148.5 x 87mm (2 gang)

45A cooker control unit with 13A switched socket



GGBL4001

Product code	Description	Pack qty
GGBL4001	45A cooker control unit with LED indicators	1
GGBL4001S	45A cooker control unit with LED indicators - display packaged	5

50A cooker connection unit



GGBL4050

Product code	Description	Pack qty
GGBL4050	50A cooker connection unit	10
GGBL4050S	50A cooker connection unit - display packaged	10

Shaver socket

115/230V dual voltage



GGBL7090S

Product code	Description	Pack qty
GGBL7090S	115/230V dual voltage	1

- **Standard of compliance:**
BS EN 61558-2-5
- **Mounting box:**
40mm deep
- **Fixing screws:**
M3.5 x 30mm
- **Plate dimensions:**
148.5 x 87mm

Telephone, USB & data outlets

USB charger outlets



GGBL70042

Product code	Description	Pack qty
GGBL70042	1 gang 2 x USB chargers 2.1A	10
GGBL70042S	1 gang 2 x USB chargers 2.1 A - display packaged	10
GGBL70043	1 gang 2 x USB chargers 3.1A	10

- **Standard of compliance:**
BS EN 41003
- **Mounting box:**
25mm deep
- **Fixing screws:**
M3.5 x 18mm
- **Plate dimensions:**
87 x 87mm

Telephone



GGBL7051



GGBL7061,
GGBL7062

Product code	Description	Pack qty
GGBL7051	RJ11	10
GGBL7051S	RJ11 - display packaged	10
GGBL7061	BT master	10
GGBL7061S	BT master - display packaged	10
GGBL7062	BT secondary	10
GGBL7062S	BT secondary - display packaged	10

RJ45 CAT5e UTP



GGBL7072C5

Product code	Description	Pack qty
GGBL7071C5	RJ45 CAT5e UTP single	10
GGBL7071C5S	RJ45 CAT5e UTP single - display packaged	10
GGBL7072C5	RJ45 CAT5e UTP twin	10
GGBL7072C5S	RJ45 CAT5e UTP twin - display packaged	10

RJ45 CAT6 UTP



GGBL7071C6

Product code	Description	Pack qty
GGBL7071C6	RJ45 CAT6 UTP single §	10
GGBL7071C6S	RJ45 CAT6 UTP single - display packaged §	10
GGBL7072C6	RJ45 CAT6 UTP twin §	10
GGBL7072C6S	RJ45 CAT6 UTP twin - display packaged §	10

TV outlets

Coaxial sockets



GGBL7010 GGBL7020



GGBL7030

Product code	Description	Pack qty
GGBL7010	TV/R	10
GGBL7010S	TV/R - display packaged	10
GGBL7020	Diplex TV-R/DAB	10
GGBL7020S	Diplex TV-R/DAB - display packaged	10
GGBL7030	Satellite "F" Type	10
GGBL7030S	Satellite "F" Type - display packaged	10

- **Standard of compliance:** BS 3041 (where applicable)
- **Mounting box:** 25mm deep for GGBL7010(S), GGBL7030(S) 35mm deep for GGBL7020(S)
- **Fixing screws:** M3.5 x 18 mm for GGBL7010(S) and GGBL7030(S) M3.5 x 25 mm for GGBL7020(S)
- **Plate dimensions:** 87 x 87mm

Combination plates

Quadplex combination



GGBL7074 GGBL707445511



GGBL70746110

Product code	Description	Pack qty
GGBL7074	Quadplex TV-R/DAB & 2 x SAT	10
GGBL7074S	Quadplex TV-R/DAB & 2 x SAT - display packaged	10
GGBL707445510	Quadplex RJ45 CAT5e & TV return	5
GGBL707445510S	Quadplex RJ45 CAT5e & TV return - display packaged	5
GGBL707445511	Quadplex RJ45 CAT5e & RJ12	5
GGBL707445511S	Quadplex RJ45 CAT5e & RJ12 - display packaged	5
GGBL70746110	Quadplex BT secondary & TV return	5
GGBL70746110S	Quadplex BT secondary & TV return - display packaged	5

- **Standard of compliance:** BS EN 5733
- **Mounting box:** 35mm deep
- **Fixing screws:** M3.5 x 25mm
- **Plate dimensions:** 87 x 87mm (1 gang) 87 x 148.5mm (2 gang)

Triplex combination



GGBL7081 GGBL7081456

Product code	Description	Pack qty
GGBL7081	Triplex TV-R/DAB & SAT	10
GGBL7081S	Triplex TV-R/DAB & SAT - display packaged	10
GGBL7081456	Triplex TV-R/DAB & RJ45 CAT6 UTP	5
GGBL7081456S	Triplex TV-R/DAB & RJ45 CAT6 UTP - display packaged	5

- **Standard of compliance:** BS5733
- **Dimensions:** 174 x 295mm
- **Mounting box:** GGBSB4724M (dimensions: 160 x 270 x 47mm depth)
- **Fixing screws:** M3.5 x 25mm
- **Plate dimensions:** 87 x 87mm (1 gang) 87 x 148.5mm (2 gang)
- Euro modules plates compatible with Schneider Electric euro modules.
- **Note:** modules from other suppliers may not be compatible, it is advised to check suitability.

Socket & media combination plate

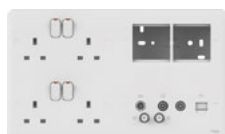

GGBL3020D4MP

Product code	Description	Pack qty
GGBL3020D4MP	2 x 2 gang 13A socket, 2 x 2 module euro outlets, quadplex, BT secondary & TV return	1

Frames, blank plates & accessories

Frames & surrounds



Product code	Description	Pack qty
GGBLSPC1FO	1 gang flex outlet frame	10
GGBLH1GS	1 gang surround with hook - display packaged	10
GGBLC1GS	1 gang surround with clip - display packaged	10
GGBLSHF2GS	2 gang surround with shelf - display packaged	10
GGBLSHF1GS	1G surround with shelf - White (Display packaged)	10

- **Standard of compliance:** BS EN 5733
- **Fixing screws:** GGBLSPC1FO is supplied with cable clamp and fix screws M3.5 x 30 mm
- **Plate dimensions:** 87 x 87mm (1 gang)
87 x 148.5mm (2 gang)

Spacers & accessories



Product code	Description	Pack qty
GGBLSPC1	1 gang spacer	10
GGBLSPC1S	1 gang spacer - display packaged	10
GGBLSPC2	2 gang spacer	5
GGBLSPC2S	2 gang spacer - display packaged	10

Blank plates & accessories



Product code	Description	Pack qty
GGBL8010	1 gang	10
GGBL8010S	1 gang - display packaged	10
GGBL8020	2 gang	5
GGBL8020S	2 gang - display packaged	10
GUMSCO	White moulded screw cap covers	100
GGBLSIND	Red LED indicators	5
USCREW50**	M3.5 x 50mm screws	100
3746130	M3.5 x 25mm raised head machine screws	100
GGBLILLIS	1G Illumination surround frame	1

- **Standard of compliance:** BS EN 5733
- **Fixing screws:** M3.5 x 18mm (blank plates only)
- **Plate dimensions:** 87 x 87mm (1 gang)
87 x 148.5mm (2 gang)

Grid plates

88 x 88mm



Product code	Description	Pack qty
GGBL01G	1 gang	5
GGBL02G	2 gang	5
GBG01	76 x 76 x 42mm flush mounted back box	1

- **Mounting box:**
42mm deep
- **Fixing screws:**
M3.5 x 30mm

88 x 148mm



Product code	Description	Pack qty
GGBL03G	3 gang	5
GGBL04G	4 gang	5
GBG02	136 x 76 x 42mm flush mounted back box	1

156 x 156mm



Product code	Description	Pack qty
GGBL06G	6 gang	1
GGBL08G	8 gang	1
GBG03	136 x 136 x 42mm flush mounted back box	1

216 x 156mm

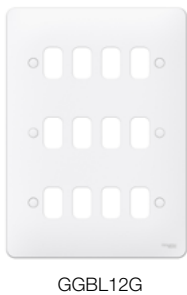

Product code	Description	Pack qty
GGBL09G	9 gang	1
GGBL12G	12 gang	1
GBG04F	193x133x42mm flush mounted back box	1

White moulded grid modules

Switch modules



GGBL102W



GGBLG2011

Product code	Description	Pack qty
GGBL102W	10AX 2 way	1
GGBL10IW	10AX intermediate	1
GGBL201W	20AX 1 way	1
GGBL202W	20AX 2 way	1
GGBL20DPW	20AX double-pole	1
GGBLG2011	20AX double-pole with neon	1

- **Standard of compliance:**
BS EN 60669-1 (switch modules)
BS 5733 (indicator modules)
BS EN 41003 (fused connection units).
- **Mounting box:**
42mm deep

20AX DP printed switch modules



GGBL20DPMWW

Product code	Description	Pack qty
GGBL20DPMWW	Printed microwave	1
GGBL20DPCHW	Printed cooker hood	1
GGBL20DPDWW	Printed dishwasher	1
GGBL20DPFZW	Printed freezer	1
GGBL20DPWMW	Printed washing machine	1
GGBL20DPTDW	Printed tumble dryer	1
GGBL20DPHTW	Printed heater	1
GGBL20DPOVW	Printed oven	1
GGBL20DPEFW	Printed extractor fan	1
GGBL20DPFAW	Printed fan	1
GGBL20DPFFZW	Printed fridge freezer	1
GGBL20DPFRW	Printed fridge	1
GGBL20DPHOW	Printed hob	1
GGBL20DPWBO	Printed boiler	1
GGBL20DPWBOT	Printed boost	1
GGBL20DPWMVHR	Printed mvhr	1
GGBL20DPWWCL	Printed wine cooler	1

Retractive switch modules



GGBL202OCW

Product code	Description	Pack qty
GGBL102RW	10AX 2 way	1
GGBL202OCW	10AX 2 way & centre off	1
GGBL2020W	20AX 2 way centre off & on	1

Key switch modules



GGBL202KEPWPW

Product code	Description	Pack qty
GGBL202KEPWPW	20AX 2 way	1
GGBL20DPKWPW	20AX double-pole	1
GGBL202KEPWPWEL	20AX 2W Key Switch Grid / EMG LTG	1
GGBL20DPKWPWEL	20AX 2W DP Key SW Grid / EMG LTG	1
GUGKSK	Spare key for SW module	1

White moulded grid modules continued

Fused connection unit, USB charger & blank modules



GGBL13FCUWPW



GGBLE7004

Product code	Description	Pack qty
GGBL13FCUWPW	13A fused connection unit	1
GGBLE7004	USB charger	1
GGBLBW	Blank	1

- **Standard of compliance:**
BS EN 60669-1 (switch modules)
BS 5733 (indicator modules)
BS EN 41003 (fused connection units)
- **Mounting box:**
42mm deep

LED rotary grid dimmer



GGBLGRDIMLW

Product code	Description	Pack qty
GGBLGRDIMLW	LED rotary grid dimmer RC 100W	1

Indicator modules



GGBLINDWG



GGBLINDWR



GGBLINDWO

Product code	Description	Pack qty
GGBLINDWG	Green indicator	1
GGBLINDWR	Red indicator	1
GGBLINDWO	Orange indicator	1

- **Standard of compliance:**
BS EN 60669-1 (switch modules)
BS 5733 (indicator modules)
BS EN 41003 (fused connection units)
- **Mounting box:**
42mm deep

Euro plates & modules

Euro plates



GGBL8050 GGBL8060



GGBL8080

Product code	Description	Pack qty
GGBL8050	1 gang 1 module	10
GGBL8060	1 gang 2 module	10
GGBL8080	2 gang 4 module	5

- **Mounting box:** 35mm deep
- **Fixing screws:** M3.5 x 30mm
- **Plate dimensions:** 87 x 87mm (1 gang)
87 x 148.5mm (2 gang)
- Euro modules plates compatible with Schneider Electric euro modules.
- **Note:** modules from other suppliers may not be compatible, it is advised to check suitability.

25 x 50mm euro modules



GUE7011W



GUE7061W



GUE7071W



VDIB1771XB12

Product code	Description	Pack qty
GUE7011W	Single IEC coax (female)	1
GUE7012W	25 x 50mm euro modules IEC coax (male)	1
GUE7021W	Single USB charger 2.1A shared	1
GUE7030W	Single F type sat	1
GUE7061W	BT master telephone	1
GUE7062WK	BT secondary telephone	1
GUE7071W	RJ45 CAT5e (not screened)	1
GUE7072W	RJ45 CAT5 (not screened)	1
GUE7073W	Single USB charger 1A 5Vdc	1
GUE7021W	Single USB charger 2.1A shared	1
GUE7051W	RJ11 modem	1
GUE7091W	Actassi module carrier for VDIB1771XB12	8
VDIB1771XB12	Actassi S-One Connector RJ45 CAT6A shielded	12
GUE7000W	2 x Phono socket	1
GUE7001W	2 x Loudspeaker socket	1
GUE8010W	Blank module	5

- **Dimensions:** 25 x 50mm
- **Mounting box:** 25mm deep
- GUE7091W[^]* compatible with VDIB1771XB12 Actassi S-One Connector RJ45

50 x 50mm euro modules



GUE7010W



GUE7081W



GUE7020W

Product code	Description	Pack qty
GUE7010W	TV/FM diplexer	1
GUE7031W	Twin USB charger 3.1A shared	1
GUE7074W	Twin USB charger 2 x 1A 5Vdc	1
GUE7081W	TV/FM/Sat triplexer	1
GUE7082W	TV/FM/Sat1/Sat2 quadplexer	1
GUE7020W	HDMI	1
GUE7078W	American power socket**	1
GUE7076W	Brush outlet**	1
GUE7077W	5A round pin socket**	1

- **Dimensions:** 50 x 50mm
- **Mounting box:** 25mm deep
- **MTO products for projects only, leadtime to be confirmed at time of ordering.

Surface pattresses

1 gang



GGBL9116 GGBL9147

Product code	Description	Pack qty
GGBL9116	1 gang 16mm	10
GGBL9116S	1 gang 16mm - display packaged	10
GGBL9125	1 gang 25mm	10
GGBL9125S	1 gang 25mm - display packaged	10
GGBL9147	1 gang 47mm	10
GGBL9147S	1 gang 47mm - display packaged	10

- **Standard of compliance:** BS 5733
- **Technical notes:** All supplied complete with earth terminals.

Surface 2 gang



GGBL9225



GGBL9D25



GGBL9247

Product code	Description	Pack qty
GGBL9225	2 gang 25mm	5
GGBL9225S	2 gang 25mm - display packaged	5
GGBL9D25	2 gang dual 25mm	5
GGBL9D25S	2 gang dual 25mm - display packaged	5
GGBL9247	2 gang 47mm	5
GGBL9247S	2 gang 47mm - display packaged	5

Architrave



GGBL9216A

Product code	Description	Pack qty
GGBL9116A	1 gang 16mm	10
GGBL9216A	2 gang 16mm	10

Flush galvanised steel boxes

16mm deep



SB161

Product code	Description	Pack qty
SB161	1 gang	20

25mm deep

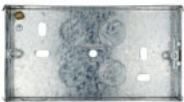

SB252

Product code	Description	Pack qty
SB251	1 gang	10
SB252	2 gang	10

35mm deep



SB351

Product code	Description	Pack qty
SB351	1 gang	10
SB352	2 gang	5

47mm deep



SB472

Product code	Description	Pack qty
SB471	1 gang	10
SB472	2 gang	4

- **Standard of compliance:**
BS 4662

- **Technical notes:**
Supplied with earth terminal and screw.

Supplied with fixed and adjustable lugs.

Fitted with selection of 20mm knockouts in sides and back.





Exclusive

Meeting all of your needs

The Exclusive range of wiring accessories offers the dependability that you need along with increased flexibility in applications, whether those are installations in the residential and commercial space or in outdoor and industrial environments.



Square Edge White Moulded

This comprehensive white moulded range will offer everything that your customers need in a traditional wiring accessory. With its classic, square edge design, the Exclusive White Moulded range will suit well with existing installations and is sure to please again and again.



Metal Clad

Looking for stronger stuff? The Exclusive Metal Clad range of wiring accessories offers an incredibly robust solution for industrial applications, with two finish options - Grey and Silver Grey.

Exclusive Square Edge White Moulded

This highly successful Exclusive Square Edge range of white moulded wiring accessories maintains superb quality, with an easy-to-install technical specification, for exceptional value for money.

Optional cable outlet facility provides the choice of either surface or flush cable access.

50A rated switches for operating appliances with higher current ratings, such as heaters, cookers and commercial refrigerating units.

Full 10AX plate switch rating for fluorescent and inductive loads.

Timeless and traditional plate profile, with generous 9mm plate depth.

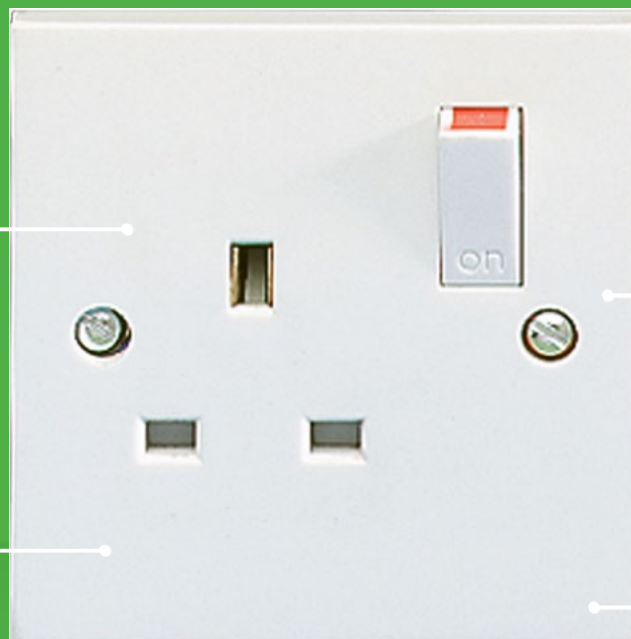

Double pole sockets provide both easy access to connections as well as twin earth terminals for high integrity earthing.

- **Passive Latching:** Designed for food freezers or garden water feature pumps, ensuring that contacts will stay closed during loss of power so that RCD does not need re-setting when the circuit is restored.
- **Active / non-latching:** Designed for lawnmowers or power tools, the RCD will tip on loss of power and requires manual resetting when the circuit is to be re-energised.

Residual current devices with active and passive controls offer added safety in the event of lost power:

Converta Socket Outlets



A converta socket outlet is an ideal retrofit solution for existing installations. The device allows single to double conversion of standard flush-mounted wiring accessories without the need for additional cabling or chasing.

- Allows 2 gang socket to fit 1 gang steel back box
- Quick and easy replacement, saving time and money
- Reduces the need for redecorating



Socket outlets

13A unswitched



GSKT1G



GSKT2G

Product code	Description	Pack qty
GSKT1G	1 gang	10
GSKT2G	2 gang	5

- **Standard of compliance:**
BS 1363 (13A)
BS 546 (round pin)
BS 7288 (RCD)
- **Mounting box:**
Minimum 25mm deep
- **Fixing screws:**
M3.5 x 30mm
- **Plate dimensions:**
86 x 86mm (1 gang)
86 x 146mm (2 gang)
- **Technical notes:**
Active control - device will fail safe in the event of loss of supply. Suitable for domestic use.

13A switched



GSKTSW1G



GSKTSW2G2

Product code	Description	Pack qty
GSKTSW1G	1 gang single-pole	10
GSKTSWDP1G	1 gang double-pole	10
GSKTSW2G2	2 gang single-pole	5
GSKTSWDP2G	2 gang double-pole	5
GSKTSW3G	3 gang single-pole with fuse	5

- **Passive control** - device will only trip in the event of a fault. Suitable for freezers and commercial applications.

All 2 gang sockets include twin earth terminals as standard, enabling high integrity earthing.

All 2 gang switched sockets (excludes unswitched and RCD protected).

13A double-pole switched with outboard rockers



GSKTSWDPOB2G



GSKTSWDP1G2G

Product code	Description	Pack qty
GSKTSWDPOB2G	2 gang	5

Round pin



GSKT2A1G



GSKT5A1G

Product code	Description	Pack qty
GSKT2A1G	2A unswitched	10
GSKT5A1G	5A unswitched	10

Double-pole 30mA RCD protected



GPRCDSKT2G

Product code	Description	Pack qty
LSKT1GR	1 gang unswitched - active control	1
GPRCDSKT1G	1 gang switched - passive control	1
LSKT2GR	2 gang unswitched - active control	1
LSKT2GRP	2 gang unswitched - passive control	1
GPRCDSKT2G	2 gang switched - passive control	1

Plate switches

10AX 1 gang



GSW1G2W

Product code	Description	Pack qty
GSW1G1W	1 gang 1 way	10
GSW1G2W	1 gang 2 way	10
GSWINT	Intermediate	10

- **Standard of compliance:**
BS EN 60669-1
BS EN 60947-3
(GSWISO2)
BS 3676
(GSWTPS)

- **Mounting box:**
16mm deep (1-2 gang)
25mm deep (3-6 gang)

- **Fixing screws:**
M3.5 x 18mm

- **Plate dimensions:**
86 x 86mm (1-3 gang)

86 x 146mm (4 gang)

33 x 86mm (1 gang
architrave)33 x 148mm (2 gang
architrave)

10A 1 gang 2 way retractive



GSW1G2WRP

Product code	Description	Pack qty
GSW1G2WR	1 gang 2 way	10
GSW1G2WRP	1 gang 2 way printed with press	10

10AX multi gang



GSW2G2W



GSW3G2W



GSW4G2W

Product code	Description	Pack qty
GSW2G2W	2 gang 2 way	10
GSW3G2W	3 gang 2 way	10
GSW4G2W	4 gang 2 way	10

10A triple pole isolator



GSWTPS



GSWISO2

Product code	Description	Pack qty
GSWTPS	Triple pole switch	10
GSWISO2	3 pole lockable isolator	10

10AX architrave



GSWA1G2W

Product code	Description	Pack qty
GSWA1G2W	1 gang 2 way	10

Dimmer switches

1 gang



GD1G2WC

Product code	Description	Pack qty
GD1G1W	60-250W 1 way mains	1
GD1G2WC	250W/VA 2 way mains & low voltage	1
GD1G2W4C	400W/VA 2 way mains & low voltage	1

- **Standard of compliance:** BS EN 60669-2-1
- **Mounting box:** 16mm (GD1G1W) 25mm deep
- **Fixing screws:** M3.5 x 30mm
- **Plate dimensions:** 86 x 86mm (1 gang) 86 x 146mm (2 gang)
- **Technical notes:** Not suitable for dimming LED or CFL lighting.

2 gang



GD2G2WC

Product code	Description	Pack qty
GD2G2WC	250W/VA 2 way mains & low voltage	1

Control switches & flex outlet plates

20AX DP 1 gang switched



GSWDPN20A

Product code	Description	Pack qty
GSWDP20A	1 gang	10
GSWDPN20A	1 gang with neon	10

- **Standard of compliance:** BS EN 60669-1
- **Mounting box:** 25mm deep
- **Fixing screws:** M3.5 x 30mm
- **Plate dimensions:** 86 x 86mm

20AX DP 1 gang switched with flex outlet



GSWDP20AFO

Product code	Description	Pack qty
GSWDP20AFO	1 gang	10

20AX DP 1 gang switched with neon & flex outlet



GSWDPN20AFO

Product code	Description	Pack qty
GSWDPN20AFO	1 gang	10

Flex outlet plates



GSFOPLATE



GFOPLATE

Product code	Description	Pack qty
GSFOPLATE	25A side entry	10
GFOPLATE	20A front entry	10

- **Standard of compliance:** BS 5733
- **Mounting box:** 25mm deep
- **Fixing screws:** M3.5 x 30mm
- **Plate dimensions:** 86 x 86mm

Fused connection units

Unswitched



GSPUR3A

GSPUR

Product code	Description	Pack qty
GSPUR3A	3A	10
GSPUR	13A	10
GNSPUR	13A with neon	10

- **Standard of compliance:**
BS 1363
- **Mounting box:**
25mm deep
- **Fixing screws:**
M3.5 x 30mm
- **Plate dimensions:**
86 x 86mm
- **Technical note:**
Optional flex outlet facility at the base of the front plate.

13A DP switched with optional flex outlet



GSWSPUR

Product code	Description	Pack qty
GSWSPUR	13A DP	10

13A DP switched with neon & optional flex outlet



GSWNSPUR

Product code	Description	Pack qty
GSWNSPUR	13A DP	10

- **Standard of compliance:**
BBS 1363
BS 7288 (RCD)
- **Mounting box:**
25mm deep
- **Fixing screws:**
M3.5 x 30mm
- **Plate dimensions:**
86 x 86mm

Double-pole 30mA RCD protected



GPRCDFCU

Product code	Description	Pack qty
GPRCDFCU	Unswitched - passive control	1

High current switches

50A DP switches



GCKRN50A



GCKR50A2G

Product code	Description	Pack qty
GCKR50A	1 gang	5
GCKRN50A	1 gang with neon	5
GCKR50A2G	2 gang	5
GCKRN50A2G	2 gang with neon	5

- **Standard of compliance:**
BS EN 60669-1 (switches)
BS 4177 (cooker control units)
BS 5733
- **Mounting box:**
47mm deep
- **Fixing screws:**
M3.5 x 30mm
- **Plate dimensions:**
86 x 86mm (1 gang)
146 x 86mm (2 gang)

45A cooker control unit with 13A switched socket



G45ACCUN

Product code	Description	Pack qty
G45ACCU	45A cooker control unit	1
G45ACCUN	45A cooker control unit with neons	1

Cooker connection unit



G45CX

Product code	Description	Pack qty
G45CX	Cooker connection unit	10

Shaver socket

115/230V dual voltage



GSHVSKT

Product code	Description	Pack qty
GSHVSKT	Dual voltage 115/230V socket	1

- **Standard of compliance:**
BS EN 61558-2-5
BS 646 (fuse)
- **Mounting box:**
47mm deep
- **Fixing screws:**
M3.5 x 30mm
- **Plate dimensions:**
146 x 86mm

Telephone & data outlets

Telephone outlets



GTELRJ11

GTELMAS

Product code	Description	Pack qty
GTELRJ11	RJ11 outlet	10
GTELMAS	BT master	10
GTELSEC	BT secondary	10

- **Standard of compliance:** BS EN 41003
- **Mounting box:** 25mm deep
- **Fixing screws:** M3.5 x 30mm
- **Plate dimensions:** 86 x 86mm

RJ45 CAT5e UTP



GTELRJ45

Product code	Description	Pack qty
GTELRJ45	RJ45 CAT5e UTP	10

TV outlets

Coaxial sockets



GSKTCOAX

GSKTCOAX2G

Product code	Description	Pack qty
GSKTCOAX	Single direct connection TV	10
GSKTCOAX2G	Twin direct connection TV	10

- **Standard of compliance:** BS 3041 (where applicable)
- **Mounting box:** 25mm deep
- **Fixing screws:** M3.5 x 30mm
- **Plate dimensions:** 86 x 86mm

Blank plates & accessories

Blank plates & machine screws



GBLANK1G

GBLANK2G

Product code	Description	Pack qty
GBLANK1G	1 gang	10
GBLANK2G	2 gang	5
USCREW50SS	M3.5 x 50mm screws	100
3746130	M3.5 x 25mm raised head machine screws	100

- **Standard of compliance:** BS EN 5733
- **Fixing screws:** M3.5 x 30mm
- **Plate dimensions:** 86 x 86mm (1 gang)
86 x 146mm (2 gang)

Euro modular plates & modules

Euro plates



Product code	Description	Pack qty
GEURO1	1 gang 1 module	10
GEURO2	1 gang 2 module	10
GEURO4	2 gang 4 module	5

- **Mounting box:** 35mm deep
- **Fixing screws:** M3.5 x 30mm
- **Plate dimensions:** 86 x 86mm (1 gang)
86 x 146mm (2 gang)

25 x 50mm euro modules



Product code	Description	Pack qty
GUE7011*	Single IEC coax (female)	1
GUE7012*	25 x 50mm euro modules IEC coax (male)	1
GUE7030*	Single F type sat	1
GUE7061*	BT master telephone	1
GUE7062*K	BT secondary telephone	1
GUE7071*	RJ45 CAT5e (not screened)	1
GUE7072*	RJ45 CAT5 (not screened)	1
GUE7073*	Single USB charger 1A 5Vdc	1
GUE7021*	Single USB charger 2.1A	1
GUE7051*	RJ11 modem	1
GUE7091W	Actassi module carrier for VDIB1771XB12	8
VDIB1771XB12	Actassi S-One Connector RJ45 CAT6A shielded	12
GUE7000*	2 x Phono socket	1
GUE7001*	2 x Loudspeaker socket	1
GUE8010*	Blank module	5

- **Mounting box:** 25mm deep (25 x 50mm modules)
- **Euro module dimensions:** 25 x 50mm (single)

50 x 50mm euro modules



Product code	Description	Pack qty
GUE7010*	TV/FM diplexer	1
GUE7074*	Twin USB charger 2 x 1A 5Vdc	1
GUE7031*	Twin USB charger 2 x 3.1A	1
GUE7081*	TV/FM/Sat triplexer	1
GUE7082*	TV/FM/Sat1/Sat2 quadplexer	1
GUE7020*	HDMI	1
GUE7078*	American power socket**	1
GUE7076*	Brush outlet**	1
GUE7077*	5A round pin socket**	1

- **Mounting box:** 35mm deep (25 x 50mm modules)
- **Euro module dimensions:** 50 x 50mm (double)
- ****Made-to-order products**
Subject to minimum order quantities and extended lead time. Contact 0870 608 8 608 for a quotation.

Surface pattresses

1 gang



GPAT1G16

Product code	Description	Pack qty
GPAT1G16	1 gang 16mm	10
GPAT1G25	1 gang 25mm	10
GPAT1G47	1 gang 47mm	10

2 gang



GPAT2G25

Product code	Description	Pack qty
GPAT2G25	2 gang 25mm	5
GPATDG25	2 gang dual 25mm	10
GPAT2G47	2 gang 47mm	5

Architrave



GPAT1G16A

Product code	Description	Pack qty
GPAT1G16A	1 gang 16mm	20

Converter



GPAT2GC25



GPAT3G25

Product code	Description	Pack qty
GPAT2GC25	1-2 gang 25mm	5
GPAT3G25	1-3 gang 25mm	5

- **Technical notes:**
GPAT3G25 is designed for use with GSKTSW3G.

Flush galvanised steel boxes

16mm deep



SB161

Product code	Description	Pack qty
SB161	1 gang	20

25mm deep



SB252

Product code	Description	Pack qty
SB251	1 gang	10
SB252	2 gang	10

35mm deep



SB351

Product code	Description	Pack qty
SB351	1 gang	10
SB352	2 gang	5

47mm deep



SB472

Product code	Description	Pack qty
SB471	1 gang	10
SB472	2 gang	4

- **Standard of compliance:**
BS 4662

- **Technical notes:**
Supplied with earth terminal and screw.

Supplied with fixed and adjustable lugs.

Fitted with selection of 20mm knockouts in sides and back.





Exclusive Metal Clad

Exclusive Metal Clad

Our Exclusive Metal Clad range has been built to perform. The strong, industrial design supported by a robust technical specification makes this range the perfect choice for a variety of commercial and public buildings.

Popular trends in the domestic market for modern loft style interiors also provide the perfect backdrop for this range which is available in either grey or silver grey finishes.

Boxes are supplied with a full selection of 20mm knockouts.

Choice of grey and silver grey finishes; ideal for commercial spaces and modern domestic interiors.

Tough and impact resistant.

50A rated plate switches for switching appliances with higher current ratings, such as heaters, cookers and commercial refrigerating units.

All products are supplied complete with 42mm deep surface mounting box in matching finish.

Finish Selection

The Exclusive Metal Clad range is available in Silver Grey or Grey finishes



Socket outlets

13A 1 gang unswitched



GMC131S

Product code	Description	Pack qty
GMC131S	Grey	10
GMCS131S	Silver Grey	10

13A 2 gang unswitched



GMC132S

Product code	Description	Pack qty
GMC132S	Grey	5
GMCS132S	Silver Grey	5

13A 1 gang single-pole switched



GMC131SS

Product code	Description	Pack qty
GMC131SS	Grey	10
GMCS131SS	Silver Grey	10

13A 2 gang single-pole switched



GMC132SS

Product code	Description	Pack qty
GMC132SS	Grey	5
GMCS132SS	Silver Grey	5

13A 2 gang single-pole switched with outboard rockers



GU3631GMC

Product code	Description	Pack qty
GU3631GMC	Grey	5

5A round pin unswitched



GMC51S

Product code	Description	Pack qty
GMC51S	Grey	10
GMCS51S	Silver Grey	10

1 gang double-pole 30mA RCD protected - active control



LMCSKT1GR

Product code	Description	Pack qty
LMCSKT1GR	Grey	1

- **Standard of compliance:**
BS 1363 (13A)
BS 546 (round pin)
BS 7288 (RCD)
- **Mounting box:**
47mm deep (back box supplied)
- **Fixing screws:**
M3.5 x 30mm
- **Plate dimensions:**
79 x 79 x 42mm (1 gang)

79 x 139 x 42mm (2 gang)

92 x 145 x 49mm (RCDs)
- **Technical notes:**
LMCSKT1GR requires a 2 gang back box.

Active control consists of an electronic latch, which will require resetting in the event of a loss of supply. Particularly useful for domestic use.

Passive control - device will only trip in the event of a fault. Suitable for freezers and commercial applications.

Socket outlets continued

1 gang double-pole 30mA RCD protected switched - passive control



GMCPRCDSKT1G

Product code	Description	Pack qty
GMCPRCDSKT1G	Grey	1

2 gang double-pole 30mA RCD protected - active control



LMCSKT2GR

Product code	Description	Pack qty
LMCSKT2GR	Grey	1

2 gang double-pole 30mA RCD protected unswitched - passive control



LMCSKT2GRP

Product code	Description	Pack qty
LMCSKT2GRP	Grey	1

2 gang double-pole 30mA RCD protected switched - passive control



GMCPRCDSKT2G

Product code	Description	Pack qty
GMCPRCDSKT2G	Grey	1

Plate switches

10AX 1 gang 2 way



GMC1012

Product code	Description	Pack qty
GMC1012	Grey	10
GMCS1012	Silver Grey	10

10AX 1 gang intermediate



GMCINT

Product code	Description	Pack qty
GMCINT	Grey	10
GMCSINT	Silver Grey	10

- **Standard of compliance:**
BS EN 60669-1
- **Mounting box:**
47mm deep (back box supplied)
- **Plate dimensions:**
79 x 79 x 42mm

Plate switches continued

10AX 2 gang 2 way



GMC1022

Product code	Description	Pack qty
GMC1022	Grey	10
GMCS1022	Silver Grey	10

- **Standard of compliance:**
BS EN 60669-1
- **Mounting box:**
47mm deep (back box supplied)
- **Plate dimensions:**
79 x 79 x 42mm

10AX 3 gang 2 way



GMC1032

Product code	Description	Pack qty
GMC1032	Grey	10
GMCS1032	Silver Grey	10

Control switches

20AX double-pole 1 gang switched



GMC20S

Product code	Description	Pack qty
GMC20S	Grey	10
GMCS20S	Silver Grey	10

- **Standard of compliance:**
BS EN 60669-1
- **Mounting box:**
47mm deep (back box supplied)
- **Plate dimensions:**
79 x 79 x 42mm

20AX double-pole 1 gang switched with neon



GMC20SN

Product code	Description	Pack qty
GMC20SN	Grey	10
GMCS20SN	Silver Grey	10

Fused connection units

13A unswitched



GMC13SP

Product code	Description	Pack qty
GMC13SP	Grey	10
GMCS13SP	Silver Grey	10

- **Standard of compliance:**
BS 1363
- **Mounting box:**
47mm deep (back box supplied)
- **Plate dimensions:**
79 x 79 x 42mm

13A unswitched with neon



GMC13SPN

Product code	Description	Pack qty
GMC13SPN	Grey	10
GMCS13SPN	Silver Grey	10

Fused connection units continued

13A unswitched with flex outlet



GMC13SPF

Product code	Description	Pack qty
GMC13SPF	Grey	10
GMCS13SPF	Silver Grey	10

13A DP unswitched with neon & flex outlet



GMC13SPNF

Product code	Description	Pack qty
GMC13SPNF	Grey	10
GMCS13SPNF	Silver Grey	10

13A double-pole switched



GMC13SSP

Product code	Description	Pack qty
GMC13SSP	Grey	10
GMCS13SSP	Silver Grey	10

13A double-pole switched with neon



GMC13SSPN

Product code	Description	Pack qty
GMC13SSPN	Grey	10
GMCS13SSPN	Silver Grey	10

13A double-pole switched with flex outlet



GMC13SSPF

Product code	Description	Pack qty
GMC13SSPF	Grey	10
GMCS13SSPF	Silver Grey	10

13A double-pole switched with neon & flex outlet



GMC13SSPNF

Product code	Description	Pack qty
GMC13SSPNF	Grey	10
GMCS13SSPNF	Silver Grey	10

Double-pole 30mA RCD protected - passive control



GMCPRCDFCU

Product code	Description	Pack qty
GMCPRCDFCU	Grey	1

- **Standard of compliance:** BS 1363
- **Mounting box:** 47mm deep (back box supplied)
- **Plate dimensions:** 79 x 79 x 42mm
- **Technical notes:** Active control consists of an electronic latch, which will require resetting in the event of a loss of supply. Particularly useful for domestic use.
- **Passive control - device will only trip in the event of a fault.** Suitable for freezers and commercial applications.

High current switches

50A 1 gang double-pole switch



GMC50S

Product code	Description	Pack qty
GMC50S	Grey	10
GMCS50S	Silver Grey	10

- **Standard of compliance:**
BS EN 60669-1
- **Mounting box:**
47mm deep (back box supplied)
- **Plate dimensions:**
79 x 79 x 42mm (1 gang)

139 x 79 x 42mm (2 gang)

50A 1 gang double-pole switch with neon



GMC50SN

Product code	Description	Pack qty
GMC50SN	Grey	10

50A 2 gang double-pole switch with neon



GMC50S2N

Product code	Description	Pack qty
GMC50S2N	Grey	5
GMCS50S2N	Silver Grey	5

Blank plates

1 gang



GMCB1

Product code	Description	Pack qty
GMCB1	Grey	10
GMCSB1	Silver Grey	10

2 gang

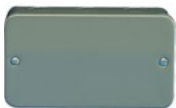

GMCB2

Product code	Description	Pack qty
GMCB2	Grey	5
GMCSB2	Silver Grey	5

- **Standard of compliance:**
BS EN 5733
- **Mounting box:**
47mm deep (back box supplied)
- **Plate dimensions:**
79 x 79 x 42mm (1 gang)
79 x 139 x 42mm (2 gang)

Grid plates

1 gang 88 x 88mm



GUG01GMC

Product code	Description	Pack qty
GUG01GMC	Grey	1
GBG01	Grey 76 x 76 x 42mm back box with knockouts	1
GUG01GSMC	Silver Grey	1
GBGS01	Silver Grey 76 x 76 x 42mm back box with knockouts	1
GBG01P	Grey 76 x 76 x 42mm back box without knockouts	1

- **Standard of compliance:**
BS 5733
- **Mounting box:**
47mm deep
- **Technical notes:**
All grid plates are supplied with the appropriate number of mounting frames.

Back box needs to be ordered separately.

2 gang 88 x 88mm



GUG02GMC

Product code	Description	Pack qty
GUG02GMC	Grey	1
GBG01	Grey 76 x 76 x 42mm back box with knockouts	1
GUG02GSMC	Silver Grey	1
GBGS01	Silver Grey 76 x 76 x 42mm back box with knockouts	1
GBG01P	Grey 76 x 76 x 42mm back box without knockouts	1

3 gang 88 x 148mm



GUG03GMC

Product code	Description	Pack qty
GUG03GMC	Grey	1
GBG02	Grey 7136 x 76 x 42mm back box with knockouts	1
GUG03GSMC	Silver Grey	1
GBGS02	Silver Grey 136 x 76 x 42mm back box with knockouts	1
GBG02P	Grey 76 x 76 x 42mm back box without knockouts	1

4 gang 88 x 148mm



GUG04GMC

Product code	Description	Pack qty
GUG04GMC	Grey	1
GBG02	Grey 7136 x 76 x 42mm back box with knockouts	1
GUG01GSMC	Silver Grey	1
GBGS02	Silver Grey 136 x 76 x 42mm back box with knockouts	1
GBG02P	Grey 76 x 76 x 42mm back box without knockouts	1

6 gang 156 x 156mm



GUG06GMC

Product code	Description	Pack qty
GUG06GMC	Grey	1
GBG03	Grey 136 x 136 x 42mm back box with knockouts	1
GUG06GSMC	Silver Grey	1
GBGS03	Silver Grey 136 x 136 x 42mm back box with knockouts	1

8 gang 156 x 156mm



GUG08GMC

Product code	Description	Pack qty
GUG08GMC	Grey	1
GBG03	Grey 136 x 136 x 42mm back box with knockouts	1
GUG08GSMC	Silver Grey	1
GBGS03	Silver Grey 136 x 136 x 42mm back box with knockouts	1

Grid plates continued

9 gang 216 x 156mm



GUG09GMC

Product code	Description	Pack qty
GUG09GMC	Grey	1
GBG04S	Grey 202 x 136 x 42mm back box	1
GUG09GSMC	Silver Grey	1
GBGS04S	Silver Grey 202 x 136 x 42mm back box	1

12 gang 216 x 156mm

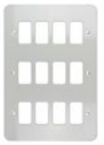

GUG12GMC

Product code	Description	Pack qty
GUG12GMC	Grey	1
GBG04S	Grey 202 x 136 x 42mm back box	1
GUG12GSMC	Silver Grey	1
GBGS04S	Silver Grey 202 x 136 x 42mm back box	1

18 gang 398 x 156mm



GUG18GMC

Product code	Description	Pack qty
GUG18GMC	Grey	1
GBG06S	Grey 334 x 136 x 42mm back box	1
GUG18GSMC	Silver Grey	1
GBGS06S	Silver Grey 334 x 136 x 42mm back box	1

24 gang 398 x 156mm



GUG24GMC

Product code	Description	Pack qty
GUG24GMC	Grey	1
GBG06S	Grey 334 x 136 x 42mm back box	1
GUG24GSMC	Silver Grey	1
GBGS06S	Silver Grey 334 x 136 x 42mm back box	1

- **Standard of compliance:**
BS 5733
- **Mounting box:**
47mm deep
- **Technical notes:**
All grid plates are supplied with the appropriate number of mounting frames.

Back box needs to be ordered separately.

White moulded grid modules

Switch modules



Switch modules



GUG102W

Product code	Description	Pack qty
GUG101W	10AX 1 way	1
GUG102W	10AX 2 way	1
GUG10IW	10AX intermediate	1
GUG201W	20AX 1 way	1
GUG202W	20AX 2 way	1
GUG20DPW	20AX DP	1

- **Standard of compliance:**
BS EN 60669-1
(switch modules)
BS 5733
(indicator modules)

20AX double-pole printed switch modules



GUG20DPMWW



GUG20DPHTW



GUG20DPHOW

Product code	Description	Pack qty
GUG20DPMWW	20AX double-pole printed microwave	1
GUG20DPCHW	20AX double-pole printed cooker hood	1
GUG20DPDWW	20AX double-pole printed dishwasher	1
GUG20DPFZW	20AX double-pole printed freezer	1
GUG20DPWMW	20AX double-pole printed washing machine	1
GUG20DPTDW	20AX double-pole printed tumble dryer	1
GUG20DPHTW	20AX double-pole printed heater	1
GUG20DPWDYW	20AX double-pole printed washer dryer	1
GUG20DPOVW	20AX double-pole printed oven	1
GUG20DPBOW	20AX double-pole printed boiler	1
GUG20DPWDW	20AX double-pole printed waste disposal	1
GUG20DPEFW	20AX double-pole printed extractor fan	1
GUG20DPFAW	20AX double-pole printed fan	1
GUG20DPFFZW	20AX double-pole printed fridge freezer	1
GUG20DPFRW	20AX double-pole printed fridge	1
GUG20DPHOW	20AX double-pole printed hob	1

Retractive switch modules

GUG202OCW,
GUG102RW,
GUG2020W

Product code	Description	Pack qty
GUG202OCW	6AX 2 way & centre off	1
GUG102RW	10AX 2 way	1
GUG2020W	20AX 2 way on & off	1

Blank & indicator modules



GUGBW



GUGINDWG



GUGINDWO

Product code	Description	Pack qty
GUGBW	Blank	1
GUGINDWG	Green indicator	1
GUGINDWR	Red indicator	1
GUGINDWO	Orange indicator	1

White painted metal grid modules

Key switch modules



GUG20DPKWPW & GUG202KWPW



GUG202KELWPW

Product code	Description	Pack qty
GUG20DPKWPW	20AX DP	1
GUG20DPKELWPW	20AX DP printed TEST EMG LTG	1
GUG202KWPW	20AX 2 way	1
GUG202KELWPW	20AX 2 way printed TEST EMG LTG	1
GUGKSK	Spare key for SW module	1

• **Standard of compliance:**
 BS EN 60669-1
 (key switches)
 BS EN 41003
 BS EN 3041

Communication modules



GUGTELMWPW & GUGTELSWPW



GUGRJ45WPW



GUGCOWPW

Product code	Description	Pack qty
GUGTELMWPW	BT master	1
GUGTELSWPW	BT secondary	1
GUGRJ11WPW	RJ11	1
GUGRJ45WPW	RJ45 CAT5e	1
GUGCOWPW	TV/FM coaxial	1
GUGSATWPW	Satellite	1

Fused connection unit & flex outlet



GUG13FCUWPW



GUG16COWPW

Product code	Description	Pack qty
GUG13FCUWPW	13A fused connection unit	1
GUG16COWPW	Flex outlet (10mm diameter)	1





T2 Ceiling

T2 Ceiling Range

The highly successful T2 range of ceiling accessories offers superb quality and easy to install technical specification that has established this design as a firm favourite.



Specification Highlights



Batten holders and ceiling roses share a common base assembly with 50.8mm fixing centres.



Pendant lamp holder has integral cord grip to prevent cable pull on terminals.



Full complementary accessories including dry lining and conduit boxes.

Batten lamp holders

Pre-wired straight



GBAT

Product code	Description	Pack qty
GBAT	Black base	10
GBATC	Clear base	10

Pre-wired angled



GABAT

Product code	Description	Pack qty
GABAT	Black base	10
GABATC	Clear base	10

3 terminal straight



GEBAT

Product code	Description	Pack qty
GEBAT	Black base	10

- **Standard of compliance:** BS EN 61184

- **Technical notes:** Large capacity earth terminals.

Ample wiring space with four knockouts.

Clear terminals for easy visibility and installation.

Pendant sets

Pre-wired 6 inch urea



GPEND62

Product code	Description	Pack qty
GPEND62	Black base	10
GPEND6C2	Clear base	10

Pre-wired 9 inch urea



GPEND92

Product code	Description	Pack qty
GPEND92	Black base	10
GPEND9C2	Clear base	10

- **Standard of compliance:** BS EN 60598-2-1
BS EN 61184

- **Technical notes:** CFL lamps not supplied with energy saving pendants.

High heat resistance to BS EN 61184:1995.

Energy saving 6 inch



GESPEND613

Product code	Description	Pack qty
GESPEND613	13W	1
GESPEND618	18W	1

Ceiling roses

Urea



GRO

Product code	Description	Pack qty
GRO	Black base	10
GROC	Clear base	10

- **Standard of compliance:** BS EN 61184
- **Technical notes:** Urea base centres are 50.8mm.

Polycarbonate



E93WE

Product code	Description	Pack qty
E93WE	Ceiling rose	1

Lamp holders

With intergral cord grip



GLHC

Product code	Description	Pack qty
GLHC	With intergral cord grip	20

- **Standard of compliance:** BS EN 61184

Ceiling switches

6AX



GSWPULL6

Product code	Description	Pack qty
GSWPULL6	1 way	10
GSWPULL62	2 way	10

- **Standard of compliance:** BS EN 60669-1
 - **Technical notes:** All switches supplied with 1.5m white nylon cord.
- 6AX switches fully rated for fluorescent and inductive loads.

50A 1 way



GSWPULL50

Product code	Description	Pack qty
GSWPULL50	1 way	10
GSWPULL50N	1 way with neon	10

50A switch suitable for use as an isolator switch.

Junction boxes

5A 4 terminal selective entry 4 x 1.5mm



GJB5ABR

Product code	Description	Pack qty
GJB5A	White	10
GJB5ABR	Brown	10

20A 4 terminal selective entry 3 x 2.5mm



GJB20A

Product code	Description	Pack qty
GJB20A	White	10
GJB20ABR	Brown	10

20A 4 terminal non-selective entry 3 x 2.5mm



GJBN20ABR

Product code	Description	Pack qty
GJBN20A	White	10
GJBN20ABR	Brown	10

20A 6 terminal selective entry x 2.5mm



GJB620A

Product code	Description	Pack qty
GJB620A	White	10
GJB620ABR	Brown	10

30A 3 terminal selective entry x 4mm



GJB30ABR

Product code	Description	Pack qty
GJB30A	White	10
GJB30ABR	Brown	10

Compact 20A 4 terminal non-selective entry 59mm diameter



GJBN20AS

Product code	Description	Pack qty
GJBN20AS	White	10
GJBN20ASBR	Brown	10

- **Standard of compliance:**
BS EN 60670-22
- **Technical notes:**
Dimensions: 5A & 20A - ϕ 74mm, 30mm - ϕ 85mm.
- **Terminal capacity:**
5A 4 x 1.5mm²
20A 2 x 2.5mm²
30A 4 x 4mm².

Dry lining boxes

Circular 50.8mm fixing centre



CRB2W

Product code	Description	Pack qty
CRB2W	Circular 50.8mm fixing centre	10

Square 34mm deep



GDL1

Product code	Description	Pack qty
GDL1	1 gang	10
GDL2	2 gang	10

- **Standard of compliance:** BS 5733
- **Technical notes:** Circular boxes suitable for pendant drops & smoke alarms.
- **Circular diameter:** 67mm
- **Square:** min. & max. thickness 2-17mm.

Flush galvanised steel boxes

16mm deep



SB161

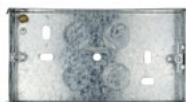

SB252



SB351



SB472

Product code	Description	Pack qty
SB161	1 gang 16mm deep	20
SB251	1 gang 25mm deep	10
SB252	2 gang 25mm deep	10
SB351	1 gang 35mm deep	10
SB352	2 gang 35mm deep	5
SB471	1 gang 47mm deep	10
SB472	2 gang 47mm deep	4

- **Standard of compliance:** BS 4662
- **Technical notes:** Supplied with earth terminal and screw.
Supplied with fixed and adjustable lugs.
Fitted with selection of 20mm knockouts in sides and back.

Switch & socket boxes for miniature trunking

25mm deep breakaway boxes



MMB251W

Product code	Description	Pack qty
MMB251W	1 gang	10
MMB252W	2 gang	10
MMB252SW	2 gang side entry	10

- **Material:** uPVC
- **Colour:** White
- BS 4662
- All boxes can be used with both standard and coiled miniature trunking
- **Note:** please see page 124 for details relating to thermal expansion

32mm deep boxes with mini entries



TBR321W



TBU321W

Product code	Description	Pack qty
TBR321W	Rounded corners 1 gang	10
TBR321CW	Rounded corners 1 gang	100
TBR322W	Rounded corners 2 gang	10
TBR322CW	Rounded corners 2 gang	100
TBU321W	Square corners 1 gang	10
TBU321CW	Square corners 1 gang	100
TBU322W	Square corners 2 gang	10
TBU322CW	Square corners 2 gang	100

44mm deep boxes with mini entries



TBU441W

Product code	Description	Pack qty
TBU441W	1 gang	10

Mini entry adapters



MTAU1W

For use with TBU and TBR boxes		
Product code	Description	Pack qty
MTAU1W	16 x 16mm	10
MTAU2W	25 x 16mm	10
MTAU3W	38 x 16mm	10

Ceiling rose box



CRA12W

Product code	Description	Pack qty
CRA12W	16 x 16mm to 25 x 16mm entries Fixing centre 50.8mm Overall diameter 82mm Depth 13.5mm	25

Conduit fed surface mounting boxes

Square corners - 25mm deep



KBS252W

Product code	Description	Pack qty
KBS252W	Knockout 2 gang	10

Round corners - 25mm deep



KBR251W

Product code	Description	Pack qty
KBR251W	Knockout 1 gang	20

Square corners - 32mm deep



KBU321W

Product code	Description	Pack qty
KBU321W	Knockout 1 gang	10
KBU321CW	Knockout 1 gang	100
KBU322W	Knockout 2 gang	10
KBU322CW	Knockout 2 gang	100

Round corners - 32mm deep



PBR322W

Product code	Description	Pack qty
PBR322W	Plain 16 x 16mm	10
KBR321W	Knockout 25 x 16mm	10
KBR321CW	Knockout 38 x 16mm	10
KBR322W	Knockout 1 gang	
KBR322CW	Knockout 1 gang	

1 gang - 44mm deep



PBU441W



KBU441W

Product code	Description	Pack qty
PBU441W	Plain	10
KBU441W	Knockout	10

Circular dry lining box

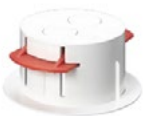

CRB2W

Product code	Description	Pack qty
CRB2W	50.8mm fixing centre	10

- **Colour:** White
- BS 4662
- The easiest and quickest box to install
- Non brittle for ease of drilling
- Fits popular wiring accessories from leading manufacturers
- 3 depths available
- **Note:** Square cornered boxes have infill corners to take round corner plates if required.

Plugs & adaptors

Round pin plug



TOP5AR



GGBLTOP13ANS

Product code	Description	Pack qty
TOP2AR	2A	20
TOP5AR	5A	20
TOP15AR	15A	20
GGBLTOP13ANS	Non-standard plug top - display packaged	20

- **Standard of compliance:**
BS 1363 (13A plugs)
BS 546 (round pin plugs)

Fused plug top



TOP133A

Product code	Description	Pack qty
TOP133A	3A white	20
TOP13A	13A white	20
400102	13A white	20

Adaptors



ADAPT3WF

Product code	Description	Pack qty
ADAPT2W	2 way unfused	10
ADAPT3WF	3 way fused	10

BS 1362 fuses



400114

Product code	Description	Pack qty
400112	3A	4
400113	5A	4
400114	13A	4

Plain IP56 moulded enclosures

6 entries



GE115P

Product code	Description	Pack qty
GE115P	100 x 100 x 50mm	1
GE125P	120 x 80 x 50mm	1

- **Technical notes:**
GE321P & GE381P
- Hinged lids.

GE84S & GE884S
- IP44 rating.

10 entries



GE197P

Product code	Description	Pack qty
GE157P	150 x 110 x 70mm	1
GE197P	190 x 140 x 70mm	1

12 entries



GE249P

Product code	Description	Pack qty
GE249P	240 x 190 x 90mm	1
GE321P	300 x 220 x 120mm	1
GE381P	380 x 300 x 120mm	1

Stepped IP56 moulded enclosures

4 entries



GE84S

Product code	Description	Pack qty
GE84S	80 x 40mm	1

- **Technical notes:**
GE321P & GE381P
- Hinged lids.

GE84S & GE884S
- IP44 rating.

6 entries



GE115S

Product code	Description	Pack qty
GE884S	80 x 80 x 40mm	1
GE115S	100 x 100 x 50mm	1



Weatherproof

Weatherproof solutions

Our Weatherproof range offers tough, durable options for outdoor applications or more arduous environments. Socket outlets are IP66 or IP55 rated for even greater weather resistance.



IP66

The IP66 range of weatherproof accessories offers the greatest amount of weatherproof protection on the market, with built-in features to safeguard users in the harshest of environments.

- Solid Protection: Completely protected against dust, the maximum rating for protection against solids.
- Liquid Protection: Protected against jets of water of similar force to heavy seas.



IP55

For general weatherproof protection, the IP55 range of switches and sockets can be comfortably operated through a protective membrane, thus maintaining its full IP rating.

- Solid Protection: Protected against quantities of dust that could interfere with satisfactory operation.
- Liquid Protection: Protected against jets of water from all directions.



KAVACHA

With its unique polycarbonate construction, Kavacha IP56 Sockets provide the ideal domestic weatherproof and waterproof solution for full-time protection in areas around the home that are susceptible to water, rain and moisture.

Offering maximum protection, the sturdy range of Kavacha IP66 switches are ideal for outdoor areas that are susceptible to heavy blows, long time exposure to the elements and risk being splashed by chemicals.

IP55 Range

For general weatherproof protection against dust and liquids, the IP55 range of switches and sockets offers an effective solution for both indoor and outdoor environments when the maximum IP66 rating is not required.

The weatherproof membrane is Phthalate free, UV stabilised and mould and algae resistant, to ensure long outdoor life without splitting or discolouring.

Switches can be operated through membrane, thereby maintaining full IP rating.

IP55 switches supplied complete in 1, 2 or 3 gang configurations using 25mm modules.

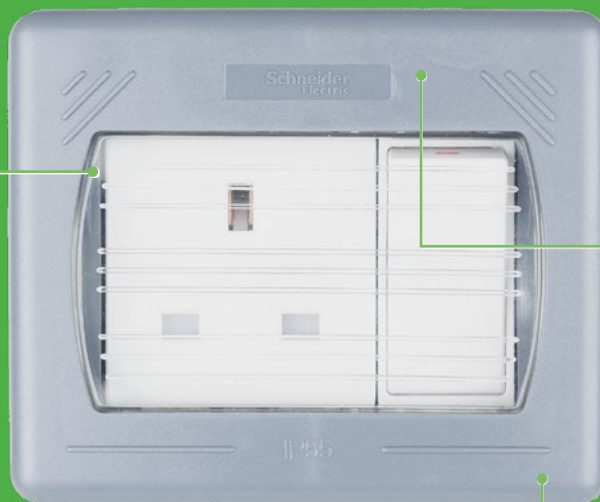

All modules are independently type tested, with the enclosures giving a degree of ingress protection of IP55 – protection against quantities of dust that could interfere with satisfactory operation or powerful jets of water from all directions.

All enclosures incorporate a 20mm knockout as standard with the option to increase to 25mm via a unique drill start feature.

Offered in two distinctive finish and design configurations.

IP66 Range

Offering the maximum levels of endurance and protection, the IP66 Weatherproof range of sockets will perform in the most arduous weather conditions.

The smooth, curved design also delivers on aesthetic appeal whilst providing a high performance application.

IP66 for maximum weatherproof protection against any particles of dust and jets of water of similar force to heavy seas whilst in use.

Manufactured from tough impact resistant thermoplastic which provides strength and durability.

Standard knockouts for 20mm conduit entry with additional cut-out facility to convert to 25mm conduit entry.

Protective gel seal ensures maximum safety whilst in use.

IP66 sockets accept standard 13A plugs including moulded on plugs.



Smooth, curved aesthetic design.

Specification Highlights:



Passive and Active RCD protected 2-gang socket outlet ensure essential personal protection.

Passive Latching: Designed for food freezers or garden water feature pumps, ensuring that contacts will stay closed during loss of power so that RCD does not need re-setting when the circuit is restored.

Active / non-latching: Designed for lawnmowers or power tools, the RCD will trip on loss of power and requires manual resetting when the circuit is to be re-energised.



Choose from a flexible selection of IP66 enclosures and modules to meet your project requirements.

Socket outlets

13A 1 gang unswitched



GWP3050

Product code	Description	Pack qty
GWPIU3050	13A 1 gang unswitched - IP66	1
GWP3050	13A 1 gang unswitched - IP55	1
E551US	13A 1 gang unswitched - IP55	1

13A 2 gang unswitched



GWPIU3060

Product code	Description	Pack qty
GWPIU3060	13A 2 gang unswitched - IP66	1
GWP3060	13A 2 gang unswitched - IP55	1

13A 1 gang switched



GWP3010

Product code	Description	Pack qty
GWP3010	13A 1 gang switched - IP55	1

13A 2 gang switched



GWPIU3020

GWP3020

Product code	Description	Pack qty
GWPIU3020	13A 2 gang switched - IP66	1
GWP3020	13A 2 gang switched - IP55	1

2 gang DP 30mA RCD protected



GWPIU3020R

Product code	Description	Pack qty
GWPIU3020R	Active control - IP66	1
GWPIU3020RP	Passive control - IP66	1

- Standard of compliance:**
 BS 1363 (13A)
 BS 7288 (RCDs)
- Mounting box:**
 47mm deep (back box supplied)
- Technical notes:**
 Active control consists of an electronic latch, which will require resetting in the event of a loss of supply. Particularly useful for domestic use.

Passive control - device will only trip in the event of a fault. Suitable for freezers and commercial applications.

IP rating maintained for IP66 devices whilst in use. IP55 sockets are rated at IP4X whilst in use.

Plate switches

10AX 1 gang 2 way



GWP1612

Product code	Description	Pack qty
GWP1612	10AX 1 gang 2 way - IP55	1

- **Standard of compliance:** BS EN 60669-1
- **Mounting box:** 47mm deep (back box supplied)

10AX 1 gang intermediate



GWP1614

Product code	Description	Pack qty
GWP1614	10AX 1 gang intermediate - IP55	1

10AX 1 gang retractive



E55PB

Product code	Description	Pack qty
E55PB	10AX 1 gang retractive - IP55	1

10AX 2 gang 2 way



GWP1622

Product code	Description	Pack qty
GWP1622	10AX 2 gang 2 way - IP55	1

10AX 3 gang 2 way



GWP1632

Product code	Description	Pack qty
GWP1632	10AX 3 gang 2 way - IP55	1

Control switches

20AX DP 1 gang switch



GWP2010

Product code	Description	Pack qty
GWP2010	20AX DP 1 gang switch - IP55	1

- **Standard of compliance:** BS EN 60669-1
- **Mounting box:** 47mm deep (back box supplied)

20AX DP 1 gang switch with neon



GWP2011

Product code	Description	Pack qty
GWP2011	20AX DP 1 gang switch with neon - IP55	1

Enclosure & modules

Enclosure



GWP9000

Product code	Description	Pack qty
GWP9000	Enclosure	1

- **Standard of compliance:**
BS 5733
BS EN 60670
- **Mounting box:**
47mm deep (back box supplied)

Seal kit - 2 x silicone seals & 2 x mounting brackets



GWPIUKIT

Product code	Description	Pack qty
GWPIUKIT	Seal kit - 2 x silicone seals & 2 x mounting brackets	1

White 20AX switch modules



Product code	Description	Pack qty
GRL2020PW	2 way & off switch module	1
GRL202KPW	2 way key	1
GRL20DPNPW	Double-pole with neon	1
GRLDPKPW	Double-pole key	1

White fuse carrier, indicator & flex modules



Product code	Description	Pack qty
GRL13FCUPW	13A single-pole fuse carrier	1
GRLINDRPW	240V red indicator	1
GRLCOPW	10mm ø cord outlet	1

Connection box & grommets

Connection box



E55CB

Product code	Description	Pack qty
E55CB	Connection box	1

- **Standard of compliance:**
BS EN 60669-1
- **Mounting box:**
47mm deep (back box supplied)

Grommets



E55GP

Product code	Description	Pack qty
E55GP	Grommets	1





Kavacha

Full time protection around the home

This sturdy range of switches and sockets are for outdoor areas that are susceptible to heavy blows, long time exposure to sunlight and where there is a risk of being splashed by chemicals.

Balconies, swimming pools, exterior walls and gardens will all be much safer from exposed electricity with Kavacha. Kavacha protects you and your family outdoors in five important ways. It guards against water sprayed from a hose. It guards against rain or water, is dust proof, impact resistant, UV resistant and also chemical resistant.

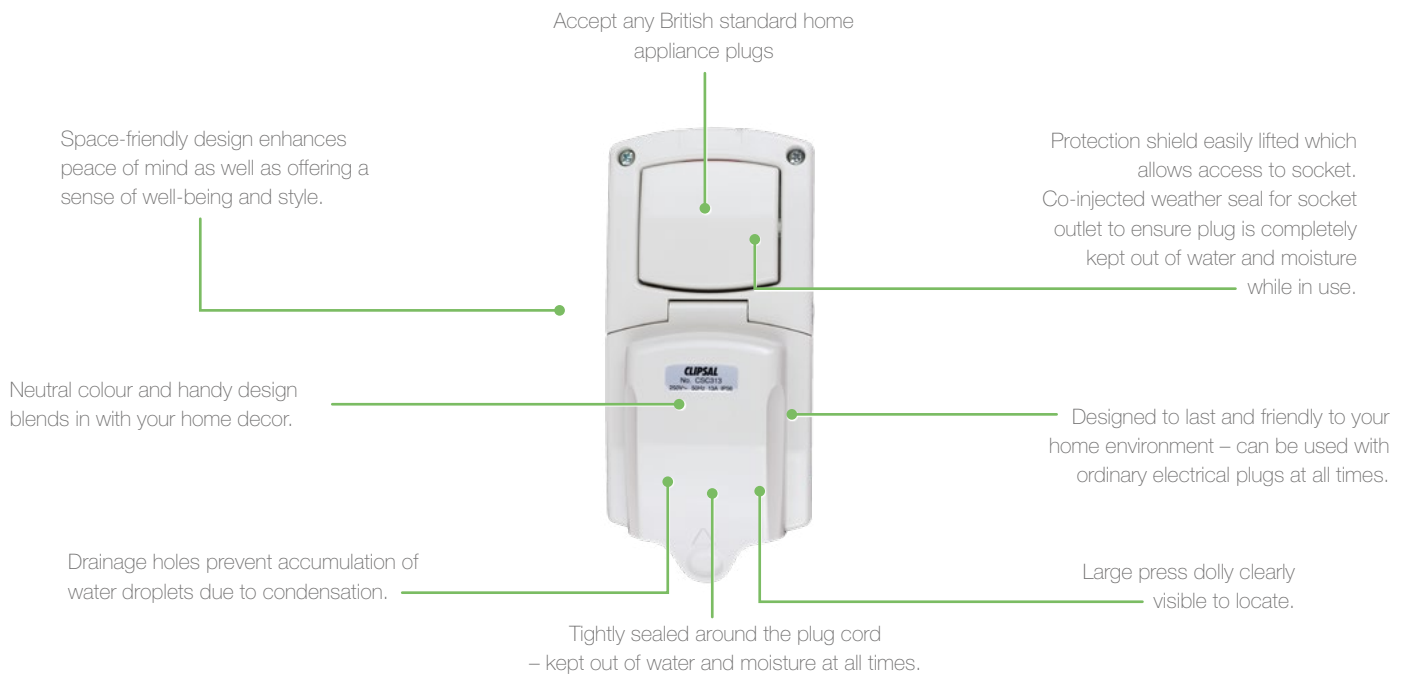

Socket outlets

IP56 13A 1 gang unswitched



CSO313

Product code	Description	Pack qty
CSO313	IP56 13A 1 gang unswitched	1

IP56 13A 2 gang unswitched



CSO3132

Product code	Description	Pack qty
CSO3132	IP56 13A 2 gang unswitched	1

IP56 13A 1 gang switched



CSC313

Product code	Description	Pack qty
CSC313	IP56 13A 1 gang switched	1

- **Standard of compliance:**

BS 1363
BS 1363-2
IEC 60529
IEC 60669-1

- **Technical notes:**

Active control consists of an electronic latch, which will require resetting in the event of a loss of supply. Particularly useful for domestic use.

Passive control - device will only trip in the event of a fault. Suitable for freezers and commercial applications.

IP rating maintained for IP66 devices whilst in use. IP55 sockets are rated at IP4X whilst in use.

Plate switches

IP66 16A 250V 1 gang 2 way



CSW120

Product code	Description	Pack qty
CSW120	IP66 16A 250V 1 gang 2 way	1

- **Standard of compliance:**

BS EN 60669-1

- **Technical notes:**

Single-pole switches include a looping terminal.

IP66 20A 250V 2 gang 2 way



CSW1202

Product code	Description	Pack qty
CSW1202	IP66 20A 250V 2 gang 2 way	1

IP66 20A 500V 1 gang double-pole isolator



CSW220

Product code	Description	Pack qty
CSW220	IP66 20A 500V 1 gang double-pole	1

Triple pole control switches

20A 440V



WHB320RG

Product code	Description	Pack qty
WHB320RG	20A 440V	1

- **Technical notes:**
32mm conduit entry each end.

40A 440V



WHB340RG

Product code	Description	Pack qty
WHB340RG	40A 440V	1

55A 440V



WHB355RG

Product code	Description	Pack qty
WHB355RG	55A 440V	1

63A 440V



WHC363RG

Product code	Description	Pack qty
WHC363RG	63A 440V	1



56 Series

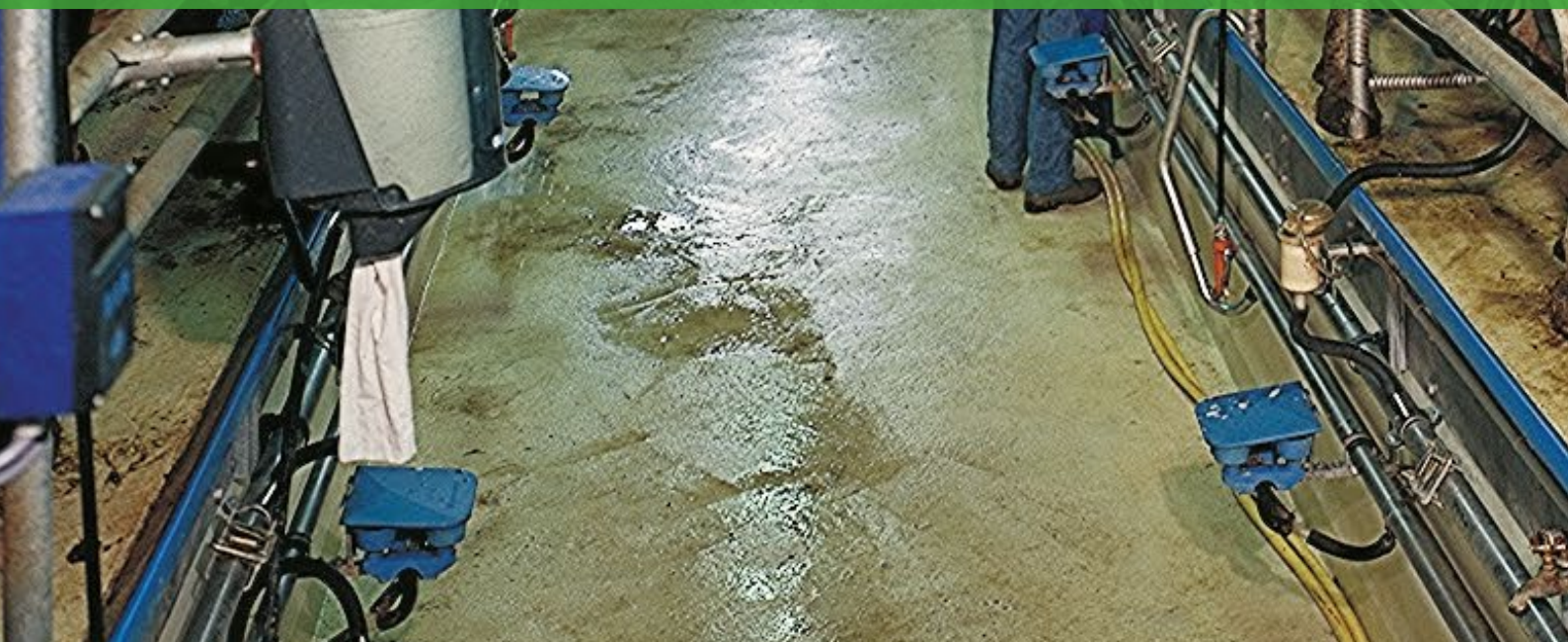

56 Series industrial switchgear

Designed to satisfy customer needs, precisely engineered and carefully manufactured, the 56 Series is as versatile as your customers' requirements. Industrial switchgear, being one of the most important components of industry, has to be tough, safe, and able to take hard knocks and give reliable performance under adverse conditions.

The 56 Series satisfies these challenges with the use of durable engineering plastics. The 56 Series has been tested for protection against ingress of water and dust to international protection ratings IP56, and in many instances exceeds this level of protection.

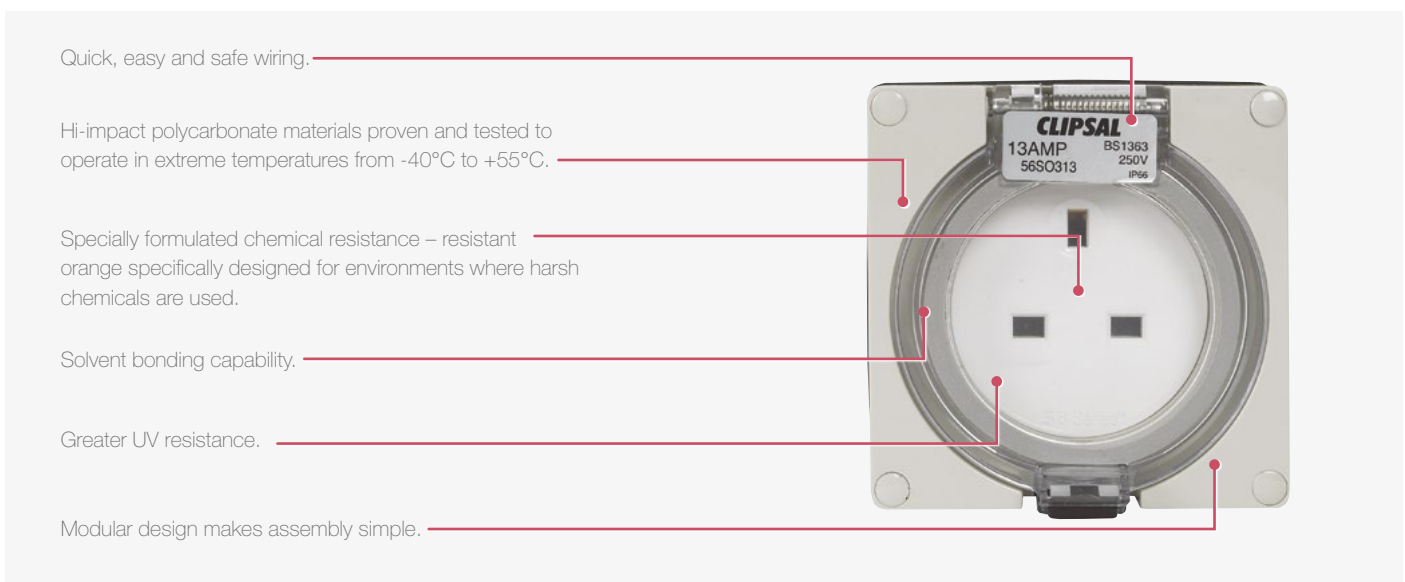
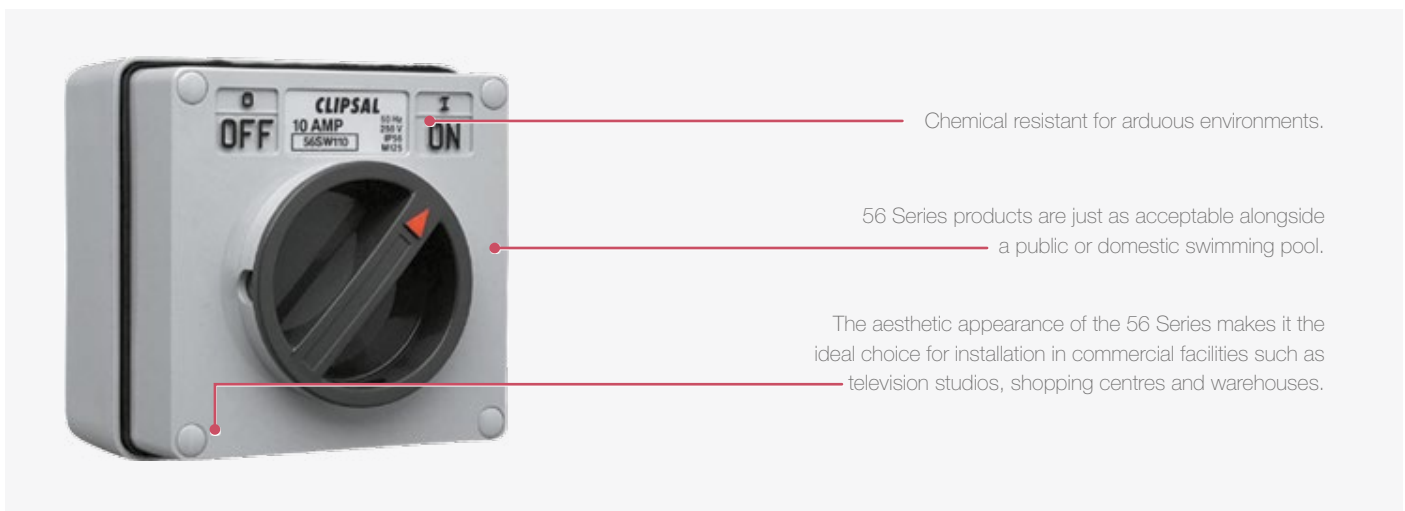

Designed to mix and match

What suits one industry might not be the perfect match for another. That's why the 56 Series was specifically designed to mix and match. There is an extensive choice of modules available, including switches, sockets and residual current devices.

56 Series mounting enclosures range from 1 to 9 gang. This allows assemblies to be customised - from a simple switch station to a large electrical control panel.

Accessories can be ordered without the back box by choosing the product code with LE (less enclosure) towards the end.





IP66 - Socket outlets

13A 250V 3 pin



56SO313LEGY

Product code	Description	Pack qty
56SO313GY	Grey (with enclosure)	1
56SO313LEGY	Grey (without enclosure)	1
56SO313RO	Resistant orange (with enclosure)	1

• **Standard of compliance:**
IEC 60529
BS 1363

16A 4h 110V

Product code	Description	Pack qty
56SO316110LEGY	Grey (without enclosure)	1

16A 6h 220/250V 3 pin



56SO3166LEGY

Product code	Description	Pack qty
56SO3166LEGY	Grey (without enclosure)	1

16A 6h 380/415V 5 pin



56SO5166LEGY

Product code	Description	Pack qty
56SO5166LEGY	Grey (without enclosure)	1

20A 220/250V 5 pin



56SO520LEGY

Product code	Description	Pack qty
56SO520LEGY	Grey (without enclosure)	1

32A 240V



56SO332GY

Product code	Description	Pack qty
56SO332GY	Grey (with enclosure)	1

32A 6h 220/250V 3 pin



56SO3326LEGY

Product code	Description	Pack qty
56SO3326LEGY	Grey (without enclosure)	1

32A 6h 380/415V 4 pin



56SO4326LEGY

Product code	Description	Pack qty
56SO4326LEGY	Grey (without enclosure)	1

IP66 - Socket outlets continued

32A 6h 380/415V 5 pin



56SO5326LEGY

Product code	Description	Pack qty
56SO5326LEGY	Grey (without enclosure)	1

IP66 - Fuse units

15A 250V switched



56FCULEGY

Product code	Description	Pack qty
56FCUGY	Grey (with enclosure)	1
56FCULEGY	Grey (without enclosure)	1

- **Standard of compliance:**
IEC 60529

IP66 - Rotary switches

10AX 240/250V 1 way



56SW110GY

Product code	Description	Pack qty
56SW110GY	Grey (with enclosure)	1
56SW110LEGY	Grey (without enclosure)	1
56SW110LERO	Resistant orange (without enclosure)	1

- **Standard of compliance:**
IEC 60669-1
IEC 60529

20A 250V



56SW120LEGY

Product code	Description	Pack qty
56SW120LEGY	Grey (without enclosure)	1
56SW120LERO	Resistant orange (without enclosure)	1

32A 250V



56SW132LEGY

Product code	Description	Pack qty
56SW132LEGY	Grey (without enclosure)	1

IP66 - Double-pole switch disconnectors

20A 500V



56SW220LERO

Product code	Description	Pack qty
56SW220LEGY	Grey (without enclosure)	1
56SW220LERO	Resistant orange (without enclosure)	1

• **Standard of compliance:**
BS EN 60947-3

32A 500V



56SW232LERO

Product code	Description	Pack qty
56SW232LEGY	Grey (without enclosure)	1
56SW232LERO	Resistant orange (without enclosure)	1

IP66 - Triple-pole switch disconnectors

10A 500V



56SW310LEGY

Product code	Description	Pack qty
56SW310LEGY	Grey (without enclosure)	1

• **Standard of compliance:**
BS EN 60947-3

20A 500V



56SW320LEGY

Product code	Description	Pack qty
56SW320LEGY	Grey (without enclosure)	1
56SW320LERO	Resistant orange (without enclosure)	1

32A 500V



56SW332LERO

Product code	Description	Pack qty
56SW332LEGY	Grey (without enclosure)	1
56SW332LERO	Resistant orange (without enclosure)	1

50A 500V



56SW350LEGY

Product code	Description	Pack qty
56SW350LEGY	Grey (without enclosure)	1

63A 500V



56SW363LEGY

Product code	Description	Pack qty
56SW363LEGY	Grey (without enclosure)	1
56SW363LERO	Resistant orange (without enclosure)	1

IP66 - Control switches

10AX 250V single sliding dolly



56SSW10LEGY

Product code	Description	Pack qty
56SSW10LEGY	Grey (without enclosure)	1

• **Standard of compliance:**
BS EN 60947-3

10A 250V two way

Product code	Description	Pack qty
56SSW210LEGY	Grey (without enclosure)	1

15AX 250V single sliding dolly



56SSW15LEGY

Product code	Description	Pack qty
56SSW15LEGY	Grey (without enclosure)	1
56SSW15LERO	Resistant orange (without enclosure)	1

15A 250V two way

Product code	Description	Pack qty
56SSW215LEGY	Grey (without enclosure)	1

20A 500V DP changeover & reversing



56SW220COLEGY

Product code	Description	Pack qty
56SW220COLEGY	Grey (without enclosure)	1

20A 440V 4 pole

Product code	Description	Pack qty
56SW420LERO	Resistant orange (without enclosure)	1

Emergency stop push



56PBS1LEGY

Product code	Description	Pack qty
56PBS1LEGY	Grey (without enclosure)	1

IP66 - Plugs

10A 250V 3 pin



56P310GY

Product code	Description	Pack qty
56P310GY	Grey	1

• **Standard of compliance:**
IEC 60529
BS 1363
BS 546

13A 250V 3 pin



56P313GY

Product code	Description	Pack qty
56P313GY	Grey	1
56P313RO	Resistant orange	1
56P313EO	Electric orange	1

15A 250V 3 pin



56P315GY

Product code	Description	Pack qty
56P315GY	Grey	1

Moulded covers

1 gang lid for 2 x E-Series mechanisms



5632LEGY

Product code	Description	Pack qty
5632LEGY	Grey	1
5632LERO	Resistant Orange	1

• **Standard of compliance:**
IEC 60529
BS 5733

2 gang lid for 4 module device



56CB4GY

Product code	Description	Pack qty
56CB4GY	Grey	1

2 gang lid for 4 module device with neons

Product code	Description	Pack qty
56CB4NGY	Grey	1
56CB4NRO	Resistant orange	1

1 gang blank lid



56L1GY

Product code	Description	Pack qty
56L1GY	Grey	1

Moulded covers continued

2 gang blank lid



56L2GY

Product code	Description	Pack qty
56L2GY	Grey	1

Surface mounted enclosure

1 gang 101 x 101 x 63mm



56E1RO

Product code	Description	Pack qty
56E1GY	Grey	1
56E1RO	Resistant orange	1

• **Standard of compliance:**
BS EN 60947-3

1 gang shallow 101 x 101 x 38mm



56ES1GY

Product code	Description	Pack qty
56ES1GY	Grey	1

2 gang 198 x 101 x 63mm



56E2RO

Product code	Description	Pack qty
56E2GY	Grey	1
56E2RO	Resistant orange	1

2 gang shallow 198 x 101 x 38mm



56ES2GY

Product code	Description	Pack qty
56ES2RO	Grey	1
56ES2GY	Resistant orange	1

2 gang deep 198 x 101 x 100mm



56ED2GY

Product code	Description	Pack qty
56ED2GY	Grey	1

3 gang 294 x 101 x 63mm



56E3GY

Product code	Description	Pack qty
56E3GY	Grey	1
56E3RO	Resistant orange	1

Surface mounted enclosure continued



56E4GY

Product code	Description	Pack qty
56E4GY	Grey	1
56E4RO	Resistant orange	1

• **Standard of compliance:**
BS EN 60947-3

4 gang vertical 391 x 101 x 63mm



56E4VHGY

Product code	Description	Pack qty
56E4VHGY	Grey	1

6 gang 294 x 198 x 63mm

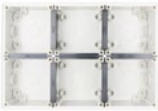

56E6GY

Product code	Description	Pack qty
56E6GY	Grey	1
56E6RO	Resistant orange	1

8 gang 391 x 198 x 63mm

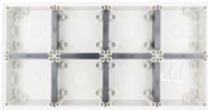

56E8GY

Product code	Description	Pack qty
56E8GY	Grey	1
56E8RO	Resistant orange	1

9 gang 294 x 294 x 63mm



56E9GY

Product code	Description	Pack qty
56E9GY	Grey	1

Flush mounted surrounds

1 gang



56FA1GY

Product code	Description	Pack qty
56FA1GY	Grey	1

2 gang



56FA2GY

Product code	Description	Pack qty
56FA2GY	Grey	1

Flush mounted surrounds continued

3 gang



56FA3GY

Product code	Description	Pack qty
56FA3GY	Grey	1

4 gang



56FA4GY

Product code	Description	Pack qty
56FA4GY	Grey	1

Combination devices

13A 250V 2 pin socket & switch



56C313GY

Product code	Description	Pack qty
56C313GY	Grey (with enclosure)	1

- **Standard of compliance:**
IEC 60529
BS 1363

13A 250V 1 gang socket with RCD



56C3134ELGY

Product code	Description	Pack qty
56C3134ELGY	Grey (with enclosure)	1

13A 250V 2 gang socket with RCD

Product code	Description	Pack qty
56C31324ELGY	Grey (with enclosure)	1

Junction box

1 gang



56JB1GY

Product code	Description	Pack qty
56JB1GY	Grey (with enclosure)	1

- **Standard of compliance:**
IEC 60529
BS 5733

A photograph of a woman and a man walking in a modern, brightly lit interior space. The woman is in the foreground, wearing a grey patterned sweater and carrying a red drawstring backpack. The man is walking slightly behind her to the right, wearing a red striped shirt and khaki pants. The background features large windows and architectural elements, with strong shadows cast on the floor.

Occupancy & Presence Detection

ARGUS and Stand-alone Occupancy Sensors



ARGUS Presence Detector System:

Enjoy the fully networked presence detector solution offered by the Argus range, as well as stand-alone options for individual requirements.



Stand-alone Occupancy Sensors

The Schneider Electric occupancy sensor range combines a selection of outdoor passive infra-red devices, and indoor ceiling or wall mountable devices to meet your energy saving needs.



Argus

Argus Presence Detector system

The Argus Presence Detector range offers efficient stand-alone and system solutions for the different requirements of your customers: daylight harvesting for consistent brightness by the use of 1-10V and DALI as well as the control of heating or ventilation.

Networking presence detectors increases the detection areas, thus providing a close detection of larger rooms and areas as required.



Master/Slave

Up to 10 masters and 10 slaves can be interconnected via a single core 230V cable. This means long corridors and large stairwells are easy to monitor.

Control via a retractive switch

The overshoot time that has been set can be activated via a retractive switch.

Staircase timer

Depending on requirements, the staircase timer can be infinitely adjusted between 10 seconds and 30 minutes.

Two channels for integrating heating or ventilation

The first channel automatically controls the lighting depending on brightness and presence; the second channel controls connected loads such as heating or ventilation depending on presence only.

Argus Presence Detectors

Master with IR, relay



MTN55101119

Product code	Description	Pack qty
MTN55101119	1 gang	1
MTN55101219	2 gang	1

Functions:

- Switching of one output.
- External triggering via one PL-input (Slaves).
- Switching.
- Brightness-dependent staircase lighting function.
- **MTN55101219** - with channel 1, staircase lighting function independent of brightness with channel 2.

Technical notes:
For ohmic, inductive and capacitive loads such as incandescent lamps, energy-saving lamps, LV halogen lighting with conventional transformer, electronic transformers, fluorescent lamps.

Master with IR, 1-10V



MTN55101419

Product code	Description	Pack qty
MTN55101419	Master with IR, 1-10V	1

Functions:

- Switching & dimming of one output.
- External triggering via one PL-input (Slaves).
- Memory function.
- Brightness-dependent staircase lighting function.

Technical notes:
For fluorescent lamps with electronic ballast or electronic transformer with 1-10V interface. The switchable light control ensures that the room illumination remains almost constant. The sensor module continuously measures the brightness in the room and adjusts the illumination to an adjustable setpoint.

Master with IR, DALI



MTN55101519

Product code	Description	Pack qty
MTN55101519	Master with IR, DALI	1

Functions:

- Switching & dimming of DALI EBs.
- External triggering via one PL-input (Slaves).
- Overload and short-circuit proof.
- Memory function.
- Up to 6 DALI control inserts can be connected to one DALI line. However, the maximum number of 64 DALI Ebs and a cable length of 300m must not be exceeded.
- Brightness-dependent staircase lighting function.

Technical notes:
For triggering up to 15 DALI Ebs. The switchable light control ensures that the room illumination remains almost constant. The sensor module continuously measures the brightness in the room and adjusts the illumination to an adjustable setpoint.

Slave



MTN55701019

Product code	Description	Pack qty
MTN55701019	Slave	1

Functions:

- Global control via four PL-outputs.
- Staircase lighting function independent of brightness.

Technical notes:
For triggering all Argus presence masters; the device has four PL-outputs. The control function via PL requires a separate core in the installation to the receiving master devices for each PL line.

Argus Presence Detectors continued

High-bay High Frequency Sensor



CCT551023

Product code	Description	Pack qty
CCT551023	High-bay high frequency sensor	1

Functions:

- 10m Detection height for High-bay applications.
- Doppler radar can penetrate non-metallic materials like wood, glass or thin brick wall.
- Unaffected by dust, temp., light, airflow, sound, vibration.
- Free potential contact on the 2nd channel for HVAC or BMS application.
- More robust than standard PIRs.
- Compatible with most available LEDs.
- Can be adjusted from the floor with remote (optional accessory).

- **Technical notes:**
LED Capable
- Network frequency: 50/60.
- Output voltage: 220...250 V.
- Output current: 10 A.
- Number of channels: 2.
- Control type: Movement sensor.
- Function available: Switching, toggling, dimming.
- Light intensity adjustment: 10...2000 lux.
- Horizontal detection angle: 360°.
- Detection face: 7000mm.
- Mounting height: 2.5 m.
- IP degree: IP52, IP40.

Ultrasonic & Infrared Dual Tech Sensors



CCT551011

Product code	Description	Pack qty
CCT551011	1 channel	1
CCT551012	2 channels	1

Functions:

- Infrared and Ultra-sonic technologies in one.
- User can select Sensing technology based on application.
- Suitable for Open offices, Conference and Class rooms.
- Compatible with most available LEDs.
- Free potential contact on the 2nd channel for HVAC or BMS application.
- Can be adjusted from the floor with remote (optional accessory).

- **Technical notes:**
LED Capable.
- Network frequency: 50/60.
- Output voltage: 220...250 V.
- Output current: 10 A.
- Number of channels: CCT551011: 1
CCT551012: 2.
- Control type: Movement sensor.
- Function available: Switching, toggling, dimming.
- Light intensity adjustment: 10...2000 lux.
- Horizontal detection angle: 360°.
- Mounting height: 2.5 m.
- IP degree: IP20.

Argus Presence Detectors continued

Mini Movement Sensor



CCT570005

Product code	Description	Pack qty
CCT570005	Mini movement sensor	1

Functions:

- Suitable for areas with simpler detection solutions.
- Best for floors, toilets, storage areas etc.
- Small diameter (<6cm) provides a non intrusive solution.
- Excellent detection range of 6m at 2.5m typical installation height.
- Time setting of 30sec to 30mins.
- 3 wire installation.

- **Technical notes:**
Output voltage: 220...250V.
- Lux setting 5 -1000 lux.
- Control type: Movement sensor.
- Light intensity adjustment: 5...1000 lux.
- Detection face: Radius 3000 mm.
- Mounting height: 2.5 m.
- IP rating: IP20.

360° Outdoor Sensor



MTN564419

Product code	Description	Pack qty
MTN564419	360° outdoor sensor	1

Functions:

- Suitable for outdoor use with its high IP rating.
- Creep zone protection enabled makes it perfect for security application.
- Large detection area makes it capable of covering larger areas than normal PIRs.

- **Technical notes:**
Surface mounting.
- Mounting height: 2.5 m.
- Detection Face: Frontal – 16m, Lateral - 10m.
- Rated operational voltage: 230 V.
- Output current: 16 A.
- Network frequency: 50 Hz.
- Light intensity adjustment 5...1000.
- IP rating 55.

Argus Presence Detectors continued

Surface mounted back box



MTN550619

Product code	Description	Pack qty
MTN550619	Surface mounted back box	1

Flush mounted back box



ALB71322

Product code	Description	Pack qty
ALB71322	Flush mounted back box	1

IR remote control, distance 2010



MTN570222

Product code	Description	Pack qty
MTN57022	IR remote control, distance 2010	1

Battery:
2 microcells (IEC LR 03, AAA).

Range:
Up to 20m.

Contents:
Without battery.

- **Technical notes:**
10 channel IR remote control.

PlusLink expander



CCTDT5130

Product code	Description	Pack qty
CCTDT5130	PlusLink expander	1

Nominal voltage:
AC 220/230V.

Neutral connector:
Required (3 conductor system).

Wire range:
Max. 4mm².

Device width:
1HP=18mm.

- **Technical notes:**
The PlusLink extension needs to be integrated into one or more PL-lines if they are protected by at least two circuit breakers. If a circuit breaker is triggered in the event of maintenance work or a fault, then the PlusLink expansion will disconnect the PlusLink line automatically as well. This is necessary because the PlusLink line would otherwise continue to be live via the other circuit breakers. With screw terminals. Suitable for installation on DIN rails TH35 according to EN 60715.

A man with dark, curly hair is standing in profile, looking towards the right. He is wearing a light pink, long-sleeved button-down shirt tucked into dark grey trousers, secured with a black belt. He has his hands in his pockets. The background consists of large glass windows reflecting the interior of a modern office building. A green horizontal bar is overlaid on the image, containing the text 'Stand-alone Detectors'.

Stand-alone Detectors

Stand-alone Detectors

By leveraging state of the art infra-red, and combined ultrasonic and infra-red (dual technologies), our ultra sensitive occupancy sensors offer you the ultimate in reliable, efficient and cost effective lighting control.

This provides a quick and environmentally friendly way of reducing energy consumption with easy setup. Compared to a traditional manual switch, there are significant potential energy savings that can be achieved by utilising occupancy sensors.

The Schneider Electric occupancy sensor range combines a selection of outdoor passive infra-red devices, and indoor ceiling or wall mountable devices.

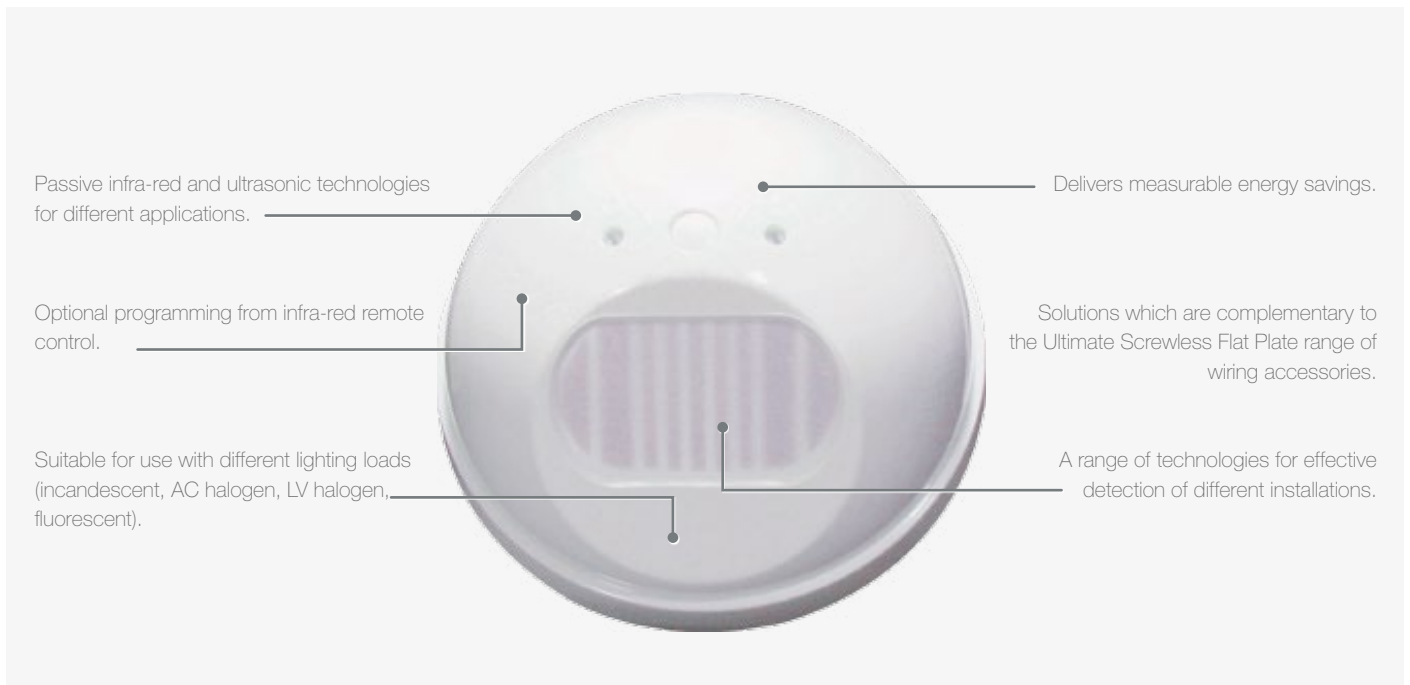

Indoor sensors

Infra-scan 120° wall mounted



E751 & E751R

Product code	Description	Pack qty
E751	2A PIR	1
E751R	10A PIR	1

- Technical notes:**
 Surface mount.
 Detection area 6m x 6m at 2.4m height range.

PIR plate switch wall mounted



GUPA1411BSS

Product code	Description	Pack qty
GUPA1411BSS	PIR plate switch wall mounted with override	1
GUP1411BSS	PIR plate switch wall mounted	1

- Technical notes:**
 Field of view: 90°. Range: 5m at 1.2m height. Time setting: 15sec - 30min. Stainless steel with black interior finish only.

Outdoor sensors

Single-load PIR



CCT56P004



CCT56P008

Product code	Description	Pack qty
CCT56P004	120°	1
CCT56P008	360°	1

- Technical notes:**
 Detection field up to 18m. Includes separate mounting base. Base includes conduit entries. Suitable for wall or ceiling mounting.

Infrascan single-load PIR



E750WPRGY

Product code	Description	Pack qty
E750WPRGY	110°	1

- Technical notes:**
 Detection field up to 18m. Includes separate mounting base. Base includes conduit entries. Suitable for wall or ceiling mounting.



KNX User Interfaces in the Ultimate Range

KNX Push-button Pro / KNX Multitouch Pro



KNX User Interfaces

KNX Push-button Pro – System M



MTN61800319

Product code	Description	Pack qty
MTN61800319	Polar white, glossy	1
MTN61800325	Active white, glossy	1
MTN61800414	Anthracite	1
MTN61800460	Aluminium	1

Functions:

- Control of lights, blinds and scenarios via one sensor cover.
- Flexible allocation of sensor zone.
- Night mode: LEDs light up with reduced brightness.
- Proximity function: display illumination triggered by approach.
- Express commissioning for rapid programming.

Accessories:

- Dismantling protection MTN62700000.
- Foil set for KNX Push-button Pro MTN62700010.
- Frames see below.



MTN62700010

Software functions

- Individual configuration Switching, toggling, dimming (single/dual-surface), blind (single/dual-surface), pulse edges trigger 1-, 2-, 4- or 8-bit telegrams (distinction between short and long operation), pulse edges with 2-byte telegrams (distinction between short and long operation), 8-bit linear regulator, scene retrieval, scene saving, disable functions.

Technical info

- Programmable with ETS4 and higher.
- 3 prefabricated foils, 24 different individual symbols with 1 carrier foil.

KNX Multitouch Pro – System M



MTN62150310

Product code	Description	Pack qty
MTN62150310	Multitouch Pro	1

Functions:

- Innovative design.
- Proximity function: display illumination is automatically activated upon approach.
- Gesture function: device recognises a gesture and triggers a function.
- Lock/unlock: Protection against unwanted access.
- Control of light, blind, temperature and scenario via touch screen.
- Scenario control: up to four scenarios per window - up to 32 scenarios.
- Customisable screensaver.

Accessories:

- Dismantling protection MTN62700000.
- Remote sensor for universal room temperature control unit with touch display MTN5775000.
- Frames see below.

Software functions

- **Control unit** Switching, toggling, dimming (single/dual-surface), blind (single/dual-surface), pulse edges trigger 1-, 2-, 4- or 8-bit telegrams, pulse edges with 2-byte telegrams, 8-bit linear regulator, scene retrieval, scene saving, signal function, fan control, operating modes, setpoint adjustment.

Technical info

- Controller type:
- 2-step controller, continuous action PI control, switching PI control (PWM). Output: continuous in the range 0 to 100% or switching ON/OFF.
 - Programmable with ETS4 and higher.

KNX Ultimate Screwless Flat Plate 1G Frames



GU8434SS

Product code	Description	Pack qty
GU8434BN	Black Nickel	1
GU8434PB	Polished Brass	1
GU8434PC	Polished Chrome	1
GU8434PN	Pearl Nickel	1
GU8434PW	Painted White	1
GU8434SS	Stainless Steel	1

KNX Easy commission software eConfigure Lite



eConfigure KNX Lite

KNX Push-button Pro – System M

Product code	Description	Pack qty
MTN61800319	Polar white, glossy	1

- **Technical notes:**
- Compatible operating system: Windows 7 SP1, Windows 8, Windows 10
- Box with KNX Dongle and USB stick containing software

A **simplified and optimized** solution for smart homes and commercial buildings

Offers all the power of **KNX** without the **complexity**, working with open protocols and devices

Delivers **convenience, comfort, and energy savings**

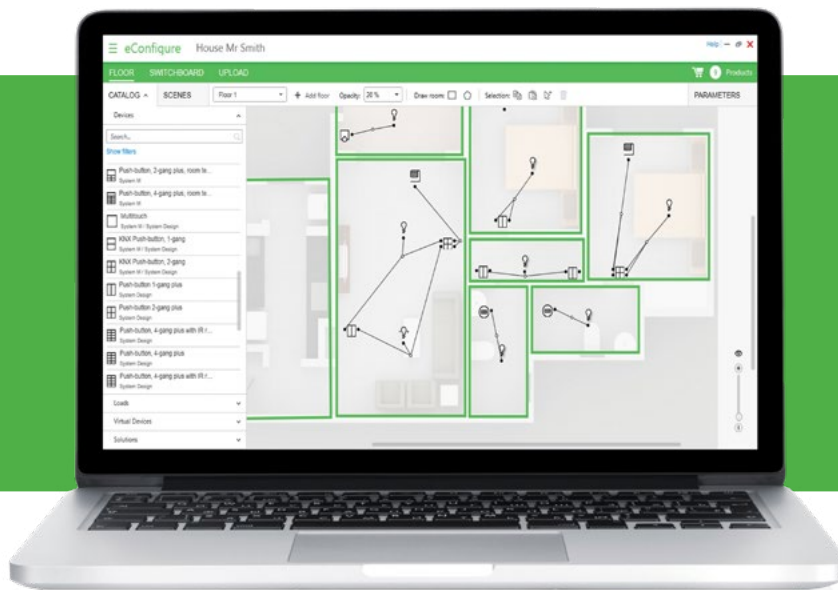

Learn to design, commission, and maintain KNX systems **autonomously in just one day**

Create and edit a professional bill of material and reports to validate specifications with stakeholders and ensure **accurate project quotations**

Build in flexibility to evolve the system if a building expands, with **complete compatibility** with ETS Pro Software for large buildings

Save time and increase efficiency on future installations — pre-made solutions, in the system or from Schneider Electric, can be re-used

Clipsal C-Bus























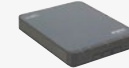



Innovative control systems for commercial or residential...

Take advantage of the benefits a fully programmable and customisable control system can provide. Introducing Clipsal, a system that can deliver a complete lighting and room control solution to help you achieve your goals, whether in residential or commercial applications.

In homes, C-Bus offers a total control solution ensuring that your property is secure, entertaining, exciting, relaxing and beautiful.

For commercial projects you will find various options for intelligent building control which offer not only improved comfort, but also provide significant energy savings.

<p>C-Bus Input Units</p>	<p>Wall Switches</p> 	<p>Touch Screen Controllers</p> 	<p>Occupancy Sensors</p> 	<p>Environment Sensors</p> 	<p>General Input Units</p> 	<p>Handheld IR Remotes</p> 
<p>C-Bus Output Units</p>	<p>DIN Rail Dimmers</p> 	<p>DIN Rail Relays</p> 	<p>Blind Control Relay</p> 	<p>1 & 2 Channel Relay Range</p> 	<p>Extra Low Voltage Relay</p> 	<p>Infrared Transmitters</p> 
<p>C-Bus System Units and Accessories</p>	<p>Controllers</p> 		<p>Network Support Devices</p> 	<p>Gateways</p> 	<p>Network Analyser</p> 	
<p>C-Bus Software</p>	<p>Toolkit Software</p> 	<p>PICED Software</p> 	<p>OPC Server Software</p> 	<p>Schedule Plus</p> 	<p>HomeGate Software</p> 	
<p>C-Bus Multi-Room Audio</p>	<p>Matrix Switcher</p> 		<p>Amplifier Power Supply</p> 	<p>Distribution Unit</p> 	<p>Amplifiers Accessories</p> 	

The best just got better...

Introducing our new Saturn eDLT range

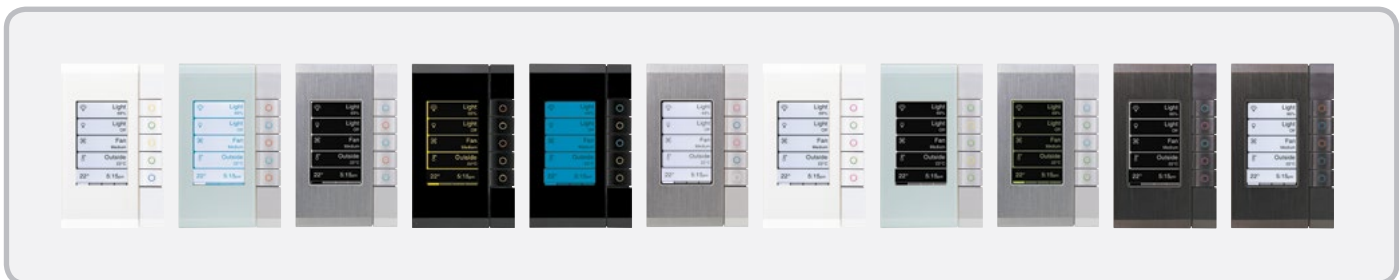
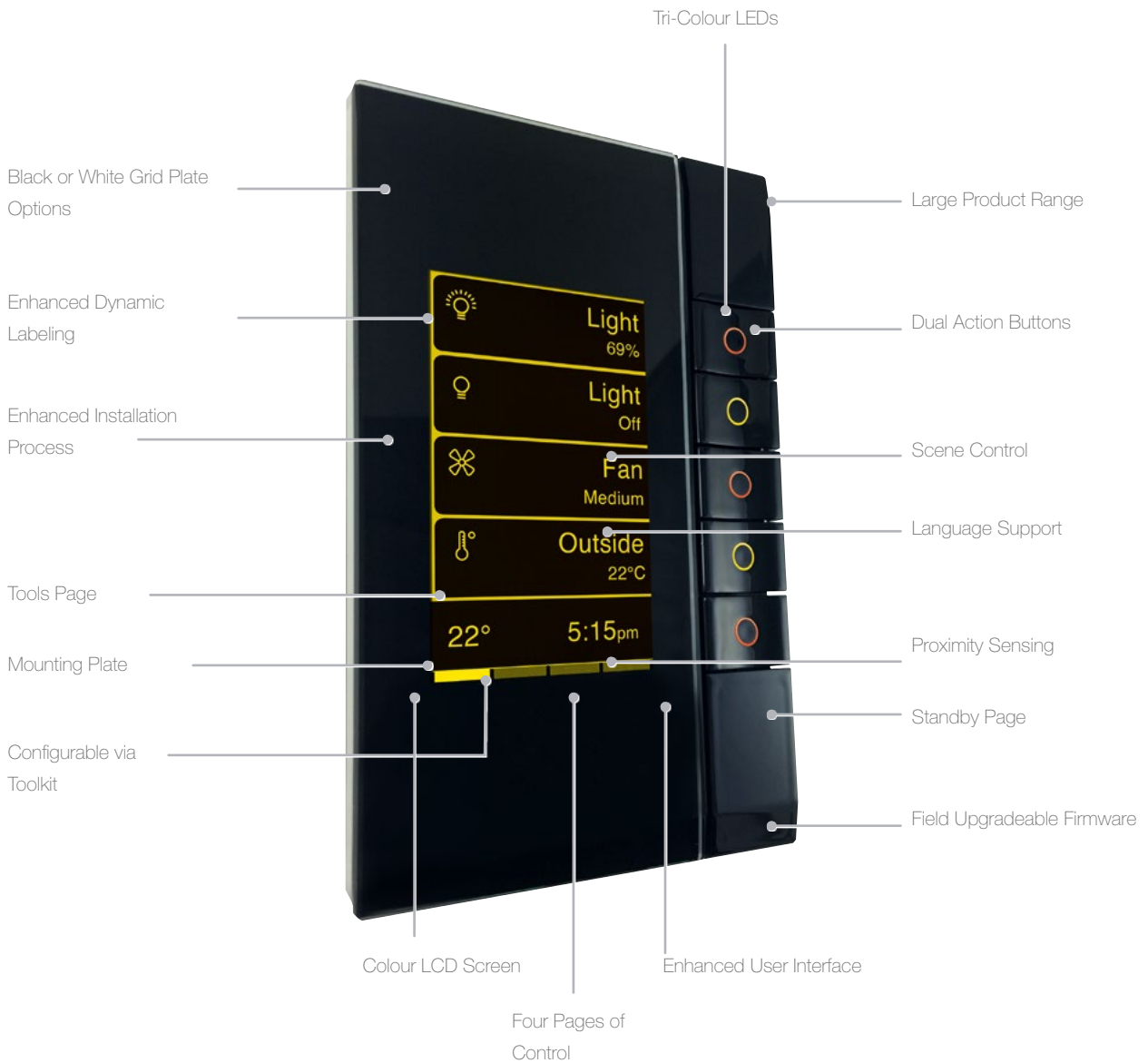

Saturn eDLT...

With the ability to customise the colour of the display and button, advanced device control, and intuitive functionality, the eDLT offers fantastic features and benefits that will enhance and complement your lifestyle.



Customisable Colour Options

Select from eight colour options to customise the screen and buttons to suit your style. The eDLT can also indicate system information for you, such as high energy use (red) or security disarmed (green).



Scene Control

The eDLT simplifies living by integrating multiple technologies around your home to work in unison at the touch of a button.

For example; a “Movie” scene for your home theatre could dim the lights, turn on the projector and lower the screen; or a “Goodnight” scene could conveniently turn off all the lights in your home from the comfort of your bedroom.



Enhanced Control Capability

The eDLT replaces the need for multiple wall switches, and provides you with up to 16 control functions in one stylish unit.

Desk units



Desk units

IDU - In-Desk Units

In Desk Units bring flexibility to the desktop, such as conference and training rooms. The range facilitates unrestricted individual access to power, media and data right on the table or desktop. Minimal depth also means no restriction on leg movement under the desk or table, even where the units are fitted near the edge.



FDU - Flush Desk Units

Flush Desk Units are perfect for commercial installations such as meeting rooms, offices or desk sharing environments. The ideal solution where flexibility is needed, these can be fixed with mounting brackets or can be free standing.



PTU - Pop Up Tower Units

Pop Up Tower units fit perfectly in any working environment. The range is ideal for integrating power and data connections in tiny spaces. Simply press down with your thumb to raise and lower the Pop Up Tower. Installation is incredibly simple. PTU is placed in a cut-out 79 mm in diameter and secured to the desk or table top from below using a lock ring.



ODU - On-Desk Units

On Desk Units can be mounted on the edge of a desk or table quickly and easily using a mounting bracket. A size 4 Allen key is required in order to tighten the inside screw on the bracket. Mounting does not damage the table/desk top.



UDU - Under Desk Units

The Under Desk Units are available with a plastic profile. It is possible to connect multiple power strips together to form a modular system. The range is designed primarily as a simple electricity supply unit for office workstations and permanently installed devices such as PCs, monitors, printers, etc. can be connected to the UDU.



Select Custom Modules

Mita SELECT Custom Modules are the central components of video, audio and network connections. Their construction offers you simple and flexible installation in facility systems, rack systems and electrical installations. The versatility of SELECT Custom Modules make Mita facility systems even more flexible.



IDU - In-Desk Units

Frames



Product Code	Description	Finish	Dimension
INS91001	Frame For 3 Way In Desk Unit	Silver-Grey	248 x 151 x 58mm
INS91002	Frame For 6 Way In Desk Unit	Silver-Grey	386.5 x 151 x 58mm

- Integrated into the top of a desk or table.
- Provides access to power, media and data.
- Minimal depth.
- Brush inserts to prevent the cables becoming lodged.
- High quality and sturdy frame design.
- Configuration can be freely selected thanks to the modular solution.

Power Strips



Product Code	Description	Finish	Dimension
INS91210	2 Power & 1 Select Module	Black/Silver	217 x 52 44mm
INS91201	2 Power & 1 Twin USB Charger	Black/Silver	TBC
INS91330	3 Power & 3 Select Modules	Black/Silver	355 x 52 x 44mm
INS91231	2 Power, 1 Twin USB & 3 Select Modules	Black/Silver	355 x 52 x 44mm

FDU - Flush Desk Units

Frames



Product Code	Description	Finish	Dimension
INS92001	Frame For 3 Way Flush Desk Unit	Silver-Grey	241 x 73 x 36mm
INS92002	Frame Cover For 3 Way Flush Desk Unit	Aluminium	255 x 87 x 43mm

- Practical and quick installation.
- Custom modules.
- Power and data sockets at the rear of the power strip.
- Configuration can be freely selected thanks to the modular solution.

Power Strips



Product Code	Description	Finish	Dimension
INS92210	2 Power & 1 Select Module	Black	220 x 52 x 44mm
INS92300	3 Power	Black	220 x 52 x 44mm

SELECT Custom Modules available on [p283](#).

PTU - Pop Up Tower Units

Pop Up Tower Units



Product Code	Description	Finish	Dimension
INS93102	1 Power & 1 Twin Usb Charger	Black/Silver	115 dia (locking ring) x 135mm Cutting diameter 80mm
INS93120	1 Power & 2 RJ45	Black/Silver	115 dia (locking ring) x 135mm Cutting diameter 80mm
INS93111	1 Power, 1 USB charger & 1 RJ45	Black/Silver	115 dia (locking ring) x 135mm Cutting diameter 80mm

- Press down to raise the pop up tower.
- Fast and easy to install.
- Available in 3 configurations.
- Suitable for desk or table tops.

ODU - On-Desk Units

Power Strips



Product Code	Description	Finish	Dimension
INS94220	2 Power & 2 Select Module	Black/Silver	346.3 x 73 x 88mm
INS94211	2 Power 45°, 1 Twin USB & 1 Select Module	Black/Silver	300.7 x 73 x 88mm
INS94312	3 Power, 1 Twin USB & 2 RJ45	Black/Silver	386.3 x 73 x 88mm
INS94302	3 Power & 2 RJ45	Black/Silver	344.2 x 73 x 88mm

- Flexible for any location.
- Suitable for meeting rooms, home offices or desk sharing environments.
- Can be mounted to a desk or table quickly and easily with the mounting brackets.
- Configuration can be freely selected thanks to the modular solution.

Accessories



Product Code	Description	Finish	Dimension
INS94001	Spax Fixing Screws For End Caps	Incl. Brass threaded sleeve	4mm Dia x 90mm (46mm thread length)
INS94002	Mounting Brackets	Anodised Aluminium	70 x 50 x 8.2mm

SELECT Custom Modules available on [p283](#).

UDU - Under Desk Units

Power Strips



Product Code	Description	Finish	Dimension
INS95102	2 Power 45° & 2 Switches	Black/Silver	245 x 52 x 43mm
INS95104	4 Power 45° & 1 Switch	Black/Silver	365 x 52 x 43mm

- Flexible and versatile power supply to workstations.
- Easy installation and can be removed at any time.
- Multiple fixing options, can be fitted under tables or desks, in cable ducts or in partitions.

Safety Module



Product Code	Description	Finish	Dimension
INS95000	Overvoltage Protection Unit	With mains & Frequency filters	220 x 52 x 43mm

Accessory



Product Code	Description	Finish	Dimension
INS95001	Stainless Steel Flat Mounting Plates		55 x 51 x 1mm

Select Custom Modules

Select Custom Modules









Product Code	Description	Finish
INS90001	1 VGA & Miniature Jack	Black
INS90002	1 HDMI Keystone	Black
INS90003	2 Keystone Modules	Black
INS90004	1 Keystone Module	Black

- Flexibly interchangeable modules.
- For data, video and audio connections.
- Easy to connect via socket/socket or screw terminal connections.
- Ability to upgrade your equipment with the latest custom modules.

Select Custom Modules continued

Select Custom Modules

	Product Code	Description	Finish
	INS90005	Cat6 Coupling Socket/Socket	Front: RJ45. Rear: Tj45 - Unshielded
	INS90006	CAT6 Coupling Socket	Front: RJ45. Rear: Tj45 - Shielded
	INS90007	Keystone Socket Cover	Black
	INS90008	1 Data Cabling Bushing	Black
	INS90009	1 VGA Cabling Bushing	Black
	INS90010	Blank Cover	Black
	INS90011	1 USB 3.0A / A Keystone	Black

GST Power Leads

GST power leads



Product Code	Description	Finish
INS90502	1.5mm2, UK 13A Plug, GST18i3 Socket	2M Length
INS90504	1.5mm2, UK 13A Plug, GST18i3 Socket	4M Length

- Supply and extension cables are pre-assembled with integrated earth connection.
- Available in different lengths enabling the extension of the power strips without the need for tools.

GST connector leads



Product Code	Description	Finish
INS90510	1.5mm2, GST18i3 Plug, GST18i3 Socket	0.3M Length
INS90511	1.5mm2, GST18i3 Plug, GST18i3 Socket	1M Length
INS90513	1.5mm2, GST18i3 Plug, GST18i3 Socket	3M Length

Connectors



Product Code	Description	Finish
INS90520	GST/GST Coupler Connector	40 x 28 x 11mm
INS90521	1xInput, 2xOutput Multiplier GST18	44 x 28 x 43mm
INS90522	1xInput, 2xOutput Multiplier GST18	65 x 48 x 15mm
INS90523	Appliance Plug With Screw Terminal	70 x 28 x 13mm



Technical Information

ARGUS Presence Detector system

ARGUS Presence Detector system

Product Code	MTN55101119	MTN55101219	
Description	Presence Master with IR, relay 1-gang	Presence Master with IR, relay 2-gang	
Nominal voltage	AC 220/230V, 50/60Hz	AC 220/230V, 50/60Hz	
Nominal current	max. 10AX, $\cos\varphi = 0.6$	Max. 10AX, $\cos\varphi = 0.6$. The total load on both channels is not allowed to exceed 14A	
Control current	-	-	
Type	-	-	
Load type	-	-	
Outputs	1 x make contacts	2 x make contacts	
Max. switching capacity per channel:			
Incandescent lamps	2200W	2200W	
HV halogen lamps	2000W	2000W	
LV halogen lamps with wound transformer	500VA	500VA	
Electronic transformers	1050W	1050W	
Capacitive load	10A, 140 μ F	10A, 140 μ F	
Energy-saving lamps	100VA	100VA	
Motor load	1000VA	1000VA	
Neutral conductor	Required (3 conductor system)	Required (3 conductor system)	
Cable capacity	max. 2x2.5mm ²	max. 2x2.5mm ²	
Angle of detection	360°	360°	
Number of levels	6	6	
Number of zones	136	136	
Number of movement sensors	4	4	
Recommended installation height	2.5m	2.5m	
Range	A radius of max. 7m (at an installation height of 2.5m)	A radius of max. 7m (at an installation height of 2.5m)	
Sensitivity	Continuously adjustable	Continuously adjustable	
Brightness threshold	Continuously adjustable between approx. 10 and 1000 lux	Continuously adjustable between approx. 10 and 1000 lux	
Overshoot time	Channel 1: continuously adjustable between approx. 10s and approx. 30min	Channel 1: continuously adjustable between approx. 10s and approx. 30min	
		Channel 2: continuously adjustable between approx. 5min and approx. 2h	
Slave	ARGUS Presence Slave MTN55701019	ARGUS Presence Slave MTN55701019	

ARGUS Presence Detector system

MTN55101419	MTN55101519	MTN55701019
Presence Master with IR, 1-10V	Ultimate Screwless	Presence Slave
AC 220/230V, 50/60Hz	230V 50Hz	AC 220/230V, 50/60Hz
max. 10AX, $\cos\varphi = 0.6$	90°	-
max. 50mA	5m at 1.2m height	-
-	Wall (flush)	-
max. 25 controllable EBs (1-10V)	Single	-
1 x make contact, 1 x (1-10V)	X	4 x PlusLink
2200W	-	-
2000W	-	-
500VA	-	-
1050W	-	-
10A, 140 μ F	-	-
-	-	-
-	-	-
Required (3 conductor system)	Required (3 conductor system)	Required (3 conductor system)
max. 2x2.5mm ²	max. 2x2.5mm ²	max. 2x2.5mm ²
360°	360°	360°
6	6	6
136	136	136
4	4	4
2.5m	2.5m	2.5m
A radius of max. 7m (at an installation height of 2.5m)	A radius of max. 7m (at an installation height of 2.5m)	A radius of max. 7m (at an installation height of 2.5m)
Continuously adjustable	Continuously adjustable	Continuously adjustable
Continuously adjustable between approx. 10 and 1000 lux	Continuously adjustable between approx. 10 and 1000 lux	-
Channel 1: continuously adjustable between approx. 10s and approx. 30min	Channel 1: continuously adjustable between approx. 10s and approx. 30min	Channel 1: continuously adjustable between approx. 10s and approx. 30min
ARGUS Presence Slave MTN55701019	ARGUS Presence Slave MTN55701019	-

Occupancy sensors technical overview

Ceiling Mounted Passive Infra Red Sensors (PIR)						
Product Code	CCT551023	CCT551011	CCT551012	CCT570005	E751	
Product Description	High-bay High Frequency Sensor	Dual Tech Sensor - 1ch	Dual Tech Sensor - 2ch	Mini Movement Sensor	Infrascan single-load 120° PIR sensor	
Operating voltage	220 - 250V 50/60Hz	220-250V 50/60Hz	220-250V 50/60Hz	220-250V	200-265V 50Hz	
Field of view	360 °	360 °	360°	360°	120°	
Range	14mx5m at 10m height	10mx16m at 2.5m height	10mx16m at 2.5m height	6m at 2.5m height	6m x 6m, 8.5m from sensor head. Head rotatable through 120°	
Mounting	Ceiling (surface)	Ceiling (surface)	Ceiling (surface)	Ceiling (surface)	Ceiling (surface)	
Single or Dual Load:	Dual	Dual	Single	Single	Single	
IR Remote Control*	CCT556023	CCT556011	CCT556011	X	X	
Incandescent	2000W	2000W	2300W	1000W	2A	
halogen lamps 230V	1000W	1000W	1200W	800W	2A	
halogen w. Electronic transformer	1000VA	1000VA	1200VA	315VA	2A (iron core transformer only)	
Fluorescent tubes	900VA	900VA/100 µF	1200VA/140µF	250VA	X	
Energy Saving lamps	600VA	600VA	600VA	X	X	
IP class	IP52, IP40	IP20	IP20	IP20	IP44	
Time setting	Time 1 (for lighting): Adjustable from approx. 10sec to 30 min. Time 2 (for HVAC): Adjustable from approx. 10sec to 60min	Aadjustable from approx. 5sec to 30min	Aadjustable from approx. 5sec to 30min	29 sec to 30 mins	5 sec to 20 min (user adjustable)	
Test Mode	X	X	X	X	Yes	
Lux setting	10 - 2000 Lux	10-1000 Lux	10-2000 Lux	5-1000 Lux	Continuous from 1 Lux to full sunlight	
Operating temp range	0 °C to +45 °C	0 °C to +45 °C	0 °C to +45 °C	X	0°C to +40°C	
Connection	X	X	X	3-wires	2 wires	
Parallel connection of detectors	X	X	X	X	No	
Switching modes	X	X	X	X	Auto mode, manual override	
Product Dimensions	X	X	X	X	Ø 100 x 57mm(H)	

Occupancy sensors technical overview

	Wall Mounted			Outdoor (wall mounted)			
E751R	GUPA1411BSS	GUP1411BSS	E750WPRGY	CCT56P004	CCT56P008	MTN564419	
Infrascan Single-load 120° PIR sensor	Ultimate Screwless 90° PIR plate switch - with override	Ultimate Screwless 90° PIR plate switch	Infrascan single-load 110° PIR sensor	Single-load 120° PIR sensor	Single-load 360° PIR sensor	360 Degree Outdoor sensor	
200-265V 50Hz	230V 50Hz	230V 50Hz	200-265V 50Hz	220-240V 50Hz	220-240V 50Hz	230V 50Hz	
120°	90°	90°	110°	120°	360°	360°	
6m x 6m, 8.5m from sensor head. Head rotatable through 120°	5m at 1.2m height	5m at 1.2m height	18m at 2.4m height	12m (forward)	12m	10mx7m at 2.5m height	
Ceiling (surface)	Wall (flush)	Wall (flush)	Wall or ceiling (surface)	Wall or ceiling (surface)	Wall or ceiling (surface)	Wall or ceiling (surface)	
Single	Single	Single	Single	Single	Single	Single	
X	X	X	X	X	X	X	
10A	150W	150W	10A	1000W	1000W	X	
10A	150W	150W	10A	900W	800W	X	
10A	150VA	150VA	10A	250VA	315VA	X	
10A	X	X	10A	200VA	250VA	X	
500W	X	X	500W	4 x 23W	4 x 23W	X	
IP44	X	X	IP66	IP55	IP55	IP55	
5 sec to 20 min (user adjustable)	15 sec – 30 min (through 7 time increments)	15 sec – 30 min (through 7 time increments)	5 sec to 20 min (user adjustable)	Approx 3 sec – 3 min, lower tolerance 2 – 6s	Approx 5 sec – 20 min, lower tolerance 2 – 8s	X	
Yes	No	No	Yes	Yes	Yes	X	
Continuous from 1 Lux to full sunlight	10 - 2000 Lux	10 - 2000 Lux	Continuous from 1 Lux to full sunlight	5 – 2000 Lux	5 – 2000 Lux	5-1000 Lux	
0°C to +40°C	+5°C to +25°C	+5°C to +25°C	0°C to +50°C	-15°C to +40°C	-15°C to +40°C	-20 °C to +25 °C	
3-wires	2 wires	2 wires	3-wires	3-wires	3-wires	X	
Yes	Yes	Yes	Yes	Yes	Yes	X	
Auto mode, manual override	Auto mode, manual override	X	Auto mode, manual override	Auto mode, manual override	Auto mode, manual override	X	
Ø 100 x 57mm(H)	88 x 88mm	88 x 88mm	Mounting centres 84mm	With corner bracket 164mm (L) x 80mm (W) x 75mm (H) without corner brackets 140mm (L) x 80mm (W) x 75mm (H)	With corner bracket 170mm (L) x 88mm (W) x 76mm (H) without corner bracket 142.5mm (L) x 88mm (W) x 76mm (H)	X	

Wiring accessories

Recommended quantity of socket outlets for domestic installation

Inadequate installations can occur when not enough socket outlets have been installed or where the existing sockets are located in the wrong areas. This could lead to potentially dangerous improvisations.

The table below summarises the recommendations of the Electrical Installation Industry Liaison Committee (EILC) regarding the minimum number of twin switched socket outlets per room, suitable for domestic installations. This takes into account uses and likely trends.

Room	Number of sockets	Room	Number of sockets
Kitchen	4	Landing/stairs	1
Lounge	6	Hall	1
Dining room	3	Garage	2
Double bedroom	3	Store/workroom	1
Single bed-sitting room	3	Central heating boiler point	1

Wiring circuits for 6AX and 10AX switches

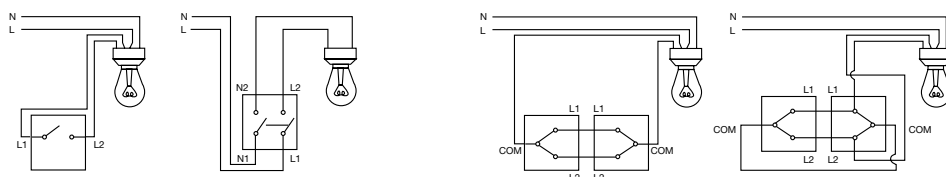

Diagram A – One way circuits

Diagram B – Two way circuits

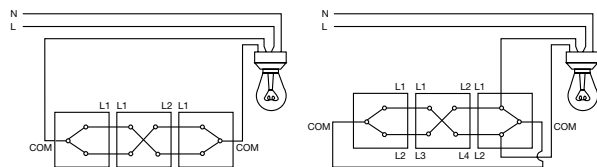

Diagram C – Intermediate circuits

Note: 1 way or 2 way switches can be replaced by dimmer switches. Rotary dimmers are 1 way only whilst push dimmers are 2 way. LV dimmers are suitable for use on the LV input side only.

Accessories mounting box

Product	Description	Ultimate Slimline	Ultimate Flat Plate	Ultimate Screwless	Ultimate Low Profile
16AX/10AX plate switches	1-2 gang	16mm	16mm	16mm	16mm
	3 gang	25mm	25mm	25mm	25mm
	4-6 gang	25mm	25mm	25mm	25mm
Dimmer switches	TP isolator	16mm/25mm [^]	16mm/25mm ^{^*}	16mm/25mm ^{^*}	16mm/25mm ^{^*}
	1 & 2 gang	16mm/25mm ^{**}	25mm	25mm	25mm
	3 & 4 gang	25mm	35mm	35mm	35mm
Socket outlets	1 gang	25mm*/35mm	25mm	25mm*/35mm	25mm
	2 gang	25mm*/35mm	25mm*/35mm	25mm*/35mm	25mm
	3 gang				
Round pin sockets		25mm	25mm	25mm	25mm
RCD socket outlets	1 & 2 gang				
Fused connection units		25mm	25mm/35mm ^{***}	25mm/35mm ^{***}	25mm/35mm ^{***}
Flex outlet plates		25mm			
20AX key switches				47mm	
20AX DP switches		25mm	35mm	35mm	35mm
32A DP plate switches	1 gang	25mm	35mm	35mm	35mm
50A DP switches	1 gang				
	2 gang	47mm			47mm
45A DP ceiling switch					
45A Cooker connection units		47mm	47mm	47mm	47mm
Cooker terminal box		47mm	47mm	47mm	47mm
Shaver sockets		47mm	47mm	47mm	47mm
Telephone socket outlets	Master & secondary	25mm	25mm/35mm ^{^^}	25mm	25mm
Co-axial socket outlets	Single & twin	25mm	35mm	25mm	25mm~
Triplex & Diplex		25mm		35mm	
Satellite socket		25mm	35mm	25mm	25mm
RJ45 & RJ11		35mm	35mm	35mm	35mm

Wiring accessories

Accessories mounting box				
Product	Description	Exclusive Square Edge White Moulded	Lisse White Moulded	Lisse Screwless Deco
16AX/10AX plate switches	1-2 gang	16mm	16mm	16mm
	3 gang	25mm	25mm	25mm
	4-6 gang	25mm	25mm	25mm
	TP isolator	25mm	16mm/25mm ^{^*}	25mm
Dimmer switches	1 & 2 gang	16mm/25mm ^{**}	16mm/25mm	16mm/25mm
	3 & 4 gang		25mm	25mm
Socket outlets	1 gang	25mm	25mm	25mm
	2 gang	25mm	25mm	25mm
	3 gang	25mm		
Round pin sockets		25mm	25mm	25mm
RCD socket outlets	1 & 2 gang	25mm		
Fused connection units		25mm	25mm	25mm
Flex outlet plates		25mm	25mm	25mm
20AX key switches				
20AX DP switches		25mm	25mm	25mm
32A DP plate switches	1 gang			
	2 gang			
45A DP switches	1 gang		47mm	47mm
	2 gang		47mm	47mm
45A DP ceiling switch		47mm		
Cooker connection units		47mm	47mm	47mm
Cooker terminal box		47mm		47mm
Shaver sockets		47mm	47mm	47mm
Telephone socket outlets	Master & secondary	25mm	25mm	25mm
Co-axial socket outlets	Single & twin	25mm	25mm/35mm	25mm/35mm
Triplex & Diplex			47mm/35mm ^{*~}	47mm/35mm ^{*~}
Satellite socket		25mm	25mm	25mm
RJ45 & RJ11		35mm	35mm	35mm

Note: Metal clad accessories are supplied complete with a 42mm surface mounted box in the same matching finish. Metal plate accessories are not suitable for mounting on surface moulded pattresses:

Mounting boxes tested are dependent upon the number and sizes of cables used and therefore should only be used as a guide.

* Dependent upon wiring configuration

** For 16mm flush fitted steel boxes use adaptor plate supplied when mounting 2 way Ultimate Slimline moulded dimmer switches

*** 25mm unswitched and 35mm switched

[^] 16mm deep for GU10/13 and architrave, 25mm deep for wide rocker

^{^^} 16mm for 1-2 gang, 25mm for 3-6 gang

[~] Single only

^{*~} 47mm Triplex, 35mm Diplex

^{^^} 25mm minimum, 35mm GU7251***

Dimmer switches

Dimmer Specification Table							
Product	Exclusive			Lisse			
Format	Monoblock			Monoblock			Grid
Configuration	1 Way	2 Way		1 Way	2 Way	2 Way	
Operation	Mains	Universal		Universal		1-10V 6A	LED
Mains & Low Voltage							
Min Rating	60W	250W/VA	400W/VA	250W/VA	1-10V Control Voltage 6A Rating		10W
Max Rating	250W						200W
LED							
Min Rating							5W
Max Rating							100W
Description							
Derating	Y			Y		N/A	N
2 Way Control	Standard 2 way switch			Standard 2 way switch			Retractive Switch Control
Ability to dim via 2 way location	No			No			Yes
Integral trimming adjustment **							Yes

Dimmer Specification Table					
Product	Ultimate				
Format	Monoblock		Grid	Grid (remote operation)*	Grid
Configuration	2 Way			Multi Way	
Operation	Universal	LED	Mains	Mains	LED
Mains & Low Voltage					
Min Rating	250W/VA &				
Max Rating	400W/VA		300W	300W	200W
LED					
Min Rating		75W/VA &			5W
Max Rating		100W/VA			100W
Description					
Derating	Y	N	Y	Y	N
2 Way Control	Standard 2 way switch	Retractive Switch Control	Retractive Switch Control	Retractive Switch Control	Retractive Switch Control
Ability to dim via 2 way location	No	No	Yes	Yes	No
Integral trimming adjustment **		Yes			

Dimmer switches

Circuit, lamp and other equipment compatibility

To ensure optimum performance and reliability is obtained from dimmer switches the following recommendations and precautions should be followed as appropriate to the type of dimmer:

General recommendations

Circuits

It is recommended that all lighting circuits incorporating dimmers be protected by a 6A or up to a 10A maximum Type B miniature circuit breaker.

Dimmable low voltage transformers

- Always check transformer compatibility BEFORE installation and if in doubt always check with the dimmer Helpline or the transformer manufacturer. It is recommended that electronic dimmable transformers be loaded to at least 70% of their rated maximum wattage.
- When running multiple lamps on dimmable electronic transformers ensure that all lamps are working correctly. Replace failed lamps as soon as possible as a single failed lamp may cause flickering of all other lamps connected to the same dimmer.
- Do NOT mix electronic and magnetic transformers on the same dimmer switch.
- It is recommended that a maximum number of 5 low voltage transformers only should be connected to an individual dimmer switch
- These electronic dimmer switches, except 1kW, use leading edge (phase delay) dimming technology and must therefore be used with compatible good quality dimmable electronic or wire-wound (magnetic) transformers. Trailing edge (phase cut) dimmable transformers must not be used.
- The 1kW dimmer switch uses trailing edge (phase cut) dimming technology and must therefore be used with compatible good quality dimmable electronic transformers. Do not use the 1kW dimmer with magnetic transformers.

Circuits

- For two-way or more switching ONLY use retractable switches. Do NOT use two-way switches
- The live supply for retractable switches must come from the live (L) connection of the dimmer.
- Do NOT use with Compact Fluorescent Lamps (CFL) even if marked "dimmable", fluorescent lamps and Light Emitting Diode (LED) lamps of any description or motor loads.

Tungsten/Mains Voltage Tungsten halogen Lighting

Most Tungsten lamps can be dimmed; these include standard GLS lamps, candle lamps, reflector and mains voltage Tungsten halogen lamps etc. Tungsten lamps of mains voltage halogen type (GZ10, GU10 or G9) can be dimmed using standard Tungsten dimmers. However, to protect the dimmer, it is important to de-rate the dimmers maximum rating by 50%, (e.g. for dimmer rated as 50W- 400W, it's Tungsten halogen lamp rating becomes 50W- 200W). This de-rating requirement only applies to plate and grid dimmers rated up to 1500W, for other dimmers, observe individual product guidelines. While observing maximum dimmer ratings, also ensure that the connected load is not less than the minimum rating of each dimmer, otherwise the lamps may flicker and the dimmer may fail.

Tungsten halogen lamps

When using mains voltage Tungsten halogen lamps, it is essential that these types of lamp incorporate internal fuses or are constructed such that arcing at the end of life cannot occur and are from quality lamp manufacturers. The use of inferior low quality lamps is not recommended and will invalidate any guarantee or warranty supplied with the dimmer switch.

LED Lamps - Important information

Schneider Electric LED dimmers have been tested to operate with a wide range of quality dimmable LED lamps. In every instance ensure a quality branded dimmable lamp is used to provide suitable compatibility. However whilst every attempt is made to ensure compatibility with the majority of manufacturer lamps due to ongoing developments of both dimmers and lamps, Schneider cannot guarantee operation in every instance. Schneider Electric always recommend that the lamp is tested for operation before it is used throughout the installation.

If the LED lamp flickers at minimum dim Level, use the below procedure to set the LED lamp to adjust and set a higher minimum dimmer position. Please note by using this procedure the minimum dim level of the LED lamp would be increased.

Attention:

* Only to be used if the lamp flickers at the minimum brightness:

Technical specification

Rated Voltage: 220 V-230 Vac 50 Hz
 (not compatible with 100-125 Vac or 60 Hz supplies)
 Product standards: EN 60669-2-1

Type of ballast	Minimum Load	Maximum load
Mains voltage tungsten halogen lamp	25 W	100 W
Low voltage halogen lamp	25 W	100 W
LED lamp*	5 W	100 W

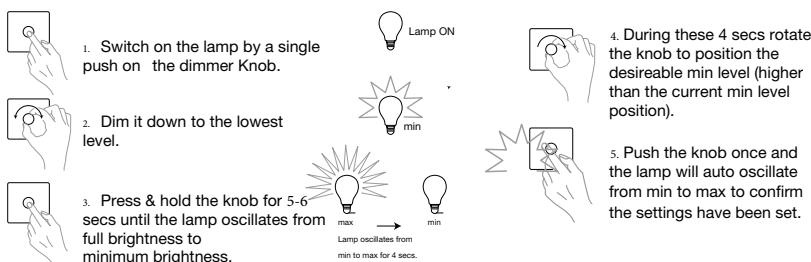

Dimmer Switches

Dimmer installation

Moulded plate mounted dimmers can generally be used with the supplied pattress to replace standard wall switches (where a 16mm box depth is typically used). For flat plate mounted dimmers, 25mm boxes are required. All rotary dimmer terminations and wiring are the same as for standard switches, i.e. COM, L2 (and also L1 for two-way dimmers). Rotary one-way dimmers can only be used for switching and dimming from one position. Rotary two-way (push) dimmers can be used to replace any one, (but not both), of the two-way switch circuit, (note that only one dimmer can be used per switch circuit or lamp(s); thus the lights can be switched from more than one position but can only be dimmed from one. With any rotary dimmer, if replacing an existing switch or dimmer, make a careful note of which wires are installed in which terminals on the old unit, and then connect them into the terminals with corresponding markings on the new dimmer. To ensure that plate temperatures are within maximum limits, maximum total connected load for a single size plate is 630W, and for a double size plate, 1000W. For low voltage lighting, remember to allow for transformer losses when calculating the total circuit load, typically 15% - 20%.

To use electronic dimmers in 1, 2 or more way circuits the specific circuit diagrams detailed and the Important Notes MUST be followed exactly.

Maximum permitted loads in Watts for multiple dimmers in a single enclosure									
Front plate gang size	2	3	4	6	8	9	12	18	24
Per row (max rating W)	400	480	480	480	480	480	480	480	480
Total plate (max rating W)	400	480	480	740	740	940	940	1440	1800

Simulated 'Off - Click'

Recent developments within the industry have resulted in rotary dimmer modules not having the positive 'Off Click' as the dimmer is switched off. This has led to consumers returning products identifying they are not functioning. To counter this, Schneider Electric have a 'simulated Off'. The range has been designed to withstand a higher inrush current than others in the market. This inrush is typical when lamps turn on for the lamps 'blow'. Typically this inrush or energy surge can be up to 100 times the normal current being supplied to a lamp. For example the inrush for a 150W lamp could be up to 40NS over 10 milliseconds. A number of dimmer products in the market when tested have a maximum capacity of approximately 20NS. The Schneider Electric product has an equivalent capacity of 50NS. This, therefore means that the Schneider Electric product will last longer within installations, depending on the switching duty. A thermal fuse protects the Schneider Electric module. This will not protect the unit against an inrush but against overloads and short-circuits etc. This fuse is not self restoring or replaceable. It's function is to protect against electrical and fire damage. This requirement was not mandatory in the previous standard and therefore some modules in circulation potentially do not have the safety feature, unlike ours.

Rotary and 2 way (push) dimmers

Circuits

- Only use two-way (push) dimmers in two-way switching circuits. Only use one two-way dimmer in a two-way switching circuit.

Lamps

- These dimmer switches are suitable for dimming incandescent lamps and dimmable CFL lamps only and are NOT to be used with fluorescent lamps, Light Emitting Diode (LED) lamps of any description or motor loads. Use of non-dimmable CFL lamps may permanently damage the dimmer or the lamp and will invalidate any guarantee or warranty supplied with the dimmer switch.
- It is recommended that a maximum number of 5 dimming CFL lamps only should be connected to an individual dimmer switch.

Dimmable low voltage transformers

- Only use low voltage dimmers with transformers. Do not use mains voltage dimmers.
- The low voltage dimmer switches use leading edge (phase delay) dimming technology and must therefore be used with compatible good quality dimmable electronic or wire-wound transformers. Trailing edge (phase cut) dimmable transformers must not be used.

1 way installation wiring diagram - electronic dimmers

IMPORTANT NOTES - for 1 way Installation

- Read General Installation Safety Instructions before starting work
- Do not connect any conductor to dimmer terminal marked RS. This is for use with 2 way switching

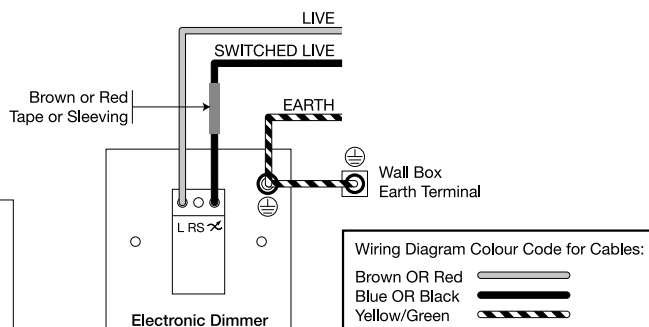

Wiring accessories

Co-Axial and Satellite sockets

Non isolated

Non-isolated products are intended for direct connection to a single or two separate TV/FM aerial downloads. These units are not designed for use in multi outlet systems.

Single TV/FM outlet for connection to a single TV or FM coaxial aerial lead.

Twin outlet for connection to each of two separate TV/FM, coaxial aerial leads.

Diplex and Triplex

Performance

Diplex

TV/FM diplex units for connection to a single coaxial aerial lead with combined TV and FM signals.

The connector standard IEC 169-2 plug for TV and IEC 169-2 socket for radio.

Triplex

TV/FM/SAT triplex unit for connection to a single coaxial aerial lead with combined TV, FM and satellite signals.

TV: 470-860MHZ

Radio: (FM) 87.5 – 108 MHz and (DAB) 217.5 – 230 MHz.

Satellite: DC – 200kHz and 950-2300MHz.

The connector standard is 'f' for satellite, IEC 169-2 plug for TV and IEC 169-2 socket for radio.

Telephone socket outlets

It is legal for a contractor to install a secondary telephone socket with associated wiring into house-holds with single exchange lines. The contractor may install a secondary socket and wire up to the master socket and wiring to the exchange. This does not include wiring the actual master socket or to the exchange itself. This final connection must be made by an approved installer.

For commercial and industrial installations a PBX (or PABX) internal exchange or 'intelligent' telephones are often fitted. In this case, the contractor may install all of the equipment except for the PBX unit installation. Again this must be carried out by a BSI approved installer and the interface between the PBX/PABX internal system and the incoming external lines must be connected by British Telecom.

Schneider Electric telephone sockets are suitable for use in accordance with BS 7671, formerly the 18th Edition of the IEE Wiring regulations and should be wired in accordance with the diagrams shown.

Example of typical connection

1 Connection to 2 & 5

2 Earth recall (when used) connect to terminal 4

3 Connection to terminal 3 is not usually required

NB (a) Standard 4 wire cable is shown below as incoming cable. If terminals 1 and 6 (normally unused) are required, 6 wire cable may be used.

(b) All socket outlet connections are parallel – any number of socket outlets can be connected, but it is recommended that only a maximum of 5 telephones be used at any one time on one line.

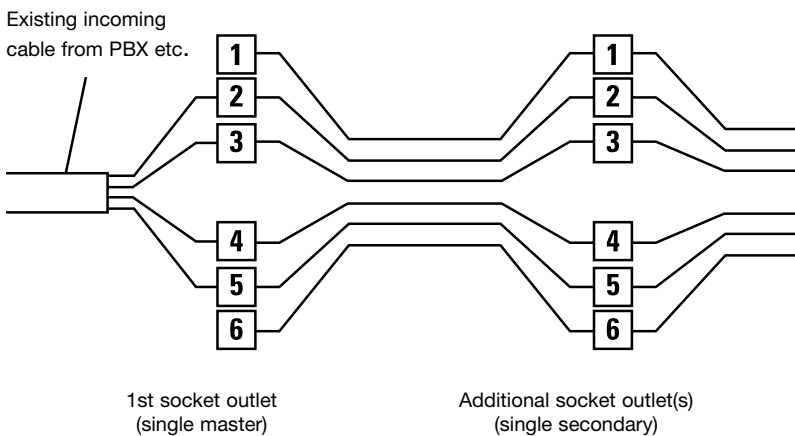

56 Series plastic chemical resistant comparison chart

Product Type (Colour)	All mounting enclosures (ie back box)	Grey transparent covers and plugs	Resistant orange (RO) covers and plugs
Acids			
Weak Solutions			
Hydrochloric	A	A	A
Nitric 10% Concentrate	A	A	A
Sulphuric Acid 100%	A	D	D
Alkalis			
Weak Solutions			
Sodium Hydroxide 10% (Caustic Soda) Concentrate	A	D	B
Potassium Hydroxide 100%	A-B	D	D
Automotive			
Petroleum Lubricating Oils Hydraulic Oil	A	D	A
Solvents			
Aliphatic hydrocarbons (alkanes)			
Methane Propane	B A	A A	A A
Alcohols			
Ethelene Glycol Glycerol (Glycerin) Methyl Alcohol (Methanol) Ethyl Alcohol (Ethanol)	A A A A	A C D A	A B B A
Amines			
Aniline	D	D	D
Aromatic Hydrocarbons			
Methyl Benzene Xylene	D D	D D	B B
Ethers			
Dimethyl Ethyl	A	A	A
Ketones			
Acetone Acetophenone Ethyl Methyl Ketone	A D D	D D D	C C C
Miscellaneous			
Detergent Inorganic Salts Magnesium Sulphate	A A	A A	A A
Oxidising agents			
Weak Solution			
Sodium Hydrochlorite 5%	A	A	A
Strong Solution			
Hydrogen Peroxide 30%	A	A	A
Water			
Ambient Hot >60°C Steam	A C D	A A D	A B D

This table should be used as a guide only. Any end user should test to evaluate the suitability of any chemical with any plastic.

A - Excellent
Recommended no
adverse effects after
extended exposure.







B - Good
Acceptable minimal loss
of mechanical properties
after long periods of
exposure.

C - Fair
Marginal acceptability.

D - Poor
Not recommended for
use.

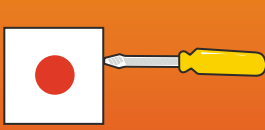



Ingress Protection ratings

PROTECTION AGAINST SOLIDS

	TEST	PROTECTION
x	No test applied	No specific protection
0	No test applied	Inherent degree of protection
1		Protected against solid objects equal to or greater than 50mm diameter. (eg. accidental contact with hand)
2		Protected against solid objects equal to or greater than 12.5mm diameter. (eg. contact with finger)
3		Protected against solid objects equal to or greater than 2.5mm diameter. (eg. tools and wires)
4		Protected against solid objects equal to or greater than 1mm diameter. (eg. fine tools and wires)
5		Protected against quantities of dust that could interfere with satisfactory operation.
6		Completely protected against dust.

Defined by IEC 60529
DIN 40050 CEI 70-1

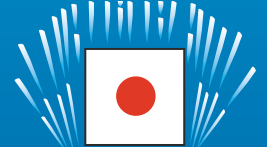
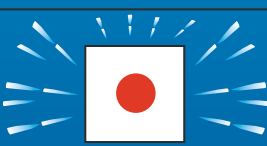
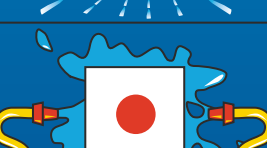
PROTECTION AGAINST LIQUIDS

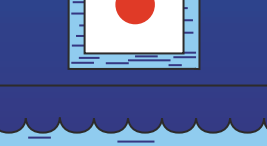
	TEST	PROTECTION
x	No test applied	No specific protection
0	No test applied	Inherent degree of protection
1		Protected against drops of water falling vertically.
2		Protected against drops of water falling at up to 15 degrees from the vertical.
3		Protected against spraying water at up to 60 degrees from the vertical.
4		Protected against splashing water from all directions.
5		Protected against jets of water from all directions.
6		Protected against jets of water of similar force to heavy seas.
7		Protected against the effects of temporary immersion.
8		Protected against the effects of continuous immersion.

Defined by IEC 60529

Index

Index

Reference	PG	Reference	PG	Reference	PG	Reference	PG	Reference	PG
400102	230	56SO520LEGY	248	GABATC	224	GGBGU3024D	143	GGBL08G	169, 189
400112	230	56SO5326LEGY	249	GBAT	224	GGBGU34102USBA*PB	62	GGBL09G	169, 189
400113	230	56SSW10LEGY	251	GBATC	224	GGBGU34102USBA*PC	62	GGBL1011	181
400114	230	56SSW15LEGY	251	GBG01	80, 110, 131, 150, 169, 189, 217	GGBGU34102USBA*SS	62	GGBL1011S	181
3746130	79, 110, 130, 149, 155, 188, 205	56SSW15LERO	251	GBG01P	217	GGBGU34102USBABBN	62	GGBL1012	163, 181
5632LEGY	252	56SSW210LEGY	251	GBG02	81, 111, 131, 150, 169, 189, 217	GGBGU34102USBAWPN	62	GGBL1012116AS	182
5632LERO	252	56SSW215LEGY	251	GBG02P	217	GGBGU34102USBAWPN	62	GGBL1012A	182
56C31324ELGY	255	56SW110GY	249	GBG03	81, 111, 131, 150, 169, 189, 217	GGBGU3410CLR	60	GGBL1012ARP	182
56C3134ELGY	255	56SW110LEGY	249	GBG02P	217	GGBGU34202USB*PB	62	GGBL1012AS	182
56C313GY	255	56SW110LERO	249	GBG03	81, 111, 131, 150, 169, 189, 217	GGBGU34202USB*PC	62	GGBL1012AR	163, 181
56CB4GY	252	56SW120LEGY	249	GBG04F	82, 111, 112, 150, 170, 189	GGBGU34202USB*SS	62	GGBL1012RB	181
56CB4NGY	252	56SW120LERO	249	GBG04S	218	GGBGU34202USBBBN	62	GGBL1012RBS	181
56CB4NRO	252	56SW132LEGY	249	GBG06F	112, 151, 82	GGBGU34202USBWPN	62	GGBL1012RP	181
56E1GY	253	56SW220COLEGY	251	GBG06S	218	GGBGU34202USBWPN	62	GGBL1012RPS	181
56E1RO	253	56SW220LEGY	250	GBGS01	217	GGBGU3420CLR	61	GGBL1012RS	181
56E2GY	253	56SW220LERO	250	GBGS02	217	GGBGU3424D*PB	62	GGBL1012S	181
56E2RO	253	56SW232LEGY	250	GBGS03	217	GGBGU3424D*PC	62	GGBL1012W	164, 182
56E3GY	253	56SW232LERO	250	GBGS04S	218	GGBGU3424D*SS	62	GGBL1012WS	182
56E3RO	253	56SW310LEGY	250	GBGS06S	218	GGBGU3424DBBN	62	GGBL1013	164, 182
56E4GY	254	56SW320LEGY	250	GBLANK1G	205	GGBGU3424DWPW	62	GGBL10131L	182
56E4RO	254	56SW320LERO	250	GCKR50A	204	GGBGU3424DWPW	62	GGBL10131R	182
56E4VHGY	254	56SW332LEGY	250	GCKR50A2G	204	GGBGU35202USB*BC	124	GGBL1013S	182
56E6GY	254	56SW332LERO	250	GCKRN50A	204	GGBGU35202USBWPC	124	GGBL1014	163, 181
56E6RO	254	56SW363LEGY	250	GCKRN50A2G	204	GGBGU6412CLR	69	GGBL1014S	181
56E8GY	254	56SW363LERO	250	GD1G1W	202	GGBGU6422CLR	69	GGBL1014W	164, 182
56E8RO	254	ADAPT2W	230	GD1G2W4C	202	GGBGU7032USBA*PB	77	GGBL1014WS	182
56E9GY	254	ADAPT3WF	230	GD1G2WC	202	GGBGU7032USBA*PC	77	GGBL1022	164, 182
56ED2GY	253	ALB71322	263	GDL1	227	GGBGU7032USBA*SS	77	GGBL1022A	182
56ES1GY	253	CCT551011	261	GDL2	227	GGBGU7032USBABBN	77	GGBL1022S	181
56ES2GY	253	CCT551012	261	GE115P	231	GGBGU7032USBAWPN	77	GGBL1022W	164, 182
56ES2RO	253	CCT551023	261	GE115S	231	GGBGU7032USBAWPN	77	GGBL1022WS	182
56FA1GY	254	CCT56P004	266	GE125P	231	GGBGUGEMDIML*PC	89, 119, 136	GGBL102M	170
56FA2GY	254	CCT56P008	266	GE157P	231	GGBGUGEMDIML*SS	89, 119, 136	GGBL102RW	190
56FA3GY	255	CCT570005	262	GE197P	231	GGBGUGEMDIMLBBN	89, 119, 136	GGBL102W	190
56FA4GY	255	CCTDT5130	263	GE249P	231	GGBGUGEMDIMLBPN	89, 119, 136	GGBL1032	164, 181
56FCUGY	249	CRA12W	228	GE321P	231	GGBGUGEMDIMLBPN	89, 119, 136	GGBL1032S	181
56FCULEGY	249	CRB2W	227, 229	GE381P	231	GGBGUGEMDIMLWPC	89, 119, 136	GGBL1032W	164, 182
56JB1GY	255	CSC313	242	GE84S	231	GGBGUGEMDIMLWPC	89, 119, 136	GGBL1032WS	182
56L1GY	252	CSO313	242	GE884S	231	GGBGUGEMDIMLWPN	89, 119, 136	GGBL1042	164, 182
56L2GY	253	CSO3132	242	GEBAT	224	GGBGUGEMDIMLWPN	89, 119, 136	GGBL1042S	182
56P310GY	252	CSW120	242	GESPEN613	224	GGBGUGEMDIMLWPN	89, 119, 136, 151	GGBL10IM	170
56P313EO	252	CSW1202	242	GESPEN618	224	GGBGUGEMDIMLWPN	89, 119, 136, 151	GGBL10IW	190
56P313GY	252	CSW220	242	GEURO1	206	GGBGUSHF1GBS	62, 95, 124, 143	GGBL12G	170, 189
56P313RO	252	E551US	236	GEURO2	206	GGBGUSHF1GS	62, 95, 124	GGBL13FCU***	171
56P315GY	252	E55CB	238	GEURO4	206	GGBGUSHF2GBS	62, 95, 124	GGBL13FCUWPN	191
56PBS1LEGY	251	E55GP	238	GFOPLATE	202	GGBGUSHF2GS	62, 95, 124	GGBL2010	165, 183
56SO313GY	248	E55PB	237	GGBGU1412BUBBN	64	GGBGUSHF2GS	62, 95, 124	GGBL2010LS	183
56SO313LEGY	248	E750WPRGY	266	GGBGU1412BUBPB	64	GGBL01G	169, 189	GGBL2011	165, 183
56SO313RO	248	E751	266	GGBGU1412BUBPC	64	GGBL02G	169, 189	GGBL2011S	183
56SO316110LEGY	248	E751R	266	GGBGU1412BUBSS	64	GGBL03G	169, 189	GGBL2014WH	165, 183
56SO3166LEGY	248	E93WE	225	GGBGU1412CLR	65	GGBL04G	169, 189	GGBL201M	170
56SO3326LEGY	248	G45ACCU	204	GGBGU1422CLR	66	GGBL06G	169, 189	GGBL201W	190
56SO332GY	248	G45ACCUJUN	204	GGBGU30102USBAS	143			GGBL2020M	170
56SO4326LEGY	248	GABAT	224	GGBGU30202USBRP	143			GGBL2020W	190
56SO5166LEGY	248							GGBL2022IMR	171, 184
								GGBL202K**	171

Index

Reference	PG	Reference	PG	Reference	PG	Reference	PG	Reference	PG
GGBL202KEPWPW	190	GGBL3060L	180	GGBL6012L**S	165	GGBL707445511***S	168	GGBLINDWGW	171, 191
GGBL202KEPWPWEL	190	GGBL3060L***	162	GGBL6012LS	183	GGBL707445511S	187	GGBLINDWOW	171, 191
GGBL202M	170	GGBL3060S	180	GGBL6012V4S	183	GGBL70746110	187	GGBLINDWR	171, 191
GGBL202OC**	171	GGBL3070	181	GGBL6022C**S	165	GGBL70746110***S	168	GGBLR**	170
GGBL202OCW	190	GGBL3070***	162	GGBL6022CS	183	GGBL70746110S	187	GGBLRBO**	170
GGBL202W	190	GGBL3080	181	GGBL6022L**S	165	GGBL7074S	187	GGBLRBOT**	170
GGBL2033	184	GGBL3080***	162	GGBL6022LS	183	GGBL7081	187	GGBLRCH**	170
GGBL2033S	184	GGBL3081	181	GGBL6022V4S	183	GGBL7081***S	168	GGBLRDWW**	170
GGBL20DPCHW	190	GGBL3081***	162	GGBL6032C**S	165	GGBL7081456	187	GGBLREF**	170
GGBL20DPDWW	190	GGBL3090	181	GGBL6032CS	183	GGBL7081456***S	168	GGBLRFA**	170
GGBL20DPEFW	190	GGBL3090***S	162	GGBL6032V4S	183	GGBL7081456S	187	GGBLRFZ**	170
GGBL20DPFAW	190	GGBL3090S	181	GGBL6042CS	183	GGBL7081S	187	GGBLRFZ**	170
GGBL20DPFFZW	190	GGBL4001	185	GGBL6042V4S	183	GGBL7090***S	166	GGBLRFZ**	170
GGBL20DPFRW	190	GGBL4001***	166	GGBL70042	186	GGBL7090S	186	GGBLRHO**	170
GGBL20DPFZW	190	GGBL4001***S	166	GGBL70042***S	167	GGBL8010	188	GGBLRHT**	170
GGBL20DPHOW	190	GGBL4001S	185	GGBL70042S	186	GGBL8010**	169	GGBLRMVHR**	170
GGBL20DPHTW	190	GGBL4011	185	GGBL70043	186	GGBL8010***S	169	GGBLRMW**	170
GGBL20DPK**	171	GGBL4011***	166	GGBL7010	187	GGBL8010S	188	GGBLROV**	170
GGBL20DPKEL**	171	GGBL4011MWW	185	GGBL7010***	168	GGBL8020	188	GGBLRTD**	170
GGBL20DPKWPW	190	GGBL4011OVW	185	GGBL7010***S	168	GGBL8020**	169	GGBLRWCL**	170
GGBL20DPKWPWEL	190	GGBL4011S	185	GGBL7010S	187	GGBL8020**S	169	GGBLRWM**	170
GGBL20DPM	170	GGBL4021	185	GGBL7020	187	GGBL8020S	188	GGBLSHF1GBS	163, 169
GGBL20DPMWW	190	GGBL4021***	166	GGBL7020***S	168	GGBL8050	192	GGBLSHF1GS	163, 169, 188
GGBL20DPOVW	190	GGBL4021***S	166	GGBL7020S	187	GGBL8050**	172	GGBLSHF2GBS	163, 169
GGBL20DPTDW	190	GGBL4021S	185	GGBL7030	187	GGBL8060	192	GGBLSHF2GS	163, 169, 188
GGBL20DPW	190	GGBL4021SHW	185	GGBL7030***S	168	GGBL8060**	172	GGBLSIND	169, 188
GGBL20DPWBO	190	GGBL4031	184	GGBL7030S	187	GGBL8080	192	GGBLSPC1	188
GGBL20DPWBOT	190	GGBL4050	185	GGBL7051	186	GGBL8080**	172	GGBLSPC1BS	169
GGBL20DPWMVHR	190	GGBL4050S	185	GGBL7051***S	167	GGBL9116	193	GGBLSPC1FO	188
GGBL20DPWMW	190	GGBL5000	184	GGBL7051S	186	GGBL9116A	193	GGBLSPC1S	169, 188
GGBL20DPWWCL	190	GGBL5000***	166	GGBL7061	186	GGBL9116S	193	GGBLSPC2	188
GGBL3010	162, 180	GGBL5000***S	166	GGBL7061***	167	GGBL9125	193	GGBLSPC2BS	169
GGBL30102USBA***S	163	GGBL5000AL	184	GGBL7061***S	167	GGBL9125S	193	GGBLSPC2S	169, 188
GGBL30102USBAS	181	GGBL5000S	184	GGBL7061S	186	GGBL9147	193	GGBLSR7004B	171
GGBL3010D	180	GGBL5003***	166	GGBL7062	186	GGBL9147S	193	GGBLSR7004W	171
GGBL3010DS	180	GGBL5003***S	166	GGBL7062***	167	GGBL9225	193	GGBLSRU7004B	171
GGBL3010S	180	GGBL5010	184	GGBL7062***S	167	GGBL9225S	193	GGBLSRU7004W	171
GGBL3011D***	162	GGBL5010***	166	GGBL7062S	186	GGBL9247	193	GGBLTOP13ANS	180, 230
GGBL3016A1	181	GGBL5010***S	166	GGBL7071C5	186	GGBL9247S	193	GGBSB4722M	64, 96
GGBL3020	180	GGBL5010BO	185	GGBL7071C5S	186	GGBL9D25	193	GGBSB4724M	64, 96, 168
GGBL30202USBA***S	163	GGBL5010CER	185	GGBL7071C6	186	GGBL9D25S	193	GJB20A	226
GGBL30202USBAS	181	GGBL5010CHR	185	GGBL7071C6***S	167	GGBLB**	171	GJB20ABR	226
GGBL3020D	180	GGBL5010FAR	185	GGBL7071C6S	186	GGBLBW	191	GJB30A	226
GGBL3020D4MP	187	GGBL5010FFR	185	GGBL7071C6S	186	GGBLC1GBS	169	GJB30ABR	226
GGBL3020DS	180	GGBL5010FRR	185	GGBL7072C5	186	GGBLC1GS	169, 188	GJB5A	226
GGBL3020S	180	GGBL5010TDR	185	GGBL7072C5***S	167	GGBLE7004	191	GJB5ABR	226
GGBL30212DS	180	GGBL5010TMR	185	GGBL7072C5S	186	GGBLE7004B	171	GJB620A	226
GGBL3021D***	162	GGBL5011	184	GGBL7072C6	186	GGBLE7014	171	GJB620ABR	226
GGBL3030	180	GGBL5011***	166	GGBL7072C6***S	167	GGBLG2011	190	GJB20A	226
GGBL3030S	180	GGBL5011***S	166	GGBL7072C6S	186	GGBLG2011**	170	GJB20ABR	226
GGBL3050	180	GGBL5013***	166	GGBL7074	187	GGBLGRDIML**	171	GJB20AS	226
GGBL3050NS	180	GGBL5013S	184	GGBL7074***S	168	GGBLGRDIMLW	191	GJB20ASBR	226
GGBL3050NS***S	162	GGBL6011C**S	165	GGBL707445510	187	GGBLH1GS	169, 188	GLHC	225
GGBL3050S	180	GGBL6011CS	183	GGBL707445510***S	168	GGBLH1GSBS	169		
GGBL3060	180	GGBL6012C**S	165	GGBL707445510S	187	GGBLILLS	169, 188		
GGBL3060***S	162	GGBL6012CS	183	GGBL707445511	187				

Index

Reference	PG	Reference	PG	Reference	PG	Reference	PG	Reference	PG
GMC1012	213	GPAT2G25	207	GSWDP20AFO	202	GU1213WPN	98	GU1412K*PB	69
GMC1022	214	GPAT2G47	207	GSWDPN20A	202	GU1213WPW	98	GU1412K*PC	69
GMC1032	214	GPAT2GC25	207	GSWDPN20AFO	202	GU1214*PB	97	GU1412K*SS	69
GMC131S	212	GPAT3G25	207	GSWINT	201	GU1214*PC	97	GU1412KBBN	69
GMC131SS	212	GPATDG25	207	GSWISO2	201	GU1214*PW	97	GU1412KWPN	69
GMC132S	212	GPEND62	224	GSWNSPUR	203	GU1214*SS	97	GU1412KWPN	69
GMC132SS	212	GPEND6C2	224	GSWPULL50	225	GU1214BBN	97	GU1412R*PB	65
GMC13SP	214	GPEND92	224	GSWPULL50N	225	GU1214WPN	97	GU1412R*PC	65
GMC13SPF	215	GPEND9C2	224	GSWPULL6	225	GU1222*PB	97	GU1412R*SS	65
GMC13SPN	214	GPRCDFCU	203	GSWPULL62	225	GU1222*PC	97	GU1412RBBN	65
GMC13SPNF	215	GPRCDSKT1G	200	GSWSPUR	203	GU1222*SS	97	GU1412RWPN	65
GMC13SSP	215	GPRCDSKT2G	200	GSWTPS	201	GU1222BBN	97	GU1412RWPN	65
GMC13SSPF	215	GPULLGY	144	GTELMAS	205	GU1222TBN	98	GU1412TBN	68
GMC13SSPN	215	GPULLRD	144	GTELRJ11	205	GU1222TPB	98	GU1412TPB	68
GMC13SSPNF	215	GRL13FCUPW	238	GTELRJ45	205	GU1222TPC	98	GU1412TPC	68
GMC20S	214	GRL2020PW	238	GTELSEC	205	GU1222TPN	98	GU1412TPN	68
GMC20SN	214	GRL202KPW	238	GU1011	143	GU1222TPW	98	GU1412TPW	68
GMC50S	216	GRL20DPNPW	238	GU1012	143	GU1222TSS	98	GU1412TSS	68
GMC50S2N	216	GRLCOPW	238	GU1012A	144	GU1222WPN	97	GU1412WPN	65
GMC50SN	216	GRLDPKPW	238	GU1012GY	143	GU1222WPW	97	GU1412WPW	65
GMC51S	212	GRLINDRPW	238	GU1012R	143	GU1232*PB	97	GU1413*PB	67
GMCB1	216	GRO	225	GU1012RB	143	GU1232*PC	97	GU1413*PC	67
GMCB2	216	GROC	225	GU1012RGY	143	GU1232*PW	97	GU1413*SS	67
GMCINT	213	GRWH1012	144	GU1012RP	143	GU1232*SS	97	GU1413BBN	67
GMCPRCDFCU	215	GRWH1012GY	144	GU1013	144	GU1232BBN	97	GU1413WPN	67
GMCPRCDSKT1G	213	GRWH1014	144	GU1014	143	GU1232TBN	99	GU1413WPW	67
GMCPRCDSKT2G	213	GRWH1014GY	144	GU1014GY	143	GU1232TPB	99	GU1414*PB	65
GMCS1012	213	GRWH1022	144	GU1022	143	GU1232TPC	99	GU1414*PC	65
GMCS1022	214	GRWH1022GY	144	GU1022A	144	GU1232TPN	99	GU1414*SS	65
GMCS1032	214	GRWH1032A	144	GU1022GY	143	GU1232TPW	99	GU1414BBN	65
GMCS131S	212	GRWH1032GY	144	GU1032	143	GU1232TSS	99	GU1414TPB	68
GMCS131SS	212	GSFOPLATE	202	GU1032GY	143	GU1232WPN	97	GU1414TPC	68
GMCS132S	212	GSHVSKT	204	GU1042	143	GU1242*PB	98	GU1414TPW	68
GMCS132SS	212	GSKT1G	200	GU1062	143	GU1242*PC	98	GU1414TSS	68
GMCS13SP	214	GSKT2A1G	200	GU1212*PB	97	GU1242*PW	98	GU1414WPN	65
GMCS13SPF	215	GSKT2G	200	GU1212*PC	97	GU1242*SS	98	GU1414WPW	65
GMCS13SPN	214	GSKT5A1G	200	GU1212*PW	97	GU1242BBN	98	GU1422*PB	66
GMCS13SPNF	215	GSKTCOAX	205	GU1212*SS	97	GU1242TPB	99	GU1422*PC	66
GMCS13SSP	215	GSKTCOAX2G	205	GU1212BBN	97	GU1242TPC	99	GU1422*SS	66
GMCS13SSPF	215	GSKTSW1G	200	GU1212R*PC	97	GU1242TPN	99	GU1422BBN	66
GMCS13SSPN	215	GSKTSW2G2	200	GU1212R*SS	97	GU1242TPW	99	GU1422TBN	68
GMCS13SSPNF	215	GSKTSW3G	200	GU1212RBBN	97	GU1242TSS	99	GU1422TPB	68
GMCS20S	214	GSKTSWDP1G	200	GU1212RBPB	97	GU1242WPN	98	GU1422TPC	68
GMCS20SN	214	GSKTSWDP2G	200	GU1212RWPN	97	GU1262*PC	98	GU1422TPN	68
GMCS50S	216	GSKTSWDP2G2	200	GU1212RWPN	97	GU1262*PW	98	GU1422TPW	68
GMCS50S2N	216	GSPUR	203	GU1212TBN	98	GU1262*SS	98	GU1422TSS	68
GMCS51S	212	GSPUR3A	203	GU1212TPB	98	GU1262BBN	98	GU1422WPN	66
GMCSB1	216	GSW1G1W	201	GU1212TPC	98	GU1262BPB	98	GU1422WPW	66
GMCSB2	216	GSW1G2W	201	GU1212TPN	98	GU1262WPN	98	GU1432*PB	66
GMCSINT	213	GSW1G2WR	201	GU1212TPW	98	GU1400F	65	GU1432*PC	66
GNSPUR	203	GSW1G2WRP	201	GU1212TSS	98	GU1401F	79	GU1432*SS	66
GPAT1G16	207	GSW2G2W	201	GU1212WPN	97	GU1402F	79	GU1432BBN	66
GPAT1G16A	154, 207	GSW3G2W	201	GU1213*PB	98	GU1412*PB	65	GU1432CLR	66
GPAT1G25	207	GSW4G2W	201	GU1213*PC	98	GU1412*PC	65	GU1432TBN	68
GPAT1G47	207	GSWA1G2W	201	GU1213*SS	98	GU1412*SS	65	GU1432TPB	68
GPAT2G16A	154	GSWDP20A	202	GU1213BBN	98	GU1412BBN	65	GU1432TPC	68

Index

Reference	PG	Reference	PG	Reference	PG	Reference	PG	Reference	PG
GU1432TPN	68	GU2211WPW	102	GU3021	142	GU3250WPN	94	GU3420BBN	61
GU1432TPW	68	GU2213*PC	102	GU3030	142	GU3250WPW	94	GU3420D*PC	61
GU1432TSS	68	GU2213*SS	102	GU3030GY	142	GU3251WSS	95	GU3420D*SS	61
GU1432WPN	66	GU2213BBN	102	GU3030RD	142	GU3252WPB	95	GU3420DBBN	61
GU1432WPW	66	GU2213BPB	102	GU3031	142	GU3252WSS	95	GU3420DWPN	61
GU1442*PB	66	GU2213WPW	102	GU3032	142	GU3260*SS	94	GU3420DWPW	61
GU1442*PC	66	GU2214*SS	102	GU3033	142	GU3260BBN	94	GU3420WPN	61
GU1442*SS	66	GU2214BBN	102	GU3034	142	GU3260WPB	94	GU3420WPW	61
GU1442BBN	66	GU2214BPB	102	GU3050	142	GU3260WPN	94	GU3421D*SS	61
GU1442TBN	68	GU2214WH*SS	102	GU3060	142	GU3260WPW	94	GU3421DBBN	61
GU1442TPB	68	GU2214WHBBN	102	GU3060RD	142	GU3270*PB	96	GU3421DWPB	61
GU1442TPC	68	GU2214WHBPB	102	GU3070	143	GU3270*PC	96	GU3421DWPN	61
GU1442TPN	68	GU2214WHWPW	102	GU3080	143	GU3270*PW	96	GU3421DWPW	61
GU1442TPW	68	GU2214WPC	102	GU3090	143	GU3270*SS	96	GU3431*SS	61
GU1442TSS	68	GU2214WPN	102	GU3091	143	GU3270BBN	96	GU3431BBN	61
GU1442WPN	66	GU2214WPW	102	GU3210*PC	94	GU3270WPN	96	GU3431BPC	61
GU1442WPW	66	GU2410*PC	72	GU3210*SS	94	GU3280*PB	96	GU3431WPW	61
GU1462*PC	66	GU2410*SS	72	GU3210BBN	94	GU3280*PC	96	GU3434*SS	62
GU1462*SS	66	GU2410BBN	72	GU3210BPB	94	GU3280*PW	96	GU3434WPC	62
GU1462BBN	66	GU2410BPB	72	GU3210D*PC	94	GU3280*SS	96	GU3450*PC	60
GU1462BPB	66	GU2410WPN	72	GU3210D*SS	94	GU3280BBN	96	GU3450*SS	60
GU1462WPN	66	GU2410WPW	72	GU3210DBBN	94	GU3280WPN	96	GU3450BBN	60
GU1462WPW	66	GU2411*PB	72	GU3210DBPB	94	GU3290*SS	96	GU3450BPB	60
GU1512*BC	125	GU2411*PC	72	GU3210DWPN	94	GU3290BBN	96	GU3450WPN	60
GU1512*PC	125	GU2411*SS	72	GU3210DWPW	94	GU3290WPW	96	GU3450WPW	60
GU1513*BC	125	GU2411BBN	72	GU3210WPN	94	GU3410*PB	60	GU3460*PB	60
GU1513*PC	125	GU2411WPN	72	GU3210WPW	94	GU3410*PC	60	GU3460*PC	60
GU1514*BC	125	GU2411WPW	72	GU3220*PC	94	GU3410*SS	60	GU3460*SS	60
GU1514*PC	125	GU2412WHBPC	73	GU3220*SS	94	GU3410BBN	60	GU3460BBN	60
GU1522*BC	125	GU2412WHWSS	73	GU32202DMP*PC	96	GU3410D*PB	60	GU3460BPC	94
GU1522*PC	125	GU2413*PB	72	GU32202DMP*SS	96	GU3410D*PC	60	GU3460WPN	60
GU1532*BC	125	GU2413*PC	72	GU32202DMPBBN	96	GU3410D*SS	60	GU3460WPW	60
GU1532*PC	125	GU2413*SS	72	GU32202DMPWPW	96	GU3410DBBN	60	GU3470*PB	63
GU1542*BC	125	GU2413BBN	72	GU32204DMP*PC	96	GU3410DWPN	60	GU3470*PC	63
GU1542*PC	125	GU2413WPN	72	GU32204DMP*SS	96	GU3410DWPW	60	GU3470*SS	63
GU2003	146	GU2413WPW	72	GU32204DMPBBN	96	GU3410WPN	60	GU3470BBN	63
GU2010	145	GU2414*PC	72	GU32204DMPBPB	96	GU3410WPW	60	GU3470WPN	63
GU2010GY	145	GU2414*SS	72	GU32204DMPWPW	96	GU3411D*PC	61	GU3470WPW	63
GU2011	145	GU2414BBN	72	GU3220BBN	94	GU3411D*SS	61	GU3480*PB	63
GU2011OV	145	GU2414BPB	72	GU3220BPB	94	GU3411DBBN	61	GU3480*PC	63
GU2011TR	145	GU2414WHBBN	73	GU3220D*PC	95	GU3411DBPB	61	GU3480*SS	63
GU2013	145	GU2414WHBPB	73	GU3220D*SS	95	GU3411DWPN	61	GU3480BBN	63
GU2014	145	GU2414WHWPW	73	GU3220DBBN	95	GU3411DWPW	61	GU3480WPN	63
GU2014WH	145	GU2414WPN	72	GU3220DBPB	95	GU3420*PB	61	GU3480WPW	63
GU2033	146	GU2414WPW	72	GU3220DWPN	95	GU3420*PC	61	GU3490*PC	63
GU2210*PC	102	GU2511*BC	126	GU3220DWPW	95	GU3420*SS	61	GU3490*SS	63
GU2210*SS	102	GU2511*PC	126	GU3220WPN	94	GU34202DMP*PC	64	GU3490BPB	63
GU2210BBN	102	GU2513*BC	126	GU3220WPW	94	GU34202DMP*SS	64	GU3490WPN	63
GU2210BPB	102	GU2513*PC	126	GU3231*PC	95	GU34202DMPBBN	64	GU3490WPW	63
GU2210WPN	102	GU3010	142	GU3231*SS	95	GU34202DMPWPN	64	GU3510*BC	124
GU2210WPW	102	GU3010D	142	GU3231BBN	95	GU34202DMPWPW	64	GU3510*PC	124
GU2211*PB	102	GU3010DGY	142	GU3234WSS	95	GU34204DMP*PC	64	GU3520*BC	124
GU2211*PC	102	GU3010DRD	142	GU3250*PC	94	GU34204DMP*SS	64	GU3520*PC	124
GU2211*SS	102	GU3011	142	GU3250*SS	94	GU34204DMPBBN	64	GU3530*BC	124
GU2211BBN	102	GU3020	142	GU3250BBN	94	GU34204DMPWPN	64	GU3530*PC	124
GU2211WPN	102	GU3020D	142	GU3250BPB	94	GU34204DMPWPW	64	GU3580*BC	124

Index

Reference	PG	Reference	PG	Reference	PG	Reference	PG	Reference	PG
GU3580*PC	124	GU50033	146	GU5213WPN	104	GU6012L	145	GU6242CPW	100
GU3631GMC	212	GU5004	146	GU5213WPW	104	GU6022C	145	GU6242CSS	100
GU4000	148	GU5010	147	GU5214*PB	104	GU6022L	145	GU6242LPC	101
GU4000GY	148	GU5010BO	147	GU5214*PC	104	GU6032C	145	GU6242LPW	101
GU4001	148	GU5010CH	147	GU5214*SS	104	GU6032L	145	GU6242LSS	101
GU4010	148	GU5010DW	147	GU5214BBN	104	GU6042C	145	GU6412CBN	69
GU4011	148	GU5010EF	147	GU5214WPN	104	GU6042L	145	GU6412CPB	69
GU4020	148	GU5010FA	147	GU5214WPW	104	GU6212CBN	99	GU6412CPC	69
GU4020GY	148	GU5010FFZ	147	GU5400*PB	73	GU6212CPB	99	GU6412CPN	69
GU4021	148	GU5010FR	147	GU5400*PC	73	GU6212CPC	99	GU6412CPW	69
GU4031	146	GU5010GY	147	GU5400*SS	73	GU6212CPN	99	GU6412CSS	69
GU4050	148	GU5010HO	147	GU5400BBN	73	GU6212CPW	99	GU6412E*SS	71
GU4201*PC	105	GU5010HT	147	GU5400WPN	73	GU6212CSS	99	GU6412EBBN	71
GU4201*SS	105	GU5010WM	147	GU5400WPW	73	GU6212EBBN	101	GU6412EWPB	71
GU4201BBN	105	GU5011	147	GU5403*PC	73	GU6212EBSS	101	GU6412EWPC	71
GU4201WPN	105	GU5011BO	147	GU5403*SS	73	GU6212EWPC	101	GU6412EWPN	71
GU4201WPW	105	GU5011CH	147	GU5403BBN	73	GU6212LBN	100	GU6412EWPW	71
GU4221*PB	105	GU5011DW	147	GU5403BPB	73	GU6212LPB	100	GU6412LBN	70
GU4221*PC	105	GU5011FA	147	GU5403WPN	73	GU6212LPC	100	GU6412LPB	70
GU4221*SS	105	GU5011FFZ	147	GU5403WPW	73	GU6212LPN	100	GU6412LPC	70
GU4221BBN	105	GU5011FR	147	GU5410*PB	74	GU6212LPW	100	GU6412LPN	70
GU4221WPN	105	GU5011GY	147	GU5410*PC	74	GU6212LSS	100	GU6412LPW	70
GU4221WPW	105	GU5011HT	147	GU5410*SS	74	GU6212R*SS	101	GU6412LSS	70
GU4231*PC	103	GU5011MW	147	GU5410BBN	74	GU6212RBPC	101	GU6412R*PC	71
GU4231*SS	103	GU5011TD	147	GU5410WPN	74	GU6212RWPN	101	GU6412R*SS	71
GU4231BBN	103	GU5011WM	147	GU5410WPW	74	GU6222CBN	99	GU6412RBBN	71
GU4231WPB	103	GU5013	147	GU5411*PB	74	GU6222CPB	99	GU6412RWPN	71
GU4231WPN	103	GU5014	147	GU5411*PC	74	GU6222CPC	99	GU6412RWPN	71
GU4231WPW	103	GU5200*PB	103	GU5411*SS	74	GU6222CPN	99	GU6422CBN	69
GU4401*PB	75	GU5200*PC	103	GU5411BBN	74	GU6222CPW	99	GU6422CPB	69
GU4401*PC	75	GU5200*SS	103	GU5411WPN	74	GU6222CSS	99	GU6422CPC	69
GU4401*SS	75	GU5200BBN	103	GU5411WPW	74	GU6222EBBN	101	GU6422CPN	69
GU4401BBN	75	GU5200WPN	103	GU5413*PB	74	GU6222EBPC	101	GU6422CPW	69
GU4401WPN	75	GU5200WPW	103	GU5413*PC	74	GU6222EBSS	101	GU6422CSS	69
GU4401WPW	75	GU5203*PC	103	GU5413*SS	74	GU6222EWPB	101	GU6422E*PB	71
GU4421*PB	75	GU5203*SS	103	GU5413BBN	74	GU6222EWPN	101	GU6422E*SS	71
GU4421*PC	75	GU5203BBN	103	GU5413WPN	74	GU6222LBN	100	GU6422EBBN	71
GU4421*SS	75	GU5203BPB	103	GU5413WPW	74	GU6222LPB	100	GU6422EBPC	71
GU4421BBN	75	GU5203WPN	103	GU5414*PC	74	GU6222LPC	100	GU6422EWPN	71
GU4421WPN	75	GU5203WPW	103	GU5414*SS	74	GU6222LPN	100	GU6422EWPN	71
GU4421WPW	75	GU5210*PC	103	GU5414BBN	74	GU6222LPW	100	GU6422LBN	70
GU4431*PB	73	GU5210*SS	103	GU5414BPB	74	GU6222LSS	100	GU6422LPB	70
GU4431*PC	73	GU5210BBN	103	GU5414WPN	74	GU6232CBN	100	GU6422LPC	70
GU4431*SS	73	GU5210BPB	103	GU5414WPW	74	GU6232CPB	100	GU6422LPN	70
GU4431BBN	73	GU5210WPN	103	GU5500*BC	127	GU6232CPC	100	GU6422LPW	70
GU4431WPN	73	GU5210WPW	103	GU5500*PC	127	GU6232CPN	100	GU6422LSS	70
GU4431WPW	73	GU5211*PC	104	GU5510*BC	127	GU6232CPW	100	GU6432CBN	70
GU4501*BC	127	GU5211*SS	104	GU5510*PC	127	GU6232CSS	100	GU6432CPB	70
GU4501*PC	127	GU5211BBN	104	GU5511*BC	127	GU6232LBN	100	GU6432CPC	70
GU4521*BC	127	GU5211BPB	104	GU5511*PC	127	GU6232LPC	100	GU6432CPN	70
GU4521*PC	127	GU5211WPN	104	GU5514*BC	127	GU6232LPW	100	GU6432CPW	70
GU5000	146	GU5211WPW	104	GU5514*PC	127	GU6232LSS	100	GU6432CSS	70
GU50003	146	GU5213 BPB	104	GU6000RC1R	71, 89, 119, 136	GU6242CBN	100	GU6432LBN	70
GU5000SS	146	GU5213*PC	104	GU6000RC1R	101	GU6242CPB	100	GU6432LPC	70
GU5000TR	146	GU5213*SS	104	GU6012C	145	GU6242CPC	100	GU6432LPN	70
GU5003	146	GU5213BBN	104			GU6242CPN	100	GU6432LPW	70

Index

Reference	PG	Reference	PG	Reference	PG	Reference	PG	Reference	PG
GU6432LSS	70	GU7261WPN	106	GU7471*PC	76	GU8280SS	108	GU9147	154
GU6442CBN	70	GU7261WPW	106	GU7471*SS	76	GU8410BN	79	GU9225	154
GU6442CPB	70	GU7262*PB	106	GU7471BBN	76	GU8410PB	79	GU9235	154
GU6442CPC	70	GU7262*PC	106	GU7471WPN	76	GU8410PC	79	GU9247	154
GU6442CPN	70	GU7262*SS	106	GU7471WPW	76	GU8410PN	79	GU9D25	154
GU6442CPW	70	GU7262BBN	106	GU7490*PB	75	GU8410PW	79	GU E7000*	78, 109, 130, 172, 206
GU6442CSS	70	GU7262WPN	106	GU7490*PC	75	GU8410SS	79	GU E7000W	153, 192
GU6442LBN	71	GU7262WPW	106	GU7490*SS	75	GU8420BN	79	GU E7001*	78, 109, 130, 172, 206
GU6442LPB	71	GU7271*PB	106	GU7490BBN	75	GU8420PB	79	GU E7001W	153, 192
GU6442LPC	71	GU7271*PC	106	GU7490WPN	75	GU8420PC	79	GU E7010*	78, 109, 130, 172, 206
GU6442LPN	71	GU7271*SS	106	GU7490WPW	75	GU8420PN	79	GU E7010W	153, 192
GU6442LPW	71	GU7271BBN	106	GU7510*BC	128	GU8420PW	79	GU E7010*	78, 109, 130, 172, 206
GU6442LSS	71	GU7271WPN	106	GU7510*PC	128	GU8420SS	79	GU E7010W	153, 192
GU6512CBC	126	GU7271WPW	106	GU7561*BC	128	GU8434BN	269	GU E7011*	78, 109, 130, 172, 206
GU6512CPC	126	GU7290*PB	105	GU7561*PC	128	GU8434BN	80	GU E7011W	153, 192
GU6522CBC	126	GU7290*PC	105	GU7562*BC	128	GU8434PB	269	GU E7012*	78, 109, 130, 172, 206
GU6522CPC	126	GU7290*SS	105	GU7562*PC	128	GU8434PB	80	GU E7012W	153, 192
GU6532CBC	126	GU7290BBN	105	GU7590*BC	128	GU8434PC	269	GU E7020*	79, 109, 130, 172, 206
GU6532CPC	126	GU7290WPN	105	GU7590*PC	128	GU8434PC	80	GU E7020W	153, 192
GU7010	149	GU7290WPW	105	GU8010	149	GU8434PN	269	GU E7021*	78, 109, 130, 172, 206
GU7020	149	GU7410*PC	77	GU8020	149	GU8434PN	80	GU E7021W	153, 192
GU7021	149	GU7410*SS	77	GU8050	153	GU8434PW	269	GU E7030*	78, 109, 130, 172, 206
GU7030	149	GU7410BBN	77	GU8050GY	153	GU8434PW	80	GU E7030W	153, 192
GU7040	149	GU7410BPB	77	GU8060	153	GU8434SS	269	GU E7031*	79, 109, 130, 172, 206
GU7051	148	GU7410WPN	77	GU8060GY	153	GU8434SS	80	GU E7031*	206
GU7061	148	GU7410WPW	77	GU8080	153	GU8450BN	78	GU E7031W	153, 192
GU7062	148	GU7420*PC	77	GU8080GY	153	GU8450PB	78	GU E7040*	79, 109, 130, 172, 206
GU7071	149	GU7420*SS	77	GU8210BN	110	GU8450PC	78	GU E7051*	78, 109, 130, 172, 206
GU7072	149	GU7420BBN	77	GU8210PB	110	GU8450PN	78	GU E7051W	153, 192
GU7081	149	GU7420WPN	77	GU8210PC	110	GU8450PW	78	GU E7061*	78, 109, 130, 172, 206
GU7090	148	GU7420WPW	77	GU8210PN	110	GU8450SS	78	GU E7061W	153, 192
GU7090GY	148	GU7430*PC	77	GU8210PW	110	GU8460BN	78	GU E7062*K	78, 109, 130, 172, 206
GU7210*SS	107	GU7430*SS	77	GU8210SS	110	GU8460PB	78	GU E7062WK	153, 192
GU7210BBN	107	GU7430BBN	77	GU8220BN	110	GU8460PC	78	GU E7071*	78, 109, 130, 172, 206
GU7210BPB	107	GU7430BPB	77	GU8220PB	110	GU8460PN	78	GU E7071W	153, 192
GU7210WPC	107	GU7430WPN	77	GU8220PC	110	GU8460PW	78	GU E7072*	78, 109, 130, 172, 206
GU7210WPN	107	GU7430WPW	77	GU8220PN	110	GU8460SS	78	GU E7072W	153, 192
GU7210WPW	107	GU7451*PB	76	GU8220PW	110	GU8480BN	78	GU E7073*	78, 109, 130, 172, 206
GU7220*PB	107	GU7451*PC	76	GU8220SS	110	GU8480PB	78	GU E7073W	153, 192
GU7220BBN	107	GU7451*SS	76	GU8250BN	108	GU8480PC	78	GU E7074*	79, 109, 130, 172, 206
GU7220BPC	107	GU7451BBN	76	GU8250PB	108	GU8480PN	78	GU E7074W	153, 192
GU7220WPW	107	GU7451WPN	76	GU8250PC	108	GU8480PW	78		
GU7230*PC	107	GU7451WPW	76	GU8250PN	108	GU8480SS	78		
GU7230*SS	107	GU7461*PB	76	GU8250PW	108	GU8510BC	130		
GU7230WPN	107	GU7461*PC	76	GU8250SS	108	GU8510PC	130		
GU7230WPW	107	GU7461*SS	76	GU8260BN	108	GU8520BC	130		
GU7251*PB	106	GU7461BBN	76	GU8260PB	108	GU8520PC	130		
GU7251*SS	106	GU7461WPN	76	GU8260PC	108	GU8550BC	129		
GU7251BBN	106	GU7461WPW	76	GU8260PN	108	GU8550PC	129		
GU7251WPC	106	GU7462*PB	76	GU8260PW	108	GU8560BC	129		
GU7251WPN	106	GU7462*PC	76	GU8260SS	108	GU8580BC	129		
GU7251WPW	106	GU7462*SS	76	GU8280BN	108	GU8580PC	129		
GU7261*PC	106	GU7462BBN	76	GU8280PB	108	GU9116	154		
GU7261*SS	106	GU7462WPN	76	GU8280PC	108	GU9125	154		
GU7261BBN	106	GU7462WPW	76	GU8280PN	108	GU9135	154		
GU7261BPB	106	GU7471*PB	76	GU8280PW	108				

Index

Reference	PG	Reference	PG	Reference	PG	Reference	PG	Reference	PG
GUE7076*	79, 109, 130, 172, 206	GUG04GPN	111	GUG10ITBPP	85, 115	GUG202KELBBN	86, 116	GUG24GPW	112
GUE7076W	153, 192	GUG04GPW	111	GUG10ITWPN	85, 115	GUG202KELBLK	134	GUG24GSMC	218
GUE7077*	79, 109, 130, 172, 206	GUG04GSS	111	GUG10ITWPW	85, 115, 134	GUG202KELWPN	86, 116	GUG24GSS	112
GUE7077W	153, 192	GUG06G	150			GUG202KELWPW	86, 116, 134	GUGB*	90, 120
GUE7078*	79, 109, 130, 172, 206	GUG06GBN	111	GUG10IW	151, 219	GUG202KELWPW	152, 220	GUGB*MS	90, 120, 137
GUE7078W	153, 192	GUG06GGY	150	GUG12G	150	GUG202KWPW	86, 116	GUGB*SS	90, 120
GUE7081*	79, 109, 130, 172, 206	GUG06GMC	217	GUG12GBN	112	GUG202KWPW	86, 116, 134, 190, 220	GUGBBBN	90, 120
GUE7081W	153, 192	GUG06GMS	111	GUG12GMC	218	GUG202M*	83, 113, 132	GUGBBLK	137
GUE7082*	79, 109, 130, 172, 206	GUG06GPB	111	GUG12GMS	112	GUG202OC*MS	84, 114, 133	GUGBBPB	90, 120
GUE7082W	153, 192	GUG06GPN	111	GUG12GPB	112	GUG202OC*MS	84, 114, 133	GUGBW	152, 219
GUE7091W	78, 109, 130, 153, 172, 206	GUG06GPW	111	GUG12GPN	112	GUG202OC*MS	84, 114, 133	GUGBWPW	90, 120
GUE8010*	78, 109, 130, 172, 206	GUG06GSMC	217	GUG12GPW	112	GUG202OC*PB	84, 114	GUGBWPW	90, 120
GUE8010W	153, 192	GUG06GSS	111	GUG12GSMC	218	GUG202OC*SS	84, 114	GUGBWPW	137
GUG01G	150	GUG08G	150	GUG12GSS	112	GUG202OCBBN	84, 114	GUGCO*MS	135
GUG01GBN	110	GUG08GBN	111	GUG13FCU*MS	90, 120, 137	GUG202OCBLK	133	GUGCO*SS	88, 118
GUG01GGY	150	GUG08GGY	150	GUG13FCU*PB	90, 120	GUG202OCW	152, 219	GUGCOBBN	88, 118, 135
GUG01GMC	217	GUG08GMC	217	GUG13FCU*SS	90, 120	GUG202OCWPN	84, 114	GUGCOBLK	135
GUG01GMS	110	GUG08GMS	111	GUG13FCUBBN	90, 120, 137	GUG202OCWPN	84, 114, 133	GUGCOWPN	88, 118
GUG01GPB	110	GUG08GPB	111	GUG13FCUWPN	90, 120	GUG202OCWPN	84, 114, 133	GUGCOWPW	88, 118, 135, 152, 220
GUG01GPN	110	GUG08GPN	111	GUG13FCUWPN	90, 120, 137, 152, 220	GUG202W	151, 219	GUGCPBMS	88, 118
GUG01GPW	110	GUG08GPW	111	GUG16CO*MS	137	GUG20DPBOW	151, 219	GUGEMDIM*SS16	89, 119
GUG01GSMC	217	GUG08GSMC	217	GUG16CO*PB	90, 120	GUG20DPCHW	151, 219	GUGEMDIMBBN16	89, 119
GUG01GSS	110	GUG08GSS	111	GUG16CO*SS	90, 120	GUG20DPDWW	151, 219	GUGEMDIMWMS16	89, 119
GUG02G	150	GUG09G	150	GUG16COBBN	90, 120, 137	GUG20DPEFW	151, 219	GUGEMDIMWPW16	89, 119, 136
GUG02GBN	110	GUG09GBN	111	GUG16CO*SS	90, 120	GUG20DPFAW	151, 219	GUGEMRDIMB16	89, 119, 136
GUG02GGY	150	GUG09GMC	218	GUG16CO*SS	90, 120	GUG20DPFFZW	151, 219	GUGEMRDIMW16	89, 119, 136
GUG02GMC	217	GUG09GMS	111	GUG16COBBN	90, 120, 137	GUG20DPFRW	151, 219	GUGEMRW*MS	89, 119
GUG02GMS	110	GUG09GPB	111	GUG16COWPN	90, 120	GUG20DPFZW	151, 219	GUGEMRW*SS	89, 119
GUG02GPB	110	GUG09GPN	111	GUG16COWPW	90, 120, 137, 152, 220	GUG20DPHAW	151, 219	GUGEMWBBN	89, 119
GUG02GPN	110	GUG09GPW	111	GUG18G	151	GUG20DPHTW	151, 219	GUGEMWWWPN	89, 119
GUG02GPW	110	GUG09GSMC	218	GUG18GBN	112	GUG20DPK*MS	86, 116, 134	GUGEMWWWPW	89, 119
GUG02GSMC	217	GUG09GSS	111	GUG18GMC	218	GUG20DPK*SS	86, 116	GUGINDBG	91, 121, 138
GUG02GSS	110	GUG101M*	83, 113, 132, 151, 219	GUG18GMS	112	GUG20DPKBBN	86, 116	GUGINDBO	91
GUG03G	150	GUG102M*	83, 113, 132	GUG18GPB	112	GUG20DPKBLK	134	GUGINDBR	91, 121, 138
GUG03GBN	111	GUG102R*MS	85, 115, 133	GUG18GPN	112	GUG20DPKWPW	86, 116, 134, 152, 220	GUGINDWG	91, 121, 138, 152, 219
GUG03GGY	150	GUG102R*PB	85, 115	GUG18GPW	112	GUG20DPK*MS	86, 116, 134, 152, 220	GUGINDWO	91, 121, 138, 152, 219
GUG03GMC	217	GUG102R*SS	85, 115	GUG18GSMC	218	GUG20DPM*	83, 113, 132	GUGINDWR	91, 121, 138, 152, 219
GUG03GMS	111	GUG102RBBN	85, 115	GUG18GSS	112	GUG20DPMW83	113, 132	GUGKSK	86, 116, 134, 171, 190, 220
GUG03GPB	111	GUG102RBLK	133	GUG201M*	83, 113, 132	GUG20DPMWW	151, 219	GUGL01BC	131
GUG03GPN	111	GUG102RW	152, 219	GUG201W	151, 219	GUG20DPOVW	151, 219	GUGL01PC	131
GUG03GPW	111	GUG102RWPW	85, 115, 133	GUG2020M*	83, 113, 132	GUG20DPTDW	151, 219	GUGL02BC	131
GUG03GSMC	217	GUG102T*MS	85, 115, 134	GUG2020M*	83, 113, 132	GUG20DPW	151, 219	GUGL02PC	131
GUG03GSS	111	GUG102T*SS	85, 115	GUG2020MB	83, 113, 132	GUG20DPWDW	151, 219	GUGL03BC	131
GUG04G	150	GUG102TBPB	85, 115	GUG2020W	151, 219	GUG20DPWDYW	151, 219	GUGL03PC	131
GUG04GBN	111	GUG102TWPN	85, 115	GUG202K*MS	86, 116, 134	GUG20DPWMW	151, 219	GUGL04BC	131
GUG04GGY	150	GUG102TWPW	85, 115, 134	GUG202K*SS	86, 116	GUG24G	151	GUGL04PC	131
GUG04GMC	217			GUG202KBBN	86, 116	GUG24GBN	112		
GUG04GMS	111	GUG102W	151, 219	GUG202KBLK	134	GUG24GMC	218		
GUG04GPB	111	GUG10IM*	83, 113, 132	GUG202KBPB	86, 116	GUG24GMS	112		
		GUG10IT*MS	85, 115, 134	GUG202KEL*MS	86, 116, 134	GUG24GPB	112		
		GUG10IT*SS	85, 115	GUG202KEL*SS	86, 116	GUG24GPN	112		
		GUG10ITBBN	85, 115						

Index

Reference	PG
KBR251W	229
KBR321CW	229
KBR321W	229
KBR322CW	229
KBR322W	229
KBS252W	229
KBU321CW	229
KBU321W	229
KBU322CW	229
KBU322W	229
KBU441W	229
LMCSKT1GR	212
LMCSKT2GR	213
LMCSKT2GRP	213
LSKT1GR	200
LSKT2GR	200
LSKT2GRP	200
MMB251W	228
MMB252SW	228
MMB252W	228
MTAU1W	228
MTAU2W	228
MTAU3W	228
MTN550619	263
MTN55101119	260
MTN55101219	260
MTN55101419	260
MTN55101519	260
MTN564419	262
MTN57022	263
MTN61800319	269, 271
MTN61800325	269
MTN61800414	269
MTN61800460	269
MTN62150310	269
PBR322W	229
PBU441W	229
SB161	91, 121, 139, 155, 173, 194, 208, 227
SB251	91, 121, 139, 155, 173, 194, 208, 227
SB252	91, 121, 139, 155, 173, 194, 208, 227
SB351	91, 121, 139, 155, 173, 194, 208, 227
SB352	91, 121, 139, 155, 173, 194, 208, 227
SB471	91, 121, 139, 155, 173, 194, 208, 227
SB472	91, 121, 139, 155, 173, 194, 208, 227
TBR321CW	228
TBR321W	228
TBR322CW	228
TBR322W	228
TBU321CW	228

Reference	PG
TBU321W	228
TBU322CW	228
TBU322W	228
TBU441W	228
TOP133A	230
TOP13A	230
TOP15AR	230
TOP2AR	230
TOP5AR	230
USCREW50**	79, 110, 169, 188
USCREW50SS	130, 149, 155, 205
VDIB1771XB12	78, 109, 130, 153, 172, 192, 206
WHB320RG	243
WHB340RG	243
WHB355RG	243
WHC363RG	243

Reference	PG
-----------	----

Reference	PG
-----------	----

Reference	PG
-----------	----



Get the support you need...
When you need it!

Our Customer Care app provides 24/7, immediate access to technical and support information;

- > Browse FAQs for instant answers
- > Search product references and download datasheets
- > Register your product for additional benefits
- > Browse MySE for delivery and price updates *

Connect to Schneider Electric

If you cannot find what you need, you can also access phone or email support directly via the Customer Care App.



**Download the app today,
Search 'Schneider Care' on your app store**



Life Is On

Schneider
Electric

*Registered MySE account holders only

About Schneider Electric

Schneider Electric is the global specialist in energy management and automation. With revenues of ~€25 billion in FY2016, our 144,000 employees serve customers in over 100 countries, helping them to manage their energy and process in ways that are safe, reliable, efficient and sustainable. From the simplest of switches to complex operational systems, our technology, software and services improve the way our customers manage and automate their operations. Our connected technologies reshape industries, transform cities and enrich lives.

At Schneider Electric, we call this **Life Is On.**

Schneider Electric

United Kingdom
Stafford Park 5,
Telford
Shropshire
TF3 3BL
Tel: 0870 608 8 608
Fax: 0870 608 8 606

Ireland
Head office, Block A
Maynooth Business Campus
Maynooth, Co. Kildare
W23 Y7X0
Tel: 1 800 805 800
Fax: (01) 601 2201

www.schneider-electric.co.uk

www.schneider-electric.ie

