

# Human/Machine Interfaces

Catalogue  
2010





## 1- Operator dialogue terminals

- Magelis Small Panels
- Magelis Advanced Panels

## 2- HMI Controllers

- Magelis HMI Controllers
- Magelis XBT GT/GK Advanced Panels with control function
- SoMachine

## 3- Industrial PCs

- PC Panels Magelis
- Magelis Smart BOX
- Magelis Compact PC BOX
- Magelis Flex PC BOX
- Magelis Flex PC BOX and Front Panels
- Magelis iDisplay

## 4- IHM software

- Vijeo Designer Lite configuration software
- Vijeo Designer configuration software

## 5- Appendices

- Technical appendices
- Product references index





## Architectures, connections to automation systems

- Presentation ..... page 1/2

## Magelis Small Panels

- Selection guide ..... page 1/4

- Magelis STO, STU Small Panels
  - General ..... page 1/6
  - Magelis STO Small Panels: 3.4" ..... page 1/12
  - Magelis STU Small Panels: 3.5" ..... page 1/12
  - Separate components ..... page 1/13
- Magelis XBT N, XBT R, XBT RT Small Panels
  - General ..... page 1/14
  - Magelis XBT N Small Panels ..... page 1/21
  - Magelis XBT R Small Panels ..... page 1/23
  - Equivalent product table - Magelis XBT P/XBT R ..... page 1/24
  - Magelis XBT RT Small Panels ..... page 1/27
- Separate components ..... page 1/28
- Dimensions, mounting ..... page 1/32

## Magelis Advanced Panels

- Selection guide ..... page 1/34

- General ..... page 1/38
- Magelis XBT GT Advanced Panels: 3.8", 5.7", 7.5", 10.4", 12.1", 15" ..... page 1/64
- Magelis XBT GK Advanced Panels: 5.7", 10.4" ..... page 1/65
- Magelis XBT GH Advanced Panels: 5.7" ..... page 1/65
- Magelis XBT GTW Advanced Panels: 8.4", 12" ..... page 1/66
- Magelis HMI GTW Advanced Panels: 15" ..... page 1/66
- Separate components ..... page 1/67
- Wiring system ..... page 1/74
- Equivalent product tables
  - Magelis XBT F/GT, XBT FC/GT and XBT F/GK ..... page 1/78
  - Magelis XBT G/GT ..... page 1/79
- Dimensions, mounting ..... page 1/82

## Presentation

Magelis operator dialogue terminals communicate with automation system equipment:

- Via serial link
- By means of integration into an Ethernet TCP/IP architecture

### Communication via serial link

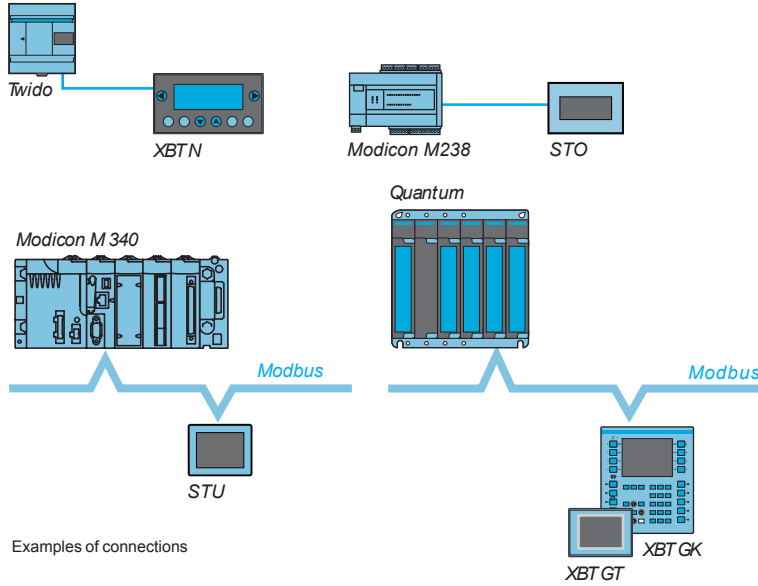

All Magelis terminals feature an integrated RS 232 C or RS 422/485 asynchronous serial link.

Use of the Uni-TE or Modbus protocol makes it easy to set up communication with Schneider Electric PLCs:

Third-party protocols enable connection to PLCs offered by major manufacturers on the market:

- DF1, DH485 for Allen-Bradley PLCs
- SysmacWay for Omron PLCs
- MPI/PPI for Siemens Simatic S7 PLCs
- Mitsubishi Melsec FX PLC

**Presentation (continued)**

**Integration into an architecture with Ethernet TCP/IP network**

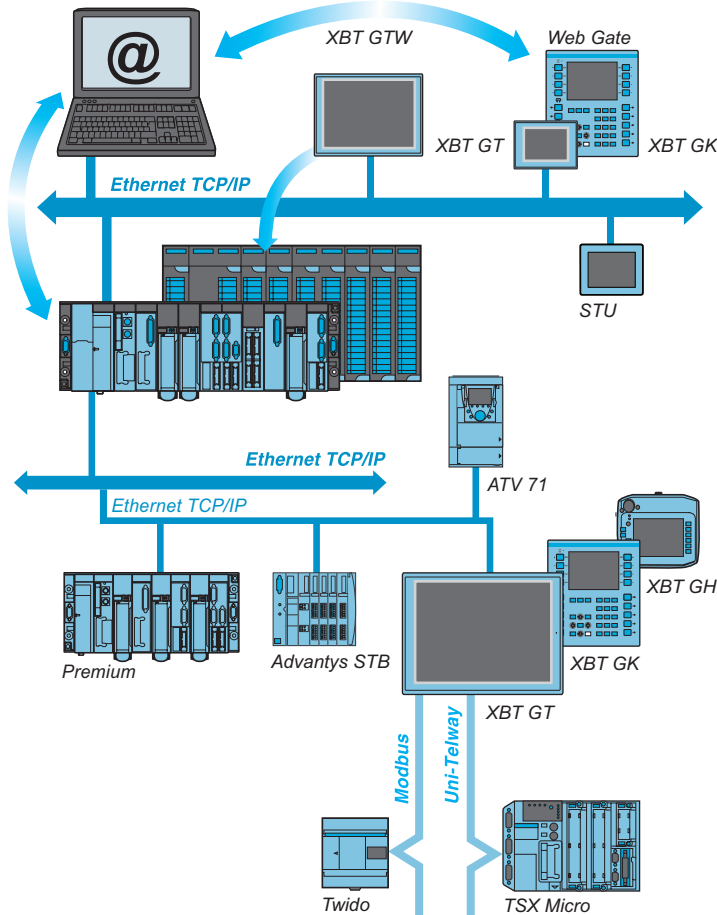

Automation platforms enable transparent routing of Uni-TE or Modbus messages from a TCP/IP network to a Uni-TE or Modbus network and vice versa.

The various services offered for the terminals are:

- **Modbus TCP/IP messaging** (for XBT GT, XBT GK, XBT GH and XBT GTW, access with Ethernet TCP/IP Modbus protocol)
- **Browse function** with XBT GTW or standard PC
- **Web Gate function:** Diagnostics to remotely control the application
- **FTP server:** Transfer of data files with the terminal
- **Data Sharing function:** Data exchange on Ethernet between 8 terminals (maximum)
- **e-mail function**

1

**Applications**

**Display of graphic pages**

**Type of terminal**

**Small Panels with touch screen**



<b>Display</b>	Type
	Capacity

Monochrome LCD STN (200 x 80 pixels), backlit - Green, orange or red - White, pink or red	Colour TFT LCD QVGA (320 x 240 pixels)
3.4" (monochrome)	3.5" (colour)

**Data entry**

Via touch screen

<b>Memory capacity</b>	Application
	Expansion

16 MB Flash  
-

<b>Functions</b>	Maximum number of pages
	Variables per page
	Representation of variables
	Recipes
	Curves
	Alarm logs
	Real-time clock
	Alarm relay
	Buzzer

Limited by internal FLASH EPROM memory capacity  
Unlimited  
Alphanumeric, bitmap, bargraph, gauge, curves, buttons, LEDs  
32 groups of 64 recipes  
Yes, with log  
Yes  
Access to the PLC real-time clock  
-  
Yes

<b>Communication</b>	Asynchronous serial link
	Downloadable protocols
	Printer link
	USB ports
	Networks

RS 232C/RS 485  
Uni-TE, Modbus and for PLC brands: Allen-Bradley, Omron, Mitsubishi, Siemens  
USB for serial or parallel printer  
1 host type A and 1 device type mini B  
-  
1 Ethernet TCP/IP port (10BASE-T/100BASE-TX)

<b>Development software</b>	Vijeo Designer (on Windows XP, Windows Vista and Windows 7)
<b>Operating systems</b>	Magelis

**Type of terminal**

**Magelis STO** | **Magelis STU**

**Pages**

1/12

Display of text messages and/or semi-graphic pages	Display of text messages and/or semi-graphic pages Control and configuration of data	
--	---	--

Small Panels with keypad	Small Panels with keypad	Small Panels with touch screen and keypad
--------------------------	--------------------------	---

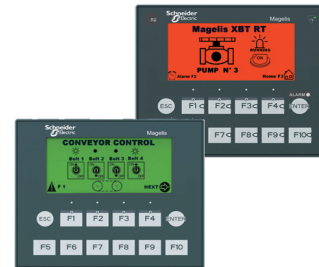
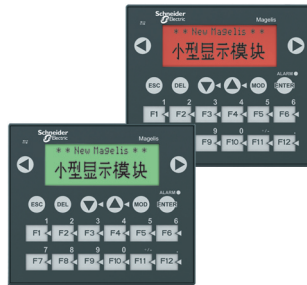

Green backlit monochrome LCD, height 5.5 mm or Green, orange or red backlit monochrome LCD, height 4.34...17.36 mm	Green, orange or red backlit monochrome LCD, height 4.34...17.36 mm	Green, orange or red backlit monochrome matrix LCD (198 x 80 pixels), height 4...16 mm
2 lines of 20 characters or 1 to 4 lines of 5 to 20 characters (monochrome)	1 to 4 lines of 5 to 20 characters (monochrome)	2 to 10 lines of 5 to 33 characters (monochrome)
Via keypad with 8 keys (4 customizable)	Via keypad with ■ 12 function keys or numeric entry (depending on context) ■ 8 service keys	Via keypad with ■ 4 function keys ■ 8 service keys Via touch screen and keypad with ■ 10 function keys ■ 2 service keys
512 KB Flash -		512 KB Flash EPROM
128/200 application pages 256 alarm pages 40...50	128/200 application pages 256 alarm pages 40...50, bargraph, buttons, LEDs	200 application pages 256 alarm pages 50
Alphanumeric -		Alphanumeric, bargraph, buttons, LEDs
Yes Yes (2)	Yes	
Access to the PLC real-time clock -	Access to the PLC real-time clock	
		Yes (1)
RS 232C/RS 485 Uni-TE, Modbus and for PLC brands: Allen-Bradley, Omron, Mitsubishi, Siemens RS 232C serial link (2) - -		
Vijeo Designer Lite (on Windows 2000, Windows XP or Windows Vista) Magelis		

<b>XBT N</b>	<b>XBT R</b>	<b>XBT RT</b>
--------------	--------------	---------------

1/21	1/23	1/27
------	------	------

(1) Only XBT RT511.  
(2) Depending on model.

1



Magelis STO Small Panel



Magelis STU Small Panel



Exploded view of Magelis STU Small Panel: simple installation by means of a 22 mm diameter hole

#### Presentation

The Magelis Small Panels offer includes the following touch screen terminals:

- Magelis STO, with 3.4" monochrome screen , available with 2 different types of backlighting:
  - Green, orange, red
  - White, pink, red
- Magelis STU, with 3.5" TFT colour screen

#### Operation

The features of Magelis STO and STU terminals draw on key technological innovations:

- All models are equipped with 2 USB V2.0 ports for data transfer.
- Magelis STU models feature an RJ45 port, enabling integration of an Ethernet TCP/IP network and the use of the services associated with this (in particular, the Web Gate function).

#### No panel cut-out required to install Magelis STU models

No panel cut-out is required to install a Magelis STU Small Panel. All you need to do is drill a hole measuring 22 mm in diameter - just as if you were installing a pushbutton.

The front module (comprising the screen) is connected to the rear module (comprising the terminals and connectors). Both modules are fixed together by means of the 22 mm diameter hole.



Display of a video sequence

### Configuration

Magelis STO/STU terminals can be configured using Vijeo Designer software in a Windows XP, Windows Vista or Windows 7 environment.

Vijeo Designer software boasts an advanced user interface with many configurable windows, enabling projects to be developed quickly and easily.

See page 4/8.

### Communication

Magelis STO/STU terminals communicate with PLCs via an integrated serial link, using the following communication protocols:

- **Schneider Electric** (Uni-TE, Modbus)
- **Third-party**: Mitsubishi Electric, Omron, Allen-Bradley and Siemens

The Magelis STU terminal is connected on Ethernet TCP/IP networks via Modbus TCP or a third-party protocol.

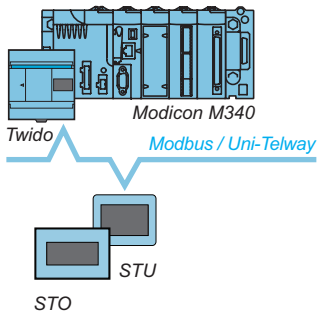

Example of serial link architecture

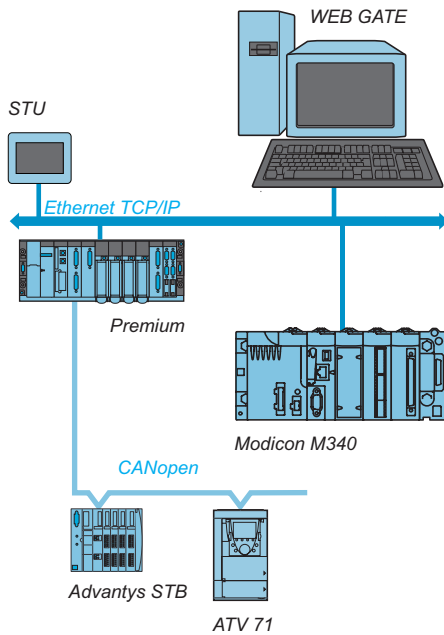

Example of Ethernet TCP/IP network architecture

1

#### Description

#### Magelis STO Small Panels 3.4"

#### Front panel

The front panels of Magelis STO 511 and STO 512 Small Panels comprise:

- 1 A touch screen for displaying synoptic views (3.4" monochrome) with:
  - Green, orange or red backlighting in the case of HMI STO 511
  - White, pink or red backlighting in the case of HMI STO 512

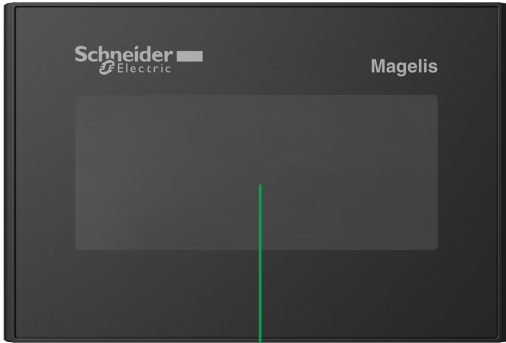

#### Rear panel

Magelis STO 511 and STO 512 Small Panels have the following on the rear panel:

- 1 A removable screw terminal block for the 24 V  $\overline{\text{DC}}$  power supply
- 2 An RJ45 connector for RS 232C or RS 485 serial link connection to PLCs (COM1)
- 3 A USB type A host connector for:
  - Connection of a peripheral device
  - Connection of a USB memory stick
  - Application transfer
  - Modicon M340 terminal port communication
- 4 A USB mini-B device connector for application transfer

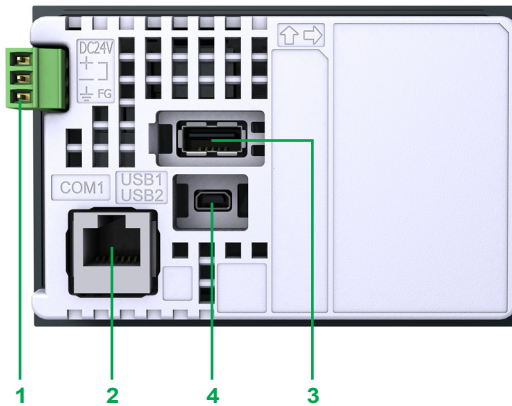



Type of terminal		HMI STO 511	HMI STO 512	
<b>Environment</b>				
<b>Conformity to standards</b>		EN 61131-2, IEC 61000-6-2, FCC (Class A), UL 508, UL 1604		
<b>Product certifications</b>		CE, cULus, CSA, Class 1 Div 2 T4A or T5 (UL), C-Tick		
<b>Temperature</b>	Operation	0...50°C		
	Storage	-20...+60°C		
<b>Relative humidity</b>		0...90% (non-condensing)		
<b>Altitude</b>		< 2000 m		
<b>Degree of protection</b>	Front panel	IP 65 conforming to IEC 60529, Nema 4X (indoor use)		
	Rear panel	IP 20 conforming to IEC 60529		
<b>Shock resistance</b>		Conforming to IEC 60068-2-27; semi-sinusoidal pulse 11 ms, 15 gn on the 3 axes		
<b>Vibrations</b>		Conforming to IEC 60068-2-6; 5...9 Hz at 3.5 mm; 9...150 Hz at 1 gn		
<b>E.S.D.</b>		Conforming to IEC 61000-4-2, level 3		
<b>Electromagnetic interference</b>		Conforming to IEC 61000-4-3, 10 V/m		
<b>Electrical interference</b>		Conforming to IEC 61000-4-4, level 3		
<b>Mechanical characteristics</b>				
<b>Mounting and fixing</b>	Mounting on 1.6...5 mm thick panel	Flush mounted, fixed by 2 spring clips (included)		
<b>Material</b>	Case	Polycarbonate/polybutylene terephthalate alloy		
<b>Electrical characteristics</b>				
<b>Power supply</b>	Voltage	24 V $\overline{\text{DC}}$		
	Limits	19.2...28.8 V $\overline{\text{DC}}$		
	Voltage break	$\leq 3$ ms		
<b>Inrush current</b>		$\leq 30$ A		
<b>Consumption</b>		5 W		
<b>Functional characteristics</b>				
<b>LCD screen</b>	Type	Backlit monochrome STN		
	Backlighting colour	Green, orange or red	White, pink or red	
	Grey levels	16 grey levels		
	Definition	200 x 80 pixels		
	Size (W x H)	3.4" (79.9 x 31.9 mm)		
	Touch-sensitive area	Analog		
	Backlighting (service life)	50,000 hours used in green or white mode, 10,000 hours used in red mode		
	Adjustments	Brightness	8 levels	
		Contrast	16 levels via touch panel	
	Character fonts	ASCII, Japanese (Kana, Kanji), Chinese (simplified Chinese), Taiwanese (traditional Chinese), Korean		
<b>Dialogue application</b>	Max. number of pages	Limited by capacity of internal Flash EPROM memory		
<b>Signalling</b>		1 LED: green for normal operation		
<b>Operating system/processor</b>	Magelis RISC CPU	333 MHz		
<b>Memory</b>	Application	Flash EPROM	16 MB	
	Data backup		128 KB used in Flash	
<b>Schneider Electric protocols</b>		Modicon	Modbus, Uni-TE	
<b>Third-party protocols</b>	Mitsubishi	Melsec	A Link (SIO)	
	Omron	Sysmac	FINS (SIO), LINK (SIO)	
	Rockwell Automation	Allen-Bradley	DF1-Full Duplex, DH 485, PLC5, SLC500, MicroLogix, ControlLogix	
	Siemens	Simatic	MPI (S7-300/400), PPI (S7-200)	
<b>Connection</b>	Power supply	Removable screw terminal block: 3 terminals (pitch 5.08 mm), tightening torque 0.5 Nm		
	COM1 serial link (115.2 kbps max.)	RJ45 connector (RS 232C/RS 485 serial link), compatible with Siemens MPI (187.5 kbps)		
	USB port (V2.0) for application transfer, peripheral connection and Modicon M340 terminal port communication	Type: A host		
	USB port (V2.0) for application transfer	Type: Mini-B device		

1

#### Description

#### Magelis STU Small Panels 3.5"

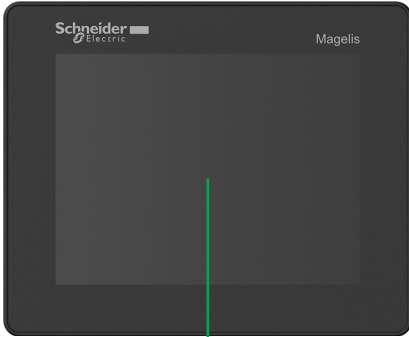

1

#### Front module

The front panels of Magelis STU 655 Small Panels comprise:

- 1 A touch screen for displaying synoptic views (3.5" colour TFT)

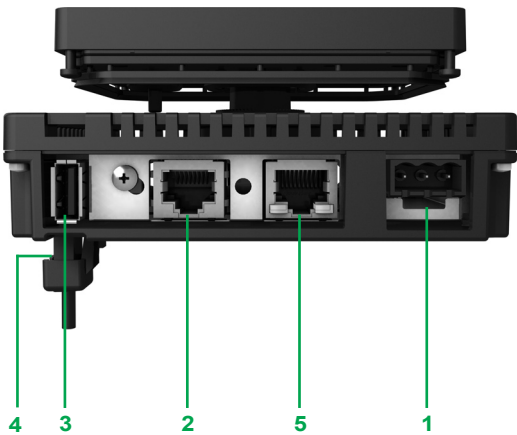

#### Rear of product

Magelis STU 655 Small Panels have the following on the rear:

- 1 A removable screw terminal block for the 24 V  $\bar{\text{---}}$  power supply
- 2 An RJ45 connector for RS 232C or RS 485 serial link connection to PLCs (COM1)
- 3 A USB type A host connector for:
  - Connection of a peripheral device
  - Connection of a USB memory stick
  - Application transfer
- 4 A USB mini-B device connector for application transfer (on the left-hand side)
- 5 An RJ45 connector for the Ethernet TCP/IP 10BASE-T/100BASE-TX link

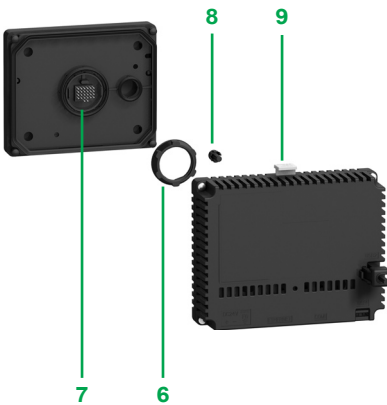

#### Fixing system

A Magelis STU Small Panel is made up of a front module (comprising the screen) and a rear module (comprising the CPU plus terminals and connectors). The two modules are fixed together by means of a hole measuring 22 mm in diameter. The fixing system contains the following elements:

- 6 An adjusting nut
- 7 A seal
- 8 An anti-rotation tee (can be used as an option)
- 9 A release mechanism: simply press to separate the two modules once they have been fixed together

<b>Type of terminal</b>		<b>HMI STU 655</b>	
<b>Environment</b>			
<b>Conformity to standards</b>		EN 61131-2, IEC 61000-6-2, FCC (Class A), UL 508, UL 1604	
<b>Product certifications</b>		CE, cULus, Class 1 Div 2 T4A or T5 (UL), C-Tick	
<b>Temperature</b>	Operation	0...50°C	
	Storage	-20...+60°C	
<b>Relative humidity</b>		0...85% (non-condensing)	
<b>Altitude</b>		< 2000 m	
<b>Degree of protection</b>	Front panel	IP 65 conforming to IEC 60529, Nema 4X (indoor use)	
	Rear panel	IP 20 conforming to IEC 60529	
<b>Shock resistance</b>		Conforming to IEC 60068-2-27; semi-sinusoidal pulse 11 ms, 15 gn on the 3 axes	
<b>Vibrations</b>		Conforming to IEC 60068-2-6; 5...9 Hz at 3.5 mm; 9...150 Hz at 1 gn	
<b>E.S.D.</b>		Conforming to IEC 61000-4-2, level 3	
<b>Electromagnetic interference</b>		Conforming to IEC 61000-4-3, 10 V/m	
<b>Electrical interference</b>		Conforming to IEC 61000-4-4, level 3	
<b>Mechanical characteristics</b>			
<b>Mounting and fixing</b>	Mounting on 1.6...5 mm thick panel	By means of a 22 mm diameter hole and nut (supplied)	
<b>Material</b>	Case	Polycarbonate/polybutylene terephthalate alloy	
<b>Keys</b>		-	
<b>Electrical characteristics</b>			
<b>Power supply</b>	Voltage	24 V ---	
	Limits	20.4...28.8 V ---	
	Voltage break	≤ 10 ms	
<b>Inrush current</b>		≤ 30 A	
<b>Consumption</b>		6.5 W	
<b>Functional characteristics</b>			
<b>LCD screen</b>	Type	Colour TFT	
	Colour	65,536 colours	
	Definition	320 x 240 pixels	
	Size (W x H)	3.5" (70.6 x 52.9 mm)	
	Touch-sensitive area	Analog	
	Backlighting (service life)	50,000 hours	
	Adjustments	Brightness	16 levels
	Character fonts		ASCII, Japanese (Kana, Kanji), Chinese (simplified Chinese), Taiwanese (traditional Chinese), Korean
<b>Dialogue application</b>	Max. number of pages	Limited by capacity of internal Flash EPROM memory	
<b>Operating system/processor</b>	Magelis RISC CPU	333 MHz	
<b>Memory</b>	Application	Flash EPROM	16 MB
	Data backup		64 KB FRAM
<b>Schneider Electric protocols</b>	Modicon		Modbus, Uni-TE and Modbus TCP/IP
<b>Third-party protocols</b>	Mitsubishi	Melsec	A Link (SIO), A/Q Ethernet (TCP), Q Ethernet (UDP)
	Omron	Symac	FINS (SIO), LINK (SIO), FINS (Ethernet)
	Rockwell Automation Allen-Bradley		DF1-Full Duplex, DH 485, PLC5, SLC500, MicroLogix, ControlLogix Ethernet IP (PLC5, SLC500, MicroLogix, ControlLogix), Ethernet IP (native)
	Siemens	Simatic	MPI (S7-300/400), PPI (S7-200) Profinet (ISO-on-TCP)
<b>Connection</b>	Power supply		Removable screw terminal block: 3 terminals (pitch 5.08 mm), tightening torque 0.5 Nm
	COM1 serial link (115.2 kbps max.)		RJ45 connector (RS 232C/RS 485 serial link), compatible with Siemens MPI (187.5 kbps)
	USB port (V2.0) for application transfer, peripheral connection and Modicon M340 terminal port communication		Type: A host
	USB port (V2.0) for application transfer		Type: Mini-B device
	Ethernet TCP/IP network		RJ45 connector (10BASE-T/100BASE-TX)

# Operator dialogue terminals

## Small Panels with touch screen

### Magelis STO, STU

1



HMI STO 511

#### Monochrome touch screen terminals

##### 3.4" screen

Type of screen	Number of ports	Application memory capacity	Compact Flash memory	Number of Ethernet ports	Reference	Weight kg
STN Green, orange, red	1 COM1 2 USB	16 MB	No	–	HMI STO 511	–
STN White, pink, red	1 COM1 2 USB	16 MB	No	–	HMI STO 512	1.000



HMI STU 655

#### Colour touch screen terminals

##### 3.5" screen

Type of screen	Number of ports	Application memory capacity	Compact Flash memory	Embedded Ethernet	Reference	Weight kg
TFT	1 COM1 2 USB	16 MB	No	1	HMI STU 655	1.000

#### Software

##### Configuration software

Description	Operating system	Reference	Weight kg
Vijeo Designer	Windows XP Professional (32 bits) Windows Vista (32 bits) Windows 7 (32 bits)	See page 4/17	–

Separate components (1)				
Designation	Description/function	Compatible with	Reference	Weight kg
<b>Accessories kit</b>	Contains: <ul style="list-style-type: none"> <li>■ An anti-rotation tee</li> <li>■ A USB A type clip</li> <li>■ A USB mini-B type clip</li> <li>■ An adaptor panel for mounting on an enclosure of 1 mm in thickness</li> </ul>	HMI STU 655	<b>HMIZSUKIT</b>	–
<b>Protective sheets</b>	5 peel-off sheets for protecting the screen	HMI STO 511 HMI STO 512	<b>HMIZS60</b>	–
		HMI STU 655	<b>HMIZS61</b>	–
<b>USB clip</b>	Holds the USB A type connection in place	HMI STO 511 HMI STO 512	<b>HMIZSCLP1</b>	–
	Holds the USB mini-B type connection in place	HMI STO 511 HMI STO 512	<b>HMIZSCLP3</b>	–
Replacement parts (2)				
Designation	Description/function	Compatible with	Reference	Weight kg
<b>Nuts</b>	Set of 10 nuts, 22 mm (front module of the HMI STU 655 is fixed to the enclosure using a nut; see page 1/6)	HMI STU 655	<b>ZB5AZ901</b>	–
<b>Bezel key</b>	Enables the adjusting nut to be tightened	HMI STU 655	<b>ZB5AZ905</b>	–
<b>Seal</b>	Dust and damp proofs the connection between the front and rear modules of the HMI STO 51●	HMI STO 511 HMI STO 512	<b>HMIZS50</b>	–

(1) Non-exhaustive list: other separate components are listed on page 1/28 onwards.  
 (2) Non-exhaustive list: other replacement parts are listed on page 1/28 onwards.

# Operator dialogue terminals

Magelis XBT N, XBT R Small Panels with keypad, Magelis XBT RT Small Panels with touch screen and keypad

1

## Presentation



XBT R411

XBT N400

XBT RT511

Magelis XBT N and Magelis XBT R/RT terminals are used to display messages and variables. In addition, Magelis terminals XBT RT can display small graphic elements.

Various keys can be used to:

- Modify variables
- Control a device
- Navigate within the operator dialogue application

On XBT RT terminals, the touch screen can also be used to modify variables, control devices and navigate within the dialogue application.

Models equipped with a printer link are able to print alarm messages.

## Operation



"Entry" customization



"Control" customization

All Magelis terminals have the same user interface:

- A configurable touch screen, on XBT RT only ("touch-sensitive" mode)
- 2 service keys (◀▶) configurable for contextual link or control, on XBT N/R and XBT RT ("entry"/"control" modes)
- 2 service keys (ESC, ENTER), non-configurable
- These keys are complemented by:
  - On XBT N terminals: 4 customizable service keys which can be configured as function keys ("control" mode) or service keys ("entry" mode)
  - On XBT R terminals: 4 service keys, non-configurable, and 12 function or numeric entry keys (depending on context)
  - On XBT RT terminals in "control" or "entry" mode: 4 customizable and configurable function keys 4 service keys (non-configurable)

# Operator dialogue terminals

Magelis XBT N, XBT R Small Panels with keypad, Magelis XBT RT Small Panels with touch screen and keypad

## Configuration

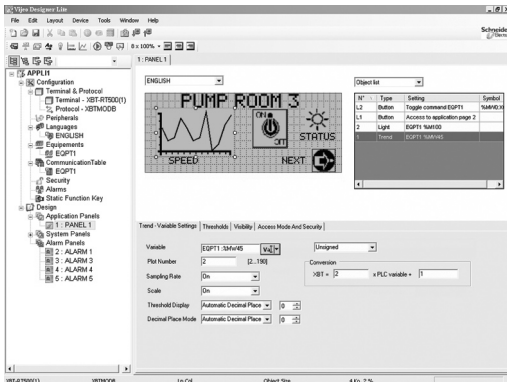

Vijeo Designer Lite

Magelis terminals can be configured using Vijeo Designer Lite software in a Windows environment.

Vijeo Designer Lite software uses the concept of pages: each page can be viewed in its entirety. A 2, 4 or 10-line window, depending on the terminal model to be configured, makes it possible to view the screen for this virtual terminal.

The symbol databases for TwidoSoft, PL7 and Concept applications can be imported into the Vijeo Designer Lite operator dialogue application.

## Communication

XBT N terminal

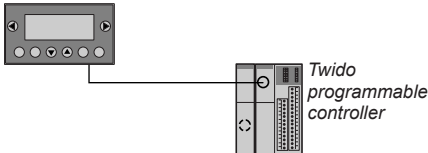

Connection example with Twido programmable controller

XBT N and XBT R/RT terminals communicate with PLCs via an integrated serial link in either point-to-point or multidrop mode, depending on the model.

The communication protocols used are those of Schneider Electric PLCs (Uni-TE, Modbus) and those of the main manufacturers on the market.

XBT N terminal

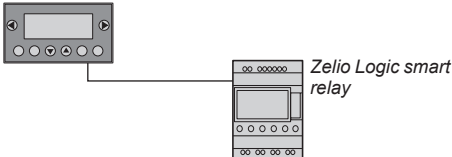

Connection example with Zelio Logic smart relay

XBT N401, XBT R411 and XBT RT 511 terminals communicate with Zelio Logic smart relays via a direct connection cable and using the Zelio protocol, which is included in Vijeo Designer Lite V1.3.

# Operator dialogue terminals

## Magelis XBT N, XBT R Small Panels with keypad, Magelis XBT RT Small Panels with touch screen and keypad

### Functions

On their front panel, XBT N/R/RT terminals have function keys and service keys (depending on how the keys have been configured for “control” and “entry” modes). XBT RT terminals feature a touch screen which can be configured in “touch-sensitive” operating mode.

#### “F” function keys

The function keys are defined for the whole application. The number of function keys depends on the model:

- F1, F2, F3, F4 on XBT N
- F1...F12 on XBT R
- F1...F10 or F1...F4 according to configuration on XBT RT

They can have the following functions:

- Accessing a page
- Impulse command
- “Toggle” command
- etc.

In addition, with the XBT R terminal, if the **MOD** key is pressed the 12 function keys become numeric entry keys **1...0**, **+/-** and **..**

#### “R” function keys for XBT RT (“entry” mode)

The R1, R2, R3 and R4 function keys on the XBT RT are defined for the pages displayed. They can be used for:

- Accessing a page
- Memorising memory bits
- Toggling memory bits (ON/OFF)
- Resetting memory bits to 1/0

An icon can be displayed on the screen, above the **Ri** keys. This icon is defined using the Vijeo Designer Lite software.

#### Matrix touch screen (5 x 11 cells) for XBT RT

The touch screen can be configured to be active on the XBT RT (“touch-sensitive” mode).

This is used for:

- Accessing a page
- Memorising/toggling memory bits
- Modifying a numeric field via a virtual numeric keypad

#### Service keys

Service keys **◀**, **ESC**, **DEL**, **▼**, **▲**, **MOD**, **ENTER** and **▶** are used to modify the parameters of the automation system.

They perform the following actions:

- ESC** Cancel an entry, suspend or stop an action in progress, go back up a level in a menu
- DEL** Delete the character selected in entry mode
- MOD** Select the variable field in which to enter data. Enable entry in the next field, on each press, from left to right and top to bottom.
- ENTER** Confirm a selection or entry, acknowledge an alarm

The “arrow” keys are used to:

- ◀ ▶**
  - Change the page within a menu
  - Display the current alarms
  - Change a digit in a variable field in which data is being entered
  - Activate the function associated with a functional link
- ▼ ▲**
  - Move up and down within a page (XBT N40●)
  - Select the value of a digit
  - Select a value from a list of choices
  - Increment or decrement the value of a variable field



## Description of XBT N terminals

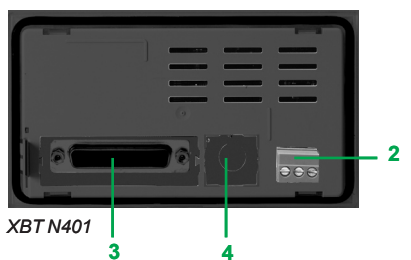
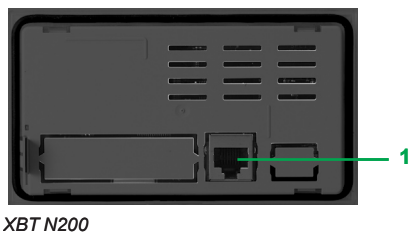
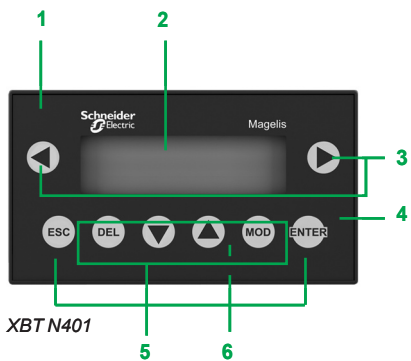
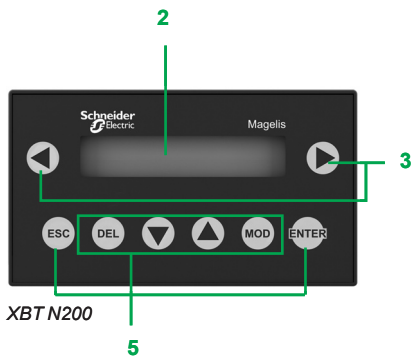

XBT N terminals comprise:

### On the front panel

- 1 A communication monitoring LED (model XBT N401)
- 2 A backlit ultra-bright LCD display: 122 x 32 pixels (matrix) or 2 lines of 20 characters (alphanumeric)
- 3 Two non-customizable command or contextual link keys
- 4 An "alarm" LED (model XBT N401)
- 5 Six service keys, 4 of which (framed) can be configured as function keys and customized using labels.
- 6 Two system LEDs in entry mode or 4 LEDs that can be controlled by the PLC in control mode (model XBT N401)

### Supplied separately

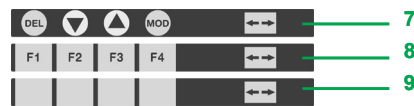

- A sheet of labels comprising:
  - 7 An "entry" label
  - 8 A "control" label (F1, F2, F3 and F4)
  - 9 4 customizable blank labels
- 2 spring clips for fixing the terminal on the panel

### On the rear panel

#### XBT N200/N400 terminals

- 1 An RJ45 connector for point-to-point serial link and connection for 5 V  $\overline{\text{DC}}$  power supply (supplied by PLC)

#### XBT N401/N410/NU400 terminals

- 2 A removable screw terminal block for the 24 V  $\overline{\text{DC}}$  external power supply
- 3 A 25-way female SUB-D connector for multidrop serial link
- 4 An 8-way female mini-DIN connector for serial printer link (model XBT N401)

### Description of XBT R terminals with keypad

1

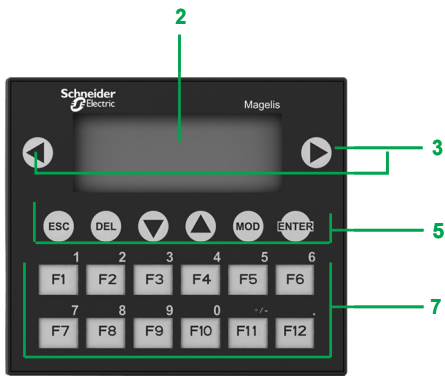

XBT R400

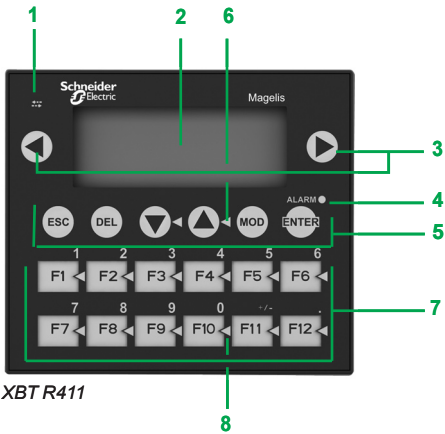

XBT R411

XBT R terminals comprise:

#### On the front panel

- 1 A communication monitoring LED (model XBT R411)
- 2 A backlit ultra-bright LCD display: 122 x 32 pixels (matrix)
- 3 Two non-customizable command or contextual link keys
- 4 An "alarm" LED (model XBT R411)
- 5 Six service keys
- 6 Two system LEDs (model XBT R411)
- 7 Twelve function or numeric entry keys (depending on context), customizable using labels
- 8 Twelve LEDs (for model XBT R411) which can be controlled by the PLC

#### Supplied separately:

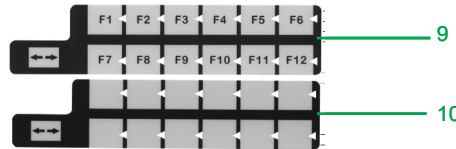

- A sheet of labels comprising:
  - 9 A "control" label (F1, F2, etc.) F12
  - 10 2 customizable blank labels
- 4 spring clips for fixing the terminal on the panel



XBT R400

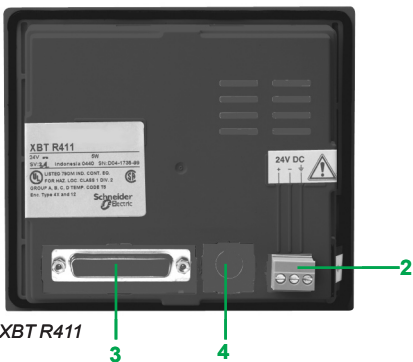

XBT R411

#### On the rear panel

##### XBT R400 terminals

- 1 An RJ45 connector for point-to-point serial link and connection for 5 V  $\overline{\text{DC}}$  power supply (supplied by PLC)

##### XBT R410/R411 terminals

- 2 A removable screw terminal block for the 24 V  $\overline{\text{DC}}$  external power supply
- 3 A 25-way female SUB-D connector for multidrop serial link
- 4 An 8-way female mini-DIN connector for serial printer link (model XBT R411)

### Description of XBT RT terminals with touch screen and keypad

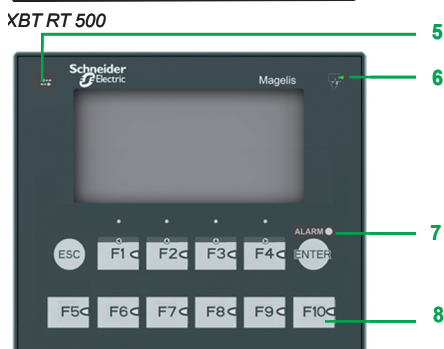
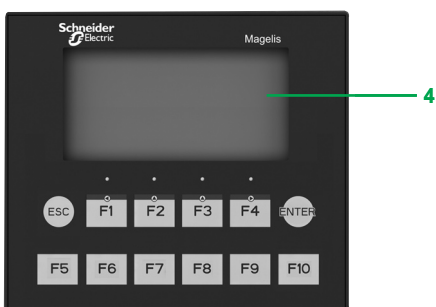
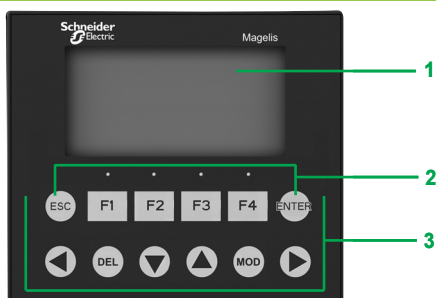

XBT RT511

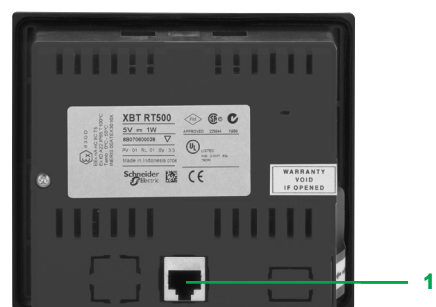

XBT RT500

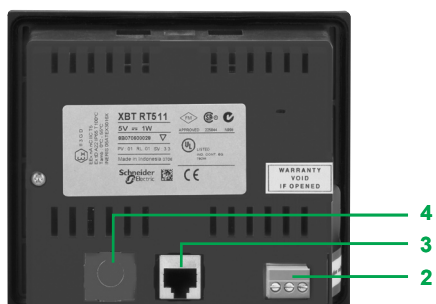

XBT RT511

XBT RT terminals comprise:

#### On the front panel

##### XBT RT terminals

- 1 An ultra-bright backlit LCD display: 198 x 80 pixels (matrix)
- 2 2 service keys
- 3 Function or service keys which can be configured and customized using labels
- 4 Matrix touch screen (11 x 5 cells)

##### XBT RT511 terminal

- 5 A communication monitoring LED
- 6 A "touch panel or keys being pressed" LED
- 7 An "alarm" LED
- 8 6 or 10 LEDs, depending on the configuration, which can be controlled by the PLC

#### Supplied separately:

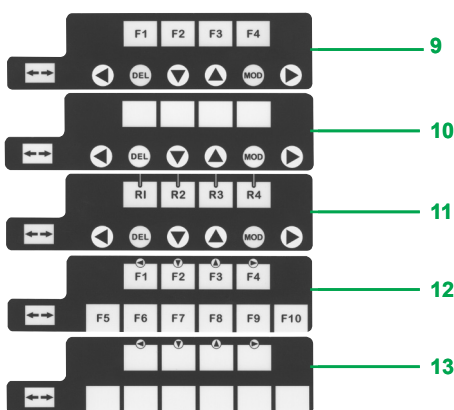

- 2 sheets of labels comprising:
  - 9 A configurable "control" label (F1...F4)
  - 10 A customizable blank "control" label
  - 11 An "entry" label (R1...R4)
  - 12 A "touch-sensitive" label (F1...F10)
  - 13 Two customizable blank "touch-sensitive" labels

#### On the rear panel

##### XBT RT500 terminal

- 1 An RJ45 connector for point-to-point serial link and connection for 5 V  $\overline{\text{DC}}$  power supply (supplied by PLC)

##### XBT RT511 terminal

- 2 A removable screw terminal block for the 24 V  $\overline{\text{DC}}$  external power supply
- 3 An RJ45 connector for multidrop serial link
- 4 An 8-way female mini-DIN connector for serial printer link

1

Type of terminal		XBT N200	XBT N400	XBT N410	XBT N401	XBT NU400	
<b>Environment</b>							
<b>Conformity to standards</b>		IEC 61131-2, IEC 60068-2-6, IEC 60068-2-27, UL 508, CSA C22-2 n° 14					
<b>Product certifications</b>		CE, UL, CSA, Class 1 Div 2 (UL and CSA), ATEX Zone 2/22					
<b>Ambient temperature</b>	For operation	°C	0...+55				
	For storage	°C	- 20...+60				
<b>Maximum relative humidity</b>		%	0...85 (non-condensing)				
<b>Degree of protection</b>	Front panel	IP 65, conforming to IEC 60529, Nema 4X ("outdoor use")					
	Rear panel	IP 20, conforming to IEC 60529					
<b>Shock resistance</b>		Conforming to IEC 60068-2-27; semi-sinusoidal pulse 11 ms, 15 gn on the 3 axes					
<b>Vibration resistance</b>		Conforming to IEC 60068-2-6 and marine certification; ±3.5 mm; 2...8.45 Hz; 1 gn 8.45...150 Hz					
<b>E.S.D.</b>		Conforming to IEC 61000-4-2, level 3					
<b>Electromagnetic interference</b>		Conforming to IEC 61000-4-3, 10 V/m					
<b>Electrical interference</b>		Conforming to IEC 61000-4-4, level 3					
<b>Mechanical characteristics</b>							
<b>Mounting and fixing</b>		Flush mounted, fixed by 2 spring clips (included), pressure-mounted for 1.5 to 6 mm thick panels					
<b>Material</b>	Screen protector	Polyester					
	Front frame	Polycarbonate/polybutylene terephthalate alloy					
	Keypad	Polyester					
<b>Keys</b>		8 keys (6 configurable and 4 customizable)					
<b>Electrical characteristics</b>							
<b>Power supply</b>	Voltage	V	5 --- via PLC terminal port	24 ---			
	Voltage limits	V	–	18...30 ---			
	Ripple factor	%	–	Max. 5			
<b>Consumption</b>		W	–	Max. 5			
<b>Functional characteristics</b>							
<b>Display</b>	Type		Green backlit LCD	Green backlit LCD (122 x 32 pixels)	Green, orange or red backlit LCD (122 x 32 pixels)	Green backlit LCD (122 x 32 pixels)	
	Capacity (height x width)		2 lines of 20 characters (5.55 x 3.2 mm)	From 1 lines of 5 characters (17.36 x 11.8 mm) to 4 lines of 20 characters (4.34 x 2.95 mm)			
	Character fonts		ASCII and Katakana	ASCII, Cyrillic, Greek, Katakana and Chinese (simplified)			
<b>Signalling</b>			–	6 LEDs		–	
<b>Dialogue application</b>	Number of pages		128 application pages (2 lines/page max.)	200 application pages (25 lines/page max.) 256 alarm pages (25 lines/page max.)			
			512 KB Flash				
<b>Memory</b>			RS 232C/RS 485				
<b>Transmission medium</b>		Asynchronous serial link	RS 232C/RS 485				
<b>Downloadable protocols</b>			Uni-TE, Modbus (1)	Uni-TE, Modbus and third-party (2)	Uni-TE, Modbus, Zelio (3) and third-party (2)	Modbus	
<b>Real-time clock</b>			Access to the PLC real-time clock				
<b>Connection</b>	Power supply		Via the PLC terminal port connection cable	Removable terminal block, 3 screw terminals (pitched at 5.08 mm) Maximum clamping capacity: 1.5 mm <sup>2</sup>			
	Serial link	Connector		Female RJ45 (RS 232C/RS 485)	25-way female SUB-D (RS 232C/RS 485)		
		Connection		Point-to-point	Multidrop		
Printer link			No	8-way female mini-DIN	No		

- (1) Modbus master for all XBT N terminals.  
Modbus slave for XBT N410 terminals (entry mode) and XBT N401 terminals (entry and control mode).
- (2) Third-party protocols:  
- Allen-Bradley DF1/DH485  
- Siemens PPI  
- Omron SysmacWay  
- Mitsubishi Melsec FX
- (3) Requires the use of an 8-way female mini-DIN connector



XBT N200



XBT N400/N410/NU400



XBT N401

521377

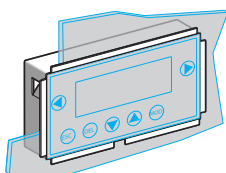

XBT ZN01

521373

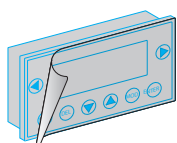

XBT ZN02

### Magelis Small Panels

Downloadable exchange protocol	Compatible PLCs	Supply voltage	Type of screen	Reference	Weight kg
<b>Terminal with 2 lines of 20 characters (with alphanumeric screen)</b>					
Uni-TE, Modbus	Twido, Nano, TSX Micro, Premium, Modicon M340	5 V $\overline{\text{---}}$ via PLC terminal port	Green backlit LCD	<b>XBT N200</b>	0.360
<b>Terminals with 4 lines of 20 characters (with matrix screen)</b>					
Uni-TE, Modbus	Twido (1), Nano, TSX Micro, Premium, Modicon M340	5 V $\overline{\text{---}}$ terminal port	Green backlit LCD (122 x 32 pixels)	<b>XBT N400</b>	0.360
	Twido (1), Nano, TSX Micro, Premium, TSX series 7, Momentum, Quantum Other Modbus slave devices, Modicon M340	24 V $\overline{\text{---}}$ external supply	Green backlit LCD (122 x 32 pixels)	<b>XBT N410</b>	0.380
Uni-TE, Modbus	Twido (1), Nano, TSX Micro, Premium, TSX series 7, Momentum, Quantum Other Modbus slave devices, Modicon M340	24 V $\overline{\text{---}}$ external supply	Green, orange and red backlit LCD (2) (122 x 32 pixels)	<b>XBT N401</b>	0.380
Zelio	Zelio Logic				
Modbus	TeSys model U motor starters (3) Altivar drives	24 V $\overline{\text{---}}$ external supply	Green backlit LCD (122 x 32 pixels)	<b>XBT NU400</b>	0.380

### Software

Description	Operating system	Reference
Configuration software	Windows 2000, XP and Vista	See pages 4/7 and 4/17

### Accessories (4)

Designation	Description	For use with	Reference	Weight kg
Accessory for flush mounting	Kit for applications requiring a higher degree of protection or customization of the control desk, using flat inner insulation (not included)	All XBT N	<b>XBT ZN01</b>	–
Protective sheets	10 peel-off sheets	All XBT N	<b>XBT ZN02</b>	–
Sheets of re-usable labels	10 sheets of 6 labels	XBT N200/400 XBT N401 XBT NU400	<b>XBL YN00</b> <b>XBL YN01</b>	–
Mechanical adaptors for substitution of XBT H	From XBT H0●2●1/H0●1010 to XBT N410 From XBT H811050 to XBT N410	–	<b>XBT ZNCO</b>	–

### Connection cables and accessories (5)

Description	Compatibility	Types of connector	Physical link	Protocol	Length	Reference	Weight kg
Adaptor cable	XBT N200 XBT N400 (6)	RJ45-RJ45	RS 232C RS 485	Modbus, Uni-TE	0.1 m	<b>XBT ZN999</b>	–

(1) Connection via integrated port or optional serial port on the Twido programmable controller

(2) Also available with 4 signalling LEDs

(3) Factory preloaded application for monitoring, diagnostics and adjustment of up to 8 TeSys model U motor starters

(4) For other accessories, see page 1/28.

(5) For other connection cables and accessories, see pages 1/28 to 1/31.

(6) Adaptor **XBT ZN999** is designed for use with **XBT N200/N400** terminals (new version) and cable **XBT Z978** (replaced by **XBT Z9780**), or with **XBT N200/N400** terminals (old version) and the new **XBT Z9780** cable.

**Note:** The new version of the XBT N terminal can be distinguished from the old version by its exterior, as it features the Schneider Electric logo on the front panel (on the left above the screen).

Type of terminal		XBT R400	XBT R410	XBT R411
<b>Environment</b>				
<b>Conformity to standards</b>		IEC 61131-2, IEC 60068-2-6, IEC 60068-2-27, UL 508, CSA C22-2 n° 14		
<b>Product certifications</b>		CE, UL, CSA, Class 1 Div 2 (UL and CSA), ATEX Zone 2/22		
<b>Ambient temperature</b>	For operation	°C	0...+55	
	For storage	°C	-20...+60	
<b>Maximum relative humidity</b>		%	0...85 (non-condensing)	
<b>Degree of protection</b>	Front panel		IP 65, conforming to IEC 60529, Nema 4X ("outdoor use")	
	Rear panel		IP 20, conforming to IEC 60529	
<b>Shock resistance</b>			Conforming to IEC 60068-2-27; semi-sinusoidal pulse 11 ms, 15 gn on the 3 axes	
<b>Vibration resistance</b>			Conforming to IEC 60068-2-6 and marine certification; ±3.5 mm; 2...8.45 Hz; 1 gn 8.45...150 Hz	
<b>E.S.D.</b>			Conforming to IEC 61000-4-2, level 3	
<b>Electromagnetic interference</b>			Conforming to IEC 61000-4-3, 10 V/m	
<b>Electrical interference</b>			Conforming to IEC 61000-4-4, level 3	
<b>Mechanical characteristics</b>				
<b>Mounting and fixing</b>			Flush mounted, fixed by 4 spring clips (included), pressure-mounted for 1.5 to 6 mm thick panels	
<b>Material</b>	Screen protector		Polyester	
	Front frame		Polycarbonate/polybutylene terephthalate alloy	
	Keypad		Polyester	
<b>Keys</b>			20 keys (12 configurable and customizable)	
<b>Electrical characteristics</b>				
<b>Power supply</b>	Voltage	V	5 --- via PLC terminal port	24 ---
	Voltage limits	V	–	18...30 ---
	Ripple factor	%	–	Max. 5
<b>Consumption</b>		W	–	Max. 5
<b>Functional characteristics</b>				
<b>Display</b>	Type		Green backlit LCD (122 x 32 pixels)	Green, orange or red backlit LCD (122 x 32 pixels)
	Capacity (height x width)		From 1 line of 5 characters (17.36 x 11.8 mm) to 4 lines of 20 characters (4.34 x 2.95 mm)	
	Character fonts		ASCII, Cyrillic, Greek, Katakana and Chinese (simplified)	
<b>Signalling</b>			–	16 LEDs
<b>Dialogue application</b>	Number of pages		200 application pages (25 lines/page max.) 256 alarm pages (25 lines/page max.)	
<b>Memory</b>			512 KB Flash	
<b>Transmission medium</b>		Asynchronous serial link	RS 232C/RS 485	
<b>Downloadable protocols</b>			Uni-TE, Modbus (1)	Uni-TE, Modbus and third-party (2)
<b>Real-time clock</b>			Access to the PLC real-time clock	
<b>Connection</b>	Power supply		Via the PLC terminal port connection cable	Removable terminal block, 3 screw terminals (pitched at 5.08 mm) Maximum clamping capacity: 1.5 mm <sup>2</sup>
	Serial link	Connector	Female RJ45 (RS 232C/RS 485)	25-way female SUB-D (RS 232C/RS 485)
		Connection	Point-to-point	Multidrop
	Printer link		No	8-way female mini-DIN

(1) Modbus master for all XBT R terminals. Modbus slave for terminal XBT R411.

(2) Third-party protocols:  
 - Allen-Bradley DF1/DH485  
 - Siemens PPI  
 - Omron SysmacWay  
 - Mitsubishi Melsec FX

(3) Requires the use of an 8-way female mini-DIN connector



XBT R400/R410



XBT R411

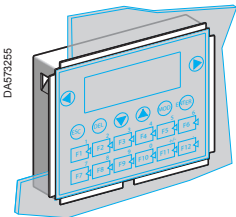

XBT ZR01

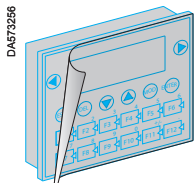

XBT ZR02

### Magelis Small Panels

Downloadable exchange protocol	Compatible PLCs	Supply voltage	Type of screen	Reference	Weight kg
<b>Terminals with 4 lines of 20 characters (with matrix screen)</b>					
Uni-TE, Modbus	Twido, Nano, TSX Micro, Premium, Modicon M340	5 V $\overline{\text{---}}$ via PLC terminal port	Green backlit LCD (122 x 32 pixels)	<b>XBT R400</b>	0.550
	Twido (1), Nano, TSX Micro, Premium, TSX series 7, Momentum, Quantum Other Modbus slave devices, Modicon M340	24 V $\overline{\text{---}}$ external supply	Green backlit LCD (122 x 32 pixels)	<b>XBT R410</b>	0.550
Uni-TE, Modbus	Twido (1), Nano, TSX Micro, Premium, TSX series 7, Momentum, Quantum Other Modbus slave devices, Modicon M340	24 V $\overline{\text{---}}$ external supply	Green, orange and red backlit LCD (2) (122 x 32 pixels)	<b>XBT R411</b>	0.550
Zelio	Zelio Logic				

### Software

Description	Operating system	Reference
Configuration software	Windows 2000 and XP	See pages 4/7 and 4/17

### Accessories (3)

Designation	Description	For use with	Reference	Weight kg
<b>Accessory for flush mounting</b>	Kit for applications requiring a higher degree of protection or customization of the control desk, using flat inner insulation (not included)	All XBT R	<b>XBT ZR01</b>	–
<b>Protective sheets</b>	10 peel-off sheets	All XBT R	<b>XBT ZR02</b>	–
<b>Sheets of re-usable labels</b>	10 sheets of 6 labels	XBT R400/R410	<b>XBL YR00</b>	–
		XBT R411	<b>XBL YR01</b>	–
<b>Mechanical adaptor for substitution of XBT P</b>	From XBT P01●010/P02●010 to XBT R410	–	<b>XBT ZRCO</b>	–
	From XBT P02●110 to XBT R411	–		–

(1) Connection via integrated port or optional serial port on the Twido PLC  
 (2) Also available with 16 signalling LEDs  
 (3) For other accessories, see pages 1/28 to 1/31



1

#### Equivalent product table - Terminals XBT P to XBT R

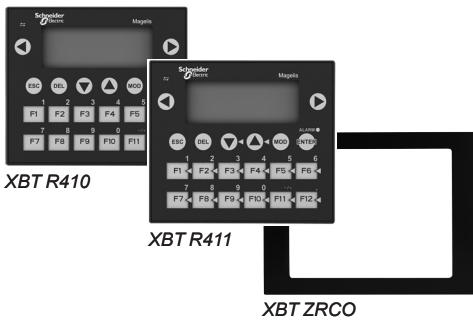

Obsolete range XBT P	New range XBT R	Mechanical adaptor (1)
XBT P011010	XBT R410	XBT ZRCO
XBT P012010	XBT R410	XBT ZRCO
XBT P021010	XBT R410	XBT ZRCO
XBT P021110	XBT R411	XBT ZRCO
XBT P022010	XBT R410	XBT ZRCO
XBT P022110	XBT R411	XBT ZRCO

(1) Mechanical adaptor for mounting XBT R terminal in place of the substituted XBT P terminal

#### Equivalent product table - Cables for connection to Schneider Electric products

Summary		
Obsolete range XBT P	New range XBT R	
Type of link	Type of link	Cable
Serial port, 25-way SUB-D RS 232C/RS 485/RS 422	Serial port, 25-way SUB-D RS 232C/RS 485	Existing cable (see below)
Printer port, 9-way SUB-D (model XBT P02110)	Printer port, 8-way mini-DIN (model XBT R411)	<b>XBT Z926</b> (new cable)

#### Equivalent product table - Cables

Obsolete range XBT P				New range XBT R			
Type of terminal	Type of link	Length	Reference	Type of terminal	Type of link	Length	Reference
<b>Twido, Modicon TSX Micro, Modicon Premium</b> , 8-way female mini-DIN terminal port, Uni-TE (V1/V2), Modbus protocol							
XBT P	RS 485 serial port, 25-way SUB-D	2.5 m	<b>XBT Z968</b>	XBT R	RS 485 serial port, 25-way SUB-D	2.5 m	<b>XBT Z968</b>
		5 m	<b>XBT Z9681</b>			5 m	<b>XBT Z9681</b>
		2.5 m, angled	<b>XBT Z9680</b>			2.5 m, angled	<b>XBT Z9680</b>
<b>Modicon Premium with TSX SCY 2160</b> , 25-way female SUB-D connector, Uni-TE (V1/V2) protocol							
XBT P	RS 485 serial port, 25-way SUB-D	2.5 m	<b>XBT Z918</b>	XBT R	RS 485 serial port, 25-way SUB-D	2.5 m	<b>XBT Z918</b>
<b>Modicon Quantum</b> , 9-way male SUB-D connector, Modbus protocol							
XBT P	RS 232C serial port, 25-way SUB-D	2.5 m	<b>XBT Z9710</b>	XBT R	RS 232C serial port, 2.5 m 25-way SUB-D		<b>XBT Z9710</b>
<b>Advantys STB</b> , HE13 connector (network interface module, NIM), Modbus protocol							
XBT P	RS 232C serial port, 25-way SUB-D	2.5 m	<b>XBT Z988</b>	XBT R	RS 232C serial port, 2.5 m 25-way SUB-D		<b>XBT Z988</b>
<b>Modicon Momentum M1</b> , RJ45 connector (port 1), Modbus protocol							
XBT P	RS 232C serial port, 25-way SUB-D	2.5 m	<b>XBT Z9711</b>	XBT R	RS 232C serial port, 2.5 m 25-way SUB-D		<b>XBT Z9711</b>
<b>TeSys U starters, ATV 31/61/71 drives, ATS 48 starters</b> , RJ45 connector, Modbus protocol							
XBT P	RS 485 serial port, 25-way SUB-D	2.5 m	<b>XBT Z938</b>	XBT R	RS 485 serial port, 2.5 m 25-way SUB-D		<b>XBT Z938</b>
<b>LT6 P multifunction protection relay</b> , 9-way female SUB-D connector, Modbus protocol							
XBT P	RS 232C serial port, 25-way SUB-D	2.5 m	<b>XBT Z938</b>	XBT R	RS 232C serial port, 2.5 m 25-way SUB-D		<b>XBT Z938</b>

#### Equivalent product table - Cables for application transfer to PC and printer cable

Obsolete range XBT P				New range XBT R			
Type of terminal	Type of link	Length	Reference	Type of terminal	Type of link	Length	Reference
<b>Cables for application transfer to PC</b>							
XBT P	25-way SUB-D/ 9-way SUB-D	2.5 m	<b>XBT Z915</b>	XBT R	25-way SUB-D/ 9-way SUB-D	2.5 m	<b>XBT Z915</b>
	25-way SUB-D/USB	2.5 m	<b>XBT Z915 + SR2 CBL 06 adaptor</b>		25-way SUB-D/USB	2.5 m	<b>XBT Z915 + SR2 CBL 06 adaptor</b>
<b>Serial printer cable</b>							
XBT P	Printer port, 9-way SUB-D	2.5 m	<b>XBT Z936</b>	XBT R	Printer port, mini-DIN 8	2.5 m	<b>XBT Z926</b>



#### Compatibility table - Downloadable third-party protocols

	PLC brand	Compatibility		Protocol name
		XBT P	XBT R	
	Allen-Bradley	■	■	DF1/DH485
	GE Fanuc	■	–	SNPX
	Omron	■	■ (on RS 232)	Sysmacway
	Siemens	■	■	PPI
		■	–	AS511, 3964R, MPI

#### Equivalent product table - Cables for connection to third-party PLCs

##### Omron CQM1 & CVM1, Sysmac PLCs

Obsolete range XBT P					New range XBT R				
Type of terminal	Type of connector	Serial port	Length	Reference	Type of terminal	Type of connector	Serial port	Length	Reference
<b>Sysmacway protocol</b>									
XBT P	25-way SUB-D/ 9-way SUB-D	RS 232	2.5 m	<b>XBT Z9740</b>	XBT R	25-way SUB-D/ 9-way SUB-D	RS 232C	2.5 m	<b>XBT Z9740</b>

##### Rockwell Automation, Allen-Bradley PLCs

Obsolete range XBT P					New range XBT R				
Type of terminal	Type of connector	Serial port	Length	Reference	Type of terminal	Type of connector	Serial port	Length	Reference
<b>DF1 protocol</b>									
XBT P	25-way SUB-D/ 9-way SUB-D	RS 232C	2.5 m	<b>XBT Z9730</b>	XBT R	25-way SUB-D/ 9-way SUB-D	RS 232C	2.5 m	<b>XBT Z9730</b>
AP SLC5					AP SLC5				
XBT P	25-way SUB-D/ 25-way SUB-D	RS 232C	2.5 m	<b>XBT Z9720</b>	XBT R	25-way SUB-D/ 25-way SUB-D	RS 232C	2.5 m	<b>XBT Z9720</b>
AP PLC5					AP PLC5				
XBT P	25-way SUB-D/ Micro-logix 1000	RS 232C	2.5 m	<b>XBT Z9731</b>	XBT R	25-way SUB-D/ Micro-logix 1000	RS 232C	2.5 m	<b>XBT Z9731</b>
AP					AP Micro-logix				
Micro-logix									
<b>DH 485 point-to-point protocol</b>									
XBT P	25-way SUB-D/ Micro-logix 1000	RS 232C	2.5 m	<b>XBT Z9732</b>	XBT R	25-way SUB-D/ Micro-logix 1000	RS 232C	2.5 m	<b>XBT Z9732</b>
AP					AP Micro-logix				
Micro-logix									
<b>DH 485 multidrop protocol</b>									
XBT P	25-way SUB-D/ 9-way SUB-D	RS 232C	2.5 m	<b>XBT Z9730</b>	XBT R	25-way SUB-D/ Micro-logix 1000	RS 232C	2.5 m	<b>XBT Z9732</b>
SLC500					AP SLC5 with				
with AIC					AIC gateway				
gateway									

##### Siemens, Simatic PLCs

Obsolete range XBT P					New range XBT R				
Type of terminal	Type of connector	Serial port	Length	Reference	Type of terminal	Type of connector	Serial port	Length	Reference
<b>PPI (S7) protocol</b>									
XBT P	25-way SUB-D/ 9-way SUB-D	RS 485	2.5 m	<b>XBT Z9721</b>	XBT R	25-way SUB-D/ 9-way SUB-D	RS 485	2.5 m	<b>XBT Z9721</b>

#### Equivalent product table - Connection to Uni-Telway serial link

Obsolete range XBT P					New range XBT R				
Type of terminal	Type of connector	Serial port	Length	Reference	Type of terminal	Type of connector	Serial port	Length	Reference
<b>On subscriber socket TSX SCA 62</b>									
XBT P	25-way SUB-D/ 15-way SUB-D	RS 485	1.8 m	<b>XBT Z908</b>	XBT R	25-way SUB-D/ 15-way SUB-D	RS 485	1.8 m	<b>XBT Z908</b>
<b>On connection box TSX P ACC 01</b>									
XBT P	25-way SUB-D/ 8-way mini-DIN	RS 485	2.5 m	<b>XBT Z968</b>	XBT R	25-way SUB-D/ 8-way mini-DIN	RS 485	2.5 m	<b>XBT Z968</b>
			5 m	<b>XBT Z9681</b>				5 m	<b>XBT Z9681</b>

#### Equivalent product table - Connection to Modbus serial link

Obsolete range XBT P					New range XBT R				
Type of terminal	Type of connector	Serial port	Length	Reference	Type of terminal	Type of connector	Serial port	Length	Reference
<b>On subscriber socket TSX SCA 64</b>									
XBT P	25-way SUB-D/ 15-way SUB-D	RS 485/ RS422	1.8 m	<b>XBT Z908</b>	XBT R	25-way SUB-D/ 15-way SUB-D	RS 485/ RS422	1.8 m	<b>XBT Z908</b>
<b>On 8-port splitter box LU9 GC3</b>									
XBT P	25-way SUB-D/RJ45	RS 485	2.5 m	<b>XBT Z938</b>	XBT R	25-way SUB-D/RJ45	RS 485	2.5 m	<b>XBT Z938</b>

1

Type of terminal		XBT RT500	XBT RT511	
<b>Environment</b>				
<b>Conformity to standards</b>		IEC 61131-2, IEC 60068-2-6, IEC 60068-2-27, UL 508, CSA C22-2 n° 14		
<b>Product certifications</b>		CE, UL, CSA, Class 1 Div 2 (UL and CSA), ATEX Zone 2/22		
<b>Ambient temperature</b>	For operation	°C	0...+55	
	For storage	°C	- 20...+60	
<b>Maximum relative humidity</b>		%	0...85 (non-condensing)	
<b>Degree of protection</b>	Front panel	IP 65, conforming to IEC 60529, Nema 4X ("indoor use")		
	Rear panel	IP 20, conforming to IEC 60529		
<b>Shock resistance</b>		Conforming to IEC 60068-2-27; semi-sinusoidal pulse 11 ms, 15 gn on the 3 axes		
<b>Vibration resistance</b>		Conforming to IEC 60068-2-6; ±3.5 mm; 2...8.45 Hz; 1 gn 8.45...150 Hz		
<b>E.S.D.</b>		Conforming to IEC 61000-4-2, level 3		
<b>Electromagnetic interference</b>		Conforming to IEC 61000-4-3, 10 V/m		
<b>Electrical interference</b>		Conforming to IEC 61000-4-4, level 3		
<b>Mechanical characteristics</b>				
<b>Mounting and fixing</b>		Flush mounted, fixed by 4 spring clips (included), pressure-mounted for 1.5 to 6 mm thick panels		
<b>Material</b>	Screen protector	Polyester		
	Front frame	Polycarbonate/polybutylene terephthalate alloy		
	Keypad	Polyester		
<b>Keys</b>		12 keys (10 configurable and customizable)		
<b>Electrical characteristics</b>				
<b>Power supply</b>	Voltage	V	5 --- via PLC terminal port	24 ---
	Voltage limits	V	–	18...30 ---
	Ripple factor	%	–	Max. 5
<b>Consumption</b>		W	–	Max. 5
<b>Functional characteristics</b>				
<b>Display</b>	Type	Green backlit ultra-bright LCD (198 x 80 pixels)		Green, orange or red ultra-bright backlit LCD (198 x 80 pixels)
	Capacity (height x width)	From 2 lines of 5 characters (16 x 16 mm) to 10 lines of 33 characters (4 x 2.7 mm)		
	Touch-sensitive area	Matrix, 11 x 5 cells		
	Character fonts	ASCII, Cyrillic, Greek, Katakana and Chinese (simplified)		
<b>Signalling</b>	–		13 LEDs + buzzer	
<b>Dialogue application</b>	Number of pages	200 application pages (10 lines/page max.) 256 alarm pages (10 lines/page max.)		
<b>Memory</b>		512 KB Flash		
<b>Transmission medium</b>	Asynchronous serial link	RS 232C/RS 485		
<b>Downloadable protocols</b>		Uni-TE and Modbus (1)		Uni-TE, Modbus (1) and Zelio (2)
<b>Third-party protocols</b>	Mitsubishi	Melsec	Melsec FX	
	Omron	Sysmac	Sysmacway	
	Rockwell Automation	Allen-Bradley	DF1/DH485	
	Siemens	Simatic	PPI	
<b>Real-time clock</b>		Access to the PLC real-time clock		
<b>Connection</b>	Power supply	Via the PLC terminal port connection cable		Removable screw terminal block, 3 terminals
	Serial link	Connector	Female RJ45 (RS 232C/RS 485)	
		Connection	Point-to-point	Multidrop
	Printer link	No		8-way female mini-DIN

(1) Modbus master for XBT RT500 terminal only  
(2) Requires the use of an 8-way female mini-DIN connector

# Operator dialogue terminals

## Small Panels with touch screen and keypad

### Magelis XBT RT



XBT RT500



XBT RT511

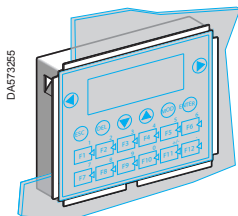

XBT ZR01

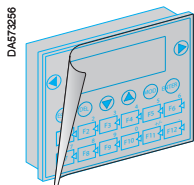

XBT ZR02

#### Magelis Small Panels

Downloadable exchange protocol	Compatible PLCs	Supply voltage	Type of screen	Reference	Weight kg
<b>Terminal with 10 lines of 30 characters (with matrix screen)</b>					
Uni-TE, Modbus	Twido, Nano, TSX Micro, Premium, Modicon M340	5 V $\overline{\text{---}}$ via PLC terminal port	Green backlit LCD (198 x 80 pixels)	<b>XBT RT500</b>	0.550
Uni-TE, Modbus	Twido, Nano, TSX Micro, Premium, TSX Series 7, Momentum, Quantum, other Modbus slave devices, Modicon M340	24 V $\overline{\text{---}}$ external supply	Green, orange or red backlit LCD (198 x 80 pixels) + 13 signalling LEDs + buzzer	<b>XBT RT511</b>	–
Zelio	Zelio Logic				

#### Software

Description	Operating system	Reference
Configuration software	Windows 2000, XP and Vista	See pages 4/7 and 4/17

#### Accessories (1)

Designation	Description	For use with	Reference	Weight kg
Accessory for flush mounting	Kit for applications requiring a higher degree of protection or customization of the control desk, using flat inner insulation (not included)	All XBT RT	<b>XBT ZR01</b>	–
Protective sheets	10 peel-off sheets	All XBT RT	<b>XBT ZR02</b>	–
Sheets of re-usable labels	10 sheets of 6 labels	XBT RT500	<b>XBL YRT00</b>	–
		XBT RT511	<b>XBL YRT01</b>	–
Mechanical adaptor for XBT P/PM substitution		–	<b>XBT ZRCO</b>	–

Description	Compatibility	Type of connector	Physical link	Protocol	Length m	Reference	Weight kg
Downloading adaptor (2)	XBT RT500	RJ45-RJ45	RS 485	Modbus	0.2	<b>XBT ZRT 999</b>	–

(1) For other accessories, see page 1/28.

For other connection cables and accessories, see pages 1/28 to 1/31.

(2) Also included in kit XBT Z 945.

# Operator dialogue terminals

## Small Panels

Separate components for Magelis XBT N/R/RT and Magelis STO/STU

1

Accessories					
Type	Compatibility	Sold in lots of	Unit reference	Weight	kg
External 5 V adaptor (1)	XBT N200/N400 XBT R400 XBT RT500	1	XBT ZRT PW	–	
XBT RT download adaptor (2)	XBT RT500/511	1	XBT ZRT999	–	
Spring clips (replacement parts)	XBT N/R/RT/GT, HMI STO	12	XBT Z3002	0.200	
Power supply connector (replacement parts)	XBT N/R/RT	10	XBT Z3004	0.200	
	HMI STO	5	HMI ZS PWO	–	
	HMI STU	5	XBT ZG PWS1	–	

Connection to PCs and printers					
Used	Compatibility	Length	Peripheral side connector	Reference	Weight kg
Cables for PC connection, RS 232C serial port	XBT N401/N410/NU400 XBT R410/R411	2.5 m	9-way male SUB-D	XBT Z915	0.200
	XBT N200/N400/R400 XBT RT500/RT511	2.5 m	9-way male SUB-D and mini-DIN (PS/2)	XBT Z945	0.200
USB cable for PC connection (3)	XBT N/R/RT	–	USB type A male	TSX CUSB 485	–
	HMI STO/STU	2.5 m	USB type A male	XBT ZG935	–
	HMI STO/STU	1.8 m	USB type mini-B male	BMX XCA USB H018	0.230
XBT adaptor for USB cable	XBT N/R/RT	2 m	Set of 2 cables (RJ45/ RJ45) / 25-way SUB-D	XBT Z925	–
Serial printer cables	XBT N/R/RT	2.5 m	25-way female SUB-D	XBT Z926	0.220
	HMI STO/STU	1.8 m	9-way male SUB-D	HMI ZURS	–
USB host extension cable	HMI STO/STU	2 m	Dust and damp proof USB type A male	XBT ZG USB	0.220
USB device extension cable	HMI STO/STU	2 m	Dust and damp proof USB type mini-B male	HMI ZS USBB	–

(1) Use a 5 V  $\overline{\text{DC}}$  power supply: ABL 8MEM 05040

(2) XBT Z945 cable included

(3) Adaptor to be used with XBT Z925 cable

## Operator dialogue terminals

## Small Panels

Separate components for Magelis XBT N/R/RT and Magelis STO/STU

## Cables for connecting Magelis terminals

Type of PLC to be connected	Type of connector	Physical link	Protocol	Length	Reference	Weight kg
<b>Direct connection of XBT N/R/RT (XBT N200/N400/R400/RT500/RT511) and HMI STO/STU terminals to Schneider Electric PLCs</b>						
Twido, Modicon Nano, Modicon TSX Micro, Modicon Premium	Mini-DIN	RS 485	Modbus/Uni-TE	2.5 m	<b>XBT Z9780</b>	–
				10 m	<b>XBT Z9782 (1)</b>	–
Modicon M340	RJ45	RS 485	Modbus	2.5 m	<b>XBT Z9980</b>	–
				10 m	<b>XBT Z9982 (1)</b>	–

<b>Direct connection of XBT N/R (XBT N410/N401/R410/R411) terminals to Schneider Electric PLCs</b>						
Twido, Modicon Nano, Modicon TSX Micro, Modicon Premium	8-way female mini-DIN terminal port	RS 485	Uni-TE (V1/V2) and Modbus	2.5 m	<b>XBT Z968</b>	0.180
				5 m	<b>XBT Z9681</b>	0.340
				2.5 m (2)	<b>XBT Z9680</b>	0.170
Modicon Premium with TSX SCY 2160●	25-way female SUB-D	RS 485	Uni-TE (V1/V2)	2.5 m	<b>XBT Z918</b>	0.230
Modicon Quantum	9-way male SUB-D	RS 232	Modbus	2.5 m	<b>XBT Z9710</b>	0.210
Advantys STB	HE13 (NIM)	RS 232	Modbus	2.5 m	<b>XBT Z988</b>	0.170
Modicon Momentum M1 (port 1)	RJ45	RS 232	Modbus	2.5 m	<b>XBT Z9711</b>	0.210
Modicon M340	RJ45	RS 485	Modbus	2.5 m	<b>XBT Z938</b>	0.210

<b>Direct connection of XBT N/R/RT (XBT N401/R411/RT511) terminals to Schneider Electric PLCs via the 2nd mini-DIN serial port and Vijeo Designer Lite 1.3 minimum</b>						
Zelio Logic	Programming port	–	Zelio	3 m	<b>SR2 CBL 08</b>	–

(1) For XBT N200/N400/R400/RT500, use a cable with adaptor **XBT ZRT PW** and a 5 V  $\pm$  power supply.

(2) Angled SUB-D connector

## Operator dialogue terminals

## Small Panels

Separate components for Magelis XBT N/R/RT and Magelis STO/STU

1

**Cables for connecting Magelis terminals (continued)****Direct connection of XBT RT500/RT511 and Magelis STO/STU terminals to Advantys STB I/O (1)**

Advantys STB	HE13 (NIM)	RS 232	Modbus	2.5 m	XBT Z9715	–
--------------	------------	--------	--------	-------	-----------	---

**Direct connection of XBT (XBT NU400/N410/N401/R410/R411) terminals to Schneider Electric motor starters and drives**

TeSys U, T ATV 312/32/61/71 drives ATS 48 starter Lexium 32, Preventa XPSMC	RJ45	RS 485	Modbus	2.5 m	XBT Z938	0.210
--	------	--------	--------	-------	----------	-------

**Direct connection of XBT (XBT N200/N400/R400/RT500/RT511) and Magelis STO/STU terminals to Schneider Electric motor starters and drives (2)**

TeSys U, T ATV 312/32/61/71 drives ATS 48 starter Lexium 32, Preventa XPSMC	RJ45	RS 485	Modbus	2.5 m	XBT Z9980	–
--	------	--------	--------	-------	-----------	---

**Direct connection of XBT (XBT N410/N401/R410/R411) terminals to third-party PLCs**

Allen-Bradley	SLC5	9-way male SUB-D	RS 232	DF1	2.5 m	XBT Z9730	0.210
	PLC5	25-way female SUB-D	RS 232	DF1	2.5 m	XBT Z9720	0.210
	Micro-logix	Micro-logix 1000	RS 232	DF1	2.5 m	XBT Z9731	0.210
DH485				2.5 m	XBT Z9732	–	
Mitsubishi	FX	8-way female mini-DIN	RS 232/ RS 422 converter	Melsec FX	2.5 m	XBT Z980	–
Omron	CPM1, CPM2, CJ1, CS1	9-way male SUB-D	RS 232	Sysmacway	2.5 m	XBT Z9740	0.210
Siemens	S7 (PG)	9-way male SUB-D	RS 485	PPI	2.5 m	XBT Z9721	0.210

**Direct connection of the XBT RT500/RT511 and Magelis STO/STU terminal to third-party PLCs (1)**

Allen-Bradley	SLC5	9-way male SUB-D	RS 232	DF1	2.5 m	XBT Z9734	–
	Micro-logix	Micro-logix 1000	RS 232	DF1	2.5 m	XBT Z9733	–
Mitsubishi	FX	8-way female mini-DIN	RS 232/ RS 422 converter	Melsec FX	2.5 m	XBT Z980 + (3)	–
Omron	CPM1, CPM2, CJ1, CS1	9-way male SUB-D	RS 232	Sysmacway	2.5 m	XBT Z9743	–
Siemens	S7 (PG)	9-way male SUB-D	RS 485	PPI	2.5 m	XBT ZG9721	0.210

(1) For XBT RT500, use a cable with adaptor XBT ZRT PW and a 5 V  $\overline{\text{---}}$  power supply.(2) For Magelis XBT N200/N400/R400/RT500, use a cable with adaptor XBT ZRT PW and a 5 V  $\overline{\text{---}}$  power supply.

(3) Adaptor XBT ZG939 to be used with cables with " + (3) " after the reference.

## Operator dialogue terminals

## Small Panels

Separate components for Magelis XBT N/R/RT and Magelis STO/STU

## Cables for connecting Magelis terminals (continued)

## Bus and network connections for XBT N410/N401/R410/R411 terminals

Type of bus/network	Tap-off units	Type of connector	Length	Reference	Weight kg
Uni-Telway serial link	Subscriber socket TSX SCA 62	15-way female SUB-D	1.8 m	XBT Z908	0.240
			2.5 m		
	Connection box TSX P ACC 01	8-way female mini-DIN	5 m	XBT Z9681	0.340
			10 m	XBT Z9686	
			20 m	XBT Z9687	
25 m	XBT Z9688				
Modbus serial link	Subscriber socket TSX SCA 64	15-way female SUB-D	1.8 m	XBT Z908	0.240
	8-port Modbus splitter box LU9 GC3, Modbus tap-off, TWD XCA ISO, TWD XCA T3RJ	RJ45	2.5 m	XBT Z938	0.210

## Bus and network connections for XBT RT511 and Magelis STO/STU terminals

Type of bus/network	Tap-off units	Type of connector	Length	Reference	Weight kg
Uni-Telway serial link	Connection box TSX P ACC 01	8-way female mini-DIN	2.5 m	XBT Z9780	0.180
Modbus serial link	8-port Modbus splitter box LU9 GC3, Modbus tap-off, TWD XCA ISO, TWD XCA T3RJ	RJ45	2.5 m	XBT Z9980	–

**Dimensions**

**HMI STO 511/512**

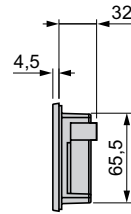
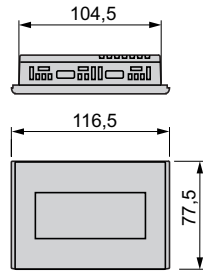

**HMI STU 655**

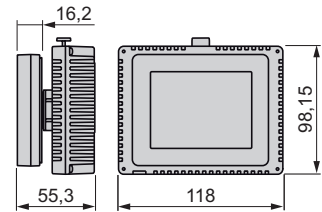

**HMI STO 511/512 with spring clip fixing**

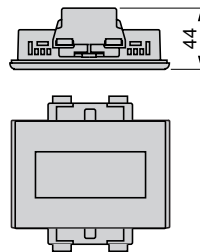

**Mounting**

**HMI STO 511/512**

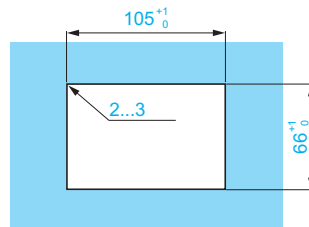

Panel thickness = 1.5...6

**HMI STU 655**

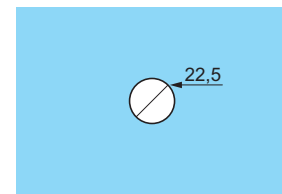

Panel thickness = 1.5...6



## Dimensions

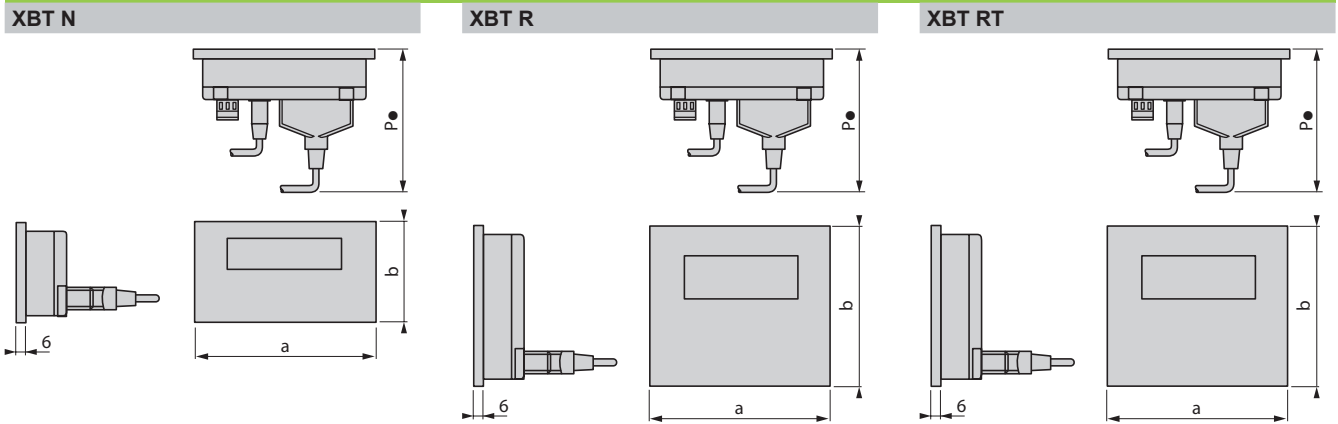

	a	a1 (1)	b	b1 (1)	P1 (2)	P2 (3)	P3 (4)	P4 (5)
XBT N200/N400	132	–	74	104	78	–	–	–
XBT N401/N410	132	–	74	104	–	–	58	104
XBT NU400	132	–	74	104	–	104	–	–
XBT R400	137	160	118	146	78	–	–	–
XBT R410/R411	137	160	118	146	–	–	58	104
XBT RT	137	160	118	146	79	104	58	104

(1) With fixing clips (included with product)

(2) P1: depth with RJ45 cable **XBT Z9780** (for Twido, TSX Micro and Premium)

(3) P2: depth with 25-way SUB-D cable **XBT Z938** (for TeSys model U and ATV 61/71 drives)

(4) P3: depth with 25-way SUB-D angled cable **XBT Z9680** (for Twido, TSX Micro and Premium) or **XBT Z998** (for Advantys STB)

(5) P4: depth with 25-way SUB-D cable **XBT Z68/Z9681** (for Twido, TSX Micro and Premium)

## Mounting

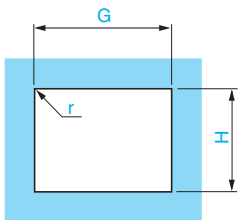

Panel thickness = 1.5...6

Graphic display terminals	Cut-out for flush mounting		
	H (±0.4 mm)	G (±0.5 mm)	r
XBT N	63	119.4	1.5 max.
XBT R	105.2	119.6	1.5 max.
XBT RT	105.2	119.6	1.5 max.

<b>Applications</b>	<b>Display of text messages, graphic objects and synoptic views Control and configuration of data</b>
---------------------	---

<b>Type of terminal</b>	<b>Touch screen Advanced Panels</b>
-------------------------	-------------------------------------

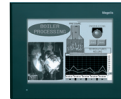

Display	Type	Backlit monochrome (amber or red mode) STN LCD (320 x 240 pixels) or TFT LCD	Backlit monochrome or colour STN LCD or backlit colour TFT LCD (320 x 240 pixels or 640 x 480 pixels) (3)	Backlit colour STN LCD or TFT LCD (640 x 480 pixels)
	Capacity		3.8" (monochrome or colour)	5.7" (monochrome or colour)

<b>Data entry</b>	Via touch screen
	–
	–
	–
	–

<b>Memory capacity</b>	Application	32 MB Flash EPROM	16 MB Flash EPROM (3)	32 MB Flash EPROM
	Expansion	–	By means of 128, 256, 512 MB, 1, 2 or 4 GB CF card (except XBT GT2110)	

<b>Functions</b>	Maximum number of pages	Limited by internal Flash EPROM memory capacity	Limited by capacity of internal Flash EPROM memory or CF card memory		
	Variables per page	Unlimited (8000 variables max.)			
	Representation of variables	Alphanumeric, bitmap, bargraph, gauge, tank, tank level indicator, curves, polygon, button, LED			
	Recipes	32 groups of 64 recipes comprising 1024 ingredients max.			
	Curves	Yes, with log			
	Alarm logs	Yes			
	Real-time clock	Built-in			
	Discrete I/O	–		1 input (reset) and 3 outputs (alarm, buzzer, run)	
	Multimedia I/O	–	(3)	1 audio input (microphone), 1 composite video input (digital or analog video camera), 1 audio output (loudspeaker) (1)	

<b>Communication</b>	Downloadable protocols	Uni-TE (2), Modbus, Modbus TCP/IP (1) and for PLC brands: Mitsubishi, Omron, Allen-Bradley and Siemens		
	Asynchronous serial link	RS 232C/485 (COM1)	RS 232C/RS 422/485 (COM1) and RS 485 (COM2)	
	USB ports	1	1 (3)	2
	Buses and networks	–	Modbus Plus and Fipway with USB gateway, Profibus DP and Device Net with optional card	
		Ethernet TCP/IP (10BASE-T/100BASE-TX) (1)		
	Printer link	USB port for parallel printer	RS 232C (COM1) serial link, USB port for parallel printer	

<b>Development software</b>	Vijeo Designer (36349/11) (on Windows XP, Windows Vista and Windows 7)		
<b>Operating system</b>	Magelis (200 MHz RISC CPU)	Magelis (133 MHz RISC CPU) (3)	Magelis (266 MHz RISC CPU)

<b>Type of terminal</b>	<b>XBT GT11/13</b>	<b>XBT GT21/22/23/24/29</b>	<b>XBT GT42/43</b>
-------------------------	--------------------	-----------------------------	--------------------

<b>Pages</b>	1/64
--------------	------

(1) Depending on model.  
 (2) Uni-TE version V2 for Twido controller and TSX Micro/Premium platform.  
 (3) For XBTGT 2430, 32 MB Flash EPROM, 1 sound output, 2 USB ports, 266 MHz RISC CPU  
 (4) For XBT GT 5430

**Display of text messages, graphic objects and synoptic views  
Control and configuration of data**

**Touch screen Advanced Panels**

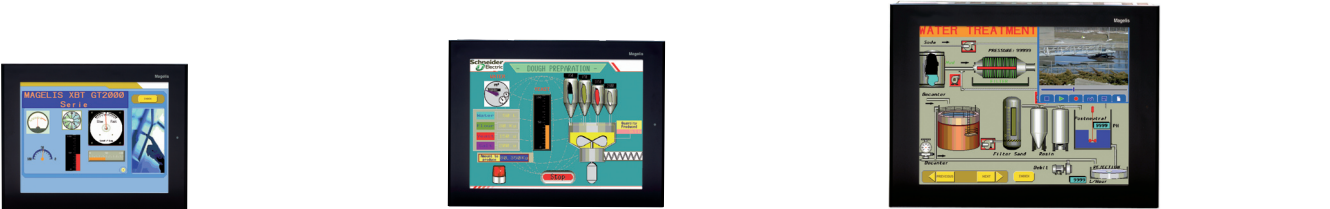

Backlit colour STN LCD or TFT LCD (640 x 480 pixels or 800 x 600 pixels) (4)	Backlit colour TFT LCD (800 x 600 pixels)	Backlit colour TFT LCD (1024 x 768 pixels)
10.4" (colour)	12.1" (colour)	15" (colour)

Via touch screen

—

—

—

—

32 MB Flash EPROM  
By means of 128, 256, 512 MB, 1, 2 or 4 GB CF card

Limited by capacity of internal Flash EPROM memory or CF card memory

Unlimited (8000 variables max.)  
Alphanumeric, bitmap, bargraph, gauge, tank, tank level indicator, curves, polygon, button, LED

32 groups of 64 recipes comprising 1024 ingredients max.

Yes, with log

Yes

Built-in

1 input (reset) and 3 outputs (alarm, buzzer, run)

1 audio input (microphone), 1 composite video input (digital or analog video camera), 1 audio output (loudspeaker) (1)

Uni-TE (2), Modbus, Modbus TCP/IP (1) and for PLC brands: Mitsubishi, Omron, Allen-Bradley and Siemens

RS 232C/RS 422/485 (COM1) and RS 485 (COM2)

2

Modbus Plus with USB gateway

Ethernet TCP/IP (10BASE-T/100BASE-TX)

RS 232C (COM1) serial link, USB port for parallel printer

Vijeo Designer (36349/11) (on Windows XP, Windows Vista and Windows 7)

Magelis  
(266 MHz RISC CPU)

**XBT GT52/53/54                      XBT GT63                      XBT GT73**

1/64

# Operator dialogue terminals

## Magelis GT, GK, GH and GTW Advanced Panels

1

<b>Applications</b>	Display of text messages, graphic objects and synoptic views Control and configuration of data			
<b>Type of terminal</b>	Advanced Panels with keypad			
				
<b>Display</b>	Type	Colour TFT LCD (320 x 240 pixels) or monochrome STN	Colour TFT LCD (640 x 480 pixels)	
	Capacity	5.7" (monochrome or colour)	10.4" (colour)	
<b>Data entry</b>	Via keypad and/or touch screen (configurable) and/or by industrial pointer			
	Static function keys	10	12	
	Dynamic function keys	14	18	
	Service keys	8		
<b>Memory capacity</b>	Application	16 MB Flash EPROM	32 MB Flash EPROM	
	Expansion	By means of 128, 256, 512 MB, 1, 2 or 4 GB CF card		
<b>Functions</b>	Maximum number of pages	Limited by capacity of internal Flash EPROM memory or CF card memory		
	Variables per page	Unlimited (8000 variables max.)		
	Representation of variables	Alphanumeric, bitmap, bargraph, gauge, tank, tank level indicator, curves, polygon, button, LED		
	Recipes	32 groups of 64 recipes comprising 1024 ingredients max.		
	Curves	Yes, with log		
	Alarm logs	Yes		
	Real-time clock	Built-in		
	Discrete I/O	–	1 input - 3 outputs	
	Multimedia I/O	–	–	
	<b>Communication</b>	Downloadable protocols	Uni-TE (2), Modbus, Modbus TCP/IP (1) and for PLC brands: Mitsubishi, Omron, Allen-Bradley and Siemens	
Asynchronous serial link		RS 232C/RS 422/485 (COM1) RS 485 (COM2)		
USB ports		1	2	
Buses and networks		Modbus Plus, Fipway with USB gateway, Profibus DP and Device Net with optional card Ethernet TCP/IP (10BASE-T/100BASE-TX)		
Printer link		RS 232C (COM1) serial link, USB port for parallel printer		
<b>Development software</b>	Vijeo Designer (36349/11) (on Windows XP, Windows Vista and Windows 7)			
<b>Operating system</b>	Magelis (266 MHz RISC CPU)			
<b>Type of terminal</b>	<b>XBT GK 21/23</b>		<b>XBT GK 53</b>	
<b>Pages</b>	1/65 (1) Depending on model. (2) Uni-TE version V2 for Twido controller and TSX Micro/Premium platform.			

**Display of text messages, graphic objects and synoptic views  
Control and configuration of data**

**Portable Advanced Panels**

**Open touch screen Advanced Panels**

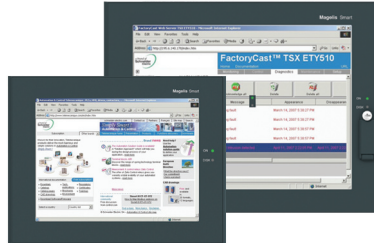

Colour TFT LCD (640 x 480 pixels)	Colour TFT LCD (800 x 600 pixels)	Colour TFT LCD (800 x 600 pixels)	Colour TFT LCD (1024 x 768 pixels)
5.7" (colour)	8.4" (colour)	12" (colour)	15" (colour)
Via touch screen	Via touch screen		
11	–		
–	–		
–	–		
–	–		
32 MB Flash EPROM	1 GB CF system card included with terminal, expandable to 4 GB	2 GB CF system card included with terminal, expandable to 4 GB	
By means of 128, 256, 512 MB, 1, 2 or 4 GB CF card			
Limited by capacity of internal Flash EPROM memory or CF card memory			
Unlimited (8000 variables max.)			
Alphanumeric, bitmap, bargraph, gauge, tank, tank level indicator, curves, polygon, button, LED			
32 groups of 64 recipes comprising 1024 ingredients max.			
Yes, with log			
Yes			
Built-in			
–			
1 audio output			
Uni-TE (2), Modbus, Modbus TCP/IP and for PLC brands: Mitsubishi, Omron, Rockwell Automation and Siemens	Uni-TE (2), Modbus, Modbus TCP/IP (1) and for PLC brands: Mitsubishi, Omron, Allen-Bradley and Siemens		
RS 232C/RS 422-485 (COM1)	RS 232C (COM1) RS 232C (COM2)	RS 232C (COM1)	RS 232C (COM1) RS 232C (COM2)
1	4	4 + 1 front-mounted	
–	Modbus Plus with USB gateway		
1 Ethernet port (10BASE-T/100BASE-TX)	1 TCP/IP Ethernet port (10BASE-T/100BASE-TX) and 1 Ethernet port (10BASE-T/100BASE-TX/1 GB)		
–	RS 232C (COM1 or COM2) serial link, USB port for parallel printer		
Vijeo Designer (36349/11) (on Windows XP, Windows Vista and Windows 7)			
Magelis (266 MHz RISC CPU)	Windows XP Embedded		

<b>XBT GH 2460</b>	<b>XBT GTW 450</b>	<b>XBT GTW 652</b>	<b>HMI GTW 7353</b>
--------------------	--------------------	--------------------	---------------------

1/65	1/66		
------	------	--	--

(1) Depending on model.  
(2) Uni-TE version V2 for Twido controller and TSX Micro/Premium platform.

# Operator dialogue terminals

## Magelis GT, GK, GH and GTW

### Advanced Panels

1

#### Presentation



*Touch screen terminals with monochrome or colour screen in 6 sizes from 3.8" to 15"*

The Magelis Advanced Panels touch screen terminals offer consists of:

- A range of 20 touch screen terminals (XBT GT) available with a wide choice of screen sizes (3.8", 5.7", 7.5", 10.4" 12.1" and 15") in various versions (monochrome, colour, STN or TFT)
- An XBT GT 5.7" terminal (XBT GT 2930) equipped with a screen featuring an anti-reflection coating and a backlit display that is twice as intense for applications in brightly-lit environments, in particular those which are exposed to sunlight
- A range of 3 keypad/touch screen terminals (XBT GK), sizes 5.7" and 10.4" (monochrome, colour)
- A range of touch screen/open terminals (GTW), sizes 8.4", 12" and 15", with Windows XP Embedded operating system for open access to new automation functions
- A portable touch screen terminal (XBT GH) with 5.7" colour screen and safety devices (emergency stop, enabling grip switch, etc.)

#### Operation

Magelis Advanced Panels feature new information and communication technologies which, depending on the model, include:

- High level of communication (on-board Ethernet, multilink, Web server and FTP)
- External storage of data (Compact Flash memory card and USB memory stick) for storing production data and backing up applications
- Multimedia data with integrated image and sound management (digital or analog camera)
- Management of peripherals: printers, bar code readers, loudspeakers, etc.



Display of a video sequence

### Configuration

Magelis Advanced Panels can be configured using Vijeo Designer software in a Windows XP or Windows Vista environment. Vijeo Designer software boasts an advanced user interface with many configurable windows, enabling projects to be developed quickly and easily. This version enables composite video signal processing from a camera or camcorder. See page 4/8.

### Communication

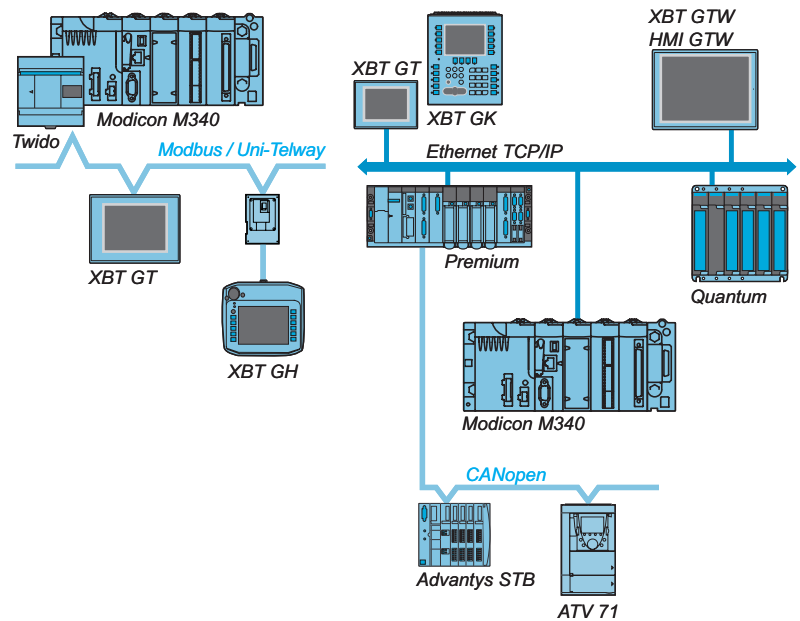

Magelis Advanced Panels communicate with PLCs via one or two integrated serial links, using communication protocols:

- Schneider Electric (Uni-TE, Modbus)
- Third party: Mitsubishi Electric, Omron, Allen-Bradley and Siemens

Depending on the model, Magelis multifunction terminals can be connected to Ethernet TCP/IP networks using Modbus TCP or third-party protocols, and to fieldbuses (FIPWAY, Modbus Plus, Device Net, Profibus DP).

#### Functions

Magelis Advanced Panels offer the following functions:

- Display of animated synoptic views with 8 types of animation (press on touch panel, change of colour, filling, movement, rotation, size, visibility or value display)
- Control and modification of numeric or alphanumeric variables
- Display of current date and time
- Real-time and trending curves with log
- Alarm display, alarm log and management of alarm groups
- Multiwindow management
- Operator-initiated page calls
- Multilingual application management (10 languages at the same time)
- Recipe management
- Data processing via Java script
- Application and log storage on external Compact Flash application memory card (multifunction range) or USB memory stick
- Serial printer and bar code reader management (multifunction range)
- Sound messages management (multifunction range)
- Composite video signal management from camera or camcorder on XBT GT and digital video signal (Webcam) management on Magelis GTW

Magelis Advanced Panels have been designed for Transparent Ready architectures and equipment (combination of web and Ethernet TCP/IP technologies). Therefore, all terminals with an Ethernet port feature a built-in FTP server for data file transfer and a Web Gate function for remote access to the application of the terminal from a PC with an Internet browser.

The latest version of Vijeo Designer thus allows Magelis Advanced Panels to browse HTML pages and send e-mails.

The flexible nature of Windows XP Embedded enables Internet Explorer or Office Readers (.pdf, .doc, .xls, .ppt documents) to be used on touch screen/open Magelis GTW Advanced Panels while a Vijeo Designer application is running.



### Panel operating modes

The following illustrations show the equipment that can be connected to Magelis Advanced Panels terminals according to their two operating modes.

#### Edit mode

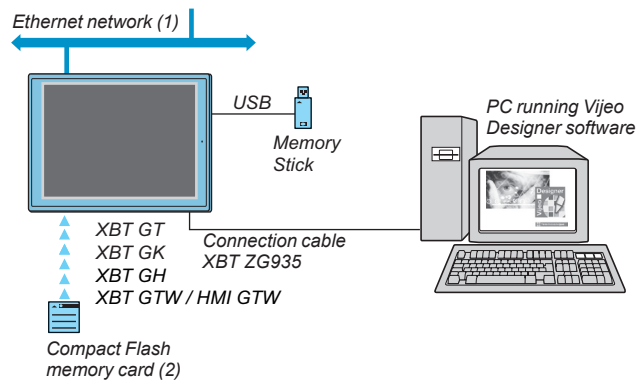

#### Run mode

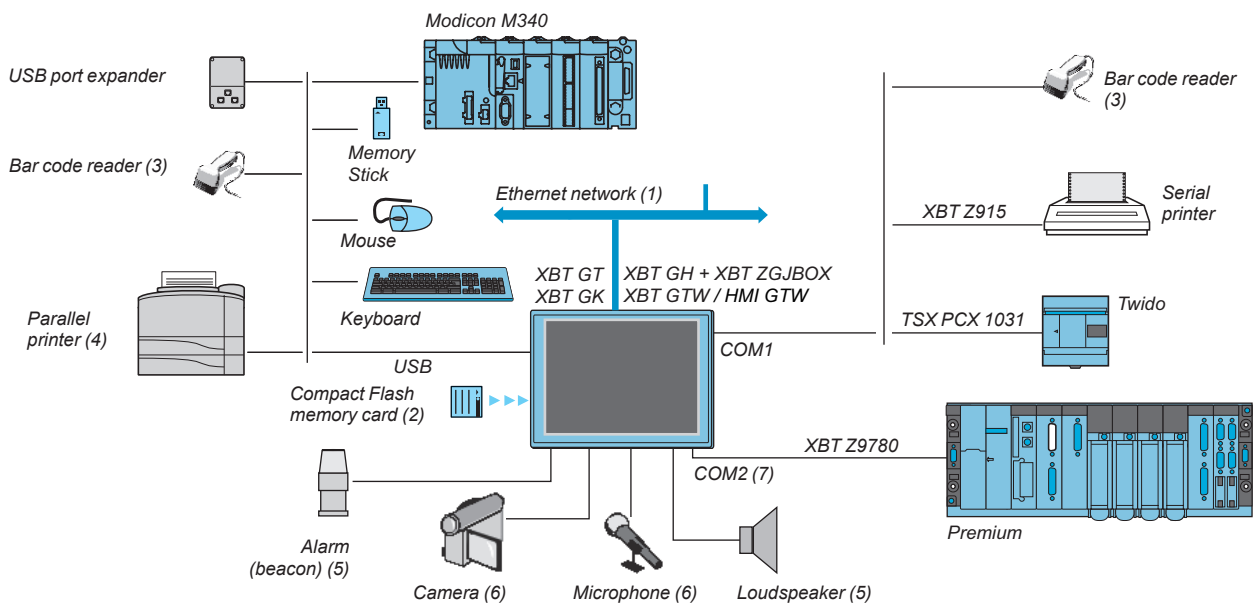

- (1) With XBT GT●●30/XBT GT●●40, XBT GK●●30/XBT GTW●●●0/XBT GH2460
- (2) Memory card, except XBT GT11/13/2110.
- (3) Validated with DataLogic Gryphon bar code reader.
- (4) Validated with Hewlett Packard printer via USB/PIO converter.
- (5) With any multifunction XBT GT, XBT GK, XBT GTW and HMI GTW 7.5" to 15".
- (6) With multimedia XBT GT 7.5" to 15" XBT GT●340.
- (7) With XBT GT and XBT GK 5.7" screen min.

### Improve environmental resistance with Conformal Coating

The Conformal Coating service offer consists of varnishing the electronic cards to prolong the service life of the terminals and enable them to be used in corrosive environments. The varnishing increases resistance to condensation, dusty atmospheres and chemical corrosion (sulphurous and halogenous atmospheres).

For further information on this service offer, please consult our Customer Care Centre.

### Description

#### Magelis XBT GT1105/1135/1335 Advanced Panels

#### Front panel

The front panels of Magelis XBT GT1105/1135/1335 Advanced Panels comprise:

- 1 A touch screen for displaying synoptic views (3.8" amber or red mode monochrome, colour TFT)
- 2 A control LED indicating the operating mode of the terminal



#### Rear panel

The rear panels of Magelis XBT GT1105/1135/1335 Advanced Panels comprise:

- 1 A removable screw terminal block for the 24 V  $\overline{\text{---}}$  power supply
- 2 An RJ45 connector for RS 232C or RS 485 serial link connection to PLCs (COM1)
- 3 A USB type A host connector for peripheral connection, application transfer and Modicon M340 terminal port communication
- 4 A switch for polarization of the serial link used on RS 485 Modbus

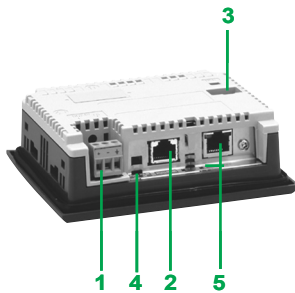

#### On XBT GT1135/1335 only

- 5 An RJ45 connector for Ethernet TCP/IP link, 10/100BASE-T

Type of terminal		XBT GT1105	XBT GT1135	XBT GT1335	
<b>Environment</b>					
<b>Conformity to standards</b>		EN 61131-2, IEC 61000-6-2, FCC (Class A), UL 508, UL 1604, CSA C22-2 no. 14			
<b>Product certifications</b>		CE, cULus, CSA, Class 1 Div 2 T4A or T5 (UL and CSA), C-Tick, ATEX Zone 2/22			
<b>Temperature</b>	Operation	0...50°C			
	Storage	-20...+60°C			
<b>Relative humidity</b>		0...85% (non-condensing)	0...90% (non-condensing)		
<b>Altitude</b>		< 2000 m			
<b>Degree of protection</b>	Front panel	IP 65 conforming to IEC 60529, Nema 4X (with fixing by means of 4 screw clips)			
	Rear panel	IP 20 conforming to IEC 60529			
<b>Shock resistance</b>		Conforming to IEC 60068-2-27; semi-sinusoidal pulse 11 ms, 15 gn on the 3 axes			
<b>Vibrations</b>		Conforming to IEC 60068-2-6; 5...9 Hz at 3.5 mm; 9...150 Hz at 1 gn			
<b>E.S.D.</b>		Conforming to IEC 61000-4-2, level 3			
<b>Electromagnetic interference</b>		Conforming to IEC 61000-4-3, 10 V/m			
<b>Electrical interference</b>		Conforming to IEC 61000-4-4, level 3			
<b>Mechanical characteristics</b>					
<b>Mounting and fixing</b>	Mounting on 1.6...5 mm thick panel	Flush mounted, fixed by 4 screw clips (included) or 2 spring clips (to be ordered separately)			
<b>Material</b>	Case	Polycarbonate/polyethylene terephthalate alloy			
<b>Keys</b>		-			
<b>Electrical characteristics</b>					
<b>Power supply</b>	Voltage	24 V ---			
	Limits	19.2...28.8 V ---			
	Voltage break	≤ 2 ms			
<b>Inrush current</b>		≤ 60 A			
<b>Consumption</b>		13 W			
<b>Functional characteristics</b>					
<b>LCD screen</b>	Type	Backlit monochrome STN		Colour TFT	
	Colour	Amber or red, 8 levels of grey		256 colours	
	Definition	320 x 240 pixels (QVGA)			
	Size (W x H)	3.8" (76.7 x 57.5 mm)			
	Touch-sensitive area		Analog		
	Backlighting (service life)		50,000 hours used in amber mode, 10,000 hours used in red mode	40,000 hours	
	Adjustments	Brightness	16 levels		
Contrast		8 levels via touch panel		-	
Character fonts		ASCII, Japanese (ANK, Kanji), Chinese (simplified Chinese), Taiwanese (traditional Chinese), Korean			
<b>Dialogue application</b>	Max. number of pages	Limited by capacity of internal Flash EPROM memory			
<b>Signalling</b>		1 LED: green for normal operation			
<b>Operating system/processor</b>		Magelis RISC CPU	200 MHz		
<b>Memory</b>	Application	Flash EPROM	32 MB		
	Data backup	512 KB SRAM (lithium batteries)			
<b>Schneider Electric protocols</b>		Modicon	Modbus, Uni-TE	Modbus, Uni-TE and Modbus TCP	
<b>Third-party protocols</b>	Mitsubishi	Melsec	A Link (SIO)	A/Q Ethernet (TCP), Q Ethernet (UDP)	
		Omron	Sysmac	FINS (SIO), LINK (SIO)	
	Rockwell Automation	Allen-Bradley	DF1-Full Duplex, DH 485		
			-		Ethernet IP (PLC5, SLC500, MicroLogix, ControlLogix), Ethernet IP (native)
	Siemens	Simatic	MPI (S7-300/400), RK512/3964R (S7-300/400), PPI (S7-200)	-	
<b>Real-time clock</b>		Built-in real-time clock			
<b>Connection</b>	Power supply	Removable screw terminal block: 3 terminals (pitch 5.08 mm), tightening torque 0.5 Nm			
	COM1 serial link (115.2 kbps max.)	RJ45 connector (RS 232C/RS 485 serial link), compatible with Siemens MPI (187.5 kbps)			
	Ethernet TCP/IP network 10/100Base-TX	-	RJ45 connector		
<b>Mini-DIN port</b>	Application downloading	-			
	USB port (V1.1) for downloading applications, peripheral connection and Modicon M340 terminal port communication	Type A host			

#### Description

#### Magelis XBT GT2110 and multifunction XBT GT220 & XBT GT230 Advanced Panels

##### The front panel comprises:

- 1 A touch screen for displaying synoptic views (5.7" monochrome or colour)
- 2 A multicolour LED (green, orange and red) indicating the operating mode of the terminal

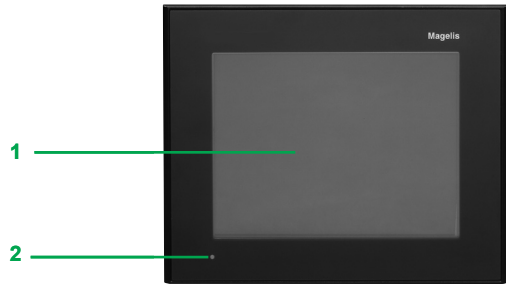

##### The rear panel comprises:

- 1 A removable screw terminal block for 24 V  $\bar{\bar{}}$  power supply
- 2 A USB type A host connector for peripheral connection, application transfer and Modicon M340 terminal port communication
- 3 A 9-way male SUB-D connector for RS 232C or RS 422/485 serial link to PLCs (COM1)
- 4 An expansion unit interface for fieldbus communication card (Device Net, PROFIBUS DP) (1)
- 5 A switch for polarization of the COM2 serial link, used on Modbus
- 6 An RJ45 connector for RS 485 serial link (COM2)
- 7 A Compact Flash memory card slot, with cover (except XBT GT2110 optimum model)

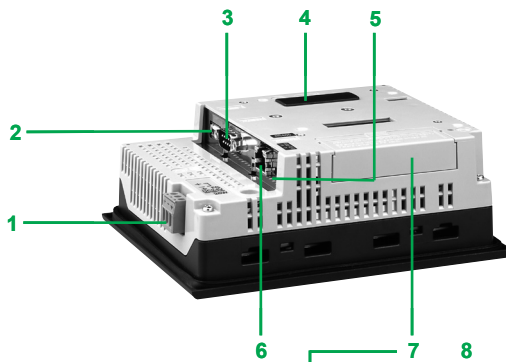

##### On XBT GT2130, GT2330 and GT 2930 only:

- 8 An RJ45 connector for Ethernet TCP/IP link, 10BASE-T/100BASE-TX

##### On XBT GT2430 only:

- 8 An RJ45 connector for Ethernet TCP/IP link, 10BASE-T/100BASE-TX
- 9 A mini-jack connector for audio output

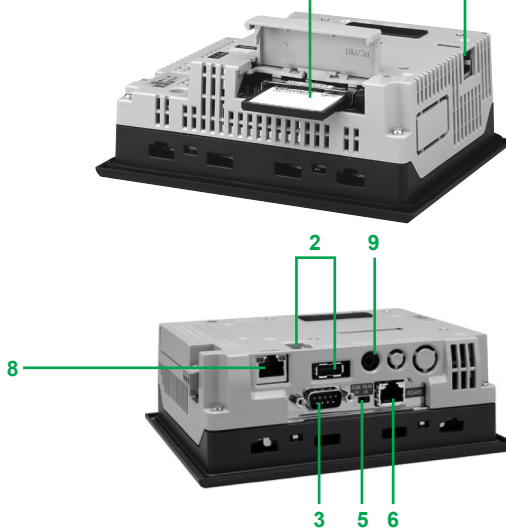

Type of terminal	XBT GT2110	GT2120	GT2130	GT2220	GT2330	GT 2930	GT 2430
<b>Environmental characteristics</b>							
Conformity to standards	EN 61131-2, IEC 61000-6-2, FCC (Class A), UL 508, UL 1604 (3), CSA C22-2 n°14 (4)						
Product certifications	CE, cULus, CSA (4), Class 1 Div 2 T4A (3) or T5 (UL and CSA) (4), C-Tick, ATEX Zone 2/22 (4)						
Temperature	Operation	0...50°C					
	Storage	- 20...+ 60°C					
Relative humidity		0...85% (non-condensing)	0...90% (non-condensing)				
Altitude		< 2000 m					
Degree of protection	Front panel	IP 65 conforming to IEC 60529, Nema 4X (3)					
	Rear panel	IP 20 conforming to IEC 60529					
Shock resistance		Conforming to IEC 60068-2-27; semi-sinusoidal pulse 11 ms, 15 gn on the 3 axes					
Vibrations		Conforming to IEC 60068-2-6; 5...9 Hz at 3.5 mm; 9...150 Hz at 1 g					
E.S.D.		Conforming to IEC 61000-4-2, level 3					
Electromagnetic interference		Conforming to IEC 61000-4-3, 10 V/m					
Electrical interference		Conforming to IEC 61000-4-4, level 3					

(1) See page 1/73 for details of the required connection accessories



1

#### Description

#### Magelis XBT GT4230 & 4300 Advanced Panels



#### The front panel comprises:

- 1 A touch screen for displaying synoptic views (7.5" colour STN or 7.5" colour TFT, depending on the model)
- 2 A multicolour LED (green, orange and red) indicating the operating mode of the terminal

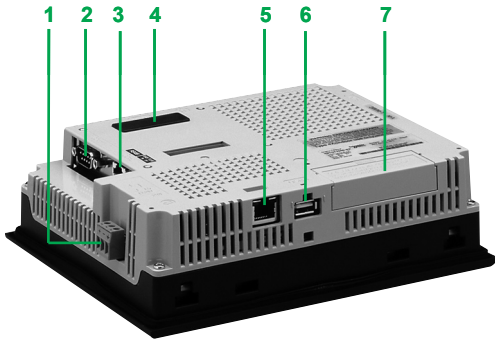

#### The rear panel comprises:

- 1 A removable screw terminal block for 24 V  $\bar{\text{---}}$  power supply
- 2 A 9-way male SUB-D connector for RS 232C or RS 422/485 serial link to PLCs (COM1)
- 3 An RJ45 connector for RS 485 serial link (COM2) with switch for polarization of the link used on Modbus
- 4 An expansion unit interface for fieldbus communication card (Device Net, PROFIBUS DP) (1)
- 5 An RJ45 connector for Ethernet TCP/IP link, 10BASE-T/100BASE-TX, with an activity LED
- 6 A USB type A host connector for peripheral connection, application transfer and Modicon M340 terminal port communication
- 7 A slot for Compact Flash memory card, with hinged cover
- 8 A removable input/output terminal block with 12 spring terminals for loudspeaker connection, one input (reset) and 3 outputs (alarm, buzzer, run)



#### On XBT GT4340 only:

- 9 A mini-jack connector for microphone connection
- 10 An RCA connector for connection of a digital or analog video camera (NTSC/PAL)

(1) See page 1/73 for details of the required connection accessories

Type of terminal		XBT GT4230	XBT GT4330	XBT GT4340	
<b>Environment</b>					
<b>Conformity to standards</b>		EN 61131-2, IEC 61000-6-2, FCC (Class A), UL 508, UL 1604, CSA C22-2 no. 14			
<b>Product certifications</b>		CE, cULus, CSA, Class 1 Div 2 T4A or T5 (UL and CSA), C-Tick, ATEX Zone 2/22			
<b>Temperature</b>	Operation	0...50°C			
	Storage	-20...+60°C			
<b>Relative humidity</b>	Operation/storage	10...90% (non-condensing)			
<b>Altitude</b>		< 2000 m			
<b>Degree of protection</b>	Front panel	IP 65 conforming to IEC 60529, Nema 4X (with fixing by means of 4 screw clips)			
	Rear panel	IP 20 conforming to IEC 60529			
<b>Shock resistance</b>		Conforming to IEC 60068-2-27; semi-sinusoidal pulse 11 ms, 15 gn on the 3 axes			
<b>Vibrations</b>		Conforming to IEC 60068-2-6; 5...9 Hz at 3.5 mm; 9...150 Hz at 1 g			
<b>E.S.D.</b>		Conforming to IEC 61000-4-2, level 3 (contact 6 kV, air 8 kV)			
<b>Electromagnetic interference</b>		Conforming to IEC 61000-4-3, 10 V/m			
<b>Electrical interference</b>		Conforming to IEC 61000-4-4, level 3 (power supply and I/O 2 kV, other ports 1 kV)			
<b>Mechanical characteristics</b>					
<b>Mounting and fixing</b>	Mounting on 1.6...10 mm thick panel	Flush mounted, fixed by 4 screw clips (included) or 4 spring clips (to be ordered separately)			
<b>Material</b>	Case	Aluminium (front) Polycarbonate/polyethylene terephthalate alloy (rear)			
<b>Electrical characteristics</b>					
<b>Power supply</b>	Voltage	24 V ---			
	Limits	19.2...28.8 V ---			
	Voltage break	≤ 10 ms			
<b>Inrush current</b>		≤ 30 A			
<b>Consumption</b>		28 W			
<b>Functional characteristics</b>					
<b>LCD screen</b>	Type	Colour STN	Colour TFT		
	Colour	4096 colours	65,536 colours, 16,384 if flashing		
	Definition	640 x 480 pixels (VGA)			
	Size (width x height in mm)	7.5" (153.7 x 115.8)			
	Touch-sensitive area	Analog, resolution 1024 x 1024			
	Backlighting (service life at 25°C for continuous use)	54,000 hours			
	Adjustments	Brightness	8 levels via touch panel		
		Contrast	8 levels via touch panel	-	
	Character fonts	ASCII (including all European characters), Japanese (ANK, Kanji), Chinese (simplified Chinese), Taiwanese (traditional Chinese), Korean			
<b>Dialogue application</b>	Max. number of pages	Limited by the capacity of the internal Flash memory or Compact Flash card			
<b>Signalling</b>		1 LED: green for normal operation, orange if backlighting faulty			
<b>Operating system/processor</b>		Magelis/266 MHz RISC CPU			
<b>Memory</b>	Application	32 MB Flash EPROM			
	Data backup	512 KB SRAM (lithium batteries)			
<b>Schneider Electric protocols</b>	Modicon	Modbus, Modbus Plus, Modbus TCP/IP, Uni-TE, FIPWAY, FIPIO			
<b>Third-party protocols</b>	Mitsubishi	Melsec	A/Q CPU (SIO), A/Q Ethernet (TCP), A Link (SIO), QnA CPU (SIO), Q Ethernet (UDP), FX (CPU)		
	Omron	Sysmac	FINS (Ethernet), FINS (SIO), LINK (SIO)		
	Rockwell Automation	Allen-Bradley	DF1-Full Duplex, DH 485, Ethernet IP (PLC5, SLC500, MicroLogix, ControlLogix), Ethernet IP (native), Device Net (1)		
	Siemens	Simatic	MPI (S7-300/400), RK512/3964R (S7-300/400), PPI (S7-200), Ethernet, Profibus DP (1)		
	<b>Real-time clock</b>		Built-in real-time clock		
<b>Expansion</b>	Compact Flash card	1 slot for 128, 256, 512 MB or 1 GB Compact Flash memory card			
	Expansion unit	For fieldbus communication card (Device Net, Profibus DP) (1)			
<b>Connections</b>	Power supply	Removable screw terminal block: 3 terminals (pitch 5.06 mm), tightening torque 0.5 Nm			
	COM1 serial link (115.2 kbps max.)	9-way male SUB-D connector (RS 232C/RS 422/485 serial link)			
	COM2 serial link (115.2 kbps max.)	RJ45 connector (RS 485 link), compatible with Siemens MPI (187.5 kbps)			
	USB port (V1.1)	A USB type A host connector for downloading applications, peripheral connection and Modicon M340 terminal port communication			
	Ethernet TCP/IP network (10BASE-T/100BASE-TX)	RJ45 connector (10BASE-T/100BASE-TX)			
	Audio input (microphone)	-	Mini-jack connector		
	Video input, NTSC/PAL (59.9/50 Hz)	-	RCA connector (75 Ω)		
	Inputs/outputs	Screw connector for 1 audio output (8 Ω, 70 mW, frequency 1 kHz), 1 discrete input and 3 discrete outputs			

(1) See page 1/73 for details of the required connection accessories



#### Description

Magelis XBT GT5230, XBT GT5300 and XBT GT 5430 Advanced Panels

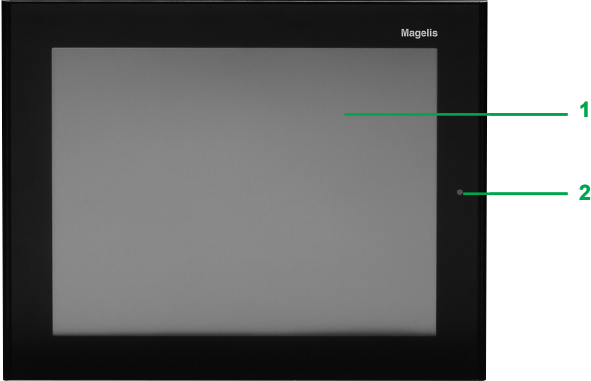

#### The front panel comprises:

- 1 A touch screen for displaying synoptic views (10.4" colour STN or 10.4" colour TFT, depending on model)
- 2 A multicolour LED (green, orange and red) indicating the operating mode of the terminal

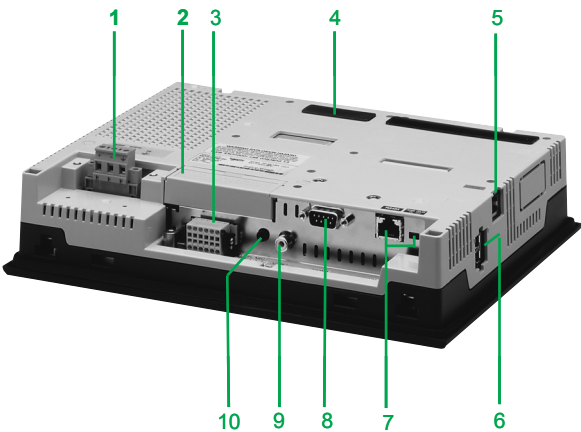

#### The rear panel comprises:

- 1 A removable screw terminal block for 24 V  $\overline{\text{---}}$  power supply
- 2 A slot for Compact Flash memory card, with hinged cover
- 3 A removable I/O terminal block (1), 12 spring terminals for loudspeaker connection, one input (reset) and 3 outputs (alarm, buzzer, run)
- 4 An expansion unit interface for fieldbus communication card (Device Net, PROFIBUS DP) (2)
- 5 An RJ45 connector for Ethernet TCP/IP link, 10BASE-T/100BASE-TX, with an activity LED
- 6 Two USB type A host connectors for peripheral connection, application transfer and Modicon M340 terminal port communication
- 7 An RJ45 connector for RS 485 serial link (COM2) with switch for polarization of the link used on Modbus
- 8 A 9-way male SUB-D connector for RS 232C or RS 422/485 serial link to PLCs (COM1)

#### On XBT GT5340 only:

- 9 A mini-jack connector for microphone connection
- 10 An RCA connector for connection of a digital or analog video camera (NTSC/PAL)

(1) On model XBT GT5230, this removable terminal block is located on the rear panel of the terminal.

(2) See page 1/73 for details of the required connection accessories.



Type of terminal	XBT GT5230	XBT GT5330	XBT GT 5430	XBT GT5340	
<b>Environment</b>					
<b>Conformity to standards</b>	EN 61131-2, IEC 61000-6-2, FCC (Class A), UL 508, UL 1604, CSA C22-2 n°14 (2)				
<b>Product certifications</b>	CE, cULus, CSA (2), Class 1 Div 2 T4A or T5 (UL and CSA) (2), C-Tick, ATEX Zone 2/22 (2)				
<b>Temperature</b>	Operation	0...50°C			
	Storage	-20...+60°C			
<b>Relative humidity</b>	Operation/storage	10...90% (non-condensing)			
<b>Altitude</b>		< 2000 m			
<b>Degree of protection</b>	Front panel	IP 65 conforming to IEC 60529, Nema 4X (with fixing by means of 4 screw clips)			
	Rear panel	IP 20 conforming to IEC 60529			
<b>Shock resistance</b>		Conforming to IEC 60068-2-27; semi-sinusoidal pulse 11 ms, 15 gn on the 3 axes			
<b>Vibrations</b>		Conforming to IEC 60068-2-6; 5...9 Hz at 3.5 mm; 9...150 Hz at 1 g			
<b>E.S.D.</b>		Conforming to IEC 61000-4-2, level 3 (contact 6 kV, air 8 kV)			
<b>Electromagnetic interference</b>		Conforming to IEC 61000-4-3, 10 V/m			
<b>Electrical interference</b>		Conforming to IEC 61000-4-4, level 3 (power supply and I/O 2 kV, other ports 1 kV)			
<b>Mechanical characteristics</b>					
<b>Mounting and fixing</b>	Mounting on 1.6...10 mm thick panel	Flush mounted, fixed by 4 screw clips (included) or 4 spring clips (to be ordered separately)			
<b>Material</b>	Case	Aluminium (front) Polycarbonate/polyethylene terephthalate alloy (rear)			
<b>Electrical characteristics</b>					
<b>Power supply</b>	Voltage	24 V ---			
	Limits	19.2...28.8 V ---			
	Voltage break	≤ 10 ms			
<b>Inrush current</b>		≤ 30 A			
<b>Consumption</b>		26 W	30 W		
<b>Functional characteristics</b>					
<b>LCD screen</b>	Type	Colour STN	Colour TFT		
	Colour	4096 colours	65,536 colours, 16,384 if flashing		
	Definition	640 x 480 pixels (VGA)	800 x 600 pixels (SVGA)	640 x 480 pixels (VGA)	
	Size (width x height in mm)	10.4" (215.2 x 162.3)	10.4" (211.2 x 158.4)		
	Touch-sensitive area	Analog, resolution 1024 x 1024			
	Backlighting (service life at 25°C for continuous use)	54,000 hours	50,000 hours		
	Adjustments	Brightness	8 levels via touch panel		
		Contrast	8 levels via touch panel	-	
	Character fonts	ASCII (including all European characters), Japanese (ANK, Kanji), Chinese (simplified Chinese), Taiwanese (traditional Chinese), Korean			
	<b>Dialogue application</b>	Max. number of pages	Limited by the capacity of the internal Flash memory or Compact Flash card		
<b>Signalling</b>		1 LED: green for normal operation, orange if backlighting faulty			
<b>Operating system/processor</b>		Magelis/266 MHz RISC CPU			
<b>Memory</b>	Application	32 MB Flash EPROM			
	Data backup	512 KB SRAM (lithium batteries)			
<b>Schneider Electric protocols</b>	Modicon	Modbus, Modbus Plus, Modbus TCP/IP, Uni-TE, FIPWAY, FIPIO			
<b>Third-party protocols</b>	Mitsubishi	Melsec	A/Q CPU (SIO), A/Q Ethernet (TCP), A Link (SIO), QnA CPU (SIO), Q Ethernet (UDP), FX (CPU)		
	Omron	Sysmac	FINS (Ethernet), FINS (SIO), LINK (SIO)		
	Rockwell Automation	Allen-Bradley	DF1-Full Duplex, DH 485, Ethernet IP (PLC5, SLC500, MicroLogix, ControlLogix), Ethernet IP (native), Device Net (1)		
	Siemens	Simatic	MPI (S7-300/400), RK512/3964R (S7-300/400), PPI (S7-200), Ethernet, Profibus DP (1)		
			Built-in real-time clock		
<b>Real-time clock</b>					
<b>Expansion</b>	Compact Flash card	1 slot for 128, 256, 512 MB or 1 GB Compact Flash memory card			
	Expansion unit	For fieldbus communication card (Device Net, Profibus DP) (1)			
<b>Connections</b>	Power supply	Removable screw terminal block: 3 terminals (pitch 5.06 mm), tightening torque 0.5 Nm			
	COM1 serial link (115.2 kbps max.)	9-way male SUB-D connector (RS 232C/RS 422/485 serial link)			
	COM2 serial link (115.2 kbps max.)	RJ45 connector (RS 485 link), compatible with Siemens MPI (187.5 kbps)			
	USB port (V1.1)	2 USB type A host connectors for downloading applications, connecting peripherals and Modicon M340 terminal port communication			
	Ethernet TCP/IP network (10BASE-T/100BASE-TX)	RJ45 connector			
	Audio input (microphone)	-	Mini-jack connector		
	Video input, NTSC/PAL (59.9/50 Hz)	-	RCA connector (75 Ω)		
	Inputs/outputs	Screw connector for 1 audio output (8 Ω, 70 mW, frequency 1 kHz), 1 discrete input and 3 discrete outputs			

(1) See page 1/73 for details of the required connection accessories  
(2) Except XBT GT 5430

1

#### Description

Magelis XBT GT6300 & XBT GT7340 Advanced Panels

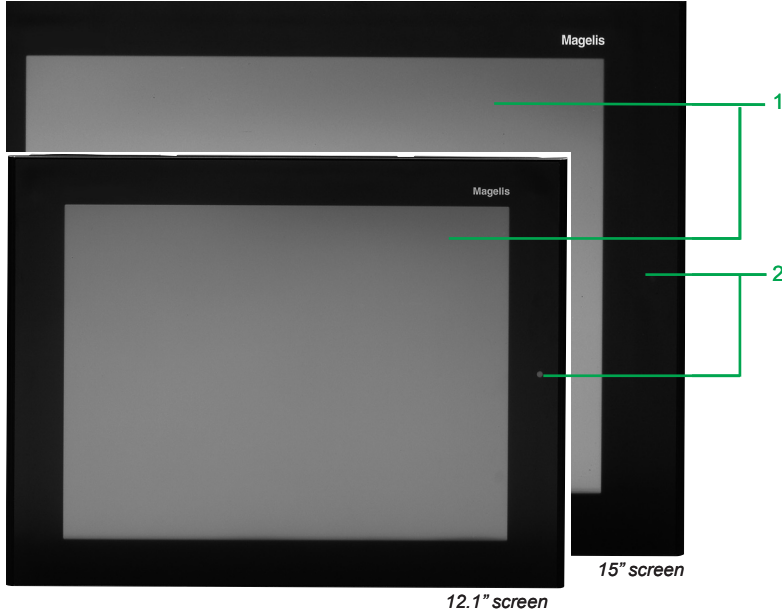

#### The front panel comprises:

- 1 A touch screen for displaying synoptic views (12.1" or 15" colour TFT, depending on model)
- 2 A multicolour LED (green, orange and red) indicating the operating mode of the terminal

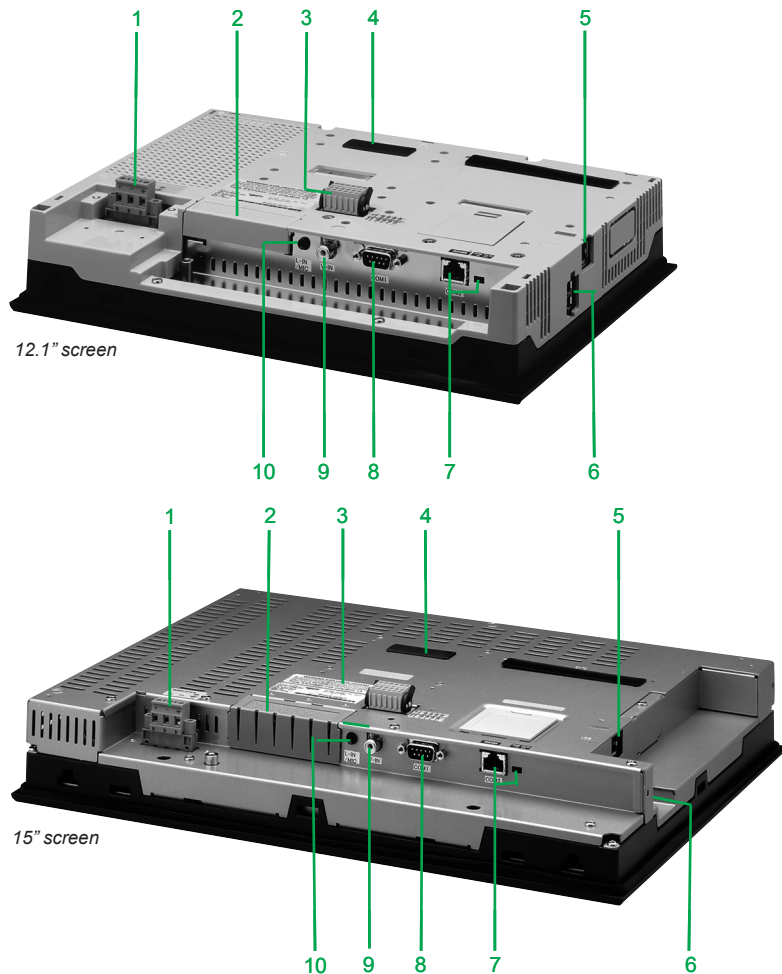

#### The rear panel comprises:

- 1 A removable screw terminal block for 24 V  $\overline{\text{---}}$  power supply
- 2 A slot for Compact Flash memory card, with hinged cover
- 3 A removable input/output terminal block with 12 spring terminals for loudspeaker connection, one input (reset) and 3 outputs (alarm, buzzer, run)
- 4 An expansion unit interface for fieldbus communication card (Device Net, PROFIBUS DP) (1)
- 5 An RJ45 connector for Ethernet TCP/IP link, 10BASE-T/100BASE-TX, with an activity LED
- 6 Two USB type A host connectors for peripheral connection, application transfer and Modicon M340 terminal port communication
- 7 An RJ45 connector for RS 485 serial link (COM2) with switch for polarization of the link used on Modbus
- 8 A 9-way male SUB-D connector for RS 232C or RS 422/485 serial link to PLCs (COM1)

#### On XBT GT6340 and XBT GT7340 only:

- 9 A mini-jack connector for microphone connection
- 10 An RCA connector for connection of a digital or analog video camera (NTSC/PAL)

(1) See page 1/73 for details of the required connection accessories

Type of terminal		XBT GT6330	XBT GT6340	XBT GT7340
<b>Environment</b>				
<b>Conformity to standards</b>		EN 61131-2, IEC 61000-6-2, FCC (Class A), UL 508, UL 1604, CSA C22-2 no. 14		
<b>Product certifications</b>		CE, cULus, CSA, Class 1 Div 2 T4A or T5 (UL and CSA), C-Tick, ATEX Zone 2/22		
<b>Temperature</b>	Operation	0...50°C		
	Storage	-20...+60°C		
<b>Relative humidity</b>	Operation/storage	10...90% (non-condensing)		
<b>Altitude</b>		< 2000 m		
<b>Degree of protection</b>	Front panel	IP 65 conforming to IEC 60529, Nema 4X (with fixing by means of 4 screw clips)		
	Rear panel	IP 20 conforming to IEC 60529		
<b>Shock resistance</b>		Conforming to IEC 60068-2-27; semi-sinusoidal pulse 11 ms, 15 gn on the 3 axes		
<b>Vibrations</b>		Conforming to IEC 60068-2-6; 5...9 Hz at 3.5 mm; 9...150 Hz at 1 g		
<b>E.S.D.</b>		Conforming to IEC 61000-4-2, level 3 (contact 6 kV, air 8 kV)		
<b>Electromagnetic interference</b>		Conforming to IEC 61000-4-3, 10 V/m		
<b>Electrical interference</b>		Conforming to IEC 61000-4-4, level 3 (power supply and I/O 2 kV, other ports 1 kV)		
<b>Mechanical characteristics</b>				
<b>Mounting and fixing</b>	Mounting on 1.6...10 mm thick panel	Flush mounted, fixed by 4 screw clamps (included) or 4 spring clips (to be ordered separately)		Flush mounted, fixed by 8 screw clips (included) or 4 spring clips (to be ordered separately)
<b>Material</b>	Case	Aluminium (front) Polycarbonate/polyethylene terephthalate alloy (rear)		Aluminium (front and rear)
<b>Electrical characteristics</b>				
<b>Power supply</b>	Voltage	24 V ---		
	Limits	19.2...28.8 V ---		
	Voltage break	≤ 10 ms		
<b>Inrush current</b>		≤ 30 A		
<b>Consumption</b>		30 W		42 W
<b>Functional characteristics</b>				
<b>LCD screen</b>	Type	Colour TFT		
	Colour	65,536 colours, 16,384 if flashing		
	Definition	800 x 600 pixels (SVGA)		1024 x 768 pixels (XGA)
	Size (width x height in mm)	12.1" (248 x 186.5)		15" (306 x 230.1)
	Touch-sensitive area	Analog, resolution 1024 x 1024		
	Backlighting (service life at 25°C for continuous use)	50,000 hours		
	Adjustments	Brightness	8 levels via touch panel	
	Contrast	-		
Character fonts		ASCII (including all European characters), Japanese (ANK, Kanji), Chinese (simplified Chinese), Taiwanese (traditional Chinese), Korean		
<b>Dialogue application</b>	Max. number of pages	Limited by the capacity of the internal Flash memory or Compact Flash card		
<b>Signalling</b>		1 LED: green for normal operation, orange if backlighting faulty		
<b>Operating system/processor</b>		Magelis/266 MHz RISC CPU		
<b>Memory</b>	Application	32 MB Flash EPROM		
	Data backup	512 KB SRAM (lithium batteries)		
<b>Schneider Electric protocols</b>		Modicon	Modbus, Modbus Plus, Modbus TCP/IP, Uni-TE, FIPWAY, FIPIO	
<b>Third-party protocols</b>	Mitsubishi	Melsec	A/Q CPU (SIO), A/Q Ethernet (TCP), A Link (SIO), QnA CPU (SIO), Q Ethernet (UDP), FX (CPU)	
	Omron	Sysmac	FINS (Ethernet), FINS (SIO), LINK (SIO)	
	Rockwell Automation	Allen-Bradley	DF1-Full Duplex, DH 485, Ethernet IP (PLC5, SLC500, MicroLogix, ControlLogix), Ethernet IP (native), Device Net (1)	
	Siemens	Simatic	MPI (S7-300/400), RK512/3964R (S7-300/400), PPI (S7-200), Ethernet, Profibus DP (1)	
	<b>Real-time clock</b>		Built-in real-time clock	
<b>Expansion</b>	Compact Flash card	1 slot for 128, 256, 512 MB or 1 GB Compact Flash memory card		
	Expansion unit	For fieldbus communication card (Device Net, Profibus DP) (1)		
<b>Connections</b>	Power supply	Removable screw terminal block: 3 terminals (pitch 5.06 mm), tightening torque 0.5 Nm		
	COM1 serial link (115.2 kbps max.)	9-way male SUB-D connector (RS 232C/RS 422/485 serial link)		
	COM2 serial link (115.2 kbps max.)	RJ45 connector (RS 485 link), compatible with Siemens MPI (187.5 kbps)		
	USB ports (V1.1)	2 USB type A host connectors for downloading applications, connecting peripherals and Modicon M340 terminal port communication		
	Ethernet TCP/IP network (10BASE-T/100BASE-TX)	1 RJ45 connector		
	Audio input (microphone)	-	Mini-jack connector	
	Video input, NTSC/PAL (59.9/50 Hz)	-	RCA connector (75 Ω)	
Inputs/outputs		Screw connector for 1 audio output (8 Ω, 70 mW, frequency 1 kHz), 1 discrete input and 3 discrete outputs		

(1) See page 1/73 for details of the required connection accessories





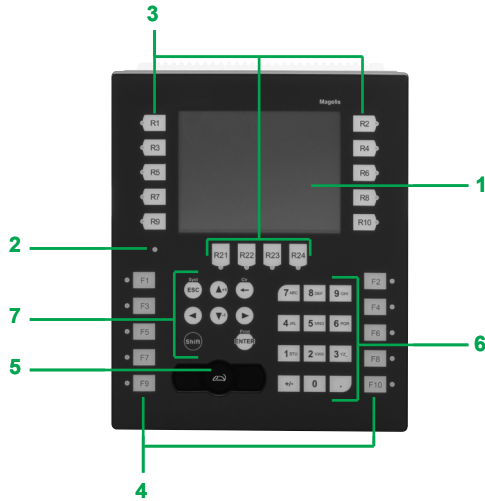



### Description

#### XBT GK2120 & XBT GK2330 Advanced Panels



#### The front panel comprises:

- 1 A touch screen for displaying synoptic views (5.7" monochrome or colour), configurable using Vijeo Designer
- 2 A multicolour LED (green, orange and red) indicating the operating mode of the terminal
- 3 14 dynamic keys (Ri) with 3-colour LED (green, orange, red)
- 4 10 static keys (Fi) with 3-colour LED (green, orange, red) and customizable labels
- 5 An industrial pointer "  ", configurable using Vijeo Designer
- 6 12 alphanumeric keys (0...9, +/-. , .), which can be pressed several times in succession to access characters (A...Z)
- 7 8 service keys:

-  Delete character to left of cursor
-  Move cursor to right or left in an entry field
-  Confirm a selection or entry
-  Access the second of the dual key functions
-  Increment or decrement a numeric field value or activate the next or previous object
-  Exit entry mode
-  Display the configuration menu of the terminal
-  Copy the current screen
-  Delete entire field

#### The rear panel comprises:

- 1 A removable screw terminal block for 24 V  $\overline{\text{---}}$  power supply
- 2 A USB type A host connector for peripheral connection, application transfer and Modicon M340 terminal port communication
- 3 A 9-way male SUB-D connector for RS 232C or RS 422/485 serial link to PLCs (COM1)
- 4 An expansion unit interface for fieldbus communication card (PROFIBUS DP, Device Net) (1)
- 5 A switch for polarization of the COM2 serial link, used on Modbus
- 6 An RJ45 connector for RS 485 serial link (COM2)
- 7 A slot for Compact Flash memory card, with cover

#### On GK2330 only:

- 8 An RJ45 connector for Ethernet TCP/IP link, 10BASE-T/100BASE-TX

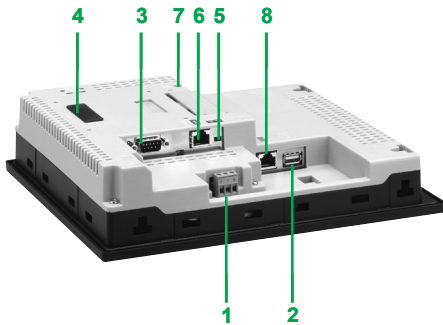

(1) See page 1/73 for details of the required connection accessories.

Type of terminal		XBT GK2120	XBT GK2330	
<b>Environment</b>				
<b>Conformity to standards</b>		EN 61131-2, IEC 61000-6-2, FCC (Class A), UL 508, UL 1604, CSA C22-2 no. 14		
<b>Product certifications</b>		CE, cULus, CSA, Class 1 Div 2 T4A or T5 (UL and CSA), C-Tick		
<b>Temperature</b>	Operation	0...50°C		
	Storage	-20...+60°C		
<b>Relative humidity</b>		0...90% (non-condensing)		
<b>Altitude</b>		< 2000 m		
<b>Degree of protection</b>	Front panel	IP 65 conforming to IEC 60529, Nema 4X		
	Rear panel	IP 20 conforming to IEC 60529		
<b>Shock resistance</b>		Conforming to IEC 60068-2-27; semi-sinusoidal pulse 11 ms, 15 gn on the 3 axes		
<b>Vibrations</b>		Conforming to IEC 60068-2-6; 5...9 Hz at 3.5 mm; 9...150 Hz at 1 g		
<b>E.S.D.</b>		Conforming to IEC 61000-4-2, level 3		
<b>Electromagnetic interference</b>		Conforming to IEC 61000-4-3, 10 V/m		
<b>Electrical interference</b>		Conforming to IEC 61000-4-4, level 3		
<b>Mechanical characteristics</b>				
<b>Mounting and fixing</b>	Mounting on 1.6...10 mm thick panel		Flush mounted, fixed by 10 spring clips (included) or 4 screw clips (to be ordered separately)	
<b>Material</b>	Case		Polycarbonate/polyethylene terephthalate alloy	
			Aluminium (front)	
<b>Keys</b>	Dynamic	14 (with LED)		
	Solid-state	10 (with LED and customizable labels)		
	Service	8		
	Alphanumeric	12		
<b>Electrical characteristics</b>				
<b>Power supply</b>	Voltage	24 V ---		
	Limits	19.2...28.8 V ---		
	Voltage break	≤ 5 ms		
<b>Inrush current</b>	≤ 30 A			
<b>Consumption</b>	26 W			
<b>Functional characteristics</b>				
<b>LCD screen</b>	Type	Backlit monochrome STN	Colour TFT	
	Colour	Black and white, 16 levels of grey	65,536 colours, 16,384 if flashing	
	Definition	320 x 240 pixels (QVGA)		
	Size (width x height in mm)	5.7" (115.2 x 86.4)		
	Touch-sensitive area	Analog, resolution 1024 x 1024		
	Backlighting (service life at 25°C for continuous use)	58,000 hours		50,000 hours
		Adjustments	Brightness	8 levels via touch panel
			Contrast	8 levels via touch panel
Character fonts	ASCII (including all European characters), Japanese (ANK, Kanji), Chinese (simplified Chinese), Taiwanese (traditional Chinese), Korean			
<b>Dialogue application</b>	Max. number of pages	Limited by the capacity of the internal Flash memory or Compact Flash card		
<b>Signalling</b>	1 LED: green for normal operation, orange if backlighting faulty			
<b>Operating system/processor</b>		Magelis/133 MHz RISC CPU		
<b>Memory</b>	Application	16 MB Flash EPROM		
	Data backup	512 KB SRAM (lithium batteries)		
<b>Schneider Electric protocols</b>	Modicon	Modbus, Uni-TE, Modbus TCP/IP, FIPWAY, FIPIO, Modbus Plus		
<b>Third-party protocols</b>	Mitsubishi	Melsec	A/Q CPU (SIO), A/Q Ethernet (TCP) (1), A Link (SIO), QnA CPU (SIO), Q Ethernet (UDP) (1), FX (CPU)	
	Omron	Sysmac	FINS (Ethernet) (1), FINS (SIO), LINK (SIO)	
	Rockwell Automation	Allen-Bradley	DF1-Full Duplex, DH 485, Ethernet IP (PLC5, SLC500, MicroLogix, ControlLogix) (1), Ethernet IP (native) (1), Device Net (2)	
	Siemens	Simatic	MPI (S7-300/400), RK512/3964R (S7-300/400), PPI (S7-200), Ethernet (1), Profibus DP (2)	
<b>Real-time clock</b>	Built-in real-time clock			
<b>Expansion</b>	Compact Flash memory card	1 slot for 128, 256, 512 MB or 1 GB Compact Flash card		
	Expansion unit	For fieldbus communication card (Device Net, Profibus DP) (2)		
<b>Connections</b>	Power supply	Removable screw terminal block: 3 terminals (pitch 5.06 mm), tightening torque 0.5 Nm		
	COM1 serial link (115.2 kbps max.)	9-way male SUB-D connector (RS 232C/RS 422/485 serial link)		
	COM2 serial link (115.2 kbps max.)	RJ45 connector (RS 485 link), compatible with Siemens MPI (187.5 kbps)		
	USB port (V1.1)	USB type A host connector for downloading applications, connecting peripherals and Modicon M340 terminal port communication		
	Ethernet TCP/IP network (10BASE-T/100BASE-TX)	–	RJ45 connector	
	Inputs/outputs	–		

(1) With model XBT GK2330.

(2) See page 1/73 for details of the required connection accessories.

**Description**  
XBT GK5330 Advanced Panels

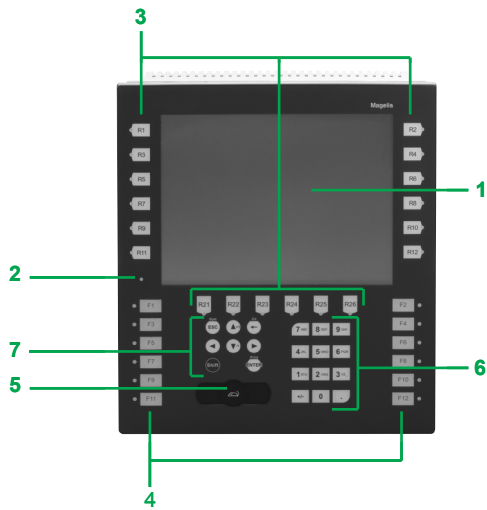

**The front panel comprises:**

- 1 A touch screen for displaying synoptic views (10.4" colour TFT), configurable using Vijeo Designer
- 2 A multicolour LED (green, orange and red) indicating the operating mode of the terminal
- 3 18 dynamic keys (Ri) with 3-colour LED (green, orange, red)
- 4 12 static keys (Fi) with 3-colour LED (green, orange, red) and customizable labels
- 5 An industrial pointer "", configurable using Vijeo Designer
- 6 12 alphanumeric keys (0...9, +/-, .), which can be pressed several times in succession to access characters (A...Z)
- 7 8 service keys:

- Delete character to left of cursor
- Move cursor to right or left in an entry field
- Confirm a selection or entry
- Access the second of the dual key functions
- Increment or decrement a numeric field value or activate the next or previous object
- Exit entry mode
- Display the configuration menu of the terminal
- Copy the current screen
- Delete entire field

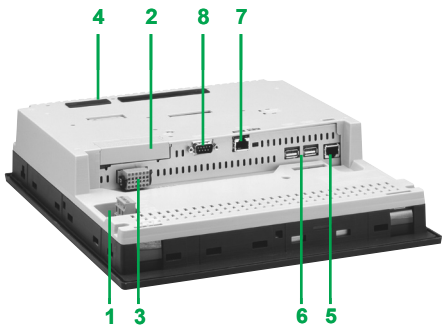

**The rear panel comprises:**

- 1 A removable screw terminal block for 24 V  $\bar{\text{---}}$  power supply
- 2 A slot for Compact Flash memory card, with hinged cover
- 3 A removable input/output terminal block with 12 spring terminals for loudspeaker connection, one input (reset) and 3 outputs (alarm, buzzer, run)
- 4 An expansion unit interface for fieldbus communication card (Device Net, PROFIBUS DP)
- 5 An RJ45 connector for Ethernet TCP/IP link, 10BASE-T/100BASE-TX with an activity LED
- 6 Two USB type A host connectors for peripheral connection, application transfer and Modicon M340 terminal port communication
- 7 An RJ45 connector for RS 485 serial link (COM2) with switch for polarization of the link used on Modbus
- 8 A 9-way male SUB-D connector for RS 232C or RS 422/485 serial link to PLCs (COM1)



<b>Type of terminal</b>		<b>XBT GK5330</b>	
<b>Environment</b>			
<b>Conformity to standards</b>		EN 61131-2, IEC 61000-6-2, FCC (Class A), UL 508, UL 1604, CSA C22-2 no. 14	
<b>Product certifications</b>		CE, cULus, CSA, Class 1 Div 2 T4A or T5 (UL and CSA), C-Tick	
<b>Temperature</b>	Operation	0...50°C	
	Storage	-20...+60°C	
<b>Relative humidity</b>	Operation/storage	10...90% (non-condensing)	
<b>Altitude</b>		< 2000 m	
<b>Degree of protection</b>	Front panel	IP 65 conforming to IEC 60529, Nema 4X (with fixing by means of 4 screw clips)	
	Rear panel	IP 20 conforming to IEC 60529	
<b>Shock resistance</b>		Conforming to IEC 60068-2-27; semi-sinusoidal pulse 11 ms, 15 gn on the 3 axes	
<b>Vibrations</b>		Conforming to IEC 60068-2-6; 5...9 Hz at 3.5 mm; 9...150 Hz at 1 g	
<b>E.S.D.</b>		Conforming to IEC 61000-4-2, level 3 (contact 6 kV, air 8 kV)	
<b>Electromagnetic interference</b>		Conforming to IEC 61000-4-3, 10 V/m	
<b>Electrical interference</b>		Conforming to IEC 61000-4-4, level 3 (power supply and I/O 2 kV, other ports 1 kV)	
<b>Mechanical characteristics</b>			
<b>Mounting and fixing</b>	Mounting on 1.5...10 mm thick panel	Flush mounted, fixed by 12 spring clips (included) or 4 screw clips (to be ordered separately)	
<b>Material</b>	Case	Aluminium (front)	
		Polycarbonate/polyethylene terephthalate alloy	
<b>Keys</b>	Dynamic	18 (with LED)	
	Solid-state	12 (with LED and customizable labels)	
	Service	8	
	Alphanumeric	12	
<b>Electrical characteristics</b>			
<b>Power supply</b>	Voltage	24 V ---	
	Limits	19.2...28.8 V ---	
	Voltage break	≤ 10 ms	
<b>Inrush current</b>		≤ 30 A	
<b>Consumption</b>		30 W	
<b>Functional characteristics</b>			
<b>LCD screen</b>	Type	Colour TFT	
	Colour	65,536 colours, 16,384 if flashing	
	Definition	640 x 480 pixels (VGA)	
	Size (width x height in mm)	10.4" (211.2 x 158.4)	
	Touch-sensitive area	Analog, resolution 1024 x 1024	
	Backlighting (service life at 25°C for continuous use)	50,000 hours	
	Adjustments	Brightness	8 levels via touch panel
Contrast		8 levels via touch panel	
Character fonts		ASCII (including all European characters), Japanese (ANK, Kanji), Chinese (simplified Chinese), Taiwanese (traditional Chinese), Korean	
<b>Dialogue application</b>	Max. number of pages	Limited by the capacity of the internal Flash memory or Compact Flash card	
<b>Signalling</b>		1 LED: green for normal operation, orange if backlighting faulty	
<b>Operating system/processor</b>		Magelis/266 MHz RISC CPU	
<b>Memory</b>	Application	32 MB Flash EPROM	
	Data backup	512 KB SRAM (lithium batteries)	
<b>Schneider Electric protocols</b>	Modicon	Modbus, Uni-TE, Modbus TCP/IP, FIPWAY, FIPIO, Modbus Plus	
<b>Third-party protocols</b>	Mitsubishi	Melsec	A/Q CPU (SIO), A/Q Ethernet (TCP), A Link (SIO), QnA CPU (SIO), Q Ethernet (UDP), FX (CPU)
	Omron	Sysmac	FINS (Ethernet), FINS (SIO), LINK (SIO)
	Rockwell Automation	Allen-Bradley	DF1-Full Duplex, DH 485, Ethernet IP (PLC5, SLC500, MicroLogix, ControlLogix), Ethernet IP (native), Device Net
	Siemens	Simatic	MPI (S7-300/400), RK512/3964R (S7-300/400), PPI (S7-200), Ethernet, PROFIBUS DP
	<b>Real-time clock</b>		Built-in real-time clock
<b>Expansion</b>	Compact Flash memory card	1 slot for 128, 256, 512 MB or 1 GB Compact Flash memory card	
	Expansion unit	For fieldbus communication card (Device Net, PROFIBUS DP)	
<b>Connections</b>	Power supply	Removable screw terminal block: 3 terminals (pitch 5.06 mm), tightening torque 0.5 Nm	
	COM1 serial link (115.2 kbps max.)	9-way male SUB-D connector (RS 232C/RS 422/485 serial link)	
	COM2 serial link (115.2 kbps max.)	RJ45 connector (RS 485 link), compatible with Siemens MPI (187.5 kbps)	
	USB port (V1.1)	USB type A host connector for downloading applications, connecting peripherals and Modicon M340 terminal port communication	
	Ethernet TCP/IP network (10BASE-T/100BASE-TX)	RJ45 connector	
	Audio input (microphone)	–	
	Video input, NTSC/PAL (59.9/50 Hz)	–	
	Inputs/outputs	Screw connector for 1 audio output (8 Ω, 70 mW, frequency 1 kHz), 1 discrete input and 3 discrete outputs	

1

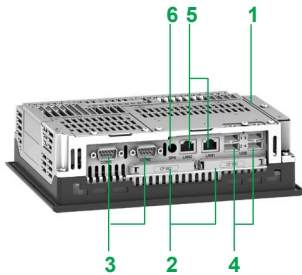
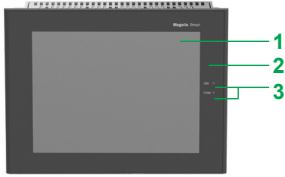

#### Description of XBT GTW terminals

##### 8.4" touch screen front panel, XBT GTW 450

The touch screen front panel of terminal **XBT GTW 450** comprises:

- 1 An 8.4" SVGA active-matrix colour TFT LCD screen (maximum display area 800 x 600 points) with high-definition analog touch panel
- 2 An aluminium alloy front panel with IP 65 membrane (mounted on a hardened steel frame)
- 3 Two LEDs marked:
  - ON (green), terminal switched on
  - DISK (green), accessing IDE bus (accessing Compact Flash memory, etc.)

##### Underside, 8.4"

All expansion slots and connection elements are accessible from the rear of the terminal, with the following elements located on the underside:

- 1 A removable screw terminal block for connecting 24 V  $\square$  power supply
- 2 Two Compact Flash memory card slots, one for the card containing the operating system and installed software, and the other free
- 3 Two 9-way male SUB-D connectors marked COM1 and COM2 for the RS 232 serial link
- 4 4 USB 2.0 ports
- 5 Two RJ45 connectors for Ethernet 10/100 Mbps and Ethernet 10/100 Base-TX/1 GB link
- 6 A mini-jack connector for loudspeaker

##### 12" touch screen front panel, XBT GTW 652

The touch screen front panel of terminal **XBT GTW 652** comprises:

- 1 An 15" SVGA active-matrix colour TFT LCD screen (maximum display area 800 x 600 points) with high-definition analog touch panel
- 2 An aluminium alloy front panel with IP 65 membrane (mounted on a hardened steel frame)
- 3 Two LEDs marked:
  - ON (green), terminal switched on
  - DISK (green), accessing IDE bus (accessing Compact Flash memory, etc.)
- 4 A USB port (dust and damp proof)

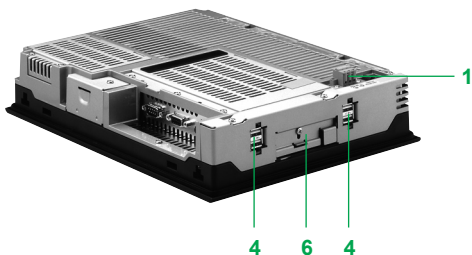
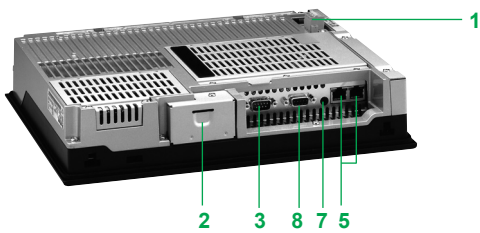

##### Underside and side panel, 12"

All expansion slots and connection elements are accessible from the rear of the terminal, with the following elements located on the underside:

- 1 A removable screw terminal block for connecting 24 V  $\square$  power supply
- 2 A slot for the Compact Flash memory card containing the operating system and integrated software
- 3 A 25-way female SUB-D connector marked RAS for product monitoring and diagnostics
- 4 Two 9-way male SUB-D connectors marked COM1 and COM2 for the RS 232 serial link
- 5 4 USB 2.0 ports
- 6 A mini-DIN PS/2 connector for connecting the external keyboard
- 7 Two RJ45 connectors for Ethernet 10/100 Mbps and Ethernet 10/100 Base-TX/1 GB link
- 8 A slot for additional PCMCIA type II cards
- 9 A mini-jack connector for loudspeaker



## Operator dialogue terminals

### Advanced Panels

Magelis HMI GTW with 15" screen

Software pre-installed on Magelis XBT GTW/HMI GTW

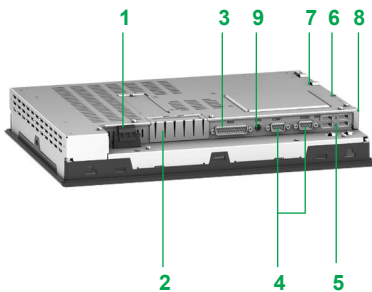
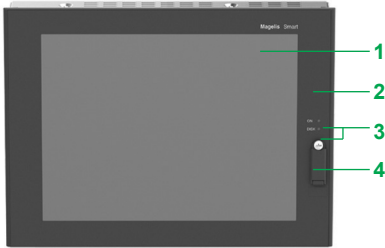

#### Description of HMI GTW terminals

##### 15" touch screen front panel, HMI GTW 7353

The touch screen front panel of terminal **HMI GTW 7353** comprises:

- 1 A 15" XGA active matrix colour TFT LCD screen (maximum display area 1024 x 768 points) with high-definition analog touch panel
- 2 An aluminium alloy front panel with IP 65 membrane (mounted on a hardened steel frame)
- 3 Two LEDs marked:
  - ON (green), terminal switched on
  - DISK (green), accessing IDE bus (accessing Compact Flash memory, etc.)
- 4 A USB port (dust and damp proof)

##### Underside, 15"

All expansion slots and connection elements are accessible from the rear of the terminal, with the following elements located on the underside:

- 1 A removable screw terminal block for connecting 24 V  $\bar{\text{---}}$  power supply
- 2 A slot for the Compact Flash memory card containing the operating system and integrated software
- 3 A 25-way female SUB-D connector marked RAS for product monitoring and diagnostics
- 4 Two 9-way male SUB-D connectors marked COM1 and COM2 for the RS 232 serial link
- 5 4 USB 2.0 ports
- 6 A mini-DIN PS/2 connector for connecting the external keyboard
- 7 Two RJ45 connectors for Ethernet 10/100 Mbps and Ethernet 10/100 Base-TX/1 GB link
- 8 A slot for additional PCMCIA type III cards
- 9 A mini-jack connector for loudspeaker

#### Pre-installed software

Magelis XBT GTW and HMI GTW terminals have the following software installed on the Compact Flash system card, in addition to Windows XP Embedded:

- Vijeo Designer Run Time, unlimited use after activation of authorization code
- Vijeo Citect web client dll on XBT GTW 652/HMI GTW 7353
- Internet Explorer
- Acrobat Reader
- Word/Excel/PowerPoint viewer
- Framework .Net on XBT GTW 652/HMI GTW 7353

# Operator dialogue terminals

Advanced Panels

Magelis XBT GTW with 8.4" or 12" screen

Magelis HMI GTW with 15" screen

1

Type of terminal		XBT GTW 450	XBT GTW 652	HMI GTW 7353
<b>Environment</b>				
<b>Conformity to standards</b>		EN 61131-2, IEC 61000-6-2, FCC (Class A), UL 508, CSA C22-2 n°14		
<b>Product certifications</b>		CE, cULus, CSA		
<b>Temperature</b>		DNV		
Operation		0...50°C		
Storage		-20...+60°C		
<b>Relative humidity</b>		10...85% (non-condensing)		
<b>Altitude</b>		< 3000 m		
<b>Degree of protection</b>		IP 65 conforming to IEC 60529, Nema 4X (with fixing by means of 4 screw clips)		
Front panel		IP 20 conforming to IEC 60529		
Rear panel		IP 20 conforming to IEC 60529		
<b>Shock resistance</b>		Conforming to IEC 60068-2-27; semi-sinusoidal pulse 11 ms, 15 gn on the 3 axes		
<b>Vibrations</b>		Conforming to IEC 60068-2-6; 5...9 Hz at 3.5 mm; 9...150 Hz at 1 g		
<b>E.S.D.</b>		Conforming to IEC 61000-4-2, level 3 (contact 6 kV, air 8 kV)		
<b>Electromagnetic interference</b>		Conforming to IEC 61000-4-3, 10 V/m		
<b>Electrical interference</b>		Conforming to IEC 61000-4-4, level 3 (power supply and I/O 2 kV, other ports 1 kV)		
<b>Mechanical characteristics</b>				
<b>Mounting and fixing</b>		Mounting on 1.6...10 mm thick panel		
Mounting on 1.6...10 mm thick panel		Flush mounted, fixed by 8 screw clips (included)		
<b>Material</b>		Case		
Case		Aluminium (front and rear)		
<b>Electrical characteristics</b>				
<b>Power supply</b>		Voltage		
Voltage		24 V ~		
Limits		21.6...26.4 V ~		
Voltage break		≤ 5 ms		
<b>Inrush current</b>		≤ 30 A		
<b>Consumption</b>		40 W		90 W

Type of terminal		XBT GTW 450	XBT GTW 652	HMI GTW 7353	
<b>Functional characteristics</b>					
<b>LCD screen</b>	Type	Colour TFT			
	Colour	262 144			
	Definition	800 x 600 pixels (SVGA)	800 x 600 pixels (SVGA)	1024 x 768 pixels (XGA)	
	Size (width x height in mm)	8.4" (171 x 128)	12" (245 x 183)	15" (306 x 230.1)	
	Touch-sensitive area	Analog, resolution 1024 x 1024			
	Backlighting (service life at 25°C for continuous use)	50,000 hours			
	Adjustments	Brightness	4 levels via touch panel		
		Contrast	-		
	Character fonts	ASCII (including all European characters), Japanese (ANK, Kanji), Chinese (simplified Chinese), Taiwanese (traditional Chinese), Korean			
<b>Dialogue application</b>	Max. number of pages	Limited by the capacity of the internal Flash memory or Compact Flash card			
<b>Signalling</b>		1 ON LED: switched on 1 DISK LED: accessing CF system card			
<b>Operating system/processor</b>		Windows XP Embedded, SP2 (1), Intel Celeron M600 MHz			
<b>Memory</b>	Application	1 GB CF system card included with terminal, expandable to 4 GB	2 GB CF system card included with terminal, expandable to 4 GB		
	Data backup	512 KB SRAM (lithium batteries)			
<b>RAM (1 memory slot)</b>		SDRAM (256 MB minimum), expandable up to 1024	SDRAM (512 MB minimum), expandable up to 1024	SDRAM (512 MB minimum), expandable up to 1024	
<b>Schneider Electric protocols</b>	Modicon	Modbus, Modbus TCP/IP, Modbus Plus, Uni-TE			
<b>Third-party protocols</b>	Mitsubishi	Melsec	A/Q CPU (SIO), A/Q Ethernet (TCP), A Link (SIO), QnA CPU (SIO), Q Ethernet (UDP), FX (CPU)		
	Omron	Sysmac	FINS (Ethernet), FINS (SIO), LINK (SIO)		
	Rockwell Automation	Allen-Bradley	DF1-Full Duplex, Ethernet IP (PLC5, SLC500, MicroLogix, ControlLogix), Ethernet IP (native)		
	Siemens	Simatic	RK512/3964R (S7-300/400), PPI (S7-200), Ethernet		
	<b>Real-time clock</b>		Built-in real-time clock		
<b>Memory card</b>	Compact Flash card	1 primary slot with a 1 GB minimum card, expandable to 4 GB, loaded with the OS and software + 1 free secondary slot	1 slot with a 2 GB minimum card, expandable to 4 GB, loaded with the OS and software		
	PCMCIA card	-	1 type II card slot	1 type III card slot	
<b>Connections</b>	Power supply	Removable screw terminal block: 3 terminals (pitch 5.06 mm), tightening torque 0.5 Nm			
	COM1 and COM2 serial links	2 9-way male SUB-D connectors (RS 232C serial link)			
	USB ports (V2.0)	Underside	4 USB type A host connectors for downloading applications, connecting peripherals and Modicon M340 terminal port communication		
		Front panel	-	1 dust and damp proof connector	1 dust and damp proof connector (15" model)
	Ethernet TCP/IP network		1 RJ45 10BASE-T/100BASE-TX connector		
			1 RJ45 10BASE-T/100BASE-TX/1 GB connector		
	Audio output (loudspeaker)	Mini-jack connector			
	PS/2 keyboard port	-	-	1 mini-DIN connector	
RAS port	-	-	1 25-way female SUB-D link		

(1) Installed in Compact Flash memory

# Operator dialogue terminals

## Advanced Panels

Magelis XBT GH with 5.7" screen

XBT ZGJBOX junction box, XBT ZGHL cables

### Description

1

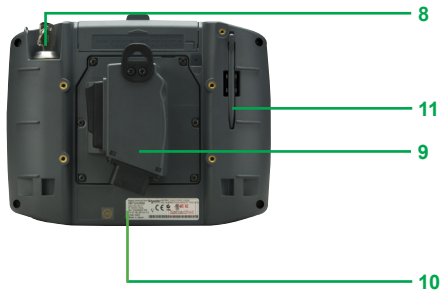
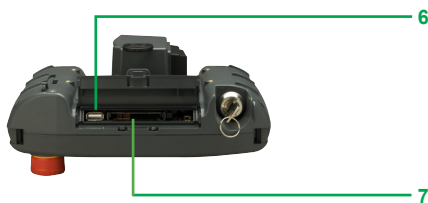
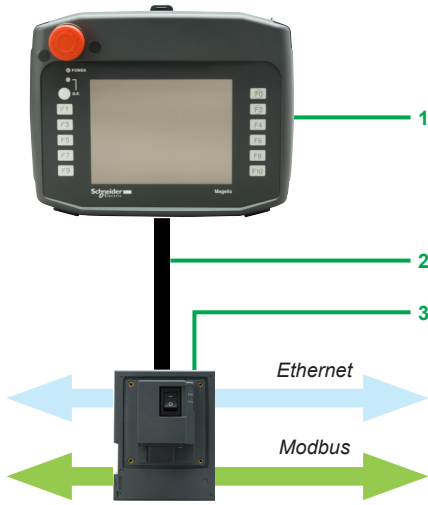

#### Overview

The Magelis XBT GH2460 **1** is a portable graphic display terminal with a 5.7" touch screen.

It enables connection on the Ethernet or Modbus network at any point where an XBT ZGJBOX junction box **3** is installed.

The connection between the terminal and junction box is established using an XBT ZGHL3 or XBT ZGHL10 cable **2**.

#### Advanced Panels XBT GH2460

##### The front panel comprises:

- 1** A touch screen for displaying synoptic views (5.7" colour), configurable using Vijeo Designer
- 2** A multicolour LED (green, orange and red) indicating the operating mode of the terminal
- 3** 11 function keys Fi
- 4** An operating key with O.P. LED (green) for touch screen validation
- 5** An emergency stop button with 2 NC safety contacts and 1 NO auxiliary contact for stopping the machine if necessary

##### The rear panel comprises:

- 6** A USB type A host connector for peripheral connection and application transfer (with protective cover)
- 7** A slot for a Compact Flash memory card (also protected by the cover)
- 8** A key switch for switching the Magelis XBT GH on/off
- 9** A 3-position enabling grip switch for protecting the operator (the OK signal is only sent when the grip switch is in the centre position)
- 10** A 24-way connector for connecting the 3 m or 10 m flexible interface cable between the Magelis XBT GH and the junction box
- 11** A stylus for the touch screen
- 12** Two holes for inserting re-usable labels in the function keys

### Description (continued)

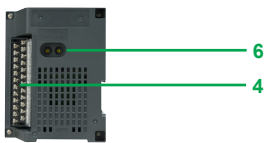
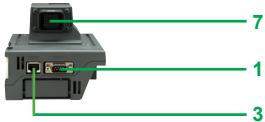
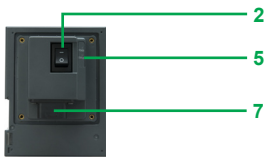

#### XBT ZGJBOX junction box for XBT GH

##### It comprises:

- 1 A 9-way SUB-D connector for RS 232C or RS 422/485 serial link to PLCs (COM1)
- 2 An ON/OFF switch for the junction box
- 3 An RJ45 connector for Ethernet TCP/IP link, 10BASE-T/100BASE-TX
- 4 A 24-way screw terminal for connecting the 24 V  $\bar{\text{---}}$  power supply and output signals from the Magelis XBT GH terminal
- 5 An LED indicating the status of the link with the Magelis XBT GH, 3 colours (green, orange and red)
- 6 2 thumbwheels for configuring the station number on the junction box
- 7 A 32-way connector for connecting the Magelis XBT GH terminal using the 3 m or 10 m flexible cable (XBT ZGHL3 or XBT ZGHL10)

#### XBT ZGHL3 and XBT ZGHZ10 flexible cables

For connecting the Magelis XBT GH terminals to their XBT ZGJBOX junction boxes

1

Product type		XBT GH2460 terminal	XBT ZGJBOX junction box
<b>Environment</b>			
<b>Conformity to standards</b>		EN 61131-2, IEC 61000-6-2, FCC (Class A), UL 508	
<b>Product certifications</b>		CE, cULus, C-Tick, certifications pending for the safety circuit combining the emergency stop button of the XBT GH and the Preventa module XPSAF5130 (Cat 4/EN954-1, PLe/ISO 13849-1, SIL3/IEC 62061)	CE, cULus, C-Tick
<b>Temperature</b>	Operation	0...40°C	
	Storage	-20...+60°C	
<b>Relative humidity</b>		0...90% (non-condensing)	
<b>Altitude</b>		< 2000 m	
<b>Case degree of protection</b>		IP 65 conforming to IEC 60529	IP 65 conforming to IEC 60529, mounted in enclosure
<b>Shock resistance</b>		Conforming to IEC 60068-2-27; semi-sinusoidal pulse 11 ms, 15 gn on the 3 axes	
<b>Vibrations</b>		Conforming to IEC 60068-2-6; 5...9 Hz at 3.5 mm; 9...150 Hz at 1 g	
<b>E.S.D.</b>		Conforming to IEC 61000-4-2, level 3	
<b>Electromagnetic interference</b>		Conforming to IEC 61000-4-3, 10 V/m	
<b>Electrical interference</b>		Conforming to IEC 61000-4-4, level 3	
<b>Impact resistance (dropping)</b>		Conforming to IEC 61131-2, 1 m (twice)	–
<b>Mechanical characteristics</b>			
<b>Case material</b>		Resin	Polycarbonate/polyethylene terephthalate alloy
<b>Mounting and fixing</b>	Mounting on 1-r rail or 1.6...10 mm thick panel	–	Flush mounting, fixed by 4 M4 screws (included)
<b>Keys</b>		11 customizable function keys + 1 operating key with LED	–
<b>Emergency stop button</b>		1 auxiliary contact (NO), 2 safety contacts (NC)	–
	Voltage	30 V $\overline{DC}$	–
	Maximum current	1 A	–
	Minimum load	5 V $\overline{DC}$ , 1 mA	–
	Conformity to standards	IEC 60947-5-1, IEC 60947-5-5	
<b>Key switch</b>		1 contact	–
	Voltage	24 V $\overline{DC}$	–
	Maximum current	300 mA	–
<b>3-position enabling grip switch</b>		2 NC safety contacts (open when gripped or released)	–
	Voltage	30 V $\overline{DC}$	–
	Maximum current	0.7 A	–
	Conformity to standards	IEC 60947-5-8, ISO 12100-1-2, IEC 60204-1	
<b>Electrical characteristics</b>			
<b>Power supply</b>	Voltage	24 V $\overline{DC}$	
	Limits	19.2...28.8 V $\overline{DC}$	
	Voltage break	$\leq 5$ ms	$\leq 10$ ms
<b>Inrush current</b>		$\leq 60$ A	$\leq 30$ A
<b>Consumption</b>		16.7 W	6.3 W

Functional characteristics		
Type of terminal	Magelis XBT GH2460	
<b>LCD screen</b>	Type	Colour TFT
	Colour	65,536 colours, 16,384 if flashing
	Definition	640 x 480 pixels (VGA)
	Size (width x height in mm)	5.7" (115.2 x 86.4)
	Touch-sensitive area	Analog, resolution 1024 x 1024
	Backlighting	50,000 hours (service life at 25°C for continuous use)
	Brightness adjustment	16 levels via touch panel
	Character fonts	ASCII (including all European characters), Japanese (ANK, Kanji), Chinese (simplified Chinese), Taiwanese (traditional Chinese), Korean
<b>Dialogue application</b>	Max. number of pages	Limited by the capacity of the internal Flash memory or Compact Flash card
<b>Signalling</b>		1 LED: green for normal operation, orange if backlighting faulty
<b>Operating system/processor</b>		Magelis/266 MHz RISC CPU
<b>Memory</b>	<b>Application</b>	32 MB Flash EPROM
	<b>Data backup</b>	512 KB SRAM (lithium batteries)
<b>Schneider Electric protocols</b>	Modicon	Modbus, Uni-TE, Modbus TCP/IP
<b>Third-party protocols</b>	Mitsubishi	Melsec
	Omron	Sysmac
	Rockwell Automation	Allen-Bradley
	Siemens	Simatic
<b>Real-time clock</b>		Built-in real-time clock
<b>Expansion</b>	Compact Flash memory card	1 slot for 128, 256, 512 MB, 1 GB, 2 GB or 4 GB Compact Flash card
	USB port (V1.1)	Type A
<b>Connection</b>	32-way quick connector	XBT ZGHL3 (3 m) or XBT ZGHL10 flexible connection cable (10 m)
<b>Junction box type</b>		<b>XBT ZGJBOX</b>
<b>Thumbwheels</b>		2 thumbwheels for configuring a station number (0 to 255) on the junction box
<b>Connections</b>	XBT GH link	32-way connector for linking XBT GH using a 3 m or 10 m cable
	COM1 serial link (115.2 kbps max.)	9-way male SUB-D connector (RS 232C/RS 422/485 serial link)
	Ethernet TCP/IP network (10BASE-T/100BASE-TX)	RJ45 connector
	Inputs/outputs on 24-way screw terminals	<ul style="list-style-type: none"> <li><input type="checkbox"/> 24 V <math>\overline{\text{---}}</math> power supply, 3 terminals, tightening torque 0.79 Nm</li> <li><input type="checkbox"/> Key switch status, 3 terminals, 2 contacts (1 NO + 1 NC)</li> <li><input type="checkbox"/> 3-position enabling grip switch status, 4 terminals, 2 contacts (2 NO)</li> <li><input type="checkbox"/> Operating key status, 2 terminals</li> <li><input type="checkbox"/> Emergency stop button status, 6 terminals, 3 contacts (2 NC + 1 NO)</li> <li><input type="checkbox"/> FO and F2 function key status, 4 terminals</li> <li><input type="checkbox"/> Buzzer output status, 2 terminals</li> </ul>

1



XBT GT1105/1135



XBT GT210/2220/2330



XBT GT4230/4300



XBT GT5300

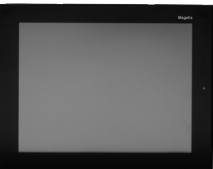

XBT GT6300



XBT GT7340

#### Monochrome touch screen terminals <sup>(1)</sup>

Type of screen	Number of ports	Application memory capacity	Compact Flash memory	Composite video input	Number of Ethernet ports	Reference	Weight kg
<b>Optimum, 3.8" QVGA screen</b>							
STN	1 COM1	32 MB	No	No	–	<b>XBT GT1105</b>	–
Amber or red	1 USB				1	<b>XBT GT1135</b>	
<b>Optimum, 5.7" QVGA screen</b>							
STN	1 COM1	16 MB	No	No	–	<b>XBT GT2110</b>	1.000
Blue mode	1 COM2 1 USB						
<b>Multifunction, 5.7" QVGA screen</b>							
STN	1 COM1	16 MB	Yes	No	–	<b>XBT GT2120</b>	1.000
Black and white	1 COM2 1 USB				1	<b>XBT GT2130</b>	1.000

#### Colour touch screen terminals <sup>(1)</sup>

Type of screen	Number of ports	Application memory capacity	Compact Flash memory	Composite video input	Embedded Ethernet	Reference	Weight kg
<b>Optimum, 3.8" QVGA screen</b>							
TFT	1 COM1 1 USB	32 MB	No	No	1	<b>XBT GT1335</b>	1.000
<b>Multifunction, 5.7" QVGA screen</b>							
STN	1 COM1 1 COM2 1 USB	16 MB	Yes	No	–	<b>XBT GT2220</b>	1.000
TFT	1 COM1 1 COM2 1 USB	16 MB	Yes	No	1	<b>XBT GT2330</b>	1.000
TFT High Brightness	1 COM1 1 COM2 1 USB	16 MB	Yes	No	1	<b>XBT GT2930</b>	1.000
<b>Multifunction, 5.7" VGA screen</b>							
TFT	1 COM1 1 COM2 2 USB	32 MB	Yes	No	1	<b>XBT GT2430</b>	–
<b>Multifunction, 7.5" VGA screen</b>							
STN	1 COM1 1 COM2 1 USB	32 MB	Yes	No	1	<b>XBT GT4230</b>	1.800
TFT	1 COM1 1 COM2 1 USB	32 MB	Yes	No Yes	1 1	<b>XBT GT4330</b> <b>XBT GT4340</b>	1.800 1.800
<b>Multifunction, 10.4" VGA</b>							
STN	1 COM1 1 COM2 2 USB	32 MB	Yes	No	1	<b>XBT GT5230</b>	3.000
TFT	1 COM1 1 COM2 2 USB	32 MB	Yes	No Yes	1 1	<b>XBT GT5330</b> <b>XBT GT5340</b>	2.500 2.500
<b>Multifunction, 10.4" SVGA</b>							
TFT	1 COM1 1 COM2 2 USB	32 MB	Yes	No	1	<b>XBT GT 5430</b>	2.500
<b>Multifunction, 12.1" SVGA</b>							
TFT	1 COM1 1 COM2 2 USB	32 MB	Yes	No Yes	1 1	<b>XBT GT6330</b> <b>XBT GT6340</b>	3.000 3.000
<b>Multifunction, 15" XGA</b>							
TFT	1 COM1 1 COM2 2 USB	32 MB	Yes	Yes	1	<b>XBT GT7340</b>	5.600

(1) Fixing kit (screw clips), locking device for USB connectors (except XBT GT 1100) and instruction sheet included with terminals. Setup documentation for XBT GT terminals is included in electronic format with Vijeo Designer configuration software (see page 4/17).





XBT GK2120/2330



XBT GK5330



XBT GH2460



XBT ZGJBOX



XBT ZGHL●●

**Keypad/touch screen terminals (1)**

Type of screen	Number of ports	Application memory capacity	Compact Flash memory	Video input	Number of Ethernet ports	Reference	Weight kg
<b>Multifunction, 5.7" screen</b>							
STN Black and white	1 COM1 1 COM2 1 USB	32 MB	Yes	No	–	XBT GK2120	–
<b>Multifunction, 5.7" screen</b>							
TFT Colour mode	1 COM1 1 COM2 1 USB	32 MB	Yes	No	1	XBT GK2330	–
<b>Multifunction, 10.4" screen</b>							
TFT Colour mode	1 COM1 1 COM2 2 USB	32 MB	Yes	No	1	XBT GK5330	–

**Portable touch screen terminal**

Type of screen	Number of ports	Application memory capacity	Compact Flash memory	Video input	Number of Ethernet ports	Reference	Weight kg
<b>Multifunction, 5.7" screen</b>							
TFT Colour mode	1 COM1 1 USB	32 MB	Yes	No	1	XBT GH2460 (2)	–

**Connection components**

Description	Used	Length	Reference	Weight kg
<b>Junction box for XBT GH</b>	Specifically for XBT GH terminal, it enables: <ul style="list-style-type: none"> <li>■ 24 V <math>\overline{\text{DC}}</math> power supply to XBT GH terminal</li> <li>■ Connection of various safety inputs/outputs</li> <li>■ Connection on multiprotocol serial link (9-way SUB-D) or Ethernet TCP/IP (RJ45).</li> </ul> Can be mounted on 35 mm $\overline{\text{DIN}}$ rail	–	XBT ZGJBOX (2) (3)	–
<b>Interface cable for XBT GH</b>	For connecting XBT GH terminal to junction box XBT ZGJBOX	3 m	XBT ZGHL3 (2)	–
		10 m	XBT ZGHL10 (2)	–

(1) Fixing kit (spring clips), locking device for USB connectors, customizable label sheets and instruction sheet included with terminals.

(2) XBT GH terminal is connected to junction box XBT ZGJBOX using cable XBT ZGHL●●, to be ordered separately (see table above). Description on page 1/60.

(3) A junction box is required at each XBT GH terminal connection point.

# Operator dialogue terminals

## Advanced Panels

Magelis XBT GTW with 8.4" or 12" screen

Magelis HMI GTW with 15" screen

1



XBT GTW450

### Open touch screen terminals (1)

Type of screen	Number of ports	Application memory capacity	Compact Flash memory	Video input	Number of Ethernet ports	Reference	Weight kg
<b>Multifunction, 8.4" screen</b>							
TFT	1 COM1 1 COM2 4 USB	256 MB RAM expandable to 1 GB, for system and application	1 GB expandable to 4 GB	No	2	<b>XBT GTW450</b>	3.500



XBT GTW652

### Multifunction, 12" screen

TFT	1 COM1 1 COM2 5 USB	512 MB RAM expandable to 1 GB, for system and application	2 GB expandable to 4 GB	No	2	<b>XBT GTW652</b>	3.800
-----	---------------------------	--	-------------------------	----	---	-------------------	-------

### Multifunction, 15" screen

TFT	1 COM1 1 COM2 5 USB	512 MB RAM expandable to 1 GB, for system and application	2 GB expandable to 4 GB	No	2	<b>HMI GTW 7353</b>	6.000
-----	---------------------------	--	-------------------------	----	---	---------------------	-------

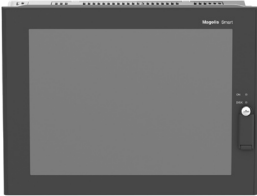

HMI GTW 7353

(1) Fixing kit (screw clips), locking device for USB connectors and instruction sheet included with terminals. Setup documentation for GTW terminals is included in electronic format with Vijeo Designer configuration software (see page 4/17).



XBT ZGM●●●

Separate components				
Description	Characteristics	Compatible with	Reference	Weight kg
<b>Compact Flash memory cards</b>	128 MB, blank	XBT terminals, except XBT GT1●●●/GT2110	<b>XBT ZGM128</b>	0.050
	256 MB, blank		<b>XBT ZGM256</b>	0.050
	512 MB, blank		<b>MPC YN0 0CFE 00N</b>	0.050
	1 GB, blank		<b>MPC YN0 0CF1 00N</b>	–
	2 GB, blank		<b>MPC YN0 0CF2 00N</b>	–
	4 GB, blank		<b>MPC YN0 0CF4 00N</b>	–
		2 GB, with the following software pre-installed: <ul style="list-style-type: none"> <li>■ Windows XP Embedded SP2 in 9 languages (Chinese, English, French, German, Italian, Portuguese, Russian, Spanish, Swedish)</li> <li>■ NET Run Time framework</li> <li>■ Web application</li> <li>■ Vijeo Designer Run Time, trial version (21-day)</li> </ul>	XBT GTW 450	<b>HMI YPSC 42E01</b>
	2 GB, with the following software pre-installed: <ul style="list-style-type: none"> <li>■ Windows XP Embedded SP2 in 9 languages (Chinese, English, French, German, Italian, Portuguese, Russian, Spanish, Swedish)</li> <li>■ NET Run Time framework</li> <li>■ Vijeo Citect Web Client</li> <li>■ Office Reader</li> <li>■ Vijeo Designer Run Time, trial version (21-day)</li> </ul>	HMI GTW 7353	<b>MPC YN5 2CF2 20T</b>	–
<b>Maintenance kits</b>	Includes panel mounting fixings and seals	8.4" models MPC ST1 1N●J 00T	<b>MPC YK1 0MNT KIT</b>	–
		12" models MPC ST2 1N●J20●	<b>MPC YK2 0MNT KIT</b>	–
		15" models MPC ST5 2NDJ 10	<b>MPC YK5 0MNT KIT</b>	–
<b>Protective sheets</b> (5 peel-off sheets)	–	XBT GT1105/GT1135/GT1335	<b>XBT ZG60</b>	–
	–	XBT GT1100/GT1130	<b>XBT ZG61</b>	–
	–	XBT GT21●0/GT2220/GT2●30	<b>XBT ZG62</b>	0.200
	–	XBT GT4230/GT43●0	<b>XBT ZG64</b>	0.200
	–	XBT GT53●0/XBT GT54●0	<b>XBT ZG65</b>	0.200
	–	XBT GT5230/GT63●0	<b>XBT ZG66</b>	0.200
	–	XBT GK 2●●0/GH2460	<b>XBT ZG68</b>	–
	–	XBT GK 5330	<b>XBT ZG69</b>	–
	–	XBT GT7340/HMI GTW 7353	<b>MPC YK5 0SPS KIT</b>	0.200
<b>Spring fixing clips</b> Sold in lots of 12	–	XBT GT terminals (number of spring clips depends on terminal)	<b>XBT Z3002</b>	–
<b>Wall mounting kit</b>	Fixing components for mounting XBT GH terminal on a wall	XBT GH terminal	<b>XBT ZGWMKT</b>	–
<b>Neck strap</b>	For use with XBT GH hand-held terminal	XBT GH terminal	<b>XBT ZGNSTP</b>	–
<b>Emergency stop button protection</b>	For preventing accidental operation of the emergency stop button	XBT GH terminal	<b>XBT ZGESGD</b>	–

1

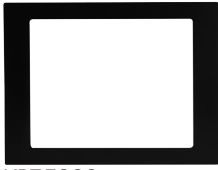

XBT ZGCO●



XBT ZGUSB

#### Separate components (continued)

Designation	Description	Length	Reference	Weight kg
Mechanical adaptors for substitution of obsolete ranges of Magelis terminals	From XBT F032●10 to XBT GT2●●0	–	XBT ZGCO1	–
	From XBT G2110 to XBT GT2●●0	–	XBT ZGCO2	–
	From XBT F034●●● to XBT GT53●0	–	XBT ZGCO3	–
	From XBT G5330 to XBT GT5330	–	XBT ZGCO4	–

Remote USB port for XBT terminal GT2●●0...GT7340 GT1●●5, GK●●●, GTW●●●	For remote location of the USB port on the rear of the XBT terminal, on a panel or the enclosure door (Ø 21 mm fixing device)	1 m	XBT ZGUSB	–
--	---	-----	-----------	---

Adaptor for Compact Flash cards	Enables a PC with a PCMCIA card slot to be adapted to accommodate a Compact Flash card	–	XBT ZGADT	0.050
---------------------------------	--	---	-----------	-------

#### Replacement parts

Description	For use with	Reference	Weight kg
Seals	XBT GH (for junction box)	XBT ZG5H	–
	XBT GT1100/GT1130/GT1105/GT1135/GT1335	XBT ZG51	0.030
	XBT GT21●0/GT2220/GT2330	XBT ZG52	0.030
	XBT GT4230/GT43●0	XBT ZG54	0.030
	XBT GT53●0	XBT ZG55	0.030
	XBT GT5230/GT63●0	XBT ZG56	0.030
	XBT GT7340	XBT ZG57	0.030
	XBT GK2●●0	XBT ZG58	–
	XBT GK5330	XBT ZG59	–
Backlighting lamps	XBT GT5230	XBT ZG43	0.100
	XBT GT53●0	XBT ZG45	0.200
	XBT GT53●0 PV ≥ 3/XBT GT54●0	XBT ZG45B	0.200
	XBT GT63●0	XBT ZG46	0.200
	XBT GT7340	XBT ZG47	0.200
USB fastenings Sold in lots of 5	XBT GT1●●0/GT2●●0/GT4●●0	XBT ZGCLP1	–
	XBT GT1●●5/GT5●●0/GT6●●0/GT7●●0	XBT ZGCLP2	–
	XBT GK	XBT ZGCLP3	–
Fixing kit	4 clips and screws (max. tightening torque: 0.5 Nm) included with all XBT GT terminals	XBT ZG FIX	0.100
Extension connector protection	XBT GT/GK, except XBT GT1●●●	XBT ZGCNC	0.030
Power supply connector Sold in lots of 5	XBT GT1●●●/GT2●●● XBT GT4●●● XBT GK2●●●	XBT ZGPWS1	0.030
	XBT GT5●●●/6●●●/7●●● XBT GK5●●● XBT GTW●●●	XBT ZGPWS2	–
Auxiliary connector	XBT GT4●●●/5●●●/6●●●/7●●●, XBT GK5●●●	XBT ZGAUX	–
Sheets of customizable labels Sold in lots of 10	XBT GK2●●0	XBL YGK2	0.030
	XBT GK5●●●	XBL YGK5	–
	XBT GH	XBT YGH2	–
Stylus Sold in lots of 5	XBT GH	XBT ZGPEN	–
Emergency stop button protection	XBT GH	XBT ZGESD	–
Hand strap	XBT GH	XBT ZGHSTP	–

**Application transfer cables - terminal to PC**

Type of terminal (terminal end connector)	Connector (PC end)	Type	Length	Reference (1)	Weight kg
XBT GT2●●0...GT7340, XBT GT1●●5, XBT GK, XBT GH XBT GTW	USB	TTL	2 m	XBT ZG935	0.290

**Printer connection cables**

Type of printer	Connector (printer end)	Type	Length	Reference	Weight kg
Serial printer (2) for XBT GT/GK/GTW terminal (except XBT GT1●●●)	25-way female SUB-D	RS 232C (COM1)	2.5 m	XBT Z915	0.200

**Adaptors and isolation boxes for XBT terminals**

These 3 adaptors are used with the connection cables depending on the application concerned. For example, cable XBT Z968 is used with "+ (2)", i.e. adaptor XBT ZG909, to connect a Twido controller (via its terminal port) to an XBT GT2●●0 terminal (via its COM1 port).

Description	Type of connector (automation product end)	Physical link (XBT GT terminal end)	Length	Reference	Weight kg
Adaptor for XBT GT1●●● (COM1 port) XBT GT2●●0...7340/ XBT GK (COM2 port)	25-way SUB-D connector	RJ45 connector	0.2 m	XBT ZG939	–
Adaptors for XBT GT2●●0...7340/ XBT GK (COM1 port) XBT GTW (COM1 and COM2 ports)	25-way SUB-D connector	9-way SUB-D connector, RS 485	0.2 m	XBT ZG909	–
		9-way SUB-D connector, RS 232C	0.2 m	XBT ZG919	–



XBT ZGI485

Description	For use with	Link to isolate	Reference	Weight kg
Serial link isolation boxes for XBT GT2●●0...7340/ XBT GK	- Connection to serial port of XBT terminal - Isolated link on 9-way SUB-D connector (3)	RS 232C/RS 485 (COM1)	XBT ZGI232	–
	- Box power supply via USB port of terminal. Incorporates a USB port expander.	RS 485 (COM2)	XBT ZGI485	–

(1) Cable included (depending on model) with Vijeo Designer software packages (see page 4/17)

(2) Parallel printer (see page 1/41)

(3) Male connector with XBT ZGI232, female connector with XBT ZGI485

#### Cables for connecting XBT GT to other Schneider Electric products

Automation product type	Type of connector (automation product end)	Protocol	Type of XBT terminal, physical link	On XBT port	Length	Reference	Weight kg
<b>Twido, Nano, Modicon TSX Micro, Modicon Premium</b>	8-way female mini-DIN terminal port	Uni-TE (V1/V2), Modbus	XBT GT1●●●, RS 485	COM1	2.5 m	<b>XBT Z9780</b>	0.180
			XBT GT2●●0...7340, XBT GK, RS 485	COM2	10 m	<b>XBT Z9782</b>	–
			XBT GT2●●0...7340, XBT GK, RS 485	COM1	2.5 m	<b>XBT Z968 + (2)</b>	0.180
			XBT GT2●●0...7340, XBT GK, RS 485	COM1	5 m	<b>XBT Z9681 + (2)</b>	0.340
			XBT GT2●●0...7340, XBT GK, RS 485 XBT GH (junction box)	COM1	2.5 m	<b>XBT Z9018</b>	0.170
			XBT GTW●●, RS 232 XBT GH (junction box)	COM1	2.5 m	<b>TSX PCX 1031</b>	–
<b>Modicon M340 Modicon M238</b>	RJ45	Modbus	XBT GT1●●●, RS 485	COM1	2.5 m	<b>XBT Z9980</b>	0.230
			XBT GT2●●0...7340, XBT GK, RS 485	COM2	10 m	<b>XBT Z9982</b>	–
			XBT GT2●●0...7340, XBT GK, RS 485	COM1	1.8 m	<b>XBT Z938 + (2)</b>	0.230
			XBT GT2●●0...7340, XBT GK, RS 485 XBT GH (junction box)	COM1	2.5 m	<b>XBT Z9008</b>	–
			USB	Terminal port	XBT GT (4) XBT GK/GTW	USB	1.8 m
					4.5 m	<b>BMX XCA USB H045</b>	–
<b>Modicon Premium with TSX SCY 2160●</b>	25-way female SUB-D	Uni-TE (V1/V2)	XBT GT1●●●, RS 485	COM1	2.5 m	<b>XBT Z918 + (1)</b>	0.230
			XBT GT2●●0...7340, XBT GK, RS 485 XBT GH (junction box)	COM1	2.5 m	<b>XBT Z918 + (2)</b>	0.230
<b>Modicon Quantum</b>	9-way male SUB-D	Modbus	XBT GT1●●●, RS 232C	COM1	2.5 m	<b>XBT Z9710 + (1)</b>	0.210
			XBT GT2●●0...7340, XBT GK/GTW, RS 232C XBT GH (junction box)	COM1	2.5 m	<b>XBT Z9710 + (3)</b>	0.210
					3.7 m	<b>990 NAA 263 20</b>	0.290
<b>Advantys STB</b>	HE13 (NIM, network interface module)	Modbus	XBT GT1●●●, RS 232C	COM1	2.5 m	<b>XBT Z988 + (1)</b>	0.220
						<b>XBT Z9715</b>	–
			XBT GT2●●0...7340, XBT GK/GTW, RS 232C XBT GH (junction box)	COM1	2 m	<b>STB XCA 4002</b>	0.210
					2.5 m	<b>XBT Z988 + (3)</b>	0.220
<b>Modicon Momentum M1</b>	RJ45 (port 1 on Momentum M1)	Modbus	XBT GT1●●●, RS 232C	COM1	2.5 m	<b>XBT Z9711 + (1)</b>	0.210
			XBT GT2●●0...7340, XBT GK, XBT GTW, RS 232C XBT GH (junction box)	COM1	2.5 m	<b>XBT Z9711 + (3)</b>	0.210
<b>TeSys U/T starters ATV 312/61/71 variable speed drives ATS 48 starters Lexium 05 Preventa XPSMC</b>	RJ45	Modbus	XBT GT1●●●, RS 485	COM1	3 m	<b>VW3 A8 306 R30</b>	0.060
					2.5 m	<b>XBT Z9980</b>	–
			XBT GT2●●0...7340, XBT GK, RS 485	COM2	10 m	<b>XBT Z9982</b>	–
			XBT GT2●●0...7340, XBT GK, RS 485 XBT GH (junction box)	COM1	2.5 m	<b>XBT Z9008</b>	–

(1) Adaptor **XBT ZG939** to be used with cables with " + (1) " after the reference.

(2) Adaptor **XBT ZG909** to be used with cables with " + (2) " after the reference.

(3) Adaptor **XBT ZG919** to be used with cables with " + (3) " after the reference.

(4) Except XBT GT1●●0.



TSX PCX 1031

#### Cables and adaptors for connecting XBT terminals to third-party PLCs

##### Mitsubishi, Melsec PLCs

Description Driver used	Type of XBT terminal	Type of connectors (fitted to cable, excluding adaptor)	Physical link (COM1)	Length	Reference	Weight kg
Connection cable, A CPU (SIO)	GT2●●0...7340/ GK/GH (junction box)	9-way SUB-D/25-way SUB-D	RS 422	5 m	<b>XBT ZG9773</b>	–
Connection cable, Q Link (SIO)	GT2●●0...7340/ GK/GTW/GH (junction box)	9-way SUB-D/9-way SUB-D	RS 232C	5 m	<b>XBT ZG9772</b>	–
Connection cable, Q CPU (SIO)	GT2●●0...7340/ GK/GTW/GH (junction box)	9-way SUB-D/mini-DIN	RS 232C	5 m	<b>XBT ZG9774</b>	–
Connection cable, A Link (SIO)	GT2●●0...7340/ GK/GTW/GH (junction box)	9-way SUB-D/25-way SUB-D	RS 232C	5 m	<b>XBT ZG9731</b>	–
Connection cable, FX (CPU)	GT2●●0...7340/ GK/GH (junction box)	9-way SUB-D/mini-DIN	RS 422	5 m	<b>XBT ZG9775</b>	–
	GT1●●●	25-way SUB-D/mini-DIN	RS 422	5 m	<b>XBT Z980 + (1)</b>	–
Cable for 2-port adaptor, FX (CPU), A CPU (SIO) QnA CPU (SIO)	GT2●●0...7340/ GK/GH (junction box)	9-way SUB-D/flying leads other end	RS 422	5 m	<b>XBT ZG9778 + (4)</b>	–
Case adaptor FX (CPU), A CPU (SIO) QnA CPU (SIO)	GT2●●0...7340/ GK/GH (junction box)	2-port case Screw terminal/2 x 9-way SUB-D	RS 422	–	<b>XBT ZG979</b>	–



XBT ZG9772



XBT ZG9731

##### Omron, Sysmac PLCs

Description Driver used	Type of XBT terminal	Type of connectors (fitted to cable, excluding adaptor)	Physical link (COM1)	Length	Reference	Weight kg
Connection cables, Link (SIO)	GT1●●●	25-way SUB-D/9-way SUB-D	RS 232C	2.5 m	<b>XBT Z9740 + (1)</b> <b>XBT Z9743</b>	0.210 –
	GT2●●0...7340/ GK/GTW/GH (junction box)	9-way SUB-D/9-way SUB-D	RS 232C	5 m	<b>XBT ZG9740</b>	–
		9-way SUB-D/25-way SUB-D	RS 232C	5 m	<b>XBT ZG 9731</b>	–
Connection cables, FINS (SIO)	GT1●●●	25-way SUB-D/9-way SUB-D	RS 232C	2.5 m	<b>XBT Z9740 + (1)</b> <b>XBT Z9743</b>	0.210 –
	GT2●●0...7340/ GK/GTW/GH (junction box)	9-way SUB-D/9-way SUB-D	RS 232C	5 m	<b>XBT ZG9740</b>	–

(1) Adaptor **XBT ZG939** to be used with cables with " + (1) " after the reference (see page 1/69).

(4) Cable **XBT ZG9778** to be used in conjunction with 9-way female/female SUB-D adaptor **XBT ZGCOM1**.



XBT ZG9731

**Cables and adaptors for connecting XBT GT terminals to third-party PLCs (continued)**

**Rockwell Automation, Allen-Bradley PLCs**

Description Driver used	Type of XBT terminal	Type of connectors (fitted to cable, excluding adaptor)	Physical link (COM1)	Length	Reference	Weight kg
Connection cables, DF1 Full Duplex	GT1●●●	25-way SUB-D/9-way SUB-D	RS 232C	2.5 m	<b>XBT Z9730 + (1)</b>	0.210
					<b>XBT Z9733</b>	–
	25-way SUB-D/8-way mini-DIN	RS 232C	2.5 m	<b>XBT Z9731 + (1)</b>	0.210	
	GT2●●0...7340/ GK/GTW/GH (junction box)	9-way SUB-D/25-way SUB-D	RS 232C	5 m	<b>XBT ZG 9731</b>	–
Connection cables, DH485	GT1●●●	25-way SUB-D/9-way SUB-D	RS 232C	2.5 m	<b>XBT Z9734</b>	–
		25-way SUB-D/8-way mini-DIN	RS 485	5 m	<b>XBT Z9732 + (1)</b>	–
	GT2●●0...7340/ GK/GH (junction box)	25-way SUB-D/8-way mini-DIN	RS 485	5 m	<b>XBT Z9732 + (2)</b>	–

**Siemens, Simatic PLCs**

Description Driver used	Type of XBT terminal	Type of connectors (fitted to cable, excluding adaptor)	Physical link	Length	Reference	Weight kg
Connection cable, PPI, S7 200	GT1●●●	RJ45/9-way SUB-D	RS 485 (COM1)	2.5 m	<b>XBT ZG9721</b>	–
		GT2●●0...7340/ GK	RJ45/9-way SUB-D	RS 485 (COM2)		
Connection cables, MPI port, S7 300/400	GT2●●0...7340/ GK/GTW/GH (junction box)	9-way SUB-D/9-way SUB-D	RS 232C (COM1)	3 m	<b>XBT ZG9292</b>	–
		GT2●●0...7340/ GK	RJ45/flying leads other end	RS 485 (4) (COM2)	3 m	<b>VW3 A8 306 D30</b>
			RJ45/9-way SUB-D	RS 485 (4) (COM2)	2.5 m	<b>XBT ZG9721</b>

**Customizable cables**

Description Driver used	Type of XBT terminal	Type of connectors (fitted to cable, excluding adaptor)	Physical link	Length	Reference	Weight kg
Universal cable, RS 422	GT2●●0...7340/ GK/GH (junction box)	9-way SUB-D/flying leads other end	RS 422 (COM1)	2.5 m	<b>XBT ZG9722</b>	0.210
Universal adaptor, RS 422/485	GT2●●0...7340/ GK/GH (junction box)	9-way SUB-D/Screw terminal	RS 422 (COM1)	–	<b>XBT ZG949 + (5)</b>	–
		9-way SUB-D/Screw terminal	RS 485 (COM2)	–	<b>XBT ZG949 + (6)</b>	–

(1) Adaptor **XBT ZG939** to be used with cables with " + (1) " after the reference (see page 1/69).

(2) Adaptor **XBT ZG909** to be used with cables with " + (2) " after the reference (see page 1/69).

(4) Non-isolated RS 485 serial link, 12 Mbps (187.5 kbps with **XBT GT11●0/2110**).

(5) Cable to be created by user and used in conjunction with 9-way female/female SUB-D adaptor **XBT ZGCOM1**.

(6) Cable to be created by user and used in conjunction with isolation box **XBT ZGI485** and 9-way male/female SUB-D adaptor **XBT ZGCOM2**.





TSX SCA 62



TSX PACC 01



TSX SCA 64



LU9 GC3



VW3 A8 306 TF10



TWDXCAISO



ABL 7RM24025

## Connection of XBT terminals via serial links and Ethernet network

Type of bus/network	Tap-off units	Connector (tap-off unit end)	Type of XBT terminal	Length	Reference	Weight kg
Uni-Telway serial link	Subscriber socket TSX SCA 62	15-way female SUB-D	GT1●●● (COM1)	3 m	VW3 A8 306	0.150
			GT2●●0...7340/GK (COM2)			
			GT2●●0...7340/GK (COM1)	1.8 m	XBT Z908 + (2)	0.240
	GH (junction box)					
	Connection box TSX P ACC01	8-way female mini-DIN	GT1●●● (COM1)	2.5 m	XBT Z9780	0.180
			GT2●●0...7340/GK (COM2)			
GT2●●0...7340/GK (COM1)			2.5 m	XBT Z9018	-	
GH (junction box)						
Modbus serial link	Subscriber socket TSX SCA 64	15-way female SUB-D	GT1●●● (COM1)	3 m	VW3 A8 306	0.150
			GT2●●0...7340/GK (COM2)			
			GT2●●0...7340/GK (COM1)	1.8 m	XBT Z908 + (2)	0.240
	GH (junction box)					
	8-port Modbus splitter box LU9 GC3	RJ45	GT1●●● (COM1)	3 m	VW3 A8 306R30	0.060
			GT2●●0...7340/GK (COM2)			
GT2●●0...7340/GK (COM1)			2.5 m	XBT Z9980	-	
GH (junction box)						
2-port tap-off junction TWDXCAISO TWDXCAT3RJ	With integrated cable, RJ45 fitted	GT1●●● (COM1)	2.5 m	XBT Z9008	-	
		GT2●●0...7340/GK (COM2)				
		GH (junction box)				
Ethernet TCP/IP network	Hubs 499 NEH/NOH Switches 499 NES, 499 NMS, 499 NSS and 499 NOS	RJ45	GT●●30/●●40	2 m	490 NTW 000 02	-
			GK●●30			
			GTW●●●	5 m	490 NTW 000 05	-
			GH (junction box)			
			GTW●●●	12 m	490 NTW 000 12	-
			GH (junction box)			
GH (junction box)	40 m	490 NTW 000 40	-			
GH (junction box)						
GH (junction box)	80 m	490 NTW 000 80	-			

## Connecting XBT terminals to fieldbuses

Type of bus/network	Connection components	Type of XBT terminal	Reference	Weight kg
FIPWAY, FIPIO	USB gateway	XBT GT/GK (3)	TSXCUSBFIP	-
Modbus Plus	USB gateway	XBT GT/GK (3)	XBTZGUMP	-
		XBT GTW	TSXCUSBMBP	-
PROFIBUS DP	Card on bus extension	XBT GT/GK (3)	XBTZGPDP	-
Device Net	Card on bus extension	XBT GT/GK (3)	XBTZGDVN	-

## Modular regulated switch mode power supplies (4)

Input voltage/output voltage	Use with XBT	Nominal power	Nominal current	Reference	Weight kg
100...240/24 V single-phase wide-range line supply 47...63 Hz	GT1100...6340/ 30 W GK/GH	30 W	1.2 A	ABL 8MEM24012	0.195
	GT7340/GTW	60 W	2.5 A	ABL 7RM24025	0.255

(2) Adaptor XBT ZG909 to be used with cables with " + (2) " after the reference (see page 1/69).

(3) Except XBT GT1●●●.

(4) Dimensions : H x W x D = 90 x 54 x 59 mm (ABL 8MEM24012),  
90 x 72 x 59 mm (ABL 7RM24025).

For further information, please refer to the "Power supplies & transformers Phase0" catalogue.

1

**XBT GT11●5 terminals and Schneider Electric products**

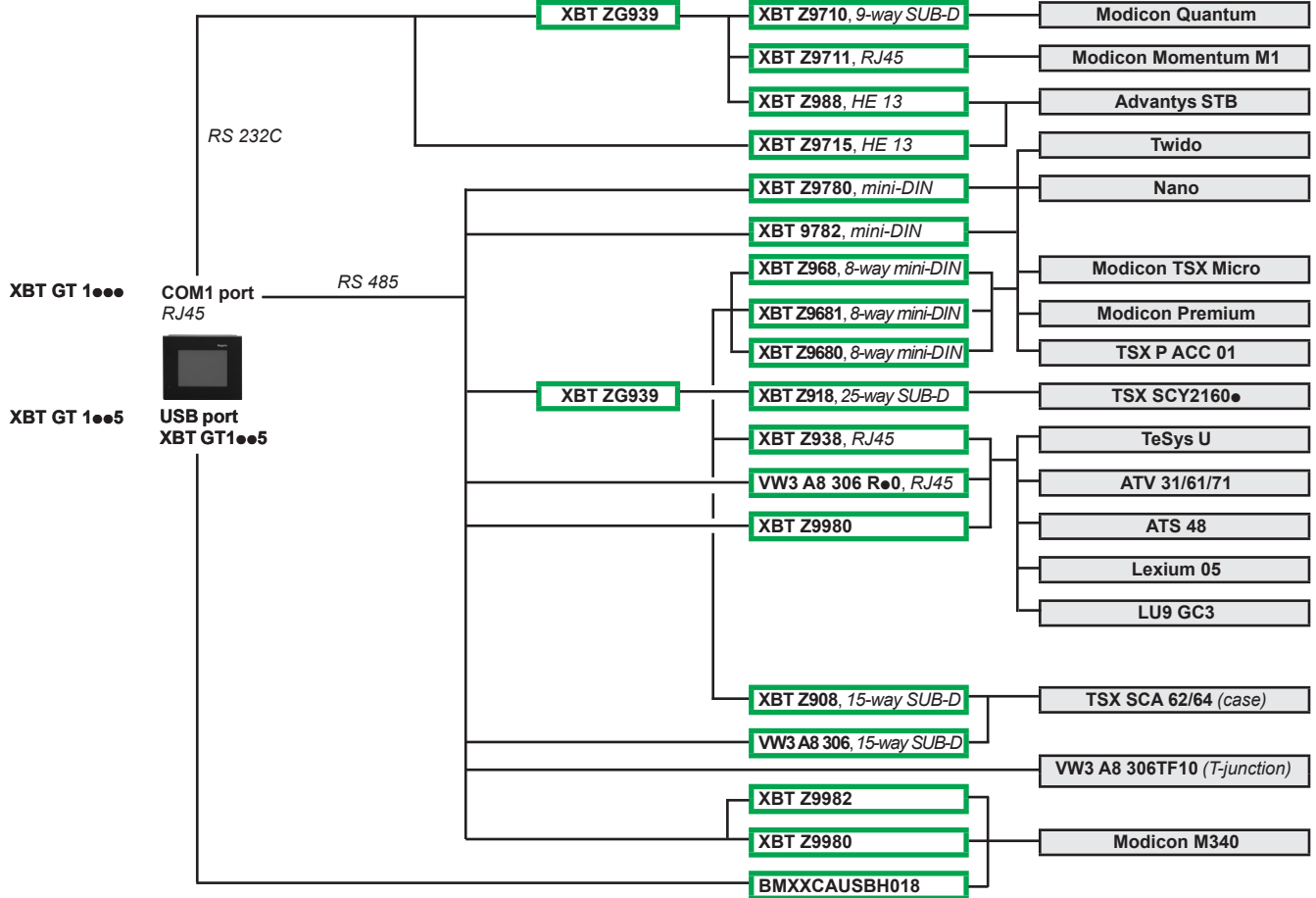

**XBT GT2●●0/GT7340/GK●●●● terminals and Schneider Electric products**

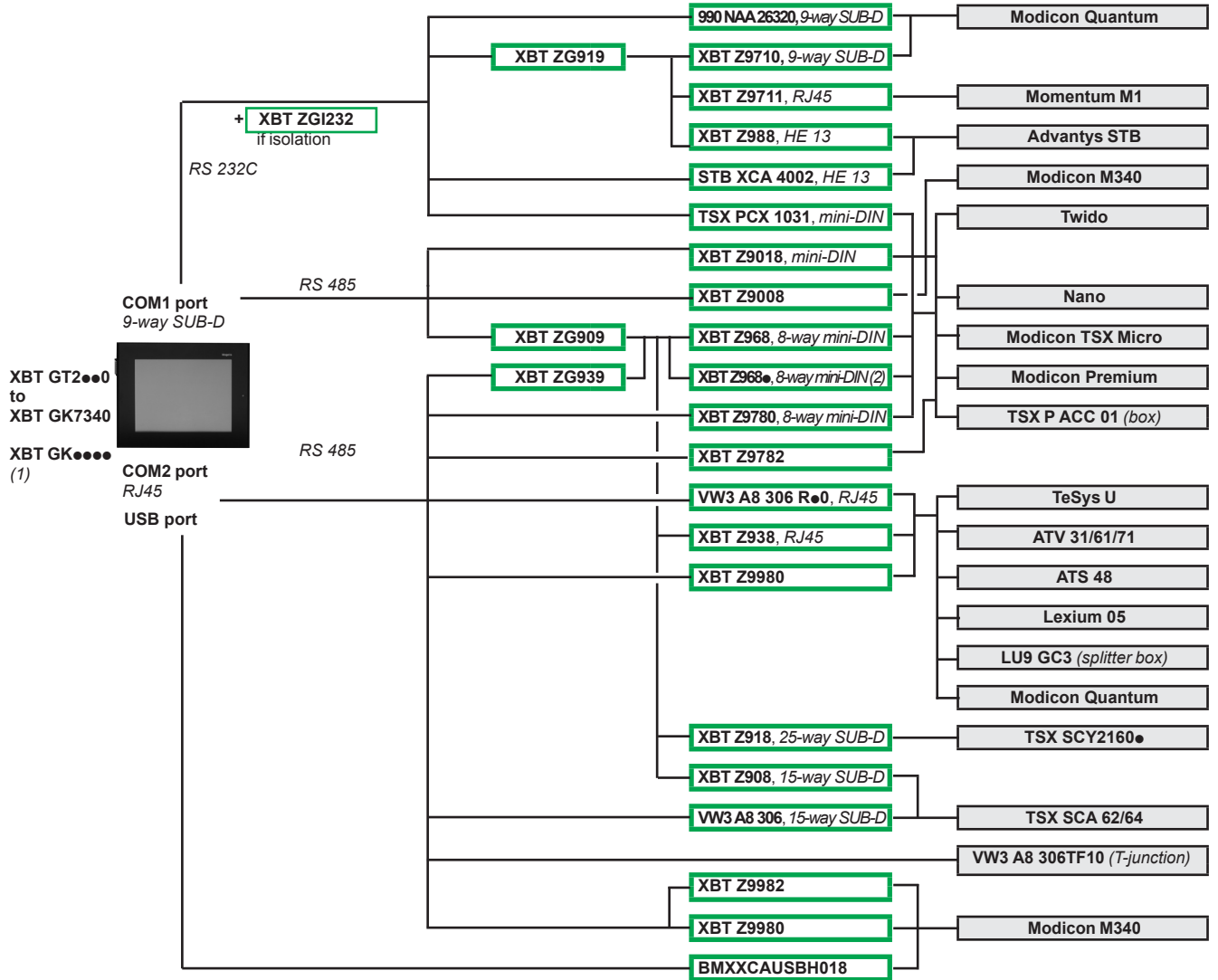

(1) XBT GK USB port only  
 (2) ● defines the length:  
 - 0, 2.5 m (angled version)  
 - 1, 5 m  
 - 6, 16 m  
 - 7, 20 m  
 - 8, 25 m



### XBT GT2000/GT7340/GK0000 terminals and third-party PLCs

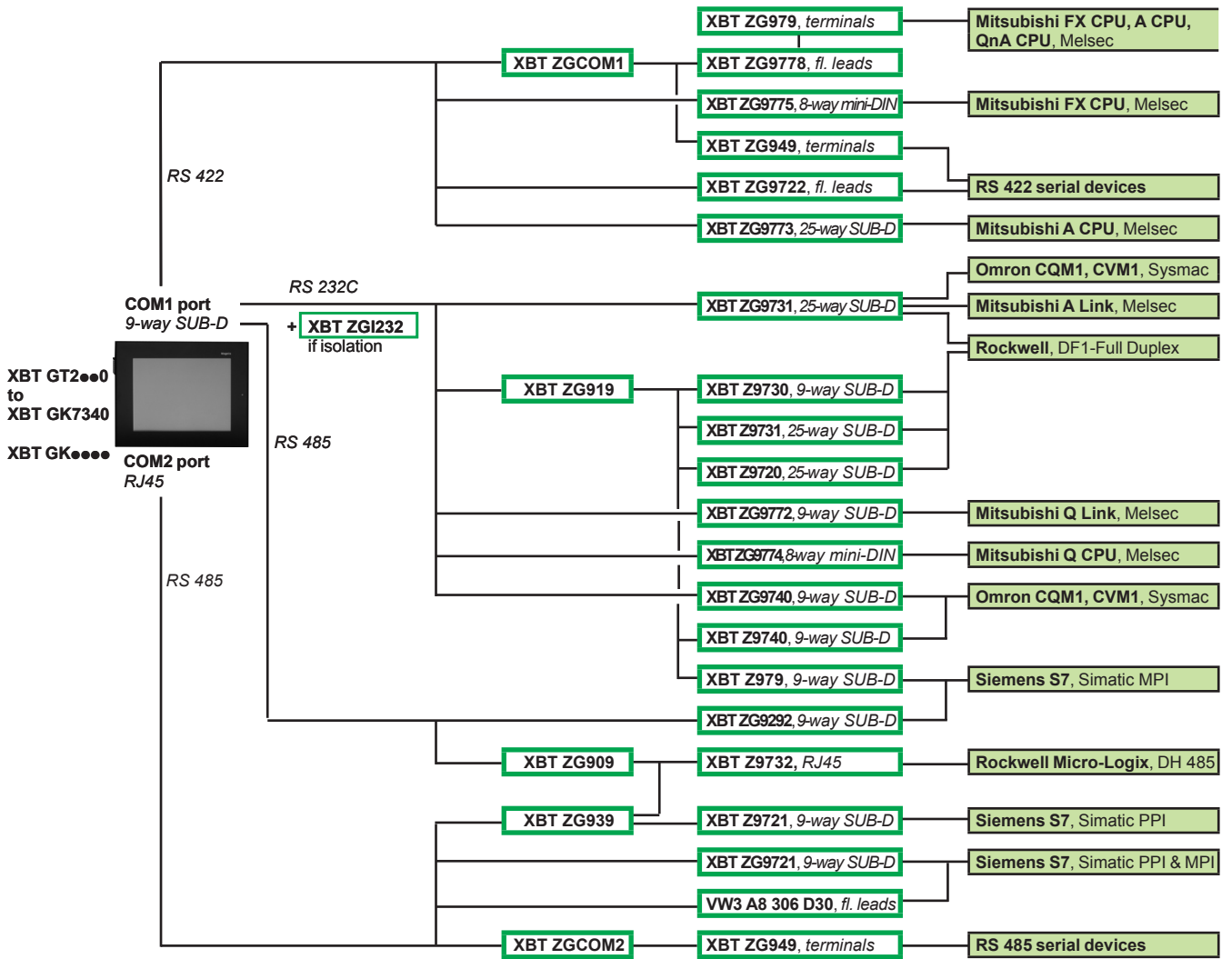

### Application transfer from XBT GT terminals to PC

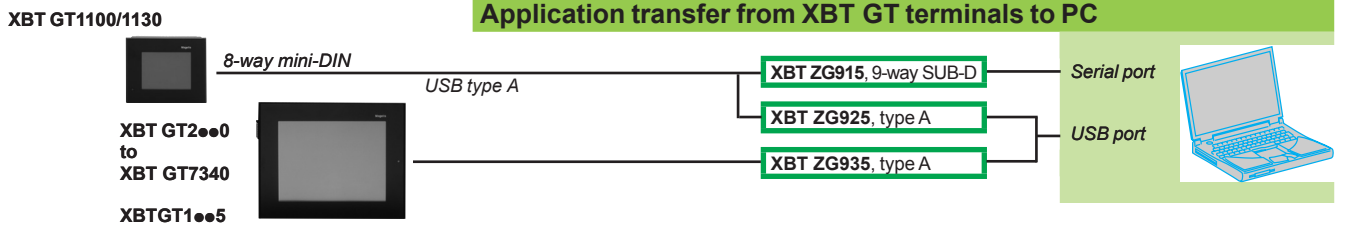

**Equivalent product table -  
XBT F 5" colour touch screen terminals to XBT GT terminals**

Obsolete range XBT F	New range XBT GT	Mechanical adaptor
XBT F032110	XBT GT2220	XBT ZGCO1
XBT F032310	XBT GT2220	XBT ZGCO1

**Equivalent product table -  
XBT F 10" colour touch screen terminals to XBT GT terminals**

Obsolete range XBT F	New range XBT GT	Mechanical adaptor
XBT F034310	XBT GT5330	XBT ZGCO3
XBT F034110	XBT GT5330	XBT ZGCO3
XBT F034510	XBT GT5330	XBT ZGCO3
XBT F034610	XBT GT5330	XBT ZGCO3

**Equivalent product table -  
XBT FC 5" terminals to XBT GT terminals**

Obsolete range XBT FC	New range XBT GT	Mechanical adaptor
XBT FC022310	XBT GT2220	XBT ZGCO1

**Equivalent product table -  
XBT FC 10" terminals to XBT GT terminals**

Obsolete range XBT FC	New range XBT GT	Mechanical adaptor
XBT FC044310	XBT GT5330	XBT ZGCO3
XBT FC044510	XBT GT5330	XBT ZGCO3
XBT FC044610	XBT GT5330	XBT ZGCO3
XBT FC064310	XBT GT5330	XBT ZGCO3
XBT FC064510	XBT GT5330	XBT ZGCO3
XBT FC064610	XBT GT5330	XBT ZGCO3
XBT FC084310	XBT GT5330	XBT ZGCO3
XBT FC084510	XBT GT5330	XBT ZGCO3
XBT FC084610	XBT GT5330	XBT ZGCO3

**Equivalent product table - Magelis XBT F/XBT GK**

**Equivalent product table -  
XBT F 5" and 10" colour keypad terminals to XBT GK terminals**

Obsolete range XBT F	New range XBT GK	Mechanical adaptor
XBT F011110	XBT GK2330/GK2120	-
XBT F011310	XBT GK2330/GK2120	-
XBT F023110	XBT GK5330	-
XBT F023310	XBT GK5330	-
XBT F024110	XBT GK5330	-
XBT F024510	XBT GK5330	-
XBT F024610	XBT GK5330	-

*The dimensions of the products are identical.*

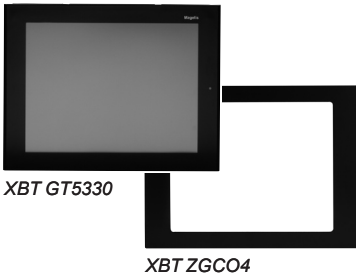

#### Equivalent product table - XBT G to XBT GT terminals

Obsolete range XBT G	New range XBT GT <i>Requires Vijeo Designer ≥ V4.3</i>	Mechanical adaptor (1)
XBT G2110	XBT GT2110	XBT ZGCO2
XBT G2120	XBT GT2120	–
XBT G2130	XBT GT2130	–
XBT G2220	XBT GT2220	–
XBT G2330	XBT GT2330	–
XBT G4320	XBT GT4330	–
XBT G4330	XBT GT4330	–
XBT G5230	XBT GT5230	–
XBT G5330	XBT GT5330	XBT ZGCO4
XBT G6330	XBT GT6330	–
XBT ZG MBP	XBT ZG UMP	Modbus Plus network connection

#### Equivalent product table - Cables for connection to Schneider Electric products

##### Summary

Obsolete range XBT G	New range XBT GT2●●0...GT6330	
Type of link	Type of link	Cable + adaptor reference
COM1, RS 232C, 25-way SUB-D	COM1, RS 232C, 9-way SUB-D	Existing cable + XBT ZG919
	COM2, RS 485, RJ45	Existing cable + RS 485/RS 232C converter + XBT ZG939
COM1, RS 485, 25-way SUB-D	COM1, RS 485, 9-way SUB-D	Existing cable + XBT ZG909
	COM2, RS 485, RJ45	Existing cable + XBT ZG939
COM2, RS 232C, 9-way SUB-D	COM1, RS 232C, 9-way SUB-D	Existing cable
	COM2, RS 485, RJ45	Existing cable + RS 485/RS 232C converter + XBT ZG939

#### Equivalent product table - Cables

Obsolete range XBT G2●●0...G6330				New range XBT GT2●●0...GT6330			
Type of terminal	Type of link	Length	Reference	Type of terminal	Type of link	Length	New reference Cable + adaptor
<b>Twido, Modicon TSX Micro, Modicon Premium</b> , 8-way female mini-DIN terminal port, Uni-TE (V1/V2), Modbus protocol							
XBT G	COM1, RS 485 25-way SUB-D	2.5 m	<b>XBT Z968</b>	XBT GT	COM1, RS 485 9-way SUB-D	2.5 m	<b>XBT Z968 + XBT ZG909</b>
		5 m	<b>XBT Z9681</b>			5 m	<b>XBT Z9681 + XBT ZG909</b>
XBT G	COM2, RS 232C 9-way SUB-D	2.5 m	<b>TSX PCX 1031</b>	XBT GT	COM1, RS 232C 9-way SUB-D	2.5 m	<b>TSX PCX 1031</b>
				XBT GT	COM2, RS 485 RJ45	2.5 m	<b>XBT Z9780</b>
<b>Modicon Premium</b> with TSX SCY 2160●, 25-way female SUB-D connector, Uni-TE (V1/V2) protocol							
XBT G	COM1, RS 485 25-way SUB-D	2.5 m	<b>XBT Z918</b>	XBT GT	COM1, RS 485 9-way SUB-D	2.5 m	<b>XBT Z918 + XBT ZG909</b>
<b>Modicon Quantum</b> , 9-way male SUB-D connector, Modbus protocol							
XBT G	COM1, RS 232C 25-way SUB-D	2.5 m	<b>XBT Z9710</b>	XBT GT	COM1, RS 232C 9-way SUB-D	2.5 m	<b>XBT Z9710 + XBT ZG919</b>
						3.7 m	<b>990 NAA 26320</b>
<b>Advantys STB</b> , HE13 connector (network interface module, NIM), Modbus protocol							
XBT G	COM2, RS 232C 9-way SUB-D	2 m	<b>STB XCA 4002</b>	XBT GT	COM1, RS 232C 9-way SUB-D	2 m	<b>STB XCA 4002</b>
<b>Modicon Momentum M1</b> , RJ45 connector (port 1), Modbus protocol							
XBT G	COM1, RS 232C 25-way SUB-D	2.5 m	<b>XBT Z9711</b>	XBT GT	COM1, RS 232C 9-way SUB-D	2.5 m	<b>XBT Z9711 + XBT ZG919</b>
<b>TeSys U starters, ATV 31/61/71 drives, ATS 48 starters</b> , RJ45 connector, Modbus protocol							
XBT G	COM1, RS 485 25-way SUB-D	2.5 m	<b>XBT Z938</b>	XBT GT	COM1, RS 485 9-way SUB-D	2.5 m	<b>XBT Z938 + XBT Z909</b>
				XBT GT	COM2, RS 485 RJ45	3 m	<b>VW3 A8 306 R30</b>

(1) Mechanical adaptor for mounting XBT GT terminal in place of the substituted XBT G terminal

1

#### Equivalent product table - Cables for application transfer to PC and printer cables

Obsolete range XBT G2●●0...G6330				New range XBT GT2●●0...GT6330			
Type of terminal	Type of link	Length	Reference	Type of terminal	Type of link	Length	New reference
<b>Cables for application transfer to PC</b>							
XBT G	Mini-DIN/9-way SUB-D	2 m	<b>XBT ZG915</b>	XBT GT	USB/USB	2 m	<b>XBT ZG935</b>
	Mini-DIN/USB	2 m	<b>XBT ZG925</b>				
<b>Serial printer cable</b>							
XBT G	COM2, RS 232C	2.5 m	<b>XBT Z915</b>	XBT GT	COM1, RS 232C	2.5 m	<b>XBT Z915</b>
<b>Parallel printer cable</b>							
XBT G	Centronics, Epson ESC/P		<b>XBT ZG946</b>	XBT GT	USB, Hewlett Packard model	2 m	Connection via USB/PIO converter <i>(not supplied by Schneider Electric)</i>
					Centronics, Epson ESC/P		<b>XBT Z925</b> <b>XBT Z935</b>

#### Equivalent product table - Cables for connection to third-party PLCs

##### Mitsubishi, Melsec PLCs

Obsolete range XBT G2●●0...G6330					New range XBT GT2●●0...GT6330				
Type of terminal	Type of connector	Physical link	Length	Substituted reference	Type of terminal	Type of connector	Physical link	Length	New reference + adaptor
<b>Q Link (SIO) protocol</b>									
XBT G	25-way SUB-D/ 9-way SUB-D	COM1, RS 232C	3 m	<b>XBT ZG9771</b>	XBT GT	9-way SUB-D/9-way SUB-D	COM1, RS 232C	5 m	<b>XBT ZG9772</b>
<b>A Link (SIO) protocol</b>									
XBT G	25-way SUB-D/ 25-way SUB-D	COM1, RS 232C	5 m	<b>XBT ZG973</b>	XBT GT	9-way SUB-D/25-way SUB-D	COM1, RS 232C	5 m	<b>XBT ZG9731</b>
	25-way SUB-D/ 9-way SUB-D	COM1, RS 232C	3 m	<b>XBT ZG9771</b>					
<b>Q FX (CPU) protocol</b>									
XBT G	25-way SUB-D/ 25-way SUB-D	COM1, RS 422	5 m	<b>XBT ZG9770</b>	XBT GT	9-way SUB-D/mini-DIN	COM1, RS 422	5 m	<b>XBT ZG9775</b>
<b>2-port adaptor, FX (CPU), A CPU (SIO) and QnA CPU (SIO) protocols</b>									
XBT G	25-way SUB-D/flying leads other end	COM1, RS 422	5 m	<b>XBT ZG9777</b>	XBT GT	9-way SUB-D/flying leads other end	COM1, RS 422	5 m	<b>XBT ZG9778</b> <b>+ XBT ZGCOM1</b>
<b>Adaptor case, FX (CPU), A CPU (SIO) and QnA CPU (SIO) protocols</b>									
XBT G	2-port case Screw terminal/2 x 9-way SUB-D	COM1, RS 422	-	<b>XBT ZG979</b>	XBT GT	2-port case Screw terminal/2 x 9-way SUB-D	COM1, RS 422	-	<b>XBT ZG979</b>
<b>Adaptor case, A Link (SIO) and Q Link (SIO) protocols</b>									
XBT G	1-port case Screw terminal/1 x 25-way SUB-D	COM1, RS 422	-	<b>XBT ZG989</b>	XBT GT	-	-	-	-



**Equivalent product table - Cables for connection to third-party PLCs (continued)**

<b>Omron, Sysmac PLCs</b>									
Obsolete range XBT G2●●0...G6330					New range XBT GT2●●0...GT6330				
Type of terminal	Type of connector	Physical link	Length	Substituted reference	Type of terminal	Type of connector	Physical link	Length	New reference
<b>Link (SIO) protocol</b>									
XBT G	9-way SUB-D/ 9-way SUB-D	COM2, RS 232C	5 m	<b>XBT ZG9740</b>	XBT GT	9-way SUB-D/ 9-way SUB-D	COM1, RS 232C	5 m	<b>XBT ZG9740</b>
	25-way SUB-D/ 25-way SUB-D	COM1, RS 232C	5 m	<b>XBT ZG973</b>		9-way SUB-D/ 25-way SUB-D	COM1, RS 232C	5 m	<b>XBT ZG 9731</b>
<b>FINS (SIO) protocol</b>									
XBT G	25-way SUB-D/ 9-way SUB-D	COM1, RS 232C	2.5 m	<b>XBT Z9740</b>	XBT GT	9-way SUB-D/ 9-way SUB-D	COM1, RS 232C	5 m	<b>XBT ZG9740</b>
<b>Rockwell Automation, Allen-Bradley PLCs</b>									
Obsolete range XBT G2●●0...G6330					New range XBT GT2●●0...GT6330				
Type of terminal	Type of connector	Physical link	Length	Substituted reference	Type of terminal	Type of connector	Physical link	Length	New reference
<b>DF1 Full Duplex protocol</b>									
XBT G	25-way SUB-D/ 25-way SUB-D	COM1, RS 232C	5 m	<b>XBT ZG973</b>	XBT GT	9-way SUB-D/ 25-way SUB-D	COM1, RS 232C	5 m	<b>XBT ZG 9731</b>
<b>Siemens, Simatic PLCs</b>									
Obsolete range XBT G2●●0...G6330					New range XBT GT2●●0...GT6330				
Type of terminal	Type of connector	Physical link	Length	Substituted reference	Type of terminal	Type of connector	Physical link	Length	New reference
<b>MPI (S7-300/400) protocol</b>									
XBT G	25-way SUB-D/ 9-way SUB-D	COM1, RS 232C	3 m	<b>XBT ZG929</b>	XBT GT	9-way SUB-D/ 9-way SUB-D	COM1, RS 232C	3 m	<b>XBT ZG9292</b>
						RJ45/9-way SUB-D	COM2, RS485	2.5 m	<b>XBT ZG9721</b>
<b>Adaptor case, RK512/3964F (S7-300/400) protocol</b>									
XBT G	1-port case Screw terminal/1 x 25-way SUB-D	COM1, RS 422	3 m	<b>XBT ZG989</b>	XBT GT	–	–	–	–

1

Dimensions

XBT GT1100/GT1130/GT1335

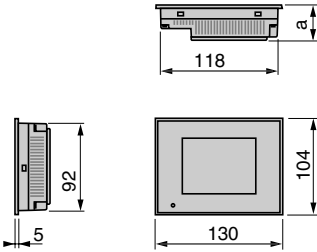

XBT GT1100/1130: a = 41; XBT GT1335: a = 40

XBT GT2110

XBT GT2120/GT2130/GT2220/GT2330

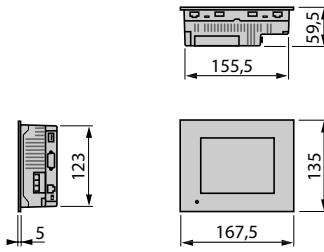

XBT GT4230/GT4330/GT4340

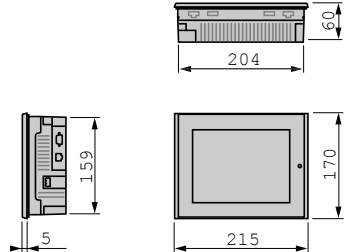

XBT GT 5230 and XBT GT 6330/GT 6340

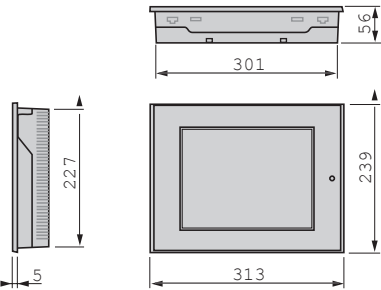

XBT GT 5330/GT 5340

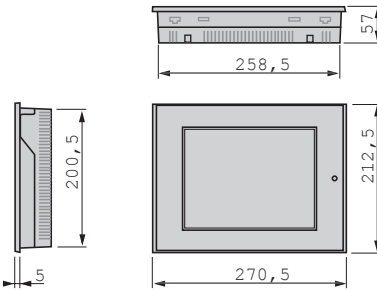

XBT GT 7340

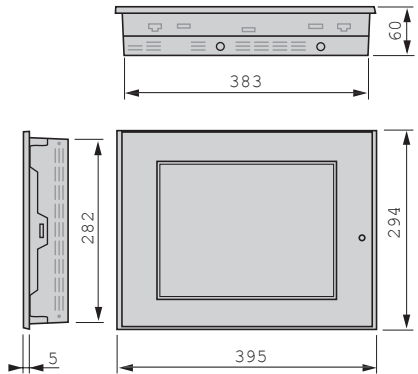

Mounting

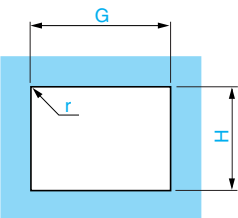

T = Panel thickness

Graphic display terminals

Cut-out for flush mounting

	H (0/+1 mm)	G (0/+1 mm)	r	T
XBT GT1100/GT1130/GT1335	92.5	118	3 max.	1.6...5
XBT GT2110/GT2120/GT2130/GT2220/GT2330	123.5	156	3 max.	1.6...5
XBT GT4230/GT4330/GT4340	159.5	204.5	3 max.	1.6...10
XBT GT5230/GT6330/GT6340	227.5	301.5	3 max.	1.6...10
XBT GT5330/GT5340	201	259	3 max.	1.6...10
XBT GT7340	282.5	383.5	3 max.	1.6...10

**Dimensions**

**XBT GK2120/GK2330/GK5330**

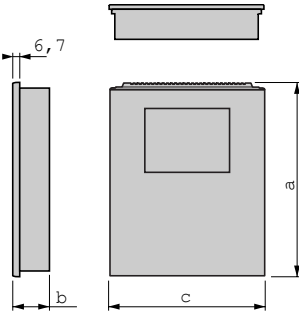

XBT GK2120/2330: a = 265, b = 60.3, c = 220.3  
XBT GK5330: a = 332, b = 72.7, c = 296

**XBT GH 2460**

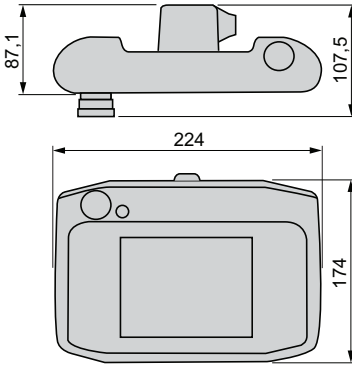

**XBT GTW 450**

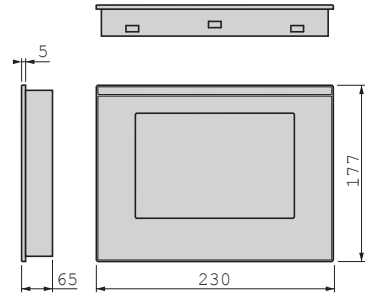

**XBT GTW 652**

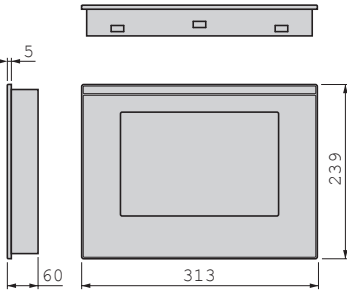

**HMI GTW 7353**

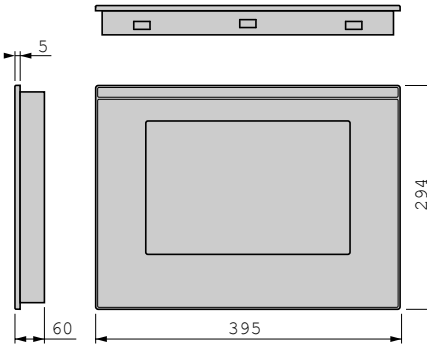

**Mounting**

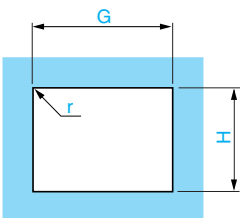

T = panel thickness

Graphic display terminals	Cut-out for flush mounting			
	H	G	r	T
XBT GK2120/GK2330	243 (+/-0.4)	209 (+/-0.4)	3 max.	1.6...10
XBT GK5330	309 (+/-0.4)	285 (+/-0.4)	3 max.	1.6...10
XBT GTW 450	165.5 (0/+1)	218.5 (0/+1)	3 < r < 4	1.6...10
XBT GTW 652	227.5 (0/+1)	301.5 (0/+1)	3 < r < 4	1.6...10
HMI GTW 7353	282.5 (0/+1)	383.5 (0/+1)	3 < r < 4	1.6...10



## HMI Controllers Magelis

- Selection guide** .....page 2/2
- General ..... page 2/4
- Magelis XBT GC HMI Controller
  - Magelis XBT GC HMI Controller: 3.8", 5.7" screen ..... page 2/14
  - Separate parts. .... page 2/15
  - Discrete I/O extension modules. .... page 2/16
  - Analog I/O extension modules. .... page 2/17
  - Modicon Telefast® pre-wired system ..... page 2/20
  - Connections ..... page 2/24
  - Dimensions ..... page 2/26
  - CANopen bus master module for XBT GC. .... page 2/29
- Magelis XBT GT/GK Advanced Panels with control function
  - CANopen bus master module for XBT GT/GK. .... page 2/31
  - Magelis XBT GT Advanced Panels: 5.7", 7.5", 10.4", 12.1", 15" ..... page 2/32
  - Magelis XBT GK Advanced Panels: 5.1", 10.4", ..... page 2/33
- Dimensions ..... page 2/33
- Wiring system CANopen bus. .... page 2/34

- Software platform**
- SoMachine Software ..... page 2/39

# HMI Controllers

## Magelis XBT GC HMI Controller

### Magelis XBT GT, GK Advanced Panels + control function

2

<b>Applications</b>		Display of text messages, graphic objects and mimics Control and configuration of data Control function IEC 1131-2		
<b>Terminal type</b>		<b>HMI Controllers</b>		
<b>Display</b>	Type	Back-lit monochrome (amber or red mode) STN LCD (320 x 240 pixels)	Back-lit monochrome STN LCD (320 x 240 pixels)	Colour STN LCD (320 x 240 pixels)
	Capacity	3.8" (monochrome)	5.7" (monochrome)	5.7" (colour)
<b>Data entry</b>		Via touch screen		
		–		
		–		
		–		
		–		
<b>Memory capacity</b>	Application	16 MB Flash EPROM		
	Extension	–		
<b>Functions</b>	Maximum number of pages and maximum number of instructions	Limited by internal Flash EPROM memory capacity		
	Variables per page	Unlimited (8000 variables max.)		
	Programmed logic	5 languages according to IEC 1131-2 (LD, ST, FBD, SFC, IL)		
	Counting/positioning	4 x 100 kHz fast counter inputs/4 x 65 kHz pulse train outputs		
	Control (PID)	Yes		
	Representation of variables	Alphanumeric, bitmap, bargraph, gauge, tank, tank level indicator, curves, polygon, button, indicator		
	Recipes	32 groups of 64 recipes comprising 1024 ingredients max.		
	Curves	Yes, with log		
	Alarm logs	Yes		
	Real-time clock	Built-in		
<b>I/O</b>	<b>Integrated</b>	12 discrete inputs 24 V --- 6 transistor outputs, sink or source (1)	16 discrete inputs 24 V --- 16 transistor outputs, sink or source (1)	
	Modular I/O extensions	Two M238 I/O modules max.	Three M238 I/O modules max.	
<b>Communication</b>	Downloadable protocols	–	Uni-TE, Modbus, Modbus TCP/IP (1) and for PLC brands: Mitsubishi, Omron, Allen-Bradley and Siemens	
	Asynchronous serial link	–	RS 232C/RS 422/485 (COM1)	
	USB ports	1		
	Buses and networks	1 CANopen master with optional module (XBT ZGC CAN)		Ethernet TCP/IP (10BASET/100 BASE-TX)
	Printer link	USB port for parallel printer		
<b>Design software</b>	SoMachine, with Windows XP and Vista (see page 2/39)			
<b>Operating system</b>	Magelis (CPU 131 MHz RISC)			
<b>Terminal type</b>	<b>XBT GC 1100 T/U</b>	<b>XBT GC 2120 T/U</b>	<b>XBT GC 2230 T/U</b>	
<b>Pages</b>	2/14	2/14	2/14	

(1) Depending on model

**Display of text messages, graphic objects and mimics  
Control and configuration of data  
Control function IEC 1131-2**

**Touch screen Advanced Panels + control function      Advanced Panels with keypad + control function**



Monochrome or colour STN LCD, back-lit colour TFT LCD (320 x 240 pixels to 1024 x 708 pixels) (1) 5.7" (monochrome or colour) 7.5", 10.4", 12.1" or 15" (colour) (1)	Monochrome STN LCD or colour TFT LCD (320 x 240 pixels or 640 x 480 pixels) (1) 5.7" (monochrome or colour) or 10.4" (colour) (1)
Via touch screen	Via keypad and/or touch screen (configurable) and/or by industrial pointer
–	10 or 12 (1)
–	14 or 18 (1)
–	8
–	12
16 MB Flash EPROM or 32 MB Flash EPROM (1) By 128 MB to 4 GB CF card (1)	
Limited by internal Flash EPROM memory capacity	
Unlimited (8000 variables max.)	
5 languages according to IEC 1131-2 (LD, ST, FBD, SFC, IL)	
–	
Yes	
Alphanumeric, bitmap, bargraph, gauge, tank, tank level indicator, curves, polygon, button, indicator	
32 groups of 64 recipes comprising 1024 ingredients max.	
Yes, with log	
Yes	
Built-in	
–	
–	
Uni-TE, Modbus, Modbus TCP/IP (1) and for PLC brands: Mitsubishi, Omron, Allen-Bradley and Siemens	
RS 232C/RS 422/485 (COM1) and RS 485 (COM2) 1 or 2 (1)	
1 CANopen master with external module (XBT ZG CANM) which is mandatory for the control function	
Ethernet TCP/IP (10BASE-T/100BASE-TX) (1)	
USB port for parallel printer	
SoMachine, with Windows XP and Vista (see page 2/39)	
Magelis (CPU 131 MHz RISC or 266 MHz RISC) (1)	Magelis (CPU 266 MHz RISC)

**XBT GT 2●/4●/5●/63/73 + XBT ZG CANM      XBT GK 2●/53 + XBT ZG CANM**

2/30      2/30

(1) Depending on model

# HMI Controllers

## Magelis XBT GC HMI Controller Magelis XBT GT, XBT GK Advanced Panels with control function

2



Magelis XBT GC HMI Controller

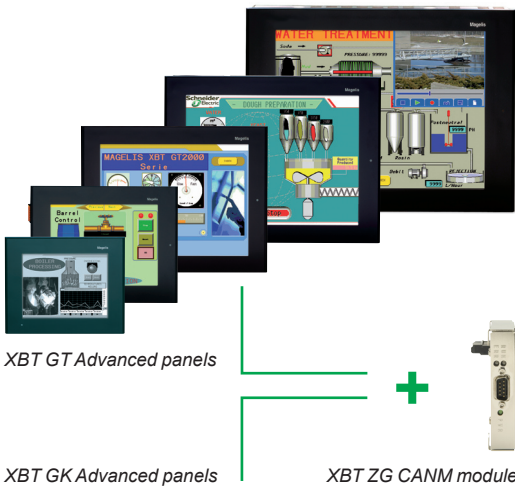

XBT GT Advanced panels

XBT GK Advanced panels

XBT ZG CANM module



HMI function: Magelis XBT GT/GK Advanced Panels  
+  
Control function: XBT ZG CANM CANOpen master module

### Presentation

The Magelis HMI Controller offer brings together HMI and control functions within in a single product. This reduces the amount of equipment required and the associated costs throughout the life cycle of the machine.

This offer comprises two ranges:

- The compact range: Magelis XBT GC HMI Controller
- The modular range: Magelis XBT GT/GK Advanced Panels + XBT ZG CANM CANOpen module

### Magelis XBT GC HMI Controllers (compact range)

Magelis XBT GC HMI Controllers optimize setup due to their compact design.

This range comprises 6 touch screen terminals, with the following, depending on the model:

- 3.8" monochrome screen, 12 integrated inputs/6 integrated outputs (sink or source)
- 5.7" monochrome or colour screen, 16 integrated inputs/16 integrated outputs (sink or source)
- A wide choice of communication interfaces: USB, serial link, CANopen and Ethernet

In order to adapt easily to different configurations, it is possible to add discrete I/O extension modules at the rear of the Controller.

### Magelis XBT GT/GK Advanced Panels + XBT ZG CANM CANOpen module (modular range)

This range comprises complete Magelis XBT GT or Magelis XBT GK Advanced Panel offers to which a control part is added with the CANOpen module XBT ZG CANM. During operation, this module controls the I/O and the peripherals distributed via the CANopen bus.

The combination with Magelis XBT GT or Magelis XBT GK Advanced Panels gives a wide choice of screen sizes and types of data entry, depending on the model:

- 17 XBT GT touch screen terminals:
  - 5.7" monochrome or colour screens
  - 7.5", 10.4", 12.1" and 15" colour screens
- 3 XBT GK terminals with keypad and/or touch screen:
  - 5.7" monochrome or colour screens
  - 10.4" colour screens

This combination also offers numerous advanced functions such as video, data management (sharing of data, log), etc.

### Operation

With their fast, multitasking processors, all the HMI Controllers combine HMI and control functions and share the same screen and communication features and dimensions.

The internal memory can be freely used by both the HMI function and the control function.

Processing is split 75% on the HMI part and 25% on the control part. The processing can be configured for 3 tasks, including 1 master task.

XBT GC HMI Controllers also have the same I/O modules, the same Telefast pre-wired system and the same peripherals on the CANopen bus as the M238 logic controller.



# HMI Controllers

Magelis XBT GC HMI Controller  
 Magelis XBT GT, XBT GK Advanced Panels  
 with control function



Displaying a video sequence



SoMachine

## Configuration

Magelis XBT GC HMI Controllers and Magelis XBT GT/GK Advanced Panels can be configured with Schneider Electric's unique machine automation software: SoMachine.

This software, combining both HMI and control functions, is based on the Vijeo Designer software in the Windows XP and Windows Vista environment. The SoMachine software boasts an advanced user interface with many configurable windows, enabling unique projects to be developed quickly and easily.

(See page 2/36)

## Communication

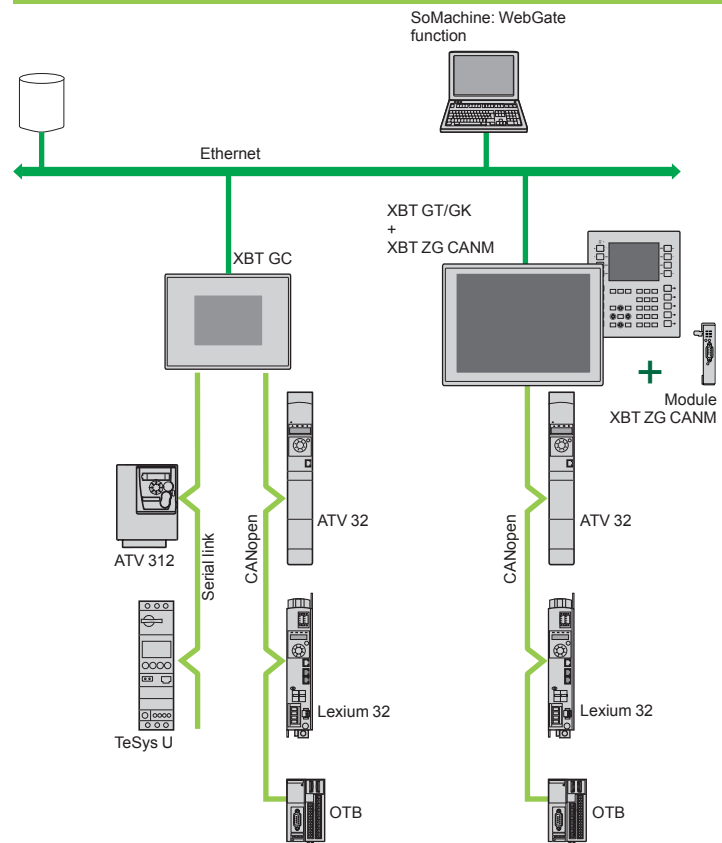

Examples of communication architectures

Depending on the model, Magelis XBT GC HMI Controllers and Magelis XBT GT/GK Advanced Panels communicate with automation equipment via 1 or 2 integrated serial links, based on communication protocols:

- Schneider Electric (Uni-TE, Modbus)
- Third party: Mitsubishi Electric, Omron, Allen-Bradley and Siemens

Depending on the model, they can be connected to Ethernet TCP/IP networks with the Modbus TCP protocol or a third-party protocol, and can be used as the CANopen master to control all the peripherals which can be connected on this bus.

# HMI Controllers

Magelis XBT GC HMI Controller

Magelis XBT GT, XBT GK Advanced Panels  
with control function

## Functions

Magelis XBT GC HMI Controllers and Magelis XBT GT/GK Advanced Panels offer the following HMI functions:

- Display of animated mimics with 8 types of animation (pressing the touch panel, colour changes, filling, movement, rotation, size, visibility and value display)
- Control, modification of numeric and alphanumeric values
- Display of current date and time
- Real-time curves and trend curves with log
- Alarm display, alarm log and management of alarm groups
- Multi-window management
- Page calls initiated by the operator
- Multilingual application management (10 languages simultaneously)
- Recipe management
- Data processing via Java script
- Application support and USB key external memory logs
- Management of serial printers and barcode readers

Magelis XBT GC HMI Controllers and Magelis XBT GT/GK Advanced Panels <sup>(1)</sup> have been designed for Transparent Ready architectures and equipment (combination of web and Ethernet TCP/IP technologies).

With the WebGate function, it is possible to control or carry out maintenance remotely.

They offer the following control functions:

- Execution of programmed logic sequences with the 5 IEC 1131-2 languages (LD, ST, FBD, SFC, IL)
  - Management of equipment on the CANopen fieldbus
- In addition to these functions, Magelis XBT GC HMI Controllers can manage:
- Discrete I/O on integrated or remote extension modules
  - Analog I/O on remote extension modules

*(1) Depending on model*

# HMI Controllers

Magelis XBT GC HMI Controller  
 Magelis XBT GT, XBT GK Advanced Panels  
 with control function

## Operating modes for the terminals

The illustrations below show which equipment can be connected to XBT terminals based on their two operating modes.

### Edit mode

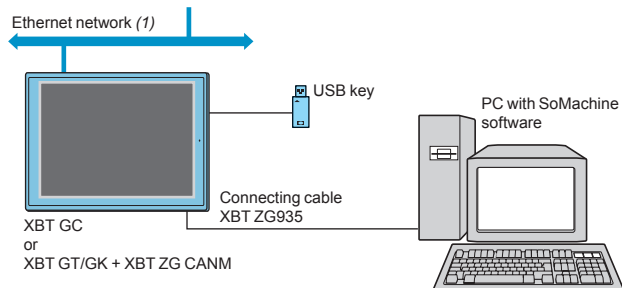

### Run mode

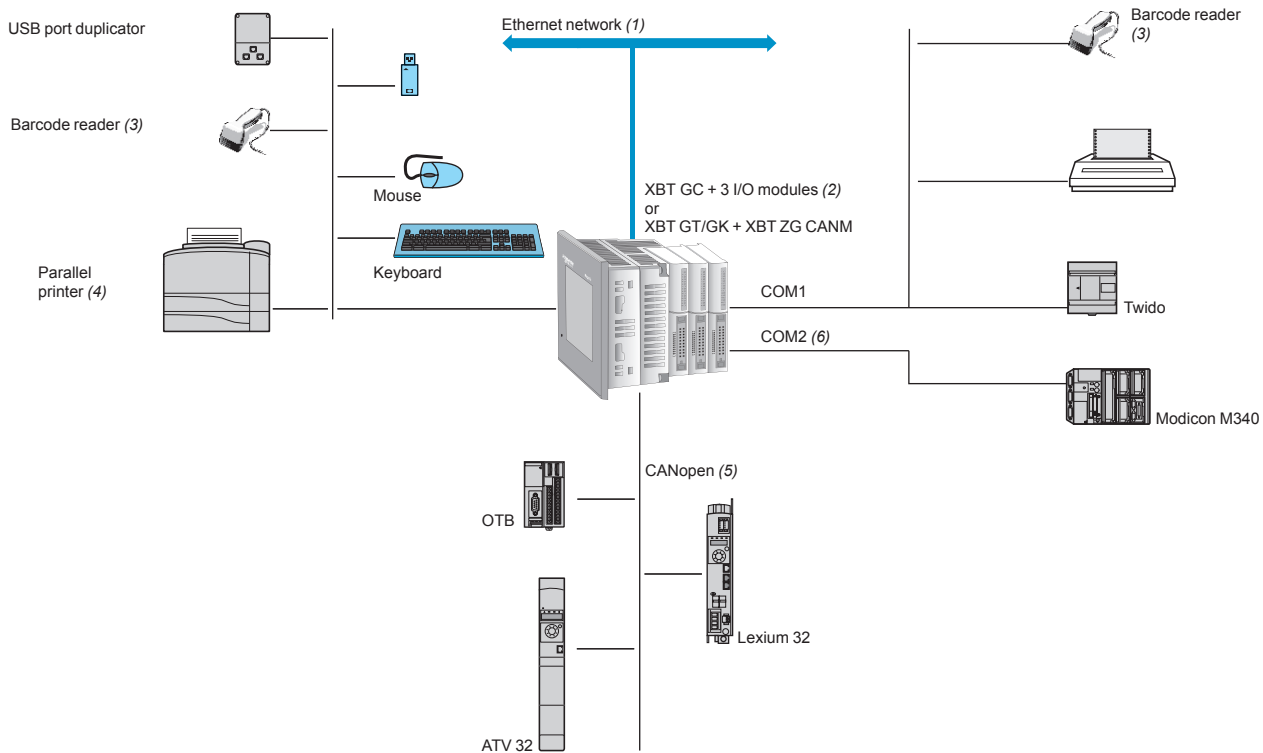

(1) With XBT GC 2230T/U, XBT GT●●30, XBT GT●●40, XBT GK●●30  
 (2) With XBT GC ●●●●T/U  
 (3) Should be a DataLogic Gryphon barcode reader  
 (4) Should be a Hewlett Packard printer via a USB/PIO converter  
 (5) Requires:  
 - For XBT GC: XBT ZGC CAN CANopen master module  
 - For XBT GT/GK: XBT ZG CANM CANopen master module  
 (6) With XBT GT/GK

### Description

#### Magelis XBT GC1100 T/U HMI Controller

##### The front panel comprises:

- 1 A touch screen for displaying mimics (3.8" amber or red mode monochrome)
- 2 A control indicator showing the terminal's operating mode

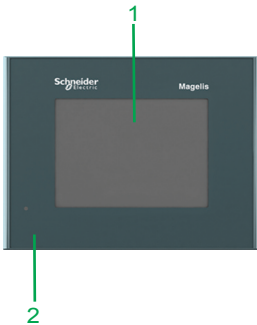

##### The rear panel comprises:

- 1 A removable screw terminal block for the 24 V  $\bar{\text{---}}$  power supply
- 2 A type A USB master connector for peripheral connection and application transfer
- 3 A removable terminal block for 12 discrete inputs and 6 discrete outputs
- 4 An interface for connecting M238 logic controller I/O extension modules
- 5 An interface for connecting the CANopen bus master module (see page 2/29)
- 6 Discrete I/O extension module (TM2 D●●). To be ordered separately (see page 2/16)

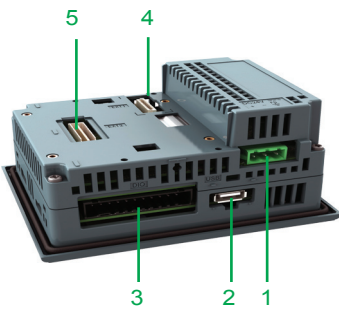

<b>Terminal type</b>		<b>XBT GC1100 T/U (1)</b>	
<b>Environment</b>			
<b>Conformity to standards</b>		EN 61131-2, IEC 61000-6-2, FCC (Class A), UL 508, UL 1604 (1), CSA C22-2 no. 14	
<b>Product certification</b>		CE, cULus, CSA, Class 1 Div 2 T4A or T5 (UL and CSA) (1), C-Tick	
<b>Temperature</b>	Operation	0...50°C	
	Storage	- 20...+ 60°C	
<b>Relative humidity</b>		10...90% (without condensation)	
<b>Altitude</b>		< 2000 m	
<b>Protection level</b>	Front	IP 65 in accordance with IEC 60529, Nema 4X (fixed by 4 screw clips)	
	Rear	IP 20 in accordance with IEC 60529	
<b>Shock resistance</b>		In accordance with IEC 60068-2-27; 147 m/s <sup>2</sup> in the 3 axes X, Y, Z	
<b>Vibration</b>		In accordance with IEC 60068-2-6; 5...9 Hz at 3.5 mm; 9...150 Hz at 1 gn	
<b>E.S.D.</b>		In accordance with IEC 61000-4-2, level 3	
<b>Electromagnetic interference</b>		In accordance with IEC 61000-4-3, 10 V/m	
<b>Electrical interference</b>		In accordance with IEC 61000-4-4, level 3	
<b>Mechanical characteristics</b>			
<b>Mounting and fixing</b>	Mounting on a panel 1.6...5 mm thick	Flush mounted, fixed with 4 screw clips (supplied)	
<b>Material</b>	Shell	Polycarbonate/polyethylene terephthalate alloy	
<b>Electrical characteristics</b>			
<b>Supply</b>	Voltage	24 V $\overline{\text{---}}$	
	Limits	19.2...28.8 V $\overline{\text{---}}$	
	Loss of power	≤ 10 ms	
<b>Inrush current</b>		≤ 30 A	
<b>Consumption</b>		18 W	
<b>Operating characteristics</b>			
<b>LCD screen</b>	Type	Back-lit monochrome STN	
	Colour	Amber or red, 8 grey levels	
	Definition	320 x 240 pixels (QVGA)	
	Size (L x H)	3.8" (76.7 x 57.5 mm)	
	Touch-sensitive area	Analog	
	Backlighting (service life)	50,000 hours if amber used 10,000 hours if red used	
	Settings	Brightness	8 levels
		Contrast	8 levels via touch panel
Character fonts	ASCII, Japanese (Kana, Kanji), Chinese (simplified Chinese), Taiwanese (traditional Chinese), Korean		
<b>Dialogue and control application</b>	Maximum number of pages and maximum number of instructions	Limited by internal Flash EPROM memory capacity	
<b>Signalling</b>		1 LED: green when operating normally	
<b>Operating system/Processor</b>		Magelis CPU RISC 131 MHz	
<b>Memory</b>	Application	16 MB Flash EPROM	
	Data backup	512 KB SRAM (lithium batteries)	
<b>Real-time clock</b>		Integrated real-time clock	
<b>Connection</b>	Supply	Removable screw terminal block: 3 terminals (pitch 5.08 mm), tightening torque 0.5 Nm	
	USB port (V1.1) for downloading applications, peripherals	Type A master	
<b>Integrated I/O</b>		12 discrete inputs and 6 transistor outputs (source/sink)	
<b>Extensions</b>	I/O extension module unit	Up to two M238 I/O modules	
	Communication extension unit	Via CANopen master fieldbus card	
<b>Characteristics of integrated functions</b>			
<b>Counting</b>	Channel/frequency	Single phase: 4 channels (%I0.0...%I0.3)/100 kHz Two-phase: 2 channels (%I0.0, %I0.1 and %I0.2, %I0.3)/50 kHz	
	Capacity	32 bits (incrementation/decrementation)	
<b>Positioning</b>	Channel	4 configurable PWM or PLS channels (%Q0.0...%Q0.3)	
	Frequency	65 kHz	
<b>Control (PID)</b>		Yes	
<b>Processing on event</b>		Yes, on inputs %I0.0...%I0.9 or internal bit	

(1) XBT GC 1100T: version with source type transistor outputs  
XBT GC 1100U: version with sink type transistor outputs

### Characteristics of $\overline{\text{I/O}}$ inputs

Number of input channels			12
Nominal input voltage		V	24 $\overline{\text{I/O}}$ sink/source (positive or negative logic)
Commons			1
Input limit values		V	20.4...28.8 $\overline{\text{I/O}}$
Nominal input current		mA	6.5 for I0.1, I0.2, I0.4 and I0.6. 5 for the other I0.i inputs
Input impedance		k $\Omega$	3.7 for I0.0, I0.2, I0.4 and I0.6. 4.7 for the other I0.i inputs
Filter time	At state 1	$\mu$ s	Filtering programmed for 0.5 to 20 ms
	At state 0	$\mu$ s	Filtering programmed for 0.5 to 20 ms (interval of 0.5 ms)
Isolation	Between channels		None
	Between channels and internal logic		Using optocouplers

### Characteristics of transistor outputs

Number of output channels			6
Output logic (1)			Source or sink
Commons			1
Nominal output values	Voltage	V	24
	Output limit values	V	20.4...28.8
Response time	Current via channels	A	0.2
	Current via commons	A	1.2
	At state 1	$\mu$ s	5 for Q0.0 to Q0.3, 500 for other Q0.i outputs
	At state 0	$\mu$ s	5 for Q0.0 to Q0.3, 500 for other Q0.i outputs
Residual voltage	At state 1	V	0.5 max.
Leakage current		mA	0.1
Protection of outputs			No
Fuse			2.5 A, 125 V non-replaceable
Isolation	Between channels		None
	Between channels and internal logic		Using optocouplers

### Input limits

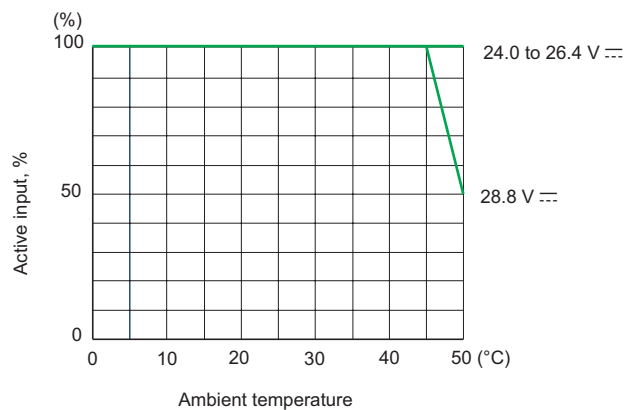



### Description

#### Magelis XBT GC2●20 and XBT GC2●30 HMI Controller

##### The front panel comprises:

- 1 A touch screen for displaying mimics (5.7" monochrome or colour)
- 2 A multicolour indicator (green, orange and red) showing the terminal's operating mode

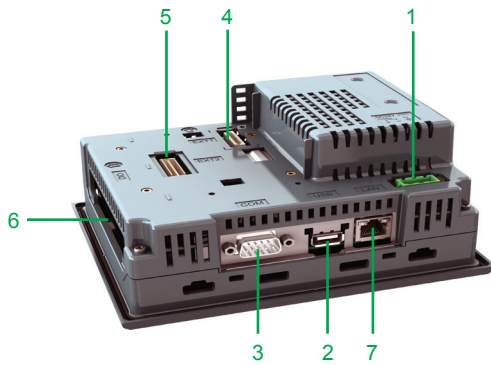

##### The rear panel comprises:

- 1 A removable screw terminal block for 24 V  $\overline{\text{---}}$  supply
- 2 A type A USB master connector for peripheral connection and application transfer
- 3 A 9-way male SUB-D connector for RS 232C or RS 422/485 serial link to PLCs (COM1)
- 4 An interface for connecting the M238 logic controller I/O extension module
- 5 An interface for connecting the CANOpen bus master module (see page 2/29)
- 6 A removable terminal block for 16 discrete inputs and 16 discrete outputs

##### On XBT GC2330 only:

- 7 An RJ45 connector for Ethernet TCP/IP, 10BASE-T/100BASE-TX connection
- 8 Discrete I/O extension module (TM2 D●●). To be ordered separately (see page 2/16)

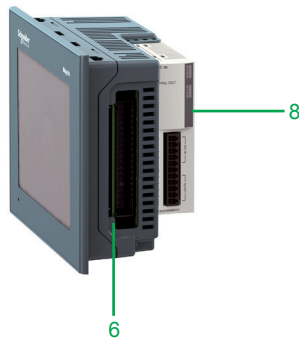

# HMI Controllers

## Magelis XBT GC HMI Controller with 5.7" screen

2

Terminal type		XBT GC2120 T/U (1)	XBT GC2230 T/U (1)	
<b>Environment</b>				
<b>Conformity to standards</b>		EN 61131-2, IEC 61000-6-2, FCC (Class A), UL 508, UL 1604, CSA C22-2 no. 14		
<b>Product certification</b>		CE, cULus, CSA, Class 1 Div 2 T4A or T5 (UL and CSA), C-Tick		
<b>Temperature</b>	Operation	0...50°C		
	Storage	- 20...+ 60°C		
<b>Relative humidity</b>		10...90% (without condensation)		
<b>Altitude</b>		< 2000 m		
<b>Protection level</b>	Front	IP 65 according to IEC 60529, Nema 4X		
	Rear	IP 20 in accordance with IEC 60529		
<b>Shock resistance</b>		In accordance with IEC 60068-2-27; pulse 147 m/s <sup>2</sup> in the 3 axes X, Y, Z		
<b>Vibration</b>		On accordance with IEC 60068-2-6; 5...9 Hz at 3.5 mm; 9...150 Hz at 1 g		
<b>E.S.D.</b>		In accordance with IEC 61000-4-2, level 3		
<b>Electromagnetic interference</b>		In accordance with IEC 61000-4-3, 10 V/m		
<b>Electrical interference</b>		In accordance with IEC 61000-4-4, level 3		
<b>Mechanical characteristics</b>				
<b>Mounting and fixing</b>	Mounting on a panel 1.6...5 mm thick	Flush mounted, fixed with 4 screw clips		
<b>Material</b>	Shell	Polycarbonate/polyethylene terephthalate alloy		
<b>Electrical characteristics</b>				
<b>Supply</b>	Voltage	24 V $\overline{\text{---}}$		
	Limits	19.2...28.8 V $\overline{\text{---}}$		
	Loss of power	$\leq$ 3 ms		
<b>Inrush current</b>		$\leq$ 30 A		
<b>Consumption</b>		27 W		
<b>Operating characteristics</b>				
<b>LCD screen</b>	Type	Back-lit monochrome STN	Colour STN	
	Colour	Black and white, 16 levels of grey	4096 colours	
	Definition	320 x 240 pixels (QVGA)		
	Size (width x height in mm)	5.7" (115.2 x 86.4)		
	Touch-sensitive area	Analog, resolution 1024 x 1024		
	Back-lighting (service life if used continuously at 25°C)	50,000 hours		
	Settings	Brightness	8 levels via touch panel	
		Contrast	8 levels via touch panel	
	Character fonts	ASCII (including all European characters), Japanese (Kana, Kanji), Chinese (simplified Chinese), Taiwanese (traditional Chinese), Korean		
<b>Dialogue and control application</b>	Maximum number of pages and maximum number of instructions	Limited by internal Flash memory capacity		
<b>Signalling</b>		1 LED: green during normal operation, orange if back-lighting defective		
<b>Operating system/Processor</b>		Magelis/CPU 131 MHz RISC		
<b>Memory</b>	Application	16 MB Flash EPROM		
	Data backup	512 KB SRAM (lithium batteries)		
<b>Schneider Electric protocols</b>	Modicon	Modbus, Modbus TCP/IP, Uni-TE		
<b>Third party protocols</b>	Mitsubishi	Melsec	A/Q CPU (SIO), A/Q Ethernet (TCP) (1), A Link (SIO), QnA CPU (SIO), Q Ethernet (UDP) (1), FX (CPU)	
	Omron	Sysmac	FINS (Ethernet) (1), FINS (SIO), LINK (SIO)	
	Rockwell Automation	Allen-Bradley	DF1-Full Duplex, DH 485, Ethernet IP (PLC5, SLC500, MicroLogix, ControlLogix) (1), Ethernet IP (native) (1)	
	Siemens	Simatic	MPI (S7-300/400), RK512/3964R (S7-300/400), PPI (S7-200), Ethernet (1)	
<b>Real-time clock</b>		Integrated real-time clock		
<b>Extensions</b>	I/O extension module unit	Three M238 I/O modules max.		
	Communication extension unit	For CANopen Master fieldbus communication card		
<b>Connections</b>	Supply	Removable screw terminal block: 3 terminals (pitch 5.06 mm), tightening torque 0.5 Nm		
	COM1 serial link (115.2 kbps max.)	9-way male SUB-D connector (RS 232C/RS 422/485 serial link)		
	USB port (V1.1)	Type A USB master connector for downloading applications, connecting peripherals		
	Ethernet TCP/IP network (10BASE-T/100BASE-TX)	-	RJ45 connector	
	Integrated I/O	16 discrete inputs and 16 transistor outputs (source/sink)		

(1) XBT GC 2●●●T: version with source type transistor outputs  
 XBT GC 2●●●U: version with sink type transistor outputs



### Characteristics of integrated functions

<b>Counting</b>	Channel/frequency		Single phase: 4 channels (%I0.0...%I0.3)/100 kHz
			Two-phase: 2 channels (%I0.0, %I0.1 and %I0.2, %I0.3)/50 kHz
	Capacity		32 bits (incrementation/decrementation)
<b>Positioning</b>	Channel		4 configurable PWM or PLS channels (%Q0.0...%Q0.3)
	Frequency		65 kHz
<b>Control (PID)</b>			Yes
<b>Processing on event</b>			Yes, on inputs %I0.0...%I0.9 or internal bit

### Characteristics of $\bar{I}$ inputs

<b>Number of input channels</b>			16
<b>Nominal input voltage</b>		V	24 $\bar{I}$ sink/source (positive or negative logic)
<b>Commons</b>			1
<b>Input limit values</b>		V	20.4...28.8 $\bar{I}$
<b>Nominal input current</b>		mA	6.5 for I0.0, I0.2, I0.4 and I0.6. 500 for the other I0.i inputs
<b>Input impedance</b>		k $\Omega$	3.7 for I0.0, I0.2, I0.4 and I0.6. 4.7 for the other I0.i inputs
<b>Filter time</b>	At state 1	$\mu$ s	Filtering programmed for 0.5 to 20 ms
	At state 0	$\mu$ s	Filtering programmed for 0.5 to 20 ms (interval of 0.5 ms)
<b>Isolation</b>	Between channels		None
	Between channels and internal logic		Using optocouplers

### Characteristics of transistor outputs

<b>Number of output channels</b>			16
<b>Output logic (1)</b>			Source or sink
<b>Commons</b>			2
<b>Nominal output values</b>	Voltage	V	24
	Voltage	V	20.4...28.8
<b>Output limit values</b>	Current via channels	A	0.2
	Current via commons	A	1.6
<b>Response time</b>	At state 1	$\mu$ s	5 for Q0.0 to Q0.3 500 for the other Q0.i outputs
	At state 0	$\mu$ s	5 for Q0.0 to Q0.3 500 for other Q0.i outputs
<b>Residual voltage</b>	At state 1	V	0.5 max.
<b>Leakage current</b>		mA	0.1
<b>Protection of outputs</b>			Not protected
<b>Fuse</b>		W	2.5 A, 125 V (non-replaceable)
<b>Isolation</b>	Between channels		None
	Between channels and internal logic	Vrms	Using optocouplers

### Input limits

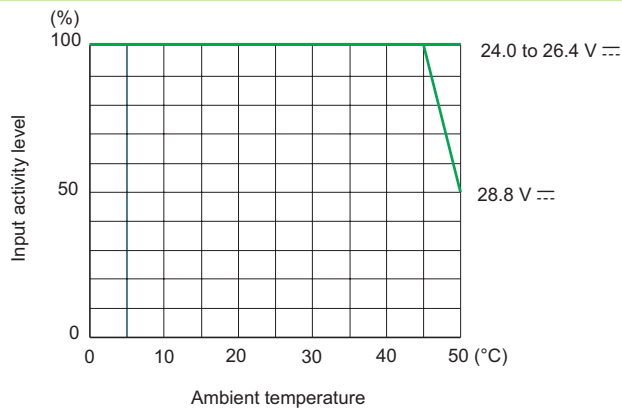

# HMI Controllers

## Magelis XBT GC HMI Controller

2

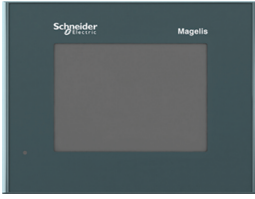

XBT GC1100●



XBT GC2●●●

Magelis XBT GC HMI Controller (1)							
Type of screen	No. of ports	Application memory capacity	Compact Flash memory	Integrated I/O	No. of Ethernet ports	Reference	Weight kg
<b>3.8" screen</b>							
STN amber or red	1 USB	16 MB	No	12 I/6 O source	-	<b>XBT GC1100T</b>	0.400
				12 I/6 O sink	-	<b>XBT GC1100U</b>	0.400
<b>5.7" screen</b>							
STN black and white mode	1 COM1	16 MB	No	16 I/16 O source	-	<b>XBT GC2120T</b>	1.000
	1 USB			16 I/16 O sink	-	<b>XBT GC2120U</b>	1.000
<b>5.7" screen</b>							
STN colour	1 COM1	16 MB	No	16 I/16 O source	1	<b>XBT GC2230T</b>	1.000
	1 USB			16 I/16 O sink	1	<b>XBT GC2230U</b>	1.000

(1) Terminals supplied with fixing kit (clips with screws), locking catch for USB connectors, spring clip for extension modules (except XBT GC 1100) and instruction sheets. The setup documentation for XBT GC terminals is supplied in electronic format with the SoMachine software (see page 2/39).

# HMI Controllers

## Separate parts for Magelis XBT GC Advanced Panels

Separate parts				
Designation	Compatibility	Size	Reference	Weight kg
<b>Protective sheets</b>	XBT GC 1100	–	<b>XBT ZG60</b>	
(5 peel-off sheets)	XBT GC2●●0	–	<b>XBT ZG62</b>	0.200
Designation	Description	Length	Reference	Weight kg
<b>Remote USB port location for type A XBT terminal</b>	Enables the USB port to be located remotely on the rear of the XBT terminal on a panel or cabinet door (Ø 21 mm fixing device)	1 m	<b>XBT ZGUSB</b>	–
<b>Remote USB port location for mini type B XBT terminal</b>		–	<b>XBT ZGUSBB</b>	–
<b>XBT GC connection to CANopen master fieldbus</b>	Connection via card on bus extension	–	<b>XBT ZGCCAN</b>	–
<b>Cable for transferring application to PC</b>	USB connector, type TTL	2 m	<b>XBT ZG 935</b>	–



XBT ZGUSB

Replacement parts			
Designation	Use for	Reference	Weight kg
<b>Installation gaskets</b>	XBT GC1100	<b>XBT ZG51</b>	0.030
	XBT GT21●0	<b>XBT ZG52</b>	0.030
<b>USB spring clip</b>	XBT GC 1100	<b>XBT ZGCLP2</b>	–
	XBT GC 2●●0	<b>XBT ZGCLP4</b>	–
<b>Mounting kit</b>	4 clips and screws (max. tightening torque: 0.5 Nm), supplied with all XBT GC terminals	<b>XBT ZG FIX</b>	0.100
<b>Spring clip for extension modules on XBT GC</b>	XBT GC2●●0 terminals	<b>XBT ZGCHOK</b>	0.030
<b>Power supply connector</b>	XBT GC1●●●/GC2●●●	<b>XBT ZGPWS1</b>	0.030
<b>Direct I/O connector</b>	XBT GC1000	<b>XBT ZG DIO1</b>	–
	XBT GC2000	<b>XBT ZG DIO2</b>	–

# HMI Controllers

## Magelis XBT GC HMI Controller

### Discrete I/O extension modules

2



TM2 DDI 8DT



TM2 DDO 8 • T/DRA 8RT



TM2 DDO 32-K



TM2 DDM 24DRF

#### Discrete I/O extension modules

Discrete I/O extension modules are mounted on the rear of XBT GC controller bases. The maximum authorized number of discrete and/or analog I/O modules depends on the type of XBT GC terminal and the thickness of the modules (see the combination rule on page 2/16).

#### Discrete input modules (1)

Input voltage	No. of channels	No. of common points	Connection	Thickness mm (Type)	Reference	Weight kg
24 V $\overline{\text{---}}$ sink/source	8	1	Via removable screw terminal block (supplied)	23.5 (B)	TM2 DDI 8DT	0.085
	16	1	Via removable screw terminal block (supplied)	23.5 (B)	TM2 DDI 16DT	0.100
			Via HE 10 connector	23.5 (B)	TM2 DDI 16DK (2)	0.065
	32	2	Via HE 10 connector	29.7 (C)	TM2 DDI 32DK (2)	0.100
$\sim 120$ V	8	1	Via removable screw terminal block (supplied)	23.5 (B)	TM2 DAI 8DT	0.081

#### Discrete output modules (1)

Input voltage	No. of channels	No. of common points	Connection	Thickness mm (Type)	Reference	Weight kg
8, sink 0.3 A	1	1	Via removable screw terminal block (supplied)	23.5 (B)	TM2 DDO 8UT	0.085
			Via removable screw terminal block (supplied)	23.5 (B)	TM2 DDO 8TT	0.085
24 V $\overline{\text{---}}$	16, sink 0.1 A	1	Via HE 10 connector	17.6 (A)	TM2 DDO 16UK	0.070
	16, source 0.4 A	1	Via HE 10 connector	17.6 (A)	TM2 DDO 16TK (2)	0.070
	32, sink 0.1 A	2	Via HE 10 connector	29.7 (C)	TM2 DDO 32UK	0.105
	32, source 0.4 A	2	Via HE 10 connector	29.7 (C)	TM2 DDO 32TK (2)	0.105
Relay, 2 A (lth) $\sim 230$ V/30 V $\overline{\text{---}}$	8 (N/O contact)	2	Via removable screw terminal block (supplied)	23.5 (B)	TM2 DRA 8RT	0.110
	16 (N/O contact)	2	Via removable screw terminal block (supplied)	23.5 (B)	TM2 DRA 16RT	0.145

#### Discrete mixed I/O modules (1)

No. of I/O	No./type of inputs	No./type of outputs	No. of common points	Connection	Thickness mm (Type)	Reference	Weight kg
8	4 I, 24 V $\overline{\text{---}}$ sink/source	4 relay O (N/O contact) 2 A (lth)	Inputs: 1 common Outputs: 1 common	Via removable screw terminal block (supplied)	23.5 (B)	TM2 DMM 8DRT	0.095
24	16 I, 24 V $\overline{\text{---}}$ sink/source	8 relay O (N/O contact) 2 A (lth)	Inputs: 1 common Outputs: 2 common	Via fixed spring terminal block	39.1 (D)	TM2 DMM 24DRF	0.140

(1) Please consult our specialist catalogue "Modicon M238 logic controller".

(2) Module supports use of the Modicon Telefast ABE 7 pre-wired system.

#### Analog I/O extension modules

Analog I/O extension modules are mounted on the rear of XBT GC controller bases. The maximum number of discrete and/or analog I/O modules depends on the type of XBT GC terminal and the thickness of the modules. See the combination rule on page 2/16.



TM2 AMI 2LT



TM2 AMM 6HT



TM2 ARI 8LRJ



TM2 ARI 8LT

Analog input modules (1)							
Channel type	Input range	Output range	Resolution	Connection via	Thickness mm (Type)	Reference	Weight kg
2 inputs	0...10 V 4...20 mA	–	12 bits	Removable screw terminal block (supplied)	23.5 (B)	TM2 AMI 2HT	0.085
	Thermocouple J, K, T	–	12 bits	Removable screw terminal block (supplied)	23.5 (B)	TM2 AMI 2LT	0.085
4 inputs	0...10 V 0...20 mA 2, 3 or 4-wire temperature probe Pt100/1000 Ni100/1000	–	12 bits	Removable screw terminal block (supplied)	23.5 (B)	TM2 AMI 4LT	0.085
8 inputs	0...10 V 4...20 mA	–	10 bits	Removable screw terminal block (supplied)	23.5 (B)	TM2 AMI 8HT	0.085
	2 or 3-wire Pt100/1000 temperature probe	–	12 bits	RJ11 connector	23.5 (B)	TM2 ARI 8LRJ	–
	PTC/NTC	–	10 bits in NTC Detection of 2 thresholds in PTC	Removable screw terminal block (supplied)	23.5 (B)	TM2 ARI 8LT	–

Analog output modules (1)							
1 output	–	0...10 V 4...20 mA	12 bits	Removable screw terminal block (supplied)	23.5 (B)	TM2 AMO 1HT	0.085
2 outputs	–	± 10 V	11 bits + sign	Removable screw terminal block (supplied)	23.5 (B)	TM2 AVO 2HT	0.085

Analog I/O modules (1)							
2 inputs and 1 output	0...10 V 4...20 mA	0...10 V 4...20 mA	12 bits	Removable screw terminal block (supplied)	23.5 (B)	TM2 AMM 3HT	0.085
	Thermocouple J, K, T Temperature probe 2 or 3-wire Pt100	0...10 V 4...20 mA	12 bits	Removable screw terminal block (supplied)	23.5 (B)	TM2 ALM 3LT	0.085
4 inputs and 1 output	0...10 V 4...20 mA	0...10 V 4...20 mA	12 bits	Removable screw terminal block (supplied)	23.5 (B)	TM2 AMM 6HT	0.085

Separate parts			
Designation	Description	Reference	Weight kg
Earth connection plate	Support equipped with 10 male Faston connectors for connecting the cable shielding (via 6.35 mm Faston connectors, not supplied) and the functional earths (FE)	TM2 XMT GB	0.045
Mounting kit Sold in lots of 5	For plate or panel mounting of analog modules	TWD XMT 5	0.065

(1) Characteristics: Please consult our specialist catalogue "Modicon M238 logic controller".

# HMI Controllers

## Magelis XBT GC HMI Controller

### I/O extension modules

2



**XBT GC1●●● Combining two extension modules**

Combinations	Type	Type	Total thickness (mm)	Combination
	A	A	35.2	<b>Authorized</b>
	A	B	41.1	
	B	B	47.0	
	A	C	47.3	
	B	C	53.2	
	A	D	56.7	
	C	C	59.4	
	B	D	62.6	<b>Prohibited</b>
	C	D	68.8	
	D	D	78.2	

# HMI Controllers

## Magelis XBT GC HMI Controller

### I/O extension modules



#### XBT GC2●●● Combining two extension modules

Combinations	Type	Type	Total thickness (mm)	Combination
	A	A	35.2	Authorized
	A	B	41.1	
	B	B	47.0	
	A	C	47.3	
	B	C	53.2	
	A	D	56.7	
	C	C	59.4	
	B	D	62.6	Prohibited
	C	D	68.8	
	D	D	78.2	

#### Combining three extension modules

Combinations	Type	Type	Type	Total thickness (mm)	Combination
	A	A	A	52.8	Authorized with hook (1)
	A	A	B	58.7	
	A	B	B	64.6	
	B	B	B	70.5	
	Any other combination				Prohibited

(1) Hook supplied with the product

# HMI Controllers

Modicon Telefast® pre-wired system  
for Magelis XBT GC HMI Controller

## Presentation

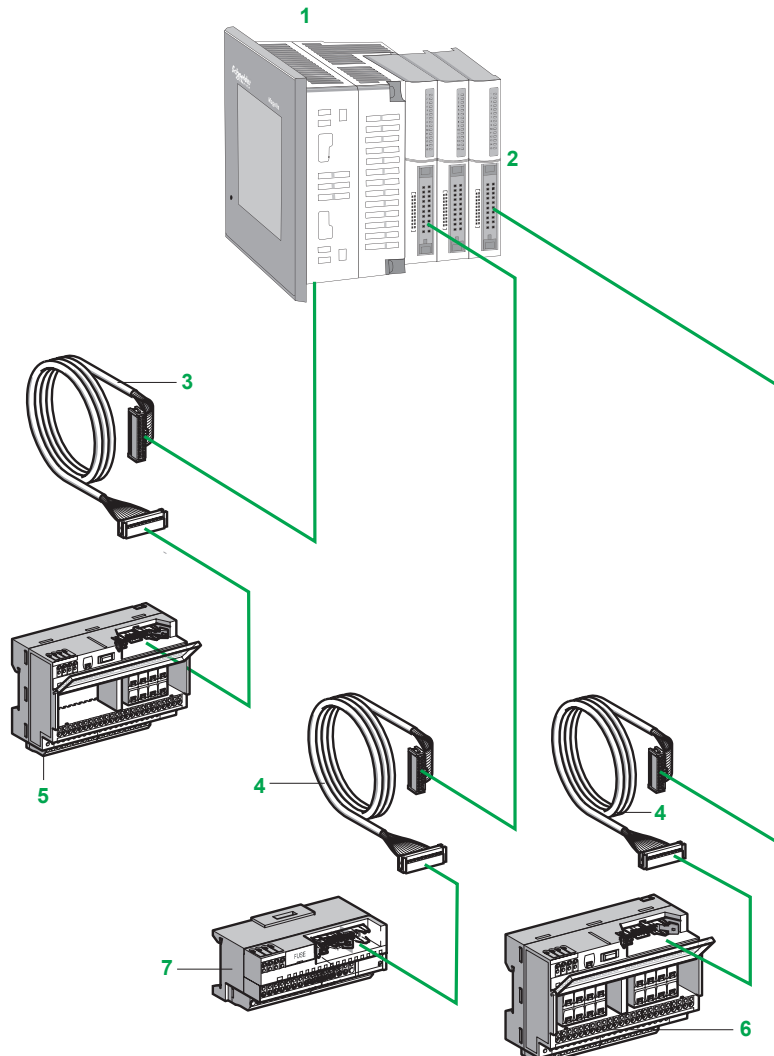

- 1 XBT GC equipped with direct I/O 22 or 38-way connectors. The modularity options offered have 18 or 32 I/O.
- 2 Input and output modules equipped with 20-way HE 10 connectors. The modularity options offered have 16 or 32 I/O.
- 3 2 m AWG 28/0.08 mm<sup>2</sup> cables, depending on the model:
  - For **XBT GC 1100T/U**: **XBT ZG ABE1** cable equipped with a 26-way HE 10 connector and a 22-way direct I/O-XBT GC connector at each end.
  - For **XBT GC 2●●●T/U**: **XBT ZG ABE2** cable equipped with two 20-way HE10 connectors and a 38-way direct I/O-XBT GC connector.
- 4 **ABF T20E●●0** cable equipped with a 20-way HE 10 connector at each end. This cable is available in 0.5, 1, 2 and 3 metre lengths (AWG 28/0.08 mm<sup>2</sup>).
- 5 Depending on model:
  - For **XBT GC 1100T**: **ABE 7B20MPN2●** or **ABE 7B20MRM20** 20 channel sub-base for bases.
  - For **XBT GC 2●●●T**: **ABE 7E16EPN20** or **ABE 7E16SPN2●** 16-channel sub-base.
- 6 **ABE 7E16SPN22** or **ABE 7E16SRM20** 16-channel sub-base for output extension modules.
- 7 **ABE 7E16EPN20** or **ABE 7E16SPN20** 16-channel sub-base for input or output extension modules.



Combinations involving modular bases and I/O expansion modules						
	XBT GC				Discrete I/O expansion modules	
	Integrated I/O				Inputs	Outputs (source)
	XBT GC 1100T		XBT GC 2●●●T		TM2 DDI 16DK (16 I) TM2 DDI 32DK (32 I)	TM2 DDO 16TK (16 O) TM2 DDO 32TK (32 O)
Integrated in Twido programmable controllers	12 I	6 O source	16 I	16 O source		
Types of connection terminal block	Direct I/O, 22-way		Direct I/O, 38-way		HE 10, 20-way	
Connection to XBT GC HMI programmable controller	XBT ZG ABE1		XBT ZG ABE2		ABF T20E●●0 (HE 10, 20-way)	
<b>Passive connection sub-bases</b>						
20 channels	ABE 7B20MPN2●		(1)			
16 channels	ABE 7E16EPN20					
	ABE 7E16SPN2●					
<b>Output adaptor sub-bases</b>						
20 channels	ABE 7B20MRM20		(2)			
16 channels	ABE 7E16SRM20					

 Compatible  
 Not compatible

Note: Telefast cables and modules are not compatible with XBT GC which have sink outputs (suffix U).

(1) 6 channels used out of 8 available

(2) 6 channels used out of 8 available with 2 transistor outputs and 4 relay outputs

# HMI Controllers

Modicon Telefast® pre-wired system  
for Magelis XBT GC HMI Controller

2

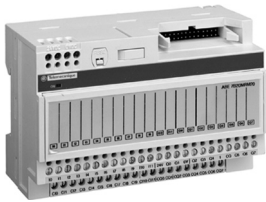

ABE 7B20MPN20



ABE 7E16EPN20

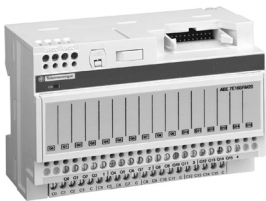

ABE 7E16SRM20

### References

#### For XBT GC 1100T bases

Number of I/O	No./ type of input	No./ type of output	Compatibility	LED per channel	Fuse	Reference	Weight kg
20	12, sink 24 V $\overline{\text{---}}$	6, source 24 V $\overline{\text{---}}$	XBT GC1100T	No	No	<b>ABE 7B20MPN20</b>	0.430
				Yes	Yes	<b>ABE 7B20MPN22</b>	0.430
	12, sink 24 V $\overline{\text{---}}$	2, source 24 V $\overline{\text{---}}$ , 2 A and 4, relay 24/250 V $\overline{\text{---}}$ $\sim$ , 3 A	XBT GC1100T	No	No	<b>ABE 7B20MRM20</b>	0.430

#### For extension modules or for XBT GC 2000T bases

Number of inputs	Type of input	Compatibility	LED per channel	Fuse	Reference	Weight kg
16	Sink 24 V $\overline{\text{---}}$	TM2 DDI16DK/ DDI32K and XBT GC2000T	No	No	<b>ABE 7E16EPN20</b>	0.430

Number of outputs	Type of output	Compatibility	LED per channel	Fuse	Reference	Weight kg
16	Source 24 V $\overline{\text{---}}$	TM2 DDO16TK/ DDO32TK and XBT GC2000T	No	No	<b>ABE 7E16SPN20</b>	0.450
			Yes	Yes	<b>ABE 7E16SPN22</b>	0.450
	Relay 24/250 V $\overline{\text{---}}$ $\sim$ , 3 A		No	No	<b>ABE 7E16SRM20</b>	0.430

#### Connection cables for XBT GC

Type of signal	Compatibility	Connection type		Gauge Cross-sect.	Length (1)	Reference	Weight kg
		XBT GC side	Telefast side				
Discrete I/O	XBT GC 1100T	Direct I/O 22-way	HE 10 26-way	AWG 28 0.08 mm <sup>2</sup>	2.0 m	<b>XBT ZG ABE1</b>	0.180
			2 x HE 10 20-way			<b>XBT ZG ABE2</b>	
	XBT GC 2000T	Direct I/O 38-way	HE 10 20-way	AWG 28 0.08 mm <sup>2</sup>	0.5 m	<b>ABF T20E050</b>	0.060
						1 m	
				2 m	<b>ABF T20E200</b>	0.140	

#### Accessories

Designation	Number of shunted terminals	Characteristics	Sold in lots of	Unit reference	Weight kg
Optional snap-on terminal blocks	20	–	5	<b>ABE 7BV20</b>	0.060
	12+8	–	5	<b>ABE 7BV20TB</b>	0.060
Quick-blow fuses 5 x 20, 250 V, UL	–	0.125 A	10	<b>ABE 7FU012</b>	0.010
		0.315 A	10	<b>ABE 7FU030</b>	0.010
		1 A	10	<b>ABE 7FU100</b>	0.010
		2 A	10	<b>ABE 7FU200</b>	0.010

(1) Please contact us for lengths > 2 m

# HMI Controllers

Modicon Telefast® pre-wired system  
for Magelis XBT GC HMI Controller

References (continued)							
Separate parts							
Description	Type	Compatibility		Reference	Weight kg		
<b>Connectors</b> Sold in lots of 5	HE 10 female 26-way	TWD LMDA20DTK/ LMDA40DTK		TWD FCN2K26	-		
	HE 10 female 20-way	TM2 DDI16DK/ DDI32DK/ DDO16TK/ DDO32TK		TWD FCN2K20	-		
<b>Screw terminals</b> Sold in lots of 5	10-way	TM2 DDI●DT/DAI8DT/ DDO8●T/DRA●RT		TWD FTB2T10	-		
	11-way	TM2 DMM8DRT/ AMI●●T/ARI8HT		TWD FTB2T11	-		
Designation	Compatibility	Connection type		Gauge/ Cross-sect.	Length	Reference	Weight kg
<b>Cables for discrete I/O</b>	TM2 DDI16DK/ DDI32DK/ DDO16TK/ DDO32TK	HE 10	Flying leads	AWG 22	3 m	TWD FCW30K	0.405
		20-way		0.035 mm <sup>2</sup>	5 m	TWD FCW50K	0.670
<b>Rolled ribbon cable</b>	20 conductors	-	-	AWG 28 0.08 mm <sup>2</sup>	20 m	ABF C20R200	1.310



# HMI Controllers

Magelis XBT GC HMI Controller with  
3.8" screen  
XBT ZGDI01 connector

2

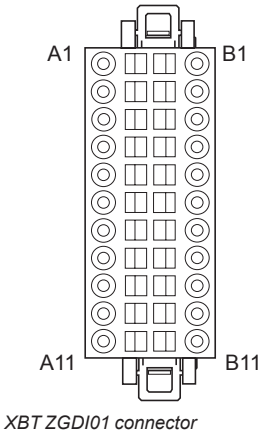

### Equivalent input scheme for XBT GC 1100●

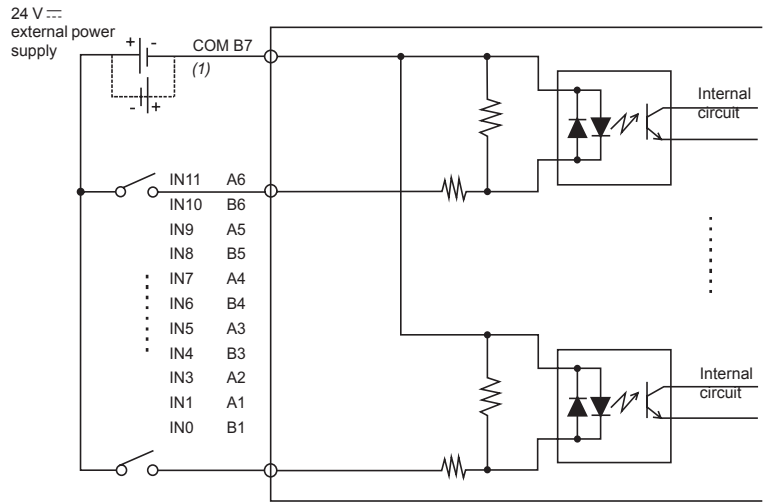

Pin	Signal	Pin	Signal
A1	IN1	B1	IN0(CT0)
A2	IN3	B2	IN2(CT1)
A3	IN5	B3	IN4(CT2)
A4	IN7	B4	IN6(CT3)
A5	IN9	B5	IN8
A6	IN11	B6	IN10
A7	NC	B7	COM
A8	0V	B8	+24V
A9	OUT1 (PLS1,PWM1)	B9	OUT0 (PLS0, PWM0)
A10	OUT3 (PLS3,PWM3)	B10	OUT2 (PLS2,PWM2)
A11	OUT5	B11	OUT4

### Equivalent output scheme for XBT GC1100U, sink type

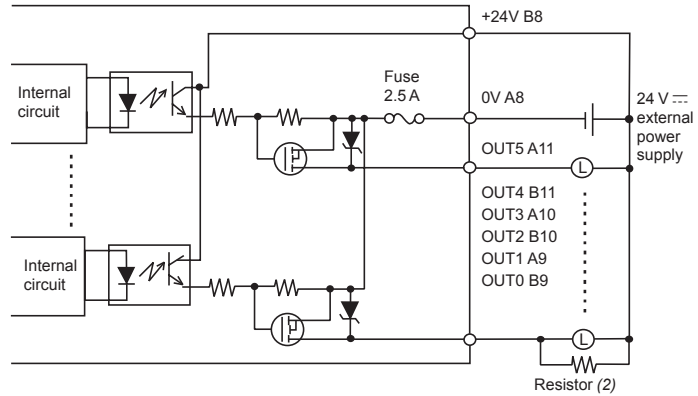

### Equivalent output scheme for XBT GC1100T, source type

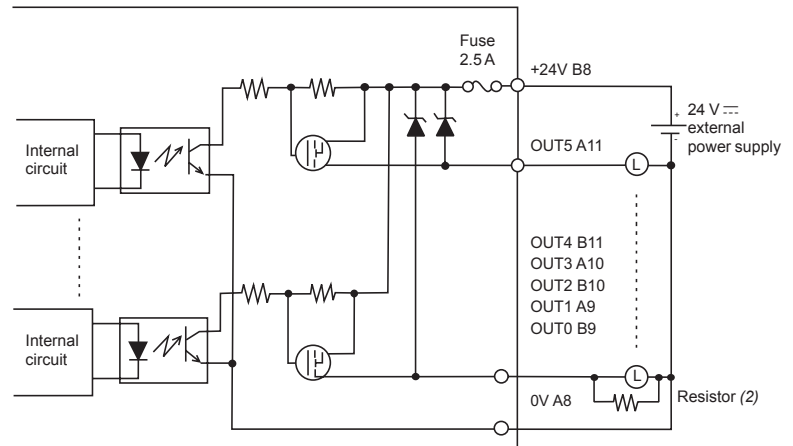

(1) Dotted lines relate to sink outputs  
(2) Resistance value: see setup manual

# HMI Controllers

## Magelis XBT GC HMI Controller with 5.7" screen

### XBT ZGDI02 connector

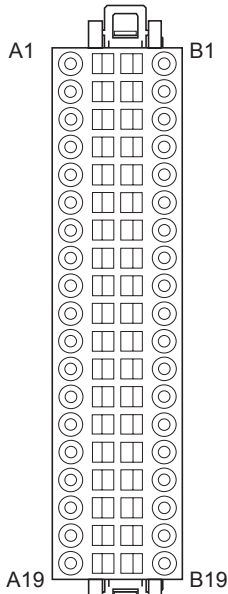

XBT ZGDI02 connector

Pin	Signal	Pin	Signal
A1	IN1	B1	IN0(CT0)
A2	IN3	B2	IN2(CT1)
A3	IN5	B3	IN4(CT2)
A4	IN7	B4	IN6(CT3)
A5	IN9	B5	IN8
A6	IN11	B6	IN10
A7	IN13	B7	IN12
A8	IN15	B8	IN14
A9	NC	B9	COM
A10	Sink: NC Source: +24V	B10	Sink: +24 Source: +24V
A11	Sink: 0V Source: NC	B11	Sink: 0V Source: 0V
A12	OUT1 (PLS1,PWM1)	B12	OUT0 (PLS0, PWM0)
A13	OUT3 (PLS3,PWM3)	B13	OUT2 (PLS2, PWM2)
A14	OUT5	B14	OUT4
A15	OUT7	B15	OUT6
A16	OUT9	B16	OUT8
A17	OUT11	B17	OUT10
A18	OUT13	B18	OUT12
A19	OUT15	B19	OUT14

#### Equivalent input scheme for XBT GC2●●0●

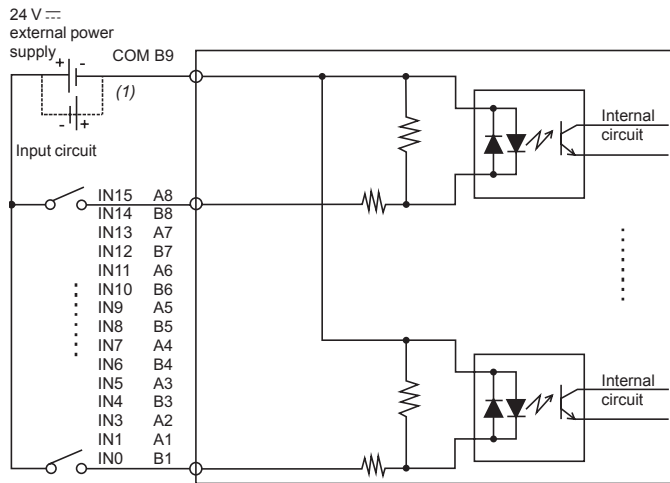

#### Equivalent output scheme for XBT GC2●●0U, sink type

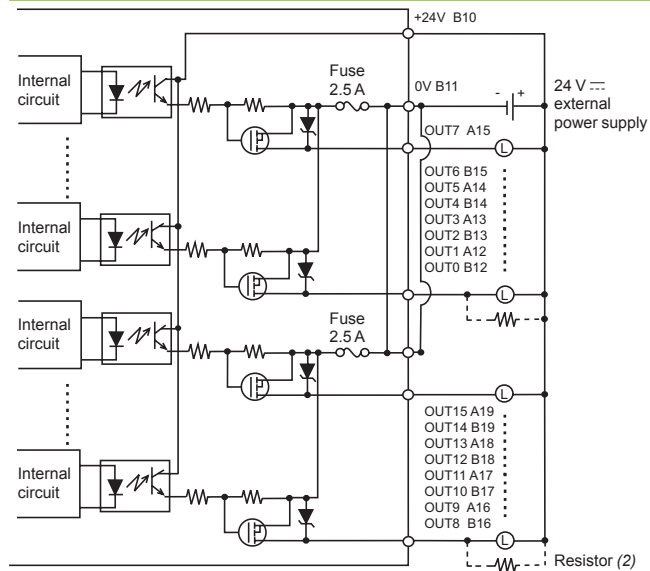

#### Equivalent output scheme for XBT GC2●●0T, source type

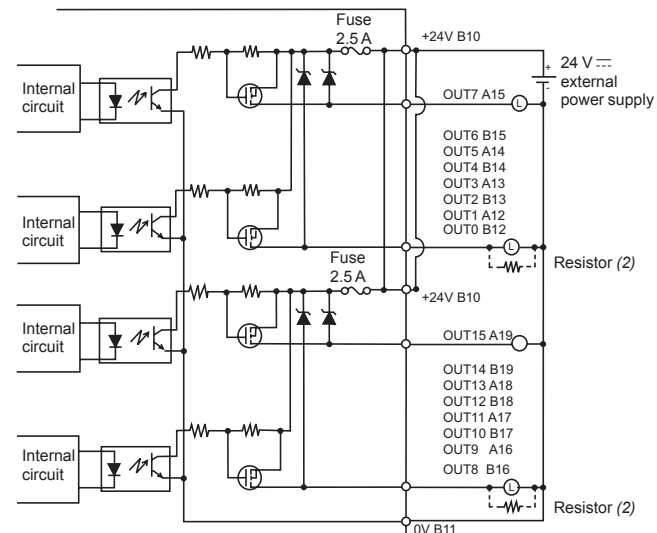

(1) Dotted lines: sink output connection  
 (2) Resistance value: see setup manual



# HMI Controllers

Magelis XBT GC HMI Controller with  
3.8" screen

## Dimension and mounting schemes

XBT GC 1100T/U

2

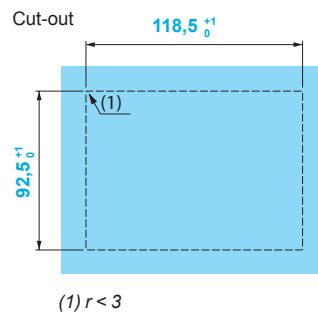
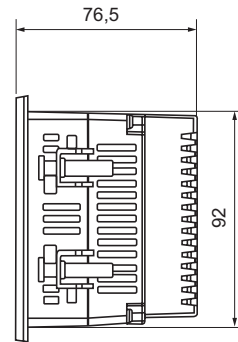
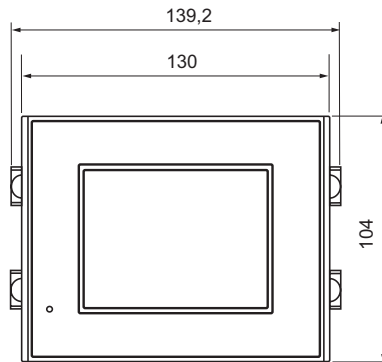
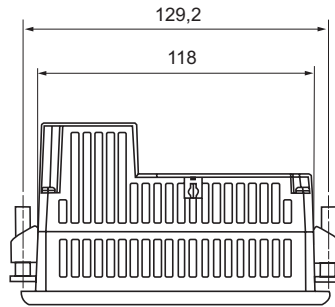

### Dimension and mounting schemes

XBT GC 2120T/U, XBT GC 2230T/U

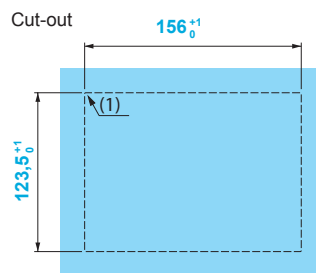
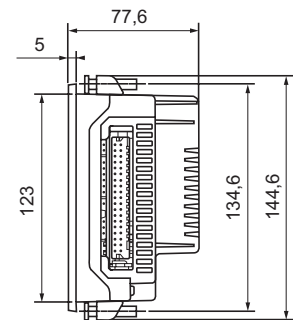
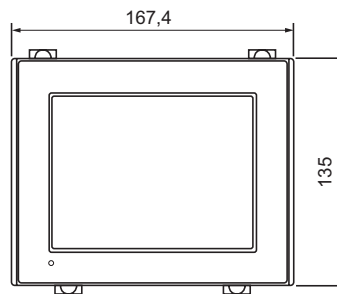
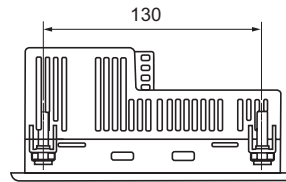

(1)  $r < 3$



#### Presentation

The SoMachine software is used to configure the CANopen bus on the XBT GC HMI Controller.

The various services available are:

- One or more profiles are supplied for Schneider Electric slaves such as ATV 312/61/71 variable speed drives and Lexium 32 servo drives. This makes it possible to configure the slave according to a predefined mode.

Profiles provide a defined operating mode so that there is no need for users to configure the mode.

- For third-party slaves

- The user can choose from a list which can be modified. This simply involves importing an EDS (Electronic Data Sheet) description file
- The slave can be positioned on the bus: the slave number, speed, monitoring, etc. can be defined
- The user can select variables from the list of variables managed by the slave
- A link between variables and the data exchanged
- Symbolization of data exchanged

#### Description

The **XBT ZGC CAN** CANopen bus master module consists of:

- 1 3 LEDs (PWR, RUN, ERR) providing details of the power supply status and module operation
- 2 A 9-way male SUB-D connector for connecting to the CANopen bus
- 3 A connector for connecting to the XBT GC HMI Controller

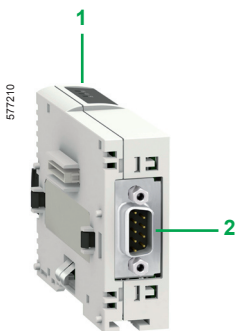
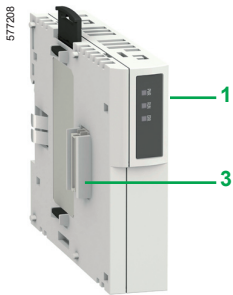



Characteristics		XBT ZGC CAN							
<b>CANopen bus master module</b>									
<b>CANopen services</b>	Conformity class	M10 limited to 16 slaves							
	Standard	DS 301 V4.02, DR 303-1							
<b>Structure</b>	Physical interface	9-way male SUB-D							
	Data rate	<b>kbps</b>	20	50	100	125	250	500	1000
	Maximum length of bus	<b>m</b>	1000	800	500	425	250	125	50
	Medium	Shielded twisted pairs							
<b>CANopen communication module</b>	Nominal voltage	<b>V <math>\overline{\text{---}}</math></b>	5						
	Power dissipation at 5 V $\overline{\text{---}}$	<b>W</b>	2.4						
	Operating temperature	<b>°C</b>	0...+ 50						
	Protection level	IP 20							
	Relative humidity	10...90% (without condensation)							
	Monitoring LEDs	PWR, RUN, ERR							
	Product certification	UL, CE							
	Number of modules per base	1							
	Max. number	Slaves	16 slaves max.						
		Channels	64 TPDO ( <i>Transmit Process Data Object</i> ) 64 RPDO ( <i>Receive Process Data Object</i> )						

Reference		Description	Reference	Weight kg
		<b>CANopen bus master module for Magelis XBT GC HMI Controller.</b>	<b>XBT ZGC CAN</b>	0.100
		Conformity class M10		

XBT ZGC CAN

2

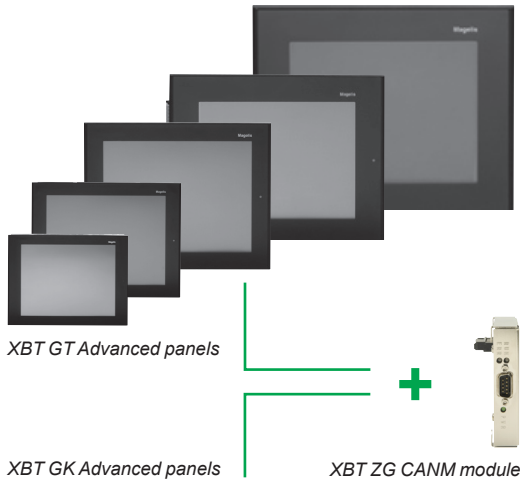

HMI function: Magelis XBT GT/GK Advanced Panels  
+  
Control function: XBT ZG CANM CANopen master module

### Presentation

The CANopen bus master module provides the control function for XBT GT (5.7", 10.4", 12.1" or 15") and XBT GK (5.7" or 10.4") Advanced Panels (see page 2/32). The SoMachine software is used to configure the machine bus for this module.

The various services available are:

- One or more profiles are supplied for Schneider Electric slaves such as ATV 312/61/71 variable speed drives and Lexium 32 servo drives. This makes it possible to configure the slave according to a predefined mode. Profiles provide a defined operating mode so that there is no need for users to configure the mode.
- For third-party slaves:
  - The user can choose from a list which can be modified. This simply involves importing an EDS (Electronic Data Sheet) description file
  - The slave can be positioned on the bus: the slave number, speed, monitoring, etc. can be defined
  - The user can select variables from the list of variables managed by the slave
  - A link between variables and the data exchanged
  - Symbolization of data exchanged

### Description

The XBT ZG CANM CANopen bus master module consists of:

- 1 3 LEDs (PWR, RUN, ERR) providing details of the power supply status and module operation
- 2 A 9-way male SUB-D connector for connecting to the CANopen bus
- 3 A connector for connecting to the rear of the Magelis XBT GT/GK Advanced Panels
- 4 Positions for fixing screws

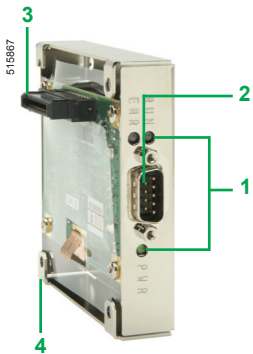

Characteristics		XBT ZG CANM							
<b>CANopen bus master module</b>									
<b>CANopen services</b>	Conformity class	M10 limited to 16 slaves							
	Standard	DS 301 V4.02, DR 303-1							
<b>Structure</b>	Physical interface	9-way male SUB-D							
	Data rate	<b>kbps</b>	20	50	100	125	250	500	1000
	Maximum length of bus	<b>m</b>	1000	800	500	425	250	125	50
	Medium	Shielded twisted pairs							
<b>CANopen communication module</b>	Nominal voltage	<b>V</b> $\overline{\text{---}}$	5						
	Power dissipation at 5 V $\overline{\text{---}}$	<b>W</b>	2.4						
	Operating temperature	<b>°C</b>	0...+ 50						
	Protection level	IP 20							
	Relative humidity	10...90% (without condensation)							
	Monitoring LEDs	PWR, RUN, ERR							
	Product certification	UL, CE							
	Number of modules per base	1							
	Max. number	Slaves	16 slaves max.						
		Channels	64 TPDO ( <i>Transmit Process Data Object</i> ) 64 RPDO ( <i>Receive Process Data Object</i> )						

### Reference



Description	Reference	Weight kg
<b>CANopen bus master module for Magelis XBT GT/GK Advanced Panels</b> Conformity class M10	<b>XBT ZG CANM</b>	0.100

2



XBT GT21●0/2220/2330



XBT GT4230/43●0



XBT GT53●0



XBT GT63●0



XBT GT7340

### XBT GT monochrome touch screen terminals compatible with the XBT ZG CANM CANopen master module (1) (2)

Type of screen	No. of ports	Application memory capacity	Compact Flash memory	Composite video input	No. of Ethernet ports	Reference	Weight kg
<b>Optimum, 5.7" QVGA screen</b>							
STN blue mode	1 COM 1 1 COM 2 1 USB	16 MB	No	No	–	XBT GT2110	1.000
<b>Multifunction, 5.7" QVGA screen</b>							
STN Black and white	1 COM 1 1 COM 2 1 USB	16 MB	Yes	No	–	XBT GT2120	1.000
					1	XBT GT2130	1.000

### XBT GT colour touch screen terminals compatible with the XBT ZG CANM CANopen master module (1) (2)

Type of screen	No. of ports	Application memory capacity	Compact Flash memory	Composite video input	On-board Ethernet	Reference	Weight kg
<b>Multifunction, 5.7" QVGA screen</b>							
STN	1 COM 1 1 COM 2 1 USB	16 MB	Yes	No	–	XBT GT2220	1.000
TFT	1 COM 1 1 COM 2 1 USB	16 MB	Yes	No	1	XBT GT2330	1.000
High Brightness TFT	1 COM 1 1 COM 2 1 USB	16 MB	Yes	No	1	XBT GT2930	1.000
<b>Multifunction, 5.7" VGA screen</b>							
TFT	1 COM 1 1 COM 2 2 USB	32 MB	Yes	No	1	XBT GT2430	–
<b>Multifunction, 7.5" VGA screen</b>							
STN	1 COM 1 1 COM 2 1 USB	32 MB	Yes	No	1	XBT GT4230	1.800
TFT	1 COM 1 1 COM 2 1 USB	32 MB	Yes	No	1	XBT GT4330	1.800
				Yes	1	XBT GT4340	1.800
<b>Multifunction, 10.4" VGA</b>							
STN	1 COM 1 1 COM 2 2 USB	32 MB	Yes	No	1	XBT GT5230	3.000
TFT	1 COM 1 1 COM 2 2 USB	32 MB	Yes	No	1	XBT GT5330	2.500
				Yes	1	XBT GT5340	2.500
<b>Multifunction, 10.4" SVGA</b>							
TFT	1 COM 1 1 COM 2 2 USB	32 MB	Yes	No	1	XBT GT 5430	2.500
<b>Multifunction, 12.1" SVGA</b>							
TFT	1 COM 1 1 COM 2 2 USB	32 MB	Yes	No	1	XBT GT6330	3.000
				Yes	1	XBT GT6340	3.000
<b>Multifunction, 15" XGA</b>							
TFT	1 COM 1 1 COM 2 2 USB	32 MB	Yes	Yes	1	XBT GT7340	5.600

(1) Terminals supplied with fixing kit (clips with screws), locking catch for USB connectors and instruction sheets. The setup documentation for XBT GT terminals is supplied in electronic format with the Vijeo Designer configuration software (see page 4/17).

(2) All the data on the Magelis XBT GT Advanced Panels is available from page 1/38 on.

**XBT GK keypad/touch screen terminals compatible with the XBT ZG CANM CANopen master module (1)**

(2)



XBT GK2120/2330



XBT GK5330

Type of screen	No. of ports	Application memory capacity	Compact Flash memory	Video input	No. of Ethernet ports	Reference	Weight kg
<b>Multifunction, 5.7" screen</b>							
STN Black and white	1 COM 1 1 COM 2 1 USB	32 MB	Yes	No	-	XBT GK2120	-
<b>Multifunction, 5.7" screen</b>							
TFT Colour mode	1 COM 1 1 COM 2 1 USB	32 MB	Yes	No	1	XBT GK2330	-
<b>Multifunction, 10.4" screen</b>							
TFT Colour mode	1 COM 1 1 COM 2 2 USB	32 MB	Yes	No	1	XBT GK5330	-

**XBT ZG CANM CANopen module dimensions and mounting**

**Dimensions**

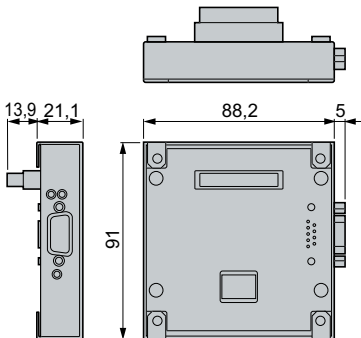

**Mounting**

XBT GT/GK + CANopen module

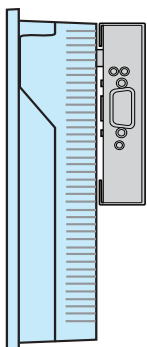

(1) Terminals supplied with fixing kit (spring clips), locking catch for USB connectors, customizable legend sheets and instruction sheets.  
 (2) All the data on the Magelis XBT GK Advanced Panels is available from page 1/38 on.

### CANopen architecture

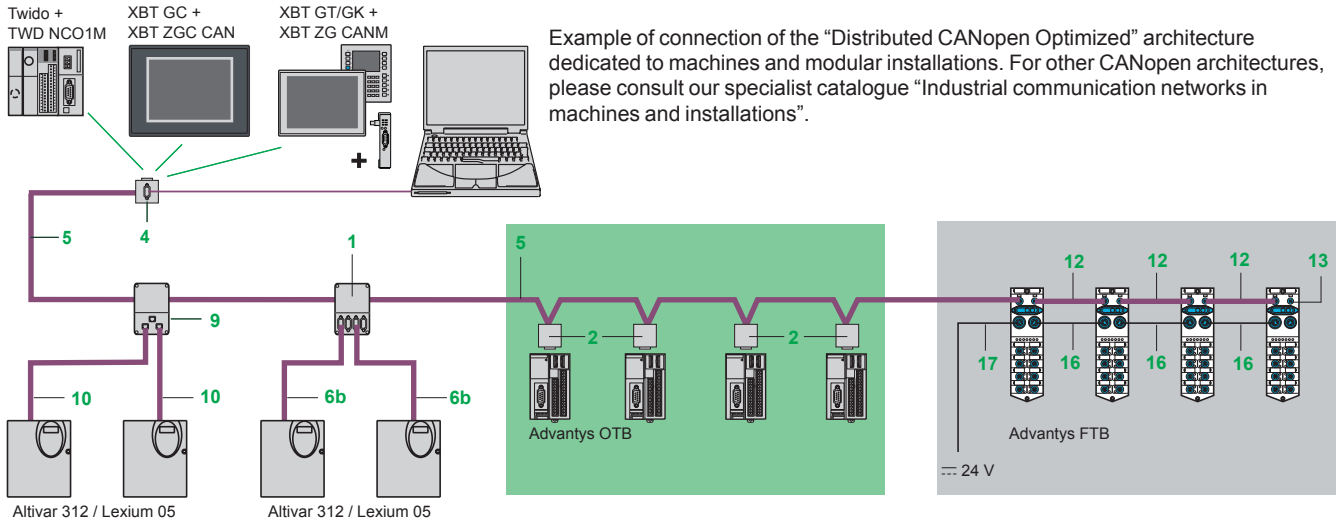

### References

#### Standard tap junctions and connectors

Designation	Description	Item no.	Length	Reference	Weight kg
<b>IP 20 CANopen tap junction</b>	4 SUB-D ports. Screw terminal block for connecting the trunk cables Line termination	1	–	TSX CAN TDM4	0.196
<b>IP 20 CANopen connectors, 9-way female SUB-D</b>	Right angle	2	–	TSX CAN KCDF 90T	0.046
	Straight (2)	–	–	TSX CAN KCDF 180T	0.049
	Right angle with 9-way SUB-D for connecting a PC or diagnostic tool	4	–	TSX CAN KCDF 90TP	0.051
<b>M12 connectors IP 67</b>	Male	–	–	FTX CN 12M5	0.050
	Female	–	–	FTX CN 12F5	0.050
<b>IP 20 CANopen tap junction for Altivar and Lexium 05</b>	2 RJ45 ports	9	–	VW3 CAN TAP2	–

#### IP 20 standard cables and preformed cordsets

Designation	Description	Item no.	Length	Unit reference	Weight kg	
<b>CANopen cables</b> (2 x AWG 22 2 x AWG 24)	For standard environment (3), CE marking: Low smoke. Zero halogen. Flame-retardant (IEC 60332-1)	5	50 m	TSX CAN CA50	4.930	
			100 m	TSX CAN CA100	8.800	
			300 m	TSX CAN CA300	24.560	
	For standard environment (3), UL certification, CE marking: Flame-retardant (IEC 60332-2)	5	50 m	TSX CAN CB50	3.580	
			100 m	TSX CAN CB100	7.840	
			300 m	TSX CAN CB300	21.870	
	For harsh environments (3) or mobile installations, CE marking: Low smoke. Zero halogen. Flame-retardant (IEC 60332-1) Resistance to oils	5	50 m	TSX CAN CD50	3.510	
			100 m	TSX CAN CD100	7.770	
			300 m	TSX CAN CD300	21.700	
<b>CANopen preformed cordsets</b> One 9-way female SUB-D connector at each end	For standard environment (3), CE marking: Low smoke. Zero halogen. Flame-retardant (IEC 60332-1)	–	0.3 m	TSX CAN CADD03	0.091	
			1 m	TSX CAN CADD1	0.143	
			3 m	TSX CAN CADD3	0.295	
			5 m	TSX CAN CADD5	0.440	
		For standard environment (3), UL certification, CE marking: Flame-retardant (IEC 60332-2)	–	0.3 m	TSX CAN CBDD03	0.086
				1 m	TSX CAN CBDD1	0.131
	3 m		TSX CAN CBDD3	0.268		
	5 m	TSX CAN CBDD5	0.400			

- (1) For connection to Controller Inside programmable card. The **VW3 CAN KCDF 180T** connector can also be used.  
 (2) Standard environment: no particular environmental constraints, operating temperature between + 5°C and + 60°C, and in fixed installations.  
 (3) Harsh environment: resistance to hydrocarbons, industrial oils, detergents and solder chips. Relative humidity up to 100%, saline atmosphere, significant temperature variations, operating temperature between - 10°C and + 70°C, or in mobile installations.

References (continued)					
IP 20 standard cables and preformed cordsets (continued)					
Designation	Description	Item no.	Length	Unit reference	Weight kg
CANopen preformed cordsets	Preformed cordsets with one 9-way female SUB-D connector and one RJ45 connector	6b	0.5 m	TCS CCN 4F3 M05T	–
			1 m	TCS CCN 4F3 M1T	–
				VW3 M38 05 R010	–
				(1)	
			3 m	TCS CCN 4F3 M3T	–
	Preformed cordsets with two 9-way SUB-D connectors, 1 female and 1 male	–	0.5 m	TLA CD CBA 005	–
			1.5 m	TLA CD CBA 015	–
			3 m	TLA CD CBA 030	–
			5 m	TLA CD CBA 050	–

IP 67 standard preformed cordsets					
CANopen preformed cordsets	Preformed cordsets with two 5-way M12 A-coded angled connectors (1 male connector and 1 female connector)	12	0.3 m	FTX CN 3203	0.400
			0.6 m	FTX CN 3206	0.700
			1 m	FTX CN 3210	0.100
			2 m	FTX CN 3220	0.160
			3 m	FTX CN 3230	0.220
			5 m	FTX CN 3250	0.430

IP 20 connection accessories					
CANopen connector for Altivar 71 (2)	9-way female SUB-D Switch for line termination. Cables exit at 180°	–	–	VW3 CAN KCDF 180T	–
Adaptor for Altivar 71 drive	SUB-D to RJ45 CANopen adaptor	–	–	VW3 CAN A71	–
CANopen preformed cordsets	1 RJ45 connector at each end	10	0.3 m	VW3 CAN CARR03	–
			1 m	VW3 CAN CARR1	–
CANopen bus adaptor for Lexium 17D	Hardware interface for link conforming to the CANopen standard + 1 connector for connecting a PC terminal	–	–	AM0 2CA 001V000	0.110
Y-connector	CANopen/Modbus	–	–	TCS CTN011M11F	–



VW3 CAN A71



AM0 2CA 001V000



FTX DP21

IP 67 connection accessories for Advantys FTB/FTM monobloc and modular splitter boxes					
Designation	Composition	Item no.	Length	Reference	Weight kg
Line terminator IP 67	Equipped with one M12 connector (for end of bus)	13	–	FTX CNTL12	0.010
24 V power supply connection cables	Equipped with two 5-way 7/8 connectors	16	0.6 m	FTX DP2206	0.150
			1 m	FTX DP2210	0.190
			2 m	FTX DP2220	0.310
			5 m	FTX DP2250	0.750
			Equipped with one 5-way 7/8 connector at one end and flying leads at the other end	17	1.5 m
3 m	FTX DP2130	0.430			
5 m	FTX DP2150	0.700			
T-connector for power supply	Equipped with two 5-way 7/8 connectors	–	–	FTX CNCT1	0.100

(1) Cordset equipped with a line terminator.

(2) For ATV 71H●●M3, ATV 71HD11M3X, HD15M3X, ATV 71H075N4... HD18N4 drives, this connector can be replaced by connector TSX CAN KCDF 180T.

(3) Standard environment: no particular environmental constraints, operating temperature between + 5°C and + 60°C, and in fixed installations.

# SoMachine

## Simplify machine programming and commissioning

2



SoMachine software platform

### Presentation

SoMachine is the OEM solution software for developing, configuring and commissioning the entire machine in a single software environment, including logic, motion control, HMI and related network automation functions.

SoMachine allows you to program and commission all the elements in Schneider Electric's Flexible and Scalable Control platform, the comprehensive solution-oriented offer for OEMs, which helps you achieve the most optimized control solution for each machine's requirements.

Flexible and Scalable Control platforms include:

**Controllers:**

- HMI controllers:
  - XBT GC,
  - XBT GT/GK CANopen,
- Logic controllers:
  - Modicon M238,
  - Modicon M258,
- Motion Controller
  - Modicon LMC 058,
- Integrated Controller Card:
  - Altivar IMC,

**HMI:**

- HMI Magelis graphic panels:
  - XBT GT,
  - XBT GK.

SoMachine is a professional, efficient, and open software solution integrating Vijeo-Designer.

It integrates also the configuring and commissioning tool for motion control devices. It features all IEC 61131-3 languages, integrated field bus configurators, expert diagnostics and debugging, as well as outstanding capabilities for maintenance and visualisation.

SoMachine integrates tested, validated, documented and supported expert application libraries dedicated to applications in Packaging, Hoisting and Conveying.

SoMachine provides you:

- One software package,
- One project file,
- One cable connection,
- One download operation.

### Visual graphic user interface

Navigation within SoMachine is intuitive and highly visual. Presentation is optimized in such a way that selecting the development stage of the desired project makes the appropriate tools available. The user interface ensures nothing is overlooked, and suggests the tasks to be performed throughout the project development cycle. The workspace has been streamlined, so that only that which is necessary and relevant to the current task is featured, without any superfluous information.

### Learning centre

From the home menu, the learning centre provides several tools to get started with SoMachine. An animated file explains briefly the SoMachine interface and concept. An e-learning allows to run a self-training about SoMachine. A third section gives access to several documented examples of simple coding with SoMachine.

### Projects management

The implemented project management principle allows to browse quickly the existing projects getting the relevant information without the need to open them before selection.

The user can create a new project, starting from several means: using Tested Validated and Documented Architectures, using the provided examples, using an existing project or from scratch. There is quick access to the most recently-used projects.

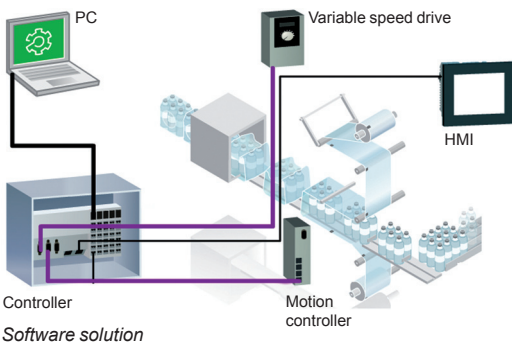

Software solution

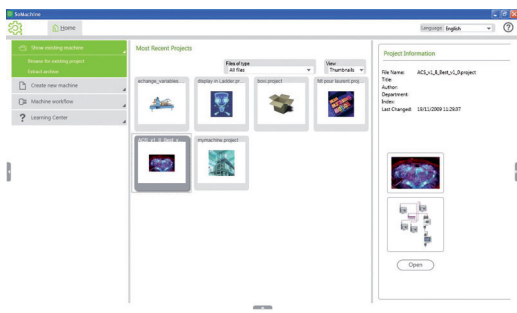

Project management



# SoMachine

## Simplify machine programming and commissioning

### Project properties

For each project, the user has the option to define additional information, through friendly forms. It's also possible to attach documents, a customer picture and a configuration picture.

### Configuration

From the graphic user interface, the user can easily build his architecture and configure the devices of this architecture.

### Description of the architecture

A graphic editor can be used to assemble the various elements easily by a simple drag & drop. A devices catalogue is displayed on the left of the screen. It is split into several sections: controllers, HMI, Miscellaneous and search.

### Configuration of the device

Directly from the topologic view of the user interface, a simple click drives the user to the configuration screen of the selected device.

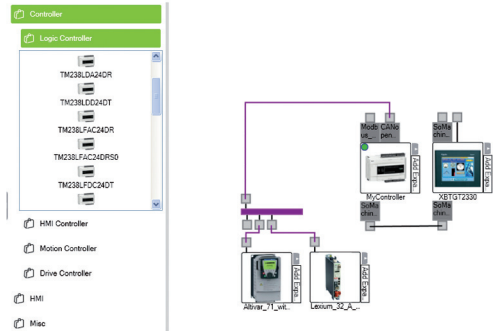

Configuration

### Programming and debug

Programming is an essential step, and the user has to carefully design it to be as efficient as possible. Advanced control and HMI functions cover all the needs of an OEM engineer in terms of creating the control and visualisation system. Powerful tools allow debug and functional tests such as simulation, step by step execution, break points, trace.

### Commissioning

For an easy and fast diagnostic, the menu commissioning allows the user to check the online state of his architecture. Through the topologic view of the configuration, the devices display if you are logged in or not, as well as if they are in run or stop mode.

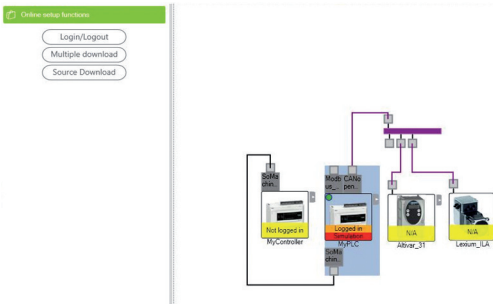

Commissioning

### Documentation

Because a printed file of the project is an important element, it is possible to build and customize the project report:

- select the items to be included in the report,
- organize the sections,
- define the page layout
- and then launch the printing.

### Transparency

SoMachine supports Device Type manager (DTM) because it is a field device tool (FDT) container.

With DTM's representing field device in SoMachine, direct communications are possible to every single device via SoMachine, the controller and the field bus CANopen, thus avoiding the lead for individual cable connections.

From the SoMachine unique environment, the remote devices can be set-up off-line and tuned on-line.

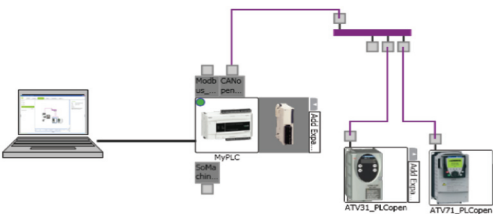

Transparency

### Dedicated OEM application libraries (AFB libraries)

SoMachine can be extended through its solution extension CD. It integrates tested, validated, documented and supported expert application libraries dedicated to many OEM applications. Their simple configuration speeds up design, commissioning, installation and troubleshooting.

These libraries cover the following applications:

- Packaging,
- Hoisting,
- Conveying.

### Tested Validated Documented Architectures (TVDA)

SoMachine provides a variety of preset projects with ready-to-use architectures you can adapt to individual requirements. Some of them are generic TVDA, they are based on controllers configuration. The solution extension CD brings solutions oriented TVDA's to SoMachine.

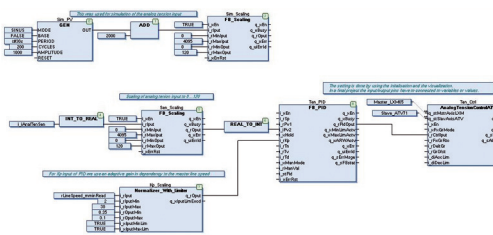

Application Function Blocks

**SoMachine characteristics**

Overview	
IEC 61131-3 programming languages	<ul style="list-style-type: none"> <li>■ IL (Instruction List)</li> <li>■ LD (Ladder Diagram)</li> <li>■ SFC (Sequential Function Chart)</li> <li>■ ST (Structured Text)</li> <li>■ FBD (Function Block Diagram)</li> <li>■ CFC (Continuous Function Chart)</li> </ul>
Controller programming services	<ul style="list-style-type: none"> <li>■ Multi-tasking: Mast, Fast, Event</li> <li>■ Functions (Func) and Function Blocks (FBs)</li> <li>■ Data Unit Type (DUTs)</li> <li>■ On-line changes</li> <li>■ Watch windows</li> <li>■ Graphical monitoring of variables (trace)</li> <li>■ Breakpoints, step-by-step execution</li> <li>■ Simulation</li> <li>■ Visualization for application and machine set-up</li> </ul>
HMI-based services	<ul style="list-style-type: none"> <li>■ Graphics libraries containing more than 4000 2D and 3D objects.</li> <li>■ Simple drawing objects (points, line, rectangles, ellipses, etc ...)</li> <li>■ Preconfigured objects (button, switch, bar graph, etc ...)</li> <li>■ Recipes (32 groups of 256 recipes with max. 1024 ingredients)</li> <li>■ Action tables</li> <li>■ Alarms</li> <li>■ Printing</li> <li>■ Java scripts</li> <li>■ Multimedia file support: wav, png, jpg, emf, bmp</li> <li>■ Variable trending</li> </ul>
Motion services	<ul style="list-style-type: none"> <li>■ Embedded devices configuration and commissioning</li> <li>■ CAM profile editor</li> <li>■ Sample application trace</li> <li>■ Motion and drive function blocks libraries for inverters, servos and steppers</li> <li>■ Visualization screens</li> </ul>
Global services	<ul style="list-style-type: none"> <li>■ User access and profile</li> <li>■ Project documentation printing</li> <li>■ Project comparison (control)</li> <li>■ Variable sharing based on publish/subscribe mechanism</li> <li>■ Library version management</li> </ul>
Integrated fieldbus configurators	<ul style="list-style-type: none"> <li>■ Control network:                             <ul style="list-style-type: none"> <li>□ Modbus Serial Line</li> <li>□ Modbus TCP</li> </ul> </li> <li>■ Field bus:                             <ul style="list-style-type: none"> <li>□ CANopen</li> <li>□ CANmotion</li> <li>□ AS-interface</li> </ul> </li> <li>■ Connectivity:                             <ul style="list-style-type: none"> <li>□ Profibus-DP</li> <li>□ Ethernet IP</li> </ul> </li> </ul>
Expert and solutions libraries	<ul style="list-style-type: none"> <li>■ PLCOpen function blocks for Motion control                             <ul style="list-style-type: none"> <li>□ Exemple: MC_MoveAbsolute, MC_CamIn, ServoDrive, ...</li> </ul> </li> <li>■ Packaging function blocks                             <ul style="list-style-type: none"> <li>□ Exemple: Analog film tension control, rotary knife, lateral film position control, ...</li> </ul> </li> <li>■ Conveying function blocks                             <ul style="list-style-type: none"> <li>□ Exemple: tracking, turntable, conveyor , ...</li> </ul> </li> <li>■ Hoisting function blocks                             <ul style="list-style-type: none"> <li>□ Exemple: anti-sway, anti-crab, hoisting position synchronisation, ...</li> </ul> </li> </ul>

# SoMachine

## Simplify machine programming and commissioning

### Product offer

SoMachine software is delivered on a DVD, it is a product oriented version that includes all SoMachine features related to generic hardware (M238, M258, XBT GC), as well as generic TVDA

The solution features are added to SoMachine by installing its solution extension CD. It includes all SoMachine solutions hardware, plus all the dedicated application libraries and TVDA.

### References

- SoMachine is available in 6 languages:
  - English
  - French
  - German
  - Italian
  - Spanish
  - Simplified Chinese.
- System Requirements:
  - Processor: Pentium 3 - 1.2 GHz or higher
  - RAM Memory: 2 GByte; recommended: 3 GByte
  - Hard Disk: 3.5 GB, recommended: 4 GB
  - OS: Windows XP Professional, Windows Vista 32 Bit
  - Drive: DVD reader
  - Display: 1024 × 786 pixel resolution or higher
  - Peripherals: a Mouse or compatible pointing device
  - Peripherals: USB interface
  - Web Access: Web registration requires Internet access
- The documentation is supplied in electronic format: complete on-line help plus pdf version.

### SoMachine software

Supported controllers	TVDA	Reference	Weight kg
M238 M258 XBT GC	Optimized HW XBT GC, Optimized HW M238, Optimized CANopen M238, Optimized AS-Interface M238, Optimized CANopen XBT GC/GT/GK, Performance HW M258, Performance CANopen M258	MSD CHNSFUV20	–

### SoMachine solution extension

Added controllers	Added TVDA	Added libraries	Reference	Weight kg
M238S M258S LMC 058 XBT GCS XBT GT/GK with control Altivar IMC	Optimized CANopen Altivar IMC, Performance CANmotion LMC058, Hoisting Optimized CANopen M238, Conveying Performance CANmotion LMC058	Hoisting Conveying Packaging	MSD CHNSFUS0V20 (1)	–

(1) For this version, please contact Schneider electric.

## Maintenance-free PC Panels Magelis

**Selection guide** ..... page 3/2

- PC Panels Magelis Opti PC
  - Presentation ..... page 3/6
  - Magelis Opti PC: 8,4", 15" ..... page 3/9
  - Dimensions ..... page 3/9
- PC Panels Magelis Smart et Smart+
  - Presentation ..... page 3/10
  - Magelis Smart: 8.4", 12", 15" ..... page 3/15
  - Magelis Smart+: 15" ..... page 3/15
  - Separate components ..... page 3/16
  - Dimensions ..... page 3/17
  - Equivalent product table ..... page 3/28

## PC Panels Magelis

**Selection guide** ..... page 3/4

- Magelis Compact iPC PC Panels
  - Presentation ..... page 3/18
  - Magelis Compact iPC : 8,4", 12", 15" screen ..... page 3/25
  - Separate components ..... page 3/26
  - Dimensions ..... page 3/27
  - Substitution ..... page 3/29

## Magelis Smart BOX, Magelis Compact PC BOX, Magelis Flex PC BOX, Front Panels

**Selection guide** ..... page 3/30

- Presentation ..... page 3/32
- Magelis Smart BOX
  - Presentation ..... page 3/34
  - Magelis Smart BOX CPUs ..... page 3/45
- Magelis Compact PC BOX
  - Presentation ..... page 3/36
  - Magelis Compact PC BOX CPUs ..... page 3/46
- Magelis Flex PC BOX
  - Presentation ..... page 3/38
  - Magelis Flex PC BOX CPUs ..... page 3/47
- Front Panels for Magelis Flex PC BOX
  - Presentation ..... page 3/42
  - Front Panels for Magelis Flex PC BOX: 12", 15", 19" ..... page 3/49
- Separate components ..... page 3/50
- Dimensions, mouting ..... page 3/52
- Connections ..... page 3/56

---

## Magelis *i*Display

*Selection guide* ..... page 3/58

■ *i*Display flat screens

- Presentation ..... page 3/60
- *i*Display flat screens: 15", 19" ..... page 3/61
- Separate components ..... page 3/61
- Dimensions ..... page 3/61

# Industrial PCs

## PC Panels

### Magelis Opti PC, Smart and Smart +

3

<b>Industrial PC</b>	<b>Maintenance-free PC Panels</b>
<b>Type</b>	<b>Optimum</b>

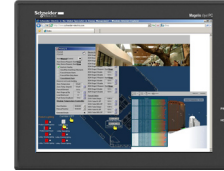

<b>Model</b>	<b>Magelis Opti PC</b>
--------------	------------------------

<b>8.4" screen</b> SVGA (800 x 600)	Data entry via touch screen	
<b>12" screen</b> SVGA (800 x 600)	Data entry via touch screen	
<b>15" screen</b> XGA (1024 x 768)	Data entry via touch screen	

<b>CPU</b>	Processor	Intel Celeron M 1 GHz
	Storage	Compact Flash 4 GB (SLC type)
	RAM	1024 MB (1 x 200-pin SO-DIMM DDR2 400 MHz)
	Expansion slots	–
	Ethernet TCP/IP network	1 RJ45 port: 1 x 10/100BASE-T
	I/O ports	on front panel – other 3 x USB 2.0, 1 x COM1(RE-232C), 1 x COM2(RE-232C), 1 x audio, 1 x eSATA, 1 x VGA (support up to QXGA 2048 x 1536@75Hz)

<b>Certifications</b>	UL/cUL60950, FCC(Class B), CE(Class B), CCC
-----------------------	---

<b>Software</b>	Operating system	Windows XP Embedded SP3
	Human machine interface	–

<b>Consumption without peripherals</b>	18 W max	28 W max
--	----------	----------

<b>Degree of protection (mounted on enclosure door)</b>	IP 54	IP 54 (IP 65 with VESA mounting only)
---	-------	---------------------------------------

<b>References</b>	AC 100 to 240 V	<b>HMI POC4AE00 (1)</b>	<b>HMI POC7AE00 (1)</b>	
	DC 24 V (1)			
	Vijeo Citect Web Client	AC 100 to 240 V		
		DC 24 V		
	Vijeo Citect Lite 1200 I/O	AC 100 to 240 V		
Vijeo Citect Full 500 I/O	AC 100 to 240 V			

<b>Pages</b>	3/9
--------------	-----

(1) All Opti PC models can be powered with 100 to 240 V AC or 24 V DC, as preferred. They are supplied with the necessary parts for each type of power supply: AC adaptor and DC cable.

**Maintenance-free PC Panels**

**Universal**

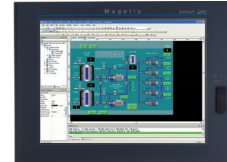
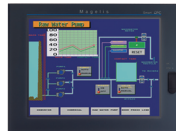

**Magelis Smart**

**Magelis Smart +**

Intel Celeron M 600 MHz	Intel Celeron M 1 GHz		
Compact Flash (SLC type) 1 GB, expandable to 4 GB	Compact Flash (SLC type) 2 GB, expandable to 4 GB	Compact Flash (SLC type) 4 GB	Flash Disk (SLC type) 15 GB
512 MB expandable to 1024 MB	512 MB expandable to 1024 MB	1024 MB	
–	1 PCMCIA slot type II	1 PCMCIA slot 1 x type III or 2 x type I	
2 RJ45 ports: 1 x 10/100/1000BASE-T 1 x 10/100BASE-T			
–	1 x USB 2.0		
4 x USB 2.0, 1 x COM1, 1 x COM2 1 x audio	4 x USB 2.0, 1 x COM1, 1 x audio, 1 x RAS	4 x USB 2.0, 1 x COM1, 1 x COM2, 1 x audio, 1 x RAS	
UL 508, CSA 142, IEC 61131-2			
DNV Marine (2) and ATEX (2)	ATEX (2)	DNV Marine (2), UL 1604 (Haz. Loc) (2), ATEX (2)	
Windows XP Embedded			Windows XP Pro
Vijeo Designer Run Time, 21-day trial version. Unlimited usage available by activation of licence VJDSNRTMPC (sold separately).			
40 W max		90 W max	
IP 65			
<b>MPC ST1 1NAJ 00T</b>			
<b>MPC ST1 1NDJ 00T</b>			
	<b>MPC ST2 1NAJ 20T</b>	<b>HMI PSC7 AE03</b>	<b>HMI PSF7 AP03</b>
	<b>MPC ST2 1NDJ 20T</b>	<b>HMI PSC7 DE03</b>	<b>HMI PSF7 DP03</b>
			<b>HMI PSF7 APL3</b>
			<b>HMI PSF7 APF3</b>

3/15

(2) DC version only

3

3

**Industrial PCs**

**Type**

**Model**

**8.4" screen** Data entry via touch screen  
SVGA (800 x 600)

**12" screen** Data entry via touch screen  
XGA (1024 x 768)

**15" screen** Data entry via touch screen  
XGA (1024 x 768)

**CPU**

Processor

Storage

RAM

DVD-ROM drive

Floppy disk drive

Expansion slots

Ethernet TCP/IP network

I/O ports on front panel  
other

**Certifications**

**Software** Operating system

Human machine interface

**Consumption**

**Degree of protection (mounted on enclosure door)**

**General Purpose (Hard Disk)** 100 to 240 V ~  
24 V ---

**Ruggedized iPC (Flash Disk)** 100 to 240 V ~  
Vijeo Citect Lite 1200 I/O 100 to 240 V ~  
Vijeo Citect Full 500 I/O 100 to 240 V ~

**Pages**

**PC Panels**

**Universal**



**Magelis Compact iPC**

Intel Celeron M 1 GHz

Hard disk ≥ 80 GB

512 MB expandable to 1024 MB

–

–

1 PCI bus slot

2 RJ45 ports:  
1 x 10/100/1000BASE-T  
1 x 10/100BASE-T

–

4 x USB 2.0,  
1 x COM1, 1 x COM2,  
1 x audio

UL 508, CSA 142, IEC 61131-2

Windows XP Pro

Vijeo Designer Run Time, 21-day trial version. Unlimited usage available by activation of licence VJDSNRTMPC (sold separately).

120 VA max.

IP 65

**MPC KT1 2NAX 00N**

3/25



## PC Panels

### Universal

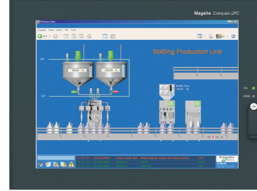

#### Magelis Compact iPC

Intel Celeron M 1.5 GHz	Pentium M 1.6 GHz
Hard disk ≥ 160 GB or Flash Disk ≥ 15 GB	Hard disk ≥ 80 GB or Flash Disk ≥ 15 GB
512 MB expandable to 1024 MB	512 MB or 1.5 GB (depending on model) expandable to 2 GB
–	Yes
–	Yes
1 x PCI bus slot 1 x PCMCIA slot 1 x type III/type I	1 PCI bus slot 1 x PCMCIA slot 1 x type III or 2 x type II
2 RJ45 ports: 1 x 10/100/1000BASE-T 1 x 10/100BASE-T	
1 x USB 2.0	
4 x USB 2.0, 1 x COM1, 1 x audio, 1 x RAS	4 x USB 2.0, 1 x COM1, 1 x COM2, 1 x COM3, 1 x COM4, 3 x audio, 1 x RAS
UL 508, IEC 61131-2, cUL	UL 508, UL 1604 (Haz Loc Class 1 Div 2), cULus, CSA, IEC 61131-2
Windows XP Pro	
Vijeo Designer Run Time, 21-day trial version. Unlimited usage available by activation of licence VJDSNRTMPC (sold separately).	
120 VA max.	150 VA max.
IP 65	
<b>MPC KT2 2NAX 20N</b>	<b>MPC KT5 5NAX 20N</b>
	<b>MPC KT5 5NDX 20N</b>
<b>MPC KT2 2MAX 20N</b>	<b>MPC KT5 5MAX 20N</b>
	<b>MPC KT5 5MAX 20L</b>
	<b>MPC KT5 5MAX 20V</b>

3/25

#### Presentation

Simple and user-friendly, Magelis Opti PC is compatible with standard Windows applications such as Internet Explorer. It is also ultra-slim and maintenance-free, as it has no moving parts (fan, hard disk).

Certified to CE, UL/cUL60950 and FCC Class B, Magelis Opti PC is designed for General Purpose applications.

*Note: For Heavy Duty applications, see pages 3/10 to 3/17 (Magelis Smart and Smart+).*

#### Magelis Opti PC

Magelis Opti PC industrial PCs are built around an IP 54 front panel (enclosure mounting) with an 8.4" or 15" colour SVGA or XGA screen and a high definition analog touch panel.

They have a built-in Ethernet TCP/IP 1 x 10/100BASE-T port that makes the terminal ideal for Transparent Ready architectures and equipment (combination of Web and Ethernet TCP/IP technologies).

Magelis Opti PC allows the viewing of Web pages either locally or remotely, with the same level of ease.

Magelis Opti PC has the following software components pre-installed:

- Internet Explorer browser
- Windows Terminal Services Client for client/server architectures

Magelis Opti PC is based on standard Windows XP Embedded SP3 technologies.

The Magelis Opti PC has particularly generous connectivity capabilities, featuring 3 or 4 USB ports and 1 eSATA port, depending on the model.

Windows XP Embedded is preloaded onto a Compact Flash memory card ready for use.

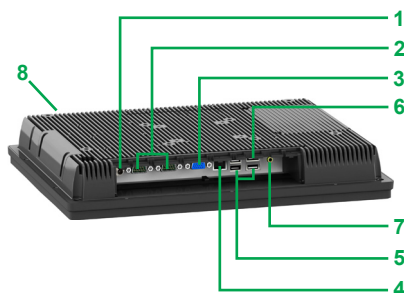
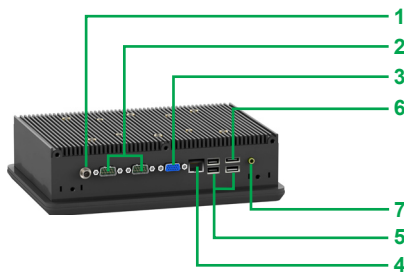
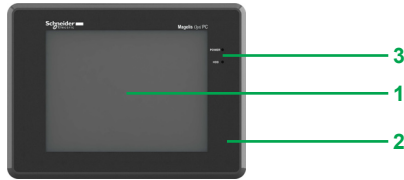

### Description of Opti PC

#### 8.4" touch screen front panel, HMI POC4AE00

The front panel of the HMI POC4AE00 industrial PC comprises:

- 1 An 8.4" SVGA colour TFT LCD screen (maximum display area 800 x 600 points) with 5-wire analog resistive touch panel
- 2 A plastic front panel (ABS-PC)
- 3 Two LEDs marked:
  - POWER (green), PC switched on
  - HDD (red), accessing IDE bus (accessing Compact Flash memory)

#### Underside and top, 8.4"

All the connection elements are accessible from the rear of the PC:

- 1 A DC power supply connector with locking tab for connecting either:
  - an AC/DC adaptor or
  - a DC cable
- 2 Two 9-pin male SUB-D connectors for RS232 serial links
- 3 A 15-pin female SUB-D connector for standard VGA QXGA 2048 x 1536 at 75 Hz
- 4 An RJ45 connector for the Ethernet 10/100 Mbps link
- 5 3 USB 2.0 ports
- 6 An eSATA port (external Serial ATA)
- 7 A mini-jack connector for loudspeaker
- 8 An On/Off switch

#### 15" touch screen front panel, HMI POC7AE00

The front panel of the HMI POC7AE00 industrial PC comprises:

- 1 A 15" VGA colour TFT LCD screen (maximum display area 1024 x 768 points) with 5-wire analog resistive touch panel
- 2 An aluminium front panel
- 3 Two LEDs marked:
  - PWR (green), PC switched on
  - HDD (red), accessing IDE bus (accessing Compact Flash memory)

#### Underside and top, 15"

All the connection elements are accessible from the rear of the PC:

- 1 A DC power supply connector with locking tab for connecting either:
  - an AC/DC adaptor or
  - a DC cable
- 2 Two 9-pin male SUB-D connectors for RS232 serial links
- 3 A 15-pin female SUB-D connector for standard VGA QXGA 2048 x 1536 at 75 Hz
- 4 An RJ45 connector for the Ethernet 10/100 Mbps link
- 5 3 USB 2.0 ports
- 6 An eSATA port (external Serial ATA)
- 7 A mini-jack connector for loudspeaker
- 8 An On/Off switch

Characteristics				
Front panel characteristics				
Type		Opti PC 8.4" HMI POC4AE00	Opti PC 15" HMI POC7AE00	
Touch screen	Type		8.4" colour TFT LCD	
	Definition	pixels	800 x 600	
	Number of colours		256 000	
	Brightness		400 cd/m <sup>2</sup> in LCD (transmittance of the touch screen: 80%)	
	Optimum viewing angle		60° (left), 60° (right), 45° (up), 55° (down)	
Touch screen	Type		60° (left), 60° (right), 60° (up), 60° (down)	
	Service life		5-wire analog resistive 35 million touches	
Front panel	Signalling		ON LED: PC switched ON - HDD LED: accessing Compact Flash system card	
	I/O ports		–	
	Material		Plastic (ABS-PC)	
	Screen protection		Aluminium PE film	
Degree of protection			IP54 (enclosure mounting)	
			IP54 (enclosure mounting), IP65 (front, rear, left and right VESA mounting)	
CPU characteristics				
Type		Opti 8.4" HMI POC4AE00	Opti 15" HMI POC7AE00	
Processor		Intel® Celeron M 1 GHz		
Chipset		Intel® 910GMLE (Graphic and Memory Controller Hub - integrated GMA 900 graphics processor) and Intel® ICH6M		
Storage	Internal hard disk	–		
	Compact Flash card	4 GB SLC card containing the OS and the software		
RAM (1 memory slot)		SDRAM, 1024 MB (200-pin SO-DIMM DDR2 400 MHz)		
CD-ROM drive		–		
Floppy disk drive		–		
Expansion slots	PCMCIA cards	–		
	PCI port	–		
Built-in I/O port	Ethernet TCP/IP port	10/100BASE-T		
	Storage device ports		3 USB 2.0 ports	
			1 eSATA port	
	Serial port COM 1	RS 232C (9-pin male SUB-D connector)		
	Serial port COM 2	RS 232C (9-pin male SUB-D connector)		
	Audio	1 mini-jack LINE output		
	PS/2 keyboard port	–		
	PS/2 pointing device port	–		
	VGA	15-pin female SUB-D connector for standard VGA QXGA 2048 x 1536 at 75 Hz		
	RAS (Reliability, Availability and Serviceability)	–		
	Operating system		Windows XP Embedded SP3	
Pre-installed software		Internet Explorer		
		Adobe Flash Player, Adobe PDF Reader for Word/Excel/PowerPoint		
		–		
Power supply	Voltage	24 V $\overline{\text{---}}$ via DC cable (1) 100 to 240 V $\sim$ /1.5 A/50 to 60 Hz with AC/DC adaptor 19 V/3.42 A/65 W (1)		
	Frequency	Hz	–	
	Micro-breaks	ms	–	
Consumption without peripherals		18 W max	28 W max	
Material		Aluminium		
Mounting		On panel or enclosure door (4 fixing bolts supplied)		
Environment	Certifications		CE (Class B) / FCC (Class B) / UL60950 / CCC	
	Temperature	In operation	°C	0 to +50
		In storage	°C	-20 to +70
	Relative humidity	%	5 to 90% without condensation	
	Operating altitude	m	–	
	Storage altitude	m	–	
	Vibration resistance	In operation	MIL-STD-810F 514.5C-1 for 60 min per axis	
Out of service		0.1" double amplitude displacement at 5 to 17 Hz and 1 g peak-to-peak acceleration at 17 to 640 Hz for 60 min per axis		

(1) All Opti PC models can be powered with 100 to 240 V AC or 24 V DC, as preferred. They are supplied with the necessary parts for each type of power supply: AC adaptor and DC cable.

### Magelis Opti PC - 8.4"

#### With 4 GB Compact Flash

Supply voltage	Processor	RAM	Reference
24 V $\overline{\text{---}}$ with DC cable (1) or 100 to 240 V $\sim$ with AC adaptor (1)	Celeron M 1 GHz	1024 MB	HMI POC4AE00

### Magelis Opti PC - 15"

#### With 4 GB Compact Flash

Supply voltage	Processor	RAM	Reference
24 V $\overline{\text{---}}$ with DC cable (1) or 100 to 240 V $\sim$ with AC adaptor (1)	Celeron M 1 GHz	1024 MB	HMI POC7AE00

### Separate Magelis components for Opti PC

Description	Characteristics	Compatible with	Reference
AC adaptor for Magelis Opti PC (replacement part)	100 to 240 V $\sim$ /1.5 A/50 to 60 Hz	All Opti PC models	HMI YPOACPS
Maintenance kits for Magelis Opti PC	Includes the enclosure mounting kit and DC cable	HMI POC4AE00	HMI YPO4MKIT
	Includes the enclosure mounting kit, DC cable and installation seal	HMI POC7AE00	HMI YPO7MKIT

(1) All Opti PC models can be powered with 100 to 240 V AC or 24 V DC, as preferred. They are supplied with the necessary parts for each type of power supply: AC adaptor and DC cable.

### Dimensions

#### HMI POC●AE00

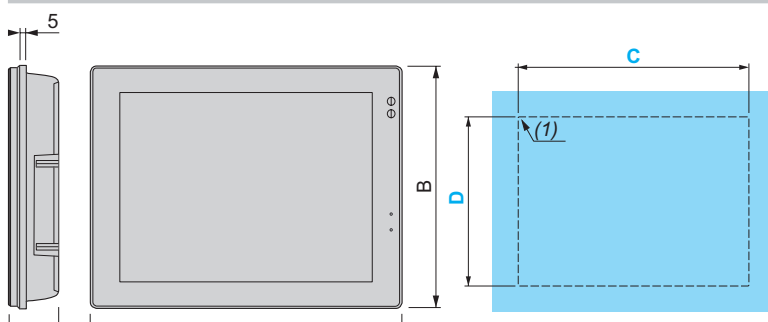

	A	B	C	D	p	(1)
HMI POC4AE00	254.3	187.5	242	172	68.5	4 x r1
HMI POC7AE00	376	292	360	276	60	4 x r5

# Industrial PCs

## PC Panels

### Magelis Smart and Smart+



3

#### Presentation

Certified to UL 508, Magelis Smart and Smart+ combine all the benefits of a PC Box industrial PC with those of an operator terminal.

On the one hand they offer the openness of PCs to Windows XP: Windows XP Embedded on Compact Flash for Magelis Smart and Windows XP Pro on Flash Disk for Magelis Smart+. They are compatible with standard Windows applications, such as Internet Explorer, Outlook Express and Office readers. They are also available bundled with the SCADA Vijeo Citect supervisor.

On the other hand they include all the features of industrial terminals:

- Maintenance-free owing to the lack of rotating parts (fan, hard disk)
- Ultra-slim, compact design
- Compatible with the human machine interface software Vijeo Designer

**Note:** For UL 60950 certified applications (information technology equipment), see pages 3/6 to 3/9 (Magelis Opti PC).

#### Magelis Smart and Smart+

Magelis Smart and Smart+ are PC Panels comprising an IP 65 front panel with an 8.4", 12" or 15" colour SVGA or XGA screen and a high-definition analog touch panel.

They have two built-in Ethernet TCP/IP ports:

- 1 x 10/100/1000BASE-T
- 1 x 10/100BASE-T

These two ports make them perfectly suited for use with Transparent Ready architectures and equipment (combination of Web and Ethernet TCP/IP technologies). They therefore allow the viewing of Web pages either locally or remotely, with the same level of ease.

Magelis Smart has Windows XP Embedded installed on its Compact Flash and the following software components:

- Internet Explorer browser and Outlook Express message client
- JVM (Java Virtual Machine)
- Windows Terminal Services Client for client/server architectures
- Office readers for access to device documentation (.pdf, .doc, .xls and .ppt documents)
- Vijeo Citect Client Web for 12" and 15" screens
- Vijeo Designer (demo version)

With these components Magelis Smart can be used for the system diagnostics, viewing and setting of Schneider Electric Transparent Ready products, as well as for access to FactoryCast services (see "Transparent Ready, embedded Web servers") and access to SCADA Vijeo Citect servers (with a Web Client licence).

Magelis Smart+ has Windows XP Pro installed on its Flash disk, making it easy to add third-party software. Magelis Smart+ 15" is also available bundled with the SCADA Vijeo Citect Lite and Full supervisor.

#### Vijeo Designer and Vijeo Citect bundle offers

Magelis Smart and Smart+ are supplied with a 21-day trial version of Vijeo Designer Run Time. Continued use of Vijeo Designer requires a licence which is sold separately (see page 3/16).

The Magelis Smart+ and Vijeo Citect bundles comprise:

- A DVD containing the software and documentation
- A USB key with the user rights already registered
- One year's technical support

The Vijeo Citect software can be used immediately upon installation (1). Updates and licence upgrades are available by providing the key number and subject to the usual conditions. This type of bundle offer enables users to acquire, at an attractive price, a tested industrial-grade system, which is correctly dimensioned to suit software application requirements and is supported across the entire Schneider Electric sales network.

(1) Requires an external DVD drive for connection to a USB port (not supplied)

#### Examples of Smart and Smart+ architecture

##### Connections to Vijeo Citect architectures

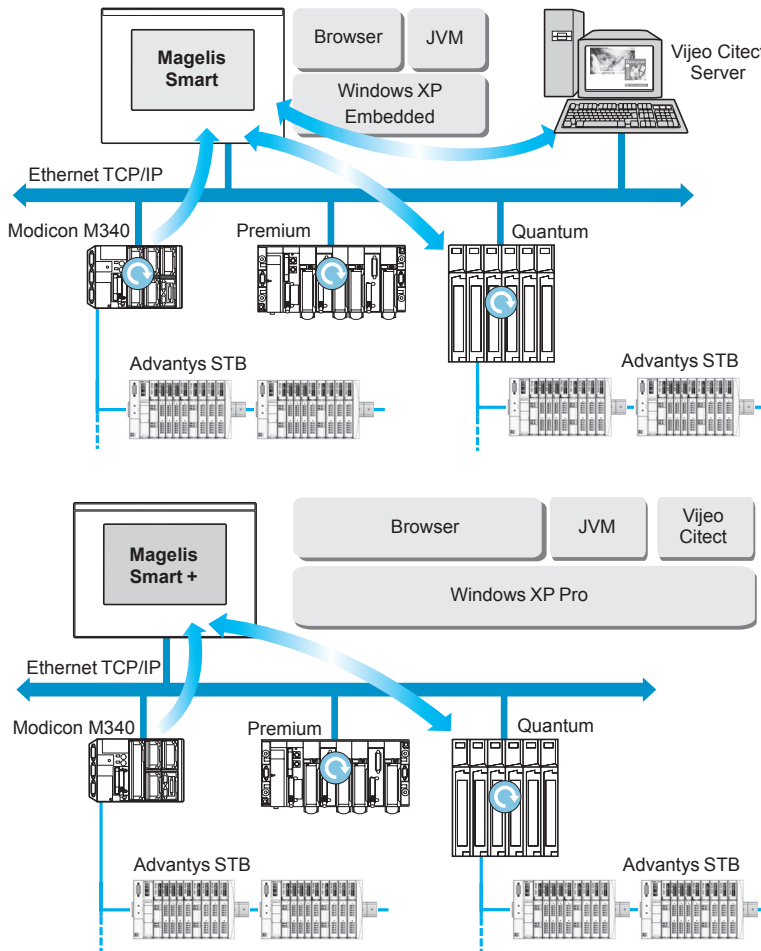

With its double integrated Ethernet port, the Magelis Smart or Smart+ can be integrated into "full Ethernet" architectures, such as Transparent Ready (transparent communication on the Ethernet TCP/IP network). Communication services and Web services assure the sharing and distribution of data between levels 1, 2 and 3 of the Transparent Ready architecture.

Used as a Client station, Magelis Smart or Smart+ makes it easier to implement Web Client solutions for:

- Basic servers embedded in field devices (Advantys STB/Momentum distributed I/O, ATV 32/ATV 61/ATV 71 drives, Ositrack identification systems, etc.).
- FactoryCast Web servers embedded in Modicon PLCs (M340, Premium and Quantum) or the FactoryCast gateway.
- The following services are available as standard (without the need for additional programming): alarm management, synoptic view management and Web home pages created by the user.
- The other services are basic data management, automatic e-mail sending triggered by specific process events and arithmetic and logic calculations for data preprocessing.



##### Magelis Smart

With the pre-installed Vijeo Citect Web Client software and by using Internet Explorer, Magelis Smart 12" and 15" are Web Client on a Vijeo Citect server. The Web Client licence must be activated on the Vijeo Citect server.

##### Magelis Smart +

Smart+ is available bundled with the SCADA Vijeo Citect supervisor.

##### Human machine interface applications

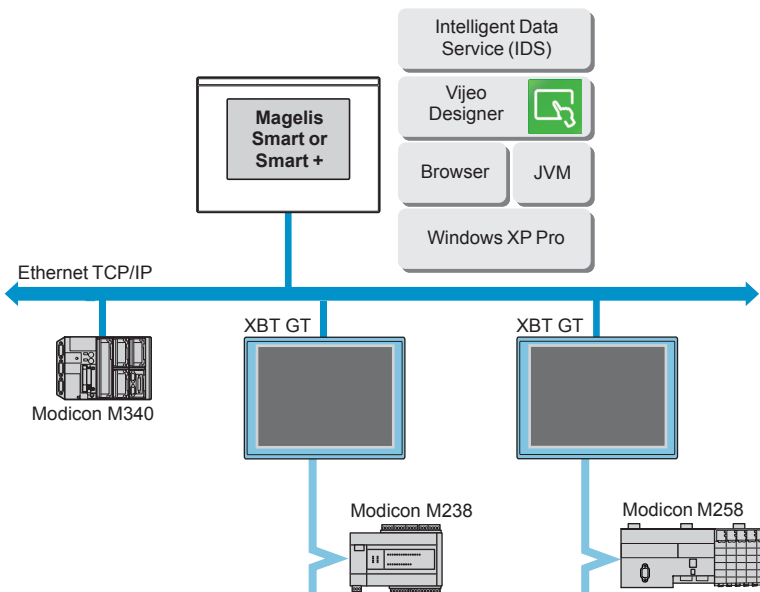

Magelis Smart and Smart+ are supplied with a 21-day trial version of Vijeo Designer Run Time. Continued use of Vijeo Designer requires a licence which is sold separately (see page 3/16).

Vijeo Designer can be used to create control applications for Magelis terminals and industrial PCs.



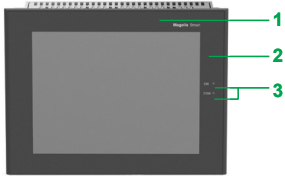

#### Description of Smart and Smart+

##### 8.4" touch screen front panel

The touch screen front panel of the industrial PC **MPC ST1 1N●J 00●** comprises:

- 1 An 8.4" SVGA active matrix colour TFT LCD screen (maximum display area 800 x 600 points) with high-definition analog touch panel
- 2 An aluminium alloy front panel with IP 65 membrane (mounted on a treated steel frame)
- 3 Two LEDs marked:
  - ON (green), PC switched on
  - DISK (green), accessing IDE bus

##### Lower and left-hand sides, 8.4"

The lower and left-hand sides of the industrial PC **MPC ST1 1N●J 00●** comprise:

- 1 A removable screw terminal block for connecting the 24 V  $\bar{\text{---}}$  power supply
- 2 A slot for the Compact Flash memory card containing the operating system and installed software
- 3 Two 9-pin male SUB-D connectors marked COM1 and COM2 for the RS 232 serial link
- 4 4 USB 2.0 ports
- 5 2 RJ45 connectors for the Ethernet link:
  - 1 x 10/100/1000 Mbps
  - 1 x 10/100 Mbps
- 6 A mini-jack connector for loudspeaker

All expansion slots and connection elements are therefore accessible from the rear of the PC.

*Note: AC versions have an On/Off switch.*

3

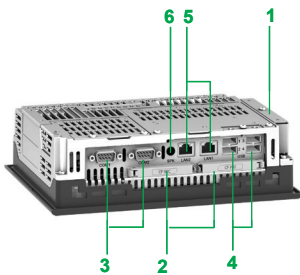

##### 12" touch screen front panel

The touch screen front panel of the industrial PC **MPC ST2 1N●J 20T** comprises:

- 1 A 12" SVGA active matrix colour TFT LCD screen (maximum display area 800 x 600 points) with high-definition analog touch panel
- 2 An aluminium alloy front panel with IP 65 membrane (mounted on a treated steel frame)
- 3 Two LEDs marked:
  - ON (green), PC switched on
  - DISK (green), accessing IDE bus (accessing Compact Flash memory, etc.)
- 4 A USB 2.0 port (dust and damp proof)

##### Lower and left-hand sides, 12"

The lower and left-hand sides of the industrial PC **MPC ST2 1N●J 20T** comprise:

- 1 A removable screw terminal block for connecting the AC power supply
- 2 A slot for the Compact Flash memory card containing the operating system and installed software
- 3 One 9-pin male SUB-D connector marked COM1 for the RS 232 serial link
- 4 4 USB 2.0 ports
- 5 2 RJ45 connectors for the Ethernet link:
  - 1 x 10/100/1000 Mbps
  - 1 x 10/100 Mbps
- 6 A slot for 1 additional PCMCIA type II card
- 7 A mini-jack connector for loudspeaker
- 8 An RAS connector (Reliability, Availability and Serviceability)

All expansion slots and connection elements are therefore accessible from the rear of the PC.

*Note: AC versions have an On/Off switch.*

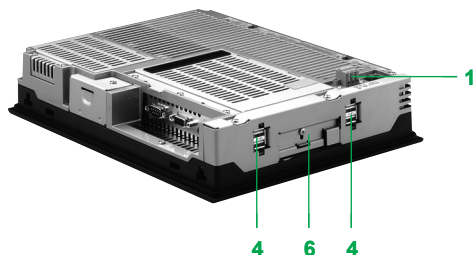
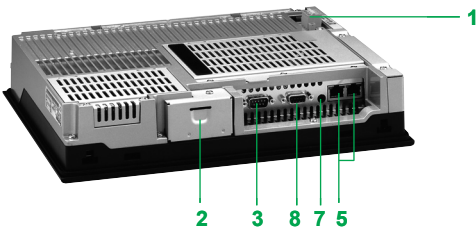



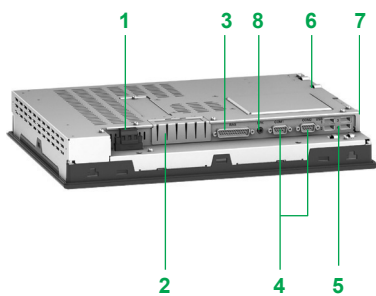
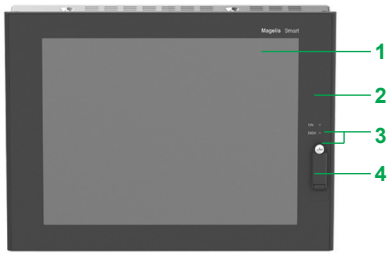

#### Description of Smart and Smart+ (continued)

##### 15" touch screen front panel

The touch screen front panel of the industrial PC HMI PS●7 ●●●3 comprises:

- 1 A 15" XGA active matrix colour TFT LCD screen (maximum display area 1024 x 768 points) with high-definition analog touch panel
- 2 An aluminium alloy front panel with IP 65 membrane (mounted on a treated steel frame)
- 3 Two LEDs marked:
  - ON (green), PC switched on
  - DISK (green), accessing IDE bus (accessing Compact Flash memory, etc.)
- 4 A USB 2.0 port (dust and damp protected)

##### Lower and left-hand sides, 15"

The lower and left-hand sides of the industrial PC HMI PS●7 ●●●3 comprise:

- 1 A removable screw terminal block for connecting the 24 V  $\bar{\text{---}}$  power supply
- 2 Depending on model:
  - Smart (HMI PSC7 ●E●3)**: a slot for the Compact Flash memory card containing the operating system and installed software
  - Smart+ (HMI PSF7 ●P●3)**: a free Compact Flash slot
- 3 A 25-pin female SUB-D connector marked RAS port for diagnostics
- 4 Two 9-pin male SUB-D connectors marked COM1 and COM2 for the RS 232 serial link
- 5 4 USB 2.0 ports
- 6 2 RJ45 connectors for the Ethernet link:
  - 1 x 10/100/1000 Mbps
  - 1 x 10/100 Mbps
- 7 A slot for 2 additional PCMCIA cards
- 8 A mini-jack connector for loudspeaker

All expansion slots and connection elements are therefore accessible from the rear of the PC.

**Note:** AC versions have an On/Off switch.



Smart and Smart+ characteristics						
Front panel characteristics						
Type		Smart 8.4" MPC ST1 1N●J 00●	Smart 12" MPC ST2 1N●J 20T	Smart 15" HMI PSC7 ●E03	Smart+ 15" HMI PSF7 ●P●3	
Touch screen	Type	8.4" SVGA active matrix colour TFT LCD	12" SVGA active matrix colour TFT LCD	15" XGA active matrix colour TFT LCD		
	Definition	800 x 600		1024 x 768		
	Number of colours	262144		16 777 216		
	Brightness	≥ 200 cd/m <sup>2</sup> adjustable	≥ 250 cd/m <sup>2</sup> adjustable			
	Optimum viewing angle	Horizontal 160°, vertical 160°				
Touch screen		Analog resistive, 1 million cycles				
Front panel	Signalling	ON LED: PC switched ON - DISK LED: accessing Compact Flash system card				
	I/O ports	1 USB port, protected by IP 65 cover				
	Material	Aluminium alloy with IP 65 membrane on treated steel frame				
	Screen protection	Polyethylene sheet				
Degree of protection		IP 65	IP 65 (when USB port on front panel not in use)			
CPU characteristics						
Type		Smart 8.4" MPC ST1 1N●J 00●	Smart 12" MPC ST2 1N●J 20T	Smart 15" HMI PSC7 ●E03	Smart+ 15" HMI PSF7 ●P●3	
Processor	MHz	Intel Celeron M 600	Intel Celeron M 1000			
Storage	Internal hard disk	–	–	–	15 GB Flash Disk (with OS and software)	
	Compact Flash card	1 GB minimum, expandable to 4 GB (with OS and software) + 1 free slot	2 GB minimum, expandable to 4 GB (with OS and software)	4 GB (with OS and software)	1 free slot	
RAM (1 memory slot)	MB	SDRAM, 512 minimum, expandable up to 1024		SDRAM, 1024		
CD-ROM drive		–	–	–	–	
Floppy disk drive		–	–	–	–	
Expansion slots	PCMCIA cards	–	1 slot (taking a maximum of 1 x type II card)	1 slot (taking a maximum of 1 type III card or 2 type I cards)		
	PCI port	–	–	–	–	
Built-in I/O ports	Ethernet TCP/IP port	2 RJ45 ports, links: 1 x 10/100/1000BASE-T and 1 x 10/100BASE-T				
	USB ports	4 USB 2.0 ports				
	Serial port COM 1	1 RS 232C link (9-pin male SUB-D connector)				
	Serial port COM 2	1 RS 232C link (9-pin male SUB-D)	–	1 RS 232C link (9-pin male SUB-D connector)		
	Audio	1 mini-jack LINE output				
	PS/2 keyboard port	–				
	PS/2 pointing device port	–				
Operating system		Windows XP Embedded SP2			Windows XP Pro	
Pre-installed software		Internet Explorer				
		Acrobat Reader, Word/Excel/PowerPoint reader				
		Vijeo Designer Run Time trial version (21 days)				
		–	Vijeo Citect Web Client	–	–	
Power supply	Voltage	24 V --- 100 to 240 V ~ with external power supply	24 V --- 100 to 240 V ~ (voltage limits 85 to 265 V), conforming to EN 61131-2			
	Frequency	Hz	–	50/60 (frequency limits 47/63), conforming to EN 61131-2		
	Micro-breaks	ms	5	5 (---) 10 (~)		
Consumption		40 W max.	40 W max. (---) 95 VA max. (~)	90 W max. (---) 150 VA max. (~)		
Material		Treated steel				
Mounting		On panel or enclosure door (8 fixing bolts supplied)				
Environment	Certifications		UL 508, CSA 142, IEC 61131-2			
			–	--- UL 1604 (HazLoc Class 1 Div 2)		
	ATEX	ATEX II 3 Gas and dust (zone 2/22) (1)				
	Marine	DNV Marine (1)	–	DNV Marine (1)		
	Immunity to interference		High frequency interference, conforming to IEC 61131-2, EN 61000-6-2, FCC (Class A)			
			Electromagnetic emissions, EN 55011 (Group 1, Class A), EN 61000-3-2, EN 61000-3-3			
	Temperature	Operation	°C	0 to +50		
		Storage	°C	-20 to +60	-10 to +60	-20 to +60
Relative humidity	%	10 to 85				
Operating altitude	m	0 to 3000, max.				
Storage altitude	m	0 to 12,000, max.				
Vibration resistance	m/s <sup>2</sup>	9.8 at 10 to 25 Hz/3 axes for 30 minutes				

(1) 24 V --- versions only



MPC ST1 1N●J 00●

#### Magelis Smart PC Panel - 8.4" screen (1)

##### With 1 GB Compact Flash minimum

Supply voltage	RAM processor	Expansion slots	Vijeo Citect	Reference	Weight kg
24 V $\overline{\text{---}}$	Celeron M 600 MHz – 512 MB expandable to 1024 MB		–	MPC ST1 1NDJ 00T	3.500
100 to 240 V $\sim$	Celeron M 600 MHz 512 MB expandable to 1024 MB		–	MPC ST1 1NAJ 00T	3.500



MPC ST2 1NAJ 10●

#### Magelis Smart PC Panel - 12" screen (1)

##### With 2 GB Compact Flash

Supply voltage	RAM processor	Expansion slots	Vijeo Citect	Reference	Weight kg
24 V $\overline{\text{---}}$	Celeron M 1 GHz 512 MB expandable to 1024 MB	PCMCIA	Web Client	MPC ST2 1NDJ 20T	3.800
100 to 240 V $\sim$	Celeron M 1 GHz 512 MB expandable to 1024 MB	PCMCIA	Web Client	MPC ST2 1NAJ 20T	3.800



MPC ST5 2N●J 20●

#### Magelis Smart PC Panel - 15" screen (1)

##### With 4 GB Compact Flash

Supply voltage	RAM processor	Expansion slots	Vijeo Citect	Reference	Weight kg
24 V $\overline{\text{---}}$	Celeron M 1 GHz 1024 MB	PCMCIA	Web Client	HMI PSC7 DE03	6.000
100 to 240 V $\sim$	Celeron M 1 GHz 1024 MB	PCMCIA	Web Client	HMI PSC7 AE03	6.000

#### Magelis Smart+ PC Panel - 15" screen (1)

##### 15 GB Flash Disk

Supply voltage	RAM processor	Expansion slots	Vijeo Citect	Reference	Weight kg
24 V $\overline{\text{---}}$	Celeron M 1 GHz 1024 MB	PCMCIA	–	HMI PSF7 DP03	6.000
100 to 240 V $\sim$	Celeron M 1 GHz 1024 MB	PCMCIA	–	HMI PSF7 AP03	6.000
			Lite 1200 I/O	HMI PSF7 APL3	6.000
			Full 500 I/O	HMI PSF7 APF3	6.000

(1) Magelis Smart and Smart+ are supplied with a trial version of Vijeo Designer Run Time. For unlimited usage see page 3/16.

Separate components for Smart and Smart+				
Description	Characteristics	Compatible with	Reference	Weight kg
<b>Vijeo Designer Run Time licence</b>	Unlimited	All Smart models	<b>VJDSNRTMPC</b>	–
<b>RAM expansion</b>	512 MB	All Smart models	<b>MPC YK0 5RAM 512</b>	–
	1024 MB	All Smart models	<b>MPC YK2 2RA1 024</b>	–
<b>Compact Flash memory cards</b>	512 MB, blank	All Smart and Smart+ models	<b>MPC YN0 0CFE 00N</b>	0.050
	1 GB, blank		<b>MPC YN0 0CF1 00N</b>	0.050
	2 GB, blank		<b>MPC YN0 0CF2 00N</b>	0.050
	4 GB, blank		<b>MPC YN0 0CF4 00N</b>	0.050
	2 GB, with pre-installed software: <ul style="list-style-type: none"> <li>■ Windows XP Embedded SP9 in 9 languages (English, French, Spanish, Italian, German, Swedish, Chinese, Russian, Portuguese)</li> <li>■ framework .NET Run Time</li> <li>■ Web Application</li> <li>■ Vijeo Designer Run Time trial version (21 days)</li> </ul>	Smart 8.4" models MPC ST1 1N●J 00●	<b>HMI YPSC 42E01</b>	–
2 GB, with pre-installed software: <ul style="list-style-type: none"> <li>■ Windows XP Embedded SP9 in 9 languages (English, French, Spanish, Italian, German, Swedish, Chinese, Russian, Portuguese)</li> <li>■ framework .NET Run Time</li> <li>■ Vijeo Citect Web Client</li> <li>■ Office Reader</li> <li>■ Vijeo Designer Run Time trial version (21 days)</li> </ul>	Smart 15" models MPC ST5 2N●J 20●	<b>MPC YN5 2CF2 20T</b>	–	
<b>PCMCIA adaptor for Compact Flash card</b>	Enables a Smart to receive the second Compact Flash card needed for Vijeo Designer at the PCMCIA slot	All Smart models All Compact Flash memory cards	<b>XBT ZGADT</b>	0.050
<b>Maintenance kits</b>	Includes panel mounting fixings and seals	8.4" Smart models	<b>MPC YK1 0MNT KIT</b>	–
		12" Smart models	<b>MPC YK2 0MNT KIT</b>	–
		15" Smart models	<b>MPC YK5 0MNT KIT</b>	–
<b>Screen protection</b>	Protective film for Smart industrial PCs	8.4" Smart models	<b>MPC YK1 0SPS KIT</b>	–
		12" Smart models	<b>MPC YK2 0SPS KIT</b>	–
		15" Smart models	<b>MPC YK5 0SPS KIT</b>	–
<b>Replacement power supply connectors</b>	AC connector	All Smart and Smart+ models with AC power supply MPC ST●●NAJ ●0●● and HMI PSC ●●A●●	<b>MPC YN0 0PWA CTE</b>	–

## Dimensions

### Smart and Smart+ models

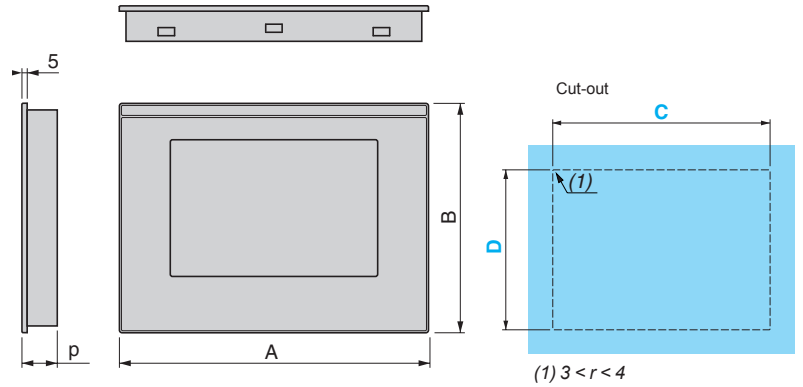

	A	B	C	D	p
MPC ST1 1N●J 00●	230	177	218.5 <sup>+1</sup> <sub>0</sub>	165.5 <sup>+1</sup> <sub>0</sub>	65.0
MPC ST2 1N●J 20●	313	239	301.5 <sup>+1</sup> <sub>0</sub>	227.5 <sup>+1</sup> <sub>0</sub>	60.0
HMI PS●7 ●●●3	395	294	383.5 <sup>+1</sup> <sub>0</sub>	282.5 <sup>+1</sup> <sub>0</sub>	60.0



3



### Presentation

Magelis Compact iPCs are "ruggedized" PCs adapted to the restrictions of industrial environments, and combine compact dimensions with advanced performance.

With identical dimensions to Magelis XBT GT (1) terminals, the Magelis Compact iPC (and the Magelis Smart) should be regarded as the natural extension of these earlier terminals.

Complementing the Magelis PC BOX range, this range of Magelis Compact iPC industrial PCs offers compact "All in One" products that meet the needs of machine manufacturers, system integrators and users. They are more compact, very easy to install/set-up and open to Web technologies.

### Magelis Compact iPC

Like Magelis Smart, Magelis Compact iPC industrial PCs are built around an IP 65 front panel with an 8.4", 12" or 15" colour TFT LCD screen and a high definition analog touch panel.

Although compact in size, the Magelis Compact iPC is an open PC designed for open-ended solutions. It offers:

- The choice of 3 processor speeds: 1 GHz (Intel Celeron M), 1.5 GHz (Intel Celeron M) or 1.6 GHz (Intel Pentium M)
- The characteristics common to all 3 sizes of Magelis Compact iPC are:
  - 512 MB expandable RAM
  - possible expansion on PCI bus (1 slot)
  - UL 508 certification
  - availability in 100 to 240 V ~ version

The 8.4" has a Celeron M 1 GHz processor.

The 12" has a Celeron M 1.5 GHz processor, its hard disk ( $\geq 160$  GB) is replaceable and it has a SATA interface. It is also available with a Flash Disk  $\geq 15$  GB and, for this, a type II PCMCIA slot is provided.

The 15" has a Pentium M 1.6 GHz processor, a hard disk  $\geq 80$  GB or a Flash Disk  $\geq 15$  GB depending on the model, and 2 slots for PCMCIA card that can take 1 type III or 2 type I cards. In addition, the 15" model is also available with 24 V --- power supply.

Magelis Compact iPC also features:

- 512 MB to 1024 MB RAM (8.4" and 12"), 512 MB to 2 GB RAM (15")
- 2 Ethernet TCP/IP ports:
  - 1 x 10/100/1000BASE-T
  - 1 x 10/100BASE-T
- USB 2.0 ports
- A 100 to 240 V ~, 50/60 Hz power supply
- Various standard serial/parallel ports
- A DVD drive (reader/writer) (15")

The Magelis Compact iPC is supplied with the Windows XP Pro operating system.

### Vijeo Designer and Vijeo Citect bundle offers

The Magelis Compact iPC is supplied with a 21-day trial version of Vijeo Designer Run Time. Continued use of Vijeo Designer requires a licence which is sold separately (see page 3/26).

In addition, references MPC KT5 5MAX 20L/V are supplied with the Vijeo Citect application software:

- DVD containing the software and documentation
- USB key with the user rights already registered
- One year's technical support

(1) Identical screen size

### Architecture examples

#### Supervision and Transparent Ready applications

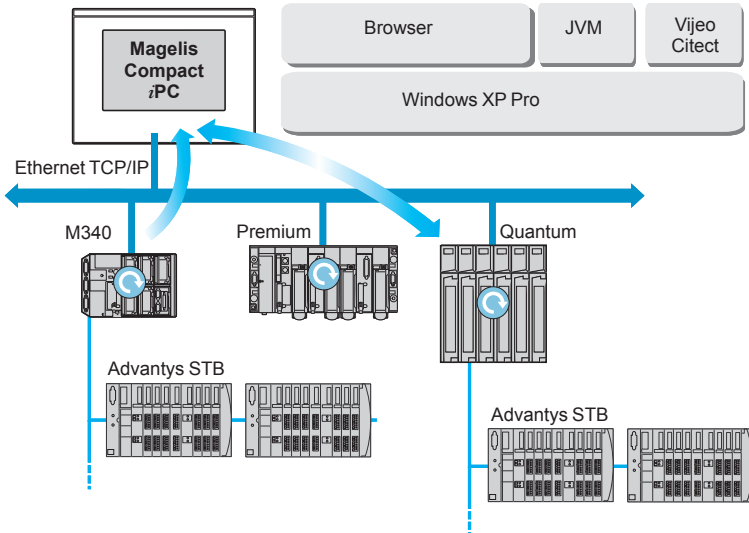

The built-in Ethernet ports on the Magelis Compact iPC allow it to be integrated into "full Ethernet" architectures, such as Transparent Ready. Transparent Ready devices with this type of architecture enable transparent communication on the Ethernet TCP/IP network. Communication services and Web services assure the sharing and distribution of data between levels 1, 2 and 3 of the Transparent Ready architecture.

Used as a Client station, Magelis Compact iPC makes it easier to implement Web Client solutions for:

- Basic servers embedded in field devices (Advantys STB/Momentum distributed I/O, ATV 32, ATV 61, ATV 71 drives, Ositrack identification systems, etc.)

- FactoryCast Web servers embedded in Modicon PLCs (M340, Premium and Quantum) or the FactoryCast gateway

The following services are available as standard (without the need for additional programming): alarm management, synoptic view management and Web home pages created by the user.

FactoryCast HMI Web servers embedded in Modicon Premium and Quantum PLCs also provide basic data management services, automatic e-mail transmission triggered by specific process events, and arithmetic and logic calculations for data preprocessing.

In addition, Vijeo Citect supervisory software is provided pre-installed on Compact iPC models with 15" screen **MPC KT5 5 MAX 20L** (Vijeo Citect Lite) and **MPC KT55 MAX 20V** (Vijeo Citect Full).



#### HMI applications

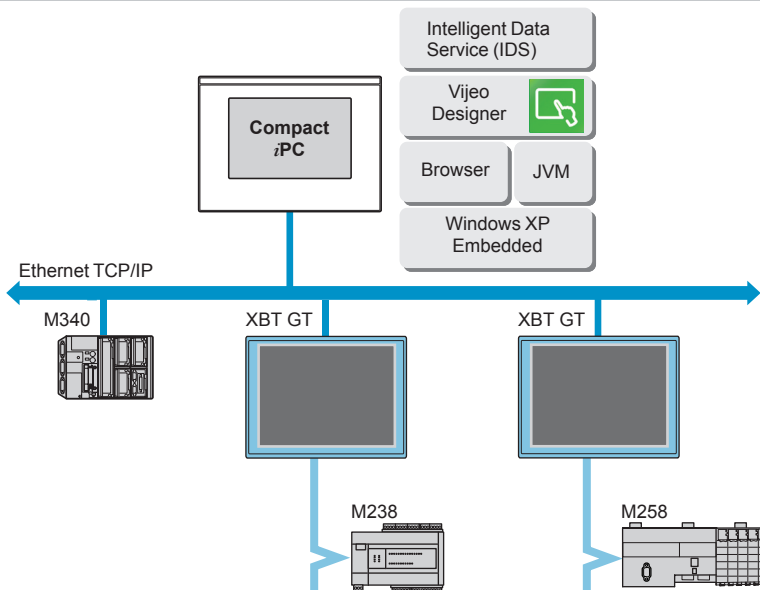

The Magelis Compact iPC is supplied with a 21-day trial version of Vijeo Designer Run Time. Continued use of Vijeo Designer requires a licence which is sold separately (see page 3/26).

Vijeo Designer can be used to create control applications for Magelis terminals and industrial PCs.

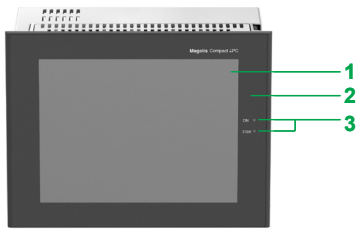

### Description of Compact iPC

#### 8.4" touch screen front panel MPC KT1 2NAX 00●

The touch screen front panel of the 8.4" MPC KT1 2NAX 00● industrial PCs comprises:

- 1 A 8.4" SVGA active matrix colour TFT LCD screen (maximum display area 800 x 600 points) with high-definition analog touch panel
- 2 An aluminium alloy front panel with IP 65 membrane (mounted on a treated steel frame)
- 3 Two LEDs marked:
  - ON (green), PC switched on
  - DISK (green), accessing IDE bus (accessing hard disk memory, etc.)

3

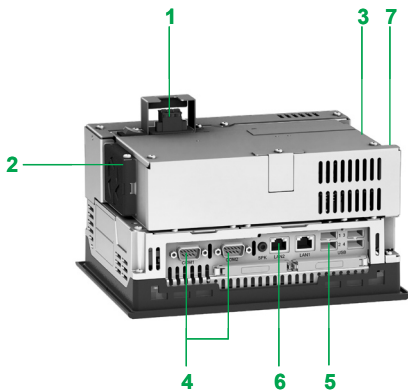

#### Underside and side panels, 8.4"

All expansion slots and connection elements are accessible from the rear of the PC:

- 1 A connector for plugging in the 100 to 240 V ~ power cable
- 2 One vent fitted with an anti-dust filter and fan
- 3 A slot for an additional Compact Flash memory card
- 4 Two 9-pin male SUB-D connectors marked COM1 and COM2 for serial links (see details on page 3/22)
- 5 4 USB 2.0 ports
- 6 2 RJ45 connectors for the Ethernet link:
  - 1 x 10/100/1000 Mbps
  - 1 x 10/100 Mbps
- 7 A slot for a PCI bus expansion card

*Note: AC versions have an On/Off switch.*



#### 12" touch screen front panel MPC KT2 2AX 20N

The touch screen front panel of the 12" MPC KT2 2AX 20N industrial PCs comprises:

- 1 A 12" XGA active matrix colour TFT LCD screen (maximum display area 1024 x 768 points) with high-definition analog touch panel
- 2 An aluminium alloy front panel with IP 65 membrane (mounted on a treated steel frame)
- 3 Two LEDs marked:
  - ON (green), PC switched on
  - DISK (green), accessing IDE bus (accessing hard disk memory, etc.)
- 4 A cover plate which provides IP 65 protection when in position and gives access when removed to:
  - a USB 2.0 port
  - a "pencil point" RESET button for restarting the processor

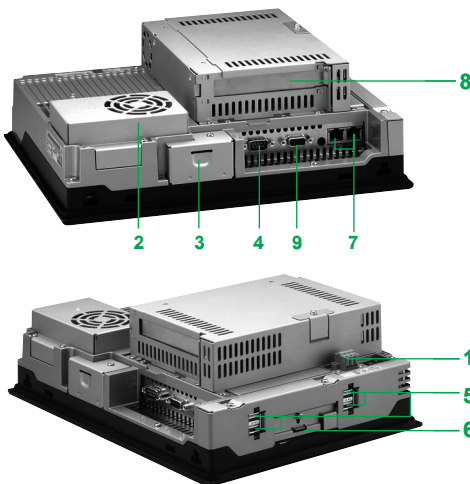

#### Underside and side panels, 12"

All expansion slots and connection elements are accessible from the rear of the PC:

- 1 A connector for plugging in the 100 to 240 V ~ power cable
- 2 One vent fitted with an anti-dust filter and fan
- 3 A slot for an additional Compact Flash memory card
- 4 A 9-pin male SUB-D connector marked COM1 for serial links (see details on page 3/22)
- 5 4 USB 2.0 ports
- 6 A slot for 1 additional PCMCIA card
- 7 2 RJ45 connectors for the Ethernet link:
  - 1 x 10/100/1000 Mbps
  - 1 x 10/100 Mbps
- 8 A slot for a PCI bus expansion card
- 9 An RAS port

*Note: AC versions have an On/Off switch.*





### Description of Compact iPC (continued)

#### 15" touch screen front panel MPC KT5 5●AX 20●

The touch screen front panel of the 15" industrial PCs MPC KT5 5●AX 20● comprises:

- 1 A 15" XGA active matrix colour TFT LCD screen (maximum display area 1024 x 768 points) with high-definition analog touch panel
- 2 An aluminium alloy front panel with IP 65 membrane (mounted on a treated steel frame)
- 3 Two LEDs marked:
  - ON (green), PC switched on
  - DISK (green), accessing IDE bus (accessing hard disk memory, etc.)
- 4 A cover plate which provides IP 65 protection when in position and gives access when removed to:
  - a USB 2.0 port
  - a "pencil point" RESET button for restarting the processor

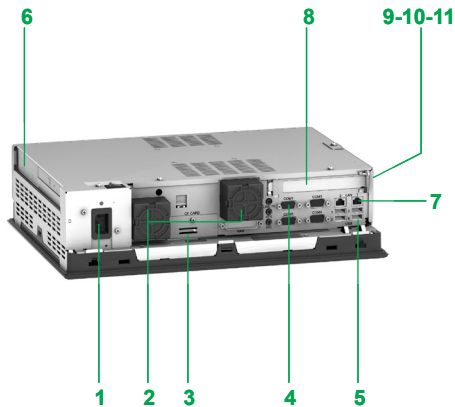

#### Underside and side panels, 15"

All expansion slots and connection elements are accessible from the rear of the PC:

- 1 A connector for plugging in the 100 to 240 V ~ power cable
- 2 2 vents, each fitted with an anti-dust filter and fan
- 3 A slot for an additional Compact Flash memory card
- 4 4 9-pin male SUB-D connectors marked COM1, COM2, COM3 and COM4 for serial links (see details on page 3/22)
- 5 4 USB 2.0 ports
- 6 A slot for 2 additional PCMCIA cards
- 7 2 RJ45 connectors for the Ethernet link:
  - 1 x 10/100/1000 Mbps
  - 1 x 10/100 Mbps
- 8 A slot for a PCI bus expansion card
- 9 A DVD-ROM drive
- 10 A 3.5" floppy disk drive
- 11 A VGA port

**Note:** AC versions have an On/Off switch.

Characteristics				
Front panel characteristics				
Type		Compact iPC 8.4" MPC KT1 2●AX 00●		
Touch screen	Size	8.4"		
	Type	SVGA active matrix colour TFT LCD		
	Definition	800 x 600		
	Number of colours	262144		
	Brightness	≥ 200 cd/m <sup>2</sup> adjustable		
	Optimum viewing angle	Horizontal 120°, vertical 100°		
Touch screen		Analog resistive, 1 million cycles		
Front panel	Signalling	ON LED: switched on DISK LED: accessing hard disk		
	I/O ports	-		
	Material	Aluminium alloy with IP 65 membrane on treated steel frame		
	Screen protection	Polyethylene sheet		
Degree of protection		IP 65		
CPU characteristics				
Type		Compact iPC 8.4" MPC KT1 2NAX 00●		
Processor		Intel Celeron M 1 GHz		
Internal hard disk		≥ 80 GB IDE, 2.5"		
Flash Disk		-		
RAM	With Windows XP Pro	MB	512 to 1024 SDRAM	
Memory slot		1 slot		
DVD-ROM drive		-		
Floppy disk drive		-		
Expansion slots	PCMCIA cards	-		
	PCI port	1 PCI bus slot		
Built-in I/O ports	Ethernet TCP/IP port	2 RJ45 ports, links: 1 x 10/100/1000BASE-T 1 x 10/100BASE-T		
	USB ports	4 USB 2.0 ports		
	Serial port COM 1	1 RS 232C link (9-pin male SUB-D connector)		
	Serial port COM 2	1 RS 232C link (9-pin male SUB-D connector)		
	Audio	1 line out		
	PS/2 keyboard port	-		
	PS/2 pointing device port	-		
	Operating system		Windows XP Pro	
	Power supply	Voltage	100 to 240 V ~ (voltage limits 85 to 265 V), conforming to EN 61131-2	
Frequency		Hz	50/60 (frequency limits 47/63), conforming to EN 61131-2	
Micro-breaks		ms	20	
Consumption		VA	120 max.	
Material		Treated steel		
Mounting		On panel or enclosure door (8 fixing bolts supplied)		
Environment	Certifications		UL 508, CSA 142, IEC 61131-2	
	Immunity to interference		High frequency interference, conforming to IEC 61131-2, EN 61000-6-2, FCC (Class A) Electromagnetic emissions, EN 55011 (Group 1, Class A), EN 61000-3-2, EN 61000-3-3	
	Temperature	Operation	°C	+5 to +50
		Storage	°C	-20 to +60
	Relative humidity		%	10 to 85
	Operating altitude		m	0 to 3000, max.
	Storage altitude		m	0 to 12,000, max.
Vibration resistance		m/s <sup>2</sup>	9.8 at 10 to 25 Hz/3 axes for 30 minutes	

Characteristics				
Front panel characteristics				
Type	Compact iPC 12" MPC KT2 2●AX 20N			
Touch screen	Size	12"		
	Type	XGA active matrix colour TFT LCD		
	Definition	1024 x 768		
	Number of colours	262144		
	Brightness	≥ 250 cd/m <sup>2</sup> adjustable		
	Optimum viewing angle	Horizontal 120°, vertical 100°		
Touch screen		Analog resistive, 1 million cycles		
Front panel	Signalling	ON LED: switched on DISK LED: accessing hard disk		
	I/O ports	1 USB port (12 Mbps), protected by IP 65 cover		
	Material	Aluminium alloy with IP 65 membrane on treated steel frame		
	Screen protection	Polyethylene sheet		
Degree of protection		IP 65		
CPU characteristics				
Type	Compact iPC 12" MPC KT2 2NAX 20N			
Processor		Intel Celeron M 1.3 GHz		
Internal hard disk		≥ 160 GB IDE, 2.5", replaceable by user	≥ 15 GB IDE, 2.5", replaceable by user	
Flash Disk		-		
RAM	With Windows XP Pro	MB	512 to 1024 SDRAM	
Memory slot			1 slot	
DVD-ROM drive		-		
Floppy disk drive		-		
Expansion slots	PCMCIA cards	1 slot (taking a maximum of 1 x type II card)		
	PCI port	1 PCI bus slot		
Built-in I/O ports	Ethernet TCP/IP port	2 RJ45 ports, links: 1 x 10/100/1000BASE-T 1 x 10/100BASE-T		
	USB ports	4 USB 2.0 ports		
	Serial port COM 1	1 RS 232C link (9-pin male SUB-D connector)		
	Serial port COM 2	-		
	Audio	1 line out		
	PS/2 keyboard port	-		
	PS/2 pointing device port	-		
	Operating system		Windows XP Pro	
Power supply	Voltage	100 to 240 V ~ (voltage limits 85 to 265 V), conforming to EN 61131-2		
	Frequency	Hz	50/60 (frequency limits 47/63), conforming to EN 61131-2	
	Micro-breaks	ms	10	
Consumption		VA	120 max.	
Material		Treated steel		
Mounting		On panel or enclosure door (8 fixing bolts supplied)		
Environment	Certifications	UL 508, IEC 61131-2, cUL		
	Immunity to interference	High frequency interference, conforming to IEC 61131-2, EN 61000-6-2, FCC (Class A) Electromagnetic emissions, EN 55011 (Group 1, Class A), EN 61000-3-2, EN 61000-3-3		
	Temperature	Operation	°C	+5 to +50
		Storage	°C	-10 to +60
	Relative humidity		%	10 to 85
	Operating altitude		m	0 to 3000, max.
	Storage altitude		m	0 to 12,000, max.
	Vibration resistance		m/s <sup>2</sup>	9.8 at 10 to 25 Hz/3 axes for 30 minutes

3

Characteristics				
Front panel characteristics				
Type		Compact iPC 15" MPC KT5 5●●X 20●		
Touch screen	Size	15"		
	Type	SVGA active matrix colour TFT LCD		
	Definition	1024 x 768		
	Number of colours	16 777 216		
	Brightness	≥ 250 cd/m <sup>2</sup> adjustable		
	Optimum viewing angle	Horizontal 120°, vertical 100°		
Touch screen		Analog resistive, 1 million cycles		
Front panel	Signalling	ON LED: switched on DISK LED: accessing hard disk		
	I/O ports	1 USB port (12 Mbps), protected by IP 65 cover		
	Material	Aluminium alloy with IP 65 membrane on treated steel frame		
	Screen protection	Polyethylene sheet		
Degree of protection		IP 65		
CPU characteristics				
Type		Compact iPC 15" MPC KT5 5●●X 20●		
		MPC KT5 5MAX 20●		
Processor		Pentium M 1.6 GHz		
Internal hard disk		≥ 80 GB IDE, 2.5"	–	
Flash Disk		–	≥ 15 GB	
RAM	With Windows XP Pro	MB	512 to 1024 SDRAM	
Memory slot			2 slots	
DVD-ROM drive		Yes		
Floppy disk drive		3.5", 1.44 MB		
Expansion slots	PCMCIA cards	2 slots (taking a maximum of 1 x type III card or 2 x type I cards)		
	PCI port	1 PCI bus slot		
Built-in I/O ports	Ethernet TCP/IP port	2 RJ45 ports, links: 1 x 10/100/1000BASE-T 1 x 10/100BASE-T		
	USB ports	4 USB 2.0 ports		
	Serial port COM 1	1 RS 232C link (9-pin male SUB-D connector)		
	Serial port COM 2	1 RS 232C link (9-pin male SUB-D connector)		
	Serial port COM 3	1 RS 232C link (9-pin male SUB-D connector)		
	Serial port COM 4	1 RS 232C link (9-pin male SUB-D connector)		
	Audio	1 line out 1 line in 1 mic in		
	Operating system		Windows XP Pro	Windows XP Pro and Vijeo Designer RT
	Power supply	Voltage	24 V --- 100 to 240 V ~ (voltage limits 85 to 265 V), conforming to EN 61131-2	100 to 240 V ~ (voltage limits 85 to 265 V), conforming to EN 61131-2
Frequency		Hz	50/60 (frequency limits 47/63), conforming to EN 61131-2	
Micro-breaks		ms	20	–
Consumption		VA	150 max.	
Material		Treated steel		
Mounting		On panel or enclosure door (8 fixing bolts supplied)		
Environment	Certifications	UL 508, UL 1604 (Haz Loc Class 1 Div 2), cULus, CSA, IEC 61131-2		
	Immunity to interference	High frequency interference, conforming to IEC 61131-2, EN 61000-6-2, FCC (Class A) Electromagnetic emissions, EN 55011 (Group 1, Class A), EN 61000-3-2, EN 61000-3-3		
	Temperature	Operation	°C	+5 to +50 (+5 to +45 when writing DVD)
		Storage	°C	-20 to +60
	Relative humidity	%	10 to 85	
	Operating altitude	m	0 to 3000, max.	
	Storage altitude	m	0 to 12,000, max.	
	Vibration resistance	m/s <sup>2</sup>	9.8 at 10 to 25 Hz/3 axes for 30 minutes	



MPC KT1 2NAX 00N

### General Purpose Compact iPC with 8.4" screen (1)

#### With hard disk

Processor Supply voltage	RAM	Expansion slots	Vijeo Citect	Reference	Weight kg
Celeron M 1 GHz 100 to 240 V ~	512 MB, expandable to 1024 MB	1 PCI	–	<b>MPC KT1 2NAX 00N</b>	4.500



MPC KT2 1NAX 00N

### General Purpose Compact iPC with 12" screen (1)

#### With hard disk

Processor Supply voltage	RAM	Expansion slots	Vijeo Citect	Reference	Weight kg
Celeron M 1.5 GHz 100 to 240 V ~	512 MB, expandable to 1024 MB	1 PCI 1 PCMCIA type II	–	<b>MPC KT2 2NAX 20N (1)</b>	4.500

#### With Flash Disk (15 GB min.)

Processor Supply voltage	RAM	Expansion slots	Vijeo Citect	Reference	Weight kg
Celeron M 1.5 GHz 100 to 240 V ~	512 MB, expandable to 1024 MB	1 PCI 1 PCMCIA type II	–	<b>MPC KT2 2MAX 20N (1)</b>	4.500



MPC KT5 5NAX 20N

### General Purpose Compact iPC with 15" screen (1)

#### With hard disk

Processor Supply voltage	RAM	Expansion slots	Vijeo Citect	Reference	Weight kg
Pentium M 1.6 GHz 100 to 240 V ~	512 MB, expandable to 2 GB	1 PCI 1 PCMCIA type III or 2 type I	–	<b>MPC KT5 5NAX 20N</b>	8.000
24 V ~	512 MB, expandable to 2 GB	1 PCI 1 PCMCIA type III or 2 type I	–	<b>MPC KT5 5NDX 20N</b>	8.000

### Heavy Duty Compact iPC with 15" screen (1)

#### With Flash Disk (15 GB min.)

Processor Supply voltage	RAM	Expansion slots	Vijeo Citect	Reference	Weight kg
Pentium M 1.6 GHz 100 to 240 V ~	512 MB, expandable to 2 GB	1 PCI 1 PCMCIA type III or 2 type I	Client Edition	<b>MPC KT5 5MAX 20N</b>	8.000
	1.5 GB, expandable to 2 GB	1 PCI 1 PCMCIA type III or 2 type I	Vijeo Citect Lite 1200 I/O	<b>MPC KT5 5MAX 20L</b>	8.000
			Vijeo Citect Full 500 I/O	<b>MPC KT5 5MAX 20V</b>	8.000

(1) Compact iPC is supplied with a trial version of Vijeo Designer Run Time. For unlimited usage see page 3/26.

Separate components for Compact iPC				
Description	Characteristics	Compatible with (1)	Reference	Weight kg
Video Designer Run Time licence	Unlimited	All Compact iPCs	VJDSNRTMPC	–
RAM expansion	512 MB	All Compact iPCs	MPC YK0 5RAM 512	–
	1024 MB	All Compact iPCs	MPC YK2 2RA1 024	–
Hard disk	≥ 160 GB	12" Compact iPC MPC YNK2 MSD 20N	MPC YNK2 SHD 20N	–
Flash disk	≥ 15 GB	12" Compact iPC MPC KT2 2MAX 20N	MPC YNK2 MSD 20N	–
Replacement power supply connector	AC connector	All Compact iPC models with AC power supply MPC KT●●●AX●0●	MPC YN0 0PWA CTE	–
Maintenance kits	Includes panel mounting fixings and seals	8.4" models MPC KT1 2NAX 00●	MPC YK1 0MNT KIT	–
		12" models MPC KT2 2●AX 00●	MPC YK2 0MNT KIT	–
		15" models MPC KT5 5●AX 20●	MPC YK5 0MNT KIT	–
Screen protection	Protective film for Compact iPC	8.4" models MPC KT1 2NAX 00●	MPC YK1 0SPS KIT	–
		12" models MPC KT2 2NAX 00●	MPC YK2 0SPS KIT	–
		15" models MPC KT5 5NAX 20●	MPC YK5 0SPS KIT	–

(1) And software package variants when available.

## Dimensions

MPC KT1 2●AX 00●/MPC KT2 2●AX 00●/MPC KT5 5●●X 20●

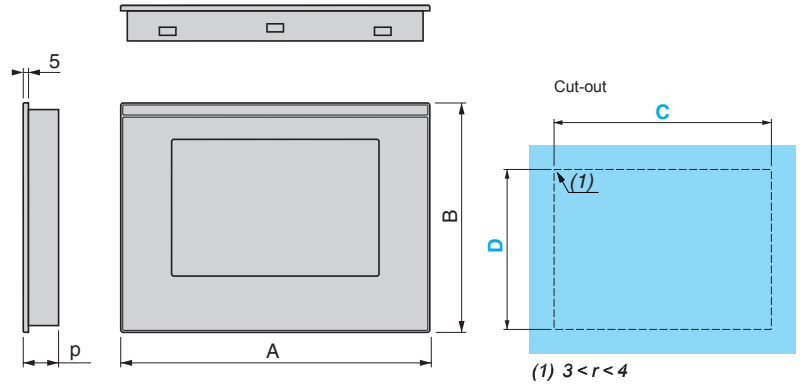

	A	B	C	D	p
MPC KT1 2●AX 00●	230	177	218.5 <sup>+1</sup> <sub>0</sub>	165.5 <sup>+1</sup> <sub>0</sub>	120
MPC KT2 2●AX 00●	313	239	301.5 <sup>+1</sup> <sub>0</sub>	227.5 <sup>+1</sup> <sub>0</sub>	103.0
MPC KT5 5●●X 20●	395	294	383.5 <sup>+1</sup> <sub>0</sub>	282.5	103.0

Magelis Smart equivalent product table		
Type	Old range	New range
~ Smart 8.4"	MPC ST1 1NAJ 00H	MPC ST1 1NAJ 00T + VJDSNRTMPC
~ Smart 12"	MPC ST2 1NAJ 10R	MPC ST2 1NAJ 20T + VJDSNRTMPC
~ Smart 15" with Vijeo Designer Run Time	MPC ST5 2NAJ 20H	MPC ST5 2NAJ 20T + VJDSNRTMPC or HMI PSC 7AE 03 + VJDSNRTMPC
≡ Smart 15"	MPC ST5 2NDJ 20T	HMI PSC 7DE 03
~ Smart 15"	MPC ST5 2NAJ 20T	HMI PSC 7AE 03

3



# Industrial PCs

Equivalent product tables for  
Magelis Compact iPC

Magelis iPC equivalent product table		
Type	Old range	New range
Compact iPC 8.4"	MPC KT1 2NAX 00H	MPC KT1 2NAX 00N + VJDSNRTMPC
Compact iPC 12"	MPC KT2 2NAX 00R	MPC KT2 2NAX 20N + VJDSNRTMPC
Compact iPC 15"	MPC KT5 5●●X 20H	MPC KT55 ●●X 20N + VJDSNRTMPC

3

<b>Industrial PC</b>	<b>Embedded Boxes</b>	<b>PC BOX</b>
<b>Type</b>	<b>Universal</b>	



<b>Model</b>		<b>Smart BOX</b>	<b>Compact PC BOX</b>
<b>Compatible screen</b>		iDisplay flat screen (see page 3/58)	
<b>CPU</b>	Processor	Intel Celeron M 600 MHz	Intel Celeron M 1 GHz
	Storage	1 GB minimum Compact Flash, expandable to 4 GB	Hard disk ≥ 80 GB
	RAM	256 MB minimum, expandable to 1024 MB	512 MB, expandable to 1024 MB
	DVD-ROM drive	–	–
	Expansion slots	–	1 PCI bus slot
	Ethernet TCP/IP network	2 RJ45 ports: 1 x 10/100/1000BASE-T and 1 x 10/100BASE-T	
	I/O ports	4 x USB 2.0, 2 x RS432, 1 x VGA RGB video port	
	<b>Certification</b>		UL 508, CSA 22.2, n° 142 DNV Marine (1), ATEX (1)
<b>Software</b>	Operating system	Windows XP Embedded SP2 (6 languages)	Windows XP Pro pre-installed
	Human machine interface	Vijeo Designer Run Time, 21-day trial version. Unlimited usage available by activation of licence VJDSNRTMPC (sold separately).	
<b>Degree of protection (mounted on enclosure door)</b>		IP 65	IP 65
<b>General Purpose (Hard Disk)</b>	100 to 240 V ~		<b>MPC KN0 2NAX 00N</b>
<b>Heavy Duty (Compact Flash)</b>	100 to 240 V ~	<b>MPC SN0 1NAJ 00T</b>	
	24 V ~	<b>MPC SN0 1NDJ 00T</b>	
<b>Pages</b>		3/45	3/46

(1) DC version only

**Industrial PC**

Type

**PC BOX**

Universal



**Model**

**Flex PC BOX F**      **Flex PC BOX H**

**Compatible screen**

Front Panel (see below) or iDisplay flat screen (see page 3/58)

<b>CPU</b>	Processor
	Storage
	RAM
	DVD-ROM drive
	Expansion slots
	Ethernet TCP/IP network
	I/O ports

Intel Celeron M 1.86 GHz or Core Duo 2 GHz	
1 or 2 hard disks ≥ 160 GB, Flash Disk ≥ 15 GB	
512 MB minimum, expandable to 4 GB (management based on operating system capacity)	
Yes, DVD reader, DVD reader/writer depending on model or available as option.	
2 PCI bus slots	4 PCI bus slots
2 RJ45 ports: 1 x 10/100/1000BASE-T and 1 x 10/100BASE-T	
4 x USB 2.0, 4 x RS432, 1 x DIO, 1 x DVI-I video port (RGB support)	

**Certification**

UL1604 (Haz Loc), ATEX (1)

<b>Software</b>	Operating system
	Human machine interface

Windows XP Pro pre-installed  
 Vijeo Designer Run Time, 21-day trial version. Unlimited usage available by activation of licence VJDSNRTMPC (sold separately)

<b>General Purpose (Hard Disk)</b>	100 to 240 V ~
	24 V ---
<b>Heavy Duty (Flash Disk)</b>	100 to 240 V ~
	Vijeo Citect Full 500 I/O      100 to 240 V ~

<b>MPC FN0 0NAX 00N</b>	<b>MPC HN0 0N0X 00N</b>
<b>MPC FN0 0NDX 00N</b>	<b>MPC HN0 5NDX 00N</b>
<b>MPC FN0 5MAX 00N</b>	<b>MPC HN0 5MAX 00N</b>
<b>MPC FN0 5MAX 00V</b>	<b>MPC HN0 5MAX 00V</b>

Pages

3/47      3/48

**Applications**

**Screens for Flex PC BOX**



**Model**

**Front Panel**

<b>12" screen</b> TFT (800 x 600)	Data entry via keypad and touch screen
<b>15" screen</b> TFT (1024 x 768)	Data entry via touch screen
	Data entry via keypad and touch screen
<b>19" screen</b> TFT (1280 x 1024)	Data entry via touch screen

<b>MPC YB2 0N0N 00N</b>		
	<b>MPC YT5 0N0N 00N</b>	
		<b>MPC YB5 0N0N 00N</b>
		<b>MPC YT9 0N0N 00N</b>

Pages

3/49

(1) DC version only

# Industrial PCs

## Magelis Smart BOX, Magelis Compact PC BOX Magelis Flex PC BOX

3



Magelis Flex PC BOX H and 19" Front Panel



Magelis Flex PC BOX F and 15" Front Panel



Magelis Compact PC BOX



Magelis Smart BOX

### Presentation

For situations where the HMI needs to be separated from a CPU operating under a Windows environment, the range of Magelis BOX industrial PCs offers a variety of solutions with graded power ratings that are designed to meet the HMI and SCADA requirements associated with both process applications and machines:

- Connection to standard PC hardware:
  - Network: two Ethernet ports (10/100/1G and 10/100)
  - USB: four USB ports for storage, WiFi connection, etc.
  - Printers: numerous printers are supported.
- Applications processed in the Microsoft Windows environment:
  - SCADA
  - HMI Vijeo Designer
  - Use of multimedia data: audio, images, video
  - Support for all types of Office files: Word, Excel, PowerPoint, etc.
  - Third-party software run in Windows
- Integration in distributed architectures:
  - Client/server architecture
  - Access to Intranet/Internet network

The Magelis BOX range consists of four CPUs and two screen families:

- **Embedded BOX Smart BOX**, with Intel Celeron M 600 MHz processor, data storage on 1 GB Compact Flash card, 256 MB memory, expandable to 1024 MB
- **Compact PC BOX**, with Intel Celeron M 1 GHz processor, data storage on hard disk  $\geq$  80 GB, 512 MB memory, expandable to 1024 MB; expansion slot available for PCI card
- **Flex PC BOX F**, with Intel Celeron M 1.86 GHz or Core Duo 2 GHz processor, data storage on one or two  $\geq$ 80 GB min. hard disks, 16 GB Flash disk, 512 MB to 2 GB memory depending on model, expandable to 4 GB (management based on operating system capacity), two expansion slots for PCI card
- **Flex PC BOX H**: As Flex PC BOX F, but with four expansion slots for PCI card

Compatible flat screens:

- **Magelis iDisplay (industrial display)** in two sizes:
    - 15" with touch screen, with or without keypad
    - 19" with touch screen
- Smart BOX and Compact PC BOX CPUs are only compatible with the Magelis iDisplay.
- **Magelis iPC front panel** (for Flex PC BOX CPUs only) in 3 sizes:
    - 12" with touch screen and keypad
    - 15" with touch screen, with or without keypad
    - 19" with touch screen
- Magelis Flex PC BOX F and Magelis Flex PC BOX H CPUs can be mounted with a Magelis iPC front panel. Depending on the requirements of the application in question, they may also be connected to a second Magelis iDisplay interface.

### Presentation (continued)

#### General Purpose, Heavy Duty and Maintenance-Free versions

Embedded BOX and PC BOX CPUs are available in three versions (1): General Purpose, Heavy Duty and Maintenance-Free.

■ **General Purpose:** Version for "standard" industrial environments, for ambient temperatures and moderate shock and vibration conditions General Purpose models feature industrial hard disks:

- Magelis Compact PC BOX: 80 GB minimum hard disk
- Magelis Flex PC BOX F/H: 160 GB minimum hard disk

■ **Heavy Duty:** "Rugged" versions of industrial PCs, designed to operate in environments where harsher conditions prevail in terms of both temperature (between 0°C and 50°C) and vibrations, due to their storage media:

- Magelis Flex PC BOX F/H: 15 GB minimum Flash disk

■ **Maintenance-Free:** Versions of industrial PCs that are completely solid-state (not a single moving part is used - no hard disk and no fan). They are designed to operate in harsh environments (0°C to 50°C) and require no maintenance. These PCs use Windows XP Embedded operating systems and a Compact Flash card for storage purposes:

- Embedded Box Smart BOX: 1 GB Compact Flash minimum, expandable to 4 GB

#### Integrated diagnostics

Diagnostic functions, specifically designed to simplify maintenance work, are integral features of the Smart BOX, Compact PC BOX and Flex PC BOX F/H CPUs:

■ Monitoring of the internal temperature of the CPU, with information provided to the user in the following ways if set values are exceeded:

- The display of an on-screen message
- A change in state on a DIO output
- The starting up of a system task, e.g. sending an e-mail
- Log in Windows Event Manager

■ Monitoring of the integrity of the hard disk on every startup.

The Magelis Flex PC BOX F/H CPUs have an integrated RAS interface (2), comprising:

- 1 alarm output
- 1 reset input
- 1 general purpose input
- 1 general purpose output

#### Vijeo Designer and Vijeo Citect bundle offers

Magelis Smart BOX, Magelis Compact PC BOX and Magelis Flex PC BOX are supplied with a 21-day trial version of Vijeo Designer Run Time. Continued use of Vijeo Designer requires a licence which is sold separately (see page 3/16).

The Magelis BOX and Vijeo Citect bundles comprise:

- A DVD containing the software and documentation
- A USB key with the user rights already registered
- One year's technical support

The Vijeo Citect software can be used immediately upon installation (3). Updates and licence upgrades are available by providing the key number and subject to the usual conditions. This type of bundle offer enables users to acquire, at an attractive price, a tested industrial-grade system, which is correctly dimensioned to suit software application requirements and is supported across the entire Schneider Electric sales network.

(1) Excluding Embedded Box Smart BOX, which is available in the Maintenance-Free version only.

(2) RAS: Reliability, Availability and Serviceability.

(3) Requires an external DVD drive for connection to a USB port (not supplied).

### Magelis Smart BOX CPUs

#### Presentation



Magelis Smart BOX: MPC SNO 1N●J 00●

Magelis Smart BOX CPUs are designed to operate in harsh industrial environments and offer state-of-the-art technology.

Two Magelis Smart BOX **MPC SNO 1N●J 00●** CPU models are available. The characteristics they share are:

- 1 GB Compact Flash mass memory
- Celeron M 600 MHz processor
- Windows XP Embedded SP2 operating system pre-installed

The CPUs differ in terms of the following functions and characteristics:

- 100 to 240 V ~ power supply for Magelis Smart BOX **MPC SNO 1NAJ 00●** models, supplied with external AC/DC adaptor
- 24 V = power supply for **MPC SNO 1NDJ 00●** models

#### Description

Magelis Smart BOX CPUs comprise the following elements:

- 1 Slot for 1 GB primary (system) Compact Flash card
- 2 Slot for secondary Compact Flash card
- 3 1 Ethernet 10/100 Base-T port and 1 Ethernet 10/100/1000 Base-T port
- 4 4 USB ports
- 5 RGB video port: connector for external screen, e.g. iDisplay
- 6 Audio output for loudspeaker
- 7 Connectors for COM1 and COM2 ports
- 8 Status and power supply LED
- 9 Disk access LED
- 10 Power supply connector
- 11 Attachment point for USB holder
- 12 Reset switch

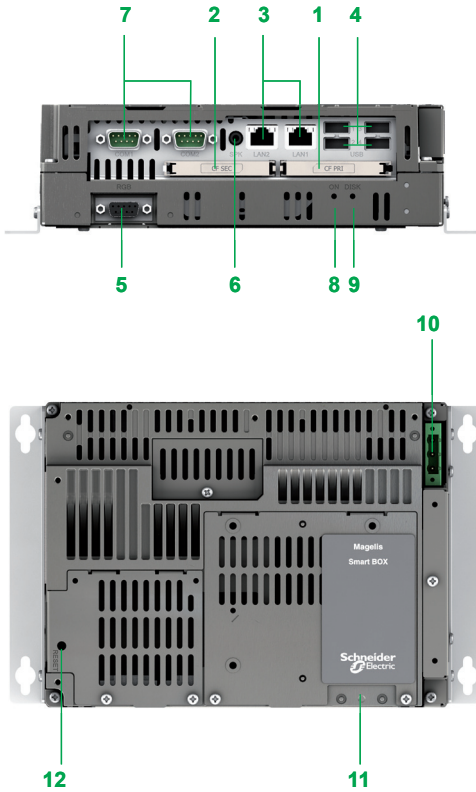



**Characteristics of Magelis Smart BOX CPUs**

<b>Type</b>		<b>Magelis Smart BOX</b> <b>MPC SNO 1N0J 000</b>
<b>Processor</b>		Intel Celeron M 600 MHz
<b>Storage</b>		1 GB Compact Flash, expandable to 4 GB
<b>RAM</b>		256 MB SDRAM, expandable to 1024 MB
<b>Built-in I/O ports</b>	Ethernet ports	<ul style="list-style-type: none"> <li>■ 1 Ethernet TCP/IP 10/100BASE-T link (RJ45 connector)</li> <li>■ 1 Ethernet TCP/IP 10/100/1000 BASE-T link (RJ45 connector)</li> </ul>
	USB	4 USB 2.0 ports
	Serial links	2: COM1, COM2, RS 232 type (9-pin male SUB-D connector)
	Video	1 connection for external RGB video screen
	Audio	1 audio output for loudspeakers (mini-jack connector)
<b>Operating system</b>		Windows XP Embedded, 6 languages (English, French, Spanish, Italian, German, Simplified Chinese)
<b>Compatible screen from the Magelis offer</b>		iDisplay
<b>Power supply</b>	AC	
	Voltages	100 to 240 V ~ (voltage limits 98 to 264 V), conforming to EN 61131-2
	Frequency	50/60 Hz (frequency limits 47/63 Hz), conforming to EN 61131-2
	Micro-breaks	10 ms
	DC	
Voltages	24 V --- (voltage limits 23 to 25 V)	
Micro-breaks	1 ms max.	
<b>Consumption</b>	AC	130 VA
	DC	40 W max.
<b>Material</b>		Nickel plated steel
<b>Mounting</b>		Horizontal or on wall (in enclosure). Supplied with 2 sets of fixings for mounting

**Environmental characteristics of Magelis Smart BOX CPUs**

<b>Type</b>		<b>MPC SNO 1N0J 000</b>
<b>Degree of protection</b>		IP 20 Standards: IEC/EN 60529, NEMA 250, EN 61131-2
<b>Pollution level</b>		Designed for use in environments with pollution level 2
<b>Temperature</b>	Operation	0 to 50°C, conforming to EN 61131-2, UL 1604
	Storage	- 20 to 60°C, conforming to IEC 60068-2-2 tests Bb and Ab, IEC 60068-2-14 test Na and EN 61131-2
<b>Operating altitude</b>		0 to 2000 m. Standard EN 61131-2
<b>Vibration resistance</b>	Operation	0.075 mm amplitude from 10 to 57.6 Hz 1 g amplitude from 57.6 to 150 Hz Standard EN 61131-2
	Out of service (in storage)	3.5 mm amplitude from 5 to 9 Hz 1 g amplitude from 9 to 150 Hz Standard EN 61131-2
<b>Shock resistance</b>	Operation	15 g peak for 11 ms. Standard IEC 60068-2-27 test Ea and EN 61131-2
<b>Humidity</b>		10 to 90% RH - wet-bulb temperature: 29°C max. - without condensation
<b>Immunity to interference</b>	High frequency interference	Conforming to EN 61131-2, IEC 61000-4-3/6 level 3
	Electromagnetic waves	Class A/EN 55022/55011
<b>Certifications</b>	Information Technology Equipment	IEC/EN 60950 C-Tick, N998
	Industrial Control Equipment	UL 508, CSA 22.2, no. 142
	ATEX	II 3 Gas and dust (zone 2/22)
	Marine	DNV

### Magelis Compact PC BOX CPUs

#### Presentation

Magelis Compact PC BOX CPUs are designed to operate in either standard industrial or harsh industrial environments.

The main characteristics of the Compact PC BOX **MPC KN0 2NAX 00N** CPUs are:

- Celeron M 1 GHz processor
- PCI card expansion: 1 slot
- 100 to 240 V ~ power supply
- Windows XP Pro SP2 operating system pre-installed
- Hard disk mass memory ≥ 80 GB



Magelis Compact PC BOX: MPC KN0 2NAX 00N

3

#### Description

Magelis Compact PC BOX CPUs comprise the following elements:

- 1 1 Ethernet 10/100 Base-T port and 1 Ethernet 10/100/1000 Base-T port
- 2 4 USB ports
- 3 RGB video port: connector for external iDisplay screen
- 4 Audio output for loudspeaker
- 5 Connectors for COM1 and COM2 ports
- 6 Status and power supply LED
- 7 Disk access LED
- 8 Power supply connector
- 9 Reset switch
- 10 On/Off switch
- 11 Cooling fan
- 12 PCI expansion unit interface
- 13 Slots for 2 Compact Flash cards

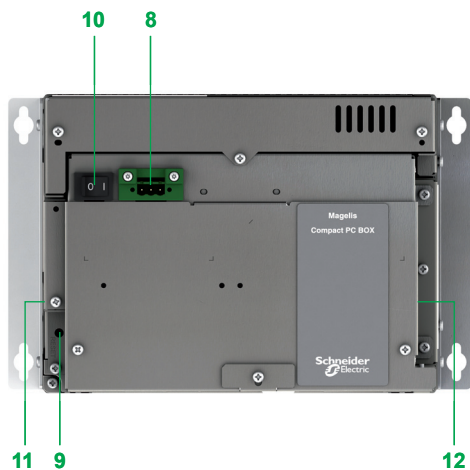
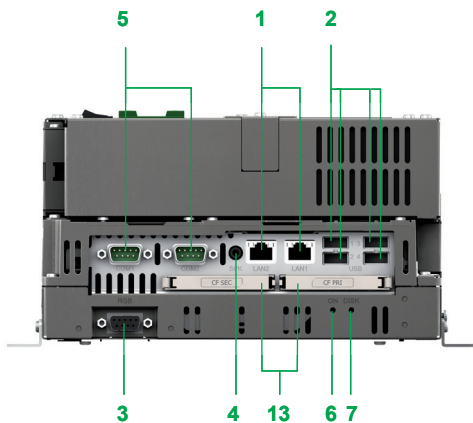



### Characteristics of Magelis Compact PC BOX CPUs

<b>Type</b>		<b>Magelis Compact PC BOX</b> <b>MPC KN0 2NAX 00N</b>
<b>Processor</b>		Intel Celeron M 1 GHz
<b>Storage</b>		Hard disk ≥ 80 GB
<b>RAM</b>		512 MB SDRAM, expandable to 1024 MB
<b>Slots for Compact Flash cards</b>		2
<b>Expansion slots</b>		1 PCI 2.2 bus slot
<b>Built-in I/O ports</b>	Ethernet ports	<ul style="list-style-type: none"> <li>■ 1 Ethernet TCP/IP 10/100BASE-T link (RJ45 connector)</li> <li>■ 1 Ethernet TCP/IP 10/100/1000 BASE-T link (RJ45 connector)</li> </ul>
	USB	4 USB 2.0 ports (at rear)
	Serial links	2: COM1, COM2, RS 232 type (9-pin male SUB-D connector)
	Video	1 connection for external RGB video screen
	Audio	1 audio output for loudspeakers (mini-jack connector)
<b>Operating system</b>		Windows XP Pro SP2 pre-installed
<b>Compatible screens from the Magelis offer</b>		iDisplay
<b>Power supply</b>	AC	
	Voltages	100 to 240 V ~ (voltage limits 85 to 265 V)
	Frequency	50/60 Hz (frequency limits 47/63 Hz), conforming to EN 61131-2
	Micro-breaks	20 ms max.
	Isolation	1500 V ~, 20 mA for 1 minute
<b>Consumption</b>		120 VA
<b>PCI expansion</b>	Capacity	<ul style="list-style-type: none"> <li>■ 5 V ---, 1.5 A</li> <li>■ 12 V ---, 0.5 A</li> <li>■ 12 V ---, 0.1 A</li> <li>■ 3.3 V ---, 0.5 A</li> </ul>
	Consumption	10.9 W between 5°C and 45°C (ambient air temperature) Linear decrease to 7.6 W between 45°C and 50°C
<b>Material</b>		Nickel plated steel
<b>Mounting</b>		In enclosure, horizontally or on a wall. Supplied with 2 sets of fixings.

### Environmental characteristics of Magelis Compact PC BOX CPUs

<b>Type</b>		<b>MPC KN0 2NAX 00N</b>
<b>Degree of protection</b>		IP 20. Standards: IEC/EN 60529, NEMA 250, EN 61131-2
<b>Pollution level</b>		Designed for use in environments with pollution level 2
<b>Temperature</b>	In operation	5 to 50°C, conforming to EN 61131-2, UL 1604
	In storage	- 20 to 60°C, conforming to IEC 60068-2-2 tests Bb and Ab, IEC 60068-2-14 test Na and EN 61131-2
<b>Operating altitude</b>		0 to 2000 m. Standard EN 61131-2
<b>Vibration resistance</b>	In operation	0.075 mm amplitude from 10 to 57.6 Hz 1 g amplitude from 57.6 to 150 Hz Standard EN 61131-2
	Out of service (in storage)	3.5 mm amplitude from 5 to 9 Hz 1 g amplitude from 9 to 150 Hz Standard EN 61131-2
<b>Shock resistance</b>	In operation	15 g peak for 11 ms. Standard IEC 60068-2-27 test Ea and EN 61131-2
<b>Humidity</b>		10 to 85% RH -wet-bulb temperature: 29°C max. -without condensation
<b>Immunity to interference</b>	High frequency interference	Conforming to EN 61131-2, IEC 61000-4-3/6 level 3
	Electromagnetic waves	Class A/EN 55022/55011
<b>Certifications</b>	Information Technology Equipment	IEC/EN 60950 C-Tick, N998
	Industrial Control Equipment	UL 508, CSA 22.2, no. 142



Magelis Flex PC BOX F: MPC FN0 000X 000



Magelis Flex PC BOX H: MPC HN0 000X 000

### Magelis Flex PC BOX CPUs

#### Presentation

Magelis Flex PC BOX high-end CPUs are designed to respond to the needs of industrial applications with the most rigorous demands in terms of processor power and PCI card expansion. There are two families:

- Magelis Flex PC BOX F: **MPC FN0 000X 000**, with 2 PCI card slots
- Magelis Flex PC BOX H: **MPC HN0 000X 000**, with 4 PCI card slots

These two families are themselves each available in two versions: General Purpose for standard industrial environments and Heavy Duty for industrial environments where harsher conditions prevail.

- General Purpose Magelis Flex PC BOX F/H models with hard disk are available with a 24 V  $\text{DC}$  or 100 to 240 V  $\text{AC}$  power supply.
- Magelis Flex PC BOX F/H Heavy Duty models with Flash disk are only available with a 100 to 240 V  $\text{AC}$  power supply.

All Magelis Flex PC BOX F/H CPUs have Windows XP Pro installed and can be connected to a screen either directly or remotely. There are two compatible screen types:

- Magelis Front Panel (direct or remote connection).
- Industrial Display Magelis iDisplay (remote connection).

All Magelis Flex PC BOX F/H CPUs feature:

- 2 Ethernet TCP/IP ports with RJ45 connector, one of which is 10/100/1000BASE-T
- 4 USB ports (12 Mbps)
- 4 serial COM ports (RS 232)
- 1 DVD reader or DVD reader/writer:
  - **MPC FN0 500X 00N** has a DVD reader/writer as standard.
  - The other models have a DVD ROM reader as standard, with the option of replacement by an MPC YN0 0CDW 30N writer.
- 1 RAS port
- 1 DVI-I video port with RGB support, making it possible to connect a Magelis iDisplay screen in addition to the main Magelis Front Panel, for example

#### System Monitor

The System Monitor function featured in Flex PC BOX F/H CPUs enables the monitoring of several parameters or system functions:

- CPU temperature
- fan speed
- supply voltages
- disk
- back lighting, etc.

System Monitor monitors the useful RAS port (Reliability, Availability, Serviceability) in order to signal an alarm (by means of a digital output), or to initiate a Flex PC BOX restart. Alerts are also signalled in the form of a pop-up message or a Windows alarm (Event Viewer).

#### RAID 1 option

The RAID 1 option **MPC YN0 0RAI D0N** (for General Purpose versions only) involves configuring a second disk within the system with a mirror image of the first disk. This increases the system's tolerance to disk errors and enables it to function provided that at least one disk is operational. The defective disk can be replaced without the need to stop the Flex PC BOX. The option includes a disk cartridge with a capacity  $\geq 80$  GB and RAID software for installation.

#### Flex PC BOX with Battery Backup

The Flex PC BOX equipped with Battery Backup **MPC HN0 5NBX 00N** (for Flex PC Box H only) enables the system to continue operating for around 5 minutes (depending on the system load) in the event of a power failure. UL 60950 certification only.

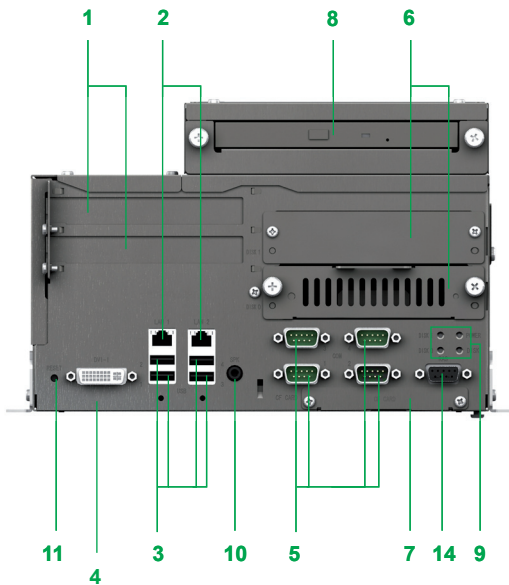

### Magelis Flex PC BOX CPUs

#### Description

Magelis Flex PC BOX CPUs comprise the following elements:

- 1 PCI expansion slots
  - Magelis Flex PC BOX F CPUs: 2 PCI cards
  - Magelis Flex PC BOX H CPUs: 4 PCI cards
- 2 1 Ethernet 10/100 Base-T port and 1 Ethernet 10/100/1000 Base-T port
- 3 4 USB ports
- 4 DVI-I interface
- 5 4 connectors for COM1 to COM4 ports
- 6 2 hard disk slots
- 7 1 slot for Compact Flash card
- 8 1 slot for DVD-ROM drive (reader or writer)
- 9 4 LEDs:
  - 2 disk status LEDs
  - 1 power supply/RAS access LED
  - 1 disk access LED
- 10 Audio output for loudspeaker
- 11 Reset switch
- 12 Cooling fan
- 13 Power supply connector and On/Off switch (AC supply models only)
- 14 RAS port

*Note: AC versions have an On/Off switch.*

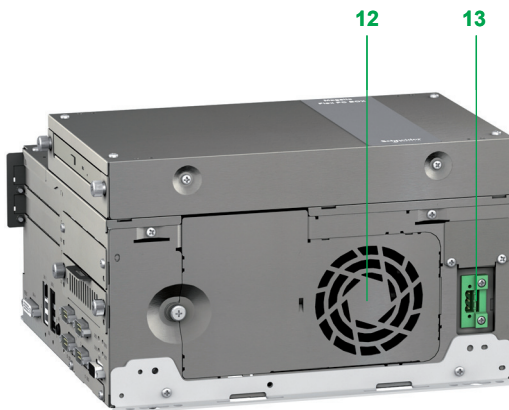

### Characteristics of Magelis Flex PC BOX CPUs

Type	General Purpose Flex PC BOX MPC ●N0 ●N●X 00● Hard disk	Heavy Duty Flex PC BOX MPC ●N0 5●AX 00● Flash disk	
Processor	Intel Celeron M 1.86 GHz or Core Duo 2 GHz		
Storage	Hard disk ≥ 160 GB, option of adding additional hard disk	Flash disk ≥ 15 GB, option of adding additional Flash disk	
RAID function	Option	–	
RAM	512 MB minimum SDRAM, expandable to 4 GB (management based on operating system capacity)		
DVD drive (reader/writer)	<ul style="list-style-type: none"> <li>■ Reader/writer as standard for MPC FN0 5●●X 00N and MPC HN0 2NAX 00N</li> <li>■ Reader as standard with writer as option for the other references</li> </ul>		
Video controller	Built-in		
Video memory	64 MB max.		
Built-in I/O ports	<ul style="list-style-type: none"> <li>■ 1 Ethernet TCP/IP 10/100/1000 BASE-T link (RJ45 connector)</li> <li>■ 1 Ethernet TCP/IP 10/100BASE-T link (RJ45 connector)</li> <li>■ 4 USB ports (12 Mbps)</li> <li>■ 4 COM1 to COM4 RS 232 serial links (9-pin male SUB-D connector)</li> <li>■ 1 connection for DVI-I external video screen (29-pin connector)</li> </ul>		
RAS interface (1)	On 9-pin female SUB-D connector <ul style="list-style-type: none"> <li>■ 1 alarm output</li> <li>■ 1 x 2 channel general purpose input</li> <li>■ 1 x 2 channel general purpose output</li> <li>■ 1 reset input</li> </ul>		
Expansion slots	<ul style="list-style-type: none"> <li>■ 2 PCI bus slots for MPC FN0 ●●●X 00●</li> <li>■ 4 PCI bus slots for MPC HN0 ●●●X 00●</li> </ul>		
Slot for Flash card memory	1 Compact Flash card reader (type I/II compatible)		
Audio port	Stereo output for loudspeakers (mini-jack stereo)		
Video	DVI-I, 29-pin		
Operating system	Windows XP Pro SP2 pre-installed		
Compatible screens	<ul style="list-style-type: none"> <li>■ Front Panels</li> <li>■ iDisplay</li> </ul>		
Power supply	AC	Voltage	100 to 240 V ~ (voltage limits 85 to 265 V ~)
		Frequency	50/60 Hz (frequency limits 47 to 63 Hz), conforming to EN 61131-2
		Consumption	120 VA max.
		Micro-breaks	20 ms max.
		Isolation	1500 V ~, 20 mA for 1 minute
	DC	Voltage	24 V ⋮ (voltage limits 19.8 to 28.8 V ⋮)
		Consumption	120 W max.
		Micro-breaks	5 ms max.
	PCI expansion	Capacity	<ul style="list-style-type: none"> <li>■ 5 V ⋮, 1.5 A</li> <li>■ 12 V ⋮, 0.5 A</li> <li>■ 12 V ⋮, 0.1 A</li> <li>■ 3.3 V ⋮, 0.5 A</li> </ul>
			Consumption
Material	Nickel plated steel		
Mounting	In a type 4X or 12 enclosure		

### Characteristics of Flash disk (Heavy Duty Flex PC BOX only)

Capacity	≥ 15 GB
Average time between 2 failures at 25°C	> 4,000,000 hours
Data integrity	< 1 non-recoverable error per 10 <sup>14</sup> bits read

(1) RAS: Reliability, Availability and Serviceability

Environmental characteristics of Magelis Flex PC BOX CPUs		
Type	General Purpose Magelis Flex PC BOX	Heavy Duty Magelis Flex PC BOX
	Hard disk	Flash disk
<b>Degree of protection</b>	IP 65/NEMA4x/12 for the screen front panels. IP 20 for screen sides and back panels, and for the control units as a whole. Standards: IEC/EN 60529, NEMA 250, EN 61131-2	
<b>Pollution level</b>	Designed for use in environments with pollution level 2. Standard: IEC/EN 61010-1	
<b>Temperature</b>	For operation	5 to 50°C, conforming to EN 61131-2, UL 1604 (5 to 45°C when writing DVD)
	For storage	- 20 to 60°C, conforming to IEC/EN 60068-2-2 tests Bb and Ab, IEC/EN 60068-2-14 test Na and EN 61131-2
<b>Operating altitude</b>	0 to 2000 m. Standard EN 61131-2	
<b>Vibration resistance</b>	In operation	0.075 mm amplitude from 10 to 57.6 Hz 1 g amplitude from 57.6 to 150 Hz. Standard EN 61131-2
	Out of service (in storage/transit)	3.5 mm amplitude from 10 to 57.6 Hz 1 g amplitude from 57.6 to 150 Hz Standard EN 61131-2
<b>Shock resistance</b>	In operation	15 g for 11 ms. Standard IEC/EN 60068-2-27 test Ea and EN 61131-2
<b>Ambient humidity</b>	In operation	10 to 85% RH - wet-bulb temperature: 29°C max. - without condensation
<b>Storage humidity</b>		10 to 85% RH - wet-bulb temperature: 29°C max. - without condensation Conforming to EN 61131-2
<b>Immunity to interference</b>	High frequency interference	Conforming to EN 61131-2, IEC 61000-4-3/6 level 3
	Electromagnetic emissions	Class A/EN 55022/55011
<b>Certifications</b>	Information Technology Equipment	IEC/EN 60950
	Industrial Control Equipment	UL 508/cUL, UL 1604/cUL (HazLoc Class 1 Div 2 cULus)
	ATEX	For the 24 V $\bar{c}$ versions only, II 3 gas and dust (zone 2/22)



MPC YB2 0NNN 00N



MPC NB5 0NAN 00N



MPC YT5 0NNN 00N



MPC YT9 0NNN 00N

### Presentation

The Front Panel flat screens are designed for use with Magelis Flex PC BOX F/H CPUs.

The screens feature TFT LCD technology and are available in 3 sizes:

- 12"
  - MPC YB2 0NNN 00N with data entry via touch screen and keypad, SVGA 800 x 600 resolution
- 15"
  - MPC NB5 0NAN 00N with data entry via touch screen and keypad
  - MPC YT5 0NNN 00N with data entry via touch screen
  - (Both with XGA 1024 x 768 resolution)
- 19"
  - MPC YT9 0NNN 00N with data entry via touch screen, SVGA 1280 x 1024 resolution

All models feature:

- a USB port on the front (with protective cover)
- a pointing device

3



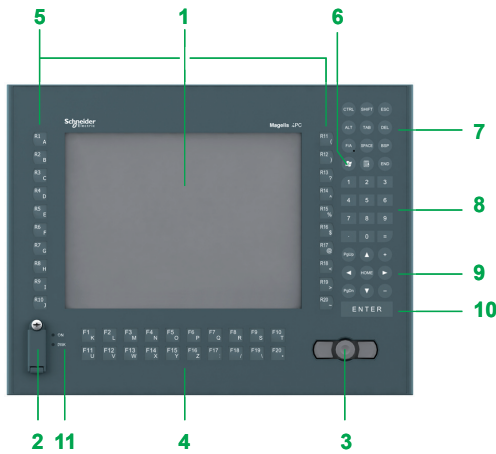

### Description

#### 12" and 15" Front Panel with touch screen and keypad MPC YB2 0NNN 00N/MPC NB5 0NAN 00N

Front Panels **MPC YB2 0NNN 00N/MPC NB5 0NAN 00N** with touch screen and keypad feature the following on the front:

- 1 An active matrix colour TFT LCD screen with high definition analog touch panel:
  - SVGA 800 x 600 for the 12" Front Panel **MPC YB2 0NNN 00N**
  - XGA 1024 x 768 for the 15" Front Panel **MPC YB2 0NNN 00N**
- 2 A USB cover for access to:
  - a **type A USB connector**
  - a **hardware reset button**
- 3 A mouse button and left/right-click buttons
- 4 20 function and character keys, F1 to F20
- 5 20 special function and character keys, R1 to R20
- 6 A key for switching between function/alphanumeric mode with an LED to indicate that character entry is active
- 7 Window navigation keys
- 8 Numeric keys
- 9 Cursor keys
- 10 Enter key
- 11 Two LEDs:
  - A **power supply/RAS access LED**
  - An **IDE/disk access LED**

#### On the rear panel:

- A connection port for the Magelis Flex PC BOX

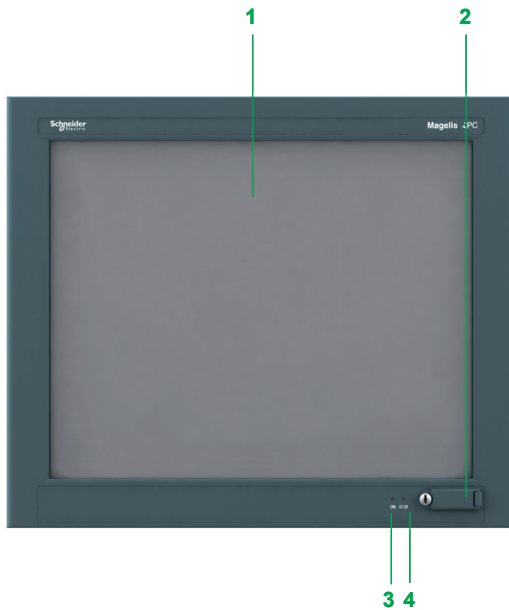

#### 15" and 19" Front Panel with touch screen MPC YT5/YT9 0NNN 00N

Front Panels **MPC YT5/YT9 0NNN 00N** with touch screen feature the following on the front:

- 1 An active matrix colour TFT LCD screen with high definition analog touch panel:
  - XGA 1024 x 768 for the 15" Front Panel **MPC YT5 0NNN 00N**
  - SXGA 1280 x 1024 for the 19" Front Panel **MPC YT9 0NNN 00N**
- 2 A type A USB connector with cover
- 3 A power supply/RAS access LED
- 4 An IDE/disk access LED

#### On the rear panel:

- A connection port for the Magelis Flex PC BOX

Characteristics of Front Panels						
Type	MPC	YB2 0NNN 20N	YT5 0NNN 00N	YB5 0NAN 00N	YT9 0NNN 00N	
<b>Screen</b>	Type	12" SVGA active matrix colour TFT LCD	15" XGA active matrix colour TFT LCD		19" SXGA active matrix colour TFT LCD	
	Definition	800 x 600	1024 x 768		1280 x 1024	
	Number of colours	262 144				
	Brightness	≥ 200 cd/m <sup>2</sup> , adjustable				
<b>Data entry</b>	Via	Keypad and touch screen	Touch screen	Keypad and touch screen	Touch screen	
<b>Keypad</b>	Alphanumeric keys	70 standard IBM keys	–	70 standard IBM keys	–	
	User function keys	2 x 20 keys	–	2 x 20 keys	–	
<b>Touch screen</b>		Analog resistive, resolution: 1024 x 1024				
<b>Front panel</b>	Pointing device	Integrated				
	USB port	1				
<b>Mounting</b>		On any Magelis Flex PC BOX CPU				
<b>Power supply</b>		From Magelis Flex PC BOX CPU				

3





MPC SN0 1N●J 00●

### Magelis Smart BOX CPUs

Magelis Smart BOX CPUs accept iDisplay flat screens and are equipped with:

- An Intel Celeron M 600 MHz processor
- A 1 GB Compact Flash card
- 256 MB of RAM as standard, expandable to 1024 MB
- Two Ethernet TCP/IP ports:
  - 10/100BASE-T, 10/100 Mbps (RJ45 connector)
  - 10/100/1000 BASE-T, 10/100/1000 Mbps (RJ45 connector)
- Four USB ports, 12 Mbps
- Two serial COM ports (RS 232)
- An RGB video port
- A pre-installed Windows XP Embedded SP2 operating system

All references are supplied with a 21-day trial version of Vijeo Designer Run Time. Unlimited usage available by activation of licence VJDSNRTMPC (sold separately).

### Magelis Smart BOX

With 1 GB Compact Flash minimum, expandable to 4 GB

Processor Supply voltage	RAM	Expansion slots	Reference	Weight kg
Celeron M 600 MHz 100 to 240 V ~	512 MB, expandable to 1 GB	–	MPC SN0 1NAJ 00T	2.800
Celeron M 600 MHz 24 V ---	512 MB, expandable to 1 GB	–	MPC SN0 1NDJ 00T	2.800

### Separate components for Magelis Smart BOX

Description	Characteristics	Compatible with	Reference	Weight kg
Compact Flash memory card	2 GB, with Windows XP Embedded SP2 software in 9 languages (English, French, German, Italian, Spanish, Chinese, Swedish, Russian and Portuguese) and Framework .NET, Vijeo Citect Web Client, Vijeo Designer Run Time Demo pre-installed	Smart BOX	MPC PSC 42E01	–



MPC KN0 2NAX 00N

### Magelis Compact PC BOX CPUs

Magelis Compact PC BOX CPUs accept rDisplay flat screens and are equipped with:

- An Intel Celeron M 1 GHz processor
- A hard disk ≥ 80 GB
- 512 MB of RAM as standard, expandable to 1024 MB
- Two Ethernet TCP/IP ports:
  - 10/100BASE-T, 10/100 Mbps (RJ45 connector)
  - 10/100/1000 BASE-T, 10/100/1000 Mbps (RJ45 connector)
- A PCI bus slot
- Four USB ports, 12 Mbps
- Two serial COM ports (RS 232)
- An RGB video port
- A pre-installed Windows XP Pro SP2 operating system

All references are supplied with a 21-day trial version of Vijeo Designer Run Time. Unlimited usage available by activation of licence VJDSNRTMPC (sold separately).

### General Purpose Compact BOX

With disk drive ≥ 80 GB

Processor Supply voltage	RAM	Expansion slots	Reference	Weight kg
Celeron M 1 GHz 100 to 240 V ~	512 MB expandable to 1024 MB	1 PCI bus	<b>MPC KN0 2NAX 00N</b>	3.500



MPC FN0 5N0X 00N

### Magelis Flex PC BOX CPUs

Magelis Flex PC BOX CPUs accept  $\pi$ Display and Front Panel flat screens. They are equipped with:

- An Intel Celeron M 1.86 GHz or Core Duo 2 GHz processor
- Either one or two hard disks  $\geq$ 160 GB or a 15 GB Flash disk
- 512 MB RAM minimum, expandable to 4 GB (management based on operating system capacity)
- Depending on models:
  - MPC FN0 500X 00N and MPC HN0 2NAX 00N: DVD drive (reader/writer)
  - other references: DVD ROM reader as standard with writer as option
- Two Ethernet TCP/IP ports:
  - 10/100BASE-T, 10/100 Mbps (RJ45 connector)
  - 10/100/1000 BASE-T, 10/100/1000 Mbps (RJ45 connector)
- Two or four PCI bus slots
- Four USB ports, 12 Mbps
- Four serial COM ports (RS 232)
- One DIO
- A DVI-I video port with RGB support
- A pre-installed Windows XP Pro operating system

All references are supplied with a 21-day trial version of Vijeo Designer Run Time. Unlimited usage available by activation of licence VJDSNRTMPC (sold separately).

### General Purpose Magelis Flex PC BOX F

#### With disk drive $\geq$ 160 GB

Processor Supply voltage	RAM	Expansion slots	Reference	Weight kg
Celeron M 1.86 GHz 100 to 240 V ~	512 MB, expandable to 4 GB	2 PCI bus	MPC FN0 2NAX 00N	6.000
Celeron M 1.86 GHz 24 V ---			MPC FN0 2NDX 00N	6.000
Core Duo 2 GHz 100 to 240 V ~	1024 MB, expandable to 4 GB	2 PCI bus	MPC FN0 5NAX 00N	6.000
Core Duo 2 GHz 24 V ---			MPC FN0 5NDX 00N	6.000

### Heavy Duty Magelis Flex PC BOX F

#### With Flash Disk $\geq$ 15 GB

Processor Supply voltage	RAM	Expansion slots	Vijeo Citect	Reference	Weight kg
Core Duo 2 GHz 100 to 240 V ~	1024 MB expandable to 4 GB	2 PCI bus	–	MPC FN0 5MAX 00N	6.000
Core Duo 2 GHz 100 to 240 V ~	2 GB expandable to 4 GB (1)	2 PCI bus	Vijeo Citect Full 500 I/O	MPC FN0 5MAX 00V	6.000

(1) Management based on operating system capacity



MPC HN0 ●N●X 00N

## General Purpose Magelis Flex PC BOX H

General Purpose with hard disk  $\geq$  160 GB

Processor Supply voltage	RAM	Expansion slots	Reference	Weight kg
Celeron M 1.86 GHz 100 to 240 V ~	512 MB, expandable to 4 GB (2)	4 PCI bus	MPC HN0 2NAX 00N	7.500
Core Duo 2 GHz 100 to 240 V ~	1024 MB, expandable to 4 GB (2)		MPC HN0 5NAX 00N	7.500
Core Duo 2 GHz 100 to 240 V ~ with backup battery			MPC HN0 5NBX 00N (1)	7.500
Core Duo 2 GHz 24 V ---			MPC HN0 5NDX 00N	7.500

## Heavy Duty Magelis Flex PC BOX H

With Flash Disk  $\geq$  15 GB

Processor Supply voltage	RAM	Expansion slots	Vijeo Citect	Reference	Weight kg
Core Duo 2 GHz 100 to 240 V ~	1024 MB expandable to 4 GB (2)	4 PCI bus	–	MPC HN0 5MAX 00N	7.500
	2 GB, expandable to 4 GB (2)		Vijeo Citect Full 500 I/O	MPC HN0 5MAX 00V	7.500

(1) UL 60950 certified, not UL 508 certified

(2) Management based on operating system capacity



MPC YB2 0NNN 00N



MPC YT5 0NNN 00N



MPC NB5 0NAN 00N

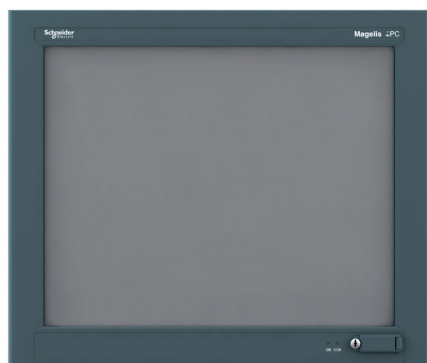

MPC YT9 0NNN 00N

### Front Panels for Magelis Flex PC BOX

Screen size	Type of screen	Data entry via	Reference	Weight kg
12"	SVGA colour TFT (800 x 600)	Touch screen and keypad	MPC YB2 0NNN 00N	5.000
15"	XGA colour TFT (1024 x 768)	Touch screen	MPC YT5 0NNN 00N	6.000
		Touch screen and keypad	MPC NB5 0NAN 00N	7.000
19"	SXGA colour TFT (1280 x 1024)	Touch screen	MPC YT9 0NNN 00N	8.000

3



MPC YN0 0FSE 00N



MPC YN0 0BBU 00N

Separate components for Magelis Flex PC BOX				
Description	Characteristics	Compatible with	Reference	Weight kg
RAID redundant hard disk	Removable cartridge ≥ 160 GB and RAID software	Flex PC BOX	MPC YN0 0RAI D0N	–
Hard disk	Removable cartridge ≥ 160 GB	Flex PC BOX	MPC YN0 0HDS 30N	–
Flash Disk	Removable cartridge ≥ 15 GB	Flex PC BOX	MPC YN0 0MSD 00N	–
PCI expansion	Adaptor for 2 PCI cards	Flex PC BOX	MPC YN0 0FSE 00N	–
Maintenance kit	–	Flex PC BOX	MPC YN0 0MKT 00N	–
DVD drive (reader/writer)	CD/DVD (reader/writer)	Flex PC BOX	MPC YN0 0CDW 30N	–
RAM expansion	512 MB	Flex PC BOX	MPC YFR AM05 12N	–
	1 GB	Flex PC BOX	MPC YFR AM10 24N	–
	2 GB	Flex PC BOX	MPC YFR AM20 48N	–
Screen adaptor Frame 1	Mechanical mounting interface for replacing an old Front Panel with a new one (see table below)	Flex PC BOX	MPC YN0 0FPF R1N	–
Screen adaptor Frame 2		Flex PC BOX	MPC YN0 0FPF R2N	–
Screen adaptor Frame 3		Flex PC BOX	MPC YN0 0FPF R3N	–

Screen adaptor selection table			
From:	To:		
	MPC YB2 0NNN 00N	MPC YT5 0NNN 00N	MPC YB5 0NNN 00N
MPC NA2 0NNN 00N			
MPC NB2 0NNN 00N			
MPC NT2 0NNN 00N			
MPC NA5 0NNN 00N			
MPC NA5 0NNN 10N			
MPC NB5 0NNN 00N			
MPC NB5 0NNN 10N			
MPC NT5 0NNN 00N			
MPC NT5 0NNN 10N			

Adaptor	Colour code
MPC YN0 0FPF R1N (Frame 1)	
MPC YN0 0FPF R2N (Frame 2)	
MPC YN0 0FPF R3N (Frame 3)	
Adaptation not possible	

## Industrial PCs

Magelis Smart BOX, Magelis Compact PC BOX,  
Magelis Flex PC BOX and Front Panels

## Separate components for all Magelis iPC ranges

Description	Size	Reference	Weight kg
Protective sheets (5 peel-off sheets)	8.4" models	MPC YK10 SPS KIT	–
	12" models	MPC YK20 SPS KIT	–
	15" models	MPC YK50 SPS KIT	0.200
	19" models	MPC YK90 SPS KIT	–

Description	Description	Reference	Weight kg
Power supply connector	Replacement connector for AC supply voltage, for all Magelis iPCs and iDisplay screens	MPC YN0 0PWA CTE	–

**Dimensions**

**Magelis Smart BOX MPC SN01 N●J 00●**

a	b	c	a1	a2	b1	c1	c2	c3
217	164	65	130	15	160	217	238	255

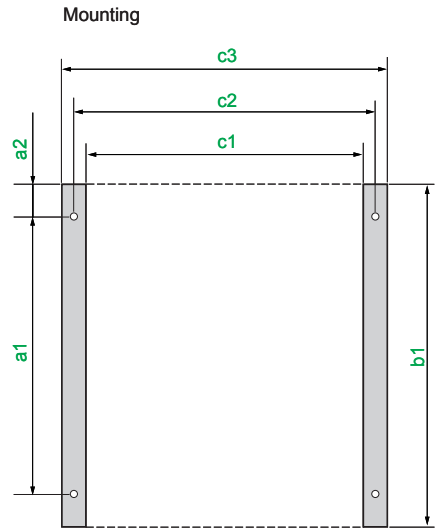
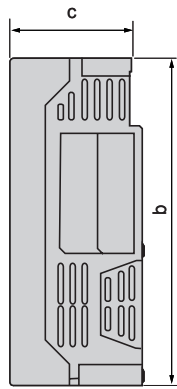
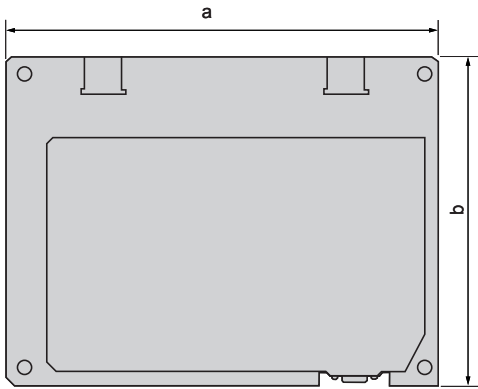
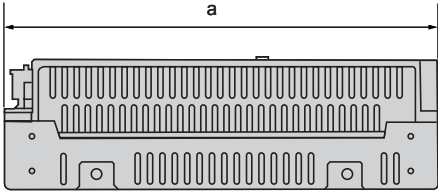

3

**Magelis Compact PC BOX MPC KN02 ●AX 00●**

a	b	c	d	a1	a2	b1	c1	c2	c3
217	164	119	65	130	15	160	217	238	255

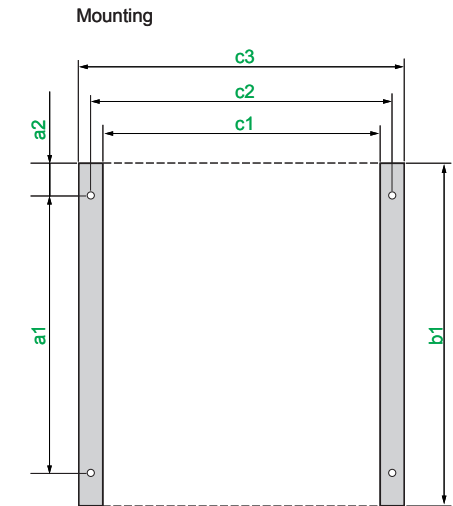
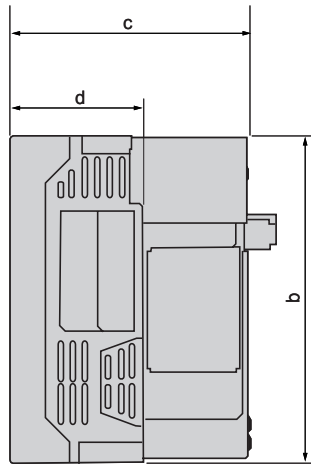
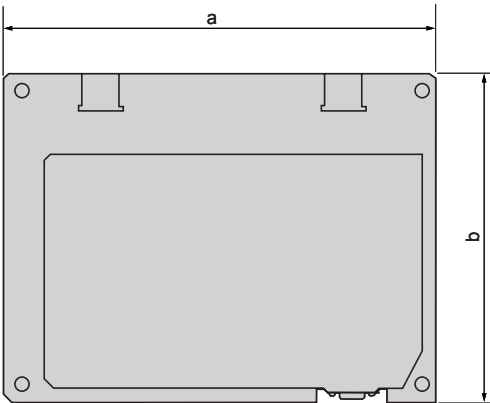
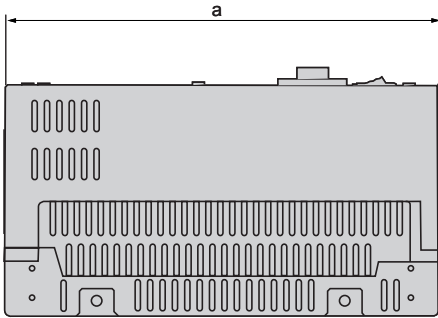



Dimensions (continued)

Magelis FLEX PC BOX MPC ●N0 ●●X 00●

	a	b	c	d	e	f	g	a1	a2	a3	b1	c1	c2	c3
MPC FN0 ●●●X 00●	243	125	161	38	12	277	289	255	14	6	275	243	258	270
MPC HN0 ●●●X 00●	243	176	161	38	12	277	289	255	14	6	275	243	258	270

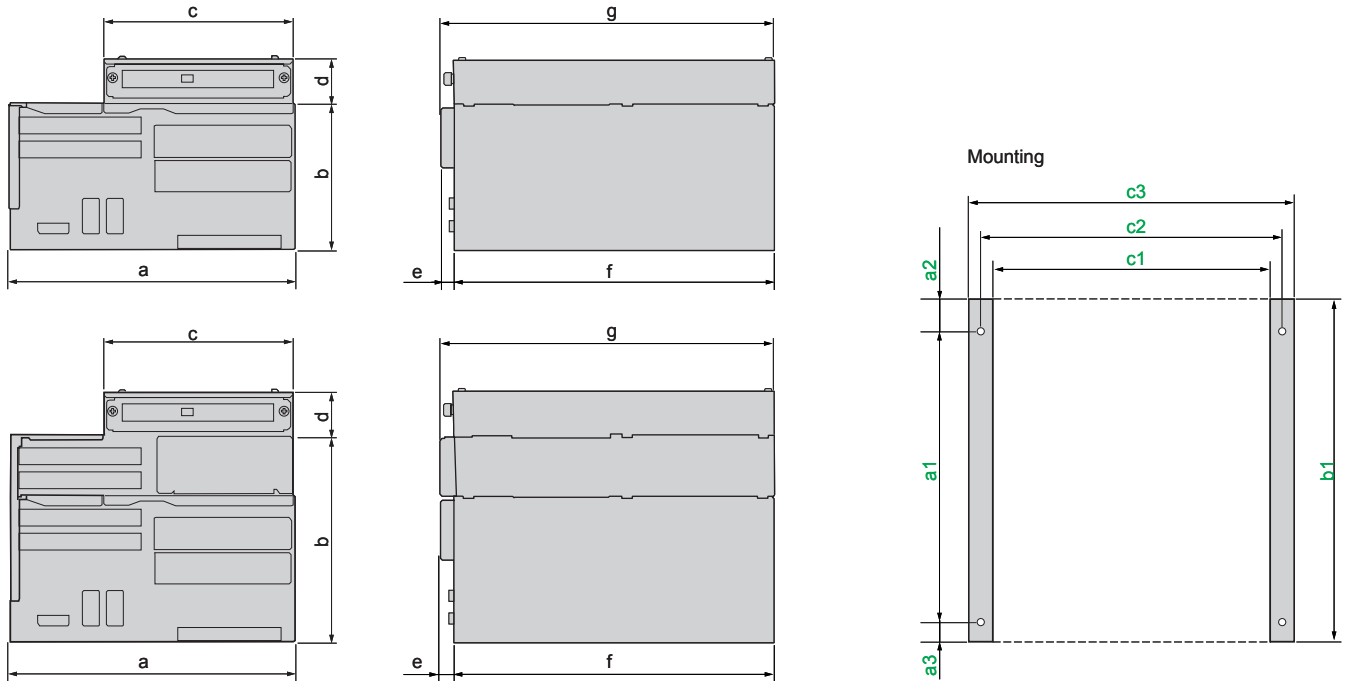

Mounting

Magelis Smart BOX, Magelis Compact PC BOX and Magelis FLEX PC BOX CPUs are mounted either horizontally or on a wall, using the fixing sets supplied. Use M4 screws.

**Dimensions (continued)**

**Front panel MPC Y●● 0NNN 00N**

Type	Reference	a	b	A	B
12" touch screen and keypad	<b>MPC YB2 0NNN 00N</b>	425	325	383.5	282.5
15" touch screen and keypad	<b>MPC NB5 0NAN 00N</b>	488	367	441.5	313.5
15" touch screen	<b>MPC YT5 0NNN 00N</b>	425	325	383.5	282.5
19" touch screen	<b>MPC YT9 0NNN 00N</b>	460	390	419.5	352.5

3

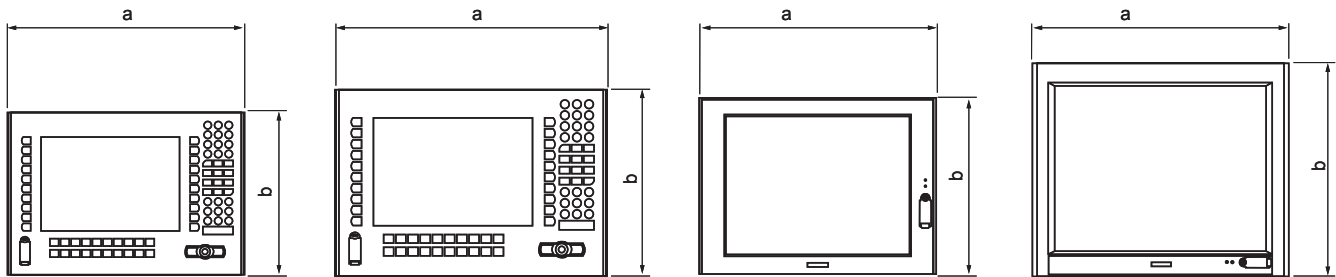

Cut-out

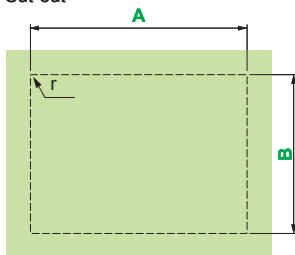

$$3 < r < 4$$

**Dimensions (continued)**

**Front Panel assemblies - Magelis Flex PC BOX**

Type	Reference	a	b	c	d	e	f
12" touch screen and keypad	<b>MPC YB2 0NNN 00N</b>	425	243	325	10	193.5	244.5
15" touch screen and keypad	<b>MPC NB5 0NAN 00N</b>	488	333.4	367	10	193	244
15" touch screen	<b>MPC YT5 0NNN 00N</b>	425	304	325	10	193	244
19" touch screen	<b>MPC YT9 0NNN 00N</b>	460	441	390	12.7	206.5	258.5

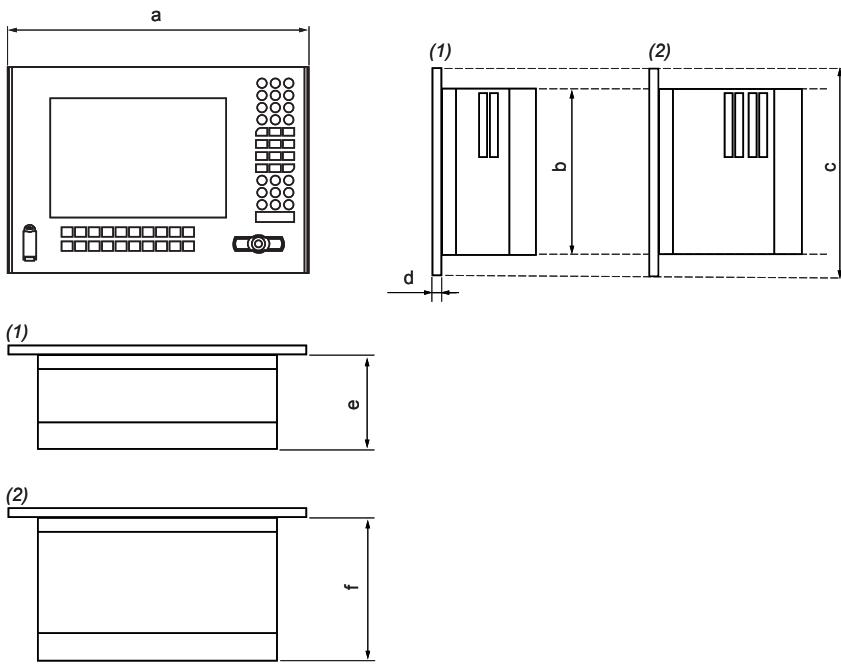

(1) Magelis Flex PC BOX F CPU with 2 PCI slots  
 (2) Magelis Flex PC BOX H with 4 PCI slots

# Industrial PCs

Magelis Smart, Magelis Compact iPC,  
Magelis Flex PC BOX

**GTW terminals and Smart, Compact iPC and Flex PC BOX industrial PCs**  
Connections to Schneider Electric devices

3

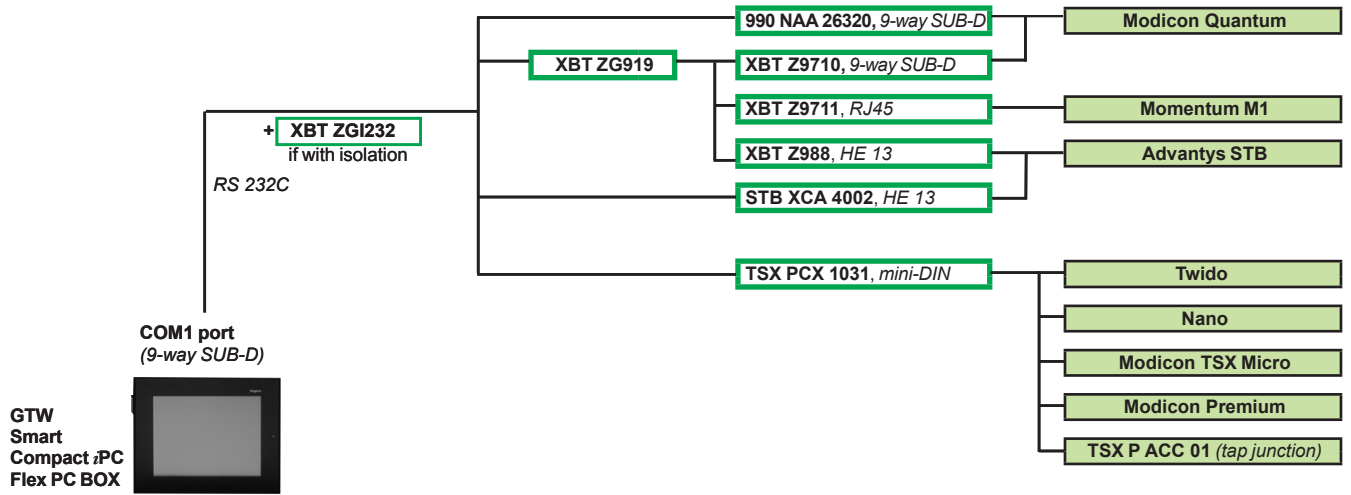

**GTW terminals and Smart, Compact iPC and Flex PC BOX industrial PCs**  
Connections to third-party devices

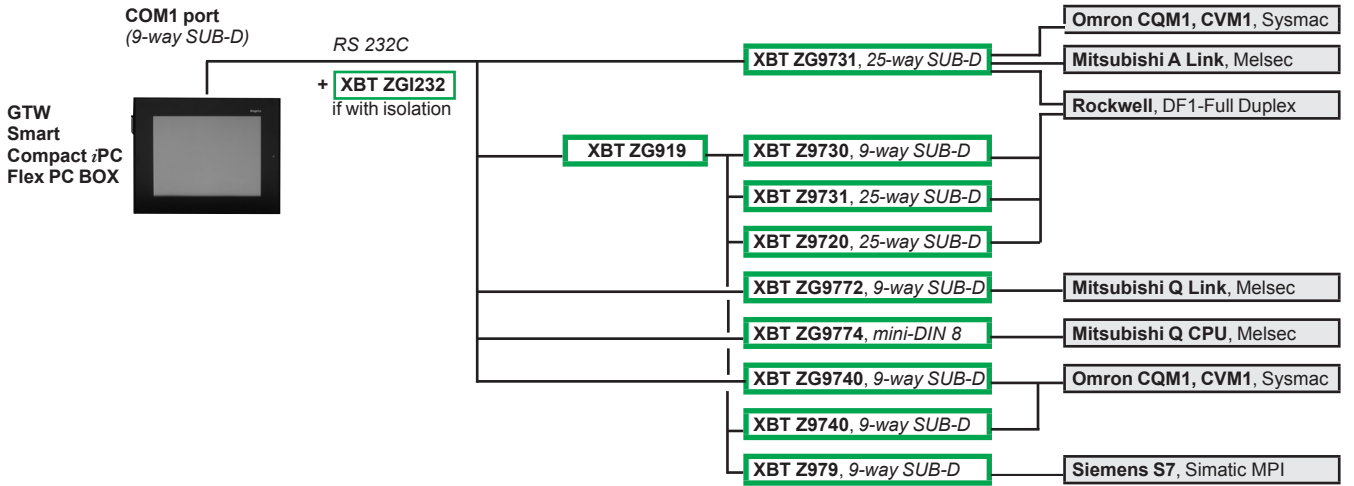

3



## Flat screens

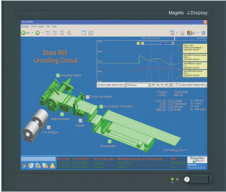

### iDisplay

3/61

### iDisplay

Active-matrix colour TFT LCD

19"

SXGA 1280 x 1024

16 777 216

≥ 200 cd/m<sup>2</sup> adjustable

Analog resistive

-

VGA or DVI-D port

USB or RS 232C port

100 to 240 V ~ (threshold values 85 to 265 V), EN 61131-2-compliant

**MPC YT9 0NAN 00N**

3/61

3



MPC YT5 0NAN 00N



MPC NB5 0NAN 00N

### Presentation

Magelis iDisplay screens are monitors with industrial flat screens designed for use in conjunction with PCs.

Two screen sizes are available: 15" and 19" to suit all your requirements.

Featuring the latest TFT LCD technology, they offer top class viewing and extended service life. Their touch screen interface enables easy creation of user-friendly and high performance HMI interfaces.

The Magelis iDisplay screen **MPC NB5 0NAN 00N** also has a 70-key (standard IBM) keypad and user function keys (2 x 20 keys).

Certified in accordance with PLC product standards, designed for use in severe industrial environments and offering an excellent screen size/dimensions ratio, they can be installed easily on any machine and in any equipment. They are suitable for use in any type of environment.

With the same dimensions and screen size as Magelis Smart and Compact iPC industrial PCs, Magelis iDisplay screens can be used to visualise the development of installations with optimum ease and simplicity.

### Architecture

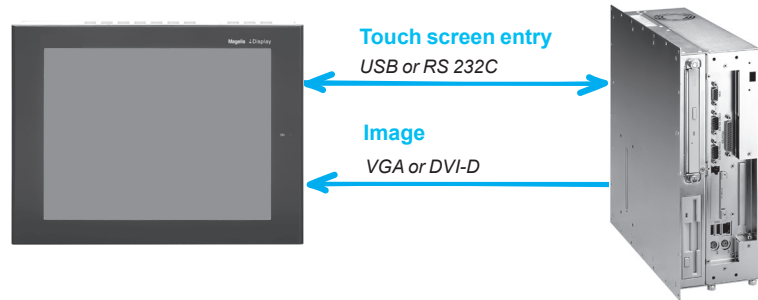

### Characteristics of Magelis iDisplay flat screens

Type	MPC YT5 0NAN 00N	MPC NB5 0NAN 00N	MPC YT9 0NAN 00N
<b>Environment</b>			
<b>Product certifications</b>			
Temperature	0 to +50°C, conforming to EN 61131-2, UL		UL 1604, UL 508, IEC 61131-2
	Operation	UL 508, CSA, IEC 61131-2	
	Storage	-10 to +60°C, conforming to IEC 68-2-2 tests Bb and Ab, IEC 68-2-14 test Na, and EN 61131-2	-20 to +60°C
<b>Electrical characteristics</b>			
Power supply	Voltages	100 to 240 V ~ (voltage limits 98 to 264 V), conforming to EN 61131-2	100 to 240 V ~ (voltage limits 85 to 265 V), conforming to EN 61131-2
	Frequency	50/60 Hz (frequency limits 47/63 Hz), conforming to EN 61131-2	50/60 Hz
	Micro-breaks	≤ 20 ms	10 ms
Consumption	120 VA	200 VA	
<b>Functional characteristics</b>			
Screen	Type	Active matrix colour TFT LCD	
	Size	15"	19"
	Resolution	XGA 1024 x 768	SXGA 1280 x 1024
	Number of colours	16 777 216	
	Brightness	≥ 200 cd/m <sup>2</sup> adjustable	
	Back-lighting (service life)	50,000 hours	
Touch screen	Analog resistive, 35 million cycles		
Keypad	–	70 keys (standard IBM) 2 x 20 function keys	–
Inputs	Image	VGA or DVI-D port	
Outputs	Touch screen	USB or RS 232C port	



### References

Description	Characteristics	Interface	Reference	Weight kg
Flat screen for flush mounting, IP 65 front panel supplied with 3 m cable.	15", XGA (1024 x 768)	Touch	MPC YT5 0NAN 00N	–
		Touch and keypad	MPC NB5 0NAN 00N	–
	19", SXGA (1280 x 1024)	Touch	MPC YT9 0NAN 00N	–

### Separate components

Description	Reference	Weight kg
Maintenance kit: mounting brackets + seals for Magelis iPC 19"	MPC YK9 0MNT KIT	–
Protective film for screen on Magelis iPC 19"	MPC YK9 0SPS KIT	–

### Dimensions

iDisplay flat screens MPC YT● 0NAN 00N and MPC NB5 0NAN 00N

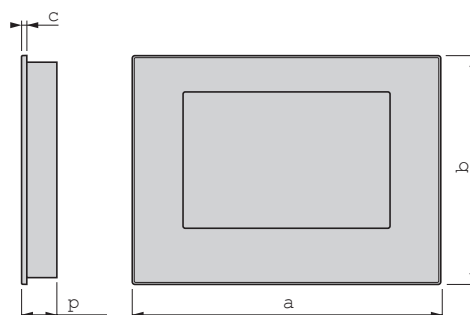

Cut-out

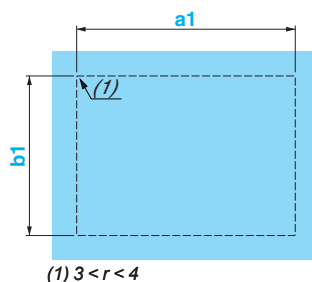

	a	b	c	p	a1	b1
MPC YT5	395	294	5	60	383.5 <sup>+1</sup> <sub>0</sub>	282.5 <sup>+1</sup> <sub>0</sub>
MPC NB5	483	365	10	31	441.5 <sup>+1</sup> <sub>0</sub>	313.5 <sup>+1</sup> <sub>0</sub>
MPC YT9	460	390	12.7	65	419.5 <sup>+1</sup> <sub>0</sub>	352.5 <sup>+1</sup> <sub>0</sub>

### Mounting

Magelis iDisplay flat screens can be mounted on a panel or enclosure door using the fixing accessories (3 x 4 spring clips) supplied with each screen.



---

## Configuration software

*Selection guide* ..... page 4/2

■ Vijeo Designer Lite

□ Presentation ..... page 4/4

□ Vijeo Designer Lite configuration software ..... page 4/7

■ Vijeo Designer

□ Presentation ..... page 4/8

□ Vijeo Designer configuration software ..... page 4/17

4

**Applications**

**Traditional architecture, HMI executed on dedicated terminal or PC platform**  
**Configuration software for operator dialogue applications**

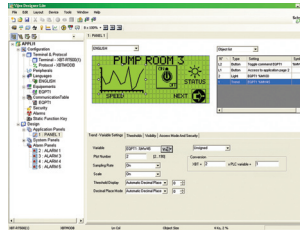

**Target products** Type  
 Operating system on terminals

Magelis XBT N (1)  
 Magelis XBT R/RT (1)  
 Proprietary Magelis

**Functions**  
 Reading/writing of PLC variables  
 Display of variables  
 Data processing  
 Sharing of variables between HMI applications  
 Saving of variables to external database

Yes  
 Yes  
 –  
 –  
 –

**Development of graphic applications**  
 Native library of graphic objects  
 Container Active X  
 Java Beans  
 Curves and alarms  
 Scripts

Yes  
 –  
 –  
 Yes (2)  
 –

**Online modification of applications**

–

**Communication between PLCs and HMI application**

Via I/O drivers

**Uploading of applications**

Yes

**Simulation of HMI applications**

Yes

**Redundancy**

–

**Recipe management**

–

**Report printing**

–

**Access security**

Linked to user profile

**Software compatible with OS**

Windows 2000, Windows XP or Windows Vista

**Software type**

**Vijeo Designer Lite**



**Pages**

4/7

(1) Magelis XBT terminals behave transparently on restoration of power.  
 (2) Depending on model.

Traditional architecture, HMI executed on dedicated terminal or PC platform

Configuration software for operator dialogue applications

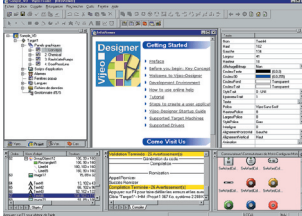

Magelis STO & Magelis STU  
Magelis XBT GT (1), Magelis XBT GK (1)  
Magelis XBT GH (1), Magelis GTW (1)

Proprietary for Magelis STO/STU, Magelis XBT GT/GK/GH  
Windows XP embedded for Magelis GTW

Yes

Yes

Yes, using expression editor or Java programming

–

–

Yes

–

Yes

Yes, with log

Java

–

Via I/O drivers

Yes

Yes

–

Yes

Real-time alarms, log data

Linked to user profile

Windows XP, Windows Vista or Windows 7

Vijeo Designer



4/17



Vijeo Designer Lite software

### Presentation

Vijeo Designer Lite configuration software can be used when creating operator dialogue applications to control simple automation systems for:

- XBT N/R/RT Small Panels

For Magelis STO/STU Small Panels, refer to the Vijeo Designer configuration software on pages 4/8 to 4/10.

For Magelis GT/GK/GH/GTW Advanced Panels, please refer to the Vijeo Designer configuration software on pages 4/8 to 4/10.

Vijeo Designer Lite has been designed with simplicity in mind and is inspired by the same user-friendly philosophy as Vijeo Designer. The primary aim of Vijeo Designer Lite is to show users who have not had any training in advance how to create applications. It does this by adopting an intuitive approach to operation and providing advice in the form of wizards.

Vijeo Designer Lite is used to design page content in WYSIWYG (*What You See Is What You Get*) format: everything created using this software is displayed in exactly the same way as it appears on the HMI.

Since Vijeo Designer Lite is capable of simultaneously defining, within the same project, as many versions in different languages as the compact terminal's memory can support, users have the option of internationalizing their applications.

The interface and documentation for Vijeo Designer Lite are also available in six languages: English, French, German, Italian, Simplified Chinese and Spanish.

As applications created with Vijeo Designer Lite are independent of the protocol used, the same operator dialogue application can be used with the different PLCs offered by the major suppliers.

Vijeo Designer Lite works on compatible PCs with Windows 2000, XP or Vista operating software.

### Configuration

With Vijeo Designer Lite configuration software, operator dialogue applications can be developed quickly and easily thanks to its very simple and user-friendly tools.

The development environment has two main windows:

- Application browser: This is a logical guide to designing applications. All of the project information can be called up on the display at any time in a clear and transparent format.
- Dialogue view: This displays the contextual information for the selection made in the application navigator. This information is arranged on a tab.

A Vijeo Designer Lite application comprises various types of page:

- Application pages (that can be interlinked)
- Alarm pages
- Preconfigured system pages

Pages can contain text or bitmaps, as well as all kinds of variable and graphic object.

Applications can be configured without dialogue boxes. Instead, preconfigured lists of parameters are available to help users make their selections and avoid errors. Vijeo Designer Lite comes with a toolset:

- Graphics editor
- Library of pictograms and symbols
- Link editor to PLC variables
- Simulator
- Application printing

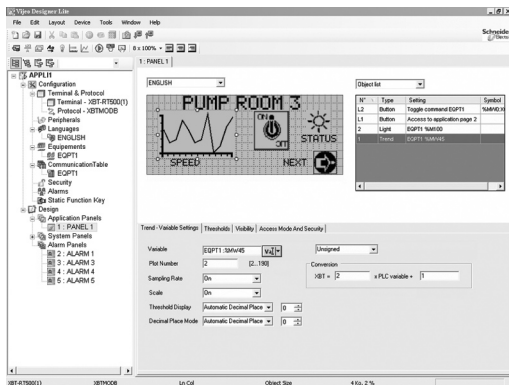

Example project

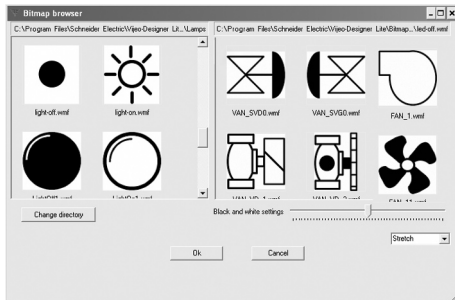

Library of symbols

### Graphics editor

The graphics editor in Vijeo Designer Lite makes it easy for developers of operator dialogue applications to create pages based on objects:

- Point, line, rectangle, ellipse
- Text and image
- Graphic, trending curve, button, light
- Enumerated list and scrolling text

### Library of symbols

The library of symbols makes the creation of pages even more efficient. It contains pictograms which are easily recognizable within industrial contexts as well as drawings of the main components used in automation. With Vijeo Designer Lite, linking of these graphic symbols to the function keys of the terminal is instantaneous.

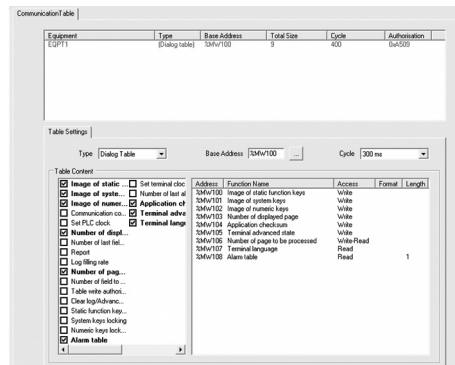

Communication table

### Links to PLC variables

Vijeo Designer Lite also enables the user to link symbols with the internal variables of Schneider Electric PLCs by importing Twido Soft, PL7 and Concept automation database files.

### Communication table

The communication table in Vijeo Designer Lite provides the user with an easy way of configuring all data exchanged between the Magelis compact XBT terminal and the main device.

The communication table is also used to define:

- Access to data: read/write
- All alarm conditions

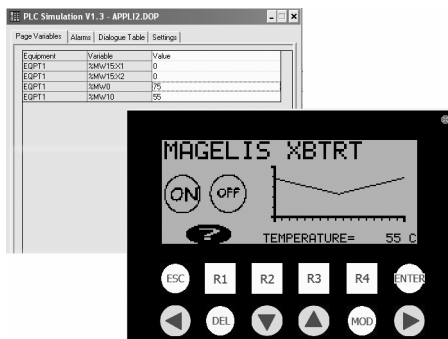

Simulation

### Simulator

Vijeo Designer Lite makes it possible to simulate the entire operator dialogue application at design office level without using a Magelis compact terminal or a PLC.

The simulator program can be used to thoroughly check the following application characteristics:

- Navigation between pages
- Entry of variables data
- Display of variables
- Display of alarms

### Application printing

The print function for Vijeo Designer Lite can be used with part or all of the HMI application. It is possible to send the data to a printer or to print to file.

### Characteristics of Vijeo Designer Lite applications

#### Schneider Electric protocols

<b>Schneider Electric protocols</b>	Vijeo Designer Lite supports Schneider Electric protocols: <ul style="list-style-type: none"> <li>- Modbus RTU Master, Slave</li> <li>- Uni-Telway</li> <li>- Zelio Logic</li> </ul>
-------------------------------------	--

### Characteristics of Vijeo Designer Lite software

<b>Operating system compatibility</b>	Windows 2000 Windows XP Professional Windows Vista Professional, 32-bit	
<b>Application validation</b>	Calculation of the maximum memory space occupied by the application. Verification of the capacity of the configured target (Magelis XBT compact terminal) to run the application in total security: <ul style="list-style-type: none"> <li>- Physical memory capacity</li> <li>- Available functions</li> </ul> If applicable: <ul style="list-style-type: none"> <li>- Disabling of application upload/download</li> <li>- Direction towards sections of the online help, which will provide tips for optimizing the application</li> </ul>	
<b>Interface languages</b>	Vijeo Designer Lite software screens and online help available in English, French, German, Italian, Simplified Chinese and Spanish	
<b>Documentation</b>	Available in electronic format in English, French, German, Italian, Simplified Chinese and Spanish. Not available in hard copy.	
<b>User licences</b>	Only 1 type of license available: <ul style="list-style-type: none"> <li>- <i>Single</i>: 1 station</li> </ul> Supplied with or without transfer cable(s) for serial link or USB port, see Table of references for each Magelis compact terminal on page 4/7.	
<b>Registration</b>	Recommended (via fax, e-mail or website <a href="http://www.schneider-electric.com/swregistration">www.schneider-electric.com/swregistration</a> ) to gain access to additional resources such as application examples, etc.	
<b>Third-party protocols</b>		
<b>Third-party protocols</b>	Mitsubishi	Melsec FX protocol (CPU)
	Omron	Sysmac protocols
	Rockwell Automation	Allen-Bradley protocols: DF1-Full Duplex, RS DataHighway 485
	Siemens	Simatic PPI protocols



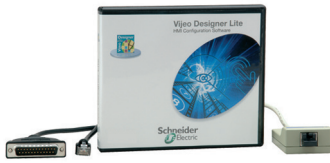

### References

All licences for the Vijeo Designer Lite configuration software listed below consist of a CD-ROM containing:

- Vijeo Designer Lite V1.3 software
- User documentation in electronic format
- The communication protocols described on page 4/6
- XBT L1001 development software for the conversion of existing XBT applications

### Single-station licences

Description	Licence type	Application transfer cable included		Reference	Weight kg
		PC side port	Terminal side Magelis XBT/ Magelis .PC		
Vijeo Designer Lite configuration software	Single (1 station)	–	– (1)	VJD SND TMS V13M	0.125
		USB		VJD SUD TMS V13M	0.675

(1) References for application transfer cables (PC to Magelis GT/GK/GTW terminal) are provided in Separate parts on page 1/28.



Vijeo Designer Lite software

### Presentation

The cross-platform Vijeo Designer configuration software can be used to create operator dialogue applications for controlling automation systems for:

- Magelis STO and STU terminals (Vijeo Designer Limited Edition is sufficient)
- Magelis XBT GT and XBT GK terminals
- Magelis XBT GH portable terminals
- Magelis GTW open terminals
- Magelis Smart industrial PCs, Magelis Compact iPC and PC BOX

**Note:** For other semi-graphic Magelis XBT terminals (except Magelis XBT G), please refer to the Vijeo Designer Lite development software. **Magelis XBT G terminals are no longer supported.**

Vijeo Designer and a suitable terminal can be combined to provide a solution for each and every control station requirement, at the cost of a simple software reconfiguration.

Capable of supporting video image streaming, the Magelis Vijeo Designer offer provides access to new types of application. Users can view their process instantly or following a delay, on the same screen as the HMI dialogue.

Vijeo Designer uses Magelis Ethernet TCP/IP connectivity and is therefore able to support WEB Gate remote access, the sharing of application data between terminals, the transfer of recipes and logs for variables and much more - all with total security.

Applications can take on an international nature, because Vijeo Designer supports up to 15 languages simultaneously in one project (40 alphabets are available on the XBT GT/GK terminal). The interface and documentation for Vijeo Designer are available in 7 languages: English, French, German, Italian, Brazilian Portuguese, Simplified Chinese and Spanish.

Vijeo Designer is the HMI component of SoMachine. Vijeo Designer will run on any PC with Windows 7, XP Professional, Windows Vista or Windows 7. It supports WYSIWYG simulation (1) of the expanded application (without Magelis GT/GK/GTW terminal or target Magelis iPC), the simulation of PLC variables (I/O, internal bits and words) and ensures that the application runs in total security on the Magelis GT/GK/GTW base terminal or Magelis industrial PCs.

### Configuration

Vijeo Designer configuration software enables operator dialogue projects to be processed quickly and easily thanks to its advanced ergonomics using up to five configurable windows:

- 1 Browser window
- 2 Object List window
- 3 Recipes window
- 4 Library of Animated Graphic Objects and Image Objects window
- 5 Report window

The software also offers a complete set of application management tools for:

- Project creation, whereby a project comprises one or a number of applications for Magelis GT/GK/GTW terminals, Smart, Compact iPC and PC BOX with sharing of variables between terminals (up to 8 terminals and 300 variables)
- Recipe management (32 groups of 256 recipes comprising up to 1024 ingredients)
- Cross-referencing application variables
- Documentation of mimics for an application
- A full simulation mode for testing the application from the design office
- Barcode reader management via:
  - USB port on multifunction XBT GT terminals, Magelis GT/GK/GTW keypad terminals and Magelis industrial PCs
  - COM1 or COM2 serial port on Magelis GT/GK/GTW (2)
- USB keyboard and mouse support for all terminals incorporating a USB port (only one peripheral can be connected at any one time)
- Retrieval of symbol files for PLC variables generated by TwidoSuite, PL7, Concept, ProWORX 32 and Unity Pro software (3)
- Report printing

(1) WYSIWYG: *What You See Is What You Get* (on the screen of the target terminal)  
 (2) Except XBT GT11 terminals  
 (3) DDT structured types and "unlocated" variables are supported.

4

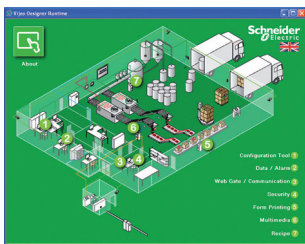

Example project

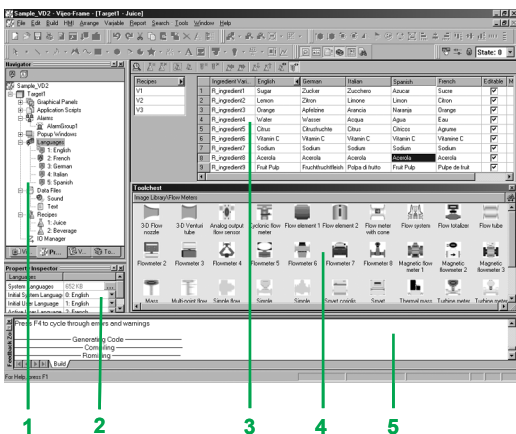



### Graphics editor

The graphics editor in Vijeo Designer offers interface consistency for simple objects as well as for more sophisticated ones. It enables application developers to create mimics easily based on:

- Simple objects to be configured:
  - Points, lines, rectangles, ellipses, arcs
  - Bar graphs, gauges, tanks, fillers, pie charts, curves
  - Polylines, polygons, regular polygons, Bézier curves, scales
  - Texts, images or alarm summary, etc.
- Preconfigured advanced objects: switches, radio buttons, indicators, buttons, tanks, bar graphs, potentiometers, selectors, text or number fields, enumerated lists, etc.
- Hiding of screens and application structure types

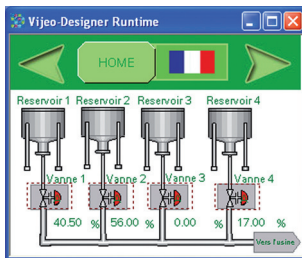

### Object animations

8 types of graphic-object animation support the rapid creation of animated mimics on the basis of:

- Pressing the touch panel
- Change of colour
- Filling
- Movement
- Rotation
- Size
- Visibility
- Display of associated value

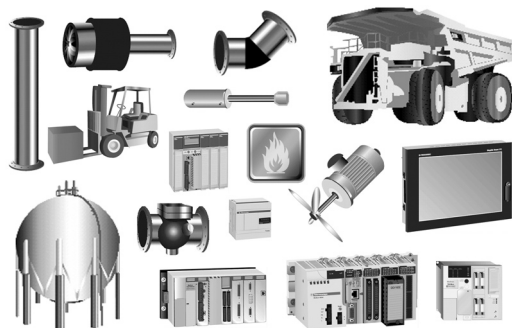

### Library of animated graphic objects

The library of animated graphic objects makes the process of creating mimics very efficient thanks to the numerous "ready-made" animation objects. It includes more than 4000 "industrial" vector images in 2 or 3 dimensions. Simply "drag and drop" the object using the mouse to position it on the mimic being created. User-defined objects can be added to this library using the same simple "drag and drop" method.

### Java scripts

Vijeo Designer supports the processing of information using Java language scripts. This function facilitates the running of complex animations, the automation of tasks within the terminal and the management of calculations in order to relieve the load on the PLC programs.

The scripts (50 lines, max.) can be associated with:

- Variables
- Operator actions
- Screens
- The application itself

### Customizable resources

To enable applications to be customized in accordance with customer requirements, Vijeo Designer features a new resource concept that makes it possible to define styles (colours, images, character fonts, text lists).

To quickly customize a generic application to meet customer requirements, simply assign these styles to the objects concerned.

The resource concept is supported by the following native objects: *Meter*, *Bar Graph*, *Slider*, *Potentiometer*, *Selector*, *Text List* and *Image List*.

```

//Script Created: 10 09, 2001
//
// Description:
//
//-----
// Replace this line with your script
int pos;

if (movebottles.getIntValue() != 0) // If conveyor is OFF, do not move bottles
{
    pos = BottlePos.getIntValue();
    if (pos >= 1000)
        pos = 0; // If bottle position has been the out of display area, reset position.
    pos = pos + 10 * 2 * ConveyorSpeed.getIntValue();
    BottlePos.write(pos);
}
    
```



Data Manager: Transfer recipes, videos, images, etc. via Ethernet or USB, simply by clicking the mouse

### Advanced functions

Based on new information technologies, Vijeo Designer features a large number of advanced functions for processing a higher volume of data, both faster and more reliably:

- Multimedia data management in the most popular formats:
  - Image display (jpeg, bmp, emf and png files)
  - Text display and processing (txt files)
  - Sound message processing (wav files)
- Alarm or curve logs recorded
- Zoom in/out on trending curves for a detailed analysis
- Alarm management All variables can be categorized as "Alarms" and can be customized in respect of visualization and acknowledgment. These Boolean and analogue threshold type alarms can be printed on the fly.
- Multimode application transfer: via serial link, via USB, via Ethernet network, and by using Compact Flash memory card on multifunction terminals
- Backup of application source files on the terminal or iPC to facilitate maintenance
- User-friendly data exchange between PC and terminal using the Data Manager tool
- Integrated FTP server for downloading/uploading recipes via Ethernet TCP/IP and restoring logs to Magelis GT/GK/GTW and Magelis iPC
- Multiport communication for multifunction terminals - 2 serial links and 1 Ethernet network can be active simultaneously
- Action table for associating a particular behaviour with an event
- Use of a USB memory stick (up to 4 GB) for application downloads/uploads, data retrieval or recipe exchange
- E-mail on action and event (the e-mail text can contain up to 1000 characters)

4

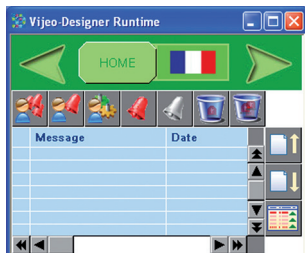

Alarm management

### WEB Gate remote connection

Vijeo Designer supports a WEB Gate remote connection with any platform which has an Ethernet connection point

WEB Gate supports remote visualization of Vijeo Designer applications with Internet Explorer on any PC running Windows XP or Windows Vista. The size of the page displayed is determined by the terminal.

WEB Gate supports the display of pages similar to those in the Vijeo Designer application, or of different pages, i.e. start-up pages and navigation pages can be differentiated in order to reflect the type of access (terminal/WEB Gate).

Several connections are possible at the same time, with the number depending on the size of the application.

The high security mode of WEB Gate excludes any risk of applications jamming as a result of variables being modified via the terminal and WEB Gate at the same time.

For increased confidentiality:

- WEB Gate access can be restricted to only those PCs whose IP address appears in the licensing list.
- Some Vijeo Designer functions are not supported by WEB Gate:
  - Application shutdown, restart
  - Terminal configuration
  - Reading of an acoustic animation (sound file)
  - Display of a recorded video sequence

### WEB Maintenance remote diagnostics

In addition to WEB Gate, Vijeo Designer features the embedded diagnostics service WEB Maintenance - Transparent Ready WEB Server Class B15 (1) - this server's navigation bar features an option for accessing the following functions:

- WEB Gate
- Animation tables
- Web interface for the restoration of data files (recipes, logs, multimedia files)

**Note:** Terminals programmed using Vijeo Designer can be accessed directly via their names. This function is supported by the DHCP and DNS network services.

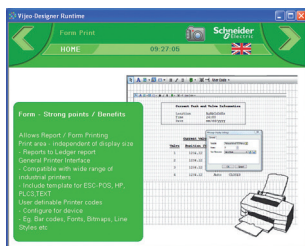

Report printing

(1) Please consult our "Control and automation, Ethernet TCP/IP and the Web" catalogue.

### Characteristics of Vijeo Designer applications

#### General characteristics

Number of targets	32, Magelis STO/STU or GT/GK/GH/GTW type terminals or Magelis industrial PCs						
Number of internal and external variables	8000						
Number of lines per Java script	50 (1)						
Sharing data between terminals	Up to 300 variables between 8 terminals, without router PLC Proprietary protocol above TCP/IP						
Internationalization	Up to 15 languages supported by 34 western alphabets, 4 Asian alphabets, 2 middle eastern alphabets:						
Western alphabets	Afrikaans Swedish Russian Norwegian Italian Greek	Belarusian Albanian Czech Serbian Polish Latvian	Spanish Bulgarian German Turkish Slovak Portuguese	Dutch Estonian Catalan French Ukrainian Slovenian	Lithuanian Hungarian Finnish Croatian Basque	Romanian Macedonian Indonesian French Danish	
Asian alphabets	Simplified Chinese	Korean	Japanese	Taiwanese			
Eastern alphabets	Hebrew	Arabic					
Functions	Languages can be programmed or selected dynamically via the menu. The character fonts are embedded in the application. The process is based on the export/import of texts in CSV format, which can be edited by the translator (each text is stamped with a unique ID).						
Keyboards that can be used to enter data	Three types of keyboard are available: - Standard QWERTY or AZERTY - Alphabetical - Compact, suitable for small screens and for pages with priority display zones						
Storage of source code	- The application source code can be stored either on the terminal or on the iPC - Password safeguards confidentiality - On request, the application can be verified each time the terminal starts up by means of a CRC calculation ( <i>High Security</i> function).						

#### Page characteristics

Internal or external variables	800
Objects	800
Switches	30
Pop-up windows	3
Number of lines per Java script	50 (1)

#### Library of graphic objects

Number of objects available	> 4000
Type	2D and 3D "industrial" vector images
Expandable	Yes

#### Recipes

Number of groups	32
Composition of a group	Up to 1024 ingredients for 256 recipes
Format	Proprietary or CSV
Multilingual support	Complete for labels and ingredients

#### Action tables

Number of actions	100
Composition	Maximum of 16 commands per action
Action type	- Periodic - Planned - Conditioned - Event-based

(1) Indicative data for a script executed cyclically.

### Characteristics of Vijeo Designer applications (continued)

#### Alarms

Number of active alarms, records or logs	9999
Type	Any variable (internal or external, Boolean or analogue threshold) can act as an alarm.
Customization	Any alarm type variable can feature a customized interface for its viewing and acknowledgment.
Associated reflex functions	Any alarm type variable can be associated with reflex functions linked to the appearance of the alarm concerned: <ul style="list-style-type: none"> <li>- Action on appearance</li> <li>- Action on selection</li> <li>- Message for the alarm bar, etc.</li> </ul>

#### Integrated diagnostics

The PLC "Diag buffer" function can be accessed via the following protocols:

	Modicon M340 Unity Pro	Premium PL7	Premium Unity Pro	Quantum Unity Pro
UNITE-Series				
UNITE-TCP/IP XWAY				
UMAS Modbus TCP				
UMAS Modbus RTU				
UMAS Modbus Plus				
UMAS UNITE-Series				
UMAS UNITE-TCP/IP XWAY				
UMAS Modbus TCP USB PPP				

Accessible  
 Not accessible

#### Video functions

Platform	XBT GT terminals	Magelis GTW terminals Magelis industrial PCs	
Video source	NTSC, PAL video channel	Webcam	
Input format	Composite video (chrominance+luminance) via RCA plug	Webcam via USB port	
Display resolution	NTSC: 640 x 480 pixels PAL: 768 x 576 pixels	Depending on webcam characteristics (usually 640 x 480 pixels)	
Duration of dynamic memorization	10 mins max., can be configured, in circular memory (MPEG-4 format)	-	
<b>Recording of sequences</b>	Media	Compact Flash card USB memory stick	
	Number of sequences	Up to 200	
	Recording format	Simple MPEG-4 profile	
	Recording resolution	320 x 240 pixels	
	Typical recording rate	3.2 MB/minute	Determined by the CODEC used on the PC
	Typical capacity	Up to 28 sequences lasting up to 10 minutes can be stored on a 1 GB Compact Flash card.	Determined by hard disk space available

4

**Characteristics of Vijeo Designer applications (continued)**

<b>Screen capture</b>		
Format		JPEG
Resolution		Display resolution
Ranges supported		XBT GT terminals (XBT GT 1105 and higher), Magelis industrial PCs
Video window included		Yes
<b>Backup</b>		
Format		JPEG
XBT GT 1105 terminals and higher		On Compact Flash card On USB memory stick
Magelis industrial PCs Compact iPC		On Compact Flash card On hard disk On USB memory stick
<b>Transfer</b>		
		Via USB memory stick or Data Manager on the terminal or on an iPC equipped with an Ethernet connection or USB port
<b>Printing</b>		
XBT GT 1105 terminals and higher		Via USB port (1) or via Ethernet port, with compatible printer (2): <input type="checkbox"/> PCL5 - HP Officejet Pro - HP LaserJet <input type="checkbox"/> PCL3 - HP Deskjet series - HP Business InkJet - HP Officejet Pro - HP LaserJet - HP Photosmart series <input type="checkbox"/> ASCII
	From Magelis industrial PC	With any printer equipped with a suitable driver for Windows
<b>Creating and printing reports and barcodes</b>		
<b>Creating reports</b>		
		Reports are created in the same way and with the same wysiwyg editor as for Vijeo Designer pages.
<b>Printing reports</b>		
	Magelis GT/GK/GH terminals	Text printer via: <input type="checkbox"/> COM port <input type="checkbox"/> USB port with PIO adapter NB: Printers with a USB port and network printers are not supported.
	Magelis GTW terminals or Magelis industrial PCs iPC or PC BOX	Based on Windows printing configuration, using a text printer via: <input type="checkbox"/> Parallel port <input type="checkbox"/> COM port <input type="checkbox"/> Network
<b>Printing barcodes</b>		
		Can be done by sending special characters to switch the printer to barcode printing mode Main barcode types supported: <input type="checkbox"/> UPC-A <input type="checkbox"/> UPC-E <input type="checkbox"/> JAN/EAN8 <input type="checkbox"/> JAN/EAN13 <input type="checkbox"/> ITF <input type="checkbox"/> CODE39 <input type="checkbox"/> CODE93 <input type="checkbox"/> CODE128 <input type="checkbox"/> CODABAR (NW-7)
<b>Internet Explorer browser object</b>		
Support		Pages created with Vijeo Designer for Magelis industrial PCs can incorporate a Microsoft Internet Explorer browser object.
Possible functions		Display, in all or part of the Vijeo Designer screen page, of: - HTML format pages: for example, websites, pages from Microsoft Office Word, Excel and PowerPoint documents saved in HTML format - Documents in Adobe pdf format - Macromedia Flash presentations - Video sequence ( <i>streaming</i> ) originating from a video server on IP - Any other Active X featuring a USB interface

(1) A printer can be connected to the USB port of XBT GT terminals (XBT GT 1105 and higher) as long as the printer connection is serial or parallel. A serial-to-USB or parallel-to-USB conversion cable is also required.  
(2) For a complete list of Hewlett Packard and other manufacturer printers supported, please consult your Customer Care Center.



### Characteristics of Vijeo Designer applications (continued)

#### Displaying user documentation pages on the XBT GT/GK

Support	User documentation stored on the Compact Flash card of the XBT GT/GK can be displayed with Vijeo Designer, provided it is in HTML V4.01 CSS 1.0 format. Most DTP software supports export to HTML format: Adobe Acrobat, Microsoft Word, Microsoft PowerPoint, etc.
---------	--

#### Traceability, logs

Vijeo Designer offers increased flexibility for implementing data traceability by means of sampling and management of log files. Every variable can be written in a recording group. All data is time-stamped and date-stamped (based on GMT) to facilitate comparison of data from different sites. *Time Zone* and DST are also supported so that local characteristics such as the change from winter to summer time can be taken into account.

A recording group defines the following elements:	Recording type	- Periodic - Event-based
	Storage media	- Compact Flash memory card - SRAM terminal memory (for alarms) - Hard disk (Magelis Compact iPC and PC BOX) - USB memory stick
	Maximum size	- Maximum number of recordings - Maximum file size
	Format	- Proprietary - CSV

#### Capacity

The designer of the application concerned is entirely free to select the number of variables sampled and the sampling frequency (these will be determined by the media present on the target).

The following are typical example values by terminal:	<b>Target terminal</b>	<b>XBT GT/GK</b>	<b>Magelis GTW</b>	<b>Magelis Smart</b>	<b>Magelis PC BOX Magelis Compact iPC</b>
	Number of variables sampled	100	250		
	Target storage media	Compact Flash card			Hard disk
	Duration and maximum size of samples per variable	Up to 5 years of recordings 8 MB of samples per variable maximum			

#### Industrial intelligence option: Intelligent Data Service

Intelligent Data Service is an extension of Vijeo Designer for the PC (Magelis or standard PC) which supports the implementation of control solutions for one or a number of terminals (up to 8). This extension offers total traceability. Both process variables and operator actions are tracked so that the right decisions can be made at the right time (Industrial Business Intelligence).

Powerful	Data can be collected from multiple terminals via Ethernet without impairing HMI reaction times.
Flexible	Various storage methods are supported, CSV file can be read directly in MS Excel, recording in user-defined format in an SQL database or secure IDV (Intelligent Data Vault) files to ensure compatibility with the requirements of 21 CFR Part 11.
Innovative	Just a few clicks of the mouse are all that is required to create control panels which can be accessed from any WEB browser (Silverlight) or clear and well-organised reporting documents.

#### Data Manager

The user-friendly Data Manager tool is used to transfer data from and to a terminal. Vijeo Designer does not have to be installed in order to run this program, which is available free of charge.

Data Manager can be installed as an independent tool supporting the following types of data transfer:	Logs	- Retrieval of log data for variables - Conversion into a single CSV format file
	Recipes	- Transfer from and to terminal - Modification using an integrated editor
	Project	- Download to PC of the project stored on Compact Flash memory card
	Video sequences, screen captures	- Download to PC

#### Data sharing

Vijeo Designer offers the possibility of sharing data between terminals (this option simply needs to be configured). The system works without a router PLC. Up to 300 variables can be shared between a maximum of 8 terminals. The exchange protocol is a TCP/IP proprietary upper layer. The high-security mode excludes any risk of applications jamming, which can occur when attempts are made to modify a variable via more than one terminal at the same time.

Vijeo Designer imposes the following restrictions on the sharing of data:	Sharing of external variables on the terminal	These variables cannot be used in the following objects: - <i>Trend Graphs</i> - <i>Data Graphs</i> These variables cannot be saved via the terminal.
	System and recipe variables	The direct sharing of these variables by means of configuration settings is not supported. However, sharing can be programmed using the <i>ReadFromVar</i> and <i>WriteToVar</i> functions.



Characteristics of Vijeo Designer applications (continued)	
<b>Terminal access security</b>	
	Access to all or some of the objects in Vijeo Designer can be made subject to users proving that they are in possession of sufficient rights: user name, password.
Types of access right	<ul style="list-style-type: none"> <li>- Application: pages, buttons with confirmation, etc.</li> <li>- Data Manager: access via FTP service</li> <li>- Web Gate: Intranet/Extranet access (IP address filtering)</li> </ul>
Number of users per group of access rights	100 max.
Number of groups of access rights	20 max.
Automatic locking	If active: automatic blocking of access via keyboard if no entries are made for a set period of time
<b>Target security</b>	
	Vijeo Designer can increase the confidentiality of applications on Magelis industrial PCs by putting protection mechanisms in place at two levels:
BIOS	<ul style="list-style-type: none"> <li>- Disabling of start-up via peripheral connected to USB port</li> <li>- Disabling of USB ports</li> <li>- Password protection for BIOS access</li> </ul>
Vijeo Designer Run Time	<ul style="list-style-type: none"> <li>- Hiding of Windows taskbar</li> <li>- Disabling of toggling between tasks (ALT+TAB)</li> <li>- Disabling of Windows Security Manager (CTRL+ALT+DEL), including the Task Manager</li> <li>- Disabling of Windows shortcuts</li> <li>- Disabling of the "Windows logo" key on the keyboard</li> <li>- Disabling of shortcut to exit run time (CTRL+Z)</li> </ul>
<b>Schneider Electric protocols</b>	
	<p>Vijeo Designer supports Schneider Electric protocols:</p> <ul style="list-style-type: none"> <li>- Modbus RTU Master</li> <li>- Modbus TCP Master</li> <li>- Modbus Plus (1)</li> <li>- Modbus 32-bit extensions</li> <li>- ELAU PacDrive (ELAU C00x/LMCx00)</li> <li>- Uni-Telway</li> <li>- UniTE TCP/IP</li> <li>- USB terminal port of Modicon M340 CPUs</li> <li>- FIPIO (5), FIPWAY (5)</li> </ul> <p>All Schneider Electric drivers provide IEC access to input bits/words and output bits/words: Modbus (RTU and TCP), Modbus Plus (GMU and USB), Uni-Telway, Xway.                      Direct I/O access authorises access to the hardware input and output registers.                      The register addresses adhere to the syntax of IEC standards and to the addressing of the UNITY configuration software (%I, %IW, %Q, %QW).                      If requested by the user, the variables associated with a PLC can be re-read ('on demand scan' function).                      The DDT and unlocated variables of Unity Pro are supported.</p>
<b>Third-party protocols</b>	
	Vijeo Designer also supports the following protocols and PLCs:
Mitsubishi	<p>Melsec protocols: A/Q CPU (SIO), A/Q Ethernet (TCP), A Link (SIO), QnA CPU (SIO), Q Ethernet (UDP), FX (CPU), FX 3U (CPU), QUTE for Q00JCPU                      Except for Melsec-A Link (SIO), Mitsubishi serial link protocols do not work on the RJ45 port (1).</p>
Omron	<p>Sysmac protocols: FINS (SIO), LINK (SIO), FINS (Ethernet) and Trajexia                      OMRON serial link protocols do not work on the RJ45 port. (2)</p>
Rockwell Automation	<p>Allen-Bradley protocols: DF1-Full Duplex, RS DataHighway 485, Ethernet IP (3) (PLC5, SLC500, MicroLogix, ControlLogix), Ethernet IP native (2) (ControlLogix), Ethernet IP High Speed access, DeviceNet Slave (6)</p>
Siemens	<p>Simatic protocols: MPI (S7-300/400), MPI Direct, RK512/3964R (S7-300/400), PPI, Siemens Ethernet (ISO-on-TCP/Profinet), MPI pass-through function                      The S7-300/400 MPI Adapter and RK512/3964R - RS 485 connection serial link protocols do not work on the RJ45 port. (2)                      Profibus DP protocol: via XBT ZG PDP (4)</p>

(1) Via USB cable: XBT ZG UMP for XBT GT 2●●● and higher, TSX C USB MBP for Smart and Compact iPC  
 (2) They are supported on XBT GT (SUB-D connector, XBT GT2 and higher).  
 (3) Certified ODVA compatibility.  
 (4) Certified by the Profibus Foundation.  
 (5) Via USB FIPIO module: TSX CUSB FIP  
 (6) Via Device Net module: XBT ZGDVN

**Characteristics of Vijeo Designer applications (continued)**

**Schneider Electric applications**

Support	Pages created with Vijeo Designer for Magelis industrial PCs can run Schneider Electric software in a window that is independent of the Windows system.
Possible functions	It is also possible to run frequently-used application software as and when required, including: <ul style="list-style-type: none"> <li>- Unity Pro</li> <li>- TwidoSuite</li> <li>- Advantys STB configuration software</li> <li>- PL7</li> <li>- PowerSuite, etc.</li> </ul>

**Characteristics of the Vijeo Designer software**

Operating system compatibility	Windows XP Professional Windows Vista (32 bits) Windows 7 (32 bits)
Graphic library	Library of vector graphic objects shared with Vijeo Citect
Number of objects available	> 4000
Type	2D and 3D "industrial" vector images
Expandable	Yes
Application validation	Calculation of the maximum memory space occupied by the application. Verification of the capacity of the configured target (XBT GT terminal, Magelis industrial PCs) to run the application in total security: <ul style="list-style-type: none"> <li>- Physical memory capacity</li> <li>- Available functions</li> </ul> If applicable: <ul style="list-style-type: none"> <li>- Disabling of application upload/download</li> <li>- Direction towards sections of the online help, which will provide tips for optimizing the application</li> </ul>
Interface languages	Vijeo Designer software screens and online help available in English, French, German, Italian, Simplified Chinese and Spanish
Documentation	Available in electronic format in English, French, German, Italian, Simplified Chinese and Spanish. Not available in hard copy.
Self-training	Multimedia tool (1 hour 30 minutes) in English/French included
User licences	Four types of licence are available: <ul style="list-style-type: none"> <li>- <i>Single</i>: 1 station</li> <li>- <i>Group</i>: 3 stations</li> <li>- <i>Team</i>: 10 stations</li> <li>- <i>Facility</i>: unlimited number of stations on one site</li> </ul> Supplied with or without transfer cable(s) for USB port: <b>XBT ZG 935</b> , see Table of references for each Magelis terminal on page 4/17.
Registration	Recommended (via fax, e-mail or website <a href="http://www.schneider-electric.com/swregistration">www.schneider-electric.com/swregistration</a> ) to gain access to additional resources such as application examples, etc.

**Services**

Switch2VijeoDesigner: Migration of XBTL 1000 applications	<p>The Switch2VijeoDesigner service offer makes it even easier to migrate XBTL 1000 applications created on XBT F terminals to Vijeo Designer applications for use on XBT GT/GK terminals.</p> <p>The service provides:</p> <ul style="list-style-type: none"> <li>- Analysis of the complexity of migration: hardware, software, communication with PLCs, etc.</li> <li>- Analysis of the new functional requirements</li> <li>- Proposal for migration methodology</li> </ul> <p>The possible deliverables include:</p> <ul style="list-style-type: none"> <li>- Simple conversion</li> <li>- Full migration of complex machines</li> <li>- Migration to SCADA system</li> <li>- Standardization process for multiple machines</li> </ul> <p>For more information on this service offer, please consult your Customer Care Center.</p>
--	--

4



VJD SUD TGA V51M

### References

All licences for the Vijeo Designer configuration software listed below consist of a DVD containing:

- Vijeo Designer software, including:
  - Copyright-free *stand-alone* installation of Data Manager
  - User documentation in electronic format, comprising:
    - Online help for the software
    - User manual for the supported targets
    - Setup manual for the different protocols supported
  - A multimedia self-teaching tool lasting 1 hour 30 minutes in English/French
  - The communication protocols described on page 4/15

**Note:** Magelis STO/STU terminals can be programmed using Vijeo Designer Limited Edition. Vijeo Designer V5.1 supports applications created with any version of Vijeo Designer ≥V4.6. If you are updating an earlier application, please consult our Schneider Electric Customer Care Centre.

### Single-station Build Time licences

Description	Licence type	Application transfer cable		Reference	Weight kg
		PC side	Magelis terminal side		
Vijeo Designer configuration software	Single (1 station)	–	– (1)	VJD SND TGS V51M	0.125
		USB	Magelis STO/STU Magelis GT/GK/GTW Magelis industrial PCs	VJD SUD TGA V51M	0.330

### Multi-station Build Time licences

Description	Licence type	Number of stations	Reference	Weight
Vijeo Designer configuration software	Group	3	VJD GND TGS V51M	0.125
	Team	10	VJD TND TGS V51M	0.125
	Facility	Unlimited number of stations on one site	VJD FND TGS V51M	0.125

### Run Time licences (2)

Description	Licence type	Number of stations	Reference	Weight
Vijeo Designer Run Time licence for Magelis GTW & iPC	Single	1	VJDSNRTMPC	–
Intelligent Data Service licence extension for Vijeo Designer Run Time	Single	1	VJDSNTRCKV51M	–

(1) References for application transfer cables (PC to Magelis GT/GK/GTW terminal) are provided in *Separate parts* on page 1/77.

(2) The Run Time licence drives the execution of an application. It is used for Magelis and Magelis GTW industrial PCs only.



---

## Technical appendices

- Certifications for automation products ..... page 5/2

## Index

- Product reference index. .... page 5/4

# Technical appendices

## Certifications for automation products







### EC regulations

Some countries require certain electrical components to undergo certification by law. This certification takes the form of a certificate of conformity to the relevant standards and is issued by the official body in question. Where applicable, certified devices must be labelled accordingly. Use of electrical equipment on board merchant vessels generally implies that it has gained prior approval (i.e. certification) by certain shipping classification societies.

Abbreviated name	Certification body	Country
<b>CSA</b>	Canadian Standards Association	Canada
<b>C-Tick</b>	Australian Communication Authority	Australia, New Zealand
<b>GOST</b>	Scientific research institute for GOST standards	CIS, Russia
<b>UL</b>	Underwriters Laboratories	USA
Abbreviated name	Classification society	Country
<b>IACS</b>	International Association of Classification Societies	International
<b>ABS</b>	American Bureau of Shipping	USA
<b>BV</b>	Bureau Veritas	France
<b>DNV</b>	Det Norske Veritas	Norway
<b>GL</b>	Germanischer Lloyd	Germany
<b>LR</b>	Lloyd's Register	UK
<b>RINA</b>	Registro Italiano Navale	Italy
<b>RMRS</b>	Russian Maritime Register of Shipping	CIS, Russia
<b>RRR</b>	Russian River Register	

The tables below provide an overview of the situation as at **01/02/2009** in terms of which certifications (listed next to their respective bodies) have been granted or are pending for our automation products. Up-to-date information on which certifications have been obtained by products bearing the Schneider Electric brand can be viewed on our website: [www.schneider-electric.com](http://www.schneider-electric.com)

#### Product certifications

	Certifications						
							
	UL USA	CSA Canada	ACA Australia	GOST CIS, Russia	Hazardous locations Class I, div 2 (1)	ATEX Europe	TÜV Rheinland
Advantys OTB							
Advantys STB					FM	Cat. 3 G	
Advantys Telefast ABE 7							
ConneXium					(2)		
Magelis iPC, Magelis GTW	(3)			(2)	UL	(2)	
Magelis XBT GT				(2)	CSA/UL	Cat. 3 G-D	
Magelis XBT GK					CSA		
Magelis XBT N/R					CSA/UL	Cat. 3 G-D	
Magelis XBT RT					CSA/UL	Cat. 3 G-D	
Modicon M340					CSA		
Modicon Momentum							
Modicon Premium				(2)	CSA		
Modicon Quantum				(2)	FM (2)		
Modicon Quantum Safety				(2)	CSA		SIL 2 (4)
Modicon TSX Micro							
Phaseo	(3) (5)						
Twido	(6)	(6)			CSA/UL (6)		

(1) **Hazardous locations:** According to UL 1604, CSA 22.2 N° 213 and FM 3611, certified products are only approved for use in hazardous locations categorized as Class I, division 2, groups A, B, C and D, or in non-classified locations.

(2) Depends on product; please visit our website: [www.schneider-electric.com](http://www.schneider-electric.com)

(3) North American certification cULus (Canada and USA)

(4) According to IEC 61508. Certified by TÜV Rheinland for integration into a safety function of up to SIL2 level.

(5) Except for power supplies and function modules in the Universal range: UL certification pending

(6) Except for AS-Interface module TWD NOI 10M3; CE only.

#### Specific certifications









<b>BG</b>	Germany	Safety module <b>TSX DPZ 10D2A</b> (Modicon TSX Micro) Safety modules <b>TSX PAY 262/282</b> (Modicon Premium)
<b>SIMTARS</b>	Australia	Modicon TSX Micro automation platform Modicon Premium (PL7) automation platform
<b>AS-Interface</b>	Europe	Master module <b>TWD NOI 10M3</b> (Twido) Master module <b>TSX SAZ 10</b> (Modicon TSX Micro) Master modules <b>TSX SAY 1000</b> (Modicon Premium)

# Technical appendices

## Certifications for automation products

### EC regulations

#### Merchant navy certifications

<div style="background-color: #008000; width: 15px; height: 10px; display: inline-block;"></div> Certified <div style="background-color: #90EE90; width: 15px; height: 10px; display: inline-block;"></div> Certification pending	Shipping classification societies							
								
	ABS	BV	DNV	GL	LR	RINA	RMRS	RRR
	USA	France	Norway	Germany	UK	Italy	CIS	CIS
Advantys OTB								
Advantys STB	(1)							
Advantys Telefast ABE 7								
ConneXium				(2)				
Magelis .PC, Magelis GTW			(2)					
Magelis XBT GT								
Magelis XBT GK								
Magelis XBT N/R								
Magelis XBT RT								
Modicon M340	(2)	(2)	(2)	(2)	(2)	(2)		
Modicon Momentum								
Modicon Premium (3)								
Modicon Quantum	(2)	(2)	(2)	(2)	(2)	(2)	(2)	
Modicon TSX Micro								
Phaseo								
Twido			(4)	(4)	(4)			

(1) Also covers US Navy requirements ABS-NRV part 4.

(2) Depends on product; please visit our website: [www.schneider-electric.com](http://www.schneider-electric.com).

(3) Modicon Premium, also certified by KRS (Korean Register of Shipping).

(4) Except for: Compact bases TWD LC●●40DRF, Extreme base TWD LEDCK1, communication modules 499 TWD 01100, TWD NCO1M and TWD NOI 10M3 and tap junctions TWD XCA ISO/T3RJ.

Certifications pending for I/O extension modules (discrete TM2 D and analogue TM2 A).

5

#### EC regulations

##### European Directives

The open nature of the European markets assumes harmonization between the regulations set by different European Union member states.

European Directives are texts whose aim is to remove restrictions on free circulation of goods and which must be applied within all European Union states.

Member states are obligated to incorporate each Directive into their national legislation, while at the same time withdrawing any regulation that contradicts it.

Directives - and particularly those of a technical nature with which we are concerned - merely set out the objectives to be fulfilled (referred to as "essential requirements").

The manufacturer is obligated to implement any and all measures to ensure that its products meet the requirements of each Directive that applies to its equipment.

As a general rule, the manufacturer certifies compliance with essential requirements of the Directive(s) that apply to its product by applying a CE mark. The CE mark has been applied to our products where applicable.

##### Significance of the CE mark

- The appearance of a CE mark on a product indicates the manufacturer's certification that the product conforms to the relevant European Directives; this is a prerequisite for placing a product which is subject to the requirements of one or more Directives on the market and for allowing its free circulation within European Union states.
- The CE mark is intended for use by those responsible for regulating national markets.

Where electrical equipment is concerned, conformity to standards indicates that the product is fit for use. Only a warranty by a well-known manufacturer can provide assurance of a high level of quality.

As far as our products are concerned, one or more Directives are likely to apply in each case; in particular:

- The Low Voltage Directive (2006/95/EC)
- The Electromagnetic Compatibility Directive (2004/108/EC)
- The ATEX CE Directive (94/9/EC)

# Product reference index

490 NTW00002	1/73	HMI YPO7MKIT	3/9	MPC YK2 2RA1024	3/26	TM2 AMI2LT	2/17	VJD FNDTGSV51M	4/17
490 NTW00005	1/73	HMI YPOACPS	3/9	MPC YK20MNTKIT	1/67	TM2 AMI4LT	2/17	VJD GNDTGSV51M	4/17
490 NTW00012	1/73	HMI YPSC42E01	1/67		3/16	TM2 AMI8HT	2/17	VJD SNTDGSV51M	4/17
490 NTW00040	1/73	HMI YPSC42E01	3/16		3/26	TM2 AMM3HT	2/17	VJD SNTDMSV13M	4/17
490 NTW00080	1/73	HMI ZS50	1/13	MPC YK20SPSKIT	1/67	TM2 AMM6HT	2/17	VJD SUDTGAV51M	4/17
990 NAA26320	1/70	HMI ZS60	1/13		3/16	TM2 AMO1HT	2/17	VJD SUDTMSV13M	4/7
	1/79	HMI ZS61	1/13		3/51	TM2 ARI8HT	2/17	VJD TNDTGSV51M	4/17
<b>A</b>		HMI ZSCLP1	1/13	MPC YK22RA1024	3/16	TM2 ARI8LRJ	2/17	VW3 A8306	1/73
ABE 7BV20	2/22	HMI ZSCLP3	1/13	MPC YK50MNTKIT	1/67	TM2 ARI8LT	2/17	VW3 A8306D30	1/72
ABE 7BV20TB	2/22	HMI ZSPWO	1/28		3/16	TM2 AVO2HT	2/17	VW3 A8306R30	1/70
ABE 7FU012	2/22	HMI ZSUKIT	1/13	MPC YK50SPSKIT	1/67	TM2 DAI8DT	2/16		1/73
ABE 7FU030	2/22	HMI ZSUSBB	1/28		3/16	TM2 DDI16DK	2/16		1/79
ABE 7FU100	2/22	HMI ZURS	1/28		3/26	TM2 DDI16DT	2/16	VW3 A8306TF10	1/73
ABE 7FU200	2/22	<b>M</b>			3/51	TM2 DDI32DK	2/16	VW3 CANA71	2/35
ABE 7B20MPN20	2/22	MPC FN02NAX00N	3/47	MPC YK90MNTKIT	3/61	TM2 DDI8DT	2/16	VW3 CANCEARR03	2/35
ABE 7B20MPN22	2/22	MPC FN02NDX00N	3/47	MPC YK90SPSKIT	3/51	TM2 DDO16TK	2/16	VW3 CANCEARR1	2/35
ABE 7B20MRM20	2/22	MPC FN05MAX00N	3/47		3/61	TM2 DDO16UK	2/16	VW3 CANKCDF180T	2/35
ABE 7E16EPN20	2/22	MPC FN05MAX00V	3/47	MPC YN00CDW30N	3/50	TM2 DDO32TK	2/16	VW3 CANTAP2	2/34
ABE 7E16SPN20	2/22	MPC FN05NAX00N	3/47	MPC YN00CF100N	1/67	TM2 DDO32UK	2/16	VW3 M3805R010	2/35
ABE 7E16SPN22	2/22	MPC FN05NDX00N	3/47		3/16	TM2 DDO8TT	2/16	<b>X</b>	
ABE 7E16SRM20	2/22	MPC HN02NAX00N	3/48	MPC YN00CF200N	1/67	TM2 DDO8UT	2/16	XBL YR00	1/23
ABF C20R200	2/23	MPC HN05MAX00N	3/48		3/16	TM2 DMM24DRF	2/16	XBL YGK2	1/68
ABF T20E050	2/22	MPC HN05MAX00V	3/48	MPC YN00CF400N	1/67	TM2 DMM8DRT	2/16	XBL YGK5	1/68
ABF T20E100	2/22	MPC HN05NAX00N	3/48		3/16	TM2 DRA16RT	2/16	XBL YN00	1/21
ABF T20E200	2/22	MPC HN05NBX00N	3/48	MPC YN00CFE00N	1/67	TM2 DRA8RT	2/16	XBL YN01	1/21
ABL 7RM2401	1/73	MPC HN05NDX00N	3/48		3/16	TM2 XMTGB	2/17	XBL YR01	1/23
ABL 7RM24025	1/73	MPC KN02NAX00N	3/46	MPC YN00FFPR1N	3/50	TSX CANCA100	2/34	XBL YRT00	1/27
AM0 2CA001V000	2/35	MPC KT12NAX00N	3/25	MPC YN00FFPR2N	3/50	TSX CANCA300	2/34	XBL YRT01	1/27
<b>B</b>		MPC KT22MAX20N	3/25	MPC YN00FFPR3N	3/50	TSX CANCA50	2/34	XBT GC1100T	2/14
BMX XCAUSBH018	1/28	MPC KT22NAX20N	3/25	MPC YN00FSE00N	3/50	TSX CANCEA00	2/34	XBT GC1100U	2/14
	1/70	MPC KT55MAX20L	3/25	MPC YN00HDS30N	3/50	TSX CANCEADD03	2/34	XBT GC2120T	2/14
BMX XCAUSBH045	1/70	MPC KT55MAX20N	3/25	MPC YN00MKT00N	3/50	TSX CANCEADD1	2/34	XBT GC2120U	2/14
<b>F</b>		MPC KT55MAX20V	3/25	MPC YN00MSD00N	3/50	TSX CANCEADD3	2/34	XBT GC2230T	2/14
FTX CN12F5	2/34	MPC KT55NAX20V	3/25	MPC YN00PWACTE	3/16	TSX CANCEADD5	2/34	XBT GC2230U	2/14
FTX CN12M5	2/34	MPC KT55NAX20N	3/25		3/26	TSX CANCEB100	2/34	XBT GK2120	2/33
FTX CN3203	2/35	MPC KT55NDX20N	3/25	MPC YN00RAID0N	3/50	TSX CANCEB300	2/34	XBT GK2330	1/65
FTX CN3206	2/35	MPC NA20NNN00N	3/50	MPC YN52CF220T	1/67	TSX CANCEB50	2/34		2/33
FTX CN3210	2/35	MPC NA50NNN00N	3/50	MPC YN52CF220T	3/16	TSX CANCEBDD03	2/34	XBT GK5330	1/65
FTX CN3220	2/35	MPC NA50NNN10N	3/50	MPC YNK2MSD20N	3/26	TSX CANCEBDD1	2/34		2/33
FTX CN3230	2/35	MPC NB20NNN00N	3/50	MPC YNK2SHD20N	3/26	TSX CANCEBDD3	2/34	XBT GT1105	1/64
FTX CN3250	2/35	MPC NB50NAN00N	3/49	MPC YT50NAN00N	3/61	TSX CANCEBDD5	2/34	XBT GT1135	1/64
FTX CNCT1	2/35		3/61	MPC YT90NAN00N	3/61	TSX CANCD100	2/34	XBT GT1335	1/64
FTX CNTL12	2/35	MPC NB50NNN00N	3/50	MPC YT90NNN00N	3/49	TSX CANCD300	2/34	XBT GT2110	1/64
FTX DP2115	2/35	MPC NB50NNN10N	3/50	MPC YT90NNN00N	3/49	TSX CANCD50	2/34		2/32
FTX DP2130	2/35	MPC NT20NNN00N	3/50	MPC ST11NAJ00T	3/15	TSX CANKCDF180T	2/34	XBT GT2120	1/64
FTX DP2150	2/35	MPC NT50NNN00N	3/50	MPC ST11NDJ 00T	3/15	TSX CANKCDF90T	2/34		2/32
FTX DP2206	2/35	MPC NT50NNN10N	3/50	MPC ST21NAJ20T	3/15	TSX CANKCDF90TP	2/34	XBT GT2130	1/64
FTX DP2210	2/35	MPC PSC42E01	3/45	MSD CHNSFUS0V20	2/39	TSX CANTDM4	2/34		2/32
FTX DP2220	2/35	MPC SN01NAJ00T	3/45	MSD CHNSFUV20	2/39	TSX CUSBFIP	1/73	XBT GT2220	1/64
FTX DP2250	2/35	MPC SN01NDJ00T	3/45	<b>S</b>		TSX CUSBMBP	1/73		2/32
<b>H</b>		MPC ST21NDJ20T	3/15	SR2 CBL08	1/29	TSX PCX1031	1/79	XBT GT2330	1/64
HMI GTW7353	1/66	MPC YB20NNN00N	3/49	STB XCA4002	1/70	TSX CUSB485	1/28		2/32
HMI POC4AE00	3/9		3/50		1/79	TSX PCX1031	1/70	XBT GT2430	1/64
HMI POC7AE00	3/9	MPC YB50NNN00N	3/50	<b>T</b>		TWD XMT5	2/17		2/32
HMI PSC7AE03	3/15	MPC YFRAM0512N	3/50	TCS CCN4F3M05T	2/35	TWD FCN2K20	2/23	XBT GT2930	1/64
HMI PSC7DE03	3/15	MPC YFRAM1024N	3/50	TCS CCN4F3M1T	2/35	TWD FCN2K26	2/23		2/32
HMI PSF7AP03	3/15	MPC YFRAM2048N	3/50	TCS CCN4F3M3T	2/35	TWD FCW30K	2/23	XBT GT4230	1/64
HMI PSF7APF3	3/15	MPC YK05RAM 512	3/16	TCS CTN011M11F	2/35	TWD FCW50K	2/23		2/32
HMI PSF7APL3	3/15		3/26	TLA CDCBA005	2/35	TWD FTB2T10	2/23	XBT GT4330	1/64
HMI PSF7DP03	3/15	MPC YK10MNTKIT	1/67	TLA CDCBA015	2/35	TWD FTB2T11	2/23		2/32
HMI STO511	1/12		3/16	TLA CDCBA030	2/35	<b>V</b>		XBT GT4340	1/64
HMI STO512	1/12		3/26	TLA CDCBA050	2/35	VJD SNRTMPC	3/26		2/32
HMI STU655	1/12	MPC YK10SPSKIT	1/67	TM2 ALM3LT	2/17		4/17	XBT GT5230	1/64
HMI YPO4MKIT	3/9		3/51	TM2 AMI2HT	2/17	VJD SNTRCKV51M	4/17		2/32
								XBT GT5330	1/64
									2/32
								XBT GT5340	1/64
									2/32



# Product reference index

XBT GT5430	1/64 2/32	XBT Z9710	1/24 1/29 1/70 1/79	XBT ZG66	1/67	XBT ZGFIX	1/68 2/15
XBT GT6330	1/64 2/32			XBT ZG68	1/67	XBT ZGHL10	1/65
XBT GT6340	1/64 2/32	XBT Z9711	1/29 1/70 1/79	XBT ZG69	1/67	XBT ZGHL3	1/65
XBT GT7340	1/64 2/32	XBT Z9715	1/30 1/70	XBT ZG909	1/69 1/79	XBT ZGHSTP	1/68
XBT GTW450	1/66	XBT Z9720	1/25 1/30	XBT ZG915	1/80	XBT ZGI232	1/69
XBT GTW652	1/66	XBT Z9721	1/25	XBT ZG919	1/69	XBT ZGI485	1/69
XBT N200	1/21	XBT Z9730	1/72	XBT ZG925	1/80	XBT ZGJBOX	1/65
XBT N400	1/21	XBT Z9731	1/25 1/30 1/72	XBT ZG929	1/81	XBT ZGM128	1/67
XBT N401	1/21	XBT Z9732	1/25 1/30 1/72	XBT ZG9292	1/72 1/81	XBT ZGM256	1/67
XBT N410	1/21	XBT Z9733	1/30 1/72	XBT ZG935	1/28 1/69 1/80 2/15	XBT ZGNSTP	1/67
XBT NU400	1/21	XBT Z9734	1/30 1/72	XBT ZG939	1/69	XBT ZGPDP	1/73
XBT R400	1/23	XBT Z9740	1/25 1/30 1/71 1/81	XBT ZG949	1/72	XBT ZGPWS1	1/28 1/68 2/15
XBT R410	1/23	XBT Z9743	1/30 1/71	XBT ZG9721	1/30 1/72 1/81	XBT ZGPWS2	1/68
XBT R411	1/23	XBT Z9780	1/29 1/31 1/70 1/79	XBT ZG9722	1/72	XBT ZGUMP	1/73
XBT RT500	1/27	XBT Z9782	1/29 1/70	XBT ZG973	1/80 1/81	XBT ZGUSB	1/28 1/68 2/15
XBT RT511	1/27	XBT Z9788	1/24 1/29 1/70	XBT ZG9731	1/71 1/72 1/80 1/81	XBT ZGUSBB	2/15
XBT YGH2	1/68	XBT Z9980	1/29 1/30 1/31 1/70	XBT ZG9740	1/71 1/81	XBT ZGWMKT	1/67
XBT Z3002	1/28 1/67	XBT Z982	1/29 1/70	XBT ZG9770	1/80	XBT ZN01	1/21
XBT Z3004	1/28	XBT Z988	1/24 1/29 1/70	XBT ZG9771	1/80	XBT ZN02	1/21
XBT Z9008	1/70 1/73	XBT Z9982	1/29 1/70	XBT ZG9772	1/71 1/80	XBT ZN999	1/21
XBT Z9018	1/70 1/73	XBT ZG43	1/68	XBT ZG9773	1/71	XBT ZR01	1/23 1/27
XBT Z908	1/25 1/31 1/73	XBT ZG45	1/68	XBT ZG9774	1/71	XBT ZR02	1/23 1/27
XBT Z909	1/79	XBT ZG45B	1/68	XBT ZG9775	1/71 1/80	XBT ZNCO	1/21
XBT Z915	1/24 1/28 1/69 1/80	XBT ZG46	1/68	XBT ZG9777	1/80	XBT ZRCO	1/23 1/27
XBT Z918	1/24 1/29 1/70 1/79	XBT ZG47	1/68	XBT ZG9778	1/71 1/80	XBT ZRT999	1/27 1/28
XBT Z925	1/28 1/80	XBT ZG51	1/68 2/15	XBT ZG979	1/71 1/80	XBT ZRTPW	1/28
XBT Z926	1/24 1/28	XBT ZG52	1/68 2/15	XBT ZG989	1/80 1/81	XBT GH2460	1/65
XBT Z935	1/80	XBT ZG54	1/68	XBT ZGABE1	2/22	XBT GK2120	1/65
XBT Z938	1/24 1/25 1/29 1/30 1/31 1/70 1/79	XBT ZG55	1/68	XBT ZGABE2	2/22	XBT ZGPEN	1/68
XBT Z945	1/28	XBT ZG56	1/68	XBT ZGADT	1/68 3/16	<b>Z</b>	
XBT Z968	1/24 1/25 1/29 1/29 1/31 1/70 1/79	XBT ZG57	1/68	XBT ZGAUX	1/68	ZB5 AZ901	1/13
XBT Z9680	1/24 1/29	XBT ZG58	1/68	XBT ZGCCAN	2/15	ZB5 AZ905	1/13
XBT Z9681	1/24 1/25 1/29 1/31 1/70 1/79	XBT ZG59	1/68	XBT ZGCHOK	2/15		
XBT Z9686	1/31	XBT ZG5H	1/68	XBT ZGCLP1	1/68		
XBT Z9687	1/31	XBT ZG60	1/67 2/15	XBT ZGCLP2	1/68 2/15		
XBT Z9688	1/31	XBT ZG61	1/67	XBT ZGCLP3	1/68		
		XBT ZG62	1/67 2/15	XBT ZGCLP4	2/15		
		XBT ZG64	1/67	XBT ZGCNC	1/68		
		XBT ZG65	1/67	XBT ZGCO1	1/68		
				XBT ZGCO2	1/68		
				XBT ZGCO3	1/68		
				XBT ZGCO4	1/68		
				XBT ZGCOM1	1/80		
				XBT ZGDIO1	2/15		
				XBT ZGDIO2	2/15		
				XBT ZGDVN	1/73		
				XBT ZGESD	1/68		
				XBT ZGESGD	1/67		

**Schneider Electric Industries SAS**

[www.schneider-electric.com](http://www.schneider-electric.com)

Head Office  
35, rue Joseph Monier  
F-92500 Rueil-Malmaison  
France

The information provided in this documentation contains general descriptions and/or technical characteristics of the performance of the products contained herein. This documentation is not intended as a substitute for and is not to be used for determining suitability or reliability of these products for specific user applications. It is the duty of any such user or integrator to perform the appropriate and complete risk analysis, evaluation and testing of the products with respect to the relevant specific application or use thereof. Neither Schneider Electric nor any of its affiliates or subsidiaries shall be responsible or liable for misuse of the information contained herein.

Design: Schneider Electric  
Photos: Schneider Electric  
Printed by: