

# Modicon Quantum automation platform

Catalogue

2008/2009



**Schneider**  
Electric



# A full range of catalogues for . . . . .



## Detection



**Global Detection  
Electronic and  
electromechanical sensors**  
n° 960262  
MKTED208052EN

Photo-electric sensors  
Proximity sensors  
Capacitive proximity sensors  
Ultrasonic sensors  
Limit switches  
Pressure switches  
Rotary encoders  
Radio frequency identification  
Machine cabling accessories

## Automation



**Modicon Momentum  
distributed I/O and control**  
n° 807861  
MKTED205061EN



**Modicon Quantum  
automation platform, Unity,  
Concept & ProWORX 32**  
n° 960237  
MKTED208011EN



**Modicon Premium and  
Unity - PL7 software**  
n° 960268  
MKTED208054EN



**Modicon M340 and  
Unity software**  
n° 960128  
DIAED2061001EN

PLCs  
Discrete, analogue I/O and  
application-specific solutions  
Communication

## Automation



**Twido programmable  
controller and TwidoSuite  
software**  
n° 960211  
DIA3ED2070902EN

Controller base  
Discrete, analogue I/O  
Communication



**Automation functions,  
relays, interfaces and  
power supplies**  
n° 960162  
MKTED207031EN

Smart relays  
Timing relays  
Measurement & control relays  
Analogue interfaces  
Counters  
Plug-in relays  
Interfaces for discrete signals  
Power supplies & transformers

**Software**  
PLCs and safety controllers  
programming software

## Operator dialog



**Control and signalling  
components**  
n° 960239  
MKTED208031EN

Control and signalling units  
Control stations & enclosures  
Cam switches  
Beacons and indicator banks  
Pendant control stations  
Controllers  
Emergency stops  
Foot switches



**Human-Machine interfaces**  
n° 821230  
MKTED206071EN

Operator interface terminals  
Industrial PCs  
HMI and SCADA PC-based  
software

**Software**  
Vijeo Designer  
Operator terminal software

## Motion and Drives



**Motion control Lexium 05**  
n° 808610  
DIA7ED2050910EN



**Motion control Lexium 15**  
n° 816811  
DIA2ED2060506EN



**Lexium Controller motion  
controllers**  
n° 960165  
DIA7ED2070410EN

Servo drives and Servo motors  
Motion controllers  
Motion control modules  
Modicon Premium and Modicon  
Quantum



**Soft starters and variable  
speed drives**  
n° 960142  
MKTED206111EN

Soft starters and variable speed  
drives

**Software**  
Software for drives and motors  
Motor control programming  
software

# ... all Automation & Control functions



## Motor control



**Motor starter solutions**  
**Control and protection components**  
 n° 814711  
 MKTED205103EN

Contactors  
 Circuit-breakers, fuse carriers  
 Thermal relays  
 Combinations, motor controllers  
 Mounting solutions  
 Motor starter mounting kits

## Machine safety

*This catalogue contains Automation and Control function products relating to machines*  
**Safety**



**Safety functions and solutions using Preventa**  
 n° 960260  
 MKTED208051EN

Safety PLCs  
 Safety controllers  
 Safety monitors  
 Safety solutions on AS-Interface cabling system  
 Safety switches  
 Safety light curtains  
 Safety mats  
 Emergency stops  
 Control stations  
 Enabling switches  
 Foot switches  
 Beacons & indicator banks  
 Switch disconnectors  
 Thermal-magnetic motor circuit breakers  
 Enclosed D.O.L. starters

**Software**  
 XPSMFWIN configuration software  
 XPSMCWIN configuration software

## Interfaces and I/O



**Interfaces, I/O splitter boxes and power supplies**  
 n° 70263  
 MKTED203113EN

Discrete interfaces  
 Pre-wired interfaces  
 IP 67 Splitter boxes



**Terminal blocks**  
 n° 960151  
 MKTED207011EN

Terminal blocks  
 Cable ends



**IP 20 distributed inputs/outputs Advantys STB**  
 n° 960266  
 MKTED208053EN

Modules for automation island  
 Network interfaces  
 Power distribution  
 Digital I/O, analogs and application-specific

**Software**  
 STB configuration software

## Power supplies



**Power supplies and transformers Phaseo**  
 n° 822591  
 DIA3ED2061209EN

Switch mode power supplies  
 Filtered rectified power supplies  
 Transformers

## Systems & architectures

*This catalogue contains Automation and Control function products relating to Communication*



**Machine & Installations with industrial communication**  
 n° 960153  
 MKTED207012EN

Preferred implementations  
 Ethernet TCP/IP, the universal communication standard  
 CANopen for machines and installations  
 AS-interface, simple and safe

### Products

Human-Machine interface  
 Controllers and PLCs  
 Field devices  
 Infrastructure and wiring  
 Gateways

### Software and tools

Collaborative Automation  
 Partner Program & Partners



---

	Welcome to the world of Schneider Electric . . . . .	0/4
<b>1</b>	<b>– Quantum safety CPUs</b>	
	1.1 - Safety PLCs .....	1/2
	1.2 - Safety architectures .....	1/10
	<i>Selection guide</i> .....	1/20
	1.3 - Safety CPUs .....	1/22
	<i>Selection guide</i> .....	1/28
	1.4 - Safety I/O modules .....	1/30
	<i>Selection guide</i> .....	1/44
	1.5 - Non-interfering modules .....	1/46
<b>2</b>	<b>– Standard Quantum CPUs</b>	
	<i>Selection guide</i> .....	2/2
	2.1 - Unity CPUs .....	2/4
	<i>Selection guide</i> .....	2/14
	2.2 - Concept/ProWORX CPUs .....	2/16
<b>3</b>	<b>– I/O architectures, Hot Standby architectures, racks and power supplies</b>	
	3.1 - I/O architectures .....	3/2
	3.2 - Hot Standby architectures .....	3/14
	Unity redundancy .....	3/14
	Concept/ProWORX redundancy .....	3/26
	3.3 - Racks .....	3/30
	<i>Selection guide</i> .....	3/32
	3.4 - Power supply modules .....	3/34
<b>4</b>	<b>– Analog and I/O modules</b>	
	<i>Selection guide</i> .....	4/2
	4.1 - Discrete I/O .....	4/12
	<i>Selection guide</i> .....	4/44
	4.2 - Analog I/O .....	4/46
	<i>Selection guide</i> .....	4/62
	4.3 - IP 20 dust- and damp-proof distributed I/O .....	4/64
	4.4 - Specialized I/O .....	4/66
<b>5</b>	<b>– Application-specific modules and solutions</b>	
	<i>Selection guide</i> .....	5/2
	5.1 - Intrinsically safe modules .....	5/4
	<i>Selection guide</i> .....	5/16
	5.2 - Application-specific modules .....	5/18
<b>6</b>	<b>– Communication</b>	
	<i>Selection guide</i> .....	6/4
	6.1 - Transparent Ready Ethernet TCP/IP architecture .....	6/6
	6.2 - EtherNet/IP network module .....	6/62
	6.3 - AS-Interface bus .....	6/64
	6.4 - Other buses and networks .....	6/70
	6.5 - Serial links .....	6/82

---

<b>7</b>	<b>– Development and runtime software</b>	
	<i>Selection guide</i>	7/2
	7.1 - Unity software	7/6
	<i>Selection guide</i>	7/54
	7.2 - Concept software	7/56
	7.3 - ProWORX software	7/66
<b>8</b>	<b>– HMI and Supervision</b>	
	<i>Selection guide</i>	8/2
	8.1 - Magelis compact display units and terminals	8/2
	<i>Selection guide</i>	8/4
	8.2 - Magelis Graphic terminals	8/4
	<i>Selection guide</i>	8/6
	8.3 - Magelis iPC industrial PCs	8/6
	<i>Selection guide</i>	8/10
	8.4 - HMI software	8/10
	8.5 - OPC data server software	8/12
	8.6 - Vijeo Citect supervisory software	8/18
	8.7 - Tego Dial	8/28
	8.8 - Tego Dial installation assistance	8/30
<b>9</b>	<b>– I/O and process power supply prewired systems</b>	
	<i>Selection guide</i>	9/2
	9.1 - Telefast 2 I/O prewired system	9/8
	<i>Selection guide</i>	9/20
	<i>Selection guide</i>	9/22
	9.2 - Phaseo DC process power supplies	9/24
<b>10</b>	<b>– Appendices and services</b>	
	10.1 - Technical appendices	10/2
	10.2 - Modules with “Conformal Coating” for severe environments	10/6
	10.3 - Certifications	10/16
	10.4 - Index	10/18



# Modicon Quantum automation platform

To the world of Schneider Electric



## Presentation

This catalogue presents the range of Modicon Quantum PLCs, with new CPUs and new I/O modules, which extend the field of applications in the range to safety functions in industrial applications.

With an already wide choice of I/O modules, and an already extensive offer in terms of communication on fieldbuses and networks, Modicon Quantum is even better suited to the needs of continuous or semi-continuous industrial processes, and control of large infrastructure sites.

Capitalizing as it does on more than 25 years' experience in redundant processing architectures, and perfectly satisfying safety requirements for people, production installations, and their environment, Modicon Quantum is the ideal solution for applications requiring maximum availability, in complete safety.

The Modicon Quantum offer is, de facto, inherently designed for critical applications in the areas below:

- Petrochemicals
- Metallurgy
- Cement
- Energy
- Tunnels
- Airports
- Water treatment

Its vocation is reaffirmed in this catalogue with in particular, alongside the development of the "safety" section:

- The introduction of the "standard" CPU, the **140 CPU 652 60** with an internal memory expanded to 3 Mb so that it can host Unity Pro applications with greater flexibility and reduce installation constraints, see page 2/10.
- Simplified Hot Standby architectures on Ethernet TCP/IP network, page 3/16, or with the **PTQ-PDPMV1** communication module from our partner Prosoft Technology, page 3/22.
- An EtherNet/IP network module conforming to the ODVA standard: the **140 NOC 771 00** module, page 6/62.
- For installations in harsh environments, an offer of racks, CPUs and I/O modules with "*Conformal coating*", see page 10/6.



## 1.1 - Safety PLCs

- Safety PLCs ..... 1/2
- Presentation ..... 1/2

## 1.2 - Safety architectures

- Safety architectures ..... 1/10
- Presentation ..... 1/10
- Collaborative architecture ..... 1/13
- Hot Standby safety architectures ..... 1/16
- References ..... 1/17

## 1.3 - Safety CPUs

### *Safety CPU selection guide..... 1/20*

- Safety CPUs ..... 1/22
- Description ..... 1/22
- Characteristics ..... 1/26
- References ..... 1/27

## 1.4 - Safety I/O modules

### *Safety I/O module selection guide..... 1/28*

- Safety discrete I/O modules ..... 1/30
- Presentation ..... 1/31
- Description ..... 1/37
- Characteristics ..... 1/38
- DC input module ..... 1/38
- DC output module ..... 1/39
- Safety analog input module ..... 1/40
- References ..... 1/41
- Connections for safety I/O modules ..... 1/42
- Safety discrete I/O modules ..... 1/42
- Safety analog input module ..... 1/43

## 1.5 - Non-interfering modules

### *Non-interfering module selection guide ..... 1/44*

- Non-interfering modules ..... 1/46
- References ..... 1/46

# Modicon Quantum automation platform Safety PLCs

1



For more detailed information about the installation, use, and maintenance of a system in accordance with the requirements of standard IEC 61508, refer to the "Quantum Safety PLC, Safety Reference Manual", 11/2007, reference 33003879.00, which has been approved by TÜV Rheinland and is available on our website [www.schneider-electric.com](http://www.schneider-electric.com).

## Presentation

Because of the potential for serious human, financial and environmental consequences of an industrial accident, safety is becoming an increasingly important factor for companies. It is not only a question of protecting employees and local residents but also of protecting production tools and the environment, and all within the terms of the applicable legislation. New safety challenges are being added to the more traditional industrial challenges of reducing operating costs and optimizing production costs.

In response to these new demands, Schneider Electric has developed a safety PLC offer based on the Modicon Quantum range. This Quantum Safety PLC offer has been certified by TÜV Rheinland Group according to IEC 61508 for use in applications requiring a level of safety up to and including SIL2.

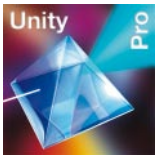

Integration of certified safety functions and Hot Standby mode in a single configurable PLC platform, which can all be programmed using a common tool, makes the Quantum Safety PLC offer unique on today's automation market.

This new offer can be used to create simple, standard safety architectures with:

- In-depth internal diagnostics at I/O management level
- Type 1oo2 CPU internal architecture
- No external voting function or additional hardware components required to guarantee the safety level

Since the safety part is integrated in the PLC itself, the I/O wiring is the same as that of standard PLCs.

The safety architectures are identical to standard Modicon Quantum architectures. They use:

- Standard remote I/O system
- CRP/CRA RIO drops providing wiring redundancy between the remote racks and the main rack
- A standard wiring system
- Standard Quantum backplanes
- A standard redundant power supply
- A Hot Standby architecture similar to that of the standard Quantum Hot Standby, which is very easy to wire and requires no special software development

## Target applications

SIL2 certified Quantum Safety Unity CPUs are the ideal solution for industrial control processes.

They have been certified for use in the following applications in particular:

- *Emergency Shut Down* (ESD) systems.
- Gas burner control systems
- *Fire and Gas* applications, fire alarm and detection system
- Safety machines

## Process safety: General

### Safety system

A system is considered to be functionally "safe" if the causes of random or systematic failures do not lead to malfunctioning of the system and do not result in injury or death, loss of equipment or pollution of the environment.

### Safety Instrumented System (SIS)

A Safety Instrumented System is an independent system of sensors, logic controllers (SIL2 certified Quantum PLCs for example) and actuators designed to place the process in a safe state if the predefined conditions for safe operation are violated.

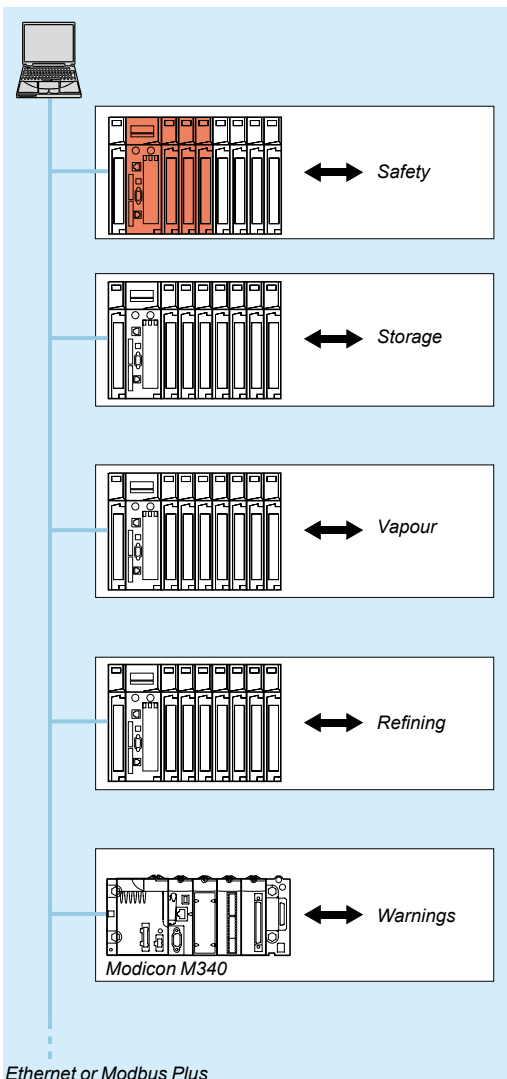

Ethernet or Modbus Plus

The same programming software and communication and system hardware components apply to both the safety and the automation functions.

### Process safety: General (continued)

#### Safety Integrity Level (SIL)

Safety Integrity Level (SIL) has become a synonym for functional safety. SIL defines the level of performance or reliability of an electrical or electronic system in terms of its safety. Hence, the SIL is an indicator of a system's capability of performing safety-related tasks.

#### Safety standards (IEC 61508 and IEC 61511)

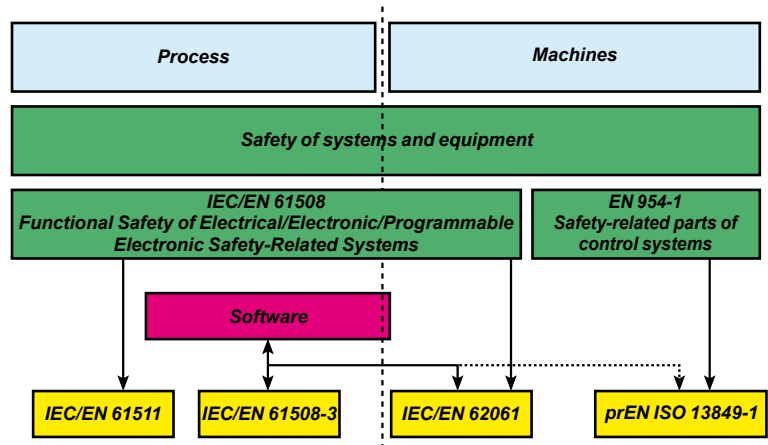

Standard 61508 “Functional Safety of Electrical/Electronic/Programmable Electronic Safety-Related Systems” was published in 1998 and validated in 2002. This new safety standard was the first to define safety requirements for control systems independently of the application. IEC 61508 is a technical standard covering the functional safety of electrical or electronic equipment. A system is said to be safe if it performs one or more specific functions in such a way as to keep any risks to an acceptable minimum. Such functions are defined as being safety functions.

IEC 61508 contains general requirements for minimizing the following risks:

- Incorrect specifications of the system, hardware or software
- Omissions in the specifications
- Random failures of hardware
- Systematic failures of hardware and software
- Common cause failures
- Environmental influences (e.g. electromagnetic, temperature, etc.)
- Supply system voltage disturbances

While IEC 61508 is primarily intended for manufacturers of components for protecting equipment and products, standard IEC 61511, Functional Safety – Technical Safety Systems for the Process Industry, is aimed at users and designers of safety equipment.

IEC 61511 provides recommendations and is meant to help assess the risk of damage to installations as well as facilitate the selection of safety components.

IEC 61511 is specific to industrial processes:

- It is widely applied to safety instrumented systems.
- It is aimed primarily at system designers, integrators and users of safety systems or equipment.

#### TÜV Rheinland

TÜV is a group of companies specializing in authorizing IEC 61508 certification. One of these companies, TÜV Rheinland (Germany), is a world-renowned leader in safety-related systems. Recognized as one of the world's best certification agencies, TÜV Rheinland has the backing of both insurance companies and governments.





## Certifications and standards

The Modicon Quantum Safety PLC offer has been certified by TÜV Rheinland for use in applications requiring a level of safety up to and including SIL2.

This certification means that Modicon Quantum Safety PLCs conform to the following standards:

- IEC 61508: Functional safety of electrical/electronic/programmable electronic safety-related control systems, Part 1-7, first edition, January 2003
- IEC 61131: PLCs: Part 2: Equipment requirements and tests: second edition, February 2003
- Protection of boilers:
  - European standards: EN 50156
  - USA standards: NFPA 85 and NFPA 86
- EN 54-2: Fire detection and fire alarm systems
- EN 298: Automatic gas burner control systems (with or without fans)
- Safety of machinery: IEC 62061 and EN ISO 13849

Modicon Quantum Safety PLCs also meet the requirements of the following certifications:

- UL
- CSA
- CE
- Hazardous Locations

## Training

With more than 30 years' experience in control and supervision of critical processes, Schneider Electric offers you its most experienced safety experts through its support and consulting services.

In collaboration with your teams, they estimate the risk, determine reasonably foreseeable parameters for it and, if a safety system needs to be installed, specify the required SIL. They can also take responsibility for designing the architecture and specifying the associated safety functions. Finally, they will be able to guide you through the process of getting the system and the application certified.

- Functional safety training
- Risk and hazard analysis
- Definition of safety functions and required SIL
- Design of safety system architecture and specification of safety functions
- Assessment of level of intrinsic safety
- Technical support for development
- Control of the safety system recipe
- Assistance with application startup
- Assistance with preventive maintenance

### Safety CPUs and modules

The offer introduces five new references - two CPUs and three I/O modules - and also uses power supply module 140 CPS 124 20. These products are certified for use in safety applications up to and including SIL2:

Safety CPU	<b>140 CPU 651 60S</b>
Hot Standby safety CPU	<b>140 CPU 671 60S</b>
Safety discrete inputs	<b>140 SDI 953 00S</b>
Safety discrete outputs	<b>140 SDO 953 00S</b>
Safety analog inputs	<b>140 SAI 940 00S</b>
Power supply	<b>140 CPS 124 20 (1)</b>

(1) Product version (PV) = 3 (minimum).

### Description of the safety loop

The safety loop into which the Quantum Safety PLC is integrated consists of the following 3 parts:

- The sensors
- The Quantum Safety PLC
- The actuators

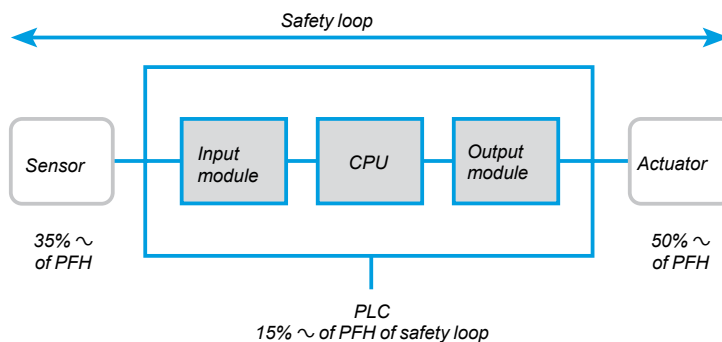

### Probability of failure PFD, PFH

As far as SIL2 applications are concerned, standard IEC 61508 defines the probability of failure on demand (PFD) or the probability of failure per hour (PFH), depending on the system's mode of operation.

$10^{-3} \leq PFD < 10^{-2}$  in a low-demand mode of operation.  
 $10^{-7} \leq PFH < 10^{-6}$  in a high-demand mode of operation.

The Quantum Safety PLC has been certified for use with both low and high-demand systems.

In terms of calculating the PFD/PFH values for a typical system, the maximum permissible value for the PLC is 15%. The PFD/PFH values for the Quantum Safety modules are listed in the table below for PTI values (see below) of 5 and 10 years:

	Reference	PTI = 5 years		PTI = 10 years	
		PFD (%)	PFH (%)	PFD (%)	PFH (%)
Safety CPU	<b>140 CPU 651 60S</b>	0.6	0.6	1.1	0.6
Hot Standby safety CPU	<b>140 CPU 671 60S</b>	0.6	0.6	1.1	0.6
Safety discrete inputs	<b>140 SDI 953 00S</b>	0.1	0.2	0.2	0.2
Safety discrete outputs	<b>140 SDO 953 00S</b>	0.1	0.2	0.2	0.2
Safety analog inputs	<b>140 SAI 940 00S</b>	0.1	0.2	0.2	0.2
Power supply	<b>140 CPS 124 20</b>	–	–	–	–

1

**PTI**

Qualification testing is a process carried out at regular intervals that is designed to determine whether the system needs to be overhauled in its entirety or only partially. The PTI (*Proof Test Interval*) is the time interval between two qualification tests.

**Example 1: Safety loop**

With:

- 1 discrete input module
- 1 discrete output module
- 1 independent CPU

**The Quantum Safety PLC** is involved in the safety loop to the following extent:  
 $0.2 + 1.1 + 0.2 = 1.5\%$ .

The sensors and actuators account for 98.5%.

**Example 2: Redundant safety loop**

With 2 sensors:

- 2 redundant analog input modules
- 2 redundant discrete output modules
- 2 high-availability CPUs (Hot Standby)

**The Quantum Safety PLC** is involved in the safety loop to the following extent:  
 $0.2 + 1.1 + 0.2 = 1.5\%$ .

The sensors and actuators account for 98.5%.

*Note: Each pair of identical modules is actually only represented once, as the sole purpose of redundancy is to increase availability. Therefore, only 1 module from each pair will be active within the safety loop.*

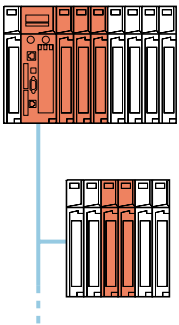

Unity Pro XLS supports a combination of safety I/O and non-interfering I/O.

**Non-interfering modules**

Certain I/O modules from the Quantum catalog can be used in a safety architecture without interfering with the safety process. Unlike the safety modules, these modules, which are referred to as “non-interfering”, are not responsible for any safety functions.

Below is a list of Quantum non-interfering modules which are fully compatible with a Quantum Safety configuration:

Type	Reference	Minimum product version (PV)
RIO head adaptor	140 CRP 932 00	6
RIO drop adaptor	140 CRA 932 00	6
Ethernet module	140 NOE 771 11	11
16-slot rack	140 XBP 016 00	2
10-slot rack	140 XBP 010 00	2
6-slot rack	140 XBP 006 00	2
Discrete inputs	140 DDI 353 00	1
Discrete outputs	140 DDO 353 00	1
Analog inputs	140 ACI 040 00	2
Analog outputs	140 ACO 020 00	1
40-way terminal block	140 XTS 002 00	0
	140 XTS 001 00	0

# Modicon Quantum automation platform

## Safety PLCs

### Unity Pro XL Safety programming software

Quantum Safety PLCs are programmed with the Unity Pro XL Safety software. This programming tool is compatible with various Schneider Electric PLC ranges (Modicon M340, Modicon Premium, Standard Modicon Quantum, Safety Modicon Quantum). Ethernet and Modbus Plus can be used to establish a connection not only with other PLCs (both Safety PLC and Standard PLC), but also the supervision system.

In order to meet the requirements of standard IEC 61508, certified programming software must be used to program the safety applications. That is why Schneider Electric has developed a special safety version of its programming software: Unity Pro XLS (XL Safety).

Not only does this version of Unity Pro support fault diagnostics, but it also ensures that the project is protected to the extent necessary for programming a safety application.

Unity Pro XLS can be used to generate both safety applications and standard applications.

Therefore, you only need to install one version of the programming software on your PC.

### Differences between Quantum Safety PLCs and Standard Quantum PLCs

The Quantum Safety PLC differs from the Standard Quantum PLC in terms of its functions and behaviour with a view to meeting the requirements of standard IEC 61508.

Feature	Standard Quantum PLC	Quantum Safety PLC
<b>Configuration</b>	<ul style="list-style-type: none"> <li>■ Backplane</li> <li>■ Local rack</li> <li>■ Remote I/O</li> <li>■ All power supplies</li> <li>■ Backplane extensions</li> <li>■ Distributed I/O</li> <li>■ I/O on a fieldbus</li> </ul>	<ul style="list-style-type: none"> <li>■ Backplane</li> <li>■ Local rack</li> <li>■ Remote I/O</li> <li>■ Dedicated power supply</li> </ul>
<b>Firmware</b>	Standard	Safety
<b>Software</b>	<ul style="list-style-type: none"> <li>■ Unity Pro XLS</li> <li>■ Unity Pro XL</li> <li>■ Unity Pro L</li> </ul>	Unity Pro XLS
<b>User logic</b>	<ul style="list-style-type: none"> <li>■ FBD</li> <li>■ LD</li> <li>■ IL</li> <li>■ ST</li> <li>■ SFC</li> </ul>	<ul style="list-style-type: none"> <li>■ FBD</li> <li>■ LD</li> </ul>
<b>Data types</b>	<ul style="list-style-type: none"> <li>■ EDT</li> <li>■ DDT</li> </ul>	<ul style="list-style-type: none"> <li>■ EDT</li> <li>■ Simple arrays only</li> </ul>
<b>Mode</b>	–	<ul style="list-style-type: none"> <li>■ Maintenance mode</li> <li>■ Safety mode</li> </ul>
<b>Restart behaviour</b>	<ul style="list-style-type: none"> <li>■ Start from stop</li> <li>■ Cold restart</li> <li>■ Warm restart</li> </ul>	<ul style="list-style-type: none"> <li>■ Start from stop</li> <li>■ Cold restart</li> </ul>
<b>Safety mode</b>	No	Yes
<b>Minimum MAST execution time in cyclic mode</b>	3 ms	20 ms
<b>Forcing in safety mode with key-switch locking</b>	No	Yes
<b>Memory check</b>	No	Yes
<b>Password</b>	No	Yes
<b>MSTR blocks</b>	Yes	No
<b>Global Data subscription (Ethernet)</b>	Access to all areas	Access to unrestricted area only
<b>Read I/O scanner (Ethernet)</b>	Access to all areas	Access to unrestricted area only
<b>PCMCIA cards</b>	Slots A and B	Slot A

Notes: The Quantum Safety PLC can only perform a cold start: The application is reinitialized on each start.  
The Quantum Safety PLC can run in cyclic or periodic modes.

### Ethernet and Modbus Plus communication

#### General principle

There are no restrictions in terms of sending information to an external PLC or HMI terminal, regardless of the type of Ethernet or Modbus Plus network used or the particular protocol involved. By contrast, data can only be received (written to the Safety PLC) in the “unrestricted” memory area (1).

### PLC-to-PLC communication

The Quantum Safety PLC is capable of communicating with other PLCs via:

- Modbus TCP. CPU connection or module **140 NOE 771 11**
- Modbus Plus (serial port of CPU), server only
- Modbus RS232/RS485 (serial port of CPU)

These communication methods are classed as “non-interfering”.

### Ethernet communication

The Ethernet network connects:

- Via the Ethernet port of the CPU
- Via Ethernet module **140 NOE 771 11**

*Note: With a Hot Standby Safety CPU, the Ethernet port is reserved for data exchange between the primary and standby PLCs.*

Ethernet module **140 NOE 771 11** has been certified as a non-interfering product for use with a Quantum Safety PLC.

Both peer-to-peer and Global Data communication are supported. All standard Ethernet components can be used for the wiring.

### Ethernet peer-to-peer communication

Using Unity Pro XLS, this type of communication is defined separately for the read and write directions in the Ethernet network configuration. Unity Pro XLS checks that read data is only using (being written to) the “un restricted” memory area (1).

### Ethernet Global Data communication

Global Data communication is configured within the Ethernet network configuration in Unity Pro XLS so that write data can be published and read data can be subscribed to.

Read data may only be sent to the “un restricted” memory area (1).

### Modbus Plus communication

On a Modbus Plus network, the CPU's Modbus Plus port is used for peer-to-peer communication and Global Data exchange.

### Peer-to-peer communication on Modbus Plus

Using Unity Pro XLS, this type of communication is defined separately for the read and write directions in the Modbus Plus network configuration. Unity Pro XLS checks that read data is only using (being written to) the “un restricted” memory area (1).

### Global Data communication on Modbus Plus

Global Data communication is defined within the Modbus Plus network configuration in Unity Pro XLS so that write data can be published and read data can be subscribed to.

Read data may only be sent to the “un restricted” memory area (1).

(1) For details about the safety memory and unrestricted memory, see page 1/24.

### Communication with HMI terminals

An HMI terminal is permitted to read data from the Quantum Safety PLC, but may only write data to the “unrestricted” memory area <sup>(1)</sup> via:

- Modbus TCP: either via the CPU port, or via module **140 NOE 771 11**
- Modbus Plus
- Modbus RS232/RS485

As this type of communication is not defined with Unity Pro XLS, it is the Quantum Safety PLC that is responsible for defending itself against write access attempts by the HMI terminal: any attempt to send a write command to the safety memory <sup>(1)</sup> will be ignored.

### Writing in maintenance mode

Even in maintenance mode, write protection prevents data being written to the safety memory by other PLCs or HMI terminals.

It is only possible to change to maintenance mode using Unity Pro XLS and after presenting a password. The data in this area can only be modified or adjusted with Unity Pro XLS in maintenance mode.

- Modification of program logic
- Assignment of values
- Forcing of values
- Debugging

### PC-to-PLC communication

Communication between Unity Pro XLS and the Quantum Safety PLC takes place via:

- Modbus TCP. CPU port or NOE module
- Modbus Plus
- Modbus RS232/RS485
- USB

Even if communication between Unity Pro XLS and the Quantum Safety PLC is not integrated into the safety loop, it is still subject to checks (e.g., a CRC) to ensure that the data is transferred correctly and that no communication errors occur.

<sup>(1)</sup> For details about the safety memory and unrestricted memory, see page 1/24.

### Introduction

Quantum safety PLC architectures feature the same flexibility and high availability benefits as standard Quantum PLC architectures.

### Flexible architectures

#### "1oo2" architectures

Example of architecture with redundant or non-redundant safety I/O

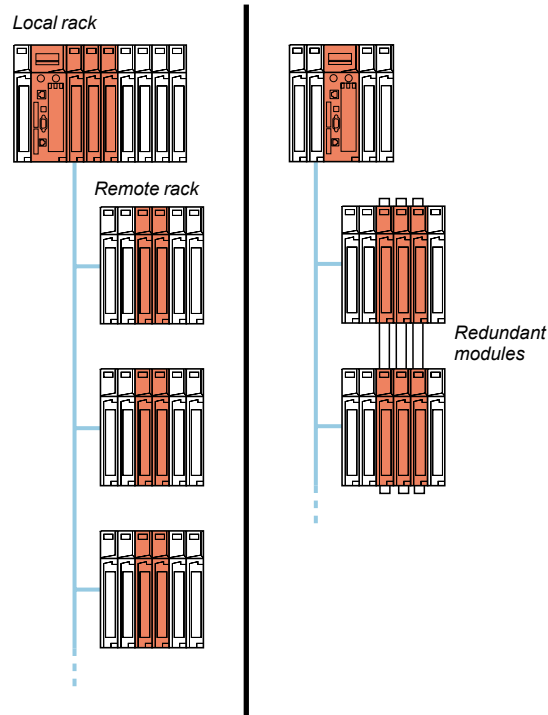

These architectures use CPU ref. **140 CPU 651 60S**.

For more information about topologies with a single cable, see page 3/5.

### Flexible architectures (continued)

#### Hot Standby safety architectures: "1oo2 Hot Repair" CPU architectures

With Hot Standby safety architectures:

- System availability can be increased significantly
- Process downtimes can be eliminated because of the redundant CPUs
- Redundancy is possible at every level within the architecture: CPU, wiring, power supply, I/O, etc.

The Hot Standby system is compatible with Unity Pro XL Safety software, and provides Quantum safety CPUs with the high level of availability required by the critical process applications, in terms of their control/command system.

At the centre of the system are two Quantum safety PLC racks, commonly known as the "Primary" PLC and the "Standby" PLC.

Their hardware configurations must be identical (same modules in each local rack). The key element, on each of them, is the **140 CPU 671 60S** processor, specially designed for Hot Standby architectures with Unity Pro XL Safety software. This processor is a double-slot module, which combines the central processor unit function with that of the redundant coprocessor in the same housing.

The "Primary" PLC executes the application program and controls the I/O. The "Standby" PLC stays in the background, ready to take over if necessary. The "Standby" PLC is connected to the "Primary" PLC via a high speed fibre optic link (100 Mbps) integrated in the CPU.

This fibre optic link (62.5/125 µm multimode) can be extended to 2 km without any additional special equipment. It is via this that the user application data is updated cyclically on the "Standby" PLC.

In the event of an unexpected failure affecting the "Primary" PLC, the standby system switches over automatically, changing execution of the application program and control of the I/O over to the standby PLC, with an up-to-date data context. Once they have changed over, the "Standby" PLC becomes the "Primary" PLC. Once the faulty PLC has been repaired and reconnected to the standby system, it takes the role of the "Standby" PLC.

Using the Hot Standby system with Unity Pro XL Safety software means a smooth changeover from normal to standby at the outputs. The changeover is transparent for the process, which will continue to be managed without any permanent ill-effects from the occurrence of a hardware failure.

The Hot Standby system with Unity Pro XL Safety software therefore increases productivity by minimizing downtime.



**Flexible architectures (continued)**

**Example of architecture with redundant or non-redundant safety I/O**

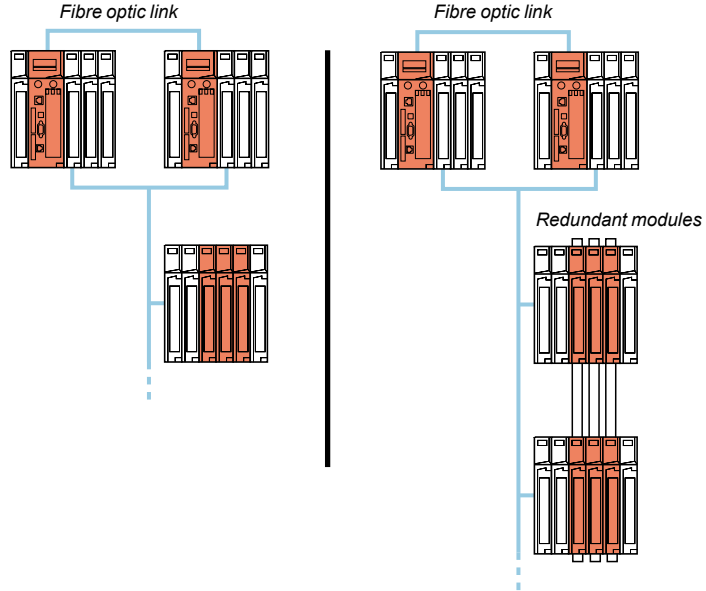

**“1oo2 Hot Repair” architecture**

A Hot Standby architecture enables safety and availability to be combined in a single PLC. This type of architecture guarantees that even if one of the CPUs fails, the system still provides SIL2 safety. Since Quantum safety PLCs are based on the same Hot Standby architecture as standard Quantum PLCs, the solution is indisputably robust and has proved its worth in the field.

Thanks to the “1oo2” design of safety CPUs (see page 1/22), they represent a simple and cost-effective solution compared to multiprocessor solutions with 3 CPUs and voting for control between one another with external equipment. The complete redundancy of functions, from the I/O through to the supervision system, has the advantage of being able to tolerate more than one error while still maintaining the required level of functional safety.

Particularly well suited to designing production systems which combine safety with availability and cost-effectiveness, the solution is the at the heart of TÜV Rheinland’s “1oo2 Hot Repair” architecture concept.

**Details**

These architectures use two **140 CPU 671 60S** connected via fibre optic link. The safety I/O modules are placed in the RIO drops to allow control by both CPUs.

*For information on the connections, see pages 3/5 and 3/6.*

The Quantum safety high availability CPU differs from the standalone CPU **140 CPU 651 60S** in its use of the Ethernet port. In a standalone configuration, the Ethernet port is used for communication with other devices via standard Ethernet cables. In a high availability safety configuration, it is used for data exchanges between the primary and standby controllers via fibre optic link. Since this fibre optic link is not part of the safety loop, the PFD and PFH values for the high availability CPU are the same as those for the standalone CPU.

### Collaborative architecture

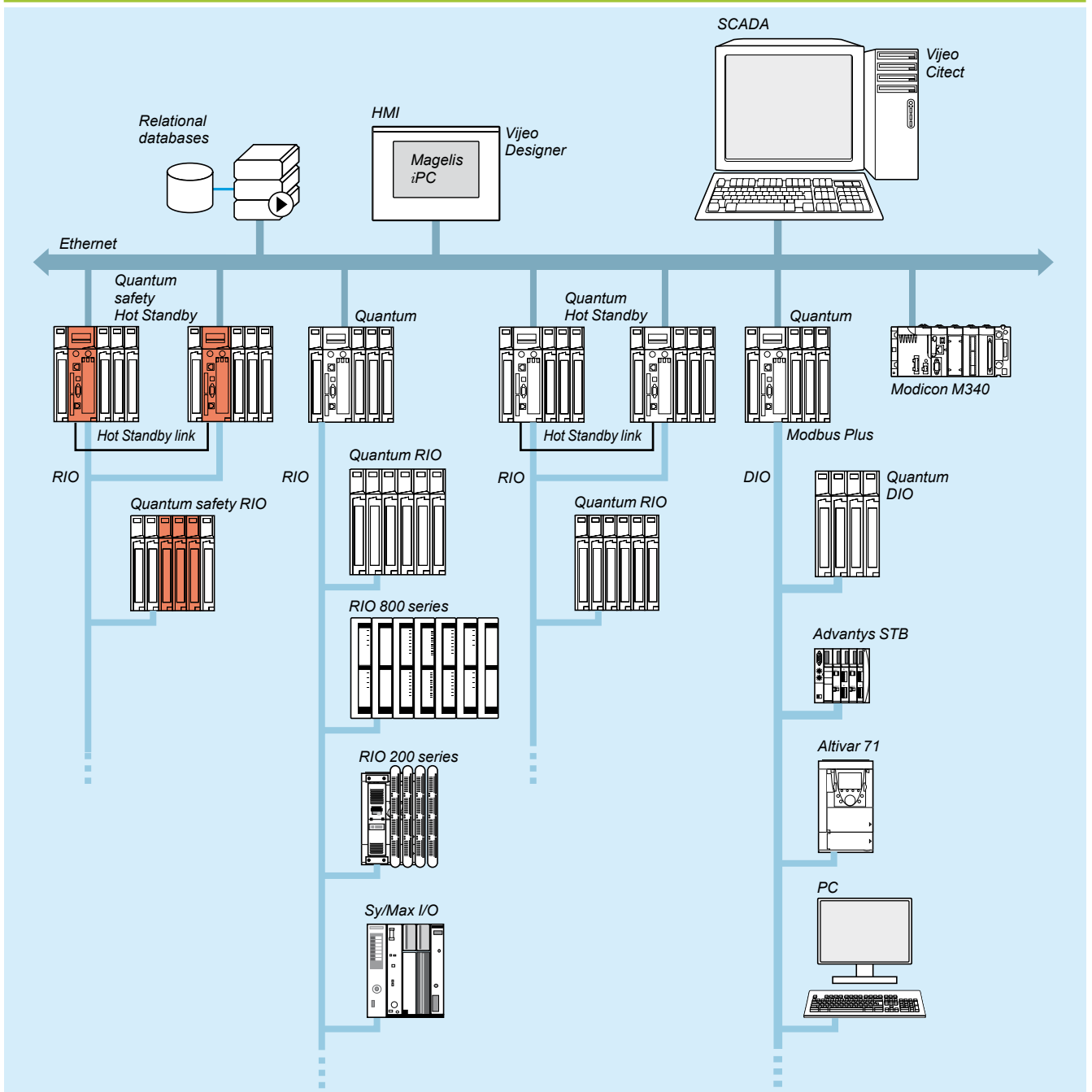

- The Quantum safety PLC is easy to use in a collaborative architecture:
- The same software tool is used for both the safety and the control PLCs.
  - The safety PLC benefits from all the protection required against write operations from other equipment in architecture.

### High availability functions

The following functions are available for high availability, in maintenance mode and safety mode:

Function	Maintenance mode	Safety mode
High availability	Yes	Yes
Role exchange	Yes	Yes
Role exchange by EFB	–	Yes
Key switch	Yes	Yes
Different logic	Yes	–
OS loading	Yes, if secondary PLC is in stop mode and disconnected	–
Application transfer	Yes	Yes, via CPU keyboard

### Safety I/O modules in high availability configurations

Safety I/O modules can be used in a redundant way to increase control system availability.

Schneider Electric offers function blocks for supervising the state of a configuration with redundant modules.

The state of the modules is available in system words, which can be made available to operators and maintenance personnel in order to inform them in case a module is defective and must be exchanged.

To increase a system's availability, Schneider Electric recommends using different remote I/O racks for redundant I/O modules.

### Analog input modules

2 different sensors must be used for high availability safety analog inputs and each must be connected to a different input channel.

It is advisable to locate these 2 input channels on different analog input modules.

Block diagram:

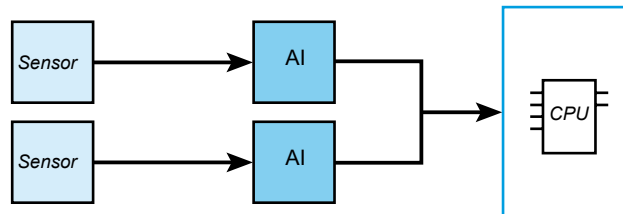

Function block S\_AISIL2 can be used for selecting data from the 2 redundant analog inputs and to supervise the state of the inputs.

### Discrete input modules

Redundant safety discrete inputs can be connected to 1 or 2 sensors. The 2 input channels should preferably be located on different input modules. If a single sensor is used, the modules share the same process power supply. The wiring must be defined to suit the conditions of use of the modules (input characteristics on short circuit, open wire, 0 and 1 logic levels, voltage and current) as specified in the Quantum Hardware Reference Guide.

**Block diagrams:**

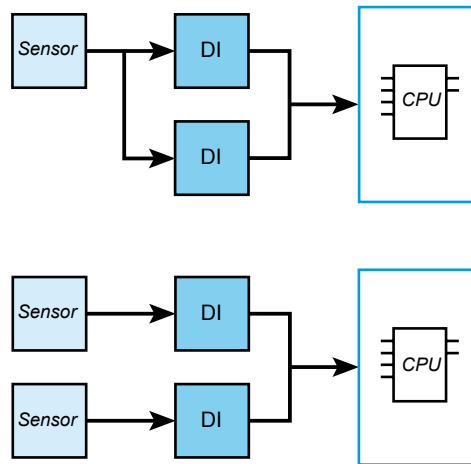

Function block S\_DISIL2 can be used for selecting data from the 2 redundant discrete inputs and to supervise the state of the inputs.

### Discrete output modules

For high availability discrete outputs, the 2 outputs must be on separate modules, wired in parallel and connected to 1 actuator.

**Block diagram:**

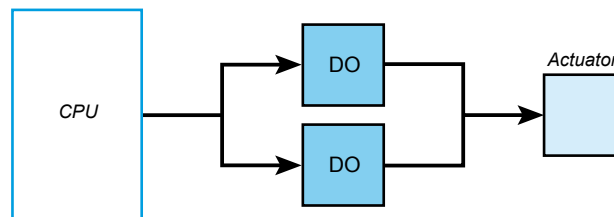

A function block is not necessary because the same signal from the CPU is connected to both outputs.

# Modicon Quantum automation platform

## Hot Standby safety architectures

1

### Hot Standby safety architecture

#### Remote I/O architecture (RIO)

These I/O drops, consisting of Quantum modules, are recognized and configured from the Unity Pro XL Safety software programming environment. They feature synchronous scanning in relation to the scan time.

A splitter box **5 MA 0186 100** is used to enable I/O exchanges between the RIO drops **4** and the "Primary" **1** and "Standby" **2** PLCs. The line impedances **6 52 0720 000** are used to maintain a suitable line when it is necessary to disconnect one of the I/O CPUs. The optional earthing terminals **7 60 0545 000**, are used to maintain the earthing of the coaxial cable in these conditions.

The availability of this I/O system is reinforced by using a dual-medium I/O wiring system.

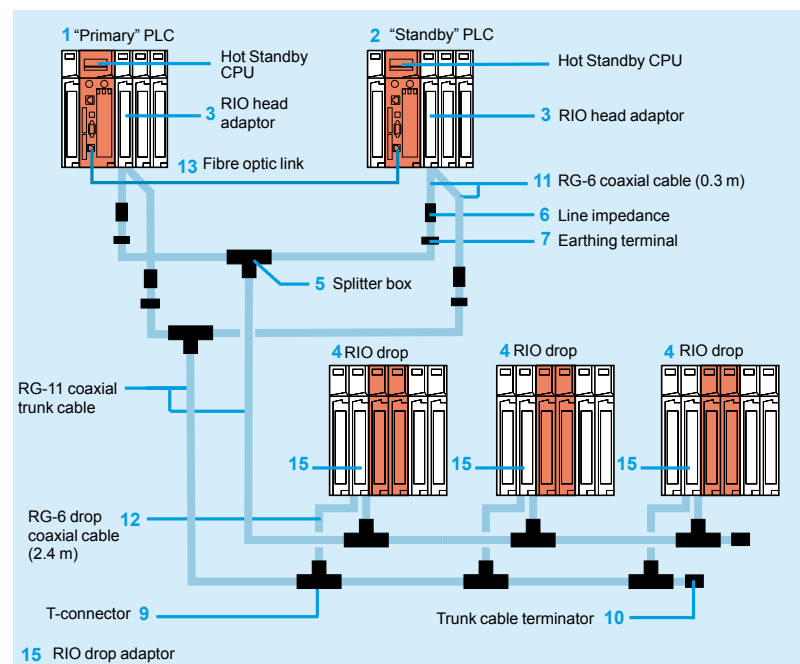

**Note:** For items **1, 2...15**, see page 1/17.

The components are available in kits.

For example, the configuration illustrated above can be created using:

- 1 splitter kit **140 CHS 320 00**
- 4 head adaptor connection kits **RPX KIT CRP**
- 6 drop kits **RPX KIT 6F**
- 1 RG-11 coaxial trunk cable: for example, a 320 m reel **97 5951 00** (see page 3/8)

# Modicon Quantum automation platform

## Hot Standby safety architectures



140 CPU 671 60S

### References

#### Hot Standby safety CPU with Unity Pro XL Safety

Hot Standby CPU		Memory (max.)			Communication ports	Safety	Reference	Weight kg
Clock speed	Coprocessor	RAM	Program (with located variables)	Program with PCMCIA card				
266 MHz	Yes, integrated Ethernet TCP/IP, use reserved for Hot Standby	2 MB	768 Kb	7168 Kb	1 Modbus (1) 1 Modbus Plus 1 USB 1 Ethernet 100 Mbps port (dedicated Hot Standby port)	Yes	140 CPU 671 60S	–



140 NOE 771 11

### Associated modules

Description	Type of architecture	Topology	Transparent Ready	No. (2)	Safety	Reference	Weight kg
RIO head adaptor modules	Remote I/O (RIO) and mixed I/O	Redundant cable	–	3	Non-interfering	140 CRP 932 00	–
RIO drop adaptor				15	Non-interfering	140 CRA 932 00	–

(1) RS 232/RS 485 Modbus port.

(2) For item numbers, see page 1/16.

1



490 NOR 000 ●●

### References (continued)

#### Fibre optic cables for Hot Standby safety architecture

Description	Use/composition	Length	No. (1)	Reference	Weight kg
Fibre optic cables for interconnecting the Ethernet port on the 140 CPU 671 60S Primary and Standby CPUs	62.5/125 µm multimode fibre optic cable, equipped with MT-RJ connectors	3 m	13	490 NOR 000 03	–
		5 m	13	490 NOR 000 05	–
		15 m	13	490 NOR 000 15	–



#### Connection kits for Hot Standby safety architecture

Description	Composition and item no. (1)	Reference	Weight kg
Hot Standby splitter kit for coaxial cable	Comprising: - 2 splitter boxes 5 MA 0186 100 for coaxial cable with terminator 520 402 000 for trunk cable - 4 line impedances 6 52 0720 000	140 CHS 320 00	–
Connection kit for head adaptor modules 140 CRP 932 00	Comprising: - 1 RG 6 coaxial cable 11 (0.3 m) equipped with type F female connectors - 1 earthing terminal 7 60 0545 000	RPX KIT CRP	–
RIO drop kit	Comprising: - 1 T-connector 9 MA 0185 100 for RG-11/RG-6 coaxial cables with trunk cable terminator 10 52 0422 000 - 2 RG-6 coaxial cables 12 (2.4 m) equipped with type F female connectors	RPX KIT 6F	–

(1) For item numbers, see page 1/16.

## References (continued)

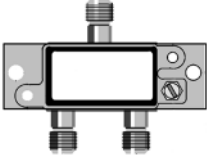
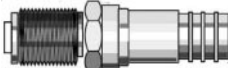
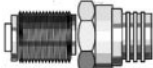
## Connection accessories for Hot Standby safety architecture (1)

Description	Use/composition	Length	No. (2)	Reference	Weight kg
 MA 0186 100	<b>Splitter box for coaxial cable</b> Tee for joining sections of RG-6 coaxial cable coming from 2 head adaptor modules (140 CRP 932 00). Forms the start of the RIO links.	–	5	MA 0186 100	–
 52 0411 000	<b>Line impedance for RG-6 coaxial cable</b> Crimp-type adaptor for RG-6 RIO coaxial cable. Used to maintain a suitable RIO line on disconnection of the cable coming from the head adaptor (140 CRP 932 00). Connection at both ends on female connector.	–		52 0411 000	–
 52 0720 000	<b>Line impedance for RG-6/RG-11 coaxial cable</b> Screw-type adaptor for RG-6/RG-11 RIO coaxial cable. Used to maintain a suitable RIO line on disconnection of the cable coming from the head adaptor (140 CRP 932 00). Connection at both ends on female connector.	–	6	52 0720 000	–
 60 0545 000	<b>Adaptor for RG-11 coaxial cable</b> Type F to BNC adapter with self-terminator for RG-11 cable	–		52 0370 000	–
 60 0545 000	<b>Earthing terminal for RG-6/RG-11 coaxial cable</b> Earthing terminal for RIO coaxial cable. Used to maintain earthing of the RIO line on disconnection of the cable coming from the head adaptor (140 CRP 932 00). Connection at both ends on female connector.	–	7	60 0545 000	–

(1) For other RG connection accessories, see pages 3/8 and 3/9.

(2) For item numbers, see page 1/16.



1

<b>Automation platform for Unity Pro XL Safety software offer</b>	<b>Safety applications</b>
---	----------------------------



<b>Number of racks</b> 2/3/4/6/10/16 slots	Local I/O	1 main rack
	Remote I/O (RIO)	31 drops x 1 rack
	Distributed I/O (DIO)	–
<b>Maximum discrete I/O (1)</b>	Local I/O	No limit (max. 13 slots)
	Remote I/O (RIO)	31,744 input channels and 31,744 output channels
	Distributed I/O (DIO)	–
<b>Maximum analog I/O (1)</b>	Local I/O	No limit (max. 13 slots)
	Remote I/O (RIO)	1984 input channels and 1984 output channels
	Distributed I/O (DIO)	–
<b>Application-specific modules</b>		–

<b>Number of communication modules (in local rack)</b>	Ethernet TCP/IP	6 Ethernet 140 NOE 771 11 modules on local rack	
	<b>Bus connections</b>	Modbus	1 integrated RS 232/485 Modbus slave RTU/ASCII port
	AS-Interface actuator/sensor bus	–	
<b>Network connections</b>	Profibus DP	–	
	Modbus Plus	1 integrated port	
	Ethernet TCP/IP	1 integrated port (10BASE-T/100BASE-TX), 6 “option” modules on local rack	
	USB	1 port reserved for programming PC	

<b>Process control</b>	Control loops	–
<b>Redundancy</b>		Power supplies, remote I/O network, Ethernet TCP/IP modules
<b>Hot Standby CPU</b>		–

<b>Memory capacity without PCMCIA card</b>	IEC program and data	1024 Kb
	<b>Memory extension with PCMCIA card</b>	Program
	Data	1024 Kb
	File storage	–

**Functional safety certification** Certified by TÜV Rheinland as suitable for use in an SIL2 level safety function

**Type of Quantum CPUs** **140 CPU 651 60S**

**Pages** 1/27

(1) The maximum values for the number of discrete I/O and analog I/O are not cumulative.

**High-availability (Hot Standby) safety applications**



1 main rack
31 drops x 1 rack
-
No limit (max. 13 slots)
31,744 input channels and 31,744 output channels
-
No limit (max. 13 slots)
1984 input channels and 1984 output channels
-
-
6 Ethernet 140 NOE 771 11 modules on local rack
1 integrated RS 232/485 Modbus slave RTU/ASCII port
-
-
1 integrated port
1 integrated port (10BASE-FX reserved for Hot Standby), 6 "option" modules on local rack
1 port reserved for programming PC
-
Power supplies, remote I/O network, Ethernet TCP/IP modules
Yes
1024 Kb
Up to 7168 Kb
1024 Kb
-
Certified by TÜV Rheinland as suitable for use in an SIL2 level safety function

**140 CPU 671 60S**

1/27

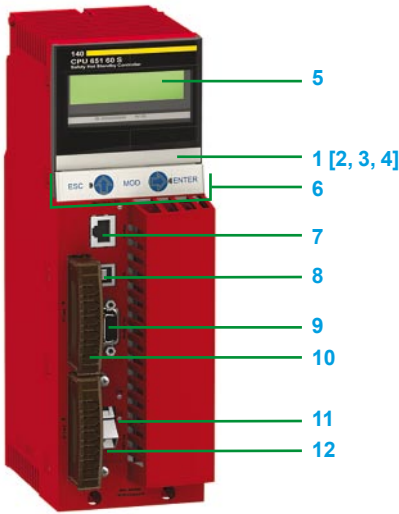

140 CPU 651 60S

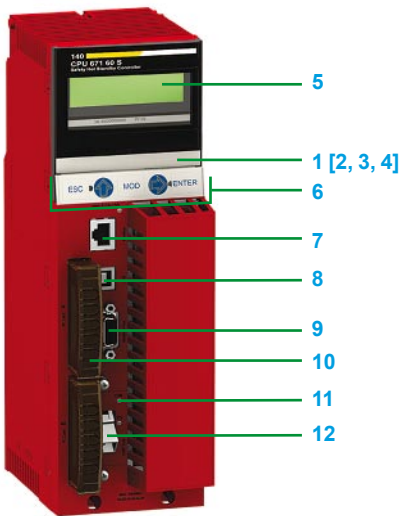

140 CPU 671 60S

### Description

#### Safety CPUs

The **140 CPU 651 60S** and **140 CPU 671 60S** CPUs have the following on the front panel:

- 1 An LCD display cover, providing access to:
  - 1 Unlocked: all system operations are able to be invoked and all changeable module parameters are able to be modified by the operator via the LCD and keypad, memory protection is off.
  - 2 Locked: no system operations are able to be invoked and all changeable module parameters are read only, memory protection is on.
- 2 A key switch:
  - 3 One backup battery slot.
  - 4 One reset button (Restart).
- 5 An LCD display (2 lines of 16 characters) with brightness and contrast controls.
- 6 A 5-button keypad with 2 LEDs (*ESC*, *ENTER*, *MOD*, *↑*, *⇒*).
- 7 An RJ45 connector for connecting to the Modbus bus.
- 8 A type B female USB connector for connecting the programming PC terminal.
- 9 A 9-way female SUB-D connector for connection to the Modbus Plus network.
- 10 A slot for PCMCIA memory extension cards (slot A).
- 11 Two LEDs:
  - COM LED (green): activity on the Ethernet port (model 140 CPU 651 60S), activity on the Hot Standby primary or redundant drop (model 140 CPU 671 60S)
  - ERR LED (red): Ethernet frame collisions (model 140 CPU 651 60S), communication error between Hot Standby primary and redundant drops (model 140 CPU 671 60S)
- 12 One connector:
  - RJ45 for connection to the Ethernet network (model 140 CPU 651 60S)
  - One MT-RJ fibre optic connector for interconnecting the primary and redundant PLCs in the Hot Standby architecture (model 140 CPU 671 60S)

### Operating principles - CPUs

Quantum safety CPUs have two processors with different technology. Each one executes its safety program in its dedicated memory area. The results are analyzed at the end of each scan by two comparison mechanisms. Each CPU has its own fallback algorithm, which allows the system to be set to a so-called safe position if something goes awry when a function is being executed or if an error is detected. This dual processing is called a 1oo2 architecture (One out of Two). The diagram below describes the internal architecture of a Quantum safety CPU:

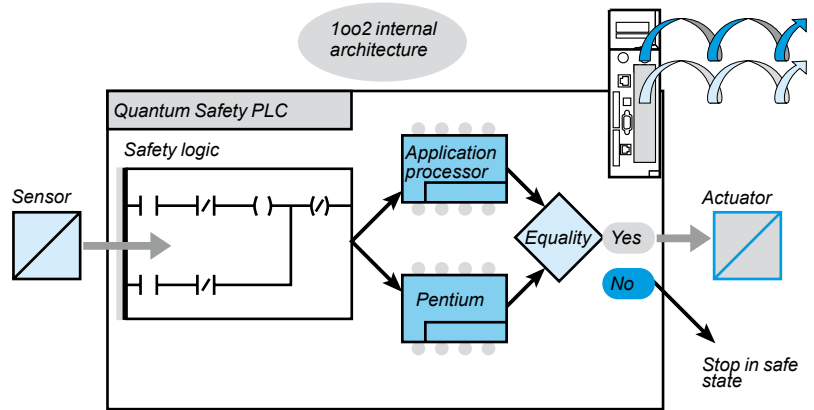

*Switch to fallback position configured.*

Combining CPUs in this way allows dual code generation and execution, offering the following advantages if an error is detected:

- Both executable codes are generated independently. The diversity of compilers allows routine errors to be detected during code generation.
- Both generated codes are executed by two different CPUs. The PLC is therefore able to detect both routine errors during code execution and random errors.
- Both CPUs use independent memory areas. The PLC can therefore detect random errors in the RAM memory.

1

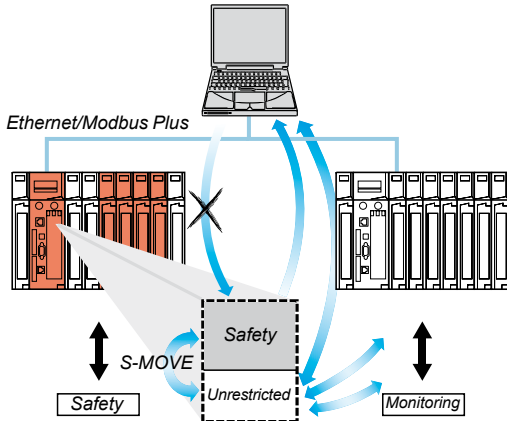

Only the S-MOVE function block is capable of reading in the unrestricted memory area.

### Safety memory

The Quantum Safety PLC memory is divided into a safety area and an unrestricted area. The safety memory area is write-protected. It is used to process data relating to safety. The unrestricted memory area is not write-protected, it is used to communicate with external devices. Values in this area cannot be manipulated directly, only via specific function blocks.

As far as slot A is concerned, PCMIA memory cards can be used in the same way as with a standard PLC. They can contain applications, not data files, see page 1/25.

However, slot B cannot be used for safety projects.

### Specific operating modes

The Quantum safety PLC has 2 specific operating modes:

- Safety mode
- Application and PLC maintenance mode

#### Safety mode

This is the Quantum safety PLC's default operating mode, in which all the safety functions are available to control the process. This is a "restricted function" mode in which modification and maintenance activities are prohibited. Only stopping or starting the PLC, or placing it in maintenance mode, is authorized.

#### Maintenance mode

The Quantum safety PLC Maintenance mode is a temporary mode which is useful for modifying the project, debugging and maintaining the application program.

#### Maintenance mode functions

When the Quantum safety PLC is running in maintenance mode, Unity Pro XLS offers the following functions:

- Changes can be downloaded.
- Safety variables can be assigned and forced: limited to EBOOL variables.
- It is possible to switch to safety mode while forcing is in progress. Forced variables stay forced.
- Debugging with breakpoint, watchpoint and step-by-step is possible. However, the Quantum safety PLC must be active.
- The animation tables and operator screens have write access to the safety variables and the safety I/O.
- The safety memory is write-protected. This means that neither the HMI terminals, nor any other PLCs, can write to it.

CPU without PCMCIA memory card

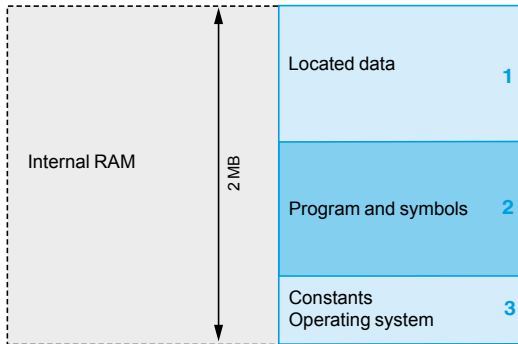

### Memory structure

The application memory is divided into memory areas, physically distributed in the internal RAM memory and on 1 PCMCIA memory extension card.

- 1 The application data area is always in internal RAM. It consists of global located data, corresponding to the data defined by an address (for example %MW237) with which a symbol can be associated.
- 2 Application program and symbols area in the internal RAM or in the PCMCIA memory card (descriptor, executable code for the tasks and application symbols database).
- 3 Constants area in internal RAM or the PCMCIA memory card (constant words, initial values and configuration).

Depending on the requirements for application memory size, there are two possible ways to organize the memory depending on whether the Quantum safety CPU is equipped with a PCMCIA memory extension card:

- Application in internal RAM, the application is entirely loaded in the internal RAM which is backed up (1) by the CPU (2 MB).
- Application in PCMCIA card, the internal RAM is now reserved for application data. The PCMCIA memory card contains the program space (program, symbols and constants areas).

CPU with PCMCIA memory card in slot A

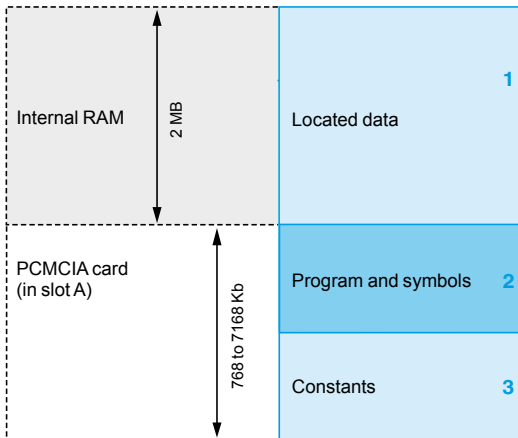

Presence of the symbols area with the program area is optional. The fact of having the application symbols database on the PLC means that, when it is connected to an empty programming PC, all the elements needed to debug or upgrade this PLC are available.

### Protecting the application

Whether located in the internal RAM or in the PCMCIA card, the application can be protected with a key switch (see page 1/23), in order to prohibit its access (read or modify program) online under Unity Pro XL Safety.

### PCMCIA cards for safety CPUs

Type	Program size Kb	Data size Kb	Reference
SRAM+FLASH	2048	1024	TSX MCPC 002M
SRAM+FLASH	512	512	TSX MCPC 512K
FLASH	1024	–	TSX MFPP 001M
FLASH	2048	–	TSX MFPP 002M
FLASH	4096	–	TSX MFPP 004M
FLASH	512	–	TSX MFPP 512K
SRAM	1024	832	TSX MRPC 001M
SRAM	2048	1856	TSX MRPC 002M
SRAM	3072	2880	TSX MRPC 003M
SRAM	7168	6976	TSX MRPC 007M
SRAM	1792	1600	TSX MRPC 01M7
SRAM	768	576	TSX MRPC 768K

(1) The internal RAM memory is backed up by a nickel cadmium battery. RAM memory cards are protected by a Lithium battery.

Quantum PLCs have been designed to conform with the main national and international standards relating to electronic devices for industrial control systems (see pages 10/2 to 10/17 “Standards, certifications and environmental conditions”).

### Characteristics and performance

Type of processor		140 CPU 651 60S	140 CPU 671 60S	
<b>Functional safety certification</b>		Certified by TÜV Rheinland as suitable for use in an SIL2 level safety function		
<b>Approvals</b>		CE, UL, CSA, CSA Hazardous Location		
<b>Maximum configuration</b>	No. of racks with Local I/O	1		
	2/3/4/6/10/16 slots Remote I/O	31 drops x 1 rack		
	Distributed I/O	-		
<b>Inputs/Outputs</b>	Discrete I/O (1)	Local I/O	Unlimited (13 slots max.)	
		Remote I/O	31,744 inputs and 31,744 outputs	
		Distributed I/O	-	
	Analog I/O (1)	Local I/O	Unlimited (13 slots max.)	
		Remote I/O	1984 inputs and 1984 outputs	
		Distributed I/O	-	
Application-specific I/O		-		
<b>Communications</b>	No. of application-specific modules (in local rack)	Ethernet	6 Ethernet modules 140 NOE 771 11	
	Maximum number of connections	Modbus	1 integrated RS 232/485 Modbus/ASCII	
		Modbus Plus	1 integrated	
		Ethernet TCP/IP	1 integrated, 6 max. in local rack	1 integrated dedicated to Hot Standby, 6 max. in local rack with 140 NOE 771 11 module
		Profibus DP	-	
AS-Interface		-		
USB	1 port, reserved for programming PC			
<b>Functions</b>	Redundancy	Power supplies, remote I/O network, Modbus Plus, Ethernet TCP/IP, CPUs		
	Process control	-		
	Hot Standby	-	Yes	
<b>Memory capacity without PCMCIA card</b>	Internal RAM	<b>MB</b>	2	
	Program (min.)	<b>Kb</b>	768	
	Located data and configuration (max.)	<b>Kb</b>	256	
<b>Memory capacity with PCMCIA card</b>	Program	<b>Kb</b>	7168	
	Located data and configuration (max.)	<b>Kb</b>	1024	
<b>Maximum capacity of memory object areas</b>	Flash	<b>Kb</b>	-	
	Located internal bits (%Mi)	<b>bits</b>	65,528	
	Located internal data	<b>Kb</b>	130	
	Unlocated internal data	<b>Kb</b>	-	
<b>Key switch</b>	Start/Stop/Mem prot		-	
	Mem prot on/off		Yes	
<b>Switch</b>	Mem prot/off		-	
	Com port: ASCII/RTU/Mem		-	
<b>Application structure</b>	Master task		1 cyclic/periodic (20 ms min.)	
	Fast task		-	
	Auxiliary tasks		-	
	Interrupt tasks	Max. number		-
		I/O interrupt		-
Time delay interrupt		-		
<b>Execution time for one instruction (2)</b>	Boolean	<b>µs</b>	0.105...0.15	
	On word	<b>µs</b>	0.09...0.12	
	Fixed point arithmetic	<b>µs</b>	0.96...1.02	
	On floating point	<b>µs</b>	-	
<b>Number of Kinstructions executed per ms</b>	100% Boolean	<b>Kins/ms</b>	5.14	
	65% Boolean and 35% numerical	<b>Kins/ms</b>	5.03	
<b>System overhead</b>	MAST task	<b>ms</b>	1.5	
	FAST task	<b>ms</b>	-	
<b>Memory backup</b>	Commercial reference		990 XCP 980 00	
	Battery type		Lithium	
	Voltage	<b>V</b>	3 ---	
	Capacity	<b>mAh</b>	1200	
	Typical current	<b>µA</b>	60	
	Maximum current	<b>µA</b>	90 (up to 60°C)	
	Storage life	<b>yr</b>	10	
<b>Consumption on the bus</b>		<b>mA</b>	2760	
			2500	

(1) The maximum values for the number of discrete and analog I/O are not cumulative.

(2) Limit values according to the type of instruction.



140 CPU 651 60S



140 CPU 671 60S



TSX C USB 232



990 NAD 218 00



TSX C USB MBP

### Safety CPUs

Both these CPUs are certified by TÜV Rheinland as suitable for use in an SIL2 level safety function.

Processor		Memory (max.)			Communication ports	Safety	Reference	Weight
Clock speed	Coprocessor	RAM	Program	Program with PCMCIA card				
MHz		MB	Kb	Kb				kg
266	Yes	2	768	7168	1 Modbus (1) 1 Modbus Plus 1 USB 1 Ethernet TCP/IP	Yes	140 CPU 651 60S	–
					1 Modbus (1) 1 Modbus Plus 1 USB 1 Hot Standby port (100 Mbps)	Yes	140 CPU 671 60S	–

(1) RS 232/RS 485 Modbus port.

### PCMCIA memory extension cards

Quantum 140 CPU 651 60S and 140 CPU 671 60S CPUs can take 1 memory extension card. See list on page 1/25.

### Connecting cables and accessories

Description	Use		Length	Reference	Weight
	From processor	To PC port			
Connecting cables to the PC	Modbus port, RJ45 for: 140 CPU 6●1 60S	RJ45 connector	1 m	110 XCA 282 01	–
			3 m	110 XCA 282 02	–
			6 m	110 XCA 282 03	–
		USB port	0.4 m	TSX C USB 232 (1)	0.145
	USB port for: 140 CPU 6●1 60S	USB port	3.3 m	UNY XCA USB 033	–
Connection cordsets for Modbus Plus network	Modbus Plus port, 9-way SUB-D for: 140 CPU 6●1 60S Straight connector	Modbus Plus tap (2)	2.4 m	990 NAD 218 10	–
			6 m	990 NAD 218 30	–
Modbus Plus/USB converter	Modbus Plus tap (2)	USB port	0.4 m	TSX C USB MBP (3)	0.186
Adaptor	RJ45 connector for 140 CPU 6●1 60S	RS 232 9-way SUB-D connector	–	110 XCA 203 00	–

(1) With the TSX C USB 232 converter, use the 110 XCA 203 00 adaptor and the 110 XCA 282 0● cordset.

(2) Modbus Plus tap: 990 NAD 230 20/21 (IP 20) or 990 NAD 230 10 (IP 65).

(3) With the TSX C USB MBP converter, use the 990 NAD 211 10/30 or 990 NAD 218 10/30 cordset.



1

Type	Discrete I/O	
------	--------------	--

Voltage	Inputs 24 V ...	Outputs 24 V ...
---------	--------------------	---------------------



Number of channels	16	
--------------------	----	--

Number of groups	1	
------------------	---	--

Number of channels per group	16	
------------------------------	----	--

Characteristics	– <b>Maximum load:</b> Current per channel: 0.5 A Current per group: 8 A Current per module: 8 A	
-----------------	---	--

Isolation between channels	–	
----------------------------	---	--

I/O addresses	7 input words	4 output words and 7 input words
---------------	---------------	----------------------------------

Bus current required	550 mA	350 mA
----------------------	--------	--------

Logic	Positive	Positive
-------	----------	----------

Functional safety certification	Certified by TÜV Rheinland as suitable for use in an SIL2 level safety function	
---------------------------------	---	--

Model	<b>140 SDI 953 00S</b>	<b>140 SDO 953 00S</b>
-------	------------------------	------------------------

Page	1/41	
------	------	--

Analog inputs

-



8

8

1

**Input range** : 4...20 mA  
**Resolution** : 16-bit

500 V for 1 minute

13 input words

400 mA

-

Certified by TÜV Rheinland as suitable for use in an SIL2 level safety function

140 SAI 940 00S

1/41

# Modicon Quantum automation platform

## Safety I/O modules

1



140 SDI 953 00 S

### Presentation

The Modicon Quantum automation platform offers a complete range of discrete I/O modules designed to interface with a wide range of equipment. All these modules comply with the internationally recognized IEC electrical standards, which ensure their reliability in the harshest environments.

### Fully-software configurable

All Quantum safety I/O modules are configured using Unity Pro XL Safety software. Software allocation of the module I/O addresses simplifies addition or changing of the modules on the configuration, without intervention on the application program.

### Definition of fault behaviour for an output module

The Quantum platform offers the option of predefining the way that a discrete output behaves in the event of a fault, if for some reason the module ceases being controlled. The outputs can be configured by the software to do one of the following:

- Go to state zero
- Position themselves in a predefined safe state
- Stay in the same state as at the time of the fault

The safe state is: de-energized.

In the event of an internal module fault, the relevant channel(s) is(are) deactivated (set to 0).

This fault behaviour can be defined for each output. When the module is changed, the fault behaviour specified earlier is transmitted to the replacement module.

### Mechanical keying

It is possible to insert mechanical keying pins between the I/O module and its screw terminal block to ensure that the connector is joined to the module correctly. These keying pins have a unique code for each type of module. When a rack contains identical modules, secondary keying pins can be used to join the connector to the module. Keying pins are supplied with each I/O module.

### I/O connectors

Each safety I/O module requires a screw connection block with 40 terminals **140 XTS 001 00/002 00**, to be ordered separately.

These connectors are identical for all discrete I/O modules (1) and analog I/O modules (not compatible with intrinsically safe I/O modules).

# Modicon Quantum automation platform

## Safety I/O modules

### I/O operating principles

The following 3 I/O modules are certified for creating the safety loop in a Quantum safety PLC solution:

<b>140 SAI 940 00S</b>	8 analog inputs
<b>140 SDI 953 00S</b>	16 x 24 V $\overline{\text{---}}$ discrete inputs
<b>140 SDO 953 00S</b>	16 x 24 V $\overline{\text{---}}$ discrete outputs

Each of these modules consists of two microprocessors executing the same program, sharing the same information, and controlling one another from time to time.

### Safety I/O module diagnostics

The table below shows the diagnostics run on I/O modules:

Diagnostics	Analog inputs	Discrete outputs	Discrete inputs
Measurement out of range	Yes	–	–
Wiring broken	Yes (4-20 mA implicit) (1)	–	–
Process power supply fault	–	Yes	Yes
Overload	–	Yes	–

(1) Detection of 4...20 mA range overshoot only.

Note: The short-circuit is not detected on discrete input modules.  
See the reference manual for Quantum discrete and analog I/O.

In addition, the Quantum safety PLC provides communication diagnostics between the safety CPU and the safety I/O modules, for example a CRC. The PLC therefore tests that:

- The data received are the data that was sent.
- The data are updated.

To manage disturbances such as EMC effects, which can corrupt data temporarily, it is possible to configure a maximum number of consecutive CRC errors for each module (between 0 and 3).

### Diagnostics on power-up

On power-up, the safety I/O modules run an exhaustive self-test which lasts about 30 s. If these tests are negative, the modules deem there to be a malfunction and do not start. The inputs and outputs are set to 0. This self-test phase is signalled by the LEDs flashing quickly on the front of the modules.

In addition, if the external 24 V  $\overline{\text{---}}$  power supply is not connected to the discrete I/O modules, the self-test is also negative, and the module does not start.

### Diagnostics on overvoltage and undervoltage conditions

The I/O modules continuously supervise the voltages provided by the various system power supplies (rack power supply and process power supply).

1

### Diagnostics of the safety discrete input module 140 SDI 953 00S

The diagram below illustrates the internal architecture of the Quantum safety discrete input module 140 SDI 953 00S.

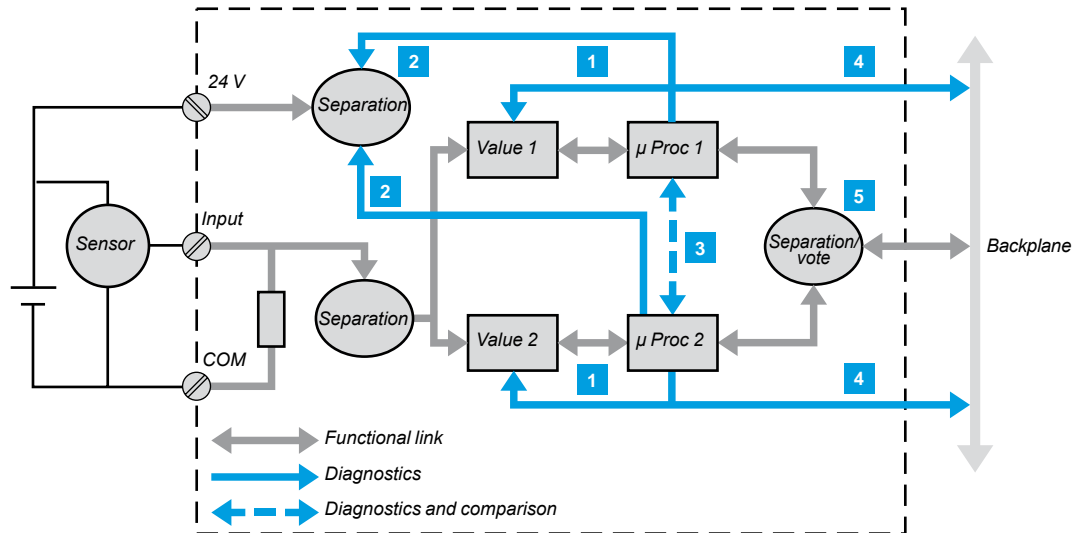

Each input channel uses a unique interface circuit and 2 independent inputs.

### Safety function

The safety function of input module 140 SDI 953 00S is to ensure the state of the module inputs, when these are usable, is transmitted to the Quantum safety PLC processor, within a guaranteed period.

The global mechanism is designed so that whenever this transmission would be impossible, the Quantum CPU would be informed of it and would take the safety measures defined in its application.

### Diagnostics of the safety discrete input module 140 SDI 953 00S (continued)

#### Internal diagnostics

As can be seen on the diagram above, apart from the input terminal block screw, and the connection to the backplane, the module is internally fully redundant. The input is connected to two different measuring devices, each controlled by a microprocessor.

The + 24 V sensor supply voltage is also supplied to each of the two measurement channels, where its validity is tested. Each microprocessor stores data, then checks that the measuring systems have worked perfectly before sending them to the PLC processor. Thus, each microprocessor:

- 1 Imposes levels 0 and 1 on its measuring system, and checks that the values read are indeed consistent with these levels.
- 2 Checks the presence of the + 24 V voltage, needed to validate the measurement.
- 3 Spies on the other microprocessor, checks that it has indeed complied with the diagnostic and measurement protocol. Both microprocessors exchange data, and compare their measurement results. Then each one defines its response to the CPU by preparing a secure response frame containing the following data:
  - Time-based data
  - Identification of the module and its address
  - CRC on 32 bits for transmission with maximum reliability. The maximum length of the data frame is 160 bits (1). The ratio of these CRC and frame lengths is such that the risk of non-detection of a transmission error on the assembly is almost zero.
- 4 The supply voltage from the backplane is also monitored. The module places itself in a safe fallback position in the event of undervoltage or overvoltage of this supply voltage.

For each input, both measurement channels must of course send the same data to the CPU. This is checked by the "vote" function 5 which eliminates any risk of degradation of the data between the microprocessor stage and the connection to the backplane.

(1) 140 SDI 953 00S: 64 bits. 140 SDO 953 00S: 64 read bits, 32 write bits.  
140 SAI 940 00S: 160 bits.

#### Input channel error detection

The digital input monitors the sensor power supply on the process side.

The external wiring is checked by leakage current measurement.

The minimum current is 1 mA. If it does not reach this value, this is deemed to mean an external failure due to a break in the circuit.

If a sensor with volt-free contacts is used, a 15 kΩ pull-up resistor is required at the +24 V to avoid detection of the circuit break.

1

### Diagnostics of the safety discrete output module 140 SDO 953 00S

The diagram below illustrates the internal architecture of the Quantum safety discrete output module 140 SDO 953 00S.

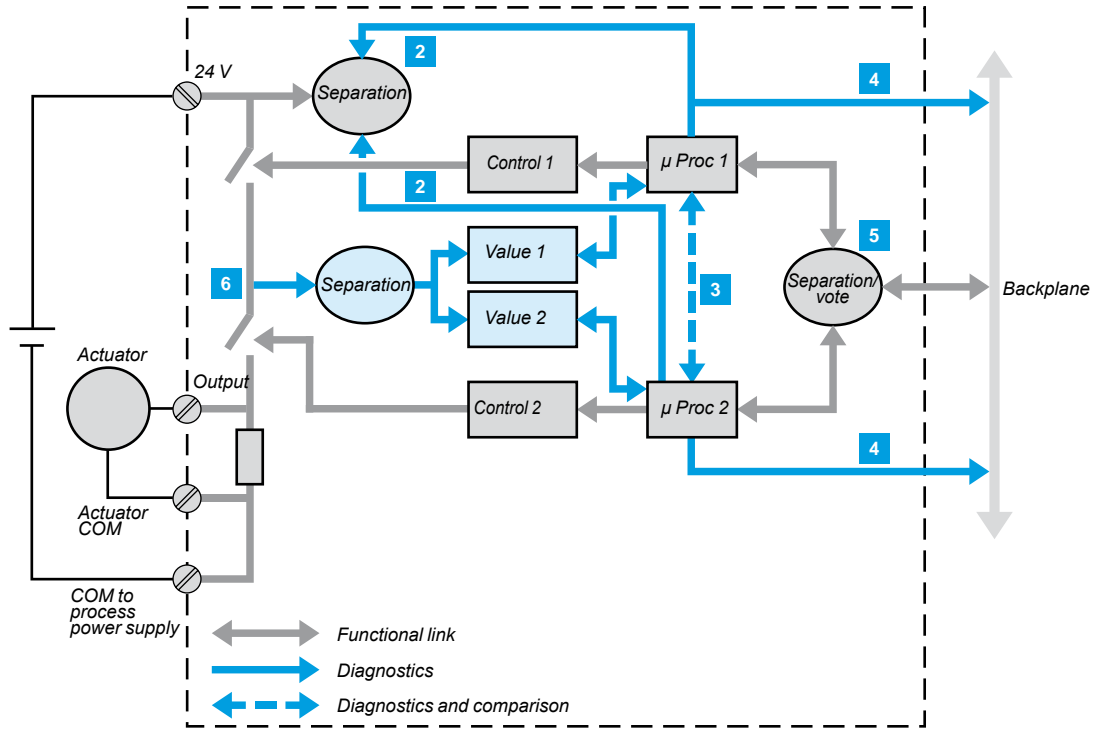

### Diagnostics of the safety discrete output module

#### 140 SDO 953 00S (continued)

##### Safety function

Module **140 SDO 953 00S** is a discrete output module and its safety function is to ensure:

That the CPU control is actually applied to the output:

- Whether communication between the module and the CPU is regular and correct.
- Whether the internal diagnostics confirm that the module is correctly integrated.

In contrast, as soon as the internal diagnostics reveal the failure of a part of the system, the module is designed to ensure the channel switches safely to the fallback position, i.e. to apply a "0" command, zero voltage, the only one that can be guaranteed.

##### Internal diagnostics

Diagnostics **2** to **5** are identical to those of the discrete input module **140 SDI 953 00S**, see page 1/32.

Like all safety modules and CPUs, the **140 SDO 953 00S** module is internally fully redundant. The output is controlled by two different control devices. Each is controlled by a microprocessor.

The output stage is checked. Schematically, each output consists of two switches in series. The mid-point voltage **6** is assessed, and this data item is sent separately to each microprocessor. As there is only one situation where at point **6** the voltage can be floating point, both switches open, the mechanism checks with certainty the possibility of opening both switches, to create the safety function. Thus:

When the current PLC command is "0", the module checks from time to time whether it is capable of controlling both switches in all possible combinations, except for a command at "1".

When the current PLC command is "1", all combinations are tested. The output changes to 0 briefly, for < 1 ms. This has no effect in industrial control where the controlled devices are motors or valves that are insensitive to disturbances in control lasting this long.

The diagram also shows the connection of the external 24 V power supply designed to ensure detection of any failure of the supply (details, see page 1/42).



1

### Timeout states

The discrete output module states in a *timeout* situation can be configured for both the following scenarios:

- Detection of incorrect operation of the Quantum safety PLC CPU
- Communication problem between the Quantum safety PLC CPU and the **140 SDO 953 00S** module

The 3 configurable states are:

- Hold last value
- Set to 0, i.e. safe state
- Set to 1

### Diagnostics of the safety analog input module **140 SAI 940 00S**

The diagram below illustrates the internal architecture of the Quantum safety analog input module **140 SAI 940 00S**.

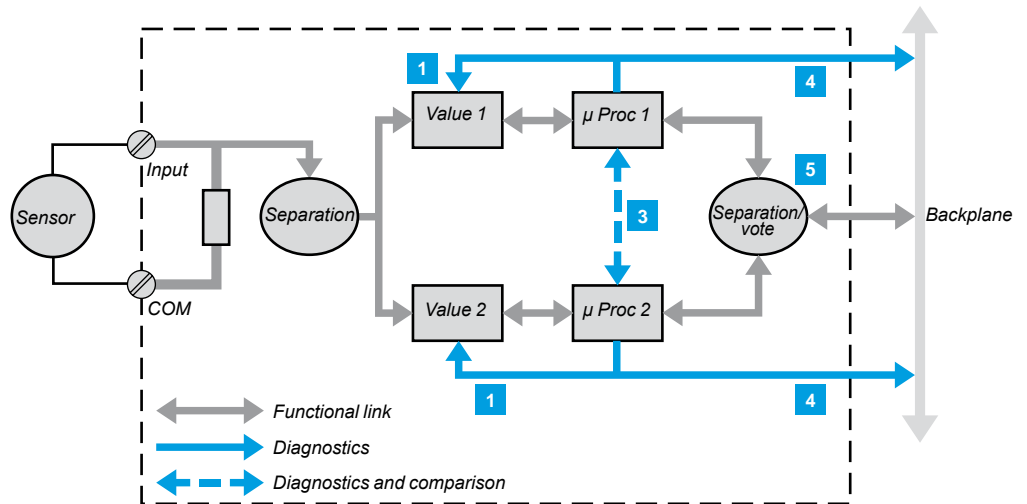

The interface on the process side consists of 8 independent isolated input channels. Each input is acquired by 2 identical circuits.

Here it is a current analog input.

In **1**: the measuring devices are regularly monitored for their capacity to measure, without error, 5 analog values between 4 and 20 mA.

The linearity of the measuring stages is checked at the same time.

The other mechanisms **3** to **5** for diagnostics of the discrete input module **140 SDI 953 00S** are created.

The three input or output modules **140 SDI 953 00S**, **140 SDO 953 00S** and **140 SAI 940 00S**, are also designed with the same electronic and software subassemblies, with the aim of maximizing their reliability.

# Modicon Quantum automation platform

## Safety discrete I/O modules

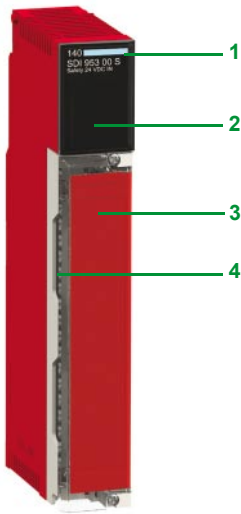

140 SDO 953 00S

### Description

Discrete I/O modules **140 S●●** have the following on the front panel:

- 1 Type and colour code.
- 2 A display block with LEDs.
- 3 A hinged removable cover and user-customizable label.

### To be ordered separately:

- 4 A screw connection block with 40 terminals **140 XTS 001 00/140 XTS 002 00**.

### Display and diagnostics

The LEDs provide a wealth of information about each of the modules. This information includes both activity on the I/O points and characteristics specific to each module, such as indications of a wiring fault or blown fuse. Visual indication about the quality of communication with the CPU is given by an “Active” display, which can be used for troubleshooting.

### 16-point I/O modules

	Active		F	
1	9	1	9	
2	10	2	10	
3	11	3	11	
4	12	4	12	
5	13	5	13	
6	14	6	14	
7	15	7	15	
8	16	8	16	

LED	Colour	Meaning when on
Active	green	Communication present on bus
F	red	External fault detected
1...16	green	The point concerned is active
1...16	red	There is a fault on the point indicated

1

Characteristics			
Safety DC input module			
Module type		140 SDI 953 00S	
Functional safety certification		Certified by TÜV Rheinland as suitable for use in an SIL2 level safety function	
Approvals		CE, UL, CSA, CSA Hazardous Location	
Number of inputs		16	
Number of groups		1	
Number of inputs per group		16	
Input voltage	V $\overline{\text{---}}$	24	
Logic		Positive	
LEDs		Active 1...16 (green) - indicates the point status Failure 1...16 (red) - indicates channel failure/break in the cable	
I/O addresses		7 input words	
Input limit values	Voltage at state 1	V $\overline{\text{---}}$	+11 ...+30
	Voltage at state 0	V $\overline{\text{---}}$	- 3...5
	Current at state 1	mA	$\geq$ 3.0
	Current at state 0	mA	$\leq$ 1.5
Leakage current		mA	–
Maximum input voltages	Permanent	V $\overline{\text{---}}$	30
Response time	Off-to-on	ms	$\leq$ 25
	On-to-off	ms	$\leq$ 25
Input protection		Via internal rectifier	
Internal resistance		k $\Omega$	3.675
Dielectric strength	Between groups	V rms	–
	Between group and bus	V rms	1500 for 1 minute
Bus current required		mA	550
Dissipated power		W	2.75 + (0.25 x number of active points)
Fault detection		- Cable broken, current < 1 mA (1) - Incorrect internal channel diagnostics - System failure	
Sensor external power supply (U <sub>s</sub> )		V $\overline{\text{---}}$	19.2...30 (2)
Fuses	Internal		–
	External		1 A fast-blow, mandatory

(1) Volt-free sensors (0 mA current if open) require a starting resistance allowing a current  $\geq$  1 mA when the break is detected.  
 (2) Always use a sensor external power supply that does not reset automatically after breaking, type **ABL8 RPS 24100** in manual mode (24 V  $\overline{\text{---}}$ , 10 A).

Characteristics (continued)			
Safety DC output module			
Module type		140 SDO 953 00S	
Functional safety certification		Certified by TÜV Rheinland as suitable for use in an SIL2 level safety function	
Approvals		CE, UL, CSA, CSA Hazardous Location	
Number of outputs		16	
Number of groups		1	
Number of outputs per group		16	
Input logic		Positive	
LEDs		Active 1...16 (green) - indicates the point status F 1...16 (red) - indicates channel failure	
I/O addresses		4 output words and 7 input words	
Voltages	Limit values	V $\overline{\text{---}}$	19.2 ...30
	Maximum values	V $\overline{\text{---}}$	34
Residual voltage		V $\overline{\text{---}}$	$\leq 0.3$ to 0.5 A
Leakage current		mA	0.5 at 30 V $\overline{\text{---}}$ per deactivated point
Max. load current	Per point	A	0.65
	Per module	A	10.4
Maximum peak current	Per point	A	2 for 10 ms, once
Response time (on resistive loads)	Off-to-on	ms	$\leq 20$
	On-to-off	ms	$\leq 20$
Output protection (internal)		- Elimination of transient voltage (internal) - Overload - Breaking (0.7 A at 10 ms) - Current limit (2 A)	
Maximum load	Inductance	Henry	0.5 at 8 Hz switching frequency $L = 1/I^2 \cdot F$ where L: load inductance (Henry). I: load current (A). F: switching frequency (Hz)
	Capacity	$\mu\text{F}$	–
	On filament lamp	W	–
Dielectric strength	Between groups	V rms	–
	Between output and bus	V rms	1500 $\sim$ for 1 minute
	Between groups and bus	V rms	
Diagnostics		- Overload - System failure - Failure of the process power supply - Failure of each channel (impulse test, channel opening < 1 ms)	
Bus current required		mA	350
Dissipated power		W	$1.9 + 0.65 I^2$ (I total module load current)
External power supply		V $\overline{\text{---}}$	19.2...30 always with manual reset (1) (2)
Fuses	Internal	Per group	–
	External	Per group	Mandatory, fast-blow, 10 A max, dependent on the module load current
		Per point	–

(1) It is mandatory to use a sensor power supply that does not reset automatically after breaking, type 24 V  $\overline{\text{---}}$  10 A: **ABL8 RPS 24100** in manual mode.

There is only one group of 16 outputs. All the 24 V commons, as well as the 0 V commons, are connected internally. For reasons of safety, it is advisable to connect at least 2 earth lines (0 V common) to the wiring terminals.

(2) There is only one group of 16 channels at the wiring terminals.

1

### Characteristics (continued)

#### Safety analog input modules

Module type		140 SAI 940 00S	
Functional safety certification		Certified by TÜV Rheinland as suitable for use in an SIL2 level safety function	
Approvals		CE, UL, CSA, CSA Hazardous Location	
Number of groups		8	
Number of inputs per group		1	
Number of channels		8	
I/O addressing		13 input words	
Input range		4...20 mA	
Resolution		16 bits (65,536 points)	
Input voltage		-	
Input current	Linearity of the measurement range	<b>mA</b>	0...25, 0...64,800 points (2592 pt/mA)
	Absolute maximum	<b>mA</b>	35
	Impedance	<b>Ω</b>	287
Precision error at 25°C	Absolute		-
	Typical		± 0.3%
	Maximum		± 0.35% over the complete temperature range
Linearity		<b>μA</b>	± 2 from 0 to 60°C
Precision drift according to temperature	Typical		-
	Maximum		-
Common mode rejection		<b>dB</b>	-70 at 50 Hz, -65 at 60 Hz
Input filter		Single-pole low-pass, -3 dB breaking at 15 Hz	
Insulation	Channel-to-bus	<b>V</b>	1500 ~ for one minute
	Channel-to-channel	<b>V</b>	500 ~ for one minute
Update time		<b>ms</b>	15 for all channels
Fault detection		Scale overrun, measurement < 9720 (3.75 mA) or > 52,488 (20.25 mA)	
Bus current required		<b>mA</b>	400
Dissipated power		<b>W</b>	3.5
External power supply		<b>V</b> ⋯	Not required

#### Earthing

Connect each end of the cable shielding as follows:

- Sensor side: To the shielding connection terminals (earth terminals)
- Module side: Fix the shielding to earth using earthing kit **STB XSP 3000** and earthing connectors (STB XSP 3010 or STB XSP 3020).

#### Wiring

The module wiring consists of shielded cables with separate twisted pairs.

**Rmin, Rmax** of the passive device according to:

- The external supply voltage
- The module input current range
- The channel input impedance

# Modicon Quantum automation platform

## Safety discrete and analog I/O modules



140 SDI 953 00S



140 SDO 953 00S



140 SAI 940 00S

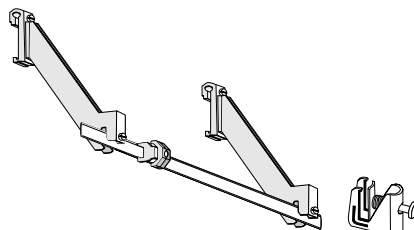

STB XSP 3000

STB XSP 3010/3020

### References

These three I/O modules are certified by TÜV Rheinland as suitable for use in an SIL2 level safety function.

#### Safety discrete input module

Voltage	Number of inputs	Description	Logic	Safety	Reference	Weight kg
24 V $\overline{\text{DC}}$	16	1 group	Positive	Yes	140 SDI 953 00S	–

#### Safety discrete output module

Voltage	Number of outputs	Description	Logic	Safety	Reference	Weight kg
24 V $\overline{\text{DC}}$	16	1 group	Positive	Yes	140 SDO 953 00S	–

#### Safety analog input module

Description	Range	Safety	Reference	Weight kg
8 channels 16 bits	4...20 mA	Yes	140 SAI 940 00S	–

#### Accessories

Description	Sold in lots of	Used for	Safety	Reference	Weight kg
Screw connection block with 40 terminals for I/O modules, degree of protection IP 20	–		Non-interfering	140 XTS 001 00	0.150
Screw connection block with 40 terminals for I/O modules, degree of protection < IP 20	–		Non-interfering	140 XTS 002 00	0.150
Pack of jumpers for 12 40-way screw terminal block			–	140 XCP 600 00	–
Earthing kit	1	Earthing the cable shielding. Kit comprises 1 bar (1 m long) and 2 lateral supports		STB XSP 3000	–
Terminals for earthing kit	10	Cables with a cross-section 1.5...6 mm <sup>2</sup>		STB XSP 3010	–
	10	Cables with a cross-section 5...11 mm <sup>2</sup>		STB XSP 3020	–

#### Replacement parts

Description	Sold in lots of	Reference	Weight kg
Set of keying pins for 40-way screw terminal block	60	140 XCP 200 00	–

1

Connections for the safety 24 V $\overline{\text{V}}$ output module	Connections for the safety 24 V $\overline{\text{V}}$ input module
140 SDO 953 00S	140 SDI 953 00S

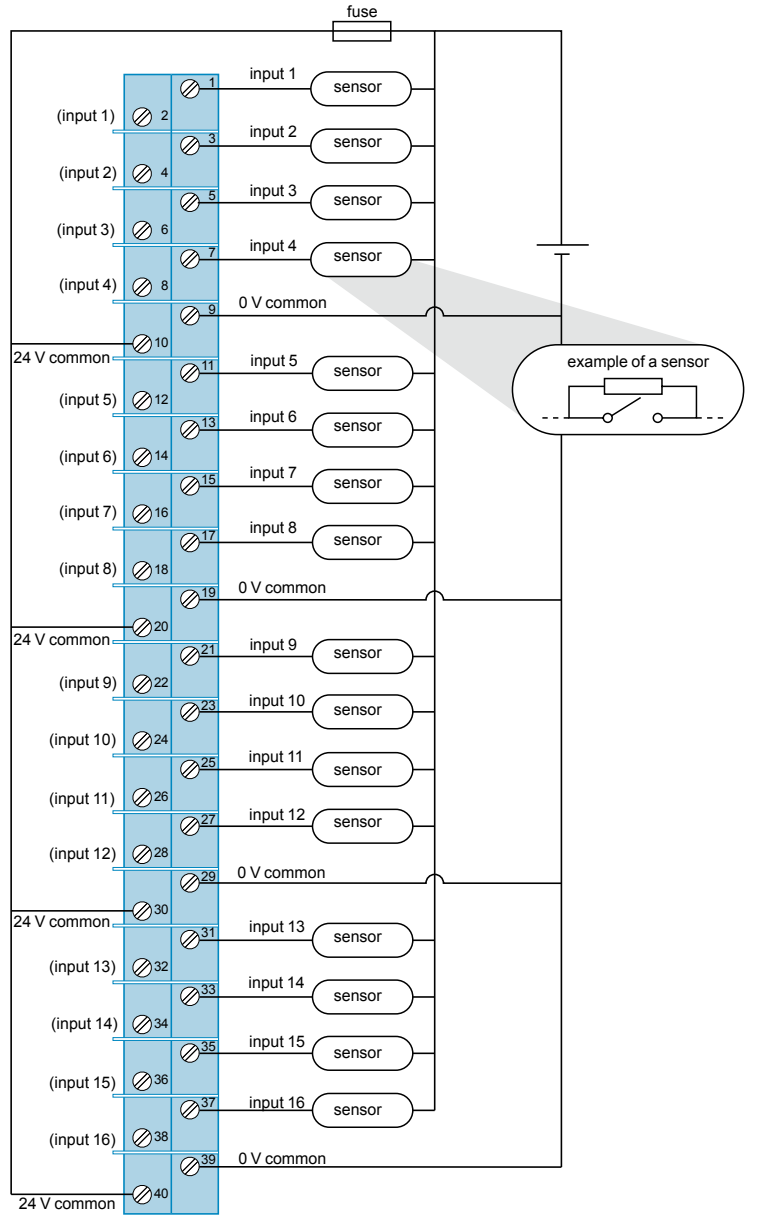
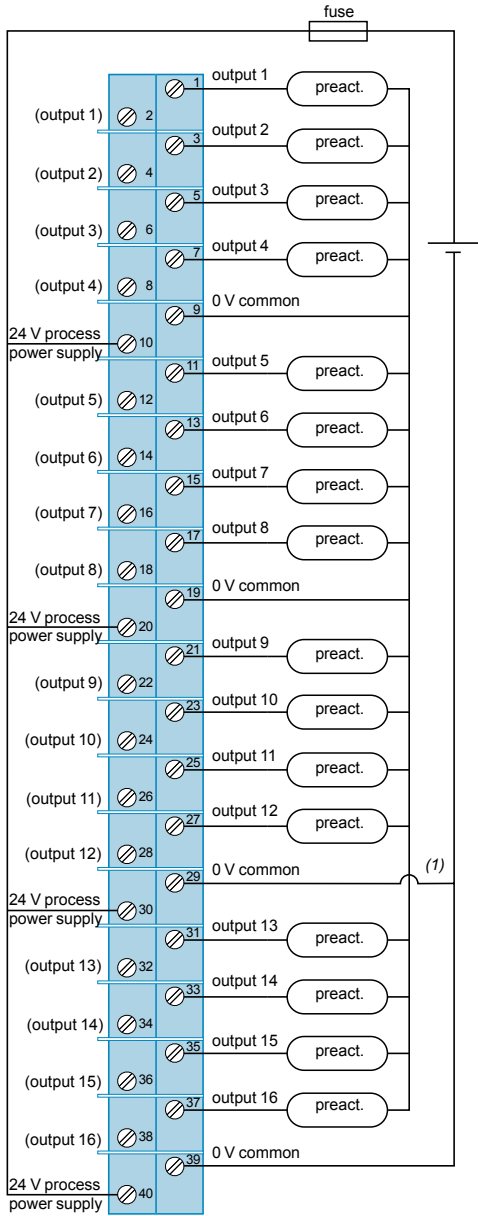

**Power supply:** 24 V  $\overline{\text{V}}$ .  
**Fuse:** max 10 A fast-blow.  
**Preact:** preactuator.

**Power supply:** 24 V  $\overline{\text{V}}$ .  
**Fuse:** 1 A fast-blow fuse.  
**Internal input impedance:** 3675 k $\Omega$ .  
**Pull-up resistor at the sensor power supply** (in the example of a sensor with volt-free contact): 15 k $\Omega$ .

(1) In order to ensure that the 0 Vs are connected inside the module (internal diagnostic function) the power supply negative must not be directly linked to the sensor negatives (0 V commons at 9 and 19).

# Modicon Quantum automation platform

## Safety analog input module

Connections for the safety analog input module  
 140 SAI 940 00S, 8 analog inputs

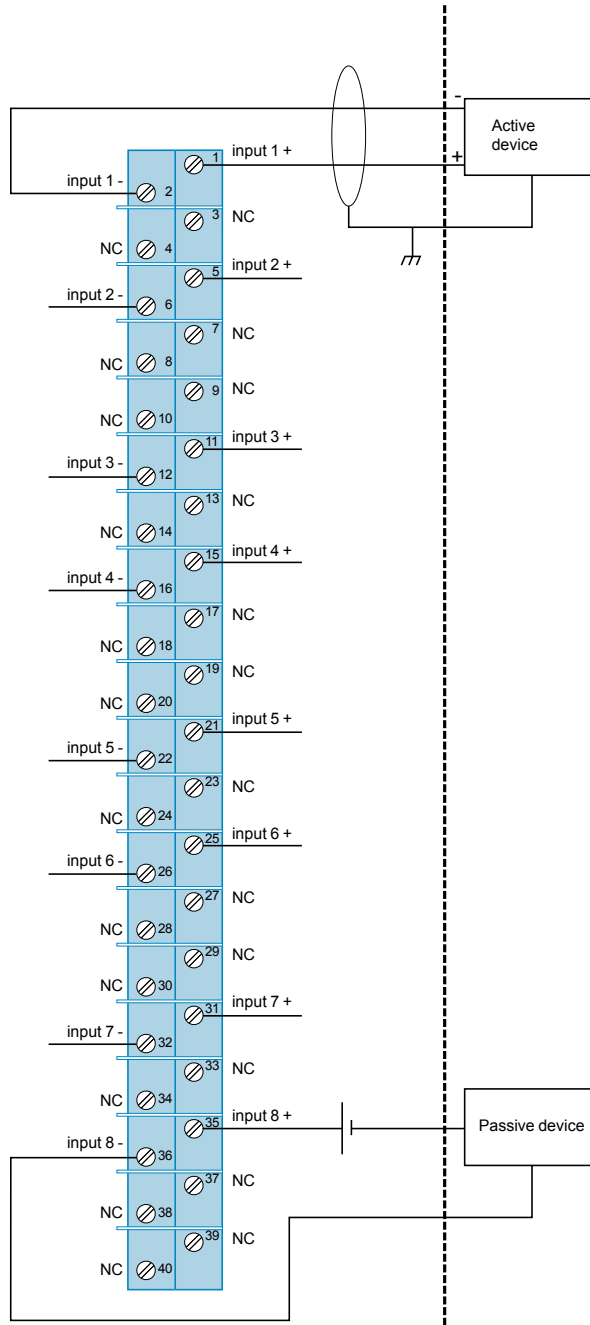

**NC:** Not connected.  
**Internal input impedance:** 287 Ω.  
**Rmin, Rmax** of the passive device according to:  
 - The external supply voltage  
 - The module input current range  
 - The channel input impedance



1

Type	Power supply module	Discrete input module	Discrete output module
			
<b>Input voltage</b>	93...138 V ~ or 170...276 V ~	24 V	
<b>Output voltage</b>			24 V
<b>Main characteristics</b>	11 A power supply at 60°C, redundant	Module with 32 discrete inputs in 4 groups of 8 channels, positive logic	Module with 32 discrete outputs in 4 groups of 8 channels, positive logic
<b>I/O addresses</b>		2 input words	2 output words
<b>Bus current required</b>		330 mA	
<b>Maximum load</b>	Current per channel		0.5 A
	Current per group		4 A
	Current per module		16 A
<b>Functional safety certification</b>	SIL2 certified	Non-interfering	
<b>Type of module</b>	<b>140 CPS 124 20</b>	<b>140 DDI 353 00</b>	<b>140 DDO 353 00</b>
<b>Page</b>	3/37	4/26	

Analog input module	Analog output module	RIO head adapter	RIO drop adapter	Ethernet TCP/IP network module
---------------------	----------------------	------------------	------------------	--------------------------------



–

–

- |  |  |   |  |   |
|--|--|---|--|---|
| <ul style="list-style-type: none"> <li>16 analog input channels, differential or common point</li> <li>Ranges: 0...25 mA, 0...20 mA, 4...20 mA</li> <li>Resolution: up to 25,000 points</li> <li>Isolation between channels: 30 V</li> </ul> | <ul style="list-style-type: none"> <li>4 analog output modules</li> <li>Range: 4...20 mA</li> <li>Resolution: 12-bit</li> <li>Isolation between channels: 500 V <math>\sim</math> at 47...63 Hz or 750 V <math>\sim</math> for 1 minute</li> </ul> | <ul style="list-style-type: none"> <li>Quantum RIO head adapter with cable, redundant</li> <li>Controls up to 31 RIO drops</li> </ul> | <ul style="list-style-type: none"> <li>Quantum RIO drop adapter with cable, redundant</li> </ul> | <ul style="list-style-type: none"> <li>Interface 10 BASE-T/100 BASE-TX (copper cable), 100 BASE-FX (fibre optic)</li> <li>CSMA-CD access</li> <li>Medium: Shielded twisted pair cables or fibre optic cables</li> <li>In safety application: Ethernet Peer-to-Peer and Global Data</li> </ul> |
|--|--|---|--|---|

17 input words	4 output words	–	
360 mA	480 mA	One channel: 600 Two channels: 750	1000 mA

–

–

–

Non-interfering

<b>140 ACI 040 00</b>	<b>140 ACO 020 00</b>	<b>140 CRP 932 00</b>	<b>140 CRA 932 00</b>	<b>140 NOE 771 11</b>
-----------------------	-----------------------	-----------------------	-----------------------	-----------------------

4/55		3/8		6/41
------	--	-----	--	------

# Modicon Quantum automation platform

## Non-interfering modules

1



140 CPS 124 20



140 CRP 932 00



140 NOE 771 11

### References

The following is a list of Quantum non-interfering modules which are fully compatible with Quantum safety modules:

#### Power supply module

Input voltage	Output current	Type	Safety	Min. PV (1)	Reference	Weight kg
115/230 V ~	11 A	Redundant	SIL2 certified	3	140 CPS 124 20	0.650

#### Discrete input module

Description	Voltage	Modularity	Logic	Safety	Reference	Weight kg
4 groups of 8 inputs	24 V $\overline{\text{DC}}$	32 inputs	Positive	Non-interfering	140 DDI 353 00	0.300

#### Discrete output module

Description	Voltage	Modularity	Logic	Safety	Reference	Weight kg
4 groups of 8 outputs	24 V $\overline{\text{DC}}$	32 outputs	Positive	Non-interfering	140 DDO 353 00	0.450

#### Analog input module

Description	Range	Safety	Reference	Weight kg
16 high level channels 0...25,000 points, single-pole	0...20 mA 0...25 mA 4...20 mA	Non-interfering	140 ACI 040 00	0.300

#### Analog output module

Description	Range	Safety	Reference	Weight kg
4 current channels 12 bits	4...20 mA	Non-interfering	140 ACO 020 00	0.300

#### Modules

Description	Type of architecture	Topology	Transparent Ready	Safety	Reference	Weight kg
Quantum RIO head adaptor (1 max.)	Remote I/O (RIO) and mixed I/O	Redundant cable	-	Non-interfering	140 CRP 932 00	-
Quantum RIO drop adaptor (31 max.)					140 CRA 932 00	-
Ethernet TCP/IP network module	Mixed	Bus or ring (copper or fibre optic)	Class C30	Non-interfering	140 NOE 771 11	0.345

#### Racks

Description	Number of positions	Safety	Reference	Weight kg
Racks for: - Local I/O modules - Remote I/O modules - Distributed I/O modules	6	Non-interfering	140 XBP 006 00	0.640
	10	Non-interfering	140 XBP 010 00	1.000
	16	Non-interfering	140 XBP 016 00	1.600

(1) PV: Product version

## References (continued)

## Accessories for power supply module 140 CPS 124 20

Description	Degree of protection	Safety	Reference	Weight kg
7-way screw terminal block	IP 20	–	140 XTS 005 00	0.150

## Accessories for mixed discrete I/O module

Description	Sold in lots of	Safety	Reference	Weight kg
40-way screw terminal block for I/O modules, degree of protection IP 20	–	Non-interfering	140 XTS 001 00	0.150
40-way screw terminal block for I/O modules, degree of protection < IP 20	–	Non-interfering	140 XTS 002 00	0.150
Empty module Without screw terminal block	–	–	140 XCP 500 00	–
Empty module with hinged cover Without screw terminal block	–	–	140 XCP 510 00	–
Pack of jumpers for 40-way screw terminal block	12	–	140 XCP 600 00	–
Discrete input simulator 16 switches for 140 DAI 540 00 and 140 DAI 740 00 modules	–	–	140 XSM 002 00	–
Set of keying pins for 40-way screw terminal block	60	–	140 XCP 200 00	–

## Rack accessories

Description	Length/Size	Safety	Reference	Weight kg
19" support for flush mounting a 140 XBP 010 00 rack	125 mm deep	–	140 XCP 401 00	–
19" support for surface mounting a 140 XBP 010 00 rack	20 mm deep	–	140 XCP 402 00	–

## Earthing accessories

Description	Sold in lots of	Used for	Safety	Reference	Weight kg
Earthing kit	1	Earthing the cable shielding. Kit comprises 1 bar (1 m long) and 2 lateral supports	–	STB XSP 3000	–
Terminals for earthing kit	10	Cables with a cross-section 1.5...6 mm <sup>2</sup>	–	STB XSP 3010	–
	10	Cables with a cross-section 5...11 mm <sup>2</sup>	–	STB XSP 3020	–

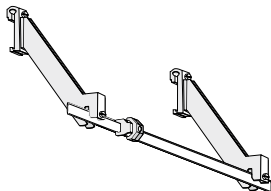

STB XSP 3000



STB XSP 3010/3020



## 2.1 - Unity CPUs

*Unity CPU selection guide* ..... 2/2

- Standard Unity CPUs ..... 2/4
  - Presentation ..... 2/4
  - Description ..... 2/5
  - Memory structure ..... 2/6
  - Characteristics ..... 2/8
  - References ..... 2/10
- PCMCIA memory extension cards ..... 2/12
  - Presentation ..... 2/12
  - References ..... 2/13

## 2.2 - Concept/ProWORX CPUs

*Concept/ProWORX standard CPU selection guide* ..... 2/14

- Concept/ProWORX standard CPUs ..... 2/16
  - Presentation ..... 2/16
  - Description ..... 2/17
  - Characteristics ..... 2/18
  - References ..... 2/19



Automation platform for Unity Pro software offer	Simple applications	Simple and complex applications
--	---------------------	---------------------------------



<b>Number of racks</b> 2/3/4/6/10/16 slots	Local I/O	2 racks (1 main + 1 extension)	
	Remote I/O (RIO)	31 drops x 2 racks	
	Distributed I/O (DIO)	3 networks with 63 single-rack drops	
<b>Maximum discrete I/O (1)</b>	Local I/O	No limit (max. 27 slots)	
	Remote I/O (RIO)	31,744 input channels and 31,744 output channels	
	Distributed I/O (DIO)	8000 input channels and 8000 output channels per network	
<b>Maximum analog I/O (1)</b>	Local I/O	No limit (max. 27 slots)	
	Remote I/O (RIO)	1984 input channels and 1984 output channels	
	Distributed I/O (DIO)	500 input channels and 500 output channels per network	
<b>Application-specific modules</b>		Intrinsically safe I/O, high-speed counter, axis control, interrupt inputs, serial link, accurate time stamping	

<b>Number of communication modules and axes (in local rack)</b>	Ethernet TCP/IP, Modbus Plus, Profibus DP, SY/Max Ethernet, all combinations	2	6
	<b>Bus connections</b>	Modbus	2 integrated RS 232/485 Modbus slave RTU/ASCII ports
	AS-Interface actuator/sensor bus	Limited number on local rack (max. 27 slots), 4 on remote rack (RIO), 2 on distributed rack (DIO)	
<b>Network connections</b>	Profibus DP (2)	2 "option" modules on local rack	6 "option" modules on local rack
	Modbus Plus	1 integrated port, 2 "option" modules on local rack	1 integrated port, 6 "option" modules on local rack (3)
	Ethernet TCP/IP	2 "option" modules on local rack	6 "option" modules on local rack
	USB	-	

<b>Process control</b>	Control loops (4)	20 to 40 programmable channels	40 to 80 programmable channels
<b>Redundancy</b>	Power supplies, remote I/O network, Modbus Plus modules, Ethernet TCP/IP modules		
<b>Hot Standby</b>	-		

<b>Memory capacity without PCMCIA card</b>	IEC program and data	548 Kb	1056 Kb
	<b>Memory extension with PCMCIA card</b>	Program	-
	Data	-	-
	File storage	-	-

<b>Functional safety certification</b>	-
--	---

<b>Quantum CPUs</b>	<b>140 CPU 311 10</b>	<b>140 CPU 434 12 U</b>
---------------------	-----------------------	-------------------------

<b>Pages</b>	2/10
--------------	------

(1) The maximum values for the number of discrete I/O and analog I/O are not cumulative.  
 (2) Profibus DP modules by our partner Prosoft.  
 (3) Modbus Plus modules: Only the first 2 of the 6 modules feature the full range of functions.  
 (4) Usage values, including memory resources and processor power.  
 (5) The number of loops is limited according to their complexity (volume of associated data to be transferred from Normal to Standby).

**Complex applications**

**Applications with redundancy (Hot Standby)**



2 racks (1 main + 1 extension)
31 drops x 2 racks (1 main + 1 extension)
3 networks with 63 single-rack drops
No limit (max. 26 slots)
31,744 input channels and 31,744 output channels
8000 input channels and 8000 output channels per network
No limit (max. 26 slots)
1984 input channels and 1984 output channels
500 input channels and 500 output channels per network
Intrinsically safe I/O, high-speed counter, axis control, interrupt inputs, serial link, accurate time stamping

6	
1 integrated RS 232/485 Modbus slave RTU/ASCII port	
Limited number on local rack (max. 26 slots), 4 on remote rack (RIO), 2 on distributed rack (DIO)	
6 "option" modules on local rack	
1 integrated port, 6 "option" modules on local rack (3)	
1 integrated port (10BASE-T/100BASE-TX), 6 "option" modules on local rack	1 integrated 100BASE-FX Hot Standby port, 6 "option" modules on local rack
1 port reserved for programming PC	

20 to 60 programmable channels	20 to 60 programmable channels (5)		
Power supplies, remote I/O network, Modbus Plus modules, Ethernet TCP/IP modules			
-	Yes		
768 Kb	1024 Kb	3072 Kb	1024 Kb
Up to 7168 Kb			
512 Kb	1024 Kb	3072 Kb	1024 Kb
8 Mb (PCMCIA extension in processor slot no. 0 and/or no. 1)			

<b>140 CPU 651 50</b>	<b>140 CPU 651 60</b>	<b>140 CPU 652 60</b>	<b>140 CPU 671 60</b>
-----------------------	-----------------------	-----------------------	-----------------------



# Modicon Quantum automation platform

## Standard Unity CPUs

2



### Presentation

CPUs for the Modicon Quantum automation platform are based on 486 and Pentium high-performance processors, and are compatible with Unity Pro software.

Numerous functions are included as standard in Quantum CPUs:

- Superior scan times and fast I/O acquisition.
- Ability to handle interrupts, timed and I/O based.
- Handling of Fast task, as well as a Master task.
- Memory expansion through PCMCIA cards.
- Multiple communication ports integrated in the CPU.
- Ease of diagnostics and maintenance via the LCD display block on the front panel of high-end CPUs.

The CPUs offered have different memory capacities, processing speeds and communication options.

### Protected backed up memory

As standard, the CPUs store the application program in a battery-backed internal RAM. This battery is located on the front of the CPU and can be replaced while the CPU is running.

To protect the application program from inadvertent changes during operation, the processors feature a key switch on the front panel to protect the memory. This key switch can also be used to start and stop the CPU. The **140 CPU 311 10** processor only has a memory-protect slide switch.

High-end **140 CPU 651 50/60**, **140 CPU 652 60** and **140 CPU 671 60** processors have 2 slots for a PCMCIA card:

- An upper slot (no. 0) to receive memory extension cards (programs, symbols, constants and/or data storage).
- A lower slot (no. 1) to receive a data storage memory extension card.

### Built-in communication ports

Quantum CPUs incorporate:

- Two Modbus RS 232 ports (Modbus RS 485 with 140 CPU 65● ●0 and 140 CPU 671 60 processors).
- One Modbus Plus port.

Depending on the model, Quantum CPUs can include:

- A 10BASE-T/100BASE-TX Ethernet TCP/IP port (RJ45 connection).
- A USB port for connecting a programming PC terminal.

### LCD display

Depending on the model, the CPUs have an LCD display (2 lines of 16 characters) with adjustable brightness and contrast controls. The keypad associated with display can be used for diagnostics, access to certain configuration parameters and starting and stopping the CPU.

### Hot Standby redundancy

The **140 CPU 671 60** processor is dedicated to the availability function of Hot Standby applications. It has an Ethernet 100 Mbps fibre optic link and the Hot Standby function can be diagnosed from the LCD display.

### Quantum application design and installation

Use of these Quantum processors requires:

- Unity Pro Large or Extra Large programming software. This software is compatible with the Premium platform.
- Optionally, as required:
  - Unity Application Generator specialist software for modelling and generating process applications
  - Unity EFB toolkit software for developing EF and EFB function block libraries in C language
  - Unity SFC View software for viewing and diagnostics of applications written in Sequential Function Chart language (SFC) or Grafcet

# Modicon Quantum automation platform

## Standard Unity CPUs

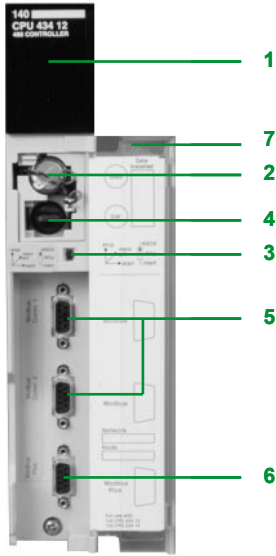

140 CPU 434 12U/534 14U

### Description

#### Standard CPUs

The **140 CPU 311 10** and **140 CPU 434 12U** processor front panel comprises:

- 1 A display block with 7 LED indicators:
  - Ready LED (green): Power-up diagnostic tests successful
  - Run LED (green): Program executing
  - Modbus LED (green): Activity on the Modbus port
  - Modbus Plus LED (green): Activity on the Modbus Plus port
  - Mem Prt LED (orange): Memory write-protected (memory protection switch activated)
  - Bat Low LED (red): Backup battery needs replacing or is missing
  - Error A LED (red): Communication fault on the Modbus Plus port
- 2 A backup battery slot.
- 3 A slide switch for selecting the Modbus port communication parameters.
  - A slide switch (140 CPU 311 10 model) for write-protecting the memory.
- 4 A key switch (140 CPU 434 12U/534 14U models):
  - Stop position: The PLC is stopped and program modifications are not permitted.
  - Mem Prt position: The PLC is either stopped or running and program modifications are not permitted.
  - Start position: The PLC is either stopped or running, program modifications are permitted.
- 5 Two 9-way female SUB-D connectors for connecting to the Modbus bus.
- 6 A 9-way female SUB-D connector for connecting to the Modbus Plus network.
- 7 A removable hinged door with a user-customizable identification label.

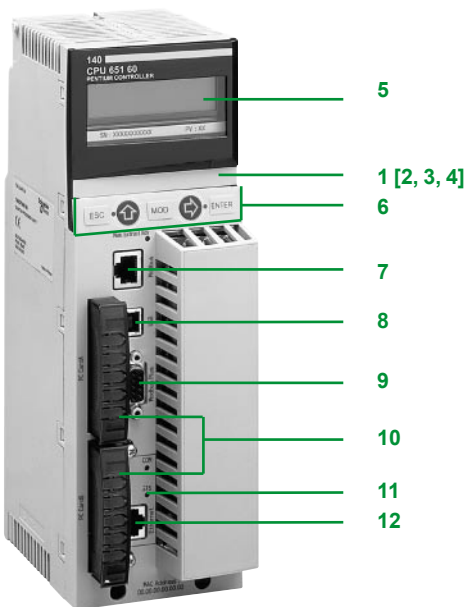

140 CPU 651 50/60  
140 CPU 652 60

#### High performance CPUs

The **140 CPU 651 50**, **140 CPU 651 60**, **140 CPU 652 60** and **140 CPU 671 60** processor front panel comprises:

- 1 An LCD display cover, providing access to:
- 2 A key switch:
  - Unlocked: All system menu operations are able to be invoked and all changeable module parameters are able to be modified by the operator via the LCD and keypad, memory protection is off.
  - Locked: No system menu operations are able to be invoked and all changeable module parameters are read only, memory protection is on.
- 3 A backup battery slot.
- 4 A reset button (Restart).
- 5 An LCD display (2 lines of 16 characters) with brightness and contrast controls.
- 6 A 5-button keypad with 2 LEDs (*ESC*, *ENTER*, *MOD*, *↑*, *⇐*).
- 7 An RJ45 connector for connecting to the Modbus bus.
- 8 A type B female USB connector for connecting the programming PC terminal.
- 9 A 9-way female SUB-D connector for connecting to the Modbus Plus network.
- 10 Two slots for PCMCIA memory extension cards.
- 11 Two LEDs:
  - COM LED (green): Activity on the Ethernet port (140 CPU 651 50/60, 140 CPU 652 60 models), activity on the Hot Standby primary or secondary drop (140 CPU 671 60 model)
  - ERR LED (red): Ethernet frame collision (140 CPU 651 50/60, 140 CPU 652 60 models), communication error between the Hot Standby primary and secondary drops (140 CPU 671 60 model).
- 12 A connector:
  - RJ45 for connecting to the Ethernet network (140 CPU 651 50/60, 140 CPU 652 60 models)
  - One MT-RJ fibre optic connector for interconnecting the primary and standby PLCs in the Hot Standby architecture (model 140 CPU 671 60)

### Memory structure

Processor without PCMCIA memory card

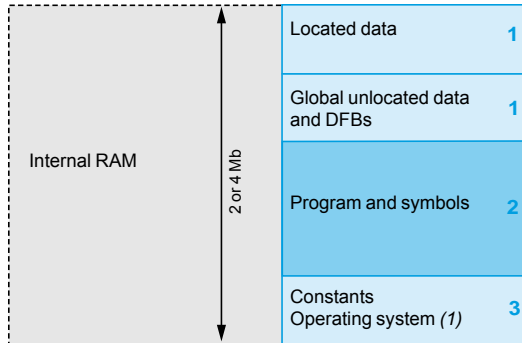

The application memory is divided into memory areas physically distributed in the internal RAM memory and on 1 or 2 PCMCIA memory extension cards (only on 140 CPU 651 50/60, 140 CPU 652 60 and 140 CPU 671 60 processors):

- Application data area always in internal RAM. This area is broken down into 2 types of data, to be used according to the user's habits and preferences:
  - Global located data, corresponding to data defined by an address (for example %MW237) with which a symbol can be associated (for example, Counting\_rejects).
  - Unlocated data, corresponding to data defined only by a symbol. This type of addressing removes the memory "mapping" management constraints because the addresses are assigned automatically.
  - DFB unlocated data corresponding to DFB user function blocks. The size of this object zone is only limited by the size of the internal RAM physical memory available.

Processor with PCMCIA memory card in slot no. 0

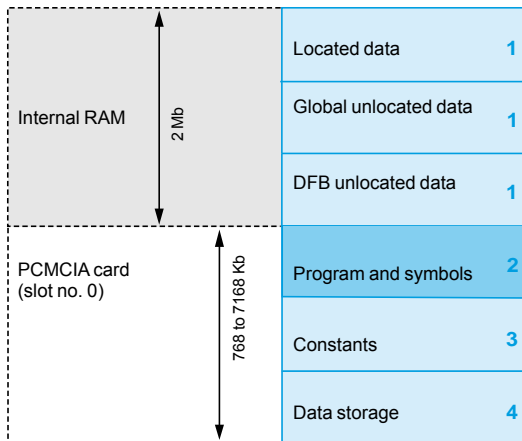

- Application program and symbols area in the internal RAM or in the PCMCIA memory card (descriptor, executable code for the tasks and application symbols database).

- Constants area in internal RAM or the PCMCIA memory card (constant words, initial values and configuration).

- Area for storing additional data that can be used for distributed applications to store information such as production data and manufacturing recipes (only on 140 CPU 651 50/60, 140 CPU 652 60 and 140 CPU 671 60).

According to the application memory size requirements, two memory structures are possible depending on whether the Quantum processor (140 CPU 651 50/60, 140 CPU 652 60 or 140 CPU 671 60) has 0, 1 or 2 PCMCIA memory extension cards:

- Application in internal RAM, the application is completely loaded into the processor's battery-backed internal RAM (2) the capacity of which depends on the processor model.

- Application in the PCMCIA card, the internal RAM is reserved for the application data. The PCMCIA memory card contains the program space (program, symbols and constants areas). Certain types of PCMCIA memory card also take the data storage area.

Processor with data storage memory card in slot no. 0

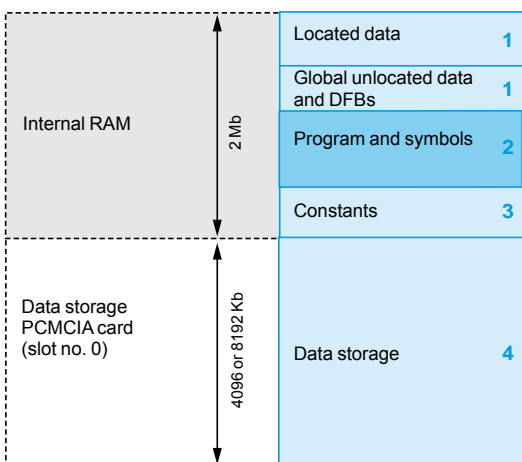

The presence of the symbols area with the program area is optional. The fact of having the application symbols database on the PLC means that, when it is connected to an empty programming PC, all the elements needed to debug or upgrade this PLC are available.

(1) Only for 140 CPU 311 10/434 12U processors.

(2) The internal RAM memory is backed up by a nickel cadmium battery. RAM memory cards are protected by a Lithium battery.

Processor with 2 PCMCIA memory cards in slot no. 0 and no. 1

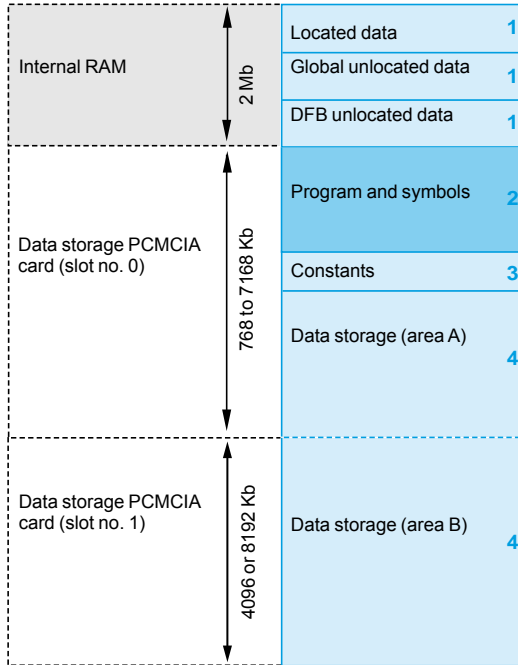

### Memory structure (continued)

#### Extension of the file storage area

With the **TSX MRP F004M/F008M** file storage memory cards (4096 or 8192 Kbytes):

- A file storage area can be provided when the application is completely loaded in the internal RAM.
- The memory space can be freed up for the program when the application is in the PCMCIA card.

The Unity Pro programming software assists the application designer with management of the structure and the occupation of memory space in the Quantum PLC.

#### Protecting the application

Whether located in the internal RAM or in the PCMCIA card, the application can be protected with a key switch (see page 2/5), in order to prohibit its access (read or modify program) online under Unity Pro.

Quantum PLCs have been designed to conform with the main national and international standards relating to electronic devices for industrial control systems (see pages 10/2 to 10/17 “Standards, certifications and environmental conditions”).

### Characteristics and performance

Processor		140 CPU 311 10	140 CPU 434 12U	140 CPU 651 50	
<b>Maximum configuration</b>	No. of racks with 2/3/4/6/10/16 slots	Local I/O	2		
		Remote I/O	31 drops x 2 racks		
		Distributed I/O	63 drops x 1 rack/3 networks		
<b>Inputs/outputs</b>	Discrete I/O (1)	Local I/O	Unlimited (27 slots max.)		
		Remote I/O	31,744 inputs and 31,744 outputs		
		Distributed I/O	8000 inputs and 8000 outputs per network		
	Analog I/O (1)	Local I/O	Unlimited (27 slots max.)		
		Remote I/O	1984 inputs and 1984 outputs		
		Distributed I/O	500 inputs and 500 outputs per network		
Application-specific I/O		Intrinsically safe and counter I/O, high-speed interrupt inputs, serial link, accurate time stamping			
<b>Communication</b>	No. of application-specific modules (in local rack)	Ethernet, Modbus Plus, Profibus DP, SERCOS, SY/Max	2	6	
		Modbus	2 integrated RS (2)	2 integrated RS 232 Modbus/ASCII	1 integrated RS 232/485 Modbus/ASCII
	Maximum number of connections	Modbus Plus	1 integrated, 2 max. in local rack	1 integrated, 6 max. in local rack	
		Ethernet TCP/IP	2 max. in local rack	6 max. in local rack	1 integrated, 6 max. in local rack
		Profibus DP	2 max. in local rack	6 max. in local rack	
		AS-Interface	Unlimited (27 slots max.) in local rack, 4 in remote drop, 2 in distributed drop		Unlimited (26 slots max.) in local rack, 4 in remote drop, 2 in distributed drop
		USB	-		1 port reserved for programming PC
<b>Functions</b>	Redundancy	Power supplies, remote I/O network, Modbus Plus, Ethernet TCP/IP, CPUs			
	Process control	Yes			
	Hot Standby	-			
<b>Memory capacity without PCMCIA card</b>	Internal RAM	<b>MB</b>	2		
	Program and unlocated data (min.)	<b>Kb</b>	400	800	512
	Located data and configuration (max.)	<b>Kb</b>	148	256	
<b>Memory capacity with PCMCIA card</b>	Program	<b>Kb</b>	-		7168
	Located/unlocated data and configuration (max.)	<b>Kb</b>	-		512
<b>Maximum capacity of memory object areas</b>	Flash	<b>Kb</b>	1152		-
	Located internal bits (%Mi)	<b>bits</b>	51,712	65,528	
	Located internal data	<b>Kb</b>	19.3	130	
	Unlocated internal data	<b>Kb</b>	548	1056	512/768 (with/without PCMCIA)
<b>Key switch</b>	Start/Stop/Mem prot		-	Yes	-
	Mem prot on/off		-		Yes
<b>Switch</b>	Mem prot/off		Yes	-	
	Com port: ASCII/RTU/Mem		Yes		-
<b>Application structure</b>	Master task		1 cyclic/periodic		
	Fast task		1 periodic		
	Auxiliary tasks		0		
	Interrupt tasks	Max. number		128	
I/O interrupt			64		128
Time delay interrupt			16		32
<b>Execution time for one instruction (3)</b>	Boolean	<b>µs</b>	0.12...0.585		
	On word	<b>µs</b>	0.12...0.585		
	Fixed point arithmetic	<b>µs</b>	0.10...0.27		
	On floating point	<b>µs</b>	0.10...0.27		
<b>Number of Kinstructions executed per ms</b>	100% Boolean	<b>Kins/ms</b>	1.86		
	65% Boolean and 35% numerical	<b>Kins/ms</b>	2.49		
<b>System overhead</b>	MAST task	<b>ms</b>	1		
	FAST task	<b>ms</b>	0.2		
<b>Functional safety certification</b>			-		
<b>Consumption on the bus</b>		<b>mA</b>	1800		2160

(1) The maximum values for the number of discrete and analog I/O are not cumulative.

(2) 2 RS 232/485 Modbus/ASCII integrated links.

(3) Limit values according to the type of instruction.

Characteristics and performance (continued)					
Processor		140 CPU 651 60	140 CPU 652 60	140 CPU 671 60	
<b>Maximum configuration</b>	No. of racks with 2/3/4/6/10/16 slots	Local I/O	2		
		Remote I/O	31 drops x 2 racks		
		Distributed I/O	63 drops x 1 rack/3 networks	63 drops x 1 rack/1 network (1)	63 drops x 1 rack/3 networks
<b>Inputs/outputs</b>	Discrete I/O (2)	Local I/O	Unlimited (26 slots max.)		
		Remote I/O	31,744 inputs and 31,744 outputs		
		Distributed I/O	8000 inputs and 8000 outputs per network		
	Analog I/O (2)	Local I/O	Unlimited (26 slots max.)		
		Remote I/O	1984 inputs and 1984 outputs		
		Distributed I/O	500 inputs and 500 outputs per network		
Application-specific I/O		Intrinsically safe and counter I/O, high-speed interrupt inputs, serial link, accurate time stamping			
<b>Communication</b>	No. of application-specific modules (in local rack)	Ethernet, Modbus Plus, Profibus DP, SERCOS, SY/Max	6		
	Maximum number of connections	Modbus	1 integrated RS 232/485 Modbus/ASCII		
		Modbus Plus	1 integrated, 6 max. in local rack		
		Ethernet TCP/IP	1 integrated, 6 max. in local rack		
		Profibus DP	6 max. in local rack		
		AS-Interface	Unlimited (26 slots max.) in local rack, 4 in remote drop, 2 in distributed drop		
USB	1 port reserved for programming PC				
<b>Functions</b>	Redundancy		Power supplies, remote I/O network, Modbus Plus, Ethernet TCP/IP, CPUs		
	Process control		Yes		
	Hot Standby			Yes	
<b>Memory capacity without PCMCIA card</b>	Internal RAM	<b>MB</b>	2	4	2
	Program and unlocated data (min.)	<b>Kb</b>	1024	2816	1024
	Located data and configuration (max.)	<b>Kb</b>	256		
<b>Memory capacity with PCMCIA card</b>	Program	<b>Kb</b>	7168		
	Located/unlocated data and configuration (max.)	<b>Kb</b>	1024	3072	1024
<b>Maximum capacity of memory object areas</b>	Flash	<b>Kb</b>	–		
	Located internal bits (%Mi)	<b>bits</b>	65,528		
	Located internal data	<b>Kb</b>	130		
	Unlocated internal data	<b>Kb</b>	1024		
<b>Key switch</b>	Start/Stop/Mem prot		–		
	Mem prot on/off		Yes		
<b>Switch</b>	Mem prot/off		–		
	Com port: ASCII/RTU/Mem		–		
<b>Application structure</b>	Master task		1 cyclic/periodic		
	Fast task		1 periodic		
	Auxiliary tasks		4		
	Interrupt tasks	Max. number		128	
		I/O interrupt		128	
	Time delay interrupt		32		
<b>Execution time for one instruction (3)</b>	Boolean	<b>µs</b>	0.0525...0.075		
	On word	<b>µs</b>	0.045...0.06		
	Fixed point arithmetic	<b>µs</b>	0.045...0.06		
	On floating point	<b>µs</b>	0.40...0.50		
<b>Number of Kinstructions executed per ms</b>	100% Boolean	<b>Kins/ms</b>	10.28		
	65% Boolean and 35% numerical	<b>Kins/ms</b>	10.07		
<b>System overhead</b>	MAST task	<b>ms</b>	1		
	FAST task	<b>ms</b>	0.2		
<b>Functional safety certification</b>			–		
<b>Consumption on the bus</b>		<b>mA</b>	2760		2500

(1) 3 networks using option module 140 NOM21• 00  
 (2) The maximum values for the number of discrete and analog I/O are not cumulative.  
 (3) Limit values according to the type of instruction.

2

**Characteristics and performance (continued)**

<b>Processor</b>		140 CPU 311 10 140 CPU 434 12U	140 CPU 651 50 140 CPU 651 60 140 CPU 652 60 140 CPU 671 60	
<b>Memory backup</b>	Product reference	990 XCP 980 00		
	Battery type	Lithium		
	Voltage	V	3	
	Capacity	mAh	1200	
	Typical current	µA	45	60
	Maximum current	µA	70 (up to 60°C)	90 (up to 60°C)
	Storage life	yr	10	10

**References**  
**Unity CPUs**

Processor		Memory (max.)			Communication ports	Safety	Reference	Weight
Clock speed	Coprocessor	RAM	Program	Program with PCMCIA card				kg
		MB	Kb	Kb				
66	Built-in math	2	400	–	2 Modbus RS 232 1 Modbus Plus	–	140 CPU 311 10	–
	Built-in math	2	800	–	2 Modbus RS 232 1 Modbus Plus	–	140 CPU 434 12U	–
166	Yes, built-in Ethernet TCP/IP	2	512	7168	1 Modbus (1) 1 Modbus Plus 1 USB 1 Ethernet TCP/IP	–	140 CPU 651 50	–
266	Yes, built-in Ethernet TCP/IP	2	1024	7168	1 Modbus (1) 1 Modbus Plus 1 USB 1 Ethernet TCP/IP	–	140 CPU 651 60	–
		4	2816	7168	1 Modbus (1) 1 Modbus Plus 1 USB 1 Ethernet TCP/IP	–	140 CPU 652 60	–
		2	1024	7168	1 Modbus (1) 1 Modbus Plus 1 USB 1 Hot Standby port (100 Mbps)	–	140 CPU 671 60	–

(1) RS 232/485 Modbus port.



140 CPU 434 12U



140 CPU 651 50



### Unity CPUs (continued)

#### PCMCIA memory extension cards

Quantum **140 CPU 651 50/60**, **140 CPU 652 60** and **140 CPU 671 60** processors can accept up to 2 memory extension cards. However, the useful memory capacity is limited to the maximum size defined for the processor model. See pages 2/4 and 2/5.

#### Connection cables and accessories

Description	Use		Length	Reference	Weight kg	
	From processor	To PC port				
PC terminal connection cables	Modbus port, 9-way SUB-D for: 140 CPU 311 10, 140 CPU 434 12U	RS 232	3.7 m	<b>990 NAA 263 20</b>	0.300	
		9-way SUB-D connector	15 m	<b>990 NAA 263 50</b>	1.820	
		USB port	0.4 m	<b>TSX C USB 232 (1)</b>	0.145	
	Modbus port, RJ45 for: 140 CPU 6●●●0	RJ45 connector	1 m		<b>110 XCA 282 01</b>	–
			3 m		<b>110 XCA 282 02</b>	–
			6 m		<b>110 XCA 282 03</b>	–
	USB port	0.4 m		<b>TSX C USB 232 (2)</b>	0.145	
	USB port for: 140 CPU 6●●	USB port	3.3 m	<b>UNY XCA USB 033</b>	–	
Connection cordsets for Modbus Plus network	Modbus Plus port, 9-way SUB-D for: 140 CPU 311 10, 140 CPU 434 12U	Modbus Plus tap (3)	2.4 m	<b>990 NAD 211 10</b>	–	
		Elbowed connector (left side)	6 m	<b>990 NAD 211 30</b>	–	
	Modbus Plus port, 9-way SUB-D for: 140 CPU 6●●●0	Modbus Plus tap (3)	2.4 m		<b>990 NAD 218 10</b>	–
			6 m		<b>990 NAD 218 30</b>	–
	Straight connector					
Modbus Plus/USB converter	Modbus Plus tap (3)	USB port	0.4 m	<b>TSX C USB MBP (4)</b>	0.186	
Adaptor	RJ45 connector for 140 CPU 6●●●0	RS 232 9-way SUB-D connector	–	<b>110 XCA 203 00</b>	–	

(1) With the **TSX C USB 232** converter, use the **990 NAA 263 20/30** cordset.

(2) With the **TSX C USB 232** converter, use the **110 XCA 203 00** adaptor and the **110 XCA 282 0●** cordset.

(3) Modbus Plus tap: **990 NAD 230 20/21** (IP 20) or **990 NAD 230 10** (IP 65).

(4) With the **TSX C USB MBP** converter, use the **990 NAD 211 10/30** or **990 NAD 218 10/30** cordset.



TSX C USB 232



990 NAD 211 ●0



990 NAD 218 ●0



TSX C USB MBP



# Modicon Quantum automation platform

## PCMCIA memory extension cards

### Unity

#### Presentation

PCMCIA memory extension cards make it possible to extend the RAM memory capacity of high-performance Quantum processors.

Depending on the model, these cards are designed to accommodate:

- The application program, symbols and constants
- The additional application data
- Or both

#### PCMCIA memory extension cards

All the cards fit into PCMCIA slots in the Quantum **140 CPU 651 ●0/671 60** processors.

These cards provide three different storage types:

- Storage of the application: program, symbols and constants in a common space 512 Kb to 4096 Kb: **TSX MFP P●●●K/M** for Flash EPROM memories.

- Storage of the application and additional data, comprising:

- application area from 192 Kb to 7 Mb
- data storage area 7 Mb to 0 Kb for additional data storage

The limit between these 2 spaces is configurable. The configurable cards are:

- TSX MRP C●●●K/M** for SRAM memories
- TSX MCP C●●●K/M** for Flash EPROM and SRAM memories

Storage of additional data, provided by SRAM **TSX MRP F004M/008M** memory cards with 4 or 8 Mb.

These cards use 2 technologies:

- Battery-backed SRAM

Used particularly in the application program design and debugging phases.

These cards provide:

- all of the application's transfer and modification services in online mode
- additional data storage

The memory is protected by a removable battery built into the PCMCIA card. A second auxiliary battery is present to enable the main battery to be replaced without loss of data.

- Flash EPROM

Used when debugging of the application program is complete. This is used to:

- overcome battery life restrictions
- perform one global application transfer

When in use, it is impossible to carry out modifications to the application in online mode.

#### Program modification in online mode

Only those extension cards in which the program is stored in SRAM memory **TSX MRP C●●●K/M** allow you to perform program modifications in online mode.

A user with a processor fitted with a memory extension card and who wishes to make modifications or additions to the program in online mode must structure the application program in several reasonably sized sections.

# Modicon Quantum automation platform

## PCMCIA memory extension cards

### Unity



TSX MRP/MCP/MRP ●●●●



TSX MFP P ●●●●

### References

Quantum 140 CPU 651 50, 140 CPU 651 60 and 140 CPU 671 60 processors can accept the following memory extension cards.

There are two types of memory limit:

- One associated with the type of processor.
- One associated with the selected PCMCIA memory card.

The lowest of these two limits defines the memory capacity accessible to users for their applications.

### PCMCIA memory extension cards

Description	Memory size		Reference	Weight kg
	Application	Data files		
Configurable SRAM application/files memory extension	192...768 Kb	576...0 Kb	TSX MRP C768K	0.076
	192...1024 Kb	832...0 Kb	TSX MRP C001M	0.076
	192...1792 Kb	1600...0 Kb	TSX MRP C01M7	0.076
	192...2048 Kb	1856...0 Kb	TSX MRP C002M	0.076
	192...3072 Kb	2880...0 Kb	TSX MRP C003M	0.076
	192...7168 Kb	6976...0 Kb	TSX MRP C007M	0.076
Flash EPROM application memory extensions	512 Kb	–	TSX MFP P512K	0.044
	1024 Kb	–	TSX MFP P001M	0.044
	2048 Kb	–	TSX MFP P002M	0.044
	4096 Kb	–	TSX MFP P004M	0.044
Configurable Flash EPROM and SRAM application/files memory extensions	512 Kb	512 Kb	TSX MCP C512K	0.076
	2048 Kb	1024 Kb	TSX MCP C002M	0.076
SRAM files memory extension (1)	–	4096 Kb	TSX MRP F004M	0.076
	–	8192 Kb	TSX MRP F008M	0.076

### Replacement parts

Description	Use	Type	Reference	Weight kg
Backup battery	SRAM PCMCIA memory card	Main	TSX BAT M02	0.010
		Auxiliary	TSX BAT M03	0.005
Handle	PCMCIA memory card	–	TSX P CAP	0.030

(1) Intended for the storage of manufacturing recipes and production data. Capacity depends on the PCMCIA card model.

# Modicon Quantum automation platform

## Concept/ProWORX standard CPUs

2

Automation platform for Concept and ProWORX software offer Simple applications



<b>Number of racks</b> 2/3/4/6/10/16 slots	Local I/O	2 racks (1 main + 1 extension)		
	Remote I/O (RIO)	31 drops x 2 racks (1 main + 1 extension)		
	Distributed I/O (DIO)	3 networks with 63 single-rack drops		
<b>Maximum discrete I/O (1)</b>	Local I/O	1024 input channels and 1024 output channels (max. 27 slots)		
	Remote I/O (RIO)	31,744 input channels and 31,744 output channels		
	Distributed I/O (DIO)	8000 input channels and 8000 output channels per network		
<b>Maximum analog I/O (1)</b>	Local I/O	64 input channels and 64 output channels (max. 27 slots)		
	Remote I/O (RIO)	1984 input channels and 1984 output channels		
	Distributed I/O (DIO)	500 input channels and 500 output channels per network		
<b>Application-specific modules</b>		Intrinsically safe I/O, high-speed counter, axis control, interrupt inputs, serial link, accurate time stamping		
<b>Number of communication modules and axes (in local rack)</b>	Ethernet TCP/IP, Modbus Plus, Profibus DP, Sy/Max Ethernet, SERCOS, all combinations	2		
<b>Bus connections</b>	Modbus	1 integrated RS 232 Modbus master or ASCII port via EFB XXMIT on Concept or XMIT module on ProWORX		
	AS-Interface actuator/sensor bus	4 on local rack, 4 on remote rack (RIO), 2 on distributed rack (DIO)		
	INTERBUS	Generation 3	3	
		Generation 4	2	
	Profibus DP	2 "option" modules on local rack		
<b>Network connections</b>	Modbus Plus	1 integrated port, 2 "option" modules on local rack		
	Ethernet TCP/IP	2 "option" modules on local rack		
<b>Process control</b>	Control loops (2)	10 to 20 programmable channels		
<b>Redundancy</b>		Power supplies, remote I/O network, Modbus Plus modules, Ethernet TCP/IP modules		
<b>Hot Standby</b>	Hot Standby LL984	Yes		
	Hot Standby IEC	-		
<b>Memory capacity</b>	LL984 program (max.)	8 Kwords	16 Kwords	
	IEC program (max.)	109 Kb	368 Kb	
	Located data (State RAM)	I/O bits (max.)	8192 input bits and 8192 output bits	
		16-bit I/O words (max.)	9999 I/O words	
<b>Functional safety certification</b>		-		

<b>Quantum CPUs</b>	<b>140 CPU 113 02</b>	<b>140 CPU 113 03</b>
---------------------	-----------------------	-----------------------

Pages 2/19

(1) The maximum values for the number of discrete I/O and analog I/O are not cumulative.  
 (2) Usage values, including memory resources and processor power.

Simple and complex applications	Complex applications
---------------------------------	----------------------



2 racks (1 main + 1 extension)	
31 drops x 2 racks (1 main + 1 extension)	
3 networks with 63 single-rack drops	
1024 input channels and 1024 output channels (max. 27 slots)	
31,744 input channels and 31,744 output channels	
8000 input channels and 8000 output channels per network	
64 input channels and 64 output channels (max. 27 slots)	
1984 input channels and 1984 output channels	
500 input channels and 500 output channels per network	
Intrinsically safe I/O, high-speed counter, axis control, interrupt inputs, serial link, accurate time stamping	
6	
2 integrated RS 232 Modbus master or ASCII ports on port no. 1 via EFB XXMIT on Concept or XMIT module on ProWORX	
Not limited on local rack (max. 27 slots), 4 on remote rack (RIO), 2 on distributed rack (DIO)	
3	
6	
6 "option" modules on local rack	
1 integrated port, 6 "option" modules on local rack	
6 "option" modules on local rack	
40 to 80 programmable channels	60 to 100 programmable channels
Power supplies, remote I/O network, Modbus Plus modules, Ethernet TCP/IP modules	
Yes	
Yes	
64 Kwords	
896 Kb	2.5 Mb
64 Kbps I/O	
57 Kwords I/O	
-	

<b>140 CPU 434 12 A</b> <sup>(3)</sup>	<b>140 CPU 534 14 B</b> <sup>(4)</sup>
--	--

2/19  
 (3) CPU able to migrate from Concept to Unity Pro.  
 (4) CPU able to migrate from Concept to Unity Pro with Unity Pro software version ≥ 3.0.

# Modicon Quantum automation platform

## Concept/ProWORX standard CPUs

### Presentation

Quantum CPUs, which are compatible with Concept and ProWORX software, are single-slot PLCs with built-in executive memory, application memory and communication ports. With all memory components on-board, you do not need extra chips or cartridges for configuration.

### Flash-based executive memory

Quantum CPUs use flash memory technology to support the CPU's executive memory and instruction set. Flash is a state-of-the-art, non-volatile memory technology that enables field upgrades by downloading files over the Modbus or Modbus Plus port as new features and maintenance updates become available.

### Memory backup and protection

The CPUs store the application program in battery-backed RAM. This battery is located on the front of the module and can be replaced while the CPU is running. To protect the application program from inadvertent changes during operation, the processors feature a memory-protect slide switch. An LED goes on when this switch is activated.

### Math coprocessor

For math-intensive applications, a math coprocessor is available on select CPU models. The coprocessor significantly improves execution times for the 984 Process Control Function Library (PCFL) and Equation Editor, as well as math operations in the IEC languages. Improved floating point execution times mean more power for processing process algorithms and math calculations.

### Write protection

PLC write protection minimizes the possibility of a programmer inadvertently writing from a source PLC to a memory area in a destination PLC. Whatever data is not enabled is prevented from writing, both locally and over the network. This data protection option provides security against data transfer errors.

### Communication ports

All CPUs support Modbus and Modbus Plus networking strategies. Simple rotary switches on the back of the modules are used to define the network address of the Modbus Plus port(s). Each device on a Modbus Plus network must have a unique address in the range 1...64. Modbus port settings include: baud rate, parity, number of data bits, number of stop bits, protocol and Slave address. By default, these settings are 9600 bps, even parity, 8 data bits, 1 stop bit, RTU mode and address 1.

A switch on the front of the CPUs can be used to configure the Modbus port as a modem communication interface (2400 bps, even parity, 7 data bits, 1 stop bit, ASCII mode and address 1).

The **140 CPU 434 12A** and **140 CPU 534 14B** processors have 2 serial Modbus ports:

- Modbus port 1, with full modem interfacing ability
- Modbus port 2, with RTS/CTS flow control (does not support modem connection)

# Modicon Quantum automation platform

## Concept/ProWORX standard CPUs

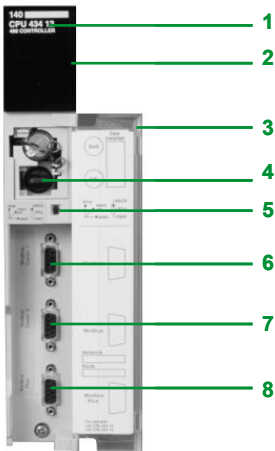

### Description

The **140 CPU ●●●** processor front panel comprises:

- 1 Model number and colour code
- 2 LED array
- 3 Removable, hinged door and customizable identification label
- 4 Battery slot
- 5 Two slide switches
- 6 One Modbus port A
- 7 One Modbus port B
- 8 One Modbus Plus port

Note:

The **140 CPU 113 0●** processors have one Modbus and one Modbus Plus communication port.

### Slide switches

Each of the two slide switches has three-position functionality:

The left slide switch activates the memory write-protection. In the upper position, write protection is enabled; in the middle position, write protection is disabled.

The right slide switch determines the startup communication parameters for the Modbus port. The middle position, RTU, is the factory-set default. The upper position, ASCII, is for modem communications (1). If you need to set special startup parameters for the Modbus port – for example, if your Modbus address is not 1 – you can set application-specific parameters in memory and set the slide switch in the bottom position.

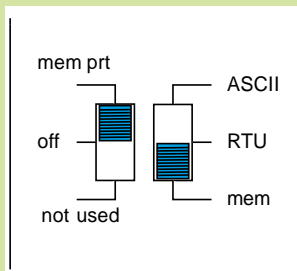

### Language choices

#### Advanced IEC 61131-3 languages

Quantum's 5 IEC 61131-3 languages are:

- Sequential Functional Chart: provides overall structure and coordination for process or machine control applications.
- Function Block Diagram: particularly well suited to process control applications.
- Ladder Language: excellent for combinational and interlocking logic.
- Structured Text: higher level language which is a terrific solution for complex algorithms and data manipulation.
- Instruction List: low level language for optimizing the size of the program code generated.

#### 984 Ladder Logic

A high performance, low level language whose application source code resides in the controller.

A full set of over 80 instructions is included with every Quantum CPU. The 984 instruction set ensures compatibility and easy integration paths for installed Modicon applications, including:

- Immediate I/O access and interrupt servicing
- Equation editor

(1) 2400 bps, even parity, 7 data bits, 1 stop bit, ASCII mode and address 1.

Characteristics		140 CPU 113 02	140 CPU 113 03	140 CPU 434 12A	140 CPU 534 14B	
Module type						
Functional safety certification		–				
Approvals		UL 508, CSA 22,2-142, C UL, FM Class 1 Div. 2, CE				
Processors		80186		80486		
Math coprocessor		No		Yes		
Clock speed		<b>MHz</b>	20	66	100	
User memory	Max. IEC program	109 Kb	368 Kb	896 Kb	2.5 Mb	
	Max. LL 984 program	8 Kwords	16 Kwords	64 Kwords		
Capacity	Bits	<b>bps</b>	8192 I/8192 Q		64 K combined	
	Registers	<b>words</b>	9999 max.		57 K max.	
	Extended memory	<b>words</b>	–		96 K	
Logic solve time (984 LL instructions)		<b>ms/K</b>	0.3...1.4		0.1...0.5	
Watchdog timer		<b>ms</b>	250 (software-adjustable)			
Real-time clock accuracy		<b>s/day</b>	± 8 at 0...60°C			
Local I/O	Maximum I/O words		64 I/64 Q			
Remote I/O (RIO)	I/O words/drop		64 I/64 Q			
	Number of drops		31			
	Number of networks		2			
Distributed I/O (DIO)	I/O words/drop		30 I/32 Q			
	I/O words/network		500 I/500 Q			
	Drops/network		63			
	Number of networks		3			
Communication ports	Modbus (RS 232)		1		2	
	Modbus Plus		1			
Maximum number of NOM, NOE, CRP or MMS modules			2		6	
Key switch			No		Yes	
Memory backup	Product reference		990 XCP 980 00			
	Battery type		Lithium			
	Voltage	<b>V</b>	3 ---			
	Capacity	<b>mAh</b>	1200			
	Typical current	<b>µA</b>	5	7	45	85
	Maximum current	<b>µA</b>	110	210	70	135
	Storage life	<b>yr</b>	10			
Bus current required		<b>mA</b>	780	790	1250	

# Modicon Quantum automation platform

## Concept/ProWORX standard CPUs

### Migration of Quantum CPUs

As both the **140 CPU 434 12A** and **140 CPU 534 14B** Quantum CPUs are compatible with Concept or ProWORX software, they can be upgraded to be compatible with the Unity Pro software without any hardware modification.. This process of migrating from Concept to Unity Pro is achieved by updating the CPU operating system. This update is performed with the aid of the OS-Loader tool included with Unity Pro (see page 7/29).

The upgraded processor **140 CPU 434 12A** is then equivalent to the corresponding Unity processor **140 CPU 434 12U**.

**Note:** Migration of the **140 CPU 534 14B** processor requires the version of Unity Pro  $\geq 3.0$ .

### CPUs

Memory (total)	Coprocessors	Safety	Reference	Weight kg
256 Kbytes	No	–	140 CPU 113 02	0.300
512 Kbytes	No	–	140 CPU 113 03	0.300
2 Mbytes	Integrated	–	140 CPU 434 12A	0.850
4 Mbytes	Integrated	–	140 CPU 534 14B	0.850

### Accessories

Description	Length	Safety	Reference (1)	Weight kg
Programming cable for Modbus interface	3.7 m	–	990 NAA 263 20	0.300
	15 m	–	990 NAA 263 50	1.820
Backup battery	–	–	990 XCP 980 00	–
Quantum automation series hardware reference guide	–	–	840 USE 100 0●	–

(1) Add one of the following digits at the end of the reference: **0**: English, **1**: French, **2**: German, **3**: Spanish.





# 3 - I/O architectures, Hot Standby architectures, racks and power supplies

## 3.1 - I/O architecture

- I/O architectures..... 3/2
- Presentation..... 3/2
- Local I/O..... 3/3
  
- Remote I/O architectures ..... 3/4
- Presentation..... 3/4
- Remote I/O (RIO)..... 3/4
- Topologies..... 3/5
- Characteristics..... 3/7
- References ..... 3/8
  
- Distributed I/O architectures..... 3/10
- Presentation..... 3/10
- Distributed I/O (DIO) ..... 3/10
- Description..... 3/11
- Characteristics..... 3/12
- References ..... 3/13

## 3.2 - Hot Standby architectures

- Hot Standby system Unity..... 3/14
- Presentation, architecture, functions..... 3/19
- Description..... 3/20
- Characteristics..... 3/21
- References ..... 3/22
  
- Hot Standby system Unity with PTQ-PDPMV1 module..... 3/24
  
- Hot Standby system Concept/ProWORX..... 3/26
- Presentation, description, topologies ..... 3/26
- Characteristics..... 3/27
- References ..... 3/29

## 3.3 - Racks

- Racks..... 3/30
- Presentation, description ..... 3/30
- References, dimensions ..... 3/31

## 3.4 - Power supply modules

- Power supply module selection guide ..... 3/32*
  
- Power supply modules..... 3/35
- Presentation, functions ..... 3/35
- Description..... 3/35
- Characteristics..... 3/36
- References, connections ..... 3/37



# Modicon Quantum automation platform

## I/O architectures

Presentation

The Quantum automation platform is based on the principles of flexible architecture that are ideal for high performance control solutions, regardless of the configuration. Quantum I/O can be used in three architectures to meet control system requirements:

- Local I/O
- Remote I/O (RIO)
- Distributed I/O

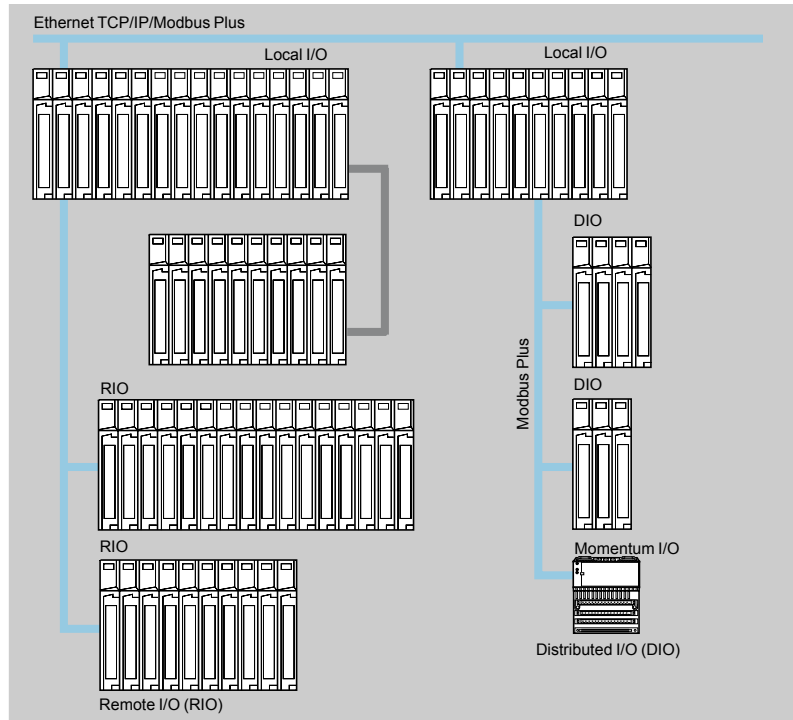

3

Type of architecture	Local I/O	Remote I/O (RIO)	Distributed I/O (DIO)
Medium	–	Coaxial	Twisted pair
Maximum distance without repeaters	–	4572 m	457 m
Data transfer rate	–	1.5 MHz	1 MHz
I/O synchronized with PLC scan	–	Yes	No
Compatibility	Hot Standby redundancy	Yes	No
	Modbus Plus network	No	Yes
	Momentum/Advantys STB distributed I/O	No	Yes
Maximum	No. of RIO/DIO networks per PLC	1	3
	Per network		
	I/O drops	31 (2 racks)	63 (1 rack)
	I/O words	1984 inputs/1984 outputs	500 inputs/500 outputs
	Discrete I/O	31,744 inputs/31,744 outputs	7840 inputs/7840 outputs
	Analog I/O	1984 inputs/1984 outputs	500 inputs/500 outputs
	Per drop		
	I/O words	No limit with Unity Pro 64 inputs/64 outputs with Concept/ProWORX	64 inputs/64 outputs 30 inputs/32 outputs
	Discrete I/O	No limit with Unity Pro (27 slots max.) 1024 inputs/1024 outputs with Concept/ProWORX	1024 inputs/1024 outputs 480 inputs/512 outputs
	Analog I/O	No limit with Unity Pro (27 slots max.) 64 inputs/64 outputs with Concept/ProWORX	64 inputs/64 outputs 30 inputs/32 outputs
Typical racks	6, 10, 16 slots	10, 16 slots	2, 3, 4 slots

# Modicon Quantum automation platform

## I/O architecture

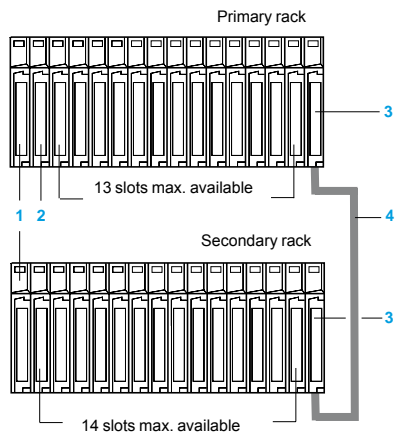

- 1 Power supply **140 CPS ●●● 00** (1 slot)
- 2 CPU **140 CPU ●●● ●●** (1 or 2 slot(s))
- 3 Rack extension module **140 XBE 100 00** (1 slot)
- 4 Rack extension cable **140 XCA 717 0●** (length 1, 2 or 3 m)

### Local I/O

The Quantum automation platform provides local I/O management for control systems that are wired on the main control cabinet.

The local I/O can comprise a maximum of 14 modules in the primary rack, including the CPU module **2** and the power supply module **1**.

These local I/O can be extended on a second rack (secondary rack) by using a **140 XBE 100 00 3** rack extension module.

If required, system modules can be installed in the local rack.

Available optional system modules include RIO CPUs (one per CPU) or DIO interfaces for Modbus Plus networks (two per CPU). All other modules are considered and configured as I/O modules.

The choice of the appropriate rack depends on the required number of modules for the system. Racks are available in the following formats: 2, 3, 4, 6, 10 and 16 slots. If required, communication and network modules can be installed in the local rack. Most communication and network modules need to be in the local rack. As well as discrete and analog I/O modules, the following modules are available:

- Modbus Plus and Modbus modules
- Ethernet modules for TCP/IP, Sy/Max
- Remote I/O modules
- Hot Standby modules (1) (Concept/ProWORX)
- INTERBUS modules (Concept/ProWORX)
- Profibus DP modules
- AS-Interface modules

### High performance interrupt functions

In some applications, the I/O need to be refreshed more quickly than the normal scan cycle. The Quantum platform provides interrupt services for this type of application. These services include the incorporation of interrupts on time bases and on inputs, as well as updating of I/O "on the fly", thus providing very fast transfer times, only on the I/O modules in the local rack.

These services are determined by instructions in the instruction set in the Quantum languages. These instructions can be programmed via the Unity Pro, Concept or ProWORX programming software. They can immediately update the I/O in the CPU. Using an segment dedicated to interrupt processing subroutines, it is therefore possible to use this "on the fly" access either on internal variables, or on outputs of modules in the local rack.

### Local I/O configuration rules

When configuring a local I/O system, the following four parameters should be considered:

- Number of slots available in the 2 local racks (primary and secondary)
- Slots available for optional modules
- Power consumed by the installed modules
- Addressing words available for configuring the modules

### Available slots and power consumption

A local I/O system can have a maximum of 27 available slots (with two 16-slot racks) for I/O modules, application-specific modules, communication modules and motion control modules. All these modules are powered from the power supply included in the rack.

To ensure a valid configuration, simply add together the consumptions (in mA) of the modules in the rack and check that the total current is less than that provided by the selected power supply.

Empty modules **140 XCP 500 00** are also available to occupy unused slots.

### Module addressing

- With Unity Pro: The I/O addressing is unlimited (physical limitation to 27 slots).
- With Concept/ProWORX: The Quantum CPU can manage up to 64 input words and 64 output words for I/O addressing on each local rack.

A 16-bit input or output module is equivalent to one word.

Simply add together the addressing requirements of each module and check that the limit is not exceeded.

(1) Under Unity Pro, Hot Standby solution with the **140 CPU 671 60 CPU**.

# Modicon Quantum automation platform

## I/O architectures Remote I/O (RIO)

### Presentation

For applications that require remotely mounted I/O drops, a higher I/O capacity, and/or connectivity to existing Modicon I/O installations, Quantum provides a remote I/O (RIO) architecture solution.

Based on the S908 remote I/O network technology, this network is compatible with existing Modicon I/O installations, including those with 800 and 200 series I/O modules and Sy/Max I/O. Retrofit installations can therefore incorporate an I/O installed base to reduce installation costs.

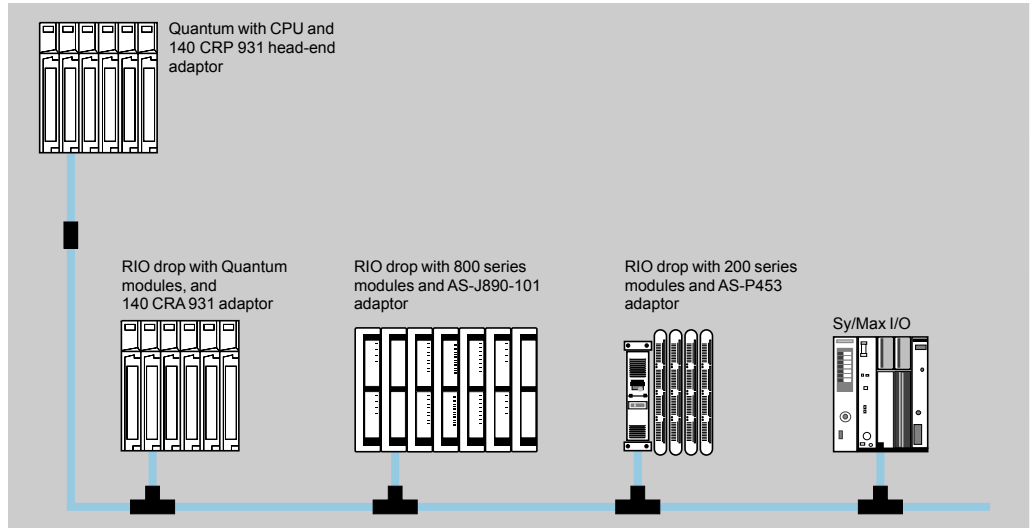

The RIO architecture uses coaxial cabling, and provides long distance capability up to 4572 km with a CATV cable, or longer with an optional fibre optic cable. It is a high-performance network, operating at 1.544 Mbps, providing a high I/O data throughput.

The RIO cabling system consists of a linear trunk cable, with line taps and drop cables for connection to each remote drop.

Up to 31 remote drops can be configured. Each drop can support up to 128 I/O words (64 input words/64 output words).

### Segment scheduler mechanism

The segment scheduler mechanism increases the performance of the RIO network by interleaving I/O scanning and execution of the program.

The segment scheduler breaks the application program into logical segments, then co-ordinates the scanning of the inputs and the updating of the outputs in conjunction with the execution of the program associated with the segment. The inputs are read before the program is processed and the outputs are written after the program is processed. This avoids having to wait for an entire scan before the outputs are set, thus giving a faster system response time. An RIO architecture does not therefore reduce system performance.

For most systems, throughput of local or remote I/O can be estimated at no less than two times scan (with 24 V  $\square$  I/O modules). Analog values and words are updated automatically, as fast as discrete I/O, with no user programming.

### Compatibility with 800 and 200 series I/O products

Quantum is compatible with 800 and 200 series I/O, which are earlier generation products. Using the same RIO head-end interface, 800 series I/O are connected via J890, J892, P890 or P892 RIO adaptors, and 200 series I/O are connected via P453/J290 and P451/J291 RIO adaptors.

Other standard components are also compatible with this system, including **MA 0185 100** network T-connectors and **MA 0186 100** splitter boxes. The Quantum remote I/O system also takes Sy/Max I/O drops.

### Configuration rules

To ensure a valid configuration, add together the consumptions (in mA) of the modules in the rack, for each drop, and check that the total is less than the power available with the selected power supply.

#### Topologies

##### Single-cable topology

Line length 4.572 km max.

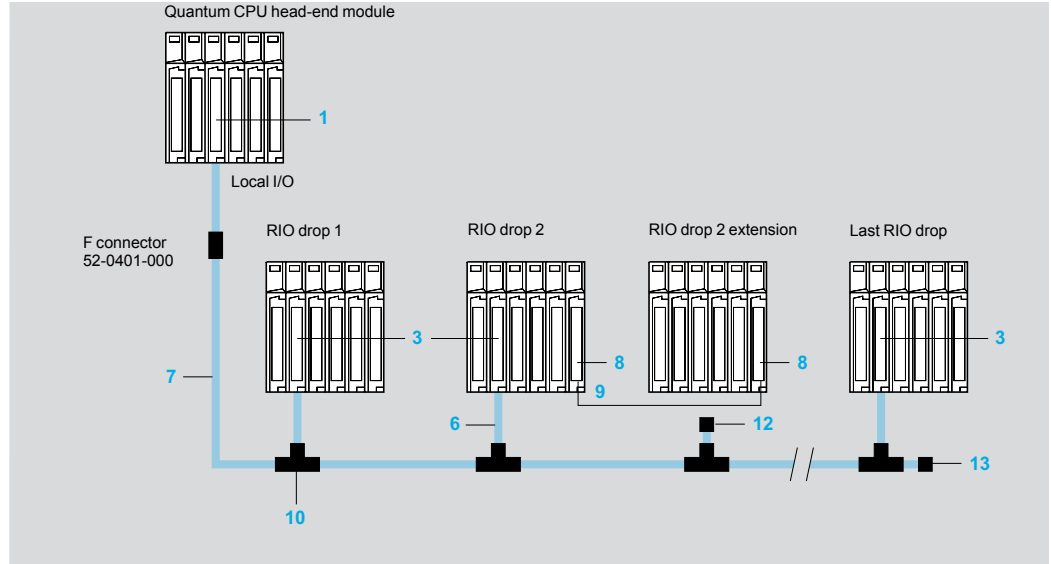

- 1 Head-end adaptor **140 CRP 931 00**
- 2 Head-end adaptor **140 CRP 932 00** (redundant)
- 3 RIO drop adaptor **140 CRA 931 00**
- 4 RIO drop adaptor **140 CRA 932 00** (redundant)
- 6 RG-6 coaxial cable (drop)
- 7 RG-11 coaxial cable (trunk)
- 8 Rack extension module **140 XBE 100 00**
- 9 Cable for extension module **140 XCA 717 0**
- 10 T-connector 2 x RG-11/1 x RG-6 **MA 0185 100**
- 12 RG-6 terminator for T-connector **52 0402 000**
- 13 RG-11 trunk cable terminator for T-connector **52 0422 000**

A T-connector **10 MA 0185 100** is required for each I/O drop on the system to electrically isolate the drop from the trunk cable and to protect the system from impedance mismatches and cable disconnections. A minimum signal strength of 14 dB is required between the trunk cable and each I/O drop to ensure correct operation. The signal loss on the trunk cable is less than 1 dB as it crosses a T-connector. A total of 35 dB is available from the head-end RIO CPU. The whole cabling architecture must not exceed this system limit.

For systems that require high availability, a solution with redundant cable is available, to provide protection against cable breaks and damaged connectors. With two cables connected between the host and each drop, the first cable break does not disrupt communication. If a cable break occurs, a status bit is set to 1 to indicate the problem drop or the faulty cable. For preventive maintenance, the system also provides retry counters for all communication transactions to all drops. High retry counts on a cable in a specific drop could indicate connection problems. This will enable corrective work to be scheduled before there is unwanted downtime.

##### RIO topology with redundant cable

Line length 4.572 km max.

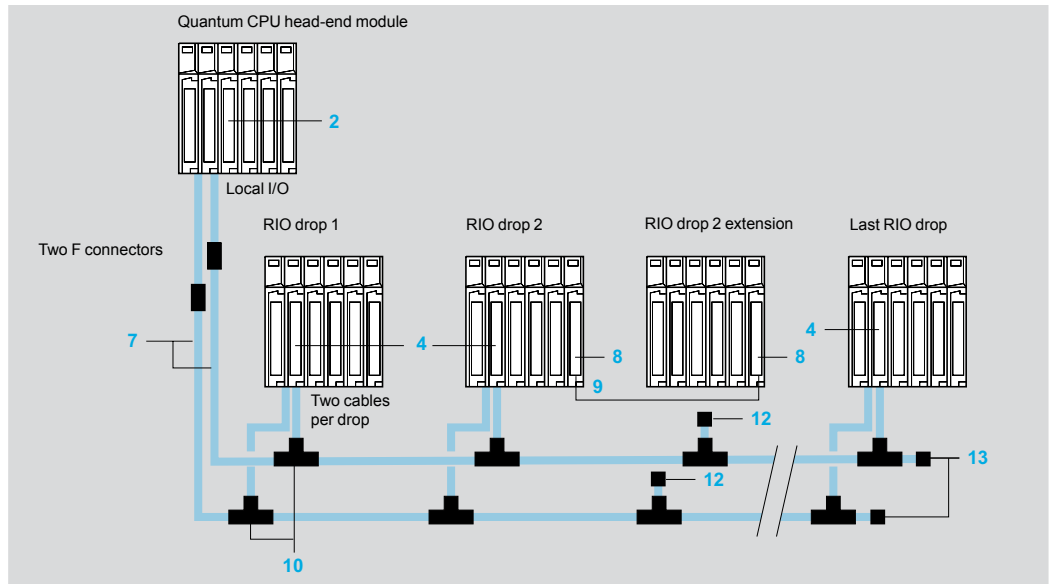

# Modicon Quantum automation platform

## I/O architectures Remote I/O (RIO)

### Point-to-point RIO communication with fibre optic repeaters

Fibre optic repeaters **5 490 NRP 954 00** are available to enhance network noise immunity and increase cable length up to 15 km.

These repeaters convert a twisted pair cable to a standard 62.5/125 µm fibre optic cable, while maintaining the dynamic range of the network.

Line length 15 km max.

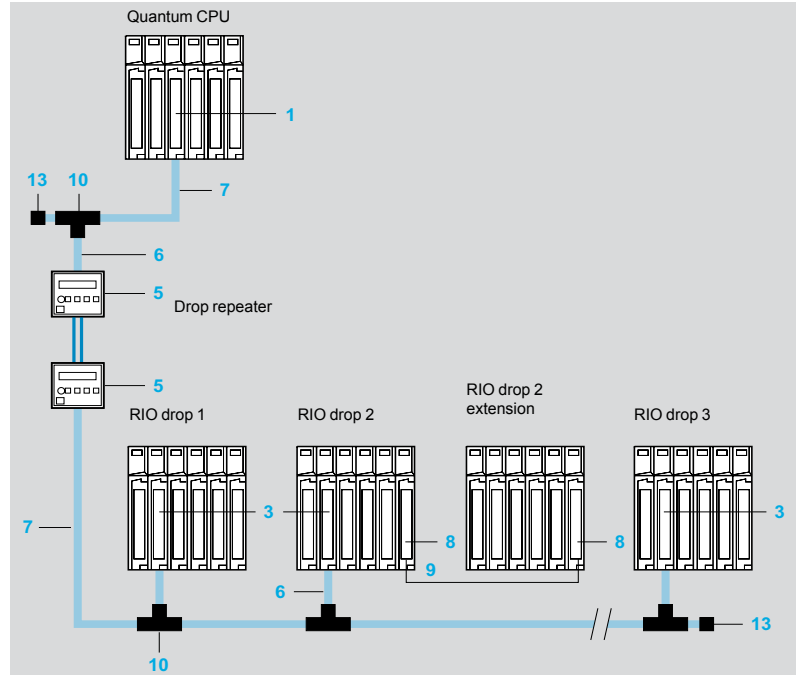

- 1 Head-end adaptor **140 CRP 931 00**
- 2 Head-end adaptor **140 CRP 932 00** (redundant)
- 3 RIO drop adaptor **140 CRA 931 00**
- 4 RIO drop adaptor **140 CRA 932 00** (redundant)
- 5 RIO drop optical repeater **490 NRP 954 00**
- 6 RG-6 coaxial cable (drop)
- 7 RG-11 coaxial cable (trunk)
- 8 Rack extension module **140 XBE 100 00**
- 9 Cable for extension module **140 XCA 717 0●**
- 10 T-connector 2 x RG-11/1 x RG-6 **MA 0185 100**
- 12 RG-6 terminator for T-connector **52 0402 000**
- 13 RG-11 trunk cable terminator for T-connector **52 0422 000**

### "Self-healing" ring topology with fibre optic repeaters

Several **490 NRP 954 00** fibre optic repeaters can be interconnected to form a ring, so that if a break occurs anywhere on the ring, the network can reconfigure itself.

The RIO signal is sent by the drop repeater to the head repeaters, in both legs of the ring. When a signal is received on one Rx line, the other Rx channel is blanked, which prevents the same signal being transmitted twice on the ring. The maximum length of fibre optic cable permitted on a self-healing ring is 10 km.

Line length 10 km max.

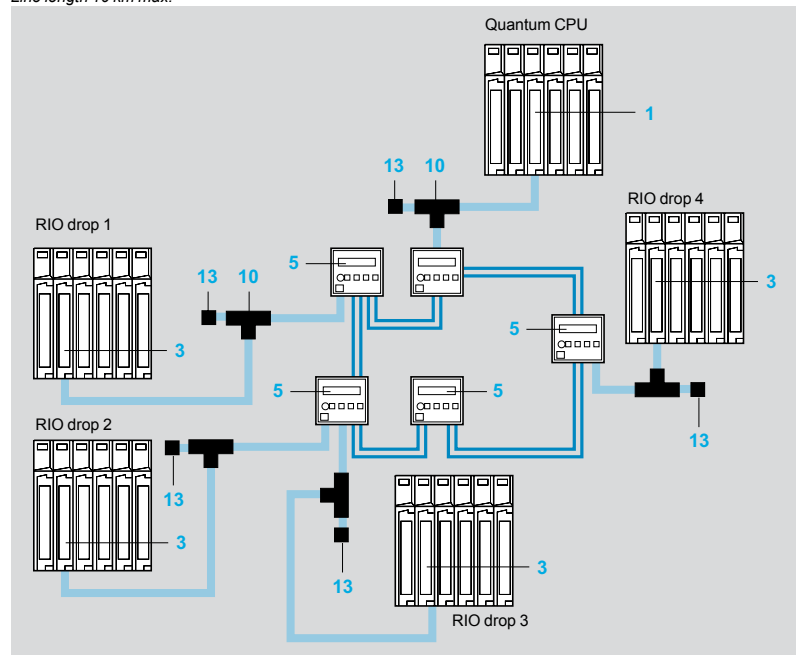

Characteristics of head-end and drop adaptors					
Type of module		140 CRP 931 00	140 CRP 932 00	140 CRA 931 00	140 CRA 932 00
Functional safety certification		–	Non-interfering	–	Non-interfering
Approvals		UL 508, CSA 22.2-142, cUL, FM Class 1 Div.2, CE			
Type		RIO head-end		RIO drop adaptor	
Drop type		Quantum, 200/500/800 series or Sy/Max (any combination)		–	
Type of I/O		–		Quantum	
Modules per drop		31 drop adaptors max.		27 I/O modules max.	
Words per drop		64 input/64 output words			
ASCII		2 ports per drop, 32 ports (16 drops), max. (Requires use of AS-P892-000, AS-J892-101/102 or AS-J290-0X0 adaptor at the RIO drops)		–	
Type of coaxial cable	<b>Ω</b>	Internal 75			
Coaxial cable shielding		Connected to the frame earth		Capacitor to earth	
Data transfer rate	<b>Mbps</b>	1.544			
Dynamic range	<b>dB</b>	35			
Isolation	<b>---</b>	500 V, between central conductor and coaxial cable earth			
Coaxial cable connection	Single cable	One "F" type female connector (90° angled)			
	Redundant cable	Two "F" type female connectors (90° angled)			
General	Holding time	–		Software configurable (1)	
	Diagnostics	Power up Memory check Network access check		Power up and runtime Application memory CRC RAM address/data	
	Maximum number of head-ends supported	1 head-end per Quantum CPU		–	
	Bus current required	<b>mA</b>	One channel: 600 Dual channel: 750		
	Power dissipation	<b>W</b>	One channel: 3 Dual channel: 3,8		

(1) In the event of loss of communication with the remote CPU, the output modules retain their last state for this holding time. Input module states are saved to the system CPU. After this time, the output modules will go to their predefined fallback states and the inputs will be reset by the CPU.

### Note on fibre optic cables

To use a fibre optic link on an RIO network, the following points must be taken into consideration when selecting the fibre optic cable from a supplier:

- For most applications, 62.5/125 µm fibre is recommended because of its relatively low loss and signal distortion. However, for high optical power applications, such as those using splitter boxes or star couplers, 100/140 µm fibre should be used.
- Whenever possible, select a multiconductor cable. For a small additional cost this provides a backup solution in case a cable breaks during installation. These additional fibres can also be used for voice, video or other types of communication.



# Modicon Quantum automation platform

I/O architectures  
Remote I/O (RIO)

## Adaptor modules

Description	Cable	Safety	No.	Reference	Weight kg
Quantum RIO head-end adaptor (1 max.)	Single cable	–	1	140 CRP 931 00	–
	Redundant cable	Non-interfering	2	140 CRP 932 00	–
Quantum Rio drop adaptor (31 max.)	Single cable	–	3	140 CRA 931 00	–
	Redundant cable	Non-interfering	4	140 CRA 932 00	–
RIO drop repeater	Optical fibre	–	5	490 NRP 954 00	–

## Connection cables

Description	Use/length	No.	Reference	Weight kg
RG 6 quad shield coaxial cable	Drop cable 320 m per reel	6	97 5750 000	–
RG 11 quad shield coaxial cable	Trunk cable 320 m per reel	7	97 5951 000	–
Pre-assembled drop cable (supplied with F connectors, line termination impedance and quad shield RG 6 cable)	15 m		AS MBII 003	–
	42 m		AS MBII 004	–

## Rack accessories <sup>(1)</sup>

Description	Length	No.	Reference	Weight kg
Rack extension module	–	8	140 XBE 100 00	–
Cables for rack extension module	1 m	9	140 XCA 717 03	–
	2 m	9	140 XCA 717 06	–
	3 m	9	140 XCA 717 09	–

(1) For racks with 2 to 16 slots, see page 3/31.

# Modicon Quantum automation platform

I/O architectures  
Remote I/O (RIO)

## Connection accessories

Description	Quantity	No.	Reference	Weight kg
<b>T-connector</b> (connects the RG-6 drop cable to the RG-11 trunk cable)	1	10	MA 0185 100	–
<b>Splitter box for coaxial cable for redundant or ring topology (1)</b>	–	11	MA 0186 100	–
<b>RG-6 terminator for T-connector</b> (for unused drop slot)	1	12	52 0402 000	–
<b>Trunk cable terminator</b> (on last T-connector on the network)	1	13	52 0422 000	–
<b>F connector cassette</b> For RG-6 cable	10		MA 0329 001	–
	For RG-11 cable	6	490 RIO 002 11	–
<b>Right angle F adaptor, for semi-rigid cable</b>	1		52 0480 000	–
<b>BNC connector for RG-6 cable</b>	1		43509446	–
<b>F (female)/BNC (male) converter for RG-11 cable</b>	1		52 0614 000	–
<b>BNC (female)/F connector (male) adaptor</b> for J890/J892 800 series drop adaptors	1		52 0724 000	–
<b>Type F to BNC adaptor with self-terminator for RG-11 cable</b>	1		52 0370 000	–
<b>BNC line terminator</b>	1		60 0513 000	–
<b>Earthing block</b>	1		60 0545 000	–

## Cabling accessories

<b>Stripping tool</b>	RG-6	1	490 RIO 004 00	–
	RG-11	1	490 RIO 0S4 11	–
<b>Replacement blades</b>	RG-6	2	490 RIO 004 06	–
	RG-11	–	Please consult your Regional Sales Office	–
<b>Crimping tools</b>	F connector on RG-6	1	60 0544 000	–
	F connector on RG-11	1	490 RIO 0C4 11	–
	BNC connector on RG-6	1	43509432	–
<b>Cable cutter</b>	–	1	60 0558 000	–

(1) T-connector for joining RG-6 coaxial cable coming from 2 head-end adaptors 140 CRP 93● 00. Constitutes the start of the RIO links.

# Modicon Quantum automation platform

## I/O architectures Distributed I/O (DIO)

### Presentation

The Modicon Quantum platform DIO (*Distributed I/O*) architecture uses the same I/O modules as a local or remote I/O (RIO) subsystem, and reduces installation costs by using low-cost twisted pair cables.

Special DIO drop adaptors, with a built-in power supply, are used at each drop. The Quantum DIO drop adaptor is specifically designed to link I/O modules to the head-end via a shielded twisted pair cable. DIO drop adaptors (one per drop) also provide the power supply to the I/O (maximum 3 A), from a 24 V  $\square$  or 115/230 V  $\sim$  source. These DIO drops can also be powered by standard 8 A power supply modules. In this case the 3 A supply built into the drop adaptor is not used.

The DIO architecture can take up to three network heads per CPU and up to 1800 m per network (using RR85 repeaters). Even greater distances can be achieved using fibre optic repeaters.

The DIO architecture is based on Modbus Plus technology. Each DIO network can take 32 nodes over 472 m (with repeaters, 64 nodes over 2000 m). Up to three DIO networks are permitted, one native to the CPU itself, and the other two by adding **140 NOM 211 ●0/212 ●0** head-end modules in the local Quantum rack. RIO and DIO can be combined in the same CPU, for large quantities of I/O.

All products that can be connected to Modbus Plus networks (for example HMI equipment) can coexist on the DIO network. For example, a programming terminal can be connected to the DIO network to monitor and troubleshoot a control system from a remote site, without requiring a separate communication link.

3

### Typical multi-network distributed I/O system

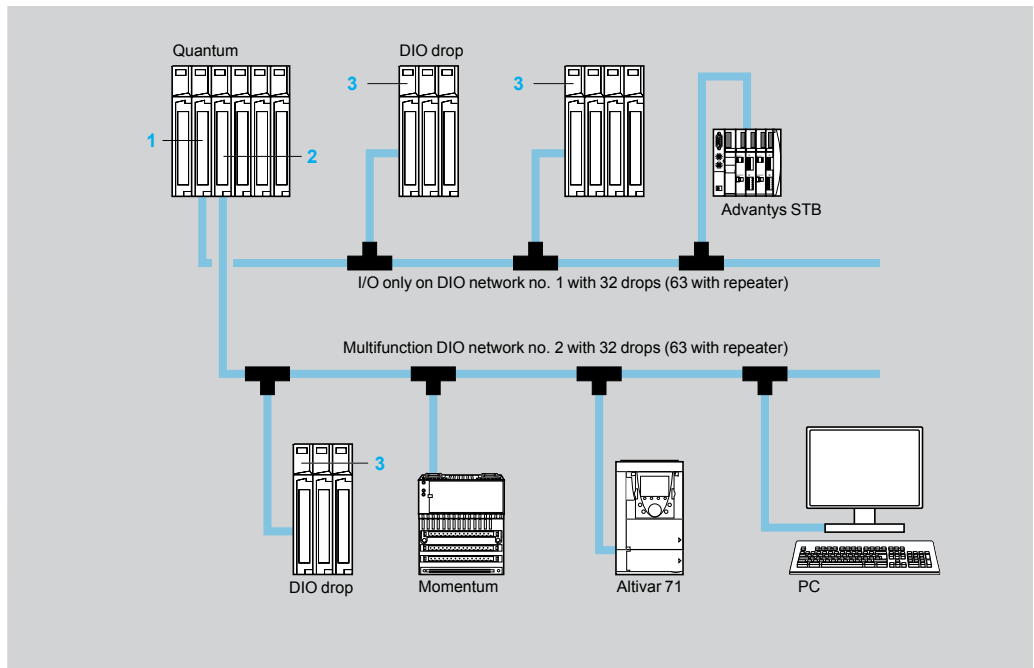

Distance 472 m max.,  
1800 m with repeaters

- 1 Quantum CPU with built-in Modbus Plus network **140 CPU ●●●●●** (for DIO no. 1)
- 2 Modbus Plus head-end adaptor **140 NOM 2●● DO** (for DIO no. 2 and no. 3).
- 3 DIO drop adaptor **140 CRA 21●●0** (including 24 V  $\square$  or 115/230 V  $\sim$  power supply).

# Modicon Quantum automation platform

I/O architectures  
Distributed I/O (DIO)

## Presentation (continued)

### Using Modbus Plus for distributed I/O (DIO)

Modbus Plus is used as a fieldbus in a distributed I/O architecture, controlled by a Quantum CPU. The Modbus Plus "master" at the head end of the network is a Quantum CPU with a built-in Modbus Plus interface or a **140 NOM 21● 00** module. A **140 CRA 211 ●0** module must be installed in each I/O drop in the DIO architecture. A **140 CRA 211 ●0** module acts both as a distributed I/O adaptor and a power supply for the I/O drop (no additional power supply module is necessary). Each DIO drop can address up to 30 input words and 32 output words.

A single or redundant cable topology can be used in a distributed I/O system. Depending on the system requirements, one of the following combinations of modules can be used to set up a DIO system on Modbus Plus:

Head-end no. 1	Head-end no. 2 or no. 3	DIO drop	Type of DIO system
CPU with built-in Modbus Plus	DIO adaptor <b>140 NOM 211 00</b>	Adaptor <b>140 CRA 211 10</b>	Single cable, with 115/230 V ~ drop power supply
		Adaptor <b>140 CRA 211 20</b>	Single cable, with 24 V --- drop power supply
-	DIO adaptor <b>140 NOM 212 00</b>	Adaptor <b>140 CRA 212 10</b>	Redundant cable, with 115/230 V ~ drop power supply
		Adaptor <b>140 CRA 212 20</b>	Redundant cable, with 24 V --- drop power supply

## Description

**140 CPU** modules incorporate a Modbus Plus port as standard, which can be used for DIO network no. 1. See description on pages 2/9 and 2/19.

**140 NOM 211 ●0/212 ●0** Modbus Plus adaptors for DIO network no. 2 or no. 3 have the following on the front panel:

- 1 Model number and colour code
- 2 A display block with 6 LED indicators:
  - Ready (green)
  - Fault (red)
  - Pwr ok (green)
  - Modbus + (green)
  - Error A (red)
  - Error B (red)
- 3 A removable hinged door with a customizable identification label
- 4 A microswitch for configuring the Modbus port (ASCII-RTU-mem) See description on page 2/17
- 5 A 9-way female SUB-D connector for connecting the Modbus link
- 6 A 9-way female SUB-D connector for connection to DIO Modbus Plus network no. 2 or no. 3

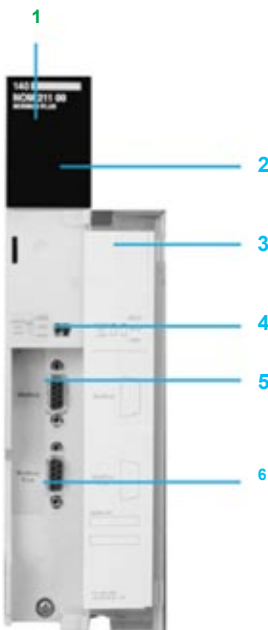

3

Characteristics of DIO I/O drop adaptors					
Type of module		140 CRA 211 10	140 CRA 212 10	140 CRA 211 20	140 CRA 212 20
Functional safety certification		-			
Function		DIO drop adaptor, power supply ~		DIO drop adaptor, power supply ---	
Network cable		Single (1 port)	Redundant (2 ports)	Single (1 port)	Redundant (2 ports)
Input voltage		85...276 V ~		20...30 V ---	
Frequency range		Hz	47...63	-	
Current		A	0.4 at 115 V ~, 0.2 at 230 V ~	1.6	
Inrush current		A	10 at 115 V ~, 20 at 230 V ~	30	
Power input		VA	50	-	
Buffer time		0.5 cycle at full load and minimum line voltage/ frequency and at least 1 s between interrupts		1 ms max.	
Fusing		A	1.5 external	2.5 external	
Bus output	Voltage	---	5.1 V		
	Current	A	3		
	Minimum load	A	0		
	Protection		Against overcurrent and overvoltage		
I/O words per DIO		30 I/32 O (two additional input words are reserved for I/O drop status)			
Typical racks		2, 3 or 4 positions			
Diagnostics at startup	RAM	Yes			
	RAM address	Yes			
	Checksum	Yes			
	CPU	-			
Runtime diagnostics	RAM	Yes			
	RAM address	Yes			
	Checksum	Yes			
	CPU	-			
Power supply connection		Terminal block, 7 points (043 503 328 terminal block included)			
Power dissipation		W	11		

Characteristics of head-end modules no. 2 and no. 3 (1)				
Type of module		140 NOM 211 00	140 NOM 212 00	140 NOM 252 00
Functional safety certification		-		
Function		DIO head-end adaptor		
Network cable		Single copper (twisted pair cable)	Redundant copper (twisted pair cable)	Single fibre optic (2 TX/RX fibres)
Built-in communication ports		1 Modbus (RS 232) 1 Modbus Plus	1 Modbus (RS 232) 2 Modbus Plus	1 Modbus (RJ 45) 1 Modbus Plus (fibre optic cable)
Words		30 I/32 O (two additional input words are reserved for I/O drop status)		
Diagnostics (startup and operation)	RAM	Yes		
	RAM address	Yes		
	Checksum	Yes		
	CPU	Yes		
Consumption on the bus	<b>mA</b>	780		750
Power dissipation	<b>W</b>	4		4
Data rate	<b>Mbps</b>	1		1
Pulse width distortion/jitter	<b>ns</b>	-		5 or better
Wavelength	<b>nm</b>	-		820
Power loss budget (including 3dB margin)	50/125 µm fibre	<b>dB</b>	-	6.5
	62.5/125 µm fibre	<b>dB</b>	-	11
	100/140 µm fibre	<b>dB</b>	-	16.5
Optical transmission	50/125 µm fibre	<b>dBm</b>	-	- 12.8...- 19.8
	62.5/125 µm fibre	<b>dBm</b>	-	- 9...- 16
	100/140 µm fibre	<b>dBm</b>	-	- 3.5...110.5
Rise/fall time	<b>ns</b>	-		20 or better
Optical receiver	Sensitivity	<b>dBm</b>	-	30 or better
	Dynamic range	<b>dB</b>	-	20
	Detected silence	<b>dBm</b>	-	- 36

### References

Description	Medium	Type of medium	No.	Reference	Weight kg
Quantum CPUs DIO head-end no. 1	Single	-	1	140 CPU ●●● (2)	-
DIO head-end adaptors no. 2 and no. 3 (3)	Single	Twisted pair cable	2	140 NOM 211 00	-
	Redundant	Twisted pair cable	-	140 NOM 212 00	-
	Single	Fibre optic cable	-	140 NOM 252 00	-
Description	Medium	Built-in power supply		Reference	Weight kg
DIO drop adaptors	Single	115/230 ~	3	140 CRA 211 10	-
		24 ...	3	140 CRA 211 20	-
	Redundant	115/230 ~	-	140 CRA 212 10	-
		24 ...	-	140 CRA 212 20	-

(1) Head-end no. 0, included in each 140 CPU (see pages 2/5 and 2/17).

(2) See pages 2/9 and 2/19.

(3) Modbus Plus network cables and accessories, see pages 6/76 and 6/77.

# Modicon Quantum automation platform

## Hot Standby system

### Unity

#### Presentation

The Hot Standby system is compatible with Unity Pro software, and provides Quantum CPUs with the high level of availability required by the most critical applications, in terms of the availability of their control system.

At the centre of the system are two Quantum PLC racks, commonly known as the "Primary" PLC and the "Standby" PLC. Their hardware configurations must be identical (same modules in each local rack). The key element, on each of them, is the **140 CPU 671 60** CPU, specially designed for Hot Standby architectures with Unity Pro software.

This CPU is a double-slot module, which combines the central processor unit function with that of the redundant coprocessor in the same housing.

The "Primary" PLC executes the application program and controls the I/O. The "Standby" PLC stays in the background, ready to take over if necessary. The "Standby" PLC is connected to the "Primary" PLC via a high-speed fibre optic link (100 Mbps) integrated in the CPU.

This fibre optic link (62.5/125 multimode) can be extended to 2 km without any additional special equipment. It is via this that the user application data is updated cyclically on the "Standby" PLC.

In the event of an unexpected failure affecting the "Primary" PLC, the standby system switches over automatically, changing execution of the application program and control of the I/O over to the "Standby" PLC, with an up-to-date data context. Once the changeover is complete, the "Standby" PLC becomes the "Primary" PLC. Once the faulty PLC has been repaired and reconnected to the standby system, it takes the role of the "Standby" PLC.

Using the Hot Standby system with Unity Pro software means there is a smooth changeover from primary to standby at the outputs. The changeover is transparent for the process, which will continue to be managed without any permanent ill-effects from the occurrence of a hardware failure. The Hot Standby system with Unity Pro software therefore increases productivity by minimizing downtime.

# Modicon Quantum automation platform

## Hot Standby system

### Unity

#### Architecture

##### Time-critical processes: remote I/O architecture (RIO)

For sensitive processes, requiring an I/O control takeover time within the region of the PLC scan time, an I/O architecture based on RIO (Remote I/O) native topology should be chosen by default.

The scanning of RIO drops is synchronous with the CPU scan time. As a result, the RIO remote I/O architecture provides a smooth CPU switchover with regard to the outputs, i.e. with no disturbance.

RIO I/O drops, consisting of Quantum modules, are recognized and configured from the Unity Pro software programming environment.

A splitter box **5 MA 0186 100** is used to enable I/O exchanges between the RIO drops **4** and the "Primary" **1** and "Standby" PLCs **2**. The line impedances **6 52 0720 000** are used to maintain a suitable line when it is necessary to disconnect one of the I/O CPUs. The optional earthing terminals **7 60 0545 000** are used to maintain the earthing of the coaxial cable in these conditions.

The availability of this I/O system can be reinforced by using a dual-medium I/O wiring system. It is possible to transpose these I/O drops on a (single or dual) optical ring, using optical repeaters.

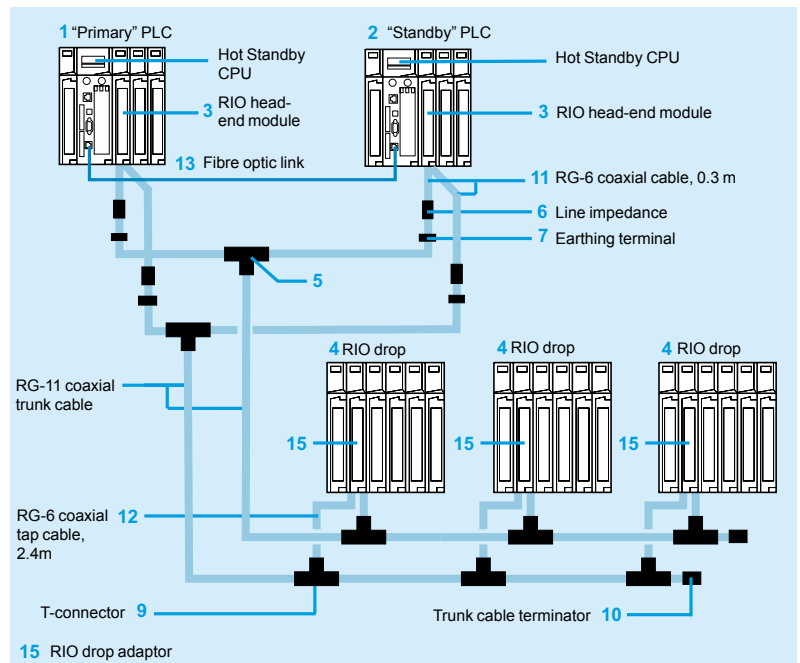

**Note:** For items 1, 2, ...15, see pages 3/21 to 3/23.

The components are available in kits.

For example, the configuration illustrated above can be created using:

- 1 splitter kit **140 CHS 320 00**
- 4 head-end adaptor connection kits **RPX KIT CRP**
- 6 drop kits **RPX KIT 6F**
- 1 RG-11 coaxial trunk cable: for example, a 320 m reel, **97 5951 00**, see page 3/8



# Modicon Quantum automation platform

## Hot Standby system

### Unity

#### Architecture (continued)

##### Ethernet Hot Standby Architecture

For processes that can use Ethernet technology, from the point of view of the I/O control time, it is possible to adopt a mixed architecture, combining both RIO type I/O distribution (Remote I/O) on at least one drop and distribution of devices on an Ethernet TCP/IP network.

From an operational point of view, client type devices (PLC modules, Human-Machine dialogue interfaces, etc.), and Modbus TCP server type devices (Advantys OTB and Momentum distributed I/O, Advantys STB I/O islands, Altivar variable speed drives, etc.) can in fact coexist on a single Ethernet TCP/IP network.

Client-server type exchanges, between the PLC module and devices communicating using the Modbus TCP protocol, use the I/O Scanning mechanism. This can be used to configure up to 128 periodic read and/or write exchanges on these target devices, via tables of word type variables. This I/O Scanning mechanism is a function available as standard with **140 NOE 771 01** and **140 NOE 771 11** Quantum Ethernet modules. This function also works in a Quantum Hot Standby architecture with Unity Pro software.

As far as Ethernet network topology elements for connection between PLC modules and distributed devices are concerned, it is better to use switches rather than hubs. The topology adopted can be bus or ring type (copper wire or fibre optic), as appropriate.

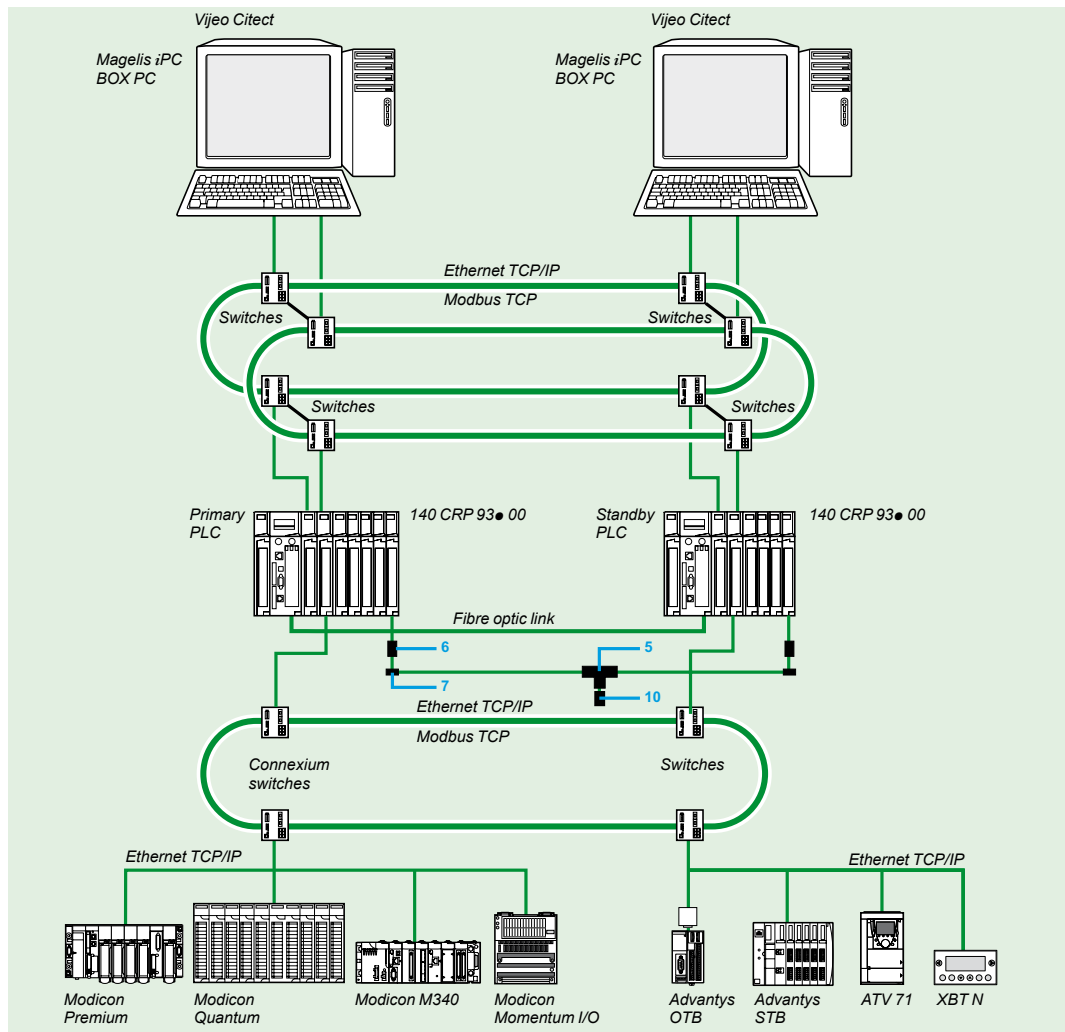

Note: For items 5, 6, 7 and 10, see pages 3/21 to 3/23.

# Modicon Quantum automation platform

## Hot Standby system

### Unity

#### Functions

##### ■ Application program memory space

All the memory space reserved for the application program is managed by the Hot Standby system with Unity Pro. With an embedded 1024 Kb RAM memory, the RAM memory for the **140 CPU 671 60** CPU, dedicated to Hot Standby applications, can be increased to 7.168 Mb by the addition of a PCMCIA format memory card, see page 2/13.

##### ■ Configuration

Installation of the application program does not differ fundamentally from installing a single PLC program. It essentially uses the information provided by a dedicated dialogue box, filled in during the configuration of the system.

##### ■ Mini-terminal on front panel

The **140 CPU 671 60** CPU is a double-slot module, with a mini-terminal at the top of the front panel. Equipped with an LCD screen and navigation buttons, it has a special sub-menu for the standby system. It can be used for example to check the status of the PLC, or to force the PLC to active or inactive standby state.

##### ■ System registers

Control of the standby system is managed by an internal register called the Command Register, carried by a system word. This Command Register accepts user requests, expressed via the configuration dialogue box and/or via the mini-terminal on the front panel. This Command Register can be used in particular to disable acknowledgement of commands made from the mini-terminal.

Feedback on the status of the standby system is given by a Status Register, which is also carried by a system word.

##### ■ Function blocks

Standard function blocks are provided in the Unity Pro programming environment, making it possible to read/write to the Command Register and read the Status Register, by individually identifying each of the bits carrying a particular function.

##### ■ Cyclic transfer of the application context

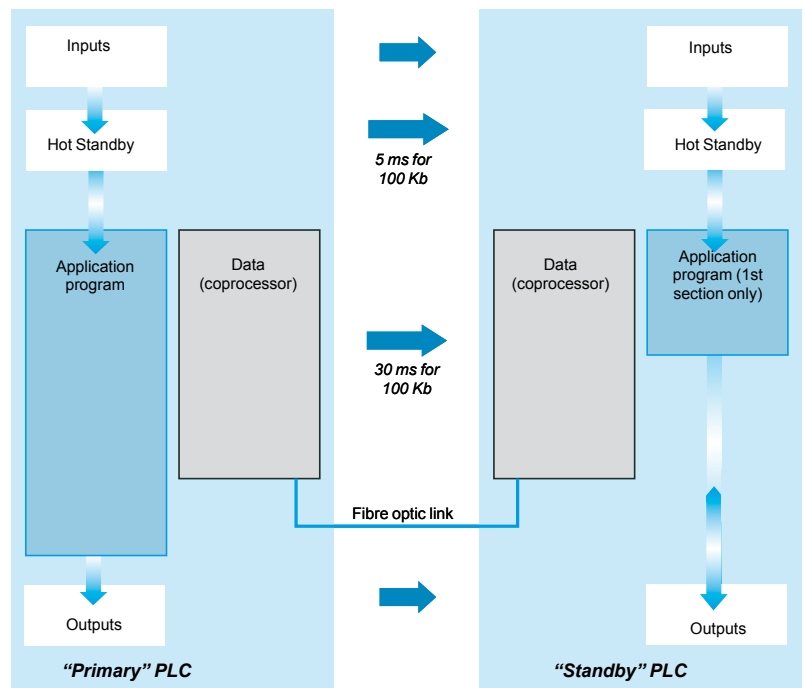

At the start of each scan cycle, the content of the current register in the "Primary" PLC is transferred to the "Standby" PLC via the fibre optic link, at the same time as the content of the I/O state tables are transferred to it. The Hot Standby system is thus able to transfer all the 128 kb made available to receive the located variables (RAM State) from the "Primary" PLC to the "Standby" PLC. As far as unlocated application variables are concerned, and also application data such as DFB instance data, for example, up to 512 Kb can be transferred.

### Functions (continued)

#### ■ Monitoring of program discrepancies

The majority of redundant PLC applications expect identical application programs on both CPUs. To this end, a comparison is made of the application program in both PLCs. It takes place immediately on power-up, and is repeated constantly while the standby system remains active.

By default, the “Standby” PLC will disconnect itself from the standby system as soon as a difference in program is detected. In order to maximize availability of the control system, including during interventions on the application program, it is however possible, via the configurator dialogue box or via the Command Register, to authorize the continued activity of the standby system with applications whose program code and/or database are different.

#### ■ Ensuring parity of the content of the PLC memories

When the second PLC is powered up, the content of the PLC memory is made identical to that of the primary PLC automatically (Plug and Play) in a number of cases. This is in particular true when this second PLC is empty. At the end of the transfer, the standby system is active, the first PLC then takes the “Primary” role and the second the “Standby” role.

The user can also request an upgrade via the mini dialogue terminal, which can be accessed from the front panel of the “Primary” PLC, especially after a modification has been made to the application. This operation on the mini-terminal can be performed by a maintenance engineer, without needing to use a programming terminal. This function is also available via a Command Register bit.

#### ■ Upgrading the operating systems

A Command Register bit, set if necessary from the configuration dialogue box of the Hot Standby system, is used for sequential upgrading of the operating systems of both PLCs, while maintaining control of the process by the application program.

#### ■ Automatic exchange of communication port addresses

When the standby system changes over, the respective addresses of the equivalent communication ports on the “Primary” and “Standby” PLCs are exchanged automatically. This exchange of addresses is unconditional for Ethernet and Modbus Plus ports. It occurs conditionally for the local Modbus port on the **140 CPU 671 60 CPU**.

This function for the automatic exchange of communication port addresses greatly simplifies the task of the developer on supervisory control systems (HMI, SCADA, etc.). In effect, a given address thus characterizes an “operational” PLC (“Primary” or “Standby”) and not a physical PLC.

#### ■ Automatic exchange mechanisms during communication

Irrespective of the I/O architectures used (RIO remote I/O or mixed I/O), the Hot Standby system automatically manages the exchange mechanisms between the I/O and the PLC performing the “Primary” function.

# Modicon Quantum automation platform

## Hot Standby system

### Unity

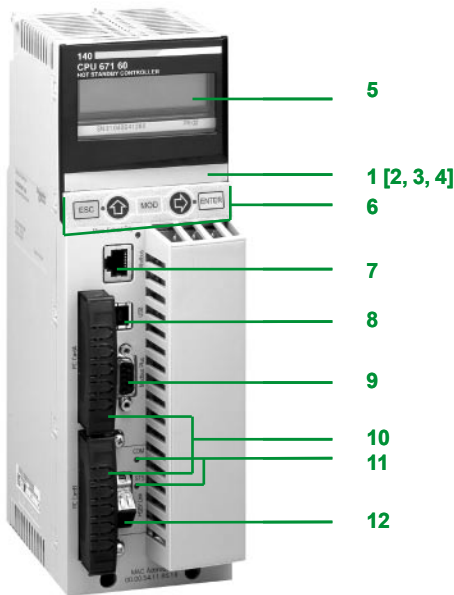

140 CPU 671 60



Mini operator dialogue terminal

#### Description of the 140 CPU 671 60 CPU

The **140 CPU 671 60** CPU front panel comprises:

- 1 An LCD display cover, providing access to:
- 2 A key switch:
  - Unlocked: All system menu operations can be invoked and all changeable module parameters can be modified by the operator via the LCD and keypad. Memory protection is off.
  - Locked: No system menu operations can be invoked and all changeable module parameters are read only Memory protection is on.
- 3 One backup battery slot
- 4 One reset button (Restart)
- 5 An LCD display (2 lines of 16 characters) with brightness and contrast controls.
- 6 A 5-button keypad with 2 LEDs (*ESC*, *ENTER*, *MOD*, *↑*, *⇒*)
- 7 An RJ45 connector for connecting to the Modbus bus
- 8 A type B female USB connector for connecting the PC terminal for programming.
- 9 One 9-way female SUB-D connector for connection to the Modbus Plus network
- 10 Two slots for PCMCIA memory extension cards
- 11 Two LEDs:
  - COM LED (green): activity on the Hot Standby primary or secondary drop
  - ERR LED (red): communication error between the Hot Standby primary and secondary drops
- 12 One MTRJ fibre optic connector for interconnecting the primary and secondary PLCs in the Hot Standby architecture



#### Mini operator dialogue terminal

The mini operator dialogue terminal, located on the front of the **140 CPU 671 60** CPU, gives the user direct information (RUN, STOP, No Conf) on the PLC status, without a programming terminal.

It can also be used to display, and if necessary to modify, a certain number of operating parameters, using the following navigation buttons:

- ESC
- ENTER
- MOD
- ↑
- ⇒

Four main command functions are accessible from a menu/sub-menu tree structure:

- Quantum PLC operating mode: **PLC Operations**
- Communication port parameter settings: **Communications**
- System information: **System Info**
- LCD screen settings: **LCD Settings**

The **PLC Operations** menu is used to execute the following commands:

- Start PLC
- Stop PLC
- Init PLC

It can also be used to go to the **Hot Standby** sub-menu that provides commands specific to the standby system.

It is possible to display (**State** sub-menu) the active/inactive state (with regard to standby) of the PLC which the user is working on, and this sub-menu also offers the option of forcing (**Mode** sub-menu) this PLC to active/inactive state.

The other sub-menus are:

- Order**: delivers topological information on the current PLC
- Diag**: gives, if necessary, error information on the state of the standby system
- Transfer**: is used to transfer the content of the "Primary" PLC memory to that of the "Standby" PLC, for updating

Characteristics			
<b>Type of CPU</b>		<b>140 CPU 671 60</b>	
<b>Functional safety certification</b>			
<b>Number of slots</b>	Primary		2
	Standby		2
<b>Microprocessor</b>			
Pentium 266 MHz			
<b>Memory backup</b>	Battery	Type	3 V Lithium
		Service	<b>mAh</b> 1200
		Retention	<b>years</b> 10, with 0.5% loss of capacity per year
		Power off charge	<b>mA</b> 14 typical, 420 max.
<b>Calendar clock</b>	Drift	<b>s/day</b>	8.0 at 60°C
<b>Maximum configuration</b>	No. of racks with 2/3/4/6/10/16 slots	Main drop(s)	1 "Primary" rack/1 "Standby" rack
		RIO remote drops	31 I/O drops x 2 racks (primary rack + extension rack)
<b>Inputs/Outputs</b>	RIO drops	No. of discrete I/O points	64 input words + 64 output words per I/O drop, i.e. 1024 inputs and 1024 outputs per I/O drop (max.), i.e. 31,744 inputs and 31,744 outputs in total (max.)
		No. of analog I/O points	64 input words + 64 output words per I/O drop, i.e. 64 inputs and 64 outputs per I/O drop (max.), i.e. 1984 inputs and 1984 outputs (max.)
	Application-specific modules		Intrinsic safety I/O, high-speed counting, ASCII, accurate time stamping
<b>Communications</b>	No. of optional modules	Ethernet, Modbus Plus	6
	Max. no. of ports	Modbus	1 port integrated in the Quantum CPU (RS 232/485)
		AS-Interface	4 on remote rack (drop)
		Modbus Plus	1 port integrated in the Quantum CPU, 6 ports max. on additional modules
		Ethernet	1 x 100 Mbps port integrated in the Quantum CPU, used exclusively for the Primary/Standby link 6 x 10/100 Mbps ports max. on additional modules
	USB	1 programming port only	
<b>Functions</b>	Mini operator dialogue terminal		Integrated on the front panel
	Redundancy		Power supplies (option), RIO wiring (option), Modbus Plus (option)
	Process control		Yes
	Hot Standby		Redundant coprocessor integrated in the Quantum CPU "Primary/Standby" link on integrated 100 Mbps fibre optic port
<b>Memory</b>	Configuration data - max.	<b>Kb</b>	128
	Program	<b>Kb</b>	1024 possible extension to 7168 with PCMCIA card (upper slot)
	Unlocated variables + internal data	<b>Kb</b>	512 max.
	Located internal bits (%Mi)	<b>bits</b>	64 K all I/O combinations
	File storage	<b>Mb</b>	Up to 8 Mb on PCMCIA card (lower slot)
<b>Application structure</b>	Master task (MAST)		1 cyclic/periodic
	Fast task (FAST) (1)		1 periodic (2)
	Auxiliary task (AUX) (1)		4 (2)
	Event-triggered tasks (3)		32 (2)
<b>Execution time for one instruction</b>	Boolean	<b>ms</b>	0.0525...0.075 (4)
	On words or fixed point arithmetic	<b>ms</b>	0.0450...0.060 (4)
	On floating point	<b>ms</b>	0.400...0.500 (4)
<b>Number of Kinstructions executed per ms</b>	100% Boolean	<b>Kinst/ ms</b>	10.28
	65% Boolean and 35% numerical	<b>Kinst/ ms</b>	10.07
<b>System overhead</b>	Master task (MAST)		<b>ms</b> 1
	Fast task (FAST)		<b>ms</b> 0.2

(1) It is recommended that only the MAST task is used in Hot Standby applications with Unity Pro. The use of FAST and AUX tasks does however remain possible, but requires an exhaustive detailed analysis of the possible effects of their use.  
 (2) Use not recommended with the Hot Standby system.  
 (3) Using a multi-task organization may involve modifications of the I/O state tables within a single scan, even during transfer of data from Primary to Standby. As a matter of principle, these modifications take place asynchronously in relation to the PLC scan cycle. For these reasons, it is recommended that only the MAST task is used in Hot Standby applications.  
 (4) Limit values according to the type of instruction.

# Modicon Quantum automation platform

## Hot Standby system

### Unity



140 CPU 671 60

References								
Hot Standby CPU with Unity Pro								
Hot Standby CPU	Memory (max.)		Program		Communication ports	Safety	Reference	Weight kg
Clock frequency	Coprocessor	RAM	Program (with located variables)	Program with PCMCIA card				
266 MHz	Yes, integrated Ethernet TCP/IP, use reserved for Hot Standby	2 Mb	1024 Kb	7168 Kb	1 Modbus (1) 1 Modbus Plus 1 USB 1 Ethernet 100 Mbps port (dedicated Hot Standby port)	–	140 CPU 671 60	–



140 NOE 771 11

Associated modules							
Description	Type of architecture	Topology	Transparent Ready	No. (2)	Safety	Reference	Weight kg
RIO head-end adaptor modules	Remote I/O (RIO) and mixed I/O	Single cable	–	3	–	140 CRP 931 00	–
		Redundant cable	–	3	Non interfering	140 CRP 932 00	–
RIO drop adaptor	–	Single cable	–	15	–	140 CRA 931 00	–
		Redundant cable	–	15	Non interfering	140 CRA 932 00	–
Ethernet TCP/IP network modules	Mixed	Bus or ring (copper or fibre optic)	Class B30	14	–	140 NOE 771 01	0.345
			Class C30	14	Non interfering	140 NOE 771 11	0.345



490 NOR 000 ●●

## References (continued)

## Fibre optic cables for Hot Standby architectures

Description	Use/composition	Length	No. (1)	Reference	Weight kg
Fibre optic cables for interconnecting the Ethernet ports on the 140 CPU 671 60S Primary and Standby CPUs	62.5/125 multimode fibre optic cable, equipped with MT-RJ connectors	3 m	13	490 NOR 000 03	–
		5 m	13	490 NOR 000 05	–
		15 m	13	490 NOR 000 15	–





## Connection kits

Description	Composition and no. (1)	Reference	Weight kg
Splitter set for coaxial cable	Comprising: - 2 splitter boxes 5 MA 0186 100 for coaxial cable with 520 402 000 terminator for trunk cable - 4 line impedances 6 52 0411 000	140 CHS 320 00	–
Connection kit for head-end modules 140 CRP 93● 00	Comprising: - 1 RG-6 coaxial cable 11 (length 0.3 m) fitted with type F female connectors - 1 earthing terminal 7 60 0545 000	RPX KIT CRP	–
RIO drop kit	Comprising: - 1 T-connector 9 MA 0185 100 for RG-11/RG-6 coaxial cables with trunk cable terminator 10 520 422 000 - 2 RG 6 coaxial cables 12 (length 2.4 m) fitted with type F female connectors	RPX KIT 6F	–

(1) For numbers, see page 3/15.

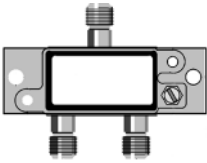
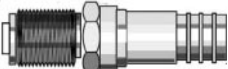
## References (continued)

## Connection accessories for Hot Standby architecture (1)

Description	Use/composition	Length	No. (2)	Reference	Weight kg
 MA 0186 100	<b>Splitter box for coaxial cable</b> T-connector for joining sections of RG-6 coaxial cable coming from two 140 CRP 932 00 head-end adaptor modules. Forms the start of the RIO links.	–	5	MA 0186 100	–
 52 0411 000	<b>Line impedance for RG-6 coaxial cable</b> Crimping adaptor for RG-6 RIO coaxial cable. Used to maintain a suitable RIO line on disconnection of the cable coming from the head-end adaptor (140 CRP 932 00). Connection at both ends on female connector.	–		52 0411 000	–
 52 0720 000	<b>Line impedance for RG-6/RG-11 coaxial cable</b> Screw adaptor for RG-6/RG-11 RIO coaxial cable. Used to maintain a suitable RIO line on disconnection of the cable coming from the head-end adaptor (140 CRP 932 00). Connection at both ends on female connector.	–	6	52 0720 000	–
 60 0545 000	<b>Adaptor for RG-11 coaxial cable</b> Type F to BNC adaptor with self-terminator for RG-11 cable.	–		52 0370 000	–
 60 0545 000	<b>Earthing terminal for RG-6/RG-11 coaxial cable</b> Earthing terminal for RIO coaxial cable. Used to maintain earthing of the RIO line on disconnection of the cable coming from the head-end adaptor (140 CRP 932 00). Connection at both ends on female connector.	–	7	60 0545 000	–

(1) For other RG connection accessories, see pages 3/8 and 3/9.

(2) For numbers, see page 1/16.



# Modicon Quantum automation platform

## Hot Standby system

### ProSoft Technology PTQ-PDPMV1 module

#### Presentation

The PTQ-PDPMV1 communication module from ProSoft Technology can be used to create Hot Standby architectures based on Modicon Quantum **140 CPU 671 60** CPUs with Unity Pro, and with I/O on Profibus DP fieldbus.

#### Description

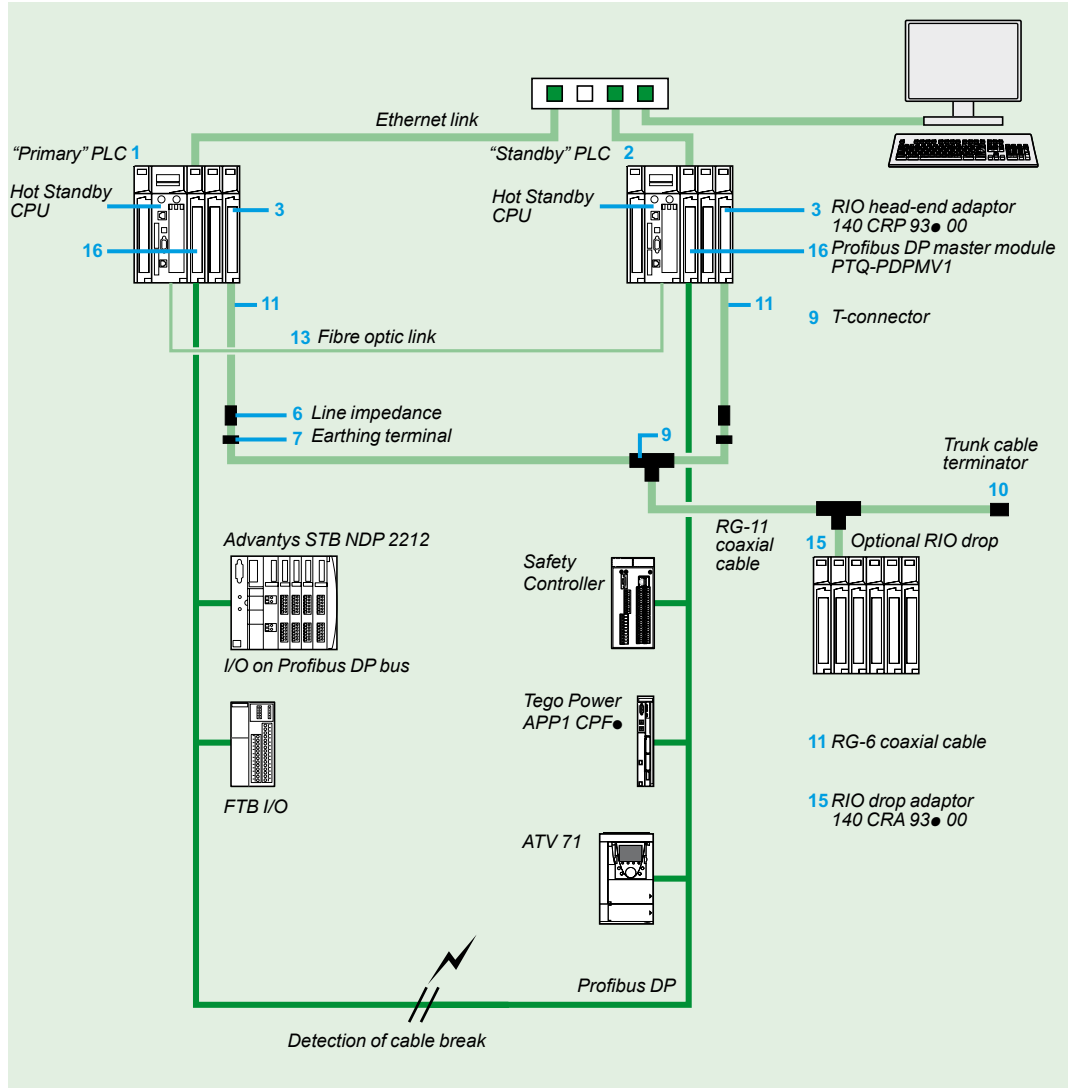

Note: For items 1, 2, ...15, see pages 3/21 to 3/23.  
 16 : Prosoft Technology PTQ-PDPMV1 module

3

# Modicon Quantum automation platform

## Hot Standby system

### ProSoft Technology PTQ-PDPMV1 module

#### Operating Principle

The **PTQ-PDPMV1** modules are connected to the primary and standby PLCs respectively.

Each **PTQ-PDPMV1** module monitors the Profibus DP bus and communicates the bus status to the other **PTQ-PDPMV1** via the integrated Ethernet connection. At the same time, the PLC application is also informed via dedicated registers in the **PTQ-PDPMV1** modules.

It is the responsibility of the PLC application to manage this status data and also to initiate the changeover of CPU via the command registers if necessary.

#### Main characteristics

- Hot Standby function compatible with the **140 CPU 671 60** CPUs.
- Up to 4 **PTQ-PDPMV1** modules per rack when the Hot Standby function is activated (1). Configuration in local rack only.
- Application monitoring of the active (primary) and passive (secondary) master modules via status words.
- Updating of the Profibus DP bus status words from the passive (secondary) master by ping on Profibus DP FDL data link layer.
- Detection of cable break with information on the number of slaves on the two segments of the broken bus.
- Changeover time on Profibus DP bus for a 500 kbps bus:
  - Typical: 100 ms
  - Max.: 300 ms

No parameter setting is required for Hot Standby operation, as the module automatically detects the Hot Standby configuration.

The ProSoft Configuration Builder (PCB) configuration software is useful to generate various DFBs for monitoring the status of the module and the bus, and managing data exchanges with the devices, keeping the input and output areas separate.

ProSoft Configuration Builder can also export a function module specific to the ProSoft Technology **PTQ-PDPMV1** module to Unity Pro.

This function module provides:

- DFBs
- Program sections with instantiated DFBs.
- Dedicated animation tables.
- A hyperlink to the PCB configurator.

#### Additional products

Any information that may be required concerning the **PTQ-PDPMV1** communication module and associated hardware and software products is available on the ProSoft Technology website <http://www.prosoft-technology.com>.

(1) Up to 6 **PTQ-PDPMV1** modules per rack in standard configuration, see page 6/80.

### Presentation

The Hot Standby system, which is compatible with Concept and ProWORX software, gives Quantum CPUs the high availability that security-critical applications demand. Central to the system is the standby PLC, the second Quantum system, configured identically to the primary system, and special modules installed in both systems. The standby PLC uses a high-speed fibre optic link to constantly maintain the current system status of the primary PLC. If there is an unexpected failure in the primary PLC, control of the system automatically switches to the standby PLC. Critical processes, interfaced via a remote I/O network, remain intact, unaffected by PLC hardware failures. The result is higher productivity with reduced downtime.

At the beginning of every primary PLC scan the current register and the I/O state tables are transferred to the standby PLC via a secure, high-speed fibre optic link. If the switchover is triggered, the standby PLC takes over control of the system, with up to date data. The transfer of control takes place smoothly with minimal impact on the process. On switchover, the standby PLC becomes the primary PLC, and when the faulty PLC has been repaired it becomes the standby.

Most applications require identical logic programs in both CPUs. A comparison of the user program in both PLCs is carried out, both at startup and during operation. By default, the standby PLC is disconnected when a difference between the programs is detected. It is possible to allow logic differences to coexist in order to obtain high availability during maintenance periods. If minor modifications to the process are necessary, the user can make them without disturbing the standby operations.

If the standby PLC does not contain an application program, it can be copied from the primary PLC. Copying the program is a simple two-step procedure using the keyswitch and the update button on the front of the standby PLC. This can be performed by a maintenance engineer, without the use of a programming terminal.

Three preconfigured kits for Hot Standby applications are available:

- The **140 CHS 210 00** kit includes all the items necessary for integrating the Hot Standby system in an existing application.
- There are also 2 complete kits **140 CHS 410 10** and **140 CHS 410 20**, which include the Hot Standby system, the racks, the power supply modules and the CPUs.

### Description

The **140 CHS 110 00** Hot Standby module comprises the following on the front panel:

- 1 Model number and colour code
- 2 A display block with 5 LED indicators:
  - Ready (green): the module has completed the startup diagnostics. Flashing: transmission errors
  - Com Act (green): communicating with the I/O bus. Flashing: transmission errors
  - Primary (green): the module controls the process
  - Com Err (red): indicates transmission errors or connection interrupted
  - Standby (amber): module in standby mode. Flashes during updating of the program
- 3 A removable hinged door with a customizable identification label
- 4 Switches: RUN/Xfer/Off line, Controller A, Controller B
- 5 A microswitch
- 6 An application program update button
- 7 A fibre optic connector: Transmission
- 8 A fibre optic connector: Reception

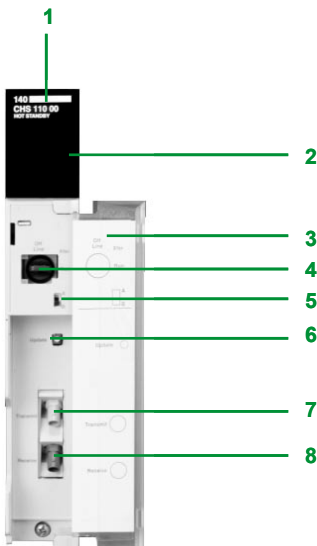

# Modicon Quantum automation platform

## Hot Standby system Concept/ProWORX

### Hot Standby system cable topologies

The Hot Standby system controls a group of I/O drops on a remote I/O (RIO) network. The local rack of each primary and standby PLC requires a **140 CPU ●●● ●● CPU**, a **140 CRP 931 00** RIO head-end adaptor module and a **140 CHS 110 00** Hot Standby module. It is recommended that I/O are not used on the local rack as they will not be taken into account when switching from one PLC to the other.

The two **140 CHS 110 00** modules are connected to one another by a special fibre optic cable. This link enables the standby PLC to maintain the current system status of the primary PLC. The two RIO head-end adaptor modules are connected to the RIO trunk cable via the **MA 0186 100** splitter box.

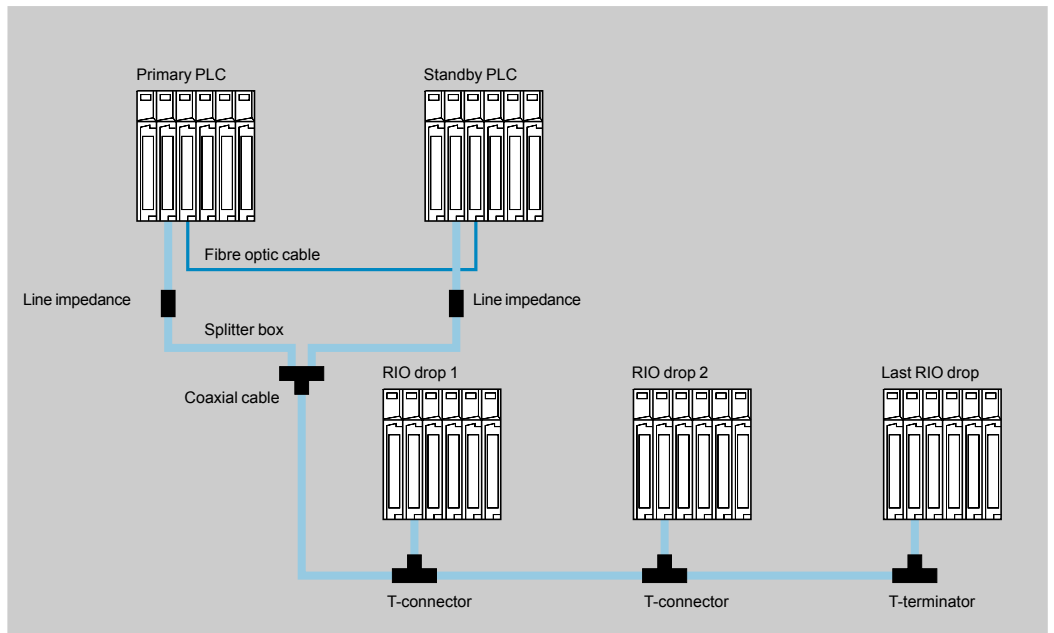

The Hot Standby system also accepts a redundant RIO cable topology. The two coaxial cables, from the two **140 CRP 932 00** head-end adaptors, on each of the two PLCs, are connected to the redundant RIO cable by two separate **MA 0186 100** splitter boxes.

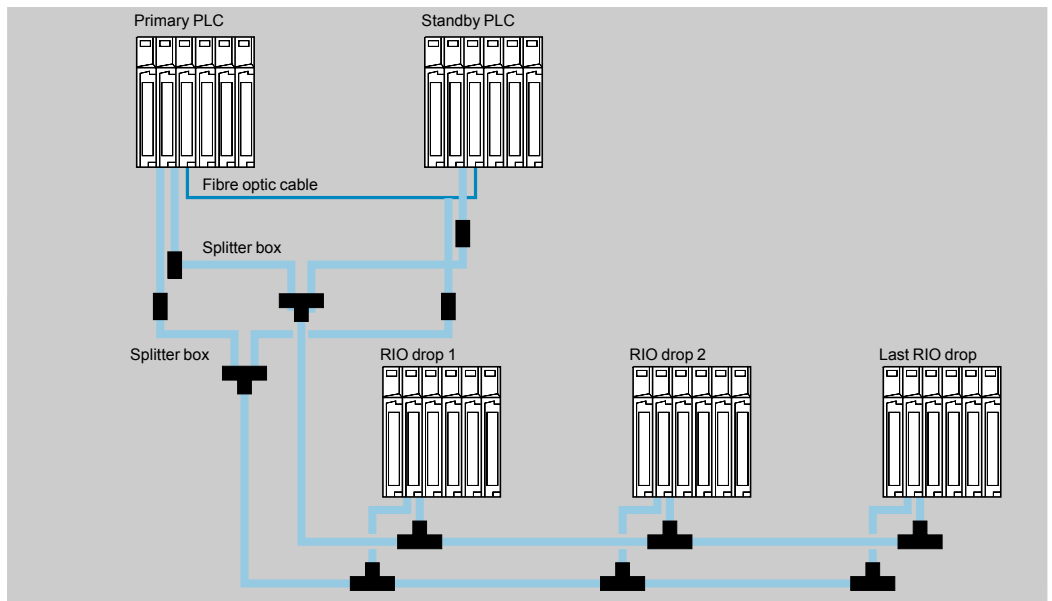

3

Characteristics		
Type of module		140 CHS 110 00
Functional safety certification		–
Communication port		2 connectors (transmission and reception) for fibre optic link
RFI immunity (according to IEC 60801-3)	<b>MHz</b>	27...1000, 10 V/m
Bus current required	<b>mA</b>	700 (typical)
Electrostatic discharge (according to IEC 60801-2)	<b>kV</b>	8 air, 4 contact
Compatibility	Software	ProWORX NxT V2.0 or Concept Version ≥ 2.0
	CPUs	All 140 CPUs in LL984 language, 140 CPU 434 12A/534 14B in IEC language
Type of I/O		Quantum, 800 Series and Sy/Max (remote I/O only)
Fibre optic ports		1 transmission; 1 reception
Programming software		ProWORX NxT V2.0 or Concept Version ≥ 2.0
Compatible Quantum CPUs		All 140 CPUs in LL984 language, 140 CPU 434 12A/534 14B in IEC language
CHS downloadable function block requirements		Version ≥ 2.0
Downloadable function block		CHS block (included in the 140 CHS 210 00 Hot Standby kit)
Switchover time	<b>ms</b>	13 to 48 for standby PLC to take over control of the process after detection of fault on primary PLC
Impact of data exchanges on scan time	<b>ms</b>	3 + 6 per Kb of configured state RAM
CHS communication rate	<b>Mbps</b>	10
Cables between Quantum systems	<b>m</b>	3, fibre optic
Consumption	<b>mA</b>	700

# Modicon Quantum automation platform

## Hot Standby system Concept/ProWORX

### References

Description	Components	Safety	Reference	Weight kg
Hot Standby module	–	–	140 CHS 110 00	1.06
Hot Standby kit	2 Hot Standby modules 1 fibre optic cable (3 m) 1 (CHS) downloadable function block 1 S908 connection kit 1 installation manual	–	140 CHS 210 00	–
Hot Standby kit with 140 CPU 113 02 CPUs	2 140 CPU 113 02 CPUs 2 140 CHS 110 00 Hot Standby modules 2 140 CRP 931 00 adaptor modules 2 140 CPS 111 00 power supply modules 2 140 XBP 006 00 racks 1 (CHS) downloadable function block 1 fibre optic cable (3 m) 1 S908 connection kit 1 installation manual	–	140 CHS 410 10	–
Hot Standby kit with 140 CPU 113 03 CPUs	2 140 CPU 113 03 CPUs 2 140 CHS 110 00 Hot Standby modules 2 140 CRP 931 00 adaptor modules 2 140 CPS 111 00 power supply modules 2 140 XBP 006 00 racks 1 (CHS) downloadable function block 1 fibre optic cable (3 m) 1 S908 connection kit 1 installation manual	–	140 CHS 410 20	–
Installation manual	Quantum Hot Standby system Installation manual	–	840 USE 106 00	–

### Associated modules

Description	Topology	Safety	Reference	Weight kg
RIO head-end adaptor modules	Single cable	–	140 CRP 931 00	–
	Redundant cable	Non-interfering	140 CRP 932 00	–

### Accessories

Description	Use/composition	Length	Safety	Reference	Weight kg
Splitter box	Special T-connector for joining sections of coaxial cable coming from 2 head-end adaptor modules (140 CRP 93● 00). Constitutes the start of the RIO I/O backbone.	–	–	MA 0186 100	–
Line impedance for RG-6/RG-11 coaxial cable	Impedance for RIO coaxial cable. Used to maintain a suitable RIO line on disconnection of the cable coming from the head-end adaptor (140 CRP 93● 00). Connection at both ends on female connector.	–	–	52 0411 000	–
Earthing terminal for RG-6/RG-11 coaxial cable	Earthing terminal for RIO coaxial cable. Used to maintain earthing of the RIO line on disconnection of the cable coming from the head-end adaptor (140 CRP 93● 00). Connection at both ends on female connector.	–	–	60 0545 000	–

### Presentation

Modicon Quantum automation platform modules mount easily in racks in standard industrial electrical cabinets or in 19 inch racks. Mounting brackets are available as options for mounting these racks. Each rack provides the control signals and distributes the power necessary to operate the installed modules.

### Description

Six different rack models are available, with 2, 3, 4, 6, 10 or 16 slots. The rack slots are universal (any module can fit into any slot). Almost all Quantum modules are designed to fit into a single slot in a Quantum rack (1).

There are no reserved slots in a Quantum system, although it is recommended that power supply modules are fitted in the extreme left slot, for optimum heat dissipation. The only limits on the rack are the power available for the modules and the addressing space. Any rack can be used in any of the three architectures supported by the Quantum platform: local I/O, remote I/O or distributed I/O.

In a Quantum system, module addressing and configuration is handled by the software. No switches or other hardware components are used.

140 XBP 0●● 00 racks comprise:

- 1 A metal frame
- 2 Connectors for module/rack connection
- 3 Tapped holes for fixing each module
- 4 Holes for fixing the rack
- 5 Earth terminals for earthing the rack

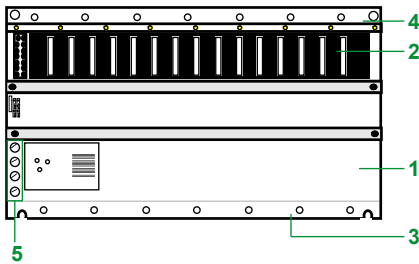

### Rack extension module

The 140 XBE 100 00 rack extension module enables I/O in an adjacent “secondary” rack to communicate with the CPU or RIO drop in the “primary” rack via a custom communication cable. An extension module must be installed in each rack. The extension cable provides all the signals necessary for data transmission between the two racks. A single rack extension module can be added to each rack.

The rack extension module has the following flexible characteristics:

- The same 140 XBE 100 00 rack extension module is used for both “primary” and “secondary” racks. A rack extension system consists of two 140 XBE 100 00 rack extension modules and one cable, available in 1, 2 or 3 m lengths.
- The system can use any Quantum power supply module. Each rack can have a different type of power supply module.
- Loss of power in the “secondary” rack will not shut down the entire drop. Only those modules located in the “secondary” rack will lose power.
- Rack extension modules can be placed in any slot in the rack and do not necessarily have to be placed in corresponding slots in the “primary” and “secondary” racks.
- The rack extension module is not recognized by the configuration software. It will appear as an unfilled slot in the I/O map.
- All rack sizes are possible.
- The rack extension supports local I/O and remote I/O (31 drops).
- Extension racks support all discrete and analog I/O modules and also high-speed counter modules.

(1) Except 140 CPU 651●0/671 60 high performance CPUs: require 2 slots.

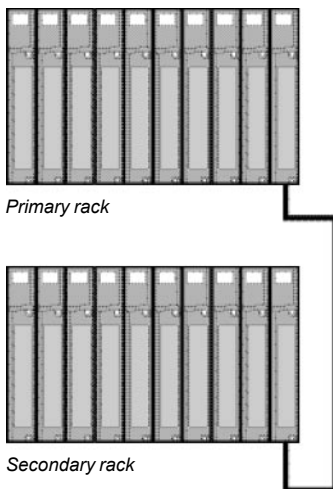

### References

Description	Number of slots	Security	Reference	Weight kg
Racks for: - Local I/O modules - Remote I/O modules - Distributed I/O modules	2	–	140 XBP 002 00	0.230
	3	–	140 XBP 003 00	0.340
	4	–	140 XBP 004 00	0.450
	6	Non-interfering	140 XBP 006 00	0.640
	10	Non-interfering	140 XBP 010 00	1.000
	16	Non-interfering	140 XBP 016 00	1.600

### Rack accessories

Description	Length/ dimensions	Reference	Weight kg
Rack extension module	–	140 XBE 100 00	–
Cables for extension racks	1 m	140 XCA 717 03	–
	2 m	140 XCA 717 06	–
	3 m	140 XCA 717 09	–
19" front rail mounting bracket for 140 XBP 010 00	125 mm deep	140 XCP 401 00	–
19" rear rail mounting bracket for 140 XBP 010 00	20 mm deep	140 XCP 402 00	–

### Dimensions

#### 140 XBP 0●● 00

#### Front view

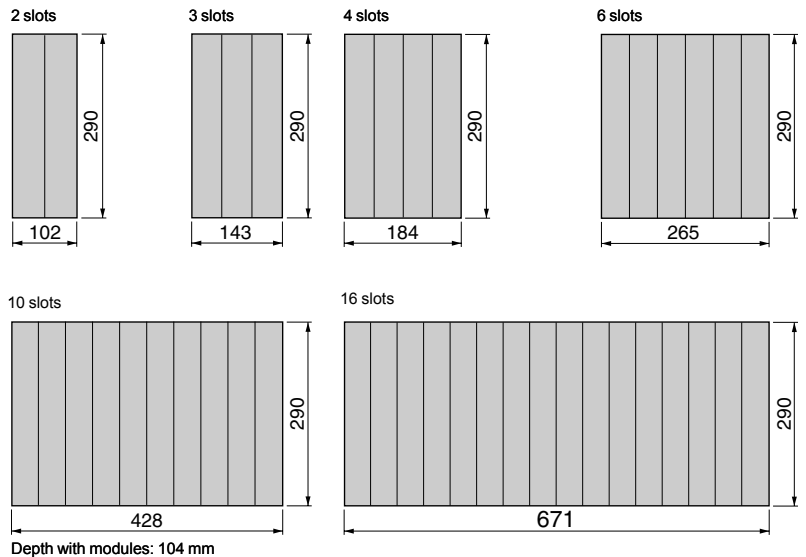



3

Applications	Standalone			Summable
Input voltage	100...276 V ~	20...30 V =	100...150 V =	93...138 V ~ or 170...276 V ~
Frequency	47...63 Hz	–		47...63 Hz
Input current	0.4 A at 115 V ~ 0.2 A at 230 V ~	1.6 A	0.4 A	1.3 A at 115 V ~ 0.75 A at 230 V ~
Output current	3.0 A max.			Standalone: 11 A at 60°C Summable: 20 A at 60°C
External fusing	1.5 A slow-blow	2.5 A slow-blow	0.7 A slow-blow	2.0 A slow-blow
Maximum power interruption	1/2 cycle at full load	1 ms	1 ms	1/2 cycle at full load
Alarm relay	No			
Functional safety certification	–			
Type of module	140 CPS 111 00	140 CPS 211 00	140 CPS 511 00	140 CPS 114 20
Page	3/37			

**Redundant**



**3**

20...30 V $\overline{\text{---}}$	48...60 V $\overline{\text{---}}$	93...138 V $\sim$ or 170...276 V $\sim$	20...30 V $\overline{\text{---}}$	48...60 V $\overline{\text{---}}$	100...150 V $\overline{\text{---}}$
–		47...63 Hz	–		
3.8 A max.		1.1 A at 115 V $\sim$ 0.6 A at 230 V $\sim$	3.8 A max.		0.5 A at 125 V $\overline{\text{---}}$
8.0 A		11 A at 60°C (124 20)	8.0 A		
5.0 A slow-blow	2.0 A medium time lag	2.0 A slow-blow	5.0 A slow-blow	2.0 A medium time lag	2.0 A slow-blow
1 ms	13 ms	1/2 cycle at full load	1 ms	13 ms	1 ms
Yes		No	Yes		No
–		Non-interfering	–		
<b>140 CPS 214 00</b>	<b>140 CPS 414 00</b>	<b>140 CPS 124 20</b>	<b>140 CPS 224 00</b>	<b>140 CPS 424 00</b>	<b>140 CPS 524 00</b>

3/37

### Presentation

Quantum power supply modules serve two purposes - they provide power to the system rack and protect the system from noise and voltage swings. All power supply modules feature overcurrent and overvoltage protection. They operate in most electrically noisy environments without the need for external isolation transformers. In the event of an unforeseen loss of power, the power supply modules ensure that the system has adequate time for a safe and orderly shutdown. A power supply module converts the input voltage to regulated + 5 V DC for the requirements of the CPU, the I/O modules and those of all the communication modules installed in the rack. The power between the sensors/preactuators and the I/O points on the Quantum system is not provided by these power supply modules.

Three types of power supply module are available for use in local or remote (RIO) architectures:

- Low power standalone power supply modules
- High power summable power supply modules
- High power redundant power supply modules

For distributed I/O (DIO) architectures, low power standalone power supplies are available. These are dedicated to distributed architectures and integrated in distributed I/O drop adaptors. Distributed power supplies are described in the pages on the distributed I/O architecture.

### Functions

#### Standalone power supply modules

A standalone power supply module provides a 3 A current to the Quantum rack. When the system only requires low power, a standalone power supply module is an economical choice. These standalone power supply modules are available for 115/230 V  $\sim$ , 24 V  $\text{---}$  and 125 V  $\text{---}$  supply voltages.

#### Summable power supply modules

A summable power supply module provides a 8 A or 11 A current to the Quantum rack. These summable power supply modules can operate in either standalone or summable mode. When two summable power supply modules are installed in the same rack, they automatically operate in summable mode, providing a current of 16 A or 20 A (depending on the model). In summable mode, both power supply modules must be the same type and must be installed in the left and right end slots of the rack for maximum life. If one of the two power supply modules fails, power is lost to the rack.

If only one summable power supply module is installed in a rack, it operates in standalone mode, supplying a current of 8 A or 11 A to this rack.

Summable power supply modules are available for 115/230 V  $\sim$ , 24 V  $\text{---}$  and 48/60 V  $\text{---}$  supply voltages.

#### Redundant power supply modules

A redundant power supply module provides a current of 8 A or 11 A (depending on the model) to the Quantum rack. For high-availability applications, two redundant power supply modules will provide a redundant current of 8 A or 11 A.

If one of the two power supply modules fails, the one that remains operational maintains the supply of the required power. Each redundant power supply module has a status bit that can be monitored by the application program or by a supervision system, in order to react quickly if the power supply fails.

If an additional power supply module is necessary in a configuration with redundant power supply modules, a third redundant power supply module can be added to the rack, increasing the available capacity to 16 A or 20 A. If one of the three power supply modules fails, those which remain operational revert to standard redundant mode, supplying a redundant current of 8 A or 11 A to the rack.

A redundant power supply module can be used as a standalone power supply module.

Redundant power supply modules are available for 115/230 V  $\sim$ , 24 V  $\text{---}$ , 48/60 V  $\text{---}$  and 125 V  $\text{---}$  supply voltages.

# Modicon Quantum automation platform

## Power supply modules

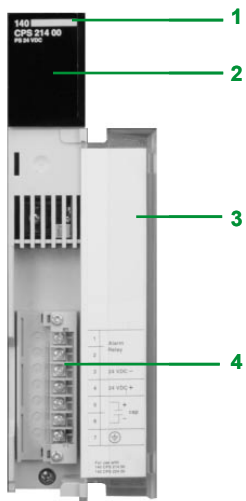

### Description

140 CPS ●●●●0 power supply modules have the following on the front panel:

- 1 Model number and colour code
- 2 An display block
- 3 A removable hinged door with a customizable identification label
- 4 A screw terminal block, 7 points (degree of protection < IP 20).

To be ordered separately if required:

- Screw terminal block, 7 points (degree of protection IP 20) **140 XTS 005 00**.

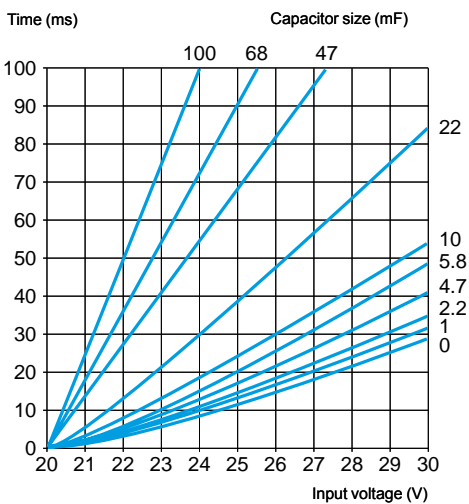

### Maximum power interruption

The processing times on loss of power for **140 CPS 214 00/224 00/414 00/424 00** power supply modules can be increased by adding DC electrolytic capacitors on terminals 5 and 6.

### Compatibility of power supplies

Adhere to the following compatibility rules for applications that require the combination of two power supplies, possibly of different ~ or --- types, on the same rack.

#### Compatibility of summable power supplies

	Type	140 CPS 114 20	140 CPS 114 10 (1)	140 CPS 214 00	140 CPS 414 00
140 CPS 114 20	~	Compatible	Compatible	Compatible	Compatible
140 CPS 114 10 (1)	~	Compatible	Compatible	Compatible	Compatible
140 CPS 214 00	---	Compatible	Compatible	Compatible	Compatible
140 CPS 414 00	---	Compatible	Compatible	Compatible	Compatible

#### Compatibility of redundant power supplies

	Type	140 CPS 124 20	140 CPS 124 00 (1)	140 CPS 224 00	140 CPS 424 00	140 CPS 524 00
140 CPS 124 20	~	Compatible	Compatible	Compatible	Compatible	Compatible
140 CPS 124 00 (1)	~	Compatible	Compatible	Compatible	Compatible	Compatible
140 CPS 224 00	---	Compatible	Compatible	Compatible	Compatible	Compatible
140 CPS 424 00	---	Compatible	Compatible	Compatible	Compatible	Compatible
140 CPS 524 00	---	Compatible	Compatible	Compatible	Compatible	Compatible

Compatible power supplies   
 Non-compatible power supplies

(1) Old model.

3

Characteristics			140 CPS 111 00 (1)	140 CPS 114 10 (2)	140 CPS 114 20 (2)	140 CPS 124 20 (3)	
Type of module							
Functional safety certification			–			Non-interfering	
Approvals			UL 508, CSA 22.2-142, cUL, FM Class 1 Div. 2, CE				
Input characteristics	Input voltage	V ~	100...276	93...138 or 170...276			
	Input frequency	Hz	47...63				
	Input current	at 230 V ~	A	0.2	0.6	0.75	0.6
		at 115 V ~	A	0.4	1.1	1.3	1.1
	Inrush current	at 230 V ~	A	20	19		
		at 115 V ~	A	10	38		
	Rating	VA	50	130			
External fusing	A	1.5 slow-blow	2.0 slow-blow				
Input power interruption		1/2 cycle at full load and minimum line voltage/frequency, and at least 1 s between interrupts					
Harmonic distortion	%	Less than 10% of fundamental rms value					
Output to bus	Voltage	V DC	5.1				
	Current	A	3 max., 0.3 min.	8 at 60°C	Summable: 20 at 60°C Standalone: 11 at 60°C	11 at 60°C	
			Overcurrent, overvoltage				
Internal power dissipation	W	2.0 + (3 x I <sub>out</sub> ), where I <sub>out</sub> is in A		6.0 + (1.5 x I <sub>out</sub> ), where I <sub>out</sub> is in A	6.0 + (1.5 x I <sub>out</sub> ), where I <sub>out</sub> is in A		

Type of module			140 CPS 211 00 (1)	140 CPS 214 00 (2)	140 CPS 224 00 (3)
Functional safety certification			–		
Approvals			UL 508, CSA 22.2-142, cUL, FM Class 1 Div. 2, CE		
Input characteristics	Input voltage	V DC	20...30		
	Input current	A	1.6	3.8 max.	
	Inrush current	A	30	25 at 24 V DC, 14 at 20 V DC	
	Input ripple	V DC	–	94...189 Hz	
	Input power interruption	ms	1.0 at 20 V DC		
	External fusing (recommended)	A	20.0 at 25 V DC 2.5 slow-blow	100 ms max. with external capacitor	5.0 slow-blow
Output to bus	Voltage	V DC	5.1		
	Current	A	3 max., 0.3 min.	8.0	
	Protection		Overcurrent, overvoltage		
Overvoltage withstand	V DC	–		2.3 x maximum rated input voltage for 1.3 ms	
Internal power dissipation	W	2.0 + (3 x I <sub>out</sub> ), where I <sub>out</sub> is in A	6.0 + (1.8 x I <sub>out</sub> ), where I <sub>out</sub> is in A		
Alarm relay		No	Yes		

Type of module			140 CPS 414 00 (2)	140 CPS 424 00 (3)	140 CPS 511 00 (1)	140 CPS 524 00 (3)
Functional safety certification			–			
Approvals			UL 508, CSA 22.2-142, cUL, FM Class 1 Div. 2, CE			
Input characteristics	Input voltage	V DC	48...60		100...150	
	Input current	A	3.8 max.		0.4	0.5 at 125 V DC
	Inrush current	A	14.0 at 40 V DC		10	28 at 125 V DC
	Input power interruption	ms	13.0 at 48 V DC		1.0 max.	
	External fusing (recommended)	A	2.0 medium time lag		3/4 slow-blow	2 slow-blow
Output to bus	Voltage	V DC	5.1			
	Current	A	8.0		3 max., 0.3 min.	8.0
	Protection		Overcurrent, overvoltage			
Internal power dissipation	W	15.6 at 8 A	17.2 at 8 A	2.0 + (3 x I <sub>out</sub> ), where I <sub>out</sub> is in A	6.0 + (1.5 x I <sub>out</sub> ), where I <sub>out</sub> is in A	
Alarm relay		Yes		No		

Use: (1) standalone, (2) summable, (3) redundant.

### References

Power supply modules						
Input voltage	Output current	Type	Security	Reference	Weight kg	
120/230 V ~	3 A	Standalone	-	140 CPS 111 00	0.650	
120/230 V ~	8 A	Summable	-	140 CPS 114 10	0.650	
115/230 V ~	11 A	Summable	-	140 CPS 114 20	0.650	
115/230 V ~	11 A	Redundant	Non-interfering	140 CPS 124 20	0.650	
24 V ...	3 A	Standalone	-	140 CPS 211 00	0.650	
	8 A	Summable	-	140 CPS 214 00	0.650	
		Redundant	-	140 CPS 224 00	0.650	
48...60 V ...	8 A	Summable	-	140 CPS 414 00	0.650	
		Redundant	-	140 CPS 424 00	0.650	
125 V ...	3 A	Standalone	-	140 CPS 511 00	0.650	
	8 A	Redundant	-	140 CPS 524 00	0.650	

Separate part			
Description	Degree of protection	Reference	Weight kg
Screw terminal block, 7 points	IP 20	140 XTS 005 00	0.150

### Connections

140 CPS 111 00	140 CPS 114 10 140 CPS 114 20 140 CPS 124 20	140 CPS 211 00
----------------	--	----------------

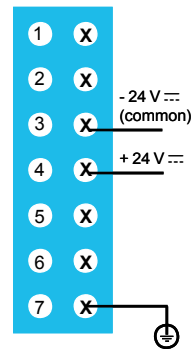
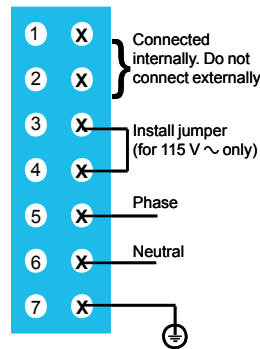
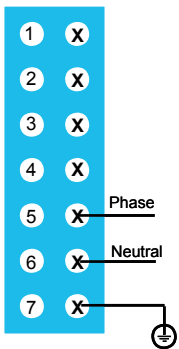

140 CPS 214/224 00	140 CPS 414/424 00	140 CPS 511 00	140 CPS 524 00
--------------------	--------------------	----------------	----------------

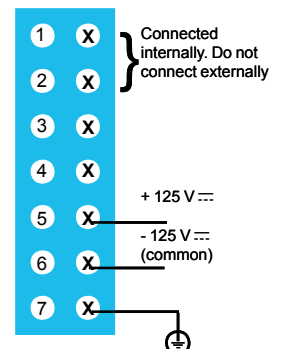
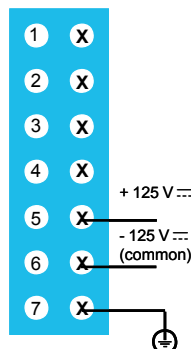
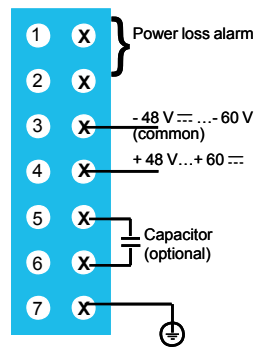
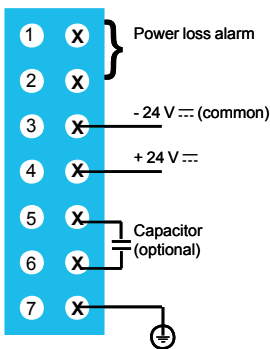



## 4.1 - Discrete I/O

*Discrete I/O modules selection guide ..... 4/2*

- Discrete I/O modules ..... 4/12
- Presentation, description ..... 4/12
- Characteristics ..... 4/14
  - DC input modules ..... 4/14
  - AC input modules ..... 4/17
  - DC output modules ..... 4/19
  - Relay output modules ..... 4/21
  - AC output modules ..... 4/22
  - AC and TTL output modules ..... 4/23
  - Mixed I/O modules ..... 4/24
- References ..... 4/26
  - Input modules and output modules ..... 4/26
  - Mixed I/O modules and accessories ..... 4/27
  
- Discrete I/O modules ..... 4/28
- Connections ..... 4/28
  - Input module connections ..... 4/28
  - Output module connections ..... 4/35
  - Relay output module connections ..... 4/40
  - 24-channel mixed module connections ..... 4/42

## 4.2 - Analog I/O

*Analog I/O modules selection guide ..... 4/44*

- Analog I/O modules ..... 4/46
- Presentation ..... 4/46
- Description ..... 4/47
- Characteristics ..... 4/48
- References ..... 4/55
- Connections ..... 4/56

## 4.3 - IP 20 and IP 65/67 distributed I/O

*IP 20 distributed I/O systems selection guide (Momentum/OTB/STB) ..... 4/62*

*IP 65/67 distributed I/O systems selection guide ..... 4/64*

## 4.4 - Specialized I/O

- TeSys Quickfit for motor starter components ..... 4/66
- Presentation ..... 4/66
  
- TeSys Quickfit for motor starter components ..... 4/68
- Compatibility ..... 4/68





# Modicon Quantum automation platform

Discrete I/O modules  
DC inputs

4

Type	---		
Input voltage	5 V/TTL	24 V	
			
Number of channels	32		
Number of groups	4		
Number of channels per common	8		
Isolation	By group		
I/O addresses	2 input words		
Bus current required	170 mA	330 mA	
Logic	Negative	Positive	Negative
Functional safety certification	–	Non-interfering	–
Model	<b>140 DDI 153 10</b>	<b>140 DDI 353 00</b>	<b>140 DDI 353 10</b>
Page	4/26		

---

24 V

10...60 V

125 V



96	32	16	32	24
6	4	8	4	3
16	8	2	8	8

By group

6 input words	4 input words	1 input word	2 input words	
270 mA	250 mA	200 mA	300 mA	200 mA

Positive

—

<b>140 DDI 364 00 (1)</b>	<b>140 DSI 353 00</b>	<b>140 DDI 841 00</b>	<b>140 DDI 853 00</b>	<b>140 DDI 673 00</b>
---------------------------	-----------------------	-----------------------	-----------------------	-----------------------

4/26

(1) For connection, requires the Advantys Telefast ABE 7 pre-wired system with TSX CDP ●●3 connection cables (with one HE10 connector at each end for 1 group of 16 channels), see pages 4/32 and 9/9.

# Modicon Quantum automation platform

Discrete I/O modules  
AC inputs

4

Type	~			
Input voltage	24 V		48 V	
				
Number of channels	16	32	16	32
Number of groups	16	4	16	4
Number of channels per common	1	8	1	8
Isolation	No common point	By group	No common point	By group
I/O addresses	1 input word	2 input words	1 input word	2 input words
Bus current required	180 mA	250 mA	180 mA	250 mA
Functional safety certification	-			
Model	<b>140 DAI 340 00</b>	<b>140 DAI 353 00</b>	<b>140 DAI 440 00</b>	<b>140 DAI 453 00</b>
Page	4/26			

~

115 V

230 V



4

16		32		16		32	
16	2	4		16	4		
1	8			1	8		
No common point		By group		No common point		By group	
1 input word		2 input words		1 input word		2 input words	
180 mA		250 mA		180 mA		250 mA	

-

<b>140 DAI 540 00</b>	<b>140 DAI 543 00</b>	<b>140 DAI 553 00</b>	<b>140 DAI 740 00</b>	<b>140 DAI 753 00</b>
-----------------------	-----------------------	-----------------------	-----------------------	-----------------------

4/26

# Modicon Quantum automation platform

Discrete I/O modules  
DC and relay outputs

4

Type	...			
Output voltage/relay type	5 V/TTL		24 V	
				
Number of channels	32		96	
Number of groups	4		6	
Number of channels per common	8		16	
Maximum load	Current per channel	75 mA	0.5 A	0.5 A
	Current per group	600 mA	4 A	3.2 A
	Current per module	2.4 A	16 A	19.2 A
I/O addresses	2 output words		6 output words	
Bus current required	350 mA	330 mA	250 mA	
Logic	Negative	Positive	Negative	Positive
Functional safety certification	-	-(1)	-	-
Module	<b>140 DDO 153 10</b>	<b>140 DDO 353 00</b> <b>140 DDO 353 01</b> <i>(1)</i>	<b>140 DDO 353 10</b>	<b>140 DDO 364 00</b> <i>(2)</i>
Page	4/26			

(1) Only module **140 DDO 353 00** is non-interfering.

(2) For connection, requires the Advantys Telefast ABE 7 pre-wired system with **TSX CDP ●●3** connection cables (1 cable with two HE10 connectors for 16 channels), see page 4/37.

---		--- controlled outputs	Relay	
-----	--	------------------------	-------	--

10...60 V	24...125 V	10...30 V	NO contacts	NO/NC contacts
-----------	------------	-----------	-------------	----------------



16	12	32	16	8
2		4	16	8
8	6	8	1	
2 A	0.75 A	0.5 A	2 A	5 A
6 A	3 A	4 A	–	–
12 A	6 A	16 A	–	40 A at 40°C 20 A at 60°C
1 output word	1 input word 1 output word	2 input words 2 output words	1 output word	0.5 output word
160 mA	375 mA at 6 points 650 mA at 12 points	500 mA	1100 mA	560 mA
Positive			–	
–	–	–	–	–
<b>140 DDO 843 00</b>	<b>140 DDO 885 00</b>	<b>140 DVO 853 00</b>	<b>140 DRA 840 00</b>	<b>140 DRC 830 00</b>

4/26

# Modicon Quantum automation platform

Discrete I/O modules  
AC output modules

4

Type	~	
Output voltage	24...230 V	24...115 V



Number of channels	16	
Number of groups	16	
Number of channels per common	1	
Maximum load	Current per channel	4 A at 20...132 V ~, 3 A at 170...253 V ~
	Current per group	4 A at 20...132 V ~
	Current per module	16 A
I/O addresses	1 output word	
Bus current required	350 mA	
Functional safety certification	-	
Module	140 DAO 840 00	140 DAO 840 10
Page	4/26	

~

100...230 V

24...48 V

24...230 V



16

32

4

4

8

4 A at 85...132 V ~, 3 A at 170...253 V ~

4 A at 20...56 V

1 A

4 A

16 A

1 output word

2 output words

350 mA

320 mA

-

**140 DAO 842 10**

**140 DAO 842 20**

**140 DAO 853 00**

4/26

4



# Modicon Quantum automation platform

Discrete I/O modules  
Mixed I/O modules

Voltage	Input	115 V ~	24 V ☐
	Output	115 V ~	24 V ☐



4

Number of channels	16 inputs/8 outputs		
Number of groups	2 groups of 8 input channels 2 groups of 4 output channels		
Maximum load	Current per channel	4 A	0.5 A
	Current per group	4 A	2 A
	Current per module	8 A	4 A
I/O addresses	1 input word 0.5 output word		
Bus current required	250 mA	330 mA	
Logic	Inputs	–	Positive
	Outputs	–	Positive
Functional safety certification	–		
Module	<b>140 DAM 590 00</b>	<b>140 DDM 390 00</b>	
Page	4/27		

125 V ~

24...125 V ~



4 inputs/4 isolated outputs

1 group of 4 input channels  
4 output channels

4 A

-

16 A

1 input word  
1 output word

350 mA

Positive

Positive or negative

-

**140 DDM 690 00**

4/27

### Presentation

The Modicon Quantum automation platform offers a complete range of discrete I/O modules designed to interface with a wide variety of devices. All these modules comply with internationally accepted IEC electrical standards that ensure their reliability in harsh environments. For increased protection and extended life in extremely harsh environments, these modules can be ordered with a special treatment (see page 10/3).

### Fully software-configurable

All Quantum I/O modules can be configured using Unity Pro, Concept or ProWORX software. The ability to assign the I/O addresses of the modules in the software makes it easy to add or change modules in the configuration, without having to change the application program.

### Definition of the behaviour of an output module in the event of a fault

The Quantum platform gives you the ability to predefine how a discrete output will behave in the event of a fault, when the module stops being controlled for any reason. The outputs can be configured in the software so that they will:

- Change to state 0
- Go to a predefined safe state
- Maintain the state they were in at the time of the fault

The behaviour in the event of a fault can be defined for each output. If the module is changed, the previously defined states in the event of faults are sent to the replacement module.

### Mechanical keying pin

It is possible to insert mechanical keying pins between the I/O module and its screw terminal block to ensure that the correct connector/module combination is used. These keying pins have codes that are unique to each type of module. When a rack contains identical modules, secondary keying pins can be used for the connector/module combination.

The keying pins are supplied with each I/O module.

### I/O connectors

Each I/O module (1) requires a screw terminal block with 40 contacts **140 XTS 001 00/002 00**, to be ordered separately. These connectors are identical for all discrete (1) and analog I/O modules (not compatible with intrinsically safe I/O modules).

### Description

**140 D●●** discrete I/O modules have the following on the front panel:

- 1 Model number and colour code
- 2 A display block with LED indicators
- 3 A removable hinged door with a customizable identification label

**To be ordered separately:**

- 4 A screw terminal block with 40 terminals **140 XTS 002 00**

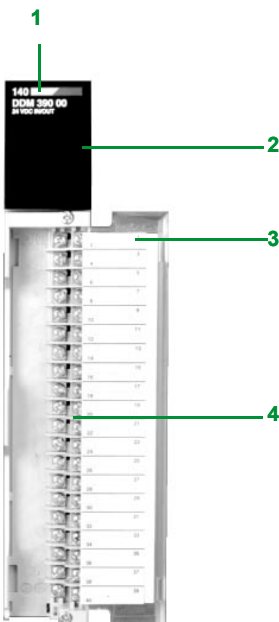

(1) Except for **140 DDI 364 00** and **140 DDO364 00** 96-channel modules which require **TSX CDP ●●3** connection cables (with one HE10 connector at each end, to be used with the Advantys Telefast ABE 7 pre-wired system).

# Modicon Quantum automation platform

## Discrete I/O modules

### Display and diagnostic information

The LEDs provide extensive information on each module. This information includes activity on the I/O points and features specific to each module, such as indication of wiring fault or blown fuse. Visual indication of the quality of the communication with the CPU is given by an "Active" display, which can be used for troubleshooting.

#### 16-point I/O modules

	Active	F	
1	9	17	25
2	10	18	26
3	11	19	27
4	12	20	28
5	13	21	29
6	14	22	30
7	15	23	31
8	16	24	32

LED	Colour	Indication when on
Active	green	Communication present on bus
F	red	External fault detected
1...32	green	The I/O concerned has been activated

#### 16-point I/O modules

	Active	F	
1	9	1	9
2	10	2	10
3	11	3	11
4	12	4	12
5	13	5	13
6	14	6	14
7	15	7	15
8	16	8	16

LED	Colour	Indication when on
Active	green	Communication present on bus
F	red	External fault detected
1...16	green	The point concerned has been activated
1...16	red	There is a fault on the indicated point

#### Bi-directional discrete modules

	Active	F	
1	1	1	
2	2	2	
		3	
		4	

LED	Colour	Indication when on
Active	green	Communication present on bus
F	red	No power supply to outputs or inputs out of tolerance
1 and 2, left column	green	Output activated
1 and 2 middle column	red	Fault detected on the output point
1 to 4, right column	red	Fault detected on the input point

4

Characteristics				
DC input modules				
Type of module		140 DDI 153 10	140 DDI 353 00	140 DDI 353 10
Functional safety certification		–	Non-interfering	–
Approvals		UL 508, CSA 22.2-142, CE, FM Class 1 Div. 2		
Number of inputs		32		
Number of groups		4		
Number of inputs per group		8		
Input voltage		<b>V</b> ⎓ 5 TTL	24	
Logic		Negative ( <i>source</i> )	Positive ( <i>sink</i> )	Negative ( <i>source</i> )
LEDs		Active 1...32 (green) - indicates the state of the point		
I/O addresses		2 input words		
Input limit values	Voltage at state 1	<b>V</b> ⎓ 0.8	15...30	- 15...-30 (in relation to the supply voltage of the groups)
	Voltage at state 0	<b>V</b> ⎓ $\geq 4$ at $U_s = 5.5$ V	-3...5	0...-5 (in relation to the supply voltage of the groups)
	Current at state 1	<b>mA</b> 4.0 at $U_s = 5.5$ V and $U_{IN} = 0$	$\geq 2.0$	$\geq 2.5$ at $U = -14$ V
	Current at state 0	<b>mA</b> –	$\leq 0.5$	
Leakage current		<b>mA</b> 200 at $U_s = 5.5$ V and $U_{IN} = 4$ V		
Maximum input voltages	Continuous	<b>V</b> ⎓ 5.5	30	
	1.0 ms	<b>V</b> –		50 (decaying pulse)
	1.3 ms	<b>V</b> 15 (decaying pulse)	56 (decaying pulse)	–
Response time	Off-on	<b>ms</b> $\leq 0.25$	$\leq 1$	
	On-off	<b>ms</b> $\leq 0.5$	$\leq 1$	
Protection of inputs		Resistor-limited		
Internal resistance		<b>kΩ</b> 7.5	2.5	2.4
Dielectric strength	Group-to-group	<b>V rms</b> 500 for 1 min		
	Group-to-bus	<b>V rms</b> 1780 for 1 min		
Bus current required		<b>mA</b> 170	330	
Power dissipation		<b>W</b> 5	1.7 + (0.36 x no. of channels at state 1)	1.5 + (0.26 x no. of channels at state 1)
External power supply ( $U_s$ )		<b>V</b> ⎓ 4.5...5.5	–	19.2...30
Fusing	Internal	–		
	External	Depending on use		

Characteristics (continued)				
DC input modules (continued)				
Type of module			140 DDI 364 00	140 DSI 353 00
Functional safety certification			–	
Approvals			–	UL 508, CSA 22.2-142, CE, FM Class 1 Div. 2
Number of inputs			96	32
Number of groups			6	4
Number of inputs per group			16	8
Input voltage		V $\overline{\text{DC}}$	24	
Input logic			Positive ( <i>sink</i> )	
LEDs			Active (green) 1...32, 33...64, 65...96	Active (2 green) Fault (1 red) 1...32 (green)
I/O addresses			6 input words	4 input words
Input limit values	Voltage at state 1	V $\overline{\text{DC}}$	15...30	$\geq 11$
	Voltage at state 0	V $\overline{\text{DC}}$	5	$\leq 5$
	Current at state 1	mA	$\geq 2.5$	
	Current at state 0	mA	$\leq 0.7$	0.3...1.2
Maximum input voltages	Continuous	V $\overline{\text{DC}}$	30	
	Peak	V $\overline{\text{DC}}$	50, decaying pulse	45 for 10 ms
Response time	Off-on	ms	$\leq 2$	2.2
	On-off	ms	$\leq 3$	3.3
Diagnostics			–	Broken wire detection: $\leq 0.15$ mA at state 0
Fault status			–	Broken wire detection for each input
Internal resistance		k $\Omega$	6.7	–
Dielectric strength	Channel-to-channel		–	
	Input-to-rack	V rms	–	1780 for 1 min, group-to-bus
	Group-to-group	V rms	500 for 1 min	500 for 1 min
Operating temperature		$^{\circ}\text{C}$	–	0...60
Bus current required		mA	< 270	250
Power dissipation		W	1.35 + (0.13 x no. of channels at state 1)	–
External power supply		V $\sim$	19.2...30	20...30 at 20 mA per group

4

Characteristics (continued)						
DC input modules (continued)						
Type of module		140 DDI 841 00	140 DDI 853 00	140 DDI 673 00		
Functional safety certification		–				
Approvals		UL 508, CSA 22.2-142, CE, FM Class 1 Div. 2				
Number of inputs		16	32	24		
Number of groups		8	4	3		
Number of inputs per group		2	8			
Input voltage		<b>V</b> $\overline{\text{---}}$	10...60	125		
Input logic		Positive ( <i>sink</i> )				
LEDs		Active 1...16 (green)	Active 1...32 (green)	Active 1...24 (green)		
I/O addresses		1 input word		2 input words		
Input limit currents	12 V $\overline{\text{---}}$	<b>mA</b>	5...10			–
	24 V $\overline{\text{---}}$	<b>mA</b>	6...30			–
	48 V $\overline{\text{---}}$	<b>mA</b>	2...15			–
	60 V $\overline{\text{---}}$	<b>mA</b>	1...5			–
	125 V $\overline{\text{---}}$		–			$\geq 2.5$
Maximum input voltage		<b>V</b>	75 $\overline{\text{---}}$			156.25 $\sim$ including ripple
Group power supply			<b>State 1</b>	<b>State 0</b>	<b>State 1</b>	<b>State 0</b>
	12 V $\overline{\text{---}}$ , $\pm 5\%$	<b>V</b>	9...12	0...1.8	9...12	0...1.8
	24 V $\overline{\text{---}}$ , - 15...20%	<b>V</b>	11...24	0...5	11...24	0...5
	48 V $\overline{\text{---}}$ , - 15...20%	<b>V</b>	34...48	0...10	34...48	0...10
	60 V $\overline{\text{---}}$ , - 15...20%	<b>V</b>	45...60	0...9	45...60	0...12.5
Response time	Off-on	<b>ms</b>	4			0.7 (default filter) 1.5 (optional filter)
	On-off	<b>ms</b>	4			0.7 (default filter) 1.5 (optional filter)
Switching frequency		<b>Hz</b>	100 max.			–
Dielectric strength	Group-to-group	<b>V rms</b>	700 $\overline{\text{---}}$ for 1 min			1780 $\sim$ for 1 min
	Group-to-bus	<b>V rms</b>	2500 $\sim$ for 1 min			
Bus current required		<b>mA</b>	200	300	200	
Power dissipation		<b>W</b>	1 + (0.62 x no. of channels at state 1)			
External power supply (U <sub>s</sub> )		<b>V</b> $\overline{\text{---}}$	10...60 (group power supply), not required for this module			
Fusing	Internal		–			
	External		Depending on use			

Characteristics (continued)						
AC input modules						
Type of module			140 DAI 340 00	140 DAI 353 00	140 DAI 440 00	140 DAI 453 00
Functional safety certification			–			
Approvals			UL 508, CSA 22.2-142, CE, FM Class 1 Div. 2			
Number of inputs			16	32	16	32
Number of groups			16	4	16	4
Number of inputs per group			1	8	1	8
Nominal input voltage			V ~ 24		48	
LEDs			Active 1...16 (green)	Active 1...32 (green)	Active 1...16 (green)	Active 1...32 (green)
I/O addresses			1 input word	2 input words	1 input word	2 input words
Input values	50 Hz	At state 1	V ~	14...30		34...56
		At state 0	V ~	0...5		0...10
		Current	mA	11.1 max.		9.8 max.
		Impedance	kΩ	3.1 capacitive		6.8 capacitive
	60 Hz	At state 1	V ~	12...30		29...56
		At state 0	V ~	0...5		0...10
		Current	mA	13.2 max.		11.7 max.
		Impedance	kΩ	2.6 capacitive		5.6 capacitive
Frequency range			Hz	47...63		
Leakage current			mA	≤ 1.9		≤ 1.7
Maximum input voltages	Continuous		V ~	30		56
	For 10 s		V ~	32		63
	For one cycle		V ~	50		100
Response time	Off-on	Minimum	ms	4.9		
		Maximum	ms	0.75 x cycle		
	On-off	Minimum	ms	7.3		
		Maximum	ms	12.3		
Dielectric strength	Input-to-input		V rms	1780 for 1 min	–	1780 for 1 min
	Group-to-group		V rms	–	1780 for 1 min	–
	Input-to-bus		V rms	1780 for 1 min	–	1780 for 1 min
	Group-to-bus		V rms	–	1780 for 1 min	–
Bus current required			mA	180	250	180
Power dissipation			W	5.5 max.	10.9 max.	5.5 max.
Fusing	Internal		–			
	External		Depending on use			



**Characteristics (continued)**

**AC input modules (continued)**

Type of module			140 DAI 540 00	140 DAI 543 00	140 DAI 553 00	140 DAI 740 00	140 DAI 753 00	
<b>Functional safety certification</b>			–					
<b>Approvals</b>			UL 508, CSA 22.2-142, CE, FM Class 1 Div. 2					
<b>Number of inputs</b>			16		32	16	32	
<b>Number of groups</b>			16	2	4	16	4	
<b>Number of inputs per group</b>			1		8	1	8	
<b>Input voltage</b>			<b>V ~</b> 115			230		
<b>LEDs</b>			Active 1...16 (green)		Active 1...32 (green)	Active 1...16 (green)	Active 1...32 (green)	
<b>I/O addresses</b>			1 input word		2 input words	1 input word	2 inputs	
<b>Input limit values</b>	50 Hz	At state 1	<b>V ~</b>	85...132		175...264		
		At state 0	<b>V ~</b>	0...20		0...40		
		Current	<b>mA</b>	≤ 11.1		≤ 9.7		
		Impedance	<b>kΩ</b>	14.4 capacitive		31.8 capacitive	32	
	60 Hz	At state 1	<b>V ~</b>	79...132		165...264		
		At state 0	<b>V ~</b>	0...20		0...40		
		Current	<b>mA</b>	≤ 13.2		≤ 11.5		
		Impedance	<b>kΩ</b>	12 capacitive		26.5 capacitive	27	
<b>Frequency range</b>			<b>Hz</b> 47...63					
<b>Leakage current</b>			<b>mA</b> ≤ 2.1			≤ 2.6		
<b>Maximum input values</b>		Continuous	<b>V ~</b>	132		264		
		For 10 s	<b>V ~</b>	156		300	312	
		For one cycle	<b>V ~</b>	200		400		
<b>Response time</b>	Off-on	Minimum	<b>ms</b>	4.9				
		Maximum	<b>ms</b>	0.75 x cycle				
	On-off	Minimum	<b>ms</b>	7.3				
		Maximum	<b>ms</b>	12.3				
<b>Dielectric strength</b>	Input-to-input		<b>V rms</b>	1780 for 1 min	–	–	1780 for 1 min	–
	Group-to-group		<b>V rms</b>	–	1780 for 1 min		–	1780 for 1 min
	Input-to-bus		<b>V rms</b>	1780 for 1 min	–	–	1780 for 1 min	–
	Group-to-bus		<b>V rms</b>	–	1780 for 1 min		–	1780 for 1 min
<b>Bus current required</b>			<b>mA</b> 180		250	180	250	
<b>Power dissipation</b>			<b>W</b> 5.5 max.		10.9 max.	5.5 max.	5 max.	
<b>Fusing</b>		Internal	–					
		External	Depending on use					

4

Characteristics (continued)					
DC output modules					
Type of module		140 DDO 353 00	140 DDO 353 01	140 DDO 353 10	140 DDO 843 00
Functional safety certification		Non-interfering	–		
Approvals		UL 508, CSA 22.2-142, CE, FM Class 1 Div. 2	UL 508, CSA 22.2-142, CE, FM Class 1 Div. 2 (pending)	UL 508, CSA 22.2-142, CE, FM Class 1 Div. 2	
Number of outputs		32 (4 groups of 8)			16 (2 groups of 8)
Nominal values	Voltage	V $\overline{\text{---}}$	24		10...60
	Current	A	0.5		2
Logic		Positive (source)		Negative (sink)	Positive (source)
LEDs		Active F 1...32 (green) - indicates the state of the point			Active 1...16 (green) - indicates the state of the point
I/O addresses		2 output words			1 output word
Voltages	Limit values	V $\overline{\text{---}}$	19.2...30		10.2...72
	Maximum values	V $\overline{\text{---}}$	56 for 1.3 ms, decaying pulse	50 for 1 ms, decaying pulse	72 (continuous)
Residual voltage		V $\overline{\text{---}}$	$\leq 0.4$ at 0.5 A		$\leq 1$ at 2 A
Leakage current		mA	0.4 at 30 V	$\leq 1$ at 24 V $\overline{\text{---}}$	0.4 at 30 V $\overline{\text{---}}$ $\leq 1$ at 60 V
Maximum load current	Per group	A	4		6
	Per module	A	16		12
Maximum peak current		Per point A	5 for 500 $\mu\text{s}$ (6 peaks max. per min)	2 (limited internally)	5 for 1 ms (6 peaks max. per min) 7.5 for 1 ms (20 peaks max. per min)
Response time (on resistive loads)	Off-on	ms	$\leq 1$		1
	On-off	ms	$\leq 1$	< 0.1	< 1 1
Output protection (internal)			Transient voltage suppression	Against short-circuits and overloads (thermal monitoring)	Transient voltage suppression Against overvoltages (by diode)
Maximum load	Inductance	Henry	0.5 at switching frequency: 4 Hz or $L = 0.5/I^2F$ where: L = load inductance (Henry), I = load current (A), F = switching frequency (Hz)		–
	Capacity	$\mu\text{F}$	50	–	
	On filament lamp	W	–	–	12 at 24 V –
Dielectric strength	Group-to-group	V rms	500 for 1 min		700 for 1 min
	Output-to-bus	V rms	1780 for 1 min		–
	Group-to-bus	V rms	–		2500 for 1 min
Diagnostics			Blown fuse, loss of external power supply		–
Bus current required		mA	330	$\leq 330$	160
Power dissipation		W	1.75 + (0.4 x total module load current)	5 (with all outputs at state 1)	2.0 + (0.4 x total module load current) 1 + (1 x total module load current)
External power supply		$\overline{\text{---}}$	19.2...30 V		10...60 V
Fusing	Internal	Per group	5 A		8 A time-lag
		Per group	5 A		8 A
	Per point	The group fuse is not guaranteed to protect each output individually against overloads. One fuse per point is recommended. 3 A, recommended			2 A, recommended

Characteristics (continued)				
DC output modules (continued)				
Type of module		140 DDO 364 00	140 DDO 885 00	140 DVO 853 00
Functional safety certification		–		
Approvals		UL 508, CSA 22.2-142, C€, FM Class 1 Div. 2 (pending)	UL 508, CSA 22.2-142, C€, FM Class 1 Div. 2	UL 508, CSA 22.2-142, C€, FM Class 1 Div. 2 (pending)
Number of outputs		96	12	32
Number of groups		6	2	4
Number of outputs per group		16	6	8
Voltages	Nominal	V $\overline{\text{---}}$ 24	24...125	10...30
	Limit	V $\overline{\text{---}}$ 19.2...30 (including ripple)	19.2...156.2 (including ripple)	50 for 1.0 ms, decaying voltage pulse
Logic		Positive (source)		
LEDs		Active 32...64 1...32 (green) - output status	Active Error (1 red) 1...12 (green) - output status 1...12 (red) - output in overcurrent condition	Active (1 green) Error 1 red 1...32 (green) - output status
I/O addresses		6 output words	1 output word and 1 input word	2 output words and 2 input words
Load current	Per channel	A $\leq$ 0.5	$\leq$ 0.75 at $< 40^{\circ}\text{C}$	$\leq$ 0.5
	Per group	A $\leq$ 3.2	$\leq$ 3.0 at $0...60^{\circ}\text{C}$	$\leq$ 4.0
	Per module	A $\leq$ 19.2	$\leq$ 6.0 at $0...60^{\circ}\text{C}$	$\leq$ 16.0
Peak current	Per channel	A $\leq$ 2 (limited internally)	$\leq$ 4 for 1 ms (6 peaks max. per min)	$\leq$ 2.5 for 1 ms (6 peaks max. per min)
Response time (on resistive loads)	Off-on	ms $<$ 0.1	1	1 typical, 2 max.
	On-off	ms $<$ 0.1	1	1 typical, 2 max.
Residual voltage	At 0.5 A	V $\overline{\text{---}}$ $<$ 0.5	0.75	0.4
Leakage current		mA 1 at 24 V $\overline{\text{---}}$	–	–
Output protection (internal)		Thermal overload and short-circuit	Varistor for each group Overcurrent detection for each output	Protection against short-circuits and transient overvoltages
Maximum load	Inductance	Henry 0.5 at switching frequency: 4 Hz or $L = 0.5/I^2F$ where: L = load inductance (Henry) I = load current (A) F = switching frequency (Hz)	No limit (protection by diode)	0.5 at switching frequency: 4 Hz or $L = 0.5/I^2F$ where: L = load inductance (Henry) I = load current (A) F = switching frequency (Hz)
	On filament lamp	W –	46 at 130 V $\overline{\text{---}}$	2.5 at 10 V $\overline{\text{---}}$
		W –	41 at 115 V $\overline{\text{---}}$	3 at 12 V $\overline{\text{---}}$
	W –	8 at 24 V $\overline{\text{---}}$	6 at 24 V $\overline{\text{---}}$	
Switching frequency		Hz –	$\leq$ 50	–
Dielectric strength	Channel-to-bus	V rms 500 for 1 min	2500 for 1 min	–
	Group-to-group	V rms –	1200 for 1 min	500 for 1 min
	Group-to-bus	V rms –	–	1780 for 1 minute
Diagnostics	Detection	Per group: loss of power supply and output fault (short-circuit or overload)	Overcurrent	Blown fuse, loss of power supply and output fault
	Sensitivity	Yes	–	–
	Reports	Yes	–	–
External power supply		V $\overline{\text{---}}$ 19.2...30	–	10...30
Bus current required		mA $<$ 250	375 (6 outputs at state 1) 650 (12 outputs at state 1)	500
Fusing	Internal	–	4 A	5 A per group
	External	Depending on use	–	–
Power dissipation		W 7 (all outputs at state 1)	1 + (0.77 x no. of outputs at state 1)	2.5 + (0.1 x no. of outputs at state 1) + (0.4 x total load current)

Characteristics (continued)			
Relay output modules			
Type of module		140 DRA 840 00	140 DRC 830 00
Functional safety certification		–	
Approvals		UL 508, CSA 22.2-142, CE, FM Class 1 Div. 2	
Number of output channels		16 (type A, 1 normally open contact per channel)	8 (type C, 1 normally open contact and 1 normally closed contact per channel)
Nominal voltage	V ~	20...250	
	V ---	5...30 with max. load current 30...150 with reduced load current	
LEDs		Active 1...16 (green) - output status	Active 1...8 (green) - output status
I/O addresses		1 output word	0.5 output word
Load current per channel	Max.	<b>A</b> 2 at 250 V ~/30 V --- at 60°C on resistive load 1 on incandescent lamp 1 for power factor = 0.4 0.09 kW (1/8 HP) at 125/250 V ~	5 at 250 V ~/30 V --- at 60°C on resistive load 2 on incandescent lamp 3 for power factor = 0.4 0.18 (1/4 HP) at 125/250 V ~
	Max. (30...150 V ---)	<b>mA ---</b> 300 (resistive load) 100 (L/R = 10 ms)	300 (resistive load) 100 (L/R = 10 ms)
	Min.	<b>mA</b> 50 (with contact used at 5...30 V --- or 20...250 V ~)	–
Currents	Total module	<b>A</b> –	40
	Peak per channel	<b>A</b> ≤ 10 with capacitive load at t = 10 ms	≤ 20 with capacitive load at t = 10 ms
Switching	Max. frequency	<b>Hz</b> –	30 on resistive load or $F = 0.5/I^2L$ where: L = load inductance (Henry) I = load current (A)
	Capacity	<b>VA</b> 500 resistive load	1250 resistive load
Response time (on resistive load)	Off-on	<b>ms</b> ≤ 10	
	On-off	<b>ms</b> ≤ 20	
Relay contact life	Mechanical operations	10,000,000 operations	
	Electrical operations (250 V ~/30 V ---)	200,000 operations (resistive load at max. current) 100,000 operations (resistive load at max. current)	
	Electrical operations (30...150 V ---)	100,000 operations, 300 mA (resistive load)	
		50,000 operations, 500 mA (resistive load) 100,000 operations, 100 mA (L/R = 10 ms) 100,000 intermediate relay operations	
Internal protection of contacts		Varistor, 275 V	
Dielectric strength	Channel-to-channel	<b>V rms</b> 1780 ~ for 1 min	
	Channel-to-bus	<b>V rms</b> 1780 ~ for 1 min 2500 --- for 1 minute	
Bus current required		<b>mA</b> 1100	560
Power dissipation		<b>W</b> 5.5 + (0.5 x N) (where N = number of channels at state 1)	2.75 + (0.5 x N) (where N = number of channels at state 1)
External power supply		–	
Fusing	Internal	–	
	External	Depending on use	

# Modicon Quantum automation platform

## Discrete I/O modules AC output modules

### Characteristics (continued)

AC output modules		140 DAO 840 00	140 DAO 842 10	140 DAO 842 20	140 DAO 853 00
Type of module					
Functional safety certification		–			
Approvals		UL 508, CSA 22.2-142, CE, FM Class 1 Div. 2			
Number of outputs		16			32
Number of groups		16	4		
Number of outputs per group		1	4		
Nominal voltage		<b>V rms</b> 24...230	100...230	24...48	24...230
Limit values	Voltage	<b>V rms</b> 20...253	85...253	20...56	20...253
	Frequency range	<b>Hz</b> 47...63			
	Residual voltage	<b>V rms</b> 1.5			
LEDs		Active 1...16 (green) - output status	Active F 1...16 (green) - output status 1 - 4, 5 - 8, 9 - 12, 13 - 16 (red) - blown fuse or loss of external power supply	Active 1...32 (green) - output status	
I/O addresses		1 output word			2 output words
Maximum voltages	For 10 s	<b>V rms</b> 300	63		300
	For 1 cycle	<b>V rms</b> 400	100		400
	Peak for 1.3 ms	<b>V rms</b> –	111		–
Load currents	Max. per channel	<b>A rms</b> 4 at 20...132 V 3 at 170...253 V	4 at 85...132 V 3 at 170...253 V	4 at 20...56 V	
	Max. for 4 contiguous channels	<b>A rms</b> 4	–		
	Max. per group	<b>A rms</b> –	4		
	Max. per module	<b>A rms</b> 16			
	Min. per channel	<b>mA rms</b> 5	10		
Leakage currents	at 24 V ~	<b>mA</b> ≤ 1	–	–	≤ 0.2
	at 48 V ~	<b>mA</b> ≤ 1	–	–	≤ 0.4
	at 115 V ~	<b>mA</b> ≤ 2	≤ 2	≤ 1	≤ 1.1
	at 230 V ~	<b>mA</b> ≤ 2.5	≤ 2.5	≤ 1	≤ 2
Max. peak currents		<b>Per point</b>	<b>Per point</b>	<b>Per group</b>	<b>Per group</b>
	1 cycle	<b>A rms</b> 30	30	45	45
	2 cycles	<b>A rms</b> 20	20	30	30
	3 cycles	<b>A rms</b> 10	10	25	25
dV/dt		<b>V/ms</b> 400			
Response time	Off-on	½ cycle max.			
	On-off	½ cycle max.			
Output protection (internal)		By RC filter			
Dielectric strength	Group-to-group	<b>V rms</b> –	1000 for 1 min, galvanically isolated		1780 for 1 min
	Output-to-output	<b>V rms</b> 1500 for 1 min	–		
	Output-to-bus	<b>V rms</b> 1780 for 1 min			
Diagnostics		–	Blown fuse Loss of external power supply		–
Bus current required		<b>mA</b> 350	320		
Power dissipation		<b>W</b> 1.85 + (1.1 x total module load current)	1.60 + (1 x total module load current)		
External power supply		<b>V rms</b> –	85...253	20...56	–
Fusing	Internal, for each group	–	5 A		4 A, 250 V
	External	5 A per channel recommended	Depending on use		

Characteristics (continued)				
AC output modules (continued) and TTL output module				
Type of module			140 DAO 840 10	140 DDO 153 10
Functional safety certification			–	
Approvals			UL 508, CSA 22.2-142, CE, FM Class 1 Div. 2	
Number of outputs			16 independent	32 (4 groups of 8 outputs)
Nominal values	Voltage	V	24 ... 115 ~ rms	5 --- TTL
	Current		4 A	75 mA
LEDs			Active 1...16 (green) - indicates the state of the point	Active F 1...32 (green) - indicates the state of the point
I/O addresses			1 output word	2 output words
Limit values	Voltage	V	20 ... 132 ~ rms	At state 1: $V_{out} = 0.2$ max. at 75 mA positive At state 0: $V_{out} = U_s - 1.25$ V at 1 mA negative At state 0: $V_{out} = U_s - 3.2$ V (min.) at 1 mA ( $U_s = 4.5$ V)
	Maximum voltages	V rms	156 for 10 s 200 for 1 cycle	–
	Frequency range	Hz	47...63	–
	Residual voltage	V rms	1.5	–
Load currents	Max. per channel		4 A	75 mA (positive, sink)
	Max. per group	mA	–	600
	Max. for 4 contiguous channels	A	4 max. continuous for the sum of the 4 points	–
	Max. per module	A	16 continuous	2.4
	Min. per channel	mA	5	–
Max. peak currents per channel	1 cycle	A rms	30	–
	2 cycles	A rms	20	–
	3 cycles	A rms	10	–
	Per channel	mA	–	750 for 500 $\mu$ s (6 peaks max. per min)
Internal load resistance		$\Omega$	–	440
Leakage current		mA	$\leq 1$ at 24/48 V $\leq 2$ at 115 V	–
dV/dt		V/ $\mu$ s	400	–
Response time	Off-on		$\frac{1}{2}$ cycle max.	$\leq 250$ $\mu$ s on resistive load
	On-off		$\frac{1}{2}$ cycle max.	$\leq 250$ $\mu$ s on resistive load
Output protection (internal)			By RC filter, varistor	Transient voltage suppression
Dielectric strength	Output-to-output	V rms	1500 for 1 min	–
	Group-to-group	V rms	–	500 for 1 min
	Output-to-bus	V rms	1780 for 1 min	–
Diagnostics			–	Blown fuse Loss of external power supply
Bus current required		mA	350	–
Power dissipation		W	$1.85 + 1.1 \times$ total module load current	4
External power supply	Continuous voltage $U_s$	V ---	–	4.5...5.5
	Maximum voltage $U_s$	V ---	–	15 for 1.3 ms (decaying voltage pulse)
	Current	mA	–	400 + sum of the load currents for the channels
Fusing	Internal		–	Yes
	External		Each output point must be protected by an external fuse: 5 A fuse recommended, or any other fuse with nominal rating $I^2t < 87$ .	–

### Characteristics (continued)

Mixed I/O modules				140 DAM 590 00	140 DDM 390 00	140 DDM 690 00		
Type of module								
Functional safety certification				-				
Approvals				UL 508, CSA 22.2-142, CE, FM Class 1 Div. 2				
Inputs	Number	16 (2 groups of 8 inputs)			4 (1 group of 4 inputs)			
	Nominal voltage	V	115 ~ (frequency 47...63 Hz)		24 ---	125 ---		
	Logic		-		Positive (source)			
Outputs	Number	8 (2 groups of 4 outputs)			4 independent outputs			
	Nominal voltage	V	115 ~ (frequency 47...63 Hz)		24 ---	24...125 ---		
	Logic		-		Positive (source)	Positive (source) or negative (sink)		
LEDs				Active F (red) - loss of group(s) power supply or blown fuse 1...16 (green, on right) - input status 1...8 (green, on left) - output status		Active F (red) - overcurrent 1...4 (green, on left) - output status 1...4 (red, centre) - output in overcurrent condition 1...4 (green, on right) - input status		
I/O addresses				1 input word/0.5 output word		1 input word/1 output word		
Inputs, limit values	Input voltage	At state 1	V	85...132 ~ at 50 Hz 79...132 ~ at 60 Hz		15...30 ---		
		At state 0	V	0...20 ~		-3...5 ---		
		Impedance	kΩ	14.4 capacitive		2.5		
	Input current	At state 1	mA	≤ 11.1 at 50 Hz ≤ 13.2 at 60 Hz		≥ 2.0		
		At state 0	mA	≤ 0.5		≤ 1.2		
	Leakage current		mA	2.1		-		
		Maximum input voltages	Continuous	V	132 ~		30 ---	
			10 s	V ~	156		≤ 1	
			1 cycle	V ~	200		≤ 1	
		1.3 ms	V ---	-		56 (decaying pulse)		
	Response time	Off-on	ms	4.9...0.75 cycle		-		
		On-off	ms	7.3...12.3		-		
	Outputs, limit values	Output voltage	Limits	V ---	-		19.2...30	
			Maximum	V ---	-		56 for 1.3 ms (decaying pulse)	
Residual voltage			V	1.5 ~		0.4 --- at 0.5 A		
Maximum output voltages		Continuous	V ~	85...132		-		
		10 s	V ~	156		-		
		1 cycle	V ~	200		-		
Load current		Max. per point	A rms	4 continuous		0.5		
		Max. per group	A rms	4 continuous		2		
		Max. per module	A rms	8 continuous		4		
		Min. per point	mA rms	5		-		
Leakage current			mA	≤ 2 at 115 V ~		0.4 at 30 V ---		
Max. peak current		1 cycle		Per point	Per group	Per point	Per point	
				A rms	30	45	5 for 500 μs	30 for 500 ms
				A rms	20	30	(6 peaks max. per min)	
			A rms	10	25			
Max. load inductance		Henry	-		0.5 at switching frequency: 4 Hz or L = 0.5/I²F			
where: L = load inductance I = load current (A) F = switching frequency (Hz)				For switching intervals ≥ 15 s acc. to ANSI/IEEE C37.90-1978/1989: L < 9 / I² For repetitive switching: L ≤ 0.7/I²F				
Maximum load capacity		μF	-		50			
					0.6 at 24 V --- 0.1 at 150 V ---			
dV/dt		V/μs	400		-			
Output protection (internal)			By RC filter		-			
Response time	Off-on	ms	≤ 0.5 cycle		≤ 1 (resistive load)			
	On-off	ms	≤ 0.5 cycle		≤ 1 (resistive load)			

Characteristics (continued)				
Mixed I/O modules (continued)				
Type of module		140 DAM 590 00	140 DDM 390 00	140 DDM 690 00
Internal protection	Inputs	–	Resistor-limited	
	Outputs	–	Transient voltage suppression	
Dielectric strength	Group-to-group	<b>V rms</b> 1000 for 1 min	500 for 1 min	–
	Channel-to-bus	<b>V rms</b> 1780 for 1 min	–	–
	Group-to-bus	<b>V rms</b> –	1780 for 1 min	2500 for 1 min
	Input group-to-output	<b>V rms</b> –	–	1780 V for 1 min
	Output-to-output	<b>V rms</b> –	–	1780 V for 1 min
Diagnostics	Outputs	Blown fuse Loss of external power supply	–	Overcurrent per channel
Bus current required		<b>mA</b> 250	330	350
Power dissipation		<b>W</b> 5,5 + 1.1 x total module load current	1,75 + 0.36 x no. of inputs at state 1 + 1.1 x total output current	0,4 + 1.0 x no. of inputs at state 1 + 0.75 x total output current
External power supply		<b>~ V</b> 85 ... 132 for output group	–	Not required
Fusing	Inputs	Internal	None	
		External	Depending on use	
	Outputs	Internal	5 A for each group	
		External	Depending on use	5 A per group  The group fuse is not guaranteed to protect each output individually against overloads. One 1.25 A fuse per output is recommended



# Modicon Quantum automation platform

## Discrete I/O modules

### Input modules and output modules

References						
Discrete input modules						
Voltage	Modularity	Description	Logic	Safety	Reference	Weight kg
5 V $\overline{\text{TTL}}$	32 inputs	4 groups of 8 inputs	Negative	–	140 DDI 153 10	0.450
24 V $\overline{\text{DC}}$	32 inputs	4 groups of 8 inputs	Positive	Non interfering (1)	140 DDI 353 00	0.300
			Negative	–	140 DDI 353 10	0.300
	96 inputs	6 groups of 16 inputs	Positive	–	140 DDI 364 00	0.300
	32 inputs	4 groups of 8 inputs	Positive	–	140 DSI 353 00	0.300
10...60 V $\overline{\text{DC}}$	16 inputs	8 groups of 2 inputs	Positive	–	140 DDI 841 00	0.300
	32 inputs	4 groups of 8 inputs	Positive	–	140 DDI 853 00	0.295
125 V $\overline{\text{DC}}$	24 inputs	3 groups of 8 inputs	Positive	–	140 DDI 673 00	0.300
24 V $\sim$	16 inputs	No common point	–	–	140 DAI 340 00	0.300
	32 inputs	4 groups of 8 inputs	–	–	140 DAI 353 00	0.340
48 V $\sim$	16 inputs	No common point	–	–	140 DAI 440 00	0.300
	32 inputs	4 groups of 8 inputs	–	–	140 DAI 453 00	0.300
115 V $\sim$	16 inputs	No common point	–	–	140 DAI 540 00	0.310
	16 inputs	2 groups of 8 inputs	–	–	140 DAI 543 00	0.300
	32 inputs	4 groups of 8 inputs	–	–	140 DAI 553 00	0.330
230 V $\sim$	16 inputs	No common point	–	–	140 DAI 740 00	0.350
	32 inputs	4 groups of 8 inputs	–	–	140 DAI 753 00	0.300

Discrete output modules						
Voltage		Description	Logic	Safety	Reference	Weight kg
5 V $\overline{\text{TTL}}$	32 outputs	4 groups of 8 outputs	Negative	–	140 DDO 153 10	0.450
24 V $\overline{\text{DC}}$	32 outputs	4 groups of 8 outputs	Positive	Non interfering (1)	140 DDO 353 00	0.450
			Positive (2)	–	140 DDO 353 01	0.450
			Negative	–	140 DDO 353 10	0.450
	96 outputs	6 groups of 16 outputs	Positive	–	140 DDO 364 00	0.450
10...30 V $\overline{\text{DC}}$	32 outputs	4 groups of 8 outputs	Positive	–	140 DVO 853 00	0.300
10...60 V $\overline{\text{DC}}$	16 outputs	2 groups of 8 outputs	Positive	–	140 DDO 843 00	0.450
24...125 V $\overline{\text{DC}}$	12 outputs	2 groups of 6 outputs	Positive	–	140 DDO 885 00	0.450
Relay 20...250 V $\sim$ 5...150 V $\overline{\text{DC}}$	16 outputs	No common point	1 "NO" contact	–	140 DRA 840 00	0.410
	8 outputs	No common point	2 "NC" and "NO" contacts	–	140 DRC 830 00	0.300
24...48 V $\sim$	16 outputs	4 groups of 4 outputs	–	–	140 DAO 842 20	0.450
24...115 V $\sim$	16 outputs	No common point	–	–	140 DAO 840 10	0.485
24...230 V $\sim$	16 outputs	No common point	–	–	140 DAO 840 00	0.485
	32 outputs	4 groups of 8 outputs	–	–	140 DAO 853 00	0.450
100...230 V $\sim$	16 outputs	4 groups of 4 outputs	–	–	140 DAO 842 10	0.450

(1) Version  $\geq 1$ .

(2) Outputs protected against short-circuits and overloads by thermal monitoring.

# Modicon Quantum automation platform

## Discrete I/O modules

### Mixed I/O modules and accessories

References (continued)					
Discrete mixed I/O modules					
Number	Inputs	Outputs	Safety	Reference	Weight kg
24 I/O	16 inputs 24 V $\overline{\text{---}}$ 2 groups of 8, positive logic	8 outputs 24 V $\overline{\text{---}}$ 2 groups of 4, positive logic	–	140 DDM 390 00	0.300
	16 inputs 125 V $\sim$ 2 groups of 8	8 outputs 125 V $\sim$ 2 groups of 4	–	140 DAM 590 00	0.450
8 I/O	4 inputs 125 V $\overline{\text{---}}$ 1 group of 4, positive logic	4 outputs 24...125 V $\overline{\text{---}}$ No common point, positive or negative logic	–	140 DDM 690 00	0.300
Accessories					
Description	Sold in lots of	Safety	Reference	Weight kg	
Screw terminal block, 40 points for I/O modules (1) Degree of protection < IP 20	–	Non interfering	140 XTS 002 00	0.150	
Screw terminal block, 40 points for I/O modules (1) Degree of protection IP 20	–	–	140 XTS 001 00	–	
Empty module without screw terminal block	–	–	140 XCP 500 00	–	
Empty module with hinged door without screw terminal block	–	–	140 XCP 510 00	–	
Pack of jumpers for 40-point screw terminal block	12	–	140 XCP 600 00	–	
Discrete input simulator 16 switches for modules 140 DAI 540 00 and 140 DAI 740 00	–	–	140 XSM 002 00	–	
Connection cables for I/O modules with HE 10 connectors					
Description	Used for	Gauge Cross-sect.	Length	Reference	Weight kg
Connection cables 1 HE 10 connector at each end	96-channel modules 140 DDI 364 00 140 DDO 364 00 With Advantys Telefast ABE 7 pre-wired system, see page 9/8	AWG 22 0.324 mm <sup>2</sup>	0.5 m	TSX CDP 053	0.085
			1 m	TSX CDP 103	0.150
			2 m	TSX CDP 203	0.280
			3 m	TSX CDP 303	0.410
			5 m	TSX CDP 503	0.670
			10 m	TSX CDP 1003	1.180
Replacement parts					
Description	Sold in lots of	Reference	Weight kg		
Set of keying pins for 40-point screw terminal blocks	60	140 XCP 200 00	–		

(1) Except for 96-channel modules 140 DDI 364 00 and 140 DDO 364 00 which are connected via six HE 10 connectors. Require the Advantys Telefast ABE 7 pre-wired system.

# Modicon Quantum automation platform

## Discrete I/O modules Input module connections

### 24 V ~ input module connections

140 DAI 340 00/140 DAI 440 00/140 DAI 740 00

140 DAI 353 00/140 DAI 453 00

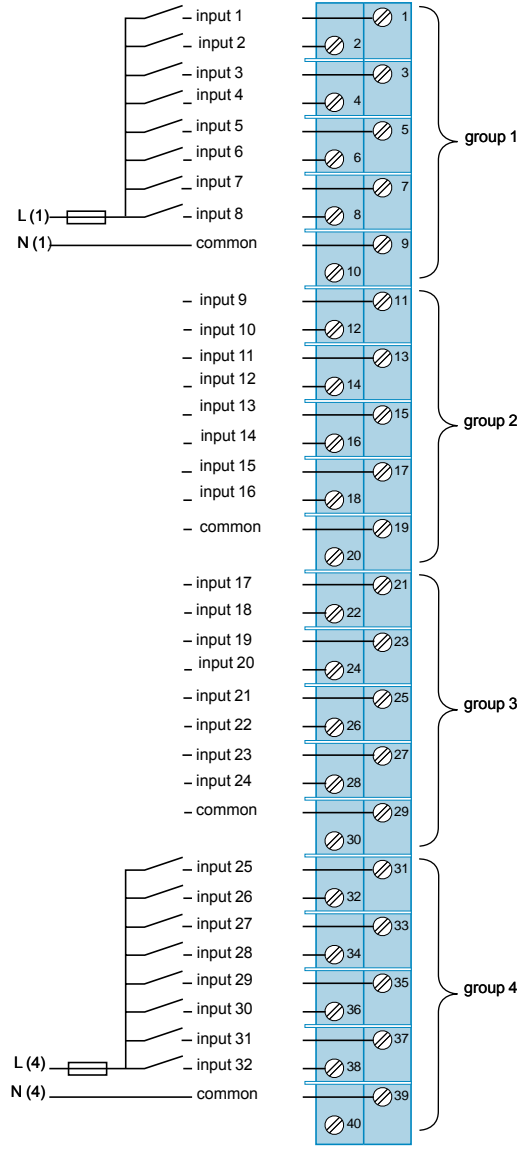
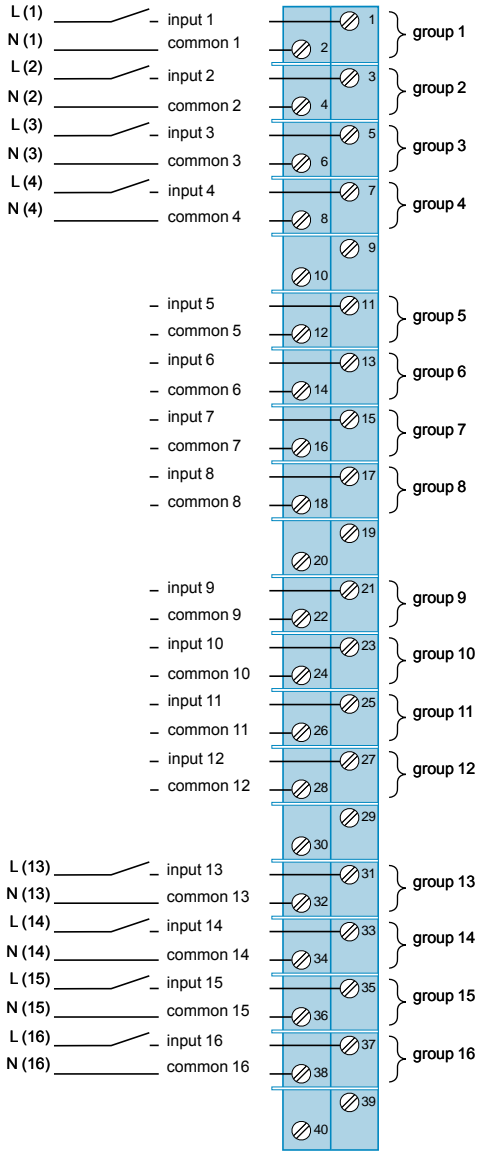

4

The document "Grounding and Electromagnetic Compatibility of PLC Systems - Basic Principles and Measures - User Manual" no. 33002439 provides helpful information on setting up Modicon Quantum PLCs in accordance with the directives and legal regulations in force in the European Union and North America.

# Modicon Quantum automation platform

## Discrete I/O modules Input module connections

### 115 V ~ input module connections

#### 140 DAI 540 00

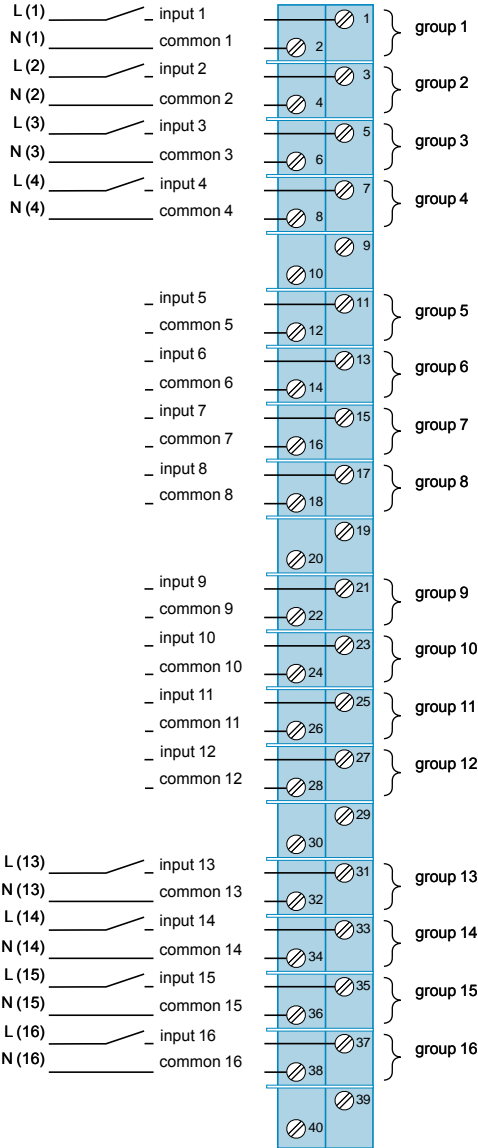

#### 140 DAI 543 00

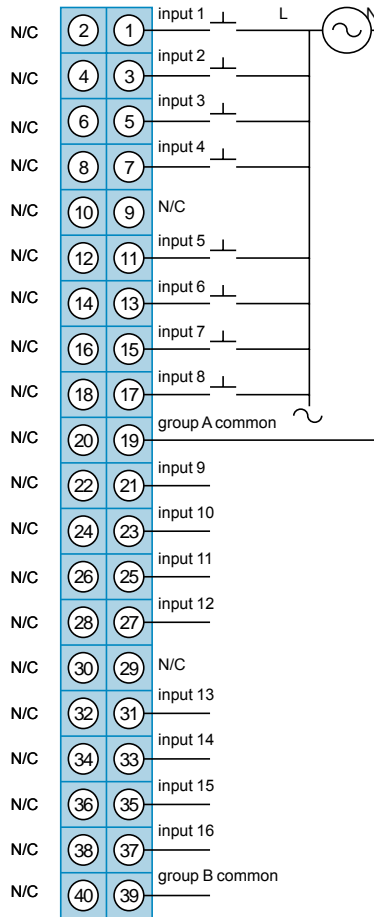

# Modicon Quantum automation platform

## Discrete I/O modules Input module connections

### 24 V ~ input module connections

140 DAI 553 00/140 DAI 753 00

140 DDI 153 10

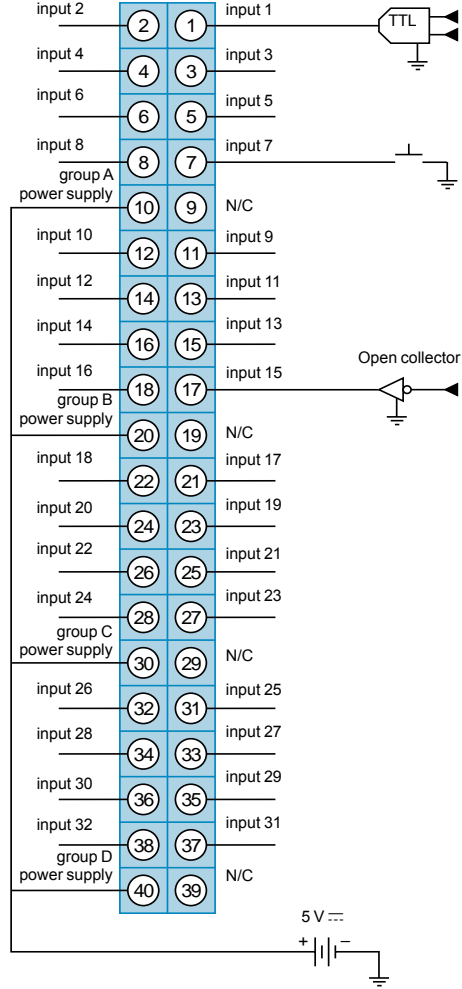
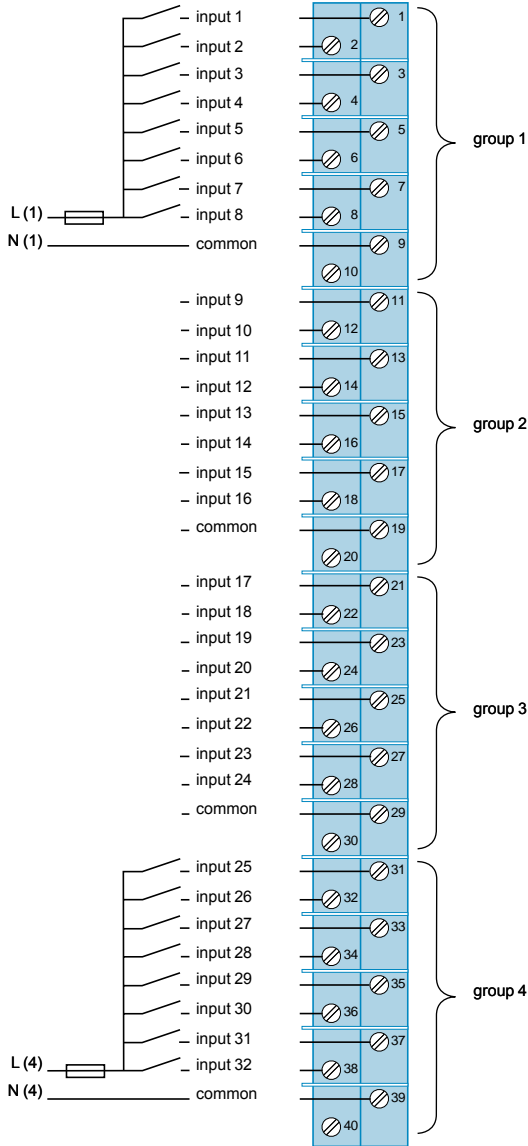

4

The document "Grounding and Electromagnetic Compatibility of PLC Systems - Basic Principles and Measures - User Manual" no. 33002439 provides helpful information on setting up Modicon Quantum PLCs in accordance with the directives and legal regulations in force in the European Union and North America.

# Modicon Quantum automation platform

## Discrete I/O modules Input module connections

### Input module connections

140 DDI 353 00

140 DDI 353 10

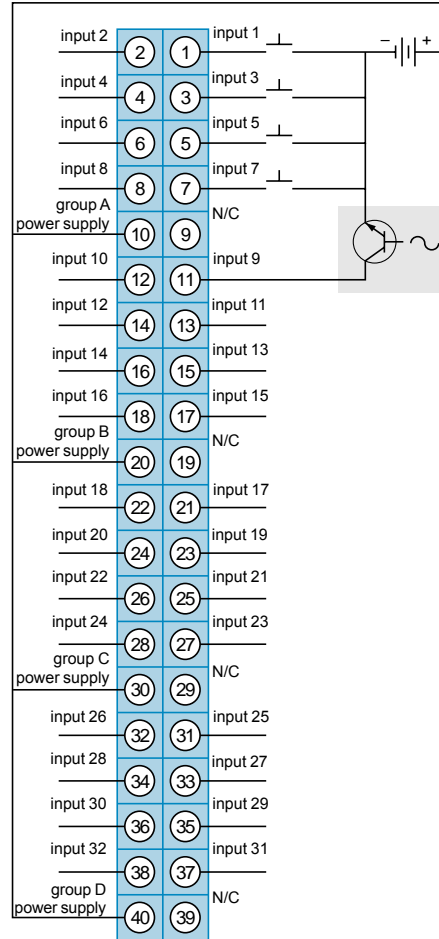
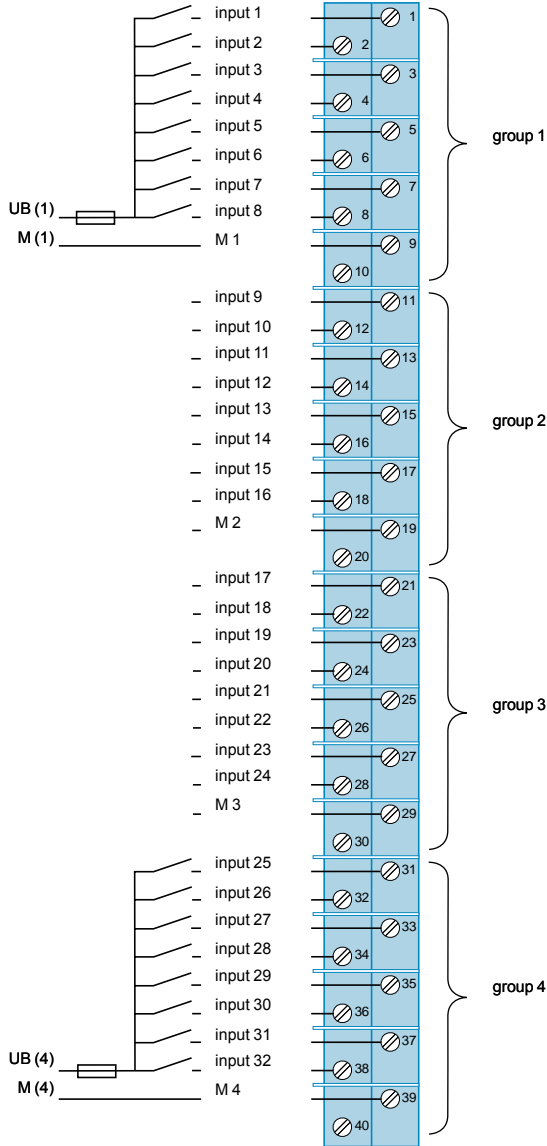

# Modicon Quantum automation platform

## Discrete I/O modules Input module connections

### Input module connections

140 DDI 364 00

6 groups of 16 inputs A...F (6 x HE 10 connectors)

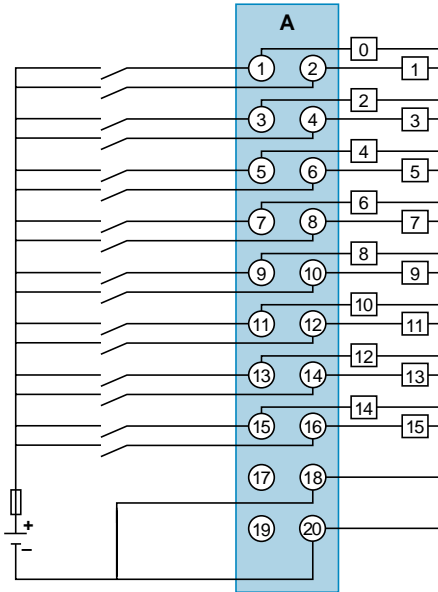

140 DDI 673

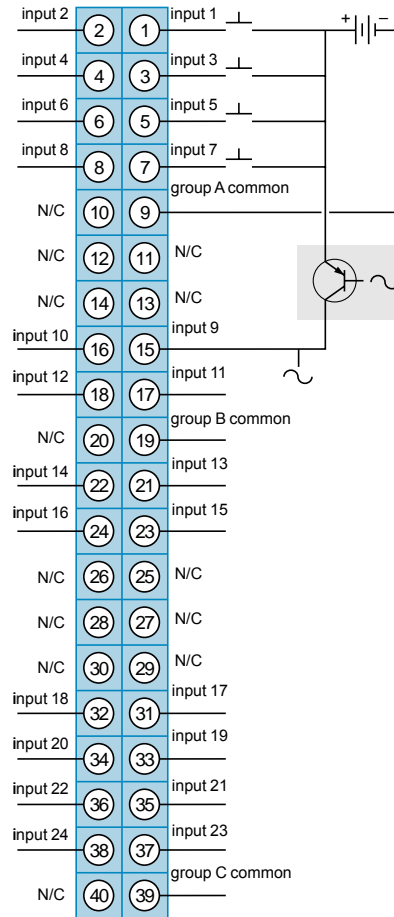

**Note:** Requires the Advantys Telefast ABE 7 pre-wired system:

- ABE 7H08●●●/7H16●●●/7S16●●● connection sub-bases, see page 9/8.
- TSX CDP 053/●03 connection cables, see page 4/27.

The document "Grounding and Electromagnetic Compatibility of PLC Systems - Basic Principles and Measures - User Manual" no. 33002439 provides helpful information on setting up Modicon Quantum PLCs in accordance with the directives and legal regulations in force in the European Union and North America.

# Modicon Quantum automation platform

## Discrete I/O modules Input module connections

### Input module connections

140 DDI 841 00

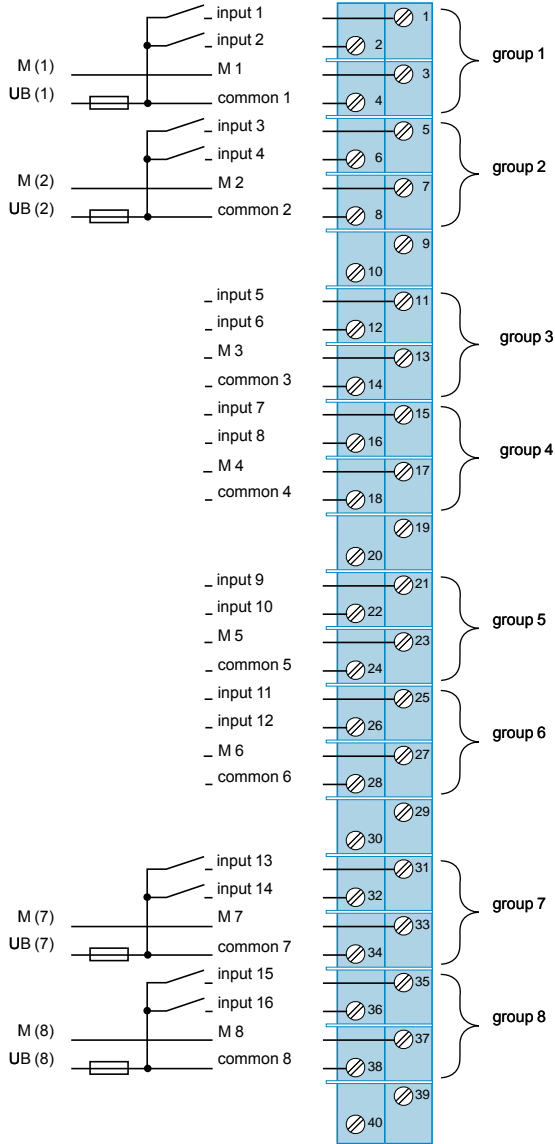

140 DDI 853 00

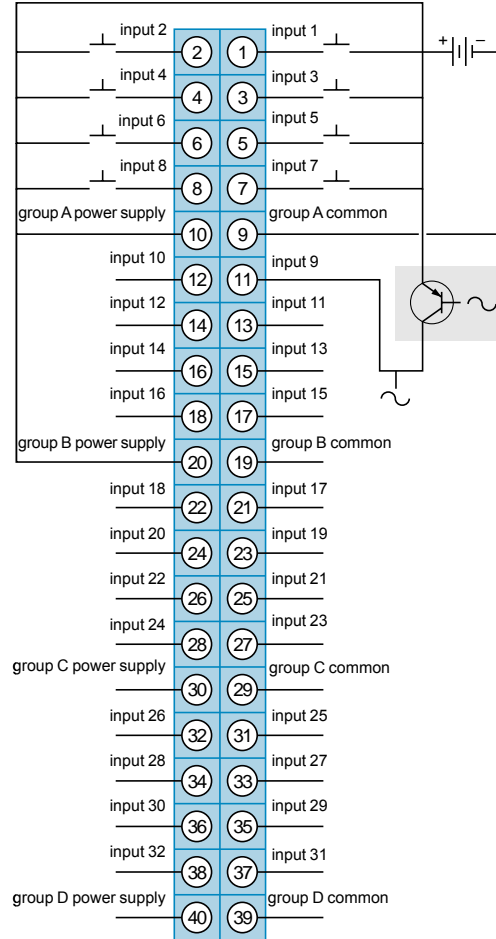



# Modicon Quantum automation platform

## Discrete I/O modules Input module connections

### Input module connections

140 DSI 353 00

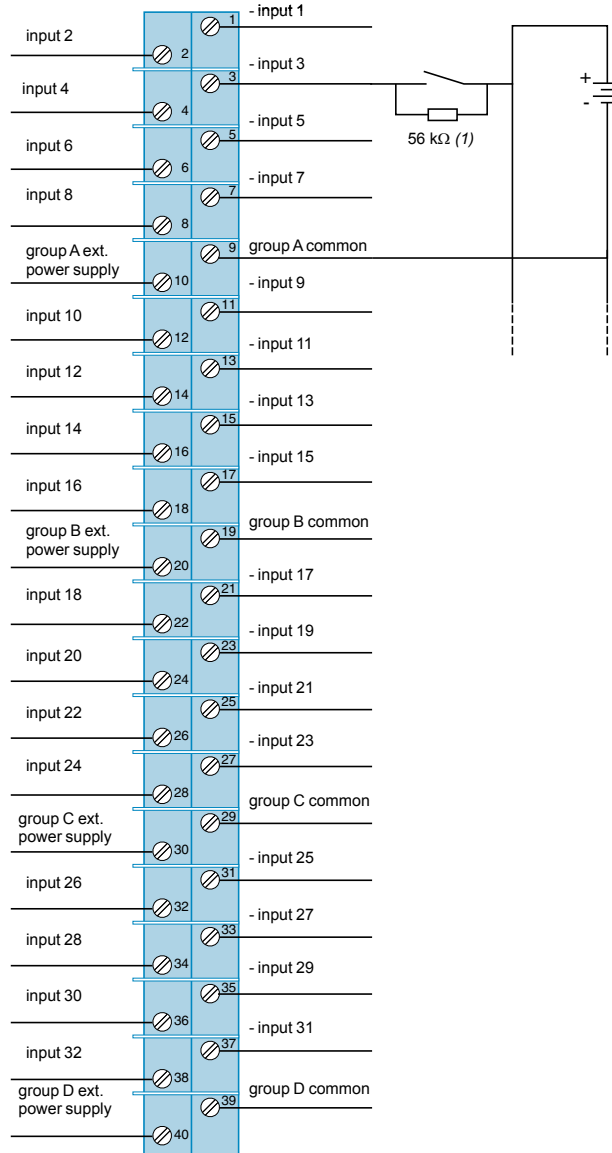

(1) Recommended resistance value for 24 V DC.

The document "Grounding and Electromagnetic Compatibility of PLC Systems - Basic Principles and Measures - User Manual" no. 33002439 provides helpful information on setting up Modicon Quantum PLCs in accordance with the directives and legal regulations in force in the European Union and North America.

# Modicon Quantum automation platform

## Discrete I/O modules Output module connections

### Output module connections

140 DAO 840 00/140 DAO 840 10

140 DAO 842 10/140 DAO 842 20

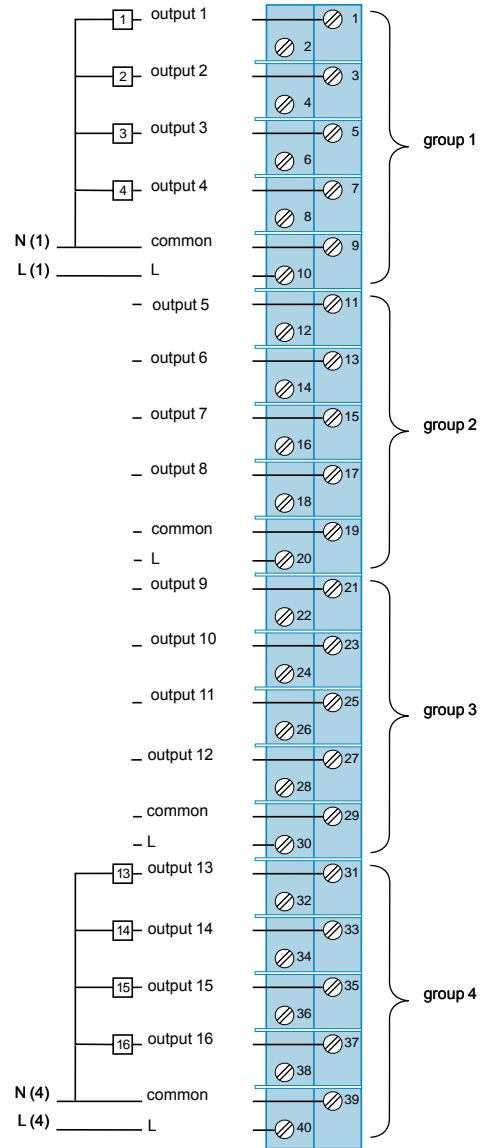
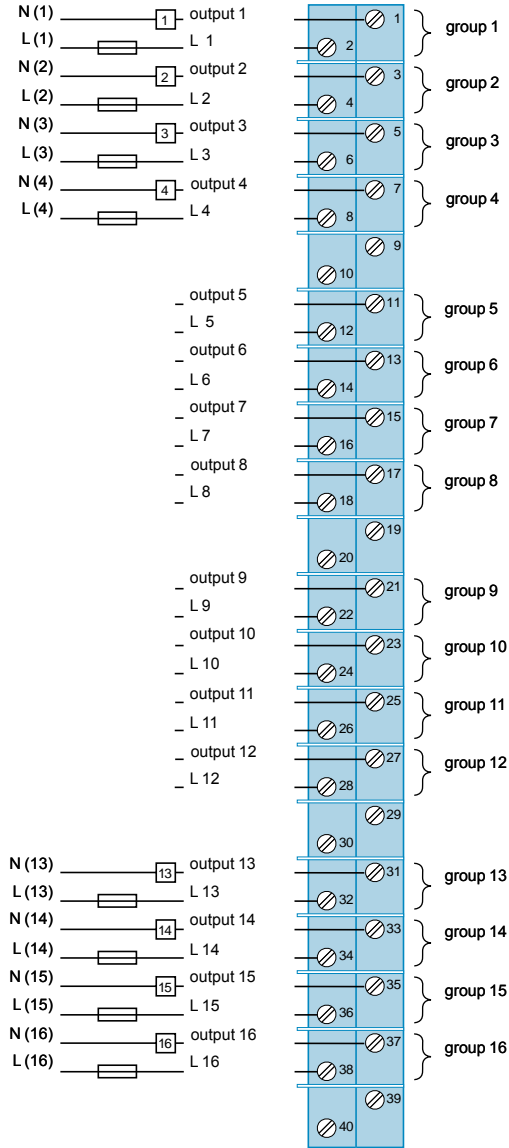

# Modicon Quantum automation platform

## Discrete I/O modules Output module connections

### Output module connections

140 DAO 853 00

140 DDO 353 00/140 DDO 153 10/140 DDO 353 10

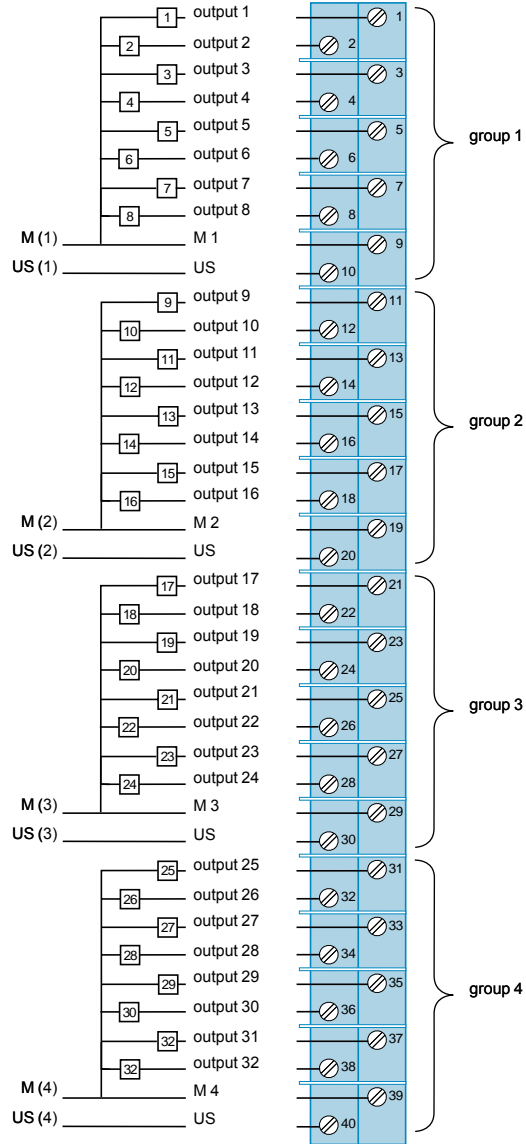
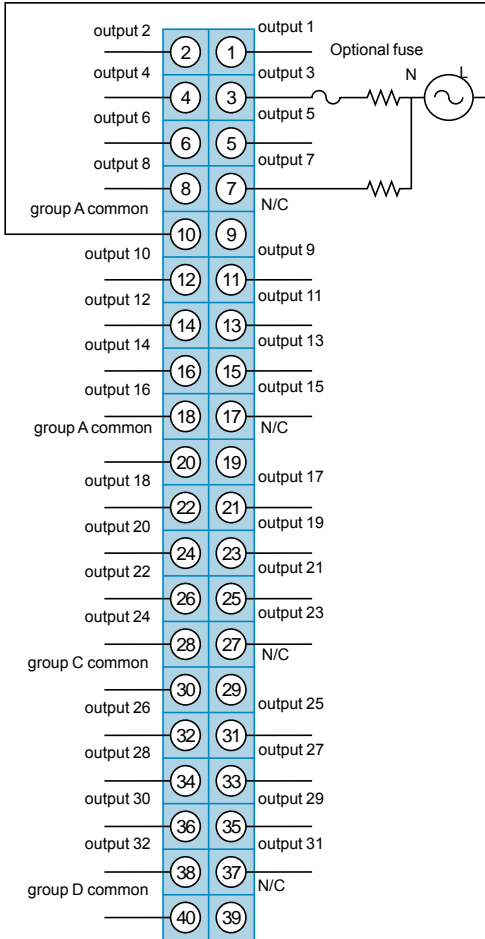

4

The document "Grounding and Electromagnetic Compatibility of PLC Systems - Basic Principles and Measures - User Manual" no. 33002439 provides helpful information on setting up Modicon Quantum PLCs in accordance with the directives and legal regulations in force in the European Union and North America.

# Modicon Quantum automation platform

## Discrete I/O modules Output module connections

### Output module connections

140 DDO 353 01

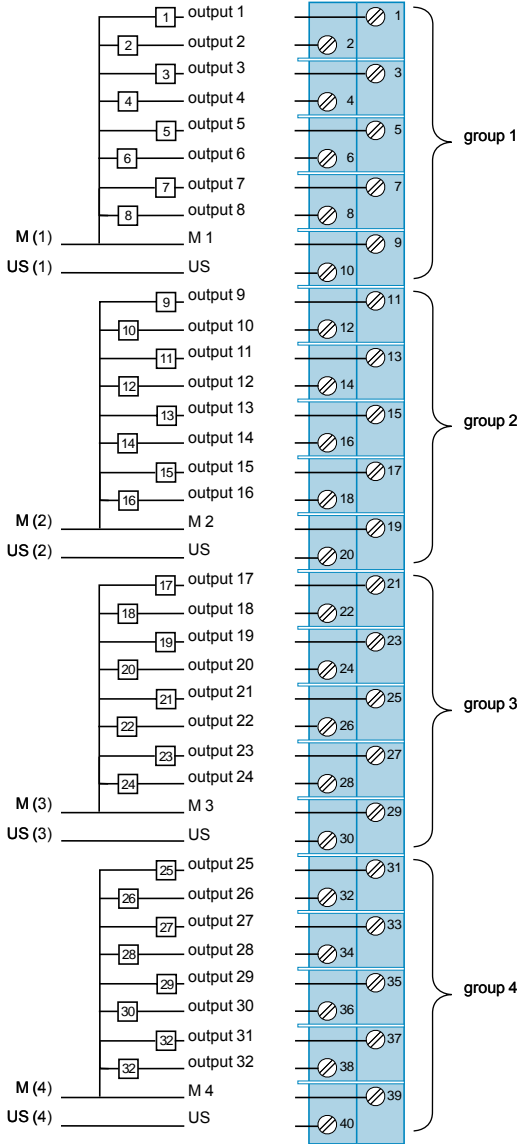

140 DDO 364 00

6 groups of 16 outputs A...F (6 x HE 10 connectors)

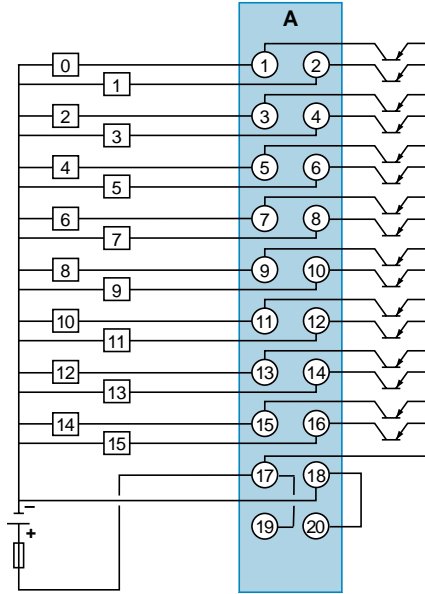

**Note:** Requires the Advantys Telefast ABE 7 pre-wired system:  
 - ABE 7R08S.../7S08.../7P08.../7R16.../7S16.../7P16... connection sub-bases, see page 9/8.  
 - TSX CDP 053/03 connection cables, see page 4/27.

# Modicon Quantum automation platform

## Discrete I/O modules Output module connections

### Output module connections

140 DDO 885 00

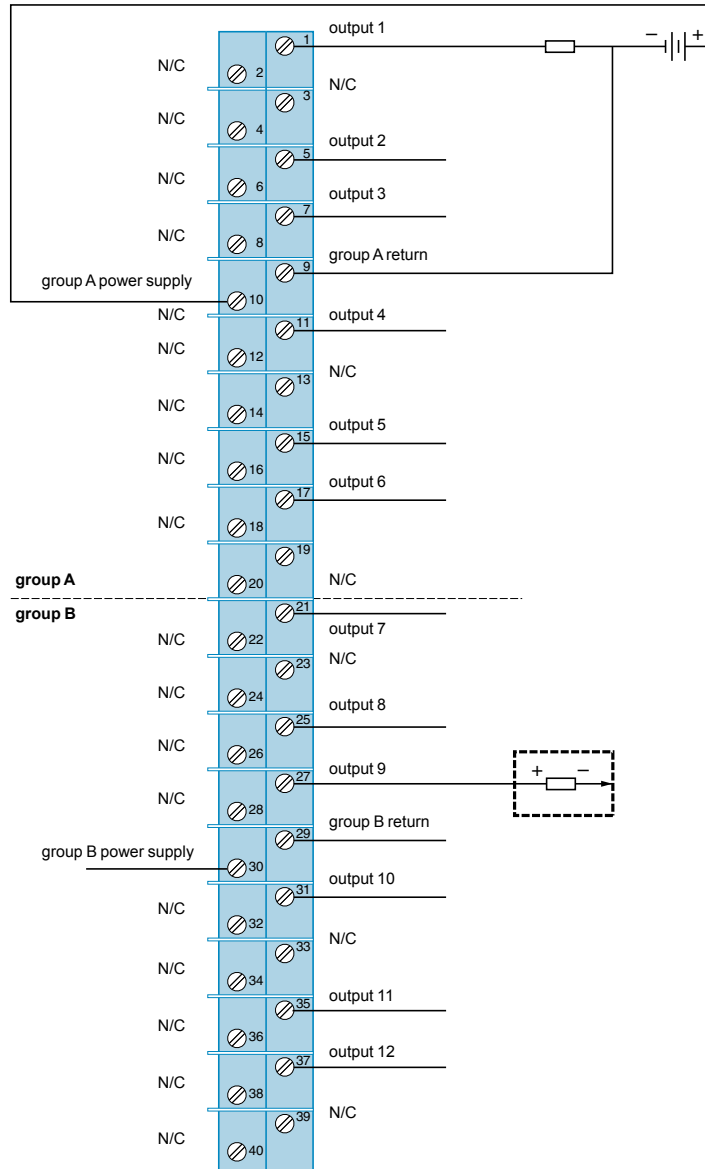

The document "Grounding and Electromagnetic Compatibility of PLC Systems - Basic Principles and Measures - User Manual" no. 33002439 provides helpful information on setting up Modicon Quantum PLCs in accordance with the directives and legal regulations in force in the European Union and North America.

# Modicon Quantum automation platform

Discrete I/O modules  
Output module connections

## Output module connections

140 DDO 843 00

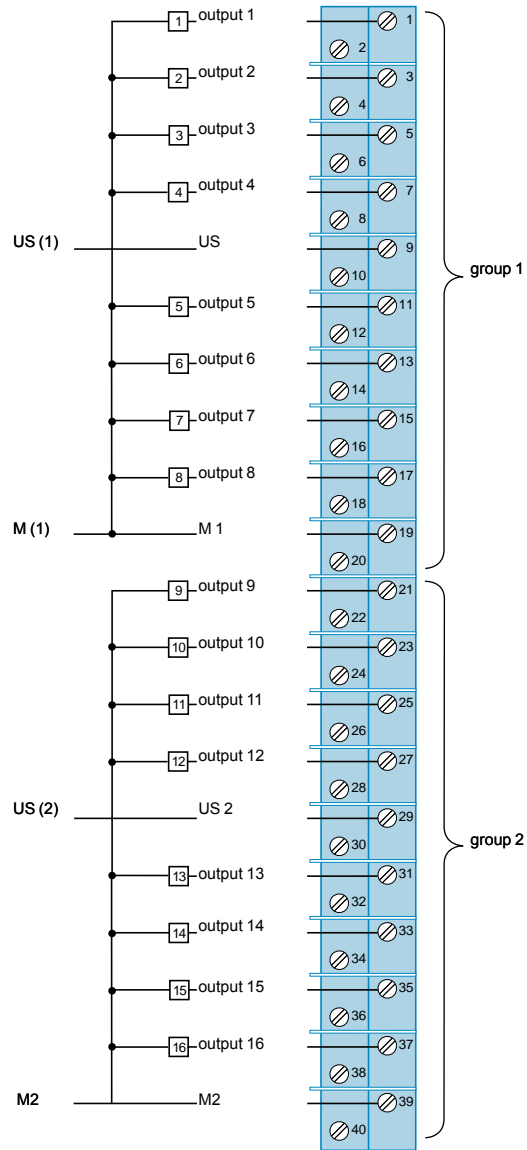

4

# Modicon Quantum automation platform

## Discrete I/O modules

### Relay output module connections

#### Relay output module connections

##### 140 DRA 840 00

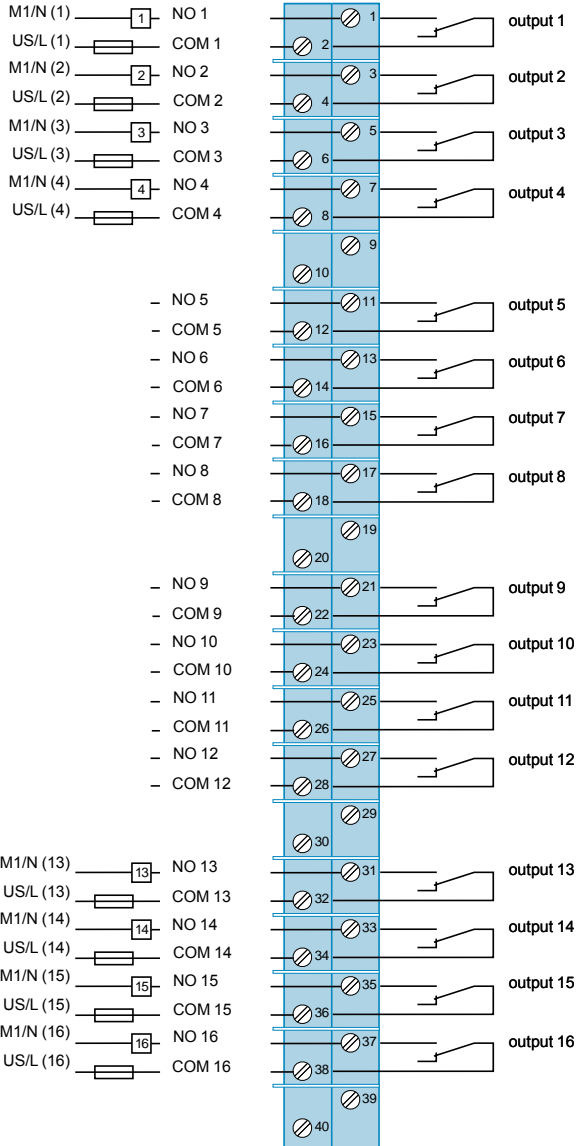

##### 140 DRC 830 00

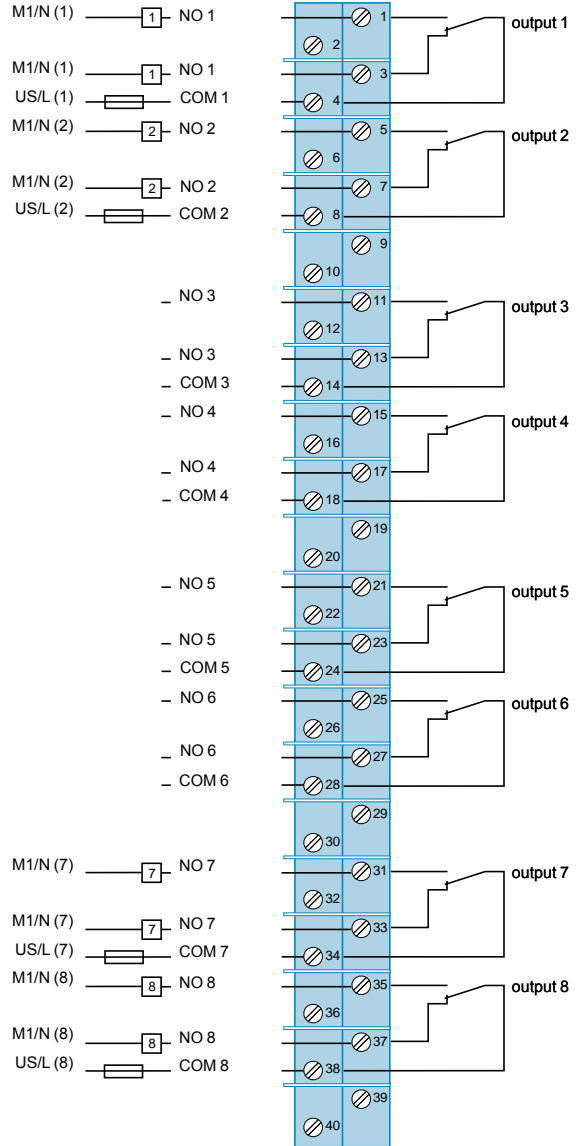

The document "Grounding and Electromagnetic Compatibility of PLC Systems - Basic Principles and Measures - User Manual" no. 33002439 provides helpful information on setting up Modicon Quantum PLCs in accordance with the directives and legal regulations in force in the European Union and North America.

# Modicon Quantum automation platform

## Discrete I/O modules

### Relay output module connections

#### Relay output module connections

140 DVO 853 00

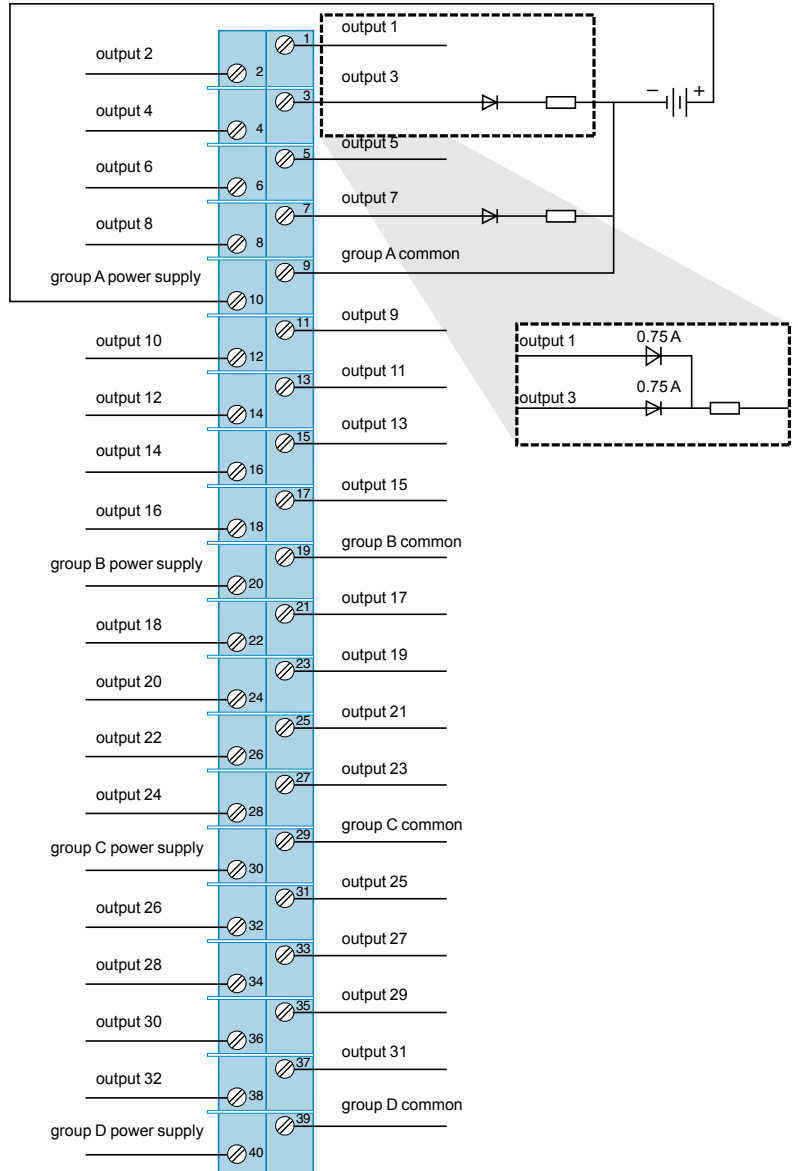

**Note:** When connecting 2 outputs in parallel, a diode is required for each point. See detailed diagram above.



# Modicon Quantum automation platform

## Discrete I/O modules

### 24-channel mixed module connections

**Mixed module connections**

140 DAM 590 00

140 DDM 390 00

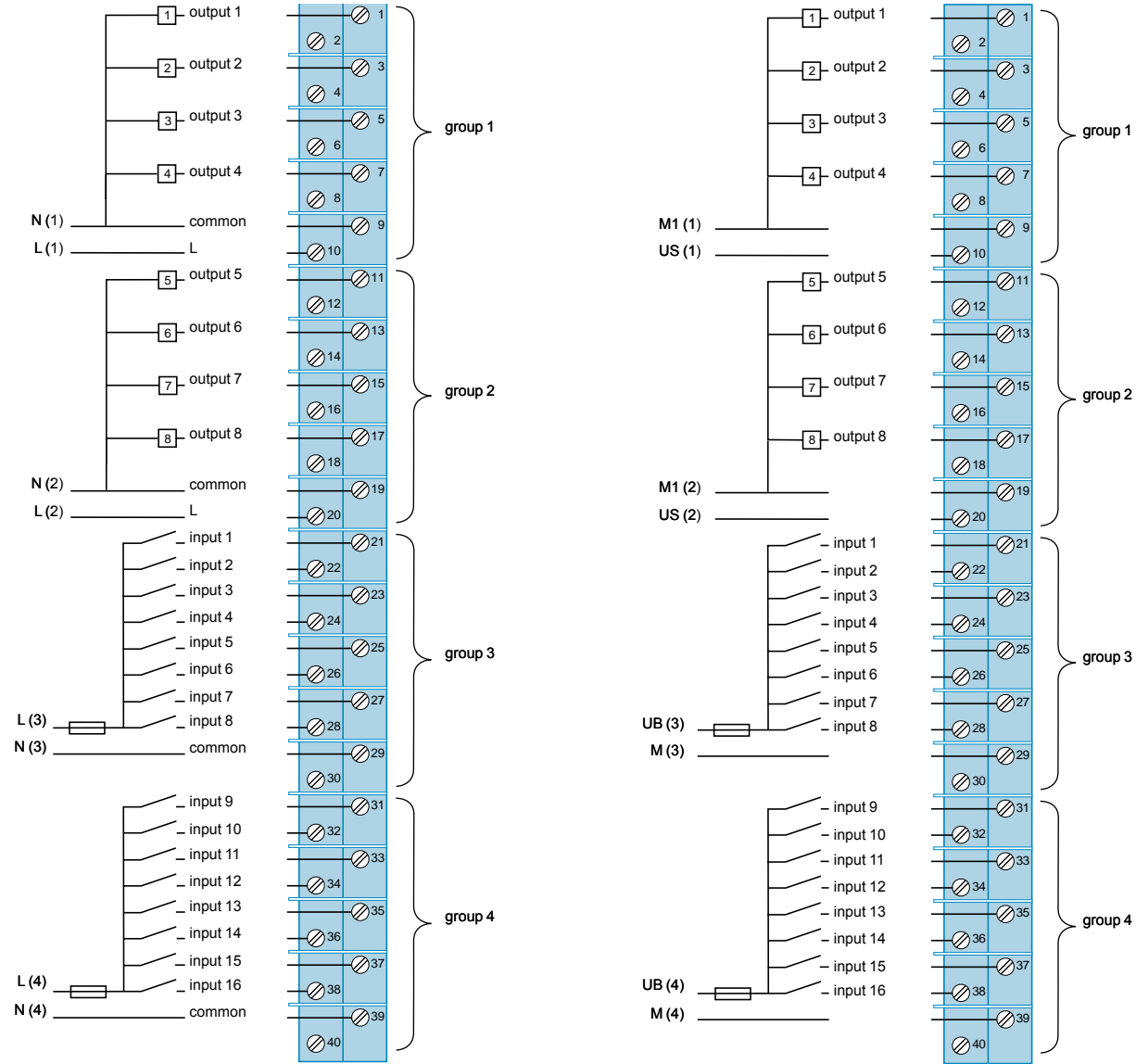

4

The document "Grounding and Electromagnetic Compatibility of PLC Systems - Basic Principles and Measures - User Manual" no. 33002439 provides helpful information on setting up Modicon Quantum PLCs in accordance with the directives and legal regulations in force in the European Union and North America.

# Modicon Quantum automation platform

## Discrete I/O modules

### 24-channel mixed module connections

#### Mixed module connections

140 DDM 690 00

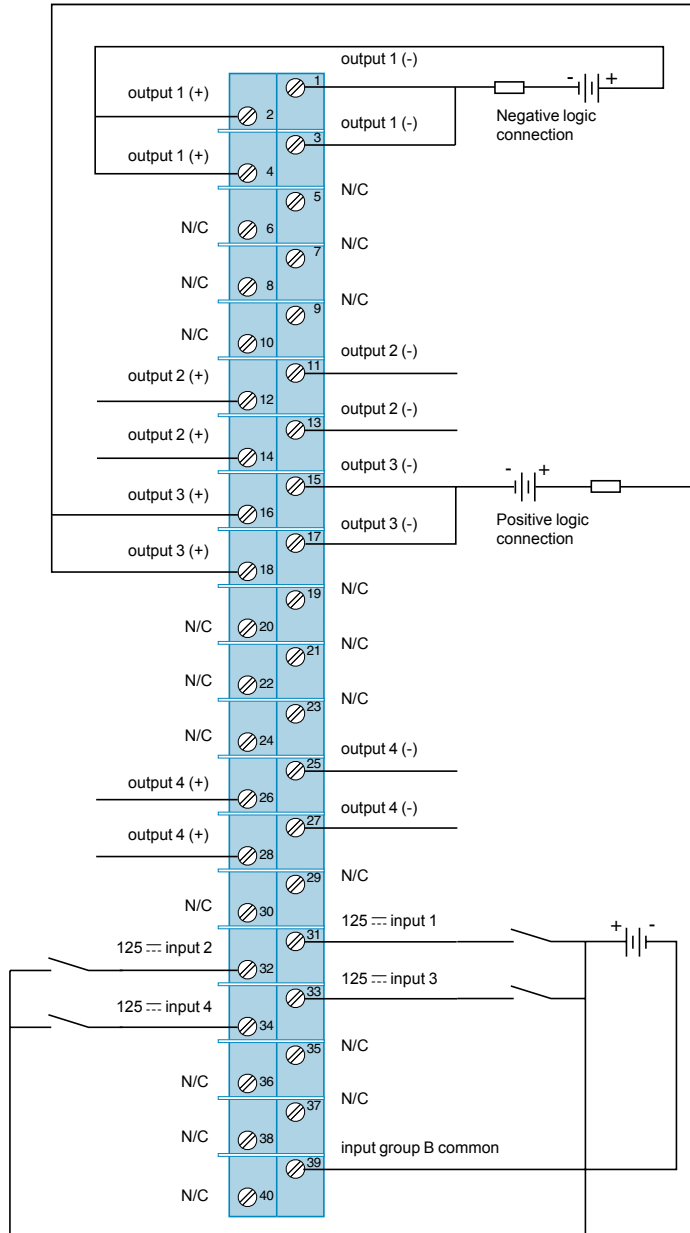

4

**Caution:**

The output points are not protected against reverse polarity. Reverse polarity will change an output point to State 1.

**Note:** Each output has two terminals for multi-wire connections.  
N/C = Not connected.

Applications

Analog inputs



4

<b>Number of channels</b>	8 differential	16 differential or 16 common point	8 differential	8
<b>Input range</b>	4...20 mA 1...5 V	0...25 mA 0...20 mA 4...20 mA	0...25 mA, ±20 mA 4...20 mA 0...10 V, ± 10 V 0...5 V, ± 5 V 1...5 V	IEC platinum, US platinum, nickel RTD (2, 3 or 4 wire)
<b>Resolution</b>	12 bits	0...4095 points 0...25,000 points 0...20,000 points 0...16,000 points (default)	16 bits max.	12 bits + sign
<b>Isolation between channels</b>	30 V $\overline{\text{---}}$		200 V $\overline{\text{---}}$ 135 $\sim$ RMS max	300 V peak
<b>I/O addressing</b>	9 input words	17 input words	9 input words	
<b>Bus current required</b>	240 mA	360 mA	280 mA	200 mA
<b>Functional safety certification</b>	–	Non-interfering (1)	–	
<b>Type of module</b>	<b>140 ACI 030 00</b>	<b>140 ACI 040 00</b>	<b>140 AVI 030 00</b>	<b>140 ARI 030 10</b>
<b>Page</b>	4/55			

(1) Modules that do not interfere with safety modules.

Analog outputs				Mixed analog I/O
----------------	--	--	--	------------------



8	4	8	4	4 inputs/2 outputs
B, E, J, K, R, S, T, mV thermocouples	4...20 mA	0...25 mA 0...20 mA 4...20 mA	0...10 V, ± 10 V 0...5 V, ± 5 V	Multirange inputs/current outputs
16 bits	12 bits	0...25,000 points 0...20,000 points 0...16,000 points (default) 0...4095 points	12 bits	Inputs 16 bits max. Outputs 12 bits
220 V ~ at 47...63 Hz or 300 V ~ max.	500 V ~ at 47...63 Hz or 750 V ~ for 1 minute	None	500 V ~ for 1 minute	Inputs: ± 40 V ~ max.
10 input words	4 output words	8 output words	4 output words	5 input words 2 output words
280 mA	480 mA	550 mA	700 mA	350 mA
–	Non-interfering (1)	–		
<b>140 ATI 030 00</b>	<b>140 ACO 020 00</b>	<b>140 ACO 130 00</b>	<b>140 AVO 020 00</b>	<b>140 AMM 090 00</b>

4

# Modicon Quantum automation platform

## Analog I/O modules

### Presentation

The Modicon Quantum automation platform offers a complete range of analog I/O modules designed to interface with a wide variety of devices. All these modules comply with internationally accepted IEC electrical standards that ensure their reliability in harsh environments. For increased protection and extended life in extremely harsh environments, these modules can be ordered with a special treatment.

### Fully software-configurable

All Quantum I/O modules can be configured using Unity Pro, Concept or ProWORX software. The ability to assign the I/O addresses of the modules in the software makes it easy to add or change modules in the configuration, without having to change the application program.

### I/O Map zoom function

Analog modules frequently require the specification of particular parameters for various functions. The ability of the Quantum platform to configure multifunction modules via the software eliminates the need for selection using miniswitches or complex programming. A software function, called I/O Map zoom, provides access to a configuration screen in which the operational parameters of the module can be initialized or modified. This zoom technique is used on multifunction analog input modules, fast counters, single-axis motion control modules or temperature measurement modules using thermocouples or RTDs.

### Definition of the behaviour of the output modules in the event of a fault

The Quantum platform gives you the ability to predefine how an analog output channel will behave in the event of a fault, when the module stops being controlled for any reason. The outputs can be configured in the software so that they will:

- Change to state 0
- Go to a predefined safe state
- Maintain the value they had at the time of the fault.

The behaviour in the event of a fault can be defined for each channel. If the module is changed, the individually defined states in the event of faults are sent to the replacement module.

### Mechanical keying pins

Optionally, primary mechanical keying pins can be inserted between the I/O module and its screw terminal block to ensure that the correct connector/module pairing is used. These primary keying pins are unique to each type of module. Secondary mechanical keying pins can be used, for example so that a rack containing identical modules, thus with the same primary keying pin, has the correct connector/module pairings. The keying pins are supplied with each I/O module.

### I/O connectors

Each I/O module requires a **140 XTS 002 00** I/O connector, to be ordered separately. This connector is identical for all I/O modules, except intrinsically safe modules.

*The "Grounding and Electromagnetic Compatibility of PLC Systems. Basic Principles and Measures. User Manual" no. 33002439 provides helpful information on setting up Modicon Quantum PLCs in accordance with the directives and legal regulations in force in the European Union and North America.*

# Modicon Quantum automation platform

## Analog I/O modules

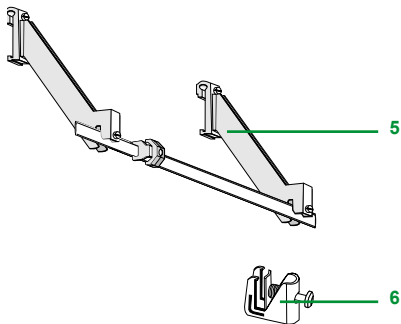
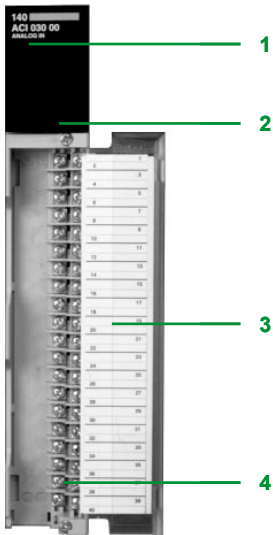

### Description

The front panel of **140 A●/A●O/AMM** analog I/O modules comprises:

- 1 Model number and colour code
- 2 A display block with LED indicators:
  - Active LED (green): communication bus detected as present
  - F LED (red): a fault (external to the module) has been detected
  - LED 1...16 (green): the indicated point or channel is on
  - LED 1...16 (red): fault present on the indicated point or channel
- 3 A removable hinged door with a customizable identification label

#### To be ordered separately:

- 4 A 40-way screw terminal block, **140 XTS 002 00** (degree of protection < IP 20) or **140 XTS 001 00** (degree of protection IP 20).

■ Earthing of the cable shielding is mandatory. The optional earthing kit **STB XSP 3000** can also be used to secure cables in installations subject to severe vibration.

- 5 Optional earthing kit **STB XSP 3000**
- 6 **STB XSP 3010** terminal block for 1.5...6 mm<sup>2</sup> cross-section cables or **STB XSP 3020** terminal block for 5...11 mm<sup>2</sup> cross-section cables.

4

Input module characteristics			140 ACI 030 00	140 AVI 030 00		
Type of module						
Functional safety certification			–			
Approvals			UL 508, CSA 22.2-142, FM Class 1 Div.2, CE			
Number of channels			8 differential			
I/O addressing			9 input words			
Input ranges (selectable by channel)	Bipolar	≡	–	± 10 V	± 5 V	20 mA
	Unipolar	≡	–	0...10 V	0... 5 V	0...20 mA
	Unipolar offset	≡	–	1... 5 V	4...20 mA	
Resolution			12 bits	16 bits, but 14 bits for 1...5 V	15 bits but 14 bits for 4...20 mA	
Input voltage	Linearity of the measurement range		1...5 V ≡	Input range x 1.024		
	Absolute maximum	V ≡	50			
	Impedance	MΩ	> 20			
Input current	Linearity of the measurement range	mA	4...20	Input range x 1.024		
	Absolute maximum	mA	25			
	Impedance	Ω	250 ± 0.03%			
Absolute accuracy error at 25°C (voltage mode)	Typical	%	± 0.05 of full scale	± 0.03 of full scale		
	Maximum	%	± 0.1 of full scale	± 0.05 of full scale		
Linearity			%	± 0.04	± 0.008	
Accuracy drift acc. to temperature	Typical	%/°C	± 0.0025 of full scale	± 0.0015 of full scale		
	Maximum	%/°C	± 0.005 of full scale	± 0.004 of full scale		
Common mode rejection			dB	> - 72 at 60 Hz	> - 80 at 60 Hz	
Input filter				Unipolar low pass, cutoff - 3 dB at 15 Hz, ± 20%	Unipolar low pass, cutoff - 3 dB at 847 Hz, ± 20%	
Isolation	Channel-to-bus		1000 V ≡, 3000 V for 1 min	750 V ≡, 500 V ~ rms for 1 min		
	Channel-to-channel		30 V ≡ max.	200 V ≡, 135 V ~ rms max.		
Update time			ms	5 for all channels	10 for all channels	
Fault detection				Broken wire (4...20 mA mode) or undervoltage (1...5 V)	Broken wire (4...20 mA mode) or scale overrun (1...5 V)	
Bus current required			mA	240	280	
Power dissipation			W	2	2.2	
External power supply				Not required		

The "Grounding and Electromagnetic Compatibility of PLC Systems. Basic Principles and Measures. User Manual" no. 33002439 provides helpful information on setting up Modicon Quantum PLCs in accordance with the directives and legal regulations in force in the European Union and North America.

Input module characteristics (continued)			
Type of module		140 ARI 030 10	140 ACI 040 00
Functional safety certification		–	Non-interfering
Approvals		UL 508, CSA 22.2-142, FM Class 1 Div.2, CE	
Number of channels		8	16 differential or 16 with common point
I/O addressing		9 input words	17 input words
Types of RTD (configurable)	Pt 100, Pt 200, Pt 500, Pt 1000	°C	- 200...+ 850
	Pt 100, Pt 200, Pt 500, Pt 1000	°C	- 100...+ 450
	Ni 100, Ni 200, Ni 500, Ni 1000	°C	- 60...+ 180
Measurement current	Pt 100, Pt 200, Ni 100, Ni 200	mA	2.5
	Pt 500, Pt 1000, Ni 500, Ni 1000	mA	0.5
Input impedance		MΩ	>10
Input ranges and resolution		0.1°C	0...25 mA, 0...25,000 points 0...20 mA, 0...20,000 points 4...20 mA, 0...16,000 points (default range) 4...20 mA, 0...4095 points
Accuracy error at 25°C		–	± 0.125% of full scale
Linearity (0...60°C)		± 0.01% of full scale ± 0.5°C	± 12 µA max. 4...20 mA range ± 6 µA max. 0...25 mA range ± 6 µA max. 0...20 mA range ± 6 µA max. 4...20 mA range
Absolute maximum input		mA	–
Accuracy drift acc. to temperature		± 0.5°C (25°C) ± 0.9°C (0...60°C)	Typical: 0.0025% of full scale/°C Maximum: 0.005% of full scale/°C
Isolation	Channel-to-channel		300 V peak
	Channel-to-bus		1780 V ~ at 47...63 Hz for 1 min or 2500 V ~ for 1 min
Operating voltage	Channel-to-channel	V ~	–
Input filter			–
Common mode rejection			–
Update time (all channels)	2-wire/4-wire	ms	640
	3-wire	s	1.2
Fault detection			–
Bus current required		mA	200
Power dissipation		W	1
			360
			5
			8 red LEDs to indicate broken wire or scale overrun conditions
			Open wire in 4...20 mA mode. Specific channel identified when open wire is detected. Information sent to the PLC.



4

Input module characteristics (continued)		
Type of module		140 ATI 030 00
Functional safety certification		–
Approvals		UL 508, CSA 22.2-142, FM Class 1 Div.2, CE
Number of channels		8
I/O addressing		10 input words
TC thermocouple types and ranges	J	°C - 210...+ 760
	K	°C - 270...+ 1370
	E	°C - 270...+ 1000
	T	°C - 270...+ 400
	S	°C - 50...+ 1665
	R	°C - 50...+ 1665
	B	°C - 130...+ 1820
Low level ranges		mV - 100...+ 100 (1) - 25...+ 25 (1)
TC resistance/max. source resistance		W 200 max. for rated accuracy
Input impedance		MΩ >1
Input filter		Single low pass at nominal 20 Hz, plus notch filter at 50/60 Hz
Normal noise rejection		120 dB min. at 50 or 60 Hz
Cold junction compensation (CJC)		Internal cold junction compensation operates between 0...60°C (errors are included in the accuracy specification). The connector door must be closed.  Remote cold junction compensation can be set up by connecting a thermocouple (which monitors the junction block temperature) to channel 1. J, K, and T thermocouples are recommended for remote cold junction compensation.
Resolution	TC ranges	1°C (default), 0.1°C, 1°F, 0.1°F
	Millivolt ranges	100 mV range, 3.05 μV (16 bits) 25 mV range, 0.76 μV (16 bits)
Thermocouple absolute accuracy	Types J, K, E, T	± 2°C plus ± 0.1% of reading
	Types S, R, B	± 4°C plus ± 0.1% of reading
Millivolt absolute accuracy	At 25°C	± 20 μV ± 0.1% of reading
	Accuracy drift acc. to temperature	0.15 μV/°C + 0.0015% of reading/°C max.
Isolation	Channel-to-channel	220 V ~ at 47...63 Hz or 300 V ~ max.
	Channel-to-bus	1780 V ~ at 47...63 Hz for 1 minute or 2500 V ~ for 1 minute
Update time (all channels)		s 1
Fault detection		8 red LEDs to indicate scale overrun or broken wire conditions
Bus current required		mA 280
Power dissipation		W 1.5
External power supply		Not required

(1) The open wire detection device can be disabled on these ranges.

The "Grounding and Electromagnetic Compatibility of PLC Systems. Basic Principles and Measures. User Manual" no. 33002439 provides helpful information on setting up Modicon Quantum PLCs in accordance with the directives and legal regulations in force in the European Union and North America.

Output module characteristics			
Type of module		140 ACO 020 00	140 AVO 020 00
Functional safety certification		Non-interfering	–
Approvals		UL 508, CSA 22.2-142, FM Class 1 Div.2, CE	
Number of channels		4	
I/O addressing		4 output words	
Loop voltage		DC	–
Loop resistance		Ω	–
		$R_{MIN} (1) = (V_{LOOP} - 30 V)/0.02 A$ $R_{MAX} = (V_{LOOP} - 7 V)/0.02 A$ No external resistor required for loop voltage ≤ 30 V. (2)	
Internal voltage drop		DC	–
		7 V min., 30 V max. at 20 mA	
Output ranges	Bipolar	DC	± 10 V (load resistance ≥ 1 kΩ) ± 5 V (load resistance ≥ 500 Ω)
	Unipolar	DC	0...10 V (load resistance ≥ 1 kΩ) 0...5 V (load resistance ≥ 500 Ω)
Output current		–	± 10 mA max, all ranges (outputs protected against short-circuits)
Source resistance		Ω	0.1
Resolution		12 bits	
Accuracy error at 25°C		%	± 0.20 of full scale ± 0.15 of full scale
Linearity		± 1 LSB	
Accuracy drift acc. to temperature	Typical	%/°C	± 0.004 of full scale –
	Maximum	%/°C	± 0.007 of full scale –
	Unipolar ranges	%/°C	– 0.003 of full scale typical 0.005 of full scale max.
	Bipolar ranges	%/°C	– 0.004 of full scale typical 0.007 of full scale max.
Isolation	Channel-to-channel	V	500 ~ at 47...63 Hz or 750 V DC for 1 min
	Channel-to-bus	V	500 at 47...63 Hz for 1 min 780 at 47...63 Hz for 1 min
Update time		ms	3 for all channels (simultaneous update) 3 for all channels
Setting time		μs	900 to ± 0.1% of final value 700 to ± 0.1% of final value (max.)
Fault detection			Open wire in 4...20 mA mode. Specific channel identified, when open wire is detected, via the red channel LED. None
Cable length		m	– 400 max.
Bus current required		mA	480 700
Power dissipation		W	5.3 max. 4.5 max.
External power supply		DC	12...30 V –
Fusing	Internal		No No
	External		– 0.063 mA, 250 V (3), 3AG fast-blow fuse
Monitor/voltmeter	Range	V	1...5 with main current loop active –
	Scaling		$V_{OUT} (V) = I_{LOOP} (mA) \times 0.25$ –
	Output impedance	Ω	300 typical –
	Cable length	m	≥ 1 –

(1) For a loop voltage of < 30 V:  $R_{MIN} = 0 \Omega$ .

(2) Up to 60 V with external resistor.

(3) External fuse to be used on the "Master Override" signal when it is connected to an external source.

Output module characteristics (continued)		
Type of module		140 ACO 130 00
Functional safety certification		–
Approvals		UL 508, CSA 22.2-142, FM Class 1 Div.2, CE
Number of channels		8
I/O addressing	Words	8 outputs
Output ranges and resolution		0...25 mA, 0...25,000 points 0...20 mA, 0...20,000 points 4...20 mA, 0...16,000 points (default range) 4...20 mA, 0...4095 points
Loop voltage	V $\overline{\text{---}}$	6...30 max.
Internal voltage drop	V $\overline{\text{---}}$	6 min., 30 max. at 25 mA
Accuracy error at 25°C	%	± 0.2 of full scale
Linearity		± 4 $\mu$ A 0...25 mA range ± 4 $\mu$ A 0...20 mA range ± 4 $\mu$ A 4...20 mA range, 0...20,000 points ± 12 $\mu$ A 4...20 mA range, 0...4095 points
Accuracy drift acc. to temperature	%/°C	Typical: 0.004 of full scale Maximum: 0.007 of full scale
Isolation	Channel-to-channel	None
	Channel-to-bus	V $\sim$ 1780 for 1 min
Update time	ms	5 for all 8 channels
Setting time	ms	1.6 to 5% of final value 3.2 to 0.1% of final value
Fault detection		Open wire in 4...20 mA mode. Specific channel identified when open wire is detected via the red channel LED. Information sent to the PLC.
Bus current required	mA	550
Power dissipation	W	5.0
External power supply	V $\overline{\text{---}}$	6...30 max.
Fusing	Internal	None
	External	None

The "Grounding and Electromagnetic Compatibility of PLC Systems. Basic Principles and Measures. User Manual" no. 33002439 provides helpful information on setting up Modicon Quantum PLCs in accordance with the directives and legal regulations in force in the European Union and North America.

Mixed I/O module characteristics							
Type of module			140 AMM 090 00				
Functional safety certification			-				
Approvals			UL 508, CSA 22.2-142, FM Class 1 Div.2, CE				
Number of channels			4 inputs/2 isolated outputs				
I/O addressing			5 input words/2 output words				
Inputs	Input ranges	Bipolar	V	± 10 V	± 5 V, ± 20 mA	-	
		Unipolar	V	0...10 V	0...5 V, 0...20 mA	-	
		Unipolar offset	V	-	-	1...5 V, 4...20 mA	
	Resolution		bits	16	15	14	
	Voltage	Linearity		2.4% over and under range			
		Absolute maximum		V	± 50		
		Impedance		MΩ	> 10 in range > 0.5 outside range		
	Current	Linearity		+ 2.4% over range, - 9.6% under range			
		Absolute maximum		mA	± 25		
		Impedance		250			
	Absolute accuracy error at 25°C (voltage mode)	Typical	%	± 0.03 of full scale			
		Maximum	%	± 0.05 of full scale			
	Linearity		Monotonic ±1 LSB				
	Offset	0...60°C	%/°C	± 0.0014 of full scale max.			
	Gain shift	0...60°C	%/°C	± 0.002 of full scale max.			
Common mode rejection		dB	> 80 at 50 or 60 Hz				
Input filter		dB	Unipolar low pass, cutoff - 3 dB at 21 Hz, ± 20%				
Operating voltage	Channel-to-channel	V	± 40 max.				
Isolation	Channel-to-bus	V	500 ~, 750 for 1 min				
	Input channel-to-output channel	V	500 ~, 750 for 1 min				
Update time		ms	320 for 4 channels				
Fault detection		Open wire in 4...20 mA range Scale over/underrun for bipolar modes only.					

### Mixed I/O module characteristics (continued)

Type of module			140 AMM 090 00	
<b>Outputs</b>	Output range	---	4...20 mA	
	Loop	Voltage	V ---	7...30, up to 60 with external resistor
		Resistance	Ω	$R_{MIN} = (V_{LOOP} - 30 \text{ V})/0.020 \text{ A}$ $R_{MAXI} = (V_{loop} - 7 \text{ V})/0.020 \text{ A}$
	Internal voltage drop	V ---	7 min., 30 max. at 20 mA	
	Resolution	bits	12	
	Accuracy error	%	± 0.20 of full scale at 25°C	
	Linearity		Monotonic ±1 LSB	
	Accuracy error 0...60°C	Typical	%/°C	± 0.004 of full scale
		Maximum	%/°C	± 0.007 of full scale
	Isolation	Channel-to-channel	V	500 ~, 750 --- for 1 min
		Channel-to-bus	V	500 ~, 750 --- for 1 min
		Output channel-to-input channel	V	500 ~, 750 --- for 1 min
	Update time	ms	15 for 2 channels	
	Setting time	μs	900 to ± 0.1% of final value	
	Fault detection		Open wire LED and status byte	
External power supply	V ---	7...30		
Monitor/voltmeter	Range	V	1...5 with main current loop active	
	Scaling		$V_{OUT} \text{ (V)} = I_{OUT} \text{ (mA)} \times 0.25$	
	Output impedance	Ω	300 typical	
	Max. wire length	m	1	
<b>Bus current required</b>		<b>mA</b>	350	
<b>Fusing</b>	Internal		None	
	External		Depending on use	

(1) No  $R_{MIN}$  required for 30 V ~ loop voltage.

The "Grounding and Electromagnetic Compatibility of PLC Systems. Basic Principles and Measures. User Manual" no. 33002439 provides helpful information on setting up Modicon Quantum PLCs in accordance with the directives and legal regulations in force in the European Union and North America.

# Modicon Quantum automation platform

## Analog I/O modules

### Analog input modules

Description	Range	Safety	Reference	Weight kg
<b>8 high level channels</b> 12-bit, unipolar	4...20 mA 1...5 V	–	<b>140 ACI 030 00</b>	0.300
<b>16 high level channels</b> 0...25,000 points, unipolar	0...20 mA, 0...25 mA 4...20 mA	Non-interfering	<b>140 ACI 040 00</b>	0.300
<b>8 RTD channels</b> 13-bit	Ni 100, Ni 200, Ni 500, Ni1000, Pt 100, Pt 200, Pt 500, Pt1000	–	<b>140 ARI 030 10</b>	0.300
<b>8 thermocouple and low level channels</b> 16-bit	Types J, K, E, T, S, R, B $\pm$ 25 mV, $\pm$ 100 mV	–	<b>140 ATI 030 00</b>	0.300
<b>8 high level channels</b> 16-bit, bipolar	$\pm$ 20 mA, 0...20 mA, 4...20 mA $\pm$ 10 V, $\pm$ 5 V, 0...10 V, 0...5 V, 1...5 V	–	<b>140 AVI 030 00</b>	0.300

### Analog output modules

Description	Range	Safety	Reference	Weight kg
<b>4 current channels</b> 12-bit	4...20 mA	Non-interfering	<b>140 ACO 020 00</b>	0.300
<b>8 current channels</b> 0...25,000 points	0...20 mA 0...25 mA 4...20 mA	–	<b>140 ACO 130 00</b>	0.300
<b>4 high level voltage channels</b> 12-bit	$\pm$ 5 V, $\pm$ 10 V 0...5 V, 0...10 V	–	<b>140 AVO 020 00</b>	0.300

### Mixed analog I/O modules

Description	Range	Safety	Reference	Weight kg
<b>4 input channels,</b> 14...16-bit	$\pm$ 20 mA, 0...20 mA, 4...20 mA $\pm$ 5 V, $\pm$ 10 V, 0...5 V, 0...10 V, 1...5 V	–	<b>140 AMM 090 00</b>	0.300
<b>2 output channels</b> 12-bit	4...20 mA			

### Accessories

Description	Degree of protection	Sold in lots of	Safety	Reference	Weight kg
<b>40-way screw terminal blocks</b> Required for all analog I/O modules	< IP 20 IP 20	– –	Non-interfering –	<b>140 XTS 002 00</b> <b>140 XTS 001 00</b>	0.150 –
<b>Keying pin kit for screw terminal block</b>	–	60	–	<b>140 XCP 200 00</b>	–
<b>Analog I/O simulation kit</b>	–	–	–	<b>140 XSM 010 00</b>	–
<b>Earthing kit</b>	–	–	–	<b>STB XSP 3000</b>	–
<b>Terminal blocks for earthing kit</b>	–	10 10	– –	<b>STB XSP 3010</b> <b>STB XSP 3020</b>	– –

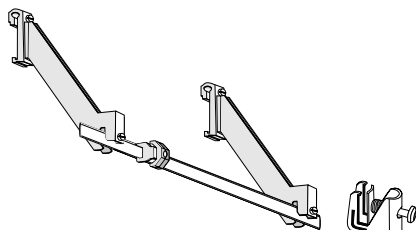

STB XSP 3000

STB XSP 3010/3020

(1) Simulation kit for 140 A*o*I 030 00, 140 A*o*O 020 00 and 140 AMM 090 00 modules, comprising:

- 1 x 0...5 V measurement device
- 2 x 10-turn potentiometers
- 1 x 24 V  $\square$  power supply

### Analog module connections

140 ACI 030 00

140 ACO 020 00

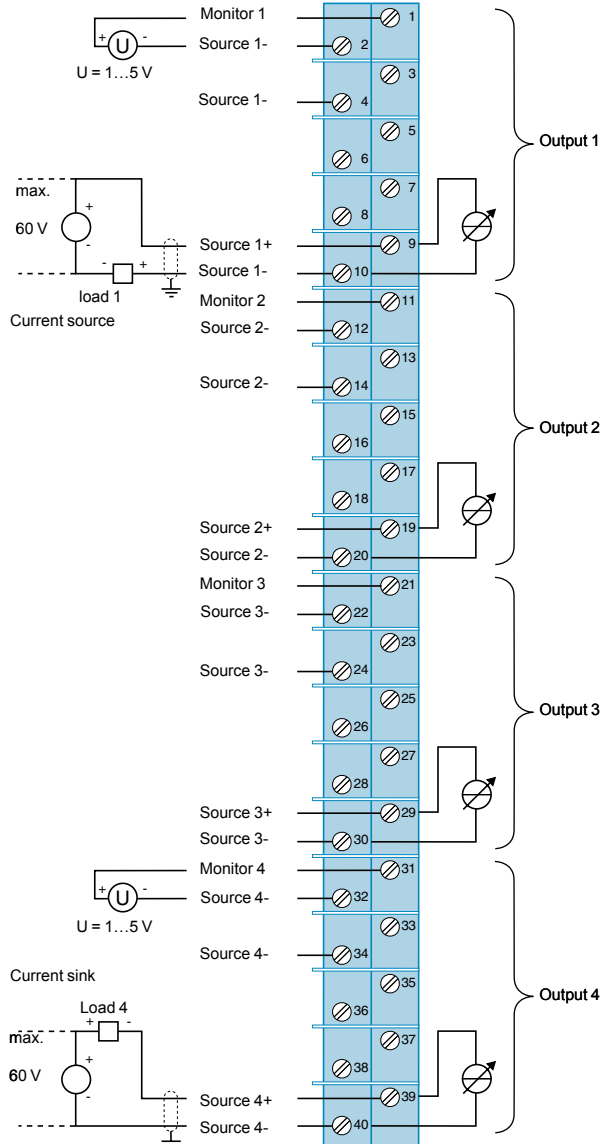
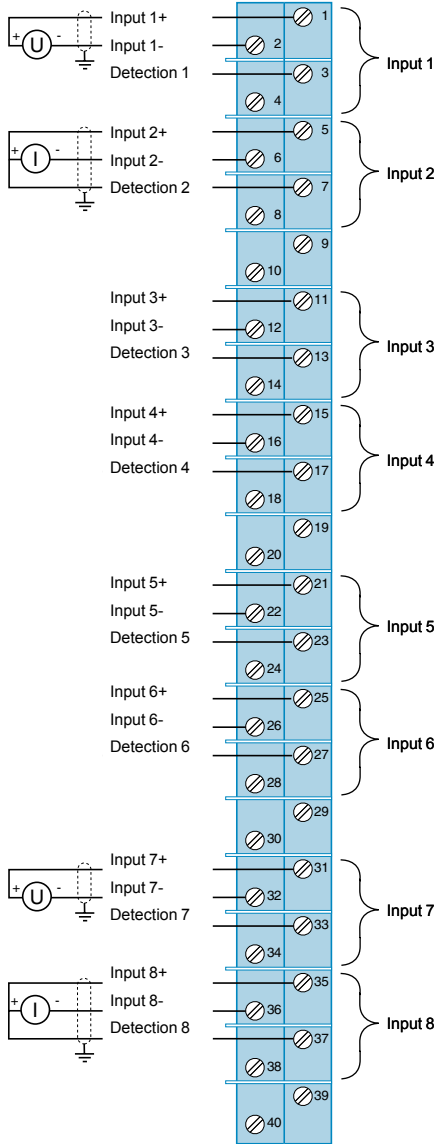

4

The "Grounding and Electromagnetic Compatibility of PLC Systems. Basic Principles and Measures. User Manual" no. 33002439 provides helpful information on setting up Modicon Quantum PLCs in accordance with the directives and legal regulations in force in the European Union and North America.

### Analog module connections (continued)

140 AVI 030 00

140 AVO 020 00

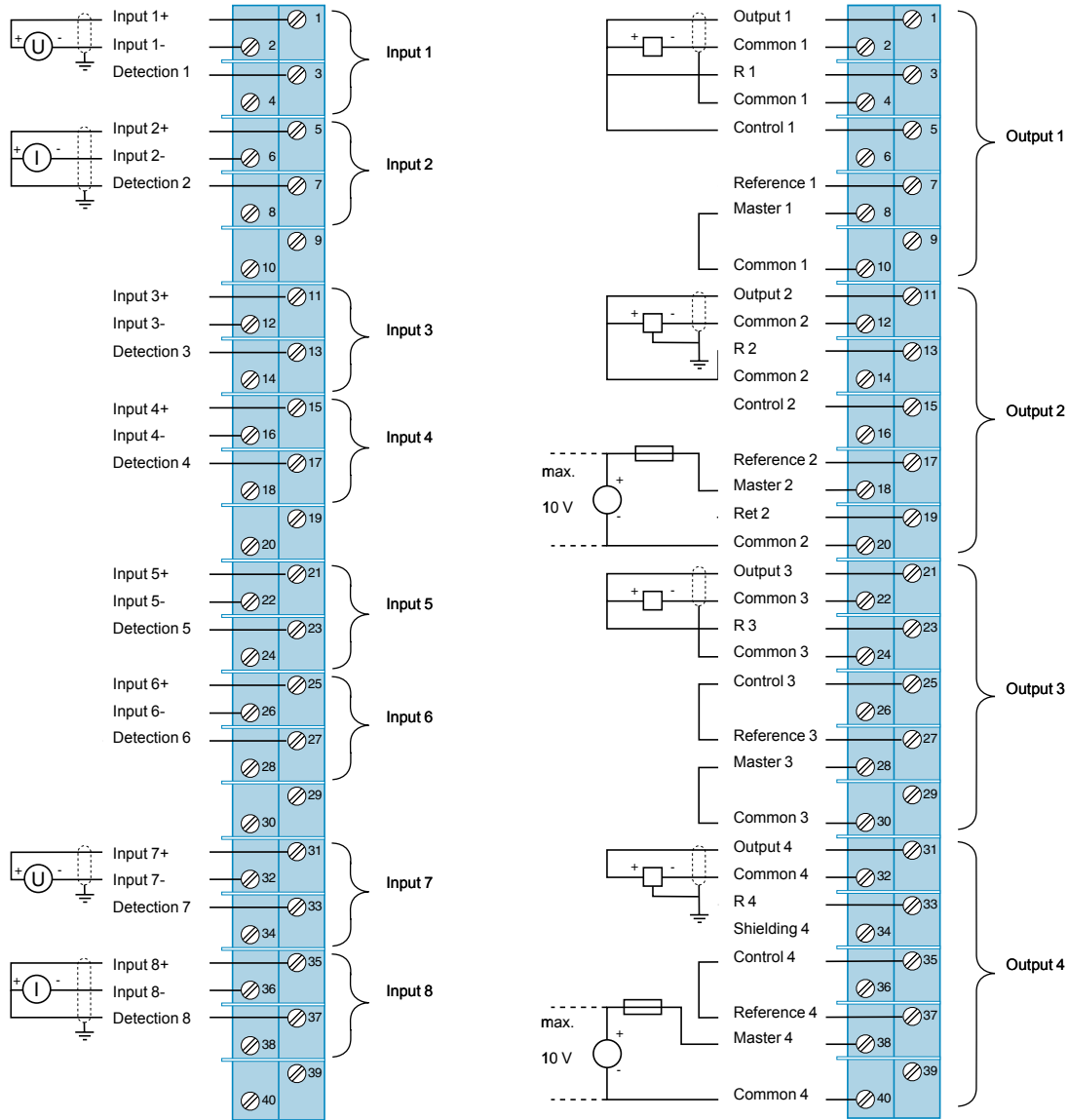

The various wiring options are:

- Channel 1: 0...5 V
- Channel 2: 0...10 V
- Channel 3: ± 5 V
- Channel 4: ± 10 V



### Connection of mixed analog I/O module

140 AMM 090 00

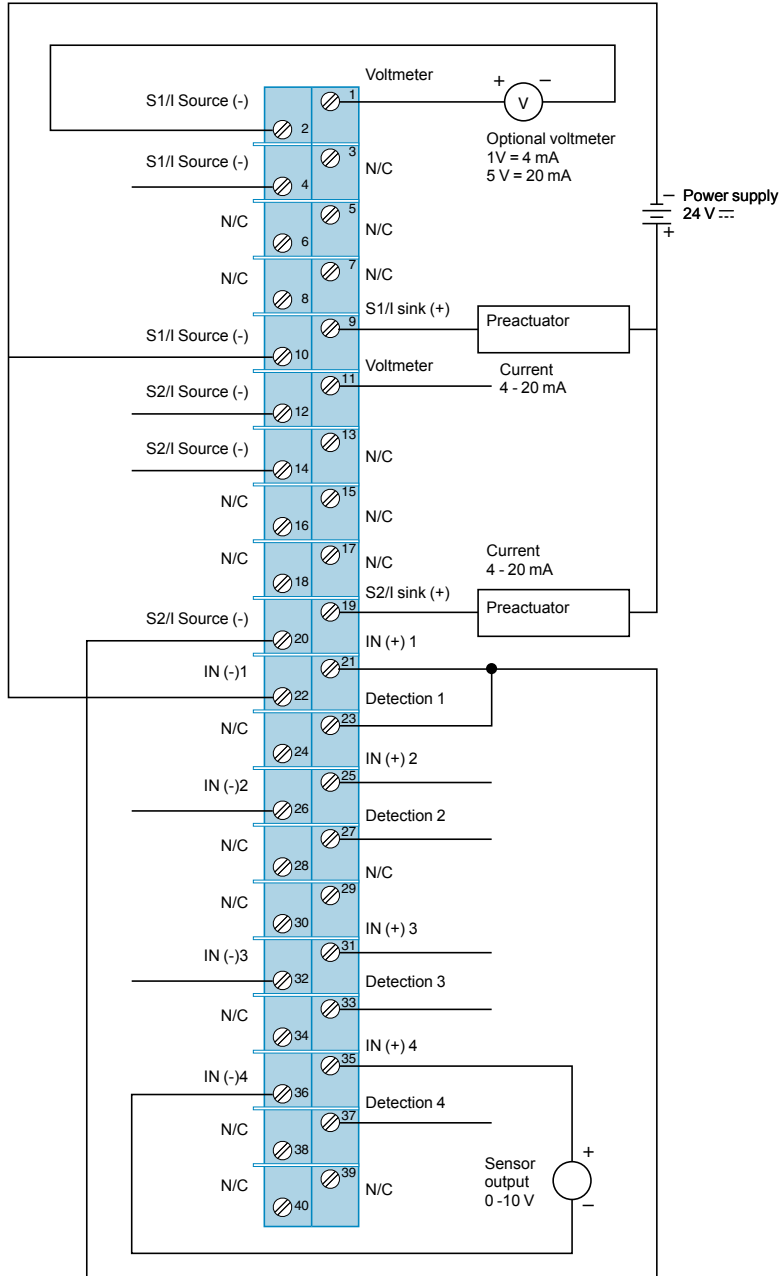

#### 2 output channels

Typical wiring

- **Channel 1:** connection to an external preactuator and an optional voltmeter.
- **Channel 2:** connection to an external preactuator and input 1.

#### 4 input channels

Typical wiring

- **Channel 1:** 4...20 mA input controlled by output channel 2.
- **Channel 4:** connection to a voltage sensor.

- Terminals 1...20 are reserved for wiring the outputs.
- Terminals 21...40 are reserved for wiring the inputs.
- 21/23, 25/27, 31/33, 35/37: terminals to be linked for connecting the channels in current mode.
- N/C = Not connected
- Si/I source (-): current emission output.
- Si/I sink (+): current drawing output.

The "Grounding and Electromagnetic Compatibility of PLC Systems. Basic Principles and Measures. User Manual" no. 33002439 provides helpful information on setting up Modicon Quantum PLCs in accordance with the directives and legal regulations in force in the European Union and North America.

### Connection of 8-channel analog input modules

140 ARI 030 10

140 ATI 030 00

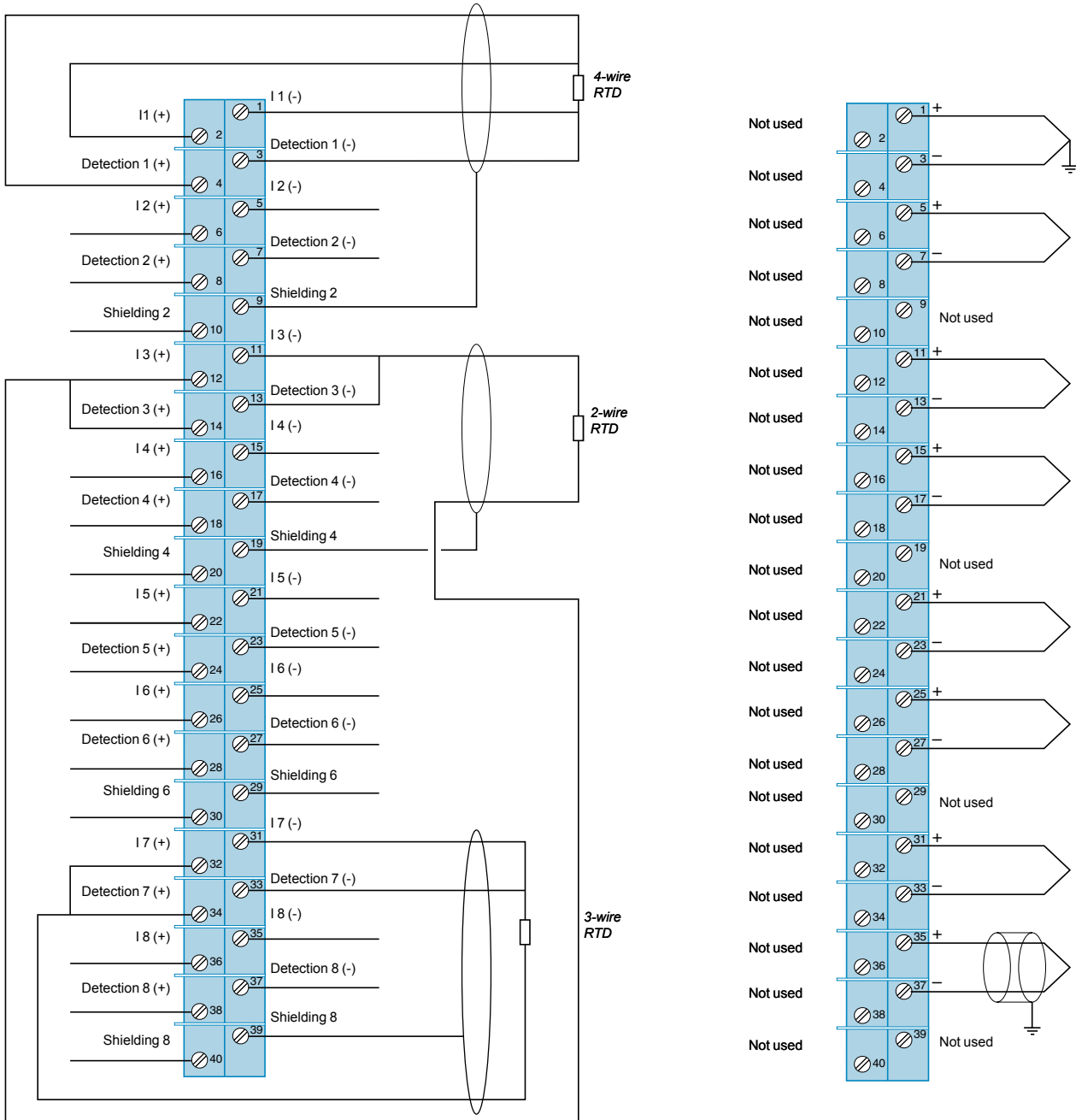

The module is calibrated in accordance with:

- The IEC publication for platinum RTDs:  $100 \Omega$  at  $0^\circ\text{C}$ ,  $\text{TCR}(a) = 0.00385 \Omega/\Omega^\circ\text{C}$
- DIN 43760 for nickel RTDs: American platinum RTDs ( $100 \Omega$  at  $0^\circ\text{C}$ ,  $\text{TCR}(a) = 0.00392 \Omega/\Omega^\circ\text{C}$ )

Terminals labelled as shielded are not connected internally, the shielding must be earthed at the sensor end.

When using 2-wire configuration, the temperature equivalent of twice the main resistance of one leg must be subtracted from the temperature reading.

Use shielded or unshielded thermocouples. It is advisable to use shielded cables in noisy environments. The shielding must be connected to the machine ground at the signal source end.

Terminals marked "Not used" are not electrically connected to the module. These points are used as thermal links for the ambient air. They are not recommended as electrical connection points as this could affect the accuracy of the cold junction compensation.

### Connection of 16-channel analog input module

140 ACI 040 00

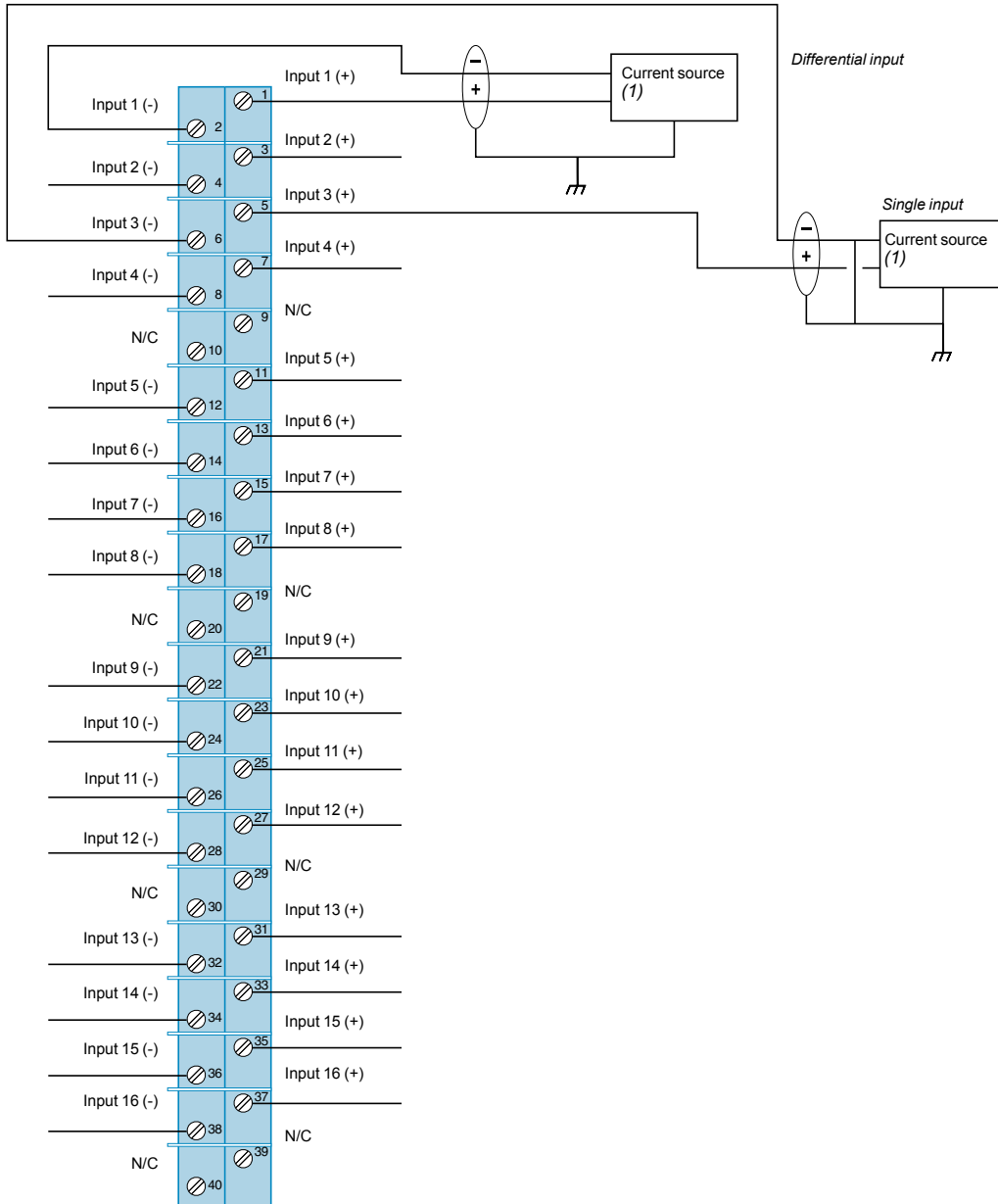

4

- Use shielded or unshielded connection cables. In noisy environments, the use of twisted shielded cable and **STB XSP 3000** earthing kits with **STB XSP 3010/3020** terminal blocks is recommended, see page 4/55. The shielded cable must be connected to the machine ground at the signal source end.
- Unused outputs may cause activation of the F LED (by default). To avoid this happening, it is recommended that the unused channels are configured in the 0 to 25 mA range.
- The channel-to-channel operating voltage must not exceed 30 V  $\overline{\text{---}}$ .
- N/C = Not connected

(1) The current sources must be supplied by the user.

The "Grounding and Electromagnetic Compatibility of PLC Systems. Basic Principles and Measures. User Manual" no. 33002439 provides helpful information on setting up Modicon Quantum PLCs in accordance with the directives and legal regulations in force in the European Union and North America.

### Connection of 8-channel analog output module

140 ACO 130 00

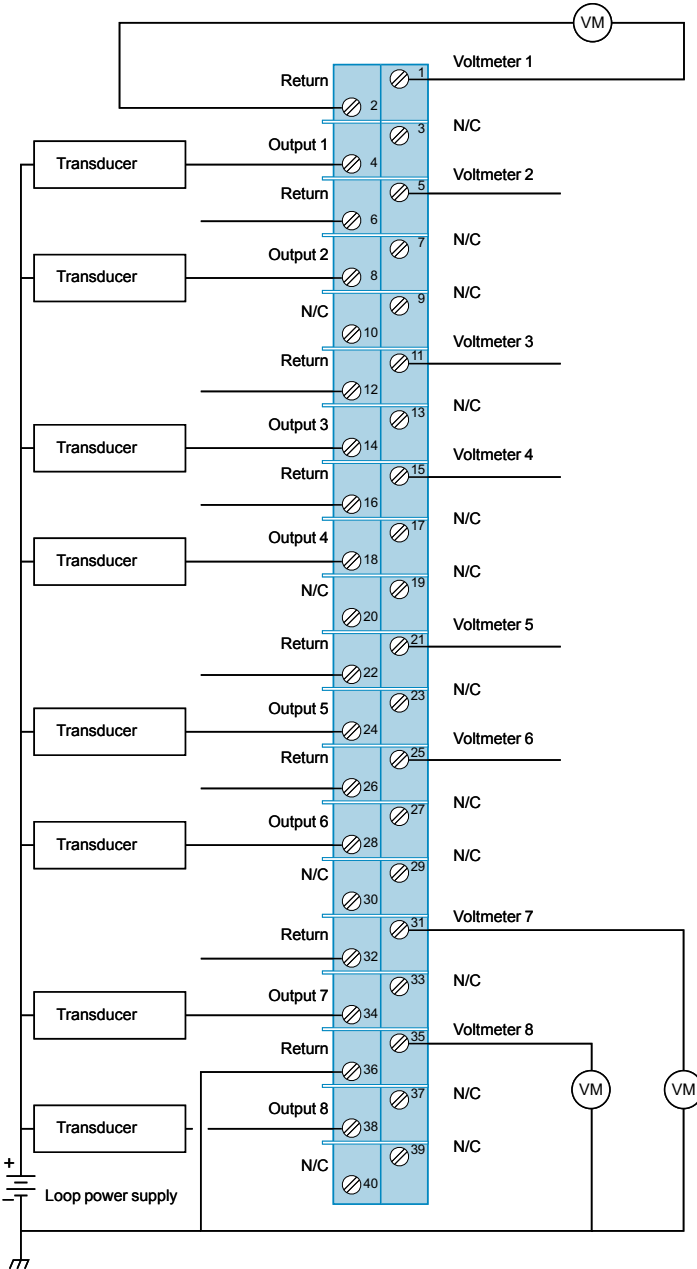

- VM is an optional voltmeter that can be connected to a voltage that is proportional to the current. The cable length is limited to 1 m.
- Use shielded or unshielded connection cables. In noisy environments, the use of a twisted shielded cable is recommended. The shielded cable must be connected to the machine ground at the signal source end.
- Unused outputs may cause activation of the F LED (by default). To avoid this happening, it is recommended that the unused channels are configured in the 0 to 25 mA range.
- All terminals labelled "Return" are common inside the module.
- N/C = Not connected
- At power-up, the channel outputs are all at 0 (zero) current.

# Modicon Quantum automation platform

## IP 20 distributed I/O

Type of module

IP 20 monobloc distributed I/O  
Modicon Momentum



4

Type of communication with the Modicon Premium platform

Ethernet TCP/IP  
Modbus Plus  
Fipio  
Profibus DP  
INTERBus

Max. number per connection point

1 base unit with 1 communicator

Discrete I/O      Modularity  
                          Input voltage  
                          Output voltage

Base unit with 16 I, 32 I, 8 Q, 16 Q, 32 Q, 10 I/8 Q, 16 I/8 Q, 16 I/12 Q and 16 I/16 Q  
24 V  $\overline{\text{DC}}$ , 120 V  $\sim$  and 230 V  $\sim$   
24 V  $\overline{\text{DC}}$ , 120 V  $\sim$  and 230 V  $\sim$  and relay

Analog I/O

Base units with 8 inputs, 16 inputs or 4 voltage/current outputs  
Base unit with 4 thermocouple or probe inputs

Application-specific I/O

10 kHz/200 kHz 2-channel counter base unit  
6 I/3 Q 120 V  $\sim$  base unit with 1 Modbus port

I/O connection

Screw or spring-type removable terminal blocks

Type of housing

Plastic

Type of module

**170 AD●**

Pages

Please consult the "Modicon Momentum automation platform" catalogue

### Optimum IP 20 distributed I/O

#### Advantys OTB



Ethernet TCP/IP  
CANopen  
Modbus (RS 485)

1 interface module and 7 Twido expansion modules

12 I/8 Q (interface module)  
8 I, 16 I, 32 I, 8 Q, 16 Q, 32 Q, 4 I/4 Q and 16 I/8 Q (expansion modules)  
24 V  $\overline{\text{DC}}$  and 120 V  $\sim$

24 V  $\overline{\text{DC}}$  and relay

2 I, 4 I, 8 I, 1 Q, 2 Q, 2 I/1 Q and 4 I/2 Q (expansion modules)  
voltage/current, thermocouple or RTD

Integrated in interface module:  
- 2 channels: 5 kHz/20 kHz  
- 2 PWM function channels

–

Removable screw terminal block (interface module)  
Removable screw terminal block, non-removable spring-type terminal block  
and HE 10 connector (expansion modules)

Plastic

#### OTB 1●0 DM9LP

Please consult the "Advantys OTB distributed I/O" catalogue

### IP 20 modular distributed I/O

#### Advantys STB



Ethernet TCP/IP  
CANopen  
Modbus Plus  
Fipio  
Profibus DP  
INTERBUS

1 "NIM" interface module + 32 I/O modules

Module with 2 I, 4 I, 6 I, 16 I, 2 Q, 4 Q, 6 Q or 16 Q

24 V  $\overline{\text{DC}}$ , 115 V  $\sim$  and 230 V  $\sim$

24 V  $\overline{\text{DC}}$ , 115/230 V  $\sim$  and relay

Modules with 2 inputs and 2 voltage/current outputs  
Module with 2 thermocouple or RTD inputs

Counter module 1 x 40 kHz channel

Parallel interface modules for TeSys Quickfit and TeSys U motor starters

Removable screw or spring-type connectors

Plastic

#### STB D●●/A●●

Please consult the "Advantys STB distributed I/O" catalogue

# Modicon Quantum automation platform

## IP 65/67 splitter boxes and modules

Type of splitter box and module	Passive splitter boxes	Monobloc I/O splitter boxes and modules
	Telefast, ABE9 splitter boxes	Advantys, FTB splitter boxes



4

Type of fieldbus	–	CANopen DeviceNet Profibus DP INTERBUS
Number of I/O	8 I/O, 16 I/O	16 I, 8 I + 8 Q, 12 I + 4 Q, 16 I/O, 8 I + 8 I/O
Type of signal	24 V $\overline{\text{DC}}$ discrete	
Functions	Connection of 1 to 16 sensors/actuators	
Type of input/output connectors	M12	
Degree of protection	IP 67	
Type of housing	Plastic	Plastic and metal
Type of module	<b>ABE 9</b>	<b>FTB 1</b>
Pages	Please consult our "IP 67 splitter boxes" catalogue	

**Monobloc I/O splitter boxes and modules**

**Modular I/O splitter boxes**

**170 ED● I/O modules**

**Modules on AS-Interface cabling system**

**Advantys, FTM splitter boxes**



INTERBUS	AS-Interface			CANopen DeviceNet Profibus DP
16 I or 16 Q	4 I or 2 I 4 Q or 2 Q	4 I	4 I or 2 I 4 Q or 2 Q	8 I, 16 I, 8 I/O and 16 I/O, discrete 4 I or 4 Q analog
24 V $\overline{\text{DC}}$ discrete				24 V $\overline{\text{DC}}$ discrete and analog
Connection of 1 to 16 sensors/actuators	Connection of 1 to 8 sensors/actuators			Connection of 1 to 256 sensors/actuators per bus module
M12	M8	M12	M8	M8 and M12
IP 65	IP 67			
Metal	Plastic			
<b>170 EDI/EDO</b>	<b>ASI ME● + ASI B●</b>	<b>ASI MMO●</b>	<b>XZ S●A</b>	<b>FTM 1</b>
	Please consult our "AS-Interface cabling system" catalogue			Please consult our "IP 67 splitter boxes" catalogue



# Modicon Quantum automation platform

## TeSys Quickfit for motor starter components

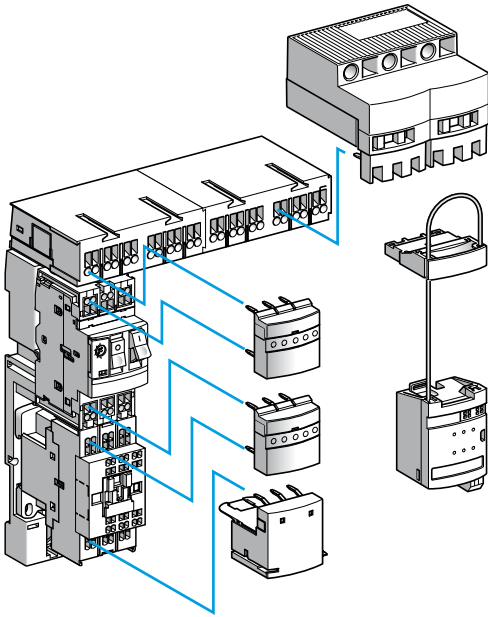

TeSys Quickfit is a modular system which standardizes and simplifies the setting up of motor starters with its pre-wired control and power circuits. The installation of a motor starter is therefore a quick, easy, reliable and open-ended process.

In addition, this system:

- Allows for customization of the motor starter at a later date
- Reduces maintenance time
- Saves space inside the equipment by reducing the number of terminals, cable ducts and intermediate interfaces.

### System for motor starters, with spring terminals, 0 to 25 A (up to 11 kW/400 V)

The motor starters concerned are those created by combining:

- GV2 ME circuit-breakers, with a usage limit of 80% of the maximum intensity at an ambient temperature of 60°C, up to 690 V
- with 9 to 25 A TeSys d contactors (LC1).

This range comprises pre-wiring components for

- The power circuits
- The control circuits

#### Power circuit pre-wiring components

- **A power kit** comprising, for each starter, a plate for mounting the contactor and the circuit-breaker, and two power connection modules
- **A power splitter box** for 2 or 4 starters
- **An upstream terminal block** for connecting a power supply up to 60 A (16 mm<sup>2</sup>)
- **A downstream terminal block** for connecting the motor power supply cables and the earth cables (6 mm<sup>2</sup>)

#### Control circuit pre-wiring components

- **A control circuit connection module** which is mounted directly on the contactor and the circuit-breaker on each starter. This module incorporates the status and control data for this motor starter.
- **A parallel wiring module** which concentrates data from each motor starter:
  - **HE 10**, for centralized applications. Data is transmitted to the PLC via the Advantys Telefast pre-wired system.
  - **STB**, designed for decentralized automation architectures. This module is suitable for use in an Advantys STB configuration for connection to the PLC via a fieldbus.

# Modicon Quantum automation platform

## TeSys Quickfit for motor starter components

### Control

#### HE 10 connection

- 1 Automation platform
- 2 Connection cable **TSXCDP●●** or **ABFH20●●**
- 3 Splitter box **LU9 G02**

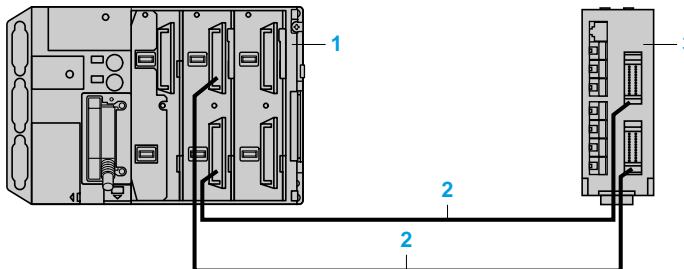

#### Connection on bus using Advantys STB (1)

Configuration example (for motor starter applications only):

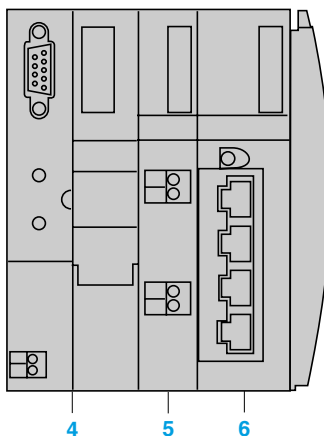

#### Power supply module

Module	STB PDT 3100
Base	STB XBA 2200
Terminal block	STB XTB 1130

#### Parallel interface module (2)

Module	STB EPI 2145
Base	STB XBA 3000

#### Network interface module (3)

CANopen	STB NCO 1010 (4)
Fipio	STB NFP 2210
Ethernet TCP/IP	STB NIP 2210
InterBus	STB NIB 1010 (4)
Profibus DP	STB NDP 1010 (4)
DeviceNet	STB NDN 1010 (4)
Modbus Plus	STB NMP 2210
Terminal block	STB WTS 2120

- 4 Network interface module
- 5 Power supply module
- 6 Parallel interface module

4

#### TeSys Quickfit LAD 9AP3 ●● used with modules APP1 C●●

- 7 TeSys Quickfit module
- 8 Adaptor plate **APP 2CX**
- 9 Splitter box **LU9 G02** for 8 direct motor starters with channel connections on the **APP 1C** module side via 2 HE 10 connectors (20 points), and on the TeSys Quickfit side via 8 RJ45 connectors
- 10 Connection cable **APP 2AH40H060**

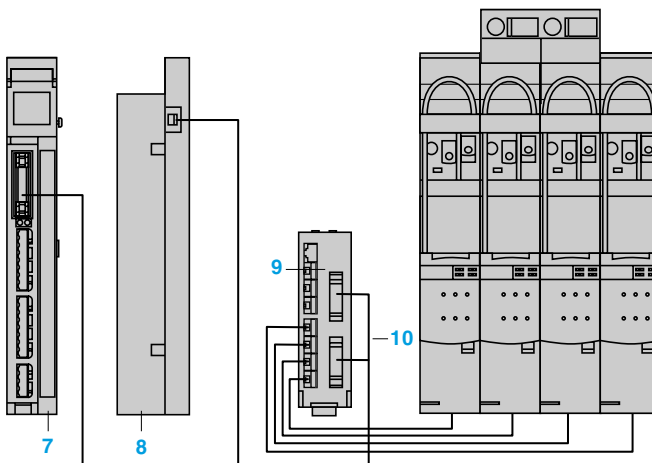

The motor starter is connected to an **APP 1C●● 7** module using an **APP 2CX 8** adaptor plate and an **APP 2AH40H060 10** cable.

Information is available on the module for each motor starter:

- 1 output: motor control
- 2 inputs: circuit-breaker status and contactor status

(1) Please consult the "Advantys STB I/O. The open solution" catalogue.  
 (2) For 4 direct or 2 reversing motor starters.  
 (3) Reference to be selected according to the network used.  
 (4) Optimized version.

# Modicon Quantum automation platform

## TeSys Quickfit for motor starter components

**TeSys Quickfit, compatibility with PLC I/O and distributed I/O**

Automation platforms	Parallel wiring module	Advantys STB parallel interface module
----------------------	------------------------	--

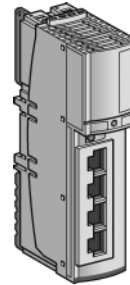
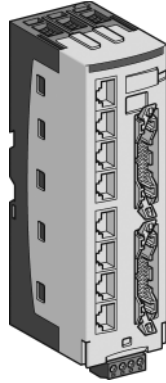

4

Type	Modularity of connection to the PLC	Compatible I/O modules	Splitter box - For 8 TeSys model U motor starters (16 PLC inputs and 8 PLC outputs) - 8 RJ45 connectors, motor starter side - 2 HE 10 connectors, PLC side	Module - For 4 TeSys model U motor starters - 4 RJ45 connectors, motor starter side
			<b>LU9 G02</b>	<b>STB EPI 2145</b>

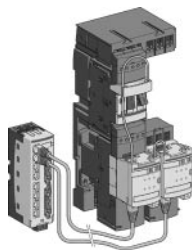

TSX Micro platform				
16 inputs + 12 outputs	TSX DMZ 28DTK	8 motor starters max.: 1 splitter box		
2 x 16 inputs + 2 x 16 outputs	TSX DMZ 64DTK	16 motor starters max.: 2 splitter boxes		
Premium platform				
16 inputs + 12 outputs	TSX DMY 28FK	8 motor starters max.: 1 splitter box		
2 x 16 inputs + 2 x 16 outputs	TSX DEY 32D2K TSX DSY32T2K	16 motor starters max.: 2 splitter boxes		
4 x 16 inputs + 2 x 16 outputs	TSX DEY 64D2K TSX DSY32T2K	32 motor starters max.: 4 splitter boxes		
Quantum platform				
2 x 16 inputs + 2 x 16 outputs	140 DDI 353 00, 140 DDI 853 00 140 DD0 353 10	16 motor starters max.: 2 splitter boxes		
6 x 16 inputs + 6 x 16 outputs	140 DDI 364 00 140 DD0 364 00	48 motor starters max.: 6 splitter boxes		
Advantys STB distributed I/O				
16 inputs + 8 outputs	STB EPI 1145			4 motor starters max.: 1 parallel interface module

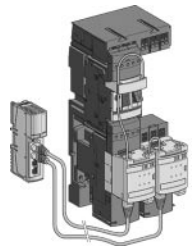

Connection accessories

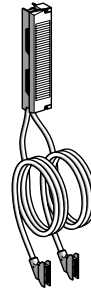
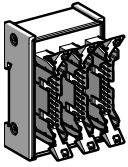

16-channel splitter box (2 x 8 channels) - 3 HE 10 connectors	Connection cables - With 2 HE 10 connectors - AWG 22, 0.324 mm <sup>2</sup> - 5 lengths: 0.5, 1, 2, 3, 5 or 10 m	Connection cables - With 2 HE 10 connectors - AWG 28, 0.080 mm <sup>2</sup> - 3 lengths: 1, 2 or 3 m	Cabled connectors - Terminal block with 2 cables fitted with HE 10 connectors - AWG 22, 0.324 mm <sup>2</sup> - 2 lengths: 1.5 or 3 m	Connection cables - With 2 RJ45 connectors - 3 lengths: 0.3, 1 or 3 m
<b>ABE 7ACC 02</b>	<b>TSX CDP ●●3 (1)</b>	<b>ABF H20 H●●0 (2)</b>	<b>ABF M32 H●●0 (3)</b>	<b>LU9 R●● (4)</b>

4

	2 cables			
1 splitter box (16 PLC outputs remain)	5 cables			
	2 cables			
1 splitter box (16 PLC outputs remain)	5 cables			
2 splitter boxes	10 cables			
3 splitter boxes (16 PLC outputs remain)			2 cabled connectors	
3 splitter boxes (48 PLC outputs remain)	15 cables			
				4 cables

- (1) Replace ●● with 05: length 0.5 m, 10: length 1 m, 20: length 2 m, 30: length 3 m, 50: length 5 m, 100: length 10 m.  
 (2) Replace ●● with 10: length 1 m, 20: length 2 m, 30: length 3 m.  
 (3) Replace ●● with 15: length 1.5 m, 30: length 3 m.  
 (4) Replace ●● with 03: length 0.3 m, 10: length 1 m, 30: length 3 m.



## 5.1 - Intrinsically safe modules

### *Intrinsically safe I/O module selection guide* ..... 5/2

- Intrinsically safe I/O modules ..... 5/4
- Presentation, description ..... 5/4
- Characteristics ..... 5/5
- References ..... 5/9
- Connections ..... 5/10

## 5.2 - Application-specific modules

### *Counter and special-purpose module selection guide* ..... 5/16

- High-speed counter modules ..... 5/18
- Presentation, description ..... 5/18
- Characteristics, references ..... 5/19
- Connections ..... 5/20
  
- High-speed input module with interrupts ..... 5/22
- Presentation, functions ..... 5/22
- Interrupts ..... 5/23
- Performance, characteristics ..... 5/24
- References, connections ..... 5/25
  
- Accurate time stamping ..... 5/26
- Presentation, operation ..... 5/26
- PLC clock synchronization module and multifunction input module ..... 5/26
- Description ..... 5/27
- Characteristics ..... 5/28
- References ..... 5/29
  
- LonWorks communication modules ..... 5/30
- Presentation, description ..... 5/30
- Characteristics, references ..... 5/31
  
- Quantum-Sy/Max integration ..... 5/32
- Presentation ..... 5/32
- Characteristics, references ..... 5/33



# Modicon Quantum automation platform

## Intrinsically safe I/O modules

**Applications**

**Intrinsically safe analog input modules**



5

**Number of channels**

8

**Range**

Temperature probes: Pt - 200...+ 850°C Ni - 60...+ 180°C Thermocouples: Types J, K, E, T, S, R, B mV	Current 4...20 mA 0...20 mA 0...25 mA
--	--

**Resolution**

Temperature probes: 12 bits + sign (0.1°C) Thermocouple (TC): 1°C (by default) 0.1°C; 1°F; 0.1°F	25,000 points max.
--	--------------------

**Insulation between channels and bus**

1780 V ~, at 47-63 Hz or 2500 V = for 1 min

**Error at 25°C**

Temperature probes: ± 0.5°C Thermocouples: J, K, E, T: ± 2°C ± 0.1% value S, R, B: ± 4°C ± 0.1% value	Typical: ± 0.05% FS Max.: ± 0.1% FS
--	--

**Bus current required**

400 mA	1.5 mA
--------	--------

**I/O addressing**

10 input words	9 input words
----------------	---------------

**Module type**

<b>140 AII 330 00</b>	<b>140 AII 330 10</b>
-----------------------	-----------------------

**Page**

5/9

**Intrinsically safe analog output module**

**Intrinsically safe discrete input module**

**Intrinsically safe discrete output module**



4 ... 20 mA (0 to 4095 points)  
 4 ... 20 mA (0 to 16,000 points)  
 0 ... 20 mA (0 to 20,000 points)  
 0 ... 25 mA (0 to 25,000 points)

No-load voltage: 8 V  $\overline{\text{---}}$   
 Short-circuit current: 8 mA  
 Switching point: 0.2 mA  
 Communication hysteresis: 0.2 mA

Max. current:  
 per point: 45 mA at 11 V  $\overline{\text{---}}$   
 per module: 360 mA  
 Off-state leakage per point: 0.4 mA  
 Output voltage: 24 V  $\overline{\text{---}}$

15-bit for 4...20 mA range

–

$\pm 0.2\%$  full scale

2.5 A

400 mA

2.2 A, full load

8 output words

0.5 input words

0.5 output words

**140 AIO 330 00**

**140 DII 330 00**

**140 DIO 330 00**



# Modicon Quantum automation platform

## Intrinsically safe I/O modules

### Presentation

The Quantum automation platform supports a full range of intrinsically safe I/O modules designed to interface with a wide variety of sensors or actuators. Intrinsic safety is a technique for ensuring that electrical energy supplied to circuits in a hazardous area is too low to ignite volatile gases, either from a spark or from heat release. Intrinsically safe circuits use energy-limiting devices, known as intrinsically safe barriers, to prevent excessive electrical energy from being applied to electrical equipment located in hazardous areas. These galvanically isolated barriers prevent the module from releasing sufficient energy to ignite volatile gases or vapours in the hazardous area.

Galvanic isolation, in the form of opto-isolators and DC/DC converters, is provided between the field side output circuitry and the Quantum bus circuitry. The DC/DC converters provide intrinsically safe power to devices located in hazardous areas. No external power is required where these modules are installed.

Intrinsically safe I/O modules are designed to fit onto standard Quantum racks. They can be mounted in any slot position on any Quantum **140 XBP 0... 00** rack (3...16 positions).

### I/O connectors

Each intrinsically safe I/O module requires an I/O connector (140 XTS 332 00). The connector is colour-coded blue to identify it as an intrinsically safe connector. These connectors are keyed to prevent the wrong connector from being applied to the module.

### Wiring recommendations

The wiring between the intrinsically safe I/O modules and the devices located in the hazardous area must be separated from all other wiring.

This separation can be achieved by either:

- Separate trunking, wiring ducts, or conduits, colour-coded blue
- Earthed metal or insulated partitions between the intrinsically safe wiring and other wiring
- Two inches (50 mm) of air space between the intrinsically safe wiring and other wiring. With this method, the wiring must be tied in separate bundles to maintain the required separation.

### Description

The **140 AII/AIO/DII/DIO 330 ●0** intrinsically safe module front panel comprises:

- 1 Model number and colour code.
- 2 A display block with LEDs.
- 3 A removable, hinged door and customizable identification label.
- 4 A screw connection block with 40 terminals (to be ordered separately).

#### To be ordered separately:

■ Earthing of the cable shielding is mandatory. The optional **STB XSP 3000** earthing kit can also be used to secure cables in installations subject to severe vibration.

- 5 Optional **STB XSP 3000** earthing kit.
- 6 **STB XSP 3010** terminals for cables with a cross-section of 1.5...6 mm<sup>2</sup> or **STB XSP 3020** terminals for cables with a cross-section of 5...11 mm<sup>2</sup>.

*The "Grounding and Electromagnetic Compatibility of PLC Systems. Basic Principles and Measures. User Manual" no. 33002439 provides helpful information on setting up Modicon Quantum PLCs in accordance with the directives and legal regulations in force in the European Union and North America.*

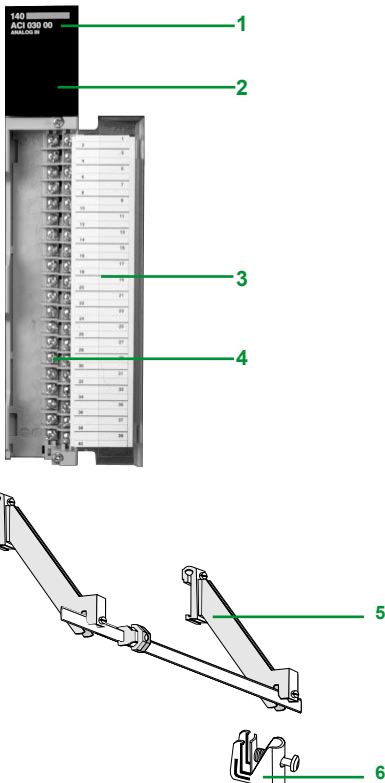

Temperature probe and thermocouple input module characteristics					
Module type			140 All 330 00 (RTD)	140 All 330 00 (TC thermocouple)	
Functional safety certification			–		
Number of channels			8		
LEDs			Active: 1 (green) F: 1 (red) 1...8 (red): Indicated channel is out of range (includes broken wire & short-circuit conditions)		
RTD types (configurable)	Platinum (American and European)	Pt 100, Pt 200, Pt 500, Pt 1000	°C	-200...+ 850	–
	Nickel	Ni 100, Ni 200, Ni 500, Ni 1000	°C	-60...+ 180	–
TC ranges (1)	J		°C	–	-210...+ 760
	K		°C	–	-270...+ 1370
	E		°C	–	-270...+ 1000
	T		°C	–	-270...+ 400
	S		°C	–	-50...+ 1665
	R		°C	–	-50...+ 1665
	B		°C	–	-130...+ 1820
	Millivolts		mV	–	-100...+ 100 (2) -25...+ 25
RTD testing current		Pt 100, Pt 200, Ni 100, Ni 200	mA	2.5	–
		Pt 500, Pt 1000, Ni 500, Ni 1000	mA	0.5	–
TC circuit maximum resistance			Ω	–	200 max. for rated accuracy
Input impedance			MΩ	> 10	> 1
Input filter			–		Single low pass at nominal 20 Hz. Plus notch filter at 50/60 Hz
Normal noise rejection			dB	> 100 at 50/60 Hz	120 min. at 50 or 60 Hz
Cold junction compensation (CJC)			–		Internal CJC operates at 0...60°C (compensation errors are included in the accuracy specification (page 5/6). <b>The connector door must be closed.</b> Remote CJC can be implemented by connecting a TC (which monitors the external junction block temperature) to channel 1. Types J, K, and T are recommended for optimum accuracy.
Linearity			± 0.003% of full scale (0...60°C)		–
Resolution	RTD		12 bits + sign (0.1°C)		–
	TC		–		1 °C (default), 0.1°C, 1°F, 0.1°F
	Millivolts		–		± 100 mV range, 3,05 µV (16 bits) ± 25 mV range, 0.76 µV (16 bits)

(1) All TC thermocouple ranges can detect open wire and scale overrun. This results in a reading 7FFFh or 32767 when an open wire is detected.  
(2) Open circuit detection can be disabled on these ranges.

# Modicon Quantum automation platform

## Intrinsically safe I/O modules

### Temperature probe and thermocouple input module characteristics (continued)

Module type		140 All 330 00 (RTD)	140 All 330 00 (TC thermocouple)
Functional safety certification		–	
Approvals		UL 508, CSA 22.2-142, FM Class 1 Div.2, CE	
Absolute accuracy	RTD	°C	± 0,5 (25°C) ± 0,9 (0...60°C)
	TC		–
	Types J, K, E, T	°C	–
	Types S, R, B	°C	–
	Millivolts at 25°C	µV	–
Accuracy error at 25°C	Typical		± 0.05% of full scale
	Maximum		± 0.1% of full scale
Accuracy drift according to temperature		µV/°C	–
Update time (for all channels)	3-wire	s	1.35
	2/4-wire	ms	750
	TC/millivolts	s	–
Isolation	Channel-to-channel		None
	Channel-to-bus		1780 V ~ at 47...63 Hz or 2500 V --- for 1 minute
Bus current required		mA	400
Fault detection		Scale overrun or broken wire conditions	
External power supply		Not required	
Dissipated power		W	2
Hot swapping		Not allowed in accordance with intrinsic safety standards	
Fuse		Internal (not accessible to the user)	
Programming software		Unity Pro, Concept Version 2.2 or higher	

The "Grounding and Electromagnetic Compatibility of PLC Systems. Basic Principles and Measures. User Manual" no. 33002439 provides helpful information on setting up Modicon Quantum PLCs in accordance with the directives and legal regulations in force in the European Union and North America.

Characteristics of analog I/O modules			140 AI1 330 10	140 AIO 330 00
Module type				
Functional safety certification			–	
Approvals			UL 508, CSA 22.2-142, FM Class 1 Div.2, Cc, Hazardous location class 1, division 1, groups A, B, C.	
Number of channels			8	
Input ranges		<b>mA</b>	4...20 0...20 0...25	–
Absolute maximum input		<b>mA</b>	25, internally limited	
Input impedance		<b>W</b>	100 ± 0.1% between V+ and signal terminals	
Resolution			4...20 mA, 0 to 4095 points 4...20 mA, 0 to 16,000 points 0...20 mA, 0 to 20,000 points 0...25 mA, 0 to 25,000 points	15-bit at 4...20 mA
Loop resistance		<b>Ω</b>	–	500 max.
Output ranges		<b>mA</b>	–	4...20 (0 to 4095 points) 4...20 (0 to 16,000 points) 0...20 (0 to 20,000 points) 0...25 (0 to 25,000 points)
Available voltage			V+, V- terminals: 14.5 V $\bar{\bar{=}}$ at 25 mA V+, signal terminals: 13.6 V $\bar{\bar{=}}$ at 20 mA	–
Accuracy error at 25°C	Typical		± 0.05% of full scale	± 0.2% of full scale
	Maximum		± 0.1% of full scale	–
Accuracy drift according to temperature	Typical		± 0.0025% of full scale/°C	40 PPM/°C
	Maximum		± 0.005 % of full scale/°C	70 PPM/°C
Linearity			+ 0.003% of full scale	± 1 bit (LSB)
Rejection in common mode			>100 dB at 50/60 Hz	
Input filter			Single-pole low-pass, - 3 dB breaking at 15 Hz, ± 20%	
Update time (for all channels)		<b>ms</b>	750	4
Settling time		<b>ms</b>	–	1, up to ± 0.1% of final value
Voltmeter characteristics	Range	<b>V</b>	–	0.250...1.250
	Scale		–	$V_{\text{output}} \text{ (Volts)} = I_{\text{loop}} \text{ (mA)} \times 0.0625$
	Output impedance	<b>Ω</b>	–	62.5 typical
	Wire length	<b>m</b>	–	1 maximum
Isolation	Channel-to-channel		None	
	Channel-to-bus		1780 V $\sim$ at 47-63 Hz or 2500 V $\bar{\bar{=}}$ for 1 minute	1780 V $\sim$ rms for 1 minute
Bus current required		<b>A</b>	1.5	2.5
Fault detection			Broken wire (4...20 mA mode)	Open circuit in 4...20 mA range
External power supply			Not required	
Dissipated power		<b>W</b>	7.5	12.5
Hot swapping			Not allowed in accordance with intrinsic safety standards	
Fuse			Internal (not accessible to the user)	
Programming software			Unity Pro, Concept, version 2.2 or higher, ProWORX	

# Modicon Quantum automation platform

## Intrinsically safe I/O modules

Discrete I/O module characteristics			
Module type		140 DII 330 00	140 DIO 330 00
Functional safety certification		–	
Approvals		UL 508, CSA 22.2-142, CE, Hazardous location class 1, division 1, groups A, B, C.	
No. of points		8 inputs	8 outputs
Output voltage		V $\overline{\text{DC}}$ –	24 (open)
Input voltage and current	No-load voltage (between + input and - input)	V $\overline{\text{DC}}$ 8	–
	Short-circuit current	mA 8	–
	Switching point	mA 1.2...2.1	–
	Communication hysteresis	mA 0.2	–
Switching frequency		Hz 100 max.	–
Maximum output current	Per point	mA –	45
	Per module	mA –	360
	Off-state leakage per point	mA –	0.4
Response (on resistive loads)	Off-to-on	ms 1	
	On-to-off	ms 1	
	Output protection (internal)	–	Elimination of transient voltage
Internal resistance		K $\Omega$ 2.5	–
Input protection		Resistor-limited	
Isolation	Channel-to-channel	None	
	Channel-to-bus	1780 V $\sim$ , 47-63 Hz or 2500 V $\overline{\text{DC}}$ for 1 minute	
Bus current required		A 0.4	2.2 (full load)
Fault detection		Resistor-limited	None
External power supply		Not required	
Dissipated power		W 2	5 (full load)
Hot swapping		Not allowed in accordance with intrinsic safety standards	
Fuse		Internal (not accessible to the user)	
Programming software		Unity Pro, Concept, version 2.2 or higher, ProWORX	

The "Grounding and Electromagnetic Compatibility of PLC Systems. Basic Principles and Measures. User Manual" no. 33002439 provides helpful information on setting up Modicon Quantum PLCs in accordance with the directives and legal regulations in force in the European Union and North America.

# Modicon Quantum automation platform

## Intrinsically safe I/O modules

### Intrinsically safe input modules

Description/resolution	Range	Safety	Reference	Weight kg
8 current analog channels (4096 to 2500 points)	4...20 mA, 0...20 mA, 0...25 mA	–	140 AII 330 10	0.300
8 channels for temperature probes/TC thermocouples (12 bits + sign)	Ni or Pt 100, 200, 500, 1000 Types J, K, E, T, S, R, B and mV	–	140 AII 330 00	0.300
8 discrete inputs	Switching current 1.2 mA...2.1 mA	–	140 DII 330 00	0.300

### Intrinsically safe output modules

Description/resolution	Range	Safety	Reference	Weight kg
8 current analog channels, 15-bit	4...20 mA, 0...20 mA, 0...25 mA	–	140 AIO 330 00	0.300
8 discrete outputs, 12-bit	$\pm 5$ V $\overline{\text{---}}$ , $\pm 10$ V, 0...5 V or 0...10 V	–	140 DIO 330 00	0.450

### Accessories

Description	Safety	Reference	Weight kg
40-way connector, colour-coded blue (degree of protection IP 20)	–	140 XTS 332 00	0.150
User documentation (contained in Quantum Hardware Reference Guide)	–	840 USE 100 00	–
Earthing kit	–	STB XSP 3000	–
Terminals for earthing kit	–	STB XSP 3010	–
	–	STB XSP 3020	–

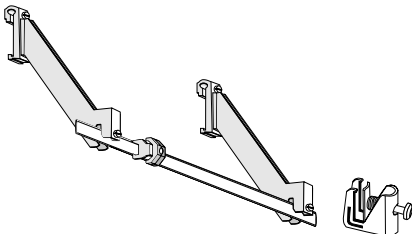

STB XSP 3000

STB XSP 3010/3020

### Connections for the temperature probe input module

140 All 330 00

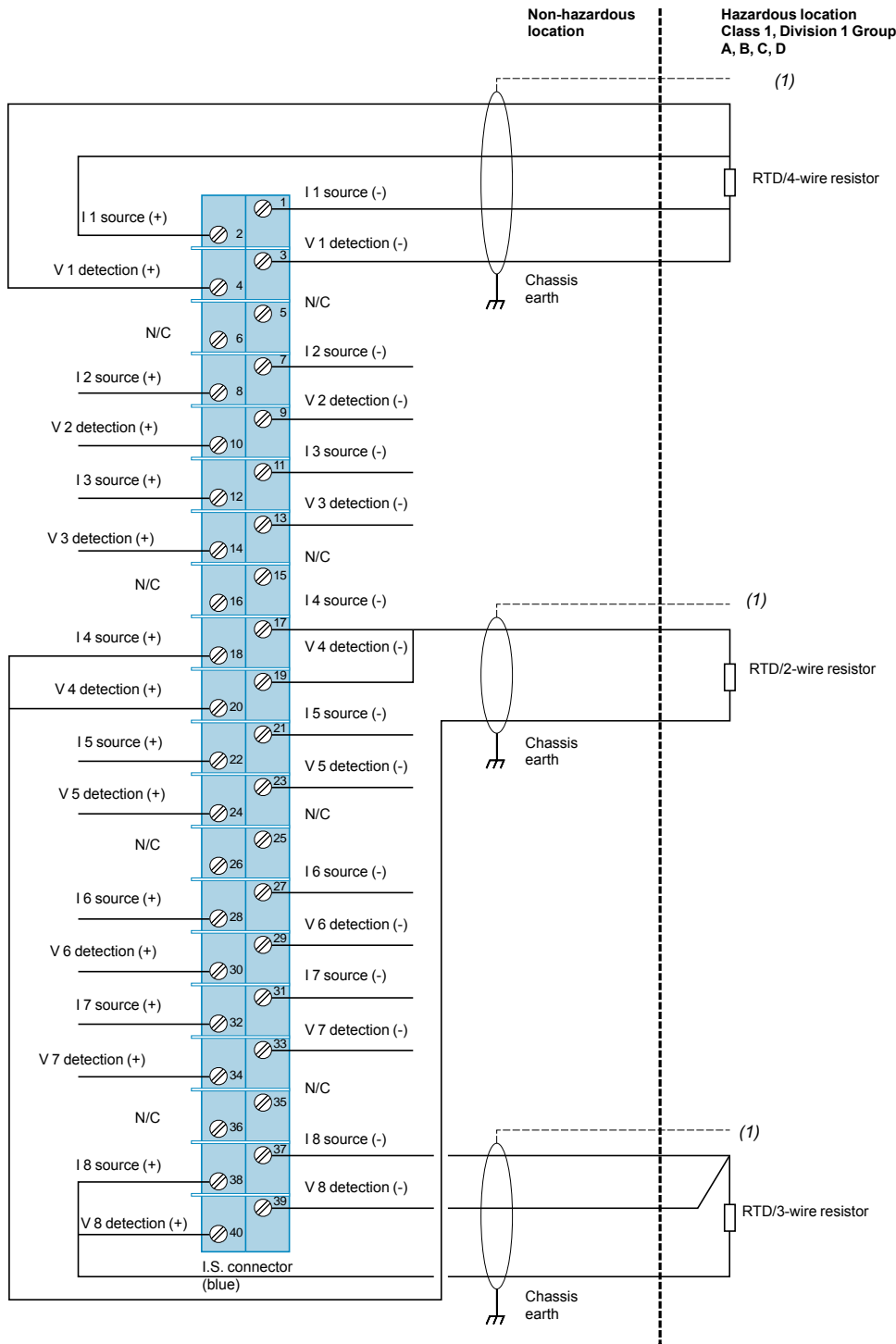

(1) Only shielded twisted pair cables should be used for connection to earth at the module end (on specially-designed screws on the rack).

The "Grounding and Electromagnetic Compatibility of PLC Systems. Basic Principles and Measures. User Manual" no. 33002439 provides helpful information on setting up Modicon Quantum PLCs in accordance with the directives and legal regulations in force in the European Union and North America.

## Connections for the thermocouple input module

140 AII 330 00

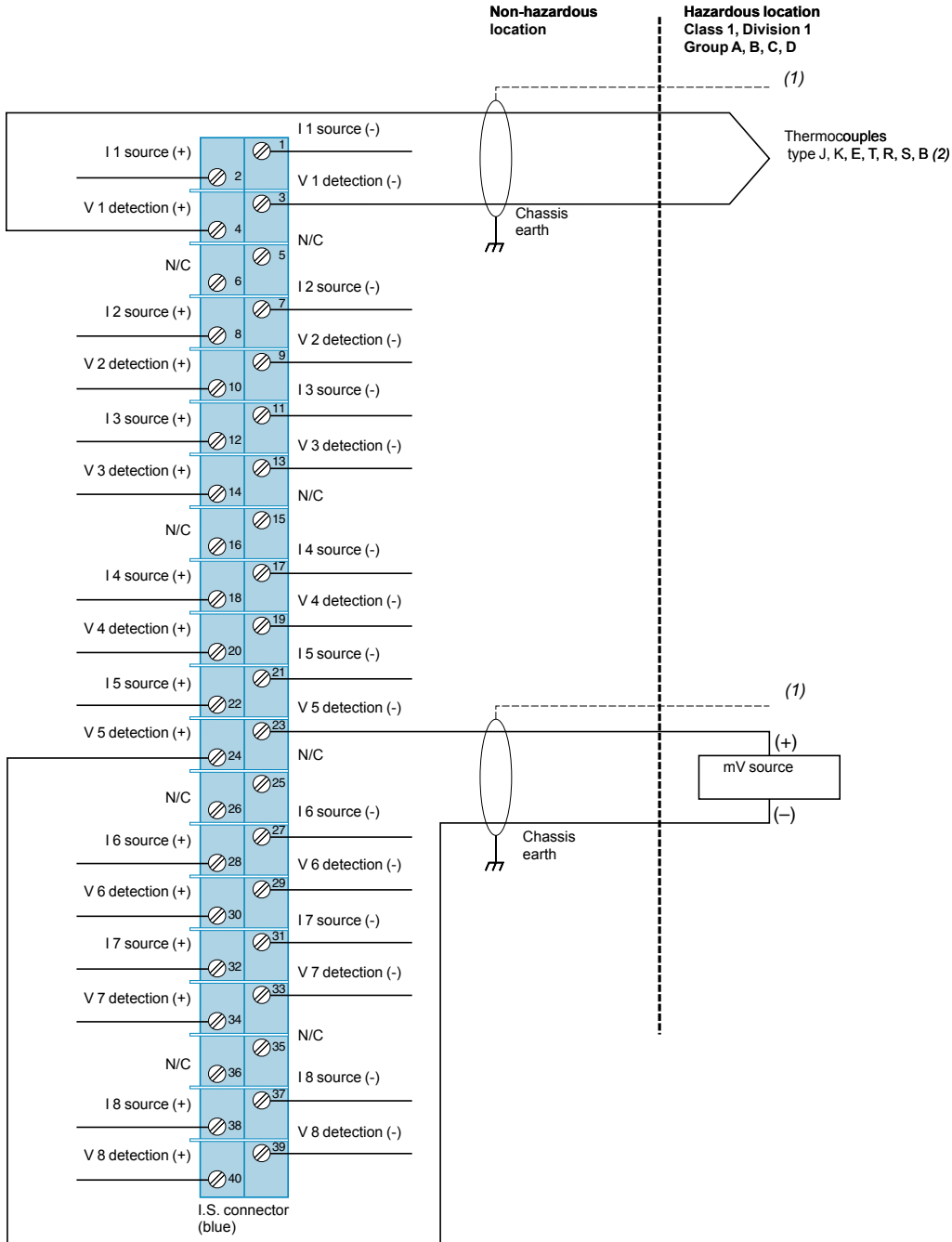

(1) Only shielded twisted pair cables should be used for connection to earth at the module end (on specially-designed screws on the rack).  
 (2) If necessary, the end of the thermocouple can be connected to earth.



### Connections for the analog input module

140 All 330 10

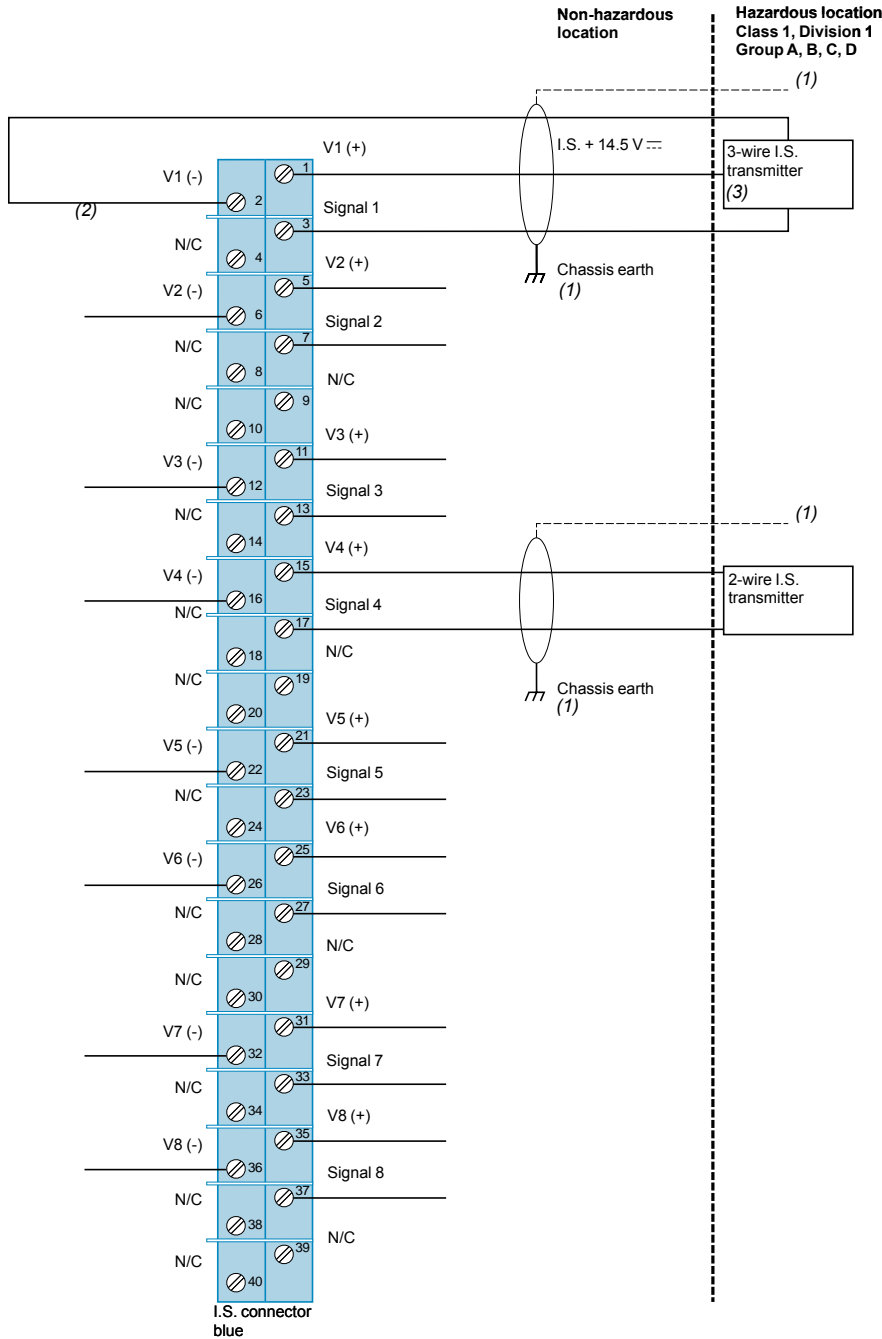

- (1) Only shielded twisted pair cables should be used for connection to earth at the module end (on specially-designed screws on the rack).
- (2) 100 Ohms current-limiting resistor placed between the signal and V (-) terminals on each channel. V (-) is internally connected to the I.S. earth.
- (3) 3-wire transmitters should be provided with power from the module only. An external power supply should not be used.

The "Grounding and Electromagnetic Compatibility of PLC Systems. Basic Principles and Measures. User Manual" no. 33002439 provides helpful information on setting up Modicon Quantum PLCs in accordance with the directives and legal regulations in force in the European Union and North America.

5

## Connections for the analog output module

140 AIO 330 00

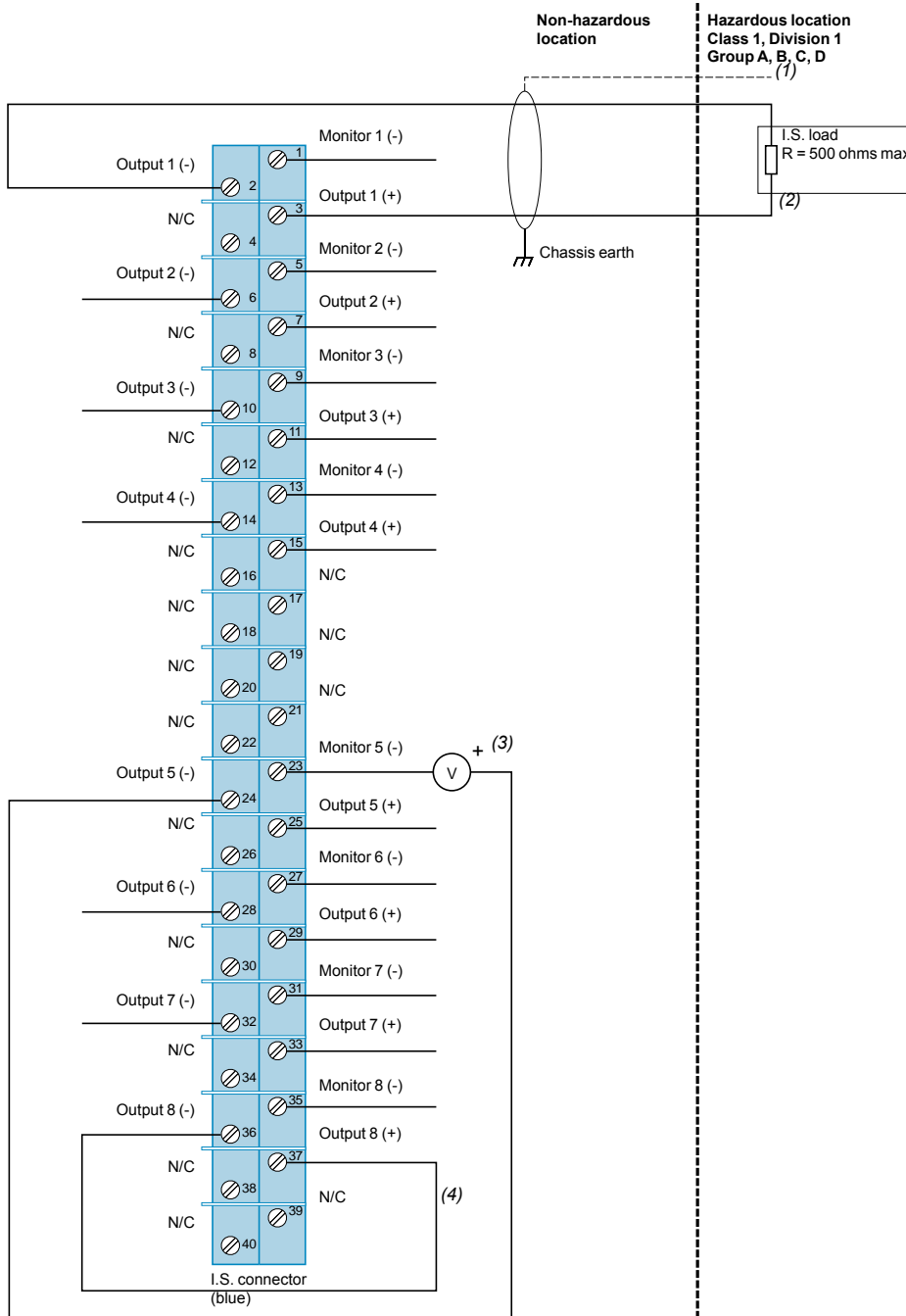

- (1) Only shielded twisted pair cables should be used for connection to earth at the module end (on specially-designed screws on the rack).
- (2) More than one device can be connected as long as they have differential inputs and the total input resistance is less than 500 ohms.
- (3) Optional voltmeter (voltage proportional to the current). Max. cable length 1 m
- (4) Unused channels will appear as open loop, unless these outputs have been short-circuited, as shown for channel 8.

5

## Connections for the discrete input module

140 DII 330 00

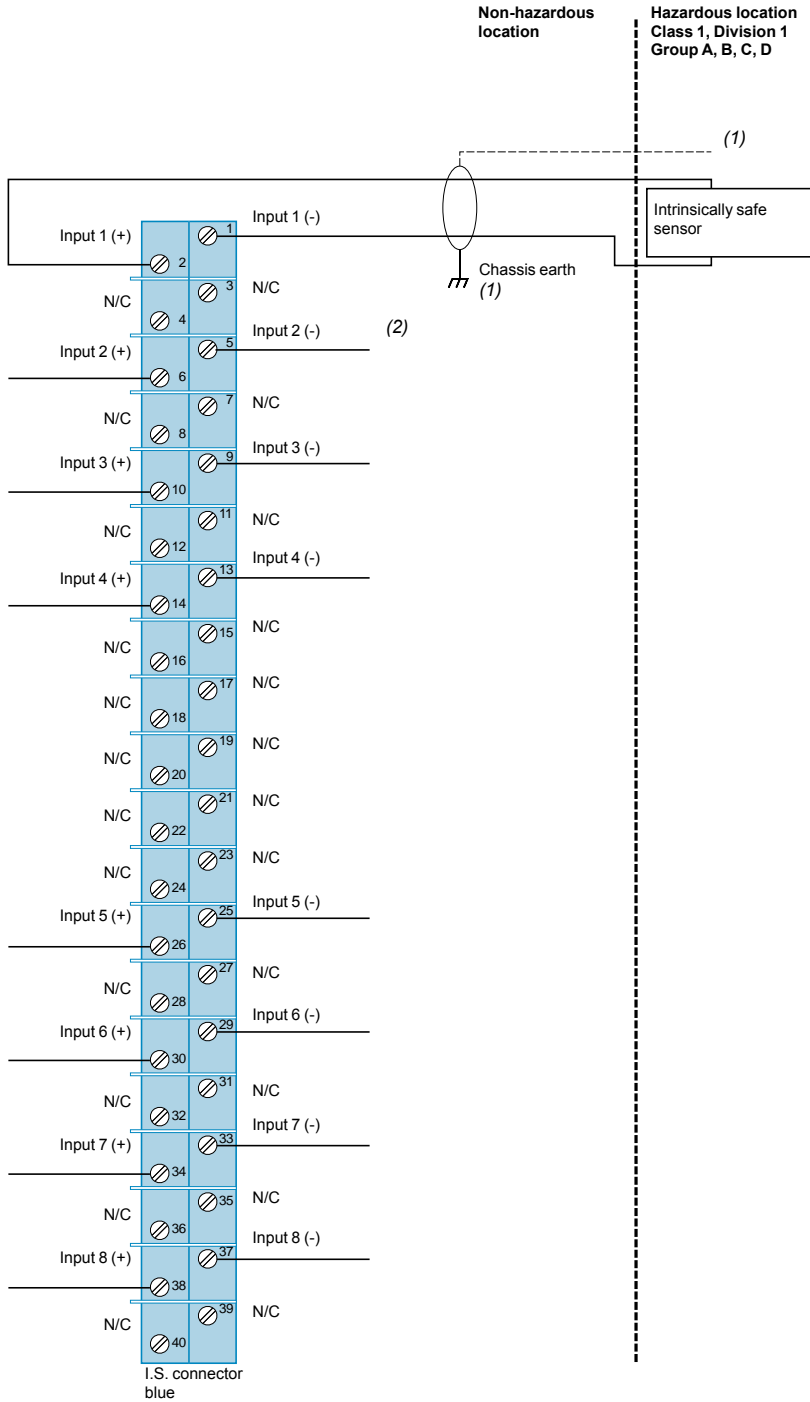

(1) Only shielded twisted pair cables should be used for connection to earth at the module end (on specially-designed screws on the rack).  
 (2) All the (-) inputs are connected together internally.

The "Grounding and Electromagnetic Compatibility of PLC Systems. Basic Principles and Measures. User Manual" no. 33002439 provides helpful information on setting up Modicon Quantum PLCs in accordance with the directives and legal regulations in force in the European Union and North America.

## Connections for the discrete output module

140 DIO 330 00

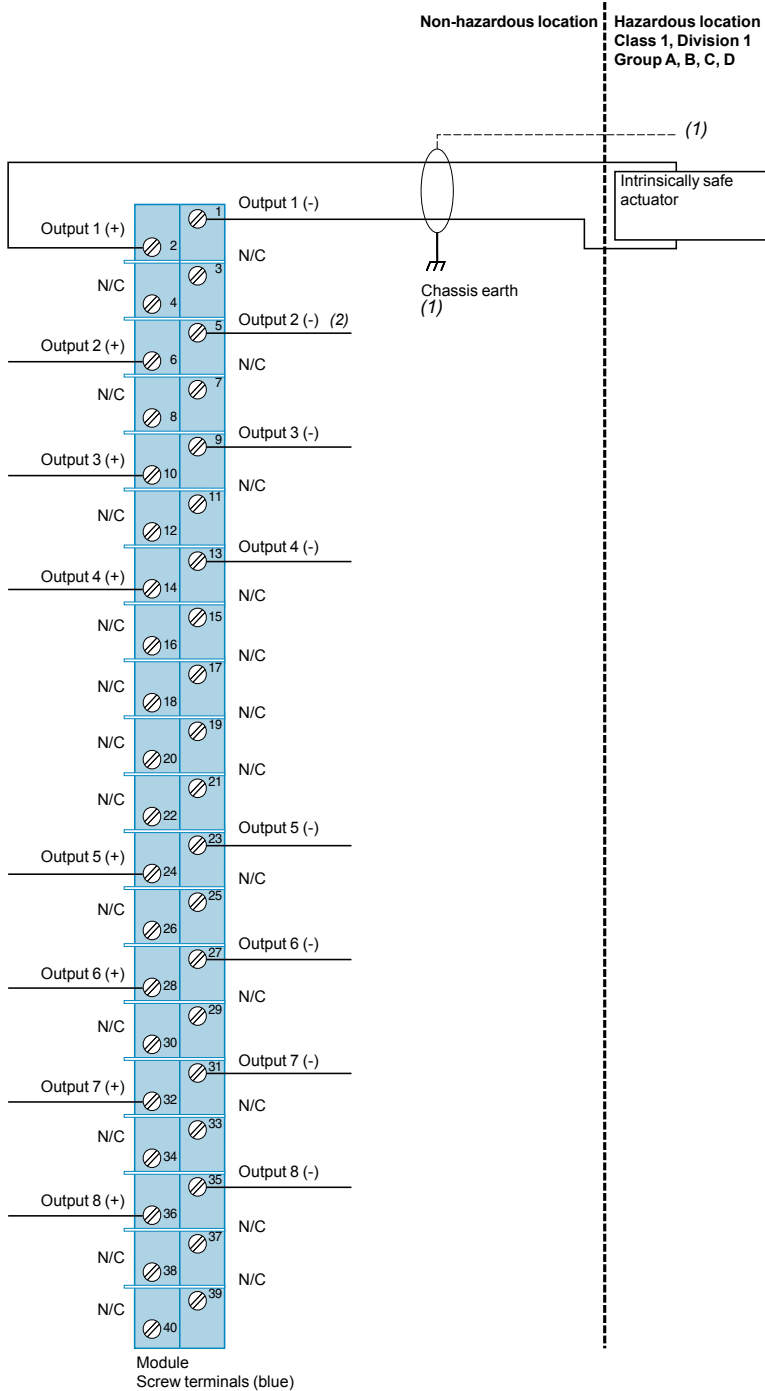

(1) Only shielded twisted pair cables should be used for connection to earth at the module end (on specially-designed screws on the rack).  
 (2) All the (-) outputs are connected together internally.

# Modicon Quantum automation platform

## Counter and special purpose modules

**Applications**

High-speed counting



**Functions**

5-channel counter for incremental encoder inputs

- Counting frequency  
100 kHz (5 V ---)  
20 kHz (24 V ---)
- Counting  
16 bits (65,635 points)  
32 bits (2,147,483,647 points)
- 8 x 24 V --- outputs

2-channel counter for incremental encoder inputs

- Counting frequency  
500 kHz (5/24 V ---)
- Counting  
16 bits (65,635 points)  
32 bits (2,147,483,647 points)
- 4 x 24 V --- outputs

**Unity Pro software compatibility**

Yes

**I/O addressing**

13 input words/13 output words

6 input words/6 output words

**Bus current required**

250 mA

650 mA

**Module type**

**140 EHC 105 00**

**140 EHC 202 00**

**Pages**

5/19

5/19

5

High-speed inputs with interrupt



- 16 x 24 V  $\overline{\text{DC}}$  inputs
- 3 operating modes
  - Interrupt handling mode on rising edge or falling edge (order of priority: depending on module addressing and channel no. in the module)
  - Automatic latch/unlatch mode on rising edge (30  $\mu\text{s}$  min.) or falling edge (130  $\mu\text{s}$  min.)
  - High-speed input mode on rising edge (30  $\mu\text{s}$  min.) or falling edge (130  $\mu\text{s}$  min.)

Accurate time stamping  
PLC clock synchronization



- 1 x 24 V  $\overline{\text{DC}}$  DCF input for GPS (470 GPS 001 00) or DCF (DCF 77E) time receiver
- Date (day of week, month, year) and time (ms, min, hour) synchronization
- Periodic or event time stamping

Accurate time stamping  
Multifunction inputs



- 32 x 24...125 V  $\overline{\text{DC}}$  discrete inputs
- Response time 0...255 ms (configurable)
- 5 operating modes
  - Discrete inputs processed cyclically
  - Event inputs (4096 time-stamped events/module)
  - Counter inputs (32-bit, 500 Hz)
  - Periodic time stamping
  - Time-delayed switching

Yes

16 input words

-

400 mA

300 mA

**140 HLI 340 00**

**140 DCF 077 00**

**140 ERT 854 10**

5/24

5/29

5/29

# Modicon Quantum automation platform

## High-speed counter modules

### Presentation

The Quantum automation platform offers two processor-controlled high-speed counter modules, the **140 EHC 105 00** module and the **140 EHC 202 00** module. These modules independently count pulses at high speeds. They automatically report the count value to the CPU on every scan and, if the counter is installed in the local rack, they can update the CPU asynchronously to the scan (via the IMOD instruction in LL984 language).

#### 140 EHC 105 00 module

The **140 EHC 105 00** is a five-channel high-speed counter, which can be configured in one of four operating modes. This module is ideal for the incremental high-speed counting of pulses up to 100 kHz at 5 V  $\overline{\text{V}}$  or 20 kHz at 24 V  $\overline{\text{V}}$ . The operating mode for each channel can be configured easily via the zoom screen in Unity Pro, Concept or ProWORX 32. These operating modes can be defined as follows:

- 32-bit event counters on one or all channels, with output mode specified (latched or timed).
- 32-bit differential counters that use two channels per function - the difference between the count values on each channel is reported to the CPU. A module can be configured to handle two differential counters, two channels per function.
- 16-bit repetitive counters on one or all channels; the counter repeats the count after reaching the setpoint.
- 32-bit rate counters on one or all channels; the rate is sampled over a time interval specified as either 1 s or 100 ms.

The counter configuration also includes 8 outputs, each of which can be triggered by a setpoint or by a programmable count value in upcount/downcount operations. Each of the outputs can be configured as follows:

- Output turns on at setpoint, either latched or as a one-shot.
- Output turns on at final value, either latched or as a one-shot.
- Output changes status on rising or falling edge applications.
- Output turns on after a specified time delay from a final count value (16,383 ms max.).

#### 140 EHC 202 00 module

The **140 EHC 202 00** is a 2-channel module best suited for high-speed counting applications up to 500 kHz or for applications that require a quadrature encoder interface. The operating mode for each channel can be configured easily via the zoom screen in Unity Pro, Concept or ProWORX 32. These operating modes can be defined as follows:

- 16-bit counters on one or both channels with two outputs, configurable in incremental or quadrature mode.
- 32-bit counters that use both channels with two outputs, configurable in incremental or quadrature mode.
- 32-bit counters on one or both channels with no outputs, configurable for incremental or quadrature mode.
- 16-bit counters on one or both channels with no outputs, in rate sampling mode for incremental or quadrature encoders.

When the counter configuration includes outputs, each can be triggered by a setpoint or by a programmable count value less than the setpoint in upcount/downcount operations.

Each of the outputs can be configured as follows:

- Output latched on at setpoint
- Output latched on at final count value
- Output timed on at setpoint, with a time range of 0...16,383 ms (only one of the four outputs can be configured in this mode)
- Output timed on at final count value, with a time range of 0...16,383 ms (only one of the four outputs can be configured in this mode)

### Description

The **140 EHC ●● 00** high-speed counter module front panel comprises:

- 1 Model number and colour code.
- 2 A display block with LED indicators.
- 3 Removable, hinged door and customizable identification label. To be ordered separately.
- 4 Screw connection block (40 terminals) **140 XTS 002 00/001 00**, to be ordered separately.

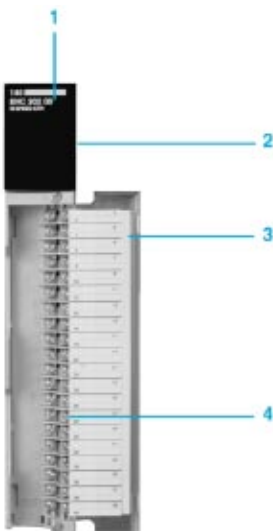

Characteristics			
Module type		140 EHC 105 00	140 EHC 202 00
Functional safety certification		–	
Number of channels		5	2
Number of inputs		8	–
Number of outputs		8	4 (2 per channel)
I/O addressing		12 input words/12 output words	6 input words/6 output words
Data formats	16-bit counter	dec 65,535	65,535
	32-bit counter	dec 2,147,483,647	2,147,483,647
Counter inputs	Input current	mA 7	–
	Duty cycle	1/1	–
	Operating mode	Incremental encoder	Incremental or quadrature
	Input voltage	--- 30 V max. (continuous)	
Discrete inputs	Operating mode	–	Incremental or quadrature
	Input voltage	--- –	30 V max. (continuous)
	Input current	mA 5	–
	Input resistance	kΩ –	10
Non-differential input thresholds	5 V --- REF	--- –	0 ... 2 V closed state/3.5...5 state 0
	12 V --- REF	--- –	0 ... 5 V closed state/7...12 V state 0
	24 V --- REF	--- 3...5 V closed state/15...30 V state 0	0 ... 11 V closed state/13...24 V state 0
Differential input thresholds		--- –	1.8 min.
Discrete outputs (1A, 2A, 1B, 2B)	FET at state 1	--- 20...30 V	Supply - 0.4 V
	FET at state 0	--- 0 V (earth reference)	
	Load current	mA 210 max./output	500 max./output
	Leakage current at state 0	mA 0.1 max. at 30 V ---	0.4 max. at 30 V
	Voltage drop at state 1	V --- 1.25 at 0.5 A	0.4 at 0.5 A
	Output protection	–	36 V transorb for elimination of transient voltage
Miscellaneous	Isolation	~ 500 V rms channel-to-bus for 1 minute	1780 V rms channel-to-bus for 1 minute
	Fault detection	Loss of external power, output short-circuited	Blown fuse detection; loss of power on outputs 1A, 1B, 2A, 2B
	Dissipated power	W ≥ 6	4 + (0.4 x total module load current)
	Bus current required	mA 250	650
	External power supply	--- 19.2...30 V, 24 V nominal, 60 mA + load current for each output	19.2...30 V, 24 V nominal, 50 mA + load current for each output
	Fuse	A Internal: none External: according to user custom	Internal: 2.5 (Ref. 043503948 or equivalent) External: according to user custom
Support rack		Local, remote and distributed	

References				
Description	Safety	Reference	Weight	kg
Counter module, 5 channels of 100 kHz max.	–	140 EHC 105 00		0.350
Counter module, 2 channels of 500 kHz max.	–	140 EHC 202 00		0.350
40-way terminal block, degree of protection less than IP 20	Non-interfering	140 XTS 002 00		0.150
40-way terminal block, degree of protection IP 20	Non-interfering	140 XTS 001 00		0.150
140 EHC 105 00 high-speed counter user guide (English version)	–	840 USE 443 00		–
140 EHC 202 00 module Included in Quantum hardware reference guide	–	840 USE 100 01		–



### Connections

140 EHC 105 00

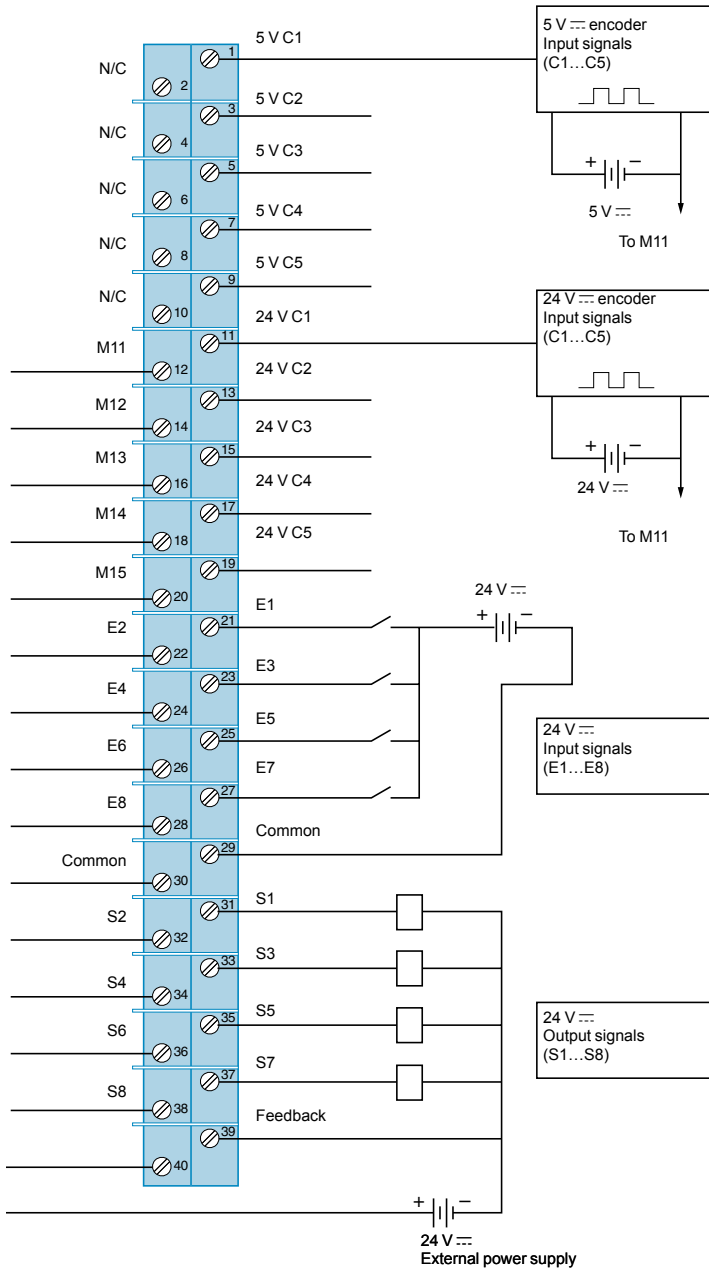

5

- N/C = Not Connected.
- Terminals 29 and 30 are common and are linked together.

**Connections (continued)**

140 EHC 202 00

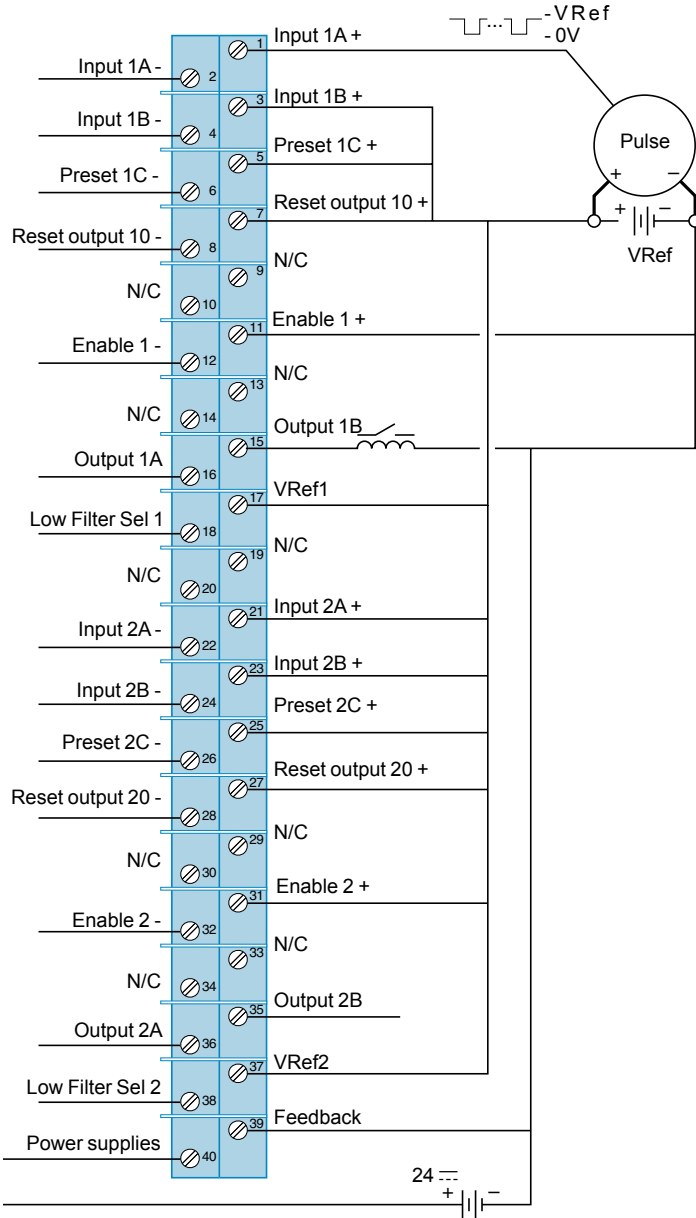

5

Basic wiring diagram showing non-differential connections for:

- Terminal 1** Pulse encoder input (current-sinking encoder)
- Terminal 3** 1B COUNTER input
- Terminal 5** Hard-wired preset (not used, forced to state 1)
- Terminal 7** Reset output forced to state 1 (not required if outputs not used)
- Terminal 11** Hardware enable (software enable also required)
- Terminal 17** Requires connection to VRef+
- Terminals 21, 23, 25, 31, 37** Encoder 2 not used. These terminals must be connected to VRef+
- Terminal 39** Power supply feedback
- Terminal 40** Power supply output

# Modicon Quantum automation platform

## High-speed input module with interrupts

### Presentation

The **140 HLI 340 00** high-speed input module with interrupts is a multipurpose, high-performance device that combines latch and interrupt capabilities for use in time-critical applications. It can only be used in the local rack, not in remote or distributed racks.

This module has 16 individually programmable 24 V  $\overline{DC}$  inputs (positive or negative logic). When it is programmed in LL984 language, the module benefits from several special interrupt-handling instructions (IMOD, ITMR, IE, ID and BMDI) and an immediate I/O access (IMIO) instruction to update its I/O asynchronously with respect to normal I/O scanning. The inputs are also updated at the end of the program segment as part of the normal logic solving process.

The **140 HLI 340 00** module is channel-configurable to any of the following modes:

- MOD interrupt handling mode
- Latch mode
- High-speed input mode

### Functions

#### IMOD interrupt mode

In IMOD interrupt mode, a physical real-world interrupt signal will stop the CPU from executing the main application program and activate a subroutine called an interrupt handler. Interrupt data coming to the CPU is taken into account almost instantaneously. Handshaking on the local rack guarantees that the interrupt data will be taken into account.

Each input can be configured to cause an interrupt whenever it changes to state 1, state 0 or both. Multiple interrupts on the same local rack are priority-handled in the following manner:

- If two interrupts on two different **140 HLI 340 00** modules in the same local rack generate interrupts simultaneously, the slot position in the rack determines its priority. An interrupt from the module in slot 3 therefore has priority over an interrupt generated by the module in slots 4...16.
- If two interrupts from the same **140 HLI 340 00** module are generated simultaneously, the number of the inputs generating the interrupts determines their priority. An interrupt generated by input No. 1 will therefore have priority over all other interrupts.
- If an interrupt occurs while another interrupt handler is running, the CPU will take the new interrupt into account, end the current interrupt handler, then handle the new interrupt as a matter of priority.

#### Latch mode

A latching signal is guaranteed to be read by the CPU, at which time it automatically unlatches the input signal. In latch mode, the **140 HLI 340 00** module can latch/unlatch inputs. The inputs cannot generate interrupts in latch mode.

The latching mechanism is used in applications where the input signal pulse duration is shorter than the CPU's scan time. Data from latched inputs is taken into account by the process during I/O updating, with no special user programming required.

If a **140 HLI 340 00** module has been configured in split mode (where some inputs are latched and others are used for interrupts), any latched input data is read and reset when the interrupt is taken into account and may not be valid at the end of scan.

In order to latch an input at state 1, the signal pulse must be at least 30  $\mu$ s long. In order to latch an input at state 0, the signal pulse must be at least 130  $\mu$ s long.

### Functions (continued)

#### High-speed input mode

When an input on the **140 HLI 340 00** module has not been configured as an interrupt or a latch, it can operate as a normal high-speed input (this is the default operating mode for all inputs on the module).

The high-speed input data is taken into account by the normal I/O handling process and is updated at the end of a program segment. These inputs are often considered auxiliary process inputs to interrupt operations that require a combination of interrupts, latches and high-speed inputs. Response times for high-speed inputs are 30  $\mu$ s from off to on and 130  $\mu$ s from on to off.

### Interrupts

#### Time-based interrupts

Another form of interrupt processing available as standard on Quantum can be accomplished by using the CPU's internal clock to generate interrupt signals at regular intervals (this method does not require the use of the 140 HLI 340 00 module). The interrupt timing is user-programmable.

These interrupts can be used when the application program needs to take account of data events at predictable or regular intervals and this process lasts less than the CPU's scan time. Timer interrupts can be programmed down to 1 ms minimum, corresponding to the CPU clock speed (see below for the impact of interrupts on the scan time).

#### 984LL interrupt instructions (built into the firmware of Quantum CPUs)

The Quantum CPU handles both timer interrupts and interrupts generated by the **140 HLI 340 00** module in the same manner, by executing the interrupt handler in the subroutine segment of the 984 ladder logic application. The logic in the interrupt handler determines what steps need to occur to handle the interrupt. The IMIO (immediate I/O) instruction can be used to force input reading or output writing in the interrupt handler. IMIO instructions can read or write real-world I/O data on the local rack.

For example, if an interrupt has been generated and the interrupt handler needs to acquire the current value in a high-speed counter module, the IMIO instruction can be activated to read the position asynchronously to the scan. This information could then be used by the interrupt handler to make a logical decision based on the current value. At the end of the interrupt handler routine, the information can be used to update an output module on the local rack.

A 984LL program is broken down into sections called segments. Real-world inputs are read just prior to segments being resolved, and real-world outputs are written just after segments are resolved. This happens in a parallel process where the I/O are updated during program execution. Within a Quantum CPU, there can be up to 32 segments of ladder logic that define the limits of the program for logic solving during normal I/O updating.

### Interrupts (continued)

#### 984LL interrupt instructions (built into the firmware of Quantum CPUs) (continued)

Interrupts allow the I/O to be updated within a segment, not at the end of the segment as normally happens. When an interrupt occurs, an ITMR or IMOD instruction provides the CPU with a pointer to a specific subroutine designed to take account of this interrupt. Subroutines reside in separate segments of the program, and individual subroutines may be called into service multiple times during a single scan or only once over many scans.

To ensure rapid execution of the interrupt handler subroutines, certain instructions must not be used within the interrupt handler subroutine. The following instructions, used in an interrupt handler subroutine, will cause it to abort:

- MSTR (for reading and writing over a Modbus Plus network)
- READ/WRITE on ASCII, PCFL strings (floating point process control library)
- Equation networks
- T1.0, T0.1 and T.01 timers
- Instructions which can be downloaded by the user

### Performance

#### Impact of interrupts on the scan time

For most applications, the impact of interrupt handlers on the scan time is minimal, even when interrupts are generated several times during the scan. Interrupt handlers allow a critical part of the application to be taken into account faster than the overall application. However, take care not to overtax the CPU's capacity by taking account of interrupts. We recommend that you create a timing diagram to ensure that interrupts do not consume more than 40% of the CPU's processing time. The percentage of CPU usage (the time required to take account of an interrupt) is critical to analyzing the impact on the scan time.

The time it takes to execute an interrupt handler subroutine can be calculated by adding the instruction execution times for the logic in the subroutine. The overhead for adding an IMOD or ITMR instruction to the CPU is 60 µs/scan; this is the amount of time it takes the CPU to constantly check whether a timer has been triggered or whether a hardware interrupt needs to be handled. There is no incremental overhead for adding a second IMOD or ITMR instruction to the CPU.

#### General performance

Interrupt handler performance is measured from the time the input signal arrives at the input module to the time an output is commanded to change state. The measurement takes account of module filter times and the time for taking account of and handling interrupts.

### Characteristics

Module type		140 HLI 340 00	
Functional safety certification		–	
Number of channels		16 isolated	
Operating voltage	State 1	---	15...30 V
	State 0	---	- 3...+5 V
Operating current	State 1	<b>mA</b>	2.0...8.0
	State 0	<b>mA</b>	0...0.5
Absolute maximum input		---	30 V continuous operation
Response time	On-to-off	<b>µs</b>	30 max.
	Off-to-on	<b>µs</b>	130 max.
Input protection		---	30 V against reverse polarity
Isolation	Point-to-point	~	500 V rms for 1 minute
	Point-to-bus	~	1780 V rms for 1 minute
Bus current required		<b>mA</b>	400
Dissipated power		<b>W</b>	2 + (0.3 x number of points)
Fuse	Internal	None	
	External	According to user custom	
Support rack		Local only	

# Modicon Quantum automation platform

## High-speed input modules with interrupts

### References

Description	Number of channels	Functions	Safety	Reference	Weight kg
High-speed input module with interrupts	16 x 24 V $\overline{\text{---}}$	Interrupts, latching, high-speed inputs	–	140 HLI 340 00	–
140 HLI 340 00 high-speed input module user guide	–	English version	–	840 USE 112 00	–

### Connections

#### 140 HLI 340 00

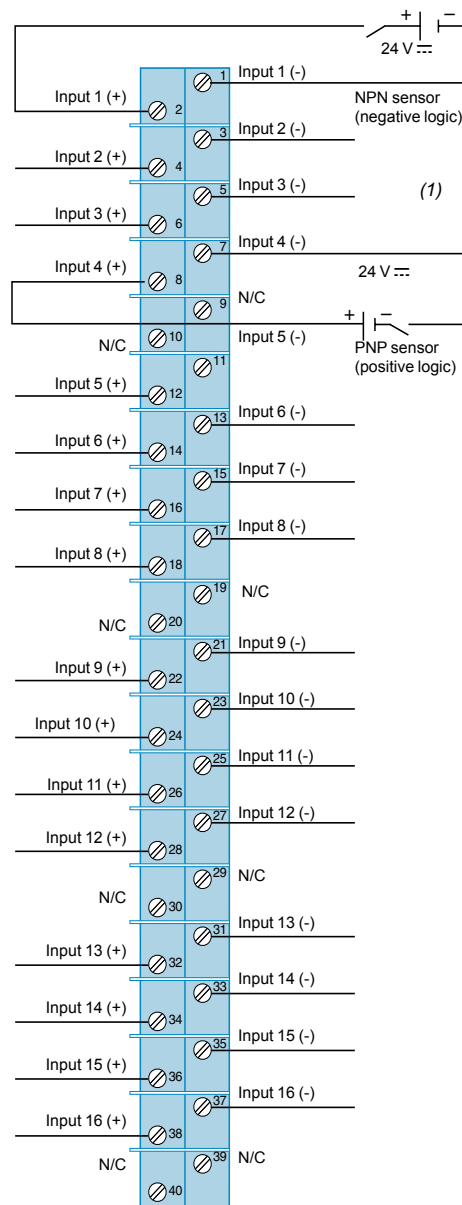

(1) We recommend the use of shielded cables in noisy environments. The shield must be connected to earth at the signal source end.

# Modicon Quantum automation platform

Accurate time stamping  
PLC clock synchronization module and multifunction input module

## Presentation

Both the **140 DCF 077 00** PLC clock synchronization module and the **140 ERT 854 10** multifunction input module are designed for time and date stamped event logging applications.

The **140 DCF 077 00** PLC clock synchronization module provides the application program with accurate time and date stamped information, so that it can be associated with the occurrence of an event. The accuracy of discrimination therefore depends directly on the scan time.

This module is designed for the following areas of application:

- Time and date stamping of events
- Periodic time and date stamping of process values
- Time-based tables

The **140 ERT 854 10** multifunction input module is suitable for combining time and date stamping with variations of discrete inputs quickly and accurately. This module can also be used for counting operations (maximum frequency of 500 Hz) on its discrete inputs.

This module is designed for the following areas of application:

- Status monitoring on discrete inputs
- Time and date stamped event logging
- Counting

Where necessary, the **140 ERT 854 10** multifunction input module offers the PLC application an image of the external clock fitted on this module. The user will be able to use this date/time information for the following areas of application:

- Periodic time and date stamping of process values
- Time-based tables

## Operation

For the PLC clock synchronization module or for the multifunction input module, the information, time and date stamped in real time, made available to the application or used to operate event logging, is generated from a GPS or DCF signal, supplied by an external time receiver.

The GPS signal indicates Greenwich Mean Time, broadcast by GPS satellites. This date/time information is converted to DCF format, for example, by the **470 GPS 001 00** receiver CPU.

The DCF signal indicates Central European Time. It is broadcast on long wave by a transmitter located near Frankfurt. This date/time information is captured and transmitted in the form of a DCF signal, for example, via a **DCF 77E** receiver.

The **140 DCF 077 00** PLC clock synchronization module provides the Quantum automation platform with the following time-based data:

- Milliseconds, minutes, hours
- Day of week, day of month
- Month, year

This module is able to perform the following tasks:

- Time and date stamping of process states and messages in real time
- Periodic time and date stamping of process values, measurements and/or counter values
- Time-based tables: adjustment of actuator commands

The **140 ERT 854 10** multifunction input module is a module with 32 discrete inputs, 24 V to 125 V  $\overline{\text{---}}$ , integrating the following functions:

- **Discrete inputs:** scanned inputs transferred cyclically to the PLC program
- **Event-triggered inputs:**
  - Time and date stamped event logs on a FIFO memory buffer, integrated in the card, which can contain 4096 of these time and date stamped events concurrently
  - Validation by the user of transmission of these time and date stamped events to the PLC memory, checked by the application program

5

PLC rack with a clock synchronization module



Configuration 1  
All **ERT 854 10** modules on the same PLC

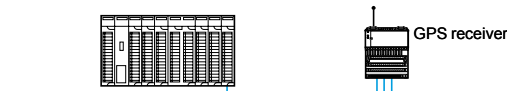

Configuration 2  
**ERT 854 10** modules on several PLCs

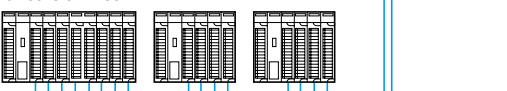

Configuration 3  
**ERT 854 10** modules on several RIO drops on the same PLC

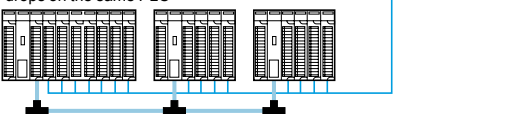

# Modicon Quantum automation platform

Accurate time stamping

PLC clock synchronization module and multifunction  
input module

## Operation (continued)

■ **Counter inputs:** counting on 32 event bits appearing at a maximum frequency of 500 Hz. Cyclical transfer of these counter values to the PLC memory.

■ **Periodic time and date stamping** of process values and logging of counter values according to the stated time intervals.

■ **Time-based tables:** special actions on the process actuators depending on the time. States consecutive to these actions can be logged by the multifunction input module.

Up to nine **140 ERT 854 10** multifunction input modules can be installed on the same rack, local or remote.

If the PLC configuration includes a **140 ERT 854 10** multifunction input module, it is not necessary to install a **140 DCF 077 00** PLC clock synchronization module for the application to have accurate date/time information.

## Description

### Description of the 140 DCF 077 00 PLC clock synchronization module

The **140 DCF 077 00** PLC clock synchronization module front panel comprises:

- 1 Module number and colour code
- 2 A display block with 7 LED indicators:
  - **R** (green): module running
  - **Active** (green): communication on the bus
  - **F** (red): fault
  - **DCF 77** (green): reception of date/time information, flashes in time with the input signal
  - **Status** (yellow): lights up once the signal supplied by the time receiver has been synchronized
  - **Error 1** (red): lights up when the signal supplied by the time receiver has not been synchronized for at least 60 minutes
  - **Error 2** (red): lights up when the signal supplied by the time receiver has not been synchronized
- 3 A standard Quantum module casing
- 4 An identification label (slipped inside the module door)
- 5 A flap for accessing the connectors and the terminal block
- 6 A reset button
- 7 A screw terminal block for connecting the external supply voltage, and also the signal provided by the time receiver (connector supplied with the module)
- 8 A module fixing screw

### Description of the 140 ERT 854 10 multifunction input module

The **140 ERT 854 10** multifunction input module front panel comprises:

- 1 Module number and colour code
- 2 A display block with 35 LED indicators:
  - status LEDs for the 32 discrete inputs (1 to 32)
  - **R** (green): self-test OK, module ready
  - **Active** (green): communication on the bus
  - **F** (red): fault
- 3 A connection block for the discrete inputs (to be ordered separately? ? ?).
- 4 An identification label (slipped inside the module door)
- 5 An access flap for the connection block
- 6 A standard Quantum module casing
- 7 A module fixing screw

To be ordered separately:

■ A 40-way screw connection block **140 XTS 002 00**

■ A backup battery holder (optional) **140 XCP 900 00** for storing, in the event of a power cut, time and date stamped events logged in the internal buffers of the **140 ERT 854 10** multifunction input modules (a module has one Quantum-format slot per rack)

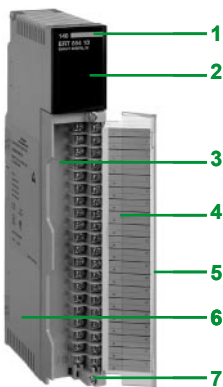
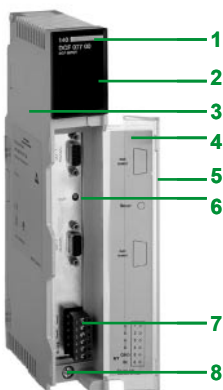



# Modicon Quantum automation platform

Accurate time stamping  
PLC clock synchronization module and multifunction input module

## Characteristics of the PLC clock synchronization module

<b>Module type</b>		<b>140 DCF 077 00</b>	
<b>Functional safety certification</b>		-	
<b>Power supply</b>	DCF receiver link	V $\overline{\text{---}}$	24, max. 30 mA
	Internal, via the system bus	V $\overline{\text{---}}$	5, max. 300 mA
<b>Clock signal input</b>	Number		1
	Input voltage	V $\overline{\text{---}}$	24
	Channel-to-bus isolation	V $\overline{\text{---}}$	700 for 1 minute by optocoupler
<b>Processor</b>	Micro-controller		80C32-25
	Clock speed	MHz	22.1184
<b>Memories</b>	RAM	Kb	256, for data and the program + 2 for the DPM
	Flash	Kb	128, for the program and the firmware
<b>Connection</b>	Time receiver (DCF or GPS)		1 plug-in connector with 6 screw terminals

## Characteristics of the multifunction input module

<b>Module type</b>		<b>140 ERT 854 10</b>					
<b>Functional safety certification</b>		-					
<b>Power supply</b>	Reference voltage, for each group of inputs	V $\overline{\text{---}}$	24...125 (max. 18...256), current consumption per group: max. 3 mA				
	Internal, via the system bus	V $\overline{\text{---}}$	5, max. 300 mA				
	Current consumption for data backup	mA	0.07 max, drawn on the batteries in the 140 XCP 900 00 module				
<b>Process inputs</b>	Number		32, divided into 2 groups				
	Input supply voltage	V $\overline{\text{---}}$	24...125				
	Channel-to-bus isolation	V $\overline{\text{---}}$	1780 for 1 min by optocoupler				
	Isolation between groups of channels	V $\overline{\text{---}}$	1780 for 1 min by optocoupler				
	Anti-bounce filtering		Configurable from 0 to 255 ms				
	Inversion of input states		Configurable				
	Maximum cable length	m	400 with unshielded cable, 600 with shielded cable				
	Level of switching	Nominal input voltage	V $\overline{\text{---}}$	24	48	60	125
			mA	6	2.5	2.5	1
		Min. current/signal at state "1"					
	Level 0 (OFF state)		Nominal 0% of the reference input voltage for the group, max. +15%, min. -5%				
Level 1 (ON state)		Nominal 100% of the reference input voltage for the group, max. 125%, min. 75%					
Internal power consumption of the process inputs		W	7.5 max.				
<b>Clock signal input</b>	Number		1 input, data format complying with standard DCF 77, controlled for example by a DCF 77E receiver, or by a 470 GPS 001 00 receiver				
	Input power supply	V $\overline{\text{---}}$	24				
	Isolation between clock signal input and bus	V $\overline{\text{---}}$	700 for 1 minute by optocoupler				
	Isolation between clock signal input and process inputs	V $\overline{\text{---}}$	1780 for 1 minute by optocoupler				
	Resolution (time and date stamping)	ms	1				
	Current required	mA	5				
<b>Connection</b>	Process inputs		By a 40-way screw terminal block (140 XTS 002 00)				

# Modicon Quantum automation platform

## Accurate time stamping

## PLC clock synchronization module and multifunction input module



140 DCF 077 00



140 ERT 584 10

### References

Description	Functions	Safety	Reference	Weight kg
<b>PLC clock synchronization module</b>	Receives a DCF 77 signal Supplies the PLC application program with the current time and date stamped information: milliseconds, minutes, hours, day, date, month, year	–	<b>140 DCF 077 00</b>	0.450
<b>Multifunction input modules</b>	32 discrete inputs, supplied at between 24 V and 125 V $\overline{\text{---}}$ Status logging 500 Hz counting	–	<b>140 ERT 854 10</b>	0.450

### Separate parts

Description	Functions	Safety	Reference	Weight kg
<b>DCF 77 clock signal receiver/generator</b>	Receives, demodulates and amplifies the DCF 77 signal (built-in aerial)	–	<b>DCF 77E</b> (1)	–
	Receives a GPS satellite signal and converts it to DCF 77 format	–	<b>470 GPS 001 00</b> (1)	–
<b>GPS aerial</b>	For 470 GPS 001 00 receiver	–	<b>470 GPA 001 00</b> (1)	–
<b>GPS aerial cable</b> (12 m long)	Connection between 470 GPA 001 00 aerial and 470 GPS 001 00 receiver	–	<b>470 XCA 646 00</b> (1)	–
<b>Cable for PC</b> (3 m long)	Connection between PC and 470 GPS 001 00 receiver for configuration	–	<b>470 XCA 323 00</b> (1)	–
<b>Screw connection block</b> (40-way)	Connection of the 140 ERT 854 10 module inputs	Non-interfering	<b>140 XTS 002 00</b>	–
<b>Backup battery holder module</b>	For backing up logs operated by 140 ERT 854 10 module(s)	–	<b>140 XCP 900 00</b>	–

(1) To order this product, contact our partner OHP:

**OHP Automatisierungssysteme GmbH**

Gutenbergstr. 16

D-63110 Rodgau 1, Germany

Tel: +49 6106 8 49 55 -0

Fax: +49 6106 8 49 55 20

E-mail: [info@ohp.de](mailto:info@ohp.de)

Web: [www.ohp.de](http://www.ohp.de)

# Modicon Quantum automation platform

## LonWorks communication modules

### Presentation

Modicon Quantum automation platforms provide support for LonWorks by means of the **140 NOL 911 10** module. LonWorks technology is a local operating network developed by Echelon Corporation as an open control architecture that conforms to the seven-layer collision avoidance OSI model for networking. As an OSI compliant device, communication messaging is very open. It is also non-deterministic by design. As such, LonWorks has been well received within the building industry, and is compatible with over 2,500 vendors, primarily of building automation systems and products. Both Motorola and Toshiba support LonWorks chip technology, which is embedded within the device.

This network is made up of nodes that can talk to one another on a peer-to-peer network. Each node contains all the necessary elements for it to operate and communicate:

- A processor called a Neuron
- A transceiver
- An I/O interface
- A communication interface
- A user program

Each node manages a small number of local I/O points, and contains the necessary Neuron program to support that device, from I/O management to event processing, sending messages, and distributing data. The terminal devices containing the Neuron processor are supplied already programmed with an industry standard program.

This standard program is called an SNVT or Standard Network Variable Type. Users or OEMs can customize the Neuron program by creating a CNVT, or Custom Network Variable Type, using Neuron® C programming language and tools.

LonWorks technology enables users to connect their industrial process, controlled by the Quantum platform, to the building automation system. Such tight cooperation between the process and plant allows tighter overall control and integration of all aspects of the industrial process, now inclusive of the plant itself. The large number of vendors who support LonWorks technology within their devices ensures simple and cost effective connectivity.

The **140 NOL 911 10** module supports up to 240 SNVTs, as well as user-defined CNVTs, which are mapped to native Quantum variables, thus providing transparent integration of LonWorks data with the Quantum application program. Several LonWorks modules may be present in the same Quantum CPU, allowing highly flexible architecture choices.

### Description

The LonWorks **140 NOL 911 10** communication module front panel comprises:

- 1 An LED array.
- 2 RS 232 serial port, 9-way SUB-D connector.
- 3 A service pin.
- 4 A reset button.
- 5 An auxiliary LonWorks communications port (1).
- 6 A primary LonWorks communications port.

(1) Not intended to be connected to any public telecommunications network.

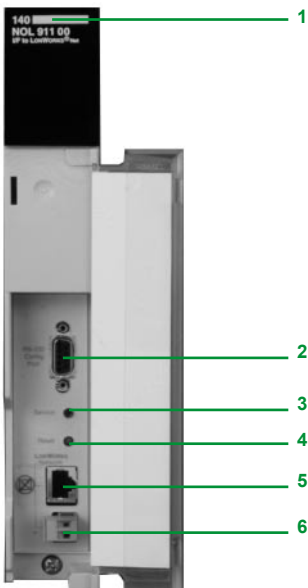

Characteristics			
<b>Module type</b>		140 NOL 911 10	
<b>Functional safety certification</b>		–	
<b>Temperature range</b>	Operation	°C	0...+ 60
	Storage	°C	- 40...+ 85
<b>Relative humidity during operation</b>		20...95%, non-condensing at 0...60°C	
<b>Ventilation</b>		Convection only	
<b>Shocks</b>		15 g half sine, 11 ms duration	
<b>Vibration</b>		IEC 68-2-6, sinusoidal 10...150 Hz (operating) 0.075 mm amplitude, 1 g 10 periods	
<b>Flammability</b>		PCB material UL-94V0. UL recognized components	
<b>Emissions</b>	Radiated	Compliant with EN55011, class A	
	Conducted	All systems AC mains tested according to EN55011, class A, group 1	
<b>ESD immunity</b>		Compliant with IEC 1000-4-2, 8 kV air discharge, 4 kV contact discharge, both polarities	
<b>Susceptibility</b>	Radiated RF	Compliant with IEC 1000-4-3, 80 MHz...1000 MHz: 10 V/m test level, 80% AM at 1 kHz. Also 1.89 GHz PM at 100 Hz, 50% duty cycle	
	Conducted RF	Compliant with IEC 1000-4-3, 80 MHz...1000 MHz: 10 V/m test level, 80% AM at 1 kHz. Also 1.89 GHz PM at 100 Hz, 50% duty cycle	
	Fast transient	Compliant with IEC 1000-4-4, table 1, test level 3. Capacitive clamp preferred for use on communications ports.	
	Voltage surge	Compliant with IEC 1000-4-5, table 1, installation class 3.5 surges each line, line-line and line-earth. Use of capacitive test clamp preferred.	
<b>Resistance to voltage dips, interruptions and variations</b>		Compliant with IEC 1000-4-11. Voltage deviations applied to system AC mains input line	
<b>Input voltage</b>		Module draws power from the Quantum backplane for operation. No external power required.	
<b>Bus current required</b>		250 mA typical, with 400 mA maximum (voltage surge on power-up) from the Quantum rack.	

References						
Designation	Transceiver type	Topology	Speed	Safety	References	Weight kg
TP/XF-78		Linear topology, twisted pair, transformer isolated	78 Kbps	–	140 NOL 911 10	0.900
<b>User guide</b> (with NOL chargeable block, for 984LL programming)		English version	–	–	840 USE 109 00	0.900

# Modicon Quantum automation platform

## Quantum-Sy/Max integration

### Presentation

#### Integration solutions

Quantum-Sy/Max integration products are designed to help Sy/Max users gradually upgrade their installations to Quantum control systems at a comfortable and cost-effective pace. These products allow users to protect their investments in communication networks, application programs, I/O installations and training. They allow Sy/Max users to move gradually toward Quantum where they can take advantage of:

- Structured programming with Unity Pro and Concept's IEC 1131 languages
- Faster logic-solve times and larger CPU memory sizes
- More flexibility in terms of network choices, including Modbus, Modbus Plus, TCP/IP Ethernet, Quantum remote I/O (RIO)
- High availability offer: Hot Standby
- A wide variety of choices from our Collaborative Automation Partners

#### Upgrading strategies

##### Upgrading Sy/Max CPUs

Schneider Electric offers a conversion service for Sy/Max application programs to 984 ladder logic. The translations include comments and header files, as well as the application program. Please consult your Regional Sales Office to find out where this service is available.

##### Upgrading Sy/Max I/O networks

A remote I/O adaptor **8030 CRM 931** can be placed in slot 1 of a Sy/Max drop. This adaptor enables Class 8030 discrete and intelligent I/O in that drop to operate under the control of a Quantum CPU (over the RIO coaxial cable network). The **8030 CRM 931** adaptor can reside in any Class 8030 Type RRK- 100, -200 or -300 register rack or any Boolean rack Class 8030, Type HRK-100, -150 or -200.

Quantum head adaptor with CPU and RIO adaptor

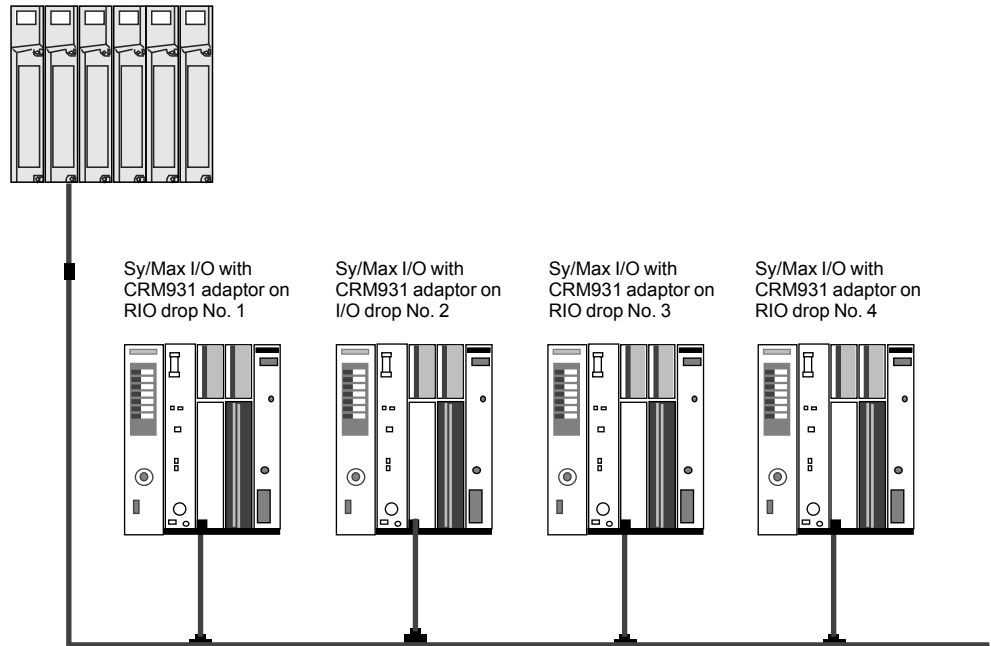

The original Sy/Max I/O wiring remains intact. Because the I/O is now on a Quantum RIO network, they can take advantage of its 1.544 Mbps data transfer rate with 16-bit CRC.

Each drop has 128 addressable registers (64 inputs and 64 outputs).

### Presentation (continued)

#### Upgrading strategies (continued)

#### Upgrading Sy/Max communication networks

The **NW BM85Y422** Modbus Plus-to-Sy/Max gateway provides a bridge for information exchange between Sy/Max or PowerLogic® systems and a Modbus Plus local area network. Modbus Plus gives the system connectivity to many HMI and motion control products, as well as small distributed PLCs. The **NW BM85Y422** gateway supports the following protocols:

- Sy/Max point-to-point
- Sy/Max net-to-net
- PowerLogic NIM

The gateway has one Modbus Plus port and four configurable (RS 422) ports for direct connection to Sy/Max devices. Each RS 422 port supports communications from 300 to 14.4 Kbps. DIP switch settings determine the gateway's mode of operation: configuration mode or protocol conversion mode. Configuration mode allows you to program communication parameters (speed and time-out values, for example) and store them in the gateway's Flash memory. The gateway parameters can be set in one of three ways using:

- An ASCII terminal or a PC with a terminal emulation program on serial port No. 1
- 984LL (MSTR) language instructions
- With Sy/Max TREAD or TWRTE instructions via serial ports No. 2, 3 or 4

An MEB Modbus Plus-to-Sy/Max NIM module is also available from our partner Niobrara R&D Corporation. This module fits in a Sy/Max RRK rack. It exchanges data between an existing Sy/Max network and a Modbus Plus network. Visit Niobrara's web site ([www.niobrara.com](http://www.niobrara.com)) for more information.

### Characteristics

Module type			8030 CRM 931	NW BM85Y422
Functional safety certification			–	–
Electrical	Consumption on Sy/Max power supply	<b>mA</b>	750 typical, 900 max.	–
	Undervoltage lockout circuit		Stops and resets the module and removes it from the RIO network when the DC supply falls below < 4.6 V	–
	Power supply		–	115/230 V ~ or 24 V =
Ambient temperature	Operation	<b>°C</b>	0...60	0...60
	Storage	<b>°C</b>	-25...80	-40...80
	Humidity	<b>%</b>	5...95% non condensing	0...95% non condensing
Compliance with standards			UL 508, CSA C22-2, FM Class 1 Division 2	UL ML file number 532F (industrial control equipment), CSA ML file number LR326 Cc

### References

Description	Type of connection	Safety	Reference	Weight kg
Adaptor module for Sy/Max drop on Quantum RIO network		–	<b>8030 CRM 931</b>	–
Modbus Plus-to-Sy/Max NIM gateway		–	<b>NW BM85Y422</b>	–
Modbus Plus-to-Sy/Max Niobrara NIM gateway module	Ethernet BNC, 2 RS 485 ports	–	<b>MEB TCP D (1)</b>	–
	Ethernet 10BASE-T – 2 RS 485 ports	–	<b>MEB TCP T (1)</b>	–

(1) To order this product, consult our partner Niobrara: [www.niobrara.com](http://www.niobrara.com)

*Networks and buses selection guide ..... 6/4*

**6.1 - Ethernet TCP/IP architecture, Transparent Ready**

- Ethernet TCP/IP network, Transparent Ready ..... 6/6
  - Architecture ..... 6/6
  - Logical Ethernet communication architecture ..... 6/6
- System approach ..... 6/8
  - Technical information ..... 6/8
  - Selecting the communication architecture ..... 6/8
  - Standard Web and FactoryCast services ..... 6/10
  - Selection of Schneider Electric brand Transparent Ready products ..... 6/11
- Transparent Ready, system approach ..... 6/12
  - Functions ..... 6/12
  - Modicon PLC standard Web services ..... 6/12
  - FactoryCast configurable Web server ..... 6/14
  - FactoryCast HMI active Web services ..... 6/16
- System approach ..... 6/22
  - Presentation ..... 6/22
  - Ethernet TCP/IP communication services ..... 6/22
  - Functions ..... 6/23
- System presentation ..... 6/32
  - Performance ..... 6/32
  - Ethernet TCP/IP network performance ..... 6/32
- Processors with integrated Ethernet port ..... 6/40
  - Product data sheet ..... 6/40
  - Ethernet network modules ..... 6/41
    - Product data sheet ..... 6/41
- Ethernet in machines and installations ..... 6/42
  - Infrastructure ..... 6/42
  - Presentation ..... 6/42
  - Topologies ..... 6/43
  - Characteristics ..... 6/45
  - Peripherals ..... 6/46
  - Redundancy ..... 6/47
- Ethernet Wiring system ..... 6/48
  - References ..... 6/50
  - ConneXium: Connection components ..... 6/50
  - Product data sheet ..... 6/52
  - ConneXium: Hub ..... 6/52
  - ConneXium: Transceiver ..... 6/53
  - ConneXium: Unmanaged switches ..... 6/54
  - ConneXium: Managed switches ..... 6/57

---

## 6.2 - Ethernet/IP network

■ Ethernet/IP network module.....	6/62
□ Presentation, description .....	6/62
□ Characteristics .....	6/62
□ References .....	6/63

## 6.3 - AS-Interface bus

■ Installation system .....	6/64
□ Presentation, description .....	6/64
- Master module for Modicon Quantum PLCs.....	6/64
□ Characteristics, references .....	6/65
■ Power supplies for control circuits for AS-Interface cabling system.....	9/34
□ Presentation .....	9/34
- Phaseo regulated switch mode power supplies for AS-Interface range .....	9/34
□ Characteristics .....	9/35
□ Output characteristics, function .....	9/36
□ Selection, references, dimensions, schemes .....	9/37

## 6.4 - Other buses and networks

■ Modbus Plus network.....	6/70
□ Presentation.....	6/70
□ Installation.....	6/71
□ Application services .....	6/72
□ Fibre optics .....	6/73
□ Connection.....	6/74
□ References .....	6/76
■ InterBus .....	6/78
□ Presentation, description .....	6/78
□ Software, characteristics, references.....	6/79
■ Profibus DP.....	6/80
□ Presentation, connectable devices .....	6/80
□ Description, characteristics .....	6/81

## 6.5 - Serial links

■ Asynchronous serial link module.....	6/82
□ Presentation, description .....	6/82
□ Characteristics, references .....	6/83









# Modicon Quantum automation platform

## Networks and buses

Type of network and bus	Ethernet TCP/IP Modbus TCP		EtherNet/IP	
Physical interface	10BASE-T/ 100BASE-TX (copper cable)	10BASE-T/100BASE-TX (copper cable) 100BASE-FX (fibre optic cable)	10BASE-T/ 100BASE-TX (copper cable)	
Access method		CSMA-CD	–	
Data rate	10/100 Mbps	10/100 Mbps (copper cable), 100 Mbps (fibre optic cable)	10/100 Mbps	
Medium	Shielded twisted pair cables	Shielded twisted pair cables Fibre optic cable	Twisted pair	
Functions, main services	<ul style="list-style-type: none"> <li>- Standard Web service</li> <li>- Modbus TCP messaging</li> <li>- I/O Scanning services</li> <li>- Global Data</li> <li>- FDR client</li> <li>- SNMP management</li> <li>- SMTP services (e-mail)</li> </ul>	<ul style="list-style-type: none"> <li>- Standard Web/ FactoryCast service depending on model</li> <li>- Modbus TCP messaging</li> <li>- I/O Scanning services</li> <li>- Global Data depending on model</li> <li>- FDR client</li> <li>- SNMP management</li> <li>- SMTP services (E-mail) depending on model</li> </ul>	<ul style="list-style-type: none"> <li>- FactoryCast HMI active Web service</li> <li>- Modbus TCP messaging</li> <li>- SNMP agent</li> </ul>	<ul style="list-style-type: none"> <li>- I/O messaging via CIP Implicit Communications</li> <li>- Message client through CIP Explicit Messaging</li> <li>- SNMP support (MIBII)</li> <li>- BootP/DHCP server</li> </ul>
Compatibility	CPU	Unity CPUs	All CPUs	Unity CPUs
	Software	Unity Pro	Unity Pro Concept ProWORX 32	Unity Pro V4.0
Power consumption	–	1000 mA	–	–
Functional safety certification	–			
Module type	140 CPU 651 50/60 140 CPU 652 60 1 integrated port	140 NOE 771 11 (1) 140 NOE 771 11 (1)	140 NWM 100 00	140 NOC 771 00
Pages or website	2/9	6/41	6/63	

(1) Only module 140 NOE 771 11 is "non-interfering"

Modbus Plus network	AS-Interface actuator/sensor bus	Modbus SL bus	Profibus DP V1 bus	INTERBUS BUS	Asynchronous serial links
					
Single or redundant copper cable Fibre optic cable	2-wire unshielded cable	Single copper cable	Single RS 485 cable	Single RS 485 cable (full-duplex)	2 non-isolated RS 232 channels
Token ring	Master/slave, M2 profile (AS-Interface V1)	Master/slave	Class 1 master	Generation 4 master	–
1 Mbps	167 kbps	19.2 kbps	9.6 kbps...12 Mbps depending on distance (1200...100 m without repeaters)	500 kbps	19.2 kbps
Twisted pair	Ribbon cable	Shielded twisted pair cable	Shielded twisted pair or fibre optic cable	Shielded twisted pair or fibre optic cable	Shielded cable
<ul style="list-style-type: none"> <li>- Reading/writing of variables</li> <li>- Global Data service</li> <li>- Peer Cop service</li> <li>- Distributed I/O (DIO) service</li> </ul>	<ul style="list-style-type: none"> <li>- Standard addressing with 31 slaves (4I/4O "discrete")</li> <li>- Local diagnostics (slave devices, channel status, etc.)</li> </ul>	<ul style="list-style-type: none"> <li>- Modbus slave protocol</li> <li>- Reading/writing of PLC variables</li> <li>- Programming</li> <li>- Download</li> <li>- 1 or 2 RS 232/485 ports depending on model</li> <li>- Modbus master protocol</li> <li>- Max. 247 slaves</li> </ul>	<ul style="list-style-type: none"> <li>- Cyclic exchanges (1536 discrete inputs/1536 discrete outputs)</li> <li>- Acyclic communication for parameter transmission (in parallel with cyclic exchanges)</li> <li>- Management of fallback modes</li> <li>- "Sync and Freeze" modes</li> <li>- Extended diagnostics</li> </ul>	<ul style="list-style-type: none"> <li>- Cyclic I/O exchanges (256 subscriber, 4096 I/O)</li> <li>- Configuration check</li> <li>- PCP V1.5 or V2.0 protocol depending on model</li> <li>- Remote bus technology</li> </ul>	<ul style="list-style-type: none"> <li>- Reading/writing of ASCII sequences, 7 or 8 bits, controlled by PLC application program</li> <li>- Application of message formats to character strings</li> <li>- Integrated command interpreter</li> </ul>
All CPUs				CPUs 140 CPU 113 03/ 434 12A/534 14B	All CPUs
Unity Pro Concept ProWORX 32			Unity Pro Concept V2.6 (min.) ProWORX 32 Configuration software: Prosoft Configuration Builder (PCB) (1)	Concept V2.5 (min.) Configuration software: SyCon	Unity Pro Concept V2.2 (min.) ProWORX 32
1300...3800 mA depending on 140 CPU model 780 mA for 140 NOM	250 mA	1300...3800 mA depending on 140 CPU model 780 mA for 140 NOM	1000 mA	800 mA	300 mA
–					
<b>140 CPU</b> 1 integrated port <b>140 NOM 2●● 00</b>	<b>140 EIA 921 00</b>	<b>140 CPU 1 or 2</b> integrated ports <b>140 NOM 2●● 00</b>	<b>PTQ PDP MV1</b> (1)	<b>140 NOA 622 00</b> (generation 4)	<b>140 ESI 062 10</b>
2/9, 2/19 and 6/76	6/65	2/9, 2/19 and 6/76	6/81	6/79	6/83

(1) Products by our partner Prosoft Technology (e-mail: [prosoft@prosoft-technology.com](mailto:prosoft@prosoft-technology.com)).

# Modicon Quantum automation platform

Ethernet TCP/IP network, Transparent Ready Logical Ethernet communication architecture

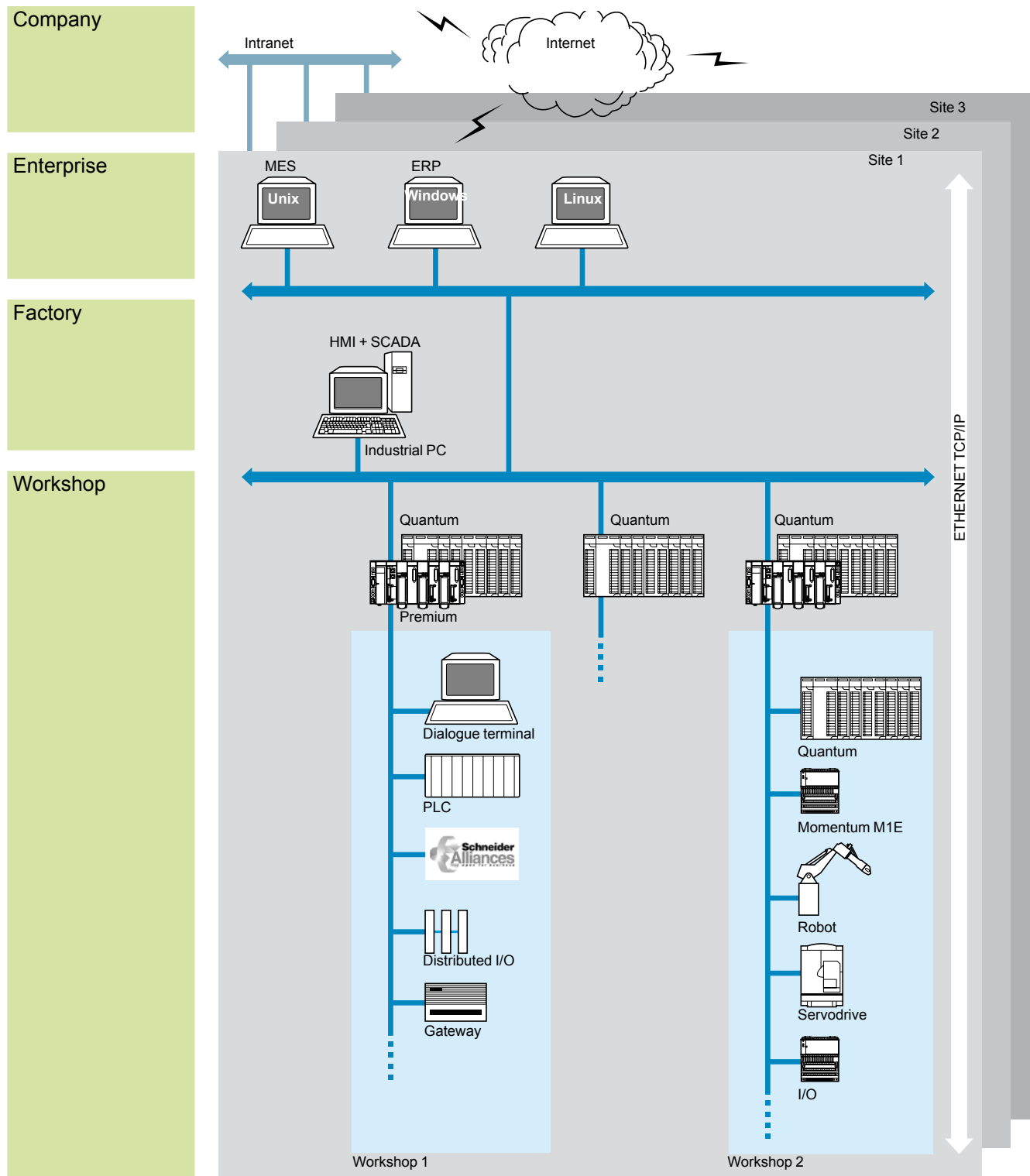

MES: Manufacturing Execution System (production management system)  
 ERP: Enterprise Resource Planning (integrated management software packages)  
 HMI/SCADA: Human/Machine Interface/Supervision Control And Data Acquisition  
 Gateway: Bridge to sensor/actuator bus, to installed base network, field bus, etc.

6

# Modicon Quantum automation platform

Ethernet TCP/IP network, Transparent Ready  
Physical Ethernet communication architecture

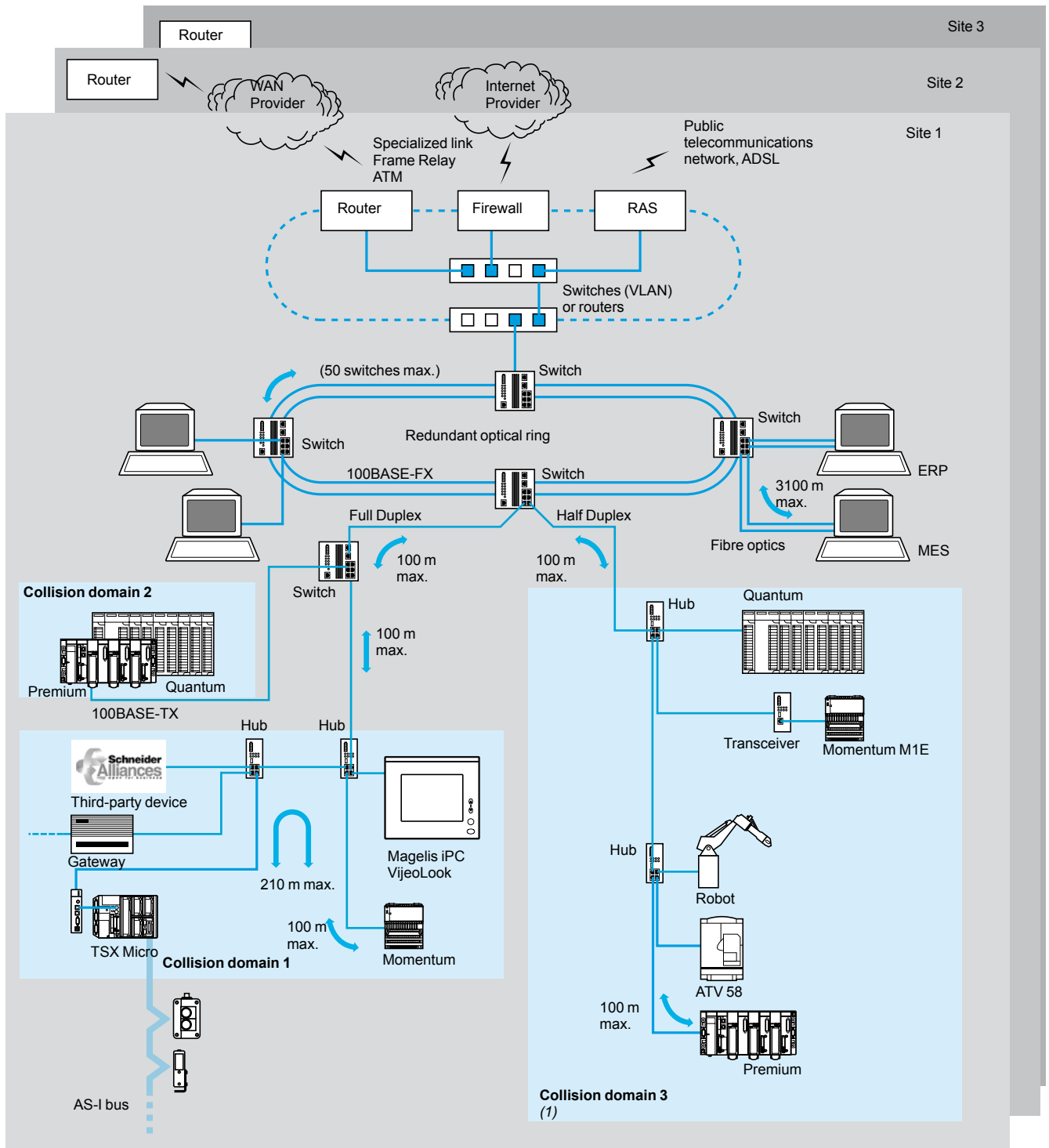

(1) In general, several collision domains should be defined in order to increase the architecture surface and improve performance. See pages 6/42 to 6/47.

#### Selecting the communication architecture

When selecting an architecture, take performance into account at the earliest possible stage. You must:

- 1 Have a clear idea of your needs with respect to:
  - quantity and type of devices to be interconnected
  - volume and type of exchanges
  - expected response times
  - environment
- 2 Compare your needs with the characteristics of the offers available and be aware that the actual performance level between any 2 points in an architecture depends on the weakest link in the chain, which can be:
  - a function of the hardware
  - a function of the applications (size, architecture, operating system, machine power, etc.) which are often poorly defined at this stage of the project.
- 3 Work out from these which is the most suitable architecture.

The purpose of the next few pages is to provide the main information and guidelines to help you answer the second point. Given that the performance of an Ethernet architecture is linked to many parameters, these pages do not provide all the information needed to calculate the network performance. Their aim is to focus on the guidelines for evaluating the network load so as to design an Ethernet network that meets the demands of the applications. Calculating the load involves many parameters, so only the main guidelines will be presented here.

#### Evaluating the network load

When evaluating the load on an Ethernet network, all the communication services of all the peripheral devices connected to the network need to be calculated. Because of the outstanding performance of the Ethernet network, the load is often less than the Ethernet network limits and does not significantly affect the application response time. This is due to the high speed of the Ethernet network: the network transaction time is less than 10% of the total application response time. In order to ensure a low network load and avoid large theoretical calculations, we strongly recommend that you separate the collision domain so as to limit the network load, using only switched network (a tree, star or daisy-chain topology).

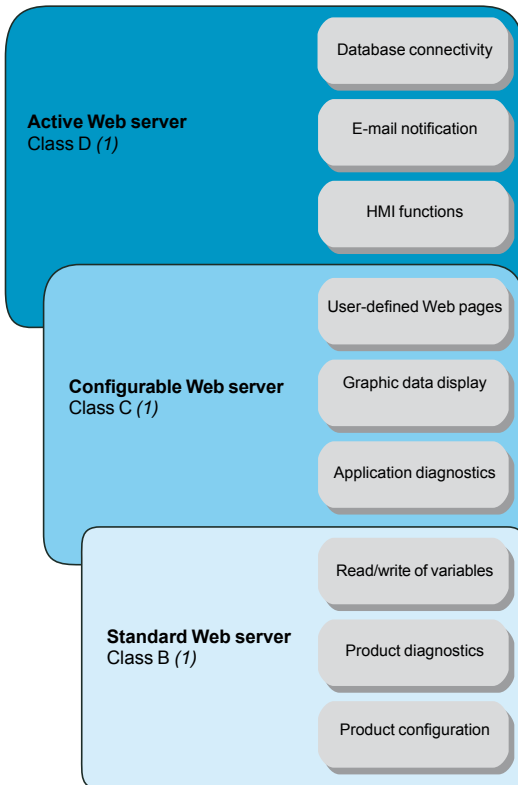

#### FactoryCast offer

Schneider Electric offers a wide range of Transparent Ready products: controllers and PLCs, industrial PCs, HMI devices (2), variable speed drives, distributed I/O modules, gateways, Web servers, switches, SCADA software, inductive identification systems, etc.

These products provide different levels of Web services and communication services on Ethernet TCP/IP, according to user requirements.

Among these Transparent Ready products, FactoryCast defines a range of modules and gateways with configurable Web server combining:

- Real-time communication functions based on Ethernet TCP/IP
- Predefined Web pages for advanced installation diagnostics
- And the capacity to host dynamic user-defined Web pages or any document (.doc, pdf, etc.) designed to assist maintenance

#### Presentation of Ethernet TCP/IP and Web modules and gateways

In the Transparent Ready approach, Ethernet network modules or Web gateways integrate Ethernet TCP/IP services (Modbus TCP/IP messaging, SNMP network management functions, etc.). They also offer, depending on the product, the following Web functions:

- Standard Web services (predefined)
- FactoryCast configurable Web services
- FactoryCast HMI active Web services

There are two ranges of configurable Web server:

- **FactoryCast Web modules embedded** in Modicon M340, TSX Micro, Premium, Quantum and Momentum automation platforms. These modules provide transparent access to system and application diagnostic information in real time using Web technologies.
- **FactoryCast Gateways** that integrate all the network interfaces, a Router RAS function and a customizable Web server in a standalone unit. The FactoryCast Gateway is a cost-effective response to the need to integrate serial installations (Modbus RTU or Uni-Telway) in an existing Ethernet TCP/IP infrastructure, as well as requirements for remote access for customized services including remote diagnostics, remote maintenance, remote monitoring and remote control using a simple Web browser.

#### Presentation of the Web services

##### Standard Web services

Standard Web services are integrated in the following Schneider Electric Ethernet products: automation platform processors and Ethernet modules, distributed I/O modules, variable speed drives and Ethernet gateways. See page 6/11.

Using a simple Internet browser, the standard Web server provides the following "ready-to-use" functions:

- Product configuration
- Remote diagnostics and maintenance of products
- Display and adjustment of products (reading/writing variables, status)

The embedded Web server is a real-time data server. All the data can be presented in the form of standard Web pages in HTML format and can therefore be accessed using any Web browser that supports the embedded Java code. The standard functions provided by the Web server are supplied "ready-to-use" and therefore do not require any programming of either the PLC or the client PC device supporting a Web browser.

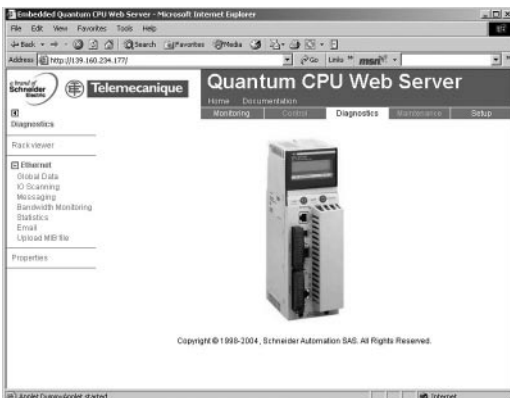

(1) In order to simplify their selection and ensure their interoperability within a system, each Transparent Ready product is identified by the class of services it provides. Letter A, B, C or D (level of service for the Web server) followed by 10, 20 or 30 (level of service for Ethernet communication).

HMI = Human Machine Interface



## Presentation of the Web services (continued)

### FactoryCast configurable Web services

The configurable Web services are integrated in the following Schneider Electric Ethernet products: FactoryCast modules for Modicon M340, TSX Micro, Premium and Quantum PLCs and FactoryCast Gateway modules.

In addition to the standard Web services, the configurable Web servers offer the following functions:

- Graphic application diagnostics (customized graphic views created by the user)
- Graphic supervision via animated Web pages created by the user and stored in the Web server module.

And depending on the products:

- Management of PLC system and application alarms with partial or total acknowledgement (ready-to-use Alarm Viewer function pages).
- SOAP/XML server interface (1)

FactoryCast Web servers can also be used to customize the supervision, diagnostics or maintenance interface via Web pages defined by the user or any other document (doc, pdf, etc.) transferred to the module.



### FactoryCast HMI active Web services

The active Web services are integrated in the FactoryCast HMI modules of Premium and Quantum PLCs.

In addition to the FactoryCast Web services, the FactoryCast HMI modules provide HMI functions, which are executed in the module itself:

- Real-time HMI database management, independent of the PLC processor
- Arithmetic and logical calculations on HMI data
- Direct connectivity with relational databases (traceability)
- Recipe management (read/write)
- Alarm and report notification by e-mail
- Active page server, dynamic generation of animated HTML pages
- SOAP/XML client/server interface (1)

FactoryCast HMI is defined as an active Web server used to execute HMI functions without any effect on the PLC application program and therefore on its scan time.

(1) Standard protocol providing interoperability with computer management applications (see page 6/11).

Selection of Schneider Electric brand Transparent Ready products				
Product	Reference	Embedded Web server		
		Standard, class B10/B20	Configurable, class C20/C30	Active, class D10
Modicon Quantum platform	Processors	140 CPU 651 50/60	–	–
	Modules	140 NOE 771 01	–	–
		140 NOE 771 11	FactoryCast	
		140 NWM 100 00	FactoryCast HMI	
Modicon Premium platform	Processors	TSX P57 2623 M	–	–
		TSX P57 2823 M	–	–
		TSX P57 3623 AM	–	–
		TSX P57 4823 AM	–	–
		TSX P57 1634 M	–	–
		TSX P57 2634 M	–	–
		TSX P57 3634 M	–	–
		TSX P57 4634 M	–	–
		TSX P57 5634 M	–	–
	Modules	TSX ETY 4103	–	–
		TSX ETY 110WS	FactoryCast	
		TSX ETY 5103	FactoryCast	
		TSX WMY 100	FactoryCast HMI	
Modicon M340 platform	Processors	BMX P34 2020	–	–
		BMX P34 2030	–	–
	Modules	BMX NOE 0100	With BMX RWS C016M memory card	–
Modicon TSX Micro platform	Modules	TSX ETZ 410	–	–
		TSX ETZ 510	FactoryCast	
Modicon Momentum platform	M1E processors	171 CCC 960 20/30	–	–
		171 CCC 980 20/30	–	–
	Modules	171 ENT 110 01/02	–	–
Advantys STB distributed I/O	Network interface	STB NIP 2212	–	–
Altivar ATV 71/61 variable speed drives	Communication card	VW3 A3 310	–	–
Inductel identification station		XGK S1715503	–	–
FactoryCast Web Gateway		TSX ETG 1000/1010	FactoryCast	
Remote management modules (RTU) for the water sector	W@de	TSX HEW 315●●C	–	–
		TSX HEW 320●●●●C	–	–
		TSX HEW 330●●	–	–



# Modicon Quantum automation platform

Transparent Ready, system approach  
Modicon PLC standard Web services

## Modicon PLC standard Web services

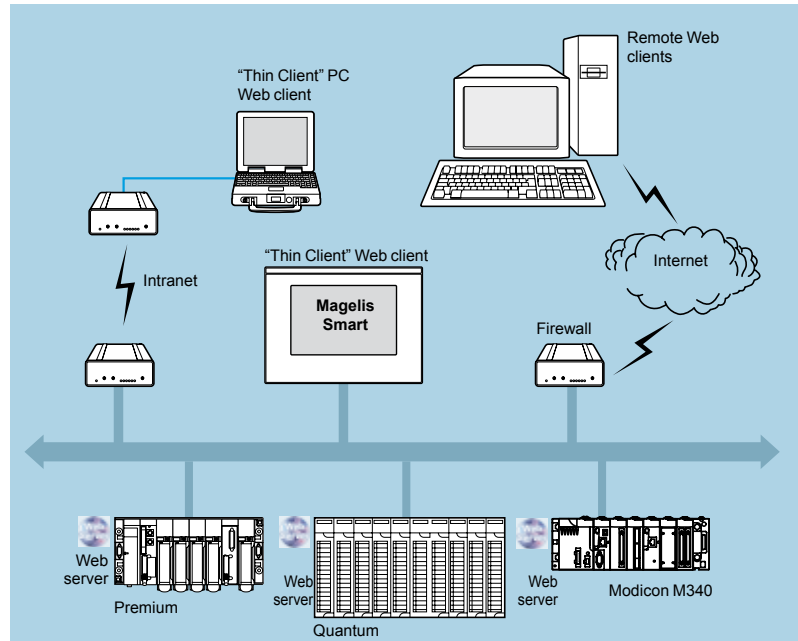

The predefined "Rack Viewer" PLC diagnostic function and the "Data editor" read/write function are supported by all Ethernet TCP/IP modules (1) in the following Modicon automation platforms:

- Modicon M340 platform
- TSX Micro platform
- Premium platform
- Quantum platform
- Momentum platform

See the selection of Schneider Electric products on page 6/11.

These functions can be accessed using a standard Internet browser connected to the network. They are "ready to use" and secure (password-protected).

They can be used locally or remotely via:

- Intranet
- A modem and RAS server
- Internet

(1) For standard Web servers integrated in variable speed drives, please consult our catalogue "Soft starters and variable speed drives".

# Modicon Quantum automation platform

Transparent Ready, system approach  
Modicon PLC standard Web services

## Modicon PLC standard Web services (continued)

### “Rack Viewer” PLC diagnostics function

The “Rack Viewer” function (PLC rack display) can be used for PLC system and I/O diagnostics. It displays the following in real time:

- Status of LEDs on the PLC front panel
- PLC type and version
- Hardware configuration of the PLC including the status of the system bits and words
- Detailed diagnostics of each I/O module channel or application-specific channel in the configuration

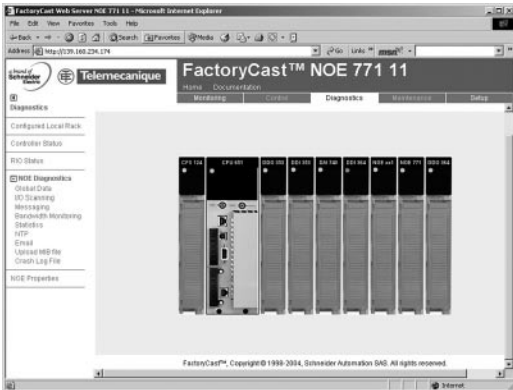

Quantum hardware configuration

### “Data Editor” read/write function for PLC data and variables

The “Data Editor” function can be used to create tables of animated variables for real-time read/write access to lists of PLC data.

Various animation tables, containing specific application variables to be monitored or modified, can be created by the user and saved in the standard Web server module.

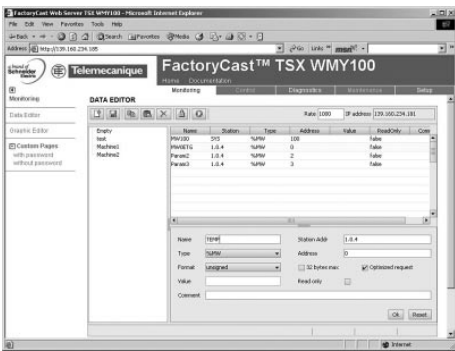

Data editor variables table

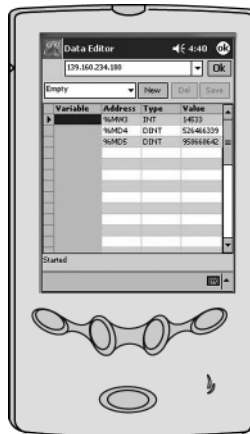

In addition to the functions provided by standard Web servers, FactoryCast Web servers offer the following:

- Variables to be displayed can be entered and displayed using their symbol (S\_Pompe 234) or their address (%MW99).
- The write access option for variables can be enabled or disabled for each of the variables using the FactoryCast configuration software.
- The read/write function can be used on tools such as “pocket” PC or PDA terminal.

# Modicon Quantum automation platform

Transparent Ready, system approach  
Modicon PLC standard Web services



## FactoryCast configurable Web server

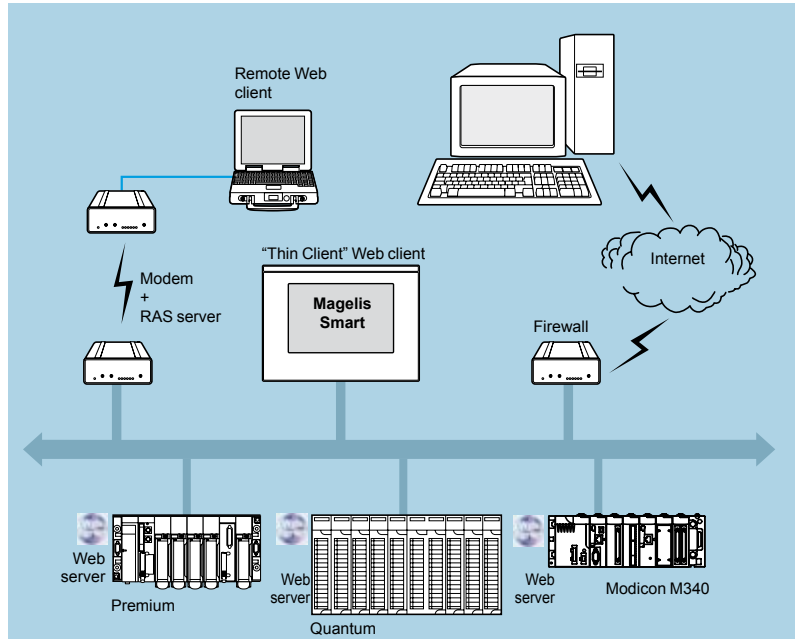

In addition to standard Web services, FactoryCast modules support the following functions:

- Alarm Viewer
- Creation and display of graphic views via an online graphics editor (Graphic Data Editor, supplied)
- Hosting and display of Web pages created by the user
- SOAP/XML server interface

6

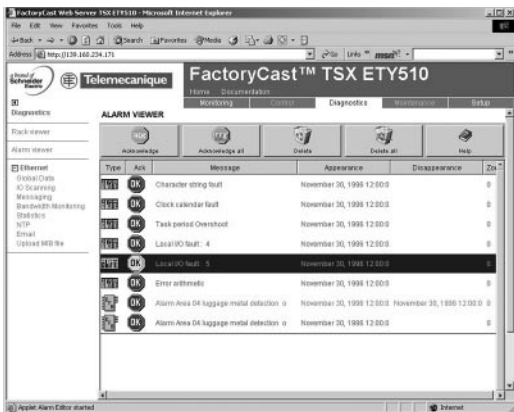

### Alarm Viewer function

The alarm viewer is a "ready to use", password-protected function. This function can be used to process alarms (display, acknowledgment and deletion) managed at PLC level by the system or using diagnostic function blocks known as DFBs (system-specific diagnostic function blocks and application-specific diagnostic function blocks created by the user).

These alarms are stored in the PLC diagnostics buffer (specific memory area used to store all diagnostic events). This function is available with the Premium/Atrium platforms (with PL7 or Unity software) and the Quantum platform (with Unity software).

The diagnostics viewer consists of a Web page displaying a list of messages with the following information for each alarm:

- Dates and times of the appearance/disappearance of the fault
- Alarm message
- Alarm status
- Type of associated diagnostic function block (DFB)

# Modicon Quantum automation platform

Transparent Ready, system approach  
Modicon PLC standard Web services

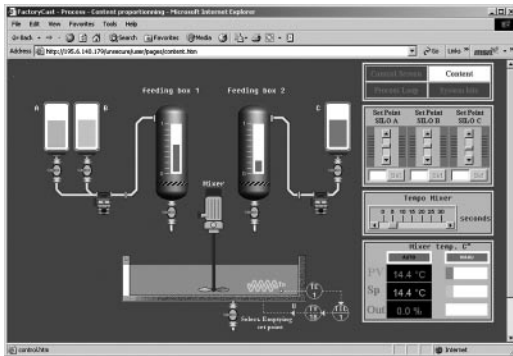

## FactoryCast configurable Web server (continued)

### User Web page hosting and display function

FactoryCast Web modules have an 8 Mbyte memory (1) which is accessed in the same way as a hard drive and can be used to host Web pages and all user-defined documents in Word or Acrobat Reader (for example, maintenance manuals, diagrams, etc.).

These Web pages can be created using any standard tool for creation and editing in HTML format. These pages can be enhanced by inserting animated graphic objects linked to PLC variables. These animated objects are created using the Graphic Data Editor supplied with FactoryCast.

The Web pages created in this way can be used, for example, to:

- Display and modify all PLC variables in real time
- Create hyperlinks to other external Web servers (documentation, suppliers, etc.)

This function is particularly suitable for creating graphic interfaces used for the following purposes:

- Real-time display and supervision
- Production monitoring
- Diagnostics and help with maintenance
- Operator guides

### SOAP/XML server interface

FactoryCast modules incorporate a standard SOAP/XML data server that provides direct interoperability between automation devices and computer management applications (MES, ERP, SAP, Net application, etc).

### Graphic Data Editor function

This function can be used to create graphic views animated by PLC variables. The graphic editor is available online “ready to use”, and also offline using FactoryCast configuration software.

These views are created from a library of predefined graphic objects by simple copy/paste operations. The object parameters are set according to user requirements (colours, PLC variables, labels, etc.).

List of graphic objects provided:

- Analog and digital indicators
- Horizontal and vertical bar charts
- Boxes for displaying messages and entering values
- Pushbutton boxes
- Functions for recording trends
- Tanks, valves, motors, etc.

Customized graphic objects can be added to this list. They can be reused in user Web pages that have been created using standard software for editing HTML pages.

The views created can be saved in the FactoryCast modules.

(1) Memory is not affected by power outages or reinitialization of the PLC

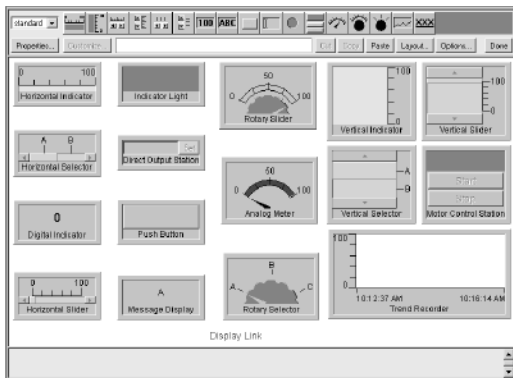

# Modicon Quantum automation platform

Transparent Ready, system approach  
FactoryCast HMI active Web services



## FactoryCast HMI active Web servers

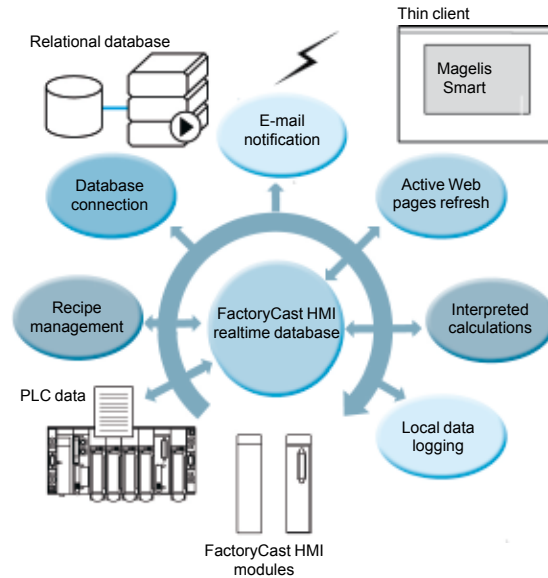

FactoryCast HMI Web services are integrated in the Web server modules embedded in the Modicon Premium and Quantum automation platforms.

These modules have the following Ethernet and Web services:

- Ethernet TCP/IP communication functions:
  - TCP/IP messaging service with Modbus TCP/IP and Uni-TE TCP/IP protocols
  - SNMP agent for standardized network management, which supports standard MIB II and Transparent Ready private MIB.
- FactoryCast configurable Web services:
  - "Rack Viewer" PLC diagnostics functions (see page 6/13)
  - "Data Editor" read/write functions for PLC variables (see page 6/13)
  - "Alarm Viewer" alarm display functions (see page 6/14)
  - "Graphic Data Editor" online graphical view editor functions (see page 6/14)
  - Function for hosting and displaying user Web pages (see page 6/15)

FactoryCast HMI modules also provide the following specialized HMI Web services:

- Real-time HMI database management, independent of the PLC processor
- Arithmetic and logical calculations on HMI data
- Direct connectivity with relational databases (traceability)
- Data Logging: recording of data in the module
- Display of Unity Pro graphic runtime screens in the form of Web pages
- Recipe management (read/write)
- E-mail notification for alarms and reports
- Active page server, dynamic generation of animated HTML pages
- Dynamic generation of HTML reports
- Open data server interface. SOAP/XML WSDL interface protocol (1).

(1) In order to simplify their selection and ensure their interoperability within a system, each Transparent Ready product is identified by the class of services it provides. Letter A, B, C or D (level of service for the Web server) followed by 10, 20 or 30 (level of service for Ethernet communication).

# Modicon Quantum automation platform

Transparent Ready, system approach  
FactoryCast HMI active Web services

## Architectures

FactoryCast HMI Web servers can be integrated in various architectures:

- Installations that require a flexible distributed HMI solution
- Combined architectures supplementing conventional SCADA systems
- Architectures where a direct link is required between automation systems and information management levels (IT link)

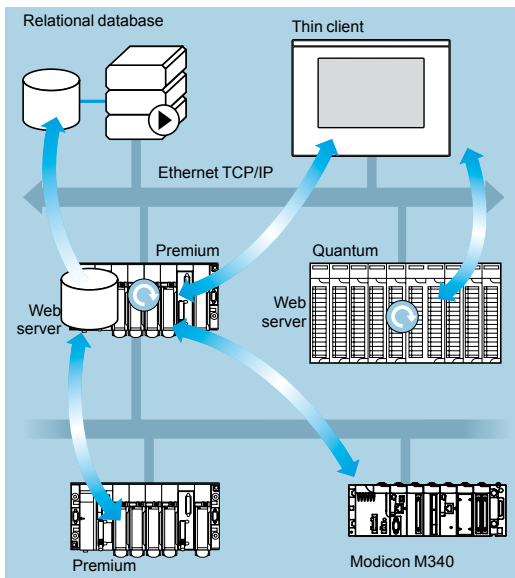

### Flexible distributed HMI solution

The use of Web-based technologies means that FactoryCast HMI can replace conventional HMI or SCADA solutions in applications where architectures require a flexible multistation HMI, thus providing a temporary "nomadic" remote control function.

These architectures consist of:

- Several PLCs networked on Ethernet, equipped with FactoryCast HMI Web server modules
- One or more PC terminals simply equipped with a Web browser thus providing a "Thin Client" interface (licence free)
- If necessary, a relational database in which FactoryCast HMI can archive data from the automation system

FactoryCast HMI modules read PLC data and execute HMI services (e-mail, interpreted calculations, connection to relational databases, updating Web pages) at source in the PLC, without affecting the PLC program or the scan time.

This solution provides:

- A reliable HMI application, which is executed at source in a robust PLC device
- An integrated multistation interface and remote access that is easy and cost-effective to set up ("Thin Client" terminal, for example Magelis Smart)
- An HMI application that is easy to maintain (the application is housed in a single location on the server side)
- Preventive maintenance via e-mail
- Greater availability for archiving data in the PLC

# Modicon Quantum automation platform

Transparent Ready, system approach  
FactoryCast HMI active Web services

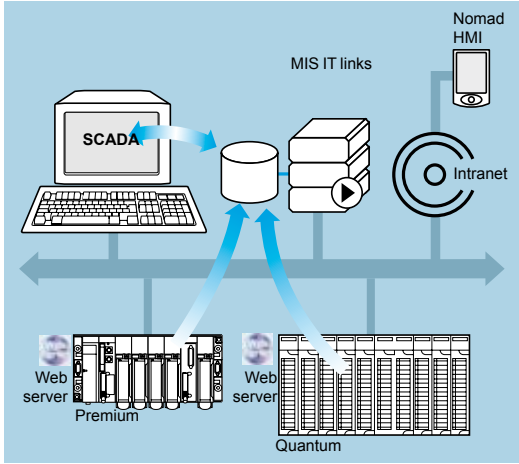

## Architectures (continued)

### Combined architectures

In this type of architecture, FactoryCast HMI supplements conventional SCADA systems, such as Vijeo Look or Monitor Pro, meeting the requirement for centralizing information for global supervision from a central site.

Combining a FactoryCast HMI solution and a conventional SCADA solution enables:

- Simplification of the SCADA application by locating some of the SCADA processing functions at source, at PLC level
- Increased availability of the traceability function due to the direct connection between FactoryCast HMI modules and relational databases
- Powerful “ready to use” remote diagnostics capacities
- “Nomadic” client stations to be connected to the Intranet or Internet via “Thin Client” PC or PDA devices

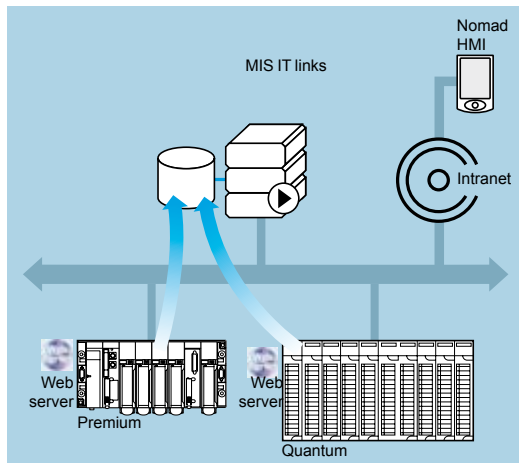

### Direct links with the information management levels

In this type of architecture, FactoryCast HMI eliminates the need for intermediate devices (software or hardware gateways), which are expensive to install and maintain, by establishing direct links between the automation levels and the global information management levels (MES, ERP, etc.).

The PLC manages the following links which allow a “collaborative” automation system to be set up, making it easier to share data in real time:

- Directly archives information from the automation system in relational databases
- Directly interacts with IT applications via the SOAP/XML client/server interface

This solution results in:

- Simplified architectures
- Lower installation, development and maintenance costs
- Increased reliability of information (the data is collected at source)
- Increased interoperability with IT applications
- Greater availability of data archiving

6



# Modicon Quantum automation platform

Transparent Ready, system approach  
FactoryCast HMI active Web services

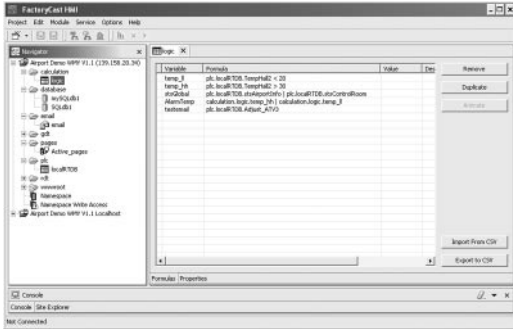

## Specialized HMI services

### Real-time database

With an internal architecture similar to that of an HMI/SCADA system, FactoryCast HMI modules manage their own variables database in realtime, independently of the PLC program. It is these variables databases that are used to execute various functions, including internal processing, archiving, alarms and e-mail, etc.

Variables in this realtime database are updated using the PLC's data acquisition service.

This service becomes operational once the following parameters have been set in the FactoryCast HMI software:

- Direct import of PLC variable/symbol databases (no double entry)
- Definition of the acquisition frequency (period at which this variable is updated)

**Note:** A FactoryCast HMI application running in a Premium configured FactoryCast HMI module can access all the PLC variables in the architecture transparently on the network (X-Way/Uni-TE transparent protocols).

### Characteristics

- Maximum number of I/O variables per application: 1000 variables from PLCs
- Maximum number of internal variables per application: 100.
- Acquisition frequency: 500 ms minimum

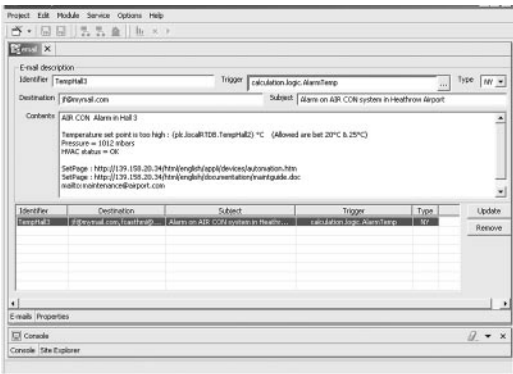

### Calculation functions

The FactoryCast HMI server can carry out various arithmetic or logical operations on a combination of variables from the HMI database. These calculations include, for example, scaling, formatting, logic processing for event triggering, etc.

This calculation function is operational from the local HMI database, independently of the PLC processor, and is in the form of spreadsheets where the formulae are defined in cells.

These spreadsheets are interpreted and processed by the server. The result of each formula is associated with a new internal variable. The processing of each spreadsheet is initiated by a trigger.

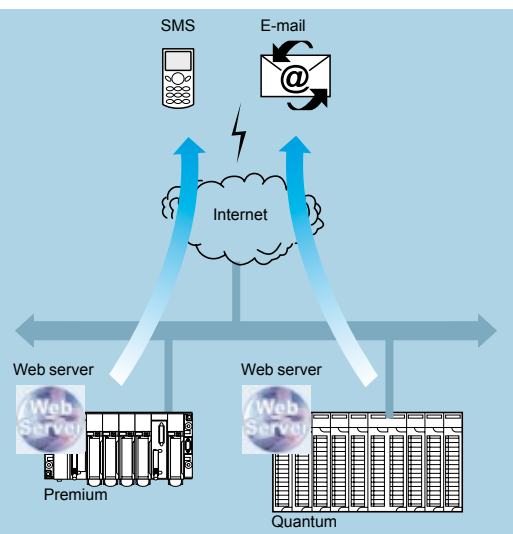

E-mail transmission

### E-mail transmission

The FactoryCast HMI module can, on a specific event, send e-mails completely autonomously to a predefined list of e-mail addresses. This function is executed independently of the PLC program.

The event that triggers the e-mail may be associated with the following:

- A PLC variable (I/O, internal variable)
- An alarm, a threshold overshoot
- A machine or process state
- An operator action, etc.

When an e-mail is sent it passes via an SMTP (Simple Mail Transfer Protocol) server. This server receives the e-mail and waits for the recipient to acknowledge it. The e-mail service is compatible with all SMTP servers. A return address can be defined should delivery to the destination address fail.

### Characteristics

- Configuration of the SMTP server: compatible with all SMTP servers
- Maximum number of e-mails: 100.
- Contents of e-mail messages: free text with embedded dynamic variable values (from the PLC) and hyperlinks (unlimited)



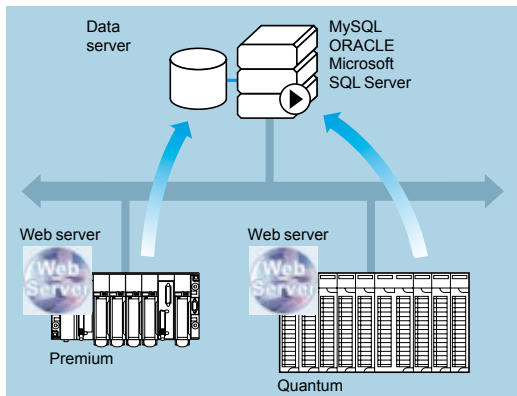

Connection to databases

### Specialized HMI services (continued)

#### Connection to relational databases

The FactoryCast HMI module can be connected directly and completely autonomously to the following remote relational databases:

- SQL Server
- MySQL
- Oracle

This connection enables all process or internal data to be archived directly in the FactoryCast HMI module without any intermediate system (hardware or software).

The data can be archived (written) periodically and/or on a specific event. These variables can be either from PLCs (I/O bits, internal bits, internal words and registers) or local to the module.

The FactoryCast HMI "Roll Over" function controls the size of tables by managing the maximum number of records. This circular data archiving function automatically deletes the oldest data and can be accessed by simply setting parameters in the FactoryCast HMI software.

#### Characteristics

- Number of databases that can be connected: 3.
- Number of tables that can be written per database: 10 maximum
- Number of columns per table: 50 maximum
- Type of database supported: Oracle, SQL Server and MySQL
- Automatic table creation: the FactoryCast HMI server creates a table in the database if one does not already exist

#### Data Logging

FactoryCast HMI modules can record data in the internal flash memory periodically or on an event.

This recording is done in a CSV file, which can be:

- Automatically exported via FTP
- Attached to an e-mail

This function is particularly useful for standalone installations, or stations that are not connected to an Intranet, or for local traceability of data.

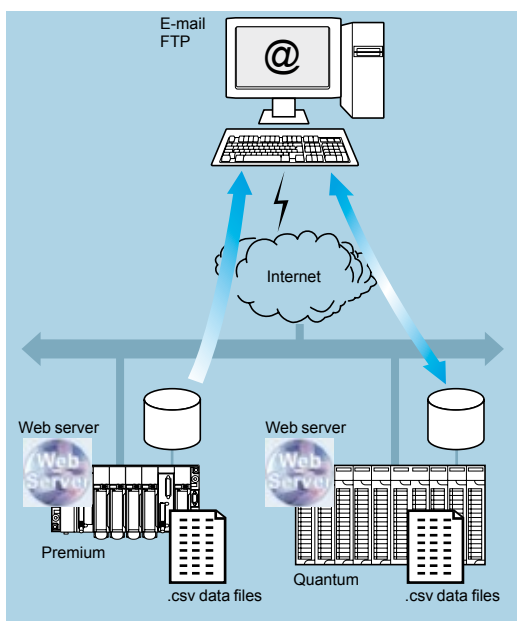

Data Logging

# Modicon Quantum automation platform

Transparent Ready, system approach  
FactoryCast HMI active Web services

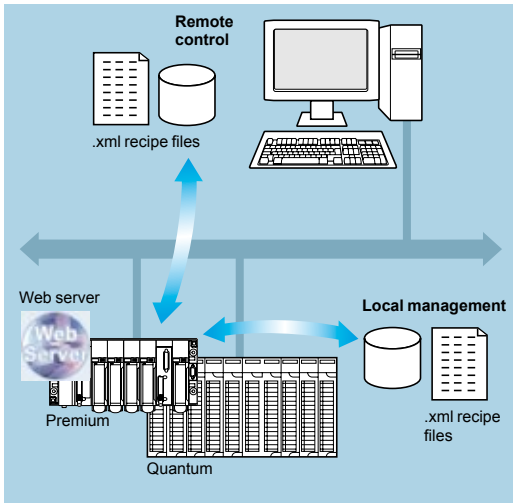

Recipe management

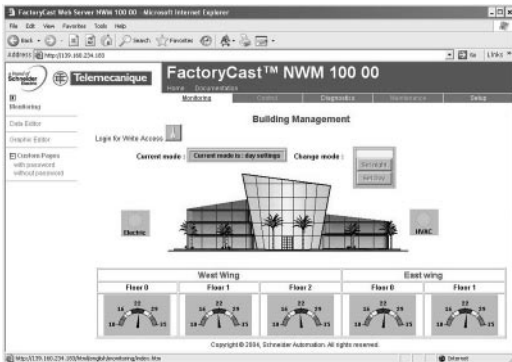

## Specialized HMI services (continued)

### Recipe management

The recipe management function enables a FactoryCast HMI application to take recipe files into account automatically on process events or at the request of an operator, applying the recipe values to the PLC data memory.

This function provides very flexible data management in the execution of production or process changes by sending new setpoints and new parameters.

### Characteristics

- Recipes are described using XML format (SOAP/XML format)
- Recipes are stored in the module or remotely
- Recipes contain setpoint values in accordance with "standard" recipes, and these values are transferred to the PLC memory

### Web based HMI interface

The memory of the FactoryCast HMI Web server receives Web pages defined by the user to provide a graphic HMI interface. The Active Web Server provides dynamic refreshing of the Web pages generated by the server itself.

FactoryCast HMI supports two types of Web page:

- HTML pages animated in real time with Java graphic objects used to create the user interface (FactoryCast HMI comes with a complete library of Java graphic objects).
- Active Web pages dynamically generated in the Web server with integration of PLC variables inside the HTML code (PLC "tags") which can be used to generate reports. These active pages consisting of HTML code are fully compatible with all "Thin Client" terminals (pocket PC, PDA, or PC terminal).

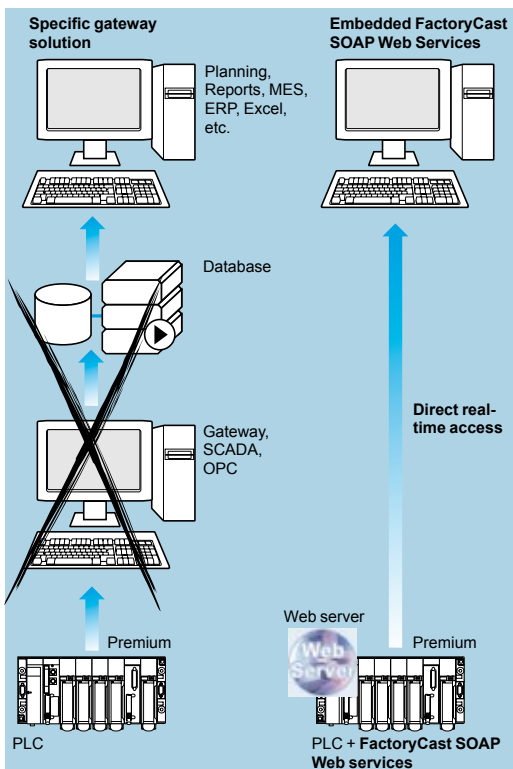

SOAP/XML client/server interface

### SOAP/XML client/server interface

For total interoperability, FactoryCast HMI implements SOAP/XML Web services such as server functions capable of answering SOAP requests generated by any client application (MES, ERP, SAP, SCADA or third-party applications developed in .NET or Java).

# Modicon Quantum automation platform

## System approach

### Ethernet TCP/IP communication services

#### Presentation

Transparent Ready products allow transparent communication on a single Ethernet TCP/IP network.

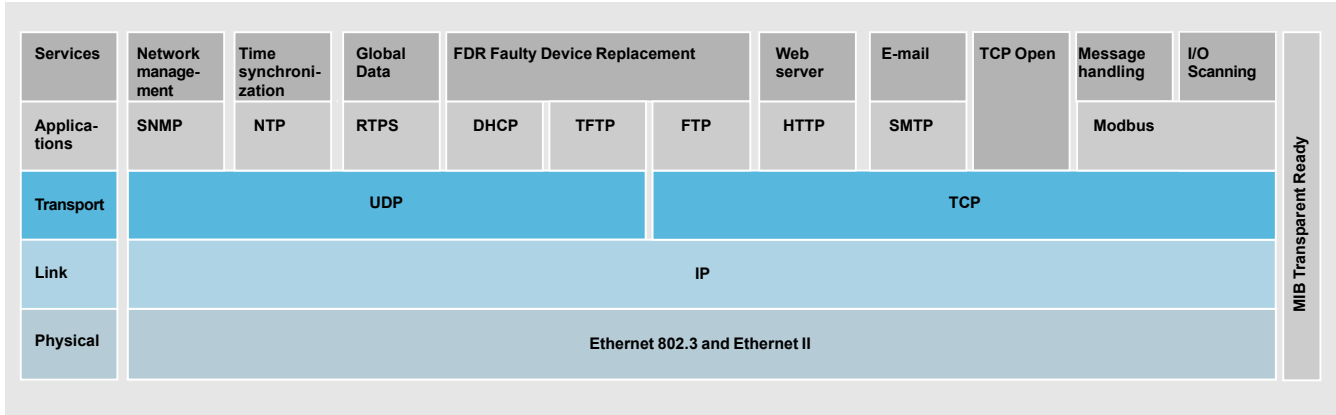

In addition to universal Ethernet services (HTTP, BOOTP/DHCP, FTP, etc.), the Transparent Ready device communication services designed for use in automation applications include:

- Modbus TCP/IP messaging for class 10, 20 or 30 devices
- I/O Scanning service for class 30 devices
- FDR (Faulty Device Replacement) for class 10, 20 or 30 devices
- SNMP (*Simple Network Management Protocol*) network administration for class 20 or 30 devices
- Global Data, for class 30 devices
- Module Bandwidth Monitoring for class 30 devices (see performance levels on pages 6/32 to 6/35)
- NTP (Network Time Protocol) time synchronization for class 30 devices
- E-mail alarm notification via SMTP server for class 30 devices
- TCP Open, optional, for class 30 devices

The following pages present the various options available through all of these services in order to facilitate the optimum choice of solutions when defining a system integrating Transparent Ready devices.

#### Functions

##### Ethernet universal services

##### HTTP "HyperText Transfer Protocol" (RFC1945)

The HTTP protocol (*HyperText Transfer Protocol*) is a protocol used for transmitting Web pages between a server and a browser. HTTP has been used on the Web since 1990.

Web servers embedded in Transparent Ready automation devices provide easy access to devices located anywhere in the world from a standard Internet browser such as Internet Explorer or Netscape Navigator.

##### BOOTP/DHCP (RFC1531)

BOOTP/DHCP is used to provide devices with IP parameters automatically. This avoids having to manage each device address individually by transferring this management to a dedicated IP address server.

The DHCP protocol (Dynamic Host Configuration Protocol) is used to assign configuration parameters to devices automatically. DHCP is an extension of BOOTP. The DHCP protocol consists of 2 components:

- One to provide the IP network address.
- One to provide the IP parameters specific to the device from a DHCP server.

Schneider Electric devices can be:

- BOOTP clients used to retrieve the IP address automatically from a server.
- BOOTP servers allowing the device to distribute IP addresses to the network stations.

Schneider Electric uses standard BOOTP/DHCP protocols for its FDR (Faulty Device Replacement) service.

##### FTP "File Transfer Protocol" (RFCs 959, 2228 and 2640)

File Transfer Protocol (FTP) provides the basic elements for file sharing. Many systems use the FTP protocol to exchange files between devices.

##### TFTP "Trivial File Transfer Protocol" (firmware updates)

Trivial File Transfer Protocol (TFTP) is a network transfer protocol used to connect to a device and download code to it.

For example, it can be used to transfer boot code to a workstation without a disk drive or to connect and download updates of network device firmware.

**Note:** *Transparent Ready devices implement FTP and TFTP for transferring certain information to or from devices, in particular for downloads of firmware or user-defined Web pages.*

## Functions (continued)

### Ethernet universal services (continued)

#### NTP "Network Time Protocol" (RFC 1305)

NTP (Network Time Protocol) is used to synchronize the time of a client or server device from a time server. Depending on the network used, it provides the following time precisions based on the UTC:

- A few milliseconds on a local area network (LAN)
- A few tens of milliseconds on a wide area network (WAN)

#### SMTP "Simple Mail Transfer Protocol" (RFC 0821)

SMTP (Simple Mail Transfer Protocol) provides an e-mail transmission service. It is used to send e-mail between a sender and a recipient via an SMTP e-mail server.

#### SNMP "Simple Network Management Protocol" (RFCs 1155, 1156 and 1157)

The Internet community developed the SNMP standard for managing the different components of a network via a single system. The network management system can exchange data with SNMP agent devices. This function allows the manager to view the status of the network and devices, modify their configuration and feed back alarms in the event of a fault.

*Note: Transparent Ready devices are SNMP-compatible and can be integrated naturally in a network managed via SNMP.*

#### COM/DCOM "Distributed Component Object Model"

COM/DCOM (Distributed Component Object Model) or OLE (Object Linking and Embedding) is the name of the technology consisting of Windows objects which enables transparent communication between Windows applications.

*Note: These technologies are used in the OFS (OLE for Process Control Factory Server) data server software.*

Modbus TCP/IP function codes		dec	hex
Bit access	Read n input bits	02	02
	Read n output bits	01	01
	Read exception status	07	07
	Write 1 output bit	05	05
	Write n output bits	15	0F
	Read 1 input word	04	04
	Read n input words	03	03
	Write 1 output word	06	06
	Write n output words	16	10
	Read device ID	43/14	2B/0E

Examples of Modbus TCP/IP function codes for accessing data and diagnostics.

### Functions (continued)

#### Modbus standard communication protocol

Modbus, the industry communication standard since 1979, has been combined with Ethernet TCP/IP, the medium for the Internet revolution, to form Modbus TCP/IP, a completely open Ethernet protocol. The development of a connection to Modbus TCP/IP does not require any proprietary component, nor purchase of a license. This protocol can easily be combined with any product supporting a standard TCP/IP communication stack. The specifications can be obtained free of charge from the following website: [www.modbus-ida.org](http://www.modbus-ida.org).

#### Modbus TCP/IP, simple and open

The Modbus application layer is very simple and universally known with its 9 million installed connections. Thousands of manufacturers are already implementing this protocol. Many have already developed a Modbus TCP/IP connection and many products are currently available. The simplicity of Modbus TCP/IP enables any field device, such as an I/O module, to communicate on Ethernet without the need for a powerful microprocessor or a lot of internal memory.

#### Modbus TCP/IP, high-performance

Because of the simplicity of its protocol and the high speed of 100 Mbps Ethernet, Modbus TCP/IP delivers excellent performance. This means it is possible to use this type of network in real-time applications such as I/O scanning.

#### Modbus TCP/IP, a standard

The application protocol is identical on serial link Modbus, Modbus Plus or Modbus TCP/IP. This means that messages can be routed from one network to another without changing protocol. Since Modbus is implemented on top of the TCP/IP layer, users can also benefit from IP routing enabling devices located anywhere in the world to communicate without worrying about the distance between them. Schneider Electric offers a complete range of gateways for interconnecting a Modbus TCP/IP network to existing Modbus Plus or Modbus serial link networks.

The IANA organization (Internet Assigned Numbers Authority) has assigned the fixed port TCP 502 ("Well known" port) to the Modbus protocol. Thus Modbus has become an Internet standard.

A study by the ARC Advisory Group, a leading analyst in the automation and software sectors, shows that Modbus TCP/IP is the world's leading Ethernet industrial protocol in terms of units sold in 2004.

Modbus and Modbus TCP/IP are recognized by the IEC 61158 international standard as a fieldbus. They are also compliant with the "Chinese National Standard" managed by ITEI.

#### Interfacing CANopen with Modbus TCP/IP

CiA DSP 309-2 provides a standardized mapping of CANopen data for transport on Modbus TCP/IP Ethernet networks. The specification reserves Modbus function code 43/13 for this purpose. This function code is reserved exclusively for CANopen.

#### Modbus TCP/IP characteristics

Maximum size of data:

- Read: 125 words or registers
- Write: 100 words or registers

#### Functions (continued)

#### I/O Scanning service

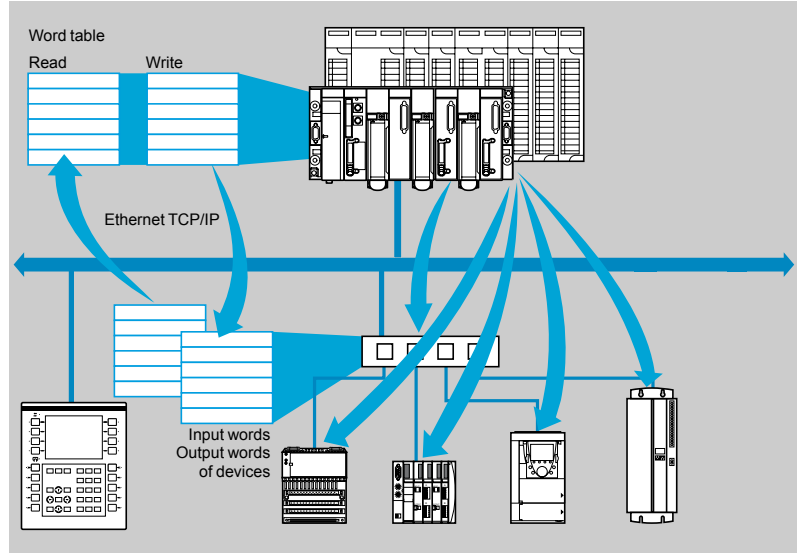

The I/O Scanning Service is used to manage the exchange of distributed I/O states on the Ethernet network after a simple configuration operation, with no need for special programming.

I/O scanning is performed transparently by means of read/write requests according to the Modbus client/server protocol on the TCP/IP profile. This principle of scanning via a standard protocol enables communication with any device supporting a Modbus server on TCP/IP.

This service can be used to define:

- A %MW word zone reserved for reading inputs
- A %MW word zone reserved for writing outputs
- Refresh periods independent of the PLC scan

During operation, the module:

- Manages TCP/IP connections with each remote device
- Scans devices and copies the I/O to the configured %MW word zone
- Feeds back status words so that correct operation of the service can be monitored from the PLC application
- Applies pre-configured fallback values in the event of a communication problem

A range of hardware and software products enabling the I/O Scanning protocol to be implemented on any type of device that can be connected to the Ethernet network is available (please consult the Modbus-IDA website: [www.modbus-ida.org](http://www.modbus-ida.org)).

#### Characteristics

- Under Unity Pro software, each station can exchange a maximum of:
  - 100 words for writing
  - 125 words for reading
- Maximum size in the PLC managing the service:
  - 2k words %MW (1) in inputs and 2k words %MW (1) in outputs with manager PLC limited to 64 stations
  - 4k words %MW (1) in inputs and 4k words %MW (1) in outputs with manager PLC limited to 128 stations

#### I/O Scanning service diagnostics

I/O Scanning service diagnostics can be performed in 3 ways:

- By the application program from a zone of data specific to the PLC
- From the debugging screen in the programming software
- From the PLC system diagnostics function viewed using an internet browser on a PC station.

(1) or 4x registers with Concept or ProWORX.

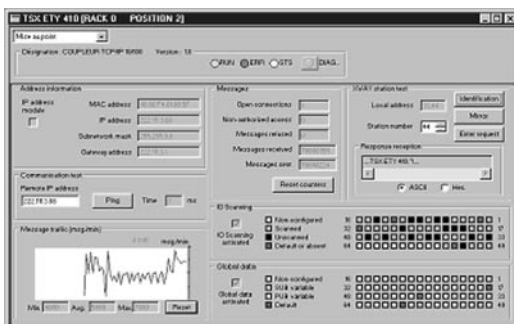

#### Functions (continued)

##### FDR (Faulty Device Replacement), replacement service for faulty devices

The Faulty Device Replacement service uses standard address management technologies (BOOTP, DHCP) and the TFTP (*Trivial File Transfer Protocol*) file management service, with the aim of simplifying maintenance of Ethernet devices.

It is used to replace a faulty device with a new device with the guarantee that it will be detected, reconfigured and automatically restarted by the system.

The main steps in replacement are:

- 1 A device using the FDR service malfunctions.
- 2 Another similar device is taken from the maintenance pool, preconfigured with the Device name (or identifier) of the faulty device, then reinstalled on the network.  
Depending on the device, addressing can be performed using rotary selector switches (for example, Advantys STB distributed I/O, **a** or Advantys OTB) or can be given using the keypad integrated in the device (for example Altivar variable speed drives).
- 3 The FDR server detects the new device, allocates it an IP address and transfers the configuration parameters to it.
- 4 The substituted device checks that all these parameters are indeed compatible with its own characteristics and switches to operational mode.

The FDR server can be a:

- Premium processor with integrated Ethernet port, **TSX P57 ●●●●M**
- Quantum processor with integrated Ethernet port, **140 CPU 651 50/60, 140 CPU 652 60**
- Premium PLC Ethernet module, **TSX ETY 4103/5103**
- Quantum PLC Ethernet module, **140 NOE 771 01/11**

See pages 6/40 and 6/41.

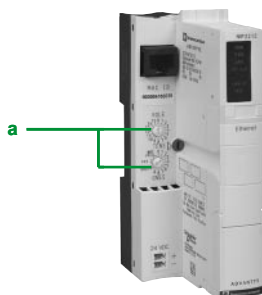

"NIM" network module for Advantys STB I/O



#### Functions (continued)

#### Global Data service

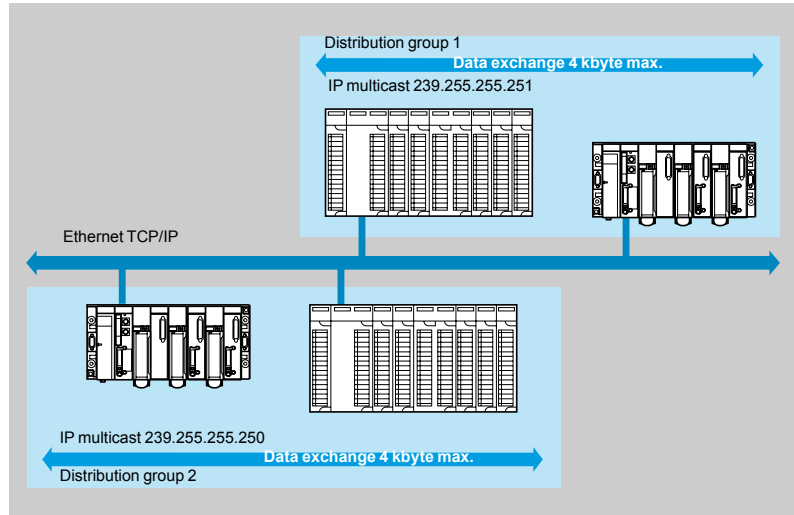

The Global Data service provides data exchanges in real time between stations belonging to the same distribution group. It is used to synchronize remote applications, or to share a common database between a number of distributed applications.

Exchanges are based on a standard producer/consumer protocol, guaranteeing optimum performance with a minimum load on the network. This RTPS (*Real Time Publisher Subscriber*) protocol is promoted by Modbus-IDA (*Interface for Distributed Automation*), and has already been adopted as a standard by several manufacturers.

#### Characteristics

A maximum of 64 stations can participate in Global Data within the same distribution group.

Each station can:

- Publish one 1024-byte variable. The publication period can be configured from 1 to n periods of the processor master task (*Mast*).
- Subscribe to between 1 and 64 variables. The validity of each variable is controlled by status bits (*Health Status bits*) linked to a refresh timeout configurable between 50 ms and 1 sec. Access to an element of a variable is not possible. The total size of subscribed variables amounts to 4k contiguous bytes.

To further optimize the performance of the Ethernet network, Global Data can be configured with the “multicast filtering” option which, together with switches in the ConneXium range (see pages 6/50 to 6/52), perform data broadcasting only on Ethernet ports where there is a Global Data service subscriber station. If these switches are not used, Global Data is transmitted in “multicast” mode on all switch ports.

#### Global Data service diagnostics

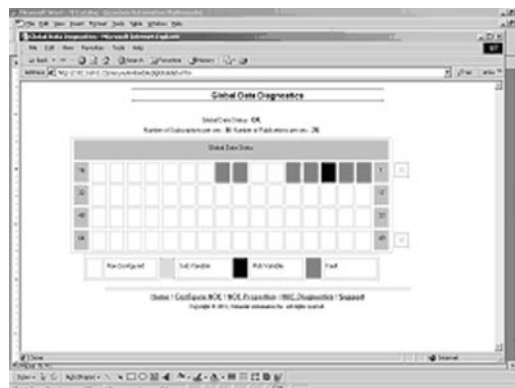

The diagnostic screens use a colour code to show Global Data status:

- Configured/not configured/faulty
- Published/subscribed

### Functions (continued)

#### NTP time synchronization service

#### Presentation

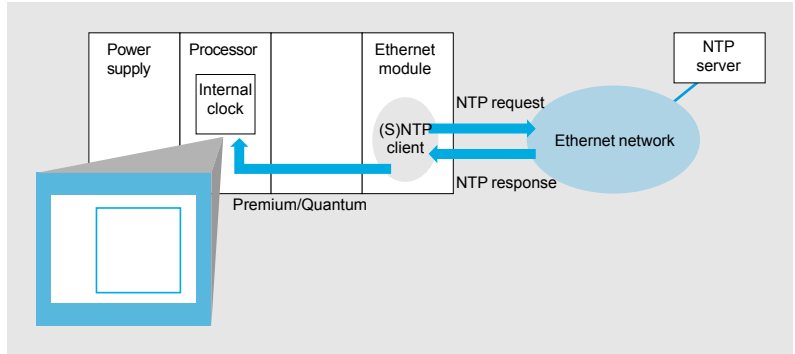

The time synchronization service is based on the NTP (*Network Time Protocol*) which is used to synchronize the time of a client or a server on Ethernet TCP/IP from a server or another reference time source (radio, satellite, etc.).

#### Operation

Ethernet TCP/IP communication modules for automation platforms:

- **140 NOE 771 11** for Modicon Quantum Unity V2.0 or later
- **TSX ETY 5103** for Modicon Premium Unity V2.0 or later have an NTP client component.

These modules can connect to an NTP server using a client request (unicast), in order to update their local time. The module clock is updated periodically (1 to 120 seconds) with an error of less than 10 ms for standard processors and less than 5 ms for high performance processors.

If the NTP server cannot be reached, the Ethernet TCP/IP module switches to a standby NTP server.

Ethernet module associated with its Unity processor		Precision with respect to the reference clock		
Ethernet modules	Unity processors	Clock synchronization (1)	Event synchronization	Time stamping (2)
TSX ETY 5103	TSX P57 0244M TSX P57 1●4M TSX P57 2●4M TSX P57 3●4M	± 1 ms typical ± 10 ms max.	= Clock synchronization precision	= Clock synchronization precision
	TSX P57 4●4M TSX P57 5●4M	± 1 ms typical ± 5 ms max.	+ Scan time for fast task	+ Scan time for I/O
140 NOE 771 11	140 CPU 311 10 140 CPU 434 12U 140 CPU 534 14U	± 1 ms typical ± 10 ms max.	+ Scan time for I/O	
	140 CPU 651 50 140 CPU 651 60 140 CPU 65 160/260 140 CPU 671 60	± 1 ms typical ± 5 ms max.		

(1) Time difference between the physical input and the central NTP server.  
 (2) With use of an interrupt input module.

The PLC processor clock is therefore itself updated with a precision of 5 ms for standard processors and 1 ms for high performance processors. A function block is available for reading this clock. In each PLC application, events or variables can be time-stamped.

The Ethernet module is configured via a Web page. The time zone can be configured. A time synchronization service (NTP) diagnostic Web page is also available.

Information on the time synchronization service (NTP) is also available in the Transparent Ready private MIB, which can be accessed via the SNMP network management service (see above).

**Functions (continued)**

**SMTP e-mail notification service**

**Introduction**

This simple e-mail notification service is programmable. It allows a PLC application to report an event when particular conditions occur. The PLC creates an e-mail automatically and dynamically, to alert a defined recipient connected to the network locally or remotely. The e-mail can contain variables, alarms and/or events.

Note: This service is available with the latest Ethernet communication modules for Modicon Premium and Modicon Quantum PLCs, and the latest CPUs with Ethernet connection of the same PLCs, used with Unity Pro software. A more comprehensive service, independent of the PLC application, is also available with the FactoryCast HMI active web server module (see page 6/19).

**Usage**

A simple yet powerful mechanism is used: predefined message headers are linked with the body of the e-mail, which is created dynamically using the latest information from the PLC application.

The PLC application prepares the message when predetermined conditions occur. Using a function block, one of 3 predefined headers is selected and an e-mail message with variable information and text (up to a maximum of 240 bytes) is created and sent directly from the PLC.

Each of the three headers contains the following predefined items: e-mail recipient list, sender's name and subject. This information is defined and updated by an authorized administrator, using the configuration web pages.

**Message creation and delivery**

The PLC application selects the appropriate header. The system architect may define the headers to indicate differing levels of importance. For example:

- Header 1 could be "URGENT: problem reported by PLC 10".
- Header 2 could be "ALARM: substation 10".
- Header 3 could be "INFORMATION: message from water quality system".

Each of these headers has its own list of recipients, so that the correct person can be informed quickly for each level of importance. The application can also insert relevant information in the body of the message, such as the device, process or location concerned.

The completed e-mail is then sent to an SMTP (Simple Mail Transfer Protocol) server for distribution to the recipients (engineers, management, process owner, etc.).

**Security**

Optionally, each e-mail can be protected by an identifier and a password, authenticated by the SMTP server. If, for additional security, the TCP port number of the e-mail server has been changed from the default of 25, the port number can be changed in the PLC e-mail configuration (via a secure web page).

**Configuration**

An authorized administrator can easily configure this e-mail service via a web page. The items (recipient list, sender and subject) in each of the three headers can be defined.

The e-mail server connection information, such as its IP address and security management information, are also defined using web pages.

**Diagnostics**

As for all other Ethernet services in Modicon Premium and Modicon Quantum PLCs, the e-mail notification service has a diagnostics web page displaying the service's status in real time.

**Remote monitoring**

Diagnostic information is also available remotely from network controllers to the SNMP standard. The e-mail service information is included in the publicly available Transparent Ready private MIB.

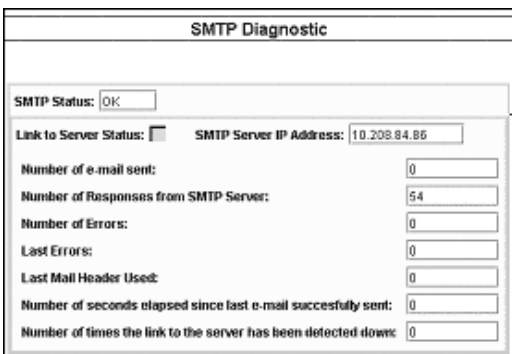

#### Functions (continued)

##### SNMP network management service

From a network management station, the SNMP (*Simple Network Management Protocol*) is used to monitor and control all Ethernet architecture components and thus ensure a rapid diagnosis in the event of a problem.

It is used to:

- Interrogate network components such as computer stations, routers, switches, bridges or terminal devices in order to view their status.
- Obtain statistics about the network to which the devices are connected.

This network management software complies with the conventional client/server model. However, to avoid confusion with other communication protocols that use this terminology, we talk instead about:

- IntraVue from Network Vision, a partner of Schneider Electric
- Network manager for the client application running on the computer station
- SNMP agent for the server application on the network device

Transparent Ready devices can be managed by any SNMP network manager, including HP Openview and IBM Netview.

The standard SNMP (*Simple Network Management Protocol*) is used to access configuration and management objects contained in the device MIBs (Management Information Bases). These MIBs must comply with certain standards in order to be accessed by all managers on the market, but, depending on device complexity, manufacturers can add certain objects to private databases.

The Transparent Ready private MIB includes management objects specific to the Schneider Electric offer. These objects simplify the installation, setup and maintenance of Transparent Ready devices in an open environment using standard network management tools.

Transparent Ready devices support 2 levels of SNMP network management:

- The Standard MIB II interface: a first level of network management can be accessed via this interface. It enables the manager to identify the devices making up the architecture and retrieve general information on the configuration and operation of the Ethernet TCP/IP interfaces.
- The Transparent Ready MIB interface: the management of Transparent Ready devices is improved via this interface. This MIB has a set of information enabling the network management system to supervise all the Transparent Ready services. The Transparent Ready MIB can be downloaded from the FTP server of any Transparent Ready Ethernet module in a PLC.

#### Selecting the communication architecture

When selecting an architecture, it is advisable to take performance into account at the earliest possible stage. When selecting an architecture, the designer must:

- 1 Have a clear idea of his needs as regards:
  - quantity and type of devices to be interconnected
  - volume and type of exchanges
  - expected response times
  - environment
- 2 Compare his needs with the characteristics of the offers available and be aware that the actual performance level between any 2 points in an architecture depends on the weakest link in the chain, which can be:
  - a function of the hardware
  - but also a function of the applications (size, architecture, operating system, machine power, etc.) which are often poorly defined at this stage of the project.
- 3 Work out from these which is the most suitable architecture.

The purpose of the next few pages is to provide the main information and guidelines needed to answer the second point. Given that the performance of an Ethernet architecture is linked to many parameters, these pages do not provide all the information needed to calculate the network performance. Their aim is to focus on the following main aspects:

■ **Guidelines for evaluating the network load** so as to design an Ethernet network that meets the application requirements. As calculating the load involves many parameters, only the main guidelines are given on pages 6/32 to 6/35.

■ **Application response time** to be obtained depending on the configuration used (see page 6/37).

■ **Processing capacities of Modicon Premium/Quantum PLCs** enabling selection of the CPU and definition of the number of Ethernet connections required on the PLC according to the application (see pages 6/38 and 6/39).

#### Evaluating the network load

##### Introduction

When evaluating the load on an Ethernet network, calculation of all the communication services of all the peripheral devices connected to the network is necessary.

Because of the high performance of the Ethernet network, the load is often less than the Ethernet network limits and does not significantly affect the application response time. This is due to the high speed of the Ethernet network: the network transaction time is less than 10% of the total application response time. To ensure a low network load and avoid large theoretical calculations, it is strongly recommended that the collision domain be separated so as to limit the network load, using only switched network (a tree, star or daisy-chain topology). See pages 6/43 and 6/44.

The following guidelines can be used to evaluate the network load. Only switched or daisy-chained networks should be used, to avoid the system being evaluated in collision domains.

The guidelines apply only to the following Ethernet communication services:

- TCP/IP Modbus messaging
- I/O Scanning
- Global Data

**Other services (FDR Faulty Device Replacement, SNMP network management, Web server, etc.) and transaction management (connection attempts, collisions, bandwidth used for establishing and managing services, etc.) are not taken into consideration in these network load evaluation guidelines.**

## Evaluating the network load (continued)

Modbus request/response (function code)	Total PDU	Function code	Parameter	Data
	length	length	length	length
<b>Read coils (01)</b>				
Request	5	1	4	0
Response	2 + N	1	1	N
<b>Read discrete inputs (02)</b>				
Request	5	1	4	0
Response	2 + N	1	1	N
<b>Read holding register (03)</b>				
Request	5	1	4	0
Response	2 + N	1	1	N
<b>Read input register (04)</b>				
Request	5	1	4	0
Response	2 + N	1	1	N
<b>Write single coil (05)</b>				
Request	5	1	4	0
Response	5	1	4	0
<b>Write single register (06)</b>				
Request	5	1	4	0
Response	5	1	4	0
<b>Write multiple coils (15)</b>				
Request	6 + N	1	5	N
Response	5	1	4	0
<b>Write multiple registers (16)</b>				
Request	6 + N	1	5	N
Response	5	1	4	0
<b>Read file record (20)</b>				
Request	9	1	8	0
Response	4 + N	1	3	N
<b>Write file record (21)</b>				
Request	9 + N	1	8	N
Response	9 + N	1	3	N
<b>Mask write registers (22)</b>				
Request	7	1	6	0
Response	7	1	6	0
<b>Read/write multiple registers (23)</b>				
Request	10 + M	1	9	M
Response	2 + N	1	1	N
<b>Read device identification (43)</b>				
Request	4	1	3	0

### Evaluation of the TCP/IP Modbus messaging

Evaluating the bandwidth used by TCP/IP Modbus messaging is particularly complex. This is because many parameters change during each transaction request from the application program:

■ **Transaction periodicity**

Transaction periodicity is not simple to determine. The request can be sent at a time when the task is already under way, and the response also varies according to the actual moment when the destination station performs the task. If the network is particularly heavily loaded, the response may take several periods. In order to define the transaction period, all these parameters must be evaluated.

■ **Message length:**

- One part of the message always has the same length (in bytes) due to successive encapsulations: Ethernet (26), IP (24), TCP (24) and Modbus-MBAP (7), which gives a total of 81 bytes, to which 12 bytes are added, corresponding to the inter-packet gap
- The length of the second part of the message depends on the length of the Modbus protocol data unit (PDU) request/ response and its parameters. The different cases are listed in the table opposite (*value in bytes*).

**Note:**

- (1) N = Number of coils/8 or  
N = Number of coils/8 + 1 (if remainder ≠ 0)
- (2) N = Number of inputs/8 or  
N = Number of inputs/8 + 1 (if remainder ≠ 0)
- (3) N = Number of registers x 2
- (4) Ki = Length of object i, with i = 1 to n,  
where n = number of objects

To evaluate the bandwidth used by Modbus TCP/IP messaging, the following parameters must be defined for each transaction:

- |   |                                 |                 |
|---|---------------------------------|-----------------|
| 1 | Message send period             | <i>in ms</i>    |
| 2 | Size of the request Modbus PDU  | <i>in bytes</i> |
| 3 | Size of the response Modbus PDU | <i>in bytes</i> |

The network load of the Modbus TCP messaging service in bps can be evaluated using the following formula:

$$\frac{(186 + \text{size of the request Modbus PDU} + \text{size of the response Modbus PDU}) \times 8000}{\text{message send period}}$$

The calculation must be performed for all peripheral devices scanned at each transaction.

### Evaluating the I/O Scanning service

To evaluate the bandwidth used by the I/O Scanning service, the following parameters must be defined for each station scanned:

- |   |                         |                 |
|---|-------------------------|-----------------|
| 1 | Scanning period         | <i>in ms</i>    |
| 2 | Size of read variables  | <i>in words</i> |
| 3 | Size of write variables | <i>in words</i> |

**Note:** The scanning period is limited by the response time of the scanned peripheral device.

The network load of the I/O Scanning service in bps can be evaluated using the following formula:

$$\frac{(103 + 2 \times \text{size of the read variables} + 95 + 2 \times \text{size of the write variables}) \times 8000}{\text{scan time}}$$

The calculation must be performed for all scanned peripheral devices on each scanning station.

# Modicon Quantum automation platform

## System approach

### Ethernet TCP/IP network performance

#### Evaluating the network load (continued)

##### Global Data service

To evaluate the bandwidth used by the Global Data service, it is necessary to have a list of all the variables belonging to the same multicast group, and their parameters:

- 1 Distribution period in number of scans
- 2 Period of Mast Task in ms
- 3 Size of variable in number of words

These parameters must be collected at each station publishing at least one variable in the multicast group.

The Global Data service network load in bps can be evaluated using the following formula: **(Size of variable x 2 + 90) x (1000/(period of Mast task x distribution period))**

This calculation must be performed for all variables in the multicast groups.

##### System evaluation

The previous evaluations give indications of traffic when considering:

- One station when sending I/O Scanning requests or messages
- A group of stations belonging to the same Global Data group

The final objective is to obtain an evaluation of the traffic when connecting several stations.

The following information is required for each station:

- Level of traffic the station has to manage (sum of I/O Scanning, messaging and Global Data services), calculated previously
- Collision domain to which the station belongs

Additional information is required for Global Data traffic:

- Level of traffic in each Global Data group, calculated previously
- List of stations belonging to the Global Data groups

The **first step** in evaluating the system consists of calculating the traffic in each collision domain. A collision domain is a domain in which a hub (*concentrator*) is used.

A hub can be used to separate two domains. If only a switched or daisy-chained network infrastructure is used (it is strongly recommended to limit the network load as much as possible), go directly to the next step.

If you are using hubs, calculate the total traffic for all the stations connected to the same collision domain. The table below makes this calculation easier.

Messages transmitted per bps from				Total number of messages received per station
	Station A	Station B	Station N	
Messages sent per second to	Station A			R1
	Station B			R2
	Station N			Ri
Total number of messages transmitted per station	E1	E2	Ei	Network load $C_{ru} = \sum [R1...Ri, E1...Ei]$
	Not applicable			

The **second step** consists of evaluating the traffic between the collision domains. If only a switched or daisy-chained network infrastructure is used (avoid using 2 hubs), it is only necessary to add the messages transmitted on each link. If hubs are used at another place in the application, add only the traffic from one hub domain to the other (for example, via a switch) during this step.



#### Evaluating the network load (continued)

##### System evaluation (continued)

The **third step** is used to calculate the total traffic of the various collision domains. For each domain, it is necessary to add the "internal" collision domain traffic to the traffic with the other collision domains.

The following rules apply when calculating the traffic for a domain:

- When a station belongs to the domain, all the traffic it initiates is included in the traffic calculation.
- When the station does not belong to the domain, only the traffic sent to the domain is included in the traffic calculation.

*Note: In the calculations, the principle is that multicast filtering is activated at the switches so that the Global Data traffic is propagated at collision domain level when a station belongs to the Global Data group.*

The aim of the **fourth step** is to compare the traffic load of each collision domain with the bandwidth of the Ethernet network (10 Mbps, 100 Mbps, etc.). The user must ensure that the application load does not exceed the network capacity in terms of useable bandwidth. Useable bandwidth in an automation network is evaluated using a percentage of the hypothetical network capacity. This percentage varies according to the industrial Ethernet standard used. The permitted bandwidth lies between 30 and 40% of the total theoretical bandwidth and varies according to the topology used.

If the application load exceeds the useable bandwidth, it must be reduced. To do this, add switches in order to reduce the number of stations in the overloaded collision domain (and therefore the internal domain traffic) and/or the industrial Ethernet standard used must be optimized.



# Modicon Quantum automation platform

## System approach

### Ethernet TCP/IP network performance

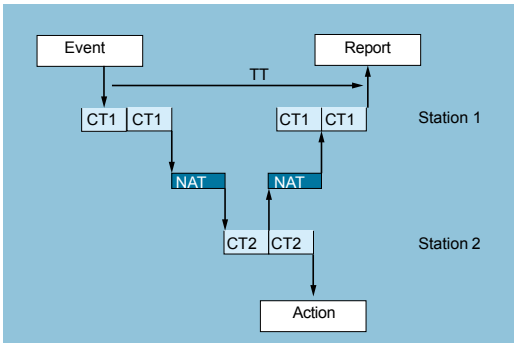

#### Application response time

##### Modbus (or Uni-TE) messaging service response time

Exchanges between the PLC processor and the Ethernet module are synchronous with the PLC cycle, just like the I/O exchanges. Upon the occurrence of an event (an input being set to 1 for example), a message can be transmitted only after this input has been taken into consideration (start of the next cycle) and the Premium or Quantum PLC program has been executed, i.e. on average approximately 1.5 cycles after the event occurred.

The network access time (NAT) shown in the table below in ms is a total of the module transit time and the delay before the message can be transmitted on the network.

Processing of Modbus message requests	Premium Ethernet TCP/IP		Quantum Ethernet TCP/IP	
	TSX ETY 210 TSX ETY 110WS	TSX ETY 4103/5103 TSX WMY 100 TSX P57 10...57 50	140 NOE 771 01/111 140 CPU 113/311 ●● 140 CPU 434/534 1●	140 CPU 65 150/160 140 CPU 67 160
Network access time NAT	< 25 ms	< 10 ms	< 10 ms	< 10 ms

The transaction time TT includes the delay between the transmission of a message from a client station 1, its reception by the server station 2, processing the request, sending back the response and it being taken into account by the station 1 (updating an output for example).

As the block diagram above shows:

- The transaction time TT will lie between:

$$2 \times CT1 + 2 \times NAT < TT < 4 \times CT1 + CT2 + 2 \times NAT$$

- The average time  $TT_{av}$  is equivalent to:

$$TT_{av} = 3 \times CT1 + 0.5 \times CT2 + 2 \times NAT$$

6

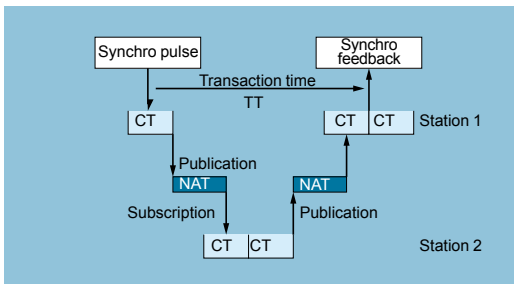

#### Global Data service response time

The transaction time TT includes the delay between publication of Global Data by the station 1, its reception and processing by the remote station 2 and its retransmission to the initial station 1:

For an exchanged variable:

- If  $CT < 5$  ms, transaction time:

$$TT = 5 \text{ to } 6 \times CT$$

- If  $CT \geq 10$  ms, transaction time:

$$TT = 3 \times CT$$

# Modicon Quantum automation platform

## System approach

### Ethernet TCP/IP network performance

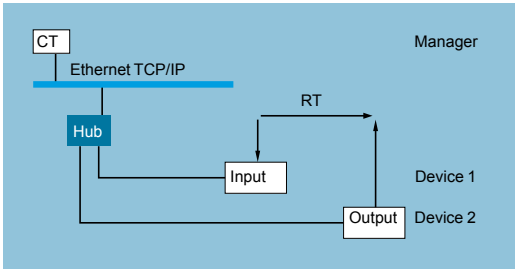

#### Application response time (continued)

##### I/O Scanning service response time

The response time RT includes the time between taking account of information from a remote input and updating the state of a remote output. It includes the processing time in the PLC.

This response time RT consists of the following parameters:

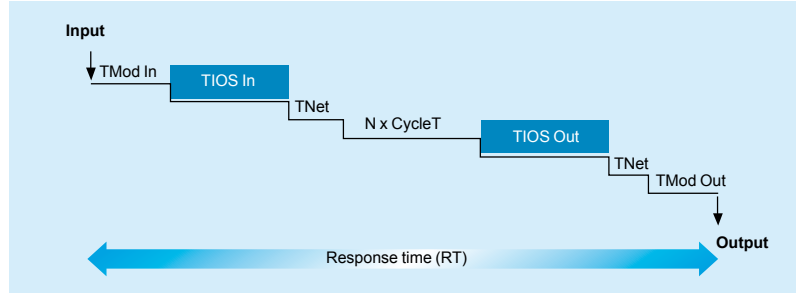

- TMod In and TMod Out: Response time of the read/written device, excluding the electrical transit time at the input/output (TMod depends on the device, usually between 1 and 8 ms).
- TIOS In and TIOS Out: Time between 2 read/write operations on the same device (0.3 ms x number of devices scanned), equivalent to at least the configured scan time. As TIOS is executed in parallel with the PLC cycle, it can be hidden from the viewpoint of the response time RT).
- CycleT: PLC cycle time.
- TNet: Propagation time on the network (depends on the application, but generally TNet = 0.05 ms at 10 Mbps and 0.005 ms at 100 Mbps).

The response time RT can be estimated using the following 3 formulae:

■  $RT_{min}$ , minimum response time with TIOS hidden and 1 PLC cycle:

$$RT_{min} = (TMod In + 0) \times TIOS In + (Tnet + N) \times CycleT + (0 \times TIOS Out) + Tnet + TMod Out$$

■  $RT_{typic}$ , typical response time with 0.5 TIOS hidden:

$$RT_{typic} = (TMod In + 0.5) \times TIOS In + (Tnet + N) \times CycleT + (0.5 \times TIOS Out) + Tnet + TMod Out$$

■  $RT_{max}$ , maximum response time with TIOS not hidden:

$$RT_{max} = TMod In + TIOS In + (Tnet + N) \times CycleT + TIOS Out + Tnet + TMod Out$$

The TMod In and TMod Out response times are shown below:

Distributed I/O	Response Time	Min.	Typical	Max.
Momentum 170 ENT 110 02	TMod In	1 ms	1 ms	1 ms
	TMod Out	5 ms	5 ms	5 ms
Momentum 170 ENT 110 01	TMod In or TMod Out	4 ms	6 ms	8 ms
Advantys STB STB NIP 2212	TMod In or TMod Out	2 ms	3 ms	4 ms

The TIOS In/TIOS Out times measured between 2 scanning cycles (network with switches) are shown below.

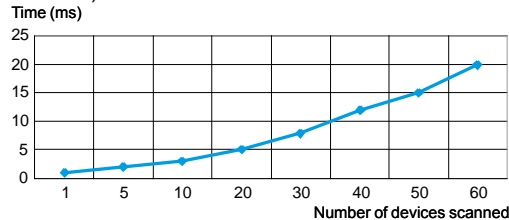

The number N of CPU cycles is shown below:

Number N of CPU cycles	Min.	Typical	Max.
Premium processors TSX P57 26/3634M and TSX P57 26/28/36/4823M	2	2.5	3
All Premium processors with TSX ETY 4103/5103 modules All Quantum processors with 140 NOE 771 01/771 11 modules	1	1	2
Premium processors TSX P57 46/5634M Quantum processors 140 CPU 651 50/60	1	1	2

# Modicon Quantum automation platform

## System approach

### Ethernet TCP/IP network performance

#### Processing capacities of Premium and Quantum PLCs

##### Processing capacity

The table below can be used to compare, for each station, the total number of messages received via the Modbus (or Uni-TE) messaging service if used (value R1, R2 or Ri) to the capacity of the station processor.

Processing of Modbus requests per PLC scan

Premium or Atrium platform		Messages received
Communication by EFs or EFBs (PL7 or Unity Pro)		
Total messages received by the PLC from all the communication modules (1)	TSX 57 10	4 messages/cycle
	TSX 57 20	8 messages/cycle
	TSX 57 30	12 messages/cycle
	TSX 57 40	16 messages/cycle
	TSX 57 50 (2)	16/20 messages/cycle

Quantum platform	Integrated port limitations		Communication module limitations		Ethernet modules per PLC
	All types of communication request	Additional read/write 4x registers	All types of communication request	Additional read/write 4x registers	
140 CPU 113 (3)	–	–	1 message/cycle	4 messages/cycle	2 max.
140 CPU 311	–	–	1 message/cycle	4 messages/cycle	2 max.
140 CPU 434/534	–	–	4 messages/cycle	8 messages/cycle	6 max.
140 CPU 651	16 messages/cycle	16 messages/cycle	4 messages/cycle	8 messages/cycle	6 max.

messages/cycle: number of messages received per cycle from the PLC master task (typical cycle of 50 to 100 ms)

Example:

Quantum 140 CPU 434 12● processor with 4 x 140 NOE 771 ●1 Ethernet modules:

- 20 messages/cycle for all types of communication request, and
- 32 messages/cycle for the read/write 4x registers

##### Ethernet connection processing capacity

For each station, compare the total number of messages received  $\Sigma$  [values Ri, Rj] and the total number of messages transmitted  $\Sigma$  [values Ei, Ej] (for station N, for example) with the Ethernet connection processing capacity shown below. Use the following items for the Ethernet connection per PLC, rather than the number of transactions required by the application.

Ethernet connection processing capacity	Premium Ethernet TCP/IP			Quantum Ethernet TCP/IP	
	TSX ETY 110/210 TSX ETY 110WS	TSX ETY 4103/5103 TSX WMY 100 (4) TSX P57 10/20/30/40	TSX P57 50	140 NOE 771 01/11 140 NWM 100 00 (4)	140 CPU 65 150/160 140 CPU 67 160
Modbus messaging	60 transactions/s	450 transactions/s	500 transactions/s	350 transactions/s	350 transactions/s
I/O Scanning services	Service not available	2 000 transactions/s	2 000 transactions/s	2 000 transactions/s	2 000 transactions/s
Global Data publication		800 transactions/s	800 transactions/s	800 transactions/s	800 transactions/s

(1) A temporary overload on a few PLC cycles, due for example to an adjustment terminal or the temporary connection of an Internet browser, is acceptable.

(4) Only with Unity Pro software.

(5) Only with Concept/ProWORX software.

(6) I/O Scanning and Global Data services not available on these modules.(TSX WMY 100 and 140 NWM 100 00).



## Processing capacities of Premium and Quantum PLCs (continued)

### Management of the Ethernet TCP/IP module bandwidth

The bandwidth management service indicates the load level of the Ethernet module. This enables the user to monitor any drift and anticipate possible problems.

The Ethernet module load is indicated in 3 ways:

- Anticipated load in the Unity Pro/PL7 configuration screen.
- Actual load in the Unity Pro/PL7 diagnostics/debug screen, as well as in the Web diagnostics pages. It is displayed in the form of a bar graph animated in real time.
- In the SNMP interface for access by the SNMP network manager.



The bandwidth is shown as a percentage for each of the following services:

- Modbus (and Uni-TE) messaging
- I/O Scanning
- Global Data
- Others

# Modicon Quantum automation platform

## Processors with integrated Ethernet port

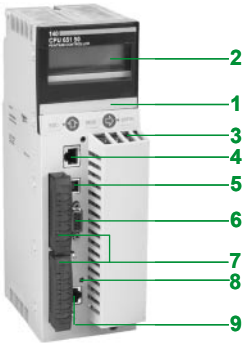

### Description

The **140 CPU 651 50**, **140 CPU 651 60** and **140 CPU 652 60** processors have the following on the front panel:

- 1 An LCD display cover, providing access to:
  - A key switch for locking system operations that may be requested and all the permitted parameters that may be modified via the LCD display (2) and 5-button keypad (3)
  - A slot for the backup battery
  - A "Restart" pushbutton
- 2 An LCD display (2 lines of 16 characters) with brightness and contrast controls
- 3 A keypad with 5 buttons (ESC, ENTER, MOD, Îl, =>) and 2 LEDs
- 4 An RJ45 connector for the connection to the Modbus bus.
- 5 A type B female USB connector for connecting the programming PC
- 6 A 9-way female SUB-D connector for the connection to the Modbus Plus network
- 7 Two slots for PCMCIA memory extension cards
- 8 Two LEDs marked COM and ERR
- 9 An RJ45 connector for the connection to the Ethernet network

### Characteristics

Module type		Unity Pro software	140 CPU 651 50	140 CPU 65 160/260	
<b>Transparent Ready services</b>	Class		B30		
	Standard Web server		"Rack Viewer" access to the product description and status and to the PLC diagnostics "Data editor" access to the configuration functions and PLC variables		
	Ethernet TCP/IP standard communication service		Modbus TCP messaging (read/write data words)		
	Ethernet TCP/IP advanced communication services	I/O Scanning		Yes (between 128 stations)	
		Global Data		Yes	
FDR Client			Automatic assignment of IP address and network parameters		
SMTP e-mail notification			Yes		
<b>Structure</b>	Physical interface		10BASE-T/100BASE-TX (RJ45)		
	Data rate		10/100 Mbps with automatic recognition		
	Medium		Twisted pair		
	<b>Quantum processor</b>	No. of discrete I/O		Local: 26 slots, decentralized: 31,744 I/31,744 Q, distributed: 8000 I/8000 Q/network	
		No. of analog I/O		Local: 26 slots, decentralized: 1984 I/1984 Q, distributed: 500 I/500 Q/network	
Max. no. of communication modules			6 in local rack		
Max. memory capacities		Program		7168 Kb	
	Localized/non-localized data		512 Kb	1024 Kb (768 Kb with no PCMCIA card)	
	Data storage		8192 Kb		
Operating temperature		0...+60°C			
Relative humidity		10...95% non condensing during operation			
Degree of protection		IP 20			
Power supply		Via the power supply of the rack supporting the processor			
Conformity to standards		UL 508, cUL, CSA 22.2-142, FM Class 1 Division 2, CE			
LED indicators		Activity on the Ethernet port (COM), collision detection (ERR)			

### References

Description	Processor clock frequency	Program/data capacity (1)	Reference	Weight kg
<b>Processors with integrated Ethernet link</b> Class B30	166 MHz	7168 Kb/512 Kb	<b>140 CPU 651 50</b>	—
	266 MHz	7168 Kb/1024 Kb	<b>140 CPU 651 60</b>	—
			<b>140 CPU 652 60</b>	—

(1) With PCMCIA card.

For further information: Please consult our "Modicon Quantum automation platform - Unity software" catalogue.



140 CPU 651 50/60

# Modicon Quantum automation platform

## Ethernet network modules



### Presentation

**140 NOE 771 ●●/NWM 100 00** Ethernet network modules are single format modules for installing in the slots of the local rack of a Modicon Quantum PLC configuration. A configuration can take from 2 to 6 application-specific modules, including network modules, depending on the type of processor.

### Description

The front panel of **140 NOE 771 01/771 11** and **140 NWM 100 00** Ethernet TCP/IP modules comprises:

- 1 A display block, which indicates the module status and the transmission status on the network.
- A hinged cover providing access to:
  - 2 A (MT-RJ) connector for 100BASE-FX optical interface.
  - 3 A standard (RJ45) connector for 10BASE-T/100BASE-TX interface.

### Characteristics

Module type		140 NOE 771 00	140 NOE 771 10	140 NOE 771 01	140 NOE 771 11	140 NWM 100 00
Transparent	Class	B20	C20	B30	C30	D10
Ready services	Standard Web server	"Rack Viewer" access to the product description and status and to the PLC diagnostics "Data editor" access to the configuration functions and variables				
	FactoryCast configurable Web server	Editor for creating Web page mimics	–	Yes	–	Yes
		User Web page hosting (available size)	–	Yes	–	Yes (8 Mb)
	FactoryCast HMI active Web server	–	–	–	–	Yes (1)
	Ethernet TCP/IP standard communication services	Modbus TCP messaging (read/write data words)				
	Ethernet TCP/IP advanced communication services	I/O Scanning	Yes	–	Yes (between 128 stations)	–
		Global Data	–	–	Yes	–
		FDR server	–	–	Automatic assignment of IP address and network parameters	–
		NTP time synchronization	–	–	Yes	–
		SMTP e-mail notification	–	–	Yes	–
	SNMP network administrator	Yes	–	–	–	SNMP agent
	Bandwidth management	–	–	Yes	–	–
Redundancy service		Compatible with Hot Standby redundant architecture				
Structure	Physical interface	10BASE-T/100BASE-TX (RJ45) or 100BASE-FX (MT/RJ)				
	Data rate	10/100 Mbps				
	Medium	Twisted pair/optical fibre				
Network module	Operating temperature	0... + 60°C				
	Relative humidity	10...95% non condensing during operation				
	Degree of protection	IP 20				
	Power supply	Via the power supply of the rack supporting the processor				
	Conformity to standards	UL 508, cUL, CSA 22.2-142, FM Class 1 Division 2, CE				
	LED indicators	Rack operational (Active), module ready (Ready), network active (Link) Ethernet network status (Run), download mode (Kernel), Full-duplex mode (Fduplex) Transmission/reception activity (TxAct/RxAct), 10 Mbps or 100 Mbps data rate (10MB/100MB) Collision detection (Coll), Ethernet module fault (Fault)				

(1) Database management, arithmetic and logic calculations, automatic e-mail transmission on process event, connection to relational databases.

### References



140 NOE 771 ●1/NWM 100 00

Description	Data rate	Transparent Ready class	Reference	Weight kg
Ethernet TCP/IP modules	10/100 Mbps	B20	140 NOE 771 00	0.345
		C20	140 NOE 771 00	0.345
		B30	140 NOE 771 01	0.345
		C30	140 NOE 771 11 (1)	0.345
		D10	140 NWM 100 00	0.345

(1) Non-interfering.



### Presentation

The ConneXium Industrial Ethernet range consists of a complete family of products and tools required to build the infrastructure of an Industrial Ethernet network. The following pages give an overall view of the information enabling optimum design of a network and selection of its components.

### Office Ethernet versus Industrial Ethernet

There are three main areas of differentiation between Ethernet applications in an office environment and Ethernet applications in an industrial environment. These are:

- Environment
- Layout (not related to the physical layers)
- Performance

Unlike the office environment, and even though ISO/IEC is currently working on them, no clearly defined specifications yet exist for Ethernet devices targeted at industrial applications. The specifications for what is referred to as Industrial Ethernet are defined by different agencies or entities according to their nature and what the automation market has traditionally used.

The environmental specifications for Industrial Ethernet devices are today defined by the agencies that traditionally define the specifications for standard industrial devices (UL, CSA, CE, etc.).

IEEE 802.3 defines the physical layer specifications for the Ethernet network (connector types, distance between devices, number of devices, etc.) while standard 11801 (similar to TIA/EIA 568B and CENELEC EN 50173) gives layout guidelines for installers.

ISO/IEC is currently working on specifications relating to performance.

### Principles of Ethernet 802.3

The Ethernet 802.3 link layer is based on the collision detection mechanism (CSMA CD). When information from a node collides on the network, a collision is generated and the information is sent again. The process of re-sending information causes delays in its propagation and could affect the application.

A collision domain is a group of Ethernet end devices interconnected by hubs or repeaters (devices that receive information and send it out to all their other ports, no matter where the destination device is connected); this means that all devices will be affected by collisions.

With the availability of full duplex switches (devices that receive information and send it out just through the port to which the destination device is connected), collision domains have disappeared.

Consequently, for industrial automation applications, it is strongly recommended to always use full duplex switches to interconnect devices. In this way, collision domains are totally eliminated.

### Different network topologies

#### Star topology

In a star topology, all devices are connected through an intermediate device.

#### Ethernet Star

In an Ethernet star, the intermediate device may be a **hub** or a **switch**. The star is the topology most frequently used in corporate networks and at present is used in almost all automation applications. As mentioned previously, for industrial Ethernet applications the use of full duplex switches (rather than hubs) as central devices is strongly recommended.

#### Deploying Star topologies with ConneXium

All hubs and switches in the ConneXium range can be used to implement a star topology.

#### Bus topology

The bus is a topology commonly used in traditional industrial automation networks. A single trunk cable connects all the devices on the network, usually via passive or active T-connectors, or directly chained (daisy chain). Devices can usually be installed anywhere along the bus.

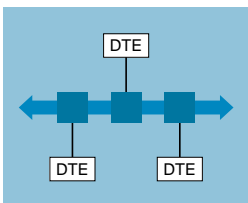
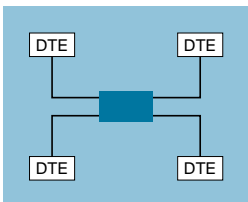

### Ethernet Bus

An Ethernet bus can be deployed by interconnecting **hubs** and/or **switches** in line and considering every one of them as the connection for a drop device. In this case, the number of hubs is limited whilst the number of switches is unlimited.

### Deploying Bus topologies with ConneXium

All hubs and switches in the ConneXium range can be used to implement a bus topology. Switches with one or two fibre optic ports are especially suitable for this purpose. These switches can be used as follows:

- Those with two fibre optic ports can be used for the connection of inline devices
- Those with a single fibre optic port can be used for the connection of end devices



### Daisy chain topology

Daisy chaining at bus level is another topology commonly used in traditional industrial automation networks. Cable segments interconnect a number of devices, being the device "part" of the network cable.

### Ethernet Daisy Chain

Daisy Chain is not yet a very common Ethernet topology, but will quickly become one when enough devices are available on the market.

In an Ethernet daisy chain, devices have:

- **2 Ethernet ports**
- and an **integrated switch**.

Schneider Electric is progressively releasing onto the industrial market Ethernet devices that can be used in daisy chain architectures.

### Deploying daisy chain topologies

No hubs or switches are required to deploy daisy chain topologies. Each device has an integrated switch. Dual-port Ethernet at device level is an essential integral component for daisy chain topologies. One port of the device is connected to one port of the neighbouring device, upstream and downstream. These consecutive connections form the daisy chain.

Ethernet switches can be inserted in a daisy chain topology when multiple scan chains are used by the control device. The Ethernet switch must be placed close to the control device, with the various scan chains coming from the switch.



### Daisy chain topology (continued)

#### Daisy chain limitations

In order to ensure the operational integrity of the network and satisfy the conditions necessary for maintaining performance, the following limitations have been defined:

- Dual-port Ethernet devices support only 10 Mbps and 100 Mbps data rates and must use only one of them.
- The network operates only as fast as the slowest device that is connected to the network.
- In order to improve network traffic, the number of devices in a single scan chain is limited to 32. With this limit, the time for a round trip of a packet through the daisy chain is evaluated at less than 5 ms.

The maximum packet latency of a packet passing through any device in a scan chain is no more than 10  $\mu$ s.

### Ring topology

In a ring topology, all devices or components of the network infrastructure are connected in a loop with no beginning or end. This type of topology enables different levels of network redundancy to be obtained.

#### Ethernet Ring

Ethernet rings are usually the backbones of applications in which high availability is required. If a ring topology is required, then switches that support this function must be used.

#### Deploying Ring topologies with ConneXium

The ConneXium range offers hubs and switches that allow the deployment of single and coupled “self-healing” rings. See additional information on page 6/47.

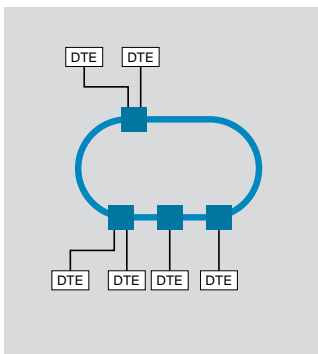

## Distance limitations and number of devices per segment

According to standard 802.3, the limits in terms of distance and number of cascaded devices are as follows:

Type	Maximum segment length (1)	Maximum segment length (offered by ConneXium devices)	Maximum number of cascaded hubs	Maximum number of cascaded switches
10BASE-T	100 m	100 m	4	Unlimited
100BASE-TX	100 m	100 m	2	Unlimited
1000BASE-T	100 m	100 m	–	Unlimited
10BASE-FL	2000 m	3100 m (2)	11 (fibre ring)	–
100BASE-FX	412 m/2000 m	4000 m with multimode, 32,500 m with single mode (3)	–	Unlimited
1000BASE-SX	275 m	–	–	Unlimited

(1) According to standard 802.3, full duplex/half duplex.

(2) Depends on the attenuation analysis and optical fibre attenuation.

(3) Depends on the attenuation analysis and optical fibre attenuation. Typical lengths are 2000 m for multimode and 15,000 m for single mode.

## Physical media

The Ethernet 802.3 standard defines the Physical Layer. The most common physical layers are shown below.

Type	Data rate	Cable type		Connector type	
		Defined by 802.3	Recommended by Schneider Electric	Defined by 802.3	Recommended by Schneider Electric
10BASE-T	10 Mbps	CAT 3 - UTP	CAT 5E - STP	RJ45	RJ45
100BASE-TX	100 Mbps	CAT 5 - UTP	CAT 5E - STP	RJ45	RJ45
1000BASE-T	1 Gbps	CAT 5 - UTP	CAT 5E - STP	RJ45	RJ45
10BASE-FL	10 Mbps	Two multimode fibre optic cables, typically 62.5/125 µm fibre, 850 nm light wavelength	Two multimode fibre optic cables, typically 62.5/125 µm fibre, 850 nm light wavelength	ST	ST
100BASE-FX	100 Mbps	Two multimode optical fibres, typically 62.5/125 µm, 1300 nm light wavelength	Two multimode optical fibres, typically 62.5/125 µm, 1300 nm light wavelength	ST	SC
		–	Two single mode optical fibres, typically 9/125 µm, 1300 nm light wavelength	–	SC
1000BASE-SX	1 Gbps	Two 62.5/125 µm or 50/125 µm multimode optical fibres, 770 to 860 nm light wavelength	Two 62.5/125 µm or 50/125 µm multimode optical fibres, 1300 nm light wavelength	SC	LC
1000BASE-LX	1 Gbps	–	Two 9/125 µm single mode optical fibres, 1300 nm light wavelength	–	LC

**Note:** The specifications above are those defined by IEEE 802.3. As certain cables are no longer sold, for example for 10BASE-T and 100BASE-TX, the cable to be used is CAT-5E.

### Management

Ethernet devices (end devices and cabling devices) can generally be divided into two categories: unmanaged and managed devices:

- **Unmanaged devices** are those for which it is not possible to configure or control the parameters of the device.
- **Managed devices** are those for which it is possible to configure or control the parameters of the device (manage them) and access their internal information.

The ConneXium product line offers both types of device. There is also a third category of device which is not specifically defined. It is however important to understand the difference. It is possible only to access the information in these devices; they cannot be controlled or configured.

These devices are generally included in the managed device category.

### Managed devices

Managed devices offer the following features:

- **Traffic optimization and filtering.** The aim is to increase the bandwidth or the traffic capacity of a network (features in this area include: message and port priority, flow control, multicast filtering, broadcast limiting, IGMP snooping, VLAN, etc.).
- **VLAN.** A virtual LAN (VLAN) consists of a group of network participants, located in one or more network segments, able to communicate with each other as if they belonged to the same LAN.

VLANs are based on logical (rather than physical) links. The main advantage of VLANs lies in the possibility of creating user groups based on the role of the participants and not on their physical location or medium.

Since large/multicast data packets are transmitted exclusively within a virtual LAN, the remaining data on the network are unaffected. The VLAN can also serve as a security mechanism to block unwanted Unicast messages.

- **Security,** a feature that helps the user protect the switch from unauthorized access that could result in changes in its configuration and impact the traffic going through the switch (features in this area include: port security, read/write community name, etc.).

The user can also configure the switch so that it blocks messages coming from addresses of unauthorized "devices" connected to the switch.

- **Time synchronization,** a feature that makes it possible to synchronize the time of all devices on the network.
- **Network redundancy,** a feature used for developing high-availability applications.
- etc.

### Redundancy

For developing high-availability applications, redundancy in the network infrastructure is the answer. Protection against loss of network segments can be obtained by implementing a single or coupled ring architecture.

#### Single ring

The first level of redundancy can be achieved by implementing a single ring. ConneXium switches allow the set up of backbone ring configurations.

The ring is constructed using HIPER-Ring ports. If a section of the line fails, the ring structure (including a maximum of 50 switches) converts to a line-type configuration within 0.5 seconds.

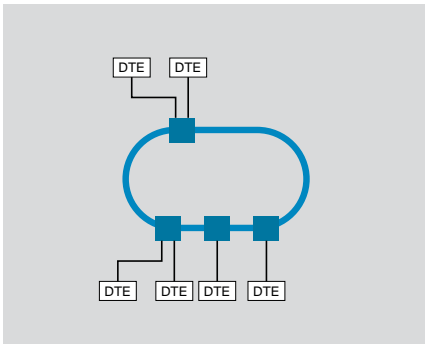

#### Dual ring

The second level of redundancy can be achieved by implementing a dual ring. The control intelligence built into the ConneXium switches allows the redundant coupling of HIPER-Ring ports and network segments.

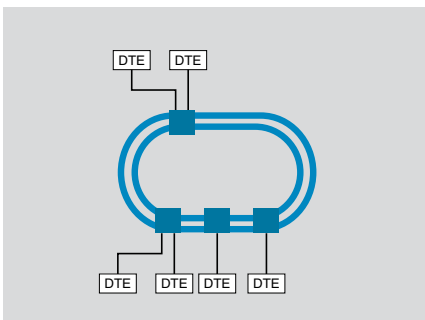

#### Mesh topology using the Rapid Spanning Tree protocol

A third level of redundancy can be achieved by implementing a mesh topology.

The "Spanning Tree" protocol is a protocol that determines a single path for the information when multiple paths exist. If the active path is broken, the Spanning Tree protocol enables one of the alternative paths.

ConneXium switches offer this possibility.

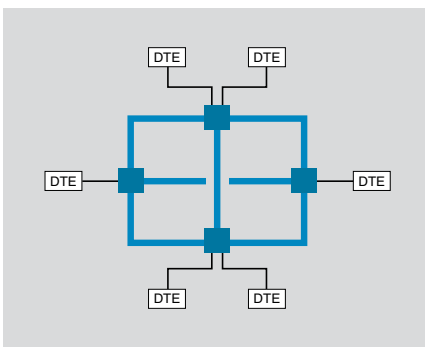

## Presentation

Schneider Electric offers copper and fibre optic cables for connecting IP 20 and IP 67 Ethernet devices.

## Examples

### Mixed IP 20 and IP 67 wiring (copper)

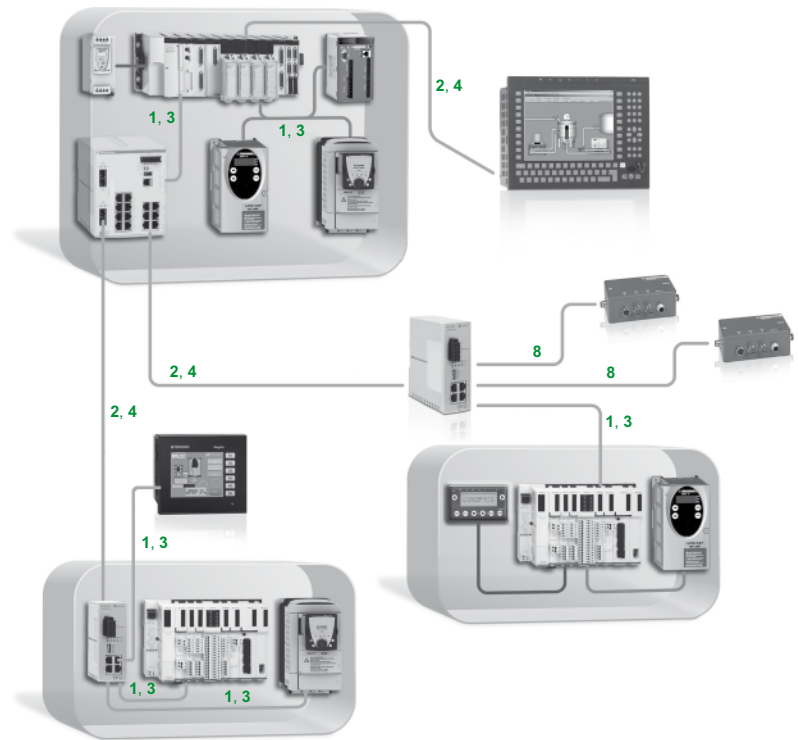

Key:  
1, 3: Straight copper cables  
2, 4: Crossed copper cables  
8: Cables with IP 67 connector  
See pages 6/50 and 6/51.

**Examples (continued)**

**Mixed copper and fibre optic wiring**

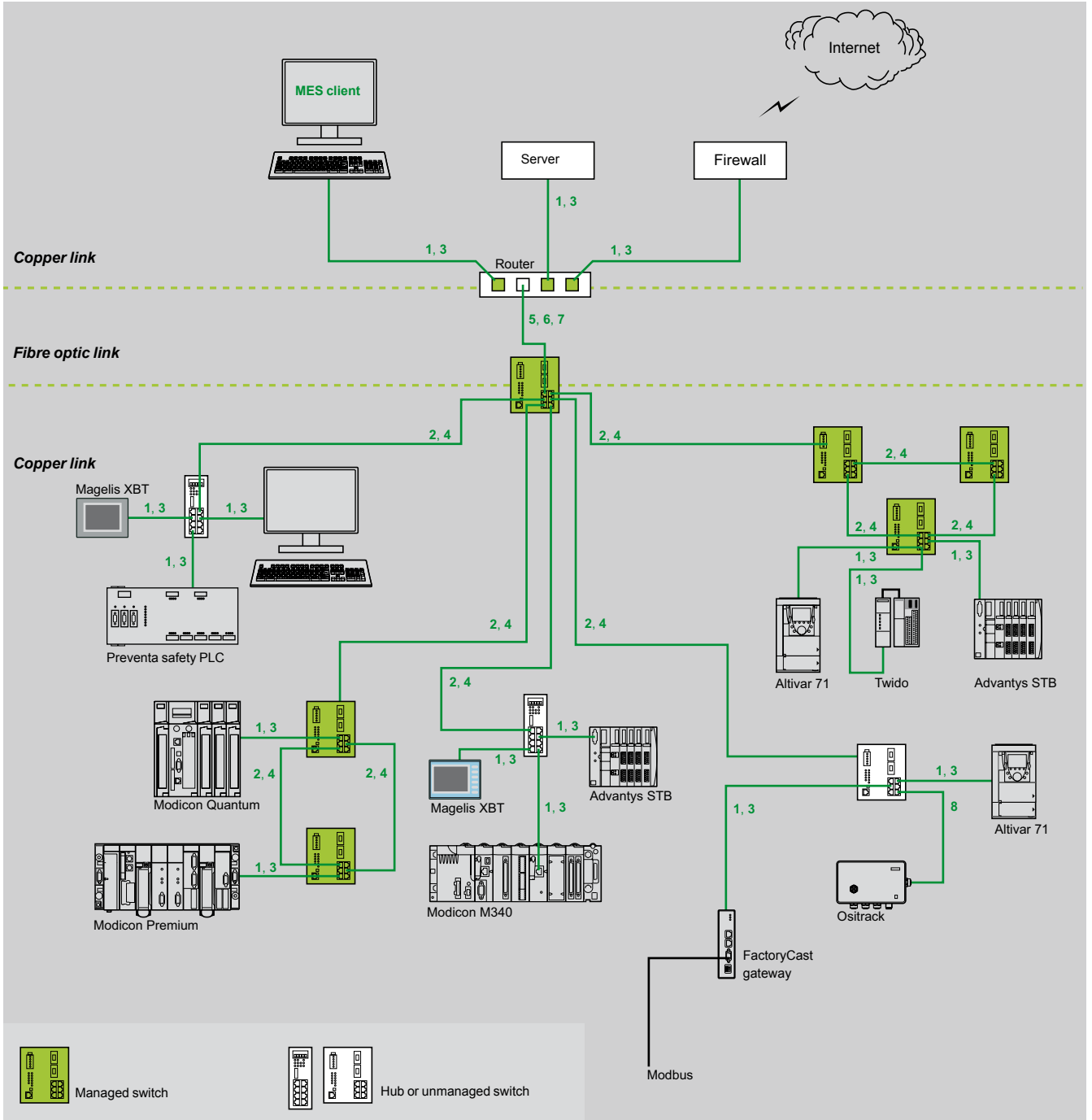

Key:  
 1, 3: Straight copper cables  
 2, 4: Crossed copper cables  
 5, 6, 7: Fibre optic cables  
 8: Cables with IP 67 connector  
 See pages 6/50 and 6/51.

# Modicon Quantum automation platform

## Wiring system

### ConneXium connection components

#### Shielded copper connection cables

ConneXium shielded connection cables are available in two versions to meet the various current standards and approvals:

■ **EIA/TIA 568 shielded twisted pair cables for C€ market**

These cables conform to:

- EIA/TIA-568, category CAT 5E
- IEC 11801/EN 50173-1, class D

Their fire resistance conforms to:

- NF C32-070, class C2
- IEC 322/1
- Low Smoke Zero Halogen (LSZH)

■ **EIA/TIA 568 shielded twisted pair cables for UL market**

These cables are:

- CEC type FT-1
- NEC type CM



490 NT● 000 ●●

#### EIA/TIA 568 shielded twisted pair cables for C€ market

Description	Preformed at both ends	No.	Length	Reference	Weight kg
<b>Straight cables</b>	2 RJ45 connectors For connection to terminal devices (DTE)	1	2 m	490 NTW 000 02	—
			5 m	490 NTW 000 05	—
			12 m	490 NTW 000 12	—
			40 m	490 NTW 000 40	—
			80 m	490 NTW 000 80	—
<b>Crossed cord cables</b>	2 RJ45 connectors For connections between hubs, switches and transceivers	2	5 m	490 NTC 000 05	—
			15 m	490 NTC 000 15	—
			40 m	490 NTC 000 40	—
			80 m	490 NTC 000 80	—

#### Shielded twisted pair cables for UL market

Description	Preformed at both ends	No.	Length	Reference	Weight kg
<b>Straight cables</b>	2 RJ45 connectors For connection to terminal devices (DTE)	3	2 m	490 NTW 000 02U	—
			5 m	490 NTW 000 05U	—
			12 m	490 NTW 000 12U	—
			40 m	490 NTW 000 40U	—
			80 m	490 NTW 000 80U	—
<b>Crossed cord cables</b>	2 RJ45 connectors For connections between hubs, switches and transceivers	4	5 m	490 NTC 000 05U	—
			15 m	490 NTC 000 15U	—
			40 m	490 NTC 000 40U	—
			80 m	490 NTC 000 80U	—

#### “Do it Yourself” cable and connectors

The ConneXium “Do it Yourself” range consists of 2 references for “field-installable” connectors (M12 and RJ45) and one reference for spooled cable measuring 300 m. They are intended for use in Ethernet networks supporting transmission rates up to 100 Mbps, with a maximum cable length of 80 m. They are quick to assemble using only a knife and simple wire cutters (no special tool is required).

Description	Characteristics	Length	Reference	Weight kg
<b>Ethernet copper cable</b> 2 shielded twisted pairs 24 AWG	Conforms to the standards and approval stated above	300 m	TCS ECN 300R2	—
<b>RJ45 connector</b>	Conforms to EIA/TIA-568-D	—	TCS EK3 MDS	—
<b>M12 connector</b>	Conforms to IEC 60176-2-101	—	TCS EK1 MDRS	—

# Modicon Quantum automation platform

## Wiring system

### ConneXium connection components

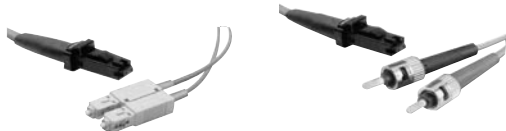

#### Glass fibre optic cables

These glass fibre optics are for making connections:

- To a terminal device (DTE)
- Between hubs, transceivers and switches

Description	Preformed at both ends	No.	Length	Reference	Weight kg
Glass fibre optic cables	1 SC connector 1 MT-RJ connector	5	5 m	490 NOC 000 05	–
	1 ST (BFOC) connector 1 MT-RJ connector	6	5 m	490 NOT 000 05	–
	2 MT-RJ connectors	7	3 m	490 NOR 000 03	–
			5 m	490 NOR 000 05	–
			15 m	490 NOR 000 15	–

#### Separate parts for TCS ESM switches

Description	Optical fibre	Type	Reference	Weight kg
Fibre optic modules for Gigabit ports with LC connector (1)	Multimode 50/125 µm or 62.5/125 µm	1000BASE-SX	TCS EAA F1LFU00	0.040
	Single mode 9/125 µm	1000BASE-LH	TCS EAA F1LFH00	0.040
	Multimode 50/125 µm or 62.5/125 µm Single mode 62.5/125 µm	1000BASE-LX	TCS EAA F1LFS00	0.040
Configuration backup key	Via the USB port on the front of the switch, used to: - save and retrieve the switch configuration - update the internal software		TCS EAM 0100	–

(1) Dimensions W x H x D = 20 x 18 x 50 mm

#### Connection components for IP 67 switch

Description	Preformed at both ends	No.	Length	Reference	Weight kg
Copper cables	1 IP 67 4-way M12 connector and 1 RJ45 connector	8	1 m	TCS ECL 1M3M 1S2	–
			3 m	TCS ECL 1M3M 3S2	–
			10 m	TCS ECL 1M3M 10S2	–
			25 m	TCS ECL 1M3M 25S2	–
		40 m	TCS ECL 1M3M 40S2	–	
	2 IP 67 4-way M12 connectors	–	1 m	TCS ECL 1M1M 1S2	–
			3 m	TCS ECL 1M1M 3S2	–
			10 m	TCS ECL 1M1M 10S2	–
		25 m	TCS ECL 1M1M 25S2	–	
	40 m	TCS ECL 1M1M 40S2	–		
Power cables	2 female M12 straight connectors	–	2 m	XZC P1164L2	–
			5 m	XZC P1164L5	–
	2 female M12 angled connectors	–	2.5 m	XZC P1264L2	–
			5 m	XZC P1264L5	–
Power cables	2 female M12 straight connectors	–	–	XZC C12 FDM 50B	–
	2 female M12 angled connectors	–	–	XZC C12 FCM 50B	–
M12/RJ45 adaptor	IP 67 female 4-way M12 connector and female RJ45 connector	–	–	TCS EAA F11F13F00	–



# Modicon Quantum automation platform

## Wiring system

### ConneXium hub

#### Presentation

Hubs (*concentrators*) are used for transmitting signals between several media (ports). Hubs are “plug and play” devices that do not need any configuring. The use of hubs makes it possible to create the following topologies:

- Star topology using hubs
- Tree topology using hubs

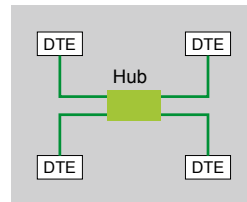

Star topology

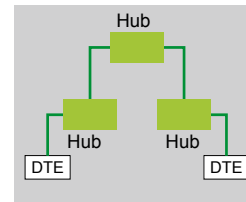

Tree topology

#### Characteristics and reference



6

Hubs			
<b>Interfaces</b>	Copper cable ports	Number and type	4 x 10BASE-T ports
		Shielded connectors	RJ45
	Medium		Shielded twisted pair, category CAT 5E
		Total length of pair	100 m
Fibre optic ports	Number and type	–	
<b>Topology</b>	Number of cascaded hubs		4 max.
	Number of hubs in a ring		–
<b>Redundancy</b>			P1 and P2 redundant power supplies
<b>Power supply</b>	Voltage		24 V $\overline{\text{---}}$ (18...32), safety extra low voltage (SELV)
	Power consumption		80 mA (130 max. at 24 V $\overline{\text{---}}$ )
	Removable terminal block		5 terminals
<b>Operating temperature</b>			0...+60°C
<b>Relative humidity</b>			10...95% non condensing
<b>Degree of protection</b>			IP 30
<b>Dimensions</b>	W x H x D		40 x 125 x 80 mm
<b>Mounting</b>			On symmetrical DIN rail, 35 mm wide
<b>Weight</b>			0.530 kg
<b>Conformity to standards</b>			cUL 60950, UL 508 and CSA 22.2 No. 142, UL 1604 and CSA 22.2 No. 213 Class 1 Division 2, CE, GL, C-Tick FM 3810, FM 3611 Class 1 Division 2
<b>LED indicators</b>			Power supply, activity, link
<b>Alarm relay</b>			Power supply fault, Ethernet network fault or communication port fault (volt-free contact 1 A max. at 24 V $\overline{\text{---}}$ )
<b>Reference</b>			499 NEH 104 10

#### Presentation

The use of ConneXium transceivers makes it possible to perform the following:

- Create fibre optic linear bus topologies, for devices with a twisted pair cable Ethernet connection.
- Interface devices with a twisted pair cable Ethernet connection with a fibre optic cable.

Transceivers are “plug and play” devices that do not need any configuring.

ConneXium transceivers provide fibre optic connections for transmission in areas subject to interference (high levels of electromagnetic interference) and for long distance communications.

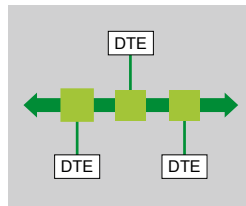

#### Characteristics and reference



Transceivers			
<b>Interfaces</b>	Copper cable ports	Number and type	1 x 100BASE-TX port
		Shielded connectors	RJ45
		Medium	Shielded twisted pair, category CAT 5E
		Total length of pair	100 m
	Fibre optic ports	Number and type	1 x 100BASE-FX port
		Connectors	SC
		Medium	Multimode optical fibre
Length of optical fibre			
50/125 µm fibre		3000 m (1)	
62.2/125 µm fibre	3000 m (1)		
Attenuation analysis	50/125 µm fibre	8 dB	
	62.2/125 µm fibre	11 dB	
<b>Redundancy</b>		P1 and P2 redundant power supplies	
<b>Power supply</b>	Voltage	24 V $\overline{\text{DC}}$ (18...32), safety extra low voltage (SELV)	
	Power consumption	160 mA (190 max. at 24 V $\overline{\text{DC}}$ )	
	Removable terminal block	5 terminals	
<b>Operating temperature</b>		0...+ 60°C	
<b>Relative humidity</b>		10...95% non condensing	
<b>Degree of protection</b>		IP 20	
<b>Dimensions</b>	W x H x D	47 x 135 x 111 mm	
<b>Mounting</b>		On symmetrical DIN rail, 35 mm wide	
<b>Weight</b>		0.230 kg	
<b>Conformity to standards</b>		cUL 60950, UL 508 and CSA 22.2 No. 142, UL 1604 and CSA 22.2 No. 213 Class 1 Division 2, CE, GL, C-Tick	
<b>LED indicators</b>		P1 and P2 power supplies, Ethernet link/port status	
<b>Alarm relay</b>		Power supply fault, Ethernet network fault or communication port fault (volt-free contact 1 A max. at 24 V $\overline{\text{DC}}$ )	
<b>Reference</b>		499 NTR 101 00	

(1) Length dependent on the attenuation analysis and attenuation of the optical fibre (typical value: 2000 m).

# Modicon Quantum automation platform

## Wiring system

### ConneXium unmanaged switches

#### Presentation

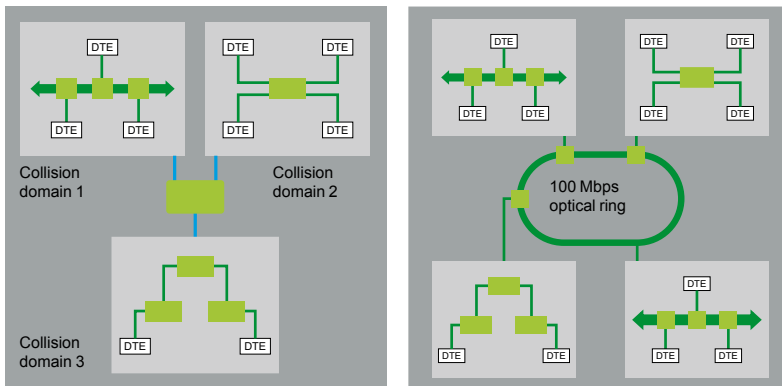

Switches are used to increase the limits of architectures based on hubs or transceivers, by separating collision domains. Higher layer communication is provided between the ports, and collisions at link layer are not propagated (filtering). They therefore improve performance by better allocation of the bandwidth due to the reduction of collisions and the network load. Certain ConneXium switch models also enable redundant architectures to be created on twisted pair copper ring or fibre optic.

Non-managed switches are “plug & play” devices that do not need any configuring. Certain models can also be managed remotely via SNMP or HTTP protocols for monitoring and diagnostic purposes.

#### Characteristics and references: twisted pair

Transparent Ready.



Switches		Copper twisted pair, unmanaged				
Interfaces	Copper cable ports	Number and type	5 x 10BASE-T/100BASE-TX ports		8 x 10BASE-T/100BASE-TX ports	
		Shielded connectors	M12 (type D)		RJ45	
		Medium	Shielded twisted pair, category CAT 5E			
		Total length of pair	100 m			
	Ethernet services	Storage and re-routing of received data, auto MDI/MDX, automatic negotiation of 10/100 Mbps and duplex mode (on all ports)			–	
Topology	Number of switches	Cascaded	Unlimited			
		Redundant in a ring	–			
Redundancy			–			
Power supply	Voltage	24 V $\bar{\text{---}}$ (18...32), safety extra low voltage (SELV)				
	Power consumption mA max.	100	125 (290 max.)			
	Removable terminal block	5 terminals, M12 (type A, male)	5 terminals			
Operating temperature		0...+60°C				
Relative humidity		–			10...95% non condensing	
Degree of protection		IP 20				
Dimensions		W x H x D	60 x 126 x 31 mm		47 x 135 x 111 mm	
Mounting		On symmetrical DIN rail, 35 mm wide				
Weight		0.210 kg		0.230 kg		
Conformity to standards		cUL 508 and CSA 22.2 No. 142		cUL 60950, UL 508 and CSA 22.2 No. 142, UL 1604 and CSA 22.2 No. 213 Class 1 Division 2, CÉ, GL, C-Tick		
LED indicators		Power supply, link status, line activity			P1 and P2 power supplies, Ethernet link/port status	
Alarm relay		–			Power supply fault, Ethernet network fault or communication port fault (volt-free contact 1 A max. at 24 V $\bar{\text{---}}$ )	
Reference		TCS ESU 051 F0		499 NES 181 00		
IP 67 cordsets						
Ethernet cordsets		Preformed at each end (see page 6/49)				
Power supply cables		Preformed at each end with M12 female straight connectors		Preformed at each end with female M12 angled connectors		
		Length 2 m	Length 2 m	Length 2 m	Length 2 m	
Reference		XZC P1164L2	XZC P1164L5	XZC P1264L2	XZC P1264L5	
Power supply connectors		Female M12 straight connector		Female M12 angled connector		
Reference		XZC C12 FDM 50B		XZC C12 FCM 50B		

#### Characteristics and references: 3, 4 and 5 ports, twisted pair and fibre optic



Switches			Twisted pair, unmanaged			
<b>Interfaces</b>	Copper cable ports	Number and type	3 x 10BASE-T/100BASE-TX ports	4 x 10BASE-T/100BASE-TX ports	5 x 10BASE-T/100BASE-TX ports	
		Shielded connectors	RJ45			
		Medium	Shielded twisted pair, category CAT 5E			
		Total length of pair	100 m			
	Fibre optic ports	Number and type	–	1 x 100BASE-FX port	–	
		Connectors	–	Duplex SC	–	
		Medium	–	Multimode optical fibre	–	
		Length of optical fibre	50/125 µm fibre	–	5000 m (1)	–
			62.2/125 µm fibre	–	4000 m (1)	–
		Attenuation analysis	50/125 µm fibre	–	8 dB	–
62.2/125 µm fibre	–		11 dB	–		
Ethernet services	Storage and re-routing of received data, auto MDI/MDX, automatic negotiation of 10/100 Mbps and duplex mode (on all ports)					
<b>Topology</b>	Number of switches	Cascaded	Unlimited			
		Redundant in a ring	–			
<b>Redundancy</b>		–				
<b>Power supply</b>	Voltage	24 V ~ (9.6...32 V ~), safety extra low voltage (SELV)				
	Power consumption	2.2 W max.	3.9 W max.	2.2 W max.		
	Connector	Removable screw terminal block, 3 terminals				
<b>Operating temperature</b>		0... +60°C				
<b>Relative humidity</b>		Max. 95% (non condensing)				
<b>Degree of protection</b>		IP 30				
<b>Dimensions</b>		W x H x D	25 x 114 x 79 mm			
<b>Weight</b>			0.113 kg	0.120 kg	0.113 kg	
<b>Conformity to standards</b>		UL 508 and CSA 22.2 No. 142 IEC/EN 61131-2, IEC 60825-1 class 1, CISPR 11A				
<b>LED indicators</b>		Power supply, copper port activity, 10 or 100 Mbps data rate				
<b>Alarm relay</b>				Fibre port activity and status	–	
			–			
<b>Reference</b>		TCS ESU 033FN0	TCS ESU 043F1N0	TCS ESU 053FN0		

(1) Length dependent on the attenuation analysis and attenuation of the optical fibre (typical value: 2000 m).

**Characteristics and references: 5 ports, twisted pair and fibre optic**

Transparent  
Ready



Switches			Copper twisted pair and fibre optic, unmanaged			
<b>Interfaces</b>	Copper cable ports	Number and type	4 x 10BASE-T/100BASE-TX ports	3 x 10BASE-T/100BASE-TX ports	4 x 10BASE-T/100BASE-TX ports	3 x 10BASE-T/100BASE-TX ports
		Shielded connectors	RJ45			
		Medium	Shielded twisted pair, category CAT 5E			
		Total length of pair	100 m			
	Fibre optic ports	Number and type	1 x 100BASE-FX port	2 x 100BASE-FX ports	1 x 100BASE-FX port	2 x 100BASE-FX ports
		Connectors	SC			
		Medium	Multimode optical fibre		Single mode optical fibre	
		Length of optical fibre				
		50/125 µm fibre	5000 m (1)		–	
		62.2/125 µm fibre	4000 m (1)		–	
9/125 µm fibre	–		32,500 m (2)			
Attenuation analysis	50/125 µm fibre	8 dB		–		
	62.2/125 µm fibre	11 dB		–		
	9/125 µm fibre	–		16 dB		
<b>Topology</b>	Number of switches	Cascaded	Unlimited			
		Redundant in a ring	–			
<b>Redundancy</b>	P1 and P2 redundant power supplies					
<b>Power supply</b>	Voltage	24 V $\overline{\text{DC}}$ (18...32), safety extra low voltage (SELV)				
	Power consumption	mA max.	200	240	200	240
	Removable terminal block	5 terminals				
<b>Operating temperature</b>	- 40...+ 70°C					
<b>Relative humidity</b>	10...95% non condensing					
<b>Degree of protection</b>	IP 20					
<b>Dimensions</b>	W x H x D		47 x 135 x 111 mm			
<b>Mounting</b>	On symmetrical DIN rail, 35 mm wide					
<b>Weight</b>			0.330 kg	0.335 kg	0.330 kg	0.335 kg
<b>Conformity to standards</b>	cUL 60950, cUL 508 and CSA 22.2 No. 142, UL 1604 and CSA 22.2 No. 213 Class 1 Division 2, CÉ, GL, C-Tick					
<b>LED indicators</b>	P1 and P2 power supplies, Ethernet link status, transmission activity					
<b>Alarm relay</b>	Activity, power supply fault, Ethernet network fault or communication port fault (volt-free contact 1 A max. at 24 V $\overline{\text{DC}}$ )					
<b>Reference</b>			499 NMS 251 01	499 NMS 251 02	499 NSS 251 01	499 NSS 251 02

(1) Length dependent on the attenuation analysis and attenuation of the optical fibre (typical value: 2000 m).

(2) Length dependent on the attenuation analysis and attenuation of the optical fibre (typical value: 15,000 m).

### Characteristics and references: 4 ports, twisted pair and fibre optic

Transparent  
Ready



Switches			Copper twisted pair and fibre optic, managed			
Interfaces	Copper cable ports	Number and type	3 x 10/100BASE-TX ports	2 x 10/100BASE-TX ports	3 x 10/100BASE-TX ports	2 x 10/100BASE-TX ports
		Shielded connectors	RJ45			
		Medium	Shielded twisted pair, category CAT 5E			
		Total length of pair	100 m			
	Fibre optic ports	Number and type	1 x 100BASE-FX port	2 x 100BASE-FX ports	1 x 100BASE-FX port	2 x 100BASE-FX ports
		Connectors	Duplex SC			
		Medium	Multimode optical fibre		Single mode optical fibre	
		Length of optical fibre				
		50/125 µm fibre	5000 m (1)		–	
		62.2/125 µm fibre	4000 m (1)		–	
9/125 µm fibre		–		32,500 m (2)		
Attenuation analysis						
50/125 µm fibre	8 dB		–			
62.2/125 µm fibre	11 dB		–			
9/125 µm fibre	–		16 dB			
Ethernet services	FDR, SMTP V3, SNMP client, multicast filtering for optimization of the Global Data protocol, configuration via Web access VLAN, IGMP Snooping, RSTP ( <i>Rapid Scanning Tree Protocol</i> ), priority port, data stream control, secure port					
Topology	Number of switches	Cascaded	Unlimited			
		Redundant in a ring	50 max.			
Redundancy	Redundant power supplies, redundant single ring, ring coupling					
Power supply	Voltage	Operation	9.6...60 V $\overline{\text{---}}$ /18...30 V $\sim$ , safety extra low voltage (SELV)			
	Power consumption		6.5 W	7.3 W	6.5 W	7.3 W
	Removable terminal block		6 terminals			
Operating temperature	0...+60°C					
Relative humidity	10...90% non condensing					
Degree of protection	IP 20					
Dimensions	W x H x D	47 x 131 x 111 mm				
Mounting	On symmetrical DIN rail, 35 mm wide					
Weight	0.400 kg					
Conformity to standards	IEC 61131-2, IEC 61850-3, UL 508, UL 1604 Class 1 Division 2, CSA 22.2 No. 142 (cUL), CSA 22.2 No. 213 Class 1 Division 2 (cUL), CE, GL, C-Tick					
LED indicators	Power supply status, alarm relay status, active redundancy, redundancy management, copper port status and copper port activity					
Alarm relay	Power supply fault, Ethernet network fault, communication port fault, redundancy fault (volt-free contact 1 A max. at 24 V $\overline{\text{---}}$ )					
Reference			TCS ESM 043F1CU0	TCS ESM 043F2CU0	TCS ESM 043F1CS0	TCS ESM 043F2CS0

(1) Length dependent on the attenuation analysis and attenuation of the optical fibre (typical value: 2000 m).

(2) Length dependent on the attenuation analysis and attenuation of the optical fibre (typical value: 15,000 m).

**Characteristics and references: 4 and 8 ports, twisted pair**

Transparent  
Ready.



Switches			Copper twisted pair, managed	
<b>Interfaces</b>	Copper cable ports	Number and type	4 x 10/100BASE-TX ports	8 x 10/100BASE-TX ports
		Shielded connectors	RJ45	
		Medium	Shielded twisted pair, category CAT 5E	
		Total length of pair	100 m	
	Fibre optic ports	Number and type	–	
		Connectors	–	
		Medium	–	
		Length of optical fibre	–	
		50/125 µm fibre	–	
		62.2/125 µm fibre	–	
Ethernet services	Attenuation analysis	–		
	50/125 µm fibre	–		
	62.2/125 µm fibre	–		
	9/125 µm fibre	–		
	FDR, SMTP V3, SNMP client, multicast filtering for optimization of the Global Data protocol, configuration via Web access			
	VLAN, IGMP Snooping, RSTP ( <i>Rapid Scanning Tree Protocol</i> ), priority port, data stream control, secure port			
<b>Topology</b>	Number of switches	Cascaded	Unlimited	
		Redundant in a ring	50 max.	
<b>Redundancy</b>		Redundant power supplies, redundant single ring, ring coupling		
<b>Power supply</b>	Voltage	Operation	9.6...60 V $\overline{\text{---}}$ /18...30 V $\sim$ , safety extra low voltage (SELV)	
	Power consumption		5.3 W	5.3 W
	Removable terminal block		6 terminals	
<b>Operating temperature</b>		0...+60°C		
<b>Relative humidity</b>		10...90% non condensing		
<b>Degree of protection</b>		IP 20		
<b>Dimensions</b>		W x H x D	47 x 131 x 111 mm	74 x 131 x 111 mm
<b>Mounting</b>		On symmetrical DIN rail, 35 mm wide		
<b>Weight</b>			0.400 kg	0.410 kg
<b>Conformity to standards</b>		IEC/EN 61131-2, IEC 61850-3, UL 508, UL 1604 Class 1 Division 2, CSA 22.2 No. 214 (cUL), CSA 22.2 No. 213 Class 1 Division 2 (cUL), CE, GL, C-Tick		
<b>LED indicators</b>		Power supply status, alarm relay status, active redundancy, redundancy management, copper port status and copper port activity	Power supply status, alarm relay status, active redundancy, redundancy management, fibre port status and fibre port activity	
<b>Alarm relay</b>		Power supply fault, Ethernet network fault or communication port fault (volt-free contact 1 A max. at 24 V $\overline{\text{---}}$ )		
<b>Reference</b>			TCS ESM 043F23F0	TCS ESM 083F23F0

6

### Characteristics and references: 8 ports, twisted pair and fibre optic



Switches			Copper twisted pair and fibre optic, managed			
Interfaces	Copper cable ports	Number and type	7 x 10/100BASE-TX ports	6 x 10/100BASE-TX ports	7 x 10/100BASE-TX ports	6 x 10/100BASE-T ports
		Shielded connectors	RJ45			
		Medium	Shielded twisted pair, category CAT 5E			
		Total length of pair	100 m			
	Fibre optic ports	Number and type	1 x 100BASE-FX port	2 x 100BASE-FX ports	1 x 100BASE-FX port	2 x 100BASE-FX ports
		Connectors	Duplex SC			
		Medium	Multimode optical fibre		Single mode optical fibre	
		Length of optical fibre				
		50/125 µm fibre	5000 m (1)		-	
		62.2/125 µm fibre	4000 m (1)		-	
9/125 µm fibre	-		32,500 m (2)			
Attenuation analysis						
50/125 µm fibre	8 dB		-			
62.2/125 µm fibre	11 dB		-			
9/125 µm fibre	-		16 dB			
Ethernet services	FDR, SMTP V3, SNTF client, multicast filtering for optimization of the Global Data protocol, configuration via Web access VLAN, IGMP Snooping, RSTP ( <i>Rapid Scanning Tree Protocol</i> ), priority port, data stream control, secure port					
Topology	Number of switches	Cascaded	Unlimited			
		Redundant in a ring	50 max.			
Redundancy	Redundant power supplies, redundant single ring, ring coupling					
Power supply	Voltage	Operation	9.6...60 V $\overline{\text{---}}$ /18...30 V $\sim$ , safety extra low voltage (SELV)			
	Power consumption		6.5 W	7.3 W	6.5 W	7.3 W
	Removable terminal block		6 terminals			
Operating temperature	0...+60°C					
Relative humidity	10...90% non condensing					
Degree of protection	IP 20					
Dimensions	W x H x D	74 x 131 x 111 mm				
Mounting	On symmetrical DIN rail, 35 mm wide					
Weight	0.410 kg					
Conformity to standards	IEC/EN 61131-2, IEC 61850-3, UL 508, UL 1604 Class 1 Division 2, CSA 22.2 No. 214 (cUL), CSA 22.2 No. 213 Class 1 Division 2 (cUL), CE, GL, C-Tick					
LED indicators	Power supply status, alarm relay status, active redundancy, redundancy management, fibre port status and fibre port activity					
Alarm relay	Power supply fault, Ethernet network fault or communication port fault (volt-free contact 1 A max. at 24 V $\overline{\text{---}}$ )					
Reference	TCS ESM 083F1CU0	TCS ESM 083F2CU0	TCS ESM 083F1CS0	TCS ESM 083F2CS0		

(1) Length dependent on the attenuation analysis and attenuation of the optical fibre (typical value: 2000 m).

(2) Length dependent on the attenuation analysis and attenuation of the optical fibre (typical value: 15,000 m).



**Characteristics and references: 16 and 24 ports, twisted pair and fibre optic**

Transparent  
Ready



Switches			Copper twisted pair, managed	Copper twisted pair and fibre optic, managed		
<b>Interfaces</b>	Copper cable ports	Number and type	16 x 10/100BASE-TX ports	14 x 10/100BASE-TX ports	22 x 10/100BASE-TX ports	
		Shielded connectors	RJ45			
		Medium	Shielded twisted pair, category CAT 5E			
		Total length of pair	100 m			
	Fibre optic ports	Number and type	–	2 x 100BASE-FX ports		
		Connectors	–	Duplex SC		
		Medium	–	Multimode optical fibre		
		Length of optical fibre	–	–		
		50/125 µm fibre	–	5000 m (1)		
		62.2/125 µm fibre	–	4000 m (1)		
Ethernet services	Attenuation analysis	–	–			
	50/125 µm fibre	–	8 dB			
	62.2/125 µm fibre	–	11 dB			
	9/125 µm fibre	–	–			
<b>Topology</b>	Number of switches	Cascaded	Unlimited			
		Redundant in a ring	50 max.			
<b>Redundancy</b>	Redundant power supplies, redundant single ring, ring coupling					
<b>Power supply</b>	Voltage	Operation	9.6...60 V $\overline{\text{---}}$ /18...30 V $\sim$ , safety extra low voltage (SELV)			
	Power consumption		9.4 W	11.8 W	15.5 W	
	Removable terminal block		6 terminals			
<b>Operating temperature</b>	0...+ 60°C					
<b>Relative humidity</b>	10...90% non condensing					
<b>Degree of protection</b>	IP 20					
<b>Dimensions</b>	W x H x D	111 x 131 x 111 mm				
<b>Mounting</b>	On symmetrical DIN rail, 35 mm wide					
<b>Weight</b>	0.600 kg				0.650 kg	
<b>Conformity to standards</b>	cUL 60950, UL 508 and CSA 22.2 No. 142, UL 1604 and CSA 22.2 No. 213 Class 1 Division 2, C€, GL, C-Tick					
<b>LED indicators</b>	Redundant power supplies, single ring		Redundant power supplies, single ring, double ring			
<b>Alarm relay</b>	Power supply fault, Ethernet network fault or communication port fault (volt-free contact 1 A max. at 24 V $\overline{\text{---}}$ )					
<b>Reference</b>	TCS ESM 163F23F0		TCS ESM 163F2CU0	TCS ESM 243F2CU0		

(1) Length dependent on the attenuation analysis and attenuation of the optical fibre (typical value: 2000 m).

Characteristics and references: 8 ports and 2 Gigabit ports, twisted pair, fibre optic

Transparent  
Ready



Switches			Copper twisted pair and fibre optic, managed			Copper twisted pair, managed		
Interfaces	Copper cable ports	Number and type	8 x 10/100BASE-TX ports			8 x 10/100BASE-TX ports and 2 x 10/100/1000BASE-TX (Gigabit) ports		
		Shielded connectors	RJ45					
		Medium	Shielded twisted pair, category CAT 5E					
		Total length of pair	100 m					
	Gigabit ports fibre optic (with SFP fibre module to be mounted on SFP connector)	Number and type	2 x 1000BASE-SX ports (1)	2 x 1000BASE-LH ports (2)	2 x 1000BASE-LX ports (3)	-		
		Connectors	LC			-		
		Medium	Multimode optical fibre	Single mode optical fibre	Single mode and multimode optical fibre	-		
		Length of optical fibre	50/125 µm fibre	550 m	-	550 m	-	
			62.2/125 µm fibre	275 m	-	550 m	-	
			9/125 µm fibre	-	8 - 72,000 m	20,000 m	-	
		Attenuation analysis	50/125 µm fibre	7.5 dB	-	11 dB	-	
			62.2/125 µm fibre	7.5 dB	-	11 dB	-	
	9/125 µm fibre		-	6 - 22 dB	11 dB	-		
Ethernet services	FDR, SMTP V3, SNTTP client, multicast filtering for optimization of the Global Data protocol, configuration via Web access VLAN, IGMP Snooping, RSTP ( <i>Rapid Scanning Tree Protocol</i> ), priority port, data stream control, secure port							
Topology	Number of switches	Cascaded	Unlimited					
		Redundant in a ring	50 max.					
Redundancy			Redundant power supplies, redundant single ring, ring coupling					
Power supply	Voltage	Operation	9.6...60 V $\overline{\text{---}}$ /18...30 V $\sim$ , safety extra low voltage (SELV)					
	Power consumption		8.9 W + 1 W per SFP fibre module		8.3 W			
	Removable terminal block		6 terminals					
Operating temperature			0... + 60°C					
Relative humidity			10...90% non condensing					
Degree of protection			IP 20					
Dimensions		W x H x D	111 x 131 x 111 mm					
Mounting			On symmetrical DIN rail, 35 mm wide					
Weight			0.410 kg					
Conformity to standards			cUL 60950, UL 508 and CSA 22.2 No. 142, UL 1604 and CSA 22.2 No. 213 Class 1 Division 2, CE, GL					
LED indicators			Power supply status, alarm relay status, active redundancy, redundancy management, fibre port status and fibre port activity					
Alarm relay			Power supply fault, Ethernet network fault or communication port fault (volt-free contact 1 A max. at 24 V $\overline{\text{---}}$ )					
Reference			TCS ESM 103F2LG0		TCS ESM 103F23G0			

- (1) With TCS EAA F1LFU00 fibre optic module to be ordered separately (see page 6/51).  
 (2) With TCS EAA F1LFH00 fibre optic module to be ordered separately (see page 6/51).  
 (3) With TCS EAA F1LFS00 fibre optic module to be ordered separately (see page 6/51).

### Presentation

**140 NOC 771 00** Ethernet/IP network modules are single format modules for installing in the slots of the local rack of a Modicon Quantum PLC configuration. A configuration can take from 2 to 6 application-specific modules, including network modules, depending on the type of processor.



### Description

The front panel of a **140 NOC 771 00** EtherNet/IP module has the following:

**1** A display block, which indicates the module status and the transmission status on the network.

A hinged cover providing access to:

**2** A standard (RJ45) connector for 10BASE-T/100BASE-TX interface.

### Characteristics

Module type		140 NOC 771 00
<b>Ethernet services</b>	SNMP	Yes
	BootP/DHCP server	Yes
<b>Network protocols</b>	EtherNet/IP	Yes
	Modbus TCP	—
<b>Structure</b>	Physical interface	10BASE-T/100BASE-TX (RJ45)
	Data rate	10/100 Mbps
	Medium	Twisted pair
<b>Network module</b>	Operating temperature	0...+ 60°C
	Relative humidity	10...95% non condensing during operation at 60°C
	Degree of protection	IP 20
	Power supply	Via the power supply of the rack supporting the module
	Conformity to standards	UL 508, cUL, CSA 22.2-142, FM Class 1 Division 2, CE, ODVA (EtherNet/IP)
	LED indicators	Communication status (Active), module status (Mod Status), network communication status (Net Status), configuration status (Ready), Ethernet connection status (Link), Transmission activity (TxActive), reception activity (RxActive), connection speed indicator (100MB), full-duplex mode and collision indicator (Fduplex/Col)

## References



140 NOC 771 00

Description	Data rate	Reference	Weight kg
Ethernet/IP modules	10/100 Mbps	140 NOC 771 00	0.345

# Modicon Quantum automation platform

## AS-Interface cabling system

### Master module for Modicon Quantum PLCs

#### Presentation

The AS-Interface (actuator sensor interface) system is a wiring solution used in machine level automated systems instead of conventional parallel wiring. This serial interface consists of an unshielded non-twisted pair enabling communication with user devices (sensors and actuators) provided with internal intelligence.

The 140 EIA 921 00 AS-Interface module for Modicon Quantum PLCs is a single-slot module with one AS-Interface channel. The Quantum I/O map interface makes the module usable in local, remote (RIO) and distributed (DIO) I/O drops.

#### Network media and topology

The AS-Interface line uses an unshielded 2-wire cable for data and power distribution. The protocol is based on a master/slave hierarchy and allows up to 31 slaves to be connected to a single network over a maximum distance of 100 metres. This length can be increased through the use of repeaters.

The 140 EIA 921 00 master module supports the AS-Interface M2 (*AS-Interface V1*) profile, one of the simplest to use. It is designed to meet the requirements of actuator and sensor devices where the connection cost is high and there is a relatively small amount of data to be handled.

The topology of the AS-Interface line is totally flexible and can be adapted to users' requirements (point-to-point, line or tree structure topology). In all cases, the total length of all branches of the line must not exceed 100 metres (without using repeaters).

The AS-Interface cable consists of one unshielded non-twisted pair enabling simultaneous powering of and communication with the connected devices. The wire has a cross-section of between 1.5 and 2.5 mm<sup>2</sup> depending on the power consumption of the devices.

#### Functions of the Modicon Quantum AS-Interface module

- Compatible with all Quantum CPUs.
- Module parameter setup using Unity Pro, Concept 2.6 or ProWORX 32 software.
- The Quantum I/O map interface allows 4 modules per local drop, 4 per remote drop (RIO) and 2 per distributed I/O drop (DIO).
- Display block of 32 LED indicators displays slave addresses and the state of slave I/O bits.
- Hot swap function available without damage for all Quantum I/O racks.
- Protected against reverse polarity of AS-Interface line inputs.
- Less commissioning time and increased diagnostic capability reduces the overall cost of an automated system.
- Automatic device reconfiguration (addresses and parameters).

#### Description



The 140 EIA 921 00 AS-Interface module consists of the following:

- 1 Model number and colour code
- 2 Display block of 32 LED indicators
- 3 Removable hinged door
- 4 SUB-D 3-way male connector for AS-Interface cable connection

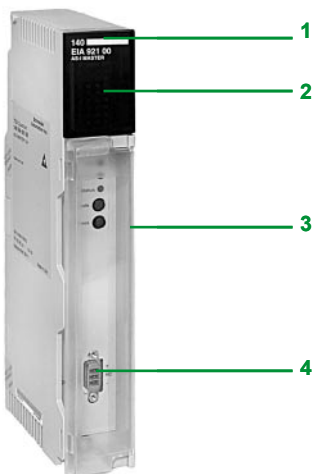
6



Characteristics			
<b>Model</b>		140 EIA 921 00	
<b>AS-Interface line</b>	AS-Interface version		V1
	AS-Interface master profile		M2 (standard addressing)
	Cycle time	<b>ms</b>	5 max.
	Maximum line length	<b>m</b>	100 m without repeater
	Max. number of I/O points		124 discrete inputs and 124 discrete outputs
	Maximum no. of slaves on the line		31
	Nominal line supply voltage	<b>V <math>\ddot{\text{~}}</math></b>	30
	AS-Interface scan time for "n" slaves	<b>ms</b>	156 x (n+2) if n < 31 slaves 156 x (n+1) if n = 31 slaves
	Transmission speed	<b>kbits</b>	167 approx.
<b>AS-Interface module</b>	Power consumption	<b>mA</b>	60 typical at 30 V $\ddot{\text{~}}$ 100 max.
	Protection against reverse polarity		Yes
	Degree of protection		IP 20
	Operating temperature	<b>°C</b>	0...+ 60
	Product certifications		UL, CSA, CE

References						
	<b>Description</b>	<b>Number per Quantum PLC</b>	<b>Profile</b>	<b>Max. number of I/O</b>	<b>Reference</b>	<b>Weight kg</b>
	<b>AS-Interface master module for Quantum PLCs</b>	4 per local drop 4 per remote drop (RIO) 2 per distributed drop (DIO)	AS-Interface M2	31 discrete devices, i.e. 248 I/O	<b>140 EIA 921 00</b>	0.450
	<b>Separate parts</b>					
	<b>Description</b>	<b>Use</b>		<b>Length</b>	<b>Reference</b>	<b>Weight kg</b>
	<b>AS-Interface line ribbon cables (yellow)</b>	For AS-Interface line		20 m	<b>XZ CB 10201</b>	1.400
				50 m	<b>XZ CB 10501</b>	3.500
			100 m	<b>XZ CB 11001</b>	7.000	
<b>Description</b>	<b>Use</b>		<b>Language</b>	<b>Reference</b>	<b>Weight kg</b>	
<b>Documentation</b>	AS-Interface module user guide		English	<b>840 USE 117 00</b>	—	

140 EIA 921 00

XZ CB1●●01

# Modicon Quantum automation platform

## Phaseo regulated switch mode power supplies for AS-Interface range

### Power supplies for AS-Interface cabling system

Compatible with the standard Phaseo line, the range of **ASI ABL** power supplies is designed to deliver a DC voltage, as required by AS-Interface cabling systems. Three versions are available to meet all needs encountered in industrial applications, in enclosures, cubicles or floor-standing enclosures. These single-phase electronic switch mode power supplies guarantee the quality of the output current, in accordance with the electrical characteristics and conforming to standard EN 50295.

#### ASI ABLB300●

Operating on a 100 to 240 V AC supply, this power supply delivers a voltage of 30 V DC. Available in 2.4 and 4.8 A ratings, the outgoing terminal block allows the cable to be connected separately to AS-Interface interface modules and the AS-Interface master. Input and output LEDs allow fast, continuous diagnostics.



ASI ABLB3002

#### ASI ABLD300●

Operating on a 100 to 240 V AC supply, this power supply delivers a voltage of 30 V DC. Available in 2.4 and 4.8 A ratings, it allows diagnosis and management of earth faults on AS-Interface interface modules. In the event of an earth fault, the Phaseo power supply stops dialogue on the AS-Interface cabling system and puts the installation in a fallback condition. Restarting is only possible after deliberate acknowledgement of the fault. Two inputs/outputs enable dialogue with a processing unit. The outgoing terminal block is used to connect the AS-Interface cable separately to the interface modules and the master. Input, output and earth fault LEDs allow fast, continuous diagnostics.



ASI ABLD3004

#### ASI ABLM3024

Operating on a 100 to 240 V AC supply, this product provides two separate power supplies which are totally independent in the way they operate. Two output voltages, 30 V/2.4 A (AS-Interface line supply) and 24 V/3 A, are available, so making it possible to power the control equipment without an additional power supply. Input and output LEDs allow fast, continuous diagnostics.



ASI ABLM3024

6

# Modicon Quantum automation platform

Phaseo regulated switch mode power supplies for AS-Interface range

Technical characteristics								
Power supply type		ASIABLB3002	ASIABLB3004	ASIABLD3002	ASIABLD3004	ASIABLM3024		
Functions		Supply to the AS-Interface line (30 V $\overline{\text{---}}$ )				30 V $\overline{\text{---}}$ supply	24 V $\overline{\text{---}}$ supply	
Product certifications		UL 508, CSA 22-2 No. 950, TÜV 60950-1						
Conforming to standards	Safety	EN 60950-1						
	EMC	EN 50081-1, IEC/EN 61000-6-2, EN 55022 class B						
	Low frequency harmonic currents	No						
<b>Input circuit</b>								
LED indication		Orange LED						
Input values	Nominal voltage	V	100...240 $\sim$					
	Limit voltages	V	85...264 $\sim$					
	Current consumption	A	0.5	1	0.5	1	1	
	Permissible frequencies	Hz	47...63					
	Maximum inrush current	A	30					
	Power factor		0.65					
	Efficiency at nominal load	%	> 83			> 83	> 80	
	Dissipated power at nominal load	W	14.7	29.5	14.7	29.5	14.7	36
	<b>Output circuit</b>							
LED indication		Green LED						
Nominal output values	Voltage ( $U_{\text{Out}}$ )	V	30 (AS-Interface)			30 $\overline{\text{---}}$	24 $\overline{\text{---}}$	
	Current	A	2.4	4.8	2.4	4.8	2.4	3
	Power	W	72	144	72	144	72	72
Precision	Adjustable output voltage	V	-				-	24... 28.8 $\overline{\text{---}}$
	Line and load regulation		3%					
	Residual ripple - noise	mV	300 - 50					
Holding time	I max. and $V_{\text{IN}}$ min.	ms	10					
Protection	Against short circuits		Permanent. Automatic restart after elimination of the fault					
	Against overloads		1.1 I <sub>n</sub>					
	Against overvoltages		Tripping if $U > 1.2 U_n$			$U > 1.2 U_n$	$U > 1.5 U_n$	
	Against undervoltages		Tripping if $U < 0.95 U_n$			$U < 0.95 U_n$	$U < 0.8 U_n$	
<b>Operating characteristics</b>								
Connections	Input	mm <sup>2</sup>	2 x 2.5 screw terminals + earth					
	Output	mm <sup>2</sup>	2 x 2.5 screw terminals + earth, multiple output					
Environment	Operating temperature	°C	0...+ 60 (derating from 50°C, see page 9/36)					
	Storage temperature	°C	- 25...+ 70					
	Maximum relative humidity		95% (without condensation or dripping water)					
	Degree of protection		IP 20 (conforming to IEC/EN 60529)					
	Vibrations		IEC/EN 61131-2					
Operating position			Vertical					
MTBF		h	> 100,000 (conforming to Bell core, at 40°C)					
Dielectric strength 50 Hz for 1 min	Input/output	V rms	3000					
	Input/earth	V rms	3000					
	Output/earth (and output/output)	V rms	500					
Input fuse incorporated			Yes (not interchangeable)					
Emission, according to EN 61000-6-3	Conducted/radiated		Class B (conforming to EN 55022)					
Immunity, according to IEC/EN 61000-6-2	Electrostatic discharge		IEC/EN 61000-4-2 (4 kV contact/8 kV air)					
	Radiated electromagnetic fields		IEC/EN 61000-4-3 level 3 (10 V/m)					
	Induced electromagnetic fields		IEC/EN 61000-4-6 (10 V)					
	Rapid transients		IEC 61000-4-4 level 3 (2 kV)					
Primary outages			IEC 61000-4-11 (voltage dips and interruptions)					



### Output characteristics

#### Derating

The ambient temperature is a determining factor which limits the power that an electronic power supply can deliver continuously. This is because, if the temperature around the electronic components is too high, their life will be significantly reduced. The graph below shows the power (in relation to the nominal power) that the power supply can deliver continuously, according to the ambient temperature.

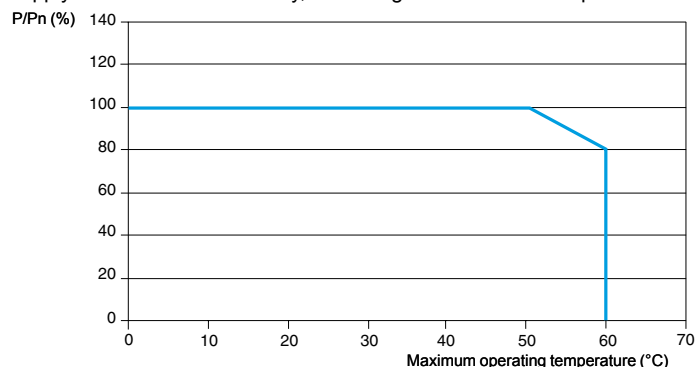

### Diagram of operation

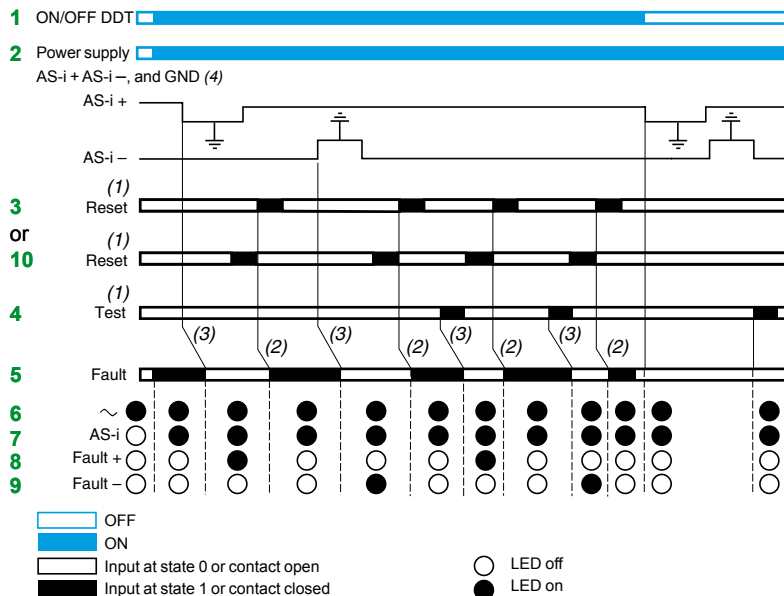
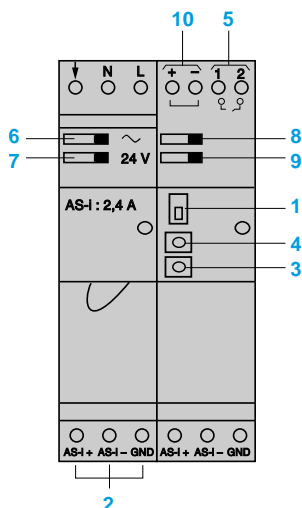

(1) 30 ms min. (2) 15 ms (3) 20 ms  
 (4) Warning: the earth fault detector will work only if the earth (GND) terminal is connected.

#### ⚠ Important:

- The earth (GND) connection (4) must be made. If disconnected, the built-in detector becomes inoperative. To obtain earth fault diagnostics, use of an **ASi ABLD3002/3004** power supply with built-in earth fault detector is recommended.
  - Appearance of an accidental earth causes activation of the built-in protection, in the following cases:
    - **Case 1:** fault between AS-i "+" and earth
    - **Case 2:** fault between AS-i "-" and earth
    - **Case 3:** fault between the sensors/actuators powered by the **ASi ABLD3002/3004** and earth
- In cases 1 and 2: switch ON -> OFF: fault maintained, no exchange between master and slaves.  
 In case 3: switch ON -> OFF: resumption of exchanges between master and slaves, but the states of the I/O of the module affected by the fault are not guaranteed.

# Modicon Quantum automation platform

Phaseo regulated switch mode power supplies for AS-Interface range

## Selection of protection on the power supply primaries

Line supply type	115 V ~ single-phase			230 V ~ single-phase		
	Thermal-magnetic circuit breaker (1)		Gg fuse	Thermal-magnetic circuit breaker (2-pole)		Gc fuse
ASI ABLB3002	GB2 ●B07	MG24517 (2)	2 A	GB2 DB06	MG24516 (2)	2 A
ASI ABLB3004	GB2 ●B08	MG24518 (2)	4 A	GB2 DB07	MG17453 (2)	2 A
ASI ABLD3002	GB2 ●B07	MG24517 (2)	2 A	GB2 DB06	MG24516 (2)	2 A
ASI ABLD3004	GB2 ●B08	MG24518 (2)	4 A	GB2 DB07	MG17453 (2)	2 A
ASI ABLM3024	GB2 ●B07	MG24517 (2)	2 A	GB2 DB06	MG17453 (2)	2 A

(1) Single-pole protection, replace ● by C; 2-pole protection, replace by D.  
(2) UL-certified circuit breaker

## References



ASI ABL●3002

Input voltage	Secondary			Reset of auto-protect	Earth fault detection	Reference	Weight kg
	Output voltage	Nominal power	Nominal current				
<b>Single-phase (N-L1) or 2-phase (L1-L2)</b>							
100...240 V ~ - 15%, + 10% 50/60 Hz	30 V $\overline{\text{---}}$	72 W	2.4 A	Auto	No	ASI ABLB3002	0.800
		144 W	4.8 A	Auto	No	ASI ABLB3004	1.300
	30 V $\overline{\text{---}}$	72 W	2.4 A	Auto	Yes	ASI ABLD3002	0.800
		144 W	4.8 A	Auto	Yes	ASI ABLD3004	1.300
30 V $\overline{\text{---}}$	72 W	2.4 A	Auto	No	ASI ABLM3024	1.300	
	24 V $\overline{\text{---}}$	72 W	3 A				

## Dimensions

Common side view  
Mounting on 35 mm and 75 mm rails

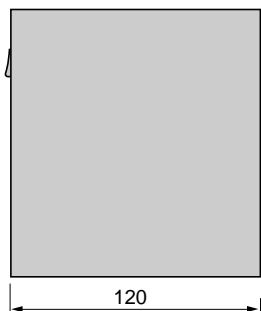

ASI ABLB3002  
ASI ABLD3002

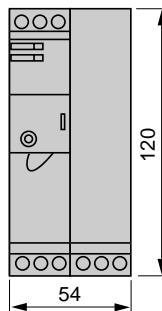

ASI ABLB3004/ABLD3004  
ASI ABLM3024

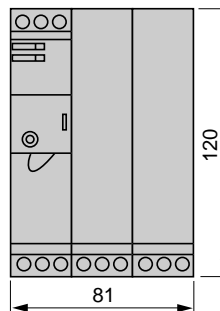

## Schemes

ASI ABLB300●

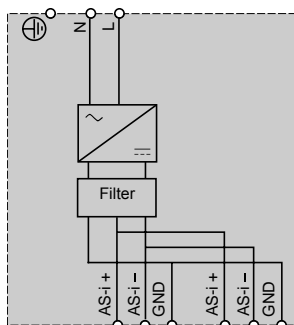

ASI ABLD300●

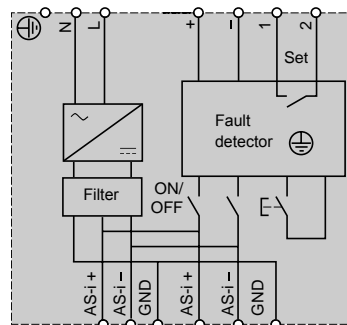

ASI ABLM3024

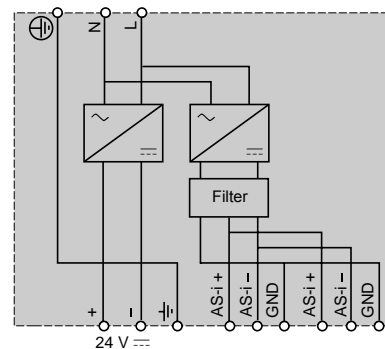

# Modicon Quantum automation platform

## Modbus Plus network

### Presentation

All Quantum 140 CPUs contain a Modbus Plus port, allowing high-speed point-to-point communications with easy implementation designed to simplify data sharing between nodes across a network. The Modbus Plus local area network facilitates communications between CPUs, host computers and other data sources via twisted-pair cable or optional fibre optic cable. Communications take place at a speed of 1 Mbps.

Typical applications include interlocking on control networks, data acquisition, uploading/downloading software, remote on-line programming, connecting to operator interfaces and host computer data export. Modbus Plus is able to handle communications for real-time systems such as I/O and drives.

### Topology

A standard Modbus Plus network based on twisted-pair cable supports up to 32 nodes and can communicate over distances up to 450 m.

If an application requires more nodes or longer distances, an RR85 Modbus Plus repeater placed between network connections allows 64 addresses over a distance of up to 900 m. As many as three repeaters can be used, supporting distances of up to 1800 m. The maximum number of network addresses supported is 64.

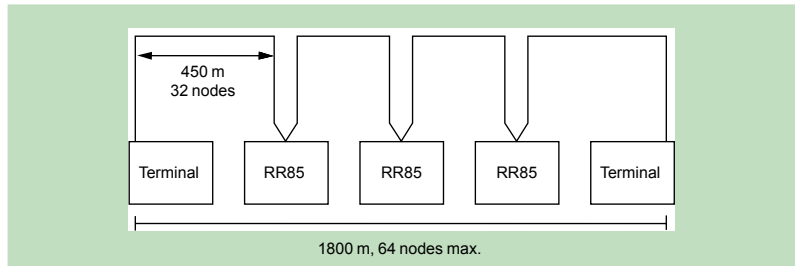

If an application requires more than 64 nodes, a BP85 Modbus Plus bridge can be used to connect two Modbus Plus networks. Bridge devices can be used to interconnect network segments in order to achieve maximum performance.

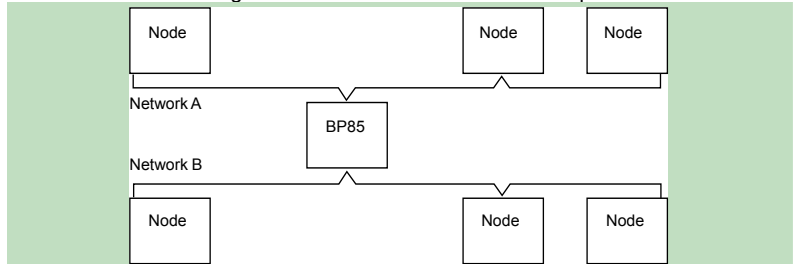

When a Modbus device, such as a programming terminal, operator interface or third-party computer, requires access to data from a Modbus Plus network, a BM85 Modbus Plus bridge must be used. The BM85 has four Modbus-compatible RS 232 serial ports, enabling a Modbus master or Modbus slave to connect to a Modbus Plus network. The bridge connections allow data exchanges between Modbus devices and with the entire Modbus Plus network.

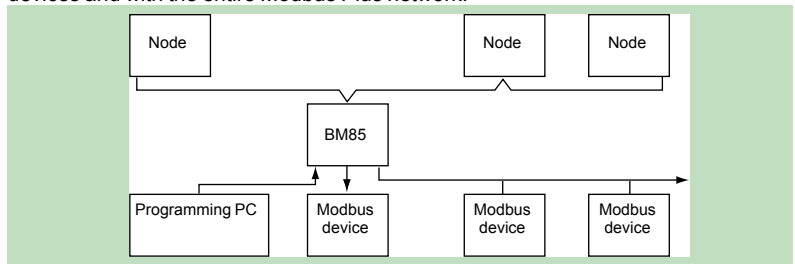

### Presentation (continued)

The application program allows event-initiated communications and incorporates network diagnostics using either instructions in MSTR 984LL language or an equivalent function in an IEC 1131 language. A central computer can implement the Modbus Plus protocol, with NetBios-compatible software libraries that are called by this computer's application program. Appropriate libraries are provided for each type of computer interface, for the majority of platforms and operating systems.

### Installation

Modbus Plus is a stand-alone network that uses inexpensive twisted-pair cables. It is a "plug and play" network. Modbus Plus connectivity is available on a great variety of PLC families, with additional connectivity made possible through our Collaborative Automation partnership programme. Modbus Plus supports up to 20,000 registers per second in a predictable, deterministic manner. Modbus Plus functionalities are based on a global database and a data table exchange mechanism. Diagnostic programs and visual LED indicators are an aid to network operation.

### Redundant cables

For high-availability applications, Schneider Automation offers a series of Modbus Plus network components and options for redundant operations. The redundant cabling enables Modbus Plus communication over two independent cable systems, with link health being checked and validated on every message transfer. A defective link is identified in the network statistics. If one link fails, for any reason whatsoever, the system will automatically switch to the other cable while the faulty link is repaired.

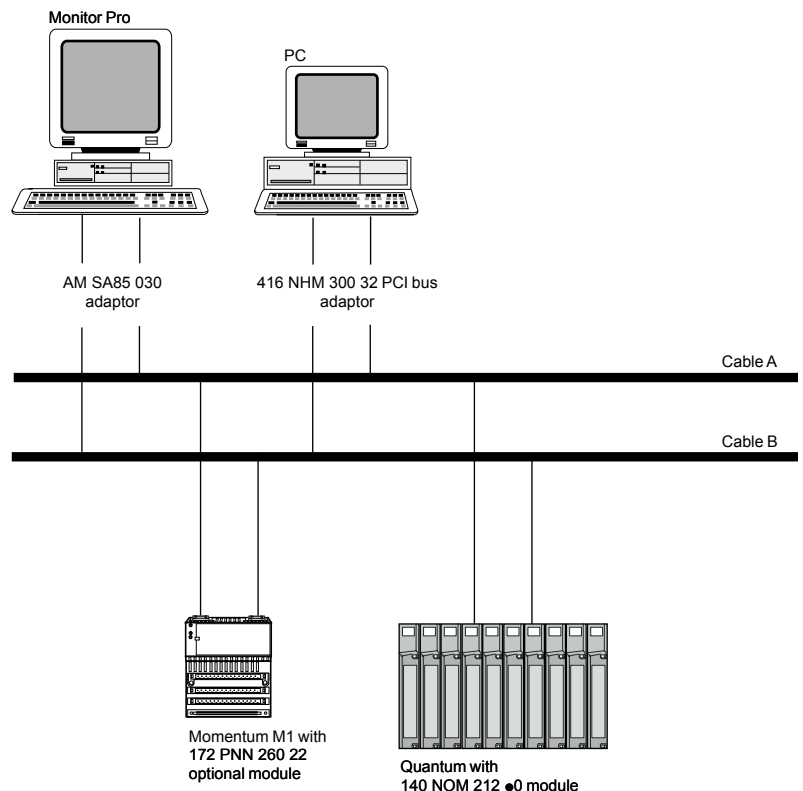

### Global database

The global database allows global variables to be shared across a Modbus Plus network of PLCs. Because the global database is broadcast, this global information is updated extremely quickly.

Each CPU has up to 32 global data registers; Modbus Plus nodes can support 2048 global data registers (32 registers x 64 CPUs). Each of up to 64 CPUs on the network is responsible for updating its own 32 global data registers using an MSTR instruction. Each CPU also has the ability to read the 32 global data registers of all the other CPUs on the network. When a CPU updates its global data, this information is automatically broadcast to all other CPUs on the network. Each receiving CPU collects the new global data and stores them in its network interface memory. A CPU wishing to access another node's global data actually extracts them from its own network interface.

The global database works only within the same segment of the Modbus Plus network. It cannot be transmitted through an NW BMB5 C00 bridge multiplexer or an NW BP85 002 bridge.

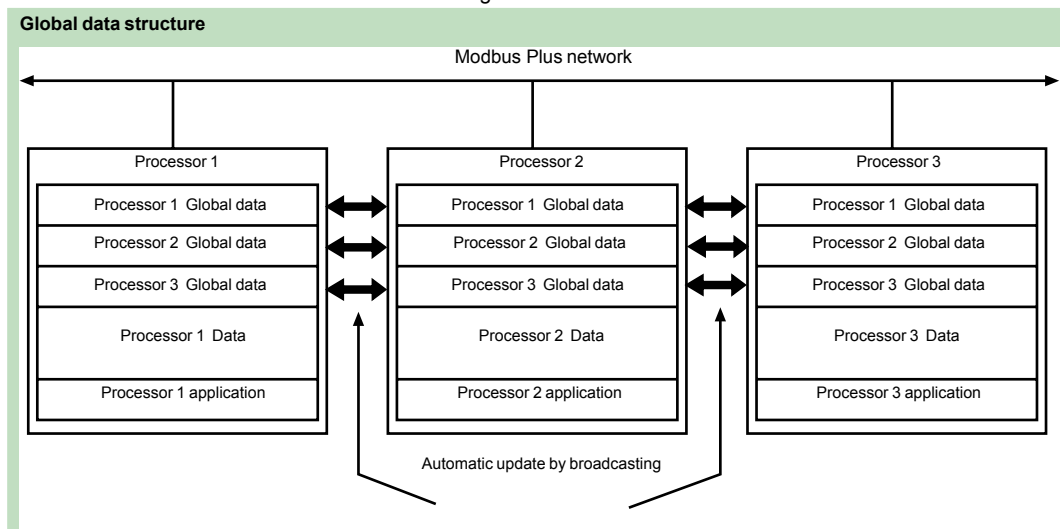

### Peer Cop

Peer Cop is a software utility accessible under Unity Pro, Concept or ProWORX and Concept and can be used to define point-to-point data transactions between a CPU and the other nodes on the Modbus Plus network. Peer Cop uses defined references (bits or registers) as source and destination. A block of registers can therefore constitute the data source on the sending node, and another block of registers can be the destination on the receiving device. A maximum of 32 words can be addressed on a CPU via Peer Cop (a 16-channel "discrete" module is equivalent to one word).

Peer Cop offers two methods of data transaction - global and specific. Because all Modbus Plus nodes monitor the network, any one of them can extract the data addressed specifically to it. Likewise, all nodes can extract global data. Peer Cop enables the Modbus Plus node currently holding the token to direct specific data to particular nodes and broadcast global data to all nodes as part of its token frame. Each sending node can specify particular references as data sources, and each receiving node can specify the same or different references as data targets. When nodes receive global data, each node can index to specific locations in the incoming data and extract specific lengths of data from those points. Data transactions can therefore take place quickly as part of the token rotation and can be set up between sending references and receiving references.

Network and data security are obtained with the CPU's write-protect feature. It is therefore possible to configure sections of references within the CPU as read-only so that those references cannot be written by a node on the network.

Peer Cop, like the global database, works only within a segment of the Modbus Plus network.

# Modicon Quantum automation platform

## Modbus Plus network

### Fibre optic network

Optional fibre optic cabling is available for a Modbus Plus network. With fibre optics, the total length of the network can be increased to as much as 3 km. The fibre optic medium provides secure links, which may be necessary in certain harsh environments. Fibre optic cabling is not susceptible to the effects of electromagnetic interference, RF interference or lightning. It also provides total isolation between terminal points on the link.

### Point-to-point topology

A point-to-point link between CPUs on a Modbus Plus network allows safe communications in a harsh environment over distances of up to 3 km.

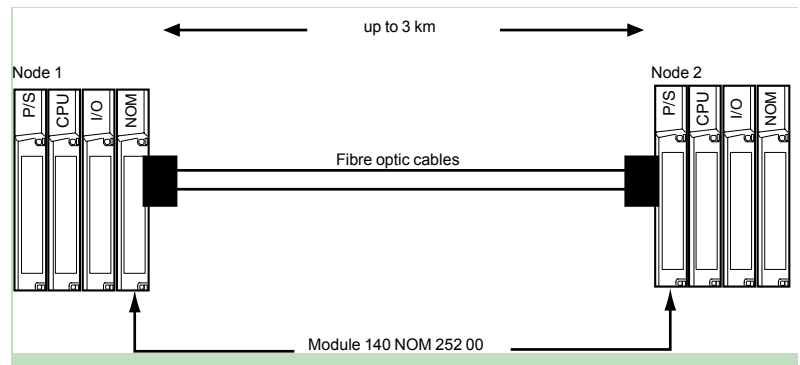

### Ring topology

It is possible to create a "self-healing" ring in a mixed fibre/twisted pair network by connecting the unused fibre optic ports of the first and last 140 NOM 252 00 modules, either directly or via a fibre optic repeater. This type of configuration retains all the advantages described previously, with built-in redundancy in addition. A broken connection between any two Quantum modules in the ring will automatically reconfigure the network into a bus configuration, and continue communication.

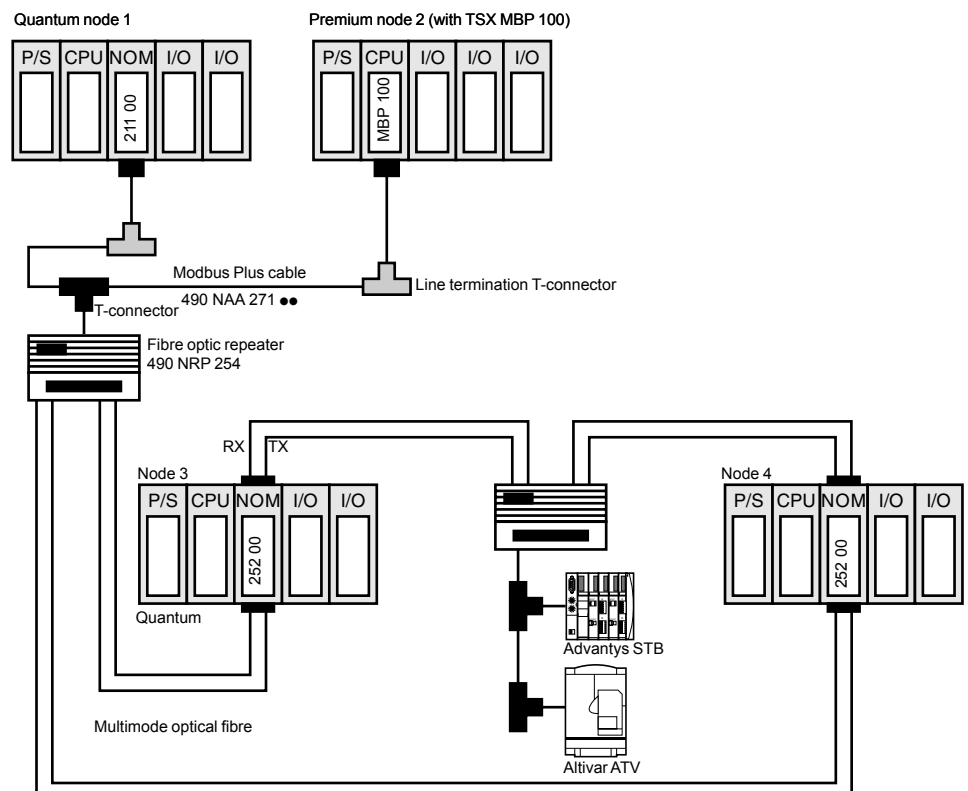

# Modicon Quantum automation platform

## Modbus Plus network

Modbus Plus redundant network

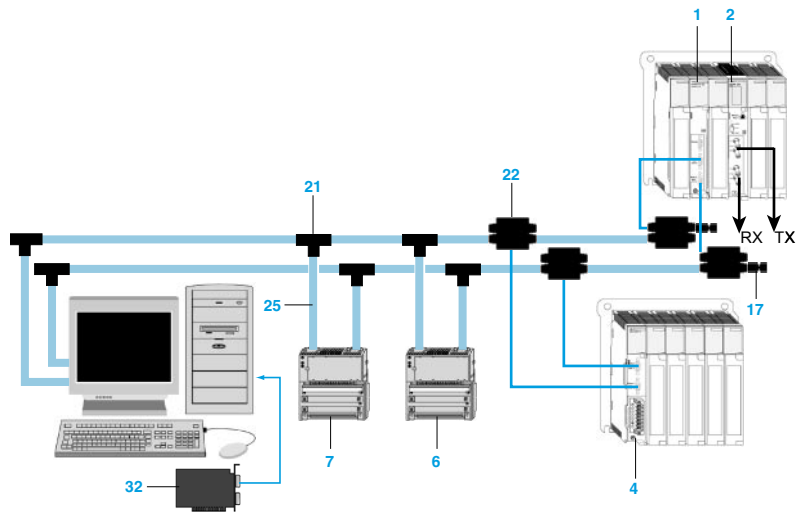

Network with PC cards for Modbus Plus

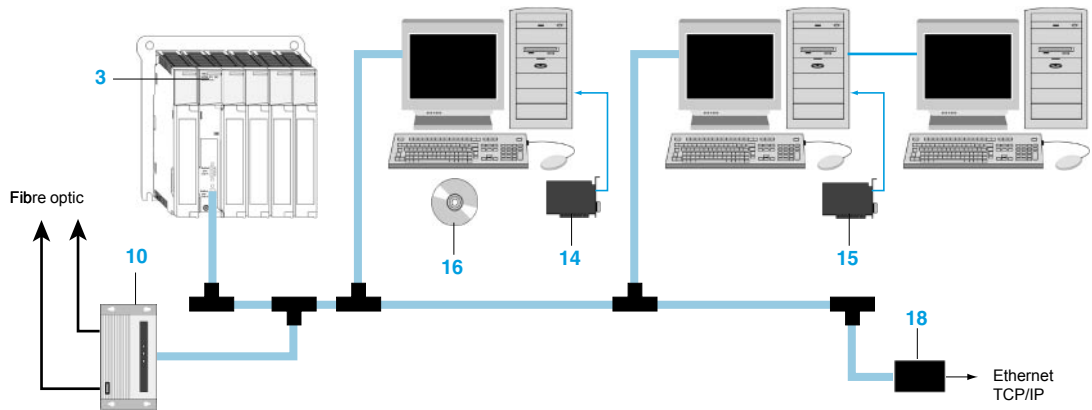

- 1 **140 NOM 212 00**: Quantum Modbus Plus head-end interface, redundant medium, twisted pair cable
- 2 **140 NOM 252 00**: Quantum Modbus Plus head-end interface, single-cable medium, fibre optic cable (TX/RX)
- 3 **140 CPU**: Quantum processor with integrated Modbus Plus port, single-cable medium, twisted pair cable
- 4 **140 CRA 212 10**: Quantum Modbus Plus drop interface and power supply, redundant medium, 115/230 V ~
- 5 **140 CRA 211 10**: Quantum Modbus Plus drop interface and power supply, single-cable medium, 115/230 V ~
- 6 **170 PNT 160 20**: Momentum Modbus Plus communication adaptor, redundant network, IEC medium
- 7 **170 NEF 160 21**: Momentum Modbus Plus communication adaptor, redundant network, 984 medium
- 8 **170 NEF 110 21**: Momentum Modbus Plus communication adaptor, non-redundant network, 984 medium
- 9 **170 PNT 110 20**: Momentum Modbus Plus communication adaptor, non-redundant network, IEC medium
- 10 **490 NRP 254 00**: Modbus Plus repeater, line/drop, fibre optic medium
- 11 **490 NRP 253 00**: Modbus Plus repeater, point-to-point, fibre optic medium
- 12 **NW-BM85C-002**: Modbus Plus bridge/multiplexer, panel or shelf mount, 4 Modbus Plus ports
- 13 **NW-RR85-001**: Modbus Plus repeater, coaxial cable
- 14 **AM-SA85-030**: Modbus Plus ISA PC adaptor, single port
- 15 **416 NHM 300 30**: Modbus Plus PCI PC adaptor, single port
- 16 **SW-MXDS-001**: Modbus Plus driver suite

# Modicon Quantum automation platform

## Modbus Plus network

### Modbus Plus network for Quantum and Momentum

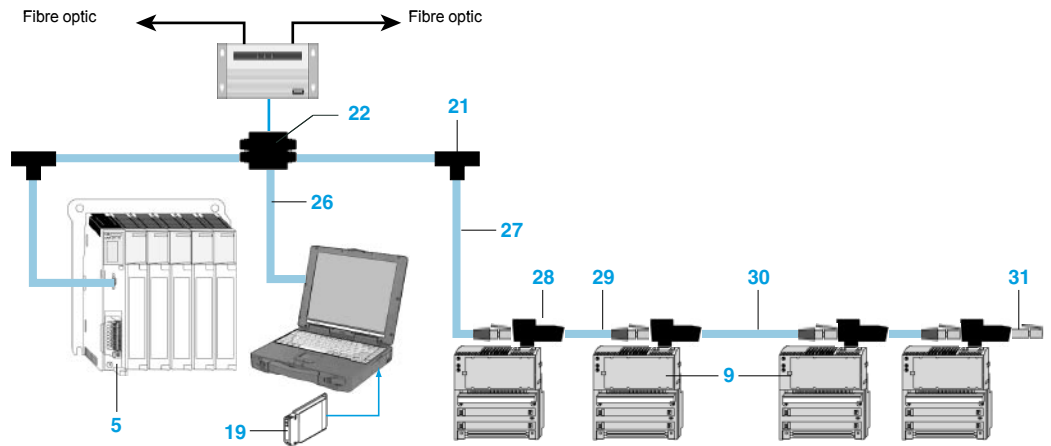

### Modbus Plus bridges, repeaters and T-connectors

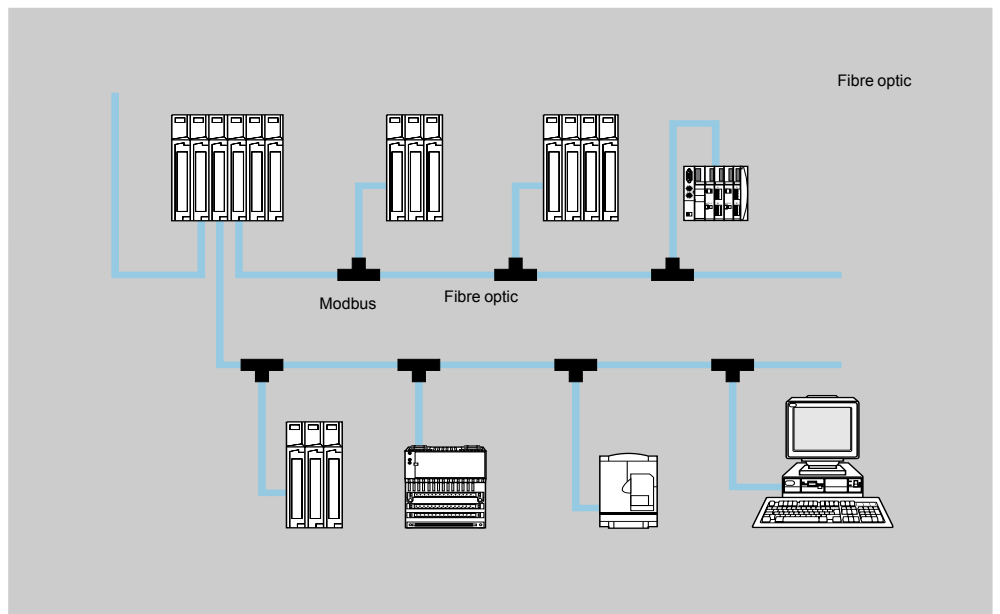

- 17 990 NAD 230 11:** Modbus Plus T-connector ruggedized terminators
- 18 74 CEV 300 20:** Modbus Plus-Ethernet bridge
- 19 16 NHM 212 33:** Modbus Plus type III PCMCIA card, single port
- 20 416 NHM 212 34:** Modbus Plus type III PCMCIA card, single port with Plug-and-Play capability
- 21 990 NAD 230 00:** Modbus Plus T-connector, IP 20
- 22 990 NAD 230 10:** Modbus Plus T-connector, IP 65
- 23 AS-MBKT-085:** Modbus Plus inline connector
- 24 AS-MBKT-185:** Modbus Plus terminating connector
- 25 990 NAD 211 10:** Drop cable, 2.4 m
- 26 990 NAD 215 10:** Ruggedized T-connector programming cable, 3.05 m
- 27 170 MCI 021 20:** Modbus Plus RJ45 cable, 3.05 m
- 28 170 XTS 020 00:** Modbus Plus "T" connector (DB9 base)
- 29 170 MCI 020 10:** Modbus Plus RS 485 cable, 25 cm
- 30 170 MCI 020 80:** Modbus Plus RJ45 cable, differential, 10 m
- 31 170 XTS 021 00:** Modbus Plus RJ45 terminator
- 32 416 NHM 300 32:** Modbus Plus PCI PC adaptor, two ports
- 33 NW-BP85-002:** Modbus Plus Bridge Plus, 4 Modbus Plus ports



# Modicon Quantum automation platform

## Modbus Plus network

### References

#### Modbus Plus bridges and repeaters

Description	Supply	Medium	Number and type of ports	No.	Reference	Weight kg
Bridge/Multiplexers	115/220 V ~ or 24 V ---	Panel or shelf	2 Modbus Plus 4 RS 232 Modbus	12	NW BM85C002	—
	115/220 V ~	Rack-mount	1 Modbus Plus 4 RS 232 Modbus	—	NW BM85000	—
	24 V --- or 115 V ---	19" rack-mount	2 Modbus Plus 4 RS 232 Modbus	—	NW BM85D008	—
Programmable Bridge/Multiplexers	115/220 V ~ or 24 V ---	Panel or shelf	2 Modbus Plus 4 RS 232	—	NW BM85S232	—
			2 Modbus Plus 4 RS 485	—	NW BM85S485	—
Gateway/Plus	115/220 V ~ or 24 V ---	Panel or shelf	4 Modbus Plus	33	NW BP85 002	—
Modbus Plus repeater		Coaxial cable		13	NW RR85 001	—
Point-to-point transceiver		Fibre optic/copper		11	490 NRP 253 00	—
Line/drop transceiver		Fibre optic/fibre optic/copper		10	490 NRP 254 00	—

#### Modbus Plus communication devices (1)

Description	Medium	Type	No.	Reference	Weight kg	
Quantum Modbus Plus	DIO drop adaptor (power supply included)	Single	115/230 ~ 24 ---	5 —	140 CRA 211 10 140 CRA 211 20	— —
		Redundant	115/230 ~ 24 ---	4 —	140 CRA 212 10 140 CRA 212 20	— —
	Quantum CPU DIO head-end 1	Single	—	3	140 CPU (2)	—
	DIO head-end interfaces 2 and 3	Single	Twisted pair cable	—	140 NOM 211 00	—
Redundant		Twisted pair cable	1	140 NOM 212 00	—	
Single		Fibre optic cable	2	140 NOM 252 00	—	
Momentum Modbus Plus	Communication adaptor	Non-redundant	IEC medium	9	170 PNT 110 20	—
		Network	984 medium	8	170 NEF 110 21	—
		Redundant	IEC medium	6	170 PNT 160 20	—
		Network	984 medium	7	170 NEF 160 21	—

#### PC interface cards

Description	Sold in lots of	No.	Reference	Weight kg
Modbus Plus ISA PC adaptor	1	14	AM SA85 030	—
	2	—	AM SA85 032	—
Modbus Plus PCI PC adaptor	1	15	416 NHM 300 30	—
	2	32	416 NHM 300 32	—
Modbus Plus type II PCMCIA card	1	—	416 NHM 212 30	—
Modbus Plus type III PCMCIA card	1	19	416 NHM 212 33	—
Modbus Plus type III PnP PCMCIA card	1	20	416 NHM 212 34	—

(1) Other devices: TSX Micro/Premium PLCs, Advantys STB distributed I/O, etc. See the appropriate catalogue.

(2) See pages 2/9 and 2/19.

# Modicon Quantum automation platform

## Modbus Plus network

References (continued)				
Connection cables				
Description	Length in m	No.	Reference	Weight kg
Modbus Plus standard cables	30.5	–	490 NAA 271 01	–
	152.5	–	490 NAA 271 02	–
	305	–	490 NAA 271 03	–
	457	–	490 NAA 271 04	–
	1525	–	490 NAA 271 06	–
Modbus Plus drop cables	2.4	25	990 NAD 211 10	–
	6	–	990 NAD 211 30	–
Programming cable PC/T-connector	3.05	26	990 NAA 215 10	–
Modbus Plus RS 485 cable	25 cm	29	170 MCI 020 10	–
	1	–	170 MCI 020 36	–
Modbus Plus RS 485 Master communication cable (RJ45/RJ45)	0.3	–	170 MCI 041 10	–
Modbus Plus RJ45 cable	3	27	170 MCI 021 20	–
Modbus Plus differential RJ45 cables	3	–	170 MCI 021 80	–
	10	30	170 MCI 020 80	–
Cable (RJ45/RJ45)	1	–	110 XCA 282 01	–
	3	–	110 XCA 282 02	–
	6	–	110 XCA 282 03	–
Wiring accessories				
Description	Type	No.	Reference	Weight kg
Modbus Plus power supply module connector	IP 20	–	140 XTS 005 00	–
Modbus Plus D-shell adaptor for AT serial port	9-pin RJ45	–	110 XCA 203 00	–
Modbus Plus D-shell adaptor for XT serial port	12-pin RJ45	–	110 XCA 204 00	–
Wiring tools				
Description		No.	Reference	Weight kg
Modbus Plus network cable installation tool	–	–	AS MBPL 001	–
RJ crimping tool	–	–	170 XTS 023 00	–
Earthing clamp	–	–	424 244 739	–
Connectors				
Description	Sold in lots of	No.	Reference	Weight kg
Modbus Plus inline	1 per kit	23	AS MBKT 085	–
Modbus Plus terminator	2 per kit	24	AS MBKT 185	–
Modbus Plus "T" connector (DB9 base)	1	28	170 XTS 020 00	–
RJ45 terminator	2 per kit	31	170 XTS 021 00	–
RJ45 "T" connector for RS 485 cable (DB9 base)	–	–	170 XTS 040 00	–
RJ45 shielded connectors	20 per kit	–	170 XTS 022 00	–
RJ45 "T" connector for RS 485 cable	1	–	170 XTS 041 00	–
RS 485 multi-master RJ45 drop connections	2	–	170 XTS 042 00	–
T-connectors				
Description	Sold in lots of	No.	Reference	Weight kg
Modbus Plus T-connector, IP 20	1	21	990 NAD 230 00	–
Modbus Plus ruggedized T-connector, IP 65	1	22	990 NAD 230 10	–
Modbus Plus T-connector ruggedized terminators	2 per kit	17	990 NAD 230 11	–
Modbus Plus DIN rack flush- mounting assembly with ruggedized T-connector	1	–	990 NAD 230 12	–
Modbus Plus lightning arrester	1	–	490 NAC 721 00	–

### Presentation

INTERBUS is a fieldbus, designed for distributing sensor and actuator devices in a master/slave topology. The slave I/O are serviced in a deterministic manner over a twisted-pair network. INTERBUS is best suited for communicating with groups of I/O rather than individual I/O points. As such, INTERBUS slaves are generally available in blocks of 8, 16 or 32 channels.

The INTERBUS master module **140 NOA 622 00** (generation 4) is available with the Quantum range. This Quantum INTERBUS master can control Momentum devices and slaves (with INTERBUS communication module), as well as third-party products, designed to operate on the fieldbus. Over 300 vendors offer INTERBUS-compatible products, ensuring open, cost-effective and wide-ranging connectivity.

The INTERBUS master module interfaces with up to 4096 I/O points distributed over a maximum of 512 slave devices. The data rate of the INTERBUS network is 500 kbps, the data being transmitted to the Quantum CPU for processing on every scan.

A Quantum local rack can support up to three INTERBUS master modules.

INTERBUS products use the remote bus technique, which enables data transfers over 12.8 km, with a total of 512 devices.

Electrical voltage levels on the Quantum remote bus are RS 485, with full-duplex mode communications. INTERBUS command words are pre-programmed in the INTERBUS master module. This is an INTERBUS standard, which is provided for 16 functions. Four pre-programmed bits are defined:

- Startup with configuration check
- Start network
- Stop network
- Clear display

An additional INTERBUS feature provided in the Quantum master is the peripheral communications protocol (PCP). This protocol supports limited data communications to intelligent devices.

PCP version 1.5 allows word communications to intelligent slaves, for advanced functions such as drive initialization, parameter-setting or non-I/O data transfer.

Many third-party slave devices do not support PCP capability, but it is supported by the Quantum master module.

### Description

The front panel of the INTERBUS module **140 NOA 622 00** comprises:

- 1 Model number and colour code
- 2 LED array consisting of:
  - R (green) Ready: The firmware is running correctly and the module is ready for service.
  - Active (green): Communication with the Quantum CPU is active.
  - F (red): Fault on the module.
  - IB-S Run (green): The INTERBUS is functioning normally and carrying data.
  - BS Off (yellow): One or more bus segments are shut down.
  - Master (red): Processor fault. Fault on the INTERBUS processor, or communication processor faulty.
  - RBUS (red): Remote bus fault. The remote bus has been diagnosed as faulty.
  - LBUS (red): Peripheral bus fault. The peripheral bus has been diagnosed as faulty.
  - Slave (red): An INTERBUS node has reported a (module) fault.
  - DEA202 (red): Initialization fault with the DEA 202.
  - Memory (red): Memory fault.
  - Start Up (red): The INTERBUS master is not operational.
- 3 Removable hinged door and customizable identification label.
- 4 RS 232C port.
- 5 INTERBUS port.

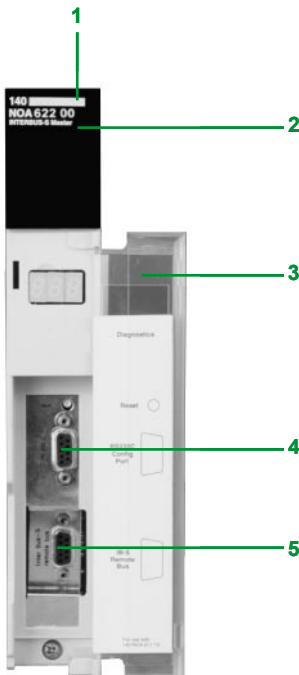

### Downloadable software

The INTERBUS generation 4 module, **140 NOA 622 00**, is configured using the SYCON software, reference **SYS SPU LF•CD28M**, to be ordered separately.

### Characteristics

<b>Module type</b>		<b>140 NOA 622 00</b>
<b>INTERBUS compatibility</b>		Generation 4
<b>Type</b>		INTERBUS master, PCP V2.0
<b>Data interface</b>	INTERBUS	RS 485, isolated (test voltage 500 V)
	RS 232C	According to DIN 66.020, non-isolated for configuration tool
	Cable length	<b>m</b> 20 maximum (shielded)
	Data rate	<b>kbits</b> 500
<b>Memory</b>	RAM	<b>bytes</b> 256k + 32 for data; 2k dual-port RAM; 64k multi-port RAM
	EPROM	<b>bytes</b> 128k + 256k firmware
	EEPROM	<b>bytes</b> 64k INTERBUS command sequence storage
<b>Bus current required</b>		<b>mA</b> 800
<b>Max. number of modules per INTERBUS local rack</b>		2 with 140 CPU 113 03 6 with 140 CPU 434 12A and CPU 534 14B
<b>Rack type</b>		Local
<b>Power dissipation</b>		<b>W</b> 4
<b>Compatibility</b>	CPU	140 CPU 113 03 140 CPU 434 12A or 140 CPU 534 14B
	Software	Concept version 2.5 SR2 or higher
<b>Approvals</b>		CE, cUL

### References

Description	Type	Reference	Weight kg
INTERBUS master module	Generation 4 (1)	140 NOA 622 00	0.900

#### Connection accessories and documentation

Description	Length	Reference	Weight kg
Preassembled cables	0.25 m	170 MCI 025 00	–
	1 m	170 MCI 100 01	–
Remote bus cables	100 m	TSX IBS CA 100	–
	400 m	TSX IBS CA 400	–
	By the metre	KAB 3225 LI	–
INTERBUS female 9-pin connector for remote bus cables	–	170 XTS 009 00	–
SYCON configuration software, single-user licence for 140 NOA 622 00 module, compatible with Concept	–	SYS SPU LFU CD28M	–
RS 232 programming cables	3.7	990 NAA 263 20	–
	15.5	990 NAA 263 50	–
140 NOA 611 10 user manual	–	840 USE 419 00	–
140 NOA 622 00 user manual	–	840 USE 497 01	–

(1) Compatible with Concept programming software.

# Modicon Quantum automation platform

Profibus DP V1

ProSoft Technology module PTQ-PDPMV1

## Presentation

PC with Unity Pro and SyCon software

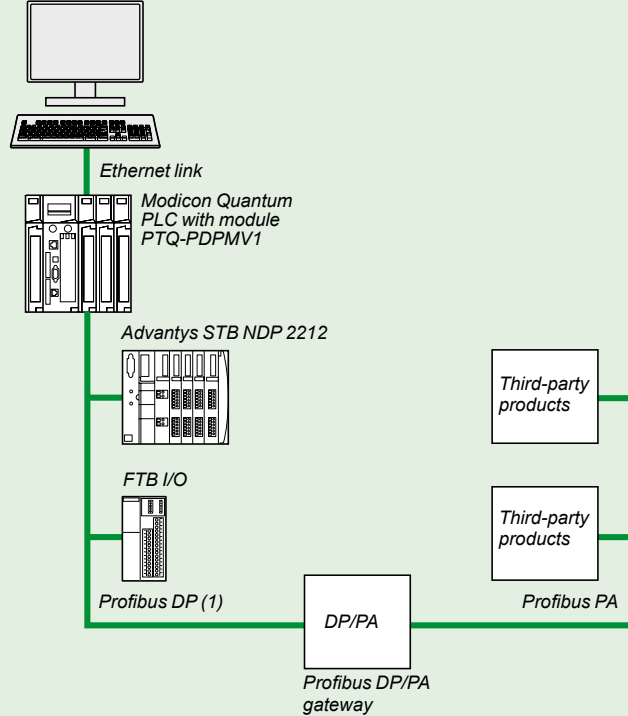

Profibus DP is a fieldbus meeting industrial communication requirements. Profibus DP uses a master/slave centralized access procedure. Only master stations, sometimes called active stations, have the right to access the bus, with slave, or passive, stations being limited to responding to interrogations. The physical link is a single shielded twisted pair, but optical interfaces are available for creating tree, star or ring structures. In relation to the ISO model, only layers 1 and 2 are implemented, with access from the user interface being made directly onto the link layer through simple mapping of variables. Specific products called “segment couplers” or “links” are used to connect Profibus DP and Profibus PA process instrumentation bus.

## Bus configuration

Profibus DP is configured using the Prosoft Configuration Builder software, supplied with the module.

This software is used to generate a file containing all the information relating to the connected devices. This extension file is transferred into the PTQ-PDPMV1 module via the serial port.

## Device configuration, adjustment and diagnostics

Integration into the software of FDT/DTM technologies makes it possible to configure, adjust and perform diagnostics on a device using the application-specific function provided by the manufacturer of the third-party device.

## Connectable devices

The Modicon Quantum automation platform, via the Prosoft Technology PTQ-PDPMV1 module, acts as master on the Profibus DP V1 bus.

The following Schneider Electric devices can be connected to this bus:

- TeSys model U starter-controllers (via Modbus bridge)
- Momentum and Advantys STB distributed I/O
- Advantys FTB/FTM I/O IP 67 monobloc and modular splitter boxes
- Altivar 31/58/58F/68/71 variable speed drives for asynchronous motors
- Twin Line TLC and Lexium MHDA variable speed drives for brushless motors
- Altistart ATS 48 soft start-soft stop units
- etc.

And any third-party device compatible with Profibus DP standard profiles.

(1) Profibus standard cabling.

#### Description

The **PTQ-PDPMV1** module has 3 connectors on the front panel:

- Profibus DP master port: 9-way female SUB-D connector, RS485
- Ethernet port for configuration/communication: RJ45 connector
- Serial link for configuring: 9-way male SUB-D, RS232, PC-compatible

#### Main characteristics

- Hot Standby function compatible with CPUs **140 CPU 671 60**. See page 3/24.
- Up to six **PTQ-PDPMV1** modules per rack (1). Configuration in local rack only.
- Application monitoring of active (primary) and passive (secondary) master modules via status words.
- Profibus DP status words updated from the passive (secondary) master by a ping on the Profibus DP FDL link layer.
- Detection of cable break with information on the number of slaves on the two segments of the broken bus.
- Profibus DP switching time for a bus at 500 kbaud:
  - typical: 100 ms
  - maximum: 300 ms
- No setup parameter is required for Hot Standby operation, as the module automatically detects the Hot Standby configuration.

The Prosoft Configuration Builder (PCB) configuration software is used for generating different DFBs for monitoring the status of the module and the bus, and for managing exchanges with the devices, by separating input zones and output zones.

Prosoft Configuration Builder can also export to Unity Pro a functional module specific to the ProSoft Technology **PTQ-PDPMV1** module.

This functional module provides:

- DFBs
- Program segments with instantiated DFBs
- Dedicated animation tables
- A hyperlink to the PCB configurator

#### Additional products

All necessary information relating to the **PTQ-PDPMV1** communication module and the associated hardware and software products is available on the ProSoft Technology website <http://www.prosoft-technology.com>.

(1) Up to four **PTQ-PDPMV1** modules per rack for Hot Standby configuration (see page 3/14).

# Modicon Quantum automation platform

## Asynchronous serial link module

### Presentation

The 140 ESI 062 10 asynchronous serial link module is a general-purpose ASCII communication module that can be used to exchange data messages with third-party devices.

This module is particularly suitable for use in applications with printers, bar code readers and scanners, or devices communicating via a serial link, such as weigh scales, meters or other measuring devices.

This module has been designed for relatively simple point-to-point ASCII communications. A resident command interpreter can be used primarily to specify the formats and baud rate of the communication ports in operational mode, using a serial link management utility such as Microsoft® HyperTerminal. This interpreter can also be used to enter ASCII message formats, which will be stored in this module.

These message formats constitute the base around which communication is organized. Thus, using an appropriate syntax, these formats define for example, for transmissions, the fixed characters that must be sent on the communication line. These transmission message formats can also be used to specify the sending of data that is an image of the card registers, in accordance with a particular representation (binary, integer, ASCII, etc.).

For reception, the message formats used are usually limited to specifying a wait for a certain number of values or characters, directed to the module's internal data registers. Unlike transmission, the specifiers used on these reception message formats can be used to define the numerical base(s).

The Quantum PLC application program communicates with the asynchronous serial link module via mailbox registers. These registers submit commands to the module and translate the responses. Communication commands are processed by requesting transmission on a port, through the use of a message format. Conversely, it is possible to listen for reception on this port, through the use of a message format.

If the exchange mailboxes between the PLC and the module are not large enough to carry all the application data required for a transaction, at the same time as the transmission and reception commands, additional commands (Get/Put) will be used for exchanges between the PLC database and the module's internal registers.

**Note:** In LL984 programming, with Concept and ProWORX programming software, it is possible to use an additional instruction (ESI), which is designed to simplify the management of data exchange sequences between the PLC application and the asynchronous serial link module. This programming software also requires integration of special software (NSUP and ESI) during PLC configuration (Concept IEC uses only ESI software). The ESI software is provided on diskette, supplied together with the asynchronous serial link module hardware reference guide.

### Description

The 140 ESI 062 10 asynchronous serial link module front panel comprises:

- 1 Module number and colour code
- 2 LED array
- 3 Removable hinged door and customizable identification label
- 4 9-way SUB-D connector (RS 232C comms port 1)
- 5 Reset button
- 6 9-way SUB-D connector (RS 232C comms port 2)

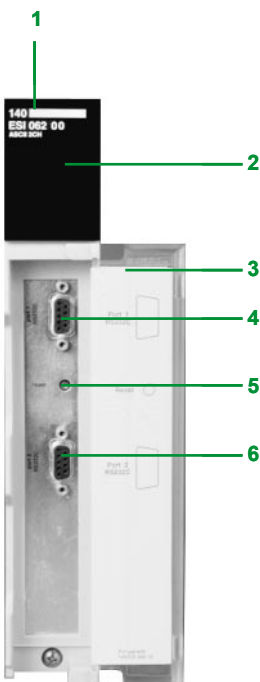

Characteristics			
Module type		140 ESI 062 10	
Data interface	Serial ports		2 RS 232C ports, according to DIN 66020, non-isolated, 9-way SUB-D connector
	Burst speed	<b>kbps</b>	19.2 on each port
	Continuous speed		Application-dependent
	Cable	<b>m</b>	20 (shielded)
Firmware	Message nesting		8 levels
	Buffer size	<b>bytes</b>	255 input and 255 output
	Number of messages		255
	Message length	<b>bytes</b>	127 characters + 1 checksum max.
	Calendar clock		Hours/Minutes/Seconds Day of week/Month/Day of month/Year
Memory	RAM	<b>KB</b>	32 (16,384 16-bit registers)
	Flash	<b>KB</b>	128 (for firmware)
Backup in the event of power outage			Battery holder module 140 XCP 900 00
Power dissipation		<b>W</b>	2 max.
Bus current required		<b>mA</b>	300
I/O addresses			12 input words and 12 output words
Compatibility	Software		Unity Pro version $\geq$ 2.0, ProWORX NxT version $\geq$ 2.0, ProWORX 32 or Concept $\geq$ 2.0
	Quantum CPU		Any type

References				
Description	Characteristic	Reference	Weight	kg
ASCII serial link module with 2 RS 232C ports	19.2 kbps	140 ESI 062 10	0.300	
Backup battery holder module	2 C type lithium batteries, 3 V	140 XCP 900 00	-	
Cables for programming terminal with Modbus interface	3.7 m	990 NAA 263 20	0.300	
	15 m	990 NAA 263 50	1.820	
140 ESI 062 10 user manual (with downloadable ESI software for Concept and ProWORX software)	in English	840 USE 108 00	-	







## 7.1 - Unity software

<b>Unity software selection guide</b> .....	<b>7/2</b>
■ Unity Pro software .....	7/6
□ Presentation .....	7/6
□ Setup .....	7/7
□ Software structure .....	7/11
□ IEC languages .....	7/14
□ Functions .....	7/20
- Integrated diagnostics .....	7/25
■ Unity Pro XL Safety software .....	7/30
□ Unity Pro XLS software .....	7/31
□ References .....	7/35
■ Unity SFC View software .....	7/40
□ Presentation .....	7/40
□ References .....	7/43
■ Unity Dif application comparison software .....	7/44
□ Presentation, setup .....	7/44
□ Reference .....	7/45
■ Regulation of programmable processes .....	7/46
□ Presentation, functions .....	7/46
□ Setup .....	7/47
■ Unity EFB Toolkit software .....	7/48
□ Presentation, setup .....	7/48
□ Reference .....	7/49

## 7.2 - UAG - Unity Application Generator Software

■ Unity Application Generator .....	7/50
□ Presentation .....	7/50
□ References .....	7/53

## 7.3 - Concept software

<b>Concept software selection guide</b> .....	<b>7/54</b>
■ Concept programming software .....	7/56
□ Presentation .....	7/56
□ Functions .....	7/57
□ References .....	7/61
■ Concept SFC View software .....	7/62
□ Presentation .....	7/62
□ References .....	7/65

## 7.4 - ProWORX software

■ ProWORX 32 programming software .....	7/66
□ Presentation .....	7/66
□ References .....	7/69



**Unity Pro programming software for Modicon M340 M , Premium P , Atrium A , Quantum Q and Safety S**

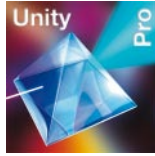

<b>IEC 61131-3 languages</b>	Instruction List (IL)	M	M - A - P
	Ladder (LD)	M	M - A - P
	Structured Text (ST)	M	M - A - P
	Function Block Diagram (FBD)	M	M - A - P
	Sequential Function Chart (SFC)/Grafcet	M	M - A - P
<b>Programming services</b>	Multitask Programming (Master, fast, and event-triggered)	M	M - A - P
	Multitask Programming (Master, fast, and event-triggered)		
	Functional view and function modules	M	M - A - P
	Block editor and DFB instances	M	M - A - P
	DDT compound data editor	M	M - A - P
	Data structure instances and tables	M	M - A - P
	EF function block libraries and EFB function blocks	M	M - A - P
	User-definable control loops		A (TSX PCI 2●) - P (TSX P57 2●)
	Programmable control loops (with process control FB library)	M	M - A - P
	Safety function block library		
	Motion function block libraries (MFB)	M	M - A - P
	Hot Standby PLC redundancy system		P (TSX H57 24M)
	System diagnostics	M	M - A - P
	Application diagnostics	M	M - A - P
	Diagnostics with location of error source	M	M - A - P
<b>Debugging and display services</b>	PLC simulator	M	M - A - P
	Hypertext link animations in graphic languages	M	M - A - P
	Step by step execution, breakpoint	M	M - A - P
	Watchpoint	M	M - A - P
	Runtime screens	M	M - A - P
	Dagnostic viewer	M	M - A - P
<b>Other services</b>	Creation of hyperlinks	M	M - A - P
	XML import/export	M	M - A - P
	Application converters (Concept, PL7)		M - A - P
	Utilities for updating PLC operating systems	M	M - A - P
	Communication drivers for Windows 2000/XP	M	M - A - P
Unity Pro servers - Openness			
<b>UDE support</b>	Dynamic exchange with 3rd party tools, OFS		
<b>OFS exchanges</b>	Static exchange via XML/XVM export files	M	M - A - P
<b>Compatible Modicon platforms</b>	Modicon M340 processors M	BMX P34 1000 BMX P34 20●0	BMX P34 1000 BMX P34 20●0
	Atrium slot-PLCs A	-	TSX PCI 57204M
	Premium CPUs P	-	TSX P57 C● 0244/0244M TSX P57 104/1634/154M TSX P57 204/2634/254M TSX H57 24M
	Quantum CPUs Q	-	-
	Safety CPUs S	-	-

<b>Software name</b>	Unity Pro Small	Unity Pro Medium
<b>Unity Pro software type</b>	UNY SPU SF● CD40	UNY SPU MF● CD40
<b>Pages</b>	7/29	

7

Unity Pro programming software for Modicon M340 M , Premium P , Atrium A , Quantum Q and Safety S

M - A - P - Q	M - A - P - Q	M - A - P - Q
M - A - P - Q	M - A - P - Q	M - A - P - Q - S
M - A - P - Q	M - A - P - Q	M - A - P - Q
M - A - P - Q	M - A - P - Q	M - A - P - Q - S
M - A - P - Q	M - A - P - Q	M - A - P - Q
M - A - P - Q	M - A - P - Q	M - A - P - Q
M - A - P - Q	M - A - P - Q	M - A - P - Q
	P (TSX P57 5●) - Q (140 CPU 651/671)	P (TSX P57 5●) - Q (140 CPU 651/671)
M - A - P - Q	M - A - P - Q	M - A - P - Q - S
M - A - P - Q	M - A - P - Q	M - A - P - Q
M - A - P - Q	M - A - P - Q	M - A - P - Q
M - A - P - Q	M - A - P - Q	M - A - P - Q
M - A - P - Q	M - A - P - Q	M - A - P - Q
A (TSX PCI 2●/3●) - P (TSX P57 2●/3●/4●)	P (TSX P57 2●/3●/4●/5●)	P (TSX P57 2●/3●/4●/5●)
M - A - P - Q	M - A - P - Q	M - A - P - Q
		S
M - A - P	M - A - P	M - A - P
P (TSX H57 24/44M)	P (TSX H57 24/44M) - Q (140 CPU 67 160)	P (TSX H57 24/44M) - Q (140 CPU 67 160) - S
M - A - P - Q	M - A - P - Q	M - A - P - Q - S
M - A - P - Q	M - A - P - Q	M - A - P - Q
M - A - P - Q	M - A - P - Q	M - A - P - Q
M - A - P - Q	M - A - P - Q	M - A - P - Q - S
M - A - P - Q	M - A - P - Q	M - A - P - Q - S
M - A - P - Q	M - A - P - Q	M - A - P - Q - S
M - A - P - Q	M - A - P - Q	M - A - P - Q - S
M - A - P - Q	M - A - P - Q	M - A - P - Q - S
M - A - P - Q	M - A - P - Q	M - A - P - Q - S
M - A - P - Q	M - A - P - Q	M - A - P - Q
M - A - P - Q	M - A - P - Q	M - A - P - Q
M - A - P - Q	M - A - P - Q	M - A - P - Q - S
	M - A - P - Q	M - A - P - Q - S
	M - A - P - Q	M - A - P - Q - S
M - A - P - Q	M - A - P - Q	M - A - P - Q - S
BMX P34 1000 BMX P34 20●0	BMX P34 1000 BMX P34 20●0	BMX P34 1000 BMX P34 20●0
TSX PCI 57204M TSX PCI 57354M	TSX PCI 57204M TSX PCI 57354M	TSX PCI 57204M TSX PCI 57354M
TSX P57 C● 0244/0244M TSX P57 104/1634/154M TSX P57 204/2634/254M TSX P57 304/3634/354M TSX P57 4634/454M TSX H57 24/44M	TSX P57 C● 0244/0244M TSX P57 104/1634/154M TSX P57 204/2634/254M TSX P57 304/3634/354M TSX P57 4634/454M TSX P57 5634/554M TSX P57 6634M TSX H57 24/44M	TSX P57 C● 0244/0244M TSX P57 104/1634/154M TSX P57 204/2634/254M TSX P57 304/3634/354M TSX P57 4634/454M TSX P57 5634/554M TSX P57 6634M TSX H57 24/44M
140 CPU 311 10 140 CPU 434 12U	140 CPU 311 10 140 CPU 434 12U 140 CPU 651 50/60 140 CPU 652 60 140 CPU 671 60	140 CPU 311 10 140 CPU 434 12U 140 CPU 651 50/60 140 CPU 652 60 140 CPU 671 60
-	-	140 CPU 651 60S 140 CPU 671 60S
<b>Unity Pro Large</b>	<b>Unity Pro Extra Large</b>	<b>Unity Pro XL Safety</b>
<b>UNY SPU LF● CD40</b>	<b>UNY SPU EF● CD40</b>	<b>UNY SPU XF● CD31</b>

# Modicon Quantum automation platform

## Unity software

	<b>EF/EFB function development software in C language</b>	<b>SFC View application diagnostic and monitoring software</b>
--	---	--

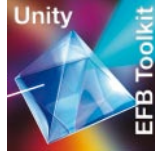

**Services**

Enhancement of EF and EFB function block libraries:

- Creation of families
- Development of functions in C language
- Access to all data and variable types
- Debugging functions (step by step, breakpoint)
- Use of functions created in all languages

Supplied with:

- Microsoft Visual C++
- GNU source code and compiler

ActiveX control component for monitoring and diagnostics of chart status (SFC or Grafcet) in sequential applications:

- Overview of charts and detailed views
- Can be integrated in human/machine interface (HMI) applications
- Access to PLC data via OFS (*OPC Factory Server*)

Includes EFB function block library for Unity Pro (for Modicon M340, Premium, Atrium and Quantum CPUs)

**Compatibility:**

**Software:**  
Unity Pro Small, Medium, Large and Extra Large

**All CPUs:**

- Modicon M340
- Atrium slot-PLCs
- Premium Unity
- Quantum Unity

**Software:**  
Unity Pro Extra Large

**All CPUs:**

- Modicon M340
- Atrium slot-PLCs
- Premium Unity
- Quantum Unity

<b>Software name</b>
Unity Pro software type
Pages

<b>Unity EFB Toolkit</b>
UNY SPU ZFU CD30E
7/49

<b>Unity SFC View</b>
UNY SDU MF CD20
7/43

7

Comparison software for Unity Pro applications	Software for loading application and firmware components	Software for modelling and generating applications batch/process	Pack for developing specific solutions
--	--	--	--

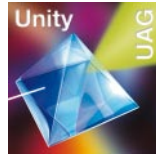
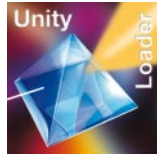

Automatic comparison of 2 Modicon M340, Premium, Atrium and Quantum applications with identification of all differences.

Simple and easy to use software to upgrade a Modicon M340 CPU when the user doesn't need to display/modify the application.

UAG specialist software for modelling and generating batch/process applications in a "Collaborative Automation" environment. It provides the unique project database:

- Proces and control (PLCs)
- HMI user interface (Magelis)
- SCADA supervision (Vijeo Citect)

Specialist software for developing made-to-order solutions (for example interfaces with an electrical CAD system, automatic application generator, etc):

- Access to Unity Pro object servers
- Reserved for IT development engineers using Visual Basic or C++

- Upload/download:
- CPU and Ethernet module firmware
  - PLC project, including:
    - Program
    - Located and unlocated data
    - User files and user web pages

Based around re-usable objects (PID, valves, etc.and complying with standard ISA S88, UAG generates the PLC code and the elements required for the HMI system. Complies with the GAMP standard (*Good Automation Manufacturing Practice*)

**Software:**  
Unity Pro Extra Large

- All CPUs:**
- Modicon M340
  - Atrium slot-PLCs
  - Premium Unity
  - Quantum Unity

**Software:**  
Unity Pro Small, Medium, Large and Extra Large

- All CPUs:**  
Modicon M340

**Software:**  
Unity Pro Extra Large

- All CPUs:**
- Premium Unity:
    - TSX P57 4634/454M
    - TSX P57 5634/554M
    - TSX P57 6634M
  - Quantum Unity

**Software:**  
Unity Pro Extra Large

- All CPUs:**
- Modicon M340
  - Atrium slot-PLCs
  - Premium Unity
  - Quantum Unity

Unity Dif

UNY SDU DFU CD20

7/43

Unity Loader

UNY SMU ZU CD20

7/29

Unity Application Generator

UNY SEW LF CD30

7/53

Unity Developer's Edition

UNY UDE VFU CD21E

7/8

### User interface

Unity Pro's welcome screen provides access to all available tools in a user-friendly format that has been redesigned on the basis of feedback received from users of Concept and PL7 Junior/Pro application design software.

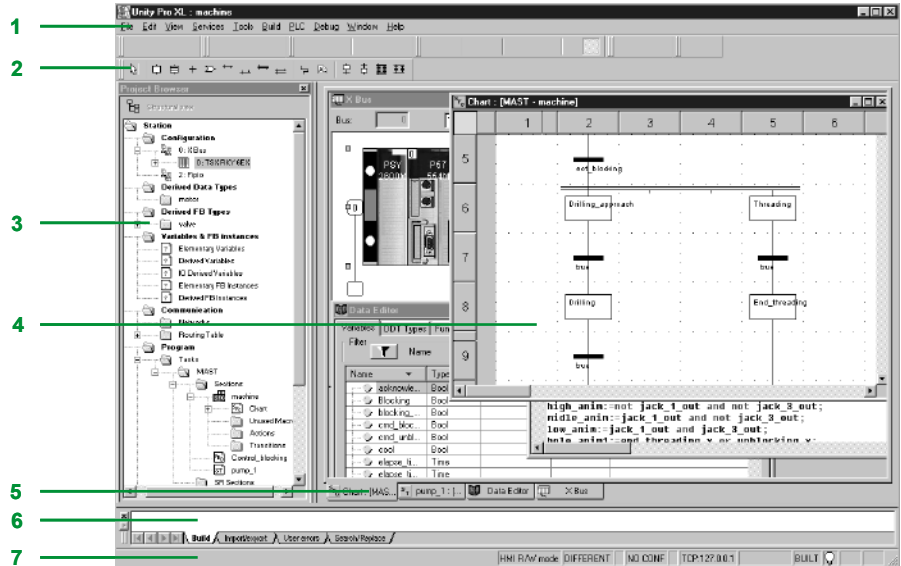

This welcome screen consists of a general view made up of a number of windows and toolbars, which can be arranged as required on the screen:

- 1 Menu bar from which all functions can be accessed
- 2 Toolbar consisting of icons from which the most frequently used functions can be accessed
- 3 Application browser, which can be used to browse the application based on a conventional and/or a functional view
- 4 Editor windows area, which can be used to view a number of editors at the same time (configuration editor, Structured Text/Ladder etc. language editors, data editor)
- 5 Tabs for direct access to editor windows
- 6 Information window with tabs (User Errors, Import/Export, Search/Replace, etc.)
- 7 Status bar

### Accessing functions

All functions can be accessed via drop-down menus from the menu bar. The toolbar, which consists of icons, provides more rapid access to the most frequently used functions. This toolbar, which is displayed by default, can be customized to meet the requirements associated with the various uses of Unity Pro software and is divided into three groups:

- Main toolbars, which are visible at all times
- Contextual toolbar, which is displayed when the corresponding editor is selected
- Toolbar with zoom functions (in and out), full-screen view for editor window

They are classified according to the category of functions available:

- File management (New Project, Open, Save, Print)
- Edit (Undo, Redo, Confirm, Go To)
- Application services (Analyze Project, Build Project, Browse, Find, Access Library)
- Automation platform operating mode (Upload/Download Project, Online/Offline, Run/Stop, Animate, PLC/Simulation Mode)
- Debug mode (Set/Remove Breakpoint, etc.)
- Window display (Cascade, Horizontal, Vertical)
- Online help (non-contextual or contextual)

7



"File/Edit" toolbar

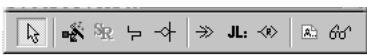

FBD language editor contextual toolbar



"PLC" toolbar for debug mode



Toolbar with zoom (in and out)

### Project browser

The project browser can be used:

- To display the content of a Modicon M340, Atrium, Premium or Quantum PLC project
- To move between the different components of the application (configuration, program, variables, communication, DFB user function blocks, DDT derived function blocks) created by the user



The project can be displayed using two view types:

- **The structural view**, which provides an overall view of the various components of the application. This representation provides a view of the order in which the program sections are processed in the PLC.
  - **The functional view**, which provides a view of the project based on specific function modules. This representation provides a breakdown according to consistent functions in relation to the process to be controlled.
- These two types of view, which are available at any time, can be displayed separately or at the same time (horizontal or vertical windows) by clicking on the icons in the toolbar.

### Structural view

This conventional view allows you to access all the different components of the application (configuration, programming, function blocks, debugging, etc.) via the application browser.

The browser gives an overall view of the program and offers fast access to all application components.

- 1 Configuration editor
- 2 DFB (user function block) and DDT (Derived Data Type) editors
- 3 Communication networks editor
- 4 Program editor
- 5 Variables editor
- 6 Animation tables editor
- 7 Runtime screens editor
- 8 Documentation editor

From any level in the tree structure, you can:

- 9 Create a hyperlink to a comment or description
  - 10 Create a directory for storing hyperlinks used to access a set of user folders
- From this level, it is also possible to zoom in and only view the detailed levels for a component on this level.

### Functional view

Unity Pro software applications support the creation of an application structure for Modicon M340, Atrium, Premium and Quantum platforms based on function modules comprising:

- Sections (program code)
- Animation tables
- Runtime screens

The designer can define a multi-level tree structure for the application, independently of the multitask structure of the PLC.

Program sections written in Ladder (LD), Structured Text (ST), Instruction List (IL), Function Block Diagram (FBD) or Sequential Function Chart (SFC) language can be associated with each level, along with animation tables and runtime screens

### Exporting/Importing function modules

It is possible to export all or part of the tree structure in function modules. In this case, all program sections on the various module levels are exported.

Utilities make it easy to reuse these modules in new applications by means of data and module name reassignment services.

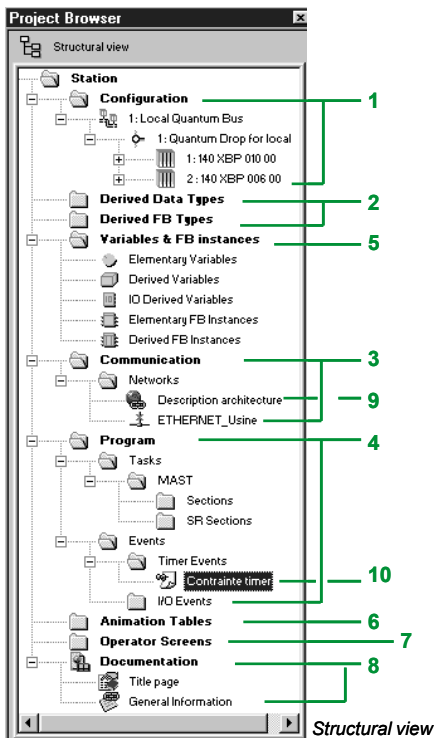

Structural view

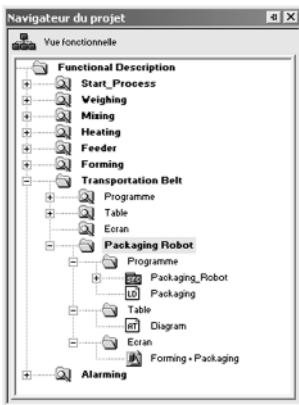

Functional view





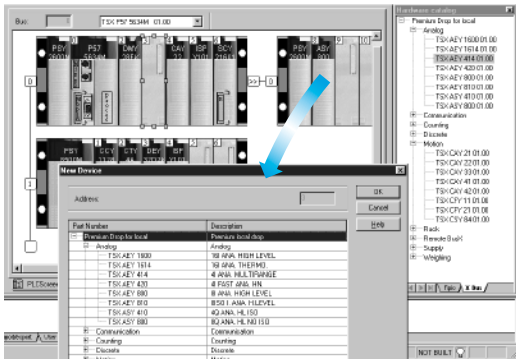

Hardware configuration

### Configuration editor

#### Hardware configuration

The first step when creating an automation project based on a Modicon M340, Atrium, Premium or Quantum platform is to select the processor for which a rack and power supply are defined by default.

The configuration editor supports the intuitive and graphics-based modification and extension of this configuration with the following elements:

- Racks, power supply
- PCMCIA memory or communication cards (Atrium/Premium) on the processor
- Discrete I/O, analog I/O, or application-specific modules
- ...

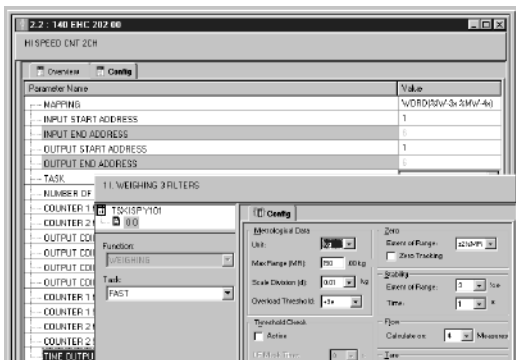

I/O module parameter setting

#### Configuration and parameter settings for I/O and application-specific modules

From the configuration screen for Modicon M340, Atrium, Premium or Quantum racks, the parameters screen displayed for the module concerned can be used to define the operating characteristics and parameters for the selected application, e.g.:

- Filter values for discrete I/O
- Voltage or current range for analog I/O
- Threshold counter values
- Trajectory of axes for position control
- Weigher calibration for weighing
- Transmission speed for communication
- Presymbolization for variables associated with modules
- ...

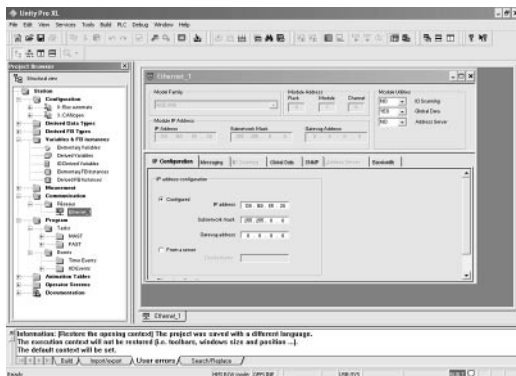

"Communication" folder with 2 networks declared

#### Configuration and parameter settings for communication networks

The "Communication" folder in the structural view can be used to define the list of networks connected to the PLC station. Then, the parameters for all elements required for networks to function correctly can be set by:

- Creating a logical network to which comments can be associated
- Configuring a logical network defining the various associated network services.

Once the network module has been created in the configuration, it must then be associated with one of the logical networks. Ethernet TCP/IP, Modbus Plus and Fipway network modules are all configured in this way.

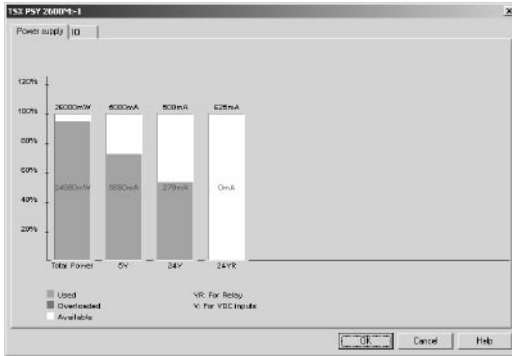

Power supply requirements analysis

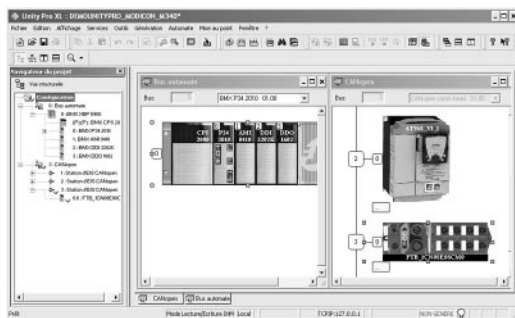

Graphical configuration of devices on CANopen bus

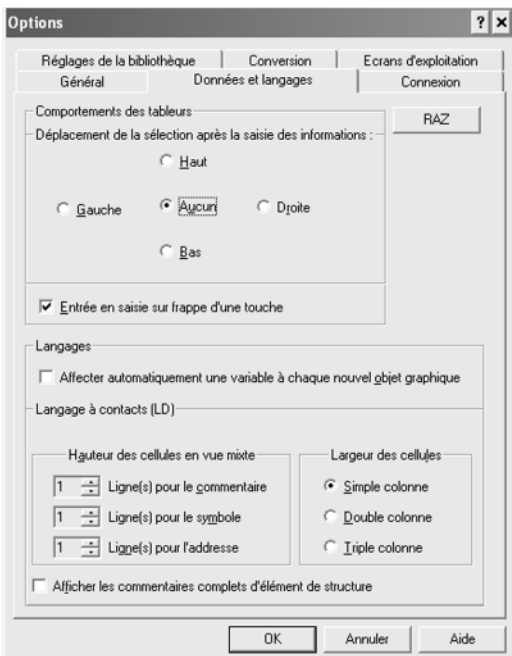

"Data & Languages" tab in the workstation options

### Configuration editor (continued)

#### Configuration check

The following information can be accessed at any time during configuration:

- The power consumption statistics for the power supply in each of the racks in the PLC configuration, for all the different voltages provided by each of these power supplies
- The number of inputs/outputs configured (with Modicon M340, Atrium or Premium platform)

#### Configuration of CANopen devices

In the same way as for in-rack modules, the configuration of devices on CANopen through a Modicon M340 processor is fully integrated into the configuration editor.

### Workstation and project configuration

Unity Pro can be used to configure both the working environment (workstation options) and the content of the project itself.

It is also possible to configure the toolbars and to run third-party applications from Unity Pro.

In addition, users can choose the working language from the list of languages selected when the software was installed.

#### Workstation options

The workstation options cover all of the characteristics specific to a given workstation. They are applied when Unity Pro is used to develop any project on that station.

The following elements can be configured:

- The way in which information is edited and presented in the project being developed (for example: whether or not coils are positioned in the last column of the editor, or the position of the cursor after confirmation of the information entered)
- The application conversion strategy from PL7, Concept IEC and LL984 language
- The function library path
- The opening mode for Unity Pro: either programming or run mode

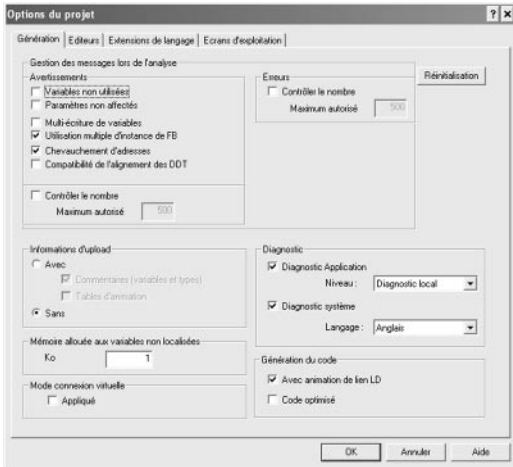

"Generation" tab in the project options

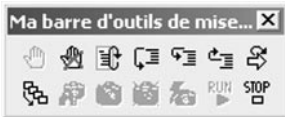

User-created toolbar containing all the debugging tools

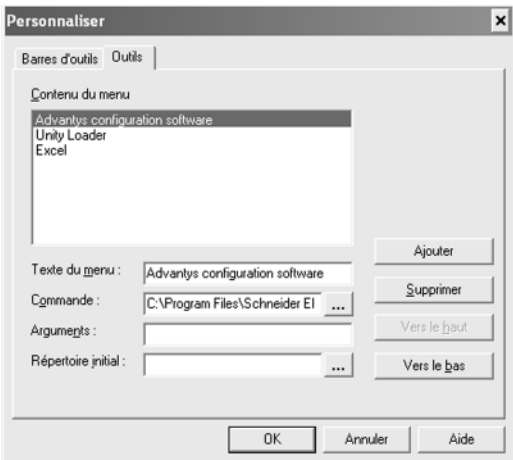

Menu for adding and deleting tool access from Unity Pro

### Workstation and project configuration (continued)

#### Project options

In contrast to the workstation options, project options cover characteristics that have a direct impact on the programming and execution capacities offered by the program in the PLC. They are saved in the application and consequently are attached to the project. They can be modified during the course of the project.

Project option configuration comprises the following elements:

- Project generation with all or part of the information enabling the project to be retrieved on a new terminal
- Use of diagnostic functions and language for messages
- Warnings generated during project analysis: overlapping of addresses, unused variables, etc.
- Language extension: If none of the boxes is checked, the program is strictly compliant with IEC 61131-3. Extensions are possible in all five Unity Pro languages.
- Access management to runtime screens in online mode.

#### Other possible options

Users can create their own toolbars by reusing the default icons provided on the toolbars.

It is also possible to enhance the main Unity Pro menu bar by adding direct links to other software tools.

A utility in the Unity Pro program group can be used to change the working language. The change will take effect the next time the software is launched.

Six languages are available: English, German, Spanish, French, Italian and Chinese.

### Software structure

The Modicon M340, Atrium, Premium and Quantum platforms implemented by Unity Pro software support two types of application structure:

- **Single-task:** This is the more simple default structure, in which only the master task is executed.
- **Multitask:** This structure, which is more suitable for high-performance real-time events, consists of a master task, a fast task, periodic tasks and high-priority event-triggered tasks.

The master, fast and periodic tasks are made up of sections and subroutines. These sections and subroutines can be programmed in any of the following languages: Structured Text (ST), Instruction List (IL), Ladder (LD) or Function Block Diagram (FBD). The event-triggered tasks use the same languages. Sequential Function Chart (SFC) or Grafcet language is reserved for master task sections.

The table below lists the possible program tasks for Modicon M340, Atrium, Premium and Quantum type processors, respectively.

Platform	Modicon M340		Premium			Atrium	Quantum	
	BMX P34 1000	BMX P34 20●0	TSX P 57 C● 244M TSX P 57 0244M TSX P 57 1●4M	TSX P 57 2●(3)4M TSX P 57 3●(3)4M TSX P 57 4●(3)4M	TSX P 57 554M TSX P 57 5634M TSX P 57 6634M	TSX PCI 57 204 M TSX PCI 57 454 M	140 CPU 31110 140 CPU 434 12U	140 CPU 651 ●0 140 CPU 671 60
Cyclic or periodic master task	Yes	Yes	Yes	Yes	Yes	Yes	Yes	Yes
Periodic fast task	Yes	Yes	Yes	Yes	Yes	Yes	Yes	Yes
Periodic auxiliary tasks	–	–	–	–	4	–	–	4
Event-triggered tasks								
From modules	32	64	32	64	128	64	64	128
From timers	32	64	–	–	32	–	16	32
Total	32	64	32	64	128	64	64	128

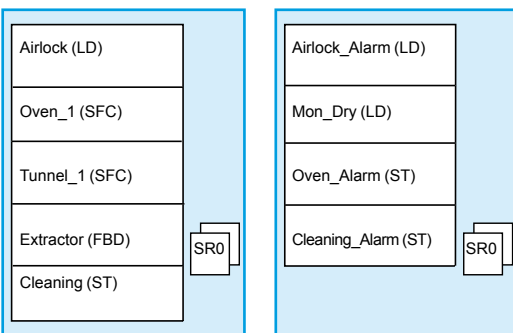

Master task

Fast task

### Structure, modular and portable programming

The tasks of a Unity Pro program for Modicon M340, Atrium, Premium or Quantum platforms are composed of several parts known as sections and subroutines. Each of these sections can be programmed in the most appropriate language for the process to be executed.

Such division into sections enables a structured program to be created and program modules to be generated or added with ease.

Subroutines can be called from any section of the task to which they belong or from other subroutines in the same task.

**Compatibility of languages compliant with IEC standard 61131-3:** Unity Pro software can be configured (*Tools/Project Settings/Language Extensions menu*) to ensure that applications generated are compliant with IEC standard 61131-3. Furthermore, as long as you use only the standard instruction libraries, you will be able to reuse programs created in this way on any Modicon M340, Atrium, Premium or Quantum platform.

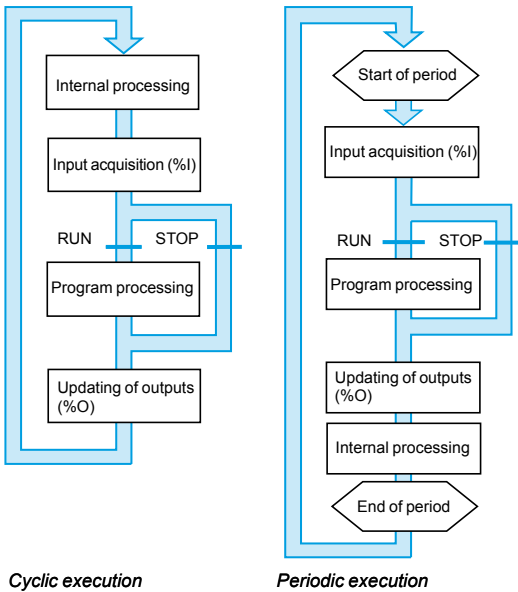

Cyclic execution

Periodic execution

### Single-task software structure

Two types of cyclic execution are supported:

- Normal cyclic execution. This is the default option.
- Periodic execution. This type of execution, as well as the period are selected by the user during programming when the task parameters are set (Mast task).

#### Normal execution (cyclic)

At the end of each scan, the PLC system launches a new scan. The execution time of each scan is monitored by a software watchdog whose value is defined by the user (max. 1500 ms).

In the event of overrun, a fault occurs causing:

- The scan to stop immediately (STOP)
- A fault state to be displayed on the front panel of the processor
- The alarm relay for the main rack power supply to be set to 0

#### Periodic execution

A new scan cycle is executed at the end of each period. The execution time of the scan must be less than the time of the period defined (max. 255 ms). In the event of overrun, the latter is stored in a system bit (%S19), which can be reset to 0 by the user (via the program or terminal).

A software watchdog, which can be configured by the user (max. 1500 ms), monitors the scan time. In the event of an overrun, an execution fault is indicated (see Normal execution). The scan execution times (the last scan, the longest scan and the shortest scan) are stored in system words %SW 30/31/32.

### Multitask software structure

Modicon M340, Atrium, Premium and Quantum platforms support a multitask structure comprising:

- 1 master task (divided into several sections programmed in ST, IL, LD, FBD and SFC languages)
- 1 fast task (divided into sections)
- 0 to 4 auxiliary tasks (divided into sections) (1)
- 1 or more event-triggered tasks (only one section per task)

These tasks are independent and executed in parallel, with the PLC processor managing their execution priority. When an event occurs, or at the start of the fast task scan:

- If any lower-priority tasks are currently being executed, they are suspended.
- The event-triggered task or fast task is executed.
- The interrupted task resumes once execution of the priority task has been completed.

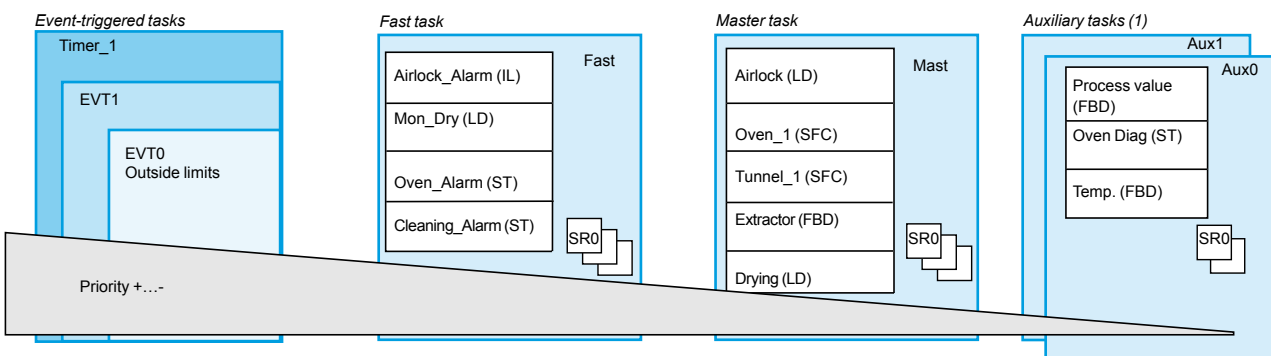

This structure optimizes the way in which processing power is employed and can be used to structure the application and simplify design and debugging, as each task can be written and debugged independently of the others.

(1) Tasks reserved for Premium TSX P57 5●4M/6634M and Quantum 140 CPU 651 ●0/67160 high-end processors.

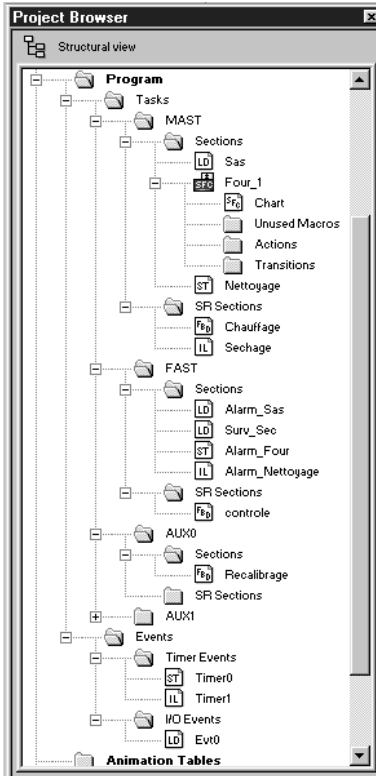

Application browser

### Multitask software structure (continued)

#### Master task

This task, which can be periodic or cyclic, executes the main program. It is activated systematically. Each of its component sections and subroutines can be programmed in Ladder (LD), Function Block Diagram (FBD), Structured Text (ST) or Instruction List (IL) language. Several sections of the master task can be programmed in Sequential Function Chart (SFC) or Grafcet language.

#### Fast task

This task, which has a higher priority than the master task, is periodic in order to allow time for tasks with lower priorities to be executed. It should be used when fast periodic changes in discrete inputs need to be monitored and acknowledged. The execution of the master task (lower priority) is suspended while the fast task is being executed. Processing operations in this task must be as short as possible in order to avoid adversely affecting master task processing operations. Each of the component sections and subroutines of the fast task can be programmed in Instruction List, Structured Text, Ladder or Function Block Diagram language (ST, IL, LD or FBD).

#### Auxiliary tasks

These tasks, which are available with the Premium and Quantum **TSX P57 5•4M/6634M** and **140 CPU 651 •0/652 60/671 60** high-end processors are intended for slower processing operations, such as measurement, process control, HMI, application diagnostics, etc. Periodic type auxiliary tasks have the lowest level of priority and are executed once the higher-priority periodic tasks (master and fast) have completed their scan. Each of the component sections and subroutines of the fast task can be programmed in Instruction List, Structured Text, Ladder or Function Block Diagram language (ST, IL, LD or FBD).

#### Event-triggered tasks

Unlike the tasks described above, these tasks are not linked to one period. The asynchronous execution of these tasks is triggered by:  
 An event from certain application-specific modules (e.g.: exceeding a counter threshold, change of state of a “discrete” input).  
 An event from the event timers.  
 These tasks are processed before all other tasks and are thus suitable for processing requiring very short reaction times in comparison to the arrival of the event.  
 Modicon M340, Atrium, Premium and Quantum platforms have 3 priority levels (these are, in descending order, EVT0 module event, EVTi module events and Timeri timer events).  
 These tasks, each comprised of a single section, can be programmed in Instruction List, Structured Text, Ladder or Function Block Diagram language (ST, IL, LD or FBD).

#### Assignment of I/O channels to tasks

Each of the master, fast or event-triggered tasks reads (at the start of the scan) and writes (at the end of the scan) the inputs assigned to it. By default, they are assigned to the master task.

For the Quantum platform, the remote inputs/outputs (RIO) are assigned only to the master task (these assignments can be made per station or for each of the component sections of the task); the distributed inputs/outputs (DIO) are all assigned to the master task (with no assignment to its component task).

For event-triggered tasks, it is possible to assign input/output channels (1) other than those relating to the event. Exchanges are then performed implicitly at the start of processing for inputs and at the end of processing for outputs.

(1) These channel assignments are made per I/O module for Quantum and per channel for Atrium/Premium inputs/outputs.

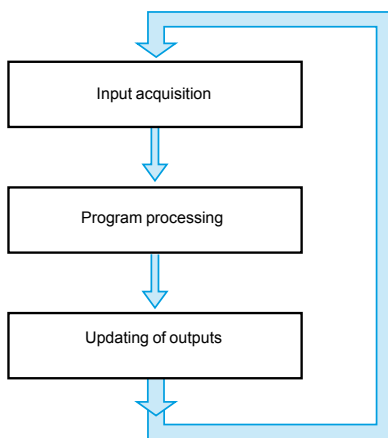

Program execution



### The five IEC languages

The five graphical or textual languages available in Unity Pro are used for programming Modicon M340, Atrium, Premium and Quantum automation platforms.

The 3 graphical languages are:

- Ladder (LD)
- Function Block Diagram (FBD)
- Sequential Function Chart (SFC) or Grafcet

The 2 textual languages are:

- Structured Text (ST)
- Instruction List (IL)

For these 5 languages, you can use the standard set of instructions compliant with IEC standard 61131-3 to create applications, which can be transferred from one platform to another. Unity Pro software also provides extensions to this standard set of instructions. As they are specific to Modicon M340, Atrium/Premium and Quantum PLCs, these extensions support the development of more complex applications in order to maximize the potential of the specific features of each of these platforms.

### Functionalities common to all five language editors

The editors for each of the 5 languages provide a number of common tools used for writing, reading and analyzing programs in a user-friendly manner:

- The text editors for Instruction List (IL) and Structured Text (ST) support:
  - Text entry in insert or overwrite mode
  - The use of dialogue boxes for the assisted entry of variables, functions, function blocks or assignment instructions
  - Checks on data entry to detect syntax or semantics errors. The user is informed of the result of this check by red "wavy" underlining or by a change in the colour of the text concerned
  - Access to a set of colours, which can be used to facilitate reading by distinguishing text (black) from operators (red), language key words (blue) and program comments (green)
- The graphics editors for Ladder (LD) language, Function Block Diagram (FBD) language and Sequential Function Chart (SFC) language feature:
  - A set of graphics elements for direct access to the various graphic symbols in the language via the mouse or keyboard
  - A pop-up menu, which can be accessed by right-clicking with the mouse
- Unlimited number and length of comments. These comments can be positioned as text objects in any cell (graphical languages) or at any point in expressions (textual languages).
- Assisted data entry functions for:
  - Accessing DFB function libraries, the variables editor or the text object for entering comments
  - Initializing a variable reference
  - Initializing the animation table on selected variables
  - Displaying and modifying the properties of the selected variable
  - Creation of variables in real time without having to use the data editor
- "Cut", "Copy", "Paste", "Delete", "Move", etc.
- Setting bookmarks on lines of text or in the margin so that you can:
  - Easily locate lines in important program sections
  - Browse in an editor by bookmark, label, or line and column number

### Ladder (LD)

Each section or subroutine using Ladder language consists of a series of rungs, which are executed sequentially by the PLC. Each rung consists of graphic objects (placed in cells arranged in columns and lines) corresponding to contacts, links, coils, operation blocks, EF/EFB/DFB function blocks, jumps, subroutine calls, etc.

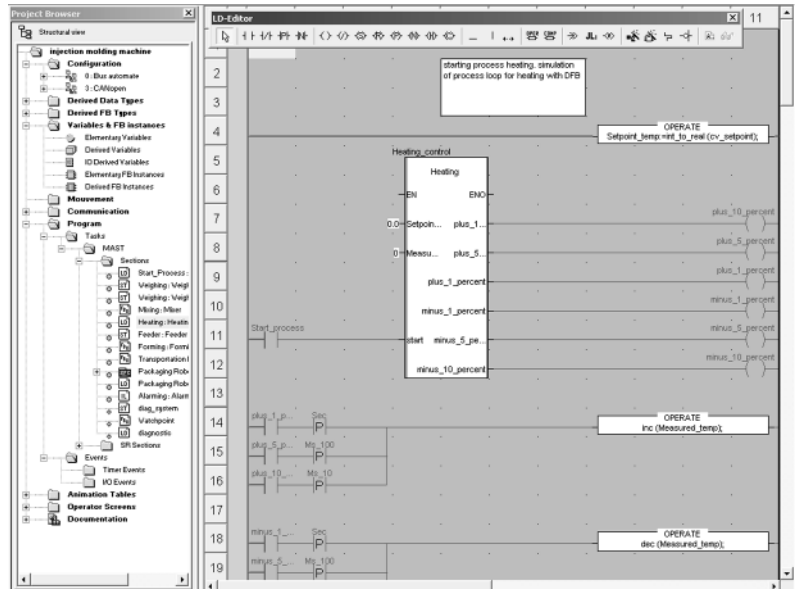

### Program structure (section or subroutine)

Each Ladder language section can contain:

- Between 11 and 64 columns (number set by user)
- Up to 2000 lines (for all rungs in the section)



Graphics palette in the Ladder language editor

“Mixed Display” mode supports the unrestricted display of comments, addresses and symbols for the variables used for rungs.



## Function Block Diagram (FBD) language

Function Block Diagram language is a graphical language based on function blocks associated with variables or parameters, which are linked together. This language is particularly well suited for process control applications.

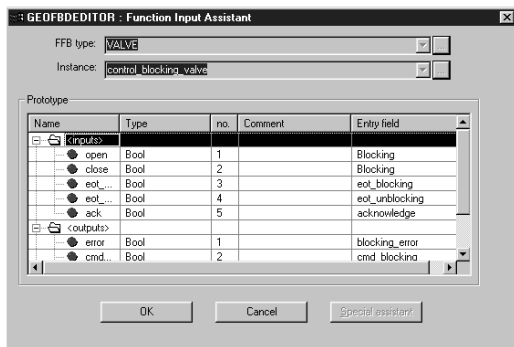
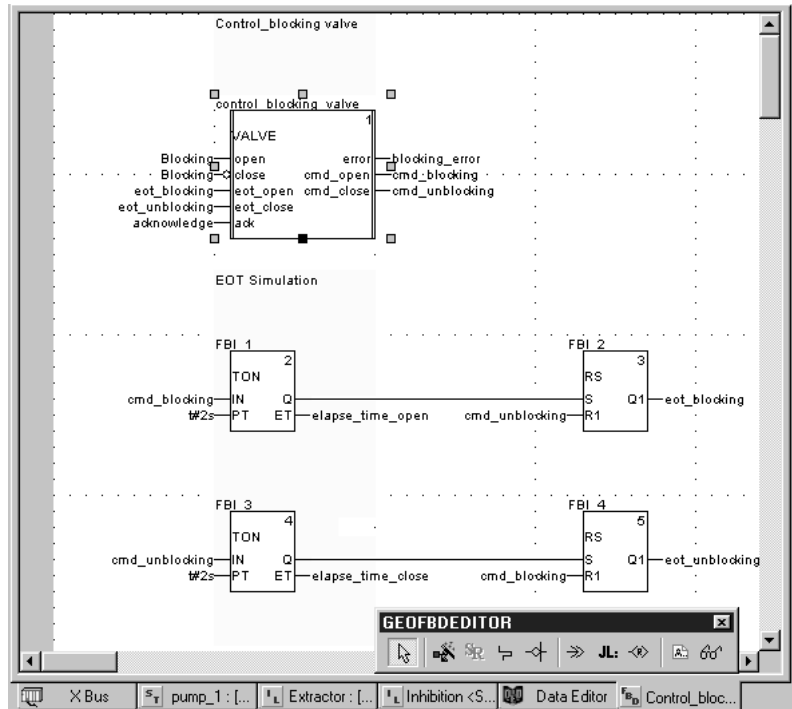

Function Block Assistant

## Program structure (section or subroutine)

The graphical language FBD supports three types of function block:

- Elementary blocks (EFs)
- Elementary Function Blocks (EFBs), sorted into different libraries depending on their type of use
- Derived Function Blocks (DFBs), which have a structure identical to that of EFBs but are created by the user with the ST, IL, LD or FBD programming languages

Within the same section, subroutines can be called using a specific block. Program jumps to a block instance can also be programmed.

A section programmed in FBD language contains the equivalent of a grid with 30 columns and 23 rows. This can be extended to a wider page.

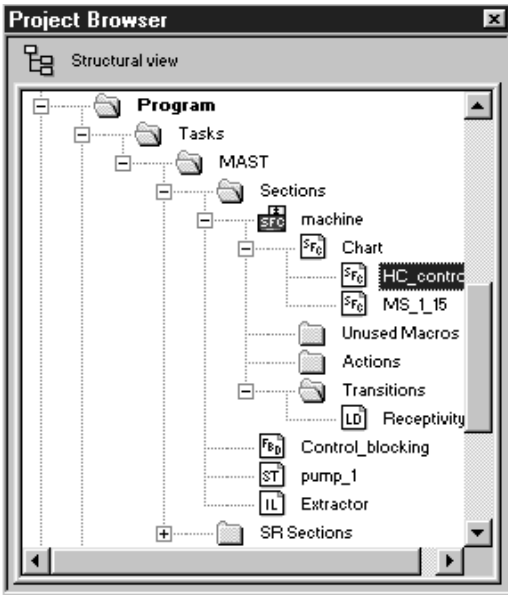

SFC structure in the browser

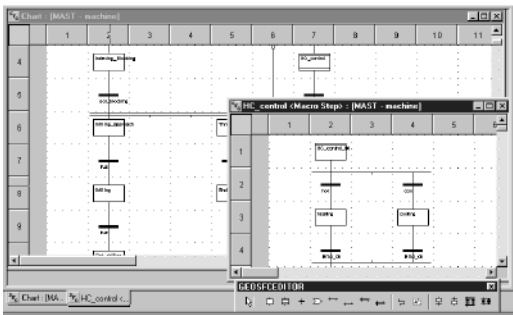

SFC charts

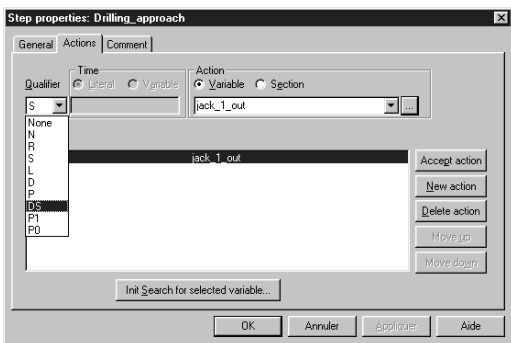

Step properties

### Sequential Function Chart (SFC) and Grafcet language

Sequential Function Chart (and Grafcet) language can be used to describe the sequential part of an automation system in simple graphical format using steps and transitions.

SFC language does not process charts in the same way as Grafcet language:

- SFC only authorizes one token in one chart.
  - Grafcet language authorizes several tokens in a single chart.
- Unity Pro software has one editor for these two languages with the option of defining behavior in the application settings (*Tools/Project Settings/Language Extensions menu*).

### Program structure (master task section)

SFC language is only used in sections belonging to the master task. Each SFC section consists of a main chart sub-section CHART and sub-sections for each of the macro-steps. Charts consist of:

- Macro-steps, which are the sole representation of a set of steps and transitions (used to set up a hierarchical chart structure)
  - Steps
  - Transitions and directed links between steps and transitions
- Associated with steps and transitions respectively, the actions and transition conditions can be:
- Integrated into the CHART or macro-step charts, in which case the actions or transition conditions are defined by a single variable
  - Processed in specific sections, in which case dedicated processing (to be programmed in Ladder, Function Block Diagram, Structured Text or Instruction List language) is necessary
- In order to check that machine scans have been completed successfully, activity times (minimum, maximum) can be associated with each step. These times are set by the user.

### Program structure (master task section)

For each SFC section, the graphics editor provides a maximum of:

- One grid containing 32 columns and 200 rows, or 6400 cells. Steps, transitions or jumps all need one cell respectively.
- 1024 steps (macro-steps and steps in macro-steps)
- 20 actions assigned to the same step
- 100 steps activated at the same time
- 100 steps activated at the same time

To help you to create basic charts, graphic screens can be used to create “n” steps in series and “m” steps in parallel in a single operation.

Dialogue boxes can be used to assign associated properties to steps (activity time, actions), transitions (variable linked to transition condition), etc.

## Structured Text (ST)

Structured Text language is a sophisticated algorithmic type language, which is particularly well suited for programming complex arithmetic functions, table operations, message handling, etc.

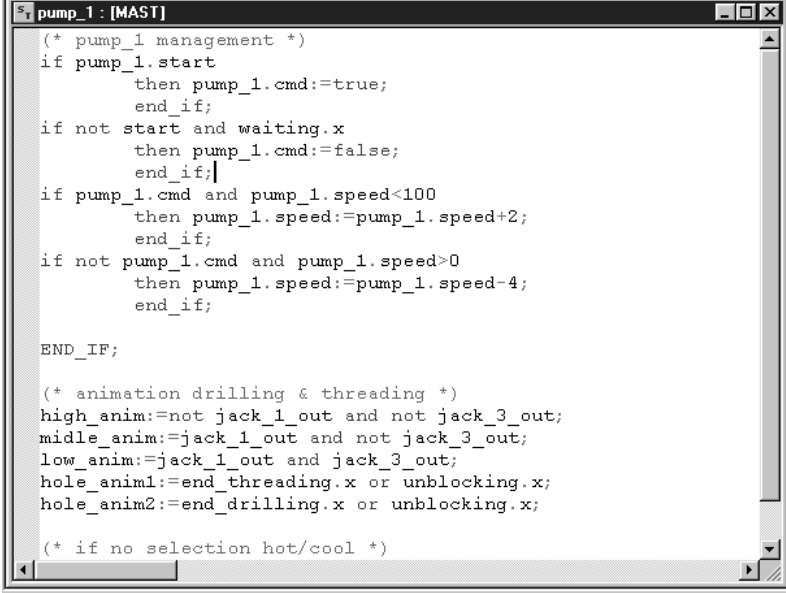

```

pump_1 : [MAST]

(* pump_1 management *)
if pump_1.start
  then pump_1.cmd:=true;
  end_if;
if not start and waiting.x
  then pump_1.cmd:=false;
  end_if;
if pump_1.cmd and pump_1.speed<100
  then pump_1.speed:=pump_1.speed+2;
  end_if;
if not pump_1.cmd and pump_1.speed>0
  then pump_1.speed:=pump_1.speed-4;
  end_if;

END_IF;

(* animation drilling & threading *)
high_anim:=not jack_1_out and not jack_3_out;
middle_anim:=jack_1_out and not jack_3_out;
low_anim:=jack_1_out and jack_3_out;
hole_anim1:=end_threading.x or unblocking.x;
hole_anim2:=end_drilling.x or unblocking.x;

(* if no selection hot/cool *)

```

### Program structure (section or subroutine)

Structured Text language, which can be used to directly transcribe an analysis based on an organization chart, is structured into expressions composed of a series of instructions organized in lines.

There is no limit to the number of characters an instruction line may contain (the only limit is the program memory available for the Modicon M340, Premium and Quantum platforms, except on TSX P57 10 40 processors, where the limit is 64 Kb). The length of the section is only limited by the size of the application memory.

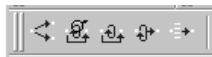

Four preformatted expression structures can be called up directly from the toolbar:

- **Conditional action:** *IF...THEN...ELSIF...THEN...ELSE...END\_IF;*
- **Iterative conditional action:** *WHILE...DO...END\_WHILE;*  
*REPEAT...UNTIL...END\_REPEAT;*
- **Repetitive action:** *FOR...TO...BY...DO...END\_FOR;*
- **Selective action:** *CASE...OF...ELSE...END\_CASE;*

The operands used in the expressions are bit variables, word variables or variables linked to function blocks.

To make the expressions easier to read, different colours are used to identify objects, language key words and program comments.

### Instruction List (IL)

Instruction List language is a language representing the equivalent of a Ladder diagram in text form. It can be used to write Boolean and arithmetic equations using all the functions available in the Unity Pro language (calling of functions and function blocks, assignment of variables, creation of program jumps, branching to subroutines within a program section, etc.).

```

(* Simple example *)
LD t#5s
ST delay

(* fault motor *)
LD overspeed
AND hot_temp
ST fault_motor

(* Start the motor after delay (in seconds) *)
CAL MOTOR_TIMER (PT := Delay, IN := start_motor)
LD motor_timer.q
ST motor_run

(* Stop the motor after ten seconds in running *)
cal stop_timer(motor_run,t#10s)
LDN stop_timer.q
ST start_motor

```

### Program structure (section or subroutine)

A program in Instruction List language comprises a sequence of instructions classified into the following different families:

- Bit instructions, e.g. read input: *LD overspeed*
- Function block instructions, e.g. call timer: *CAL MOTOR\_TIMER*
- Numerical instructions using single, double and floating point integers, e.g.:  
*LD Result ADD Surplus ST Archive*
- Word table or character string instructions, e.g. make assignment:  
*LD Result:10:=Setpoint:10*
- Program instructions, e.g. SR call: *CALL SR10*.

The operands used in the expressions are bit variables, word variables or variables linked to function blocks.

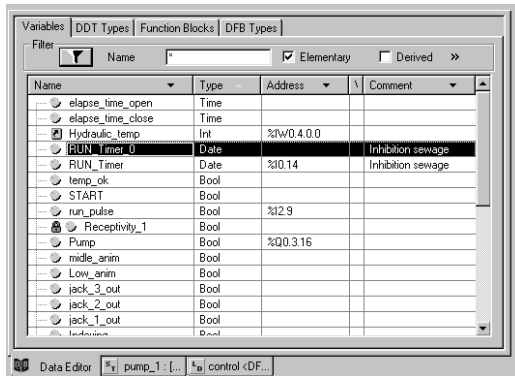

Data editor

## Data editor

The data editor, which can be accessed from the structural view of the project, provides a single tool for performing the following editing tasks:

- Declaration of data including variables and function blocks (declaration of their type, instances and attributes)
- Use and archiving of function block data types in different libraries
- Hierarchical view of data structures
- Searching, sorting and filtering of data
- Creation of a hyperlink to access a description from any variable comment

The data is displayed under four tabs:

- "Variables" tab for the creation and management of the following data instances: bits, words, double words, inputs/outputs, tables and structures
- "DDT Types" tab for the creation of derived data types (tables and structures)
- "Function Blocks" tabs for the declaration of EFB and DFB function blocks
- "DDT Types" tab for the creation of derived data types (tables and structures)

Each data element has several attributes, of which:

- The name and type of the variable are mandatory
- The comment, physical address in the memory or initial values are optional

The data editor columns can be configured (number of columns, order). All the attributes associated with a variable can be displayed in a properties window.

This editor can be accessed at any time during programming by selecting variables for data modification or creation.

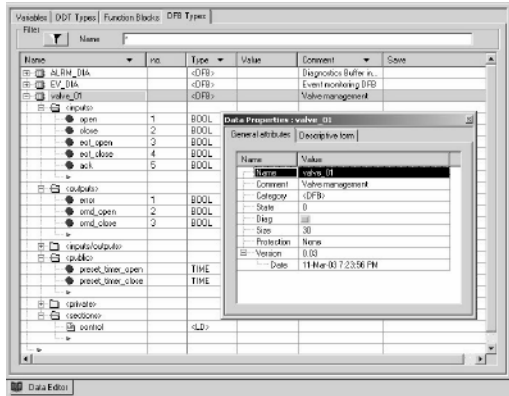

Data properties

### DFB user function blocks

The user can create his own function blocks for specific application requirements on Modicon M340, Atrium, Premium and Quantum platforms using Unity Pro software. Once created and saved in the library, these user function blocks can be reused as easily as EFBs (Elementary Function Blocks).

These user function blocks can be used to structure an application. They are used when a program sequence is repeated several times in the application or for fixing a standard programming routine. They can be read-only protected or read/write-protected. They can be exported to all other Unity Pro applications.

Using a DFB function block in one or more applications:

- Simplifies program design and entry
- Improves program readability and understanding
- Facilitates program debugging (all variables handled by the DFB block function are identified in the data editor)
- Enables the use of private variables specific to the DFBs, which are independent of the application

A DFB function block is set up in several phases:

- The DFB is designed by assigning a name, a set of parameters (inputs, outputs, public and private internal variables) and a comment to it via the data editor.
- The code is created in one or more sections of the program, with the following languages selected according to requirements: Structured Text, Instruction List, Ladder or Function Block Diagram (ST, IL, LD or FBD).
- The DFB may be stored in a library with an associated version number.
- A DFB instance is created in the data editor or when the function is called in the program editor.
- This instance is used in the program in the same way as an EFB (Elementary Function Block). (The instance can be created from within the program.)

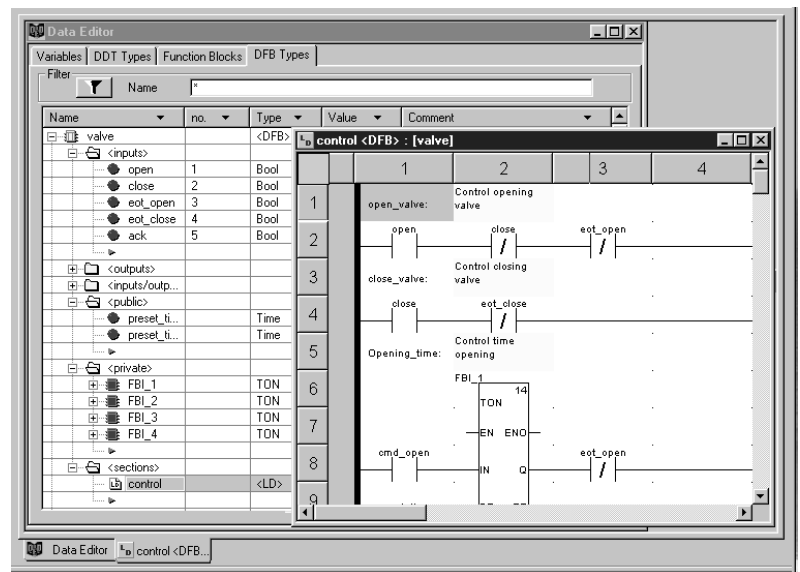

#### Main characteristics

<b>Inputs</b>	32 max. (1)
<b>Outputs</b>	32 max. (2)
<b>Inputs/outputs</b>	32 max. (1) (2)
<b>Public internal variables</b>	Unlimited (3), can be accessed via the application program
<b>Private internal variables</b>	Unlimited (3), cannot be accessed via the application program
<b>Comment</b>	1024 characters max.
<b>Program sections</b>	Unlimited, each section can be programmed independently in one of the 4 languages (IL, ST, LD and FBD).

(1) The maximum cumulative total of inputs and inputs/outputs is 32.

(2) The maximum cumulative total of outputs and inputs/outputs is 32.

(3) For Premium processors, see page 43400/7. Characteristics, memory capacity, maximum size of object areas, unlocated internal data and DFB and EFB function blocks.

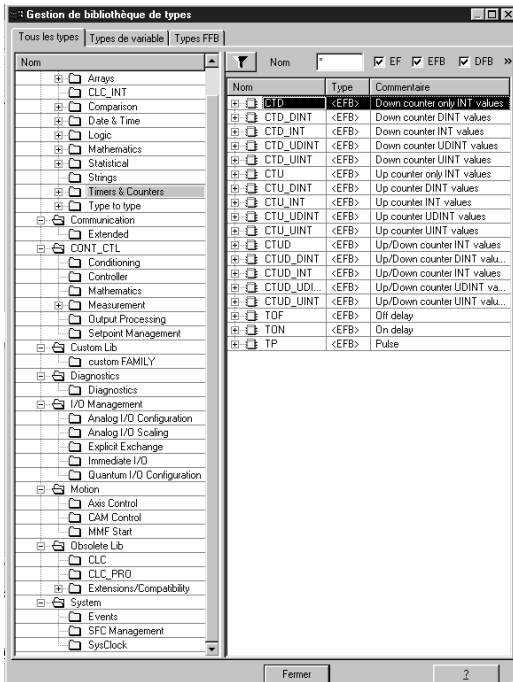

Standard function block libraries

### Function block libraries

The function and function block libraries manager contains all the elements provided with Unity Pro software. The functions and function blocks are organized into libraries, which themselves consist of families. Depending on the type of PLC selected and the model of processor, the user will have a sub-set of these libraries available to write his/her applications. However, the “Base Lib” library contains a set of functions and function blocks, the majority of which are compatible with all platforms. In particular, it contains the blocks compliant with IEC61131-3.

The “Base Lib” library is structured into families:

- Timers and counters
- Process control on integers
- Array management
- Comparison
- Date and time management
- Logic processing
- Mathematical processing
- Statistical processing
- Character string processing
- Type-to-type data conversion

The “Base Lib” library, which covers standard automation functions, is supplemented by other, more application-specific libraries and platform-specific functions:

- **Communication library**, providing an easy means of integrating communication programs from PLCs with those used by HMIs from the PLC application program. Like other function blocks, these EFBs can be used in all languages to exchange data among PLCs or to deliver data to be displayed on an HMI.
- **Process control library**. The CONT\_CTL library can be used to set up process-specific control loops. It offers controller, derivative and integral control functions plus additional algorithms such as: EFBs for calculating mean values, selecting a maximum value, detecting edges, or assigning a hysteresis to process values, etc.
- **Diagnostics library**, which can be used to monitor actuators and contains EFBs for active diagnostics, reactive diagnostics, interlocking diagnostics, permanent process condition diagnostics, dynamic diagnostics, monitoring of signal groups, etc.
- **I/O management library**, providing services to handle information exchanged with hardware modules (formatting data, scaling, etc.)
- **Motion Function Blocks library**, containing a set of predefined functions and structures to manage motion controlled by drives and servo drives connected on CANopen
- **Motion library** for motion control and fast counting
- **“System” library**, which provides EFBs for the execution of system functions, including: evaluation of scan time, availability of several different system clocks, SFC section monitoring, display of system state, management of files on the memory cartridge of the Modicon M340 processor, etc.
- Finally, a library named “obsolete” containing all function blocks used by legacy programming software needed to perform application conversions

### Management of user standards

Users may create libraries and families in order to store their own DFB function blocks and DDT data structures. This enhancement allows users to take advantage of programming standards adapted to their needs, along with version management. This means that it is possible to:

- Check the version of the elements used in an application program against those stored in the library
- Perform an upgrade, if necessary

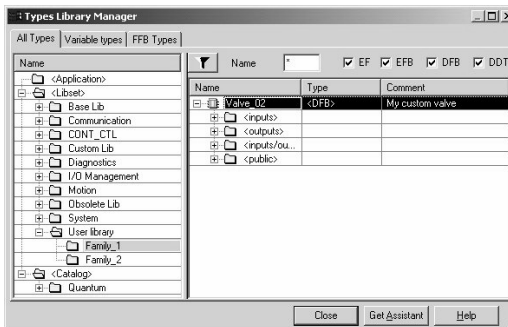

User-defined libraries





Insertion/removal of watchpoint

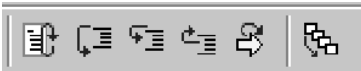

Perform step by step execution

```
Secure : [MAST]
IF Niveau_1 >= 600 THEN Pompe_1 := False;
END_IF;
IF Niveau_2 >= 200 Then Pompe_2 := False;
END_IF;
IF Niveau_3 >= 400 Then Vanne_1 := False;
Vanne_2 := False;
END_IF;
IF Boite = 10 Then Vanne_3 := False;
End_IF;
IF Niveau_3 < 80 Then Chauff_on := False;
:= False;
```

Animation of ST program

Name	Value	Type	Comment
Initial	0	Bool	
Niveau_1	420	Int	
Niveau_2	0	Int	
Niveau_3	333	Int	
Boite	0	Int	
Quantite_a_pr...	0	Int	
Quantite prod...	0	Int	
Pompe_1	1	Bool	
Melange_2	0	Bool	

Animation table

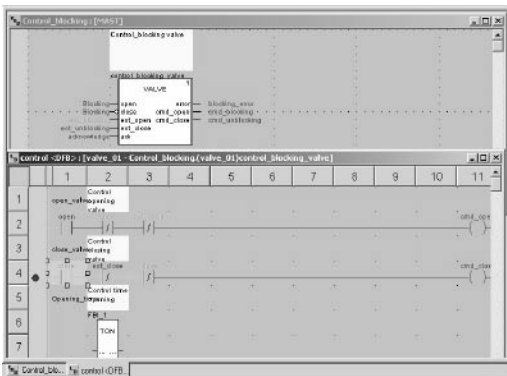

### Debugging tools

Unity Pro software offers a complete set of tools for debugging Modicon M340, Atrium, Premium or Quantum applications. A tool palette provides direct access to the main functions:

- Dynamic program animation
- Setting of watchpoints or breakpoints (not authorized in event-triggered tasks)
- Step-by-step program execution A function in this mode enables section-by-section execution. Instruction-by-instruction execution can be launched from the previous breakpoint. Three execution commands are therefore possible when the element to be processed is a subroutine (SR) or DFB user block:
  - Detailed step-by-step or “Step Into”. This command is used to move to the first element of the SR or DFB.
  - Overall step-by-step or “Step Over”. This command is used to process the entire SR or DFB.
  - Outgoing step-by-step or “Step Out”. This command is used to move to the next instruction after the SR or DFB element.
- Independent execution of the master (MAST), fast (FAST), auxiliary (AUX) and event-triggered (EVTi) tasks.

### Animation of program elements

Dynamic animation is managed section by section. A button in the toolbar is used to activate or deactivate animation for each section.

When the PLC is in RUN, this mode can be used to view, simultaneously:

- The animation of a program section, regardless of the language used
- The variables window containing the application objects created automatically from the section viewed

Several windows can be displayed and animated simultaneously. The “Tool tip” function, which uses help balloons, can be used to view a variable and its content simultaneously when the object is selected with the mouse (or other pointing device). Users can add inspection windows to display program variables.

Two types of animation are supported:

- Standard: The variables of the active section are refreshed at the end of the master task (MAST).
- Synchronized: The watchpoint can be used to synchronize the display of animated variables with a program element in order to determine their value at this precise point in the program.

### Animation table

Tables containing the variables of the application to be monitored or modified can be created by data entry or initialized automatically from the program selected.

In both these tools, in addition to animating the data, it is possible to:

- Modify bit variables or force them to 0 or 1
- Change the display format
- Copy or move variables
- Search by cross-reference
- Display the list of forced bits

These tables can be stored in the application and retrieved from there at a later time, at a later time.

### Debugging of DFB user function blocks

The parameters and public variables of these blocks are displayed and animated in real time using animation tables, with the possibility of modifying and forcing the required objects.

In exactly the same way as with other program elements, the watchpoint, breakpoint, step-by-step execution and program code diagnostics functions can be used to analyze the behavior of DFBs. Setting a breakpoint in a DFB user function block instance stops the execution of the task containing this block.





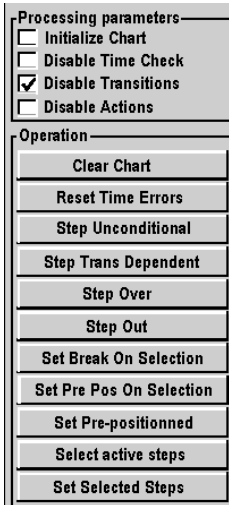

SFC control panel

### Debugging tools (continued)

#### Debugging in Sequential Function Chart (SFC) language

The various debugging tools are also available in SFC language. However, unlike other sections (IL, ST, LD or FBD) an SFC section executed step by step does not stop execution of the task but instead freezes the SFC chart. Several breakpoints can be declared simultaneously within a single SFC section.

Numerous commands are available in this debugging mode via the control panel:

- Deactivate active step(s)
- Activate initial step(s)
- Disable step execution times
- Freeze chart regardless of transition conditions
- Stop processing of steps
- Move to the next step taking account of the transition conditions
- Enable transition and move to next step(s) (detailed step-by-step command: "Step Into")
- Enable transition in order to execute the end of the macro-step (outgoing step-by-step command, "Step Out")
- Pre-position chart on steps for which markers have been set, etc.

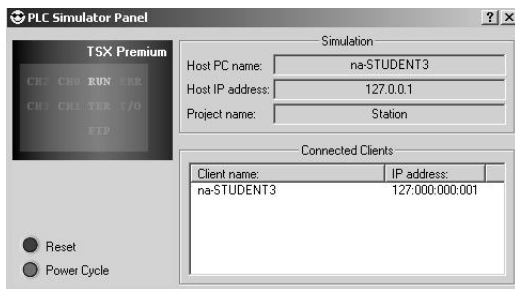

Simulator control panel

### PLC simulator

The simulator integrated into Unity Pro can be used to test the application program for Modicon M340, Atrium, Premium, or Quantum PLCs from the PC terminal without having to connect to the PLC processor. The functions provided by the debugging tools are available for debugging the master, fast and auxiliary tasks.

As the simulator does not manage the PLC I/O, animation tables can be used to simulate the state of inputs by forcing them to 0 or 1.

The simulator can be connected to third-party applications via an OPC server with OFS (OPC Factory Server) software.

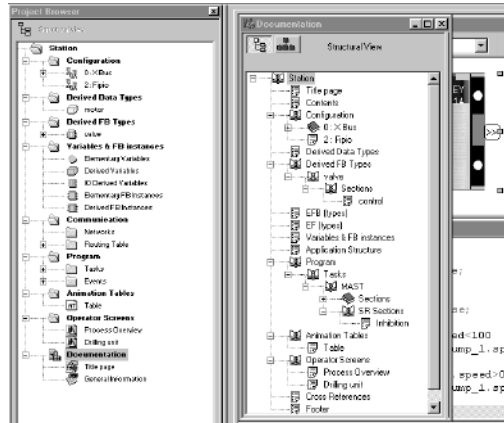

Access to documentation editor

### Documentation editor

The documentation editor is based on the Documentation Browser, which shows the file structure in tree form.

It allows all or part of the application file to be printed on any graphics printer accessible under Windows and using True Type technology, in A4 or US letter print format.

The documentation editor supports the creation of user-specific files using the following headings:

- Title page
- Contents
- General information
- Footer
- Configuration
- EF, EFB and DFB type function blocks
- User variables
- Communication
- Project structure
- Program
- Animation tables and cross references
- Runtime screens

The documentation editor can generate the documentation file based on two different structures:

- Structural view: All the objects in the project are associated with their corresponding headings.
- Functional view: The objects in the project are associated with the function modules to which they belong.

The documentation file can be created and saved as the project progresses, from one Unity Pro session to another.

### Presentation

Diagnostics integrated into Modicon M340, Atrium, Premium and Quantum automation platforms

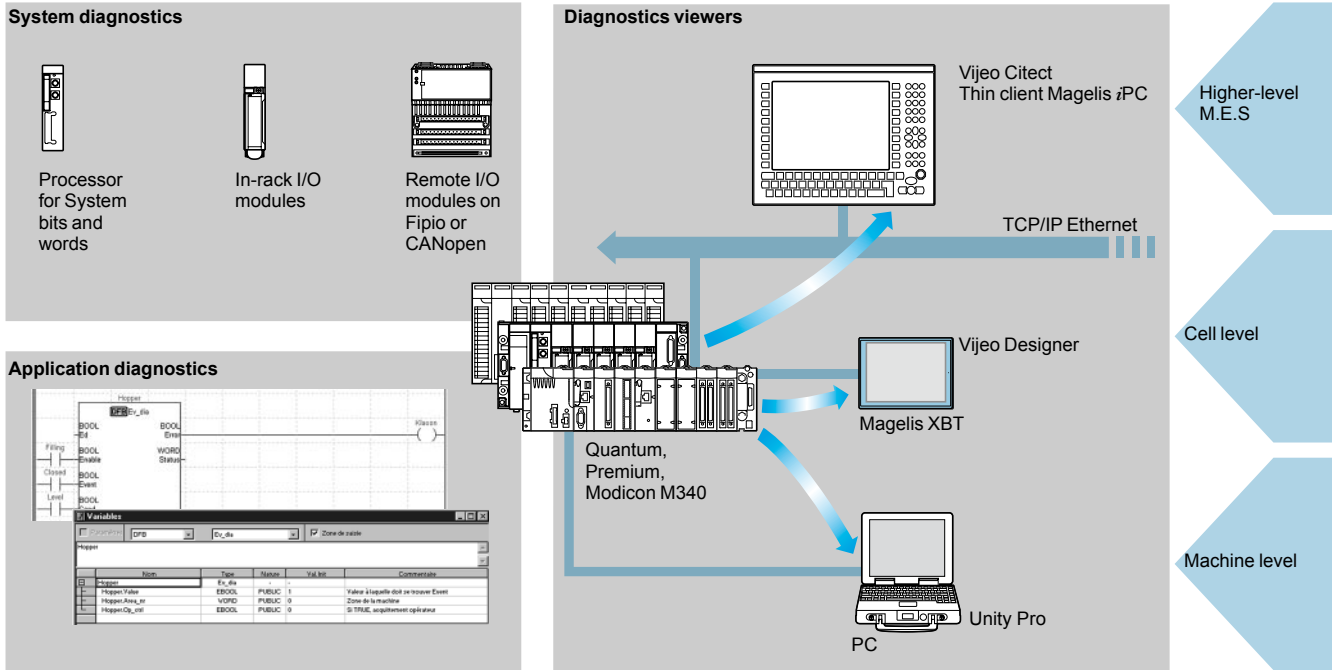

The diagnostics offer for Modicon M340, Atrium, Premium and Quantum is based on three components:

- System diagnostics
- DFB and EFB diagnostic function blocks (for system and application diagnostics)
- Error message display system, called viewers, supplied as a standard component of Magelis XBT terminals, Vijeo Citect supervisory software and Unity Pro setup software

### Functions

#### System diagnostics

The system diagnostics for the Modicon M340, Atrium, Premium and Quantum platforms support the monitoring of system bits/words, I/O modules and activity times (minimum/maximum) of SFC steps. By simply choosing the relevant option during application configuration, any event will generate time-stamped messages logged in the diagnostic buffer of the PLC.

These events are displayed automatically on a diagnostics viewer (1) without requiring any additional programming.

With Unity Pro integrated diagnostics, this function can be used to perform 1<sup>st</sup> level diagnostics of the elements in the configuration, up to and including each I/O module channel.



(1) Diagnostics viewers are tools used to display and acknowledge diagnostic error messages. They are supplied as a standard component of Unity Pro and Vijeo Designer software with Magelis terminals and with the PLC Web server that can be accessed via a Magelis iPC thin client.



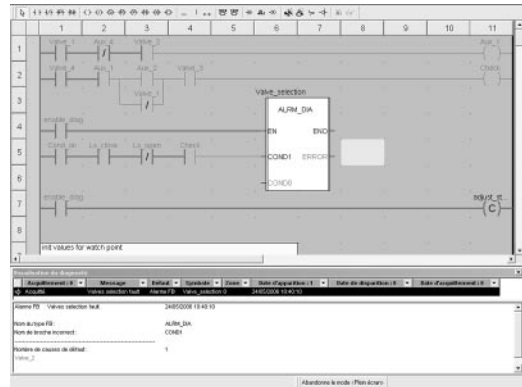
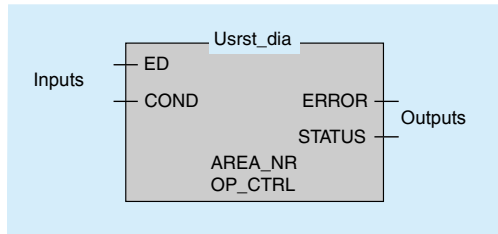

Diagnostics with fault cause analysis

## Functions (continued)

### Application diagnostics

Unity Pro software features a library of function blocks for monitoring, called diagnostic DFBs and EFBs. The library of diagnostic function blocks comprises:

#### Manufacturer blocks for system diagnostics

- I/O module parameter setting which is used to monitor the I/O states
- ASI\_DIA, which monitors whether an error has occurred on the AS-i bus (module or bus fault, no slave, slave not configured or faulty)

#### Manufacturer blocks for application diagnostics

- EV\_DIA, which monitors that an event (bit status) assumes the correct value at a specific time (no notion of timing)
- MV\_DIA, D\_GRP, D\_REA, which monitor whether an event (change of bit status) occurs according to predefined time conditions
- ALRM\_DIA, which monitors the combination of the status of 2 bits
- NEPO\_DIA and TEPO\_DIA, which are used to check, control and perform diagnostics on elements of the application consisting of a combination of 2 preactuators and 2 sensors

#### Open diagnostic blocks

These blocks allow users to create their own diagnostic function blocks customized to their specific applications, thus supplementing the manufacturer DFBs and EFBs presented above. Open diagnostic blocks are created from 2 model blocks, which must be written in Ladder (LD), Structured Text (ST), Function Block Diagram (FBD) or Instruction List (IL) language.

### Diagnostics with fault cause analysis

In addition, when a fault occurs, Unity Pro analyses the relevant program sections and displays the probable causes and sources of the fault in a second window.

Thus, the user or process operator is guided through the fault analysis process and will be able to reduce machine downtime as a result.

Furthermore, with the diagnostics viewer integrated into Unity Pro, the instruction or module that caused the fault can be accessed directly from the alarm displayed in the viewer display window (see page 7/25).

# Modicon Quantum automation platform

Unity Pro software  
Integrated diagnostics



Viewer

## Functions (continued)

### Diagnostics viewers

All the diagnostic events processed by the Modicon M340, Atrium, Premium and Quantum platforms via diagnostic DFBs/EFBs are stored in a buffer (specific data memory area of the PLC). The information contained in the Premium buffer is sent (transparently for the user) to viewers for automatic display and for management of faults and alarms. The view function is supplied as a standard component for:

- Vijeo Designer configuration software
- Unity Pro programming software
- Magelis XBT GT and Magelis iPC graphic display terminals

The viewer integrated into Unity Pro can also be used to access the instruction or module that is the source of the fault. See "Diagnostics with fault case analysis" on page 7/24.

The Modicon M340, Atrium, Premium and Quantum platforms have multiviewer capability (and can be connected to up to 15 viewers). A PC-compatible station with the viewer function can have multi-PLC capability (and can be connected to up to 15 Modicon M340/Atrium/Premium/Quantum platforms).

The buffer/viewer structure supports:

- A single point for fault management in each application
- Time-stamping of the occurrence of faults at the source
- Storage of intermittent faults in memory
- Independence with regard to the viewer functions. The frame sent from the PLC buffer is identical for all viewers
- Automatic archiving of all error messages

### Display window

The diagnostics viewer takes the form of a display window divided into 2 sections:

- A message list area containing, for each alarm: state, DFB type, geographical zone, dates and times of appearance/disappearance, associated message and status
- An area for additional information about the selected message: type, comments, date of appearance, specific data, variables in error state, etc.

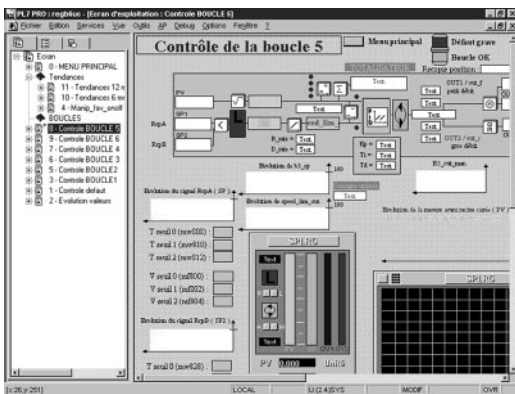

## Runtime screens

The runtime screens tool is integrated into Unity Pro software. Runtime screens are designed to facilitate the running of automated processes during debugging, startup and maintenance. Runtime screens provide a range of information (explanatory texts, display of dynamic values, control buttons and views), enabling users to act quickly and easily to modify and dynamically monitor PLC variables.

The runtime screens editor provides all of the HMI (Human/Machine Interface) elements needed for the animated design and viewing of processes. It enables these screens to be designed using specific tools:

- Screen: creation of runtime screens, which can be classified according to family
- Message: creation of messages to be displayed
- Objects: creation of a graphic objects libraries based on:
  - Geometrical elements (line, rectangle, ellipse, incorporation of images, controller front panels, etc.)
  - Control elements (buttons, data entry fields, screen browsing controls, etc.)
  - Animation elements (colours, flashing elements, bar graphs, etc)

When the station on which Unity Pro has been installed is connected to the PLC, users can obtain a dynamic screen display based on the process state. Depending on the assigned priority, screens can be sequenced via a keyboard command or a PLC request.

In online mode, the Unity Pro application program can be accessed directly via the runtime screens simply by clicking the selected object in a screen view. It is also possible to activate the animation table or cross-reference functions after selecting one or more variables on the screen. To make the display easier to read, the synoptic views can be displayed on full screen. Because it is possible to create or modify a runtime screen when the PLC is in Run mode, this service increases productivity during installation and maintenance phases.

### Modifying the program with the PLC in RUN mode

With Unity Pro, changes can be made to the program when the PLC connected to the programming terminal is in RUN mode. These modifications are performed with the following operations:

- The application contained in the PLC is transferred to the PC terminal running Unity Pro, if necessary.
- Program changes are prepared. These program modifications can be of any type and in any language (IL, ST, LD, FBD and SFC), for example, addition or deletion of SFC steps or actions. The code of a DFB user function block can also be modified (however, modifications of its interface are not permitted).
- These program changes are updated in the PLC (in RUN mode).

This function makes it possible to add or modify program code and data in different parts of the application in one single modification session (thus resulting in a unified, consistent modification with respect to the controlled process). This increased flexibility comes at a cost in terms of the amount of program memory required.

### Cross-reference function

The Unity Pro cross reference function, which is available in standalone mode (offline) and when connected to the PLC in Run (online), allows users to view all the elements of a PLC application when searching for any type of variable. This view indicates where the declared variable is used, as well as how it is used (for writing, reading, etc.).

This function also provides access to the Search/Replace function for variable names.

The variable search can be initialized from any editor (language, data, runtime screen, animation table, etc.).

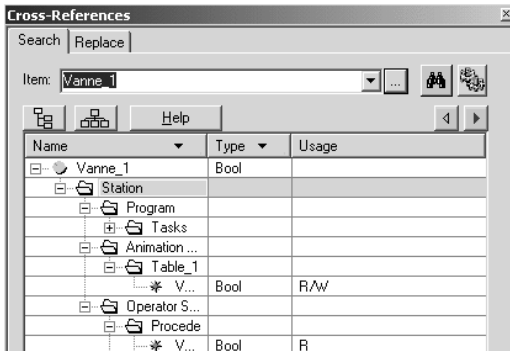

### Import/export function

The import/export function available in Unity Pro supports the following operations from the structural and functional project views:

- Via the import function, reuse in the current project of all or part of a project created previously
- Via the export function, copying of all or part of the current project to a file for subsequent reuse

The files generated during export are generally in XML format (1). However, in addition to XML, variables can be exported and imported in the following formats:

- .xvm format compatible with OFS data server software
- Source format, in an .scy file compatible with the PL7 design software
- Text format with separator (TAB) in a .txt file for compatibility with any other system

During an import, a wizard can be used to reassign data to new instances of:

- DFB function blocks
- DDT data structures
- Single loops

In addition, when a functional module is imported, the data associated with animation tables and runtime screens are also reassigned.

The XML import function also supports the transfer of a Modicon M340, Atrium, Premium, or Quantum PLC configuration prepared in the SIS Pro costing and configuration tool for use in the creation of a project in Unity Pro.

This import function spares the user from having to redefine the PLC configuration when the PLC has already been configured with the SIS Pro tool.

(1) XML language: An open, text-based language that provides structural and semantic information.

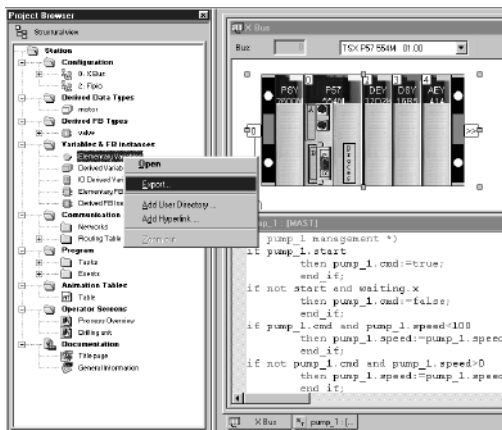



### Application converters

Unity Pro integrated conversion tools can be used to convert PLC applications created with Concept and PL7 programming and setup software to Unity Pro applications.

#### Concept/Unity Pro converter (Quantum PLC)

This conversion is performed with a Concept application V2.5 or later (it can also be performed in V2.11 or later, but only after an update to V2.5). In order to perform the conversion, the application must be exported to an ASCII file in Concept. The export file is converted to a Unity Pro source file automatically. This source file is then analyzed by Unity Pro. At the end of the procedure, a conversion report is generated and an output window displays any conversion errors and provides direct access to the part of the program to be modified. The Concept application converter converts the application to Unity Pro, but does not guarantee that it will operate correctly in real time. It is therefore essential to test or debug all converted applications.

#### PL7/Unity Pro converter (Premium PLC and Atrium slot PLC)

This conversion is performed with a PL7 application V4 or later (Premium PLC or Atrium slot PLC). In order to perform the conversion, the source file (complete application) or source file (user function block) must be exported in PL7. The conversion procedure is similar to that of the Concept conversion described above.

**Note:** Applications created with Concept, Modsoft and ProWorx can be converted to LL984. Please consult your Regional Sales Office.

### Utilities for updating PLC operating systems

The OS-Loader software designed for updating operating systems on Atrium, Premium and Quantum platforms is supplied with Unity Pro software. It is used to upgrade processors and modules in PL7 or Concept for compatibility with Unity Pro:

- Premium **TSX P57 2•3M/2623M**, **TSX P57 3•3M/3623M** processors.
  - Quantum **140 CPU 434 12A** et **140 CPU 534 14A** processors (requires version PV 04 or later)
  - Ethernet **TSX ETY •102** and **140 NOE 771 •1** communication modules.
  - EtherNet/IP **TSX ETC 100** and **140 NOC 771 00** communication modules.
- These operating system updates are performed as follows for the various processor types:
- Uni-Telway RS 485 terminal link for Premium processors
  - Modbus or Modbus Plus terminal link for Quantum processors
  - Ethernet TCP/IP network for integrated Ethernet port on Premium processors and Ethernet Premium and Quantum modules (1).

**Note:** For Modicon M340, this service is provided by Unity Loader.

(1) The operating system of the Quantum **140 CPU 671 60** processor is updated over an Ethernet network using its MT-RJ type fibre-optic connector (via a ConneXium transceiver or switch for a copper wire/fibre-optic interface).

### Unity Pro XL Safety

In addition to the functions of Unity Pro Extra Large, Unity Pro XL Safety provides a set of function blocks of specific checks and protections to facilitate the creation and debugging of Quantum safety projects.

For a description of these characteristics and their setup, as well as the functional limitations provided for within the framework of SIL 2-certifiable safety projects according to IEC 61508, refer to the document entitled “*Quantum Safety PLC, Safety Reference Manual*” 11/2007, No. 3303879.00, approved by TÜV Rheinland and available at [www.schneider-electric.com](http://www.schneider-electric.com).

The Unity Pro XLS programming tool is certified compliant with the requirements of IEC 61508 for the management of safety applications with Quantum **140 CPU 651 60S/671 60S PLCs**.

It offers the complete range of functions required to program a safety project:

- In-depth error diagnostics
- Project protection

During project creation, it is the selection of the Quantum CPU that determines whether or not the project created will be a safety project.

Unity Pro XLS is capable of processing all Unity Pro application types. No other programming tool is needed on the computer.

To program a safety project, Unity Pro XLS provides two IEC 61131-3 programming languages:

- Function Block Diagram (FBD)
- Ladder language (LD)

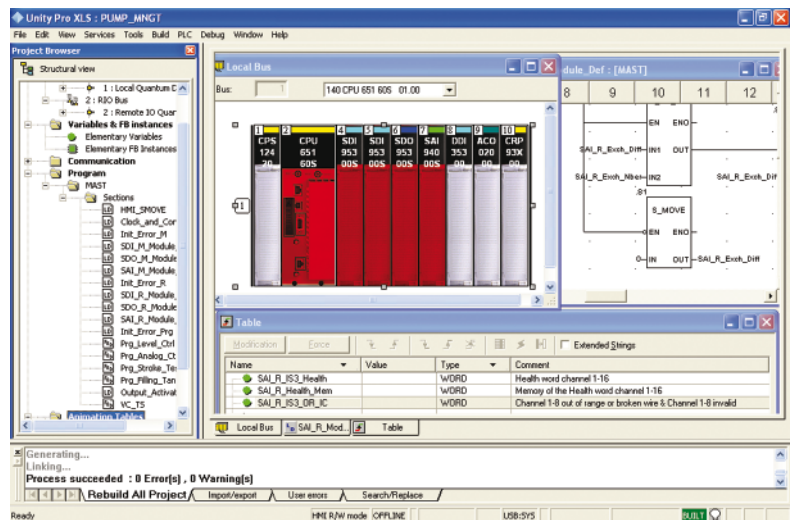

### Unity Pro XL Safety (continued)

#### Safety program structure

A safety project must be programmed entirely in a master task (MAST).

It is not possible to:

- Program FAST, TIMER, INTERRUPT, or AUX tasks
- Use subroutines (SR sections)

#### Language elements

Unity Pro XLS provides a set of specific, certified functions and function blocks. These are available in the "Unity Pro safety function block library".

Moreover, most of the language elements are available:

- Elementary data types (EDTs): BOOL, EBOOL, BYTE, WORD, DWORD, INT, UINT, DINT, UDINT and TIME
- Simple tables used exclusively for Ethernet Global Data communication,
- Direct addressing, for example, writing to %MW memory via a coil in Ladder Logic (LD)
- Located variables

#### Project checking options

Unity Pro XLS provides the following different options for the checks performed by the language analyzer:

- Unused variables
- Variables written multiple times
- Unassigned parameters
- FB instances used multiple times
- Address overlapping

It is advisable to enable all options when checking a safety project.



### Unity Pro XL Safety (continued)

#### Protecting the project

Unity Pro XLS provides protective functions against unauthorized access to safety projects, to the Quantum safety PLC and to Unity Pro XLS itself.

- The application password, defined when the safety project was created, is requested:
  - When the safety application file is opened
  - Upon connection to the safety PLC



- The safety editor integrated into Unity Pro XLS is used to define the access permissions and the list of authorized functions for each user, in particular:
  - Creation and modification of the application password
  - Activation of maintenance mode
- Adjustment of the auto-lock period

#### Functions and function blocks for safety applications

Unity Pro XLS provides a set of elementary functions (EFs) and elementary function blocks (EFBs) certified for use in safety applications:

- Standard functions certified for safety applications:
  - Mathematical functions and functions for manipulating data from the unrestricted memory area in the safety logic
  - Comparison functions
  - Logical functions, rotations, offsets
  - Statistical functions
  - Timer and counter setup
  - Type conversions
- Specific functions for safety architectures:
  - Setup of high availability: choice between two discrete I/O module inputs or redundant analog inputs
  - Hot Standby PLC redundancy system to cause the two processors involved in a hot standby configuration to change roles from primary to standby and standby to primary, respectively. The objective is to verify the capacity of each processor to take over in case the other processor fails. With Unity Pro XLS, this function can easily be programmed in the application by setting up the S\_HSBY\_SWAP elementary function from the library.

### Unity Pro XL Safety (continued)

#### Distinctive features and specific procedures

##### Auto-testing software tools

Unity Pro XLS provides the option of performing an auto-test to verify that the software components installed have not been corrupted, for example, due to a hard disk failure. This auto-test is based on a CRC calculation.

Unity Pro XLS checks the version and CRC:

- Of its DLLs
- Of the library database of the safety FFB
- Of the catalogue database of hardware products

Unity Pro XLS auto-tests are performed upon request by the user, for example:

- After installing or uninstalling any program on the computer
- Before loading the final application program onto the safety PLC
- Before modifying the application program executed on the safety PLC

##### Time-stamping binary files

With Unity Pro XLS, every binary file generated for a safety project features a version management field that provides the date and time at which it was generated. This information is useful for checking the project.

##### Downloading a project to Unity Pro XLS

It is possible to download a safety project from the PLC to Unity Pro XLS under the following conditions:

- This must have been defined as an option for the safety project.
- The user must know the application password to establish a connection to the safety PLC.
- The safety PLC must be placed in maintenance mode to perform the download.

##### Unrestricted memory

The unrestricted memory area contains bits and words that are not protected against write operations from external equipment such as HMI terminals, PLCs, etc.

- It is located at the beginning of the memory.
- Its size can be configured with Unity Pro XLS.
- Values cannot be used directly in the unrestricted memory area and can only be used in conjunction with specific function blocks: S\_MOVE\_BIT and S\_MOVE\_WORD.

In the edit phase first and then in the generation phase, Unity Pro XLS checks to make sure that only data from the unrestricted memory area are used at the input of the function blocks S\_MOVE\_BIT and S\_MOVE\_WORD.

Furthermore, Unity Pro XLS provides a useful list of cross references, allowing easy identification of the way in which variables are used and verification of the application of this rule.

*Note: For safety applications, it is common practice to verify the correct transfer of data by writing the data twice (to different variables) and then comparing them.*

### Communication drivers

The drivers used most frequently with the Atrium, Premium and Quantum platforms are installed at the same time as the Unity Pro software.

Unity Pro also includes the following communication drivers, which can be installed as required (1):

Driver type	Windows XP Windows 2000	Windows NT	Windows 98 Millennium	Windows 95
Uni-Telway COM port	V1.9 IE20	V1.9 IE17	V1.7 IE18	V7.8 IE18
Uni-Telway TSX SCP 114	V1.2 IE05			
Modbus COM port	V1.6 IE29			
Fip ISATSX FPC10 card	V1.4 IE06	V1.3 IE08	V1.4 IE06	V2.4 IE08
Fip PCMCIA TSX FPC20 card	V1.2 IE03	V1.1 IE08	V1.2 IE04	
Ethway	V1.4 IE05	V1.1 IE03	V2.6 IE06 (2)	
ISAway PCX 57, ISA card	V1.2 IE04	V1.5 IE06	V1.2 IE04	V1.2 IE09
PClway Atrium, PCI card	V1.1 IE09	-		
XIP X-Way on TCP/IP	V1.10 IE22			
USB for USB terminal port	V1.2 IE17	-		

### Unity Developer's Edition, advanced open access

Advanced open access, intended for experienced IT engineers, supports the development of interfaces between Unity and expert tools, as well as specific user-defined functions.

This type of development requires experience in the following IT areas:

- C++ or Visual Basic languages
- Client/server architectures
- XML and COM/DCOM technologies
- Database synchronization

As a supplement to the Unity Pro Extra Large software(3), the UDE (Unity Developer's Edition) development kit **UNY UDE VFU CD21E** enables the development of customized solutions. In addition to the development kit, the Unity servers and accompanying documentation are also provided.

Unity Developer's Edition is compatible with:

- Unity Pro Extra Large
- All Modicon M340 processors
- All Atrium slot-PLCs
- All Premium Unity processors
- All Quantum Unity processors

(1) Also available separately under reference **TLX CD DRV 20M**.

(2) Windows 98 only.

(3) Only the Unity Pro Extra Large version enables dynamic database management for data to be exchanged with the OFS data server or a third-party tool.

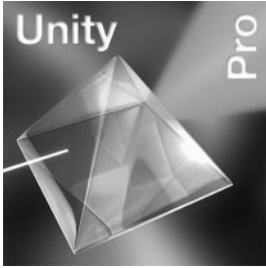

### References

#### Unity Pro Small, Medium, Large, Extra Large and XL Safety software packages

The software is available in 5 versions:

- **Unity Pro Small** for programming and setting up Unity automation platforms:
  - Modicon M340 BMX P34 1000 and BMX P34 20●0
- **Unity Pro Small** for programming and setting up Unity automation platforms:
  - Modicon M340 BMX P34 1000 and BMX P34 20●0
  - Atrium TSX PCI 57 20
  - Premium TSX 57 0●, 57 10 and 57 20
- **Unity Pro Small** for programming and setting up Unity automation platforms:
  - Modicon M340 BMX P34 1000 and BMX P34 20●0
  - Atrium TSX PCI 57 20 and 57 30
  - Premium TSX 57 0●, 57 10, 57 20, 57 30 and 57 40
  - Quantum with 140 CPU 311 10, 434 12U and 534 14U CPUs
- **Unity Pro Small** for programming and setting up all Unity automation platforms:
  - Modicon M340 BMX P34 1000 and BMX P34 20●0
  - Atrium TSX PCI 57 20 and 57 30
  - Premium TSX 57 0●, 57 10, 57 20, 57 30, 57 40, 57 50 and 57 60
  - Quantum with 140 CPU 311 10, 434 12U, 534 14U, 651 50, 651 60 and 652 60 CPUs and Hot Standby CPU 140 CPU 671 60
- **Unity Pro Small** for programming and setting up all Unity automation platforms:
  - Modicon M340 BMX P34 1000 and BMX P34 20●0
  - Atrium TSX PCI 57 20 and 57 30
  - Premium TSX 57 0●, 57 10, 57 20, 57 30, 57 40, 57 50 and 57 60
  - Quantum with 140 CPU 311 10, 434 12U, 534 14U, 651 50, 651 60 and 652 60 CPUs and Hot Standby CPU 140 CPU 671 60
  - Quantum with safety CPU 140 CPU 651 60S and Hot Standby CPU 140 CPU 671 60S

#### Upgrade kits for Concept, PL7 Pro and ProWORX software

These upgrade kits allow users who already have these software programs from the installed base and who have a **current subscription** to obtain Unity Pro version V3.1 software at a reduced price. These upgrades are only available for licences of the same type (from Concept XL licence group to Unity Pro Extra Large licence group).

#### Composition and Windows OS compatibility

Unity Pro multilingual software packages are compatible with Windows 2000 Professional and Windows XP operating systems.

They comprise the following elements:

- Documentation in electronic format in 6 languages (English, German, Chinese, Spanish, French and Italian)

This documentation can be ordered separately in hard copy format.

- Converters for converting applications created with Concept and PL7 Pro programming software
- PLC simulator

Cables for connecting the processor to the programming PC must be ordered separately.



### References for Unity Pro Small version 4.0 software

For PLCs: **BMX P34 1000** **BMX P34 20●0**

#### Unity Pro Small version 4.0 software packages

Description	Licence type	Reference	Weight kg
Unity Pro Small software packages	Single (1 station)	<b>UNY SPU SFU CD 40</b>	–
	Group (3 stations)	<b>UNY SPU SFG CD 40</b>	–
	Team (10 stations)	<b>UNY SPU SFT CD 40</b>	–
Software upgrades from: - Concept S - PL7 Micro - ProWORX NxT/32 Lite	Single (1 station)	<b>UNY SPU SZU CD 40</b>	–
	Group (3 stations)	<b>UNY SPU SZG CD 40</b>	–
	Team (10 stations)	<b>UNY SPU SZT CD 40</b>	–

#### Licence type extensions for Unity Pro Small version 4.0

From	To	Reference	Weight kg
Single (1 station)	Group (3 stations)	<b>UNY SPU SZUG CD 40</b>	–
Group (3 stations)	Team (10 stations)	<b>UNY SPU SZGT CD 40</b>	–

### Unity Pro Medium version 4.0 software

For PLCs: **BMX P34 1000** **BMX P34 20●0** **TSX 57 0●...57 20** **TSX PCI 57 20**

#### Unity Pro Medium version 4.0 software packages

Description	Licence type	Reference	Weight kg
Unity Pro Medium software packages	Single (1 station)	<b>UNY SPU MFU CD 40</b>	–
	Group (3 stations)	<b>UNY SPU MFG CD 40</b>	–
	Team (10 stations)	<b>UNY SPU MFT CD 40</b>	–
Software upgrades from: - Concept S, M - PL7 Micro, Junior - ProWORX NxT/32 Lite	Single (1 station)	<b>UNY SPU MZU CD 40</b>	–
	Group (3 stations)	<b>UNY SPU MZG CD 40</b>	–
	Team (10 stations)	<b>UNY SPU MZT CD 40</b>	–

#### Licence type extensions for Unity Pro Medium version 4.0

From	To	Reference	Weight kg
Single (1 station)	Group (3 stations)	<b>UNY SPU MZUG CD 40</b>	–
Group (3 stations)	Team (10 stations)	<b>UNY SPU MZGT CD 40</b>	–

#### Software upgrade to Unity Pro Medium from Unity Pro Small

Type of upgrade	Reference	Weight kg
The number of stations is unchanged		
Small to Medium Single (1 station)	<b>UNY SPU MZSU CD 40</b>	–
Small to Medium Group (3 stations)	<b>UNY SPU MZSG CD 40</b>	–
Small to Medium Team (10 stations)	<b>UNY SPU MZST CD 40</b>	–

# Modicon Quantum automation platform

## Unity Pro software



### Unity Pro Large version 4.0 software

For PLCs:	BMX P34 1000	140 CPU 311 10
	BMX P34 20●0	140 CPU 434 12U
	TSX 57 0●...57 40	140 CPU 534 14U
	TSX PCI 57 20/30	

### Unity Pro Large version 4.0 software packages

Description	Licence type	Reference	Weight kg
Unity Pro Large software packages	Single (1 station)	UNY SPU LFU CD 40	–
	Group (3 stations)	UNY SPU LFG CD 40	–
	Team (10 stations)	UNY SPU LFT CD 40	–
	Site (≤ 100 users)	UNY SPU LFF CD 40	–
Software upgrades from: - Concept S, M - PL7 Micro, Junior, Pro - ProWORX NxT/32 Lite	Single (1 station)	UNY SPU LZU CD 40	–
	Group (3 stations)	UNY SPU LZG CD 40	–
	Team (10 stations)	UNY SPU LZT CD 40	–
	Site (≤ 100 users)	UNY SPU LZF CD 40	–

### Licence type extensions for Unity Pro Medium version 4.0

From	To	Reference	Weight kg
Single (1 station)	Group (3 stations)	UNY SPU LZUG CD 40	–
Group (3 stations)	Team (10 stations)	UNY SPU LZGT CD 40	–

### Software upgrade to Unity Pro Large from Unity Pro Medium

Type of upgrade	Reference	Weight kg
The number of stations is unchanged		
Medium to Large Single (1 station)	UNY SPU LZSU CD 40	–
Medium to Large Group (3 station)		–
Medium to Large Team (10 station)	UNY SPU LZST CD 40	–

### Unity Pro Extra Large version 4.0 software

For PLCs:	BMX P34 1000	140 CPU 434 12U
	BMX P34 20●0	140 CPU 534 14U
	TSX 57 0●...57 60	140 CPU 651 50/60
	TSX PCI 57 20/30	140 CPU 652 60
	140 CPU 311 10	140 CPU 671 60

### Unity Pro Extra Large version 4.0 software packages

Description	Licence type	Reference	Weight kg
Unity Pro Extra Large software packages	Single (1 station)	UNY SPU EFU CD 40	–
	Group (3 stations)	UNY SPU EFG CD 40	–
	Team (10 stations)	UNY SPU EFT CD 40	–
	Site (≤ 100 users)	UNY SPU EFF CD 40	–
Software upgrades from: - Concept S, M, XL - PL7 Micro, Junior, Pro - ProWORX NxT Lite, Full - ProWORX 32 Lite, Full	Single (1 station)	UNY SPU EZU CD 40	–
	Group (3 stations)	UNY SPU EZG CD 40	–
	Team (10 stations)	UNY SPU EZT CD 40	–
	Site (≤ 100 users)	UNY SPU EZF CD 40	–

### Licence type extensions for Unity Pro Extra Large

From	To	Reference	Weight kg
Single (1 station)	Group (3 stations)	UNY SPU EZUG CD 40	–
Group (3 stations)	Team (10 stations)	UNY SPU EZGT CD 40	–

### Software change to Unity Pro Extra Large from Unity Pro Large

Type of upgrade	Reference	Weight kg
The number of stations is unchanged		
Large to Extra Large Single (1 station)	UNY SPU EZSU CD 40	–
Large to Extra Large Group (3 stations)	UNY SPU EZSG CD 40	–
Large to Extra Large Team (10 stations)	UNY SPU EZST CD 40	–

# Modicon Quantum automation platform

## Unity Pro software

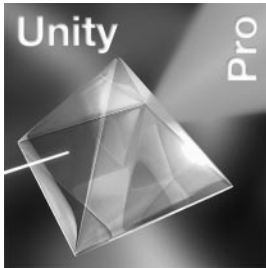

### Unity Pro XL Safety version 3.1 software

For PLCs:	BMX P34 1000	140 CPU 311 10
	BMX P34 20●0	140 CPU 434 12U
	TSX 57 0●...57 60	140 CPU 534 14U
	TSX PCI 57 20/30	140 CPU 651 50/60
		140 CPU 652 60
		140 CPU 671 60
		140 CPU 651 60S
		140 CPU 671 60S

### Unity Pro XL Safety version 3.1 software packages

Description	Licence type	Reference	Weight kg
Unity Pro XL Safety software packages	Single (1 station)	UNY SPU XFU CD 31	–
	Group (3 stations)	UNY SPU XFG CD 31	–
	Team (10 stations)	UNY SPU XFT CD 31	–
	Site (≤ 100 users)	UNY SPU XFF CD 31	–
Software upgrades from: - Concept S, M, XL - PL7 Micro, Junior, Pro - ProWORX NxT Lite, Full - ProWORX 32 Lite, Full	Single (1 station)	UNY SPU XZU CD 31	–
	Group (3 stations)	UNY SPU XZG CD 31	–
	Team (10 stations)	UNY SPU XZT CD 31	–
	Site (≤ 100 users)	UNY SPU XZF CD 31	–

### Software for Unity Pro version 4.0

#### Unity Developer's Edition

For PLCs:	BMX P34 1000	140 CPU 311 10
	BMX P34 20●0	140 CPU 434 12U
	TSX 57 0●...57 60	140 CPU 534 14U
	TSX PCI 57 20/30	140 CPU 652 60
		140 CPU 671 60
		140 CPU 651 60S
		140 CPU 671 60S

Description	Licence type	Reference	Weight kg
UDE Unity Developer's Edition Requires Unity Pro Extra Large or Unity Pro XL Safety	Single (1 station)	UNY UDE VFU CD21E	–

## References (continued)

## Documentation for Unity Pro version 4.0

For PLCs	Description	Licence type	Reference	Weight kg
Hardware and software manuals (on DVD)	Platform setup for: - Modicon M340 - Atrium/Premium - Quantum - Momentum  Electromagnetic compatibility of networks and fieldbuses  Software setup for: - Unity Pro - Function block libraries	Multilingual: English, German, Chinese, Spanish, French	UNY USE 909 CD M	–

## Separate parts

Description	From Processor	To PC port	Length	Reference	Weight kg
PC terminal connection cables	USB mini B BMX P34 1000/20●0	USB port	1.8 m	BMX XCA USB H018	0.065
			4.5 m	BMX XCA USB H045	0.110
	Mini-DIN Premium port TSx 57 1●/2●/3●/4● Atrium TSX PCI 57	RS 232D (9-way SUB-D connector)	2.5 m	TSX PCX 1031	0.170
		USB port (USB/RS 485 converter)	0.4 m	TSX CUSB 485 (1)	0.144
		USB port (mini-DIN/RJ45 cordset)	2.5 m	TSX CRJMD 25 (1)	0.150
	Modbus port	RS 232D	3.7 m	990 NAA 263 20	0.300
	15-way SUB-D Quantum	(15-way SUB-D connector)	15 m	990 NAA 263 50	0.180
	140 CPU 311 10				
	140 CPU 434 12A				
	140 CPU 534 14A				
	USB port Premium TSX 57 5●/6● Quantum 140 CPU 6●1	USB port	3.3 m	UNY XCA USB 033	–
	Modbus port, RJ45 connector	RJ 45 connector	1 m	110 XCA 282 01	–
	Quantum 140 CPU 6●1		3 m	110 XCA 282 02	–
			6 m	110 XCA 282 03	–



BMX XCA USB H0●●



TSX PCX 1031



TSX CUSB 485

(1) Use the TSX CRJMD 25 mini-DIN/RJ45 cordset with converter TSX CUSB 485.



# Modicon Quantum automation platform

## Unity SFC View software

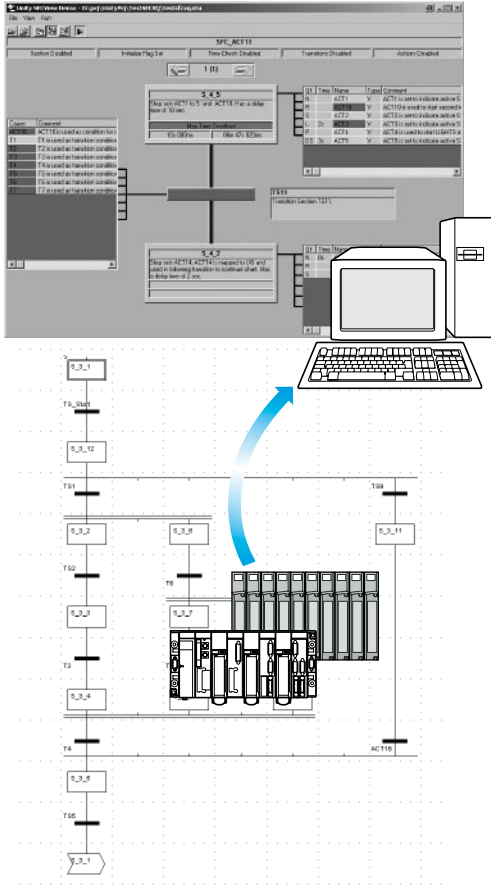

### Presentation

Unity SFC View is integrated in human/machine interface (HMI) applications for monitoring Unity Pro sequential applications written in sequential function chart language (SFC or Grafset) executed by a PLC.

Set up in the same way as an ActiveX control component, Unity SFC View is used to display status information relating to SFC charts executed by a Modicon M340, Premium, or Quantum PLC. Installed on an HMI station, Unity SFC View monitors and controls the status of SFC charts in real time, supplying detailed diagnostic data.

Unity SFC View reads the necessary data from the Unity project database in offline mode. The PLC data is accessed online via the OFS (*OPC Factory Server*).

Without needing to recreate SFC charts in the HMI environment, Unity SFC View reads the structure of the SFC charts directly from the Unity project database. Modifications made to the SFC application are detected and updated at any time. Working online, Unity SFC View accesses the diagnostic information of the PLC permitting the tracking and calculation of the occurrence of the first fault and the following faults. System downtime is much reduced since Unity SFC View enables maintenance staff to locate the source of the problem much more quickly.

Unity SFC View is designed for end users and system designers who wish to integrate this control into their HMI system. Unity SFC View is compatible with most HMI platforms handling ActiveX Control components such as Vijeo Designer configuration software (Magelis *iPC*) or in a programming environment such as Visual Basic.

### The 3 Unity SFC View views

Unity SFC View offers 3 views:

- An overview for managing selection of SFC charts.
- Two detailed views presenting the status and diagnostic data of the selected SFC chart.



Overview

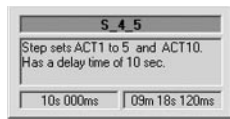

Simple detailed view

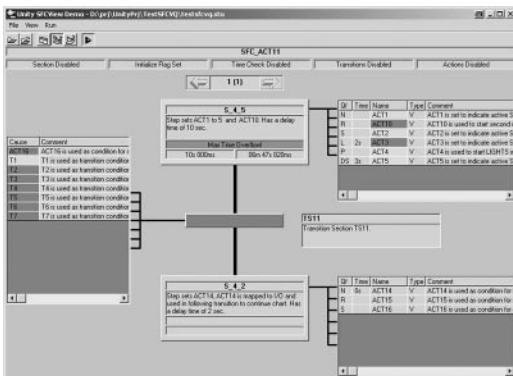

Detailed view

The **overview** provides a general view of all the SFC charts in a Unity project. It contains real-time data such as current step, simultaneous steps, chart error with indication of the SFC chart status. The overview makes it easy to browse through SFC charts and switch quickly to the detailed view of the desired SFC chart in the Unity Pro application.

The **simple detailed view** shows the elementary data on the active step (or selected step) of the SFC chart in real time. The data displayed may include the name, comment, chart and step status, as well as the activity times (min, max, actual). You can also enable the chart navigation option.

Because of the compact size of the simple detailed view, it is possible to place several instances of it on a single HMI screen relating to a certain part of the process. From this simple detailed mode, you can navigate between HMI screens with SFC View controls and display the detailed view of SFC charts.

The **detailed view** illustrates the details of an SFC chart in real time. The display indicates the current step, the transition awaiting activation and the next step. The actions associated with the steps are displayed along with sequence selections or parallel branches. The detailed diagnostic data includes analysis of the causes of the fault at transition level. Dependent on the diagnostic mode the error grid contains error causes or all the variables assigned to the transition logic. The current state of the various variables and selected errors are identified by different colours.

### Diagnostic mode

Transition logic diagnostics is a key function of Unity SFC View. It minimizes system downtimes in the event of a fault.

Two different diagnostic modes are available:

- Unity SFC View reads the data in the Unity PLC diagnostic buffer. It provides information about faulty or missing events that are preventing the transition from being enabled. This mode does not require any configuration or additional programming in the PLC program.
- Unity SFC View internally backtracks the transition conditions. This mode provides diagnostic data concerning all the inputs connected to the transition (not limited to faulty inputs). In this mode, for the Premium, Atrium and Quantum platforms, Unity SFC View uses specific EFB function blocks linked to the transition conditions. The library for these blocks is supplied with the Unity SFC View software.

### Easy customization

Unity SFC View offers a programming interface that can be used to integrate the ActiveX Control component in an HMI application and customize its functions and its operator interface.

The ActiveX Control component in Unity SFC View can be customized. It accepts properties, methods and events (all the properties have a default value). The properties pages simplify configuration. Unity SFC View accepts scripts with methods such as browsing through charts, status control of charts and also events such as error notification or chart selection. This data can be used to launch programs or operator screens.

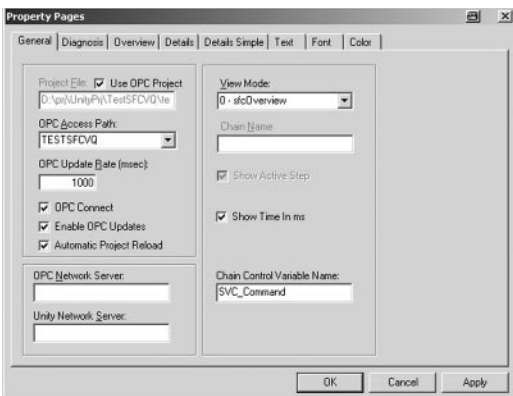

SFC View properties page



# Modicon Quantum automation platform

## Unity SFC View software

### Possible architectures

#### Basic architecture

Unity SFC View is used in a configuration where the OFS and Unity Pro software reside on the same PC platform as the HMI application.

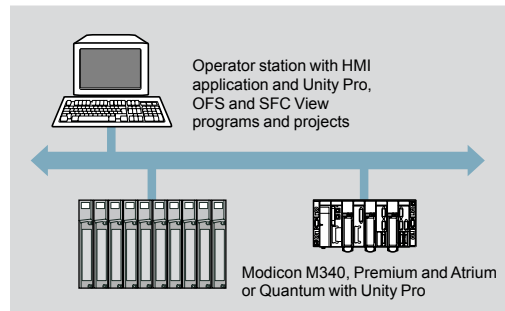

#### Distributed architecture

In a distributed configuration, the OFS and Unity Pro software can be installed on different servers.

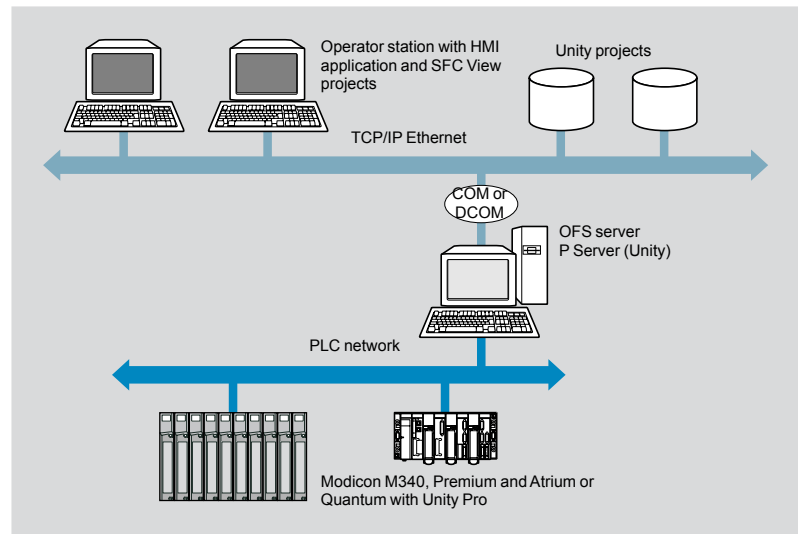

# Modicon Quantum automation platform

## Unity SFC View software



### References

When integrated in an HMI application, Unity SFC View can be used to monitor and control charts in applications developed in Sequential Function Chart (SFC) language running on Premium/Quantum Unity PLCs.

The HMI station, compatible with Windows 2000 or Windows XP Professional operating systems, must support ActiveX Control components. Unity SFC View V2.0 requires:

- Unity Pro V3● XL, to be ordered separately.
- OFS V3.1 data server software, to be ordered separately

Unity SFC View multilingual software, supplied on a CD-ROM, includes:

- The SFC View ActiveX Control component
- The EFB function block library for Unity Pro V2.0●
- An example of how to integrate SFC View into Unity Pro projects
- The electronic documentation (English, French and German)

The Unity SFC View integration example illustrates the main possibilities offered by Unity SFC View. This is an executable program which does not need HMI software in order to run. It helps the user understand how to configure and use the Unity SFC View ActiveX Control component.

Description	Type of license	Reference	Weight kg
<b>Unity SFC View software packages</b> (version V2.0)	Single (1 station)	<b>UNY SDU MFU CD20</b>	–
	Team (10 stations)	<b>UNY SDU MFT CD20</b>	–
	Site (100 stations)	<b>UNY SDU MFF CD20</b>	–



## Presentation

Unity Dif application comparison software for Modicon M340/Premium/Atrium/Quantum platforms is an optional program which complements the Unity Pro Extra Large programming software.

It is used to compare two Unity applications generated by Unity Pro and automatically provide an exhaustive list of all the differences between them.

The Unity Dif program increases productivity in the main life phases of a control system based on M340/Premium/Atrium/Quantum platforms:

- Application development and debugging
- Starting up installations and processes
- Operation and maintenance of installations and processes

Unity Dif software is an efficient tool for handling Unity applications for:

- Control system design offices
- Operation and maintenance managers
- Installers and systems integrators

## Software setup

The Unity Dif software can be used in one of two modes:

- Interactive mode, when the comparison is launched by an operator command (double-click on the Unity Dif software icon)
- Automatic mode, when it is launched by a previously established call command

These comparison commands locate all the differences between two applications in terms of:

- The hardware configuration (Modicon M340/Premium/Atrium/Quantum)
- The network configuration (Ethernet TCP/IP network, CANopen bus and Remote I/O (RIO) (1)).
- The entire set of variables and function block instances
- The application structure and its content (regardless of the language(s) used)
- The function modules
- The code for the DFB user function blocks and DDT compound data
- The project options

The result of the comparison between the two applications can be:

- Displayed
- Printed
- Saved in .txt format in a differences list

## Comparison

The end of the comparison operation is signalled by the appearance of the application browser with its two tabs:



**1** Identification tab for accessing the characteristics of the two applications being compared. The differences are marked by the # sign.

**2** Browser tab for accessing the application multilevel tree structure.

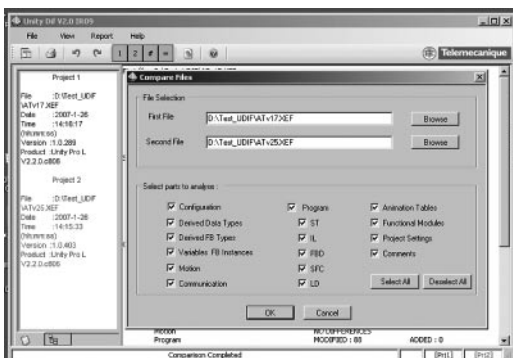

Comparison after selection of elements to be analyzed

(1) Remote I/O for Modicon Quantum platform.

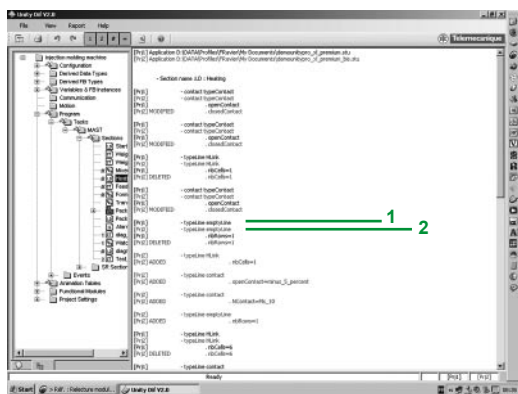

Detection of a modification in the EUSU\_RESS rung

## Setup (continued)

### Display of results

The representation of the application multilevel tree structure, which can be accessed via the browser tab after launching a comparison, is annotated by 4 symbols in which the information associated with application 1 appear in blue and those associated with application 2 appear in red:



This branch, found in this level of the tree structure, contains at least one difference



This block contains at least one difference



This section is only present in application 1



This section is only present in application 2

In the example opposite, a difference on the rung causing changeover to manual mode is detected:

- 1 The line displayed in blue belongs to application 1 [Prj1].
- 2 The line displayed in red belongs to application 2 [Prj1].

The source code extracts of both applications can be used to locate the differences precisely.

### Differentiation report generation

The "Report" command makes it possible to generate the report file (.txt):

```
Compared Files:
[Prj1] D:\Test_UDIF\ATV17.XEF
[Prj2] D:\Test_UDIF\ATV25.XEF

DateTime of ReportGeneration : 26/03/2007 10:16:13
Machine Name : so-Fravier
Windows Username : FR.ACC\Fravier

First file : D:\Test_UDIF\ATV17.XEF
Name : OA604
Size : 4163,72 KB
Date : 2007-1-26 (yyyy-mm-dd)
Time : 14:16:17 (hh:mm:ss)
Version : 1.0.289
Product : Unity Pro L V2.2.0.c806
Company : Schneider Automation
PLC Address : {2.0}SYS, XIP01

Second file : D:\Test_UDIF\ATV25.XEF
Name : OA604
Size : 4183,58 KB
Date : 2007-1-26 (yyyy-mm-dd)
Time : 14:15:33 (hh:mm:ss)
Version : 1.0.403
Product : Unity Pro L V2.2.0.c806
Company : Schneider Automation
PLC Address : {2.0}SYS, XIP01

Compared Part(s):
Configuration MODIFIED : 0 ADDED : 21 DELETED : 21
Derived Data Types NO DIFFERENCES
Derived FB Types MODIFIED : 51 ADDED : 27 DELETED : 24 MOVED : 0
Variables & FB Instances MODIFIED : 09 ADDED : 71 DELETED : 2
Communication MODIFIED : 0 ADDED : 0 DELETED : 2
Motion NO DIFFERENCES
Program ADDED : 0 DELETED : 0 MOVED : 0
Function Block Diagram MODIFIED : 48 ADDED : 93 DELETED : 70
Ladder Diagram MODIFIED : 276 ADDED : 383 DELETED : 446
Structured Text MODIFIED : 433 ADDED : 4291 DELETED : 4195 MOVED : 0
Instruction List NO DIFFERENCES
Sequential Function Chart NO DIFFERENCES
Animation Tables MODIFIED : 0 ADDED : 60 DELETED : 24
Functional Modules MODIFIED : 23 ADDED : 0 DELETED : 0 MOVED : 0
Project Settings NO DIFFERENCES

Non compared part(s) :

Filters :
Shown : 1, 2, #
Hidden : =

Report in Tree View:
( )OA604
|--( #)Configuration
|   |--( #)0: XBus
|   |   |--( #)0: TSX8KY12
|   |   |--( #)1: TSXP574624M
|   |   |--( #)3: TSXET4103
|--( #)Derived Data Types
|--( #)Derived FB Types
|--( #)RESS_DE_3F_TEST
|--( #)Regulation
```



## Reference

This Unity Dif software extension is used to compare two Unity applications generated by Unity Pro software version ≥ V2.1.

Function	Target extension	Type	Reference	Weight kg
Unity Dif comparison software extension for Unity Pro applications	Unity Pro Extra Large Modicon M340 Premium/Atrium Quantum	Single licence (1 station)	UNY SDU DFU CD20	-
CD-ROM containing software and electronic documentation (English-French)				

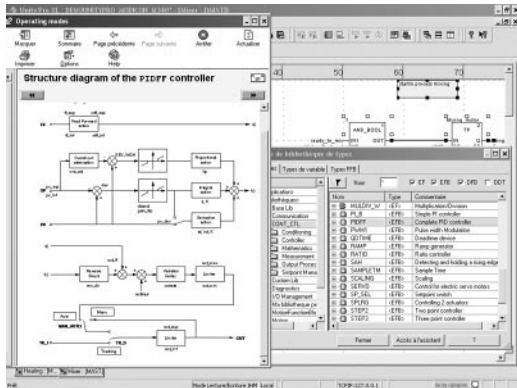

CONT\_CTL, programmable process control integrated in Unity Pro

## Process control in machines

Unity Pro contains CONT\_CTL, a library of 36 function blocks used to create control loops for machine control.

All requirements for closed loop control functions in machines are adequately met by Modicon M340/Premium/Quantum platforms thanks to the wealth of functions in the library and the flexibility with which function blocks can be linked together through programming. This solution therefore eliminates the need for external controllers and simplifies the overall control architecture of the machine, as well as its design, roll-out and operation.

The function blocks, EF or EFB, can be used in all Unity Pro languages: LD, ST, IL, FBD. FBD is particularly suitable for accessing control processing operations in Unity Pro through its assistant for entering and viewing parameters and function block variables.

## CONT\_CTL library functions

The library consists of five function families:

- Input data conditioning
- Controllers
- Math functions
- Measurement processing
- Output value processing

### Input data conditioning

DTIME	Pure delay
INTEGRATOR	Integrator with limiting
LAG_FILTER	First order time lag device
LDLG	PD device with smoothing
LEAD	Differentiator with smoothing
MFLOW	Mass flow calculation based on the measurement of differential pressure or flow speed with pressure and temperature compensation
QDIME	Deadtime device
SCALING	Scaling
TOTALIZER	Integrator (typically of flow) until a limit (typically a volume) is reached, with automatic reset
VEL_LIM	Velocity limiter, with manipulated variable limiting

### Controllers

PI_B	Simple PI controller: PI algorithm with a mixed structure (series/parallel)
PIDFF	Complete PID controller: PID algorithm with a parallel or mixed structure (series/parallel)
AUTOTUNE	Automatic tuner setting for the PIDFF (complete PID) controller or the PI_B (simple PI) controller <ul style="list-style-type: none"> <li>□ Identification using Ziegler Nichols type method</li> <li>□ Modelling based on 1<sup>st</sup> order process</li> <li>□ Building of control parameters with criterion for prioritizing either the reaction time to disturbance (dynamic) or the stability of the process</li> </ul>
IMC	Model corrector. The model is a first order model with delay. This corrector is useful: <ul style="list-style-type: none"> <li>□ When there are serious delays compared with the main time constant of the process; this scenario cannot be satisfactorily resolved by standard PID process control</li> <li>□ For regulating a non-linear process IMC can handle any stable and aperiodic process of any order</li> </ul>
SAMPLETM	Control of controller startup and sampling
STEP2	Two-point controller
STEP3	Three-point controller for temperature regulation

### Math functions

COMP_DB	Comparison of two values, with dead zone and hysteresis
K_SQRT	Square root, with weighting and threshold, useful for linearization of flow measurements
MULDIV_W	Weighted multiplication/division of 3 numerical values
SUM_W	Weighted summation of 3 numerical values

7

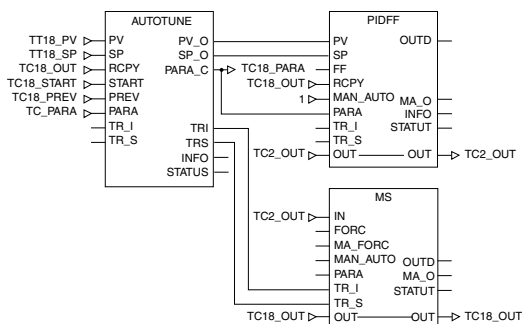

Example: PID controller with MS manual control



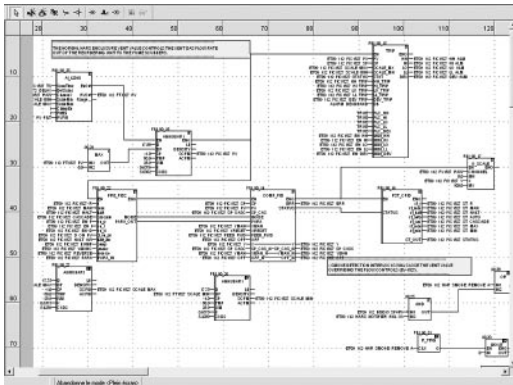

Programming in Unity Pro in offline mode

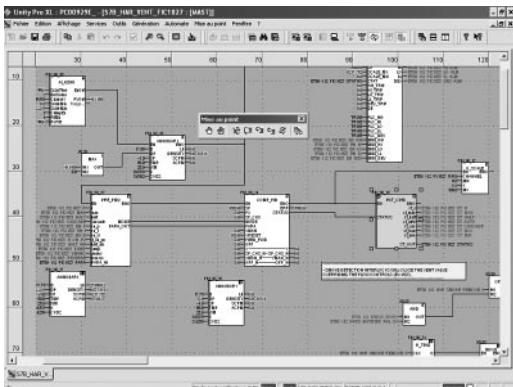

Programming in online mode

### Measurement processing

AVGMV	Moving average with fixed number of samples (50 max.)
AVGMV_K	Moving average with constant correction factor, 10,000 samples max.
DEAD_ZONE	Dead zone
LOOKUP_TABLE1	Linearization of characteristic curves using first-order interpolation
SAH	Detection of a rising edge
HYST_XXX	Detection of high threshold with hysteresis (1)
INDLIM_XXX	Detection of high and low thresholds with hysteresis (1)

### Output value processing

MS	Manual control of an output
MS_DB	Manual control of an output with dead zone
PWM1	Control via pulse width modulation
SERVO	Control for servo motors
SPLRG	Control of two <i>Split Range</i> actuators

### Setpoint management

RAMP	Ramp generator, with separate ascending and descending ramps
RATIO	Ratio controller
SP_SEL	Selection of setpoint value: local (operator) or <i>remote</i> (processing)

### Setting up process control function blocks

Based on the sequencing of function blocks, the FBD language integrated into Unity Pro is a programming language particularly suitable for building control loops. Designers can use FBD to easily associate blocks from the CONT\_CTL library with their own DFB blocks written in Unity Pro's ST, IL or LD language, or in C language.

### Debugging, operation

All Unity Pro's standard debugging services (see page 7/23) are available. In particular, the Modicon M340 processor simulator can be used to check correct execution of processing offline.

### Compatibility

In particular, the Modicon M340 processor simulator can be used to check correct execution of processing offline. It is compatible with all processors in the Modicon M340, Premium, Quantum and Atrium ranges.

### Resources

The technical documentation provides many examples of how to set up programmable process control function blocks in FBD, LD, IL and ST languages.

The techniques for adjusting process control loops are described in the document "Process control, Unity V3.0" available online at [www.schneider-electric.com](http://www.schneider-electric.com)

(1) XXX depending on the type of variable: DINT, INT, UINT, UDINT, REAL





## Presentation

Unity EFB Toolkit is the software for developing EF functions and EFB function blocks in C language and is optional software for Unity Pro. It can be used to develop new functions (whose internal code is written in C language) to extend and complete the set of functions proposed as standard in Unity Pro. This software comes with *Microsoft Visual C++ @.Net* which can be used to debug the functions used on the Unity Pro PLC simulator. Unity EFB Toolkit also includes a service for creating and managing families of functions, with a view to their integration in the Unity Pro function libraries.

## Setup

C language development software is a proper tool for managing the whole function while it is being performed:

- A user-friendly creation interface, integrated in Unity Pro, with automatic file organization
- Powerful tools for testing and debugging
- Management of compatibilities and software versions of created functions
- Generation of files for subsequent installation of functions on other development stations

## Managing function families

The software can be used to define different function families. These functions, also known as EF/EFBs, are stored in families, making it possible to create an organized library of functions written in C language.

Once created, these families can be distributed and integrated in the Unity Pro libraries.

They are:

- Arranged in families/functions
- Used in all languages with the same flexibility as standard functions (data entry wizard)
- Managed by the Unity Pro library tool (version management)

## Editing functions

The various tabs in the EFB Toolkit software editor allow the user to create the function by:

- Declaring the interface, all data types are possible (elementary, structures, tables)
- Supporting public and private variables

## Writing the source code file in C language

A function written in C language can access numerous internal PLC services such as the real-time clock, PLC variables, system words, math functions. In particular, it is possible to perform numerical processing in floating point format.

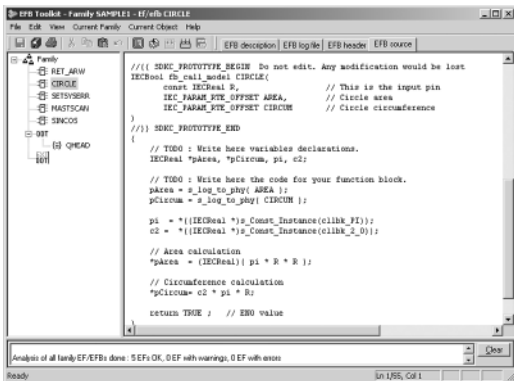
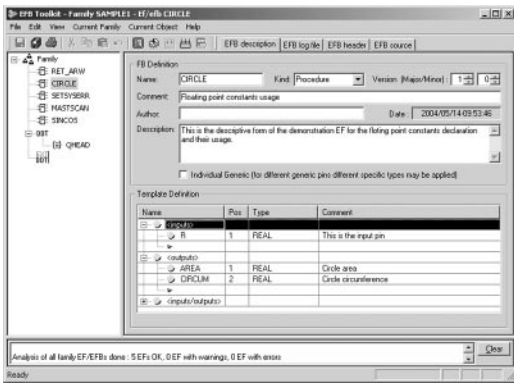

## Setup (continued)

### Debugging functions

The function created can be tested after insertion in an application and loading into the Unity Pro PLC simulator.

The Microsoft Visual C++ tool is used to debug the function.

It supports:

- Insert breakpoints
- Perform step by step execution
- Display the code with the breakpoints visible
- Display of manipulated data

**Note:** To generate the code for a Modicon M340 platform, a specific GNU compiler is used. It is supplied with the Unity EFB Toolkit.

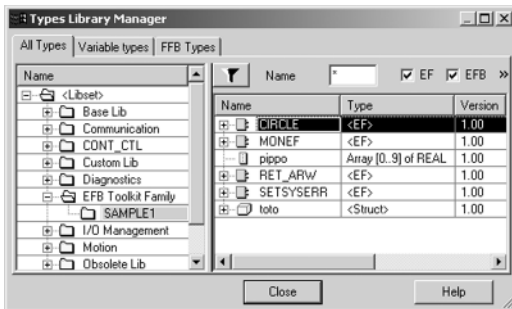

### Enhancing the function library

As the function has been debugged, it can be generated and distributed and the updating tool supplied with Unity Pro can be used to enhance the libraries on a user station.

Version management means that at any time the user knows the level of functions installed on a station and can update the application with the latest existing versions.

### Compatibility:

Unity EFB Toolkit is compatible with Unity Pro Small, Medium, Large and Extra Large. Developing EF functions and EFB functions is possible for the Modicon M340, Premium, Atrium and Quantum platforms.

## Reference

The "companion" software for Unity Pro, Unity EFB Toolkit can be used to create EF elementary blocks and EFB elementary function blocks. These are developed in Visual C++ language and are integrated in Unity Pro function block libraries.

The Unity EFB Toolkit software and its documentation are supplied in electronic form on CD-ROM in English.

Description	Licence type	Language	Reference	Weight kg
Unity EFB Toolkit for developing EF and EFB blocks	Single (1 station)	English (software and electronic documentation)	UNY SPU ZFU CD 30E	—

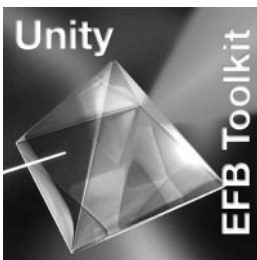

# Modicon Quantum automation platform

## UAG software

### Unity Application Generator



#### Advanced design tool for automation solutions

Deliver your automation projects faster and re-use your know how! Unity Application Generator (UAG) is an advanced design and generation software tool that integrates multiple PLCs and HMI/SCADA systems to provide an automation solution similar to a Distributed Control System. Using an approach based upon reusable objects (Application Libraries) and automatic application generation, UAG ensures consistent design and implementation of user-defined standards & specifications. Providing change tracking and automatic documentation, UAG supports standards including ISA-88 and GAMP.

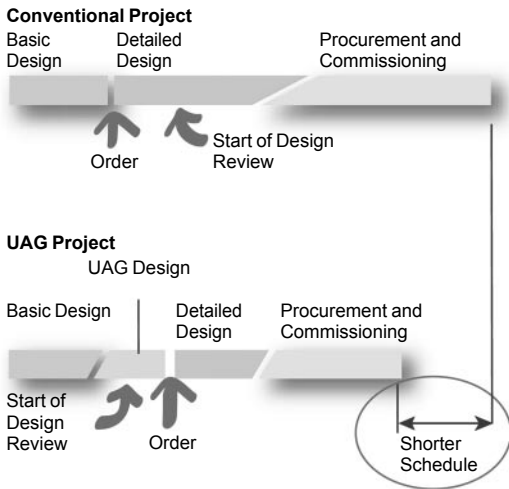

#### Business advantage

UAG provides significant business advantages in terms of cost reduction, quality and performance improvement.

- **Cost**
  - savings in system implementation cost
  - improved time-to-market for the end-user by allowing the project to go live and get a return on investment sooner
- **Quality**
  - improved software quality
  - improved maintainability
  - reduced risk and improved project schedules
- **Performance**
  - standardized design and systematic improvement
  - capture and re-use of your best practices

#### Working efficiently

UAG provides the key features for an advanced automation solution to increase efficiency and share and re-use your know-how.

**Structured Project Design** - bridge from the process engineer to the control/ automation designer (from the PID to the automation system). Capture and re-use of the Customer's best practices within **application specific libraries** that reduce the dependency on experts, enable standardization and increase software robustness. **Single Database** entry avoids duplicate effort and resulting errors. **Automatic Application Generation** including the **automatic configuration of networks** in multi device systems increases efficiency, improves software quality, speeds commissioning while simultaneously **reducing project risk**. **Integrated change tracking** and **automatic documentation generation** reduces engineering effort and enables system validation.

#### Advanced automation platform

UAG integrates best-in-class products from Schneider Electric and leading partners into an advanced automation platform based on standards, including **ISA-88, GAMP, CEI 61131-3**:

- Premium, Quantum, and Modicon M340 PLCs
- Premium I/O, Quantum I/O, Momentum I/O, Advantys I/O
- Leading HMI/SCADA systems including Vijeo Citect and Monitor Pro
- Modbus TCP/IP communication
- OPC data server software (OFS)
- Fieldbus support

Single data point entry and management integrates the process control, monitoring and supervision and ensures data consistency and integrated communication between all devices.

7



# Modicon Quantum automation platform

## UAG software

### Unity Application Generator

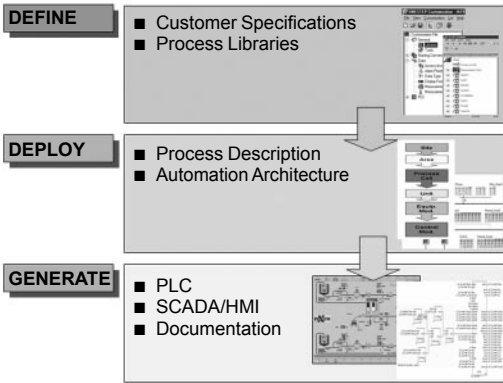

### Working with UAG

#### Methodology

UAG enables you to capture and re-use your know-how.

YOUR standards, rules, instructions, configurations and naming convention are defined in the UAG library. Using UAG, OEM and System Integrators can deploy your standards easily and consistently.

Through automatic generation, the project information is propagated to all applications consistently, easily and quickly.

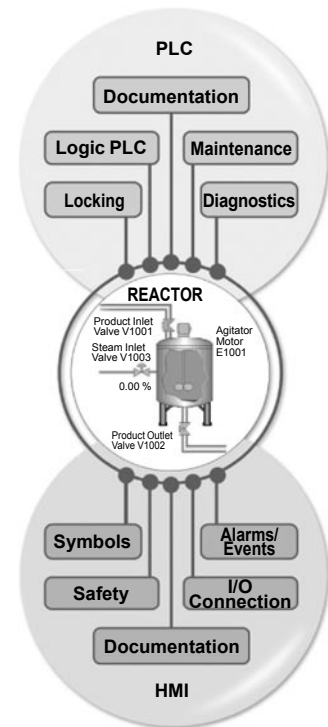

### Creating user libraries

Libraries are based on re-usable control devices Smart Control object Devices (SCoDs).

SCoDs are versatile, multi-faceted objects describing the functional, control, supervisory and configuration aspects of your process elements.

Based on control logic (DFB/EFB) and its graphical description (symbol), the definition of control devices is enhanced and organized in libraries. Existing control logic/symbols can be used directly.

The SCoDs encapsulate your standards and rules. They are pre-qualified and deployed according to the UAG methodology. A simple setting allows the usage within the project, automatically taking care of the application and device specific context, including all communication definition.

### Structuring your project

A Structured Project Design - bridge from the process engineer to the control automation designer (from the PID to the automation system) based on the ISA-88 standard. The PID drawing is mapped to the physical model in UAG.

This process can be automated through import functions providing UAG the specific setting of the model.

#### PLC related requirements:

- location of devices and functions
- interlocking
- data communication

#### HMI/SCADA related requirements:

- process visualization
- operator control
- logging, trends, alarms, etc.

### Multi-station automation configuration

Inside UAG the entire process controls, monitoring and supervision topology of the distributed automation system is managed.

Global resources for networks and communication are managed.

Device specific resources like I/O definition and address management are also automatically configured.

No platform or application specific expert knowledge is required. UAG translates the customer requirement into the automation solution.

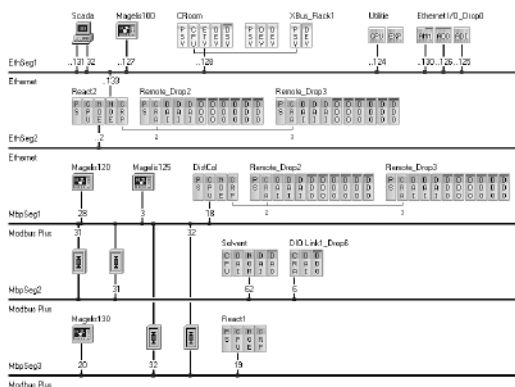

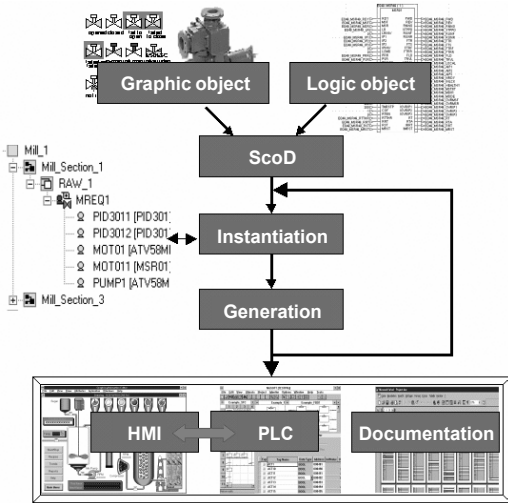

#### Working with UAG (continued)

##### Generating the application

Based on the structured design and your standards contained within the pre-qualified UAG library, the automation solution is generated ensuring consistent information for the PLCs and the HMI/SCADA. The resources (addresses, name space, etc.) are used in an optimized mode without conflicts or errors.

UAG can generate complete projects as well as **incremental changes** when modifications occur:

- For the PLC:
  - variables
  - IEC 61131-3 compliant logic
  - I/O configuration
  - communication.
- For the HMI/SCADA the complete server and client application:
  - screens
  - symbols
  - variables
  - trends and alarms
  - access attributes (security, access)
- Complete pre-configured and optimized communication between all devices and the HMI/SCADA:
  - Modbus TCP
  - OPC data server software (OFS)
- Documentation and change tracking:
  - automatic documentation of the application
  - change tracking supporting FDA compliance

##### Validation

UAG simplifies validation when required by regulation or to comply with GAMP (Good Automation Manufacturing Practice).

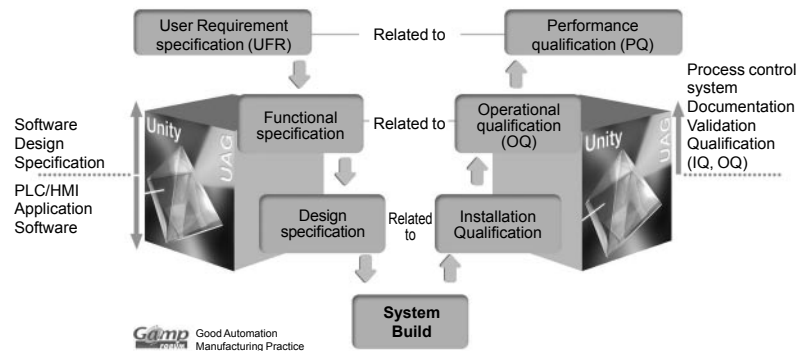

UAG uses ISA 88 standard terminology for batch control and supports the GAMP methodology for creating an automation system. The use of these two standards is a key element to achieve process validation.

In addition, UAG provides:

- All process information at a single point, based on functional analysis.
- Automatic generation of process applications by UAG
- Archiving which supports 21 CFR 11 compliance
- A log of all interactions by UAG
- Electronic documentation

# Modicon Quantum automation platform

## UAG software

### Unity Application Generator

```

<?xml version="1.0" encoding="ISO-8859-1" standalone="yes" ?>
<!-- <?xml-stylesheet type="text/xsl" base="" ?-->
<generic_hmi_file version="1.0" ?>
<file_header company="Schneider Electric" product="Unity Application Generator V2.0"
date_time="4/1/2004 2:59:35 PM + 0200" content="Generic HMI data" />
<content_header esp_project_file="C:\UAG\demo1.osp" />
<topological_media>
<network_segments>
<network_segment name="FactoryFloor" network_type="Ethernet" subnetmask="255.255.255.0"
default_gateway="" />
</network_segments>
<data_servers>
<data_server name="DB1" application_path="C:\UAG\" />
</data_servers>
<drive />
<opics>
<opc name="Q01" description="Quantum" project_name="PLC1" project_path="C:\CG\">
<channels>
<channel name="Q01_DS" communication_type="data_server"
communication_partner="DB1">
<communication_path>
<communication_path ordinal_number="1" plc_network_segment="FactoryFloor"
plc_network_address="190.158.105.10"
partner_network_segment="FactoryFloor"
partner_network_address="190.158.105.11" global_path="" />
</communication_path>
</channels>
</channel>
<opc_variables />
</opc>
</topological_media>
</generic_hmi_file>
    
```



### Working with UAG (continued)

#### Basic Libraries

A Basic Library is available providing sample SCoDs as a template to develop your library. Basic functions include:

- I/O processing
- motor (1/2 speed, 1/2 directions)
- valves (Mono, Bistable, proportional)
- control (PID)
- Schneider Electric devices (Altivar, TeSys U)
- PLC status

#### Segment/Application specific libraries

A number of more specialized libraries have been developed which provide a more complete starting point for the projects, for example:

- Water
- Cement
- Metal processing

#### Supported platforms

- **PLC Software**
  - Unity Pro V2.3 or higher
  - Concept V2.6 or higher
- **PLC Hardware**
  - Quantum, Premium, Modicon M340
  - Premium I/O, Quantum I/O, Momentum I/O, Advantys STB I/O
  - Modbus-TCP, Modbus Plus
- **HMI/SCADA**
  - Monitor Pro V7.2/V7.6
  - Vijeo Citect
  - other HMI/SCADA via the UAG "Plug-In" interface.
- **Export of information for other devices/applications**
  - XML export file
  - CSV export file

### References

This specialized software program UAG (Unity Application Generator) is multilingual (available in English, French and German) and is compatible with the Windows 2000 Professional and Windows XP operating systems.

Documentation is supplied in electronic format.

The PLC/SCADA programming tools and/or communication driver must be ordered separately.

#### UAG software suites

Description	Licence type	Reference	Weight kg
UAG software suites (Unity Application Generator)	Single (1 station)	UAG SEW LFU CD30	–
	Site	UAG SEW LFF CD30	–

#### UAG process application library for Vijeo Citect

Description	Licence type	Reference	Weight kg
UAG process application library V1.0 for Vijeo Citect 6.10 and Vijeo Citect 7.0	Unlimited installation Requires registration	UAG SBT XFT CD10	–

Concept programming software



<b>IEC 61131-3 languages</b>	Instruction List (IL)	
	Ladder (LD)	
	Structured Text (ST)	
	Function Block Diagram (FBD)	
	Sequential Function Chart (SFC)	
<b>LL984 Ladder Logic language</b>		
<b>Programming services</b>	Multitask Programming (master, fast, and event-triggered)	
	DFB editor	
	DDT compound data editor	
	Data structure instances and tables	
	Use of DFB instances	
	EF function block libraries and EFB function blocks	
	Programmable control loops (with FB library)	
	Hot Standby PLC redundancy system	IEC LL 984
	System diagnostics	
	Application diagnostics	
	Diagnostics with location of error source	
	<b>Debugging and display services</b>	PLC simulator
		Step by step execution, breakpoint
Watchpoint		
Diagnostics viewers		
<b>Programming services</b>	Modsoft application converters	
	Safety	

MI	MI - C	MI - C - Q
MI	MI - C	MI - C - Q
MI	MI - C	MI - C - Q
MI	MI - C	MI - C - Q
	MI - C	MI - C - Q
ML	ML - C	ML - C - Q
	MI - ML - C	MI - ML - C - Q
MI - ML	MI - ML - C	MI - ML - C - Q
MI - ML	MI - ML - C	MI - ML - C - Q
MI - ML	MI - ML - C	MI - ML - C - Q
MI - ML	MI - ML - C	MI - ML - C - Q
MI - ML	MI - ML - C	MI - ML - C - Q
MI - ML	MI - ML - C	MI - ML - C - Q
		Q (140 CPU 434 12A/534 14B)
		Q
MI - ML	MI - ML - C	MI - ML - C - Q
MI - ML	MI - ML - C	MI - ML - C - Q
MI - ML	MI - ML - C	MI - ML - C - Q
MI - ML	MI - ML - C	MI - ML - C - Q
MI - ML	MI - ML - C	MI - ML - C - Q
MI - ML	MI - ML - C	MI - ML - C - Q
MI - ML	MI - ML - C	MI - ML - C - Q
	MI - ML - C	MI - ML - C - Q

7

<b>Compatible Modicon platforms</b>	Quantum CPUs Q
	Momentum M1 and M1E processors M● M●
	Compact processors C

-		140 CPU 113 02 140 CPU 113 03 140 CPU 434 12A 140 CPU 534 14B
171 CCS 700 00 ML		
171 CCS 700 10 ML		
171 CCS 780 00 ML		
171 CCS 760 00 ML - MI		
171 CCC 760 10 ML - MI		
171 CCC 780 10 ML - MI		
171 CCC 980 20 ML		
171 CCC 980 30 ML - MI		
171 CCC 960 20 ML		
171 CCC 960 30 ML - MI		
-	PC E984 258 PC E984 265 PC E984 275 PC E984 285	

<b>Software name</b>
<b>Type of Concept software</b>
<b>Pages</b>

<b>Concept S</b>	<b>Concept M</b>	<b>Concept XL</b>
372 SPU 471 01 V26	372 SPU 472 01 V26	372 SPU 474 ●1 V26
7/61		



EF/EFB function development software in C language	Concept operation/maintenance version software	Software for modelling and generating batch/process applications	SFC View application diagnostic and monitoring software
--	--	--	---

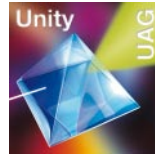

<p>Enhancement of EF and EFB function block libraries:</p> <ul style="list-style-type: none"> <li><input type="checkbox"/> Creation of families</li> <li><input type="checkbox"/> Development of functions in C language</li> <li><input type="checkbox"/> Access to all data and variable types</li> <li><input type="checkbox"/> Use of functions created in all languages</li> </ul> <p>Supplied with Borland C++ software</p>	<p>Software intended for maintenance technicians for runtime applications:</p> <ul style="list-style-type: none"> <li><input type="checkbox"/> Remote program loading</li> <li><input type="checkbox"/> Application monitoring and diagnostics</li> </ul> <p>Does not allow program modification</p>	<p>UAG specialist software for modelling and generating batch/process applications.</p> <p>It provides the unique project database:</p> <ul style="list-style-type: none"> <li><input type="checkbox"/> Process and control (PLCs)</li> <li><input type="checkbox"/> HMI user interface (Magelis)</li> <li><input type="checkbox"/> SCADA supervision (Monitor Pro V7.2)</li> </ul> <p>Based around re-usable objects (PID, valves, etc.) and complying with standard ISA S88, UAG generates the PLC code and the elements required for the HMI system.</p> <p>Complies with the GAMP standard (<i>Good Automation Manufacturing Practice</i>)</p>	<p>ActiveX control component for monitoring and diagnostics of chart status (SFC or Grafset) in sequential applications:</p> <ul style="list-style-type: none"> <li><input type="checkbox"/> Overview of charts and detailed views</li> <li><input type="checkbox"/> Can be integrated in human/machine interface (HMI) applications</li> <li><input type="checkbox"/> Access to PLC data via OFS (<i>OPC Factory Server</i>)</li> </ul> <p>Includes EFB function block library for Concept</p>
---	--	--	---

<p>Compatible with:</p> <ul style="list-style-type: none"> <li><input type="checkbox"/> Concept S, M, and XL</li> <li><input type="checkbox"/> All processors for Concept</li> </ul>	<p>Compatible with all processors for Concept</p>	<p>Version V2.0 compatible:</p> <ul style="list-style-type: none"> <li><input type="checkbox"/> Concept S, M, and XL (V2.6)</li> <li><input type="checkbox"/> All Quantum CPUs for Concept</li> </ul>	<p>Compatible with:</p> <ul style="list-style-type: none"> <li><input type="checkbox"/> Concept S, M, and XL</li> <li><input type="checkbox"/> All processors for Concept</li> </ul>
--	---	---	--

<b>Concept EFB Toolkit</b>	<b>Concept Application Loader</b>	<b>Unity Application Generator UAG Medium/Large</b>	<b>Concept SFC View</b>
372 SPU 470 01 V26	372 SPU 477 01 V26	UNY SEW ●F● CD22	372 SFV 160●0 V20
7/61	7/61	7/53	7/65



# Modicon Quantum automation platform

## Concept programming software

### Presentation

Concept is a software configuration and application programming tool for the Quantum and Momentum automation platforms. It is Windows-based software that can be run on a standard PC. The configuration task can be carried out online (with the PC connected to the Quantum processor) or offline (PC only). Concept supports the configuration by recommending only permissible combinations. During online operation, the configured hardware is checked immediately for validity, and illegal statements are rejected.

When the connection between programming unit (PC) and Quantum CPU is established, the configured values are checked and compared with actual hardware resources. If a mismatch is detected, an error message is issued.

Concept editors support five IEC programming languages:

- Function Block Diagram (FBD) language
- Ladder (LD)
- Sequential Function Chart (SFC) and Grafcet language
- Instruction List (IL)
- Structured Text (ST)

as well as Modsoft-compatible ladder logic (LL984). IEC 61131-3 compliant data types are also available. With the data type editor, custom data types can be converted to and from the IEC data types.

The basic elements of the FBD programming language are functions and function blocks that can be combined to create a logical unit. The same basic elements are used in the LD programming language; LD provides contact and coil elements.

The Grafcet SFC programming language (SFC) uses basic step, transition, connection, branch, join and jump elements. The IL and ST text programming languages use instructions, expressions, and key words. The LL984 programming language uses an instruction set and contact and coil elements.

You can write your control program in logical segments. A segment can be a functional unit, such as conveyor belt control. Only one programming language is used within a given segment. You build the control program, which the automation device uses to control the process, by combining segments within one program. Within the program, IEC segments (written in FBD, LD, SFC, IL and ST) can be merged. The LL984 segments are always processed as a block by the IEC segments. Concept's sophisticated user interface uses windows and menus for easy navigation. Commands can be selected and executed quickly and easily using a mouse. Context-sensitive help is available at each editing step.

### PLC configuration

Variables for linking basic objects within one section are not required by the graphic programming languages (FBD, LD, SFC and LL984).

These connections are managed by the system, which eliminates any configuration effort. Other variables, such as variables for data transfers between different sections, are configured with the variables editor. With the data type editor, custom data types can be derived from existing data types.

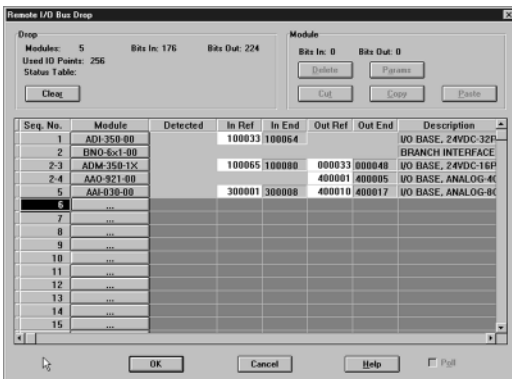

### Functions

Concept provides an editor for each programming language. These editors contain custom menus and tool bars. You can select the editor to be used as you create each program segment.

In addition to the language editors, Concept provides a data type editor, a variables editor and a reference data editor.

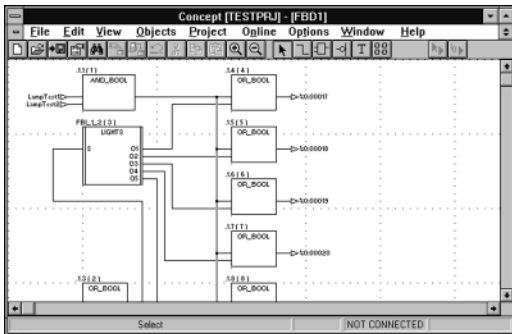

### Function Block Diagram (FBD) language

With the IEC 61131-3 function block diagram language, you can combine elementary functions, elementary function blocks (EFBs) and derived function blocks (all three of which are known as FFBs) with variables in an FBD. FFBs and variables can be commented. Text can be freely placed within the graphic. Many FFBs offer an option for input extensions.

Concept provides various block libraries with predefined EFBs for programming an FBD. EFBs are grouped in the libraries according to application types to facilitate the search.

In the FBD editor, you can display, modify and load initial values; current values can be displayed. The CONT\_CTL control library allows you to display animated diagrams of the FFBs and a graph of the current values.

For custom function blocks (DFBs), the Concept-DFB editor is used. In this editor, you can create your own function blocks from EFBs or existing DFBs. DFBs created in the FBD editor can be recalled in the LD, IL and ST editors, and DFBs created in the LD, IL and ST editors can be used in the FBD editor.

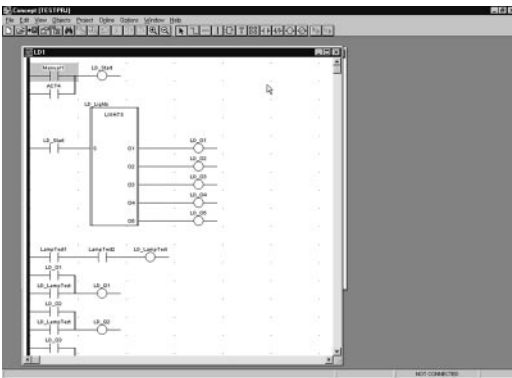

### Ladder (LD)

With the IEC 61131-3 ladder diagram language, you can build an LD program with elementary functions, function blocks and derived function blocks (all of which are known as FFBs), along with contacts, coils and variables. FFBs, contacts, coils and variables can be commented. Text can be freely placed within the graphic. Many FFBs offer an option for input extensions.

The structure of an LD segment corresponds to that of a current path for relay circuits. On its left side is a left bus bar, which corresponds to the phase (L conductor) of a current path. As with a current path, only the LD objects (contacts, coils) connected to a power supply (i.e., connected to the left bus bar) are processed in LD programming. The right bus bar, which corresponds to the neutral conductor, is not visible. However, all coils and FFB outputs are internally connected to it in order to create a current flow.

The same EFB block libraries available for the FBD editor can be used in the LD editor to program a ladder diagram.

In the FBD editor, you can display, modify and load initial values; current values can be displayed. The CONT\_CTL control library, for example allows you to display animated diagrams of the FFBs, along with a graph of the current values.

For custom function blocks (DFBs), the Concept-DFB editor is used. In this editor, you can create your own function blocks from EFBs or existing DFBs. DFBs created in the LD editor can be recalled in the FBD, IL and ST editors, and DFBs created in the FBD, IL and ST editors can be used in the LD editor.



# Modicon Quantum automation platform

## Concept programming software

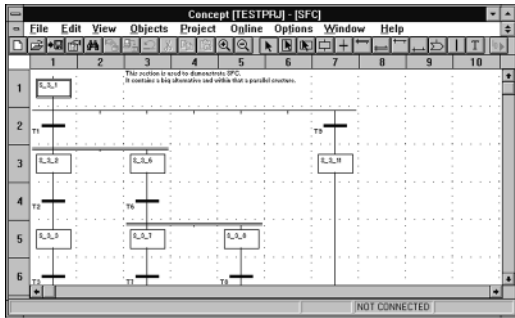

### Functions (continued)

#### Sequential Function Chart (SFC) language

With the IEC 61131-3 sequential function chart (SFC) language, you can define a series of SFC objects that comprise a control sequence. Steps, transitions and jumps in the sequence can be commented. Text can be freely placed within the graphics. You can assign any number of actions to every step. A series of monitoring functions – e.g., maximum and minimum monitoring time – can be integrated into each step’s characteristics. The actions can be assigned an attribute symbol (as required by IEC) to control the action’s performance after it has been activated – e.g., a variable can be set to remain active after exiting.

#### Instruction List (IL)

With the IEC 61131-3 IL language, you can call entire functions and function blocks conditionally or unconditionally, execute assignments and make conditional and unconditional jumps within a program segment.

IL is a text-based language, and standard Windows word processing tools can be used to generate code. The IL editor also provides several word processing commands. Keywords, separators and comments are spell-checked automatically as they are entered. Errors are highlighted in color.

For custom function blocks (DFBs), the Concept-DFB editor is used. In this editor, you can create your own function blocks from EFBs or existing DFBs. DFBs created in the IL editor can be recalled in the ST, LD, and FBD, DFBs created in the ST, LD, and FBD editors can be recalled in the IL editor.

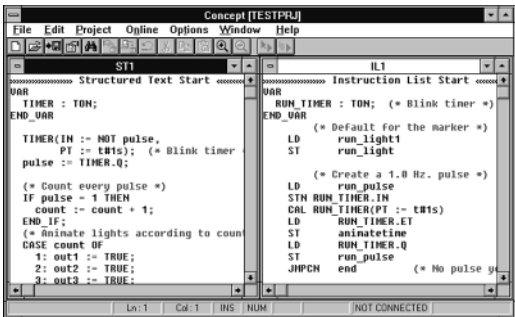

#### Structured Text (ST)

With the IEC 61131-3 ST language, you can call function blocks, execute functions and assignments and conditionally execute and repeat instructions. The ST programming environment is similar to Pascal. IL is a text-based language, and therefore standard Windows word processing tools can be used to generate code. The ST editor also provides several word processing commands. Keywords, separators and comments are spell-checked automatically as they are entered. Errors are highlighted in color.

Custom function blocks (DFBs) created with the ST editor can be called in the IL, LD and FBD editors; DFBs created in the IL, LD and FBD editors can be used in the ST editor.

## Functions (continued)

### Data type editor

The data type editor defines new derived data types. Any elementary data types and derived data types already existing in a project can be used for defining new data types. With derived data types, various block parameters can be transferred as one set. Within the program, this set is divided again into single parameters, processed, then output as either a parameter set or individual parameters. Derived data types are defined in text format, and standard Windows word processing tools can be used. The data type editor also provides several word processing commands.

### Variables editor

The variables editor contains input options for:

- The variable type (located variable, unlocated variable, constant).
- The symbolic name
- The data type
- Direct address (explicit, if desired)
- Comments
- Identification as human-machine interface (HMI) variable for data exchange

### Animation tables editor

In online mode, the reference data editor displays, forces and controls variables.

The editor contains the following options:

- Default values for the variable
- Status display for the variable
- Various format definitions
- The ability to isolate the variable from the process

## Functions (continued)

### Libraries

#### IEC library

The IEC library contains the EFBs defined in IEC 61131-3 (calculations, counters, timers, etc).

#### Extended library

The extended library contains useful supplements to various libraries. It provides EFBs for mean value creation, maximum value selection, negation, triggering, converting, building a traverse with interpolation of the first order, edge detection and determination of the neutral range for process variables.

#### System library

The system library contains EFBs in support of system functions. It provides EFBs for cycle time detection, utilization of various system clocks, control of SFC sections and system status display.

#### CLC and CLC\_PRO library

The Continuous Control library can be used to set up process-specific control loops. In particular, it offers controller, derivative and integral control functions. The CLC\_PRO library contains the same EFBs as the CLC library along with data structures.

#### Communication library

The communication libraries of built-in function blocks provide easy integration of programs which allow communication between PLCs or HMI devices from within the PLC's application program. Like other function blocks, these EFBs can be used in all languages to share data, or provide data to the HMI device for display to the operator.

#### Diagnostics library

The diagnostics library is used for troubleshooting the control program. It contains EFBs for action, reaction, interlocking, and process prerequisite diagnostics, along with signal monitoring.

#### LIB984 library

The LIB984 library provides common function blocks used in both the 984 ladder logic editor and the IEC languages. This allows for easy transition of portions of application code from the 984LL environment to the IEC environment.

#### Fuzzy logic library

The fuzzy library contains EFBs for fuzzy logic.

#### Analog I/O library

The ANA\_IO library is used to process analog values.

# Modicon Quantum automation platform

## Concept programming software

### References

#### Concept packages

Description	Licence type	Reference	Weight kg
Concept S Version 2.6	Single (1 station)	372 SPU 471 01 V26	–
Concept M Version 2.6	Single (1 station)	372 SPU 472 01 V26	–
Concept XL Version 2.6	Single (1 station)	372 SPU 474 01 V26	–
	Group (3 stations)	372 SPU 474 11 V26	–
	Team (10 stations)	372 SPU 474 21 V26	–
	Site (network)	372 SPU 474 31 V26	–
Concept EFB Toolkit Version 2.6	Single (1 station)	332 SPU 470 01 V26	–
HVAC Function Blocks Library	Site (network)	372 HVA 160 30V25	–

#### Concept maintenance and diagnostics packages

Description	Licence type	Reference	Weight kg
Concept Application Loader Version 2.6	Single (1 station)	372 SPU 477 01 V26	–

#### Concept Updates

Description	Licence type	Reference	Weight kg
Concept XL Version ●● to Concept XL V 2.6	Single (1 station)	372 ESS 474 01	–
	Group (3 stations)	372 ESS 474 03	–
	Team (10 stations)	372 ESS 474 10	–
	Site (network)	372 ESS 474 00	–
Concept S Version ●● to Concept S V 2.6	Single (1 station)	372 ESS 471 01	–
Concept M Version ●● to Concept M V 2.6	Single (1 station)	372 ESS 472 01	–
Modsoft version ●● to Concept XL V 2.6	Depends on number of users	372 ESS 485 01	–
Concept EFB Toolkit version ●● to version 2.6	–	372 ESS 470 01	–

#### Concept Documentation

Description	Number of volumes	Reference (1)	Weight kg
Installation	1	840 USE 492 0●	–
Programming	3	840 USE 493 0●	–
Concept IEC Block library	13	840 USE 494 0●	–
Concept 984 LL Block Library	2	840 USE 496 0●	–
Concept EFB Tool User Manual	1	840 USE 495 01	–

(1) ● = Defines the documentation language: 0 English, 1 French, 2 German, and 3 Spanish.

# Modicon Quantum automation platform

## Concept SFC View software

### Presentation

Concept SFC View is integrated in human/machine interface (HMI) applications for monitoring Concept sequential applications written in sequential function chart language (SFC or Grafset) executed by a PLC.

Set up in the same way as an ActiveX control component, Concept SFC View is used to display status information relating to SFC charts executed by a Quantum PLC. Installed on an HMI station, Concept SFC View monitors and controls the status of SFC charts in real time, supplying detailed diagnostic data.

Concept SFC View reads the necessary data from the Concept project database in offline mode. The PLC data is accessed online via the OFS (*OPC Factory Server*).

Without needing to recreate SFC charts in the HMI environment, Concept SFC View reads the structure of the SFC charts directly from the Unity project database. Modifications made to the SFC application are detected and updated at any time. Working online, Concept SFC View accesses the diagnostic information of the PLC permitting the tracking and calculation of the occurrence of the first fault and the following faults. System downtime is much reduced since Concept SFC View enables maintenance staff to locate the source of the problem much more quickly.

Concept SFC View is designed for end users and system designers who wish to integrate this control into their HMI system. Concept SFC View is compatible with most HMI platforms handling ActiveX Control components such as Vijeo Look control software or Monitor Pro supervisory software or in a programming environment such as Visual Basic.

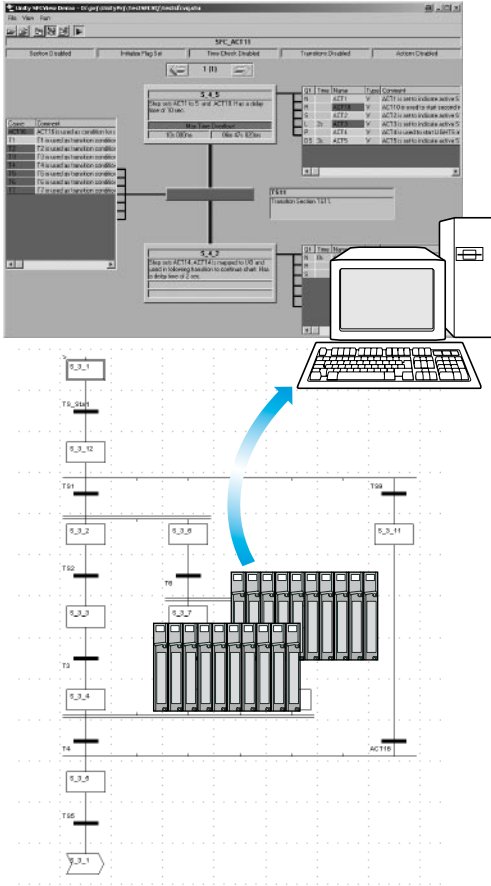

### The 3 Unity Concept View views

Concept SFC View offers 3 views:

- An overview for managing selection of SFC charts.
- Two detailed views presenting the status and diagnostic data of the selected SFC chart.



Overview

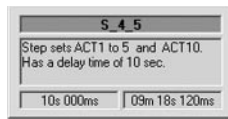

Simple detailed view

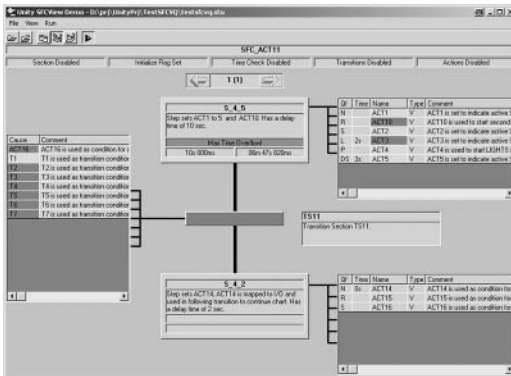

Detailed view

**The overview** provides a general view of all the SFC charts in a Concept project. It contains real-time data such as current step, simultaneous steps, chart error with indication of the SFC chart status. The overview makes it easy to browse through SFC charts and switch quickly to the detailed view of the desired SFC chart in the Concept application.

**The simple detailed view** shows the elementary data on the active step (or selected step) of the SFC chart in real time. The data displayed may include the name, comment, chart and step status, as well as the activity times (min, max, actual). You can also enable the chart navigation option.

Because of the compact size of the simple detailed view, it is possible to place several instances of it on a single HMI screen relating to a certain part of the process. From this simple detailed mode, you can navigate between HMI screens with SFC View controls and display the detailed view of SFC charts.

**The detailed view** illustrates the details of an SFC chart in real time. The display indicates the current step, the transition awaiting activation and the next step. The actions associated with the steps are displayed along with sequence selections or parallel branches. The detailed diagnostic data includes analysis of the causes of the fault at transition level. Dependent on the diagnostic mode the error grid contains error causes or all the variables assigned to the transition logic. The current state of the various variables and selected errors are identified by different colors.

### Diagnostic mode

Transition logic diagnostics is a key function of Concept SFC View. It minimizes system downtimes in the event of a fault.

Two different diagnostic modes are available:

- Concept SFC View reads the data in the Quantum PLC diagnostic buffer. It provides information about faulty or missing events that are preventing the transition from being enabled. This mode does not require any configuration or additional programming in the PLC program.
- Concept SFC View internally backtracks the transition conditions. This mode provides diagnostic data concerning all the inputs connected to the transition (not limited to faulty inputs). In this mode, Concept SFC View uses specific EFB function blocks linked to the transition conditions. The library for these blocks is supplied with the Concept SFC View software.

### Easy customization

Concept SFC View offers a programming interface that can be used to integrate the ActiveX Control component in an HMI application and customize its functions and its operator interface.

The ActiveX Control component in Concept SFC View can be customized. It accepts properties, methods, and events (all the properties have a default value). The properties pages simplify configuration. Concept SFC View accepts scripts with methods such as browsing through charts, status control of charts, and also events such as error notification or chart selection. This data can be used to launch programs or operator screens.

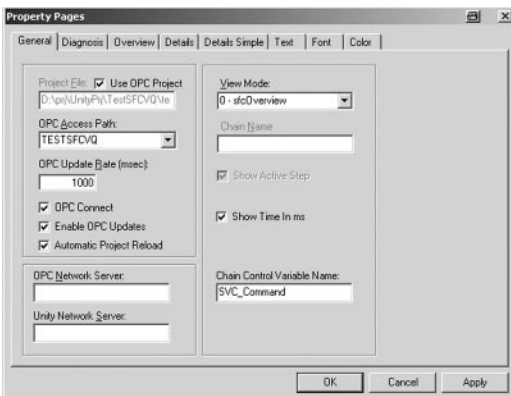

SFC View properties page





# Modicon Quantum automation platform

## Concept SFC View software

### Possible architectures

Concept SFC View is used in a configuration where the OFS and Concept software reside on the same PC platform as the HMI application.

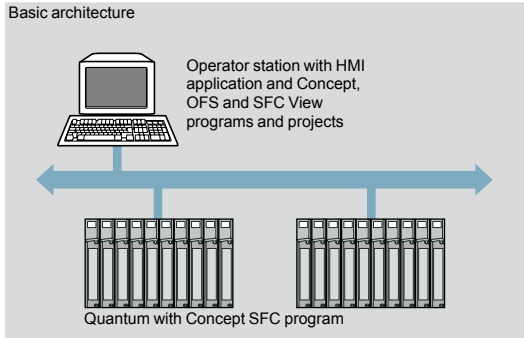

In a distributed configuration, the OFS and Concept software can be installed on different servers.

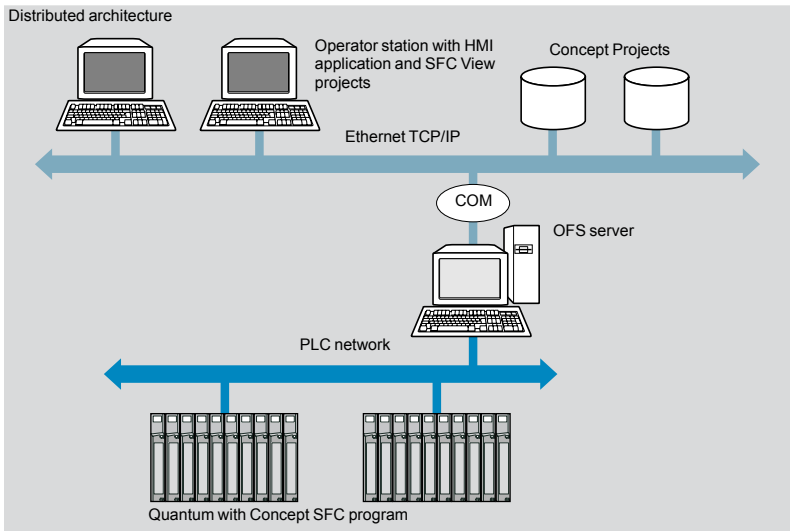

# Modicon Quantum automation platform

## Concept SFC View software

### References

When integrated in an HMI application, Concept SFC View can be used to monitor and control charts in applications developed in Sequential Function Chart (SFC) language running on Quantum PLCs.

The HMI station, compatible with Windows NT4 SP5 or Windows 2000 Professional operating systems, must support ActiveX Control components. Concept SFC View V3.0 requires:

- Concept V2.2 SR2, V2.5 SR2 or V2.6 SR1, to be ordered separately
- OFS V > 2.2 data server software, to be ordered separately

Concept SFC View multilingual software, supplied on a CD-ROM, includes:

- The SFC View ActiveX Control component
- The EFB function block library for Concept
- An example of how to integrate SFC View into Concept projects
- The electronic documentation (in English)

The Concept SFC View integration example illustrates the main possibilities offered by Concept SFC View. This is an executable program which does not need HMI software in order to run. It helps the user understand how to configure and use the Concept SFC View ActiveX Control component.

Description	Type of licence	Reference	Weight kg
Concept SFC View software packages (version V3.0)	Single (1 station)	372 SFV 16000 V30	-
	Team (10 stations)	372 SFV 16020 V30	-
	Site (100 stations)	372 SFV 16030 V30	-

# Modicon Quantum automation platform

## ProWORX 32 programming software

### Presentation

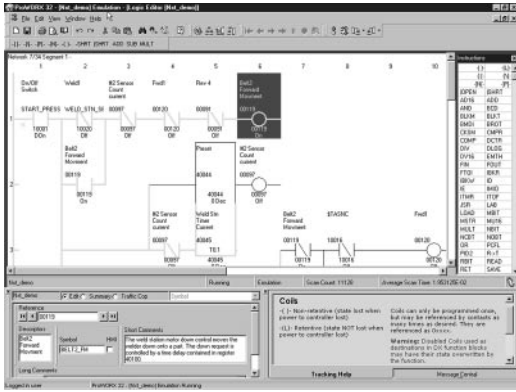

ProWORX 32 LL984 programming software is a full-featured, Modicon Quantum and Momentum M1/M1E PLC programming software that is compatible with Windows platforms (98/NT/2000/XP) that gives you the power to program all your Modicon controllers online or offline, manage your I/O subsystems, and analyze your plant's activity in real time.

ProWORX32 offers client-server functions for organizing groups and user rights, centralize project backup, and serve as a bridge between design department and workshop. The project emulator makes it possible to test projects before executing them in a PLC operating environment so as to ensure optimal system effectiveness at any time.

Some of the new ProWORX 32 features:

**32-bit processing.** With 32-bit processing, ProWORX 32 is an even more powerful solution than its predecessors, ProWORX Plus and ProWORX NxT. 32-bit processing lets you utilize the power of state-of-the-art operating systems for optimal development and operational performance.

**A comprehensive suite of tools.** ProWORX 32 provides everything you will need to start, configure, test and complete your project, quickly, reliably and professionally. And with its improved suite of standard utilities, ProWORX 32 is a virtual "one stop shop" for your Automation Journey. No more searching on the web for special features or functions, they're all included to save you time and increase your productivity.

**A high-performance offer.** In addition, ProWORX 32 will simplify and speed up your system development and commissioning time with powerful diagnostics, easier integration, and greater openness and flexibility.

**Easier integration.** Using standard Microsoft components for the basis of ProWORX 32 opens up a wealth of user data. Import and export capabilities have been enhanced to provide a variety of integration options for HMI and third party devices, such as a built in "Alliance Tool" which allows users to create hardware profiles for newly developed devices. The profiles can even be sent electronically to Schneider Electric for inclusion in future ProWORX 32 releases.

### Windows environment

The familiar Windows-based programming environment means you spend less time learning how to do things, and more time being productive. ProWORX uses familiar Windows features like user-defined screens, drag-and-drop, cut and paste, search, and global replace.

### Conversion

484 to 984 in one step! The most flexible conversion tools available in the automation industry. That is the reputation ProWORX products have always enjoyed, and ProWORX 32 is no exception. With the ability to convert from older project databases to this latest tool, ProWORX 32 supports almost 30 years of PLC heritage.

### Multiple projects

Imagine the time and effort you could save by testing a new project with an existing project while it is running live. Now you can with the Multiple Projects function of ProWORX 32, even with two PLCs running simultaneously! Perform diagnostic checks to validate interdependencies between your emulated project and your live applications, all in real time, so you can go live with total confidence.

### Intuitive register editor

A powerful analysis tool, the Data Watch Window shows you information from your plant in real time, or logs it to disk for in-depth historical analysis later on. Easily get the data you need to make informed, effective production decisions. View and edit data in full page display, see trends and track data points against time in a spreadsheet, and monitor any combinations of discrete and analog data.

# Modicon Quantum automation platform

## ProWORX 32 programming software

### Presentation (continued)

#### I/O drawing generator

Save hours of painstaking effort with ProWORX 32's I/O Drawing Generator, which automatically creates wiring diagrams for the I/O cards defined in the Traffic Cop. Generate necessary drawings all at once or just one card at a time – simply select an address the I/O card uses with the Network Editor, then click the drawing button on the Hardware Back Referencing panel to display the diagram, and if desired, save it as an AUTOCAD-compatible .DXF file or prints it.

#### Network editor

With the Network Editor, ProWORX 32 reduces development time by using the same commands and instructions for every controller. Simply cut, copy, and paste networks from one platform to any other.

#### Program documentation

ProWORX is first-class software with first-class program documentation. Use one of the many standard templates to get started, and progress to assemble your own custom documentation. For better references and easier-to-use documentation, we have provided annotation down to the "Bit" level to allow longer comments and more lines of text. Even simple things like using Windows O/S fonts to eliminate printer issues demonstrates that every detail has been considered.

#### Realtime network status

Find the controller you need fast and simplify network diagnostics with ProWORX 32's powerful Network Scan feature. Network Scan searches your Modbus or Modbus Plus networks, then identifies and graphically displays each device found and shows its status.

#### Advanced I/O management

Ensure that the I/O card you are configuring in the software matches the one on your plant floor with ProWORX 32's graphical Traffic Cop. It displays I/O cards on your screen the same way they look in real life, eliminating all confusion. To place a card, just select it from the convenient drop down menu and then drag it into the controller slot you want. To save even more time, the Traffic Cop automatically associates the card's I/O points with a block of free addresses in your controller. Once configured, manage your I/O with Pro WORX 32's complete documentation tools, with references for each head, drop, rack, slot and address And the Traffic Cop's graphical display shows you at a glance that your I/O is healthy.

# Modicon Quantum automation platform

## ProWORX 32 programming software

### Presentation (continued)

#### Client/Server Tools

ProWORX 32 allows projects to be developed in a collaborative environment without sacrificing control and security by utilizing the ProWORX 32 server as the central repository for projects, the center for security, and the hub for communications. The system administrator has total control over user accounts, user groups, passwords, rights, and auditing policies and can grant access when and where needed.

The client/server relationship allows projects to be skillfully managed and controlled. The server can be used to keep "Master" versions of PLC projects for editing (subject to rights), while editing is achieved using the client. This can be done via a standalone PC or even on the server since both client and server can reside on the same PC.

The server has the capability to schedule software backups of the controller, detect software modifications and store multiple versions. Even more powerful is the ability to communicate from the client to the server using either Ethernet TCP/IP or Modbus Plus.

#### Project Emulator

The project emulator is a very powerful tool that will help save considerable time in the design and testing of your system. It provides the ability to test projects prior to running them in the PLC run-time environment to ensure your system will run at peak efficiency immediately upon commissioning.

Two emulators are provided that test interdependent projects.

They are used to test communication, like I/O polling and monitoring network activities between projects.

#### Material List Generation

Want a shopping list for your PLC equipment? The Material List Generation function automatically creates a list for the project, either online or offline, even taking into account the contents of the Traffic Cop. Add prices and comments once the list is generated, saving you time and insuring that all required components are fully documented and identified.

# Modicon Quantum automation platform

## ProWORX 32 programming software

# ProWORX<sup>32</sup>

### ProWORX Client/Server software

#### ProWORX packages

Description	Used with	Licence type	Reference	Weight kg	
ProWORX 32	Server	Single-station	372 SPU 780 01 PSEV	–	
	Client/Server Suite	Single-station	372 SPU 780 01 PSSV	–	
	Client, design/operation	Single-station	372 SPU 780 01 PDEV	–	
		Group (3 stations)	372 SPU 780 01 PSTH	–	
		Team (10 stations)	372 SPU 780 01 PSTE	–	
		Site	372 SPU 780 01 SITE	–	
	Run Time client	Single-station	372 SPU 781 01 PONL	–	
	ProWORX 32 Lite	Client, design/operation	Single-station	372 SPU 710 01 PLDV	–
			Group (3 stations)	372 SPU 710 01 PLTH	–
			Team (10 stations)	372 SPU 710 01 PLTE	–
ProWORX 32 Upgrades	Client	Single-station	372 SPU 784 01 LPUP	–	
		Additional multi-use	372 SPU 784 01 SEAT	–	
		Group (3 stations)	372 SPU 784 01 LPTH	–	
		Team (10 stations)	372 SPU 784 01 LPTE	–	

#### Documentation

Description	Language	Reference	Weight kg
ProWORX 32 programming manuals	English	372 SPU 780 01 EMAN	–
	French	372 SPU 780 01 FMAN	–
	German	372 SPU 780 01 DMAN	–
	Spanish	372 SPU 780 01 SMAN	–



## 8.1 - Magelis compact display units and terminals

*Magelis compact display units and terminals selection guide ..... 8/2*

## 8.2 - Magelis graphic terminals

*Magelis graphic terminals selection guide ..... 8/4*

## 8.3 - Magelis iPC industrial PCs

*Magelis iPC industrial PC selection guide..... 8/6*

## 8.4 - HMI software

*HMI software selection guide ..... 8/10*

## 8.5 - Vijeo Citect supervisory software

- Vijeo Citect supervisory software ..... 8/18
- Presentation, licenses..... 8/18
- Architecture..... 8/20
- References ..... 8/22

## 8.6 - OPC data server software

- OPC data server software ..... 8/12
- Presentation..... 8/12
- OPC Factory Server ..... 8/12
- Setup ..... 8/15
- Functions ..... 8/16
- References ..... 8/17

## 8.7 - Tego Dial

- Tego Dial for Human-Machine interfaces ..... 8/28
- Presentation, description ..... 8/28

## 8.8 - Tego Dial installation assistance

- Tego Dial installation help systems ..... 8/30
- Compatibility ..... 8/30



**Applications**

**Display of text messages**

**Type of terminal**

**Small Panels with keypad**



<b>Display</b>	Type
	Capacity

Green back-lit LCD, height 5.5 mm or Green, orange or red back-lit LCD, height 4.34...17.36 mm
2 lines of 20 characters or 1 to 4 lines of 5 to 20 characters

**Data entry**

Via keypad with 8 keys (4 customisable)

<b>Memory capacity</b>	Application
	Expansion by PCMCIA type II

512 kB Flash
–

<b>Functions</b>	Maximum number of pages
	Variables per page
	Representation of variables
	Recipes
	Curves
	Alarm logs
	Real-time clock
	Alarm relay
	Buzzer

128/200 application pages 256 alarm pages
40...50
Alphanumeric
–
–
Depending on model
Access to the PLC real-time clock
–
–

<b>Communication</b>	Asynchronous serial link
	Downloadable protocols
	Printer link

RS 232C/RS 485
Uni-TE, Modbus and for PLC brands: Allen-Bradley, Omron, Mitsubishi, Siemens
RS 232C serial link (2)

<b>Development software</b>	Vijeo Designer Lite (on Windows 2000, XP and Vista)
<b>Operating system</b>	Magelis

Vijeo Designer Lite (on Windows 2000, XP and Vista)
Magelis

**Terminal type**

**XBT N**

**Page**

Please consult our "Human-Machine Interfaces" catalogue.

(1) Only XBT RT511.  
(2) Depending on model.

<b>Display of text messages Control and parametering of data</b>	<b>Display of text messages and/or semi-graphics Control and parametering of data</b>
--	---

<b>Small Panels with keypad</b>	<b>Touchscreen Small Panels and with keypad</b>
---------------------------------	---



Green, orange or red back-lit LCD, height 4.34...17.36 mm	Green, orange or red back-lit LCD (198 x 80 pixels), height 4...16 mm
1 to 4 lines of 5 to 20 characters	2 to 10 lines of 5 to 33 characters

Via keypad with 12 function or numeric entry keys (depending on context) + 8 service keys	Via keypad with 4 function keys 8 service keys	Via touchscreen and keypad with 10 function keys 2 service keys
---	--	---

512 kB Flash -	512 kB Flash EPROM -
-------------------	-------------------------

128/200 application pages 256 alarm pages 40...50 Alphanumeric - - Yes Access to the PLC real-time clock - -	200 application pages 256 alarm pages 50 Alphanumeric, bargraph, buttons, lights - Yes Yes Yes (1)
---	---

RS 232C/RS 485 Uni-TE, Modbus and for PLC brands: Allen-Bradley, Omron, Mitsubishi, Siemens RS 232C serial link (2)
--

Vijeo Designer Lite (on Windows 2000, XP and Vista) Magelis
--



<b>XBT R</b>	<b>XBT RT</b>
--------------	---------------

Please consult our "Human-Machine Interfaces" catalogue.

# Modicon Quantum automation platform

## Operator dialogue terminals

### Magelis Graphic Terminals

<b>Applications</b>		Display of text messages, graphic objects and synoptic views Control and configuring of data		
<b>Type of device</b>		Touch screen graphic terminals		
<b>Display</b>	Type	 Back-lit monochrome (amber or red mode) STN LCD (320 x 240 pixels) or TFT LCD	 Back-lit monochrome or colour LCD STN or backlit colour TFT LCD (320 x 240 pixels)	 Colour STN LCD or backlit colour TFT LCD (640 x 480 pixels)
	Capacity	3.8" (monochrome or colour)	5.7" (monochrome or colour)	7.5 (colour)
<b>Input</b>	Static function keys	Touch screen		
	Dynamic function keys	–		
	Service keys	6 (1)	–	
	Alphanumeric keys	–		
	Application Extension	8 MB Flash EPROM	16 MB Flash EPROM	32 MB Flash EPROM
<b>Functions</b>	Maximum Number of pages	Limited by internal Flash EPROM memory capacity	Limited by internal Flash EPROM memory capacity or CF card memory capacity	
	Variables per page	Unlimited (8000 slots max.)		
	Representation of variables	Alphanumeric, bitmap, bargraph, gauge, tank, tank level indicator, curves, polygon, button, light		
	Recipes	32 groups of 64 recipes comprising 1024 ingredients max.		
	Curve	Yes, with log		
	Alarm logs	Yes		
	Real-time clock	Built-in		
	Discrete inputs/outputs	–	1 input (reset) and 3 outputs (alarm, buzzer, run)	
	Multimedia inputs/outputs	–	1 audio input (microphone), 1 composite video input (digital or analog video camera), 1 audio output (loudspeaker) (1)	
	<b>Communication</b>	Downloadable protocols	Uni-TE(2), Modbus and (1) for PLC brands: Mitsubishi, Omron, Allen-Bradley and Siemens	
Asynchronous serial link		RS 232C/485 (COM1)	RS 232C/RS 422/485 (COM1) and RS 485 (COM2)	
USB ports		1 (1)	1	2
Bus and networks		–	Modbus Plus and Fipway with USB gateway, Profibus DP and Device Net with optional card	
		Ethernet TCP/IP (10BASE-T/100BASE-TX) (1)		
Printer link		USB port for parallel printer (1)	RS 232C (COM1) serial link, USB port for parallel printer	
<b>Design software</b>	Vijeo Designer (on Windows 2000, Windows XP and Vista)			
<b>Operating system</b>	Magelis (CPU 100 MHz RISC) or (CPU 200 MHz RISC)	Magelis (CPU 133 MHz RISC)	Magelis (CPU 266 MHz RISC)	
	<b>XBT GT11/13</b>		<b>XBT GT21/22/23</b>	
	<b>XBT GT42/43</b>			
<b>Pages</b>	Please consult our "Human-Machine Interfaces" catalogue. (1) Depending on model (2) Uni-TE version V2 for Twido controller and TSX Micro/Premium platform			



Touch screen graphic terminals	Graphic terminals with keypad		Open graphic terminals	
--------------------------------	-------------------------------	--	------------------------	--



Colour STN LCD or backlit colour TFT LCD (640 x 480 pixels)	Backlit colour TFT LCD (800 x 600 pixels)	Backlit colour TFT LCD (1024 x 768 pixels)	Colour TFT LCD (320 x 240 pixels) or monochrome STN	Colour TFT LCD (640 x 480 pixels)	Colour TFT LCD (800 x 600 pixels)	Colour TFT LCD (1024 x 768 pixels)
10.4" (colour)	12.1" (colour)	15" (colour)	5.7" (monochrome or colour)	10.4" (colour)	8.4" (colour)	15" (colour)

Touch screen	Via keypad and/or touchscreen (configurable) and/or by industrial pointer		Touch screen	
–	10	12	–	–
–	14	18	–	–
–	8	–	–	–
–	12	–	–	–

32 MB Flash EPROM	16 MB Flash EPROM	32 MB Flash EPROM	Limited by 1 GB CF system
By 128, 256, 512 MB or 1 GB CF card			

Limited by internal Flash EPROM memory capacity or CF card memory capacity

Unlimited (8000 slots max.)

Alphanumeric, bitmap, bargraph, gauge, tank, tank level indicator, curves, polygon, button, light

32 groups of 64 recipes comprising 1024 ingredients max.

Yes, with log

Yes

Built-in

1 input (reset) and 3 outputs (alarm, buzzer, run)	–	1 input - 3 outputs	–
--	---	---------------------	---

1 audio input (microphone), 1 composite video input (digital or analog video camera), 1 audio output (loudspeaker) (1)	–	1 audio output	–
--	---	----------------	---

Uni-TE(2), Modbus and (1) for PLC brands: Mitsubishi, Omron, Allen-Bradley and Siemens

RS 232C/RS 422/485 (COM1) and RS 485 (COM2)	RS 232C/RS 422/485 (COM1) RS 485 (COM2)	RS 232C (COM1) RS 232C (COM2)
2	1	2

Modbus Plus and Fipway with USB gateway, Profibus DP and Device Net with optional card	Modbus Plus with USB gateway
--	------------------------------

Ethernet TCP/IP (10BASE-T/100BASE-TX)	1 TCP/IP Ethernet port (10BASE-T/100BASE-TX) and 1 Ethernet port (10BASE-T/100BASE-TX/1 Gb)
---------------------------------------	---

RS 232C (COM1) serial link, USB port for parallel printer

Vijeo Designer (on Windows 2000 and XP)	Vijeo Designer (Windows 2000 Windows XP and Vista)
---	--

Magelis (CPU 266 MHz RISC)	Windows XP embedded
----------------------------	---------------------

<b>XBT GT52/53</b>	<b>XBT GT63</b>	<b>XBT GT73</b>	<b>XBT GK 21/23</b>	<b>XBT GK 53</b>	<b>XBT GTW 450</b>	<b>XBT GTW 750</b>
--------------------	-----------------	-----------------	---------------------	------------------	--------------------	--------------------

Please consult our "Human-Machine Interfaces" catalogue.

# Modicon Quantum automation platform

## Human Machine Interface

### Magelis iPC industrial PCs

**Applications**

**"All in One" products**



**Model**

**8.4" screen** Data entry via touch screen  
SVGA (800 x 600)

**12" screen** Data entry via touch screen  
XGA (1024 x 768)

**12" screen** Data entry via touch screen  
SVGA (800 x 600)

**15" screen** Data entry via touch screen  
XGA (1024 x 768)

**Pages**

**Smart**

Please consult our "Human-Machine Interfaces" catalogue.

**Model**

**CPU** Processor

Storage

RAM

CD-ROM drive

Floppy disk drive

Slots available for expansion

Ethernet TCP/IP network

I/O ports On front panel  
Other

Operating system

Pre-installed application or software package

Power supply

Type of PC or Control box

**Smart**

Intel Celeron M 600 MHz

1 GB Compact Flash

256 MB expandable up to 1024 MB

–

–

–	1 x PCMCIA slot 1 x type III/type I	1 x PCMCIA slot 1 x type III or 2 x type I
---	--	---

2 RJ45 ports: 1 x 10/100/1000BASE-T 1 x 10/100BASE-T	2 RJ45 ports: 2 x 10/100BASE-T	2 RJ45 ports: 1 x 10/100/1000BASE-T 1 x 10/100BASE-T
--	-----------------------------------	--

– 1 x USB 2.0

4 x USB 2.0,  
1 x COM1, 1 x COM2

Windows Embedded XPe SP2

Client edition or  
HMI edition - Vijeo Designer Run-Time

24 V  $\overline{\text{---}}$ , 100...240 V  $\sim$  100...240 V  $\sim$  24 V  $\overline{\text{---}}$

**MPC ST1 1N●J 00●** **MPC ST2 1NAJ 10●** **MPC ST5 2N●J 20●**

**Pages**

Please consult our "Human-Machine Interfaces" catalogue.

**"All in One" products**



**Compact iPC**

●		
	●	
		●

Please consult our "Human-Machine Interfaces" catalogue.

**Compact iPC**

Intel Celeron M 1 GHz	Intel Celeron M 1.3 GHz	Pentium M 1.6 GHz
Hard disk ≥ 40 GB		
512 MB expandable up to 1024 MB		512 MB expandable up to 2 GB
–	–	Yes
–	–	Yes
–	1 x PCI bus slot 1 x PCMCIA slot 1 x type III/type I	1 x PCI bus slot 1 x PCMCIA slot 1 x type III or 2 x type II
2 RJ45 ports: 1 x 10/100/1000BASE-T 1 x 10/100BASE-T	2 RJ45 ports: 2 x 10/100BASE-T	2 RJ45 ports: 1 x 10/100/1000BASE-T 1 x 10/100BASE-T
–	1 x USB 2.0	
4 x USB 2.0, 1 x COM1, 1 x COM2		4 x USB 2.0, 1 x COM1, 1 x COM2, 1 x parallel, 1 x PS2 keyboard, 1 x PS2 pointing device
Windows XP Pro		
Vijeo Designer Run Time pack		
100...240 V ~		
<b>MPC KT1 2NAX 00●</b>	<b>MPC KT2 2NAX 00●</b>	<b>MPC KT5 5NAX 20●</b>

Please consult our "Human-Machine Interfaces" catalogue.

# Modicon Quantum automation platform

## Human Machine Interface

### Magelis iPC industrial PCs

#### Applications

#### Modular products

(Control box to be connected to a front panel or used as a stand-alone device) (1)



#### Model

#### Front panel

**8.4" screen** Data entry via touch screen  
SVGA (800 x 600)

**MPC NA5 0NNN 20N**

**12" screen** Data entry via touch screen  
XGA (1024 x 768)

**MPC NB5 0NNN 20N**

**12" screen** Data entry via touch screen  
SVGA (800 x 600)

**MPC NT5 0NNN 20N**

**15" screen** Data entry via touch screen  
XGA (1024 x 768)

#### Pages

Please consult our "Human-Machine Interfaces" catalogue.



#### Model

#### Control box 102 Control box 402

**CPU** Processor

Intel Celeron M 1.3 GHz or Intel Pentium M 1.6 GHz

Storage

Hard disk ≥ 40 GB, removable

RAM

512 MB expandable up to 2 GB

CD-ROM drive

Yes, removable. Combined DVD-R/CD-RW drive available as an option.

Floppy disk drive

Yes

Slots available for expansion

1 PCI bus slot and 2 x PCMCIA slots type 1/2 (or 1 type III)	4 PCI bus slots and 2 x PCMCIA slots type 1/2 (or 1 type III)
--	---

Ethernet TCP/IP network

1 x 10BASE-T/100BASE-TX (RJ45)

I/O ports

2 x USB, 1 x COM1, 1 x COM4 and 1 x parallel, 1 x VGA external video port, 1 x PS/2 port (2)

Operating system

Windows XP Pro or Windows 2000 operating system pre-installed

Pre-installed application or software package

Package A: Vijeo Look Run-Time	Package A: Vijeo Look Run-Time or Package B: Vijeo Look Build-Time
--------------------------------	---

Power supply

115...230 V ~ or 24 V = depending on model

Type of PC or Control box

**MPC EN0 ●N●● 00N MPC DN0 ●N●● 00N**

#### Pages

See our "Human-Machine Interfaces" catalogue.

(1) To use a Control box without a front panel screen, you will require the mounting panel **MPC NP0 0NNN 00N**.  
(2) Port not operational when the Control box is fitted with the front panel screen.

**Applications**

**Flat screens**

**Model**

<b>15" screen</b> XGA (1024 x 768)	Data entry via keyboard
	Data entry via keyboard and touch screen
	Data entry via touch screen

<b>19" screen</b> SXGA (1024 x 1024)	Data entry via touch screen
---	-----------------------------

**Pages**



**iDisplay**

●	

	●
--	---

Please consult our "Human-Machine Interfaces" catalogue.

**Model**

<b>Screen</b>	Type
	Size
	Resolution
	Number of colours
	Brightness

**Touch panel**

<b>Inputs</b>	Image
---------------	-------

<b>Outputs</b>	Touch panel
----------------	-------------

<b>Power supply</b>	Voltages
---------------------	----------

**Type**

**Pages**

**iDisplay**

Active-matrix colour TFT LCD

15"	19"
-----	-----

XGA 1024 x 768	SXGA 1280 x 1024
----------------	------------------

16,777,216

≥ 200 cd/m<sup>2</sup> adjustable

Resistive analog

VGA or DVI-D port



USB or RS 232C port

100 to 240 V ~ (threshold values 98 to 264 V), EN 61131-2-compliant	100 to 240 V ~ (threshold values 85 to 264 V), EN 61131-2-compliant
---	---

<b>MPC YT5 0NAN 00N</b>	<b>MPC YT9 0NAN 00N</b>
-------------------------	-------------------------

Please consult our "Human-Machine Interfaces" catalogue.



<b>Applications</b>	<b>Traditional architecture, HMI executed on PC platform or dedicated terminal</b>	
	<b>Configuration software for operator dialogue applications</b>	
		
<b>Target products</b>	Type	
	Operating system on terminals	
		Magelis XBT N (1) Magelis XBT R/RT (1)
		Magelis XBT G (1) Magelis XBT GT (1) Magelis XBT GK (1) Magelis XBT GTW (1)
		Proprietary Magelis
		Except Magelis XBT GTW: Windows XP embedded
<b>Functions</b>	Reading/writing of PLC variables	Yes
	Display of variables	Yes
	Data processing	–
	Sharing of variables between HMI applications	Yes, using expression editor or Java programming
	Saving of variables to external database	–
<b>Development of graphics applications</b>	Native library of graphic objects	Yes
	Container	–
	Active X	–
	Java Beans	Yes
	Curves and alarms	Yes (2)
	Scripts	–
		Java
<b>Online modification of applications</b>		–
<b>Communication between PLCs and HMI application</b>		Via I/O drivers
<b>Uploading of applications</b>		Yes
<b>Simulation of HMI applications</b>		Yes
<b>Redundancy</b>		–
<b>Recipe management</b>		No
		Yes
<b>Report printing</b>		On the fly alarms, log data
<b>Access security</b>		Linked to user profiles
<b>Software compatible with OS</b>		Windows 2000 or Windows XP
		Windows 2000, Windows XP or Windows Vista
<b>Type of software</b>	<b>Vijeo Designer Lite</b>	<b>Vijeo Designer</b>
		
<b>Pages</b>		

(1) Magelis XBT terminals behave transparently on restoration of power.  
 (2) Depending on model

SCADA supervisor software	Data logging/reporting software
---------------------------	---------------------------------



Magelis Compact iPC industrial PCs Magelis Modular iPC industrial PCs PC micro-computers	Magelis Compact iPC industrial PCs Magelis Modular iPC industrial PCs PC micro-computers Servers	Magelis Compact iPC industrial PCs Magelis Modular iPC industrial PCs PC micro-computers Servers
Microsoft Windows		Microsoft Windows
Yes		No
Yes		Yes
Yes		Yes
Yes		-
Client/server architecture		-
Yes		-
Yes		No
Yes		-
-		-
Yes, with log		-
C compiler integrated		-
Yes (version 7.0 upwards)		-
Via OFS data server		-
No		-
-		-
Yes		-
Yes		-
All information in the real-time database	-	-
Linked to user profiles		Linked to user profiles
Windows XP, Servers		Windows XP, Servers

### Vijeo Citect Lite



### Vijeo Citect



### Vijeo Historian



# Modicon Quantum automation platform

## OPC data server software

### OPC Factory Server

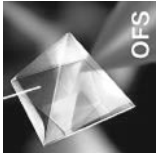

#### Presentation

Based on the OLE for Process Control (OPC) standard, Schneider-Electric's OPC Factory Server (OFS) software allows "client" software applications, such as supervisors/SCADA and customized interfaces, to access the data of Schneider Electric automation system and electrical distribution devices connected to networks or fieldbus in real-time. It also allows communication with third-party devices supporting Modbus and Modbus TCP protocols.

At the heart of the Transparent Ready offer, OFS enables simpler, more open and transparent communication between your software applications and your devices. These are just some of the advantages that ensure a complete interoperability solution that is central to your process.

In version V3.3, the OFS data server integrates the most recent specifications of the OPC Foundation:

- OPC-DA (OPC Data Access)
- .NET API interface
- OPC XML-DA V1.0 (OPC XML Data Access)

The OFS V3.3 offer is available in two levels:

- **OFS Small:** Data server for 1000 items (1) that does not support the OPC XML-DA protocol
- **OFS Large:** Complete data server

#### Devices and protocols supported

OFS software is a multi-device data server: it allows simultaneous use of several communication protocols, and it provides client applications with a set of services for accessing control system items that may be local or remote, via physical address or via symbol.

##### Siemens devices:

- Modicon Quantum, Premium, Micro, Compact and Momentum PLCs
- TSX Series 7 and April Series 1000 PLCs
- Modbus Serial devices connected via Schneider-Electric and Merlin Gerin gateways: ranges: TSX ETG 10●●, EGX ●●●etc.
- Uni-Telway serial devices connected via gateways (TSX ETG 1010)

##### Networks and protocols supported:

- Modbus: Modbus Serial, Modbus Plus, Modbus TCP/IP
- XWAY/UNI-TE: Uni-Telway, FIPWAY, ETHWAY, ISAWAY, PCIWAY

#### Openness

The development of specialized interfaces is simpler with OFS V3.3 software, which is aimed at two types of user in particular:

- **End users** who want either to interface their supervision or human/machine interface applications with Schneider Electric equipment, or to develop applications on a PC (supervisory control screens, Excel tables, etc.) requiring access to control system data.
- **Suppliers of automation system or industrial data processing software** (supervision, human/machine interfaces, etc.) seeking to develop, within their standard products, an OPC Client interface capable of accessing data in Schneider Electric equipment via the OFS server.

(1) Item: A variable, structure, table, etc. of the Unity Pro application.



Web-enabled Power & Control  
**Transparent Ready**

# Modicon Quantum automation platform

## OPC data server software

### OPC Factory Server

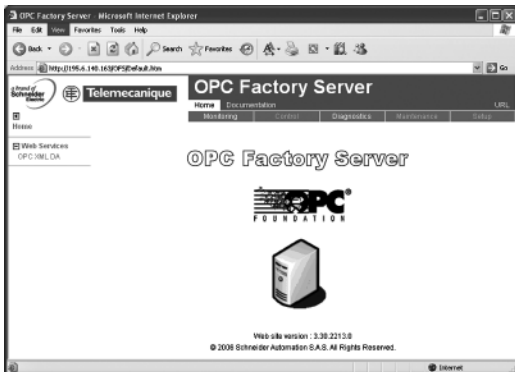

OPC Factory Server: Home page

### Supported Architectures

The OFS server allows four access modes:

- A purely local mode
- Remote access from an OPC-DA client
- Remote access from an OPC.NET client
- Remote access from an OPC XML-DA client

#### Local access

The client application and the OFS server are on the same PC.

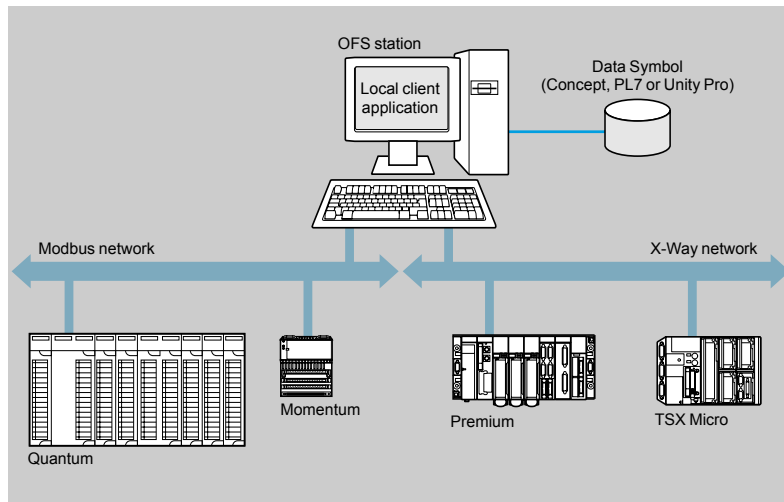

#### Remote access from an OPC-DA client

The client application and the OFS data server are on remote stations.

Communication between the client station and the OFS server is conducted through the DCOM layer (Microsoft) via the OPC-DA protocol.

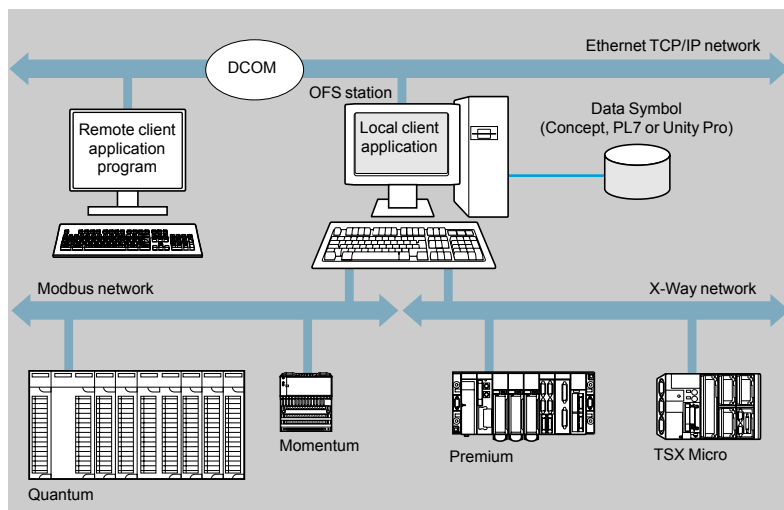

# Modicon Quantum automation platform

## OPC data server software

### OPC Factory Server

#### Architectures (continued)

##### Remote access from an OPC .NET client

The .NET client application and the OFS data server are on remote stations. Communication between the client station and the OFS server is conducted through the DCOM layer (Microsoft) via the OPC-DA protocol.

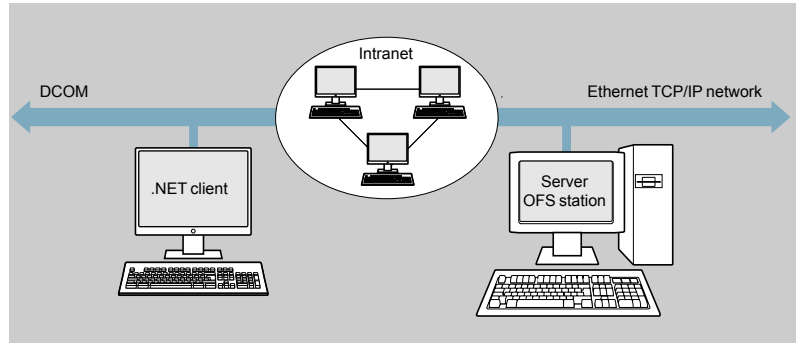

The Microsoft .NET compatibility of the OFS server has been developed to allow an OPC .NET client to access OFS server items on an Intranet network via the OPC .NET API interface.

This interface ensures interoperability between existing OPC applications and applications developed in the standard .NET environment.

##### Remote access from an OPC XML-DA client via HTTP

The client application program and the OFS server are on remote stations, using the SOAP protocol to communicate via the Internet in conformity with the OPC XML-DA V1.01 specification of the OPC Foundation. The OFS data server is based on an HTTP server installed on the same station.

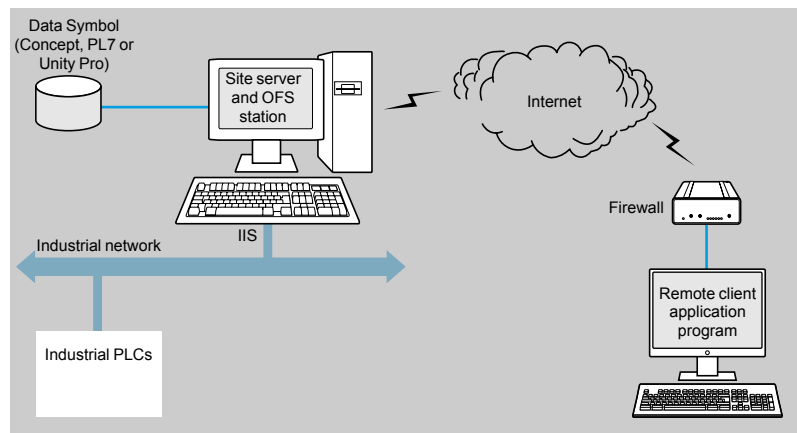

The OPC XML-DA V1.0 specifications are designed to overcome the limitations of COM/DCOM by providing:

- An OPC interface for Windows and non-Windows client applications
- Beyond the Intranet perimeter, remote access via the Internet through firewalls

The OPC XML-DA specification is based on Web Services standards such as SOAP, XML, WSDL(1). A SOAP client can access data on the OFS server via Intranet or Internet using the SOAP protocol in conformity with the OPC XML-DA V1.01 specification of the OPC Foundation.

(1) SOAP: Simple Object Access Protocol  
XML: Extended Markup Language  
WSDL: Web Services Description Language

# Modicon Quantum automation platform

OPC data server software  
OPC Factory Server

## Setup

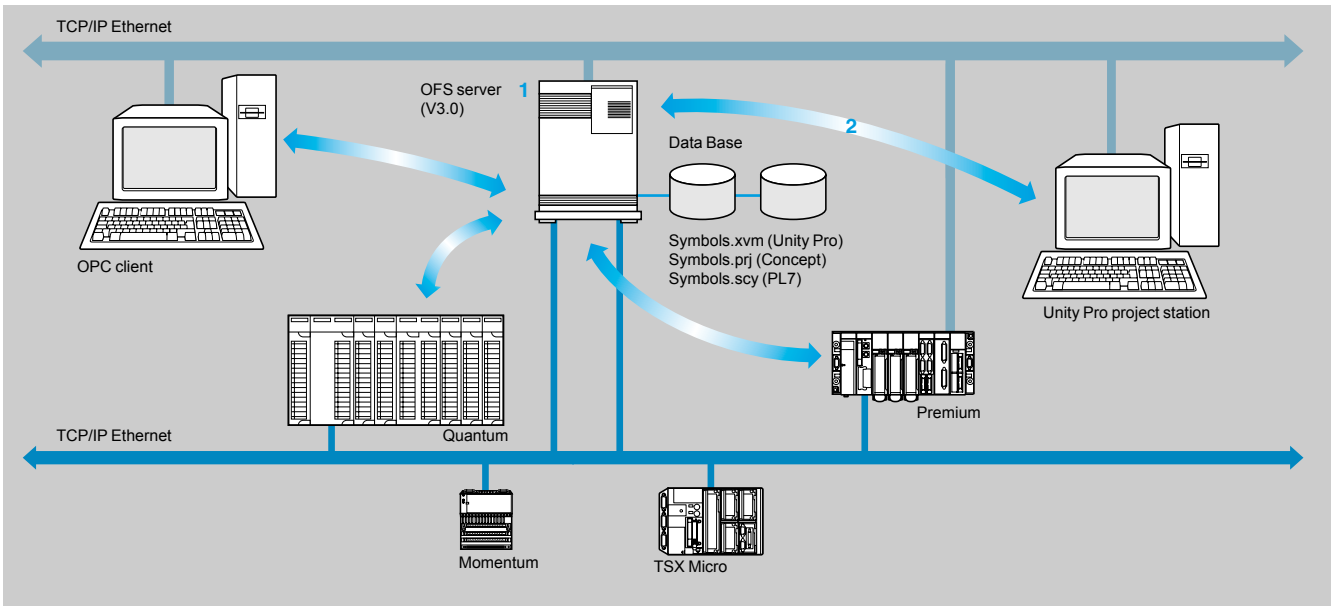

The OFS server **1** is at the center of the data exchanges.

The direct and dynamic link **2** between the OFS server and the Unity Pro project station results in productivity gains for designers and users of the devices.

OFS has direct access to the items in the Unity Pro project. In addition, it performs a consistency check between these items and those of the Premium and Quantum PLCs.

**Note:** Depending on the software used for Modicon PLCs:

- PL7 software generates PLC variable symbol export files. These export files (symbols.scy) should be integrated in the OPC server.
- Concept: The variables can be accessed directly in the project (file.prj) of the Concept application. This direct link requires Concept (version > 2.0) to be installed on the OFS station **1**.
- If the Unity Pro project development station is not accessible via the OFS station, the PLC variable symbol export files (symbols.xvm) generated by Unity Pro should be integrated into the OPC server.

### Functions

#### Development of client applications

OFS software has 4 types of interface:

##### ■ OLE Automation interface (OPC-DA)

Particularly suitable for end users, this enables the development of OPC client applications in Visual Basic, in Visual Basic for Excel, and in C++.

##### ■ OLE Automation interface (OPC-DA)

Used primarily by suppliers of automated control system or industrial IT products, this interface enables the development of applications in C++ in order to access the OFS software OPC server. It is aimed at software development experts in particular, so that they can integrate the client application into their standard products. This is the interface with the highest performance, in terms of access time, to data stored in the OPC server. It requires extensive knowledge of C++ programming to set up.

##### ■ OPC .NET API wrapper interface

The .NET Microsoft compatibility of the OFS data server gives an OPC .NET client standard access to items of the OFS server via an Intranet network, thus ensuring greater interoperability with standard .NET environments.

*Note: In this case, communication between the OPC .NET client and the OFS server is conducted through the DCOM layer (or COM layer in a local configuration) via the OPC-DA protocol.*

##### ■ OPC XML-DA interface (1)

The OPC XML-DA V1.0 specifications are designed to overcome the limitations of the OPC-DA specification and COM/DCOM by providing:

- An interface for Windows and non-Windows client applications
- Remote access via the Internet through firewalls (beyond the Intranet perimeter)

The OPC XML-DA specification is based on Web Services standards such as SOAP, XML, WSDL. A SOAP client can access data on the OFS server via Intranet or Internet using the SOAP protocol in conformity with the OPC XML-DA V1.01 specification of the OPC Foundation.

(1) Available only with the Large version of OPC Factory Server V3.3

# Modicon Quantum automation platform

## OPC data server software

### OPC Factory Server

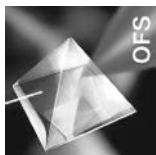

#### References

OFS V3.3 software for PC compatible stations (minimum configuration: Pentium 566 MHz processor, 128 Mb of RAM) running Windows 2000 Professional (1) or Windows XP Professional.

The OFS V3.3 offer comprises:

- OPC server software
- OPC server simulator (for debugging the application when no PLCs are present)
- OFS server configuration software
- An example of OPC client for setting up applications
- The setup documentation on CD-ROM

Supplied on CD-ROM, the software operates independently on a PC. It interfaces with the variable export files generated by PL7, ProWORX, Concept, and Unity Pro software.

It also provides a direct and dynamic link to the Unity Pro and Concept applications (2).

OFS V3.3 software is available in two versions:

- **Small Version TLX CD S•OFS 33**
  - Maximum of 1000 items
  - All protocols supported except OPCXML-DA
  - Single station and 10-station site licenses
- **Large Version TLX CD L•OFS 33**
  - Full version
  - Single station and 10-station and 200-station site licenses

OPC Factory Server V3.3 Small			
Description	License type	Reference	Weight (kg)
OPC Factory Server V3.3 Small software	Single station	TLX CD SUOFS 33	–
	10 stations	TLX CD STOFS 33	–

OPC Factory Server V3.3 Large			
Description	License type	Reference	Weight (kg)
OPC Factory Server V3.3 Large software Full version.	Single station	TLX CD LUOFS 33	–
	10 stations	TLX CD LTOFS 33	–
	200 stations	TLX CD LFOFS 33	–

(1) Must be updated with Service Pack 1 or higher

(2) Requires Concept > version 2.0 software to be installed on the same station



# Modicon Quantum automation platform

## Vijeo Citect supervisory software

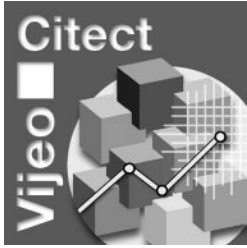

### Presentation

The flexibility of Vijeo Citect supervisory software enables users to achieve the solution that best suits their supervision requirements for installations.

Vijeo Citect offers all the functions of a modern supervisor. Its distributed client-server architecture is applicable to a multitude of applications in the varied segments:

- Oil and Gas,
- MMM, Mining, Metals and Minerals,
- WWW, Water and Washwater treatment,
- Power,
- Food and Beverage,

obviously the Vijeo Citect flexibility allows it to fit the requirements in many others applications like tunnels, airports, ...

A unique development tool enabling the development of any supervision application, from small stand-alone systems to large distributed redundant systems.

Application designers and users benefit from the competence of Schneider Electric for its mastery of system integration. Moreover the offer is continuously updated in order to make the last technologies available to the customers.

### Redundancy

Vijeo Citect offers total redundancy that covers all components. The redundancy functions are fully integrated within the system and intuitive to configure.

### Server license

Vijeo Citect exists:

- in a **Client-Server** architecture and ranges from 75 Points to an unlimited number of Points,
- in a **stand-alone** version called **Vijeo Citect Lite** that can manage 300, 600 or 1200 Points, see page 8/23.

Vijeo Citect automatically installs OFS, the OPC server of Schneider Electric. This does not require registration. This component can only be used with Vijeo Citect software.

OFS software provides access to any of the PLC variables: Elementary Data type, Derived Data type and Function Blocks. Furthermore OFS checks periodically the consistency between the PLC applications and the SCADA one. This is one of major benefits provided by Schneider Electric integration.

Server licenses **VJC 1011 ●●** are purchased by number of Points that are required for processing, not I/O (1). An upgrade offer **VJC 1011 1● ●●** is available for increasing the number of Client and Server Points if required at a later date (2).

---

(1) Vijeo Citect counts all the variables exchanged with external devices, such as PLCs.  
 (2) If the Server or Client is upgraded, the keys must be reprogrammed

Web-enabled Power & Control  
**Transparent Ready™**

## Client license

Client licenses are generally purchased using the same Points Count as the Server to which they are connected. Four types of Clients are available:

- **Display Client, VJC 1020 ●●**: used by operators accessing the Vijeo Citect Server through a local connection,
- **Manager Client, VJC 1030 ●●**: for users needing to view the Vijeo Citect application via a local connection, but not needing to control the system,
- **Web Display Client, VJC 1022 ●●**: similar to Display Client but through a Web connection,
- **Web Manager Client, VJC 1032 ●●**: similar to Manager Client but via the Web.

## Static, Floating and Redundancy Client license

According to requirements, a Client license can either be Static, Floating or Redundancy:

- **Static Client license**: for operators that must have immediate access to the system, irrespective of the number of connections already established by other Clients.  
A Static Client license guarantees permanent access to the control system since they physically reside in the key plugged into the Client PC.
- **Floating Client license**: Users who need to occasionally use a Client for operator tasks can purchase Floating licenses. Connections will be allowed provided that the number of valid licenses is not exceeded. Floating Client licenses are stored on the key plugged into the Server.
- **Redundant Client license**: Redundant Client licenses **VJC 10●● 88** are solely intended for the Standby Server in a Redundant configuration. They are used to ensure that the number of Client licenses purchased are all available.

## Development workshop

Development workshop **VJC 1099 ●2** comprises the physical items such as the CD-Rom, hardware keys, installation guide and storage boxes.

Set up:

- each Server requires a hardware key (USB or parallel) in order to operate,
- the Server key is also used to store the Floating Client licenses,
- the key controls the number of Points that can be used,
- the key is programmed to operate up to predetermined version.

## Promotional and Evaluation License

A development workshop Promotional License **VJC 1095 ●●** is available. It is only available for teaching purposes and meets requirements for demonstrations and testing.

With an Evaluation License it is possible to develop an application and test it for 10 minutes in stand-alone mode.

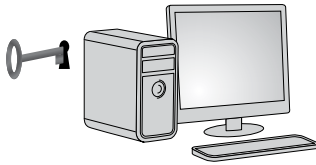

Single station architecture

## Architectures

### SCADA system stand-alone single station, 5000 Points

**Development workshop**

- 1 x VJC 1099 22, physical delivery of the CD with USB key.

**Server license**

- 1 x VJC 1011 14, Server license for 5000 Points, including Server Client.

**Client license**

- Not required, included in the Server license.



Single server architecture with Web Manager Client access

### Remote Server system with remote access via the Web

**Development workshop**

- 1 x VJC 1099 22, physical delivery of the CD with USB key.

**Server license**

- 1 x VJC 1011 15, Server license for 15000 Points, including Server Client.

**Client license**

- 1 x VJC 1032 15, Web Manager Client license for 15000 Points.

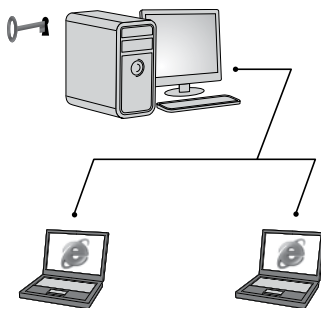

Single server architecture with 1 Web Display Client and 1 Web Manager Client

### Networked Server system with remote Web Clients

Example: Networked Server system, 500 Points, with 2 remote Clients via the Web: one Web Display and one Web Manager.

**Development workshop**

- 1 x VJC 1099 22, physical delivery of the CD with USB key.

**Server license**

- 1 x VJC 1011 12, Server license for 500 Points, including Server Client.

**Client licenses**

- 1 x VJC 1022 12, Web Display Client license for 500 Points.
- 1 x VJC 1032 12, Web Manager Client license for 500 Points.

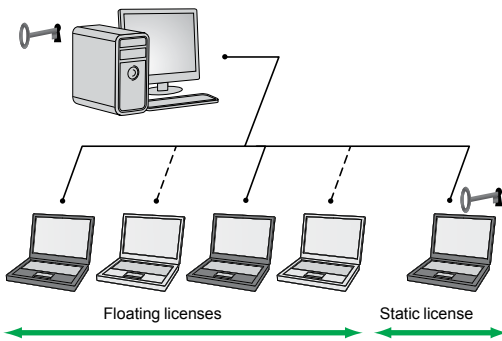

Single server architecture with 2 Floating Display Client licenses and 1 Static license

### Architectures (continued)

#### Networked server system with floating and static access

Example: Networked Server system, 5000 Points, with 5 Client PCs and 3 Client licenses, including 2 Floating licenses and 1 Static license.

#### Development workshop

- 1 x **VJC 1099 22**, physical delivery of the CD with USB key.
- 1 x **VJC 1099 21**, additional USB key for Static Client.

#### Server license

- 1 x **VJC 1011 14**, Server license for 5000 Points, including Client Server (local Display Client type on the Server PC).

#### Client licenses

- 3 x **VJC 1020 14**, Display Client licenses for 5000 Points.

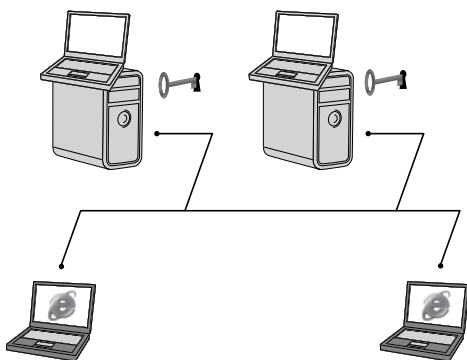

Redundant architecture with 2 Display Clients on servers and 2 Web Manager Clients

#### Redundant server with Server Display Clients and Web Manager Clients

Example: Redundant server, 1500 Points, with 2 Display Clients on the Servers and 2 Web Manager Clients.

#### Development workshop

- 1 x **VJC 1099 22**, physical delivery of the CD with USB key: Primary server key.
- 1 x **VJC 1099 21**, additional USB key for Standby Server (rule: 1 key per Server).

#### Server licenses

- 2 x **VJC 1011 13**, Server licenses for 1500 Points, including Server Client.
  - the first Server acts as the Primary Server,
  - the second Server acts as the Standby Server,
  - one license will be placed on each key (Primary and Standby).

#### Client licenses

- 2 x **VJC 1032 13**, Web Manager Client licenses for 1500 Points.
  - these 2 licenses will be placed on the Primary Server key.

#### Redundant Client license:

- 2 x **VJC 1032 88**, Redundant Web Manager Client licenses
  - floating Redundant licenses for Web Manager Client licenses,
  - these 2 licenses will be placed on the Standby Server key.

# Modicon Quantum automation platform

## Vijeo Citect supervisory software



VJC 1099 22/12



VJC 1099 21

VJC 1099 11



### Development workshop - Vijeo Citect Box and key(s)

Vijeo Citect Box VJC 1099 ●2 includes:

- 1 CD-Rom with Vijeo Citect software,
- Schneider Electric drivers pack,
- an installation guide,
- a hardware key.

Additional keys are also delivered in the Vijeo Citect Box.

#### Development workshop - Vijeo Citect Box

Description	Type of key included	Reference	Weight kg
Vijeo Citect Box USB key	USB	VJC 1099 22	0.410
Vijeo Citect Box Parallel key	Parallel	VJC 1099 12	0.420

#### Additional Vijeo Citect keys

Description	Target license	Reference	Weight kg
Additional Vijeo Citect USB key Delivered in Vijeo Citect Box	Redundant Server and Static (non-floating) licenses.	VJC 1099 21	–
Additional Vijeo Citect parallel key Delivered in Vijeo Citect Box	Redundant Server, Static (non-floating) and demonstration licenses.	VJC 1099 11	–

### Vijeo Citect Lite, stand-alone

The Vijeo Citect Lite stand-alone license, for 300, 600 or 1200 Points, includes:

- 1 CD-Rom with Vijeo Citect software,
- Schneider Electric drivers pack,
- an installation guide,
- a hardware key.

A simple solution for stand-alone applications, a Vijeo Citect Lite license is used for connecting a single client to a single sector. It cannot be made redundant.

A Vijeo Citect Lite license can be upgraded to a full Vijeo Citect license (1).

#### Vijeo Citect Lite license

Description	Number of Points	Reference	Weight kg
Vijeo Citect Lite	300	VJC 3011 27	–
Stand-alone: no connectivity	600	VJC 3011 59	–
Key to be ordered separately	1200	VJC 3011 50	–

#### Vijeo Citect Lite upgrades

The references indicated below are for upgrading the number of Vijeo Citect Lite Points:

- regarding the number of Points in the Lite version,
- from Vijeo Citect Lite to the full Vijeo Citect Server version (see below).

Description	Number of Points	Reference	Weight kg
Vijeo Citect Lite number of Points upgrade	300 to 600	VJC L27 L59	–
	600 (2) to 1200	VJC L59 L50	–
Vijeo Citect Lite to Vijeo Citect Server upgrade	300 Lite to 600 Server	VJC L27 F12	–
	600 Lite (2) to 1500 Server	VJC L59 F13	–
	1200 Lite to 1500 Server	VJC L50 F13	–

(1) Requires reprogramming of key VJC 1094 00.

(2) Also for existing Lite 500 Point versions installed

# Modicon Quantum automation platform

## Vijeo Citect supervisory software



### Vijeo Citect Server

Vijeo Citect Server licenses (complete system), graded by the number of points Points, include:

- 1 CD-Rom with Vijeo Citect including OFS and SpeedLink,
- Schneider Electric drivers pack,
- an installation guide,
- a hardware key.

### Redundant system

For a redundant system simply order 2 Server licenses.

No other option is required regarding the Servers.

The programmed key (USB or parallel) must be ordered separately.

### Vijeo Citect Server license

Description	Number of Points	Reference	Weight kg
<b>Vijeo Citect Server</b>	75	<b>VJC 1011 10</b>	–
Full version.	150	<b>VJC 1011 11</b>	–
Key to be ordered separately.	500	<b>VJC 1011 12</b>	–
	1500	<b>VJC 1011 13</b>	–
	5000	<b>VJC 1011 14</b>	–
	15000	<b>VJC 1011 15</b>	–
	Unlimited	<b>VJC 1011 99</b>	–

### Vijeo Citect Server upgrade

The references indicated below are for upgrading the number of Points on the Server.

Description	Number of Points	Reference	Weight kg
<b>Vijeo Citect Server upgrade</b>	75 to 150	<b>VJC 1011 10 11</b>	–
	150 to 500	<b>VJC 1011 11 12</b>	–
	500 to 1500	<b>VJC 1011 12 13</b>	–
	1500 to 5000	<b>VJC 1011 13 14</b>	–
	5000 to 15000	<b>VJC 1011 14 15</b>	–
	15000 to Unlimited	<b>VJC 1011 15 99</b>	–

# Modicon Quantum automation platform

## Vijeo Citect supervisory software

### Vijeo Citect Display Client

Vijeo Citect Display Client licenses are intended for operators. Licenses for these Clients are graded according to the number of Points to be displayed. They can either use:

- a Floating license, residing on the Server key,
- a Static license: requiring a separate key on the Client PC.

#### Redundant system

- the number of Floating Clients ordered is added to the Primary Server key,
- for the Standby Server, the same number of Redundant Display Client licenses **VJC 1020 88** must be ordered.

#### Vijeo Citect Display Client license

Description	Number of Points	Reference	Weight kg
Vijeo Citect Display Client licence	75	<b>VJC 1020 10</b>	–
	150	<b>VJC 1020 11</b>	–
	500	<b>VJC 1020 12</b>	–
	1500	<b>VJC 1020 13</b>	–
	5000	<b>VJC 1020 14</b>	–
	15000	<b>VJC 1020 15</b>	–
	Unlimited	<b>VJC 1020 99</b>	–

Description	Details	Reference	Weight kg
Vijeo Citect Redundant Display Client licence	Floating license only	<b>VJC 1020 88</b>	–

### Vijeo Citect Manager Client

Vijeo Citect Manager Client licenses are available for users who need to view the application, without controlling it. Licenses for these Clients are graded according to the number of Points to be displayed. They can either use:

- a Floating license, residing on the Server key,
- a Static license, the hardware key being plugged into the Client station.

#### Redundant system

- the number of Floating Clients ordered is added to the Primary Server key,
- for the Standby Server, the same number of Redundant Manager Client licenses **VJC 1030 88** must be ordered.

#### Vijeo Citect Manager Client license

Description	Number of Points	Reference	Weight kg
Vijeo Citect Manager Client licence	75	<b>VJC 1030 10</b>	–
	150...unlimited	<b>VJC 1030 99</b>	–

Description	Details	Reference	Weight kg
Vijeo Citect Redundant Manager Client licence	Floating license only	<b>VJC 1030 88</b>	–

# Modicon Quantum automation platform

## Vijeo Citect supervisory software



### Vijeo Citect Web Display Client

Vijeo Citect Web Display Client licenses are intended for users who need full control of the application but prefer the flexibility of access via a Web connection. These Client licenses are graded according to the number of Points displayed and must be of the floating type (residing on the key plugged into the Server).

#### Redundant system

- the number of floating Clients ordered is added to the Primary Server key,
- for the Standby Server, the same number of Redundant Web Display Client licenses **VJC 1030 88** must be ordered.

#### Vijeo Citect Web Display Client license

Description	Number of Points	Reference	Weight kg
Vijeo Citect	75	<b>VJC 1022 10</b>	–
Web Display Client license	150	<b>VJC 1022 11</b>	–
	500	<b>VJC 1022 12</b>	–
	1500	<b>VJC 1022 13</b>	–
	5000	<b>VJC 1022 14</b>	–
	15000	<b>VJC 1022 15</b>	–
	Unlimited	<b>VJC 1022 99</b>	–

Description	Details	Reference	Weight kg
Vijeo Citect Redundant Web Display Client license	Floating license only	<b>VJC 1022 88</b>	–

### Vijeo Citect Web Manager Client

Vijeo Citect Web Manager Client licenses are intended for users who need to view the application via a Web connection, without controlling the system. These Client licenses are graded according to the number of Points displayed and must be of the floating type (residing on the key plugged into the Server).

#### Redundant system

- the number of Floating Clients ordered is added to the Primary Server key,
- for the associated Standby server, the same number of Manager Client Redundant licenses **VJC 1032 88** must be ordered.

#### Vijeo Citect Web Manager Client license

Description	Number of Points	Reference	Weight kg
Vijeo Citect	75	<b>VJC 1032 10</b>	–
Web Manager Client license	150...unlimited	<b>VJC 1032 99</b>	–

Description	Details	Reference	Weight kg
Vijeo Citect Redundant Web Manager Client license	Floating license only	<b>VJC 1032 88</b>	–



# Modicon Quantum automation platform

## Vijeo Citect supervisory software

### Display Client upgrade

The references indicated below are for upgrading the number of Points on:

- the Server in which the hardware key is plugged, for floating licenses,
- the Client in which the hardware key is plugged, for static licenses.

#### Vijeo Citect Display Client upgrade (1)

Description	Number of Points	Reference	Weight kg
Vijeo Citect	75 to 150	VJC 1020 10 11	–
Display Client upgrade	150 to 500	VJC 1020 11 12	–
	500 to 1500	VJC 1020 12 13	–
	1500 to 5000	VJC 1020 13 14	–
	5000 to 15000	VJC 1020 14 15	–
	15000 to Unlimited	VJC 1020 15 99	–

### Manager Client upgrade

The references indicated below are for upgrading the number of Points on:

- the Server in which the hardware key is plugged, for floating licenses,
- the Client in which the hardware key is plugged, for static licenses.

#### Vijeo Citect Manager Client upgrade (1)

Description	Number of Points	Reference	Weight kg
Citect	75 to 150	VJC 1030 10 11	–
Manager Client upgrade	150 to 500	VJC 1030 11 12	–
	500 to 1500	VJC 1030 12 13	–
	1500 to 5000	VJC 1030 13 14	–
	5000 to 15000	VJC 1030 14 15	–
	15000 to Unlimited	VJC 1030 15 99	–

### Web Display Client upgrade

The references indicated below are for upgrading the number of Points on: the Server in which the hardware key is plugged.

#### Vijeo Citect Web Display Client upgrade (1)

Description	Number of Points	Reference	Weight kg
Vijeo Citect	75 to 150	VJC 1022 10 11	–
Web Display Client upgrade	150 to 500	VJC 1022 11 12	–
	500 to 1500	VJC 1022 12 13	–
	1500 to 5000	VJC 1022 13 14	–
	5000 to 15000	VJC 1022 14 15	–
	15000 to Unlimited	VJC 1022 15 99	–

### Web Manager Client upgrade

The references indicated below are for upgrading the number of Points on: the Server in which the hardware key is plugged.

#### Vijeo Citect Web Manager Client upgrade (1)

Description	Number of Points	Reference	Weight kg
Vijeo Citect	75 to 150	VJC 1032 10 11	–
Web Manager Client upgrade	150 to 500	VJC 1032 11 12	–
	500 to 1500	VJC 1032 12 13	–
	1500 to 5000	VJC 1032 13 14	–
	5000 to 15000	VJC 1032 14 15	–
	15000 to Unlimited	VJC 1032 15 99	–

(1) The reprogramming fee VJC 1094 00 is applicable for any key upgrade.

# Modicon Quantum automation platform

## Vijeo Citect supervisory software

### Vijeo Citect - Specific drivers

The Vijeo Citect offer includes an extensive number of drivers as standard. However, for copyright reasons, some drivers have a specific reference and they must be ordered separately. Purchasing a specific driver includes access to the appropriate technical support for the driver for one year.

Description	Protocol	Reference	Weight kg
Vijeo Citect specific driver	IEC 60870-5-104	<b>VJC 3051 41</b>	–
	PSDirect ETH	<b>VJC 3051 40</b>	–
	PSDirect MPI	<b>VJC 3051 42</b>	–
	Bailey	<b>VJC 3051 44</b>	–
	SEMAPI	<b>VJC 3051 48</b>	–
	MOSCAD	<b>VJC 3051 49</b>	–

**Note:** Before ordering a Vijeo Citect specific driver, please consult your Schneider Electric Regional Sales Office.

### Vijeo Citect - Key reprogramming

Any reprogramming of the Vijeo Citect key is subject to order reference

#### VJC 1094 00:

- upgrading the number of Points,
- adding Clients,
- upgrading a Vijeo Citect Lite license to a full Vijeo Citect license,
- exchanging a parallel key for a USB key.

**Note:** If a new key is required, purchase an additional Vijeo Citect key, see page 8/22.

Description	Reference	Weight kg
Vijeo Citect Key reprogramming	<b>VJC 1094 00</b>	–

### Vijeo Citect Support

From the second year of ownership of one or more Vijeo Citect licenses, Vijeo Citect Support enables the user to continue receiving the benefits of full support for the installed base. One of the services included in this offer is the supply of all the latest version updates.

Description	Details	Reference	Weight kg
Support	For Vijeo Citect software and licenses	<b>VJC 1091 01</b>	–
	For Vijeo Citect specific drivers	<b>VJC 1091 01D3</b>	–

### Third-party applications converter

Switch 2 Vijeo Citect is a conversion tool that helps to convert legacy SCADA to Vijeo Citect. It allows the tag database and graphic information to be reproduced inside Vijeo Citect. The conversion rate depends upon the complexity of the application and can vary from 15 % to 80 %.

Description	Details	Reference	Weight kg
Switch 2 Vijeo Citect	Third-party applications converter	<b>VJC 1090 88</b>	–

### Vijeo Citect Loan key

Description	Details	Reference	Weight kg
Vijeo Citect Loan key USB key only (1)	Provides temporary access to a key (2). 8 days continuous usage. The hardware key must be returned at the end of the loan period.	<b>VJC 1095 03</b>	–

(1) Also requires an "additional USB key" **VJC 1099 21**.

(2) The quantity to be ordered equals the number of months of the required loan period.

#### Presentation

The modular Tego Dial system is used to define Human-Machine interfaces. It facilitates the installation of Ø 22, 16 and 30 mm control and signalling units, DIN format display units, Magelis terminals and display units, XBL keypads and other products.

Tego Dial simplifies each stage of an HMI application:

- Definition of the application by Tego Dial Design software
- Quick assembly of control, signalling and display units, through the use of modular elements
- Standard connections from the control and signalling units to PLCs, buses and other products
- Easy integration of the dialogue application into the machine, control panel, enclosure or machine housing, either directly or using suspension arms

#### Description

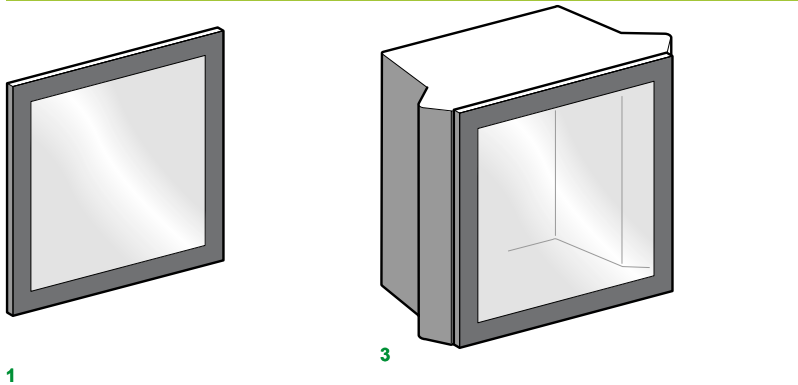

1

3

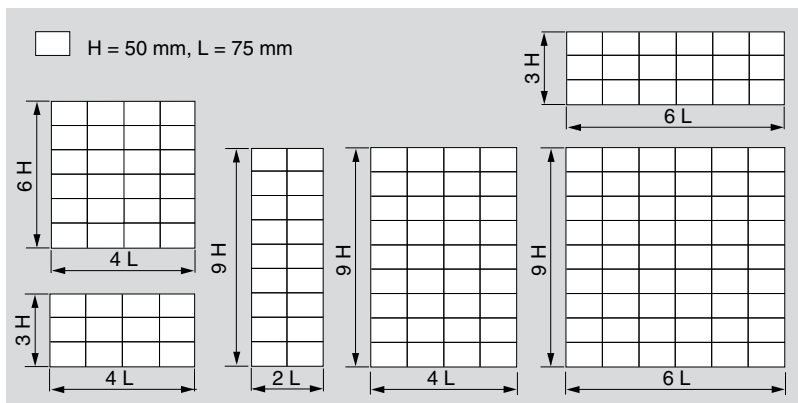

2

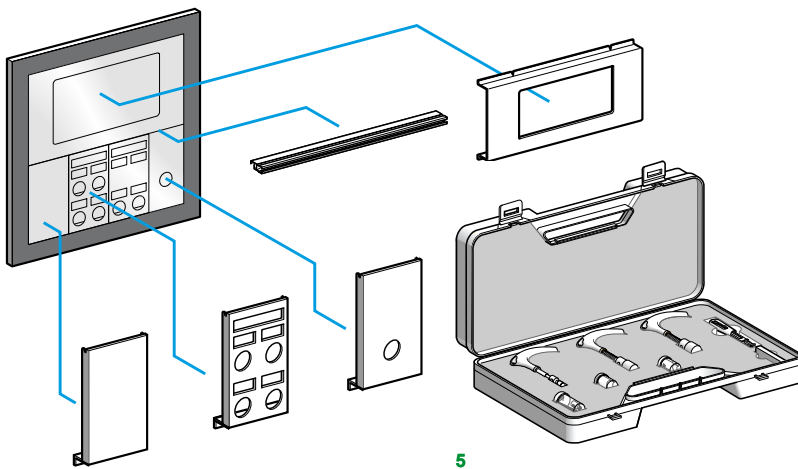

4

5

#### ■ Tego Dial Design definition software

This software on CD-ROM facilitates graphical definition of the dialogue application in relation to the pushbuttons, pilot lights and display units necessary for the device.

It selects the correct Tego Dial components that are required for the application and also features a legend design and printing function, for both the front panel and the connections.

#### ■ Dialboard front panels 1

The front panels basically comprise a grey, RAL 7016, painted aluminium frame which is covered by a polycarbonate film. Six sizes are available 2 based on a modular pattern of height H = 50 mm and width W = 75 mm. The sizes are 3H x 4W, 3H x 6W, 6H x 4W, 9H x 2W, 9H x 4W and 9H x 6W.

#### ■ Dialpack control consoles 3

Four control consoles are available in the following modular sizes: 3H x 4W, 6H x 4W, 9H x 4W and 9H x 6W.

The Dialpack console is an assembly comprising a Dialboard type front panel and a folded and welded sheet steel enclosure, painted in textured grey RAL 7016. The front panel is hinged and can be opened to 120°. Closing is by a 1/4 turn device, with stop and locking by Ronis key n° 455. Double bar or CNOMO triangular key locks are also available. A customizing component in 2 versions - yellow or unpainted - enhances the Dialpak unit and makes it more ergonomic. A Dialpack S version in stainless steel type 304 is available for corrosive environments. This version conforms to enclosure standard EN 50298.

#### ■ Plates and cross-pieces 4

A range of modular dimensioned plates facilitates the installation of all combinations of control and signalling units, operator dialogue terminals and other devices. These plates are attached directly to the framework of the front panel. The plates, made from sheet steel and painted grey RAL 7016, are designed for the following product ranges:

- Ø 22, Ø 16 and Ø 30 control and signalling units,
- DIN format display units,
- operator terminals and displays (Magelis and others),
- keypads,
- other units: joystick controllers, cam switches, etc.

Cross-pieces aid vertical mounting of several rows of plates. Cut-outs in the plates are dimensioned to suit the dialogue or display units that are to be installed. Some plate versions for Ø 22 units are available with knock-outs, which need to be removed before mounting the product. Other versions incorporate cut-outs for clip-in mounting of the transparent polycarbonate legend holders included with the plate. Alternatively, solid plates are also available for mounting any special equipment required.

#### ■ Tool Kit 5

The installation of dialogue and display units requires cut-outs to be made through the polycarbonate film. To simplify this operation, the plate is marked with cut-out guides and a tool kit is available, comprising cutting tools and replacement blades.

#### ■ Pre-assembled kits

Dialboard and Dialpack with pre-assembled plates and crosspieces are available.

#### Standard connections

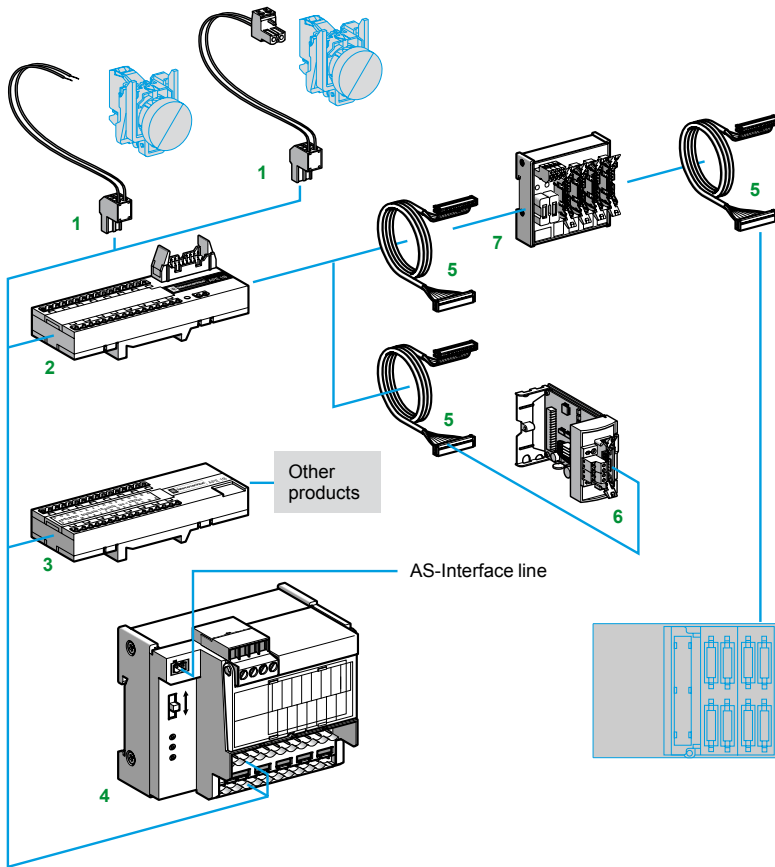

Tego Dial offers a range of interface components and cabling accessories that simplify connection of control and signalling units to PLCs, buses and other products.

This range includes in particular:

- Prefabricated connection cables and self-stripping connectors **1**, on 5 mm pitch, for connecting control and signalling units to Dialbase interfaces
  - Dialbase 8I/8Q or 16I interfaces **2**, with integrated commons, for connecting control and signalling units to PLCs via prefabricated Telefast connection cables **5**
  - An active splitter box **7** for connecting a Dialbase 8I/8Q interface to PLCs with a connection modularity greater than 8I/8Q
  - A Dialbase 230 V interface **3** for connecting control and signalling units to any product up to 230V
  - A Dialbase AS-Interface 4I/4Q module **4**, with integrated commons for connecting control and signalling units to the AS-Interface line
- The selection guide indicates the type and quantity of components (Dialbase interfaces, active splitter box, Telefast connection cables) required to connect the control and signalling units to various types of PLC. The most efficient connection is achieved using the Dialbase 8I/8Q interface and the Schneider-Electric TSX Micro PLC card TSX DMZ16DTK **6**.

#### Dialfix and Dialmove suspension arms

The Dialpack control console can be fitted directly using four adjustable lugs, AE3-FX122. However, for improved ergonomics, it is usually mounted on a suspension arm. This can be either fixed (Dialfix) or moving (Dialmove).

##### Dialfix fixed arms

Two versions are available:

- A straight fixed arm kit, comprising a straight  $\varnothing 70$  mm tube, 500 or 1000 mm in length, and a pair of clamps (one for each end). Depending on which way round the clamps are fitted, an inclination of  $\pm 15^\circ$  from the neutral position can be achieved.
- An elbowed ( $90^\circ$ ) fixed arm kit, 500 mm in length. This kit also includes the pair of clamps described above.

##### Arms for corrosive environments

These arms, in 304 type stainless steel, provide  $350^\circ$  rotation on the Dialpack fixing side. Two versions are available:

- Straight arm kit, length 1000 mm
- an elbowed ( $90^\circ$ ) fixed arm kit, length 500 mm

##### Dialmove moving arms

This arm enables an extensive choice of mounting configurations. The cabling runs through the elements which have removable side covers for easy access.

Various configurations can be achieved by combining the following components:

- Straight tubes (100 to 1000 mm long)
- $90^\circ$  joint
- Wall fixing brackets (straight or elbowed, fixed or mobile)
- Straight fixing plates (one fixed, one rotating) for Dialpack
- $15^\circ$  tilted joints
- Rotating joint allowing  $-90^\circ$  to  $+90^\circ$  rotation in the same plane



### Tego Dial for operator dialogue interfaces

Automation platforms	Tego Dial components
----------------------	----------------------

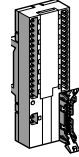
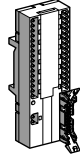

Type	Modularity of connection to the PLC	Compatible I/O modules	Tego Dialbase 8 I/8 Q	Tego Dialbase 16 I
			APE 1B24M	APE 1B24E

#### TSX Micro platform

8 inputs + 8 outputs	TSX DMZ 16DTK	1 dialbase	
16 inputs + 16 outputs	TSX DMZ 64DTK	1 dialbase (1)	
16 inputs	TSX DMZ 64DTK/28DTK		1 dialbase

#### Premium platform

16 inputs + 16 outputs	TSX DEY 16FK/32D2K/64D2K TSX DSY 32T2K/64T2K	1 dialbase (1)	
16 inputs	TSX DEY 16FK/32D2K/64D2K		1 dialbase

#### Quantum platform

32 inputs + 32 outputs	140 DDI 353 00/10, 140 DDI 853 00, 140 DD0 353 00/10	1 dialbase (1)	
32 inputs	140 DDI 353 00/10, 140 DDI 853 00		1 dialbase

(1) To connect a second Dialbase APE 1B24M, use 2 TSX CDP ●●3 cables.

## Connecting components

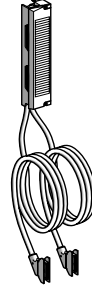
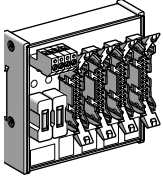

Splitter box with 16 I + 16 Q, available as 2 x (8 I + 8 Q)	Cordsets	Ribbon cables with terminal block
APE 1R1628	TSX CDP ●●3 (2)	ABF M32 H●●0 (3)
	1 cord	
1 splitter box	2 cords	
1 splitter box		
	1 splitter box	2 cords
	2 cords	
1 splitter box	1 cord	2 ribbon cables
		1 ribbon cable

(2) Replace ●● with 05: length 0.5 m, 10: length 1 m, 20: length 2 m, 30: length 3 m, 50: length 5 m, 100: length 10 m.

(3) Replace ●● with 15: length 1.5 m, 30: length 3 m.



## 9.1 - Telefast ABE 7 I/O prewired system

*Advantys Telefast ABE 7 prewired system selection guide ..... 9/2*

- Advantys Telefast ABE 7 pre-wired system ..... 9/8
- Presentation ..... 9/8
- Cordsets for Modicon Quantum platform..... 9/8
- I/O modules for Modicon Quantum platforms and Telefast ABE 7 sub-bases ..... 9/9
- Combinations ..... 9/9
  
- Advantys Telefast ABE 7 pre-wired system ..... 9/10
- References ..... 9/10
- Passive connection sub-bases..... 9/10
- Adaptor sub-bases with soldered relays and plug-in terminal blocks ..... 9/13
- Input/output adaptor sub-bases for or with plug-in relays ..... 9/13
- Output adaptor sub-bases for plug-in relays ..... 9/14
- Plug-in relays ..... 9/15
  
- Advantys Telefast ABE 7 pre-wired system ..... 9/16
- References ..... 9/16
- Connection sub-bases and cabled connectors for Modicon Quantum I/O modules ..... 9/16
  
- Advantys Telefast ABE 7 pre-wired system ..... 9/18
- Dimensions ..... 9/18

## 9.2 - Phaseo DC process power supplies

*Power supplies for DC control circuits selection guide ..... 9/20*

*Power supplies for DC control circuits selection guide ..... 9/22*

- Power supplies for DC control circuits ..... 9/24
- Presentation ..... 9/24
- Universal range of Phaseo regulated switch mode power supplies ..... 9/24
- Description ..... 9/25
- Characteristics ..... 9/26
- Output characteristics ..... 9/28
- Options, schemes ..... 9/30
- References ..... 9/31
- Dimensions, internal schemes ..... 9/32
- Connections ..... 9/33



# Modicon Quantum automation platform

Advantys Telefast ABE 7 pre-wired system  
Discrete input and/or output sub-bases

Applications	Discrete inputs or outputs		
	Optimum "low-cost"	Optimum "miniature"	Universal

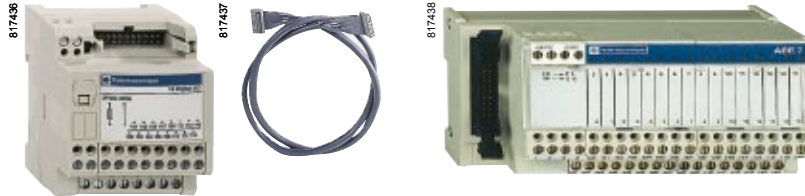

<b>Sub-base type</b>	Passive connection sub-bases			
<b>Equipped with relay</b>	-			
<b>Control voltage</b>	24V ~			
<b>Output voltage</b>	24V ~			
<b>Output current per channel</b>	0.5 A			
<b>Modularity</b>	16		8-12-16	
<b>No. of terminals per channel</b>	1	1 to 3	1	2
<b>Type of connection terminals</b>	Signal	Signal, common (configurable as 24 V or 0 V ~)	Signal	Signal, common (configurable as 24 V or 0 V ~)
<b>Connectors</b>	20-way HE10 connector			
<b>Terminal block</b>	No Screw		No Screw or spring	
<b>Additional or optional* function</b>	Low-cost version fitted with cable (1)	Miniature sub-bases	Compact size *	Input type 2 * (2)
<b>Device type</b>	<b>ABE 7H20E●00</b>	<b>ABE 7H16C●●</b>	<b>ABE 7H●●R1●</b> <b>ABE 7H●●R50</b>	<b>ABE 7H●●R2●</b> <b>ABE 7H●●S21</b>
<b>Pages</b>	9/10		9/11	

(1) Optimum "low-cost" **ABE 7H20E●00** sub-bases are not compatible with Modicon M340 PLCs.  
(2) For Modicon TSX Micro and Modicon Premium PLCs.

**Discrete inputs and outputs**

**Optimum "miniature"**

**Optimum**



Passive connection sub-bases		Plug-in electromechanical or solid state	
-		No	Yes
24V $\overline{\text{---}}$			
24V $\overline{\text{---}}$		24V $\overline{\text{---}}$ (solid state) 5... 24V $\overline{\text{---}}$ , 230 V $\sim$ (electromechanical)	
0.5 A	0.5 A	5 A (E.M.), 2 A (solid state)	5 A (th)
16		16 8 passive inputs 8 relay outputs	
1	2	1	
Signal, 2 common connections between the inputs and the outputs.	Signal, common, 2 common connections between the inputs and the outputs.	1 N/O contact and common, 4 output channels 2 input connection points	
20-way HE10 connectors			
No			
Screw			
Miniature sub-base Synergy with Tego Power and Micro PLC		Miniature sub-base - Common per 4 channels Synergy with Tego Power and Micro PLC	
<b>ABE 7H16CM11</b>	<b>ABE 7H16CM21</b>	<b>ABE 7P16M111</b>	<b>ABE 7R16M111</b>
9/10		9/14	9/13

# Modicon Quantum automation platform

## Advantys Telefast ABE 7 pre-wired system

### Discrete input and output sub-bases

<b>Applications</b>	<b>Discrete outputs</b>					
	<b>Optimum</b>		<b>Universal</b>	<b>Optimum</b>		<b>Universal</b>
						
<b>Relay sub-base</b>	Electromechanical, fixed			Electromechanical or solid state		
<b>Equipped with relay</b>	Yes			Yes	No	No
<b>Control voltage</b>	24 V $\overline{\text{DC}}$					
<b>Output voltage</b>	5 V... 30 V $\overline{\text{DC}}$ 230 V $\sim$		5 V... 150 V $\overline{\text{DC}}$ 230 V $\sim$	24 V $\overline{\text{DC}}$ (solid state) 5 V... 24 V $\overline{\text{DC}}$ , 230 V $\sim$ (E.M.)		5 V... 150 V $\overline{\text{DC}}$ 230 V $\sim$
<b>Output current per channel</b>	2 A (th)	3 A (th)	5 A (th)	2 A (solid state) 6 A (electromechanical)		Depends on relay mounted 0.5 to 10 A
<b>Modularity</b>	8	8 - 16		16	8 or 16	
<b>No. of terminals per channel</b>	2	1	2	1	2 to 3	
<b>Type of connection terminals</b>	1 N/O contact and common Volt-free	1 N/O contact	1 N/O contact and common	1 N/O contact	Signal, Polarities	
<b>Connectors</b>	20-way HE 10 connector					
<b>Terminal block</b>	<b>Removable</b>	Yes	Yes	Yes	No	No
	<b>Type of terminals</b>	Screw or spring			Screw	
<b>Additional or optional* function</b>	Miniature sub-base Latching relay	Volt-free or common per 8 channels		Miniature sub-bases Common per 4 channels		Isolator and fuse
<b>Device type</b>	<b>ABE 7R08S216●</b>	<b>ABE 7R●●S1●●</b>	<b>ABE 7R●●S2●●</b>	<b>ABE 7R16T111</b>	<b>ABE 7P16T111</b>	<b>ABE 7P16T2●●●</b> <b>ABE 7P08T3●●●</b>
<b>Pages</b>	9/12			9/13	9/14	

(1) For TSX Micro and Premium PLCs

<b>Discrete outputs</b>	<b>Discrete inputs</b>
<b>Universal</b>	<b>Universal</b>

817499



Electromechanical, plug-in		Solid state, fixed		Solid state, fixed		Solid state, plug-in	
Yes		Yes		Yes		No	
24 V $\overline{\text{DC}}$				From 24 V $\overline{\text{DC}}$ to 230 V $\sim$		From 5 V TTL to 230 V $\sim$	
5 V... 150 V $\overline{\text{DC}}$ 230 V $\sim$		24 V $\overline{\text{DC}}$					
5A (th)	8 A (th)	0.5 to 2 A	125 mA	0.5 A	125 mA	12 mA	
16							
2 to 3	2 to 6	2		3	2		
1 C/O contact or 1 N/O contact and common	1 C/O contact or 2 C/O contacts and common	Signal and 0 V		24 V $\overline{\text{DC}}$ signal and 0 V	Signal can be isolated, Protected common	Signal	Signal and common
20-way HE 10 connector							
No		Yes	No	No	Yes	No	
Screw		Screw or spring		Screw	Screw or spring		
Volt-free or common per:		Fault signal	Isolator and fuse (indicator)	3-wire proximity sensor	Isolator and fuse (indicator)	-	
8 channels	4 channels						
<b>ABE 7R16T2●●</b>	<b>ABE 7R16T3●●</b>	<b>ABE 7S●●S2B●</b>	<b>ABE 7H16F43</b>	<b>ABE 7H16R3●</b>	<b>ABE 7H16S43</b>	<b>ABE 7S16E2●●</b>	<b>ABE 7P16F31</b>
9/13		9/12	9/11		9/12		9/15

# Modicon Quantum automation platform

Advantys Telefast ABE 7 pre-wired system  
Analog and application-specific sub-bases

**Applications**

**Analog signals and special functions**



<b>Combination</b>	TSX Micro	Premium	Standard	Standard	Modicon M340 BMX ART 0414/0814 BMX ART AMI 0410
<b>Type of signal</b>	Counter inputs and analog I/O	Counter inputs Axis control Position control	Analog inputs Current/Voltage Pt 100	Analog outputs Current Voltage	Analog inputs
<b>Functions</b>	Passive connection, point-to-point with shield continuity				Connection of cold junction compensation or supply and distribution of isolated power supplies
<b>Modularity</b>	1 counter channel or 8 analog inputs + 2 analog outputs		8 channels	4 channels	4 channels
<b>Control voltage</b>	24 V $\overline{\text{---}}$				–
<b>Output voltage</b>	24 V $\overline{\text{---}}$				–
<b>Output current per channel</b>	25 mA				–
<b>No. of terminals per channel</b>	2		2 or 4	2 or 4	2 or 4
<b>Connector type</b>	15-way SUB-D + 9-way SUB-D		25-way SUB-D		25-way SUB-D
<b>Terminal block</b>	Removable Type of terminals		No Screw	No Screw	No Screw
<b>Device type</b>	<b>ABE 7CPA01</b>		<b>ABE 7CPA02</b>	<b>ABE 7CPA21</b>	<b>ABE 7CPA412/410</b>
<b>Pages</b>					

## Analog signals and special functions



Standard	Premium TSXAEY810	Premium TSX CAY●1 TSX CTY2C	Premium TSXAEY1614	Premium TSX PAY2●2
Analog inputs Current Voltage Pt 100	Isolated analog inputs	Inputs Upcounting	Inputs for thermocouples	Inputs/outputs
Distribution of sensor power supplies by limiter (25 mA)	Distribution of isolated sensor power supplies by converter	Acquisition of value from an absolute encoder	Connection of 16 thermocouples with cold junction compensation	Safety module (BG)
8 channels	8 channels	1 channel	16 channels	12 Emergency stops
24 V $\overline{\text{---}}$				
24 V $\overline{\text{---}}$ ⚡				
25 mA				–
2 or 4		–	2 or 4	1
25-way SUB-D	25-way SUB-D	15-way SUB-D	25-way SUB-D	50-way SUB-D
No	No	No	No	No
Screw	Screw or spring	Screw	Screw	Screw
<b>ABE 7CPA03</b>	<b>ABE 7CPA31●</b>	<b>ABE 7CPA11</b>	<b>ABE 7CPA12</b>	<b>ABE 7CPA13</b>

# Modicon Quantum automation platform

Advantys Telefast ABE 7 pre-wired system  
Cordsets for Modicon Quantum platform

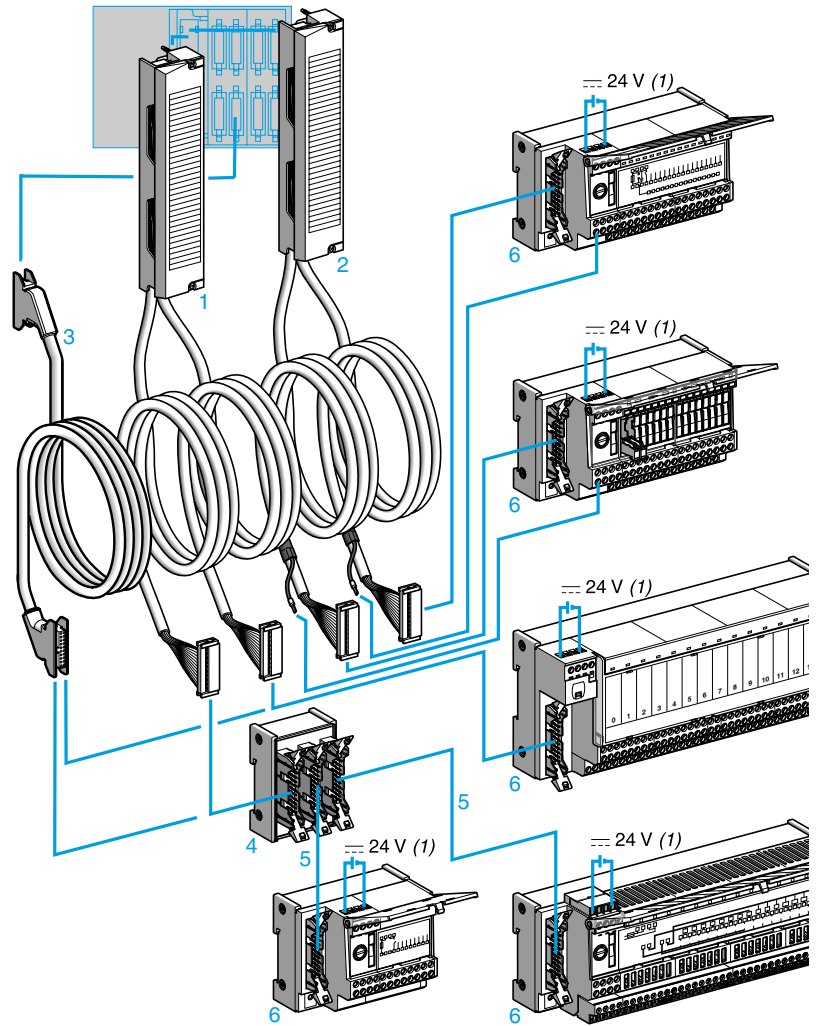

- 1-2 Cabled connectors combining a standard terminal block, two multicore (AWG 2) cables and two 20-way HE 10 connectors. Two types of cabled connector are available:
  - **ABF M32H●●0 1** cabled connectors for I/O modules (32 channels) on the Modicon Quantum platform, with 2 HE 10 connectors each integrating 16 channels.
  - **ABF M32H●●1 2** cabled connectors for I/O modules (32 channels) on the Modicon Quantum platform, with 2 HE 10 connectors each integrating 16 channels and an external power supply with a direct connection to the terminal marked (1) on the sub-bases 6.
- ABF M0●S20●** cabled connectors for analog I/O modules (4, 8 or 16 channels) on the Modicon Quantum platform equipped with a standard screw terminal block and a 25-way SUB-D connector at the other end.
- 3 Cordsets (AWG 22) equipped with a 20-way HE 10 connector **TSX CDP 053/●03** for 96-channel I/O modules (connected on six 20-way HE 10 connectors).
- 4 **ABE 7ACC02** splitter box (16 to 2 x 8 channels) for use with 8-channel sub-bases.
- 5 A single type of cable equipped with 20-way HE 10 connectors, irrespective of the 8 or 16-channel modularity. The HE 10 connectors can be moulded **TSX CDP●●●** or insulation piercing **ABF H20H●●●**.
- 6 8 and 16-channel connection sub-bases from the Advantys Telefast ABE 7 range.

(1) The 24 V  $\overline{\text{---}}$  power supply of Quantum I/O modules must only be connected via Telefast ABE 7 sub-bases. The 0 V  $\overline{\text{---}}$  connections must be equipotential.

# Modicon Quantum automation platform

Advantys Telefast ABE 7 pre-wired system  
I/O modules for Modicon Quantum platforms and Telefast ABE 7 sub-bases

Quantum I/O modules		24 V $\overline{DC}$ discrete I/O				Analog I/O				
		Inputs	Outputs	Inputs	Outputs	Inputs		Outputs		
		32 I	32 Q	96 I	96 Q	8 I	16 I	4 Q	8 Q	
140	DDI 353 00 DDI 853 00	DDO 353 00		DDI 364 00	DDO 364 00	AVI 030 00 ACI 030 00	ACI 040 00	AVO 020 00	AVO 020 00	ACO 130 00
Cabled connectors	ABF	M32 H●●0	M32 H●●1	-		M08 S201	M16 S201	M04 S200	M04 S201	M08 S202
Cordsets	TSX	-		CDP 053/●03		-				
Passive sub-bases										
8 channels	ABE 7H08R●●	(1)		(1)						
	ABE 7H08S21			(1)						
16 channels	ABE 7H16R●●/H16C●●									
	ABE 7H16S21									
	ABE 7H16R23	(2)								
	ABE 7H16F43									
	ABE 7H16S43	(3)								
Input adaptor sub-bases										
16 channels	ABE 7S16E2B1●/7P16F31●●									
	ABE 7P08T330		(1)							
Output adaptor sub-bases										
8 channels	ABE 7S08S2●●				(1)					
	ABE 7R08S●●●/7P08T330	(1)			(1)					
16 channels	ABE 7R16S●●●									
	ABE 7R16T●●●/7P16T●●●									
	ABE 7S16S●●●									
Sub-bases for analog I/O										
4 channels	ABE 7CPA21									
8 channels	ABE 7CPA02						(4)			
	ABE 7CPA03						(4)			
	ABE 7CPA31						(4)			

ABF M●● cabled connectors  
TSX CDP ●●● cordsets

(1) With the ABE 7ACC02 splitter sub-base (16 channels as 2 x 8).  
 (2) With the 170 DDI 353 00 module only.  
 (3) With the 170 DDI 853 00 module only.  
 (4) 2 ABE 7CPA●● sub-bases are required.



# Modicon Quantum automation platform

## Advantys Telefast ABE 7 pre-wired system

### Passive connection sub-bases

#### Passive connection sub-bases for discrete signals

Optimum "low-cost" sub-bases								
Function	No. of channels	No. of terminals per on row channel number		For PLCs	Length of PLC connection cable	Type of connection	Reference	Weight kg
Input or output	16	1	2	Modicon TSX Micro	1 m	Screw	<b>ABE 7H20E100</b>	0.330
				Modicon Premium (1)	2 m	Screw	<b>ABE 7H20E200</b>	0.410
					3 m	Screw	<b>ABE 7H20E300</b>	0.480
				Siemens S7	1.5 m	Screw	<b>ABE 7H32E150</b>	0.360
					3 m	Screw	<b>ABE 7H32E300</b>	0.460



816460



816461

ABE 7H20E●●●

Optimum "miniature" sub-bases								
Function	No. of channels	No. of terminals per on row channel number		LED per channel	Polarity distribution	Type of connection	Reference	Weight kg
Input or output	16	1	1	No	No	Screw	<b>ABE 7H16C10</b>	0.160
				Yes	No	Screw	<b>ABE 7H16C11</b>	0.160
					0 or 24 V	Screw	<b>ABE 7H16C21</b>	0.205
					0 or 24 V	Screw	<b>ABE 7H16C31</b>	0.260
Input and output (2)	16	1	1	Yes	No	Screw	<b>ABE 7H16CM11</b>	0.160
				Yes	0 or 24 V	Screw	<b>ABE 7H16CM21</b>	0.200



816463

ABE 7H16C21



816462

ABE 7H16CM21

(1) Optimum "low-cost" ABE 7H20E●●● sub-bases are not compatible with Modicon M340 PLCs.

(2) 8 I + 8 Q: these products have 2 common connections which enable inputs and outputs to be connected to the same sub-base at the same time.

# Modicon Quantum automation platform

## Advantys Telefast ABE 7 pre-wired system

### Passive connection sub-bases

816464  
ABE 7H16R50816465  
ABE 7H16R31

#### Passive connection sub-bases for discrete signals (continued)

##### Universal sub-bases

Function	No. of channels	No. of terminals per channel	No. of terminals on row number	LED per channel	Polarity distribution	Isolator (I) Fuse (F) per channel	Type of perconnection	Reference	Weight kg	
Input or output	8	1	1	No	No	–	Screw	ABE 7H08R10	0.187	
				Yes	No	–	Screw	ABE 7H08R11	0.187	
		2	2	Yes	0 or 24 V	–	Screw	ABE 7H08R21	0.218	
						I	Screw	ABE 7H08S21	0.245	
		12	1	1	No	No	–	Screw	ABE 7H12R10	0.274
					Yes	No	–	Screw	ABE 7H12R11	0.274
	2		2	No	No	–	Screw	ABE 7H12R50	0.196	
				Yes	0 or 24 V	–	Screw	ABE 7H12R20	0.300	
	2		2	No	0 or 24 V	–	Screw	ABE 7H12R21	0.300	
						I	Screw	ABE 7H12S21	0.375	
	16	1	1	No	No	–	Screw	ABE 7H16R10	0.274	
				Yes	No	–	Screw	ABE 7H16R11	0.274	
2			2	No	No	–	Screw	ABE 7H16R50	0.196	
						Spring	ABE 7H16R50E	0.196		
2			2	No	0 or 24 V	–	Screw	ABE 7H16R20	0.300	
				Yes	0 or 24 V	–	Screw	ABE 7H16R21	0.300	
2		2	No	0 or 24 V	–	Spring	ABE 7H16R21E	0.300		
					I	Screw	ABE 7H16S21	0.375		
							Spring	ABE 7H16S21E	0.375	
3		3	No	0 or 24 V	–	Screw	ABE 7H16R30	0.346		
			Yes	0 or 24 V	–	Screw	ABE 7H16R31	0.346		
Input type 2 (1)	16	2	2	Yes	0 or 24 V	–	Screw	ABE 7H16R23	0.320	
Input	16	2	1	Yes	24 V	I, F (2)	Screw	ABE 7H16S43	0.640	
Output	16	2	1	Yes	0 V	I, F (2)	Screw	ABE 7H16F43	0.640	

(1) For TSX Micro, Premium

(2) With LED to indicate blown fuse.

# Modicon Quantum automation platform

Advantys Telefast ABE 7 pre-wired system  
Adaptor sub-bases with soldered relays and plug-in terminal blocks

## Adaptor sub-bases with soldered relays, plug-in terminal blocks

### Universal input sub-bases with solid state relays

Number of channels	No. of terminals per channel	Isolation PLC/ Operative part	Voltage	Type of connection	Reference	Weight kg
16	2	Yes	24 V $\overline{\text{---}}$	Screw	ABE 7S16E2B1	0.370
				Spring	ABE 7S16E2B1E	0.370
			4 V $\overline{\text{---}}$	Screw	ABE 7S16E2E1	0.370
				Spring	ABE 7S16E2E1E	0.370
			48 V $\sim$	Screw	ABE 7S16E2E0	0.386
				Spring	ABE 7S16E2E0E	0.386
			110 V $\sim$	Screw	ABE 7S16E2F0	0.397
				Spring	ABE 7S16E2F0E	0.397
			230 V $\sim$	Screw	ABE 7S16E2M0	0.407
				Spring	ABE 7S16E2M0E	0.407

### Universal output sub-bases with solid state relays

Number of channels	Isolation PLC/ Operative part	Output voltage	Output current	Fault detection signal (1)	Type of connection	Reference	Weight kg
8	No	24 V $\overline{\text{---}}$	0.5 A	Yes (2)	Screw	ABE 7S08S2B0	0.252
					Spring	ABE 7S08S2B0E	0.252
			2 A	Yes (2)	Screw	ABE 7S08S2B1	0.448
					Spring	ABE 7S08S2B1E	0.448
16	No	24 V $\overline{\text{---}}$	0.5 A	Yes (2)	Screw	ABE 7S16S2B0	0.405
					Spring	ABE 7S16S2B0E	0.405
			No		Screw	ABE 7S16S1B2	0.400
					Spring	ABE 7S16S1B2E	0.400

### Optimum and Universal output sub-bases with electromechanical relays

Number of channels	Relay width	Number of contacts	Output current	Polarity distribution/ operative part	Type of connection	Reference	Weight kg
8	5 mm	1 N/O	2 A	Contact common per group of 4 channels	Screw	ABE 7R08S111	0.252
					Spring	ABE 7R08S111E	0.252
		Latching	2 A	Volt-free	Screw	ABE 7R08S216	0.448
	Spring				ABE 7R08S216E	0.448	
	10 mm	1 N/O	5 A	Volt-free	Screw	ABE 7R08S210	0.448
					Spring	ABE 7R08S210E	0.448
16	5 mm	1 N/O	2 A	Contact common per group of 8 channels	Screw	ABE 7R16S111	0.405
					Spring	ABE 7R16S111E	0.405
		10 mm	1 N/O	5 A	Volt-free	Screw	ABE 7R16S210
	Spring					ABE 7R16S210E	0.405
	Common per group of 8 channels on both poles				Screw	ABE 7R16S212	0.400
					Spring	ABE 7R16S212E	0.400



ABE 7R08S216

(1) A fault on a sub-base output Qn will set PLC output Qn to safety mode, which will be detected by the PLC.

(2) Can only be used with modules with protected outputs.

# Modicon Quantum automation platform

## Advantys Telefast ABE 7 pre-wired system

### Input/output adaptor sub-bases for or with plug-in relays

#### Adaptor sub-bases with plug-in terminal blocks <sup>(1)</sup>

##### Universal input sub-bases for solid state relays

Number of channels	No. of terminals per channel	For relay type	Isolation PLC/Operative part	Input connection	Type of connection	Reference	Weight kg
16	2	ABS 7E	Yes	Volt-free	Screw	<b>ABE 7P16F310</b>	0.850
		ABR 7			Spring	<b>ABE 7P16F310E</b>	0.850
		ABS 7S33E			Polarity distribution	Screw	<b>ABE 7P16F312</b>

##### Optimum and Universal output sub-bases with electromechanical relays <sup>(2)</sup>

Number of channels	Relay width	For relay type	Number and type of contacts	Polarity distribution/operative part	Reference	Weight kg	
16	5 mm	ABR 7S11	1 N/O	Contact common per group of 4 channels	<b>ABE 7R16T111</b>	0.600	
				Contact common per group of 4 output channels + 2 common input terminals	<b>ABE 7R16M111</b> (3)	0.600	
	10 mm	ABR 7S21	1 N/O	Volt-free	Common on both poles (4)	<b>ABE 7R16T210</b>	0.735
						<b>ABE 7R16T212</b>	0.730
			ABR 7S23	1 C/O	Volt-free	<b>ABE 7R16T230</b>	0.775
					Contact common (4)	<b>ABE 7R16T231</b>	0.730
	12 mm	ABR 7S33	1 C/O	Volt-free	Common on both poles (5)	<b>ABE 7R16T330</b>	1.300
						<b>ABE 7R16T332</b>	1.200
			ABR 7S37	2 C/O	Volt-free	<b>ABE 7R16T370</b>	1.300



816471  
**ABE 7R16M111**



522345  
**ABE 7R16T210**

(1) Not equipped with relays.

(2) Both technologies (electromechanical and solid state) can be combined on the same sub-base.

(3) 2 connection methods are available, enabling inputs and outputs to be connected to the same sub-base at the same time.

(4) Per group of 8 channels.

(5) Per group of 4 channels.

# Modicon Quantum automation platform

## Advantys Telefast ABE 7 pre-wired system

### Output adaptor sub-bases for plug-in relays

Output adaptor sub-bases for plug-in relays												
Optimum and Universal output sub-bases for solid state relays and/or electromechanical relays (1)												
No. of channels	Relay width	For relay type	Isolator per channel	Fuse per channel	Polarity distribution/operative part	Type of connection	Reference	Weight				
mm								kg				
16	5 mm	ABR 7S11 ABS 7SC1B	No	No	Contact common per group of 4 channels		ABE 7P16T111	0.550				
							Contact common per group of 4 output channels and 2 common input terminals	ABE 7P16M111 (2)	0.550			
16	10 mm	ABR 7S2● ABS 7SA2● ABS 7SC2● ABE 7ACC20	No	No	Volt-free	Screw	ABE 7P16T210 (3)	0.615				
							ABE 7P16T230 (3)	0.655				
						Spring	ABE 7P16T230E (3)	0.655				
							Yes	Volt-free	Screw	ABE 7P16T214	0.675	
						No	Common on both poles (4)	Screw	ABE 7P16T212	0.615		
Yes	Common on both poles (4)	Screw	ABE 7P16T215	0.670								
8	12 mm	ABR 7S33 ABS 7A3● ABS 7SC3●● ABE 7ACC21	No	No	Volt-free	Screw	ABE 7P08T330	0.450				
						Spring	ABE 7P08T330E	0.450				
16	12 mm	ABR 7S33 ABS 7A3● ABS 7SC3●● ABE 7ACC21	No	No	Volt-free	Screw	ABE 7P16T330	0.900				
						Spring	ABE 7P16T330E	0.900				
						Common on both poles (5)	Screw	ABE 7P16T332	0.900			
						ABR 7S33 ABS 7A3M ABS 7SC3E ABE 7ACC21	No	Yes	Volt-free	Screw	ABE 7P16T334	0.900
						Yes	Yes	Common on both poles (5)	Screw	ABE 7P16T318	1.000	
				Spring	ABE 7P16T318E	1.000						



ABE 7P16T210

(1) Not equipped with relays.  
 (2) 2 connection methods are available, enabling inputs and outputs to be connected to the same sub-base at the same time.  
 (3) With relay ABR 7S21 for sub-base ABE 7P16T210, with relay ABR 7S23 for sub-base ABE 7P16T230●.  
 (4) Per group of 8 channels.  
 (5) Per group of 4 channels.

# Modicon Quantum automation platform

## Advantys Telefast ABE 7 pre-wired system

### Plug-in relays



Plug-in solid state relays								
Relay width	Functions	Input circuit		Output circuit		Unit reference	Weight	
		Current	Nominal voltage	Current	Nominal voltage			
5 mm	Output	---	24 V	2 A	24 V ---	<b>Sold in lots of 4</b> ABS 7SC1B	kg 0.010	
10 mm	Output	---	24 V	0.5 A	5...48 V ---	ABS 7SC2E	0.016	
					24...240 V ~	ABS 7SA2M	0.016	
12 mm	Input	---	5 V TTL	–	24 V ---	ABS 7EC3AL	0.014	
			24 V Type 2	–	24 V ---	ABS 7EC3B2	0.014	
			48 V Type 2	–	24 V ---	ABS 7EC3E2	0.014	
			50 Hz ~	48 V	–	24 V ---	ABS 7EA3E5	0.014
			60 Hz ~	110...130 V	–	24 V ---	ABS 7EA3F5	0.014
			50 Hz ~	230...240 V	–	24 V ---	ABS 7EA3M5	0.014
	Output	---	24 V	2 A Self-protected	24 V ---	ABS 7SC3BA	0.016	
			1.5 A	5...48 V ---	ABS 7SC3E	0.016		
				1.5 A	24...240 V ~	ABS 7SA3MA	0.016	



Plug-in electromechanical relays							
Relay width	Control voltage	Output current (1)	Number of contacts	Sold in lots of	Unit reference	Weight kg	
5 mm	24 V ---	5 A (lth)	1 N/O	4	ABR 7S11	0.005	
10 mm	24 V ---	5 A (lth)	1 N/O	4	ABR 7S21	0.008	
			1 C/O	4	ABR 7S23	0.008	
12 mm	2 V ---	10 A (lth)	1 C/O	4	ABR 7S33	0.017	
			8 A (lth)	2 C/O	4	ABR 7S37	0.017
			48 V ---	8 A (lth)	1 C/O	4	ABR 7S33E

Accessory		
Description	Reference	Weight kg
Extractor for 5 mm miniature relay	ABE 7ACC12	0.010

# Modicon Quantum automation platform

Advantys Telefast ABE 7 pre-wired system  
Connection sub-bases and cabled connectors for Modicon Quantum I/O modules



ABE 7CPA02

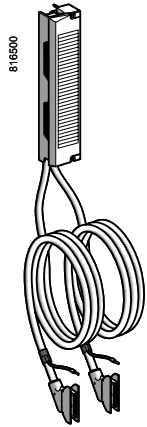

ABF M32H001

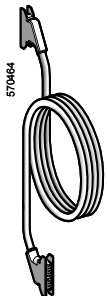

TSX CDP003

## Connection sub-bases for Modicon Quantum analog modules

Functions	For PLCs	Compatible modules	Type of connection on Telefast end	Type of connection	Reference	Weight kg
Passive distribution of 8 channels on screw terminals with shielding continuity	Quantum	140 AVI 030 00 140 ACI 030 00 140 ACI 040 00 140 ACO 130 00	25-way SUB-D	Screw	<b>ABE 7CPA02</b>	0.290
Distribution of 4 analog output channels	Quantum	140 AVO 020 00 140 ACO 020 00	25-way SUB-D	Screw	<b>ABE 7CPA21</b>	0.210
Distribution and supply of 8 analog channels with limitation of each current loop	Quantum	140 AVI 030 00 140 ACI 030 00 140 ACI 040 00	25-way SUB-D	Screw	<b>ABE 7CPA03</b>	0.330
Distribution and supply of 8 analog input channels isolated from one another with 25 mA/channel limiter	Quantum	140 AVI 030 00 140 ACI 030 00 140 ACI 040 00	25-way SUB-D	Screw	<b>ABE 7CPA31</b>	0.410
				Spring	<b>ABE 7CPA31E</b>	0.410

## Cabled connectors for Modicon Quantum I/O modules

Type of signal	I/O modules	Type of connector	Gauge	Cross-section	Length	No. of channels	Reference	Weight kg	
			AWG	mm <sup>2</sup>					
Inputs and relay outputs	See page 9/9	2 x 20-way HE 10	22	0.324	1.5	2 x 16	<b>ABF M32H150</b>	0.650	
						3	2 x 16	<b>ABF M32H300</b>	1.150
0.5 A outputs	See page 9/9	2 x 20-way HE 10 + external power supply	22	0.324	1.5	2 x 16	<b>ABF M32H151</b>	0.650	
						3	2 x 16	<b>ABF M32H301</b>	1.150
Inputs or outputs (96 channels)	140 DDI 364 00 140 DDO 364 00	2 x 20-way HE 10	22	0.324	0.5	6 x 16	<b>TSX CDP 053</b>	0.085	
						1	6 x 16	<b>TSX CDP 103</b>	0.150
						2	6 x 16	<b>TSX CDP 203</b>	0.280
						3	6 x 16	<b>TSX CDP 303</b>	0.410
						5	6 x 16	<b>TSX CDP 503</b>	0.670
Analog inputs	140 AVI 030 00 140 ACI 030 00	1 x 25-way SUB-D	24	0.22	2	8	<b>ABF M08S201</b>	0.600	
	140 ACI 040 00	2 x 25-way SUB-D	24	0.22	2	16	<b>ABF M16S201</b>	0.620	
Analog outputs	140 AVO 020 00	1 x 25-way SUB-D	24	0.22	2	4	<b>ABF M04S200</b>	0.450	
	140 ACO 020 00	1 x 25-way SUB-D	24	0.22	2	4	<b>ABF M04S201</b>	0.450	
	140 ACO 130 00	1 x 25-way SUB-D	24	0.22	2	8	<b>ABF M04S202</b>	0.450	

# Modicon Quantum automation platform

Advantys Telefast ABE 7 pre-wired system  
Connection sub-bases and cabled connectors for  
Modicon Quantum I/O modules

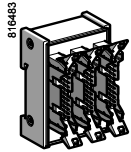

ABE 7ACC02

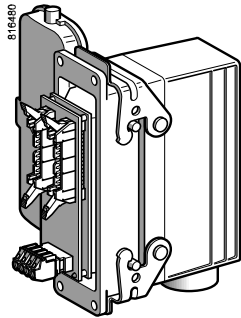

ABE 7ACC80 + ABE 7ACC81

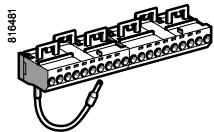

ABE 7BV20

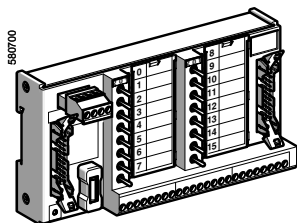

ABE 7TES160

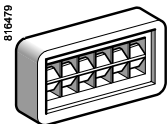

AR1 SB3

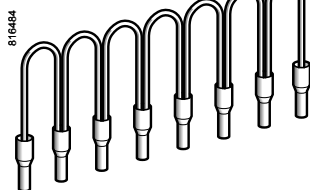

ABE C08R...

Software				
Description	Operating system	Reference	Weight kg	
Software for customer label marking	In Windows version 3.1 or 95	ABE 7LOGV10	0.350	
Pack of 25 pre-cut label sheets (160 labels)	-	ABE 7LOGF25	0.200	

Accessories					
Description	No. of channels	Characteristics	Sold in lots of	Unit reference	Weight kg
Kit for fixing on solid plate	-	-	10	ABE 7ACC01	0.008
Splitter sub-base	-	16 as 2 x 8 channels	1	ABE 7ACC02	0.075
Redundant output sub-base	-	16 as 2 x 16 channels	1	ABE 7ACC10	0.075
Redundant input sub-base	-	16 as 2 x 16 channels	1	ABE 7ACC11	0.075
Plug-in continuity blocks	-	Width 10 mm	4	ABE 7ACC20	0.007
		Width 12 mm	4	ABE 7ACC21	0.010
Locating device for removable terminal block	-	-	100	ABE 7ACC30	0.100
Enclosure feedthrough with industrial connector	32	40-way	1	ABE 7ACC80	0.300
Plug-in 40-way male connector	32	For mounting on ABE 7ACC80	1	ABE 7ACC81	0.370
Enclosure feedthrough with CNOMO M23 connector (1 x 20-way HE 10 connector, PLC end)	8 and 12	19-way	1	ABE 7ACC82	0.150
		19-way	1	ABE 7ACC83	0.150
Impedance adaptor for Type 2 compatibility	-	Used with ABE 7ACC82 and ABE 7ACC83	1	ABE 7ACC85	0.012
IP 65 cable gland	-	For 3 cables	5	ABE 7ACC84	0.300
		10 screw terminals 10 spring terminals	5 5	ABE 7BV10 ABE 7BV10E	0.030 0.030
Additional snap-on terminal blocks (shunted terminals)	16	20 screw terminals 20 spring terminals	5 5	ABE 7BV20 ABE 7BV20E	0.060 0.060
		I/O simulator sub-base	16	Display, forcing inhibition, continuity	1
Self-adhesive marker tag holder	-	For 6 characters	50	AR1 SB3	0.001
Quick-blow fuses 5 x 20, 250 V, UL	-	0.125 A	10	ABE 7FU012	0.010
		0.5 A	10	ABE 7FU050	0.010
		1 A	10	ABE 7FU100	0.010
		2 A	10	ABE 7FU200	0.010
		4 A	10	ABE 7FU400	0.010
		6.3 A	10	ABE 7FU630	0.010

Commoning link accessories					
Description	For common	Colour	Distance between cable ends	Reference	Weight kg
Commoning links Modularity 8 x 1 mm <sup>2</sup>	Coil	White	12	ABF C08R12W	0.020
			2	ABF C08R02W	0.010
	~	Red	12	ABF C08R12R	0.020
			2	ABF C08R02R	0.010
	---	Blue	12	ABF C08R12B	0.020
			2	ABF C08R02B	0.010

Dimensions:  
pages 9/18 and 9/19



# Modicon Quantum automation platform

## Advantys Telefast ABE 7 pre-wired system

Common side view

ABE 7H20E●●●  
ABE 7H32E●●●

ABE 7H16C●●/ABE 7H16CM●●,  
ABE 7●16M111/ABE 7●16T111

ABE 7H16R50, ABE 7H12R50,  
ABE 7H08R1●, ABE 7H08R21,  
ABE 7R08S111/S111E,  
ABE 7H08S21, ABE 7CPA21/40/412

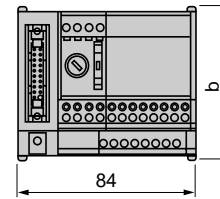
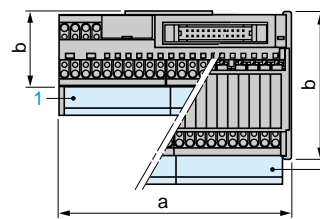
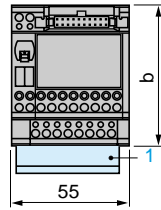
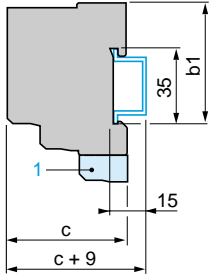

ABE	7H20E/7H32E●●●
b	67
b1	56
c	59

ABE	7H16C●●, 7●16M111, 7H16CM●●	7●16T111
a	106	110
b	49	89
b1	41.5	58
c	60	54

ABE	7H16/12/08●●● 7R08S111● 7CPA21/410/412
b	70
b1	58
c	58

1 Additional shunt terminal block ABE 7BV10/7BV20

Common side view

ABE 7H16R2●, ABE 7H12R2●, ABE 7H16R3●,  
ABE 7H16R1●, ABE 7H12R1●, ABE 7H12S21,  
ABE 7H16S2●, ABE 7R16S11●, ABE 7R08S210,  
ABE 7S08S2B0, ABE 7CPA02, ABE 7CPA03  
ABE 7S16S1B2, ABE 7R08S216

ABE 7R16S21●, ABE 7H16●43  
ABE 7S16S2B0/S2B02E,  
ABE 7S16E2●●/S16E2●●E,  
ABE 7S08S2B1/S08S2B1E  
ABE 7CPA31

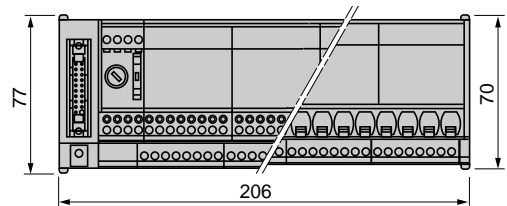
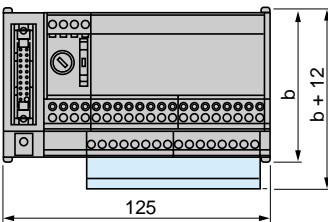
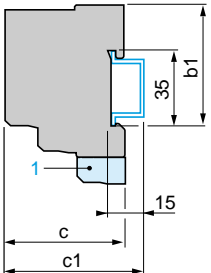

ABE	7●●●●●	7●R08S210●, 7S16S1B2●, 7R08S216
b	70	77
b1	58	58
c	58	58

All sub-bases	
b1	
c	58

1 Additional shunt terminal block ABE 7BV10/7BV20

ABE 7R16T2●●, ABE 7P16T2●●

ABE 7CPA01, ABE 7CPA11/CPA12/CPA13

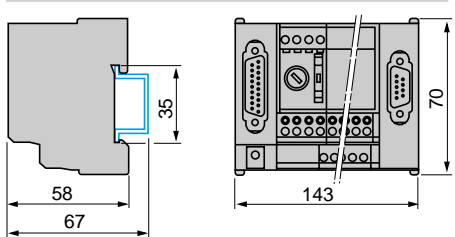
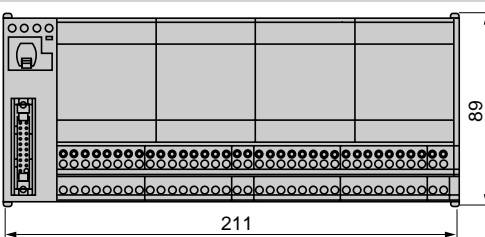
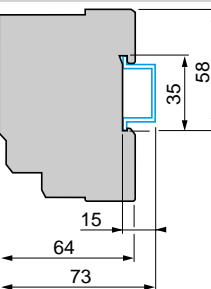

Note: Details of the front view are the same as for the ABE 7CPA01.

ABE 7P08T330

ABE 7R16T3●●, ABE 7P16T3●●, ABE 7P16F31●

Common side view

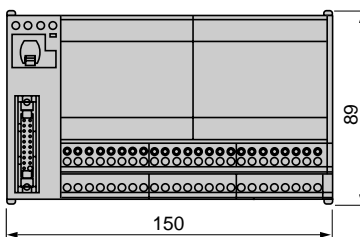
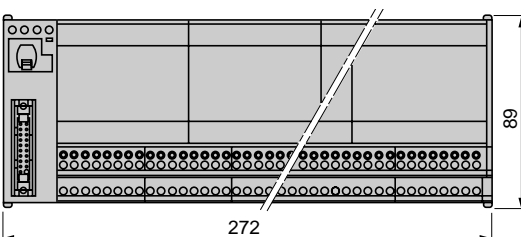
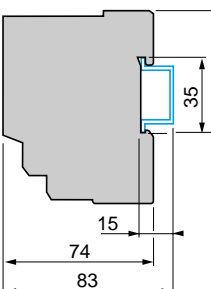

# Modicon Quantum automation platform

## Advantys Telefast ABE 7 pre-wired system

ABE 7ACC02

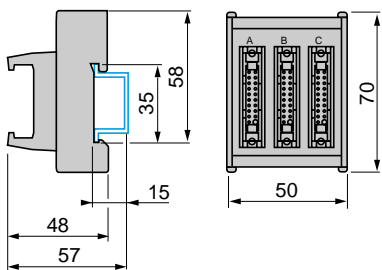

ABE 7ACC03

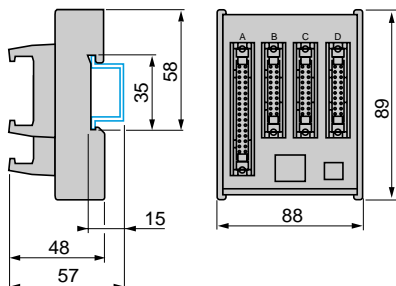

ABE 7ACC04, ABE 7ACC05  
ABE 7ACC10, ABE 7ACC11

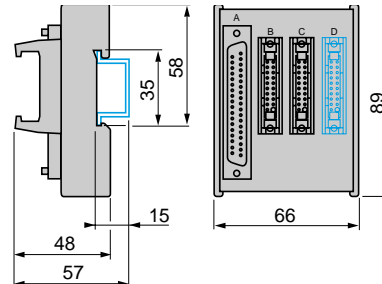

Note: Drawing representing ABE 7ACC04 and ABE 7ACC05

ABE 7ACC80

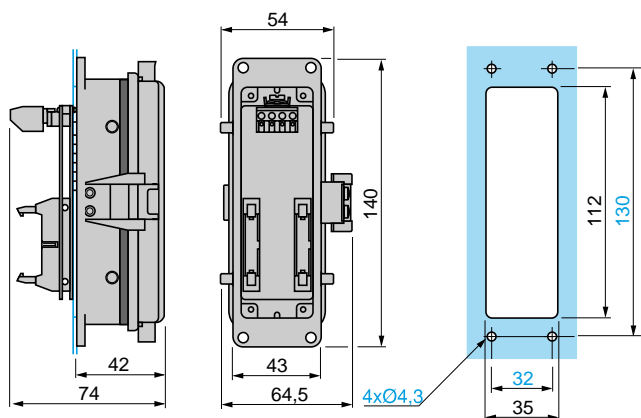

ABE 7ACC82, ABE 7ACC83

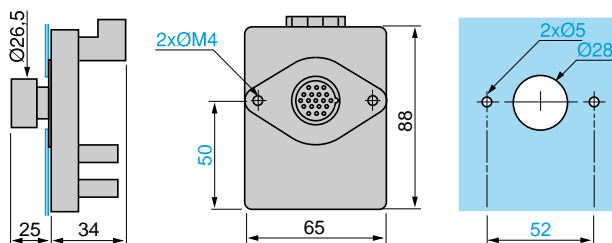

ABE 7ACC84

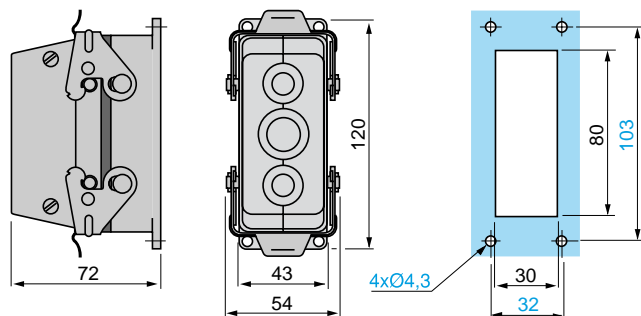

ABE 7TES160

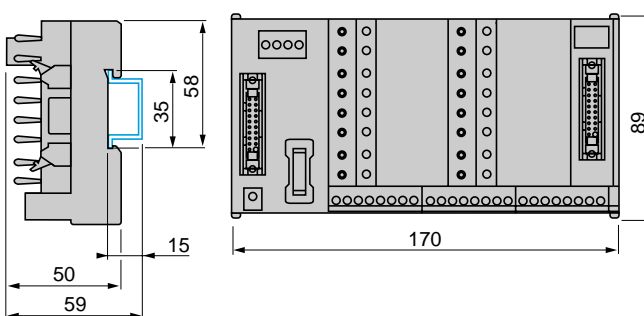

Fixing centres for sub-bases using mounting kit ABE 7ACC01

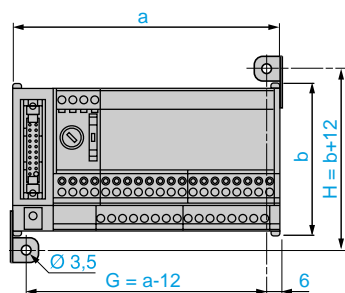

ABE 7	G	H
ACC02	38	82
ACC03	53	101
ACC04	53	101
ACC05	53	101
ACC10/11	53	101
H08R●●	72	82
H08S21	72	82
H12R50	72	82
H16R50	72	82
R08S111	72	82
CPA01	131	82
CPA02	113	82
CPA1●	131	82
CPA03	113	82

ABE 7	G	H
H12R1●	113	82
H12R2●	113	82
H16R1●	113	82
H16R2●	113	82
H16R3●	113	82
H12S21	113	82
H16S21	113	82
R08S210	113	82
R16S111	113	82
R16S21●	194	82
S08S2B0	113	82
S08S2B1	194	82

ABE 7	G	H
H16F43	194	82
H16S43	194	82
S16E2●●	194	82
S16S1B2	113	82
S16S2●●	194	82
R16T2●●	199	101
P16T2●●	199	101
R16T3●●	260	101
P08T330	150	101
P16T3●●	260	101
P16F3●●	260	101

# Modicon Quantum automation platform

Phaseo power supplies  
for DC control circuits

**Power supplies**

**Regulated switch mode**

Phaseo Modular range and Optimum range of industrial power supplies



**Input voltage**

<b>Connection to worldwide line supplies</b>	United States
	- 120 V (phase-to-neutral)
	- 240 V (phase-to-phase)
	Europe
- 230 V (phase-to-neutral)	
- 400 V (phase-to-phase)	
United States	
- 277 V (phase-to-neutral)	
- 480 V (phase-to-phase)	

100...240 V ~  
120...250 V ---

Single-phase (N-L1) or phase-to-phase (L1-L2) connection

Single-phase connection (N-L1)

–

**IEC/EN 61000-3-2 conformity**

**Undervoltage control**

**Short-circuit and overload protection**

**Diagnostic relay**

**Compatibility with function modules**

**Power reserve (Boost)**

Yes for ABL 7RP, not for ABL 8REM and not applicable for ABL 8MEM and ABL 7RM

Yes

Yes, voltage detection. Automatic reset on correction of the fault

–

–

1.25 to 1.4 I<sub>n</sub> for 1 minute, depending on model (with ABL 8MEM)

No

**Output voltage**

<b>Output current</b>	0.3 A
	0.6 A
	1.2 A
	2 A
	2.5 A
	3 A
	4 A
	5 A
	6 A
	10 A
	20 A
	40 A

5 V ---

12 V ---

24 V ---

48 V ---

**ABL 8MEM24003**  
(Modular)

**ABL 8MEM24006**  
(Modular)

**ABL 8MEM24012**  
(Modular)

**ABL 8MEM12020**  
(Modular)

**ABL 7RM24025**  
(Modular)

**ABL 7RP4803**  
(Optimum)

**ABL 8REM24030**  
(Optimum)

**ABL 8MEM05040**  
(Modular)

**ABL 7RP1205**  
(Optimum)

**ABL 8REM24050**  
(Optimum)

**Pages**

Consult our catalogue "Phaseo Power Supplies and Transformers"

**Regulated switch mode**  
**Phaseo Universal range of industrial power supplies**



100...120 V ~ and 200...500 V ~ (1)	380...500 V ~	24 V ---	
Single-phase (N-L1) or phase-to-phase (L1-L2) connection	–	–	
	Three-phase connection (L1-L2-L3)	–	
	Three-phase connection (L1-L2-L3)	–	
Yes		–	
Yes		–	
Yes, current limitation or undervoltage detection		Yes, current limitation	
Yes, depending on model			
Yes with buffer module, battery and battery check modules, redundancy module and discriminating downstream protection module			
1.5 In for 4 seconds		No	
24 V ---		5 V ---	7...12 V ---
			ABL 8DCC12020 (2)
ABL 8RPS24030			
ABL 8RPS24050			
		ABL 8DCC05060 (2)	
ABL 8RPS24100			
ABL 8RPM24200	ABL 8WPS24200		
	ABL 8WPS24400		

Consult our catalogue "Phaseo Power Supplies and Transformers"

(1) Except **ABL 8RPM24200**, 100...120 V ~ and 200...240 V ~.

(2) --- converter module, must be associated with a Phaseo Universal power supply.

# Modicon Quantum automation platform

Phaseo power supplies  
for DC control circuits

**Power supplies**

**Regulated switch mode**

Phaseo Dedicated range of power supplies for repetitive machines



**Input voltage**

<b>Connection to worldwide line supplies</b>	United States
	- 120 V (phase-to-neutral)
	- 240 V (phase-to-phase)
	Europe
	- 230 V (phase-to-neutral)
	- 400 V (phase-to-phase)
United States	
- 277 V (phase-to-neutral)	
- 480 V (phase-to-phase)	

100...240 V ~  
120...370 V ☰

Single-phase (N-L1) or phase-to-phase (L1-L2) connection

Single-phase connection (N-L1)

Single-phase connection (N-L1)

**IEC/EN 61000-3-2 conformity**

**Undervoltage control**

**Short-circuit and overload protection**

**Diagnostic relay**

**Compatibility with function modules**

**Power reserve (Boost)**

Yes for ABL 1RP, not applicable for ABL1REM24025/12050

Yes, voltage detection. Automatic reset on correction of the fault

No

**Output voltage**

**Output current** 0.5 A

1 A

2 A

2.5 A

3 A

4 A

4.2 A

4.8 A

5 A

6 A

6.2 A

8.3 A

10 A

15 A

20 A

30 A

40 A

60 A

12 V ☰

24 V ☰

**ABL 1REM24025**

**ABL 1R◉M24042**

**ABL 1REM12050**

**ABL 1R◉M24062**

**ABL 1RPM12083**

**ABL 1R◉M24100**

**Pages**

**Rectified and filtered**

Phaseo Rectified range of power supplies for harsh environments

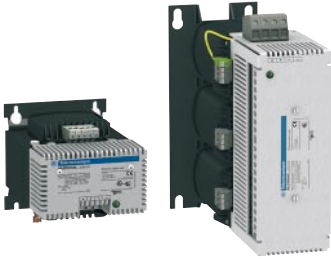

230 V ~ and 400 V ~

400 V ~

–

Single-phase (N-L1) or phase-to-phase (L1-L2) connection

Three-phase connection (L1-L2-L3)

–

Yes

No

Yes depending on model, by fuse

Yes, by external protection

No

No

No

24 V ☰

ABL 8FEQ24005

ABL 8FEQ24010

ABL 8FEQ24020

ABL 8FEQ24040

ABL 8FEQ24060

ABL 8FEQ24100

ABL 8TEQ24100

ABL 8FEQ24150

ABL 8FEQ24200

ABL 8TEQ24200

ABL 8TEQ24300

ABL 8TEQ24400

ABL 8TEQ24600

**Regulated switch mode**

Phaseo AS-Interface range of power supplies for AS-Interface cabling system



100...240 V ~

Single-phase connection (N-L1)

Single-phase connection (N-L1)

–

No

Yes

–

Yes

Yes

–

–

No

30 V ☰

24 V ☰

ASI ABLB3002  
ASI ABLD3002 (1)  
ASI ABLM3024 (2)

ASI ABLM3024 (2)

ASI ABLB3004  
ASI ABLD3004 (1)

(1) With earth fault detection.

(2) One 30 V ☰ output and one 24 V ☰ output ± 5%.

# Modicon Quantum automation platform

Power supplies for DC control circuits

Phaseo regulated switch mode power supplies

Universal range

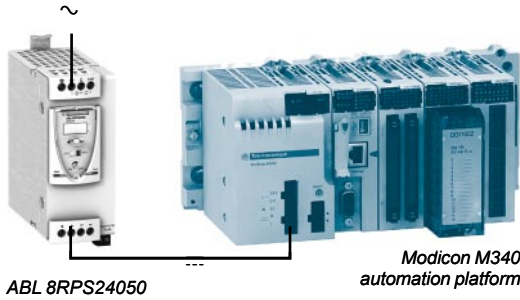

## Switch mode power supplies: Universal range

The **ABL 8RPS/RPM/WPS** power supply offer is designed to provide the DC voltage necessary for the control circuits of automation system equipment. Comprising six products, this range meets the needs encountered in industrial and commercial applications. These compact electronic switch mode power supplies provide a quality of output current that is suitable for the loads supplied and compatible with the **Modicon M340**, Premium and Quantum ranges. When used with additional function modules, they ensure continuity of service in the event of power outages or application malfunctions. Clear guidelines are given on selecting the function modules and upstream protection devices which are often used with them, and thus a comprehensive solution is provided that can be used in total safety.

The Universal range of Phaseo power supplies must be connected in phase-to-neutral or phase-to-phase for **ABL 8RPS/RPM**, and in three-phase for **ABL 8WPS**. They deliver a voltage that is precise to 3%, whatever the load and whatever the type of line supply, within the ranges:

- 85 to 132 V ~ and 170 to 550 V ~ for **ABL 8RPS** units
- 85 to 132 V ~ and 170 to 264 V ~ for **ABL 8RPM** units
- 340 to 550 V ~ for **ABL 8WPS** units

Their very wide input voltage range allows a considerable reduction of parts held in stock and offers a distinct advantage in terms of machine design.

Conforming to IEC standards and UL and CSA certified, they are suitable for universal use.

**ABL 8RPS/RPM** and **ABL 8WPS** power supplies are all equipped with a harmonic filter, ensuring compliance with standard IEC/EN 61000-3-2 concerning harmonic pollution.

All the Universal range of Phaseo power supplies have protection devices to ensure optimum performance of the automation system. Their operating mode can be configured as required by the user:

- **Manual reset protection mode:** Priority is given to the voltage so as to ensure the PLC logic states and nominal operation of the supplied actuators.
- **Automatic reset protection mode:** Priority is given to the current to allow troubleshooting for example, or to ensure continuity of service until the arrival of the maintenance team.

The Universal range of Phaseo power supplies also has a power reserve, allowing them to deliver a current of 1.5 In at regular intervals. This avoids the need to oversize the power supply if the device has a high inrush current, while ensuring optimum performance of the automation system.

The diagnostics for the Universal range of Phaseo power supplies are available on the front of the device via LEDs ( $U_{out}$  and  $I_{out}$ ) and via a volt-free relay contact (whether or not the PLC states are guaranteed).

All products are equipped with an output voltage adjustment potentiometer in order to be able to compensate for any line voltage drops in installations with long connection cable runs.

These power supplies are designed for direct mounting on a 35 mm rail.

# Modicon Quantum automation platform

Power supplies for DC control circuits

Phaseo regulated switch mode power supplies

Universal range

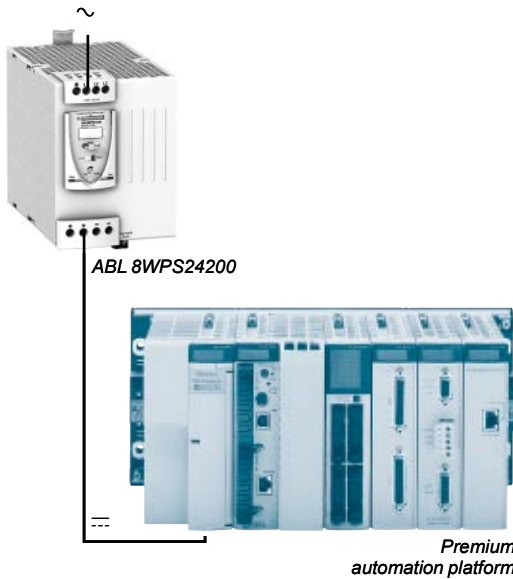

## Switch mode power supplies: Universal range (continued)

There are four references available in the Universal range of Phaseo power supplies for phase-to-neutral or phase-to-phase connection:

■ ABL 8RPS24030	72 W	3 A	24 V $\overline{\text{---}}$
■ ABL 8RPS24050	120 W	5 A	24 V $\overline{\text{---}}$
■ ABL 8RPS24100	240 W	10 A	24 V $\overline{\text{---}}$
■ ABL 8RPM24200	480 W	20 A	24 V $\overline{\text{---}}$

The Universal range of Phaseo power supplies also features two references for three-phase connection:

■ ABL 8WPS24200	480 W	20 A	24 V $\overline{\text{---}}$
■ ABL 8WPS24400	960 W	40 A	24 V $\overline{\text{---}}$

A range of function modules also allows functions to be added to the Universal range of Phaseo power supplies so as to ensure continuity of service:

- A Buffer module or Battery check modules and their batteries to ensure continuity of service in the event of a power outage (see selection table)
- A Redundancy module to meet the most demanding requirements for continuity of service even if the power supply fails
- Downstream electronic Protection modules to ensure that the protection in the application is discriminating
- Converter modules delivering nominal voltages of 5 and 12 V  $\overline{\text{---}}$  from the 24 V  $\overline{\text{---}}$  output of the Universal range of Phaseo power supplies

## Description

### Universal range of power supplies

The Universal range of Phaseo regulated switch mode power supplies,

**ABL 8RPS24●●0/RPM24200/WPS24●00**, comprise:

- 1 Spring clip for 35 mm  $\overline{\text{---}}$  rail
- 2 4 mm<sup>2</sup> enclosed screw terminals for connection of the AC voltage (single-phase, phase-to-phase or three-phase connection)
- 3 Protective glass flap
- 4 Clip-on marker label
- 5 Locking catch for the glass flap (sealable)
- 6 Protection mode selector
- 7 Output voltage adjustment potentiometer
- 8 Output voltage status LED (green and red)
- 9 Output current status LED (green, red, and orange)
- 10 Screw terminals for connection of the diagnostic relay contact, except **ABL 8RPS24030**
- 11 4 mm<sup>2</sup> (10 mm<sup>2</sup> on **ABL 8WPS24●00** and **ABL 8RPM24200**) enclosed screw terminals for connection of the DC output voltage

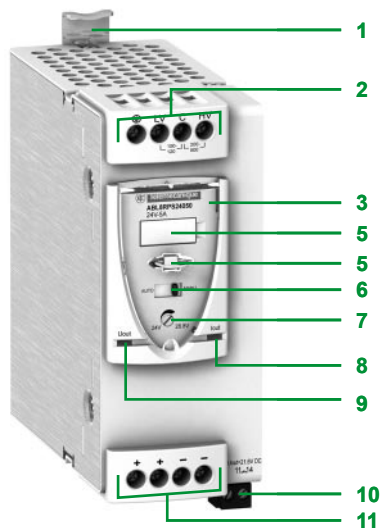



# Modicon Quantum automation platform

Power supplies for DC control circuits  
Phaseo regulated switch mode power supplies  
Universal range

Technical characteristics						
Power supply type			ABL 8RPS24030	ABL 8RPS24050	ABL 8RPS24100	ABL 8RPM24200
Certifications			CB scheme EN 60950-1, UL, cCSAus, CE, C-Tick			
Compliance with standards	Safety		IEC/EN 60950-1, EN 61204, SELV			
	EMC		EN 61000-6-1, EN 61000-6-2, EN 61000-6-3, EN 61000-6-4, EN 61204-3			
Input circuit						
Input values phase-to-neutral (N-L1) or phase-to-phase (L1-L2)	Nominal voltages	V	100...120 V ~/200...500 V ~			100...120 V ~/ 200...240 V ~
	Limit voltage	V	85...132 V ~/170...550 V ~			85...132 V ~/ 170...264 V ~
	Permissible frequencies	Hz	47...63			
	Maximum inrush current	A	30 for 2 ms max.			
	Power factor		0.59 at 120 V ~/0.51 at 240 V ~		0.69 at 120 V ~/0.68 at 240 V ~	
	Efficiency at nominal load		> 87%			
	Dissipated power at nominal load	W	7.8	15.5	31	57.6
Anti-harmonic filtering	According to IEC/EN 61000-3-2		Yes, via integrated PFC ( <i>Power Factor Correction</i> )			
Output circuit						
Compatibility with function modules			Buffer, battery and battery check unit, redundancy, discriminating protection			
Diagnostics	LEDs on front panel		Current (green, orange and red), voltage (green, red and off)			
	Relay		- Relay closed $U_{out} > 21.6$ V contact 230 V ~, 0.5 A max; 24 V ~, 5 mA min			
Nominal output values	Output voltage ( $U_{out}$ )	V	24 ~			
	Current	A	3	5	10	20
	Power	W	72	120	240	480
Permissible temporary inrush current (boost)		A	1.5 In for 4 s maximum, see curves on page 9/29			
Accuracy	Output voltage ( $U_{out}$ )	V	Adjustable 24...28.8			
	Line and load regulation		1%...3%			
	Residual ripple - noise	mV	< 200 (peak-peak)			
Holding time for I max	$U_{in} = 100$ V ~	ms	≥ 20			
	$U_{in} = 240$ V ~	ms	≥ 40			
	$U_{in} = 400$ V ~	ms	≥ 120			
Protection	Against short-circuits		Permanent, automatic or manual restart			
	Against overloads		Permanent, automatic or manual restart			
	Against overvoltages	V	30...32 ~, automatic or manual restart			
	Against undervoltages	V	Tripping if $U_{out} < 21.6$ (manual mode)			
	Thermal		Yes, automatic restart only			
Operational and environmental characteristics						
Connections	Input	mm <sup>2</sup>	2 x 0.5...4 screw terminals (22...12 AWG) + earth terminal			
	Output	mm <sup>2</sup>	4 x 0.5...4 screw terminals (22...12 AWG) + earth terminal (1)			
	Diagnostic relay	mm <sup>2</sup>	-	2 x 2.5 removable screw terminal block		
Mounting	On $\perp$ rail		35 x 7.5 mm and 35 x 15 mm			
Operating position			Vertical			
Connections	Serial		Possible, see page 9/30			
	Parallel		Possible, see page 9/30			
Degree of protection	According to IEC 60529		IP 20			IP 20 except output terminals (+, -) IP 10
Environment	Operating temperature	°C	-25...+60 (derating from 50°C, see page 9/28)			
	Storage temperature	°C	-40...+70			
	Maximum relative humidity		90% during operation, 95% in storage			
	Vibration acc. to IEC/EN 61131-2		3...11.9 Hz amplitude 3.5 mm & 11.9 -150 Hz acceleration 2 g			
Protection class	According to VDE 0106 1		Class I			
Dielectric strength 50 Hz for 1 min	Input/output	V rms	4000 ~			3000 ~
	Input/earth	V rms	3500 ~			2500 ~
	Output/earth	V rms	500 ~			
Input fuse incorporated			No			
Emission, according to EN 61000-6-3	Radiation		EN 55022 Class B and GL levels			
	Conducted on the power line		EN 55022 Class B and GL levels			
	Harmonic currents		IEC/EN 61000-3-2			
Immunity, according to IEC/ EN 61000-6-2	Electrostatic discharge		IEC/EN 61000-4-2 (8 kV contact/15 kV air)			
	Radiated electromagnetic fields		IEC/EN 61000-4-3 level 3 (10 V/m)			
	Induced electromagnetic fields		IEC/EN 61000-4-6 level 3 (30 V/m)			
	Rapid transients		IEC/EN 61000-4-4 (4 kV)			
	Surges, IEC/EN 61000-4-5		Input: 4 kV in common mode, 2 kV in differential mode Output: 2 kV in common mode, 1 kV in differential mode			
	Primary outages		IEC/EN 61000-4-11 (voltage dips and interruptions)			

(1) No earth screw on ABL 8RPM 24200 power supply

# Modicon Quantum automation platform

Power supplies for DC control circuits

Phaseo regulated switch mode power supplies

Universal range

Technical characteristics				
Power supply type		ABL 8WPS24200	ABL 8WPS24400	
<b>Certifications</b>		CB scheme EN 60950-1, UL, cCSAus, CE, C-Tick		
<b>Compliance with standards</b>	Safety	EN 60950-1, EN 61204, SELV		
	EMC	EN 61000-6-1, EN 61000-6-2, EN 61000-6-3, EN 61000-6-4, EN 61204-3		
<b>Input circuit</b>				
<b>LED indication</b>		-		
<b>Input values</b> 3 phases (L1-L2-L3)	Nominal values	<b>V</b>	380-500 V ~	
	Permissible values	<b>V</b>	320-550 V ~	
	Permissible frequencies	<b>Hz</b>	47...63	
	Maximum inrush current	<b>A</b>	25 for 2 ms max.	
	Power factor		0.65	0.85
	Efficiency at nominal load		> 92%	
	Dissipated power at nominal load	<b>W</b>	38.4	76.8
<b>Anti-harmonic filtering</b>	According to IEC/EN 61000-3-2	Yes, via integrated PFC ( <i>Power Factor Correction</i> )		
<b>Run mode in the event of phase failure</b>		<b>V</b>	Operation possible for a few minutes then protection trips	
<b>Output circuit</b>				
<b>Compatibility with function modules</b>		Buffer, battery and battery check unit, redundancy, discriminating protection		
<b>Diagnostics</b>	LEDs on front panel	Current (green, orange and red), voltage (green, red and off)		
	Relay	Closed relay $U_{out} > 21.6$ V, contact 230 V ~, 0.5 A max; 24 V ---, 5 mA min		
<b>Nominal output values</b>	Output voltage ( $U_{out}$ )	<b>V</b>	24 ---	
	Current	<b>A</b>	0...20	0...40
	Power	<b>W</b>	480	960
<b>Permissible temporary inrush current (boost)</b>		<b>A</b>	1.5 $I_n$ for 4 s maximum, see curves	
<b>Accuracy</b>	Output voltage ( $U_{out}$ )	<b>V</b>	Adjustable 24...28.8	
	Line and load regulation		1%...3%	
	Residual ripple - noise	<b>mV</b>	< 200 (peak-peak)	
<b>Holding time</b> for $I_{max}$	$U_{in} = 400$ V ~	<b>ms</b>	≥ 18	≥ 14
	<b>Protection</b>		Against short-circuits: Permanent, automatic or manual restart	
			Against overloads: Permanent, automatic or manual restart	
		<b>V</b>	Against overvoltages: 30...32 ---, automatic or manual restart	
		<b>V</b>	Against undervoltages: Tripping if $U_{out} < 21.6$ (in manual mode)	
	Thermal		Yes, automatic restart only	
<b>Operational and environmental characteristics</b>				
<b>Connections</b>	Input	<b>mm<sup>2</sup></b>	3 x 0.5...4 screw terminals (22...12 AWG) + earth	
	Output	<b>mm<sup>2</sup></b>	4 x 0.5...10 screw terminals (22...8 AWG)	
	Diagnostic relay	<b>mm<sup>2</sup></b>	2 x 2.5 removable screw terminal block	
<b>Mounting</b>	On $\perp$ rail		35 x 7.5 mm and 35 x 15 mm	
<b>Operating position</b>			Vertical	
<b>Connections</b>	Serial		Possible, see page 9/30	
	Parallel		Possible, see page 9/30	
<b>Degree of protection</b>	According to IEC 60529		IP 20 except output terminals (+, -) IP 10	
<b>Environment</b>	Operating temperature	<b>°C</b>	- 25...+ 60 (derating from 50°C, see page 9/28)	
	Storage temperature	<b>°C</b>	- 40...+ 70	
	Maximum relative humidity		90% during operation, 95% in storage	
	Vibration acc. to IEC/EN 61131-2		3...11.9 Hz amplitude 3.5 mm & 11.9 -150 Hz acceleration 2 g	
<b>Protection class</b> , according to VDE 0106 1			Class I	
<b>Dielectric strength</b> 50 Hz for 1 min	Input/output	<b>V rms</b>	4000 ~	
	Input/earth	<b>V rms</b>	3500 ~	
	Output/earth	<b>V rms</b>	500 ~	
<b>Input fuse incorporated</b>			No	
<b>Emission</b> , according to EN 61000-6-3	Radiation		EN 55022 Class B and GL levels	
	Conducted on the power line		EN 55022 Class B and GL levels	
	Harmonic currents		IEC/EN 61000-3-2	
<b>Immunity</b> , according to IEC/ EN 61000-6-2	Electrostatic discharge		IEC/EN 61000-4-2 (8 kV contact/15 kV air)	
	Radiated electromagnetic fields		IEC/EN 61000-4-3 level 3 (10 V/m)	
	Induced electromagnetic fields		IEC/EN 61000-4-6 level 3 (30 V/m)	
	Rapid transients		IEC/EN 61000-4-4 (4 kV)	
	Surges, IEC/EN 61000-4-5		Input: 4 kV in common mode, 2 kV in differential mode Output: 2 kV in common mode, 1 kV in differential mode	
	Primary outages		IEC/EN 61000-4-11 (voltage dips and interruptions)	

# Modicon Quantum automation platform

Power supplies for DC control circuits

Phaseo regulated switch mode power supplies

Universal range

## Output characteristics

### Derating

The ambient temperature is a determining factor which limits the power that an electronic power supply can deliver continuously. If the temperature around the electronic components is too high, their life will be significantly reduced.

The nominal ambient temperature for the Universal range of Phaseo power supplies is 50°C. Above this temperature, derating is necessary up to a maximum temperature of 60°C.

The graph below shows the power (in relation to the nominal power) that the power supply can deliver continuously, according to the ambient temperature.

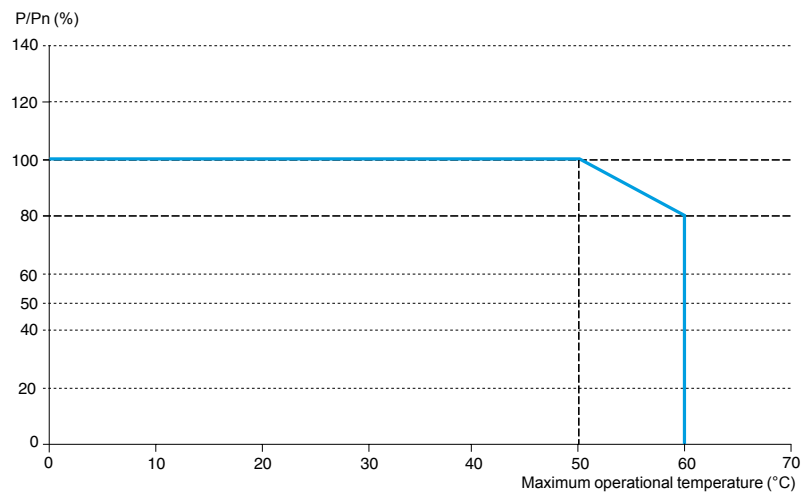

ABL 8RPM, ABL 8RPS, ABL 8WPS mounted vertically

Derating should be considered in extreme operating conditions:

- Intensive operation (output current permanently close to the nominal current, combined with a high ambient temperature)
- Output voltage set above 24V (to compensate for line voltage drops, for example)
- Parallel connection to increase the total power

### General rules to be complied with

<b>Intensive operation</b>	See derating on above graph. Example for ABL 8RPS: - Without derating, from 0°C to 50°C - Derating of nominal current by 2% per additional °C, up to 60°C
<b>Rise in output voltage</b>	The nominal power is fixed. Increasing the output voltage means that the current delivered is reduced.
<b>Mounting</b>	To allow heat dissipation, the power supplies must not be in contact with each other.

In all cases, there must be adequate convection around the products to assist cooling. There must be sufficient clearance around the Universal range of Phaseo power supplies:

- 50 mm above and below
- 10 mm on the sides

## Output characteristics (continued)

### Behaviour in the event of overloads

Behaviour in the event of overloads:

■ **Automatic reset protection mode (current limiting):** If the output current exceeds approximately  $1.2 I_n$ , the output current is limited to this value. The value of the output voltage can then be less than 21 V but the diagnostic relay opens, allowing the anomaly to be fed back to the automation system and thus prevent feedback of any undefined logic state. On elimination of the overload, the output voltage reverts to its preset value.

■ **Manual reset protection mode (undervoltage detection):** If the output current exceeds approximately  $1.2 I_n$ , the power supply stops completely before the output voltage drops below 21 V and no longer delivers any current. The fault is memorized as long as voltage is present at the power supply primary. The power supply will become operational again, if the fault has disappeared, after de-energizing the primary for a few seconds.

*Note: In both these modes, any overload of less than  $1.5 I_n$  and lasting less than 4 s will be absorbed by the "boost" circuit and the voltage delivered will stay within the specified limits (adjustment voltage +/- 3%).*

### Load limit

#### Manual reset protection mode

ABL 8RPM24200/ABL 8RPS24●●●/ABL 8WPS24●●●

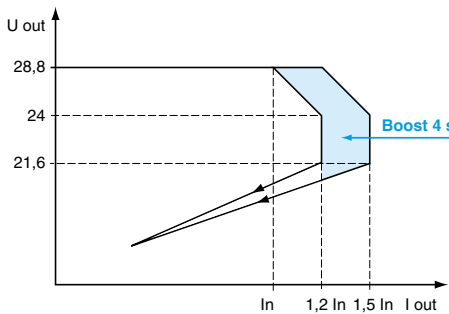

#### Automatic reset protection mode

ABL 8RPM24200/ABL 8RPS24●●●/ABL 8WPS24●●●

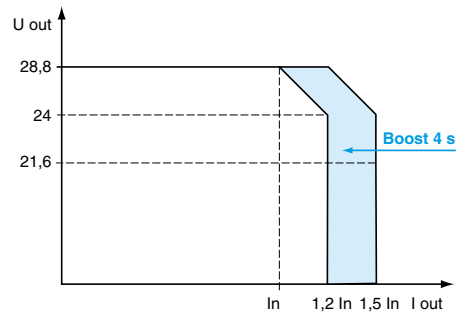

### "Boost" repeat accuracy

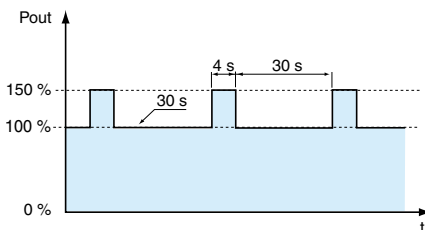

The **ABL 8RPS/RPM/WPS** Universal range of Phaseo power supplies has a power reserve, allowing them to supply the application with energy up to 1.5 times the nominal current at the intervals illustrated by the graph opposite.

The "boost" amplitude and repeat accuracy depend on:

- The overload duration
- The overload intensity
- The period between each consumption peak

When the power supply can no longer cope (repeated overloads, overload duration > 4 seconds, power rating > 150% of nominal power) the built-in protection trips.

This type of operation is described in detail in the user manual, which can be downloaded from our website, [www.schneider-electric.com](http://www.schneider-electric.com)

### Behaviour in the event of phase failure on three-phase power supplies

The **ABL 8WPS24●00** Universal range of Phaseo power supplies is capable of starting and delivering a nominal current and voltage for a few minutes in the event of failure of one phase. Their protection (thermal) then trips and they are reset automatically.

## Output characteristics (continued)

### Series or parallel connection

#### Series connection

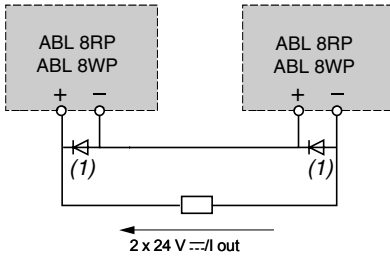

#### Parallel connection

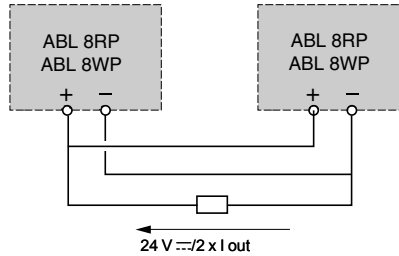

Family	Series	Parallel
ABL 8RPS/8RPM/8WPS	2 products max. (1)	2 products max.

**Note:** Series or parallel connection is only recommended for products with identical references.

For better availability, the power supplies can also be connected in parallel using the **ABL8 RED24400** Redundancy module.

## Selection of protection on the power supply primaries

Type of line supply	115 V ~ phase-to-neutral			230 V ~ phase-to-phase			400 V ~ phase-to-phase	
	Thermal-magnetic circuit-breaker		gG/gL fuse	Thermal-magnetic circuit-breaker		gG/gL fuse	Thermal-magnetic circuit-Sbreaker	gG/gL fuse
Type of protection	Schneider Electric GB2 (IEC) (2)	Merlin Gerin C60N (IEC) C60N (UL)		Schneider Electric GB2 (IEC) (2)	Merlin Gerin C60N (IEC) C60N (UL)			
ABL 8RPS24030	GB2 CD07	MG24443	2 A (8 x 32)	GB2 CD07	MG24443	2 A (8 x 32)	GV2 RT06	2 A (14 x 51)
ABL 8RPS24050	GB2 CD08	MG24444	4 A (8 x 32)	GB2 CD07	MG24443	2 A (8 x 32)	GV2 RT06	2 A (14 x 51)
ABL 8RPS24100	GB2 CD12	MG24447	6 A (8 x 32)	GB2 CD08	MG24444	4 A (8 x 32)	GV2 RT07	4 A (14 x 51)
ABL 8RPM24200	GB2 CD16	MG24449	10 A (8 x 32)	GB2 CD12	MG24447	6 A (8 x 32)	-	-
ABL 8WPS24200	-	-	-	-	-	-	GV2 ME06	2 A (14 x 51)
ABL 8WPS24400	-	-	-	-	-	-	GV2 ME07	4 A (14 x 51)

## Schemes

### GB2 CD●●

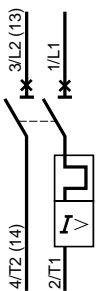

### GV2 RT●●

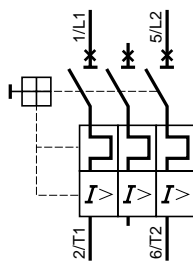

### GV2 ME0●

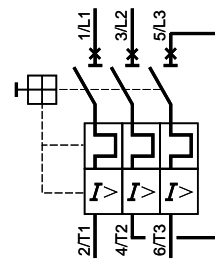

(3) Single-phase connection (N-L1) or phase-to-phase (L1-L2)

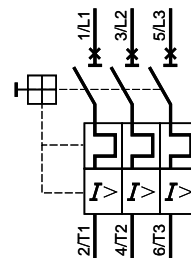

(4) Three-phase connection (L1-L2-L3)

(1) Two Schottky diodes  $I_{min}$  = power supply  $I_n$  and  $V_{min}$  = 50 V  
(2) UL certification pending

# Modicon Quantum automation platform

Power supplies for DC control circuits

Phaseo regulated switch mode power supplies

Universal range



ABL 8RPS24050



ABL 8RPM24200



ABL 8WPS24200



ABL 8BUF24400



ABL 8BBU24200



ABL 8RED24400

## Phaseo regulated switch mode power supplies: Universal range

Input voltage	Secondary		Reset	IEC/EN 61000-3-2 conformity	Reference	Weight kg
	Output voltage	Nominal power				
<b>Single-phase (N-L1) or 2-phase (L1-L2) connection</b>						
100...120 V ~	24...28.8 V	72 W	3 A	Auto/man	Yes	ABL 8RPS24030
200...500 V	---	120 W	5 A	Auto/man	Yes	ABL 8RPS24050
- 15%, + 10%		240 W	10 A	Auto/man	Yes	ABL 8RPS24100
50/60 Hz						
100...120 V ~/	24...28.8 V	480 W	20 A	Auto/man	Yes	ABL 8RPM24200
200...240 V	---					
- 15%, + 10%						
50/60 Hz						
<b>Three-phase connection (L1-L2-L3)</b>						
380...500 V ~	24...28.8 V	480 W	20 A	Auto/man	Yes	ABL 8WPS24200
± 10%	---	960 W	40 A	Auto/man	Yes	ABL 8WPS24400
50/60 Hz						

## Function modules for continuity of service (1)

Function	Use	Description	Reference	Weight kg
Continuity after a power outage	Holding time 100 ms at 40 A and 2 s at Buffer module		ABL 8BUF24400	1.200
	Holding time 9 min at 40 A...2 hrs at 1 A (depending on use with a battery check module-battery unit and load)	Battery check module 20 A output current	ABL 8BBU24200	0.500
	(2)	Battery check module, 40 A output current	ABL 8BBU24400	0.700
		3.2 Ah battery module (3)	ABL 8BPK24A03	3.500
		7 Ah battery module (3)	ABL 8BPK24A07	6.500
		12 Ah battery module (3)	ABL 8BPK24A12	12.000
Continuity after a malfunction	Paralleling and redundancy of the power supply to ensure uninterrupted operation of the application excluding mains failures and application overloads	Redundancy module	ABL 8RED24400	0.700
Discriminating downstream protection	Electronic protection (1...10 A overload or short-circuit) of 4 output terminals from a Phaseo Universal range power supply	Protection module with 2-pole breaking (4)	ABL 8PRP24100	0.270

## ---/--- converters (1)

Primary (5)	Secondary		Reference	Weight kg
	Input voltage	Output voltage		
24 V ---	Universal range power supply module output current	5...6.5 V ---	6 A	ABL 8DCC05060
- 9%, + 24%	1.7 A	7...15 V ---	2 A	ABL 8DCC12020

## Separate and replacement parts

Description	Use	Composition	Unit reference	Weight kg
Fuse assemblies	For ABL 8PRP24100 discriminating protection modules	4 x 5 A, 4 x 7.5 A and 4 x 10 A	ABL 8FUS01	—
	ABL 8BKP24A●● battery	4 x 20 A and 6 x 30 A	ABL 8FUS02	—
Clip-on marker labels	All products except ABL 8PR●24100	<b>Sold in lots of 100</b>	LAD 90	0.030
	ABL 8PR●24100	<b>Sold in lots of 22</b>	ASI20 MACC5	—
DIN rail mounting kit	ABL 8BPK2403 battery module	<b>Single unit</b>	ABL 1A02	—
EEPROM memory	Backup and duplication of ABL8 BBU24●00 battery control module parameters	<b>Single unit</b>	SR2 MEMO2	0.010

(1) For use with Universal range of Phaseo power supplies.

(2) Table of compatibility of battery check module-battery unit with holding time depending on the load.

(3) Supplied with 20 or 30 A fuse depending on the model.

(4) Supplied with four 15 A fuses.

(5) Local reset via pushbutton or automatic reset on elimination of the fault. Supplied with four 15 A fuses.

(6) Voltage from a 24 V --- Universal range Phaseo power supply.

## Dimensions

ABL 8RPS24.../ABL 8RPM24200/ABL 8WPS24...  
Common side view

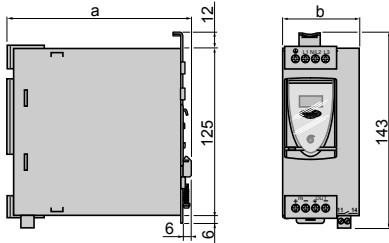

ABL 8	a	b
RPS24030	120	44
RPS24050	120	56
RPS24100	140	85
RPM24200	140	145
WPS24200	155	95
WPS24400	155	165

## Internal schemes

ABL 8RPS24030

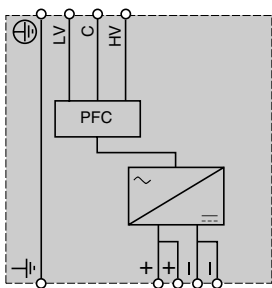

ABL 8RPS24050

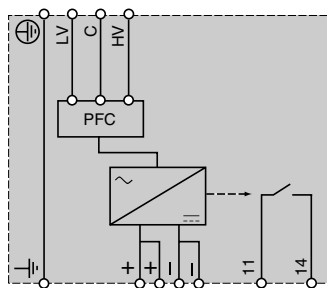

ABL 8RPS24100

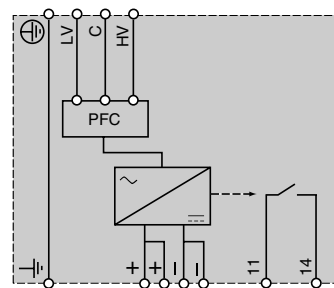

ABL 8RPM24200

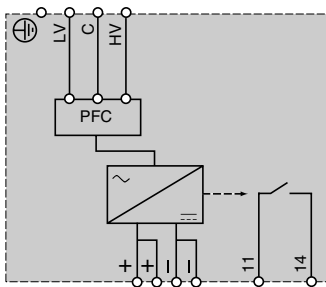

ABL 8WPS24200

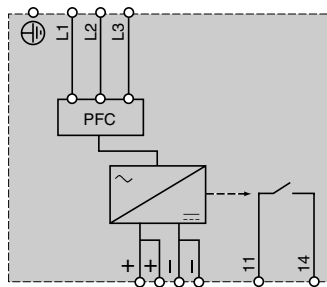

ABL 8WPS24400

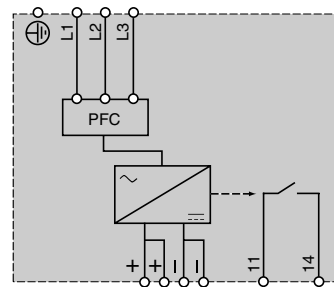

# Modicon Quantum automation platform

Power supplies for DC control circuits  
 Regulated switch mode power supplies  
 Phaseo Universal range

## Line supply connection schemes

Single-phase (L-N) 100 to 120 V

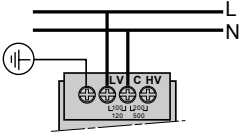

Phase-to-phase (L1-L2) 200 to 500 V

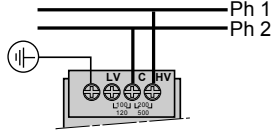

Three-phase (L1-L2-L3) 3 x 380 to 500 V

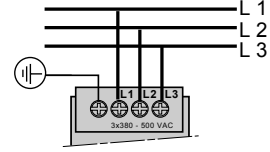

Single-phase (L-N) 200 to 500 V

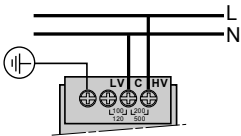



# Modicon Quantum automation platform

## Phaseo regulated switch mode power supplies for AS-Interface range

### Power supplies for AS-Interface cabling system

Compatible with the standard Phaseo line, the range of **ASI ABL** power supplies is designed to deliver a DC voltage, as required by AS-Interface cabling systems. Three versions are available to meet all needs encountered in industrial applications, in enclosures, cubicles or floor-standing enclosures. These single-phase electronic switch mode power supplies guarantee the quality of the output current, in accordance with the electrical characteristics and conforming to standard EN 50295.

#### ASI ABLB300●

Operating on a 100 to 240 V AC supply, this power supply delivers a voltage of 30 V DC. Available in 2.4 and 4.8 A ratings, the outgoing terminal block allows the cable to be connected separately to AS-Interface interface modules and the AS-Interface master. Input and output LEDs allow fast, continuous diagnostics.



ASI ABLB3002

#### ASI ABLD300●

Operating on a 100 to 240 V AC supply, this power supply delivers a voltage of 30 V DC. Available in 2.4 and 4.8 A ratings, it allows diagnosis and management of earth faults on AS-Interface interface modules. In the event of an earth fault, the Phaseo power supply stops dialogue on the AS-Interface cabling system and puts the installation in a fallback condition. Restarting is only possible after deliberate acknowledgement of the fault. Two inputs/outputs enable dialogue with a processing unit. The outgoing terminal block is used to connect the AS-Interface cable separately to the interface modules and the master. Input, output and earth fault LEDs allow fast, continuous diagnostics.



ASI ABLD3004

#### ASI ABLM3024

Operating on a 100 to 240 V AC supply, this product provides two separate power supplies which are totally independent in the way they operate. Two output voltages, 30 V/2.4 A (AS-Interface line supply) and 24 V/3 A, are available, so making it possible to power the control equipment without an additional power supply. Input and output LEDs allow fast, continuous diagnostics.



ASI ABLM3024

# Modicon Quantum automation platform

Phaseo regulated switch mode power supplies for AS-Interface range

Technical characteristics								
Power supply type		ASIABLB3002	ASIABLB3004	ASIABLD3002	ASIABLD3004	ASIABLM3024		
Functions		Supply to the AS-Interface line (30 V $\overline{\text{---}}$ )				30 V $\overline{\text{---}}$ supply	24 V $\overline{\text{---}}$ supply	
Product certifications		UL 508, CSA 22-2 No. 950, TÜV 60950-1						
Conforming to standards	Safety	EN 60950-1						
	EMC	EN 50081-1, IEC/EN 61000-6-2, EN 55022 class B						
	Low frequency harmonic currents	No						
<b>Input circuit</b>								
LED indication		Orange LED						
Input values	Nominal voltage	V	100...240 $\sim$					
	Limit voltages	V	85...264 $\sim$					
	Current consumption	A	0.5	1	0.5	1	1	
	Permissible frequencies	Hz	47...63					
	Maximum inrush current	A	30					
	Power factor		0.65					
	Efficiency at nominal load	%	> 83				> 83	> 80
	Dissipated power at nominal load	W	14.7	29.5	14.7	29.5	14.7	36
	<b>Output circuit</b>							
LED indication		Green LED						
Nominal output values	Voltage ( $U_{\text{Out}}$ )	V	30 (AS-Interface)			30 $\overline{\text{---}}$	24 $\overline{\text{---}}$	
	Current	A	2.4	4.8	2.4	4.8	2.4	3
	Power	W	72	144	72	144	72	72
Precision	Adjustable output voltage	V	-				-	24...28.8 $\overline{\text{---}}$
	Line and load regulation		3%					
	Residual ripple - noise	mV	300 - 50					
Holding time	I max. and $V_{\text{in}}$ min.	ms	10					
Protection	Against short circuits		Permanent. Automatic restart after elimination of the fault					
	Against overloads		1.1 I <sub>n</sub>					
	Against overvoltages		Tripping if $U > 1.2 U_n$			$U > 1.2 U_n$	$U > 1.5 U_n$	
	Against undervoltages		Tripping if $U < 0.95 U_n$			$U < 0.95 U_n$	$U < 0.8 U_n$	
<b>Operating characteristics</b>								
Connections	Input	mm <sup>2</sup>	2 x 2.5 screw terminals + earth					
	Output	mm <sup>2</sup>	2 x 2.5 screw terminals + earth, multiple output					
Environment	Operating temperature	°C	0...+ 60 (derating from 50°C, see page 9/36)					
	Storage temperature	°C	- 25...+ 70					
	Maximum relative humidity		95% (without condensation or dripping water)					
	Degree of protection		IP 20 (conforming to IEC/EN 60529)					
	Vibrations		IEC/EN 61131-2					
Operating position			Vertical					
MTBF		h	> 100,000 (conforming to Bell core, at 40°C)					
Dielectric strength 50 Hz for 1 min	Input/output	V rms	3000					
	Input/earth	V rms	3000					
	Output/earth (and output/output)	V rms	500					
Input fuse incorporated			Yes (not interchangeable)					
Emission, according to EN 61000-6-3	Conducted/radiated		Class B (conforming to EN 55022)					
Immunity, according to IEC/EN 61000-6-2	Electrostatic discharge		IEC/EN 61000-4-2 (4 kV contact/8 kV air)					
	Radiated electromagnetic fields		IEC/EN 61000-4-3 level 3 (10 V/m)					
	Induced electromagnetic fields		IEC/EN 61000-4-6 (10 V)					
	Rapid transients		IEC 61000-4-4 level 3 (2 kV)					
Primary outages			IEC 61000-4-11 (voltage dips and interruptions)					

### Output characteristics

#### Derating

The ambient temperature is a determining factor which limits the power that an electronic power supply can deliver continuously. This is because, if the temperature around the electronic components is too high, their life will be significantly reduced. The graph below shows the power (in relation to the nominal power) that the power supply can deliver continuously, according to the ambient temperature.

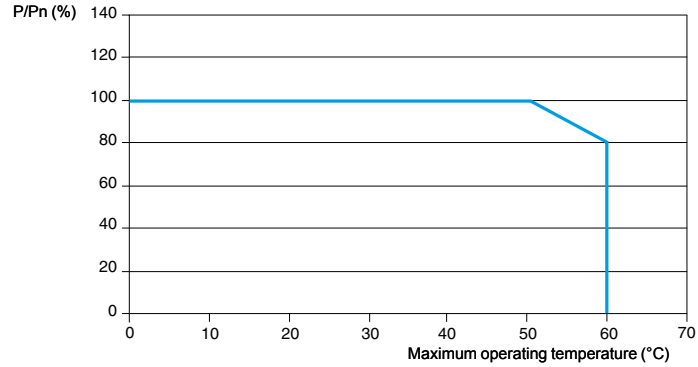

### Diagram of operation

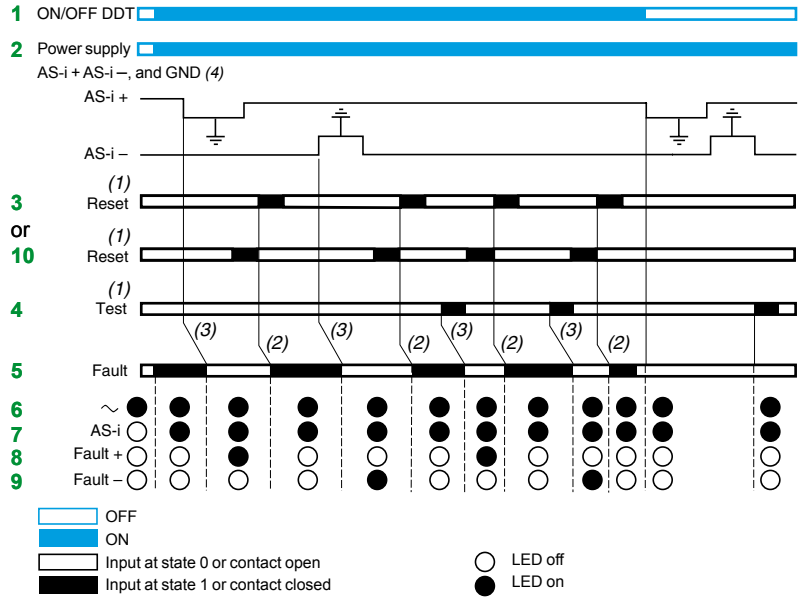
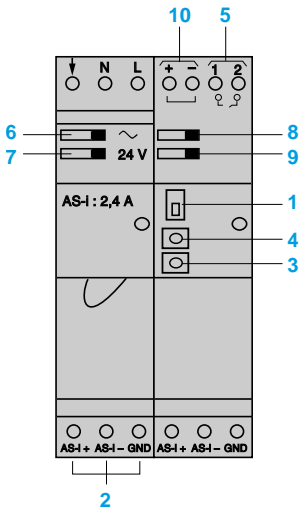

(1) 30 ms min. (2) 15 ms (3) 20 ms  
 (4) Warning: the earth fault detector will work only if the earth (GND) terminal is connected.

#### Important:

- The earth (GND) connection (4) must be made. If disconnected, the built-in detector becomes inoperative. To obtain earth fault diagnostics, use of an **ASI ABLD3002/3004** power supply with built-in earth fault detector is recommended.
- Appearance of an accidental earth causes activation of the built-in protection, in the following cases:
  - **Case 1:** fault between AS-i "+" and earth
  - **Case 2:** fault between AS-i "-" and earth
  - **Case 3:** fault between the sensors/actuators powered by the **ASI ABLD3002/3004** and earth
- In case 1 and 2: switch ON -> OFF: fault maintained, no exchange between master and slaves.
- In case 3: switch ON -> OFF: resumption of exchanges between master and slaves, but the states of the I/O of the module affected by the fault are not guaranteed.

# Modicon Quantum automation platform

Phaseo regulated switch mode power supplies  
for AS-Interface range

## Selection of protection on the power supply primaries

Line supply type	115 V ~ single-phase			230 V ~ single-phase		
	Thermal-magnetic circuit breaker (1)		Gg fuse	Thermal-magnetic circuit breaker (2-pole)		Gc fuse
ASI ABLB3002	GB2 ●B07	MG24517 (2)	2 A	GB2 DB06	MG24516 (2)	2 A
ASI ABLB3004	GB2 ●B08	MG24518 (2)	4 A	GB2 DB07	MG17453 (2)	2 A
ASI ABLD3002	GB2 ●B07	MG24517 (2)	2 A	GB2 DB06	MG24516 (2)	2 A
ASI ABLD3004	GB2 ●B08	MG24518 (2)	4 A	GB2 DB07	MG17453 (2)	2 A
ASI ABLM3024	GB2 ●B07	MG24517 (2)	2 A	GB2 DB06	MG17453 (2)	2 A

(1) Single-pole protection, replace ● by C; 2-pole protection, replace by D.

(2) UL-certified circuit breaker

## References



ASI ABL●3002

Input voltage	Secondary			Reset of auto-protect	Earth fault detection	Reference	Weight kg
	Output voltage	Nominal power	Nominal current				
<b>Single-phase (N-L1) or 2-phase (L1-L2)</b>							
100...240 V ~ - 15%, + 10% 50/60 Hz	30 V ~	72 W	2.4 A	Auto	No	ASI ABLB3002	0.800
		144 W	4.8 A	Auto	No	ASI ABLB3004	1.300
	30 V ~	72 W	2.4 A	Auto	Yes	ASI ABLD3002	0.800
		144 W	4.8 A	Auto	Yes	ASI ABLD3004	1.300
24 V ~	72 W	2.4 A	Auto	No	ASI ABLM3024	1.300	
	72 W	3 A					

## Dimensions

Common side view  
Mounting on 35 mm and 75 mm rails

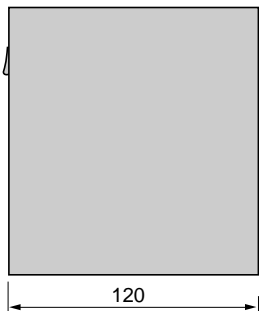

ASI ABLB3002  
ASI ABLD3002

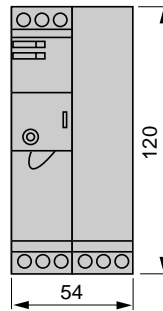

ASI ABLB3004/ABLD3004  
ASI ABLM3024

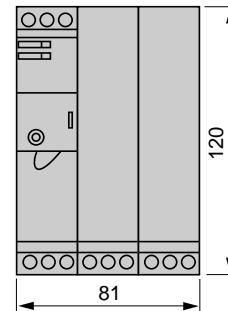

## Schemes

ASI ABLB300●

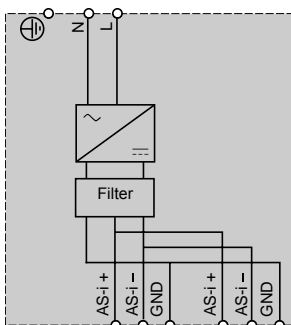

ASI ABLD300●

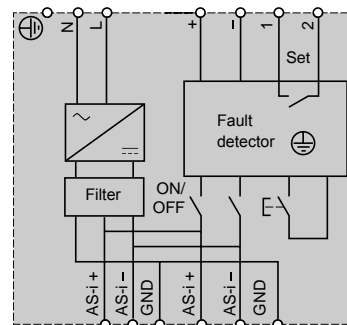

ASI ABLM3024

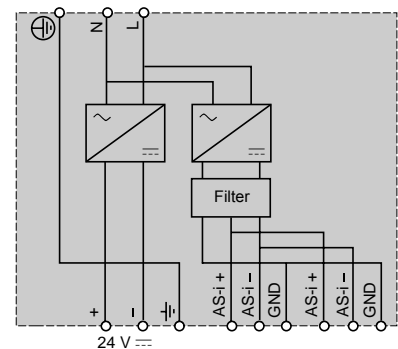



## 10.1 - Technical appendices

- Technical appendices..... 10/2
- Characteristics..... 10/2
- Special protective treatment..... 10/3

## 10.2 - Treatment for severe environments, “Conformal Coating” modules

- “Conformal Coating” modules ..... 10/6
- Standard Unity CPUs..... 10/7
- Standard Concept/ProWORX CPUs..... 10/7
- Racks and extensions for racks..... 10/8
- Power supply modules..... 10/8
- PCMCIA memory extension cards ..... 10/8
- “Conformal Coating” remote I/O (RIO) modules..... 10/9
- Distributed I/O (DIO) modules..... 10/9
- Discrete input modules..... 10/10
- Discrete output modules..... 10/10
- Discrete mixed I/O modules..... 10/11
- Analog input modules..... 10/12
- Analog output modules..... 10/12
- Mixed analog I/O modules..... 10/12
- Intrinsically safe input modules..... 10/13
- Intrinsically safe output modules..... 10/13
- High-speed counter modules..... 10/13
- High-speed input with interrupt module..... 10/13
- Unity Hot Standby system..... 10/14
- Concept/ProWORX Hot Standby system..... 10/14
- AS-Interface cabling system..... 10/15
- Modbus Plus communication devices..... 10/15
- Asynchronous serial link module..... 10/15

## 10.3 - Certifications

- Certifications for automation products..... 10/16
- EC regulations..... 10/17

## 10.4 - Index

- Index of references ..... 10/18

## Standards and certifications

Modicon Quantum PLCs have been developed to comply with the main national and international standards relating to electronic equipment for industrial automation systems.

- Requirements specific to PLCs: functional characteristics, immunity, resistance, safety, etc.: IEC 61131-2, CSA 22.2 No. 142, UL 508.
- Merchant navy requirements from the main international bodies: ABS, BV, DNV, GL, LR, RINA, etc.
- Compliance with European Directives:
  - Low voltage: 2006/95/EC
  - Electromagnetic compatibility: 2004/108/EC
- Electrical characteristics and self-extinguishing capacity of insulating materials: UL 746C, UL 94.
- Hazardous areas:
  - CSA 22.2 No. 213, Class I, Division 2, groups A, B, C and D
  - FM 3610, Class I, Division 2, groups A, B, C and D
- Specific requirements for safety CPUs and modules:
  - IEC 61508
  - IEC 62021

## Characteristics

### Operating conditions and requirements relating to the environment

Temperature	Operation	°C	0...+60 (IEC 61131-2: +5...+55) (1)
	Storage	°C	-40...+85
Relative humidity	Operation	%	0...95 non-condensing
	Storage	%	0...95 non-condensing (according to IEC 61131-2) at 60°C (140°F)
Altitude		m	0...5000 max. during operation. For altitudes > 2000 m, the max. temperature of 60°C must be reduced by 6°C for each additional 1000 m

## Protective treatment of Modicon Quantum PLCs

Modicon Quantum PLCs comply with “TC” treatment requirements (*all climates treatment*).

For installations in industrial production workshops or environments that correspond to “TH” treatment (*treatment for hot and humid environments*), the PLCs must be incorporated in casings with at least IP 54 protection, as specified by IEC 60664 and NF C 20 040.

These PLC themselves have an **IP 20 protection index** (2).

They can therefore be installed without casings in reserved access areas that do not exceed **pollution level 2** (control room containing no machinery or activity that produces dust). Pollution level 2 does not take account of harsher environments: air polluted with dust, fumes, corrosive or radioactive particles, vapours or salts, moulds, insects, etc.

(1) TSX P57 0244/104/154M and TSX P57 454/4634/554/5634M CPUs: 0...+57°C (or 0...+67°C with TSX FAN fan modules) when certain I/O modules are mounted in the slot next to the above-mentioned CPUs.

(2) If a slot is not occupied by a module, it must be fitted with a protective cover **TSX RKA 02**.

Environmental tests		
Description of test	Standards	Levels
<b>Immunity to Low Frequency (L.F.) interference (CE) (1)</b>		
Voltage and frequency variation	IEC/EN 61131-2	0.9/1.10 Un; 0.95/1.05 Fn for 30 min 0.8 Un/0.9 Fn for 5 s; 1.2 Un/1.1 Fn for 5 s
DC voltage variation	IEC/EN 61131-1	0.85 Un...1.2 Un for 30 min with 5% ripple (peak values)
Third harmonic	IEC/EN 61131-2	10% Un; 0°/5 min...180°/5 min
Short interruptions	IEC/EN 61131-2	10 ms with power supply ~; 1 ms with power supply ---
Voltage dips and pick-ups	IEC/EN 61131-2	Un-0-Un; Un for 60 s; 3 separate cycles of 10 s Un-0-Un; Un for 5 s; 3 separate cycles of 1 to 5 s Un-0.9 Udl; Un for 60 s; 3 separate cycles of 1 to 5 s
Un: nominal voltage Fn: nominal frequency Udl: undervoltage detection level		
Immunity to High Frequency (H.F.) interference (CE) (1)		
Description of test	Standards	Levels
Electrical fast transients/Bursts	IEC 61000-4-4	~/-: power supply: 2 kV in wired mode/common mode Discrete I/O > 48V: 2 kV in common mode; other ports: 1 kV in common mode
Hybrid surge	IEC 61000-4-5	2 kV between shielding and earth
Electrostatic discharge	IEC 61000-4-2	4 kV contact, 8 kV air
Radiated electromagnetic field	IEC 61000-4-3	10 V/m; 80 MHz...2 GHz Sinusoidal amplitude modulation 80%/1 kHz
Conducted interference, induced by radiated fields	IEC 61000-4-6	3 V: 0.15 MHz...80 MHz Sinusoidal amplitude modulation 80%/1 kHz
<b>Electromagnetic emissions (CE) (1) (2)</b>		
Interference voltage	IEC 61000-6-4 EN 55011 IEC 61131-2	Class A 150 kHz...500 kHz quasi-peak 79 dB (µV); average 66 dB (µV) 500 kHz...0.30 MHz quasi-peak 73 dB (µV); average 60 dB (µV)
Field interference	IEC 61000-6-4 EN 55011 IEC 61131-2	Class A, measurement at 10 m 30 MHz...230 MHz quasi-peak 40 dB (µV); 230 MHz...1 GHz quasi-peak 47 dB (µV)
<b>Immunity to climatic variations</b>		
Dry heat	IEC 60068-2-2 Bd	60°C for 16 h
Cold	IEC 60068-2-1 Ad	0°C for 16 h
Damp heat, steady state	IEC 60068-2-30 Ca	60°C with 93% relative humidity/96 h
Damp heat, cyclic	IEC 60068-2-3 Db	[55°C (E.O)] - 25°C with 93...95% relative humidity; 2 cycles: 12 h/12 h
Cyclic temperature variations	IEC 60068-2-14 Nb	0...60°C/5 cycles: 6 h/6 h (3)
<b>Resistance to climatic variations</b>		
Dry heat when not operating	IEC 60068-2-2 Bb	85°C for 96 h
Cold when not operating	IEC 60068-2-1 Ab	-40°C for 96 h
Damp heat when not operating	IEC 60068-2-30 Db	25...60°C with 93...95% relative humidity; 2 cycles: 12 h/12 h
Thermal shocks when not operating	IEC 60068-2-14 Na	-40...85°C; 2 cycles: 3 h/3 h

(CE): tests required by the CE European Directives and based on standard IEC/EN 61131-2.

(1) Devices must be installed and wired in accordance with the instructions in the "Earthing and electromagnetic compatibility with PLCs" manual, electronic version in PDF format supplied on CD-ROM with the Unity Pro software packages or included on DVD reference **UNY USE 909 CD M** (see page 7/39).

(2) These tests are carried out with no enclosure, with the devices **fixed on a metal grid** and wired in accordance with the recommendations in the manual.

(3) Refer to note (1) at the bottom of page 10/2.



Environmental tests (continued)		
Description of test	Standards	Levels
<b>Immunity to mechanical stress (1)</b>		
Sinusoidal vibration	IEC 60068-2-6 Fc	5...150 Hz/3.5 mm amplitude/1 g; endurance: 10 cycles of 1 octave/min per axis
Shocks	IEC 60068-2-27 Ea	15 g-11 ms; 3 shocks/direction/axis
<b>Resistance to mechanical stress</b>		
Controlled position free fall	IEC 60068-2-31 Ec	30° or 10 cm/2 falls
Random free fall, equipment in packaging	IEC 60068-2-32 method 1	1 m/5 falls
<b>Safety of equipment and personnel (2)</b>		
Dielectric strength and insulation resistance (C€)	UL 508, FM 3610 CSA 22-2 No. 142/IEC 61131-2	2 U + 1000 V/1 min. > 10 MΩ
Temperature rise	IEC 61131-2/UL 508 CSA 22-2 No. 142 and No. 213 FM 3610	Ambient temperature: 60°C
Electrical continuity (C€)	UL 508 CSA 22-2 No. 142	< 0.1 Ω/30 A/2 min
Leakage current (C€)	IEC 61131-2	< 3.5 mA fixed device
Protection provided by enclosures (C€)	CSA 22-2 No. 142/ CEI 61131-2 UL 508	IP 20
Resistance to impacts	CSA 22-2 No. 142/ CEI 61131-2 UL 508 FM 3610	500 g sphere: fall from 1.3 m

(C€): tests required by the C€ European Directives and based on standard IEC/EN 61131-2.

(1) These tests are carried out with no enclosure, with the devices **fixed on a metal grid** and wired in accordance with the recommendations in the manual "Electromagnetic compatibility of industrial networks and fieldbuses" **TSX DG KBL F**.

(2) The devices must be installed and wired in accordance with the instructions given in the manual "Electromagnetic compatibility of networks and fieldbuses" **TSX DG KBL F**.

When a control system has to operate in a corrosive environment, it is possible to order Quantum modules with a special treatment. This treatment will extend the life of the module and enhance its environmental resistance capabilities.

Gas flow rate (power on)			
Standard	Pollutant	Parts/ billion	Quantum protection level
EIA 364-65 level III	Cl <sub>2</sub>	20 (± 5)	Conforms to the standard
	NO <sub>2</sub>	200 (± 50)	Exceeds the standard (1250 parts/billion)
	H <sub>2</sub> S	100 (± 20)	Conforms to the standard
ISA-S71.04GX severe	Cl <sub>2</sub>	10	Exceeds the standard (1250 parts/billion)
	NO <sub>2</sub>	1250	Conforms to the standard
	H <sub>2</sub> S	50	Exceeds the standard (1250 parts/billion)
	SO <sub>2</sub>	300	Conforms to the standard

Humidity (during operation)		
Standard	Concentration (%)	Quantum protection level
IEC 60068-2-30	93 at 60°C	Conforms to the standard

Salt mist (not during operation)		
Standard	Concentration (%)	Quantum protection level
IEC 60068-2-11	5 (± 1)	Exceeds the standard (5.7%)

Mould resistance	
Standard	Quantum protection level
MIL-I-46058C	Designed to conform to the standard

Cyclic temperature variations (during operation)		
Standard	Cycles	Quantum protection level
IEC/EN 60068-2-14	100 at 0...60°C	Conforms to the standard

Dust (not during operation)			
Standard	Pollutant	Weight (%)	Quantum protection level
EIA 364-TP1 (pending)	Silica	36	Conforms to the standard
	Calcite	29	Conforms to the standard
	Iron oxide	12	Conforms to the standard
	Alumina	8	Conforms to the standard
	Gypsum	5	Conforms to the standard
	Paper fibre	3	Conforms to the standard
	Cotton fibre	3	Conforms to the standard
	Polyester fibre	2	Conforms to the standard
	Carbon black	1	Conforms to the standard
	Human hair	0.5	Conforms to the standard
	Cigarette ash	0.5	Conforms to the standard

For an exhaustive list of Modicon Quantum products available with special "Conformal Coating" treatment: see pages 10/7 to 10/15.

# Modicon Quantum automation platform

## Treatment for severe environments “Conformal Coating” modules

### Presentation

#### Protective treatment of Modicon Quantum PLCs

Modicon Quantum PLCs comply with “TC” treatment requirements (Treatment for all Climates).

For installations in industrial production workshops or environments corresponding to “TH” treatment (Treatment for Hot and humid environments), PLCs must be incorporated in casings with at least IP 54 protection, as specified by IEC/EN 60529 or an equivalent level in accordance with NEMA 250.

These PLC themselves have an IP 20 protection index <sup>(1)</sup>. They can therefore be installed without casings in reserved access areas that do not exceed **pollution level 2** (control room containing no machinery or activity that produces dust). **Pollution level 2** does not take account of harsher environments: air polluted with dust, fumes, corrosive or radioactive particles, vapours or salts, moulds, insects, etc.

#### Treatment for more severe environments

If the Modicon Quantum automation platform has to be used in a severe environment, the “Conformal Coating” offer provides CPU modules and power supplies, I/O modules and racks with “**Humiseal 1A33**” coating on their electronic cards.

This treatment increases the isolation capability of the cards and their resistance to:

- Condensation
- Dusty atmospheres (conducting foreign particles)
- Chemical corrosion in particular during use in sulphurous atmospheres (oil refinery, purification plant, etc.) or atmospheres containing halogens (chlorine, etc.).

This protection, combined with appropriate installation and maintenance, enables Modicon Quantum products to be used in harsh chemical environments such as types **3C2** and **3C3** described in IEC/EN 60721-3-3.

The functional and electrical characteristics of the coated modules are identical to those of the non-coated versions. Please consult the characteristics pages of this catalogue (chapter 1...chapter 5).

To order modules and racks with Conformal Coating protection, please refer to references pages 10/7 to 10/15 (for coated products, add the letter “C” at the end of the standard reference).

(1) Any slot in **TSX RKY ●●** racks that is not occupied by a module must be fitted with a **TSX RKA 02** screw-on protective cover (sold in lots of 5).

# Modicon Quantum automation platform

## Treatment for severe environments “Conformal Coating” CPUs



140 CPU 434 12UC



140 CPU 650 00C

### Standard “Conformal Coating” Unity CPUs

CPU	Coprocessor	Memory (max.)			Communication ports	Safety	Reference	Weight
		RAM	Program	Program with PCMCIA card Kb				
Clock frequency		Mb	Kb					kg
66	Built-in math	2	400	–	2 Modbus RS 232 1 Modbus Plus	–	140 CPU 311 10C	–
	Built-in math	2	800	–	2 Modbus RS 232 1 Modbus Plus	–	140 CPU 434 12UC	–
166	Yes, built-in Ethernet TCP/IP	2	512	7168	1 Modbus (1) 1 Modbus Plus 1 USB 1 Ethernet TCP/IP	–	140 CPU 651 50C	–
266	Yes, built-in Ethernet TCP/IP	2	1024	7168	1 Modbus (1) 1 Modbus Plus 1 USB 1 Ethernet TCP/IP	–	140 CPU 651 60C	–
		4	3072	7168	1 Modbus (1) 1 Modbus Plus 1 USB 1 Ethernet TCP/IP	–	140 CPU 652 60C	–
		2	1024	7168	1 Modbus (1) 1 Modbus Plus 1 USB 1 Hot Standby port (100 Mbps)	–	140 CPU 671 60C	–

(1) RS 232/485 Modbus port

Connection cables and accessories: see page 2/11

### Migrating Quantum CPUs

The 2 Quantum CPUs, **140 CPU 434 12AC** and **140 CPU 534 14BC**, that are compatible with the Concept or ProWORX software can migrate so as to become compatible with Unity Pro software with no hardware change. The Concept to Unity Pro migration is carried out by updating the CPU operating system. This update is carried out using the OS-Loader loader tool which is included in the Unity Pro software (see page 7/29).

The **140 CPU 434 12AC** CPU that has been migrated is then equivalent to the corresponding Unity CPU, **140 CPU 434 12UC**.

**Note:** Migration of the **140 CPU 534 14BC** CPU requires version  $\geq 3.0$  of the Unity Pro software.

### Standard “Conformal Coating” Concept/ProWORX CPUs

Memory (total)	Coprocessors	Safety	Reference	Weight
				kg
256 Kb	No	–	140 CPU 113 02C	0.300
512 Kb	No	–	140 CPU 113 03C	0.300
2 Mb	Integrated	–	140 CPU 434 12AC	0.850
4 Mb	Integrated	–	140 CPU 534 14BC	0.850

Accessories: see page 2/19

# Modicon Quantum automation platform

Treatment for severe environments  
 “Conformal Coating” Racks, power supplies, memory cards

## “Conformal Coating” racks

Description	Number of slots	Safety	Reference	Weight kg
Racks for: - Local I/O modules - Remote I/O modules - Distributed I/O modules	2	–	140 XBP 002 00C	0.230
	3	–	140 XBP 003 00C	0.340
	4	–	140 XBP 004 00C	0.450
	6	Non-interfering	140 XBP 006 00C	0.640
	10	Non-interfering	140 XBP 010 00C	1.000
	16	Non-interfering	140 XBP 016 00C	1.600

## Extension for “Conformal Coating” rack

Description	Length/ dimensions	Reference	Weight kg
Rack extension module	–	140 XBE 100 00C	–

Accessories, dimensions: see page 3/31

## “Conformal Coating” power supply modules

Input voltage	Output current	Type	Safety	Reference	Weight kg
120/230 V ~	3 A	Standalone	–	140 CPS 111 00C	0.650
115/230 V ~	11 A	Summable	–	140 CPS 114 20C	0.650
115/230 V ~	11 A	Redundant	Non-interfering	140 CPS 124 20C	0.650
24 V ☰	3 A	Standalone	–	140 CPS 211 00C	0.650
		8 A	Summable	–	140 CPS 214 00C
	8 A	Redundant	–	140 CPS 224 00C	0.650
48...60 V ☰	8 A	Summable	–	140 CPS 414 00C	0.650
		Redundant	–	140 CPS 424 00C	0.650
125 V ☰	3 A	Standalone	–	140 CPS 511 00C	0.650
		8 A	Redundant	–	140 CPS 524 00C

Note: For the separate part and connections see page 3/36.

## “Conformal Coating” PCMCIA memory extension cards

140 CPU 651 50C, 140 CPU 651 60C and 140 CPU 671 60C Quantum CPUs can take the following memory extension cards.

There are two types of memory limit:

- One associated with the type of CPU.
- One associated with the chosen model of PCMCIA memory card.

The lower of these two limits defines the memory capacity that is accessible to the user for the application.

Description	Memory size		Reference	Weight kg
	Application	Data file		
Application/ configurable data file SRAM memory extension	192...1024 Kb	832...0 Kb	TSX MRP C001MC	0.076
	192...3072 Kb	2880...0 Kb	TSX MRP C003MC	0.076
	192...7168 Kb	6976...0 Kb	TSX MRP C007MC	0.076

Note: Replacement parts: see page 2/13



TSX MRP/MCP/MRP ●●●●

# Modicon Quantum automation platform

Treatment for severe environments  
“Conformal Coating” I/O architectures

“Conformal Coating” remote I/O (RIO) modules				
Description	Cable	Safety	Reference	Weight kg
Quantum RIO head-end adaptor (1 max.)	Single cable	–	140 CRP 931 00C	–
	Redundant cable	Non- interfering	140 CRP 932 00C	–
Quantum RIO drop adaptor (31 max.)	Single cable	–	140 CRA 931 00C	–
	Redundant cable	Non- interfering	140 CRA 932 00C	–

Connection cables, and rack, connection and wiring accessories: see page 3/9

“Conformal Coating” distributed I/O (DIO) modules				
Description	Medium	Type of medium	Reference	Weight kg
DIO head-end adaptors no. 2 and no. 3 (3)	Single	Twisted pair cable	140 NOM 211 00C	–
	Redundant	Twisted pair cable	140 NOM 212 00C	–
	Single	Fibre optic cable	140 NOM 252 00C	–
Description	Medium	Built-in power supply	Reference	Weight kg
DIO drop adaptors	Single	115/230 ~	140 CRA 211 10C	–
		24 ---	140 CRA 211 20C	–
	Redundant	115/230 ~	140 CRA 212 10C	–
		24 ---	140 CRA 212 20C	–

(1) Head-end no. 0, included in each 140 CPU (see pages 2/5 and 2/17).

(2) See pages 2/9 and 2/19.

(3) Modbus Plus network cables and accessories, see pages 6/74 to 6/77.

Presentation: see page 6/70

# Modicon Quantum automation platform

Treatment for severe environments  
“Conformal Coating” Discrete I/O modules

“Conformal Coating” discrete input modules						
Voltage	Modularity	Description	Logic	Safety	Reference	Weight kg
5 V $\overline{\text{TTL}}$	32 inputs	4 groups of 8 inputs	Negative	–	140 DDI 153 10C	0.450
24 V $\overline{\text{---}}$	32 inputs	4 groups of 8 inputs	Positive	Non interfering (1)	140 DDI 353 00C	0.300
			Negative	–	140 DDI 353 10C	0.300
	96 inputs	6 groups of 16 inputs	Positive	–	140 DDI 364 00C	0.300
	32 inputs	4 groups of 8 inputs	Positive	–	140 DSI 353 00C	0.300
10...60 V $\overline{\text{---}}$	16 inputs	8 groups of 2 inputs	Positive	–	140 DDI 841 00C	0.300
	32 inputs	4 groups of 8 inputs	Positive	–	140 DDI 853 00C	0.295
125 V $\overline{\text{---}}$	24 inputs	3 groups of 8 inputs	Positive	–	140 DDI 673 00C	0.300
24 V $\sim$	16 inputs	No common point	–	–	140 DAI 340 00C	0.300
	32 inputs	4 groups of 8 inputs	–	–	140 DAI 353 00C	0.340
48 V $\sim$	16 inputs	No common point	–	–	140 DAI 440 00C	0.300
	32 inputs	4 groups of 8 inputs	–	–	140 DAI 453 00C	0.300
115 V $\sim$	16 inputs	No common point	–	–	140 DAI 540 00C	0.310
	16 inputs	2 groups of 8 inputs	–	–	140 DAI 543 00C	0.300
	32 inputs	4 groups of 8 inputs	–	–	140 DAI 553 00C	0.330
230 V $\sim$	16 inputs	No common point	–	–	140 DAI 740 00C	0.350
	32 inputs	4 groups of 8 inputs	–	–	140 DAI 753 00C	0.300

“Conformal Coating” discrete output modules						
Voltage		Description	Logic	Safety	Reference	Weight kg
5 V $\overline{\text{TTL}}$	32 outputs	4 groups of 8 outputs	Negative	–	140 DDO 153 10C	0.450
24 V $\overline{\text{---}}$	32 outputs	4 groups of 8 outputs	Positive	Non interfering (1)	140 DDO 353 00C	0.450
			Positive (2)	–	140 DDO 353 01C	0.450
			Negative	–	140 DDO 353 10C	0.450
	96 outputs	6 groups of 16 outputs	Positive	–	140 DDO 364 00C	0.450
10...30 V $\overline{\text{---}}$	32 outputs	4 groups of 8 outputs	Positive	–	140 DVO 853 00C	0.300
10...60 V $\overline{\text{---}}$	16 outputs	2 groups of 8 outputs	Positive	–	140 DDO 843 00C	0.450
24...125 V $\overline{\text{---}}$	12 outputs	2 groups of 6 outputs	Positive	–	140 DDO 885 00C	0.450
Relay 20...250 V $\sim$ 5...150 V $\overline{\text{---}}$	16 outputs	No common point	1 “NO” contact	–	140 DRA 840 00C	0.410
	8 outputs	No common point	2 “NC” and “NO” contacts	–	140 DRC 830 00C	0.300
24...48 V $\sim$	16 outputs	4 groups of 4 outputs	–	–	140 DAO 842 20C	0.450
24...115 V $\sim$	16 outputs	No common point	–	–	140 DAO 840 10C	0.485
24...230 V $\sim$	16 outputs	No common point	–	–	140 DAO 840 00C	0.485
	32 outputs	4 groups of 8 outputs	–	–	140 DAO 853 00C	0.450
100...230 V $\sim$	16 outputs	4 groups of 4 outputs	–	–	140 DAO 842 10C	0.450

(1) Version  $\geq 1$ .

(2) Outputs protected against short-circuits and overloads by thermal monitoring.

# Modicon Quantum automation platform

Treatment for severe environments  
“Conformal Coating” Discrete I/O modules

<b>“Conformal Coating” discrete mixed I/O modules</b>					
No.	Inputs	Outputs	Safety	Reference	Weight kg
24 I/O	16 inputs 24 V $\overline{\text{DC}}$ 2 groups of 8, positive logic	8 outputs 24 V $\overline{\text{DC}}$ 2 groups of 4, positive logic	–	140 DDM 390 00C	0.300
	16 inputs 125 V $\sim$ 2 groups of 8	8 outputs 125 V $\sim$ 2 groups of 4	–	140 DAM 590 00C	0.450
8 I/O	4 inputs 125 V $\overline{\text{DC}}$ 1 group of 4, positive logic	4 outputs 24...125 V $\overline{\text{DC}}$ – No common point, positive or negative logic	–	140 DDM 690 00C	0.300

Accessories, connection cables, replacement parts: see page 4/27



# Modicon Quantum automation platform

Treatment for severe environments  
“Conformal Coating” Analog I/O modules

## “Conformal Coating” analog input modules

Description	Range	Safety	Reference	Weight kg
<b>8 high level channels</b> 12-bit, unipolar	4...20 mA 1...5 V	–	<b>140 ACI 030 00C</b>	0.300
<b>16 high level channels</b> 0...25,000 points, unipolar	0...20 mA, 0...25 mA 4...20 mA	Non- interfering	<b>140 ACI 040 00C</b>	0.300
<b>8 RTD channels</b> 13-bit	Ni 100, Ni 200, Ni 500, Ni1000, Pt 100, Pt 200, Pt 500, Pt1000	–	<b>140 ARI 030 10C</b>	0.300
<b>8 thermocouple and low level channels</b> 16-bit	Types J, K, E, T, S, R, B ± 25 mV, ± 100 mV	–	<b>140 ATI 030 00C</b>	0.300
<b>8 high level channels</b> 16-bit, bipolar	± 20 mA, 0...20 mA, 4...20 mA ± 10 V, ± 5 V, 0...10 V, 0...5 V, 1...5 V	–	<b>140 AVI 030 00C</b>	0.300

## “Conformal Coating” analog output modules

Description	Range	Safety	Reference	Weight kg
<b>4 current channels</b> 12-bit	4...20 mA	Non- interfering	<b>140 ACO 020 00C</b>	0.300
<b>8 current channels</b> 0...25,000 points	0...20 mA 0...25 mA 4...20 mA	–	<b>140 ACO 130 00C</b>	0.300
<b>4 high level voltage channels</b> 12-bit	± 5 V, ± 10 V 0...5 V, 0...10 V	–	<b>140 AVO 020 00C</b>	0.300

## “Conformal Coating” mixed analog I/O modules

Description	Range	Safety	Reference	Weight kg
<b>4 input channels,</b> 14...16-bit	± 20 mA, 0...20 mA, 4...20 mA ± 5 V, ± 10 V, 0...5 V, 0...10 V, 1...5 V	–	<b>140 AMM 090 00C</b>	0.300
<b>2 output channels</b> 12-bit	4...20 mA			

Accessories: see page 4/55

# Modicon Quantum automation platform

Treatment for severe environments  
 “Conformal Coating” intrinsically safe inputs and outputs, high-speed counter, high-speed inputs

## “Conformal Coating” intrinsically safe input modules

Description/resolution	Range	Safety	Reference	Weight kg
8 analog current channels (4096 to 2500 points)	4...20 mA, 0...20 mA, 0...25 mA	–	140 AII 330 10C	0.300
8 channels for TC RTDs/ thermocouples (12-bit + sign)	Ni or Pt 100, 200, 500, 1000 Types J, K, E, T, S, R, B and mV	–	140 AII 330 00C	0.300
8 discrete inputs	Switching current 1.2 mA...2.1 mA	–	140 DII 330 00C	0.300

## “Conformal Coating” intrinsically safe output modules

Description/resolution	Range	Safety	Reference	Weight kg
8 analog current channels, 15-bit	4...20 mA, 0...20 mA, 0...25 mA	–	140 AIO 330 00C	0.300
8 discrete outputs, 12-bit	$\pm 5\text{ V} \overline{\text{---}}$ , $\pm 10\text{ V}$ , 0...5 V or 0...10 V	–	140 DIO 330 00C	0.450

Accessories: see page 5/9

## “Conformal Coating” high-speed counter modules

Description	Safety	Reference	Weight kg
Counter module, 5 x 100 kHz channels max.	–	140 EHC 105 00C	0.350
Counter module, 2 x 500 kHz channels max.	–	140 EHC 202 00C	0.350

Characteristics: see page 5/19

## “Conformal Coating” high-speed input with interrupt module

Description	Number of channels	Functions	Safety	Reference	Weight kg
High-speed input with interrupt module	16   24 V $\overline{\text{---}}$	Interrupt, latch, high-speed inputs	–	140 HLI 340 00C	–

Connections: see page 5/25

# Modicon Quantum automation platform

Treatment for severe environments  
“Conformal Coating” Hot Standby system



140 NOE 771 01

### “Conformal Coating” Unity Hot Standby system

Associated modules						
Description	Type of architecture	Topology	Transparent Ready	Safety	Reference	Weight kg
RIO head-end adaptor modules	Remote I/O (RIO) and mixed I/O	Single cable	–	–	<b>140 CRP 931 00C</b>	–
		Redundant cable	–	Non-interfering	<b>140 CRP 932 00C</b>	–
RIO drop adaptor	–	Single cable	–	–	<b>140 CRA 931 00C</b>	–
		Redundant cable	–	Non-interfering	<b>140 CRA 932 00C</b>	–
Ethernet TCP/IP network modules	Mixed	Bus or ring (copper or fibre optic)	Class B30	–	<b>140 NOE 771 01C</b>	0.345
			Class C30	Non-interfering	<b>140 NOE 771 11C</b>	0.345

Fibre optic cables for Hot Standby architecture, connection kits and accessories: see pages 3/22 and 3/23.

### “Conformal Coating” Concept/ProWORX Hot Standby system

Description	Components	Safety	Reference	Weight kg
Hot Standby module	–	–	<b>140 CHS 110 00C</b>	1.06
Hot Standby kit	2 Hot Standby modules 1 fibre optic cable (3 m) 1 CHS) downloadable function block 1 S908 connection kit 1 installation manual	–	<b>140 CHS 210 00C</b>	–

Associated modules and accessories: see page 3/29

# Modicon Quantum automation platform

Treatment for severe environments  
AS-Interface cabling system, Modbus Plus  
communication, asynchronous serial link.



140 EIA 921 00

## “Conformal Coating” AS-Interface cabling system

Description	Number per Quantum PLC	Profile	Max. number of I/O	Reference	Weight kg
<b>AS-Interface master module for Quantum PLCs</b>	4 per local drop 4 per remote drop (RIO) 2 per distributed drop (DIO)	AS-Interface M2	31 discrete devices, i.e. 248 I/O	<b>140 EIA 921 00C</b>	0.450

Characteristics, separate parts: see page 4/47

## “Conformal Coating” Modbus Plus communication devices

Description	Medium	Type	Reference	Weight kg	
<b>Quantum Modbus Plus</b>	<b>DIO drop adaptors (including power supply)</b>	Single	115/230 ~ 24 ---	<b>140 CRA 211 10C</b> <b>140 CRA 211 20C</b>	– –
		Redundant	115/230 ~ 24 ---	<b>140 CRA 212 10C</b> <b>140 CRA 212 20C</b>	– –
	<b>DIO head-end adaptors no. 2 and no. 3</b>	Single	Twisted pair cable	<b>140 NOM 211 00C</b>	–
		Redundant	Twisted pair cable	<b>140 NOM 212 00C</b>	–
		Single	Fibre optic cable	<b>140 NOM 252 00C</b>	–

Modbus Plus gateways and repeaters, and PC interface cards, see pages 6/70 to 6/77.

## “Conformal Coating” asynchronous serial link module

Description	Feature	Reference	Weight kg
<b>ASCII serial link module, 2 x RS 232 C ports</b>	19.2 kbps	<b>140 ESI 062 10C</b>	0.300
<b>Backup battery holder module</b>	2 type C lithium batteries, 3 V	<b>140 XCP 900 00C</b>	–

Characteristics: see page 6/83



# Technical information

## Automation products certifications







In some countries, certification of certain electrical components is enforced by law. A standard conformity certificate is then issued by the official organization. Each certified product must carry approval symbols when enforced. Use on board merchant navy vessels generally requires prior approval (= certification) of an electrical device by certain marine classification authorities.

Key	Certification body	Country
CSA	Canadian Standards Association	Canada
C-Tick	Australian Communication Authority	Australia, New Zealand
GOST	Gost Standard Scientific Research Institute	C.I.S., Russia
UL	Underwriters Laboratories	USA
Key	Classification authority	Country
IACS	International Association of Classification Societies	International
ABS	American Bureau of Shipping	USA
BV	Bureau Veritas	France
DNV	Det Norske Veritas	Norway
GL	Germanischer Lloyd	Germany
LR	Lloyd's Register	United Kingdom
RINA	Registro Italiano Navale	Italy
RMRS	Russian Maritime Register of Shipping	C.I.S., Russia

The table below shows the situation as at 01.08.2008 for certifications obtained or pending from organizations for base PLCs. An overview of certificates for Schneider-electric products is available on our Internet website:

[www.schneider-electric.com](http://www.schneider-electric.com)

### Product certifications

	Approvals						
	 UL USA	 CSA Canada	 ACA Australia	 GOST CIS, Russia	 Class I, Div 2 (1) USA, Canada	 ATEX Europe	 TÜV Rheinland
Advantys OTB							
Advantys STB					FM	Cat 3 G	
Advantys Telefast ABE 7							
ConneXium					(2)		
Magelis iPC, Magelis XBT GTW	(3)				UL		
Magelis XBT GT					CSA/UL	Cat 3 G-D	
Magelis XBT GK							
Magelis XBT F/FC/HM/PM							
Magelis XBT N/R					CSA/UL	Cat 3 G-D	
Magelis XBT RT					CSA/UL	Cat 3 G-D	
Modicon M340					CSA		
Modicon Momentum							
Modicon Premium				(2)	CSA		
Modicon Quantum				(2)	FM (2)		
Modicon Quantum Safety				(2)	CSA		SIL 2 (4)
Modicon TSX Micro							
Phaseo	(3) (5)						
Twido	(6)	(6)			CSA/UL (6)		

(1) Hazardous locations: UL 1604, CSA 22.2 no. 213 or FM 3611, certified products are acceptable for use in hazardous locations of Class I, division 2, groups A, B, C and D or unclassified only.

(2) Depending on product, consult our website: [www.schneider-electric.com](http://www.schneider-electric.com)

(3) cULus North American certification (Canada and USA).

(4) Certified for use in applications up to and including SIL2 according to IEC 61508.

(5) Except Universal power supplies and Function modules: UL certification pending.

(6) Except TWD NOI 10M3 AS-Interface module, only CE.

#### Local certifications







BG	Germany	TSX DPZ 10D2A safety module (Modicon TSX Micro). TSX PAY 262/282 safety modules (Modicon Premium).
SIMTARS	Australia	Modicon TSX Micro automation platform Modicon Premium automation platform (PL7)
AS-Interface	Europe	TWD NOI 10M3 master module (Twido). TSX SAZ 10 master module (Modicon TSX Micro). TSX SAY 1000 master modules (Modicon Premium).

# Technical information

## Automation products certifications

### Community regulations

#### Marine classification

	Marine classification authorities						
							
	ABS	BV	DNV	GL	LR	RINA	RMRS
	USA	France	Norway	Germany	UK	Italy	C.I.S.
Advantys OTB							
Advantys STB	(1)						
Advantys Telefast ABE 7							
ConneXium				(2)			
Magelis iPC							
Magelis iPC, Magelis XBT GTW	(2)	(2)	(2)	(2)	(2)	(2)	
Magelis XBT GK							
Magelis XBT F/FC/HM/PM							
Magelis XBT N/R		(2)	(2)	(2)		(2)	
Magelis XBT RT							
Modicon M340							
Modicon Momentum							
Modicon Premium (3)	(2)	(2)	(2)	(2)	(2)	(2)	(2)
Modicon Quantum	(2)	(2)	(2)	(2)	(2)	(2)	(2)
Modicon TSX Micro							
Phaseo							
Twido			(4)	(4)	(4)		

(1) Also meets US Navy requirements, **ABS-NRV part 4**.

(2) Depending on product, consult our website: [www.schneider-electric.com](http://www.schneider-electric.com).

(3) Modicon Premium, also **KRS (Korean register of Shipping)** certified.

(4) Except: compact bases **TWD LC●● 40DRF**, Extreme base **TWD LEDCK1**, I/O module **TWD DAI 8DT**, analogue I/O modules **TWD AMI 2LT/4LT/8HT**, **TWD ARI 8HT**, **TWD AVO 2HT**, **TWD AMM 6HT**, communication modules **499 TWD 01100**, **TWD NCO1M**, **TWD NOI 10M3** and taps **TWD XCA ISO/T3RJ**.

#### Community regulations

##### European directives

The opening of European markets implies a harmonization of regulations in the various European Union member states.

European Directives are documents used to remove obstacles to the free movement of goods and their application is compulsory in all states of the European Union. Member states are obliged to transcribe each Directive into their national legislation and, at the same time, to withdraw any conflicting regulations.

The Directives, particularly those of a technical nature with which we are concerned, only set objectives, called "general requirements".

The manufacturer must take all necessary measures to ensure that his products conform to the requirements of each Directive relating to his equipment.

As a general rule, the manufacturer affirms that his product conforms to the necessary requirements of the Directive(s) by applying the CE label to his product. The CE marking is applied to Schneider-electric products where relevant.

##### The signifiacnce of CE marking

- The CE marking on a product means that the manufacturer certifies that his product conforms to the relevant European Directives; it is necessary in order that a product which is subject to a Directive(s) can be marketed and freely moved within the European Union.
- The CE marking is intended solely for the national authorities responsible for market regulation.

For electrical equipment, conformity of the product to standards indicates that it is suitable for use. Only the guarantee of a recognized manufacturer provides an assurance of high quality.

One or more Directives, as appropriate, may apply to our products, in particular:

- The Low Voltage Directive 2006/95/EC.
- The Electromagnetic Compatibility Directive 2004/108/EC.
- Directive CE ATEX 94/9/EC.

Table with 3 columns: Product Name, Location, and Date. Rows include 110 XCA 203 00, 140 CPU 671 60C, 140 DDO 353 01, 140 XCP 510 00, 372 SPU 780 01 SITE, etc. Includes a '4' section on the right side.



52 0614 000	3/9	ABE 7ACC85	9/17	ABE 7R16S210	9/12	ABS 7SC2E	9/15	<b>S</b>	
52 0720 000	1/19	ABE 7BV10	9/17	ABE 7R16S210E	9/12	ABS 7SC3BA	9/15		
	and 3/23	ABE 7BV10E	9/17	ABE 7R16S212	9/12	ABS 7SC3E	9/15	SR2 MEMO2	9/31
52 0724 000	3/9	ABE 7BV20	9/17	ABE 7R16S212E	9/12	AM SA85 030	6/74	STB XSP 3000	1/41, 1/47, 4/55
52 0411 000	3/29	ABE 7BV20E	9/17	ABE 7R16T111	9/13	AM SA85 032	6/74		and 5/9
		ABE 7CPA02	9/16	ABE 7R16T210	9/13	AR1 SB3	9/17	STB XSP 3010	1/41, 1/47, 4/55
<b>6</b>		ABE 7CPA03	9/16	ABE 7R16T212	9/13	ASI20 MACC5	9/31		and 5/9
		ABE 7CPA21	9/16	ABE 7R16T230	9/13	ASI ABLB3002	6/67	STB XSP 3020	1/41, 1/47, 4/55
		ABE 7CPA31	9/16	ABE 7R16T231	9/13		and 9/37		and 5/9
60 0513 000	3/9	ABE 7CPA31E	9/16	ABE 7R16T330	9/13	ASI ABLB3004	6/67		
60 0544 000	3/9	ABE 7FU012	9/17	ABE 7R16T332	9/13		and 9/37		
60 0545 000	3/9	ABE 7FU050	9/17	ABE 7R16T370	9/13	ASI ABLD3002	6/67		and 5/9
60 0558 000	3/9	ABE 7FU100	9/17	ABE 7S08S2B0	9/12		and 9/37	SYC SPU LF● CD28M	6/78
60 0545 000	1/19, 3/23 and 3/29	ABE 7FU200	9/17	ABE 7S08S2B0E	9/12	ASI ABLD3004	6/67	SYC SPU LFU CD28M	6/77
		ABE 7FU400	9/17	ABE 7S08S2B1	9/12		and 9/37		
		ABE 7FU630	9/17	ABE 7S08S2B1E	9/12	ASI ABLM3024	6/67		
		ABE 7H08R10	9/11	ABE 7S16E2B1	9/12		and 9/37	<b>T</b>	
<b>8</b>		ABE 7H08R11	9/11	ABE 7S16E2B1E	9/12	AS MBII 003	3/8	TCS EAA F11F13F00	6/49
		ABE 7H08R21	9/11	ABE 7S16E2E0	9/12	AS MBII 004	3/8	TCS EAA F1LFH00	6/49
8030 CRM 931	5/33	ABE 7H08S21	9/11	ABE 7S16E2E0E	9/12	AS MBKT 085	6/75	TCS EAA F1LFS00	6/49
840 USE 100 01	5/19	ABE 7H12R10	9/11	ABE 7S16E2E1	9/12	AS MBKT 185	6/75	TCS EAA F1LFU00	6/49
840 USE 100 0●	2/19	ABE 7H12R11	9/11	ABE 7S16E2E1E	9/12	AS MBPL 001	6/75	TCS EAM 0100	6/49
840 USE 106 00	3/29	ABE 7H12R20	9/11	ABE 7S16E2F0	9/12			TCS ECL 1M1M 10S2	6/49
840 USE 108 00	6/81	ABE 7H12R21	9/11	ABE 7S16E2F0E	9/12	<b>B</b>		TCS ECL 1M1M 1S2	6/49
840 USE 109 00	5/31	ABE 7H12R50	9/11	ABE 7S16E2M0	9/12			TCS ECL 1M1M 2S2	6/49
840 USE 112 00	5/25	ABE 7H12S21	9/11	ABE 7S16E2M0E	9/12	BMX XCA USB H018	7/39	TCS ECL 1M1M 3S2	6/49
840 USE 117 01	6/63	ABE 7H16C10	9/10	ABE 7S16S1B2	9/12	BMX XCA USB H045	7/39	TCS ECL 1M1M 40S2	6/49
840 USE 419 00	6/77	ABE 7H16C11	9/10	ABE 7S16S1B2E	9/12			TCS ECL 1M3M 10S2	6/49
840 USE 443 00	5/19	ABE 7H16C21	9/10	ABE 7S16S2B0	9/12	<b>D</b>		TCS ECL 1M3M 1S2	6/49
840 USE 492 0●	7/61	ABE 7H16C31	9/10	ABE 7S16S2B0E	9/12			TCS ECL 1M3M 25S2	6/49
840 USE 493 0●	7/61	ABE 7H16CM11	9/10	ABE 7TES160	9/17	DCF 77E	5/29	TCS ECL 1M3M 3S2	6/49
840 USE 494 0●	7/61	ABE 7H16CM21	9/10	ABF M04S200	9/16			TCS ECL 1M3M 40S2	6/49
840 USE 495 01	7/61	ABE 7H16F43	9/11	ABF M04S201	9/16	<b>K</b>		TCS ECN 300R2	6/48
840 USE 496 0●	7/61	ABE 7H16R10	9/11	ABF M04S202	9/16			TCS EK1 MDRS	6/48
840 USE 497 01	6/77	ABE 7H16R11	9/11	ABF M08S201	9/16			TCS EK3 MDS	6/48
840 USE 100 00	5/9	ABE 7H16R11E	9/11	ABF M16S201	9/16	KAB 3225 LI	6/77	TLX CD LFOFS 33	8/17
		ABE 7H16R20	9/11	ABF M32H150	9/16			TLX CD LTOFS 33	8/17
<b>9</b>		ABE 7H16R21	9/11	ABF M32H151	9/16			TLX CD LUOFS 33	8/17
		ABE 7H16R21E	9/11	ABF M32H300	9/16	L		TLX CD STOFS 33	8/17
		ABE 7H16R23	9/11	ABF M32H301	9/16	LAD 90	9/31	TLX CD SUOFS 33	8/17
97 5750 000	3/8	ABE 7H16R30	9/11	ABF C08R02B	9/17			TSX BAT M02	2/13
97 5951 000	3/8	ABE 7H16R31	9/11	ABF C08R02R	9/17			TSX BAT M03	2/13
990 NAA 215 10	6/75	ABE 7H16R50	9/11	ABF C08R02W	9/17			TSX CDP 053	4/27
990 NAA 263 20	2/11, 2/19, 6/77	ABE 7H16R50E	9/11	ABF C08R12B	9/17	<b>M</b>			and 9/16
	and 6/81	ABE 7H16S21	9/11	ABF C08R12R	9/17			TSX CDP 1003	4/27
990 NAA 263 50	2/11, 2/19, 6/77	ABE 7H16S21E	9/11	ABF C08R12W	9/17	MA 0185 100	3/9	TSX CDP 103	4/27
	and 6/81	ABE 7H16S43	9/11	ABL 1A02	9/31	MA 0186 100	3/9		and 9/16
990 NAD 211 10	2/11	ABE 7H20E100	9/10	ABL 8BBU24200	9/31	MA 0329 001	3/9	TSX CDP 203	4/27
	and 6/75	ABE 7H20E200	9/10	ABL 8BBU24400	9/31	MA 0186 100	1/19, 3/23 and 3/29		and 9/16
990 NAD 211 30	2/11	ABE 7H20E300	9/10	ABL 8BPK24A03	9/31			TSX CDP 303	4/27
	and 6/75	ABE 7H32E150	9/10	ABL 8BPK24A07	9/31	MEB TCP D	5/33		and 9/16
990 NAD 218 10	1/27	ABE 7H32E300	9/10	ABL 8BPK24A12	9/31	MEB TCP T	5/33	TSX CDP 503	4/27
	and 2/11	ABE 7P08T330	9/14	ABL 8BPK24A12	9/31				and 9/16
	and 2/11	ABE 7P08T330E	9/14	ABL 8DCC05060	9/31	<b>N</b>		TSX C USB 232	1/27
990 NAD 218 30	1/27	ABE 7P16F310	9/13	ABL 8DCC12020	9/31				and 2/11
	and 2/11	ABE 7P16F310E	9/13	ABL 8FUS01	9/31	NW BM85000	6/74	TSX C USB MBP	1/27
990 NAD 230 00	6/75	ABE 7P16F312	9/13	ABL 8FUS02	9/31	NW BM85C002	6/74		and 2/11
990 NAD 230 10	6/75	ABE 7P16M111	9/14	ABL 8PRP24100	9/31	NW BM85D008	6/74	TSX IBS CA 100	6/77
990 NAD 230 11	6/75	ABE 7P16T111	9/14	ABL 8RED24400	9/31	NW BM85S232	6/74	TSX IBS CA 400	6/77
990 NAD 230 12	6/75	ABE 7P16T210	9/14	ABL 8RPM24200	9/31	NW BM85S485	6/74	TSX MCPC 002M	1/25
990 XCP 980 00	2/19	ABE 7P16T212	9/14	ABL 8RPS24030	9/31	NW BM85Y422	5/33		and 2/13
990 NAA 263 20	7/39	ABE 7P16T214	9/14	ABL 8RPS24050	9/31	NW BP85 002	6/74	TSX MCPC 512K	1/25
990 NAA 263 50	7/39	ABE 7P16T215	9/14	ABL 8RPS24100	9/31	NW RR85 001	6/74		and 2/13
		ABE 7P16T230	9/14	ABL 8WPS24200	9/31			TSX MFPP 001M	1/25
		ABE 7P16T230E	9/14	ABL 8WPS24400	9/31	<b>P</b>			and 2/13
		ABE 7P16T318	9/14	ABR 7S11	9/15			TSX MFPP 002M	1/25
		ABE 7P16T318E	9/14	ABR 7S21	9/15	PTQ-PDPMV1	3/25		and 2/13
ABE 7ACC01	9/17	ABE 7P16T330	9/14	ABR 7S23	9/15			TSX MFPP 004M	1/25
ABE 7ACC02	9/17	ABE 7P16T330E	9/14	ABR 7S33	9/15				and 2/13
ABE 7ACC10	9/17	ABE 7P16T332	9/14	ABR 7S33E	9/15			TSX MFPP 512K	1/25
ABE 7ACC11	9/17	ABE 7P16T334	9/14	ABR 7S37	9/15	<b>R</b>			and 2/13
ABE 7ACC12	9/15	ABE 7R08S111	9/12	ABS 7EA3E5	9/15			TSX MRPC 001M	1/25
ABE 7ACC20	9/17	ABE 7R08S111E	9/12	ABS 7EA3F5	9/15	RPX KIT 6F	1/18		and 2/13
ABE 7ACC21	9/17	ABE 7R08S210	9/12	ABS 7EA3M5	9/15		and 3/22	TSX MRP C001MC	10/8
ABE 7ACC30	9/17	ABE 7R08S210E	9/12	ABS 7EC3AL	9/15	RPX KIT CRP	1/18	TSX MRPC 002M	1/25
ABE 7ACC80	9/17	ABE 7R08S216	9/12	ABS 7EC3B2	9/15		and 3/22		and 2/13
ABE 7ACC81	9/17	ABE 7R08S216E	9/12	ABS 7EC3E2	9/15			TSX MRPC 003M	1/25
ABE 7ACC82	9/17	ABE 7R16M111	9/13	ABS 7SA2M	9/15				and 2/13
ABE 7ACC83	9/17	ABE 7R16S111	9/12	ABS 7SA3MA	9/15				and 2/13
ABE 7ACC84	9/17	ABE 7R16S111E	9/12	ABS 7SC1B	9/15			TSX MRP C003MC	10/8



TSX MRPC 007M	1/25	<b>V</b>	VJC L27 L59	8/22
	and 2/13		VJC L50 F13	8/22
TSX MRP C007MC	10/8	VJC 1011 10	VJC L59 F13	8/22
TSX MRPC 01M7	1/25	VJC 1011 10 11	VJC L59 L50	8/22
	and 2/13	VJC 1011 11		
TSX MRPC 768K	1/25	VJC 1011 11 12		
	and 2/13	VJC 1011 12	<b>X</b>	
TSX MRP F004M	2/13	VJC 1011 12 13	XZ CB 10201	6/63
TSX MRP F008M	2/13	VJC 1011 13	XZ CB 10501	6/63
TSX P CAP	2/13	VJC 1011 13 14	XZ CB 11001	6/63
TSX CRJMD 25	7/39	VJC 1011 14	XZC C12 FCM 50B	6/49
TSX CUSB 485	7/39	VJC 1011 14 15	XZC C12 FDM 50B	6/49
TSX PCX 1031	7/39	VJC 1011 15	XZC P1164L2	6/49
		VJC 1011 15 99	XZC P1164L5	6/49
		VJC 1011 99	XZC P1264L2	6/49
<b>U</b>		VJC 1020 10	XZC P1264L5	6/49
UAG SBT XFT CD10	7/53	VJC 1020 10 11		
UAG SEW LFF CD30	7/53	VJC 1020 11		
UAG SEW LFF CD30	7/53	VJC 1020 11 12		
UNY SPU EFF CD 40	7/37	VJC 1020 12		
UNY SPU EFG CD 40	7/37	VJC 1020 12 13		
UNY SPU EFT CD 40	7/37	VJC 1020 13		
UNY SPU EFU CD 40	7/37	VJC 1020 13 14		
UNY SPU EZF CD 40	7/37	VJC 1020 14		
UNY SPU EZG CD 40	7/37	VJC 1020 14 15		
UNY SPU EZGT CD 40	7/37	VJC 1020 15		
UNY SPU EZSG CD 40	7/37	VJC 1020 15 99		
UNY SPU EZST CD 40	7/37	VJC 1020 88		
UNY SPU EZSU CD 40	7/37	VJC 1020 99		
UNY SPU EZT CD 40	7/37	VJC 1022 10		
UNY SPU EZU CD 40	7/37	VJC 1022 10 11		
UNY SPU EZUG CD 40	7/37	VJC 1022 11		
UNY SPU LFF CD 40	7/37	VJC 1022 11 12		
UNY SPU LFG CD 40	7/37	VJC 1022 12		
UNY SPU LFT CD 40	7/37	VJC 1022 12 13		
UNY SPU LFU CD 40	7/37	VJC 1022 13		
UNY SPU LZF CD 40	7/37	VJC 1022 13 14		
UNY SPU LZG CD 40	7/37	VJC 1022 14		
UNY SPU LZGT CD 40	7/37	VJC 1022 14 15		
UNY SPU LZSG CD 40	7/37	VJC 1022 15		
UNY SPU LZST CD 40	7/37	VJC 1022 15 99		
UNY SPU LZSU CD 40	7/37	VJC 1022 88		
UNY SPU LZT CD 40	7/37	VJC 1022 99		
UNY SPU LZU CD 40	7/37	VJC 1030 10		
UNY SPU LZUG CD 40	7/37	VJC 1030 10 11		
UNY SPU MFG CD 40	7/36	VJC 1030 11 12		
UNY SPU MFT CD 40	7/36	VJC 1030 12 13		
UNY SPU MFU CD 40	7/36	VJC 1030 13 14		
UNY SPU MZG CD 40	7/36	VJC 1030 14 15		
UNY SPU MZGT CD 40	7/36	VJC 1030 15 99		
UNY SPU MZSG CD 40	7/36	VJC 1030 88		
UNY SPU MZST CD 40	7/36	VJC 1030 99		
UNY SPU MZSU CD 40	7/36	VJC 1032 10		
UNY SPU MZT CD 40	7/36	VJC 1032 10 11		
UNY SPU MZU CD 40	7/36	VJC 1032 11 12		
UNY SPU MZUG CD 40	7/36	VJC 1032 12 13		
UNY SPU SFG CD 40	7/36	VJC 1032 13 14		
UNY SPU SFT CD 40	7/36	VJC 1032 14 15		
UNY SPU SFU CD 40	7/36	VJC 1032 15 99		
UNY SPU SZG CD 40	7/36	VJC 1032 88		
UNY SPU SZGT CD 40	7/36	VJC 1032 99		
UNY SPU SZT CD 40	7/36	VJC 1090 88		
UNY SPU SZU CD 40	7/36	VJC 1091 01		
UNY SPU SZUG CD 40	7/36	VJC 1091 01D3		
UNY XCA USB 033	1/27	VJC 1094 00		
	and 2/11	VJC 1095 03		
UNY SDU DFU CD20	7/45	VJC 1099 11		
UNY SDU MFF CD20	7/43	VJC 1099 12		
UNY SDU MFT CD20	7/43	VJC 1099 21		
UNY SDU MFU CD20	7/43	VJC 1099 22		
UNY SPU ZFU CD 30E	7/49	VJC 3011 27		
UNY USE 909 CD M	7/39	VJC 3011 50		
UNY XCA USB 033	7/39	VJC 3011 59		
		VJC 3051 41		
		VJC 3051 40		
		VJC 3051 42		
		VJC 3051 44		
		VJC 3051 48		
		VJC 3051 49		
		VJC L27 F12		



**Schneider Electric Industries SAS**

[www.schneider-electric.com](http://www.schneider-electric.com)

Head Office  
89, bd Franklin Roosevelt  
92506 Rueil-Malmaison Cedex  
France

Due to evolution of standards and equipment, the characteristics indicated in texts and images of this document do not constitute a commitment on our part without confirmation.  
Design: Schneider Electric  
Photos: Schneider Electric  
Printed by: Ingoprint