

Zelio Control

Temperature controller

Quick start

04/2009



Schneider Electric assumes no responsibility for any errors that may appear in this document. If you have any suggestions for improvements or amendments or have found errors in this publication, please notify us.

No part of this document may be reproduced in any form or by any means, electronic or mechanical, including photocopying, without express written permission of Schneider Electric.

All pertinent state, regional, and local safety regulations must be observed when installing and using this product. For reasons of safety and to help ensure compliance with documented system data, only the manufacturer should perform repairs to components.

When devices are used for applications with technical safety requirements, the relevant instructions must be followed.

Failure to use Schneider Electric software or approved software with our hardware products may result in injury, harm, or improper operating results.

Failure to observe this information can result in injury or equipment damage.

© 2009 Schneider Electric. All rights reserved.

SOMMAIRE

SOMMAIRE.....	3
CHAPTER 1 INTRODUCTION.....	5
Fonctioning:	5
Application examples:	5
Identification and fonctionnalités: Chapter 1 Introduction	6
CHAPTER 2 : TERMINOLOGY.....	7
PID : Proportionnel Intégral Dérivé :.....	7
The outputs:	8
Regulation principle:	9
CHAPTER 3: EXAMPLES OF INTEGRATED FUNCTIONS INTO THE CONTROLLERS.....	11
Auto tuning:	11
Fuzzy logic:	11
Self control :.....	11
Ramps: Chapter 3 Example of functions.....	12
Pid 2 :.....	12
Soft start :.....	12
Alarms:	12
CHAPTER 4 : WIRING AND SCHEMATICS :.....	13
REG 24 (12 models) :.....	13
REG 48 (14 models) :.....	13
REG 96 (14 models): Chapter 4 wiring and shematics.....	14
CHAPTER 5: IMPLEMENTATION.....	15
Selection guide:	15
Front face description : Chapter 5 Implementation.....	16
CHAPTER 6: EXAMPLE OF IMPLEMENTATION.....	17
1 st step : Controller selection.....	17
2sd step : The cabling.....	17
3 Rd step : Front face programming Chapter 6 Example of implementation.....	18
Probe type setting (PT100).....	18
Setting of the PT100 probe range (0 to 400°C).....	19
Setting of the minimum value for the PT100 probe Pvb = 0°C.....	19
Setting of the maximum value for the PT100 probe PvF = 400°C.....	19
Chapter 6 Example of implementation.....	20
Setting of the choosen decimal value (Pvd) (to display the tenth).....	20
Chapter 6 Example of implementation.....	21
Regulation mode selection = heating on channel 1 (rEv).....	21
Alarms 1 and 2 parameters setting.....	21
Alarm 1 parameters setting at 32°C Chapter 6 Example of implementation.....	22
Alarm 2 setting at 38°C.....	22
Parameter setting of the alarms on high overtaking (do1T).....	22
4 Th step: Functional test.....	23
1 St step: install the software ZelioControl Soft (compatible with Windows XP and Vista) ...	23
2 Nd step: installation of the TSXCUSB485 driver.....	23
3 Rd step: connect the TSXUSB485 to your PC and the controller.....	23
4 Th step : check the communication port parameters of the TSXCUSB485 driver.....	24
5 Th step: Discover the software ZelioControl Soft.....	24
Chapter 6 Example of implementation.....	25
6 Th step: check the communication parameters of the TSXCUSB485 driver.....	25
7 Th step: Communication parameters setting:.....	25
Chapter 6 Setup example.....	26
8 Th step: Connection to the régulator and application Upload.....	26
9 Th step: Application display.....	26
CHAPITRE 7: ZelioControl SOFT software.....	27
ZelioControl Soft screen - oPE CH1.....	27

ZelioControl SOFT screen PID CH2.....	27
ZelioControl SOFT screen PID CH2.....	28
ZelioControl Soft screen - PLT CH3.....	29
ZelioControl Soft screen - PRG CH4.....	30
ZelioControl Soft screen - MON Ch5.....	31
ZelioControl Soft screen – SET Ch6.....	32
ZelioControl Soft screen – SyS Ch7.....	33
ZelioControl Soft screen – ALM Ch8.....	34
ZelioControl Soft screen - CoM CH9.....	35
ZelioControl Soft screen - PFb CH10.....	35
ZelioControl Soft screen - PAS CH11.....	36
ZelioControl Soft screen - CFG CH13.....	37
Application file saving under ZelioControl SOFT.....	38

CHAPTER 1 INTRODUCTION

Fonctioning:

The temperature control relays are equipped with a sensor input that permits to use multiple types of sensors (PT100 probe, thermocouple, current or voltage sensors depending the model), one or two process outputs (relay, solid state relay interface or analog) for heating, cooling or heating and cooling regulation based on PID algorithm.

The measured temperature and the setpoint can be displayed in °Celsius or °Fahrenheit.

Advanced functions are embedded: Ramps (up to 16), hysteresis, fuzzy logic, auto tuning, soft start, alarms.

The temperature controllers can be setup using the front face interface or through a common software by a communication port and the integrated Modbus.

This communication port provides intergartion capability in an itelligente architecture supervised by Magelis terminal or controled by PLCs(Twido, M340 or Premium) to exchange setpoints, process values and alarms.

Application examples:

The temperature controllers Zélio control REG provide a solution for temperature control in the following applications:

- Ovens and furnaces,
- Extrusion lines,
- Plastic and rubber presses,
- thermo-forming,
- Production of synthetic fibres an polymerisation,
- Food and drink processing lines,
- Moulding presses,
- Environmental chambers, overhead furnaces and test benches,
- UV &laser technologies,
- Cabin of painting,
- Cold rooms,
- Horticultural and livestock farms,
- Maintening the temperature of a colour bath...

The product part number allows identification of the embedded functions:

24 controllers :

REG	24	P	TP	1	A	R	HU
		P	UJ			L	LU
						J	
Regulator	Size	PID	Input type	Output number	Without modbus	Output type	power supply
		P = PID					
Input type:		TP = Thermocouples and PT100					
		UJ = Analog signal					
Modbus function:		A = no modbus available					
Output type:		R = relay					
		L = solid state relay interface					
		J = analog (4/20mA)					
Power supply:		HU = 110/220 VAC					
		LU = 24 V AC/DC					

48/96 controllers :

REG	48	P	UN	1	L	R	HU
	96			2		L	LU
						J	
Regulator	Size	PID	Input type	Output number	Without modbus	Output type	Power supply
		P = PID					
Input type:		UN = universal input thermocouple / PT100 / analog					
Output type:		R = relay					
		L = solid state relay interface					
		J = analog (4/20mA)					
Modbus function:		L = no modbus available					
Power supply :		HU = 110/220 VAC					
		LU = 24 V AC/DC					

Note : When 2 outputs possible combination between 1 relay and 1 solid state relay interface or 1 solid state relay and one current (for detail see doc 24480-EN page 6)

CHAPTER 2 : TERMINOLOGY

PID : Proportionnel Intégral Dérivé :

The principle of the PID algorithm consists on 3 actions that are dependant to the difference between the setpoint (SV) and the measured process value (PV).

- A proportional action ne action proportionnelle, the error is multiplied by a gain GR
- A complete action, the error is integrated on an interval of time TI
- Derivated action, the error is derivated according to time TD

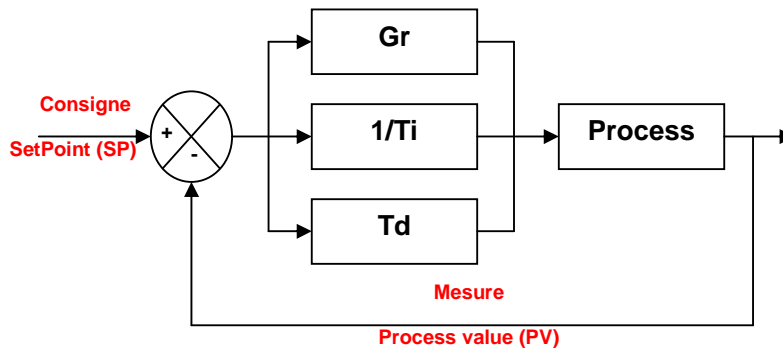

PID principle schematic

The parameters of the PID influence the answer of the system in the following way:

- When the proportional gain GR increases, the time of rise is shorter but there is a more important overshoot of the setpoint. The time of stabilization varies little and the static error is improved.
- When $1 / TI$ increase, the time of rise is shorter, but there is a more important overtaking of the setpoint. The time of stabilization stretches out but we assure a static no error.
- When TD increases, the time of rise changes little, but the overshoot decreases. The time of stabilization is better and there is no influence on the static error.

The use of 24/48/96 controllers is going to allow through a parameter setting of variables to appeal to automatic functions or manual regulations.

These variables are going to allow:

- To choose the type of sensor used (probe thermocouple or PT100, analogical sensor),
- To choose the type of output used according to the actuator(s) (relay, solid state relay, analogical),
- To choose the function of regulation (heating or cooling or heating and cooling),
- To reduce the time of establishment (the value of measure reaches as quickly as possible the setpoint),
- Avoid overshoot (fuzzy logic and PID2),
- To maintain the temperature very close to the setpoint (réduction of the hysteresis and the dead band),
- Avoid influence of perturbation,
- To activate alarms (high, low, delayed...),
- Setup ramps (up to 16 depending the model) to chain cycles of regulations,
- To have information of defects (overflowing measures, defect sensors),
- To lock or authorize the modification of the parameters from the front face of the product.

Chapter 2 Terminology

The outputs:

- **Relay** : Output type mostly used
- **Solid state relay interface**: Used to contrôle actuator with no noise or frequent switching.
- **Courant** : used to drive analog actuator such as speed drives

On and OFF control: Most simple algorithm, no anticipation of the setpoint, not precized, we notice a lot of oscillations.

Proportional control: The process output is proportional to the derivation from the. The proportional band allows overshoots anticipation.

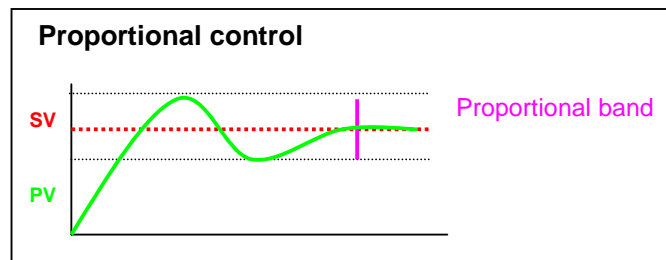

Regulation principle:

Proportional

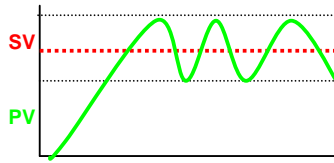

P too low = oscillations

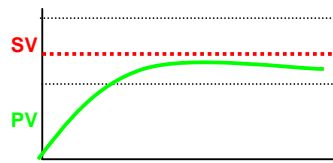

P too high = slow rise and important gap

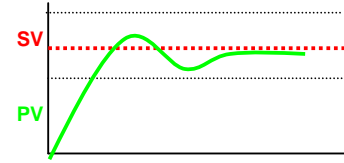

P correct = correct rise and minor gap

Intégrale

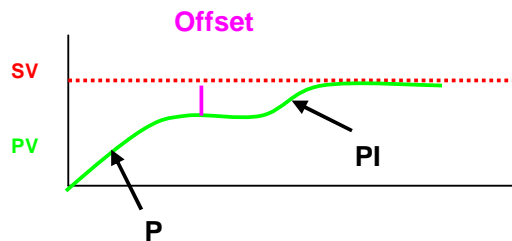

The integral allow catching up the setpoint when there is an offset with the process value. In combination with the proportional, the integrale function reaches the setpoint.

Derivative

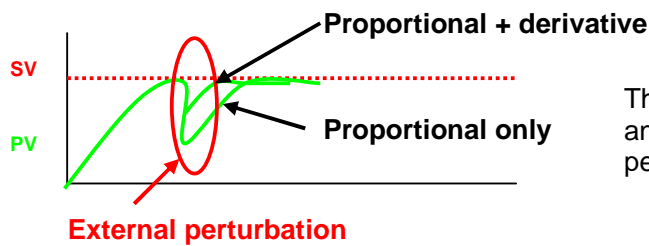

The derived control allows countering any distance created by an external perturbation.

PID

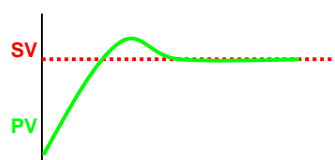

The combination of proportional, derivative and integrale optimized the regulation

Visualization of PID structure:

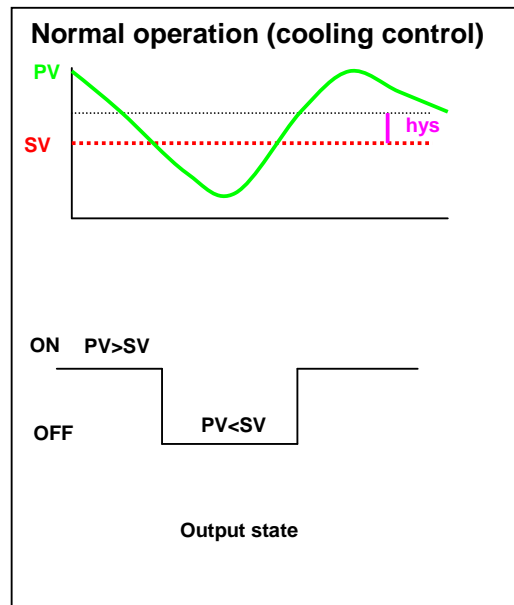
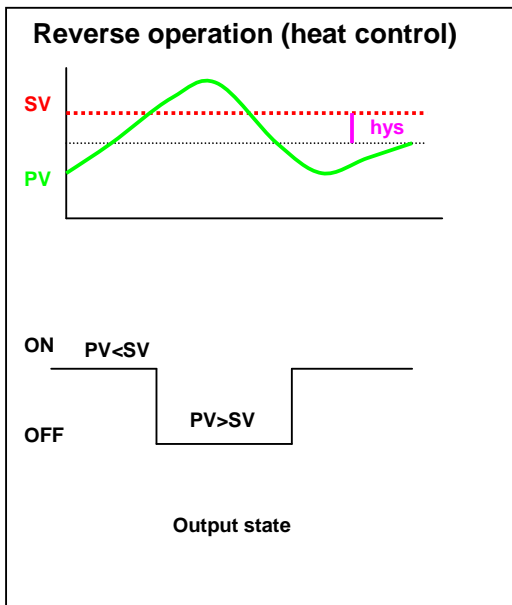
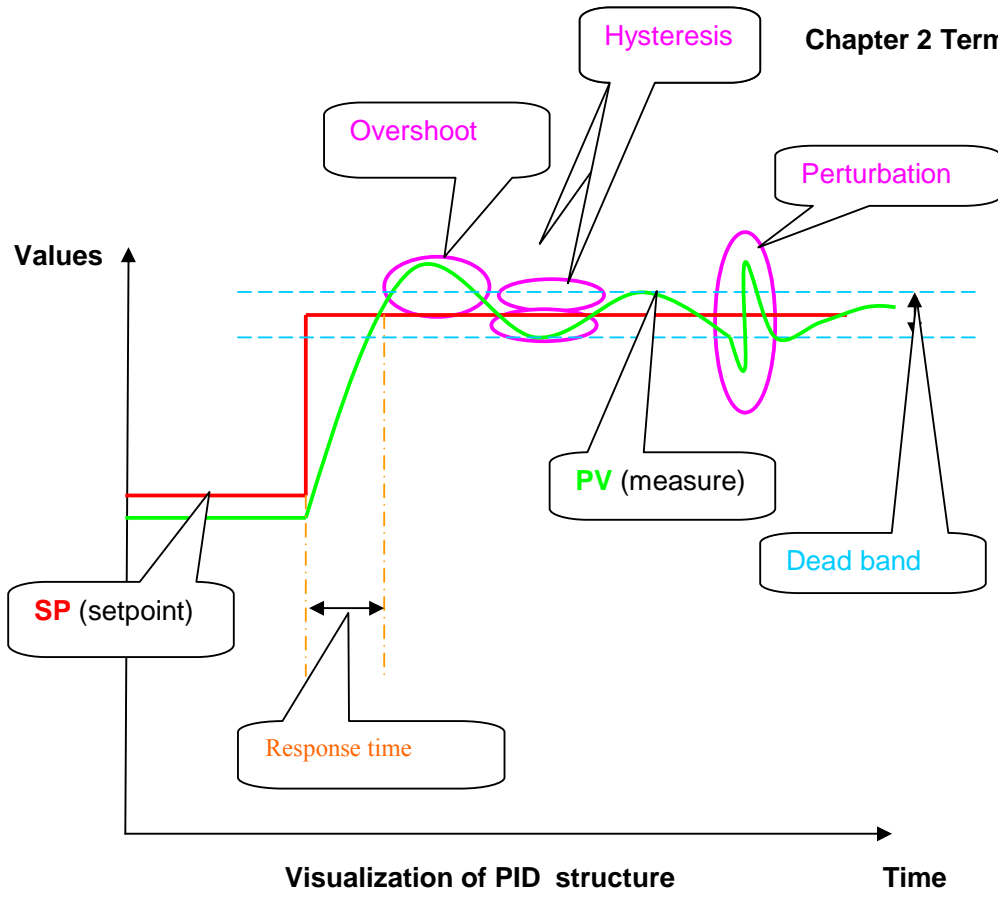

Choice of regulation type

CHAPTER 3: EXAMPLES OF INTEGRATED FUNCTIONS INTO THE CONTROLLERS

Auto tuning:

This function calculates automatically the proportional, derivative and integrals factors of the PID function. This calculation is done during 2 regulation cycles.

Fuzzy logic:

The fuzzy logic manages the command of the process in a range of 0 to 100% of the measure scale. This logic applies a command to the process to optimize the switching between heating and cooling outputs depending the setpoint and avoid overshoot.

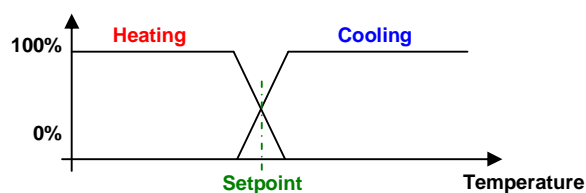

Fuzzy logic principle

Self control :

This function restarts the calculation of the PID parameters at each setpoint change or after a power on.

Remark: This command will generate temporarily a perturbation of the regulation close to the setpoint value. Some applications might be sensitive to this function.

Ramps:

Chapter 3 Example of functions

This function allows a sequence of setpoints (up to 16 ramps for REG48 and REG96) during a certain period of time. For each setpoint, a response time and the duration of the level can be setup.

These times can be defined in hour and minutes or in minutes and seconds.

Example:

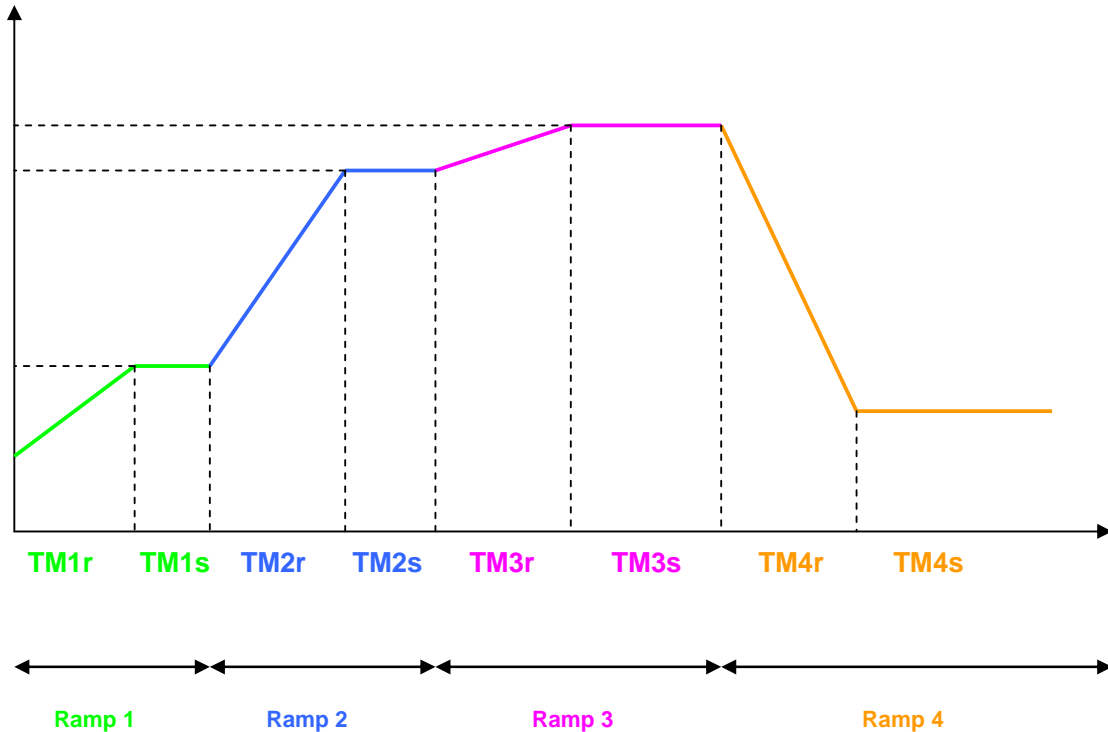

Pid 2 :

Choice of a PID that avoid overshoot during the regulation phase.

Soft start :

Moderate starting up, the time of establishment (the process value reaches the setpoint) is adjustable. This function can be used in the case of machines sensitive to the abrupt variations of temperature.

Alarms:

One to 3 alarms are available depending the models. Each alarm is based on an output relay (1 to 3A depending the model). Two more alarms are available through Modbus on REG96 and one on the REG48 models.

The alarms can be configured for a low or high level and can also be delayed.

CHAPTER 4 : WIRING AND SCHEMATICS :

REG 24 (12 models) :

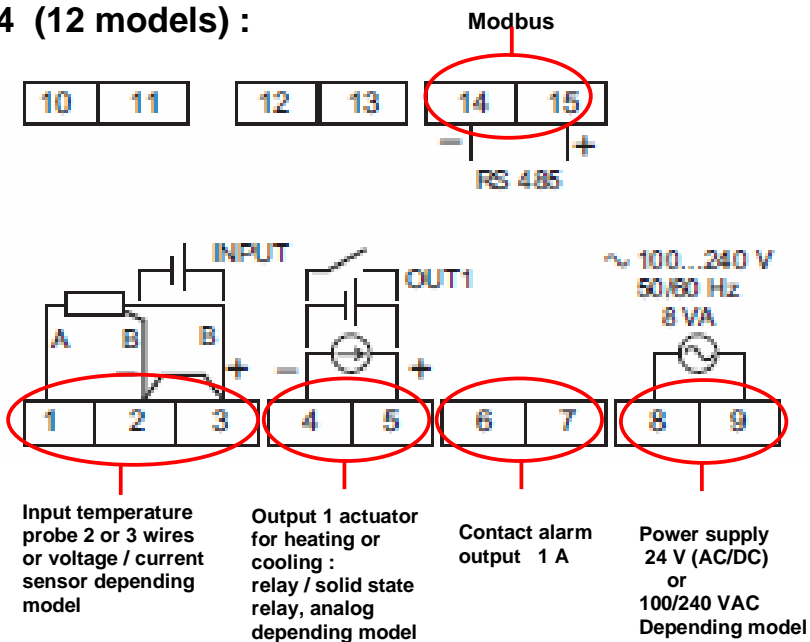

REG 48 (14 models) :

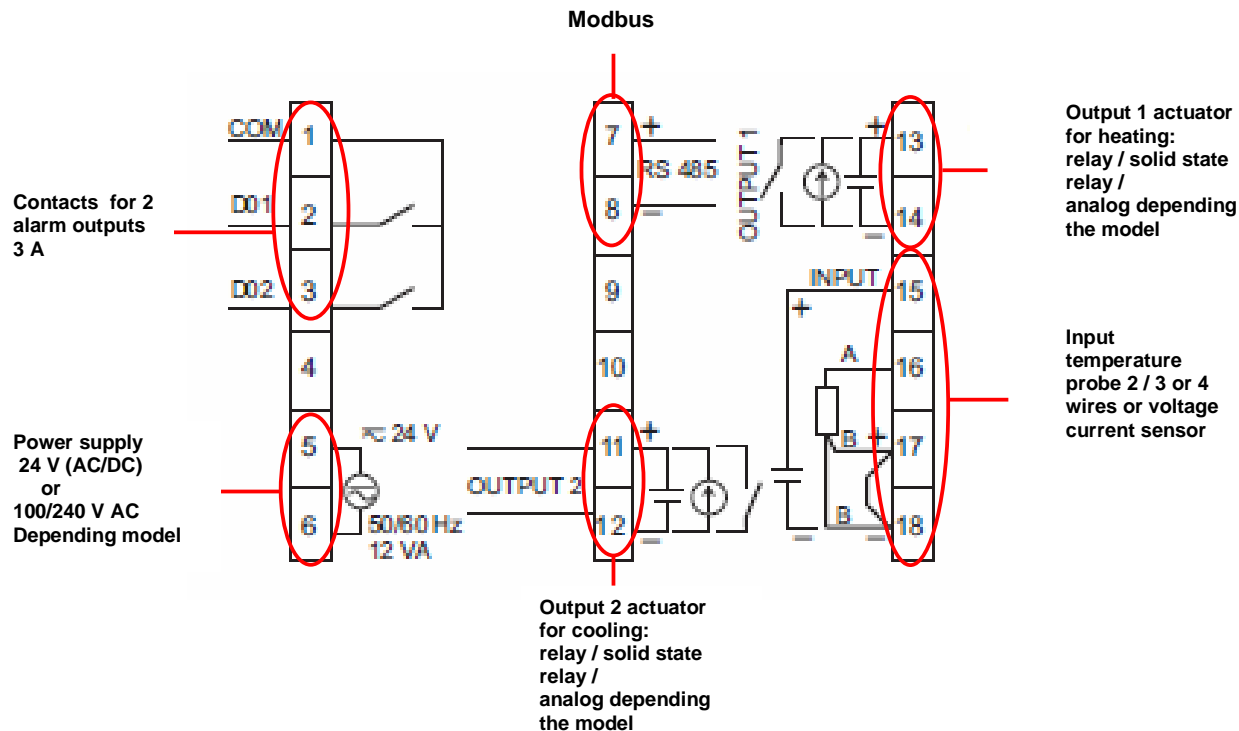

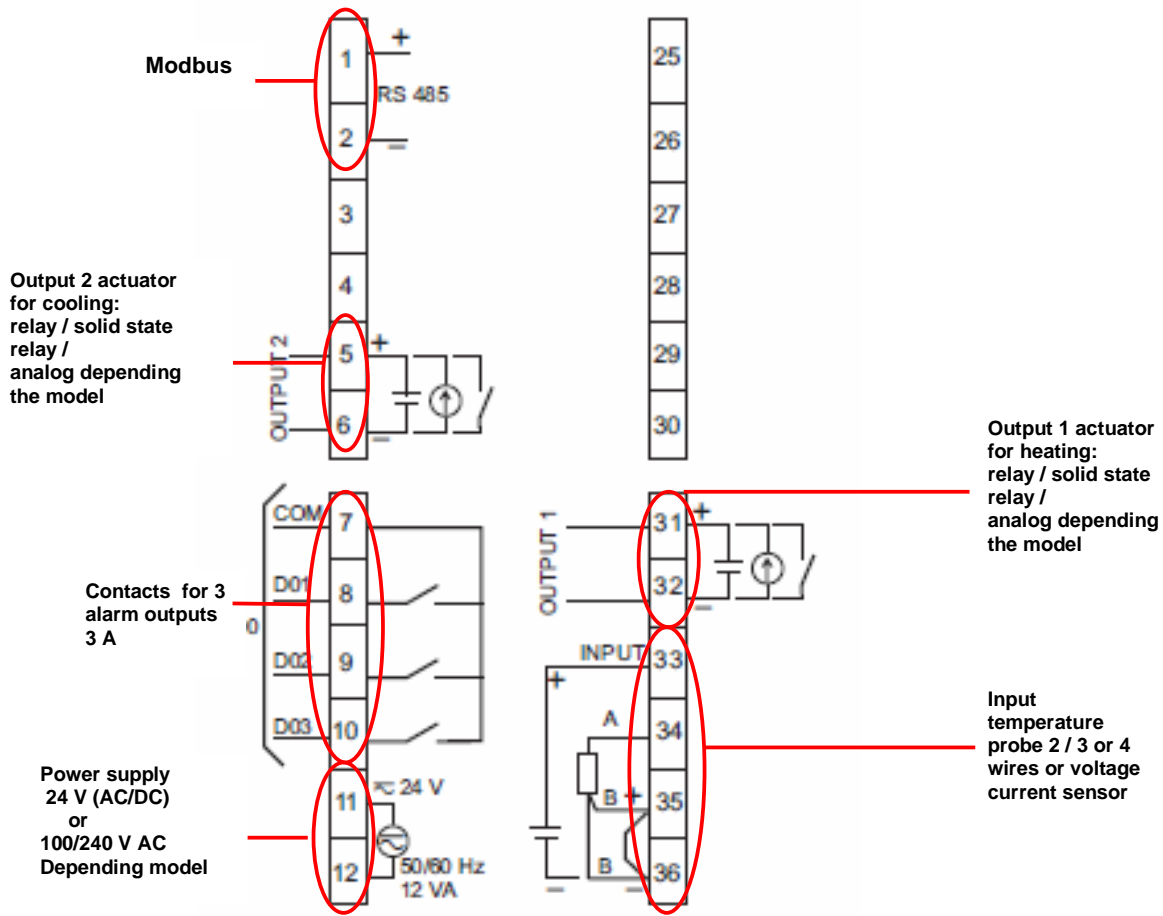

Note :

The alarms D4 and D5 are only available through Modbus
 The output(s) type depends on the product (see page 6 of the document).

Remark:

The wiring of the solid state relays or analog actuators and input probe must follow the wiring schematics, especially the polarity..

For the modbus connection availability check carefully the part number and the table described page 6.

The modbus connection is connected to the screw terminals:

- **14/15** for REG 24
- **7/8** for REG 48
- **1 /2** for REG 96

CHAPTER 5: IMPLEMENTATION

Selection guide:

To choose the most adapted controller the characteristics that must be take into account are (functional analysis):

- The sensor type connected to the input (PT100, thermocouple, analog, current or voltage);
- The number and type of the outputs: need to manage one or 2 actuators for heating, cooling or heating and cooling regulation (relay or solid state relay interface or analog (proportional valve, speed drive) ;
- The number of alarms;
- The number of ramps;
- Operation mode (automatic or automatic and manual);
- **Modbus** communication available (need of multiple controllers, communication with a Magelis, a PLC such as TWIDO, M340 or Premium);

Advanced function easy to use and to setup embedded on controllers:

- hysteresis
- auto tuning
- fuzzy logic (see page 8)
- soft start (on REG48 and REG96)

	REG 24	REG 48	REG 96
Input type	-PT100 -Themocouple J,K,R,B,S,T,E,N,PLII -Voltage 1....5V -Current 4...20mA	-PT100 -Themocouple J,K,R,B,S,T,E,N,PLII -Voltage 0....5V,1....5V,0....10V, 2...10V, -Current 0...20mA, 4....20mA	-PT100 -Themocouple J,K,R,B,S,T,E,N,PLII -Voltage 0....5V,1....5V,0....10V, 2...10V, -Current 0...20mA, 4....20mA
Process output type	-SPDT Relay 220VAC, 30VAC/DC 3A -Solid state interface 24VDC, 20 mA, 850Ω - analog 4....20mA (600Ω maxi)	-SPST Relay 220VAC, 30VAC/DC 3A -Solid state interface 24VDC, 20 mA, 850Ω - analog 4....20mA (600Ω maxi) 0....5V, 1....5V, 0....10V (10KΩ mini)	
Number of process outputs	1relay ou 1 solid sate relay interface ou 1 analog current	1 relay ou 2 relays ou 1 solide state relay interface ou 1 relay + 1 solid state relay interface ou 1 analog current ou 1 solid state relay interface + 1 analog current	
Alarms	1 physical or 1Modbus	2 + 1Modbus	3 + 2 Modbus
Sampling time	500ms	200ms	200ms
Precision	0,5% FS	0,3% FS	
Number of ramps	8	16	
Hysteresis	OUI		
PID	OUI		
PID2	NON	OUI	
Auto tuning	OUI		
Fuzzy logic	Yes		
Soft start	NO	Yes	
Operating mode	AUTOMATIC	AUTOMATIC and MANUAL	
Modbus communication	NO if A letter in the part number	NO if L letter in the part number before the number of output	

Front face description :

Chapter 5 Implementation

REG 24



- 1 **C1** : indicator showing output 1 ON
- 2 **SV** : set-point value indicator; on = SV, off=PV present value indicator, if parameter entry
- 3 **SEL** : selector button
- 4 Display of parameter value entered, 4 red digits, 10mm high
- 5 UP (increment) arrow.
- 6 DOWN (decrement) arrow
- 7 **AL1** : relay output alarm on REG24PTP1A•HU only.
- 8 **AL2** : Modbus alarm.

REG 48



- 1 **C1** : set-point value indicator.
- 2 **PV** : process value indicator
- 3 **C1** : indicator showing output 1 ON.
- 4 **C2** : indicator showing output 2 ON.
- 5 **D01** : Alarm 1 output ON
- 6 **D02** : Alarm 2 output ON
- 7 Display of process value, 4 red digits, 12 mm high
- 8 Display of parameter value entered, 4 green digits, 10mm high
- 9 UP (increment) arrow
- 10 DOWN (decrement) arrow.
- 11 **SEL** : selector button.
- 12 **A/M** : automatic / manual mode or configuration key.

REG 96



- 1 **SV** : set-point value indicator
- 2 **PV** : process value indicator
- 3 **C1** : indicator showing output 1 ON
- 4 **C2** : indicator showing output 2 ON
- 5 **D01** : alarm 1 output ON
- 6 **D02** : alarm 2 output ON
- 7 **D03** : alarm 3 output ON
- 8 Display of process value, 4 red digits, 12 mm high
- 9 Display of parameter value entered, 4 green digits, 10mm high
- 10 UP (increment) arrow
- 11 DOWN (decrement) arrow.
- 12 **SEL** : selector button.
- 13 **A/M** : automatic / manual mode or configuration key.

CHAPTER 6: EXAMPLE OF IMPLEMENTATION

The function to be done is the piloting of a system of heating. The actuator is managed by a relay and the temperature probe is a PT100, range from 0 to 400 °Celsius.
 The temperature setpoint is 28°C. It can be adjusted by the operator from 24 to 30°C.
 One alarm must turn on when the temperature reaches 32°C and a second alarm when the temperature reaches 36°C.
 The controller power supply is 220VAC.

At first no particular function is needed, just a regulation closer of to the setpoint.

1 st step : Controller selection

The demand of two alarms imposes at least a regulator of type 48, Modbus communication to use the software ZelioControl soft.

The selected model is:

REG 48 PUN 1 R HU: 1 universal input, 1 relay output, 220VAC power supply, Modbus communication to allow parameter setting using the software

2sd step : The cabling

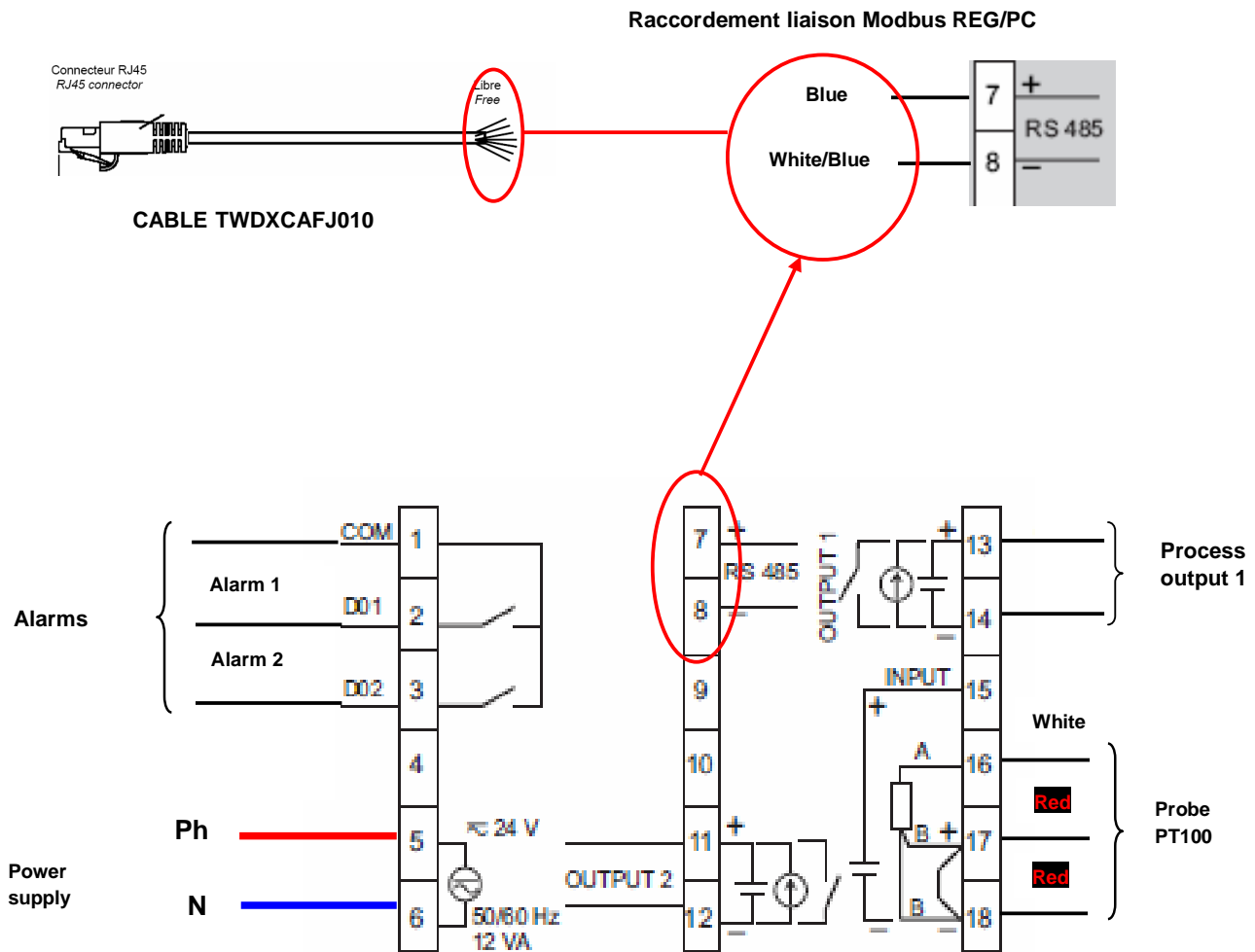

3 Rd step : Front face programming

Power on the controller,

Probe type setting (PT100)



From the main screen push on the  key until this screen appears

Ch 1 functions, for detail see the user guide



Push on the  key until this screen appears

Ch 6 functions, for detail see the user guide



Push on  key until this screen appears

PvT choice of the probe type



Push on the  key, the green figure is blinking

PvT = 1 (PT100 probe)

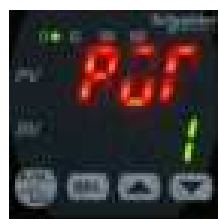

Impulsion sur  jusqu'à l'apparition du chiffre 1

Choice validation by pushing the  key

Setting of the PT100 probe range (0 to 400°C)



Push on  key to get this screen

Setting of the minimum value for the PT100 probe Pvb = 0°C

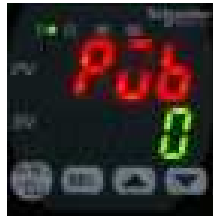



Push on the  key, the green figure is blinking

Push on the  key to get 0

Choice validation by pushing the  key

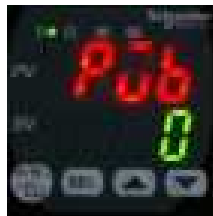
Setting of the maximum value for the PT100 probe PvF = 400°C



Push on  key until this screen appears



Push on  key, the green figure is blinking

Push on  key to reach 400

Choice validation by pushing the  key



Push on  key to get this screen

Setting of the chosen decimal value (Pvd) (to display the tenth)



Push the  key, the green figure is blinking

Push the  key to get the figure 1

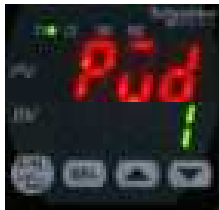



Choice validation by pushing the key 

Back to the main screen by pushing 

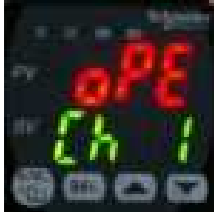

Push the  key until this screen appears





Push the  key until this screen appears

Ch 2 functions, for details see the user guide

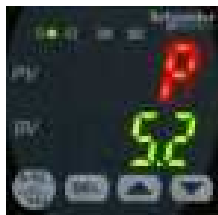

Push the  key until this screen appears



Push the  key until this screen appears

Regulation mode selection = heating on channel 1 (rEv)

see details of the choices page 8



Push the  key, the line **no- -** is blinking

One push on  to get **rv --**

Choice validation by the  key





Back to the main screen by pushing 

Alarms 1 and 2 parameters setting

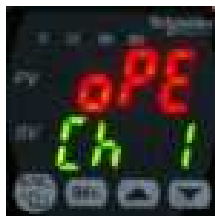

Push the  key key until this screen appears



Push the  key until this screen appears





Push the key  key until this screen appears

Alarm 1 parameters setting at 32°C

Chapter 6 Example of implementation



Push the key  the green figure is blinking

Push the key  until 32.0 value di sdisplayed

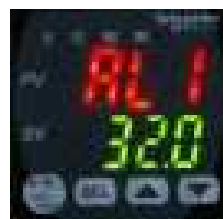

Choice validation by pushing the key 

One push on  to adjust alarm 2

Alarm 2 setting at 38°C



Same operation as for alarm 1, adjust at 38.0°C

Validation of the choice by pushing the key 

Back to the main screen by pushing 

Parameter setting of the alarms on high overtaking (do1T)



Push the key  the green figure is blinking

1 push on the key  to display the number 1

Validation using the key 

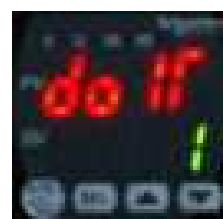

Back to the main screen by pushing 

4 Th step: Functional test

The controller has been configured as for the example. Real tests can be made.
(Status of the alarm 1 and 2 compare to the temperature displayed on the front face....)

Following the same method it's possible to modify through the front face the other parameters
(Auto Tunning, PID2, etc...)

Use of the ZelioControl SOFT software

1 St step: install the software ZelioControl Soft (compatible with Windows XP and Vista)

2 Nd step: installation of the TSXCUSB485 driver

3 Rd step: connect the TSXCUSB485 to your PC and the controller

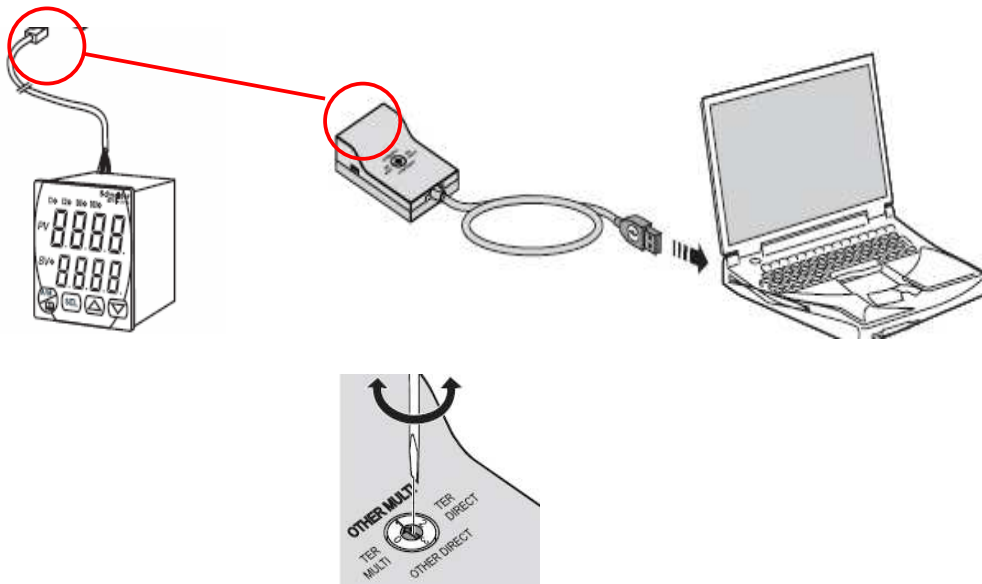

Check the rotary switch is positionned to OTHER MULTI

4 Th step : check the communication port parameters of the TSXCUSB485 driver

Open the Windows configuration panel (1), then “System”, then “Hardware” (2) and “peripheral management” (3):

Chapter 6 Example of implementation

1 Start menu -> Control Panel

2 System Properties -> Hardware tab

3 Device Manager -> Ports (COM and LPT) -> TSX C USB 485 (COM7)

Communication port assigned to the driver : in this case COM7

If the communication port number is higher than 10 you must reassign the communication port to a lower number. Open the port property window, click on the advance button, in the field « Number » of the COM port, you must choose a number less or equal to 10. Validate the change using the “OK” button.

5 Th step: Discover the software ZelioControl Soft

After the installation of ZelioControl Soft done, start ZelioControl Soft :

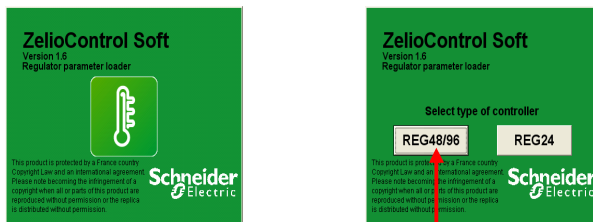

Select the controllers 48/96

6 Th step: check the communication parameters of the TSXCUSB485 driver

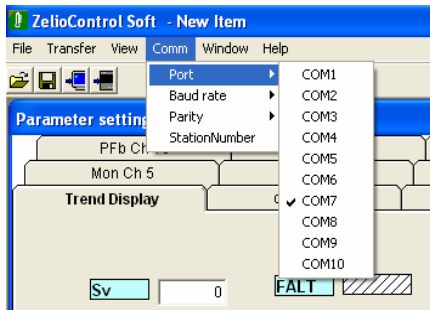

Select the same communication port than for step 4

7 Th step: Communication parameters setting:

Baudrate, parity, station number:

These parameters must be the same than the controller's one. You can check this value using the controller front face interface and the screen CH9:



In this example: baudrate 9600, parity odd, station number 5

Communication setting using ZelioControl Soft (Communication default values are : 19200 bauds, parity Even, station n°248)

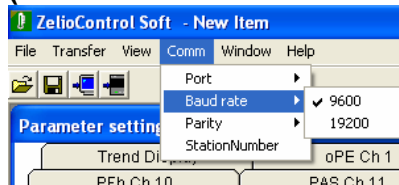

Baudrate 9600 bds

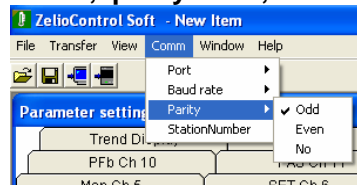

Parity odd

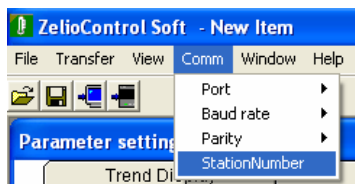

Station n°5

8 Th step: Connection to the régulator and application Upload

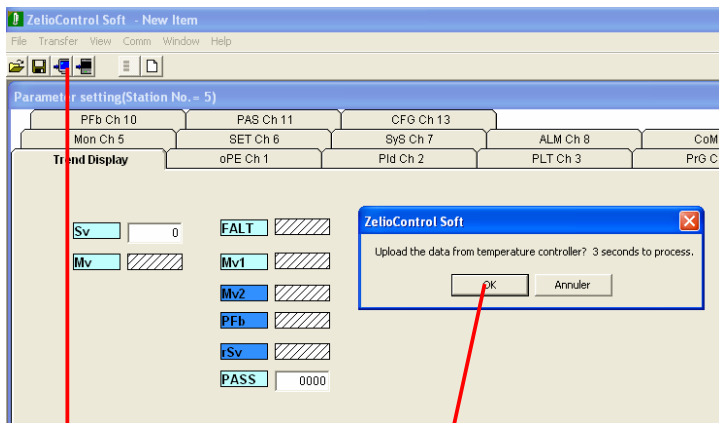

Important :
 Before exit of ZelioControl Soft, don't forget to save your application.
 The software closes without an automatic save of the file. (see page 36)

1 Upload choice 2 Confirmation

9 Th step: Application display

ZelioControl Soft principal screen

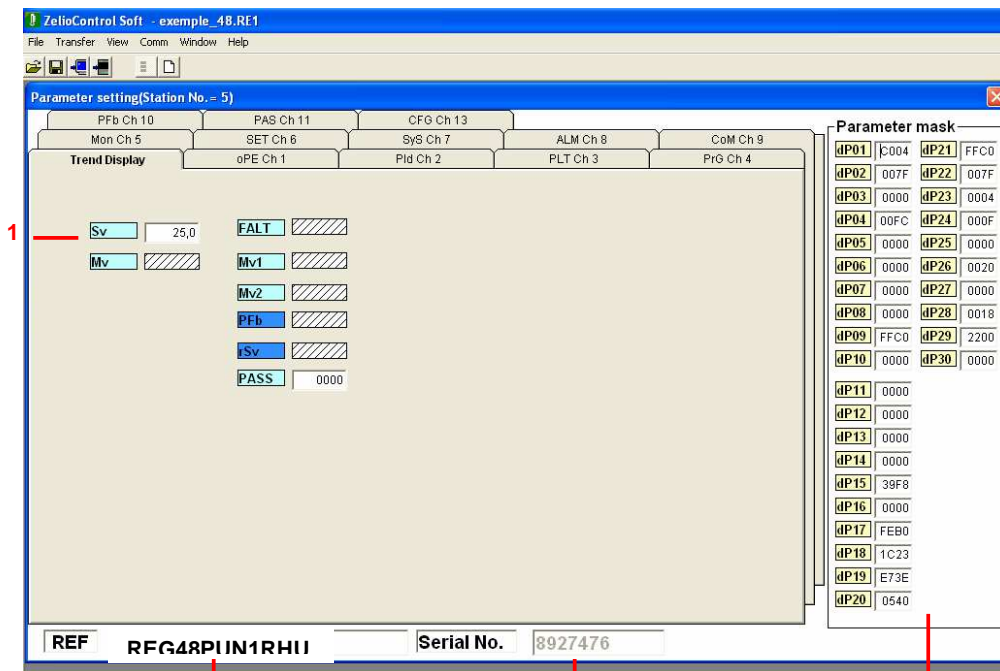

1

2

Controller identification

Serial Number

1 Sv (setpoint) = 25,0

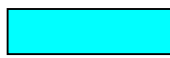

Visible parameter on the product

2 Hidden parameters for details see user guide



Hidden parameter on the product (Settable through the software)



No display through ZelioControl Soft

CHAPITRE 7: ZelioControl SOFT software

ZelioControl Soft screen - oPE CH1

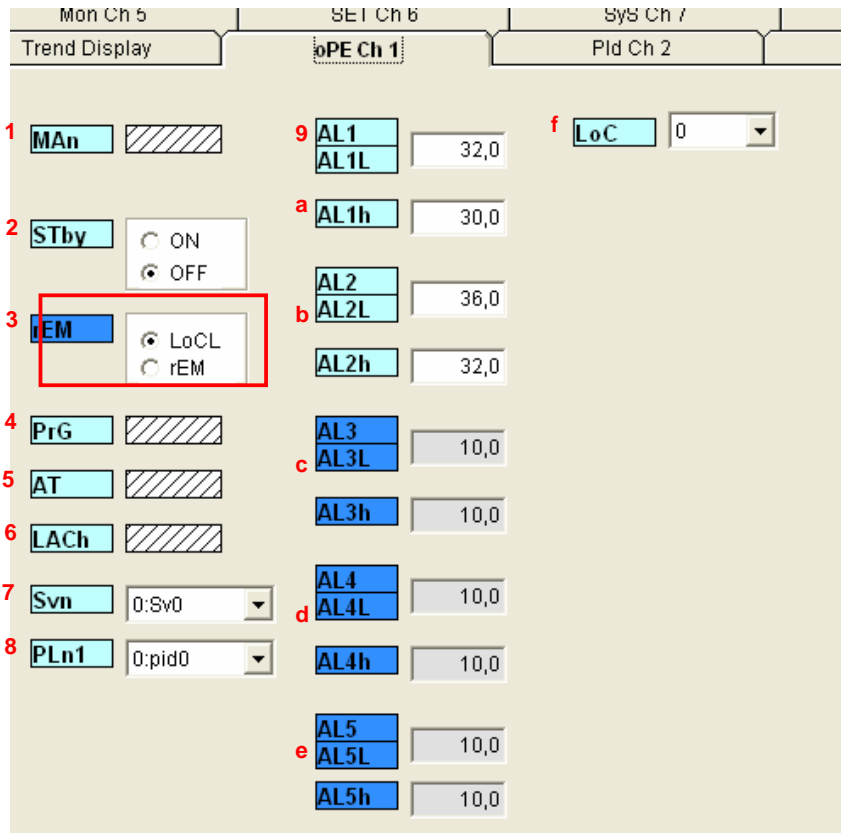

Operations :

- 1 Man switches to manual mode
- 2 Stby Control RUN/STANDBY
- 3 **NOT USED**
- 4 PrG Ramp soak operation command (Off/Run/hold)
- 5 AT Auto Tuning Command (Off/ON/Low)
- 6 LACH Output alarm retain
- 7 Svn Preselection setpoint (0:Sv0 default value)
- 8 PLn1 Preselection PID (0:pid0 default value)
- 9 AL1 AL1L Alarm 1 low limit (example : 32°C)
- a AL1h Alarm 1 high limit
- b AL2 AL2L Alarm 2 low limit (example : 36°C)
- AL2h Alarm 2 high limit
- c AL3 AL3L Alarm 3 low limit
- AL3h Alarm 3 high limit
- d AL4 AL4L Alarm 4 low limit
- AL4h Alarm 4 high limit
- e AL5 AL5L Alarm 5 low limit
- AL5h Alarm 5 high limit
- f LoC Front face keys locked

Note : the REG48 includes 2 alarms, the REG96 3 alarms. The alarms 4 and 5 are accessible through Modbus only

Note : if auto tuning then the setting of P/I/D/hys/bal/ar is automatic

ZelioControl SOFT screen PID CH2

Mon Ch 5	SET Ch 6	SyS Ch 7
Trend Display	oPE Ch 1	PId Ch 2
1 Sv0 <input type="text" value=""/>	d TC1 <input type="text" value="2"/> S	
2 P <input type="text" value="5,0"/> %	e TC2 <input type="text" value="2"/> S	
3 i <input type="text" value="240"/> S	f PLC1 <input type="text" value="-3,0"/> %	
4 d <input type="text" value="60,0"/> S	g PhC1 <input type="text" value="103,0"/> %	
5 hyS <input type="text" value="1"/>	h PLC2 <input type="text" value="-3,0"/> %	
6 CoL <input type="text" value="1,0"/>	i PhC2 <input type="text" value="103,0"/> %	
7 db <input type="text" value="0,0"/> %	j PCUT <input type="text" value="0"/>	
8 bAL <input type="text" value="0,0"/> %	k EMv1 <input type="text" value="-3,0"/> %	
9 Ar <input type="text" value="400"/>	EMv2 <input type="text" value="-3,0"/> %	
a rEv <input type="text" value="0:rv--"/>	PMv <input type="radio"/> ON	
b SvL <input type="text" value="0"/>	<input checked="" type="radio"/> OFF	
c SvH <input type="text" value="400"/>	PMv1 <input type="text" value="-3,0"/> %	
	PMv2 <input type="text" value="-3,0"/> %	

PID parameters:

1 Sv0 Setpoint

2 P proportional factor

3 i integrale factor

4 d derivation factor

5 hyS hysteresis (0 to 50% FS)

6 CoL cooling proportional band

7 db dead band

8 bAL output convergence value

9 Ar anti reset windup – ovoid overshoot if PID inactive

a rEv normal/reverse – selection type (example : rEv - see page 8)

b SvL SV low limit - (example : 0°C)

c SvH SV high limit - (example: 400°C)

d TC1 OUT 1 proportionnal cycle (if solid state interface type : max frequency swithing)

e TC2 OUT 1 proportionnal cycle (if solid state interface type : max frequency swithing)

f PLC1 OUT 1 lower limit - (if analog)

g PhC1 OUT 1 upper limit - (if analog)

h PLC2 OUT 2 lower limit - (if analog)

i PhC2 OUT 2 upper limit - (if analog)

i PCUT Select ouput limiter type - (PLC1/2 – PHC1/2)

K NOT USED

Remind: if auto tuning then the setting of P/I/D/hys/bal/ar is automatic

ZelioControl Soft screen - PLT CH3

	Trend Display	oPE Ch 1	Pld Ch 2	PLT Ch 3	PrG Ch 4					
1	Sv1	15,0	Sv3	15,0	Sv5	15,0	Sv7	0,0	8 SvMX	7:Sv7
	P1	5,0 %	P3	5,0 %	P5	5,0 %	P7	5,0 %	9 PL1M	7:pid7
	i1	240 S	i3	240 S	i5	240 S	i7	240 S		
	d1	60,0 S	d3	60,0 S	d5	60,0 S	d7	60,0 S		
	hyS1	1,0	hyS3	1,0	hyS5	1,0	hyS7	1,0		
	CoL1	1,0	CoL3	1,0	CoL5	1,0	CoL7	1,0		
	db1	0,0 %	db3	0,0 %	db5	0,0 %	db7	0,0 %		
	bAL1	50,0 %	bAL3	50,0 %	bAL5	50,0 %	bAL7	50,0 %		
	Ar1	385,0	Ar3	385,0	Ar5	400,0	Ar7	400,0		
	rEv1	2:rvo	rEv3	2:rvo	rEv5	2:rvo	rEv7	2:rvo		
2	Sv2	15,0	Sv4	15,0	Sv6	0,0				
	P2	5,0 %	P4	5,0 %	P6	5,0 %				
	i2	240 S	i4	240 S	i6	240 S				
	d2	60,0 S	d4	60,0 S	d6	60,0 S				
	hyS2	1,0	hyS4	1,0	hyS6	1,0				
	CoL2	1,0	CoL4	1,0	CoL6	1,0				
	db2	0,0 %	db4	0,0 %	db6	0,0 %				
	bAL2	50,0 %	bAL4	50,0 %	bAL6	50,0 %				
	Ar2	385,0	Ar4	385,0	Ar6	400,0				
	rEv2	2:rvo	rEv4	2:rvo	rEv6	2:rvo				

Setpoints and PID settings:

1 Sv1 setpoint 1

P1 Proportional 1

i1 Integrale 1

d1 Derivative 1

hyS1 hysteresis 1

CoL1 Cooling proportional band 1

db1 dead band 1

bAL1 output convergence 1

Ar1 anti reset windup 1

rEv1 Normal/reverse function selection

2 Same for PID 2

3 Same for PID 3

4 Same for PID 4

5 Same for PID 5

6 Same for PID 6

7 Same for PID 7

8 SvMX Selectable Sv numbers

9 PL1M Currently select PID

ZelioControl Soft screen - PRG CH4

Mon Ch 5	SET Ch 6	sys Ch 7	ALM Ch 8	Com Ch 9
Trend Display	oPE Ch 1	Pld Ch 2	PLT Ch 3	PrG Ch 4
1 PTn 0:Ptn0	7 Sv-5 15,0	Sv11 15,0	j Mod 0	
2 TiMU hh:mm mm:ss	TM5r 0 h 0 m	T11r 0 h 0 m	k GSoK ON OFF	
	TM5S 0 h 0 m	T11S 0 h 0 m	l GS-L 1,0	
3 Sv-1 15,0	8 Sv-6 15,0	Sv12 15,0	m GS-h 1,0	
TM1r 0 h 0 m	TM6r 0 h 0 m	T12r 0 h 0 m	n PvST ON OFF	
TM1S 0 h 0 m	TM6S 0 h 0 m	T12S 0 h 0 m	o ConT rES	
4 Sv-2 15,0	9 Sv-7 15,0	Sv13 15,0	p PTnM 6:Ptn6	
TM2r 0 h 0 m	TM7r 0 h 0 m	T13r 0 h 0 m	q PMin 0:Ptn0	
TM2S 0 h 0 m	TM7S 0 h 0 m	T13S 0 h 0 m		
5 Sv-3 15,0	a Sv-8 15,0	Sv14 0,0		
TM3r 0 h 0 m	TM8r 0 h 0 m	T14r 0 h 0 m		
TM3S 0 h 0 m	TM8S 0 h 0 m	T14S 0 h 0 m		
6 Sv-4 15,0	b Sv-9 15,0	Sv15 15,0		
TM4r 0 h 0 m	TM9r 0 h 0 m	T15r 0 h 0 m		
TM4S 0 h 0 m	TM9S 0 h 0 m	T15S 0 h 0 m		
	c Sv-10 15,0	Sv16 15,0		
	T10r 0 h 0 m	T16r 0 h 0 m		
	T10S 0 h 0 m	T16S 0 h 0 m		

Ramp parameters:

- 1 **PTn** ramp soak pattern – ramp number selection
- 2 **TiMU** ramp soak time unit (hhmm or mmss)
- 3 **Sv1** setpoint ramp 1
 - TM1r** ramp soak 1 ramp time
 - TM1s** ramp soak 1 seg soak
- 4 Same for ramp 2
- 5 Same for ramp 3
- 6 Same for ramp 4
- 7 Same for ramp 5
- 8 Same for ramp 6
- 9 Same for ramp 7
- a Same for ramp 8
- b Same for ramp 9
- c Same for ramp 10
- d Same for ramp 11
- e Same for ramp 12
- f Same for ramp 13
- g Same for ramp 14
- h Same for ramp 15
- i Same for ramp 16
- j MoD** ramp soak mod (0 to 15)
- k GSoK** garanty soak (ON/OFF)
- l GS-L** garanty soak lower limit
- m GS-h** garanty soak upper limit
- n PvST** Consideration of the global nature of the programmed curve (OFF)
Consideration of the real value measured for starting up (ON)
- o ConT** 3 choices rES/CON/INI
- p PTnM** sets the max pattern selection
- q Pmin** sets the min pattern selection

ZelioControl Soft screen - MON Ch5

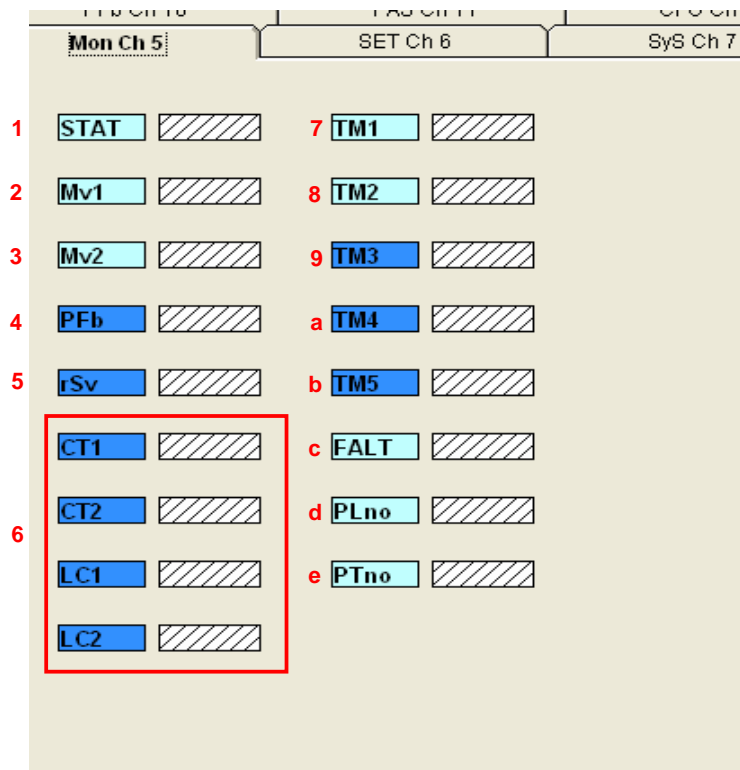

Monitoring functions:

- 1 STAT ramp soaks progress
- 2 Mv1 output 1
- 3 Mv2 output 2
- 4 PFb PFB input value display
- 5 rSv RSV input value display
- 6 **NOT USED**
- 7 TM1 remaining time on timer 1
- 8 TM2 remaining time on timer 2
- 9 TM3 remaining time on timer 3
- a TM4 remaining time on timer 4
- b TM5 remaining time on timer 5
- c FALT Fault status error source display
- d PLno PID in progress
- e Ptno ramp in progress

Note: Data used only with the Software. Updated only after the upload.

ZelioControl Soft screen – SET Ch6

Setup :

- 1 PvT Sensor type selection (example: 1 PT100)
- 2 Pvb Pv input lower limit - (example: 0,0°C)
- 3 PvF Pv input upper limit - (example: 400,0°C)
- 4 Pvd decimal position - (example: 1)
- 5 PvU unit selection °Celsius or °Fahrenheit (example: °C)
- 6 CUT
- 7 PvoF PV input shift offset
- 8 SvoF SV shift offset
- 9 TF PV input filter
- a AdJO user zero adjustment
- b AdJS user span adjustment
- c rCJ Compensation weld for thermocouple probe
- d NOT USED**
- f C1r OUT1 range (if OUT 1 is analog)
- g C2r OUT2 range (if OUT 2 is analog)
- h FL01 OUTPUT 1 set value during fault
- i FL02 OUTPUT 2 set value during fault
- j SF01 Soft start OUT 1 set value (if Output 1 digital -3% =0 , 103% =1)
- k SF02 Soft start OUT 2 set value (if Output 2 digital -3% =0 , 103% =1)
- l SFTM Soft start set time
- m Sbo1 during standby OUT 1 set value
- n Sbo2 during standby OUT 2 set value
- o SbMd standby mode setting – alarms output state in standby mode
- p AoT type off output retransmission (Modbus only)
- q AoL AO lower limit scaling (Modbus only)
- r Aoh AO upper limit scaling (Modbus only)

ZelioControl Soft screen – SyS Ch7

Label	Parameter	Value/Setting
1	UkEy	2
2	di1	0
	di2	0
	di3	0
	di4	0
	di5	0
3	do1T	1
4	doP1	0000
5	do2T	1
6	doP2	0000
7	do3T	0
8	doP3	0000
9	do4T	0
a	doP4	0000
b	do5T	0
c	doP5	0000
d	rMP	ON
e	rMPL	0,0
f	rMPH	0,0
g	rMPU	0:hoUr
h	SvT	rMP
i	CTrL	Pid
j	PrCS	SRV1
k	onoF	ON
l	SLFb	8,0
m	STMd	AUTo

System parameters:

1 UkEy User key assignement setting

2 **NOT USED**

3 do1T DO1 output event setting - alarm 1 type configuration

4 doP1 DO1 option function setting - hold alarm 1

5 do2T DO2 output event setting - alarm 1 type configuration

6 doP2 DO2 option function setting - hold alarm 2

7 do3T DO3 output event setting - alarm 1 type configuration

8 doP3 DO3 option function setting - hold alarm 3

9 do4T DO4 output event setting - alarm 1 type configuration

a doP4 DO4 option function setting - hold alarm 4

b do5T DO5 output event setting - alarm 1 type configuration

c doP5 DO5 option function setting - hold alarm 5

d rMP ramp use on setpoint change

e rMPL ramp SV decline

f rMPH ramp SV incline

g rMPU ramp SV slipe time unit

h SvT ramp SV-SV display mode selection

i CTrL select PID/FUZZY/SELF function

j **NOT USED**

k onoF hysteresis mode setting

l SLFb pv stable range

m STMd start mode selection

ZelioControl Soft screen – ALM Ch8

Mon Ch 5	SET Ch 6	SyS Ch 7	ALM Ch 8
1 A1hy <input type="text" value="1,0"/>	a A4hy <input type="text" value="1,0"/>	g hb1 <input type="text" value="0,0"/> A hb1h <input type="text" value="0,5"/> A hS1 <input type="text" value="0,0"/> A hS1h <input type="text" value="0,5"/> A hb2 <input type="text" value="0,0"/> A hb2h <input type="text" value="0,5"/> A hS2 <input type="text" value="0,0"/> A hS2h <input type="text" value="0,5"/> A	
2 dLy1 <input type="text" value="0"/> S	b dLy4 <input type="text" value="0"/> S		
3 dL1U <input type="radio"/> Sec <input type="radio"/> Min	c dL4U <input type="radio"/> Sec <input type="radio"/> Min		
4 A2hy <input type="text" value="1,0"/>	d A5hy <input type="text" value="1,0"/>		
5 dLy2 <input type="text" value="0"/> S	e dLy5 <input type="text" value="0"/> S		
6 dL2U <input type="radio"/> Sec <input type="radio"/> Min	f dL5U <input type="radio"/> Sec <input type="radio"/> Min		
7 A3hy <input type="text" value="1,0"/>			
8 dLy3 <input type="text" value="0"/> S			
9 dL3U <input type="radio"/> Sec <input type="radio"/> Min			
		h LbTM <input type="text" value="0"/> S	
		i LbAb <input type="text" value="10,0"/>	

Alarms setting:

- 1 **A1hy** alarm 1 hysteresis (0 to 50% FS)
- 2 **dLy1** alarm 1 delay – alarm 1 depending the selected unit
- 3 **dL1U** alarm 1 time unit – alarm time unit (0=second – 1=minute)
- 4 **A2hy** alarm 2 hysteresis
- 5 **dLy2** alarm 2 delay délai - alarm 2 depending the selected unit
- 6 **dL2U** alarm 2 time unit - alarm time unit (0=second – 1=minute)
- 7 **A3hy** alarm 3 hysteresis
- 8 **dLy3** alarm 3 delay - alarm 3 depending the selected unit
- 9 **dL3U** alarm 3 time unit - alarm time unit (0=second – 1=minute)
- a **A4hy** alarm 4 hysteresis
- b **dLy4** alarm 4 delay - alarm 4 depending the selected unit
- c **dL4U** alarm 4 time unit - alarm time unit (0=second – 1=minute)
- d **A5hy** alarm 5 hysteresis
- e **dLy5** alarm 5 delay - alarm 5 depending the selected unit
- f **dL5U** alarm 5 time unit - alarm time unit (0=second – 1=minute)
- g NOT USED**
- h NOT USED**
- i NOT USED**

ZelioControl Soft screen - CoM CH9

PFb Ch 10 PAS Ch 11 CFG Ch 13
Mon Ch 5 SET Ch 6 Sys Ch 7 ALM Ch 8 CoM Ch 9

1 STno 5
2 CoM 960d
3 PCoL ASCII MODBUS
4 SCC r rW

Modbus communication parameters display :

- 1 Stno station number (5 in the example)
- 2 CoM baudrate and parity (96 = 9600 bauds, odd parity (as for the example))
- 3 PcoL Communication type (Modbus fixed value)
- 4 SCC read/write possible (up load/down load (fixed value))

Note: For communication parameters setting see page 23

ZelioControl Soft screen - PFb CH10

Trend Display oPE Ch 1 PAS Ch 11 PFb Ch 10

1 PGAP 5,0
TrvL 30
FbEr hLd
CAL

Feedback position:

1 NOT USED

ZelioControl Soft screen - PAS CH11

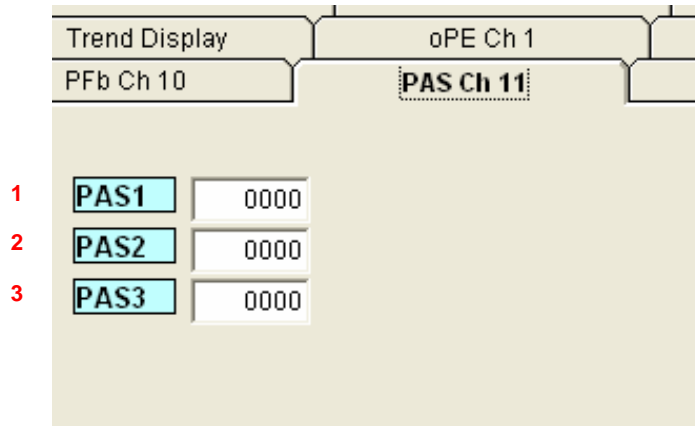

Passwords setting:

- 1 PAS1 Password 1 (default value = 0000)
- 2 PAS2 Password 2 (default value = 0000)
- 3 PAS3 Password 3 (default value = 0000)

ZelioControl Soft screen - CFG CH13

Environment parameters configuration:

1 ToUT Time delay to principal screen return after key action

2 **NOT USED**

3 SoFK

4 ALMF Blinking or fix state of front face alarm leds

5 bCon

6 PTnT Ramps execution order modification

7 **NOT USED**

8 L-C1 Led function selection

9 L-C2

a Ldo1

b Ldo2

c Ldo3

d L-Sv

e L-Mv

f LMAn

g LSTB

h LrEM

i L-AT

j rST controller reset

Application file saving under ZelioControl SOFT

Application file saving :

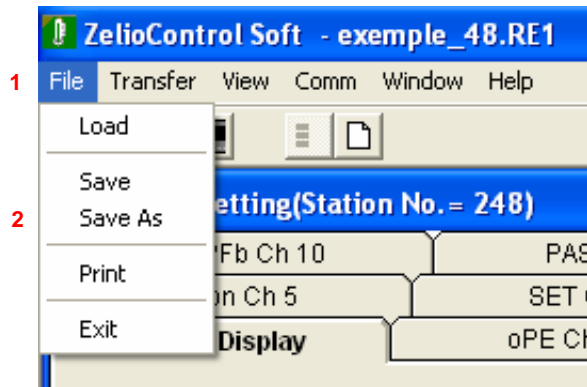

- 1 File selection
- 2 Save As and then indicates the path for the file

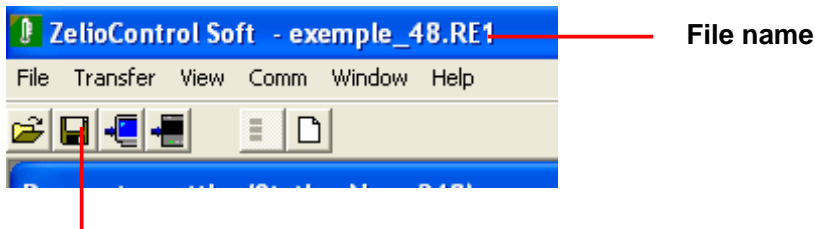

Current file saving

Other functions :

