

Smart relays Zelio Logic

Catalogue

June 2008



Selection guide pages 2 to 5

Compact and modular smart relays

- Presentation pages 6 to 9
- Functions pages 10 to 12
- Description page 13
- Characteristics pages 14 to 19
- Curves pages 20 and 21
- References pages 22 to 27
- Dimensions, mounting, schemes pages 28 to 31

Communication

- Presentation page 32

Programming protocol

- Description, characteristics page 33

Modbus slave communication protocol

- Presentation, description page 34
- Characteristics page 36
- Functions page 37

Ethernet server communication protocol

- Presentation, description page 38
- Characteristics page 40
- Functions page 41

Communication

- References page 42
- Dimensions, mounting page 43

Analogue I/O extension modules

- Presentation, description page 44
- Characteristics page 45
- References, dimensions, schemes pages 46 and 47

Modem communication interface

- Presentation, description pages 48 and 49
- Functions, setting-up pages 50 and 51
- Characteristics pages 52 and 53
- References page 54
- Dimensions, connections pages 55 to 57

Analogue interfaces

Selection guide pages 58 and 59

- Presentation pages 60 and 61
- Characteristics pages 62 and 63
- References page 64
- Dimensions, mounting, schemes page 65

Powers supplies and transformers

- Presentation, description page 66
- Characteristics pages 67 to 70
- References, dimensions, schemes page 71

Product type

Compact smart relays



Supply voltage	~ 24 V	~ 100...240 V
Number of I/O	12 20	10 12 20
Number of discrete inputs (of which analogue inputs)	8 (0) 12 (0)	6 (0) 8 (0) 12 (0)
Number of "relay"/"transistor" outputs	4/0 8/0	4/0 4/0 8/0
With display, with clock Programming language	SR2 B●●1B FBD (1) or LADDER	SR2 B●●1FU FBD (1) or LADDER
With display, without clock Programming language		SR2 A●●1FU LADDER only
Without display, with clock Programming language	SR2 E●●1B FBD (1) or LADDER	SR2 E●●1FU FBD (1) or LADDER
Without display, without clock Programming language		SR2 D●●1FU LADDER only
Programming software (see page 26)	"Zelio Soft 2" SR2 SFT01	"Zelio Soft 2" SR2 SFT01
Connection accessories (see page 26)	SR2 CBL01 SR2 USB01 SR2 BTC01	SR2 CBL01 SR2 USB01 SR2 BTC01
Memory cartridge (see page 26)	SR2 MEM02 (⚠ incompatible with SR2 COM01)	SR2 MEM02 (⚠ incompatible with SR2 COM01)
"Discovery" packs (see page 22)		SR2 PACK●FU
Modem communication interface (see page 54)	SR2 COM01	SR2 COM01 (for SR2 B and SR2 E)
Analogue (PSTN) or GSM modem (see page 54)	SR2 MOD0●	SR2 MOD0●
Alarm management software (see page 54)	"Zelio Logic Alarm" SR2 SFT02	"Zelio Logic Alarm" SR2 SFT02
Converters (thermocouple types J and K, Pt100 probes and voltage/current) (see page 64) (2)		
Power supplies for d.c. control circuit (see page 71)		
References	SR2●●●1B	SR2●●●1FU
Pages	22 and 23	22 and 23

(1) FBD: Function Block Diagram.
 (2) See Zelio Analog analogue interfaces, pages 58 to 65.



~ 12 V

12	20
8 (4)	12 (6)
4/0	8/0

SR2 B...1JD
FBD (1) or LADDER

"Zelio Soft 2" **SR2 SFT01**
SR2 CBL01
SR2 USB01
SR2 BTC01

SR2 MEM02
(⚠ incompatible with SR2 COM01)

SR2 COM01
SR2 MOD0●
"Zelio Logic Alarm" **SR2 SFT02**

RM● ●●●BD

ABL 8MEM12020

SR2 B...1JD

22

~ 24 V

10	12	20
6 (0)	8 (4)	12 (2), 12 (6)
4/0	4/0, 0/4	8/0, 0/8

SR2 B...BD
FBD (1) or LADDER
SR2 A...BD
LADDER only
SR2 E...BD
FBD (1) or LADDER
SR2 D...BD
LADDER only

"Zelio Soft 2" **SR2 SFT01**
SR2 CBL01
SR2 USB01
SR2 BTC01

SR2 MEM02
(⚠ incompatible with SR2 COM01)

SR2 PACK●BD

SR2 COM01 (for SR2 B and SR2 E)
SR2 MOD0●
"Zelio Logic Alarm" **SR2 SFT02**

RM● ●●●BD

ABL 8MEM240●●
ABL 7RM24025

SR2 ●●●●BD

22 and 23

Zelio Logic smart relays

Modular smart relays and I/O extension and communication modules

Product types

Modular smart relays



Supply voltage

~ 24 V

~ 100...240 V

Number of I/O
Number of discrete inputs
(of which analogue inputs)
Number of "relay"/"transistor" outputs

10	26
6 (0)	16 (0)
4/0	10/0

10	26
6 (0)	16 (0)
4/0	10/0

With display, with clock
Programming language

Yes
 FBD or LADDER

Yes
 FBD or LADDER

Programming software (see page 26)

"Zelio Soft 2" **SR2 SFT01**

"Zelio Soft 2" **SR2 SFT01**

Connection accessories (see page 26)

- SR2 CBL01** Serial link cable
- SR2 USB01** USB connecting cable
- SR2 BTC01** Bluetooth interface

- SR2 CBL01** Serial link cable
- SR2 USB01** USB connecting cable
- SR2 BTC01** Bluetooth interface

Memory cartridge (see page 26)

SR2 MEM02
 (⚠ incompatible with SR2 COM01)

SR2 MEM02
 (⚠ incompatible with SR2 COM01)

"Discovery" packs (see page 24)

SR3 PACK●BD

Modem communication interface (see page 54)

SR2 COM01

SR2 COM01

Analogue (PSTN) or GSM modem (see page 54)

SR2 MOD0●

SR2 MOD0●

Alarm management software (see page 54)

"Zelio Logic Alarm" **SR2 SFT02**

"Zelio Logic Alarm" **SR2 SFT02**

Converters (thermocouple types J and K, Pt100 probes and voltage/current) (see page 64) (1)

Power supplies for d.c. control circuit (see page 71)

References (see page 24)

SR3 B●●1B

SR3 B●●1FU

(1) See Zelio Analog analogue interfaces, pages 58 to 65.

Associated I/O extension and communication module types

Discrete I/O extension modules

Discrete I/O extension modules



Number of I/O

6	10	14
---	----	----

6	10	14
---	----	----

Type and number of discrete inputs
(or analogue inputs)

4 (0)	6 (0)	8 (0)
-------	-------	-------

4 (0)	6 (0)	8 (0)
-------	-------	-------

Type and number of relay outputs
(or analogue outputs)

2 (0)	4 (0)	6 (0)
-------	-------	-------

2 (0)	4 (0)	6 (0)
-------	-------	-------

References

SR3 XT●●●B

SR3 XT●●●FU

Pages

25

25



~ 12 V

26
16 (6)
10/0

Yes
FBD or LADDER

“Zelio Soft 2” SR2 SFT01

SR2 CBL01
SR2 USB01
SR2 BTC01

SR2 MEM02
(⚠ incompatible with SR2 COM01)

SR2 COM01
SR2 MOD0●
“Zelio Logic Alarm” SR2 SFT02

RM●●●BD

ABL 8MEM12020

SR3 B261JD



~ 24 V

10 26
6 (4) 16 (6)
4/0, 0/4 10/0, 0/10

Yes
FBD or LADDER

“Zelio Soft 2” SR2 SFT01

SR2 CBL01
SR2 USB01
SR2 BTC01

SR2 MEM02
(⚠ incompatible with SR2 COM01)

SR3 PACK●BD

SR2 COM01
SR2 MOD0●
“Zelio Logic Alarm” SR2 SFT02

RM●●●BD

ABL 8MEM24006, ABL 8MEM24012, ABL 7RM24025

SR3 B●●●BD

Discrete I/O extension modules



6 10 14
4 (0) 6 (0) 8 (0)
2 (0) 4 (0) 6 (0)

SR3 XT●●●JD

25

Network communication modules

Modbus slave Ethernet server

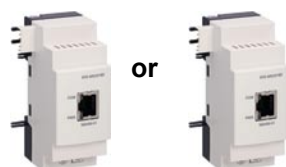

■ Number of words:
□ 4 (inputs)
□ 4 (outputs)
□ 4 (clock)
□ 1 (status)

SR3 MBU01BD

42

I/O extension modules

Analogue Discrete



4 6 10 14
0 (2) 4 (0) 6 (0) 8 (0)
0 (2) 2 (0) 4 (0) 6 (0)

SR3 XT43BD

46

SR3 XT●●●BD

25

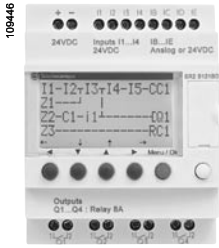

Zelio Logic compact smart relay

Combination of modular smart relays with communication and I/O extension modules



- 1 Zelio Logic modular smart relay (10 or 26 I/O)
- 2 I/O extension module: discrete (6, 10 or 14 I/O) or analogue (4 I/O)

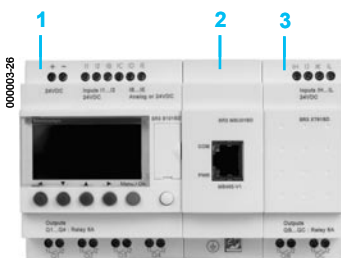

- 1 Zelio Logic modular smart relay (10 or 26 I/O)
- 2 Modbus or Ethernet communication modules
- 3 I/O extension module: discrete (6, 10 or 14 I/O) or analogue (4 I/O)

⚠ The order shown above must be observed when using a Modbus slave or Ethernet server communication module and a discrete or analogue I/O extension module. An I/O extension module cannot be fitted before the Modbus slave communication module.

Presentation

Zelio Logic smart relays are designed for use in small automated systems. They are used in both the industrial and commercial sectors.

- **For industry:**
 - automation of small finishing, production, assembly or packaging machines,
 - decentralised automation of ancillary equipment of large and medium-sized machines (textile, plastics, materials processing sectors, etc.),
 - automation systems for agricultural machinery (irrigation, pumping, greenhouses etc.)

- **For the commercial/building sectors:**
 - automation of barriers, roller shutters, access control,
 - automation of lighting systems,
 - automation of compressors and air conditioning systems.
 - etc.

Their compact size and ease of setting-up make them a competitive alternative to solutions based on cabled logic or specific cards.

■ Programming

Simple programming, ensured by the universal nature of the languages, meets all the requirements of automation specialists and also the needs of the electrician.

Programming can be performed:

- independently, using the buttons on the Zelio Logic smart relay (ladder language),
- on a PC using “Zelio Soft 2” software.

When using a PC, programming can be performed either in LADDER language or in function block diagram (FBD) language, see pages 8 to 12.

Backlighting of the LCD display (1) is obtained by activating one of the 6 programming buttons on the Zelio Logic smart relay or by programming with “Zelio Soft 2” software (example: flashing in the event of a malfunction).

The autonomous operating time of the clock, assured by a lithium battery, is 10 years.

Data backup (preset values and current values) is provided by an EEPROM Flash memory (10 years).

Compact smart relays

Compact smart relays meet requirements for simple automation systems.

The number of inputs/outputs can be:

- 12 or 20 I/O, supplied with ~ 24 V or ~ 12 V,
- 10, 12 or 20 I/O, supplied with ~ 100...240 V or ~ 24 V.

Modular smart relays and extensions

The number of inputs/outputs for modular smart relays can be:

- 26 I/O, supplied with ~ 12 V,
- 10 or 26 I/O, supplied with ~ 24 V, ~ 100...240 V or ~ 24 V

To improve performance and flexibility, Zelio Logic modular smart relays can be fitted with communication modules and I/O extension modules to obtain a maximum of 40 I/O:

- Modbus or Ethernet communication modules, supplied with ~ 24 V via the Zelio Logic smart relay at the same voltage.
- analogue I/O extension modules with 4 I/O, supplied with ~ 24 V via the Zelio Logic smart relay at the same voltage,
- discrete I/O extension modules with 6, 10 or 14 I/O, supplied via the Zelio Logic smart relay at the same voltage.

(1) LCD: Liquid Crystal Display.



Connecting cable



Bluetooth interface



Memory cartridge



Modbus communication module



Ethernet communication module



Modem communication interface



Analogue PSTN Modem



GSM modem

Communication

Cabled and wireless programming tools

- These programming tools allow the Zelio Logic smart relay to be connected to a PC running “Zelio Soft 2” software:
 - Link by cables:
 - Cable SR2 CBL01 to 9-pin serial port
 - or
 - Cable SR2 USB01 to USB port
 - Wireless link:
 - Bluetooth interface SR2 BTC01

Memory cartridge

The Zelio Logic smart relay can be fitted with a backup memory cartridge which enables the application program to be copied into another Zelio Logic smart relay. However, loading and updating of the firmware (software embedded in the product) is only possible with memory cartridge SR2 MEM02.

The memory cartridge also enables a backup copy of the program to be saved prior to replacing the product.

When used with a smart relay without display or buttons, the copy of the program contained in the cartridge is automatically transferred into the Zelio Logic smart relay on power-up.

Modbus slave and Ethernet server communication modules

Modbus and Ethernet communication modules allow connection to automation system equipment such as display units or programmable controllers (see pages 32 to 43).

Modem communication interface

The “Modem communication interface” products in the Zelio Logic range include:

- a Modem communication interface SR2 COM01 connected between a Zelio Logic smart relay and a Modem,
- analogue (PSTN) (1) SR2 MOD01 or GSM (2) SR2 MOD02, Modems
- “Zelio Logic Alarm” software SR2 SFT02.

They are designed for monitoring or remote control of machines or installations which operate without personnel.

The Modem communication interface, supplied with $\approx 12...24$ V, enables messages, telephone numbers and calling conditions to be stored, see pages 48 to 57.

(1) Public Switched Telephone Network.

(2) Global System Mobile.

Zelio Logic smart relays

Compact and modular smart relays

"Zelio Soft 2" programming software

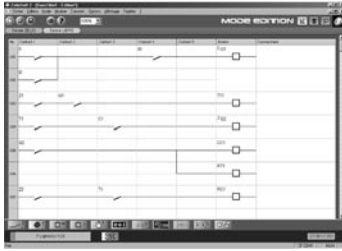

Programming in LADDER language

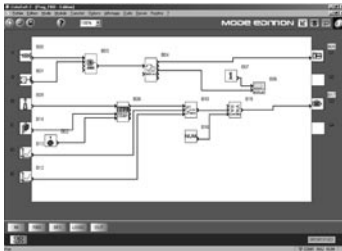

Programming in FBD language

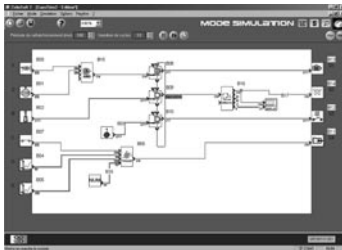

Simulation mode

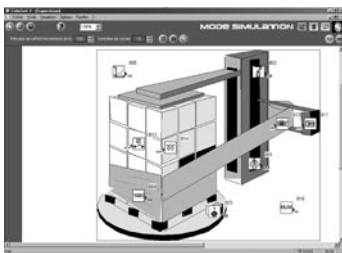

Monitoring window

"Zelio Soft 2" for PC (versions ≥ 4.1)

"Zelio Soft 2" software enables:

- programming in LADDER language or in function block diagram (FBD) language, see pages 10 to 12,
- simulation, monitoring and supervision,
- uploading and downloading of programs,
- output of personalised files,
- automatic compiling of programs,
- on-line help.

Coherence tests and application languages

"Zelio Soft 2" software monitors applications by means of its coherence test function. An indicator turns red at the slightest input error. The problem can be located by simply clicking the mouse.

"Zelio Soft 2" software allows switching, at any time, to any of the 6 languages (English, French, German, Spanish, Italian, Portuguese) and editing of the application file in the selected language.

Inputting messages for display on Zelio Logic

"Zelio Soft 2" software allows Text function blocks to be configured, which can then be displayed on all Zelio Logic smart relays which have a display.

Program testing

2 test modes are provided:

- "Zelio Soft 2" **simulation** mode allows a program to be tested without a Zelio Logic smart relay, i.e.:
 - enable discrete inputs,
 - display the status of outputs,
 - vary the voltage of the analogue inputs,
 - enable the programming buttons,
 - simulate the application program in real time or in accelerated time,
 - dynamically display (in red) the various active elements of the program.
- "Zelio Soft 2" **monitoring** mode makes it possible to test the program executed by the smart relay, i.e.:
 - display the program "on-line",
 - force inputs, outputs, control relays and current values of the function blocks,
 - adjust the time,
 - change from STOP mode to RUN mode and vice versa.

In simulation or monitoring mode, the monitoring window allows the status of the smart relay I/Os to be displayed within your application environment (diagram or image).

User interfaces

Version 4.1 of “Zelio Soft 2” software improves, amongst other things, the ease of use of user interfaces for the following functions:

“Split wiring sheet” function (FBD language)

The wiring sheet can be split into 2. Splitting allows two separate parts of the wiring sheet to be displayed on the same screen.

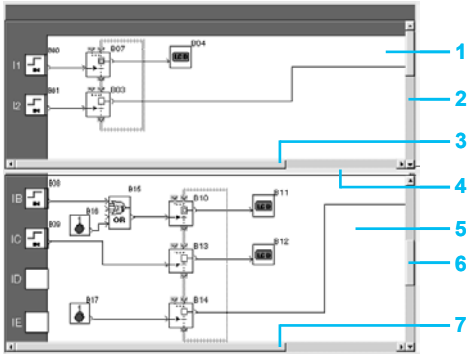

Structure of a split wiring sheet

This makes it possible to:

- Display the required function blocks in the top and bottom parts.
- Move the split bar as required.
- Connect the function blocks between the 2 parts of the wiring sheet.

The split wiring sheet is structured as follows:

- 1 View of top part
- 2 Top window vertical scroll bar
- 3 Top window horizontal scroll bar
- 4 Split bar
- 5 View of bottom part
- 6 Bottom window vertical scroll bar
- 7 Bottom window horizontal scroll bar

“Replacement of a function block” (FBD language)

A function allows a block to be replaced without losing the input and output connections.

E.g.: Replacement of an “OR” block by a “NOR” block.

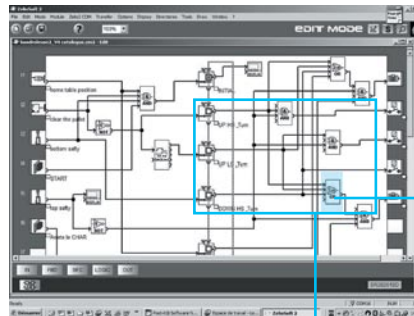

1 “OR” block to be replaced

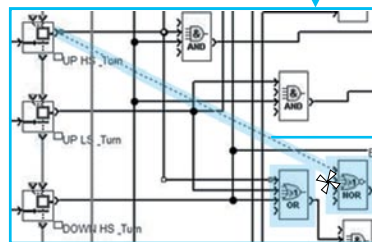

2 Move all links to the new “NOR” block

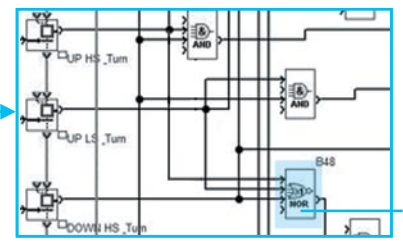

3 Delete the “OR” block and position the “NOR” block in its place



2

1

“Acceleration and simulation terminals” window

“Time Prog Simulation” function (LADDER and FBD languages)

LADDER or FBD program simulation mode allows the program to be debugged by simulating it on the software workshop host computer.

A function allows the time on the simulator clock to be modified by setting to 3 seconds before the start of the next event.

The “Next event” button 1 allows modification of the simulator clock 2.

LADDER language

Definition



Text function block



Timer



Up/down counter



Fast counter



Analogue comparator



Clock



Control relay



Counter comparator



LCD backlighting



Summer/Winter time switching



Output coil



Message

LADDER language enables a LADDER program to be written with elementary functions, elementary function blocks and derived function blocks, as well as with contacts, coils and variables.

The contacts, coils and variables can be annotated. Text can be placed freely within the graphic.

■ Control scheme input modes

“Zelio input” mode enables users who have directly programmed the Zelio Logic smart relay to find the same user interface, even when using the software for the first time.

“Free input” mode, which is more intuitive, is very user-friendly and incorporates many additional features.

With LADDER programming language, two alternative types of symbol can be used:

- LADDER symbols,
- electrical symbols.

“Free input” mode also allows the creation of mnemonics and notes associated with each line of the program.

Instant switching from one input mode to the other is possible at any time, by simply clicking the mouse.

Up to 120 control scheme lines can be programmed, with 5 contacts and 1 coil per program line

■ Functions:

- 16 Text function blocks,
- 16 time delay function blocks; parameters of 11 different types can be set for each of these (1/10th second to 9999 hours),
- 16 up/down counter function blocks from 0 to 32767,
- 1 fast counter (1 kHz),
- 16 analogue comparator function blocks,
- 8 clock function blocks, each with 4 channels,
- 28 control relays,
- 8 counter comparators,
- LCD screen with programmable backlighting,
- automatic Summer/Winter time switching,
- variety of functions: coil, latching (Set/Reset), impulse relay, contactor,
- 28 message blocks (with communication interface, see page 48).

Functions

Function	Electrical scheme	LADDER language	Notes
Contact			I corresponds to the real state of the contact connected to the input of the smart relay. i corresponds to the inverse state of the contact connected to the input of the smart relay.
Standard coil			The coil is energised when the contacts to which it is connected are closed.
Latch coil (Set)			The coil is energised (set) when the contacts to which it is connected are closed. It remains set even if the contacts are no longer closed.
Unlatch coil (Reset)			The coil is de-energised (reset) when the contacts to which it is connected are closed. It remains disabled even if the contacts are no longer closed.

Function block diagram language (FBD / Grafcet SFC / Logic functions) (1)



































Definition

FBD language allows graphical programming based on the use of predefined function blocks; it provides the use of:







- 32 pre-programmed functions for counting, time delay, timing, definition of switching threshold, (for example: temperature regulation), generation of impulses, time programming, multiplexing, display,
- 7 SFC functions,
- 6 logic functions.

Pre-programmed functions

Zelio Logic smart relays provide a high processing capacity, up to 200 function blocks, including 32 pre-programmed functions:

 TIMER AC  TIMER A+C Timer. Function A/C (ON-delay and OFF-delay)	 TIMER BH  TIMER B+H Timer. Function BH. (adjustable pulsed signal)	 TIMER Li  TIMER Li Pulse generator (ON-delay, OFF-delay)	 TIMER BW  TIMER B+W Timer. Function BW (pulse on rising/falling edge)
 TIMER A+C Timer. Function A/C with external preset adjustment (ON-delay and OFF-delay)	 TIMER B+H Timer. Function BH with external preset adjustment (adjustable pulsed signal)	 TIMER Li Pulse generator with external preset adjustment (ON-delay, OFF-delay)	
 BISTABLE Impulse relay function	 SET-RESET Bistable latching - Priority assigned either to SET or RESET function	 BOOLEAN Allows logic equations to be created between connected inputs	 CAM Cam programmer
 UP DOWN COUNT Up/down counter with external preset	 PRESET H-METER Hour counter (hour, minute preset)	 TIME PROG Time programmer, weekly and annual.	 GAIN Allows conversion of an analogue value by change of scale and offset.
 TRIGGER Defines an activation zone with hysteresis			
 MUX Multiplexing functions on 2 analogue values	 COMP IN ZONE Zone comparison (Min. ≤ Value ≤ Max.)	 ADD/SUB Add and/or subtract function	 MUL/DIV Multiply and/or divide function
 TEXT Display of 4 pieces of data: digital, analogue, date, time, messages for Human-Machine interface.			
 DISPLAY Display of digital and analogue data, date, time, messages for Human-Machine interface.	 COM Sending of messages with communication interface (see page 48)	 COMPARE Comparison of 2 analogue values using the operands =, >, <, ≤, ≥.	 STATUS Access to smart relay status
 ARCHIVE Storage of 2 values simultaneously			
 SPEED COUNT Fast counting up to 1 kHz	 CAN Analog/digital converter	 CNA Digital/analog converter	 SL In Input of a word via serial link
 SL Out Output of a word via serial link			

SFC functions(2) (GRAF CET)

 RESET-INIT Reinitialisable step	 INIT STEP Initial step	 STEP SFC step	 DIV-OR 2 Divergence to OR	 CONV-OR 2 Convergence to OR
 DIV-AND 2 Divergence to AND	 CONV-AND 2 Convergence to AND			

Logic functions

 AND AND function	 OR OR function	 NAND NOT AND function	 NOR NOT OR function	 XOR Exclusive OR function	 NOT NOT function
---	---	--	--	--	---

(1) Function Block Diagram

(2) Sequential Function Chart.

Function block diagram language (FBD / Grafset SFC / Logic functions) (continued)

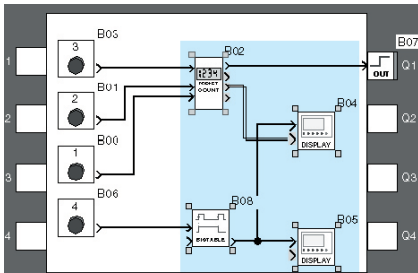

Creation of a Macro

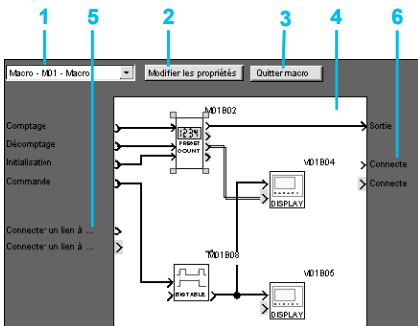

Inside of a Macro

- 1 Macro selection
- 2 Edit properties
- 3 Allows return to external view of a Macro
- 4 Internal function block within the Macro
- 5 Non connected inputs
- 6 Non connected outputs

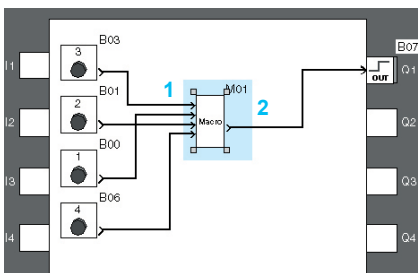

Outside of a Macro

- 1 Input connections
- 2 Output connection

Macro Function

A Macro is a grouping of function blocks. It is characterised by its number, its name, its links, its internal function blocks (255 max.) and by its I/O connections.

Seen from the outside, a Macro behaves like a function block with inputs and/or outputs that can be connected to links.
Once created, a Macro can be manipulated like a function block.

■ Macro characteristics:

- The maximum number of Macros is 64.
- A password dedicated to Macros can be used to protect their content,
- A Macro can be edited / duplicated,
- A Macro's comments can be edited.

■ Macro properties:

A “Macro properties” dialogue box allows the properties of a Macro to be entered or edited.

The properties of a Macro are:

- Macro name (optional)
- The block Symbol, which may be:
 - an identifier,
 - an image.
- Name of inputs.
- Name of outputs.

Compact smart relays

With display - 10, 12 and 20 I/O

Without display - 10, 12 and 20 I/O

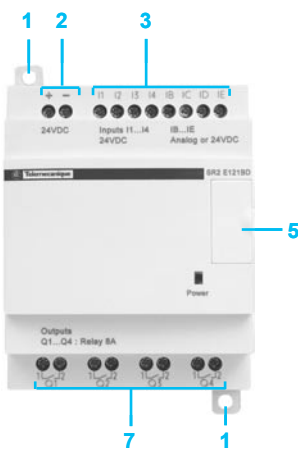
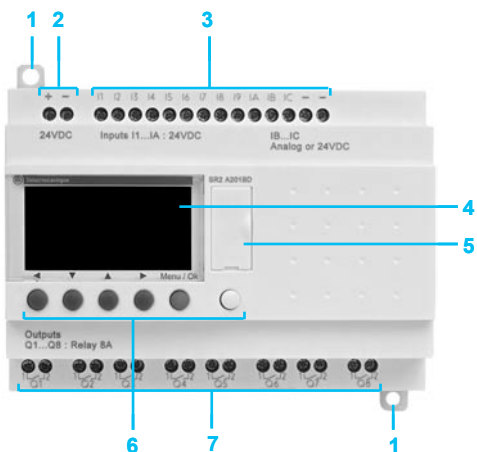

Zelio Logic compact smart relays have the following on their front panel:

- 1 Two retractable fixing lugs
- 2 Two power supply terminals.
- 3 Terminals for connection of the inputs.
- 4 Backlit LCD display with 4 lines of 18 characters.
- 5 Slot for memory cartridge or connection to a PC or Modem communication interface.
- 6 6 buttons for programming and parameter entry.
- 7 Terminals for connection of the outputs

Modular smart relays

With display - 10 and 26 I/O

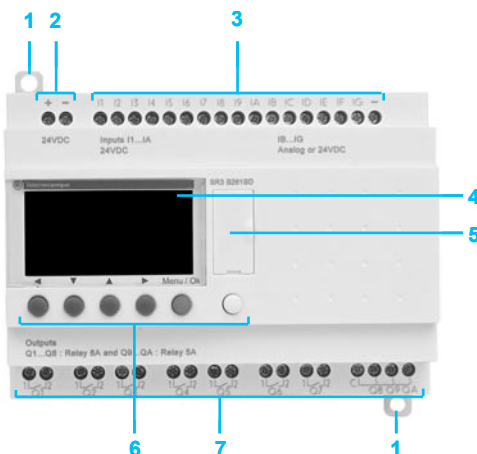

Zelio Logic modular smart relays have the following on their front panel:

- 1 Two retractable fixing lugs
- 2 Two power supply terminals.
- 3 Terminals for connection of the inputs.
- 4 Backlit LCD display with 4 lines of 18 characters.
- 5 Slot for memory cartridge or connection to a PC or Modem communication interface.
- 6 6 buttons for programming and parameter entry.
- 7 Terminals for connection of the outputs

Discrete I/O extension modules

6 discrete I/O

10 and 14 discrete I/O

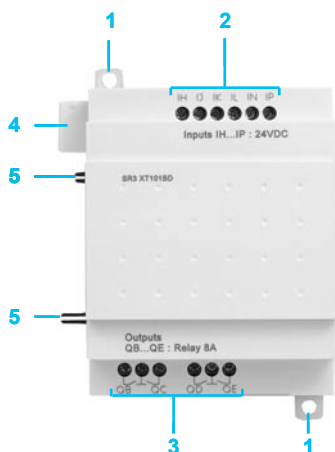
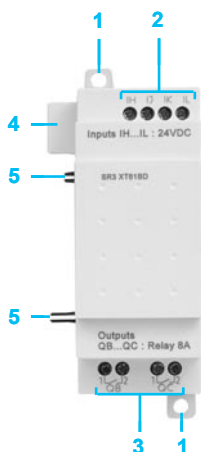

Discrete I/O extension modules have the following on their front panel:

- 1 Two retractable fixing lugs
- 2 Terminals for connection of the inputs.
- 3 Terminals for connection of the outputs
- 4 A connector for connection to the Zelio Logic smart relay (powered via the Zelio Logic smart relay).
- 5 Locating pegs.

General environment characteristics			
Type			SR2A / SR2B / SR2D / SR2E / SR3B / SR3XT●●1●●
Product certifications			UL, CSA, GL, C-Tick, GOST
Conformity with the low voltage directive	Conforming to 2006/95/EC		EN (IEC) 61131-2 (open equipment)
Conformity with the EMC directive	Conforming to 2004/108/EC		EN (IEC) 61131-2 (Zone B) EN (IEC) 61000-6-2, EN (IEC) 61000-6-3 (1) and EN (IEC) 61000-6-4
Degree of protection	Conforming to IEC/EN 60529		IP 20 (terminal block), IP 40 (front panel)
Overvoltage category	Conforming to IEC/EN 60664-1		3
Degree of pollution	Conforming to IEC/EN 61131-2		2
Ambient air temperature around de device conforming to IEC 60028-2-1 and IEC 60068-2-2	Operation	°C	- 20...+ 55 (+ 40 in non-ventilated enclosure)
	Storage	°C	- 40...+ 70
Maximum relative humidity	Conforming to IEC/EN 60068-2-30		95% without condensation or dripping water
Maximum operating altitude	Operation	m	2000
	Transport	m	3048
Mechanical resistance	Immunity to vibration		IEC/EN 60068-2-6, test Fc
	Immunity to mechanical shock		IEC/EN 60068-2-27, test Ea
Resistance to electrostatic discharge	Immunity to electrostatic discharge		IEC/EN 61000-4-2, level 3
Resistance to HF interference (immunity)	Immunity to electromagnetic radiated fields		IEC/EN 61000-4-3
	Immunity to fast transients in bursts		IEC/EN 61000-4-4, level 3
	Immunity to shock waves		IEC/EN 61000-4-5
	Radio frequency in common mode		IEC/EN 61000-4-6, level 3
	Voltage dips and breaks (~)		IEC/EN 61000-4-11
	Immunity to damped oscillation waves		IEC/EN 61000-4-12
	Conducted and radiated emissions	Conforming to EN 55022/11 (Group 1)	
Connection capacity to screw terminals	Flexible cable with cable end	mm ²	1 conductor: 0.25...2.5, cable: AWG 24...AWG 14 2 conductors: 0.25...0.75, cable: AWG 24...AWG 18
	Semi-solid cable	mm ²	1 conductor: 0.2...2.5, cable: AWG 25...AWG 14
	Solid cable	mm ²	1 conductor: 0.2...2.5, cable: AWG 25...AWG 14 2 conductors: 0.2...1.5, cable: AWG 24...AWG 16
	Tightening torque	N.m	0.5 (tightened using Ø 3.5 mm screwdriver)

Processing characteristics			
Number of control scheme lines	With LADDER programming		120
Number of function blocks	With FBD programming		Up to 200
Cycle time		ms	6...90
Response time		ms	Input acquisition time + 1 to 2 cycle times
Backup time (in the event of power failure)	Day/time		10 years (lithium battery) at 25 °C
	Program and adjustments in the Zelio Logic smart relay and in EEPROM memory cartridge SR2 MEM0●		10 years
Program memory checking			On each power-up
Clock drift			12 min/year (0 to 55 °C) 6 sec/month (at 25 °C and calibration)
Timer block accuracy			1% ± 2 of the cycle time

(1) Except for configuration SR3 B●●●BD + SR3 MBU01BD + SR3 XT43BD or SR3 B●●●BD + SR3 NET01BD + SR3 XT43BD class A (class B: use in a metal enclosure).

Supply characteristics, ~ 24 V products				SR2 ●121B	SR2 ●201B	SR3 B101B	SR3 B261B
Type			V	~ 24			
Nominal voltage			V	~ 20.4...28.8			
Voltage limits			Hz	50-60			
Nominal frequency			mA	145	233	160	280
Nominal input current	Without extensions		mA	-		280	415
	With extensions		mA	-		280	415
Power dissipated	Without extensions		VA	4	6	4	7,5
	With extensions		VA	-		7.5	10
Micro-breaks	Permissible duration		ms	≤ 10 (repeated 20 times)			
rms insulation voltage			V	~ 1780			

Discrete input characteristics, ~ 24 V products				SR●●●●B	
Type			V	~ 24	
Nominal value of inputs	Voltage		V	~ 24	
	Current		mA	4.4	
	Frequencies		Hz	47...53 and 57...63	
Input switching limit values	At state 1	Voltage	V	≥ ~ 14	
		Current	mA	> 2	
	At state 0	Voltage	V	≤ ~ 5	
		Current	mA	< 0.5	
Input impedance at state 1			KΩ	4.6	
Response time	LADDER language	State 0 to 1 (50/60 Hz)	ms	50	
		State 1 to 0 (50/60 Hz)	ms	50	
	FBD language	State 0 to 1 (50/60 Hz)	ms	50 min., 255 max. (in increments of 10)	
		State 1 to 0 (50/60 Hz)	ms	50 min., 255 max. (in increments of 10)	
Isolation	Between supply and inputs			None	
	Between inputs			None	
Protection	Against inversion of terminals			Yes (control instructions not executed)	

Relay output characteristics, ~ 24 V products				SR2 ●121B SR3 B101B SR3 XT101B	SR2 ●201B	SR3 B261B	SR3 XT61B	SR3 XT141B
Operating limit values			V	= 5...30, ~ 24...250				
Contact type				N/O				
Thermal current			A	4 outputs: 8 A	8 outputs: 8 A	8 outputs: 8 A 2 outputs: 5 A	2 outputs: 8 A	4 outputs: 8 A 2 outputs: 5 A
Electrical durability for 500 000 operating cycles Conforming to IEC/EN 60947-5-1	Utilisation category	DC-12	V	= 24				
			A	1.5				
	DC-13	V	= 24 (L/R = 10 ms)					
		A	0.6					
		AC-12	V	~ 230				
		AC-15	V	~ 230				
			A	0.9				
Minimum switching capacity	At minimum voltage of = 12 V		mA	10				
Low power switching reliability of contact				= 12 V - 10 mA				
Maximum operating rate	No-load		Hz	10				
	At I _e (operational current)		Hz	0.1				
Mechanical life	In millions of operating cycles			10				
Rated impulse withstand voltage	Conforming to IEC/EN 60947-1 and IEC/EN 60664-1		kV	4				
Response time	Set		ms	10				
	Reset		ms	5				
Built-in protection	Against short-circuits			None				
	Against overvoltage and overload			None				

Supply characteristics, ~ 100...240 V products						
Type		SR2●●●1FU SR2●121FU	SR2●201FU	SR3 B101FU	SR3 B261FU	
Nominal voltage	V	~ 100...240				
Voltage limits	V	~ 85...264				
Nominal frequency	Hz	50-60				
Nominal input current	Without extensions	mA	80/30	100/50	80/30	100/50
	With extensions	mA	-		80/40	80/60
Power dissipated	Without extensions	VA	7	11	7	12
	With extensions	VA	-		12	17
Micro-breaks	Permissible duration	ms	10			
rms insulation voltage	V	~ 1780				

Discrete input characteristics, ~ 100...240 V products					
Type			SR●●●●FU		
Nominal value of inputs	Voltage	V	~ 100... 240		
	Current	mA	0.6		
	Frequencies	Hz	47...53 and 57...63		
Input switching limit values	At state 1	Voltage	V	≥ ~ 79	
		Current	mA	> 0.17	
	At state 0	Voltage	V	≤ ~ 40	
		Current	mA	< 0.5	
Input impedance at state 1		KΩ	350		
Response time	LADDER language	State 0 to 1 (50/60 Hz)	ms	50	
		State 1 to 0 (50/60 Hz)	ms	50	
	FBD language	State 0 to 1 (50/60 Hz)	ms	50 min., 255 max. (in increments of 10)	
		State 1 to 0 (50/60 Hz)	ms	50 min., 255 max. (in increments of 10)	
Isolation	Between supply and inputs		None		
	Between inputs		None		
Protection	Against inversion of terminals		Yes (control instructions not executed)		

Relay output characteristics, ~ 100...240 V products							
Type			SR2●101FU SR2●121FU SR3 B101FU SR3 XT101FU	SR2●201FU	SR3 B261FU	SR3 XT61FU	SR3 XT141FU
Operating limit values		V	--- 5...30, ~ 24...250				
Contact type			N/O				
Thermal current		A	4 outputs: 8 A	8 outputs: 8 A	8 outputs: 8 A 2 outputs: 5 A	2 outputs: 8 A	4 outputs: 8 A 2 outputs: 5 A
Electrical durability for 500 000 operating cycles Conforming to IEC/EN 60947-5-1	Utilisation category	DC-12	V	--- 24			
			A	1.5			
	DC-13	V	--- 24 (L/R = 10 ms)				
		A	0.6				
		AC-12	V	~ 230			
			A	1.5			
AC-15	V	~ 230					
	A	0.9					
Minimum switching capacity	At minimum voltage of --- 12 V	mA	10				
Low power switching reliability of contact			--- 12 V - 10 mA				
Maximum operating rate	No-load	Hz	10				
	At I _e (operational current)	Hz	0.1				
Mechanical life	In millions of operating cycles		10				
Rated impulse withstand voltage	Conforming to IEC/EN 60947-1 and IEC/EN 60664-1	kV	4				
Response time	Set	ms	10				
	Reset	ms	5				
Built-in protection	Against short-circuits		None				
	Against overvoltage and overload		None				

Supply characteristics, $\bar{\bar{\bar{}}}$ 12 V products					
Type			SR2 B121JD	SR2 B201JD	SR3 B261JD
Nominal voltage		V	$\bar{\bar{\bar{}}}$ 12		
Voltage limits	Including ripple	V	$\bar{\bar{\bar{}}}$ 10.4...14.4		
Nominal input current	Without extensions	mA	120	200	250
	With extensions	mA	-		
Power dissipated	Without extensions	W	1.5	2.5	3
	With extensions	W	-		
Micro-breaks	Permissible duration	ms	\leq 1 (repeated 20 times)		
Protection	Against reversed polarity		Yes		

Discrete input characteristics, $\bar{\bar{\bar{}}}$ 12 V products				
Type			SR●●●●JD (inputs I1...IA, IH...IR)	SR●●●●JD (inputs IB...IG used as discrete inputs)
Nominal value of inputs	Voltage	V	$\bar{\bar{\bar{}}}$ 12	
	Current	mA	4	
Input switching limit values	At state 1	Voltage	\geq $\bar{\bar{\bar{}}}$ 5.6	\geq $\bar{\bar{\bar{}}}$ 7
		Current	\geq 2	\geq 0.5
	At state 0	Voltage	\leq $\bar{\bar{\bar{}}}$ 2.4	\leq $\bar{\bar{\bar{}}}$ 3
		Current	$<$ 0.9	$<$ 0.2
Input impedance at state 1		K Ω	2.7	14
Conforming to IEC/EN 61131-2			Type 1	Type 1
Sensor compatibility	3-wire		Yes PNP	Yes PNP
	2-wire		No	No
Input type			Resistive	Resistive
Isolation	Between supply and inputs		None	None
	Between inputs		None	None
Maximum counting frequency		kHz	1	1
Protection	Against reversed polarity		Yes (control instructions not executed)	Yes (control instructions not executed)

Supply characteristics, $\bar{\bar{\bar{}}}$ 12 V products			
Type		SR●●●●JD (inputs IB...IG used as analogue inputs)	
Input range	V	$\bar{\bar{\bar{}}}$ 0...10 or $\bar{\bar{\bar{}}}$ 0...12	
Input impedance	K Ω	14	
Maximum non destructive voltage	V	$\bar{\bar{\bar{}}}$ 14.4	
Value of LSB		39 mV	
Input type		Common mode	
Conversion	Resolution		8 bits at maximum voltage
	Conversion time		Smart relay cycle time
	Precision		\pm 5 % at 25 °C and \pm 6.2 % at 55 °C
	Repeat accuracy		\pm 2 % at 55 °C
Isolation	Between analogue channel and supply		None
Cabling distance	m		10 max., with screened cable (sensor not isolated)
Protection	Against reversed polarity		Yes

Relay output characteristics $\bar{\bar{\bar{}}}$ 12 V products							
Type			SR2 B121JD SR3 XT101JD	SR2 B201JD	SR3 B261JD	SR3 XT61JD	SR3 XT141JD
Operating limit values		V	$\bar{\bar{\bar{}}}$ 5...30, \sim 24...250				
Contact type			N/O				
Thermal current		A	4 outputs: 8 A	8 outputs: 8 A	8 outputs: 8 A 2 outputs: 5 A	2 outputs: 8 A	4 outputs: 8 A 2 outputs: 5 A
	Utilisation category	DC-12	V $\bar{\bar{\bar{}}}$ 24				
Electrical durability for 500 000 operating cycles Conforming to EN/IEC 60947-5-1	DC-13		A 1.5				
			V $\bar{\bar{\bar{}}}$ 24 (L/R = 10 ms)				
	AC-12		A 0.6				
			V \sim 230				
	AC-15		A 1.5				
			V \sim 230				
Minimum switching capacity	At minimum voltage of $\bar{\bar{\bar{}}}$ 12 V	mA	10				
Low power switching reliability of contact			$\bar{\bar{\bar{}}}$ 12 V - 10 mA				
Maximum operating rate	No-load	Hz	10				
	At le (operational current)	Hz	0.1				
Mechanical life	In millions of operating cycles		10				
Rated impulse withstand voltage	Conforming to IEC/EN 60947-1 and IEC/EN 60664-1	kV	4				
Response time	Set	ms	10				
	Reset	ms	5				
Built-in protection	Against short-circuits		None				
	Against overvoltage and overload		None				

Supply characteristics, 24 V products

Type		SR2 ●1●1BD	SR2 B122BD	SR2 ●201BD	SR2 B202BD	SR3 B101BD	SR3 B102BD	SR3 B261BD	SR3 B262BD
Nominal voltage	V	24							
Voltage limits	Including ripple	19.2...30							
Nominal input current	Without extensions	100					50	190	70
	With extensions	-					100	160	300
Power dissipated	Without extensions	3	6	3					
	With extensions	-					8	10	
Micro-breaks	Permissible duration	≤ 1 (repeated 20 times)							
Protection	Against reversed polarity	Yes							

Discrete input characteristics, 24 V products

Type		SR●●●●BD (input I1...IA, IH...IR)	SR●●●●BD (input IB...IG used as a discrete input)
Nominal value of inputs	Voltage	24	
	Current	4	
Input switching limit values	At state 1	Voltage	≥ 24
		Current	≥ 2.2
	At state 0	Voltage	≤ 5
		Current	< 0.75
Input impedance at state 1	KΩ	7.4	12
Conforming to IEC/EN 61131-2		Type 1	Type 1
Sensor compatibility	3-wire	Yes PNP	Yes PNP
	2-wire	No	No
Input type		Resistive	Resistive
Isolation	Between supply and inputs	None	None
	Between inputs	None	None
Maximum counting frequency	kHz	1	1
Protection	Against reversed polarity	Yes (control instructions not executed)	Yes (control instructions not executed)

Supply characteristics, 24 V products

Type		SR●●●●BD (input IB...IG used as an analogue input)
Input range	V	0...10 or 0..0.24
Input impedance	KΩ	12
Maximum non destructive voltage	V	30
Value of LSB		39 mV
Input type		Common mode
Conversion	Resolution	8 bits at maximum voltage
	Conversion time	Smart relay cycle time
	Precision	± 5 % at 25 °C and ± 6.2 % at 55 °C
	Repeat accuracy	± 2 % at 55 °C
Isolation	Between analogue channel and supply	None
Cabling distance	m	10 maximum, with screened cable (sensor not isolated)
Protection	Against reversed polarity	Yes

Relay output characteristics, $\bar{\sim}$ 24 V products								
Type			SR2 ●101BD SR2 ●121BD SR3 B101BD SR3 XT101BD	SR2 ●201BD	SR3 B261BD	SR3 XT61BD	SR3 XT141BD	
Operating limit values			V	$\bar{\sim}$ 5...30, \sim 24...250				
Contact type				N/O				
Thermal current			A	4 outputs: 8 A	8 outputs: 8 A	8 outputs: 8 A 2 outputs: 5 A	2 outputs: 8 A	4 outputs: 8 A 2 outputs: 5 A
Electrical durability for 500 000 operating cycles Conforming to IEC/EN 60947-5-1	Utilisation category	DC-12	V	$\bar{\sim}$ 24				
			A	1.5				
	DC-13	V	$\bar{\sim}$ 24 (L/R = 10 ms)					
		A	0.6					
	AC-12	V	\sim 230					
		A	1.5					
AC-15	V	\sim 230						
	A	0.9						
Minimum switching capacity	At minimum voltage of $\bar{\sim}$ 12 V		mA	10				
Low power switching reliability of contact				$\bar{\sim}$ 12 V - 10 mA				
Maximum operating rate	No-load		Hz	10				
	At I _e (operational current)		Hz	0.1				
Mechanical life	In millions of operating cycles			10				
Rated impulse withstand voltage	Conforming to IEC/EN 60947-1 and IEC/EN 60664-1		kV	4				
Response time	Set		ms	10				
	Reset		ms	5				
Built-in protection	Against short-circuits			None				
	Against overvoltage and overload			None				

Relay output characteristics, $\bar{\sim}$ 24 V products						
Type			SR● B●●2BD			
Operating limit values			V	$\bar{\sim}$ 19.2..0.30		
Load	Nominal voltage		V	$\bar{\sim}$ 24		
	Nominal current		A	0.5		
	Maximum current		A	0.625 at 30 V		
Residual voltage	At state 1		V	\leq 2 for I = 0.5 A		
Response time	Set		ms	\leq 1		
	Reset		ms	\leq 1		
Built-in protection	Against overload and short-circuits			Yes		
	Against overvoltage			Yes		
	Against inversions of power supply			Yes		

Electrical durability of relay outputs

(in millions of operating cycles, conforming to IEC/EN 60947-5-1)

d.c. loads

DC-12 (1)

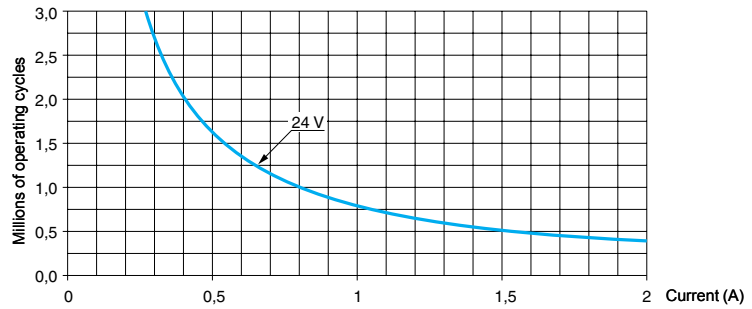

DC-13 (2)

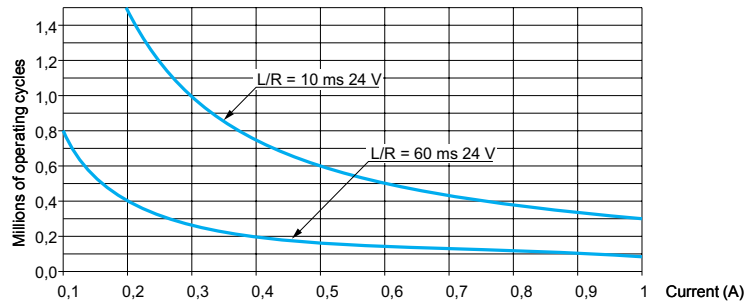

- (1) DC-12: control of resistive loads and of solid state loads isolated by opto-coupler, $L/R \leq 1$ ms.
 (2) DC-13: switching electromagnets, $L/R \leq 2 \times (U_e \times I_e)$ in ms, U_e : rated operational voltage, I_e : rated operational current (with a protection diode on the load, DC-12 curves must be used with a coefficient of 0.9 applied to the number in millions of operating cycles).

Electrical durability of relay outputs (continued)

(in millions of operating cycles, conforming to IEC/EN 60947-5-1)

a.c. loads

AC-12 (1)

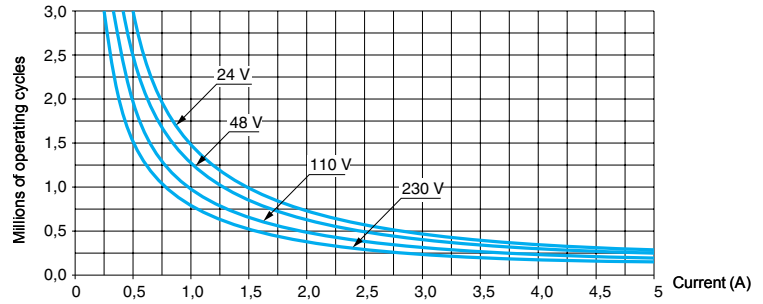

AC-14 (2)

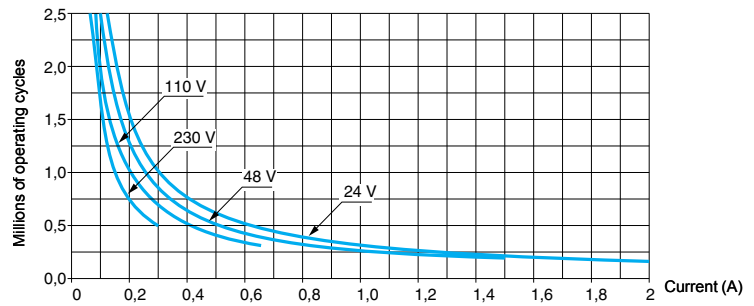

AC-15 (3)

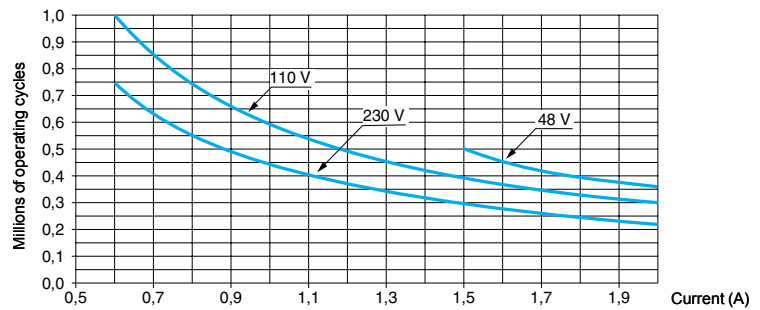

- (1) AC-12: switching resistive loads and opto-coupler isolated solid-state loads, $\cos \geq 0.9$.
 (2) AC-14: switching small electromagnetic loads ≤ 72 VA, make: $\cos = 0.3$, break: $\cos = 0.3$.
 (3) AC-15: switching electromagnetic loads > 72 VA, make: $\cos = 0.7$, break: $\cos = 0.4$.

Zelio Logic smart relays

Compact smart relays



SR2 A201BD



SR2 SFT01



SR2 PACK



Modem communication interface

Compact smart relays with display

Number of I/O	Discrete inputs	Including 0-10 V analogue inputs	Relay outputs	Transistor outputs	Clock	Reference	Weight kg
Supply ~ 24 V							
12	8	0	4	0	Yes	SR2 B121B	0.250
20	12	0	8	0	Yes	SR2 B201B	0.380
Supply ~ 100...240 V							
10	6	0	4	0	No	SR2 A101FU (1)	0.250
12	8	0	4	0	Yes	SR2 B121FU	0.250
20	12	0	8	0	No	SR2 A201FU (1)	0.380
					Yes	SR2 B201FU	0.380
Supply ~ 12 V							
12	8	4	4	0	Yes	SR2 B121JD	0.250
20	12	6	8	0	Yes	SR2 B201JD	0.380
Supply ~ 24 V							
10	6	0	4	0	No	SR2 A101BD (1)	0.250
12	8	4	4	0	Yes	SR2 B121BD	0.250
			0	4	Yes	SR2 B122BD	0.220
20	12	2	8	0	No	SR2 A201BD (1)	0.380
		6	8	0	Yes	SR2 B201BD	0.380
			0	8	Yes	SR2 B202BD	0.280

"Zelio Soft 2" software for PC

Description	Application	Reference	Weight kg
Programming software "Zelio Soft 2", multi-language	For PC, supplied on CD-ROM (2), compatible with Windows 98, NT, 2000, XP	SR2 SFT01	0.200

Accessories

Connection accessories

Description	Application	Length	Reference	Weight kg
Connecting cable	Between the PC (USB connector) and the Zelio Logic smart relay	3 m	SR2 USB01	0.100

Other accessories: see pages 26 and 27

Compact "discovery" packs

Number of I/O	Pack contents: - Compact smart relay with display - "Zelio Soft 2" programming software supplied on CD-Rom - Cable SR2 USB01 for connection to PC (3) Description of compact smart relay with display	Reference	Weight kg
Supply ~ 100...240 V			
12	SR2 B121FU	SR2 PACKFU	0.700
20	SR2 B201FU	SR2 PACK2FU	0.850
Supply ~ 24 V			
12	SR2 B121BD	SR2 PACKBD	0.700
20	SR2 B201BD	SR2 PACK2BD	0.700

Modem communication interface

Supply ~ 12...24 V				
Description	Application	Reference	Weight kg	
Modem communication interface	For SR2 B	See page 54	0.200	

(1) Programming on Zelio Logic smart relay in LADDER language only.

(2) CD-ROM comprising "Zelio Soft 2" software, an application library, a self-training manual, installation instructions and a user's manual.

(3) Replaces cable SR2 CBL01 which is still available separately, as an accessory (see page 26).

Zelio Logic smart relays

Compact smart relays



SR2 E121BD



SR2 SFT01



SR2 USB01



Modem communication interface

Compact smart relays without display

Number of I/O	Discrete inputs	Including 0-10 V analogue inputs	Relay outputs	Transistor outputs	Clock	Reference	Weight kg
Supply ~ 24 V							
12	8	0	4	0	Yes	SR2 E121B	0.220
20	12	0	8	0	Yes	SR2 E201B	0.350
Supply ~ 100...240 V							
10	6	0	4	0	No	SR2 D101FU (1)	0.220
12	8	0	4	0	Yes	SR2 E121FU	0.220
20	12	0	8	0	No	SR2 D201FU (1)	0.350
					Yes	SR2 E201FU	0.350
Supply ~ 24 V							
10	6	0	4	0	No	SR2 D101BD (1)	0.220
12	8	4	4	0	Yes	SR2 E121BD	0.220
20	12	2	8	0	No	SR2 D201BD (1)	0.350
		6	8	0	Yes	SR2 E201BD	0.350

"Zelio Soft 2" software for PC

Description	Application	Reference	Weight kg
Programming software "Zelio Soft 2", multi-language	For PC, supplied on CD-Rom (2), compatible with Windows 98, NT, 2000, XP	SR2 SFT01	0.200

Accessories

Connection accessories

Description	Application	Length	Reference	Weight kg
Connecting cable	Between the PC (USB connector) and the Zelio Logic smart relay.	3 m	SR2 USB01	0.100

Other accessories: see pages 26 and 27

Modem communication interface

Supply ~ 12...24 V

Description	Application	Reference	Weight kg
Modem communication interface	For SR2 E	See page 54	0.200

(1) Programming on Zelio Logic smart relay in LADDER language only.

(2) CD-ROM comprising "Zelio Soft 2" software, an application library, a self-training manual, installation instructions and a user's manual.

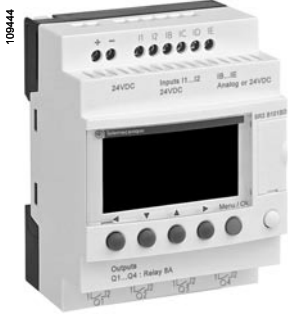

SR3 B101BD



SR2 SFT01



SR2 USB01



SR2 PACK...

Modular smart relays with display

Number of I/O	Discrete inputs	Including 0-10 V analogue inputs	Relay outputs	Transistor outputs	Clock	Reference	Weight kg
Supply ~ 24 V							
10	6	0	4	0	Yes	SR3 B101B	0.250
26	16	0	10 (1)	0	Yes	SR3 B261B	0.400
Supply ~ 100...240 V							
10	6	0	4	0	Yes	SR3 B101FU	0.250
26	16	0	10 (1)	0	Yes	SR3 B261FU	0.400
Supply ~ 12 V							
26	16	6	10 (1)	0	Yes	SR3 B261JD (2)	0.400
Supply ~ 24 V							
10	6	4	4	0	Yes	SR3 B101BD	0.250
			0	4	Yes	SR3 B102BD	0.220
26	16	6	10 (1)	0	Yes	SR3 B261BD	0.400
			0	10	Yes	SR3 B262BD	0.300

"Zelio Soft 2" software for PC

Description	Application	Reference	Weight kg
Programming software "Zelio Soft 2", multi-language	For PC, supplied on CD-ROM (3), compatible with Windows 98, NT, 2000, XP	SR2 SFT01	0.200

Accessories

Connection accessories

Description	Application	Length	Reference	Weight kg
Connecting cable	Between the PC (USB connector) and the Zelio Logic smart relay	3 m	SR2 USB01	0.100

Other accessories: see pages 26 and 27

Modular "discovery" packs

Number of I/O	Pack contents: - Compact smart relay with display - "Zelio Soft 2" programming software supplied on CD-Rom - Cable SR2 USB01 for connection to PC (4)	Reference	Weight kg
Description of compact smart relay with display			
Supply ~ 100...240 V			
10	SR3 B101FU	SR3 PACKFU	0.700
26	SR3 B261FU	SR3 PACK2FU	0.850
Supply ~ 24 V			
10	SR3 B101BD	SR3 PACKBD	0.700
26	SR3 B261BD	SR3 PACK2BD	0.850

(1) Including 8 outputs at maximum current of 8 A and 2 outputs at maximum current of 5 A.

(2) Can only be used with "Zelio Soft 2" software version ≥ V 3.1.

(3) CD-ROM comprising "Zelio Soft 2" software, an application library, a self-training manual, installation instructions and a user's manual.

(4) Replaces cable SR2 CBL01 which is still available separately, as an accessory (see page 26).

Note: The Zelio Logic smart relay and its associated extensions must have an identical voltage.



Modbus communication module

Ethernet communication module



SR3 XT61BD



SR3 XT141BD



Modem communication interface

Modbus and Ethernet communication module (1)

Supply \sim 24 V (via smart relays SR3B...BD)

For use with	Network	Reference	Weight kg
Zelio Logic modular smart relays SR3 B●●1BD and SR3 B●●2BD	Modbus	See page 42	0.110
	Ethernet	See page 42	0.110

Analogue I/O extension module (2)

Supply \sim 24 V (via Zelio logic smart relay SR3 B...BD)

Number of I/O	Inputs	Including \sim 0-10 V	Including \sim 0-20 mA	Including \sim Pt100	Output \sim 0-10 V	Reference	Weight kg
4	2 (3)	2 max	2 max	1 max	2	See page 46	0.110

Discrete I/O extension modules

Number of I/O	Discrete inputs	Relay outputs	Reference	Weight kg
6	4	2	SR3 XT61B	0.125
10	6	4	SR3 XT101B	0.200
14	8	6 (4)	SR3 XT141B	0.220

Supply \sim 24 V (via Zelio logic smart relays SR3 B●●●B)

Number of I/O	Discrete inputs	Relay outputs	Reference	Weight kg
6	4	2	SR3 XT61FU	0.125
10	6	4	SR3 XT101FU	0.200
14	8	6 (4)	SR3 XT141FU	0.220

Supply \sim 100-240 V (via Zelio logic smart relays SR3 B●●●FU)

Number of I/O	Discrete inputs	Relay outputs	Reference	Weight kg
6	4	2	SR3 XT61JD	0.125
10	6	4	SR3 XT101JD	0.200
14	8	6 (4)	SR3 XT141JD	0.220

Supply \sim 24 V (via Zelio logic smart relays SR3 B●●●BD)

Number of I/O	Discrete inputs	Relay outputs	Reference	Weight kg
6	4	2	SR3 XT61BD	0.125
10	6	4	SR3 XT101BD	0.200
14	8	6 (4)	SR3 XT141BD	0.220

Modem communication interface (5)

Supply \sim 12...24 V

Description	Reference	Weight kg
Modem communication interface	See page 54	0.200

(1) See pages 32 to 41.

(2) See pages 44 to 47.

(3) See page 47.

(4) Including 4 outputs at maximum current of 8 A and 2 outputs at maximum current of 5 A.

(5) See pages 48 to 57.

Note: The Zelio Logic smart relay and its associated extensions must have an identical voltage.

Zelio Logic smart relays

Compact and modular smart relays



SR2 SFT01



SR2 USB01



SR2 BTC01



SR2 MEM02

Programming

"Zelio Soft 2" software for PC

Description	Application	Reference	Weight kg
Programming software "Zelio Soft 2", multi-language	For PC, supplied on CD-ROM (1), compatible with Windows 98, NT, 2000, XP	SR2 SFT01	0.200

Connection accessories

Description	Application	Reference	Weight kg
Connecting cables	Between the PC (SUB-D, 9-pin connector) and the Zelio Logic smart relay. Length: 3 m	SR2 CBL01	0.150
	Between the PC (USB connector) and the Zelio Logic smart relay. PC compatible with Windows 2000, XP. Length: 3 m	SR2 USB01	0.100
Bluetooth interface for Zelio Logic smart relays	Between the PC (wireless link) and the Zelio Logic smart relay. Range of 10m (class 2)	SR2 BTC01 (2)	0.015

Bluetooth adapter for non-equipped PC	To be used in conjunction with SR2BTC01 when the PC is not equipped with Bluetooth technology. Connection to the USB port on the PC. PC compatible with Windows 98SE, 2000, XP. Range 10 m (class 2)	VW3 A8115	0.290
---------------------------------------	--	-----------	-------

Memory cartridges (3)

Description	Application	Reference	Weight kg
EEPROM memory cartridges	For firmware (software embedded in the smart relay) version ≤ 2.4	SR2 MEM01	0.010
	For firmware (software embedded in the smart relay) version ≥ 3.0	SR2 MEM02	0.010

Documentation

Description/application	Language	Reference	Weight kg
User's manual for direct programming on the Zelio Logic smart relay	English	SR2 MAN01EN	0.100
	French	SR2 MAN01FR	0.100
	German	SR2 MAN01DE	0.100
	Spanish	SR2 MAN01ES	0.100
	Italian	SR2 MAN01IT	0.100
	Portuguese	SR2 MAN01P0	0.100

(1) CD-ROM comprising "Zelio Soft 2" software, an application library, a self-training manual, installation instructions and a user's manual.

(2) Can only be used with "Zelio Soft 2" software version $\geq V 4.1$.

(3) Program loading using memory cartridge SR2 MEM02 is incompatible with Modem communication interface SR2 COM01.



Regulated switch mode power supply



Converters for thermocouples

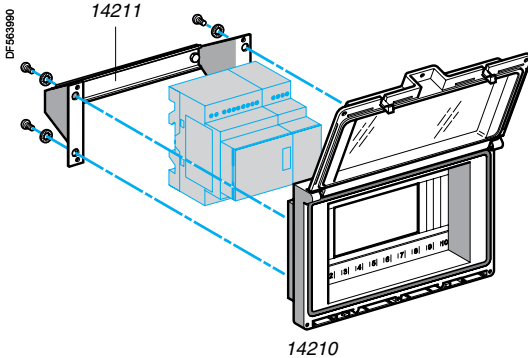

Regulated switch mode power supplies (1)

Input voltage	Nominal output voltage	Reference	Weight kg
~ 100...240 V (50/60 Hz)	≡ 5 V, ≡ 12 V or ≡ 24 V	See page 71	–

Converters (2)

Description	Reference	Weight kg
Converters for J and K type thermocouples, for Pt100 probes and voltage/current	See page 64	–

Mounting accessories

Description/application	Mounting capacity	Reference	Weight kg
Dust and damp-proof enclosure with split blanking plate arrangement, fitted with an IP 55 dust and damp-proof window with hinged flap, for mounting through a door	- 1 or 2 SR2 smart relays with 10 or 12 I/O or - 1 SR2 smart relay with 20 I/O or - 1 SR3 smart relay with 10 I/O + 1 I/O extension module (6, 10 or 14 I/O) or - 1 SR3 smart relay with 26 I/O + 1 I/O extension module (6 I/O).	14210	0.350
Fixing bracket and symmetrical mounting rail	For mounting enclosure 14210 through a door panel	14211	0.210

(1) See pages 66 to 71.
(2) See pages 60 to 65.

Compact and modular smart relays

SR●●10●●● (10 I/O), SR2●12●●● (12 I/O)

Mounting on 35 mm L-r rail

Screw fixing (retractable lugs)

Position of display

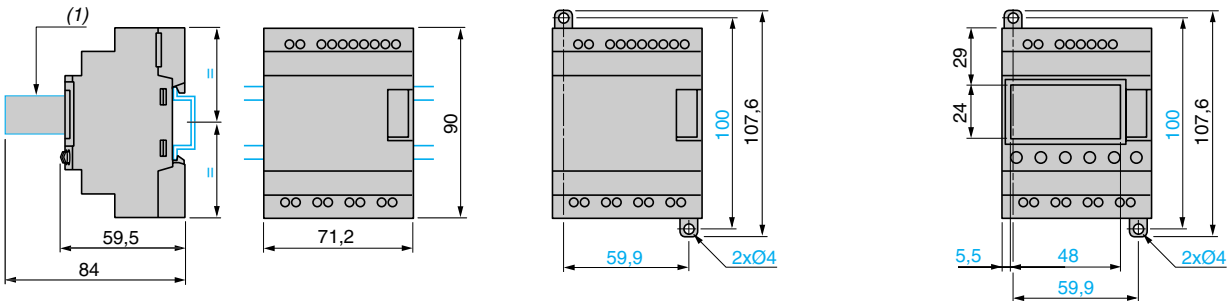

SR2●20●●● (20 I/O), SR3 B26●●● (26 I/O)

Mounting on 35 mm L-r rail

Screw fixing (retractable lugs)

Position of display

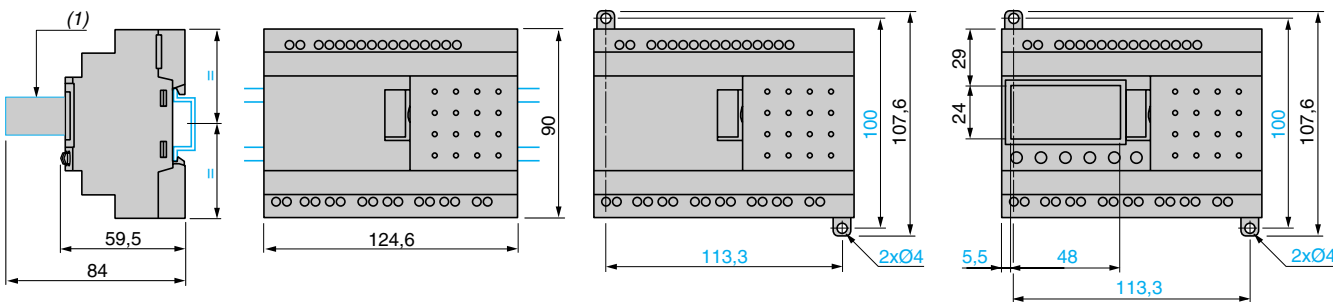

(1) With SR2 USB01 or SR2 BTC01

I/O extension modules

SR3 XT61●● (6 I/O), SR3 XT101●● and SR3 XT141●● (10 and 14 I/O)

Mounting on 35 mm L-r rail

Screw fixing (retractable lugs)

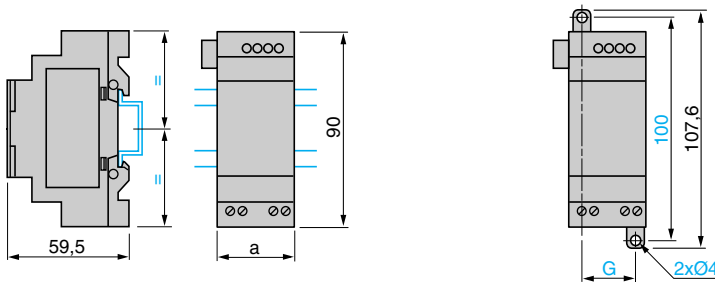

SR3	a	G
XT61●●	3,5	25
XT101●●	72	60
XT141●●	72	60

Dust and damp-proof enclosure + fixing bracket

14210 + 14211

Cut-out

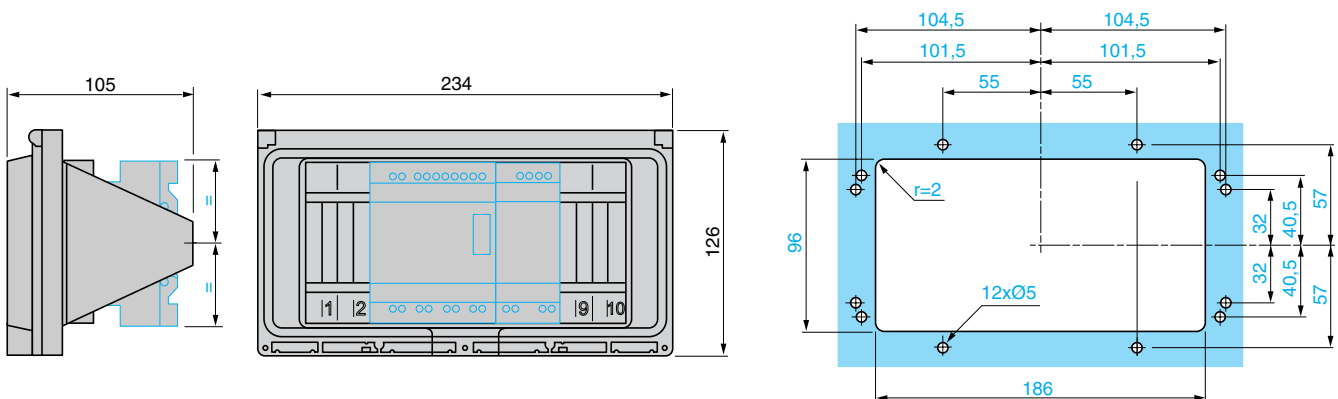

Connection of smart relays on \approx supply

SR●●●1BD, SR●●●1JD

SR3 B261●D

SR2 B●●2BD and SR3 B●●2BD

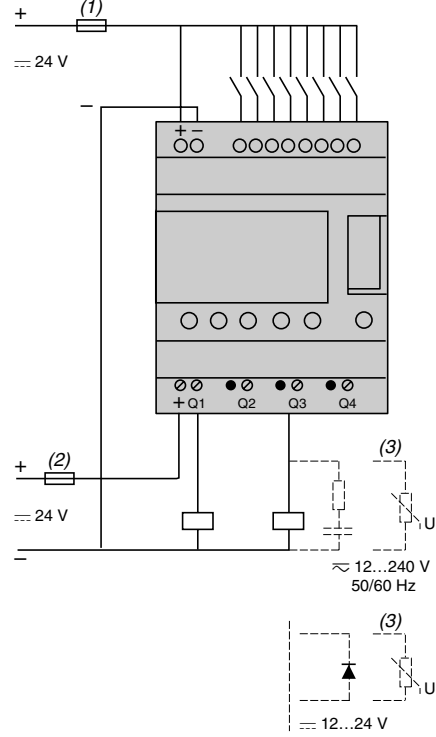
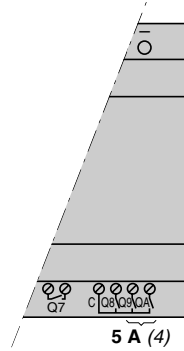
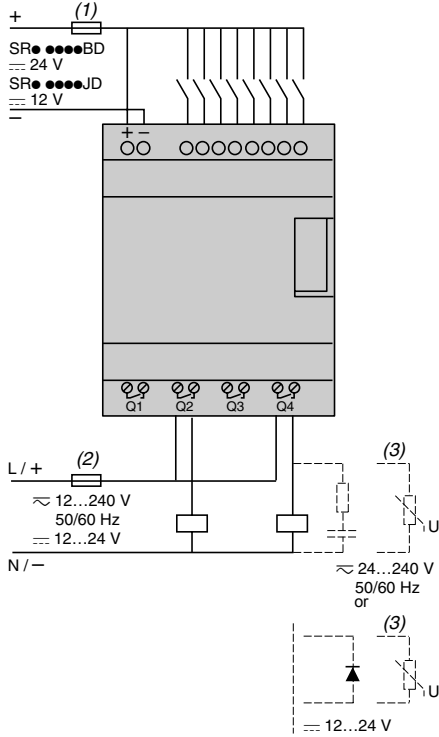

- (1) 1 A quick-blow fuse or circuit-breaker.
- (2) Fuse or circuit-breaker.
- (3) Inductive load.
- (4) Q9 and QA: 5 A (max. current in terminal C: 10 A).

Discrete input used for 3-wire sensors

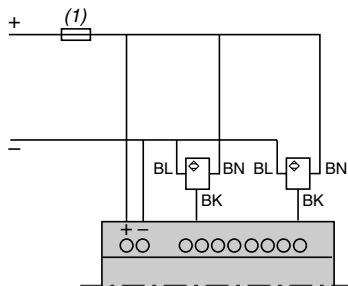

- (1) 1 A quick-blow fuse or circuit-breaker.

Connection of smart relays on $\bar{\bar{}}$ supply (continued)

Analogue inputs

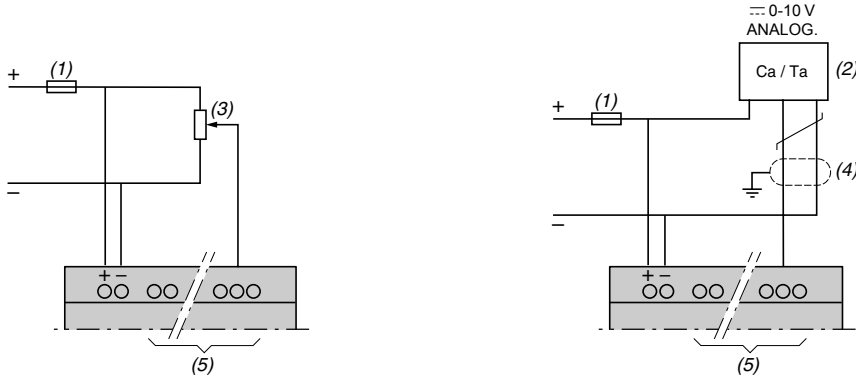

- (1) 1 A quick-blow fuse or circuit-breaker.
- (2) Ca: Analogue sensor / Ta: Analogue transmitter.
- (3) Recommended values: 2.2 k Ω /0.5 W (10 k Ω max)
- (4) Screened cables, maximum length 10 m.
- (5) Analogue inputs according to Zelio Logic smart relay type, see table below:

Smart relays	Analogue inputs
SR2 \bullet 12 \bullet \bullet D	IB...IE
SR2 A201BD	IB and IC
SR2 D201BD	IB and IC
SR2 B20 \bullet \bullet D	IB...IG
SR2 E201BD	IB...IG
SR3 B10 \bullet BD	IB...IE
SR3 B26 \bullet \bullet D	IB...IG

Connection of smart relays on $\bar{\bar{}}$ supply, with discrete I/O extension modules

SR3 B \bullet \bullet \bullet JD + SR3 XT \bullet \bullet \bullet JD, SR3 B \bullet \bullet \bullet BD + SR3 XT \bullet \bullet \bullet BD

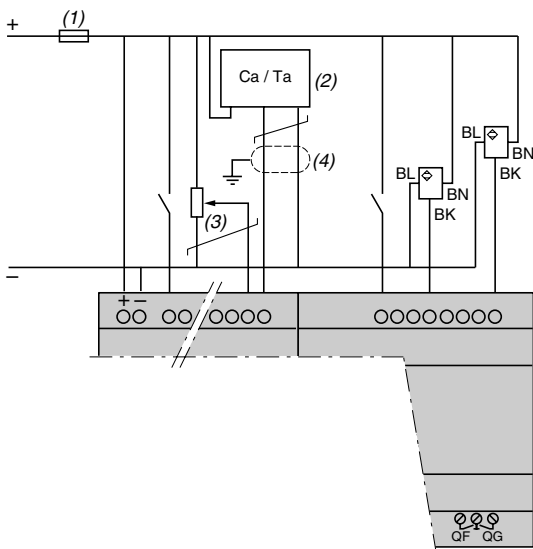

Warning: QF and QG : 5 A for SR3 XT141 \bullet \bullet

- (1) 1 A quick-blow fuse or circuit-breaker.
- (2) Ca: Analogue sensor / Ta: Analogue transmitter.
- (3) Recommended values: 2.2 k Ω /0.5 W (10 k Ω max)
- (4) Screened cables, maximum length 10 m.

Connection of smart relays on ~ supply

SR●●●●1B, SR●●●●1FU

SR3 B261B and SR3 B261FU

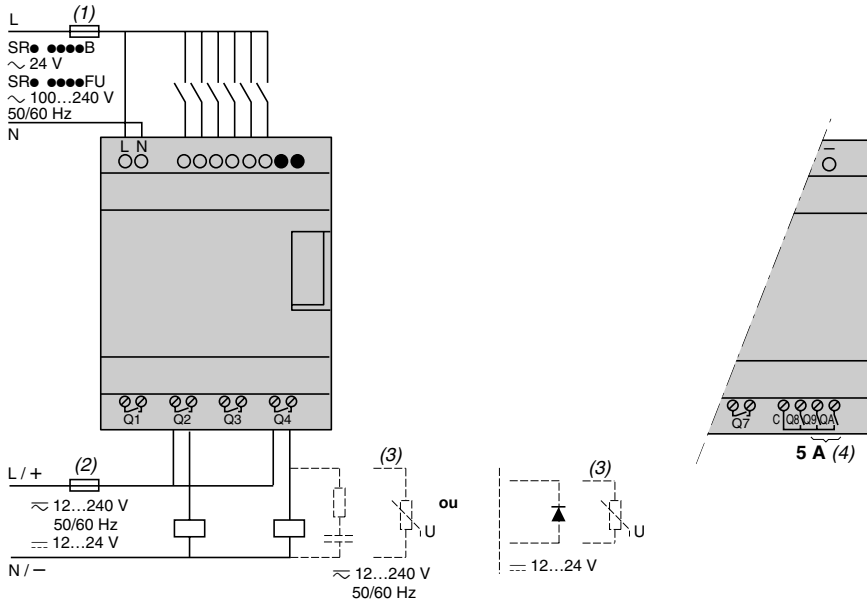

- (1) 1 A quick-blow fuse or circuit-breaker.
- (2) Fuse or circuit-breaker.
- (3) Inductive load.
- (4) Q9 and QA: 5 A (max. current in terminal C: 10 A).

With discrete I/O extension module

SR3 B●●●B + SR3 XT●●●B, SR3 B●●●FU + SR3 XT●●●FU

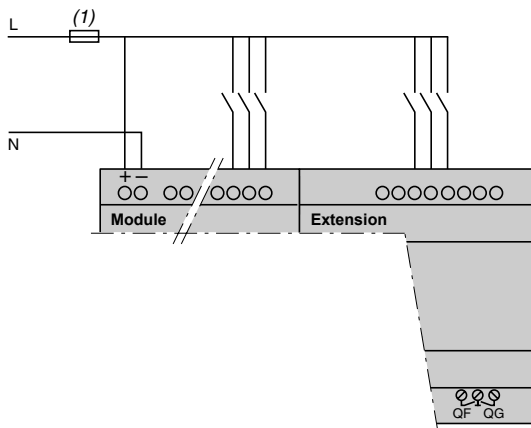

Warning: QF and QG: 5 A for SR3 XT141●●

- (1) 1 A quick-blow fuse or circuit-breaker.

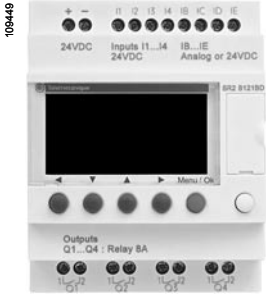

Smart relay

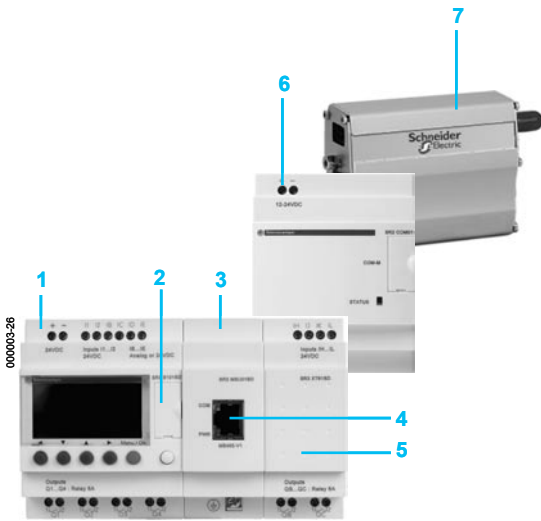

- 1 Modular smart relay (10 or 26 I/O).
- 2 RS 232 serial port, Zelio Logic type connector.
- 3 Modbus slave or Ethernet server communication module.
- 4 RJ45 connector for Modbus or Ethernet network connection.
- 5 I/O extension module: discrete (6, 10 or 14 I/O) or analogue (4 I/O).
- 6 Modem communication interface.
- 7 GSM (or analogue PSTN) Modem.

⚠ The order shown above must be observed when using a Modbus slave or Ethernet server communication module and a discrete or analogue I/O extension module. An I/O extension module cannot be fitted before the Modbus slave or Ethernet server communication module

Presentation

In order to communicate with an intelligent environment, Zelio Logic smart relays and their I/O extension and communication modules are equipped with various types of communication port.

- Compact and modular smart relays offer:
 - 1 RS 232 serial port for connection of the PC, the Modem communication interface or a memory cartridge slot.
- Zelio Logic modular smart relay I/O extension and communication modules offer:
 - 1 Modbus RS 485 port on communication module SR3 MBU01BD,
 - 1 Ethernet 10/100 base T port supporting the Modbus TCP protocol on communication module SR3 NET01BD.

These three ports allow Zelio Logic compact or modular smart relays to use 3 communication protocols:

- Programming,
- Modbus,
- Ethernet.

Communication ports on Zelio Logic smart relays and their I/O extension and communication modules:

Communication port	Serial port	Modbus port on communication module SR3 MBU01BD	Ethernet port on communication module SR3 NET01BD	Modem communication interface port
Physical layer	RS 232	RS 485	10/100 base T	RS 232
Connector	Specific to Zelio	RJ45	RJ45	Specific to Zelio
Compact smart relays	All types (connection and isolation via cable SR2 CBL01 or SR2 USB01)	–	–	All modules with clock SR2 B●●●●● SR2 E●●●●● (see page 54)
Modular smart relays	All types (connection and isolation via cable SR2 CBL01 or SR2 USB01)	All modules with 24 V supply SR3 B●●●BD	All modules with 24 V supply SR3 B●●●BD	All types (see page 54)

Description

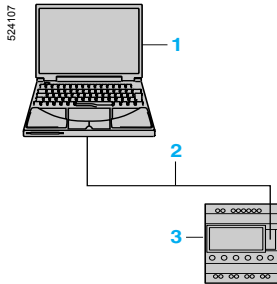

Link by cable

- 1 Programming PC.
- 2 RS 232 serial link cable (SR2 CBL01) or USB cable (SR2 USB01) (1).
- 3 Zelio Logic compact or modular smart relay.

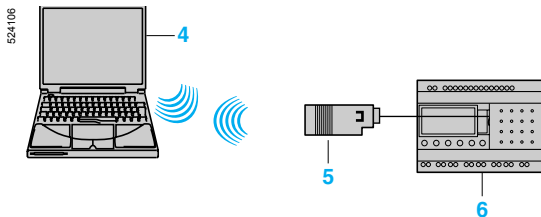

Wireless link

- 4 Programming PC with integrated Bluetooth technology (or Bluetooth adapter VW3 A8115 for PC not equipped with Bluetooth technology) (1).
- 5 Bluetooth interface (SR2 BTC01) for Zelio Logic smart relay (1).
- 6 Zelio Logic compact or modular smart relay.

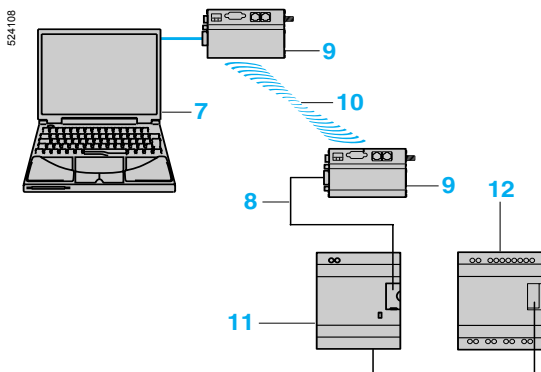

Link by Modem

- 7 Programming PC.
- 8 Modem interface connecting cable supplied with SR2 COM01(2).
- 9 Modem for transmitting/receiving data SR2 MOD01 or SR2 MOD02 (2).
- 10 Telephone or radio link.
- 11 Communication interface SR2 COM01.
- 12 Zelio Logic compact or modular smart relay.

(1) See page 26.
(2) See page 54.

Serial link characteristics

Product type	All Zelio Logic smart relays	
Flow rate	Kbit/s	115.2
Data bits		7
Stop bits		1
Parity		Even
Physical layer		RS 232
Type of connector		Specific to Zelio Logic

824131



Modbus communication module

Presentation

The Modbus communication protocol is of the master/slave type.

Two exchange methods are possible:

■ Request/reply:

- The request from the master is addressed to a specific slave.
- The master waits for the reply to be returned by the slave polled.

■ Distribution:

- The master distributes a request to all the slave stations on the bus. These stations execute the instruction without sending a reply.

Zelio Logic modular smart relays are connected to the Modbus network via the Modbus slave communication module. This module is a slave that is not electrically isolated.

The Modbus slave communication module must be connected to an SR3 B●●●BD modular smart relay, with a $\bar{\sim}$ 24 V supply.

Configuration

The Modbus network slave communication module can be configured:

- independently, using the buttons on the smart relay (1).
- on a PC, using "Zelio Soft 2" software, see page 9.

When using a PC, programming can be performed either in LADDER language or in function block diagram (FBD) language, see pages 10 to 13.

Description

Modbus slave communication module **SR3 MBU01BD** comprises:

- 1 Two retractable fixing lugs
- 2 A Modbus network connection (RJ45 screened female connector).
- 3 A communication LED (COM).
- 4 A "Power on" LED (PWR).
- 5 A screw terminal block for the protective earth connection.
- 6 A spring for clip-on mounting on a 35 mm mounting rail.
- 7 Two locating pegs.
- 8 Two locating pegs for clip-on fixing.

(1) Programming from the front panel and buttons on the smart relay is only possible in LADDER language.

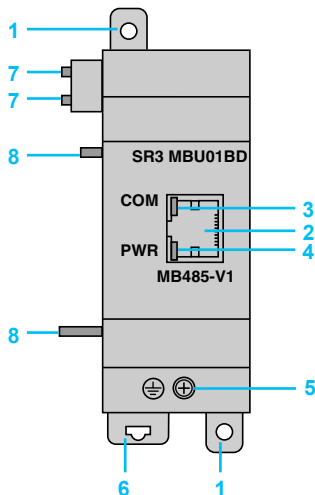

Connection examples

Example 1

- 1 Twido master.
- 2 Modbus network (cable TWD XCA RJP03)
- 3 Slave display unit XUBT N401.
- 4 Connecting cable XBT Z938.
- 5 Junction box TWD XCA T3RJ (polarisation and line end adapter activated).
- 5 bis Junction box TWD XCA T3RJ (no polarisation but line end adapter activated).
- 6 Modbus network (cables VW3 A8 306R●●).
- 7 T-junction VW3 A8 306TF●●.
- 8 ATV 31 variable speed controller.
- 9 Modbus communication module SR3 MBU01BD.
- 10 Modular smart relay SR3 B●●●BD.

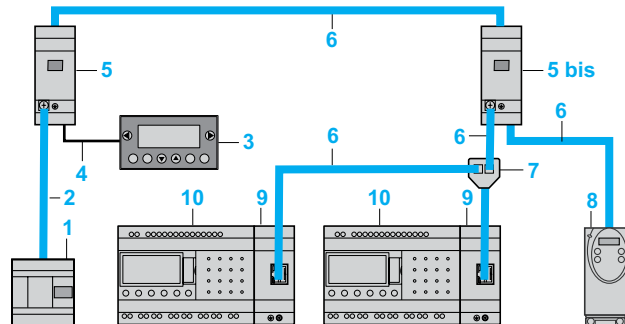

Total length of cables between Twido and ATV 31: ≤ 30 m

Example 2

- 1 Twido master.
- 2 Modbus network (cable TWD XCA RJP03)
- 3 Slave display unit XUBT N401.
- 4 Connecting cable XBT Z938.
- 5 Junction box TWD XCA ISO (polarisation and line end adapter activated).
- 5 bis Junction box TWD XCA ISO (no polarisation but line end adapter activated).
- 6 Modbus network (cables TSX CSA ●00).
- 7 Modbus network (cables VW3 A8 306R●●).
- 8 Supply cable 24 V.
- 9 Regulated power supply from the Phaseo Modular range.
- 10 T-junction 170XTS04100.
- 11 Modbus communication module SR3 MBU01BD.
- 12 Modular smart relay SR3 B●●●BD.

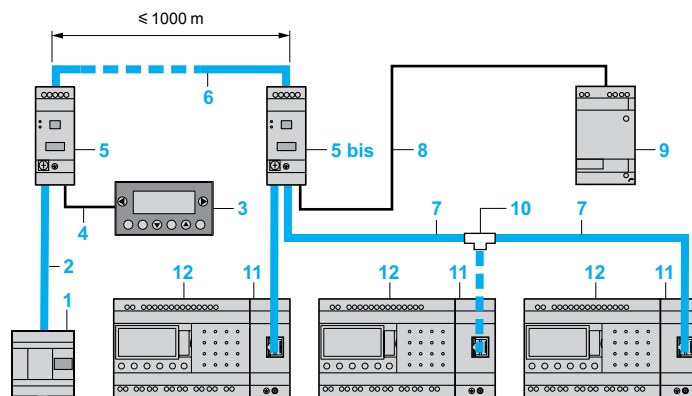

Function description

- The Modbus slave communication module is connected to a 2-wire or 4-wire Modbus network (1).
- The maximum length of the network between the two TWD XCAISO T-junctions is 1000 m (9600 bauds max., AWG 26).
- A maximum of 32 slaves can be connected to the Modbus network, or a maximum of 247 slaves with repeaters.
- Line end adapters must be fitted to both ends of the line (1 nF/10 V, 120 Ω /0.25 W in series).
- The line must be polarised (470 Ω /0.25 W resistors) (2).
- The connection cable and its RJ45 male connectors must be screened.
- The ⚡ terminal on the module must be connected directly to the protective earth at one point on the bus.

(1) Please refer to installation instructions supplied with the product.

(2) The polarisation resistors must be managed by the master.

Environment characteristics			
Type	SR3 MBU01BD		
Product certifications			UL, CSA, GL, C-TICK, GOST
Conformity with the low voltage directive	Conforming to 2006/95/EC		EN (IEC) 61131-2 (open equipment)
Conformity with the EMC directive	Conforming to 2004/108/EC		EN (IEC) 61131-2 (Zone B) EN (IEC) 61000-6-2, EN (IEC) 61000-6-3 (1) and EN (IEC) 61000-6-4
Degree of protection	Conforming to IEC/EN 60529		IP 20 (terminal block) IP 40 (front panel)
Overvoltage category	Conforming to IEC/EN 60664-1		3
Degree of pollution	Conforming to IEC/EN 61131-2		2
Ambient air temperature around the device Conforming to IEC/EN 60068-2-1 and IEC/EN 60068-2-2	Operation	°C	- 20...+ 55 (+ 40 in non-ventilated enclosure)
	Storage	°C	- 40... + 70
Max. relative humidity	Conforming to IEC/EN 60068-2-30		95% without condensation or dripping water
Maximum operating altitude	Operation	m	2000
	Transport	m	3048
Mechanical resistance	Immunity to vibration		IEC/EN 60068-2-6, test Fc
	Immunity to mechanical shock		IEC/EN 60068-2-27, test Ea
Resistance to electrostatic discharge	Immunity to electrostatic discharge		IEC/EN 61000-4-2, level 3
Resistance to HF interference(immunity)	Immunity to electromagnetic radiated fields		IEC/EN 61000-4-3
	Immunity to fast transients in bursts		IEC/EN 61000-4-4, level 3
	Immunity to shock waves		IEC/EN 61000-4-5
	Radio frequency in common mode		IEC/EN 61000-4-6, level 3
	Voltage dips and breaks (~)		IEC/EN 61000-4-11
	Immunity to damped oscillation waves		IEC/EN 61000-4-12
	Conducted and radiated emissions	Conforming to EN 55022/11 (Group 1)	
Earthing			Yes (please refer to installation instructions supplied with the product).

(1) Except for the configuration SR3 B●●●BD + SR3 MBU01BD + SR3 XT43BD class A (class B: use in a metal enclosure).

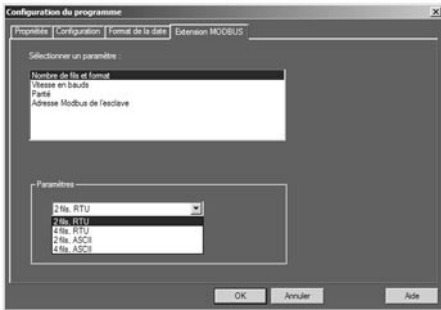

Software workshop parameter entry window

Parameter entry

Parameters can be entered either using “Zelio Soft 2” software, or directly using the buttons on the Zelio Logic smart relay (1).

When the “RUN” instruction is given, the Zelio Logic smart relay initialises the Modbus network slave communication module in a configuration previously defined in the basic program.

The Modbus slave communication module has 4 parameters:

- number of UART wires and format of the frames on the Modbus network,
- transmission speed,
- parity,
- network address of the Modbus module.

The default parameter settings are as follows: 2-wire, RTU, 19 200 bauds, even parity, address n° 1.

Parameter entry	Options
Number of wires	2 or 4
Frame format	RTU or ASCII
Transmission speed in bauds	1200, 2400, 4800, 9600, 19 200, 28 800, 38 400, 57 600
Parity	None, even, odd
Network address	1 to 247

Addressing of Modbus exchanges

LADDER programming

In LADDER mode, the 4 data words (16 bits) to be exchanged cannot be accessed by the application. Transfers with the master are implicit and are effected in a way that is totally transparent.

Modbus exchanges	Code	Number of words
Image of smart relay I/O	Read 03	4
Clock words	Read/Write 16, 06 or 03	4
Status words	Read 03	1

Function block diagram (FBD) programming

In FBD mode, the 4 input data words (16 bits) (J1XT1 to J4XT1) and the 4 output data words (O1XT1 to O4XT1) can be accessed by the application. Dedicated function blocks make it possible to:

- break down a ‘complete’ type input (16 bits) into 16 separate “bit” type outputs.
 - example: break down a J1XT1 to J4XT1 type input and copy these status values to discrete outputs.
- make up a ‘complete’ type output (16 bits) from 16 separate “bit” type inputs.
 - example: transfer the status value of the discrete inputs or the status of a function to an O1XT1 to O4XT1 type output.

Modbus exchanges	Code	Number of words
Input words	Read/Write 16, 06 or 03	4
Output words	Read 03	4
Clock words	Read/Write 16, 06 or 03	4
Status words	Read 03	1

(1) Programming from the front panel and buttons on the smart relay is only possible in LADDER language.

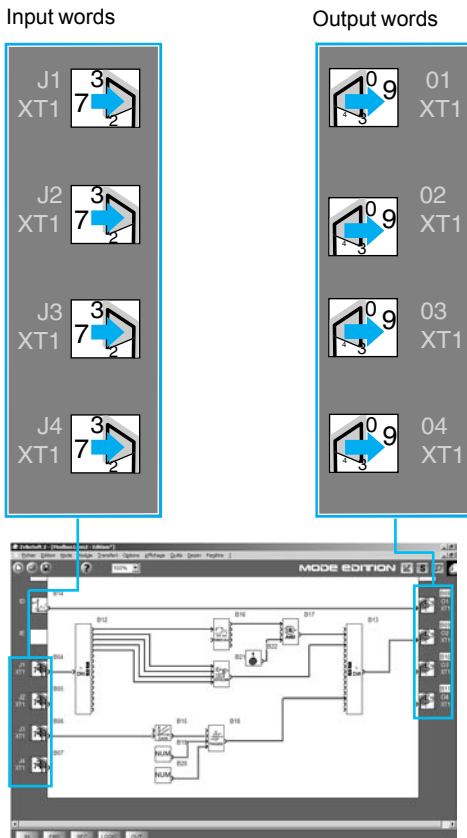

FBD program Editing window

524133



Ethernet server
communication module

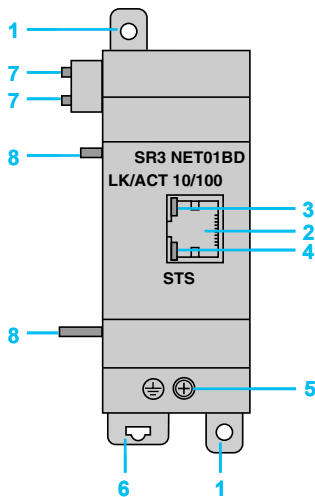

Presentation

Zelio Logic modular smart relays are connected to the Ethernet network via the Ethernet server communication module.

Communication module SR3 NET01BD allows communication on the Ethernet network under the Modbus TCP protocol.

The Ethernet server communication module must be connected to an SR3 B●●●BD modular smart relay, with a \approx 24 V supply.

Configuration

The Ethernet server communication module can be configured from a PC with "Zelio Soft" software, see page 9.

On the PC, programming is effected in function block (FDB) language, see pages 12 and 13.

Description

Ethernet server communication modules **SR3 NET01BD** comprise:

- 1 Two retractable fixing lugs
- 2 An Ethernet network connection (RJ45 screened female connector).
- 3 A communication LED (LK/ACT 10/100).
- 4 A status LED (STS).
- 5 A screw terminal block for the protective earth connection.
- 6 A spring for clip-on mounting on a 35 mm mounting rail.
- 7 Two locating pegs.
- 8 Two locating pegs for clip-on fixing.

Connection example

- 1 Twido client, 40 I/O compact base controller TWD LCAE 40DRF.
- 2 Ethernet network (cables 490 NTW 000●●).
- 3 ConneXium Switch 499 NES 2B1 00.
- 4 Zelio Logic modular smart relay SR3 B●●●BD.
- 5 Communication interface SR2 COM01.
- 6 Connecting cable SR2 CBL07 (supplied with the Modem communication interface).
- 7 GSM (or analogue PSTN) Modem.
- 8 Ethernet server network communication module SR3 NET01BD.
- 9 Analogue I/O extension module SR3 XT43BD.

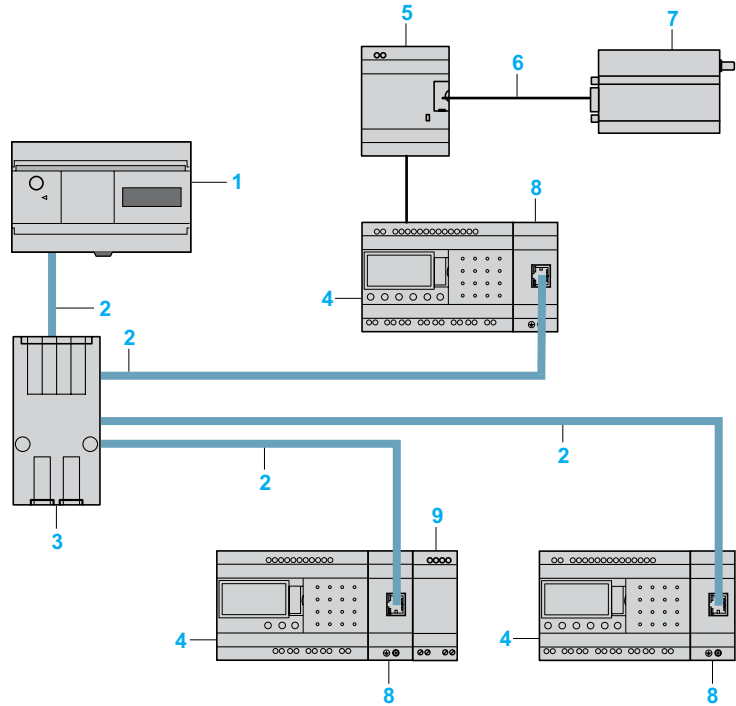

Function description

- The Ethernet server network communication module is connected to a local LAN type network.
- The maximum cable length between 2 devices is 100 m.
- The connection cable must be at least category 5, and its RJ45 male connectors must be screened.
- The \perp terminal must be connected directly to the protective earth.

Environment characteristics			
Type	SR3 NET01BD		
Product certifications			UL, CSA, GL (pending), C-TICK, GOST
Conformity with the low voltage directive	Conforming to 2006/95/EC		EN (IEC) 61131-2 (open equipment)
Conformity with the EMC directive	Conforming to 2004/108/EC		EN (IEC) 61131-2 (Zone B) EN (IEC) 61000-6-2, EN (IEC) 61000-6-3 (1) and EN (IEC) 61000-6-4
Degree of protection	Conforming to IEC/EN 60529		IP 20 (terminal block) IP 40 (front panel)
Overvoltage category	Conforming to IEC/EN 60664-1		3
Degree of pollution	Conforming to IEC/EN 61131-2		2
Ambient air temperature around the device Conforming to IEC/EN 60068-2-1 and IEC/EN 60068-2-2	Operation	°C	0... + 55 (+ 40 in non-ventilated enclosure)
	Storage	°C	- 40... + 70
Max. relative humidity	Conforming to IEC/EN 60068-2-30		95% without condensation or dripping water
Maximum operating altitude	Operation	m	2000
	Transport	m	3048
Mechanical resistance	Immunity to vibration		IEC/EN 60068-2-6, test Fc
	Immunity to mechanical shock		IEC/EN 60068-2-27, test Ea
Resistance to electrostatic discharge	Immunity to electrostatic discharge		IEC/EN 61000-4-2, level 3
Resistance to HF interference (immunity)	Immunity to electromagnetic radiated fields		IEC/EN 61000-4-3
	Immunity to fast transients in bursts		IEC/EN 61000-4-4, level 3
	Immunity to shock waves		IEC/EN 61000-4-5
	Radio frequency in common mode		IEC/EN 61000-4-6, level 3
	Voltage dips and breaks (~)		IEC/EN 61000-4-11
	Immunity to damped oscillation waves		IEC/EN 61000-4-12
Conducted and radiated emissions	Conforming to EN 55022/11 (Group 1)		Class B (1)
Earthing			Yes (please refer to installation instructions supplied with the product).

(1) Except for the configuration SR3 B●●●BD + SR3 NET01BD + SR3 XT43BD class A (class B: use in a metal enclosure).



Ethernet communication module configuration window

Parameter entry

Parameter entry must be carried out using “Zelio Soft 2” software. When the “RUN” instruction is given, the Zelio Logic smart relay initialises the Ethernet server communication module in a configuration previously defined in the basic program.

The Ethernet server communication module has 6 parameters:

- type of addressing (dynamic or static).
- IP address,
- sub-network mask,
- gateway address,
- reserved address,
- time out.

Addressing of Ethernet exchanges

Function block diagram (FBD) programming

In FBD mode, the 4 input data words (16 bits) (J1XT1 to J4XT1) and the 4 output data words (O1XT1 to O4XT1) can be accessed by the application. Dedicated function blocks make it possible to:

- break down a ‘complete’ type input (16 bits) into 16 separate “bit” type outputs.
 - example: break down a J1XT1 to J4XT1 type input and copy these status values to discrete outputs.
- make up a ‘complete’ type output (16 bits) from 16 separate “bit” type inputs.
 - example: transfer the status value of the discrete inputs or the status of a function to an O1XT1 to O4XT1 type output.

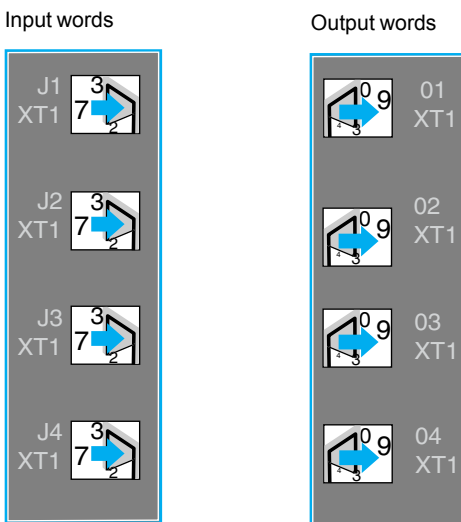

Ethernet exchanges	Code	Number of words
Input words	Read/Write 16, 06 or 03	4
Output words	Read 03	4
Clock words	Read/Write 16, 06 or 03	4
Status words	Read 03	1

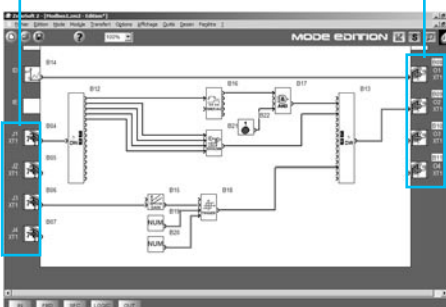

FBD program Editing window



SR3 MBU01BD



SR3 NET01BD



TWD XCA T3RJ



TWD XCA ISO



499 NES 251 00

Modbus slave and Ethernet server communication modules

For use with	Network	Reference	Weight kg
Zelio Logic modular smart relays SR3 B●●1BD and SR3 B●●2BD (1)	Modbus	SR3 MBU01BD	0.110
	Ethernet	SR3 NET01BD (2), (3)	0.110

Connection accessories

Accessory	Description	Network	Length m	Reference	Weight kg
T-junctions	<input type="checkbox"/> 2 x RJ45 connectors <input type="checkbox"/> 1 cable with integrated RJ45 connector	Modbus	0.3	VW3 A8 306TF03	0.190
			1	VW3 A8 306TF10	0.210
Junction boxes	<input type="checkbox"/> 2 x RJ45 female connectors <input type="checkbox"/> 1 x RJ45 male connector	Modbus	Without cable	170 XTS 04100	0.020
			–	TWD XCA ISO	0.100
Line end adapter	<input type="checkbox"/> Screw terminal block for main cable <input type="checkbox"/> 2 x RJ45 connectors for tap link <input type="checkbox"/> Isolation of RS 485 serial link <input type="checkbox"/> Polarisation and line end adapter <input type="checkbox"/> Supply --- 24 V <input type="checkbox"/> Mounting on 35 mm rail	Modbus	–	TWD XCA T3RJ	0.080
			–	VW3 A8306RC	0.200
RS 485 cables	2 x RJ45 connectors	Modbus	0.3	VW3 A8306R03	0.030
			1	VW3 A8306R10	0.050
			3	VW3 A8306R30	0.150
Main cables RS 485 shielded double twisted pair	Modbus serial link, supplied without connector	Modbus	100	TSX CSA 100	5.680
			200	TSX CSA 200	10.920
			500	TSX CSA 500	30.000
Straight shielded twisted pair cable	2 x RJ45 connectors	Ethernet	2	490 NTW 000 02 (4)	–
			5	490 NTW 000 05 (4)	–
			12	490 NTW 000 12 (4)	–
			40	490 NTW 000 40 (4)	–
			80	490 NTW 000 80 (4)	–
conneXium switch	–	Ethernet	–	499 NES 251 00	0.190

(1) Compatible with SR3 B●●2BD featuring hardware version "H1.0.01", available since June 2005.

(2) Can only be used in FBD language.

(3) Can only be used with "Zelio Soft 2" software version ≥ V 4.1.

(4) Cable conforming to EIA/TIA-568 standard category 5 and IEC 1180/EN 50 173, class D. For UL and CSA 22.1 approved cables, add the letter U at the end of the reference.

Communication modules SR3 ●●●01BD

Common side view

Rail mounting

Screw mounting (retractable lugs)

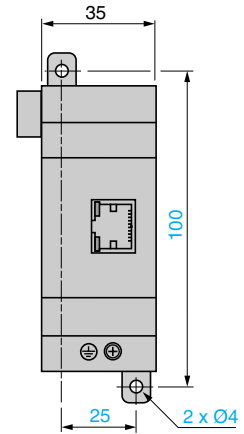
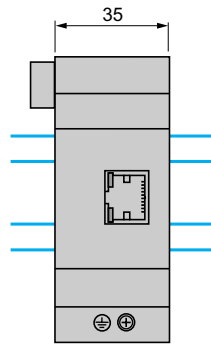
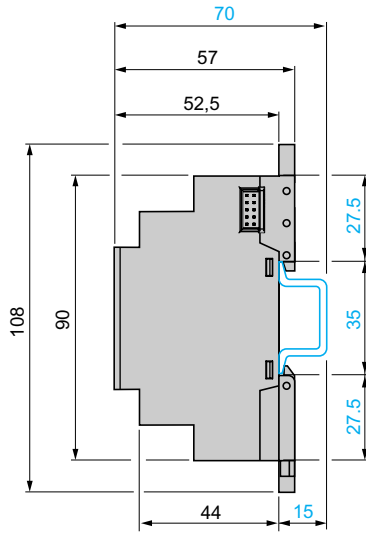



Analogue I/O extension modules

Presentation

Modular smart relays and analogue I/O extension modules

To improve performance and flexibility, Zelio Logic modular smart relays can be fitted with analogue I/O extension modules with 10-bit resolution. The inputs accept 0-10 V, 0-20 mA and Pt 100 type signals.

Using a Zelio Logic modular smart relay with a \pm 24 V supply in conjunction with an analogue 4 I/O extension module makes it possible to obtain up to 30 I/O, including 8 analogue inputs and 2 analogue outputs.

The analogue I/O extension module must be connected to an SR3 ●●●BD modular smart relay with a \pm 24 V supply.

Combination of modular smart relays with communication and I/O extension modules



- 1 Modular smart relay (10 or 26 I/O)
- 2 Analogue I/O extension module (4 I/O)

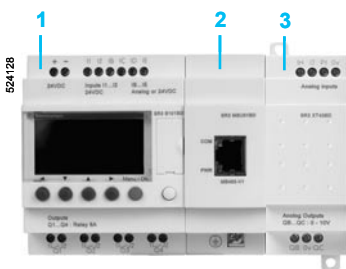

- 1 Modular smart relay (10 or 26 I/O)
- 2 Modbus or Ethernet communication modules
- 3 Analogue I/O extension module (4 I/O)

⚠ The order shown above must be observed when using a network communication module and an analogue I/O extension module. An I/O extension module cannot be fitted before the network communication module.

Description



The analogue I/O extension module has the following on its front panel:

- 1 Two retractable fixing lugs
- 2 Terminals for connection of the inputs.
- 3 Terminals for connection of the outputs
- 4 A connector for connection to the smart relay (powered via the smart relay).
- 5 Locating pegs.

General environment characteristics				
Type		SR3 XT43BD		
Product certifications		UL, CSA, C-Tick, GL (pending), GOST		
Conformity with the low voltage directive	Conforming to 2006/95/EC	EN (IEC) 61131-2 (open equipment)		
Conformity with the EMC directive	Conforming to 2004/108/EC	EN (IEC) 61131-2 (Zone B) EN (IEC) 61000-6-2, EN (IEC) 61000-6-3 (1) and EN (IEC) 61000-6-4		
Degree of protection	Conforming to IEC/EN 60529	IP 20 (terminal block), IP 40 (front panel)		
Overvoltage category	Conforming to IEC/EN 60664-1	3		
Degree of pollution	Conforming to IEC/EN 61131-2	2		
Ambient air temperature around the device conforming to IEC/EN 60068-2-1 and IEC/EN 60068-2-2	Operation	°C	- 20... + 55 (+ 40 in enclosure)	
	Storage	°C	- 40... + 70	
Maximum relative humidity	Conforming to IEC/EN 60068-2-30	95% without condensation or dripping water		
Maximum operating altitude	Operation	m	2000	
	Transport	m	3048	
Mechanical resistance	Immunity to vibration	IEC/EN 60068-2-6, test Fc		
	Immunity to mechanical shock	IEC/EN 60068-2-27, test Ea		
Resistance to electrostatic discharge	Immunity to electrostatic discharge	IEC/EN 61000-4-2, level 3		
Resistance to HF interference (immunity)	Immunity to electromagnetic radiated fields	IEC/EN 61000-4-3		
	Immunity to fast transients in bursts	IEC/EN 61000-4-4, level 3		
	Immunity to shock waves	IEC/EN 61000-4-5		
	Radio frequency in common mode	IEC/EN 61000-4-6, level 3		
	Voltage dips and breaks (~)	IEC/EN 61000-4-11		
	Immunity to damped oscillation waves	IEC/EN 61000-4-12		
Conducted and radiated emissions	Conforming to EN 55022/11 (Group 1)	Class B (1)		
Connection capacity to screw terminals	Flexible cable with cable end	mm ²	1 conductor: 0.25...2.5, cable: AWG 24...AWG 14 2 conductors: 0.25...0.75, cable: AWG 24...AWG 18	
	Semi-solid cable	mm ²	1 conductor: 0.2...2.5, cable: AWG 25...AWG 14	
	Solid cable	mm ²	1 conductor: 0.2...2.5, cable: AWG 25...AWG 14 2 conductors: 0.2...1.5, cable: AWG 24...AWG 16	
	Tightening torque	N.m	0.5 (tightened using Ø 3.5 mm screwdriver)	
--- analogue input characteristics (inputs IH, IJ and Pt)				
Analogue inputs	For use with	--- 0-10 V		
	Assignable inputs	IH and IJ		Pt100
	Input range	--- 0..0.10 V		--- 0..0.20 mA
	Input impedance	Ω	18 K	247
	Maximum non destructive value	--- 30 V		--- 30 mA
	Value of LSB	9.8 mV		20 µA
	Input type	Common mode		
Conversion	Resolution	10 bits on the input range		
	Conversion time	Smart relay cycle time		
	Precision	at 25 °C	± 1 % of the full scale value	
		at 55 °C	± 1 % of the full scale value	
	Repeat accuracy	at 25 °C	< ± 1 %	
Isolation	Between analogue channel and supply	None		
Cabling distance		m	10 maximum, with screened cable	
Protection	Against reversed polarity	Yes		-
--- analogue output characteristics (QB, QC)				
Analogue outputs	Output range	V	--- 0...10	
	Type of load	Resistive		
	Maximum load	mA	10	
	Value of LSB	mV	9.8	
Conversion	Resolution	10 bits on the output range		
	Conversion time	Smart relay cycle time		
	Precision	at 25 °C	± 1 % of the full scale value	
		at 55 °C	± 1 % of the full scale value	
Repeat accuracy	at 55 °C	< ± 1 %		
Isolation	Between analogue channel and supply	None		
Cabling distance		m	10 maximum, with screened cable	
Built-in protection	Against short-circuits	Yes		

(1) Except for configuration SR3 B...BD + SR3 MBU01BD + SR3 XT43BD or SR3 B...BD + SR3 NET01BD + SR3 XT43BD class A (class B: use in a metal enclosure).

Analogue I/O extension modules



Supply $\bar{\bar{}}$ 24 V (via smart relays SR3 B●●●BD)

Number of I/O	Number of inputs	Including 0-10 V	Including 0-20 mA	Including Pt100	0-10 V output	Reference	Weight kg
4	2 (1)	2 max	2 max	1 max	2	SR3 XT43BD (2),(3)	0.110

- (1) See page 47.
 (2) Can only be used with "Zelio Soft 2" software version \geq V 3.1.
 (3) Can only be used in FBD language.

Dimensions

Mounting on 35 mm $\bar{\bar{}}$ rail

Screw fixing (retractable lugs)

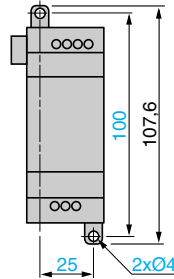
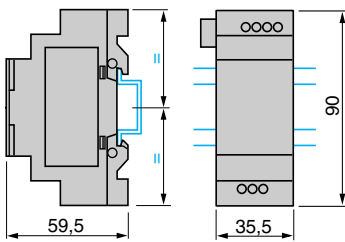

Connection of smart relays on \bar{a} supply, with analogue I/O extension module

SR3 B●●●BD + SR3 XT43BD

Connection alternatives

0 - 10 V	0 - 20 mA	Pt100
2	0	0
1	1	0
0	2	0
1	0	1
0	1	1

Application example with 1 x 0 - 10 V input and 1 x Pt100 input

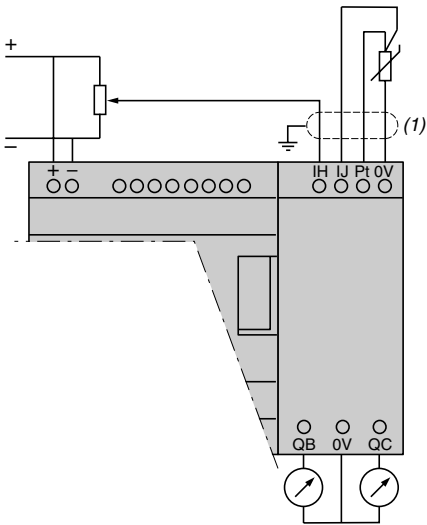

(1) Screened cables, maximum length 10m.

Application example with 1 x 0 - 20 mA input and 1 x 0 - 10 V input

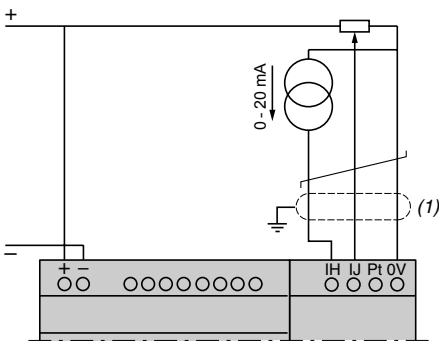

(1) Screened cables, maximum length 10m.

523093



Modem communication interface

Presentation

The communication products in the Zelio Logic range are primarily designed for monitoring or remote control of machines or installations which operate without personnel.

Examples:

- monitoring of lift pumps, livestock buildings (ventilation, feed level, etc.), refrigeration units, car-washes,
- alarm in the event of failure of industrial or domestic heating boilers,
- remote control of lighting: car parks, warehouses,
- remote control and monitoring of escalators in large stores, in the transport sector,
- refuse compactor full alert.

The communication range comprises:

- a communication interface connected between a smart relay and a Modem,
- GSM (1) or analogue (PSTN) (2) modems,
- "Zelio Logic Alarm" software.

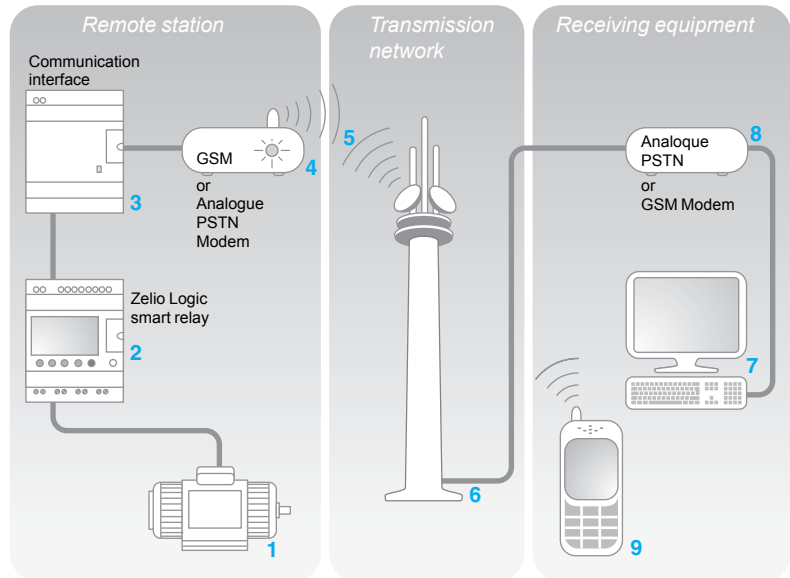

The system comprises:

- a *Remote station*, machine or installation to be monitored **1**: control is achieved using a Zelio Logic smart relay with clock from the SR● B●●●●● or SR2 E●●●●● **2** range, via its inputs and outputs. The smart relay is connected via a communication interface **3** to a GSM (1) type modem **4**, or, when a telephone line is available nearby, to an analogue PSTN modem (2),
- the GSM **5** or analogue PSTN **6** *Transmission network* provided by different telecommunication operators,
- a monitoring or control *Receiving device* which may be one of the following:
 - a PC **7** fitted with an analogue PSTN Modem **8** or a GSM modem,
 - or a GSM telephone **9**.

Note: the majority of Modems built into PCs can be used.

Various combinations are possible between the types of Modem used on the *Remote station* and the type of *Receiving device* (PC + Modems or GSM telephone). The type of architecture selected will therefore depend mainly on:

- whether or not an analogue telephone line is available,
- whether or not it is necessary to send SMS messages, see page 51.

(1) Global System Mobile.

(2) Public Switched Telephone Network.



GSM Modem



Analogue PSTN Modem

Presentation (continued)

Smart relay (*Remote station*)

- The smart relay, as on an independent machine or installation, is used for control (1). It contains the application program created using "Zelio Soft2" software. The smart relay may be selected from the various models in the Zelio Logic range:
 - for all supply voltages,
 - with 10, 12, 20 or 26 I/O (up to 40 I/O with discrete extension module),
 - with or without display,
 - with clock.

The firmware version of the smart relay must be V3 or above.

Modem communication interface (*Remote station*)

The Modem communication interface allows messages, telephone numbers and calling conditions to be stored.

When the calling conditions are met, the messages, as well as any values to be sent, are date-stamped and stored in the interface.

The Modem communication interface scales analogue values to the physical values (degrees, bar, Pascal, etc.) required by the user.

Modems

Either GSM or analogue PSTN type Modems can be used on both the *Remote Station* and PC type *Receiving devices* (when the PC is not fitted with an internal Modem).

GSM Modem

In order to exploit all the capabilities associated with Modem communication, the Modem(s) must be fitted with DATA type SIM cards. VOICE type SIM cards may be used but some functions will not be available. See table on page 51.

"Zelio Logic Alarm" alarm management software (*PC type Receiving device*)

This software makes it possible to:

- receive, classify and export alarm messages,
- read or remotely force the status of program elements (inputs, outputs, control relays, timing or counting values, etc.),
- send control instructions (RUN, STOP, setting the time of the smart relay, etc.),
- send specific instructions (modifying access rights, recipients, etc.).

(1) *Zelio Logic smart relays*, see pages 6 to 25.

Description

The Zelio Logic SR2 COM01 communication interface comprises:

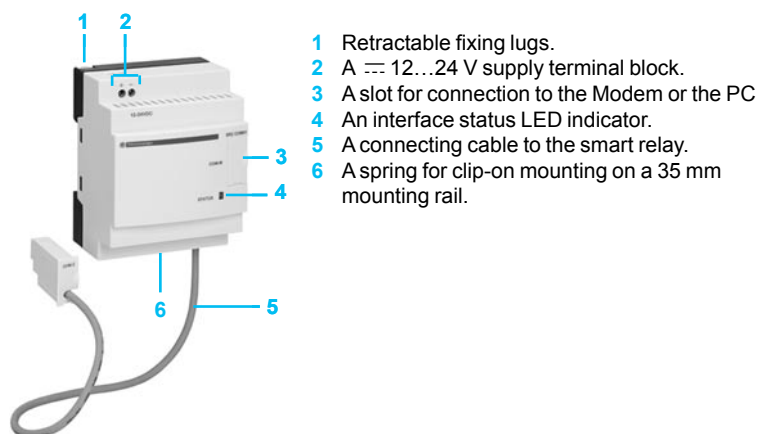

- 1 Retractable fixing lugs.
- 2 A $\bar{\text{---}}$ 12...24 V supply terminal block.
- 3 A slot for connection to the Modem or the PC
- 4 An interface status LED indicator.
- 5 A connecting cable to the smart relay.
- 6 A spring for clip-on mounting on a 35 mm mounting rail.

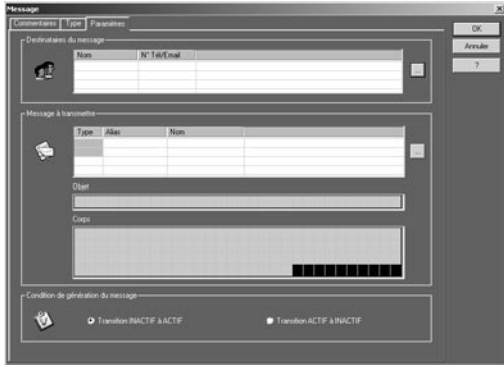

Message parameter entry window

Functions

Sending of alarms

This function makes it possible to send an alarm message to a *Receiving device*. When the calling condition is met, a message is sent to one or several telephone numbers or e-mail addresses.

Types of message:

- alarm message to a PC with Modem and "Zelio Logic Alarm" software,
- "SMS" message (1) to a GSM telephone,
- e-mail via SMS (1) (2).

One or all of the solutions can be selected simultaneously.

The *Remote station* to be monitored initiates the call.

The telephone line is only used while the alarm message is being transmitted.

Up to 28 messages can be used.

These messages consist of:

- a 160 character text, which may contain a discrete and/or analogue value (counting values, analogue input voltages that can be scaled, etc.),
- 1 to 10 recipient telephone numbers/e-mail addresses.

Receipt of instruction

This function allows the status or the value of a program element to be modified from the *Receiving device*.

The operator initiates the call using the *Receiving device* (PC or GSM telephone). It is then possible to force the status of the discrete and/or analogue value of each of the 28 messages.

Remote dialogue using "Zelio Soft 2"

This function enables use of the Transfer, Monitoring and Diagnostics modes available in "Zelio Soft 2" via the *Transmission network* instead of the physical link (cable SR2 USB01 or SR2 CBL01) between the product (*Remote station*) and the PC (*Receiving device*).

It is then possible to:



- transfer a program created on a PC station to the *Remote station*,
- transfer a program installed on the *Remote station* to the PC station,
- modify, from the PC, the receiving device telephone numbers/e-mail addresses, and the alarm sending conditions,
- update the firmware in the smart relay and in the Modem communication interface,
- display and modify discrete and analogue values,
- perform diagnostics on the smart relay and on the Modem communication interface.

(1) Requires the use of a GSM Modem on the *Remote station* side.

(2) Verify with the *Transmission network operator* that the e-mail by SMS service is available.

Functions available depending on the hardware architecture and/or type of SIM card

Function	Remote station device				
	Analogue PSTN Modem	GSM Modem			
		Type of SIM card		VOICE	
	DATA	DATA VOICE DATA N°	VOICE N°	VOICE	
Send alarm/receive instruction with GSM telephone					
Send alarm/receive instruction with PC running "Zelio Logic Alarm" software (1)					
Transfer program					
Update firmware Monitoring (1)					
Send alarm to e-mail address					

 Functions available
 Functions not available

Note: Instructions cannot be transmitted by e-mail.

(1) When using a GSM Modem on the PC side, the SIM card must have a DATA number.

Installation set-up

Setting-up of the installation or the machine to be monitored involves 2 steps:

Connection for programming the smart relay and the interface

- 1 Interface cable marked COM-Z.
- 2 Cable SR2 USB01 or SR2 CBL01.

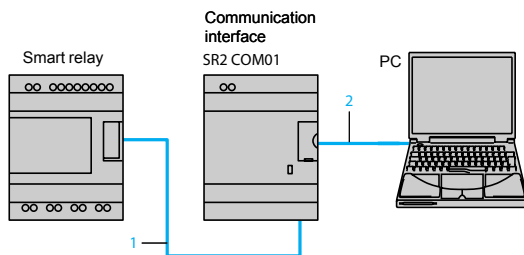

After having powered-up the smart relay and the interface, the application program can be transferred in order to simultaneously:

- load the automation system program into the smart relay,
- load the alarm conditions, messages and telephone numbers/e-mail addresses into the interface.

This operation can also be carried out remotely using "Transfer" mode, after having made the operating connections described below.

△ Program loading using memory cartridges SR2 MEM01 or SR2 MEM02 is incompatible with Modem communication interface SR2 COM01.

Operating connections

PSTN analogue modem

- 1 Interface cable marked COM-Z.
- 2 Cable SR2 CBL07 included with the interface.

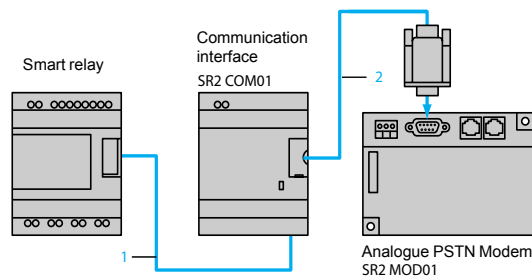

GSM Modem

- 1 Interface cable marked COM-Z.
- 2 Cable SR2 CBL07 included with the interface.
- 3 Antenna and cable included with the Modem.

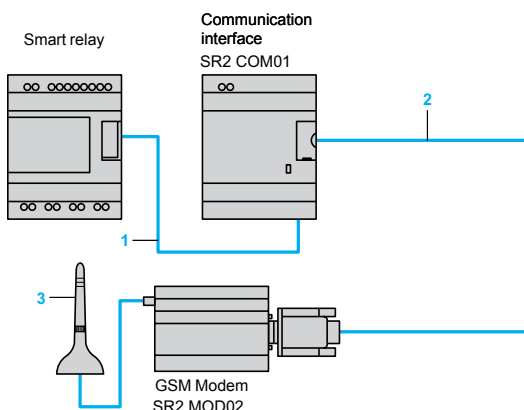

Communication interface environment characteristics				
Interface type			SR2 COM01	SR2 MOD02
Product certifications			UL, CSA, C-Tick, GOST	UL, CSA, IC, PTCRB, FCC part 15 standards, GOST (pending)
Conformity with the low voltage directive	Conforming to 2006/95/EC		EN (IEC) 61131-2 (open equipment)	EN (IEC) 60950-1
Conformity with the EMC directive	Conforming to 2004/108/EC		EN (IEC) 61131-2 (Zone B) EN (IEC) 61000-6-2, EN (IEC) 61000-6-3 and EN (IEC) 61000-6-4	EN 301 489-1
Conformity to the R and TTE directive	Conforming to 1999/5/EC		–	ETSI EN 301 489-7, EN 301 419-1, EN 301 511
Degree of protection	Conforming to IEC/EN 60529		IP 20 (terminal block), IP 40 (front panel)	IP 31
Overvoltage category			3 (conforming to IEC/EN 60664-1)	2 (conforming to IEC/EN 60950-1)
Degree of pollution			2 (conforming to IEC/EN 61131-2)	2 (conforming to IEC/EN 60950-1)
Ambient air temperature around the device conforming to IEC/EN 60028-2-1 and IEC/EN 60068-2-2	Operation	°C	- 20...+ 55 (+ 40 in non-ventilated enclosure)	- 20...+ 55
	Storage	°C	- 40...+ 70	- 40...+ 70
Maximum relative humidity conforming to IEC/EN 60068-2-30	Operation		95% without condensation or dripping water	95 % at 55°C without condensation
	Storage		95% without condensation or dripping water	30 %...95 % without condensation
Maximum operating altitude	Operation	m	2000	2000
	Transport	m	3048	3048
Mechanical resistance	Immunity to vibration		IEC/EN 60068-2-6, test Fc	IEC/EN 60068-2-6, test Fc
	Immunity to free fall		–	EN (IEC) 60068-2-32
Resistance to electrostatic discharge	Immunity to electrostatic discharge		IEC/EN 61000-4-2, level 3	IEC/EN 61000-4-2 - contact: level 2 - air: level 3
Resistance to HF interference (immunity)	Immunity to electromagnetic radiated fields		IEC/EN 61000-4-3	IEC/EN 61000-4-3
	Immunity to fast transients in bursts		IEC/EN 61000-4-4, level 3	IEC/EN 61000-4-4, level 1
	Immunity to shock waves		IEC/EN 61000-4-5	–
	Radio frequency in common mode		IEC/EN 61000-4-6, level 3	IEC/EN 61000-4-6, level 2
	Immunity to damped oscillation waves		IEC/EN 61000-4-12	–
Conducted and radiated emissions	Conforming to EN 55022/11 (Group 1)		Class B	Class B
Screw terminals connection capacity	Flexible cable with cable end	mm ²	1 conductor: 0.25...2.5, cable: AWG 24...AWG 14 2 conductors: 0.25...0.75, cable: AWG 24...AWG 18	–
	Semi-solid cable	mm ²	1 conductor: 0.2...2.5, cable: AWG 25...AWG 14	–
	Solid cable	mm ²	1 conductor: 0.2...2.5, cable: AWG 25...AWG 14 2 conductors: 0.2...1.5, cable: AWG 24...AWG 16	–
	Tightening torque	N.m	0.5 (tightened using Ø 3.5 mm screwdriver)	–

Supply characteristics					
Interface type			SR2 COM01	SR2 MOD01	SR2 MOD02
Nominal voltage		V	≡ 12...24		
Voltage limits		V	≡ 10...28.8	≡ 10...30	≡ 5.5...32
Maximum ripple			5 %	–	–
Nominal current	≡ 12 V	mA	30	140	165
	≡ 24 V	mA	30	70	87
	Current peak on power-up	mA	550	9600	2100 on 5.5 V
Power dissipated		W	1.1	1.7	2.1
Micro-breaks	Permissible duration		1 ms, repeated 20 times	–	–
Protection	Integrated		Against reversed polarity	–	–
	To be provided externally	A	1 A fuse	–	Supplied with 2.5 A fuse

Characteristics of "Com-Z" link with the smart relay		
Type of connector		Specific to Zelio
Type of link		Specific Zelio communication protocol
Compatibility		Only with Zelio Logic smart relays SR● B●●●●● and SR2 E●●●●● version ≥ V3.1 and above
Isolation of "Com-Z" connector	From the "Com-M" connector	By ~ 1780 V opto-coupler
	From the +/- supply terminals	By ~ 1780 V opto-coupler
Characteristics of "Com-M" link with the Modem		
Type of connector		Specific to Zelio
Type of link with SR2 CBL07		RS 232 serial (included with the communication interface))
Compatibility	PSTN analogue modem	AT commands
	GSM Modem	AT commands
Isolation of "Com-M" connector	From the Modem	By the cable SR2 CBL07
	From the +/- supply terminals	By the cable SR2 CBL07
Processing characteristics		
Data saved by the interface	Messages	Up to 28 messages
	Telephone/e-mail details and recipient profiles	1 to 10 recipients (telephone numbers and/or e-mail addresses) per message
	Date and time	Dating of messages to be sent
	Discrete and digital values	Backup of values when the message activation condition is triggered.
Backup of data to be sent		Flash memory

523083



SR2 COM01

535522



SR2 MOD01

538474



SR2 MOD02

523086



SR2 CBL07

Modem communication interface

Description	For use with	Supply	Reference	Weight kg
Modem communication interface (including cable SR2 CBL07)	SR● B●●●●● SR2 E●●●●●	≡ 12...24 V	SR2 COM01 (1)	0.200

Modems

Description	Supply voltage	Reference	Weight kg
Analogue PSTN Modem Type SIXNET VT-MODEM-5-WW, including a telephone cable (length 2 m). Tested with SR2 COM01 (for additional information, please contact SIXNET company)	≡ 12...24 V	SR2 MOD01	0.265

GSM Modem Type quad band 900/1800 MHz, 850/1900 MHz including: ■ a supply cable (length 1.5 m), ■ an antenna with cable (length 2.5 m), ■ fixing on T rail (assembled with the GSM Modem) ■ two lugs for plate mounting	≡ 12...24 V	SR2 MOD02 (2)	0.335
--	-------------	------------------	-------

Software

Description	Application Compatibility	Medium	Reference	Weight kg
Zelio Logic Alarm	PC Windows 98, NT4, 2000 and XP	CD-ROM	SR2 SFT02	0.200

Connection accessories

Description	Composition/ Application	Length m	Reference	Weight kg
Connection cables	SUB-D9/SUB-D9 connectors Between Modem and PC	1.8	SR1 CBL03	0.110
	Specific Zelio/ SUB-D9 connector Between communication interface and modem	0.5	SR2 CBL07 (3)	0.050

(1) Can only be used with "Zelio Soft 2" software version ≥ 3.1.

(2) Not recommended for Japan.

(3) Spare part (cable included with communication interface SR2 COM01).

Communication interface

SR2 COM01

Common side view

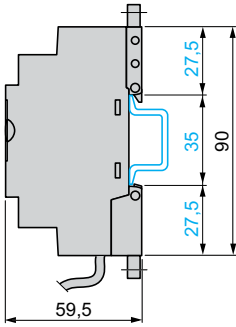

Rail mounting

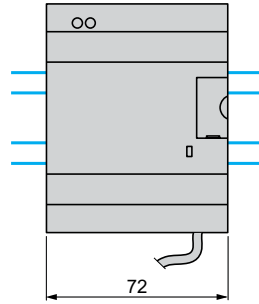

Screw mounting (retractable lugs)

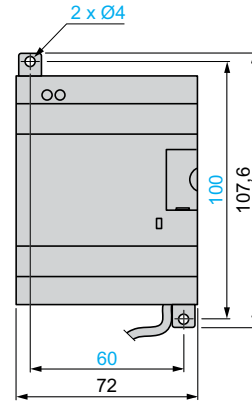

Modems

SR2 MOD01 (Analogue PSTN modem)

Common side view

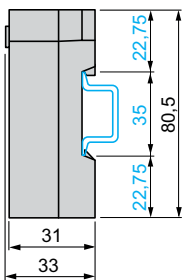

Rail mounting

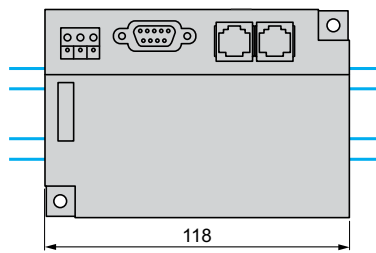

Screw fixing

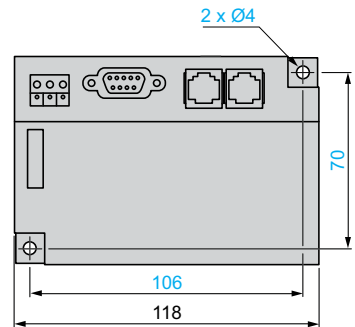

SR2 MOD02 (GSM modem)

Rail mounting

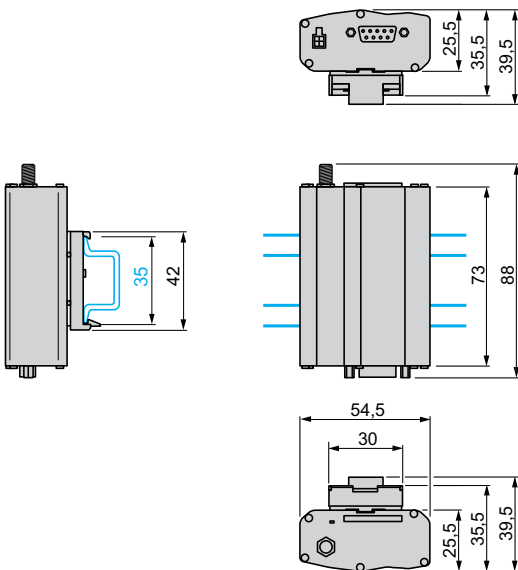

Screw fixing

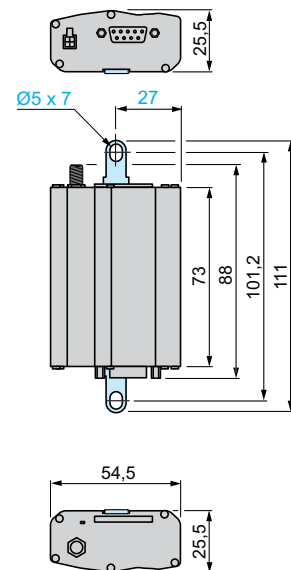

Connection schemes for connecting communication interface SR2 COM01 to the smart relay and the Modem

SR● B●●1JD, SR● B●●●BD and SR2 E●●●BD

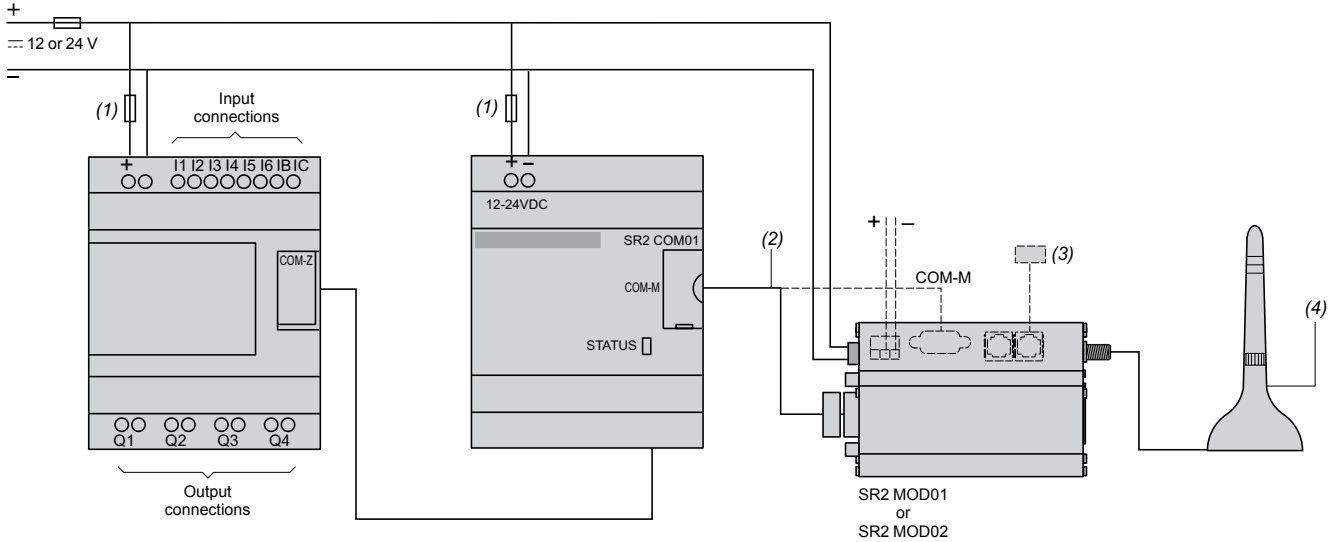

- (1) 1 A quick-blow fuse.
- (2) Cable included with Modem communication interface SR2 COM01.
- (3) Cable for connection to the Transmission network (included with analogue PSTN modem).
- (4) Antenna included with GSM modem.

SR● B●●1B, SR● B●●●FU, SR2 E●●●B and SR2 E●●●FU

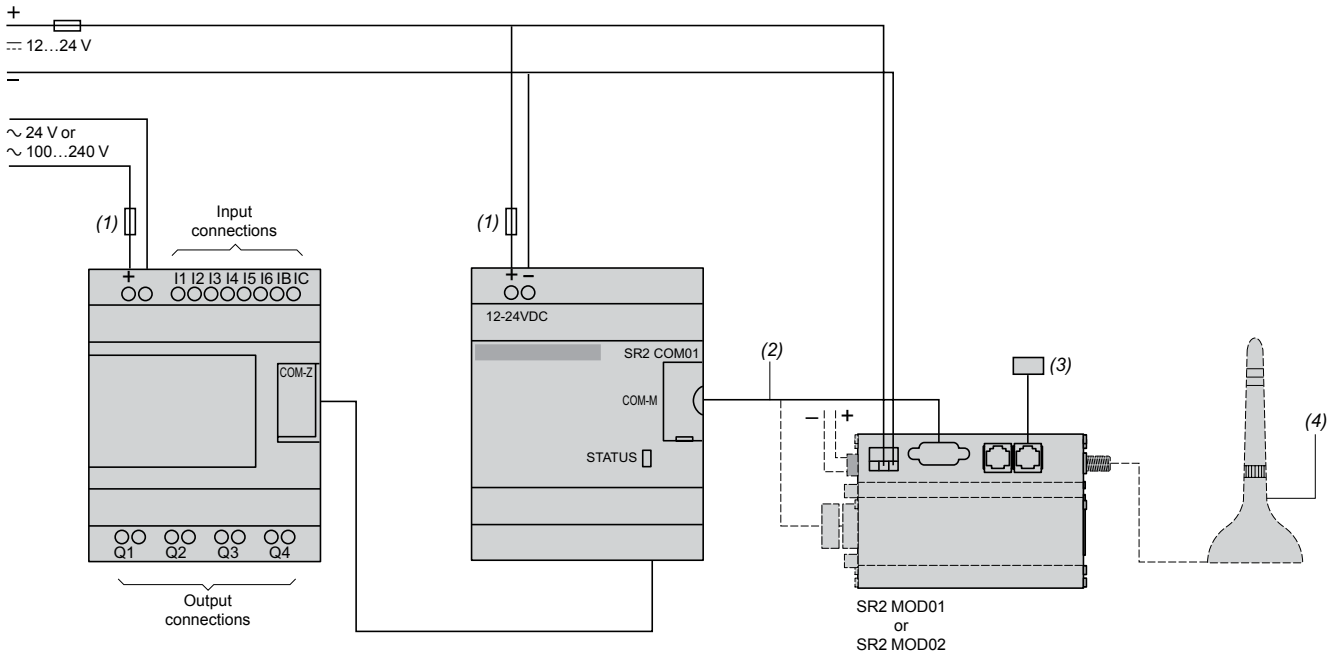

- (1) 1 A quick-blow fuse.
- (2) Cable included with Modem communication interface SR2 COM01.
- (3) Cable for connection to the Transmission network (included with analogue PSTN modem).
- (4) Antenna included with GSM modem.

Connection schemes for connecting the PC to the Modem

For PCs without an internal Modem.

Analogue PSTN Modem

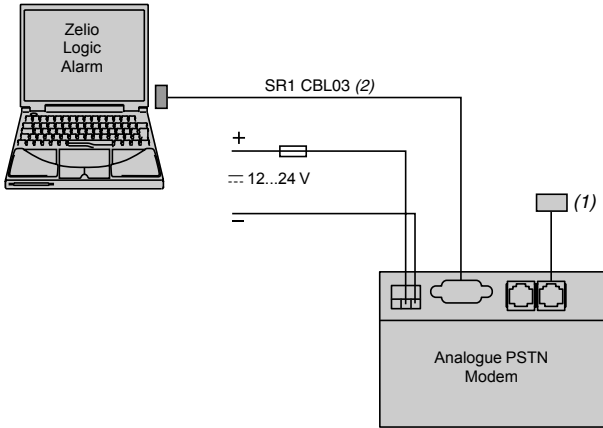

- (1) Cable for connection to the Transmission network (included with analogue PSTN modem).
 (2) To be ordered separately.

GSM Modem

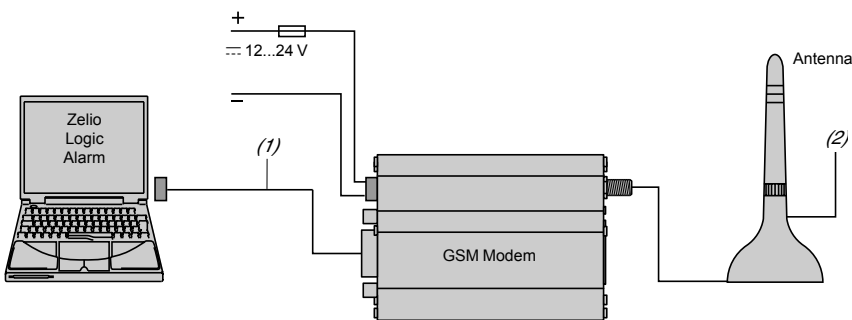

- (1) Cable SR1 CBL03 (1.8 m).
 (2) Antenna included with GSM modem.

Analogue interfaces Zelio Analog

Converters for thermocouples and Pt100 probes
Voltage/current converters

Product types

Converters for thermocouples



Input type

Input signal	Temperature range
	Voltage
	Current

J (Fe-CuNi)			K (Ni-CrNi)	
0...150 °C	0...300 °C	0...600 °C	0... 600 °C	0...1200 °C
32...302 °F	32...572 °F	32...1112 °F	32...1112 °F	32...2192 °F
-				
-				

Output signal	Voltage/Current
----------------------	-----------------

Switchable: 0...10 V / 0...20 mA; 4...20 mA

Supply voltage	Rated
-----------------------	-------

~ 24V ± 20%, not isolated

Built-in protection	Outputs
	Supply

Reverse polarity, overvoltage and short-circuit
Output safety feature, if input not wired or wire broken
Reverse polarity

Signalling	
-------------------	--

Green LED (power on)

Conformity/Approvals	Conforming to standards
	Approvals

IEC 60947-1, IEC 60584-1
UL, CSA, GL, CE

Type	
-------------	--

RMT J40BD	RMT J60BD	RMT J80BD	RMT K80 BD	RMT K90BD
------------------	------------------	------------------	-------------------	------------------

Pages	
--------------	--

64

Converters for Universal and Optimum Pt100 probes

Voltage/current converters



Pt100, 2, 3 and 4-wire					-				
-40...40 °C	-100...100 °C	0...100 °C	0...250 °C	0...500 °C	-				
-40...104 °F	-148...212 °F	32...212 °F	32...482 °F	32...932 °F	-				
-					0...10 V	0...10 V; ±10 V	0...50 V; 0...300 V; 0...500 V ⎓ or ~ 50/60 Hz	-	
-					4...20 mA	0...20 mA; 4...20 mA	-	0...1.5 A; 0...5 A; 0...15 A ⎓ or ~ 50/60 Hz	
Switchable: 0...10 V/0...20 mA, 4...20 mA for the Universal range RMP T●0BD 0...10 V or 4...20 mA for the Optimum range RMP T●3BD					0...10 V or 4...20 mA	Switchable: 0...10 V; ±10 V/ 0...20 mA; 4...20 mA	Switchable: 0...10 V/ 4...20 mA; 0...20 mA	0...10 V or 0...20 mA or 4...20 mA	
⎓ 24V ± 20%, not isolated						⎓ 24V ± 20%, isolated			
Reverse polarity, overvoltage and short-circuit Output safety feature, if input not wired or wire broken Reverse polarity									
Green LED (power on)									
IEC 60751, DIN 43 760 UL, CSA, GL, CE					IEC 60947-1				

- RMP T1●BD
- RMP T2●BD
- RMP T3●BD
- RMP T5●BD
- RMP T7●BD
- RMC N22BD
- RMC L55BD
- RMC V60BD
- RMC A61BD

Analogue interfaces

Zelio Analog

Converters for thermocouples and Pt100 probes
Voltage/current converters

The Zelio Analog range of converters is designed to convert signals emitted by sensors or electrical measurements into standard electrical signals which are compatible with automation platforms, controllers (thermal processes, speed, ...). They also allow the connection distance between a sensor and the measurement acquisition device to be increased: for example between a thermocouple and a programmable controller.

Conforming to IEC standards, UL and CSA certified, these converters are suitable for universal use.

Measurement signals for thermocouples and Pt100 probes

The voltages induced by thermocouples vary between 10 and 80 $\mu\text{V}/^\circ\text{C}$, Pt100 probes (100 ohms at 0 $^\circ\text{C}$) produce about 0.5 $\text{mV}/^\circ\text{C}$, with measurement currents of 1 mA. Depending on the sensor, the signal to be measured ranges from a few μV (thermocouple) to 250 and 700 mV for a Pt100 probe.

It is therefore difficult to transmit these low level signals over long electric lines without encountering problems of interference, signal reduction or errors.

Connecting Zelio Analog converters close to the sensors resolves these problems :

- 4-20 mA current loops transmitted over a long distance are less sensitive to interference than low level voltage signals from sensors,
- signal reductions during transmission (resistance) of voltages do not occur,
- the cables used to connect the converters to process equipment (programmable controllers) are standard cables, which are more cost effective than extension cables or compensation cables suitable for low level signals for Pt100 probes or thermocouples.

Presentation

The Zelio Analog range

The Zelio Analog range has been developed both to take account of the most common applications and to ensure great simplicity of installation:

- pre-set input and output scales, requiring no adjustment
- outputs protected against reverse polarity, overvoltage and short-circuits
- \sim 24 V power supply
- sealable protective cover
- rail mounting and screw fixing onto mounting plate
- LED indicator on the front panel
- input and output selector switches on the front panel
- output with fallback value if no input signal is present (due to failure of a sensor, for example).

The Zelio Analog converter range is divided into four families:

- Converters for J and K type thermocouples: **RMT J/K**
- Universal converters for Pt100 probes: **RMP T●0**
- Optimum converters for Pt100 probes: **RMP T●3**
- Universal voltage/current converters: **RMC**.

Converters for J and K type thermocouples

Thermocouples, which consist of two metals with different thermo-electric characteristics, produce a voltage that varies according to temperature. This voltage is transmitted to the Zelio Analog converter which converts it to a standard signal. Converters for thermocouples have cold junction compensation to allow detection of measurement errors induced by the connection to the device itself.

Converters for J and K type thermocouples have :

- for inputs, a pre-set temperature range, depending on the model:
 - Type J: 0...150 $^\circ\text{C}$, 0...300 $^\circ\text{C}$, 0...600 $^\circ\text{C}$
 - Type K: 0...600 $^\circ\text{C}$, 0...1200 $^\circ\text{C}$.
- for outputs, a switchable signal:
 - 0...10 V, 0... 20 mA, 4... 20 mA.



RMT J40BD



RMT K90BD

Analogue interfaces

Zelio Analog

Converters for thermocouples and Pt100 probes
Voltage/current converters



RMP T70BD

Universal converters for Pt100 probes

Pt100 probes with platinum resistor are electrical conductors whose resistance varies according to the temperature.

This ohmic resistance is transmitted to the Zelio Analog converter which converts it to a standard signal.

Universal converters for Pt100 probes have :

■ for inputs, a pre-set temperature range, depending on the model:

- -100...100 °C,
- -40...40 °C,
- 0...100 °C,
- 0...250 °C,
- 0...500 °C.

■ for outputs, a switchable signal:

- 0... 10 V, 0... 20 mA, 4... 20 mA.

The products in the family Universal converters for Pt100 probes allow wiring of Pt100 probes in 2, 3 and 4-wire mode.

Optimum converters for Pt100 probes

Derived from the above family, these converters have:

■ for inputs, a pre-set temperature range identical to that of universal converters for Pt100 probes.

■ for outputs: 0...10V signal dedicated to Zelio Logic analogue inputs.

They allow Pt100 probes to be wired in 2, 3 and 4-wire mode.



RMC A61BD

Universal voltage/current converters

This family of converters allows the adaptation of electrical values (voltage/current). Four products are available:

■ a cost effective converter which will convert a 0...10 V signal to a 4...20mA signal or vice versa.

■ a Universal voltage/current converter allowing the most common signals. They have:

- for inputs, a voltage/current range:
 - 0...10 V, ± 10 V, 0...20 mA, 4...20 mA.
- for outputs, a switchable voltage/current range:
 - 0...10 V, ± 10 V, 0...20 mA, 4...20 mA.

■ two Universal voltage/current converters which allow conversion of electrical power signals, both a.c. and d.c.

They have the following, depending on the model:

- **for voltage inputs**, a range of 0 to 500 V (~ or ---)
- for outputs, a switchable voltage/current range:
 - 0...10 V, 0...20 mA, 4...20 mA.
- **for current inputs**, a range of 0 to 15 A (~ or ---)
- for outputs, a voltage/current range:
 - 0...10 V, 0...20 mA, 4...20 mA.

Description

Zelio Analog converters have the following on their front panel, depending on the model:

- 1 Two terminals for --- 24 V supply connection
- 2 A 'Power ON' LED
- 3 Three input selector switches (depending on model)
- 4 An output selector switch (depending on model)
- 5 A sealable protective cover
- 6 A screw terminal block for inputs
- 7 A screw terminal block for outputs.



RMC L55BD

Analogue interfaces Zelio Analog

Converters for thermocouples and Pt100 probes
Voltage/current converters

Environment characteristics							
Converter types			RMT J/K●●●●●, RMP ●●●●●, RMC●●●●●				
Conforming to standards			IEC 60947-1, IEC 60584-1 (IEC 60751, DIN 43760 for RMP●●●●●)				
Product certifications			UL, CSA, GL, CE				
Degree of protection							
Housing			IP 50				
Terminal block			IP 20				
Flame resistance			°C 850 conforming to UL, IEC 60695-2-1				
Shock resistance			50 gn/11 ms conforming to IEC 68-2-27				
Vibration resistance			5 gn (10...100 Hz) conforming to IEC 68-2-6				
Immunity to EMC							
Resistance to electrostatic discharge		kV	Level 3: 8 (air), 6 (contact) conforming to IEC 1000-4-2				
Immunity to fast transient currents		kV	On the power supply: 2; on the input-output: 1 conforming to IEC 1004-4				
Surge withstand		kV	0.5 - waves 1.2/50 µs; 0.5 J conforming to IEC 1000-4-5				
Disturbance							
Radiated/conducted			CISPR11 and CISPR22 Group 1- Class B				
Insulation voltage			kV 2				
Ambient air temperature around the device							
Storage		°C	-40...85 (-40...185 °F)				
Operation		°C	Mounted side-by-side: 0...50 (32...122 °F); 2 cm spacing: 0...60 (32...140 °F)				
Degree of pollution			2 conforming to IEC 60664-1				
Mounting			35 mm DIN rail, clip-on or fixed on mounting plate				
Connection			mm² 2 x 1.5 or 1 x 2.5 cable				
Tightening torque			Nm 0.6...1.1				
Specific characteristics							
Types of converter for thermocouples			RMT J40BD	RMT J60BD	RMT J80BD	RMT K80BD	RMT K90BD
Input types		Thermocouple type to IEC 60584	J (Fe-CuNi)		K (Ni-CrNi)		
		Temperature range	°C	0...150	0...300	0...600	0...1200
			°F	32...302	32...572	32...1112	32...2192
Analogue output switchable to voltage or current							
Voltage		Range	V	0...10			
		Minimum impedance of load	kΩ	100			
Current		Range	mA	0...20 ; 4...20			
		Maximum impedance of load	Ω	500			
Built-in protection			Reverse polarity, overvoltage (± 30 V) and short-circuit				
Safety		Output state when no inputs are wired or when input wire broken	Output predetermined according to type of output selected: voltage = - 13 V current = 0 mA				
Supply							
Voltage		Rated	V	24 ± 20 %, non isolated			
Maximum current consumption		For voltage output	mA	40			
		For current output	mA	60			
Built-in protection			Reverse polarity				
Signalling			Green LED (power on)				
Measurements							
Accuracy		At 20 °C	%	± 1 of the full scale value ± 10 of the full-scale value (in an environment subject to electromagnetic interference of 10 V/m)			
Repeat accuracy		At 20 °C	%	± 0.25 of the full scale value			
		At 60 °C	%	± 0.8 of the full scale value			
Temperature coefficient			ppm/°C	200 (0.02 %)			
Cold junction compensation			Built-in, cold junction measurement: 0 to 60 °C (0...140 °F)				

Analogue interfaces

Zelio Analog

Converters for thermocouples and Pt100 probes
Voltage/current converters

Specific characteristics (continued)							
Types of converter for Pt100 probes			RMP T10/13BD	RMP T20/23BD	RMP T30/33BD	RMP T50/53BD	RMP T70/73BD
Input types	Probe type		Pt100 - IEC 60751; DIN 43760 (2, 3, 4-wire)				
	Temperature range	°C	- 40...40	- 100...100	0...100	0...250	0...500
		°F	- 40...104	- 148...212	32...212	32...482	32...932
Analogue output			0...10 V/0...20 mA, 4...20 mA switchable for RMP T●0BD				
Output selection			0...10 V or 4...20 mA for RMP T●3BD				
Voltage	Minimum impedance of load	kΩ	100				
Current	Maximum impedance of load	Ω	500				
Built-in protection			Reverse polarity, overvoltage (± 30 V) and short-circuit				
Safety	Output state when no inputs are wired or when input wire broken		Output predetermined according to type of output selected: voltage = ± 13 V current = 0 mA				
Supply							
Voltage	Rated	~ V	24 ± 20 %, non isolated				
Maximum current consumption	For voltage output	mA	40				
	For current output	mA	60				
Built-in protection			Reverse polarity				
Signalling			Green LED (power on)				
Measurements							
Accuracy	At 20 °C	%	± 0.5 (3, 4-wire connection) of the full scale value ± 1 (2-wire connection) of the full scale value ± 10 of the full-scale value (in an environment subject to electromagnetic interference of 10 V/m)				
Repeat accuracy	At 20 °C	%	± 0.2 of the full scale value				
	At 60 °C	%	± 0.6 of the full scale value				
Temperature coefficient		ppm/°C	150 (0.015 %)				
Connection in 2-wire mode							
	Maximum resistance of cable	mΩ	200				

Specific characteristics							
Types of voltage/current converters			RMC N22BD	RMC L55BD	RMC V60BD	RMC A61BD	
Input types	Voltage	V	~ 0...10	~ 0...10, ±10	0...50; 0...300; 0...500 ~ or ~ 50/60 Hz	–	
	Current	mA A	4...20 –	0...20; 4...20 –	– –	0...1.5; 0...5; 0...15 ~ or ~ 50/60 Hz	
Analogue output			By cabling		Switchable	Switchable	By cabling
Voltage	Range	V	0...10	0...10; ± 10	0...10	0...10	
	Minimum impedance of load	kΩ	100				
Current	Range	mA	4...20	0...20; 4...20	0...20; 4...20	0...20 4...20	
	Maximum impedance of load	Ω	500				
Built-in protection			Reverse polarity, overvoltage (± 30 V) and short-circuit				
Safety	Output state when no inputs are wired or when input wire broken		Output predetermined according to type of output selected: voltage: < 0 V current: < 4 mA	voltage: - 10...+ 10 V; -10 V 0...+ 10 V; 0 V current: 0...20 mA : 0 mA 4...20 mA : 4 mA	voltage: < 0 V current: 0...20 mA : 0 mA 4...20 mA : < 4 mA		
Supply							
Voltage	Rated	V	~ 24 ± 20 % non isolated	~ 24 ± 20 % isolated (1.5 kV)			
Maximum current consumption	For voltage output	mA	40	70			
	For current output	mA	60	90			
Built-in protection			Reverse polarity				
Signalling			Green LED (power on)				
Measurements							
Accuracy	At 20 °C	%	± 1 of the full scale value ± 10 of the full-scale value (in an environment subject to electromagnetic interference of 10 V/m)		± 5 of the full scale value ± 10 of the full-scale value (in an environment subject to electromagnetic interference of 10 V/m)		
Repeat accuracy	At 20 °C	%	± 0.2 of the full scale value				
	At 60 °C	%	± 0.6 of the full scale value				
Temperature coefficient		ppm/°C	200 (0.02 %)		0...1.5 A: 500 (0.05 %) 0...5 A: 1000 (0.1 %) 0...15 A: 2000 (0.2 %)		

Analogue interfaces

Zelio Analog

Converters for thermocouples and Pt100 probes
Voltage/current converters



RMT J40BD



RMT K90BD



RMP T70BD



RMP T13BD



RMC N22BD



RMC L55BD



RMC A61BD

Converters for J and K type thermocouples

Supply voltage $\approx 24\text{ V} \pm 20\%$, non isolated

Type	Temperature range °C	°F	Switchable output signal	Reference	Weight kg
Type J	0...150	32...302	0...10 V, 0...20 mA, 4...20 mA	RMT J40BD	0.120
	0...300	32...572	0...10 V, 0...20 mA, 4...20 mA	RMT J60BD	0.120
	0...600	32...1112	0...10 V, 0...20 mA, 4...20 mA	RMT J80BD	0.120
Type K	0...600	32...1112	0...10 V, 0...20 mA, 4...20 mA	RMT K80BD	0.120
	0...1200	32...2192	0...10 V, 0...20 mA, 4...20 mA	RMT K90BD	0.120

Universal converters for Pt100 probes

Supply voltage $\approx 24\text{ V} \pm 20\%$, non isolated

Type	Temperature range °C	°F	Switchable output signal	Reference	Weight kg
Pt100 2-wire, 3-wire and 4-wire	-40...40	-40...104	0...10 V, 0...20 mA, 4...20 mA	RMP T10BD	0.120
	-100...100	-148...212	0...10 V, 0...20 mA, 4...20 mA	RMP T20BD	0.120
	0...100	32...212	0...10 V, 0...20 mA, 4...20 mA	RMP T30BD	0.120
	0...250	32...482	0...10 V, 0...20 mA, 4...20 mA	RMP T50BD	0.120
	0...500	32...932	0...10 V, 0...20 mA, 4...20 mA	RMP T70BD	0.120

Optimum converters for Pt100 probes (1)

Supply voltage $\approx 24\text{ V} \pm 20\%$, non isolated

Type	Temperature range °C	°F	Output signal	Reference	Weight kg
Pt100 2-wire, 3-wire and 4-wire	-40...40	-40...104	0...10 V or 4...20 mA	RMP T13BD	0.120
	-100...100	-148...212	0...10 V or 4...20 mA	RMP T23BD	0.120
	0...100	32...212	0...10 V or 4...20 mA	RMP T33BD	0.120
	0...250	32...482	0...10 V or 4...20 mA	RMP T53BD	0.120
	0...500	32...932	0...10 V or 4...20 mA	RMP T73BD	0.120

Universal voltage/current converters

Supply voltage $\approx 24\text{ V} \pm 20\%$, non isolated

Input signal	Output signal	Reference	Weight kg
0...10 V or 4...20 mA	0...10 V or 4...20 mA	RMC N22BD	0.120

Supply voltage $\approx 24\text{ V} \pm 20\%$, isolated

Input signal	Output signal	Reference	Weight kg
0...10 V, $\pm 10\text{ V}$, 0...20 mA, 4...20 mA	Switchable: 0...10 V, $\pm 10\text{ V}$, 0...20 mA, 4...20 mA	RMC L55BD	0.120
0...50 V, 0...300 V, 0...500 V \approx or $\sim 50/60\text{ Hz}$	Switchable: 0...10 V, 0...20 mA, 4...20 mA	RMC V60BD	0.150
0...1.5 A, 0...5 A, 0...15 A \approx or $\sim 50/60\text{ Hz}$	0...10 V or 0...20 mA or 4...20 mA	RMC A61BD	0.150

Connection accessories

Description	Type	Sold in lots of	Unit reference	Weight kg
Terminal blocks for connection of protective earth conductor	Screw	100	AB1 RRTP435U	0.025
	Spring	100	AB1 RRTP435U2	0.015

(1) Converters dedicated to Zelio Logic smart relays.

Dimensions, mounting

RMT ●●●●/RMP ●●●●/RMC ●●●●

RMT ●●●●/RMC A61BD
RMP ●●●●
RMC ●●●●

Mounting on rails AM1 ●●●●

Panel mounting

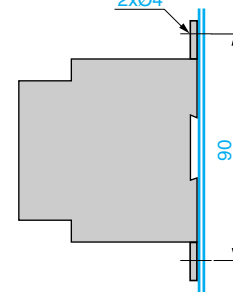
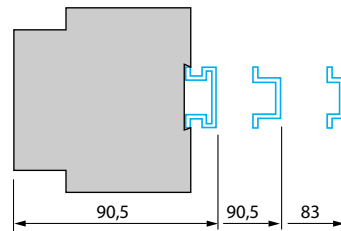
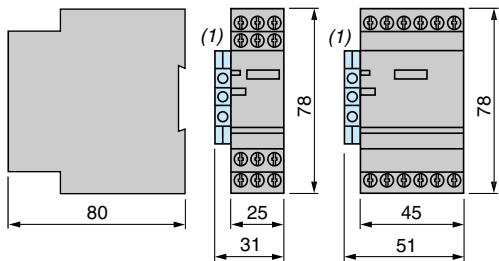

(1) Terminal block AB1 RRTP435U or AB1 RRTP435U2.

Schemes

RMT J●●●, RMT K●●●

RMP T●0BD

RMP T●3BD

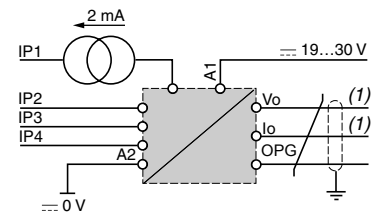
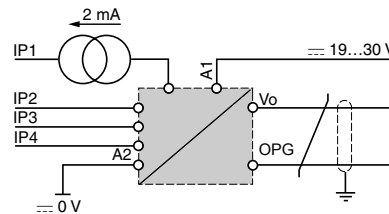
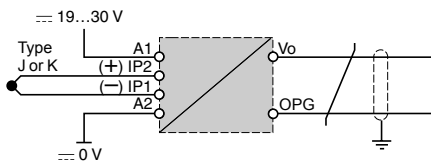

(1) Use one output only.

Input connections on RMP T●●●●

2-wire type
 $RL1 + RL2 \leq 200 \Omega$

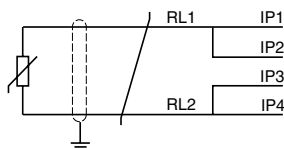

3-wire type
 $RL1 = RL2 = RL3$
 $RL1 + RL2 \leq 200 \Omega$

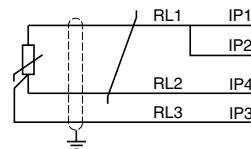

4-wire type
 $RL1 + RL2 \leq 200 \Omega$

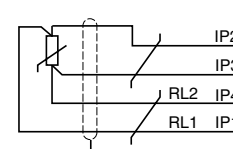

RMC ●●●●

RMC N22BD

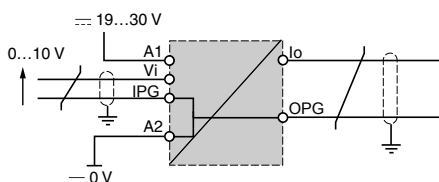
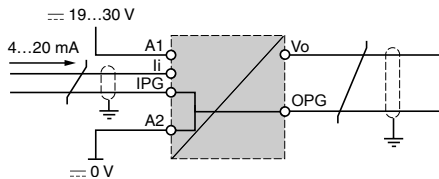

RMC L55BD

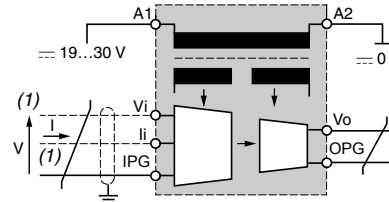

(1) Use one input only.

RMC V60BD

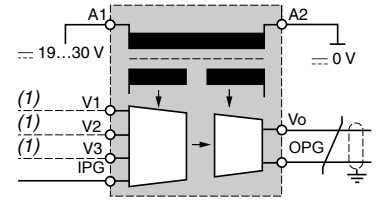

(1) Use one input only.

RMC A61BD

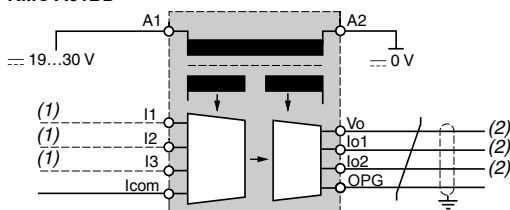

(1) Use one input only.
(2) Use one output only.

⚠ The input, output and power supply lines must be kept away from the power cables to avoid effects due to induced interference. The input and output cables must be shielded as indicated in the schemes and must be kept away from each other.

Power supplies and transformers

Power supplies for DC control circuits

Regulated switch mode power supplies

Phaseo Modular range

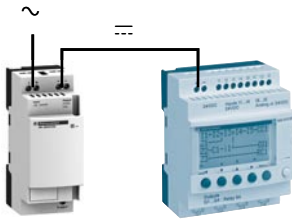

ABL 8MEM..... Zelio Logic

Switch mode power supplies: Modular range

The **ABL 8MEM/7RM** power supply offer is designed to provide the DC voltage necessary for the control circuits of automation system equipment consuming 7 to 60 W in 5, 12 and 24 V \dots . Comprising six products, this range meets the needs encountered in industrial, commercial, and residential applications. These modular electronic switch mode power supplies provide a quality of output current that is suitable for the loads supplied and compatible with the **Zelio Logic** range. Clear guidelines are given on selecting the upstream protection devices which are often used with them, and thus a comprehensive solution is provided that can be used in total safety.

The Modular range of Phaseo power supplies can be connected in phase-to-neutral (N-L1) or in phase-to-phase (1) (L1-L2). They deliver a voltage that is precise to 3%, whatever the load and whatever the type of line supply, within a range of 85 to 264 V \sim . Conforming to IEC standards and UL, CSA and TUV certified, they are suitable for universal use. The inclusion of overload and short-circuit protection makes downstream protection unnecessary if discrimination is not required.

Due to their low power, the Modular range of Phaseo power supplies consume very little harmonic current and thus are not subject to the requirements of standard IEC/EN 61000-3-2 concerning harmonic pollution.

All the Modular range of Phaseo power supplies have protection devices to ensure optimum performance of the automation system with an automatic reset mode on elimination of the fault.

All products are equipped with an output voltage adjustment potentiometer in order to be able to compensate for any line voltage drops in installations with long cable runs.

These power supplies also have a cable run inside the unit so that the outputs can be connected at the top or bottom of the product as required.

These power supplies are designed for direct mounting on 35 mm \perp rails, or on a mounting plate using their retractable fixing lugs.

There are six references available in the Phaseo Modular range:

■ ABL8MEM24003	7 W	300 mA	24 V \dots
■ ABL8MEM24006	15 W	600 mA	24 V \dots
■ ABL8MEM24012	30 W	1.2 A	24 V \dots
■ ABL7RM24025	60 W	2.5 A	24 V \dots
■ ABL8MEM05040	20 W	4 A	5 V \dots
■ ABL8MEM12020	25 W	2 A	12 V \dots

(1) 240 V \sim nominal.

Description

ABL 8MEM.....

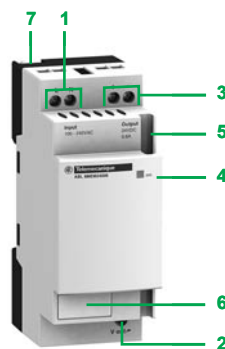

ABL7RM24025

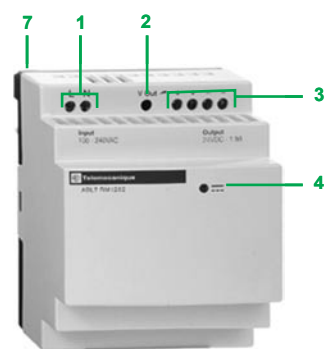

- 1 2.5 mm² screw terminal for connection of the AC input voltage
- 2 Output voltage adjustment potentiometer
- 3 2.5 mm² screw terminal for connection of the output voltage
- 4 LED indicating presence of the DC output voltage
- 5 Duct for throughwiring of the output voltage conductors at the bottom (except for model ABL 7RM24025)
- 6 Clip-on marker label (except for model ABL 7RM24025)
- 7 Retractable fixing lugs for panel mounting

Technical characteristics						
Power supply type		ABL 8MEM24003	ABL 8MEM24006	ABL 8MEM24012	ABL 7RM24025	
Certifications		cULus 508, cCSAus (CSA22.2 n950-1), TUV 60950-1, CE, C-Tick			cULus, CSA, C-Tick TUV 60950-1, CE	
Conformity to standards	Safety	IEC/EN 60950-1, SELV				
	EMC	IEC/EN 61000-6-2, EN 61000-6-3, IEC/EN 61204-3, EN 55022 Class B				
Input circuit						
LED indication		No				
Input values	Nominal voltage	V	100...240 ~			
	Limit voltage	V	85...264 ~		85...264 ~	
			120...250 --- (1)			
	Current consumption	A	0.25 (100 V ~)	0.4 (100 V ~)	0.65 (100 V ~)	1.2 (120 V ~)
			0.18 (240 V ~)	0.25 (240 V ~)	0.4 (240 V ~)	0.7 (240 V ~)
	Permissible frequencies	Hz	47...63			
	Maximum inrush current	A	20			90 for 1 ms
	Power factor		> 0.5			
	Efficiency at nominal load		> 78%	> 80%	> 82%	> 84%
	Dissipated power at nominal load	W	2	3.8	6.6	11.4
Output circuit						
LED indication		Green LED				
Nominal output values	Voltage U _{OUT}	V	24 ---			
	Current	A	0.3	0.6	1.2	2.5
	Power	W	7	15	30	60
Precision	Output voltage	V	Adjustable from 22.8 to 28.8			
	Line and load regulation		± 3%			
	Residual ripple - noise	mV	250			200
Holding time for I max.	U _{IN} = 100 V ~	ms	≥ 10			
	U _{IN} = 230 V ~	ms	≥ 150			
Protection	Against short-circuits		Permanent			
	Against undervoltages	V	-			< 19
	Thermal		Yes			-
Operating and environmental characteristics						
Connections	Input	mm ²	2 x 0.14...2.5 screw terminals (26...14 AWG)			
	Output	mm ²	2 x 0.14...2.5 screw terminals (26...14 AWG)	4 x 0.14...2.5 screw terminals (26...14 AWG)		
Mounting			On D-rail, 35 x 7.5 mm and 35 x 15 mm or on panel (2 x Ø 4 mm)			
Operating position		On vertical plane	Vertical			
Connections	Series		Possible, see page 69			
	Parallel		Possible, see page 69			
Environment	Operating temperature	°C	- 25...+ 70 (derating from 55°C, see page 69)		- 25...+ 55	
	Storage temperature	°C	- 40...+ 70			
	Relative humidity		90% during operation 95% in storage			
	Degree of protection		IP 20 conforming to IEC/EN 60529			
	Vibration acc. to IEC/EN 61131-2		3...11.9 Hz amplitude 3.5 mm and 11.9 -150 Hz acceleration 2 g			
Protection class		According to VDE 0106 1	Class II			
Dielectric strength 50 Hz for 1 min		Input/output	V rms	3000 ~		
Input fuse incorporated			Yes (not interchangeable)			
Emissions according to EN 61000-6-3			EN 50081-1 (generic)			
	Radiation		EN 55022 Class B			
	Conducted on the power line		EN 55022 Class B			
	Harmonic currents		IEC/EN 61000-3-2			
Immunity according to IEC/EN 61000-6-2			IEC 61000-6-2 (generic)			
	Electrostatic discharge		IEC/EN 61000-4-2 (6 kV contact/8 kV air)		IEC/EN 61000-4-2 (4 kV contact/8 kV air)	
	Radiated electromagnetic fields		IEC/EN 61000-4-3 level 3 (10 V/m)			
	Induced electromagnetic fields		IEC/EN 61000-4-6 level 3 (10 V/m)			
	Rapid transients		IEC 61000-4-4 (4 kV)			
	Surges		IEC/EN 61000-4-5 (1 kV)			
	Primary outages		IEC 61000-4-11 (voltage dips and interruptions)			

(1) The certifications cULus 508, cCSAus, TUV 60950-1 are not valid for DC input voltages.

Technical characteristics			
Power supply type		ABL 8MEM05040	ABL 8MEM12020
Certifications		cULus 508, cCSAus (CSA22.2 n950-1), TUV EN 60950-1, CE, C-Tick	
Conformity to standards	Safety	IEC/EN 60950-1, SELV	
	EMC	IEC/EN 61000-6-2, EN 61000-6-3, IEC/EN 61204-3, EN 55022 Class B	
Input circuit			
LED indication		No	
Input values	Nominal voltage	V	100...240 ~
	Limit voltage	V	85...264 V ~ 120...250 V ~ (1)
	Current consumption	A	0.55 (100 V ~) 0.6 (100 V ~) 0.35 (240 V ~) 0.35 (240 V ~)
	Permissible frequencies	Hz	47...63
	Maximum inrush current	A	20
	Power factor		> 0.5
	Efficiency at nominal load		> 75% > 80%
	Dissipated power at nominal load	W	6.7 6.2
Output circuit			
LED indication		Green LED	
Nominal output values	Voltage U _{OUT}	V	5 ~ 12...15 ~
	Current	A	4 2.1
	Power	W	20 25
Precision	Output voltage	V	Adjustable from 4.75 to 6.25 Adjustable from 11.4 to 15
	Line and load regulation		± 3%
	Residual ripple - noise	mV	250
Holding time for I_{max}	U _{IN} min	ms	≥ 10
Protection	Against short-circuits		Permanent
	Against undervoltages		-
	Thermal		-
Operating and environmental characteristics			
Connections	Input	mm²	2 x 0.14...2.5 screw terminals (26...14 AWG)
	Output	mm²	4 x 0.14...2.5 screw terminals (26...14 AWG)
Mounting			On 1 _U rail, 35 x 7.5 mm and 35 x 15 mm or on panel (2 x Ø 4 mm)
Operating position	On vertical plane		Vertical
Connections	Series		Possible, see page 69
	Parallel		Possible, see page 69
Environment	Operating temperature	°C	- 25...+ 70 (derating from 55°C, see page 69)
	Storage temperature	°C	- 40...+ 70
	Maximum relative humidity		90% during operation 95% in storage
	Degree of protection		IP 20 conforming to IEC/EN 60529
	Vibration acc. to IEC/EN 61131-2		3...11.9 Hz amplitude 3.5 mm and 11.9 -150 Hz acceleration 2 g
Protection class	According to VDE 0106 1		Class II
Dielectric strength 50 Hz for 1 min	Input/output	V rms	3000 ~
Input fuse incorporated			Yes (not interchangeable)
Emissions according to EN 61000-6-3			EN 50081-1 (generic)
	Radiation		EN 55022 Class B
	Conducted on the power line		EN 55022 Class B
	Harmonic currents		IEC/EN 61000-3-2
Immunity according to EN 61000-6-2			IEC 61000-6-2 (generic)
	Electrostatic discharge		IEC/EN 61000-4-2 (6 kV contact/8 kV air)
	Radiated electromagnetic fields		IEC/EN 61000-4-3 level 3 (10 V/m)
	Induced electromagnetic fields		IEC/EN 61000-4-6 level 3 (10 V/m)
	Rapid transients		IEC 61000-4-4 (4 kV)
	Surges		IEC/EN 61000-4-5 (1 kV)
	Primary outages		IEC 61000-4-11 (voltage dips and interruptions)

(1) The certifications cULus 508, cCSAus, TUV 60950-1 are not valid for DC input voltages.

Output characteristics

Behavior in the event of short-circuits and overloads

Phaseo power supplies are equipped with an electronic protection device.

In the event of an overload or short-circuit, the integrated protection interrupts the current supply before the output voltage drops below 19 V.

The output voltage reverts to its nominal value on elimination of the fault, which avoids having to take any action.

Derating

The ambient temperature is a determining factor that limits the power an electronic power supply can deliver continuously. If the temperature around the electronic components is too high, their life will be significantly reduced.

The nominal ambient temperature for the Modular range of Phaseo power supplies is 55°C. Above this temperature, derating is necessary up to a maximum temperature of 70°C (except for the ABL 7RM24025 model).

The graph below shows the power as a percentage of the nominal power that the power supply can deliver continuously, depending on the ambient temperature.

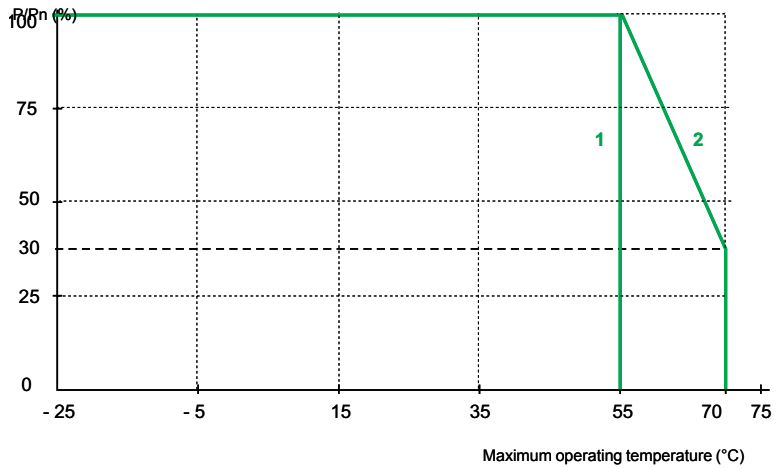

- 1 With an ABL 7RM24025
- 2 With an ABL 8MEM●●●●●

Temporary overloads

The ABL 8MEM●●●●● Modular range of power supplies have an energy reserve that can be used to supply the application with 125 % to 140 % of the nominal output current for a maximum of 1 minute, depending on the model.

Series or parallel connection

Series connection

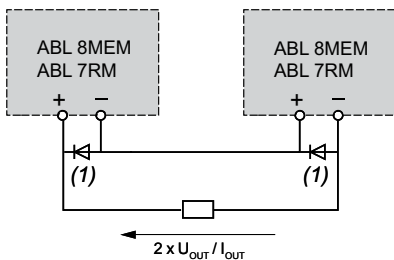

Parallel connection

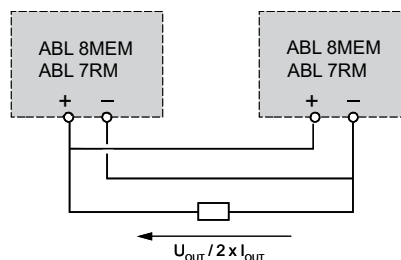

(1) Two Schottky diodes I_{min} = power supply I_n and V_{min} = 50 V

Family	Series	Parallel
ABL 7RM/8MEM	2 products max.	2 products max.

Note: Series or parallel connection is only recommended for products with identical references.

Selection of protection for the power supply primary

Type of line supply	100 to 240 V ~ single-phase		
Type of protection	Thermal-magnetic circuit-breaker		gG fuse
	GB2 (IEC) (1)	C60N (IEC) C60N (UL/CSA)	
ABL 8MEM05040	GB2 ●●07 (2)	24581 24517	2 A
ABL 8MEM12020			
ABL 8MEM24003			
ABL 8MEM24006			
ABL 8MEM24012			
ABL 7RM24025	GB2 ●●08 (2)	24582 24518	3 A

(1) UL pending

(2) Complete the reference by replacing ●● as required:

- **CB** for single-pole circuit-breaker with magnetic trip threshold 12 to 16 In
- **CD** for single-pole + neutral circuit-breaker with magnetic trip threshold 12 to 16 In
- **DB** for 2-pole circuit-breaker with magnetic trip threshold 12 to 16 In
- **CS** for single-pole circuit-breaker with magnetic trip threshold 5 to 7 In

Circuit-breaker schemes

GB2 CB●●



GB2 CD●●



GB2 DB●●

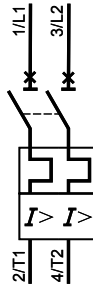

GB2 CS●●



References



ABL 8MEM05040/12020/24012



ABL 8MEM24003/24006



ABL 7RM24025

Input voltage	Secondary			Reset	Conforming to standard IEC/EN 61000-3-2 (1)	Reference	Weight kg
	Output voltage	Nominal power	Nominal current				
Single-phase (N-L1) or 2-phase (L1-L2) connection							
100...240 V -15%, +10% 50/60 Hz	5 V $\overline{\text{---}}$	20 W	4 A	Automatic	Not applicable	ABL 8MEM05040	0.195
	12 V $\overline{\text{---}}$	25 W	2 A	Automatic	Not applicable	ABL 8MEM12020	0.195
	24 V $\overline{\text{---}}$	7 W	0.3 A	Automatic	Not applicable	ABL 8MEM24003	0.100
		15 W	0.6 A	Automatic	Not applicable	ABL 8MEM24006	0.100
		30 W	1.2 A	Automatic	Not applicable	ABL 8MEM24012	0.195
		60 W	2.5 A	Automatic	Not applicable	ABL 7RM24025	0.255

Designation	Use	Order in multiples of	Unit reference	Weight kg
Clip-on marker labels	Replacement parts for ABL 8MEM power supplies	100	LAD 90	0.030

(1) Due to their power < 75 W, the ABL 8MEM/7RM Modular range of power supplies is not subject to the requirements of standard IEC/EN 61000-3-2.

Dimensions

ABL 8MEM●●●●/ABL 7RM24025 power supply

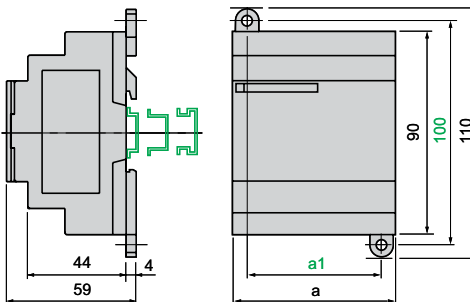

	a	a1
ABL 8MEM05040	54	42
ABL 8MEM12020	54	42
ABL 8MEM24003	36	24
ABL 8MEM24006	36	24
ABL 8MEM24012	54	42
ABL 7RM24025	72	60

Internal schemes

ABL 8MEM2400●

ABL 8MEM05040/8MEM12020/8MEM24012/7RM24025

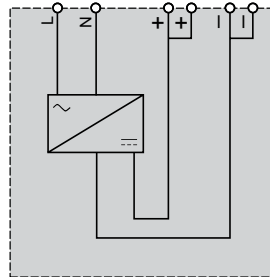
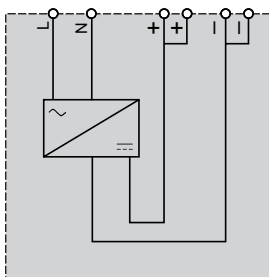

Schneider Electric Industries SAS

www.schneider-electric.com

Head Office
89, bd Franklin Roosevelt
92506 Rueil-Malmaison Cedex
France

Due to evolution of standards and equipment, the characteristics indicated in texts and images of this document do not constitute a commitment on our part without confirmation.
Design: Schneider Electric
Photos: Schneider Electric
Printed by: