

Wiring Accessories • Smart lighting Control • Wireless Audio • Circuit Protection



Hamilton[®]

making connections beautifully

2020/2021

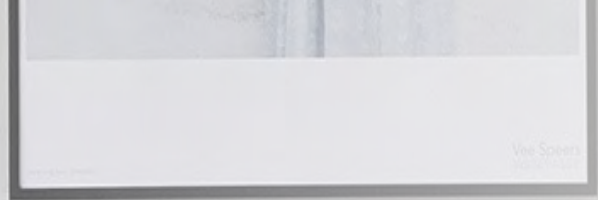

Hamilton®

making connections beautifully

Hamilton is a British electrical solutions provider that designs, develops and manufactures innovative electrical accessories of the highest quality.

With a vast product range including decorative switch plates and sockets, smart lighting control, new wireless audio devices and 18th Edition consumer units it is a one-stop shop for all wiring requirements for both the residential and hotel industries.

A family-owned and run company, Hamilton continues to build on its reputation as a trusted brand who consistently delivers high end premium wiring accessories.

In today's market, technology is moving at a fast pace. Hamilton's expert knowledge, pioneering engineering skills and first class test facilities allow Hamilton to support this ever changing landscape.

Hamilton celebrated a fantastic milestone in 2018 when the business reached its 50th anniversary.

It operates under the direction of Ian Hamilton and has grown since its inception to employ over 150 customer-focused staff and distribute its class-leading solutions around the world.

Hamilton's outstanding reputation is built on delivering quality, both in terms of design and manufacture. Supplying the latest technology and 'smart' solutions all supported by exceptional customer service.

An industry leading company, Hamilton's persistent mission to produce revolutionary solutions that are competitively priced, easy to install and have a stylish, classy finish suitable for any interior project.

Contemporary and Classic

Electrical wiring accessories

Vast collection of finishes available across the Hamilton ranges including Antique, Satin and Polished Brass. Bronze finishes include Richmond, Etrium, Connaught and Copper Bronze. Contemporary finishes available across most ranges include Satin Stainless, Bright Steel, Bright Chrome, Polished and Black Nickel. As well as bespoke paintable colours available on request.

Some of Hamilton's most popular ranges feature entirely concealed fixings, perfect for ultra-modern rooms that require a smooth, minimalist feel.

Hamilton supplies a full range of electrical products that are suitable for British Standard markets as well as offering a range of international sockets in its Euro Fix range.

All of Hamilton's electrical wiring accessories conform to current British or European standards and are manufactured under an accredited BS EN ISO 9001: 2008 quality system.

The Hamilton 13-amp sockets have also been accredited with the ASTA certification, providing confidence in their safe operation.

Hamilton Plate Finishes

Hamilton have a wide variety of plate finishes available across most ranges and styles, please see the Hamilton catalogue for more details.

METAL PLATES



PLASTIC PLATES



WOOD PLATES

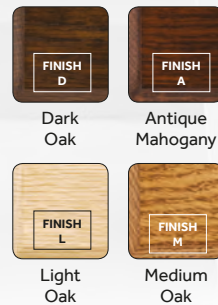

GLASS PLATES

Available as part of Hamilton range of lighting and audio controls. A capacitive touch plate. Linea-CFX Vetro is available in various frame styles and finishes and a choice of either black or white coloured glass.



Note: In the Cheriton Victorian range some finish numbers will vary

Bright Chrome = 5, Polished Brass = 2, Satin Brass = 4, Antique Brass = 3

In the Cheriton Georgian range some finish numbers will vary
Polished Brass = 0, Antique Brass = 1

In the Linea range the Bright Stainless is referred to as Bright Steel

Piano Black is only available in the Linea range.

Note: Colours may vary due to the manufacturing process



Contents

6	Linea-Rondo CFX®
34	Linea-Duo CFX®
62	Linea-Scala CFX®
90	Linea-Perlina CFX®
116	Linea-Georgian CFX®
142	Bespoke
148	Perception CFX®
164	Hartland
188	Hartland G2
204	Hartland CFX®
230	Hartland CFX Colours
242	Sheer
266	Sheer CFX®
292	Sheer Floor Socket
298	EuroFix
306	GRID-IT
320	Cheriton
346	Woods
370	Bloomsbury
376	Smart Lighting Control
398	Wireless Audio
404	LED Dimmer Modules
406	Domestic Circuit Protection
412	Vogue
424	Elemento
428	Metal Clad
432	White Plastic
436	Technical Specifications



Linea-Rondo CFX[®] Range

Simple and elegant with a smooth rounded frame

The Linea CFX[®] range comes in five different designs to suit either contemporary or classic interiors. Linea CFX[®] has a separate back frame and our patented four point face plate clipping system, allowing the option of matching or contrasting elements.

- Stunning front plate finishes and frame and insert finishes gives a huge choice of combinations
- Two-part frame and plate for 'mix and match'
- Concealed fixing
- Grid Fix and Eurofix options also available (see separate GRID-IT and EuroFix sections)



Linea-Rondo CFX® Range

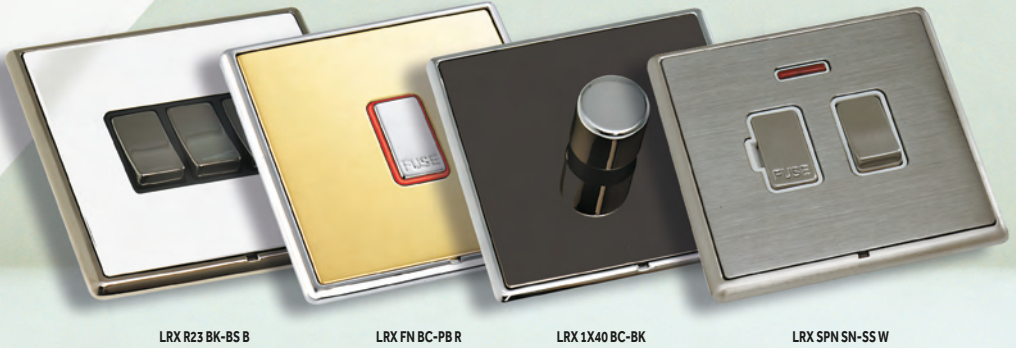

LRX R23 BK-BS B

LRX FN BC-PB R

LRX 1X40 BC-BK

LRX SPN SN-SS W

Product Code Configurator

1. Select the required electrical accessory from the following pages.
e.g. **LRX R21** = Linea-Rondo CFX 1 gang 10AX 2 way Rocker Switch.
2. Using the Frame & Finishes Chart on the next page;
 - a. Select the required Frame Finish
e.g. Bright Chrome = **BC**-_-_-.
 - b. Select the required Front Plate Finish
e.g. Satin Steel = _-_-**SS**_-.
 - c. Select the required Insert Surround Colour
e.g. White = _-_-_-**W**.



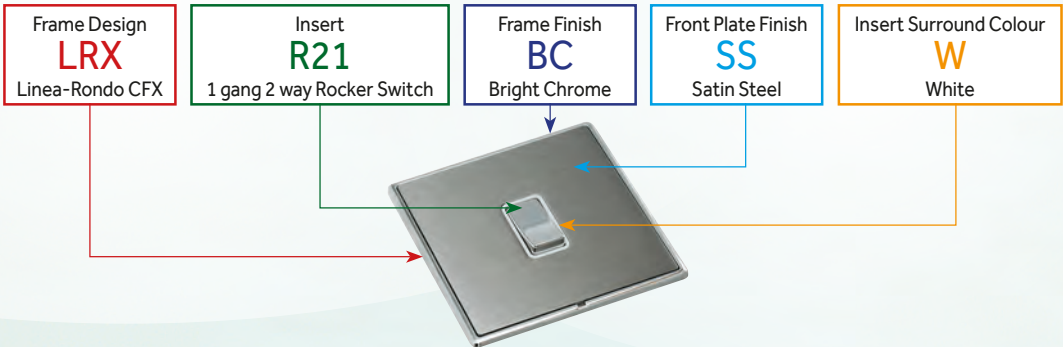



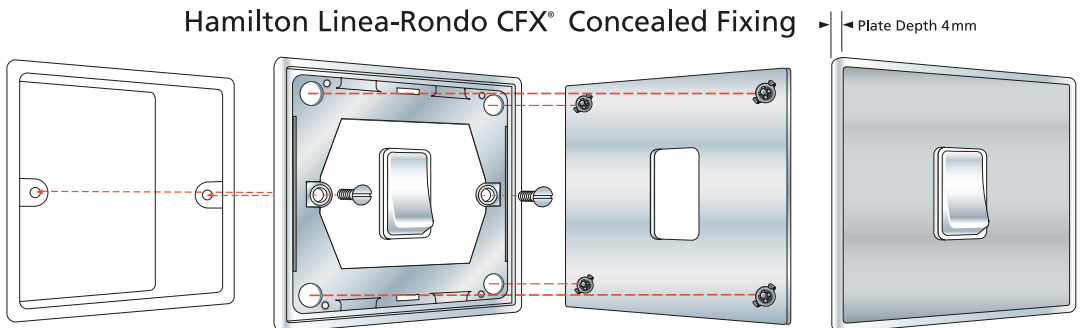



























Therefore a Linea-Rondo CFX 1 gang 10AX 2 way Rocker Switch as illustrated below = **LRX R21 BC-SS W**



Hamilton Linea-Rondo CFX® Concealed Fixing



Frame & Finishes Chart

Frame and Insert Finish	Polished Brass (PB)	Satin Brass (SB)	Antique Brass (AB)	Bright Steel (BS)	Satin Steel (SS)	Black Nickel (BK)	Piano Black (N)	Connaught Bronze (HB)	Copper Bronze (CB)	Etrium Bronze (EB)	Richmond Bronze (RB)
Bright Chrome (BC) Matching Insert with White Surround	 BC-PB W			 BC-BS W	 BC-SS W						
Bright Chrome (BC) Matching Insert with Black Surround	 BC-PB B			 BC-BS B	 BC-SS B	 BC-BK B	 BC-N B				
Polished Brass (PB) Matching Insert with White Surround	 PB-PB W	 PB-SB W	 PB-AB W	 PB-BS W	 PB-SS W						
Polished Brass (PB) Matching Insert with Black Surround	 PB-PB B	 PB-SB B	 PB-AB B	 PB-BS B	 PB-SS B						
Satin Brass (SB) Matching Insert with White Surround		 SB-SB W			 SB-SS W						
Satin Brass (SB) Matching Insert with Black Surround		 SB-SB B			 SB-SS B						
Antique Brass (AB) Matching Insert with Black Surround		 AB-SB B	 AB-AB B								
Satin Nickel (SN) Matching Insert with White Surround				 SN-BS W	 SN-SS W						
Satin Nickel (SN) Matching Insert with Black Surround				 SN-BS B	 SN-SS B						
Black Nickel (BK) Matching Insert with Black Surround	 BK-PB B			 BK-BS B		 BK-BK B					
Connaught Bronze Frame (HB) Matching Insert with Black Surround								 HB-HB B			
Copper Bronze Frame (CB) Matching Insert with Black Surround									 CB-CB B		
Etrium Bronze Frame (EB) Matching Insert with Black Surround										 EB-EB B	
Richmond Bronze Frame (RB) Matching Insert with Black Surround											 RB-RB B

Frame Finishes



Bright Chrome



Polished Brass



Satin Brass



Antique Brass



Satin Nickel



Black Nickel



Connaught Bronze



Copper Bronze



Etrium Bronze



Richmond Bronze

Insert Surround Colour Key: (-B) Black, (-W) White

Linea-Rondo CFX®

Rocker Switches

LINEA-RONDO CFX RANGE



LRX R21 BK-BK B



LRX R22 SB-SB B



LRX R24 BK-BK B



LRX R26 SN-BS W



1 gang 10AX
2 Way Rocker



2 gang 10AX
2 Way Rocker



3 gang 10AX
2 Way Rocker



4 gang 10AX
2 Way Rocker

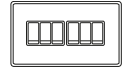

6 gang 10AX
2 Way Rocker

Frame / Front Plate	1 gang 10AX 2 Way Rocker	2 gang 10AX 2 Way Rocker	3 gang 10AX 2 Way Rocker	4 gang 10AX 2 Way Rocker	6 gang 10AX 2 Way Rocker
Antique Brass Frame/Antique Brass	LRX R21 AB-AB B	LRX R22 AB-AB B	LRX R23 AB-AB B	LRX R24 AB-AB B	LRX R26 AB-AB B
Antique Brass Frame/Satin Brass	LRX R21 AB-SB B	LRX R22 AB-SB B	LRX R23 AB-SB B	LRX R24 AB-SB B	LRX R26 AB-SB B
Black Nickel Frame/Black Nickel	LRX R21 BK-BK B	LRX R22 BK-BK B	LRX R23 BK-BK B	LRX R24 BK-BK B	LRX R26 BK-BK B
Black Nickel Frame/Bright Steel	LRX R21 BK-BS B	LRX R22 BK-BS B	LRX R23 BK-BS B	LRX R24 BK-BS B	LRX R26 BK-BS B
Black Nickel Frame/Polished Brass	LRX R21 BK-PB B	LRX R22 BK-PB B	LRX R23 BK-PB B	LRX R24 BK-PB B	LRX R26 BK-PB B
Bright Chrome Frame/Black Nickel	LRX R21 BC-BK B	LRX R22 BC-BK B	LRX R23 BC-BK B	LRX R24 BC-BK B	LRX R26 BC-BK B
Bright Chrome Frame/Bright Steel	LRX R21 BC-BS B	LRX R22 BC-BS B	LRX R23 BC-BS B	LRX R24 BC-BS B	LRX R26 BC-BS B
Bright Chrome Frame/Bright Steel	LRX R21 BC-BS W	LRX R22 BC-BS W	LRX R23 BC-BS W	LRX R24 BC-BS W	LRX R26 BC-BS W
Bright Chrome Frame/Plano Black	LRX R21 BC-NB	LRX R22 BC-NB	LRX R23 BC-NB	LRX R24 BC-NB	LRX R26 BC-NB
Bright Chrome Frame/Polished Brass	LRX R21 BC-PB B	LRX R22 BC-PB B	LRX R23 BC-PB B	LRX R24 BC-PB B	LRX R26 BC-PB B
Bright Chrome Frame/Polished Brass	LRX R21 BC-PB W	LRX R22 BC-PB W	LRX R23 BC-PB W	LRX R24 BC-PB W	LRX R26 BC-PB W
Bright Chrome Frame/Satin Steel	LRX R21 BC-SS B	LRX R22 BC-SS B	LRX R23 BC-SS B	LRX R24 BC-SS B	LRX R26 BC-SS B
Bright Chrome Frame/Satin Steel	LRX R21 BC-SS W	LRX R22 BC-SS W	LRX R23 BC-SS W	LRX R24 BC-SS W	LRX R26 BC-SS W
Connaught Bronze Frame/Connaught Bronze	LRX R21 HB-HB B	LRX R22 HB-HB B	LRX R23 HB-HB B	LRX R24 HB-HB B	LRX R26 HB-HB B
Copper Bronze Frame/Copper Bronze	LRX R21 CB-CB B	LRX R22 CB-CB B	LRX R23 CB-CB B	LRX R24 CB-CB B	LRX R26 CB-CB B
Etrium Bronze Frame/Etrium Bronze	LRX R21 EB-EB B	LRX R22 EB-EB B	LRX R23 EB-EB B	LRX R24 EB-EB B	LRX R26 EB-EB B
Polished Brass Frame/Antique Brass	LRX R21 PB-AB B	LRX R22 PB-AB B	LRX R23 PB-AB B	LRX R24 PB-AB B	LRX R26 PB-AB B
Polished Brass Frame/Antique Brass	LRX R21 PB-AB W	LRX R22 PB-AB W	LRX R23 PB-AB W	LRX R24 PB-AB W	LRX R26 PB-AB W
Polished Brass Frame/Bright Steel	LRX R21 PB-BS B	LRX R22 PB-BS B	LRX R23 PB-BS B	LRX R24 PB-BS B	LRX R26 PB-BS B
Polished Brass Frame/Bright Steel	LRX R21 PB-BS W	LRX R22 PB-BS W	LRX R23 PB-BS W	LRX R24 PB-BS W	LRX R26 PB-BS W
Polished Brass Frame/Polished Brass	LRX R21 PB-PB B	LRX R22 PB-PB B	LRX R23 PB-PB B	LRX R24 PB-PB B	LRX R26 PB-PB B
Polished Brass Frame/Polished Brass	LRX R21 PB-PB W	LRX R22 PB-PB W	LRX R23 PB-PB W	LRX R24 PB-PB W	LRX R26 PB-PB W
Polished Brass Frame/Satin Brass	LRX R21 PB-SB B	LRX R22 PB-SB B	LRX R23 PB-SB B	LRX R24 PB-SB B	LRX R26 PB-SB B
Polished Brass Frame/Satin Brass	LRX R21 PB-SB W	LRX R22 PB-SB W	LRX R23 PB-SB W	LRX R24 PB-SB W	LRX R26 PB-SB W
Polished Brass Frame/Satin Steel	LRX R21 PB-SS B	LRX R22 PB-SS B	LRX R23 PB-SS B	LRX R24 PB-SS B	LRX R26 PB-SS B
Polished Brass Frame/Satin Steel	LRX R21 PB-SS W	LRX R22 PB-SS W	LRX R23 PB-SS W	LRX R24 PB-SS W	LRX R26 PB-SS W
Richmond Bronze Frame/Richmond Bronze	LRX R21 RB-RB B	LRX R22 RB-RB B	LRX R23 RB-RB B	LRX R24 RB-RB B	LRX R26 RB-RB B
Satin Brass Frame/Satin Brass	LRX R21 SB-SB B	LRX R22 SB-SB B	LRX R23 SB-SB B	LRX R24 SB-SB B	LRX R26 SB-SB B
Satin Brass Frame/Satin Brass	LRX R21 SB-SB W	LRX R22 SB-SB W	LRX R23 SB-SB W	LRX R24 SB-SB W	LRX R26 SB-SB W
Satin Brass Frame/Satin Steel	LRX R21 SB-SS B	LRX R22 SB-SS B	LRX R23 SB-SS B	LRX R24 SB-SS B	LRX R26 SB-SS B
Satin Brass Frame/Satin Steel	LRX R21 SB-SS W	LRX R22 SB-SS W	LRX R23 SB-SS W	LRX R24 SB-SS W	LRX R26 SB-SS W
Satin Nickel Frame/Bright Steel	LRX R21 SN-BS B	LRX R22 SN-BS B	LRX R23 SN-BS B	LRX R24 SN-BS B	LRX R26 SN-BS B
Satin Nickel Frame/Bright Steel	LRX R21 SN-BS W	LRX R22 SN-BS W	LRX R23 SN-BS W	LRX R24 SN-BS W	LRX R26 SN-BS W
Satin Nickel Frame/Satin Steel	LRX R21 SN-SS B	LRX R22 SN-SS B	LRX R23 SN-SS B	LRX R24 SN-SS B	LRX R26 SN-SS B
Satin Nickel Frame/Satin Steel	LRX R21 SN-SS W	LRX R22 SN-SS W	LRX R23 SN-SS W	LRX R24 SN-SS W	LRX R26 SN-SS W
Nominal Size:	91.5mm x 91.5m	91.5mm x 91.5mm	91.5mm x 91.5mm	150.5mm x 91.5mm	150.5mm x 91.5mm
Minimum Wall Box Depth:	25mm	25mm	25mm	25mm	25mm
Technical Insert Ref:	R21	R22	R23	R24	R26

Insert Surround Colour Key: (B) Black, (W) White

Linea-Rondo CFX

Rocker Switches



LRX R31 BK-BK B



LRX R32 PB-BS W



LRX RRT PB-SB B



LRX TP BK-BK B



1 gang 10AX
Intermediate Rocker



2 gang 10AX
Intermediate Rocker



1 gang 10AX
Push To Make/
Push to Break
Retractive Rocker



1 gang 10A Triple Pole
Rocker

Frame / Front Plate	1 gang 10AX Intermediate Rocker	2 gang 10AX Intermediate Rocker	1 gang 10AX Push To Make/ Push to Break Retractive Rocker	1 gang 10A Triple Pole Rocker
Antique Brass Frame/Antique Brass	LRX R31 AB-AB B	LRX R32 AB-AB B	LRX RRT AB-AB B	LRX TP AB-AB B
Antique Brass Frame/Satin Brass	LRX R31 AB-SB B	LRX R32 AB-SB B	LRX RRT AB-SB B	LRX TP AB-SB B
Black Nickel Frame/Black Nickel	LRX R31 BK-BK B	LRX R32 BK-BK B	LRX RRT BK-BK B	LRX TP BK-BK B
Black Nickel Frame/Bright Steel	LRX R31 BK-BS B	LRX R32 BK-BS B	LRX RRT BK-BS B	LRX TP BK-BS B
Black Nickel Frame/Polished Brass	LRX R31 BK-PB B	LRX R32 BK-PB B	LRX RRT BK-PB B	LRX TP BK-PB B
Bright Chrome Frame/Black Nickel	LRX R31 BC-BK B	LRX R32 BC-BK B	LRX RRT BC-BK B	LRX TP BC-BK B
Bright Chrome Frame/Bright Steel	LRX R31 BC-BS B	LRX R32 BC-BS B	LRX RRT BC-BS B	LRX TP BC-BS B
Bright Chrome Frame/Bright Steel	LRX R31 BC-BS W	LRX R32 BC-BS W	LRX RRT BC-BS W	LRX TP BC-BS W
Bright Chrome Frame/Piano Black	LRX R31 BC-NB	LRX R32 BC-NB	LRX RRT BC-NB	LRX TP BC-NB
Bright Chrome Frame/Polished Brass	LRX R31 BC-PB B	LRX R32 BC-PB B	LRX RRT BC-PB B	LRX TP BC-PB B
Bright Chrome Frame/Polished Brass	LRX R31 BC-PB W	LRX R32 BC-PB W	LRX RRT BC-PB W	LRX TP BC-PB W
Bright Chrome Frame/Satin Steel	LRX R31 BC-SS B	LRX R32 BC-SS B	LRX RRT BC-SS B	LRX TP BC-SS B
Bright Chrome Frame/Satin Steel	LRX R31 BC-SS W	LRX R32 BC-SS W	LRX RRT BC-SS W	LRX TP BC-SS W
Connaught Bronze Frame/Connaught Bronze	LRX R31 HB-HB B	LRX R32 HB-HB B	LRX RRT HB-HB B	LRX TP HB-HB B
Copper Bronze Frame/Copper Bronze	LRX R31 CB-CB B	LRX R32 CB-CB B	LRX RRT CB-CB B	LRX TP CB-CB B
Etrium Bronze Frame/Etrium Bronze	LRX R31 EB-EB B	LRX R32 EB-EB B	LRX RRT EB-EB B	LRX TP EB-EB B
Polished Brass Frame/Antique Brass	LRX R31 PB-AB B	LRX R32 PB-AB B	LRX RRT PB-AB B	LRX TP PB-AB B
Polished Brass Frame/Antique Brass	LRX R31 PB-AB W	LRX R32 PB-AB W	LRX RRT PB-AB W	LRX TP PB-AB W
Polished Brass Frame/Bright Steel	LRX R31 PB-BS B	LRX R32 PB-BS B	LRX RRT PB-BS B	LRX TP PB-BS B
Polished Brass Frame/Bright Steel	LRX R31 PB-BS W	LRX R32 PB-BS W	LRX RRT PB-BS W	LRX TP PB-BS W
Polished Brass Frame/Polished Brass	LRX R31 PB-PB B	LRX R32 PB-PB B	LRX RRT PB-PB B	LRX TP PB-PB B
Polished Brass Frame/Polished Brass	LRX R31 PB-PB W	LRX R32 PB-PB W	LRX RRT PB-PB W	LRX TP PB-PB W
Polished Brass Frame/Satin Brass	LRX R31 PB-SB B	LRX R32 PB-SB B	LRX RRT PB-SB B	LRX TP PB-SB B
Polished Brass Frame/Satin Brass	LRX R31 PB-SB W	LRX R32 PB-SB W	LRX RRT PB-SB W	LRX TP PB-SB W
Polished Brass Frame/Satin Steel	LRX R31 PB-SS B	LRX R32 PB-SS B	LRX RRT PB-SS B	LRX TP PB-SS B
Polished Brass Frame/Satin Steel	LRX R31 PB-SS W	LRX R32 PB-SS W	LRX RRT PB-SS W	LRX TP PB-SS W
Richmond Bronze Frame/Richmond Bronze	LRX R31 RB-RB B	LRX R32 RB-RB B	LRX RRT RB-RB B	LRX TP RB-RB B
Satin Brass Frame/Satin Brass	LRX R31 SB-SB B	LRX R32 SB-SB B	LRX RRT SB-SB B	LRX TP SB-SB B
Satin Brass Frame/Satin Brass	LRX R31 SB-SB W	LRX R32 SB-SB W	LRX RRT SB-SB W	LRX TP SB-SB W
Satin Brass Frame/Satin Steel	LRX R31 SB-SS B	LRX R32 SB-SS B	LRX RRT SB-SS B	LRX TP SB-SS B
Satin Brass Frame/Satin Steel	LRX R31 SB-SS W	LRX R32 SB-SS W	LRX RRT SB-SS W	LRX TP SB-SS W
Satin Nickel Frame/Bright Steel	LRX R31 SN-BS B	LRX R32 SN-BS B	LRX RRT SN-BS B	LRX TP SN-BS B
Satin Nickel Frame/Bright Steel	LRX R31 SN-BS W	LRX R32 SN-BS W	LRX RRT SN-BS W	LRX TP SN-BS W
Satin Nickel Frame/Satin Steel	LRX R31 SN-SS B	LRX R32 SN-SS B	LRX RRT SN-SS B	LRX TP SN-SS B
Satin Nickel Frame/Satin Steel	LRX R31 SN-SS W	LRX R32 SN-SS W	LRX RRT SN-SS W	LRX TP SN-SS W
Nominal Size:	91.5mm x 91.5mm	91.5mm x 91.5mm	91.5mm x 91.5mm	91.5mm x 91.5mm
Minimum Wall Box Depth:	25mm	25mm	25mm	25mm
Technical Insert Ref:	R31	R32	RRT	TP

Insert Surround Colour Key: (B) Black, (W) White

Linea-Rondo CFX

Rocker Switches

LINEA-RONDO CFX RANGE



LRX R212 HB-HB B



LRX R222 BC-BK B



LRX R242 PB-SB B



LRX R312 SN-SB W



1 gang 20AX
2 Way Rocker



2 gang 20AX
2 Way Rocker

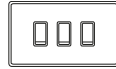

3 gang 20AX
2 Way Rocker

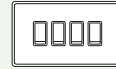

4 gang 20AX
2 Way Rocker



1 gang 20AX
Intermediate
Rocker



2 gang 20AX
Intermediate
Rocker

Frame / Front Plate	1 gang 20AX 2 Way Rocker	2 gang 20AX 2 Way Rocker	3 gang 20AX 2 Way Rocker	4 gang 20AX 2 Way Rocker	1 gang 20AX Intermediate Rocker	2 gang 20AX Intermediate Rocker
Antique Brass Frame/Antique Brass	LRX R212 AB-AB B	LRX R222 AB-AB B	LRX R232 AB-AB B	LRX R242 AB-AB B	LRX R312 AB-AB B	LRX R322 AB-AB B
Antique Brass Frame/Satin Brass	LRX R212 AB-SB B	LRX R222 AB-SB B	LRX R232 AB-SB B	LRX R242 AB-SB B	LRX R312 AB-SB B	LRX R322 AB-SB B
Black Nickel Frame/Black Nickel	LRX R212 BK-BK B	LRX R222 BK-BK B	LRX R232 BK-BK B	LRX R242 BK-BK B	LRX R312 BK-BK B	LRX R322 BK-BK B
Black Nickel Frame/Bright Steel	LRX R212 BK-BS B	LRX R222 BK-BS B	LRX R232 BK-BS B	LRX R242 BK-BS B	LRX R312 BK-BS B	LRX R322 BK-BS B
Black Nickel Frame/Polished Brass	LRX R212 BK-PB B	LRX R222 BK-PB B	LRX R232 BK-PB B	LRX R242 BK-PB B	LRX R312 BK-PB B	LRX R322 BK-PB B
Bright Chrome Frame/Black Nickel	LRX R212 BC-BK B	LRX R222 BC-BK B	LRX R232 BC-BK B	LRX R242 BC-BK B	LRX R312 BC-BK B	LRX R322 BC-BK B
Bright Chrome Frame/Bright Steel	LRX R212 BC-BS B	LRX R222 BC-BS B	LRX R232 BC-BS B	LRX R242 BC-BS B	LRX R312 BC-BS B	LRX R322 BC-BS B
Bright Chrome Frame/Bright Steel	LRX R212 BC-BS W	LRX R222 BC-BS W	LRX R232 BC-BS W	LRX R242 BC-BS W	LRX R312 BC-BS W	LRX R322 BC-BS W
Bright Chrome Frame/Piano Black	LRX R212 BC-NB	LRX R222 BC-NB	LRX R232 BC-NB	LRX R242 BC-NB	LRX R312 BC-NB	LRX R322 BC-NB
Bright Chrome Frame/Polished Brass	LRX R212 BC-PB B	LRX R222 BC-PB B	LRX R232 BC-PB B	LRX R242 BC-PB B	LRX R312 BC-PB B	LRX R322 BC-PB B
Bright Chrome Frame/Antique Brass	LRX R212 BC-PB W	LRX R222 BC-PB W	LRX R232 BC-PB W	LRX R242 BC-PB W	LRX R312 BC-PB W	LRX R322 BC-PB W
Bright Chrome Frame/Satin Steel	LRX R212 BC-SS B	LRX R222 BC-SS B	LRX R232 BC-SS B	LRX R242 BC-SS B	LRX R312 BC-SS B	LRX R322 BC-SS B
Bright Chrome Frame/Satin Steel	LRX R212 BC-SS W	LRX R222 BC-SS W	LRX R232 BC-SS W	LRX R242 BC-SS W	LRX R312 BC-SS W	LRX R322 BC-SS W
Connaught Bronze Frame/Connaught Bronze	LRX R212 HB-HB B	LRX R222 HB-HB B	LRX R232 HB-HB B	LRX R242 HB-HB B	LRX R312 HB-HB B	LRX R322 HB-HB B
Copper Bronze Frame/Copper Bronze	LRX R212 CB-CB B	LRX R222 CB-CB B	LRX R232 CB-CB B	LRX R242 CB-CB B	LRX R312 CB-CB B	LRX R322 CB-CB B
Etrium Bronze Frame/Etrium Bronze	LRX R212 EB-EB B	LRX R222 EB-EB B	LRX R232 EB-EB B	LRX R242 EB-EB B	LRX R312 EB-EB B	LRX R322 EB-EB B
Polished Brass Frame/Antique Brass	LRX R212 PB-AB B	LRX R222 PB-AB B	LRX R232 PB-AB B	LRX R242 PB-AB B	LRX R312 PB-AB B	LRX R322 PB-AB B
Polished Brass Frame/Antique Brass	LRX R212 PB-AB W	LRX R222 PB-AB W	LRX R232 PB-AB W	LRX R242 PB-AB W	LRX R312 PB-AB W	LRX R322 PB-AB W
Polished Brass Frame/Bright Steel	LRX R212 PB-BS B	LRX R222 PB-BS B	LRX R232 PB-BS B	LRX R242 PB-BS B	LRX R312 PB-BS B	LRX R322 PB-BS B
Polished Brass Frame/Bright Steel	LRX R212 PB-BS W	LRX R222 PB-BS W	LRX R232 PB-BS W	LRX R242 PB-BS W	LRX R312 PB-BS W	LRX R322 PB-BS W
Polished Brass Frame/Polished Brass	LRX R212 PB-PB B	LRX R222 PB-PB B	LRX R232 PB-PB B	LRX R242 PB-PB B	LRX R312 PB-PB B	LRX R322 PB-PB B
Polished Brass Frame/Polished Brass	LRX R212 PB-PB W	LRX R222 PB-PB W	LRX R232 PB-PB W	LRX R242 PB-PB W	LRX R312 PB-PB W	LRX R322 PB-PB W
Polished Brass Frame/Satin Brass	LRX R212 PB-SB B	LRX R222 PB-SB B	LRX R232 PB-SB B	LRX R242 PB-SB B	LRX R312 PB-SB B	LRX R322 PB-SB B
Polished Brass Frame/Satin Brass	LRX R212 PB-SB W	LRX R222 PB-SB W	LRX R232 PB-SB W	LRX R242 PB-SB W	LRX R312 PB-SB W	LRX R322 PB-SB W
Polished Brass Frame/Satin Steel	LRX R212 PB-SS B	LRX R222 PB-SS B	LRX R232 PB-SS B	LRX R242 PB-SS B	LRX R312 PB-SS B	LRX R322 PB-SS B
Polished Brass Frame/Satin Steel	LRX R212 PB-SS W	LRX R222 PB-SS W	LRX R232 PB-SS W	LRX R242 PB-SS W	LRX R312 PB-SS W	LRX R322 PB-SS W
Richmond Bronze Frame/Richmond Bronze	LRX R212 RB-RB B	LRX R222 RB-RB B	LRX R232 RB-RB B	LRX R242 RB-RB B	LRX R312 RB-RB B	LRX R322 RB-RB B
Satin Brass Frame/Satin Brass	LRX R212 SB-SB B	LRX R222 SB-SB B	LRX R232 SB-SB B	LRX R242 SB-SB B	LRX R312 SB-SB B	LRX R322 SB-SB B
Satin Brass Frame/Satin Brass	LRX R212 SB-SB W	LRX R222 SB-SB W	LRX R232 SB-SB W	LRX R242 SB-SB W	LRX R312 SB-SB W	LRX R322 SB-SB W
Satin Brass Frame/Satin Steel	LRX R212 SB-SS B	LRX R222 SB-SS B	LRX R232 SB-SS B	LRX R242 SB-SS B	LRX R312 SB-SS B	LRX R322 SB-SS B
Satin Brass Frame/Satin Steel	LRX R212 SB-SS W	LRX R222 SB-SS W	LRX R232 SB-SS W	LRX R242 SB-SS W	LRX R312 SB-SS W	LRX R322 SB-SS W
Satin Nickel Frame/Bright Steel	LRX R212 SN-BS B	LRX R222 SN-BS B	LRX R232 SN-BS B	LRX R242 SN-BS B	LRX R312 SN-BS B	LRX R322 SN-BS B
Satin Nickel Frame/Bright Steel	LRX R212 SN-BS W	LRX R222 SN-BS W	LRX R232 SN-BS W	LRX R242 SN-BS W	LRX R312 SN-BS W	LRX R322 SN-BS W
Satin Nickel Frame/Satin Steel	LRX R212 SN-SS B	LRX R222 SN-SS B	LRX R232 SN-SS B	LRX R242 SN-SS B	LRX R312 SN-SS B	LRX R322 SN-SS B
Satin Nickel Frame/Satin Steel	LRX R212 SN-SS W	LRX R222 SN-SS W	LRX R232 SN-SS W	LRX R242 SN-SS W	LRX R312 SN-SS W	LRX R322 SN-SS W
Nominal Size:	91.5mm x 91.5mm	91.5mm x 91.5mm	150.5mm x 91.5mm	150.5mm x 91.5mm	91.5mm x 91.5mm	91.5mm x 91.5mm
Minimum Wall Box Depth:	35mm	35mm	35mm	35mm	35mm	35mm
Technical Insert Ref:	R212	R222	R232	R232	R312	R322

Insert Surround Colour Key: (B) Black, (W) White

Linea-Rondo CFX

Wide Rockers



LRX WR21 PB-PB B



LRX WR21 SB-SB B



LRX WR23 BK-BK B



LRX WR23 BC-BS B



1 gang 10AX
2 Way Rocker



2 gang 10AX
2 Way Rocker



3 gang 10AX
2 Way Rocker



1 gang 10AX
Intermediate
Rocker



1 gang 10AX
Push To Make
Frame/ Push to
Break Retractive
Rocker



1 gang 10AX
Double Pole
Rocker

Frame Frame/ Front Plate

Antique Brass Frame/Antique Brass	LRX WR21 AB-AB B	LRX WR22 AB-AB B	LRX WR23 AB-AB B	LRX WR31 AB-AB B	LRX WRRT AB-AB B	LRX W10DP AB-AB B
Antique Brass Frame/Satin Brass	LRX WR21 AB-SB B	LRX WR22 AB-SB B	LRX WR23 AB-SB B	LRX WR31 AB-SB B	LRX WRRT AB-SB B	LRX W10DP AB-SB B
Black Nickel Frame/Black Nickel	LRX WR21 BK-BK B	LRX WR22 BK-BK B	LRX WR23 BK-BK B	LRX WR31 BK-BK B	LRX WRRT BK-BK B	LRX W10DP BK-BK B
Black Nickel Frame/Bright Steel	LRX WR21 BK-BS B	LRX WR22 BK-BS B	LRX WR23 BK-BS B	LRX WR31 BK-BS B	LRX WRRT BK-BS B	LRX W10DP BK-BS B
Black Nickel Frame/Polished Brass	LRX WR21 BK-PB B	LRX WR22 BK-PB B	LRX WR23 BK-PB B	LRX WR31 BK-PB B	LRX WRRT BK-PB B	LRX W10DP BK-PB B
Bright Chrome Frame/Black Nickel	LRX WR21 BC-BK B	LRX WR22 BC-BK B	LRX WR23 BC-BK B	LRX WR31 BC-BK B	LRX WRRT BC-BK B	LRX W10DP BC-BK B
Bright Chrome Frame/Bright Steel	LRX WR21 BC-BS B	LRX WR22 BC-BS B	LRX WR23 BC-BS B	LRX WR31 BC-BS B	LRX WRRT BC-BS B	LRX W10DP BC-BS B
Bright Chrome Frame/Bright Steel	LRX WR21 BC-BS W	LRX WR22 BC-BS W	LRX WR23 BC-BS W	LRX WR31 BC-BS W	LRX WRRT BC-BS W	LRX W10DP BC-BS W
Bright Chrome Frame/Plano Black	LRX WR21 BC-NB	LRX WR22 BC-NB	LRX WR23 BC-NB	LRX WR31 BC-NB	LRX WRRT BC-NB	LRX W10DP BC-NB
Bright Chrome Frame/Polished Brass	LRX WR21 BC-PB B	LRX WR22 BC-PB B	LRX WR23 BC-PB B	LRX WR31 BC-PB B	LRX WRRT BC-PB B	LRX W10DP BC-PB B
Bright Chrome Frame/Polished Brass	LRX WR21 BC-PB W	LRX WR22 BC-PB W	LRX WR23 BC-PB W	LRX WR31 BC-PB W	LRX WRRT BC-PB W	LRX W10DP BC-PB W
Bright Chrome Frame/Satin Steel	LRX WR21 BC-SS B	LRX WR22 BC-SS B	LRX WR23 BC-SS B	LRX WR31 BC-SS B	LRX WRRT BC-SS B	LRX W10DP BC-SS B
Bright Chrome Frame/Steel Steel	LRX WR21 BC-SS W	LRX WR22 BC-SS W	LRX WR23 BC-SS W	LRX WR31 BC-SS W	LRX WRRT BC-SS W	LRX W10DP BC-SS W
Connaught Bronze Frame/Connaught Bronze	LRX WR21 HB-HB B	LRX WR22 HB-HB B	LRX WR23 HB-HB B	LRX WR31 HB-HB B	LRX WRRT HB-HB B	LRX W10DP HB-HB B
Copper Bronze Frame/Copper Bronze	LRX WR21 CB-CB B	LRX WR22 CB-CB B	LRX WR23 CB-CB B	LRX WR31 CB-CB B	LRX WRRT CB-CB B	LRX W10DP CB-CB B
Etrium Bronze Frame/Etrium Bronze	LRX WR21 EB-EB B	LRX WR22 EB-EB B	LRX WR23 EB-EB B	LRX WR31 EB-EB B	LRX WRRT EB-EB B	LRX W10DP EB-EB B
Polished Brass Frame/Antique Brass	LRX WR21 PB-AB B	LRX WR22 PB-AB B	LRX WR23 PB-AB B	LRX WR31 PB-AB B	LRX WRRT PB-AB B	LRX W10DP PB-AB B
Polished Brass Frame/Antique Brass	LRX WR21 PB-AB W	LRX WR22 PB-AB W	LRX WR23 PB-AB W	LRX WR31 PB-AB W	LRX WRRT PB-AB W	LRX W10DP PB-AB W
Polished Brass Frame/Bright Steel	LRX WR21 PB-BS B	LRX WR22 PB-BS B	LRX WR23 PB-BS B	LRX WR31 PB-BS B	LRX WRRT PB-BS B	LRX W10DP PB-BS B
Polished Brass Frame/Bright Steel	LRX WR21 PB-BS W	LRX WR22 PB-BS W	LRX WR23 PB-BS W	LRX WR31 PB-BS W	LRX WRRT PB-BS W	LRX W10DP PB-BS W
Polished Brass Frame/Polished Brass	LRX WR21 PB-PB B	LRX WR22 PB-PB B	LRX WR23 PB-PB B	LRX WR31 PB-PB B	LRX WRRT PB-PB B	LRX W10DP PB-PB B
Polished Brass Frame/Polished Brass	LRX WR21 PB-PB W	LRX WR22 PB-PB W	LRX WR23 PB-PB W	LRX WR31 PB-PB W	LRX WRRT PB-PB W	LRX W10DP PB-PB W
Polished Brass Frame/Satin Brass	LRX WR21 PB-SB B	LRX WR22 PB-SB B	LRX WR23 PB-SB B	LRX WR31 PB-SB B	LRX WRRT PB-SB B	LRX W10DP PB-SB B
Polished Brass Frame/Satin Brass	LRX WR21 PB-SB W	LRX WR22 PB-SB W	LRX WR23 PB-SB W	LRX WR31 PB-SB W	LRX WRRT PB-SB W	LRX W10DP PB-SB W
Polished Brass Frame/Satin Steel	LRX WR21 PB-SS B	LRX WR22 PB-SS B	LRX WR23 PB-SS B	LRX WR31 PB-SS B	LRX WRRT PB-SS B	LRX W10DP PB-SS B
Polished Brass Frame/Satin Steel	LRX WR21 PB-SS W	LRX WR22 PB-SS W	LRX WR23 PB-SS W	LRX WR31 PB-SS W	LRX WRRT PB-SS W	LRX W10DP PB-SS W
Richmond Bronze Frame/ Richmond Bronze	LRX WR21 RB-RB B	LRX WR22 RB-RB B	LRX WR23 RB-RB B	LRX WR31 RB-RB B	LRX WRRT RB-RB B	LRX W10DP RB-RB B
Satin Brass Frame/Satin Brass	LRX WR21 SB-SB B	LRX WR22 SB-SB B	LRX WR23 SB-SB B	LRX WR31 SB-SB B	LRX WRRT SB-SB B	LRX W10DP SB-SB B
Satin Brass Frame/Satin Brass	LRX WR21 SB-SB W	LRX WR22 SB-SB W	LRX WR23 SB-SB W	LRX WR31 SB-SB W	LRX WRRT SB-SB W	LRX W10DP SB-SB W
Satin Brass Frame/Satin Steel	LRX WR21 SB-SS B	LRX WR22 SB-SS B	LRX WR23 SB-SS B	LRX WR31 SB-SS B	LRX WRRT SB-SS B	LRX W10DP SB-SS B
Satin Brass Frame/Satin Steel	LRX WR21 SB-SS W	LRX WR22 SB-SS W	LRX WR23 SB-SS W	LRX WR31 SB-SS W	LRX WRRT SB-SS W	LRX W10DP SB-SS W
Satin Nickel Frame/Bright Steel	LRX WR21 SN-BS B	LRX WR22 SN-BS B	LRX WR23 SN-BS B	LRX WR31 SN-BS B	LRX WRRT SN-BS B	LRX W10DP SN-BS B
Satin Nickel Frame/Bright Steel	LRX WR21 SN-BS W	LRX WR22 SN-BS W	LRX WR23 SN-BS W	LRX WR31 SN-BS W	LRX WRRT SN-BS W	LRX W10DP SN-BS W
Satin Nickel Frame/Satin Steel	LRX WR21 SN-SS B	LRX WR22 SN-SS B	LRX WR23 SN-SS B	LRX WR31 SN-SS B	LRX WRRT SN-SS B	LRX W10DP SN-SS B
Satin Nickel Frame/Satin Steel	LRX WR21 SN-SS W	LRX WR22 SN-SS W	LRX WR23 SN-SS W	LRX WR31 SN-SS W	LRX WRRT SN-SS W	LRX W10DP SN-SS W
Satin Nickel Frame/Satin Steel	LRX WR21 SN-SS QG	LRX WR22 SN-SS QG	LRX WR23 SN-SS QG	LRX WR31 SN-SS QG	LRX WRRT SN-SS QG	LRX W10DP SN-SS QG
Satin Nickel Frame/Satin Steel	LRX WR21 SN-SS W	LRX WR22 SN-SS W	LRX WR23 SN-SS W	LRX WR31 SN-SS W	LRX WRRT SN-SS W	LRX W10DP SN-SS W
Nominal Size:	91.5mm x 91.5mm	91.5mm x 91.5mm	91.5mm x 91.5mm	91.5mm x 91.5mm	91.5mm x 91.5mm	91.5mm x 91.5mm
Minimum Wall Box Depth:	25mm	25mm	25mm	25mm	25mm	25mm
Technical Insert Ref:	WR21	WR22	WR23	WR31	WRRT	W10DP

Insert Surround Colour Key: (B) Black, (W) White, (QG) Quartz Grey

Linea-Rondo CFX

Toggle Switches



LRX T21 AB-SB



LRX T22 BK-BK



LRX T23 PB-BS



LRX T24 BC-SS



1 gang 20AX
2 Way Toggle



2 gang 20AX
2 Way Toggle



3 gang 20AX
2 Way Toggle



4 gang 20AX
2 Way Toggle



1 gang 20AX
Intermediate Toggle

Frame / Front Plate	LRX T21 AB-AB	LRX T22 AB-AB	LRX T23 AB-AB	LRX T24 AB-AB	LRX T31 AB-AB
Antique Brass Frame/Antique Brass	LRX T21 AB-SB	LRX T22 AB-SB	LRX T23 AB-SB	LRX T24 AB-SB	LRX T31 AB-SB
Antique Brass Frame/Satin Brass	LRX T21 BK-BK	LRX T22 BK-BK	LRX T23 BK-BK	LRX T24 BK-BK	LRX T31 BK-BK
Black Nickel Frame/Black Nickel	LRX T21 BK-BS	LRX T22 BK-BS	LRX T23 BK-BS	LRX T24 BK-BS	LRX T31 BK-BS
Black Nickel Frame/Bright Steel	LRX T21 BK-PB	LRX T22 BK-PB	LRX T23 BK-PB	LRX T24 BK-PB	LRX T31 BK-PB
Black Nickel Frame/Polished Brass	LRX T21 BC-BK	LRX T22 BC-BK	LRX T23 BC-BK	LRX T24 BC-BK	LRX T31 BC-BK
Bright Chrome Frame/Black Nickel	LRX T21 BC-BS	LRX T22 BC-BS	LRX T23 BC-BS	LRX T24 BC-BS	LRX T31 BC-BS
Bright Chrome Frame/Bright Steel	LRX T21 BC-N	LRX T22 BC-N	LRX T23 BC-N	LRX T24 BC-N	LRX T31 BC-N
Bright Chrome Frame/Plano Black	LRX T21 BC-PB	LRX T22 BC-PB	LRX T23 BC-PB	LRX T24 BC-PB	LRX T31 BC-PB
Bright Chrome Frame/Polished Brass	LRX T21 BC-SS	LRX T22 BC-SS	LRX T23 BC-SS	LRX T24 BC-SS	LRX T31 BC-SS
Bright Chrome Frame/Satin Steel	LRX T21 HB-HB	LRX T22 HB-HB	LRX T23 HB-HB	LRX T24 HB-HB	LRX T31 HB-HB
Connaught Bronze Frame/Connaught Bronze	LRX T21 CB-CB	LRX T22 CB-CB	LRX T23 CB-CB	LRX T24 CB-CB	LRX T31 CB-CB
Copper Bronze Frame/Copper Bronze	LRX T21 EB-EB	LRX T22 EB-EB	LRX T23 EB-EB	LRX T24 EB-EB	LRX T31 EB-EB
Etrium Bronze Frame/Etrium Bronze	LRX T21 PB-AB	LRX T22 PB-AB	LRX T23 PB-AB	LRX T24 PB-AB	LRX T31 PB-AB
Polished Brass Frame/Antique Brass	LRX T21 PB-BS	LRX T22 PB-BS	LRX T23 PB-BS	LRX T24 PB-BS	LRX T31 PB-BS
Polished Brass Frame/Bright Steel	LRX T21 PB-PB	LRX T22 PB-PB	LRX T23 PB-PB	LRX T24 PB-PB	LRX T31 PB-PB
Polished Brass Frame/Polished Brass	LRX T21 PB-SB	LRX T22 PB-SB	LRX T23 PB-SB	LRX T24 PB-SB	LRX T31 PB-SB
Polished Brass Frame/Satin Brass	LRX T21 PB-SS	LRX T22 PB-SS	LRX T23 PB-SS	LRX T24 PB-SS	LRX T31 PB-SS
Polished Brass Frame/Satin Steel	LRX T21 RB-RB	LRX T22 RB-RB	LRX T23 RB-RB	LRX T24 RB-RB	LRX T31 RB-RB
Richmond Bronze Frame/Richmond Bronze	LRX T21 SB-SB	LRX T22 SB-SB	LRX T23 SB-SB	LRX T24 SB-SB	LRX T31 SB-SB
Satin Brass Frame/Satin Brass	LRX T21 SB-SS	LRX T22 SB-SS	LRX T23 SB-SS	LRX T24 SB-SS	LRX T31 SB-SS
Satin Brass Frame/Satin Steel	LRX T21 SN-BS	LRX T22 SN-BS	LRX T23 SN-BS	LRX T24 SN-BS	LRX T31 SN-BS
Satin Nickel Frame/Bright Steel*	LRX T21 SN-SS	LRX T22 SN-SS	LRX T23 SN-SS	LRX T24 SN-SS	LRX T31 SN-SS
Satin Nickel Frame/Satin Steel*					
Nominal Size:	91.5mm x 91.5mm	91.5mm x 91.5mm	150.5mm x 91.5mm	150.5mm x 91.5mm	91.5mm x 91.5mm
Minimum Wall Box Depth:	35mm	35mm	35mm	35mm	35mm
Technical Insert Ref:	T21	T22	T23	T24	T31

Toggles to match Frame Finish as standard except where specified.

*Satin Chrome Toggles

Linea-Rondo CFX

Power Sockets



LRX SS1 SB-SB W

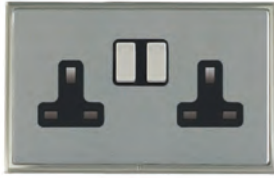

LRX SS2 SN-SS B



LRX US5 PB-PB W



LRX SHS PB-SB B



1 gang 13A
Double Pole
Switched
Socket

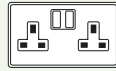

2 gang 13A
Double Pole
Switched
Socket

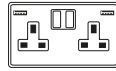

2 gang 13A Double
Pole Switched
Socket with 2 USB
Outlet 2x2.4A (4.8A
Total)



1 gang 2A
Unswitched
Socket



1 gang 5A
Unswitched
Socket

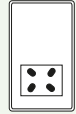

Shaver
Dual Voltage
Unswitched Socket
(Vertically Mounted)

Frame / Front Plate	LRX SS1 AB-AB B	LRX SS2 AB-AB B	LRX SS2USBULT AB-AB B	LRX US2 AB-AB B	LRX US5 AB-AB B	LRX SHS AB-AB B
Antique Brass Frame/Antique Brass	LRX SS1 AB-AB B	LRX SS2 AB-AB B	LRX SS2USBULT AB-AB B	LRX US2 AB-AB B	LRX US5 AB-AB B	LRX SHS AB-AB B
Antique Brass Frame/Satin Brass	LRX SS1 AB-SB B	LRX SS2 AB-SB B	LRX SS2USBULT AB-SB B	LRX US2 AB-SB B	LRX US5 AB-SB B	LRX SHS AB-SB B
Black Nickel Frame/Black Nickel	LRX SS1 BK-BK B	LRX SS2 BK-BK B	LRX SS2USBULT BK-BK B	LRX US2 BK-BK B	LRX US5 BK-BK B	LRX SHS BK-BK B
Black Nickel Frame/Bright Steel	LRX SS1 BK-BS B	LRX SS2 BK-BS B	LRX SS2USBULT BK-BS B	LRX US2 BK-BS B	LRX US5 BK-BS B	LRX SHS BK-BS B
Black Nickel Frame/Polished Brass	LRX SS1 BK-PB B	LRX SS2 BK-PB B	LRX SS2USBULT BK-PB B	LRX US2 BK-PB B	LRX US5 BK-PB B	LRX SHS BK-PB B
Bright Chrome Frame/Black Nickel	LRX SS1 BC-BK B	LRX SS2 BC-BK B	LRX SS2USBULT BC-BK B	LRX US2 BC-BK B	LRX US5 BC-BK B	LRX SHS BC-BK B
Bright Chrome Frame/Bright Steel	LRX SS1 BC-BS B	LRX SS2 BC-BS B	LRX SS2USBULT BC-BS B	LRX US2 BC-BS B	LRX US5 BC-BS B	LRX SHS BC-BS B
Bright Chrome Frame/LRXL	LRX SS1 BC-BW	LRX SS2 BC-BW	LRX SS2USBULT BC-BW	LRX US2 BC-BW	LRX US5 BC-BW	LRX SHS BC-BW
Bright Chrome Frame/Piano Black	LRX SS1 BC-NB	LRX SS2 BC-NB	LRX SS2USBULT BC-NB	LRX US2 BC-NB	LRX US5 BC-NB	LRX SHS BC-NB
Bright Chrome Frame/Polished Brass	LRX SS1 BC-PB B	LRX SS2 BC-PB B	LRX SS2USBULT BC-PB B	LRX US2 BC-PB B	LRX US5 BC-PB B	LRX SHS BC-PB B
Bright Chrome Frame/Polished Brass	LRX SS1 BC-PB W	LRX SS2 BC-PB W	LRX SS2USBULT BC-PB W	LRX US2 BC-PB W	LRX US5 BC-PB W	LRX SHS BC-PB W
Bright Chrome Frame/Satin Steel	LRX SS1 BC-SS B	LRX SS2 BC-SS B	LRX SS2USBULT BC-SS B	LRX US2 BC-SS B	LRX US5 BC-SS B	LRX SHS BC-SS B
Bright Chrome Frame/Satin Steel	LRX SS1 BC-SS W	LRX SS2 BC-SS W	LRX SS2USBULT BC-SS W	LRX US2 BC-SS W	LRX US5 BC-SS W	LRX SHS BC-SS W
Connaught Bronze Frame/Connaught Bronze	LRX SS1 HB-HB B	LRX SS2 HB-HB B	LRX SS2USBULT HB-HB B	LRX US2 HB-HB B	LRX US5 HB-HB B	LRX SHS HB-HB B
Copper Bronze Frame/Copper Bronze	LRX SS1 CB-CB B	LRX SS2 CB-CB B	LRX SS2USBULT CB-CB B	LRX US2 CB-CB B	LRX US5 CB-CB B	LRX SHS CB-CB B
Etrium Bronze Frame/Etrium Bronze	LRX SS1 EB-EB B	LRX SS2 EB-EB B	LRX SS2USBULT EB-EB B	LRX US2 EB-EB B	LRX US5 EB-EB B	LRX SHS EB-EB B
Polished Brass Frame/Antique Brass	LRX SS1 PB-AB B	LRX SS2 PB-AB B	LRX SS2USBULT PB-AB B	LRX US2 PB-AB B	LRX US5 PB-AB B	LRX SHS PB-AB B
Polished Brass Frame/Antique Brass	LRX SS1 PB-AB W	LRX SS2 PB-AB W	LRX SS2USBULT PB-AB W	LRX US2 PB-AB W	LRX US5 PB-AB W	LRX SHS PB-AB W
Polished Brass Frame/Bright Steel	LRX SS1 PB-BS B	LRX SS2 PB-BS B	LRX SS2USBULT PB-BS B	LRX US2 PB-BS B	LRX US5 PB-BS B	LRX SHS PB-BS B
Polished Brass Frame/Bright Steel	LRX SS1 PB-BS W	LRX SS2 PB-BS W	LRX SS2USBULT PB-BS W	LRX US2 PB-BS W	LRX US5 PB-BS W	LRX SHS PB-BS W
Polished Brass Frame/Polished Brass	LRX SS1 PB-PB B	LRX SS2 PB-PB B	LRX SS2USBULT PB-PB B	LRX US2 PB-PB B	LRX US5 PB-PB B	LRX SHS PB-PB B
Polished Brass Frame/Polished Brass	LRX SS1 PB-PB W	LRX SS2 PB-PB W	LRX SS2USBULT PB-PB W	LRX US2 PB-PB W	LRX US5 PB-PB W	LRX SHS PB-PB W
Polished Brass Frame/Satin Brass	LRX SS1 PB-SB B	LRX SS2 PB-SB B	LRX SS2USBULT PB-SB B	LRX US2 PB-SB B	LRX US5 PB-SB B	LRX SHS PB-SB B
Polished Brass Frame/Satin Brass	LRX SS1 PB-SB W	LRX SS2 PB-SB W	LRX SS2USBULT PB-SB W	LRX US2 PB-SB W	LRX US5 PB-SB W	LRX SHS PB-SB W
Polished Brass Frame/Satin Steel	LRX SS1 PB-SS B	LRX SS2 PB-SS B	LRX SS2USBULT PB-SS B	LRX US2 PB-SS B	LRX US5 PB-SS B	LRX SHS PB-SS B
Polished Brass Frame/Satin Steel	LRX SS1 PB-SS W	LRX SS2 PB-SS W	LRX SS2USBULT PB-SS W	LRX US2 PB-SS W	LRX US5 PB-SS W	LRX SHS PB-SS W
Richmond Bronze Frame/Richmond Bronze	LRX SS1 RB-RB B	LRX SS2 RB-RB B	LRX SS2USBULT RB-RB B	LRX US2 RB-RB B	LRX US5 RB-RB B	LRX SHS RB-RB B
Satin Brass Frame/Satin Brass	LRX SS1 SB-SB B	LRX SS2 SB-SB B	LRX SS2USBULT SB-SB B	LRX US2 SB-SB B	LRX US5 SB-SB B	LRX SHS SB-SB B
Satin Brass Frame/Satin Brass	LRX SS1 SB-SB W	LRX SS2 SB-SB W	LRX SS2USBULT SB-SB W	LRX US2 SB-SB W	LRX US5 SB-SB W	LRX SHS SB-SB W
Satin Brass Frame/Satin Steel	LRX SS1 SB-SS B	LRX SS2 SB-SS B	LRX SS2USBULT SB-SS B	LRX US2 SB-SS B	LRX US5 SB-SS B	LRX SHS SB-SS B
Satin Brass Frame/Satin Steel	LRX SS1 SB-SS W	LRX SS2 SB-SS W	LRX SS2USBULT SB-SS W	LRX US2 SB-SS W	LRX US5 SB-SS W	LRX SHS SB-SS W
Satin Nickel Frame/Bright Steel	LRX SS1 SN-BS B	LRX SS2 SN-BS B	LRX SS2USBULT SN-BS B	LRX US2 SN-BS B	LRX US5 SN-BS B	LRX SHS SN-BS B
Satin Nickel Frame/Bright Steel	LRX SS1 SN-BS W	LRX SS2 SN-BS W	LRX SS2USBULT SN-BS W	LRX US2 SN-BS W	LRX US5 SN-BS W	LRX SHS SN-BS W
Satin Nickel Frame/Satin Steel	LRX SS1 SN-SS B	LRX SS2 SN-SS B	LRX SS2USBULT SN-SS B	LRX US2 SN-SS B	LRX US5 SN-SS B	LRX SHS SN-SS B
Satin Nickel Frame/Satin Steel	LRX SS1 SN-SS W	LRX SS2 SN-SS W	LRX SS2USBULT SN-SS W	LRX US2 SN-SS W	LRX US5 SN-SS W	LRX SHS SN-SS W
Nominal Size:	91.5mm x 91.5mm	150.5mm x 91.5mm	150.5mm x 91.5mm	91.5mm x 91.5mm	91.5mm x 91.5mm	91.5mm x 150.5mm
Minimum Wall Box Depth:	35mm	35mm	35mm	35mm	35mm	47mm
Technical Insert Ref:	SS1	SS2	SS2USBULT	US2	US5	SHS

Insert Surround Colour Key: (B) Black, (W) White

Linea-Rondo CFX

International Power Sockets



LRX 5320 CB-CB B



LRX 5320 PB-AB B



LRX 6126 SN-BS W



1 gang 15A 110V
AC American
Unswitched Socket

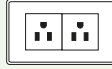

2 gang 15A 110V
AC American
Unswitched Socket



1 gang 10/16A
220/250V AC
German Unswitched
Socket

Frame / Front Plate	1 gang 15A 110V AC American Unswitched Socket	2 gang 15A 110V AC American Unswitched Socket	1 gang 10/16A 220/250V AC German Unswitched Socket
Antique Brass Frame/Antique Brass	LRX 5258 AB-AB B	LRX 5320 AB-AB B	LRX 6126 AB-AB B
Antique Brass Frame/Satin Brass	LRX 5258 AB-SB B	LRX 5320 AB-SB B	LRX 6126 AB-SB B
Black Nickel Frame/Black Nickel	LRX 5258 BK-BK B	LRX 5320 BK-BK B	LRX 6126 BK-BK B
Black Nickel Frame/Bright Steel	LRX 5258 BK-BS B	LRX 5320 BK-BS B	LRX 6126 BK-BS B
Black Nickel Frame/Polished Brass	LRX 5258 BK-PB B	LRX 5320 BK-PB B	LRX 6126 BK-PB B
Bright Chrome Frame/Black Nickel	LRX 5258 BC-BK B	LRX 5320 BC-BK B	LRX 6126 BC-BK B
Bright Chrome Frame/Bright Steel	LRX 5258 BC-BS B	LRX 5320 BC-BS B	LRX 6126 BC-BS B
Bright Chrome Frame/Bright Steel	LRX 5258 BC-BS W	LRX 5320 BC-BS W	LRX 6126 BC-BS W
Bright Chrome Frame/Piano Black	LRX 5258 BC-N B	LRX 5320 BC-N B	LRX 6126 BC-N B
Bright Chrome Frame/Polished Brass	LRX 5258 BC-PB B	LRX 5320 BC-PB B	LRX 6126 BC-PB B
Bright Chrome Frame/Polished Brass	LRX 5258 BC-PB W	LRX 5320 BC-PB W	LRX 6126 BC-PB W
Bright Chrome Frame/Satin Steel	LRX 5258 BC-SS B	LRX 5320 BC-SS B	LRX 6126 BC-SS B
Bright Chrome Frame/Satin Steel	LRX 5258 BC-SS W	LRX 5320 BC-SS W	LRX 6126 BC-SS W
Connaught Bronze Frame/Connaught Bronze	LRX 5258 HB-HB B	LRX 5320 HB-HB B	LRX 6126 HB-HB B
Copper Bronze Frame/Copper Bronze	LRX 5258 CB-CB B	LRX 5320 CB-CB B	LRX 6126 CB-CB B
Etrium Bronze Frame/Etrium Bronze	LRX 5258 EB-EB B	LRX 5320 EB-EB B	LRX 6126 EB-EB B
Polished Brass Frame/Antique Brass	LRX 5258 PB-AB B	LRX 5320 PB-AB B	LRX 6126 PB-AB B
Polished Brass Frame/Antique Brass	LRX 5258 PB-AB W	LRX 5320 PB-AB W	LRX 6126 PB-AB W
Polished Brass Frame/Bright Steel	LRX 5258 PB-BS B	LRX 5320 PB-BS B	LRX 6126 PB-BS B
Polished Brass Frame/Bright Steel	LRX 5258 PB-BS W	LRX 5320 PB-BS W	LRX 6126 PB-BS W
Polished Brass Frame/Polished Brass	LRX 5258 PB-PB B	LRX 5320 PB-PB B	LRX 6126 PB-PB B
Polished Brass Frame/Polished Brass	LRX 5258 PB-PB W	LRX 5320 PB-PB W	LRX 6126 PB-PB W
Polished Brass Frame/Satin Brass	LRX 5258 PB-SB B	LRX 5320 PB-SB B	LRX 6126 PB-SB B
Polished Brass Frame/Satin Brass	LRX 5258 PB-SB W	LRX 5320 PB-SB W	LRX 6126 PB-SB W
Polished Brass Frame/Satin Steel	LRX 5258 PB-SS B	LRX 5320 PB-SS B	LRX 6126 PB-SS B
Polished Brass Frame/Satin Steel	LRX 5258 PB-SS W	LRX 5320 PB-SS W	LRX 6126 PB-SS W
Richmond Bronze Frame/Richmond Bronze	LRX 5258 RB-RB B	LRX 5320 RB-RB B	LRX 6126 RB-RB B
Satin Brass Frame/Satin Brass	LRX 5258 SB-SB B	LRX 5320 SB-SB B	LRX 6126 SB-SB B
Satin Brass Frame/Satin Brass	LRX 5258 SB-SB W	LRX 5320 SB-SB W	LRX 6126 SB-SB W
Satin Brass Frame/Satin Steel	LRX 5258 SB-SS B	LRX 5320 SB-SS B	LRX 6126 SB-SS B
Satin Brass Frame/Satin Steel	LRX 5258 SB-SS W	LRX 5320 SB-SS W	LRX 6126 SB-SS W
Satin Nickel Frame/Bright Steel	LRX 5258 SN-BS B	LRX 5320 SN-BS B	LRX 6126 SN-BS B
Satin Nickel Frame/Bright Steel	LRX 5258 SN-BS W	LRX 5320 SN-BS W	LRX 6126 SN-BS W
Satin Nickel Frame/Satin Steel	LRX 5258 SN-SS B	LRX 5320 SN-SS B	LRX 6126 SN-SS B
Satin Nickel Frame/Satin Steel	LRX 5258 SN-SS W	LRX 5320 SN-SS W	LRX 6126 SN-SS W
Nominal Size:	91.5mm x 91.5mm	150.5mm x 91.5mm	91.5mm x 91.5mm
Minimum Wall Box Depth:	35mm	35mm	47mm
Technical Insert Ref:	5258	5320	6126

Insert Surround Colour Key: (B) Black, (W) White

Linea-Rondo CFX

Key Switches



LRX K21 BK-BK B



LRX KEL SB-SB W



LRX C11 BC-BS W



1 gang 20AX 2 Way Key Switch



1 gang 20AX 2 Way Key Switch EMG LTG TEST



1 gang 10A (6AX) Card Switch On/Off with Blue LED Locator

Frame / Front Plate	LRX K21 AB-AB B	LRX KEL AB-AB B
Antique Brass Frame/Antique Brass	LRX K21 AB-AB B	LRX KEL AB-AB B
Antique Brass Frame/Satin Brass	LRX K21 AB-SB B	LRX KEL AB-SB B
Black Nickel Frame/Black Nickel	LRX K21 BK-BK B	LRX KEL BK-BK B
Black Nickel Frame/Bright Steel	LRX K21 BK-BS B	LRX KEL BK-BS B
Black Nickel Frame/Polished Brass	LRX K21 BK-PB B	LRX KEL BK-PB B
Bright Chrome Frame/Black Nickel	LRX K21 BC-BK B	LRX KEL BC-BK B
Bright Chrome Frame/Bright Steel	LRX K21 BC-BS B	LRX KEL BC-BS B
Bright Chrome Frame/Bright Steel	LRX K21 BC-BS W	LRX KEL BC-BS W
Bright Chrome Frame/Piano Black	LRX K21 BC-N B	LRX KEL BC-N B
Bright Chrome Frame/Polished Brass	LRX K21 BC-PB B	LRX KEL BC-PB B
Bright Chrome Frame/Polished Brass	LRX K21 BC-PB W	LRX KEL BC-PB W
Bright Chrome Frame/Satin Steel	LRX K21 BC-SS B	LRX KEL BC-SS B
Bright Chrome Frame/Satin Steel	LRX K21 BC-SS W	LRX KEL BC-SS W
Connaught Bronze Frame/Connaught Bronze	LRX K21 HB-HB B	LRX KEL HB-HB B
Copper Bronze Frame/Copper Bronze	LRX K21 CB-CB B	LRX KEL CB-CB B
Etrium Bronze Frame/Etrium Bronze	LRX K21 EB-EB B	LRX KEL EB-EB B
Polished Brass Frame/Antique Brass	LRX K21 PB-AB B	LRX KEL PB-AB B
Polished Brass Frame/Antique Brass	LRX K21 PB-AB W	LRX KEL PB-AB W
Polished Brass Frame/Bright Steel	LRX K21 PB-BS B	LRX KEL PB-BS B
Polished Brass Frame/Bright Steel	LRX K21 PB-BS W	LRX KEL PB-BS W
Polished Brass Frame/Polished Brass	LRX K21 PB-PB B	LRX KEL PB-PB B
Polished Brass Frame/Polished Brass	LRX K21 PB-PB W	LRX KEL PB-PB W
Polished Brass Frame/Satin Brass	LRX K21 PB-SB B	LRX KEL PB-SB B
Polished Brass Frame/Satin Brass	LRX K21 PB-SB W	LRX KEL PB-SB W
Polished Brass Frame/Satin Steel	LRX K21 PB-SS B	LRX KEL PB-SS B
Polished Brass Frame/Satin Steel	LRX K21 PB-SS W	LRX KEL PB-SS W
Richmond Bronze Frame/Richmond Bronze	LRX K21 RB-RB B	LRX KEL RB-RB B
Satin Brass Frame/Satin Brass	LRX K21 SB-SB B	LRX KEL SB-SB B
Satin Brass Frame/Satin Brass	LRX K21 SB-SB W	LRX KEL SB-SB W
Satin Brass Frame/Satin Steel	LRX K21 SB-SS B	LRX KEL SB-SS B
Satin Brass Frame/Satin Steel	LRX K21 SB-SS W	LRX KEL SB-SS W
Satin Nickel Frame/Bright Steel	LRX K21 SN-BS B	LRX KEL SN-BS B
Satin Nickel Frame/Bright Steel	LRX K21 SN-BS W	LRX KEL SN-BS W
Satin Nickel Frame/Satin Steel	LRX K21 SN-SS B	LRX KEL SN-SS B
Satin Nickel Frame/Satin Steel	LRX K21 SN-SS W	LRX KEL SN-SS W
Nominal Size:	91.5mm x 91.5mm	91.5mm x 91.5mm
Minimum Wall Box Depth:	35mm	35mm
Technical Insert Ref:	K21	KEL

Hotel Card Switch with LED

Frame / Front Plate	LRX C11 AB-AB B
Antique Brass Frame/Antique Brass	LRX C11 AB-AB B
Antique Brass Frame/Satin Brass	LRX C11 AB-SB B
Black Nickel Frame/Black Nickel	LRX C11 BK-BK B
Black Nickel Frame/Bright Steel	LRX C11 BK-BS B
Black Nickel Frame/Polished Brass	LRX C11 BK-PB B
Bright Chrome Frame/Black Nickel	LRX C11 BC-BK B
Bright Chrome Frame/Bright Steel	LRX C11 BC-BS B
Bright Chrome Frame/Bright Steel	LRX C11 BC-BS W
Bright Chrome Frame/Piano Black	LRX C11 BC-N B
Bright Chrome Frame/Polished Brass	LRX C11 BC-PB B
Bright Chrome Frame/Polished Brass	LRX C11 BC-PB W
Bright Chrome Frame/Satin Steel	LRX C11 BC-SS B
Bright Chrome Frame/Satin Steel	LRX C11 BC-SS W
Connaught Bronze Frame/Connaught Bronze	LRX C11 HB-HB B
Copper Bronze Frame/Copper Bronze	LRX C11 CB-CB B
Etrium Bronze Frame/Etrium Bronze	LRX C11 EB-EB B
Polished Brass Frame/Antique Brass	LRX C11 PB-AB B
Polished Brass Frame/Antique Brass	LRX C11 PB-AB W
Polished Brass Frame/Bright Steel	LRX C11 PB-BS B
Polished Brass Frame/Bright Steel	LRX C11 PB-BS W
Polished Brass Frame/Polished Brass	LRX C11 PB-PB B
Polished Brass Frame/Polished Brass	LRX C11 PB-PB W
Polished Brass Frame/Satin Brass	LRX C11 PB-SB B
Polished Brass Frame/Satin Brass	LRX C11 PB-SB W
Polished Brass Frame/Satin Steel	LRX C11 PB-SS B
Polished Brass Frame/Satin Steel	LRX C11 PB-SS W
Richmond Bronze Frame/Richmond Bronze	LRX C11 RB-RB B
Satin Brass Frame/Satin Brass	LRX C11 SB-SB B
Satin Brass Frame/Satin Brass	LRX C11 SB-SB W
Satin Brass Frame/Satin Steel	LRX C11 SB-SS B
Satin Brass Frame/Satin Steel	LRX C11 SB-SS W
Satin Nickel Frame/Bright Steel	LRX C11 SN-BS B
Satin Nickel Frame/Bright Steel	LRX C11 SN-BS W
Satin Nickel Frame/Satin Steel	LRX C11 SN-SS B
Satin Nickel Frame/Satin Steel	LRX C11 SN-SS W
Nominal Size:	91.5mm x 91.5mm
Minimum Wall Box Depth:	35mm
Technical Insert Ref:	C11

Insert Surround Colour Key: (B) Black, (W) White

Linea-Rondo CFX

Television Coaxial Sockets

LINEA-RONDO CFX RANGE



LRX TV BK-BK B



LRX TVFM BC-NB



LRX SATN PB-BS W



LRX SATI SN-BS W



1 gang
Non-Isolated
TV 1in/1out



Isolated TV/FM
Diplexer
1in/2out



1 gang
Isolated
TV 1in/1out



2 gang
Non-Isolated
TV+Satellite
2in/2out



1 gang
Non-Isolated
Satellite



1 gang
Isolated Satellite

Frame / Front Plate	1 gang Non-Isolated TV 1in/1out	Isolated TV/FM Diplexer 1in/2out	1 gang Isolated TV 1in/1out	2 gang Non-Isolated TV+Satellite 2in/2out	1 gang Non-Isolated Satellite	1 gang Isolated Satellite
Antique Brass Frame/Antique Brass	LRX TV AB-AB B	LRX TVFM AB-AB B	LRX TVI AB-AB B	LRX TVSAT AB-AB B	LRX SATN AB-AB B	LRX SATI AB-AB B
Antique Brass Frame/Satin Brass	LRX TV AB-SB B	LRX TVFM AB-SB B	LRX TVI AB-SB B	LRX TVSAT AB-SB B	LRX SATN AB-SB B	LRX SATI AB-SB B
Black Nickel Frame/Black Nickel	LRX TV BK-BK B	LRX TVFM BK-BK B	LRX TVI BK-BK B	LRX TVSAT BK-BK B	LRX SATN BK-BK B	LRX SATI BK-BK B
Black Nickel Frame/Bright Steel	LRX TV BK-BS B	LRX TVFM BK-BS B	LRX TVI BK-BS B	LRX TVSAT BK-BS B	LRX SATN BK-BS B	LRX SATI BK-BS B
Black Nickel Frame/Polished Brass	LRX TV BK-PB B	LRX TVFM BK-PB B	LRX TVI BK-PB B	LRX TVSAT BK-PB B	LRX SATN BK-PB B	LRX SATI BK-PB B
Bright Chrome Frame/Black Nickel	LRX TV BC-BK B	LRX TVFM BC-BK B	LRX TVI BC-BK B	LRX TVSAT BC-BK B	LRX SATN BC-BK B	LRX SATI BC-BK B
Bright Chrome Frame/Bright Steel	LRX TV BC-BS B	LRX TVFM BC-BS B	LRX TVI BC-BS B	LRX TVSAT BC-BS B	LRX SATN BC-BS B	LRX SATI BC-BS B
Bright Chrome Frame/Bright Steel	LRX TV BC-BS W	LRX TVFM BC-BS W	LRX TVI BC-BS W	LRX TVSAT BC-BS W	LRX SATN BC-BS W	LRX SATI BC-BS W
Bright Chrome Frame/Poliano Black	LRX TV BC-NB	LRX TVFM BC-NB	LRX TVI BC-NB	LRX TVSAT BC-NB	LRX SATN BC-NB	LRX SATI BC-NB
Bright Chrome Frame/Polished Brass	LRX TV BC-PB B	LRX TVFM BC-PB B	LRX TVI BC-PB B	LRX TVSAT BC-PB B	LRX SATN BC-PB B	LRX SATI BC-PB B
Bright Chrome Frame/Polished Brass	LRX TV BC-PB W	LRX TVFM BC-PB W	LRX TVI BC-PB W	LRX TVSAT BC-PB W	LRX SATN BC-PB W	LRX SATI BC-PB W
Bright Chrome Frame/Satin Steel	LRX TV BC-SS B	LRX TVFM BC-SS B	LRX TVI BC-SS B	LRX TVSAT BC-SS B	LRX SATN BC-SS B	LRX SATI BC-SS B
Bright Chrome Frame/Satin Steel	LRX TV BC-SS W	LRX TVFM BC-SS W	LRX TVI BC-SS W	LRX TVSAT BC-SS W	LRX SATN BC-SS W	LRX SATI BC-SS W
Connaught Bronze Frame/Connaught Bronze	LRX TV HB-HB B	LRX TVFM HB-HB B	LRX TVI HB-HB B	LRX TVSAT HB-HB B	LRX SATN HB-HB B	LRX SATI HB-HB B
Copper Bronze Frame/Copper Bronze	LRX TV CB-CB B	LRX TVFM CB-CB B	LRX TVI CB-CB B	LRX TVSAT CB-CB B	LRX SATN CB-CB B	LRX SATI CB-CB B
Etrium Bronze Frame/Etrium Bronze	LRX TV EB-EB B	LRX TVFM EB-EB B	LRX TVI EB-EB B	LRX TVSAT EB-EB B	LRX SATN EB-EB B	LRX SATI EB-EB B
Polished Brass Frame/Antique Brass	LRX TV PB-AB B	LRX TVFM PB-AB B	LRX TVI PB-AB B	LRX TVSAT PB-AB B	LRX SATN PB-AB B	LRX SATI PB-AB B
Polished Brass Frame/Antique Brass	LRX TV PB-AB W	LRX TVFM PB-AB W	LRX TVI PB-AB W	LRX TVSAT PB-AB W	LRX SATN PB-AB W	LRX SATI PB-AB W
Polished Brass Frame/Bright Steel	LRX TV PB-BS B	LRX TVFM PB-BS B	LRX TVI PB-BS B	LRX TVSAT PB-BS B	LRX SATN PB-BS B	LRX SATI PB-BS B
Polished Brass Frame/Bright Steel	LRX TV PB-BS W	LRX TVFM PB-BS W	LRX TVI PB-BS W	LRX TVSAT PB-BS W	LRX SATN PB-BS W	LRX SATI PB-BS W
Polished Brass Frame/Polished Brass	LRX TV PB-PB B	LRX TVFM PB-PB B	LRX TVI PB-PB B	LRX TVSAT PB-PB B	LRX SATN PB-PB B	LRX SATI PB-PB B
Polished Brass Frame/Polished Brass	LRX TV PB-PB W	LRX TVFM PB-PB W	LRX TVI PB-PB W	LRX TVSAT PB-PB W	LRX SATN PB-PB W	LRX SATI PB-PB W
Polished Brass Frame/Satin Brass	LRX TV PB-SB B	LRX TVFM PB-SB B	LRX TVI PB-SB B	LRX TVSAT PB-SB B	LRX SATN PB-SB B	LRX SATI PB-SB B
Polished Brass Frame/Satin Brass	LRX TV PB-SB W	LRX TVFM PB-SB W	LRX TVI PB-SB W	LRX TVSAT PB-SB W	LRX SATN PB-SB W	LRX SATI PB-SB W
Polished Brass Frame/Satin Steel	LRX TV PB-SS B	LRX TVFM PB-SS B	LRX TVI PB-SS B	LRX TVSAT PB-SS B	LRX SATN PB-SS B	LRX SATI PB-SS B
Polished Brass Frame/Satin Steel	LRX TV PB-SS W	LRX TVFM PB-SS W	LRX TVI PB-SS W	LRX TVSAT PB-SS W	LRX SATN PB-SS W	LRX SATI PB-SS W
Richmond Bronze Frame/Richmond Bronze	LRX TV RB-RB B	LRX TVFM RB-RB B	LRX TVI RB-RB B	LRX TVSAT RB-RB B	LRX SATN RB-RB B	LRX SATI RB-RB B
Satin Brass Frame/Satin Brass	LRX TV SB-SB B	LRX TVFM SB-SB B	LRX TVI SB-SB B	LRX TVSAT SB-SB B	LRX SATN SB-SB B	LRX SATI SB-SB B
Satin Brass Frame/Satin Brass	LRX TV SB-SB W	LRX TVFM SB-SB W	LRX TVI SB-SB W	LRX TVSAT SB-SB W	LRX SATN SB-SB W	LRX SATI SB-SB W
Satin Brass Frame/Satin Steel	LRX TV SB-SS B	LRX TVFM SB-SS B	LRX TVI SB-SS B	LRX TVSAT SB-SS B	LRX SATN SB-SS B	LRX SATI SB-SS B
Satin Brass Frame/Satin Steel	LRX TV SB-SS W	LRX TVFM SB-SS W	LRX TVI SB-SS W	LRX TVSAT SB-SS W	LRX SATN SB-SS W	LRX SATI SB-SS W
Satin Nickel Frame/Bright Steel	LRX TV SN-BS B	LRX TVFM SN-BS B	LRX TVI SN-BS B	LRX TVSAT SN-BS B	LRX SATN SN-BS B	LRX SATI SN-BS B
Satin Nickel Frame/Bright Steel	LRX TV SN-BS W	LRX TVFM SN-BS W	LRX TVI SN-BS W	LRX TVSAT SN-BS W	LRX SATN SN-BS W	LRX SATI SN-BS W
Satin Nickel Frame/Satin Steel	LRX TV SN-SS B	LRX TVFM SN-SS B	LRX TVI SN-SS B	LRX TVSAT SN-SS B	LRX SATN SN-SS B	LRX SATI SN-SS B
Satin Nickel Frame/Satin Steel	LRX TV SN-SS W	LRX TVFM SN-SS W	LRX TVI SN-SS W	LRX TVSAT SN-SS W	LRX SATN SN-SS W	LRX SATI SN-SS W
Nominal Size: Minimum Wall Box Depth: Technical Insert Ref:	91.5mm x 91.5mm 25mm TV	91.5mm x 91.5mm 25mm TVFM	91.5mm x 91.5mm 25mm TVI	91.5mm x 91.5mm 35mm TVSAT	91.5mm x 91.5mm 35mm SATN	91.5mm x 91.5mm 35mm SATI

Insert Surround Colour Key: (B) Black, (W) White

Linea-Rondo CFX

Digital Television Sockets

- Screened Non-Isolated / DAB Compatible



LRX DTRID BK-BK B



LRX DTVF BK-BS B



LRX DTVM PB-PB W



Non-Isolated
TV+FM+SAT
Triplexer 1in/3out
(DAB Compatible)



1 gang
Non-Isolated TV
(Female)
(DAB Compatible)



1 gang
Non-Isolated TV
(Male)
(DAB Compatible)

Frame / Front Plate	Non-Isolated TV+FM+SAT Triplexer 1in/3out (DAB Compatible)	1 gang Non-Isolated TV (Female) (DAB Compatible)	1 gang Non-Isolated TV (Male) (DAB Compatible)
Antique Brass Frame/Antique Brass	LRX DTRID AB-AB B	LRX DTVF AB-AB B	LRX DTVM AB-AB B
Antique Brass Frame/Satin Brass	LRX DTRID AB-SB B	LRX DTVF AB-SB B	LRX DTVM AB-SB B
Black Nickel Frame/Black Nickel	LRX DTRID BK-BK B	LRX DTVF BK-BK B	LRX DTVM BK-BK B
Black Nickel Frame/Bright Steel	LRX DTRID BK-BS B	LRX DTVF BK-BS B	LRX DTVM BK-BS B
Black Nickel Frame/Polished Brass	LRX DTRID BK-PB B	LRX DTVF BK-PB B	LRX DTVM BK-PB B
Bright Chrome Frame/Black Nickel	LRX DTRID BC-BK B	LRX DTVF BC-BK B	LRX DTVM BC-BK B
Bright Chrome Frame/Bright Steel	LRX DTRID BC-BS B	LRX DTVF BC-BS B	LRX DTVM BC-BS B
Bright Chrome Frame/Bright Steel	LRX DTRID BC-BS W	LRX DTVF BC-BS W	LRX DTVM BC-BS W
Bright Chrome Frame/Piano Black	LRX DTRID BC-N B	LRX DTVF BC-N B	LRX DTVM BC-N B
Bright Chrome Frame/Polished Brass	LRX DTRID BC-PB B	LRX DTVF BC-PB B	LRX DTVM BC-PB B
Bright Chrome Frame/Polished Brass	LRX DTRID BC-PB W	LRX DTVF BC-PB W	LRX DTVM BC-PB W
Bright Chrome Frame/Satin Steel	LRX DTRID BC-SS B	LRX DTVF BC-SS B	LRX DTVM BC-SS B
Bright Chrome Frame/Satin Steel	LRX DTRID BC-SS W	LRX DTVF BC-SS W	LRX DTVM BC-SS W
Connaught Bronze Frame/Connaught Bronze	LRX DTRID HB-HB B	LRX DTVF HB-HB B	LRX DTVM HB-HB B
Copper Bronze Frame/Copper Bronze	LRX DTRID CB-CB B	LRX DTVF CB-CB B	LRX DTVM CB-CB B
Etrium Bronze Frame/Etrium Bronze	LRX DTRID EB-EB B	LRX DTVF EB-EB B	LRX DTVM EB-EB B
Polished Brass Frame/Antique Brass	LRX DTRID PB-AB B	LRX DTVF PB-AB B	LRX DTVM PB-AB B
Polished Brass Frame/Antique Brass	LRX DTRID PB-AB W	LRX DTVF PB-AB W	LRX DTVM PB-AB W
Polished Brass Frame/Bright Steel	LRX DTRID PB-BS B	LRX DTVF PB-BS B	LRX DTVM PB-BS B
Polished Brass Frame/Bright Steel	LRX DTRID PB-BS W	LRX DTVF PB-BS W	LRX DTVM PB-BS W
Polished Brass Frame/Polished Brass	LRX DTRID PB-PB B	LRX DTVF PB-PB B	LRX DTVM PB-PB B
Polished Brass Frame/Polished Brass	LRX DTRID PB-PB W	LRX DTVF PB-PB W	LRX DTVM PB-PB W
Polished Brass Frame/Satin Brass	LRX DTRID PB-SB B	LRX DTVF PB-SB B	LRX DTVM PB-SB B
Polished Brass Frame/Satin Brass	LRX DTRID PB-SB W	LRX DTVF PB-SB W	LRX DTVM PB-SB W
Polished Brass Frame/Satin Steel	LRX DTRID PB-SS B	LRX DTVF PB-SS B	LRX DTVM PB-SS B
Polished Brass Frame/Satin Steel	LRX DTRID PB-SS W	LRX DTVF PB-SS W	LRX DTVM PB-SS W
Richmond Bronze Frame/Richmond Bronze	LRX DTRID RB-RB B	LRX DTVF RB-RB B	LRX DTVM RB-RB B
Satin Brass Frame/Satin Brass	LRX DTRID SB-SB B	LRX DTVF SB-SB B	LRX DTVM SB-SB B
Satin Brass Frame/Satin Brass	LRX DTRID SB-SB W	LRX DTVF SB-SB W	LRX DTVM SB-SB W
Satin Brass Frame/Satin Steel	LRX DTRID SB-SS B	LRX DTVF SB-SS B	LRX DTVM SB-SS B
Satin Brass Frame/Satin Steel	LRX DTRID SB-SS W	LRX DTVF SB-SS W	LRX DTVM SB-SS W
Satin Nickel Frame/Bright Steel	LRX DTRID SN-BS B	LRX DTVF SN-BS B	LRX DTVM SN-BS B
Satin Nickel Frame/Bright Steel	LRX DTRID SN-BS W	LRX DTVF SN-BS W	LRX DTVM SN-BS W
Satin Nickel Frame/Satin Steel	LRX DTRID SN-SS B	LRX DTVF SN-SS B	LRX DTVM SN-SS B
Satin Nickel Frame/Satin Steel	LRX DTRID SN-SS W	LRX DTVF SN-SS W	LRX DTVM SN-SS W
Nominal Size:	91.5mm x 91.5mm	91.5mm x 91.5mm	91.5mm x 91.5mm
Minimum Wall Box Depth:	35mm	35mm	35mm
Technical Insert Ref:	DTRID	DTV F	DTVM

Insert Surround Colour Key: (B) Black, (W) White

Linea-Rondo CFX

Digital Television Sockets

- Screened Non-Isolated / DAB Compatible



LRX DSAT BC-SB B



LRX DENT BC-PB W



LRX DSAT+ CB-CB B



1 gang
Non-Isolated
Satellite
(DAB Compatible)



Non-Isolated
TV+FM+SAT1+SAT2
Quadplexer 2in/4out
(DAB Compatible)

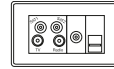

Non-Isolated
TV+FM+SAT1+SAT2
Quadplexer 2in/4out
+TVF+TCS
(DAB Compatible)

Frame / Front Plate

Antique Brass Frame/Antique Brass	LRX DSAT AB-AB B	LRX DENT AB-AB B	LRX DSAT+ AB-AB B
Antique Brass Frame/Satin Brass	LRX DSAT AB-SB B	LRX DENT AB-SB B	LRX DSAT+ AB-SB B
Black Nickel Frame/Black Nickel	LRX DSAT BK-BK B	LRX DENT BK-BK B	LRX DSAT+ BK-BK B
Black Nickel Frame/Bright Steel	LRX DSAT BK-BS B	LRX DENT BK-BS B	LRX DSAT+ BK-BS B
Black Nickel Frame/Polished Brass	LRX DSAT BK-PB B	LRX DENT BK-PB B	LRX DSAT+ BK-PB B
Bright Chrome Frame/Black Nickel	LRX DSAT BC-BK B	LRX DENT BC-BK B	LRX DSAT+ BC-BK B
Bright Chrome Frame/Bright Steel	LRX DSAT BC-BS B	LRX DENT BC-BS B	LRX DSAT+ BC-BS B
Bright Chrome Frame/Bright Steel	LRX DSAT BC-BS W	LRX DENT BC-BS W	LRX DSAT+ BC-BS W
Bright Chrome Frame/Piano Black	LRX DSAT BC-N B	LRX DENT BC-N B	LRX DSAT+ BC-N B
Bright Chrome Frame/Polished Brass	LRX DSAT BC-PB B	LRX DENT BC-PB B	LRX DSAT+ BC-PB B
Bright Chrome Frame/Polished Brass	LRX DSAT BC-PB W	LRX DENT BC-PB W	LRX DSAT+ BC-PB W
Bright Chrome Frame/Satin Steel	LRX DSAT BC-SS B	LRX DENT BC-SS B	LRX DSAT+ BC-SS B
Bright Chrome Frame/Satin Steel	LRX DSAT BC-SS W	LRX DENT BC-SS W	LRX DSAT+ BC-SS W
Connaught Bronze Frame/Connaught Bronze	LRX DSAT HB-HB B	LRX DENT HB-HB B	LRX DSAT+ HB-HB B
Copper Bronze Frame/Copper Bronze	LRX DSAT CB-CB B	LRX DENT CB-CB B	LRX DSAT+ CB-CB B
Etrium Bronze Frame/Etrium Bronze	LRX DSAT EB-EB B	LRX DENT EB-EB B	LRX DSAT+ EB-EB B
Polished Brass Frame/Antique Brass	LRX DSAT PB-AB B	LRX DENT PB-AB B	LRX DSAT+ PB-AB B
Polished Brass Frame/Antique Brass	LRX DSAT PB-AB W	LRX DENT PB-AB W	LRX DSAT+ PB-AB W
Polished Brass Frame/Bright Steel	LRX DSAT PB-BS B	LRX DENT PB-BS B	LRX DSAT+ PB-BS B
Polished Brass Frame/Bright Steel	LRX DSAT PB-BS W	LRX DENT PB-BS W	LRX DSAT+ PB-BS W
Polished Brass Frame/Polished Brass	LRX DSAT PB-PB B	LRX DENT PB-PB B	LRX DSAT+ PB-PB B
Polished Brass Frame/Polished Brass	LRX DSAT PB-PB W	LRX DENT PB-PB W	LRX DSAT+ PB-PB W
Polished Brass Frame/Satin Brass	LRX DSAT PB-SB B	LRX DENT PB-SB B	LRX DSAT+ PB-SB B
Polished Brass Frame/Satin Brass	LRX DSAT PB-SB W	LRX DENT PB-SB W	LRX DSAT+ PB-SB W
Polished Brass Frame/Satin Steel	LRX DSAT PB-SS B	LRX DENT PB-SS B	LRX DSAT+ PB-SS B
Polished Brass Frame/Satin Steel	LRX DSAT PB-SS W	LRX DENT PB-SS W	LRX DSAT+ PB-SS W
Richmond Bronze Frame/Richmond Bronze	LRX DSAT RB-RB B	LRX DENT RB-RB B	LRX DSAT+ RB-RB B
Satin Brass Frame/Satin Brass	LRX DSAT SB-SB B	LRX DENT SB-SB B	LRX DSAT+ SB-SB B
Satin Brass Frame/Satin Brass	LRX DSAT SB-SB W	LRX DENT SB-SB W	LRX DSAT+ SB-SB W
Satin Brass Frame/Satin Steel	LRX DSAT SB-SS B	LRX DENT SB-SS B	LRX DSAT+ SB-SS B
Satin Brass Frame/Satin Steel	LRX DSAT SB-SS W	LRX DENT SB-SS W	LRX DSAT+ SB-SS W
Satin Nickel Frame/Bright Steel	LRX DSAT SN-BS B	LRX DENT SN-BS B	LRX DSAT+ SN-BS B
Satin Nickel Frame/Bright Steel	LRX DSAT SN-BS W	LRX DENT SN-BS W	LRX DSAT+ SN-BS W
Satin Nickel Frame/Satin Steel	LRX DSAT SN-SS B	LRX DENT SN-SS B	LRX DSAT+ SN-SS B
Satin Nickel Frame/Satin Steel	LRX DSAT SN-SS W	LRX DENT SN-SS W	LRX DSAT+ SN-SS W
Nominal Size:	91.5mm x 91.5mm	91.5mm x 91.5mm	150.5mm x 91.5mm
Minimum Wall Box Depth:	35mm	35mm	35mm
Technical Insert Ref:	DSAT	DENT	DSAT+

Insert Surround Colour Key: (B) Black, (W) White

Linea-Rondo CFX

Telephone and Data Outlets



LRX TCM BC-BS B



LRX TCS BC-BK B



LRX J12 PB-BS W



LRX J45 SB-SB W



1 gang Telephone Master



1 gang Telephone Slave



1 gang RJ12 Outlet - Unshielded



2 gang RJ12 Outlet - Unshielded



1 gang RJ45 CAT 5E Outlet - Unshielded



2 gang RJ45 CAT 5E Outlet - Unshielded

Frame / Front Plate	1 gang Telephone Master	1 gang Telephone Slave	1 gang RJ12 Outlet - Unshielded	2 gang RJ12 Outlet - Unshielded	1 gang RJ45 CAT 5E Outlet - Unshielded	2 gang RJ45 CAT 5E Outlet - Unshielded
Antique Brass Frame/Antique Brass	LRX TCM AB-AB B	LRX TCS AB-AB B	LRX J12 AB-AB B	LRX 2J12 AB-AB B	LRX J45 AB-AB B	LRX 2J45 AB-AB B
Antique Brass Frame/Satin Brass	LRX TCM AB-SB B	LRX TCS AB-SB B	LRX J12 AB-SB B	LRX 2J12 AB-SB B	LRX J45 AB-SB B	LRX 2J45 AB-SB B
Black Nickel Frame/Black Nickel	LRX TCM BK-BK B	LRX TCS BK-BK B	LRX J12 BK-BK B	LRX 2J12 BK-BK B	LRX J45 BK-BK B	LRX 2J45 BK-BK B
Black Nickel Frame/Bright Steel	LRX TCM BK-BS B	LRX TCS BK-BS B	LRX J12 BK-BS B	LRX 2J12 BK-BS B	LRX J45 BK-BS B	LRX 2J45 BK-BS B
Black Nickel Frame/Polished Brass	LRX TCM BK-PB B	LRX TCS BK-PB B	LRX J12 BK-PB B	LRX 2J12 BK-PB B	LRX J45 BK-PB B	LRX 2J45 BK-PB B
Bright Chrome Frame/Black Nickel	LRX TCM BC-BK B	LRX TCS BC-BK B	LRX J12 BC-BK B	LRX 2J12 BC-BK B	LRX J45 BC-BK B	LRX 2J45 BC-BK B
Bright Chrome Frame/Bright Steel	LRX TCM BC-BS B	LRX TCS BC-BS B	LRX J12 BC-BS B	LRX 2J12 BC-BS B	LRX J45 BC-BS B	LRX 2J45 BC-BS B
Bright Chrome Frame/Bright Steel	LRX TCM BC-BS W	LRX TCS BC-BS W	LRX J12 BC-BS W	LRX 2J12 BC-BS W	LRX J45 BC-BS W	LRX 2J45 BC-BS W
Bright Chrome Frame/Piano Black	LRX TCM BC-N B	LRX TCS BC-N B	LRX J12 BC-N B	LRX 2J12 BC-N B	LRX J45 BC-N B	LRX 2J45 BC-N B
Bright Chrome Frame/Polished Brass	LRX TCM BC-PB B	LRX TCS BC-PB B	LRX J12 BC-PB B	LRX 2J12 BC-PB B	LRX J45 BC-PB B	LRX 2J45 BC-PB B
Bright Chrome Frame/Polished Brass	LRX TCM BC-PB W	LRX TCS BC-PB W	LRX J12 BC-PB W	LRX 2J12 BC-PB W	LRX J45 BC-PB W	LRX 2J45 BC-PB W
Bright Chrome Frame/Satin Steel	LRX TCM BC-SS B	LRX TCS BC-SS B	LRX J12 BC-SS B	LRX 2J12 BC-SS B	LRX J45 BC-SS B	LRX 2J45 BC-SS B
Bright Chrome Frame/Satin Steel	LRX TCM BC-SS W	LRX TCS BC-SS W	LRX J12 BC-SS W	LRX 2J12 BC-SS W	LRX J45 BC-SS W	LRX 2J45 BC-SS W
Connaught Bronze Frame/Connaught Bronze	LRX TCM HB-HB B	LRX TCS HB-HB B	LRX J12 HB-HB B	LRX 2J12 HB-HB B	LRX J45 HB-HB B	LRX 2J45 HB-HB B
Copper Bronze Frame/Copper Bronze	LRX TCM CB-CB B	LRX TCS CB-CB B	LRX J12 CB-CB B	LRX 2J12 CB-CB B	LRX J45 CB-CB B	LRX 2J45 CB-CB B
Etrium Bronze Frame/Etrium Bronze	LRX TCM EB-EB B	LRX TCS EB-EB B	LRX J12 EB-EB B	LRX 2J12 EB-EB B	LRX J45 EB-EB B	LRX 2J45 EB-EB B
Polished Brass Frame/Antique Brass	LRX TCM PB-AB B	LRX TCS PB-AB B	LRX J12 PB-AB B	LRX 2J12 PB-AB B	LRX J45 PB-AB B	LRX 2J45 PB-AB B
Polished Brass Frame/Antique Brass	LRX TCM PB-AB W	LRX TCS PB-AB W	LRX J12 PB-AB W	LRX 2J12 PB-AB W	LRX J45 PB-AB W	LRX 2J45 PB-AB W
Polished Brass Frame/Bright Steel	LRX TCM PB-BS B	LRX TCS PB-BS B	LRX J12 PB-BS B	LRX 2J12 PB-BS B	LRX J45 PB-BS B	LRX 2J45 PB-BS B
Polished Brass Frame/Bright Steel	LRX TCM PB-BS W	LRX TCS PB-BS W	LRX J12 PB-BS W	LRX 2J12 PB-BS W	LRX J45 PB-BS W	LRX 2J45 PB-BS W
Polished Brass Frame/Polished Brass	LRX TCM PB-PB B	LRX TCS PB-PB B	LRX J12 PB-PB B	LRX 2J12 PB-PB B	LRX J45 PB-PB B	LRX 2J45 PB-PB B
Polished Brass Frame/Polished Brass	LRX TCM PB-PB W	LRX TCS PB-PB W	LRX J12 PB-PB W	LRX 2J12 PB-PB W	LRX J45 PB-PB W	LRX 2J45 PB-PB W
Polished Brass Frame/Satin Brass	LRX TCM PB-SB B	LRX TCS PB-SB B	LRX J12 PB-SB B	LRX 2J12 PB-SB B	LRX J45 PB-SB B	LRX 2J45 PB-SB B
Polished Brass Frame/Satin Brass	LRX TCM PB-SB W	LRX TCS PB-SB W	LRX J12 PB-SB W	LRX 2J12 PB-SB W	LRX J45 PB-SB W	LRX 2J45 PB-SB W
Polished Brass Frame/Satin Steel	LRX TCM PB-SS B	LRX TCS PB-SS B	LRX J12 PB-SS B	LRX 2J12 PB-SS B	LRX J45 PB-SS B	LRX 2J45 PB-SS B
Polished Brass Frame/Satin Steel	LRX TCM PB-SS W	LRX TCS PB-SS W	LRX J12 PB-SS W	LRX 2J12 PB-SS W	LRX J45 PB-SS W	LRX 2J45 PB-SS W
Richmond Bronze Frame/Richmond Bronze	LRX TCM RB-RB B	LRX TCS RB-RB B	LRX J12 RB-RB B	LRX 2J12 RB-RB B	LRX J45 RB-RB B	LRX 2J45 RB-RB B
Satin Brass Frame/Satin Brass	LRX TCM SB-SB B	LRX TCS SB-SB B	LRX J12 SB-SB B	LRX 2J12 SB-SB B	LRX J45 SB-SB B	LRX 2J45 SB-SB B
Satin Brass Frame/Satin Brass	LRX TCM SB-SB W	LRX TCS SB-SB W	LRX J12 SB-SB W	LRX 2J12 SB-SB W	LRX J45 SB-SB W	LRX 2J45 SB-SB W
Satin Brass Frame/Satin Steel	LRX TCM SB-SS B	LRX TCS SB-SS B	LRX J12 SB-SS B	LRX 2J12 SB-SS B	LRX J45 SB-SS B	LRX 2J45 SB-SS B
Satin Brass Frame/Satin Steel	LRX TCM SB-SS W	LRX TCS SB-SS W	LRX J12 SB-SS W	LRX 2J12 SB-SS W	LRX J45 SB-SS W	LRX 2J45 SB-SS W
Satin Nickel Frame/Bright Steel	LRX TCM SN-BS B	LRX TCS SN-BS B	LRX J12 SN-BS B	LRX 2J12 SN-BS B	LRX J45 SN-BS B	LRX 2J45 SN-BS B
Satin Nickel Frame/Bright Steel	LRX TCM SN-BS W	LRX TCS SN-BS W	LRX J12 SN-BS W	LRX 2J12 SN-BS W	LRX J45 SN-BS W	LRX 2J45 SN-BS W
Satin Nickel Frame/Satin Steel	LRX TCM SN-SS B	LRX TCS SN-SS B	LRX J12 SN-SS B	LRX 2J12 SN-SS B	LRX J45 SN-SS B	LRX 2J45 SN-SS B
Satin Nickel Frame/Satin Steel	LRX TCM SN-SS W	LRX TCS SN-SS W	LRX J12 SN-SS W	LRX 2J12 SN-SS W	LRX J45 SN-SS W	LRX 2J45 SN-SS W
Nominal Size:	91.5mm x 91.5mm	91.5mm x 91.5mm	91.5mm x 91.5mm	91.5mm x 91.5mm	91.5mm x 91.5mm	91.5mm x 91.5mm
Minimum Wall Box Depth:	25mm	25mm	35mm	35mm	35mm	35mm
Technical Insert Ref:	TCM	TCS	J12	2J12	J45	2J45

Insert Surround Colour Key: (B) Black, (W) White

Linea-Rondo CFX

Double Pole Switches



LRX DPN BC-NB



LRX 45N BC-BK B



LRX 45SS1 SB-SB B



1 gang 20AX
Double Pole
Rocker +
Neon



1 gang 45A
Double Pole
Red Rocker +
Neon

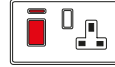

45A Double
Pole Red Rocker +
Neon +
13A Switched
Socket

Frame / Front Plate

Antique Brass Frame/Antique Brass	LRX DPN AB-AB B	LRX 45N AB-AB B	LRX 45SS1 AB-AB B
Antique Brass Frame/Satin Brass	LRX DPN AB-SB B	LRX 45N AB-SB B	LRX 45SS1 AB-SB B
Black Nickel Frame/Black Nickel	LRX DPN BK-BK B	LRX 45N BK-BK B	LRX 45SS1 BK-BK B
Black Nickel Frame/Bright Steel	LRX DPN BK-BS B	LRX 45N BK-BS B	LRX 45SS1 BK-BS B
Black Nickel Frame/Polished Brass	LRX DPN BK-PB B	LRX 45N BK-PB B	LRX 45SS1 BK-PB B
Bright Chrome Frame/Black Nickel	LRX DPN BC-BK B	LRX 45N BC-BK B	LRX 45SS1 BC-BK B
Bright Chrome Frame/Bright Steel	LRX DPN BC-BS B	LRX 45N BC-BS B	LRX 45SS1 BC-BS B
Bright Chrome Frame/Bright Steel	LRX DPN BC-BS W	LRX 45N BC-BS W	LRX 45SS1 BC-BS W
Bright Chrome Frame/Piano Black	LRX DPN BC-NB	LRX 45N BC-N B	LRX 45SS1 BC-NB
Bright Chrome Frame/Polished Brass	LRX DPN BC-PB B	LRX 45N BC-PB B	LRX 45SS1 BC-PB B
Bright Chrome Frame/Polished Brass	LRX DPN BC-PB W	LRX 45N BC-PB W	LRX 45SS1 BC-PB W
Bright Chrome Frame/Satin Steel	LRX DPN BC-SS B	LRX 45N BC-SS B	LRX 45SS1 BC-SS B
Bright Chrome Frame/Satin Steel	LRX DPN BC-SS W	LRX 45N BC-SS W	LRX 45SS1 BC-SS W
Connaught Bronze Frame/Connaught Bronze	LRX DPN HB-HB B	LRX 45N HB-HB B	LRX 45SS1 HB-HB B
Copper Bronze Frame/Copper Bronze	LRX DPN CB-CB B	LRX 45N CB-CB B	LRX 45SS1 CB-CB B
Etrium Bronze Frame/Etrium Bronze	LRX DPN EB-EB B	LRX 45N EB-EB B	LRX 45SS1 EB-EB B
Polished Brass Frame/Antique Brass	LRX DPN PB-AB B	LRX 45N PB-AB B	LRX 45SS1 PB-AB B
Polished Brass Frame/Antique Brass	LRX DPN PB-AB W	LRX 45N PB-AB W	LRX 45SS1 PB-AB W
Polished Brass Frame/Bright Steel	LRX DPN PB-BS B	LRX 45N PB-BS B	LRX 45SS1 PB-BS B
Polished Brass Frame/Bright Steel	LRX DPN PB-BS W	LRX 45N PB-BS W	LRX 45SS1 PB-BS W
Polished Brass Frame/Polished Brass	LRX DPN PB-PB B	LRX 45N PB-PB B	LRX 45SS1 PB-PB B
Polished Brass Frame/Polished Brass	LRX DPN PB-PB W	LRX 45N PB-PB W	LRX 45SS1 PB-PB W
Polished Brass Frame/Satin Brass	LRX DPN PB-SB B	LRX 45N PB-SB B	LRX 45SS1 PB-SB B
Polished Brass Frame/Satin Brass	LRX DPN PB-SB W	LRX 45N PB-SB W	LRX 45SS1 PB-SB W
Polished Brass Frame/Satin Steel	LRX DPN PB-SS B	LRX 45N PB-SS B	LRX 45SS1 PB-SS B
Polished Brass Frame/Satin Steel	LRX DPN PB-SS W	LRX 45N PB-SS W	LRX 45SS1 PB-SS W
Richmond Bronze Frame/Richmond Bronze	LRX DPN RB-RB B	LRX 45N RB-RB B	LRX 45SS1 RB-RB B
Satin Brass Frame/Satin Brass	LRX DPN SB-SB B	LRX 45N SB-SB B	LRX 45SS1 SB-SB B
Satin Brass Frame/Satin Brass	LRX DPN SB-SB W	LRX 45N SB-SB W	LRX 45SS1 SB-SB W
Satin Brass Frame/Satin Steel	LRX DPN SB-SS B	LRX 45N SB-SS B	LRX 45SS1 SB-SS B
Satin Brass Frame/Satin Steel	LRX DPN SB-SS W	LRX 45N SB-SS W	LRX 45SS1 SB-SS W
Satin Nickel Frame/Bright Steel	LRX DPN SN-BS B	LRX 45N SN-BS B	LRX 45SS1 SN-BS B
Satin Nickel Frame/Bright Steel	LRX DPN SN-BS W	LRX 45N SN-BS W	LRX 45SS1 SN-BS W
Satin Nickel Frame/Satin Steel	LRX DPN SN-SS B	LRX 45N SN-SS B	LRX 45SS1 SN-SS B
Satin Nickel Frame/Satin Steel	LRX DPN SN-SS W	LRX 45N SN-SS W	LRX 45SS1 SN-SS W
Nominal Size:	91.5mm x 91.5mm	91.5mm x 91.5mm	150.5mm x 91.5mm
Minimum Wall Box Depth:	35mm	35mm	35mm
Technical Insert Ref:	DPN	45N	45SS1

Insert Surround Colour Key: (B) Black, (W) White

Linea-Rondo CFX

Connection Units



LRX SPN BC-BK B



LRX FN PB-BS R



1 gang 13A
Double Pole
Fused Spur +
Neon



1 gang 13A
Fuse with
Red Neon
Halo

Frame / Front Plate	1 gang 13A Double Pole Fused Spur + Neon	1 gang 13A Fuse with Red Neon Halo
Antique Brass Frame/Antique Brass	LRX SPN AB-AB B	LRX FN AB-AB R
Antique Brass Frame/Satin Brass	LRX SPN AB-SB B	LRX FN AB-SB R
Black Nickel Frame/Black Nickel	LRX SPN BK-BK B	LRX FN BK-BK R
Black Nickel Frame/Bright Steel	LRX SPN BK-BS B	LRX FN BK-BS R
Black Nickel Frame/Polished Brass	LRX SPN BK-PB B	LRX FN BK-PB R
Bright Chrome Frame/Black Nickel	LRX SPN BC-BK B	LRX FN BC-BK R
Bright Chrome Frame/Bright Steel	LRX SPN BC-BS B	LRX FN BC-BS R
Bright Chrome Frame/Bright Steel	LRX SPN BC-BS W	-
Bright Chrome Frame/Plano Black	LRX SPN BC-NB	LRX FN BC-N R
Bright Chrome Frame/Polished Brass	LRX SPN BC-PB B	LRX FN BC-PB R
Bright Chrome Frame/Polished Brass	LRX SPN BC-PB W	-
Bright Chrome Frame/Satin Steel	LRX SPN BC-SS B	LRX FN BC-SS R
Bright Chrome Frame/Satin Steel	LRX SPN BC-SS W	-
Connaught Bronze Frame/Connaught Bronze	LRX SPN HB-HB B	LRX FN HB-HB R
Copper Bronze Frame/Copper Bronze	LRX SPN CB-CB B	LRX FN CB-CB R
Etrium Bronze Frame/Etrium Bronze	LRX SPN EB-EB B	LRX FN EB-EB R
Polished Brass Frame/Antique Brass	LRX SPN PB-AB B	LRX FN PB-AB R
Polished Brass Frame/Antique Brass	LRX SPN PB-AB W	-
Polished Brass Frame/Bright Steel	LRX SPN PB-BS B	LRX FN PB-BS R
Polished Brass Frame/Bright Steel	LRX SPN PB-BS W	-
Polished Brass Frame/Polished Brass	LRX SPN PB-PB B	LRX FN PB-PB R
Polished Brass Frame/Polished Brass	LRX SPN PB-PB W	-
Polished Brass Frame/Satin Brass	LRX SPN PB-SB B	LRX FN PB-SB R
Polished Brass Frame/Satin Brass	LRX SPN PB-SB W	-
Polished Brass Frame/Satin Steel	LRX SPN PB-SS B	LRX FN PB-SS R
Polished Brass Frame/Satin Steel	LRX SPN PB-SS W	-
Richmond Bronze Frame/Richmond Bronze	LRX SPN RB-RB B	LRX FN RB-RB R
Satin Brass Frame/Satin Brass	LRX SPN SB-SB B	LRX FN SB-SB R
Satin Brass Frame/Satin Brass	LRX SPN SB-SB W	-
Satin Brass Frame/Satin Steel	LRX SPN SB-SS B	LRX FN SB-SS R
Satin Brass Frame/Satin Steel	LRX SPN SB-SS W	-
Satin Nickel Frame/Bright Steel	LRX SPN SN-BS B	LRX FN SN-BS R
Satin Nickel Frame/Bright Steel	LRX SPN SN-BS W	-
Satin Nickel Frame/Satin Steel	LRX SPN SN-SS B	LRX FN SN-SS R
Satin Nickel Frame/Satin Steel	LRX SPN SN-SS W	-
Nominal Size:	91.5mm x 91.5mm	91.5mm x 91.5mm
Minimum Wall Box Depth:	35mm	35mm
Technical Insert Ref:	SPN	FN

Insert Surround Colour Key: (B) Black, (W) White

Linea-Rondo CFX

LED Trailing/Leading Edge Push On/Off Rotary 2 Way Switching Dimmers

LINEA-RONDO CFX RANGE



LRX 1XLEDITB100 BC-BK



LRX 2XLEDITB100 BC-N



LRX 3XLEDITB100 AB-SB



LRX 4XLEDITB100 BC-B5



1 gang 100W LED Trailing/
Leading Edge Push
On/Off Rotary 2 Way
Switching Dimmer



2 gang 100W LED Trailing/
Leading Edge Push
On/Off Rotary 2 Way
Switching Dimmer

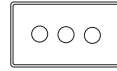

3 gang 100W LED Trailing/
Leading Edge Push
On/Off Rotary 2 Way
Switching Dimmer



4 gang 100W LED Trailing/
Leading Edge Push
On/Off Rotary 2 Way
Switching Dimmer

Frame / Front Plate	1 gang 100W LED Trailing/ Leading Edge Push On/Off Rotary 2 Way Switching Dimmer	2 gang 100W LED Trailing/ Leading Edge Push On/Off Rotary 2 Way Switching Dimmer	3 gang 100W LED Trailing/ Leading Edge Push On/Off Rotary 2 Way Switching Dimmer	4 gang 100W LED Trailing/ Leading Edge Push On/Off Rotary 2 Way Switching Dimmer
Antique Brass Frame/Antique Brass	LRX 1XLEDITB100 AB-AB	LRX 2XLEDITB100 AB-AB	LRX 3XLEDITB100 AB-AB	LRX 4XLEDITB100 AB-AB
Antique Brass Frame/Satin Brass	LRX 1XLEDITB100 AB-SB	LRX 2XLEDITB100 AB-SB	LRX 3XLEDITB100 AB-SB	LRX 4XLEDITB100 AB-SB
Black Nickel Frame/Black Nickel	LRX 1XLEDITB100 BK-BK	LRX 2XLEDITB100 BK-BK	LRX 3XLEDITB100 BK-BK	LRX 4XLEDITB100 BK-BK
Black Nickel Frame/Bright Steel	LRX 1XLEDITB100 BK-BS	LRX 2XLEDITB100 BK-BS	LRX 3XLEDITB100 BK-BS	LRX 4XLEDITB100 BK-BS
Black Nickel Frame/Polished Brass	LRX 1XLEDITB100 BK-PB	LRX 2XLEDITB100 BK-PB	LRX 3XLEDITB100 BK-PB	LRX 4XLEDITB100 BK-PB
Bright Chrome Frame/Black Nickel	LRX 1XLEDITB100 BC-BK	LRX 2XLEDITB100 BC-BK	LRX 3XLEDITB100 BC-BK	LRX 4XLEDITB100 BC-BK
Bright Chrome Frame/Bright Steel	LRX 1XLEDITB100 BC-BS	LRX 2XLEDITB100 BC-BS	LRX 3XLEDITB100 BC-BS	LRX 4XLEDITB100 BC-BS
Bright Chrome Frame/Piano Black	LRX 1XLEDITB100 BC-N	LRX 2XLEDITB100 BC-N	LRX 3XLEDITB100 BC-N	LRX 4XLEDITB100 BC-N
Bright Chrome Frame/Polished Brass	LRX 1XLEDITB100 BC-PB	LRX 2XLEDITB100 BC-PB	LRX 3XLEDITB100 BC-PB	LRX 4XLEDITB100 BC-PB
Bright Chrome Frame/Satin Steel	LRX 1XLEDITB100 BC-SS	LRX 2XLEDITB100 BC-SS	LRX 3XLEDITB100 BC-SS	LRX 4XLEDITB100 BC-SS
Connaught Bronze Frame/Connaught Bronze	LRX 1XLEDITB100 HB-HB	LRX 2XLEDITB100 HB-HB	LRX 3XLEDITB100 HB-HB	LRX 4XLEDITB100 HB-HB
Copper Bronze Frame/Copper Bronze	LRX 1XLEDITB100 CB-CB	LRX 2XLEDITB100 CB-CB	LRX 3XLEDITB100 CB-CB	LRX 4XLEDITB100 CB-CB
Etrium Bronze Frame/Etrium Bronze	LRX 1XLEDITB100 EB-EB	LRX 2XLEDITB100 EB-EB	LRX 3XLEDITB100 EB-EB	LRX 4XLEDITB100 EB-EB
Polished Brass Frame/Antique Brass	LRX 1XLEDITB100 PB-AB	LRX 2XLEDITB100 PB-AB	LRX 3XLEDITB100 PB-AB	LRX 4XLEDITB100 PB-AB
Polished Brass Frame/Bright Steel	LRX 1XLEDITB100 PB-BS	LRX 2XLEDITB100 PB-BS	LRX 3XLEDITB100 PB-BS	LRX 4XLEDITB100 PB-BS
Polished Brass Frame/Polished Brass	LRX 1XLEDITB100 PB-PB	LRX 2XLEDITB100 PB-PB	LRX 3XLEDITB100 PB-PB	LRX 4XLEDITB100 PB-PB
Polished Brass Frame/Satin Brass	LRX 1XLEDITB100 PB-SB	LRX 2XLEDITB100 PB-SB	LRX 3XLEDITB100 PB-SB	LRX 4XLEDITB100 PB-SB
Polished Brass Frame/Satin Steel	LRX 1XLEDITB100 PB-SS	LRX 2XLEDITB100 PB-SS	LRX 3XLEDITB100 PB-SS	LRX 4XLEDITB100 PB-SS
Richmond Bronze Frame/Richmond Bronze	LRX 1XLEDITB100 RB-RB	LRX 2XLEDITB100 RB-RB	LRX 3XLEDITB100 RB-RB	LRX 4XLEDITB100 RB-RB
Satin Brass Frame/Satin Brass	LRX 1XLEDITB100 SB-SB	LRX 2XLEDITB100 SB-SB	LRX 3XLEDITB100 SB-SB	LRX 4XLEDITB100 SB-SB
Satin Brass Frame/Satin Steel	LRX 1XLEDITB100 SB-SS	LRX 2XLEDITB100 SB-SS	LRX 3XLEDITB100 SB-SS	LRX 4XLEDITB100 SB-SS
Satin Nickel Frame/Bright Steel	LRX 1XLEDITB100 SN-BS	LRX 2XLEDITB100 SN-BS	LRX 3XLEDITB100 SN-BS	LRX 4XLEDITB100 SN-BS
Satin Nickel Frame/Satin Steel	LRX 1XLEDITB100 SN-SS	LRX 2XLEDITB100 SN-SS	LRX 3XLEDITB100 SN-SS	LRX 4XLEDITB100 SN-SS
Nominal Size:	91.5mm x 91.5mm	91.5mm x 91.5mm	150.5mm x 91.5mm	150.5mm x 91.5mm
Minimum Wall Box Depth:	35mm	35mm	35mm	35mm
Technical Insert Ref:	1XLEDITB	2XLEDITB	3XLEDITB	4XLEDITB

NOTE: Tungsten filament GU10 lamps must be branded and with a fused base.
NOTE: Please refer to the Dimmer Technical Section for the max Wattage.
NOTE: Please contact our Technical Department for compatibility.

Linea-Rondo CFX

LED Trailing/Leading Edge Push On/Off Rotary Multi-Way Dimmers



LRX 1X100LED AB-SB



LRX 2X100LED BC-N



LRX 3X100LED BC-BK



LRX 4X100LED BC-PB



1 gang 100W LED Trailing/
Leading Edge Push
On/Off Rotary
Multi-Way Dimmer



2 gang 100W LED Trailing/
Leading Edge Push
On/Off Rotary
Multi-Way Dimmer

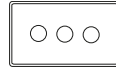

3 gang 100W LED Trailing/
Leading Edge Push
On/Off Rotary
Multi-Way Dimmer



4 gang 100W LED Trailing/
Leading Edge Push
On/Off Rotary
Multi-Way Dimmer

Frame / Front Plate	1 gang 100W LED Trailing/ Leading Edge Push On/Off Rotary Multi-Way Dimmer	2 gang 100W LED Trailing/ Leading Edge Push On/Off Rotary Multi-Way Dimmer	3 gang 100W LED Trailing/ Leading Edge Push On/Off Rotary Multi-Way Dimmer	4 gang 100W LED Trailing/ Leading Edge Push On/Off Rotary Multi-Way Dimmer
Antique Brass Frame/Antique Brass	LRX 1X100LED AB-AB	LRX 2X100LED AB-AB	LRX 3X100LED AB-AB	LRX 4X100LED AB-AB
Antique Brass Frame/Satin Brass	LRX 1X100LED AB-SB	LRX 2X100LED AB-SB	LRX 3X100LED AB-SB	LRX 4X100LED AB-SB
Black Nickel Frame/Black Nickel	LRX 1X100LED BK-BK	LRX 2X100LED BK-BK	LRX 3X100LED BK-BK	LRX 4X100LED BK-BK
Black Nickel Frame/Bright Steel	LRX 1X100LED BK-BS	LRX 2X100LED BK-BS	LRX 3X100LED BK-BS	LRX 4X100LED BK-BS
Black Nickel Frame/Polished Brass	LRX 1X100LED BK-PB	LRX 2X100LED BK-PB	LRX 3X100LED BK-PB	LRX 4X100LED BK-PB
Bright Chrome Frame/Black Nickel	LRX 1X100LED BC-BK	LRX 2X100LED BC-BK	LRX 3X100LED BC-BK	LRX 4X100LED BC-BK
Bright Chrome Frame/Bright Steel	LRX 1X100LED BC-BS	LRX 2X100LED BC-BS	LRX 3X100LED BC-BS	LRX 4X100LED BC-BS
Bright Chrome Frame/Piano Black	LRX 1X100LED BC-N	LRX 2X100LED BC-N	LRX 3X100LED BC-N	LRX 4X100LED BC-N
Bright Chrome Frame/Polished Brass	LRX 1X100LED BC-PB	LRX 2X100LED BC-PB	LRX 3X100LED BC-PB	LRX 4X100LED BC-PB
Bright Chrome Frame/Satin Steel	LRX 1X100LED BC-SS	LRX 2X100LED BC-SS	LRX 3X100LED BC-SS	LRX 4X100LED BC-SS
Connaught Bronze Frame/Connaught Bronze	LRX 1X100LED HB-HB	LRX 2X100LED HB-HB	LRX 3X100LED HB-HB	LRX 4X100LED HB-HB
Copper Bronze Frame/Copper Bronze	LRX 1X100LED CB-CB	LRX 2X100LED CB-CB	LRX 3X100LED CB-CB	LRX 4X100LED CB-CB
Etrium Bronze Frame/Etrium Bronze	LRX 1X100LED EB-EB	LRX 2X100LED EB-EB	LRX 3X100LED EB-EB	LRX 4X100LED EB-EB
Polished Brass Frame/Antique Brass	LRX 1X100LED PB-AB	LRX 2X100LED PB-AB	LRX 3X100LED PB-AB	LRX 4X100LED PB-AB
Polished Brass Frame/Bright Steel	LRX 1X100LED PB-BS	LRX 2X100LED PB-BS	LRX 3X100LED PB-BS	LRX 4X100LED PB-BS
Polished Brass Frame/Polished Brass	LRX 1X100LED PB-PB	LRX 2X100LED PB-PB	LRX 3X100LED PB-PB	LRX 4X100LED PB-PB
Polished Brass Frame/Satin Brass	LRX 1X100LED PB-SB	LRX 2X100LED PB-SB	LRX 3X100LED PB-SB	LRX 4X100LED PB-SB
Polished Brass Frame/Satin Steel	LRX 1X100LED PB-SS	LRX 2X100LED PB-SS	LRX 3X100LED PB-SS	LRX 4X100LED PB-SS
Richmond Bronze Frame/Richmond Bronze	LRX 1X100LED RB-RB	LRX 2X100LED RB-RB	LRX 3X100LED RB-RB	LRX 4X100LED RB-RB
Satin Brass Frame/Satin Brass	LRX 1X100LED SB-SB	LRX 2X100LED SB-SB	LRX 3X100LED SB-SB	LRX 4X100LED SB-SB
Satin Brass Frame/Satin Steel	LRX 1X100LED SB-SS	LRX 2X100LED SB-SS	LRX 3X100LED SB-SS	LRX 4X100LED SB-SS
Satin Nickel Frame/Bright Steel	LRX 1X100LED SN-BS	LRX 2X100LED SN-BS	LRX 3X100LED SN-BS	LRX 4X100LED SN-BS
Satin Nickel Frame/Satin Steel	LRX 1X100LED SN-SS	LRX 2X100LED SN-SS	LRX 3X100LED SN-SS	LRX 4X100LED SN-SS
Nominal Size:	91.5mm x 91.5mm	91.5mm x 91.5mm	150.5mm x 91.5mm	150.5mm x 91.5mm
Minimum Wall Box Depth:	35mm	35mm	35mm	35mm
Technical Insert Ref:	1X100LED	2X100LED	3X100LED	4X100LED

NOTE: Tungsten filament GU10 lamps must be branded and with a fused base.
NOTE: Please refer to the Dimmer Technical Section for the max Wattage.
NOTE: Please contact our Technical Department for compatibility.

Linea-Rondo CFX

Resistive Leading Edge Push On/Off Rotary 2 Way Switching Dimmers

LINEA-RONDO CFX RANGE



LRX 1X40 BC-BK



LRX 2X40 BC-N



LRX 4X40 PB-BS



1 gang 400W Resistive Leading Edge Push On/Off Rotary 2 Way Switching Dimmer



2 gang 400W Resistive Leading Edge Push On/Off Rotary 2 Way Switching Dimmer
Max 300W per gang



3 gang 400W Resistive Leading Edge Push On/Off Rotary 2 Way Switching Dimmer

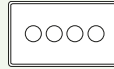

4 gang 400W Resistive Leading Edge Push On/Off Rotary 2 Way Switching Dimmer
Max 300W per gang



1 gang 600W Resistive Leading Edge Push On/Off Rotary 2 Way Switching Dimmer

Frame / Front Plate	LRX 1X40 AB-AB	LRX 2X40 AB-AB	LRX 3X40 AB-AB	LRX 4X40 AB-AB	LRX 1X60 AB-AB
Antique Brass Frame/Antique Brass	LRX 1X40 AB-AB	LRX 2X40 AB-AB	LRX 3X40 AB-AB	LRX 4X40 AB-AB	LRX 1X60 AB-AB
Antique Brass Frame/Satin Brass	LRX 1X40 AB-SB	LRX 2X40 AB-SB	LRX 3X40 AB-SB	LRX 4X40 AB-SB	LRX 1X60 AB-SB
Black Nickel Frame/Black Nickel	LRX 1X40 BK-BK	LRX 2X40 BK-BK	LRX 3X40 BK-BK	LRX 4X40 BK-BK	LRX 1X60 BK-BK
Black Nickel Frame/Bright Steel	LRX 1X40 BK-BS	LRX 2X40 BK-BS	LRX 3X40 BK-BS	LRX 4X40 BK-BS	LRX 1X60 BK-BS
Black Nickel Frame/Polished Brass	LRX 1X40 BK-PB	LRX 2X40 BK-PB	LRX 3X40 BK-PB	LRX 4X40 BK-PB	LRX 1X60 BK-PB
Bright Chrome Frame/Black Nickel	LRX 1X40 BC-BK	LRX 2X40 BC-BK	LRX 3X40 BC-BK	LRX 4X40 BC-BK	LRX 1X60 BC-BK
Bright Chrome Frame/Bright Steel	LRX 1X40 BC-BS	LRX 2X40 BC-BS	LRX 3X40 BC-BS	LRX 4X40 BC-BS	LRX 1X60 BC-BS
Bright Chrome Frame/Piano Black	LRX 1X40 BC-N	LRX 2X40 BC-N	LRX 3X40 BC-N	LRX 4X40 BC-N	LRX 1X60 BC-N
Bright Chrome Frame/Polished Brass	LRX 1X40 BC-PB	LRX 2X40 BC-PB	LRX 3X40 BC-PB	LRX 4X40 BC-PB	LRX 1X60 BC-PB
Bright Chrome Frame/Satin Steel	LRX 1X40 BC-SS	LRX 2X40 BC-SS	LRX 3X40 BC-SS	LRX 4X40 BC-SS	LRX 1X60 BC-SS
Connaught Bronze Frame/Connaught Bronze	LRX 1X40 HB-HB	LRX 2X40 HB-HB	LRX 3X40 HB-HB	LRX 4X40 HB-HB	LRX 1X60 HB-HB
Copper Bronze Frame/Copper Bronze	LRX 1X40 CB-CB	LRX 2X40 CB-CB	LRX 3X40 CB-CB	LRX 4X40 CB-CB	LRX 1X60 CB-CB
Etrium Bronze Frame/Etrium Bronze	LRX 1X40 EB-EB	LRX 2X40 EB-EB	LRX 3X40 EB-EB	LRX 4X40 EB-EB	LRX 1X60 EB-EB
Polished Brass Frame/Antique Brass	LRX 1X40 PB-AB	LRX 2X40 PB-AB	LRX 3X40 PB-AB	LRX 4X40 PB-AB	LRX 1X60 PB-AB
Polished Brass Frame/Bright Steel	LRX 1X40 PB-BS	LRX 2X40 PB-BS	LRX 3X40 PB-BS	LRX 4X40 PB-BS	LRX 1X60 PB-BS
Polished Brass Frame/Polished Brass	LRX 1X40 PB-PB	LRX 2X40 PB-PB	LRX 3X40 PB-PB	LRX 4X40 PB-PB	LRX 1X60 PB-PB
Polished Brass Frame/Satin Brass	LRX 1X40 PB-SB	LRX 2X40 PB-SB	LRX 3X40 PB-SB	LRX 4X40 PB-SB	LRX 1X60 PB-SB
Polished Brass Frame/Satin Steel	LRX 1X40 PB-SS	LRX 2X40 PB-SS	LRX 3X40 PB-SS	LRX 4X40 PB-SS	LRX 1X60 PB-SS
Richmond Bronze Frame/Richmond Bronze	LRX 1X40 RB-RB	LRX 2X40 RB-RB	LRX 3X40 RB-RB	LRX 4X40 RB-RB	LRX 1X60 RB-RB
Satin Brass Frame/Satin Brass	LRX 1X40 SB-SB	LRX 2X40 SB-SB	LRX 3X40 SB-SB	LRX 4X40 SB-SB	LRX 1X60 SB-SB
Satin Brass Frame/Satin Steel	LRX 1X40 SB-SS	LRX 2X40 SB-SS	LRX 3X40 SB-SS	LRX 4X40 SB-SS	LRX 1X60 SB-SS
Satin Nickel Frame/Bright Steel	LRX 1X40 SN-BS	LRX 2X40 SN-BS	LRX 3X40 SN-BS	LRX 4X40 SN-BS	LRX 1X60 SN-BS
Satin Nickel Frame/Satin Steel	LRX 1X40 SN-SS	LRX 2X40 SN-SS	LRX 3X40 SN-SS	LRX 4X40 SN-SS	LRX 1X60 SN-SS
Nominal Size:	91.5mm x 91.5mm	91.5mm x 91.5mm	150.5mm x 91.5mm	150.5mm x 91.5mm	91.5mm x 91.5mm
Minimum Wall Box Depth:	35mm	35mm	35mm	35mm	35mm
Technical Insert Ref:	1X40	2X40	3X40	4X40	1X60

NOTE: Tungsten filament GU10 lamps must be branded and with a fused base
 NOTE: When using mains voltage halogen lamps – dimmers should be re-rated by 25%
 NOTE: When dimming LED lamps de-rate by 75% - please contact our Technical Department for compatibility.
 NOTE: Please refer to the Dimmer Technical Section for the max wattage

Linea-Rondo CFX

Inductive Leading Edge Push On/Off Rotary 2 Way Switching Dimmers



LRX 1X2V BC-BK



1 gang 200VA
Inductive Leading
Edge Push
On/Off Rotary
2 Way Switching Dimmer

Frame / Front Plate	
Antique Brass Frame/Antique Brass	LRX 1X2V AB-AB
Antique Brass Frame/Satin Brass	LRX 1X2V AB-SB
Black Nickel Frame/Black Nickel	LRX 1X2V BK-BK
Black Nickel Frame/Bright Steel	LRX 1X2V BK-BS
Black Nickel Frame/Polished Brass	LRX 1X2V BK-PB
Bright Chrome Frame/Black Nickel	LRX 1X2V BC-BK
Bright Chrome Frame/Bright Steel	LRX 1X2V BC-BS
Bright Chrome Frame/Piano Black	LRX 1X2V BC-N
Bright Chrome Frame/Polished Brass	LRX 1X2V BC-PB
Bright Chrome Frame/Satin Steel	LRX 1X2V BC-SS
Connaught Bronze Frame/Connaught Bronze	LRX 1X2V HB-HB
Copper Bronze Frame/Copper Bronze	LRX 1X2V CB-CB
Etrium Bronze Frame/Etrium Bronze	LRX 1X2V EB-EB
Polished Brass Frame/Antique Brass	LRX 1X2V PB-AB
Polished Brass Frame/Bright Steel	LRX 1X2V PB-BS
Polished Brass Frame/Polished Brass	LRX 1X2V PB-PB
Polished Brass Frame/Satin Brass	LRX 1X2V PB-SB
Polished Brass Frame/Satin Steel	LRX 1X2V PB-SS
Richmond Bronze Frame/Richmond Bronze	LRX 1X2V RB-RB
Satin Brass Frame/Satin Brass	LRX 1X2V SB-SB
Satin Brass Frame/Satin Steel	LRX 1X2V SB-SS
Satin Nickel Frame/Bright Steel	LRX 1X2V SN-BS
Satin Nickel Frame/Satin Steel	LRX 1X2V SN-SS
Nominal Size:	91.5mm x 91.5mm
Minimum Wall Box Depth:	35mm
Technical Insert Ref:	1X2V

NOTE: Tungsten filament GU10 lamps must be branded and with a fused base

NOTE: When using mains voltage halogen lamps – dimmers should be re-rated by 25%

NOTE: When dimming LED lamps de-rate by 75% - please contact our Technical Department for compatibility.

NOTE: Please refer to the Dimmer Technical Section for the max wattage

Linea-Rondo CFX

Resistive/Inductive Trailing Edge Push On/Off Rotary Multi-Way Dimmers

LINEA-RONDO CFX RANGE



LRX 1XTE BC-BK



LRX 2XTE BC-N



LRX 3XTE BK-BK



LRX 4XTE PB-BS



1 gang 250W/210VA
Resistive/Inductive Trailing
Edge Push On/Off Rotary
Multi-Way Dimmer



2 gang 250W/210VA
Resistive/Inductive Trailing
Edge Push On/Off Rotary
Multi-Way Dimmer

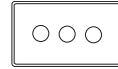

3 gang 250W/210VA
Resistive/Inductive Trailing
Edge Push On/Off Rotary
Multi-Way Dimmer



4 gang 250W/210VA
Resistive/Inductive Trailing
Edge Push On/Off Rotary
Multi-Way Dimmer

Frame / Front Plate	1 gang 250W/210VA Resistive/Inductive Trailing Edge Push On/Off Rotary Multi-Way Dimmer	2 gang 250W/210VA Resistive/Inductive Trailing Edge Push On/Off Rotary Multi-Way Dimmer	3 gang 250W/210VA Resistive/Inductive Trailing Edge Push On/Off Rotary Multi-Way Dimmer	4 gang 250W/210VA Resistive/Inductive Trailing Edge Push On/Off Rotary Multi-Way Dimmer
Antique Brass Frame/Antique Brass	LRX 1XTE AB-AB	LRX 2XTE AB-AB	LRX 3XTE AB-AB	LRX 4XTE AB-AB
Antique Brass Frame/Satin Brass	LRX 1XTE AB-SB	LRX 2XTE AB-SB	LRX 3XTE AB-SB	LRX 4XTE AB-SB
Black Nickel Frame/Black Nickel	LRX 1XTE BK-BK	LRX 2XTE BK-BK	LRX 3XTE BK-BK	LRX 4XTE BK-BK
Black Nickel Frame/Bright Steel	LRX 1XTE BK-BS	LRX 2XTE BK-BS	LRX 3XTE BK-BS	LRX 4XTE BK-BS
Black Nickel Frame/Polished Brass	LRX 1XTE BK-PB	LRX 2XTE BK-PB	LRX 3XTE BK-PB	LRX 4XTE BK-PB
Bright Chrome Frame/Black Nickel	LRX 1XTE BC-BK	LRX 2XTE BC-BK	LRX 3XTE BC-BK	LRX 4XTE BC-BK
Bright Chrome Frame/Bright Steel	LRX 1XTE BC-BS	LRX 2XTE BC-BS	LRX 3XTE BC-BS	LRX 4XTE BC-BS
Bright Chrome Frame/Piano Black	LRX 1XTE BC-N	LRX 2XTE BC-N	LRX 3XTE BC-N	LRX 4XTE BC-N
Bright Chrome Frame/Polished Brass	LRX 1XTE BC-PB	LRX 2XTE BC-PB	LRX 3XTE BC-PB	LRX 4XTE BC-PB
Bright Chrome Frame/Satin Steel	LRX 1XTE BC-SS	LRX 2XTE BC-SS	LRX 3XTE BC-SS	LRX 4XTE BC-SS
Connaught Bronze Frame/Connaught Bronze	LRX 1XTE HB-HB	LRX 2XTE HB-HB	LRX 3XTE HB-HB	LRX 4XTE HB-HB
Copper Bronze Frame/Copper Bronze	LRX 1XTE CB-CB	LRX 2XTE CB-CB	LRX 3XTE CB-CB	LRX 4XTE CB-CB
Etrium Bronze Frame/Etrium Bronze	LRX 1XTE EB-EB	LRX 2XTE EB-EB	LRX 3XTE EB-EB	LRX 4XTE EB-EB
Polished Brass Frame/Antique Brass	LRX 1XTE PB-AB	LRX 2XTE PB-AB	LRX 3XTE PB-AB	LRX 4XTE PB-AB
Polished Brass Frame/Bright Steel	LRX 1XTE PB-BS	LRX 2XTE PB-BS	LRX 3XTE PB-BS	LRX 4XTE PB-BS
Polished Brass Frame/Polished Brass	LRX 1XTE PB-PB	LRX 2XTE PB-PB	LRX 3XTE PB-PB	LRX 4XTE PB-PB
Polished Brass Frame/Satin Brass	LRX 1XTE PB-SB	LRX 2XTE PB-SB	LRX 3XTE PB-SB	LRX 4XTE PB-SB
Polished Brass Frame/Satin Steel	LRX 1XTE PB-SS	LRX 2XTE PB-SS	LRX 3XTE PB-SS	LRX 4XTE PB-SS
Richmond Bronze Frame/Richmond Bronze	LRX 1XTE RB-RB	LRX 2XTE RB-RB	LRX 3XTE RB-RB	LRX 4XTE RB-RB
Satin Brass Frame/Satin Brass	LRX 1XTE SB-SB	LRX 2XTE SB-SB	LRX 3XTE SB-SB	LRX 4XTE SB-SB
Satin Brass Frame/Satin Steel	LRX 1XTE SB-SS	LRX 2XTE SB-SS	LRX 3XTE SB-SS	LRX 4XTE SB-SS
Satin Nickel Frame/Bright Steel	LRX 1XTE SN-BS	LRX 2XTE SN-BS	LRX 3XTE SN-BS	LRX 4XTE SN-BS
Satin Nickel Frame/Satin Steel	LRX 1XTE SN-SS	LRX 2XTE SN-SS	LRX 3XTE SN-SS	LRX 4XTE SN-SS
Nominal Size:	91.5mm x 91.5mm	91.5mm x 91.5mm	150.5mm x 91.5mm	150.5mm x 91.5mm
Minimum Wall Box Depth:	35mm	35mm	35mm	35mm
Technical Insert Ref:	1XTE	2XTE	3XTE	4XTE

NOTE: Tungsten filament GU10 lamps must be branded and with a fused base
 NOTE: When using mains voltage halogen lamps – dimmers should be re-rated by 25%
 NOTE: When dimming LED lamps de-rate by 75% - please contact our Technical Department for compatibility.
 NOTE: Please refer to the Dimmer Technical Section for the max wattage

Linea-Rondo CFX

Resistive/Inductive Trailing Edge Touch Master Multi-Way Dimmers



LRX 1XTM BC-BK B





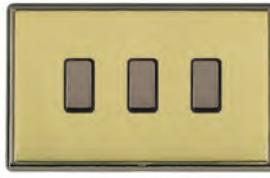

LRX 1XTM BC-PB B

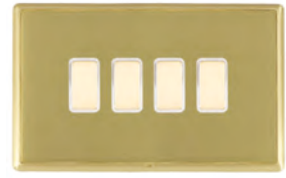

LRX 2XTM BK-PB B

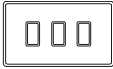

LRX 4XTM SB-SB W

Frame / Front Plate	 1 gang 250W/210VA Resistive/Inductive Trailing Edge Touch Master Multi-Way Dimmer	 2 gang 250W/210VA Resistive/Inductive Trailing Edge Touch Master Multi-Way Dimmer	 3 gang 250W/210VA Resistive/Inductive Trailing Edge Touch Master Multi-Way Dimmer	 4 gang 250W/210VA Resistive/Inductive Trailing Edge Touch Master Multi-Way Dimmer
Antique Brass Frame/Antique Brass	LRX 1XTM AB-AB B	LRX 2XTM AB-AB B	LRX 3XTM AB-AB B	LRX 4XTM AB-AB B
Antique Brass Frame/Satin Brass	LRX 1XTM AB-SB B	LRX 2XTM AB-SB B	LRX 3XTM AB-SB B	LRX 4XTM AB-SB B
Black Nickel Frame/Black Nickel	LRX 1XTM BK-BK B	LRX 2XTM BK-BK B	LRX 3XTM BK-BK B	LRX 4XTM BK-BK B
Black Nickel Frame/Bright Steel	LRX 1XTM BK-BS B	LRX 2XTM BK-BS B	LRX 3XTM BK-BS B	LRX 4XTM BK-BS B
Black Nickel Frame/Polished Brass	LRX 1XTM BK-PB B	LRX 2XTM BK-PB B	LRX 3XTM BK-PB B	LRX 4XTM BK-PB B
Bright Chrome Frame/Black Nickel	LRX 1XTM BC-BK B	LRX 2XTM BC-BK B	LRX 3XTM BC-BK B	LRX 4XTM BC-BK B
Bright Chrome Frame/Bright Steel	LRX 1XTM BC-BS B	LRX 2XTM BC-BS B	LRX 3XTM BC-BS B	LRX 4XTM BC-BS B
Bright Chrome Frame/Bright Steel	LRX 1XTM BC-BS W	LRX 2XTM BC-BS W	LRX 3XTM BC-BS W	LRX 4XTM BC-BS W
Bright Chrome Frame/Piano Black	LRX 1XTM BC-NB	LRX 2XTM BC-NB	LRX 3XTM BC-NB	LRX 4XTM BC-NB
Bright Chrome Frame/Polished Brass	LRX 1XTM BC-PB B	LRX 2XTM BC-PB B	LRX 3XTM BC-PB B	LRX 4XTM BC-PB B
Bright Chrome Frame/Polished Brass	LRX 1XTM BC-PB W	LRX 2XTM BC-PB W	LRX 3XTM BC-PB W	LRX 4XTM BC-PB W
Bright Chrome Frame/Satin Steel	LRX 1XTM BC-SS B	LRX 2XTM BC-SS B	LRX 3XTM BC-SS B	LRX 4XTM BC-SS B
Bright Chrome Frame/Satin Steel	LRX 1XTM BC-SS W	LRX 2XTM BC-SS W	LRX 3XTM BC-SS W	LRX 4XTM BC-SS W
Connaught Bronze Frame/Connaught Bronze	LRX 1XTM HB-HB B	LRX 2XTM HB-HB B	LRX 3XTM HB-HB B	LRX 4XTM HB-HB B
Copper Bronze Frame/Copper Bronze	LRX 1XTM CB-CB B	LRX 2XTM CB-CB B	LRX 3XTM CB-CB B	LRX 4XTM CB-CB B
Etrium Bronze Frame/Etrium Bronze	LRX 1XTM EB-EB B	LRX 2XTM EB-EB B	LRX 3XTM EB-EB B	LRX 4XTM EB-EB B
Polished Brass Frame/Antique Brass	LRX 1XTM PB-AB B	LRX 2XTM PB-AB B	LRX 3XTM PB-AB B	LRX 4XTM PB-AB B
Polished Brass Frame/Antique Brass	LRX 1XTM PB-AB W	LRX 2XTM PB-AB W	LRX 3XTM PB-AB W	LRX 4XTM PB-AB W
Polished Brass Frame/Bright Steel	LRX 1XTM PB-BS B	LRX 2XTM PB-BS B	LRX 3XTM PB-BS B	LRX 4XTM PB-BS B
Polished Brass Frame/Bright Steel	LRX 1XTM PB-BS W	LRX 2XTM PB-BS W	LRX 3XTM PB-BS W	LRX 4XTM PB-BS W
Polished Brass Frame/Polished Brass	LRX 1XTM PB-PB B	LRX 2XTM PB-PB B	LRX 3XTM PB-PB B	LRX 4XTM PB-PB B
Polished Brass Frame/Polished Brass	LRX 1XTM PB-PB W	LRX 2XTM PB-PB W	LRX 3XTM PB-PB W	LRX 4XTM PB-PB W
Polished Brass Frame/Satin Brass	LRX 1XTM PB-SB B	LRX 2XTM PB-SB B	LRX 3XTM PB-SB B	LRX 4XTM PB-SB B
Polished Brass Frame/Satin Brass	LRX 1XTM PB-SB W	LRX 2XTM PB-SB W	LRX 3XTM PB-SB W	LRX 4XTM PB-SB W
Polished Brass Frame/Satin Steel	LRX 1XTM PB-SS B	LRX 2XTM PB-SS B	LRX 3XTM PB-SS B	LRX 4XTM PB-SS B
Polished Brass Frame/Satin Steel	LRX 1XTM PB-SS W	LRX 2XTM PB-SS W	LRX 3XTM PB-SS W	LRX 4XTM PB-SS W
Richmond Bronze Frame/Richmond Bronze	LRX 1XTM RB-RB B	LRX 2XTM RB-RB B	LRX 3XTM RB-RB B	LRX 4XTM RB-RB B
Satin Brass Frame/Satin Brass	LRX 1XTM SB-SB B	LRX 2XTM SB-SB B	LRX 3XTM SB-SB B	LRX 4XTM SB-SB B
Satin Brass Frame/Satin Brass	LRX 1XTM SB-SB W	LRX 2XTM SB-SB W	LRX 3XTM SB-SB W	LRX 4XTM SB-SB W
Satin Brass Frame/Satin Steel	LRX 1XTM SB-SS B	LRX 2XTM SB-SS B	LRX 3XTM SB-SS B	LRX 4XTM SB-SS B
Satin Brass Frame/Satin Steel	LRX 1XTM SB-SS W	LRX 2XTM SB-SS W	LRX 3XTM SB-SS W	LRX 4XTM SB-SS W
Satin Nickel Frame/Bright Steel	LRX 1XTM SN-BS B	LRX 2XTM SN-BS B	LRX 3XTM SN-BS B	LRX 4XTM SN-BS B
Satin Nickel Frame/Bright Steel	LRX 1XTM SN-BS W	LRX 2XTM SN-BS W	LRX 3XTM SN-BS W	LRX 4XTM SN-BS W
Satin Nickel Frame/Satin Steel	LRX 1XTM SN-SS B	LRX 2XTM SN-SS B	LRX 3XTM SN-SS B	LRX 4XTM SN-SS B
Satin Nickel Frame/Satin Steel	LRX 1XTM SN-SS W	LRX 2XTM SN-SS W	LRX 3XTM SN-SS W	LRX 4XTM SN-SS W
Nominal Size:	91.5mm x 91.5mm	91.5mm x 91.5mm	150.5mm x 91.5mm	150.5mm x 91.5mm
Minimum Wall Box Depth:	35mm	35mm	35mm	35mm
Technical Insert Ref:	1XTM	2XTM	3XTM	4XTM

NOTE: Tungsten filament GU10 lamps must be branded and with a fused base
 NOTE: When using mains voltage halogen lamps – dimmers should be re-rated by 25%
 NOTE: When dimming LED lamps de-rate by 75% - please contact our Technical Department for compatibility.
 NOTE: Please refer to the Dimmer Technical Section for the max wattage

Insert Surround Colour Key: (B) Black, (W) White

Linea-Rondo CFX

Multi-Way Touch Slave Controllers

LINEA-RONDO CFX RANGE



LRX 1XTS BC-NB





LRX 2XTS BK-BK B

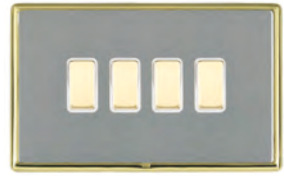

LRX 3XTS BK-PB B

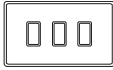
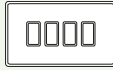

LRX 4XTS PB-SS W

Frame / Front Plate	 1 gang Multi-Way Touch Slave Controller	 2 gang Multi-Way Touch Slave Controller	 3 gang Multi-Way Touch Slave Controller	 4 gang Multi-Way Touch Slave Controller
Antique Brass Frame/Antique Brass	LRX 1XTS AB-AB B	LRX 2XTS AB-AB B	LRX 3XTS AB-AB B	LRX 4XTS AB-AB B
Antique Brass Frame/Satin Brass	LRX 1XTS AB-SB B	LRX 2XTS AB-SB B	LRX 3XTS AB-SB B	LRX 4XTS AB-SB B
Black Nickel Frame/Black Nickel	LRX 1XTS BK-BK B	LRX 2XTS BK-BK B	LRX 3XTS BK-BK B	LRX 4XTS BK-BK B
Black Nickel Frame/Bright Steel	LRX 1XTS BK-BS B	LRX 2XTS BK-BS B	LRX 3XTS BK-BS B	LRX 4XTS BK-BS B
Black Nickel Frame/Polished Brass	LRX 1XTS BK-PB B	LRX 2XTS BK-PB B	LRX 3XTS BK-PB B	LRX 4XTS BK-PB B
Bright Chrome Frame/Black Nickel	LRX 1XTS BC-BK B	LRX 2XTS BC-BK B	LRX 3XTS BC-BK B	LRX 4XTS BC-BK B
Bright Chrome Frame/Bright Steel	LRX 1XTS BC-BS B	LRX 2XTS BC-BS B	LRX 3XTS BC-BS B	LRX 4XTS BC-BS B
Bright Chrome Frame/Bright Steel	LRX 1XTS BC-BS W	LRX 2XTS BC-BS W	LRX 3XTS BC-BS W	LRX 4XTS BC-BS W
Bright Chrome Frame/Piano Black	LRX 1XTS BC-NB	LRX 2XTS BC-NB	LRX 3XTS BC-NB	LRX 4XTS BC-NB
Bright Chrome Frame/Polished Brass	LRX 1XTS BC-PB B	LRX 2XTS BC-PB B	LRX 3XTS BC-PB B	LRX 4XTS BC-PB B
Bright Chrome Frame/Polished Brass	LRX 1XTS BC-PB W	LRX 2XTS BC-PB W	LRX 3XTS BC-PB W	LRX 4XTS BC-PB W
Bright Chrome Frame/Satin Steel	LRX 1XTS BC-SS B	LRX 2XTS BC-SS B	LRX 3XTS BC-SS B	LRX 4XTS BC-SS B
Bright Chrome Frame/Satin Steel	LRX 1XTS BC-SS W	LRX 2XTS BC-SS W	LRX 3XTS BC-SS W	LRX 4XTS BC-SS W
Connaught Bronze Frame/Connaught Bronze	LRX 1XTS HB-HB B	LRX 2XTS HB-HB B	LRX 3XTS HB-HB B	LRX 4XTS HB-HB B
Copper Bronze Frame/Copper Bronze	LRX 1XTS CB-CB B	LRX 2XTS CB-CB B	LRX 3XTS CB-CB B	LRX 4XTS CB-CB B
Etrium Bronze Frame/Etrium Bronze	LRX 1XTS EB-EB B	LRX 2XTS EB-EB B	LRX 3XTS EB-EB B	LRX 4XTS EB-EB B
Polished Brass Frame/Antique Brass	LRX 1XTS PB-AB B	LRX 2XTS PB-AB B	LRX 3XTS PB-AB B	LRX 4XTS PB-AB B
Polished Brass Frame/Antique Brass	LRX 1XTS PB-AB W	LRX 2XTS PB-AB W	LRX 3XTS PB-AB W	LRX 4XTS PB-AB W
Polished Brass Frame/Bright Steel	LRX 1XTS PB-BS B	LRX 2XTS PB-BS B	LRX 3XTS PB-BS B	LRX 4XTS PB-BS B
Polished Brass Frame/Bright Steel	LRX 1XTS PB-BS W	LRX 2XTS PB-BS W	LRX 3XTS PB-BS W	LRX 4XTS PB-BS W
Polished Brass Frame/Polished Brass	LRX 1XTS PB-PB B	LRX 2XTS PB-PB B	LRX 3XTS PB-PB B	LRX 4XTS PB-PB B
Polished Brass Frame/Polished Brass	LRX 1XTS PB-PB W	LRX 2XTS PB-PB W	LRX 3XTS PB-PB W	LRX 4XTS PB-PB W
Polished Brass Frame/Satin Brass	LRX 1XTS PB-SB B	LRX 2XTS PB-SB B	LRX 3XTS PB-SB B	LRX 4XTS PB-SB B
Polished Brass Frame/Satin Brass	LRX 1XTS PB-SB W	LRX 2XTS PB-SB W	LRX 3XTS PB-SB W	LRX 4XTS PB-SB W
Polished Brass Frame/Satin Steel	LRX 1XTS PB-SS B	LRX 2XTS PB-SS B	LRX 3XTS PB-SS B	LRX 4XTS PB-SS B
Polished Brass Frame/Satin Steel	LRX 1XTS PB-SS W	LRX 2XTS PB-SS W	LRX 3XTS PB-SS W	LRX 4XTS PB-SS W
Richmond Bronze Frame/Richmond Bronze	LRX 1XTS RB-RB B	LRX 2XTS RB-RB B	LRX 3XTS RB-RB B	LRX 4XTS RB-RB B
Satin Brass Frame/Satin Brass	LRX 1XTS SB-SB B	LRX 2XTS SB-SB B	LRX 3XTS SB-SB B	LRX 4XTS SB-SB B
Satin Brass Frame/Satin Brass	LRX 1XTS SB-SB W	LRX 2XTS SB-SB W	LRX 3XTS SB-SB W	LRX 4XTS SB-SB W
Satin Brass Frame/Satin Steel	LRX 1XTS SB-SS B	LRX 2XTS SB-SS B	LRX 3XTS SB-SS B	LRX 4XTS SB-SS B
Satin Brass Frame/Satin Steel	LRX 1XTS SB-SS W	LRX 2XTS SB-SS W	LRX 3XTS SB-SS W	LRX 4XTS SB-SS W
Satin Nickel Frame/Bright Steel	LRX 1XTS SN-BS B	LRX 2XTS SN-BS B	LRX 3XTS SN-BS B	LRX 4XTS SN-BS B
Satin Nickel Frame/Bright Steel	LRX 1XTS SN-BS W	LRX 2XTS SN-BS W	LRX 3XTS SN-BS W	LRX 4XTS SN-BS W
Satin Nickel Frame/Satin Steel	LRX 1XTS SN-SS B	LRX 2XTS SN-SS B	LRX 3XTS SN-SS B	LRX 4XTS SN-SS B
Satin Nickel Frame/Satin Steel	LRX 1XTS SN-SS W	LRX 2XTS SN-SS W	LRX 3XTS SN-SS W	LRX 4XTS SN-SS W
Nominal Size:	91.5mm x 91.5mm	91.5mm x 91.5mm	150.5mm x 91.5mm	150.5mm x 91.5mm
Minimum Wall Box Depth:	35mm	35mm	35mm	35mm
Technical Insert Ref:	1XTS	2XTS	3XTS	4XTS

NOTE: To only be used with Touch Masters

Insert Surround Colour Key: (-B) Black, (-W) White

Linea-Rondo CFX

Blank Plates



LRX BPS BC-BK



LRX BPD SB-SB

Frame / Front Plate	Single Blank Plate	Double Blank Plate
Antique Brass Frame/Antique Brass	LRX BPS AB-AB	LRX BPD AB-AB
Antique Brass Frame/Satin Brass	LRX BPS AB-SB	LRX BPD AB-SB
Black Nickel Frame/Black Nickel	LRX BPS BK-BK	LRX BPD BK-BK
Black Nickel Frame/Bright Steel	LRX BPS BK-BS	LRX BPD BK-BS
Black Nickel Frame/Polished Brass	LRX BPS BK-PB	LRX BPD BK-PB
Bright Chrome Frame/Black Nickel	LRX BPS BC-BK	LRX BPD BC-BK
Bright Chrome Frame/Bright Steel	LRX BPS BC-BS	LRX BPD BC-BS
Bright Chrome Frame/Piano Black	LRX BPS BC-N	LRX BPD BC-N
Bright Chrome Frame/Polished Brass	LRX BPS BC-PB	LRX BPD BC-PB
Bright Chrome Frame/Satin Steel	LRX BPS BC-SS	LRX BPD BC-SS
Connaught Bronze Frame/Connaught Bronze	LRX BPS HB-HB	LRX BPD HB-HB
Copper Bronze Frame/Copper Bronze	LRX BPS CB-CB	LRX BPD CB-CB
Etrium Bronze Frame/Etrium Bronze	LRX BPS EB-EB	LRX BPD EB-EB
Polished Brass Frame/Antique Brass	LRX BPS PB-AB	LRX BPD PB-AB
Polished Brass Frame/Bright Steel	LRX BPS PB-BS	LRX BPD PB-BS
Polished Brass Frame/Polished Brass	LRX BPS PB-PB	LRX BPD PB-PB
Polished Brass Frame/Satin Brass	LRX BPS PB-SB	LRX BPD PB-SB
Polished Brass Frame/Satin Steel	LRX BPS PB-SS	LRX BPD PB-SS
Richmond Bronze Frame/Richmond Bronze	LRX BPS RB-RB	LRX BPD RB-RB
Satin Brass Frame/Satin Brass	LRX BPS SB-SB	LRX BPD SB-SB
Satin Brass Frame/Satin Steel	LRX BPS SB-SS	LRX BPD SB-SS
Satin Nickel Frame/Bright Steel	LRX BPS SN-BS	LRX BPD SN-BS
Satin Nickel Frame/Satin Steel	LRX BPS SN-SS	LRX BPD SN-SS
Nominal Size:	91.5mm x 91.5mm	150.5mm x 91.5mm
Minimum Wall Box Depth:	Any Box	Any Box
Technical Insert Ref:	BPS	BPD

Linea-Rondo CFX

Grid-IT GridFix Plates complete with Fixing Grid

LINEA-RONDO CFX RANGE



LRX 1GP BC-N



LRX 2GP AB-SB



LRX 3GP BK-BS



LRX 4GP BC-BK

Frame / Front Plate	1 Gang Grid Fix Aperture Plate with Grid	2 Gang Grid Fix Aperture Plate with Grid	3 Gang Grid Fix Aperture Plate with Grid	4 Gang Grid Fix Aperture Plate with Grid
Antique Brass Frame/Antique Brass	LRX 1GP AB-AB	LRX 2GP AB-AB	LRX 3GP AB-AB	LRX 4GP AB-AB
Antique Brass Frame/Satin Brass	LRX 1GP AB-SB	LRX 2GP AB-SB	LRX 3GP AB-SB	LRX 4GP AB-SB
Bright Chrome Frame/Black Nickel	LRX 1GP BC-BK	LRX 2GP BC-BK	LRX 3GP BC-BK	LRX 4GP BC-BK
Bright Chrome Frame/Bright Steel	LRX 1GP BC-BS	LRX 2GP BC-BS	LRX 3GP BC-BS	LRX 4GP BC-BS
Bright Chrome Frame/Piano Black	LRX 1GP BC-N	LRX 2GP BC-N	LRX 3GP BC-N	LRX 4GP BC-N
Bright Chrome Frame/Polished Brass	LRX 1GP BC-PB	LRX 2GP BC-PB	LRX 3GP BC-PB	LRX 4GP BC-PB
Bright Chrome Frame/Satin Steel	LRX 1GP BC-SS	LRX 2GP BC-SS	LRX 3GP BC-SS	LRX 4GP BC-SS
Black Nickel Frame/Black Nickel	LRX 1GP BK-BK	LRX 2GP BK-BK	LRX 3GP BK-BK	LRX 4GP BK-BK
Black Nickel Frame/Bright Steel	LRX 1GP BK-BS	LRX 2GP BK-BS	LRX 3GP BK-BS	LRX 4GP BK-BS
Black Nickel Frame/Polished Brass	LRX 1GP BK-PB	LRX 2GP BK-PB	LRX 3GP BK-PB	LRX 4GP BK-PB
Copper Bronze Frame/Copper Bronze	LRX 1GP CB-CB	LRX 2GP CB-CB	LRX 3GP CB-CB	LRX 4GP CB-CB
Etrium Bronze Frame/Etrium Bronze	LRX 1GP EB-EB	LRX 2GP EB-EB	LRX 3GP EB-EB	LRX 4GP EB-EB
Connaught Bronze Frame/Connaught Bronze	LRX 1GP HB-HB	LRX 2GP HB-HB	LRX 3GP HB-HB	LRX 4GP HB-HB
Polished Brass Frame/Antique Brass	LRX 1GP PB-AB	LRX 2GP PB-AB	LRX 3GP PB-AB	LRX 4GP PB-AB
Polished Brass Frame/Bright Steel	LRX 1GP PB-BS	LRX 2GP PB-BS	LRX 3GP PB-BS	LRX 4GP PB-BS
Polished Brass Frame/Polished Brass	LRX 1GP PB-PB	LRX 2GP PB-PB	LRX 3GP PB-PB	LRX 4GP PB-PB
Polished Brass Frame/Satin Brass	LRX 1GP PB-SB	LRX 2GP PB-SB	LRX 3GP PB-SB	LRX 4GP PB-SB
Polished Brass Frame/Satin Steel	LRX 1GP PB-SS	LRX 2GP PB-SS	LRX 3GP PB-SS	LRX 4GP PB-SS
Richmond Bronze Frame/Richmond Bronze	LRX 1GP RB-RB	LRX 2GP RB-RB	LRX 3GP RB-RB	LRX 4GP RB-RB
Satin Brass Frame/Satin Brass	LRX 1GP SB-SB	LRX 2GP SB-SB	LRX 3GP SB-SB	LRX 4GP SB-SB
Satin Brass Frame/Satin Steel	LRX 1GP SB-SS	LRX 2GP SB-SS	LRX 3GP SB-SS	LRX 4GP SB-SS
Satin Nickel Frame/Bright Steel	LRX 1GP SN-BS	LRX 2GP SN-BS	LRX 3GP SN-BS	LRX 4GP SN-BS
Satin Nickel Frame/Satin Steel	LRX 1GP SN-SS	LRX 2GP SN-SS	LRX 3GP SN-SS	LRX 4GP SN-SS
Nominal Size:	91.5mm x 91.5mm	91.5mm x 91.5mm	150.5mm x 91.5mm	150.5mm x 91.5mm
Minimum Wall Box Depth:	As Per Insert	As Per Inserts	As Per Inserts	As Per Inserts
Technical Insert Ref:	1GP	2GP	3GP	4GP

Note: Minimum Wall Box depth is dependant on the Grid Fix insert fitted, please see the GRID-IT section for the complete range of inserts.

Linea-Rondo CFX

EuroFix Apertured Plates complete with Fixing Grid



LRX EURO1 AB-SB



LRX EURO2 BC-N



LRX EURO3 BK-BK



LRX EURO4 PB-SS

Frame / Front Plate	1 Module EuroFix 25x50mm Apertured Plate with Grid	2 Module EuroFix 50x50mm Apertured Plate with Grid	3 Module EuroFix 75x50mm Apertured Plate with Grid	4 Module EuroFix 100x50mm Apertured Plate with Grid
Antique Brass Frame/Antique Brass	LRX EURO1 AB-AB	LRX EURO2 AB-AB	LRX EURO3 AB-AB	LRX EURO4 AB-AB
Antique Brass Frame/Satin Brass	LRX EURO1 AB-SB	LRX EURO2 AB-SB	LRX EURO3 AB-SB	LRX EURO4 AB-SB
Bright Chrome Frame/Bright Steel	LRX EURO1 BC-BS	LRX EURO2 BC-BS	LRX EURO3 BC-BS	LRX EURO4 BC-BS
Bright Chrome Frame/Satin Steel	LRX EURO1 BC-SS	LRX EURO2 BC-SS	LRX EURO3 BC-SS	LRX EURO4 BC-SS
Bright Chrome Frame/Polished Brass	LRX EURO1 BC-PB	LRX EURO2 BC-PB	LRX EURO3 BC-PB	LRX EURO4 BC-PB
Bright Chrome Frame/Black Nickel	LRX EURO1 BC-BK	LRX EURO2 BC-BK	LRX EURO3 BC-BK	LRX EURO4 BC-BK
Bright Chrome Frame/Piano Black	LRX EURO1 BC-N	LRX EURO2 BC-N	LRX EURO3 BC-N	LRX EURO4 BC-N
Black Nickel Frame/Black Nickel	LRX EURO1 BK-BK	LRX EURO2 BK-BK	LRX EURO3 BK-BK	LRX EURO4 BK-BK
Black Nickel Frame/Bright Steel	LRX EURO1 BK-BS	LRX EURO2 BK-BS	LRX EURO3 BK-BS	LRX EURO4 BK-BS
Black Nickel Frame/Polished Brass	LRX EURO1 BK-PB	LRX EURO2 BK-PB	LRX EURO3 BK-PB	LRX EURO4 BK-PB
Copper Bronze Frame/Copper Bronze	LRX EURO1 CB-CB	LRX EURO2 CB-CB	LRX EURO3 CB-CB	LRX EURO4 CB-CB
Etrium Bronze Frame/Etrium Bronze	LRX EURO1 EB-EB	LRX EURO2 EB-EB	LRX EURO3 EB-EB	LRX EURO4 EB-EB
Connaught Bronze Frame/Connaught Bronze	LRX EURO1 HB-HB	LRX EURO2 HB-HB	LRX EURO3 HB-HB	LRX EURO4 HB-HB
Polished Brass Frame/Polished Brass	LRX EURO1 PB-PB	LRX EURO2 PB-PB	LRX EURO3 PB-PB	LRX EURO4 PB-PB
Polished Brass Frame/Satin Brass	LRX EURO1 PB-SB	LRX EURO2 PB-SB	LRX EURO3 PB-SB	LRX EURO4 PB-SB
Polished Brass Frame/Antique Brass	LRX EURO1 PB-AB	LRX EURO2 PB-AB	LRX EURO3 PB-AB	LRX EURO4 PB-AB
Polished Brass Frame/Bright Steel	LRX EURO1 PB-BS	LRX EURO2 PB-BS	LRX EURO3 PB-BS	LRX EURO4 PB-BS
Polished Brass Frame/Satin Steel	LRX EURO1 PB-SS	LRX EURO2 PB-SS	LRX EURO3 PB-SS	LRX EURO4 PB-SS
Richmond Bronze Frame/Richmond Bronze	LRX EURO1 RB-RB	LRX EURO2 RB-RB	LRX EURO3 RB-RB	LRX EURO4 RB-RB
Satin Brass Frame/Satin Brass	LRX EURO1 SB-SB	LRX EURO2 SB-SB	LRX EURO3 SB-SB	LRX EURO4 SB-SB
Satin Brass Frame/Satin Steel	LRX EURO1 SB-SS	LRX EURO2 SB-SS	LRX EURO3 SB-SS	LRX EURO4 SB-SS
Satin Nickel Frame/Bright Steel	LRX EURO1 SN-BS	LRX EURO2 SN-BS	LRX EURO3 SN-BS	LRX EURO4 SN-BS
Satin Nickel Frame/Satin Steel	LRX EURO1 SN-SS	LRX EURO2 SN-SS	LRX EURO3 SN-SS	LRX EURO4 SN-SS
Nominal Size:	91.5mm x 91.5mm	91.5mm x 91.5mm	150.5mm x 91.5mm	150.5mm x 91.5mm
Minimum Wall Box Depth:	As Per Insert	As Per Inserts	As Per Inserts	As Per Inserts
Technical Insert Ref:	EURO1	EURO2	EURO3	EURO4

Note: Minimum Wall Box depth is dependant on the EuroFix insert fitted, please see the EuroFix section for our complete range of inserts.



Linea-Duo CFX[®] Range

Simple and elegant with a minimalist straight frame design

The Linea CFX[®] range comes in five different designs to suit either contemporary or classic interiors. Linea CFX[®] has a separate back frame and our patented four point face plate clipping system, allowing the option of matching or contrasting elements.

- Minimal depth and a modern look
- Stunning front plate finishes and frame and insert finishes gives a huge choice of combinations
- Two-part frame and plate for 'mix and match'
- Concealed fixing
- Grid Fix and Eurofix options also available (see separate GRID-IT and EuroFix sections)



Linea-Duo CFX® Range

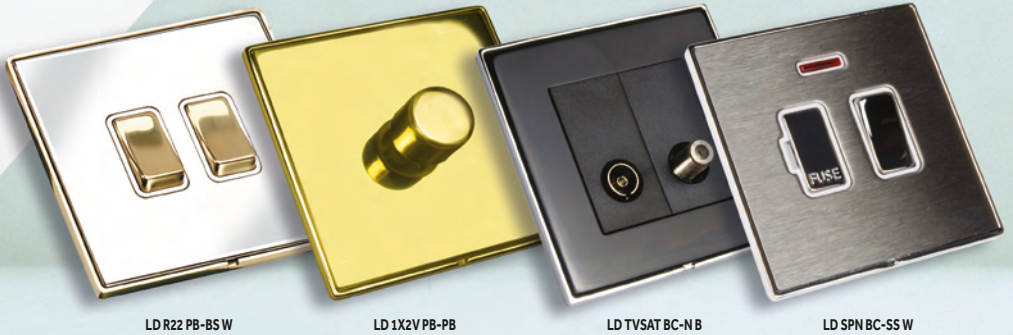

LD R22 PB-BS W

LD 1X2V PB-PB

LD TVSAT BC-NB

LD SPN BC-SS W

Product Code Configurator

1. Select the required electrical accessory from the following pages.
e.g. **LD R21** = Linea-Duo CFX 1 gang 10AX 2 way Rocker Switch.
2. Using the Frames & Finishes Chart on the next page;
 - a. Select the required Frame Finish
e.g. Bright Chrome = **BC**-_-_-.
 - b. Select the required Front Plate Finish
e.g. Satin Steel = _-_-**SS**_-.
 - c. Select the required Insert Surround Colour
e.g. White = _-_-**W**.

Therefore a Linea-Duo CFX 1 gang 10AX 2 way Rocker Switch as illustrated below = **LD R21 BC-SS W**

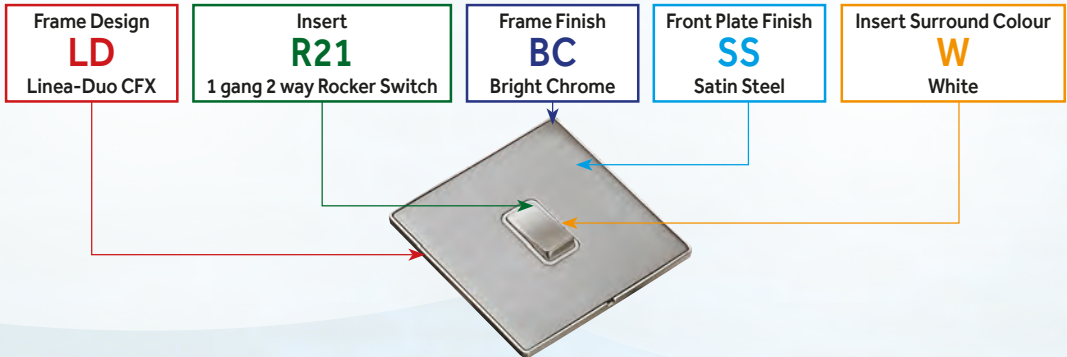





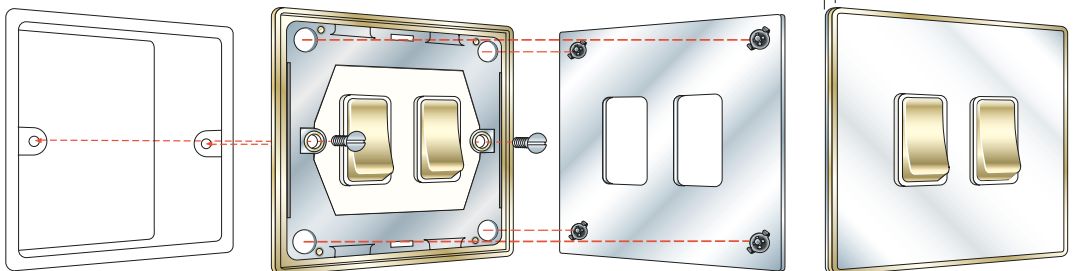





























Hamilton Linea-Duo CFX® Concealed Fixing

← Plate Depth 4.2 mm



Frame and Finishes Chart

Frame and Insert Finish	Polished Brass (PB)	Satin Brass (SB)	Antique Brass (AB)	Bright Steel (BS)	Satin Steel (SS)	Black Nickel (BK)	Piano Black (N)	Connaught Bronze (HB)	Copper Bronze (CB)	Etrium Bronze (EB)	Richmond Bronze (RB)
Bright Chrome (BC) Matching Insert with White Surround	 BC-PB W			 BC-BS W	 BC-SS W						
Bright Chrome (BC) Matching Insert with Black Surround	 BC-PB B			 BC-BS B	 BC-SS B	 BC-BK B	 BC-N B				
Polished Brass (PB) Matching Insert with White Surround	 PB-PB W	 PB-SB W	 PB-AB W	 PB-BS W	 PB-SS W						
Polished Brass (PB) Matching Insert with Black Surround	 PB-PB B	 PB-SB B	 PB-AB B	 PB-BS B	 PB-SS B						
Satin Brass (SB) Matching Insert with White Surround		 SB-SB W			 SB-SS W						
Satin Brass (SB) Matching Insert with Black Surround		 SB-SB B			 SB-SS B						
Antique Brass (AB) Matching Insert with Black Surround		 AB-SB B	 AB-AB B								
Satin Nickel (SN) Matching Insert with White Surround				 SN-BS W	 SN-SS W						
Satin Nickel (SN) Matching Insert with Black Surround				 SN-BS B	 SN-SS B						
Black Nickel (BK) Matching Insert with Black Surround	 BK-PB B			 BK-BS B		 BK-BK B					
Connaught Bronze Frame (HB) Matching Insert with Black Surround								 HB-HB B			
Copper Bronze Frame (CB) Matching Insert with Black Surround									 CB-CB B		
Etrium Bronze Frame (EB) Matching Insert with Black Surround										 EB-EB B	
Richmond Bronze Frame (RB) Matching Insert with Black Surround											 RB-RB B

Frame Finishes



Bright Chrome



Polished Brass



Satin Brass



Antique Brass



Satin Nickel



Black Nickel



Connaught Bronze



Copper Bronze



Etrium Bronze



Richmond Bronze

Linea-Duo CFX

Rocker Switches



LD R21 AB-AB B







LD R22 AB-SB B

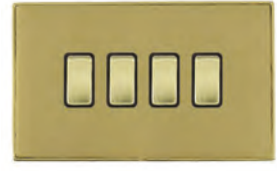

LD R23 BC-BK B



LD R24 PB-SB B

					
	1 gang 10AX 2 Way Rocker	2 gang 10AX 2 Way Rocker	3 gang 10AX 2 Way Rocker	4 gang 10AX 2 Way Rocker	6 gang 10AX 2 Way Rocker
Frame / Front Plate					
Antique Brass Frame/Antique Brass	LD R21 AB-AB B	LD R22 AB-AB B	LD R23 AB-AB B	LD R24 AB-AB B	LD R26 AB-AB B
Antique Brass Frame/Satin Brass	LD R21 AB-SB B	LD R22 AB-SB B	LD R23 AB-SB B	LD R24 AB-SB B	LD R26 AB-SB B
Black Nickel Frame/Black Nickel	LD R21 BK-BK B	LD R22 BK-BK B	LD R23 BK-BK B	LD R24 BK-BK B	LD R26 BK-BK B
Black Nickel Frame/Bright Steel	LD R21 BK-BS B	LD R22 BK-BS B	LD R23 BK-BS B	LD R24 BK-BS B	LD R26 BK-BS B
Black Nickel Frame/Polished Brass	LD R21 BK-PB B	LD R22 BK-PB B	LD R23 BK-PB B	LD R24 BK-PB B	LD R26 BK-PB B
Bright Chrome Frame/Black Nickel	LD R21 BC-BK B	LD R22 BC-BK B	LD R23 BC-BK B	LD R24 BC-BK B	LD R26 BC-BK B
Bright Chrome Frame/Bright Steel	LD R21 BC-BS B	LD R22 BC-BS B	LD R23 BC-BS B	LD R24 BC-BS B	LD R26 BC-BS B
Bright Chrome Frame/Bright Steel	LD R21 BC-BS W	LD R22 BC-BS W	LD R23 BC-BS W	LD R24 BC-BS W	LD R26 BC-BS W
Bright Chrome Frame/Piano Black	LD R21 BC-NB	LD R22 BC-NB	LD R23 BC-NB	LD R24 BC-NB	LD R26 BC-NB
Bright Chrome Frame/Polished Brass	LD R21 BC-PB B	LD R22 BC-PB B	LD R23 BC-PB B	LD R24 BC-PB B	LD R26 BC-PB B
Bright Chrome Frame/Polished Brass	LD R21 BC-PB W	LD R22 BC-PB W	LD R23 BC-PB W	LD R24 BC-PB W	LD R26 BC-PB W
Bright Chrome Frame/Satin Steel	LD R21 BC-SS B	LD R22 BC-SS B	LD R23 BC-SS B	LD R24 BC-SS B	LD R26 BC-SS B
Bright Chrome Frame/Satin Steel	LD R21 BC-SS W	LD R22 BC-SS W	LD R23 BC-SS W	LD R24 BC-SS W	LD R26 BC-SS W
Connaught Bronze Frame/Connaught Bronze	LD R21 HB-HB B	LD R22 HB-HB B	LD R23 HB-HB B	LD R24 HB-HB B	LD R26 HB-HB B
Copper Bronze Frame/Copper Bronze	LD R21 CB-CB B	LD R22 CB-CB B	LD R23 CB-CB B	LD R24 CB-CB B	LD R26 CB-CB B
Etrium Bronze Frame/Etrium Bronze	LD R21 EB-EB B	LD R22 EB-EB B	LD R23 EB-EB B	LD R24 EB-EB B	LD R26 EB-EB B
Polished Brass Frame/Antique Brass	LD R21 PB-AB B	LD R22 PB-AB B	LD R23 PB-AB B	LD R24 PB-AB B	LD R26 PB-AB B
Polished Brass Frame/Antique Brass	LD R21 PB-AB W	LD R22 PB-AB W	LD R23 PB-AB W	LD R24 PB-AB W	LD R26 PB-AB W
Polished Brass Frame/Bright Steel	LD R21 PB-BS B	LD R22 PB-BS B	LD R23 PB-BS B	LD R24 PB-BS B	LD R26 PB-BS B
Polished Brass Frame/Bright Steel	LD R21 PB-BS W	LD R22 PB-BS W	LD R23 PB-BS W	LD R24 PB-BS W	LD R26 PB-BS W
Polished Brass Frame/Polished Brass	LD R21 PB-PB B	LD R22 PB-PB B	LD R23 PB-PB B	LD R24 PB-PB B	LD R26 PB-PB B
Polished Brass Frame/Polished Brass	LD R21 PB-PB W	LD R22 PB-PB W	LD R23 PB-PB W	LD R24 PB-PB W	LD R26 PB-PB W
Polished Brass Frame/Satin Brass	LD R21 PB-SB B	LD R22 PB-SB B	LD R23 PB-SB B	LD R24 PB-SB B	LD R26 PB-SB B
Polished Brass Frame/Satin Brass	LD R21 PB-SB W	LD R22 PB-SB W	LD R23 PB-SB W	LD R24 PB-SB W	LD R26 PB-SB W
Polished Brass Frame/Satin Steel	LD R21 PB-SS B	LD R22 PB-SS B	LD R23 PB-SS B	LD R24 PB-SS B	LD R26 PB-SS B
Polished Brass Frame/Satin Steel	LD R21 PB-SS W	LD R22 PB-SS W	LD R23 PB-SS W	LD R24 PB-SS W	LD R26 PB-SS W
Richmond Bronze Frame/Richmond Bronze	LD R21 RB-RB B	LD R22 RB-RB B	LD R23 RB-RB B	LD R24 RB-RB B	LD R26 RB-RB B
Satin Brass Frame/Satin Brass	LD R21 SB-SB B	LD R22 SB-SB B	LD R23 SB-SB B	LD R24 SB-SB B	LD R26 SB-SB B
Satin Brass Frame/Satin Brass	LD R21 SB-SB W	LD R22 SB-SB W	LD R23 SB-SB W	LD R24 SB-SB W	LD R26 SB-SB W
Satin Brass Frame/Satin Steel	LD R21 SB-SS B	LD R22 SB-SS B	LD R23 SB-SS B	LD R24 SB-SS B	LD R26 SB-SS B
Satin Brass Frame/Satin Steel	LD R21 SB-SS W	LD R22 SB-SS W	LD R23 SB-SS W	LD R24 SB-SS W	LD R26 SB-SS W
Satin Nickel Frame/Bright Steel	LD R21 SN-BS B	LD R22 SN-BS B	LD R23 SN-BS B	LD R24 SN-BS B	LD R26 SN-BS B
Satin Nickel Frame/Bright Steel	LD R21 SN-BS W	LD R22 SN-BS W	LD R23 SN-BS W	LD R24 SN-BS W	LD R26 SN-BS W
Satin Nickel Frame/Satin Steel	LD R21 SN-SS B	LD R22 SN-SS B	LD R23 SN-SS B	LD R24 SN-SS B	LD R26 SN-SS B
Satin Nickel Frame/Satin Steel	LD R21 SN-SS W	LD R22 SN-SS W	LD R23 SN-SS W	LD R24 SN-SS W	LD R26 SN-SS W
Nominal Size:	86.0mm x 86.0mm	86.0mm x 86.0mm	86.0mm x 86.0mm	145.0mm x 86.0mm	145.0mm x 86.0mm
Minimum Wall Box Depth:	25mm	25mm	25mm	25mm	25mm
Technical Insert Ref:	R21	R22	R23	R24	R26

Insert Surround Colour Key: (B) Black, (W) White

Linea-Duo CFX

Rocker Switches



LD R31 HB-HB B







LD R32 BK-BK B



LD RRT SN-BS W



LD TP BC-PB B

				
Frame / Front Plate	1 gang 10AX Intermediate Rocker	2 gang 10AX Intermediate Rocker	1 gang 10AX Push To Make/Push to Break Retractive Rocker	1 gang 10A Triple Pole Rocker
Antique Brass Frame/Antique Brass	LD R31 AB-AB B	LD R32 AB-AB B	LD RRT AB-AB B	LD TP AB-AB B
Antique Brass Frame/Satin Brass	LD R31 AB-SB B	LD R32 AB-SB B	LD RRT AB-SB B	LD TP AB-SB B
Black Nickel Frame/Black Nickel	LD R31 BK-BK B	LD R32 BK-BK B	LD RRT BK-BK B	LD TP BK-BK B
Black Nickel Frame/Bright Steel	LD R31 BK-BS B	LD R32 BK-BS B	LD RRT BK-BS B	LD TP BK-BS B
Black Nickel Frame/Polished Brass	LD R31 BK-PB B	LD R32 BK-PB B	LD RRT BK-PB B	LD TP BK-PB B
Bright Chrome Frame/Black Nickel	LD R31 BC-BK B	LD R32 BC-BK B	LD RRT BC-BK B	LD TP BC-BK B
Bright Chrome Frame/Bright Steel	LD R31 BC-BS B	LD R32 BC-BS B	LD RRT BC-BS B	LD TP BC-BS B
Bright Chrome Frame/Bright Steel	LD R31 BC-BS W	LD R32 BC-BS W	LD RRT BC-BS W	LD TP BC-BS W
Bright Chrome Frame/Piano Black	LD R31 BC-NB	LD R32 BC-NB	LD RRT BC-NB	LD TP BC-NB
Bright Chrome Frame/Polished Brass	LD R31 BC-PB B	LD R32 BC-PB B	LD RRT BC-PB B	LD TP BC-PB B
Bright Chrome Frame/Polished Brass	LD R31 BC-PB W	LD R32 BC-PB W	LD RRT BC-PB W	LD TP BC-PB W
Bright Chrome Frame/Satin Steel	LD R31 BC-SS B	LD R32 BC-SS B	LD RRT BC-SS B	LD TP BC-SS B
Bright Chrome Frame/Satin Steel	LD R31 BC-SS W	LD R32 BC-SS W	LD RRT BC-SS W	LD TP BC-SS W
Connaught Bronze Frame/Connaught Bronze	LD R31 HB-HB B	LD R32 HB-HB B	LD RRT HB-HB B	LD TP HB-HB B
Copper Bronze Frame/Copper Bronze	LD R31 CB-CB B	LD R32 CB-CB B	LD RRT CB-CB B	LD TP CB-CB B
Etrium Bronze Frame/Etrium Bronze	LD R31 EB-EB B	LD R32 EB-EB B	LD RRT EB-EB B	LD TP EB-EB B
Polished Brass Frame/Antique Brass	LD R31 PB-AB B	LD R32 PB-AB B	LD RRT PB-AB B	LD TP PB-AB B
Polished Brass Frame/Antique Brass	LD R31 PB-AB W	LD R32 PB-AB W	LD RRT PB-AB W	LD TP PB-AB W
Polished Brass Frame/Bright Steel	LD R31 PB-BS B	LD R32 PB-BS B	LD RRT PB-BS B	LD TP PB-BS B
Polished Brass Frame/Bright Steel	LD R31 PB-BS W	LD R32 PB-BS W	LD RRT PB-BS W	LD TP PB-BS W
Polished Brass Frame/Polished Brass	LD R31 PB-PB B	LD R32 PB-PB B	LD RRT PB-PB B	LD TP PB-PB B
Polished Brass Frame/Polished Brass	LD R31 PB-PB W	LD R32 PB-PB W	LD RRT PB-PB W	LD TP PB-PB W
Polished Brass Frame/Satin Brass	LD R31 PB-SB B	LD R32 PB-SB B	LD RRT PB-SB B	LD TP PB-SB B
Polished Brass Frame/Satin Brass	LD R31 PB-SB W	LD R32 PB-SB W	LD RRT PB-SB W	LD TP PB-SB W
Polished Brass Frame/Satin Steel	LD R31 PB-SS B	LD R32 PB-SS B	LD RRT PB-SS B	LD TP PB-SS B
Polished Brass Frame/Satin Steel	LD R31 PB-SS W	LD R32 PB-SS W	LD RRT PB-SS W	LD TP PB-SS W
Richmond Bronze Frame/Richmond Bronze	LD R31 RB-RB B	LD R32 RB-RB B	LD RRT RB-RB B	LD TP RB-RB B
Satin Brass Frame/Satin Brass	LD R31 SB-SB B	LD R32 SB-SB B	LD RRT SB-SB B	LD TP SB-SB B
Satin Brass Frame/Satin Brass	LD R31 SB-SB W	LD R32 SB-SB W	LD RRT SB-SB W	LD TP SB-SB W
Satin Brass Frame/Satin Steel	LD R31 SB-SS B	LD R32 SB-SS B	LD RRT SB-SS B	LD TP SB-SS B
Satin Brass Frame/Satin Steel	LD R31 SB-SS W	LD R32 SB-SS W	LD RRT SB-SS W	LD TP SB-SS W
Satin Nickel Frame/Bright Steel	LD R31 SN-BS B	LD R32 SN-BS B	LD RRT SN-BS B	LD TP SN-BS B
Satin Nickel Frame/Bright Steel	LD R31 SN-BS W	LD R32 SN-BS W	LD RRT SN-BS W	LD TP SN-BS W
Satin Nickel Frame/Satin Steel	LD R31 SN-SS B	LD R32 SN-SS B	LD RRT SN-SS B	LD TP SN-SS B
Satin Nickel Frame/Satin Steel	LD R31 SN-SS W	LD R32 SN-SS W	LD RRT SN-SS W	LD TP SN-SS W
Nominal Size:	86.0mm x 86.0mm	86.0mm x 86.0mm	86.0mm x 86.0mm	86.0mm x 86.0mm
Minimum Wall Box Depth:	25mm	25mm	25mm	25mm
Technical Insert Ref:	R31	R32	RRT	TP

Insert Surround Colour Key: (B) Black, (W) White

Linea-Duo CFX

Rocker Switches



LD R212 EB-EB B



LD R222 AB-SB B



LD R242 PB-SB W



LD R322 SN-SB B

Frame / Front Plate	1 gang 20AX 2 Way Rocker	2 gang 20AX 2 Way Rocker	3 gang 20AX 2 Way Rocker	4 gang 20AX 2 Way Rocker	1 gang 20AX Intermediate Rocker	2 gang 20AX Intermediate Rocker
Antique Brass Frame/Antique Brass	LD R212 AB-AB B	LD R222 AB-AB B	LD R232 AB-AB B	LD R242 AB-AB B	LD R312 AB-AB B	LD R322 AB-AB B
Antique Brass Frame/Satin Brass	LD R212 AB-SB B	LD R222 AB-SB B	LD R232 AB-SB B	LD R242 AB-SB B	LD R312 AB-SB B	LD R322 AB-SB B
Black Nickel Frame/Black Nickel	LD R212 BK-BK B	LD R222 BK-BK B	LD R232 BK-BK B	LD R242 BK-BK B	LD R312 BK-BK B	LD R322 BK-BK B
Black Nickel Frame/Bright Steel	LD R212 BK-SB B	LD R222 BK-SB B	LD R232 BK-SB B	LD R242 BK-SB B	LD R312 BK-SB B	LD R322 BK-SB B
Black Nickel Frame/Polished Brass	LD R212 BK-PB B	LD R222 BK-PB B	LD R232 BK-PB B	LD R242 BK-PB B	LD R312 BK-PB B	LD R322 BK-PB B
Bright Chrome Frame/Black Nickel	LD R212 BC-BK B	LD R222 BC-BK B	LD R232 BC-BK B	LD R242 BC-BK B	LD R312 BC-BK B	LD R322 BC-BK B
Bright Chrome Frame/Bright Steel	LD R212 BC-SB B	LD R222 BC-SB B	LD R232 BC-SB B	LD R242 BC-SB B	LD R312 BC-SB B	LD R322 BC-SB B
Bright Chrome Frame/Bright Steel	LD R212 BC-SB W	LD R222 BC-SB W	LD R232 BC-SB W	LD R242 BC-SB W	LD R312 BC-SB W	LD R322 BC-SB W
Bright Chrome Frame/Piano Black	LD R212 BC-NB	LD R222 BC-NB	LD R232 BC-NB	LD R242 BC-NB	LD R312 BC-NB	LD R322 BC-NB
Bright Chrome Frame/Polished Brass	LD R212 BC-PB B	LD R222 BC-PB B	LD R232 BC-PB B	LD R242 BC-PB B	LD R312 BC-PB B	LD R322 BC-PB B
Bright Chrome Frame/Polished Brass	LD R212 BC-PB W	LD R222 BC-PB W	LD R232 BC-PB W	LD R242 BC-PB W	LD R312 BC-PB W	LD R322 BC-PB W
Bright Chrome Frame/Satin Steel	LD R212 BC-SS B	LD R222 BC-SS B	LD R232 BC-SS B	LD R242 BC-SS B	LD R312 BC-SS B	LD R322 BC-SS B
Bright Chrome Frame/Satin Steel	LD R212 BC-SS W	LD R222 BC-SS W	LD R232 BC-SS W	LD R242 BC-SS W	LD R312 BC-SS W	LD R322 BC-SS W
Connaught Bronze Frame/Connaught Bronze	LD R212 HB-HB B	LD R222 HB-HB B	LD R232 HB-HB B	LD R242 HB-HB B	LD R312 HB-HB B	LD R322 HB-HB B
Copper Bronze Frame/Copper Bronze	LD R212 CB-CB B	LD R222 CB-CB B	LD R232 CB-CB B	LD R242 CB-CB B	LD R312 CB-CB B	LD R322 CB-CB B
Etrium Bronze Frame/Etrium Bronze	LD R212 EB-EB B	LD R222 EB-EB B	LD R232 EB-EB B	LD R242 EB-EB B	LD R312 EB-EB B	LD R322 EB-EB B
Polished Brass Frame/Antique Brass	LD R212 PB-AB B	LD R222 PB-AB B	LD R232 PB-AB B	LD R242 PB-AB B	LD R312 PB-AB B	LD R322 PB-AB B
Polished Brass Frame/Antique Brass	LD R212 PB-AB W	LD R222 PB-AB W	LD R232 PB-AB W	LD R242 PB-AB W	LD R312 PB-AB W	LD R322 PB-AB W
Polished Brass Frame/Bright Steel	LD R212 PB-SB B	LD R222 PB-SB B	LD R232 PB-SB B	LD R242 PB-SB B	LD R312 PB-SB B	LD R322 PB-SB B
Polished Brass Frame/Bright Steel	LD R212 PB-SB W	LD R222 PB-SB W	LD R232 PB-SB W	LD R242 PB-SB W	LD R312 PB-SB W	LD R322 PB-SB W
Polished Brass Frame/Polished Brass	LD R212 PB-PB B	LD R222 PB-PB B	LD R232 PB-PB B	LD R242 PB-PB B	LD R312 PB-PB B	LD R322 PB-PB B
Polished Brass Frame/Polished Brass	LD R212 PB-PB W	LD R222 PB-PB W	LD R232 PB-PB W	LD R242 PB-PB W	LD R312 PB-PB W	LD R322 PB-PB W
Polished Brass Frame/Satin Brass	LD R212 PB-SB B	LD R222 PB-SB B	LD R232 PB-SB B	LD R242 PB-SB B	LD R312 PB-SB B	LD R322 PB-SB B
Polished Brass Frame/Satin Brass	LD R212 PB-SB W	LD R222 PB-SB W	LD R232 PB-SB W	LD R242 PB-SB W	LD R312 PB-SB W	LD R322 PB-SB W
Polished Brass Frame/Satin Steel	LD R212 PB-SS B	LD R222 PB-SS B	LD R232 PB-SS B	LD R242 PB-SS B	LD R312 PB-SS B	LD R322 PB-SS B
Polished Brass Frame/Satin Steel	LD R212 PB-SS W	LD R222 PB-SS W	LD R232 PB-SS W	LD R242 PB-SS W	LD R312 PB-SS W	LD R322 PB-SS W
Richmond Bronze Frame/Richmond Bronze	LD R212 RB-RB B	LD R222 RB-RB B	LD R232 RB-RB B	LD R242 RB-RB B	LD R312 RB-RB B	LD R322 RB-RB B
Satin Brass Frame/Satin Brass	LD R212 SB-SB B	LD R222 SB-SB B	LD R232 SB-SB B	LD R242 SB-SB B	LD R312 SB-SB B	LD R322 SB-SB B
Satin Brass Frame/Satin Brass	LD R212 SB-SB W	LD R222 SB-SB W	LD R232 SB-SB W	LD R242 SB-SB W	LD R312 SB-SB W	LD R322 SB-SB W
Satin Brass Frame/Satin Steel	LD R212 SB-SS B	LD R222 SB-SS B	LD R232 SB-SS B	LD R242 SB-SS B	LD R312 SB-SS B	LD R322 SB-SS B
Satin Brass Frame/Satin Steel	LD R212 SB-SS W	LD R222 SB-SS W	LD R232 SB-SS W	LD R242 SB-SS W	LD R312 SB-SS W	LD R322 SB-SS W
Satin Nickel Frame/Bright Steel	LD R212 SN-SB B	LD R222 SN-SB B	LD R232 SN-SB B	LD R242 SN-SB B	LD R312 SN-SB B	LD R322 SN-SB B
Satin Nickel Frame/Bright Steel	LD R212 SN-SB W	LD R222 SN-SB W	LD R232 SN-SB W	LD R242 SN-SB W	LD R312 SN-SB W	LD R322 SN-SB W
Satin Nickel Frame/Satin Steel	LD R212 SN-SS B	LD R222 SN-SS B	LD R232 SN-SS B	LD R242 SN-SS B	LD R312 SN-SS B	LD R322 SN-SS B
Satin Nickel Frame/Satin Steel	LD R212 SN-SS W	LD R222 SN-SS W	LD R232 SN-SS W	LD R242 SN-SS W	LD R312 SN-SS W	LD R322 SN-SS W
Nominal Size:	86.0mm x 86.0mm	86.0mm x 86.0mm	145.0mm x 86.0mm	145.0mm x 86.0mm	86.0mm x 86.0mm	86.0mm x 86.0mm
Minimum Wall Box Depth:	35mm	35mm	35mm	35mm	35mm	35mm
Technical Insert Ref:	R212	R222	R232	R242	R312	R322

Insert Surround Colour Key: (B) Black, (W) White

Linea-Duo CFX

Wide Rockers



LD WR21 SN-SS B



LD W10DP RB-RB B



LD WR22 AB-AB B



LD WR23 SN-BS B



1 gang 10AX
2 Way Rocker



2 gang 10AX
2 Way Rocker



3 gang 10AX
2 Way Rocker



1 gang 10AX
Intermediate
Rocker



1 gang 10AX
Push To Make
Frame/ Push to
Break Retractive
Rocker



1 gang 10AX
Double Pole
Rocker

Frame Frame/ Front Plate

Antique Brass Frame/Antique Brass	LD WR21 AB-AB B	LD WR22 AB-AB B	LD WR23 AB-AB B	LD WR31 AB-AB B	LD WRRT AB-AB B	LD W10DP AB-AB B
Antique Brass Frame/Satin Brass	LD WR21 AB-SB B	LD WR22 AB-SB B	LD WR23 AB-SB B	LD WR31 AB-SB B	LD WRRT AB-SB B	LD W10DP AB-SB B
Black Nickel Frame/Black Nickel	LD WR21 BK-BK B	LD WR22 BK-BK B	LD WR23 BK-BK B	LD WR31 BK-BK B	LD WRRT BK-BK B	LD W10DP BK-BK B
Black Nickel Frame/Bright Steel	LD WR21 BK-BS B	LD WR22 BK-BS B	LD WR23 BK-BS B	LD WR31 BK-BS B	LD WRRT BK-BS B	LD W10DP BK-BS B
Black Nickel Frame/Polished Brass	LD WR21 BK-PB B	LD WR22 BK-PB B	LD WR23 BK-PB B	LD WR31 BK-PB B	LD WRRT BK-PB B	LD W10DP BK-PB B
Bright Chrome Frame/Black Nickel	LD WR21 BC-BK B	LD WR22 BC-BK B	LD WR23 BC-BK B	LD WR31 BC-BK B	LD WRRT BC-BK B	LD W10DP BC-BK B
Bright Chrome Frame/Bright Steel	LD WR21 BC-BS B	LD WR22 BC-BS B	LD WR23 BC-BS B	LD WR31 BC-BS B	LD WRRT BC-BS B	LD W10DP BC-BS B
Bright Chrome Frame/Bright Steel	LD WR21 BC-BS W	LD WR22 BC-BS W	LD WR23 BC-BS W	LD WR31 BC-BS W	LD WRRT BC-BS W	LD W10DP BC-BS W
Bright Chrome Frame/Plano Black	LD WR21 BC-N B	LD WR22 BC-N B	LD WR23 BC-N B	LD WR31 BC-N B	LD WRRT BC-N B	LD W10DP BC-N B
Bright Chrome Frame/Polished Brass	LD WR21 BC-PB B	LD WR22 BC-PB B	LD WR23 BC-PB B	LD WR31 BC-PB B	LD WRRT BC-PB B	LD W10DP BC-PB B
Bright Chrome Frame/Polished Brass	LD WR21 BC-PB W	LD WR22 BC-PB W	LD WR23 BC-PB W	LD WR31 BC-PB W	LD WRRT BC-PB W	LD W10DP BC-PB W
Bright Chrome Frame/Satin Steel	LD WR21 BC-SS B	LD WR22 BC-SS B	LD WR23 BC-SS B	LD WR31 BC-SS B	LD WRRT BC-SS B	LD W10DP BC-SS B
Bright Chrome Frame/Satin Steel	LD WR21 BC-SS W	LD WR22 BC-SS W	LD WR23 BC-SS W	LD WR31 BC-SS W	LD WRRT BC-SS W	LD W10DP BC-SS W
Connaught Bronze Frame/Connaught Bronze	LD WR21 HB-HB B	LD WR22 HB-HB B	LD WR23 HB-HB B	LD WR31 HB-HB B	LD WRRT HB-HB B	LD W10DP HB-HB B
Copper Bronze Frame/Copper Bronze	LD WR21 CB-CB B	LD WR22 CB-CB B	LD WR23 CB-CB B	LD WR31 CB-CB B	LD WRRT CB-CB B	LD W10DP CB-CB B
Etrium Bronze Frame/Etrium Bronze	LD WR21 EB-EB B	LD WR22 EB-EB B	LD WR23 EB-EB B	LD WR31 EB-EB B	LD WRRT EB-EB B	LD W10DP EB-EB B
Polished Brass Frame/Antique Brass	LD WR21 PB-AB B	LD WR22 PB-AB B	LD WR23 PB-AB B	LD WR31 PB-AB B	LD WRRT PB-AB B	LD W10DP PB-AB B
Polished Brass Frame/Antique Brass	LD WR21 PB-AB W	LD WR22 PB-AB W	LD WR23 PB-AB W	LD WR31 PB-AB W	LD WRRT PB-AB W	LD W10DP PB-AB W
Polished Brass Frame/Bright Steel	LD WR21 PB-BS B	LD WR22 PB-BS B	LD WR23 PB-BS B	LD WR31 PB-BS B	LD WRRT PB-BS B	LD W10DP PB-BS B
Polished Brass Frame/Bright Steel	LD WR21 PB-BS W	LD WR22 PB-BS W	LD WR23 PB-BS W	LD WR31 PB-BS W	LD WRRT PB-BS W	LD W10DP PB-BS W
Polished Brass Frame/Polished Brass	LD WR21 PB-PB B	LD WR22 PB-PB B	LD WR23 PB-PB B	LD WR31 PB-PB B	LD WRRT PB-PB B	LD W10DP PB-PB B
Polished Brass Frame/Polished Brass	LD WR21 PB-PB W	LD WR22 PB-PB W	LD WR23 PB-PB W	LD WR31 PB-PB W	LD WRRT PB-PB W	LD W10DP PB-PB W
Polished Brass Frame/Satin Brass	LD WR21 PB-SB B	LD WR22 PB-SB B	LD WR23 PB-SB B	LD WR31 PB-SB B	LD WRRT PB-SB B	LD W10DP PB-SB B
Polished Brass Frame/Satin Brass	LD WR21 PB-SB W	LD WR22 PB-SB W	LD WR23 PB-SB W	LD WR31 PB-SB W	LD WRRT PB-SB W	LD W10DP PB-SB W
Polished Brass Frame/Satin Steel	LD WR21 PB-SS B	LD WR22 PB-SS B	LD WR23 PB-SS B	LD WR31 PB-SS B	LD WRRT PB-SS B	LD W10DP PB-SS B
Polished Brass Frame/Satin Steel	LD WR21 PB-SS W	LD WR22 PB-SS W	LD WR23 PB-SS W	LD WR31 PB-SS W	LD WRRT PB-SS W	LD W10DP PB-SS W
Richmond Bronze Frame/ Richmond Bronze	LD WR21 RB-RB B	LD WR22 RB-RB B	LD WR23 RB-RB B	LD WR31 RB-RB B	LD WRRT RB-RB B	LD W10DP RB-RB B
Satin Brass Frame/Satin Brass	LD WR21 SB-SB B	LD WR22 SB-SB B	LD WR23 SB-SB B	LD WR31 SB-SB B	LD WRRT SB-SB B	LD W10DP SB-SB B
Satin Brass Frame/Satin Brass	LD WR21 SB-SB W	LD WR22 SB-SB W	LD WR23 SB-SB W	LD WR31 SB-SB W	LD WRRT SB-SB W	LD W10DP SB-SB W
Satin Brass Frame/Satin Steel	LD WR21 SB-SS B	LD WR22 SB-SS B	LD WR23 SB-SS B	LD WR31 SB-SS B	LD WRRT SB-SS B	LD W10DP SB-SS B
Satin Brass Frame/Satin Steel	LD WR21 SB-SS W	LD WR22 SB-SS W	LD WR23 SB-SS W	LD WR31 SB-SS W	LD WRRT SB-SS W	LD W10DP SB-SS W
Satin Nickel Frame/Bright Steel	LD WR21 SN-BS B	LD WR22 SN-BS B	LD WR23 SN-BS B	LD WR31 SN-BS B	LD WRRT SN-BS B	LD W10DP SN-BS B
Satin Nickel Frame/Bright Steel	LD WR21 SN-BS W	LD WR22 SN-BS W	LD WR23 SN-BS W	LD WR31 SN-BS W	LD WRRT SN-BS W	LD W10DP SN-BS W
Satin Nickel Frame/Satin Steel	LD WR21 SN-SS B	LD WR22 SN-SS B	LD WR23 SN-SS B	LD WR31 SN-SS B	LD WRRT SN-SS B	LD W10DP SN-SS B
Satin Nickel Frame/Satin Steel	LD WR21 SN-SS QG	LD WR22 SN-SS QG	LD WR23 SN-SS QG	LD WR31 SN-SS QG	LD WRRT SN-SS QG	LD W10DP SN-SS QG
Satin Nickel Frame/Satin Steel	LD WR21 SN-SS W	LD WR22 SN-SS W	LD WR23 SN-SS W	LD WR31 SN-SS W	LD WRRT SN-SS W	LD W10DP SN-SS W
Nominal Size:	86.0mm x 86.0mm	86.0mm x 86.0mm	86.0mm x 86.0mm	86.0mm x 86.0mm	86.0mm x 86.0mm	86.0mm x 86.0mm
Minimum Wall Box Depth:	25mm	25mm	25mm	25mm	25mm	25mm
Technical Insert Ref:	WR21	WR22	WR213	WR231	WRRT	W10DP

Insert Surround Colour Key: (B) Black, (W) White, (QG) Quartz Grey

Linea-Duo CFX

Toggle Switches



LD T21 BC-BK







LD T22 BC-PB



LD T23 BK-PB



LD T31 SN-BS

					
Frame / Front Plate	1 gang 20AX 2 Way Toggle	2 gang 20AX 2 Way Toggle	3 gang 20AX 2 Way Toggle	4 gang 20AX 2 Way Toggle	1 gang 20AX Intermediate Toggle
Antique Brass Frame/Antique Brass	LD T21 AB-AB	LD T22 AB-AB	LD T23 AB-AB	LD T24 AB-AB	LD T31 AB-AB
Antique Brass Frame/Satin Brass	LD T21 AB-SB	LD T22 AB-SB	LD T23 AB-SB	LD T24 AB-SB	LD T31 AB-SB
Black Nickel Frame/Black Nickel	LD T21 BK-BK	LD T22 BK-BK	LD T23 BK-BK	LD T24 BK-BK	LD T31 BK-BK
Black Nickel Frame/Bright Steel	LD T21 BK-BS	LD T22 BK-BS	LD T23 BK-BS	LD T24 BK-BS	LD T31 BK-BS
Black Nickel Frame/Polished Brass	LD T21 BK-PB	LD T22 BK-PB	LD T23 BK-PB	LD T24 BK-PB	LD T31 BK-PB
Bright Chrome Frame/Black Nickel	LD T21 BC-BK	LD T22 BC-BK	LD T23 BC-BK	LD T24 BC-BK	LD T31 BC-BK
Bright Chrome Frame/Bright Steel	LD T21 BC-BS	LD T22 BC-BS	LD T23 BC-BS	LD T24 BC-BS	LD T31 BC-BS
Bright Chrome Frame/Piano Black	LD T21 BC-N	LD T22 BC-N	LD T23 BC-N	LD T24 BC-N	LD T31 BC-N
Bright Chrome Frame/Polished Brass	LD T21 BC-PB	LD T22 BC-PB	LD T23 BC-PB	LD T24 BC-PB	LD T31 BC-PB
Bright Chrome Frame/Satin Steel	LD T21 BC-SS	LD T22 BC-SS	LD T23 BC-SS	LD T24 BC-SS	LD T31 BC-SS
Connaught Bronze Frame/Connaught Bronze	LD T21 HB-HB	LD T22 HB-HB	LD T23 HB-HB	LD T24 HB-HB	LD T31 HB-HB
Copper Bronze Frame/Copper Bronze	LD T21 CB-CB	LD T22 CB-CB	LD T23 CB-CB	LD T24 CB-CB	LD T31 CB-CB
Etrium Bronze Frame/Etrium Bronze	LD T21 EB-EB	LD T22 EB-EB	LD T23 EB-EB	LD T24 EB-EB	LD T31 EB-EB
Polished Brass Frame/Antique Brass	LD T21 PB-AB	LD T22 PB-AB	LD T23 PB-AB	LD T24 PB-AB	LD T31 PB-AB
Polished Brass Frame/Bright Steel	LD T21 PB-BS	LD T22 PB-BS	LD T23 PB-BS	LD T24 PB-BS	LD T31 PB-BS
Polished Brass Frame/Polished Brass	LD T21 PB-PB	LD T22 PB-PB	LD T23 PB-PB	LD T24 PB-PB	LD T31 PB-PB
Polished Brass Frame/Satin Brass	LD T21 PB-SB	LD T22 PB-SB	LD T23 PB-SB	LD T24 PB-SB	LD T31 PB-SB
Polished Brass Frame/Satin Steel	LD T21 PB-SS	LD T22 PB-SS	LD T23 PB-SS	LD T24 PB-SS	LD T31 PB-SS
Richmond Bronze Frame/Richmond Bronze	LD T21 RB-RB	LD T22 RB-RB	LD T23 RB-RB	LD T24 RB-RB	LD T31 RB-RB
Satin Brass Frame/Satin Brass	LD T21 SB-SB	LD T22 SB-SB	LD T23 SB-SB	LD T24 SB-SB	LD T31 SB-SB
Satin Brass Frame/Satin Steel	LD T21 SB-SS	LD T22 SB-SS	LD T23 SB-SS	LD T24 SB-SS	LD T31 SB-SS
Satin Nickel Frame/Bright Steel*	LD T21 SN-BS	LD T22 SN-BS	LD T23 SN-BS	LD T24 SN-BS	LD T31 SN-BS
Satin Nickel Frame/Satin Steel*	LD T21 SN-SS	LD T22 SN-SS	LD T23 SN-SS	LD T24 SN-SS	LD T31 SN-SS
Nominal Size:	86.0mm x 86.0mm	86.0mm x 86.0mm	145.0mm x 86.0mm	145.0mm x 86.0mm	86.0mm x 86.0mm
Minimum Wall Box Depth:	35mm	35mm	35mm	35mm	35mm
Technical Insert Ref:	T21	T22	T23	T24	T31

Toggles to match Frame Finish as standard except where specified.

*Satin Chrome Toggles

Linea-Duo CFX

Power Sockets



LD SS1 AB-SB B



LD SS2 BC-PB B



LD US5 BK-BS B



LD SHS SN-SS W



1 gang 13A
Double Pole
Switched Socket

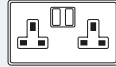

2 gang 13A
Double Pole
Switched Socket

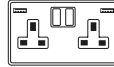

2 gang 13A Double
Pole Switched
Socket with 2 USB
Outlet 2x2.4A (4.8A
Total)



1 gang 2A
Unswitched
Socket



1 gang 5A
Unswitched
Socket

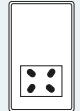

Shaver Dual Voltage
Unswitched Socket
(Vertically Mounted)

Frame / Front Plate	LD SS1 AB-AB B	LD SS2 AB-AB B	LD SS2USBULT AB-AB B	LD US2 AB-AB B	LD US5 AB-AB B	LD SHS AB-AB B
Antique Brass Frame/Antique Brass	LD SS1 AB-AB B	LD SS2 AB-AB B	LD SS2USBULT AB-AB B	LD US2 AB-AB B	LD US5 AB-AB B	LD SHS AB-AB B
Antique Brass Frame/Satin Brass	LD SS1 AB-SB B	LD SS2 AB-SB B	LD SS2USBULT AB-SB B	LD US2 AB-SB B	LD US5 AB-SB B	LD SHS AB-SB B
Black Nickel Frame/Black Nickel	LD SS1 BK-BK B	LD SS2 BK-BK B	LD SS2USBULT BK-BK B	LD US2 BK-BK B	LD US5 BK-BK B	LD SHS BK-BK B
Black Nickel Frame/Bright Steel	LD SS1 BK-BS B	LD SS2 BK-BS B	LD SS2USBULT BK-BS B	LD US2 BK-BS B	LD US5 BK-BS B	LD SHS BK-BS B
Black Nickel Frame/Polished Brass	LD SS1 BK-PB B	LD SS2 BK-PB B	LD SS2USBULT BK-PB B	LD US2 BK-PB B	LD US5 BK-PB B	LD SHS BK-PB B
Bright Chrome Frame/Black Nickel	LD SS1 BC-BK B	LD SS2 BC-BK B	LD SS2USBULT BC-BK B	LD US2 BC-BK B	LD US5 BC-BK B	LD SHS BC-BK B
Bright Chrome Frame/Bright Steel	LD SS1 BC-BS B	LD SS2 BC-BS B	LD SS2USBULT BC-BS B	LD US2 BC-BS B	LD US5 BC-BS B	LD SHS BC-BS B
Bright Chrome Frame/Bright Steel	LD SS1 BC-BS W	LD SS2 BC-BS W	LD SS2USBULT BC-BS W	LD US2 BC-BS W	LD US5 BC-BS W	LD SHS BC-BS W
Bright Chrome Frame/Piano Black	LD SS1 BC-NB	LD SS2 BC-NB	LD SS2USBULT BC-NB	LD US2 BC-NB	LD US5 BC-NB	LD SHS BC-NB
Bright Chrome Frame/Polished Brass	LD SS1 BC-PB B	LD SS2 BC-PB B	LD SS2USBULT BC-PB B	LD US2 BC-PB B	LD US5 BC-PB B	LD SHS BC-PB B
Bright Chrome Frame/Polished Brass	LD SS1 BC-PB W	LD SS2 BC-PB W	LD SS2USBULT BC-PB W	LD US2 BC-PB W	LD US5 BC-PB W	LD SHS BC-PB W
Bright Chrome Frame/Satin Steel	LD SS1 BC-SS B	LD SS2 BC-SS B	LD SS2USBULT BC-SS B	LD US2 BC-SS B	LD US5 BC-SS B	LD SHS BC-SS B
Bright Chrome Frame/Satin Steel	LD SS1 BC-SS W	LD SS2 BC-SS W	LD SS2USBULT BC-SS W	LD US2 BC-SS W	LD US5 BC-SS W	LD SHS BC-SS W
Connaught Bronze Frame/Connaught Bronze	LD SS1 HB-HB B	LD SS2 HB-HB B	LD SS2USBULT HB-HB B	LD US2 HB-HB B	LD US5 HB-HB B	LD SHS HB-HB B
Copper Bronze Frame/Copper Bronze	LD SS1 CB-CB B	LD SS2 CB-CB B	LD SS2USBULT CB-CB B	LD US2 CB-CB B	LD US5 CB-CB B	LD SHS CB-CB B
Etrium Bronze Frame/Etrium Bronze	LD SS1 EB-EB B	LD SS2 EB-EB B	LD SS2USBULT EB-EB B	LD US2 EB-EB B	LD US5 EB-EB B	LD SHS EB-EB B
Polished Brass Frame/Antique Brass	LD SS1 PB-AB B	LD SS2 PB-AB B	LD SS2USBULT PB-AB B	LD US2 PB-AB B	LD US5 PB-AB B	LD SHS PB-AB B
Polished Brass Frame/Antique Brass	LD SS1 PB-AB W	LD SS2 PB-AB W	LD SS2USBULT PB-AB W	LD US2 PB-AB W	LD US5 PB-AB W	LD SHS PB-AB W
Polished Brass Frame/Bright Steel	LD SS1 PB-BS B	LD SS2 PB-BS B	LD SS2USBULT PB-BS B	LD US2 PB-BS B	LD US5 PB-BS B	LD SHS PB-BS B
Polished Brass Frame/Bright Steel	LD SS1 PB-BS W	LD SS2 PB-BS W	LD SS2USBULT PB-BS W	LD US2 PB-BS W	LD US5 PB-BS W	LD SHS PB-BS W
Polished Brass Frame/Polished Brass	LD SS1 PB-PB B	LD SS2 PB-PB B	LD SS2USBULT PB-PB B	LD US2 PB-PB B	LD US5 PB-PB B	LD SHS PB-PB B
Polished Brass Frame/Polished Brass	LD SS1 PB-PB W	LD SS2 PB-PB W	LD SS2USBULT PB-PB W	LD US2 PB-PB W	LD US5 PB-PB W	LD SHS PB-PB W
Polished Brass Frame/Satin Brass	LD SS1 PB-SB B	LD SS2 PB-SB B	LD SS2USBULT PB-SB B	LD US2 PB-SB B	LD US5 PB-SB B	LD SHS PB-SB B
Polished Brass Frame/Satin Brass	LD SS1 PB-SB W	LD SS2 PB-SB W	LD SS2USBULT PB-SB W	LD US2 PB-SB W	LD US5 PB-SB W	LD SHS PB-SB W
Polished Brass Frame/Satin Steel	LD SS1 PB-SS B	LD SS2 PB-SS B	LD SS2USBULT PB-SS B	LD US2 PB-SS B	LD US5 PB-SS B	LD SHS PB-SS B
Polished Brass Frame/Satin Steel	LD SS1 PB-SS W	LD SS2 PB-SS W	LD SS2USBULT PB-SS W	LD US2 PB-SS W	LD US5 PB-SS W	LD SHS PB-SS W
Richmond Bronze Frame/Richmond Bronze	LD SS1 RB-RB B	LD SS2 RB-RB B	LD SS2USBULT RB-RB B	LD US2 RB-RB B	LD US5 RB-RB B	LD SHS RB-RB B
Satin Brass Frame/Satin Brass	LD SS1 SB-SB B	LD SS2 SB-SB B	LD SS2USBULT SB-SB B	LD US2 SB-SB B	LD US5 SB-SB B	LD SHS SB-SB B
Satin Brass Frame/Satin Brass	LD SS1 SB-SB W	LD SS2 SB-SB W	LD SS2USBULT SB-SB W	LD US2 SB-SB W	LD US5 SB-SB W	LD SHS SB-SB W
Satin Brass Frame/Satin Steel	LD SS1 SB-SS B	LD SS2 SB-SS B	LD SS2USBULT SB-SS B	LD US2 SB-SS B	LD US5 SB-SS B	LD SHS SB-SS B
Satin Brass Frame/Satin Steel	LD SS1 SB-SS W	LD SS2 SB-SS W	LD SS2USBULT SB-SS W	LD US2 SB-SS W	LD US5 SB-SS W	LD SHS SB-SS W
Satin Nickel Frame/Bright Steel	LD SS1 SN-BS B	LD SS2 SN-BS B	LD SS2USBULT SN-BS B	LD US2 SN-BS B	LD US5 SN-BS B	LD SHS SN-BS B
Satin Nickel Frame/Bright Steel	LD SS1 SN-BS W	LD SS2 SN-BS W	LD SS2USBULT SN-BS W	LD US2 SN-BS W	LD US5 SN-BS W	LD SHS SN-BS W
Satin Nickel Frame/Satin Steel	LD SS1 SN-SS B	LD SS2 SN-SS B	LD SS2USBULT SN-SS B	LD US2 SN-SS B	LD US5 SN-SS B	LD SHS SN-SS B
Satin Nickel Frame/Satin Steel	LD SS1 SN-SS W	LD SS2 SN-SS W	LD SS2USBULT SN-SS W	LD US2 SN-SS W	LD US5 SN-SS W	LD SHS SN-SS W
Nominal Size:	86.0mm x 86.0mm	145.0mm x 86.0mm	145.0mm x 86.0mm	86.0mm x 86.0mm	86.0mm x 86.0mm	86.0mm x 145.0mm
Minimum Wall Box Depth:	35mm	35mm	35mm	35mm	35mm	47mm
Technical Insert Ref:	SS1	SS2	SS2USBULT	US2	US5	SHS

Insert Surround Colour Key: (B) Black, (W) White

Linea-Duo CFX

International Power Sockets



LD 5258 BK-BK B



LD 5258 AB-AB B



LD 5320 HB-HB B



LD 5320 SN-BS W



1 gang 15A 110V AC
American Unswitched
Socket

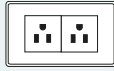

2 gang 15A 110V AC
American Unswitched
Socket



1 gang 10/16A
220/250V AC German
Unswitched Socket

Frame / Front Plate	LD 5258 BK-BK B	LD 5258 AB-AB B	LD 5320 HB-HB B	LD 5320 SN-BS W
Antique Brass Frame/Antique Brass	LD 5258 BK-BK B	LD 5258 AB-AB B	LD 5320 HB-HB B	LD 5320 SN-BS W
Antique Brass Frame/Satin Brass	LD 5258 BK-BS B	LD 5258 AB-SB B	LD 5320 HB-SB B	LD 5320 SN-SS B
Black Nickel Frame/Black Nickel	LD 5258 BK-BK B	LD 5258 AB-AB B	LD 5320 HB-HB B	LD 5320 SN-BS W
Black Nickel Frame/Bright Steel	LD 5258 BK-BS B	LD 5258 AB-SB B	LD 5320 HB-SB B	LD 5320 SN-SS B
Black Nickel Frame/Polished Brass	LD 5258 BK-PB B	LD 5258 AB-PB B	LD 5320 HB-PB B	LD 5320 SN-SS W
Bright Chrome Frame/Black Nickel	LD 5258 BC-BK B	LD 5258 BC-AB B	LD 5320 BC-HB B	LD 5320 BC-SB W
Bright Chrome Frame/Bright Steel	LD 5258 BC-BS B	LD 5258 BC-SB B	LD 5320 BC-SB B	LD 5320 BC-SS B
Bright Chrome Frame/Bright Steel	LD 5258 BC-BS W	LD 5258 BC-BS W	LD 5320 BC-BS W	LD 5320 BC-SS W
Bright Chrome Frame/Piano Black	LD 5258 BC-N B	LD 5258 BC-N B	LD 5320 BC-N B	LD 5320 BC-N B
Bright Chrome Frame/Polished Brass	LD 5258 BC-PB B	LD 5258 BC-PB B	LD 5320 BC-PB B	LD 5320 BC-PB B
Bright Chrome Frame/Polished Brass	LD 5258 BC-PB W	LD 5258 BC-PB W	LD 5320 BC-PB W	LD 5320 BC-PB W
Bright Chrome Frame/Satin Steel	LD 5258 BC-SS B	LD 5258 BC-SS B	LD 5320 BC-SS B	LD 5320 BC-SS B
Bright Chrome Frame/Satin Steel	LD 5258 BC-SS W	LD 5258 BC-SS W	LD 5320 BC-SS W	LD 5320 BC-SS W
Connaught Bronze Frame/Connaught Bronze	LD 5258 HB-HB B	LD 5258 HB-HB B	LD 5320 HB-HB B	LD 5320 SN-BS W
Copper Bronze Frame/Copper Bronze	LD 5258 CB-CB B	LD 5258 CB-CB B	LD 5320 CB-CB B	LD 5320 SN-BS W
Etrium Bronze Frame/Etrium Bronze	LD 5258 EB-EB B	LD 5258 EB-EB B	LD 5320 EB-EB B	LD 5320 SN-BS W
Polished Brass Frame/Antique Brass	LD 5258 PB-AB B	LD 5258 PB-AB B	LD 5320 PB-AB B	LD 5320 SN-BS W
Polished Brass Frame/Antique Brass	LD 5258 PB-AB W	LD 5258 PB-AB W	LD 5320 PB-AB W	LD 5320 SN-SS B
Polished Brass Frame/Bright Steel	LD 5258 PB-BS B	LD 5258 PB-BS B	LD 5320 PB-BS B	LD 5320 SN-SS B
Polished Brass Frame/Bright Steel	LD 5258 PB-BS W	LD 5258 PB-BS W	LD 5320 PB-BS W	LD 5320 SN-SS W
Polished Brass Frame/Polished Brass	LD 5258 PB-PB B	LD 5258 PB-PB B	LD 5320 PB-PB B	LD 5320 SN-SS W
Polished Brass Frame/Polished Brass	LD 5258 PB-PB W	LD 5258 PB-PB W	LD 5320 PB-PB W	LD 5320 SN-SS W
Polished Brass Frame/Satin Brass	LD 5258 PB-SB B	LD 5258 PB-SB B	LD 5320 PB-SB B	LD 5320 SN-SS W
Polished Brass Frame/Satin Brass	LD 5258 PB-SB W	LD 5258 PB-SB W	LD 5320 PB-SB W	LD 5320 SN-SS W
Polished Brass Frame/Satin Steel	LD 5258 PB-SS B	LD 5258 PB-SS B	LD 5320 PB-SS B	LD 5320 SN-SS W
Polished Brass Frame/Satin Steel	LD 5258 PB-SS W	LD 5258 PB-SS W	LD 5320 PB-SS W	LD 5320 SN-SS W
Richmond Bronze Frame/Richmond Bronze	LD 5258 RB-RB B	LD 5258 RB-RB B	LD 5320 RB-RB B	LD 5320 SN-SS W
Satin Brass Frame/Satin Brass	LD 5258 SB-SB B	LD 5258 SB-SB B	LD 5320 SB-SB B	LD 5320 SN-SS W
Satin Brass Frame/Satin Brass	LD 5258 SB-SB W	LD 5258 SB-SB W	LD 5320 SB-SB W	LD 5320 SN-SS W
Satin Brass Frame/Satin Steel	LD 5258 SB-SS B	LD 5258 SB-SS B	LD 5320 SB-SS B	LD 5320 SN-SS W
Satin Brass Frame/Satin Steel	LD 5258 SB-SS W	LD 5258 SB-SS W	LD 5320 SB-SS W	LD 5320 SN-SS W
Satin Nickel Frame/Bright Steel	LD 5258 SN-BS B	LD 5258 SN-BS B	LD 5320 SN-BS B	LD 5320 SN-SS W
Satin Nickel Frame/Bright Steel	LD 5258 SN-BS W	LD 5258 SN-BS W	LD 5320 SN-BS W	LD 5320 SN-SS W
Satin Nickel Frame/Satin Steel	LD 5258 SN-SS B	LD 5258 SN-SS B	LD 5320 SN-SS B	LD 5320 SN-SS W
Satin Nickel Frame/Satin Steel	LD 5258 SN-SS W	LD 5258 SN-SS W	LD 5320 SN-SS W	LD 5320 SN-SS W
Nominal Size:	86.0mm x 86.0mm	145.0mm x 86.0mm	145.0mm x 86.0mm	86.0mm x 86.0mm
Minimum Wall Box Depth:	35mm	35mm	35mm	47mm
Technical Insert Ref:	5258	5320	5320	6126

Insert Surround Colour Key: (B) Black, (W) White

Linea-Duo CFX



Key Switches



LD K21 BK-BK B



LD KEL SN-BS W

Frame / Front Plate	 1 gang 20AX 2 Way Key Switch	 1 gang 20AX 2 Way Key Switch EMG LTG TEST
	Antique Brass Frame/Antique Brass	LD K21 AB-AB B
Antique Brass Frame/Satin Brass	LD K21 AB-SB B	LD KEL AB-SB B
Black Nickel Frame/Black Nickel	LD K21 BK-BK B	LD KEL BK-BK B
Black Nickel Frame/Bright Steel	LD K21 BK-BS B	LD KEL BK-BS B
Black Nickel Frame/Polished Brass	LD K21 BK-PB B	LD KEL BK-PB B
Bright Chrome Frame/Black Nickel	LD K21 BC-BK B	LD KEL BC-BK B
Bright Chrome Frame/Bright Steel	LD K21 BC-BS B	LD KEL BC-BS B
Bright Chrome Frame/Bright Steel	LD K21 BC-BS W	LD KEL BC-BS W
Bright Chrome Frame/Piano Black	LD K21 BC-N B	LD KEL BC-N B
Bright Chrome Frame/Polished Brass	LD K21 BC-PB B	LD KEL BC-PB B
Bright Chrome Frame/Polished Brass	LD K21 BC-PB W	LD KEL BC-PB W
Bright Chrome Frame/Satin Steel	LD K21 BC-SS B	LD KEL BC-SS B
Bright Chrome Frame/Satin Steel	LD K21 BC-SS W	LD KEL BC-SS W
Connaught Bronze Frame/Connaught Bronze	LD K21 HB-HB B	LD KEL HB-HB B
Copper Bronze Frame/Copper Bronze	LD K21 CB-CB B	LD KEL CB-CB B
Etrium Bronze Frame/Etrium Bronze	LD K21 EB-EB B	LD KEL EB-EB B
Polished Brass Frame/Antique Brass	LD K21 PB-AB B	LD KEL PB-AB B
Polished Brass Frame/Antique Brass	LD K21 PB-AB W	LD KEL PB-AB W
Polished Brass Frame/Bright Steel	LD K21 PB-BS B	LD KEL PB-BS B
Polished Brass Frame/Bright Steel	LD K21 PB-BS W	LD KEL PB-BS W
Polished Brass Frame/Polished Brass	LD K21 PB-PB B	LD KEL PB-PB B
Polished Brass Frame/Polished Brass	LD K21 PB-PB W	LD KEL PB-PB W
Polished Brass Frame/Satin Brass	LD K21 PB-SB B	LD KEL PB-SB B
Polished Brass Frame/Satin Brass	LD K21 PB-SB W	LD KEL PB-SB W
Polished Brass Frame/Satin Steel	LD K21 PB-SS B	LD KEL PB-SS B
Polished Brass Frame/Satin Steel	LD K21 PB-SS W	LD KEL PB-SS W
Richmond Bronze Frame/Richmond Bronze	LD K21 RB-RB B	LD KEL RB-RB B
Satin Brass Frame/Satin Brass	LD K21 SB-SB B	LD KEL SB-SB B
Satin Brass Frame/Satin Brass	LD K21 SB-SB W	LD KEL SB-SB W
Satin Brass Frame/Satin Steel	LD K21 SB-SS B	LD KEL SB-SS B
Satin Brass Frame/Satin Steel	LD K21 SB-SS W	LD KEL SB-SS W
Satin Nickel Frame/Bright Steel	LD K21 SN-BS B	LD KEL SN-BS B
Satin Nickel Frame/Bright Steel	LD K21 SN-BS W	LD KEL SN-BS W
Satin Nickel Frame/Satin Steel	LD K21 SN-SS B	LD KEL SN-SS B
Satin Nickel Frame/Satin Steel	LD K21 SN-SS W	LD KEL SN-SS W
Nominal Size:	86.0mm x 86.0mm	86.0mm x 86.0mm
Minimum Wall Box Depth:	35mm	35mm
Technical Insert Ref:	K21	KEL

Hotel Card Switch with LED



LDC11 BC-BK B



LDC11 EB-EB B

Frame / Front Plate	 1 gang 10A (6AX) Card Switch On/Off with Blue LED Locator
Antique Brass Frame/Antique Brass	LD C11 AB-AB B
Antique Brass Frame/Satin Brass	LD C11 AB-SB B
Black Nickel Frame/Black Nickel	LD C11 BK-BK B
Black Nickel Frame/Bright Steel	LD C11 BK-BS B
Black Nickel Frame/Polished Brass	LD C11 BK-PB B
Bright Chrome Frame/Black Nickel	LD C11 BC-BK B
Bright Chrome Frame/Bright Steel	LD C11 BC-BS B
Bright Chrome Frame/Bright Steel	LD C11 BC-BS W
Bright Chrome Frame/Piano Black	LD C11 BC-N B
Bright Chrome Frame/Polished Brass	LD C11 BC-PB B
Bright Chrome Frame/Polished Brass	LD C11 BC-PB W
Bright Chrome Frame/Satin Steel	LD C11 BC-SS B
Bright Chrome Frame/Satin Steel	LD C11 BC-SS W
Connaught Bronze Frame/Connaught Bronze	LD C11 HB-HB B
Copper Bronze Frame/Copper Bronze	LD C11 CB-CB B
Etrium Bronze Frame/Etrium Bronze	LD C11 EB-EB B
Polished Brass Frame/Antique Brass	LD C11 PB-AB B
Polished Brass Frame/Antique Brass	LD C11 PB-AB W
Polished Brass Frame/Bright Steel	LD C11 PB-BS B
Polished Brass Frame/Bright Steel	LD C11 PB-BS W
Polished Brass Frame/Polished Brass	LD C11 PB-PB B
Polished Brass Frame/Polished Brass	LD C11 PB-PB W
Polished Brass Frame/Satin Brass	LD C11 PB-SB B
Polished Brass Frame/Satin Brass	LD C11 PB-SB W
Polished Brass Frame/Satin Steel	LD C11 PB-SS B
Polished Brass Frame/Satin Steel	LD C11 PB-SS W
Richmond Bronze Frame/Richmond Bronze	LD C11 RB-RB B
Satin Brass Frame/Satin Brass	LD C11 SB-SB B
Satin Brass Frame/Satin Brass	LD C11 SB-SB W
Satin Brass Frame/Satin Steel	LD C11 SB-SS B
Satin Brass Frame/Satin Steel	LD C11 SB-SS W
Satin Nickel Frame/Bright Steel	LD C11 SN-BS B
Satin Nickel Frame/Bright Steel	LD C11 SN-BS W
Satin Nickel Frame/Satin Steel	LD C11 SN-SS B
Satin Nickel Frame/Satin Steel	LD C11 SN-SS W
Nominal Size:	86.0mm x 86.0mm
Minimum Wall Box Depth:	35mm
Technical Insert Ref:	C11

Insert Surround Colour Key: (B) Black, (W) White

Linea-Duo CFX

Television Coaxial Sockets



LD TV BC-BK B



LD TVFM BC-BS W



LD TVSAT BC-PB B



LD SATI BK-BK B



1 gang
Non-Isolated
Television
1in/1out



Isolated TV/FM
Diplexer 1in/2out



1 gang Isolated
TV 1in/1out



2 gang
Non-Isolated
TV+Satellite
2in/2out



1 gang Non-
Isolated Satellite



1 gang Isolated
Satellite

Frame / Front Plate	1 gang Non-Isolated Television 1in/1out	Isolated TV/FM Diplexer 1in/2out	1 gang Isolated TV 1in/1out	2 gang Non-Isolated TV+Satellite 2in/2out	1 gang Non- Isolated Satellite	1 gang Isolated Satellite
Antique Brass Frame/Antique Brass	LD TV AB-AB B	LD TVFM AB-AB B	LD TVI AB-AB B	LD TVSAT AB-AB B	LD SATN AB-AB B	LD SATI AB-AB B
Antique Brass Frame/Satin Brass	LD TV AB-SB B	LD TVFM AB-SB B	LD TVI AB-SB B	LD TVSAT AB-SB B	LD SATN AB-SB B	LD SATI AB-SB B
Black Nickel Frame/Black Nickel	LD TV BK-BK B	LD TVFM BK-BK B	LD TVI BK-BK B	LD TVSAT BK-BK B	LD SATN BK-BK B	LD SATI BK-BK B
Black Nickel Frame/Bright Steel	LD TV BK-BS B	LD TVFM BK-BS B	LD TVI BK-BS B	LD TVSAT BK-BS B	LD SATN BK-BS B	LD SATI BK-BS B
Black Nickel Frame/Polished Brass	LD TV BK-PB B	LD TVFM BK-PB B	LD TVI BK-PB B	LD TVSAT BK-PB B	LD SATN BK-PB B	LD SATI BK-PB B
Bright Chrome Frame/Black Nickel	LD TV BC-BK B	LD TVFM BC-BK B	LD TVI BC-BK B	LD TVSAT BC-BK B	LD SATN BC-BK B	LD SATI BC-BK B
Bright Chrome Frame/Bright Steel	LD TV BC-BS B	LD TVFM BC-BS B	LD TVI BC-BS B	LD TVSAT BC-BS B	LD SATN BC-BS B	LD SATI BC-BS B
Bright Chrome Frame/Bright Steel	LD TV BC-BS W	LD TVFM BC-BS W	LD TVI BC-BS W	LD TVSAT BC-BS W	LD SATN BC-BS W	LD SATI BC-BS W
Bright Chrome Frame/Plano Black	LD TV BC-N B	LD TVFM BC-N B	LD TVI BC-N B	LD TVSAT BC-N B	LD SATN BC-N B	LD SATI BC-N B
Bright Chrome Frame/Polished Brass	LD TV BC-PB B	LD TVFM BC-PB B	LD TVI BC-PB B	LD TVSAT BC-PB B	LD SATN BC-PB B	LD SATI BC-PB B
Bright Chrome Frame/Polished Brass	LD TV BC-PB W	LD TVFM BC-PB W	LD TVI BC-PB W	LD TVSAT BC-PB W	LD SATN BC-PB W	LD SATI BC-PB W
Bright Chrome Frame/Satin Steel	LD TV BC-SS B	LD TVFM BC-SS B	LD TVI BC-SS B	LD TVSAT BC-SS B	LD SATN BC-SS B	LD SATI BC-SS B
Bright Chrome Frame/Satin Steel	LD TV BC-SS W	LD TVFM BC-SS W	LD TVI BC-SS W	LD TVSAT BC-SS W	LD SATN BC-SS W	LD SATI BC-SS W
Connaught Bronze Frame/Connaught Bronze	LD TV HB-HB B	LD TVFM HB-HB B	LD TVI HB-HB B	LD TVSAT HB-HB B	LD SATN HB-HB B	LD SATI HB-HB B
Copper Bronze Frame/Copper Bronze	LD TV CB-CB B	LD TVFM CB-CB B	LD TVI CB-CB B	LD TVSAT CB-CB B	LD SATN CB-CB B	LD SATI CB-CB B
Etrium Bronze Frame/Etrium Bronze	LD TV EB-EB B	LD TVFM EB-EB B	LD TVI EB-EB B	LD TVSAT EB-EB B	LD SATN EB-EB B	LD SATI EB-EB B
Polished Brass Frame/Antique Brass	LD TV PB-AB B	LD TVFM PB-AB B	LD TVI PB-AB B	LD TVSAT PB-AB B	LD SATN PB-AB B	LD SATI PB-AB B
Polished Brass Frame/Antique Brass	LD TV PB-AB W	LD TVFM PB-AB W	LD TVI PB-AB W	LD TVSAT PB-AB W	LD SATN PB-AB W	LD SATI PB-AB W
Polished Brass Frame/Bright Steel	LD TV PB-BS B	LD TVFM PB-BS B	LD TVI PB-BS B	LD TVSAT PB-BS B	LD SATN PB-BS B	LD SATI PB-BS B
Polished Brass Frame/Bright Steel	LD TV PB-BS W	LD TVFM PB-BS W	LD TVI PB-BS W	LD TVSAT PB-BS W	LD SATN PB-BS W	LD SATI PB-BS W
Polished Brass Frame/Polished Brass	LD TV PB-PB B	LD TVFM PB-PB B	LD TVI PB-PB B	LD TVSAT PB-PB B	LD SATN PB-PB B	LD SATI PB-PB B
Polished Brass Frame/Polished Brass	LD TV PB-PB W	LD TVFM PB-PB W	LD TVI PB-PB W	LD TVSAT PB-PB W	LD SATN PB-PB W	LD SATI PB-PB W
Polished Brass Frame/Satin Brass	LD TV PB-SB B	LD TVFM PB-SB B	LD TVI PB-SB B	LD TVSAT PB-SB B	LD SATN PB-SB B	LD SATI PB-SB B
Polished Brass Frame/Satin Brass	LD TV PB-SB W	LD TVFM PB-SB W	LD TVI PB-SB W	LD TVSAT PB-SB W	LD SATN PB-SB W	LD SATI PB-SB W
Polished Brass Frame/Satin Steel	LD TV PB-SS B	LD TVFM PB-SS B	LD TVI PB-SS B	LD TVSAT PB-SS B	LD SATN PB-SS B	LD SATI PB-SS B
Polished Brass Frame/Satin Steel	LD TV PB-SS W	LD TVFM PB-SS W	LD TVI PB-SS W	LD TVSAT PB-SS W	LD SATN PB-SS W	LD SATI PB-SS W
Richmond Bronze Frame/Richmond Bronze	LD TV RB-RB B	LD TVFM RB-RB B	LD TVI RB-RB B	LD TVSAT RB-RB B	LD SATN RB-RB B	LD SATI RB-RB B
Satin Brass Frame/Satin Brass	LD TV SB-SB B	LD TVFM SB-SB B	LD TVI SB-SB B	LD TVSAT SB-SB B	LD SATN SB-SB B	LD SATI SB-SB B
Satin Brass Frame/Satin Brass	LD TV SB-SB W	LD TVFM SB-SB W	LD TVI SB-SB W	LD TVSAT SB-SB W	LD SATN SB-SB W	LD SATI SB-SB W
Satin Brass Frame/Satin Steel	LD TV SB-SS B	LD TVFM SB-SS B	LD TVI SB-SS B	LD TVSAT SB-SS B	LD SATN SB-SS B	LD SATI SB-SS B
Satin Brass Frame/Satin Steel	LD TV SB-SS W	LD TVFM SB-SS W	LD TVI SB-SS W	LD TVSAT SB-SS W	LD SATN SB-SS W	LD SATI SB-SS W
Satin Nickel Frame/Bright Steel	LD TV SN-BS B	LD TVFM SN-BS B	LD TVI SN-BS B	LD TVSAT SN-BS B	LD SATN SN-BS B	LD SATI SN-BS B
Satin Nickel Frame/Bright Steel	LD TV SN-BS W	LD TVFM SN-BS W	LD TVI SN-BS W	LD TVSAT SN-BS W	LD SATN SN-BS W	LD SATI SN-BS W
Satin Nickel Frame/Satin Steel	LD TV SN-SS B	LD TVFM SN-SS B	LD TVI SN-SS B	LD TVSAT SN-SS B	LD SATN SN-SS B	LD SATI SN-SS B
Satin Nickel Frame/Satin Steel	LD TV SN-SS W	LD TVFM SN-SS W	LD TVI SN-SS W	LD TVSAT SN-SS W	LD SATN SN-SS W	LD SATI SN-SS W
Nominal Size:	86.0mm x 86.0mm	86.0mm x 86.0mm	86.0mm x 86.0mm	86.0mm x 86.0mm	86.0mm x 86.0mm	86.0mm x 86.0mm
Minimum Wall Box Depth:	25mm	25mm	25mm	35mm	35mm	35mm
Technical Insert Ref:	TV	TVFM	TVI	TVSAT	SATN	SATI

Insert Surround Colour Key: (B) Black, (W) White

Linea-Duo CFX

Digital Television Sockets

- Screened Non Isolated / DAB Compatible



LD DTRID AB-AB B



LD DTVF SN-BS W



LD DTVM SN-BS B



Non-Isolated
TV+FM+SAT Triplexer
1in/3out (DAB
Compatible)



1 gang Non-Isolated
TV (female) (DAB
Compatible)



1 gang Non-Isolated
TV (Male) (DAB
Compatible)

Frame / Front Plate	Non-Isolated TV+FM+SAT Triplexer 1in/3out (DAB Compatible)	1 gang Non-Isolated TV (female) (DAB Compatible)	1 gang Non-Isolated TV (Male) (DAB Compatible)
Antique Brass Frame/Antique Brass	LD DTRID AB-AB B	LD DTVF AB-AB B	LD DTVM AB-AB B
Antique Brass Frame/Satin Brass	LD DTRID AB-SB B	LD DTVF AB-SB B	LD DTVM AB-SB B
Black Nickel Frame/Black Nickel	LD DTRID BK-BK B	LD DTVF BK-BK B	LD DTVM BK-BK B
Black Nickel Frame/Bright Steel	LD DTRID BK-BS B	LD DTVF BK-BS B	LD DTVM BK-BS B
Black Nickel Frame/Polished Brass	LD DTRID BK-PB B	LD DTVF BK-PB B	LD DTVM BK-PB B
Bright Chrome Frame/Black Nickel	LD DTRID BC-BK B	LD DTVF BC-BK B	LD DTVM BC-BK B
Bright Chrome Frame/Bright Steel	LD DTRID BC-BS B	LD DTVF BC-BS B	LD DTVM BC-BS B
Bright Chrome Frame/Bright Steel	LD DTRID BC-BS W	LD DTVF BC-BS W	LD DTVM BC-BS W
Bright Chrome Frame/Piano Black	LD DTRID BC-NB	LD DTVF BC-NB	LD DTVM BC-NB
Bright Chrome Frame/Polished Brass	LD DTRID BC-PB B	LD DTVF BC-PB B	LD DTVM BC-PB B
Bright Chrome Frame/Polished Brass	LD DTRID BC-PB W	LD DTVF BC-PB W	LD DTVM BC-PB W
Bright Chrome Frame/Satin Steel	LD DTRID BC-SS B	LD DTVF BC-SS B	LD DTVM BC-SS B
Bright Chrome Frame/Satin Steel	LD DTRID BC-SS W	LD DTVF BC-SS W	LD DTVM BC-SS W
Connaught Bronze Frame/Connaught Bronze	LD DTRID HB-HB B	LD DTVF HB-HB B	LD DTVM HB-HB B
Copper Bronze Frame/Copper Bronze	LD DTRID CB-CB B	LD DTVF CB-CB B	LD DTVM CB-CB B
Etrium Bronze Frame/Etrium Bronze	LD DTRID EB-EB B	LD DTVF EB-EB B	LD DTVM EB-EB B
Polished Brass Frame/Antique Brass	LD DTRID PB-AB B	LD DTVF PB-AB B	LD DTVM PB-AB B
Polished Brass Frame/Antique Brass	LD DTRID PB-AB W	LD DTVF PB-AB W	LD DTVM PB-AB W
Polished Brass Frame/Bright Steel	LD DTRID PB-BS B	LD DTVF PB-BS B	LD DTVM PB-BS B
Polished Brass Frame/Bright Steel	LD DTRID PB-BS W	LD DTVF PB-BS W	LD DTVM PB-BS W
Polished Brass Frame/Polished Brass	LD DTRID PB-PB B	LD DTVF PB-PB B	LD DTVM PB-PB B
Polished Brass Frame/Polished Brass	LD DTRID PB-PB W	LD DTVF PB-PB W	LD DTVM PB-PB W
Polished Brass Frame/Satin Brass	LD DTRID PB-SB B	LD DTVF PB-SB B	LD DTVM PB-SB B
Polished Brass Frame/Satin Brass	LD DTRID PB-SB W	LD DTVF PB-SB W	LD DTVM PB-SB W
Polished Brass Frame/Satin Steel	LD DTRID PB-SS B	LD DTVF PB-SS B	LD DTVM PB-SS B
Polished Brass Frame/Satin Steel	LD DTRID PB-SS W	LD DTVF PB-SS W	LD DTVM PB-SS W
Richmond Bronze Frame/Richmond Bronze	LD DTRID RB-RB B	LD DTVF RB-RB B	LD DTVM RB-RB B
Satin Brass Frame/Satin Brass	LD DTRID SB-SB B	LD DTVF SB-SB B	LD DTVM SB-SB B
Satin Brass Frame/Satin Brass	LD DTRID SB-SB W	LD DTVF SB-SB W	LD DTVM SB-SB W
Satin Brass Frame/Satin Steel	LD DTRID SB-SS B	LD DTVF SB-SS B	LD DTVM SB-SS B
Satin Brass Frame/Satin Steel	LD DTRID SB-SS W	LD DTVF SB-SS W	LD DTVM SB-SS W
Satin Nickel Frame/Bright Steel	LD DTRID SN-BS B	LD DTVF SN-BS B	LD DTVM SN-BS B
Satin Nickel Frame/Bright Steel	LD DTRID SN-BS W	LD DTVF SN-BS W	LD DTVM SN-BS W
Satin Nickel Frame/Satin Steel	LD DTRID SN-SS B	LD DTVF SN-SS B	LD DTVM SN-SS B
Satin Nickel Frame/Satin Steel	LD DTRID SN-SS W	LD DTVF SN-SS W	LD DTVM SN-SS W
Nominal Size:	86.0mm x 86.0mm	86.0mm x 86.0mm	86.0mm x 86.0mm
Minimum Wall Box Depth:	35mm	35mm	35mm
Technical Insert Ref:	DTRID	DTV F	DTVM

Insert Surround Colour Key: (B) Black, (W) White

Linea-Duo CFX

Digital Television Sockets

- Screened Non Isolated / DAB Compatible



LD DSAT PB-BS B



LD DSAT+ PB-PB W



1 gang Non-Isolated
Satellite (DAB
Compatible)



Non-Isolated
TV+FM+SAT1+SAT2
Quadplexer 2in/4out
(DAB Compatible)

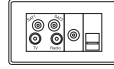

Non-Isolated
TV+FM+SAT1+SAT2
Quadplexer 2in/4out
+TVF+TCS (DAB
Compatible)

Frame / Front Plate	LD DSAT AB-AB B	LD DENT AB-AB B	LD DSAT+ AB-AB B
Antique Brass Frame/Antique Brass	LD DSAT AB-AB B	LD DENT AB-AB B	LD DSAT+ AB-AB B
Antique Brass Frame/Satin Brass	LD DSAT AB-SB B	LD DENT AB-SB B	LD DSAT+ AB-SB B
Black Nickel Frame/Black Nickel	LD DSAT BK-BK B	LD DENT BK-BK B	LD DSAT+ BK-BK B
Black Nickel Frame/Bright Steel	LD DSAT BK-BS B	LD DENT BK-BS B	LD DSAT+ BK-BS B
Black Nickel Frame/Polished Brass	LD DSAT BK-PB B	LD DENT BK-PB B	LD DSAT+ BK-PB B
Bright Chrome Frame/Black Nickel	LD DSAT BC-BK B	LD DENT BC-BK B	LD DSAT+ BC-BK B
Bright Chrome Frame/Bright Steel	LD DSAT BC-BS B	LD DENT BC-BS B	LD DSAT+ BC-BS B
Bright Chrome Frame/Bright Steel	LD DSAT BC-BS W	LD DENT BC-BS W	LD DSAT+ BC-BS W
Bright Chrome Frame/Piano Black	LD DSAT BC-N B	LD DENT BC-N B	LD DSAT+ BC-N B
Bright Chrome Frame/Polished Brass	LD DSAT BC-PB B	LD DENT BC-PB B	LD DSAT+ BC-PB B
Bright Chrome Frame/Polished Brass	LD DSAT BC-PB W	LD DENT BC-PB W	LD DSAT+ BC-PB W
Bright Chrome Frame/Satin Steel	LD DSAT BC-SS B	LD DENT BC-SS B	LD DSAT+ BC-SS B
Bright Chrome Frame/Satin Steel	LD DSAT BC-SS W	LD DENT BC-SS W	LD DSAT+ BC-SS W
Connaught Bronze Frame/Connaught Bronze	LD DSAT HB-HB B	LD DENT HB-HB B	LD DSAT+ HB-HB B
Copper Bronze Frame/Copper Bronze	LD DSAT CB-CB B	LD DENT CB-CB B	LD DSAT+ CB-CB B
Etrium Bronze Frame/Etrium Bronze	LD DSAT EB-EB B	LD DENT EB-EB B	LD DSAT+ EB-EB B
Polished Brass Frame/Antique Brass	LD DSAT PB-AB B	LD DENT PB-AB B	LD DSAT+ PB-AB B
Polished Brass Frame/Antique Brass	LD DSAT PB-AB W	LD DENT PB-AB W	LD DSAT+ PB-AB W
Polished Brass Frame/Bright Steel	LD DSAT PB-BS B	LD DENT PB-BS B	LD DSAT+ PB-BS B
Polished Brass Frame/Bright Steel	LD DSAT PB-BS W	LD DENT PB-BS W	LD DSAT+ PB-BS W
Polished Brass Frame/Polished Brass	LD DSAT PB-PB B	LD DENT PB-PB B	LD DSAT+ PB-PB B
Polished Brass Frame/Polished Brass	LD DSAT PB-PB W	LD DENT PB-PB W	LD DSAT+ PB-PB W
Polished Brass Frame/Satin Brass	LD DSAT PB-SB B	LD DENT PB-SB B	LD DSAT+ PB-SB B
Polished Brass Frame/Satin Brass	LD DSAT PB-SB W	LD DENT PB-SB W	LD DSAT+ PB-SB W
Polished Brass Frame/Satin Steel	LD DSAT PB-SS B	LD DENT PB-SS B	LD DSAT+ PB-SS B
Polished Brass Frame/Satin Steel	LD DSAT PB-SS W	LD DENT PB-SS W	LD DSAT+ PB-SS W
Richmond Bronze Frame/Richmond Bronze	LD DSAT RB-RB B	LD DENT RB-RB B	LD DSAT+ RB-RB B
Satin Brass Frame/Satin Brass	LD DSAT SB-SB B	LD DENT SB-SB B	LD DSAT+ SB-SB B
Satin Brass Frame/Satin Brass	LD DSAT SB-SB W	LD DENT SB-SB W	LD DSAT+ SB-SB W
Satin Brass Frame/Satin Steel	LD DSAT SB-SS B	LD DENT SB-SS B	LD DSAT+ SB-SS B
Satin Brass Frame/Satin Steel	LD DSAT SB-SS W	LD DENT SB-SS W	LD DSAT+ SB-SS W
Satin Nickel Frame/Bright Steel	LD DSAT SN-BS B	LD DENT SN-BS B	LD DSAT+ SN-BS B
Satin Nickel Frame/Bright Steel	LD DSAT SN-BS W	LD DENT SN-BS W	LD DSAT+ SN-BS W
Satin Nickel Frame/Satin Steel	LD DSAT SN-SS B	LD DENT SN-SS B	LD DSAT+ SN-SS B
Satin Nickel Frame/Satin Steel	LD DSAT SN-SS W	LD DENT SN-SS W	LD DSAT+ SN-SS W
Nominal Size:	86.0mm x 86.0mm	86.0mm x 86.0mm	145.0mm x 86.0mm
Minimum Wall Box Depth:	35mm	35mm	35mm
Technical Insert Ref:	DSAT	DENT	DSAT+

Insert Surround Colour Key: (B) Black, (W) White

LINEA-DUO CFX RANGE

Linea-Duo CFX

Telephone and Data Outlets



LD TCM BK-PB B









LD TCS BC-BK B



LD J45 BC-BS W



LD 2J45 BC-PB W

Frame / Front Plate	 1 gang Telephone Master	 1 gang Telephone Slave	 1 gang RJ12 Outlet - Unshielded	 2 gang RJ12 Outlet - Unshielded	 1 gang RJ45 CAT 5E Outlet - Unshielded	 2 gang RJ45 CAT 5E Outlet - Unshielded
Antique Brass Frame/Antique Brass	LD TCM AB-AB B	LD TCS AB-AB B	LD J12 AB-AB B	LD 2J12 AB-AB B	LD J45 AB-AB B	LD 2J45 AB-AB B
Antique Brass Frame/Satin Brass	LD TCM AB-SB B	LD TCS AB-SB B	LD J12 AB-SB B	LD 2J12 AB-SB B	LD J45 AB-SB B	LD 2J45 AB-SB B
Black Nickel Frame/Black Nickel	LD TCM BK-BK B	LD TCS BK-BK B	LD J12 BK-BK B	LD 2J12 BK-BK B	LD J45 BK-BK B	LD 2J45 BK-BK B
Black Nickel Frame/Bright Steel	LD TCM BK-BS B	LD TCS BK-BS B	LD J12 BK-BS B	LD 2J12 BK-BS B	LD J45 BK-BS B	LD 2J45 BK-BS B
Black Nickel Frame/Polished Brass	LD TCM BK-PB B	LD TCS BK-PB B	LD J12 BK-PB B	LD 2J12 BK-PB B	LD J45 BK-PB B	LD 2J45 BK-PB B
Bright Chrome Frame/Black Nickel	LD TCM BC-BK B	LD TCS BC-BK B	LD J12 BC-BK B	LD 2J12 BC-BK B	LD J45 BC-BK B	LD 2J45 BC-BK B
Bright Chrome Frame/Bright Steel	LD TCM BC-BS B	LD TCS BC-BS B	LD J12 BC-BS B	LD 2J12 BC-BS B	LD J45 BC-BS B	LD 2J45 BC-BS B
Bright Chrome Frame/Bright Steel	LD TCM BC-BS W	LD TCS BC-BS W	LD J12 BC-BS W	LD 2J12 BC-BS W	LD J45 BC-BS W	LD 2J45 BC-BS W
Bright Chrome Frame/Piano Black	LD TCM BC-N B	LD TCS BC-N B	LD J12 BC-N B	LD 2J12 BC-N B	LD J45 BC-N B	LD 2J45 BC-N B
Bright Chrome Frame/Polished Brass	LD TCM BC-PB B	LD TCS BC-PB B	LD J12 BC-PB B	LD 2J12 BC-PB B	LD J45 BC-PB B	LD 2J45 BC-PB B
Bright Chrome Frame/Polished Brass	LD TCM BC-PB W	LD TCS BC-PB W	LD J12 BC-PB W	LD 2J12 BC-PB W	LD J45 BC-PB W	LD 2J45 BC-PB W
Bright Chrome Frame/Satin Steel	LD TCM BC-SS B	LD TCS BC-SS B	LD J12 BC-SS B	LD 2J12 BC-SS B	LD J45 BC-SS B	LD 2J45 BC-SS B
Bright Chrome Frame/Satin Steel	LD TCM BC-SS W	LD TCS BC-SS W	LD J12 BC-SS W	LD 2J12 BC-SS W	LD J45 BC-SS W	LD 2J45 BC-SS W
Connaught Bronze Frame/Connaught Bronze	LD TCM HB-HB B	LD TCS HB-HB B	LD J12 HB-HB B	LD 2J12 HB-HB B	LD J45 HB-HB B	LD 2J45 HB-HB B
Copper Bronze Frame/Copper Bronze	LD TCM CB-CB B	LD TCS CB-CB B	LD J12 CB-CB B	LD 2J12 CB-CB B	LD J45 CB-CB B	LD 2J45 CB-CB B
Etrium Bronze Frame/Etrium Bronze	LD TCM EB-EB B	LD TCS EB-EB B	LD J12 EB-EB B	LD 2J12 EB-EB B	LD J45 EB-EB B	LD 2J45 EB-EB B
Polished Brass Frame/Antique Brass	LD TCM PB-AB B	LD TCS PB-AB B	LD J12 PB-AB B	LD 2J12 PB-AB B	LD J45 PB-AB B	LD 2J45 PB-AB B
Polished Brass Frame/Antique Brass	LD TCM PB-AB W	LD TCS PB-AB W	LD J12 PB-AB W	LD 2J12 PB-AB W	LD J45 PB-AB W	LD 2J45 PB-AB W
Polished Brass Frame/Bright Steel	LD TCM PB-BS B	LD TCS PB-BS B	LD J12 PB-BS B	LD 2J12 PB-BS B	LD J45 PB-BS B	LD 2J45 PB-BS B
Polished Brass Frame/Bright Steel	LD TCM PB-BS W	LD TCS PB-BS W	LD J12 PB-BS W	LD 2J12 PB-BS W	LD J45 PB-BS W	LD 2J45 PB-BS W
Polished Brass Frame/Polished Brass	LD TCM PB-PB B	LD TCS PB-PB B	LD J12 PB-PB B	LD 2J12 PB-PB B	LD J45 PB-PB B	LD 2J45 PB-PB B
Polished Brass Frame/Polished Brass	LD TCM PB-PB W	LD TCS PB-PB W	LD J12 PB-PB W	LD 2J12 PB-PB W	LD J45 PB-PB W	LD 2J45 PB-PB W
Polished Brass Frame/Satin Brass	LD TCM PB-SB B	LD TCS PB-SB B	LD J12 PB-SB B	LD 2J12 PB-SB B	LD J45 PB-SB B	LD 2J45 PB-SB B
Polished Brass Frame/Satin Brass	LD TCM PB-SB W	LD TCS PB-SB W	LD J12 PB-SB W	LD 2J12 PB-SB W	LD J45 PB-SB W	LD 2J45 PB-SB W
Polished Brass Frame/Satin Steel	LD TCM PB-SS B	LD TCS PB-SS B	LD J12 PB-SS B	LD 2J12 PB-SS B	LD J45 PB-SS B	LD 2J45 PB-SS B
Polished Brass Frame/Satin Steel	LD TCM PB-SS W	LD TCS PB-SS W	LD J12 PB-SS W	LD 2J12 PB-SS W	LD J45 PB-SS W	LD 2J45 PB-SS W
Richmond Bronze Frame/Richmond Bronze	LD TCM RB-RB B	LD TCS RB-RB B	LD J12 RB-RB B	LD 2J12 RB-RB B	LD J45 RB-RB B	LD 2J45 RB-RB B
Satin Brass Frame/Satin Brass	LD TCM SB-SB B	LD TCS SB-SB B	LD J12 SB-SB B	LD 2J12 SB-SB B	LD J45 SB-SB B	LD 2J45 SB-SB B
Satin Brass Frame/Satin Brass	LD TCM SB-SB W	LD TCS SB-SB W	LD J12 SB-SB W	LD 2J12 SB-SB W	LD J45 SB-SB W	LD 2J45 SB-SB W
Satin Brass Frame/Satin Steel	LD TCM SB-SS B	LD TCS SB-SS B	LD J12 SB-SS B	LD 2J12 SB-SS B	LD J45 SB-SS B	LD 2J45 SB-SS B
Satin Brass Frame/Satin Steel	LD TCM SB-SS W	LD TCS SB-SS W	LD J12 SB-SS W	LD 2J12 SB-SS W	LD J45 SB-SS W	LD 2J45 SB-SS W
Satin Nickel Frame/Bright Steel	LD TCM SN-BS B	LD TCS SN-BS B	LD J12 SN-BS B	LD 2J12 SN-BS B	LD J45 SN-BS B	LD 2J45 SN-BS B
Satin Nickel Frame/Bright Steel	LD TCM SN-BS W	LD TCS SN-BS W	LD J12 SN-BS W	LD 2J12 SN-BS W	LD J45 SN-BS W	LD 2J45 SN-BS W
Satin Nickel Frame/Satin Steel	LD TCM SN-SS B	LD TCS SN-SS B	LD J12 SN-SS B	LD 2J12 SN-SS B	LD J45 SN-SS B	LD 2J45 SN-SS B
Satin Nickel Frame/Satin Steel	LD TCM SN-SS W	LD TCS SN-SS W	LD J12 SN-SS W	LD 2J12 SN-SS W	LD J45 SN-SS W	LD 2J45 SN-SS W
Nominal Size:	86.0mm x 86.0mm	86.0mm x 86.0mm	86.0mm x 86.0mm	86.0mm x 86.0mm	86.0mm x 86.0mm	86.0mm x 86.0mm
Minimum Wall Box Depth:	25mm	25mm	35mm	35mm	35mm	35mm
Technical Insert Ref:	TCM	TCS	J12	2J12	J45	2J45

Insert Surround Colour Key: (B) Black, (W) White

Linea-Duo CFX

Double Pole Switches



LD DPN AB-SB B



LD 45N BK-BK B



LD 45SS1 PB-SB W



1 gang 20AX Double Pole Rocker + Neon



1 gang 45A Double Pole Red Rocker + Neon

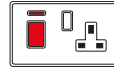

45A Double Pole Red Rocker + Neon + 13A Switched Socket

Frame / Front Plate	1 gang 20AX Double Pole Rocker + Neon	1 gang 45A Double Pole Red Rocker + Neon	45A Double Pole Red Rocker + Neon + 13A Switched Socket
Antique Brass Frame/Antique Brass	LD DPN AB-AB B	LD 45N AB-AB B	LD 45SS1 AB-AB B
Antique Brass Frame/Satin Brass	LD DPN AB-SB B	LD 45N AB-SB B	LD 45SS1 AB-SB B
Black Nickel Frame/Black Nickel	LD DPN BK-BK B	LD 45N BK-BK B	LD 45SS1 BK-BK B
Black Nickel Frame/Bright Steel	LD DPN BK-BS B	LD 45N BK-BS B	LD 45SS1 BK-BS B
Black Nickel Frame/Polished Brass	LD DPN BK-PB B	LD 45N BK-PB B	LD 45SS1 BK-PB B
Bright Chrome Frame/Black Nickel	LD DPN BC-BK B	LD 45N BC-BK B	LD 45SS1 BC-BK B
Bright Chrome Frame/Bright Steel	LD DPN BC-BS B	LD 45N BC-BS B	LD 45SS1 BC-BS B
Bright Chrome Frame/Bright Steel	LD DPN BC-BS W	LD 45N BC-BS W	LD 45SS1 BC-BS W
Bright Chrome Frame/Piano Black	LD DPN BC-NB	LD 45N BC-NB	LD 45SS1 BC-NB
Bright Chrome Frame/Polished Brass	LD DPN BC-PB B	LD 45N BC-PB B	LD 45SS1 BC-PB B
Bright Chrome Frame/Polished Brass	LD DPN BC-PB W	LD 45N BC-PB W	LD 45SS1 BC-PB W
Bright Chrome Frame/Satin Steel	LD DPN BC-SS B	LD 45N BC-SS B	LD 45SS1 BC-SS B
Bright Chrome Frame/Satin Steel	LD DPN BC-SS W	LD 45N BC-SS W	LD 45SS1 BC-SS W
Connaught Bronze Frame/Connaught Bronze	LD DPN HB-HB B	LD 45N HB-HB B	LD 45SS1 HB-HB B
Copper Bronze Frame/Copper Bronze	LD DPN CB-CB B	LD 45N CB-CB B	LD 45SS1 CB-CB B
Etrium Bronze Frame/Etrium Bronze	LD DPN EB-EB B	LD 45N EB-EB B	LD 45SS1 EB-EB B
Polished Brass Frame/Antique Brass	LD DPN PB-AB B	LD 45N PB-AB B	LD 45SS1 PB-AB B
Polished Brass Frame/Antique Brass	LD DPN PB-AB W	LD 45N PB-AB W	LD 45SS1 PB-AB W
Polished Brass Frame/Bright Steel	LD DPN PB-BS B	LD 45N PB-BS B	LD 45SS1 PB-BS B
Polished Brass Frame/Bright Steel	LD DPN PB-BS W	LD 45N PB-BS W	LD 45SS1 PB-BS W
Polished Brass Frame/Polished Brass	LD DPN PB-PB B	LD 45N PB-PB B	LD 45SS1 PB-PB B
Polished Brass Frame/Polished Brass	LD DPN PB-PB W	LD 45N PB-PB W	LD 45SS1 PB-PB W
Polished Brass Frame/Satin Brass	LD DPN PB-SB B	LD 45N PB-SB B	LD 45SS1 PB-SB B
Polished Brass Frame/Satin Brass	LD DPN PB-SB W	LD 45N PB-SB W	LD 45SS1 PB-SB W
Polished Brass Frame/Satin Steel	LD DPN PB-SS B	LD 45N PB-SS B	LD 45SS1 PB-SS B
Polished Brass Frame/Satin Steel	LD DPN PB-SS W	LD 45N PB-SS W	LD 45SS1 PB-SS W
Richmond Bronze Frame/Richmond Bronze	LD DPN RB-RB B	LD 45N RB-RB B	LD 45SS1 RB-RB B
Satin Brass Frame/Satin Brass	LD DPN SB-SB B	LD 45N SB-SB B	LD 45SS1 SB-SB B
Satin Brass Frame/Satin Brass	LD DPN SB-SB W	LD 45N SB-SB W	LD 45SS1 SB-SB W
Satin Brass Frame/Satin Steel	LD DPN SB-SS B	LD 45N SB-SS B	LD 45SS1 SB-SS B
Satin Brass Frame/Satin Steel	LD DPN SB-SS W	LD 45N SB-SS W	LD 45SS1 SB-SS W
Satin Nickel Frame/Bright Steel	LD DPN SN-BS B	LD 45N SN-BS B	LD 45SS1 SN-BS B
Satin Nickel Frame/Bright Steel	LD DPN SN-BS W	LD 45N SN-BS W	LD 45SS1 SN-BS W
Satin Nickel Frame/Satin Steel	LD DPN SN-SS B	LD 45N SN-SS B	LD 45SS1 SN-SS B
Satin Nickel Frame/Satin Steel	LD DPN SN-SS W	LD 45N SN-SS W	LD 45SS1 SN-SS W
Nominal Size:	86.0mm x 86.0mm	86.0mm x 86.0mm	145.0mm x 86.0mm
Minimum Wall Box Depth:	35mm	35mm	35mm
Technical Insert Ref:	DPN	45N	45SS1

Insert Surround Colour Key: (B) Black, (W) White

Linea-Duo CFX

Connection Units



LD SPN SN-BS W



LD FN PB-SB R



1 gang 13A Double Pole Fused Spur + Neon



1 gang 13A Fuse with Red Neon Halo

Frame / Front Plate	1 gang 13A Double Pole Fused Spur + Neon	1 gang 13A Fuse with Red Neon Halo
Antique Brass Frame/Antique Brass	LD SPN AB-AB B	LD FN AB-AB R
Antique Brass Frame/Satin Brass	LD SPN AB-SB B	LD FN AB-SB R
Black Nickel Frame/Black Nickel	LD SPN BK-BK B	LD FN BK-BK R
Black Nickel Frame/Bright Steel	LD SPN BK-BS B	LD FN BK-BS R
Black Nickel Frame/Polished Brass	LD SPN BK-PB B	LD FN BK-PB R
Bright Chrome Frame/Black Nickel	LD SPN BC-BK B	LD FN BC-BK R
Bright Chrome Frame/Bright Steel	LD SPN BC-BS B	LD FN BC-BS R
Bright Chrome Frame/Bright Steel	LD SPN BC-BS W	-
Bright Chrome Frame/Piano Black	LD SPN BC-NB	LD FN BC-NR
Bright Chrome Frame/Polished Brass	LD SPN BC-PB B	LD FN BC-PB R
Bright Chrome Frame/Polished Brass	LD SPN BC-PB W	-
Bright Chrome Frame/Satin Steel	LD SPN BC-SS B	LD FN BC-SS R
Bright Chrome Frame/Satin Steel	LD SPN BC-SS W	-
Connaught Bronze Frame/Connaught Bronze	LD SPN HB-HB B	LD FN HB-HB R
Copper Bronze Frame/Copper Bronze	LD SPN CB-CB B	LD FN CB-CB R
Etrium Bronze Frame/Etrium Bronze	LD SPN EB-EB B	LD FN EB-EB R
Polished Brass Frame/Antique Brass	LD SPN PB-AB B	LD FN PB-AB R
Polished Brass Frame/Antique Brass	LD SPN PB-AB W	-
Polished Brass Frame/Bright Steel	LD SPN PB-BS B	LD FN PB-BS R
Polished Brass Frame/Bright Steel	LD SPN PB-BS W	-
Polished Brass Frame/Polished Brass	LD SPN PB-PB B	LD FN PB-PB R
Polished Brass Frame/Polished Brass	LD SPN PB-PB W	-
Polished Brass Frame/Satin Brass	LD SPN PB-SB B	LD FN PB-SB R
Polished Brass Frame/Satin Brass	LD SPN PB-SB W	-
Polished Brass Frame/Satin Steel	LD SPN PB-SS B	LD FN PB-SS R
Polished Brass Frame/Satin Steel	LD SPN PB-SS W	-
Richmond Bronze Frame/Richmond Bronze	LD SPN RB-RB B	LD FN RB-RB R
Satin Brass Frame/Satin Brass	LD SPN SB-SB B	LD FN SB-SB R
Satin Brass Frame/Satin Brass	LD SPN SB-SB W	-
Satin Brass Frame/Satin Steel	LD SPN SB-SS B	LD FN SB-SS R
Satin Brass Frame/Satin Steel	LD SPN SB-SS W	-
Satin Nickel Frame/Bright Steel	LD SPN SN-BS B	LD FN SN-BS R
Satin Nickel Frame/Bright Steel	LD SPN SN-BS W	-
Satin Nickel Frame/Satin Steel	LD SPN SN-SS B	LD FN SN-SS R
Satin Nickel Frame/Satin Steel	LD SPN SN-SS W	-
Nominal Size:	86.0mm x 86.0mm	86.0mm x 86.0mm
Minimum Wall Box Depth:	35mm	35mm
Technical Insert Ref:	SPN	FN

Insert Surround Colour Key: (B) Black, (W) White

Linea-Duo CFX

LED Trailing/Leading Edge Push On/Off Rotary 2 Way Switching Dimmers



LD 1XLEDITB100 AB-AB





LD 2XLEDITB100 PB-SB



LD 3XLEDITB100 BC-N

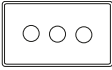
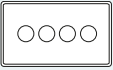

LD 4XLEDITB100 SN-BS

Frame / Front Plate	 1 gang 100W LED Trailing/Leading Edge Push On/Off Rotary 2 Way Switching Dimmer	 2 gang 100W LED Trailing/Leading Edge Push On/Off Rotary 2 Way Switching Dimmer	 3 gang 100W LED Trailing/Leading Edge Push On/Off Rotary 2 Way Switching Dimmer	 4 gang 100W LED Trailing/Leading Edge Push On/Off Rotary 2 Way Switching Dimmer
Antique Brass Frame/Antique Brass	LD 1XLEDITB100 AB-AB	LD 2XLEDITB100 AB-AB	LD 3XLEDITB100 AB-AB	LD 4XLEDITB100 AB-AB
Antique Brass Frame/Satin Brass	LD 1XLEDITB100 AB-SB	LD 2XLEDITB100 AB-SB	LD 3XLEDITB100 AB-SB	LD 4XLEDITB100 AB-SB
Black Nickel Frame/Black Nickel	LD 1XLEDITB100 BK-BK	LD 2XLEDITB100 BK-BK	LD 3XLEDITB100 BK-BK	LD 4XLEDITB100 BK-BK
Black Nickel Frame/Bright Steel	LD 1XLEDITB100 BK-BS	LD 2XLEDITB100 BK-BS	LD 3XLEDITB100 BK-BS	LD 4XLEDITB100 BK-BS
Black Nickel Frame/Polished Brass	LD 1XLEDITB100 BK-PB	LD 2XLEDITB100 BK-PB	LD 3XLEDITB100 BK-PB	LD 4XLEDITB100 BK-PB
Bright Chrome Frame/Black Nickel	LD 1XLEDITB100 BC-BK	LD 2XLEDITB100 BC-BK	LD 3XLEDITB100 BC-BK	LD 4XLEDITB100 BC-BK
Bright Chrome Frame/Bright Steel	LD 1XLEDITB100 BC-BS	LD 2XLEDITB100 BC-BS	LD 3XLEDITB100 BC-BS	LD 4XLEDITB100 BC-BS
Bright Chrome Frame/Piano Black	LD 1XLEDITB100 BC-N	LD 2XLEDITB100 BC-N	LD 3XLEDITB100 BC-N	LD 4XLEDITB100 BC-N
Bright Chrome Frame/Polished Brass	LD 1XLEDITB100 BC-PB	LD 2XLEDITB100 BC-PB	LD 3XLEDITB100 BC-PB	LD 4XLEDITB100 BC-PB
Bright Chrome Frame/Satin Steel	LD 1XLEDITB100 BC-SS	LD 2XLEDITB100 BC-SS	LD 3XLEDITB100 BC-SS	LD 4XLEDITB100 BC-SS
Connaught Bronze Frame/Connaught Bronze	LD 1XLEDITB100 HB-HB	LD 2XLEDITB100 HB-HB	LD 3XLEDITB100 HB-HB	LD 4XLEDITB100 HB-HB
Copper Bronze Frame/Copper Bronze	LD 1XLEDITB100 CB-CB	LD 2XLEDITB100 CB-CB	LD 3XLEDITB100 CB-CB	LD 4XLEDITB100 CB-CB
Etrium Bronze Frame/Etrium Bronze	LD 1XLEDITB100 EB-EB	LD 2XLEDITB100 EB-EB	LD 3XLEDITB100 EB-EB	LD 4XLEDITB100 EB-EB
Polished Brass Frame/Antique Brass	LD 1XLEDITB100 PB-AB	LD 2XLEDITB100 PB-AB	LD 3XLEDITB100 PB-AB	LD 4XLEDITB100 PB-AB
Polished Brass Frame/Bright Steel	LD 1XLEDITB100 PB-BS	LD 2XLEDITB100 PB-BS	LD 3XLEDITB100 PB-BS	LD 4XLEDITB100 PB-BS
Polished Brass Frame/Polished Brass	LD 1XLEDITB100 PB-PB	LD 2XLEDITB100 PB-PB	LD 3XLEDITB100 PB-PB	LD 4XLEDITB100 PB-PB
Polished Brass Frame/Satin Brass	LD 1XLEDITB100 PB-SB	LD 2XLEDITB100 PB-SB	LD 3XLEDITB100 PB-SB	LD 4XLEDITB100 PB-SB
Polished Brass Frame/Satin Steel	LD 1XLEDITB100 PB-SS	LD 2XLEDITB100 PB-SS	LD 3XLEDITB100 PB-SS	LD 4XLEDITB100 PB-SS
Richmond Bronze Frame/Richmond Bronze	LD 1XLEDITB100 RB-RB	LD 2XLEDITB100 RB-RB	LD 3XLEDITB100 RB-RB	LD 4XLEDITB100 RB-RB
Satin Brass Frame/Satin Brass	LD 1XLEDITB100 SB-SB	LD 2XLEDITB100 SB-SB	LD 3XLEDITB100 SB-SB	LD 4XLEDITB100 SB-SB
Satin Brass Frame/Satin Steel	LD 1XLEDITB100 SB-SS	LD 2XLEDITB100 SB-SS	LD 3XLEDITB100 SB-SS	LD 4XLEDITB100 SB-SS
Satin Nickel Frame/Bright Steel	LD 1XLEDITB100 SN-BS	LD 2XLEDITB100 SN-BS	LD 3XLEDITB100 SN-BS	LD 4XLEDITB100 SN-BS
Satin Nickel Frame/Satin Steel	LD 1XLEDITB100 SN-SS	LD 2XLEDITB100 SN-SS	LD 3XLEDITB100 SN-SS	LD 4XLEDITB100 SN-SS
Nominal Size:	86.0mm x 86.0mm	86.0mm x 86.0mm	145.0mm x 86.0mm	145.0mm x 86.0mm
Minimum Wall Box Depth:	35mm	35mm	35mm	35mm
Technical Insert Ref:	1XLEDITB	2XLEDITB	3XLEDITB	4XLEDITB

NOTE: Tungsten filament GU10 lamps must be branded and with a fused base.

NOTE: Please refer to the Dimmer Technical Section for the max Wattage.

NOTE: Please contact our Technical Department for compatibility.

LINEA-DUO CFX RANGE

Linea-Duo CFX

LED Trailing/Leading Edge Push On/Off Rotary Multi-Way Dimmers

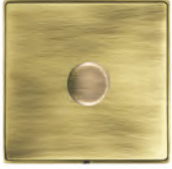

LD 1X100LED AB-AB







LD 2X100LED SN-BS



LD 3X100LED BK-BS

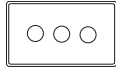

LD 4X100LED BC-BK

Frame / Front Plate	 1 gang 100W LED Trailing/ Leading Edge Push On/Off Rotary Multi-Way Dimmer	 2 gang 100W LED Trailing/ Leading Edge Push On/Off Rotary Multi-Way Dimmer	 3 gang 100W LED Trailing/ Leading Edge Push On/Off Rotary Multi-Way Dimmer	 4 gang 100W LED Trailing/ Leading Edge Push On/Off Rotary Multi-Way Dimmer
Antique Brass Frame/Antique Brass	LD 1X100LED AB-AB	LD 2X100LED AB-AB	LD 3X100LED AB-AB	LD 4X100LED AB-AB
Antique Brass Frame/Satin Brass	LD 1X100LED AB-SB	LD 2X100LED AB-SB	LD 3X100LED AB-SB	LD 4X100LED AB-SB
Black Nickel Frame/Black Nickel	LD 1X100LED BK-BK	LD 2X100LED BK-BK	LD 3X100LED BK-BK	LD 4X100LED BK-BK
Black Nickel Frame/Bright Steel	LD 1X100LED BK-BS	LD 2X100LED BK-BS	LD 3X100LED BK-BS	LD 4X100LED BK-BS
Black Nickel Frame/Polished Brass	LD 1X100LED BK-PB	LD 2X100LED BK-PB	LD 3X100LED BK-PB	LD 4X100LED BK-PB
Bright Chrome Frame/Black Nickel	LD 1X100LED BC-BK	LD 2X100LED BC-BK	LD 3X100LED BC-BK	LD 4X100LED BC-BK
Bright Chrome Frame/Bright Steel	LD 1X100LED BC-BS	LD 2X100LED BC-BS	LD 3X100LED BC-BS	LD 4X100LED BC-BS
Bright Chrome Frame/Piano Black	LD 1X100LED BC-N	LD 2X100LED BC-N	LD 3X100LED BC-N	LD 4X100LED BC-N
Bright Chrome Frame/Polished Brass	LD 1X100LED BC-PB	LD 2X100LED BC-PB	LD 3X100LED BC-PB	LD 4X100LED BC-PB
Bright Chrome Frame/Satin Steel	LD 1X100LED BC-SS	LD 2X100LED BC-SS	LD 3X100LED BC-SS	LD 4X100LED BC-SS
Connaught Bronze Frame/Connaught Bronze	LD 1X100LED HB-HB	LD 2X100LED HB-HB	LD 3X100LED HB-HB	LD 4X100LED HB-HB
Copper Bronze Frame/Copper Bronze	LD 1X100LED CB-CB	LD 2X100LED CB-CB	LD 3X100LED CB-CB	LD 4X100LED CB-CB
Etrium Bronze Frame/Etrium Bronze	LD 1X100LED EB-EB	LD 2X100LED EB-EB	LD 3X100LED EB-EB	LD 4X100LED EB-EB
Polished Brass Frame/Antique Brass	LD 1X100LED PB-AB	LD 2X100LED PB-AB	LD 3X100LED PB-AB	LD 4X100LED PB-AB
Polished Brass Frame/Bright Steel	LD 1X100LED PB-BS	LD 2X100LED PB-BS	LD 3X100LED PB-BS	LD 4X100LED PB-BS
Polished Brass Frame/Polished Brass	LD 1X100LED PB-PB	LD 2X100LED PB-PB	LD 3X100LED PB-PB	LD 4X100LED PB-PB
Polished Brass Frame/Satin Brass	LD 1X100LED PB-SB	LD 2X100LED PB-SB	LD 3X100LED PB-SB	LD 4X100LED PB-SB
Polished Brass Frame/Satin Steel	LD 1X100LED PB-SS	LD 2X100LED PB-SS	LD 3X100LED PB-SS	LD 4X100LED PB-SS
Richmond Bronze Frame/Richmond Bronze	LD 1X100LED RB-RB	LD 2X100LED RB-RB	LD 3X100LED RB-RB	LD 4X100LED RB-RB
Satin Brass Frame/Satin Brass	LD 1X100LED SB-SB	LD 2X100LED SB-SB	LD 3X100LED SB-SB	LD 4X100LED SB-SB
Satin Brass Frame/Satin Steel	LD 1X100LED SB-SS	LD 2X100LED SB-SS	LD 3X100LED SB-SS	LD 4X100LED SB-SS
Satin Nickel Frame/Bright Steel	LD 1X100LED SN-BS	LD 2X100LED SN-BS	LD 3X100LED SN-BS	LD 4X100LED SN-BS
Satin Nickel Frame/Satin Steel	LD 1X100LED SN-SS	LD 2X100LED SN-SS	LD 3X100LED SN-SS	LD 4X100LED SN-SS
Nominal Size:	86.0mm x 86.0mm	86.0mm x 86.0mm	145.0mm x 86.0mm	145.0mm x 86.0mm
Minimum Wall Box Depth:	35mm	35mm	35mm	35mm
Technical Insert Ref:	1X100LED	2X100LED	3X100LED	4X100LED

NOTE: Tungsten filament GU10 lamps must be branded and with a fused base.
 NOTE: Please refer to the Dimmer Technical Section for the max Wattage.
 NOTE: Please contact our Technical Department for compatibility.

Linea-Duo CFX

Resistive Leading Edge Push On/Off Rotary 2 Way Switching Dimmers



LD 1X40 BC-BS



LD 2X40 BC-PB



LD 3X40 BC-SS



LD 1X60 BK-BK



1 gang 400W
Resistive Leading
Edge Push
On/Off Rotary 2
Way Switching
Dimmer



2 gang 400W
Resistive Leading
Edge Push
On/Off Rotary 2
Way Switching
Dimmer

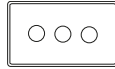

3 gang 400W
Resistive Leading
Edge Push
On/Off Rotary 2
Way Switching
Dimmer

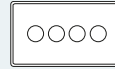

4 gang 400W
Resistive Leading
Edge Push
On/Off Rotary 2
Way Switching
Dimmer



1 gang 600W
Resistive Leading
Edge Push
On/Off Rotary 2
Way Switching
Dimmer

Frame / Front Plate	LD 1X40 AB-AB	LD 2X40 AB-AB	LD 3X40 AB-AB	LD 4X40 AB-AB	LD 1X60 AB-AB
Antique Brass Frame/Antique Brass	LD 1X40 AB-AB	LD 2X40 AB-AB	LD 3X40 AB-AB	LD 4X40 AB-AB	LD 1X60 AB-AB
Antique Brass Frame/Satin Brass	LD 1X40 AB-SB	LD 2X40 AB-SB	LD 3X40 AB-SB	LD 4X40 AB-SB	LD 1X60 AB-SB
Black Nickel Frame/Black Nickel	LD 1X40 BK-BK	LD 2X40 BK-BK	LD 3X40 BK-BK	LD 4X40 BK-BK	LD 1X60 BK-BK
Black Nickel Frame/Bright Steel	LD 1X40 BK-BS	LD 2X40 BK-BS	LD 3X40 BK-BS	LD 4X40 BK-BS	LD 1X60 BK-BS
Black Nickel Frame/Polished Brass	LD 1X40 BK-PB	LD 2X40 BK-PB	LD 3X40 BK-PB	LD 4X40 BK-PB	LD 1X60 BK-PB
Bright Chrome Frame/Black Nickel	LD 1X40 BC-BK	LD 2X40 BC-BK	LD 3X40 BC-BK	LD 4X40 BC-BK	LD 1X60 BC-BK
Bright Chrome Frame/Bright Steel	LD 1X40 BC-BS	LD 2X40 BC-BS	LD 3X40 BC-BS	LD 4X40 BC-BS	LD 1X60 BC-BS
Bright Chrome Frame/Piano Black	LD 1X40 BC-N	LD 2X40 BC-N	LD 3X40 BC-N	LD 4X40 BC-N	LD 1X60 BC-N
Bright Chrome Frame/Polished Brass	LD 1X40 BC-PB	LD 2X40 BC-PB	LD 3X40 BC-PB	LD 4X40 BC-PB	LD 1X60 BC-PB
Bright Chrome Frame/Satin Steel	LD 1X40 BC-SS	LD 2X40 BC-SS	LD 3X40 BC-SS	LD 4X40 BC-SS	LD 1X60 BC-SS
Connaught Bronze Frame/Connaught Bronze	LD 1X40 HB-HB	LD 2X40 HB-HB	LD 3X40 HB-HB	LD 4X40 HB-HB	LD 1X60 HB-HB
Copper Bronze Frame/Copper Bronze	LD 1X40 CB-CB	LD 2X40 CB-CB	LD 3X40 CB-CB	LD 4X40 CB-CB	LD 1X60 CB-CB
Etrium Bronze Frame/Etrium Bronze	LD 1X40 EB-EB	LD 2X40 EB-EB	LD 3X40 EB-EB	LD 4X40 EB-EB	LD 1X60 EB-EB
Polished Brass Frame/Antique Brass	LD 1X40 PB-AB	LD 2X40 PB-AB	LD 3X40 PB-AB	LD 4X40 PB-AB	LD 1X60 PB-AB
Polished Brass Frame/Bright Steel	LD 1X40 PB-BS	LD 2X40 PB-BS	LD 3X40 PB-BS	LD 4X40 PB-BS	LD 1X60 PB-BS
Polished Brass Frame/Polished Brass	LD 1X40 PB-PB	LD 2X40 PB-PB	LD 3X40 PB-PB	LD 4X40 PB-PB	LD 1X60 PB-PB
Polished Brass Frame/Satin Brass	LD 1X40 PB-SB	LD 2X40 PB-SB	LD 3X40 PB-SB	LD 4X40 PB-SB	LD 1X60 PB-SB
Polished Brass Frame/Satin Steel	LD 1X40 PB-SS	LD 2X40 PB-SS	LD 3X40 PB-SS	LD 4X40 PB-SS	LD 1X60 PB-SS
Richmond Bronze Frame/Richmond Bronze	LD 1X40 RB-RB	LD 2X40 RB-RB	LD 3X40 RB-RB	LD 4X40 RB-RB	LD 1X60 RB-RB
Satin Brass Frame/Satin Brass	LD 1X40 SB-SB	LD 2X40 SB-SB	LD 3X40 SB-SB	LD 4X40 SB-SB	LD 1X60 SB-SB
Satin Brass Frame/Satin Steel	LD 1X40 SB-SS	LD 2X40 SB-SS	LD 3X40 SB-SS	LD 4X40 SB-SS	LD 1X60 SB-SS
Satin Nickel Frame/Bright Steel	LD 1X40 SN-BS	LD 2X40 SN-BS	LD 3X40 SN-BS	LD 4X40 SN-BS	LD 1X60 SN-BS
Satin Nickel Frame/Satin Steel	LD 1X40 SN-SS	LD 2X40 SN-SS	LD 3X40 SN-SS	LD 4X40 SN-SS	LD 1X60 SN-SS
Nominal Size:	86.0mm x 86.0mm	86.0mm x 86.0mm	145.0mm x 86.0mm	145.0mm x 86.0mm	86.0mm x 86.0mm
Minimum Wall Box Depth:	35mm	35mm	35mm	35mm	35mm
Technical Insert Ref:	1X40	2X40	3X40	4X40	1X60

NOTE: Tungsten filament GU10 lamps must be branded and with a fused base
 NOTE: When using mains voltage halogen lamps – dimmers should be re-rated by 25%
 NOTE: When dimming LED lamps de-rate by 75% - please contact our Technical Department for compatibility.
 NOTE: Please refer to the Dimmer Technical Section for the max wattage

Linea-Duo CFX

Inductive Leading Edge Push On/Off Rotary 2 Way Switching Dimmers



LD 1X2V BK-BS



1 gang 200VA
Inductive Leading
Edge Push On/
Off Rotary 2 Way
Switching Dimmer

Frame / Front Plate	
Antique Brass Frame/Antique Brass	LD 1X2V AB-AB
Antique Brass Frame/Satin Brass	LD 1X2V AB-SB
Black Nickel Frame/Black Nickel	LD 1X2V BK-BK
Black Nickel Frame/Bright Steel	LD 1X2V BK-BS
Black Nickel Frame/Polished Brass	LD 1X2V BK-PB
Bright Chrome Frame/Black Nickel	LD 1X2V BC-BK
Bright Chrome Frame/Bright Steel	LD 1X2V BC-BS
Bright Chrome Frame/Piano Black	LD 1X2V BC-N
Bright Chrome Frame/Polished Brass	LD 1X2V BC-PB
Bright Chrome Frame/Satin Steel	LD 1X2V BC-SS
Connaught Bronze Frame/Connaught Bronze	LD 1X2V HB-HB
Copper Bronze Frame/Copper Bronze	LD 1X2V CB-CB
Etrium Bronze Frame/Etrium Bronze	LD 1X2V EB-EB
Polished Brass Frame/Antique Brass	LD 1X2V PB-AB
Polished Brass Frame/Bright Steel	LD 1X2V PB-BS
Polished Brass Frame/Polished Brass	LD 1X2V PB-PB
Polished Brass Frame/Satin Brass	LD 1X2V PB-SB
Polished Brass Frame/Satin Steel	LD 1X2V PB-SS
Richmond Bronze Frame/Richmond Bronze	LD 1X2V RB-RB
Satin Brass Frame/Satin Brass	LD 1X2V SB-SB
Satin Brass Frame/Satin Steel	LD 1X2V SB-SS
Satin Nickel Frame/Bright Steel	LD 1X2V SN-BS
Satin Nickel Frame/Satin Steel	LD 1X2V SN-SS
Nominal Size:	86.0mm x 86.0mm
Minimum Wall Box Depth:	35mm
Technical Insert Ref:	1X2V

NOTE: Tungsten filament GU10 lamps must be branded and with a fused base
 NOTE: When using mains voltage halogen lamps – dimmers should be re-rated by 25%
 NOTE: When dimming LED lamps de-rate by 75% - please contact our Technical Department for compatibility.
 NOTE: Please refer to the Dimmer Technical Section for the max wattage

Linea-Duo CFX

Resistive/Inductive Trailing Edge Push On/Off Rotary Multi-Way Dimmers



LD 1XTE BC-BK



LD 2XTE BC-BS



LD 3XTE BC-PB



LD 4XTE BC-SS



1 gang 250W/210VA
Resistive/Inductive Trailing
Edge Push On/Off Rotary
Multi-Way Dimmer



2 gang 250W/210VA
Resistive/Inductive Trailing
Edge Push On/Off Rotary
Multi-Way Dimmer



3 gang 250W/210VA
Resistive/Inductive Trailing
Edge Push On/Off Rotary
Multi-Way Dimmer

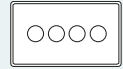

4 gang 250W/210VA
Resistive/Inductive Trailing
Edge Push On/Off Rotary
Multi-Way Dimmer

Ufitm Label Plate Desc	1 gang 250W/210VA Resistive/Inductive Trailing Edge Push On/Off Rotary Multi-Way Dimmer	2 gang 250W/210VA Resistive/Inductive Trailing Edge Push On/Off Rotary Multi-Way Dimmer	3 gang 250W/210VA Resistive/Inductive Trailing Edge Push On/Off Rotary Multi-Way Dimmer	4 gang 250W/210VA Resistive/Inductive Trailing Edge Push On/Off Rotary Multi-Way Dimmer
Antique Brass Frame/Antique Brass	LD 1XTE AB-AB	LD 2XTE AB-AB	LD 3XTE AB-AB	LD 4XTE AB-AB
Antique Brass Frame/Satin Brass	LD 1XTE AB-SB	LD 2XTE AB-SB	LD 3XTE AB-SB	LD 4XTE AB-SB
Black Nickel Frame/Black Nickel	LD 1XTE BK-BK	LD 2XTE BK-BK	LD 3XTE BK-BK	LD 4XTE BK-BK
Black Nickel Frame/Bright Steel	LD 1XTE BK-BS	LD 2XTE BK-BS	LD 3XTE BK-BS	LD 4XTE BK-BS
Black Nickel Frame/Polished Brass	LD 1XTE BK-PB	LD 2XTE BK-PB	LD 3XTE BK-PB	LD 4XTE BK-PB
Bright Chrome Frame/Black Nickel	LD 1XTE BC-BK	LD 2XTE BC-BK	LD 3XTE BC-BK	LD 4XTE BC-BK
Bright Chrome Frame/Bright Steel	LD 1XTE BC-BS	LD 2XTE BC-BS	LD 3XTE BC-BS	LD 4XTE BC-BS
Bright Chrome Frame/Piano Black	LD 1XTE BC-N	LD 2XTE BC-N	LD 3XTE BC-N	LD 4XTE BC-N
Bright Chrome Frame/Polished Brass	LD 1XTE BC-PB	LD 2XTE BC-PB	LD 3XTE BC-PB	LD 4XTE BC-PB
Bright Chrome Frame/Satin Steel	LD 1XTE BC-SS	LD 2XTE BC-SS	LD 3XTE BC-SS	LD 4XTE BC-SS
Connaught Bronze Frame/Connaught Bronze	LD 1XTE HB-HB	LD 2XTE HB-HB	LD 3XTE HB-HB	LD 4XTE HB-HB
Copper Bronze Frame/Copper Bronze	LD 1XTE CB-CB	LD 2XTE CB-CB	LD 3XTE CB-CB	LD 4XTE CB-CB
Etrium Bronze Frame/Etrium Bronze	LD 1XTE EB-EB	LD 2XTE EB-EB	LD 3XTE EB-EB	LD 4XTE EB-EB
Polished Brass Frame/Antique Brass	LD 1XTE PB-AB	LD 2XTE PB-AB	LD 3XTE PB-AB	LD 4XTE PB-AB
Polished Brass Frame/Bright Steel	LD 1XTE PB-BS	LD 2XTE PB-BS	LD 3XTE PB-BS	LD 4XTE PB-BS
Polished Brass Frame/Polished Brass	LD 1XTE PB-PB	LD 2XTE PB-PB	LD 3XTE PB-PB	LD 4XTE PB-PB
Polished Brass Frame/Satin Brass	LD 1XTE PB-SB	LD 2XTE PB-SB	LD 3XTE PB-SB	LD 4XTE PB-SB
Polished Brass Frame/Satin Steel	LD 1XTE PB-SS	LD 2XTE PB-SS	LD 3XTE PB-SS	LD 4XTE PB-SS
Richmond Bronze Frame/Richmond Bronze	LD 1XTE RB-RB	LD 2XTE RB-RB	LD 3XTE RB-RB	LD 4XTE RB-RB
Satin Brass Frame/Satin Brass	LD 1XTE SB-SB	LD 2XTE SB-SB	LD 3XTE SB-SB	LD 4XTE SB-SB
Satin Brass Frame/Satin Steel	LD 1XTE SB-SS	LD 2XTE SB-SS	LD 3XTE SB-SS	LD 4XTE SB-SS
Satin Nickel Frame/Bright Steel	LD 1XTE SN-BS	LD 2XTE SN-BS	LD 3XTE SN-BS	LD 4XTE SN-BS
Satin Nickel Frame/Satin Steel	LD 1XTE SN-SS	LD 2XTE SN-SS	LD 3XTE SN-SS	LD 4XTE SN-SS
Nominal Size:	86.0mm x 86.0mm	86.0mm x 86.0mm	145.0mm x 86.0mm	145.0mm x 86.0mm
Minimum Wall Box Depth:	35mm	35mm	35mm	35mm
Technical Insert Ref:	1XTE	2XTE	3XTE	4XTE

NOTE: Tungsten filament GU10 lamps must be branded and with a fused base
 NOTE: When using mains voltage halogen lamps – dimmers should be re-rated by 25%
 NOTE: When dimming LED lamps de-rate by 75% - please contact our Technical Department for compatibility.
 NOTE: Please refer to the Dimmer Technical Section for the max wattage

LINEA-DUO CFX RANGE

Linea-Duo CFX

Resistive/Inductive Trailing Edge Touch Master Multi-Way Dimmers



LD 1XTM BC-BK B



LD 2XTM BK-BS B

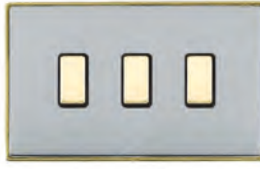

LD 3XTM PB-BS B

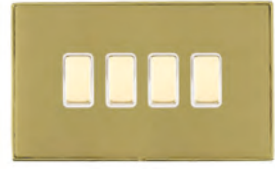

LD 4XTM PB-SB W

Frame / Front Plate	1 gang 250W/210VA Resistive/Inductive Trailing Edge Touch Master Multi-Way Dimmer	2 gang 250W/210VA Resistive/Inductive Trailing Edge Touch Master Multi-Way Dimmer	3 gang 250W/210VA Resistive/Inductive Trailing Edge Touch Master Multi-Way Dimmer	4 gang 250W/210VA Resistive/Inductive Trailing Edge Touch Master Multi-Way Dimmer
Antique Brass Frame/Antique Brass	LD 1XTM AB-AB B	LD 2XTM AB-AB B	LD 3XTM AB-AB B	LD 4XTM AB-AB B
Antique Brass Frame/Satin Brass	LD 1XTM AB-SB B	LD 2XTM AB-SB B	LD 3XTM AB-SB B	LD 4XTM AB-SB B
Black Nickel Frame/Black Nickel	LD 1XTM BK-BK B	LD 2XTM BK-BK B	LD 3XTM BK-BK B	LD 4XTM BK-BK B
Black Nickel Frame/Bright Steel	LD 1XTM BK-BS B	LD 2XTM BK-BS B	LD 3XTM BK-BS B	LD 4XTM BK-BS B
Black Nickel Frame/Polished Brass	LD 1XTM BK-PB B	LD 2XTM BK-PB B	LD 3XTM BK-PB B	LD 4XTM BK-PB B
Bright Chrome Frame/Black Nickel	LD 1XTM BC-BK B	LD 2XTM BC-BK B	LD 3XTM BC-BK B	LD 4XTM BC-BK B
Bright Chrome Frame/Bright Steel	LD 1XTM BC-BS B	LD 2XTM BC-BS B	LD 3XTM BC-BS B	LD 4XTM BC-BS B
Bright Chrome Frame/Bright Steel	LD 1XTM BC-BS W	LD 2XTM BC-BS W	LD 3XTM BC-BS W	LD 4XTM BC-BS W
Bright Chrome Frame/Piano Black	LD 1XTM BC-NB	LD 2XTM BC-NB	LD 3XTM BC-NB	LD 4XTM BC-NB
Bright Chrome Frame/Polished Brass	LD 1XTM BC-PB B	LD 2XTM BC-PB B	LD 3XTM BC-PB B	LD 4XTM BC-PB B
Bright Chrome Frame/Polished Brass	LD 1XTM BC-PB W	LD 2XTM BC-PB W	LD 3XTM BC-PB W	LD 4XTM BC-PB W
Bright Chrome Frame/Satin Steel	LD 1XTM BC-SS B	LD 2XTM BC-SS B	LD 3XTM BC-SS B	LD 4XTM BC-SS B
Bright Chrome Frame/Satin Steel	LD 1XTM BC-SS W	LD 2XTM BC-SS W	LD 3XTM BC-SS W	LD 4XTM BC-SS W
Connaught Bronze Frame/Connaught Bronze	LD 1XTM HB-HB B	LD 2XTM HB-HB B	LD 3XTM HB-HB B	LD 4XTM HB-HB B
Copper Bronze Frame/Copper Bronze	LD 1XTM CB-CB B	LD 2XTM CB-CB B	LD 3XTM CB-CB B	LD 4XTM CB-CB B
Etrium Bronze Frame/Etrium Bronze	LD 1XTM EB-EB B	LD 2XTM EB-EB B	LD 3XTM EB-EB B	LD 4XTM EB-EB B
Polished Brass Frame/Antique Brass	LD 1XTM PB-AB B	LD 2XTM PB-AB B	LD 3XTM PB-AB B	LD 4XTM PB-AB B
Polished Brass Frame/Antique Brass	LD 1XTM PB-AB W	LD 2XTM PB-AB W	LD 3XTM PB-AB W	LD 4XTM PB-AB W
Polished Brass Frame/Bright Steel	LD 1XTM PB-BS B	LD 2XTM PB-BS B	LD 3XTM PB-BS B	LD 4XTM PB-BS B
Polished Brass Frame/Bright Steel	LD 1XTM PB-BS W	LD 2XTM PB-BS W	LD 3XTM PB-BS W	LD 4XTM PB-BS W
Polished Brass Frame/Polished Brass	LD 1XTM PB-PB B	LD 2XTM PB-PB B	LD 3XTM PB-PB B	LD 4XTM PB-PB B
Polished Brass Frame/Polished Brass	LD 1XTM PB-PB W	LD 2XTM PB-PB W	LD 3XTM PB-PB W	LD 4XTM PB-PB W
Polished Brass Frame/Satin Brass	LD 1XTM PB-SB B	LD 2XTM PB-SB B	LD 3XTM PB-SB B	LD 4XTM PB-SB B
Polished Brass Frame/Satin Brass	LD 1XTM PB-SB W	LD 2XTM PB-SB W	LD 3XTM PB-SB W	LD 4XTM PB-SB W
Polished Brass Frame/Satin Steel	LD 1XTM PB-SS B	LD 2XTM PB-SS B	LD 3XTM PB-SS B	LD 4XTM PB-SS B
Polished Brass Frame/Satin Steel	LD 1XTM PB-SS W	LD 2XTM PB-SS W	LD 3XTM PB-SS W	LD 4XTM PB-SS W
Richmond Bronze Frame/Richmond Bronze	LD 1XTM RB-RB B	LD 2XTM RB-RB B	LD 3XTM RB-RB B	LD 4XTM RB-RB B
Satin Brass Frame/Satin Brass	LD 1XTM SB-SB B	LD 2XTM SB-SB B	LD 3XTM SB-SB B	LD 4XTM SB-SB B
Satin Brass Frame/Satin Brass	LD 1XTM SB-SB W	LD 2XTM SB-SB W	LD 3XTM SB-SB W	LD 4XTM SB-SB W
Satin Brass Frame/Satin Steel	LD 1XTM SB-SS B	LD 2XTM SB-SS B	LD 3XTM SB-SS B	LD 4XTM SB-SS B
Satin Brass Frame/Satin Steel	LD 1XTM SB-SS W	LD 2XTM SB-SS W	LD 3XTM SB-SS W	LD 4XTM SB-SS W
Satin Nickel Frame/Bright Steel	LD 1XTM SN-BS B	LD 2XTM SN-BS B	LD 3XTM SN-BS B	LD 4XTM SN-BS B
Satin Nickel Frame/Bright Steel	LD 1XTM SN-BS W	LD 2XTM SN-BS W	LD 3XTM SN-BS W	LD 4XTM SN-BS W
Satin Nickel Frame/Satin Steel	LD 1XTM SN-SS B	LD 2XTM SN-SS B	LD 3XTM SN-SS B	LD 4XTM SN-SS B
Satin Nickel Frame/Satin Steel	LD 1XTM SN-SS W	LD 2XTM SN-SS W	LD 3XTM SN-SS W	LD 4XTM SN-SS W
Nominal Size:	86.0mm x 86.0mm	86.0mm x 86.0mm	145.0mm x 86.0mm	145.0mm x 86.0mm
Minimum Wall Box Depth:	35mm	35mm	35mm	35mm
Technical Insert Ref:	1XTM	2XTM	3XTM	4XTM

NOTE: Tungsten filament GU10 lamps must be branded and with a fused base
 NOTE: When using mains voltage halogen lamps – dimmers should be re-rated by 25%
 NOTE: When dimming LED lamps de-rate by 75% - please contact our Technical Department for compatibility.
 NOTE: Please refer to the Dimmer Technical Section for the max wattage

Insert Surround Colour Key: (B) Black, (W) White

Linea-Duo CFX

Multi-Way Touch Slave Controllers

LINEA-DUO CFX RANGE



LD 1XTS BC-BK B



LD 2XTS BC-BS B



LD 3XTS PB-BS B



LD 4XTS PB-SB W

Frame / Front Plate	1 gang Multi-Way Touch Slave Controller	2 gang Multi-Way Touch Slave Controller	3 gang Multi-Way Touch Slave Controller	4 gang Multi-Way Touch Slave Controller
Antique Brass Frame/Antique Brass	LD 1XTS AB-AB B	LD 2XTS AB-AB B	LD 3XTS AB-AB B	LD 4XTS AB-AB B
Antique Brass Frame/Satin Brass	LD 1XTS AB-SB B	LD 2XTS AB-SB B	LD 3XTS AB-SB B	LD 4XTS AB-SB B
Black Nickel Frame/Black Nickel	LD 1XTS BK-BK B	LD 2XTS BK-BK B	LD 3XTS BK-BK B	LD 4XTS BK-BK B
Black Nickel Frame/Bright Steel	LD 1XTS BK-BS B	LD 2XTS BK-BS B	LD 3XTS BK-BS B	LD 4XTS BK-BS B
Black Nickel Frame/Polished Brass	LD 1XTS BK-PB B	LD 2XTS BK-PB B	LD 3XTS BK-PB B	LD 4XTS BK-PB B
Bright Chrome Frame/Black Nickel	LD 1XTS BC-BK B	LD 2XTS BC-BK B	LD 3XTS BC-BK B	LD 4XTS BC-BK B
Bright Chrome Frame/Bright Steel	LD 1XTS BC-BS B	LD 2XTS BC-BS B	LD 3XTS BC-BS B	LD 4XTS BC-BS B
Bright Chrome Frame/Bright Steel	LD 1XTS BC-BS W	LD 2XTS BC-BS W	LD 3XTS BC-BS W	LD 4XTS BC-BS W
Bright Chrome Frame/Piano Black	LD 1XTS BC-NB	LD 2XTS BC-NB	LD 3XTS BC-NB	LD 4XTS BC-NB
Bright Chrome Frame/Polished Brass	LD 1XTS BC-PB B	LD 2XTS BC-PB B	LD 3XTS BC-PB B	LD 4XTS BC-PB B
Bright Chrome Frame/Polished Brass	LD 1XTS BC-PB W	LD 2XTS BC-PB W	LD 3XTS BC-PB W	LD 4XTS BC-PB W
Bright Chrome Frame/Satin Steel	LD 1XTS BC-SS B	LD 2XTS BC-SS B	LD 3XTS BC-SS B	LD 4XTS BC-SS B
Bright Chrome Frame/Satin Steel	LD 1XTS BC-SS W	LD 2XTS BC-SS W	LD 3XTS BC-SS W	LD 4XTS BC-SS W
Connaught Bronze Frame/Connaught Bronze	LD 1XTS HB-HB B	LD 2XTS HB-HB B	LD 3XTS HB-HB B	LD 4XTS HB-HB B
Copper Bronze Frame/Copper Bronze	LD 1XTS CB-CB B	LD 2XTS CB-CB B	LD 3XTS CB-CB B	LD 4XTS CB-CB B
Etrium Bronze Frame/Etrium Bronze	LD 1XTS EB-EB B	LD 2XTS EB-EB B	LD 3XTS EB-EB B	LD 4XTS EB-EB B
Polished Brass Frame/Antique Brass	LD 1XTS PB-AB B	LD 2XTS PB-AB B	LD 3XTS PB-AB B	LD 4XTS PB-AB B
Polished Brass Frame/Antique Brass	LD 1XTS PB-AB W	LD 2XTS PB-AB W	LD 3XTS PB-AB W	LD 4XTS PB-AB W
Polished Brass Frame/Bright Steel	LD 1XTS PB-BS B	LD 2XTS PB-BS B	LD 3XTS PB-BS B	LD 4XTS PB-BS B
Polished Brass Frame/Bright Steel	LD 1XTS PB-BS W	LD 2XTS PB-BS W	LD 3XTS PB-BS W	LD 4XTS PB-BS W
Polished Brass Frame/Polished Brass	LD 1XTS PB-PB B	LD 2XTS PB-PB B	LD 3XTS PB-PB B	LD 4XTS PB-PB B
Polished Brass Frame/Polished Brass	LD 1XTS PB-PB W	LD 2XTS PB-PB W	LD 3XTS PB-PB W	LD 4XTS PB-PB W
Polished Brass Frame/Satin Brass	LD 1XTS PB-SB B	LD 2XTS PB-SB B	LD 3XTS PB-SB B	LD 4XTS PB-SB B
Polished Brass Frame/Satin Brass	LD 1XTS PB-SB W	LD 2XTS PB-SB W	LD 3XTS PB-SB W	LD 4XTS PB-SB W
Polished Brass Frame/Satin Steel	LD 1XTS PB-SS B	LD 2XTS PB-SS B	LD 3XTS PB-SS B	LD 4XTS PB-SS B
Polished Brass Frame/Satin Steel	LD 1XTS PB-SS W	LD 2XTS PB-SS W	LD 3XTS PB-SS W	LD 4XTS PB-SS W
Richmond Bronze Frame/Richmond Bronze	LD 1XTS RB-RB B	LD 2XTS RB-RB B	LD 3XTS RB-RB B	LD 4XTS RB-RB B
Satin Brass Frame/Satin Brass	LD 1XTS SB-SB B	LD 2XTS SB-SB B	LD 3XTS SB-SB B	LD 4XTS SB-SB B
Satin Brass Frame/Satin Brass	LD 1XTS SB-SB W	LD 2XTS SB-SB W	LD 3XTS SB-SB W	LD 4XTS SB-SB W
Satin Brass Frame/Satin Steel	LD 1XTS SB-SS B	LD 2XTS SB-SS B	LD 3XTS SB-SS B	LD 4XTS SB-SS B
Satin Brass Frame/Satin Steel	LD 1XTS SB-SS W	LD 2XTS SB-SS W	LD 3XTS SB-SS W	LD 4XTS SB-SS W
Satin Nickel Frame/Bright Steel	LD 1XTS SN-BS B	LD 2XTS SN-BS B	LD 3XTS SN-BS B	LD 4XTS SN-BS B
Satin Nickel Frame/Bright Steel	LD 1XTS SN-BS W	LD 2XTS SN-BS W	LD 3XTS SN-BS W	LD 4XTS SN-BS W
Satin Nickel Frame/Satin Steel	LD 1XTS SN-SS B	LD 2XTS SN-SS B	LD 3XTS SN-SS B	LD 4XTS SN-SS B
Satin Nickel Frame/Satin Steel	LD 1XTS SN-SS W	LD 2XTS SN-SS W	LD 3XTS SN-SS W	LD 4XTS SN-SS W
Nominal Size:	86.0mm x 86.0mm	86.0mm x 86.0mm	145.0mm x 86.0mm	145.0mm x 86.0mm
Minimum Wall Box Depth:	35mm	35mm	35mm	35mm
Technical Insert Ref:	1XTS	2XTS	3XTS	4XTS

NOTE: To only be used with Touch Masters

Insert Surround Colour Key: (B) Black, (W) White

Linea-Duo CFX

Blank Plates



LD BPS AB-SB



LD BPD PB-AB



Single Blank Plate

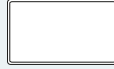

Double Blank Plate

Frame / Front Plate	Single Blank Plate	Double Blank Plate
Antique Brass Frame/Antique Brass	LD BPS AB-AB	LD BPD AB-AB
Antique Brass Frame/Satin Brass	LD BPS AB-SB	LD BPD AB-SB
Black Nickel Frame/Black Nickel	LD BPS BK-BK	LD BPD BK-BK
Black Nickel Frame/Bright Steel	LD BPS BK-BS	LD BPD BK-BS
Black Nickel Frame/Polished Brass	LD BPS BK-PB	LD BPD BK-PB
Bright Chrome Frame/Black Nickel	LD BPS BC-BK	LD BPD BC-BK
Bright Chrome Frame/Bright Steel	LD BPS BC-BS	LD BPD BC-BS
Bright Chrome Frame/Piano Black	LD BPS BC-N	LD BPD BC-N
Bright Chrome Frame/Polished Brass	LD BPS BC-PB	LD BPD BC-PB
Bright Chrome Frame/Satin Steel	LD BPS BC-SS	LD BPD BC-SS
Connaught Bronze Frame/Connaught Bronze	LD BPS HB-HB	LD BPD HB-HB
Copper Bronze Frame/Copper Bronze	LD BPS CB-CB	LD BPD CB-CB
Etrium Bronze Frame/Etrium Bronze	LD BPS EB-EB	LD BPD EB-EB
Polished Brass Frame/Antique Brass	LD BPS PB-AB	LD BPD PB-AB
Polished Brass Frame/Bright Steel	LD BPS PB-BS	LD BPD PB-BS
Polished Brass Frame/Polished Brass	LD BPS PB-PB	LD BPD PB-PB
Polished Brass Frame/Satin Brass	LD BPS PB-SB	LD BPD PB-SB
Polished Brass Frame/Satin Steel	LD BPS PB-SS	LD BPD PB-SS
Richmond Bronze Frame/Richmond Bronze	LD BPS RB-RB	LD BPD RB-RB
Satin Brass Frame/Satin Brass	LD BPS SB-SB	LD BPD SB-SB
Satin Brass Frame/Satin Steel	LD BPS SB-SS	LD BPD SB-SS
Satin Nickel Frame/Bright Steel	LD BPS SN-BS	LD BPD SN-BS
Satin Nickel Frame/Satin Steel	LD BPS SN-SS	LD BPD SN-SS
Nominal Size:	86.0mm x 86.0mm	145.0mm x 86.0mm
Minimum Wall Box Depth:	Any Box	Any Box
Technical Insert Ref:	BPS	BPD

Linea-Duo CFX

Grid-IT GridFix Plates complete with Fixing Grid

LINEA-DUO CFX RANGE



LD 1GP AB-SB



LD 2GP BC-BS



LD 3GP BC-PB



LD 4GP PB-PB



1 Gang Grid Fix Aperture Plate with Grid



2 Gang Grid Fix Aperture Plate with Grid

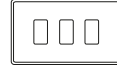

3 Gang Grid Fix Aperture Plate with Grid



4 Gang Grid Fix Aperture Plate with Grid

Frame / Front Plate	1 Gang Grid Fix Aperture Plate with Grid	2 Gang Grid Fix Aperture Plate with Grid	3 Gang Grid Fix Aperture Plate with Grid	4 Gang Grid Fix Aperture Plate with Grid
Antique Brass Frame/Antique Brass	LD 1GP AB-AB	LD 2GP AB-AB	LD 3GP AB-AB	LD 4GP AB-AB
Antique Brass Frame/Satin Brass	LD 1GP AB-SB	LD 2GP AB-SB	LD 3GP AB-SB	LD 4GP AB-SB
Bright Chrome Frame/Black Nickel	LD 1GP BC-BK	LD 2GP BC-BK	LD 3GP BC-BK	LD 4GP BC-BK
Bright Chrome Frame/Bright Steel	LD 1GP BC-BS	LD 2GP BC-BS	LD 3GP BC-BS	LD 4GP BC-BS
Bright Chrome Frame/Piano Black	LD 1GP BC-N	LD 2GP BC-N	LD 3GP BC-N	LD 4GP BC-N
Bright Chrome Frame/Polished Brass	LD 1GP BC-PB	LD 2GP BC-PB	LD 3GP BC-PB	LD 4GP BC-PB
Bright Chrome Frame/Satin Steel	LD 1GP BC-SS	LD 2GP BC-SS	LD 3GP BC-SS	LD 4GP BC-SS
Black Nickel Frame/Black Nickel	LD 1GP BK-BK	LD 2GP BK-BK	LD 3GP BK-BK	LD 4GP BK-BK
Black Nickel Frame/Bright Steel	LD 1GP BK-BS	LD 2GP BK-BS	LD 3GP BK-BS	LD 4GP BK-BS
Black Nickel Frame/Polished Brass	LD 1GP BK-PB	LD 2GP BK-PB	LD 3GP BK-PB	LD 4GP BK-PB
Copper Bronze Frame/Copper Bronze	LD 1GP CB-CB	LD 2GP CB-CB	LD 3GP CB-CB	LD 4GP CB-CB
Etrium Bronze Frame/Etrium Bronze	LD 1GP EB-EB	LD 2GP EB-EB	LD 3GP EB-EB	LD 4GP EB-EB
Connaught Bronze Frame/Connaught Bronze	LD 1GP HB-HB	LD 2GP HB-HB	LD 3GP HB-HB	LD 4GP HB-HB
Polished Brass Frame/Antique Brass	LD 1GP PB-AB	LD 2GP PB-AB	LD 3GP PB-AB	LD 4GP PB-AB
Polished Brass Frame/Bright Steel	LD 1GP PB-BS	LD 2GP PB-BS	LD 3GP PB-BS	LD 4GP PB-BS
Polished Brass Frame/Polished Brass	LD 1GP PB-PB	LD 2GP PB-PB	LD 3GP PB-PB	LD 4GP PB-PB
Polished Brass Frame/Satin Brass	LD 1GP PB-SB	LD 2GP PB-SB	LD 3GP PB-SB	LD 4GP PB-SB
Polished Brass Frame/Satin Steel	LD 1GP PB-SS	LD 2GP PB-SS	LD 3GP PB-SS	LD 4GP PB-SS
Richmond Bronze Frame/Richmond Bronze	LD 1GP RB-RB	LD 2GP RB-RB	LD 3GP RB-RB	LD 4GP RB-RB
Satin Brass Frame/Satin Brass	LD 1GP SB-SB	LD 2GP SB-SB	LD 3GP SB-SB	LD 4GP SB-SB
Satin Brass Frame/Satin Steel	LD 1GP SB-SS	LD 2GP SB-SS	LD 3GP SB-SS	LD 4GP SB-SS
Satin Nickel Frame/Bright Steel	LD 1GP SN-BS	LD 2GP SN-BS	LD 3GP SN-BS	LD 4GP SN-BS
Satin Nickel Frame/Satin Steel	LD 1GP SN-SS	LD 2GP SN-SS	LD 3GP SN-SS	LD 4GP SN-SS
Nominal Size:	86.0mm x 86.0mm	86.0mm x 86.0mm	145.0mm x 86.0mm	145.0mm x 86.0mm
Minimum Wall Box Depth:	As Per Insert	As Per Inserts	As Per Inserts	As Per Inserts
Technical Insert Ref:	1GP	2GP	3GP	4GP

Note: Minimum Wall Box depth is dependant on the Grid Fix insert fitted, please see the GRID-IT section for the complete range of inserts.

Linea-Duo CFX

EuroFix Apertured Plates complete with Fixing Grid



LD EURO1 BC-PB



LD EURO2 BK-BK



LD EURO3 PB-AB

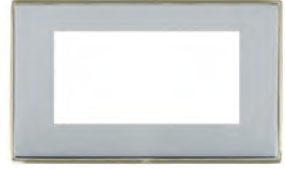

LD EURO4 SN-BS



Single Plate complete with 1 EuroFix Aperture 25x50mm and Grid



Single Plate complete with 2 EuroFix Apertures 50x50mm and Grid

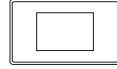

Double Plate complete with 3 EuroFix Apertures 75x50mm and Grid

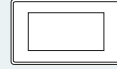

Double Plate complete with 4 EuroFix Apertures 100x50mm and Grid

Frame / Front Plate	LD EURO1 CB-CB	LD EURO2 CB-CB	LD EURO3 CB-CB	LD EURO4 CB-CB
Copper Bronze Frame/Copper Bronze	LD EURO1 CB-CB	LD EURO2 CB-CB	LD EURO3 CB-CB	LD EURO4 CB-CB
Etrium Bronze Frame/Etrium Bronze	LD EURO1 EB-EB	LD EURO2 EB-EB	LD EURO3 EB-EB	LD EURO4 EB-EB
Connaught Bronze Frame/Connaught Bronze	LD EURO1 HB-HB	LD EURO2 HB-HB	LD EURO3 HB-HB	LD EURO4 HB-HB
Richmond Bronze Frame/Richmond Bronze	LD EURO1 RB-RB	LD EURO2 RB-RB	LD EURO3 RB-RB	LD EURO4 RB-RB
Bright Chrome Frame/Bright Steel	LD EURO1 BC-BS	LD EURO2 BC-BS	LD EURO3 BC-BS	LD EURO4 BC-BS
Bright Chrome Frame/Satin Steel	LD EURO1 BC-SS	LD EURO2 BC-SS	LD EURO3 BC-SS	LD EURO4 BC-SS
Bright Chrome Frame/Polished Brass	LD EURO1 BC-PB	LD EURO2 BC-PB	LD EURO3 BC-PB	LD EURO4 BC-PB
Bright Chrome Frame/Black Nickel	LD EURO1 BC-BK	LD EURO2 BC-BK	LD EURO3 BC-BK	LD EURO4 BC-BK
Bright Chrome Frame/Piano Black	LD EURO1 BC-N	LD EURO2 BC-N	LD EURO3 BC-N	LD EURO4 BC-N
Polished Brass Frame/Polished Brass	LD EURO1 PB-PB	LD EURO2 PB-PB	LD EURO3 PB-PB	LD EURO4 PB-PB
Polished Brass Frame/Satin Brass	LD EURO1 PB-SB	LD EURO2 PB-SB	LD EURO3 PB-SB	LD EURO4 PB-SB
Polished Brass Frame/Antique Brass	LD EURO1 PB-AB	LD EURO2 PB-AB	LD EURO3 PB-AB	LD EURO4 PB-AB
Polished Brass Frame/Bright Steel	LD EURO1 PB-BS	LD EURO2 PB-BS	LD EURO3 PB-BS	LD EURO4 PB-BS
Polished Brass Frame/Satin Steel	LD EURO1 PB-SS	LD EURO2 PB-SS	LD EURO3 PB-SS	LD EURO4 PB-SS
Satin Brass Frame/Satin Brass	LD EURO1 SB-SB	LD EURO2 SB-SB	LD EURO3 SB-SB	LD EURO4 SB-SB
Satin Brass Frame/Satin Steel	LD EURO1 SB-SS	LD EURO2 SB-SS	LD EURO3 SB-SS	LD EURO4 SB-SS
Antique Brass Frame/Antique Brass	LD EURO1 AB-AB	LD EURO2 AB-AB	LD EURO3 AB-AB	LD EURO4 AB-AB
Antique Brass Frame/Satin Brass	LD EURO1 AB-SB	LD EURO2 AB-SB	LD EURO3 AB-SB	LD EURO4 AB-SB
Satin Nickel Frame/Bright Steel	LD EURO1 SN-BS	LD EURO2 SN-BS	LD EURO3 SN-BS	LD EURO4 SN-BS
Satin Nickel Frame/Satin Steel	LD EURO1 SN-SS	LD EURO2 SN-SS	LD EURO3 SN-SS	LD EURO4 SN-SS
Black Nickel Frame/Black Nickel	LD EURO1 BK-BK	LD EURO2 BK-BK	LD EURO3 BK-BK	LD EURO4 BK-BK
Black Nickel Frame/Bright Steel	LD EURO1 BK-BS	LD EURO2 BK-BS	LD EURO3 BK-BS	LD EURO4 BK-BS
Black Nickel Frame/Polished Brass	LD EURO1 BK-PB	LD EURO2 BK-PB	LD EURO3 BK-PB	LD EURO4 BK-PB
Nominal Size:	86.0mm x 86.0mm	86.0mm x 86.0mm	145.0mm x 86.0mm	145.0mm x 86.0mm
Minimum Wall Box Depth:	As Per Insert	As Per Insert	As Per Insert	As Per Inserts
Technical Insert Ref:	EURO1	EURO2	EURO3	EURO4

Note: Minimum Wall Box depth is dependant on the EuroFix insert fitted, please see the EuroFix section for our complete range of inserts.



Linea-Scala CFX[®] Range

Concealed Fixing Accessories on Stepped Edge Plates

The Linea CFX[®] range comes in five different designs to suit either contemporary or classic interiors. Linea CFX[®] has a separate back frame and our patented four point face plate clipping system, allowing the option of matching or contrasting elements.



- Stunning front plate finishes and frame and insert finishes gives a huge choice of combinations
- Two-part frame and plate for 'mix and match'
- Concealed fixing
- Grid Fix and Eurofix options also available (see separate GRID-IT and EuroFix sections)



Linea-Scala CFX® Range



Product Code Configurator

1. Select the required electrical accessory from the following pages.
e.g. **LSX R21** = Linea-Scala CFX 1 gang 10AX 2 way Rocker Switch.
2. Using the Frame & Finishes Chart on the next page;
 - a. Select the required Frame Finish
e.g. Black Nickel = **BK**-__-__.
 - b. Select the required Front Plate Finish
e.g. Bright Steel = __-**BS**__.
 - c. Select the required Insert Surround Colour
e.g. Black = __-__-**B**.

Therefore a Linea-Scala CFX 1 gang 10AX 2 way Rocker Switch as illustrated below = **LSX R21 BK-BS B**

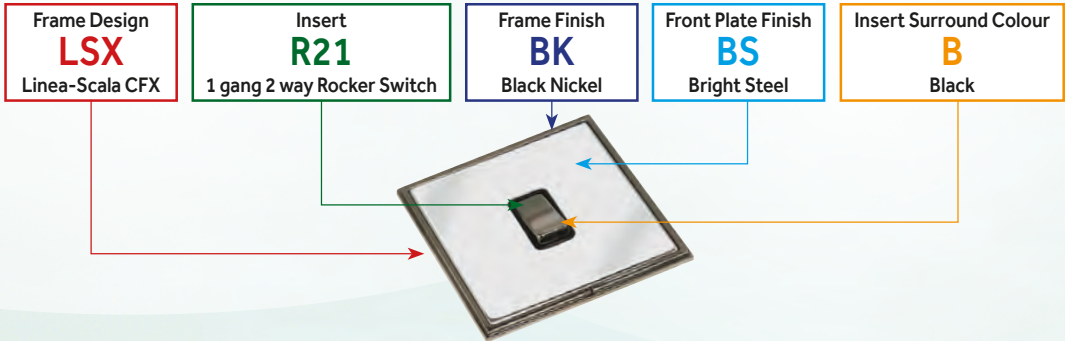





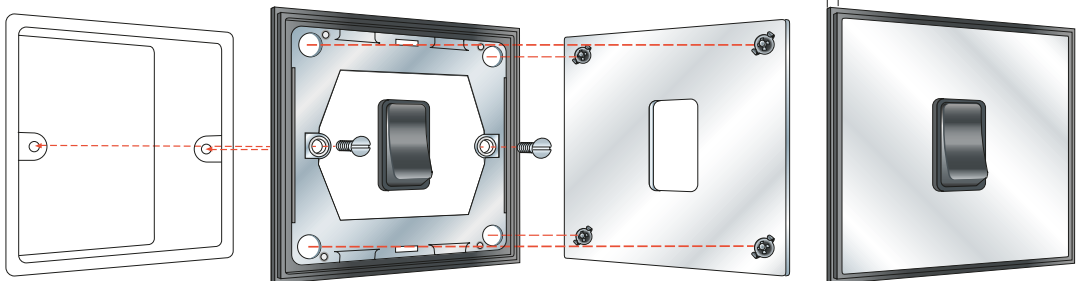















Hamilton Linea-Scala CFX® Concealed Fixing

Plate Depth 4.2 mm



Frame & Finishes Chart

Frame and Insert Finish	Polished Brass (PB)	Satin Brass (SB)	Antique Brass (AB)	Bright Steel (BS)	Satin Steel (SS)	Black Nickel (BK)	Piano Black (N)	Connaught Bronze (HB)	Copper Bronze (CB)	Etrium Bronze (EB)	Richmond Bronze (RB)
Bright Chrome (BC) Matching Insert with White Surround	 BC-PB W			 BC-BS W	 BC-SS W						
Bright Chrome (BC) Matching Insert with Black Surround	 BC-PB B			 BC-BS B	 BC-SS B	 BC-BK B	 BC-N B				
Polished Brass (PB) Matching Insert with White Surround	 PB-PB W	 PB-SB W	 PB-AB W	 PB-BS W	 PB-SS W						
Polished Brass (PB) Matching Insert with Black Surround	 PB-PB B	 PB-SB B	 PB-AB B	 PB-BS B	 PB-SS B						
Satin Brass (SB) Matching Insert with White Surround		 SB-SB W			 SB-SS W						
Satin Brass (SB) Matching Insert with Black Surround		 SB-SB B			 SB-SS B						
Antique Brass (AB) Matching Insert with Black Surround		 AB-SB B	 AB-AB B								
Satin Nickel (SN) Matching Insert with White Surround				 SN-BS W	 SN-SS W						
Satin Nickel (SN) Matching Insert with Black Surround				 SN-BS B	 SN-SS B						
Black Nickel (BK) Matching Insert with Black Surround	 BK-PB B			 BK-BS B		 BK-BK B					
Connaught Bronze Frame (HB) Matching Insert with Black Surround								 HB-HB B			
Copper Bronze Frame (CB) Matching Insert with Black Surround									 CB-CB B		
Etrium Bronze Frame (EB) Matching Insert with Black Surround										 EB-EB B	
Richmond Bronze Frame (RB) Matching Insert with Black Surround											 RB-RB B

Frame Finishes



Bright Chrome



Polished Brass



Satin Brass



Antique Brass



Satin Nickel



Black Nickel



Connaught Bronze



Copper Bronze



Etrium Bronze



Richmond Bronze

Linea-Scala CFX

Rocker Switches



LSX R21 HB-HB B



LSX R22 AB-SB B



LSX R24 BC-BK B



LSX R26 RB-RB B



1 gang 10AX 2 Way Rocker



2 gang 10AX 2 Way Rocker



3 gang 10AX 2 Way Rocker



4 gang 10AX 2 Way Rocker

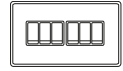

6 gang 10AX 2 Way Rocker

Frame / Front Plate	1 gang 10AX 2 Way Rocker	2 gang 10AX 2 Way Rocker	3 gang 10AX 2 Way Rocker	4 gang 10AX 2 Way Rocker	6 gang 10AX 2 Way Rocker
Antique Brass Frame/Antique Brass	LSX R21 AB-AB B	LSX R22 AB-AB B	LSX R23 AB-AB B	LSX R24 AB-AB B	LSX R26 AB-AB B
Antique Brass Frame/Satin Brass	LSX R21 AB-SB B	LSX R22 AB-SB B	LSX R23 AB-SB B	LSX R24 AB-SB B	LSX R26 AB-SB B
Black Nickel Frame/Black Nickel	LSX R21 BK-BK B	LSX R22 BK-BK B	LSX R23 BK-BK B	LSX R24 BK-BK B	LSX R26 BK-BK B
Black Nickel Frame/Bright Steel	LSX R21 BK-BS B	LSX R22 BK-BS B	LSX R23 BK-BS B	LSX R24 BK-BS B	LSX R26 BK-BS B
Black Nickel Frame/Polished Brass	LSX R21 BK-PB B	LSX R22 BK-PB B	LSX R23 BK-PB B	LSX R24 BK-PB B	LSX R26 BK-PB B
Bright Chrome Frame/Black Nickel	LSX R21 BC-BK B	LSX R22 BC-BK B	LSX R23 BC-BK B	LSX R24 BC-BK B	LSX R26 BC-BK B
Bright Chrome Frame/Bright Steel	LSX R21 BC-BS B	LSX R22 BC-BS B	LSX R23 BC-BS B	LSX R24 BC-BS B	LSX R26 BC-BS B
Bright Chrome Frame/Bright Steel	LSX R21 BC-BS W	LSX R22 BC-BS W	LSX R23 BC-BS W	LSX R24 BC-BS W	LSX R26 BC-BS W
Bright Chrome Frame/Piano Black	LSX R21 BC-NB	LSX R22 BC-NB	LSX R23 BC-NB	LSX R24 BC-NB	LSX R26 BC-NB
Bright Chrome Frame/Polished Brass	LSX R21 BC-PB B	LSX R22 BC-PB B	LSX R23 BC-PB B	LSX R24 BC-PB B	LSX R26 BC-PB B
Bright Chrome Frame/Polished Brass	LSX R21 BC-PB W	LSX R22 BC-PB W	LSX R23 BC-PB W	LSX R24 BC-PB W	LSX R26 BC-PB W
Bright Chrome Frame/Satin Steel	LSX R21 BC-SS B	LSX R22 BC-SS B	LSX R23 BC-SS B	LSX R24 BC-SS B	LSX R26 BC-SS B
Bright Chrome Frame/Satin Steel	LSX R21 BC-SS W	LSX R22 BC-SS W	LSX R23 BC-SS W	LSX R24 BC-SS W	LSX R26 BC-SS W
Connaught Bronze Frame/Connaught Bronze	LSX R21 HB-HB B	LSX R22 HB-HB B	LSX R23 HB-HB B	LSX R24 HB-HB B	LSX R26 HB-HB B
Copper Bronze Frame/Copper Bronze	LSX R21 CB-CB B	LSX R22 CB-CB B	LSX R23 CB-CB B	LSX R24 CB-CB B	LSX R26 CB-CB B
Etrium Bronze Frame/Etrium Bronze	LSX R21 EB-EB B	LSX R22 EB-EB B	LSX R23 EB-EB B	LSX R24 EB-EB B	LSX R26 EB-EB B
Polished Brass Frame/Antique Brass	LSX R21 PB-AB B	LSX R22 PB-AB B	LSX R23 PB-AB B	LSX R24 PB-AB B	LSX R26 PB-AB B
Polished Brass Frame/Antique Brass	LSX R21 PB-AB W	LSX R22 PB-AB W	LSX R23 PB-AB W	LSX R24 PB-AB W	LSX R26 PB-AB W
Polished Brass Frame/Bright Steel	LSX R21 PB-BS B	LSX R22 PB-BS B	LSX R23 PB-BS B	LSX R24 PB-BS B	LSX R26 PB-BS B
Polished Brass Frame/Bright Steel	LSX R21 PB-BS W	LSX R22 PB-BS W	LSX R23 PB-BS W	LSX R24 PB-BS W	LSX R26 PB-BS W
Polished Brass Frame/Polished Brass	LSX R21 PB-PB B	LSX R22 PB-PB B	LSX R23 PB-PB B	LSX R24 PB-PB B	LSX R26 PB-PB B
Polished Brass Frame/Polished Brass	LSX R21 PB-PB W	LSX R22 PB-PB W	LSX R23 PB-PB W	LSX R24 PB-PB W	LSX R26 PB-PB W
Polished Brass Frame/Satin Brass	LSX R21 PB-SB B	LSX R22 PB-SB B	LSX R23 PB-SB B	LSX R24 PB-SB B	LSX R26 PB-SB B
Polished Brass Frame/Satin Brass	LSX R21 PB-SB W	LSX R22 PB-SB W	LSX R23 PB-SB W	LSX R24 PB-SB W	LSX R26 PB-SB W
Polished Brass Frame/Satin Steel	LSX R21 PB-SS B	LSX R22 PB-SS B	LSX R23 PB-SS B	LSX R24 PB-SS B	LSX R26 PB-SS B
Polished Brass Frame/Satin Steel	LSX R21 PB-SS W	LSX R22 PB-SS W	LSX R23 PB-SS W	LSX R24 PB-SS W	LSX R26 PB-SS W
Richmond Bronze Frame/Richmond Bronze	LSX R21 RB-RB B	LSX R22 RB-RB B	LSX R23 RB-RB B	LSX R24 RB-RB B	LSX R26 RB-RB B
Satin Brass Frame/Satin Brass	LSX R21 SB-SB B	LSX R22 SB-SB B	LSX R23 SB-SB B	LSX R24 SB-SB B	LSX R26 SB-SB B
Satin Brass Frame/Satin Brass	LSX R21 SB-SB W	LSX R22 SB-SB W	LSX R23 SB-SB W	LSX R24 SB-SB W	LSX R26 SB-SB W
Satin Brass Frame/Satin Steel	LSX R21 SB-SS B	LSX R22 SB-SS B	LSX R23 SB-SS B	LSX R24 SB-SS B	LSX R26 SB-SS B
Satin Brass Frame/Satin Steel	LSX R21 SB-SS W	LSX R22 SB-SS W	LSX R23 SB-SS W	LSX R24 SB-SS W	LSX R26 SB-SS W
Satin Nickel Frame/Bright Steel	LSX R21 SN-BS B	LSX R22 SN-BS B	LSX R23 SN-BS B	LSX R24 SN-BS B	LSX R26 SN-BS B
Satin Nickel Frame/Bright Steel	LSX R21 SN-BS W	LSX R22 SN-BS W	LSX R23 SN-BS W	LSX R24 SN-BS W	LSX R26 SN-BS W
Satin Nickel Frame/Satin Steel	LSX R21 SN-SS B	LSX R22 SN-SS B	LSX R23 SN-SS B	LSX R24 SN-SS B	LSX R26 SN-SS B
Satin Nickel Frame/Satin Steel	LSX R21 SN-SS W	LSX R22 SN-SS W	LSX R23 SN-SS W	LSX R24 SN-SS W	LSX R26 SN-SS W
Nominal Size:	91.5mm x 91.5mm	91.5mm x 91.5mm	91.5mm x 91.5mm	150.5mm x 91.5mm	150.5mm x 91.5mm
Minimum Wall Box Depth:	25mm	25mm	25mm	25mm	25mm
Technical Insert Ref:	R21	R22	R23	R24	R26

Insert Surround Colour Key: (B) Black, (W) White

Linea-Scala CFX

Rocker Switches



LSX R31 BC-BK B







LSX R32 BC-PB W



LSX RRT PB-BB



LSX TP SB-SB W

Frame / Front Plate	 1 gang 10AX Intermediate Rocker	 2 gang 10AX Intermediate Rocker	 1 gang 10AX Push To Make/Retractive Rocker	 1 gang 10A Triple Pole Rocker
Antique Brass Frame/Antique Brass	LSX R31 AB-AB B	LSX R32 AB-AB B	LSX RRT AB-AB B	LSX TP AB-AB B
Antique Brass Frame/Satin Brass	LSX R31 AB-SB B	LSX R32 AB-SB B	LSX RRT AB-SB B	LSX TP AB-SB B
Black Nickel Frame/Black Nickel	LSX R31 BK-BK B	LSX R32 BK-BK B	LSX RRT BK-BK B	LSX TP BK-BK B
Black Nickel Frame/Bright Steel	LSX R31 BK-BS B	LSX R32 BK-BS B	LSX RRT BK-BS B	LSX TP BK-BS B
Black Nickel Frame/Polished Brass	LSX R31 BK-PB B	LSX R32 BK-PB B	LSX RRT BK-PB B	LSX TP BK-PB B
Bright Chrome Frame/Black Nickel	LSX R31 BC-BK B	LSX R32 BC-BK B	LSX RRT BC-BK B	LSX TP BC-BK B
Bright Chrome Frame/Bright Steel	LSX R31 BC-BS B	LSX R32 BC-BS B	LSX RRT BC-BS B	LSX TP BC-BS B
Bright Chrome Frame/Bright Steel	LSX R31 BC-BS W	LSX R32 BC-BS W	LSX RRT BC-BS W	LSX TP BC-BS W
Bright Chrome Frame/Piano Black	LSX R31 BC-NB	LSX R32 BC-NB	LSX RRT BC-NB	LSX TP BC-NB
Bright Chrome Frame/Polished Brass	LSX R31 BC-PB B	LSX R32 BC-PB B	LSX RRT BC-PB B	LSX TP BC-PB B
Bright Chrome Frame/Polished Brass	LSX R31 BC-PB W	LSX R32 BC-PB W	LSX RRT BC-PB W	LSX TP BC-PB W
Bright Chrome Frame/Satin Steel	LSX R31 BC-SS B	LSX R32 BC-SS B	LSX RRT BC-SS B	LSX TP BC-SS B
Bright Chrome Frame/Satin Steel	LSX R31 BC-SS W	LSX R32 BC-SS W	LSX RRT BC-SS W	LSX TP BC-SS W
Connaught Bronze Frame/Connaught Bronze	LSX R31 HB-HB B	LSX R32 HB-HB B	LSX RRT HB-HB B	LSX TP HB-HB B
Copper Bronze Frame/Copper Bronze	LSX R31 CB-CB B	LSX R32 CB-CB B	LSX RRT CB-CB B	LSX TP CB-CB B
Etrium Bronze Frame/Etrium Bronze	LSX R31 EB-EB B	LSX R32 EB-EB B	LSX RRT EB-EB B	LSX TP EB-EB B
Polished Brass Frame/Antique Brass	LSX R31 PB-AB B	LSX R32 PB-AB B	LSX RRT PB-AB B	LSX TP PB-AB B
Polished Brass Frame/Antique Brass	LSX R31 PB-AB W	LSX R32 PB-AB W	LSX RRT PB-AB W	LSX TP PB-AB W
Polished Brass Frame/Bright Steel	LSX R31 PB-BS B	LSX R32 PB-BS B	LSX RRT PB-BS B	LSX TP PB-BS B
Polished Brass Frame/Bright Steel	LSX R31 PB-BS W	LSX R32 PB-BS W	LSX RRT PB-BS W	LSX TP PB-BS W
Polished Brass Frame/Polished Brass	LSX R31 PB-PB B	LSX R32 PB-PB B	LSX RRT PB-PB B	LSX TP PB-PB B
Polished Brass Frame/Polished Brass	LSX R31 PB-PB W	LSX R32 PB-PB W	LSX RRT PB-PB W	LSX TP PB-PB W
Polished Brass Frame/Satin Brass	LSX R31 PB-SB B	LSX R32 PB-SB B	LSX RRT PB-SB B	LSX TP PB-SB B
Polished Brass Frame/Satin Brass	LSX R31 PB-SB W	LSX R32 PB-SB W	LSX RRT PB-SB W	LSX TP PB-SB W
Polished Brass Frame/Satin Steel	LSX R31 PB-SS B	LSX R32 PB-SS B	LSX RRT PB-SS B	LSX TP PB-SS B
Polished Brass Frame/Satin Steel	LSX R31 PB-SS W	LSX R32 PB-SS W	LSX RRT PB-SS W	LSX TP PB-SS W
Richmond Bronze Frame/Richmond Bronze	LSX R31 RB-RB B	LSX R32 RB-RB B	LSX RRT RB-RB B	LSX TP RB-RB B
Satin Brass Frame/Satin Brass	LSX R31 SB-SB B	LSX R32 SB-SB B	LSX RRT SB-SB B	LSX TP SB-SB B
Satin Brass Frame/Satin Brass	LSX R31 SB-SB W	LSX R32 SB-SB W	LSX RRT SB-SB W	LSX TP SB-SB W
Satin Brass Frame/Satin Steel	LSX R31 SB-SS B	LSX R32 SB-SS B	LSX RRT SB-SS B	LSX TP SB-SS B
Satin Brass Frame/Satin Steel	LSX R31 SB-SS W	LSX R32 SB-SS W	LSX RRT SB-SS W	LSX TP SB-SS W
Satin Nickel Frame/Bright Steel	LSX R31 SN-BS B	LSX R32 SN-BS B	LSX RRT SN-BS B	LSX TP SN-BS B
Satin Nickel Frame/Bright Steel	LSX R31 SN-BS W	LSX R32 SN-BS W	LSX RRT SN-BS W	LSX TP SN-BS W
Satin Nickel Frame/Satin Steel	LSX R31 SN-SS B	LSX R32 SN-SS B	LSX RRT SN-SS B	LSX TP SN-SS B
Satin Nickel Frame/Satin Steel	LSX R31 SN-SS W	LSX R32 SN-SS W	LSX RRT SN-SS W	LSX TP SN-SS W
Nominal Size:	91.5mm x 91.5mm	91.5mm x 91.5mm	91.5mm x 91.5mm	91.5mm x 91.5mm
Minimum Wall Box Depth:	25mm	25mm	25mm	25mm
Technical Insert Ref:	R31	R32	CFXRRT	TP

Insert Surround Colour Key: (B) Black, (W) White

Linea-Scala CFX

Rocker Switches



LSX R212 BC-BS W









LSX R222 BC-PB B



LSX R232 BC-SS B



LSX R242 BK-BK B

Frame / Front Plate	 1 gang 20AX 2 Way Rocker	 2 gang 20AX 2 Way Rocker	 3 gang 20AX 2 Way Rocker	 4 gang 20AX 2 Way Rocker	 1 gang 20AX Intermediate Rocker	 2 gang 20AX Intermediate Rocker
Antique Brass Frame/Antique Brass	LSX R212 AB-AB B	LSX R222 AB-AB B	LSX R232 AB-AB B	LSX R242 AB-AB B	LSX R312 AB-AB B	LSX R322 AB-AB B
Antique Brass Frame/Satin Brass	LSX R212 AB-SB B	LSX R222 AB-SB B	LSX R232 AB-SB B	LSX R242 AB-SB B	LSX R312 AB-SB B	LSX R322 AB-SB B
Black Nickel Frame/Black Nickel	LSX R212 BK-BK B	LSX R222 BK-BK B	LSX R232 BK-BK B	LSX R242 BK-BK B	LSX R312 BK-BK B	LSX R322 BK-BK B
Black Nickel Frame/Bright Steel	LSX R212 BK-BS B	LSX R222 BK-BS B	LSX R232 BK-BS B	LSX R242 BK-BS B	LSX R312 BK-BS B	LSX R322 BK-BS B
Black Nickel Frame/Polished Brass	LSX R212 BK-PB B	LSX R222 BK-PB B	LSX R232 BK-PB B	LSX R242 BK-PB B	LSX R312 BK-PB B	LSX R322 BK-PB B
Bright Chrome Frame/Black Nickel	LSX R212 BC-BK B	LSX R222 BC-BK B	LSX R232 BC-BK B	LSX R242 BC-BK B	LSX R312 BC-BK B	LSX R322 BC-BK B
Bright Chrome Frame/Bright Steel	LSX R212 BC-BS B	LSX R222 BC-BS B	LSX R232 BC-BS B	LSX R242 BC-BS B	LSX R312 BC-BS B	LSX R322 BC-BS B
Bright Chrome Frame/Bright Steel	LSX R212 BC-BS W	LSX R222 BC-BS W	LSX R232 BC-BS W	LSX R242 BC-BS W	LSX R312 BC-BS W	LSX R322 BC-BS W
Bright Chrome Frame/Piano Black	LSX R212 BC-NB	LSX R222 BC-NB	LSX R232 BC-NB	LSX R242 BC-NB	LSX R312 BC-NB	LSX R322 BC-NB
Bright Chrome Frame/Polished Brass	LSX R212 BC-PB B	LSX R222 BC-PB B	LSX R232 BC-PB B	LSX R242 BC-PB B	LSX R312 BC-PB B	LSX R322 BC-PB B
Bright Chrome Frame/Polished Brass	LSX R212 BC-PB W	LSX R222 BC-PB W	LSX R232 BC-PB W	LSX R242 BC-PB W	LSX R312 BC-PB W	LSX R322 BC-PB W
Bright Chrome Frame/Satin Steel	LSX R212 BC-SS B	LSX R222 BC-SS B	LSX R232 BC-SS B	LSX R242 BC-SS B	LSX R312 BC-SS B	LSX R322 BC-SS B
Bright Chrome Frame/Satin Steel	LSX R212 BC-SS W	LSX R222 BC-SS W	LSX R232 BC-SS W	LSX R242 BC-SS W	LSX R312 BC-SS W	LSX R322 BC-SS W
Connaught Bronze Frame/Connaught Bronze	LSX R212 HB-HB B	LSX R222 HB-HB B	LSX R232 HB-HB B	LSX R242 HB-HB B	LSX R312 HB-HB B	LSX R322 HB-HB B
Copper Bronze Frame/Copper Bronze	LSX R212 CB-CB B	LSX R222 CB-CB B	LSX R232 CB-CB B	LSX R242 CB-CB B	LSX R312 CB-CB B	LSX R322 CB-CB B
Etrium Bronze Frame/Etrium Bronze	LSX R212 EB-EB B	LSX R222 EB-EB B	LSX R232 EB-EB B	LSX R242 EB-EB B	LSX R312 EB-EB B	LSX R322 EB-EB B
Polished Brass Frame/Antique Brass	LSX R212 PB-AB B	LSX R222 PB-AB B	LSX R232 PB-AB B	LSX R242 PB-AB B	LSX R312 PB-AB B	LSX R322 PB-AB B
Polished Brass Frame/Bright Steel	LSX R212 PB-BS B	LSX R222 PB-BS B	LSX R232 PB-BS B	LSX R242 PB-BS B	LSX R312 PB-BS B	LSX R322 PB-BS B
Polished Brass Frame/Bright Steel	LSX R212 PB-BS W	LSX R222 PB-BS W	LSX R232 PB-BS W	LSX R242 PB-BS W	LSX R312 PB-BS W	LSX R322 PB-BS W
Polished Brass Frame/Polished Brass	LSX R212 PB-PB B	LSX R222 PB-PB B	LSX R232 PB-PB B	LSX R242 PB-PB B	LSX R312 PB-PB B	LSX R322 PB-PB B
Polished Brass Frame/Polished Brass	LSX R212 PB-PB W	LSX R222 PB-PB W	LSX R232 PB-PB W	LSX R242 PB-PB W	LSX R312 PB-PB W	LSX R322 PB-PB W
Polished Brass Frame/Satin Brass	LSX R212 PB-SB B	LSX R222 PB-SB B	LSX R232 PB-SB B	LSX R242 PB-SB B	LSX R312 PB-SB B	LSX R322 PB-SB B
Polished Brass Frame/Satin Brass	LSX R212 PB-SB W	LSX R222 PB-SB W	LSX R232 PB-SB W	LSX R242 PB-SB W	LSX R312 PB-SB W	LSX R322 PB-SB W
Polished Brass Frame/Satin Steel	LSX R212 PB-SS B	LSX R222 PB-SS B	LSX R232 PB-SS B	LSX R242 PB-SS B	LSX R312 PB-SS B	LSX R322 PB-SS B
Polished Brass Frame/Satin Steel	LSX R212 PB-SS W	LSX R222 PB-SS W	LSX R232 PB-SS W	LSX R242 PB-SS W	LSX R312 PB-SS W	LSX R322 PB-SS W
Richmond Bronze Frame/Richmond Bronze	LSX R212 RB-RB B	LSX R222 RB-RB B	LSX R232 RB-RB B	LSX R242 RB-RB B	LSX R312 RB-RB B	LSX R322 RB-RB B
Satin Brass Frame/Satin Brass	LSX R212 SB-SB B	LSX R222 SB-SB B	LSX R232 SB-SB B	LSX R242 SB-SB B	LSX R312 SB-SB B	LSX R322 SB-SB B
Satin Brass Frame/Satin Brass	LSX R212 SB-SB W	LSX R222 SB-SB W	LSX R232 SB-SB W	LSX R242 SB-SB W	LSX R312 SB-SB W	LSX R322 SB-SB W
Satin Brass Frame/Satin Steel	LSX R212 SB-SS B	LSX R222 SB-SS B	LSX R232 SB-SS B	LSX R242 SB-SS B	LSX R312 SB-SS B	LSX R322 SB-SS B
Satin Brass Frame/Satin Steel	LSX R212 SB-SS W	LSX R222 SB-SS W	LSX R232 SB-SS W	LSX R242 SB-SS W	LSX R312 SB-SS W	LSX R322 SB-SS W
Satin Nickel Frame/Bright Steel	LSX R212 SN-BS B	LSX R222 SN-BS B	LSX R232 SN-BS B	LSX R242 SN-BS B	LSX R312 SN-BS B	LSX R322 SN-BS B
Satin Nickel Frame/Bright Steel	LSX R212 SN-BS W	LSX R222 SN-BS W	LSX R232 SN-BS W	LSX R242 SN-BS W	LSX R312 SN-BS W	LSX R322 SN-BS W
Satin Nickel Frame/Satin Steel	LSX R212 SN-SS B	LSX R222 SN-SS B	LSX R232 SN-SS B	LSX R242 SN-SS B	LSX R312 SN-SS B	LSX R322 SN-SS B
Satin Nickel Frame/Satin Steel	LSX R212 SN-SS W	LSX R222 SN-SS W	LSX R232 SN-SS W	LSX R242 SN-SS W	LSX R312 SN-SS W	LSX R322 SN-SS W
Nominal Size:	91.5mm x 91.5mm	91.5mm x 91.5mm	150.5mm x 91.5mm	150.5mm x 91.5mm	91.5mm x 91.5mm	91.5mm x 91.5mm
Minimum Wall Box Depth:	35mm	35mm	35mm	35mm	35mm	35mm
Technical Insert Ref:	R212	R222	R232	R242	R312	R322

Insert Surround Colour Key: (B) Black, (W) White

Linea-Scala CFX

Wide Rockers



LSX W10DP SN-BS B



LSX WR21 HB-HB B



LSX WR22 AB-AB B



LSX WR23 BC-BS W



1 gang 10AX
2 Way Rocker



2 gang 10AX
2 Way Rocker



3 gang 10AX
2 Way Rocker



1 gang 10AX
Intermediate
Rocker



1 gang 10AX
Push To Make
Frame/ Push to
Break Retractive
Rocker



1 gang 10AX
Double Pole
Rocker

Frame Frame/ Front Plate

Antique Brass Frame/Antique Brass	LSX WR21 AB-AB B	LSX WR22 AB-AB B	LSX WR23 AB-AB B	LSX WR31 AB-AB B	LSX WVRT AB-AB B	LSX W10DP AB-AB B
Antique Brass Frame/Satin Brass	LSX WR21 AB-SB B	LSX WR22 AB-SB B	LSX WR23 AB-SB B	LSX WR31 AB-SB B	LSX WVRT AB-SB B	LSX W10DP AB-SB B
Black Nickel Frame/Black Nickel	LSX WR21 BK-BK B	LSX WR22 BK-BK B	LSX WR23 BK-BK B	LSX WR31 BK-BK B	LSX WVRT BK-BK B	LSX W10DP BK-BK B
Black Nickel Frame/Bright Steel	LSX WR21 BK-BS B	LSX WR22 BK-BS B	LSX WR23 BK-BS B	LSX WR31 BK-BS B	LSX WVRT BK-BS B	LSX W10DP BK-BS B
Black Nickel Frame/Polished Brass	LSX WR21 BK-PB B	LSX WR22 BK-PB B	LSX WR23 BK-PB B	LSX WR31 BK-PB B	LSX WVRT BK-PB B	LSX W10DP BK-PB B
Bright Chrome Frame/Black Nickel	LSX WR21 BC-BK B	LSX WR22 BC-BK B	LSX WR23 BC-BK B	LSX WR31 BC-BK B	LSX WVRT BC-BK B	LSX W10DP BC-BK B
Bright Chrome Frame/Bright Steel	LSX WR21 BC-BS B	LSX WR22 BC-BS B	LSX WR23 BC-BS B	LSX WR31 BC-BS B	LSX WVRT BC-BS B	LSX W10DP BC-BS B
Bright Chrome Frame/Bright Steel	LSX WR21 BC-BS W	LSX WR22 BC-BS W	LSX WR23 BC-BS W	LSX WR31 BC-BS W	LSX WVRT BC-BS W	LSX W10DP BC-BS W
Bright Chrome Frame/Plano Black	LSX WR21 BC-NB	LSX WR22 BC-NB	LSX WR23 BC-NB	LSX WR31 BC-NB	LSX WVRT BC-NB	LSX W10DP BC-NB
Bright Chrome Frame/Polished Brass	LSX WR21 BC-PB B	LSX WR22 BC-PB B	LSX WR23 BC-PB B	LSX WR31 BC-PB B	LSX WVRT BC-PB B	LSX W10DP BC-PB B
Bright Chrome Frame/Polished Brass	LSX WR21 BC-PB W	LSX WR22 BC-PB W	LSX WR23 BC-PB W	LSX WR31 BC-PB W	LSX WVRT BC-PB W	LSX W10DP BC-PB W
Bright Chrome Frame/Satin Steel	LSX WR21 BC-SS B	LSX WR22 BC-SS B	LSX WR23 BC-SS B	LSX WR31 BC-SS B	LSX WVRT BC-SS B	LSX W10DP BC-SS B
Bright Chrome Frame/Satin Steel	LSX WR21 BC-SS W	LSX WR22 BC-SS W	LSX WR23 BC-SS W	LSX WR31 BC-SS W	LSX WVRT BC-SS W	LSX W10DP BC-SS W
Connaught Bronze Frame/Connaught Bronze	LSX WR21 HB-HB B	LSX WR22 HB-HB B	LSX WR23 HB-HB B	LSX WR31 HB-HB B	LSX WVRT HB-HB B	LSX W10DP HB-HB B
Copper Bronze Frame/Copper Bronze	LSX WR21 CB-CB B	LSX WR22 CB-CB B	LSX WR23 CB-CB B	LSX WR31 CB-CB B	LSX WVRT CB-CB B	LSX W10DP CB-CB B
Etrium Bronze Frame/Etrium Bronze	LSX WR21 EB-EB B	LSX WR22 EB-EB B	LSX WR23 EB-EB B	LSX WR31 EB-EB B	LSX WVRT EB-EB B	LSX W10DP EB-EB B
Polished Brass Frame/Antique Brass	LSX WR21 PB-AB B	LSX WR22 PB-AB B	LSX WR23 PB-AB B	LSX WR31 PB-AB B	LSX WVRT PB-AB B	LSX W10DP PB-AB B
Polished Brass Frame/Antique Brass	LSX WR21 PB-AB W	LSX WR22 PB-AB W	LSX WR23 PB-AB W	LSX WR31 PB-AB W	LSX WVRT PB-AB W	LSX W10DP PB-AB W
Polished Brass Frame/Bright Steel	LSX WR21 PB-BS B	LSX WR22 PB-BS B	LSX WR23 PB-BS B	LSX WR31 PB-BS B	LSX WVRT PB-BS B	LSX W10DP PB-BS B
Polished Brass Frame/Bright Steel	LSX WR21 PB-BS W	LSX WR22 PB-BS W	LSX WR23 PB-BS W	LSX WR31 PB-BS W	LSX WVRT PB-BS W	LSX W10DP PB-BS W
Polished Brass Frame/Polished Brass	LSX WR21 PB-PB B	LSX WR22 PB-PB B	LSX WR23 PB-PB B	LSX WR31 PB-PB B	LSX WVRT PB-PB B	LSX W10DP PB-PB B
Polished Brass Frame/Polished Brass	LSX WR21 PB-PB W	LSX WR22 PB-PB W	LSX WR23 PB-PB W	LSX WR31 PB-PB W	LSX WVRT PB-PB W	LSX W10DP PB-PB W
Polished Brass Frame/Satin Brass	LSX WR21 PB-SB B	LSX WR22 PB-SB B	LSX WR23 PB-SB B	LSX WR31 PB-SB B	LSX WVRT PB-SB B	LSX W10DP PB-SB B
Polished Brass Frame/Satin Brass	LSX WR21 PB-SB W	LSX WR22 PB-SB W	LSX WR23 PB-SB W	LSX WR31 PB-SB W	LSX WVRT PB-SB W	LSX W10DP PB-SB W
Polished Brass Frame/Satin Steel	LSX WR21 PB-SS B	LSX WR22 PB-SS B	LSX WR23 PB-SS B	LSX WR31 PB-SS B	LSX WVRT PB-SS B	LSX W10DP PB-SS B
Polished Brass Frame/Satin Steel	LSX WR21 PB-SS W	LSX WR22 PB-SS W	LSX WR23 PB-SS W	LSX WR31 PB-SS W	LSX WVRT PB-SS W	LSX W10DP PB-SS W
Richmond Bronze Frame/ Richmond Bronze	LSX WR21 RB-RB B	LSX WR22 RB-RB B	LSX WR23 RB-RB B	LSX WR31 RB-RB B	LSX WVRT RB-RB B	LSX W10DP RB-RB B
Satin Brass Frame/Satin Brass	LSX WR21 SB-SB B	LSX WR22 SB-SB B	LSX WR23 SB-SB B	LSX WR31 SB-SB B	LSX WVRT SB-SB B	LSX W10DP SB-SB B
Satin Brass Frame/Satin Brass	LSX WR21 SB-SB W	LSX WR22 SB-SB W	LSX WR23 SB-SB W	LSX WR31 SB-SB W	LSX WVRT SB-SB W	LSX W10DP SB-SB W
Satin Brass Frame/Satin Steel	LSX WR21 SB-SS B	LSX WR22 SB-SS B	LSX WR23 SB-SS B	LSX WR31 SB-SS B	LSX WVRT SB-SS B	LSX W10DP SB-SS B
Satin Brass Frame/Satin Steel	LSX WR21 SB-SS W	LSX WR22 SB-SS W	LSX WR23 SB-SS W	LSX WR31 SB-SS W	LSX WVRT SB-SS W	LSX W10DP SB-SS W
Satin Nickel Frame/Bright Steel	LSX WR21 SN-BS B	LSX WR22 SN-BS B	LSX WR23 SN-BS B	LSX WR31 SN-BS B	LSX WVRT SN-BS B	LSX W10DP SN-BS B
Satin Nickel Frame/Bright Steel	LSX WR21 SN-BS W	LSX WR22 SN-BS W	LSX WR23 SN-BS W	LSX WR31 SN-BS W	LSX WVRT SN-BS W	LSX W10DP SN-BS W
Satin Nickel Frame/Satin Steel	LSX WR21 SN-SS B	LSX WR22 SN-SS B	LSX WR23 SN-SS B	LSX WR31 SN-SS B	LSX WVRT SN-SS B	LSX W10DP SN-SS B
Satin Nickel Frame/Satin Steel	LSX WR21 SN-SS W	LSX WR22 SN-SS W	LSX WR23 SN-SS W	LSX WR31 SN-SS W	LSX WVRT SN-SS W	LSX W10DP SN-SS W
Satin Nickel Frame/Satin Steel	LSX WR21 SN-SS QG	LSX WR22 SN-SS QG	LSX WR23 SN-SS QG	LSX WR31 SN-SS QG	LSX WVRT SN-SS QG	LSX W10DP SN-SS QG
Satin Nickel Frame/Satin Steel	LSX WR21 SN-SS W	LSX WR22 SN-SS W	LSX WR23 SN-SS W	LSX WR31 SN-SS W	LSX WVRT SN-SS W	LSX W10DP SN-SS W
Nominal Size:	91.5mm x 91.5mm	91.5mm x 91.5mm	91.5mm x 91.5mm	91.5mm x 91.5mm	91.5mm x 91.5mm	91.5mm x 91.5mm
Minimum Wall Box Depth:	25mm	25mm	25mm	25mm	25mm	25mm
Technical Insert Ref:	WR21	WR22	WR23	WR31	WVRT	W10DP

Insert Surround Colour Key: (B) Black, (W) White, (QG) Quartz Grey

Linea-Scala CFX

Toggle Switches



LSX T21 BC-BK







LSX T22 BC-BS



LSX T31 PB-BB

LINEA-SCALA CFX RANGE

Frame / Front Plate	 1 gang 20AX 2 Way Toggle	 2 gang 20AX 2 Way Toggle	 3 gang 20AX 2 Way Toggle	 4 gang 20AX 2 Way Toggle	 1 gang 20AX Intermediate Toggle
Antique Brass Frame/Antique Brass	LSX T21 AB-AB	LSX T22 AB-AB	LSX T23 AB-AB	LSX T24 AB-AB	LSX T31 AB-AB
Antique Brass Frame/Satin Brass	LSX T21 AB-SB	LSX T22 AB-SB	LSX T23 AB-SB	LSX T24 AB-SB	LSX T31 AB-SB
Black Nickel Frame/Black Nickel	LSX T21 BK-BK	LSX T22 BK-BK	LSX T23 BK-BK	LSX T24 BK-BK	LSX T31 BK-BK
Black Nickel Frame/Bright Steel	LSX T21 BK-BS	LSX T22 BK-BS	LSX T23 BK-BS	LSX T24 BK-BS	LSX T31 BK-BS
Black Nickel Frame/Polished Brass	LSX T21 BK-PB	LSX T22 BK-PB	LSX T23 BK-PB	LSX T24 BK-PB	LSX T31 BK-PB
Bright Chrome Frame/Black Nickel	LSX T21 BC-BK	LSX T22 BC-BK	LSX T23 BC-BK	LSX T24 BC-BK	LSX T31 BC-BK
Bright Chrome Frame/Bright Steel	LSX T21 BC-BS	LSX T22 BC-BS	LSX T23 BC-BS	LSX T24 BC-BS	LSX T31 BC-BS
Bright Chrome Frame/Piano Black	LSX T21 BC-N	LSX T22 BC-N	LSX T23 BC-N	LSX T24 BC-N	LSX T31 BC-N
Bright Chrome Frame/Polished Brass	LSX T21 BC-PB	LSX T22 BC-PB	LSX T23 BC-PB	LSX T24 BC-PB	LSX T31 BC-PB
Bright Chrome Frame/Satin Steel	LSX T21 BC-SS	LSX T22 BC-SS	LSX T23 BC-SS	LSX T24 BC-SS	LSX T31 BC-SS
Connaught Bronze Frame/Connaught Bronze	LSX T21 HB-HB	LSX T22 HB-HB	LSX T23 HB-HB	LSX T24 HB-HB	LSX T31 HB-HB
Copper Bronze Frame/Copper Bronze	LSX T21 CB-CB	LSX T22 CB-CB	LSX T23 CB-CB	LSX T24 CB-CB	LSX T31 CB-CB
Etrium Bronze Frame/Etrium Bronze	LSX T21 EB-EB	LSX T22 EB-EB	LSX T23 EB-EB	LSX T24 EB-EB	LSX T31 EB-EB
Polished Brass Frame/Antique Brass	LSX T21 PB-AB	LSX T22 PB-AB	LSX T23 PB-AB	LSX T24 PB-AB	LSX T31 PB-AB
Polished Brass Frame/Bright Steel	LSX T21 PB-BS	LSX T22 PB-BS	LSX T23 PB-BS	LSX T24 PB-BS	LSX T31 PB-BS
Polished Brass Frame/Polished Brass	LSX T21 PB-PB	LSX T22 PB-PB	LSX T23 PB-PB	LSX T24 PB-PB	LSX T31 PB-PB
Polished Brass Frame/Satin Brass	LSX T21 PB-SB	LSX T22 PB-SB	LSX T23 PB-SB	LSX T24 PB-SB	LSX T31 PB-SB
Polished Brass Frame/Satin Steel	LSX T21 PB-SS	LSX T22 PB-SS	LSX T23 PB-SS	LSX T24 PB-SS	LSX T31 PB-SS
Richmond Bronze Frame/Richmond Bronze	LSX T21 RB-RB	LSX T22 RB-RB	LSX T23 RB-RB	LSX T24 RB-RB	LSX T31 RB-RB
Satin Brass Frame/Satin Brass	LSX T21 SB-SB	LSX T22 SB-SB	LSX T23 SB-SB	LSX T24 SB-SB	LSX T31 SB-SB
Satin Brass Frame/Satin Steel	LSX T21 SB-SS	LSX T22 SB-SS	LSX T23 SB-SS	LSX T24 SB-SS	LSX T31 SB-SS
Satin Nickel Frame/Bright Steel*	LSX T21 SN-BS	LSX T22 SN-BS	LSX T23 SN-BS	LSX T24 SN-BS	LSX T31 SN-BS
Satin Nickel Frame/Satin Steel*	LSX T21 SN-SS	LSX T22 SN-SS	LSX T23 SN-SS	LSX T24 SN-SS	LSX T31 SN-SS
Nominal Size:	91.5mm x 91.5mm	91.5mm x 91.5mm	150.5mm x 91.5mm	150.5mm x 91.5mm	91.5mm x 91.5mm
Minimum Wall Box Depth:	35mm	35mm	35mm	35mm	35mm
Technical Insert Ref:	T21	T22	T23	T24	T31

Toggles to match Frame Finish as standard except where specified.

*Satin Chrome Toggles

Linea-Scala CFX

Power Sockets



LSX SS1 AB-SB B



LSX SS2 BC-BS W



LSX US2 AB-AB B



LSX US5 SN-BS W



1 gang 13A
Double Pole
Switched Socket

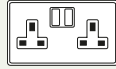

2 gang 13A
Double Pole
Switched Socket

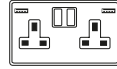

2 gang 13A Double
Pole Switched
Socket with 2 USB
Outlet 2x2.4A (4.8A
Total)



1 gang 2A
Unswitched
Socket



1 gang 5A
Unswitched
Socket

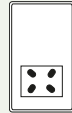

Shaver Dual Voltage
Unswitched Socket
(Vertically Mounted)

Frame / Front Plate	LSX SS1 AB-AB B	LSX SS2 AB-AB B	LSX SS2USBULT AB-AB B	LSX US2 AB-AB B	LSX US5 AB-AB B	LSX SH5 AB-AB B
Antique Brass Frame/Antique Brass	LSX SS1 AB-SB B	LSX SS2 AB-SB B	LSX SS2USBULT AB-SB B	LSX US2 AB-SB B	LSX US5 AB-SB B	LSX SH5 AB-SB B
Black Nickel Frame/Black Nickel	LSX SS1 BK-BK B	LSX SS2 BK-BK B	LSX SS2USBULT BK-BK B	LSX US2 BK-BK B	LSX US5 BK-BK B	LSX SH5 BK-BK B
Black Nickel Frame/Bright Steel	LSX SS1 BK-BS B	LSX SS2 BK-BS B	LSX SS2USBULT BK-BS B	LSX US2 BK-BS B	LSX US5 BK-BS B	LSX SH5 BK-BS B
Black Nickel Frame/Polished Brass	LSX SS1 BK-PB B	LSX SS2 BK-PB B	LSX SS2USBULT BK-PB B	LSX US2 BK-PB B	LSX US5 BK-PB B	LSX SH5 BK-PB B
Bright Chrome Frame/Black Nickel	LSX SS1 BC-BK B	LSX SS2 BC-BK B	LSX SS2USBULT BC-BK B	LSX US2 BC-BK B	LSX US5 BC-BK B	LSX SH5 BC-BK B
Bright Chrome Frame/Bright Steel	LSX SS1 BC-BS B	LSX SS2 BC-BS B	LSX SS2USBULT BC-BS B	LSX US2 BC-BS B	LSX US5 BC-BS B	LSX SH5 BC-BS B
Bright Chrome Frame/Bright Steel	LSX SS1 BC-BS W	LSX SS2 BC-BS W	LSX SS2USBULT BC-BS W	LSX US2 BC-BS W	LSX US5 BC-BS W	LSX SH5 BC-BS W
Bright Chrome Frame/Piano Black	LSX SS1 BC-NB	LSX SS2 BC-NB	LSX SS2USBULT BC-NB	LSX US2 BC-NB	LSX US5 BC-NB	LSX SH5 BC-NB
Bright Chrome Frame/Polished Brass	LSX SS1 BC-PB B	LSX SS2 BC-PB B	LSX SS2USBULT BC-PB B	LSX US2 BC-PB B	LSX US5 BC-PB B	LSX SH5 BC-PB B
Bright Chrome Frame/Polished Brass	LSX SS1 BC-PB W	LSX SS2 BC-PB W	LSX SS2USBULT BC-PB W	LSX US2 BC-PB W	LSX US5 BC-PB W	LSX SH5 BC-PB W
Bright Chrome Frame/Satin Steel	LSX SS1 BC-SS B	LSX SS2 BC-SS B	LSX SS2USBULT BC-SS B	LSX US2 BC-SS B	LSX US5 BC-SS B	LSX SH5 BC-SS B
Bright Chrome Frame/Satin Steel	LSX SS1 BC-SS W	LSX SS2 BC-SS W	LSX SS2USBULT BC-SS W	LSX US2 BC-SS W	LSX US5 BC-SS W	LSX SH5 BC-SS W
Connaught Bronze Frame/Connaught Bronze	LSX SS1 HB-HB B	LSX SS2 HB-HB B	LSX SS2USBULT HB-HB B	LSX US2 HB-HB B	LSX US5 HB-HB B	LSX SH5 HB-HB B
Copper Bronze Frame/Copper Bronze	LSX SS1 CB-CB B	LSX SS2 CB-CB B	LSX SS2USBULT CB-CB B	LSX US2 CB-CB B	LSX US5 CB-CB B	LSX SH5 CB-CB B
Etrium Bronze Frame/Etrium Bronze	LSX SS1 EB-EB B	LSX SS2 EB-EB B	LSX SS2USBULT EB-EB B	LSX US2 EB-EB B	LSX US5 EB-EB B	LSX SH5 EB-EB B
Polished Brass Frame/Antique Brass	LSX SS1 PB-AB B	LSX SS2 PB-AB B	LSX SS2USBULT PB-AB B	LSX US2 PB-AB B	LSX US5 PB-AB B	LSX SH5 PB-AB B
Polished Brass Frame/Antique Brass	LSX SS1 PB-AB W	LSX SS2 PB-AB W	LSX SS2USBULT PB-AB W	LSX US2 PB-AB W	LSX US5 PB-AB W	LSX SH5 PB-AB W
Polished Brass Frame/Bright Steel	LSX SS1 PB-BS B	LSX SS2 PB-BS B	LSX SS2USBULT PB-BS B	LSX US2 PB-BS B	LSX US5 PB-BS B	LSX SH5 PB-BS B
Polished Brass Frame/Bright Steel	LSX SS1 PB-BS W	LSX SS2 PB-BS W	LSX SS2USBULT PB-BS W	LSX US2 PB-BS W	LSX US5 PB-BS W	LSX SH5 PB-BS W
Polished Brass Frame/Polished Brass	LSX SS1 PB-PB B	LSX SS2 PB-PB B	LSX SS2USBULT PB-PB B	LSX US2 PB-PB B	LSX US5 PB-PB B	LSX SH5 PB-PB B
Polished Brass Frame/Polished Brass	LSX SS1 PB-PB W	LSX SS2 PB-PB W	LSX SS2USBULT PB-PB W	LSX US2 PB-PB W	LSX US5 PB-PB W	LSX SH5 PB-PB W
Polished Brass Frame/Satin Brass	LSX SS1 PB-SB B	LSX SS2 PB-SB B	LSX SS2USBULT PB-SB B	LSX US2 PB-SB B	LSX US5 PB-SB B	LSX SH5 PB-SB B
Polished Brass Frame/Satin Brass	LSX SS1 PB-SB W	LSX SS2 PB-SB W	LSX SS2USBULT PB-SB W	LSX US2 PB-SB W	LSX US5 PB-SB W	LSX SH5 PB-SB W
Polished Brass Frame/Satin Steel	LSX SS1 PB-SS B	LSX SS2 PB-SS B	LSX SS2USBULT PB-SS B	LSX US2 PB-SS B	LSX US5 PB-SS B	LSX SH5 PB-SS B
Polished Brass Frame/Satin Steel	LSX SS1 PB-SS W	LSX SS2 PB-SS W	LSX SS2USBULT PB-SS W	LSX US2 PB-SS W	LSX US5 PB-SS W	LSX SH5 PB-SS W
Richmond Bronze Frame/Richmond Bronze	LSX SS1 RB-RB B	LSX SS2 RB-RB B	LSX SS2USBULT RB-RB B	LSX US2 RB-RB B	LSX US5 RB-RB B	LSX SH5 RB-RB B
Satin Brass Frame/Satin Brass	LSX SS1 SB-SB B	LSX SS2 SB-SB B	LSX SS2USBULT SB-SB B	LSX US2 SB-SB B	LSX US5 SB-SB B	LSX SH5 SB-SB B
Satin Brass Frame/Satin Brass	LSX SS1 SB-SB W	LSX SS2 SB-SB W	LSX SS2USBULT SB-SB W	LSX US2 SB-SB W	LSX US5 SB-SB W	LSX SH5 SB-SB W
Satin Brass Frame/Satin Steel	LSX SS1 SB-SS B	LSX SS2 SB-SS B	LSX SS2USBULT SB-SS B	LSX US2 SB-SS B	LSX US5 SB-SS B	LSX SH5 SB-SS B
Satin Brass Frame/Satin Steel	LSX SS1 SB-SS W	LSX SS2 SB-SS W	LSX SS2USBULT SB-SS W	LSX US2 SB-SS W	LSX US5 SB-SS W	LSX SH5 SB-SS W
Satin Nickel Frame/Bright Steel	LSX SS1 SN-BS B	LSX SS2 SN-BS B	LSX SS2USBULT SN-BS B	LSX US2 SN-BS B	LSX US5 SN-BS B	LSX SH5 SN-BS B
Satin Nickel Frame/Bright Steel	LSX SS1 SN-BS W	LSX SS2 SN-BS W	LSX SS2USBULT SN-BS W	LSX US2 SN-BS W	LSX US5 SN-BS W	LSX SH5 SN-BS W
Satin Nickel Frame/Satin Steel	LSX SS1 SN-SS B	LSX SS2 SN-SS B	LSX SS2USBULT SN-SS B	LSX US2 SN-SS B	LSX US5 SN-SS B	LSX SH5 SN-SS B
Satin Nickel Frame/Satin Steel	LSX SS1 SN-SS W	LSX SS2 SN-SS W	LSX SS2USBULT SN-SS W	LSX US2 SN-SS W	LSX US5 SN-SS W	LSX SH5 SN-SS W
Nominal Size:	91.5mm x 91.5mm	150.5mm x 91.5mm	150.5mm x 91.5mm	91.5mm x 91.5mm	91.5mm x 91.5mm	91.5mm x 150.5mm
Minimum Wall Box Depth:	35mm	35mm	35mm	35mm	35mm	47mm
Technical Insert Ref:	SS1	SS2	SS2USBULT	US2	US5	SH5

Insert Surround Colour Key: (B) Black, (W) White

Linea-Scala CFX

International Power Sockets



LSX 5258 HB-HB B



LSX 5320 PB-AB B



LSX 6126 CB-CB B



1 gang 15A 110V
AC American
Unswitched
Socket

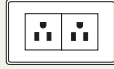

2 gang 15A 110V
AC American
Unswitched
Socket



1 gang 10/16A
220/250V
AC German
Unswitched
Socket

Frame / Front Plate	LSX 5258 AB-AB B	LSX 5320 AB-AB B	LSX 6126 AB-AB B
Antique Brass Frame/Antique Brass	LSX 5258 AB-AB B	LSX 5320 AB-AB B	LSX 6126 AB-AB B
Antique Brass Frame/Satin Brass	LSX 5258 AB-SB B	LSX 5320 AB-SB B	LSX 6126 AB-SB B
Black Nickel Frame/Black Nickel	LSX 5258 BK-BK B	LSX 5320 BK-BK B	LSX 6126 BK-BK B
Black Nickel Frame/Bright Steel	LSX 5258 BK-BS B	LSX 5320 BK-BS B	LSX 6126 BK-BS B
Black Nickel Frame/Polished Brass	LSX 5258 BK-PB B	LSX 5320 BK-PB B	LSX 6126 BK-PB B
Bright Chrome Frame/Black Nickel	LSX 5258 BC-BK B	LSX 5320 BC-BK B	LSX 6126 BC-BK B
Bright Chrome Frame/Bright Steel	LSX 5258 BC-BS B	LSX 5320 BC-BS B	LSX 6126 BC-BS B
Bright Chrome Frame/Bright Steel	LSX 5258 BC-BS W	LSX 5320 BC-BS W	LSX 6126 BC-BS W
Bright Chrome Frame/Piano Black	LSX 5258 BC-N B	LSX 5320 BC-N B	LSX 6126 BC-N B
Bright Chrome Frame/Polished Brass	LSX 5258 BC-PB B	LSX 5320 BC-PB B	LSX 6126 BC-PB B
Bright Chrome Frame/Polished Brass	LSX 5258 BC-PB W	LSX 5320 BC-PB W	LSX 6126 BC-PB W
Bright Chrome Frame/Satin Steel	LSX 5258 BC-SS B	LSX 5320 BC-SS B	LSX 6126 BC-SS B
Bright Chrome Frame/Satin Steel	LSX 5258 BC-SS W	LSX 5320 BC-SS W	LSX 6126 BC-SS W
Connaught Bronze Frame/Connaught Bronze	LSX 5258 HB-HB B	LSX 5320 HB-HB B	LSX 6126 HB-HB B
Copper Bronze Frame/Copper Bronze	LSX 5258 CB-CB B	LSX 5320 CB-CB B	LSX 6126 CB-CB B
Etrium Bronze Frame/Etrium Bronze	LSX 5258 EB-EB B	LSX 5320 EB-EB B	LSX 6126 EB-EB B
Polished Brass Frame/Antique Brass	LSX 5258 PB-AB B	LSX 5320 PB-AB B	LSX 6126 PB-AB B
Polished Brass Frame/Antique Brass	LSX 5258 PB-AB W	LSX 5320 PB-AB W	LSX 6126 PB-AB W
Polished Brass Frame/Bright Steel	LSX 5258 PB-BS B	LSX 5320 PB-BS B	LSX 6126 PB-BS B
Polished Brass Frame/Bright Steel	LSX 5258 PB-BS W	LSX 5320 PB-BS W	LSX 6126 PB-BS W
Polished Brass Frame/Polished Brass	LSX 5258 PB-PB B	LSX 5320 PB-PB B	LSX 6126 PB-PB B
Polished Brass Frame/Polished Brass	LSX 5258 PB-PB W	LSX 5320 PB-PB W	LSX 6126 PB-PB W
Polished Brass Frame/Satin Brass	LSX 5258 PB-SB B	LSX 5320 PB-SB B	LSX 6126 PB-SB B
Polished Brass Frame/Satin Brass	LSX 5258 PB-SB W	LSX 5320 PB-SB W	LSX 6126 PB-SB W
Polished Brass Frame/Satin Steel	LSX 5258 PB-SS B	LSX 5320 PB-SS B	LSX 6126 PB-SS B
Polished Brass Frame/Satin Steel	LSX 5258 PB-SS W	LSX 5320 PB-SS W	LSX 6126 PB-SS W
Richmond Bronze Frame/Richmond Bronze	LSX 5258 RB-RB B	LSX 5320 RB-RB B	LSX 6126 RB-RB B
Satin Brass Frame/Satin Brass	LSX 5258 SB-SB B	LSX 5320 SB-SB B	LSX 6126 SB-SB B
Satin Brass Frame/Satin Brass	LSX 5258 SB-SB W	LSX 5320 SB-SB W	LSX 6126 SB-SB W
Satin Brass Frame/Satin Steel	LSX 5258 SB-SS B	LSX 5320 SB-SS B	LSX 6126 SB-SS B
Satin Brass Frame/Satin Steel	LSX 5258 SB-SS W	LSX 5320 SB-SS W	LSX 6126 SB-SS W
Satin Nickel Frame/Bright Steel	LSX 5258 SN-BS B	LSX 5320 SN-BS B	LSX 6126 SN-BS B
Satin Nickel Frame/Bright Steel	LSX 5258 SN-BS W	LSX 5320 SN-BS W	LSX 6126 SN-BS W
Satin Nickel Frame/Satin Steel	LSX 5258 SN-SS B	LSX 5320 SN-SS B	LSX 6126 SN-SS B
Satin Nickel Frame/Satin Steel	LSX 5258 SN-SS W	LSX 5320 SN-SS W	LSX 6126 SN-SS W
Nominal Size:	91.5mm x 91.5mm	150.5mm x 91.5mm	91.5mm x 91.5mm
Minimum Wall Box Depth:	35mm	35mm	47mm
Technical Insert Ref:	5258	5320	6126

Insert Surround Colour Key: (B) Black, (W) White

Linea-Scala CFX

Key Switches



LSX K21 SB-SB W



LSX KEL SN-BS B



LSX C11 SN-BS B



1 gang 20AX 2 Way
Key Switch



1 gang 20AX 2 Way
Key Switch EMG LITG
TEST



1 gang 10A (6AX) Card Switch
On/Off with Blue LED Locator

Frame / Front Plate	LSX K21 AB-AB B	LSX KEL AB-AB B
Antique Brass Frame/Antique Brass	LSX K21 AB-AB B	LSX KEL AB-AB B
Antique Brass Frame/Satin Brass	LSX K21 AB-SB B	LSX KEL AB-SB B
Black Nickel Frame/Black Nickel	LSX K21 BK-BK B	LSX KEL BK-BK B
Black Nickel Frame/Bright Steel	LSX K21 BK-BS B	LSX KEL BK-BS B
Black Nickel Frame/Polished Brass	LSX K21 BK-PB B	LSX KEL BK-PB B
Bright Chrome Frame/Black Nickel	LSX K21 BC-BK B	LSX KEL BC-BK B
Bright Chrome Frame/Bright Steel	LSX K21 BC-BS B	LSX KEL BC-BS B
Bright Chrome Frame/Bright Steel	LSX K21 BC-BS W	LSX KEL BC-BS W
Bright Chrome Frame/Piano Black	LSX K21 BC-N B	LSX KEL BC-N B
Bright Chrome Frame/Polished Brass	LSX K21 BC-PB B	LSX KEL BC-PB B
Bright Chrome Frame/Polished Brass	LSX K21 BC-PB W	LSX KEL BC-PB W
Bright Chrome Frame/Satin Steel	LSX K21 BC-SS B	LSX KEL BC-SS B
Bright Chrome Frame/Satin Steel	LSX K21 BC-SS W	LSX KEL BC-SS W
Connaught Bronze Frame/Connaught Bronze	LSX K21 HB-HB B	LSX KEL HB-HB B
Copper Bronze Frame/Copper Bronze	LSX K21 CB-CB B	LSX KEL CB-CB B
Etrium Bronze Frame/Etrium Bronze	LSX K21 EB-EB B	LSX KEL EB-EB B
Polished Brass Frame/Antique Brass	LSX K21 PB-AB B	LSX KEL PB-AB B
Polished Brass Frame/Antique Brass	LSX K21 PB-AB W	LSX KEL PB-AB W
Polished Brass Frame/Bright Steel	LSX K21 PB-BS B	LSX KEL PB-BS B
Polished Brass Frame/Bright Steel	LSX K21 PB-BS W	LSX KEL PB-BS W
Polished Brass Frame/Polished Brass	LSX K21 PB-PB B	LSX KEL PB-PB B
Polished Brass Frame/Polished Brass	LSX K21 PB-PB W	LSX KEL PB-PB W
Polished Brass Frame/Satin Brass	LSX K21 PB-SB B	LSX KEL PB-SB B
Polished Brass Frame/Satin Brass	LSX K21 PB-SB W	LSX KEL PB-SB W
Polished Brass Frame/Satin Steel	LSX K21 PB-SS B	LSX KEL PB-SS B
Polished Brass Frame/Satin Steel	LSX K21 PB-SS W	LSX KEL PB-SS W
Richmond Bronze Frame/Richmond Bronze	LSX K21 RB-RB B	LSX KEL RB-RB B
Satin Brass Frame/Satin Brass	LSX K21 SB-SB B	LSX KEL SB-SB B
Satin Brass Frame/Satin Brass	LSX K21 SB-SB W	LSX KEL SB-SB W
Satin Brass Frame/Satin Steel	LSX K21 SB-SS B	LSX KEL SB-SS B
Satin Brass Frame/Satin Steel	LSX K21 SB-SS W	LSX KEL SB-SS W
Satin Nickel Frame/Bright Steel	LSX K21 SN-BS B	LSX KEL SN-BS B
Satin Nickel Frame/Bright Steel	LSX K21 SN-BS W	LSX KEL SN-BS W
Satin Nickel Frame/Satin Steel	LSX K21 SN-SS B	LSX KEL SN-SS B
Satin Nickel Frame/Satin Steel	LSX K21 SN-SS W	LSX KEL SN-SS W
Nominal Size: Minimum Wall Box Depth: Technical Insert Ref:	91.5mm x 91.5mm 35mm K21	91.5mm x 91.5mm 35mm KEL

Hotel Card Switch with LED

Frame / Front Plate	LSX C11 AB-AB B
Antique Brass Frame/Antique Brass	LSX C11 AB-AB B
Antique Brass Frame/Satin Brass	LSX C11 AB-SB B
Black Nickel Frame/Black Nickel	LSX C11 BK-BK B
Black Nickel Frame/Bright Steel	LSX C11 BK-BS B
Black Nickel Frame/Polished Brass	LSX C11 BK-PB B
Bright Chrome Frame/Black Nickel	LSX C11 BC-BK B
Bright Chrome Frame/Bright Steel	LSX C11 BC-BS B
Bright Chrome Frame/Bright Steel	LSX C11 BC-BS W
Bright Chrome Frame/Piano Black	LSX C11 BC-N B
Bright Chrome Frame/Polished Brass	LSX C11 BC-PB B
Bright Chrome Frame/Polished Brass	LSX C11 BC-PB W
Bright Chrome Frame/Satin Steel	LSX C11 BC-SS B
Bright Chrome Frame/Satin Steel	LSX C11 BC-SS W
Connaught Bronze Frame/Connaught Bronze	LSX C11 HB-HB B
Copper Bronze Frame/Copper Bronze	LSX C11 CB-CB B
Etrium Bronze Frame/Etrium Bronze	LSX C11 EB-EB B
Polished Brass Frame/Antique Brass	LSX C11 PB-AB B
Polished Brass Frame/Antique Brass	LSX C11 PB-AB W
Polished Brass Frame/Bright Steel	LSX C11 PB-BS B
Polished Brass Frame/Bright Steel	LSX C11 PB-BS W
Polished Brass Frame/Polished Brass	LSX C11 PB-PB B
Polished Brass Frame/Polished Brass	LSX C11 PB-PB W
Polished Brass Frame/Satin Brass	LSX C11 PB-SB B
Polished Brass Frame/Satin Brass	LSX C11 PB-SB W
Polished Brass Frame/Satin Steel	LSX C11 PB-SS B
Polished Brass Frame/Satin Steel	LSX C11 PB-SS W
Richmond Bronze Frame/Richmond Bronze	LSX C11 RB-RB B
Satin Brass Frame/Satin Brass	LSX C11 SB-SB B
Satin Brass Frame/Satin Brass	LSX C11 SB-SB W
Satin Brass Frame/Satin Steel	LSX C11 SB-SS B
Satin Brass Frame/Satin Steel	LSX C11 SB-SS W
Satin Nickel Frame/Bright Steel	LSX C11 SN-BS B
Satin Nickel Frame/Bright Steel	LSX C11 SN-BS W
Satin Nickel Frame/Satin Steel	LSX C11 SN-SS B
Satin Nickel Frame/Satin Steel	LSX C11 SN-SS W
Nominal Size: Minimum Wall Box Depth: Technical Insert Ref:	91.5mm x 91.5mm 35mm C11

Insert Surround Colour Key: (B) Black, (W) White

Linea-Scala CFX

Television Coaxial Sockets



LSX TV BC-BK B



LSX TVFM AB-AB B



LSX TVI BK-BK B



LSX TVSAT PB-PB W



1 gang
Non-Isolated
Television
1in/1out



Isolated TV/FM
Diplexer 1in/2out



1 gang Isolated
TV 1in/1out



2 gang
Non-Isolated
TV+Satellite
2in/2out



1 gang Non-
Isolated Satellite



1 gang Isolated
Satellite

Frame / Front Plate	1 gang Non-Isolated Television 1in/1out	Isolated TV/FM Diplexer 1in/2out	1 gang Isolated TV 1in/1out	2 gang Non-Isolated TV+Satellite 2in/2out	1 gang Non-Isolated Satellite	1 gang Isolated Satellite
Antique Brass Frame/Antique Brass	LSX TV AB-AB B	LSX TVFM AB-AB B	LSX TVI AB-AB B	LSX TVSAT AB-AB B	LSX SATN AB-AB B	LSX SATI AB-AB B
Antique Brass Frame/Satin Brass	LSX TV AB-SB B	LSX TVFM AB-SB B	LSX TVI AB-SB B	LSX TVSAT AB-SB B	LSX SATN AB-SB B	LSX SATI AB-SB B
Black Nickel Frame/Black Nickel	LSX TV BK-BK B	LSX TVFM BK-BK B	LSX TVI BK-BK B	LSX TVSAT BK-BK B	LSX SATN BK-BK B	LSX SATI BK-BK B
Black Nickel Frame/Bright Steel	LSX TV BK-BS B	LSX TVFM BK-BS B	LSX TVI BK-BS B	LSX TVSAT BK-BS B	LSX SATN BK-BS B	LSX SATI BK-BS B
Black Nickel Frame/Polished Brass	LSX TV BK-PB B	LSX TVFM BK-PB B	LSX TVI BK-PB B	LSX TVSAT BK-PB B	LSX SATN BK-PB B	LSX SATI BK-PB B
Bright Chrome Frame/Black Nickel	LSX TV BC-BK B	LSX TVFM BC-BK B	LSX TVI BC-BK B	LSX TVSAT BC-BK B	LSX SATN BC-BK B	LSX SATI BC-BK B
Bright Chrome Frame/Bright Steel	LSX TV BC-BS B	LSX TVFM BC-BS B	LSX TVI BC-BS B	LSX TVSAT BC-BS B	LSX SATN BC-BS B	LSX SATI BC-BS B
Bright Chrome Frame/Bright Steel	LSX TV BC-BS W	LSX TVFM BC-BS W	LSX TVI BC-BS W	LSX TVSAT BC-BS W	LSX SATN BC-BS W	LSX SATI BC-BS W
Bright Chrome Frame/Piano Black	LSX TV BC-N B	LSX TVFM BC-N B	LSX TVI BC-N B	LSX TVSAT BC-N B	LSX SATN BC-N B	LSX SATI BC-N B
Bright Chrome Frame/Polished Brass	LSX TV BC-PB B	LSX TVFM BC-PB B	LSX TVI BC-PB B	LSX TVSAT BC-PB B	LSX SATN BC-PB B	LSX SATI BC-PB B
Bright Chrome Frame/Polished Brass	LSX TV BC-PB W	LSX TVFM BC-PB W	LSX TVI BC-PB W	LSX TVSAT BC-PB W	LSX SATN BC-PB W	LSX SATI BC-PB W
Bright Chrome Frame/Satin Steel	LSX TV BC-SS B	LSX TVFM BC-SS B	LSX TVI BC-SS B	LSX TVSAT BC-SS B	LSX SATN BC-SS B	LSX SATI BC-SS B
Bright Chrome Frame/Satin Steel	LSX TV BC-SS W	LSX TVFM BC-SS W	LSX TVI BC-SS W	LSX TVSAT BC-SS W	LSX SATN BC-SS W	LSX SATI BC-SS W
Connaught Bronze Frame/Connaught Bronze	LSX TV HB-HB B	LSX TVFM HB-HB B	LSX TVI HB-HB B	LSX TVSAT HB-HB B	LSX SATN HB-HB B	LSX SATI HB-HB B
Copper Bronze Frame/Copper Bronze	LSX TV CB-CB B	LSX TVFM CB-CB B	LSX TVI CB-CB B	LSX TVSAT CB-CB B	LSX SATN CB-CB B	LSX SATI CB-CB B
Etrium Bronze Frame/Etrium Bronze	LSX TV EB-EB B	LSX TVFM EB-EB B	LSX TVI EB-EB B	LSX TVSAT EB-EB B	LSX SATN EB-EB B	LSX SATI EB-EB B
Polished Brass Frame/Antique Brass	LSX TV PB-AB B	LSX TVFM PB-AB B	LSX TVI PB-AB B	LSX TVSAT PB-AB B	LSX SATN PB-AB B	LSX SATI PB-AB B
Polished Brass Frame/Antique Brass	LSX TV PB-AB W	LSX TVFM PB-AB W	LSX TVI PB-AB W	LSX TVSAT PB-AB W	LSX SATN PB-AB W	LSX SATI PB-AB W
Polished Brass Frame/Bright Steel	LSX TV PB-BS B	LSX TVFM PB-BS B	LSX TVI PB-BS B	LSX TVSAT PB-BS B	LSX SATN PB-BS B	LSX SATI PB-BS B
Polished Brass Frame/Bright Steel	LSX TV PB-BS W	LSX TVFM PB-BS W	LSX TVI PB-BS W	LSX TVSAT PB-BS W	LSX SATN PB-BS W	LSX SATI PB-BS W
Polished Brass Frame/Polished Brass	LSX TV PB-PB B	LSX TVFM PB-PB B	LSX TVI PB-PB B	LSX TVSAT PB-PB B	LSX SATN PB-PB B	LSX SATI PB-PB B
Polished Brass Frame/Polished Brass	LSX TV PB-PB W	LSX TVFM PB-PB W	LSX TVI PB-PB W	LSX TVSAT PB-PB W	LSX SATN PB-PB W	LSX SATI PB-PB W
Polished Brass Frame/Satin Brass	LSX TV PB-SB B	LSX TVFM PB-SB B	LSX TVI PB-SB B	LSX TVSAT PB-SB B	LSX SATN PB-SB B	LSX SATI PB-SB B
Polished Brass Frame/Satin Brass	LSX TV PB-SB W	LSX TVFM PB-SB W	LSX TVI PB-SB W	LSX TVSAT PB-SB W	LSX SATN PB-SB W	LSX SATI PB-SB W
Polished Brass Frame/Satin Steel	LSX TV PB-SS B	LSX TVFM PB-SS B	LSX TVI PB-SS B	LSX TVSAT PB-SS B	LSX SATN PB-SS B	LSX SATI PB-SS B
Polished Brass Frame/Satin Steel	LSX TV PB-SS W	LSX TVFM PB-SS W	LSX TVI PB-SS W	LSX TVSAT PB-SS W	LSX SATN PB-SS W	LSX SATI PB-SS W
Richmond Bronze Frame/Richmond Bronze	LSX TV RB-RB B	LSX TVFM RB-RB B	LSX TVI RB-RB B	LSX TVSAT RB-RB B	LSX SATN RB-RB B	LSX SATI RB-RB B
Satin Brass Frame/Satin Brass	LSX TV SB-SB B	LSX TVFM SB-SB B	LSX TVI SB-SB B	LSX TVSAT SB-SB B	LSX SATN SB-SB B	LSX SATI SB-SB B
Satin Brass Frame/Satin Brass	LSX TV SB-SB W	LSX TVFM SB-SB W	LSX TVI SB-SB W	LSX TVSAT SB-SB W	LSX SATN SB-SB W	LSX SATI SB-SB W
Satin Brass Frame/Satin Steel	LSX TV SB-SS B	LSX TVFM SB-SS B	LSX TVI SB-SS B	LSX TVSAT SB-SS B	LSX SATN SB-SS B	LSX SATI SB-SS B
Satin Brass Frame/Satin Steel	LSX TV SB-SS W	LSX TVFM SB-SS W	LSX TVI SB-SS W	LSX TVSAT SB-SS W	LSX SATN SB-SS W	LSX SATI SB-SS W
Satin Nickel Frame/Bright Steel	LSX TV SN-BS B	LSX TVFM SN-BS B	LSX TVI SN-BS B	LSX TVSAT SN-BS B	LSX SATN SN-BS B	LSX SATI SN-BS B
Satin Nickel Frame/Bright Steel	LSX TV SN-BS W	LSX TVFM SN-BS W	LSX TVI SN-BS W	LSX TVSAT SN-BS W	LSX SATN SN-BS W	LSX SATI SN-BS W
Satin Nickel Frame/Satin Steel	LSX TV SN-SS B	LSX TVFM SN-SS B	LSX TVI SN-SS B	LSX TVSAT SN-SS B	LSX SATN SN-SS B	LSX SATI SN-SS B
Satin Nickel Frame/Satin Steel	LSX TV SN-SS W	LSX TVFM SN-SS W	LSX TVI SN-SS W	LSX TVSAT SN-SS W	LSX SATN SN-SS W	LSX SATI SN-SS W
Nominal Size: Minimum Wall Box Depth: Technical Insert Ref:	91.5mm x 91.5mm 25mm TV	91.5mm x 91.5mm 25mm TVFM	91.5mm x 91.5mm 25mm TVI	91.5mm x 91.5mm 35mm TVSAT	91.5mm x 91.5mm 35mm SATN	91.5mm x 91.5mm 35mm SATI

Insert Surround Colour Key: (B) Black, (W) White

Linea-Scala CFX

Digital Television Sockets

- Screened Non Isolated / DAB Compatible



LSX DGENT AB-AB B



LSX DTVF BC-BS W



LSX DTVM BK-BS B



Non-Isolated
TV+FM+SAT Triplexer
1in/3out (DAB
Compatible)



1 gang Non-Isolated
TV (female) (DAB
Compatible)



1 gang Non-Isolated
TV (Male) (DAB
Compatible)

Frame / Front Plate	Non-Isolated TV+FM+SAT Triplexer 1in/3out (DAB Compatible)	1 gang Non-Isolated TV (female) (DAB Compatible)	1 gang Non-Isolated TV (Male) (DAB Compatible)
Antique Brass Frame/Antique Brass	LSX DTRID AB-AB B	LSX DTVF AB-AB B	LSX DTVM AB-AB B
Antique Brass Frame/Satin Brass	LSX DTRID AB-SB B	LSX DTVF AB-SB B	LSX DTVM AB-SB B
Black Nickel Frame/Black Nickel	LSX DTRID BK-BK B	LSX DTVF BK-BK B	LSX DTVM BK-BK B
Black Nickel Frame/Bright Steel	LSX DTRID BK-BS B	LSX DTVF BK-BS B	LSX DTVM BK-BS B
Black Nickel Frame/Polished Brass	LSX DTRID BK-PB B	LSX DTVF BK-PB B	LSX DTVM BK-PB B
Bright Chrome Frame/Black Nickel	LSX DTRID BC-BK B	LSX DTVF BC-BK B	LSX DTVM BC-BK B
Bright Chrome Frame/Bright Steel	LSX DTRID BC-BS B	LSX DTVF BC-BS B	LSX DTVM BC-BS B
Bright Chrome Frame/Bright Steel	LSX DTRID BC-BS W	LSX DTVF BC-BS W	LSX DTVM BC-BS W
Bright Chrome Frame/Piano Black	LSX DTRID BC-NB	LSX DTVF BC-NB	LSX DTVM BC-NB
Bright Chrome Frame/Polished Brass	LSX DTRID BC-PB B	LSX DTVF BC-PB B	LSX DTVM BC-PB B
Bright Chrome Frame/Polished Brass	LSX DTRID BC-PB W	LSX DTVF BC-PB W	LSX DTVM BC-PB W
Bright Chrome Frame/Satin Steel	LSX DTRID BC-SS B	LSX DTVF BC-SS B	LSX DTVM BC-SS B
Bright Chrome Frame/Satin Steel	LSX DTRID BC-SS W	LSX DTVF BC-SS W	LSX DTVM BC-SS W
Connaught Bronze Frame/Connaught Bronze	LSX DTRID HB-HB B	LSX DTVF HB-HB B	LSX DTVM HB-HB B
Copper Bronze Frame/Copper Bronze	LSX DTRID CB-CB B	LSX DTVF CB-CB B	LSX DTVM CB-CB B
Etrium Bronze Frame/Etrium Bronze	LSX DTRID EB-EB B	LSX DTVF EB-EB B	LSX DTVM EB-EB B
Polished Brass Frame/Antique Brass	LSX DTRID PB-AB B	LSX DTVF PB-AB B	LSX DTVM PB-AB B
Polished Brass Frame/Antique Brass	LSX DTRID PB-AB W	LSX DTVF PB-AB W	LSX DTVM PB-AB W
Polished Brass Frame/Bright Steel	LSX DTRID PB-BS B	LSX DTVF PB-BS B	LSX DTVM PB-BS B
Polished Brass Frame/Bright Steel	LSX DTRID PB-BS W	LSX DTVF PB-BS W	LSX DTVM PB-BS W
Polished Brass Frame/Polished Brass	LSX DTRID PB-PB B	LSX DTVF PB-PB B	LSX DTVM PB-PB B
Polished Brass Frame/Polished Brass	LSX DTRID PB-PB W	LSX DTVF PB-PB W	LSX DTVM PB-PB W
Polished Brass Frame/Satin Brass	LSX DTRID PB-SB B	LSX DTVF PB-SB B	LSX DTVM PB-SB B
Polished Brass Frame/Satin Brass	LSX DTRID PB-SB W	LSX DTVF PB-SB W	LSX DTVM PB-SB W
Polished Brass Frame/Satin Steel	LSX DTRID PB-SS B	LSX DTVF PB-SS B	LSX DTVM PB-SS B
Polished Brass Frame/Satin Steel	LSX DTRID PB-SS W	LSX DTVF PB-SS W	LSX DTVM PB-SS W
Richmond Bronze Frame/Richmond Bronze	LSX DTRID RB-RB B	LSX DTVF RB-RB B	LSX DTVM RB-RB B
Satin Brass Frame/Satin Brass	LSX DTRID SB-SB B	LSX DTVF SB-SB B	LSX DTVM SB-SB B
Satin Brass Frame/Satin Brass	LSX DTRID SB-SB W	LSX DTVF SB-SB W	LSX DTVM SB-SB W
Satin Brass Frame/Satin Steel	LSX DTRID SB-SS B	LSX DTVF SB-SS B	LSX DTVM SB-SS B
Satin Brass Frame/Satin Steel	LSX DTRID SB-SS W	LSX DTVF SB-SS W	LSX DTVM SB-SS W
Satin Nickel Frame/Bright Steel	LSX DTRID SN-BS B	LSX DTVF SN-BS B	LSX DTVM SN-BS B
Satin Nickel Frame/Bright Steel	LSX DTRID SN-BS W	LSX DTVF SN-BS W	LSX DTVM SN-BS W
Satin Nickel Frame/Satin Steel	LSX DTRID SN-SS B	LSX DTVF SN-SS B	LSX DTVM SN-SS B
Satin Nickel Frame/Satin Steel	LSX DTRID SN-SS W	LSX DTVF SN-SS W	LSX DTVM SN-SS W
Nominal Size:	91.5mm x 91.5mm	91.5mm x 91.5mm	91.5mm x 91.5mm
Minimum Wall Box Depth:	35mm	35mm	35mm
Technical Insert Ref:	DTRID	DTVF	DTVM

Insert Surround Colour Key: (B) Black, (W) White

Linea-Scala CFX

Digital Television Sockets

- Screened Non Isolated / DAB Compatible

LINEA-SCALA CFX RANGE



LSX DSAT BC-PB W



LSX DENT BK-BS B



LSX DSAT+ SN-BS W



1 gang Non-Isolated
Satellite (DAB
Compatible)



Non-Isolated
TV+FM+SAT1+SAT2
Quadplexer 2in/4out
(DAB Compatible)

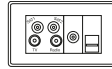

Non-Isolated
TV+FM+SAT1+SAT2
Quadplexer 2in/4out
+TVF+TCS (DAB
Compatible)

Frame / Front Plate

Antique Brass Frame/Antique Brass	LSX DSAT AB-AB B	LSX DENT AB-AB B	LSX DSAT+ AB-AB B
Antique Brass Frame/Satin Brass	LSX DSAT AB-SB B	LSX DENT AB-SB B	LSX DSAT+ AB-SB B
Black Nickel Frame/Black Nickel	LSX DSAT BK-BK B	LSX DENT BK-BK B	LSX DSAT+ BK-BK B
Black Nickel Frame/Bright Steel	LSX DSAT BK-BS B	LSX DENT BK-BS B	LSX DSAT+ BK-BS B
Black Nickel Frame/Polished Brass	LSX DSAT BK-PB B	LSX DENT BK-PB B	LSX DSAT+ BK-PB B
Bright Chrome Frame/Black Nickel	LSX DSAT BC-BK B	LSX DENT BC-BK B	LSX DSAT+ BC-BK B
Bright Chrome Frame/Bright Steel	LSX DSAT BC-BS B	LSX DENT BC-BS B	LSX DSAT+ BC-BS B
Bright Chrome Frame/Bright Steel	LSX DSAT BC-BS W	LSX DENT BC-BS W	LSX DSAT+ BC-BS W
Bright Chrome Frame/Piano Black	LSX DSAT BC-N B	LSX DENT BC-N B	LSX DSAT+ BC-N B
Bright Chrome Frame/Polished Brass	LSX DSAT BC-PB B	LSX DENT BC-PB B	LSX DSAT+ BC-PB B
Bright Chrome Frame/Polished Brass	LSX DSAT BC-PB W	LSX DENT BC-PB W	LSX DSAT+ BC-PB W
Bright Chrome Frame/Satin Steel	LSX DSAT BC-SS B	LSX DENT BC-SS B	LSX DSAT+ BC-SS B
Bright Chrome Frame/Satin Steel	LSX DSAT BC-SS W	LSX DENT BC-SS W	LSX DSAT+ BC-SS W
Connaught Bronze Frame/Connaught Bronze	LSX DSAT HB-HB B	LSX DENT HB-HB B	LSX DSAT+ HB-HB B
Copper Bronze Frame/Copper Bronze	LSX DSAT CB-CB B	LSX DENT CB-CB B	LSX DSAT+ CB-CB B
Etrium Bronze Frame/Etrium Bronze	LSX DSAT EB-EB B	LSX DENT EB-EB B	LSX DSAT+ EB-EB B
Polished Brass Frame/Antique Brass	LSX DSAT PB-AB B	LSX DENT PB-AB B	LSX DSAT+ PB-AB B
Polished Brass Frame/Antique Brass	LSX DSAT PB-AB W	LSX DENT PB-AB W	LSX DSAT+ PB-AB W
Polished Brass Frame/Bright Steel	LSX DSAT PB-BS B	LSX DENT PB-BS B	LSX DSAT+ PB-BS B
Polished Brass Frame/Bright Steel	LSX DSAT PB-BS W	LSX DENT PB-BS W	LSX DSAT+ PB-BS W
Polished Brass Frame/Polished Brass	LSX DSAT PB-PB B	LSX DENT PB-PB B	LSX DSAT+ PB-PB B
Polished Brass Frame/Polished Brass	LSX DSAT PB-PB W	LSX DENT PB-PB W	LSX DSAT+ PB-PB W
Polished Brass Frame/Satin Brass	LSX DSAT PB-SB B	LSX DENT PB-SB B	LSX DSAT+ PB-SB B
Polished Brass Frame/Satin Brass	LSX DSAT PB-SB W	LSX DENT PB-SB W	LSX DSAT+ PB-SB W
Polished Brass Frame/Satin Steel	LSX DSAT PB-SS B	LSX DENT PB-SS B	LSX DSAT+ PB-SS B
Polished Brass Frame/Satin Steel	LSX DSAT PB-SS W	LSX DENT PB-SS W	LSX DSAT+ PB-SS W
Richmond Bronze Frame/Richmond Bronze	LSX DSAT RB-RB B	LSX DENT RB-RB B	LSX DSAT+ RB-RB B
Satin Brass Frame/Satin Brass	LSX DSAT SB-SB B	LSX DENT SB-SB B	LSX DSAT+ SB-SB B
Satin Brass Frame/Satin Brass	LSX DSAT SB-SB W	LSX DENT SB-SB W	LSX DSAT+ SB-SB W
Satin Brass Frame/Satin Steel	LSX DSAT SB-SS B	LSX DENT SB-SS B	LSX DSAT+ SB-SS B
Satin Brass Frame/Satin Steel	LSX DSAT SB-SS W	LSX DENT SB-SS W	LSX DSAT+ SB-SS W
Satin Nickel Frame/Bright Steel	LSX DSAT SN-BS B	LSX DENT SN-BS B	LSX DSAT+ SN-BS B
Satin Nickel Frame/Bright Steel	LSX DSAT SN-BS W	LSX DENT SN-BS W	LSX DSAT+ SN-BS W
Satin Nickel Frame/Satin Steel	LSX DSAT SN-SS B	LSX DENT SN-SS B	LSX DSAT+ SN-SS B
Satin Nickel Frame/Satin Steel	LSX DSAT SN-SS W	LSX DENT SN-SS W	LSX DSAT+ SN-SS W
Nominal Size:	91.5mm x 91.5mm	91.5mm x 91.5mm	150.5mm x 91.5mm
Minimum Wall Box Depth:	35mm	35mm	35mm
Technical Insert Ref:	DSAT	DENT	DSAT+

Insert Surround Colour Key: (B) Black, (W) White

Linea-Scala CFX

Telephone and Data Outlets



LSX TCM CB-CB B









LSX TCS BK-BK B



LSX 2J12 BC-PB W



LSX 2J45 HB-HB B

Frame / Front Plate	 1 gang Telephone Master	 1 gang Telephone Slave	 1 gang RJ12 Outlet - Unshielded	 2 gang RJ12 Outlet - Unshielded	 1 gang RJ45 CAT 5E Outlet - Unshielded	 2 gang RJ45 CAT 5E Outlet - Unshielded
Antique Brass Frame/Antique Brass	LSX TCM AB-AB B	LSX TCS AB-AB B	LSX J12 AB-AB B	LSX 2J12 AB-AB B	LSX J45 AB-AB B	LSX 2J45 AB-AB B
Antique Brass Frame/Satin Brass	LSX TCM AB-SB B	LSX TCS AB-SB B	LSX J12 AB-SB B	LSX 2J12 AB-SB B	LSX J45 AB-SB B	LSX 2J45 AB-SB B
Black Nickel Frame/Black Nickel	LSX TCM BK-BK B	LSX TCS BK-BK B	LSX J12 BK-BK B	LSX 2J12 BK-BK B	LSX J45 BK-BK B	LSX 2J45 BK-BK B
Black Nickel Frame/Bright Steel	LSX TCM BK-BS B	LSX TCS BK-BS B	LSX J12 BK-BS B	LSX 2J12 BK-BS B	LSX J45 BK-BS B	LSX 2J45 BK-BS B
Black Nickel Frame/Polished Brass	LSX TCM BK-PB B	LSX TCS BK-PB B	LSX J12 BK-PB B	LSX 2J12 BK-PB B	LSX J45 BK-PB B	LSX 2J45 BK-PB B
Bright Chrome Frame/Black Nickel	LSX TCM BC-BK B	LSX TCS BC-BK B	LSX J12 BC-BK B	LSX 2J12 BC-BK B	LSX J45 BC-BK B	LSX 2J45 BC-BK B
Bright Chrome Frame/Bright Steel	LSX TCM BC-BS B	LSX TCS BC-BS B	LSX J12 BC-BS B	LSX 2J12 BC-BS B	LSX J45 BC-BS B	LSX 2J45 BC-BS B
Bright Chrome Frame/Bright Steel	LSX TCM BC-BS W	LSX TCS BC-BS W	LSX J12 BC-BS W	LSX 2J12 BC-BS W	LSX J45 BC-BS W	LSX 2J45 BC-BS W
Bright Chrome Frame/Piano Black	LSX TCM BC-NB	LSX TCS BC-NB	LSX J12 BC-NB	LSX 2J12 BC-NB	LSX J45 BC-NB	LSX 2J45 BC-NB
Bright Chrome Frame/Polished Brass	LSX TCM BC-PB B	LSX TCS BC-PB B	LSX J12 BC-PB B	LSX 2J12 BC-PB B	LSX J45 BC-PB B	LSX 2J45 BC-PB B
Bright Chrome Frame/Polished Brass	LSX TCM BC-PB W	LSX TCS BC-PB W	LSX J12 BC-PB W	LSX 2J12 BC-PB W	LSX J45 BC-PB W	LSX 2J45 BC-PB W
Bright Chrome Frame/Satin Steel	LSX TCM BC-SS B	LSX TCS BC-SS B	LSX J12 BC-SS B	LSX 2J12 BC-SS B	LSX J45 BC-SS B	LSX 2J45 BC-SS B
Bright Chrome Frame/Satin Steel	LSX TCM BC-SS W	LSX TCS BC-SS W	LSX J12 BC-SS W	LSX 2J12 BC-SS W	LSX J45 BC-SS W	LSX 2J45 BC-SS W
Connaught Bronze Frame/Connaught Bronze	LSX TCM HB-HB B	LSX TCS HB-HB B	LSX J12 HB-HB B	LSX 2J12 HB-HB B	LSX J45 HB-HB B	LSX 2J45 HB-HB B
Copper Bronze Frame/Copper Bronze	LSX TCM CB-CB B	LSX TCS CB-CB B	LSX J12 CB-CB B	LSX 2J12 CB-CB B	LSX J45 CB-CB B	LSX 2J45 CB-CB B
Etrium Bronze Frame/Etrium Bronze	LSX TCM EB-EB B	LSX TCS EB-EB B	LSX J12 EB-EB B	LSX 2J12 EB-EB B	LSX J45 EB-EB B	LSX 2J45 EB-EB B
Polished Brass Frame/Antique Brass	LSX TCM PB-AB B	LSX TCS PB-AB B	LSX J12 PB-AB B	LSX 2J12 PB-AB B	LSX J45 PB-AB B	LSX 2J45 PB-AB B
Polished Brass Frame/Antique Brass	LSX TCM PB-AB W	LSX TCS PB-AB W	LSX J12 PB-AB W	LSX 2J12 PB-AB W	LSX J45 PB-AB W	LSX 2J45 PB-AB W
Polished Brass Frame/Bright Steel	LSX TCM PB-BS B	LSX TCS PB-BS B	LSX J12 PB-BS B	LSX 2J12 PB-BS B	LSX J45 PB-BS B	LSX 2J45 PB-BS B
Polished Brass Frame/Bright Steel	LSX TCM PB-BS W	LSX TCS PB-BS W	LSX J12 PB-BS W	LSX 2J12 PB-BS W	LSX J45 PB-BS W	LSX 2J45 PB-BS W
Polished Brass Frame/Polished Brass	LSX TCM PB-PB B	LSX TCS PB-PB B	LSX J12 PB-PB B	LSX 2J12 PB-PB B	LSX J45 PB-PB B	LSX 2J45 PB-PB B
Polished Brass Frame/Polished Brass	LSX TCM PB-PB W	LSX TCS PB-PB W	LSX J12 PB-PB W	LSX 2J12 PB-PB W	LSX J45 PB-PB W	LSX 2J45 PB-PB W
Polished Brass Frame/Satin Brass	LSX TCM PB-SB B	LSX TCS PB-SB B	LSX J12 PB-SB B	LSX 2J12 PB-SB B	LSX J45 PB-SB B	LSX 2J45 PB-SB B
Polished Brass Frame/Satin Brass	LSX TCM PB-SB W	LSX TCS PB-SB W	LSX J12 PB-SB W	LSX 2J12 PB-SB W	LSX J45 PB-SB W	LSX 2J45 PB-SB W
Polished Brass Frame/Satin Steel	LSX TCM PB-SS B	LSX TCS PB-SS B	LSX J12 PB-SS B	LSX 2J12 PB-SS B	LSX J45 PB-SS B	LSX 2J45 PB-SS B
Polished Brass Frame/Satin Steel	LSX TCM PB-SS W	LSX TCS PB-SS W	LSX J12 PB-SS W	LSX 2J12 PB-SS W	LSX J45 PB-SS W	LSX 2J45 PB-SS W
Richmond Bronze Frame/Richmond Bronze	LSX TCM RB-RB B	LSX TCS RB-RB B	LSX J12 RB-RB B	LSX 2J12 RB-RB B	LSX J45 RB-RB B	LSX 2J45 RB-RB B
Satin Brass Frame/Satin Brass	LSX TCM SB-SB B	LSX TCS SB-SB B	LSX J12 SB-SB B	LSX 2J12 SB-SB B	LSX J45 SB-SB B	LSX 2J45 SB-SB B
Satin Brass Frame/Satin Brass	LSX TCM SB-SB W	LSX TCS SB-SB W	LSX J12 SB-SB W	LSX 2J12 SB-SB W	LSX J45 SB-SB W	LSX 2J45 SB-SB W
Satin Brass Frame/Satin Steel	LSX TCM SB-SS B	LSX TCS SB-SS B	LSX J12 SB-SS B	LSX 2J12 SB-SS B	LSX J45 SB-SS B	LSX 2J45 SB-SS B
Satin Brass Frame/Satin Steel	LSX TCM SB-SS W	LSX TCS SB-SS W	LSX J12 SB-SS W	LSX 2J12 SB-SS W	LSX J45 SB-SS W	LSX 2J45 SB-SS W
Satin Nickel Frame/Bright Steel	LSX TCM SN-BS B	LSX TCS SN-BS B	LSX J12 SN-BS B	LSX 2J12 SN-BS B	LSX J45 SN-BS B	LSX 2J45 SN-BS B
Satin Nickel Frame/Bright Steel	LSX TCM SN-BS W	LSX TCS SN-BS W	LSX J12 SN-BS W	LSX 2J12 SN-BS W	LSX J45 SN-BS W	LSX 2J45 SN-BS W
Satin Nickel Frame/Satin Steel	LSX TCM SN-SS B	LSX TCS SN-SS B	LSX J12 SN-SS B	LSX 2J12 SN-SS B	LSX J45 SN-SS B	LSX 2J45 SN-SS B
Satin Nickel Frame/Satin Steel	LSX TCM SN-SS W	LSX TCS SN-SS W	LSX J12 SN-SS W	LSX 2J12 SN-SS W	LSX J45 SN-SS W	LSX 2J45 SN-SS W
Nominal Size:	91.5mm x 91.5mm	91.5mm x 91.5mm	91.5mm x 91.5mm	91.5mm x 91.5mm	91.5mm x 91.5mm	91.5mm x 91.5mm
Minimum Wall Box Depth:	25mm	25mm	35mm	35mm	35mm	35mm
Technical Insert Ref:	TCM	TCS	J12	2J12	J45	2J45

Insert Surround Colour Key: (B) Black, (W) White

Linea-Scala CFX

Double Pole Switches



LSX DPN BC-BK B



LSX 45N BC-PB W



LSX 45SS1 BK-BK B



1 gang 20AX Double Pole Rocker + Neon



1 gang 45A Double Pole Red Rocker + Neon

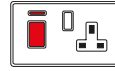

45A Double Pole Red Rocker + Neon + 13A Switched Socket

Frame / Front Plate	1 gang 20AX Double Pole Rocker + Neon	1 gang 45A Double Pole Red Rocker + Neon	45A Double Pole Red Rocker + Neon + 13A Switched Socket
Antique Brass Frame/Antique Brass	LSX DPN AB-AB B	LSX 45N AB-AB B	LSX 45SS1 AB-AB B
Antique Brass Frame/Satin Brass	LSX DPN AB-SB B	LSX 45N AB-SB B	LSX 45SS1 AB-SB B
Black Nickel Frame/Black Nickel	LSX DPN BK-BK B	LSX 45N BK-BK B	LSX 45SS1 BK-BK B
Black Nickel Frame/Bright Steel	LSX DPN BK-BS B	LSX 45N BK-BS B	LSX 45SS1 BK-BS B
Black Nickel Frame/Polished Brass	LSX DPN BK-PB B	LSX 45N BK-PB B	LSX 45SS1 BK-PB B
Bright Chrome Frame/Black Nickel	LSX DPN BC-BK B	LSX 45N BC-BK B	LSX 45SS1 BC-BK B
Bright Chrome Frame/Bright Steel	LSX DPN BC-BS B	LSX 45N BC-BS B	LSX 45SS1 BC-BS B
Bright Chrome Frame/Bright Steel	LSX DPN BC-BS W	LSX 45N BC-BS W	LSX 45SS1 BC-BS W
Bright Chrome Frame/Piano Black	LSX DPN BC-NB	LSX 45N BC-NB	LSX 45SS1 BC-NB
Bright Chrome Frame/Polished Brass	LSX DPN BC-PB B	LSX 45N BC-PB B	LSX 45SS1 BC-PB B
Bright Chrome Frame/Polished Brass	LSX DPN BC-PB W	LSX 45N BC-PB W	LSX 45SS1 BC-PB W
Bright Chrome Frame/Satin Steel	LSX DPN BC-SS B	LSX 45N BC-SS B	LSX 45SS1 BC-SS B
Bright Chrome Frame/Satin Steel	LSX DPN BC-SS W	LSX 45N BC-SS W	LSX 45SS1 BC-SS W
Connaught Bronze Frame/Connaught Bronze	LSX DPN HB-HB B	LSX 45N HB-HB B	LSX 45SS1 HB-HB B
Copper Bronze Frame/Copper Bronze	LSX DPN CB-CB B	LSX 45N CB-CB B	LSX 45SS1 CB-CB B
Etrium Bronze Frame/Etrium Bronze	LSX DPN EB-EB B	LSX 45N EB-EB B	LSX 45SS1 EB-EB B
Polished Brass Frame/Antique Brass	LSX DPN PB-AB B	LSX 45N PB-AB B	LSX 45SS1 PB-AB B
Polished Brass Frame/Antique Brass	LSX DPN PB-AB W	LSX 45N PB-AB W	LSX 45SS1 PB-AB W
Polished Brass Frame/Bright Steel	LSX DPN PB-BS B	LSX 45N PB-BS B	LSX 45SS1 PB-BS B
Polished Brass Frame/Bright Steel	LSX DPN PB-BS W	LSX 45N PB-BS W	LSX 45SS1 PB-BS W
Polished Brass Frame/Polished Brass	LSX DPN PB-PB B	LSX 45N PB-PB B	LSX 45SS1 PB-PB B
Polished Brass Frame/Polished Brass	LSX DPN PB-PB W	LSX 45N PB-PB W	LSX 45SS1 PB-PB W
Polished Brass Frame/Satin Brass	LSX DPN PB-SB B	LSX 45N PB-SB B	LSX 45SS1 PB-SB B
Polished Brass Frame/Satin Brass	LSX DPN PB-SB W	LSX 45N PB-SB W	LSX 45SS1 PB-SB W
Polished Brass Frame/Satin Steel	LSX DPN PB-SS B	LSX 45N PB-SS B	LSX 45SS1 PB-SS B
Polished Brass Frame/Satin Steel	LSX DPN PB-SS W	LSX 45N PB-SS W	LSX 45SS1 PB-SS W
Richmond Bronze Frame/Richmond Bronze	LSX DPN RB-RB B	LSX 45N RB-RB B	LSX 45SS1 RB-RB B
Satin Brass Frame/Satin Brass	LSX DPN SB-SB B	LSX 45N SB-SB B	LSX 45SS1 SB-SB B
Satin Brass Frame/Satin Brass	LSX DPN SB-SB W	LSX 45N SB-SB W	LSX 45SS1 SB-SB W
Satin Brass Frame/Satin Steel	LSX DPN SB-SS B	LSX 45N SB-SS B	LSX 45SS1 SB-SS B
Satin Brass Frame/Satin Steel	LSX DPN SB-SS W	LSX 45N SB-SS W	LSX 45SS1 SB-SS W
Satin Nickel Frame/Bright Steel	LSX DPN SN-BS B	LSX 45N SN-BS B	LSX 45SS1 SN-BS B
Satin Nickel Frame/Bright Steel	LSX DPN SN-BS W	LSX 45N SN-BS W	LSX 45SS1 SN-BS W
Satin Nickel Frame/Satin Steel	LSX DPN SN-SS B	LSX 45N SN-SS B	LSX 45SS1 SN-SS B
Satin Nickel Frame/Satin Steel	LSX DPN SN-SS W	LSX 45N SN-SS W	LSX 45SS1 SN-SS W
Nominal Size:	91.5mm x 91.5mm	91.5mm x 91.5mm	150.5mm x 91.5mm
Minimum Wall Box Depth:	35mm	35mm	35mm
Technical Insert Ref:	DPN	45N	45SS1

Insert Surround Colour Key: (B) Black, (W) White

Linea-Scala CFX

Connection Units



LSX SPN BK-BK B



LSX FN SN-SS R



1 gang 13A Double Pole Fused Spur + Neon



1 gang 13A Fuse with Red Neon Halo

Frame / Front Plate	1 gang 13A Double Pole Fused Spur + Neon	1 gang 13A Fuse with Red Neon Halo
Antique Brass Frame/Antique Brass	LSX SPN AB-AB B	LSX FN AB-AB R
Antique Brass Frame/Satin Brass	LSX SPN AB-SB B	LSX FN AB-SB R
Black Nickel Frame/Black Nickel	LSX SPN BK-BK B	LSX FN BK-BK R
Black Nickel Frame/Bright Steel	LSX SPN BK-BS B	LSX FN BK-BS R
Black Nickel Frame/Polished Brass	LSX SPN BK-PB B	LSX FN BK-PB R
Bright Chrome Frame/Black Nickel	LSX SPN BC-BK B	LSX FN BC-BK R
Bright Chrome Frame/Bright Steel	LSX SPN BC-BS B	LSX FN BC-BS R
Bright Chrome Frame/Bright Steel	LSX SPN BC-BS W	-
Bright Chrome Frame/Piano Black	LSX SPN BC-NB	LSX FN BC-N R
Bright Chrome Frame/Polished Brass	LSX SPN BC-PB B	LSX FN BC-PB R
Bright Chrome Frame/Polished Brass	LSX SPN BC-PB W	-
Bright Chrome Frame/Satin Steel	LSX SPN BC-SS B	LSX FN BC-SS R
Bright Chrome Frame/Satin Steel	LSX SPN BC-SS W	-
Connaught Bronze Frame/Connaught Bronze	LSX SPN HB-HB B	LSX FN HB-HB R
Copper Bronze Frame/Copper Bronze	LSX SPN CB-CB B	LSX FN CB-CB R
Etrium Bronze Frame/Etrium Bronze	LSX SPN EB-EB B	LSX FN EB-EB R
Polished Brass Frame/Antique Brass	LSX SPN PB-AB B	LSX FN PB-AB R
Polished Brass Frame/Antique Brass	LSX SPN PB-AB W	-
Polished Brass Frame/Bright Steel	LSX SPN PB-BS B	LSX FN PB-BS R
Polished Brass Frame/Bright Steel	LSX SPN PB-BS W	-
Polished Brass Frame/Polished Brass	LSX SPN PB-PB B	LSX FN PB-PB R
Polished Brass Frame/Polished Brass	LSX SPN PB-PB W	-
Polished Brass Frame/Satin Brass	LSX SPN PB-SB B	LSX FN PB-SB R
Polished Brass Frame/Satin Brass	LSX SPN PB-SB W	-
Polished Brass Frame/Satin Steel	LSX SPN PB-SS B	LSX FN PB-SS R
Polished Brass Frame/Satin Steel	LSX SPN PB-SS W	-
Richmond Bronze Frame/Richmond Bronze	LSX SPN RB-RB B	LSX FN RB-RB R
Satin Brass Frame/Satin Brass	LSX SPN SB-SB B	LSX FN SB-SB R
Satin Brass Frame/Satin Brass	LSX SPN SB-SB W	-
Satin Brass Frame/Satin Steel	LSX SPN SB-SS B	LSX FN SB-SS R
Satin Brass Frame/Satin Steel	LSX SPN SB-SS W	-
Satin Nickel Frame/Bright Steel	LSX SPN SN-BS B	LSX FN SN-BS R
Satin Nickel Frame/Bright Steel	LSX SPN SN-BS W	-
Satin Nickel Frame/Satin Steel	LSX SPN SN-SS B	LSX FN SN-SS R
Satin Nickel Frame/Satin Steel	LSX SPN SN-SS W	-
Nominal Size:	91.5mm x 91.5mm	91.5mm x 91.5mm
Minimum Wall Box Depth:	35mm	35mm
Technical Insert Ref:	SPN	FN

Insert Surround Colour Key: (B) Black, (W) White

Linea-Scala CFX

LED Trailing/Leading Edge Push On/Off Rotary 2 Way Switching Dimmers

LINEA-SCALA CFX RANGE



LSX 1XLEDITB100 AB-SB



LSX 2XLEDITB100 BC-BK



LSX 3XLEDITB100 BC-BK



LSX 4XLEDITB100 BC-N



1 gang 100W LED Trailing/
Leading Edge Push On/
Off Rotary 2 Way Switching
Dimmer



2 gang 100W LED Trailing/
Leading Edge Push On/
Off Rotary 2 Way Switching
Dimmer

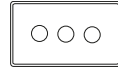

3 gang 100W LED Trailing/
Leading Edge Push On/
Off Rotary 2 Way Switching
Dimmer

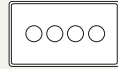

4 gang 100W LED Trailing/
Leading Edge Push On/
Off Rotary 2 Way Switching
Dimmer

Frame / Front Plate	1 gang 100W LED Trailing/ Leading Edge Push On/ Off Rotary 2 Way Switching Dimmer	2 gang 100W LED Trailing/ Leading Edge Push On/ Off Rotary 2 Way Switching Dimmer	3 gang 100W LED Trailing/ Leading Edge Push On/ Off Rotary 2 Way Switching Dimmer	4 gang 100W LED Trailing/ Leading Edge Push On/ Off Rotary 2 Way Switching Dimmer
Antique Brass Frame/Antique Brass	LSX 1XLEDITB100 AB-AB	LSX 2XLEDITB100 AB-AB	LSX 3XLEDITB100 AB-AB	LSX 4XLEDITB100 AB-AB
Antique Brass Frame/Satin Brass	LSX 1XLEDITB100 AB-SB	LSX 2XLEDITB100 AB-SB	LSX 3XLEDITB100 AB-SB	LSX 4XLEDITB100 AB-SB
Black Nickel Frame/Black Nickel	LSX 1XLEDITB100 BK-BK	LSX 2XLEDITB100 BK-BK	LSX 3XLEDITB100 BK-BK	LSX 4XLEDITB100 BK-BK
Black Nickel Frame/Bright Steel	LSX 1XLEDITB100 BK-BS	LSX 2XLEDITB100 BK-BS	LSX 3XLEDITB100 BK-BS	LSX 4XLEDITB100 BK-BS
Black Nickel Frame/Polished Brass	LSX 1XLEDITB100 BK-PB	LSX 2XLEDITB100 BK-PB	LSX 3XLEDITB100 BK-PB	LSX 4XLEDITB100 BK-PB
Bright Chrome Frame/Black Nickel	LSX 1XLEDITB100 BC-BK	LSX 2XLEDITB100 BC-BK	LSX 3XLEDITB100 BC-BK	LSX 4XLEDITB100 BC-BK
Bright Chrome Frame/Bright Steel	LSX 1XLEDITB100 BC-BS	LSX 2XLEDITB100 BC-BS	LSX 3XLEDITB100 BC-BS	LSX 4XLEDITB100 BC-BS
Bright Chrome Frame/Piano Black	LSX 1XLEDITB100 BC-N	LSX 2XLEDITB100 BC-N	LSX 3XLEDITB100 BC-N	LSX 4XLEDITB100 BC-N
Bright Chrome Frame/Polished Brass	LSX 1XLEDITB100 BC-PB	LSX 2XLEDITB100 BC-PB	LSX 3XLEDITB100 BC-PB	LSX 4XLEDITB100 BC-PB
Bright Chrome Frame/Satin Steel	LSX 1XLEDITB100 BC-SS	LSX 2XLEDITB100 BC-SS	LSX 3XLEDITB100 BC-SS	LSX 4XLEDITB100 BC-SS
Connaught Bronze Frame/Connaught Bronze	LSX 1XLEDITB100 HB-HB	LSX 2XLEDITB100 HB-HB	LSX 3XLEDITB100 HB-HB	LSX 4XLEDITB100 HB-HB
Copper Bronze Frame/Copper Bronze	LSX 1XLEDITB100 CB-CB	LSX 2XLEDITB100 CB-CB	LSX 3XLEDITB100 CB-CB	LSX 4XLEDITB100 CB-CB
Etrium Bronze Frame/Etrium Bronze	LSX 1XLEDITB100 EB-EB	LSX 2XLEDITB100 EB-EB	LSX 3XLEDITB100 EB-EB	LSX 4XLEDITB100 EB-EB
Polished Brass Frame/Antique Brass	LSX 1XLEDITB100 PB-AB	LSX 2XLEDITB100 PB-AB	LSX 3XLEDITB100 PB-AB	LSX 4XLEDITB100 PB-AB
Polished Brass Frame/Bright Steel	LSX 1XLEDITB100 PB-BS	LSX 2XLEDITB100 PB-BS	LSX 3XLEDITB100 PB-BS	LSX 4XLEDITB100 PB-BS
Polished Brass Frame/Polished Brass	LSX 1XLEDITB100 PB-PB	LSX 2XLEDITB100 PB-PB	LSX 3XLEDITB100 PB-PB	LSX 4XLEDITB100 PB-PB
Polished Brass Frame/Satin Brass	LSX 1XLEDITB100 PB-SB	LSX 2XLEDITB100 PB-SB	LSX 3XLEDITB100 PB-SB	LSX 4XLEDITB100 PB-SB
Polished Brass Frame/Satin Steel	LSX 1XLEDITB100 PB-SS	LSX 2XLEDITB100 PB-SS	LSX 3XLEDITB100 PB-SS	LSX 4XLEDITB100 PB-SS
Richmond Bronze Frame/Richmond Bronze	LSX 1XLEDITB100 RB-RB	LSX 2XLEDITB100 RB-RB	LSX 3XLEDITB100 RB-RB	LSX 4XLEDITB100 RB-RB
Satin Brass Frame/Satin Brass	LSX 1XLEDITB100 SB-SB	LSX 2XLEDITB100 SB-SB	LSX 3XLEDITB100 SB-SB	LSX 4XLEDITB100 SB-SB
Satin Brass Frame/Satin Steel	LSX 1XLEDITB100 SB-SS	LSX 2XLEDITB100 SB-SS	LSX 3XLEDITB100 SB-SS	LSX 4XLEDITB100 SB-SS
Satin Nickel Frame/Bright Steel	LSX 1XLEDITB100 SN-BS	LSX 2XLEDITB100 SN-BS	LSX 3XLEDITB100 SN-BS	LSX 4XLEDITB100 SN-BS
Satin Nickel Frame/Satin Steel	LSX 1XLEDITB100 SN-SS	LSX 2XLEDITB100 SN-SS	LSX 3XLEDITB100 SN-SS	LSX 4XLEDITB100 SN-SS
Nominal Size:	91.5mm x 91.5mm	91.5mm x 91.5mm	150.5mm x 91.5mm	150.5mm x 91.5mm
Minimum Wall Box Depth:	35mm	35mm	35mm	35mm
Technical Insert Ref:	1XLEDITB	2XLEDITB	3XLEDITB	4XLEDITB

NOTE: Tungsten filament GU10 lamps must be branded and with a fused base.
NOTE: Please refer to the Dimmer Technical Section for the max Wattage.
NOTE: Please contact our Technical Department for compatibility.

Linea-Scala CFX

LED Trailing/Leading Edge Push On/Off Rotary Multi-Way Dimmers



LSX 1X100LED AB-SB



LSX 2X100LED BC-BK



LSX 3X100LED BC-BS



LSX 4X100LED BC-N

Frame / Front Plate	1 gang 100W LED Trailing/Leading Edge Push On/Off Rotary Multi-Way Dimmer	2 gang 100W LED Trailing/Leading Edge Push On/Off Rotary Multi-Way Dimmer	3 gang 100W LED Trailing/Leading Edge Push On/Off Rotary Multi-Way Dimmer	4 gang 100W LED Trailing/Leading Edge Push On/Off Rotary Multi-Way Dimmer
Antique Brass Frame/Antique Brass	LSX 1X100LED AB-AB	LSX 2X100LED AB-AB	LSX 3X100LED AB-AB	LSX 4X100LED AB-AB
Antique Brass Frame/Satin Brass	LSX 1X100LED AB-SB	LSX 2X100LED AB-SB	LSX 3X100LED AB-SB	LSX 4X100LED AB-SB
Black Nickel Frame/Black Nickel	LSX 1X100LED BK-BK	LSX 2X100LED BK-BK	LSX 3X100LED BK-BK	LSX 4X100LED BK-BK
Black Nickel Frame/Bright Steel	LSX 1X100LED BK-BS	LSX 2X100LED BK-BS	LSX 3X100LED BK-BS	LSX 4X100LED BK-BS
Black Nickel Frame/Polished Brass	LSX 1X100LED BK-PB	LSX 2X100LED BK-PB	LSX 3X100LED BK-PB	LSX 4X100LED BK-PB
Bright Chrome Frame/Black Nickel	LSX 1X100LED BC-BK	LSX 2X100LED BC-BK	LSX 3X100LED BC-BK	LSX 4X100LED BC-BK
Bright Chrome Frame/Bright Steel	LSX 1X100LED BC-BS	LSX 2X100LED BC-BS	LSX 3X100LED BC-BS	LSX 4X100LED BC-BS
Bright Chrome Frame/Piano Black	LSX 1X100LED BC-N	LSX 2X100LED BC-N	LSX 3X100LED BC-N	LSX 4X100LED BC-N
Bright Chrome Frame/Polished Brass	LSX 1X100LED BC-PB	LSX 2X100LED BC-PB	LSX 3X100LED BC-PB	LSX 4X100LED BC-PB
Bright Chrome Frame/Satin Steel	LSX 1X100LED BC-SS	LSX 2X100LED BC-SS	LSX 3X100LED BC-SS	LSX 4X100LED BC-SS
Connaught Bronze Frame/Connaught Bronze	LSX 1X100LED HB-HB	LSX 2X100LED HB-HB	LSX 3X100LED HB-HB	LSX 4X100LED HB-HB
Copper Bronze Frame/Copper Bronze	LSX 1X100LED CB-CB	LSX 2X100LED CB-CB	LSX 3X100LED CB-CB	LSX 4X100LED CB-CB
Etrium Bronze Frame/Etrium Bronze	LSX 1X100LED EB-EB	LSX 2X100LED EB-EB	LSX 3X100LED EB-EB	LSX 4X100LED EB-EB
Polished Brass Frame/Antique Brass	LSX 1X100LED PB-AB	LSX 2X100LED PB-AB	LSX 3X100LED PB-AB	LSX 4X100LED PB-AB
Polished Brass Frame/Bright Steel	LSX 1X100LED PB-BS	LSX 2X100LED PB-BS	LSX 3X100LED PB-BS	LSX 4X100LED PB-BS
Polished Brass Frame/Polished Brass	LSX 1X100LED PB-PB	LSX 2X100LED PB-PB	LSX 3X100LED PB-PB	LSX 4X100LED PB-PB
Polished Brass Frame/Satin Brass	LSX 1X100LED PB-SB	LSX 2X100LED PB-SB	LSX 3X100LED PB-SB	LSX 4X100LED PB-SB
Polished Brass Frame/Satin Steel	LSX 1X100LED PB-SS	LSX 2X100LED PB-SS	LSX 3X100LED PB-SS	LSX 4X100LED PB-SS
Richmond Bronze Frame/Richmond Bronze	LSX 1X100LED RB-RB	LSX 2X100LED RB-RB	LSX 3X100LED RB-RB	LSX 4X100LED RB-RB
Satin Brass Frame/Satin Brass	LSX 1X100LED SB-SB	LSX 2X100LED SB-SB	LSX 3X100LED SB-SB	LSX 4X100LED SB-SB
Satin Brass Frame/Satin Steel	LSX 1X100LED SB-SS	LSX 2X100LED SB-SS	LSX 3X100LED SB-SS	LSX 4X100LED SB-SS
Satin Nickel Frame/Bright Steel	LSX 1X100LED SN-BS	LSX 2X100LED SN-BS	LSX 3X100LED SN-BS	LSX 4X100LED SN-BS
Satin Nickel Frame/Satin Steel	LSX 1X100LED SN-SS	LSX 2X100LED SN-SS	LSX 3X100LED SN-SS	LSX 4X100LED SN-SS
Nominal Size:	91.5mm x 91.5mm	91.5mm x 91.5mm	150.5mm x 91.5mm	150.5mm x 91.5mm
Minimum Wall Box Depth:	35mm	35mm	35mm	35mm
Technical Insert Ref:	1X100LED	2X100LED	3X100LED	4X100LED

NOTE: Tungsten filament GU10 lamps must be branded and with a fused base.
 NOTE: Please refer to the Dimmer Technical Section for the max Wattage.
 NOTE: Please contact our Technical Department for compatibility.

Linea-Scala CFX

Resistive Leading Edge Push On/Off Rotary 2 Way Switching Dimmers

LINEA-SCALA CFX RANGE



LSX 1X40 AB-SB



LSX 2X40 BC-BK



LSX 3X40 BC-BS



LSX 4X40 BC-N



1 gang 400W
Resistive Leading
Edge Push On/Off
2 Way Switching
Dimmer



2 gang 400W
Resistive Leading
Edge Push On/Off
2 Way Switching
Dimmer

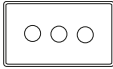

3 gang 400W
Resistive Leading
Edge Push On/Off
2 Way Switching
Dimmer

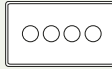

4 gang 400W
Resistive Leading
Edge Push On/Off
2 Way Switching
Dimmer



1 gang 600W
Resistive Leading
Edge Push On/Off
2 Way Switching
Dimmer

Frame / Front Plate	1 gang 400W Resistive Leading Edge Push On/Off 2 Way Switching Dimmer	2 gang 400W Resistive Leading Edge Push On/Off 2 Way Switching Dimmer	3 gang 400W Resistive Leading Edge Push On/Off 2 Way Switching Dimmer	4 gang 400W Resistive Leading Edge Push On/Off 2 Way Switching Dimmer	1 gang 600W Resistive Leading Edge Push On/Off 2 Way Switching Dimmer
Antique Brass Frame/Antique Brass	LSX 1X40 AB-AB	LSX 2X40 AB-AB	LSX 3X40 AB-AB	LSX 4X40 AB-AB	LSX 1X60 AB-AB
Antique Brass Frame/Satin Brass	LSX 1X40 AB-SB	LSX 2X40 AB-SB	LSX 3X40 AB-SB	LSX 4X40 AB-SB	LSX 1X60 AB-SB
Black Nickel Frame/Black Nickel	LSX 1X40 BK-BK	LSX 2X40 BK-BK	LSX 3X40 BK-BK	LSX 4X40 BK-BK	LSX 1X60 BK-BK
Black Nickel Frame/Bright Steel	LSX 1X40 BK-BS	LSX 2X40 BK-BS	LSX 3X40 BK-BS	LSX 4X40 BK-BS	LSX 1X60 BK-BS
Black Nickel Frame/Polished Brass	LSX 1X40 BK-PB	LSX 2X40 BK-PB	LSX 3X40 BK-PB	LSX 4X40 BK-PB	LSX 1X60 BK-PB
Bright Chrome Frame/Black Nickel	LSX 1X40 BC-BK	LSX 2X40 BC-BK	LSX 3X40 BC-BK	LSX 4X40 BC-BK	LSX 1X60 BC-BK
Bright Chrome Frame/Bright Steel	LSX 1X40 BC-BS	LSX 2X40 BC-BS	LSX 3X40 BC-BS	LSX 4X40 BC-BS	LSX 1X60 BC-BS
Bright Chrome Frame/Piano Black	LSX 1X40 BC-N	LSX 2X40 BC-N	LSX 3X40 BC-N	LSX 4X40 BC-N	LSX 1X60 BC-N
Bright Chrome Frame/Polished Brass	LSX 1X40 BC-PB	LSX 2X40 BC-PB	LSX 3X40 BC-PB	LSX 4X40 BC-PB	LSX 1X60 BC-PB
Bright Chrome Frame/Satin Steel	LSX 1X40 BC-SS	LSX 2X40 BC-SS	LSX 3X40 BC-SS	LSX 4X40 BC-SS	LSX 1X60 BC-SS
Connaught Bronze Frame/Connaught Bronze	LSX 1X40 HB-HB	LSX 2X40 HB-HB	LSX 3X40 HB-HB	LSX 4X40 HB-HB	LSX 1X60 HB-HB
Copper Bronze Frame/Copper Bronze	LSX 1X40 CB-CB	LSX 2X40 CB-CB	LSX 3X40 CB-CB	LSX 4X40 CB-CB	LSX 1X60 CB-CB
Etrium Bronze Frame/Etrium Bronze	LSX 1X40 EB-EB	LSX 2X40 EB-EB	LSX 3X40 EB-EB	LSX 4X40 EB-EB	LSX 1X60 EB-EB
Polished Brass Frame/Antique Brass	LSX 1X40 PB-AB	LSX 2X40 PB-AB	LSX 3X40 PB-AB	LSX 4X40 PB-AB	LSX 1X60 PB-AB
Polished Brass Frame/Bright Steel	LSX 1X40 PB-BS	LSX 2X40 PB-BS	LSX 3X40 PB-BS	LSX 4X40 PB-BS	LSX 1X60 PB-BS
Polished Brass Frame/Polished Brass	LSX 1X40 PB-PB	LSX 2X40 PB-PB	LSX 3X40 PB-PB	LSX 4X40 PB-PB	LSX 1X60 PB-PB
Polished Brass Frame/Satin Brass	LSX 1X40 PB-SB	LSX 2X40 PB-SB	LSX 3X40 PB-SB	LSX 4X40 PB-SB	LSX 1X60 PB-SB
Polished Brass Frame/Satin Steel	LSX 1X40 PB-SS	LSX 2X40 PB-SS	LSX 3X40 PB-SS	LSX 4X40 PB-SS	LSX 1X60 PB-SS
Richmond Bronze Frame/Richmond Bronze	LSX 1X40 RB-RB	LSX 2X40 RB-RB	LSX 3X40 RB-RB	LSX 4X40 RB-RB	LSX 1X60 RB-RB
Satin Brass Frame/Satin Brass	LSX 1X40 SB-SB	LSX 2X40 SB-SB	LSX 3X40 SB-SB	LSX 4X40 SB-SB	LSX 1X60 SB-SB
Satin Brass Frame/Satin Steel	LSX 1X40 SB-SS	LSX 2X40 SB-SS	LSX 3X40 SB-SS	LSX 4X40 SB-SS	LSX 1X60 SB-SS
Satin Nickel Frame/Bright Steel	LSX 1X40 SN-BS	LSX 2X40 SN-BS	LSX 3X40 SN-BS	LSX 4X40 SN-BS	LSX 1X60 SN-BS
Satin Nickel Frame/Satin Steel	LSX 1X40 SN-SS	LSX 2X40 SN-SS	LSX 3X40 SN-SS	LSX 4X40 SN-SS	LSX 1X60 SN-SS
Nominal Size:	91.5mm x 91.5mm	91.5mm x 91.5mm	150.5mm x 91.5mm	150.5mm x 91.5mm	91.5mm x 91.5mm
Minimum Wall Box Depth:	35mm	35mm	35mm	35mm	35mm
Technical Insert Ref:	1X40	2X40	3X40	4X40	1X60

NOTE: Tungsten filament GU10 lamps must be branded and with a fused base
 NOTE: When using mains voltage halogen lamps – dimmers should be re-rated by 25%
 NOTE: When dimming LED lamps de-rate by 75% - please contact our Technical Department for compatibility.
 NOTE: Please refer to the Dimmer Technical Section for the max wattage

Linea-Scala CFX

Inductive Leading Edge Push On/Off Rotary 2 Way Switching Dimmers



LSX 1X2V BC-PB



1 gang 200VA Inductive
Leading Edge Push
On/Off Rotary 2 Way Switching
Dimmer

Frame / Front Plate	
Antique Brass Frame/Antique Brass	LSX 1X2V AB-AB
Antique Brass Frame/Satin Brass	LSX 1X2V AB-SB
Black Nickel Frame/Black Nickel	LSX 1X2V BK-BK
Black Nickel Frame/Bright Steel	LSX 1X2V BK-BS
Black Nickel Frame/Polished Brass	LSX 1X2V BK-PB
Bright Chrome Frame/Black Nickel	LSX 1X2V BC-BK
Bright Chrome Frame/Bright Steel	LSX 1X2V BC-BS
Bright Chrome Frame/Piano Black	LSX 1X2V BC-N
Bright Chrome Frame/Polished Brass	LSX 1X2V BC-PB
Bright Chrome Frame/Satin Steel	LSX 1X2V BC-SS
Connaught Bronze Frame/Connaught Bronze	LSX 1X2V HB-HB
Copper Bronze Frame/Copper Bronze	LSX 1X2V CB-CB
Etrium Bronze Frame/Etrium Bronze	LSX 1X2V EB-EB
Polished Brass Frame/Antique Brass	LSX 1X2V PB-AB
Polished Brass Frame/Bright Steel	LSX 1X2V PB-BS
Polished Brass Frame/Polished Brass	LSX 1X2V PB-PB
Polished Brass Frame/Satin Brass	LSX 1X2V PB-SB
Polished Brass Frame/Satin Steel	LSX 1X2V PB-SS
Richmond Bronze Frame/Richmond Bronze	LSX 1X2V RB-RB
Satin Brass Frame/Satin Brass	LSX 1X2V SB-SB
Satin Brass Frame/Satin Steel	LSX 1X2V SB-SS
Satin Nickel Frame/Bright Steel	LSX 1X2V SN-BS
Satin Nickel Frame/Satin Steel	LSX 1X2V SN-SS
Nominal Size:	91.5mm x 91.5mm
Minimum Wall Box Depth:	35mm
Technical Insert Ref:	1X2V

NOTE: Tungsten filament GU10 lamps must be branded and with a fused base

NOTE: When using mains voltage halogen lamps – dimmers should be re-rated by 25%

NOTE: When dimming LED lamps de-rate by 75% - please contact our Technical Department for compatibility.

NOTE: Please refer to the Dimmer Technical Section for the max wattage

Linea-Scala CFX

Resistive/Inductive Trailing Edge Push On/Off Rotary Multi-Way Dimmers

LINEA-SCALA CFX RANGE



LSX 1XTE BK-BK



LSX 2XTE BK-PB



LSX 3XTE PB-BS



LSX 4XTE PB-PB



1 gang 250W/210VA Resistive/Inductive Trailing Edge Push On/Off Rotary Multi-Way Dimmer



2 gang 250W/210VA Resistive/Inductive Trailing Edge Push On/Off Rotary Multi-Way Dimmer

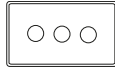

3 gang 250W/210VA Resistive/Inductive Trailing Edge Push On/Off Rotary Multi-Way Dimmer

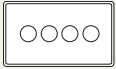

4 gang 250W/210VA Resistive/Inductive Trailing Edge Push On/Off Rotary Multi-Way Dimmer

Frame / Front Plate	LSX 1XTE AB-AB	LSX 2XTE AB-AB	LSX 3XTE AB-AB	LSX 4XTE AB-AB
Antique Brass Frame/Antique Brass	LSX 1XTE AB-AB	LSX 2XTE AB-AB	LSX 3XTE AB-AB	LSX 4XTE AB-AB
Antique Brass Frame/Satin Brass	LSX 1XTE AB-SB	LSX 2XTE AB-SB	LSX 3XTE AB-SB	LSX 4XTE AB-SB
Black Nickel Frame/Black Nickel	LSX 1XTE BK-BK	LSX 2XTE BK-BK	LSX 3XTE BK-BK	LSX 4XTE BK-BK
Black Nickel Frame/Bright Steel	LSX 1XTE BK-BS	LSX 2XTE BK-BS	LSX 3XTE BK-BS	LSX 4XTE BK-BS
Black Nickel Frame/Polished Brass	LSX 1XTE BK-PB	LSX 2XTE BK-PB	LSX 3XTE BK-PB	LSX 4XTE BK-PB
Bright Chrome Frame/Black Nickel	LSX 1XTE BC-BK	LSX 2XTE BC-BK	LSX 3XTE BC-BK	LSX 4XTE BC-BK
Bright Chrome Frame/Bright Steel	LSX 1XTE BC-BS	LSX 2XTE BC-BS	LSX 3XTE BC-BS	LSX 4XTE BC-BS
Bright Chrome Frame/Piano Black	LSX 1XTE BC-N	LSX 2XTE BC-N	LSX 3XTE BC-N	LSX 4XTE BC-N
Bright Chrome Frame/Polished Brass	LSX 1XTE BC-PB	LSX 2XTE BC-PB	LSX 3XTE BC-PB	LSX 4XTE BC-PB
Bright Chrome Frame/Satin Steel	LSX 1XTE BC-SS	LSX 2XTE BC-SS	LSX 3XTE BC-SS	LSX 4XTE BC-SS
Connaught Bronze Frame/Connaught Bronze	LSX 1XTE HB-HB	LSX 2XTE HB-HB	LSX 3XTE HB-HB	LSX 4XTE HB-HB
Copper Bronze Frame/Copper Bronze	LSX 1XTE CB-CB	LSX 2XTE CB-CB	LSX 3XTE CB-CB	LSX 4XTE CB-CB
Etrium Bronze Frame/Etrium Bronze	LSX 1XTE EB-EB	LSX 2XTE EB-EB	LSX 3XTE EB-EB	LSX 4XTE EB-EB
Polished Brass Frame/Antique Brass	LSX 1XTE PB-AB	LSX 2XTE PB-AB	LSX 3XTE PB-AB	LSX 4XTE PB-AB
Polished Brass Frame/Bright Steel	LSX 1XTE PB-BS	LSX 2XTE PB-BS	LSX 3XTE PB-BS	LSX 4XTE PB-BS
Polished Brass Frame/Polished Brass	LSX 1XTE PB-PB	LSX 2XTE PB-PB	LSX 3XTE PB-PB	LSX 4XTE PB-PB
Polished Brass Frame/Satin Brass	LSX 1XTE PB-SB	LSX 2XTE PB-SB	LSX 3XTE PB-SB	LSX 4XTE PB-SB
Polished Brass Frame/Satin Steel	LSX 1XTE PB-SS	LSX 2XTE PB-SS	LSX 3XTE PB-SS	LSX 4XTE PB-SS
Richmond Bronze Frame/Richmond Bronze	LSX 1XTE RB-RB	LSX 2XTE RB-RB	LSX 3XTE RB-RB	LSX 4XTE RB-RB
Satin Brass Frame/Satin Brass	LSX 1XTE SB-SB	LSX 2XTE SB-SB	LSX 3XTE SB-SB	LSX 4XTE SB-SB
Satin Brass Frame/Satin Steel	LSX 1XTE SB-SS	LSX 2XTE SB-SS	LSX 3XTE SB-SS	LSX 4XTE SB-SS
Satin Nickel Frame/Bright Steel	LSX 1XTE SN-BS	LSX 2XTE SN-BS	LSX 3XTE SN-BS	LSX 4XTE SN-BS
Satin Nickel Frame/Satin Steel	LSX 1XTE SN-SS	LSX 2XTE SN-SS	LSX 3XTE SN-SS	LSX 4XTE SN-SS
Nominal Size:	91.5mm x 91.5mm	91.5mm x 91.5mm	150.5mm x 91.5mm	150.5mm x 91.5mm
Minimum Wall Box Depth:	35mm	35mm	35mm	35mm
Technical Insert Ref:	1XTE	2XTE	3XTE	4XTE

NOTE: Tungsten filament GU10 lamps must be branded and with a fused base
 NOTE: When using mains voltage halogen lamps – dimmers should be re-rated by 25%
 NOTE: When dimming LED lamps de-rate by 75% - please contact our Technical Department for compatibility.
 NOTE: Please refer to the Dimmer Technical Section for the max wattage

Linea-Scala CFX

Resistive/Inductive Trailing Edge Touch Master Multi-Way Dimmers



LSX 1XTM PB-SB W



LSX 1XTM PB-SS B



LSX 3XTM SN-BS W

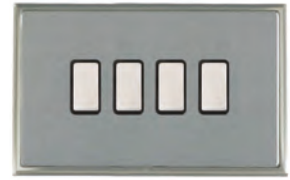

LSX 4XTM SN-SS B

Frame / Front Plate	1 gang 250W/210VA Resistive/Inductive Trailing Edge Touch Master Multi-Way Dimmer	2 gang 250W/210VA Resistive/Inductive Trailing Edge Touch Master Multi-Way Dimmer	3 gang 250W/210VA Resistive/Inductive Trailing Edge Touch Master Multi-Way Dimmer	4 gang 250W/210VA Resistive/Inductive Trailing Edge Touch Master Multi-Way Dimmer
Antique Brass Frame/Antique Brass	LSX 1XTM AB-AB B	LSX 2XTM AB-AB B	LSX 3XTM AB-AB B	LSX 4XTM AB-AB B
Antique Brass Frame/Satin Brass	LSX 1XTM AB-SB B	LSX 2XTM AB-SB B	LSX 3XTM AB-SB B	LSX 4XTM AB-SB B
Black Nickel Frame/Black Nickel	LSX 1XTM BK-BK B	LSX 2XTM BK-BK B	LSX 3XTM BK-BK B	LSX 4XTM BK-BK B
Black Nickel Frame/Bright Steel	LSX 1XTM BK-BS B	LSX 2XTM BK-BS B	LSX 3XTM BK-BS B	LSX 4XTM BK-BS B
Black Nickel Frame/Polished Brass	LSX 1XTM BK-PB B	LSX 2XTM BK-PB B	LSX 3XTM BK-PB B	LSX 4XTM BK-PB B
Bright Chrome Frame/Black Nickel	LSX 1XTM BC-BK B	LSX 2XTM BC-BK B	LSX 3XTM BC-BK B	LSX 4XTM BC-BK B
Bright Chrome Frame/Bright Steel	LSX 1XTM BC-BS B	LSX 2XTM BC-BS B	LSX 3XTM BC-BS B	LSX 4XTM BC-BS B
Bright Chrome Frame/Bright Steel	LSX 1XTM BC-BS W	LSX 2XTM BC-BS W	LSX 3XTM BC-BS W	LSX 4XTM BC-BS W
Bright Chrome Frame/Piano Black	LSX 1XTM BC-NB	LSX 2XTM BC-NB	LSX 3XTM BC-NB	LSX 4XTM BC-NB
Bright Chrome Frame/Polished Brass	LSX 1XTM BC-PB B	LSX 2XTM BC-PB B	LSX 3XTM BC-PB B	LSX 4XTM BC-PB B
Bright Chrome Frame/Polished Brass	LSX 1XTM BC-PB W	LSX 2XTM BC-PB W	LSX 3XTM BC-PB W	LSX 4XTM BC-PB W
Bright Chrome Frame/Satin Steel	LSX 1XTM BC-SS B	LSX 2XTM BC-SS B	LSX 3XTM BC-SS B	LSX 4XTM BC-SS B
Bright Chrome Frame/Satin Steel	LSX 1XTM BC-SS W	LSX 2XTM BC-SS W	LSX 3XTM BC-SS W	LSX 4XTM BC-SS W
Connaught Bronze Frame/Connaught Bronze	LSX 1XTM HB-HB B	LSX 2XTM HB-HB B	LSX 3XTM HB-HB B	LSX 4XTM HB-HB B
Copper Chrome Frame/Copper Chrome	LSX 1XTM CB-CB B	LSX 2XTM CB-CB B	LSX 3XTM CB-CB B	LSX 4XTM CB-CB B
Etrium Bronze Frame/Etrium Bronze	LSX 1XTM EB-EB B	LSX 2XTM EB-EB B	LSX 3XTM EB-EB B	LSX 4XTM EB-EB B
Polished Brass Frame/Antique Brass	LSX 1XTM PB-AB B	LSX 2XTM PB-AB B	LSX 3XTM PB-AB B	LSX 4XTM PB-AB B
Polished Brass Frame/Antique Brass	LSX 1XTM PB-AB W	LSX 2XTM PB-AB W	LSX 3XTM PB-AB W	LSX 4XTM PB-AB W
Polished Brass Frame/Bright Steel	LSX 1XTM PB-BS B	LSX 2XTM PB-BS B	LSX 3XTM PB-BS B	LSX 4XTM PB-BS B
Polished Brass Frame/Bright Steel	LSX 1XTM PB-BS W	LSX 2XTM PB-BS W	LSX 3XTM PB-BS W	LSX 4XTM PB-BS W
Polished Brass Frame/Polished Brass	LSX 1XTM PB-PB B	LSX 2XTM PB-PB B	LSX 3XTM PB-PB B	LSX 4XTM PB-PB B
Polished Brass Frame/Polished Brass	LSX 1XTM PB-PB W	LSX 2XTM PB-PB W	LSX 3XTM PB-PB W	LSX 4XTM PB-PB W
Polished Brass Frame/Satin Brass	LSX 1XTM PB-SB B	LSX 2XTM PB-SB B	LSX 3XTM PB-SB B	LSX 4XTM PB-SB B
Polished Brass Frame/Satin Brass	LSX 1XTM PB-SB W	LSX 2XTM PB-SB W	LSX 3XTM PB-SB W	LSX 4XTM PB-SB W
Polished Brass Frame/Satin Steel	LSX 1XTM PB-SS B	LSX 2XTM PB-SS B	LSX 3XTM PB-SS B	LSX 4XTM PB-SS B
Polished Brass Frame/Satin Steel	LSX 1XTM PB-SS W	LSX 2XTM PB-SS W	LSX 3XTM PB-SS W	LSX 4XTM PB-SS W
Richmond Bronze Frame/Richmond Bronze	LSX 1XTM RB-RB B	LSX 2XTM RB-RB B	LSX 3XTM RB-RB B	LSX 4XTM RB-RB B
Satin Brass Frame/Satin Brass	LSX 1XTM SB-SB B	LSX 2XTM SB-SB B	LSX 3XTM SB-SB B	LSX 4XTM SB-SB B
Satin Brass Frame/Satin Brass	LSX 1XTM SB-SB W	LSX 2XTM SB-SB W	LSX 3XTM SB-SB W	LSX 4XTM SB-SB W
Satin Brass Frame/Satin Steel	LSX 1XTM SB-SS B	LSX 2XTM SB-SS B	LSX 3XTM SB-SS B	LSX 4XTM SB-SS B
Satin Brass Frame/Satin Steel	LSX 1XTM SB-SS W	LSX 2XTM SB-SS W	LSX 3XTM SB-SS W	LSX 4XTM SB-SS W
Satin Nickel Frame/Bright Steel	LSX 1XTM SN-BS B	LSX 2XTM SN-BS B	LSX 3XTM SN-BS B	LSX 4XTM SN-BS B
Satin Nickel Frame/Bright Steel	LSX 1XTM SN-BS W	LSX 2XTM SN-BS W	LSX 3XTM SN-BS W	LSX 4XTM SN-BS W
Satin Nickel Frame/Satin Steel	LSX 1XTM SN-SS B	LSX 2XTM SN-SS B	LSX 3XTM SN-SS B	LSX 4XTM SN-SS B
Satin Nickel Frame/Satin Steel	LSX 1XTM SN-SS W	LSX 2XTM SN-SS W	LSX 3XTM SN-SS W	LSX 4XTM SN-SS W
Nominal Size:	91.5mm x 91.5mm	91.5mm x 91.5mm	150.5mm x 91.5mm	150.5mm x 91.5mm
Minimum Wall Box Depth:	35mm	35mm	35mm	35mm
Technical Insert Ref:	1XTM	2XTM	3XTM	4XTM

NOTE: Tungsten filament GU10 lamps must be dimmed and with a fused base
 NOTE: When using mains voltage halogen lamps – dimmers should be re-rated by 25%
 NOTE: When dimming LED lamps de-rate by 75% - please contact our Technical Department for compatibility.
 NOTE: Please refer to the Dimmer Technical Section for the max wattage

Insert Surround Colour Key: (B) Black, (W) White

Linea-Scala CFX

Multi-Way Touch Slave Controllers



LSX 1XTS AB-SB B



LSX 2XTS BC-BK B

Frame / Front Plate	1 gang Multi-Way Touch Slave Controller	2 gang Multi-Way Touch Slave Controller	3 gang Multi-Way Touch Slave Controller	4 gang Multi-Way Touch Slave Controller
Antique Brass Frame/Antique Brass	LSX 1XTS AB-AB B	LSX 2XTS AB-AB B	LSX 3XTS AB-AB B	LSX 4XTS AB-AB B
Antique Brass Frame/Satin Brass	LSX 1XTS AB-SB B	LSX 2XTS AB-SB B	LSX 3XTS AB-SB B	LSX 4XTS AB-SB B
Black Nickel Frame/Black Nickel	LSX 1XTS BK-BK B	LSX 2XTS BK-BK B	LSX 3XTS BK-BK B	LSX 4XTS BK-BK B
Black Nickel Frame/Bright Steel	LSX 1XTS BK-BS B	LSX 2XTS BK-BS B	LSX 3XTS BK-BS B	LSX 4XTS BK-BS B
Black Nickel Frame/Polished Brass	LSX 1XTS BK-PB B	LSX 2XTS BK-PB B	LSX 3XTS BK-PB B	LSX 4XTS BK-PB B
Bright Chrome Frame/Black Nickel	LSX 1XTS BC-BK B	LSX 2XTS BC-BK B	LSX 3XTS BC-BK B	LSX 4XTS BC-BK B
Bright Chrome Frame/Bright Steel	LSX 1XTS BC-BS B	LSX 2XTS BC-BS B	LSX 3XTS BC-BS B	LSX 4XTS BC-BS B
Bright Chrome Frame/Bright Steel	LSX 1XTS BC-BS W	LSX 2XTS BC-BS W	LSX 3XTS BC-BS W	LSX 4XTS BC-BS W
Bright Chrome Frame/Piano Black	LSX 1XTS BC-NB	LSX 2XTS BC-NB	LSX 3XTS BC-NB	LSX 4XTS BC-NB
Bright Chrome Frame/Polished Brass	LSX 1XTS BC-PB B	LSX 2XTS BC-PB B	LSX 3XTS BC-PB B	LSX 4XTS BC-PB B
Bright Chrome Frame/Polished Brass	LSX 1XTS BC-PB W	LSX 2XTS BC-PB W	LSX 3XTS BC-PB W	LSX 4XTS BC-PB W
Bright Chrome Frame/Satin Steel	LSX 1XTS BC-SS B	LSX 2XTS BC-SS B	LSX 3XTS BC-SS B	LSX 4XTS BC-SS B
Bright Chrome Frame/Satin Steel	LSX 1XTS BC-SS W	LSX 2XTS BC-SS W	LSX 3XTS BC-SS W	LSX 4XTS BC-SS W
Connaught Bronze Frame/Connaught Bronze	LSX 1XTS HB-HB B	LSX 2XTS HB-HB B	LSX 3XTS HB-HB B	LSX 4XTS HB-HB B
Copper Bronze Frame/Copper Bronze	LSX 1XTS CB-CB B	LSX 2XTS CB-CB B	LSX 3XTS CB-CB B	LSX 4XTS CB-CB B
Etrium Bronze Frame/Etrium Bronze	LSX 1XTS EB-EB B	LSX 2XTS EB-EB B	LSX 3XTS EB-EB B	LSX 4XTS EB-EB B
Polished Brass Frame/Antique Brass	LSX 1XTS PB-AB B	LSX 2XTS PB-AB B	LSX 3XTS PB-AB B	LSX 4XTS PB-AB B
Polished Brass Frame/Antique Brass	LSX 1XTS PB-AB W	LSX 2XTS PB-AB W	LSX 3XTS PB-AB W	LSX 4XTS PB-AB W
Polished Brass Frame/Bright Steel	LSX 1XTS PB-BS B	LSX 2XTS PB-BS B	LSX 3XTS PB-BS B	LSX 4XTS PB-BS B
Polished Brass Frame/Bright Steel	LSX 1XTS PB-BS W	LSX 2XTS PB-BS W	LSX 3XTS PB-BS W	LSX 4XTS PB-BS W
Polished Brass Frame/Polished Brass	LSX 1XTS PB-PB B	LSX 2XTS PB-PB B	LSX 3XTS PB-PB B	LSX 4XTS PB-PB B
Polished Brass Frame/Polished Brass	LSX 1XTS PB-PB W	LSX 2XTS PB-PB W	LSX 3XTS PB-PB W	LSX 4XTS PB-PB W
Polished Brass Frame/Satin Brass	LSX 1XTS PB-SB B	LSX 2XTS PB-SB B	LSX 3XTS PB-SB B	LSX 4XTS PB-SB B
Polished Brass Frame/Satin Brass	LSX 1XTS PB-SB W	LSX 2XTS PB-SB W	LSX 3XTS PB-SB W	LSX 4XTS PB-SB W
Polished Brass Frame/Satin Steel	LSX 1XTS PB-SS B	LSX 2XTS PB-SS B	LSX 3XTS PB-SS B	LSX 4XTS PB-SS B
Polished Brass Frame/Satin Steel	LSX 1XTS PB-SS W	LSX 2XTS PB-SS W	LSX 3XTS PB-SS W	LSX 4XTS PB-SS W
Richmond Bronze Frame/Richmond Bronze	LSX 1XTS RB-RB B	LSX 2XTS RB-RB B	LSX 3XTS RB-RB B	LSX 4XTS RB-RB B
Satin Brass Frame/Satin Brass	LSX 1XTS SB-SB B	LSX 2XTS SB-SB B	LSX 3XTS SB-SB B	LSX 4XTS SB-SB B
Satin Brass Frame/Satin Brass	LSX 1XTS SB-SB W	LSX 2XTS SB-SB W	LSX 3XTS SB-SB W	LSX 4XTS SB-SB W
Satin Brass Frame/Satin Steel	LSX 1XTS SB-SS B	LSX 2XTS SB-SS B	LSX 3XTS SB-SS B	LSX 4XTS SB-SS B
Satin Brass Frame/Satin Steel	LSX 1XTS SB-SS W	LSX 2XTS SB-SS W	LSX 3XTS SB-SS W	LSX 4XTS SB-SS W
Satin Nickel Frame/Bright Steel	LSX 1XTS SN-BS B	LSX 2XTS SN-BS B	LSX 3XTS SN-BS B	LSX 4XTS SN-BS B
Satin Nickel Frame/Bright Steel	LSX 1XTS SN-BS W	LSX 2XTS SN-BS W	LSX 3XTS SN-BS W	LSX 4XTS SN-BS W
Satin Nickel Frame/Satin Steel	LSX 1XTS SN-SS B	LSX 2XTS SN-SS B	LSX 3XTS SN-SS B	LSX 4XTS SN-SS B
Satin Nickel Frame/Satin Steel	LSX 1XTS SN-SS W	LSX 2XTS SN-SS W	LSX 3XTS SN-SS W	LSX 4XTS SN-SS W
Nominal Size:	91.5mm x 91.5mm	91.5mm x 91.5mm	150.5mm x 91.5mm	150.5mm x 91.5mm
Minimum Wall Box Depth:	35mm	35mm	35mm	35mm
Technical Insert Ref:	1XTS	2XTS	3XTS	4XTS

NOTE: To only be used with Touch Masters

Insert Surround Colour Key: (B) Black, (W) White

Linea-Scala CFX

Blank Plates



LSX BPS AB-AB



LSX BPD PB-BS



Single Blank Plate

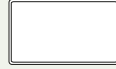

Double Blank Plate

Frame / Front Plate	Single Blank Plate	Double Blank Plate
Antique Brass Frame/Antique Brass	LSX BPS AB-AB	LSX BPD AB-AB
Antique Brass Frame/Satin Brass	LSX BPS AB-SB	LSX BPD AB-SB
Black Nickel Frame/Black Nickel	LSX BPS BK-BK	LSX BPD BK-BK
Black Nickel Frame/Bright Steel	LSX BPS BK-BS	LSX BPD BK-BS
Black Nickel Frame/Polished Brass	LSX BPS BK-PB	LSX BPD BK-PB
Bright Chrome Frame/Black Nickel	LSX BPS BC-BK	LSX BPD BC-BK
Bright Chrome Frame/Bright Steel	LSX BPS BC-BS	LSX BPD BC-BS
Bright Chrome Frame/Piano Black	LSX BPS BC-N	LSX BPD BC-N
Bright Chrome Frame/Polished Brass	LSX BPS BC-PB	LSX BPD BC-PB
Bright Chrome Frame/Satin Steel	LSX BPS BC-SS	LSX BPD BC-SS
Connaught Bronze Frame/Connaught Bronze	LSX BPS HB-HB	LSX BPD HB-HB
Copper Bronze Frame/Copper Bronze	LSX BPS CB-CB	LSX BPD CB-CB
Etrium Bronze Frame/Etrium Bronze	LSX BPS EB-EB	LSX BPD EB-EB
Polished Brass Frame/Antique Brass	LSX BPS PB-AB	LSX BPD PB-AB
Polished Brass Frame/Bright Steel	LSX BPS PB-BS	LSX BPD PB-BS
Polished Brass Frame/Polished Brass	LSX BPS PB-PB	LSX BPD PB-PB
Polished Brass Frame/Satin Brass	LSX BPS PB-SB	LSX BPD PB-SB
Polished Brass Frame/Satin Steel	LSX BPS PB-SS	LSX BPD PB-SS
Richmond Bronze Frame/Richmond Bronze	LSX BPS RB-RB	LSX BPD RB-RB
Satin Brass Frame/Satin Brass	LSX BPS SB-SB	LSX BPD SB-SB
Satin Brass Frame/Satin Steel	LSX BPS SB-SS	LSX BPD SB-SS
Satin Nickel Frame/Bright Steel	LSX BPS SN-BS	LSX BPD SN-BS
Satin Nickel Frame/Satin Steel	LSX BPS SN-SS	LSX BPD SN-SS
Nominal Size:	91.5mm x 91.5mm	150.5mm x 91.5mm
Minimum Wall Box Depth:	Any Box	Any Box
Technical Insert Ref:	BPS	BPD

Linea-Scala CFX

Grid-IT GridFix Plates complete with Fixing Grid

LINEA-SCALA CFX RANGE



LSX 1GP PB-BS



LSX 2GP AB-AB

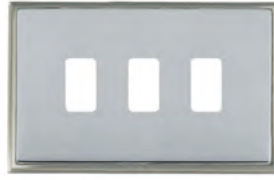

LSX 3GP SN-BS

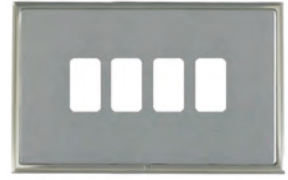

LSX 4GP SN-SS



1 Gang Grid Fix Aperture Plate with Grid



2 Gang Grid Fix Aperture Plate with Grid

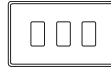

3 Gang Grid Fix Aperture Plate with Grid

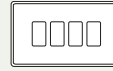

4 Gang Grid Fix Aperture Plate with Grid

Frame / Front Plate	1 Gang Grid Fix Aperture Plate with Grid	2 Gang Grid Fix Aperture Plate with Grid	3 Gang Grid Fix Aperture Plate with Grid	4 Gang Grid Fix Aperture Plate with Grid
Antique Brass Frame/Antique Brass	LSX 1GP AB-AB	LSX 2GP AB-AB	LSX 3GP AB-AB	LSX 4GP AB-AB
Antique Brass Frame/Satin Brass	LSX 1GP AB-SB	LSX 2GP AB-SB	LSX 3GP AB-SB	LSX 4GP AB-SB
Bright Chrome Frame/Black Nickel	LSX 1GP BC-BK	LSX 2GP BC-BK	LSX 3GP BC-BK	LSX 4GP BC-BK
Bright Chrome Frame/Bright Steel	LSX 1GP BC-BS	LSX 2GP BC-BS	LSX 3GP BC-BS	LSX 4GP BC-BS
Bright Chrome Frame/Plano Black	LSX 1GP BC-N	LSX 2GP BC-N	LSX 3GP BC-N	LSX 4GP BC-N
Bright Chrome Frame/Polished Brass	LSX 1GP BC-PB	LSX 2GP BC-PB	LSX 3GP BC-PB	LSX 4GP BC-PB
Bright Chrome Frame/Satin Steel	LSX 1GP BC-SS	LSX 2GP BC-SS	LSX 3GP BC-SS	LSX 4GP BC-SS
Black Nickel Frame/Black Nickel	LSX 1GP BK-BK	LSX 2GP BK-BK	LSX 3GP BK-BK	LSX 4GP BK-BK
Black Nickel Frame/Bright Steel	LSX 1GP BK-BS	LSX 2GP BK-BS	LSX 3GP BK-BS	LSX 4GP BK-BS
Black Nickel Frame/Polished Brass	LSX 1GP BK-PB	LSX 2GP BK-PB	LSX 3GP BK-PB	LSX 4GP BK-PB
Copper Bronze Frame/Copper Bronze	LSX 1GP CB-CB	LSX 2GP CB-CB	LSX 3GP CB-CB	LSX 4GP CB-CB
Etrium Bronze Frame/Etrium Bronze	LSX 1GP EB-EB	LSX 2GP EB-EB	LSX 3GP EB-EB	LSX 4GP EB-EB
Connaught Bronze Frame/Connaught Bronze	LSX 1GP HB-HB	LSX 2GP HB-HB	LSX 3GP HB-HB	LSX 4GP HB-HB
Polished Brass Frame/Antique Brass	LSX 1GP PB-AB	LSX 2GP PB-AB	LSX 3GP PB-AB	LSX 4GP PB-AB
Polished Brass Frame/Bright Steel	LSX 1GP PB-BS	LSX 2GP PB-BS	LSX 3GP PB-BS	LSX 4GP PB-BS
Polished Brass Frame/Polished Brass	LSX 1GP PB-PB	LSX 2GP PB-PB	LSX 3GP PB-PB	LSX 4GP PB-PB
Polished Brass Frame/Satin Brass	LSX 1GP PB-SB	LSX 2GP PB-SB	LSX 3GP PB-SB	LSX 4GP PB-SB
Polished Brass Frame/Satin Steel	LSX 1GP PB-SS	LSX 2GP PB-SS	LSX 3GP PB-SS	LSX 4GP PB-SS
Richmond Bronze Frame/Richmond Bronze	LSX 1GP RB-RB	LSX 2GP RB-RB	LSX 3GP RB-RB	LSX 4GP RB-RB
Satin Brass Frame/Satin Brass	LSX 1GP SB-SB	LSX 2GP SB-SB	LSX 3GP SB-SB	LSX 4GP SB-SB
Satin Brass Frame/Satin Steel	LSX 1GP SB-SS	LSX 2GP SB-SS	LSX 3GP SB-SS	LSX 4GP SB-SS
Satin Nickel Frame/Bright Steel	LSX 1GP SN-BS	LSX 2GP SN-BS	LSX 3GP SN-BS	LSX 4GP SN-BS
Satin Nickel Frame/Satin Steel	LSX 1GP SN-SS	LSX 2GP SN-SS	LSX 3GP SN-SS	LSX 4GP SN-SS
Nominal Size:	91.5mm x 91.5mm	91.5mm x 91.5mm	150.5mm x 91.5mm	150.5mm x 91.5mm
Minimum Wall Box Depth:	As Per Insert	As Per Inserts	As Per Inserts	As Per Inserts
Technical Insert Ref:	1GP	2GP	3GP	4GP

Note: Minimum Wall Box depth is dependant on the Grid Fix insert fitted, please see the GRID-IT section for the complete range of inserts.

Linea-Scala CFX

EuroFix Apertured Plates complete with Fixing Grid



LSX EURO1 AB-AB



LSX EURO2 BC-BK



LSX EURO3 BK-BS



LSX EURO4 SB-SB



Single Plate complete with 1 EuroFix Aperture 25x50mm and Grid



Single Plate complete with 2 EuroFix Apertures 50x50mm and Grid

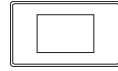

Double Plate complete with 3 EuroFix Apertures 75x50mm and Grid

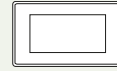

Double Plate complete with 4 EuroFix Apertures 100x50mm and Grid

Frame / Front Plate	LSX EURO1 AB-AB	LSX EURO2 AB-AB	LSX EURO3 AB-AB	LSX EURO4 AB-AB
Antique Brass Frame/Antique Brass	LSX EURO1 AB-AB	LSX EURO2 AB-AB	LSX EURO3 AB-AB	LSX EURO4 AB-AB
Antique Brass Frame/Satin Brass	LSX EURO1 AB-SB	LSX EURO2 AB-SB	LSX EURO3 AB-SB	LSX EURO4 AB-SB
Black Nickel Frame/Black Nickel	LSX EURO1 BK-BK	LSX EURO2 BK-BK	LSX EURO3 BK-BK	LSX EURO4 BK-BK
Black Nickel Frame/Bright Steel	LSX EURO1 BK-BS	LSX EURO2 BK-BS	LSX EURO3 BK-BS	LSX EURO4 BK-BS
Black Nickel Frame/Polished Brass	LSX EURO1 BK-PB	LSX EURO2 BK-PB	LSX EURO3 BK-PB	LSX EURO4 BK-PB
Bright Chrome Frame/Bright Steel	LSX EURO1 BC-BS	LSX EURO2 BC-BS	LSX EURO3 BC-BS	LSX EURO4 BC-BS
Bright Chrome Frame/Satin Steel	LSX EURO1 BC-SS	LSX EURO2 BC-SS	LSX EURO3 BC-SS	LSX EURO4 BC-SS
Bright Chrome Frame/Polished Brass	LSX EURO1 BC-PB	LSX EURO2 BC-PB	LSX EURO3 BC-PB	LSX EURO4 BC-PB
Bright Chrome Frame/Black Nickel	LSX EURO1 BC-BK	LSX EURO2 BC-BK	LSX EURO3 BC-BK	LSX EURO4 BC-BK
Bright Chrome Frame/Piano Black	LSX EURO1 BC-N	LSX EURO2 BC-N	LSX EURO3 BC-N	LSX EURO4 BC-N
Connaught Bronze Frame/Connaught Bronze	LSX EURO1 HB-HB	LSX EURO2 HB-HB	LSX EURO3 HB-HB	LSX EURO4 HB-HB
Copper Bronze Frame/Copper Bronze	LSX EURO1 CB-CB	LSX EURO2 CB-CB	LSX EURO3 CB-CB	LSX EURO4 CB-CB
Etrium Bronze Frame/Etrium Bronze	LSX EURO1 EB-EB	LSX EURO2 EB-EB	LSX EURO3 EB-EB	LSX EURO4 EB-EB
Polished Brass Frame/Polished Brass	LSX EURO1 PB-PB	LSX EURO2 PB-PB	LSX EURO3 PB-PB	LSX EURO4 PB-PB
Polished Brass Frame/Satin Brass	LSX EURO1 PB-SB	LSX EURO2 PB-SB	LSX EURO3 PB-SB	LSX EURO4 PB-SB
Polished Brass Frame/Antique Brass	LSX EURO1 PB-AB	LSX EURO2 PB-AB	LSX EURO3 PB-AB	LSX EURO4 PB-AB
Polished Brass Frame/Bright Steel	LSX EURO1 PB-BS	LSX EURO2 PB-BS	LSX EURO3 PB-BS	LSX EURO4 PB-BS
Polished Brass Frame/Satin Steel	LSX EURO1 PB-SS	LSX EURO2 PB-SS	LSX EURO3 PB-SS	LSX EURO4 PB-SS
Richmond Bronze Frame/Richmond Bronze	LSX EURO1 RB-RB	LSX EURO2 RB-RB	LSX EURO3 RB-RB	LSX EURO4 RB-RB
Satin Brass Frame/Satin Brass	LSX EURO1 SB-SB	LSX EURO2 SB-SB	LSX EURO3 SB-SB	LSX EURO4 SB-SB
Satin Brass Frame/Satin Steel	LSX EURO1 SB-SS	LSX EURO2 SB-SS	LSX EURO3 SB-SS	LSX EURO4 SB-SS
Satin Nickel Frame/Bright Steel	LSX EURO1 SN-BS	LSX EURO2 SN-BS	LSX EURO3 SN-BS	LSX EURO4 SN-BS
Satin Nickel Frame/Satin Steel	LSX EURO1 SN-SS	LSX EURO2 SN-SS	LSX EURO3 SN-SS	LSX EURO4 SN-SS
Nominal Size:	91.5mm x 91.5mm	91.5mm x 91.5mm	150.5mm x 91.5mm	150.5mm x 91.5mm
Minimum Wall Box Depth:	As Per Insert	As Per Inserts	As per Inserts	As per Inserts
Technical Insert Ref:	EURO1	EURO2	EURO3	EURO4

Note: Minimum Wall Box depth is dependant on the EuroFix insert fitted, please see the EuroFix section for our complete range of inserts.



SURVIVE
THE DAY

Linea-Perlina CFX[®] Range

Elegant and classic with a Beaded Edge Frame

The Linea CFX[®] range comes in five different designs to suit either contemporary or classic interiors. Linea CFX[®] has a separate back frame and our patented four point face plate clipping system, allowing the option of matching or contrasting elements.

- Seven stunning front plate finishes and Six frame and insert finishes
- Two-part frame and plate for 'mix and match'
- Concealed fixing
- Grid Fix and Eurofix options also available (see separate GRID-IT and EuroFix sections)



Linea-Perlina CFX® Range

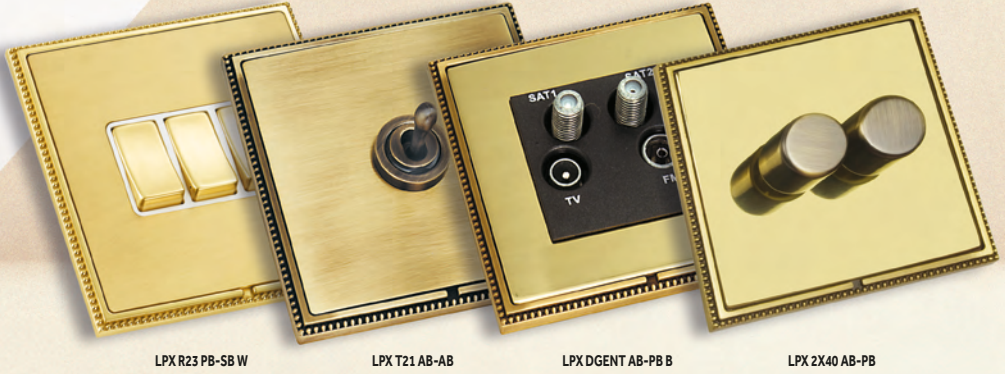

LINEA-PERLINA CFX RANGE

Product Code Configurator

- Select the required electrical accessory from the following pages.
e.g. **LPX R23** = Linea-Perlina CFX 3 gang 10AX 2 way Rocker Switch.
- Using the Frames & Finishes Chart on the next page;
 - Select the required Frame Finish
e.g. Polished Brass = **PB**-__-__.
 - Select the required Front Plate Finish
e.g. Satin Brass = __-**SB**__.
 - Select the required Insert Surround Colour
e.g. White = __-__-**W**.



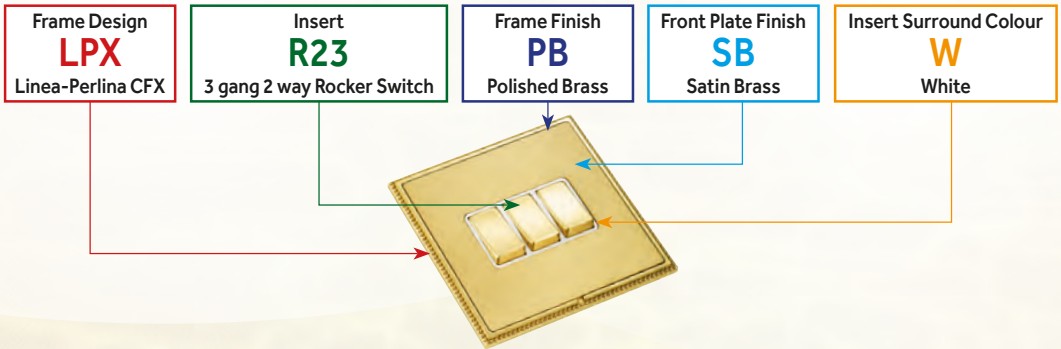



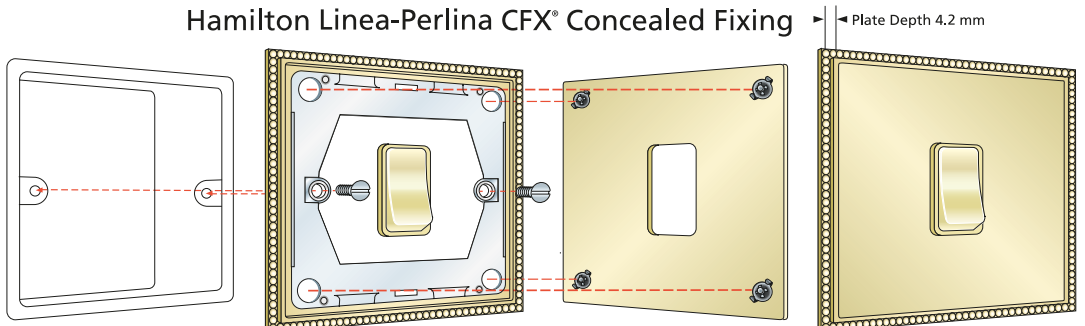





Therefore a Linea-Perlina CFX 3 gang 10AX 2 way Rocker Switch as illustrated below = **LPX R23 PB-SB W**



Hamilton Linea-Perlina CFX® Concealed Fixing



Frames and Finishes chart

Frame and Insert Finish	Polished Brass (PB)	Satin Brass (SB)	Antique Brass (AB)	Connaught Bronze (HB)	Copper Bronze (CB)	Etrium Bronze (EB)	Richmond Bronze (RB)
Polished Brass Frame Matching Insert with White Surround	 PB-PB W	 PB-SB W	 PB-AB W				
Polished Brass Frame Matching Insert with Black Surround	 PB-PB B	 PB-SB B	 PB-AB B				
Antique Brass Frame Matching Insert with Black Surround		 AB-SB B	 AB-AB B				
Connaught Bronze Frame (HB) Matching Insert with Black Surround				 HB-HB B			
Copper Bronze Frame (CB) Matching Insert with Black Surround					 CB-CB B		
Etrium Bronze Frame (EB) Matching Insert with Black Surround						 EB-EB B	
Richmond Bronze Frame (RB) Matching Insert with Black Surround							 RB-RB B

Frame Finishes

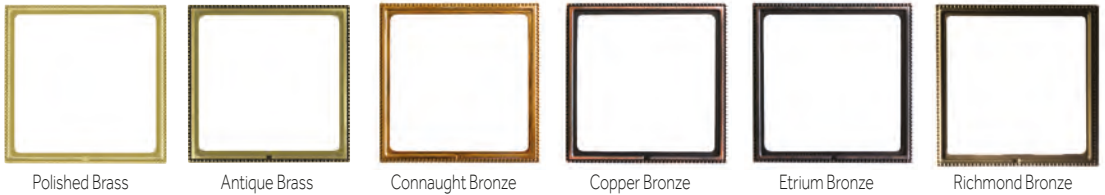

Linea-Perlina CFX

Rocker Switches

LINEA-PERLINA CFX RANGE



LPX R21 CB-CB B



LPX R22 AB-SB B



LPX R23 PB-SB W



LPX R26 PB-PB W



1 gang 10AX 2 Way Rocker



2 gang 10AX 2 Way Rocker



3 gang 10AX 2 Way Rocker

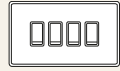

4 gang 10AX 2 Way Rocker

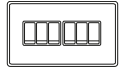

6 gang 10AX 2 Way Rocker

Frame / Front Plate	1 gang 10AX 2 Way Rocker	2 gang 10AX 2 Way Rocker	3 gang 10AX 2 Way Rocker	4 gang 10AX 2 Way Rocker	6 gang 10AX 2 Way Rocker
Antique Brass Frame/Antique Brass	LPX R21 AB-AB B	LPX R22 AB-AB B	LPX R23 AB-AB B	LPX R24 AB-AB B	LPX R26 AB-AB B
Antique Brass Frame/Polished Brass	LPX R21 AB-PB B	LPX R22 AB-PB B	LPX R23 AB-PB B	LPX R24 AB-PB B	LPX R26 AB-PB B
Antique Brass Frame/Satin Brass	LPX R21 AB-SB B	LPX R22 AB-SB B	LPX R23 AB-SB B	LPX R24 AB-SB B	LPX R26 AB-SB B
Connaught Bronze Frame/Connaught Bronze	LPX R21 HB-HB B	LPX R22 HB-HB B	LPX R23 HB-HB B	LPX R24 HB-HB B	LPX R26 HB-HB B
Copper Bronze Frame/Copper Bronze	LPX R21 CB-CB B	LPX R22 CB-CB B	LPX R23 CB-CB B	LPX R24 CB-CB B	LPX R26 CB-CB B
Etrium Bronze Frame/Etrium Bronze	LPX R21 EB-EB B	LPX R22 EB-EB B	LPX R23 EB-EB B	LPX R24 EB-EB B	LPX R26 EB-EB B
Polished Brass Frame/Antique Brass	LPX R21 PB-AB B	LPX R22 PB-AB B	LPX R23 PB-AB B	LPX R24 PB-AB B	LPX R26 PB-AB B
Polished Brass Frame/Antique Brass	LPX R21 PB-AB W	LPX R22 PB-AB W	LPX R23 PB-AB W	LPX R24 PB-AB W	LPX R26 PB-AB W
Polished Brass Frame/Polished Brass	LPX R21 PB-PB B	LPX R22 PB-PB B	LPX R23 PB-PB B	LPX R24 PB-PB B	LPX R26 PB-PB B
Polished Brass Frame/Polished Brass	LPX R21 PB-PB W	LPX R22 PB-PB W	LPX R23 PB-PB W	LPX R24 PB-PB W	LPX R26 PB-PB W
Polished Brass Frame/Satin Brass	LPX R21 PB-SB B	LPX R22 PB-SB B	LPX R23 PB-SB B	LPX R24 PB-SB B	LPX R26 PB-SB B
Polished Brass Frame/Satin Brass	LPX R21 PB-SB W	LPX R22 PB-SB W	LPX R23 PB-SB W	LPX R24 PB-SB W	LPX R26 PB-SB W
Richmond Bronze Frame/Richmond Bronze	LPX R21 RB-RB B	LPX R22 RB-RB B	LPX R23 RB-RB B	LPX R24 RB-RB B	LPX R26 RB-RB B
Nominal Size:	92.0mm x 92.0mm	92.0mm x 92.0mm	92.0mm x 92.0mm	151.0mm x 92.0mm	151.0mm x 92.0mm
Minimum Wall Box Depth:	25mm	25mm	25mm	25mm	25mm
Technical Insert Ref:	R21	R22	R23	R24	R26

Insert Surround Colour Key: (B) Black, (W) White

Linea-Perlina CFX

Rocker Switches



LPX R31 EB-EB B







LPX R32 PB-SB B



LPX RRT PB-PB W



LPX TP PB-PB W

Frame / Front Plate	 1 gang 10AX Intermediate Rocker	 2 gang 10AX Intermediate Rocker	 1 gang 10AX Push To Make/ Push to Break Retractive Rocker	 1 gang 10A Triple Pole Rocker
Antique Brass Frame/Antique Brass	LPX R31 AB-AB B	LPX R32 AB-AB B	LPX RRT AB-AB B	LPX TP AB-AB B
Antique Brass Frame/Polished Brass	LPX R31 AB-PB B	LPX R32 AB-PB B	LPX RRT AB-PB B	LPX TP AB-PB B
Antique Brass Frame/Satin Brass	LPX R31 AB-SB B	LPX R32 AB-SB B	LPX RRT AB-SB B	LPX TP AB-SB B
Connaught Bronze Frame/Connaught Bronze	LPX R31 HB-HB B	LPX R32 HB-HB B	LPX RRT HB-HB B	LPX TP HB-HB B
Copper Bronze Frame/Copper Bronze	LPX R31 CB-CB B	LPX R32 CB-CB B	LPX RRT CB-CB B	LPX TP CB-CB B
Etrium Bronze Frame/Etrium Bronze	LPX R31 EB-EB B	LPX R32 EB-EB B	LPX RRT EB-EB B	LPX TP EB-EB B
Polished Brass Frame/Antique Brass	LPX R31 PB-AB B	LPX R32 PB-AB B	LPX RRT PB-AB B	LPX TP PB-AB B
Polished Brass Frame/Antique Brass	LPX R31 PB-AB W	LPX R32 PB-AB W	LPX RRT PB-AB W	LPX TP PB-AB W
Polished Brass Frame/Polished Brass	LPX R31 PB-PB B	LPX R32 PB-PB B	LPX RRT PB-PB B	LPX TP PB-PB B
Polished Brass Frame/Polished Brass	LPX R31 PB-PB W	LPX R32 PB-PB W	LPX RRT PB-PB W	LPX TP PB-PB W
Polished Brass Frame/Satin Brass	LPX R31 PB-SB B	LPX R32 PB-SB B	LPX RRT PB-SB B	LPX TP PB-SB B
Polished Brass Frame/Satin Brass	LPX R31 PB-SB W	LPX R32 PB-SB W	LPX RRT PB-SB W	LPX TP PB-SB W
Richmond Bronze Frame/Richmond Bronze	LPX R31 RB-RB B	LPX R32 RB-RB B	LPX RRT RB-RB B	LPX TP RB-RB B
Nominal Size:	92.0mm x 92.0mm	92.0mm x 92.0mm	92.0mm x 92.0mm	92.0mm x 92.0mm
Minimum Wall Box Depth:	25mm	25mm	25mm	25mm
Technical Insert Ref:	R31	R32	RRT	TP

Insert Surround Colour Key: (B) Black, (W) White

Linea-Perlina CFX

Rocker Switches

LINEA-PERLINA CFX RANGE



LPX R212 HB-HB B







LPX R222 AB-PB B



LPX R242 AB-PB B

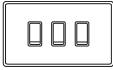
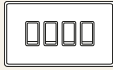

LPX R322 AB-SB B

Frame / Front Plate	 1 gang 20AX 2 Way Rocker	 2 gang 20AX 2 Way Rocker	 3 gang 20AX 2 Way Rocker	 4 gang 20AX 2 Way Rocker	 1 gang 20AX Intermediate Rocker	 2 gang 20AX Intermediate Rocker
Antique Brass Frame/Antique Brass	LPX R212 AB-AB B	LPX R222 AB-AB B	LPX R232 AB-AB B	LPX R242 AB-AB B	LPX R312 AB-AB B	LPX R322 AB-AB B
Antique Brass Frame/Polished Brass	LPX R212 AB-PB B	LPX R222 AB-PB B	LPX R232 AB-PB B	LPX R242 AB-PB B	LPX R312 AB-PB B	LPX R322 AB-PB B
Antique Brass Frame/Satin Brass	LPX R212 AB-SB B	LPX R222 AB-SB B	LPX R232 AB-SB B	LPX R242 AB-SB B	LPX R312 AB-SB B	LPX R322 AB-SB B
Connaught Bronze Frame/Connaught Bronze	LPX R212 HB-HB B	LPX R222 HB-HB B	LPX R232 HB-HB B	LPX R242 HB-HB B	LPX R312 HB-HB B	LPX R322 HB-HB B
Copper Bronze Frame/Copper Bronze	LPX R212 CB-CB B	LPX R222 CB-CB B	LPX R232 CB-CB B	LPX R242 CB-CB B	LPX R312 CB-CB B	LPX R322 CB-CB B
Etrium Bronze Frame/Etrium Bronze	LPX R212 EB-EB B	LPX R222 EB-EB B	LPX R232 EB-EB B	LPX R242 EB-EB B	LPX R312 EB-EB B	LPX R322 EB-EB B
Polished Brass Frame/Antique Brass	LPX R212 PB-AB B	LPX R222 PB-AB B	LPX R232 PB-AB B	LPX R242 PB-AB B	LPX R312 PB-AB B	LPX R322 PB-AB B
Polished Brass Frame/Antique Brass	LPX R212 PB-AB W	LPX R222 PB-AB W	LPX R232 PB-AB W	LPX R242 PB-AB W	LPX R312 PB-AB W	LPX R322 PB-AB W
Polished Brass Frame/Polished Brass	LPX R212 PB-PB B	LPX R222 PB-PB B	LPX R232 PB-PB B	LPX R242 PB-PB B	LPX R312 PB-PB B	LPX R322 PB-PB B
Polished Brass Frame/Polished Brass	LPX R212 PB-PB W	LPX R222 PB-PB W	LPX R232 PB-PB W	LPX R242 PB-PB W	LPX R312 PB-PB W	LPX R322 PB-PB W
Polished Brass Frame/Satin Brass	LPX R212 PB-SB B	LPX R222 PB-SB B	LPX R232 PB-SB B	LPX R242 PB-SB B	LPX R312 PB-SB B	LPX R322 PB-SB B
Polished Brass Frame/Satin Brass	LPX R212 PB-SB W	LPX R222 PB-SB W	LPX R232 PB-SB W	LPX R242 PB-SB W	LPX R312 PB-SB W	LPX R322 PB-SB W
Richmond Bronze Frame/Richmond Bronze	LPX R212 RB-RB B	LPX R222 RB-RB B	LPX R232 RB-RB B	LPX R242 RB-RB B	LPX R312 RB-RB B	LPX R322 RB-RB B
Nominal Size:	92.0mm x 92.0mm	92.0mm x 92.0mm	151.0mm x 92.0mm	151.0mm x 92.0mm	92.0mm x 92.0mm	92.0mm x 92.0mm
Minimum Wall Box Depth:	35mm	35mm	35mm	35mm	35mm	35mm
Technical Insert Ref:	R212	R222	R232	R242	R312	R322

Insert Surround Colour Key: (B) Black, (W) White

Linea-Perlina CFX

Wide Rockers



LPX W10DP HB HB B



LPX WR21 CB-CB B



LPX WR21 PB-PB B



LPX WR23 PB-PB B



1 gang 10AX 2 Way Rocker



2 gang 10AX 2 Way Rocker



3 gang 10AX 2 Way Rocker



1 gang 10AX Intermediate Rocker



1 gang 10AX Push To Make Frame/ Push to Break Retractive Rocker



1 gang 10AX Double Pole Rocker

Frame Frame/ Front Plate

Antique Brass Frame/Antique Brass	LPX WR21 AB-AB B	LPX WR22 AB-AB B	LPX WR23 AB-AB B	LPX WR31 AB-AB B	LPX WRRT AB-AB B	LPX W10DP AB-AB B
Antique Brass Frame/Polished Brass	LPX WR21 AB-PB B	LPX WR22 AB-PB B	LPX WR23 AB-PB B	LPX WR31 AB-PB B	LPX WRRT AB-PB B	LPX W10DP AB-PB B
Antique Brass Frame/Satin Brass	LPX WR21 AB-SB B	LPX WR22 AB-SB B	LPX WR23 AB-SB B	LPX WR31 AB-SB B	LPX WRRT AB-SB B	LPX W10DP AB-SB B
Connaught Bronze Frame/ Connaught Bronze	LPX WR21 HB-HB B	LPX WR22 HB-HB B	LPX WR23 HB-HB B	LPX WR31 HB-HB B	LPX WRRT HB-HB B	LPX W10DP HB-HB B
Copper Bronze Frame/Copper Bronze	LPX WR21 CB-CB B	LPX WR22 CB-CB B	LPX WR23 CB-CB B	LPX WR31 CB-CB B	LPX WRRT CB-CB B	LPX W10DP CB-CB B
Etrium Bronze Frame/Etrium Bronze	LPX WR21 EB-EB B	LPX WR22 EB-EB B	LPX WR23 EB-EB B	LPX WR31 EB-EB B	LPX WRRT EB-EB B	LPX W10DP EB-EB B
Polished Brass Frame/Antique Brass	LPX WR21 PB-AB B	LPX WR22 PB-AB B	LPX WR23 PB-AB B	LPX WR31 PB-AB B	LPX WRRT PB-AB B	LPX W10DP PB-AB B
Polished Brass Frame/Antique Brass	LPX WR21 PB-AB W	LPX WR22 PB-AB W	LPX WR23 PB-AB W	LPX WR31 PB-AB W	LPX WRRT PB-AB W	LPX W10DP PB-AB W
Polished Brass Frame/Polished Brass	LPX WR21 PB-PB B	LPX WR22 PB-PB B	LPX WR23 PB-PB B	LPX WR31 PB-PB B	LPX WRRT PB-PB B	LPX W10DP PB-PB B
Polished Brass Frame/Polished Brass	LPX WR21 PB-PB W	LPX WR22 PB-PB W	LPX WR23 PB-PB W	LPX WR31 PB-PB W	LPX WRRT PB-PB W	LPX W10DP PB-PB W
Polished Brass Frame/Satin Brass	LPX WR21 PB-SB B	LPX WR22 PB-SB B	LPX WR23 PB-SB B	LPX WR31 PB-SB B	LPX WRRT PB-SB B	LPX W10DP PB-SB B
Polished Brass Frame/Satin Brass	LPX WR21 PB-SB W	LPX WR22 PB-SB W	LPX WR23 PB-SB W	LPX WR31 PB-SB W	LPX WRRT PB-SB W	LPX W10DP PB-SB W
Richmond Bronze Frame/ Richmond Bronze	LPX WR21 RB-RB B	LPX WR22 RB-RB B	LPX WR23 RB-RB B	LPX WR31 RB-RB B	LPX WRRT RB-RB B	LPX W10DP RB-RB B
Nominal Size:	92.0mm x 92.0mm	92.0mm x 92.0mm	92.0mm x 92.0mm	92.0mm x 92.0mm	92.0mm x 92.0mm	92.0mm x 92.0mm
Minimum Wall Box Depth:	25mm	25mm	25mm	25mm	25mm	25mm
Technical Insert Ref:	WR21	WR22	WR23	WR31	WRRT	W10DP

Insert Surround Colour Key: (B) Black, (W) White

Linea-Perlina CFX

Toggle Switches

LINEA-PERLINA CFX RANGE







LPX T21 AB-SB



LPX T22 PB-SB



LPX T23 CB-CB

Frame / Front Plate	 1 gang 20AX 2 Way Toggle	 2 gang 20AX 2 Way Toggle	 3 gang 20AX 2 Way Toggle	 4 gang 20AX 2 Way Toggle	 1 gang 20AX Intermediate Toggle
Antique Brass Frame/Antique Brass	LPX T21 AB-AB	LPX T22 AB-AB	LPX T23 AB-AB	LPX T24 AB-AB	LPX T31 AB-AB
Antique Brass Frame/Polished Brass	LPX T21 AB-PB	LPX T22 AB-PB	LPX T23 AB-PB	LPX T24 AB-PB	LPX T31 AB-PB
Antique Brass Frame/Satin Brass	LPX T21 AB-SB	LPX T22 AB-SB	LPX T23 AB-SB	LPX T24 AB-SB	LPX T31 AB-SB
Connaught Bronze Frame/Connaught Bronze	LPX T21 HB-HB	LPX T22 HB-HB	LPX T23 HB-HB	LPX T24 HB-HB	LPX T31 HB-HB
Copper Bronze Frame/Copper Bronze	LPX T21 CB-CB	LPX T22 CB-CB	LPX T23 CB-CB	LPX T24 CB-CB	LPX T31 CB-CB
Etrium Bronze Frame/Etrium Bronze	LPX T21 EB-EB	LPX T22 EB-EB	LPX T23 EB-EB	LPX T24 EB-EB	LPX T31 EB-EB
Polished Brass Frame/Antique Brass	LPX T21 PB-AB	LPX T22 PB-AB	LPX T23 PB-AB	LPX T24 PB-AB	LPX T31 PB-AB
Polished Brass Frame/Polished Brass	LPX T21 PB-PB	LPX T22 PB-PB	LPX T23 PB-PB	LPX T24 PB-PB	LPX T31 PB-PB
Polished Brass Frame/Satin Brass	LPX T21 PB-SB	LPX T22 PB-SB	LPX T23 PB-SB	LPX T24 PB-SB	LPX T31 PB-SB
Richmond Bronze Frame/Richmond Bronze	LPX T21 RB-RB	LPX T22 RB-RB	LPX T23 RB-RB	LPX T24 RB-RB	LPX T31 RB-RB
Nominal Size:	92.0mm x 92.0mm	92.0mm x 92.0mm	151.0mm x 92.0mm	151.0mm x 92.0mm	92.0mm x 92.0mm
Minimum Wall Box Depth:	35mm	35mm	35mm	35mm	35mm
Technical Insert Ref:	T21	T22	T23	T24	T31

Toggles to match Frame Finish as standard except where specified.

Linea-Perlina CFX

Power Sockets



LPX SS1 AB-SB B



LPX US2 AB-SB B



1 gang 13A
Double Pole
Switched Socket

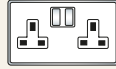

2 gang 13A
Double Pole
Switched Socket

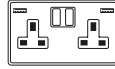

2 gang 13A Double
Pole Switched
Socket with 2 USB
Outlet 2x2.4A (4.8A
Total)



1 gang 2A
Unswitched
Socket



1 gang 5A
Unswitched
Socket

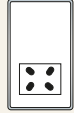

Shaver Dual Voltage
Unswitched Socket
(Vertically Mounted)

Frame / Front Plate	1 gang 13A Double Pole Switched Socket	2 gang 13A Double Pole Switched Socket	2 gang 13A Double Pole Switched Socket with 2 USB Outlet 2x2.4A (4.8A Total)	1 gang 2A Unswitched Socket	1 gang 5A Unswitched Socket	Shaver Dual Voltage Unswitched Socket (Vertically Mounted)
Antique Brass Frame/Antique Brass	LPX SS1 AB-AB B	LPX SS2 AB-AB B	LPX SS2USBULT AB-AB B	LPX US2 AB-AB B	LPX US5 AB-AB B	LPX SHS AB-AB B
Antique Brass Frame/Polished Brass	LPX SS1 AB-PB B	LPX SS2 AB-PB B	LPX SS2USBULT AB-PB B	LPX US2 AB-PB B	LPX US5 AB-PB B	LPX SHS AB-PB B
Antique Brass Frame/Satin Brass	LPX SS1 AB-SB B	LPX SS2 AB-SB B	LPX SS2USBULT AB-SB B	LPX US2 AB-SB B	LPX US5 AB-SB B	LPX SHS AB-SB B
Connaught Bronze Frame/Connaught Bronze	LPX SS1 HB-HB B	LPX SS2 HB-HB B	LPX SS2USBULT HB-HB B	LPX US2 HB-HB B	LPX US5 HB-HB B	LPX SHS HB-HB B
Copper Bronze Frame/Copper Bronze	LPX SS1 CB-CB B	LPX SS2 CB-CB B	LPX SS2USBULT CB-CB B	LPX US2 CB-CB B	LPX US5 CB-CB B	LPX SHS CB-CB B
Etrium Bronze Frame/Etrium Bronze	LPX SS1 EB-EB B	LPX SS2 EB-EB B	LPX SS2USBULT EB-EB B	LPX US2 EB-EB B	LPX US5 EB-EB B	LPX SHS EB-EB B
Polished Brass Frame/Antique Brass	LPX SS1 PB-AB B	LPX SS2 PB-AB B	LPX SS2USBULT PB-AB B	LPX US2 PB-AB B	LPX US5 PB-AB B	LPX SHS PB-AB B
Polished Brass Frame/Antique Brass	LPX SS1 PB-AB W	LPX SS2 PB-AB W	LPX SS2USBULT PB-AB W	LPX US2 PB-AB W	LPX US5 PB-AB W	LPX SHS PB-AB W
Polished Brass Frame/Polished Brass	LPX SS1 PB-PB B	LPX SS2 PB-PB B	LPX SS2USBULT PB-PB B	LPX US2 PB-PB B	LPX US5 PB-PB B	LPX SHS PB-PB B
Polished Brass Frame/Polished Brass	LPX SS1 PB-PB W	LPX SS2 PB-PB W	LPX SS2USBULT PB-PB W	LPX US2 PB-PB W	LPX US5 PB-PB W	LPX SHS PB-PB W
Polished Brass Frame/Satin Brass	LPX SS1 PB-SB B	LPX SS2 PB-SB B	LPX SS2USBULT PB-SB B	LPX US2 PB-SB B	LPX US5 PB-SB B	LPX SHS PB-SB B
Polished Brass Frame/Satin Brass	LPX SS1 PB-SB W	LPX SS2 PB-SB W	LPX SS2USBULT PB-SB W	LPX US2 PB-SB W	LPX US5 PB-SB W	LPX SHS PB-SB W
Richmond Bronze Frame/Richmond Bronze	LPX SS1 RB-RB B	LPX SS2 RB-RB B	LPX SS2USBULT RB-RB B	LPX US2 RB-RB B	LPX US5 RB-RB B	LPX SHS RB-RB B
Nominal Size: Minimum Wall Box Depth: Technical Insert Ref:	92.0mm x 92.0mm 35mm SS1	151.0mm x 92.0mm 35mm SS2	151.0mm x 92.0mm 35mm SS2USBULT	92.0mm x 92.0mm 35mm US2	92.0mm x 92.0mm 35mm US5	92.0mm x 151.0mm 47mm SHS

Insert Surround Colour Key: (B) Black, (W) White

Linea-Perlina CFX

International Power Sockets



LPX 5258 PB-PB W



LPX 5320 RB-RB B



LPX 6126 HB-HB B



1 gang 15A 110V AC
American Unswitched
Socket

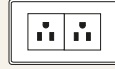

2 gang 15A 110V AC
American Unswitched
Socket



1 gang 10/16A
220/250V AC German
Unswitched Socket

Frame / Front Plate	1 gang 15A 110V AC American Unswitched Socket	2 gang 15A 110V AC American Unswitched Socket	1 gang 10/16A 220/250V AC German Unswitched Socket
Antique Brass Frame/Antique Brass	LPX 5258 AB-AB B	LPX 5320 AB-AB B	LPX 6126 AB-AB B
Antique Brass Frame/Polished Brass	LPX 5258 AB-PB B	LPX 5320 AB-PB B	LPX 6126 AB-PB B
Antique Brass Frame/Satin Brass	LPX 5258 AB-SB B	LPX 5320 AB-SB B	LPX 6126 AB-SB B
Connaught Bronze Frame/Connaught Bronze	LPX 5258 HB-HB B	LPX 5320 HB-HB B	LPX 6126 HB-HB B
Copper Bronze Frame/Copper Bronze	LPX 5258 CB-CB B	LPX 5320 CB-CB B	LPX 6126 CB-CB B
Etrium Bronze Frame/Etrium Bronze	LPX 5258 EB-EB B	LPX 5320 EB-EB B	LPX 6126 EB-EB B
Polished Brass Frame/Antique Brass	LPX 5258 PB-AB B	LPX 5320 PB-AB B	LPX 6126 PB-AB B
Polished Brass Frame/Antique Brass	LPX 5258 PB-AB W	LPX 5320 PB-AB W	LPX 6126 PB-AB W
Polished Brass Frame/Polished Brass	LPX 5258 PB-PB B	LPX 5320 PB-PB B	LPX 6126 PB-PB B
Polished Brass Frame/Polished Brass	LPX 5258 PB-PB W	LPX 5320 PB-PB W	LPX 6126 PB-PB W
Polished Brass Frame/Satin Brass	LPX 5258 PB-SB B	LPX 5320 PB-SB B	LPX 6126 PB-SB B
Polished Brass Frame/Satin Brass	LPX 5258 PB-SB W	LPX 5320 PB-SB W	LPX 6126 PB-SB W
Richmond Bronze Frame/Richmond Bronze	LPX 5258 RB-RB B	LPX 5320 RB-RB B	LPX 6126 RB-RB B
Nominal Size:	92.0mm x 92.0mm	151.0mm x 92.0mm	92.0mm x 92.0mm
Minimum Wall Box Depth:	35mm	35mm	47mm
Technical Insert Ref:	5258	5320	6126

Insert Surround Colour Key: (B) Black, (W) White

Linea-Perlina CFX

Key Switches



LPX K21 AB-SB B



LPX KEL PB-PB W

Frame / Front Plate	1 gang 20AX 2 Way Key Switch	1 gang 20AX 2 Way Key Switch EMG LTG TEST
Antique Brass Frame/Antique Brass	LPX K21 AB-AB B	LPX KEL AB-AB B
Antique Brass Frame/Polished Brass	LPX K21 AB-PB B	LPX KEL AB-PB B
Antique Brass Frame/Satin Brass	LPX K21 AB-SB B	LPX KEL AB-SB B
Connaught Bronze Frame/Connaught Bronze	LPX K21 HB-HB B	LPX KEL HB-HB B
Copper Bronze Frame/Copper Bronze	LPX K21 CB-CB B	LPX KEL CB-CB B
Etrium Bronze Frame/Etrium Bronze	LPX K21 EB-EB B	LPX KEL EB-EB B
Polished Brass Frame/Antique Brass	LPX K21 PB-AB B	LPX KEL PB-AB B
Polished Brass Frame/Antique Brass	LPX K21 PB-AB W	LPX KEL PB-AB W
Polished Brass Frame/Polished Brass	LPX K21 PB-PB B	LPX KEL PB-PB B
Polished Brass Frame/Polished Brass	LPX K21 PB-PB W	LPX KEL PB-PB W
Polished Brass Frame/Satin Brass	LPX K21 PB-SB B	LPX KEL PB-SB B
Polished Brass Frame/Satin Brass	LPX K21 PB-SB W	LPX KEL PB-SB W
Richmond Bronze Frame/Richmond Bronze	LPX K21 RB-RB B	LPX KEL RB-RB B
Nominal Size:	92.0mm x 92.0mm	92.0mm x 92.0mm
Minimum Wall Box Depth:	35mm	35mm
Technical Insert Ref:	K21	KEL

Hotel Card Switch with LED



LPX C11 PB-PB W

Frame / Front Plate	1 gang 10A (6AX) Card Switch On/Off with Blue LED Locator
Antique Brass Frame/Antique Brass	LPX C11 AB-AB B
Antique Brass Frame/Polished Brass	LPX C11 AB-PB B
Antique Brass Frame/Satin Brass	LPX C11 AB-SB B
Connaught Bronze Frame/Connaught Bronze	LPX C11 HB-HB B
Copper Bronze Frame/Copper Bronze	LPX C11 CB-CB B
Etrium Bronze Frame/Etrium Bronze	LPX C11 EB-EB B
Polished Brass Frame/Antique Brass	LPX C11 PB-AB B
Polished Brass Frame/Antique Brass	LPX C11 PB-AB W
Polished Brass Frame/Polished Brass	LPX C11 PB-PB B
Polished Brass Frame/Polished Brass	LPX C11 PB-PB W
Polished Brass Frame/Satin Brass	LPX C11 PB-SB B
Polished Brass Frame/Satin Brass	LPX C11 PB-SB W
Richmond Bronze Frame/Richmond Bronze	LPX C11 RB-RB B
Nominal Size:	92.0mm x 92.0mm
Minimum Wall Box Depth:	35mm
Technical Insert Ref:	C11

Insert Surround Colour Key: (B) Black, (W) White

Linea-Perlina CFX

Television Coaxial Sockets

LINEA-PERLINA CFX RANGE



LPX TV PB-PB W

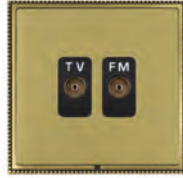

LPX TVFM AB-SB B



LPX TVI AB-SB B



LPX TVSAT PB-PB W



1 gang
Non-Isolated
Television
1in/1out



Isolated TV/FM
Diplexer 1in/2out



1 gang Isolated
TV 1in/1out



2 gang
Non-Isolated
TV+Satellite
2in/2out



1 gang Non-
Isolated Satellite



1 gang Isolated
Satellite

Frame / Front Plate	1 gang Non-Isolated Television 1in/1out	Isolated TV/FM Diplexer 1in/2out	1 gang Isolated TV 1in/1out	2 gang Non-Isolated TV+Satellite 2in/2out	1 gang Non-Isolated Satellite	1 gang Isolated Satellite
Antique Brass Frame/Antique Brass	LPX TV AB-AB B	LPX TVFM AB-AB B	LPX TVI AB-AB B	LPX TVSAT AB-AB B	LPX SATN AB-AB B	LPX SATI AB-AB B
Antique Brass Frame/Polished Brass	LPX TV AB-PB B	LPX TVFM AB-PB B	LPX TVI AB-PB B	LPX TVSAT AB-PB B	LPX SATN AB-PB B	LPX SATI AB-PB B
Antique Brass Frame/Satin Brass	LPX TV AB-SB B	LPX TVFM AB-SB B	LPX TVI AB-SB B	LPX TVSAT AB-SB B	LPX SATN AB-SB B	LPX SATI AB-SB B
Connaught Bronze Frame/Connaught Bronze	LPX TV HB-HB B	LPX TVFM HB-HB B	LPX TVI HB-HB B	LPX TVSAT HB-HB B	LPX SATN HB-HB B	LPX SATI HB-HB B
Copper Bronze Frame/Copper Bronze	LPX TV CB-CB B	LPX TVFM CB-CB B	LPX TVI CB-CB B	LPX TVSAT CB-CB B	LPX SATN CB-CB B	LPX SATI CB-CB B
Etrium Bronze Frame/Etrium Bronze	LPX TV EB-EB B	LPX TVFM EB-EB B	LPX TVI EB-EB B	LPX TVSAT EB-EB B	LPX SATN EB-EB B	LPX SATI EB-EB B
Polished Brass Frame/Antique Brass	LPX TV PB-AB B	LPX TVFM PB-AB B	LPX TVI PB-AB B	LPX TVSAT PB-AB B	LPX SATN PB-AB B	LPX SATI PB-AB B
Polished Brass Frame/Polished Brass	LPX TV PB-PB B	LPX TVFM PB-PB B	LPX TVI PB-PB B	LPX TVSAT PB-PB B	LPX SATN PB-PB B	LPX SATI PB-PB B
Polished Brass Frame/Polished Brass	LPX TV PB-PB W	LPX TVFM PB-PB W	LPX TVI PB-PB W	LPX TVSAT PB-PB W	LPX SATN PB-PB W	LPX SATI PB-PB W
Polished Brass Frame/Satin Brass	LPX TV PB-SB B	LPX TVFM PB-SB B	LPX TVI PB-SB B	LPX TVSAT PB-SB B	LPX SATN PB-SB B	LPX SATI PB-SB B
Polished Brass Frame/Satin Brass	LPX TV PB-SB W	LPX TVFM PB-SB W	LPX TVI PB-SB W	LPX TVSAT PB-SB W	LPX SATN PB-SB W	LPX SATI PB-SB W
Richmond Bronze Frame/Richmond Bronze	LPX TV RB-RB B	LPX TVFM RB-RB B	LPX TVI RB-RB B	LPX TVSAT RB-RB B	LPX SATN RB-RB B	LPX SATI RB-RB B
Nominal Size: Minimum Wall Box Depth: Technical Insert Ref:	92.0mm x 92.0mm 25mm TV	92.0mm x 92.0mm 25mm TVFM	92.0mm x 92.0mm 25mm TVI	92.0mm x 92.0mm 35mm TVSAT	92.0mm x 92.0mm 35mm SATN	92.0mm x 92.0mm 35mm SATI

Insert Surround Colour Key: (B) Black, (W) White

Linea-Perlina CFX

Digital Television Sockets

- Screened Non Isolated / DAB Compatible



LPX DTRID AB-PB B



LPX DTVF PB-PB W



LPX DTVM PB-SB B



LPX DENT AB-SB B



Non-Isolated TV+FM+SAT Triplexer 1in/3out (DAB Compatible)



1 gang Non-Isolated TV (female) (DAB Compatible)



1 gang Non-Isolated TV (Male) (DAB Compatible)



1 gang Non-Isolated Satellite (DAB Compatible)



Non-Isolated TV+FM+SAT1+SAT2 Quadplexer 2in/4out (DAB Compatible)

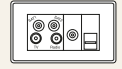

Non-Isolated TV+FM+SAT1+SAT2 Quadplexer 2in/4out +TVF+TCS (DAB Compatible)

Frame / Front Plate	LPX DTRID AB-AB B	LPX DTVF AB-AB B	LPX DTVM AB-AB B	LPX DSAT AB-AB B	LPX DENT AB-AB B	LPX DSAT+ AB-AB B
Antique Brass Frame/Antique Brass	LPX DTRID AB-PB B	LPX DTVF AB-PB B	LPX DTVM AB-PB B	LPX DSAT AB-PB B	LPX DENT AB-PB B	LPX DSAT+ AB-PB B
Antique Brass Frame/Polished Brass	LPX DTRID AB-SB B	LPX DTVF AB-SB B	LPX DTVM AB-SB B	LPX DSAT AB-SB B	LPX DENT AB-SB B	LPX DSAT+ AB-SB B
Antique Brass Frame/Satin Brass	LPX DTRID HB-HB B	LPX DTVF HB-HB B	LPX DTVM HB-HB B	LPX DSAT HB-HB B	LPX DENT HB-HB B	LPX DSAT+ HB-HB B
Connaught Bronze Frame/Connaught Bronze	LPX DTRID CB-CB B	LPX DTVF CB-CB B	LPX DTVM CB-CB B	LPX DSAT CB-CB B	LPX DENT CB-CB B	LPX DSAT+ CB-CB B
Copper Bronze Frame/Copper Bronze	LPX DTRID EB-EB B	LPX DTVF EB-EB B	LPX DTVM EB-EB B	LPX DSAT EB-EB B	LPX DENT EB-EB B	LPX DSAT+ EB-EB B
Etrium Bronze Frame/Etrium Bronze	LPX DTRID PB-AB B	LPX DTVF PB-AB B	LPX DTVM PB-AB B	LPX DSAT PB-AB B	LPX DENT PB-AB B	LPX DSAT+ PB-AB B
Polished Brass Frame/Antique Brass	LPX DTRID PB-AB W	LPX DTVF PB-AB W	LPX DTVM PB-AB W	LPX DSAT PB-AB W	LPX DENT PB-AB W	LPX DSAT+ PB-AB W
Polished Brass Frame/Polished Brass	LPX DTRID PB-PB B	LPX DTVF PB-PB B	LPX DTVM PB-PB B	LPX DSAT PB-PB B	LPX DENT PB-PB B	LPX DSAT+ PB-PB B
Polished Brass Frame/Polished Brass	LPX DTRID PB-PB W	LPX DTVF PB-PB W	LPX DTVM PB-PB W	LPX DSAT PB-PB W	LPX DENT PB-PB W	LPX DSAT+ PB-PB W
Polished Brass Frame/Satin Brass	LPX DTRID PB-SB B	LPX DTVF PB-SB B	LPX DTVM PB-SB B	LPX DSAT PB-SB B	LPX DENT PB-SB B	LPX DSAT+ PB-SB B
Polished Brass Frame/Satin Brass	LPX DTRID PB-SB W	LPX DTVF PB-SB W	LPX DTVM PB-SB W	LPX DSAT PB-SB W	LPX DENT PB-SB W	LPX DSAT+ PB-SB W
Richmond Bronze Frame/Richmond Bronze	LPX DTRID RB-RB B	LPX DTVF RB-RB B	LPX DTVM RB-RB B	LPX DSAT RB-RB B	LPX DENT RB-RB B	LPX DSAT+ RB-RB B
Nominal Size:	92.0mm x 92.0mm	92.0mm x 92.0mm	92.0mm x 92.0mm	92.0mm x 92.0mm	92.0mm x 92.0mm	151.0mm x 92.0mm
Minimum Wall Box Depth:	35mm	35mm	35mm	35mm	35mm	35mm
Technical Insert Ref:	DTRID	DTVf	DTVM	DSAT	DENT	DSAT+

Insert Surround Colour Key: (B) Black, (W) White

Linea-Perlina CFX

Telephone and Data Outlets

LINEA-PERLINA CFX RANGE



LPX TCM AB-PB B





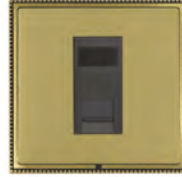



LPX TCS PB-PB B



LPX J12 AB-SB B



LPX 2J45 AB-SB B

Frame / Front Plate	 1 gang Telephone Master	 1 gang Telephone Slave	 1 gang RJ12 Outlet - Unshielded	 2 gang RJ12 Outlet - Unshielded	 1 gang RJ45 CAT 5E Outlet - Unshielded	 2 gang RJ45 CAT 5E Outlet - Unshielded
Antique Brass Frame/Antique Brass	LPX TCM AB-AB B	LPX TCS AB-AB B	LPX J12 AB-AB B	LPX 2J12 AB-AB B	LPX J45 AB-AB B	LPX 2J45 AB-AB B
Antique Brass Frame/Polished Brass	LPX TCM AB-PB B	LPX TCS AB-PB B	LPX J12 AB-PB B	LPX 2J12 AB-PB B	LPX J45 AB-PB B	LPX 2J45 AB-PB B
Antique Brass Frame/Satin Brass	LPX TCM AB-SB B	LPX TCS AB-SB B	LPX J12 AB-SB B	LPX 2J12 AB-SB B	LPX J45 AB-SB B	LPX 2J45 AB-SB B
Connaught Bronze Frame/Connaught Bronze	LPX TCM HB-HB B	LPX TCS HB-HB B	LPX J12 HB-HB B	LPX 2J12 HB-HB B	LPX J45 HB-HB B	LPX 2J45 HB-HB B
Copper Bronze Frame/Copper Bronze	LPX TCM CB-CB B	LPX TCS CB-CB B	LPX J12 CB-CB B	LPX 2J12 CB-CB B	LPX J45 CB-CB B	LPX 2J45 CB-CB B
Etrium Bronze Frame/Etrium Bronze	LPX TCM EB-EB B	LPX TCS EB-EB B	LPX J12 EB-EB B	LPX 2J12 EB-EB B	LPX J45 EB-EB B	LPX 2J45 EB-EB B
Polished Brass Frame/Antique Brass	LPX TCM PB-AB B	LPX TCS PB-AB B	LPX J12 PB-AB B	LPX 2J12 PB-AB B	LPX J45 PB-AB B	LPX 2J45 PB-AB B
Polished Brass Frame/Antique Brass	LPX TCM PB-AB W	LPX TCS PB-AB W	LPX J12 PB-AB W	LPX 2J12 PB-AB W	LPX J45 PB-AB W	LPX 2J45 PB-AB W
Polished Brass Frame/Polished Brass	LPX TCM PB-PB B	LPX TCS PB-PB B	LPX J12 PB-PB B	LPX 2J12 PB-PB B	LPX J45 PB-PB B	LPX 2J45 PB-PB B
Polished Brass Frame/Polished Brass	LPX TCM PB-PB W	LPX TCS PB-PB W	LPX J12 PB-PB W	LPX 2J12 PB-PB W	LPX J45 PB-PB W	LPX 2J45 PB-PB W
Polished Brass Frame/Satin Brass	LPX TCM PB-SB B	LPX TCS PB-SB B	LPX J12 PB-SB B	LPX 2J12 PB-SB B	LPX J45 PB-SB B	LPX 2J45 PB-SB B
Polished Brass Frame/Satin Brass	LPX TCM PB-SB W	LPX TCS PB-SB W	LPX J12 PB-SB W	LPX 2J12 PB-SB W	LPX J45 PB-SB W	LPX 2J45 PB-SB W
Richmond Bronze Frame/Richmond Bronze	LPX TCM RB-RB B	LPX TCS RB-RB B	LPX J12 RB-RB B	LPX 2J12 RB-RB B	LPX J45 RB-RB B	LPX 2J45 RB-RB B
Nominal Size:	92.0mm x 92.0mm	92.0mm x 92.0mm	92.0mm x 92.0mm	92.0mm x 92.0mm	92.0mm x 92.0mm	92.0mm x 92.0mm
Minimum Wall Box Depth:	25mm	25mm	35mm	35mm	35mm	35mm
Technical Insert Ref:	TCM	TCS	J12	2J12	J45	2J45

Insert Surround Colour Key: (B) Black, (W) White

Linea-Perlina CFX

Double Pole Switches



LPX DPN AB-SB B



LPX 45SS1 AB-PB B



LPX SPN PB-PB B



1 gang 20AX
Double Pole
Rocker + Neon



1 gang 45A
Double Pole Red
Rocker + Neon

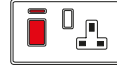

45A Double
Pole Red Rocker
+ Neon + 13A
Switched Socket



1 gang 13A
Double Pole
Fused Spur +
Neon



1 gang 13A Fuse
with Red Neon
Halo

Frame / Front Plate

Antique Brass Frame/Antique Brass	LPX DPN AB-AB B	LPX 45N AB-AB B	LPX 45SS1 AB-AB B
Antique Brass Frame/Polished Brass	LPX DPN AB-PB B	LPX 45N AB-PB B	LPX 45SS1 AB-PB B
Antique Brass Frame/Satin Brass	LPX DPN AB-SB B	LPX 45N AB-SB B	LPX 45SS1 AB-SB B
Connaught Bronze Frame/Connaught Bronze	LPX DPN HB-HB B	LPX 45N HB-HB B	LPX 45SS1 HB-HB B
Copper Bronze Frame/Copper Bronze	LPX DPN CB-CB B	LPX 45N CB-CB B	LPX 45SS1 CB-CB B
Etrium Bronze Frame/Etrium Bronze	LPX DPN EB-EB B	LPX 45N EB-EB B	LPX 45SS1 EB-EB B
Polished Brass Frame/Antique Brass	LPX DPN PB-AB B	LPX 45N PB-AB B	LPX 45SS1 PB-AB B
Polished Brass Frame/Polished Brass	LPX DPN PB-AB W	LPX 45N PB-AB W	LPX 45SS1 PB-AB W
Polished Brass Frame/Polished Brass	LPX DPN PB-PB B	LPX 45N PB-PB B	LPX 45SS1 PB-PB B
Polished Brass Frame/Polished Brass	LPX DPN PB-PB W	LPX 45N PB-PB W	LPX 45SS1 PB-PB W
Polished Brass Frame/Satin Brass	LPX DPN PB-SB B	LPX 45N PB-SB B	LPX 45SS1 PB-SB B
Polished Brass Frame/Satin Brass	LPX DPN PB-SB W	LPX 45N PB-SB W	LPX 45SS1 PB-SB W
Richmond Bronze Frame/Richmond Bronze	LPX DPN RB-RB B	LPX 45N RB-RB B	LPX 45SS1 RB-RB B
Nominal Size:	92.0mm x 92.0mm	92.0mm x 92.0mm	151.0mm x 92.0mm
Minimum Wall Box Depth:	35mm	35mm	35mm
Technical Insert Ref:	DPN	45N	45SS1

Connection Units

LPX SPN AB-AB B	LPX FN AB-AB R
LPX SPN AB-PB B	LPX FN AB-PB R
LPX SPN AB-SB B	LPX FN AB-SB R
LPX SPN HB-HB B	LPX FN HB-HB R
LPX SPN CB-CB B	LPX FN CB-CB R
LPX SPN EB-EB B	LPX FN EB-EB R
LPX SPN PB-AB B	-
LPX SPN PB-AB W	LPX FN PB-AB R
LPX SPN PB-PB B	LPX FN PB-PB R
LPX SPN PB-PB W	-
LPX SPN PB-SB B	LPX FN PB-SB R
LPX SPN PB-SB W	-
LPX SPN RB-RB B	LPX FN RB-RB R
92.0mm x 92.0mm 35mm SPN	92.0mm x 92.0mm 35mm FN

Insert Surround Colour Key: (B) Black, (W) White

Linea-Perlina CFX

LED Trailing/Leading Edge Push On/Off Rotary 2 Way Switching Dimmers





LINEA-PERLINA CFX RANGE



LPX 1XLEDITB100 AB-PB

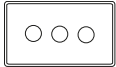

LPX 2XLEDITB100 AB-SB

Frame / Front Plate	 1 gang 100W LED Trailing/ Leading Edge Push On/ Off Rotary 2 Way Switching Dimmer	 2 gang 100W LED Trailing/ Leading Edge Push On/ Off Rotary 2 Way Switching Dimmer	 3 gang 100W LED Trailing/ Leading Edge Push On/ Off Rotary 2 Way Switching Dimmer	 4 gang 100W LED Trailing/ Leading Edge Push On/ Off Rotary 2 Way Switching Dimmer
Antique Brass Frame/Antique Brass	LPX 1XLEDITB100 AB-AB	LPX 2XLEDITB100 AB-AB	LPX 3XLEDITB100 AB-AB	LPX 4XLEDITB100 AB-AB
Antique Brass Frame/Polished Brass	LPX 1XLEDITB100 AB-PB	LPX 2XLEDITB100 AB-PB	LPX 3XLEDITB100 AB-PB	LPX 4XLEDITB100 AB-PB
Antique Brass Frame/Satin Brass	LPX 1XLEDITB100 AB-SB	LPX 2XLEDITB100 AB-SB	LPX 3XLEDITB100 AB-SB	LPX 4XLEDITB100 AB-SB
Connaught Bronze Frame/Connaught Bronze	LPX 1XLEDITB100 HB-HB	LPX 2XLEDITB100 HB-HB	LPX 3XLEDITB100 HB-HB	LPX 4XLEDITB100 HB-HB
Copper Bronze Frame/Copper Bronze	LPX 1XLEDITB100 CB-CB	LPX 2XLEDITB100 CB-CB	LPX 3XLEDITB100 CB-CB	LPX 4XLEDITB100 CB-CB
Etrium Bronze Frame/Etrium Bronze	LPX 1XLEDITB100 EB-EB	LPX 2XLEDITB100 EB-EB	LPX 3XLEDITB100 EB-EB	LPX 4XLEDITB100 EB-EB
Polished Brass Frame/Antique Brass	LPX 1XLEDITB100 PB-AB	LPX 2XLEDITB100 PB-AB	LPX 3XLEDITB100 PB-AB	LPX 4XLEDITB100 PB-AB
Polished Brass Frame/Polished Brass	LPX 1XLEDITB100 PB-PB	LPX 2XLEDITB100 PB-PB	LPX 3XLEDITB100 PB-PB	LPX 4XLEDITB100 PB-PB
Polished Brass Frame/Satin Brass	LPX 1XLEDITB100 PB-SB	LPX 2XLEDITB100 PB-SB	LPX 3XLEDITB100 PB-SB	LPX 4XLEDITB100 PB-SB
Richmond Bronze Frame/Richmond Bronze	LPX 1XLEDITB100 RB-RB	LPX 2XLEDITB100 RB-RB	LPX 3XLEDITB100 RB-RB	LPX 4XLEDITB100 RB-RB
Nominal Size:	92.0mm x 92.0mm	92.0mm x 92.0mm	151.0mm x 92.0mm	151.0mm x 92.0mm
Minimum Wall Box Depth:	35mm	35mm	35mm	35mm
Technical Insert Ref:	1XLEDITB	2XLEDITB	3XLEDITB	4XLEDITB

NOTE: Tungsten filament GU10 lamps must be branded and with a fused base.

NOTE: Please refer to the Dimmer Technical Section for the max Wattage.

NOTE: Please contact our Technical Department for compatibility.

Linea-Perlina CFX

LED Trailing/Leading Edge Push On/Off Rotary Multi-Way Dimmers



LPX 1X100LED PB-SB



LPX 2X100LED PB-PB



LPX 3X100LED AB-SB



LPX 4X100LED AB-PB



1 gang 100W LED Trailing/
Leading Edge Push On/Off
Rotary Multi-Way Dimmer



2 gang 100W LED Trailing/
Leading Edge Push On/Off
Rotary Multi-Way Dimmer



3 gang 100W LED Trailing/
Leading Edge Push On/Off
Rotary Multi-Way Dimmer



4 gang 100W LED Trailing/
Leading Edge Push On/Off
Rotary Multi-Way Dimmer

Frame / Front Plate	1 gang 100W LED Trailing/ Leading Edge Push On/Off Rotary Multi-Way Dimmer	2 gang 100W LED Trailing/ Leading Edge Push On/Off Rotary Multi-Way Dimmer	3 gang 100W LED Trailing/ Leading Edge Push On/Off Rotary Multi-Way Dimmer	4 gang 100W LED Trailing/ Leading Edge Push On/Off Rotary Multi-Way Dimmer
Antique Brass Frame/Antique Brass	LPX 1X100LED AB-AB	LPX 2X100LED AB-AB	LPX 3X100LED AB-AB	LPX 4X100LED AB-AB
Antique Brass Frame/Polished Brass	LPX 1X100LED AB-PB	LPX 2X100LED AB-PB	LPX 3X100LED AB-PB	LPX 4X100LED AB-PB
Antique Brass Frame/Satin Brass	LPX 1X100LED AB-SB	LPX 2X100LED AB-SB	LPX 3X100LED AB-SB	LPX 4X100LED AB-SB
Connaught Bronze Frame/Connaught Bronze	LPX 1X100LED HB-HB	LPX 2X100LED HB-HB	LPX 3X100LED HB-HB	LPX 4X100LED HB-HB
Copper Bronze Frame/Copper Bronze	LPX 1X100LED CB-CB	LPX 2X100LED CB-CB	LPX 3X100LED CB-CB	LPX 4X100LED CB-CB
Etrium Bronze Frame/Etrium Bronze	LPX 1X100LED EB-EB	LPX 2X100LED EB-EB	LPX 3X100LED EB-EB	LPX 4X100LED EB-EB
Polished Brass Frame/Antique Brass	LPX 1X100LED PB-AB	LPX 2X100LED PB-AB	LPX 3X100LED PB-AB	LPX 4X100LED PB-AB
Polished Brass Frame/Polished Brass	LPX 1X100LED PB-PB	LPX 2X100LED PB-PB	LPX 3X100LED PB-PB	LPX 4X100LED PB-PB
Polished Brass Frame/Satin Brass	LPX 1X100LED PB-SB	LPX 2X100LED PB-SB	LPX 3X100LED PB-SB	LPX 4X100LED PB-SB
Richmond Bronze Frame/Richmond Bronze	LPX 1X100LED RB-RB	LPX 2X100LED RB-RB	LPX 3X100LED RB-RB	LPX 4X100LED RB-RB
Nominal Size:	92.0mm x 92.0mm	92.0mm x 92.0mm	151.0mm x 92.0mm	151.0mm x 92.0mm
Minimum Wall Box Depth:	35mm	35mm	35mm	35mm
Technical Insert Ref:	1X100LED	2X100LED	3X100LED	4X100LED

NOTE: Tungsten filament GU10 lamps must be branded and with a fused base.

NOTE: Please refer to the Dimmer Technical Section for the max Wattage.

NOTE: Please contact our Technical Department for compatibility.

Linea-Perlina CFX

Resistive Leading Edge Push On/Off Rotary 2 Way Switching Dimmers

LINEA-PERLINA CFX RANGE



LPX 1X40 PB-SB



LPX 2X40 AB-PB



LPX 3X40 AB-SB



1 gang 400W Resistive Leading Edge Push On/Off Rotary 2 Way Switching Dimmer



2 gang 400W Resistive Leading Edge Push On/Off Rotary 2 Way Switching Dimmer

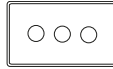

3 gang 400W Resistive Leading Edge Push On/Off Rotary 2 Way Switching Dimmers

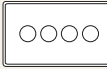

4 gang 400W Resistive Leading Edge Push On/Off Rotary 2 Way Switching Dimmer



1 gang 600W Resistive Leading Edge Push On/Off Rotary 2 Way Switching Dimmer

Frame / Front Plate	1 gang 400W Resistive Leading Edge Push On/Off Rotary 2 Way Switching Dimmer	2 gang 400W Resistive Leading Edge Push On/Off Rotary 2 Way Switching Dimmer	3 gang 400W Resistive Leading Edge Push On/Off Rotary 2 Way Switching Dimmers	4 gang 400W Resistive Leading Edge Push On/Off Rotary 2 Way Switching Dimmer	1 gang 600W Resistive Leading Edge Push On/Off Rotary 2 Way Switching Dimmer
Antique Brass Frame/Antique Brass	LPX 1X40 AB-AB	LPX 2X40 AB-AB	LPX 3X40 AB-AB	LPX 4X40 AB-AB	LPX 1X60 AB-AB
Antique Brass Frame/Polished Brass	LPX 1X40 AB-PB	LPX 2X40 AB-PB	LPX 3X40 AB-PB	LPX 4X40 AB-PB	LPX 1X60 AB-PB
Antique Brass Frame/Satin Brass	LPX 1X40 AB-SB	LPX 2X40 AB-SB	LPX 3X40 AB-SB	LPX 4X40 AB-SB	LPX 1X60 AB-SB
Connaught Bronze Frame/Connaught Bronze	LPX 1X40 HB-HB	LPX 2X40 HB-HB	LPX 3X40 HB-HB	LPX 4X40 HB-HB	LPX 1X60 HB-HB
Copper Bronze Frame/Copper Bronze	LPX 1X40 CB-CB	LPX 2X40 CB-CB	LPX 3X40 CB-CB	LPX 4X40 CB-CB	LPX 1X60 CB-CB
Etrium Bronze Frame/Etrium Bronze	LPX 1X40 EB-EB	LPX 2X40 EB-EB	LPX 3X40 EB-EB	LPX 4X40 EB-EB	LPX 1X60 EB-EB
Polished Brass Frame/Antique Brass	LPX 1X40 PB-AB	LPX 2X40 PB-AB	LPX 3X40 PB-AB	LPX 4X40 PB-AB	LPX 1X60 PB-AB
Polished Brass Frame/Polished Brass	LPX 1X40 PB-PB	LPX 2X40 PB-PB	LPX 3X40 PB-PB	LPX 4X40 PB-PB	LPX 1X60 PB-PB
Polished Brass Frame/Satin Brass	LPX 1X40 PB-SB	LPX 2X40 PB-SB	LPX 3X40 PB-SB	LPX 4X40 PB-SB	LPX 1X60 PB-SB
Richmond Bronze Frame/Richmond Bronze	LPX 1X40 RB-RB	LPX 2X40 RB-RB	LPX 3X40 RB-RB	LPX 4X40 RB-RB	LPX 1X60 RB-RB
Nominal Size:	92.0mm x 92.0mm	92.0mm x 92.0mm	151.0mm x 92.0mm	151.0mm x 92.0mm	92.0mm x 92.0mm
Minimum Wall Box Depth:	35mm	35mm	35mm	35mm	35mm
Technical Insert Ref:	1X40	2X40	3X40	4X40	1X60

NOTE: Tungsten filament GU10 lamps must be branded and with a fused base
 NOTE: When using mains voltage halogen lamps – dimmers should be re-rated by 25%
 NOTE: When dimming LED lamps de-rate by 75% - please contact our Technical Department for compatibility.
 NOTE: Please refer to the Dimmer Technical Section for the max wattage

Linea-Perlina CFX

Inductive Leading Edge Push On/Off Rotary 2 Way Switching Dimmers



LPX 1X2V PB-PB



1 gang 200VA
Inductive Leading
Edge Push On/
Off Rotary 2 Way
Switching Dimmer

Frame / Front Plate	
Antique Brass Frame/Antique Brass	LPX 1X2V AB-AB
Antique Brass Frame/Polished Brass	LPX 1X2V AB-PB
Antique Brass Frame/Satin Brass	LPX 1X2V AB-SB
Connaught Bronze Frame/Connaught Bronze	LPX 1X2V HB-HB
Copper Bronze Frame/Copper Bronze	LPX 1X2V CB-CB
Etrium Bronze Frame/Etrium Bronze	LPX 1X2V EB-EB
Polished Brass Frame/Antique Brass	LPX 1X2V PB-AB
Polished Brass Frame/Polished Brass	LPX 1X2V PB-PB
Polished Brass Frame/Satin Brass	LPX 1X2V PB-SB
Richmond Bronze Frame/Richmond Bronze	LPX 1X2V RB-RB
Nominal Size:	92.0mm x 92.0mm
Minimum Wall Box Depth:	35mm
Technical Insert Ref:	1X2V

NOTE: Tungsten filament GU10 lamps must be branded and with a fused base
 NOTE: When using mains voltage halogen lamps – dimmers should be re-rated by 25%
 NOTE: When dimming LED lamps de-rate by 75% - please contact our Technical Department for compatibility.
 NOTE: Please refer to the Dimmer Technical Section for the max wattage

Linea-Perlina CFX

Resistive/Inductive Trailing Edge Push On/Off Rotary Multi-Way Dimmers

LINEA-PERLINA CFX RANGE

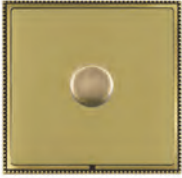

LPX 1XTE AB-SB



LPX 2XTE AB-PB



1 gang 250W/210VA
Resistive/Inductive Trailing
Edge Push On/Off Rotary
Multi-Way Dimmer



2 gang 250W/210VA
Resistive/Inductive Trailing
Edge Push On/Off Rotary
Multi-Way Dimmer

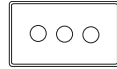

3 gang 250W/210VA
Resistive/Inductive Trailing
Edge Push On/Off Rotary
Multi-Way Dimmer



4 gang 250W/210VA
Resistive/Inductive Trailing
Edge Push On/Off Rotary
Multi-Way Dimmer

Frame / Front Plate	1 gang 250W/210VA Resistive/Inductive Trailing Edge Push On/Off Rotary Multi-Way Dimmer	2 gang 250W/210VA Resistive/Inductive Trailing Edge Push On/Off Rotary Multi-Way Dimmer	3 gang 250W/210VA Resistive/Inductive Trailing Edge Push On/Off Rotary Multi-Way Dimmer	4 gang 250W/210VA Resistive/Inductive Trailing Edge Push On/Off Rotary Multi-Way Dimmer
Antique Brass Frame/Antique Brass	LPX 1XTE AB-AB	LPX 2XTE AB-AB	LPX 3XTE AB-AB	LPX 4XTE AB-AB
Antique Brass Frame/Polished Brass	LPX 1XTE AB-PB	LPX 2XTE AB-PB	LPX 3XTE AB-PB	LPX 4XTE AB-PB
Antique Brass Frame/Satin Brass	LPX 1XTE AB-SB	LPX 2XTE AB-SB	LPX 3XTE AB-SB	LPX 4XTE AB-SB
Connaught Bronze Frame/Connaught Bronze	LPX 1XTE HB-HB	LPX 2XTE HB-HB	LPX 3XTE HB-HB	LPX 4XTE HB-HB
Copper Bronze Frame/Copper Bronze	LPX 1XTE CB-CB	LPX 2XTE CB-CB	LPX 3XTE CB-CB	LPX 4XTE CB-CB
Etrium Bronze Frame/Etrium Bronze	LPX 1XTE EB-EB	LPX 2XTE EB-EB	LPX 3XTE EB-EB	LPX 4XTE EB-EB
Polished Brass Frame/Antique Brass	LPX 1XTE PB-AB	LPX 2XTE PB-AB	LPX 3XTE PB-AB	LPX 4XTE PB-AB
Polished Brass Frame/Polished Brass	LPX 1XTE PB-PB	LPX 2XTE PB-PB	LPX 3XTE PB-PB	LPX 4XTE PB-PB
Polished Brass Frame/Satin Brass	LPX 1XTE PB-SB	LPX 2XTE PB-SB	LPX 3XTE PB-SB	LPX 4XTE PB-SB
Richmond Bronze Frame/Richmond Bronze	LPX 1XTE RB-RB	LPX 2XTE RB-RB	LPX 3XTE RB-RB	LPX 4XTE RB-RB
Nominal Size:	92.0mm x 92.0mm	92.0mm x 92.0mm	151.0mm x 92.0mm	151.0mm x 92.0mm
Minimum Wall Box Depth:	35mm	35mm	35mm	35mm
Technical Insert Ref:	1XTE	2XTE	3XTE	4XTE

NOTE: Tungsten filament GU10 lamps must be branded and with a fused base
 NOTE: When using mains voltage halogen lamps – dimmers should be re-rated by 25%
 NOTE: When dimming LED lamps de-rate by 75% - please contact our Technical Department for compatibility.
 NOTE: Please refer to the Dimmer Technical Section for the max wattage

Linea-Perlina CFX

Resistive/Inductive Trailing Edge Touch Master Multi-Way Dimmers



LPX 1XTM PB-PB W

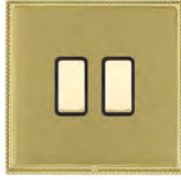

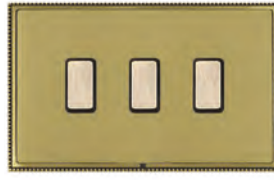

LPX 2XTM PB-SB B



LPX 3XTM AB-SB B

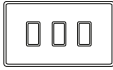
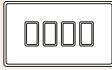

LPX 4XTM AB-PB B

Frame / Front Plate	 1 gang 250W/210VA Resistive/Inductive Trailing Edge Touch Master Multi- Way Dimmer	 2 gang 250W/210VA Resistive/Inductive Trailing Edge Touch Master Multi- Way Dimmer	 3 gang 250W/210VA Resistive/Inductive Trailing Edge Touch Master Multi- Way Dimmer	 4 gang 250W/210VA Resistive/Inductive Trailing Edge Touch Master Multi- Way Dimmer
Antique Brass Frame/Antique Brass	LPX 1XTM AB-AB B	LPX 2XTM AB-AB B	LPX 3XTM AB-AB B	LPX 4XTM AB-AB B
Antique Brass Frame/Polished Brass	LPX 1XTM AB-PB B	LPX 2XTM AB-PB B	LPX 3XTM AB-PB B	LPX 4XTM AB-PB B
Antique Brass Frame/Satin Brass	LPX 1XTM AB-SB B	LPX 2XTM AB-SB B	LPX 3XTM AB-SB B	LPX 4XTM AB-SB B
Connaught Bronze Frame/Connaught Bronze	LPX 1XTM HB-HB B	LPX 2XTM HB-HB B	LPX 3XTM HB-HB B	LPX 4XTM HB-HB B
Copper Bronze Frame/Copper Bronze	LPX 1XTM CB-CB B	LPX 2XTM CB-CB B	LPX 3XTM CB-CB B	LPX 4XTM CB-CB B
Etrium Bronze Frame/Etrium Bronze	LPX 1XTM EB-EB B	LPX 2XTM EB-EB B	LPX 3XTM EB-EB B	LPX 4XTM EB-EB B
Polished Brass Frame/Antique Brass	LPX 1XTM PB-AB B	LPX 2XTM PB-AB B	LPX 3XTM PB-AB B	LPX 4XTM PB-AB B
Polished Brass Frame/Antique Brass	LPX 1XTM PB-AB W	LPX 2XTM PB-AB W	LPX 3XTM PB-AB W	LPX 4XTM PB-AB W
Polished Brass Frame/Polished Brass	LPX 1XTM PB-PB B	LPX 2XTM PB-PB B	LPX 3XTM PB-PB B	LPX 4XTM PB-PB B
Polished Brass Frame/Polished Brass	LPX 1XTM PB-PB W	LPX 2XTM PB-PB W	LPX 3XTM PB-PB W	LPX 4XTM PB-PB W
Polished Brass Frame/Satin Brass	LPX 1XTM PB-SB B	LPX 2XTM PB-SB B	LPX 3XTM PB-SB B	LPX 4XTM PB-SB B
Polished Brass Frame/Satin Brass	LPX 1XTM PB-SB W	LPX 2XTM PB-SB W	LPX 3XTM PB-SB W	LPX 4XTM PB-SB W
Richmond Bronze Frame/Richmond Bronze	LPX 1XTM RB-RB B	LPX 2XTM RB-RB B	LPX 3XTM RB-RB B	LPX 4XTM RB-RB B
Nominal Size:	92.0mm x 92.0mm	92.0mm x 92.0mm	151.0mm x 92.0mm	151.0mm x 92.0mm
Minimum Wall Box Depth:	35mm	35mm	35mm	35mm
Technical Insert Ref:	1XTM	2XTM	3XTM	4XTM

NOTE: Tungsten filament GU10 lamps must be branded and with a fused base
 NOTE: When using mains voltage halogen lamps – dimmers should be re-rated by 25%
 NOTE: When dimming LED lamps de-rate by 75% - please contact our Technical Department for compatibility.
 NOTE: Please refer to the Dimmer Technical Section for the max wattage

Insert Surround Colour Key: (B) Black, (W) White

Linea-Perlina CFX

Multi-Way Touch Slave Controllers

LINEA-PERLINA CFX RANGE





LPX 1XTS PB-SB W



LPX 2XTS AB-SB B

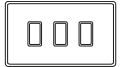
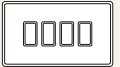

LPX 3XTS AB-PB B

Frame / Front Plate	 1 gang Multi-Way Touch Slave Controller	 2 gang Multi-Way Touch Slave Controller	 3 gang Multi-Way Touch Slave Controller	 4 gang Multi-Way Touch Slave Controller
Antique Brass Frame/Antique Brass	LPX 1XTS AB-AB B	LPX 2XTS AB-AB B	LPX 3XTS AB-AB B	LPX 4XTS AB-AB B
Antique Brass Frame/Polished Brass	LPX 1XTS AB-PB B	LPX 2XTS AB-PB B	LPX 3XTS AB-PB B	LPX 4XTS AB-PB B
Antique Brass Frame/Satin Brass	LPX 1XTS AB-SB B	LPX 2XTS AB-SB B	LPX 3XTS AB-SB B	LPX 4XTS AB-SB B
Connaught Bronze Frame/Connaught Bronze	LPX 1XTS HB-HB B	LPX 2XTS HB-HB B	LPX 3XTS HB-HB B	LPX 4XTS HB-HB B
Copper Bronze Frame/Copper Bronze	LPX 1XTS CB-CB B	LPX 2XTS CB-CB B	LPX 3XTS CB-CB B	LPX 4XTS CB-CB B
Etrium Bronze Frame/Etrium Bronze	LPX 1XTS EB-EB B	LPX 2XTS EB-EB B	LPX 3XTS EB-EB B	LPX 4XTS EB-EB B
Polished Brass Frame/Antique Brass	LPX 1XTS PB-AB B	LPX 2XTS PB-AB B	LPX 3XTS PB-AB B	LPX 4XTS PB-AB B
Polished Brass Frame/Polished Brass	LPX 1XTS PB-PB B	LPX 2XTS PB-PB B	LPX 3XTS PB-PB B	LPX 4XTS PB-PB B
Polished Brass Frame/Polished Brass	LPX 1XTS PB-PB W	LPX 2XTS PB-PB W	LPX 3XTS PB-PB W	LPX 4XTS PB-PB W
Polished Brass Frame/Satin Brass	LPX 1XTS PB-SB B	LPX 2XTS PB-SB B	LPX 3XTS PB-SB B	LPX 4XTS PB-SB B
Polished Brass Frame/Satin Brass	LPX 1XTS PB-SB W	LPX 2XTS PB-SB W	LPX 3XTS PB-SB W	LPX 4XTS PB-SB W
Richmond Bronze Frame/Richmond Bronze	LPX 1XTS RB-RB B	LPX 2XTS RB-RB B	LPX 3XTS RB-RB B	LPX 4XTS RB-RB B
Nominal Size:	92.0mm x 92.0mm	92.0mm x 92.0mm	151.0mm x 92.0mm	151.0mm x 92.0mm
Minimum Wall Box Depth:	35mm	35mm	35mm	35mm
Technical Insert Ref:	1XTS	2XTS	3XTS	4XTS

NOTE: To only be used with Touch Masters

Insert Surround Colour Key: (B) Black, (W) White

Linea-Perlina CFX

Blank Plates



LPX BPS AB-AB



LPX BPD AB-AB

Frame / Front Plate	Single Blank Plate	Double Blank Plate
Antique Brass Frame/Antique Brass	LPX BPS AB-AB	LPX BPD AB-AB
Antique Brass Frame/Polished Brass	LPX BPS AB-PB	LPX BPD AB-PB
Antique Brass Frame/Satin Brass	LPX BPS AB-SB	LPX BPD AB-SB
Connaught Bronze Frame/Connaught Bronze	LPX BPS HB-HB	LPX BPD HB-HB
Copper Bronze Frame/Copper Bronze	LPX BPS CB-CB	LPX BPD CB-CB
Etrium Bronze Frame/Etrium Bronze	LPX BPS EB-EB	LPX BPD EB-EB
Polished Brass Frame/Antique Brass	LPX BPS PB-AB	LPX BPD PB-AB
Polished Brass Frame/Polished Brass	LPX BPS PB-PB	LPX BPD PB-PB
Polished Brass Frame/Satin Brass	LPX BPS PB-SB	LPX BPD PB-SB
Richmond Bronze Frame/Richmond Bronze	LPX BPS RB-RB	LPX BPD RB-RB
Nominal Size:	92.0mm x 92.0mm	151.0mm x 92.0mm
Minimum Wall Box Depth:	Any Box	Any Box
Technical Insert Ref:	BPS	BPD

Linea-Perlina CFX

Grid-IT GridFix Plates complete with Fixing Grid

LINEA-PERLINA CFX RANGE





LPX 1GP PB-PB



LPX 2GP AB-PB

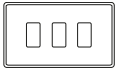
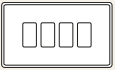

LPX 3GP AB-SB

Frame / Front Plate	 1 Gang Grid Fix Aperture Plate with Grid	 2 Gang Grid Fix Aperture Plate with Grid	 3 Gang Grid Fix Aperture Plate with Grid	 4 Gang Grid Fix Aperture Plate with Grid
Antique Brass Frame/Antique Brass	LPX 1GP AB-AB	LPX 2GP AB-AB	LPX 3GP AB-AB	LPX 4GP AB-AB
Antique Brass Frame/Polished Brass	LPX 1GP AB-PB	LPX 2GP AB-PB	LPX 3GP AB-PB	LPX 4GP AB-PB
Antique Brass Frame/Satin Brass	LPX 1GP AB-SB	LPX 2GP AB-SB	LPX 3GP AB-SB	LPX 4GP AB-SB
Copper Bronze Frame/Copper Bronze	LPX 1GP CB-CB	LPX 2GP CB-CB	LPX 3GP CB-CB	LPX 4GP CB-CB
Etrium Bronze Frame/Etrium Bronze	LPX 1GP EB-EB	LPX 2GP EB-EB	LPX 3GP EB-EB	LPX 4GP EB-EB
Connaught Bronze Frame/Connaught Bronze	LPX 1GP HB-HB	LPX 2GP HB-HB	LPX 3GP HB-HB	LPX 4GP HB-HB
Polished Brass Frame/Antique Brass	LPX 1GP PB-AB	LPX 2GP PB-AB	LPX 3GP PB-AB	LPX 4GP PB-AB
Polished Brass Frame/Polished Brass	LPX 1GP PB-PB	LPX 2GP PB-PB	LPX 3GP PB-PB	LPX 4GP PB-PB
Polished Brass Frame/Satin Brass	LPX 1GP PB-SB	LPX 2GP PB-SB	LPX 3GP PB-SB	LPX 4GP PB-SB
Richmond Bronze Frame/Richmond Bronze	LPX 1GP RB-RB	LPX 2GP RB-RB	LPX 3GP RB-RB	LPX 4GP RB-RB
Nominal Size:	92.0mm x 92.0mm	92.0mm x 92.0mm	151.0mm x 92.0mm	151.0mm x 92.0mm
Minimum Wall Box Depth:	As Per Insert	As Per Inserts	As Per Inserts	As Per Inserts
Technical Insert Ref:	1GP	2GP	3GP	4GP

Note: Minimum Wall Box depth is dependant on the Grid Fix insert fitted, please see the GRID-IT section for the complete range of inserts.

Linea-Perlina CFX





EuroFix Apertured Plates complete with Fixing Grid



LPX EURO1 AB-SB



LPX EURO2 AB-PB

Frame / Front Plate	 Single Plate complete with 1 EuroFix Aperture 25x50mm and Grid	 Single Plate complete with 2 EuroFix Apertures 50x50mm and Grid	 Double Plate complete with 3 EuroFix Apertures 75x50mm and Grid	 Double Plate complete with 4 EuroFix Apertures 100x50mm and Grid
Copper Bronze Frame/Copper Bronze	LPX EURO1 CB-CB	LPX EURO2 CB-CB	LPX EURO3 CB-CB	LPX EURO4 CB-CB
Etrium Bronze Frame/Etrium Bronze	LPX EURO1 EB-EB	LPX EURO2 EB-EB	LPX EURO3 EB-EB	LPX EURO4 EB-EB
Connaught Bronze Frame/Connaught Bronze	LPX EURO1 HB-HB	LPX EURO2 HB-HB	LPX EURO3 HB-HB	LPX EURO4 HB-HB
Richmond Bronze Frame/Richmond Bronze	LPX EURO1 RB-RB	LPX EURO2 RB-RB	LPX EURO3 RB-RB	LPX EURO4 RB-RB
Polished Brass Frame/Polished Brass	LPX EURO1 PB-PB	LPX EURO2 PB-PB	LPX EURO3 PB-PB	LPX EURO4 PB-PB
Polished Brass Frame/Satin Brass	LPX EURO1 PB-SB	LPX EURO2 PB-SB	LPX EURO3 PB-SB	LPX EURO4 PB-SB
Polished Brass Frame/Antique Brass	LPX EURO1 PB-AB	LPX EURO2 PB-AB	LPX EURO3 PB-AB	LPX EURO4 PB-AB
Antique Brass Frame/Antique Brass	LPX EURO1 AB-AB	LPX EURO2 AB-AB	LPX EURO3 AB-AB	LPX EURO4 AB-AB
Antique Brass Frame/Polished Brass	LPX EURO1 AB-PB	LPX EURO2 AB-PB	LPX EURO3 AB-PB	LPX EURO4 AB-PB
Antique Brass Frame/Satin Brass	LPX EURO1 AB-SB	LPX EURO2 AB-SB	LPX EURO3 AB-SB	LPX EURO4 AB-SB
Nominal Size:	92.0mm x 92.0mm	92.0mm x 92.0mm	151.0mm x 92.0mm	151.0mm x 92.0mm
Minimum Wall Box Depth:	As Per Insert	As Per Inserts	As Per Inserts	As Per Inserts
Technical Insert Ref:	EURO1	EURO2	EURO3	EURO4

Note: Minimum Wall Box depth is dependant on the EuroFix insert fitted, please see the EuroFix section for our complete range of inserts.



Linea-Georgian CFX[®] Range

Stylish and attractive with a Georgian Rope Frame design

The Linea CFX[®] range comes in five different designs to suit either contemporary or classic interiors. Linea CFX[®] has a separate back frame and our patented four point face plate clipping system, allowing the option of matching or contrasting elements.

- Stunning front plate finishes and frame and insert finishes
- Two-part frame and plate for 'mix and match'
- Concealed fixing
- Grid Fix and Eurofix options also available (see separate GRID-IT and EuroFix sections)

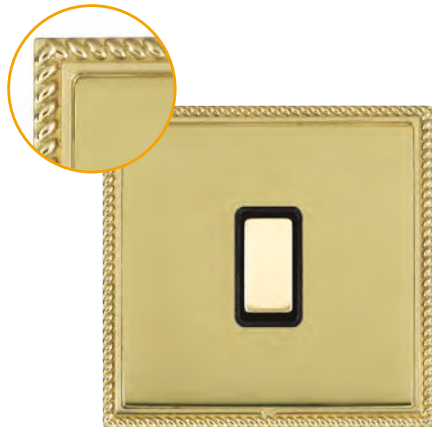

Linea-Georgian CFX® Range



LGX R21 AB-PB B

LGX T22 AB-PB

LGX DPN PB-PB W

LGX SS1 AB-SB B

LINEA-GEORGIAN CFX RANGE

Product Code Configurator

1. Select the required electrical accessory from the following pages.
e.g. **LGX R21** = Linea-Georgian CFX 1 gang 10AX 2 way Rocker Switch.
2. Using the Frame and Finishes Chart on the next page;
 - a. Select the required Frame Finish
e.g. Antique Brass = **AB**-__-__.
 - b. Select the required Front Plate Finish
e.g. Polished Brass = __-**PB**__.
 - c. Select the required Insert Surround Colour
e.g. Black = __-__-**B**.

Therefore a Linea-Georgian CFX 1 gang 10AX 2 way Rocker Switch as illustrated below = **LGX R21 AB-PB B**

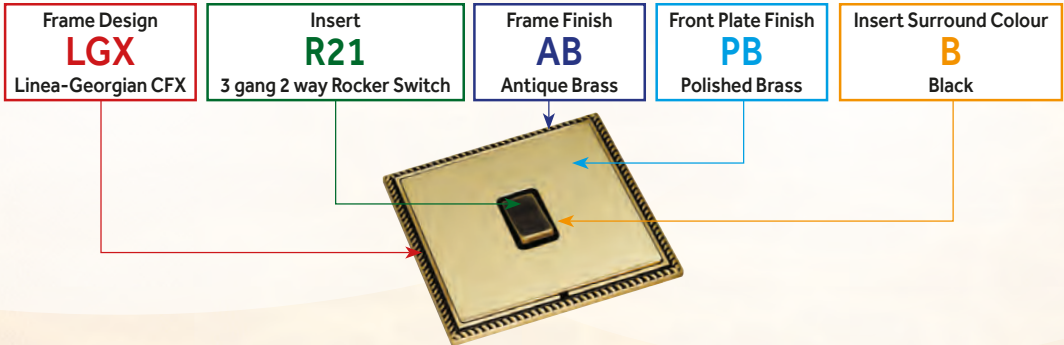





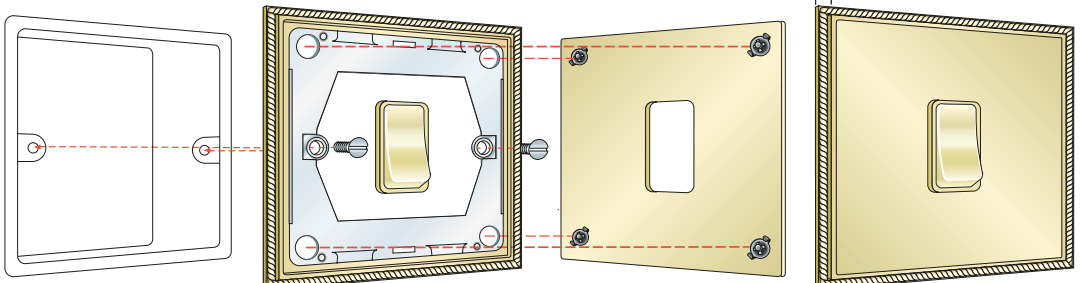







Hamilton Linea-Georgian CFX® Concealed Fixing

Plate Depth 4.2 mm



Frame and Finishes Chart

Frame and Insert Finish	Polished Brass (PB)	Satin Brass (SB)	Antique Brass (AB)	Connaught Bronze (HB)	Copper Bronze (CB)	Etrium Bronze (EB)	Richmond Bronze (RB)
Polished Brass Frame (PB) Matching Insert with White Surround	 PB-PB W	 PB-SB W	 PB-AB W				
Polished Brass Frame (PB) Matching Insert with Black Surround	 PB-PB B	 PB-SB B	 PB-AB B				
Antique Brass Frame (AB) Matching Insert with Black Surround	 AB-PB B	 AB-SB B	 AB-AB B				
Connaught Bronze Frame (HB) Matching Insert with Black Surround				 HB-HB B			
Copper Bronze Frame (CB) Matching Insert with Black Surround					 CB-CB B		
Etrium Bronze Frame (EB) Matching Insert with Black Surround						 EB-EB B	
Richmond Bronze Frame (RB) Matching Insert with Black Surround							 RB-RB B

Frame Finishes



Linea-Georgian CFX

Rocker Switches

LINEA-GEORGIAN CFX RANGE



LGX R21 HB-HB B



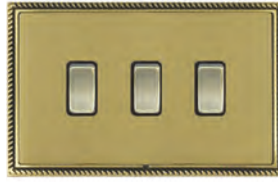

LGX R22 AB-PB B



LGX R23 AB-SB B

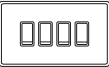
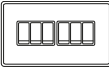

LGX R24 PB-PB W

Frame / Front Plate	 1 gang 10AX 2 Way Rocker	 2 gang 10AX 2 Way Rocker	 3 gang 10AX 2 Way Rocker	 4 gang 10AX 2 Way Rocker	 6 gang 10AX 2 Way Rocker
Antique Brass Frame/Antique Brass	LGX R21 AB-AB B	LGX R22 AB-AB B	LGX R23 AB-AB B	LGX R24 AB-AB B	LGX R26 AB-AB B
Antique Brass Frame/Polished Brass	LGX R21 AB-PB B	LGX R22 AB-PB B	LGX R23 AB-PB B	LGX R24 AB-PB B	LGX R26 AB-PB B
Antique Brass Frame/Satin Brass	LGX R21 AB-SB B	LGX R22 AB-SB B	LGX R23 AB-SB B	LGX R24 AB-SB B	LGX R26 AB-SB B
Connaught Bronze Frame/Connaught Bronze	LGX R21 HB-HB B	LGX R22 HB-HB B	LGX R23 HB-HB B	LGX R24 HB-HB B	LGX R26 HB-HB B
Copper Bronze Frame/Copper Bronze	LGX R21 CB-CB B	LGX R22 CB-CB B	LGX R23 CB-CB B	LGX R24 CB-CB B	LGX R26 CB-CB B
Etrium Bronze Frame/Etrium Bronze	LGX R21 EB-EB B	LGX R22 EB-EB B	LGX R23 EB-EB B	LGX R24 EB-EB B	LGX R26 EB-EB B
Polished Brass Frame/Antique Brass	LGX R21 PB-AB B	LGX R22 PB-AB B	LGX R23 PB-AB B	LGX R24 PB-AB B	LGX R26 PB-AB B
Polished Brass Frame/Antique Brass	LGX R21 PB-AB W	LGX R22 PB-AB W	LGX R23 PB-AB W	LGX R24 PB-AB W	LGX R26 PB-AB W
Polished Brass Frame/Polished Brass	LGX R21 PB-PB B	LGX R22 PB-PB B	LGX R23 PB-PB B	LGX R24 PB-PB B	LGX R26 PB-PB B
Polished Brass Frame/Polished Brass	LGX R21 PB-PB W	LGX R22 PB-PB W	LGX R23 PB-PB W	LGX R24 PB-PB W	LGX R26 PB-PB W
Polished Brass Frame/Satin Brass	LGX R21 PB-SB B	LGX R22 PB-SB B	LGX R23 PB-SB B	LGX R24 PB-SB B	LGX R26 PB-SB B
Polished Brass Frame/Satin Brass	LGX R21 PB-SB W	LGX R22 PB-SB W	LGX R23 PB-SB W	LGX R24 PB-SB W	LGX R26 PB-SB W
Richmond Bronze Frame/Richmond Bronze	LGX R21 RB-RB B	LGX R22 RB-RB B	LGX R23 RB-RB B	LGX R24 RB-RB B	LGX R26 RB-RB B
Nominal Size:	95.5mm x 95.5mm	95.5mm x 95.5mm	95.5mm x 95.5mm	154.5mm x 95.5mm	154.5mm x 95.5mm
Minimum Wall Box Depth:	25mm	25mm	25mm	25mm	25mm
Technical Insert Ref:	R21	R22	R23	R24	R26

Insert Surround Colour Key: (B) Black, (W) White

Linea-Georgian CFX

Rocker Switches



LGX R31 CB-CB B







LGX R32 AB-PB B



LGX RRT AB-SB B



LGX TP PB-PB W

Frame / Front Plate	 1 gang 10AX Intermediate Rocker	 2 gang 10AX Intermediate Rocker	 1 gang 10AX Push To Make/Retractable Rocker	 1 gang 10A Triple Pole Rocker
Antique Brass Frame/Antique Brass	LGX R31 AB-AB B	LGX R32 AB-AB B	LGX RRT AB-AB B	LGX TP AB-AB B
Antique Brass Frame/Polished Brass	LGX R31 AB-PB B	LGX R32 AB-PB B	LGX RRT AB-PB B	LGX TP AB-PB B
Antique Brass Frame/Satin Brass	LGX R31 AB-SB B	LGX R32 AB-SB B	LGX RRT AB-SB B	LGX TP AB-SB B
Connaught Bronze Frame/Connaught Bronze	LGX R31 HB-HB B	LGX R32 HB-HB B	LGX RRT HB-HB B	LGX TP HB-HB B
Copper Bronze Frame/Copper Bronze	LGX R31 CB-CB B	LGX R32 CB-CB B	LGX RRT CB-CB B	LGX TP CB-CB B
Etrium Bronze Frame/Etrium Bronze	LGX R31 EB-EB B	LGX R32 EB-EB B	LGX RRT EB-EB B	LGX TP EB-EB B
Polished Brass Frame/Antique Brass	LGX R31 PB-AB B	LGX R32 PB-AB B	LGX RRT PB-AB B	LGX TP PB-AB B
Polished Brass Frame/Antique Brass	LGX R31 PB-AB W	LGX R32 PB-AB W	LGX RRT PB-AB W	LGX TP PB-AB W
Polished Brass Frame/Polished Brass	LGX R31 PB-PB B	LGX R32 PB-PB B	LGX RRT PB-PB B	LGX TP PB-PB B
Polished Brass Frame/Polished Brass	LGX R31 PB-PB W	LGX R32 PB-PB W	LGX RRT PB-PB W	LGX TP PB-PB W
Polished Brass Frame/Satin Brass	LGX R31 PB-SB B	LGX R32 PB-SB B	LGX RRT PB-SB B	LGX TP PB-SB B
Polished Brass Frame/Satin Brass	LGX R31 PB-SB W	LGX R32 PB-SB W	LGX RRT PB-SB W	LGX TP PB-SB W
Richmond Bronze Frame/Richmond Bronze	LGX R31 RB-RB B	LGX R32 RB-RB B	LGX RRT RB-RB B	LGX TP RB-RB B
Nominal Size:	95.5mm x 95.5mm	95.5mm x 95.5mm	95.5mm x 95.5mm	95.5mm x 95.5mm
Minimum Wall Box Depth:	25mm	25mm	25mm	25mm
Technical Insert Ref:	R31	R32	RRT	TP

Insert Surround Colour Key: (B) Black, (W) White

Linea-Georgian CFX

Rocker Switches

LINEA-GEORGIAN CFX RANGE



LGX R212 AB-PB B







LGX R222 AB-AB B

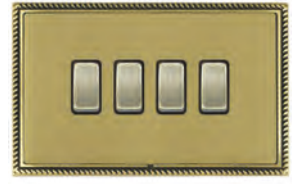

LGX R232 PB-PB W

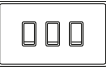
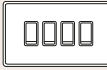

LGX R242 AB-SB B

Frame / Front Plate	 1 gang 20AX 2 Way Rocker	 2 gang 20AX 2 Way Rocker	 3 gang 20AX 2 Way Rocker	 4 gang 20AX 2 Way Rocker	 1 gang 20AX Intermediate Rocker	 2 gang 20AX Intermediate Rocker
Antique Brass Frame/Antique Brass	LGX R212 AB-AB B	LGX R222 AB-AB B	LGX R232 AB-AB B	LGX R242 AB-AB B	LGX R312 AB-AB B	LGX R322 AB-AB B
Antique Brass Frame/Polished Brass	LGX R212 AB-PB B	LGX R222 AB-PB B	LGX R232 AB-PB B	LGX R242 AB-PB B	LGX R312 AB-PB B	LGX R322 AB-PB B
Antique Brass Frame/Satin Brass	LGX R212 AB-SB B	LGX R222 AB-SB B	LGX R232 AB-SB B	LGX R242 AB-SB B	LGX R312 AB-SB B	LGX R322 AB-SB B
Connaught Bronze Frame/Connaught Bronze	LGX R212 HB-HB B	LGX R222 HB-HB B	LGX R232 HB-HB B	LGX R242 HB-HB B	LGX R312 HB-HB B	LGX R322 HB-HB B
Copper Bronze Frame/Copper Bronze	LGX R212 CB-CB B	LGX R222 CB-CB B	LGX R232 CB-CB B	LGX R242 CB-CB B	LGX R312 CB-CB B	LGX R322 CB-CB B
Etrium Bronze Frame/Etrium Bronze	LGX R212 EB-EB B	LGX R222 EB-EB B	LGX R232 EB-EB B	LGX R242 EB-EB B	LGX R312 EB-EB B	LGX R322 EB-EB B
Polished Brass Frame/Antique Brass	LGX R212 PB-AB B	LGX R222 PB-AB B	LGX R232 PB-AB B	LGX R242 PB-AB B	LGX R312 PB-AB B	LGX R322 PB-AB B
Polished Brass Frame/Antique Brass	LGX R212 PB-AB W	LGX R222 PB-AB W	LGX R232 PB-AB W	LGX R242 PB-AB W	LGX R312 PB-AB W	LGX R322 PB-AB W
Polished Brass Frame/Polished Brass	LGX R212 PB-PB B	LGX R222 PB-PB B	LGX R232 PB-PB B	LGX R242 PB-PB B	LGX R312 PB-PB B	LGX R322 PB-PB B
Polished Brass Frame/Polished Brass	LGX R212 PB-PB W	LGX R222 PB-PB W	LGX R232 PB-PB W	LGX R242 PB-PB W	LGX R312 PB-PB W	LGX R322 PB-PB W
Polished Brass Frame/Satin Brass	LGX R212 PB-SB B	LGX R222 PB-SB B	LGX R232 PB-SB B	LGX R242 PB-SB B	LGX R312 PB-SB B	LGX R322 PB-SB B
Polished Brass Frame/Satin Brass	LGX R212 PB-SB W	LGX R222 PB-SB W	LGX R232 PB-SB W	LGX R242 PB-SB W	LGX R312 PB-SB W	LGX R322 PB-SB W
Richmond Bronze Frame/Richmond Bronze	LGX R212 RB-RB B	LGX R222 RB-RB B	LGX R232 RB-RB B	LGX R242 RB-RB B	LGX R312 RB-RB B	LGX R322 RB-RB B
Nominal Size:	95.5mm x 95.5mm	95.5mm x 95.5mm	154.5mm x 95.5mm	154.5mm x 95.5mm	95.5mm x 95.5mm	95.5mm x 95.5mm
Minimum Wall Box Depth:	35mm	35mm	35mm	35mm	35mm	35mm
Technical Insert Ref:	R212	R222	R232	R242	R312	R322

Insert Surround Colour Key: (B) Black, (W) White

Linea-Georgian CFX

Wide Rockers

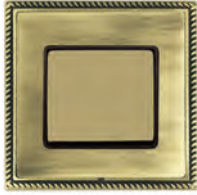

LGX W10DP AB-AB B



LGX WR21 EB-EB B



LGX WR21 PB-PB W



LGX WR23 RB-RB B

LINEA-GEORGIAN CFX RANGE



1 gang 10AX 2 Way Rocker



2 gang 10AX 2 Way Rocker



3 gang 10AX 2 Way Rocker



1 gang 10AX Intermediate Rocker



1 gang 10AX Push To Make Frame/ Push to Break Retractive Rocker



1 gang 10AX Double Pole Rocker

Frame Frame/ Front Plate

Antique Brass Frame/Antique Brass	LGX WR21 AB-AB B	LGX WR22 AB-AB B	LGX WR23 AB-AB B	LGX WR31 AB-AB B	LGX WRRT AB-AB B	LGX W10DP AB-AB B
Antique Brass Frame/Polished Brass	LGX WR21 AB-PB B	LGX WR22 AB-PB B	LGX WR23 AB-PB B	LGX WR31 AB-PB B	LGX WRRT AB-PB B	LGX W10DP AB-PB B
Antique Brass Frame/Satin Brass	LGX WR21 AB-SB B	LGX WR22 AB-SB B	LGX WR23 AB-SB B	LGX WR31 AB-SB B	LGX WRRT AB-SB B	LGX W10DP AB-SB B
Connaught Bronze Frame/ Connaught Bronze	LGX WR21 HB-HB B	LGX WR22 HB-HB B	LGX WR23 HB-HB B	LGX WR31 HB-HB B	LGX WRRT HB-HB B	LGX W10DP HB-HB B
Copper Bronze Frame/Copper Bronze	LGX WR21 CB-CB B	LGX WR22 CB-CB B	LGX WR23 CB-CB B	LGX WR31 CB-CB B	LGX WRRT CB-CB B	LGX W10DP CB-CB B
Etrium Bronze Frame/Etrium Bronze	LGX WR21 EB-EB B	LGX WR22 EB-EB B	LGX WR23 EB-EB B	LGX WR31 EB-EB B	LGX WRRT EB-EB B	LGX W10DP EB-EB B
Polished Brass Frame/Antique Brass	LGX WR21 PB-AB B	LGX WR22 PB-AB B	LGX WR23 PB-AB B	LGX WR31 PB-AB B	LGX WRRT PB-AB B	LGX W10DP PB-AB B
Polished Brass Frame/Antique Brass	LGX WR21 PB-AB W	LGX WR22 PB-AB W	LGX WR23 PB-AB W	LGX WR31 PB-AB W	LGX WRRT PB-AB W	LGX W10DP PB-AB W
Polished Brass Frame/Polished Brass	LGX WR21 PB-PB B	LGX WR22 PB-PB B	LGX WR23 PB-PB B	LGX WR31 PB-PB B	LGX WRRT PB-PB B	LGX W10DP PB-PB B
Polished Brass Frame/Polished Brass	LGX WR21 PB-PB W	LGX WR22 PB-PB W	LGX WR23 PB-PB W	LGX WR31 PB-PB W	LGX WRRT PB-PB W	LGX W10DP PB-PB W
Polished Brass Frame/Satin Brass	LGX WR21 PB-SB B	LGX WR22 PB-SB B	LGX WR23 PB-SB B	LGX WR31 PB-SB B	LGX WRRT PB-SB B	LGX W10DP PB-SB B
Polished Brass Frame/Satin Brass	LGX WR21 PB-SB W	LGX WR22 PB-SB W	LGX WR23 PB-SB W	LGX WR31 PB-SB W	LGX WRRT PB-SB W	LGX W10DP PB-SB W
Richmond Bronze Frame/ Richmond Bronze	LGX WR21 RB-RB B	LGX WR22 RB-RB B	LGX WR23 RB-RB B	LGX WR31 RB-RB B	LGX WRRT RB-RB B	LGX W10DP RB-RB B
Nominal Size:	95.5mm x 95.5mm	95.5mm x 95.5mm	95.5mm x 95.5mm	95.5mm x 95.5mm	95.5mm x 95.5mm	95.5mm x 95.5mm
Minimum Wall Box Depth:	25mm	25mm	25mm	25mm	25mm	25mm
Technical Insert Ref:	WR21	WR22	WR23	WR31	WRRT	W10DP

Insert Surround Colour Key: (B) Black, (W) White

Linea-Georgian CFX

Toggle Switches

LINEA-GEORGIAN CFX RANGE



LGX T21 AB-AB







LGX T22 AB-PB



LGX T23 AB-SB



LGX T24 PB-PB

Frame / Front Plate	 1 gang 20AX 2 Way Toggle	 2 gang 20AX 2 Way Toggle	 3 gang 20AX 2 Way Toggle	 4 gang 20AX 2 Way Toggle	 1 gang 20AX Intermediate Toggle
Antique Brass Frame/Antique Brass	LGX T21 AB-AB	LGX T22 AB-AB	LGX T23 AB-AB	LGX T24 AB-AB	LGX T31 AB-AB
Antique Brass Frame/Polished Brass	LGX T21 AB-PB	LGX T22 AB-PB	LGX T23 AB-PB	LGX T24 AB-PB	LGX T31 AB-PB
Antique Brass Frame/Satin Brass	LGX T21 AB-SB	LGX T22 AB-SB	LGX T23 AB-SB	LGX T24 AB-SB	LGX T31 AB-SB
Connaught Bronze Frame/Connaught Bronze	LGX T21 HB-HB	LGX T22 HB-HB	LGX T23 HB-HB	LGX T24 HB-HB	LGX T31 HB-HB
Copper Bronze Frame/Copper Bronze	LGX T21 CB-CB	LGX T22 CB-CB	LGX T23 CB-CB	LGX T24 CB-CB	LGX T31 CB-CB
Etrium Bronze Frame/Etrium Bronze	LGX T21 EB-EB	LGX T22 EB-EB	LGX T23 EB-EB	LGX T24 EB-EB	LGX T31 EB-EB
Polished Brass Frame/Antique Brass	LGX T21 PB-AB	LGX T22 PB-AB	LGX T23 PB-AB	LGX T24 PB-AB	LGX T31 PB-AB
Polished Brass Frame/Polished Brass	LGX T21 PB-PB	LGX T22 PB-PB	LGX T23 PB-PB	LGX T24 PB-PB	LGX T31 PB-PB
Polished Brass Frame/Satin Brass	LGX T21 PB-SB	LGX T22 PB-SB	LGX T23 PB-SB	LGX T24 PB-SB	LGX T31 PB-SB
Richmond Bronze Frame/Richmond Bronze	LGX T21 RB-RB	LGX T22 RB-RB	LGX T23 RB-RB	LGX T24 RB-RB	LGX T31 RB-RB
Nominal Size:	95.5mm x 95.5mm	95.5mm x 95.5mm	154.5mm x 95.5mm	154.5mm x 95.5mm	95.5mm x 95.5mm
Minimum Wall Box Depth:	35mm	35mm	35mm	35mm	35mm
Technical Insert Ref:	T21	T22	T23	T24	T31

Toggles to match Frame Finish as standard except where specified.

Linea-Georgian CFX

Power Sockets



LGX SS1 AB-AB B

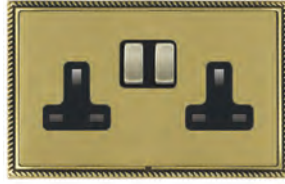

LGX SS2 AB-SB B



LGX US2 PB-PB W



1 gang 13A
Double Pole
Switched Socket

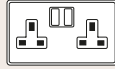

2 gang 13A
Double Pole
Switched Socket

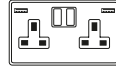

2 gang 13A Double
Pole Switched
Socket with 2 USB
Outlet 2x2.4A (4.8A
Total)



1 gang 2A
Unswitched
Socket



1 gang 5A
Unswitched
Socket

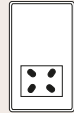

Shaver Dual Voltage
Unswitched Socket
(Vertically Mounted)

Frame / Front Plate

Antique Brass Frame/Antique Brass	LGX SS1 AB-AB B	LGX SS2 AB-AB B	LGX SS2USBULT AB-AB B	LGX US2 AB-AB B	LGX US5 AB-AB B	LGX SHS AB-AB B
Antique Brass Frame/Polished Brass	LGX SS1 AB-PB B	LGX SS2 AB-PB B	LGX SS2USBULT AB-PB B	LGX US2 AB-PB B	LGX US5 AB-PB B	LGX SHS AB-PB B
Antique Brass Frame/Satin Brass	LGX SS1 AB-SB B	LGX SS2 AB-SB B	LGX SS2USBULT AB-SB B	LGX US2 AB-SB B	LGX US5 AB-SB B	LGX SHS AB-SB B
Connaught Bronze Frame/Connaught Bronze	LGX SS1 HB-HB B	LGX SS2 HB-HB B	LGX SS2USBULT HB-HB B	LGX US2 HB-HB B	LGX US5 HB-HB B	LGX SHS HB-HB B
Copper Bronze Frame/Copper Bronze	LGX SS1 CB-CB B	LGX SS2 CB-CB B	LGX SS2USBULT CB-CB B	LGX US2 CB-CB B	LGX US5 CB-CB B	LGX SHS CB-CB B
Etrium Bronze Frame/Etrium Bronze	LGX SS1 EB-EB B	LGX SS2 EB-EB B	LGX SS2USBULT EB-EB B	LGX US2 EB-EB B	LGX US5 EB-EB B	LGX SHS EB-EB B
Polished Brass Frame/Antique Brass	LGX SS1 PB-AB B	LGX SS2 PB-AB B	LGX SS2USBULT PB-AB B	LGX US2 PB-AB B	LGX US5 PB-AB B	LGX SHS PB-AB B
Polished Brass Frame/Antique Brass	LGX SS1 PB-AB W	LGX SS2 PB-AB W	LGX SS2USBULT PB-AB W	LGX US2 PB-AB W	LGX US5 PB-AB W	LGX SHS PB-AB W
Polished Brass Frame/Polished Brass	LGX SS1 PB-PB B	LGX SS2 PB-PB B	LGX SS2USBULT PB-PB B	LGX US2 PB-PB B	LGX US5 PB-PB B	LGX SHS PB-PB B
Polished Brass Frame/Polished Brass	LGX SS1 PB-PB W	LGX SS2 PB-PB W	LGX SS2USBULT PB-PB W	LGX US2 PB-PB W	LGX US5 PB-PB W	LGX SHS PB-PB W
Polished Brass Frame/Satin Brass	LGX SS1 PB-SB B	LGX SS2 PB-SB B	LGX SS2USBULT PB-SB B	LGX US2 PB-SB B	LGX US5 PB-SB B	LGX SHS PB-SB B
Polished Brass Frame/Satin Brass	LGX SS1 PB-SB W	LGX SS2 PB-SB W	LGX SS2USBULT PB-SB W	LGX US2 PB-SB W	LGX US5 PB-SB W	LGX SHS PB-SB W
Richmond Bronze Frame/Richmond Bronze	LGX SS1 RB-RB B	LGX SS2 RB-RB B	LGX SS2USBULT RB-RB B	LGX US2 RB-RB B	LGX US5 RB-RB B	LGX SHS RB-RB B
Nominal Size:	95.5mm x 95.5mm	154.5mm x 95.5mm	154.5mm x 95.5mm	95.5mm x 95.5mm	95.5mm x 95.5mm	95.5mm x 154.5mm
Minimum Wall Box Depth:	35mm	35mm	35mm	35mm	35mm	47mm
Technical Insert Ref:	SS1	SS2	SS2USBULT	US2	US5	SHS

Insert Surround Colour Key: (B) Black, (W) White

Linea-Georgian CFX

International Power Sockets

LINEA-GEORGIAN CFX RANGE



LGX 5258 PB-PB B



LGX 5320 EB-EB B



LGX 6126 RB-RB B



1 gang 15A 110V AC
American Unswitched
Socket

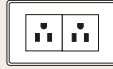

2 gang 15A 110V AC
American Unswitched
Socket



1 gang 10/16A 220/250V
AC German Unswitched
Socket

Frame / Front Plate	1 gang 15A 110V AC American Unswitched Socket	2 gang 15A 110V AC American Unswitched Socket	1 gang 10/16A 220/250V AC German Unswitched Socket
Antique Brass Frame/Antique Brass	LGX 5258 AB-AB B	LGX 5320 AB-AB B	LGX 6126 AB-AB B
Antique Brass Frame/Polished Brass	LGX 5258 AB-PB B	LGX 5320 AB-PB B	LGX 6126 AB-PB B
Antique Brass Frame/Satin Brass	LGX 5258 AB-SB B	LGX 5320 AB-SB B	LGX 6126 AB-SB B
Connaught Bronze Frame/Connaught Bronze	LGX 5258 HB-HB B	LGX 5320 HB-HB B	LGX 6126 HB-HB B
Copper Bronze Frame/Copper Bronze	LGX 5258 CB-CB B	LGX 5320 CB-CB B	LGX 6126 CB-CB B
Etrium Bronze Frame/Etrium Bronze	LGX 5258 EB-EB B	LGX 5320 EB-EB B	LGX 6126 EB-EB B
Polished Brass Frame/Antique Brass	LGX 5258 PB-AB B	LGX 5320 PB-AB B	LGX 6126 PB-AB B
Polished Brass Frame/Antique Brass	LGX 5258 PB-AB W	LGX 5320 PB-AB W	LGX 6126 PB-AB W
Polished Brass Frame/Polished Brass	LGX 5258 PB-PB B	LGX 5320 PB-PB B	LGX 6126 PB-PB B
Polished Brass Frame/Polished Brass	LGX 5258 PB-PB W	LGX 5320 PB-PB W	LGX 6126 PB-PB W
Polished Brass Frame/Satin Brass	LGX 5258 PB-SB B	LGX 5320 PB-SB B	LGX 6126 PB-SB B
Polished Brass Frame/Satin Brass	LGX 5258 PB-SB W	LGX 5320 PB-SB W	LGX 6126 PB-SB W
Richmond Bronze Frame/Richmond Bronze	LGX 5258 RB-RB B	LGX 5320 RB-RB B	LGX 6126 RB-RB B
Nominal Size:	95.5mm x 95.5mm	154.5mm x 95.5mm	95.5mm x 95.5mm
Minimum Wall Box Depth:	35mm	35mm	47mm
Technical Insert Ref:	5258	5320	6126

Insert Surround Colour Key: (B) Black, (W) White

Linea-Georgian CFX



Key Switches



LGX K21 AB-AB B



LGX KEL PB-PB W

Frame / Front Plate	 1 gang 20AX 2 Way Key Switch	 1 gang 20AX 2 Way Key Switch EMG LTG TEST
Antique Brass Frame/Antique Brass	LGX K21 AB-AB B	LGX KEL AB-AB B
Antique Brass Frame/Polished Brass	LGX K21 AB-PB B	LGX KEL AB-PB B
Antique Brass Frame/Satin Brass	LGX K21 AB-SB B	LGX KEL AB-SB B
Connaught Bronze Frame/Connaught Bronze	LGX K21 HB-HB B	LGX KEL HB-HB B
Copper Bronze Frame/Copper Bronze	LGX K21 CB-CB B	LGX KEL CB-CB B
Etrium Bronze Frame/Etrium Bronze	LGX K21 EB-EB B	LGX KEL EB-EB B
Polished Brass Frame/Antique Brass	LGX K21 PB-AB B	LGX KEL PB-AB B
Polished Brass Frame/Antique Brass	LGX K21 PB-AB W	LGX KEL PB-AB W
Polished Brass Frame/Polished Brass	LGX K21 PB-PB B	LGX KEL PB-PB B
Polished Brass Frame/Polished Brass	LGX K21 PB-PB W	LGX KEL PB-PB W
Polished Brass Frame/Satin Brass	LGX K21 PB-SB B	LGX KEL PB-SB B
Polished Brass Frame/Satin Brass	LGX K21 PB-SB W	LGX KEL PB-SB W
Richmond Bronze Frame/Richmond Bronze	LGX K21 RB-RB B	LGX KEL RB-RB B
Nominal Size:	95.5mm x 95.5mm	95.5mm x 95.5mm
Minimum Wall Box Depth:	35mm	35mm
Technical Insert Ref:	K21	KEL

Hotel Card Switch with LED



LGX C11 AB-AB B

Frame / Front Plate	 1 gang 10A (6AX) Card Switch On/Off with Blue LED Locator
Antique Brass Frame/Antique Brass	LGX C11 AB-AB B
Antique Brass Frame/Polished Brass	LGX C11 AB-PB B
Antique Brass Frame/Satin Brass	LGX C11 AB-SB B
Connaught Bronze Frame/Connaught Bronze	LGX C11 HB-HB B
Copper Bronze Frame/Copper Bronze	LGX C11 CB-CB B
Etrium Bronze Frame/Etrium Bronze	LGX C11 EB-EB B
Polished Brass Frame/Antique Brass	LGX C11 PB-AB B
Polished Brass Frame/Antique Brass	LGX C11 PB-AB W
Polished Brass Frame/Polished Brass	LGX C11 PB-PB B
Polished Brass Frame/Polished Brass	LGX C11 PB-PB W
Polished Brass Frame/Satin Brass	LGX C11 PB-SB B
Polished Brass Frame/Satin Brass	LGX C11 PB-SB W
Richmond Bronze Frame/Richmond Bronze	LGX C11 RB-RB B
Nominal Size:	95.5mm x 95.5mm
Minimum Wall Box Depth:	35mm
Technical Insert Ref:	C11

Insert Surround Colour Key: (B) Black, (W) White

Linea-Georgian CFX

Television Coaxial Sockets

LINEA-GEORGIAN CFX RANGE



LGX TV AB-SB B



LGX TVFM PB-PB W



LGX TVSAT AB-SB B



LGX SATI AB-AB B



1 gang
Non-Isolated
Television
1in/1out



Isolated TV/FM
Diplexer 1in/2out



1 gang Isolated
TV 1in/1out



2 gang
Non-Isolated
TV+Satellite
2in/2out



1 gang Non-
Isolated Satellite



1 gang Isolated
Satellite

Frame / Front Plate

Antique Brass Frame/Antique Brass	LGX TV AB-AB B	LGX TVFM AB-AB B	LGX TVI AB-AB B	LGX TVSAT AB-AB B	LGX SATN AB-AB B	LGX SATI AB-AB B
Antique Brass Frame/Polished Brass	LGX TV AB-PB B	LGX TVFM AB-PB B	LGX TVI AB-PB B	LGX TVSAT AB-PB B	LGX SATN AB-PB B	LGX SATI AB-PB B
Antique Brass Frame/Satin Brass	LGX TV AB-SB B	LGX TVFM AB-SB B	LGX TVI AB-SB B	LGX TVSAT AB-SB B	LGX SATN AB-SB B	LGX SATI AB-SB B
Connaught Bronze Frame/Connaught Bronze	LGX TV HB-HB B	LGX TVFM HB-HB B	LGX TVI HB-HB B	LGX TVSAT HB-HB B	LGX SATN HB-HB B	LGX SATI HB-HB B
Copper Bronze Frame/Copper Bronze	LGX TV CB-CB B	LGX TVFM CB-CB B	LGX TVI CB-CB B	LGX TVSAT CB-CB B	LGX SATN CB-CB B	LGX SATI CB-CB B
Etrium Bronze Frame/Etrium Bronze	LGX TV EB-EB B	LGX TVFM EB-EB B	LGX TVI EB-EB B	LGX TVSAT EB-EB B	LGX SATN EB-EB B	LGX SATI EB-EB B
Polished Brass Frame/Antique Brass	LGX TV PB-AB B	LGX TVFM PB-AB B	LGX TVI PB-AB B	LGX TVSAT PB-AB B	LGX SATN PB-AB B	LGX SATI PB-AB B
Polished Brass Frame/Antique Brass	LGX TV PB-AB W	LGX TVFM PB-AB W	LGX TVI PB-AB W	LGX TVSAT PB-AB W	LGX SATN PB-AB W	LGX SATI PB-AB W
Polished Brass Frame/Polished Brass	LGX TV PB-PB B	LGX TVFM PB-PB B	LGX TVI PB-PB B	LGX TVSAT PB-PB B	LGX SATN PB-PB B	LGX SATI PB-PB B
Polished Brass Frame/Polished Brass	LGX TV PB-PB W	LGX TVFM PB-PB W	LGX TVI PB-PB W	LGX TVSAT PB-PB W	LGX SATN PB-PB W	LGX SATI PB-PB W
Polished Brass Frame/Satin Brass	LGX TV PB-SB B	LGX TVFM PB-SB B	LGX TVI PB-SB B	LGX TVSAT PB-SB B	LGX SATN PB-SB B	LGX SATI PB-SB B
Polished Brass Frame/Satin Brass	LGX TV PB-SB W	LGX TVFM PB-SB W	LGX TVI PB-SB W	LGX TVSAT PB-SB W	LGX SATN PB-SB W	LGX SATI PB-SB W
Richmond Bronze Frame/Richmond Bronze	LGX TV RB-RB B	LGX TVFM RB-RB B	LGX TVI RB-RB B	LGX TVSAT RB-RB B	LGX SATN RB-RB B	LGX SATI RB-RB B
Nominal Size:	95.5mm x 95.5mm	95.5mm x 95.5mm	95.5mm x 95.5mm	95.5mm x 95.5mm	95.5mm x 95.5mm	95.5mm x 95.5mm
Minimum Wall Box Depth:	25mm	25mm	25mm	35mm	35mm	35mm
Technical Insert Ref:	TV	TVFM	TVI	TVSAT	SATN	SATI

Insert Surround Colour Key: (B) Black, (W) White

Linea-Georgian CFX

Digital Television Sockets

- Screened Non Isolated / DAB Compatible



LGX DTRID AB-AB B



LGX DTVF AB-PB B



LGX DTVM AB-SB B



LGX DENT PB-SB W



Non-Isolated TV+FM+SAT Triplexer 1in/3out (DAB Compatible)



1 gang Non-Isolated TV (female) (DAB Compatible)



1 gang Non-Isolated TV (Male) (DAB Compatible)



1 gang Non-Isolated Satellite (DaB Compatible)



Non-Isolated TV+FM+SAT1+SAT2 Quadplexer 2in/4out (DAB Compatible)



Non-Isolated TV+FM+SAT1+SAT2 Quadplexer 2in/4out +TVF+TCS (DAB Compatible)

Frame / Front Plate	Non-Isolated TV+FM+SAT Triplexer 1in/3out (DAB Compatible)	1 gang Non-Isolated TV (female) (DAB Compatible)	1 gang Non-Isolated TV (Male) (DAB Compatible)	1 gang Non-Isolated Satellite (DaB Compatible)	Non-Isolated TV+FM+SAT1+SAT2 Quadplexer 2in/4out (DAB Compatible)	Non-Isolated TV+FM+SAT1+SAT2 Quadplexer 2in/4out +TVF+TCS (DAB Compatible)
Antique Brass Frame/Antique Brass	LGX DTRID AB-AB B	LGX DTVF AB-AB B	LGX DTVM AB-AB B	LGX DSAT AB-AB B	LGX DENT AB-AB B	LGX DSAT+ AB-AB B
Antique Brass Frame/Polished Brass	LGX DTRID AB-PB B	LGX DTVF AB-PB B	LGX DTVM AB-PB B	LGX DSAT AB-PB B	LGX DENT AB-PB B	LGX DSAT+ AB-PB B
Antique Brass Frame/Satin Brass	LGX DTRID AB-SB B	LGX DTVF AB-SB B	LGX DTVM AB-SB B	LGX DSAT AB-SB B	LGX DENT AB-SB B	LGX DSAT+ AB-SB B
Connaught Bronze Frame/Connaught Bronze	LGX DTRID HB-HB B	LGX DTVF HB-HB B	LGX DTVM HB-HB B	LGX DSAT HB-HB B	LGX DENT HB-HB B	LGX DSAT+ HB-HB B
Copper Bronze Frame/Copper Bronze	LGX DTRID CB-CB B	LGX DTVF CB-CB B	LGX DTVM CB-CB B	LGX DSAT CB-CB B	LGX DENT CB-CB B	LGX DSAT+ CB-CB B
Etrium Bronze Frame/Etrium Bronze	LGX DTRID EB-EB B	LGX DTVF EB-EB B	LGX DTVM EB-EB B	LGX DSAT EB-EB B	LGX DENT EB-EB B	LGX DSAT+ EB-EB B
Polished Brass Frame/Antique Brass	LGX DTRID PB-AB B	LGX DTVF PB-AB B	LGX DTVM PB-AB B	LGX DSAT PB-AB B	LGX DENT PB-AB B	LGX DSAT+ PB-AB B
Polished Brass Frame/Antique Brass	LGX DTRID PB-AB W	LGX DTVF PB-AB W	LGX DTVM PB-AB W	LGX DSAT PB-AB W	LGX DENT PB-AB W	LGX DSAT+ PB-AB W
Polished Brass Frame/Polished Brass	LGX DTRID PB-PB B	LGX DTVF PB-PB B	LGX DTVM PB-PB B	LGX DSAT PB-PB B	LGX DENT PB-PB B	LGX DSAT+ PB-PB B
Polished Brass Frame/Polished Brass	LGX DTRID PB-PB W	LGX DTVF PB-PB W	LGX DTVM PB-PB W	LGX DSAT PB-PB W	LGX DENT PB-PB W	LGX DSAT+ PB-PB W
Polished Brass Frame/Satin Brass	LGX DTRID PB-SB B	LGX DTVF PB-SB B	LGX DTVM PB-SB B	LGX DSAT PB-SB B	LGX DENT PB-SB B	LGX DSAT+ PB-SB B
Polished Brass Frame/Satin Brass	LGX DTRID PB-SB W	LGX DTVF PB-SB W	LGX DTVM PB-SB W	LGX DSAT PB-SB W	LGX DENT PB-SB W	LGX DSAT+ PB-SB W
Richmond Bronze Frame/Richmond Bronze	LGX DTRID RB-RB B	LGX DTVF RB-RB B	LGX DTVM RB-RB B	LGX DSAT RB-RB B	LGX DENT RB-RB B	LGX DSAT+ RB-RB B
Nominal Size:	95.5mm x 95.5mm	95.5mm x 95.5mm	95.5mm x 95.5mm	95.5mm x 95.5mm	95.5mm x 95.5mm	154.5mm x 95.5mm
Minimum Wall Box Depth:	35mm	35mm	35mm	35mm	35mm	35mm
Technical Insert Ref:	DTRID	DTVf	DTVM	DSAT	DENT	DSAT+

Insert Surround Colour Key: (B) Black, (W) White

Linea-Georgian CFX

Telephone and Data Outlets

LINEA-GEORGIAN CFX RANGE



LGX J12 AB-AB B









LGX TCS AB-PB B



LGX 2J12 AB-AB B



LGX 2J45 PB-SB W

Frame / Front Plate	 1 gang Telephone Master	 1 gang Telephone Slave	 1 gang RJ12 Outlet - Unshielded	 2 gang RJ12 Outlet - Unshielded	 1 gang RJ45 CAT 5E Outlet - Unshielded	 2 gang RJ45 CAT 5E Outlet - Unshielded
Antique Brass Frame/Antique Brass	LGX TCM AB-AB B	LGX TCS AB-AB B	LGX J12 AB-AB B	LGX 2J12 AB-AB B	LGX J45 AB-AB B	LGX 2J45 AB-AB B
Antique Brass Frame/Polished Brass	LGX TCM AB-PB B	LGX TCS AB-PB B	LGX J12 AB-PB B	LGX 2J12 AB-PB B	LGX J45 AB-PB B	LGX 2J45 AB-PB B
Antique Brass Frame/Satin Brass	LGX TCM AB-SB B	LGX TCS AB-SB B	LGX J12 AB-SB B	LGX 2J12 AB-SB B	LGX J45 AB-SB B	LGX 2J45 AB-SB B
Connaught Bronze Frame/Connaught Bronze	LGX TCM HB-HB B	LGX TCS HB-HB B	LGX J12 HB-HB B	LGX 2J12 HB-HB B	LGX J45 HB-HB B	LGX 2J45 HB-HB B
Copper Bronze Frame/Copper Bronze	LGX TCM CB-CB B	LGX TCS CB-CB B	LGX J12 CB-CB B	LGX 2J12 CB-CB B	LGX J45 CB-CB B	LGX 2J45 CB-CB B
Etrium Bronze Frame/Etrium Bronze	LGX TCM EB-EB B	LGX TCS EB-EB B	LGX J12 EB-EB B	LGX 2J12 EB-EB B	LGX J45 EB-EB B	LGX 2J45 EB-EB B
Polished Brass Frame/Antique Brass	LGX TCM PB-AB B	LGX TCS PB-AB B	LGX J12 PB-AB B	LGX 2J12 PB-AB B	LGX J45 PB-AB B	LGX 2J45 PB-AB B
Polished Brass Frame/Antique Brass	LGX TCM PB-AB W	LGX TCS PB-AB W	LGX J12 PB-AB W	LGX 2J12 PB-AB W	LGX J45 PB-AB W	LGX 2J45 PB-AB W
Polished Brass Frame/Polished Brass	LGX TCM PB-PB B	LGX TCS PB-PB B	LGX J12 PB-PB B	LGX 2J12 PB-PB B	LGX J45 PB-PB B	LGX 2J45 PB-PB B
Polished Brass Frame/Polished Brass	LGX TCM PB-PB W	LGX TCS PB-PB W	LGX J12 PB-PB W	LGX 2J12 PB-PB W	LGX J45 PB-PB W	LGX 2J45 PB-PB W
Polished Brass Frame/Satin Brass	LGX TCM PB-SB B	LGX TCS PB-SB B	LGX J12 PB-SB B	LGX 2J12 PB-SB B	LGX J45 PB-SB B	LGX 2J45 PB-SB B
Polished Brass Frame/Satin Brass	LGX TCM PB-SB W	LGX TCS PB-SB W	LGX J12 PB-SB W	LGX 2J12 PB-SB W	LGX J45 PB-SB W	LGX 2J45 PB-SB W
Richmond Bronze Frame/Richmond Bronze	LGX TCM RB-RB B	LGX TCS RB-RB B	LGX J12 RB-RB B	LGX 2J12 RB-RB B	LGX J45 RB-RB B	LGX 2J45 RB-RB B
Nominal Size:	95.5mm x 95.5mm	95.5mm x 95.5mm	95.5mm x 95.5mm	95.5mm x 95.5mm	95.5mm x 95.5mm	95.5mm x 95.5mm
Minimum Wall Box Depth:	25mm	25mm	35mm	35mm	35mm	35mm
Technical Insert Ref:	TCM	TCS	J12	2J12	J45	2J45

Insert Surround Colour Key: (B) Black, (W) White

Linea-Georgian CFX

Double Pole Switches

Connection Units



LGX DPN AB-SB B



LGX 45SS1 AB-PB B



LGX SPN AB-SB B



1 gang 20AX
Double Pole
Rocker + Neon



1 gang 45A
Double Pole Red
Rocker + Neon

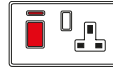

45A Double
Pole Red Rocker
+ Neon + 13A
Switched Socket



1 gang 13A
Double Pole Fused
Spur + Neon



1 gang 13A
Fuse with Red
Neon Halo

Frame / Front Plate

Antique Brass Frame/Antique Brass	LGX DPN AB-AB B	LGX 45N AB-AB B	LGX 45SS1 AB-AB B
Antique Brass Frame/Polished Brass	LGX DPN AB-PB B	LGX 45N AB-PB B	LGX 45SS1 AB-PB B
Antique Brass Frame/Satin Brass	LGX DPN AB-SB B	LGX 45N AB-SB B	LGX 45SS1 AB-SB B
Connaught Bronze Frame/Connaught Bronze	LGX DPN HB-HB B	LGX 45N HB-HB B	LGX 45SS1 HB-HB B
Copper Bronze Frame/Copper Bronze	LGX DPN CB-CB B	LGX 45N CB-CB B	LGX 45SS1 CB-CB B
Etrium Bronze Frame/Etrium Bronze	LGX DPN EB-EB B	LGX 45N EB-EB B	LGX 45SS1 EB-EB B
Polished Brass Frame/Antique Brass	LGX DPN PB-AB B	LGX 45N PB-AB B	LGX 45SS1 PB-AB B
Polished Brass Frame/Antique Brass	LGX DPN PB-AB W	LGX 45N PB-AB W	LGX 45SS1 PB-AB W
Polished Brass Frame/Polished Brass	LGX DPN PB-PB B	LGX 45N PB-PB B	LGX 45SS1 PB-PB B
Polished Brass Frame/Polished Brass	LGX DPN PB-PB W	LGX 45N PB-PB W	LGX 45SS1 PB-PB W
Polished Brass Frame/Satin Brass	LGX DPN PB-SB B	LGX 45N PB-SB B	LGX 45SS1 PB-SB B
Polished Brass Frame/Satin Brass	LGX DPN PB-SB W	LGX 45N PB-SB W	LGX 45SS1 PB-SB W
Richmond Bronze Frame/Richmond Bronze	LGX DPN RB-RB B	LGX 45N RB-RB B	LGX 45SS1 RB-RB B
Nominal Size:	95.5mm x 95.5mm	95.5mm x 95.5mm	154.5mm x 95.5mm
Minimum Wall Box Depth:	35mm	35mm	35mm
Technical Insert Ref:	DPN	45N	45SS1

LGX SPN AB-AB B	LGX FN AB-AB R
LGX SPN AB-PB B	LGX FN AB-PB R
LGX SPN AB-SB B	LGX FN AB-SB R
LGX SPN HB-HB B	LGX FN HB-HB R
LGX SPN CB-CB B	LGX FN CB-CB R
LGX SPN EB-EB B	LGX FN EB-EB R
LGX SPN PB-AB B	LGX FN PB-AB R
LGX SPN PB-AB W	-
LGX SPN PB-PB B	LGX FN PB-PB R
LGX SPN PB-PB W	-
LGX SPN PB-SB B	LGX FN PB-SB R
LGX SPN PB-SB W	-
LGX SPN RB-RB B	LGX FN RB-RB R
95.5mm x 95.5mm	95.5mm x 95.5mm
35mm	35mm
SPN	FN

Insert Surround Colour Key: (B) Black, (W) White

Linea-Georgian CFX

LED Trailing/Leading Edge Push On/Off Rotary 2 Way Switching Dimmers

LINEA-GEORGIAN CFX RANGE



LGX 1XLEDITB100 HB-HB



LGX 2XLEDITB100 AB-SB



LGX 3XLEDITB100 AB-PB



LGX 4XLEDITB100 PB-SB

Frame / Front Plate	 1 gang 100W LED Trailing/ Leading Edge Push On/ Off Rotary 2 Way Switching Dimmer	 2 gang 100W LED 2 Trailing/ Leading Edge Push On/ Off Rotary 2 Way Switching Dimmer	 3 gang 100W LED Trailing/ Leading Edge Push On/ Off Rotary 2 Way Switching Dimmer	 4 gang 100W LED Trailing/ Leading Edge Push On/ Off Rotary 2 Way Switching Dimmer
Antique Brass Frame/Antique Brass	LGX 1XLEDITB100 AB-AB	LGX 2XLEDITB100 AB-AB	LGX 3XLEDITB100 AB-AB	LGX 4XLEDITB100 AB-AB
Antique Brass Frame/Polished Brass	LGX 1XLEDITB100 AB-PB	LGX 2XLEDITB100 AB-PB	LGX 3XLEDITB100 AB-PB	LGX 4XLEDITB100 AB-PB
Antique Brass Frame/Satin Brass	LGX 1XLEDITB100 AB-SB	LGX 2XLEDITB100 AB-SB	LGX 3XLEDITB100 AB-SB	LGX 4XLEDITB100 AB-SB
Connaught Bronze Frame/Connaught Bronze	LGX 1XLEDITB100 HB-HB	LGX 2XLEDITB100 HB-HB	LGX 3XLEDITB100 HB-HB	LGX 4XLEDITB100 HB-HB
Copper Bronze Frame/Copper Bronze	LGX 1XLEDITB100 CB-CB	LGX 2XLEDITB100 CB-CB	LGX 3XLEDITB100 CB-CB	LGX 4XLEDITB100 CB-CB
Etrium Bronze Frame/Etrium Bronze	LGX 1XLEDITB100 EB-EB	LGX 2XLEDITB100 EB-EB	LGX 3XLEDITB100 EB-EB	LGX 4XLEDITB100 EB-EB
Polished Brass Frame/Antique Brass	LGX 1XLEDITB100 PB-AB	LGX 2XLEDITB100 PB-AB	LGX 3XLEDITB100 PB-AB	LGX 4XLEDITB100 PB-AB
Polished Brass Frame/Polished Brass	LGX 1XLEDITB100 PB-PB	LGX 2XLEDITB100 PB-PB	LGX 3XLEDITB100 PB-PB	LGX 4XLEDITB100 PB-PB
Polished Brass Frame/Satin Brass	LGX 1XLEDITB100 PB-SB	LGX 2XLEDITB100 PB-SB	LGX 3XLEDITB100 PB-SB	LGX 4XLEDITB100 PB-SB
Richmond Bronze Frame/Richmond Bronze	LGX 1XLEDITB100 RB-RB	LGX 2XLEDITB100 RB-RB	LGX 3XLEDITB100 RB-RB	LGX 4XLEDITB100 RB-RB
Nominal Size:	95.5mm x 95.5mm	95.5mm x 95.5mm	154.5mm x 95.5mm	154.5mm x 95.5mm
Minimum Wall Box Depth:	35mm	35mm	35mm	35mm
Technical Insert Ref:	1XLEDITB	2XLEDITB	3XLEDITB	4XLEDITB

NOTE: Tungsten filament GU10 lamps must be branded and with a fused base.

NOTE: Please refer to the Dimmer Technical Section for the max Wattage.

NOTE: Please contact our Technical Department for compatibility.

Linea-Georgian CFX

LED Trailing/Leading Edge Push On/Off Rotary Multi-Way Dimmers



LGX 1X100LED RB-RB







LGX 2X100LED PB-PB



LGX 3X100LED PB-SB

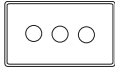

LGX 4X100LED AB-PB

Frame / Front Plate	 1 gang 100W LED Trailing/Leading Edge Push On/Off Rotary Multi-Way Dimmer	 2 gang 100W LED Trailing/Leading Edge Push On/Off Rotary Multi-Way Dimmer	 3 gang 100W LED Trailing/Leading Edge Push On/Off Rotary Multi-Way Dimmer	 4 gang 100W LED Trailing/Leading Edge Push On/Off Rotary Multi-Way Dimmer
Antique Brass Frame/Antique Brass	LGX 1X100LED AB-AB	LGX 2X100LED AB-AB	LGX 3X100LED AB-AB	LGX 4X100LED AB-AB
Antique Brass Frame/Polished Brass	LGX 1X100LED AB-PB	LGX 2X100LED AB-PB	LGX 3X100LED AB-PB	LGX 4X100LED AB-PB
Antique Brass Frame/Satin Brass	LGX 1X100LED AB-SB	LGX 2X100LED AB-SB	LGX 3X100LED AB-SB	LGX 4X100LED AB-SB
Connaught Bronze Frame/Connaught Bronze	LGX 1X100LED HB-HB	LGX 2X100LED HB-HB	LGX 3X100LED HB-HB	LGX 4X100LED HB-HB
Copper Bronze Frame/Copper Bronze	LGX 1X100LED CB-CB	LGX 2X100LED CB-CB	LGX 3X100LED CB-CB	LGX 4X100LED CB-CB
Etrium Bronze Frame/Etrium Bronze	LGX 1X100LED EB-EB	LGX 2X100LED EB-EB	LGX 3X100LED EB-EB	LGX 4X100LED EB-EB
Polished Brass Frame/Antique Brass	LGX 1X100LED PB-AB	LGX 2X100LED PB-AB	LGX 3X100LED PB-AB	LGX 4X100LED PB-AB
Polished Brass Frame/Polished Brass	LGX 1X100LED PB-PB	LGX 2X100LED PB-PB	LGX 3X100LED PB-PB	LGX 4X100LED PB-PB
Polished Brass Frame/Satin Brass	LGX 1X100LED PB-SB	LGX 2X100LED PB-SB	LGX 3X100LED PB-SB	LGX 4X100LED PB-SB
Richmond Bronze Frame/Richmond Bronze	LGX 1X100LED RB-RB	LGX 2X100LED RB-RB	LGX 3X100LED RB-RB	LGX 4X100LED RB-RB
Nominal Size:	95.5mm x 95.5mm	95.5mm x 95.5mm	154.5mm x 95.5mm	154.5mm x 95.5mm
Minimum Wall Box Depth:	35mm	35mm	35mm	35mm
Technical Insert Ref:	1X100LED	2X100LED	3X100LED	4X100LED

NOTE: Tungsten filament GU10 lamps must be branded and with a fused base.

NOTE: Please refer to the Dimmer Technical Section for the max Wattage.

NOTE: Please contact our Technical Department for compatibility.

Linea-Georgian CFX

Resistive Leading Edge Push On/Off Rotary 2 Way Switching Dimmers

LINEA-GEORGIAN CFX RANGE



LGX 1X40 RB-RB







LGX 2X40 AB-PB



LGX 3X40 AB-SB

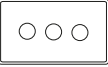
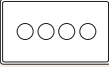

LGX 4X40 AB-SB

Frame / Front Plate	 1 gang 400W Resistive Leading Edge Push On/Off Rotary 2 Way Switching Dimmer	 2 gang 400W Resistive Leading Edge Push On/Off Rotary 2 Way Switching Dimmer	 3 gang 400W Resistive Leading Edge Push On/Off Rotary 2 Way Switching Dimmer	 4 gang 400W Resistive Leading Edge Push ON/Off Rotary 2 Way Switching Dimmer	 1 gang 600W Resistive Leading Edge Push On/Off Rotary 2 Way Switching Dimmer
Antique Brass Frame/Antique Brass	LGX 1X40 AB-AB	LGX 2X40 AB-AB	LGX 3X40 AB-AB	LGX 4X40 AB-AB	LGX 1X60 AB-AB
Antique Brass Frame/Polished Brass	LGX 1X40 AB-PB	LGX 2X40 AB-PB	LGX 3X40 AB-PB	LGX 4X40 AB-PB	LGX 1X60 AB-PB
Antique Brass Frame/Satin Brass	LGX 1X40 AB-SB	LGX 2X40 AB-SB	LGX 3X40 AB-SB	LGX 4X40 AB-SB	LGX 1X60 AB-SB
Connaught Bronze Frame/Connaught Bronze	LGX 1X40 HB-HB	LGX 2X40 HB-HB	LGX 3X40 HB-HB	LGX 4X40 HB-HB	LGX 1X60 HB-HB
Copper Bronze Frame/Copper Bronze	LGX 1X40 CB-CB	LGX 2X40 CB-CB	LGX 3X40 CB-CB	LGX 4X40 CB-CB	LGX 1X60 CB-CB
Etrium Bronze Frame/Etrium Bronze	LGX 1X40 EB-EB	LGX 2X40 EB-EB	LGX 3X40 EB-EB	LGX 4X40 EB-EB	LGX 1X60 EB-EB
Polished Brass Frame/Antique Brass	LGX 1X40 PB-AB	LGX 2X40 PB-AB	LGX 3X40 PB-AB	LGX 4X40 PB-AB	LGX 1X60 PB-AB
Polished Brass Frame/Polished Brass	LGX 1X40 PB-PB	LGX 2X40 PB-PB	LGX 3X40 PB-PB	LGX 4X40 PB-PB	LGX 1X60 PB-PB
Polished Brass Frame/Satin Brass	LGX 1X40 PB-SB	LGX 2X40 PB-SB	LGX 3X40 PB-SB	LGX 4X40 PB-SB	LGX 1X60 PB-SB
Richmond Bronze Frame/Richmond Bronze	LGX 1X40 RB-RB	LGX 2X40 RB-RB	LGX 3X40 RB-RB	LGX 4X40 RB-RB	LGX 1X60 RB-RB
Nominal Size:	95.5mm x 95.5mm	95.5mm x 95.5mm	154.5mm x 95.5mm	154.5mm x 95.5mm	95.5mm x 95.5mm
Minimum Wall Box Depth:	35mm	35mm	35mm	35mm	35mm
Technical Insert Ref:	1X40	2X40	3X40	4X40	1X60

NOTE: Tungsten filament GU10 lamps must be branded and with a fused base
 NOTE: When using mains voltage halogen lamps – dimmers should be re-rated by 25%
 NOTE: When dimming LED lamps de-rate by 75% - please contact our Technical Department for compatibility.
 NOTE: Please refer to the Dimmer Technical Section for the max wattage

Linea-Georgian CFX

Inductive Leading Edge Push On/Off Rotary 2 Way Switching Dimmers



LGX 1X2V AB-SB



LGX 1X2V PB-PB



1 gang 200VA Inductive
Leading Edge Push
On/Off Rotary 2 Way
Switching Dimmer

Frame / Front Plate	
Antique Brass Frame/Antique Brass	LGX 1X2V AB-AB
Antique Brass Frame/Polished Brass	LGX 1X2V AB-PB
Antique Brass Frame/Satin Brass	LGX 1X2V AB-SB
Connaught Bronze Frame/Connaught Bronze	LGX 1X2V HB-HB
Copper Bronze Frame/Copper Bronze	LGX 1X2V CB-CB
Etrium Bronze Frame/Etrium Bronze	LGX 1X2V EB-EB
Polished Brass Frame/Antique Brass	LGX 1X2V PB-AB
Polished Brass Frame/Polished Brass	LGX 1X2V PB-PB
Polished Brass Frame/Satin Brass	LGX 1X2V PB-SB
Richmond Bronze Frame/Richmond Bronze	LGX 1X2V RB-RB
Nominal Size:	95.5mm x 95.5mm
Minimum Wall Box Depth:	35mm
Technical Insert Ref:	1X2V

NOTE: Tungsten filament GU10 lamps must be branded and with a fused base
 NOTE: When using mains voltage halogen lamps – dimmers should be re-rated by 25%
 NOTE: When dimming LED lamps de-rate by 75% - please contact our Technical Department for compatibility.
 NOTE: Please refer to the Dimmer Technical Section for the max wattage

Linea-Georgian CFX

Resistive/Inductive Trailing Edge Push On/Off Rotary Multi-Way Dimmers

LINEA-GEORGIAN CFX RANGE



LGX 1XTE HB-HB



LGX 2XTE AB-PB



LGX 3XTE AB-SB



LGX 4XTE PB-SB



1 gang 250W/210VA Resistive/Inductive Trailing Edge Push On/Off Rotary Multi-Way Dimmer



2 gang 250W/210VA Resistive/Inductive Trailing Edge Push On/Off Rotary Multi-Way Dimmer

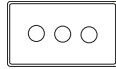

3 gang 250W/210VA Resistive/Inductive Trailing Edge Push On/Off Rotary Multi-Way Dimmer

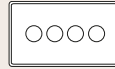

4 gang 250W/210VA Resistive/Inductive Trailing Edge Push On/Off Rotary Multi-Way Dimmer

Frame / Front Plate	1 gang 250W/210VA Resistive/Inductive Trailing Edge Push On/Off Rotary Multi-Way Dimmer	2 gang 250W/210VA Resistive/Inductive Trailing Edge Push On/Off Rotary Multi-Way Dimmer	3 gang 250W/210VA Resistive/Inductive Trailing Edge Push On/Off Rotary Multi-Way Dimmer	4 gang 250W/210VA Resistive/Inductive Trailing Edge Push On/Off Rotary Multi-Way Dimmer
Antique Brass Frame/Antique Brass	LGX 1XTE AB-AB	LGX 2XTE AB-AB	LGX 3XTE AB-AB	LGX 4XTE AB-AB
Antique Brass Frame/Polished Brass	LGX 1XTE AB-PB	LGX 2XTE AB-PB	LGX 3XTE AB-PB	LGX 4XTE AB-PB
Antique Brass Frame/Satin Brass	LGX 1XTE AB-SB	LGX 2XTE AB-SB	LGX 3XTE AB-SB	LGX 4XTE AB-SB
Connaught Bronze Frame/Connaught Bronze	LGX 1XTE HB-HB	LGX 2XTE HB-HB	LGX 3XTE HB-HB	LGX 4XTE HB-HB
Copper Bronze Frame/Copper Bronze	LGX 1XTE CB-CB	LGX 2XTE CB-CB	LGX 3XTE CB-CB	LGX 4XTE CB-CB
Etrium Bronze Frame/Etrium Bronze	LGX 1XTE EB-EB	LGX 2XTE EB-EB	LGX 3XTE EB-EB	LGX 4XTE EB-EB
Polished Brass Frame/Antique Brass	LGX 1XTE PB-AB	LGX 2XTE PB-AB	LGX 3XTE PB-AB	LGX 4XTE PB-AB
Polished Brass Frame/Polished Brass	LGX 1XTE PB-PB	LGX 2XTE PB-PB	LGX 3XTE PB-PB	LGX 4XTE PB-PB
Polished Brass Frame/Satin Brass	LGX 1XTE PB-SB	LGX 2XTE PB-SB	LGX 3XTE PB-SB	LGX 4XTE PB-SB
Richmond Bronze Frame/Richmond Bronze	LGX 1XTE RB-RB	LGX 2XTE RB-RB	LGX 3XTE RB-RB	LGX 4XTE RB-RB
Nominal Size:	95.5mm x 95.5mm	95.5mm x 95.5mm	154.5mm x 95.5mm	154.5mm x 95.5mm
Minimum Wall Box Depth:	35mm	35mm	35mm	35mm
Technical Insert Ref:	1XTE	2XTE	3XTE	4XTE

NOTE: Tungsten filament GU10 lamps must be branded and with a fused base
 NOTE: When using mains voltage halogen lamps – dimmers should be re-rated by 25%
 NOTE: When dimming LED lamps de-rate by 75% - please contact our Technical Department for compatibility.
 NOTE: Please refer to the Dimmer Technical Section for the max wattage

Linea-Georgian CFX

Resistive/Inductive Trailing Edge Touch Master Multi-Way Dimmers



LGX 1XTM PB-SB W



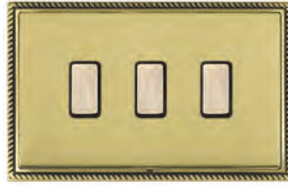

LGX 2XTM AB-AB B



LGX 3XTM AB-PB B

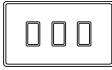
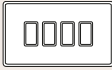

LGX 4XTM PB-PB W

Frame / Front Plate	 1 gang 250W/210VA Resistive/Inductive Trailing Edge Touch Master Multi- Way Dimmer	 2 gang 250W/210VA Resistive/Inductive Trailing Edge Touch Master Multi- Way Dimmer	 3 gang 250W/210VA Resistive/Inductive Trailing Edge Touch Master Multi- Way Dimmer	 4 gang 250W/210VA Resistive/Inductive Trailing Edge Touch Master Multi- Way Dimmer
Antique Brass Frame/Antique Brass	LGX 1XTM AB-AB B	LGX 2XTM AB-AB B	LGX 3XTM AB-AB B	LGX 4XTM AB-AB B
Antique Brass Frame/Polished Brass	LGX 1XTM AB-PB B	LGX 2XTM AB-PB B	LGX 3XTM AB-PB B	LGX 4XTM AB-PB B
Antique Brass Frame/Satin Brass	LGX 1XTM AB-SB B	LGX 2XTM AB-SB B	LGX 3XTM AB-SB B	LGX 4XTM AB-SB B
Connaught Bronze Frame/Connaught Bronze	LGX 1XTM HB-HB B	LGX 2XTM HB-HB B	LGX 3XTM HB-HB B	LGX 4XTM HB-HB B
Copper Bronze Frame/Copper Bronze	LGX 1XTM CB-CB B	LGX 2XTM CB-CB B	LGX 3XTM CB-CB B	LGX 4XTM CB-CB B
Etrium Bronze Frame/Etrium Bronze	LGX 1XTM EB-EB B	LGX 2XTM EB-EB B	LGX 3XTM EB-EB B	LGX 4XTM EB-EB B
Polished Brass Frame/Antique Brass	LGX 1XTM PB-AB B	LGX 2XTM PB-AB B	LGX 3XTM PB-AB B	LGX 4XTM PB-AB B
Polished Brass Frame/Antique Brass	LGX 1XTM PB-AB W	LGX 2XTM PB-AB W	LGX 3XTM PB-AB W	LGX 4XTM PB-AB W
Polished Brass Frame/Polished Brass	LGX 1XTM PB-PB B	LGX 2XTM PB-PB B	LGX 3XTM PB-PB B	LGX 4XTM PB-PB B
Polished Brass Frame/Polished Brass	LGX 1XTM PB-PB W	LGX 2XTM PB-PB W	LGX 3XTM PB-PB W	LGX 4XTM PB-PB W
Polished Brass Frame/Satin Brass	LGX 1XTM PB-SB B	LGX 2XTM PB-SB B	LGX 3XTM PB-SB B	LGX 4XTM PB-SB B
Polished Brass Frame/Satin Brass	LGX 1XTM PB-SB W	LGX 2XTM PB-SB W	LGX 3XTM PB-SB W	LGX 4XTM PB-SB W
Richmond Bronze Frame/Richmond Bronze	LGX 1XTM RB-RB B	LGX 2XTM RB-RB B	LGX 3XTM RB-RB B	LGX 4XTM RB-RB B
Nominal Size:	95.5mm x 95.5mm	95.5mm x 95.5mm	154.5mm x 95.5mm	154.5mm x 95.5mm
Minimum Wall Box Depth:	35mm	35mm	35mm	35mm
Technical Insert Ref:	1XTM	2XTM	3XTM	4XTM

LINEA-GEORGIAN CFX RANGE

NOTE: Tungsten filament GU10 lamps must be branded and with a fused base
 NOTE: When using mains voltage halogen lamps – dimmers should be re-rated by 25%
 NOTE: When dimming LED lamps de-rate by 75% - please contact our Technical Department for compatibility.
 NOTE: Please refer to the Dimmer Technical Section for the max wattage

Insert Surround Colour Key: (B) Black, (W) White

Linea-Georgian CFX

Multi-Way Touch Slave Controllers

LINEA-GEORGIAN CFX RANGE



LGX 1XTS PB-PB W

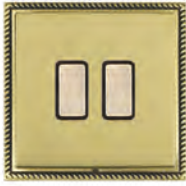

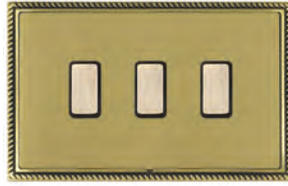

LGX 2XTS AB-PB B



LGX 3XTS AB-SB B

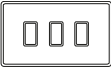
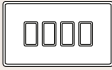

LGX 4XTS PB-SB W

Frame / Front Plate	 1 gang Multi-Way Touch Slave Controller	 2 gang Multi-Way Touch Slave Controller	 3 gang Multi-Way Touch Slave Controller	 4 gang Multi-Way Touch Slave Controller
Antique Brass Frame/Antique Brass	LGX 1XTS AB-AB B	LGX 2XTS AB-AB B	LGX 3XTS AB-AB B	LGX 4XTS AB-AB B
Antique Brass Frame/Polished Brass	LGX 1XTS AB-PB B	LGX 2XTS AB-PB B	LGX 3XTS AB-PB B	LGX 4XTS AB-PB B
Antique Brass Frame/Satin Brass	LGX 1XTS AB-SB B	LGX 2XTS AB-SB B	LGX 3XTS AB-SB B	LGX 4XTS AB-SB B
Connaught Bronze Frame/Connaught Bronze	LGX 1XTS HB-HB B	LGX 2XTS HB-HB B	LGX 3XTS HB-HB B	LGX 4XTS HB-HB B
Copper Bronze Frame/Copper Bronze	LGX 1XTS CB-CB B	LGX 2XTS CB-CB B	LGX 3XTS CB-CB B	LGX 4XTS CB-CB B
Etrium Bronze Frame/Etrium Bronze	LGX 1XTS EB-EB B	LGX 2XTS EB-EB B	LGX 3XTS EB-EB B	LGX 4XTS EB-EB B
Polished Brass Frame/Antique Brass	LGX 1XTS PB-AB B	LGX 2XTS PB-AB B	LGX 3XTS PB-AB B	LGX 4XTS PB-AB B
Polished Brass Frame/Antique Brass	LGX 1XTS PB-AB W	LGX 2XTS PB-AB W	LGX 3XTS PB-AB W	LGX 4XTS PB-AB W
Polished Brass Frame/Polished Brass	LGX 1XTS PB-PB B	LGX 2XTS PB-PB B	LGX 3XTS PB-PB B	LGX 4XTS PB-PB B
Polished Brass Frame/Polished Brass	LGX 1XTS PB-PB W	LGX 2XTS PB-PB W	LGX 3XTS PB-PB W	LGX 4XTS PB-PB W
Polished Brass Frame/Satin Brass	LGX 1XTS PB-SB B	LGX 2XTS PB-SB B	LGX 3XTS PB-SB B	LGX 4XTS PB-SB B
Polished Brass Frame/Satin Brass	LGX 1XTS PB-SB W	LGX 2XTS PB-SB W	LGX 3XTS PB-SB W	LGX 4XTS PB-SB W
Richmond Bronze Frame/Richmond Bronze	LGX 1XTS RB-RB B	LGX 2XTS RB-RB B	LGX 3XTS RB-RB B	LGX 4XTS RB-RB B
Nominal Size:	95.5mm x 95.5mm	95.5mm x 95.5mm	154.5mm x 95.5mm	154.5mm x 95.5mm
Minimum Wall Box Depth:	35mm	35mm	35mm	35mm
Technical Insert Ref:	1XTS	2XTS	3XTS	4XTS

NOTE: To only be used with Touch Masters

Insert Surround Colour Key: (B) Black, (W) White

Linea-Georgian CFX

Blank Plates



LGX BPS AB-PB



LGX BPD AB-AB

Frame / Front Plate	Single Blank Plate	Double Blank Plate
Antique Brass Frame/Antique Brass	LGX BPS AB-AB	LGX BPD AB-AB
Antique Brass Frame/Polished Brass	LGX BPS AB-PB	LGX BPD AB-PB
Antique Brass Frame/Satin Brass	LGX BPS AB-SB	LGX BPD AB-SB
Connaught Bronze Frame/Connaught Bronze	LGX BPS HB-HB	LGX BPD HB-HB
Copper Bronze Frame/Copper Bronze	LGX BPS CB-CB	LGX BPD CB-CB
Etrium Bronze Frame/Etrium Bronze	LGX BPS EB-EB	LGX BPD EB-EB
Polished Brass Frame/Antique Brass	LGX BPS PB-AB	LGX BPD PB-AB
Polished Brass Frame/Polished Brass	LGX BPS PB-PB	LGX BPD PB-PB
Polished Brass Frame/Satin Brass	LGX BPS PB-SB	LGX BPD PB-SB
Richmond Bronze Frame/Richmond Bronze	LGX BPS RB-RB	LGX BPD RB-RB
Nominal Size:	95.5mm x 95.5mm	154.5mm x 95.5mm
Minimum Wall Box Depth:	Any Box	Any Box
Technical Insert Ref:	BPS	BPD

Linea-Georgian CFX

Grid-IT GridFix Plates complete with Fixing Grid

LINEA-GEORGIAN CFX RANGE



LGX 1GP PB-PB





LGX 2GP AB-PB



LGX 3GP PB-PB

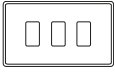
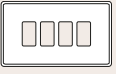

LGX 4GP PB-SB

Frame / Front Plate	 1 Gang Grid Fix Aperture Plate with Grid	 2 Gang Grid Fix Aperture Plate with Grid	 3 Gang Grid Fix Aperture Plate with Grid	 4 Gang Grid Fix Aperture Plate with Grid
Antique Brass Frame/Antique Brass	LGX 1GP AB-AB	LGX 2GP AB-AB	LGX 3GP AB-AB	LGX 4GP AB-AB
Antique Brass Frame/Polished Brass	LGX 1GP AB-PB	LGX 2GP AB-PB	LGX 3GP AB-PB	LGX 4GP AB-PB
Antique Brass Frame/Satin Brass	LGX 1GP AB-SB	LGX 2GP AB-SB	LGX 3GP AB-SB	LGX 4GP AB-SB
Copper Bronze Frame/Copper Bronze	LGX 1GP CB-CB	LGX 2GP CB-CB	LGX 3GP CB-CB	LGX 4GP CB-CB
Etrium Bronze Frame/Etrium Bronze	LGX 1GP EB-EB	LGX 2GP EB-EB	LGX 3GP EB-EB	LGX 4GP EB-EB
Connaught Bronze Frame/Connaught Bronze	LGX 1GP HB-HB	LGX 2GP HB-HB	LGX 3GP HB-HB	LGX 4GP HB-HB
Polished Brass Frame/Antique Brass	LGX 1GP PB-AB	LGX 2GP PB-AB	LGX 3GP PB-AB	LGX 4GP PB-AB
Polished Brass Frame/Polished Brass	LGX 1GP PB-PB	LGX 2GP PB-PB	LGX 3GP PB-PB	LGX 4GP PB-PB
Polished Brass Frame/Satin Brass	LGX 1GP PB-SB	LGX 2GP PB-SB	LGX 3GP PB-SB	LGX 4GP PB-SB
Richmond Bronze Frame/Richmond Bronze	LGX 1GP RB-RB	LGX 2GP RB-RB	LGX 3GP RB-RB	LGX 4GP RB-RB
Nominal Size:	95.5mm x 95.5mm	95.5mm x 95.5mm	154.5mm x 95.5mm	154.5mm x 95.5mm
Minimum Wall Box Depth:	As Per Insert	As Per Inserts	As Per Inserts	As Per Inserts
Technical Insert Ref:	1GP	2GP	3GP	4GP

Note: Minimum Wall Box depth is dependant on the Grid Fix insert fitted, please see the GRID-IT section for the complete range of inserts.

Linea-Georgian CFX

EuroFix Apertured Plates complete with Fixing Grid



LGX EURO1 AB-AB

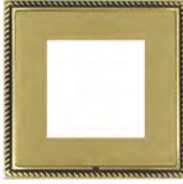

LGX EURO2 AB-SB



LGX EURO3 PB-PB



LGX EURO4 AB-PB



Single Plate complete with 1 EuroFix Aperture 25x50mm and Grid



Single Plate complete with 2 EuroFix Apertures 50x50mm and Grid

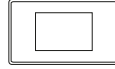

Double Plate complete with 3 EuroFix Apertures 75x50mm and Grid

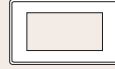

Double Plate complete with 4 EuroFix Apertures 100x50mm and Grid

Frame / Front Plate	Single Plate complete with 1 EuroFix Aperture 25x50mm and Grid	Single Plate complete with 2 EuroFix Apertures 50x50mm and Grid	Double Plate complete with 3 EuroFix Apertures 75x50mm and Grid	Double Plate complete with 4 EuroFix Apertures 100x50mm and Grid
Copper Bronze Frame/Copper Bronze	LGX EURO1 CB-CB	LGX EURO2 CB-CB	LGX EURO3 CB-CB	LGX EURO4 CB-CB
Etrium Bronze Frame/Etrium Bronze	LGX EURO1 EB-EB	LGX EURO2 EB-EB	LGX EURO3 EB-EB	LGX EURO4 EB-EB
Connaught Bronze Frame/Connaught Bronze	LGX EURO1 HB-HB	LGX EURO2 HB-HB	LGX EURO3 HB-HB	LGX EURO4 HB-HB
Richmond Bronze Frame/Richmond Bronze	LGX EURO1 RB-RB	LGX EURO2 RB-RB	LGX EURO3 RB-RB	LGX EURO4 RB-RB
Polished Brass Frame/Polished Brass	LGX EURO1 PB-PB	LGX EURO2 PB-PB	LGX EURO3 PB-PB	LGX EURO4 PB-PB
Polished Brass Frame/Satin Brass	LGX EURO1 PB-SB	LGX EURO2 PB-SB	LGX EURO3 PB-SB	LGX EURO4 PB-SB
Polished Brass Frame/Antique Brass	LGX EURO1 PB-AB	LGX EURO2 PB-AB	LGX EURO3 PB-AB	LGX EURO4 PB-AB
Antique Brass Frame/Antique Brass	LGX EURO1 AB-AB	LGX EURO2 AB-AB	LGX EURO3 AB-AB	LGX EURO4 AB-AB
Antique Brass Frame/Polished Brass	LGX EURO1 AB-PB	LGX EURO2 AB-PB	LGX EURO3 AB-PB	LGX EURO4 AB-PB
Antique Brass Frame/Satin Brass	LGX EURO1 AB-SB	LGX EURO2 AB-SB	LGX EURO3 AB-SB	LGX EURO4 AB-SB
Nominal Size:	95.5mm x 95.5mm	95.5mm x 95.5mm	154.5mm x 95.5mm	154.5mm x 95.5mm
Minimum Wall Box Depth:	As Per Insert	As Per Inserts	As Per Inserts	As Per Inserts
Technical Insert Ref:	EURO1	EURO2	EURO3	EURO4

Note: Minimum Wall Box depth is dependant on the EuroFix insert fitted, please see the EuroFix section for our complete range of inserts.



Bespoke

As a major supplier to the boutique hotel sector, Hamilton offer a comprehensive range of quality plates and sockets: including room card switches, bath/shower room shaver sockets, numerous data and media options, plus ultra fast USB charging and international sockets - all available in our extensive range of decorative plate finishes.

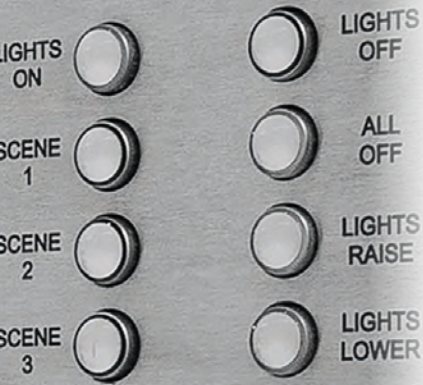

Bespoke Design

Every now and then a project needs something a little different ...*a special!*



Using our bespoke design and manufacturing service, we can create tailor-made prototypes to a highly finished standard for you to show your clients exactly how your ideas will look, and work as a custom-built electrical accessory.

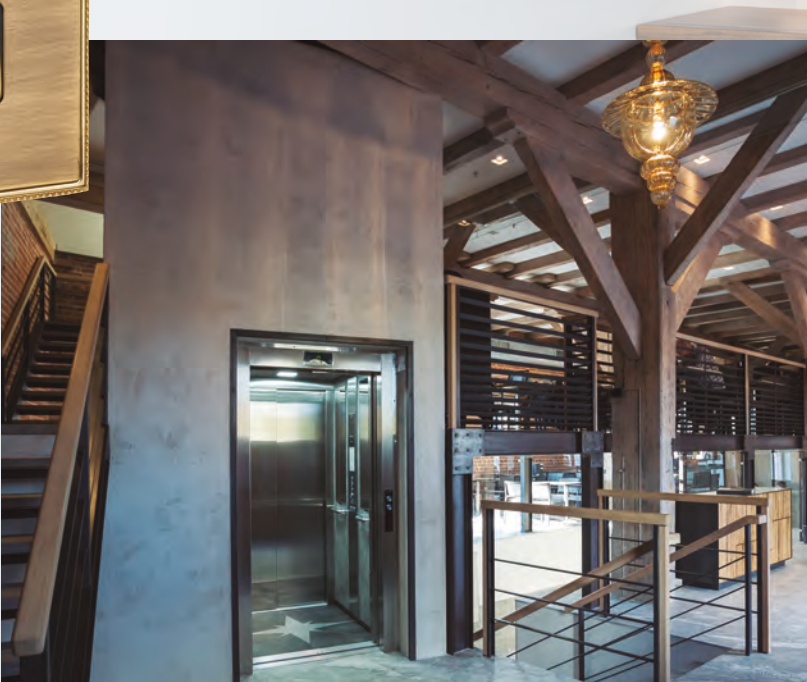



Tell us what function the item is to fulfil, what style and finish you are leaning towards, and our in-house team of experts will design and manufacture a unique personalised solution that will match your exact requirements. We'll start by creating 3D CAD views, enabling your idea to take shape and be inspected from different angles and perspectives before proceeding to prototype sampling.



Whether it's a particular finish, specific energy-saving remit, special shape, combination of functions or any other request, Hamilton will work with you to develop a stylish and efficient solution that will exceed expectations.



- Unique text or graphics can be printed on the plates by laser etching, pad printing or engraving.



- Custom-made back box assemblies to specific measurements and designs can be manufactured to suit non-standard plate configurations.

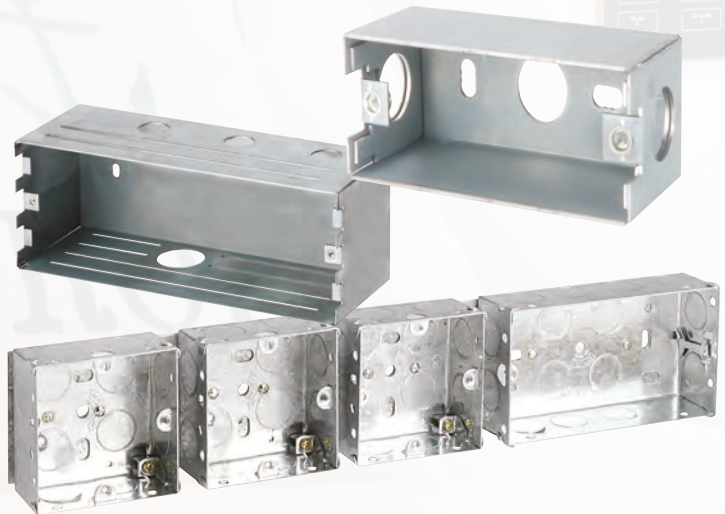



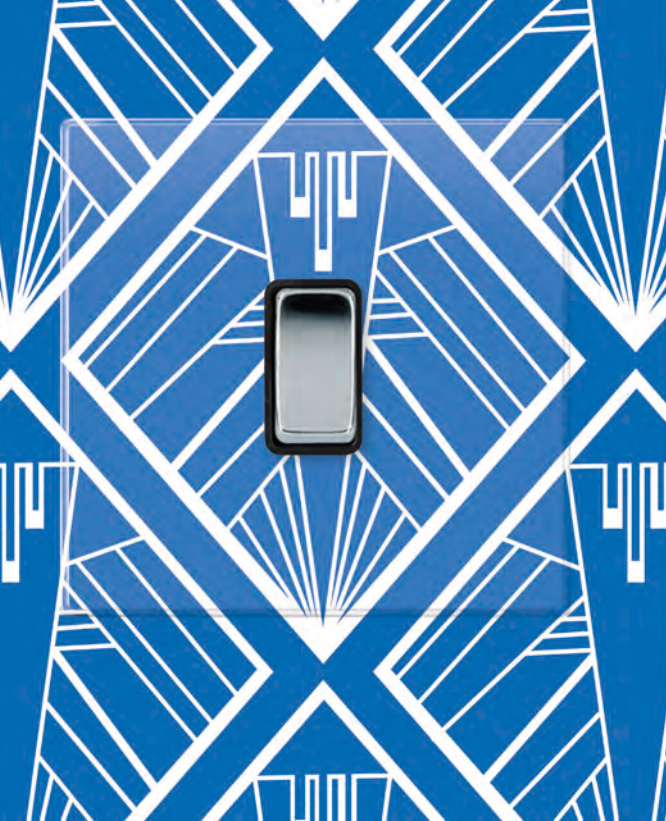

Photo: Vinicius Amano

Wall coverings/murals supplied by www.ATADesigns.com

Perception CFX[®]

Concealed Fixing Accessories on subtle clear plastic plates

The Perception CFX[®] range of concealed fixing electrical wiring accessories with snap-on clear front plates, are cleverly designed to insert your own wallpaper or alternatively the supplied template can be painted, thereby blending discreetly into the interior decor.

- A clear plate that blends into the décor
- Concealed fixing
- Accommodates your own choice of wall covering
- A cutting template is supplied with each electrical accessory
- Grid and EuroFix options also available (see separate GRID-IT and EuroFix Sections)

Perception Range



PC1XTE5C



PC T22 PB

Wall coverings/murals supplied by www.ATADesigns.com

Insert finishes available in this range



Plate Dimensions

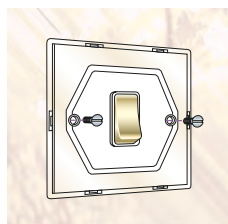

Step 1
Having applied the desired wall covering and cut away from the wall box aperture, insert and fix the accessory using the two screws supplied.

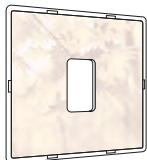

Step 3
Place the cut out piece of wallpaper into the back of the clear front plate.



Step 2
Using a spare piece of wall covering that matches the pattern exactly, carefully cut out the shape of the front plate using the template supplied.

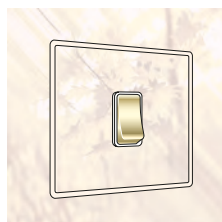

Step 4
Position and snap the front plate onto the accessory backplate using the integral clips to conceal the accessory and fixing screws.

Perception CFX

Rocker Switches - on Transparent Plates



PC R21 SC-W







PC R22 PB-B



PC R23 AB-B

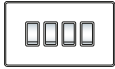

PC R24 AB-B

Plate Finish	Insert Finish/ Surround Colour						
		1 gang 10AX 2 Way Rocker	2 gang 10AX 2 Way Rocker	3 gang 10AX 2 Way Rocker	4 gang 10AX 2 Way Rocker	1 gang 10AX Intermediate Rocker	1 gang 10A Triple Pole Rocker
Clear	Antique Brass/Black	PC R21 AB-B	PC R22 AB-B	PC R23 AB-B	PC R24 AB-B	PC R31 AB-B	-
Clear	Bright Chrome/Black	PC R21 BC-B	PC R22 BC-B	PC R23 BC-B	PC R24 BC-B	PC R31 BC-B	-
Clear	Bright Chrome/White	PC R21 BC-W	PC R22 BC-W	PC R23 BC-W	PC R24 BC-W	PC R31 BC-W	-
Clear	Black Nickel/Black	PC R21 BK-B	PC R22 BK-B	PC R23 BK-B	PC R24 BK-B	PC R31 BK-B	-
Clear	Black/Black	PC R21 BL-B	PC R22 BL-B	PC R23 BL-B	PC R24 BL-B	PC R31 BL-B	PCTPBL-B
Clear	Polished Brass/Black	PC R21 PB-B	PC R22 PB-B	PC R23 PB-B	PC R24 PB-B	PC R31 PB-B	-
Clear	Polished Brass/White	PC R21 PB-W	PC R22 PB-W	PC R23 PB-W	PC R24 PB-W	PC R31 PB-W	-
Clear	Satin Brass/Black	PC R21 SB-B	PC R22 SB-B	PC R23 SB-B	PC R24 SB-B	PC R31 SB-B	-
Clear	Satin Brass/White	PC R21 SB-W	PC R22 SB-W	PC R23 SB-W	PC R24 SB-W	PC R31 SB-W	-
Clear	Satin Chrome/Black	PC R21 SC-B	PC R22 SC-B	PC R23 SC-B	PC R24 SC-B	PC R31 SC-B	-
Clear	Satin Chrome/White	PC R21 SC-W	PC R22 SC-W	PC R23 SC-W	PC R24 SC-W	PC R31 SC-W	-
Clear	White/White	PC R21 WH-W	PC R22 WH-W	PC R23 WH-W	PC R24 WH-W	PC R31 WH-W	PCTPWH-W
Nominal Size:		86.0mm x 86.0mm	86.0mm x 86.0mm	86.0mm x 86.0mm	145.0mm x 86.0mm	86.0mm x 86.0mm	86.0mm x 86.0mm
Minimum Wall Box Depth:		25mm	25mm	25mm	25mm	25mm	25mm
Technical Insert Ref:		R21	R22	R23	R24	R31	TP

Insert Surround Colour Key: (-B) Black, (-W) White

Perception CFX

Rocker Switches - on Transparent Plates



PC R222 WH-W







PC R212 BC-W



PC R232 SB-B

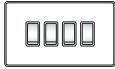

PC R242 SB-B

Plate Finish	Insert Finish/ Surround Colour	 1 gang 20AX 2 Way Rocker	 2 gang 20AX 2 Way Rocker	 3 gang 20AX 2 Way Rocker	 4 gang 20AX 2 Way Rocker	 1 gang 20AX Intermediate Rocker
Clear	Antique Brass/Black	PC R212 AB-B	PC R222 AB-B	PC R232 AB-B	PC R242 AB-B	PC R312 AB-B
Clear	Bright Chrome/Black	PC R212 BC-B	PC R222 BC-B	PC R232 BC-B	PC R242 BC-B	PC R312 BC-B
Clear	Bright Chrome/White	PC R212 BC-W	PC R222 BC-W	PC R232 BC-W	PC R242 BC-W	PC R312 BC-W
Clear	Black Nickel/Black	PC R212 BK-B	PC R222 BK-B	PC R232 BK-B	PC R242 BK-B	PC R312 BK-B
Clear	Black/Black	PC R212 BL-B	PC R222 BL-B	PC R232 BL-B	PC R242 BL-B	PC R312 BL-B
Clear	Polished Brass/Black	PC R212 PB-B	PC R222 PB-B	PC R232 PB-B	PC R242 PB-B	PC R312 PB-B
Clear	Polished Brass/White	PC R212 PB-W	PC R222 PB-W	PC R232 PB-W	PC R242 PB-W	PC R312 PB-W
Clear	Satin Brass/Black	PC R212 SB-B	PC R222 SB-B	PC R232 SB-B	PC R242 SB-B	PC R312 SB-B
Clear	Satin Brass/White	PC R212 SB-W	PC R222 SB-W	PC R232 SB-W	PC R242 SB-W	PC R312 SB-W
Clear	Satin Chrome/Black	PC R212 SC-B	PC R222 SC-B	PC R232 SC-B	PC R242 SC-B	PC R312 SC-B
Clear	Satin Chrome/White	PC R212 SC-W	PC R222 SC-W	PC R232 SC-W	PC R242 SC-W	PC R312 SC-W
Clear	White/White	PC R212 WH-W	PC R222 WH-W	PC R232 WH-W	PC R242 WH-W	PC R312 WH-W
	Nominal Size:	86.0mm x 86.0mm	86.0mm x 86.0mm	145.0mm x 86.0mm	145.0mm x 86.0mm	86.0mm x 86.0mm
	Minimum Wall Box Depth:	25mm	25mm	25mm	25mm	25mm
	Technical Insert Ref:	R212	R222	R232	R242	R312

Insert Surround Colour Key: (-B) Black, (-W) White

Perception CFX

Toggle Switches - on Transparent Plates



PC T21 AB







PC T22 BC



PC T23 BK



PC T24 AB

Plate Finish	Insert Finish	 1 gang 20AX 2 Way Toggle	 2 gang 20AX 2 Way Toggle	 3 gang 20AX 2 Way Toggle	 4 gang 20AX 2 Way Toggle	 1 gang 20AX Intermediate Toggle
Clear	Antique Brass	PC T21 AB	PC T22 AB	PC T23 AB	PC T24 AB	PC T31 AB
Clear	Bright Chrome	PC T21 BC	PC T22 BC	PC T23 BC	PC T24 BC	PC T31 BC
Clear	Black Nickel	PC T21 BK	PC T22 BK	PC T23 BK	PC T24 BK	PC T31 BK
Clear	Polished Brass	PC T21 PB	PC T22 PB	PC T23 PB	PC T24 PB	PC T31 PB
Clear	Satin Brass	PC T21 SB	PC T22 SB	PC T23 SB	PC T24 SB	PC T31 SB
Clear	Satin Chrome	PC T21 SC	PC T22 SC	PC T23 SC	PC T24 SC	PC T31 SC
	Nominal Size:	86.0mm x 86.0mm	86.0mm x 86.0mm	145.0mm x 86.0mm	145.0mm x 86.0mm	86.0mm x 86.0mm
	Minimum Wall Box Depth:	35mm	35mm	35mm	35mm	35mm
	Technical Insert Ref:	T21	T22	T23	T24	T31

Perception CFX



Power Sockets - on Transparent Plates





PC SS1 BC-W

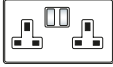
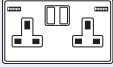

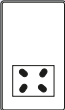
PC SS2 BC-W

Plate Finish	Insert Finish/ Surround Colour	 1 gang 13A Double Pole Switched Socket	 2 gang 13A Double Pole Switched Socket	 2 gang 13A Double Pole Switched Socket with 2 USB Outlet 2x2.4A (4.8A Total)	 1 gang 5A Unswitched Socket	 Shaver Dual Voltage Unswitched Socket (Vertically Mounted)
Clear	Antique Brass/Black	PC SS1 AB-B	PC SS2 AB-B	-	-	-
Clear	Bright Chrome/Black	PC SS1 BC-B	PC SS2 BC-B	-	-	-
Clear	Bright Chrome/White	PC SS1 BC-W	PC SS2 BC-W	-	-	-
Clear	Black Nickel/Black	PC SS1 BK-B	PC SS2 BK-B	-	-	-
Clear	Black/Black	PC SS1 BL-B	PC SS2 BL-B	-	PC USS B	PC SHS B
Clear	Polished Brass/Black	PC SS1 PB-B	PC SS2 PB-B	-	-	-
Clear	Polished Brass/White	PC SS1 PB-W	PC SS2 PB-W	-	-	-
Clear	Satin Brass/Black	PC SS1 SB-B	PC SS2 SB-B	-	-	-
Clear	Satin Brass/White	PC SS1 SB-W	PC SS2 SB-W	-	-	-
Clear	Satin Chrome/Black	PC SS1 SC-B	PC SS2 SC-B	-	-	-
Clear	Satin Chrome/White	PC SS1 SC-W	PC SS2 SC-W	-	-	-
Clear	White/White	PC SS1 WH-W	PC SS2 WH-W	-	PC USS W	PC SHS W
	Nominal Size:	86.0mm x 86.0mm	145.0mm x 86.0mm		86.0mm x 86.0mm	86.0mm x 145.0mm
	Minimum Wall Box Depth:	35mm	35mm		35mm	47mm
	Technical Insert Ref:	SS1	SS2		USS	SHS

International Power Sockets - on Transparent Plates

Plate Finish	Insert Finish/ Surround Colour	 1 gang 15A 110V AC American Unswitched Socket	 2 gang 15A 110V AC American Unswitched Socket	 1 gang 10/16A 220/250V AC German Unswitched Socket
Clear	Antique Brass/Black	-	-	-
Clear	Bright Chrome/Black	-	-	-
Clear	Bright Chrome/White	-	-	-
Clear	Black Nickel/Black	-	-	-
Clear	Black/Black	PC 5258 B	PC 5320 B	PC 6126 B
Clear	Polished Brass/Black	-	-	-
Clear	Polished Brass/White	-	-	-
Clear	Satin Brass/Black	-	-	-
Clear	Satin Brass/White	-	-	-
Clear	Satin Chrome/Black	-	-	-
Clear	Satin Chrome/White	-	-	-
Clear	White/White	PC 5258 W	PC 5320 W	PC 6126 W
	Nominal Size:	86.0mm x 86.0mm	145.0mm x 86.0mm	86.0mm x 86.0mm
	Minimum Wall Box Depth:	35mm	35mm	47mm
	Technical Insert Ref:	5258	5320	6126



Insert Surround Colour Key: (-B) Black, (-W) White

Perception CFX

Key Switches - on Transparent Plates



PC K21 B

Plate Finish	Insert Colour	 1 gang 20AX 2 Way Key Switch	 1 gang 20AX 2 Way Key Switch EMG LTG TEST
Clear	Black	PC K21 B	PC KEL B
Clear	White	PC K21 W	PC KEL W
Nominal Size:		86.0mm x 86.0mm	86.0mm x 86.0mm
Minimum Wall Box Depth:		25mm	25mm
Technical Insert Ref:		K21	KEL

Hotel Card Switch with LED - on Transparent Plates



PC C11 SC-W

Plate Finish	Insert Finish/ Surround Colour	 1 gang 10A (6AX) Card Switch On/Off with Blue LED Locator
Clear	Antique Brass/Black	PC C11 AB-B
Clear	Bright Chrome/Black	PC C11 BC-B
Clear	Bright Chrome/White	PC C11 BC-W
Clear	Black Nickel/Black	PC C11 BK-B
Clear	Black/Black	PC C11 BL-B
Clear	Polished Brass/Black	PC C11 PB-B
Clear	Polished Brass/White	PC C11 PB-W
Clear	Satin Brass/Black	PC C11 SB-B
Clear	Satin Brass/White	PC C11 SB-W
Clear	Satin Chrome/Black	PC C11 SC-B
Clear	Satin Chrome/White	PC C11 SC-W
Clear	White/White	PC C11 WH-W
Nominal Size:		86.0mm x 86.0mm
Minimum Wall Box Depth:		35mm
Technical Insert Ref:		C11

Insert Surround Colour Key: (-B) Black, (-W) White

Perception CFX

Television Coaxial Sockets - on Transparent Plates



PCTVB



PCTVFMW



PCTVIB



PCSATI W

Plate Finish	Insert Colour						
		1 gang Non-Isolated TV 1in/1out	Isolated TV/FM Diplexer 1in/2out	1 gang Isolated TV 1in/1out	2 gang Non-Isolated TV+Satellite 2in/2out	1 gang Non-Isolated Satellite	1 gang Isolated Satellite
Clear	Black	PCTVB B	PCTVFM B	PCTVIB B	PCTVSAT B	PCSATN B	PCSATIB
Clear	White	PCTV W	PCTVFM W	PCTV W	PCTVSAT W	PCSATN W	PCSATI W
Nominal Size:		86.0mm x 86.0mm	86.0mm x 86.0mm	86.0mm x 86.0mm	86.0mm x 86.0mm	86.0mm x 86.0mm	86.0mm x 86.0mm
Minimum Wall Box Depth:		25mm	25mm	25mm	35mm	35mm	35mm
Technical Insert Ref:		TV	TVFM	TVI	TVSAT	SATN	SATI

Digital Television Sockets - on Transparent Plates - Screened Non-Isolated / DAB Compatible



PC DTRID B



PC DTVF W



PC DTVM B



PC DSAT W

Plate Finish	Insert Colour						
		Non-Isolated TV+FM+SAT Triplexer 1in/3out (DAB Compatible)	1 gang Non-Isolated TV (Female) (DAB Compatible)	1 gang Non-Isolated TV (Male) (DAB Compatible)	1 gang Non-Isolated Satellite (DAB Compatible)	Non-Isolated TV+FM+SAT1+SAT2 Quadplexer 2in/4out (DAB Compatible)	Non-Isolated TV+FM+SAT1+SAT2 Quadplexer 2in/4out +TVF+TCS (DAB Compatible)
Clear	Black	PC DTRID B	PC DTVF B	PC DTVM B	PC DSAT B	PC DENT B	PC DSAT+ B
Clear	White	PC DTRID W	PC DTVF W	PC DTVM W	PC DSAT W	PC DENT W	PC DSAT+ W
Nominal Size:		86.0mm x 86.0mm	86.0mm x 86.0mm	86.0mm x 86.0mm	86.0mm x 86.0mm	86.0mm x 86.0mm	145.0mm x 86.0mm
Minimum Wall Box Depth:		35mm	35mm	35mm	35mm	35mm	35mm
Technical Insert Ref:		DTRID	DTV F	DTVM	DSAT	DENT	DSAT+

Insert Surround Colour Key: (-B) Black, (-W) White

Perception CFX

Telephone and Data Outlets - on Transparent Plates



PC TCS W









PC 2J12 W



PC J45 B



PC 2J45 W

Plate Finish	Insert Colour						
		1 gang Telephone Master	1 gang Telephone Slave	1 gang RJ12 Outlet - Unshielded	2 gang RJ12 Outlet - Unshielded	1 gang RJ45 CAT 5E Outlet - Unshielded	2 gang RJ45 CAT 5E Outlet - Unshielded
Clear	Black	PC TCM B	PC TCS B	PC J12 B	PC 2J12 B	PC J45 B	PC 2J45 B
Clear	White	PC TCM W	PC TCS W	PC J12 W	PC 2J12 W	PC J45 W	PC 2J45 W
Nominal Size:		86.0mm x 86.0mm	86.0mm x 86.0mm	86.0mm x 86.0mm	86.0mm x 86.0mm	86.0mm x 86.0mm	86.0mm x 86.0mm
Minimum Wall Box Depth:		25mm	25mm	35mm	35mm	35mm	35mm
Technical Insert Ref:		TCM	TCS	J12	2J12	J45	2J45



Insert Surround Colour Key: (-B) Black, (-W) White

Perception CFX

Double Pole Switches - on Transparent Plates





PC DPN SC-W

Plate Colour	Insert Finish/ Surround Colour	 1 gang 20AX Double Pole Rocker + Neon	 1 gang 45A Double Pole Red Rocker + Neon	 45A Double Pole Red Rocker + Neon + 13A Switched Socket
Clear	Antique Brass/Black	PC DPN AB-B	-	PC 45SS1 AB-B
Clear	Bright Chrome/Black	PC DPN BC-B	-	PC 45SS1 BC-B
Clear	Bright Chrome/White	PC DPN BC-W	-	PC 45SS1 BC-W
Clear	Black Nickel/Black	PC DPN BK-B	-	PC 45SS1 BK-B
Clear	Black/Black	PC DPN BL-B	PC 45N B	PC 45SS1 BL-B
Clear	Polished Brass/Black	PC DPN PB-B	-	PC 45SS1 PB-B
Clear	Polished Brass/White	PC DPN PB-W	-	PC 45SS1 PB-W
Clear	Satin Brass/Black	PC DPN SB-B	-	PC 45SS1 SB-B
Clear	Satin Brass/White	PC DPN SB-W	-	PC 45SS1 SB-W
Clear	Satin Chrome/Black	PC DPN SC-B	-	PC 45SS1 SC-B
Clear	Satin Chrome/White	PC DPN SC-W	-	PC 45SS1 SC-W
Clear	White/White	PC DPN WH-W	PC 45N W	PC 45SS1 WH-W
Nominal Size:		86.0mm x 86.0mm	86.0mm x 86.0mm	145.0mm x 86.0mm
Minimum Wall Box Depth:		25mm	35mm	35mm
Technical Insert Ref:		DPN	45N	45SS1

Connection Units - on Transparent Plates



PC SPN BC-B

Insert Finish/ Surround Colour	 1 gang 13A Double Pole Fused Spur + Neon	 1 gang 13A Fuse with Red Neon Halo
Antique Brass/Black	PC SPN AB-B	-
Antique Brass/Red	-	PC FN AB-R
Bright Chrome/Black	PC SPN BC-B	-
Bright Chrome/Red	-	PC FN BC-R
Bright Chrome/White	PC SPN BC-W	-
Black Nickel/Black	PC SPN BK-B	-
Black Nickel/Red	-	PC FN BK-R
Black/Black	PC SPN BL-B	-
Black/Red	-	PC FN BL-R
Polished Brass/Black	PC SPN PB-B	-
Polished Brass/Red	-	PC FN PB-R
Polished Brass/White	PC SPN PB-W	-
Satin Brass/Black	PC SPN SB-B	-
Satin Brass/Red	-	PC FN SB-R
Satin Brass/White	PC SPN SB-W	-
Satin Chrome/Black	PC SPN SC-B	-
Satin Chrome/Red	-	PC FN SC-R
Satin Chrome/White	PC SPN SC-W	-
White/White	PC SPN WH-W	-
White/Red	-	PC FN WH-R
Nominal Size:		86.0mm x 86.0mm
Minimum Wall Box Depth:		35mm
Technical Insert Ref:		SPN
		86.0mm x 86.0mm 35mm FN

Insert Surround Colour Key: (-B) Black, (-W) White

Perception CFX

LED Trailing/Leading Edge Push On/Off Rotary 2 Way Switching Dimmers - on Transparent Plates

PERCEPTION CFX RANGE



PC 1XLEDITB100 SC





PC 2XLEDITB100 BC





PC 3XLEDITB100 PB

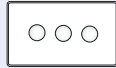
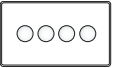

PC 4XLEDITB100 SC

Plate Finish	Insert Finish	 1 gang 100W LED Trailing/Leading Edge Push On/Off Rotary 2 Way Switching Dimmer	 2 gang 100W LED Trailing/Leading Edge Push On/Off Rotary 2 Way Switching Dimmer	 3 gang 100W LED Trailing/Leading Edge Push On/Off Rotary 2 Way Switching Dimmer	 4 gang 100W LED Trailing/Leading Edge Push On/Off Rotary 2 Way Switching Dimmer
Clear	Antique Brass	PC 1XLEDITB100 AB	PC 2XLEDITB100 AB	PC 3XLEDITB100 AB	PC 4XLEDITB100 AB
Clear	Bright Chrome	PC 1XLEDITB100 BC	PC 2XLEDITB100 BC	PC 3XLEDITB100 BC	PC 4XLEDITB100 BC
Clear	Black Nickel	PC 1XLEDITB100 BK	PC 2XLEDITB100 BK	PC 3XLEDITB100 BK	PC 4XLEDITB100 BK
Clear	Black	PC 1XLEDITB100 BL	PC 2XLEDITB100 BL	PC 3XLEDITB100 BL	PC 4XLEDITB100 BL
Clear	Polished Brass	PC 1XLEDITB100 PB	PC 2XLEDITB100 PB	PC 3XLEDITB100 PB	PC 4XLEDITB100 PB
Clear	Satin Brass	PC 1XLEDITB100 SB	PC 2XLEDITB100 SB	PC 3XLEDITB100 SB	PC 4XLEDITB100 SB
Clear	Satin Chrome	PC 1XLEDITB100 SC	PC 2XLEDITB100 SC	PC 3XLEDITB100 SC	PC 4XLEDITB100 SC
Clear	White	PC 1XLEDITB100 WH	PC 2XLEDITB100 WH	PC 3XLEDITB100 WH	PC 4XLEDITB100 WH
	Nominal Size:	86.0mm x 86.0mm	86.0mm x 86.0mm	145.0mm x 86.0mm	145.0mm x 86.0mm
	Minimum Wall Box Depth:	35mm	35mm	35mm	35mm
	Technical Insert Ref:	1XLEDITB	2XLEDITB	3XLEDITB	4XLEDITB

LED Trailing/Leading Edge Push On/Off Rotary Multi-Way Dimmers - on Transparent Plates

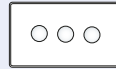
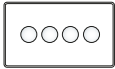
Plate Finish	Insert Finish	 1 gang 100W LED Trailing/Leading Edge Push On/Off Rotary Multi-Way Dimmer	 2 gang 100W LED Trailing/Leading Edge Push On/Off Rotary Multi-Way Dimmer	 3 gang 100W LED Trailing/Leading Edge Push On/Off Rotary Multi-Way Dimmer	 4 gang 100W LED Trailing/Leading Edge Push On/Off Rotary Multi-Way Dimmer
Clear	Antique Brass	PC 1X100LED AB	PC 2X100LED AB	PC 3X100LED AB	PC 4X100LED AB
Clear	Bright Chrome	PC 1X100LED BC	PC 2X100LED BC	PC 3X100LED BC	PC 4X100LED BC
Clear	Black Nickel	PC 1X100LED BK	PC 2X100LED BK	PC 3X100LED BK	PC 4X100LED BK
Clear	Black	PC 1X100LED BL	PC 2X100LED BL	PC 3X100LED BL	PC 4X100LED BL
Clear	Polished Brass	PC 1X100LED PB	PC 2X100LED PB	PC 3X100LED PB	PC 4X100LED PB
Clear	Satin Brass	PC 1X100LED SB	PC 2X100LED SB	PC 3X100LED SB	PC 4X100LED SB
Clear	Satin Chrome	PC 1X100LED SC	PC 2X100LED SC	PC 3X100LED SC	PC 4X100LED SC
Clear	White	PC 1X100LED WH	PC 2X100LED WH	PC 3X100LED WH	PC 4X100LED WH
	Nominal Size:	86.0mm x 86.0mm	86.0mm x 86.0mm	145.0mm x 86.0mm	145.0mm x 86.0mm
	Minimum Wall Box Depth:	35mm	35mm	35mm	35mm
	Technical Insert Ref:	1X100LED	2X100LED	3X100LED	4X100LED

NOTE: Tungsten filament GU10 lamps must be branded and with a fused base.
 NOTE: Please refer to the Dimmer Technical Section for the max Wattage.
 NOTE: Please contact our Technical Department for compatibility.

Perception CFX





Resistive Leading Edge Push On/Off Rotary 2 Way Switching Dimmers - on Transparent Plates



PC 1X40 BL



PC 2X40 BC

Plate Finish	Insert Finish	 1 gang 400W Resistive Leading Edge Push On/Off Rotary 2 Way Switching Dimmer	 2 gang 400W Resistive Leading Edge Push On/Off Rotary 2 Way Switching Dimmer Max 300W per gang	 3 gang 400W Resistive Leading Edge Push On/Off Rotary 2 Way Switching Dimmer Max 300W per gang	 4 gang 400W Resistive Leading Edge Push On/Off Rotary 2 Way Switching Dimmer Max 300W per gang
Clear	Antique Brass	PC 1X40 AB	PC 2X40 AB	PC 3X40 AB	PC 4X40 AB
Clear	Bright Chrome	PC 1X40 BC	PC 2X40 BC	PC 3X40 BC	PC 4X40 BC
Clear	Black Nickel	PC 1X40 BK	PC 2X40 BK	PC 3X40 BK	PC 4X40 BK
Clear	Black	PC 1X40 BL	PC 2X40 BL	PC 3X40 BL	PC 4X40 BL
Clear	Polished Brass	PC 1X40 PB	PC 2X40 PB	PC 3X40 PB	PC 4X40 PB
Clear	Satin Brass	PC 1X40 SB	PC 2X40 SB	PC 3X40 SB	PC 4X40 SB
Clear	Satin Chrome	PC 1X40 SC	PC 2X40 SC	PC 3X40 SC	PC 4X40 SC
Clear	White	PC 1X40 WH	PC 2X40 WH	PC 3X40 WH	PC 4X40 WH
	Nominal Size:	86.0mm x 86.0mm	86.0mm x 86.0mm	145.0mm x 86.0mm	145.0mm x 86.0mm
	Minimum Wall Box Depth:	35mm	35mm	35mm	35mm
	Technical Insert Ref:	1X40	2X40	3X40	4X40

Inductive Leading Edge Push On/Off Rotary 2 Way Switching Dimmers - on Transparent Plates

Plate Finish	Insert Finish	 1 gang 200VA Inductive Leading Edge Push On/Off Rotary 2 Way Switching Dimmer
Clear	Antique Brass	PC 1X2V AB
Clear	Bright Chrome	PC 1X2V BC
Clear	Black Nickel	PC 1X2V BK
Clear	Black	PC 1X2V BL
Clear	Polished Brass	PC 1X2V PB
Clear	Satin Brass	PC 1X2V SB
Clear	Satin Chrome	PC 1X2V SC
Clear	White	PC 1X2V WH
	Nominal Size:	86.0mm x 86.0mm
	Minimum Wall Box Depth:	35mm
	Technical Insert Ref:	1X2V

NOTE: Tungsten filament GU10 lamps must be branded and with a fused base
 NOTE: When using mains voltage halogen lamps – dimmers should be re-rated by 25%
 NOTE: When dimming LED lamps de-rate by 75% - please contact our Technical Department for compatibility.
 NOTE: Please refer to the Dimmer Technical Section for the max wattage

Perception CFX

Resistive/Inductive Trailing Edge Push On/Off Rotary Multi-Way Dimmers - on Transparent Plates

PERCEPTION CFX RANGE



PC 1XTE SC



PC 2XTE SB



PC 3XTE AB



PC 4XTE BC



1 gang 250W/210VA
Resistive/Inductive Trailing
Edge Push On/Off Rotary
Multi-Way Dimmer



2 gang 250W/210VA
Resistive/Inductive Trailing
Edge Push On/Off Rotary
Multi-Way Dimmer

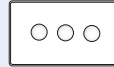

3 gang 250W/210VA
Resistive/Inductive Trailing
Edge Push On/Off Rotary
Multi-Way Dimmer

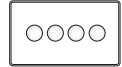

4 gang 250W/210VA
Resistive/Inductive Trailing
Edge Push On/Off Rotary
Multi-Way Dimmer

Plate Finish	Insert Finish	PC 1XTE AB	PC 2XTE BC	PC 3XTE BK	PC 4XTE BL
Clear	Antique Brass	PC 1XTE AB	PC 2XTE AB	PC 3XTE AB	PC 4XTE AB
Clear	Bright Chrome	PC 1XTE BC	PC 2XTE BC	PC 3XTE BC	PC 4XTE BC
Clear	Black Nickel	PC 1XTE BK	PC 2XTE BK	PC 3XTE BK	PC 4XTE BK
Clear	Black	PC 1XTE BL	PC 2XTE BL	PC 3XTE BL	PC 4XTE BL
Clear	Polished Brass	PC 1XTE PB	PC 2XTE PB	PC 3XTE PB	PC 4XTE PB
Clear	Satin Brass	PC 1XTE SB	PC 2XTE SB	PC 3XTE SB	PC 4XTE SB
Clear	Satin Chrome	PC 1XTE SC	PC 2XTE SC	PC 3XTE SC	PC 4XTE SC
Clear	White	PC 1XTE WH	PC 2XTE WH	PC 3XTE WH	PC 4XTE WH
Nominal Size:		86.0mm x 86.0mm	86.0mm x 86.0mm	145.0mm x 86.0mm	145.0mm x 86.0mm
Minimum Wall Box Depth:		35mm	35mm	35mm	35mm
Technical Insert Ref:		1XTE	2XTE	3XTE	4XTE

NOTE: Tungsten filament GU10 lamps must be branded and with a fused base
 NOTE: When using mains voltage halogen lamps – dimmers should be re-rated by 25%
 NOTE: When dimming LED lamps de-rate by 75% - please contact our Technical Department for compatibility.
 NOTE: Please refer to the Dimmer Technical Section for the max wattage

Perception CFX



Resistive/Inductive Trailing Edge Touch Master Multi-Way Dimmers - on Transparent Plates



PC 1XTM SC-W

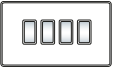

PC 2XTM SC-W

Plate Finish	Insert Finish/ Surround Colour				
		1 gang 250W/210VA Resistive/Inductive Trailing Edge Touch Master Multi-Way Dimmer	2 gang 250W/210VA Resistive/Inductive Trailing Edge Touch Master Multi-Way Dimmer	3 gang 250W/210VA Resistive/Inductive Trailing Edge Touch Master Multi-Way Dimmer	4 gang 250W/210VA Resistive/Inductive Trailing Edge Touch Master Multi-Way Dimmer
Clear	Antique Brass/Black	PC 1XTM AB-B	PC 2XTM AB-B	PC 3XTM AB-B	PC 4XTM AB-B
Clear	Bright Chrome/Black	PC 1XTM BC-B	PC 2XTM BC-B	PC 3XTM BC-B	PC 4XTM BC-B
Clear	Bright Chrome/White	PC 1XTM BC-W	PC 2XTM BC-W	PC 3XTM BC-W	PC 4XTM BC-W
Clear	Black Nickel/Black	PC 1XTM BK-B	PC 2XTM BK-B	PC 3XTM BK-B	PC 4XTM BK-B
Clear	Black/Black	-	-	-	-
Clear	Polished Brass/Black	PC 1XTM PB-B	PC 2XTM PB-B	PC 3XTM PB-B	PC 4XTM PB-B
Clear	Polished Brass/White	PC 1XTM PB-W	PC 2XTM PB-W	PC 3XTM PB-W	PC 4XTM PB-W
Clear	Satin Brass/Black	PC 1XTM SB-B	PC 2XTM SB-B	PC 3XTM SB-B	PC 4XTM SB-B
Clear	Satin Brass/White	PC 1XTM SB-W	PC 2XTM SB-W	PC 3XTM SB-W	PC 4XTM SB-W
Clear	Satin Chrome/Black	PC 1XTM SC-B	PC 2XTM SC-B	PC 3XTM SC-B	PC 4XTM SC-B
Clear	Satin Chrome/White	PC 1XTM SC-W	PC 2XTM SC-W	PC 3XTM SC-W	PC 4XTM SC-W
Clear	White/White	-	-	-	-
	Nominal Size:	86.0mm x 86.0mm	86.0mm x 86.0mm	145.0mm x 86.0mm	145.0mm x 86.0mm
	Minimum Wall Box Depth:	35mm	35mm	35mm	35mm
	Technical Insert Ref:	1XTM	2XTM	3XTM	4XTM

NOTE: Tungsten filament GU10 lamps must be branded and with a fused base

NOTE: When using mains voltage halogen lamps – dimmers should be re-rated by 25%

NOTE: When dimming LED lamps de-rate by 75% - please contact our Technical Department for compatibility.

NOTE: Please refer to the Dimmer Technical Section for the max wattage

Insert Surround Colour Key: (-B) Black, (-W) White

Perception CFX

Multi-Way Touch Slave Controllers - on Transparent Plates

PERCEPTION CFX RANGE



PC 1XTS AB-B



PC 2XTS SC-B



PC 3XTS AB-B



PC 4XTS SB-B

Plate Finish	Insert Finish/ Surround Colour	1 gang Multi-Way Touch Slave Controller	2 gang Multi-Way Touch Slave Controller	3 gang Multi-Way Touch Slave Controller	4 gang Multi-Way Touch Slave Controller
Clear	Antique Brass/Black	PC 1XTS AB-B	PC 2XTS AB-B	PC 3XTS AB-B	PC 4XTS AB-B
Clear	Bright Chrome/Black	PC 1XTS BC-B	PC 2XTS BC-B	PC 3XTS BC-B	PC 4XTS BC-B
Clear	Bright Chrome/White	PC 1XTS BC-W	PC 2XTS BC-W	PC 3XTS BC-W	PC 4XTS BC-W
Clear	Black Nickel/Black	PC 1XTS BK-B	PC 2XTS BK-B	PC 3XTS BK-B	PC 4XTS BK-B
Clear	Black/Black	-	-	-	-
Clear	Polished Brass/Black	PC 1XTS PB-B	PC 2XTS PB-B	PC 3XTS PB-B	PC 4XTS PB-B
Clear	Polished Brass/White	PC 1XTS PB-W	PC 2XTS PB-W	PC 3XTS PB-W	PC 4XTS PB-W
Clear	Satin Brass/Black	PC 1XTS SB-B	PC 2XTS SB-B	PC 3XTS SB-B	PC 4XTS SB-B
Clear	Satin Brass/White	PC 1XTS SB-W	PC 2XTS SB-W	PC 3XTS SB-W	PC 4XTS SB-W
Clear	Satin Chrome/Black	PC 1XTS SC-B	PC 2XTS SC-B	PC 3XTS SC-B	PC 4XTS SC-B
Clear	Satin Chrome/White	PC 1XTS SC-W	PC 2XTS SC-W	PC 3XTS SC-W	PC 4XTS SC-W
Clear	White/White	-	-	-	-
	Nominal Size:	86.0mm x 86.0mm	86.0mm x 86.0mm	145.0mm x 86.0mm	145.0mm x 86.0mm
	Minimum Wall Box Depth:	35mm	35mm	35mm	35mm
	Technical Insert Ref:	1XTS	2XTS	3XTS	4XTS

NOTE: To only be used with Touch Masters

Insert Surround Colour Key: (-B) Black, (-W) White

Perception CFX

Blank Plates on Transparent Plates



PC BPS

Plate Finish	Single Blank Plate	Double Blank Plate
Clear	PC BPS	PC BPD
Nominal Size:	86.0mm x 86.0mm	145.0mm x 86.0mm
Minimum Wall Box Depth:	Any Box	Any Box
Technical Insert Ref:	BPS	BPD

GRID-IT GridFix Apertured Plates complete with Fixing Grid - on Transparent Plates



PC 1GP



PC 2GP



PC 4GP

Plate Finish	1 Gang Grid Fix Aperture Plate with Grid	2 Gang Grid Fix Aperture Plate with Grid	3 Gang Grid Fix Aperture Plate with Grid	4 Gang Grid Fix Aperture Plate with Grid
Clear	PC 1GP	PC 2GP	PC 3GP	PC 4GP
Nominal Size:	86.0mm x 86.0mm	86.0mm x 86.0mm	86.0mm x 86.0mm	86.0mm x 86.0mm
Minimum Wall Box Depth:	As Per Insert	As Per Insert	As Per Insert	As Per Insert
Technical Insert Ref:	1GP	2GP	3GP	4GP

Note: Minimum Wall Box depth is dependant on the Grid Fix insert fitted, please see the GRID-IT section for the complete range of inserts.

EuroFix Apertured Plates complete with Fixing Grid - on Transparent Plates



PC EURO2

Plate Finish	1 Module EuroFix 25x50mm Apertured Plate with Grid	2 Module EuroFix 50x50mm Apertured Plate with Grid	3 Module EuroFix 75x50mm Apertured Plate with Grid	4 Module EuroFix 100x50mm Apertured Plate with Grid
Clear	PC EURO1	PC EURO2	PC EURO3	PC EURO4
Nominal Size:	86.0mm x 86.0mm	86.0mm x 86.0mm	146.0mm x 86.0mm	146.0mm x 86.0mm
Aperture:	25x50mm	50x50mm	75x50mm	100x50mm
Minimum Wall Box Depth:	As Per Insert	As Per Insert	As Per Insert	As Per Insert
Technical Insert Ref:	EURO1	EURO2	EURO3	EURO4

Note: Minimum Wall Box depth is dependant on the EuroFix insert fitted, please see the EuroFix section for our complete range of inserts.



Hartland

Quality Accessories on Stylish Slim Plates

A range of sleek and stylish accessories with slim front plates to complement today's interiors. This attractive range is available in many elegant finishes with complementary switch insert finishes.

- Slim, sleek and stylish
- Visible fixing
- Elegant finishes with complementary finishes on switch inserts
- Standard box-fix electrical accessories
- Ultra fast USB charging technology
- Grid and EuroFix options also available (see separate GRID-IT and EuroFix sections for inserts.)



Hartland Range



71 T22 PB

79 SS1 AB B

77 R23 BC B

74 DTRID W

Plate finishes available in this range



Hamilton Hartland

Plate depth 5 mm

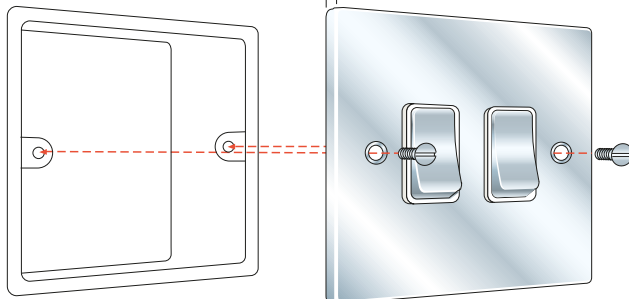

Box-Fix to Back Box

Hartland

Rocker Switches



79 R21 AB-B



78 R22 BK-B



73 R23 WH-W



72 R26 SB-W

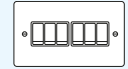
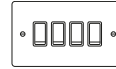

Plate Finish	Insert Finish/ Surround Colour	1 gang 10AX 2 Way Rocker	2 gang 10AX 2 Way Rocker	3 gang 10AX 2 Way Rocker	4 gang 10AX 2 Way Rocker	6 gang 10AX 2 Way Rocker
Antique Brass	Antique Brass/Black	79 R21 AB-B	79 R22 AB-B	79 R23 AB-B	79 R24 AB-B	79 R26 AB-B
Black Nickel	Black Nickel/Black	78 R21 BK-B	78 R22 BK-B	78 R23 BK-B	78 R24 BK-B	78 R26 BK-B
Bright Chrome	Black/Black	77 R21 BL-B	77 R22 BL-B	77 R23 BL-B	77 R24 BL-B	77 R26 BL-B
Bright Chrome	Bright Chrome/Black	77 R21 BC-B	77 R22 BC-B	77 R23 BC-B	77 R24 BC-B	77 R26 BC-B
Bright Chrome	Bright Chrome/White	77 R21 BC-W	77 R22 BC-W	77 R23 BC-W	77 R24 BC-W	77 R26 BC-W
Bright Chrome	White/White	77 R21 WH-W	77 R22 WH-W	77 R23 WH-W	77 R24 WH-W	77 R26 WH-W
Bright Steel	Black/Black	73 R21 BL-B	73 R22 BL-B	73 R23 BL-B	73 R24 BL-B	73 R26 BL-B
Bright Steel	Bright Chrome/Black	73 R21 BC-B	73 R22 BC-B	73 R23 BC-B	73 R24 BC-B	73 R26 BC-B
Bright Steel	Bright Chrome/White	73 R21 BC-W	73 R22 BC-W	73 R23 BC-W	73 R24 BC-W	73 R26 BC-W
Bright Steel	White/White	73 R21 WH-W	73 R22 WH-W	73 R23 WH-W	73 R24 WH-W	73 R26 WH-W
Gloss White	White/White	70 R21 WH-W	70 R22 WH-W	70 R23 WH-W	70 R24 WH-W	70 R26 WH-W
Matt Black	Black/Black	7MB R21 BL-B	7MB R22 BL-B	-	-	-
Matt White	White/White	7MW R21 WH-W	7MW R22 WH-W	-	-	-
Polished Brass	Black/Black	71 R21 BL-B	71 R22 BL-B	71 R23 BL-B	71 R24 BL-B	71 R26 BL-B
Polished Brass	Polished Brass/Black	71 R21 PB-B	71 R22 PB-B	71 R23 PB-B	71 R24 PB-B	71 R26 PB-B
Polished Brass	Polished Brass/White	71 R21 PB-W	71 R22 PB-W	71 R23 PB-W	71 R24 PB-W	71 R26 PB-W
Polished Brass	White/White	71 R21 WH-W	71 R22 WH-W	71 R23 WH-W	71 R24 WH-W	71 R26 WH-W
Richmond Bronze	Black/Black	7RB R21 BL-B	7RB R22 BL-B	-	-	-
Satin Brass	Black/Black	72 R21 BL-B	72 R22 BL-B	72 R23 BL-B	72 R24 BL-B	72 R26 BL-B
Satin Brass	Satin Brass/Black	72 R21 SB-B	72 R22 SB-B	72 R23 SB-B	72 R24 SB-B	72 R26 SB-B
Satin Brass	Satin Brass/White	72 R21 SB-W	72 R22 SB-W	72 R23 SB-W	72 R24 SB-W	72 R26 SB-W
Satin Brass	White/White	72 R21 WH-W	72 R22 WH-W	72 R23 WH-W	72 R24 WH-W	72 R26 WH-W
Satin Chrome	Black/Black	76 R21 BL-B	76 R22 BL-B	76 R23 BL-B	76 R24 BL-B	76 R26 BL-B
Satin Chrome	Satin Chrome/Black	76 R21 SC-B	76 R22 SC-B	76 R23 SC-B	76 R24 SC-B	76 R26 SC-B
Satin Chrome	Satin Chrome/White	76 R21 SC-W	76 R22 SC-W	76 R23 SC-W	76 R24 SC-W	76 R26 SC-W
Satin Chrome	White/White	76 R21 WH-W	76 R22 WH-W	76 R23 WH-W	76 R24 WH-W	76 R26 WH-W
Satin Steel	Black/Black	74 R21 BL-B	74 R22 BL-B	74 R23 BL-B	74 R24 BL-B	74 R26 BL-B
Satin Steel	Satin Steel/Black	74 R21 SS-B	74 R22 SS-B	74 R23 SS-B	74 R24 SS-B	74 R26 SS-B
Satin Steel	Satin Steel/White	74 R21 SS-W	74 R22 SS-W	74 R23 SS-W	74 R24 SS-W	74 R26 SS-W
Satin Steel	White/White	74 R21 WH-W	74 R22 WH-W	74 R23 WH-W	74 R24 WH-W	74 R26 WH-W
	Nominal Size:	88.0mm x 88.0mm	88.0mm x 88.0mm	88.0mm x 88.0mm	144.5mm x 88.0mm	144.5mm x 88.0mm
	Minimum Wall Box Depth:	25mm	25mm	25mm	25mm	25mm
	Technical Insert Ref:	R21	R22	R23	R24	R26

Insert Surround Colour Key: (-B) Black, (-W) White

Hartland

Rocker Switches



78 R31 BK-B



74 R32 SS-W



76 RRT BL-B



74 TP WH-W



1 gang 10AX
Intermediate Rocker



2 gang 10AX
Intermediate Rocker



1 gang 10AX
Push To Make
Retractive Rocker



1 gang 10A
Triple Pole Rocker

Plate Finish	Insert Finish/ Surround Colour	1 gang 10AX Intermediate Rocker	2 gang 10AX Intermediate Rocker	1 gang 10AX Push To Make Retractive Rocker	1 gang 10A Triple Pole Rocker
Antique Brass	Antique Brass/Black	79 R31 AB-B	-	-	-
Antique Brass	Black/Black	-	-	-	79 TP BL-B
Black Nickel	Black/Black	-	-	-	78 TP BL-B
Black Nickel	Black Nickel/Black	78 R31 BK-B	-	-	-
Bright Chrome	Black/Black	77 R31 BL-B	77 R32 BL-B	77 RRT BL-B	77 TP BL-B
Bright Chrome	Bright Chrome/Black	77 R31 BC-B	77 R32 BC-B	77 RRT BC-B	-
Bright Chrome	Bright Chrome/White	77 R31 BC-W	77 R32 BC-W	77 RRT BC-W	-
Bright Chrome	White/White	77 R31 WH-W	77 R32 WH-W	77 RRT WH-W	77 TP WH-W
Bright Steel	Black/Black	73 R31 BL-B	73 R32 BL-B	73 RRT BL-B	73 TP BL-B
Bright Steel	Bright Chrome/Black	73 R31 BC-B	73 R32 BC-B	73 RRT BC-B	-
Bright Steel	Bright Chrome/White	73 R31 BC-W	73 R32 BC-W	73 RRT BC-W	-
Bright Steel	White/White	73 R31 WH-W	73 R32 WH-W	73 RRT WH-W	73 TP WH-W
Gloss White	White/White	70 R31 WH-W	70 R32 WH-W	70 RRT WH-W	70 TP WH-W
Matt Black	Black/Black	-	-	-	7MB TP BL-B
Matt White	White/White	-	-	-	7MW TP WH-W
Polished Brass	Black/Black	71 R31 BL-B	71 R32 BL-B	71 RRT BL-B	71 TP BL-B
Polished Brass	Polished Brass/Black	71 R31 PB-B	71 R32 PB-B	71 RRT PB-B	-
Polished Brass	Polished Brass/White	71 R31 PB-W	71 R32 PB-W	71 RRT PB-W	-
Polished Brass	White/White	71 R31 WH-W	71 R32 WH-W	71 RRT WH-W	71 TP WH-W
Richmond Bronze	Black/Black	-	-	-	7RB TP BL-B
Satin Brass	Black/Black	72 R31 BL-B	72 R32 BL-B	72 RRT BL-B	72 TP BL-B
Satin Brass	Satin Brass/Black	72 R31 SB-B	72 R32 SB-B	72 RRT SB-B	-
Satin Brass	Satin Brass/White	72 R31 SB-W	72 R32 SB-W	72 RRT SB-W	-
Satin Brass	White/White	72 R31 WH-W	72 R32 WH-W	72 RRT WH-W	72 TP WH-W
Satin Chrome	Black/Black	76 R31 BL-B	76 R32 BL-B	76 RRT BL-B	76 TP BL-B
Satin Chrome	Satin Chrome/Black	76 R31 SC-B	76 R32 SC-B	76 RRT SC-B	-
Satin Chrome	Satin Chrome/White	76 R31 SC-W	76 R32 SC-W	76 RRT SC-W	-
Satin Chrome	White/White	76 R31 WH-W	76 R32 WH-W	76 RRT WH-W	76 TP WH-W
Satin Steel	Black/Black	74 R31 BL-B	74 R32 BL-B	74 RRT BL-B	74 TP BL-B
Satin Steel	Satin Steel/Black	74 R31 SS-B	74 R32 SS-B	74 RRT SS-B	-
Satin Steel	Satin Steel/White	74 R31 SS-W	74 R32 SS-W	74 RRT SS-W	-
Satin Steel	White/White	74 R31 WH-W	74 R32 WH-W	74 RRT WH-W	74 TP WH-W
Nominal Size:		88.0mm x 88.0mm	88.0mm x 88.0mm	88.0mm x 88.0mm	88.0mm x 88.0mm
Minimum Wall Box Depth:		25mm	25mm	25mm	25mm
Technical Insert Ref:		R31	R32	RRT	TP

Insert Surround Colour Key: (-B) Black, (-W) White

Hartland

Toggle Switches



77 T21



73 T22



71 T23



74 T24



1 gang 20AX
2 Way Toggle



2 gang 20AX
2 Way Toggle



3 gang 20AX
2 Way Toggle



4 gang 20AX
2 Way Toggle



1 gang 20AX
Intermediate
Toggle



1 gang 20AX
Double Pole
Toggle



1 gang 10AX
Push To Make/
Break Retractive
Toggle

Plate Finish	Insert Finish	1 gang 20AX 2 Way Toggle	2 gang 20AX 2 Way Toggle	3 gang 20AX 2 Way Toggle	4 gang 20AX 2 Way Toggle	1 gang 20AX Intermediate Toggle	1 gang 20AX Double Pole Toggle	1 gang 10AX Push To Make/Break Retractive Toggle
Antique Brass	Antique Brass	79 T21	79 T22	79 T23	79 T24	79 T31	79 TDP	79 TRT
Black Nickel	Black Nickel	78 T21	78 T22	78 T23	78 T24	78 T31	78 TDP	78 TRT
Bright Chrome	Bright Chrome	77 T21	77 T22	77 T23	77 T24	77 T31	77 TDP	77 TRT
Bright Steel	Bright Chrome	73 T21	73 T22	73 T23	73 T24	73 T31	73 TDP	73 TRT
Gloss White	-	-	-	-	-	-	-	-
Matt Black	-	-	-	-	-	-	-	-
Matt White	-	-	-	-	-	-	-	-
Polished Brass	Polished Brass	71 T21	71 T22	71 T23	71 T24	71 T31	71 TDP	71 TRT
Richmond Bronze	-	-	-	-	-	-	-	-
Satin Brass	Satin Brass	72 T21	72 T22	72 T23	72 T24	72 T31	72 TDP	72 TRT
Satin Chrome	Satin Chrome	76 T21	76 T22	76 T23	76 T24	76 T31	76 TDP	76 TRT
Satin Steel	Satin Steel	74 T21	74 T22	74 T23	74 T24	74 T31	74 TDP	74 TRT
	Nominal Size:	88.0mm x 88.0mm	88.0mm x 88.0mm	144.5mm x 88.0mm	144.5mm x 88.0mm	88.0mm x 88.0mm	88.0mm x 88.0mm	88.0mm x 88.0mm
	Minimum Wall Box Depth:	35mm	35mm	35mm	35mm	35mm	35mm	35mm
	Technical Insert Ref:	T21	T22	T23	T24	T31	TDP	TRT

Hartland

Power Sockets



73 SS1 WH-W







71 SS2 BL-B



78 US2 B

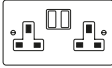

76 US13 B

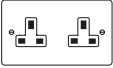
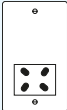
Plate Finish	Insert Finish/ Surround Colour							
		1 gang 13A Double Pole Switched Socket	2 gang 13A Double Pole Switched Socket	1 gang 2A Unswitched Socket	1 gang 5A Unswitched Socket	1 gang 13A Unswitched Socket	2 gang 13A Unswitched Socket	Shaver Dual Voltage Unswitched Socket (Vertically Mounted)
Antique Brass	Antique Brass/Black	79 SS1 AB-B	79 SS2 AB-B	-	-	-	-	-
Antique Brass	Black/Black	-	-	79 US2 B	79 US5 B	79 US13 B	79 US99 B	79 SH5 B
Black Nickel	Black/Black	-	-	78 US2 B	78 US5 B	-	78 US99 B	78 SH5 B
Black Nickel	Black Nickel/Black	78 SS1 BK-B	78 SS2 BK-B	-	-	-	-	-
Bright Chrome	Black/Black	77 SS1 BL-B	77 SS2 BL-B	77 US2 B	77 US5 B	77 US13 B	77 US99 B	77 SH5 B
Bright Chrome	Bright Chrome/Black	77 SS1 BC-B	77 SS2 BC-B	-	-	-	-	-
Bright Chrome	Bright Chrome/White	77 SS1 BC-W	77 SS2 BC-W	-	-	-	-	-
Bright Chrome	White/White	77 SS1 WH-W	77 SS2 WH-W	77 US2 W	77 US5 W	77 US13 W	77 US99 W	77 SH5 W
Bright Steel	Black/Black	73 SS1 BL-B	73 SS2 BL-B	73 US2 B	73 US5 B	73 US13 B	73 US99 B	73 SH5 B
Bright Steel	Bright Chrome/Black	73 SS1 BC-B	73 SS2 BC-B	-	-	-	-	-
Bright Steel	Bright Chrome/White	73 SS1 BC-W	73 SS2 BC-W	-	-	-	-	-
Bright Steel	White/White	73 SS1 WH-W	73 SS2 WH-W	73 US2 W	73 US5 W	73 US13 W	73 US99 W	73 SH5 W
Gloss White	White/White	70 SS1 WH-W	70 SS2 WH-W	70 US2 W	70 US5 W	70 US13 W	70 US99 W	70 SH5 W
Matt Black	Black/Black	7MB SS1 BL-B	7MB SS2 BL-B	-	7MB US5 B	-	-	7MB SH5 B
Matt White	White/White	7MW SS1 WH-W	7MW SS2 WH-W	-	7MW US5 W	-	-	7MW SH5 W
Polished Brass	Black/Black	71 SS1 BL-B	71 SS2 BL-B	71 US2 B	71 US5 B	71 US13 B	71 US99 B	71 SH5 B
Polished Brass	Polished Brass/Black	71 SS1 PB-B	71 SS2 PB-B	-	-	-	-	-
Polished Brass	Polished Brass/White	71 SS1 PB-W	71 SS2 PB-W	-	-	-	-	-
Polished Brass	White/White	71 SS1 WH-W	71 SS2 WH-W	71 US2 W	71 US5 W	71 US13 W	71 US99 W	71 SH5 W
Richmond Bronze	Black/Black	7RB SS1 BL-B	7RB SS2 BL-B	-	7RB US5 B	-	-	7RB SH5 B
Satin Brass	Black/Black	72 SS1 BL-B	72 SS2 BL-B	72 US2 B	72 US5 B	72 US13 B	72 US99 B	72 SH5 B
Satin Brass	Satin Brass/Black	72 SS1 SB-B	72 SS2 SB-B	-	-	-	-	-
Satin Brass	Satin Brass/White	72 SS1 SB-W	72 SS2 SB-W	-	-	-	-	-
Satin Brass	White/White	72 SS1 WH-W	72 SS2 WH-W	72 US2 W	72 US5 W	72 US13 W	72 US99 W	72 SH5 W
Satin Chrome	Black/Black	76 SS1 BL-B	76 SS2 BL-B	76 US2 B	76 US5 B	76 US13 B	76 US99 B	76 SH5 B
Satin Chrome	Satin Chrome/Black	76 SS1 SC-B	76 SS2 SC-B	-	-	-	-	-
Satin Chrome	Satin Chrome/White	76 SS1 SC-W	76 SS2 SC-W	-	-	-	-	-
Satin Chrome	White/White	76 SS1 WH-W	76 SS2 WH-W	76 US2 W	76 US5 W	76 US13 W	76 US99 W	76 SH5 W
Satin Steel	Black/Black	74 SS1 BL-B	74 SS2 BL-B	74 US2 B	74 US5 B	74 US13 B	74 US99 B	74 SH5 B
Satin Steel	Satin Steel/Black	74 SS1 SS-B	74 SS2 SS-B	-	-	-	-	-
Satin Steel	Satin Steel/White	74 SS1 SS-W	74 SS2 SS-W	-	-	-	-	-
Satin Steel	White/White	74 SS1 WH-W	74 SS2 WH-W	74 US2 W	74 US5 W	74 US13 W	74 US99 W	74 SH5 W
Nominal Size:		88.0mm x 88.0mm	144.5mm x 88.0mm	88.0mm x 88.0mm	88.0mm x 88.0mm	88.0mm x 88.0mm	144.5mm x 88.0mm	88.0mm x 144.5mm
Minimum Wall Box Depth:		35mm	35mm	35mm	35mm	35mm	35mm	47mm
Technical Insert Ref:		SS1	SS2	US2	US5	US13	US99	SH5

Insert Surround Colour Key: (-B) Black, (-W) White

Hartland

USB Power Sockets



77 SS1USB BC-B



74 SS2USBULT SS-W



76 SS2USBC SC-B



1 gang 13A Single Pole Switched Socket with 1 USB Outlet 1x2.1A

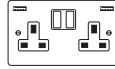

2 gang 13A Double Pole Switched Socket with 2 USB Outlet 2x2.4A (4.8A Total)

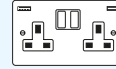

2 gang 13A Double Pole Switched Socket with 1 USB Outlet + 1 USB Type C Outlet 2x2.4A (4.8A Total)

Plate Finish	Insert Finish/ Surround Colour			
Antique Brass	Antique Brass/Black	79 SS1USB AB-B	79 SS2USBULT AB-B	79 SS2USBC AB-B
Black Nickel	Black Nickel/Black	78 SS1USB BK-B	78 SS2USBULT BK-B	78 SS2USBC BK-B
Bright Chrome	Bright Chrome/Black	77 SS1USB BC-B	77 SS2USBULT BC-B	77 SS2USBC BC-B
Bright Chrome	Bright Chrome/White	77 SS1USB BC-W	77 SS2USBULT BC-W	77 SS2USBC BC-W
Bright Steel	Bright Chrome/Black	73 SS1USB BC-B	73 SS2USBULT BC-B	73 SS2USBC BC-B
Bright Steel	Bright Chrome/White	73 SS1USB BC-W	73 SS2USBULT BC-W	73 SS2USBC BC-W
Gloss White	White/White	70 SS1USB WH-W	70 SS2USBULT WH-W	70 SS2USBC WH-W
Matt Black	Black/Black	7MB SS1USB BL-B	7MB SS2USBULT BL-B	7MB SS2USBC BL-B
Matt White	White/White	7MW SS1USB WH-W	7MW SS2USBULT WH-W	7MW SS2USBC WH-W
Polished Brass	Polished Brass/Black	71 SS1USB PB-B	71 SS2USBULT PB-B	71 SS2USBC PB-B
Polished Brass	Polished Brass/White	71 SS1USB PB-W	71 SS2USBULT PB-W	71 SS2USBC PB-W
Richmond Bronze	Black/Black	7RB SS1USB BL-B	7RB SS2USBULT BL-B	7RB SS2USBC BL-B
Satin Brass	Satin Brass/Black	72 SS1USB SB-B	72 SS2USBULT SB-B	72 SS2USBC SB-B
Satin Brass	Satin Brass/White	72 SS1USB SB-W	72 SS2USBULT SB-W	72 SS2USBC SB-W
Satin Chrome	Satin Chrome/Black	76 SS1USB SC-B	76 SS2USBULT SC-B	76 SS2USBC SC-B
Satin Chrome	Satin Chrome/White	76 SS1USB SC-W	76 SS2USBULT SC-W	76 SS2USBC SC-W
Satin Steel	Satin Steel/Black	74 SS1USB SS-B	74 SS2USBULT SS-B	74 SS2USBC SS-B
Satin Steel	Satin Steel/White	74 SS1USB SS-W	74 SS2USBULT SS-W	74 SS2USBC SS-W
	Nominal Size:	88.0mm x 88.0mm	144.5mm x 88.0mm	144.5mm x 88.0mm
	Minimum Wall Box Depth:	35mm	35mm	35mm
	Technical Insert Ref:	SS1USBX1	SS2USBX2ULT	SS2USBC

Insert Surround Colour Key: (-B) Black, (-W) White

Hartland

Television Coaxial Sockets

HARTLAND RANGE



78 TV B



73 TV2 B



77 TVSAT B



72 SATI W



1 gang
Non-Isolated
TV
1in/1out



2 gang
Non-Isolated
TV
2in/2out



Isolated TV/FM
Diplexer
1in/2out



1 gang
Isolated
TV
1in/1out



2 gang
Non-Isolated
TV+Satellite
2in/2out



1 gang
Non-Isolated
Satellite



1 gang
Isolated
Satellite

Plate Finish	Insert Colour	1 gang Non-Isolated TV 1in/1out	2 gang Non-Isolated TV 2in/2out	Isolated TV/FM Diplexer 1in/2out	1 gang Isolated TV 1in/1out	2 gang Non-Isolated TV+Satellite 2in/2out	1 gang Non-Isolated Satellite	1 gang Isolated Satellite
Antique Brass	Black	79 TV B	79 TV2 B	79 TVFM B	79 TVI B	79 TVSAT B	79 SATN B	79 SATI B
Black Nickel	Black	78 TV B	78 TV2 B	78 TVFM B	78 TVI B	78 TVSAT B	78 SATN B	78 SATI B
Bright Chrome	Black	77 TV B	77 TV2 B	77 TVFM B	77 TVI B	77 TVSAT B	77 SATN B	77 SATI B
Bright Chrome	White	77 TV W	77 TV2 W	77 TVFM W	77 TVI W	77 TVSAT W	77 SATN W	77 SATI W
Bright Steel	Black	73 TV B	73 TV2 B	73 TVFM B	73 TVI B	73 TVSAT B	73 SATN B	73 SATI B
Bright Steel	White	73 TV W	73 TV2 W	73 TVFM W	73 TVI W	73 TVSAT W	73 SATN W	73 SATI W
Gloss White	White	70 TV W	70 TV2 W	70 TVFM W	70 TVI W	70 TVSAT W	70 SATN W	70 SATI W
Matt White	-	-	-	-	-	-	-	-
Matt Black	-	-	-	-	-	-	-	-
Polished Brass	Black	71 TV B	71 TV2 B	71 TVFM B	71 TVI B	71 TVSAT B	71 SATN B	71 SATI B
Polished Brass	White	71 TV W	71 TV2 W	71 TVFM W	71 TVI W	71 TVSAT W	71 SATN W	71 SATI W
Richmond Bronze	-	-	-	-	-	-	-	-
Satin Brass	Black	72 TV B	72 TV2 B	72 TVFM B	72 TVI B	72 TVSAT B	72 SATN B	72 SATI B
Satin Brass	White	72 TV W	72 TV2 W	72 TVFM W	72 TVI W	72 TVSAT W	72 SATN W	72 SATI W
Satin Chrome	Black	76 TV B	76 TV2 B	76 TVFM B	76 TVI B	76 TVSAT B	76 SATN B	76 SATI B
Satin Chrome	White	76 TV W	76 TV2 W	76 TVFM W	76 TVI W	76 TVSAT W	76 SATN W	76 SATI W
Satin Steel	Black	74 TV B	74 TV2 B	74 TVFM B	74 TVI B	74 TVSAT B	74 SATN B	74 SATI B
Satin Steel	White	74 TV W	74 TV2 W	74 TVFM W	74 TVI W	74 TVSAT W	74 SATN W	74 SATI W
Nominal Size:		88.0mm x 88.0mm	88.0mm x 88.0mm	88.0mm x 88.0mm	88.0mm x 88.0mm	88.0mm x 88.0mm	88.0mm x 88.0mm	88.0mm x 88.0mm
Minimum Wall Box Depth:		25mm	25mm	25mm	25mm	35mm	35mm	35mm
Technical Insert Ref:		TV	TV2	TVFM	TVI	TVSAT	SATN	SATI

Insert Surround Colour Key: (-B) Black, (-W) White

Hartland

Digital Television Sockets

- Screened Non-Isolated / DAB compatible



73 DTRID W



71 DTVF B



72 DTVM W



76 DSAT+ W



Non-Isolated
TV+FM+SAT
Triplexer 1in/3out
(DAB Compatible)



1 gang
Non-Isolated
TV (Female)
(DAB Compatible)



1 gang
Non-Isolated
TV (Male)
(DAB Compatible)



1 gang
Non-Isolated
Satellite
(DAB Compatible)



Non-Isolated
TV+FM+SAT1+SAT2
Quadplexer 2in/4out
(DAB Compatible)

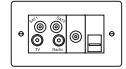

Non-Isolated
TV+FM+SAT1+SAT2
Quadplexer 2in/4out
+TVF+TCS
(DAB Compatible)

Plate Finish	Insert Colour	73 DTRID W	71 DTVF B	72 DTVM W	79 DSAT B	79 DENT B	79 DSAT+ B
Antique Brass	Black	79 DTRID B	79 DTVF B	79 DTVM B	79 DSAT B	79 DENT B	79 DSAT+ B
Black Nickel	Black	78 DTRID B	78 DTVF B	78 DTVM B	78 DSAT B	78 DENT B	78 DSAT+ B
Bright Chrome	Black	77 DTRID B	77 DTVF B	77 DTVM B	77 DSAT B	77 DENT B	77 DSAT+ B
Bright Chrome	White	77 DTRID W	77 DTVF W	77 DTVM W	77 DSAT W	77 DENT W	77 DSAT+ W
Bright Steel	Black	73 DTRID B	73 DTVF B	73 DTVM B	73 DSAT B	73 DENT B	73 DSAT+ B
Bright Steel	White	73 DTRID W	73 DTVF W	73 DTVM W	73 DSAT W	73 DENT W	73 DSAT+ W
Gloss White	White	70 DTRID W	70 DTVF W	70 DTVM W	70 DSAT W	70 DENT W	70 DSAT+ W
Matt Black	-	-	-	-	-	-	-
Matt White	-	-	-	-	-	-	-
Polished Brass	Black	71 DTRID B	71 DTVF B	71 DTVM B	71 DSAT B	71 DENT B	71 DSAT+ B
Polished Brass	White	71 DTRID W	71 DTVF W	71 DTVM W	71 DSAT W	71 DENT W	71 DSAT+ W
Richmond Bronze	-	-	-	-	-	-	-
Satin Brass	Black	72 DTRID B	72 DTVF B	72 DTVM B	72 DSAT B	72 DENT B	72 DSAT+ B
Satin Brass	White	72 DTRID W	72 DTVF W	72 DTVM W	72 DSAT W	72 DENT W	72 DSAT+ W
Satin Chrome	Black	76 DTRID B	76 DTVF B	76 DTVM B	76 DSAT B	76 DENT B	76 DSAT+ B
Satin Chrome	White	76 DTRID W	76 DTVF W	76 DTVM W	76 DSAT W	76 DENT W	76 DSAT+ W
Satin Steel	Black	74 DTRID B	74 DTVF B	74 DTVM B	74 DSAT B	74 DENT B	74 DSAT+ B
Satin Steel	White	74 DTRID W	74 DTVF W	74 DTVM W	74 DSAT W	74 DENT W	74 DSAT+ W
Nominal Size:		88.0mm x 88.0mm	88.0mm x 88.0mm	88.0mm x 88.0mm	88.0mm x 88.0mm	88.0mm x 88.0mm	144.5mm x 88.0mm
Minimum Wall Box Depth:		35mm	35mm	35mm	35mm	35mm	35mm
Technical Insert Ref:		DTRID	DTVf	DTVM	DSAT	DENT	DSAT+

Insert Surround Colour Key: (-B) Black, (-W) White

Hartland

Telephone and Data Outlets



79 TCM B



77 TCS W



78 J12 B



77 2J45 W



Plate Finish	Insert Colour	1 gang Telephone Master	1 gang Telephone Slave	1 gang RJ12 Outlet - Unshielded	2 gang RJ12 Outlet - Unshielded	1 gang RJ45 CAT 5E Outlet - Unshielded	2 gang RJ45 CAT 5E Outlet - Unshielded
Antique Brass	Black	79 TCM B	79 TCS B	79 J12 B	79 2J12 B	79 J45 B	79 2J45 B
Black Nickel	Black	78 TCM B	78 TCS B	78 J12 B	78 2J12 B	78 J45 B	78 2J45 B
Bright Chrome	Black	77 TCM B	77 TCS B	77 J12 B	77 2J12 B	77 J45 B	77 2J45 B
Bright Chrome	White	77 TCM W	77 TCS W	77 J12 W	77 2J12 W	77 J45 W	77 2J45 W
Bright Steel	Black	73 TCM B	73 TCS B	73 J12 B	73 2J12 B	73 J45 B	73 2J45 B
Bright Steel	White	73 TCM W	73 TCS W	73 J12 W	73 2J12 W	73 J45 W	73 2J45 W
Gloss White	White	70 TCM W	70 TCS W	70 J12 W	70 2J12 W	70 J45 W	70 2J45 W
Matt Black	-	-	-	-	-	-	-
Matt White	-	-	-	-	-	-	-
Polished Brass	Black	71 TCM B	71 TCS B	71 J12 B	71 2J12 B	71 J45 B	71 2J45 B
Polished Brass	White	71 TCM W	71 TCS W	71 J12 W	71 2J12 W	71 J45 W	71 2J45 W
Richmond Bronze	-	-	-	-	-	-	-
Satin Brass	Black	72 TCM B	72 TCS B	72 J12 B	72 2J12 B	72 J45 B	72 2J45 B
Satin Brass	White	72 TCM W	72 TCS W	72 J12 W	72 2J12 W	72 J45 W	72 2J45 W
Satin Chrome	Black	76 TCM B	76 TCS B	76 J12 B	76 2J12 B	76 J45 B	76 2J45 B
Satin Chrome	White	76 TCM W	76 TCS W	76 J12 W	76 2J12 W	76 J45 W	76 2J45 W
Satin Steel	Black	74 TCM B	74 TCS B	74 J12 B	74 2J12 B	74 J45 B	74 2J45 B
Satin Steel	White	74 TCM W	74 TCS W	74 J12 W	74 2J12 W	74 J45 W	74 2J45 W
Nominal Size:		88.0mm x 88.0mm	88.0mm x 88.0mm	88.0mm x 88.0mm	88.0mm x 88.0mm	88.0mm x 88.0mm	88.0mm x 88.0mm
Minimum Wall Box Depth:		25mm	25mm	35mm	35mm	35mm	35mm
Technical Insert Ref:		TCM	TCS	J12	2J12	J45	2J45

Insert Surround Colour Key: (-B) Black, (-W) White

Hartland

Double Pole Switches



77 DP BC-W



73 DPN BC-B



71 45V B



72 45SS1 SB-W



1 gang 20AX
Double Pole
Rocker



1 gang 20AX
Double Pole
Rocker +
Neon



1 gang 20AX
Double Pole
Rocker +
Neon +
Cable Outlet



1 gang 45A
Double Pole
Red Rocker



1 gang 45A
Double Pole
Red Rocker +
Neon



45A Double
Pole Red Rocker
+ Neon +
13A Switched
Socket



1 gang 45A Double
Pole Red Rocker +
Neon
(Vertically Mounted)

Plate Finish	Insert Finish/ Surround Colour							
Antique Brass	Antique Brass/Black	-	79 DPN AB-B	-	-	-	79 45SS1 AB-B	-
Antique Brass	Black/Black	-	-	-	79 45 B	79 45N B	-	-
Black Nickel	Black/Black	-	-	-	78 45 B	78 45N B	-	-
Black Nickel	Black Nickel/Black	-	78 DPN BK-B	-	-	-	78 45SS1 BK-B	-
Bright Chrome	Black/Black	77 DP BL-B	77 DPN BL-B	77 DPNC BL-B	77 45 B	77 4 5N B	77 4 5SS1 BL-B	77 4 5V B
Bright Chrome	Bright Chrome/Black	77 DP BC-B	77 DPN BC-B	77 DPNC BC-B	-	-	77 4 5SS1 BC-B	-
Bright Chrome	Bright Chrome/White	77 DP BC-W	77 DPN BC-W	77 DPNC BC-W	-	-	77 4 5SS1 BC-W	-
Bright Chrome	White/White	77 DP WH-W	77 DPN WH-W	77 DPNC WH-W	77 45 W	77 4 5N W	77 4 5SS1 WH-W	77 4 5V W
Bright Steel	Black/Black	73 DP BL-B	73 DPN BL-B	73 DPNC BL-B	73 45 B	73 45N B	73 45SS1 BL-B	73 45V B
Bright Steel	Bright Chrome/Black	73 DP BC-B	73 DPN BC-B	73 DPNC BC-B	-	-	73 45SS1 BC-B	-
Bright Steel	Bright Chrome/White	73 DP BC-W	73 DPN BC-W	73 DPNC BC-W	-	-	73 45SS1 BC-W	-
Bright Steel	White/White	73 DP WH-W	73 DPN WH-W	73 DPNC WH-W	73 45 W	73 45N W	73 45SS1 WH-W	73 45V W
Gloss White	White/White	70 DP WH-W	70 DPN WH-W	70 DPNC WH-W	70 45 W	70 45N W	70 45SS1 WH-W	70 45V W
Matt Black	-	-	-	-	-	-	-	-
Matt White	-	-	-	-	-	-	-	-
Polished Brass	Black/Black	71 DP BL-B	71 DPN BL-B	71 DPNC BL-B	71 45 B	71 45N B	71 45SS1 BL-B	71 45V B
Polished Brass	Polished Brass/Black	71 DP PB-B	71 DPN PB-B	71 DPNC PB-B	-	-	71 45SS1 PB-B	-
Polished Brass	Polished Brass/White	71 DP PB-W	71 DPN PB-W	71 DPNC PB-W	-	-	71 45SS1 PB-W	-
Polished Brass	White/White	71 DP WH-W	71 DPN WH-W	71 DPNC WH-W	71 45 W	71 45N W	71 45SS1 WH-W	71 45V W
Richmond Bronze	-	-	-	-	-	-	-	-
Satin Brass	Black/Black	72 DP BL-B	72 DPN BL-B	72 DPNC BL-B	72 45 B	72 45N B	72 45SS1 BL-B	72 45V B
Satin Brass	Satin Brass/Black	72 DP SB-B	72 DPN SB-B	72 DPNC SB-B	-	-	72 45SS1 SB-B	-
Satin Brass	Satin Brass/White	72 DP SB-W	72 DPN SB-W	72 DPNC SB-W	-	-	72 45SS1 SB-W	-
Satin Brass	White/White	72 DP WH-W	72 DPN WH-W	72 DPNC WH-W	72 45 W	72 45N W	72 45SS1 WH-W	72 45V W
Satin Chrome	Black/Black	76 DP BL-B	76 DPN BL-B	76 DPNC BL-B	76 45 B	76 45N B	76 45SS1 BL-B	76 45V B
Satin Chrome	Satin Chrome/Black	76 DP SC-B	76 DPN SC-B	76 DPNC SC-B	-	-	76 45SS1 SC-B	-
Satin Chrome	Satin Chrome/White	76 DP SC-W	76 DPN SC-W	76 DPNC SC-W	-	-	76 45SS1 SC-W	-
Satin Chrome	White/White	76 DP WH-W	76 DPN WH-W	76 DPNC WH-W	76 45 W	76 45N W	76 45SS1 WH-W	76 45V W
Satin Steel	Black/Black	74 DP BL-B	74 DPN BL-B	74 DPNC BL-B	74 45 B	74 45N B	74 45SS1 BL-B	74 45V B
Satin Steel	Satin Steel/Black	74 DP SS-B	74 DPN SS-B	74 DPNC SS-B	-	-	74 45SS1 SS-B	-
Satin Steel	Satin Steel/White	74 DP SS-W	74 DPN SS-W	74 DPNC SS-W	-	-	74 45SS1 SS-W	-
Satin Steel	White/White	74 DP WH-W	74 DPN WH-W	74 DPNC WH-W	74 45 W	74 45N W	74 45SS1 WH-W	74 45V W
	Nominal Size:	88.0mm x 88.0mm	88.0mm x 88.0mm	88.0mm x 88.0mm	88.0mm x 88.0mm	88.0mm x 88.0mm	144.5mm x 88.0mm	88.0mm x 144.5mm
	Minimum Wall Box Depth:	35mm	35mm	35mm	35mm	35mm	35mm	35mm
	Technical Insert Ref:	DP	DPN	DPNC	45	45N	45SS1	45V

Insert Surround Colour Key: (-B) Black, (-W) White

Hartland

Connection Units

HARTLAND RANGE



79 SP AB-B



71 SPN PB-B



72 FOC WH-W



76 CO B



1 gang 13A
Double Pole
Fused Spur



1 gang 13A
Double Pole
Fused Spur +
Neon



1 gang 13A
Double Pole
Fused Spur +
Neon +
Cable Outlet



1 gang 13A Fuse
Only



1 gang 13A Fuse +
Cable Outlet



1 gang 20A
Cable Outlet

Insert Finish/ Surround Colour		1 gang 13A Double Pole Fused Spur	1 gang 13A Double Pole Fused Spur + Neon	1 gang 13A Double Pole Fused Spur + Neon + Cable Outlet	1 gang 13A Fuse Only	1 gang 13A Fuse + Cable Outlet	1 gang 20A Cable Outlet
Plate Finish	Insert Finish/ Surround Colour						
Antique Brass	Antique Brass/Black	79 SP AB-B	79 SPN AB-B	-	79 FO AB-B	-	-
Antique Brass	Black/Black	-	-	-	-	-	79 CO B
Black Nickel	Black/Black	-	-	-	-	-	78 CO B
Black Nickel	Black Nickel/Black	78 SP BK-B	78 SPN BK-B	-	78 FO BK-B	-	-
Bright Chrome	Black/Black	77 SP BL-B	77 SPN BL-B	77 SPNC BL-B	77 FO BL-B	77 FOC BL-B	77 CO B
Bright Chrome	Bright Chrome/Black	77 SP BC-B	77 SPN BC-B	77 SPNC BC-B	77 FO BC-B	77 FOC BC-B	-
Bright Chrome	Bright Chrome/White	77 SP BC-W	77 SPN BC-W	77 SPNC BC-W	77 FO BC-W	77 FOC BC-W	-
Bright Chrome	White/White	77 SP WH-W	77 SPN WH-W	77 SPNC WH-W	77 FO WH-W	77 FOC WH-W	77 CO W
Bright Steel	Black/Black	73 SP BL-B	73 SPN BL-B	73 SPNC BL-B	73 FO BL-B	73 FOC BL-B	73 CO B
Bright Steel	Bright Chrome/Black	73 SP BC-B	73 SPN BC-B	73 SPNC BC-B	73 FO BC-B	73 FOC BC-B	-
Bright Steel	Bright Chrome/White	73 SP BC-W	73 SPN BC-W	73 SPNC BC-W	73 FO BC-W	73 FOC BC-W	-
Bright Steel	White/White	73 SP WH-W	73 SPN WH-W	73 SPNC WH-W	73 FO WH-W	73 FOC WH-W	73 CO W
Gloss White	White/White	70 SP WH-W	70 SPN WH-W	70 SPNC WH-W	70 FO WH-W	70 FOC WH-W	70 CO W
Matt Black	Black/Black	7MB SP BL-B	-	-	-	-	-
Matt White	White/White	7MW SP WH-W	-	-	-	-	-
Polished Brass	Black/Black	71 SP BL-B	71 SPN BL-B	71 SPNC BL-B	71 FO BL-B	71 FOC BL-B	71 CO B
Polished Brass	Polished Brass/Black	71 SP PB-B	71 SPN PB-B	71 SPNC PB-B	71 FO PB-B	71 FOC PB-B	-
Polished Brass	Polished Brass/White	71 SP PB-W	71 SPN PB-W	71 SPNC PB-W	71 FO PB-W	71 FOC PB-W	-
Polished Brass	White/White	71 SP WH-W	71 SPN WH-W	71 SPNC WH-W	71 FO WH-W	71 FOC WH-W	71 CO W
Richmond Bronze	Black/Black	7RB SP BL-B	-	-	-	-	-
Satin Brass	Black/Black	72 SP BL-B	72 SPN BL-B	72 SPNC BL-B	72 FO BL-B	72 FOC BL-B	72 CO B
Satin Brass	Satin Brass/Black	72 SP SB-B	72 SPN SB-B	72 SPNC SB-B	72 FO SB-B	72 FOC SB-B	-
Satin Brass	Satin Brass/White	72 SP SB-W	72 SPN SB-W	72 SPNC SB-W	72 FO SB-W	72 FOC SB-W	-
Satin Brass	White/White	72 SP WH-W	72 SPN WH-W	72 SPNC WH-W	72 FO WH-W	72 FOC WH-W	72 CO W
Satin Chrome	Black/Black	76 SP BL-B	76 SPN BL-B	76 SPNC BL-B	76 FO BL-B	76 FOC BL-B	76 CO B
Satin Chrome	Satin Chrome/Black	76 SP SC-B	76 SPN SC-B	76 SPNC SC-B	76 FO SC-B	76 FOC SC-B	-
Satin Chrome	Satin Chrome/White	76 SP SC-W	76 SPN SC-W	76 SPNC SC-W	76 FO SC-W	76 FOC SC-W	-
Satin Chrome	White/White	76 SP WH-W	76 SPN WH-W	76 SPNC WH-W	76 FO WH-W	76 FOC WH-W	76 CO W
Satin Steel	Black/Black	74 SP BL-B	74 SPN BL-B	74 SPNC BL-B	74 FO BL-B	74 FOC BL-B	74 CO B
Satin Steel	Satin Steel/Black	74 SP SS-B	74 SPN SS-B	74 SPNC SS-B	74 FO SS-B	74 FOC SS-B	-
Satin Steel	Satin Steel/White	74 SP SS-W	74 SPN SS-W	74 SPNC SS-W	74 FO SS-W	74 FOC SS-W	-
Satin Steel	White/White	74 SP WH-W	74 SPN WH-W	74 SPNC WH-W	74 FO WH-W	74 FOC WH-W	74 CO W
	Nominal Size:	88.0mm x 88.0mm	88.0mm x 88.0mm	88.0mm x 88.0mm	88.0mm x 88.0mm	88.0mm x 88.0mm	88.0mm x 88.0mm
	Minimum Wall Box Depth:	35mm	35mm	35mm	35mm	35mm	35mm
	Technical Insert Ref:	SP	SPN	SPNC	FO	FOC	CO

Note: TP only available in Black/Black or White/White Insert

Insert Surround Colour Key: (-B) Black, (-W) White

Hartland

LED Trailing/Leading Edge Push On/Off Rotary 2 Way Switching Dimmers



77 1XLEDITB100



74 2XLEDITB100



71 3XLEDITB100



78 4XLEDITB100



1 gang 100W LED Trailing/
Leading Edge Push
On/Off Rotary
2 Way Switching Dimmer



2 gang 100W LED Trailing/
Leading Edge Push
On/Off Rotary
2 Way Switching Dimmer



3 gang 100W LED Trailing/
Leading Edge Push
On/Off Rotary
2 Way Switching Dimmer



4 gang 100W LED Trailing/
Leading Edge Push
On/Off Rotary
2 Way Switching Dimmer

Plate Finish	Insert Finish	77 1XLEDITB100	74 2XLEDITB100	71 3XLEDITB100	78 4XLEDITB100
Antique Brass	Antique Brass	79 1XLEDITB100	79 2XLEDITB100	79 3XLEDITB100	79 4XLEDITB100
Black Nickel	Black Nickel	78 1XLEDITB100	78 2XLEDITB100	78 3XLEDITB100	78 4XLEDITB100
Bright Chrome	Bright Chrome	77 1XLEDITB100	77 2XLEDITB100	77 3XLEDITB100	77 4XLEDITB100
Bright Steel	Bright Steel	73 1XLEDITB100	73 2XLEDITB100	73 3XLEDITB100	73 4XLEDITB100
Gloss White	Gloss White	70 1XLEDITB100	70 2XLEDITB100	70 3XLEDITB100	70 4XLEDITB100
Matt Black	Matt Black	7MB 1XLEDITB100	7MB 2XLEDITB100	-	-
Matt White	Matt White	7MW 1XLEDITB100	7MW 2XLEDITB100	-	-
Polished Brass	Polished Brass	71 1XLEDITB100	71 2XLEDITB100	71 3XLEDITB100	71 4XLEDITB100
Richmond Bronze	-	-	-	-	-
Satin Brass	Satin Brass	72 1XLEDITB100	72 2XLEDITB100	72 3XLEDITB100	72 4XLEDITB100
Satin Chrome	Satin Chrome	76 1XLEDITB100	76 2XLEDITB100	76 3XLEDITB100	76 4XLEDITB100
Satin Steel	Satin Steel	74 1XLEDITB100	74 2XLEDITB100	74 3XLEDITB100	74 4XLEDITB100
	Nominal Size:	88.0mm x 88.0mm	88.0mm x 88.0mm	144.5mm x 88.0mm	144.5mm x 88.0mm
	Minimum Wall Box Depth:	35mm	35mm	35mm	35mm
	Technical Insert Ref:	1XLEDITB	2XLEDITB	3XLEDITB	4XLEDITB

LED Trailing/Leading Edge Push On/Off Rotary Multi-Way Dimmers



1 gang 100W LED Trailing/
Leading Edge Push
On/Off Rotary
Multi-Way Dimmer



2 gang 100W LED Trailing/
Leading Edge Push
On/Off Rotary
Multi-Way Dimmer



3 gang 100W LED Trailing/
Leading Edge Push
On/Off Rotary
Multi-Way Dimmer



4 gang 100W LED Trailing/
Leading Edge Push
On/Off Rotary
Multi-Way Dimmer

Plate Finish	Insert Finish	79 1X100LED	79 2X100LED	79 3X100LED	79 4X100LED
Antique Brass	Antique Brass	79 1X100LED	79 2X100LED	79 3X100LED	79 4X100LED
Black Nickel	Black Nickel	78 1X100LED	78 2X100LED	78 3X100LED	78 4X100LED
Bright Chrome	Bright Chrome	77 1X100LED	77 2X100LED	77 3X100LED	77 4X100LED
Bright Steel	Bright Steel	73 1X100LED	73 2X100LED	73 3X100LED	73 4X100LED
Gloss White	Gloss White	70 1X100LED	70 2X100LED	70 3X100LED	70 4X100LED
Matt Black	Matt Black	-	-	-	-
Matt White	Matt White	-	-	-	-
Polished Brass	Polished Brass	71 1X100LED	71 2X100LED	71 3X100LED	71 4X100LED
Richmond Bronze	-	-	-	-	-
Satin Brass	Satin Brass	72 1X100LED	72 2X100LED	72 3X100LED	72 4X100LED
Satin Chrome	Satin Chrome	76 1X100LED	76 2X100LED	76 3X100LED	76 4X100LED
Satin Steel	Satin Steel	74 1X100LED	74 2X100LED	74 3X100LED	74 4X100LED
	Nominal Size:	88.0mm x 88.0mm	88.0mm x 88.0mm	144.5mm x 88.0mm	144.5mm x 88.0mm
	Minimum Wall Box Depth:	35mm	35mm	35mm	35mm
	Technical Insert Ref:	1X100LED	2X100LED	3X100LED	4X100LED

NOTE: Tungsten filament GU10 lamps must be branded and with a fused base.
NOTE: Please refer to the Dimmer Technical Section for the max Wattage.
NOTE: Please contact our Technical Department for compatibility.

Hartland

Resistive Leading Edge Push On/Off Rotary 2 Way Switching Dimmers

HARTLAND RANGE



78 1X40



71 2X40



72 3X40



76 4X40

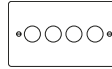
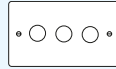

1 gang 400W Resistive Leading Edge Push On/Off Rotary 2 Way Switching Dimmer

2 gang 400W Resistive Leading Edge Push On/Off Rotary 2 Way Switching Dimmer

3 gang 400W Resistive Leading Edge Push On/Off Rotary 2 Way Switching Dimmer

4 gang 400W Resistive Leading Edge Push On/Off Rotary 2 Way Switching Dimmer

1 gang 600W Resistive Leading Edge Push On/Off Rotary 2 Way Switching Dimmer

Plate Finish	Insert Finish	1 gang 400W Resistive Leading Edge Push On/Off Rotary 2 Way Switching Dimmer	2 gang 400W Resistive Leading Edge Push On/Off Rotary 2 Way Switching Dimmer	3 gang 400W Resistive Leading Edge Push On/Off Rotary 2 Way Switching Dimmer	4 gang 400W Resistive Leading Edge Push On/Off Rotary 2 Way Switching Dimmer	1 gang 600W Resistive Leading Edge Push On/Off Rotary 2 Way Switching Dimmer
Antique Brass	Antique Brass	79 1X40	79 2X40	79 3X40	79 4X40	79 1X60
Black Nickel	Black Nickel	78 1X40	78 2X40	78 3X40	78 4X40	78 1X60
Bright Chrome	Bright Chrome	77 1X40	77 2X40	77 3X40	77 4X40	77 1X60
Bright Steel	Bright Steel	73 1X40	73 2X40	73 3X40	73 4X40	73 1X60
Gloss White	Gloss White	70 1X40	70 2X40	70 3X40	70 4X40	70 1X60
Matt Black	Matt Black	7MB 1X40	7MB 2X40	-	-	-
Matt White	Matt White	7MW 1X40	7MW 2X40	-	-	-
Polished Brass	Polished Brass	71 1X40	71 2X40	71 3X40	71 4X40	71 1X60
Richmond Bronze	Richmond Bronze	7RB 1X40	7RB 2X40	-	-	-
Satin Brass	Satin Brass	72 1X40	72 2X40	72 3X40	72 4X40	72 1X60
Satin Chrome	Satin Chrome	76 1X40	76 2X40	76 3X40	76 4X40	76 1X60
Satin Steel	Satin Steel	74 1X40	74 2X40	74 3X40	74 4X40	74 1X60
Nominal Size:		88.0mm x 88.0mm	88.0mm x 88.0mm	144.5mm x 88.0mm	144.5mm x 88.0mm	88.0mm x 88.0mm
Minimum Wall Box Depth:		35mm	35mm	35mm	35mm	35mm
Technical Insert Ref:		1X40	2X40	3X40	4X40	1X60

NOTE: Tungsten filament GU10 lamps must be branded and with a fused base
 NOTE: When using mains voltage halogen lamps – dimmers should be re-rated by 25%
 NOTE: When dimming LED lamps de-rate by 75% - please contact our Technical Department for compatibility.
 NOTE: Please refer to the Dimmer Technical Section for the max wattage

Hartland

Inductive Leading Edge Push On/Off Rotary 2 Way Switching Dimmers



77 1X2V



78 2X2V



1 gang 200VA
Inductive Leading Edge
Push On/Off Rotary
2 Way Switching Dimmer



2 gang 200VA
Inductive Leading Edge
Push On/Off Rotary
2 Way Switching Dimmer

Plate Finish / Insert	Insert Finish		
Antique Brass	Antique Brass	79 1X2V	79 2X2V
Black Nickel	Black Nickel	78 1X2V	78 2X2V
Bright Chrome	Bright Chrome	77 1X2V	77 2X2V
Bright Steel	Bright Steel	73 1X2V	73 2X2V
Gloss White	Gloss White	70 1X2V	70 2X2V
Matt Black	-	-	-
Matt White	-	-	-
Polished Brass	Polished Brass	71 1X2V	71 2X2V
Richmond Bronze	-	-	-
Satin Brass	Satin Brass	72 1X2V	72 2X2V
Satin Chrome	Satin Chrome	76 1X2V	76 2X2V
Satin Steel	Satin Steel	74 1X2V	74 2X2V
	Nominal Size:	88.0mm x 88.0mm	88.0mm x 88.0mm
	Minimum Wall Box Depth:	35mm	35mm
	Technical Insert Ref:	1X2V	2X2V

NOTE: Tungsten filament GU10 lamps must be branded and with a fused base

NOTE: When using mains voltage halogen lamps – dimmers should be re-rated by 25%

NOTE: When dimming LED lamps de-rate by 75% - please contact our Technical Department for compatibility.

NOTE: Please refer to the Dimmer Technical Section for the max wattage

Hartland

Resistive/Inductive Trailing Edge Push On/Off Rotary Multi-Way Dimmers

HARTLAND RANGE



74 1XTE



77 2XTE

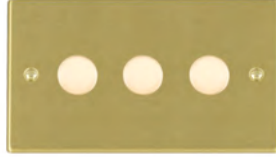

72 3XTE



71 4XTE



1 gang 250W/210VA
Resistive/Inductive Trailing
Edge Push On/Off Rotary
Multi-Way Dimmer



2 gang 250W/210VA
Resistive/Inductive Trailing
Edge Push On/Off Rotary
Multi-Way Dimmer

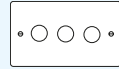

3 gang 250W/210VA
Resistive/Inductive Trailing
Edge Push On/Off Rotary
Multi-Way Dimmer

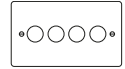

4 gang 250W/210VA
Resistive/Inductive Trailing
Edge Push On/Off Rotary
Multi-Way Dimmer

Plate Finish	Insert Finish	1 gang 250W/210VA Resistive/Inductive Trailing Edge Push On/Off Rotary Multi-Way Dimmer	2 gang 250W/210VA Resistive/Inductive Trailing Edge Push On/Off Rotary Multi-Way Dimmer	3 gang 250W/210VA Resistive/Inductive Trailing Edge Push On/Off Rotary Multi-Way Dimmer	4 gang 250W/210VA Resistive/Inductive Trailing Edge Push On/Off Rotary Multi-Way Dimmer
Antique Brass	Antique Brass	79 1XTE	79 2XTE	79 3XTE	79 4XTE
Black Nickel	Black Nickel	78 1XTE	78 2XTE	78 3XTE	78 4XTE
Bright Chrome	Bright Chrome	77 1XTE	77 2XTE	77 3XTE	77 4XTE
Bright Steel	Bright Steel	73 1XTE	73 2XTE	73 3XTE	73 4XTE
Gloss White	Gloss White	70 1XTE	70 2XTE	70 3XTE	70 4XTE
Matt Black	-	-	-	-	-
Matt White	-	-	-	-	-
Polished Brass	Polished Brass	71 1XTE	71 2XTE	71 3XTE	71 4XTE
Richmond Bronze	Richmond Bronze	-	-	-	-
Satin Brass	Satin Brass	72 1XTE	72 2XTE	72 3XTE	72 4XTE
Satin Chrome	Satin Chrome	76 1XTE	76 2XTE	76 3XTE	76 4XTE
Satin Steel	Satin Steel	74 1XTE	74 2XTE	74 3XTE	74 4XTE
Nominal Size:		88.0mm x 88.0mm	88.0mm x 88.0mm	144.5mm x 88.0mm	144.5mm x 88.0mm
Minimum Wall Box Depth:		35mm	35mm	35mm	35mm
Technical Insert Ref:		1XTE	2XTE	3XTE	4XTE

NOTE: Tungsten filament GU10 lamps must be branded and with a fused base
 NOTE: When using mains voltage halogen lamps – dimmers should be re-rated by 25%
 NOTE: When dimming LED lamps de-rate by 75% - please contact our Technical Department for compatibility.
 NOTE: Please refer to the Dimmer Technical Section for the max wattage

Hartland

Resistive/Inductive Trailing Edge Touch Master Multi-Way Dimmers



78 1XTM BK-B







73 2XTM BC-W



71 3XTM PB-W



72 4XTM SB-B

Plate Finish	Insert Finish/ Surround Colour	 1 gang 250W/210VA Resistive/Inductive Trailing Edge Touch Master Multi-Way Dimmer	 2 gang 250W/210VA Resistive/Inductive Trailing Edge Touch Master Multi-Way Dimmer	 3 gang 250W/210VA Resistive/Inductive Trailing Edge Touch Master Multi-Way Dimmer	 4 gang 250W/210VA Resistive/Inductive Trailing Edge Touch Master Multi-Way Dimmer
Antique Brass	Antique Brass/Black	79 1XTM AB-B	79 2XTM AB-B	79 3XTM AB-B	79 4XTM AB-B
Black Nickel	Black Nickel/Black	78 1XTM BK-B	78 2XTM BK-B	78 3XTM BK-B	78 4XTM BK-B
Bright Chrome	Bright Chrome/Black	77 1XTM BC-B	77 2XTM BC-B	77 3XTM BC-B	77 4XTM BC-B
Bright Chrome	Bright Chrome/White	77 1XTM BC-W	77 2XTM BC-W	77 3XTM BC-W	77 4XTM BC-W
Bright Steel	Bright Chrome/Black	73 1XTM BC-B	73 2XTM BC-B	73 3XTM BC-B	73 4XTM BC-B
Bright Steel	Bright Chrome/White	73 1XTM BC-W	73 2XTM BC-W	73 3XTM BC-W	73 4XTM BC-W
Gloss White	-	-	-	-	-
Matt Black	-	-	-	-	-
Matt White	-	-	-	-	-
Polished Brass	Polished Brass/Black	71 1XTM PB-B	71 2XTM PB-B	71 3XTM PB-B	71 4XTM PB-B
Polished Brass	Polished Brass/White	71 1XTM PB-W	71 2XTM PB-W	71 3XTM PB-W	71 4XTM PB-W
Richmond Bronze	-	-	-	-	-
Satin Brass	Satin Brass/Black	72 1XTM SB-B	72 2XTM SB-B	72 3XTM SB-B	72 4XTM SB-B
Satin Brass	Satin Brass/White	72 1XTM SB-W	72 2XTM SB-W	72 3XTM SB-W	72 4XTM SB-W
Satin Chrome	Satin Chrome/Black	76 1XTM SC-B	76 2XTM SC-B	76 3XTM SC-B	76 4XTM SC-B
Satin Chrome	Satin Chrome/White	76 1XTM SC-W	76 2XTM SC-W	76 3XTM SC-W	76 4XTM SC-W
Satin Steel	Satin Steel/Black	74 1XTM SS-B	74 2XTM SS-B	74 3XTM SS-B	74 4XTM SS-B
Satin Steel	Satin Steel/White	74 1XTM SS-W	74 2XTM SS-W	74 3XTM SS-W	74 4XTM SS-W
	Nominal Size:	88.0mm x 88.0mm	88.0mm x 88.0mm	144.5mm x 88.0mm	144.5mm x 88.0mm
	Minimum Wall Box Depth:	35mm	35mm	35mm	35mm
	Technical Insert Ref:	1XTM	2XTM	3XTM	4XTM

NOTE: Tungsten filament GU10 lamps must be branded and with a fused base
 NOTE: When using mains voltage halogen lamps – dimmers should be re-rated by 25%
 NOTE: When dimming LED lamps de-rate by 75% - please contact our Technical Department for compatibility.
 NOTE: Please refer to the Dimmer Technical Section for the max wattage

Insert Surround Colour Key: (-B) Black, (-W) White

Hartland

Multi-Way Touch Slave Controllers

HARTLAND RANGE



71 1XTS PB-B





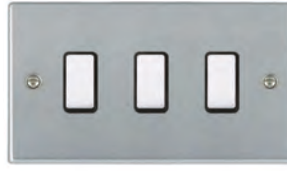

72 2XTS SB-W



76 3XTS SC-B



74 4XTS SS-W

Plate Finish	Insert Finish/ Surround Colour	 1 gang Multi-Way Touch Slave Controller	 2 gang Multi-Way Touch Slave Controller	 3 gang Multi-Way Touch Slave Controller	 4 gang Multi-Way Touch Slave Controller
Antique Brass	Antique Brass/Black	79 1XTS AB-B	79 2XTS AB-B	79 3XTS AB-B	79 4XTS AB-B
Black Nickel	Black Nickel/Black	78 1XTS BK-B	78 2XTS BK-B	78 3XTS BK-B	78 4XTS BK-B
Bright Chrome	Bright Chrome/Black	77 1XTS BC-B	77 2XTS BC-B	77 3XTS BC-B	77 4XTS BC-B
Bright Chrome	Bright Chrome/White	77 1XTS BC-W	77 2XTS BC-W	77 3XTS BC-W	77 4XTS BC-W
Bright Steel	Bright Chrome/Black	73 1XTS BC-B	73 2XTS BC-B	73 3XTS BC-B	73 4XTS BC-B
Bright Steel	Bright Chrome/White	73 1XTS BC-W	73 2XTS BC-W	73 3XTS BC-W	73 4XTS BC-W
Gloss White	-	-	-	-	-
Matt Black	-	-	-	-	-
Matt White	-	-	-	-	-
Polished Brass	Polished Brass/Black	71 1XTS PB-B	71 2XTS PB-B	71 3XTS PB-B	71 4XTS PB-B
Polished Brass	Polished Brass/White	71 1XTS PB-W	71 2XTS PB-W	71 3XTS PB-W	71 4XTS PB-W
Richmond Bronze	-	-	-	-	-
Satin Brass	Satin Brass/Black	72 1XTS SB-B	72 2XTS SB-B	72 3XTS SB-B	72 4XTS SB-B
Satin Brass	Satin Brass/White	72 1XTS SB-W	72 2XTS SB-W	72 3XTS SB-W	72 4XTS SB-W
Satin Chrome	Satin Chrome/Black	76 1XTS SC-B	76 2XTS SC-B	76 3XTS SC-B	76 4XTS SC-B
Satin Chrome	Satin Chrome/White	76 1XTS SC-W	76 2XTS SC-W	76 3XTS SC-W	76 4XTS SC-W
Satin Steel	Satin Steel/Black	74 1XTS SS-B	74 2XTS SS-B	74 3XTS SS-B	74 4XTS SS-B
Satin Steel	Satin Steel/White	74 1XTS SS-W	74 2XTS SS-W	74 3XTS SS-W	74 4XTS SS-W
	Nominal Size:	88.0mm x 88.0mm	88.0mm x 88.0mm	144.5mm x 88.0mm	144.5mm x 88.0mm
	Minimum Wall Box Depth:	35mm	35mm	35mm	35mm
	Technical Insert Ref:	1XTS	2XTS	3XTS	4XTS

NOTE: To only be used with Touch Masters

Insert Surround Colour Key: (-B) Black, (-W) White

Hartland

Blank Plates



72 BPS

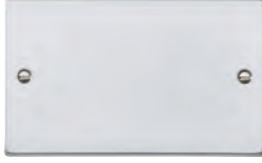

73 BPD



Plate Finish	Single Blank Plate	Double Blank Plate
Antique Brass	79 BPS	79 BPD
Black Nickel	78 BPS	78 BPD
Bright Chrome	77 BPS	77 BPD
Bright Steel	73 BPS	73 BPD
Gloss White	70 BPS	70 BPD
Matt Black	7MB BPS	7MB BPD
Matt White	7MW BPS	7MW BPD
Polished Brass	71 BPS	71 BPD
Richmond Bronze	-	-
Satin Brass	72 BPS	72 BPD
Satin Chrome	76 BPS	76 BPD
Satin Steel	74 BPS	74 BPD
Nominal Size:	88.0mm x 88.0mm	144.5mm x 88.0mm
Minimum Wall Box Depth:	Any Box	Any Box
Technical Insert Ref:	BPS	BPD

Hartland

GRID-IT GridFix Plates complete with Fixing Grid



79 1GP



71 2GP



71 3GP

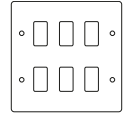
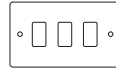
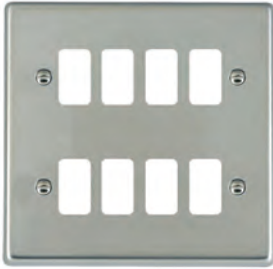

Plate Finish / Insert	1 Gang Grid Fix Aperture Plate with Grid	2 Gang Grid Fix Aperture Plate with Grid	3 Gang Grid Fix Aperture Plate with Grid	4 Gang Grid Fix Aperture Plate with Grid	6 Gang Grid Fix Aperture Plate with Grid
Antique Brass	79 1GP	79 2GP	79 3GP	79 4GP	79 6GP
Black Nickel	78 1GP	78 2GP	78 3GP	78 4GP	78 6GP
Bright Chrome	77 1GP	77 2GP	77 3GP	77 4GP	77 6GP
Bright Steel	73 1GP	73 2GP	73 3GP	73 4GP	73 6GP
Gloss White	70 1GP	70 2GP	70 3GP	70 4GP	70 6GP
Matt Black	-	-	-	-	-
Matt White	-	-	-	-	-
Polished Brass	71 1GP	71 2GP	71 3GP	71 4GP	71 6GP
Richmond Bronze	-	-	-	-	-
Satin Brass	72 1GP	72 2GP	72 3GP	72 4GP	72 6GP
Satin Chrome	76 1GP	76 2GP	76 3GP	76 4GP	76 6GP
Satin Steel	74 1GP	74 2GP	74 3GP	74 4GP	74 6GP
Nominal Size:	88.0mm x 88.0mm	88.0mm x 88.0mm	144.5mm x 88.0mm	144.5mm x 88.0mm	146.0mm x 146.0mm
Minimum Wall Box Depth:	As Per Insert	As Per Inserts	As Per Inserts	As Per Inserts	As Per Inserts
Technical Insert Ref:	1GP	2GP	3GP	4GP	6GP

Note: Minimum Wall Box depth is dependant on the Grid Fix insert fitted, please see the GRID-IT section for the complete range of inserts.

Hartland

GRID-IT GridFix Plates complete with Fixing Grid



77 8GP

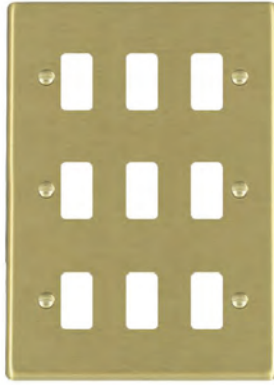

72 9GP

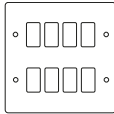

8 Gang Grid Fix Aperture Plate with Grid

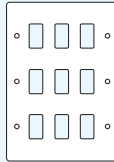

9 Gang Grid Fix Aperture Plate with Grid

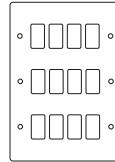

12 Gang Grid Fix Aperture Plate with Grid



1 gang 13A Switched Socket Grid Fix Aperture Plate (Grids supplied with inserts)

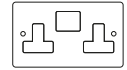

2 gang 13A Switched Socket Grid Fix Aperture Plate (Grids supplied with inserts)

Plate Finish	8 Gang Grid Fix Aperture Plate with Grid	9 Gang Grid Fix Aperture Plate with Grid	12 Gang Grid Fix Aperture Plate with Grid	1 gang 13A Switched Socket Grid Fix Aperture Plate (Grids supplied with inserts)	2 gang 13A Switched Socket Grid Fix Aperture Plate (Grids supplied with inserts)
Antique Brass	79 8GP	79 9GP	79 12GP	79 SS1GP	79 SS2GP
Black Nickel	78 8GP	78 9GP	78 12GP	78 SS1GP	78 SS2GP
Bright Chrome	77 8GP	77 9GP	77 12GP	77 SS1GP	77 SS2GP
Bright Steel	73 8GP	73 9GP	73 12GP	73 SS1GP	73 SS2GP
Gloss White	70 8GP	70 9GP	70 12GP	70 SS1GP	70 SS2GP
Matt Black	-	-	-	-	-
Matt White	-	-	-	-	-
Polished Brass	71 8GP	71 9GP	71 12GP	71 SS1GP	71 SS2GP
Richmond Bronze	-	-	-	-	-
Satin Brass	72 8GP	72 9GP	72 12GP	72 SS1GP	72 SS2GP
Satin Chrome	76 8GP	76 9GP	76 12GP	76 SS1GP	76 SS2GP
Satin Steel	74 8GP	74 9GP	74 12GP	74 SS1GP	74 SS2GP
Nominal Size:	146.0mm x 146.0mm	146.0mm x 210mm	146.0mm x 210mm	88.0mm x 88.0mm	144.5mm x 88.0mm
Minimum Wall Box Depth:	As Per Inserts	As Per Inserts	As Per Inserts	As Per Insert	As Per Insert
Technical Insert Ref:	8GP	9GP	12GP	SS1GP	SS2GP

Note: Minimum Wall Box depth is dependant on the Grid Fix insert fitted, please see the GRID-IT section for the complete range of inserts.

Hartland

EuroFix Apertured Plates complete with Fixing Grid



76 EURO1



79 EURO2



77 EURO4



1 Module EuroFix
25x50mm Apertured
Plate with Grid



2 Module EuroFix
50x50mm Apertured
Plate with Grid



3 Module EuroFix
75x50mm Apertured
Plate with Grid



4 Module EuroFix
100x50mm Apertured
Plate with Grid

Plate Finish / Insert	1 Module EuroFix 25x50mm Apertured Plate with Grid	2 Module EuroFix 50x50mm Apertured Plate with Grid	3 Module EuroFix 75x50mm Apertured Plate with Grid	4 Module EuroFix 100x50mm Apertured Plate with Grid
Antique Brass	79 EURO1	79 EURO2	79 EURO3	79 EURO4
Black Nickel	78 EURO1	78 EURO2	78 EURO3	78 EURO4
Bright Chrome	77 EURO1	77 EURO2	77 EURO3	77 EURO4
Bright Steel	73 EURO1	73 EURO2	73 EURO3	73 EURO4
Gloss White	70 EURO1	70 EURO2	70 EURO3	70 EURO4
Matt Black	-	7MB EURO2	-	7MB EURO4
Matt White	-	7MW EURO2	-	7MW EURO4
Polished Brass	71 EURO1	71 EURO2	71 EURO3	71 EURO4
Richmond Bronze	-	7RB EURO2	-	7RB EURO4
Satin Brass	72 EURO1	72 EURO2	72 EURO3	72 EURO4
Satin Chrome	76 EURO1	76 EURO2	76 EURO3	76 EURO4
Satin Steel Effect	74 EURO1	74 EURO2	74 EURO3	74 EURO4
Nominal Size:	86.0mm x 86.0mm	86.0mm x 86.0mm	145.0mm x 86.0mm	145.0mm x 86.0mm
Minimum Wall Box Depth:	As Per Insert	As Per Inserts	As Per Inserts	As Per Inserts
Technical Insert Ref:	EURO1	EURO2	EURO3	EURO4

Insert Surround Colour Key: (-B) Black, (-W) White

Hartland

EuroFix Media Plates complete with 13A Unswitched Power Sockets



73 MED1 W



77 MED2 B

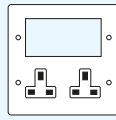

Media Plate EURO4
aperture + 2 X 13A
Unswitched Socket

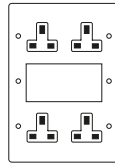

Media Plate EURO4
aperture + 4 X 13A
Unswitched Socket

Plate Finish	Insert Finish/ Surround Colour	Media Plate EURO4 aperture + 2 X 13A Unswitched Socket	Media Plate EURO4 aperture + 4 X 13A Unswitched Socket
Antique Brass		-	-
Black Nickel		-	-
Bright Chrome	Black	77 MED1 B	77 MED2 B
Bright Chrome	White	77 MED1 W	77 MED2 W
Bright Steel		-	-
Gloss White		-	-
Matt Black		-	-
Matt White		-	-
Polished Brass	Black	71 MED1 B	71 MED2 B
Polished Brass	White	71 MED1 W	71 MED2 W
Richmond Bronze		-	-
Satin Brass	Black	72 MED1 B	72 MED2 B
Satin Brass	White	72 MED1 W	72 MED2 W
Satin Chrome	Black	76 MED1 B	76 MED2 B
Satin Chrome	White	76 MED1 W	76 MED2 W
Bright Steel	Black	73 MED1 B	73 MED2 B
Bright Steel	White	73 MED1 W	73 MED2 W
Satin Steel	Black	74 MED1 B	74 MED2 B
Satin Steel	White	74 MED1 W	74 MED2 W
	Nominal Size:	146.0mm x 146.0mm	146.0mm x 210mm
	Minimum Wall Box Depth:	As Per Inserts	As Per Inserts
	Technical Insert Ref:	MED1	MED2

Note: Minimum Wall Box depth is dependant on the EuroFix insert fitted, please see the EuroFix section for our complete range of inserts.

Insert Surround Colour Key: (-B) Black, (-W) White



Hartland G2[®]

Stylish, slimline screwless wiring accessories

- Comes in seven superb finishes
- New Slim, sleek & stylish screwless design
- Now available with Quartz Grey inserts
- Latest 4.8A ultra fast USB Type A & Type C charging technology
- Grid and EuroFix options also available (see separate GRID-IT and EuroFix sections for inserts.)

25
YEAR Guarantee



Hartland G2® Range

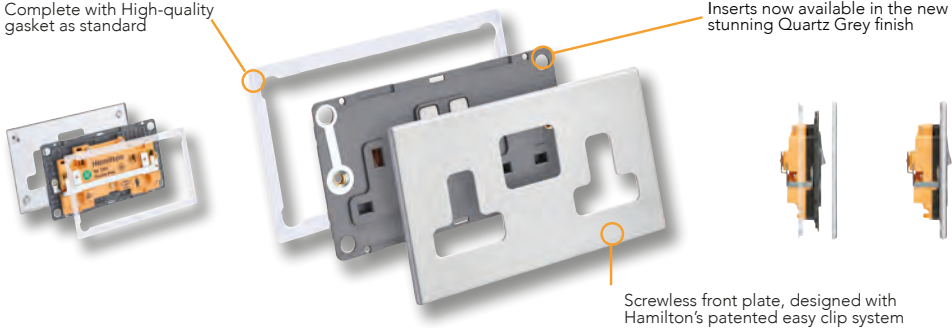

Plate finishes available in this range



Complete with High-quality gasket as standard

Inserts now available in the new stunning Quartz Grey finish



Hartland G2

Rocker Switches



7G27 R21 BC-QG





7G29 R22 AB-B



7G2MB R23 BL-B

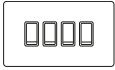

7G28 R24 BK-B

Plate Finish	Insert Finish / Surround Colour				
		1 gang 10AX 2 Way Rocker	2 gang 10AX 2 Way Rocker	3 gang 10AX 2 Way Rocker	4 gang 10AX 2 Way Rocker
Antique Brass	Antique Brass/Black	7G29 R21 AB-B	7G29 R22 AB-B	7G29 R23 AB-B	7G29 R24 AB-B
Black Nickel	Black Nickel/Black	7G28 R21 BK-B	7G28 R22 BK-B	7G28 R23 BK-B	7G28 R24 BK-B
Bright Chrome	Bright Chrome/Black	7G27 R21 BC-B	7G27 R22 BC-B	7G27 R23 BC-B	7G27 R24 BC-B
Bright Chrome	Bright Chrome/White	7G27 R21 BC-W	7G27 R22 BC-W	7G27 R23 BC-W	7G27 R24 BC-W
Bright Chrome	Black/Black	-	-	-	-
Bright Chrome	Bright Chrome/Quartz Grey	7G27 R21 BC-QG	7G27 R22 BC-QG	7G27 R23 BC-QG	7G27 R24 BC-QG
Bright Chrome	White/White	-	-	-	-
Matt Black	Black/Black	7G2MB R21 BL-B	7G2MB R22 BL-B	7G2MB R23 BL-B	7G2MB R24 BL-B
Matt White	White/White	7G2MW R21 WH-W	7G2MW R22 WH-W	7G2MW R23 WH-W	7G2MW R24 WH-W
Richmond Bronze	Black/Black	7G2RB R21 BL-B	7G2RB R22 BL-B	7G2RB R23 BL-B	7G2RB R24 BL-B
Satin Stainless	Black/Black	-	-	-	-
Satin Stainless	Satin Stainless/Black	7G24 R21 SS-B	7G24 R22 SS-B	7G24 R23 SS-B	7G24 R24 SS-B
Satin Stainless	Satin Stainless/Quartz Grey	7G24 R21 SS-QG	7G24 R22 SS-QG	7G24 R23 SS-QG	7G24 R24 SS-QG
Satin Stainless	Satin Stainless/White	7G24 R21 SS-W	7G24 R22 SS-W	7G24 R23 SS-W	7G24 R24 SS-W
Satin Stainless	White/White	-	-	-	-
Nominal Size:		87.4mm x 87.4mm	87.4mm x 87.4mm	87.4mm x 87.4mm	144.4 x 87.4mm
Minimum Wall Box Depth:		25mm	25mm	25mm	25mm
Technical Insert Ref:		R21	R22	R23	R24

Insert Surround Colour Key: (-B) Black, (-W) White, (-QG) Quartz Grey

Hartland G2

Rocker Switches



7G28 R31 BK-B



7G27 R32 BC-QG



7G24 RRT SS-W



7G2MB TP BL-B



1 gang 10AX Intermediate Rocker



2 gang 10AX Intermediate Rocker



1 gang 10AX PTM Retractive



1 gang 10A Triple Pole

Plate Finish	Insert Finish / Surround Colour	1 gang 10AX Intermediate Rocker	2 gang 10AX Intermediate Rocker	1 gang 10AX PTM Retractive	1 gang 10A Triple Pole
Antique Brass	Antique Brass/Black	7G29 R31 AB-B	7G29 R32 AB-B	7G29 RRT AB-B	7G29 TP BL-B
Black Nickel	Black Nickel/Black	7G28 R31 BK-B	7G28 R32 BK-B	7G28 RRT BK-B	7G28 TP BL-B
Bright Chrome	Bright Chrome/Black	7G27 R31 BC-B	7G27 R32 BC-B	7G27 RRT BC-B	-
Bright Chrome	Bright Chrome/White	7G27 R31 BC-W	7G27 R32 BC-W	7G27 RRT BC-W	-
Bright Chrome	Black/Black	-	-	-	7G27 TP BL-B
Bright Chrome	Bright Chrome/Quartz Grey	7G27 R31 BC-QG	7G27 R32 BC-QG	7G27 RRT BC-QG	-
Bright Chrome	White/White	-	-	-	7G27 TP WH-W
Matt Black	Black/Black	7G2MB R31 BL-B	7G2MB R32 BL-B	7G2MB RRT BL-B	7G2MB TP BL-B
Matt White	White/White	7G2MW R31 WH-W	7G2MW R32 WH-W	7G2MW RRT WH-W	7G2MW TP WH-W
Richmond Bronze	Black/Black	7G2RB R31 BL-B	7G2RB R32 BL-B	7G2RB RRT BL-B	7G2RB TP BL-B
Satin Stainless	Black/Black	-	-	-	7G24 TP BL-B
Satin Stainless	Satin Stainless/Black	7G24 R31 SS-B	7G24 R32 SS-B	7G24 RRT SS-B	-
Satin Stainless	Satin Stainless/Quartz Grey	7G24 R31 SS-QG	7G24 R32 SS-QG	7G24 RRT SS-QG	-
Satin Stainless	Satin Stainless/White	7G24 R31 SS-W	7G24 R32 SS-W	7G24 RRT SS-W	-
Satin Stainless	White/White	-	-	-	7G24 TP WH-W
Nominal Size:		87.4mm x 87.4mm	87.4mm x 87.4mm	87.4mm x 87.4mm	144.4 x 87.4mm
Minimum Wall Box Depth:		25mm	25mm	25mm	25mm
Technical Insert Ref:		R31	R32	RRT	TP

Insert Surround Colour Key: (-B) Black, (-W) White, (-QG) Quartz Grey

Hartland G2

Toggle Switches



7G24 T21







7G29 T22



7G2RB T23



7G28 T31

Plate Finish	Toggle Colour	 1 gang 20AX 2Way Toggle	 2 gang 20AX 2Way Toggle	 3 gang 20AX 2Way Toggle	 4 gang 20AX 2Way Toggle	 1 gang 20AX Intermediate
Antique Brass	Antique Brass	7G29 T21	7G29 T22	7G29 T23	7G29 T24	7G29 T31
Black Nickel	Black Nickel/Black	7G28 T21	7G28 T22	7G28 T23	7G28 T24	7G28 T31
Bright Chrome	Bright Chrome	7G27 T21	7G27 T22	7G27 T23	7G27 T24	7G27 T31
Matt Black	-	-	-	-	-	-
Matt White	-	-	-	-	-	-
Richmond Bronze	Richmond Bronze	7G2RB T21	7G2RB T22	7G2RB T23	7G2RB T24	7G2RB T31
Satin Stainless	Satin Stainless	7G24 T21	7G24 T22	7G24 T23	7G24 T24	7G24 T31
	Nominal Size:	87.4mm x 87.4mm	87.4mm x 87.4mm	144.4mm x 87.4mm	144.4 x 87.4mm	87.4mm x 87.4mm
	Minimum Wall Box Depth:	35mm	35mm	35mm	35mm	35mm
	Technical Insert Ref:	T21	T22	T23	T24	T31

Hartland G2

Power Sockets



7G28 SS1 BK-B

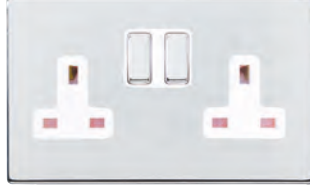

7G27 SS2 BC-W



7G24 US5 B



7G28 SHS B



1 gang 13A Double Pole Switched Socket

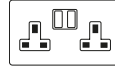

2 gang 13A Double Pole Switched Socket



1 gang 5A Unswitched Socket

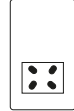

Dual Voltage Unswitched Shaver (Vertical Mounted)

Plate Finish	Insert Finish / Surround Colour	1 gang 13A Double Pole Switched Socket	2 gang 13A Double Pole Switched Socket	1 gang 5A Unswitched Socket	Dual Voltage Unswitched Shaver (Vertical Mounted)
Antique Brass	Antique Brass/Black	7G29 SS1 AB-B	7G29 SS2 AB-B	-	-
Antique Brass	Black/Black	-	-	7G29 US5 B	7G29 SHS B
Black Nickel	Black Nickel/Black	7G28 SS1 BK-B	7G28 SS2 BK-B	7G28 US5 B	7G28 SHS B
Bright Chrome	Bright Chrome/Black	7G27 SS1 BC-B	7G27 SS2 BC-B	-	-
Bright Chrome	Bright Chrome/White	7G27 SS1 BC-W	7G27 SS2 BC-W	-	-
Bright Chrome	Black/Black	-	-	7G27 US5 B	7G27 SHS B
Bright Chrome	Bright Chrome/Quartz Grey	7G27 SS1 BC-QG	7G27 SS2 BC-QG	-	-
Bright Chrome	Quartz Grey	-	-	7G27 US5 QG	-
Bright Chrome	White/White	-	-	7G27 US5 W	7G27 SHS W
Matt Black	Black/Black	7G2MB SS1 BL-B	7G2MB SS2 BL-B	7G2MB US5 B	7G2MB SHS B
Matt White	White/White	7G2MW SS1 WH-W	7G2MW SS2 WH-W	7G2MW US5 W	7G2MW SHS W
Richmond Bronze	Black/Black	7G2RB SS1 BL-B	7G2RB SS2 BL-B	7G2RB US5 B	7G2RB SHS B
Satin Stainless	Black/Black	-	-	7G24 US5 B	7G24 SHS B
Satin Stainless	Satin Stainless/Black	7G24 SS1 SS-B	7G24 SS2 SS-B	-	-
Satin Stainless	Satin Stainless/Quartz Grey	7G24 SS1SS-QG	7G24 SS2SS-QG	-	-
Satin Stainless	Quartz Grey	-	-	7G24 US5 QG	-
Satin Stainless	Satin Stainless/White	7G24 SS1 SS-W	7G24 SS2 SS-W	-	-
Satin Stainless	White/White	-	-	7G24 US5 W	7G24 SHS W
	Nominal Size:	87.4mm x 87.4mm	144.4mm x 87.4mm	87.4mm x 87.4mm	144.4 x 87.4mm
	Minimum Wall Box Depth:	35mm	35mm	35mm	47mm
	Technical Insert Ref:	SS1	SS2	US5	SHS

Insert Surround Colour Key: (-B) Black, (-W) White, (-QG) Quartz Grey

Hartland G2

USB Power Sockets



7G2RB SS1USB BL-B



7G28 SS2 USBULT BK-B



7G24 SS2USBC SS-B



1 gang 13A Single Pole Switched Socket with 1xUSB Outlet (2.1A)

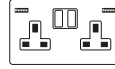

2 gang 13A Double Pole Switched Socket with 2 Ultra Outlets (4.8A Total)

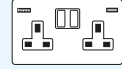

2 gang 13A Double Pole Switched with 1 USB Outlet + 1 USB Type C Outlet 2x2.4A (4.8A Total)

Plate Finish	Insert Finish / Surround Colour			
Antique Brass	Antique Brass/Black	7G29 SS1USB AB-B	7G29 SS2USBULT AB-B	7G29 SS2USBC AB-B
Black Nickel	Black Nickel/Black	7G28 SS1USB BK-B	7G28 SS2USBULT BK-B	7G28 SS2USBC BK-B
Bright Chrome	Bright Chrome/Black	7G27 SS1USB BC-B	7G27 SS2USBULT BC-B	7G27 SS2USBC BC-B
Bright Chrome	Bright Chrome/White	7G27 SS1USB BC-W	7G27 SS2USBULT BC-W	7G27 SS2USBC BC-W
Bright Chrome	Black/Black	-	-	-
Bright Chrome	Bright Chrome/Quartz Grey	7G27 SS1USB BC-QG	7G27 SS2USBULT BC-QG	-
Bright Chrome	White/White	-	-	-
Matt Black	Black/Black	7G2MB SS1USB BL-B	7G2MB SS2USBULT BL-B	7G2MB SS2USBC BL-B
Matt White	White/White	7G2MW SS1USB WH-W	7G2MW SS2USBULT WH-W	7G2MW SS2USBC WH-W
Richmond Bronze	Black/Black	7G2RB SS1USB BL-B	7G2RB SS2USBULT BL-B	7G2RB SS2USBC BL-B
Satin Stainless	Black/Black	-	-	-
Satin Stainless	Satin Stainless/Black	7G24 SS1USB SS-B	7G24 SS2USBULT SS-B	7G24 SS2USBC SS-B
Satin Stainless	Satin Stainless/Quartz Grey	7G24 SS1USBSS-QG	7G24 SS2USBULTSS-QG	-
Satin Stainless	Satin Stainless/White	7G24 SS1USB SS-W	7G24 SS2USBULT SS-W	7G24 SS2USBC SS-W
Satin Stainless	White/White	-	-	-
	Nominal Size:	87.4mm x 87.4mm	144.4 x 87.4mm	144.4 x 87.4mm
	Minimum Wall Box Depth:	35mm	35mm	35mm
	Technical Insert Ref:	SS1USB	SS2USBULT	SS2USBC

Insert Surround Colour Key: (-B) Black, (-W) White, (-QG) Quartz Grey

Hartland G2

Hotel Cards / Television Coaxial Socket



7G28 C11 BK-B







7G27 TV W



7G24 TVI B



7G2MW TVSAT W

Plate Finish	Insert Finish / Surround Colour				
		1 gang 10AX (6AX) On/Off Blue LED	1 gang Non-Isolated TV 1in/1out	1 gang Isolated TV 1in/1out	2 gang Non-Isolated TV + Satellite 2in/2out
Antique Brass	Antique Brass/Black	7G29 C11 AB-B	-	-	-
Antique Brass	Black/Black	-	7G29 TV B	7G29 TVI B	7G29 TVSAT B
Black Nickel	Black Nickel/Black	7G28 C11 BK-B	-	-	-
Black Nickel	Black/Black	-	7G28 TV B	7G28 TVI B	7G28 TVSAT B
Bright Chrome	Bright Chrome/White	7G27 C11 BC-W	-	-	-
Bright Chrome	Bright Chrome/Black	7G27 C11 BC-B	-	-	-
Bright Chrome	Black/Black	-	7G27 TV B	7G27 TVI B	7G27 TVSAT B
Bright Chrome	Quartz Grey	-	7G27 TV QG	-	-
Bright Chrome	White/White	-	7G27 TV W	7G27 TVI W	7G27 TVSAT W
Matt Black	Black/Black	7G2MB C11 BL-B	7G2MB TV B	7G2MB TVI B	7G2MB TVSAT B
Matt White	White/White	7G2MW C11 WH-W	7G2MW TV W	7G2MW TVI W	7G2MW TVSAT W
Richmond Bronze	Black/Black	7G2RB C11 BL-B	7G2RB TV B	7G2RB TVI B	7G2RB TVSAT B
Satin Stainless	Black/Black	-	7G24 TV B	7G24 TVI B	7G24 TVSAT B
Satin Stainless	Satin Stainless/Black	7G24 C11 SS-B	-	-	-
Satin Stainless	Quartz Grey	-	7G24 TV QG	-	-
Satin Stainless	Satin Stainless/White	7G24 C11 SS-W	-	-	-
Satin Stainless	White/White	-	7G24 TV W	7G24 TVI W	7G24 TVSAT W
	Nominal Size:	87.4mm x 87.4mm	87.4mm x 87.4mm	87.4mm x 87.4mm	87.4mm x 87.4mm
	Minimum Wall Box Depth:	35mm	25mm	25mm	35mm
	Technical Insert Ref:	C11	TV	TVI	TVSAT

Insert Surround Colour Key: (-B) Black, (-W) White, (-QG) Quartz Grey

Hartland G2

Digital Television Sockets / Telephone Sockets



7G2MB DTVF B



7G29 DENT B



7G27 TCM W



7G24 TCS QG



1 gang TV Female
Non-Isolated DAB
Compatible



TV/FM/SAT
Non-Isolated DAB
1 SAT 2 Quadplexer
2in/4out



1 gang
Telephone
Master



1 gang
Telephone
Slave

Plate Finish	Insert Finish / Surround Colour	1 gang TV Female Non-Isolated DAB Compatible	TV/FM/SAT Non-Isolated DAB 1 SAT 2 Quadplexer 2in/4out	1 gang Telephone Master	1 gang Telephone Slave
Antique Brass	Black	-	-	-	-
Antique Brass	Black	7G29 DTVF B	7G29 DENT B	7G29 TCM B	7G29 TCS B
Black Nickel	Black	7G28 DTVF B	7G28 DENT B	7G28 TCM B	7G28 TCS B
Bright Chrome	Black	-	-	-	-
Bright Chrome	White	-	-	-	-
Bright Chrome	Black	7G27 DTVF B	7G27 DENT B	7G27 TCM B	7G27 TCS B
Bright Chrome	Quartz Grey	-	-	7G27 TCM QG	7G27 TCS QG
Bright Chrome	White	7G27 DTVF W	7G27 DENT W	7G27 TCM W	7G27 TCS W
Matt Black	Black	7G2MB DTVF B	7G2MB DENT B	7G2MB TCM B	7G2MB TCS B
Matt White	White	7G2MW DTVF W	7G2MW DENT W	7G2MW TCM W	7G2MW TCS W
Richmond Bronze	Black	7G2RB DTVF B	7G2RB DENT B	7G2RB TCM B	7G2RB TCS B
Satin Stainless	Black	7G24 DTVF B	7G24 DENT B	7G24 TCM B	7G24 TCS B
Satin Stainless	Black	-	-	-	-
Satin Stainless	Quartz Grey	-	-	7G24 TCM QG	7G24 TCS QG
Satin Stainless	White	-	-	-	-
Satin Stainless	White	7G24 DTVF W	7G24 DENT W	7G24 TCM W	7G24 TCS W
	Nominal Size:	87.4mm x 87.4mm	87.4mm x 87.4mm	87.4mm x 87.4mm	87.4mm x 87.4mm
	Minimum Wall Box Depth:	35mm	35mm	25mm	25mm
	Technical Insert Ref:	DTV F	DENT	TCM	TCS

Insert Surround Colour Key: (-B) Black, (-W) White, (-QG) Quartz Grey

Hartland G2

Data Outlets



7G2MB J45 B







7G24 J45 QG



7G28 J45-C6 B



7G27 2J45 C6 B

Plate Finish	Insert Finish / Surround Colour				
		1 gang RJ45 CAT 5E Outlet Unshielded	2 gang RJ45 CAT 5E Outlet Unshielded	1 gang RJ45 CAT 6 Outlet Unshielded	2 gang RJ45 CAT 6 Outlet Unshielded
Antique Brass	Black	7G29 J45 B	7G29 2J45 B	7G29 J45-C6 B	7G29 2J45-C6 B
Black Nickel	Black	7G28 J45 B	7G28 2J45 B	7G28 J45-C6 B	7G28 2J45-C6 B
Bright Chrome	Black	7G27 J45 B	7G27 2J45 B	7G27 J45-C6 B	7G27 2J45-C6 B
Bright Chrome	Quartz Grey	7G27 J45 QG	7G27 2J45 QG	7G27 J45-C6 QG	7G27 2J45-C6 QG
Bright Chrome	White	7G27 J45 W	7G27 2J45 W	7G27 J45-C6 W	7G27 2J45-C6 W
Matt Black	Black	7G2MB J45 B	7G2MB 2J45 B	7G2MB J45-C6 B	7G2MB 2J45-C6 B
Matt White	White	7G2MW J45 W	7G2MW 2J45 W	7G2MW J45-C6 W	7G2MW 2J45-C6 W
Richmond Bronze	Black	7G2RB J45 B	7G2RB 2J45 B	7G2RB J45-C6 B	7G2RB 2J45-C6 B
Satin Stainless	Black	7G24 J45 B	7G24 2J45 B	7G24 J45-C6 B	7G24 2J45-C6 B
Satin Stainless	Quartz Grey	7G24 J45 QG	7G24 2J45 QG	7G24 J45-C6 QG	7G24 2J45-C6 QG
Satin Stainless	White	7G24 J45 W	7G24 2J45 W	7G24 J45-C6 W	7G24 2J45-C6 W
	Nominal Size:	87.4mm x 87.4mm	87.4mm x 87.4mm	87.4mm x 87.4mm	87.4 x 87.4mm
	Minimum Wall Box Depth:	35mm	35mm	35mm	35mm
	Technical Insert Ref:	J45	2J45	J45-C6	2J45-C6

Insert Surround Colour Key: (-B) Black, (-W) White, (-QG) Quartz Grey

Hartland G2

Double Pole Switches



7G2RB DPNBL-B





7G2MB DPNC BL-B



7G28 45N B

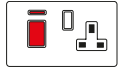

7G27 45SS1 BC-W

Plate Finish	Insert Finish / Surround Colour	 1 gang 20AX Double Pole Rocker + Neon	 1 gang 20AX Double Pole Rocker + Neon + Cable Outlet	 1 gang 45A Double Pole Red Rocker + Neon	 45A Double Pole Red Rocker + Neon + 13A Switched Socket
Antique Brass	Antique Brass/Black	7G29 DPN AB-B	7G29 DPNC AB-B	-	7G29 45SS1 AB-B
Antique Brass	Black/Black	-	-	7G29 45N B	-
Black Nickel	Black Nickel/Black	7G28 DPN BK-B	7G28 DPNC BK-B	-	7G28 45SS1 BK-B
Black Nickel	Black/Black	-	-	7G28 45N B	-
Bright Chrome	Bright Chrome/Black	7G27 DPN BC-B	7G27 DPNC BC-B	-	7G27 45SS1 BC-B
Bright Chrome	Bright Chrome/White	7G27 DPN BC-W	7G27 DPNC BC-W	-	7G27 45SS1 BC-W
Bright Chrome	Black/Black	-	-	7G27 45N B	-
Bright Chrome	Bright Chrome/Quartz Grey	-	-	-	7G27 45SS1 BC-QG
Bright Chrome	Quartz Grey	-	-	7G27 45N QG	-
Bright Chrome	White/White	-	-	7G27 45N W	-
Matt Black	Black/Black	7G2MB DPN BL-B	7G2MB DPNC BL-B	7G2MB 45N B	7G2MB 45SS1 BL-B
Matt White	White/White	7G2MW DPN WH-W	7G2MW DPNC WH-W	7G2MW 45N W	7G2MW 45SS1 WH-W
Richmond Bronze	Black/Black	7G2RB DPN BL-B	7G2RB DPNC BL-B	7G2RB 45N B	7G2RB 45SS1 BL-B
Satin Stainless	Black/Black	-	-	7G24 45N B	-
Satin Stainless	Satin Stainless/Black	7G24 DPN SS-B	7G24 DPNC SS-B	-	7G24 45SS1 SS-B
Satin Stainless	Satin Stainless/Quartz Grey	-	-	-	7G24 45SS1SS-QG
Satin Stainless	Quartz Grey	-	-	7G24 45N QG	-
Satin Stainless	Satin Stainless/White	7G24 DPN SS-W	7G24 DPNC SS-W	-	7G24 45SS1 SS-W
Satin Stainless	White/White	-	-	7G24 45N W	-
	Nominal Size:	87.4mm x 87.4mm	87.4mm x 87.4mm	87.4mm x 87.4mm	144.4 x 87.4mm
	Minimum Wall Box Depth:	25mm	35mm	35mm	35mm
	Technical Insert Ref:	DPN	DPNC	45N	45SS1

Insert Surround Colour Key: (-B) Black, (-W) White, (-QG) Quartz Grey

Hartland G2

Connection Units





7G28 SPN BK-B



7G27 SP BC-B



7G2MB FN BL-R

Plate Finish	Insert Finish / Surround Colour	 1 gang 13A Double Pole+ Fused Spur+Neon	 1 gang 13A Double Pole+ Fused Spur	 1 gang 13A Fuse with Red Neon Halo
Antique Brass	Antique Brass/Black	7G29 SPN AB-B	7G29 SP AB-B	7G29 FN AB-R
Antique Brass	Black/Black	-	-	-
Black Nickel	Black Nickel/Black	7G28 SPN BK-B	7G28 SP BK-B	7G28 FN BK-R
Bright Chrome	Bright Chrome/Black	7G27 SPN BC-B	7G27 SP BC-B	-
Bright Chrome	Bright Chrome/White	7G27 SPN BC-W	7G27 SP BC-W	7G27 FN BC-R
Bright Chrome	Black/Black	-	-	-
Bright Chrome	Bright Chrome/Quartz Grey	7G27 SPN BC-QG	-	-
Bright Chrome	Quartz Grey	-	-	-
Bright Chrome	White/White	-	-	-
Matt Black	Black/Black	7G2MB SPN BL-B	7G2MB SP BL-B	7G2MB FN BL-R
Matt White	White/White	7G2MW SPN WH-W	7G2MW SP WH-W	7G2MW FN WH-R
Richmond Bronze	Black/Black	7G2RB SPN BL-B	7G2RB SP BL-B	7G2RB FN BL-R
Satin Stainless	Black/Black	-	-	-
Satin Stainless	Satin Stainless/Black	7G24 SPN SS-B	7G24 SP SS-B	7G24 FN SS-R
Satin Stainless	Satin Stainless/Quartz Grey	7G24 SPN SS-QG	-	-
Satin Stainless	Satin Stainless/White	7G24 SPN SS-W	7G24 SP SS-W	-
Satin Stainless	White/White	-	-	-
	Nominal Size:	87.4mm x 87.4mm	87.4mm x 87.4mm	87.4mm x 87.4mm
	Minimum Wall Box Depth:	35mm	35mm	35mm
	Technical Insert Ref:	SPN	SP	FN

Insert Surround Colour Key: (-B) Black, (-W) White, (-QG) Quartz Grey

Hartland G2

LED Trailing / Leading Edge Push On/Off Rotary Multi-Way Dimmers



7G2MB 1X100LED





7G27 2X100LED



7G28 3X100LED



7G29 4X100LED

Plate Finish	Insert Finish / Surround Colour	 1 gang 100W LED Multi-Way	 2 gang 100W LED Multi-Way	 3 gang 100W LED Multi-Way	 4 gang 100W LED Multi-Way
Antique Brass	Antique Brass	7G29 1X100LED	7G29 2X100LED	7G29 3X100LED	7G29 4X100LED
Black Nickel	Black Nickel/Black	7G28 1X100LED	7G28 2X100LED	7G28 3X100LED	7G28 4X100LED
Bright Chrome	Bright Chrome	7G27 1X100LED	7G27 2X100LED	7G27 3X100LED	7G27 4X100LED
Matt Black	Black/Black	7G2MB 1X100LED	7G2MB 2X100LED	7G2MB 3X100LED	7G2MB 4X100LED
Matt White	White/White	7G2MW 1X100LED	7G2MW 2X100LED	7G2MW 3X100LED	7G2MW 4X100LED
Richmond Bronze	Richmond Bronze	7G2RB 1X100LED	7G2RB 2X100LED	7G2RB 3X100LED	7G2RB 4X100LED
Satin Stainless	Satin Stainless	7G24 1X100LED	7G24 2X100LED	7G24 3X100LED	7G24 4X100LED
	Nominal Size:	87.4mm x 87.4mm	87.4mm x 87.4mm	144.4mm x 87.4mm	144.4 x 87.4mm
	Minimum Wall Box Depth:	35mm	35mm	35mm	35mm
	Technical Insert Ref:	1X100LED	2X100LED	3X100LED	4X100LED

NOTE: Tungsten filament GU10 lamps must be branded and with a fused base.
 NOTE: Please refer to the Dimmer Technical Section for the max Wattage.
 NOTE: Please contact our Technical Department for compatibility.

Hartland G2

LED Trailing/Leading Edge Push On/Off Rotary 2 Way Switching Dimmers



7G27 1XLEDITB100



7G29 2XLEDITB100



7G28 3XLEDITB100



7G2RB 4XLEDITB100

100W LED Trailing/Leading Edge Push On/Off Rotary 2-Way

Plate Finish	Insert Finish / Surround Colour	 1 gang 100W LED 2 Way	 2 gang 100W LED 2 way	 3 gang 100W LED 2 way	 4 gang 100W LED 2 way
Antique Brass	Antique Brass	7G29 1XLEDITB100	7G29 2XLEDITB100	7G29 3XLEDITB100	7G29 4XLEDITB100
Black Nickel	Black Nickel/Black	7G28 1XLEDITB100	7G28 2XLEDITB100	7G28 3XLEDITB100	7G28 4XLEDITB100
Bright Chrome	Bright Chrome	7G27 1XLEDITB100	7G27 2XLEDITB100	7G27 3XLEDITB100	7G27 4XLEDITB100
Matt Black	Black/Black	7G2MB 1XLEDITB100	7G2MB 2XLEDITB100	7G2MB 3XLEDITB100	7G2MB 4XLEDITB100
Matt White	White/White	7G2MW 1XLEDITB100	7G2MW 2XLEDITB100	7G2MW 3XLEDITB100	7G2MW 4XLEDITB100
Richmond Bronze	Richmond Bronze	7G2RB 1XLEDITB100	7G2RB 2XLEDITB100	7G2RB 3XLEDITB100	7G2RB 4XLEDITB100
Satin Stainless	Satin Stainless	7G24 1XLEDITB100	7G24 2XLEDITB100	7G24 3XLEDITB100	7G24 4XLEDITB100
Nominal Size:		87.4mm x 87.4mm	87.4mm x 87.4mm	144.4mm x 87.4mm	144.4 x 87.4mm
Minimum Wall Box Depth:		35mm	35mm	35mm	35mm
Technical Insert Ref:		1XLEDITB100	2XLEDITB100	3XLEDITB100	4XLEDITB100

NOTE: Tungsten filament GU10 lamps must be branded and with a fused base.



NOTE: Please refer to the Dimmer Technical Section for the max Wattage.

NOTE: Please contact our Technical Department for compatibility.

Blank Plates



7G29 BPD

Plate Finish	 Single Plate	 Double Plate
Antique Brass	7G29 BPS	7G29 BPD
Black Nickel	7G28 BPS	7G28 BPD
Bright Chrome	7G27 BPS	7G27 BPD
Matt Black	7G2MB BPS	7G2MB BPD
Matt White	7G2MW BPS	7G2MW BPD
Richmond Bronze	7G2RB BPS	7G2RB BPD
Satin Stainless	7G24 BPS	7G24 BPD
Nominal Size:	87.4mm x 87.4mm	144.4 x 87.4mm
Minimum Wall Box Depth:	As per inserts	As per inserts
Technical Insert Ref:	BPS	BPD

Hartland G2

Grid-IT - Concealed Fixing Grid Fix Plates complete with Fixing Grid



7G28 1GP



7G29 1GP

Plate Finish	Insert Finish / Surround Colour	1 Gang Grid Fix Aperture Plate with grid	2 Gang Grid Fix Aperture Plate with grid	3 Gang Grid Fix Aperture Plate with grid	4 Gang Grid Fix Aperture Plate with grid
Antique Brass	-	7G29 1GP	7G29 2GP	7G29 3GP	7G29 4GP
Black Nickel	-	7G28 1GP	7G28 2GP	7G28 3GP	7G28 4GP
Bright Chrome	-	7G27 1GP	7G27 2GP	7G27 3GP	7G27 4GP
Matt Black	-	7G2MB 1GP	7G2MB 2GP	7G2MB 3GP	7G2MB 4GP
Matt White	-	7G2MW 1GP	7G2MW 2GP	7G2MW 3GP	7G2MW 4GP
Richmond Bronze	-	7G2RB 1GP	7G2RB 2GP	7G2RB 3GP	7G2RB 4GP
Satin Stainless	-	7G24 1GP	7G24 2GP	7G24 3GP	7G24 4GP
Nominal Size:		87.4mm x 87.4mm	87.4mm x 87.4mm	144.4mm x 87.4mm	144.4mm x 87.4mm
Minimum Wall Box Depth:		As per Inserts 1GP	As per inserts 2GP	As per inserts 3GP	As per Inserts 4GP
Technical Insert Ref:					

EuroFix Plates



7G2MB EURO1



7G27 EURO2



7G28 EURO4

Plate Finish	Insert Finish / Surround Colour	1 Module EuroFix Aperture 25x50	2 Module EuroFix Aperture 50x50	4 Module EuroFix Aperture 100x50
Antique Brass	-	7G29 EURO1	7G29 EURO2	7G29 EURO4
Black Nickel	-	7G28 EURO1	7G28 EURO2	7G28 EURO4
Bright Chrome	-	7G27 EURO1	7G27 EURO2	7G27 EURO4
Matt Black	-	7G2MB EURO1	7G2MB EURO2	7G2MB EURO4
Matt White	-	7G2MW EURO1	7G2MW EURO2	7G2MW EURO4
Richmond Bronze	-	7G2RB EURO1	7G2RB EURO2	7G2RB EURO4
Satin Stainless	-	7G24 EURO1	7G24 EURO2	7G24 EURO4
Nominal Size:		87.4mm x 87.4mm	87.4mm x 87.4mm	144.4mm x 87.4mm
Minimum Wall Box Depth:		As per inserts EURO1	As per inserts EURO2	As per inserts EURO4
Technical Insert Ref:				



Hartland CFX[®]

Concealed Fixing Accessories on Stylish Slim Plates

Slim and stylish with soft rounded edges, the Hartland CFX[®] range helps provide the finishing touch to any project. The face plates are firmly held in place to the back frame with a patented 4 point clipping system, concealing the fixings for a seamless finish.

- Superb finishes, including four shades of bronze
- Elegant finishes with complementary finishes on switch inserts
- Concealed fixing
- Comprehensive range of electrical accessories
- Grid and EuroFix options also available (see separate GRID-IT and EuroFix sections for inserts.)



Hartland CFX[®] Range



71CDPNPBW

79C TVB

77C 2J45 B

74C C11 55 W

Plate finishes available in this range



Antique Brass

Black Nickel

Bright Chrome

Connaught Bronze

Copper Bronze

Etrium Bronze

Gloss White

Matt Black

Polished Nickel

Primed White

Richmond Bronze

Satin Brass

Satin Steel Effect

Hamilton Hartland CFX[®] Concealed Fixing

Plate depth 5 mm including gasket

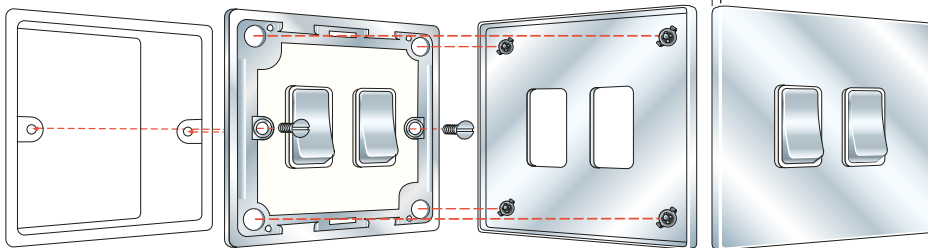

Screw fixings to Back Box

Frame and Insert showing the two back box screws

Front Plate viewed from the back showing the snap-in fixing clips

The finished product with all fixing screws concealed

Hartland CFX

Rocker Switches



79C R21 AB-B





78C R22 BK-B



74C R23 SS-W

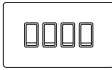
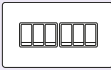

72C R26 SB-W

Plate Finish	Insert Finish/ Surround Colour	 1 gang 10AX 2 Way Rocker	 2 gang 10AX 2 Way Rocker	 3 gang 10AX 2 Way Rocker	 4 gang 10AX 2 Way Rocker	 6 gang 10AX 2 Way Rocker
Antique Brass	Antique Brass/Black	79C R21 AB-B	79C R22 AB-B	79C R23 AB-B	79C R24 AB-B	79C R26 AB-B
Black Nickel	Black Nickel/Black	78C R21 BK-B	78C R22 BK-B	78C R23 BK-B	78C R24 BK-B	78C R26 BK-B
Bright Chrome	Bright Chrome/Black	77C R21 BC-B	77C R22 BC-B	77C R23 BC-B	77C R24 BC-B	77C R26 BC-B
Bright Chrome	Bright Chrome/White	77C R21 BC-W	77C R22 BC-W	77C R23 BC-W	77C R24 BC-W	77C R26 BC-W
Connaught Bronze	Black/Black	7HBC R21 BL-B	7HBC R22 BL-B	7HBC R23 BL-B	7HBC R24 BL-B	7HBC R26 BL-B
Copper Bronze	Black/Black	7CBC R21 BL-B	7CBC R22 BL-B	7CBC R23 BL-B	7CBC R24 BL-B	7CBC R26 BL-B
Etrium Bronze	Black/Black	7EBC R21 BL-B	7EBC R22 BL-B	7EBC R23 BL-B	7EBC R24 BL-B	7EBC R26 BL-B
Gloss White	White/White	70C R21 WH-W	70C R22 WH-W	70C R23 WH-W	70C R24 WH-W	70C R26 WH-W
Polished Brass	Polished Brass/Black	71C R21 PB-B	71C R22 PB-B	71C R23 PB-B	71C R24 PB-B	71C R26 PB-B
Polished Brass	Polished Brass/White	71C R21 PB-W	71C R22 PB-W	71C R23 PB-W	71C R24 PB-W	71C R26 PB-W
Polished Nickel	Bright Chrome/Black	7PNC R21 BC-B	7PNC R22 BC-B	7PNC R23 BC-B	-	-
Polished Nickel	Bright Chrome/White	7PNC R21 BC-W	7PNC R22 BC-W	7PNC R23 BC-W	-	-
Primed White	Black/Black	7WPC R21 BL-B	7WPC R22 BL-B	7WPC R23 BL-B	7WPC R24 BL-B	7WPC R26 BL-B
Primed White	White/White	7WPC R21 WH-W	7WPC R22 WH-W	7WPC R23 WH-W	7WPC R24 WH-W	7WPC R26 WH-W
Richmond Bronze	Black/Black	7RBC R21 BL-B	7RBC R22 BL-B	7RBC R23 BL-B	7RBC R24 BL-B	7RBC R26 BL-B
Satin Brass	Satin Brass/Black	72C R21 SB-B	72C R22 SB-B	72C R23 SB-B	72C R24 SB-B	72C R26 SB-B
Satin Brass	Satin Brass/White	72C R21 SB-W	72C R22 SB-W	72C R23 SB-W	72C R24 SB-W	72C R26 SB-W
Satin Steel Effect	Satin Steel/Black	74C R21 SS-B	74C R22 SS-B	74C R23 SS-B	74C R24 SS-B	74C R26 SS-B
Satin Steel Effect	Satin Steel/White	74C R21 SS-W	74C R22 SS-W	74C R23 SS-W	74C R24 SS-W	74C R26 SS-W
	Nominal Size: Minimum Wall Box Depth: Technical Insert Ref:	86.0mm x 86.0mm 25mm R21	86.0mm x 86.0mm 25mm R22	86.0mm x 86.0mm 25mm R23	145.0mm x 86.0mm 25mm R24	145.0mm x 86.0mm 25mm R26

Insert Surround Colour Key: (-B) Black, (-W) White

Hartland CFX

Rocker Switches



79C R31 AB-B







78C R32 BK-B



71C RRT PB-B



72C TP WH-W

Plate Finish	Insert Finish/ Surround Colour				
		1 gang 10AX Intermediate Rocker	2 gang 10AX Intermediate Rocker	1 gang 10AX Push To Make/ Push to Break Retractable Rocker	1 gang 10A Triple Pole Rocker
Antique Brass	Antique Brass/Black	79C R31 AB-B	79C R32 AB-B	79C RRT AB-B	-
Antique Brass	Black/Black	-	-	-	79C TP BL-B
Black Nickel	Black/Black	-	-	-	78C TP BL-B
Black Nickel	Black Nickel/Black	78C R31 BK-B	78C R32 BK-B	78C RRT BK-B	-
Bright Chrome	Black/Black	-	-	-	77C TP BL-B
Bright Chrome	Bright Chrome/Black	77C R31 BC-B	77C R32 BC-B	77C RRT BC-B	-
Bright Chrome	Bright Chrome/White	77C R31 BC-W	77C R32 BC-W	77C RRT BC-W	-
Bright Chrome	White/White	-	-	-	77C TP WH-W
Connaught Bronze	Black/Black	7HBC R31 BL-B	7HBC R32 BL-B	7HBC RRT BL-B	7HBC TP BL-B
Copper Bronze	Black/Black	7CBC R31 BL-B	7CBC R32 BL-B	7CBC RRT BL-B	7CBC TP BL-B
Etrium Bronze	Black/Black	7EBC R31 BL-B	7EBC R32 BL-B	7EBC RRT BL-B	7EBC TP BL-B
Gloss White	White/White	70C R31 WH-W	70C R32 WH-W	70C RRT WH-W	70C TP WH-W
Polished Brass	Black/Black	-	-	-	71C TP BL-B
Polished Brass	Polished Brass/Black	71C R31 PB-B	71C R32 PB-B	71C RRT PB-B	-
Polished Brass	Polished Brass/White	71C R31 PB-W	71C R32 PB-W	71C RRT PB-W	-
Polished Brass	White/White	-	-	-	71C TP WH-W
Polished Nickel	Black/Black	-	-	-	7PNC TP BL-B
Polished Nickel	Bright Chrome/Black	7PNC R31 BC-B	-	-	-
Polished Nickel	Bright Chrome/White	7PNC R31 BC-W	-	-	-
Polished Nickel	White/White	-	-	-	7PNC TP WH-W
Primed White	Black/Black	7WPC R31 BL-B	7WPC R32 BL-B	7WPC RRT BL-B	7WPC TP BL-B
Primed White	White/White	7WPC R31 WH-W	7WPC R32 WH-W	7WPC RRT WH-W	7WPC TP WH-W
Richmond Bronze	Black/Black	7RBC R31 BL-B	7RBC R32 BL-B	7RBC RRT BL-B	7RBC TP BL-B
Satin Brass	Black/Black	-	-	-	72C TP BL-B
Satin Brass	Satin Brass/Black	72C R31 SB-B	72C R32 SB-B	72C RRT SB-B	-
Satin Brass	Satin Brass/White	72C R31 SB-W	72C R32 SB-W	72C RRT SB-W	-
Satin Brass	White/White	-	-	-	72C TP WH-W
Satin Steel Effect	Black/Black	-	-	-	74C TP BL-B
Satin Steel Effect	Satin Steel/Black	74C R31 SS-B	74C R32 SS-B	74C RRT SS-B	-
Satin Steel Effect	Satin Steel/White	74C R31 SS-W	74C R32 SS-W	74C RRT SS-W	-
Satin Steel Effect	White/White	-	-	-	74C TP WH-W
	Nominal Size:	86.0mm x 86.0mm	86.0mm x 86.0mm	86.0mm x 86.0mm	86.0mm x 86.0mm
	Minimum Wall Box Depth:	25mm	25mm	25mm	25mm
	Technical Insert Ref:	R31	R32	RRT	TP

Insert Surround Colour Key: (-B) Black, (-W) White

Hartland CFX

Rocker Switches



77C R212 BC-B









78C R222 BK-B



71C R232 PB-W



72C R242 SB-B

Plate Finish	Insert Finish/ Surround Colour	 		 		 	
		1 gang 20AX 2 Way Rocker	2 gang 20AX 2 Way Rocker	3 gang 20AX 2 Way Rocker	4 gang 20AX 2 Way Rocker	1 gang 20AX Intermediate Rocker	2 gang 20AX Intermediate Rocker
Antique Brass	Antique Brass/Black	79C R212 AB-B	79C R222 AB-B	79C R232 AB-B	79C R242 AB-B	79C R312 AB-B	79C R322 AB-B
Black Nickel	Black Nickel/Black	78C R212 BK-B	78C R222 BK-B	78C R232 BK-B	78C R242 BK-B	78C R312 BK-B	78C R322 BK-B
Bright Chrome	Bright Chrome/Black	77C R212 BC-B	77C R222 BC-B	77C R232 BC-B	77C R242 BC-B	77C R312 BC-B	77C R322 BC-B
Bright Chrome	Bright Chrome/White	77C R212 BC-W	77C R222 BC-W	77C R232 BC-W	77C R242 BC-W	77C R312 BC-W	77C R322 BC-W
Connaught Bronze	Black/Black	7HBC R212 BL-B	7HBC R222 BL-B	7HBC R232 BL-B	7HBC R242 BL-B	7HBC R312 BL-B	7HBC R322 BL-B
Copper Bronze	Black/Black	7CBC R212 BL-B	7CBC R222 BL-B	7CBC R232 BL-B	7CBC R242 BL-B	7CBC R312 BL-B	7CBC R322 BL-B
Etrium Bronze	Black/Black	7EBC R212 BL-B	7EBC R222 BL-B	7EBC R232 BL-B	7EBC R242 BL-B	7EBC R312 BL-B	7EBC R322 BL-B
Gloss White	White/White	70C R212 WH-W	70C R222 WH-W	70C R232 WH-W	70C R242 WH-W	70C R312 WH-W	70C R322 WH-W
Polished Brass	Polished Brass/Black	71C R212 PB-B	71C R222 PB-B	71C R232 PB-B	71C R242 PB-B	71C R312 PB-B	71C R322 PB-B
Polished Brass	Polished Brass/White	71C R212 PB-W	71C R222 PB-W	71C R232 PB-W	71C R242 PB-W	71C R312 PB-W	71C R322 PB-W
Primed White	Black/Black	7WPC R212 BL-B	7WPC R222 BL-B	7WPC R232 BL-B	7WPC R242 BL-B	7WPC R312 BL-B	7WPC R322 BL-B
Primed White	White/White	7WPC R212 WH-W	7WPC R222 WH-W	7WPC R232 WH-W	7WPC R242 WH-W	7WPC R312 WH-W	7WPC R322 WH-W
Richmond Bronze	Black/Black	7RBC R212 BL-B	7RBC R222 BL-B	7RBC R232 BL-B	7RBC R242 BL-B	7RBC R312 BL-B	7RBC R322 BL-B
Satin Brass	Satin Brass/Black	72C R212 SB-B	72C R222 SB-B	72C R232 SB-B	72C R242 SB-B	72C R312 SB-B	72C R322 SB-B
Satin Brass	Satin Brass/White	72C R212 SB-W	72C R222 SB-W	72C R232 SB-W	72C R242 SB-W	72C R312 SB-W	72C R322 SB-W
Satin Steel Effect	Satin Steel/Black	74C R212 SS-B	74C R222 SS-B	74C R232 SS-B	74C R242 SS-B	74C R312 SS-B	74C R322 SS-B
Satin Steel Effect	Satin Steel/White	74C R212 SS-W	74C R222 SS-W	74C R232 SS-W	74C R242 SS-W	74C R312 SS-W	74C R322 SS-W
Nominal Size:		86.0mm x 86.0mm	86.0mm x 86.0mm	145.0mm x 86.0mm	145.0mm x 86.0mm	86.0mm x 86.0mm	86.0mm x 86.0mm
Minimum Wall Box Depth:		25mm	25mm	25mm	25mm	25mm	25mm
Technical Insert Ref:		R212	R222	R232	R242	R312	R322

Insert Surround Colour Key: (-B) Black, (-W) White

Hartland CFX

Wide Rockers



70C WR21 WH-W



74C WR22 SS-B



74C WR23 SS-B



79C W10DP AB-B



1 gang 10AX
2 Way Rocker



2 gang 10AX
2 Way Rocker



3 gang 10AX
2 Way Rocker



1 gang 10AX
Intermediate
Rocker



1 gang 10AX
Push To Make/
Push to Break
Retractive
Rocker



1 gang 10AX
Double Pole

Insert Finish/ Surround Colour							
Plate Finish							
Antique Brass	Antique Brass/Black	79CW R21 AB-B	79CW R22 AB-B	79CW R23 AB-B	79CW R31 AB-B	79CW RRT AB-B	79CW 10DP AB-B
Black Nickel	Black Nickel/Black	78CW R21 BK-B	78CW R22 BK-B	78CW R23 BK-B	78CW R31 BK-B	78CW RRT BK-B	78CW 10DP BK-B
Bright Chrome	Bright Chrome/Black	77CW R21 BC-B	77CW R22 BC-B	77CW R23 BC-B	77CW R31 BC-B	77CW RRT BC-B	77CW 10DP BC-B
Bright Chrome	Bright Chrome/White	77CW R21 BC-W	77CW R22 BC-W	77CW R23 BC-W	77CW R31 BC-W	77CW RRT BC-W	77CW 10DP BC-W
Etrium Bronze	Etrium Bronze/Black	7EBCW R21 BL-B	7EBCW R22 BL-B	7EBCW R23 BL-B	7EBCW R31 BL-B	7EBCW RRT BL-B	7EBCW 10DP BL-B
Gloss White	White/White	70CW R21 WH-W	70CW R22 WH-W	70CW R23 WH-W	70CW R31 WH-W	70CW RRT WH-W	70CW 10DP WH-W
Polished Brass	Polished Brass/Black	71CW R21 PB-B	71CW R22 PB-B	71CW R23 PB-B	71CW R31 PB-B	71CW RRT PB-B	71CW 10DP PB-B
Polished Brass	Polished Brass/White	71CW R21 PB-W	71CW R22 PB-W	71CW R23 PB-W	71CW R31 PB-W	71CW RRT PB-W	71CW 10DP PB-W
Richmond Bronze	Richmond Bronze/Black	7RBCW R21 BL-B	7RBCW R22 BL-B	7RBCW R23 BL-B	7RBCW R31 BL-B	7RBCW RRT BL-B	7RBCW 10DP BL-B
Satin Brass	Satin Brass/Black	72CW R21 SB-B	72CW R22 SB-B	72CW R23 SB-B	72CW R31 SB-B	72CW RRT SB-B	72CW 10DP SB-B
Satin Brass	Satin Brass/White	72CW R21 SB-W	72CW R22 SB-W	72CW R23 SB-W	72CW R31 SB-W	72CW RRT SB-W	72CW 10DP SB-W
Satin Steel Effect	Satin Steel Effect/Black	74CW R21 SS-B	74CW R22 SS-B	74CW R23 SS-B	74CW R31 SS-B	74CW RRT SS-B	74CW 10DP SS-B
Satin Steel Effect	Satin Steel Effect/White	74CW R21 SS-W	74CW R22 SS-W	74CW R23 SS-W	74CW R31 SS-W	74CW RRT SS-W	74CW 10DP SS-W
Nominal Size:		86.0mm x 86.0mm	86.0mm x 86.0mm	86.0mm x 86.0mm	86.0mm x 86.0mm	86.0mm x 86.0mm	86.0mm x 86.0mm
Minimum Wall Box Depth:		25mm	25mm	25mm	25mm	25mm	25mm
Technical Insert Ref:		R21	R22	R23	R31	RRT	10DP

Insert Surround Colour Key: (-B) Black, (-W) White

Hartland CFX

Toggle Switches



79C T21







77C T22



78C T23



71C T24

Plate Finish	Insert Finish/ Surround Colour					
		1 gang 20AX 2 Way Toggle	2 gang 20AX 2 Way Toggle	3 gang 20AX 2 Way Toggle	4 gang 20AX 2 Way Toggle	1 gang 20AX Intermediate Toggle
Antique Brass	Antique Brass	79C T21	79C T22	79C T23	79C T24	79C T31
Black Nickel	Black Nickel	78C T21	78C T22	78C T23	78C T24	78C T31
Bright Chrome	Bright Chrome	77C T21	77C T22	77C T23	77C T24	77C T31
Connaught Bronze	Antique Brass	7HBC T21	7HBC T22	7HBC T23	7HBC T24	7HBC T31
Copper Bronze	Black Nickel	7CBC T21	7CBC T22	7CBC T23	7CBC T24	7CBC T31
Etrium Bronze	Black Nickel	7EBC T21	7EBC T22	7EBC T23	7EBC T24	7EBC T31
Gloss White	-	-	-	-	-	-
Polished Brass	Polished Brass	71C T21	71C T22	71C T23	71C T24	71C T31
Polished Nickel	-	-	-	-	-	-
Primed White	-	-	-	-	-	-
Richmond Bronze	Richmond Bronze	7RBC T21	7RBC T22	7RBC T23	7RBC T24	7RBC T31
Satin Brass	Satin Brass	72C T21	72C T22	72C T23	72C T24	72C T31
Satin Steel Effect	Satin Steel	74C T21	74C T22	74C T23	74C T24	74C T31
	Nominal Size:	86.0mm x 86.0mm	86.0mm x 86.0mm	145.0mm x 86.0mm	145.0mm x 86.0mm	86.0mm x 86.0mm
	Minimum Wall Box Depth:	35mm	35mm	35mm	35mm	35mm
	Technical Insert Ref:	T21	T22	T23	T24	T31

Hartland CFX

Power Sockets



79C SS1 AB-B



77C SS2 BC-W



71C US2 W



72C US99 W

Plate Finish	Insert Finish/ Surround Colour							
		1 gang 13A Double Pole Switched Socket	2 gang 13A Double Pole Switched Socket	1 gang 2A Unswitched Socket	1 gang 5A Unswitched Socket	1 gang 13A Unswitched Socket	2 gang 13A Unswitched Socket	Shaver Dual Voltage Unswitched Socket (Vertically Mounted)
Antique Brass	Antique Brass/Black	79C SS1 AB-B	79C SS2 AB-B	-	-	-	-	-
Antique Brass	Black/Black	-	-	79C US2 B	79C US5 B	79C US13 B	79C US99 B	79C SHS B
Black Nickel	Black Nickel/Black	78C SS1 BK-B	78C SS2 BK-B	-	-	-	-	-
Black Nickel	Black/Black	-	-	78C US2 B	78C US5 B	-	78C US99 B	78C SHS B
Bright Chrome	Bright Chrome/Black	77C SS1 BC-B	77C SS2 BC-B	-	-	-	-	-
Bright Chrome	Black/Black	-	-	77C US2 B	77C US5 B	77C US13 B	77C US99 B	77C SHS B
Bright Chrome	Bright Chrome/White	77C SS1 BC-W	77C SS2 BC-W	-	-	-	-	-
Bright Chrome	White/White	-	-	77C US2 W	77C US5 W	77C US13 W	77C US99 W	77C SHS W
Connaught Bronze	Black/Black	7HBC SS1 BL-B	7HBC SS2 BL-B	7HBC US2 B	7HBC US5 B	7HBC US13 B	7HBC US99 B	7HBC SHS B
Copper Bronze	Black/Black	7CBC SS1 BL-B	7CBC SS2 BL-B	7CBC US2 B	7CBC US5 B	7CBC US13 B	7CBC US99 B	7CBC SHS B
Etrium Bronze	Black/Black	7EBC SS1 BL-B	7EBC SS2 BL-B	7EBC US2 B	7EBC US5 B	7EBC US13 B	7EBC US99 B	7EBC SHS B
Gloss White	White/White	70C SS1 WH-W	70C SS2 WH-W	70C US2 W	70C US5 W	70C US13 W	70C US99 W	70C SHS W
Polished Brass	Polished Brass/Black	71C SS1 PB-B	71C SS2 PB-B	-	-	-	-	-
Polished Brass	Black/Black	-	-	71C US2 B	71C US5 B	71C US13 B	71C US99 B	71C SHS B
Polished Brass	Polished Brass/White	71C SS1 PB-W	71C SS2 PB-W	-	-	-	-	-
Polished Brass	White/White	-	-	71C US2 W	71C US5 W	71C US13 W	71C US99 W	71C SHS W
Polished Nickel	Bright Chrome/Black	7PNC SS1 BC-B	7PNC SS2 BC-B	-	-	-	-	-
Polished Nickel	Black/Black	-	-	-	7PNC US5 B	-	-	7PNC SHS B
Polished Nickel	Bright Chrome/White	7PNC SS1 BC-W	7PNC SS2 BC-W	-	-	-	-	-
Polished Nickel	White/White	-	-	-	7PNC US5 W	-	-	7PNC SHS W
Primed White	Black/Black	7WPC SS1 BL-B	7WPC SS2 BL-B	7WPC US2 B	7WPC US5 B	7WPC US13 B	7WPC US99 B	7WPC SHS B
Primed White	White/White	7WPC SS1 WH-W	7WPC SS2 WH-W	7WPC US2 W	7WPC US5 W	7WPC US13 W	7WPC US99 W	7WPC SHS W
Richmond Bronze	Black/Black	7RBC SS1 BL-B	7RBC SS2 BL-B	7RBC US2 B	7RBC US5 B	7RBC US13 B	7RBC US99 B	7RBC SHS B
Satin Brass	Satin Brass/Black	72C SS1 SB-B	72C SS2 SB-B	-	-	-	-	-
Satin Brass	Black/Black	-	-	72C US2 B	72C US5 B	72C US13 B	72C US99 B	72C SHS B
Satin Brass	Satin Brass/White	72C SS1 SB-W	72C SS2 SB-W	-	-	-	-	-
Satin Brass	White/White	-	-	72C US2 W	72C US5 W	72C US13 W	72C US99 W	72C SHS W
Satin Steel Effect	Satin Steel/Black	74C SS1 SS-B	74C SS2 SS-B	-	-	-	-	-
Satin Steel Effect	Black/Black	-	-	74C US2 B	74C US5 B	74C US13 B	74C US99 B	74C SHS B
Satin Steel Effect	Satin Steel/White	74C SS1 SS-W	74C SS2 SS-W	-	-	-	-	-
Satin Steel Effect	White/White	-	-	74C US2 W	74C US5 W	74C US13 W	74C US99 W	74C SHS W
	Nominal Size:	86.0mm x 86.0mm	145.0mm x 86.0mm	86.0mm x 86.0mm	86.0mm x 86.0mm	86.0mm x 86.0mm	145.0mm x 86.0mm	86.0mm x 145.0mm
	Minimum Wall Box Depth:	35mm	35mm	35mm	35mm	35mm	35mm	47mm
	Technical Insert Ref:	SS1	SS2	US2	US5	US13	US99	SHS

Insert Surround Colour Key: (-B) Black, (-W) White

Hartland CFX

USB Power Sockets



77C SS1USB BC-B



74C SS2USBULT SS-B

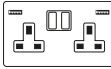
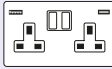

79C SS2USBC AB-B

Plate Finish	Insert Finish/ Surround Colour			
		1 gang 13A Single Pole Switched Socket with 1 USB Outlet 1x2.1A	2 gang 13A Double Pole Switched Socket with 2 USB Outlet 2x2.4A (4.8A Total)	2 gang 13A Double Pole Switched Socket with 1 USB Outlet + 1 USB Type C Outlet 2x2.4A (4.8A Total)
Antique Brass	Antique Brass/Black	79C SS1USB AB-B	79C SS2USBULT AB-B	79C SS2USBC AB-B
Black Nickel	Black Nickel/Black	78C SS1USB BK-B	78C SS2USBULT BK-B	78C SS2USBC BK-B
Bright Chrome	Bright Chrome/Black	77C SS1USB BC-B	77C SS2USBULT BC-B	77C SS2USBC BC-B
Bright Chrome	Bright Chrome/White	77C SS1USB BC-W	77C SS2USBULT BC-W	77C SS2USBC BC-W
Connaught Bronze	Black/Black	7HBC SS1USB BL-B	7HBC SS2USBULT BL-B	7CHBC SS2USBC BL-B
Copper Bronze	Black/Black	7CBC SS1USB BL-B	7CBC SS2USBULT BL-B	7CBC SS2USBC BL-B
Etrium Bronze	Black/Black	7EBC SS1USB BL-B	7EBC SS2USBULT BL-B	7EBC SS2USBC BL-B
Gloss White	White/White	70C SS1USB WH-W	70C SS2USBULT WH-W	70C SS2USBC WH-W
Polished Brass	Polished Brass/Black	71C SS1USB PB-B	71C SS2USBULT PB-B	71C SS2USBC PB-B
Polished Brass	Polished Brass/White	71C SS1USB PB-W	71C SS2USBULT PB-W	71C SS2USBC PB-W
Polished Nickel	Bright Chrome/Black	7PNC SS1USB BC-B	7PNC SS2USBULT BC-B	7PNC SS2USBC BC-B
Polished Nickel	Bright Chrome/White	7PNC SS1USB BC-W	7PNC SS2USBULT BC-W	7PNC SS2USBC BC-W
Primed White	Black/Black	7WPC SS1USB BL-B	7WPC SS2USBULT BL-B	7WPC SS2USBC BL-B
Primed White	White/White	7WPC SS1USB WH-W	7WPC SS2USBULT WH-W	7WPC SS2USBC WH-W
Richmond Bronze	Black/Black	7RBC SS1USB BL-B	7RBC SS2USBULT BL-B	7RBC SS2USBC BL-B
Satin Brass	Satin Brass/Black	72C SS1USB SB-B	72C SS2USBULT SB-B	72C SS2USBC SB-B
Satin Brass	Satin Brass/White	72C SS1USB SB-W	72C SS2USBULT SB-W	72C SS2USBC SB-W
Satin Steel Effect	Satin Steel/Black	74C SS1USB SS-B	74C SS2USBULT SS-B	74C SS2USBC SS-B
Satin Steel Effect	Satin Steel/White	74C SS1USB SS-W	74C SS2USBULT SS-W	74C SS2USBC SS-W
	Nominal Size:	86.0mm x 86.0mm	145.0mm x 86.0mm	145.0mm x 86.0mm
	Minimum Wall Box Depth:	35mm	35mm	35mm
	Technical Insert Ref:	SS1USBX1	SS2USBX2ULT	SS2USBC

Insert Surround Colour Key: (-B) Black, (-W) White

Hartland CFX

Key Switches



71C K21 W



72C KEL B



71C C11 PB-B



1 gang 20AX 2 Way
Key Switch



1 gang 20AX 2 Way
Key Switch EMG LTG
TEST

Plate Finish	Insert Colour		
Antique Brass	Black	79C K21 B	79C KEL B
Black Nickel	Black	78C K21 B	78C KEL B
Bright Chrome	Black	77C K21 B	77C KEL B
Bright Chrome	White	77C K21 W	77C KEL W
Connaught Bronze	Black	7HBC K21 B	7HBC KEL B
Copper Bronze	Black	7CBC K21 B	7CBC KEL B
Etrium Bronze	Black	7EBC K21 B	7EBC KEL B
Gloss White	White	70C K21 W	70C KEL W
Polished Brass	Black	71C K21 B	71C KEL B
Polished Brass	White	71C K21 W	71C KEL W
Polished Nickel	-	-	-
Primed White	Black	7WPC K21 B	7WPC KEL B
Primed White	White	7WPC K21 W	7WPC KEL W
Richmond Bronze	Black	7RBC K21 B	7RBC KEL B
Satin Brass	Black	72C K21 B	72C KEL B
Satin Brass	White	72C K21 W	72C KEL W
Satin Steel Effect	Black	74C K21 B	74C KEL B
Satin Steel Effect	White	74C K21 W	74C KEL W
Nominal Size:		86.0mm x 86.0mm	86.0mm x 86.0mm
Minimum Wall Box Depth:		25mm	25mm
Technical Insert Ref:		K21	KEL



1 gang 10A (6AX)
Card Switch On/Off with
Blue LED Locator

Plate Finish	Insert Finish / Surround Colour	
Antique Brass	Antique Brass/Black	79C C11 AB-B
Black Nickel	Black Nickel/Black	78C C11 BK-B
Bright Chrome	Bright Chrome/Black	77C C11 BC-B
Bright Chrome	Bright Chrome/White	77C C11 BC-W
Connaught Bronze	Black/Black	7HBC C11 BL-B
Copper Bronze	Black/Black	7CBC C11 BL-B
Etrium Bronze	Black/Black	7EBC C11 BL-B
Gloss White	White/White	70C C11 WH-W
Polished Brass	Polished Brass/Black	71C C11 PB-B
Polished Brass	Polished Brass/White	71C C11 PB-W
Polished Nickel	-	-
Primed White	Black/Black	7WPC C11 BL-B
Primed White	White/White	7WPC C11 WH-W
Richmond Bronze	Black/Black	7RBC C11 BL-B
Satin Brass	Satin Brass/Black	72C C11 SB-B
Satin Brass	Satin Brass/White	72C C11 SB-W
Satin Steel Effect	Satin Steel/Black	74C C11 SS-B
Satin Steel Effect	Satin Steel/White	74C C11 SS-W
Nominal Size:		86.0mm x 86.0mm
Minimum Wall Box Depth:		35mm
Technical Insert Ref:		C11

Insert Surround Colour Key: (-B) Black, (-W) White

Hotel Card Switch with LED

Hartland CFX

Television Coaxial Sockets



78C TV B



71C TVFM W



72C TVSAT B



74C SATI W

Plate Finish	Insert Colour						
		1 gang Non-Isolated TV 1in/1out	Isolated TV/FM Diplexer 1in/2out	1 gang Isolated TV 1in/1out	2 gang Non-Isolated TV+Satellite 2in/2out	1 gang Non-Isolated Satellite	1 gang Isolated Satellite
Antique Brass	Black	79C TV B	79C TVFM B	79C TVI B	79C TVSAT B	79C SATN B	79C SATI B
Black Nickel	Black	78C TV B	78C TVFM B	78C TVI B	78C TVSAT B	78C SATN B	78C SATI B
Bright Chrome	Black	77C TV B	77C TVFM B	77C TVI B	77C TVSAT B	77C SATN B	77C SATI B
Bright Chrome	White	77C TV W	77C TVFM W	77C TVI W	77C TVSAT W	77C SATN W	77C SATI W
Connaught Bronze	Black	7HBC TV B	7HBC TVFM B	7HBC TVI B	7HBC TVSAT B	7HBC SATN B	7HBC SATI B
Copper Bronze	Black	7CBC TV B	7CBC TVFM B	7CBC TVI B	7CBC TVSAT B	7CBC SATN B	7CBC SATI B
Etrium Bronze	Black	7EBC TV B	7EBC TVFM B	7EBC TVI B	7EBC TVSAT B	7EBC SATN B	7EBC SATI B
Gloss White	White	70C TV W	70C TVFM W	70C TVI W	70C TVSAT W	70C SATN W	70C SATI W
Polished Brass	Black	71C TV B	71C TVFM B	71C TVI B	71C TVSAT B	71C SATN B	71C SATI B
Polished Brass	White	71C TV W	71C TVFM W	71C TVI W	71C TVSAT W	71C SATN W	71C SATI W
Polished Nickel	Black	7PNC TV B	-	-	-	-	-
Polished Nickel	White	7PNC TV W	-	-	-	-	-
Primed White	Black	7WPC TV B	7WPC TVFM B	7WPC TVI B	7WPC TVSAT B	7WPC SATN B	7WPC SATI B
Primed White	White	7WPC TV W	7WPC TVFM W	7WPC TVI W	7WPC TVSAT W	7WPC SATN W	7WPC SATI W
Richmond Bronze	Black	7RBC TV B	7RBC TVFM B	7RBC TVI B	7RBC TVSAT B	7RBC SATN B	7RBC SATI B
Satin Brass	Black	72C TV B	72C TVFM B	72C TVI B	72C TVSAT B	72C SATN B	72C SATI B
Satin Brass	White	72C TV W	72C TVFM W	72C TVI W	72C TVSAT W	72C SATN W	72C SATI W
Satin Steel Effect	Black	74C TV B	74C TVFM B	74C TVI B	74C TVSAT B	74C SATN B	74C SATI B
Satin Steel Effect	White	74C TV W	74C TVFM W	74C TVI W	74C TVSAT W	74C SATN W	74C SATI W
Nominal Size:		86.0mm x 86.0mm	86.0mm x 86.0mm	86.0mm x 86.0mm	86.0mm x 86.0mm	86.0mm x 86.0mm	86.0mm x 86.0mm
Minimum Wall Box Depth:		25mm	25mm	25mm	35mm	35mm	35mm
Technical Insert Ref:		TV	TVFM	TVI	TVSAT	SATN	SATI

Insert Surround Colour Key: (-B) Black, (-W) White

Hartland CFX

Digital Television Sockets

- Screened Non-Isolated / DAB Compatible



77C DTRID W



78C DTVF B



71C DSAT W



72C DSAT+ W



Non-Isolated
TV+FM+SAT
Triplexer 1in/3out
(DAB Compatible)



1 gang
Non-Isolated TV
(Female)
(DAB Compatible)



1 gang
Non-Isolated TV
(Male)
(DAB Compatible)



1 gang
Non-Isolated
Satellite
(DAB Compatible)



Non-Isolated
TV+FM+SAT1+SAT2
Quadplexer 2in/4out
(DAB Compatible)

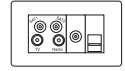

Non-Isolated
TV+FM+SAT1+SAT2
Quadplexer 2in/4out
+TVF+TCS
(DAB Compatible)

Plate Finish	Insert Colour	79C DTRID B	79C DTVF B	79C DTVM B	79C DSAT B	79C DENT B	79C DSAT+ B
Antique Brass	Black	79C DTRID B	79C DTVF B	79C DTVM B	79C DSAT B	79C DENT B	79C DSAT+ B
Black Nickel	Black	78C DTRID B	78C DTVF B	78C DTVM B	78C DSAT B	78C DENT B	78C DSAT+ B
Bright Chrome	Black	77C DTRID B	77C DTVF B	77C DTVM B	77C DSAT B	77C DENT B	77C DSAT+ B
Bright Chrome	White	77C DTRID W	77C DTVF W	77C DTVM W	77C DSAT W	77C DENT W	77C DSAT+ W
Connaught Bronze	Black	7HBC DTRID B	7HBC DTVF B	7HBC DTVM B	7HBC DSAT B	7HBC DENT B	7HBC DSAT+ B
Copper Bronze	Black	7CBC DTRID B	7CBC DTVF B	7CBC DTVM B	7CBC DSAT B	7CBC DENT B	7CBC DSAT+ B
Etrium Bronze	Black	7EBC DTRID B	7EBC DTVF B	7EBC DTVM B	7EBC DSAT B	7EBC DENT B	7EBC DSAT+ B
Gloss White	White	70C DTRID W	70C DTVF W	70C DTVM W	70C DSAT W	70C DENT W	70C DSAT+ W
Polished Brass	Black	71C DTRID B	71C DTVF B	71C DTVM B	71C DSAT B	71C DENT B	71C DSAT+ B
Polished Brass	White	71C DTRID W	71C DTVF W	71C DTVM W	71C DSAT W	71C DENT W	71C DSAT+ W
Polished Nickel	-	-	-	-	-	-	-
Primed White	Black	7WPC DTRID B	7WPC DTVF B	7WPC DTVM B	7WPC DSAT B	7WPC DENT B	7WPC DSAT+ B
Primed White	White	7WPC DTRID W	7WPC DTVF W	7WPC DTVM W	7WPC DSAT W	7WPC DENT W	7WPC DSAT+ W
Richmond Bronze	Black	7RBC DTRID B	7RBC DTVF B	7RBC DTVM B	7RBC DSAT B	7RBC DENT B	7RBC DSAT+ B
Satin Brass	Black	72C DTRID B	72C DTVF B	72C DTVM B	72C DSAT B	72C DENT B	72C DSAT+ B
Satin Brass	White	72C DTRID W	72C DTVF W	72C DTVM W	72C DSAT W	72C DENT W	72C DSAT+ W
Satin Steel Effect	Black	74C DTRID B	74C DTVF B	74C DTVM B	74C DSAT B	74C DENT B	74C DSAT+ B
Satin Steel Effect	White	74C DTRID W	74C DTVF W	74C DTVM W	74C DSAT W	74C DENT W	74C DSAT+ W
Nominal Size:		86.0mm x 86.0mm	86.0mm x 86.0mm	86.0mm x 86.0mm	86.0mm x 86.0mm	86.0mm x 86.0mm	145.0mm x 86.0mm
Minimum Wall Box Depth:		35mm	35mm	35mm	35mm	35mm	35mm
Technical Insert Ref:		DTRID	DTV F	DTVM	DSAT	DENT	DSAT+

Insert Surround Colour Key: (-B) Black, (-W) White

Hartland CFX

Telephone and Data Outlets



79C TCM B









78C TCS B



71C J12 W



74C 2J45 B

Plate Finish	Insert Colour						
		1 gang Telephone Master	1 gang Telephone Slave	1 gang RJ12 Outlet - Unshielded	2 gang RJ12 Outlet - Unshielded	1 gang RJ45 CAT 5E Outlet - Unshielded	2 gang RJ45 CAT 5E Outlet - Unshielded
Antique Brass	Black	79C TCM B	79C TCS B	79C J12 B	79C 2J12 B	79C J45 B	79C 2J45 B
Black Nickel	Black	78C TCM B	78C TCS B	78C J12 B	78C 2J12 B	78C J45 B	78C 2J45 B
Bright Chrome	Black	77C TCM B	77C TCS B	77C J12 B	77C 2J12 B	77C J45 B	77C 2J45 B
Bright Chrome	White	77C TCM W	77C TCS W	77C J12 W	77C 2J12 W	77C J45 W	77C 2J45 W
Connaught Bronze	Black	7HBC TCM B	7HBC TCS B	7HBC J12 B	7HBC 2J12 B	7HBC J45 B	7HBC 2J45 B
Copper Bronze	Black	7CBC TCM B	7CBC TCS B	7CBC J12 B	7CBC 2J12 B	7CBC J45 B	7CBC 2J45 B
Etrium Bronze	Black	7EBC TCM B	7EBC TCS B	7EBC J12 B	7EBC 2J12 B	7EBC J45 B	7EBC 2J45 B
Gloss White	White	70C TCM W	70C TCS W	70C J12 W	70C 2J12 W	70C J45 W	70C 2J45 W
Polished Brass	Black	71C TCM B	71C TCS B	71C J12 B	71C 2J12 B	71C J45 B	71C 2J45 B
Polished Brass	White	71C TCM W	71C TCS W	71C J12 W	71C 2J12 W	71C J45 W	71C 2J45 W
Polished Nickel	Black	7PNC TCM B	7PNC TCS B	-	-	-	-
Polished Nickel	White	7PNC TCM W	7PNC TCS W	-	-	-	-
Primed White	Black	7WPC TCM B	7WPC TCS B	7WPC J12 B	7WPC 2J12 B	7WPC J45 B	7WPC 2J45 B
Primed White	White	7WPC TCM W	7WPC TCS W	7WPC J12 W	7WPC 2J12 W	7WPC J45 W	7WPC 2J45 W
Richmond Bronze	Black	7RBC TCM B	7RBC TCS B	7RBC J12 B	7RBC 2J12 B	7RBC J45 B	7RBC 2J45 B
Satin Brass	Black	72C TCM B	72C TCS B	72C J12 B	72C 2J12 B	72C J45 B	72C 2J45 B
Satin Brass	White	72C TCM W	72C TCS W	72C J12 W	72C 2J12 W	72C J45 W	72C 2J45 W
Satin Steel Effect	Black	74C TCM B	74C TCS B	74C J12 B	74C 2J12 B	74C J45 B	74C 2J45 B
Satin Steel Effect	White	74C TCM W	74C TCS W	74C J12 W	74C 2J12 W	74C J45 W	74C 2J45 W
Nominal Size:		86.0mm x 86.0mm	86.0mm x 86.0mm	86.0mm x 86.0mm	86.0mm x 86.0mm	86.0mm x 86.0mm	86.0mm x 86.0mm
Minimum Wall Box Depth:		25mm	25mm	35mm	35mm	35mm	35mm
Technical Insert Ref:		TCM	TCS	J12	2J12	J45	2J45

Insert Surround Colour Key: (-B) Black, (-W) White

Hartland CFX

Double Pole Switches



77C DPN BC-B



78C 45N B



79C 45SS1 AB-B

Plate Finish	Insert Finish/ Surround Colour	 1 gang 20AX Double Pole Rocker + Neon	 1 gang 45A Double Pole Red Rocker + Neon	 45A Double Pole Red Rocker + Neon + 13A Switched Socket
Antique Brass	Antique Brass/Black	79C DPN AB-B	-	79C 45SS1 AB-B
Antique Brass	Black/Black	-	79C 45N B	-
Black Nickel	Black/Black	-	78C 45N B	-
Black Nickel	Black Nickel/Black	78C DPN BK-B	-	78C 45SS1 BK-B
Bright Chrome	Black/Black	-	77C 45N B	-
Bright Chrome	Bright Chrome/Black	77C DPN BC-B	-	77C 45SS1 BC-B
Bright Chrome	Bright Chrome/White	77C DPN BC-W	-	77C 45SS1 BC-W
Bright Chrome	White/White	-	77C 45N W	-
Connaught Bronze	Black/Black	7HBC DPN BL-B	7HBC 45N B	7HBC 45SS1 BL-B
Copper Bronze	Black/Black	7CBC DPN BL-B	7CBC 45N B	7CBC 45SS1 BL-B
Etrium Bronze	Black/Black	7EBC DPN BL-B	7EBC 45N B	7EBC 45SS1 BL-B
Gloss White	White/White	70C DPN WH-W	70C 45N W	70C 45SS1 WH-W
Polished Brass	Black/Black	-	71C 45N B	-
Polished Brass	Polished Brass/Black	71C DPN PB-B	-	71C 45SS1 PB-B
Polished Brass	Polished Brass/White	71C DPN PB-W	-	71C 45SS1 PB-W
Polished Brass	White/White	-	71C 45N W	-
Polished Nickel	-	-	-	-
Primed White	Black/Black	7WPC DPN BL-B	7WPC 45N B	7WPC 45SS1 BL-B
Primed White	White/White	7WPC DPN WH-W	7WPC 45N W	7WPC 45SS1 WH-W
Richmond Bronze	Black/Black	7RBC DPN BL-B	7RBC 45N B	7RBC 45SS1 BL-B
Satin Brass	Black/Black	-	72C 45N B	-
Satin Brass	Satin Brass/Black	72C DPN SB-B	-	72C 45SS1 SB-B
Satin Brass	Satin Brass/White	72C DPN SB-W	-	72C 45SS1 SB-W
Satin Brass	White/White	-	72C 45N W	-
Satin Steel Effect	Black/Black	-	74C 45N B	-
Satin Steel Effect	Satin Steel/Black	74C DPN SS-B	-	74C 45SS1 SS-B
Satin Steel Effect	Satin Steel/White	74C DPN SS-W	-	74C 45SS1 SS-W
Satin Steel Effect	White/White	-	74C 45N W	-
Nominal Size:		86.0mm x 86.0mm	86.0mm x 86.0mm	145.0mm x 86.0mm
Minimum Wall Box Depth:		25mm	35mm	35mm
Technical Insert Ref:		DPN	45N	45SS1

Insert Surround Colour Key: (-B) Black, (-W) White

Hartland CFX

Connection Units



72C SPN SB-B



74C FN SS-R



1 gang 13A
Double Pole
Fused Spur +
Neon



1 gang 13A Fuse with
Red Neon Halo

Plate Finish	Insert Finish/ Surround Colour	1 gang 13A Double Pole Fused Spur + Neon	1 gang 13A Fuse with Red Neon Halo
Antique Brass	Antique Brass/Black	79C SPN AB-B	79C FN AB-R
Black Nickel	Black Nickel/Black	78C SPN BK-B	78C FN BK-R
Bright Chrome	Bright Chrome/Black	77C SPN BC-B	77C FN BC-R
Bright Chrome	Bright Chrome/White	77C SPN BC-W	-
Connaught Bronze	Black/Black	7HBC SPN BL-B	7HBC FN BL-R
Copper Bronze	Black/Black	7CBC SPN BL-B	7CBC FN BL-R
Etrium Bronze	Black/Black	7EBC SPN BL-B	7EBC FN BL-R
Gloss White	White/White	70C SPN WH-W	70C FN WH-R
Polished Brass	Polished Brass/Black	71C SPN PB-B	71C FN PB-R
Polished Brass	Polished Brass/White	71C SPN PB-W	-
Polished Nickel	Bright Chrome/Black	7PNC SPN BC-B	-
Polished Nickel	Bright Chrome/White	7PNC SPN BC-W	-
Primed White	Black/Black	7WPC SPN BL-B	7WPC FN BL-R
Primed White	White/White	7WPC SPN WH-W	7WPC FN WH-R
Richmond Bronze	Black/Black	7RBC SPN BL-B	7RBC FN BL-R
Satin Brass	Satin Brass/Black	72C SPN SB-B	72C FN SB-R
Satin Brass	Satin Brass/White	72C SPN SB-W	-
Satin Steel Effect	Satin Steel/Black	74C SPN SS-B	74C FN SS-R
Satin Steel Effect	Satin Steel/White	74C SPN SS-W	-
	Nominal Size:	86.0mm x 86.0mm	86.0mm x 86.0mm
	Minimum Wall Box Depth:	35mm	35mm
	Technical Insert Ref:	SPN	FN

Insert Surround Colour Key: (-B) Black, (-W) White

Hartland CFX

LED Trailing/Leading Edge Push On/Off Rotary 2 Way Switching Dimmers



74C 1XLEDITB100



77C 2XLEDITB100



72C 3XLEDITB100



71C 4XLEDITB100

Plate Finish	Insert Finish	1 gang 100W LED Trailing/Leading Edge Push On/Off Rotary 2 Way Switching Dimmer	2 gang 100W LED Trailing/Leading Edge Push On/Off Rotary 2 Way Switching Dimmer	3 gang 100W LED Trailing/Leading Edge Push On/Off Rotary 2 Way Switching Dimmer	4 gang 100W LED Trailing/Leading Edge Push On/Off Rotary 2 Way Switching Dimmer
Antique Brass	Antique Brass	79C 1XLEDITB100	79C 2XLEDITB100	79C 3XLEDITB100	79C 4XLEDITB100
Black Nickel	Black Nickel	78C 1XLEDITB100	78C 2XLEDITB100	78C 3XLEDITB100	78C 4XLEDITB100
Bright Chrome	Bright Chrome	77C 1XLEDITB100	77C 2XLEDITB100	77C 3XLEDITB100	77C 4XLEDITB100
Connaught Bronze	Connaught Bronze	7HBC 1XLEDITB100	7HBC 2XLEDITB100	7HBC 3XLEDITB100	7HBC 4XLEDITB100
Copper Bronze	Copper Bronze	7CBC 1XLEDITB100	7CBC 2XLEDITB100	7CBC 3XLEDITB100	7CBC 4XLEDITB100
Etrium Bronze	Etrium Bronze	7EBC 1XLEDITB100	7EBC 2XLEDITB100	7EBC 3XLEDITB100	7EBC 4XLEDITB100
Gloss White	Gloss White	70C 1XLEDITB100	70C 2XLEDITB100	70C 3XLEDITB100	70C 4XLEDITB100
Polished Brass	Polished Brass	71C 1XLEDITB100	71C 2XLEDITB100	71C 3XLEDITB100	71C 4XLEDITB100
Polished Nickel	-	-	-	-	-
Primed White	White	7WPC 1XLEDITB100	7WPC 2XLEDITB100	7WPC 3XLEDITB100	7WPC 4XLEDITB100
Richmond Bronze	Richmond Bronze	7RBC 1XLEDITB100	7RBC 2XLEDITB100	7RBC 3XLEDITB100	7RBC 4XLEDITB100
Satin Brass	Satin Brass	72C 1XLEDITB100	72C 2XLEDITB100	72C 3XLEDITB100	72C 4XLEDITB100
Satin Steel Effect	Satin Steel	74C 1XLEDITB100	74C 2XLEDITB100	74C 3XLEDITB100	74C 4XLEDITB100
	Nominal Size:	86.0mm x 86.0mm	86.0mm x 86.0mm	145.0mm x 86.0mm	145.0mm x 86.0mm
	Minimum Wall Box Depth:	35mm	35mm	35mm	35mm
	Technical Insert Ref:	1XLEDITB	2XLEDITB	3XLEDITB	4XLEDITB

LED Trailing/Leading Edge Push On/Off Rotary Multi-Way Dimmers

Plate Finish	Insert Finish	1 gang 100W LED Trailing/Leading Edge Push On/Off Rotary Multi-Way Dimmer	2 gang 100W LED Trailing/Leading Edge Push On/Off Rotary Multi-Way Dimmer	3 gang 100W LED Trailing/Leading Edge Push On/Off Rotary Multi-Way Dimmer	4 gang 100W LED Trailing/Leading Edge Push On/Off Rotary Multi-Way Dimmer
Antique Brass	Antique Brass	79C 1X100LED	79C 2X100LED	79C 3X100LED	79C 4X100LED
Black Nickel	Black Nickel	78C 1X100LED	78C 2X100LED	78C 3X100LED	78C 4X100LED
Bright Chrome	Bright Chrome	77C 1X100LED	77C 2X100LED	77C 3X100LED	77C 4X100LED
Connaught Bronze	Connaught Bronze	7HBC 1X100LED	7HBC 2X100LED	7HBC 3X100LED	7HBC 4X100LED
Copper Bronze	Copper Bronze	7CBC 1X100LED	7CBC 2X100LED	7CBC 3X100LED	7CBC 4X100LED
Etrium Bronze	Etrium Bronze	7EBC 1X100LED	7EBC 2X100LED	7EBC 3X100LED	7EBC 4X100LED
Gloss White	Gloss White	70C 1X100LED	70C 2X100LED	70C 3X100LED	70C 4X100LED
Polished Brass	Polished Brass	71C 1X100LED	71C 2X100LED	71C 3X100LED	71C 4X100LED
Polished Nickel	-	-	-	-	-
Primed White	White	7WPC 1X100LED	7WPC 2X100LED	7WPC 3X100LED	7WPC 4X100LED
Richmond Bronze	Richmond Bronze	7RBC 1X100LED	7RBC 2X100LED	7RBC 3X100LED	7RBC 4X100LED
Satin Brass	Satin Brass	72C 1X100LED	72C 2X100LED	72C 3X100LED	72C 4X100LED
Satin Steel Effect	Satin Steel	74C 1X100LED	74C 2X100LED	74C 3X100LED	74C 4X100LED
	Nominal Size:	86.0mm x 86.0mm	86.0mm x 86.0mm	145.0mm x 86.0mm	145.0mm x 86.0mm
	Minimum Wall Box Depth:	35mm	35mm	35mm	35mm
	Technical Insert Ref:	1X100LED	2X100LED	3X100LED	4X100LED

NOTE: Tungsten filament GU10 lamps must be branded and with a fused base.
 NOTE: Please refer to the Dimmer Technical Section for the max Wattage.
 NOTE: Please contact our Technical Department for compatibility.

Hartland CFX

Resistive Leading Edge Push On/Off Rotary 2 Way Switching Dimmers



79C 1X40



79C 2X40



79C 3X40

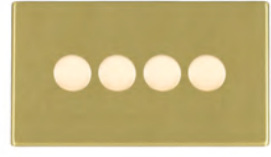

79C 4X40

Plate Finish	Insert Finish	1 gang 400W Resistive Leading Edge Push On/Off Rotary 2 Way Switching Dimmer	2 gang 400W Resistive Leading Edge Push On/Off Rotary 2 Way Switching Dimmer	3 gang 400W Resistive Leading Edge Push On/Off Rotary 2 Way Switching Dimmer	4 gang 400W Resistive Leading Edge Push On/Off Rotary 2 Way Switching Dimmer	1 gang 600W Resistive Leading Edge Push On/Off Rotary 2 Way Switching Dimmer
Antique Brass	Antique Brass	79C 1X40	79C 2X40	79C 3X40	79C 4X40	79C 1X60
Black Nickel	Black Nickel	78C 1X40	78C 2X40	78C 3X40	78C 4X40	78C 1X60
Bright Chrome	Bright Chrome	77C 1X40	77C 2X40	77C 3X40	77C 4X40	77C 1X60
Connaught Bronze	Connaught Bronze	7HBC 1X40	7HBC 2X40	7HBC 3X40	7HBC 4X40	7HBC 1X60
Copper Bronze	Copper Bronze	7CBC 1X40	7CBC 2X40	7CBC 3X40	7CBC 4X40	7CBC 1X60
Etrium Bronze	Etrium Bronze	7EBC 1X40	7EBC 2X40	7EBC 3X40	7EBC 4X40	7EBC 1X60
Gloss White	Gloss White	70C 1X40	70C 2X40	70C 3X40	70C 4X40	70C 1X60
Polished Brass	Polished Brass	71C 1X40	71C 2X40	71C 3X40	71C 4X40	71C 1X60
Polished Nickel	-	-	-	-	-	-
Primed White	White	7WPC 1X40	7WPC 2X40	7WPC 3X40	7WPC 4X40	7WPC 1X60
Richmond Bronze	Richmond Bronze	7RBC 1X40	7RBC 2X40	7RBC 3X40	7RBC 4X40	7RBC 1X60
Satin Brass	Satin Brass	72C 1X40	72C 2X40	72C 3X40	72C 4X40	72C 1X60
Satin Steel Effect	Satin Steel	74C 1X40	74C 2X40	74C 3X40	74C 4X40	74C 1X60
	Nominal Size:	86.0mm x 86.0mm	86.0mm x 86.0mm	145.0mm x 86.0mm	145.0mm x 86.0mm	86.0mm x 86.0mm
	Minimum Wall Box Depth:	35mm	35mm	35mm	35mm	35mm
	Technical Insert Ref:	1X40	2X40	3X40	4X40	1X60

NOTE: Tungsten filament GU10 lamps must be branded and with a fused base

NOTE: When using mains voltage halogen lamps – dimmers should be re-rated by 25%

NOTE: When dimming LED lamps de-rate by 75% - please contact our Technical Department for compatibility.

NOTE: Please refer to the Dimmer Technical Section for the max wattage

Hartland CFX

Inductive Leading Edge Push On/Off Rotary 2 Way Switching Dimmers



71C 1X2V



1 gang 200VA
Inductive Leading Edge
Push On/Off Rotary
2 Way Switching Dimmer

Plate Finish	Insert Finish	
Antique Brass	Antique Brass	79C 1X2V
Black Nickel	Black Nickel	78C 1X2V
Bright Chrome	Bright Chrome	77C 1X2V
Connaught Bronze	Connaught Bronze	7HBC 1X2V
Copper Bronze	Copper Bronze	7CBC 1X2V
Etrium Bronze	Etrium Bronze	7EBC 1X2V
Gloss White	Gloss White	70C 1X2V
Polished Brass	Polished Brass	71C 1X2V
Polished Nickel	-	-
Primed White	White	7WPC 1X2V
Richmond Bronze	Richmond Bronze	7RBC 1X2V
Satin Brass	Satin Brass	72C 1X2V
Satin Steel Effect	Satin Steel	74C 1X2V
	Nominal Size:	86.0mm x 86.0mm
	Minimum Wall Box Depth:	35mm
	Technical Insert Ref:	1X2V

NOTE: Tungsten filament GU10 lamps must be branded and with a fused base

NOTE: When using mains voltage halogen lamps – dimmers should be re-rated by 25%

NOTE: When dimming LED lamps de-rate by 75% - please contact our Technical Department for compatibility.

NOTE: Please refer to the Dimmer Technical Section for the max wattage

Hartland CFX

Resistive/Inductive Trailing Edge Push On/Off Rotary Multi-Way Dimmers



79C 1XTE





77C 2XTE



72C 3XTE

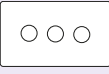
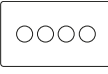

74C 4XTE

Plate Finish	Insert Finish	 1 gang 250W/210VA Resistive/Inductive Trailing Edge Push On/Off Rotary Multi-Way Dimmer	 2 gang 250W/210VA Resistive/Inductive Trailing Edge Push On/Off Rotary Multi-Way Dimmer	 3 gang 250W/210VA Resistive/Inductive Trailing Edge Push On/Off Rotary Multi-Way Dimmer	 4 gang 250W/210VA Resistive/Inductive Trailing Edge Push On/Off Rotary Multi-Way Dimmer
Antique Brass	Antique Brass	79C 1XTE	79C 2XTE	79C 3XTE	79C 4XTE
Black Nickel	Black Nickel	78C 1XTE	78C 2XTE	78C 3XTE	78C 4XTE
Bright Chrome	Bright Chrome	77C 1XTE	77C 2XTE	77C 3XTE	77C 4XTE
Connaught Bronze	Connaught Bronze	7HBC 1XTE	7HBC 2XTE	7HBC 3XTE	7HBC 4XTE
Copper Bronze	Copper Bronze	7CBC 1XTE	7CBC 2XTE	7CBC 3XTE	7CBC 4XTE
Etrium Bronze	Etrium Bronze	7EBC 1XTE	7EBC 2XTE	7EBC 3XTE	7EBC 4XTE
Gloss White	Gloss White	70C 1XTE	70C 2XTE	70C 3XTE	70C 4XTE
Polished Brass	Polished Brass	71C 1XTE	71C 2XTE	71C 3XTE	71C 4XTE
Polished Nickel	-	-	-	-	-
Primed White	White	7WPC 1XTE	7WPC 2XTE	7WPC 3XTE	7WPC 4XTE
Richmond Bronze	Richmond Bronze	7RBC 1XTE	7RBC 2XTE	7RBC 3XTE	7RBC 4XTE
Satin Brass	Satin Brass	72C 1XTE	72C 2XTE	72C 3XTE	72C 4XTE
Satin Steel Effect	Satin Steel	74C 1XTE	74C 2XTE	74C 3XTE	74C 4XTE
	Nominal Size:	86.0mm x 86.0mm	86.0mm x 86.0mm	145.0mm x 86.0mm	145.0mm x 86.0mm
	Minimum Wall Box Depth:	35mm	35mm	35mm	35mm
	Technical Insert Ref:	1XTE	2XTE	3XTE	4XTE

NOTE: Tungsten filament GU10 lamps must be branded and with a fused base
 NOTE: When using mains voltage halogen lamps – dimmers should be re-rated by 25%
 NOTE: When dimming LED lamps de-rate by 75% - please contact our Technical Department for compatibility.
 NOTE: Please refer to the Dimmer Technical Section for the max wattage

Hartland CFX

Resistive/Inductive Trailing Edge Touch Master Multi-Way Dimmers



77C 1XTM BC-W





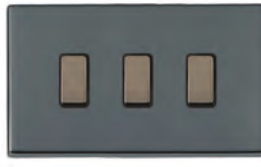

77C 2XTM BC-B

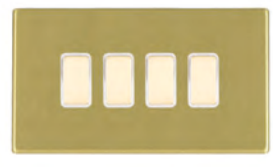

78C 3XTM BK-B



72C 4XTM SB-W

Plate Finish	Insert Finish / Surround Colour	 1 gang 250W/210VA Resistive/Inductive Trailing Edge Touch Master Multi-Way Dimmer	 2 gang 250W/210VA Resistive/Inductive Trailing Edge Touch Master Multi-Way Dimmer	 3 gang 250W/210VA Resistive/Inductive Trailing Edge Touch Master Multi-Way Dimmer	 4 gang 250W/210VA Resistive/Inductive Trailing Edge Touch Master Multi-Way Dimmer
Antique Brass	Antique Brass/Black	79C 1XTM AB-B	79C 2XTM AB-B	79C 3XTM AB-B	79C 4XTM AB-B
Black Nickel	Black Nickel/Black	78C 1XTM BK-B	78C 2XTM BK-B	78C 3XTM BK-B	78C 4XTM BK-B
Bright Chrome	Bright Chrome/Black	77C 1XTM BC-B	77C 2XTM BC-B	77C 3XTM BC-B	77C 4XTM BC-B
Bright Chrome	Bright Chrome/White	77C 1XTM BC-W	77C 2XTM BC-W	77C 3XTM BC-W	77C 4XTM BC-W
Connaught Bronze	Antique Brass/Black	7HBC 1XTM AB-B	7HBC 2XTM AB-B	7HBC 3XTM AB-B	7HBC 4XTM AB-B
Copper Bronze	Black Nickel/Black	7CBC 1XTM BK-B	7CBC 2XTM BK-B	7CBC 3XTM BK-B	7CBC 4XTM BK-B
Etrium Bronze	Black Nickel/Black	7EBC 1XTM BK-B	7EBC 2XTM BK-B	7EBC 3XTM BK-B	7EBC 4XTM BK-B
Gloss White	-	-	-	-	-
Polished Brass	Polished Brass/Black	71C 1XTM PB-B	71C 2XTM PB-B	71C 3XTM PB-B	71C 4XTM PB-B
Polished Brass	Polished Brass/White	71C 1XTM PB-W	71C 2XTM PB-W	71C 3XTM PB-W	71C 4XTM PB-W
Polished Nickel	-	-	-	-	-
Primed White	-	-	-	-	-
Richmond Bronze	Black Nickel/Black	7RBC 1XTM BK-B	7RBC 2XTM BK-B	7RBC 3XTM BK-B	7RBC 4XTM BK-B
Satin Brass	Satin Brass/Black	72C 1XTM SB-B	72C 2XTM SB-B	72C 3XTM SB-B	72C 4XTM SB-B
Satin Brass	Satin Brass/White	72C 1XTM SB-W	72C 2XTM SB-W	72C 3XTM SB-W	72C 4XTM SB-W
Satin Steel Effect	Satin Steel/Black	74C 1XTM SS-B	74C 2XTM SS-B	74C 3XTM SS-B	74C 4XTM SS-B
Satin Steel Effect	Satin Steel/White	74C 1XTM SS-W	74C 2XTM SS-W	74C 3XTM SS-W	74C 4XTM SS-W
	Nominal Size: Minimum Wall Box Depth: Technical Insert Ref:	86.0mm x 86.0mm 35mm 1XTM	86.0mm x 86.0mm 35mm 2XTM	145.0mm x 86.0mm 35mm 3XTM	145.0mm x 86.0mm 35mm 4XTM

NOTE: Tungsten filament GU10 lamps must be branded and with a fused base
 NOTE: When using mains voltage halogen lamps – dimmers should be re-rated by 25%
 NOTE: When dimming LED lamps de-rate by 75% - please contact our Technical Department for compatibility.
 NOTE: Please refer to the Dimmer Technical Section for the max wattage

Insert Surround Colour Key: (-B) Black, (-W) White

Hartland CFX

Multi-Way Touch Slave Controllers



77C 1XTS BC-B



78C 2XTS BK-B



71C 3XTS PB-W



74C 4XTS SS-W

Plate Finish	Insert Finish/ Surround Colour				
		1 gang Multi-Way Touch Slave Controller	2 gang Multi-Way Touch Slave Controller	3 gang Multi-Way Touch Slave Controller	4 gang Multi-Way Touch Slave Controller
Antique Brass	Antique Brass/Black	79C 1XTS AB-B	79C 2XTS AB-B	79C 3XTS AB-B	79C 4XTS AB-B
Black Nickel	Black Nickel/Black	78C 1XTS BK-B	78C 2XTS BK-B	78C 3XTS BK-B	78C 4XTS BK-B
Bright Chrome	Bright Chrome/Black	77C 1XTS BC-B	77C 2XTS BC-B	77C 3XTS BC-B	77C 4XTS BC-B
Bright Chrome	Bright Chrome/White	77C 1XTS BC-W	77C 2XTS BC-W	77C 3XTS BC-W	77C 4XTS BC-W
Connaught Bronze	Antique Brass/Black	7HBC 1XTS AB-B	7HBC 2XTS AB-B	7HBC 3XTS AB-B	7HBC 4XTS AB-B
Copper Bronze	Black Nickel/Black	7CBC 1XTS BK-B	7CBC 2XTS BK-B	7CBC 3XTS BK-B	7CBC 4XTS BK-B
Etrium Bronze	Black Nickel/Black	7EBC 1XTS BK-B	7EBC 2XTS BK-B	7EBC 3XTS BK-B	7EBC 4XTS BK-B
Gloss White	-	-	-	-	-
Polished Brass	Polished Brass/Black	71C 1XTS PB-B	71C 2XTS PB-B	71C 3XTS PB-B	71C 4XTS PB-B
Polished Brass	Polished Brass/White	71C 1XTS PB-W	71C 2XTS PB-W	71C 3XTS PB-W	71C 4XTS PB-W
Polished Nickel	-	-	-	-	-
Primed White	-	-	-	-	-
Richmond Bronze	Black Nickel/Black	7RBC 1XTS BK-B	7RBC 2XTS BK-B	7RBC 3XTS BK-B	7RBC 4XTS BK-B
Satin Brass	Satin Brass/Black	72C 1XTS SB-B	72C 2XTS SB-B	72C 3XTS SB-B	72C 4XTS SB-B
Satin Brass	Satin Brass/White	72C 1XTS SB-W	72C 2XTS SB-W	72C 3XTS SB-W	72C 4XTS SB-W
Satin Steel Effect	Satin Steel/Black	74C 1XTS SS-B	74C 2XTS SS-B	74C 3XTS SS-B	74C 4XTS SS-B
Satin Steel Effect	Satin Steel/White	74C 1XTS SS-W	74C 2XTS SS-W	74C 3XTS SS-W	74C 4XTS SS-W
	Nominal Size:	86.0mm x 86.0mm	86.0mm x 86.0mm	145.0mm x 86.0mm	145.0mm x 86.0mm
	Minimum Wall Box Depth:	35mm	35mm	35mm	35mm
	Technical Insert Ref:	1XTS	2XTS	3XTS	4XTS

NOTE: To only be used with Touch Masters

Insert Surround Colour Key: (-B) Black, (-W) White

Hartland CFX

Blank Plates



71C BPS

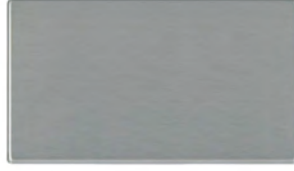

74C BPD



Plate Finish	Single Blank Plate	Double Blank Plate
Antique Brass	79C BPS	79C BPD
Black Nickel	78C BPS	78C BPD
Bright Chrome	77C BPS	77C BPD
Connaught Bronze	7HBC BPS	7HBC BPD
Copper Bronze	7CBC BPS	7CBC BPD
Etrium Bronze	7EBC BPS	7EBC BPD
Gloss White	70C BPS	70C BPD
Polished Brass	71C BPS	71C BPD
Polished Nickel	-	-
Primed White	7WPC BPS	7WPC BPD
Richmond Bronze	7RBC BPS	7RBC BPD
Satin Brass	72C BPS	72C BPD
Satin Steel Effect	74C BPS	74C BPD
Nominal Size:	86.0mm x 86.0mm	145.0mm x 86.0mm
Minimum Wall Box Depth:	Any Box	Any Box
Technical Insert Ref:	BPS	BPD

Hartland CFX





Grid-IT - Concealed Fixing Grid Fix Plates complete with Fixing Grid



79C 1GP



71C 3GP

				
	1 gang Grid Fix Aperture Plate with Grid	2 gang Grid Fix Aperture Plate with Grid	3 gang Grid Fix Aperture Plate with Grid	4 gang Grid Fix Aperture Plate with Grid
Plate Finish				
Antique Brass	79C 1GP	79C 2GP	79C 3GP	79C 4GP
Black Nickel	78C 1GP	78C 2GP	78C 3GP	78C 4GP
Bright Chrome	77C 1GP	77C 2GP	77C 3GP	77C 4GP
Connaught Bronze	7HBC 1GP	7HBC 2GP	7HBC 3GP	7HBC 4GP
Copper Bronze	7CBC 1GP	7CBC 2GP	7CBC 3GP	7CBC 4GP
Etrium Bronze	7EBC 1GP	7EBC 2GP	7EBC 3GP	7EBC 4GP
Gloss White	70C 1GP	70C 2GP	70C 3GP	70C 4GP
Polished Brass	71C 1GP	71C 2GP	71C 3GP	71C 4GP
Polished Nickel	7PNC 1GP	7PNC 2GP	7PNC 3GP	7PNC 4GP
Primed White	7WPC 1GP	7WPC 2GP	7WPC 3GP	7WPC 4GP
Richmond Bronze	7RBC 1GP	7RBC 2GP	7RBC 3GP	7RBC 4GP
Satin Brass	72C 1GP	72C 2GP	72C 3GP	72C 4GP
Satin Steel Effect	74C 1GP	74C 2GP	74C 3GP	74C 4GP
Nominal Size:	86.0mm x 86.0mm	86.0mm x 86.0mm	145.0mm x 86.0mm	146.0mm x 86.0mm
Minimum Wall Box Depth:	As Per Insert	As Per Inserts	As Per Inserts	As Per Inserts
Technical Insert Ref:	1GP	2GP	3GP	4GP

Spare Fixing Grid



7C 1G

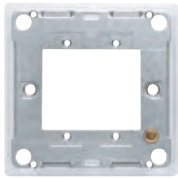



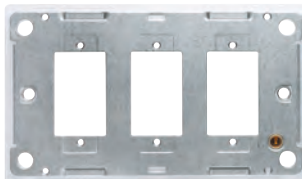

7C 2G



7C 3G



7C 4G

				
	1 gang Insert Grid complete with Gasket	2 gang Insert Grid complete with Gasket	3 gang Insert Grid complete with Gasket	4 gang Insert Grid complete with Gasket
Plate Finish				
No Plate Colour	7C 1G	7C 2G	7C 3G	7C 4G
Nominal Size:	86.0mm x 86.0mm	86.0mm x 86.0mm	145mm x 86.0mm	145mm x 86.0mm
Technical Insert Ref:	7C1G	7C2G	7C3G	7C4G

Note: Minimum Wall Box depth is dependant on the Grid Fix insert fitted, please see the GRID-IT section for the complete range of inserts.

Hartland CFX

EuroFix Apertured Plates complete with Fixing Grids



79CEURO2



78CEURO3

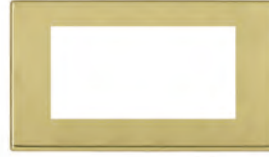

71CEURO4



1 Module EuroFix
25x50mm Apertured
Plate with Grid



2 Module EuroFix
50x50mm Apertured
Plate with Grid

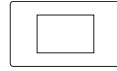

3 Module EuroFix
75x50mm Apertured
Plate with Grid

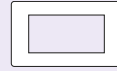

4 Module EuroFix
100x50mm Apertured
Plate with Grid

Plate Finish / Insert	1 Module EuroFix 25x50mm Apertured Plate with Grid	2 Module EuroFix 50x50mm Apertured Plate with Grid	3 Module EuroFix 75x50mm Apertured Plate with Grid	4 Module EuroFix 100x50mm Apertured Plate with Grid
Antique Brass	79C EURO1	79C EURO2	79C EURO3	79C EURO4
Black Nickel	78C EURO1	78C EURO2	78C EURO3	78C EURO4
Bright Chrome	77C EURO1	77C EURO2	77C EURO3	77C EURO4
Connaught Bronze	7HBC EURO1	7HBC EURO2	7HBC EURO3	7HBC EURO4
Copper Bronze	7CBC EURO1	7CBC EURO2	7CBC EURO3	7CBC EURO4
Etrium Bronze	7EBC EURO1	7EBC EURO2	7EBC EURO3	7EBC EURO4
Gloss White	70C EURO1	70C EURO2	70C EURO3	70C EURO4
Polished Brass	71C EURO1	71C EURO2	71C EURO3	71C EURO4
Polished Nickel	-	7PNC EURO2	-	7PNC EURO4
Primed White	7WPC EURO1	7WPC EURO2	7WPC EURO3	7WPC EURO4
Richmond Bronze	7RBC EURO1	7RBC EURO2	7RBC EURO3	7RBC EURO4
Satin Brass	72C EURO1	72C EURO2	72C EURO3	72C EURO4
Satin Steel Effect	74C EURO1	74C EURO2	74C EURO3	74C EURO4
Nominal Size:	86.0mm x 86.0mm	86.0mm x 86.0mm	145.0mm x 86.0mm	145.0mm x 86.0mm
Minimum Wall Box Depth:	As Per Insert	As Per Inserts	As Per Inserts	As Per Inserts
Technical Insert Ref:	EURO1	EURO2	EURO3	EURO4

Note: Minimum Wall Box depth is dependant on the EuroFix insert fitted, please see the EuroFix section for our complete range of inserts.



INDUSTRY
PARTNER

SWITCH PLATES & SOCKETS

• PAINTABLE •



Add the finishing touches with Paintable



Hamilton's Paintable range offers a colour-match made in interior heaven. Plates can be supplied pre-painted to exactly colour-match – or even contrast – any wall colour; or to replicate the finer tones used in your soft furnishings. Available in Hartland CFX® and Sheer CFX® collections.



Find your nearest stockist online.

Hamilton®

making connections beautifully

Wiring Accessories • Smart Lighting Control & Audio Solutions

www.hamilton-litestat.com

+44 (0)1747 860088

info@hamilton-litestat.com





Hartland CFX[®] Colours

Concealed Fixing Accessories on glossy Colour Slim Plates

The Hartland CFX[®] Colour range will enhance any surrounding and its patented concealed fixing system affords seamless styling and sophistication. It has a sleek finish that is attractive and tactile, whilst the practical robust plastic provides a lower priced alternative to the metal designs.

- A member of the Hartland 'family'
- Practical, robust plastic
- Concealed fixing
- Comprehensive range of electrical accessories
- Further flexibility for the cost-conscious designer
- Grid and EuroFix options also available (see separate GRID-IT and EuroFix sections for inserts.)



Hartland CFX® Colours Range

HARTLAND CFX COLOURS RANGE



7WC TCM W

7WC C11 WH-W

7RC R23 WH-W

7BC 45N B

Plate finishes available in this range



Pillar Red



Jet Black

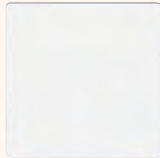

Bright White

Hamilton Hartland CFX® Colours

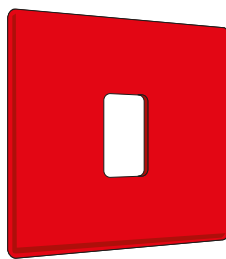
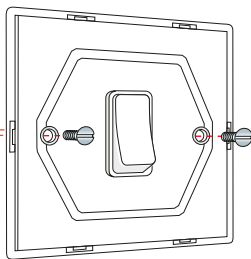
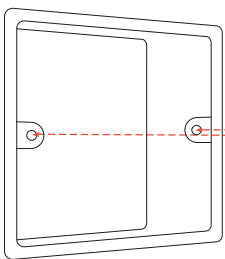
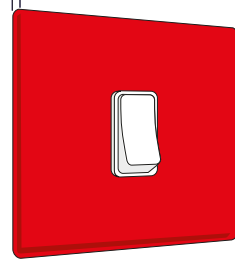

Plate Depth 4.5mm



4,5mm

86 mm

Hartland CFX Colours

Rocker Switches



7WC R21 WH-W









7BC R22 BL-B



7RC R23 WH-W



7BC R24 BL-B

Plate Finish	Insert Finish / Surround Colour	 1 gang 10AX 2 Way Rocker	 2 gang 10AX 2 Way Rocker	 3 gang 10AX 2 Way Rocker	 4 gang 10AX 2 Way Rocker	 1 gang 10AX Intermediate Rocker	 1 gang 10A Triple Pole Rocker
Bright White	White/White	7WC R21 WH-W	7WC R22 WH-W	7WC R23 WH-W	7WC R24 WH-W	7WC R31 WH-W	7WC TP WH-W
Jet Black	Black/Black	7BC R21 BL-B	7BC R22 BL-B	7BC R23 BL-B	7BC R24 BL-B	7BC R31 BL-B	7BC TP BL-B
Pillar Box Red	Black/Black	7RC R21 BL-B	7RC R22 BL-B	7RC R23 BL-B	7RC R24 BL-B	7RC R31 BL-B	7RC TP BL-B
Pillar Box Red	White/White	7RC R21 WH-W	7RC R22 WH-W	7RC R23 WH-W	7RC R24 WH-W	7RC R31 WH-W	7RC TP WH-W
Nominal Size:		86.0mm x 86.0mm	86.0mm x 86.0mm	86.0mm x 86.0mm	146.0mm x 86.0mm	86.0mm x 86.0mm	86.0mm x 86.0mm
Minimum Wall Box Depth:		25mm	25mm	25mm	25mm	25mm	25mm
Technical Insert Ref:		R21	R22	R23	R24	R31	TP



7BC R212 BL-B







7RC R222 BL-B



7WC R232 WH-W



7RC R312 WH-W

Plate Finish	Insert Finish / Surround Colour	 1 gang 20AX 2 Way Rocker	 2 gang 20AX 2 Way Rocker	 3 gang 20AX 2 Way Rocker	 4 gang 20AX 2 Way Rocker	 1 gang 20AX Intermediate Rocker
Bright White	White/White	7WC R212 WH-W	7WC R222 WH-W	7WC R232 WH-W	7WC R242 WH-W	7WC R312 WH-W
Jet Black	Black/Black	7BC R212 BL-B	7BC R222 BL-B	7BC R232 BL-B	7BC R242 BL-B	7BC R312 BL-B
Pillar Box Red	Black/Black	7RC R212 BL-B	7RC R222 BL-B	7RC R232 BL-B	7RC R242 BL-B	7RC R312 BL-B
Pillar Box Red	White/White	7RC R212 WH-W	7RC R222 WH-W	7RC R232 WH-W	7RC R242 WH-W	7RC R312 WH-W
Nominal Size:		86.0mm x 86.0mm	86.0mm x 86.0mm	146.0mm x 86.0mm	146.0mm x 86.0mm	86.0mm x 86.0mm
Minimum Wall Box Depth:		25mm	25mm	25mm	25mm	25mm
Technical Insert Ref:		R212	R222	R232	R242	R312

Insert Surround Colour Key: (-B) Black, (-W) White

Hartland CFX Colours

Power Sockets

HARTLAND CFX COLOURS RANGE



7BC SS1 BL-B





7WC SS2 WH-W



7RC US5 B

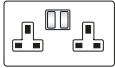

7RC SHS B

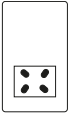
Plate Finish	Insert Finish / Surround Colour	 1 gang 13A Double Pole Switched Socket	 2 gang 13A Double Pole Switched Socket	 1 gang 5A Unswitched Socket	 Shaver Dual Voltage Unswitched Socket (Vertically Mounted)
Bright White	White/White	7WC SS1 WH-W	7WC SS2 WH-W	7WC US5 W	7WC SHS W
Jet Black	Black/Black	7BC SS1 BL-B	7BC SS2 BL-B	7BC US5 B	7BC SHS B
Pillar Box Red	Black/Black	7RC SS1 BL-B	7RC SS2 BL-B	7RC US5 B	7RC SHS B
Pillar Box Red	White/White	7RC SS1 WH-W	7RC SS2 WH-W	7RC US5 W	7RC SHS W
	Nominal Size:	86.0mm x 86.0mm	146.0mm x 86.0mm	86.0mm x 86.0mm	86.0mm x 146.0mm
	Minimum Wall Box Depth:	35mm	35mm	35mm	47mm
	Technical Insert Ref:	SS1	SS2	US5	SHS

USB Power Sockets



7WC SS2USBULT WH-W

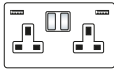

7BC SS2USBULT BL-B

Plate Finish	Insert Finish / Surround Colour	 1 gang 13A Single Pole Switched Socket with 1 USB Outlet 1x2.1A	 2 gang 13A Double Pole Switched Socket with 2 USB Outlets 2x2.4A (4.8 Total)
Bright White	White/White	7WC SS1USB WH-W	7WC SS2USBULT WH-W
Jet Black	Black/Black	7BC SS1USB BL-B	7BC SS2USBULT BL-B
Pillar Box Red	Black/Black	7RC SS1USB BL-B	7RC SS2USBULT BL-B
Pillar Box Red	White/White	7RC SS1USB WH-W	7RC SS2USBULT WH-W
	Nominal Size:	86.0mm x 86.0mm	146.0mm x 86.0mm
	Minimum Wall Box Depth:	35mm	35mm
	Technical Insert Ref:	SS1USBX1	SS2USBX2ULT

Insert Surround Colour Key: (-B) Black, (-W) White

Hartland CFX Colours

International Power Sockets





7RC 5320 W

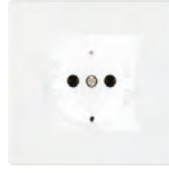

7BC 5258 B

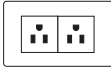

7WC 6126 W

Plate Finish	Insert Colour	 1 gang 15A 110V AC American Unswitched Socket	 2 gang 15A 110V AC American Unswitched Socket	 1 gang 10/16A 220/250V AC German Unswitched Socket
Bright White	White	7WC 5258 W	7WC 5320 W	7WC 6126 W
Jet Black	Black	7BC 5258 B	7BC 5320 B	7BC 6126 B
Pillar Box Red	Black	7RC 5258 B	7RC 5320 B	7RC 6126 B
Pillar Box Red	White	7RC 5258 W	7RC 5320 W	7RC 6126 W
Nominal Size:		86.0mm x 86.0mm	146.0mm x 86.0mm	86.0mm x 86.0mm
Minimum Wall Box Depth:		35mm	35mm	47mm
Technical Insert Ref:		5258	5320	6126

Key Switches



7RC K21 W

Plate Finish	Insert Colour	 1 gang 20AX 2 Way Key Switch
Bright White	White	7WC K21 W
Jet Black	Black	7BC K21 B
Pillar Box Red	Black	7RC K21 B
Pillar Box Red	White	7RC K21 W
Nominal Size:		86.0mm x 86.0mm
Minimum Wall Box Depth:		25mm
Technical Insert Ref:		K21

Hotel Card Switch with LED



7WC C11 WH-W

Plate Finish	Insert Colour	 1 gang 10A (6AX) Card Switch On/Off with Blue LED Locator
Bright White	White	7WC C11 WH-W
Jet Black	Black	7BC C11 BL-B
Pillar Box Red	Black	7RC C11 BL-B
Pillar Box Red	White	7RC C11 WH-W
Nominal Size:		86.0mm x 86.0mm
Minimum Wall Box Depth:		35mm
Technical Insert Ref:		C11

Insert Surround Colour Key: (-B) Black, (-W) White

Hartland CFX Colours

Television Coaxial Sockets

HARTLAND CFX COLOURS RANGE



78C TV B



78C TVFM W

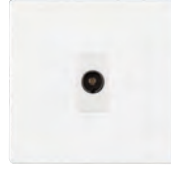

78C TVI W



78C SATN B



1 gang
Non-Isolated
TV
1in/1out



Isolated TV/FM
Diplexer
1in/2out



1 gang
Isolated
TV
1in/1out



2 gang
Non-Isolated
TV+Satellite
2in/2out



1 gang
Non-Isolated
Satellite



1 gang
Isolated
Satellite

Plate Finish	Insert Colour	78C TV B	78C TVFM B	78C TVI B	78C TVSAT B	78C SATN B	78C SATI B
Bright White	White	78C TV B	78C TVFM W	78C TVI W	78C TVSAT W	78C SATN W	78C SATI W
Jet Black	Black	78C TV B	78C TVFM B	78C TVI B	78C TVSAT B	78C SATN B	78C SATI B
Pillar Box Red	Black	78C TV B	78C TVFM B	78C TVI B	78C TVSAT B	78C SATN B	78C SATI B
Pillar Box Red	White	78C TV W	78C TVFM W	78C TVI W	78C TVSAT W	78C SATN W	78C SATI W
Nominal Size:		86.0mm x 86.0mm	86.0mm x 86.0mm	86.0mm x 86.0mm	86.0mm x 86.0mm	86.0mm x 86.0mm	86.0mm x 86.0mm
Minimum Wall Box Depth:		25mm	25mm	25mm	35mm	35mm	35mm
Technical Insert Ref:		TV	TVFM	TVI	TVSAT	SATN	SATI

Digital Television Sockets

- Screen Non-Isolated / DAB Compatible



78C DTRID W



78C DTVF B



78C DSAT B



78C DSAT+ W



Non-Isolated
TV+FM+SAT
Triplexer
1in/3out
(DAB Compatible)



1 gang
Non-Isolated
TV (Female)
(DAB Compatible)



1 gang
Non-Isolated
TV (Male)
(DAB Compatible)



1 gang
Non-Isolated
Satellite
(DAB Compatible)



Non-Isolated
TV+FM+SAT1+SAT2
Quadplexer
2in/4out
(DAB Compatible)

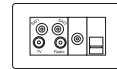

Non-Isolated
TV+FM+SAT1+SAT2
Quadplexer
2in/4out
+TVF+TCS
(DAB Compatible)

Plate Finish	Insert Colour	78C DTRID W	78C DTVF B	78C DTVM W	78C DSAT W	78C DENT W	78C DSAT+ W
Bright White	White	78C DTRID W	78C DTVF W	78C DTVM W	78C DSAT W	78C DENT W	78C DSAT+ W
Jet Black	Black	78C DTRID B	78C DTVF B	78C DTVM B	78C DSAT B	78C DENT B	78C DSAT+ B
Pillar Box Red	Black	78C DTRID B	78C DTVF B	78C DTVM B	78C DSAT B	78C DENT B	78C DSAT+ B
Pillar Box Red	White	78C DTRID W	78C DTVF W	78C DTVM W	78C DSAT W	78C DENT W	78C DSAT+ W
Nominal Size:		86.0mm x 86.0mm	86.0mm x 86.0mm	86.0mm x 86.0mm	86.0mm x 86.0mm	86.0mm x 86.0mm	146.0mm x 86.0mm
Minimum Wall Box Depth:		35mm	35mm	35mm	35mm	35mm	35mm
Technical Insert Ref:		DTRID	DTV F	DTVM	DSAT	DENT	DSAT+

Insert Surround Colour Key: (-B) Black, (-W) White

Hartland CFX Colours

Telephone and Data Outlets



7BC TCM B









7RC TCS W



7RC J12 W



7WC J45 W

Plate Finish	Insert Colour	 1 gang Telephone Master	 1 gang Telephone Slave	 1 gang RJ12 Outlet - Unshielded	 2 gang RJ12 Outlet - Unshielded	 1 gang RJ45 CAT 5E Outlet - Unshielded	 2 gang RJ45 CAT 5E Outlet - Unshielded
Bright White	White/White	7WC TCM W	7WC TCS W	7WC J12 W	7WC 2J12 W	7WC J45 W	7WC 2J45 W
Jet Black	Black/Black	7BC TCM B	7BC TCS B	7BC J12 B	7BC 2J12 B	7BC J45 B	7BC 2J45 B
Pillar Box Red	Black/Black	7RC TCM B	7RC TCS B	7RC J12 B	7RC 2J12 B	7RC J45 B	7RC 2J45 B
Pillar Box Red	White/White	7RC TCM W	7RC TCS W	7RC J12 W	7RC 2J12 W	7RC J45 W	7RC 2J45 W
Nominal Size:		86.0mm x 86.0mm	86.0mm x 86.0mm	86.0mm x 86.0mm	86.0mm x 86.0mm	86.0mm x 86.0mm	86.0mm x 86.0mm
Minimum Wall Box Depth:		25mm	25mm	35mm	35mm	35mm	35mm
Technical Insert Ref:		TCM	TCS	J12	2J12	J45	2J45

Double Pole Switches





7WC DPN WH-W





7RC 45SS1 WH-W

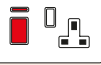

7BC SPN BL-B

Plate Finish	Insert Colour	 1 gang 20AX Double Pole Rocker + Neon	 1 gang 45A Double Pole Rocker + Neon	 45A Double Pole Red Rocker + Neon + 13A Switched Socket
Bright White	White/White	7WC DPN WH-W	7WC 45N W	7WC 45SS1 WH-W
Jet Black	Black/Black	7BC DPN BL-B	7BC 45N B	7BC 45SS1 BL-B
Pillar Box Red	Black/Black	7RC DPN BL-B	7RC 45N B	7RC 45SS1 BL-B
Pillar Box Red	White/White	7RC DPN WH-W	7RC 45N W	7RC 45SS1 WH-W
Nominal Size:		86.0mm x 86.0mm	86.0mm x 86.0mm	146.0mm x 86.0mm
Minimum Wall Box Depth:		25mm	35mm	35mm
Technical Insert Ref:		DPN	45N	45SS1

Connection Units

Plate Finish	Insert Colour	 1 gang 13A Double Pole Fused Spur + Neon	 1 gang 13A Fuse with Red Neon Halo
Bright White	White/White	7WC SPN WH-W	7WC FN WH-R
Jet Black	Black/Black	7BC SPN BL-B	7BC FN BL-R
Pillar Box Red	Black/Black	7RC SPN BL-B	7RC FN BL-R
Pillar Box Red	White/White	7RC SPN WH-W	7RC FN WH-R
Nominal Size:		86.0mm x 86.0mm	86.0mm x 86.0mm
Minimum Wall Box Depth:		35mm	35mm
Technical Insert Ref:		SPN	FN

Insert Surround Colour Key: (-B) Black, (-W) White

Hartland CFX Colours

LED Trailing/Leading Edge Push On/Off Rotary 2 Way Switching Dimmers

HARTLAND CFX COLOURS RANGE



7WC 1XLEDITB100 WH



7BC 2XLEDITB100 BL



7RC 3XLEDITB100 BL

Plate Finish	Insert Colour	1 gang 100W LED Trailing/Leading Edge Push On/Off Rotary 2 Way Switching Dimmer	2 gang 100W LED Trailing/Leading Edge Push On/Off Rotary 2 Way Switching Dimmer	3 gang 100W LED Trailing/Leading Edge Push On/Off Rotary 2 Way Switching Dimmer	4 gang 100W LED Trailing/Leading Edge Push On/Off Rotary 2 Way Switching Dimmer
Bright White*	White/White	7WC 1XLEDITB100 WH	7WC 2XLEDITB100 WH	7WC 3XLEDITB100 WH	7WC 4XLEDITB100 WH
Jet Black	Black/Black	7BC 1XLEDITB100 BL	7BC 2XLEDITB100 BL	7BC 3XLEDITB100 BL	7BC 4XLEDITB100 BL
Pillar Box Red	Black/Black	7RC 1XLEDITB100 BL	7RC 2XLEDITB100 BL	7RC 3XLEDITB100 BL	7RC 4XLEDITB100 BL
Pillar Box Red	White/White	7RC 1XLEDITB100 WH	7RC 2XLEDITB100 WH	7RC 3XLEDITB100 WH	7RC 4XLEDITB100 WH
Nominal Size:		86.0mm x 86.0mm	86.0mm x 86.0mm	146.0mm x 86.0mm	146.0mm x 86.0mm
Minimum Wall Box Depth:		35mm	35mm	35mm	35mm
Technical Insert Ref:		1XLEDITB	2XLEDITB	3XLEDITB	4XLEDITB

LED Trailing/Leading Edge Push On/Off Rotary Multi-Way Dimmers



7RC 1X100LED WH



7BC 3X100LED BL

Plate Finish	Insert Colour	1 gang 100W LED Trailing/Leading Edge Push On/Off Rotary Multi-Way Dimmer	2 gang 100W LED Trailing/Leading Edge Push On/Off Rotary Multi-Way Dimmer	3 gang 100W LED Trailing/Leading Edge Push On/Off Rotary Multi-Way Dimmer	4 gang 100W LED Trailing/Leading Edge Push On/Off Rotary Multi-Way Dimmer
Bright White*	White/White	7WC 1X100LED WH	7WC 2X100LED WH	7WC 3X100LED WH	7WC 4X100LED WH
Jet Black	Black/Black	7BC 1X100LED BL	7BC 2X100LED BL	7BC 3X100LED BL	7BC 4X100LED BL
Pillar Box Red	Black/Black	7RC 1X100LED BL	7RC 2X100LED BL	7RC 3X100LED BL	7RC 4X100LED BL
Pillar Box Red	White/White	7RC 1X100LED WH	7RC 2X100LED WH	7RC 3X100LED WH	7RC 4X100LED WH
Nominal Size:		86.0mm x 86.0mm	86.0mm x 86.0mm	146.0mm x 86.0mm	146.0mm x 86.0mm
Minimum Wall Box Depth:		35mm	35mm	35mm	35mm
Technical Insert Ref:		1X100LED	2X100LED	3X100LED	4X100LED

NOTE: Tungsten filament GU10 lamps must be branded and with a fused base.
 NOTE: Please refer to the Dimmer Technical Section for the max Wattage.
 NOTE: Please contact our Technical Department for compatibility.

Hartland CFX Colours

Resistive Leading Edge Push On/Off Rotary 2 Way Switching Dimmers



7RC 1X40 BL



7RC 2X40 WH



7BC 4X40 BL

Plate Finish	Insert Colour	1 gang 400W Resistive Leading Edge Push On/Off Rotary 2 Way Switching Dimmer	2 gang 400W Resistive Leading Edge Push On/Off Rotary 2 Way Switching Dimmer	3 gang 400W Resistive Leading Edge Push On/Off Rotary 2 Way Switching Dimmer	4 gang 400W Resistive Leading Edge Push On/Off Rotary 2 Way Switching Dimmer
Bright White	White	7WC 1X40 WH	7WC 2X40 WH	7WC 3X40 WH	7WC 4X40 WH
Jet Black	Black	7BC 1X40 BL	7BC 2X40 BL	7BC 3X40 BL	7BC 4X40 BL
Pillar Box Red	Black	7RC 1X40 BL	7RC 2X40 BL	7RC 3X40 BL	7RC 4X40 BL
Pillar Box Red	White	7RC 1X40 WH	7RC 2X40 WH	7RC 3X40 WH	7RC 4X40 WH
Nominal Size:		86.0mm x 86.0mm	86.0mm x 86.0mm	146.0mm x 86.0mm	146.0mm x 86.0mm
Minimum Wall Box Depth:		35mm	35mm	35mm	35mm
Technical Insert Ref:		1X40	2X40	3X40	4X40

Inductive Leading Edge Push On/Off Rotary 2 Way Switching Dimmers



7WC 1X2V WH



7BC 1X2V BL

Plate Finish	Insert Colour	1 gang 200VA Inductive Leading Edge Push On/Off Rotary 2 Way Switching Dimmer
Bright White	White	7WC 1X2V WH
Jet Black	Black	7BC 1X2V BL
Pillar Box Red	Black	7RC 1X2V BL
Pillar Box Red	White	7RC 1X2V WH
Nominal Size:		86.0mm x 86.0mm
Minimum Wall Box Depth:		35mm
Technical Insert Ref:		1X2V

NOTE: Tungsten filament GU10 lamps must be branded and with a fused base
 NOTE: When using mains voltage halogen lamps – dimmers should be re-rated by 25%
 NOTE: When dimming LED lamps de-rate by 75% - please contact our Technical Department for compatibility.
 NOTE: Please refer to the Dimmer Technical Section for the max wattage

Hartland CFX Colours

Resistive/Inductive Trailing Edge Push On/Off Rotary Multi-Way Dimmers

HARTLAND CFX COLOURS RANGE



7RC 1XTE BL



7RC 3XTE WH

Plate Finish	Insert Colour	1 gang 250W/210VA Resistive/Inductive Trailing Edge Push On/Off Rotary Multi-Way Dimmer	2 gang 250W/210VA Resistive/Inductive Trailing Edge Push On/Off Rotary Multi-Way Dimmer	3 gang 250W/210VA Resistive/Inductive Trailing Edge Push On/Off Rotary Multi-Way Dimmer	4 gang 250W/210VA Resistive/Inductive Trailing Edge Push On/Off Rotary Multi-Way Dimmer
Bright White	White/White	7WC 1XTE WH	7WC 2XTE WH	7WC 3XTE WH	7WC 4XTE WH
Jet Black	Black/Black	7BC 1XTE BL	7BC 2XTE BL	7BC 3XTE BL	7BC 4XTE BL
Pillar Box Red	Black/Black	7RC 1XTE BL	7RC 2XTE BL	7RC 3XTE BL	7RC 4XTE BL
Pillar Box Red	White/White	7RC 1XTE WH	7RC 2XTE WH	7RC 3XTE WH	7RC 4XTE WH
Nominal Size:		86.0mm x 86.0mm	86.0mm x 86.0mm	146.0mm x 86.0mm	146.0mm x 86.0mm
Minimum Wall Box Depth:		35mm	35mm	35mm	35mm
Technical Insert Ref:		1XTE	2XTE	3XTE	4XTE

Blank Plates



7WC BPS









7BC BPD

Plate Finish	Single Blank Plate	Double Blank Plate
Bright White	7WC BPS	7WC BPD
Jet Black	7BC BPS	7BC BPD
Pillar Box Red	7RC BPS	7RC BPD
Nominal Size:		146.0mm x 86.0mm
Minimum Wall Box Depth:		Any Box
Technical Insert Ref:		BPS BPD

NOTE: Tungsten filament GU10 lamps must be branded and with a fused base
 NOTE: When using mains voltage halogen lamps – dimmers should be re-rated by 25%
 NOTE: When dimming LED lamps de-rate by 75% - please contact our Technical Department for compatibility.
 NOTE: Please refer to the Dimmer Technical Section for the max wattage



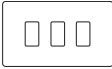
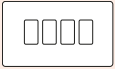

Hartland CFX Colours

GRID-IT Grid Fix Plates complete with Fixing Grid

				
	7RC 1GP	7WC 2GP	7RC 3GP	7WC 4GP
				
Plate Finish	1 gang Grid Fix Aperture Plate with Grid	2 gang Grid Fix Aperture Plate with Grid	3 gang Grid Fix Aperture Plate with Grid	4 gang Grid Fix Aperture Plate with Grid
Bright White	7WC 1GP	7WC 2GP	7WC 3GP	7WC 4GP
Jet Black	7BC 1GP	7BC 2GP	7BC 3GP	7BC 4GP
Pillar Box Red	7RC 1GP	7RC 2GP	7RC 3GP	7RC 4GP
Nominal Size:	86.0mm x 86.0mm	86.0mm x 86.0mm	146.0mm x 86.0mm	146.0mm x 86.0mm
Minimum Wall Box Depth:	As Per Insert	As Per Inserts	As Per Inserts	As Per Inserts
Technical Insert Ref:	1GP	2GP	3GP	4GP

Note: Minimum Wall Box depth is dependant on the Grid Fix insert fitted, please see the GRID-IT section for the complete range of inserts.

EuroFix Plates complete with Fixing Grid

		
	7WC EURO2	7RC EURO4
		
Plate Finish	2 Module EuroFix 50x50mm Apertured Plate with Grid	4 Module EuroFix 100x50mm Aperture Plate with Grid
Bright White	7WC EURO2	7WC EURO4
Jet Black	7BC EURO2	7BC EURO4
Pillar Box Red	7RC EURO2	7RC EURO4
Nominal Size:	86.0mm x 86.0mm	146.0mm x 86.0mm
Aperture:	50 x 50mm	50 x 50mm
Technical Insert Ref:	EURO2	EURO4

Note: Minimum Wall Box depth is dependant on the EuroFix insert fitted, please see the EuroFix section for our complete range of inserts.



Sheer

Quality Accessories on Stylish Flat Plates

Sheer's minimalist flat plate switches and sockets meld seamlessly into modern interiors. This modern and elegant range is available in fantastic finishes and by mixing box fix with grid and concealed fixing in this range, allows it to be very flexible for different areas of a project and costs can be minimised without losing continuity of design.

- Minimalist, modern flat plate
- Visible fixing
- Fantastic finishes
- Standard box-fix electrical accessories
- Grid and EuroFix options also available (see separate GRID-IT and EuroFix section for inserts)



Sheer Range



87 5S1USB BC-B

89 45N B

81 R22 PB W

84 DTRID W

Plate finishes available in this range



Antique Brass

Black Nickel

Bright Chrome

Bright Stainless

Gloss White

Matt Black

Matt White

Polished Brass

Richmond Bronze

Satin Brass

Satin Chrome

Satin Stainless

Hamilton Sheer

Plate Depth 1.5 mm including Gasket

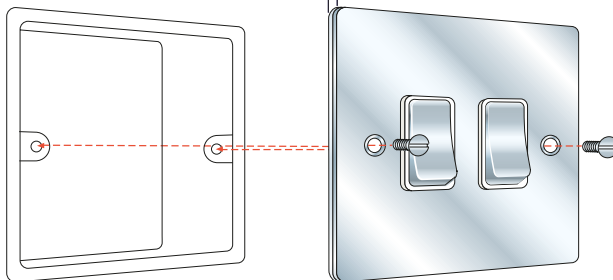

Box-Fix to Back Box

Sheer

Rocker Switches



89 R21 AB-B



81 R22 PB-W



87 R23 BC-B



83 R24 BC-W



1 gang 10AX
2 Way Rocker



2 gang 10AX
2 Way Rocker



3 gang 10AX
2 Way Rocker



4 gang 10AX
2 Way Rocker

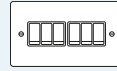

6 gang 10AX
2 Way Rocker

Plate Finish	Insert Finish/ Surround Colour	1 gang 10AX 2 Way Rocker	2 gang 10AX 2 Way Rocker	3 gang 10AX 2 Way Rocker	4 gang 10AX 2 Way Rocker	6 gang 10AX 2 Way Rocker
Antique Brass	Antique Brass/Black	89 R21 AB-B	89 R22 AB-B	89 R23 AB-B	89 R24 AB-B	89 R26 AB-B
Black Nickel	Black Nickel/Black	88 R21 BK-B	88 R22 BK-B	88 R23 BK-B	88 R24 BK-B	88 R26 BK-B
Bright Chrome	Black/Black	87 R21 BL-B	87 R22 BL-B	87 R23 BL-B	87 R24 BL-B	87 R26 BL-B
Bright Chrome	Bright Chrome/Black	87 R21 BC-B	87 R22 BC-B	87 R23 BC-B	87 R24 BC-B	87 R26 BC-B
Bright Chrome	Bright Chrome/White	87 R21 BC-W	87 R22 BC-W	87 R23 BC-W	87 R24 BC-W	87 R26 BC-W
Bright Chrome	White/White	87 R21 WH-W	87 R22 WH-W	87 R23 WH-W	87 R24 WH-W	87 R26 WH-W
Bright Steel	Bright Chrome/Black	83 R21 BC-B	83 R22 BC-B	83 R23 BC-B	83 R24 BC-B	83 R26 BC-B
Bright Steel	Bright Chrome/White	83 R21 BC-W	83 R22 BC-W	83 R23 BC-W	83 R24 BC-W	83 R26 BC-W
Gloss White	White/White	80 R21 WH-W	80 R22 WH-W	80 R23 WH-W	80 R24 WH-W	80 R26 WH-W
Matt Black	Black/Black	8MB R21 BL-B	8MB R22 BL-B	-	-	-
Matt White	White/White	8MW R21 WH-W	8MW R22 WH-W	8MW R23 WH-W	8MW R24 WH-W	8MW R26 WH-W
Polished Brass	Black/Black	81 R21 BL-B	81 R22 BL-B	81 R23 BL-B	81 R24 BL-B	81 R26 BL-B
Polished Brass	Polished Brass/Black	81 R21 PB-B	81 R22 PB-B	81 R23 PB-B	81 R24 PB-B	81 R26 PB-B
Polished Brass	Polished Brass/White	81 R21 PB-W	81 R22 PB-W	81 R23 PB-W	81 R24 PB-W	81 R26 PB-W
Polished Brass	White/White	81 R21 WH-W	81 R22 WH-W	81 R23 WH-W	81 R24 WH-W	81 R26 WH-W
Richmond Bronze	Black/Black	8RB R21 BL-B	8RB R22 BL-B	-	-	-
Satin Brass	Black/Black	82 R21 BL-B	82 R22 BL-B	82 R23 BL-B	82 R24 BL-B	82 R26 BL-B
Satin Brass	Satin Brass/Black	82 R21 SB-B	82 R22 SB-B	82 R23 SB-B	82 R24 SB-B	82 R26 SB-B
Satin Brass	Satin Brass/White	82 R21 SB-W	82 R22 SB-W	82 R23 SB-W	82 R24 SB-W	82 R26 SB-W
Satin Brass	White/White	82 R21 WH-W	82 R22 WH-W	82 R23 WH-W	82 R24 WH-W	82 R26 WH-W
Satin Chrome	Black/Black	86 R21 BL-B	86 R22 BL-B	86 R23 BL-B	86 R24 BL-B	86 R26 BL-B
Satin Chrome	Satin Chrome/Black	86 R21 SC-B	86 R22 SC-B	86 R23 SC-B	86 R24 SC-B	86 R26 SC-B
Satin Chrome	Satin Chrome/White	86 R21 SC-W	86 R22 SC-W	86 R23 SC-W	86 R24 SC-W	86 R26 SC-W
Satin Chrome	White/White	86 R21 WH-W	86 R22 WH-W	86 R23 WH-W	86 R24 WH-W	86 R26 WH-W
Satin Steel	Black/Black	84 R21 BL-B	84 R22 BL-B	84 R23 BL-B	84 R24 BL-B	84 R26 BL-B
Satin Steel	Satin Steel/Black	84 R21 SS-B	84 R22 SS-B	84 R23 SS-B	84 R24 SS-B	84 R26 SS-B
Satin Steel	Satin Steel/White	84 R21 SS-W	84 R22 SS-W	84 R23 SS-W	84 R24 SS-W	84 R26 SS-W
Satin Steel	White/White	84 R21 WH-W	84 R22 WH-W	84 R23 WH-W	84 R24 WH-W	84 R26 WH-W
Nominal Size:		86.0mm x 86.0mm	86.0mm x 86.0mm	86.0mm x 86.0mm	146.0mm x 86.0mm	146.0mm x 86.0mm
Minimum Wall Box Depth:		25mm	25mm	25mm	25mm	25mm
Technical Insert Ref:		R21	R22	R23	R24	R26

Insert Surround Colour Key: (-B) Black, (-W) White

Sheer

Rocker Switches

SHEER RANGE



88 R31 BK-B



87 R32 BC-W



83 RRT BC-W



87 TP BL-B



1 gang 10AX Intermediate Rocker



2 gang 10AX Intermediate Rocker



1 gang 10AX Push To Make Retractable Rocker



1 gang 10A Triple Pole Rocker

Plate Finish	Insert Finish/ Surround Colour	1 gang 10AX Intermediate Rocker	2 gang 10AX Intermediate Rocker	1 gang 10AX Push To Make Retractable Rocker	1 gang 10A Triple Pole Rocker
Antique Brass	Antique Brass/Black	89 R31 AB-B	-	-	-
Antique Brass	Black/Black	-	-	-	89 TP BL-B
Black Nickel	Black/Black	-	-	-	88 TP BL-B
Black Nickel	Black Nickel/Black	88 R31 BK-B	-	-	-
Bright Chrome	Black/Black	87 R31 BL-B	87 R32 BL-B	87 RRT BL-B	87 TP BL-B
Bright Chrome	Bright Chrome/Black	87 R31 BC-B	87 R32 BC-B	87 RRT BC-B	-
Bright Chrome	Bright Chrome/White	87 R31 BC-W	87 R32 BC-W	87 RRT BC-W	-
Bright Chrome	White/White	87 R31 WH-W	87 R32 WH-W	87 RRT WH-W	87 TP WH-W
Bright Steel	Black/Black	-	-	-	83 TP BL-B
Bright Steel	Bright Chrome/Black	83 R31 BC-B	83 R32 BC-B	83 RRT BC-B	-
Bright Steel	Bright Chrome/White	83 R31 BC-W	83 R32 BC-W	83 RRT BC-W	-
Bright Steel	White/White	-	-	-	83 TP WH-W
Gloss White	White/White	80 R31 WH-W	80 R32 WH-W	80 RRT WH-W	80 TP WH-W
Matt Black	Black/Black	-	-	-	8MB TP BL-B
Matt White	White/White	-	-	-	8MW TP WH-W
Polished Brass	Black/Black	81 R31 BL-B	81 R32 BL-B	81 RRT BL-B	81 TP BL-B
Polished Brass	Polished Brass/Black	81 R31 PB-B	81 R32 PB-B	81 RRT PB-B	-
Polished Brass	Polished Brass/White	81 R31 PB-W	81 R32 PB-W	81 RRT PB-W	-
Polished Brass	White/White	81 R31 WH-W	81 R32 WH-W	81 RRT WH-W	81 TP WH-W
Richmond Bronze	Black/Black	-	-	-	8RB TP BL-B
Satin Brass	Black/Black	82 R31 BL-B	82 R32 BL-B	82 RRT BL-B	82 TP BL-B
Satin Brass	Satin Brass/Black	82 R31 SB-B	82 R32 SB-B	82 RRT SB-B	-
Satin Brass	Satin Brass/White	82 R31 SB-W	82 R32 SB-W	82 RRT SB-W	-
Satin Brass	White/White	82 R31 WH-W	82 R32 WH-W	82 RRT WH-W	82 TP WH-W
Satin Chrome	Black/Black	86 R31 BL-B	86 R32 BL-B	86 RRT BL-B	86 TP BL-B
Satin Chrome	Satin Chrome/Black	86 R31 SC-B	86 R32 SC-B	86 RRT SC-B	-
Satin Chrome	Satin Chrome/White	86 R31 SC-W	86 R32 SC-W	86 RRT SC-W	-
Satin Chrome	White/White	86 R31 WH-W	86 R32 WH-W	86 RRT WH-W	86 TP WH-W
Satin Steel	Black/Black	84 R31 BL-B	84 R32 BL-B	84 RRT BL-B	84 TP BL-B
Satin Steel	Satin Steel/Black	84 R31 SS-B	84 R32 SS-B	84 RRT SS-B	-
Satin Steel	Satin Steel/White	84 R31 SS-W	84 R32 SS-W	84 RRT SS-W	-
Satin Steel	White/White	84 R31 WH-W	84 R32 WH-W	84 RRT WH-W	84 TP WH-W
Nominal Size: Minimum Wall Box Depth: Technical Insert Ref:		86.0mm x 86.0mm 25mm R31	86.0mm x 86.0mm 25mm R32	86.0mm x 86.0mm 25mm RRT	86.0mm x 86.0mm 25mm TP

Insert Surround Colour Key: (-B) Black, (-W) White

Sheer

Toggle Switches



89 T21



81 T22



87 T23



84 T24



1 gang 20AX
2 Way Toggle



2 gang 20AX
2 Way Toggle



3 gang 20AX
2 Way Toggle



4 gang 20AX
2 Way Toggle



1 gang 20AX
Intermediate
Toggle



1 gang 20AX
Double Pole
Toggle



1 gang 10AX
Push To Make/
Push To Break
Retractive
Toggle

Plate Finish	Insert Finish	1 gang 20AX 2 Way Toggle	2 gang 20AX 2 Way Toggle	3 gang 20AX 2 Way Toggle	4 gang 20AX 2 Way Toggle	1 gang 20AX Intermediate Toggle	1 gang 20AX Double Pole Toggle	1 gang 10AX Push To Make/ Push To Break Retractive Toggle
Antique Brass	Antique Brass	89 T21	89 T22	89 T23	89 T24	89 T31	89 TDP	89 TRT
Black Nickel	Black Nickel	88 T21	88 T22	88 T23	88 T24	88 T31	88 TDP	88 TRT
Bright Chrome	Bright Chrome	87 T21	87 T22	87 T23	87 T24	87 T31	87 TDP	87 TRT
Bright Steel	Bright Chrome	83 T21	83 T22	83 T23	83 T24	83 T31	83 TDP	83 TRT
Gloss White	-	-	-	-	-	-	-	-
Matt Black	-	-	-	-	-	-	-	-
Matt White	-	-	-	-	-	-	-	-
Polished Brass	Polished Brass	81 T21	81 T22	81 T23	81 T24	81 T31	81 TDP	81 TRT
Richmond Bronze	-	-	-	-	-	-	-	-
Satin Brass	Satin Brass	82 T21	82 T22	82 T23	82 T24	82 T31	82 TDP	82 TRT
Satin Chrome	Satin Chrome	86 T21	86 T22	86 T23	86 T24	86 T31	86 TDP	86 TRT
Satin Steel	Satin Steel	84 T21	84 T22	84 T23	84 T24	84 T31	84 TDP	84 TRT
	Nominal Size:	86.0mm x 86.0mm	86.0mm x 86.0mm	146.0mm x 86.0mm	146.0mm x 86.0mm	86.0mm x 86.0mm	86.0mm x 86.0mm	86.0mm x 86.0mm
	Minimum Wall Box Depth:	35mm	35mm	35mm	35mm	35mm	35mm	35mm
	Technical Insert Ref:	T21	T22	T23	T24	T31	TDP	TRT

Sheer

Power Sockets

SHEER RANGE



89 SS1 AB-B



87 SS2 BC-W



84 US5 W



88 SHS B



1 gang 13A
Double Pole
Switched
Socket

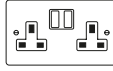

2 gang 13A
Double Pole
Switched
Socket



1 gang 2A
Unswitched
Socket



1 gang 5A
Unswitched
Socket



1 gang 13A
Unswitched
Socket

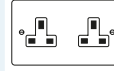

2 gang 13A
Unswitched
Socket

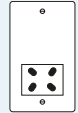

Shaver Dual
Voltage
Unswitched
Socket
(Vertically
Mounted)

Plate Finish	Insert Finish/ Surround Colour	89 SS1 AB-B	89 SS2 AB-B	-	-	-	-	-
Antique Brass	Antique Brass/Black	-	-	89 US2 B	89 US5 B	89 US13 B	89 US99 B	89 SHS B
Antique Brass	Black/Black	-	-	88 US2 B	88 US5 B	-	-	88 SHS B
Black Nickel	Black/Black	88 SS1 BK-B	88 SS2 BK-B	-	-	-	-	-
Black Nickel	Black Nickel/Black	87 SS1 BL-B	87 SS2 BL-B	87 US2 B	87 US5 B	87 US13 B	87 US99 B	87 SHS B
Bright Chrome	Black/Black	87 SS1 BC-B	87 SS2 BC-B	-	-	-	-	-
Bright Chrome	Bright Chrome/Black	87 SS1 BC-W	87 SS2 BC-W	-	-	-	-	-
Bright Chrome	Bright Chrome/White	87 SS1 BC-W	87 SS2 BC-W	-	-	-	-	-
Bright Chrome	White/White	87 SS1 WH-W	87 SS2 WH-W	87 US2 W	87 US5 W	87 US13 W	87 US99 W	87 SHS W
Bright Steel	Bright Chrome/Black	83 SS1 BC-B	83 SS2 BC-B	83 US2 B	83 US5 B	83 US13 B	83 US99 B	83 SHS B
Bright Steel	Bright Chrome/White	83 SS1 BC-W	83 SS2 BC-W	83 US2 W	83 US5 W	83 US13 W	83 US99 W	83 SHS W
Gloss White	White/White	80 SS1 WH-W	80 SS2 WH-W	80 US2 W	80 US5 W	80 US13 W	80 US99 W	80 SHS W
Matt Black	Black/Black	8MB SS1 BL-B	8MB SS2 BL-B	-	8MB US5 B	-	-	8MB SHS B
Matt White	White/White	8MW SS1 WH-W	8MW SS2 WH-W	-	8MW US5 W	-	-	8MW SHS W
Polished Brass	Black/Black	81 SS1 BL-B	81 SS2 BL-B	81 US2 B	81 US5 B	81 US13 B	81 US99 B	81 SHS B
Polished Brass	Polished Brass/Black	81 SS1 PB-B	81 SS2 PB-B	-	-	-	-	-
Polished Brass	Polished Brass/White	81 SS1 PB-W	81 SS2 PB-W	-	-	-	-	-
Polished Brass	White/White	81 SS1 WH-W	81 SS2 WH-W	81 US2 W	81 US5 W	81 US13 W	81 US99 W	81 SHS W
Richmond Bronze	Black/Black	8RB SS1 BL-B	8RB SS2 BL-B	-	8RB US5 B	-	-	8RB SHS B
Satin Brass	Black/Black	82 SS1 BL-B	82 SS2 BL-B	-	-	-	-	-
Satin Brass	Satin Brass/Black	82 SS1 SB-B	82 SS2 SB-B	82 US2 B	82 US5 B	82 US13 B	82 US99 B	82 SHS B
Satin Brass	Satin Brass/White	82 SS1 SB-W	82 SS2 SB-W	82 US2 W	82 US5 W	82 US13 W	82 US99 W	82 SHS W
Satin Brass	White/White	82 SS1 WH-W	82 SS2 WH-W	-	-	-	-	-
Satin Chrome	Black/Black	86 SS1 BL-B	86 SS2 BL-B	86 US2 B	86 US5 B	86 US13 B	86 US99 B	86 SHS B
Satin Chrome	Satin Chrome/Black	86 SS1 SC-B	86 SS2 SC-B	-	-	-	-	-
Satin Chrome	Satin Chrome/White	86 SS1 SC-W	86 SS2 SC-W	-	-	-	-	-
Satin Chrome	White/White	86 SS1 WH-W	86 SS2 WH-W	86 US2 W	86 US5 W	86 US13 W	86 US99 W	86 SHS W
Satin Steel	Black/Black	84 SS1 BL-B	84 SS2 BL-B	84 US2 B	84 US5 B	84 US13 B	84 US99 B	84 SHS B
Satin Steel	Satin Steel/Black	84 SS1 SS-B	84 SS2 SS-B	-	-	-	-	-
Satin Steel	Satin Steel/White	84 SS1 SS-W	84 SS2 SS-W	-	-	-	-	-
Satin Steel	White/White	84 SS1 WH-W	84 SS2 WH-W	84 US2 W	84 US5 W	84 US13 W	84 US99 W	84 SHS W
	Nominal Size:	86.0mm x 86.0mm	146.0mm x 86.0mm	86.0mm x 96mm	86.0mm x 96mm	86.0mm x 96mm	146mm x 86mm	86.0mm x 146.0mm
	Minimum Wall Box Depth:	35mm	35mm	35mm	35mm	35mm	35mm	47mm
	Technical Insert Ref:	SS1	SS2	US2	US5	US13	US99	SHS

Insert Surround Colour Key: (-B) Black, (-W) White

USB Power Sockets



89 SS2USBULT AB-B

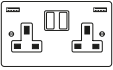

84 SS2USBULT SS-W

Plate Colour	Insert Finish/ Surround Colour		
		1 gang 13A Single Pole Switched Socket with 1 USB Outlet 1x2.1A	2 gang 13A Double Pole Switched Socket with 2 USB Outlet 2x2.4A (4.8A Total)
Antique Brass	Antique Brass/Black	89 SS1USB AB-B	89 SS2USBULT AB-B
Black Nickel	Black Nickel/Black	88 SS1USB BK-B	88 SS2USBULT BK-B
Bright Chrome	Bright Chrome/Black	87 SS1USB BC-B	87 SS2USBULT BC-B
Bright Chrome	Bright Chrome/White	87 SS1USB BC-W	87 SS2USBULT BC-W
Bright Steel	Bright Chrome/Black	83 SS1USB BC-B	83 SS2USBULT BC-B
Bright Steel	Bright Chrome/White	83 SS1USB BC-W	83 SS2USBULT BC-W
Gloss White	White/White	80 SS1USB WH-W	80 SS2USBULT WH-W
Matt Black	Black/Black	8MB SS1USB BL-B	8MB SS2USBULT BL-B
Matt White	White/White	8MW SS1USB WH-W	8MW SS2USBULT WH-W
Polished Brass	Polished Brass/Black	81 SS1USB PB-B	81 SS2USBULT PB-B
Polished Brass	Polished Brass/White	81 SS1USB PB-W	81 SS2USBULT PB-W
Richmond Bronze	Black/Black	8RB SS1USB BL-B	8RB SS2USBULT BL-B
Satin Brass	Satin Brass/Black	82 SS1USB SB-B	82 SS2USBULT SB-B
Satin Brass	Satin Brass/White	82 SS1USB SB-W	82 SS2USBULT SB-W
Satin Chrome	Satin Chrome/Black	86 SS1USB SC-B	86 SS2USBULT SC-B
Satin Chrome	Satin Chrome/White	86 SS1USB SC-W	86 SS2USBULT SC-W
Satin Steel	Satin Steel/Black	84 SS1USB SS-B	84 SS2USBULT SS-B
Satin Steel	Satin Steel/White	84 SS1USB SS-W	84 SS2USBULT SS-W
	Nominal Size:	86.0mm x 86.0mm	146.0mm x 86.0mm
	Minimum Wall Box Depth:	35mm	35mm
	Technical Insert Ref:	SS1USBX1	SS2USBX2ULT

Insert Surround Colour Key: (-B) Black, (-W) White

Sheer

Television Coaxial Sockets

SHEER RANGE



89 TV B



81 TVFM W



87 TVSAT B



87 SATI W



1 gang
Non-Isolated
TV 1in/1out



2 gang
Non-Isolated
TV 2in/2out



Isolated TV/FM
Diplexer
1in/2out



1 gang
Isolated
TV 1in/1out



2 gang
Non-Isolated
TV+Satellite
2in/2out



1 gang
Non-Isolated
Satellite



1 gang
Isolated
Satellite

Plate Finish	Insert Colour	1 gang Non-Isolated TV 1in/1out	2 gang Non-Isolated TV 2in/2out	Isolated TV/FM Diplexer 1in/2out	1 gang Isolated TV 1in/1out	2 gang Non-Isolated TV+Satellite 2in/2out	1 gang Non-Isolated Satellite	1 gang Isolated Satellite
Antique Brass	Black	89 TV B	89 TV2 B	89 TVFM B	89 TVI B	89 TVSAT B	89 SATN B	89 SATI B
Black Nickel	Black	88 TV B	88 TV2 B	88 TVFM B	88 TVI B	88 TVSAT B	88 SATN B	88 SATI B
Bright Chrome	Black	87 TV B	87 TV2 B	87 TVFM B	87 TVI B	87 TVSAT B	87 SATN B	87 SATI B
Bright Chrome	White	87 TV W	87 TV2 W	87 TVFM W	87 TVI W	87 TVSAT W	87 SATN W	87 SATI W
Bright Steel	Black	83 TV B	83 TV2 B	83 TVFM B	83 TVI B	83 TVSAT B	83 SATN B	83 SATI B
Bright Steel	White	83 TV W	83 TV2 W	83 TVFM W	83 TVI W	83 TVSAT W	83 SATN W	83 SATI W
Gloss White	White	80 TV W	80 TV2 W	80 TVFM W	80 TVI W	80 TVSAT W	80 SATN W	80 SATI W
Matt Black	-	-	-	-	-	-	-	-
Matt White	-	-	-	-	-	-	-	-
Polished Brass	Black	81 TV B	81 TV2 B	81 TVFM B	81 TVI B	81 TVSAT B	81 SATN B	81 SATI B
Polished Brass	White	81 TV W	81 TV2 W	81 TVFM W	81 TVI W	81 TVSAT W	81 SATN W	81 SATI W
Richmond Bronze	-	-	-	-	-	-	-	-
Satin Brass	Black	82 TV B	82 TV2 B	82 TVFM B	82 TVI B	82 TVSAT B	82 SATN B	82 SATI B
Satin Brass	White	82 TV W	82 TV2 W	82 TVFM W	82 TVI W	82 TVSAT W	82 SATN W	82 SATI W
Satin Chrome	Black	86 TV B	86 TV2 B	86 TVFM B	86 TVI B	86 TVSAT B	86 SATN B	86 SATI B
Satin Chrome	White	86 TV W	86 TV2 W	86 TVFM W	86 TVI W	86 TVSAT W	86 SATN W	86 SATI W
Satin Steel	Black	84 TV B	84 TV2 B	84 TVFM B	84 TVI B	84 TVSAT B	84 SATN B	84 SATI B
Satin Steel	White	84 TV W	84 TV2 W	84 TVFM W	84 TVI W	84 TVSAT W	84 SATN W	84 SATI W
Nominal Size:		86.0mm x 86.0mm	86.0mm x 86.0mm	86.0mm x 86.0mm	86.0mm x 86.0mm	86.0mm x 86.0mm	86.0mm x 86.0mm	86.0mm x 86.0mm
Minimum Wall Box Depth:		25mm	25mm	25mm	25mm	35mm	35mm	35mm
Technical Insert Ref:		TV2	TV2	TVFM	TVI	TVSAT	SATN	SATI

Insert Surround Colour Key: (-B) Black, (-W) White

Sheer

Digital Television Sockets

- Screened Non-Isolated / DAB Compatible



88 DTVF B



87 DTRID W



84 DTRID W



82 DSAT W



Non-Isolated
TV+FM+SAT
Triplexer 1in/3out
(DAB Compatible)



1 gang
Non-Isolated
TV (Female)
(DAB Compatible)



1 gang
Non-Isolated
TV (Male)
(DAB Compatible)



1 gang
Non-Isolated
Satellite
(DAB Compatible)



Non-Isolated
TV+FM+SAT1+SAT2
Quadplexer 2in/4out
(DAB Compatible)

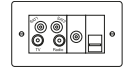

Non-Isolated
TV+FM+SAT1+SAT2
Quadplexer 2in/4out
+TVF+TCS
(DAB Compatible)

Plate Finish	Insert Colour	89 DTRID B	89 DTVF B	89 DTVM B	89 DSAT B	89 DENT B	89 DSAT+ B
Antique Brass	Black	88 DTRID B	88 DTVF B	88 DTVM B	88 DSAT B	88 DENT B	88 DSAT+ B
Black Nickel	Black	87 DTRID B	87 DTVF B	87 DTVM B	87 DSAT B	87 DENT B	87 DSAT+ B
Bright Chrome	Black	87 DTRID W	87 DTVF W	87 DTVM W	87 DSAT W	87 DENT W	87 DSAT+ W
Bright Chrome	White	83 DTRID B	83 DTVF B	83 DTVM B	83 DSAT B	83 DENT B	83 DSAT+ B
Bright Steel	Black	83 DTRID W	83 DTVF W	83 DTVM W	83 DSAT W	83 DENT W	83 DSAT+ W
Bright Steel	White	80 DTRID W	80 DTVF W	80 DTVM W	80 DSAT W	80 DENT W	80 DSAT+ W
Gloss White	White	-	-	-	-	-	-
Matt Black	Black	-	-	-	-	-	-
Matt White	White	-	-	-	-	-	-
Polished Brass	Black	81 DTRID B	81 DTVF B	81 DTVM B	81 DSAT B	81 DENT B	81 DSAT+ B
Polished Brass	White	81 DTRID W	81 DTVF W	81 DTVM W	81 DSAT W	81 DENT W	81 DSAT+ W
Richmond Bronze	Black	-	-	-	-	-	-
Satin Brass	Black	82 DTRID B	82 DTVF B	82 DTVM B	82 DSAT B	82 DENT B	82 DSAT+ B
Satin Brass	White	82 DTRID W	82 DTVF W	82 DTVM W	82 DSAT W	82 DENT W	82 DSAT+ W
Satin Chrome	Black	86 DTRID B	86 DTVF B	86 DTVM B	86 DSAT B	86 DENT B	86 DSAT+ B
Satin Chrome	White	86 DTRID W	86 DTVF W	86 DTVM W	86 DSAT W	86 DENT W	86 DSAT+ W
Satin Steel	Black	84 DTRID B	84 DTVF B	84 DTVM B	84 DSAT B	84 DENT B	84 DSAT+ B
Satin Steel	White	84 DTRID W	84 DTVF W	84 DTVM W	84 DSAT W	84 DENT W	84 DSAT+ W
Nominal Size:		86.0mm x 86.0mm	86.0mm x 86.0mm	86.0mm x 86.0mm	86.0mm x 86.0mm	86.0mm x 86.0mm	146.0mm x 86.0mm
Minimum Wall Box Depth:		35mm	35mm	35mm	35mm	35mm	35mm
Technical Insert Ref:		DTRID	DTVf	DTVM	DSAT	DENT	DSAT+

Insert Surround Colour Key: (-B) Black, (-W) White

Telephone and Data Outlets



84 TCS W



89 J45 B



87 2J12 B



81 J12 W



1 gang Telephone Master



1 gang Telephone Slave



1 gang RJ12 Outlet - Unshielded



2 gang RJ12 Outlet - Unshielded



1 gang RJ45 CAT 5E Outlet - Unshielded



2 gang RJ45 CAT 5E Outlet - Unshielded

Plate Finish	Insert Colour	1 gang Telephone Master	1 gang Telephone Slave	1 gang RJ12 Outlet - Unshielded	2 gang RJ12 Outlet - Unshielded	1 gang RJ45 CAT 5E Outlet - Unshielded	2 gang RJ45 CAT 5E Outlet - Unshielded
Antique Brass	Black	89 TCM B	89 TCS B	89 J12 B	89 2J12 B	89 J45 B	89 2J45 B
Black Nickel	Black	88 TCM B	88 TCS B	88 J12 B	88 2J12 B	88 J45 B	88 2J45 B
Bright Chrome	Black	87 TCM B	87 TCS B	87 J12 B	87 2J12 B	87 J45 B	87 2J45 B
Bright Chrome	White	87 TCM W	87 TCS W	87 J12 W	87 2J12 W	87 J45 W	87 2J45 W
Bright Steel	Black	83 TCM B	83 TCS B	83 J12 B	83 2J12 B	83 J45 B	83 2J45 B
Bright Steel	White	83 TCM W	83 TCS W	83 J12 W	83 2J12 W	83 J45 W	83 2J45 W
Gloss White	White	80 TCM W	80 TCS W	80 J12 W	80 2J12 W	80 J45 W	80 2J45 W
Matt Black	-	-	-	-	-	-	-
Matt White	-	-	-	-	-	-	-
Polished Brass	Black	81 TCM B	81 TCS B	81 J12 B	81 2J12 B	81 J45 B	81 2J45 B
Polished Brass	White	81 TCM W	81 TCS W	81 J12 W	81 2J12 W	81 J45 W	81 2J45 W
Richmond Bronze	-	-	-	-	-	-	-
Satin Brass	Black	82 TCM B	82 TCS B	82 J12 B	82 2J12 B	82 J45 B	82 2J45 B
Satin Brass	White	82 TCM W	82 TCS W	82 J12 W	82 2J12 W	82 J45 W	82 2J45 W
Satin Chrome	Black	86 TCM B	86 TCS B	86 J12 B	86 2J12 B	86 J45 B	86 2J45 B
Satin Chrome	White	86 TCM W	86 TCS W	86 J12 W	86 2J12 W	86 J45 W	86 2J45 W
Satin Steel	Black	84 TCM B	84 TCS B	84 J12 B	84 2J12 B	84 J45 B	84 2J45 B
Satin Steel	White	84 TCM W	84 TCS W	84 J12 W	84 2J12 W	84 J45 W	84 2J45 W
Nominal Size:		86.0mm x 86.0mm	86.0mm x 86.0mm	86.0mm x 86.0mm	86.0mm x 86.0mm	86.0mm x 86.0mm	86.0mm x 86.0mm
Minimum Wall Box Depth:		25mm	25mm	35mm	35mm	35mm	35mm
Technical Insert Ref:		TCM	TCS	J12	2J12	J45	2J45

Insert Surround Colour Key: (-B) Black, (-W) White

Sheer

Double Pole Switches



81 DPN WH-W



87 DPN BC-B



89 45N B



87 45SS1 BC-W



1 gang 20AX
Double Pole
Rocker



1 gang 20AX
Double Pole
Rocker +
Neon



1 gang 20AX
Double Pole
Rocker +
Neon +
Cable Outlet



1 gang 45A
Double Pole
Red Rocker



1 gang 45A
Double Pole
Red Rocker +
Neon

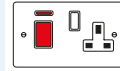

45A Double
Pole Red
Rocker +
Neon +
13A Switched
Socket



1 gang 45A
Double Pole
Red Rocker +
Neon
(Vertically
Mounted)

Plate Finish	Insert Finish/ Surround Colour							
Antique Brass	Antique Brass/Black	-	89 DPN AB-B	-	-	-	89 45SS1 AB-B	-
Antique Brass	Black/Black	-	-	-	89 45 B	89 45N B	-	-
Black Nickel	Black Nickel/Black	-	88 DPN BK-B	-	-	-	88 4 55S1 BK-B	-
Black Nickel	Black/Black	-	-	-	88 45 B	88 4 5N B	-	-
Bright Chrome	Black/Black	87 DP BL-B	87 DPN BL-B	87 DPNC BL-B	87 45 B	87 45N B	87 45SS1 BL-B	87 45V B
Bright Chrome	Bright Chrome/Black	87 DP BC-B	87 DPN BC-B	87 DPNC BC-B	-	-	87 45SS1 BC-B	-
Bright Chrome	Bright Chrome/White	87 DP BC-W	87 DPN BC-W	87 DPNC BC-W	-	-	87 45SS1 BC-W	-
Bright Chrome	White/White	87 DP WH-W	87 DPN WH-W	87 DPNC WH-W	87 45 W	87 45N W	87 45SS1 WH-W	87 45V W
Bright Steel	Black/Black	-	-	-	83 45 B	83 45N B	-	83 45V B
Bright Steel	Bright Chrome/Black	83 DP BC-B	83 DPN BC-B	83 DPNC BC-B	-	-	83 45SS1 BC-B	-
Bright Steel	Bright Chrome/White	83 DP BC-W	83 DPN BC-W	83 DPNC BC-W	-	-	83 45SS1 BC-W	-
Bright Steel	White/White	-	-	-	83 45 W	83 45N W	-	83 45V W
Gloss White	White/White	80 DP WH-W	80 DPN WH-W	80 DPNC WH-W	80 45 W	80 45N W	80 45SS1 WH-W	80 45V W
Polished Brass	Black/Black	81 DP BL-B	81 DPN BL-B	81 DPNC BL-B	81 45 B	81 45N B	81 45SS1 BL-B	81 45V B
Polished Brass	Polished Brass/Black	81 DP PB-B	81 DPN PB-B	81 DPNC PB-B	-	-	81 45SS1 PB-B	-
Polished Brass	Polished Brass/White	81 DP PB-W	81 DPN PB-W	81 DPNC PB-W	-	-	81 45SS1 PB-W	-
Polished Brass	White/White	81 DP WH-W	81 DPN WH-W	81 DPNC WH-W	81 45 W	81 45N W	81 45SS1 WH-W	81 45V W
Satin Brass	Black/Black	82 DP BL-B	82 DPN BL-B	82 DPNC BL-B	82 45 B	82 45N B	82 45SS1 BL-B	82 45V B
Satin Brass	Satin Brass/Black	82 DP SB-B	82 DPN SB-B	82 DPNC SB-B	-	-	82 45SS1 SB-B	-
Satin Brass	Satin Brass/White	82 DP SB-W	82 DPN SB-W	82 DPNC SB-W	-	-	82 45SS1 SB-W	-
Satin Brass	White/White	82 DP WH-W	82 DPN WH-W	82 DPNC WH-W	82 45 W	82 45N W	82 45SS1 WH-W	82 45V W
Satin Chrome	Black/Black	86 DP BL-B	86 DPN BL-B	86 DPNC BL-B	86 45 B	86 45N B	86 45SS1 BL-B	86 45V B
Satin Chrome	Satin Chrome/Black	86 DP SC-B	86 DPN SC-B	86 DPNC SC-B	-	-	86 45SS1 SC-B	-
Satin Chrome	Satin Chrome/White	86 DP SC-W	86 DPN SC-W	86 DPNC SC-W	-	-	86 45SS1 SC-W	-
Satin Chrome	White/White	86 DP WH-W	86 DPN WH-W	86 DPNC WH-W	86 45 W	86 45N W	86 45SS1 WH-W	86 45V W
Satin Steel	Black/Black	84 DP BL-B	84 DPN BL-B	84 DPNC BL-B	84 45 B	84 45N B	84 45SS1 BL-B	84 45V B
Satin Steel	Satin Steel/Black	84 DP SS-B	84 DPN SS-B	84 DPNC SS-B	-	-	84 45SS1 SS-B	-
Satin Steel	Satin Steel/White	84 DP SS-W	84 DPN SS-W	84 DPNC SS-W	-	-	84 45SS1 SS-W	-
Satin Steel	White/White	84 DP WH-W	84 DPN WH-W	84 DPNC WH-W	84 45 W	84 45N W	84 45SS1 WH-W	84 45V W
	Nominal Size:	86.0mm x 86.0mm	86.0mm x 86.0mm	86.0mm x 86.0mm	86.0mm x 86.0mm	86.0mm x 86.0mm	146.0mm x 86.0mm	86.0mm x 146.0mm
	Minimum Wall Box Depth:	35mm	35mm	35mm	35mm	35mm	35mm	35mm
	Technical Insert Ref:	DP	DPN	DPNC	45	45N	45SS1	45V

Insert Surround Colour Key: (-B) Black, (-W) White



87 SP WH-W



88 SPN BK-B



83 SPNC BC-W



87 CO B



1 gang 13A
Double Pole Fused
Spur



1 gang 13A
Double Pole Fused
Spur + Neon



1 gang 13A
Double Pole Fused
Spur + Neon +
Cable Outlet



1 gang 13A
Fuse Only



1 gang 13A Fuse +
Cable Outlet



1 gang 20A
Cable Outlet

Frame Finish	Insert Finish/ Surround Colour	1 gang 13A Double Pole Fused Spur	1 gang 13A Double Pole Fused Spur + Neon	1 gang 13A Double Pole Fused Spur + Neon + Cable Outlet	1 gang 13A Fuse Only	1 gang 13A Fuse + Cable Outlet	1 gang 20A Cable Outlet
Antique Brass	Antique Brass/Black	89 SP AB-B	89 SPN AB-B	-	89 FO AB-B	-	-
Antique Brass	Black/Black	-	-	-	-	-	89 CO B
Black Nickel	Black/Black	-	-	-	-	-	88 CO B
Black Nickel	Black Nickel/Black	88 SP BK-B	88 SPN BK-B	-	88 FO BK-B	-	-
Bright Chrome	Black/Black	87 SP BL-B	87 SPN BL-B	87 SPNC BL-B	87 FO BL-B	87 FOC BL-B	87 CO B
Bright Chrome	Bright Chrome/Black	87 SP BC-B	87 SPN BC-B	87 SPNC BC-B	87 FO BC-B	87 FOC BC-B	-
Bright Chrome	Bright Chrome/White	87 SP BC-W	87 SPN BC-W	87 SPNC BC-W	87 FO BC-W	87 FOC BC-W	-
Bright Chrome	White/White	87 SP WH-W	87 SPN WH-W	87 SPNC WH-W	87 FO WH-W	87 FOC WH-W	87 CO W
Bright Steel	Bright Chrome/Black	83 SP BC-B	83 SPN BC-B	83 SPNC BC-B	83 FO BC-B	83 FOC BC-B	83 CO B
Bright Steel	Bright Chrome/White	83 SP BC-W	83 SPN BC-W	83 SPNC BC-W	83 FO BC-W	83 FOC BC-W	83 CO W
Gloss White	White/White	80 SP WH-W	80 SPN WH-W	80 SPNC WH-W	80 FO WH-W	80 FOC WH-W	80 CO W
Matt Black	Black/Black	8MB SP PL-B	-	-	-	-	-
Matt White	White/White	8MW SP WH-W	-	-	-	-	-
Polished Brass	Black/Black	81 SP BL-B	81 SPN BL-B	81 SPNC BL-B	81 FO BL-B	81 FOC BL-B	81 CO B
Polished Brass	Polished Brass/Black	81 SP PB-B	81 SPN PB-B	81 SPNC PB-B	81 FO PB-B	81 FOC PB-B	-
Polished Brass	Polished Brass/White	81 SP PB-W	81 SPN PB-W	81 SPNC PB-W	81 FO PB-W	81 FOC PB-W	-
Polished Brass	White/White	81 SP WH-W	81 SPN WH-W	81 SPNC WH-W	81 FO WH-W	81 FOC WH-W	81 CO W
Richmond Bronze	Black/Black	8RB SP PL-B	-	-	-	-	-
Satin Brass	Black/Black	82 SP BL-B	82 SPN BL-B	82 SPNC BL-B	82 FO BL-B	82 FOC BL-B	82 CO B
Satin Brass	Satin Brass/Black	82 SP SB-B	82 SPN SB-B	82 SPNC SB-B	82 FO SB-B	82 FOC SB-B	-
Satin Brass	Satin Brass/White	82 SP SB-W	82 SPN SB-W	82 SPNC SB-W	82 FO SB-W	82 FOC SB-W	-
Satin Brass	White/White	82 SP WH-W	82 SPN WH-W	82 SPNC WH-W	82 FO WH-W	82 FOC WH-W	82 CO W
Satin Chrome	Black/Black	86 SP BL-B	86 SPN BL-B	86 SPNC BL-B	86 FO BL-B	86 FOC BL-B	86 CO B
Satin Chrome	Satin Chrome/Black	86 SP SC-B	86 SPN SC-B	86 SPNC SC-B	86 FO SC-B	86 FOC SC-B	-
Satin Chrome	Satin Chrome/White	86 SP SC-W	86 SPN SC-W	86 SPNC SC-W	86 FO SC-W	86 FOC SC-W	-
Satin Chrome	White/White	86 SP WH-W	86 SPN WH-W	86 SPNC WH-W	86 FO WH-W	86 FOC WH-W	86 CO W
Satin Steel	Black/Black	84 SP BL-B	84 SPN BL-B	84 SPNC BL-B	84 FO BL-B	84 FOC BL-B	84 CO B
Satin Steel	Satin Steel/Black	84 SP SS-B	84 SPN SS-B	84 SPNC SS-B	84 FO SS-B	84 FOC SS-B	-
Satin Steel	Satin Steel/White	84 SP SS-W	84 SPN SS-W	84 SPNC SS-W	84 FO SS-W	84 FOC SS-W	-
Satin Steel	White/White	84 SP WH-W	84 SPN WH-W	84 SPNC WH-W	84 FO WH-W	84 FOC WH-W	84 CO W
	Nominal Size:	86.0mm x 86.0mm	86.0mm x 86.0mm	86.0mm x 86.0mm	86.0mm x 86.0mm	86.0mm x 86.0mm	86.0mm x 86.0mm
	Minimum Wall Box Depth:	35mm	35mm	35mm	35mm	35mm	35mm
	Technical Insert Ref:	SP	SPN	SPNC	FO	FOC	CO

Insert Surround Colour Key: (-B) Black, (-W) White

Sheer

LED Trailing/Leading Edge Push On/Off Rotary 2 Way Switching Dimmers



87 1XLEDITB100



89 2XLEDITB100



88 4XLEDITB100



1 gang 100W LED Trailing/Leading Edge Push On/Off Rotary 2 Way Switching Dimmer



2 gang 100W LED Trailing/Leading Edge Push On/Off Rotary 2 Way Switching Dimmer

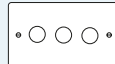

3 gang 100W LED Trailing/Leading Edge Push On/Off Rotary 2 Way Switching Dimmer



4 gang 100W LED Trailing/Leading Edge Push On/Off Rotary 2 Way Switching Dimmer

Plate Finish	Insert Finish	89 1XLEDITB100	89 2XLEDITB100	89 3XLEDITB100	89 4XLEDITB100
Antique Brass	Antique Brass	89 1XLEDITB100	89 2XLEDITB100	89 3XLEDITB100	89 4XLEDITB100
Black Nickel	Black Nickel	88 1XLEDITB100	88 2XLEDITB100	88 3XLEDITB100	88 4XLEDITB100
Bright Chrome	Bright Chrome	87 1XLEDITB100	87 2XLEDITB100	87 3XLEDITB100	87 4XLEDITB100
Bright Steel	Bright Steel	83 1XLEDITB100	83 2XLEDITB100	83 3XLEDITB100	83 4XLEDITB100
Gloss White	Gloss White	80 1XLEDITB100	80 2XLEDITB100	80 3XLEDITB100	80 4XLEDITB100
Matt Black	Matt Black	8MB 1XLEDITB100	8MB 2XLEDITB100	-	-
Matt White	Matt White	8MW 1XLEDITB100	8MW 2XLEDITB100	-	-
Polished Brass	Polished Brass	81 1XLEDITB100	81 2XLEDITB100	81 3XLEDITB100	81 4XLEDITB100
Richmond Bronze	Richmond Bronze	8RB 1XLEDITB100	8RB 2XLEDITB100	8RB 3XLEDITB100	8RB 4XLEDITB100
Satin Brass	Satin Brass	82 1XLEDITB100	82 2XLEDITB100	82 3XLEDITB100	82 4XLEDITB100
Satin Chrome	Satin Chrome	86 1XLEDITB100	86 2XLEDITB100	86 3XLEDITB100	86 4XLEDITB100
Satin Steel	Satin Steel	84 1XLEDITB100	84 2XLEDITB100	84 3XLEDITB100	84 4XLEDITB100
Nominal Size:		86.0mm x 86.0mm	86.0mm x 86.0mm	146.0mm x 86.0mm	146.0mm x 86.0mm
Minimum Wall Box Depth:		35mm	35mm	35mm	35mm
Technical Insert Ref:		1XLEDITB	2XLEDITB	3XLEDITB	4XLEDITB

LED Trailing/Leading Edge Push On/Off Rotary Multi-Way Dimmers



1 gang 100W LED Trailing/Leading Edge Push On/Off Rotary Multi-Way Dimmer



2 gang 100W LED Trailing/Leading Edge Push On/Off Rotary Multi-Way Dimmers



3 gang 100W LED Trailing/Leading Edge Push On/Off Rotary Multi-Way Dimmers



4 gang 100W LED Trailing/Leading Edge Push On/Off Rotary Multi-Way Dimmers

Plate Finish	Insert Finish	89 1X100LED	89 2X100LED	89 3X100LED	89 4X100LED
Antique Brass	Antique Brass	89 1X100LED	89 2X100LED	89 3X100LED	89 4X100LED
Black Nickel	Black Nickel	88 1X100LED	88 2X100LED	88 3X100LED	88 4X100LED
Bright Chrome	Bright Chrome	87 1X100LED	87 2X100LED	87 3X100LED	87 4X100LED
Bright Steel	Bright Steel	83 1X100LED	83 2X100LED	83 3X100LED	83 4X100LED
Gloss White	Gloss White	80 1X100LED	80 2X100LED	80 3X100LED	80 4X100LED
Polished Brass	Polished Brass	81 1X100LED	81 2X100LED	81 3X100LED	81 4X100LED
Richmond Bronze	Richmond Bronze	8RB 1X100LED	8RB 2X100LED	8RB 3X100LED	8RB 4X100LED
Satin Brass	Satin Brass	82 1X100LED	82 2X100LED	82 3X100LED	82 4X100LED
Satin Chrome	Satin Chrome	86 1X100LED	86 2X100LED	86 3X100LED	86 4X100LED
Satin Steel	Satin Steel	84 1X100LED	84 2X100LED	84 3X100LED	84 4X100LED
Nominal Size:		86.0mm x 86.0mm	86.0mm x 86.0mm	146.0mm x 86.0mm	146.0mm x 86.0mm
Minimum Wall Box Depth:		35mm	35mm	35mm	35mm
Technical Insert Ref:		1X100LED	2X100LED	3X100LED	4X100LED

NOTE: Tungsten filament GU10 lamps must be branded and with a fused base.
 NOTE: Please refer to the Dimmer Technical Section for the max Wattage.
 NOTE: Please contact our Technical Department for compatibility.

Sheer

Resistive Leading Edge Push On/Off Rotary 2 Way Switching Dimmers



89 1X40



87 2X40



88 3X40



1 gang 400W Resistive Leading Edge Push On/Off Rotary 2 Way Switching Dimmer



2 gang 400W Resistive Leading Edge Push On/Off Rotary 2 Way Switching Dimmer

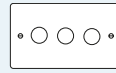

3 gang 400W Resistive Leading Edge Push On/Off Rotary 2 Way Switching Dimmer

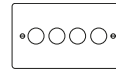

4 gang 400W Resistive Leading Edge Push On/Off Rotary 2 Way Switching Dimmer



1 gang 600W Resistive Leading Edge Push On/Off Rotary 2 Way Switching Dimmer

Plate Finish	Insert Finish	1 gang 400W Resistive Leading Edge Push On/Off Rotary 2 Way Switching Dimmer	2 gang 400W Resistive Leading Edge Push On/Off Rotary 2 Way Switching Dimmer	3 gang 400W Resistive Leading Edge Push On/Off Rotary 2 Way Switching Dimmer	4 gang 400W Resistive Leading Edge Push On/Off Rotary 2 Way Switching Dimmer	1 gang 600W Resistive Leading Edge Push On/Off Rotary 2 Way Switching Dimmer
Antique Brass	Antique Brass	89 1X40	89 2X40	89 3X40	89 4X40	89 1X60
Black Nickel	Black Nickel	88 1X40	88 2X40	88 3X40	88 4X40	88 1X60
Bright Chrome	Bright Chrome	87 1X40	87 2X40	87 3X40	87 4X40	87 1X60
Bright Steel	Bright Steel	83 1X40	83 2X40	83 3X40	83 4X40	83 1X60
Gloss White	Gloss White	80 1X40	80 2X40	80 3X40	80 4X40	80 1X60
Matt Black	Matt Black	8MB 1X40	8MB 2X40	-	-	-
Matt White	Matt White	8MW 1X40	8MW 2X40	-	-	-
Polished Brass	Polished Brass	81 1X40	81 2X40	81 3X40	81 4X40	81 1X60
Richmond Bronze	Richmond Bronze	8RB 1X40	8RB 2X40	-	-	-
Satin Brass	Satin Brass	82 1X40	82 2X40	82 3X40	82 4X40	82 1X60
Satin Chrome	Satin Chrome	86 1X40	86 2X40	86 3X40	86 4X40	86 1X60
Satin Steel	Satin Steel	84 1X40	84 2X40	84 3X40	84 4X40	84 1X60
	Nominal Size:	86.0mm x 86.0mm	86.0mm x 86.0mm	146.0mm x 86.0mm	146.0mm x 86.0mm	86.0mm x 86.0mm
	Minimum Wall Box Depth:	35mm	35mm	35mm	35mm	35mm
	Technical Insert Ref:	1X40	2X40	3X40	4X40	1X60

NOTE: Tungsten filament GU10 lamps must be branded and with a fused base
 NOTE: When using mains voltage halogen lamps – dimmers should be re-rated by 25%
 NOTE: When dimming LED lamps de-rate by 75% - please contact our Technical Department for compatibility.
 NOTE: Please refer to the Dimmer Technical Section for the max wattage

Sheer

Inductive Leading Edge Push On/Off Rotary 2 Way Switching Dimmers



89 1X2V



87 2X2V



1 gang 200VA
Inductive Leading Edge Push
On/Off Rotary
2 Way Switching Dimmer



2 gang 200VA
Inductive Leading Edge Push
On/Off Rotary
2 Way Switching Dimmer

Plate Finish	Insert Finish	1 gang 200VA Inductive Leading Edge Push On/Off Rotary 2 Way Switching Dimmer	2 gang 200VA Inductive Leading Edge Push On/Off Rotary 2 Way Switching Dimmer
Antique Brass	Antique Brass	89 1X2V	89 2X2V
Black Nickel	Black Nickel	88 1X2V	88 2X2V
Bright Chrome	Bright Chrome	87 1X2V	87 2X2V
Bright Steel	Bright Steel	83 1X2V	83 2X2V
Gloss White	Gloss White	80 1X2V	80 2X2V
Matt Black	-	-	-
Matt White	-	-	-
Polished Brass	Polished Brass	81 1X2V	81 2X2V
Richmond Bronze	-	-	-
Satin Brass	Satin Brass	82 1X2V	82 2X2V
Satin Chrome	Satin Chrome	86 1X2V	86 2X2V
Satin Steel	Satin Steel	84 1X2V	84 2X2V
Nominal Size:		86.0mm x 86.0mm	86.0mm x 86.0mm
Minimum Wall Box Depth:		35mm	35mm
Technical Insert Ref:		1X2V	2X2V

NOTE: Tungsten filament GU10 lamps must be branded and with a fused base

NOTE: When using mains voltage halogen lamps – dimmers should be re-rated by 25%

NOTE: When dimming LED lamps de-rate by 75% - please contact our Technical Department for compatibility.

NOTE: Please refer to the Dimmer Technical Section for the max wattage

Sheer

Resistive/Inductive Trailing Edge Push On/Off Rotary Multi-Way Dimmers



89 1XTE



87 2XTE



88 3XTE



83 4XTE



1 gang 250W/210VA Resistive/Inductive Trailing Edge Push On/Off Rotary Multi-Way Dimmer



2 gang 250W/210VA Resistive/Inductive Trailing Edge Push On/Off Rotary Multi-Way Dimmer

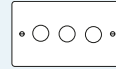

3 gang 250W/210VA Resistive/Inductive Trailing Edge Push On/Off Rotary Multi-Way Dimmer

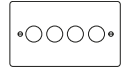

4 gang 250W/210VA Resistive/Inductive Trailing Edge Push On/Off Rotary Multi-Way Dimmer

Plate Finish	Insert Finish	1 gang 250W/210VA Resistive/Inductive Trailing Edge Push On/Off Rotary Multi-Way Dimmer	2 gang 250W/210VA Resistive/Inductive Trailing Edge Push On/Off Rotary Multi-Way Dimmer	3 gang 250W/210VA Resistive/Inductive Trailing Edge Push On/Off Rotary Multi-Way Dimmer	4 gang 250W/210VA Resistive/Inductive Trailing Edge Push On/Off Rotary Multi-Way Dimmer
Antique Brass	Antique Brass	89 1XTE	89 2XTE	89 3XTE	89 4XTE
Black Nickel	Black Nickel	88 1XTE	88 2XTE	88 3XTE	88 4XTE
Bright Chrome	Bright Chrome	87 1XTE	87 2XTE	87 3XTE	87 4XTE
Bright Steel	Bright Steel	83 1XTE	83 2XTE	83 3XTE	83 4XTE
Gloss White	Gloss White	80 1XTE	80 2XTE	80 3XTE	80 4XTE
Matt Black	-	-	-	-	-
Matt White	-	-	-	-	-
Polished Brass	Polished Brass	81 1XTE	81 2XTE	81 3XTE	81 4XTE
Richmond Bronze	-	-	-	-	-
Satin Brass	Satin Brass	82 1XTE	82 2XTE	82 3XTE	82 4XTE
Satin Chrome	Satin Chrome	86 1XTE	86 2XTE	86 3XTE	86 4XTE
Satin Steel	Satin Steel	84 1XTE	84 2XTE	84 3XTE	84 4XTE
Nominal Size:		86.0mm x 86.0mm	86.0mm x 86.0mm	146.0mm x 86.0mm	146.0mm x 86.0mm
Minimum Wall Box Depth:		35mm	35mm	35mm	35mm
Technical Insert Ref:		1XTE	2XTE	3XTE	4XTE

NOTE: Tungsten filament GU10 lamps must be branded and with a fused base
 NOTE: When using mains voltage halogen lamps – dimmers should be re-rated by 25%
 NOTE: When dimming LED lamps de-rate by 75% - please contact our Technical Department for compatibility.
 NOTE: Please refer to the Dimmer Technical Section for the max wattage

Sheer

Resistive/Inductive Trailing Edge Touch Master Multi-Way Dimmers



88 1XTM BK-B



82 2XTM PB-W

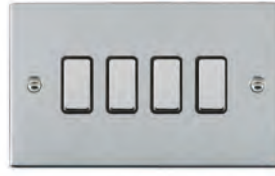

87 4XTM BC-B

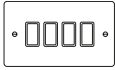
Plate Finish	Insert Finish/ Surround Colour				
		1 gang 250W/210VA Resistive/Inductive Trailing Edge Touch Master Multi-Way Dimmer	2 gang 250W/210VA Resistive/Inductive Trailing Edge Touch Master Multi-Way Dimmer	3 gang 250W/210VA Resistive/Inductive Trailing Edge Touch Master Multi-Way Dimmer	4 gang 250W/210VA Resistive/Inductive Trailing Edge Touch Master Multi-Way Dimmer
Antique Brass	Antique Brass/Black	89 1XTM AB-B	89 2XTM AB-B	89 3XTM AB-B	89 4XTM AB-B
Black Nickel	Black Nickel/Black	88 1XTM BK-B	88 2XTM BK-B	88 3XTM BK-B	88 4XTM BK-B
Bright Chrome	Bright Chrome/Black	87 1XTM BC-B	87 2XTM BC-B	87 3XTM BC-B	87 4XTM BC-B
Bright Chrome	Bright Chrome/White	87 1XTM BC-W	87 2XTM BC-W	87 3XTM BC-W	87 4XTM BC-W
Bright Steel	Bright Chrome/Black	83 1XTM BC-B	83 2XTM BC-B	83 3XTM BC-B	83 4XTM BC-B
Bright Steel	Bright Chrome/White	83 1XTM BC-W	83 2XTM BC-W	83 3XTM BC-W	83 4XTM BC-W
Matt Black	-	-	-	-	-
Matt White	-	-	-	-	-
Polished Brass	Polished Brass/Black	81 1XTM PB-B	81 2XTM PB-B	81 3XTM PB-B	81 4XTM PB-B
Polished Brass	Polished Brass/White	81 1XTM PB-W	81 2XTM PB-W	81 3XTM PB-W	81 4XTM PB-W
Richmond Bronze	-	-	-	-	-
Satin Brass	Satin Brass/Black	82 1XTM SB-B	82 2XTM SB-B	82 3XTM SB-B	82 4XTM SB-B
Satin Brass	Satin Brass/White	82 1XTM SB-W	82 2XTM SB-W	82 3XTM SB-W	82 4XTM SB-W
Satin Chrome	Satin Chrome/Black	86 1XTM SC-B	86 2XTM SC-B	86 3XTM SC-B	86 4XTM SC-B
Satin Chrome	Satin Chrome/White	86 1XTM SC-W	86 2XTM SC-W	86 3XTM SC-W	86 4XTM SC-W
Satin Steel	Satin Steel/Black	84 1XTM SS-B	84 2XTM SS-B	84 3XTM SS-B	84 4XTM SS-B
Satin Steel	Satin Steel/White	84 1XTM SS-W	84 2XTM SS-W	84 3XTM SS-W	84 4XTM SS-W
Nominal Size:		86.0mm x 86.0mm	86.0mm x 86.0mm	146.0mm x 86.0mm	146.0mm x 86.0mm
Minimum Wall Box Depth:		35mm	35mm	35mm	35mm
Technical Insert Ref:		1XTM	2XTM	3XTM	4XTM

NOTE: Tungsten filament GU10 lamps must be branded and with a fused base
 NOTE: When using mains voltage halogen lamps – dimmers should be re-rated by 25%
 NOTE: When dimming LED lamps de-rate by 75% - please contact our Technical Department for compatibility.
 NOTE: Please refer to the Dimmer Technical Section for the max wattage

Insert Surround Colour Key: (-B) Black, (-W) White

Sheer

Multi-Way Touch Slave Controllers

SHEER RANGE



81 1XTS PB-B



87 2XTS BC-W



83 4XTS BC-W

Plate Finish	Insert Finish/ Surround Colour				
		1 gang Multi-Way Touch Slave Controller	2 gang Multi-Way Touch Slave Controller	3 gang Multi-Way Touch Slave Controller	4 gang Multi-Way Touch Slave Controller
Antique Brass	Antique Brass/Black	89 1XTS AB-B	89 2XTS AB-B	89 3XTS AB-B	89 4XTS AB-B
Black Nickel	Black Nickel/Black	88 1 XTS BK-B	88 2 XTS BK-B	88 3XTS BK-B	88 4XTS BK-B
Bright Chrome	Bright Chrome/Black	87 1XTS BC-B	87 2XTS BC-B	87 3XTS BC-B	87 4XTS BC-B
Bright Chrome	Bright Chrome/White	87 1XTS BC-W	87 2XTS BC-W	87 3XTS BC-W	87 4XTS BC-W
Bright Steel	Bright Chrome/Black	83 1XTS BC-B	83 2XTS BC-B	83 3XTS BC-B	83 4XTS BC-B
Bright Steel	Bright Chrome/White	83 1XTS BC-W	83 2XTS BC-W	83 3XTS BC-W	83 4XTS BC-W
Matt Black	-	-	-	-	-
Matt White	-	-	-	-	-
Polished Brass	Polished Brass/Black	81 1XTS PB-B	81 2XTS PB-B	81 3XTS PB-B	81 4XTS PB-B
Polished Brass	Polished Brass/White	81 1XTS PB-W	81 2XTS PB-W	81 3XTS PB-W	81 4XTS PB-W
Richmond Bronze	-	-	-	-	-
Satin Brass	Satin Brass/Black	82 1XTS SB-B	82 2XTS SB-B	82 3XTS SB-B	82 4XTS SB-B
Satin Brass	Satin Brass/White	82 1XTS SB-W	82 2XTS SB-W	82 3XTS SB-W	82 4XTS SB-W
Satin Chrome	Satin Chrome/Black	86 1XTS SC-B	86 2XTS SC-B	86 3XTS SC-B	86 4XTS SC-B
Satin Chrome	Satin Chrome/White	86 1XTS SC-W	86 2XTS SC-W	86 3XTS SC-W	86 4XTS SC-W
Satin Steel	Satin Steel/Black	84 1XTS SS-B	84 2XTS SS-B	84 3XTS SS-B	84 4XTS SS-B
Satin Steel	Satin Steel/White	84 1XTS SS-W	84 2XTS SS-W	84 3XTS SS-W	84 4XTS SS-W
Nominal Size:		86.0mm x 86.0mm	86.0mm x 86.0mm	146.0mm x 86.0mm	146.0mm x 86.0mm
Minimum Wall Box Depth:		35mm	35mm	35mm	35mm
Technical Insert Ref:		1XTS	2XTS	3XTS	4XTS

NOTE: To only be used with Touch Masters

Insert Surround Colour Key: (-B) Black, (-W) White

Sheer

Blank Plates



89 BPS

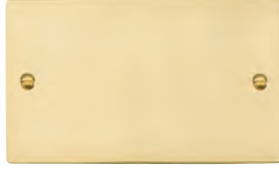

81 BPD



Single Blank Plate



Double Blank Plate

Plate Finish	Single Blank Plate	Double Blank Plate
Antique Brass	89 BPS	89 BPD
Black Nickel	88 BPS	88 BPD
Bright Chrome	87 BPS	87 BPD
Bright Steel	83 BPS	83 BPD
Gloss White	80 BPS	80 BPD
Matt Black	-	-
Matt White	-	-
Polished Brass	81 BPS	81 BPD
Richmond Bronze	-	-
Satin Brass	82 BPS	82 BPD
Satin Chrome	86 BPS	86 BPD
Satin Steel	84 BPS	84 BPD
Nominal Size:	86.0mm x 86.0mm	146.0mm x 86.0mm
Minimum Wall Box Depth:	Any Box	Any Box
Technical Insert Ref:	BPS	BPD

Sheer

GRID-IT Grid Fix Plates complete with Fixing Grid



89 1GP

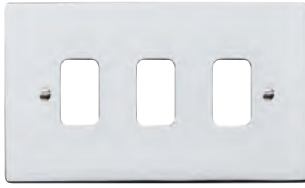

87 3GP

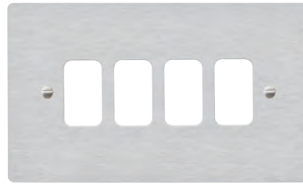

84 4GP

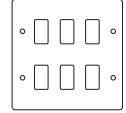

Plate Finish	1 Gang Grid Fix Aperture Plate with Grid	2 Gang Grid Fix Aperture Plate with Grid	3 Gang Grid Fix Aperture Plate with Grid	4 Gang Grid Fix Aperture Plate with Grid	6 Gang Grid Fix Aperture Plate with Grid
Antique Brass	89 1GP	89 2GP	89 3GP	89 4GP	89 6GP
Black Nickel	88 1GP	88 2GP	-	88 4GP	88 6GP
Bright Chrome	87 1GP	87 2GP	87 3GP	87 4GP	87 6GP
Bright Steel	83 1GP	83 2GP	83 3GP	83 4GP	83 6GP
Gloss White	80 1GP	80 2GP	80 3GP	80 4GP	80 6GP
Matt Black	-	-	-	-	-
Matt White	-	-	-	-	-
Polished Brass	81 1GP	81 2GP	81 3GP	81 4GP	81 6GP
Primed White	8WP 1GP	8WP 2GP	8WP 3GP	8WP 4GP	8WP 6GP
Richmond Bronze	-	-	-	-	-
Satin Chrome	86 1GP	86 2GP	86 3GP	86 4GP	86 6GP
Satin Brass	82 1GP	82 2GP	82 3GP	82 4GP	82 6GP
Satin Steel	84 1GP	84 2GP	84 3GP	84 4GP	84 6GP
Nominal Size:	86.0mm x 86.0mm	86.0mm x 86.0mm	146.0mm x 86.0mm	146.0mm x 86.0mm	146.0mm x 146.0mm
Minimum Wall Box Depth:	As Per insert	As Per inserts	As Per Inserts	As Per Inserts	As Per Inserts
Technical Insert Ref:	1GP	2GP	3GP	4GP	6GP

Note: Minimum Wall Box depth is dependant on the Grid Fix insert fitted, please see the GRID-IT section for the complete range of inserts.

Sheer

GRID-IT Fix Plates complete with Fixing Grid



83 8GP

87 9GP

88 SS2GP

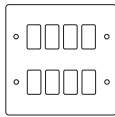

8 gang Grid Fix Aperture Plate with Grid

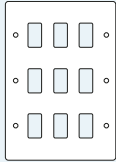

9 gang Grid Fix Aperture Plate with Grid

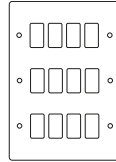

12 gang Grid Fix Aperture Plate with Grid



1 gang 13A Switched Socket Grid Fix Aperture Plate (Grids supplied with inserts)

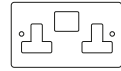

2 gang 13A Switched Socket Grid Fix Aperture Plate (Grids supplied with inserts)

Plate Finish	8 gang Grid Fix Aperture Plate with Grid	9 gang Grid Fix Aperture Plate with Grid	12 gang Grid Fix Aperture Plate with Grid	1 gang 13A Switched Socket Grid Fix Aperture Plate (Grids supplied with inserts)	2 gang 13A Switched Socket Grid Fix Aperture Plate (Grids supplied with inserts)
Antique Brass	89 8GP	89 9GP	89 12GP	89 SS1GP	89 SS2GP
Black Nickel	88 8GP	88 9GP	88 12GP	88 SS1GP	88 SS2GP
Bright Chrome	87 8GP	87 9GP	87 12GP	87 SS1GP	87 SS2GP
Bright Steel	83 8GP	83 9GP	83 12GP	83 SS1GP	83 SS2GP
Gloss White	80 8GP	80 9GP	80 12GP	80 SS1GP	80 SS2GP
Matt Black	-	-	-	-	-
Matt White	-	-	-	-	-
Polished Brass	81 8GP	81 9GP	81 12GP	81 SS1GP	81 SS2GP
Primed White	8WP 8GP	8WP 9GP	8WP 12GP	-	-
Richmond Bronze	-	-	-	-	-
Satin Chrome	86 8GP	86 9GP	86 12GP	86 SS1GP	86 SS2GP
Satin Brass	82 8GP	82 9GP	82 12GP	82 SS1GP	82 SS2GP
Satin Steel	84 8GP	84 9GP	84 12GP	84 SS1GP	84 SS2GP
Nominal Size:	146.0mm x 146.0mm	146.0mm x 210mm	146.0mm x 210mm	86.0mm x 86.0mm	146.0mm x 86.0mm
Minimum Wall Box Depth:	As Per Inserts	As Per Inserts	As Per Inserts	As Per insert	As Per insert
Technical Insert Ref:	8GP	9GP	12GP	SS1GP	SS2GP

Note: Minimum Wall Box depth is dependant on the Grid Fix insert fitted, please see the GRID-IT section for the complete range of inserts.

Sheer

EuroFix Media Plates

complete with 13A Unswitched Power Sockets



87 MED2 B

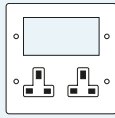

Media Plate EURO4 Aperture +
2 X 13A Unswitched Socket

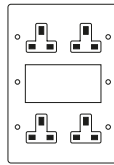

Media Plate EURO4 Aperture +
4 X 13A Unswitched Socket

Plate Finish	Insert Finish	Media Plate EURO4 Aperture + 2 X 13A Unswitched Socket	Media Plate EURO4 Aperture + 4 X 13A Unswitched Socket
Bright Chrome	Black	87 MED1 B	87 MED2 B
Bright Chrome	White	87 MED1 W	87 MED2 W
Satin Chrome	Black	86 MED1 B	86 MED2 B
Satin Chrome	White	86 MED1 W	86 MED2 W
Matt Black	-	-	-
Matt White	-	-	-
Polished Brass	Black	81 MED1 B	81 MED2 B
Polished Brass	White	81 MED1 W	81 MED2 W
Richmond Bronze	-	-	-
Satin Brass	Black	82 MED1 B	82 MED2 B
Satin Brass	White	82 MED1 W	82 MED2 W
Bright Steel	Black	83 MED1 B	83 MED2 B
Bright Steel	White	83 MED1 W	83 MED2 W
Satin Steel	Black	84 MED1 B	84 MED2 B
Satin Steel	White	84 MED1 W	84 MED2 W
Nominal Size:		146.0mm x 146.0mm	146.0mm x 210mm
Minimum Wall Box Depth:		As Per Inserts	As Per Inserts
Technical Insert Ref:		MED1	MED2

Note: Minimum Wall Box depth is dependant on the EuroFix insert fitted, please see the EuroFix section for our complete range of inserts.

Insert Surround Colour Key: (-B) Black, (-W) White

Sheer

EuroFix Plates complete with Fixing Grid



87 EURO1



89 EURO2

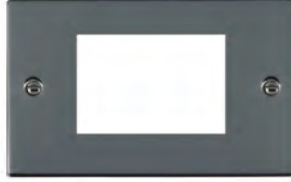

88 EURO3

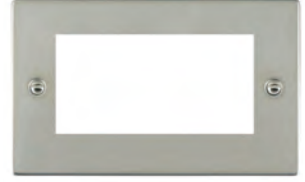

83 EURO4



1 Module EuroFix
25x50 Apertured
Plate with Grid



2 Module Eurofix
50x50mm Apertured
Plate with Grid

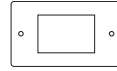

3 Module EuroFix
75x50mm Apertured
Plate with Grid

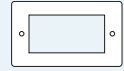

4 Modules
100x50mm Apertured
Plate with Grid

Plate Colour	1 Module EuroFix 25x50 Apertured Plate with Grid	2 Module Eurofix 50x50mm Apertured Plate with Grid	3 Module EuroFix 75x50mm Apertured Plate with Grid	4 Modules 100x50mm Apertured Plate with Grid
Antique Brass	89 EURO1	89 EURO2	89 EURO3	89 EURO4
Black Nickel	88 EURO1	88 EURO2	88 EURO3	88 EURO4
Bright Chrome	87 EURO1	87 EURO2	87 EURO3	87 EURO4
Bright Steel	83 EURO1	83 EURO2	83 EURO3	83 EURO4
Gloss White	80 EURO1	80 EURO2	80 EURO3	80 EURO4
Matt Black	-	8MB EURO2	-	8MB EURO4
Matt White	-	8MW EURO2	-	8MW EURO4
Polished Brass	81 EURO1	81 EURO2	81 EURO3	81 EURO4
Richmond Bronze	-	8RB EURO2	-	8RB EURO4
Satin Chrome	86 EURO1	86 EURO2	86 EURO3	86 EURO4
Satin Brass	82 EURO1	82 EURO2	82 EURO3	82 EURO4
Satin Steel	84 EURO1	84 EURO2	84 EURO3	84 EURO4
Nominal Size:	86.0mm x 86.0mm	86.0mm x 86.0mm	146.0mm x 86.0mm	146.0mm x 86.0mm
Minimum Wall Box Depth:	As Per Insert	As Per Inserts	As Per Inserts	As Per Inserts
Technical Insert Ref:	EURO1	EURO2	EURO3	EURO4

Note: Minimum Wall Box depth is dependant on the EuroFix insert fitted, please see the EuroFix section for our complete range of inserts.



Sheer CFX[®]

Concealed Fixing Accessories on Stylish Flat Plates

Sheer CFX[®] are simple and elegant, flat-plate switches and sockets. The range features Hamilton's patented CFX[®] 4 point face plate clipping system allowing concealed fixing for a clean and contemporary finish that looks stylish in any environment. Sheer CFX[®] also benefits from an integral gasket that forms part of the mounting frame, this is ideal for use on walls that are not perfectly flat.

- Minimalist, modern flat plate
- Beautiful finishes, including four shades of bronze
- Concealed fixing
- Integral gasket – perfect for uneven walls
- Grid and EuroFix options also available (see separate GRID-IT and EuroFix section for inserts)



Sheer CFX® Range



Plate finishes available in this range



Hamilton Sheer CFX® Concealed Fixing

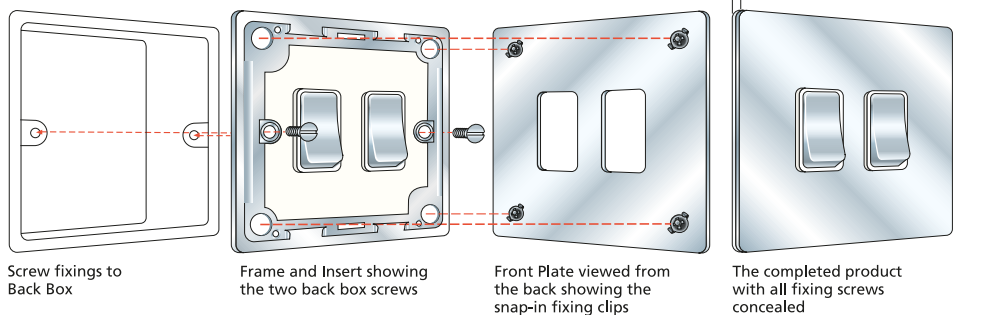

Sheer CFX®

Rocker Switches



89C R21 AB-B







87C R22 BC-W



87C R23 BC-B



84C R24 SS-W

Plate Colour	Insert Finish/ Surround Colour					
		1 gang 10AX 2 Way Rocker	2 gang 10AX 2 Way Rocker	3 gang 10AX 2 Way Rocker	4 gang 10AX 2 Way Rocker	6 gang 10AX 2 Way Rocker
Antique Brass	Antique Brass/Black	89C R21 AB-B	89C R22 AB-B	89C R23 AB-B	89C R24 AB-B	89C R26 AB-B
Black Nickel	Black Nickel/Black	88C R21 BK-B	88C R22 BK-B	88C R23 BK-B	88C R24 BK-B	88C R26 BK-B
Bright Chrome	Bright Chrome/Black	87C R21 BC-B	87C R22 BC-B	87C R23 BC-B	87C R24 BC-B	87C R26 BC-B
Bright Chrome	Bright Chrome/White	87C R21 BC-W	87C R22 BC-W	87C R23 BC-W	87C R24 BC-W	87C R26 BC-W
Connaught Bronze	Black/Black	8HBC R21 BL-B	8HBC R22 BL-B	8HBC R23 BL-B	8HBC R24 BL-B	8HBC R26 BL-B
Copper Bronze	Black/Black	8CBC R21 BL-B	8CBC R22 BL-B	8CBC R23 BL-B	8CBC R24 BL-B	8CBC R26 BL-B
Etrium Bronze	Black/Black	8EBC R21 BL-B	8EBC R22 BL-B	8EBC R23 BL-B	8EBC R24 BL-B	8EBC R26 BL-B
Gloss White	White/White	80C R21 WH-W	80C R22 WH-W	80C R23 WH-W	80C R24 WH-W	80C R26 WH-W
Polished Brass	Polished Brass/Black	81C R21 PB-B	81C R22 PB-B	81C R23 PB-B	81C R24 PB-B	81C R26 PB-B
Polished Brass	Polished Brass/White	81C R21 PB-W	81C R22 PB-W	81C R23 PB-W	81C R24 PB-W	81C R26 PB-W
Polished Nickel	Bright Chrome/Black	8PNC R21 BC-B	8PNC R22 BC-B	8PNC R23 BC-B	-	-
Polished Nickel	Bright Chrome/White	8PNC R21 BC-W	8PNC R22 BC-W	8PNC R23 BC-W	-	-
Primed White	Black/Black	8WPC R21 BL-B	8WPC R22 BL-B	8WPC R23 BL-B	8WPC R24 BL-B	8WPC R26 BL-B
Primed White	White/White	8WPC R21 WH-W	8WPC R22 WH-W	8WPC R23 WH-W	8WPC R24 WH-W	8WPC R26 WH-W
Richmond Bronze	Black/Black	8RBC R21 BL-B	8RBC R22 BL-B	8RBC R23 BL-B	8RBC R24 BL-B	8RBC R26 BL-B
Satin Brass	Satin Brass/Black	82C R21 SB-B	82C R22 SB-B	82C R23 SB-B	82C R24 SB-B	82C R26 SB-B
Satin Brass	Satin Brass/White	82C R21 SB-W	82C R22 SB-W	82C R23 SB-W	82C R24 SB-W	82C R26 SB-W
Satin Steel	Satin Steel/Black	84C R21 SS-B	84C R22 SS-B	84C R23 SS-B	84C R24 SS-B	84C R26 SS-B
Satin Steel	Satin Steel/White	84C R21 SS-W	84C R22 SS-W	84C R23 SS-W	84C R24 SS-W	84C R26 SS-W
Nominal Size:		86.0mm x 86.0mm	86.0mm x 86.0mm	86.0mm x 86.0mm	145.0mm x 86.0mm	145.0mm x 86.0mm
Minimum Wall Box Depth:		25mm	25mm	25mm	25mm	25mm
Technical Insert Ref:		R21	R22	R23	R24	R26

Insert Surround Colour Key: (-B) Black, (-W) White

Sheer CFX®

Rocker Switches



84C R31 SS-W







89C R32 AB-B



87C TP WH-W



82C TP BL-B

Plate Colour	Insert Finish/ Surround Colour				
		1 gang 10AX Intermediate Rocker	2 gang 10AX Intermediate Rocker	1 gang 10AX Push To Make/ Push to Break Retractive Rocker	1 gang 10A Triple Pole Rocker
Antique Brass	Antique Brass/Black	89C R31 AB-B	89C R32 AB-B	89C RRT AB-B	-
Antique Brass	Black/Black	-	-	-	89C TP BL-B
Black Nickel	Black/Black	-	-	-	88C TP BL-B
Black Nickel	Black Nickel/Black	88C R31 BK-B	88C R32 BK-B	88C RRT BK-B	-
Bright Chrome	Black/Black	-	-	-	87C TP BL-B
Bright Chrome	Bright Chrome/Black	87C R31 BC-B	87C R32 BC-B	87C RRT BC-B	-
Bright Chrome	Bright Chrome/White	87C R31 BC-W	87C R32 BC-W	87C RRT BC-W	-
Bright Chrome	White/White	-	-	-	87C TP WH-W
Connought Bronze	Black/Black	8HBC R31 BL-B	8HBC R32 BL-B	8HBC RRT BL-B	8HBC TP BL-B
Copper Bronze	Black/Black	8CBC R31 BL-B	8CBC R32 BL-B	8CBC RRT BL-B	8CBC TP BL-B
Etrium Bronze	Black/Black	8EBC R31 BL-B	8EBC R32 BL-B	8EBC RRT BL-B	8EBC TP BL-B
Gloss White	White/White	80C R31 WH-W	80C R32 WH-W	80C RRT WH-W	80C TP WH-W
Polished Brass	Black/Black	-	-	-	81C TP BL-B
Polished Brass	Polished Brass/Black	81C R31 PB-B	81C R32 PB-B	81C RRT PB-B	-
Polished Brass	Polished Brass/White	81C R31 PB-W	81C R32 PB-W	81C RRT PB-W	-
Polished Brass	White/White	-	-	-	81C TP WH-W
Polished Nickel	Black/Black	-	-	-	8PNC TP BL-B
Polished Nickel	Bright Chrome/Black	8PNC R31 BC-B	-	-	-
Polished Nickel	Bright Chrome/White	8PNC R31 BC-W	-	-	-
Polished Nickel	White/White	-	-	-	8PNC TP WH-W
Primed White	Black/Black	8WPC R31 BL-B	8WPC R32 BL-B	8WPC RRT BL-B	8WPC TP BL-B
Primed White	White/White	8WPC R31 WH-W	8WPC R32 WH-W	8WPC RRT WH-W	8WPC TP WH-W
Richmond Bronze	Black/Black	8RBC R31 BL-B	8RBC R32 BL-B	8RBC RRT BL-B	8RBC TP BL-B
Satin Brass	Black/Black	-	-	-	82C TP BL-B
Satin Brass	Satin Brass/Black	82C R31 SB-B	82C R32 SB-B	82C RRT SB-B	-
Satin Brass	Satin Brass/White	82C R31 SB-W	82C R32 SB-W	82C RRT SB-W	-
Satin Brass	White/White	-	-	-	82C TP WH-W
Satin Steel	Black/Black	-	-	-	84C TP BL-B
Satin Steel	Satin Steel/Black	84C R31 SS-B	84C R32 SS-B	84C RRT SS-B	-
Satin Steel	Satin Steel/White	84C R31 SS-W	84C R32 SS-W	84C RRT SS-W	-
Satin Steel	White/White	-	-	-	84C TP WH-W
	Nominal Size:	86.0mm x 86.0mm	86.0mm x 86.0mm	86.0mm x 86.0mm	86.0mm x 86.0mm
	Minimum Wall Box Depth:	25mm	25mm	25mm	25mm
	Technical Insert Ref:	R31	R32	RRT	TP

Insert Surround Colour Key: (-B) Black, (-W) White

Sheer CFX®

Rocker Switches



84C R212 SS-W







81C R222 PB-B



87C R222 BC-W

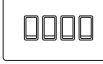

89C R242 AB-B

Plate Colour	Insert Finish/ Surround Colour						
		1 gang 20AX 2 Way Rocker	2 gang 20AX 2 Way Rocker	3 gang 20AX 2 Way Rocker	4 gang 20AX 2 Way Rocker	1 gang 20AX Intermediate Rocker	2 gang 20AX Intermediate Rocker
Antique Brass	Antique Brass/Black	89C R212 AB-B	89C R222 AB-B	89C R232 AB-B	89C R242 AB-B	89C R312 AB-B	89C R322 AB-B
Black Nickel	Black Nickel/Black	88C R212 BK-B	88C R222 BK-B	88C R232 BK-B	88C R242 BK-B	88C R312 BK-B	88C R322 BK-B
Bright Chrome	Bright Chrome/Black	87C R212 BC-B	87C R222 BC-B	87C R232 BC-B	87C R242 BC-B	87C R312 BC-B	87C R322 BC-B
Bright Chrome	Bright Chrome/White	87C R212 BC-W	87C R222 BC-W	87C R232 BC-W	87C R242 BC-W	87C R312 BC-W	87C R322 BC-W
Connaught Bronze	Black/Black	8HBC R212 BL-B	8HBC R222 BL-B	8HBC R232 BL-B	8HBC R242 BL-B	8HBC R312 BL-B	8HBC R322 BL-B
Copper Bronze	Black/Black	8CBC R212 BL-B	8CBC R222 BL-B	8CBC R232 BL-B	8CBC R242 BL-B	8CBC R312 BL-B	8CBC R322 BL-B
Etrium Bronze	Black/Black	8EBC R212 BL-B	8EBC R222 BL-B	8EBC R232 BL-B	8EBC R242 BL-B	8EBC R312 BL-B	8EBC R322 BL-B
Gloss White	White/White	80C R212 WH-W	80C R222 WH-W	80C R232 WH-W	80C R242 WH-W	80C R312 WH-W	80C R322 WH-W
Polished Brass	Polished Brass/Black	81C R212 PB-B	81C R222 PB-B	81C R232 PB-B	81C R242 PB-B	81C R312 PB-B	81C R322 PB-B
Polished Brass	Polished Brass/White	81C R212 PB-W	81C R222 PB-W	81C R232 PB-W	81C R242 PB-W	81C R312 PB-W	81C R322 PB-W
Polished Nickel	-	-	-	-	-	-	-
Primed White	Black/Black	8WPC R212 BL-B	8WPC R222 BL-B	8WPC R232 BL-B	8WPC R242 BL-B	8WPC R312 BL-B	8WPC R322 BL-B
Primed White	White/White	8WPC R212 WH-W	8WPC R222 WH-W	8WPC R232 WH-W	8WPC R242 WH-W	8WPC R312 WH-W	8WPC R322 WH-W
Richmond Bronze	Black/Black	8RBC R212 BL-B	8RBC R222 BL-B	8RBC R232 BL-B	8RBC R242 BL-B	8RBC R312 BL-B	8RBC R322 BL-B
Satin Brass	Satin Brass/Black	82C R212 SB-B	82C R222 SB-B	82C R232 SB-B	82C R242 SB-B	82C R312 SB-B	82C R322 SB-B
Satin Brass	Satin Brass/White	82C R212 SB-W	82C R222 SB-W	82C R232 SB-W	82C R242 SB-W	82C R312 SB-W	82C R322 SB-W
Satin Steel	Satin Steel/Black	84C R212 SS-B	84C R222 SS-B	84C R232 SS-B	84C R242 SS-B	84C R312 SS-B	84C R322 SS-B
Satin Steel	Satin Steel/White	84C R212 SS-W	84C R222 SS-W	84C R232 SS-W	84C R242 SS-W	84C R312 SS-W	84C R322 SS-W
Nominal Size:		86.0mm x 86.0mm	86.0mm x 86.0mm	145.0mm x 86.0mm	145.0mm x 86.0mm	86.0mm x 86.0mm	86.0mm x 86.0mm
Minimum Wall Box Depth:		25mm	25mm	25mm	25mm	25mm	25mm
Technical Insert Ref:		R212	R222	R232	R242	R312	R322

Insert Surround Colour Key: (-B) Black, (-W) White

Sheer CFX®

Wide Rockers



84C WR22 SS B



87C WR23 BC B



88C W10DP BK-B

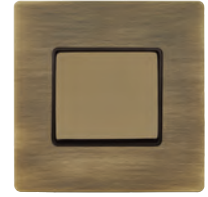

89C WR21 AB-B

SHEER CFX RANGE



1 gang 10AX
2 Way Rocker



2 gang 10AX
2 Way Rocker



3 gang 10AX
2 Way Rocker



1 gang 10AX
Intermediate
Rocker



1 gang 10AX
Push To Make/
Push to Break
Retractive
Rocker



1 gang 10AX
Double Pole

Plate Finish	Insert Finish/ Surround Colour	1 gang 10AX 2 Way Rocker	2 gang 10AX 2 Way Rocker	3 gang 10AX 2 Way Rocker	1 gang 10AX Intermediate Rocker	1 gang 10AX Push To Make/ Push to Break Retractive Rocker	1 gang 10AX Double Pole
Antique Brass	Antique Brass/Black	89CW R21 AB-B	89CW R22 AB-B	89CW R23 AB-B	89CW R31 AB-B	89CW RRT AB-B	89CW 10DP AB-B
Black Nickel	Black Nickel/Black	88CW R21 BK-B	88CW R22 BK-B	88CW R23 BK-B	88CW R31 BK-B	88CW RRT BK-B	88CW 10DP BK-B
Bright Chrome	Bright Chrome/Black	87CW R21 BC-B	87CW R22 BC-B	87CW R23 BC-B	87CW R31 BC-B	87CW RRT BC-B	87CW 10DP BC-B
Bright Chrome	Bright Chrome/White	87CW R21 BC-W	87CW R22 BC-W	87CW R23 BC-W	87CW R31 BC-W	87CW RRT BC-W	87CW 10DP BC-W
Etrium Bronze	Etrium Bronze/Black	8EBCW R21 BL-B	8EBCW R22 BL-B	8EBCW R23 BL-B	8EBCW R31 BL-B	8EBCW RRT BL-B	8EBCW 10DP BL-B
Gloss White	White/White	80CW R21 WH-W	80CW R22 WH-W	80CW R23 WH-W	80CW R31 WH-W	80CW RRT WH-W	80CW 10DP WH-W
Polished Brass	Polished Brass/Black	81CW R21 PB-B	81CW R22 PB-B	81CW R23 PB-B	81CW R31 PB-B	81CW RRT PB-B	81CW 10DP PB-B
Polished Brass	Polished Brass/White	81CW R21 PB-W	81CW R22 PB-W	81CW R23 PB-W	81CW R31 PB-W	81CW RRT PB-W	81CW 10DP PB-W
Richmond Bronze	Richmond/Black	8RBCW R21 BL-B	8RBCW R22 BL-B	8RBCW R23 BL-B	8RBCW R31 BL-B	8RBCW RRT BL-B	8RBCW 10DP BL-B
Satin Brass	Satin Brass/Black	82CW R21 SB-B	82CW R22 SB-B	82CW R23 SB-B	82CW R31 SB-B	82CW RRT SB-B	82CW 10DP SB-B
Satin Brass	Satin Brass/White	82CW R21 SB-W	82CW R22 SB-W	82CW R23 SB-W	82CW R31 SB-W	82CW RRT SB-W	82CW 10DP SB-W
Satin Steel	Satin Steel/Black	84CW R21 SS-B	84CW R22 SS-B	84CW R23 SS-B	84CW R31 SS-B	84CW RRT SS-B	84CW 10DP SS-B
Satin Steel	Satin Steel/White	84CW R21 SS-W	84CW R22 SS-W	84CW R23 SS-W	84CW R31 SS-W	84CW RRT SS-W	84CW 10DP SS-W
	Nominal Size:	86.0mm x 86.0mm	86.0mm x 86.0mm	86.0mm x 86.0mm	86.0mm x 86.0mm	86.0mm x 86.0mm	86.0mm x 86.0mm
	Minimum Wall Box Depth:	25mm	25mm	25mm	25mm	25mm	25mm
	Technical Insert Ref:	R21	R22	R23	R31	RRT	10DP

Insert Surround Colour Key: (-B) Black, (-W) White

Sheer CFX®

Toggle Switches



89C T21







81C T22



87C T23



84C T24

Plate Finish	Insert Finish	 1 gang 20AX 2 Way Toggle	 2 gang 20AX 2 Way Toggle	 3 gang 20AX 2 Way Toggle	 4 gang 20AX 2 Way Toggle	 1 gang 20AX Intermediate Toggle
Antique Brass	Antique Brass	89C T21	89C T22	89C T23	89C T24	89C T31
Black Nickel	Black Nickel	88C T21	88C T22	88C T23	88C T24	88C T31
Bright Chrome	Bright Chrome	87C T21	87C T22	87C T23	87C T24	87C T31
Connaught Bronze	Antique Brass	8HBC T21	8HBC T22	8HBC T23	8HBC T24	8HBC T31
Copper Bronze	Black Nickel	8CBC T21	8CBC T22	8CBC T23	8CBC T24	8CBC T31
Etrium Bronze	Black Nickel	8EBC T21	8EBC T22	8EBC T23	8EBC T24	8EBC T31
Gloss White	-	-	-	-	-	-
Polished Brass	Polished Brass	81C T21	81C T22	81C T23	81C T24	81C T31
Polished Nickel	-	-	-	-	-	-
Primed White	-	-	-	-	-	-
Richmond Bronze	Richmond Bronze	8RBC T21	8RBC T22	8RBC T23	8RBC T24	8RBC T31
Satin Brass	Satin Brass	82C T21	82C T22	82C T23	82C T24	82C T31
Satin Steel	Satin Chrome	84C T21	84C T22	84C T23	84C T24	84C T31
	Nominal Size:	86.0mm x 86.0mm	86.0mm x 86.0mm	145.0mm x 86.0mm	145.0mm x 86.0mm	86.0mm x 86.0mm
	Minimum Wall Box Depth:	35mm	35mm	35mm	35mm	35mm
	Technical Insert Ref:	T21	T22	T23	T24	T31

Sheer CFX[®]

Power Sockets



89C SS1 AB-B



84C SS2 SS-W



87C US5 W



8RBC SHS B



1 gang 13A
Double Pole
Switched
Socket

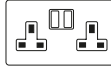

2 gang 13A
Double Pole
Switched
Socket



1 gang 2A
Unswitched
Socket



1 gang 5A
Unswitched
Socket



1 gang 13A
Unswitched
Socket



2 gang 13A
Unswitched
Socket



Shaver Dual
Voltage
Unswitched
Socket
(Vertically
Mounted)

Plate Colour	Insert Finish/ Surround Colour	89C SS1 AB-B	89C SS2 AB-B	-	-	-	-	-
Antique Brass	Antique Brass/Black	89C SS1 AB-B	89C SS2 AB-B	-	-	-	-	-
Antique Brass	Black/Black	-	-	89C US2 B	89C US5 B	89C US13 B	89C US99 B	89C SHS B
Black Nickel	Black Nickel/Black	88C SS1 BK-B	88C SS2 BK-B	-	-	-	-	-
Black Nickel	Black/Black	-	-	88C US2 B	88C US5 B	88C US13 B	88C US99 B	88C SHS B
Bright Chrome	Black/Black	-	-	87C US2 B	87C US5 B	87C US13 B	87C US99 B	87C SHS B
Bright Chrome	Bright Chrome/Black	87C SS1 BC-B	87C SS2 BC-B	-	-	-	-	-
Bright Chrome	Bright Chrome/White	87C SS1 BC-W	87C SS2 BC-W	-	-	-	-	-
Bright Chrome	White/White	-	-	87C US2 W	87C US5 W	87C US13 W	87C US99 W	87C SHS W
Connought Bronze	Black/Black	8HBC SS1 BL-B	8HBC SS2 BL-B	8HBC US2 B	8HBC US5 B	8HBC US13 B	8HBC US99 B	8HBC SHS B
Copper Bronze	Black/Black	8CBC SS1 BL-B	8CBC SS2 BL-B	8CBC US2 B	8CBC US5 B	8CBC US13 B	8CBC US99 B	8CBC SHS B
Etrium Bronze	Black/Black	8EBC SS1 BL-B	8EBC SS2 BL-B	8EBC US2 B	8EBC US5 B	8EBC US13 B	8EBC US99 B	8EBC SHS B
Gloss White	White/White	80C SS1 WH-W	80C SS2 WH-W	80C US2 W	80C US5 W	80C US13 W	80C US99 W	80C SHS W
Polished Brass	Black/Black	-	--	81C US2 B	81C US5 B	81C US13 B	81C US99 B	81C SHS B
Polished Brass	Polished Brass/Black	81C SS1 PB-B	81C SS2 PB-B	-	-	-	-	-
Polished Brass	Polished Brass/White	81C SS1 PB-W	81C SS2 PB-W	-	-	-	-	-
Polished Brass	White/White	-	-	81C US2 W	81C US5 W	81C US13 W	81C US99 W	81C SHS W
Polished Nickel	Black/Black	-	-	-	8PNC US5 B	-	-	8PNC SHS B
Polished Nickel	Bright Chrome/Black	8PNC SS1 BC-B	8PNC SS2 BC-B	-	-	-	-	-
Polished Nickel	Bright Chrome/White	8PNC SS1 BC-W	8PNC SS2 BC-W	-	-	-	-	-
Polished Nickel	White/White	-	-	-	8PNC US5 W	-	-	8PNC SHS W
Primed White	Black/Black	8WPC SS1 BL-B	8WPC SS2 BL-B	8WPC US2 B	8WPC US5 B	8WPC US13 B	8WPC US99 B	8WPC SHS B
Primed White	White/White	8WPC SS1 WH-W	8WPC SS2 WH-W	8WPC US2 W	8WPC US5 W	8WPC US13 W	8WPC US99 W	8WPC SHS W
Richmond Bronze	Black/Black	8RBC SS1 BL-B	8RBC SS2 BL-B	8RBC US2 B	8RBC US5 B	8RBC US13 B	8RBC US99 B	8RBC SHS B
Satin Brass	Black/Black	-	-	82C US2 B	82C US5 B	82C US13 B	82C US99 B	82C SHS B
Satin Brass	Satin Brass/Black	82C SS1 SB-B	82C SS2 SB-B	-	-	-	-	-
Satin Brass	Satin Brass/White	82C SS1 SB-W	82C SS2 SB-W	-	-	-	-	-
Satin Brass	White/White	-	-	82C US2 W	82C US5 W	82C US13 W	82C US99 W	82C SHS W
Satin Steel	Black/Black	-	-	84C US2 B	84C US5 B	84C US13 B	84C US99 B	84C SHS B
Satin Steel	Satin Steel/Black	84C SS1 SS-B	84C SS2 SS-B	-	-	-	-	-
Satin Steel	Satin Steel/White	84C SS1 SS-W	84C SS2 SS-W	-	-	-	-	-
Satin Steel	White/White	-	-	84C US2 W	84C US5 W	84C US13 W	84C US99 W	84C SHS W
	Nominal Size:	86.0mm x 86.0mm	145.0mm x 86.0mm	86.0mm x 86.0mm	86.0mm x 86.0mm	86.0mm x 86.0mm	145.0mm x 86.0mm	86.0mm x 145.0mm
	Minimum Wall Box Depth:	35mm	35mm	35mm	35mm	35mm	35mm	47mm
	Technical Insert Ref:	SS1	SS2	US2	US5	US13	US99	SHS

Insert Surround Colour Key: (-B) Black, (-W) White



87C SS1USB BC-B



89C SS2USBULT AB-B



1 gang 13A Single Pole Switched Socket with 1 USB Outlet 1x2.1A

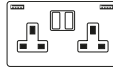

2 gang 13A Double Pole Switched Socket with 2 USB Outlets 2x2.4A (4.8 Total)

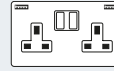



2 gang 13A Double Pole Switched Socket with 1 USB Outlet + 1 USB Type C Outlet 2x2.4A (4.8A Total)

Plate Colour	Insert Finish/ Surround Colour			
Antique Brass	Antique Brass/Black	89C SS1USB AB-B	89C SS2USBULT AB-B	89C SS2USBC AB-B
Black Nickel	Black Nickel/Black	88C SS1USB BK-B	88C SS2USBULT BK-B	88C SS2USBC BK-B
Bright Chrome	Bright Chrome/Black	87C SS1USB BC-B	87C SS2USBULT BC-B	87C SS2USBC BC-B
Bright Chrome	Bright Chrome/White	87C SS1USB BC-W	87C SS2USBULT BC-W	87C SS2USBC BC-W
Connaught Bronze	Black/Black	8HBC SS1USB BL-B	8HBC SS2USBULT BL-B	8HBC SS2USBC BL-B
Copper Bronze	Black/Black	8CBC SS1USB BL-B	8CBC SS2USBULT BL-B	8CBC SS2USBC BL-B
Etrium Bronze	Black/Black	8EBC SS1USB BL-B	8EBC SS2USBULT BL-B	8EBC SS2USBC BL-B
Gloss White	White/White	80C SS1USB WH-W	80C SS2USBULT WH-W	80C SS2USBC WH-W
Polished Brass	Polished Brass/Black	81C SS1USB PB-B	81C SS2USBULT PB-B	81C SS2USBC PB-B
Polished Brass	Polished Brass/White	81C SS1USB PB-W	81C SS2USBULT PB-W	81C SS2USBC PB-W
Polished Nickel	Bright Chrome/Black	8PNC SS1USB BC-B	8PNC SS2USBULT BC-B	8PNC SS2USBC BC-B
Polished Nickel	Bright Chrome/White	8PNC SS1USB BC-W	8PNC SS2USBULT BC-W	8PNC SS2USBC BC-W
Primed White	Black/Black	8WPC SS1USB BL-B	8WPC SS2USBULT BL-B	8WPC SS2USBC BL-B
Primed White	White/White	8WPC SS1USB WH-W	8WPC SS2USBULT WH-W	8WPC SS2USBC WH-W
Richmond Bronze	Black/Black	8RBC SS1USB BL-B	8RBC SS2USBULT BL-B	8RBC SS2USBC BL-B
Satin Brass	Satin Brass/Black	82C SS1USB SB-B	82C SS2USBULT SB-B	82C SS2USBC SB-B
Satin Brass	Satin Brass/White	82C SS1USB SB-W	82C SS2USBULT SB-W	82C SS2USBC SB-W
Satin Steel	Satin Steel/Black	84C SS1USB SS-B	84C SS2USBULT SS-B	84C SS2USBC SS-B
Satin Steel	Satin Steel/White	84C SS1USB SS-W	84C SS2USBULT SS-W	84C SS2USBC SS-W
	Nominal Size:	86.0mm x 86.0mm	145.0mm x 86.0mm	144.5mm x 88.0mm
	Minimum Wall Box Depth:	35mm	35mm	35mm
	Technical Insert Ref:	SS1USBX1	SS2USBX2ULT	SS2USBC

Insert Surround Colour Key: (-B) Black, (-W) White



8EBC KEL B

Plate Colour	Insert Colour	 1 gang 20AX 2 Way Key Switch	 1 gang 20AX 2 Way Key switch EMG LTG TEST
Antique Brass	Black	89C K21 B	89C KEL B
Black Nickel	Black	88C K21 B	88C KEL B
Bright Chrome	Black	87C K21 B	87C KEL B
Bright Chrome	White	87C K21 W	87C KEL W
Connaught Bronze	Black	8HBC K21 B	8HBC KEL B
Copper Bronze	Black	8CBC K21 B	8CBC KEL B
Etrium Bronze	Black	8EBC K21 B	8EBC KEL B
Gloss White	White	80C K21 W	80C KEL W
Polished Brass	Black	81C K21 B	81C KEL B
Polished Brass	White	81C K21 W	81C KEL W
Primed White	Black	8WPC K21 B	8WPC KEL B
Primed White	White	8WPC K21 W	8WPC KEL W
Richmond Bronze	Black	8RBC K21 B	8RBC KEL B
Satin Brass	Black	82C K21 B	82C KEL B
Satin Brass	White	82C K21 W	82C KEL W
Satin Steel	Black	84C K21 B	84C KEL B
Satin Steel	White	84C K21 W	84C KEL W
Nominal Size:		86.0mm x 86.0mm	86.0mm x 86.0mm
Minimum Wall Box Depth:		25mm	25mm
Technical Insert Ref:		K21	KEL



89C C11 AB-B



87C C11 BC-B

Plate Colour	Insert Finish/ Surround Colour	 1 gang 10A (6AX) Card Switch On/Off with Blue LED Locator
Antique Brass	Antique Brass/Black	89C C11 AB-B
Black Nickel	Black Nickel/Black	88C C11 BK-B
Bright Chrome	Bright Chrome/Black	87C C11 BC-B
Bright Chrome	Bright Chrome/White	87C C11 BC-W
Connaught Bronze	Black/Black	8HBC C11 BL-B
Copper Bronze	Black/Black	8CBC C11 BL-B
Etrium Bronze	Black/Black	8EBC C11 BL-B
Gloss White	White/White	80C C11 WH-W
Polished Brass	Polished Brass/Black	81C C11 PB-B
Polished Brass	Polished Brass/White	81C C11 PB-W
Primed White	Black/Black	8WPC C11 BL-B
Primed White	White/White	8WPC C11 WH-W
Richmond Bronze	Black/Black	8RBC C11 BL-B
Satin Brass	Satin Brass/Black	82C C11 SB-B
Satin Brass	Satin Brass/White	82C C11 SB-W
Satin Steel	Satin Steel/Black	84C C11 SS-B
Satin Steel	Satin Steel/White	84C C11 SS-W
Nominal Size:		86.0mm x 86.0mm
Minimum Wall Box Depth:		35mm
Technical Insert Ref:		C11

Insert Surround Colour Key: (-B) Black, (-W) White

Sheer CFX®

Television Coaxial Sockets



89C TV B



82C TVFM W



87C TVSAT B



84C TV W

Plate Colour	Insert Colour						
		1 gang Non-Isolated TV 1in/1out	Isolated TV/FM Diplexer 1in/2out	1 gang Isolated TV 1in/1out	2 gang Non-Isolated TV+Satellite 2in/2out	1 gang Non-Isolated Satellite	1 gang Isolated Satellite
Antique Brass	Black	89C TV B	89C TVFM B	89C TVI B	89C TVSAT B	89C SATN B	89C SATI B
Black Nickel	Black	88C TV B	88C TVFM B	88C TVI B	88C TVSAT B	88C SATN B	88C SATI B
Bright Chrome	Black	87C TV B	87C TVFM B	87C TVI B	87C TVSAT B	87C SATN B	87C SATI B
Bright Chrome	White	87C TV W	87C TVFM W	87C TVI W	87C TVSAT W	87C SATN W	87C SATI W
Connaught Bronze	Black	8HBC TV B	8HBC TVFM B	8HBC TVI B	8HBC TVSAT B	8HBC SATN B	8HBC SATI B
Copper Bronze	Black	8CBC TV B	8CBC TVFM B	8CBC TVI B	8CBC TVSAT B	8CBC SATN B	8CBC SATI B
Etrium Bronze	Black	8EBC TV B	8EBC TVFM B	8EBC TVI B	8EBC TVSAT B	8EBC SATN B	8EBC SATI B
Gloss White	White	80C TV W	80C TVFM W	80C TVI W	80C TVSAT W	80C SATN W	80C SATI W
Polished Brass	Black	81C TV B	81C TVFM B	81C TVI B	81C TVSAT B	81C SATN B	81C SATI B
Polished Brass	White	81C TV W	81C TVFM W	81C TVI W	81C TVSAT W	81C SATN W	81C SATI W
Polished Nickel	Black	8PNC TV B	-	-	-	-	-
Polished Nickel	White	8PNC TV W	-	-	-	-	-
Primed White	Black	8WPC TV B	8WPC TVFM B	8WPC TVI B	8WPC TVSAT B	8WPC SATN B	8WPC SATI B
Primed White	White	8WPC TV W	8WPC TVFM W	8WPC TVI W	8WPC TVSAT W	8WPC SATN W	8WPC SATI W
Richmond Bronze	Black	8RBC TV B	8RBC TVFM B	8RBC TVI B	8RBC TVSAT B	8RBC SATN B	8RBC SATI B
Satin Brass	Black	82C TV B	82C TVFM B	82C TVI B	82C TVSAT B	82C SATN B	82C SATI B
Satin Brass	White	82C TV W	82C TVFM W	82C TVI W	82C TVSAT W	82C SATN W	82C SATI W
Satin Steel	Black	84C TV B	84C TVFM B	84C TVI B	84C TVSAT B	84C SATN B	84C SATI B
Satin Steel	White	84C TV W	84C TVFM W	84C TVI W	84C TVSAT W	84C SATN W	84C SATI W
Nominal Size:		86.0mm x 86.0mm	86.0mm x 86.0mm	86.0mm x 86.0mm	86.0mm x 86.0mm	86.0mm x 86.0mm	86.0mm x 86.0mm
Minimum Wall Box Depth:		25mm	25mm	25mm	35mm	35mm	35mm
Technical Insert Ref:		TV	TVFM	TVI	TVSAT	SATN	SATI

Insert Surround Colour Key: (-B) Black, (-W) White

Sheer CFX®

Digital Television Sockets

- Screened Non-Isolated / DAB Compatible



84C DTRID W



88C DTRID B



81C DENT B



Non-Isolated
TV+FM+SAT
Triplexer 1in/3out
(DAB Compatible)



1 gang
Non-Isolated TV
(Female)
(DAB Compatible)



1 gang
Non-Isolated TV
(Male)
(DAB Compatible)



1 gang
Non-Isolated
Satellite
(DAB Compatible)



Non-Isolated
TV+FM+SAT+1+SAT2
Quadplexer 2in/4out
(DAB Compatible)

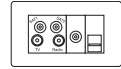

Non-Isolated
TV+FM+SAT+1+SAT2
Quadplexer 2in/4out
+TVF+TCS (DAB
Compatible)

Plate Finish	Insert Colour	Non-Isolated TV+FM+SAT Triplexer 1in/3out (DAB Compatible)	1 gang Non-Isolated TV (Female) (DAB Compatible)	1 gang Non-Isolated TV (Male) (DAB Compatible)	1 gang Non-Isolated Satellite (DAB Compatible)	Non-Isolated TV+FM+SAT+1+SAT2 Quadplexer 2in/4out (DAB Compatible)	Non-Isolated TV+FM+SAT+1+SAT2 Quadplexer 2in/4out +TVF+TCS (DAB Compatible)
Antique Brass	Black	89C DTRID B	89C DTVF B	89C DTVM B	89C DSAT B	89C DENT B	89C DSAT+ B
Black Nickel	Black	88C DTRID B	88C DTVF B	88C DTVM B	88C DSAT B	88C DENT B	88C DSAT+ B
Bright Chrome	Black	87C DTRID B	87C DTVF B	87C DTVM B	87C DSAT B	87C DENT B	87C DSAT+ B
Bright Chrome	White	87C DTRID W	87C DTVF W	87C DTVM W	87C DSAT W	87C DENT W	87C DSAT+ W
Connaught Bronze	Black	8HBC DTRID B	8HBC DTVF B	8HBC DTVM B	8HBC DSAT B	8HBC DENT B	8HBC DSAT+ B
Copper Bronze	Black	8CBC DTRID B	8CBC DTVF B	8CBC DTVM B	8CBC DSAT B	8CBC DENT B	8CBC DSAT+ B
Etrium Bronze	Black	8EBC DTRID B	8EBC DTVF B	8EBC DTVM B	8EBC DSAT B	8EBC DENT B	8EBC DSAT+ B
Gloss White	White	80C DTRID W	80C DTVF W	80C DTVM W	80C DSAT W	80C DENT W	80C DSAT+ W
Polished Brass	Black	81C DTRID B	81C DTVF B	81C DTVM B	81C DSAT B	81C DENT B	81C DSAT+ B
Polished Brass	White	81C DTRID W	81C DTVF W	81C DTVM W	81C DSAT W	81C DENT W	81C DSAT+ W
Polished Nickel	-	-	-	-	-	-	-
Primed White	Black	8WPC DTRID B	8WPC DTVF B	8WPC DTVM B	8WPC DSAT B	8WPC DENT B	8WPC DSAT+ B
Primed White	White	8WPC DTRID W	8WPC DTVF W	8WPC DTVM W	8WPC DSAT W	8WPC DENT W	8WPC DSAT+ W
Richmond Bronze	Black	8RBC DTRID B	8RBC DTVF B	8RBC DTVM B	8RBC DSAT B	8RBC DENT B	8RBC DSAT+ B
Satin Brass	Black	82C DTRID B	82C DTVF B	82C DTVM B	82C DSAT B	82C DENT B	82C DSAT+ B
Satin Brass	White	82C DTRID W	82C DTVF W	82C DTVM W	82C DSAT W	82C DENT W	82C DSAT+ W
Satin Steel	Black	84C DTRID B	84C DTVF B	84C DTVM B	84C DSAT B	84C DENT B	84C DSAT+ B
Satin Steel	White	84C DTRID W	84C DTVF W	84C DTVM W	84C DSAT W	84C DENT W	84C DSAT+ W
Nominal Size:		86.0mm x 86.0mm	86.0mm x 86.0mm	86.0mm x 86.0mm	86.0mm x 86.0mm	86.0mm x 86.0mm	145.0mm x 86.0mm
Minimum Wall Box Depth:		35mm	35mm	35mm	35mm	35mm	35mm
Technical Insert Ref:		DTRID	DTVf	DTVM	DSAT	DENT	DSAT+

Insert Surround Colour Key: (-B) Black, (-W) White

Telephone and Data Outlets



89C TCM B









81C J12 W



87C 2J12 B



84C J45 W

Plate Colour	Insert Colour						
		1 gang Telephone Master	1 gang Telephone Slave	1 gang RJ12 Outlet - Unshielded	2 gang RJ12 Outlet - Unshielded	1 gang RJ45 CAT 5E Outlet - Unshielded	2 gang RJ45 CAT 5E Outlet - Unshielded
Antique Brass	Black	89C TCM B	89C TCS B	89C J12 B	89C 2J12 B	89C J45 B	89C 2J45 B
Black Nickel	Black	88C TCM B	88C TCS B	88C J12 B	88C 2J12 B	88C J45 B	88C 2J45 B
Bright Chrome	Black	87C TCM B	87C TCS B	87C J12 B	87C 2J12 B	87C J45 B	87C 2J45 B
Bright Chrome	White	87C TCM W	87C TCS W	87C J12 W	87C 2J12 W	87C J45 W	87C 2J45 W
Connaught Bronze	Black	8HBC TCM B	8HBC TCS B	8HBC J12 B	8HBC 2J12 B	8HBC J45 B	8HBC 2J45 B
Copper Bronze	Black	8CBC TCM B	8CBC TCS B	8CBC J12 B	8CBC 2J12 B	8CBC J45 B	8CBC 2J45 B
Etrium Bronze	Black	8EBC TCM B	8EBC TCS B	8EBC J12 B	8EBC 2J12 B	8EBC J45 B	8EBC 2J45 B
Gloss White	White	80C TCM W	80C TCS W	80C J12 W	80C 2J12 W	80C J45 W	80C 2J45 W
Polished Brass	Black	81C TCM B	81C TCS B	81C J12 B	81C 2J12 B	81C J45 B	81C 2J45 B
Polished Brass	White	81C TCM W	81C TCS W	81C J12 W	81C 2J12 W	81C J45 W	81C 2J45 W
Polished Nickel	Black	8PNC TCM B	8PNC TCS B	-	-	-	-
Polished Nickel	White	8PNC TCM W	8PNC TCS W	-	-	-	-
Primed White	Black	8WPC TCM B	8WPC TCS B	8WPC J12 B	8WPC 2J12 B	8WPC J45 B	8WPC 2J45 B
Primed White	White	8WPC TCM W	8WPC TCS W	8WPC J12 W	8WPC 2J12 W	8WPC J45 W	8WPC 2J45 W
Richmond Bronze	Black	8RBC TCM B	8RBC TCS B	8RBC J12 B	8RBC 2J12 B	8RBC J45 B	8RBC 2J45 B
Satin Brass	Black	82C TCM B	82C TCS B	82C J12 B	82C 2J12 B	82C J45 B	82C 2J45 B
Satin Brass	White	82C TCM W	82C TCS W	82C J12 W	82C 2J12 W	82C J45 W	82C 2J45 W
Satin Steel	Black	84C TCM B	84C TCS B	84C J12 B	84C 2J12 B	84C J45 B	84C 2J45 B
Satin Steel	White	84C TCM W	84C TCS W	84C J12 W	84C 2J12 W	84C J45 W	84C 2J45 W
Nominal Size:		86.0mm x 86.0mm	86.0mm x 86.0mm	86.0mm x 86.0mm	86.0mm x 86.0mm	86.0mm x 86.0mm	86.0mm x 86.0mm
Minimum Wall Box Depth:		25mm	25mm	35mm	35mm	35mm	35mm
Technical Insert Ref:		TCM	TCS	J12	2J12	J45	2J45

Insert Surround Colour Key: (-B) Black, (-W) White

Sheer CFX®

Double Pole Switches



81C DPN PB-W



87C 45N B



89C 45SS1 AB-B



84C 45SS1 SS-W

Plate Colour	Insert Finish/ Surround Colour	 1 gang 20AX Double Pole Rocker + Neon	 1 gang 45A Double Pole Red Rocker + Neon	 45A Double Pole Red Rocker + Neon + 13A Switched Socket
Antique Brass	Antique Brass/Black	89C DPN AB-B	-	89C 45SS1 AB-B
Antique Brass	Black/Black	-	89C 45N B	-
Black Nickel	Black/Black	-	88C 45N B	-
Black Nickel	Black Nickel/Black	88C DPN BK-B	-	88C 45SS1 BK-B
Bright Chrome	Black/Black	-	87C 45N B	-
Bright Chrome	Bright Chrome/Black	87C DPN BC-B	-	87C 45SS1 BC-B
Bright Chrome	Bright Chrome/White	87C DPN BC-W	-	87C 45SS1 BC-W
Bright Chrome	White/White	-	87C 45N W	-
Connought Bronze	Black/Black	8HBC DPN BL-B	8HBC 45N B	8HBC 45SS1 BL-B
Copper Bronze	Black/Black	8CBC DPN BL-B	8CBC 45N B	8CBC 45SS1 BL-B
Etium Bronze	Black/Black	8EBC DPN BL-B	8EBC 45N B	8EBC 45SS1 BL-B
Gloss White	White/White	80C DPN WH-W	80C 45N W	80C 45SS1 WH-W
Polished Brass	Black/Black	-	81C 45N B	-
Polished Brass	Polished Brass/Black	81C DPN PB-B	-	81C 45SS1 PB-B
Polished Brass	Polished Brass/White	81C DPN PB-W	-	81C 45SS1 PB-W
Polished Brass	White/White	-	81C 45N W	-
Polished Nickel	-	-	-	-
Primed White	Black/Black	8WPC DPN WH-B	8WPC 45N B	8WPC 45SS1 WH-B
Primed White	White/White	8WPC DPN WH-W	8WPC 45N W	8WPC 45SS1 WH-W
Richmond Bronze	Black/Black	8RBC DPN BL-B	-	8RBC 45SS1 BL-B
Satin Brass	Black/Black	-	82C 45N B	-
Satin Brass	Satin Brass/Black	82C DPN SB-B	-	82C 45SS1 SB-B
Satin Brass	Satin Brass/White	82C DPN SB-W	-	82C 45SS1 SB-W
Satin Brass	White/White	-	82C 45N W	-
Satin Steel	Black/Black	-	84C 45N B	-
Satin Steel	Satin Steel/Black	84C DPN SS-B	-	84C 45SS1 SS-B
Satin Steel	Satin Steel/White	84C DPN SS-W	-	84C 45SS1 SS-W
Satin Steel	White/White	-	84C 45N W	-
Nominal Size:		86.0mm x 86.0mm	86.0mm x 86.0mm	145.0mm x 86.0mm
Minimum Wall Box Depth:		25mm	35mm	35mm
Technical Insert Ref:		DPN	45N	45SS1

Insert Surround Colour Key: (-B) Black, (-W) White

Sheer CFX®

Connection Units



84C SPN SS-W



1 gang 13A
Double Pole
Fused Spur +
Neon



1 gang 13A
Fuse with
Red Neon Halo

Plate Colour	Insert Finish/ Surround Colour		
Antique Brass	Antique Brass/Black	89C SPN AB-B	89C FN AB-R
Black Nickel	Black Nickel/Black	88C SPN BK-B	88C FN BK-R
Bright Chrome	Bright Chrome/Black	87C SPN BC-B	87C FN BC-R
Bright Chrome	Bright Chrome/White	87C SPN BC-W	-
Connaught Bronze	Black/Black	8HBC SPN BL-B	8HBC FN BL-R
Copper Bronze	Black/Black	8CBC SPN BL-B	8CBC FN BL-R
Etrium Bronze	Black/Black	8EBC SPN BL-B	8EBC FN BL-R
Gloss White	White/White	80C SPN WH-W	80C FN WH-R
Polished Brass	Polished Brass/Black	81C SPN PB-B	81C FN PB-R
Polished Brass	Polished Brass/White	81C SPN PB-W	-
Polished Nickel	Bright Chrome/Black	8PNC SPN BC-B	-
Polished Nickel	Bright Chrome/White	8PNC SPN BC-W	-
Primed White	Black/Black	8WPC SPN BL-B	8WPC FN BL-R
Primed White	White/White	8WPC SPN WH-W	8WPC FN WH-R
Richmond Bronze	Black/Black	8RBC SPN BL-B	8RBC FN BL-R
Satin Brass	Satin Brass/Black	82C SPN SB-B	82C FN SB-R
Satin Brass	Satin Brass/White	82C SPN SB-W	-
Satin Steel	Satin Steel/Black	84C SPN SS-B	84C FN SS-R
Satin Steel	Satin Steel/White	84C SPN SS-W	-
	Nominal Size:	86.0mm x 86.0mm	86.0mm x 86.0mm
	Minimum Wall Box Depth:	35mm	35mm
	Technical Insert Ref:	SPN	FN

Insert Surround Colour Key: (-B) Black, (-W) White

Sheer CFX®

LED Trailing/Leading Edge Push On/Off Rotary 2 Way Switching Dimmers



84C 1XLEDITB100



87C 2XLEDITB100

SHEER CFX RANGE

Plate Finish	Insert Finish	1 gang 100W LED Trailing/Leading Edge Push On/Off Rotary 2 Way Switching Dimmer	2 gang 100W LED Trailing/Leading Edge Push On/Off Rotary 2 Way Switching Dimmer	3 gang 100W LED Trailing/Leading Edge Push On/Off Rotary 2 Way Switching Dimmer	4 gang 100W LED Trailing/Leading Edge Push On/Off Rotary 2 Way Switching Dimmer
Antique Brass	Antique Brass	89C 1XLEDITB100	89C 2XLEDITB100	89C 3XLEDITB100	89C 4XLEDITB100
Black Nickel	Black Nickel	88C 1XLEDITB100	88C 2XLEDITB100	88C 3XLEDITB100	88C 4XLEDITB100
Bright Chrome	Bright Chrome	87C 1XLEDITB100	87C 2XLEDITB100	87C 3XLEDITB100	87C 4XLEDITB100
Connaught Bronze	Connaught Bronze	8HBC 1XLEDITB100	8HBC 2XLEDITB100	8HBC 3XLEDITB100	8HBC 4XLEDITB100
Copper Bronze	Copper Bronze	8CBC 1XLEDITB100	8CBC 2XLEDITB100	8CBC 3XLEDITB100	8CBC 4XLEDITB100
Etrium Bronze	Etrium Bronze	8EBC 1XLEDITB100	8EBC 2XLEDITB100	8EBC 3XLEDITB100	8EBC 4XLEDITB100
Gloss White	Gloss White	80C 1XLEDITB100	80C 2XLEDITB100	80C 3XLEDITB100	80C 4XLEDITB100
Polished Brass	Polished Brass	81C 1XLEDITB100	81C 2XLEDITB100	81C 3XLEDITB100	81C 4XLEDITB100
Polished Nickel	-	-	-	-	-
Primed White	White	8WPC 1XLEDITB100	8WPC 2XLEDITB100	8WPC 3XLEDITB100	8WPC 4XLEDITB100
Richmond Bronze	Richmond Bronze	8RBC 1XLEDITB100	8RBC 2XLEDITB100	8RBC 3XLEDITB100	8RBC 4XLEDITB100
Satin Brass	Satin Brass	82C 1XLEDITB100	82C 2XLEDITB100	82C 3XLEDITB100	82C 4XLEDITB100
Satin Steel	Satin Steel	84C 1XLEDITB100	84C 2XLEDITB100	84C 3XLEDITB100	84C 4XLEDITB100
Nominal Size:		86.0mm x 86.0mm	86.0mm x 86.0mm	145.0mm x 86.0mm	145.0mm x 86.0mm
Minimum Wall Box Depth:		35mm	35mm	35mm	35mm
Technical Insert Ref:		1XLEDITB	2XLEDITB	3XLEDITB	4XLEDITB

LED Trailing/Leading Edge Push On/Off Rotary Multi-Way Dimmers

Plate Finish	Insert Finish	1 gang 100W LED Trailing/Leading Edge Push On/Off Rotary Multi-Way Dimmer	2 gang 100W LED Trailing/Leading Edge Push On/Off Rotary Multi-Way Dimmer	3 gang 100W LED Trailing/Leading Edge Push On/Off Rotary Multi-Way Dimmer	4 gang 100W LED Trailing/Leading Edge Push On/Off Rotary Multi-Way Dimmer
Antique Brass	Antique Brass	89C 1X100LED	89C 2X100LED	89C 3X100LED	89C 4X100LED
Black Nickel	Black Nickel	88C 1X100LED	88C 2X100LED	88C 3X100LED	88C 4X100LED
Bright Chrome	Bright Chrome	87C 1X100LED	87C 2X100LED	87C 3X100LED	87C 4X100LED
Connaught Bronze	Connaught Bronze	8HBC 1X100LED	8HBC 2X100LED	8HBC 3X100LED	8HBC 4X100LED
Copper Bronze	Copper Bronze	8CBC 1X100LED	8CBC 2X100LED	8CBC 3X100LED	8CBC 4X100LED
Etrium Bronze	Etrium Bronze	8EBC 1X100LED	8EBC 2X100LED	8EBC 3X100LED	8EBC 4X100LED
Gloss White	Gloss White	80C 1X100LED	80C 2X100LED	80C 3X100LED	80C 4X100LED
Polished Brass	Polished Brass	81C 1X100LED	81C 2X100LED	81C 3X100LED	81C 4X100LED
Polished Nickel	-	-	-	-	-
Primed White	White	8WPC 1X100LED	8WPC 2X100LED	8WPC 3X100LED	8WPC 4X100LED
Richmond Bronze	Richmond Bronze	8RBC 1X100LED	8RBC 2X100LED	8RBC 3X100LED	8RBC 4X100LED
Satin Brass	Satin Brass	82C 1X100LED	82C 2X100LED	82C 3X100LED	82C 4X100LED
Satin Steel	Satin Steel	84C 1X100LED	84C 2X100LED	84C 3X100LED	84C 4X100LED
Nominal Size:		86.0mm x 86.0mm	86.0mm x 86.0mm	145.0mm x 86.0mm	145.0mm x 86.0mm
Minimum Wall Box Depth:		35mm	35mm	35mm	35mm
Technical Insert Ref:		1X100LED	2X100LED	3X100LED	4X100LED

NOTE: Tungsten filament GU10 lamps must be branded and with a fused base.
 NOTE: Please refer to the Dimmer Technical Section for the max Wattage.
 NOTE: Please contact our Technical Department for compatibility.

Sheer CFX®



Resistive Leading Edge Push On/Off Rotary 2 Way Switching Dimmers



8CBC 1X40

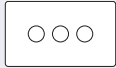
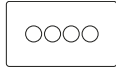

89C 2X40

Plate Finish	Insert Finish	 1 gang 400W Resistive Leading Edge Push On/Off Rotary 2 Way Switching Dimmer	 2 gang 400W Resistive Leading Edge Push On/Off Rotary 2 Way Switching Dimmer	 3 gang 400W Resistive Leading Edge Push On/Off Rotary 2 Way Switching Dimmer	 4 gang 400W Resistive Leading Edge Push On/Off Rotary 2 Way Switching Dimmer
Antique Brass	Antique Brass	89C 1X40	89C 2X40	89C 3X40	89C 4X40
Black Nickel	Black Nickel	88C 1X40	88C 2X40	88C 3X40	88C 4X40
Bright Chrome	Bright Chrome	87C 1X40	87C 2X40	87C 3X40	87C 4X40
Connaught Bronze	Connaught Bronze	8HBC 1X40	8HBC 2X40	8HBC 3X40	8HBC 4X40
Copper Bronze	Copper Bronze	8CBC 1X40	8CBC 2X40	8CBC 3X40	8CBC 4X40
Etrium Bronze	Etrium Bronze	8EBC 1X40	8EBC 2X40	8EBC 3X40	8EBC 4X40
Gloss White	Gloss White	80C 1X40	80C 2X40	80C 3X40	80C 4X40
Polished Brass	Polished Brass	81C 1X40	81C 2X40	81C 3X40	81C 4X40
Polished Nickel	-	-	-	-	-
Primed White	Primed White	8WPC 1X40	8WPC 2X40	8WPC 3X40	8WPC 4X40
Richmond Bronze	Richmond Bronze	8RBC 1X40	8RBC 2X40	8RBC 3X40	8RBC 4X40
Satin Brass	Satin Brass	82C 1X40	82C 2X40	82C 3X40	82C 4X40
Satin Steel	Satin Steel	84C 1X40	84C 2X40	84C 3X40	84C 4X40
	Nominal Size:	86.0mm x 86.0mm	86.0mm x 86.0mm	145.0mm x 86.0mm	145.0mm x 86.0mm
	Minimum Wall Box Depth:	35mm	35mm	35mm	35mm
	Technical Insert Ref:	1X40	2X40	3X40	4X40

NOTE: Tungsten filament GU10 lamps must be branded and with a fused base
 NOTE: When using mains voltage halogen lamps – dimmers should be re-rated by 25%
 NOTE: When dimming LED lamps de-rate by 75% - please contact our Technical Department for compatibility.
 NOTE: Please refer to the Dimmer Technical Section for the max wattage

Sheer CFX®

Inductive Leading Edge Push On/Off Rotary 2 Way Switching Dimmers



8WPC 1X2V



1 gang 200VA
Inductive Leading Edge
Push On/Off Rotary
2 Way Switching
Dimmer

Plate Finish	Insert Finish	
Antique Brass	Antique Brass	89C 1X2V
Black Nickel	Black Nickel	88C 1X2V
Bright Chrome	Bright Chrome	87C 1X2V
Connaught Bronze	Connaught Bronze	8HBC 1X2V
Copper Bronze	Copper Bronze	8CBC 1X2V
Etrium Bronze	Etrium Bronze	8EBC 1X2V
Gloss White	Gloss White	80C 1X2V
Polished Brass	Polished Brass	81C 1X2V
Polished Nickel	-	-
Primed White	Primed White	8WPC 1X2V
Richmond Bronze	Richmond Bronze	8RBC 1X2V
Satin Brass	Satin Brass	82C 1X2V
Satin Steel	Satin Steel	84C 1X2V
Nominal Size:		86.0mm x 86.0mm
Minimum Wall Box Depth:		35mm
Technical Insert Ref:		1X2V

NOTE: Tungsten filament GU10 lamps must be branded and with a fused base
 NOTE: When using mains voltage halogen lamps – dimmers should be re-rated by 25%
 NOTE: When dimming LED lamps de-rate by 75% - please contact our Technical Department for compatibility.
 NOTE: Please refer to the Dimmer Technical Section for the max wattage

Sheer CFX®



Resistive/Inductive Trailing Edge Push On/Off Rotary Multi-Way Dimmers



8WPC 1XTE

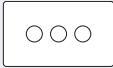
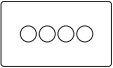

89C 2XTE

Plate Finish	Insert Finish	 1 gang 250W/210VA Resistive/Inductive Trailing Edge Push On/Off Rotary Multi-Way Dimmer	 2 gang 250W/210VA Resistive/Inductive Trailing Edge Push On/Off Rotary Multi-Way Dimmer	 3 gang 250W/210VA Resistive/Inductive Trailing Edge Push On/Off Rotary Multi-Way Dimmer	 4 gang 250W/210VA Resistive/Inductive Trailing Edge Push On/Off Rotary Multi-Way Dimmer
Antique Brass	Antique Brass	89C 1XTE	89C 2XTE	89C 3XTE	89C 4XTE
Black Nickel	Black Nickel	88C 1XTE	88C 2XTE	88C 3XTE	88C 4XTE
Bright Chrome	Bright Chrome	87C 1XTE	87C 2XTE	87C 3XTE	87C 4XTE
Connaught Bronze	Connaught Bronze	8HBC 1XTE	8HBC 2XTE	8HBC 3XTE	8HBC 4XTE
Copper Bronze	Copper Bronze	8CBC 1XTE	8CBC 2XTE	8CBC 3XTE	8CBC 4XTE
Etrium Bronze	Etrium Bronze	8EBC 1XTE	8EBC 2XTE	8EBC 3XTE	8EBC 4XTE
Gloss White	Gloss White	80C 1XTE	80C 2XTE	80C 3XTE	80C 4XTE
Polished Brass	Polished Brass	81C 1XTE	81C 2XTE	81C 3XTE	81C 4XTE
Polished Nickel	-	-	-	-	-
Primed White	Primed White	8WPC 1XTE	8WPC 2XTE	8WPC 3XTE	8WPC 4XTE
Richmond Bronze	Richmond Bronze	8RBC 1XTE	8RBC 2XTE	8RBC 3XTE	8RBC 4XTE
Satin Brass	Satin Brass	82C 1XTE	82C 2XTE	82C 3XTE	82C 4XTE
Satin Steel	Satin Steel	84C 1XTE	84C 2XTE	84C 3XTE	84C 4XTE
	Nominal Size:	86.0mm x 86.0mm	86.0mm x 86.0mm	145.0mm x 86.0mm	145.0mm x 86.0mm
	Minimum Wall Box Depth:	35mm	35mm	35mm	35mm
	Technical Insert Ref:	1XTE	2XTE	3XTE	4XTE

NOTE: Tungsten filament GU10 lamps must be branded and with a fused base
 NOTE: When using mains voltage halogen lamps – dimmers should be re-rated by 25%
 NOTE: When dimming LED lamps de-rate by 75% - please contact our Technical Department for compatibility.
 NOTE: Please refer to the Dimmer Technical Section for the max wattage

Sheer CFX®

Resistive/Inductive Trailing Edge Touch Master Multi-Way Dimmers





82C 1XTM SB-B



87C 2XTM BC-B

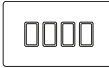

88C 3XTM BK-B

Plate Finish	Insert Finish/ Surround Colour	   			
		1 gang 250W/210VA Resistive/Inductive Trailing Edge Touch Master Multi-Way Dimmer	2 gang 250W/210VA Resistive/Inductive Trailing Edge Touch Master Multi-Way Dimmer	3 gang 250W/210VA Resistive/Inductive Trailing Edge Touch Master Multi-Way Dimmer	4 gang 250W/210VA Resistive/Inductive Trailing Edge Touch Master Multi-Way Dimmer
Antique Brass	Antique Brass/Black	89C 1XTM AB-B	89C 2XTM AB-B	89C 3XTM AB-B	89C 4XTM AB-B
Black Nickel	Black Nickel/Black	88C 1XTM BK-B	88C 2XTM BK-B	88C 3XTM BK-B	88C 4XTM BK-B
Bright Chrome	Bright Chrome/Black	87C 1XTM BC-B	87C 2XTM BC-B	87C 3XTM BC-B	87C 4XTM BC-B
Bright Chrome	Bright Chrome/White	87C 1XTM BC-W	87C 2XTM BC-W	87C 3XTM BC-W	87C 4XTM BC-W
Connaught Bronze	Antique Brass/Black	8HBC 1XTM AB-B	8HBC 2XTM AB-B	8HBC 3XTM AB-B	8HBC 4XTM AB-B
Copper Bronze	Black Nickel/Black	8CBC 1XTM BK-B	8CBC 2XTM BK-B	8CBC 3XTM BK-B	8CBC 4XTM BK-B
Etrium Bronze	Black Nickel/Black	8EBC 1XTM BK-B	8EBC 2XTM BK-B	8EBC 3XTM BK-B	8EBC 4XTM BK-B
Gloss White	-	-	-	-	-
Polished Brass	Polished Brass/Black	81C 1XTM PB-B	81C 2XTM PB-B	81C 3XTM PB-B	81C 4XTM PB-B
Polished Brass	Polished Brass/White	81C 1XTM PB-W	81C 2XTM PB-W	81C 3XTM PB-W	81C 4XTM PB-W
Polished Nickel	-	-	-	-	-
Primed White	-	-	-	-	-
Richmond Bronze	Black Nickel/Black	8RBC 1XTM BK-B	8RBC 2XTM BK-B	8RBC 3XTM BK-B	8RBC 4XTM BK-B
Satin Brass	Satin Brass/Black	82C 1XTM SB-B	82C 2XTM SB-B	82C 3XTM SB-B	82C 4XTM SB-B
Satin Brass	Satin Brass/White	82C 1XTM SB-W	82C 2XTM SB-W	82C 3XTM SB-W	82C 4XTM SB-W
Satin Steel	Satin Steel/Black	84C 1XTM SS-B	84C 2XTM SS-B	84C 3XTM SS-B	84C 4XTM SS-B
Satin Steel	Satin Steel/White	84C 1XTM SS-W	84C 2XTM SS-W	84C 3XTM SS-W	84C 4XTM SS-W
	Nominal Size:	86.0mm x 86.0mm	86.0mm x 86.0mm	145.0mm x 86.0mm	145.0mm x 86.0mm
	Minimum Wall Box Depth:	35mm	35mm	35mm	35mm
	Technical Insert Ref:	1XTM	2XTM	3XTM	4XTM

NOTE: Tungsten filament GU10 lamps must be branded and with a fused base

NOTE: When using mains voltage halogen lamps – dimmers should be re-rated by 25%

NOTE: When dimming LED lamps de-rate by 75% - please contact our Technical Department for compatibility.

NOTE: Please refer to the Dimmer Technical Section for the max wattage

Insert Surround Colour Key: (-B) Black, (-W) White

Sheer CFX®

Multi-Way Touch Slave Controllers



82C 1XTS SB-W



87C 2XTS BC-W

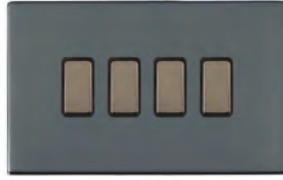

88C 4XTS BK-B

Plate Finish	Insert Finish/ Surround Colour	1 gang Multi-Way Touch Slave Controller		2 gang Multi-Way Touch Slave Controller		3 gang Multi-Way Touch Slave Controller		4 gang Multi-Way Touch Slave Controller	
		89C 1XTS AB-B	89C 2XTS AB-B	89C 3XTS AB-B	89C 4XTS AB-B	89C 1XTS AB-B	89C 2XTS AB-B	89C 3XTS AB-B	89C 4XTS AB-B
Antique Brass	Antique Brass/Black	89C 1XTS AB-B	89C 2XTS AB-B	89C 3XTS AB-B	89C 4XTS AB-B	88C 1XTS BK-B	88C 2XTS BK-B	88C 3XTS BK-B	88C 4XTS BK-B
Black Nickel	Black Nickel/Black	88C 1XTS BK-B	88C 2XTS BK-B	88C 3XTS BK-B	88C 4XTS BK-B	87C 1XTS BC-B	87C 2XTS BC-B	87C 3XTS BC-B	87C 4XTS BC-B
Bright Chrome	Bright Chrome/Black	87C 1XTS BC-B	87C 2XTS BC-B	87C 3XTS BC-B	87C 4XTS BC-B	87C 1XTS BC-W	87C 2XTS BC-W	87C 3XTS BC-W	87C 4XTS BC-W
Bright Chrome	Bright Chrome/White	87C 1XTS BC-W	87C 2XTS BC-W	87C 3XTS BC-W	87C 4XTS BC-W	8HBC 1XTS AB-B	8HBC 2XTS AB-B	8HBC 3XTS AB-B	8HBC 4XTS AB-B
Connaught Bronze	Antique Brass/Black	8HBC 1XTS AB-B	8HBC 2XTS AB-B	8HBC 3XTS AB-B	8HBC 4XTS AB-B	8CBC 1XTS BK-B	8CBC 2XTS BK-B	8CBC 3XTS BK-B	8CBC 4XTS BK-B
Copper Bronze	Black Nickel/Black	8CBC 1XTS BK-B	8CBC 2XTS BK-B	8CBC 3XTS BK-B	8CBC 4XTS BK-B	8EBC 1XTS BK-B	8EBC 2XTS BK-B	8EBC 3XTS BK-B	8EBC 4XTS BK-B
Etrium Bronze	Black Nickel/Black	8EBC 1XTS BK-B	8EBC 2XTS BK-B	8EBC 3XTS BK-B	8EBC 4XTS BK-B	-	-	-	-
Gloss White	-	-	-	-	-	81C 1XTS PB-B	81C 2XTS PB-B	81C 3XTS PB-B	81C 4XTS PB-B
Polished Brass	Polished Brass/Black	81C 1XTS PB-B	81C 2XTS PB-B	81C 3XTS PB-B	81C 4XTS PB-B	81C 1XTS PB-W	81C 2XTS PB-W	81C 3XTS PB-W	81C 4XTS PB-W
Polished Brass	Polished Brass/White	81C 1XTS PB-W	81C 2XTS PB-W	81C 3XTS PB-W	81C 4XTS PB-W	-	-	-	-
Polished Nickel	-	-	-	-	-	-	-	-	-
Primed White	-	-	-	-	-	8RBC 1XTS BK-B	8RBC 2XTS BK-B	8RBC 3XTS BK-B	8RBC 4XTS BK-B
Richmond Bronze	Black Nickel/Black	8RBC 1XTS BK-B	8RBC 2XTS BK-B	8RBC 3XTS BK-B	8RBC 4XTS BK-B	82C 1XTS SB-B	82C 2XTS SB-B	82C 3XTS SB-B	82C 4XTS SB-B
Satin Brass	Satin Brass/Black	82C 1XTS SB-B	82C 2XTS SB-B	82C 3XTS SB-B	82C 4XTS SB-B	82C 1XTS SB-W	82C 2XTS SB-W	82C 3XTS SB-W	82C 4XTS SB-W
Satin Brass	Satin Brass/White	82C 1XTS SB-W	82C 2XTS SB-W	82C 3XTS SB-W	82C 4XTS SB-W	84C 1XTS SS-B	84C 2XTS SS-B	84C 3XTS SS-B	84C 4XTS SS-B
Satin Steel	Satin Steel/Black	84C 1XTS SS-B	84C 2XTS SS-B	84C 3XTS SS-B	84C 4XTS SS-B	84C 1XTS SS-W	84C 2XTS SS-W	84C 3XTS SS-W	84C 4XTS SS-W
Satin Steel	Satin Steel/White	84C 1XTS SS-W	84C 2XTS SS-W	84C 3XTS SS-W	84C 4XTS SS-W	Nominal Size: 86.0mm x 86.0mm		145.0mm x 86.0mm	
	Minimum Wall Box Depth:	35mm		35mm		35mm		35mm	
	Technical Insert Ref:	1XTS		2XTS		3XTS		4XTS	

NOTE: To only be used with Touch Masters

Insert Surround Colour Key: (-B) Black, (-W) White

Blank Plates



81C BPS



88C BPD

Plate Finish	Single Blank Plate	Double Blank Plate
Antique Brass	89C BPS	89C BPD
Black Nickel	88C BPS	88C BPD
Bright Chrome	87C BPS	87C BPD
Connaught Bronze	8HBC BPS	8HBC BPD
Copper Bronze	8CBC BPS	8CBC BPD
Etrium Bronze	8EBC BPS	8EBC BPD
Gloss White	80C BPS	80C BPD
Polished Brass	81C BPS	81C BPD
Polished Nickel	-	-
Primed White	8WPC BPS	8WPC BPD
Richmond Bronze	8RBC BPS	8RBC BPD
Satin Brass	82C BPS	82C BPD
Satin Steel	84C BPS	84C BPD
Nominal Size:	86.0mm x 86.0mm	145.0mm x 86.0mm
Minimum Wall Box Depth:	Any Box	Any Box
Technical Insert Ref:	BPS	BPD

Sheer CFX®

GRID-IT Grid Fix Plates complete with Fixing Grid







89C 1GP

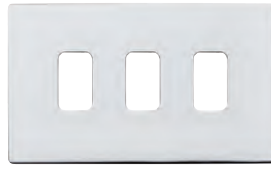

81C 2GP

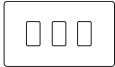

87C 3GP

				
Plate Finish	1 gang Grid Fix Apertured Plate with Grid	2 gang Grid Fix Apertured Plate with Grid	3 gang Grid Fix Apertured Plate with Grid	4 gang Grid Fix Apertured Plate with Grid
Antique Brass	89C 1GP	89C 2GP	89C 3GP	89C 4GP
Black Nickel	88C 1GP	88C 2GP	88C 3GP	88C 4GP
Bright Chrome	87C 1GP	87C 2GP	87C 3GP	87C 4GP
Connaught Bronze	8HBC 1GP	8HBC 2GP	8HBC 3GP	8HBC 4GP
Copper Bronze	8CBC 1GP	8CBC 2GP	8CBC 3GP	8CBC 4GP
Etrium Bronze	8EBC 1GP	8EBC 2GP	8EBC 3GP	8EBC 4GP
Gloss White	80C 1GP	80C 2GP	80C 3GP	80C 4GP
Polished Brass	81C 1GP	81C 2GP	81C 3GP	81C 4GP
Polished Nickel	8PNC 1GP	8PNC 2GP	8PNC 3GP	8PNC 4GP
Primed White	8WPC 1GP	8WPC 2GP	8WPC 3GP	8WPC 4GP
Richmond Bronze	8RBC 1GP	8RBC 2GP	8RBC 3GP	8RBC 4GP
Satin Brass	82C 1GP	82C 2GP	82C 3GP	82C 4GP
Satin Steel	84C 1GP	84C 2GP	84C 3GP	84C 4GP
Nominal Size:	86.0mm x 86.0mm	86.0mm x 86.0mm	145.0mm x 86.0mm	145.0mm x 86.0mm
Minimum Wall Box Depth:	As Per insert	As Per inserts	As Per Inserts	As Per Inserts
Technical Insert Ref:	1GP	2GP	3GP	4GP

Spare Fixing Grid



8C 1G

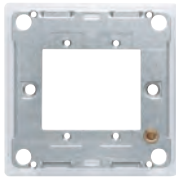

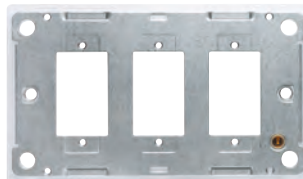

8C 2G



8C 3G

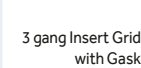
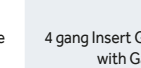

8C 4G

				
Plate Finish	1 gang Insert Grid complete with Gasket	2 gang Insert Grid complete with Gasket	3 gang Insert Grid complete with Gasket	4 gang Insert Grid complete with Gasket
No Plate Colour	8C1G	8C2G	8C3G	8C4G
Nominal Size:	86.0mm x 86.0mm	86.0mm x 86.0mm	145.0mm x 86.0mm	145.0mm x 86.0mm
Minimum Wall Box Depth:	As Per insert	As Per inserts	As Per Inserts	As Per Inserts
Technical Insert Ref:	8C1G	8C2G	8C3G	8C4G

Note: Minimum Wall Box depth is dependant on the Grid Fix insert fitted, please see the GRID-IT section for the complete range of inserts.

Sheer CFX®

EuroFix Plates complete with Fixing Grid





89C EURO2



87CEURO4

SHEER CFX RANGE

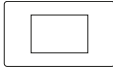
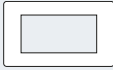
Plate Finish	 1 Module EuroFix 25x50mm Apertured Plate with Grid	 2 Module EuroFix 50x50mm Apertured Plate with Grid	 3 Module EuroFix 75x50mm Apertured Plate with Grid	 4 Module EuroFix 100x50mm Apertured Plate with Grid
Antique Brass	89C EURO1	89C EURO2	89C EURO3	89C EURO4
Black Nickel	88C EURO1	88C EURO2	88C EURO3	88C EURO4
Bright Chrome	87C EURO1	87C EURO2	87C EURO3	87C EURO4
Copper Bronze	8CBC EURO1	8CBC EURO2	8CBC EURO3	8CBC EURO4
Connaught Bronze	8HBC EURO1	8HBC EURO2	8EBC EURO3	8HBC EURO4
Etrium Bronze	8EBC EURO1	8EBC EURO2	8HBC EURO3	8EBC EURO4
Gloss White	80C EURO1	80C EURO2	80C EURO3	80C EURO4
Primed White	8WPC EURO1	8WPC EURO2	8WPC EURO3	8WPC EURO4
Richmond Bronze	8RBC EURO1	8RBC EURO2	8RBC EURO3	8RBC EURO4
Polished Brass	81C EURO1	81C EURO2	81C EURO3	81C EURO4
Polished Nickel	-	8PNC EURO2	-	8PNC EURO4
Satin Brass	82C EURO1	82C EURO2	82C EURO3	82C EURO4
Satin Steel	84C EURO1	84C EURO2	84C EURO3	84C EURO4
Nominal Size:	86.0mm x 86.0mm	86.0mm x 86.0mm	145.0mm x 86.0mm	145.0mm x 86.0mm
Minimum Wall Box Depth:	As Per Insert	As Per Inserts	As Per Inserts	As Per Inserts
Technical Insert Ref:	EURO1	EURO2	EURO3	EURO4

Note: Minimum Wall Box depth is dependant on the EuroFix insert fitted, please see the EuroFix section for our complete range of inserts.

SWITCH PLATES & SOCKETS

COLLECTIONS FOR KITCHENS & BATHROOMS

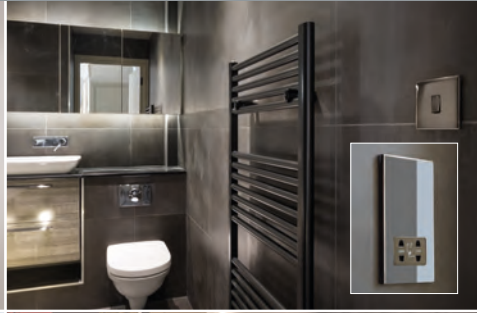

Hartland



Woods



Paintable



Sheer CFX®



Linea-Scala CFX

Add the finishing touches in Kitchens & Bathrooms

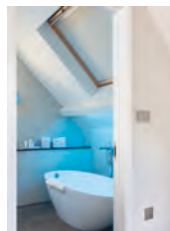

- 17 unique designer collections
- 14 stunning finishes
- Choice of grid plates & modules
- Smart lighting control & audio
- New 'Paintable' range available
- New LED dimmer in various finishes

Talk to your local wholesaler.

Hamilton®

making connections beautifully

Wiring Accessories • Smart Lighting Control & Audio Solutions

www.hamilton-litestat.com

+44 (0)1747 860088 | [f](#) [t](#) [p](#) [i](#) [n](#)

info@hamilton-litestat.com |  BRITISH MANUFACTURER



Sheer Floor Sockets

A contemporary design and superior, high quality finish ensure that the Floor Sockets effortlessly inject style into your interior, be that in the home or at the office.

- Practical and robust
- Protective sprung cover
- Accessibility to power in large, open plan areas
- Both British and International power accessories along with Telephone and TV available

Sheer Floor Sockets Range



Plate finishes available in this range



Bright
Chrome



Polished
Brass



Satin
Brass



Antique
Brass



Satin
Stainless



Satin
Nickel

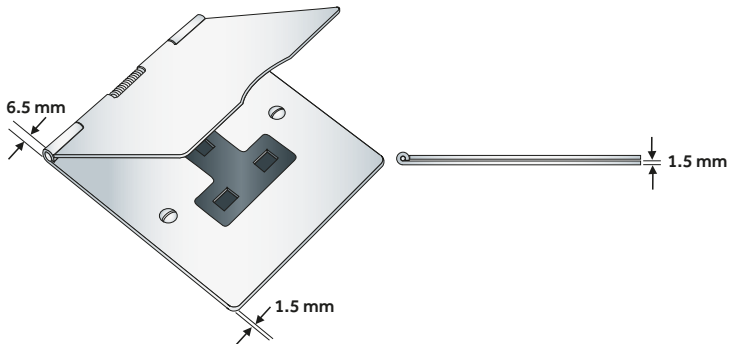

Sheer Floor Sockets

Power Sockets





SHEER FLOOR SOCKET RANGE



84D US13 W



85D US5 W

Plate Finish	Insert Finish	 1 gang 2A Unswitched Socket	 1 gang 5A Unswitched Socket	 1 gang 13A Unswitched Socket	 2 gang 13A Unswitched Socket
Antique Brass	Black	89D US2 B	89D US5 B	89D US13 B	89D US99 B
Bright Chrome	Black	87D US2 B	87D US5 B	87D US13 B	87D US99 B
Bright Chrome	White	87D US2 W	87D US5 W	87D US13 W	87D US99 W
Polished Brass	Black	81D US2 B	81D US5 B	81D US13 B	81D US99 B
Polished Brass	White	81D US2 W	81D US5 W	81D US13 W	81D US99 W
Satin Brass	Black	82D US2 B	82D US5 B	82D US13 B	82D US99 B
Satin Brass	White	82D US2 W	82D US5 W	82D US13 W	82D US99 W
Satin Nickel	Black	85D US2 B	85D US5 B	85D US13 B	85D US99 B
Satin Nickel	White	85D US2 W	85D US5 W	85D US13 W	85D US99 W
Satin Steel	Black	84D US2 B	84D US5 B	84D US13 B	84D US99 B
Satin Steel	White	84D US2 W	84D US5 W	84D US13 W	84D US99 W
Nominal Size:		85.5mm x 93.5mm	85.5mm x 93.5mm	85.5mm x 93.5mm	145mm x 93.5mm
Minimum Wall Box Depth:		35mm	35mm	35mm	35mm
Technical Insert Ref:		US2	US5	US13	US99

Insert Surround Colour Key: (-B) Black, (-W) White

Sheer Floor Sockets

International Power Sockets

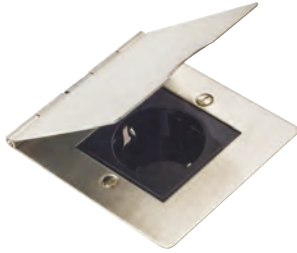

85D 6126 B

Television Coaxial Socket



87D TV W



1 gang 10/16A 220/250V AC
German Unswitched
Socket

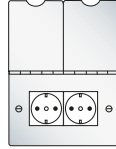

2 gang 10/16A 220/250V AC
German Unswitched
Socket



1 gang
Non-Isolated
TV
1in/1out

Plate Finish	Insert Finish		
Antique Brass	Black	89D 6126 B	89D 26126 B
Bright Chrome	Black	87D 6126 B	87D 26126 B
Bright Chrome	White	87D 6126 W	87D 26126 W
Polished Brass	Black	81D 6126 B	81D 26126 B
Polished Brass	White	81D 6126 W	81D 26126 W
Satin Brass	Black	82D 6126 B	82D 26126 B
Satin Brass	White	82D 6126 W	82D 26126 W
Satin Nickel	Black	85D 6126 B	85D 26126 B
Satin Nickel	White	85D 6126 W	85D 26126 W
Satin Steel	Black	84D 6126 B	84D 26126 B
Satin Steel	White	84D 6126 W	84D 26126 W
Nominal Size:		85.5mm x 93.5mm	145mm x 93.5mm
Minimum Wall Box Depth:		47mm	47mm
Technical Insert Ref:		6126	26126

Plate Finish	Insert Finish	
Antique Brass	Black	89D TV B
Bright Chrome	Black	87D TV B
Bright Chrome	White	87D TV W
Polished Brass	Black	81D TV B
Polished Brass	White	81D TV W
Satin Brass	Black	82D TV B
Satin Brass	White	82D TV W
Satin Nickel	Black	85D TV B
Satin Nickel	White	85D TV W
Satin Steel	Black	84D TV B
Satin Steel	White	84D TV W
Nominal Size:		85.5mm x 93.5mm
Minimum Wall Box Depth:		25mm
Technical Insert Ref:		TV

Insert Surround Colour Key: (-B) Black, (-W) White

Sheer Floor Sockets

Telephone and Data Outlets

SHEER FLOOR SOCKET RANGE



82D TCM B



82D J45 B



1 gang Telephone Master



1 gang Telephone Slave



1 gang RJ12 Outlet - Unshielded



1 gang RJ45 CAT 5E Outlet - Unshielded

Plate Finish	Insert Finish	1 gang Telephone Master	1 gang Telephone Slave	1 gang RJ12 Outlet - Unshielded	1 gang RJ45 CAT 5E Outlet - Unshielded
Antique Brass	Black	89D TCM B	89D TCS B	89D J12 B	89D J45 B
Bright Chrome	Black	87D TCM B	87D TCS B	87D J12 B	87D J45 B
Bright Chrome	White	87D TCM W	87D TCS W	87D J12 W	87D J45 W
Polished Brass	Black	81D TCM B	81D TCS B	81D J12 B	81D J45 B
Polished Brass	White	81D TCM W	81D TCS W	81D J12 W	81D J45 W
Satin Brass	Black	82D TCM B	82D TCS B	82D J12 B	82D J45 B
Satin Brass	White	82D TCM W	82D TCS W	82D J12 W	82D J45 W
Satin Nickel	Black	85D TCM B	85D TCS B	85D J12 B	85D J45 B
Satin Nickel	White	85D TCM W	85D TCS W	85D J12 W	85D J45 W
Satin Steel	Black	84D TCM B	84D TCS B	84D J12 B	84D J45 B
Satin Steel	White	84D TCM W	84D TCS W	84D J12 W	84D J45 W
Nominal Size:		85.5mm x 93.5mm	85.5mm x 93.5mm	85.5mm x 93.5mm	85.5mm x 93.5mm
Minimum Wall Box Depth:		25mm	25mm	35mm	35mm
Technical Insert Ref:		TCM	TCS	J12	J45

Insert Surround Colour Key: (-B) Black, (-W) White

Sheer Floor Sockets

EuroFix Plates complete with Fixing Grid



82D EURO4

Plate Finish	1 Module EuroFix 25x50mm Apertured Plate with Grid	2 Module EuroFix 50x50mm Apertured Plate with Grid	3 Module EuroFix 75x50mm Apertured Plate with Grid	4 Module EuroFix 100x50mm Apertured Plate with Grid
Antique Brass	89D EURO1	89D EURO2	89D EURO3	89D EURO4
Bright Chrome	87D EURO1	87D EURO2	87D EURO3	87D EURO4
Polished Brass	81D EURO1	81D EURO2	81D EURO3	81D EURO4
Satin Brass	82D EURO1	82D EURO2	82D EURO3	82D EURO4
Satin Nickel	85D EURO1	85D EURO2	85D EURO3	85D EURO4
Satin Steel	84D EURO1	84D EURO2	84D EURO3	84D EURO4
Nominal Size:	85.5mm x 93.5mm	85.5mm x 93.5mm	145mm x 93.5mm	145mm x 93.5mm
Minimum Wall Box Depth:	As Per Insert	As Per Inserts	As Per Inserts	As Per Inserts
Technical Insert Ref:	EURO1	EURO2	EURO3	EURO4

Note: Minimum Wall Box depth is dependant on the EuroFix insert fitted, please see the EuroFix section for our complete range of inserts.

Insert Surround Colour Key: (-B) Black, (-W) White









EuroFix

A Comprehensive range of modular Data and Media units







EuroFix Modules are designed to fit most Hamilton Plate Ranges.

- Standard Euro apertures
- Plates affix to BS wall boxes
- Inserts clip into plates
- EuroFix White Polycarbonate Plates
- USB Charger/Power Socket Module
- AV/Audio/HDMI Outlet Modules
- Digital Television/Satellite Outlet Modules
- Data Outlet Modules
- Hotel Card Switch with LED Modules





50x50mm Module 13A UK Unswitched Socket			13A Universal Unswitched Socket 50x50mm Module			USBULTX2 Charger 50x50mm Module (4.8A total)		
	Black	MOD-ENG13A B		Black	MOD-UNIV B		Black	MOD-USBULTX2-CHARGER B
	White	MOD-ENG13A W		White	MOD-UNIV W		White	MOD-USBULTX2-CHARGER W
							Quartz Grey	MOD-USBULTX2-CHARGER QG
Module Size:		50 x 50mm	Module Size:		50 x 50mm	Module Size:		50 x 50mm
Wall Box Depth:		35mm	Wall Box Depth:		47mm	Wall Box Depth:		35mm
Technical Insert Ref:		MOD-ENG13A	Technical Insert Ref:		MOD-UNI13A	Technical Insert Ref:		MOD-USBULTX2

International Power Sockets

50x50mm Module 16A German Unswitched Socket			50x50mm Module 15A 110V American Unswitched Socket		
	Black	MOD-GER16A B		Black	MOD-USA15A B
	White	MOD-GER16A W		White	MOD-USA15A W
	Quartz Grey	MOD-GER16A QG		Quartz Grey	MOD-USA15A QG
Module Size:		50 x 50mm	Module Size:		50 x 50mm
Wall Box Depth:		47mm	Wall Box Depth:		35mm
Technical Insert Ref:		MOD-GER16A	Technical Insert Ref:		MOD-USA15A

Cable Tidy

Cable Tidy 50x50mm Module		
	Black	MOD-50TIDY B
	White	MOD-50TIDY W
Module Size:		50 x 50mm
Wall Box Depth:		35mm
Technical Insert Ref:		MOD-TIDY

Television Coaxial Sockets



25x50mm Module
Non-Isolated
TV 1in/1out

	Black	MOD-TV B
	White	MOD-TV W

Technical Information: Non Isolated Co-Ax outlet
(IEC 169 Female Socket)

Module Size: 25 x 50mm
Wall Box Depth: 35mm
Technical Insert Ref: MOD-TV



25x50mm Module
Isolated
TV 1in/1out

	Black	MOD-TVI B
	White	MOD-TVI W
	Quartz Grey	MOD-TV QG

Technical Information: Isolated Co-Ax outlet
(IEC 169 Female Socket)

Module Size: 25 x 50mm
Wall Box Depth: 35mm
Technical Insert Ref: MOD-TVI



50x50mm Module
Isolated
TVFM Diplexer 1in/2out

	Black	MOD-TVFM B
	White	MOD-TVFM W

Technical Information: Isolated Diplexer Co-Ax outlets for use with
combined TV and FM signal

Module Size: 50 x 50mm
Wall Box Depth: 35mm
Technical Insert Ref: MOD-TVFM



25x50mm Module
Non-Isolated
Satellite

	Black	MOD-SATN B
	White	MOD-SATN W

Technical Information: Non Isolated F-Type outlet for Satellite or Cable
TV installations

Module Size: 25 x 50mm
Wall Box Depth: 35mm
Technical Insert Ref: MOD-SATN

25x50mm Module
Isolated
Satellite

	Black	MOD-SATI B
	White	MOD-SATI W
	Quartz Grey	MOD-SATI QG

Technical Information: Isolated F-Type outlet for Satellite or Cable TV
installations where a DC signal back to the LNB unit on the Satellite
Dish is NOT required

Module Size: 25 x 50mm
Wall Box Depth: 35mm
Technical Insert Ref: MOD-SATI

Digital Television Sockets - Fully Screened Non Isolated / DAB Compatible

EURO RANGE

50x50mm Module
Non-Isolated
TV+FM+SAT Triplexer
1in/3out
(DAB Compatible)



Technical Information: Triplexer for use with combined TV, FM and Satellite Signals. (DAB compatible)
Frequency: TV = 5-68 MHz, 125-860 MHz, FM = 88-108 MHz, SAT DC = 950-2200 MHz.

Module Size: 50 x 50mm
Wall Box Depth: 35mm
Technical Insert Ref: MOD-DTRID

50x50mm Module
Non-Isolated
TV+FM+SAT1+SAT2 Quadplexer
2in/4out
(DAB Compatible)



Technical Information: Quadplexer for use with combined TV, FM and Satellite Signals. (DAB compatible)
Frequency: TV = 5-68 MHz, 125-860 MHz, FM = 88-108 MHz, SAT DC = 950-2200 MHz.

Module Size: 50 x 50mm
Wall Box Depth: 35mm
Technical Insert Ref: MOD-DENT

25x50mm Module
Non-Isolated
TV (female)

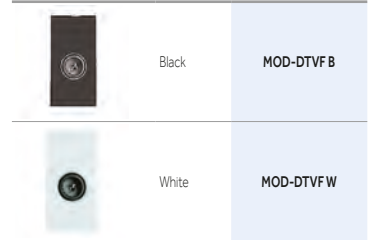

Technical Information: TV outlet (IEC 169 Female Socket). Usually used for FM (DAB) outlet.
Frequency: TV DC = 5-2200 MHz

Module Size: 25 x 50mm
Wall Box Depth: 35mm
Technical Insert Ref: MOD-DTVF

25x50mm Module
Non-Isolated
TV (Male)



Technical Information: TV outlet (IEC Male Socket). Usually used for FM (DAB) outlet.
Frequency: FM DC = 5-2200 MHz

Module Size: 25 x 50mm
Wall Box Depth: 35mm
Technical Insert Ref: MOD-DTVM

25x50mm Module
Non-Isolated
Satellite

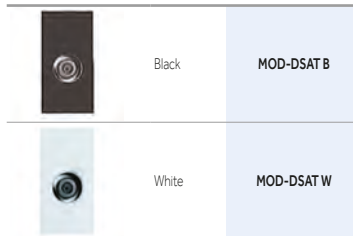

Technical Information: F Type Satellite Outlet.
Frequency: SAT DC = 50-2200 MHz

Module Size: 25 x 50mm
Wall Box Depth: 35mm
Technical Insert Ref: MOD-DSAT



25x50mm Module
Latching Audio Connector
3 Pin XLR Socket

	Black	MOD-XLR B
	White	MOD-XLR W

25x50mm Module
3.5mm Stereo Socket (MP3)
Screened

	Black	MOD-MP3 B
	White	MOD-MP3 W

25x50mm Module
D-Range PC Socket
9 Pin

	Black	MOD-DIN9 B
	White	MOD-DIN9 W

25x50mm Module
D-Range SVGA Socket
15 Pin

	Black	MOD-SVGA B
	White	MOD-SVGA W

Technical Information: Current Rating: 15A at 120VAC Contact Resistance 5mW Max.



Module Size:	25 x 50mm
Wall Box Depth:	35mm
Technical Insert Ref:	MOD-XLR

Module Size:	25 x 50mm
Wall Box Depth:	35mm
Technical Insert Ref:	MOD-MP3



Module Size:	25 x 50mm
Wall Box Depth:	35mm
Technical Insert Ref:	MOD-DIN9

Module Size:	25 x 50mm
Wall Box Depth:	35mm
Technical Insert Ref:	MOD-SVGA



25x50mm Module
1 x Gold Phone/Audio Socket
(1xBlack)

	Black	MOD-RCA1 B
	White	MOD-RCA1 W



25x50mm Module
2 x Gold Phone/Audio Socket
(1xRed 1xBlack)

	Black	MOD-RCA2 B
	White	MOD-RCA2 W

25x50mm Module
3 x Gold Composite Video/Audio Socket
(1xRed 1xWhite 1xYellow)

	Black	MOD-RCA3 B
	White	MOD-RCA3 W

25x50mm Module
2 x Gold Binding Post Socket
(1xRed 1xBlack)

	Black	MOD-BAN2 B
	White	MOD-BAN2 W

Technical Information:
Current Rating: Mating Connector Dependent
Contact Resistance: Mating Connector Dependent
Insulation Resistance: >1GW
Dielectric Strength: 500V DC
Life Cycle: 5000 Cable OD: 4-9mm
Solder Compatibility: IEC 68-2-20
Operating Temperature: -25°C to +70°C

Module Size:	25 x 50mm
Wall Box Depth:	35mm
Technical Insert Ref:	MOD-RCA1

Technical Information:
Current Rating: Mating Connector Dependent
Contact Resistance: Mating Connector Dependent
Insulation Resistance: >1GW
Dielectric Strength: 500V DC
Life Cycle: 5000 Cable OD: 4-9mm
Solder Compatibility: IEC 68-2-20
Operating Temperature: -25°C to +70°C

Module Size:	25 x 50mm
Wall Box Depth:	35mm
Technical Insert Ref:	MOD-RCA2

Technical Information:
Current Rating: Mating Connector Dependent
Contact Resistance: Mating Connector Dependent
Insulation Resistance: >1GW
Dielectric Strength: 500V DC
Life Cycle: 5000 Cable OD: 4-9mm
Solder Compatibility: IEC 68-2-20
Operating Temperature: -25°C to +70°C

Module Size:	25 x 50mm
Wall Box Depth:	35mm
Technical Insert Ref:	MOD-RCA3

Technical Information:
Socket: 4mm
Suitable for 'Banana' Plugs



Module Size:	25 x 50mm
Wall Box Depth:	35mm
Technical Insert Ref:	MOD-BAN2

25x50mm Module HDMI
Chassis Mounted Socket
Type A
(Female Mounted-Female Free)

	Black	MOD-HDMI B
	White	MOD-HDMI W



Cable Length:	155mm
Module Size:	25 x 50mm
Wall Box Depth:	35mm
Technical Insert Ref:	MOD-HDMI

25x50mm Module USB
2 Panel Mounted Socket
Type A
(Female Mounted - Male Free)

	Black	MOD-USBAFM B
	White	MOD-USBAFM W

Cable Length:	500mm
Module Size:	25 x 50mm
Wall Box Depth:	35mm
Technical Insert Ref:	MOD-USBAFM

25x50mm Module USB
2 Panel Mounted Socket
Type A
(Female Mounted - Female Free)

	Black	MOD-USBAFF B
	White	MOD-USBAFF W

Cable Length:	155mm
Module Size:	25 x 50mm
Wall Box Depth:	35mm
Technical Insert Ref:	MOD-USBAFF

Telephone and Data Outlets

25x50mm Module Telephone Master			25x50mm Module Telephone Slave			25x50mm Module RJ12 Outlet - Unshielded			Carrier for Keystone RJ Data Socket 25x50mm Module		
	Black	MOD-TCM B		Black	MOD-TCS B		Black	MOD-J12 B		Black	MOD-KSC B
	White	MOD-TCM W		White	MOD-TCS W		White	MOD-J12 W		White	MOD-KSC W
	Quartz Grey	MOD-TCM QG		Quartz Grey	MOD-TCS QG						
Technical Information: Used as the first socket outlet on the installation			Technical Information: Used as the extension socket outlets of the installation			Technical Information: Can be used as either an RJ11 (4 wires) or RJ12 (6 wires)					
Module Size:	25 x 50mm		Module Size:	25 x 50mm		Module Size:	25 x 50mm		Module Size:	25mm x 50mm	
Wall Box Depth:	25mm		Wall Box Depth:	25mm		Wall Box Depth:	35mm		Wall Box Depth:	35mm	
Technical Insert Ref:	MOD-TCM		Technical Insert Ref:	MOD-TCS		Technical Insert Ref:	MOD-J12		Technical Insert Ref:	MOD-KEYSTONE	
25x50mm Module RJ45 CAT 6S Outlet - Shielded			25x50mm Module RJ45 CAT 5E Outlet - Unshielded			25x50mm Module RJ45 CAT 6 Outlet - Unshielded			25x50mm Module RJ45 Angled - Unshielded		
	Black	MOD-J45-C6S B		Black	MOD-J45-C5 B		Black	MOD-J45-C6 B		45 Degree Angle Cat 5 Module	MODA-J45-C5B
	White	MOD-J45-C6S W		White	MOD-J45-C5 W		White	MOD-J45-C6 W		45 Degree Angle Module	MODA-J45-C5W
				Quartz Grey	MOD-J45-C5 QG		Quartz Grey	MOD-J45-C6 QG		Modular 50/25mm Socket RJ-45-Front Black 45 Deg	MODA-J45-C6B
Technical Information: Can be used in both EIA 568A and EIA 568B wiring schedules			Technical Information: Enhanced CAT 5E performance (Unshielded) Can be used in both EIA 568A and EIA 568B wiring schedules			Technical Information: Can be used in both EIA 568A and EIA 568B wiring schedules					
Module Size:	25mm x 50mm		Module Size:	25 x 50mm		Module Size:	25 x 50mm				
Wall Box Depth:	47mm		Wall Box Depth:	47mm		Wall Box Depth:	47mm				
Technical Insert Ref:	MOD-J45-C6S		Technical Insert Ref:	MOD-J45-C5		Technical Insert Ref:	MOD-J45-C6				MODA-J45-C6W

Blanking Insert Plates

12.5x50mm Half Module Blank			25x50mm 1 Module Blank		
	Black	MOD-HALFBLANK B		Black	MOD-1BLANK B
	White	MOD-HALFBLANK W		White	MOD-1BLANK W
				Quartz Grey	MOD-1BLANK QG
Module Size:	12.5 x 50mm		Module Size:	25 x 50mm	
Technical Insert Ref:	MOD-HALFBLANK		Technical Insert Ref:	MOD-1BLANK	

EuroFix Apertured Plates

50x50mm 2 Module Aperture

Designed to hold one 50 x 50mm module or two 25 x 50mm modules or one 25 x 50mm module and two 12.5mm x 50mm Blanking Plates



White	MOD-P2MW
Nominal Plate Size:	86 x 86mm
Aperture:	50 x 50mm
Technical Insert Ref:	MOD-P2M

50x100mm 4 Module Aperture

Designed to hold one 100 x 50mm module or two 50 x 50mm modules or one 50 x 50mm module and two 25 x 50mm or four 25 x 50mm modules



White	MOD-P4MW
Nominal Plate Size:	146 x 86mm
Aperture:	100 x 50mm
Technical Insert Ref:	MOD-P4M

Hotel Card Switch with LED



MOD-C11-BC-W



1 gang 10A (6AX) Card Switch On/Off with Blue LED Locator

Insert Finish / Surround Colour	
Antique Brass/Black	MOD-C11-AB-B
Black Nickel/Black	MOD-C11-BK-B
Bright Chrome/White	MOD-C11-BC-W
Bright Chrome/Black	MOD-C11-BC-B
Polished Brass/White	MOD-C11-PB-W
Polished Brass/Black	MOD-C11-PB-B
Satin Chrome/White	MOD-C11-SC-W
Satin Chrome/Black	MOD-C11-SC-B
Satin Brass/White	MOD-C11-SB-W
Satin Brass/Black	MOD-C11-SB-B
Satin Stainless/White	MOD-C11-SS-W
Satin Stainless/Black	MOD-C11-SS-B
Black Plastic/Black	MOD-C11-BL-B
White Plastic/White	MOD-C11-WH-W
Nominal Size:	50 x 50mm
Minimum Wall Box Depth:	35mm
Technical Insert Ref:	MOD-C11



Grid-IT

A comprehensive range of Grid-Fix electrical wiring accessory modules

Grid-It switches and sockets are grid-fixed to provide flexibility. Separate modules can be clipped together on the grid to create the desired combination. This can be done on-site for an instant solution.

- Flexibility of separate modules
- Larger sized plates
- Neon switch halos for visual identification; available in four colours
- Printed words or symbols for appliance or function identification
- Available on many regular Hamilton plate styles

GRID-IT Modules

Rocker Switches

Insert Finish/Surround Colour	10AX 2 Way Rocker Module	20AX 2 Way Rocker Module	20AX Intermediate Rocker Module	20AX Double Pole Rocker	10AX Push To Make/Break Retractive Rocker Module	10AX Retractive 2 Way + Off Rocker Module	20AX Non-Retractive 2 Way + Off Rocker Module
Antique Brass/Black	IR21 AB-B	IR212 AB-B	IR312 AB-B	IDP AB-B	IRRT AB-B	IRR2W AB-B	IR2WO AB-B
Bright Chrome/Black	IR21 BC-B	IR212 BC-B	IR312 BC-B	IDP BC-B	IRRT BC-B	IRR2W BC-B	IR2WO BC-B
Bright Chrome/Quartz Grey		IR212 BC-QG	IR312 BC-QG	IDP BC-QG			
Bright Chrome/White	IR21 BC-W	IR212 BC-W	IR312 BC-W	IDP BC-W	IRRT BC-W	IRR2W BC-W	IR2WO BC-W
Black Nickel/Black	IR21 BK-B	IR212 BK-B	IR312 BK-B	IDP BK-B	IRRT BK-B	IRR2W BK-B	IR2WO BK-B
Black/Black	IR21 BL-B	IR212 BL-B	IR312 BL-B	IDP BL-B	IRRT BL-B	IRR2W BL-B	IR2WO BL-B
Polished Brass/Black	IR21 PB-B	IR212 PB-B	IR312 PB-B	IDP PB-B	IRRT PB-B	IRR2W PB-B	IR2WO PB-B
Polished Brass/White	IR21 PB-W	IR212 PB-W	IR312 PB-W	IDP PB-W	IRRT PB-W	IRR2W PB-W	IR2WO PB-W
Satin Brass/Black	IR21 SB-B	IR212 SB-B	IR312 SB-B	IDP SB-B	IRRT SB-B	IRR2W SB-B	IR2WO SB-B
Satin Brass/White	IR21 SB-W	IR212 SB-W	IR312 SB-W	IDP SB-W	IRRT SB-W	IRR2W SB-W	IR2WO SB-W
Satin Chrome/Black	IR21 SC-B	IR212 SC-B	IR312 SC-B	IDP SC-B	IRRT SC-B	IRR2W SC-B	IR2WO SC-B
Satin Chrome/White	IR21 SC-W	IR212 SC-W	IR312 SC-W	IDP SC-W	IRRT SC-W	IRR2W SC-W	IR2WO SC-W
Satin Steel/Black	IR21 SS-B	IR212 SS-B	IR312 SS-B	IDP SS-B	IRRT SS-B	IRR2W SS-B	IR2WO SS-B
Satin Steel/Quartz Grey		IR212 SS-QG	IR312 SS-QG	IDP SS-QG			
Satin Steel/White	IR21 SS-W	IR212 SS-W	IR312 SS-W	IDP SS-W	IRRT SS-W	IRR2W SS-W	IR2WO SS-W
White	IR21 WH-W	IR212 WH-W	IR312 WH-W	IDP WH-W	IRRT WH-W	IRR2W WH-W	IR2WO WH-W

Pack Quantity: 5
Minimum Wall Box Depth: 35mm
British Standard: BS EN 60669-1

Technical Insert Ref:	Technical Insert Ref:	Technical Insert Ref:	Technical Insert Ref:	Technical Insert Ref:	Technical Insert Ref:	Technical Insert Ref:
GR21	GR212	GR312	GDP	GRRT	GRR2W	GR2WO

10AX Push To Make Rocker Modules with Bell Symbol



10AX Push To Make Rocker Module Bell Symbol

Insert Finish/Surround Colour	White/White	Black/Black
	IBP WH-W	IBP BL-B

Pack Quantity: 5
Minimum Wall Box Depth: 35mm
British Standard: BS EN 60669-1
Technical Insert Ref: GRBP

Connection Unit 20A Cable Outlet Modules



20A Cable Outlet Module

Insert Finish	White	Black
	IC020 W	IC020 B

Pack Quantity: 5
Minimum Wall Box Depth: 35mm
British Standard: BS EN 60669-1
Technical Insert Ref: GC20

GRID-IT Modules

20AX Double Pole Rocker Module + Printed Legend

1 gang 20AX Double Pole Rocker

Pack Quantity: 5
 Minimum Wall Depth: 35mm
 British Standard: BS 60669-1

GRID-IT RANGE



White/White
IDPBO WH-W



Black/Black
IDPBO BL-B



White/White
IDPCM WH-W



Black/Black
IDPCM BL-B



White/White
IDPCH WH-W



Black/Black
IDPCH BL-B



White/White
IDPDW WH-W



Black/Black
IDPDW BL-B



White/White
IDPFN WH-W



Black/Black
IDPFN BL-B



White/White
IDPFZ WH-W



Black/Black
IDPFZ BL-B



White/White
IDPFG WH-W



Black/Black
IDPFG BL-B



White/White
IDPFF WH-W



Black/Black
IDPFF BL-B



White/White
IDPHT WH-W



Black/Black
IDPHT BL-B



White/White
IDPHO WH-W



Black/Black
IDPHO BL-B



White/White
IDPMW WH-W



Black/Black
IDPMW BL-B



White/White
IDPOV WH-W



Black/Black
IDPOV BL-B



White/White
IDPSO WH-W



Black/Black
IDPSO BL-B



White/White
IDPTD WH-W



Black/Black
IDPTD BL-B



White/White
IDPDR WH-W



Black/Black
IDPDR BL-B



White/White
IDPWDY WH-W



Black/Black
IDPWDY BL-B



White/White
IDPWM WH-W



Black/Black
IDPWM BL-B



White/White
IDPWD WH-W



Black/Black
IDPWD BL-B



White/White
IDPWT WH-W



Black/Black
IDPWT BL-B



White/White
IDPWC WH-W



Black/Black
IDPWC BL-B

Technical Insert Reference: GDP-PRINTED

GRID-IT Modules

Blanking Module

Pack Quantity: 5
Minimum Wall Depth: 35mm

					
Antique Brass/Black IBMOD AB-B	Bright Chrome/Black IBMOD BC-B	Bright Chrome/White IBMOD BC-W	Black Nickel/Black IBMOD BK-B	Black/Black IBMOD BL-B	Polished Brass/Black IBMOD PB-B
					
Polished Brass/White IBMOD PB-W	Satin Brass/White IBMOD SB-W	Satin Brass/Black IBMOD SB-B	Satin Chrome/Black IBMOD SC-B	Satin Chrome/White IBMOD SC-W	White/White IBMOD WH-W
					
Satin Steel/Black IBMOD SS-B	Satin Steel/White IBMOD SS-W				

Technical Insert Reference: BMOD

GRID-IT Modules

Connection Units with Neon Halo Module

13A Fuse Modules with Amber Neon Halo

Pack Quantity: 5
 Minimum Wall Box Depth: 35mm
 British Standard: BS 5733
 Replacement Fuses to BS 1362 Standard



Antique Brass	Bright Chrome	Black Nickel	Black	Polished Brass	Satin Brass	Satin Chrome	Satin Steel	White
IFN AB-A	IFN BC-A	IFN BK-A	IFN BL-A	IFN PB-A	IFN SB-A	IFN SC-A	IFN SS-A	IFN WH-A

Technical Insert Reference: GFN

13A Fuse Modules with Blue Neon Halo

Pack Quantity: 5
 Minimum Wall Box Depth: 35mm
 British Standard: BS 5733
 Replacement Fuses to BS 1362 Standard



Antique Brass	Bright Chrome	Black Nickel	Black	Polished Brass	Satin Brass	Satin Chrome	Satin Steel	White
IFN AB-B	IFN BC-B	IFN BK-B	IFN BL-B	IFN PB-B	IFN SB-B	IFN SC-B	IFN SS-B	IFN WH-B

Technical Insert Reference: GFN

13A Fuse Modules with Green Neon Halo

Pack Quantity: 5
 Minimum Wall Box Depth: 35mm
 British Standard: BS 5733
 Replacement Fuses to BS 1362 Standard



Antique Brass	Bright Chrome	Black Nickel	Black	Polished Brass	Satin Brass	Satin Chrome	Satin Steel	White
IFN AB-G	IFN BC-G	IFN BK-G	IFN BL-G	IFN PB-G	IFN SB-G	IFN SC-G	IFN SS-G	IFN WH-G

Technical Insert Reference: GFN

13A Fuse Modules with Red Neon Halo

Pack Quantity: 5
 Minimum Wall Box Depth: 35mm
 British Standard: BS 5733
 Replacement Fuses to BS 1362 Standard



Antique Brass	Bright Chrome	Black Nickel	Black	Polished Brass	Satin Brass	Satin Chrome	Satin Steel	White
IFN AB-R	IFN BC-R	IFN BK-R	IFN BL-R	IFN PB-R	IFN SB-R	IFN SC-R	IFN SS-R	IFN WH-R

Technical Insert Reference: GFN

GRID-IT Modules

Connection Units

Neon Modules with Amber Neon Halo

Pack Quantity: 5
 Minimum Wall Box Depth: 35mm
 British Standard: BS 5733

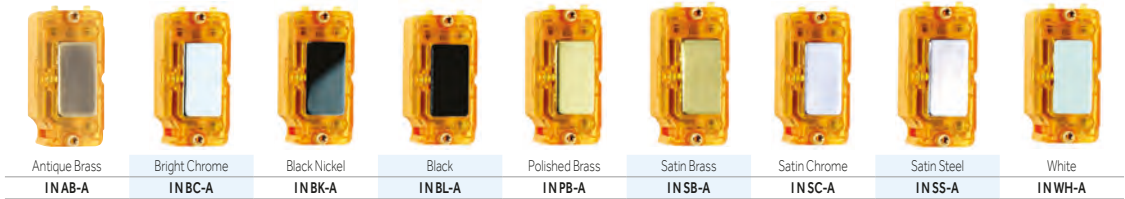

Technical Insert Reference: GN

Neon Modules with Blue Neon Halo

Pack Quantity: 5
 Minimum Wall Box Depth: 35mm
 British Standard: BS 5733



Technical Insert Reference: GN

Neon Modules with Green Neon Halo

Pack Quantity: 5
 Minimum Wall Box Depth: 35mm
 British Standard: BS 5733

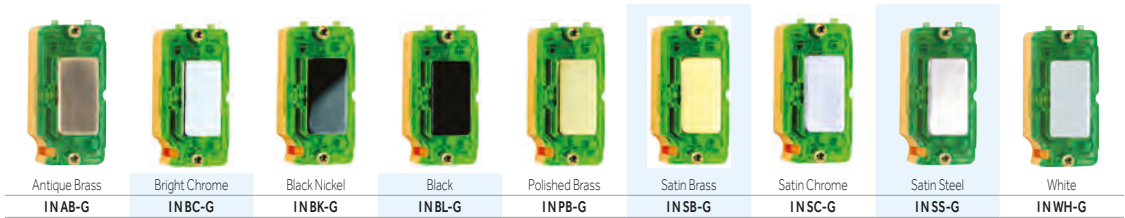

Technical Insert Reference: GN

Neon Modules with Red Neon Halo

Pack Quantity: 5
 Minimum Wall Box Depth: 35mm
 British Standard: BS 5733

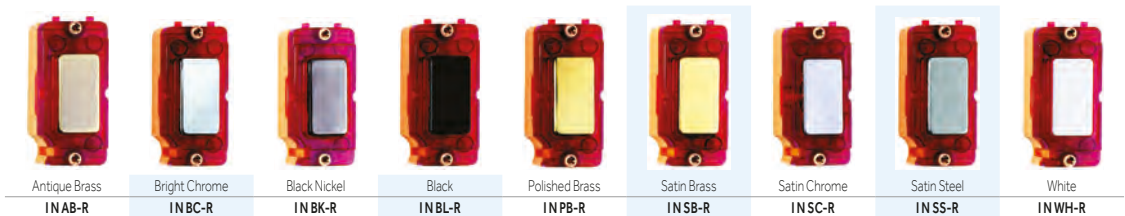

Technical Insert Reference: GN

GRID-IT Modules

Connection Units

Neon Only Module

Pack Quantity: 5
 Minimum Wall Depth: 35mm
 British Standard: BS 5733



INO A



INO B



INO G



INO R

Technical Insert Reference: GNO

Hotel Maid Service Neon Modules

Pack Quantity: 5
 Minimum Wall Depth: 35mm
 British Standard: BS 5733

Neon Halo Module
 Maid Symbol

Neon Halo Module
 Crossed Bell Symbol

Neon Halo Module
 Please Clean Room
 (Horizontally Mounted)

Neon Halo Module
 Do Not Disturb
 (Horizontally Mounted)



INOMA G
 GN-MAID



INOBER
 GN-BELL



INOPCRG
 GNH-PCR



INODND R
 GNH-DND

Technical Insert Reference:

GRID-IT Modules

Resistive/Inductive Trailing Edge Touch Master Multi-Way Dimmers

250W/210VA

Resistive/Inductive Trailing Edge

Touch Master Multi-Way Dimmer Module

Pack Quantity: 5

Minimum Wall Depth: 35mm

British Standard: BS 606 69-2-1

Note: When using mains voltage halogen lamps - dimmers should be de-rated by 25%

Note: When using mains voltage halogen load transformers - maximum rating is 210VA

Note: When dimming LED lamps de-rate by 75% - please contact our Technical Department for compatibility



Bright Chrome/White

Bright Chrome/Black

Satin Chrome/White

Satin Chrome/Black

Satin Steel/White

Satin Steel/Black

IDTM BC-W

IDTM BC-B

IDTM SC-W

IDTM SC-B

IDTM SS-W

IDTM SS-B



Polished Brass/White

Polished Brass/Black

Satin Brass/White

Satin Brass/Black

Antique Brass/Black

Black Nickel/Black

IDTM PB-W

IDTM PB-B

IDTM SB-W

IDTM SB-B

IDTM AB-B

IDTM BK-B

Technical Insert Reference: DTM

Multi-Way Touch Slave Controllers

Multi-Way Touch Slave Controller Module

Pack Quantity: 5

Minimum Wall Depth: 35mm

British Standard: BS 5733

Note: To only be used with Touch Master Dimmers

Note: Tungsten Filament GU10 Lamps must be branded with a Fused Base

Note: When using mains voltage halogen lamps - dimmers should be de-rated by 25%

Note: When using mains voltage halogen load transformers - maximum rating is 210VA



Bright Chrome/White

Bright Chrome/Black

Satin Chrome/White

Satin Chrome/Black

Satin Steel/White

Satin Steel/Black

IDTS BC-W

IDTS BC-B

IDTS SC-W

IDTS SC-B

IDTS SS-W

IDTS SS-B



Polished Brass/White

Polished Brass/Black

Satin Brass/White

Satin Brass/Black

Antique Brass/Black

Black Nickel/Black

IDTS PB-W

IDTS PB-B

IDTS SB-W

IDTS SB-B

IDTS AB-B

IDTS BK-B

Technical Insert Reference: DTS

GRID-IT Modules

Resistive/Inductive Trailing Edge Push On/Off Rotary Multi-Way Dimmers

250W/210VA
Multi-Way
Trailing Edge Push On/Off
Dimmer Module and Knob Kit

Quantity: 5
Minimum Wall Depth: 35mm
British Standard: 60669-2-1

Note: Tungsten Filament GU10 Lamps must be branded with a Fused Base.
Note: When using mains voltage halogen lamps - dimmers should be de-rated by 25%
Note: When using mains voltage halogen load transformers - maximum rating is 210VA
Note: When dimming LED lamps de-rate by 75% - please contact our Technical Department for compatibility



Antique Brass	Bright Chrome	Black Nickel	Polished Brass	Satin Brass	Satin Chrome	Satin Steel	White Plastic
IDTE AB	IDTE BC	IDTE BK	IDTE PB	IDTE SB	IDTE SC	IDTE SS	IDTE WH

Technical Insert Reference: DTE

Grid Fix Dimmer Kit inc Knob and Inlays

Consisting of Black and White Frame with Matching Metal Inlay,
Dimmer Knob and Retaining Ring

Note: Not suitable for LED Modules



Satin Steel

Polished Brass

Antique Brass	Bright Chrome	Black Nickel	Polished Brass	Satin Brass	Satin Chrome	Satin Steel
IDKIT AB	IDKIT BC	IDKIT BK	IDKIT PB	IDKIT SB	IDKIT SC	IDKIT SS

Technical Insert Reference: DKIT

GRID-IT Modules

Push On/Off Switches

3A Intermediate Push On/Off Module

*Tungsten Filament and Halogen
Rating: Maximum 3A per gang*

Pack Quantity: 5	White/White
Minimum Wall Box Depth: 35mm	IDIP WH
British Standard: BS 5733	
Technical Insert Reference:	DIP



6A 2 Way Push On/Off Switch Module

*Tungsten Filament and Halogen
Rating: Maximum 6AX per gang*

Pack Quantity: 5	White/White
Minimum Wall Box Depth: 35mm	IDPS WH
British Standard: BS 60669-1	
Technical Insert Reference:	DPS



Resistive Leading Edge Push On/Off 2 Way Switching Dimmers

400W 2 Way Dimmer Module

*Tungsten Filament and Halogen
Rating: Minimum 40W per gang
Tungsten Filament Rating: Maximum 400W per gang
Halogen Rating: Maximum 300W per gang*

*Note: Tungsten Filament GU10 Lamps must be branded with a Fused Base.
Note: When using mains voltage halogen lamps - dimmers should be de-rated by 25%.
Note: When dimming LED lamps de-rate by 75% - please contact our Technical Department for compatibility.*

Pack Quantity: 5	White/White
Minimum Wall Box Depth: 35mm	ID40 WH
British Standard: BS 60669-2-1	
Technical Insert Reference:	D40



High Frequency Ballast Controller Module

1-10V DC High Frequency Ballast Controller Module (No Off)

*Tungsten Filament and Halogen
Rating: Max. 50 Ballasts per Controller. 1-10V
DC Control - NOT for connection to 230V Mains.
Only to be used in conjunction with a 10A or 20A 2 Way Rocker Switch.*

Pack Quantity: 5	White/White
Minimum Wall Box Depth: 35mm	IDHF10V WH
British Standard: BS 60669-2-1	
Technical Insert Reference:	DHF



GRID-IT Modules

Power Sockets

1 gang 13A
Double Pole
Switched Socket Module

Quantity: 5
Minimum Wall Depth: 35mm
British Standard: BS1363



Bright Chrome/White ISS1 BC-W	Bright Chrome/Black ISS1 BC-B	Satin Chrome/White ISS1 SC-W	Satin Chrome/Black ISS1 SC-B	Satin Steel/White ISS1 SS-W	Satin Steel/Black ISS1 SS-B
---	---	--	--	---------------------------------------	---------------------------------------



Polished Brass/White ISS1 PB-W	Polished Brass/Black ISS1 PB-B	Satin Brass/White ISS1 SB-W	Satin Brass/Black ISS1 SB-B	Antique Brass/Black ISS1 AB-B	Black Nickel/Black ISS1 BK-B
--	--	---------------------------------------	---------------------------------------	---	--



White/White ISS1 WH-W	Black/Black ISS1 BL-B
---------------------------------	---------------------------------

Technical Insert Reference: GSS1

GRID-IT RANGE

GRID-IT Modules

Power Sockets

2 gang 13A
Double Pole
Switched Socket Module

Quantity: 5
Minimum Wall Depth: 35mm
British Standard: BS1363



Bright Chrome/White
ISS2 BC-W



Bright Chrome/Black
ISS2 BC-B

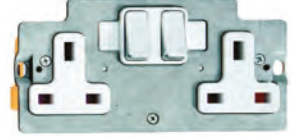

Satin Chrome/White
ISS2 SC-W



Satin Chrome/Black
ISS2 SC-B



Satin Steel/White
ISS2 SS-W



Satin Steel/Black
ISS2 SS-B



Polished Brass/White
ISS2 PB-W



Polished Brass/Black
ISS2 PB-B



Satin Brass/White
ISS2 SB-W



Satin Brass/Black
ISS2 SB-B



Antique Brass/Black
ISS2 AB-B



Black Nickel/Black
ISS2 BK-B



White/White
ISS2 WH-W



Black/Black
ISS2 BL-B

Technical Insert Reference: GSS2

GRID-IT Modules

Key Switches

Pack Quantity: 5
 Minimum Wall Depth: 35mm
 British Standard: EN60669-2-1

20AX
 2 Way
 Key Switch
 Module



Technical Insert Reference: GK21

20AX
 Double Pole
 Key Switch
 Module



Technical Insert Reference: GKDP

20AX 2 Way
 Key switch
 EMG LTG TEST
 Module



Technical Insert Reference: GKEL

Key Switches - Spare Key

Spare Key For
 Key Switch

Pack Quantity: 5



IKEY

Technical Insert Reference: GKEY

Spare Screws

Screws From Apertured Plate to Grid,
 Dome-Headed Slotted M3 x 5mm

Box Quantity: 50 Size: M3 x 5mm	White	Polished Brass	Satin Brass	Bright Chrome	Black Nickel	Antique Brass
	PS GR WH	PS GR PB	PS GR SB	PS GR BC	PS GR BK	PS GR AB
Technical Insert Reference:	SCREW-PSGR					

Screws From Socket Apertured Plate to Grid,
 Countersunk Slotted M3 x 5mm

Box Quantity: 50 Size: M3 x 5mm	White	Polished Brass	Satin Brass	Bright Chrome	Black Nickel	Antique Brass
	PS GS AB	PS GS PB	PS GS SB	PS GS BC	PS GS BK	PS GS AB
Technical Insert Reference:	SCREW-PSGS					

Box Quantity: 50 Size: M3.5 x 25mm	Screws From Grid To Back Box, Slotted Countersunk M3.5 x 25mm
	SG BOX25

Technical Insert Reference: SCREW-SG25

Box Quantity: 50 Size: M3.5 x 50mm	Screws From Grid To Back Box, Slotted Countersunk M3.5 x 50mm
	SG BOX50

Technical Insert Reference: SCREW-SG50

Box Quantity: 50 Size: M2.5 x 25mm	Screws From Module Insert to Grid, Countersunk Cross Slotted M2.5 x 25mm
	SG INS

Technical Insert Reference: SCREW-MISC

GRID-IT Modules

Spare Fixing Grids

For Sheer, Hartland and Cheriton Front Plates



1 gang Insert Grid	2 gang Insert Grid	3 gang Insert Grid	4 gang Insert Grid
1G-GRID	2G-GRID	3G-GRID	4G-GRID
Technical Insert Reference: 1G-GRID	Technical Insert Reference: 2G-GRID	Technical Insert Reference: 3G-GRID	Technical Insert Reference: 4G-GRID

Pack Quantity: 5



Cheriton

Quality Accessories on Georgian and Victorian Plates

Capturing all the charm and elegance of the Georgian and Victorian period. The plates are traditional cast brass with a choice of finishes. The range consists of two designs, Georgian and Victorian.

- Two designs – Georgian and Victorian
- Georgian available in two finishes
- Victorian available in six finishes
- Switch inserts to match the plate finish
- Standard box-fix electrical accessories
- Grid and EuroFix options also available (see separate GRID-IT and EuroFix sections for inserts.)



Cheriton Range

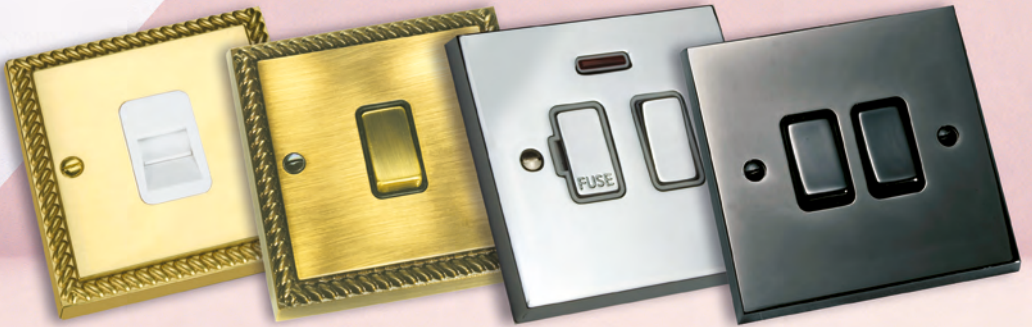

90 TCM W

91 R21 AB-B

95 SPN BC-W

98 R22 BK-B

Plate finishes available in this range

Georgian Plate Finishes



Antique Brass

Polished Brass

Victorian Plate Finishes



Antique Brass

Black Nickel

Bright Chrome



Polished Brass

Satin Brass

Satin Chrome

Hamilton Cheriton

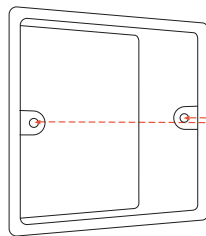

Victorian Plate Depth 7.5mm
Georgian Plate Depth 10.5mm

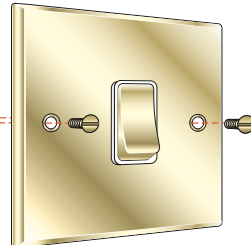

Box-Fix to Back Box

Cheriton

Victorian Rocker Switches



93 R23 AB-B



98 R26 BK-B

Plate Finish	Insert Finish / Surround Colour	1 gang 10AX 2 Way Rocker	2 gang 10AX 2 Way Rocker	3 gang 10AX 2 Way Rocker	4 gang 10AX 2 Way Rocker	6 gang 10AX 2 Way Rocker
Antique Brass	Antique Brass/Black	93 R21 AB-B	93 R22 AB-B	93 R23 AB-B	93 R24 AB-B	93 R26 AB-B
Antique Brass	Black/Black	93 R21 BL-B	93 R22 BL-B	93 R23 BL-B	93 R24 BL-B	93 R26 BL-B
Black Nickel	Black Nickel/Black	98 R21 BK-B	98 R22 BK-B	98 R23 BK-B	98 R24 BK-B	98 R26 BK-B
Bright Chrome	Bright Chrome/Black	95 R21 BC-B	95 R22 BC-B	95 R23 BC-B	95 R24 BC-B	95 R26 BC-B
Bright Chrome	Bright Chrome/White	95 R21 BC-W	95 R22 BC-W	95 R23 BC-W	95 R24 BC-W	95 R26 BC-W
Bright Chrome	Black/Black	95 R21 BL-B	95 R22 BL-B	95 R23 BL-B	95 R24 BL-B	95 R26 BL-B
Bright Chrome	White/White	95 R21 WH-W	95 R22 WH-W	95 R23 WH-W	95 R24 WH-W	95 R26 WH-W
Polished Brass	Black/Black	92 R21 BL-B	92 R22 BL-B	92 R23 BL-B	92 R24 BL-B	92 R26 BL-B
Polished Brass	Polished Brass/Black	92 R21 PB-B	92 R22 PB-B	92 R23 PB-B	92 R24 PB-B	92 R26 PB-B
Polished Brass	Polished Brass/White	92 R21 PB-W	92 R22 PB-W	92 R23 PB-W	92 R24 PB-W	92 R26 PB-W
Polished Brass	White/White	92 R21 WH-W	92 R22 WH-W	92 R23 WH-W	92 R24 WH-W	92 R26 WH-W
Satin Brass	Black/Black	94 R21 BL-B	94 R22 BL-B	94 R23 BL-B	94 R24 BL-B	94 R26 BL-B
Satin Brass	Satin Brass/Black	94 R21 SB-B	94 R22 SB-B	94 R23 SB-B	94 R24 SB-B	94 R26 SB-B
Satin Brass	Satin Brass/White	94 R21 SB-W	94 R22 SB-W	94 R23 SB-W	94 R24 SB-W	94 R26 SB-W
Satin Brass	White/White	94 R21 WH-W	94 R22 WH-W	94 R23 WH-W	94 R24 WH-W	94 R26 WH-W
Satin Chrome	Black/Black	96 R21 BL-B	96 R22 BL-B	96 R23 BL-B	96 R24 BL-B	96 R26 BL-B
Satin Chrome	Satin Chrome/Black	96 R21 SC-B	96 R22 SC-B	96 R23 SC-B	96 R24 SC-B	96 R26 SC-B
Satin Chrome	Satin Chrome/White	96 R21 SC-W	96 R22 SC-W	96 R23 SC-W	96 R24 SC-W	96 R26 SC-W
Satin Chrome	White/White	96 R21 WH-W	96 R22 WH-W	96 R23 WH-W	96 R24 WH-W	96 R26 WH-W
Nominal Size:		88.5mm x 88.5mm	88.5mm x 88.5mm	88.5mm x 88.5mm	146.0mm x 86.5mm	146.0mm x 86.5mm
Minimum Wall Box Depth:		25mm	25mm	25mm	25mm	25mm
Technical Insert Ref:		R21	R22	R23	R24	R26

Georgian Rocker Switches



91 R21 AB-B



90 R22 WH-W

Plate Finish	Insert Finish / Surround Colour	1 gang 10AX 2 Way Rocker	2 gang 10AX 2 Way Rocker	3 gang 10AX 2 Way Rocker	4 gang 10AX 2 Way Rocker	6 gang 10AX 2 Way Rocker
Antique Brass	Antique Brass/Black	91 R21 AB-B	91 R22 AB-B	91 R23 AB-B	91 R24 AB-B	91 R26 AB-B
Antique Brass	Black/Black	91 R21 BL-B	91 R22 BL-B	91 R23 BL-B	91 R24 BL-B	91 R26 BL-B
Polished Brass	Black/Black	90 R21 BL-B	90 R22 BL-B	90 R23 BL-B	90 R24 BL-B	90 R26 BL-B
Polished Brass	Polished Brass/Black	90 R21 PB-B	90 R22 PB-B	90 R23 PB-B	90 R24 PB-B	90 R26 PB-B
Polished Brass	Polished Brass/White	90 R21 PB-W	90 R22 PB-W	90 R23 PB-W	90 R24 PB-W	90 R26 PB-W
Polished Brass	White/White	90 R21 WH-W	90 R22 WH-W	90 R23 WH-W	90 R24 WH-W	90 R26 WH-W
Nominal Size:		88.0mm x 88.0mm	88.0mm x 88.0mm	88.0mm x 88.0mm	146.0mm x 86.5mm	146.0mm x 86.5mm
Minimum Wall Box Depth:		25mm	25mm	25mm	25mm	25mm
Technical Insert Ref:		R21	R22	R23	R24	R26

Insert Surround Colour Key: (-B) Black, (-W) White

Cheriton

Victorian Rocker Switches







93 R31 AB-B



98 TPBL-B

CHERITON RANGE

Plate Finish	Insert Finish / Surround Colour				
		1 gang 10AX Intermediate Rocker	2 gang 10AX Intermediate Rocker	1 gang 10AX Push To Make Retractive Rocker	1 gang 10AX Triple Pole Rocker
Antique Brass	Antique Brass/Black	93 R31 AB-B	93 R32 AB-B	93 RRT AB-B	-
Antique Brass	Black/Black	93 R31 BL-B	93 R32 BL-B	-	93 TP BL-B
Black Nickel	Black Nickel/Black	98 R31 BK-B	-	-	-
Black Nickel	Black/Black	-	-	-	98 TP BL-B
Bright Chrome	Bright Chrome/Black	95 R31 BC-B	95 R32 BC-B	95 RRT BC-B	-
Bright Chrome	Bright Chrome/White	95 R31 BC-W	95 R32 BC-W	95 RRT BC-W	-
Bright Chrome	Black/Black	95 R31 BL-B	95 R32 BL-B	95 RRT BL-B	95 TP BL-B
Bright Chrome	White/White	95 R31 WH-W	95 R32 WH-W	95 RRT WH-W	95 TP WH-W
Polished Brass	Black/Black	92 R31 BL-B	92 R32 BL-B	92 RRT BL-B	92 TP BL-B
Polished Brass	Polished Brass/Black	92 R31 PB-B	92 R32 PB-B	92 RRT PB-B	-
Polished Brass	Polished Brass/White	92 R31 PB-W	92 R32 PB-W	92 RRT PB-W	-
Polished Brass	White/White	92 R31 WH-W	92 R32 WH-W	92 RRT WH-W	92 TP WH-W
Satin Brass	Black/Black	94 R31 BL-B	94 R32 BL-B	94 RRT BL-B	94 TP BL-B
Satin Brass	Satin Brass/Black	94 R31 SB-B	94 R32 SB-B	94 RRT SB-B	-
Satin Brass	Satin Brass/White	94 R31 SB-W	94 R32 SB-W	94 RRT SB-W	-
Satin Brass	White/White	94 R31 WH-W	94 R32 WH-W	94 RRT WH-W	94 TP WH-W
Satin Chrome	Black/Black	96 R31 BL-B	96 R32 BL-B	96 RRT BL-B	96 TP BL-B
Satin Chrome	Satin Chrome/Black	96 R31 SC-B	96 R32 SC-B	96 RRT SC-B	-
Satin Chrome	Satin Chrome/White	96 R31 SC-W	96 R32 SC-W	96 RRT SC-W	-
Satin Chrome	White/White	96 R31 WH-W	96 R32 WH-W	96 RRT WH-W	96 TP WH-W
Nominal Size:		88.5mm x 88.5mm	88.5mm x 88.5mm	88.5mm x 88.5mm	88.5mm x 88.5mm
Minimum Wall Box Depth:		25mm	25mm	25mm	25mm
Technical Insert Ref:		R31	R32	RRT	TP





Georgian Rocker Switches



91 R32 AB-B



90 RRT PB-W

Plate Finish	Insert Finish / Surround Colour				
		1 gang 10AX Intermediate Rocker	2 gang 10AX Intermediate Rocker	1 gang 10AX Push To Make Retractive Rocker	1 gang 10AX Triple Pole Rocker
Antique Brass	Antique Brass/Black	91 R31 AB-B	91 R32 AB-B	91 RRT AB-B	-
Antique Brass	Black/Black	91 R31 BL-B	91 R32 BL-B	-	91 TP BL-B
Polished Brass	Black/Black	90 R31 BL-B	90 R32 BL-B	90 RRT BL-B	90 TP BL-B
Polished Brass	Polished Brass/Black	90 R31 PB-B	90 R32 PB-B	90 RRT PB-B	-
Polished Brass	Polished Brass/White	90 R31 PB-W	90 R32 PB-W	90 RRT PB-W	-
Polished Brass	White/White	90 R31 WH-W	90 R32 WH-W	90 RRT WH-W	90 TP WH-W
Nominal Size:		88.0mm x 88.0mm	88.0mm x 88.0mm	88.0mm x 88.0mm	88.0mm x 88.0mm
Minimum Wall Box Depth:		25mm	25mm	25mm	25mm
Technical Insert Ref:		R31	R32	RRT	TP

Insert Surround Colour Key: (-B) Black, (-W) White

Cheriton







Victorian Toggle Switches



93 T21



94 T24

							
Plate Finish	1 gang 20AX 2 Way Toggle	2 gang 20AX 2 Way Toggle	3 gang 20AX 2 Way Toggle	4 gang 20AX 2 Way Toggle	1 gang 20AX Intermediate Toggle	1 gang 20AX Double Pole Toggle	1 gang 10AX Push To Make/ Push To Break Retractive Toggle
Antique Brass	93 T21	93 T22	93 T23	93 T24	93 T31	93 TDP	93 TRT
Black Nickel	98 T21	98 T22	98 T23	98 T24	98 T31	98 TDP	98 TRT
Bright Chrome	95 T21	95 T22	95 T23	95 T24	95 T31	95 TDP	95 TRT
Polished Brass	92 T21	92 T22	92 T23	92 T24	92 T31	92 TDP	92 TRT
Satin Brass	94 T21	94 T22	94 T23	94 T24	94 T31	94 TDP	94 TRT
Satin Chrome	96 T21	96 T22	96 T23	96 T24	96 T31	96 TDP	96 TRT
Nominal Size:	88.5mm x 88.5mm	88.5mm x 88.5mm	146.0mm x 86.5mm	146.0mm x 86.5mm	88.5mm x 88.5mm	88.5mm x 88.5mm	88.5mm x 88.5mm
Minimum Wall Box Depth:	25mm	25mm	25mm	25mm	25mm	25mm	25mm
Technical Insert Ref:	T21	T22	T23	T24	T31	TDP	TRT







Georgian Toggle Switches



90 T21



91 T24

							
Plate Finish	1 gang 20AX 2 Way Toggle	2 gang 20AX 2 Way Toggle	3 gang 20AX 2 Way Toggle	4 gang 20AX 2 Way Toggle	1 gang 20AX Intermediate Toggle	1 gang 20AX Double Pole Toggle	1 gang 10AX Push To Make/ Push To Break Retractive Toggle
Antique Brass	91 T21	91 T22	91 T23	91 T24	91 T31	91 TDP	91 TRT
Polished Brass	90 T21	90 T22	90 T23	90 T24	90 T31	90 TDP	90 TRT
Nominal Size:	88.0mm x 88.0mm	88.0mm x 88.0mm	146.0mm x 86.5mm	146.0mm x 86.5mm	88.0mm x 88.0mm	88.0mm x 88.0mm	88.0mm x 88.0mm
Minimum Wall Box Depth:	25mm	25mm	25mm	25mm	25mm	25mm	25mm
Technical Insert Ref:	T21	T22	T23	T24	T31	TDP	TRT

Cheriton

Victorian Power Sockets

CHERITON RANGE



96 SS1 BL-B



94 US99 W



1 gang 13A
Double Pole
Switched
Socket

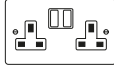

2 gang 13A
Double Pole
Switched
Socket



1 gang 2A
Unswitched
Socket



1 gang 5A
Unswitched
Socket



1 gang 13A
Unswitched
Socket

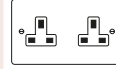

2 gang 13A
Unswitched
Socket

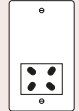

Shaver Dual
Voltage
Unswitched
Socket
(Vertically
Mounted)

Plate Finish	Insert Finish / Surround Colour	1 gang 13A Double Pole Switched Socket	2 gang 13A Double Pole Switched Socket	1 gang 2A Unswitched Socket	1 gang 5A Unswitched Socket	1 gang 13A Unswitched Socket	2 gang 13A Unswitched Socket	Shaver Dual Voltage Unswitched Socket (Vertically Mounted)
Antique Brass	Antique Brass/Black	93 SS1 AB-B	93 SS2 AB-B	-	-	-	-	-
Antique Brass	Black/Black	93 SS1 BL-B	93 SS2 BL-B	93 US2 B	93 US5 B	93 US13 B	93 US99 B	93 SHS B
Black Nickel	Black Nickel/Black	98 SS1 BK-B	98 SS2 BK-B	-	-	-	-	-
Black Nickel	Black/Black	-	-	98 US2 B	98 US5 B	-	-	98 SHS B
Bright Chrome	Bright Chrome/Black	95 SS1 BC-B	95 SS2 BC-B	-	-	-	-	-
Bright Chrome	Bright Chrome/White	95 SS1 BC-W	95 SS2 BC-W	-	-	-	-	-
Bright Chrome	Black/Black	95 SS1 BL-B	95 SS2 BL-B	95 US2 B	95 US5 B	95 US13 B	95 US99 B	95 SHS B
Bright Chrome	White/White	95 SS1 WH-W	95 SS2 WH-W	95 US2 W	95 US5 W	95 US13 W	95 US99 W	95 SHS W
Polished Brass	Black/Black	92 SS1 BL-B	92 SS2 BL-B	92 US2 B	92 US5 B	92 US13 B	92 US99 B	92 SHS B
Polished Brass	Polished Brass/Black	92 SS1 PB-B	92 SS2 PB-B	-	-	-	-	-
Polished Brass	Polished Brass/White	92 SS1 PB-W	92 SS2 PB-W	-	-	-	-	-
Polished Brass	White/White	92 SS1 WH-W	92 SS2 WH-W	92 US2 W	92 US5 W	92 US13 W	92 US99 W	92 SHS W
Satin Brass	Black/Black	94 SS1 BL-B	94 SS2 BL-B	94 US2 B	94 US5 B	94 US13 B	94 US99 B	94 SHS B
Satin Brass	Satin Brass/Black	94 SS1 SB-B	94 SS2 SB-B	-	-	-	-	-
Satin Brass	Satin Brass/White	94 SS1 SB-W	94 SS2 SB-W	-	-	-	-	-
Satin Brass	White/White	94 SS1 WH-W	94 SS2 WH-W	94 US2 W	94 US5 W	94 US13 W	94 US99 W	94 SHS W
Satin Chrome	Black/Black	96 SS1 BL-B	96 SS2 BL-B	96 US2 B	96 US5 B	96 US13 B	96 US99 B	96 SHS B
Satin Chrome	Satin Chrome/Black	96 SS1 SC-B	96 SS2 SC-B	-	-	-	-	-
Satin Chrome	Satin Chrome/White	96 SS1 SC-W	96 SS2 SC-W	-	-	-	-	-
Satin Chrome	White/White	96 SS1 WH-W	96 SS2 WH-W	96 US2 W	96 US5 W	96 US13 W	96 US99 W	96 SHS W
Nominal Size:		88.5mm x 88.5mm	146.0mm x 86.5mm	88.5mm x 88.5mm	88.5mm x 88.5mm	88.5mm x 88.5mm	146.0mm x 86.5mm	86.5mm x 146.0mm
Minimum Wall Box Depth:		35mm	35mm	35mm	35mm	35mm	35mm	47mm
Technical Insert Ref:		SS1	SS2	US2	US5	US13	US99	SHS

Insert Surround Colour Key: (-B) Black, (-W) White

Cheriton





Georgian Power Sockets



90 SS1 BL-B

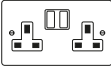

91 US99 B

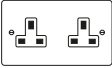
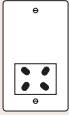
Plate Finish	Insert Finish / Surround Colour							
		1 gang 13A Double Pole Switched Socket	2 gang 13A Double Pole Switched Socket	1 gang 2A Unswitched Socket	1 gang 5A Unswitched Socket	1 gang 13A Unswitched Socket	2 gang 13A Unswitched Socket	Shaver Dual Voltage Unswitched Socket (Vertically Mounted)
Antique Brass	Antique Brass/Black	91 SS1 AB-B	91 SS2 AB-B	-	-	-	-	-
Antique Brass	Black/Black	91 SS1 BL-B	91 SS2 BL-B	91 US2 B	91 US5 B	91 US13 B	91 US99 B	91 SHS B
Polished Brass	Black/Black	90 SS1 BL-B	90 SS2 BL-B	90 US2 B	90 US5 B	90 US13 B	90 US99 B	90 SHS B
Polished Brass	Polished Brass/Black	90 SS1 PB-B	90 SS2 PB-B	-	-	-	-	-
Polished Brass	Polished Brass/White	90 SS1 PB-W	90 SS2 PB-W	-	-	-	-	-
Polished Brass	White/White	90 SS1 WH-W	90 SS2 WH-W	90 US2 W	90 US5 W	90 US13 W	90 US99 W	90 SHS W
	Nominal Size:	88.0mm x 88.0mm	146.0mm x 86.5mm	88.0mm x 88.0mm	88.0mm x 88.0mm	88.0mm x 88.0mm	146.0mm x 86.5mm	86.5mm x 146.0mm
	Minimum Wall Box Depth:	35mm	35mm	35mm	35mm	35mm	35mm	47mm
	Technical Insert Ref:	SS1	SS2	US2	US5	US13	US99	SHS

Insert Surround Colour Key: (-B) Black, (-W) White

Cheriton

Victorian Television Coaxial Sockets









95 TV W



92 TVSAT W

CHERITON RANGE

Plate Finish	Insert Colour							
		1 gang Non-Isolated TV 1in/1out	2 gang Non-Isolated TV 2in/2out	Isolated TV/FM Diplexer 1in/2out	1 gang Isolated TV 1in/1out	2 gang Non-Isolated TV+Satellite 2in/2out	1 gang Non-Isolated Satellite	1 gang Isolated Satellite
Antique Brass	Black	93 TV B	93 TV2 B	93 TVFM B	93 TVI B	93 TVSAT B	93 SATN B	93 SATI B
Black Nickel	Black	98 TV B	98 TV2 B	98 TVFM B	98 TVI B	98 TVSAT B	98 SATN B	98 SATI B
Bright Chrome	Black	95 TV B	95 TV2 B	95 TVFM B	95 TVI B	95 TVSAT B	95 SATN B	95 SATI B
Bright Chrome	White	95 TV W	95 TV2 W	95 TVFM W	95 TVI W	95 TVSAT W	95 SATN W	95 SATI W
Polished Brass	Black	92 TV B	92 TV2 B	92 TVFM B	92 TVI B	92 TVSAT B	92 SATN B	92 SATI B
Polished Brass	White	92 TV W	92 TV2 W	92 TVFM W	92 TVI W	92 TVSAT W	92 SATN W	92 SATI W
Satin Brass	Black	94 TV B	94 TV2 B	94 TVFM B	94 TVI B	94 TVSAT B	94 SATN B	94 SATI B
Satin Brass	White	94 TV W	94 TV2 W	94 TVFM W	94 TVI W	94 TVSAT W	94 SATN W	94 SATI W
Satin Chrome	Black	96 TV B	96 TV2 B	96 TVFM B	96 TVI B	96 TVSAT B	96 SATN B	96 SATI B
Satin Chrome	White	96 TV W	96 TV2 W	96 TVFM W	96 TVI W	96 TVSAT W	96 SATN W	96 SATI W
Nominal Size:		88.5mm x 88.5mm	88.5mm x 88.5mm	88.5mm x 88.5mm	88.5mm x 88.5mm	88.5mm x 88.5mm	88.5mm x 88.5mm	88.5mm x 88.5mm
Minimum Wall Box Depth:		25mm	25mm	25mm	25mm	35mm	35mm	35mm
Technical Insert Ref:		TV	TV2	TVFM	TVI	TVSAT	SATN	SATI



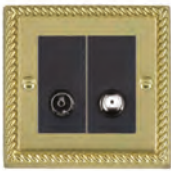



Georgian Television Coaxial Sockets



90 TVSAT B



91 SATI B

Plate Finish	Insert Colour							
		1 gang Non-Isolated TV 1in/1out	2 gang Non-Isolated TV 2in/2out	Isolated TV/FM Diplexer 1in/2out	1 gang Isolated TV 1in/1out	2 gang Non-Isolated TV+Satellite 2in/2out	1 gang Non-Isolated Satellite	1 gang Isolated Satellite
Antique Brass	Black	91 TV B	91 TV2 B	91 TVFM B	91 TVI B	91 TVSAT B	91 SATN B	91 SATI B
Polished Brass	Black	90 TV B	90 TV2 B	90 TVFM B	90 TVI B	90 TVSAT B	90 SATN B	90 SATI B
Polished Brass	White	90 TV W	90 TV2 W	90 TVFM W	90 TVI W	90 TVSAT W	90 SATN W	90 SATI W
Nominal Size:		88.0mm x 88.0mm	88.0mm x 88.0mm	88.0mm x 88.0mm	88.0mm x 88.0mm	88.0mm x 88.0mm	88.0mm x 88.0mm	88.0mm x 88.0mm
Minimum Wall Box Depth:		25mm	25mm	25mm	25mm	35mm	35mm	35mm
Technical Insert Ref:		TV	TV2	TVFM	TVI	TVSAT	SATN	SATI

Insert Surround Colour Key: (-B) Black, (-W) White

Cheriton





Victorian Digital Television Sockets - Screened Non-Isolated / DAB Compatible



93 DTVF B

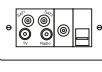

92 DENT W

Plate Finish	Insert Colour						
Antique Brass	Black	93 DTRID B	93 DTVF B	93 DTVM B	93 DSAT B	93 DENT B	93 DSAT+ B
Black Nickel	Black	98 DTRID B	98 DTVF B	98 DTVM B	98 DSAT B	98 DENT B	98 DSAT+ B
Bright Chrome	Black	95 DTRID B	95 DTVF B	95 DTVM B	95 DSAT B	95 DENT B	95 DSAT+ B
Bright Chrome	White	95 DTRID W	95 DTVF W	95 DTVM W	95 DSAT W	95 DENT W	95 DSAT+ W
Polished Brass	Black	92 DTRID B	92 DTVF B	92 DTVM B	92 DSAT B	92 DENT B	92 DSAT+ B
Polished Brass	White	92 DTRID W	92 DTVF W	92 DTVM W	92 DSAT W	92 DENT W	92 DSAT+ W
Satin Brass	Black	94 DTRID B	94 DTVF B	94 DTVM B	94 DSAT B	94 DENT B	94 DSAT+ B
Satin Brass	White	94 DTRID W	94 DTVF W	94 DTVM W	94 DSAT W	94 DENT W	94 DSAT+ W
Satin Chrome	Black	96 DTRID B	96 DTVF B	96 DTVM B	96 DSAT B	96 DENT B	96 DSAT+ B
Satin Chrome	White	96 DTRID W	96 DTVF W	96 DTVM W	96 DSAT W	96 DENT W	96 DSAT+ W
Nominal Size:		88.5mm x 88.5mm	88.5mm x 88.5mm	88.5mm x 88.5mm	88.5mm x 88.5mm	88.5mm x 88.5mm	146.0mm x 86.5mm
Minimum Wall Box Depth:		35mm	35mm	35mm	35mm	35mm	35mm
Technical Insert Ref:		DTRID	DTVf	DTVM	DSAT	DENT	DSAT+





Georgian Digital Television Sockets - Screened Non-Isolated / DAB Compatible

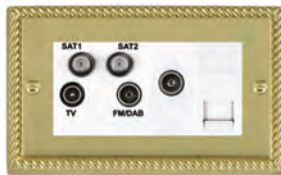

91 DTRID B

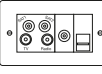

90 DSAT+ W

Plate Finish	Insert Colour						
Antique Brass	Black	91 DTRID B	91 DTVF B	91 DTVM B	91 DSAT B	91 DENT B	91 DSAT+ B
Polished Brass	Black	90 DTRID B	90 DTVF B	90 DTVM B	90 DSAT B	90 DENT B	90 DSAT+ B
Polished Brass	White	90 DTRID W	90 DTVF W	90 DTVM W	90 DSAT W	90 DENT W	90 DSAT+ W
Nominal Size:		88.0mm x 88.0mm	88.0mm x 88.0mm	88.0mm x 88.0mm	88.0mm x 88.0mm	88.0mm x 88.0mm	146.0mm x 86.5mm
Minimum Wall Box Depth:		35mm	35mm	35mm	35mm	35mm	35mm
Technical Insert Ref:		DTRID	DTVf	DTVM	DSAT	DENT	DSAT+

Insert Surround Colour Key: (-B) Black, (-W) White

Cheriton

Victorian Telephone and Data Outlets



93 J12 B



94 2J45 W

Plate Finish	Insert Finish	1 gang Telephone Master	1 gang Telephone Slave	1 gang RJ12 Outlet - Unshielded	2 gang RJ12 Outlet - Unshielded	1 gang RJ45 CAT 5E Outlet - Unshielded	2 gang RJ45 CAT 5E Outlet - Unshielded
Antique Brass	Black	93 TCM B	93 TCS B	93 J12 B	93 2J12 B	93 J45 B	93 2J45 B
Black Nickel	Black	98 TCM B	98 TCS B	98 J12 B	98 2J12 B	98 J45 B	98 2J45 B
Bright Chrome	Black	95 TCM B	95 TCS B	95 J12 B	95 2J12 B	95 J45 B	95 2J45 B
Bright Chrome	White	95 TCM W	95 TCS W	95 J12 W	95 2J12 W	95 J45 W	95 2J45 W
Polished Brass	Black	92 TCM B	92 TCS B	92 J12 B	92 2J12 B	92 J45 B	92 2J45 B
Polished Brass	White	92 TCM W	92 TCS W	92 J12 W	92 2J12 W	92 J45 W	92 2J45 W
Satin Brass	Black	94 TCM B	94 TCS B	94 J12 B	94 2J12 B	94 J45 B	94 2J45 B
Satin Brass	White	94 TCM W	94 TCS W	94 J12 W	94 2J12 W	94 J45 W	94 2J45 W
Satin Chrome	Black	96 TCM B	96 TCS B	96 J12 B	96 2J12 B	96 J45 B	96 2J45 B
Satin Chrome	White	96 TCM W	96 TCS W	96 J12 W	96 2J12 W	96 J45 W	96 2J45 W
Nominal Size:		88.5mm x 88.5mm	88.5mm x 88.5mm	88.5mm x 88.5mm	88.5mm x 88.5mm	88.5mm x 88.5mm	88.5mm x 88.5mm
Minimum Wall Box Depth:		25mm	25mm	35mm	35mm	35mm	35mm
Technical Insert Ref:		TCM	TCS	J12	2J12	J45	2J45

Georgian Telephone and Data Outlets



91 TCS B



90 2J45 W

Plate Finish	Insert Finish	1 gang Telephone Master	1 gang Telephone Slave	1 gang RJ12 Outlet - Unshielded	2 gang RJ12 Outlet - Unshielded	1 gang RJ45 CAT 5E Outlet - Unshielded	2 gang RJ45 CAT 5E Outlet - Unshielded
Antique Brass	Black	91 TCM B	91 TCS B	91 J12 B	91 2J12 B	91 J45 B	91 2J45 B
Polished Brass	Black	90 TCM B	90 TCS B	90 J12 B	90 2J12 B	90 J45 B	90 2J45 B
Polished Brass	White	90 TCM W	90 TCS W	90 J12 W	90 2J12 W	90 J45 W	90 2J45 W
Nominal Size:		88.0mm x 88.0mm	88.0mm x 88.0mm	88.0mm x 88.0mm	88.0mm x 88.0mm	88.0mm x 88.0mm	88.0mm x 88.0mm
Minimum Wall Box Depth:		25mm	25mm	35mm	35mm	35mm	35mm
Technical Insert Ref:		TCM	TCS	J12	2J12	J45	2J45

Insert Surround Colour Key: (-B) Black, (-W) White

Cheriton







Victorian Double Pole Switches



95 45 W

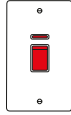

94 45N B

Plate Finish	Insert Finish / Surround Colour	 1 gang 20AX Double Pole Rocker	 1 gang 20AX Double Pole Rocker + Neon	 1 gang 20AX Double Pole Rocker + Neon + Cable Outlet	 1 gang 45A Double Pole Red Rocker	 1 gang 45A Double Pole Red Rocker + Neon	 1 gang 45A Double Pole Red Rocker + Neon (Vertically Mounted)	 45A Double Pole Red Rocker + Neon + 13A Switched Socket
Antique Brass	Antique Brass/Black	93 DP AB-B	93 DPN AB-B	93 DPNC AB-B	-	-	-	93 45SS1 AB-B
Antique Brass	Black/Black	93 DP BL-B	93 DPN BL-B	93 DPNC BL-B	93 45 B	93 45N B	93 45V B	93 45SS1 BL-B
Black Nickel	Black Nickel/Black	-	98 DPN BK-B	-	-	-	-	98 45SS1 BK-B
Black Nickel	Black/Black	-	-	-	98 45 B	98 45N B	-	-
Bright Chrome	Bright Chrome/Black	95 DP BC-B	95 DPN BC-B	95 DPNC BC-B	-	-	-	95 45SS1 BC-B
Bright Chrome	Bright Chrome/White	95 DP BC-W	95 DPN BC-W	95 DPNC BC-W	-	-	-	95 45SS1 BC-W
Bright Chrome	Black/Black	95 DP BL-B	95 DPN BL-B	95 DPNC BL-B	95 45 B	95 45N B	95 45V B	95 45SS1 BL-B
Bright Chrome	White/White	95 DP WH-W	95 DPN WH-W	95 DPNC WH-W	95 45 W	95 45N W	95 45V W	95 45SS1 WH-W
Polished Brass	Black/Black	92 DP BL-B	92 DPN BL-B	92 DPNC BL-B	92 45 B	92 45N B	92 45V B	92 45SS1 BL-B
Polished Brass	Polished Brass/Black	92 DP PB-B	92 DPN PB-B	92 DPNC PB-B	-	-	-	92 45SS1 PB-B
Polished Brass	Polished Brass/White	92 DP PB-W	92 DPN PB-W	92 DPNC PB-W	-	-	-	92 45SS1 PB-W
Polished Brass	White/White	92 DP WH-W	92 DPN WH-W	92 DPNC WH-W	92 45 W	92 45N W	92 45V W	92 45SS1 WH-W
Satin Brass	Black/Black	94 DP BL-B	94 DPN BL-B	94 DPNC BL-B	94 45 B	94 45N B	94 45V B	94 45SS1 BL-B
Satin Brass	Satin Brass/Black	94 DP SB-B	94 DPN SB-B	94 DPNC SB-B	-	-	-	94 45SS1 SB-B
Satin Brass	Satin Brass/White	94 DP SB-W	94 DPN SB-W	94 DPNC SB-W	-	-	-	94 45SS1 SB-W
Satin Brass	White/White	94 DP WH-W	94 DPN WH-W	94 DPNC WH-W	94 45 W	94 45N W	94 45V W	94 45SS1 WH-W
Satin Chrome	Black/Black	96 DP BL-B	96 DPN BL-B	96 DPNC BL-B	96 45 B	96 45N B	96 45V B	96 45SS1 BL-B
Satin Chrome	Satin Chrome/Black	96 DP SC-B	96 DPN SC-B	96 DPNC SC-B	-	-	-	96 45SS1 SC-B
Satin Chrome	Satin Chrome/White	96 DP SC-W	96 DPN SC-W	96 DPNC SC-W	-	-	-	96 45SS1 SC-W
Satin Chrome	White/White	96 DP WH-W	96 DPN WH-W	96 DPNC WH-W	96 45 W	96 45N W	96 45V W	96 45SS1 WH-W
	Nominal Size:	88.5mm x 88.5mm	88.5mm x 88.5mm	88.5mm x 88.5mm	88.5mm x 88.5mm	88.5mm x 88.5mm	86.5mm x 146.0mm	146.0mm x 86.5mm
	Minimum Wall Box Depth:	25mm	25mm	25mm	35mm	35mm	35mm	35mm
	Technical Insert Ref:	DP	DPN	DPNC	45	45N	45V	45SS1

Insert Surround Colour Key: (-B) Black, (-W) White

Cheriton

Georgian Double Pole Switches



91 DP AB-B



90 DPNC WH-W

CHERITON RANGE



1 gang 20AX
Double Pole
Rocker



1 gang 20AX
Double Pole
Rocker +
Neon



1 gang 20AX
Double Pole
Rocker +
Neon +
Cable Outlet



1 gang 45A
Double Pole
Red Rocker



1 gang 45A
Double Pole
Red Rocker +
Neon

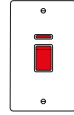

1 gang 45A
Double Pole
Red Rocker +
Neon
(Vertically
Mounted)

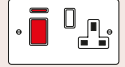

45A Double Pole
Red Rocker +
Neon +
13A Switched
Socket

Plate Finish	Insert Finish / Surround Colour						
Antique Brass	Antique Brass/Black	91 DP AB-B	91 DPN AB-B	91 DPNC AB-B	-	-	-
Antique Brass	Black/Black	91 DP BL-B	91 DPN BL-B	91 DPNC BL-B	91 45 B	91 45N B	91 45V B
Polished Brass	Black/Black	90 DP BL-B	90 DPN BL-B	90 DPNC BL-B	90 45 B	90 45N B	90 45V B
Polished Brass	Polished Brass/Black	90 DP PB-B	90 DPN PB-B	90 DPNC PB-B			90 45SS1 PB-B
Polished Brass	Polished Brass/White	90 DP PB-W	90 DPN PB-W	90 DPNC PB-W	-	-	-
Polished Brass	White/White	90 DP WH-W	90 DPN WH-W	90 DPNC WH-W	90 45 W	90 45N W	90 45V W
	Nominal Size:	88.0mm x 88.0mm	88.0mm x 88.0mm	88.0mm x 88.0mm	88.0mm x 88.0mm	88.0mm x 88.0mm	86.5mm x 146.0mm
	Minimum Wall Box Depth:	25mm	25mm	25mm	35mm	35mm	35mm
	Technical Insert Ref:	DP	DPN	DPNC	45	45N	45V
							146.0mm x 86.5mm
							35mm
							45SS1

Insert Surround Colour Key: (-B) Black, (-W) White

Cheriton

Victorian Connection Units



96 SPN WH-W



98 FOBK-B



1 gang 13A
Double Pole
Fused Spur



1 gang 13A
Double Pole
Fused Spur +
Neon



1 gang 13A
Double Pole
Fused Spur +
Neon +
Cable Outlet



1 gang 13A
Fuse Only



1 gang 13A
Fuse +
Cable Outlet



1 gang 20A
Cable Outlet

Plate Finish	Insert Finish / Surround Colour	1 gang 13A Double Pole Fused Spur	1 gang 13A Double Pole Fused Spur + Neon	1 gang 13A Double Pole Fused Spur + Neon + Cable Outlet	1 gang 13A Fuse Only	1 gang 13A Fuse + Cable Outlet	1 gang 20A Cable Outlet
Antique Brass	Antique Brass/Black	93 SP AB-B	93 SPN AB-B	93 SPNC AB-B	93 FO AB-B	93 FOC AB-B	-
Antique Brass	Black/Black	93 SP BL-B	93 SPN BL-B	93 SPNC BL-B	93 FO BL-B	93 FOC BL-B	93 CO B
Black Nickel	Black Nickel/Black	98 SP BK-B	98 SPN BK-B	-	98 FO BK-B	-	-
Bright Chrome	Bright Chrome/Black	95 SP BC-B	95 SPN BC-B	95 SPNC BC-B	95 FO BC-B	95 FOC BC-B	-
Bright Chrome	Bright Chrome/White	95 SP BC-W	95 SPN BC-W	95 SPNC BC-W	95 FO BC-W	95 FOC BC-W	-
Bright Chrome	Black/Black	95 SP BL-B	95 SPN BL-B	95 SPNC BL-B	95 FO BL-B	95 FOC BL-B	95 CO B
Bright Chrome	White/White	95 SP WH-W	95 SPN WH-W	95 SPNC WH-W	95 FO WH-W	95 FOC WH-W	95 CO W
Polished Brass	Black/Black	92 SP BL-B	92 SPN BL-B	92 SPNC BL-B	92 FO BL-B	92 FOC BL-B	92 CO B
Polished Brass	Polished Brass/Black	92 SP PB-B	92 SPN PB-B	92 SPNC PB-B	92 FO PB-B	92 FOC PB-B	-
Polished Brass	Polished Brass/White	92 SP PB-W	92 SPN PB-W	92 SPNC PB-W	92 FO PB-W	92 FOC PB-W	-
Polished Brass	White/White	92 SP WH-W	92 SPN WH-W	92 SPNC WH-W	92 FO WH-W	92 FOC WH-W	92 CO W
Satin Brass	Black/Black	94 SP BL-B	94 SPN BL-B	94 SPNC BL-B	94 FO BL-B	94 FOC BL-B	94 CO B
Satin Brass	Satin Brass/Black	94 SP SB-B	94 SPN SB-B	94 SPNC SB-B	94 FO SB-B	94 FOC SB-B	-
Satin Brass	Satin Brass/White	94 SP SB-W	94 SPN SB-W	94 SPNC SB-W	94 FO SB-W	94 FOC SB-W	-
Satin Brass	White/White	94 SP WH-W	94 SPN WH-W	94 SPNC WH-W	94 FO WH-W	94 FOC WH-W	94 CO W
Satin Chrome	Black/Black	96 SP BL-B	96 SPN BL-B	96 SPNC BL-B	96 FO BL-B	96 FOC BL-B	96 CO B
Satin Chrome	Satin Chrome/Black	96 SP SC-B	96 SPN SC-B	96 SPNC SC-B	96 FO SC-B	96 FOC SC-B	-
Satin Chrome	Satin Chrome/White	96 SP SC-W	96 SPN SC-W	96 SPNC SC-W	96 FO SC-W	96 FOC SC-W	-
Satin Chrome	White/White	96 SP WH-W	96 SPN WH-W	96 SPNC WH-W	96 FO WH-W	96 FOC WH-W	96 CO W
Nominal Size:		88.5mm x 88.5mm	88.5mm x 88.5mm	88.5mm x 88.5mm	88.5mm x 88.5mm	88.5mm x 88.5mm	88.5mm x 88.5mm
Minimum Wall Box Depth:		35mm	35mm	35mm	35mm	35mm	35mm
Technical Insert Ref:		SP	SPN	SPNC	FO	FOC	CO

Insert Surround Colour Key: (-B) Black, (-W) White

Cheriton

Georgian Connection Units



91 FO AB-B



90 CO B

CHERITON RANGE



1 gang 13A
Double Pole
Fused Spur



1 gang 13A
Double Pole
Fused Spur + Neon



1 gang 13A
Double Pole
Fused Spur +
Neon +
Cable Outlet



1 gang 13A
Fuse Only



1 gang 13A
Fuse +
Cable Outlet



1 gang 20A
Cable Outlet

Plate Finish	Insert Finish / Surround Colour						
Antique Brass	Antique Brass/Black	91 SP AB-B	91 SPN AB-B	91 SPNC AB-B	91 FO AB-B	91 FOC AB-B	-
Antique Brass	Black/Black	91 SP BL-B	91 SPN BL-B	91 SPNC BL-B	91 FO BL-B	91 FOC BL-B	91 CO B
Polished Brass	Black/Black	90 SP BL-B	90 SPN BL-B	90 SPNC BL-B	90 FO BL-B	90 FOC BL-B	90 CO B
Polished Brass	Polished Brass/Black	90 SP PB-B	90 SPN PB-B	90 SPNC PB-B	90 FO PB-B	90 FOC PB-B	-
Polished Brass	Polished Brass/White	90 SP PB-W	90 SPN PB-W	90 SPNC PB-W	90 FO PB-W	90 FOC PB-W	-
Polished Brass	White/White	90 SP WH-W	90 SPN WH-W	90 SPNC WH-W	90 FO WH-W	90 FOC WH-W	90 CO W
	Nominal Size:	88.0mm x 88.0mm	88.0mm x 88.0mm	88.0mm x 88.0mm	88.0mm x 88.0mm	88.0mm x 88.0mm	88.0mm x 88.0mm
	Minimum Wall Box Depth:	35mm	35mm	35mm	35mm	35mm	35mm
	Technical Insert Ref:	SP	SPN	SPNC	FO	FOC	CO

Insert Surround Colour Key: (-B) Black, (-W) White

Cheriton



Victorian LED Trailing/Leading Edge Push On/Off Rotary 2 Way Switching Dimmers



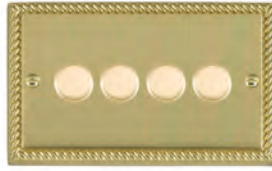



96 1XLEDITB100

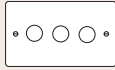
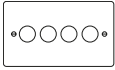

90 4XLEDITB100

Plate Finish	Insert Finish	 1 gang 100W LED Trailing/ Leading Edge Push On/ Off Rotary 2 Way Switching Dimmer	 2 gang 100W LED Trailing/ Leading Edge Push On/ Off Rotary 2 Way Switching Dimmer	 3 gang 100W LED Trailing/ Leading Edge Push On/ Off Rotary 2 Way Switching Dimmer	 4 gang 100W LED Trailing/ Leading Edge Push On/ Off Rotary 2 Way Switching Dimmer
Antique Brass	Antique Brass	93 1XLEDITB100	93 2XLEDITB100	93 3XLEDITB100	93 4XLEDITB100
Black Nickel	Black Nickel	98 1XLEDITB100	98 2XLEDITB100	98 3XLEDITB100	98 4XLEDITB100
Bright Chrome	Bright Chrome	95 1XLEDITB100	95 2XLEDITB100	95 3XLEDITB100	95 4XLEDITB100
Polished Brass	Polished Brass	92 1XLEDITB100	92 2XLEDITB100	92 3XLEDITB100	92 4XLEDITB100
Satin Brass	Satin Brass	94 1XLEDITB100	94 2XLEDITB100	94 3XLEDITB100	94 4XLEDITB100
Satin Chrome	Satin Chrome	96 1XLEDITB100	96 2XLEDITB100	96 3XLEDITB100	96 4XLEDITB100
Nominal Size:		88.5mm x 88.5mm	88.5mm x 88.5mm	146.0mm x 86.5mm	146.0mm x 86.5mm
Minimum Wall Box Depth:		35mm	35mm	35mm	35mm
Technical Insert Ref:		1XLEDITB	2XLEDITB	3XLEDITB	4XLEDITB

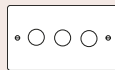
Georgian LED Trailing/Leading Edge Push On/Off Rotary 2 Way Switching Dimmers

Plate Finish	Insert Finish	 1 gang 100W LED Trailing/ Leading Edge Push On/ Off Rotary 2 Way Switching Dimmer	 2 gang 100W LED Trailing/ Leading Edge Push On/ Off Rotary 2 Way Switching Dimmer	 3 gang 100W LED Trailing/ Leading Edge Push On/ Off Rotary 2 Way Switching Dimmer	 4 gang 100W LED Trailing/ Leading Edge Push On/ Off Rotary 2 Way Switching Dimmer
Antique Brass	Antique Brass	91 1XLEDITB100	91 2XLEDITB100	91 3XLEDITB100	91 4XLEDITB100
Polished Brass	Polished Brass	90 1XLEDITB100	90 2XLEDITB100	90 3XLEDITB100	90 4XLEDITB100
Nominal Size:		88.0mm x 88.0mm	88.0mm x 88.0mm	146.0mm x 86.5mm	146.0mm x 86.5mm
Minimum Wall Box Depth:		35mm	35mm	35mm	35mm
Technical Insert Ref:		1XLEDITB	2XLEDITB	3XLEDITB	4XLEDITB

NOTE: Tungsten filament GU10 lamps must be branded and with a fused base.
 NOTE: Please refer to the Dimmer Technical Section for the max Wattage.
 NOTE: Please contact our Technical Department for compatibility.

Cheriton

Victorian LED Trailing/Leading Edge Push On/Off Rotary Multi-Way Dimmers

CHERITON RANGE



98 3X100LED



92 4X100LED

Plate Finish	Insert Finish	1 gang 100W LED Trailing/Leading Edge Push On/Off Rotary Multi-Way Dimmer	2 gang 100W LED Trailing/Leading Edge Push On/Off Rotary Multi-Way Dimmer	3 gang 100W LED Trailing/Leading Edge Push On/Off Rotary Multi-Way Dimmer	4 gang 100W LED Trailing/Leading Edge Push On/Off Rotary Multi-Way Dimmer
Antique Brass	Antique Brass	93 1X100LED	93 2X100LED	93 3X100LED	93 4X100LED
Black Nickel	Black Nickel	98 1X100LED	98 2X100LED	98 3X100LED	98 4X100LED
Bright Chrome	Bright Chrome	95 1X100LED	95 2X100LED	95 3X100LED	95 4X100LED
Polished Brass	Polished Brass	92 1X100LED	92 2X100LED	92 3X100LED	92 4X100LED
Satin Brass	Satin Brass	94 1X100LED	94 2X100LED	94 3X100LED	94 4X100LED
Satin Chrome	Satin Chrome	96 1X100LED	96 2X100LED	96 3X100LED	96 4X100LED
Nominal Size:		88.5mm x 88.5mm	88.5mm x 88.5mm	146.0mm x 86.5mm	146.0mm x 86.5mm
Minimum Wall Box Depth:		35mm	35mm	35mm	35mm
Technical Insert Ref:		1X100LED	2X100LED	3X100LED	4X100LED

Georgian LED Trailing/Leading Edge Push On/Off Rotary Multi-Way Dimmers



91 3X100LED

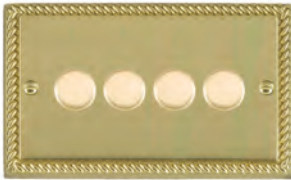

90 4X100LED

Plate Finish	Insert Finish	1 gang 100W LED Trailing/Leading Edge Push On/Off Rotary Multi-Way Dimmer	2 gang 100W LED Trailing/Leading Edge Push On/Off Rotary Multi-Way Dimmer	3 gang 100W LED Trailing/Leading Edge Push On/Off Rotary Multi-Way Dimmer	4 gang 100W LED Trailing/Leading Edge Push On/Off Rotary Multi-Way Dimmer
Antique Brass	Antique Brass	91 1X100LED	91 2X100LED	91 3X100LED	91 4X100LED
Polished Brass	Polished Brass	90 1X100LED	90 2X100LED	90 3X100LED	90 4X100LED
Nominal Size:		88.5mm x 88.5mm	88.5mm x 88.5mm	146.0mm x 86.5mm	146.0mm x 86.5mm
Minimum Wall Box Depth:		35mm	35mm	35mm	35mm
Technical Insert Ref:		1X100LED	2X100LED	3X100LED	4X100LED

Note: Tungsten filament GU10 lamps must be branded and with a fused base.
 Note: When using mains voltage halogen lamps - dimmers should be de-rated by 25%
 Note: When dimming LED lamps de-rate by 75% - please contact our Technical Department for compatibility.
 Note: Please refer to the Dimmer Technical Section for the max Wattage

Cheriton

Victorian Resistive Leading Edge Push On/Off Rotary 2 Way Switching Dimmers



95 2X40



95 3X40

Plate Finish	Insert Finish	1 gang 400W Resistive Leading Edge Push On/Off Rotary 2 Way Switching Dimmer	2 gang 400W Resistive Leading Edge Push On/Off Rotary 2 Way Switching Dimmer Max 300W per gang	3 gang 400W Resistive Leading Edge Push On/Off Rotary 2 Way Switching Dimmer	4 gang 400W Resistive Leading Edge Push On/Off Rotary 2 Way Switching Dimmer Max 300W per gang	1 gang 600W Resistive Leading Edge Push On/Off Rotary 2 Way Switching Dimmer
Antique Brass	Antique Brass	93 1X40	93 2X40	93 3X40	93 4X40	93 1X60
Black Nickel	Black Nickel	98 1X40	98 2X40	98 3X40	98 4X40	98 1X60
Bright Chrome	Bright Chrome	95 1X40	95 2X40	95 3X40	95 4X40	95 1X60
Polished Brass	Polished Brass	92 1X40	92 2X40	92 3X40	92 4X40	92 1X60
Satin Brass	Satin Brass	94 1X40	94 2X40	94 3X40	94 4X40	94 1X60
Satin Chrome	Satin Chrome	96 1X40	96 2X40	96 3X40	96 4X40	96 1X60
Nominal Size:		88.5mm x 88.5mm	88.5mm x 88.5mm	146.0mm x 86.5mm	146.0mm x 86.5mm	88.5mm x 88.5mm
Minimum Wall Box Depth:		35mm	35mm	35mm	35mm	35mm
Technical Insert Ref:		1X40	2X40	3X40	4X40	1X60

Georgian Resistive Leading Edge Push On/Off Rotary 2 Way Switching Dimmers



91 2X40

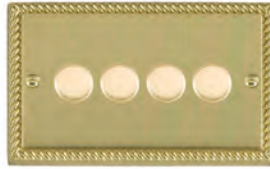

90 4X40

Plate Finish	Insert Finish	1 gang 400W Resistive Leading Edge Push On/Off Rotary 2 Way Switching Dimmer	2 gang 400W Resistive Leading Edge Push On/Off Rotary 2 Way Switching Dimmer Max 300W per gang	3 gang 400W Resistive Leading Edge Push On/Off Rotary 2 Way Switching Dimmer	4 gang 400W Resistive Leading Edge Push On/Off Rotary 2 Way Switching Dimmer Max 300W per gang	1 gang 600W Resistive Leading Edge Push On/Off Rotary 2 Way Switching Dimmer
Antique Brass	Antique Brass	91 1X40	91 2X40	91 3X40	91 4X40	91 1X60
Polished Brass	Polished Brass	90 1X40	90 2X40	90 3X40	90 4X40	90 1X60
Nominal Size:		88.0mm x 88.0mm	88.0mm x 88.0mm	146.0mm x 86.5mm	146.0mm x 86.5mm	88.0mm x 88.0mm
Minimum Wall Box Depth:		35mm	35mm	35mm	35mm	35mm
Technical Insert Ref:		1X40	2X40	3X40	4X40	1X60

NOTE: Tungsten filament GU10 lamps must be branded and with a fused base

NOTE: When using mains voltage halogen lamps – dimmers should be re-rated by 25%

NOTE: When dimming LED lamps de-rate by 75% - please contact our Technical Department for compatibility.

NOTE: Please refer to the Dimmer Technical Section for the max wattage

Cheriton

Victorian Inductive Leading Edge Push On/Off Rotary 2 Way Switching Dimmers



98 1X2V



94 1X2V



1 gang 200VA
Inductive Leading Edge
Push On/Off Rotary
2 Way Switching Dimmer



2 gang 200VA
Inductive Leading Edge
Push On/Off Rotary
2 Way Switching Dimmer

Plate Finish	Insert Finish		
Antique Brass	Antique Brass	93 1X2V	93 2X2V
Black Nickel	Black Nickel	98 1X2V	98 2X2V
Bright Chrome	Bright Chrome	95 1X2V	95 2X2V
Polished Brass	Polished Brass	92 1X2V	92 2X2V
Satin Brass	Satin Brass	94 1X2V	94 2X2V
Satin Chrome	Satin Chrome	96 1X2V	96 2X2V
Nominal Size:		88.5mm x 88.5mm	88.5mm x 88.5mm
Minimum Wall Box Depth:		35mm	35mm
Technical Insert Ref:		1X2V	2X2V

Georgian Inductive Leading Edge Push On/Off Rotary 2 Way Switching Dimmers



90 1X2V

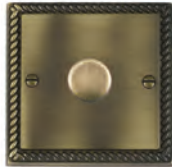

91 1X2V



1 gang 200VA
Inductive Leading Edge
Push On/Off Rotary
2 Way Switching Dimmer



2 gang 200VA
Inductive Leading Edge
Push On/Off Rotary
2 Way Switching Dimmer

Plate Finish	Insert Finish		
Antique Brass	Antique Brass	91 1X2V	91 2X2V
Polished Brass	Polished Brass	90 1X2V	90 2X2V
Nominal Size:		88.0mm x 88.0mm	88.0mm x 88.0mm
Minimum Wall Box Depth:		35mm	35mm
Technical Insert Ref:		1X2V	2X2V

NOTE: Tungsten filament GU10 lamps must be branded and with a fused base
 NOTE: When using mains voltage halogen lamps – dimmers should be re-rated by 25%
 NOTE: When dimming LED lamps de-rate by 75% - please contact our Technical Department for compatibility.
 NOTE: Please refer to the Dimmer Technical Section for the max wattage

Cheriton



Victorian Resistive/Inductive Trailing Edge Push On/Off Rotary Multi-Way Dimmers



93 1XTE

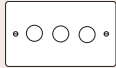
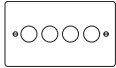

94 3XTE

Plate Finish	Insert Finish	 1 gang 250W/210VA Resistive/Inductive Trailing Edge Push On/Off Rotary Multi-Way Dimmer	 2 gang 250W/210VA Resistive/Inductive Trailing Edge Push On/Off Rotary Multi-Way Dimmer	 3 gang 250W/210VA Resistive/Inductive Trailing Edge Push On/Off Rotary Multi-Way Dimmer	 4 gang 250W/210VA Resistive/Inductive Trailing Edge Push On/Off Rotary Multi-Way Dimmer
Antique Brass	Antique Brass	93 1XTE	93 2XTE	93 3XTE	93 4XTE
Black Nickel	Black Nickel	98 1XTE	98 2XTE	98 3XTE	98 4XTE
Bright Chrome	Bright Chrome	95 1XTE	95 2XTE	95 3XTE	95 4XTE
Polished Brass	Polished Brass	92 1XTE	92 2XTE	92 3XTE	92 4XTE
Satin Brass	Satin Brass	94 1XTE	94 2XTE	94 3XTE	94 4XTE
Satin Chrome	Satin Chrome	96 1XTE	96 2XTE	96 3XTE	96 4XTE
Nominal Size:		88.5mm x 88.5mm	88.5mm x 88.5mm	146.0mm x 86.5mm	146.0mm x 86.5mm
Minimum Wall Box Depth:		35mm	35mm	35mm	35mm
Technical Insert Ref:		1XTE	2XTE	3XTE	4XTE





Georgian Resistive/Inductive Trailing Edge Push On/Off Rotary Multi-Way Dimmers

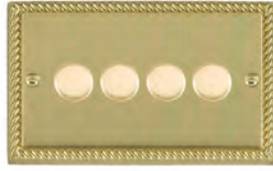

91 2XTE



90 4XTE

Plate Finish	Insert Finish	 1 gang 250W/210VA Resistive/Inductive Trailing Edge Push On/Off Rotary Multi-Way Dimmer	 2 gang 250W/210VA Resistive/Inductive Trailing Edge Push On/Off Rotary Multi-Way Dimmer	 3 gang 250W/210VA Resistive/Inductive Trailing Edge Push On/Off Rotary Multi-Way Dimmer	 4 gang 250W/210VA Resistive/Inductive Trailing Edge Push On/Off Rotary Multi-Way Dimmer
Antique Brass	Antique Brass	91 1XTE	91 2XTE	91 3XTE	91 4XTE
Polished Brass	Polished Brass	90 1XTE	90 2XTE	90 3XTE	90 4XTE
Nominal Size:		88.5mm x 88.5mm	88.5mm x 88.5mm	146.0mm x 86.5mm	146.0mm x 86.5mm
Minimum Wall Box Depth:		35mm	35mm	35mm	35mm
Technical Insert Ref:		1XTE	2XTE	3XTE	4XTE

NOTE: Tungsten filament GU10 lamps must be branded and with a fused base
 NOTE: When using mains voltage halogen lamps – dimmers should be re-rated by 25%
 NOTE: When dimming LED lamps de-rate by 75% - please contact our Technical Department for compatibility.
 NOTE: Please refer to the Dimmer Technical Section for the max wattage

Cheriton





Victorian Resistive/Inductive Trailing Edge Touch Master Multi-Way Dimmers





92 1XTSPB B



92 3XTMPB W

Plate Finish	Insert Finish / Surround Colour	 1 gang 250W/210VA Resistive/Inductive Trailing Edge Touch Master Multi-Way Dimmer	 2 gang 250W/210VA Resistive/Inductive Trailing Edge Touch Master Multi-Way Dimmer	 3 gang 250W/210VA Resistive/Inductive Trailing Edge Touch Master Multi-Way Dimmer	 4 gang 250W/210VA Resistive/Inductive Trailing Edge Touch Master Multi-Way Dimmer
Antique Brass	Antique Brass/Black	93 1XTM AB-B	93 2XTM AB-B	93 3XTM AB-B	93 4XTM AB-B
Black Nickel	Black Nickel/Black	98 1XTM BK-B	98 2XTM BK-B	98 3XTM BK-B	98 4XTM BK-B
Bright Chrome	Bright Chrome/Black	95 1XTM BC-B	95 2XTM BC-B	95 3XTM BC-B	95 4XTM BC-B
Bright Chrome	Bright Chrome/White	95 1XTM BC-W	95 2XTM BC-W	95 3XTM BC-W	95 4XTM BC-W
Polished Brass	Polished Brass/Black	92 1XTM PB-B	92 2XTM PB-B	92 3XTM PB-B	92 4XTM PB-B
Polished Brass	Polished Brass/White	92 1XTM PB-W	92 2XTM PB-W	92 3XTM PB-W	92 4XTM PB-W
Satin Brass	Satin Brass/Black	94 1XTM SB-B	94 2XTM SB-B	94 3XTM SB-B	94 4XTM SB-B
Satin Brass	Satin Brass/White	94 1XTM SB-W	94 2XTM SB-W	94 3XTM SB-W	94 4XTM SB-W
Satin Chrome	Satin Chrome/Black	96 1XTM SC-B	96 2XTM SC-B	96 3XTM SC-B	96 4XTM SC-B
Satin Chrome	Satin Chrome/White	96 1XTM SC-W	96 2XTM SC-W	96 3XTM SC-W	96 4XTM SC-W
Nominal Size:		88.5mm x 88.5mm	88.5mm x 88.5mm	146.0mm x 86.5mm	146.0mm x 86.5mm
Minimum Wall Box Depth:		35mm	35mm	35mm	35mm
Technical Insert Ref:		1XTM	2XTM	3XTM	4XTM

Georgian Resistive/Inductive Trailing Edge Touch Master Multi-Way Dimmers

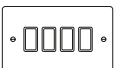
Plate Finish	Insert Finish / Surround Colour	 1 gang 250W/210VA Resistive/Inductive Trailing Edge Touch Master Multi-Way Dimmer	 2 gang 250W/210VA Resistive/Inductive Trailing Edge Touch Master Multi-Way Dimmer	 3 gang 250W/210VA Resistive/Inductive Trailing Edge Touch Master Multi-Way Dimmer	 4 gang 250W/210VA Resistive/Inductive Trailing Edge Touch Master Multi-Way Dimmer
Antique Brass	Antique Brass/Black	91 1XTM AB-B	91 2XTM AB-B	91 3XTM AB-B	91 4XTM AB-B
Polished Brass	Polished Brass/Black	90 1XTM PB-B	90 2XTM PB-B	90 3XTM PB-B	90 4XTM PB-B
Polished Brass	Polished Brass/White	90 1XTM PB-W	90 2XTM PB-W	90 3XTM PB-W	90 4XTM PB-W
Nominal Size:		88.5mm x 88.5mm	88.5mm x 88.5mm	146.0mm x 86.5mm	146.0mm x 86.5mm
Minimum Wall Box Depth:		35mm	35mm	35mm	35mm
Technical Insert Ref:		1XTM	2XTM	3XTM	4XTM

NOTE: Tungsten filament GU10 lamps must be branded and with a fused base
 NOTE: When using mains voltage halogen lamps – dimmers should be re-rated by 25%
 NOTE: When dimming LED lamps de-rate by 75% - please contact our Technical Department for compatibility.
 NOTE: Please refer to the Dimmer Technical Section for the max wattage

Insert Surround Colour Key: (-B) Black, (-W) White

Cheriton

Victorian Multi-Way Touch Slave Controllers



95 1XTS BC-W



94 4XTS SB-B

Plate Finish	Insert Finish/ Surround Colour	1 gang Multi-Way Touch Slave Controller	2 gang Multi-Way Touch Slave Controller	3 gang Multi-Way Touch Slave Controller	4 gang Multi-Way Touch Slave Controller
Antique Brass	Antique Brass/Black	93 1XTS AB-B	93 2XTS AB-B	93 3XTS AB-B	93 4XTS AB-B
Black Nickel	Black Nickel/Black	98 1XTS BK-B	98 2XTS BK-B	98 3XTS BK-B	98 4XTS BK-B
Bright Chrome	Bright Chrome/Black	95 1XTS BC-B	95 2XTS BC-B	95 3XTS BC-B	95 4XTS BC-B
Bright Chrome	Bright Chrome/White	95 1XTS BC-W	95 2XTS BC-W	95 3XTS BC-W	95 4XTS BC-W
Polished Brass	Polished Brass/Black	92 1XTS PB-B	92 2XTS PB-B	92 3XTS PB-B	92 4XTS PB-B
Polished Brass	Polished Brass/White	92 1XTS PB-W	92 2XTS PB-W	92 3XTS PB-W	92 4XTS PB-W
Satin Brass	Satin Brass/Black	94 1XTS SB-B	94 2XTS SB-B	94 3XTS SB-B	94 4XTS SB-B
Satin Brass	Satin Brass/White	94 1XTS SB-W	94 2XTS SB-W	94 3XTS SB-W	94 4XTS SB-W
Satin Chrome	Satin Chrome/Black	96 1XTS SC-B	96 2XTS SC-B	96 3XTS SC-B	96 4XTS SC-B
Satin Chrome	Satin Chrome/White	96 1XTS SC-W	96 2XTS SC-W	96 3XTS SC-W	96 4XTS SC-W
Nominal Size:		88.5mm x 88.5mm	88.5mm x 88.5mm	146.0mm x 86.5mm	146.0mm x 86.5mm
Minimum Wall Box Depth:		35mm	35mm	35mm	35mm
Technical Insert Ref:		1XTS	2XTS	3XTS	4XTS

Georgian Multi-Way Touch Slave Controllers



91 1XTS AB-B

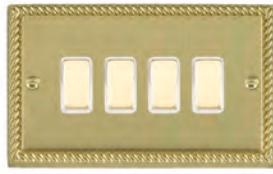

90 4XTS PB-W

Plate Finish	Insert Finish/ Surround Colour	1 gang Multi-Way Touch Slave Controller	2 gang Multi-Way Touch Slave Controller	3 gang Multi-Way Touch Slave Controller	4 gang Multi-Way Touch Slave Controller
Antique Brass	Antique Brass/Black	91 1XTS AB-B	91 2XTS AB-B	91 3XTS AB-B	91 4XTS AB-B
Polished Brass	Polished Brass/Black	90 1XTS PB-B	90 2XTS PB-B	90 3XTS PB-B	90 4XTS PB-B
Polished Brass	Polished Brass/White	90 1XTS PB-W	90 2XTS PB-W	90 3XTS PB-W	90 4XTS PB-W
Nominal Size:		88.5mm x 88.5mm	88.5mm x 88.5mm	146.0mm x 86.5mm	146.0mm x 86.5mm
Minimum Wall Box Depth:		35mm	35mm	35mm	35mm
Technical Insert Ref:		1XTS	2XTS	3XTS	4XTS

NOTE: To only be used with Touch Masters

Insert Surround Colour Key: (-B) Black, (-W) White

Cheriton

Victorian Blank Plates



93 BPS

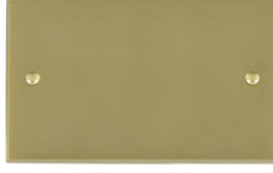

94 BPD

Plate Finish	Single Blank Plate	Double Blank Plate
Antique Brass	93 BPS	93 BPD
Black Nickel	98 BPS	98 BPD
Bright Chrome	95 BPS	95 BPD
Polished Brass	92 BPS	92 BPD
Satin Brass	94 BPS	94 BPD
Satin Chrome	96 BPS	96 BPD
Nominal Size:	88.5mm x 88.5mm	146.0mm x 86.5mm
Minimum Wall Box Depth:	Any Box	Any Box
Technical Insert Ref:	BPS	BPD

Georgian Blank Plates



91 BPS



90 BPD

Plate Finish	Single Blank Plate	Double Blank Plate
Antique Brass	91 BPS	91 BPD
Polished Brass	90 BPS	90 BPD
Nominal Size:	88.5mm x 88.5mm	146.0mm x 86.5mm
Minimum Wall Box Depth:	Any Box	Any Box
Technical Insert Ref:	BPS	BPD

Insert Surround Colour Key: (-B) Black, (-W) White

Cheriton

Victorian GRID-IT Grid Fix Plates complete with Fixing Grid

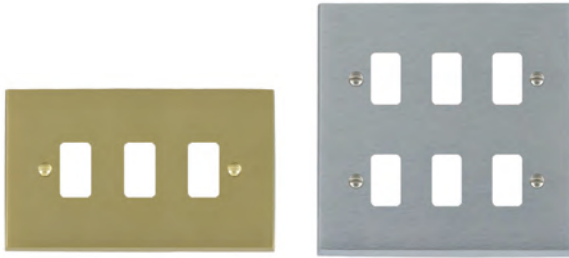

94 3GP

96 6GP

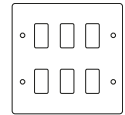
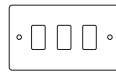

Plate Finish	1 Gang Grid Fix Aperture Plate with Grid	2 Gang Grid Fix Aperture Plate with Grid	3 Gang Grid Fix Aperture Plate with Grid	4 Gang Grid Fix Aperture Plate with Grid	6 Gang Grid Fix Aperture Plate with Grid
Antique Brass	93 1GP	93 2GP	93 3GP	93 4GP	93 6GP
Bright Chrome	95 1GP	95 2GP	95 3GP	95 4GP	95 6GP
Satin Chrome	96 1GP	96 2GP	96 3GP	96 4GP	96 6GP
Polished Brass	92 1GP	92 2GP	92 3GP	92 4GP	92 6GP
Satin Brass	94 1GP	94 2GP	94 3GP	94 4GP	94 6GP
Nominal Size:	88.5mm x 88.5mm	88.5mm x 88.5mm	146.0mm x 86.5mm	146.0mm x 86.5mm	148.5mm x 148.5mm
Minimum Wall Box Depth:	As Per Insert	As Per Inserts	As Per Inserts	As Per Inserts	As Per Inserts
Technical Insert Ref:	1GP	2GP	3GP	4GP	6GP

Georgian GRID-IT Grid Fix Plates complete with Fixing Grid



90 3GP

90 4GP

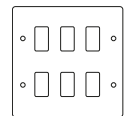
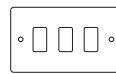

Plate Finish	1 Gang Grid Fix Aperture Plate with Grid	2 Gang Grid Fix Aperture Plate with Grid	3 Gang Grid Fix Aperture Plate with Grid	4 Gang Grid Fix Aperture Plate with Grid	6 Gang Grid Fix Aperture Plate with Grid
Antique Brass	91 1GP	91 2GP	91 3GP	91 4GP	91 6GP
Polished Brass	90 1GP	90 2GP	90 3GP	90 4GP	90 6GP
Nominal Size:	88.0mm x 88.0mm	88.0mm x 88.0mm	146mm x 86.5mm	146mm x 86.5mm	150.5mm x 150.5mm
Minimum Wall Box Depth:	As Per Insert	As Per Insert	As Per Insert	As Per Insert	As Per Insert
Technical Insert Ref:	1GP	2GP	3GP	4GP	6GP

Note: Minimum Wall Box depth is dependant on the Grid Fix insert fitted, please see the GRID-IT section for the complete range of inserts.

Cheriton

Victorian GRID-IT Grid Fix Plates complete with Fixing Grid

CHERITON RANGE



96 8GP

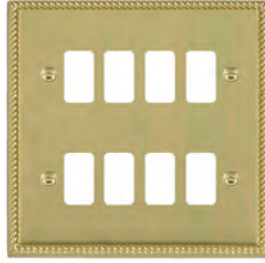

90 8GP

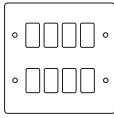

8 Gang Grid Fix Aperture Plate with Grid

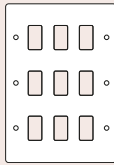

9 Gang Grid Fix Aperture Plate with Grid

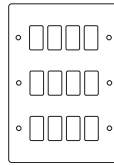

12 Gang Grid Fix Aperture Plate with Grid



1 gang 13A Switched Socket Grid Fix Aperture Plate (Grids supplied with Inserts)

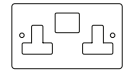

2 gang 13A Switched Socket Grid Fix Aperture Plate (Grids supplied with Inserts)

Plate Finish	95 8GP	96 8GP	95 9GP	96 9GP	95 12GP	96 12GP	95 SS1GP	96 SS1GP	95 SS2GP	96 SS2GP
Bright Chrome	95 8GP	96 8GP	95 9GP	96 9GP	95 12GP	96 12GP	95 SS1GP	96 SS1GP	95 SS2GP	96 SS2GP
Satin Chrome	96 8GP	96 8GP	96 9GP	96 9GP	96 12GP	96 12GP	96 SS1GP	96 SS1GP	96 SS2GP	96 SS2GP
Polished Brass	92 8GP	92 8GP	92 9GP	92 9GP	92 12GP	92 12GP	92 SS1GP	92 SS1GP	92 SS2GP	92 SS2GP
Satin Brass	94 8GP	94 8GP	94 9GP	94 9GP	94 12GP	94 12GP	94 SS1GP	94 SS1GP	94 SS2GP	94 SS2GP
Nominal Size:	148.5mm x 148.5mm		148.0mm x 210mm		148.0mm x 210mm		88.5mm x 88.5mm		146.0mm x 86.5mm	
Minimum Wall Box Depth:	As Per Inserts		As Per Inserts		As Per Inserts		As Per Insert		As Per Insert	
Technical Insert Ref:	8GP		9GP		12GP		SS1GP		SS2GP	

Georgian GRID-IT Grid Fix Plates complete with Fixing Grid

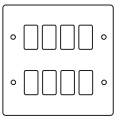

8 Gang Grid Fix Aperture Plate with Grid

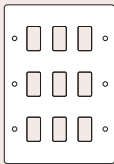

9 Gang Grid Fix Aperture Plate with Grid

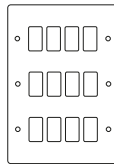

12 Gang Grid Fix Aperture Plate with Grid



1 Gang 13A Switched Socket Grid Fix Aperture (Grids supplied with inserts)

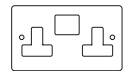

2 Gang 13A Switched Socket Grid Fix Aperture (Grid supplied with inserts)

Plate Finish	90 8GP	90 9GP	90 12GP	90 SS1GP	90 SS2GP	
Polished Brass	90 8GP	90 9GP	90 12GP	90 SS1GP	90 SS2GP	
Nominal Size:	150.5mm x 150.5mm		150.0mm x 210mm		150.0mm x 210mm	
Minimum Wall Box Depth:	As Per Inserts		As Per Inserts		As Per Inserts	
Technical Insert Ref:	8GP		9GP		12GP	
			As Per Insert		As Per Insert	
			SS1GP		SS2GP	

Note: Minimum Wall Box depth is dependant on the Grid Fix insert fitted, please see the GRID-IT section for the complete range of inserts.

Cheriton

Victorian EuroFix Plates complete with Fixing Grid



95 EURO3



94 EURO4

Plate Finish	1 Module EuroFix 25x50mm Aperture Plate with Grid	2 Module Eurofix 50x50mm Aperture Plate with Grid	3 Module Eurofix 75x50mm Aperture Plate with Grid	4 Module Eurofix 100x50mm Aperture Plate with Grid
Antique Brass	93 EURO1	93 EURO2	93 EURO3	93 EURO4
Black Nickel	98 EURO1	98 EURO2	98 EURO3	98 EURO4
Bright Chrome	95 EURO1	95 EURO2	95 EURO3	95 EURO4
Polished Brass	92 EURO1	92 EURO2	92 EURO3	92 EURO4
Satin Brass	94 EURO1	94 EURO2	94 EURO3	94 EURO4
Satin Chrome	96 EURO1	96 EURO2	96 EURO3	96 EURO4
Nominal Size:	88.5mm x 88.5mm	88.5mm x 88.5mm	146.0mm x 86.5mm	146.0mm x 86.5mm
Minimum Wall Box Depth:	As Per Insert	As Per Inserts	As Per Inserts	As Per Inserts
Technical Insert Ref:	EURO1	EURO2	EURO3	EURO4

Georgian EuroFix Plates complete with Fixing Grid



91 EURO1



90 EURO2

Plate Finish	1 Module EuroFix 25x50mm Aperture Plate with Grid	2 Module Eurofix 50x50mm Aperture Plate with Grid	3 Module EuroFix 75x50mm Aperture Plate with Grid	4 Module Eurofix 100x50mm Aperture Plate with Grid
Antique Brass	91 EURO1	91 EURO2	91 EURO3	91 EURO4
Polished Brass	90 EURO1	90 EURO2	90 EURO3	90 EURO4
Nominal Size:	88.5mm x 88.5mm	88.5mm x 88.5mm	146.0mm x 86.5mm	146.0mm x 86.5mm
Minimum Wall Box Depth:	As Per Insert	As Per Inserts	As Per Inserts	As Per Inserts
Technical Insert Ref:	EURO1	EURO2	EURO3	EURO4

Note: Minimum Wall Box depth is dependant on the EuroFix insert fitted, please see the EuroFix section for our complete range of inserts.



Woods

Quality Accessories on Natural Wood Plinth Plates

An attractive and unique range Woods is available in four natural wood finishes with a choice of Ovolo or Chamfered edge. The plates of the Woods range are manufactured from timber sourced from sustainable woodland, as far as possible. They are treated to meet BS EN standards and carry all of Hamilton's standard electrical inserts. Ideal for a building with character.



- Four natural wood finishes
- Choice of Ovolo or Chamfered edge
- Timber sourced from suppliers who carry the FSC logo
- Plates treated to meet BS EN standards
- Euro Fix also available (see separate EuroFix section for inserts)



Woods Range



WOA T21 PB

WOM SPN BC-B

WOL 2XTE BC

WOD SS1 PB-B

Wood Finishes

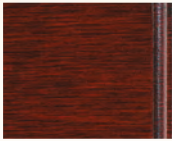

Antique Mahogany



Dark Oak



Medium Oak



Light Oak

Edges



Chamfered Profile Edge



Ovolo Profile Edge

Insert Finishes



Polished Brass



Antique Brass

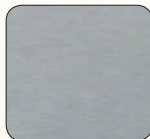

Satin Chrome



Bright Chrome

Woods

Rocker Switches



WCA R21 AB-B





WCA R22 BC-B



WOA R24 SC-W

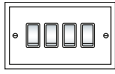
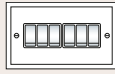

WOD R26 SC-W

Front Plate	Insert Finish/ Surround Colour	Edge					
			1 gang 10AX 2 Way Rocker	2 gang 10AX 2 Way Rocker	3 gang 10AX 2 Way Rocker	4 gang 10AX 2 Way Rocker	6 gang 10AX 2 Way Rocker
Antique Mahogany	Antique Brass/Black	Chamfered	WCA R21 AB-B	WCA R22 AB-B	WCA R23 AB-B	WCA R24 AB-B	WCA R26 AB-B
Antique Mahogany	Bright Chrome/Black	Chamfered	WCA R21 BC-B	WCA R22 BC-B	WCA R23 BC-B	WCA R24 BC-B	WCA R26 BC-B
Antique Mahogany	Bright Chrome/White	Chamfered	WCA R21 BC-W	WCA R22 BC-W	WCA R23 BC-W	WCA R24 BC-W	WCA R26 BC-W
Antique Mahogany	Polished Brass/Black	Chamfered	WCA R21 PB-B	WCA R22 PB-B	WCA R23 PB-B	WCA R24 PB-B	WCA R26 PB-B
Antique Mahogany	Polished Brass/White	Chamfered	WCA R21 PB-W	WCA R22 PB-W	WCA R23 PB-W	WCA R24 PB-W	WCA R26 PB-W
Antique Mahogany	Satin Chrome/Black	Chamfered	WCA R21 SC-B	WCA R22 SC-B	WCA R23 SC-B	WCA R24 SC-B	WCA R26 SC-B
Antique Mahogany	Satin Chrome/White	Chamfered	WCA R21 SC-W	WCA R22 SC-W	WCA R23 SC-W	WCA R24 SC-W	WCA R26 SC-W
Antique Mahogany	Antique Brass/Black	Ovolo	WOA R21 AB-B	WOA R22 AB-B	WOA R23 AB-B	WOA R24 AB-B	WOA R26 AB-B
Antique Mahogany	Bright Chrome/Black	Ovolo	WOA R21 BC-B	WOA R22 BC-B	WOA R23 BC-B	WOA R24 BC-B	WOA R26 BC-B
Antique Mahogany	Bright Chrome/White	Ovolo	WOA R21 BC-W	WOA R22 BC-W	WOA R23 BC-W	WOA R24 BC-W	WOA R26 BC-W
Antique Mahogany	Polished Brass/Black	Ovolo	WOA R21 PB-B	WOA R22 PB-B	WOA R23 PB-B	WOA R24 PB-B	WOA R26 PB-B
Antique Mahogany	Polished Brass/White	Ovolo	WOA R21 PB-W	WOA R22 PB-W	WOA R23 PB-W	WOA R24 PB-W	WOA R26 PB-W
Antique Mahogany	Satin Chrome/Black	Ovolo	WOA R21 SC-B	WOA R22 SC-B	WOA R23 SC-B	WOA R24 SC-B	WOA R26 SC-B
Antique Mahogany	Satin Chrome/White	Ovolo	WOA R21 SC-W	WOA R22 SC-W	WOA R23 SC-W	WOA R24 SC-W	WOA R26 SC-W
Dark Oak	Antique Brass/Black	Chamfered	WCD R21 AB-B	WCD R22 AB-B	WCD R23 AB-B	WCD R24 AB-B	WCD R26 AB-B
Dark Oak	Bright Chrome/Black	Chamfered	WCD R21 BC-B	WCD R22 BC-B	WCD R23 BC-B	WCD R24 BC-B	WCD R26 BC-B
Dark Oak	Bright Chrome/White	Chamfered	WCD R21 BC-W	WCD R22 BC-W	WCD R23 BC-W	WCD R24 BC-W	WCD R26 BC-W
Dark Oak	Polished Brass/Black	Chamfered	WCD R21 PB-B	WCD R22 PB-B	WCD R23 PB-B	WCD R24 PB-B	WCD R26 PB-B
Dark Oak	Polished Brass/White	Chamfered	WCD R21 PB-W	WCD R22 PB-W	WCD R23 PB-W	WCD R24 PB-W	WCD R26 PB-W
Dark Oak	Satin Chrome/Black	Chamfered	WCD R21 SC-B	WCD R22 SC-B	WCD R23 SC-B	WCD R24 SC-B	WCD R26 SC-B
Dark Oak	Satin Chrome/White	Chamfered	WCD R21 SC-W	WCD R22 SC-W	WCD R23 SC-W	WCD R24 SC-W	WCD R26 SC-W
Dark Oak	Antique Brass/Black	Ovolo	WOD R21 AB-B	WOD R22 AB-B	WOD R23 AB-B	WOD R24 AB-B	WOD R26 AB-B
Dark Oak	Bright Chrome/Black	Ovolo	WOD R21 BC-B	WOD R22 BC-B	WOD R23 BC-B	WOD R24 BC-B	WOD R26 BC-B
Dark Oak	Bright Chrome/White	Ovolo	WOD R21 BC-W	WOD R22 BC-W	WOD R23 BC-W	WOD R24 BC-W	WOD R26 BC-W
Dark Oak	Polished Brass/Black	Ovolo	WOD R21 PB-B	WOD R22 PB-B	WOD R23 PB-B	WOD R24 PB-B	WOD R26 PB-B
Dark Oak	Polished Brass/White	Ovolo	WOD R21 PB-W	WOD R22 PB-W	WOD R23 PB-W	WOD R24 PB-W	WOD R26 PB-W
Dark Oak	Satin Chrome/Black	Ovolo	WOD R21 SC-B	WOD R22 SC-B	WOD R23 SC-B	WOD R24 SC-B	WOD R26 SC-B
Dark Oak	Satin Chrome/White	Ovolo	WOD R21 SC-W	WOD R22 SC-W	WOD R23 SC-W	WOD R24 SC-W	WOD R26 SC-W
Nominal Size:			88.0mm x 88.0mm	88.0mm x 88.0mm	88.0mm x 88.0mm	146.0mm x 88.0mm	146.0mm x 88.0mm
Minimum Wall Box Depth:			25mm	25mm	25mm	25mm	25mm
Technical Insert Ref:			R21	R21	R23	R24	R26

Woods

Rocker Switches



WCL R21 PB-B



WCM R22 BC-B



WOL R24 SC-B



WOM R26 SC-W



1 gang 10AX
2 Way Rocker



2 gang 10AX
2 Way Rocker



3 gang 10AX
2 Way Rocker

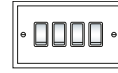

4 gang 10AX
2 Way Rocker

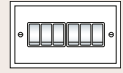

6 gang 10AX
2 Way Rocker

Front Plate	Insert Finish/ Surround Colour	Edge	1 gang 10AX 2 Way Rocker	2 gang 10AX 2 Way Rocker	3 gang 10AX 2 Way Rocker	4 gang 10AX 2 Way Rocker	6 gang 10AX 2 Way Rocker
Medium Oak	Antique Brass/Black	Chamfered	WCM R21 AB-B	WCM R22 AB-B	WCM R23 AB-B	WCM R24 AB-B	WCM R26 AB-B
Medium Oak	Bright Chrome/Black	Chamfered	WCM R21 BC-B	WCM R22 BC-B	WCM R23 BC-B	WCM R24 BC-B	WCM R26 BC-B
Medium Oak	Bright Chrome/White	Chamfered	WCM R21 BC-W	WCM R22 BC-W	WCM R23 BC-W	WCM R24 BC-W	WCM R26 BC-W
Medium Oak	Polished Brass/Black	Chamfered	WCM R21 PB-B	WCM R22 PB-B	WCM R23 PB-B	WCM R24 PB-B	WCM R26 PB-B
Medium Oak	Polished Brass/White	Chamfered	WCM R21 PB-W	WCM R22 PB-W	WCM R23 PB-W	WCM R24 PB-W	WCM R26 PB-W
Medium Oak	Satin Chrome/Black	Chamfered	WCM R21 SC-B	WCM R22 SC-B	WCM R23 SC-B	WCM R24 SC-B	WCM R26 SC-B
Medium Oak	Satin Chrome/White	Chamfered	WCM R21 SC-W	WCM R22 SC-W	WCM R23 SC-W	WCM R24 SC-W	WCM R26 SC-W
Medium Oak	Antique Brass/Black	Ovolo	WOM R21 AB-B	WOM R22 AB-B	WOM R23 AB-B	WOM R24 AB-B	WOM R26 AB-B
Medium Oak	Bright Chrome/Black	Ovolo	WOM R21 BC-B	WOM R22 BC-B	WOM R23 BC-B	WOM R24 BC-B	WOM R26 BC-B
Medium Oak	Bright Chrome/White	Ovolo	WOM R21 BC-W	WOM R22 BC-W	WOM R23 BC-W	WOM R24 BC-W	WOM R26 BC-W
Medium Oak	Polished Brass/Black	Ovolo	WOM R21 PB-B	WOM R22 PB-B	WOM R23 PB-B	WOM R24 PB-B	WOM R26 PB-B
Medium Oak	Polished Brass/White	Ovolo	WOM R21 PB-W	WOM R22 PB-W	WOM R23 PB-W	WOM R24 PB-W	WOM R26 PB-W
Medium Oak	Satin Chrome/Black	Ovolo	WOM R21 SC-B	WOM R22 SC-B	WOM R23 SC-B	WOM R24 SC-B	WOM R26 SC-B
Medium Oak	Satin Chrome/White	Ovolo	WOM R21 SC-W	WOM R22 SC-W	WOM R23 SC-W	WOM R24 SC-W	WOM R26 SC-W
Light Oak	Antique Brass/Black	Chamfered	WCL R21 AB-B	WCL R22 AB-B	WCL R23 AB-B	WCL R24 AB-B	WCL R26 AB-B
Light Oak	Bright Chrome/Black	Chamfered	WCL R21 BC-B	WCL R22 BC-B	WCL R23 BC-B	WCL R24 BC-B	WCL R26 BC-B
Light Oak	Bright Chrome/White	Chamfered	WCL R21 BC-W	WCL R22 BC-W	WCL R23 BC-W	WCL R24 BC-W	WCL R26 BC-W
Light Oak	Polished Brass/Black	Chamfered	WCL R21 PB-B	WCL R22 PB-B	WCL R23 PB-B	WCL R24 PB-B	WCL R26 PB-B
Light Oak	Polished Brass/White	Chamfered	WCL R21 PB-W	WCL R22 PB-W	WCL R23 PB-W	WCL R24 PB-W	WCL R26 PB-W
Light Oak	Satin Chrome/Black	Chamfered	WCL R21 SC-B	WCL R22 SC-B	WCL R23 SC-B	WCL R24 SC-B	WCL R26 SC-B
Light Oak	Satin Chrome/White	Chamfered	WCL R21 SC-W	WCL R22 SC-W	WCL R23 SC-W	WCL R24 SC-W	WCL R26 SC-W
Light Oak	Antique Brass/Black	Ovolo	WOL R21 AB-B	WOL R22 AB-B	WOL R23 AB-B	WOL R24 AB-B	WOL R26 AB-B
Light Oak	Bright Chrome/Black	Ovolo	WOL R21 BC-B	WOL R22 BC-B	WOL R23 BC-B	WOL R24 BC-B	WOL R26 BC-B
Light Oak	Bright Chrome/White	Ovolo	WOL R21 BC-W	WOL R22 BC-W	WOL R23 BC-W	WOL R24 BC-W	WOL R26 BC-W
Light Oak	Polished Brass/Black	Ovolo	WOL R21 PB-B	WOL R22 PB-B	WOL R23 PB-B	WOL R24 PB-B	WOL R26 PB-B
Light Oak	Polished Brass/White	Ovolo	WOL R21 PB-W	WOL R22 PB-W	WOL R23 PB-W	WOL R24 PB-W	WOL R26 PB-W
Light Oak	Satin Chrome/Black	Ovolo	WOL R21 SC-B	WOL R22 SC-B	WOL R23 SC-B	WOL R24 SC-B	WOL R26 SC-B
Light Oak	Satin Chrome/White	Ovolo	WOL R21 SC-W	WOL R22 SC-W	WOL R23 SC-W	WOL R24 SC-W	WOL R26 SC-W
Nominal Size:			88.0mm x 88.0mm	88.0mm x 88.0mm	88.0mm x 88.0mm	146.0mm x 88.0mm	146.0mm x 88.0mm
Minimum Wall Box Depth:			25mm	25mm	25mm	25mm	25mm
Technical Insert Ref:			R21	R21	R23	R24	R26

Woods

Rocker Switches



WCA R31 SC-W



WOL R31 PB-W



1 gang 10AX
Intermediate Rocker

Front Plate	Insert Finish/ Surround Colour	Edge	
Antique Mahogany	Antique Brass/Black	Chamfered	WCA R31 AB-B
Antique Mahogany	Bright Chrome/Black	Chamfered	WCA R31 BC-B
Antique Mahogany	Bright Chrome/White	Chamfered	WCA R31 BC-W
Antique Mahogany	Polished Brass/Black	Chamfered	WCA R31 PB-B
Antique Mahogany	Polished Brass/White	Chamfered	WCA R31 PB-W
Antique Mahogany	Satin Chrome/Black	Chamfered	WCA R31 SC-B
Antique Mahogany	Satin Chrome/White	Chamfered	WCA R31 SC-W
Antique Mahogany	Antique Brass/Black	Ovolo	WOA R31 AB-B
Antique Mahogany	Bright Chrome/Black	Ovolo	WOA R31 BC-B
Antique Mahogany	Bright Chrome/White	Ovolo	WOA R31 BC-W
Antique Mahogany	Polished Brass/Black	Ovolo	WOA R31 PB-B
Antique Mahogany	Polished Brass/White	Ovolo	WOA R31 PB-W
Antique Mahogany	Satin Chrome/Black	Ovolo	WOA R31 SC-B
Antique Mahogany	Satin Chrome/White	Ovolo	WOA R31 SC-W
Dark Oak	Antique Brass/Black	Chamfered	WCD R31 AB-B
Dark Oak	Bright Chrome/Black	Chamfered	WCD R31 BC-B
Dark Oak	Bright Chrome/White	Chamfered	WCD R31 BC-W
Dark Oak	Polished Brass/Black	Chamfered	WCD R31 PB-B
Dark Oak	Polished Brass/White	Chamfered	WCD R31 PB-W
Dark Oak	Satin Chrome/Black	Chamfered	WCD R31 SC-B
Dark Oak	Satin Chrome/White	Chamfered	WCD R31 SC-W
Dark Oak	Antique Brass/Black	Ovolo	WOD R31 AB-B
Dark Oak	Bright Chrome/Black	Ovolo	WOD R31 BC-B
Dark Oak	Bright Chrome/White	Ovolo	WOD R31 BC-W
Dark Oak	Polished Brass/Black	Ovolo	WOD R31 PB-B
Dark Oak	Polished Brass/White	Ovolo	WOD R31 PB-W
Dark Oak	Satin Chrome/Black	Ovolo	WOD R31 SC-B
Dark Oak	Satin Chrome/White	Ovolo	WOD R31 SC-W
Nominal Size:			88.0mm x 88.0mm
Minimum Wall Box Depth:			25mm
Technical Insert Ref:			R31



1 gang 10AX
Intermediate Rocker

Front Plate	Insert Finish/ Surround Colour	Edge	
Light Oak	Antique Brass/Black	Chamfered	WCL R31 AB-B
Light Oak	Bright Chrome/Black	Chamfered	WCL R31 BC-B
Light Oak	Bright Chrome/White	Chamfered	WCL R31 BC-W
Light Oak	Polished Brass/Black	Chamfered	WCL R31 PB-B
Light Oak	Polished Brass/White	Chamfered	WCL R31 PB-W
Light Oak	Satin Chrome/Black	Chamfered	WCL R31 SC-B
Light Oak	Satin Chrome/White	Chamfered	WCL R31 SC-W
Light Oak	Antique Brass/Black	Ovolo	WOL R31 AB-B
Light Oak	Bright Chrome/Black	Ovolo	WOL R31 BC-B
Light Oak	Bright Chrome/White	Ovolo	WOL R31 BC-W
Light Oak	Polished Brass/Black	Ovolo	WOL R31 PB-B
Light Oak	Polished Brass/White	Ovolo	WOL R31 PB-W
Light Oak	Satin Chrome/Black	Ovolo	WOL R31 SC-B
Light Oak	Satin Chrome/White	Ovolo	WOL R31 SC-W
Medium Oak	Antique Brass/Black	Chamfered	WCM R31 AB-B
Medium Oak	Bright Chrome/Black	Chamfered	WCM R31 BC-B
Medium Oak	Bright Chrome/White	Chamfered	WCM R31 BC-W
Medium Oak	Polished Brass/Black	Chamfered	WCM R31 PB-B
Medium Oak	Polished Brass/White	Chamfered	WCM R31 PB-W
Medium Oak	Satin Chrome/Black	Chamfered	WCM R31 SC-B
Medium Oak	Satin Chrome/White	Chamfered	WCM R31 SC-W
Medium Oak	Antique Brass/Black	Ovolo	WOM R31 AB-B
Medium Oak	Bright Chrome/Black	Ovolo	WOM R31 BC-B
Medium Oak	Bright Chrome/White	Ovolo	WOM R31 BC-W
Medium Oak	Polished Brass/Black	Ovolo	WOM R31 PB-B
Medium Oak	Polished Brass/White	Ovolo	WOM R31 PB-W
Medium Oak	Satin Chrome/Black	Ovolo	WOM R31 SC-B
Medium Oak	Satin Chrome/White	Ovolo	WOM R31 SC-W
Nominal Size:			88.0mm x 88.0mm
Minimum Wall Box Depth:			25mm
Technical Insert Ref:			R31

Woods

Rocker Switches



WCD TP BL-B

WOODS RANGE



1 gang 10A
Triple Pole Rocker

Front Plate	Insert Finish/ Surround Colour	Edge	
Antique Mahogany	Black/Black	Chamfered	WCA TP BL-B
Antique Mahogany	White/White	Chamfered	WCA TP WH-W
Antique Mahogany	Black/Black	Ovolo	WOA TP BL-B
Antique Mahogany	White/White	Ovolo	WOA TP WH-W
Dark Oak	Black/Black	Chamfered	WCD TP BL-B
Dark Oak	White/White	Chamfered	WCD TP WH-W
Dark Oak	Black/Black	Ovolo	WOD TP BL-B
Dark Oak	White/White	Ovolo	WOD TP WH-W
Light Oak	Black/Black	Chamfered	WCL TP BL-B
Light Oak	White/White	Chamfered	WCL TP WH-W
Light Oak	Black/Black	Ovolo	WOL TP BL-B
Light Oak	White/White	Ovolo	WOL TP WH-W
Medium Oak	Black/Black	Chamfered	WCM TP BL-B
Medium Oak	White/White	Chamfered	WCM TP WH-W
Medium Oak	Black/Black	Ovolo	WOM TP BL-B
Medium Oak	White/White	Ovolo	WOM TP WH-W
Nominal Size:			88.0mm x 88.0mm
Minimum Wall Box Depth:			25mm
Technical Insert Ref:			TP

Woods

Toggle Switches



WOA T21 AB



WOD T22 BC



WOL T23 PB



WOM T24 SC



1 gang 20AX
2 Way Toggle



2 gang 20AX
2 Way Toggle



3 gang 20AX
2 Way Toggle



4 gang 20AX
2 Way Toggle



1 gang 20AX
Intermediate Toggle

Front Plate	Insert Finish	Edge	1 gang 20AX 2 Way Toggle	2 gang 20AX 2 Way Toggle	3 gang 20AX 2 Way Toggle	4 gang 20AX 2 Way Toggle	1 gang 20AX Intermediate Toggle
Antique Mahogany	Antique Brass	Chamfered	WCA T21 AB	WCA T22 AB	WCA T23 AB	WCA T24 AB	WCA T31 AB
Antique Mahogany	Bright Chrome	Chamfered	WCA T21 BC	WCA T22 BC	WCA T23 BC	WCA T24 BC	WCA T31 BC
Antique Mahogany	Polished Brass	Chamfered	WCA T21 PB	WCA T22 PB	WCA T23 PB	WCA T24 PB	WCA T31 PB
Antique Mahogany	Satin Chrome	Chamfered	WCA T21 SC	WCA T22 SC	WCA T23 SC	WCA T24 SC	WCA T31 SC
Antique Mahogany	Antique Brass	Ovolo	WOA T21 AB	WOA T22 AB	WOA T23 AB	WOA T24 AB	WOA T31 AB
Antique Mahogany	Bright Chrome	Ovolo	WOA T21 BC	WOA T22 BC	WOA T23 BC	WOA T24 BC	WOA T31 BC
Antique Mahogany	Polished Brass	Ovolo	WOA T21 PB	WOA T22 PB	WOA T23 PB	WOA T24 PB	WOA T31 PB
Antique Mahogany	Satin Chrome	Ovolo	WOA T21 SC	WOA T22 SC	WOA T23 SC	WOA T24 SC	WOA T31 SC
Dark Oak	Antique Brass	Chamfered	WCD T21 AB	WCD T22 AB	WCD T23 AB	WCD T24 AB	WCD T31 AB
Dark Oak	Bright Chrome	Chamfered	WCD T21 BC	WCD T22 BC	WCD T23 BC	WCD T24 BC	WCD T31 BC
Dark Oak	Polished Brass	Chamfered	WCD T21 PB	WCD T22 PB	WCD T23 PB	WCD T24 PB	WCD T31 PB
Dark Oak	Satin Chrome	Chamfered	WCD T21 SC	WCD T22 SC	WCD T23 SC	WCD T24 SC	WCD T31 SC
Dark Oak	Antique Brass	Ovolo	WOD T21 AB	WOD T22 AB	WOD T23 AB	WOD T24 AB	WOD T31 AB
Dark Oak	Bright Chrome	Ovolo	WOD T21 BC	WOD T22 BC	WOD T23 BC	WOD T24 BC	WOD T31 BC
Dark Oak	Polished Brass	Ovolo	WOD T21 PB	WOD T22 PB	WOD T23 PB	WOD T24 PB	WOD T31 PB
Dark Oak	Satin Chrome	Ovolo	WOD T21 SC	WOD T22 SC	WOD T23 SC	WOD T24 SC	WOD T31 SC
Light Oak	Antique Brass	Chamfered	WCL T21 AB	WCL T22 AB	WCL T23 AB	WCL T24 AB	WCL T31 AB
Light Oak	Bright Chrome	Chamfered	WCL T21 BC	WCL T22 BC	WCL T23 BC	WCL T24 BC	WCL T31 BC
Light Oak	Polished Brass	Chamfered	WCL T21 PB	WCL T22 PB	WCL T23 PB	WCL T24 PB	WCL T31 PB
Light Oak	Satin Chrome	Chamfered	WCL T21 SC	WCL T22 SC	WCL T23 SC	WCL T24 SC	WCL T31 SC
Light Oak	Antique Brass	Ovolo	WOL T21 AB	WOL T22 AB	WOL T23 AB	WOL T24 AB	WOL T31 AB
Light Oak	Bright Chrome	Ovolo	WOL T21 BC	WOL T22 BC	WOL T23 BC	WOL T24 BC	WOL T31 BC
Light Oak	Polished Brass	Ovolo	WOL T21 PB	WOL T22 PB	WOL T23 PB	WOL T24 PB	WOL T31 PB
Light Oak	Satin Chrome	Ovolo	WOL T21 SC	WOL T22 SC	WOL T23 SC	WOL T24 SC	WOL T31 SC
Medium Oak	Antique Brass	Chamfered	WCM T21 AB	WCM T22 AB	WCM T23 AB	WCM T24 AB	WCM T31 AB
Medium Oak	Bright Chrome	Chamfered	WCM T21 BC	WCM T22 BC	WCM T23 BC	WCM T24 BC	WCM T31 BC
Medium Oak	Polished Brass	Chamfered	WCM T21 PB	WCM T22 PB	WCM T23 PB	WCM T24 PB	WCM T31 PB
Medium Oak	Satin Chrome	Chamfered	WCM T21 SC	WCM T22 SC	WCM T23 SC	WCM T24 SC	WCM T31 SC
Medium Oak	Antique Brass	Ovolo	WOM T21 AB	WOM T22 AB	WOM T23 AB	WOM T24 AB	WOM T31 AB
Medium Oak	Bright Chrome	Ovolo	WOM T21 BC	WOM T22 BC	WOM T23 BC	WOM T24 BC	WOM T31 BC
Medium Oak	Polished Brass	Ovolo	WOM T21 PB	WOM T22 PB	WOM T23 PB	WOM T24 PB	WOM T31 PB
Medium Oak	Satin Chrome	Ovolo	WOM T21 SC	WOM T22 SC	WOM T23 SC	WOM T24 SC	WOM T31 SC
	Nominal Size:		88.0mm x 88.0mm	88.0mm x 88.0mm	146.0mm x 88.0mm	146.0mm x 88.0mm	88.0mm x 88.0mm
	Minimum Wall Box Depth:		25mm	25mm	25mm	25mm	25mm
	Technical Insert Ref:		T21	T22	T23	T24	T31

Woods

Power Sockets



WCA SS1 SC-B



WCD SS2 PB-W



WCL SS1 PB-B



WCM SS2 BC-W



1 gang 13A
Double Pole
Switched
Socket

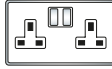

2 gang 13A
Double Pole
Switched
Socket



1 gang 13A
Double Pole
Switched
Socket

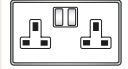

2 gang 13A
Double Pole
Switched
Socket

Front Plate	Insert Finish/ Surround Colour	Edge	1 gang 13A Double Pole Switched Socket	2 gang 13A Double Pole Switched Socket	Front Plate	Insert Finish/ Surround Colour	Edge	1 gang 13A Double Pole Switched Socket	2 gang 13A Double Pole Switched Socket
Antique Mahogany	Antique Brass/Black	Chamfered	WCA SS1 AB-B	WCA SS2 AB-B	Light Oak	Antique Brass/Black	Chamfered	WCL SS1 AB-B	WCL SS2 AB-B
Antique Mahogany	Bright Chrome/Black	Chamfered	WCA SS1 BC-B	WCA SS2 BC-B	Light Oak	Bright Chrome/Black	Chamfered	WCL SS1 BC-B	WCL SS2 BC-B
Antique Mahogany	Bright Chrome/White	Chamfered	WCA SS1 BC-W	WCA SS2 BC-W	Light Oak	Bright Chrome/White	Chamfered	WCL SS1 BC-W	WCL SS2 BC-W
Antique Mahogany	Polished Brass/Black	Chamfered	WCA SS1 PB-B	WCA SS2 PB-B	Light Oak	Polished Brass/Black	Chamfered	WCL SS1 PB-B	WCL SS2 PB-B
Antique Mahogany	Polished Brass/White	Chamfered	WCA SS1 PB-W	WCA SS2 PB-W	Light Oak	Polished Brass/White	Chamfered	WCL SS1 PB-W	WCL SS2 PB-W
Antique Mahogany	Satin Chrome/Black	Chamfered	WCA SS1 SC-B	WCA SS2 SC-B	Light Oak	Satin Chrome/Black	Chamfered	WCL SS1 SC-B	WCL SS2 SC-B
Antique Mahogany	Satin Chrome/White	Chamfered	WCA SS1 SC-W	WCA SS2 SC-W	Light Oak	Satin Chrome/White	Chamfered	WCL SS1 SC-W	WCL SS2 SC-W
Antique Mahogany	Antique Brass/Black	Ovolo	WOA SS1 AB-B	WOA SS2 AB-B	Light Oak	Antique Brass/Black	Ovolo	WOL SS1 AB-B	WOL SS2 AB-B
Antique Mahogany	Bright Chrome/Black	Ovolo	WOA SS1 BC-B	WOA SS2 BC-B	Light Oak	Bright Chrome/Black	Ovolo	WOL SS1 BC-B	WOL SS2 BC-B
Antique Mahogany	Bright Chrome/White	Ovolo	WOA SS1 BC-W	WOA SS2 BC-W	Light Oak	Bright Chrome/White	Ovolo	WOL SS1 BC-W	WOL SS2 BC-W
Antique Mahogany	Polished Brass/Black	Ovolo	WOA SS1 PB-B	WOA SS2 PB-B	Light Oak	Polished Brass/Black	Ovolo	WOL SS1 PB-B	WOL SS2 PB-B
Antique Mahogany	Polished Brass/White	Ovolo	WOA SS1 PB-W	WOA SS2 PB-W	Light Oak	Polished Brass/White	Ovolo	WOL SS1 PB-W	WOL SS2 PB-W
Antique Mahogany	Satin Chrome/Black	Ovolo	WOA SS1 SC-B	WOA SS2 SC-B	Light Oak	Satin Chrome/Black	Ovolo	WOL SS1 SC-B	WOL SS2 SC-B
Antique Mahogany	Satin Chrome/White	Ovolo	WOA SS1 SC-W	WOA SS2 SC-W	Light Oak	Satin Chrome/White	Ovolo	WOL SS1 SC-W	WOL SS2 SC-W
Dark Oak	Antique Brass/Black	Chamfered	WCD SS1 AB-B	WCD SS2 AB-B	Medium Oak	Antique Brass/Black	Chamfered	WCM SS1 AB-B	WCM SS2 AB-B
Dark Oak	Bright Chrome/Black	Chamfered	WCD SS1 BC-B	WCD SS2 BC-B	Medium Oak	Bright Chrome/Black	Chamfered	WCM SS1 BC-B	WCM SS2 BC-B
Dark Oak	Bright Chrome/White	Chamfered	WCD SS1 BC-W	WCD SS2 BC-W	Medium Oak	Bright Chrome/White	Chamfered	WCM SS1 BC-W	WCM SS2 BC-W
Dark Oak	Polished Brass/Black	Chamfered	WCD SS1 PB-B	WCD SS2 PB-B	Medium Oak	Polished Brass/Black	Chamfered	WCM SS1 PB-B	WCM SS2 PB-B
Dark Oak	Polished Brass/White	Chamfered	WCD SS1 PB-W	WCD SS2 PB-W	Medium Oak	Polished Brass/White	Chamfered	WCM SS1 PB-W	WCM SS2 PB-W
Dark Oak	Satin Chrome/Black	Chamfered	WCD SS1 SC-B	WCD SS2 SC-B	Medium Oak	Satin Chrome/Black	Chamfered	WCM SS1 SC-B	WCM SS2 SC-B
Dark Oak	Satin Chrome/White	Chamfered	WCD SS1 SC-W	WCD SS2 SC-W	Medium Oak	Satin Chrome/White	Chamfered	WCM SS1 SC-W	WCM SS2 SC-W
Dark Oak	Antique Brass/Black	Ovolo	WOD SS1 AB-B	WOD SS2 AB-B	Medium Oak	Antique Brass/Black	Ovolo	WOM SS1 AB-B	WOM SS2 AB-B
Dark Oak	Bright Chrome/Black	Ovolo	WOD SS1 BC-B	WOD SS2 BC-B	Medium Oak	Bright Chrome/Black	Ovolo	WOM SS1 BC-B	WOM SS2 BC-B
Dark Oak	Bright Chrome/White	Ovolo	WOD SS1 BC-W	WOD SS2 BC-W	Medium Oak	Bright Chrome/White	Ovolo	WOM SS1 BC-W	WOM SS2 BC-W
Dark Oak	Polished Brass/Black	Ovolo	WOD SS1 PB-B	WOD SS2 PB-B	Medium Oak	Polished Brass/Black	Ovolo	WOM SS1 PB-B	WOM SS2 PB-B
Dark Oak	Polished Brass/White	Ovolo	WOD SS1 PB-W	WOD SS2 PB-W	Medium Oak	Polished Brass/White	Ovolo	WOM SS1 PB-W	WOM SS2 PB-W
Dark Oak	Satin Chrome/Black	Ovolo	WOD SS1 SC-B	WOD SS2 SC-B	Medium Oak	Satin Chrome/Black	Ovolo	WOM SS1 SC-B	WOM SS2 SC-B
Dark Oak	Satin Chrome/White	Ovolo	WOD SS1 SC-W	WOD SS2 SC-W	Medium Oak	Satin Chrome/White	Ovolo	WOM SS1 SC-W	WOM SS2 SC-W
Nominal Size:			88.0mm x 88.0mm	146.0mm x 88.0mm	Nominal Size:			88.0mm x 88.0mm	146.0mm x 88.0mm
Minimum Wall Box Depth:			35mm	35mm	Minimum Wall Box Depth:			35mm	35mm
Technical Insert Ref:			SS1	SS2	Technical Insert Ref:			SS1	SS2

Woods

Power Sockets



WOM US5 B



WCA SHS W



1 gang 5A
Unswitched
Socket

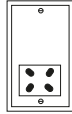

Shaver Dual
Voltage
Unswitched
Socket
(Vertically
Mounted)

Frame / Front Plate	Insert Finish	Edge		
Antique Mahogany	Black	Chamfered	WCA US5 B	WCA SHS B
Antique Mahogany	White	Chamfered	WCA US5 W	WCA SHS W
Antique Mahogany	Black	Ovolo	WOA US5 B	WOA SHS B
Antique Mahogany	White	Ovolo	WOA US5 W	WOA SHS W
Dark Oak	Black	Chamfered	WCD US5 B	WCD SHS B
Dark Oak	White	Chamfered	WCD US5 W	WCD SHS W
Dark Oak	Black	Ovolo	WOD US5 B	WOD SHS B
Dark Oak	White	Ovolo	WOD US5 W	WOD SHS W
Light Oak	Black	Chamfered	WCL US5 B	WCL SHS B
Light Oak	White	Chamfered	WCL US5 W	WCL SHS W
Light Oak	Black	Ovolo	WOL US5 B	WOL SHS B
Light Oak	White	Ovolo	WOL US5 W	WOL SHS W
Medium Oak	Black	Chamfered	WCM US5 B	WCM SHS B
Medium Oak	White	Chamfered	WCM US5 W	WCM SHS W
Medium Oak	Black	Ovolo	WOM US5 B	WOM SHS B
Medium Oak	White	Ovolo	WOM US5 W	WOM SHS W
	Nominal Size:		88.0mm x 88.0mm	88.0mm x 146.0mm
	Minimum Wall Box Depth:		35mm	47mm
	Technical Insert Ref:		US5	SHS

Woods

International Power Sockets



WCD 5320 W



WCL 5258 W



WOA 6126 B



1 gang 15A 110V
American Unswitched
Socket

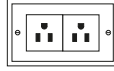

2 gang 15A 110V AC
American Unswitched
Socket



1 gang 10/16A
220/250V AC
German Unswitched
Socket

Front Plate	Insert Colour	Edge			
Antique Mahogany	Black	Chamfered	WCA 5258 B	WCA 5320 B	WCA 6126 B
Antique Mahogany	White	Chamfered	WCA 5258 W	WCA 5320 W	WCA 6126 W
Antique Mahogany	Black	Ovolo	WOA 5258 B	WOA 5320 B	WOA 6126 B
Antique Mahogany	White	Ovolo	WOA 5258 W	WOA 5320 W	WOA 6126 W
Dark Oak	Black	Chamfered	WCD 5258 B	WCD 5320 B	WCD 6126 B
Dark Oak	White	Chamfered	WCD 5258 W	WCD 5320 W	WCD 6126 W
Dark Oak	Black	Ovolo	WOD 5258 B	WOD 5320 B	WOD 6126 B
Dark Oak	White	Ovolo	WOD 5258 W	WOD 5320 W	WOD 6126 W
Light Oak	Black	Chamfered	WCL 5258 B	WCL 5320 B	WCL 6126 B
Light Oak	White	Chamfered	WCL 5258 W	WCL 5320 W	WCL 6126 W
Light Oak	Black	Ovolo	WOL 5258 B	WOL 5320 B	WOL 6126 B
Light Oak	White	Ovolo	WOL 5258 W	WOL 5320 W	WOL 6126 W
Medium Oak	Black	Chamfered	WCM 5258 B	WCM 5320 B	WCM 6126 B
Medium Oak	White	Chamfered	WCM 5258 W	WCM 5320 W	WCM 6126 W
Medium Oak	Black	Ovolo	WOM 5258 B	WOM 5320 B	WOM 6126 B
Medium Oak	White	Ovolo	WOM 5258 W	WOM 5320 W	WOM 6126 W
Nominal Size:			88.0mm x 88.0mm	146.0mm x 88.0mm	88.0mm x 88.0mm
Minimum Wall Box Depth:			35mm	35mm	47mm
Technical Insert Ref:			5258	5320	6126

Woods

Hotel Card Switch with LED



WCA C11 AB-B



WCL C11 SC-B



1 gang 10A (6AX) Card Switch On/Off with Blue LED Locator

Front Plate	Insert Finish/ Surround Colour	Edge	
Antique Mahogany	Antique Brass/Black	Chamfered	WCA C11 AB-B
Antique Mahogany	Bright Chrome/Black	Chamfered	WCA C11 BC-B
Antique Mahogany	Bright Chrome/White	Chamfered	WCA C11 BC-W
Antique Mahogany	Polished Brass/Black	Chamfered	WCA C11 PB-B
Antique Mahogany	Polished Brass/White	Chamfered	WCA C11 PB-W
Antique Mahogany	Satin Chrome/Black	Chamfered	WCA C11 SC-B
Antique Mahogany	Satin Chrome/White	Chamfered	WCA C11 SC-W
Antique Mahogany	Antique Brass/Black	Ovolo	WOA C11 AB-B
Antique Mahogany	Bright Chrome/Black	Ovolo	WOA C11 BC-B
Antique Mahogany	Bright Chrome/White	Ovolo	WOA C11 BC-W
Antique Mahogany	Polished Brass/Black	Ovolo	WOA C11 PB-B
Antique Mahogany	Polished Brass/White	Ovolo	WOA C11 PB-W
Antique Mahogany	Satin Chrome/Black	Ovolo	WOA C11 SC-B
Antique Mahogany	Satin Chrome/White	Ovolo	WOA C11 SC-W
Dark Oak	Antique Brass/Black	Chamfered	WCD C11 AB-B
Dark Oak	Bright Chrome/Black	Chamfered	WCD C11 BC-B
Dark Oak	Bright Chrome/White	Chamfered	WCD C11 BC-W
Dark Oak	Polished Brass/Black	Chamfered	WCD C11 PB-B
Dark Oak	Polished Brass/White	Chamfered	WCD C11 PB-W
Dark Oak	Satin Chrome/Black	Chamfered	WCD C11 SC-B
Dark Oak	Satin Chrome/White	Chamfered	WCD C11 SC-W
Dark Oak	Antique Brass/Black	Ovolo	WOD C11 AB-B
Dark Oak	Bright Chrome/Black	Ovolo	WOD C11 BC-B
Dark Oak	Bright Chrome/White	Ovolo	WOD C11 BC-W
Dark Oak	Polished Brass/Black	Ovolo	WOD C11 PB-B
Dark Oak	Polished Brass/White	Ovolo	WOD C11 PB-W
Dark Oak	Satin Chrome/Black	Ovolo	WOD C11 SC-B
Dark Oak	Satin Chrome/White	Ovolo	WOD C11 SC-W
Nominal Size:			88.0mm x 88.0mm
Minimum Wall Box Depth:			35mm
Technical Insert Ref:			C11



1 gang 10A (6AX) Card Switch On/Off with Blue LED Locator

Front Plate	Insert Finish/ Surround Colour	Edge	
Light Oak	Antique Brass/Black	Chamfered	WCL C11 AB-B
Light Oak	Bright Chrome/Black	Chamfered	WCL C11 BC-B
Light Oak	Bright Chrome/White	Chamfered	WCL C11 BC-W
Light Oak	Polished Brass/Black	Chamfered	WCL C11 PB-B
Light Oak	Polished Brass/White	Chamfered	WCL C11 PB-W
Light Oak	Satin Chrome/Black	Chamfered	WCL C11 SC-B
Light Oak	Satin Chrome/White	Chamfered	WCL C11 SC-W
Light Oak	Antique Brass/Black	Ovolo	WOL C11 AB-B
Light Oak	Bright Chrome/Black	Ovolo	WOL C11 BC-B
Light Oak	Bright Chrome/White	Ovolo	WOL C11 BC-W
Light Oak	Polished Brass/Black	Ovolo	WOL C11 PB-B
Light Oak	Polished Brass/White	Ovolo	WOL C11 PB-W
Light Oak	Satin Chrome/Black	Ovolo	WOL C11 SC-B
Light Oak	Satin Chrome/White	Ovolo	WOL C11 SC-W
Medium Oak	Antique Brass/Black	Chamfered	WCM C11 AB-B
Medium Oak	Bright Chrome/Black	Chamfered	WCM C11 BC-B
Medium Oak	Bright Chrome/White	Chamfered	WCM C11 BC-W
Medium Oak	Polished Brass/Black	Chamfered	WCM C11 PB-B
Medium Oak	Polished Brass/White	Chamfered	WCM C11 PB-W
Medium Oak	Satin Chrome/Black	Chamfered	WCM C11 SC-B
Medium Oak	Satin Chrome/White	Chamfered	WCM C11 SC-W
Medium Oak	Antique Brass/Black	Ovolo	WOM C11 AB-B
Medium Oak	Bright Chrome/Black	Ovolo	WOM C11 BC-B
Medium Oak	Bright Chrome/White	Ovolo	WOM C11 BC-W
Medium Oak	Polished Brass/Black	Ovolo	WOM C11 PB-B
Medium Oak	Polished Brass/White	Ovolo	WOM C11 PB-W
Medium Oak	Satin Chrome/Black	Ovolo	WOM C11 SC-B
Medium Oak	Satin Chrome/White	Ovolo	WOM C11 SC-W
Nominal Size:			88.0mm x 88.0mm
Minimum Wall Box Depth:			35mm
Technical Insert Ref:			C11

Woods

Television Coaxial Sockets



WOD TV B



WOL TVFM W



WOM TVSAT B



WCA SATI W



1 gang
Non-Isolated
TV 1in/1out



Isolated
TV/FM Diplexer
1in/2out



1 gang
Isolated
TV 1in/1out



2 gang
Non-Isolated
TV+Satellite
2in/2out



1 gang
Non-Isolated
Satellite



1 gang
Isolated
Satellite

Front Plate	Insert Colour	Edge	1 gang Non-Isolated TV 1in/1out	Isolated TV/FM Diplexer 1in/2out	1 gang Isolated TV 1in/1out	2 gang Non-Isolated TV+Satellite 2in/2out	1 gang Non-Isolated Satellite	1 gang Isolated Satellite
Antique Mahogany	Black	Chamfered	WCA TV B	WCA TVFM B	WCA TVI B	WCA TVSAT B	WCA SATN B	WCA SATI B
Antique Mahogany	White	Chamfered	WCA TV W	WCA TVFM W	WCA TVI W	WCA TVSAT W	WCA SATN W	WCA SATI W
Antique Mahogany	Black	Ovolo	WOA TV B	WOA TVFM B	WOA TVI B	WOA TVSAT B	WOA SATN B	WOA SATI B
Antique Mahogany	White	Ovolo	WOA TV W	WOA TVFM W	WOA TVI W	WOA TVSAT W	WOA SATN W	WOA SATI W
Dark Oak	Black	Chamfered	WCD TV B	WCD TVFM B	WCD TVI B	WCD TVSAT B	WCD SATN B	WCD SATI B
Dark Oak	White	Chamfered	WCD TV W	WCD TVFM W	WCD TVI W	WCD TVSAT W	WCD SATN W	WCD SATI W
Dark Oak	Black	Ovolo	WOD TV B	WOD TVFM B	WOD TVI B	WOD TVSAT B	WOD SATN B	WOD SATI B
Dark Oak	White	Ovolo	WOD TV W	WOD TVFM W	WOD TVI W	WOD TVSAT W	WOD SATN W	WOD SATI W
Light Oak	Black	Chamfered	WCL TV B	WCL TVFM B	WCL TVI B	WCL TVSAT B	WCL SATN B	WCL SATI B
Light Oak	White	Chamfered	WCL TV W	WCL TVFM W	WCL TVI W	WCL TVSAT W	WCL SATN W	WCL SATI W
Light Oak	Black	Ovolo	WOL TV B	WOL TVFM B	WOL TVI B	WOL TVSAT B	WOL SATN B	WOL SATI B
Light Oak	White	Ovolo	WOL TV W	WOL TVFM W	WOL TVI W	WOL TVSAT W	WOL SATN W	WOL SATI W
Medium Oak	Black	Chamfered	WCM TV B	WCM TVFM B	WCM TVI B	WCM TVSAT B	WCM SATN B	WCM SATI B
Medium Oak	White	Chamfered	WCM TV W	WCM TVFM W	WCM TVI W	WCM TVSAT W	WCM SATN W	WCM SATI W
Medium Oak	Black	Ovolo	WOM TV B	WOM TVFM B	WOM TVI B	WOM TVSAT B	WOM SATN B	WOM SATI B
Medium Oak	White	Ovolo	WOM TV W	WOM TVFM W	WOM TVI W	WOM TVSAT W	WOM SATN W	WOM SATI W
Nominal Size:			88.0mm x 88.0mm	88.0mm x 88.0mm	88.0mm x 88.0mm	88.0mm x 88.0mm	88.0mm x 88.0mm	88.0mm x 88.0mm
Minimum Wall Box Depth:			25mm	25mm	25mm	35mm	35mm	35mm
Technical Insert Ref:			TV	TVFM	TVI	TVSAT	SATN	SATI

Woods

Digital Television Sockets

- Screened Non-Isolated / DAB Compatible



WCD DTRID B



WCL DTVF B



WCM DENT W



WOA DSAT+W



Non-Isolated
TV+FM+SAT
Triplexer
1in/3out (DAB
Compatible)



1 gang
Non-Isolated
TV (Female)
(DAB
Compatible)



1 gang
Non-Isolated
TV (Male)
(DAB
Compatible)



1 gang
Non-Isolated
Satellite
(DAB
Compatible)



Non-Isolated
TV+FM+SAT1+SAT2
Quadplexer
2in/4out (DAB
Compatible)

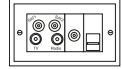

Non-Isolated
TV+FM+SAT1+SAT2
Quadplexer
2in/4out+TVF+TCS
(DAB Compatible)

Front Plate	Insert Colour	Edge	WCA DTRID B	WCA DTVF B	WCA DTVM B	WCA DSAT B	WCA DENT B	WCA DSAT+B
Antique Mahogany	Black	Chamfered	WCA DTRID B	WCA DTVF B	WCA DTVM B	WCA DSAT B	WCA DENT B	WCA DSAT+B
Antique Mahogany	White	Chamfered	WCA DTRID W	WCA DTVF W	WCA DTVM W	WCA DSAT W	WCA DENT W	WCA DSAT+W
Antique Mahogany	Black	Ovolo	WOA DTRID B	WOA DTVF B	WOA DTVM B	WOA DSAT B	WOA DENT B	WOA DSAT+B
Antique Mahogany	White	Ovolo	WOA DTRID W	WOA DTVF W	WOA DTVM W	WOA DSAT W	WOA DENT W	WOA DSAT+W
Dark Oak	Black	Chamfered	WCD DTRID B	WCD DTVF B	WCD DTVM B	WCD DSAT B	WCD DENT B	WCD DSAT+B
Dark Oak	White	Chamfered	WCD DTRID W	WCD DTVF W	WCD DTVM W	WCD DSAT W	WCD DENT W	WCD DSAT+W
Dark Oak	Black	Ovolo	WOD DTRID B	WOD DTVF B	WOD DTVM B	WOD DSAT B	WOD DENT B	WOD DSAT+B
Dark Oak	White	Ovolo	WOD DTRID W	WOD DTVF W	WOD DTVM W	WOD DSAT W	WOD DENT W	WOD DSAT+W
Light Oak	Black	Chamfered	WCL DTRID B	WCL DTVF B	WCL DTVM B	WCL DSAT B	WCL DENT B	WCL DSAT+B
Light Oak	White	Chamfered	WCL DTRID W	WCL DTVF W	WCL DTVM W	WCL DSAT W	WCL DENT W	WCL DSAT+W
Light Oak	Black	Ovolo	WOL DTRID B	WOL DTVF B	WOL DTVM B	WOL DSAT B	WOL DENT B	WOL DSAT+B
Light Oak	White	Ovolo	WOL DTRID W	WOL DTVF W	WOL DTVM W	WOL DSAT W	WOL DENT W	WOL DSAT+W
Medium Oak	Black	Chamfered	WCM DTRID B	WCM DTVF B	WCM DTVM B	WCM DSAT B	WCM DENT B	WCM DSAT+B
Medium Oak	White	Chamfered	WCM DTRID W	WCM DTVF W	WCM DTVM W	WCM DSAT W	WCM DENT W	WCM DSAT+W
Medium Oak	Black	Ovolo	WOM DTRID B	WOM DTVF B	WOM DTVM B	WOM DSAT B	WOM DENT B	WOM DSAT+B
Medium Oak	White	Ovolo	WOM DTRID W	WOM DTVF W	WOM DTVM W	WOM DSAT W	WOM DENT W	WOM DSAT+W
Nominal Size:			88.0mm x 88.0mm	88.0mm x 88.0mm	88.0mm x 88.0mm	88.0mm x 88.0mm	88.0mm x 88.0mm	146.0mm x 88.0mm
Minimum Wall Box Depth:			35mm	35mm	35mm	35mm	35mm	35mm
Technical Insert Ref:			DTRID	DTVF	DTVM	DSAT	DENT	DSAT+

Woods

Telephone and Data Outlets



WOA TCM B



WOA TCS W



WOL J12 B



WOM 2J45 W



1 gang Telephone Master



1 gang Telephone Slave



1 gang RJ12 Outlet - Unshielded



2 gang RJ12 Outlet - Unshielded



1 gang RJ45 CAT 5E Outlet - Unshielded



2 gang RJ45 CAT 5E Outlet - Unshielded

Front Plate	Insert Colour	Edge	1 gang Telephone Master	1 gang Telephone Slave	1 gang RJ12 Outlet - Unshielded	2 gang RJ12 Outlet - Unshielded	1 gang RJ45 CAT 5E Outlet - Unshielded	2 gang RJ45 CAT 5E Outlet - Unshielded
Antique Mahogany	Black	Chamfered	WCA TCM B	WCA TCS B	WCA J12 B	WCA 2J12 B	WCA J45 B	WCA 2J45 B
Antique Mahogany	White	Chamfered	WCA TCM W	WCA TCS W	WCA J12 W	WCA 2J12 W	WCA J45 W	WCA 2J45 W
Antique Mahogany	Black	Ovolo	WOA TCM B	WOA TCS B	WOA J12 B	WOA 2J12 B	WOA J45 B	WOA 2J45 B
Antique Mahogany	White	Ovolo	WOA TCM W	WOA TCS W	WOA J12 W	WOA 2J12 W	WOA J45 W	WOA 2J45 W
Dark Oak	Black	Chamfered	WCD TCM B	WCD TCS B	WCD J12 B	WCD 2J12 B	WCD J45 B	WCD 2J45 B
Dark Oak	White	Chamfered	WCD TCM W	WCD TCS W	WCD J12 W	WCD 2J12 W	WCD J45 W	WCD 2J45 W
Dark Oak	Black	Ovolo	WOD TCM B	WOD TCS B	WOD J12 B	WOD 2J12 B	WOD J45 B	WOD 2J45 B
Dark Oak	White	Ovolo	WOD TCM W	WOD TCS W	WOD J12 W	WOD 2J12 W	WOD J45 W	WOD 2J45 W
Light Oak	Black	Chamfered	WCL TCM B	WCL TCS B	WCL J12 B	WCL 2J12 B	WCL J45 B	WCL 2J45 B
Light Oak	White	Chamfered	WCL TCM W	WCL TCS W	WCL J12 W	WCL 2J12 W	WCL J45 W	WCL 2J45 W
Light Oak	Black	Ovolo	WOL TCM B	WOL TCS B	WOL J12 B	WOL 2J12 B	WOL J45 B	WOL 2J45 B
Light Oak	White	Ovolo	WOL TCM W	WOL TCS W	WOL J12 W	WOL 2J12 W	WOL J45 W	WOL 2J45 W
Medium Oak	Black	Chamfered	WCM TCM B	WCM TCS B	WCM J12 B	WCM 2J12 B	WCM J45 B	WCM 2J45 B
Medium Oak	White	Chamfered	WCM TCM W	WCM TCS W	WCM J12 W	WCM 2J12 W	WCM J45 W	WCM 2J45 W
Medium Oak	Black	Ovolo	WOM TCM B	WOM TCS B	WOM J12 B	WOM 2J12 B	WOM J45 B	WOM 2J45 B
Medium Oak	White	Ovolo	WOM TCM W	WOM TCS W	WOM J12 W	WOM 2J12 W	WOM J45 W	WOM 2J45 W
Nominal Size:			88.0mm x 88.0mm	88.0mm x 88.0mm	88.0mm x 88.0mm	88.0mm x 88.0mm	88.0mm x 88.0mm	88.0mm x 88.0mm
Minimum Wall Box Depth:			25mm	25mm	35mm	35mm	35mm	35mm
Technical Insert Ref:			TCM	TCS	J12	2J12	J45	2J45

Woods



Double Pole Switches



WOD DPN AB-B

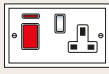

WOM DPN BC-W

Frame / Front Plate	Insert Finish/ Surround Colour	Edge	 1 gang 20AX Double Pole Rocker + Neon	 1 gang 45A Double Pole Red Rocker + Neon	 45A Double Pole Red Rocker + Neon + 13A Switched Socket
Antique Mahogany	Antique Brass/Black	Chamfered	WCA DPN AB-B	-	WCA 45SS1 AB-B
Antique Mahogany	Red/Black	Chamfered	-	WCA 45N B	-
Antique Mahogany	Bright Chrome/Black	Chamfered	WCA DPN BC-B	-	WCA 45SS1 BC-B
Antique Mahogany	Bright Chrome/White	Chamfered	WCA DPN BC-W	-	WCA 45SS1 BC-W
Antique Mahogany	Polished Brass/Black	Chamfered	WCA DPN PB-B	-	WCA 45SS1 PB-B
Antique Mahogany	Polished Brass/White	Chamfered	WCA DPN PB-W	-	WCA 45SS1 PB-W
Antique Mahogany	Satin Chrome/Black	Chamfered	WCA DPN SC-B	-	WCA 45SS1 SC-B
Antique Mahogany	Satin Chrome/White	Chamfered	WCA DPN SC-W	-	WCA 45SS1 SC-W
Antique Mahogany	Red/White	Chamfered	-	WCA 45N W	-
Antique Mahogany	Antique Brass/Black	Ovolo	WOA DPN AB-B	-	WOA 45SS1 AB-B
Antique Mahogany	Red/Black	Ovolo	-	WOA 45N B	-
Antique Mahogany	Bright Chrome/Black	Ovolo	WOA DPN BC-B	-	WOA 45SS1 BC-B
Antique Mahogany	Bright Chrome/White	Ovolo	WOA DPN BC-W	-	WOA 45SS1 BC-W
Antique Mahogany	Polished Brass/Black	Ovolo	WOA DPN PB-B	-	WOA 45SS1 PB-B
Antique Mahogany	Polished Brass/White	Ovolo	WOA DPN PB-W	-	WOA 45SS1 PB-W
Antique Mahogany	Satin Chrome/Black	Ovolo	WOA DPN SC-B	-	WOA 45SS1 SC-B
Antique Mahogany	Satin Chrome/White	Ovolo	WOA DPN SC-W	-	WOA 45SS1 SC-W
Antique Mahogany	Red/White	Ovolo	-	WOA 45N W	-
Dark Oak	Antique Brass/Black	Chamfered	WCD DPN AB-B	-	WCD 45SS1 AB-B
Dark Oak	Bright Chrome/Black	Chamfered	WCD DPN BC-B	-	WCD 45SS1 BC-B
Dark Oak	Bright Chrome/White	Chamfered	WCD DPN BC-W	-	WCD 45SS1 BC-W
Dark Oak	Red/Black	Chamfered	-	WCD 45N B	-
Dark Oak	Polished Brass/Black	Chamfered	WCD DPN PB-B	-	WCD 45SS1 PB-B
Dark Oak	Polished Brass/White	Chamfered	WCD DPN PB-W	-	WCD 45SS1 PB-W
Dark Oak	Satin Chrome/Black	Chamfered	WCD DPN SC-B	-	WCD 45SS1 SC-B
Dark Oak	Satin Chrome/White	Chamfered	WCD DPN SC-W	-	WCD 45SS1 SC-W
Dark Oak	Red/White	Chamfered	-	WCD 45N W	-
Dark Oak	Antique Brass/Black	Ovolo	WOD DPN AB-B	-	WOD 45SS1 AB-B
Dark Oak	Bright Chrome/Black	Ovolo	WOD DPN BC-B	-	WOD 45SS1 BC-B
Dark Oak	Bright Chrome/White	Ovolo	WOD DPN BC-W	-	WOD 45SS1 BC-W
Dark Oak	Red/Black	Ovolo	-	WOD 45N B	-
Dark Oak	Polished Brass/Black	Ovolo	WOD DPN PB-B	-	WOD 45SS1 PB-B
Dark Oak	Polished Brass/White	Ovolo	WOD DPN PB-W	-	WOD 45SS1 PB-W
Dark Oak	Satin Chrome/Black	Ovolo	WOD DPN SC-B	-	WOD 45SS1 SC-B
Dark Oak	Satin Chrome/White	Ovolo	WOD DPN SC-W	-	WOD 45SS1 SC-W
Dark Oak	Red/White	Ovolo	-	WOD 45N W	-
	Nominal Size:		88.0mm x 88.0mm	88.0mm x 88.0mm	146.0mm x 88.0mm
	Minimum Wall Box Depth:		25mm	25mm	35mm
	Technical Insert Ref:		DPN	45N	45SS1

Woods

Double Pole Switches



WCL DPN AB-B



WOL 45SS1 PB-W

WOODS RANGE

Frame / Front Plate	Insert Finish/ Surround Colour	Edge	 1 gang 20AX Double Pole Red Rocker + Neon	 1 gang 45A Double Pole Red Rocker + Neon	 45A Double Pole Red Rocker + Neon + 13A Switched Socket
Light Oak	Antique Brass/Black	Chamfered	WCL DPN AB-B	-	WCL 45SS1 AB-B
Light Oak	Red/Black	Chamfered	-	WCL 45N B	-
Light Oak	Bright Chrome/Black	Chamfered	WCL DPN BC-B	-	WCL 45SS1 BC-B
Light Oak	Bright Chrome/White	Chamfered	WCL DPN BC-W	-	WCL 45SS1 BC-W
Light Oak	Red/White		-	WCL 45N W	-
Light Oak	Polished Brass/Black	Chamfered	WCL DPN PB-B	-	WCL 45SS1 PB-B
Light Oak	Polished Brass/White	Chamfered	WCL DPN PB-W	-	WCL 45SS1 PB-W
Light Oak	Satin Chrome/Black	Chamfered	WCL DPN SC-B	-	WCL 45SS1 SC-B
Light Oak	Red/Black	Chamfered	-	WOL 45N B	-
Light Oak	Satin Chrome/White	Chamfered	WCL DPN SC-W	-	WCL 45SS1 SC-W
Light Oak	Red/White	Chamfered	-	WOL 45N W	-
Light Oak	Antique Brass/Black	Ovolo	WOL DPN AB-B	-	WOL 45SS1 AB-B
Light Oak	Bright Chrome/Black	Ovolo	WOL DPN BC-B	-	WOL 45SS1 BC-B
Light Oak	Bright Chrome/White	Ovolo	WOL DPN BC-W	-	WOL 45SS1 BC-W
Light Oak	Polished Brass/Black	Ovolo	WOL DPN PB-B	-	WOL 45SS1 PB-B
Light Oak	Polished Brass/White	Ovolo	WOL DPN PB-W	-	WOL 45SS1 PB-W
Light Oak	Satin Chrome/Black	Ovolo	WOL DPN SC-B	-	WOL 45SS1 SC-B
Light Oak	Satin Chrome/White	Ovolo	WOL DPN SC-W	-	WOL 45SS1 SC-W
Medium Oak	Antique Brass/Black	Chamfered	WCM DPN AB-B	-	WCM 45SS1 AB-B
Medium Oak	Red/Black	Chamfered	-	WCM 45N B	-
Medium Oak	Bright Chrome/Black	Chamfered	WCM DPN BC-B	-	WCM 45SS1 BC-B
Medium Oak	Bright Chrome/White	Chamfered	WCM DPN BC-W	-	WCM 45SS1 BC-W
Medium Oak	Red/White	Chamfered	-	WCM 45N W	-
Medium Oak	Polished Brass/Black	Chamfered	WCM DPN PB-B	-	WCM 45SS1 PB-B
Medium Oak	Polished Brass/White	Chamfered	WCM DPN PB-W	-	WCM 45SS1 PB-W
Medium Oak	Satin Chrome/Black	Chamfered	WCM DPN SC-B	-	WCM 45SS1 SC-B
Medium Oak	Red/Black	Chamfered	-	WOM 45N B	-
Medium Oak	Satin Chrome/White	Chamfered	WCM DPN SC-W	-	WCM 45SS1 SC-W
Medium Oak	Red/White	Chamfered	-	WOM 45N W	-
Medium Oak	Antique Brass/Black	Ovolo	WOM DPN AB-B	-	WOM 45SS1 AB-B
Medium Oak	Bright Chrome/Black	Ovolo	WOM DPN BC-B	-	WOM 45SS1 BC-B
Medium Oak	Bright Chrome/White	Ovolo	WOM DPN BC-W	-	WOM 45SS1 BC-W
Medium Oak	Polished Brass/Black	Ovolo	WOM DPN PB-B	-	WOM 45SS1 PB-B
Medium Oak	Polished Brass/White	Ovolo	WOM DPN PB-W	-	WOM 45SS1 PB-W
Medium Oak	Satin Chrome/Black	Ovolo	WOM DPN SC-B	-	WOM 45SS1 SC-B
Medium Oak	Satin Chrome/White	Ovolo	WOM DPN SC-W	-	WOM 45SS1 SC-W
	Nominal Size:		88.0mm x 88.0mm	88.0mm x 88.0mm	146.0mm x 88.0mm
	Minimum Wall Box Depth:		25mm	25mm	35mm
	Technical Insert Ref:		DPN	45N	45SS1

Woods

Connection Units



WOD SPN SC-B



WCD FO BC-W



WCM SPN SC-W



WOM FO BC-B



1 gang 13A
Double Pole
Fused Spur +
Neon



1 gang 13A
Fuse Only



1 gang 13A
Double Pole
Fused Spur +
Neon



1 gang 13A
Fuse Only

Front Plate	Insert Finish/ Surround Colour	Edge		
Antique Mahogany	Antique Brass/Black	Chamfered	WCA SPN AB-B	WCA FO AB-B
Antique Mahogany	Bright Chrome/Black	Chamfered	WCA SPN BC-B	WCA FO BC-B
Antique Mahogany	Bright Chrome/White	Chamfered	WCA SPN BC-W	WCA FO BC-W
Antique Mahogany	Polished Brass/Black	Chamfered	WCA SPN PB-B	WCA FO PB-B
Antique Mahogany	Polished Brass/White	Chamfered	WCA SPN PB-W	WCA FO PB-W
Antique Mahogany	Satin Chrome/Black	Chamfered	WCA SPN SC-B	WCA FO SC-B
Antique Mahogany	Satin Chrome/White	Chamfered	WCA SPN SC-W	WCA FO SC-W
Antique Mahogany	Antique Brass/Black	Ovolo	WOA SPN AB-B	WOA FO AB-B
Antique Mahogany	Bright Chrome/Black	Ovolo	WOA SPN BC-B	WOA FO BC-B
Antique Mahogany	Bright Chrome/White	Ovolo	WOA SPN BC-W	WOA FO BC-W
Antique Mahogany	Polished Brass/Black	Ovolo	WOA SPN PB-B	WOA FO PB-B
Antique Mahogany	Polished Brass/White	Ovolo	WOA SPN PB-W	WOA FO PB-W
Antique Mahogany	Satin Chrome/Black	Ovolo	WOA SPN SC-B	WOA FO SC-B
Antique Mahogany	Satin Chrome/White	Ovolo	WOA SPN SC-W	WOA FO SC-W
Dark Oak	Antique Brass/Black	Chamfered	WCD SPN AB-B	WCD FO AB-B
Dark Oak	Bright Chrome/Black	Chamfered	WCD SPN BC-B	WCD FO BC-B
Dark Oak	Bright Chrome/White	Chamfered	WCD SPN BC-W	WCD FO BC-W
Dark Oak	Polished Brass/Black	Chamfered	WCD SPN PB-B	WCD FO PB-B
Dark Oak	Polished Brass/White	Chamfered	WCD SPN PB-W	WCD FO PB-W
Dark Oak	Satin Chrome/Black	Chamfered	WCD SPN SC-B	WCD FO SC-B
Dark Oak	Satin Chrome/White	Chamfered	WCD SPN SC-W	WCD FO SC-W
Dark Oak	Antique Brass/Black	Ovolo	WOD SPN AB-B	WOD FO AB-B
Dark Oak	Bright Chrome/Black	Ovolo	WOD SPN BC-B	WOD FO BC-B
Dark Oak	Bright Chrome/White	Ovolo	WOD SPN BC-W	WOD FO BC-W
Dark Oak	Polished Brass/Black	Ovolo	WOD SPN PB-B	WOD FO PB-B
Dark Oak	Polished Brass/White	Ovolo	WOD SPN PB-W	WOD FO PB-W
Dark Oak	Satin Chrome/Black	Ovolo	WOD SPN SC-B	WOD FO SC-B
Dark Oak	Satin Chrome/White	Ovolo	WOD SPN SC-W	WOD FO SC-W
Nominal Size:			88.0mm x 88.0mm	88.0mm x 88.0mm
Minimum Wall Box Depth:			35mm	35mm
Technical Insert Ref:			SPN	FO

Front Plate	Insert Finish/ Surround Colour	Edge		
Light Oak	Antique Brass/Black	Chamfered	WCL SPN AB-B	WCL FO AB-B
Light Oak	Bright Chrome/Black	Chamfered	WCL SPN BC-B	WCL FO BC-B
Light Oak	Bright Chrome/White	Chamfered	WCL SPN BC-W	WCL FO BC-W
Light Oak	Polished Brass/Black	Chamfered	WCL SPN PB-B	WCL FO PB-B
Light Oak	Polished Brass/White	Chamfered	WCL SPN PB-W	WCL FO PB-W
Light Oak	Satin Chrome/Black	Chamfered	WCL SPN SC-B	WCL FO SC-B
Light Oak	Satin Chrome/White	Chamfered	WCL SPN SC-W	WCL FO SC-W
Light Oak	Antique Brass/Black	Ovolo	WOL SPN AB-B	WOL FO AB-B
Light Oak	Bright Chrome/Black	Ovolo	WOL SPN BC-B	WOL FO BC-B
Light Oak	Bright Chrome/White	Ovolo	WOL SPN BC-W	WOL FO BC-W
Light Oak	Polished Brass/Black	Ovolo	WOL SPN PB-B	WOL FO PB-B
Light Oak	Polished Brass/White	Ovolo	WOL SPN PB-W	WOL FO PB-W
Light Oak	Satin Chrome/Black	Ovolo	WOL SPN SC-B	WOL FO SC-B
Light Oak	Satin Chrome/White	Ovolo	WOL SPN SC-W	WOL FO SC-W
Medium Oak	Antique Brass/Black	Chamfered	WCM SPN AB-B	WCM FO AB-B
Medium Oak	Bright Chrome/Black	Chamfered	WCM SPN BC-B	WCM FO BC-B
Medium Oak	Bright Chrome/White	Chamfered	WCM SPN BC-W	WCM FO BC-W
Medium Oak	Polished Brass/Black	Chamfered	WCM SPN PB-B	WCM FO PB-B
Medium Oak	Polished Brass/White	Chamfered	WCM SPN PB-W	WCM FO PB-W
Medium Oak	Satin Chrome/Black	Chamfered	WCM SPN SC-B	WCM FO SC-B
Medium Oak	Satin Chrome/White	Chamfered	WCM SPN SC-W	WCM FO SC-W
Medium Oak	Antique Brass/Black	Ovolo	WOM SPN AB-B	WOM FO AB-B
Medium Oak	Bright Chrome/Black	Ovolo	WOM SPN BC-B	WOM FO BC-B
Medium Oak	Bright Chrome/White	Ovolo	WOM SPN BC-W	WOM FO BC-W
Medium Oak	Polished Brass/Black	Ovolo	WOM SPN PB-B	WOM FO PB-B
Medium Oak	Polished Brass/White	Ovolo	WOM SPN PB-W	WOM FO PB-W
Medium Oak	Satin Chrome/Black	Ovolo	WOM SPN SC-B	WOM FO SC-B
Medium Oak	Satin Chrome/White	Ovolo	WOM SPN SC-W	WOM FO SC-W
Nominal Size:			88.0mm x 88.0mm	88.0mm x 88.0mm
Minimum Wall Box Depth:			35mm	35mm
Technical Insert Ref:			SPN	FO

Woods

LED Trailing/Leading Edge Push On/Off Rotary 2 Way Switching Dimmers



WCD 1XLEDITB100 PB



WCA 3XLEDITB100 SC



WOM 3XLEDITB100 AB



WOL 4XLEDITB100 SC



1 gang 100W LED Trailing/Leading Edge On/Off Rotary 2 Way Switching Dimmer

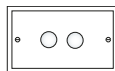

2 gang 100W LED Trailing/Leading Edge On/Off Rotary 2 Way Switching Dimmer

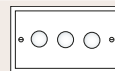

3 gang 100W LED Trailing/Leading Edge On/Off Rotary 2 Way Switching Dimmer

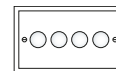

4 gang 100W LED Trailing/Leading Edge On/Off Rotary 2 Way Switching Dimmer

Front Plate	Insert Finish	Edge	1 gang 100W LED Trailing/Leading Edge On/Off Rotary 2 Way Switching Dimmer	2 gang 100W LED Trailing/Leading Edge On/Off Rotary 2 Way Switching Dimmer	3 gang 100W LED Trailing/Leading Edge On/Off Rotary 2 Way Switching Dimmer	4 gang 100W LED Trailing/Leading Edge On/Off Rotary 2 Way Switching Dimmer
Antique Mahogany	Antique Brass	Chamfered	WCA 1XLEDITB100 AB	WCA 2XLEDITB100 AB	WCA 3XLEDITB100 AB	WCA 4XLEDITB100 AB
Antique Mahogany	Bright Chrome	Chamfered	WCA 1XLEDITB100 BC	WCA 2XLEDITB100 BC	WCA 3XLEDITB100 BC	WCA 4XLEDITB100 BC
Antique Mahogany	Polished Brass	Chamfered	WCA 1XLEDITB100 PB	WCA 2XLEDITB100 PB	WCA 3XLEDITB100 PB	WCA 4XLEDITB100 PB
Antique Mahogany	Satin Chrome	Chamfered	WCA 1XLEDITB100 SC	WCA 2XLEDITB100 SC	WCA 3XLEDITB100 SC	WCA 4XLEDITB100 SC
Antique Mahogany	Antique Brass	Ovolo	WOA 1XLEDITB100 AB	WOA 2XLEDITB100 AB	WOA 3XLEDITB100 AB	WOA 4XLEDITB100 AB
Antique Mahogany	Bright Chrome	Ovolo	WOA 1XLEDITB100 BC	WOA 2XLEDITB100 BC	WOA 3XLEDITB100 BC	WOA 4XLEDITB100 BC
Antique Mahogany	Polished Brass	Ovolo	WOA 1XLEDITB100 PB	WOA 2XLEDITB100 PB	WOA 3XLEDITB100 PB	WOA 4XLEDITB100 PB
Antique Mahogany	Satin Chrome	Ovolo	WOA 1XLEDITB100 SC	WOA 2XLEDITB100 SC	WOA 3XLEDITB100 SC	WOA 4XLEDITB100 SC
Dark Oak	Antique Brass	Chamfered	WCD 1XLEDITB100 AB	WCD 2XLEDITB100 AB	WCD 3XLEDITB100 AB	WCD 4XLEDITB100 AB
Dark Oak	Bright Chrome	Chamfered	WCD 1XLEDITB100 BC	WCD 2XLEDITB100 BC	WCD 3XLEDITB100 BC	WCD 4XLEDITB100 BC
Dark Oak	Polished Brass	Chamfered	WCD 1XLEDITB100 PB	WCD 2XLEDITB100 PB	WCD 3XLEDITB100 PB	WCD 4XLEDITB100 PB
Dark Oak	Satin Chrome	Chamfered	WCD 1XLEDITB100 SC	WCD 2XLEDITB100 SC	WCD 3XLEDITB100 SC	WCD 4XLEDITB100 SC
Dark Oak	Antique Brass	Ovolo	WOD 1XLEDITB100 AB	WOD 2XLEDITB100 AB	WOD 3XLEDITB100 AB	WOD 4XLEDITB100 AB
Dark Oak	Bright Chrome	Ovolo	WOD 1XLEDITB100 BC	WOD 2XLEDITB100 BC	WOD 3XLEDITB100 BC	WOD 4XLEDITB100 BC
Dark Oak	Polished Brass	Ovolo	WOD 1XLEDITB100 PB	WOD 2XLEDITB100 PB	WOD 3XLEDITB100 PB	WOD 4XLEDITB100 PB
Dark Oak	Satin Chrome	Ovolo	WOD 1XLEDITB100 SC	WOD 2XLEDITB100 SC	WOD 3XLEDITB100 SC	WOD 4XLEDITB100 SC
Light Oak	Antique Brass	Chamfered	WCL 1XLEDITB100 AB	WCL 2XLEDITB100 AB	WCL 3XLEDITB100 AB	WCL 4XLEDITB100 AB
Light Oak	Bright Chrome	Chamfered	WCL 1XLEDITB100 BC	WCL 2XLEDITB100 BC	WCL 3XLEDITB100 BC	WCL 4XLEDITB100 BC
Light Oak	Polished Brass	Chamfered	WCL 1XLEDITB100 PB	WCL 2XLEDITB100 PB	WCL 3XLEDITB100 PB	WCL 4XLEDITB100 PB
Light Oak	Satin Chrome	Chamfered	WCL 1XLEDITB100 SC	WCL 2XLEDITB100 SC	WCL 3XLEDITB100 SC	WCL 4XLEDITB100 SC
Light Oak	Antique Brass	Ovolo	WOL 1XLEDITB100 AB	WOL 2XLEDITB100 AB	WOL 3XLEDITB100 AB	WOL 4XLEDITB100 AB
Light Oak	Bright Chrome	Ovolo	WOL 1XLEDITB100 BC	WOL 2XLEDITB100 BC	WOL 3XLEDITB100 BC	WOL 4XLEDITB100 BC
Light Oak	Polished Brass	Ovolo	WOL 1XLEDITB100 PB	WOL 2XLEDITB100 PB	WOL 3XLEDITB100 PB	WOL 4XLEDITB100 PB
Light Oak	Satin Chrome	Ovolo	WOL 1XLEDITB100 SC	WOL 2XLEDITB100 SC	WOL 3XLEDITB100 SC	WOL 4XLEDITB100 SC
Medium Oak	Antique Brass	Chamfered	WCM 1XLEDITB100 AB	WCM 2XLEDITB100 AB	WCM 3XLEDITB100 AB	WCM 4XLEDITB100 AB
Medium Oak	Bright Chrome	Chamfered	WCM 1XLEDITB100 BC	WCM 2XLEDITB100 BC	WCM 3XLEDITB100 BC	WCM 4XLEDITB100 BC
Medium Oak	Polished Brass	Chamfered	WCM 1XLEDITB100 PB	WCM 2XLEDITB100 PB	WCM 3XLEDITB100 PB	WCM 4XLEDITB100 PB
Medium Oak	Satin Chrome	Chamfered	WCM 1XLEDITB100 SC	WCM 2XLEDITB100 SC	WCM 3XLEDITB100 SC	WCM 4XLEDITB100 SC
Medium Oak	Antique Brass	Ovolo	WOM 1XLEDITB100 AB	WOM 2XLEDITB100 AB	WOM 3XLEDITB100 AB	WOM 4XLEDITB100 AB
Medium Oak	Bright Chrome	Ovolo	WOM 1XLEDITB100 BC	WOM 2XLEDITB100 BC	WOM 3XLEDITB100 BC	WOM 4XLEDITB100 BC
Medium Oak	Polished Brass	Ovolo	WOM 1XLEDITB100 PB	WOM 2XLEDITB100 PB	WOM 3XLEDITB100 PB	WOM 4XLEDITB100 PB
Medium Oak	Satin Chrome	Ovolo	WOM 1XLEDITB100 SC	WOM 2XLEDITB100 SC	WOM 3XLEDITB100 SC	WOM 4XLEDITB100 SC
Nominal Size:			88.0mm x 88.0mm	146.0mm x 88.0mm	146.0mm x 88.0mm	146.0mm x 88.0mm
Minimum Wall Box Depth:			35mm	35mm	35mm	35mm
Technical Insert Ref:			1XLEDITB	2XLEDITB	3XLEDITB	4XLEDITB

NOTE: Tungsten filament GU10 lamps must be branded and with a fused base.
 NOTE: Please refer to the Dimmer Technical Section for the max Wattage.
 NOTE: Please contact our Technical Department for compatibility.

Woods

Resistive Leading Edge Push On/Off Rotary 2 Way Switching Dimmers



WCA 1X40 SC



WCD 3X40 PB



WCM 3X40 SC



WOA 1X40 BC

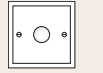

1 gang 400W Resistive Leading Edge Push On/Off Rotary 2 Way Switching Dimmer



2 gang 400W Resistive Leading Edge Push On/Off Rotary 2 Way Switching Dimmer
Max 300W per gang



3 gang 400W Resistive Leading Edge Push On/Off Rotary 2 Way Switching Dimmer
Max 300W per gang

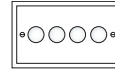

4 gang 400W Resistive Leading Edge Push On/Off Rotary 2 Way Switching Dimmer
Max 250W gang

Front Plate	Insert Finish	Edge				
Antique Mahogany	Antique Brass	Chamfered	WCA 1X40 AB	WCA 2X40 AB	WCA 3X40 AB	WCA 4X40 AB
Antique Mahogany	Bright Chrome	Chamfered	WCA 1X40 BC	WCA 2X40 BC	WCA 3X40 BC	WCA 4X40 BC
Antique Mahogany	Polished Brass	Chamfered	WCA 1X40 PB	WCA 2X40 PB	WCA 3X40 PB	WCA 4X40 PB
Antique Mahogany	Satin Chrome	Chamfered	WCA 1X40 SC	WCA 2X40 SC	WCA 3X40 SC	WCA 4X40 SC
Antique Mahogany	Antique Brass	Ovolo	WOA 1X40 AB	WOA 2X40 AB	WOA 3X40 AB	WOA 4X40 AB
Antique Mahogany	Bright Chrome	Ovolo	WOA 1X40 BC	WOA 2X40 BC	WOA 3X40 BC	WOA 4X40 BC
Antique Mahogany	Polished Brass	Ovolo	WOA 1X40 PB	WOA 2X40 PB	WOA 3X40 PB	WOA 4X40 PB
Antique Mahogany	Satin Chrome	Ovolo	WOA 1X40 SC	WOA 2X40 SC	WOA 3X40 SC	WOA 4X40 SC
Dark Oak	Antique Brass	Chamfered	WCD 1X40 AB	WCD 2X40 AB	WCD 3X40 AB	WCD 4X40 AB
Dark Oak	Bright Chrome	Chamfered	WCD 1X40 BC	WCD 2X40 BC	WCD 3X40 BC	WCD 4X40 BC
Dark Oak	Polished Brass	Chamfered	WCD 1X40 PB	WCD 2X40 PB	WCD 3X40 PB	WCD 4X40 PB
Dark Oak	Satin Chrome	Chamfered	WCD 1X40 SC	WCD 2X40 SC	WCD 3X40 SC	WCD 4X40 SC
Dark Oak	Antique Brass	Ovolo	WOD 1X40 AB	WOD 2X40 AB	WOD 3X40 AB	WOD 4X40 AB
Dark Oak	Bright Chrome	Ovolo	WOD 1X40 BC	WOD 2X40 BC	WOD 3X40 BC	WOD 4X40 BC
Dark Oak	Polished Brass	Ovolo	WOD 1X40 PB	WOD 2X40 PB	WOD 3X40 PB	WOD 4X40 PB
Dark Oak	Satin Chrome	Ovolo	WOD 1X40 SC	WOD 2X40 SC	WOD 3X40 SC	WOD 4X40 SC
Light Oak	Antique Brass	Chamfered	WCL 1X40 AB	WCL 2X40 AB	WCL 3X40 AB	WCL 4X40 AB
Light Oak	Bright Chrome	Chamfered	WCL 1X40 BC	WCL 2X40 BC	WCL 3X40 BC	WCL 4X40 BC
Light Oak	Polished Brass	Chamfered	WCL 1X40 PB	WCL 2X40 PB	WCL 3X40 PB	WCL 4X40 PB
Light Oak	Satin Chrome	Chamfered	WCL 1X40 SC	WCL 2X40 SC	WCL 3X40 SC	WCL 4X40 SC
Light Oak	Antique Brass	Ovolo	WOL 1X40 AB	WOL 2X40 AB	WOL 3X40 AB	WOL 4X40 AB
Light Oak	Bright Chrome	Ovolo	WOL 1X40 BC	WOL 2X40 BC	WOL 3X40 BC	WOL 4X40 BC
Light Oak	Polished Brass	Ovolo	WOL 1X40 PB	WOL 2X40 PB	WOL 3X40 PB	WOL 4X40 PB
Light Oak	Satin Chrome	Ovolo	WOL 1X40 SC	WOL 2X40 SC	WOL 3X40 SC	WOL 4X40 SC
Medium Oak	Antique Brass	Chamfered	WCM 1X40 AB	WCM 2X40 AB	WCM 3X40 AB	WCM 4X40 AB
Medium Oak	Bright Chrome	Chamfered	WCM 1X40 BC	WCM 2X40 BC	WCM 3X40 BC	WCM 4X40 BC
Medium Oak	Polished Brass	Chamfered	WCM 1X40 PB	WCM 2X40 PB	WCM 3X40 PB	WCM 4X40 PB
Medium Oak	Satin Chrome	Chamfered	WCM 1X40 SC	WCM 2X40 SC	WCM 3X40 SC	WCM 4X40 SC
Medium Oak	Antique Brass	Ovolo	WOM 1X40 AB	WOM 2X40 AB	WOM 3X40 AB	WOM 4X40 AB
Medium Oak	Bright Chrome	Ovolo	WOM 1X40 BC	WOM 2X40 BC	WOM 3X40 BC	WOM 4X40 BC
Medium Oak	Polished Brass	Ovolo	WOM 1X40 PB	WOM 2X40 PB	WOM 3X40 PB	WOM 4X40 PB
Medium Oak	Satin Chrome	Ovolo	WOM 1X40 SC	WOM 2X40 SC	WOM 3X40 SC	WOM 4X40 SC
Nominal Size:			88.0mm x 88.0mm	146.0mm x 88.0mm	146.0mm x 88.0mm	146.0mm x 88.0mm
Minimum Wall Box Depth:			35mm	35mm	35mm	35mm
Technical Insert Ref:			1X40	WD2X40	W3X40	W4X40

NOTE: Tungsten filament GU10 lamps must be branded and with a fused base
 NOTE: When using mains voltage halogen lamps – dimmers should be re-rated by 25%
 NOTE: When dimming LED lamps de-rate by 75% - please contact our Technical Department for compatibility.
 NOTE: Please refer to the Dimmer Technical Section for the max wattage

Woods

Inductive Leading Edge Push On/Off Rotary 2 Way Switching Dimmers



WCA 1X2V SC

WOODS RANGE



1 gang 200VA
Inductive Leading
Edge Push On/Off
Rotary 2 Way Switching
Dimmer

Front Plate	Insert Finish	Edge	
Antique Mahogany	Antique Brass	Chamfered	WCA 1X2V AB
Antique Mahogany	Bright Chrome	Chamfered	WCA 1X2V BC
Antique Mahogany	Polished Brass	Chamfered	WCA 1X2V PB
Antique Mahogany	Satin Chrome	Chamfered	WCA 1X2V SC
Antique Mahogany	Antique Brass	Ovolo	WOA 1X2V AB
Antique Mahogany	Bright Chrome	Ovolo	WOA 1X2V BC
Antique Mahogany	Polished Brass	Ovolo	WOA 1X2V PB
Antique Mahogany	Satin Chrome	Ovolo	WOA 1X2V SC
Dark Oak	Antique Brass	Chamfered	WCD 1X2V AB
Dark Oak	Bright Chrome	Chamfered	WCD 1X2V BC
Dark Oak	Polished Brass	Chamfered	WCD 1X2V PB
Dark Oak	Satin Chrome	Chamfered	WCD 1X2V SC
Dark Oak	Antique Brass	Ovolo	WOD 1X2V AB
Dark Oak	Bright Chrome	Ovolo	WOD 1X2V BC
Dark Oak	Polished Brass	Ovolo	WOD 1X2V PB
Dark Oak	Satin Chrome	Ovolo	WOD 1X2V SC
Light Oak	Antique Brass	Chamfered	WCL 1X2V AB
Light Oak	Bright Chrome	Chamfered	WCL 1X2V BC
Light Oak	Polished Brass	Chamfered	WCL 1X2V PB
Light Oak	Satin Chrome	Chamfered	WCL 1X2V SC
Light Oak	Antique Brass	Ovolo	WOL 1X2V AB
Light Oak	Bright Chrome	Ovolo	WOL 1X2V BC
Light Oak	Polished Brass	Ovolo	WOL 1X2V PB
Light Oak	Satin Chrome	Ovolo	WOL 1X2V SC
Medium Oak	Antique Brass	Chamfered	WCM 1X2V AB
Medium Oak	Bright Chrome	Chamfered	WCM 1X2V BC
Medium Oak	Polished Brass	Chamfered	WCM 1X2V PB
Medium Oak	Satin Chrome	Chamfered	WCM 1X2V SC
Medium Oak	Antique Brass	Ovolo	WOM 1X2V AB
Medium Oak	Bright Chrome	Ovolo	WOM 1X2V BC
Medium Oak	Polished Brass	Ovolo	WOM 1X2V PB
Medium Oak	Satin Chrome	Ovolo	WOM 1X2V SC
	Nominal Size:		88.0mm x 88.0mm
	Minimum Wall Box Depth:		35mm
	Technical Insert Ref:		1X2V

NOTE: Tungsten filament GU10 lamps must be branded and with a fused base

NOTE: When using mains voltage halogen lamps – dimmers should be re-rated by 25%

NOTE: When dimming LED lamps de-rate by 75% - please contact our Technical Department for compatibility.

NOTE: Please refer to the Dimmer Technical Section for the max wattage

Woods

Resistive/Inductive Trailing Edge Push On/Off Rotary Multi-Way Dimmers



WOL 1XTE BC



WOA 2XTE AB



WCA 3XTE SC



WOM 4XTE AB



1 gang 250W/210VA Resistive/Inductive Trailing Edge Push On/Off Rotary Multi-Way Dimmer



2 gang 250W/210VA Resistive/Inductive Trailing Edge Push On/Off Rotary Multi-Way Dimmer (Max 200W per gang)



3 gang 250W/210VA Resistive/Inductive Trailing Edge Push On/Off Rotary Multi-Way Dimmer



4 gang 250W/210VA Resistive/Inductive Trailing Edge Push On/Off Rotary Multi-Way Dimmer (Max 200W per gang)

Front Plate	Insert Finish	Edge	1 gang 250W/210VA Resistive/Inductive Trailing Edge Push On/Off Rotary Multi-Way Dimmer	2 gang 250W/210VA Resistive/Inductive Trailing Edge Push On/Off Rotary Multi-Way Dimmer (Max 200W per gang)	3 gang 250W/210VA Resistive/Inductive Trailing Edge Push On/Off Rotary Multi-Way Dimmer	4 gang 250W/210VA Resistive/Inductive Trailing Edge Push On/Off Rotary Multi-Way Dimmer (Max 200W per gang)
Antique Mahogany	Antique Brass	Chamfered	WCA 1XTE AB	WCA 2XTE AB	WCA 3XTE AB	WCA 4XTE AB
Antique Mahogany	Bright Chrome	Chamfered	WCA 1XTE BC	WCA 2XTE BC	WCA 3XTE BC	WCA 4XTE BC
Antique Mahogany	Polished Brass	Chamfered	WCA 1XTE PB	WCA 2XTE PB	WCA 3XTE PB	WCA 4XTE PB
Antique Mahogany	Satin Chrome	Chamfered	WCA 1XTE SC	WCA 2XTE SC	WCA 3XTE SC	WCA 4XTE SC
Antique Mahogany	Antique Brass	Ovolo	WOA 1XTE AB	WOA 2XTE AB	WOA 3XTE AB	WOA 4XTE AB
Antique Mahogany	Bright Chrome	Ovolo	WOA 1XTE BC	WOA 2XTE BC	WOA 3XTE BC	WOA 4XTE BC
Antique Mahogany	Polished Brass	Ovolo	WOA 1XTE PB	WOA 2XTE PB	WOA 3XTE PB	WOA 4XTE PB
Antique Mahogany	Satin Chrome	Ovolo	WOA 1XTE SC	WOA 2XTE SC	WOA 3XTE SC	WOA 4XTE SC
Dark Oak	Antique Brass	Chamfered	WCD 1XTE AB	WCD 2XTE AB	WCD 3XTE AB	WCD 4XTE AB
Dark Oak	Bright Chrome	Chamfered	WCD 1XTE BC	WCD 2XTE BC	WCD 3XTE BC	WCD 4XTE BC
Dark Oak	Polished Brass	Chamfered	WCD 1XTE PB	WCD 2XTE PB	WCD 3XTE PB	WCD 4XTE PB
Dark Oak	Satin Chrome	Chamfered	WCD 1XTE SC	WCD 2XTE SC	WCD 3XTE SC	WCD 4XTE SC
Dark Oak	Antique Brass	Ovolo	WOD 1XTE AB	WOD 2XTE AB	WOD 3XTE AB	WOD 4XTE AB
Dark Oak	Bright Chrome	Ovolo	WOD 1XTE BC	WOD 2XTE BC	WOD 3XTE BC	WOD 4XTE BC
Dark Oak	Polished Brass	Ovolo	WOD 1XTE PB	WOD 2XTE PB	WOD 3XTE PB	WOD 4XTE PB
Dark Oak	Satin Chrome	Ovolo	WOD 1XTE SC	WOD 2XTE SC	WOD 3XTE SC	WOD 4XTE SC
Light Oak	Antique Brass	Chamfered	WCL 1XTE AB	WCL 2XTE AB	WCL 3XTE AB	WCL 4XTE AB
Light Oak	Bright Chrome	Chamfered	WCL 1XTE BC	WCL 2XTE BC	WCL 3XTE BC	WCL 4XTE BC
Light Oak	Polished Brass	Chamfered	WCL 1XTE PB	WCL 2XTE PB	WCL 3XTE PB	WCL 4XTE PB
Light Oak	Satin Chrome	Chamfered	WCL 1XTE SC	WCL 2XTE SC	WCL 3XTE SC	WCL 4XTE SC
Light Oak	Antique Brass	Ovolo	WOL 1XTE AB	WOL 2XTE AB	WOL 3XTE AB	WOL 4XTE AB
Light Oak	Bright Chrome	Ovolo	WOL 1XTE BC	WOL 2XTE BC	WOL 3XTE BC	WOL 4XTE BC
Light Oak	Polished Brass	Ovolo	WOL 1XTE PB	WOL 2XTE PB	WOL 3XTE PB	WOL 4XTE PB
Light Oak	Satin Chrome	Ovolo	WOL 1XTE SC	WOL 2XTE SC	WOL 3XTE SC	WOL 4XTE SC
Medium Oak	Antique Brass	Chamfered	WCM 1XTE AB	WCM 2XTE AB	WCM 3XTE AB	WCM 4XTE AB
Medium Oak	Bright Chrome	Chamfered	WCM 1XTE BC	WCM 2XTE BC	WCM 3XTE BC	WCM 4XTE BC
Medium Oak	Polished Brass	Chamfered	WCM 1XTE PB	WCM 2XTE PB	WCM 3XTE PB	WCM 4XTE PB
Medium Oak	Satin Chrome	Chamfered	WCM 1XTE SC	WCM 2XTE SC	WCM 3XTE SC	WCM 4XTE SC
Medium Oak	Antique Brass	Ovolo	WOM 1XTE AB	WOM 2XTE AB	WOM 3XTE AB	WOM 4XTE AB
Medium Oak	Bright Chrome	Ovolo	WOM 1XTE BC	WOM 2XTE BC	WOM 3XTE BC	WOM 4XTE BC
Medium Oak	Polished Brass	Ovolo	WOM 1XTE PB	WOM 2XTE PB	WOM 3XTE PB	WOM 4XTE PB
Medium Oak	Satin Chrome	Ovolo	WOM 1XTE SC	WOM 2XTE SC	WOM 3XTE SC	WOM 4XTE SC
		Nominal Size: Minimum Wall Box Depth: Technical Insert Ref:	88.0mm x 88.0mm 35mm 1XTE	88.0mm x 88.0mm 35mm W2XTE	146.0mm x 88.0mm 35mm 3XTE	146.0mm x 88.0mm 35mm W4XTE

NOTE: Tungsten filament GU10 lamps must be branded and with a fused base
 NOTE: When using mains voltage halogen lamps – dimmers should be re-rated by 25%
 NOTE: When dimming LED lamps de-rate by 75% - please contact our Technical Department for compatibility.
 NOTE: Please refer to the Dimmer Technical Section for the max wattage

Woods

EuroFix Apertured Plates complete with Grid



WCA EURO2



WOA EURO4



2 Module EuroFix
50x50mm Apertured
Plate with Grid

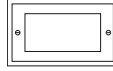

4 Module EuroFix
100x50mm Apertured
Plate with Grid

Front Plate	Edge	2 Module EuroFix 50x50mm Apertured Plate with Grid	4 Module EuroFix 100x50mm Apertured Plate with Grid
Antique Mahogany	Chamfered	WCA EURO2	WCA EURO4
Antique Mahogany	Ovolo	WOA EURO2	WOA EURO4
Light Oak	Chamfered	WCL EURO2	WCL EURO4
Light Oak	Ovolo	WOL EURO2	WOL EURO4
Medium Oak	Chamfered	WCM EURO2	WCM EURO4
Medium Oak	Ovolo	WOM EURO2	WOM EURO4
Dark Oak	Chamfered	WCD EURO2	WCD EURO4
Dark Oak	Ovolo	WOD EURO2	WOD EURO4
Nominal Size:		88.0mm x 88.0mm	146.0mm x 88.0mm
Minimum Wall Box Depth:		As Per Inserts	As Per Inserts
Technical Insert Ref:		EURO2	EURO4

Note: Minimum Wall Box depth is dependant on the EuroFix insert fitted, please see the EuroFix section for our complete range of inserts.

Woods

Blank Plates



WCA BPS

Front Plate	Edge	Single Blank Plate	Double Blank Plate
Antique Mahogany	Chamfered	WCA BPS	WCA BPD
Antique Mahogany	Ovolo	WOA BPS	WOA BPD
Dark Oak	Chamfered	WCD BPS	WCD BPD
Dark Oak	Ovolo	WOD BPS	WOD BPD
Light Oak	Chamfered	WCL BPS	WCL BPD
Light Oak	Ovolo	WOL BPS	WOL BPD
Medium Oak	Chamfered	WCM BPS	WCM BPD
Medium Oak	Ovolo	WOM BPS	WOM BPD
	Nominal Size:	88.0mm x 88.0mm	146.0mm x 88.0mm
	Minimum Wall Box Depth:	Any Box	Any Box
	Technical Insert Ref:	BPS	BPD

Mounting Box Surround



Single



Double

Wood Colour	Single Surface Mounting Box Surround Depth 30mm	Double Surface Mounting Box Surround Depth 30mm
Antique Mahogany	WA BFS	WA BFD
Dark Oak	WD BFS	WD BFD
Light Oak	WL BFS	WL BFD
Medium Oak	WM BFS	WM BFD
	Nominal Size:	90x90x30mm
	Minimum Wall Box Depth:	25mm
	Technical Insert Ref:	WBFS
		148x90x30mm
		25mm
		WBFD



Bloomsbury

Antique style Plain or Fluted Domes with Toggle Switches on Natural Wood Plinth Plates

Bloomsbury replicates the traditional style of the original light switch while meeting today's standards. The range features two designs of dome, a Plain Dome in Polished Brass or Bright Chrome and a Fluted Dome in Polished Brass or Antique Brass - both come with a choice of either Black or White collars.

- Classic style
- Fits most flush mounted metal wall boxes
- Four different finishes with a choice of Ovolo or Chamfered edge
- Fluted or plain dome design
- Timber sourced from suppliers who carry the FSC logo

Bloomsbury Range



BOAF T21 AB-B



BCLP T21 PB-W



BODF T21 PB-W



BOAF T23 AB-B

Wood Finishes

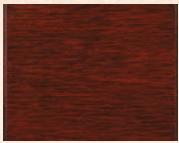

Antique Mahogany

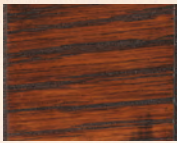

Dark Oak



Medium Oak



Light Oak

Edges

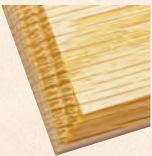

Chamfered Profile Edge

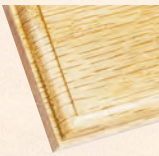

Ovolo Profile Edge

Insert Finishes



Polished Brass



Antique Brass



Bright Chrome

Bloomsbury Fluted Dome

Toggle Switches



BCAF T21 AB-W



BCDF T22 PB-B



BCLF T24 AB-B

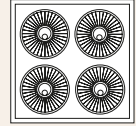
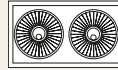

Plate Finish	Dome & Insert / Collar Finish	Edge	1 gang 20AX 2 Way Toggle	2 gang 20AX 2 Way Toggle	3 gang 20AX 2 Way Toggle	4 gang 20AX 2 Way Toggle
Antique Mahogany	Antique Brass/Black Collar	Chamfered	BCAF T21 AB-B	BCAF T22 AB-B	BCAF T23 AB-B	BCAF T24 AB-B
Antique Mahogany	Antique Brass/White Collar	Chamfered	BCAF T21 AB-W	BCAF T22 AB-W	BCAF T23 AB-W	BCAF T24 AB-W
Antique Mahogany	Polished Brass/Black Collar	Chamfered	BCAF T21 PB-B	BCAF T22 PB-B	BCAF T23 PB-B	BCAF T24 PB-B
Antique Mahogany	Polished Brass/White Collar	Chamfered	BCAF T21 PB-W	BCAF T22 PB-W	BCAF T23 PB-W	BCAF T24 PB-W
Antique Mahogany	Antique Brass/Black Collar	Ovolo	BOAF T21 AB-B	BOAF T22 AB-B	BOAF T23 AB-B	BOAF T24 AB-B
Antique Mahogany	Antique Brass/White Collar	Ovolo	BOAF T21 AB-W	BOAF T22 AB-W	BOAF T23 AB-W	BOAF T24 AB-W
Antique Mahogany	Polished Brass/Black Collar	Ovolo	BOAF T21 PB-B	BOAF T22 PB-B	BOAF T23 PB-B	BOAF T24 PB-B
Antique Mahogany	Polished Brass/White Collar	Ovolo	BOAF T21 PB-W	BOAF T22 PB-W	BOAF T23 PB-W	BOAF T24 PB-W
Dark Oak	Antique Brass/Black Collar	Chamfered	BCDF T21 AB-B	BCDF T22 AB-B	BCDF T23 AB-B	BCDF T24 AB-B
Dark Oak	Antique Brass/White Collar	Chamfered	BCDF T21 AB-W	BCDF T22 AB-W	BCDF T23 AB-W	BCDF T24 AB-W
Dark Oak	Polished Brass/Black Collar	Chamfered	BCDF T21 PB-B	BCDF T22 PB-B	BCDF T23 PB-B	BCDF T24 PB-B
Dark Oak	Polished Brass/White Collar	Chamfered	BCDF T21 PB-W	BCDF T22 PB-W	BCDF T23 PB-W	BCDF T24 PB-W
Dark Oak	Antique Brass/Black Collar	Ovolo	BODF T21 AB-B	BODF T22 AB-B	BODF T23 AB-B	BODF T24 AB-B
Dark Oak	Antique Brass/White Collar	Ovolo	BODF T21 AB-W	BODF T22 AB-W	BODF T23 AB-W	BODF T24 AB-W
Dark Oak	Polished Brass/Black Collar	Ovolo	BODF T21 PB-B	BODF T22 PB-B	BODF T23 PB-B	BODF T24 PB-B
Dark Oak	Polished Brass/White Collar	Ovolo	BODF T21 PB-W	BODF T22 PB-W	BODF T23 PB-W	BODF T24 PB-W
Light Oak	Antique Brass/Black Collar	Chamfered	BCLF T21 AB-B	BCLF T22 AB-B	BCLF T23 AB-B	BCLF T24 AB-B
Light Oak	Antique Brass/White Collar	Chamfered	BCLF T21 AB-W	BCLF T22 AB-W	BCLF T23 AB-W	BCLF T24 AB-W
Light Oak	Polished Brass/Black Collar	Chamfered	BCLF T21 PB-B	BCLF T22 PB-B	BCLF T23 PB-B	BCLF T24 PB-B
Light Oak	Polished Brass/White Collar	Chamfered	BCLF T21 PB-W	BCLF T22 PB-W	BCLF T23 PB-W	BCLF T24 PB-W
Light Oak	Antique Brass/Black Collar	Ovolo	BOLF T21 AB-B	BOLF T22 AB-B	BOLF T23 AB-B	BOLF T24 AB-B
Light Oak	Antique Brass/White Collar	Ovolo	BOLF T21 AB-W	BOLF T22 AB-W	BOLF T23 AB-W	BOLF T24 AB-W
Light Oak	Polished Brass/Black Collar	Ovolo	BOLF T21 PB-B	BOLF T22 PB-B	BOLF T23 PB-B	BOLF T24 PB-B
Light Oak	Polished Brass/White Collar	Ovolo	BOLF T21 PB-W	BOLF T22 PB-W	BOLF T23 PB-W	BOLF T24 PB-W
Medium Oak	Antique Brass/Black Collar	Chamfered	BCMF T21 AB-B	BCMF T22 AB-B	BCMF T23 AB-B	BCMF T24 AB-B
Medium Oak	Antique Brass/White Collar	Chamfered	BCMF T21 AB-W	BCMF T22 AB-W	BCMF T23 AB-W	BCMF T24 AB-W
Medium Oak	Polished Brass/Black Collar	Chamfered	BCMF T21 PB-B	BCMF T22 PB-B	BCMF T23 PB-B	BCMF T24 PB-B
Medium Oak	Polished Brass/White Collar	Chamfered	BCMF T21 PB-W	BCMF T22 PB-W	BCMF T23 PB-W	BCMF T24 PB-W
Medium Oak	Antique Brass/Black Collar	Ovolo	BOMF T21 AB-B	BOMF T22 AB-B	BOMF T23 AB-B	BOMF T24 AB-B
Medium Oak	Antique Brass/White Collar	Ovolo	BOMF T21 AB-W	BOMF T22 AB-W	BOMF T23 AB-W	BOMF T24 AB-W
Medium Oak	Polished Brass/Black Collar	Ovolo	BOMF T21 PB-B	BOMF T22 PB-B	BOMF T23 PB-B	BOMF T24 PB-B
Medium Oak	Polished Brass/White Collar	Ovolo	BOMF T21 PB-W	BOMF T22 PB-W	BOMF T23 PB-W	BOMF T24 PB-W
	Nominal Size:		88.0mm x 88.0mm	154mm x 88.0mm	88.0mm x 230mm	163mm x 163mm
	Minimum Wall Box Depth:		25mm	25mm	35mm	25mm
	Technical Insert Ref:		T21	T22	T23	T24

Bloomsbury Fluted Dome

Toggle Switches





BOMF T31 PB-W



BOLF T32 AB-W

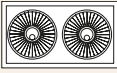

BODF TDP PB-B

Plate Finish	Dome & Insert / Collar Finish	Edge			
			1 gang 20AX Intermediate Toggle	2 gang 20AX Intermediate Toggle	1 gang 20AX Double Pole Toggle
Antique Mahogany	Antique Brass/Black Collar	Chamfered	BCAF T31 AB-B	BCAF T32 AB-B	BCAF TDP AB-B
Antique Mahogany	Antique Brass/White Collar	Chamfered	BCAF T31 AB-W	BCAF T32 AB-W	BCAF TDP AB-W
Antique Mahogany	Polished Brass/Black Collar	Chamfered	BCAF T31 PB-B	BCAF T32 PB-B	BCAF TDP PB-B
Antique Mahogany	Polished Brass/White Collar	Chamfered	BCAF T31 PB-W	BCAF T32 PB-W	BCAF TDP PB-W
Antique Mahogany	Antique Brass/Black Collar	Ovolo	BOAF T31 AB-B	BOAF T32 AB-B	BOAF TDP AB-B
Antique Mahogany	Antique Brass/White Collar	Ovolo	BOAF T31 AB-W	BOAF T32 AB-W	BOAF TDP AB-W
Antique Mahogany	Polished Brass/Black Collar	Ovolo	BOAF T31 PB-B	BOAF T32 PB-B	BOAF TDP PB-B
Antique Mahogany	Polished Brass/White Collar	Ovolo	BOAF T31 PB-W	BOAF T32 PB-W	BOAF TDP PB-W
Dark Oak	Antique Brass/Black Collar	Chamfered	BCDF T31 AB-B	BCDF T32 AB-B	BCDF TDP AB-B
Dark Oak	Antique Brass/White Collar	Chamfered	BCDF T31 AB-W	BCDF T32 AB-W	BCDF TDP AB-W
Dark Oak	Polished Brass/Black Collar	Chamfered	BCDF T31 PB-B	BCDF T32 PB-B	BCDF TDP PB-B
Dark Oak	Polished Brass/White Collar	Chamfered	BCDF T31 PB-W	BCDF T32 PB-W	BCDF TDP PB-W
Dark Oak	Antique Brass/Black Collar	Ovolo	BODF T31 AB-B	BODF T32 AB-B	BODF TDP AB-B
Dark Oak	Antique Brass/White Collar	Ovolo	BODF T31 AB-W	BODF T32 AB-W	BODF TDP AB-W
Dark Oak	Polished Brass/Black Collar	Ovolo	BODF T31 PB-B	BODF T32 PB-B	BODF TDP PB-B
Dark Oak	Polished Brass/White Collar	Ovolo	BODF T31 PB-W	BODF T32 PB-W	BODF TDP PB-W
Light Oak	Antique Brass/Black Collar	Chamfered	BCLF T31 AB-B	BCLF T32 AB-B	BCLF TDP AB-B
Light Oak	Antique Brass/White Collar	Chamfered	BCLF T31 AB-W	BCLF T32 AB-W	BCLF TDP AB-W
Light Oak	Polished Brass/Black Collar	Chamfered	BCLF T31 PB-B	BCLF T32 PB-B	BCLF TDP PB-B
Light Oak	Polished Brass/White Collar	Chamfered	BCLF T31 PB-W	BCLF T32 PB-W	BCLF TDP PB-W
Light Oak	Antique Brass/Black Collar	Ovolo	BOLF T31 AB-B	BOLF T32 AB-B	BOLF TDP AB-B
Light Oak	Antique Brass/White Collar	Ovolo	BOLF T31 AB-W	BOLF T32 AB-W	BOLF TDP AB-W
Light Oak	Polished Brass/Black Collar	Ovolo	BOLF T31 PB-B	BOLF T32 PB-B	BOLF TDP PB-B
Light Oak	Polished Brass/White Collar	Ovolo	BOLF T31 PB-W	BOLF T32 PB-W	BOLF TDP PB-W
Medium Oak	Antique Brass/Black Collar	Chamfered	BCMF T31 AB-B	BCMF T32 AB-B	BCMF TDP AB-B
Medium Oak	Antique Brass/White Collar	Chamfered	BCMF T31 AB-W	BCMF T32 AB-W	BCMF TDP AB-W
Medium Oak	Polished Brass/Black Collar	Chamfered	BCMF T31 PB-B	BCMF T32 PB-B	BCMF TDP PB-B
Medium Oak	Polished Brass/White Collar	Chamfered	BCMF T31 PB-W	BCMF T32 PB-W	BCMF TDP PB-W
Medium Oak	Antique Brass/Black Collar	Ovolo	BOMF T31 AB-B	BOMF T32 AB-B	BOMF TDP AB-B
Medium Oak	Antique Brass/White Collar	Ovolo	BOMF T31 AB-W	BOMF T32 AB-W	BOMF TDP AB-W
Medium Oak	Polished Brass/Black Collar	Ovolo	BOMF T31 PB-B	BOMF T32 PB-B	BOMF TDP PB-B
Medium Oak	Polished Brass/White Collar	Ovolo	BOMF T31 PB-W	BOMF T32 PB-W	BOMF TDP PB-W
Nominal Size:			88.0mm x 88.0mm	154mm x 88.0mm	88.0mm x 88.0mm
Minimum Wall Box Depth:			25mm	25mm	25mm
Technical Insert Ref:			T31	T32	TDP

Bloomsbury Plain Dome

Toggle Switches



BCMP T21 BC-B



BOAP T22 BC-W



BODP T24 PB-W

Plate Finish	Dome & Insert / Collar Finish	Edge	1 gang 20AX 2 Way Toggle	2 gang 20AX 2 Way Toggle	3 gang 20AX 2 Way Toggle	4 gang 20AX 2 Way Toggle
Antique Mahogany	Bright Chrome/Black Collar	Chamfered	BCAP T21 BC-B	BCAP T22 BC-B	BCAP T23 BC-B	BCAP T24 BC-B
Antique Mahogany	Bright Chrome/White Collar	Chamfered	BCAP T21 BC-W	BCAP T22 BC-W	BCAP T23 BC-W	BCAP T24 BC-W
Antique Mahogany	Polished Brass/Black Collar	Chamfered	BCAP T21 PB-B	BCAP T22 PB-B	BCAP T23 PB-B	BCAP T24 PB-B
Antique Mahogany	Polished Brass/White Collar	Chamfered	BCAP T21 PB-W	BCAP T22 PB-W	BCAP T23 PB-W	BCAP T24 PB-W
Antique Mahogany	Bright Chrome/Black Collar	Ovolo	BOAP T21 BC-B	BOAP T22 BC-B	BOAP T23 BC-B	BOAP T24 BC-B
Antique Mahogany	Bright Chrome/White Collar	Ovolo	BOAP T21 BC-W	BOAP T22 BC-W	BOAP T23 BC-W	BOAP T24 BC-W
Antique Mahogany	Polished Brass/Black Collar	Ovolo	BOAP T21 PB-B	BOAP T22 PB-B	BOAP T23 PB-B	BOAP T24 PB-B
Antique Mahogany	Polished Brass/White Collar	Ovolo	BOAP T21 PB-W	BOAP T22 PB-W	BOAP T23 PB-W	BOAP T24 PB-W
Dark Oak	Bright Chrome/Black Collar	Chamfered	BCDP T21 BC-B	BCDP T22 BC-B	BCDP T23 BC-B	BCDP T24 BC-B
Dark Oak	Bright Chrome/White Collar	Chamfered	BCDP T21 BC-W	BCDP T22 BC-W	BCDP T23 BC-W	BCDP T24 BC-W
Dark Oak	Polished Brass/Black Collar	Chamfered	BCDP T21 PB-B	BCDP T22 PB-B	BCDP T23 PB-B	BCDP T24 PB-B
Dark Oak	Polished Brass/White Collar	Chamfered	BCDP T21 PB-W	BCDP T22 PB-W	BCDP T23 PB-W	BCDP T24 PB-W
Dark Oak	Bright Chrome/Black Collar	Ovolo	BODP T21 BC-B	BODP T22 BC-B	BODP T23 BC-B	BODP T24 BC-B
Dark Oak	Bright Chrome/White Collar	Ovolo	BODP T21 BC-W	BODP T22 BC-W	BODP T23 BC-W	BODP T24 BC-W
Dark Oak	Polished Brass/Black Collar	Ovolo	BODP T21 PB-B	BODP T22 PB-B	BODP T23 PB-B	BODP T24 PB-B
Dark Oak	Polished Brass/White Collar	Ovolo	BODP T21 PB-W	BODP T22 PB-W	BODP T23 PB-W	BODP T24 PB-W
Light Oak	Bright Chrome/Black Collar	Chamfered	BCLP T21 BC-B	BCLP T22 BC-B	BCLP T23 BC-B	BCLP T24 BC-B
Light Oak	Bright Chrome/White Collar	Chamfered	BCLP T21 BC-W	BCLP T22 BC-W	BCLP T23 BC-W	BCLP T24 BC-W
Light Oak	Polished Brass/Black Collar	Chamfered	BCLP T21 PB-B	BCLP T22 PB-B	BCLP T23 PB-B	BCLP T24 PB-B
Light Oak	Polished Brass/White Collar	Chamfered	BCLP T21 PB-W	BCLP T22 PB-W	BCLP T23 PB-W	BCLP T24 PB-W
Light Oak	Bright Chrome/Black Collar	Ovolo	BOLP T21 BC-B	BOLP T22 BC-B	BOLP T23 BC-B	BOLP T24 BC-B
Light Oak	Bright Chrome/White Collar	Ovolo	BOLP T21 BC-W	BOLP T22 BC-W	BOLP T23 BC-W	BOLP T24 BC-W
Light Oak	Polished Brass/Black Collar	Ovolo	BOLP T21 PB-B	BOLP T22 PB-B	BOLP T23 PB-B	BOLP T24 PB-B
Light Oak	Polished Brass/White Collar	Ovolo	BOLP T21 PB-W	BOLP T22 PB-W	BOLP T23 PB-W	BOLP T24 PB-W
Medium Oak	Bright Chrome/Black Collar	Chamfered	BCMP T21 BC-B	BCMP T22 BC-B	BCMP T23 BC-B	BCMP T24 BC-B
Medium Oak	Bright Chrome/White Collar	Chamfered	BCMP T21 BC-W	BCMP T22 BC-W	BCMP T23 BC-W	BCMP T24 BC-W
Medium Oak	Polished Brass/Black Collar	Chamfered	BCMP T21 PB-B	BCMP T22 PB-B	BCMP T23 PB-B	BCMP T24 PB-B
Medium Oak	Polished Brass/White Collar	Chamfered	BCMP T21 PB-W	BCMP T22 PB-W	BCMP T23 PB-W	BCMP T24 PB-W
Medium Oak	Bright Chrome/Black Collar	Ovolo	BOMP T21 BC-B	BOMP T22 BC-B	BOMP T23 BC-B	BOMP T24 BC-B
Medium Oak	Bright Chrome/White Collar	Ovolo	BOMP T21 BC-W	BOMP T22 BC-W	BOMP T23 BC-W	BOMP T24 BC-W
Medium Oak	Polished Brass/Black Collar	Ovolo	BOMP T21 PB-B	BOMP T22 PB-B	BOMP T23 PB-B	BOMP T24 PB-B
Medium Oak	Polished Brass/White Collar	Ovolo	BOMP T21 PB-W	BOMP T22 PB-W	BOMP T23 PB-W	BOMP T24 PB-W
Nominal Size:			88.0mm x 88.0mm	154mm x 88.0mm	88.0mm x 230mm	163mm x 163mm
Minimum Wall Box Depth:			25mm	25mm	35mm	25mm
Technical Insert Ref:			T21	T22	T23	T24

Bloomsbury Plain Dome

Toggle Switches



BCDP T31 BC-B





BCDP T32 BC-W



BCLP TDP BC-B

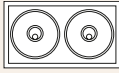

BCLP TDP PB-W

Plate Finish	Dome & Insert / Collar Finish	Edge			
			1 gang 20AX Intermediate Toggle	2 gang 20AX Intermediate Toggle	1 gang 20AX Double Pole Toggle
Antique Mahogany	Bright Chrome/Black Collar	Chamfered	BCAP T31 BC-B	BCAP T32 BC-B	BCAP TDP BC-B
Antique Mahogany	Bright Chrome/White Collar	Chamfered	BCAP T31 BC-W	BCAP T32 BC-W	BCAP TDP BC-W
Antique Mahogany	Polished Brass/Black Collar	Chamfered	BCAP T31 PB-B	BCAP T32 PB-B	BCAP TDP PB-B
Antique Mahogany	Polished Brass/White Collar	Chamfered	BCAP T31 PB-W	BCAP T32 PB-W	BCAP TDP PB-W
Antique Mahogany	Bright Chrome/Black Collar	Ovolo	BOAP T31 BC-B	BOAP T32 BC-B	BOAP TDP BC-B
Antique Mahogany	Bright Chrome/White Collar	Ovolo	BOAP T31 BC-W	BOAP T32 BC-W	BOAP TDP BC-W
Antique Mahogany	Polished Brass/Black Collar	Ovolo	BOAP T31 PB-B	BOAP T32 PB-B	BOAP TDP PB-B
Antique Mahogany	Polished Brass/White Collar	Ovolo	BOAP T31 PB-W	BOAP T32 PB-W	BOAP TDP PB-W
Dark Oak	Bright Chrome/Black Collar	Chamfered	BCDP T31 BC-B	BCDP T32 BC-B	BCDP TDP BC-B
Dark Oak	Bright Chrome/White Collar	Chamfered	BCDP T31 BC-W	BCDP T32 BC-W	BCDP TDP BC-W
Dark Oak	Polished Brass/Black Collar	Chamfered	BCDP T31 PB-B	BCDP T32 PB-B	BCDP TDP PB-B
Dark Oak	Polished Brass/White Collar	Chamfered	BCDP T31 PB-W	BCDP T32 PB-W	BCDP TDP PB-W
Dark Oak	Bright Chrome/Black Collar	Ovolo	BODP T31 BC-B	BODP T32 BC-B	BODP TDP BC-B
Dark Oak	Bright Chrome/White Collar	Ovolo	BODP T31 BC-W	BODP T32 BC-W	BODP TDP BC-W
Dark Oak	Polished Brass/Black Collar	Ovolo	BODP T31 PB-B	BODP T32 PB-B	BODP TDP PB-B
Dark Oak	Polished Brass/White Collar	Ovolo	BODP T31 PB-W	BODP T32 PB-W	BODP TDP PB-W
Light Oak	Bright Chrome/Black Collar	Chamfered	BCLP T31 BC-B	BCLP T32 BC-B	BCLP TDP BC-B
Light Oak	Bright Chrome/White Collar	Chamfered	BCLP T31 BC-W	BCLP T32 BC-W	BCLP TDP BC-W
Light Oak	Polished Brass/Black Collar	Chamfered	BCLP T31 PB-B	BCLP T32 PB-B	BCLP TDP PB-B
Light Oak	Polished Brass/White Collar	Chamfered	BCLP T31 PB-W	BCLP T32 PB-W	BCLP TDP PB-W
Light Oak	Bright Chrome/Black Collar	Ovolo	BOLP T31 BC-B	BOLP T32 BC-B	BOLP TDP BC-B
Light Oak	Bright Chrome/White Collar	Ovolo	BOLP T31 BC-W	BOLP T32 BC-W	BOLP TDP BC-W
Light Oak	Polished Brass/Black Collar	Ovolo	BOLP T31 PB-B	BOLP T32 PB-B	BOLP TDP PB-B
Light Oak	Polished Brass/White Collar	Ovolo	BOLP T31 PB-W	BOLP T32 PB-W	BOLP TDP PB-W
Medium Oak	Bright Chrome/Black Collar	Chamfered	BCMP T31 BC-B	BCMP T32 BC-B	BCMP TDP BC-B
Medium Oak	Bright Chrome/White Collar	Chamfered	BCMP T31 BC-W	BCMP T32 BC-W	BCMP TDP BC-W
Medium Oak	Polished Brass/Black Collar	Chamfered	BCMP T31 PB-B	BCMP T32 PB-B	BCMP TDP PB-B
Medium Oak	Polished Brass/White Collar	Chamfered	BCMP T31 PB-W	BCMP T32 PB-W	BCMP TDP PB-W
Medium Oak	Bright Chrome/Black Collar	Ovolo	BOMP T31 BC-B	BOMP T32 BC-B	BOMP TDP BC-B
Medium Oak	Bright Chrome/White Collar	Ovolo	BOMP T31 BC-W	BOMP T32 BC-W	BOMP TDP BC-W
Medium Oak	Polished Brass/Black Collar	Ovolo	BOMP T31 PB-B	BOMP T32 PB-B	BOMP TDP PB-B
Medium Oak	Polished Brass/White Collar	Ovolo	BOMP T31 PB-W	BOMP T32 PB-W	BOMP TDP PB-W
Nominal Size:			88.0mm x 88.0mm	154mm x 88.0mm	88.0mm x 88.0mm
Minimum Wall Box Depth:			25mm	25mm	25mm
Technical Insert Ref:			T31	T32	TDP



Smart Lighting Control

- Control basic day-to-day lighting scenarios; from simple dimming to scene-setting programmes which can be set, stored and recalled with ease
- Entry level system comprises: a control hub, wall-mounted control plates
- Can be controlled with a smart device using Hamilton's downloadable iOS/Android app
- Standard large enclosures available off the shelf up to 30 channels
- Bespoke systems built to customer's specification



Smart Lighting Control

DK1M Lighting Control Kit

Everything about this 'out-of-the-box' solution just looks and feels right. Simplicity is at the forefront of its design, making it so easy to install. With no special knowledge required, boxes can be linked together to create additional channels e.g. 5-8, 9-12.

THE KIT CONSISTS OF:

- MDP4x600+3AR Dimming Pack
- 7WC 4S+4C-SV Hartland CFX® Colours mechanical button wall plate with silver buttons

SYSTEM FEATURES:

- Simple to program scene setting
- Compatible with LED lamps*
- Expandable system beyond lighting control e.g. blinds, extractor fans



TECHNICAL INFORMATION:

Ratings:	220/240Vac 50/60Hz
Power Output:	600 watts per circuit/150W LED 1 x 3A Relay
Loads:	Resistive LV with selected electronic transformers Selected LEDs*
No. of Channels:	4 Dim + 1 Non-Dim
Environment:	-10°C to 45°C 90% humidity non-condensing
Dimensions:	457mm x 205mm x 78mm
Standard / Approval:	EN60669-2-1
Wiring Control:	CAT 5/6 UTP cable (unscreened 4x twisted pairs) OR CAT 5/6 STP cable (screened 4x twisted pairs) OR SELV supply (<15Vdc) (To control outstations or plates) OR Belden 1502R

IN THE BOX:

MDP4X600+3AR Dimming Pack

- Outputs protected by MCBs and a mains switch disconnecter.
- Soft start feature - extends lamp life.
- Not reliant on manufacturer's commissioning.
- Individual circuit control



7WC 4S+4C-SV Hartland CFX® Colours mechanical button wall plate + silver buttons

- Internal memory
- 8 Button Mechanical Plate
- 4 Scene recall buttons



Hartland CFX® Colours

Code	DK1M Kit
7WC DKIM	MDP4X600+3AR Dimmer Pack 7WC 4S+4C-SV Hartland CFX® Colours

For LED compatibility Hamilton recommends:

*De-rate dimmers by 75% eg. 600Watt dimmer = 150W LED

Due to the different design and component variations we recommend that when dimming mains (GU10) type LEDs compatibility is sought between dimmer and lamp prior to purchase and installation.

For more information contact our technical support.

Smart Lighting Control

DK1ME Lighting Control Kit - built in ethernet

Everything about this 'out-of-the-box' solution just looks and feels right. Simplicity is at the forefront of its design, making it so easy to install. With no special knowledge required, boxes can be linked together to create additional channels e.g 5-8, 9-12.

THE KIT CONSISTS OF:

- MDP4x600+3AR+E Dimming Pack
- 7WC 4S+4C-SV Hartland CFX® Colours mechanical button wall plate with silver buttons



SYSTEM FEATURES:

- Simple to program scene setting
- Compatible with LED lamps*
- Expandable system beyond lighting control e.g. blinds, extractor fans
- Wireless control from smart phone or tablet via the Hamilton app

TECHNICAL INFORMATION:

Ratings:	220/240Vac 50/60Hz
Power Output:	600 watts per circuit/150W LED 1 x 3A Relay
Loads:	Resistive LV with selected electronic transformers Selected LEDs*
No. of Channels:	4 Dim + 1 Non Dim
Environment:	-10°C to 45°C 90% humidity non-condensing
Dimensions:	457mm x 205mm x 78mm
Standard / Approval:	EN60669-2-1

Code	Remote Dimmer Packs
DK1ME Kit	7WCDKIME MDP4X600+3AR Dimmer Pack 7WC 4S+4C-SV Hartland CFX® Colours

Wiring: CAT 5/6 UTP cable (unscreened 4x twisted pairs) OR CAT 5/6 STP cable (screened 4x twisted pairs) OR SELV supply (<15Vdc) (To control outstations or plates) OR Belden 1502R

IN THE BOX:

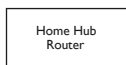

MDP4X600+3AR+E Dimming Pack

- Outputs protected by MCBs and a mains switch disconnecter.
- Soft start feature - extends lamp life.
- Not reliant on manufacturer's commissioning.
- Individual circuit control
- RJ45 port for internet connection



7WC 4S+4C-SV Hartland CFX® Colours mechanical button wall plate with silver button

- 8 Button Mechanical plate
- Internal memory
- 4 scene recall buttons



Hartland CFX® Colours

Apple and the Apple logo are trademarks of Apple Inc., registered in the U.S. and other countries.
App Store is a service mark of Apple Inc., registered in the U.S. and other countries.
Google Play and the Google Play logo are trademarks of Google Inc.

For LED compatibility Hamilton recommends:
*De-rate dimmers by 75% eg. 600Watt dimmer = 150W LED

Due to the different design and component variations we recommend that when dimming mains (GU10) type LEDs compatibility is sought between dimmer and lamp prior to purchase and installation.
For more information contact our technical support.



Smart Lighting Control

SMART LIGHTING



Smart Lighting Control

MDP4X600+3AR Dimming Pack

The Hamilton dimming pack gives simple and effective control of lighting and building systems. It also benefits from being one of the easiest systems to install and operate, allowing you to transform a space to suit any mood and is essential for creating the right atmosphere in all kinds of environments: residential, hotels, restaurants, bars/clubs, health spas, museums, entertainment spaces such as home cinemas and so much more, both inside and out.



SYSTEM FEATURES

- 4 channels each rated at 600W, 150W LED, plus one additional 3 amp relay output, so that you have the ability to switch a non-dim circuit items such as an extractor fan.
- All 5 outputs are protected by MCBs (miniature circuit breaker) and a mains switch disconnecter.
- Soft start feature prevents nuisance tripping and extends lamp life.
- Not reliant on manufacturer's commissioning.
- LED lamp compatible*
- Settings unaffected by power failure.
- Easily added to and upgraded at a later stage.
- Multiple control options and mixes.
- Wiring between dimmer pack and control station is CAT5/6 cable or Beldon 20AWG cable (twisted pairs) 1502R.
- Individual circuit control for on/off, raise/lower

TECHNICAL INFORMATION:

Designed to comply with EN60669-2-1 (safety, operation and EMC)

Ratings:	220/240Vac 50/60Hz
Power Output:	600 watts per circuit/150W LED 1 x 3A Relay
Loads:	Resistive LV with selected electronic transformers Selected LEDs*
No. of Channels:	4 Dim + 1 Non Dim
Environment:	-10°C to 45°C 90% humidity non-condensing
Dimensions:	457mm x 205mm x 78mm
Weight:	5.3KG
Standard / Approval:	EN60669-2-1
Wiring Control:	CAT 5/6 UTP cable (unscreened 4x twisted pairs) OR CAT 5/6 STP cable (screened 4x twisted pairs) OR SELV supply (<15Vdc) (To control outstations or plates) OR Belden 1502R

Code	Remote Dimmer Packs
MDP4X600+3AR	4 x 600W + 3A relay dimmer pack

For LED compatibility Hamilton recommends:

*De-rate dimmers by 75% eg. 600Watt dimmer = 150W LED

Due to the different design and component variations we recommend that when dimming mains (GU10) type LEDs compatibility is sought between dimmer and lamp prior to purchase and installation.

For more information contact our technical support.

Smart Lighting Control

MDP4X600+3AR+E Dimming Pack - with built in Ethernet Bridge

The Hamilton dimming pack gives simple and effective control of lighting and building systems. It also benefits from being one of the easiest systems to install and operate, allowing you to transform a space to suit any mood and is essential for creating the right atmosphere in all kinds of environments. The MDP4x600+3AR-E has the added bonus of wireless control. Simply connect the integrated Ethernet port to a wireless router to allow full control of the lighting system from the Hamilton® App via a smart device or tablet.



SYSTEM FEATURES

- 4 channels each rated at 600W, 150W LED, plus one additional 3 amp relay output, so that you have the ability to switch on non-dim circuit items such as an extractor fan.
- All 5 outputs are protected by MCBs (miniature circuit breaker) and a mains switch disconnector.
- Soft start feature prevents nuisance tripping and extends lamp life.
- Not reliant on manufacturer's commissioning.
- Individual circuit control for on/off, raise/lower.
- LED lamp compatible*
- Settings unaffected by power failure.
- Easily added to and upgraded at a later stage.
- Multiple control options and mixes.
- Wiring between dimmer pack and control station is CAT5/6 cable or Beldon 20AWG cable (twisted pairs).
- On board Ethernet interface.
- Remote control from smart phone or tablet via app.
- Variable fade rates.

TECHNICAL INFORMATION:

Designed to comply with EN60669-2-1 (safety, operation and EMC)

Ratings:	220/240Vac 50/60Hz
Power Output:	600 watts per circuit/150W LED 1 x 3A Relay
Environment:	-10°C to 45°C 90% humidity non-condensing
Loads:	Resistive LV with selected electronic transformers Selected LEDs*
No. of Channels:	4 Dim + 1 Non Dim
Environment:	-10°C to 45°C 90% humidity non-condensing
Dimensions:	457mm x 205mm x 78mm
Weight:	5.3KG Approx
Standard / Approval:	EN60669-2-1
Wiring Control:	CAT 5/6 UTP cable (unscreened 4x twisted pairs) OR CAT 5/6 STP cable (screened 4x twisted pairs) OR SELV supply (<15Vdc) (To control outstations or plates) OR Belden 1502R
Network:	10 Mbps RJ45

Code	Remote Packs
MDP4X600+3AR+E	4 x 600W + 3A relay pack with built in Ethernet Bridge

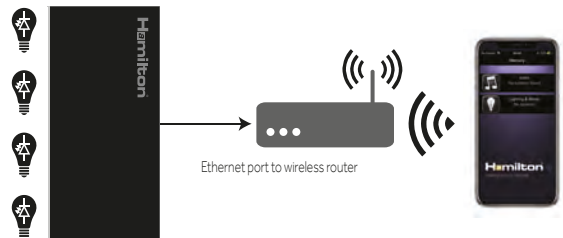

For LED compatibility Hamilton recommends:

*De-rate dimmers by 75% eg. 600Watt dimmer = 150W LED

Due to the different design and component variations we recommend that when dimming mains (GU10) type LEDs compatibility is sought between dimmer and lamp prior to purchase and installation.

For more information contact our technical support.

Smart Lighting Control

MRP4X10A+3AR Relay Pack

The Hamilton relay pack gives simple and effective control of peripheral devices such as security systems and fans, great for all kinds of environments: residential, hotels, restaurants, bars/clubs, health spas, museums, entertainment spaces such as home cinemas and so much more, both inside and out. It also benefits from being one of the easiest systems to install and operate.



SYSTEM FEATURES

- Standard system does not require any software knowledge or programming input by the specifier, installer or the end-user.
- Not reliant on manufacturer's commissioning.
- 4 relays each rated at 10 amps plus one additional relay rated at 3 amp.
- All 5 outputs are protected by MCBs (miniature circuit breaker) and a mains switch disconnecter.
- Individual on/off circuit control.
- Settings unaffected by power failure.
- Can easily be added to and upgraded at a later stage.
- Larger, multi-channel configurations possible by networking systems together.
- Multiple control options and mixes.
- Wiring between relay pack and control station is CAT5/6 cable or Beldon 20AWG cable (twisted pairs).

TECHNICAL INFORMATION:

Designed to comply with EN60669-2-1 (safety, operation and EMC)

Ratings:	220/240Vac 50/60Hz
Environment:	-10°C to 45°C 90% humidity non-condensing
Loads:	4x10A Relay + 1x 3A Relay
Dimensions:	457mm x 205mm x 78mm
Weight:	5.3KG
Standard / Approval:	EN60669-2-1
Wiring Control:	CAT 5/6 UTP cable (unscreened 4x twisted pairs) OR CAT 5/6 STP cable (screened 4x twisted pairs) OR SELV supply (<15Vdc) (To control outstations or plates)

The relay pack consists of an enclosure housing the electronic power handling equipment. This should be mounted in a suitable and convenient location such as electrical switch room, cupboard or roof space. These locations must have good access and free airflow.

Code	Remote Relay Packs
MRP4X10A+3AR	4 x 10A + 3A relay remote pack

Smart Lighting Control

Lighting Control - Wiring Diagram

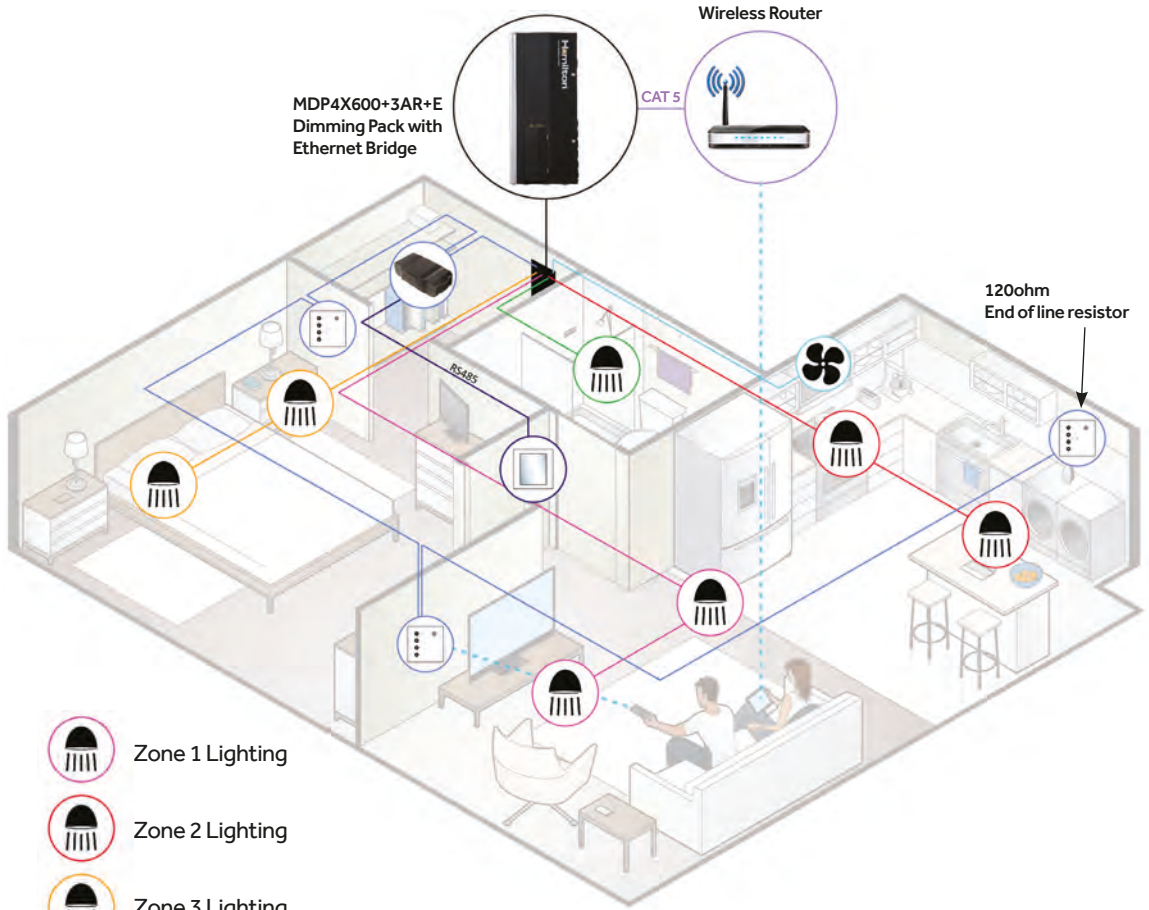

-  Zone 1 Lighting
-  Zone 2 Lighting
-  Zone 3 Lighting
-  Zone 4 Lighting
-  Fan
-  Controllers - Mechanical Button
-  Controllers - Touch Screen
-  TCHINT-L Touch Screen Interface



Apple and the Apple logo are trademarks of Apple Inc., registered in the U.S. and other countries. App Store is a service mark of Apple Inc., registered in the U.S. and other countries. Google Play and the Google Play logo are trademarks of Google Inc.

Smart Lighting Control

Expanding the Lighting Control System

SYSTEM CONFIGURATION

- Simple DIP switch settings allow installer to link multiple packs together to add extra circuits in a larger area ie. no laptop or end user software is required.
- Larger, multi-channel configurations possible by networking dimming/switched systems together. The Hamilton installer software gives access to the many features embedded in the system allowing configuration of larger, more complex applications.

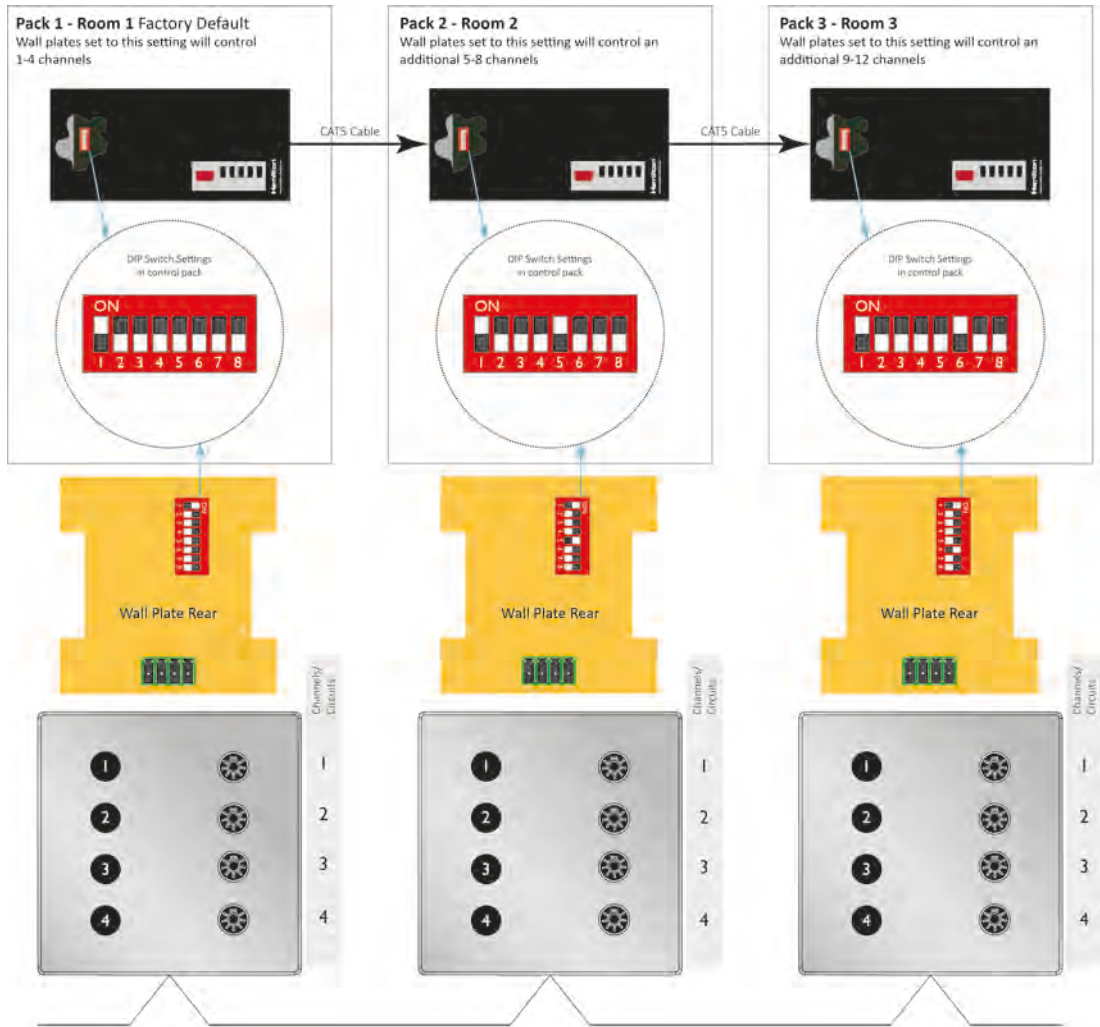

Smart Lighting Control

Mechanical Button

LIGHTING CONTROL

Control your lighting system with a mechanical button wall plate, available in Hartland, Hartland CFX®, Sheer, Sheer CFX® and Linea CFX® ranges. Any button can be configured for any function with Hamilton's designer software.

Controllers will fit into any single wall box (BS4662) with a minimum depth of 35mm.

- Dim up and down - Power on/off
- 4 - 16 mechanical buttons as standard
- 4 scene recall - more available as bespoke or with handset
- Engraved legend
- Bespoke plates available

INSTALLATION

For connection of additional controls use CAT5/6 cable wired in parallel.
Note: if other dimmer packs are included within the same system, link all with CAT5/6 cable.

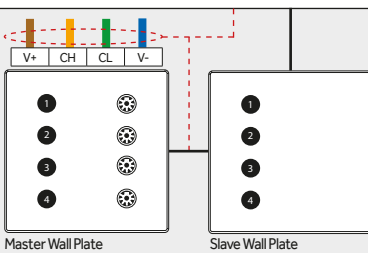

You can also add additional wall plates by duplicating the DIP switch setting.

QUICK AND SIMPLE TO USE

Store scenes at the touch of a button:

1. Adjust the lighting levels using the circuit buttons. A brief press will turn the lights on/off, a prolonged press will raise/lower the light level.
2. Once you've selected the desired light level for all four circuits, press and hold down scene button one. The LED will flash five times. Keep your finger on the scene button until the LED stops flashing.
3. Your new scene is now stored. Repeat above to store further scenes on buttons 2,3 and 4. No commissioning work is required.
4. To recall a scene, press the desired scene button. To turn the zone off press the currently selected scene button.
5. To adjust a circuit without changing stored scene simply press or hold desired circuit button.

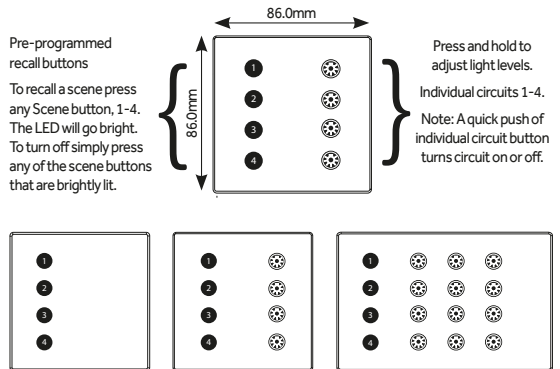

Smart Lighting Control

Capacitive Touch

LIGHTING CONTROL

Capacitive touch, glass control plate, based on technology gained in the smart phone market. White LED buttons can be configured for any function with Hamilton designer software. Controllers will fit into any single wall box (BS4662) with a minimum depth of 35mm.

- 4-16 capacitive touch switches with white LED
- Engraved legends
- 4 scene selection
- Dim up and down/Power on/off
- Available in various colours
- Available in a selection of frame styles

QUICK AND SIMPLE TO USE

Store scenes at a touch:

1. Adjust the lighting levels by touching the plate. A brief touch will turn the lights on/off, a prolonged press will raise/lower the light level.
2. Once you've selected the desired light level for all four circuits, touch and hold scene one. The LED will flash five times. Keep your finger on the scene until the LED stops flashing.
3. Your new scene is now stored. Repeat above to store further scenes 2,3 and 4. No commissioning work is required.

INSTALLATION

For connection of additional controls use CAT5/6 cable wired in parallel.
Note: if other dimmer packs are included within the same system, link all with CAT5/6 cable.

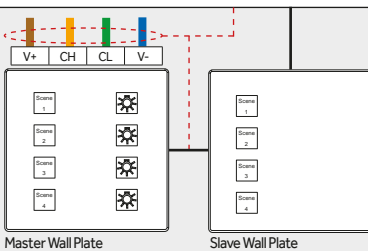

You can also add additional wall plates.



To recall a scene press any Scene button, 1-4. The LED will go bright. To turn off simply press any of the scene buttons that are brightly lit. To change scene see notes above - Store scenes

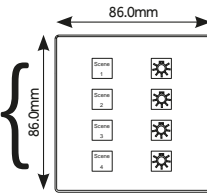

Touch and hold individual circuit to adjust light levels. Note: A quick push of individual circuit button turns circuit on or off

Smart Lighting Control

Touch Screen

The Hamilton Touch Screen offers additional features to control the Lighting. It can be connected to a Lighting System using a Touch Screen Interface (available from Hamilton).

The Touch Screen acts as a master switch and is particularly useful for commercial installations, as it allows all connected circuits to be controlled from one place. Up to 3 Rooms, 16 circuits per room. The Touch Screen is designed to enable users to customise their Hamilton Lighting Control, it allows you to rename Lighting Zones and Lighting Scenes.

SYSTEM FEATURES:

General:

- Fits a 35mm back box
- Concealed fixing
- Available in various plate styles and finishes
- Resistive touch screen

Modes:

- For lighting use with a RS232 interface
- For lighting only use 1 x RS485 per 2 x touch screens

Lighting:

- Control up to 3 zones of lighting (rooms)
- Control up to 16 circuits per zone (room)
- 4 scene selection per zone
- Master on/off



Smart Lighting Control

Product Codes

DK1M KIT



All DK1M and DK1ME dimmer packs will be supplied with a Hartland CFX® Colours 8 Button mechanical plate as standard. In order to co-ordinate plate design and colour after installation, a replacement metal decorative plate from either our Hartland CFX® or Sheer CFX® ranges can be supplied at no extra cost.

Simply contact the Hamilton sales office and supply the following information;

- 1) Simply unclip the white plastic faceplate and then quote the serial number displayed.
- 2) Confirm selected replacement metal decorative plate from our Hartland CFX®/Sheer CFX® range.

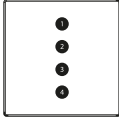
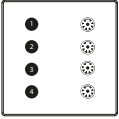
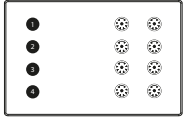
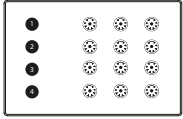
LIGHTING - MECHANICAL BUTTON CONTROL PLATES Will fit into any single/double wall boxes (BS4662) with a minimum depth of 35mm

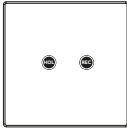
4SL	4S+4C	4S+8C	4S+12C
			
4 button scene slave with LED indication	8 button control plate, 4 scene recall buttons + 4 momentary circuit control with LED indication	12 button control plate, 4 scene recall buttons + 8 momentary circuit control with LED indication	16 button control plate, 4 scene recall buttons + 12 momentary circuit control with LED indication

HOLM	ROTE	TCHSCRN
		
Holiday Mode	Rotary Encoder Note: Knob is same colour as plate	Touch Screen Control

Smart Lighting Control

Product Codes

MECHANICAL BUTTONS - LIGHTING

When ordering a product from this range please specify our product codes. Replace ??? with plate prefix and replace ## with button colour suffix (as shown below)

e.g. Plate Prefix Product Button Colour Suffix
 | | |
 77C 4S+4C SV

PRODUCT CODE CONFIGURATOR

Code	Mechanical Button Controller
??? 4SL - ##	Four button slave
??? 4S+4C - ##	Eight button controller
??? 4S+8C - ##	Twelve button controller
??? 4S+12C - ##	Sixteen button controller
??? HOLM - ##	Holiday Mode
??? ROTE - ##	Rotary Encoder
??? TCHSCRN - AL	Touch screen control

Plate Finish Colour	Hartland CFX	Sheer CFX	Hartland CFX Colour	Perception CFX	Hartland	Sheer	Cheriton Victorian	Cheriton Georgian	Button Colour Suffix
	Plate Prefix								
Gloss White/Silver Button	70C	70C	-	-	70	80	-	-	SV
Polished Brass/Black Button	71C	81C	-	-	71	81	92	90	BL
Satin Brass/Black Button	72C	82C	-	-	72	82	94	-	BL
Bright Steel/Silver Button	-	-	-	-	73	83	-	-	SV
Satin Steel Effect/Silver Button	74C	84C	-	-	-	-	-	-	SV
Satin Steel/Silver Button	-	-	-	-	74	84	-	-	SV
Satin Chrome/Silver Button	-	-	-	-	76	86	96	-	SV
Bright Chrome/Silver Button	77C	87C	-	-	77	87	95	-	SV
Black Nickel/Black Button	78C	88C	-	-	78	88	98	-	BL
Antique Brass/Black Button	79C	89C	-	-	79	89	93	91	BL
Matt White	-	-	-	-	-	-	-	-	-
Matt Black	-	-	-	-	-	-	-	-	-
Copper Bronze/Black Button	7CBC	8CBC	-	-	-	-	-	-	BL
Etrium Bronze/Black Button	7EBC	8EBC	-	-	-	-	-	-	BL
Connaught Bronze/Black Button	7HBC	8HBC	-	-	-	-	-	-	BL
Richmond Bronze/Black Button	7RBC	8RBC	-	-	-	-	-	-	BL
Polish Nickel	-	-	-	-	-	-	-	-	-
Primed White	-	-	-	-	-	-	-	-	-
Bright White/Black Button	-	-	7WC	-	-	-	-	-	BL
Bright White/Silver Button	-	-	7WC	-	-	-	-	-	SV
Jet Black/Black Button	-	-	7BC	-	-	-	-	-	BL
Jet Black/Silver Button	-	-	7BC	-	-	-	-	-	SV
Pillar Box Red/Black Button	-	-	7RC	-	-	-	-	-	BL
Pillar Box Red/Silver Button	-	-	7RC	-	-	-	-	-	SV
Clear Transparent/Black Button	-	-	-	PC	-	-	-	-	BL
Clear Transparent/Silver Button	-	-	-	PC	-	-	-	-	SV

Note: Smart Lighting controllers are not available in Bloomsbury, Woods and Vogue ranges

SMART AUDIO AND LIGHTING

Smart Lighting Control

Product Codes

CAPACITIVE TOUCH CONTROL PLATES Will fit into any single / double wall boxes (BS4662) with a minimum depth of 35mm

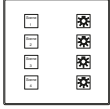
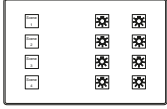
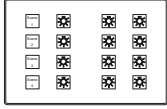
CPT4S	CPT4S+4C	CPT4S+8C	CPT4S+12C
			
Capacitive touch plate, with 4 scene recall with white LED, engraved legends	Capacitive touch plate with 4 scene recall, 4 circuit control buttons with white LED, engraved legends	Capacitive touch plate with 4 scene recall, 8 circuit control buttons with white LED, engraved legends	Capacitive touch plate with 4 scene recall, 12 circuit control buttons with white LED, engraved legends

LINEA-VETRO CFX® CAPACITIVE TOUCH CONTROL PLATE Supplied with Bright Chrome Frame

Plate Type	Codes		
	Linea-Duo Vetro CFX® - Black Glass	Linea-Rondo Vetro CFX® - Black Glass	Linea-Scala Vetro CFX® - Black Glass
CPT4S	LD CPT4S BC-VB	LRX CPT4S BC-VB	LSX CPT4S BC-VB
CPT4S+4C	LD CPT4S+4C BC-VB	LRX CPT4S+4C BC-VB	LSX CPT4S+4C BC-VB
CPT4S+8C	LD CPT4S+8C BC-VB	LRX CPT4S+8C BC-VB	LSX CPT4S+8C BC-VB
CPT4S+12C	LD CPT4S+12C BC-VB	LRX CPT4S+12C BC-VB	LSX CPT4S+12C BC-VB

Plate Type	Codes		
	Linea-Duo Vetro CFX® - White Glass	Linea-Scala Vetro CFX® - White Glass	Linea-Rondo Vetro CFX® - White Glass
CPT4S	LD CPT4S BC-VW	LSX CPT4S BC-VW	LRX CPT4S BC-VW
CPT4S+4C	LD CPT4S+4C BC-VW	LSX CPT4S+4C BC-VW	LRX CPT4S+4C BC-VW
CPT4S+8C	LD CPT4S+8C BC-VW	LSX CPT4S+8C BC-VW	LRX CPT4S+8C BC-VW
CPT4S+12C	LD CPT4S+12C BC-VW	LSX CPT4S+12C BC-VW	LRX CPT4S+12C BC-VW



SMART AUDIO AND LIGHTING

Smart Lighting Control

Smart Lighting Enclosures

Multi-Gang Remote Dimmer Packs

- Each 3A relay can be wired as a Volt Free Relay (VFR), if required.

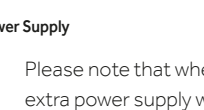
			Total Channels
	MDP 12X600 + 3X3AR	Digital Dimmer Pack 12 channels x 600w + 3 x 3A relay Dimensions: 800h x 400w x 120d mm Incoming mains input via switch dis-connector Outgoing protection via 3 amp MCBs 220-240VAC outputs only	15
	MDP 16X600 + 4X3AR	Digital Dimmer Pack 16 channels x 600w + 4 x 3A relay Dimensions: 800h x 400w x 120d mm Incoming mains input via switch dis-connector Outgoing protection via 3 amp MCBs 220-240VAC outputs only	20
	MDP 20X600 + 5X3AR	Digital Dimmer Pack 20 channels x 600w + 5 x 3A relay Dimensions: 600h x 600w x 210d mm Incoming mains input via switch dis-connector Outgoing protection via 3 amp MCBs 220-240VAC outputs only	25
	MDP 24X600 + 6X3AR	Digital Dimmer Pack 24 channels x 600w + 6 x 3A relay Dimensions: 600h x 600w x 210d mm Incoming mains input via switch dis-connector Outgoing protection via 3 amp MCBs 220-240VAC outputs only	30

Technical Insert Ref: SML-MGDIMPK

Power Supply

- Please note that when using touchscreen controllers an extra power supply will be required for the Dimmer Packs*

	MDP-POWERSUPPLY	Smart Lighting Control-mains incoming. 12v DC outgoing power supply that comes in a 4 module insulated IP20 enclosure (HL4MODINS) protected by a 3A MCB is used to facilitate additional controllers on the smart lighting network
---	-----------------	--

* Depends on the system being used

Smart Lighting Control





Din Rail Modules

Din Rail Modules - Dimmers

			Requires Additional CPU (MDRB-CPU-6CH)	Requires Additional Power Supply (MDRB-6XPSU)
	MDRB - 1X1000	1 X 1000W/700VA 250W LED Dimmer Module	✓	



Technical Insert Ref: SML-DINDIM

Din Rail Modules - Relays (Analogue)

			Requires Additional CPU (MDRB-CPU-6CH)	Requires Additional Power Supply (MDRB-6XPSU)
	MDRB - 1X4A	Unintelligent 1 Channel Single Pole Relay Max 4A 230V	✓	
	MDRB - 4X1-10V+VFR	1 - 10V 4 Channel Analogue Dimmer+ 4 Channel 2A Volt Free Relay		✓
	MDRB - 4X2A	4 Channel 2A Volt Free Relay Max 3amp 230V AC 2amp 24VDC		✓
	MDRB - 2X2A-COR	2 Channel 2A Cross Over Relay Max 3amp 230V AC 2amp 24VDC		✓

Technical Insert Ref: SML-DINREL

Din Rail Modules - Controllers



			Requires Additional CPU (MDRB-CPU-6CH)	Requires Additional Power Supply (MDRB-6XPSU)
	MDRB - CPU-6CH	6 Channel CPU 230VAC, 5VA	n/a	
	MDRB - DMX36CH	36 Channel DMX Controller		✓

Technical Insert Ref: SML-DINCONT

Smart Lighting Control

Din Rail Modules

Din Rail Modules - Interfaces

			Requires Additional CPU (MDRB-CPU-6CH)	Requires Additional Power Supply (MDRB- 6XPSU)
	MDRB - E-BRIDGE	Ethernet Bridge		
	MDRB - DALI-BRIDGE	DALI Bridge interfaces with DALI Dimmers Max 42 devices		

Technical Insert Ref: SML-DININTF

Interfaces

			Requires Additional CPU (MDRB-CPU-6CH)	Requires Additional Power Supply (MDRB- 6XPSU)
	MDRB - 4XIOINT	4 Channel Multi-Function I/O Interface		

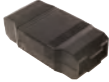

Technical Insert Ref: SML-DININTF

TCHINT-L - Touch Screen Interface

			Requires Additional CPU (MDRB-CPU-6CH)	Requires Additional Power Supply (MDRB-6XPSU)
	TCHINT-L	RS485 interface (2 x RJ45 socket) Allows use of a touch screen (lighting system only) Requires 1 interface per 2 control plates	n/a	

Technical Insert Ref: SML-ACCES

Din Rail Modules - Ancillaries





			Requires Additional CPU (MDRB-CPU-6CH)	Requires Additional Power Supply (MDRB-6XPSU)
	MDRB - 6XPSU	12V Power Supply 230V AC, 5VA	n/a	
	MDRB - NET-BOOST	12-24V Network Booster		✓

Technical Insert Ref: SML-NET-BOOST

Smart Lighting Control



Hamilton Air Modules

Din Rail Mount

			Module Size	Range Max
	MDR - 1CHRR	1 Channel Radio Receiver 230V AC Range up to 250m	1	250m
Technical Insert Ref: SML-AIRDIN				
	MDR - 2CHRR	2 Channel Radio Receiver 230V AC Range up to 250m	2	250m
Technical Insert Ref: SML-AIRDIN				
	MWM - GSM-NET	Remote control of the electrical devices by means of commands (incoming phone connection, text message) sent from a mobile phone Din Rail Mountable	3	n/a
Technical Insert Ref: SML-AIRDIN				
	MWM - SWT-01	Twilight Switch Used in conjunction with MWM-LIG-SEN	1	n/a

Technical Insert Ref: SML-AIRTWLIGHT

Wireless Transmitters

	MWM - 2CHRT-WH-W	2 Channel Radio Transmitter (White Plate + White Switch) Battery Powered Range up to 250m
	MWM - 4CHRT-WH-W	4 Channel Radio Transmitter (White Plate + White Switch) Battery Powered Range up to 250m
	MWM - JB4CHRT-M	Junction Box 4 Channel Radio Transmitter 230V AC Range up to 200m
	MWM - JB4CHRT	Junction Box 4 Channel Radio Transmitter Battery Powered Range up to 250m

Technical Insert Ref: SML-AIRTRAN

Wireless Receivers



	MWM - JB1CHRR	Junction Box 1 Channel Radio Receiver 230V AC Range up to 180m
	MWM - JB2CHRR	Junction Box 2 Channel Radio Receiver 230V AC Range up to 200m
	MWM - JB3CHRR	Junction Box 10-14v radio receiver is a switch to work with current lighting fittings and other receivers and is ideal for controlling LED Lamps and Lighting circuits. Range up to 250m.
	MWM - JB1CHDIM	Junction Box 2 Channel Radio Dimmer 230V AC Range up to 180m

Technical Insert Ref: SML-AIRREC

Smart Lighting Control



Hamilton Air Modules

Roller Blind Controls

	MWM - JB-R-BLIND	Flush roller blinds controller used in local and/or central control of window roller blinds or other devices with 230V AC one-phase motors WIRED
	MWM - JB-R-BLIND2	Radio roller blinds controller to control roller blind drives with 230V AC motor with a limit switch WIRELESS

Technical Insert Ref: SML-AIRROLL

Hand Held Remotes

	MWM - 2CHRC	2 Channel Remote Control Range up to 250m
	MWM - 4CHRC	4 Channel Remote Control Range up to 250m

Technical Insert Ref: SML-AIRHHR

Accessories

	MWM - EXT-ANT	External Antenna to extend range and boost signal strength Note: Not compatible with Elemento Wireless 4 Channel Radio Receiver (MWM-4CHPSKIT)
--	---------------	--

Technical Insert Ref: SML-AIRACC

PIR Units

	MWM - RMS	1 Channel Radio Motion Sensor Battery Powered Range up to 200m
---	-----------	--

Technical Insert Ref: SML-AIRPIR

Light Sensors

	MWM - LIG-SEN	Light Sensor cable - 5m Used in conjunction with MWM-SWT-01
---	---------------	---

Technical Insert Ref: SML-AIRLIG



Wireless Audio

- Supports Android and iOS
- All in one solution
- Smart Audio allows playback via wi-fi
- Wirelessly link all our Hamilton Audio products together



Wireless Audio

Wi-Fi Audio Product Range

- Supports Android and iOS
- All in one solution
- Smart Audio allows playback via wi-fi
- Stream music in one or multiple rooms
- Wirelessly link all our Hamilton Audio products together
- Streaming services Spotify, Tune-in Radio, Tidal & more
- Playable formats: aac, wav, flac, mp3, wma, vorbis



WSA 50

Wireless Streaming Amplifier

AUDIO SPECIFICATION WSA50-KIT

- Power Amplifier
- 2 x 50w 8ohms
- Frequency Response: 20Hz-20kHz

AUDIO INTERFACE

- 1 x Line in
- 1 x Pre-out
- L/R Speaker Out
- 1 x USB

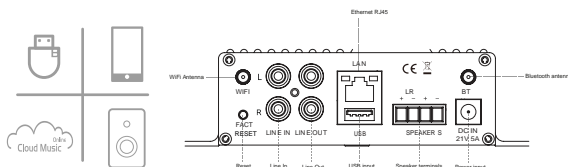

Code	Box Contents
WSA50	1 x Main unit 1 x Power supply DC IN 21V 5A 2 x RCA cables 1 X Manual
WSA50KIT	1 x Main unit 1 x Power supply DC IN 21V 5A 2 x RCA cables 1 X Manual 2 X Ceiling Speakers



H600-80W8

Ceiling Speakers

SPEAKER SPECIFICATION

- Woofers 6inch Kevlar Cone
- Tweeters 1 inch Titanium Dome
- Magnetic Front Grill
- Power Handling 80 Watts
- Frequency Response 100Hz-20kHz



Code	Box Contents
H600-80W8	2 X Ceiling Speakers

Wireless Audio

Wi-Fi Audio Product Range

appio WMS-1 Wireless Active Speaker



AUDIO SPECIFICATION

- Built in Amplifier
- 20 Watts RMS

FUNCTION & INTERFACE

- 1 x Aux in
- 1 x LAN
- DC in
- On app: EQ, Alarm, Sleep Timer

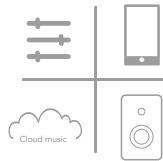

Code	Box Contents
WMS-1	WMS-1 Speaker Power Adapter 3.5mm Stereo Jack to 3.5mm Stereo Jack Manual



MULTI-ROOM

MULTI-SOURCE

Wireless Audio

Wireless Audio Receiver Oyster AWR-1

Connect the Oyster to the Line input on your existing Hi-Fi amplifier to add music streaming features.

With the Oyster connected, you can wirelessly connect your Home System to other Hamilton Wireless audio devices and Play music in sync in different rooms around your home.

AUDIO SPECIFICATION

- Aux out
- Micro SD Card

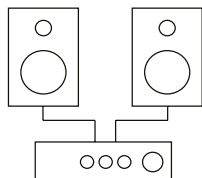

MULTI-ROOM

MULTI-SOURCE



Code	Box Contents
Oyster-AWR-1	Wi-fi Receiver Power Adaptor USB Power Lead 3.5mm Stereo Jack Plug to 2 x Phono (RCA) Plug Audio Cable User Manual

Ancillaries and Speakers

CODE: H525-75W8

PAIR OF 5¼" WHITE CEILING SPEAKERS INDOOR USE ONLY



- Woofer: 133mm, 5¼" kevlar or polypropylene, rubber surround
- Tweeter: 19mm, ¾" Ferrofluid cooled silk dome in swivel mount +/-3dB treble switch
- Power handling: 75 Watts
- Frequency: Response: 60 - 20000 Hz
- Sensitivity: 89 dB @ 1W / 1M
- Impedance: 8 Ohms
- Dimension (Dia): 205 x 64mm / 8¼" x 2½"
- Cutout size (Dia): 180 mm 7¼/16"
- Mounting depth: 61 mm 2¾"

CODE: H650-100W8

SINGLE 6½" WHITE STEREO CEILING SPEAKER INDOOR USE ONLY



- Woofer: Dual voice coil, 165mm, 6½" kevlar or polypropylene, rubber surround
- Tweeter: Dual 19mm, ¾" Ferrofluid cooled silk dome +/-3dB Treble Switch
- Power handling: 100 Watts
- Frequency: Response: 30 - 20000Hz
- Sensitivity: 89 dB @ 1W / 1M
- Impedance: 8 Ohms
- Dimension (Dia): 234 x 74mm / 9¼" x 21½/16"
- Cutout size (Dia): 208mm, 8¼/8"
- Mounting depth: 70mm, 2¾"

CODE: H400-50W8-OD

PAIR OF 4" WHITE SPEAKERS INDOOR AND OUTDOOR USE. 2-WAY, WEATHER RESISTANT



- IP Rating: IP65
- Woofer: 102mm, 4" Polypropylene
- Tweeter: 19mm, ¾" Polycarbonate, fluid-cooled
- Power handling: 50 Watts
- Frequency: Response: 50 - 20,000Hz
- Sensitivity: 88 dB @ 1W / 1M
- Impedance: 8 Ohms
- Housing: Polypropylene with aluminium grille
- Dimension (W x H x D): 135 x 205 x 136 mm / 5½/16" x 8¼/16" x 5³/8"

CODE: MLB-S-INT AUDIO

LIGHTING INTERFACE



- RS232 interface
- Audio to Lighting

Hamilton®

making connections beautifully

Smart Lighting Training Programmes

Training Courses – Train your way to the top Course (1 Day): Essentials in Smart Lighting Control & Wireless Audio

Demand for smart lighting control is increasing at an unprecedented rate, and smart technology is ever-present in all areas of our lives both work and play. For electrical contractors, the requirement to fit hardware – switch plates and touch-screen controllers remains, but customers expect the ability to control lighting with their smart devices too. Hamilton provides classroom-based training sessions at its dedicated training centres. Installers get a detailed introduction to smart lighting control, along with tuition on how to complete a full system installation without the need for programming. At individual workstations, trainees are taught to select the right system component for a project and install Hamilton's plug-and-play, programming free, four-channel lighting control solution. Following this, they are shown how to configure the system for their own individual project

through laptop programming. They will be shown how to incorporate 1-10V dimming, DALI, RGB and blind control into a system design and discuss any additional factors they might need to discuss with their client whilst designing a system.

Trainees are also able to get hands on with our new Wireless audio streaming products. These include stand alone wireless music speakers and fixed amplifiers. They can use our audio app to link devices and stream via Spotify, Deezer, Tidal and select Tune-In stations world-wide.

We believe it's really important to get one-on-one attention during training and that's something that we can offer in the classroom environment; we feel it's best suited to giving installers hands-on experience and making them feel completely at ease with the product, whatever their level or capability.

Hamilton are constantly working to ensure that our training courses remain relevant. We work alongside leading industry bodies such as CEDIA (1 Day course 4 CEDIA points) and BIID to offer accredited CPD training.



CPD
PROVIDER



CUSTOM
ELECTRONIC
DESIGN &
INSTALLATION
ASSOCIATION



TRAINING CENTRES

For course dates or more information please email us at
technical@hamilton-litestat.com or info@hamilton-litestat.com

Or Call us to arrange your training today on

01747860088

BRISTOL

Unit 10, Carrick Business Centre,
4-5 Bonville Road, Brislington,
Bristol, BS4 5NZ

LONDON

City Pavilion, 27 Bush Lane,
Cannon Green Building,
London, EC4R 0AA

MERE

Unit G, Quarry Industrial estate,
Mere, Wiltshire,
BA12 6LA

LED Dimmer Modules

- Control mains dimmable LED lamps and luminaires
- Choice of dimming options available

LEDstat

- Auto adjustment to deliver superior dimming performance
- Multi way dimming available when using a retractive switch
- Leading or trailing edge options
- Available in 1-4 gang plate or as a grid module

LEDIT-B

- Control 1 to 10 dimmable LEDs (Maximum 100W)
- Perfect for retrofit installations where 1 or 2 way switching is required
- Leading or trailing edge options
- Available in 1-4 gang plate or as a module



**LED
Compatible**



**Rotary
Dimmer**



**Stylish
Design**



**Decorative
Finishes**

LED Dimmer Modules

LED Trailing/Leading Edge Push On/Off Rotary 2 Way Switching Dimmers

LED Trailing/Leading Edge Push On/Off Rotary Multi-Way Dimmers



1 gang 100W LED 2 Way Push On/Off Rotary Dimmer

	LEDITB100
Minimum Wall Box Depth:	35mm
Technical Insert Ref:	DLEDITB



1 gang 100W LED Trailing/Leading Edge Push On/Off Rotary Multi-Way Dimmer

	GRID100LED
Minimum Wall Box Depth:	35mm
Technical Insert Ref:	1X100LED

LED Grid Kits



LED GridFix Tree moulding c/w fixings tool small & large knobs

LED GridFix Tree moulding c/w fixings tool small & large knobs

	GRIDKITBL	GRIDKITWH
Minimum Wall Box Depth:	35mm	35mm
Technical Insert Ref:	LEDGRIDKIT	LEDGRIDKIT



G U A R D I A N

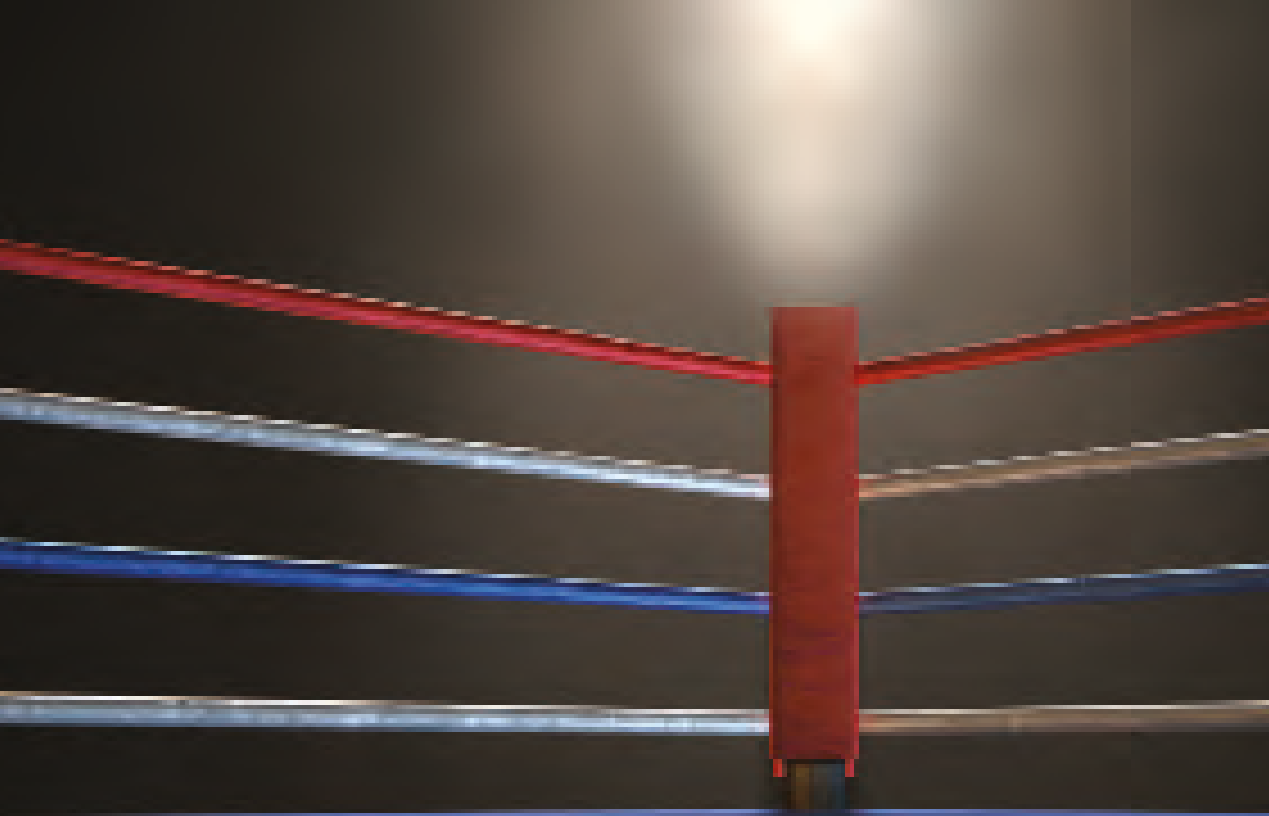

Box clever with
NEW Hamilton Guardian
Range

Guardian

...back the one that packs the biggest punch!

- Fit & Forget 10 Year Guarantee
- UK Product Test Facilities
- Greater safety and more wiring space
- Fully lockable cover as standard
- Fuse Switch and Garage Units available

**10
YEAR**

Guarantee





Domestic Circuit Protection

Guardian Consumer Units

DOMESTIC CIRCUIT PROTECTION

		Main Switch Board	
	HT2MSW	2 Way 63A Main Switch Board	
	HT8MSW	8 Way 100A Main Switch Board	
	HT12MSW	12 Way 100A Main Switch Board	
	HT16MSW	16 Way 100A Main Switch Board	
	HT20MSW	20 Way 100A Main Switch Board	

		Main Switch Board + Surge	
	HT2MSWSU	2 Way 63A Main Switch Board + Surge	
	HT6MSWSU	6 Way 100A Main Switch Board + Surge	
	HT10MSWSU	10 Way 100A Main Switch Board + Surge	
	HT14MSWSU	14 Way 100A Main Switch Board + Surge	
	HT18MSWSU	18 Way 100A Main Switch Board + Surge	

		Main Switch Board Surge Populated	
	HT6MSWSUP	6 Way 100A Main Switch Board Surge Populated + 4 RCBOs Type A Electronic	
	HT10MSWSUP	10 Way 100A Main Switch Board Surge Populated + 6 RCBOs Type A Electronic	

		High Integrity/Dual RCD	
	HT8HI	8 Way High Integrity/Dual RCD (100A Type A RCDs)	
	HT12HI	12 Way High Integrity/Dual RCD (100A Type A RCDs)	
	HT16HI	16 Way High Integrity/Dual RCD (100A Type A RCDs)	

		High Integrity/Dual RCD Populated	
	HT12HIP	12 Way High Integrity/Dual RCD Populated + 10 MCBs (100A Type A RCDs)	

Domestic Circuit Protection

Fuse Switch



Fuse Switch (63A/80A/100A fuses)

HTMFS

Garage Unit



Garage Unit Populated (63A RCD + 6A & 16A MCB)

HTGUP

Single Pole Miniature Circuit Breakers



Type B

SP 6A MCB SP Type B 6kA HTMCB106B	SP 10A MCB SP Type B 6kA HTMCB110B	SP 16A MCB SP Type B 6kA HTMCB116B	SP 20A MCB SP Type B 6kA HTMCB120B	SP 25A MCB SP Type B 6kA HTMCB125B	SP 32A MCB SP Type B 6kA HTMCB132B	SP 40A MCB SP Type B 6kA HTMCB140B	SP 50A MCB SP Type B 6kA HTMCB150B
---	--	--	--	--	--	--	--

Type C

SP 6A MCB SP Type C 6kA HTMCB106C	SP 10A MCB SP Type C 6kA HTMCB110C	SP 16A MCB SP Type C 6kA HTMCB116C	SP 20A MCB SP Type C 6kA HTMCB120C	SP 25A MCB SP Type C 6kA HTMCB125C	SP 32A MCB SP Type C 6kA HTMCB132C	SP 40A MCB SP Type C 6kA HTMCB140C	SP 50A MCB SP Type C 6kA HTMCB150C
---	--	--	--	--	--	--	--



Blank Module

Blank Module

HTBMI

Blank 1 Module

Domestic Circuit Protection

Single Pole Residual Circuit Breakers with Overload Protection (6kA)

DOMESTIC CIRCUIT PROTECTION



SP 6A 30MA RCBO 6kA B Curve (Type A) HTRCBO0630B	SP 10A 30MA RCBO 6kA B Curve (Type A) HTRCBO1030B	SP 16A 30MA RCBO 6kA B Curve (Type A) HTRCBO1630B	SP 20A 30MA RCBO 6kA B Curve (Type A) HTRCBO2030B	SP 32A 30MA RCBO 6kA B Curve (Type A) HTRCBO3230B	SP 40A 30MA RCBO 6kA B Curve (Type A) HTRCBO4030B	SP 40A 30MA RCBO 6kA B Curve (Type A) HTRCBO5030B
--	---	---	---	---	---	---

Residual Circuit Breakers



100A 30MA RCD Type A
HTRCD10030AA

100A 30MA RCD Type A (Time Delay)
HTRCD10030AS

100A DP Main Switch



100A DP Main Switch
HTMSW100

DP Type 2 Surge Device



DP Type 2 Surge Device
HTSPD2P

Domestic Circuit Protection

DCP Ancillaries

Enclosures



IP20 Weatherproof insulated Enclosure
Holds up to 2 single/1 double module
HL 2MODINS



IP20 Weatherproof insulated Enclosure
Holds up to 4 single/2 double module
HL 4MODINS



IP20 Weatherproof Steel Enclosure
Holds up to 4 single/2 double module
HL 4MODSTEEL



IP65 Weatherproof insulated Enclosure with
hinge cover holds up to 3 modules
HL IP65ENC

Main Switch Incomer



100A Double Pole 2 Module
HL MSW100

Time Switches

Manual override 24hrs / 7 day programme
Summer/Winter switch over
35mm Din Rail mounting



HL AT1

HL AT1	Analogue 1 Channel 1 Module
HLD T1	Digital 1 Channel 1 Module
HLD T2	Digital 2 Channel 2 Module

Contactors



35mm Din Rail Mounting	
HL CON20A	20A 1 Module
HL CON25A	25A 1 Module
HL CON40A	40A 2 Module

Bell Transformer



2 Module
35mm Din Rail Mounting
HL BT

32A Triple Pole and Neutral Metal Switch



HL SW32TPN



Vogue

- Comprehensive range for most residential and light commercial applications
- Manufactured from high grade thermoset material
- 13A Sockets ASTA certified
- Flexible grid solutions, both traditional and micro grid available. 1 to 8 gang front plates

10^{*}
YEAR Guarantee

* Excludes dimmers covered by a 1 year guarantee and USB sockets which have a 2 year guarantee



Vogue Box Fix

Rocker Switches



VWPR21 W



VWPR22 W



VWPR23 W

	1 gang 10AX 2 Way Rocker	2 gang 10AX 2 Way Rocker	3 gang 10AX 2 Way Rocker	4 gang 10AX 2 Way Rocker	6 gang 10AX 2 Way Rocker	1 gang 10AX Intermediate Rocker	1 gang 10AX 2 Way Rocker (Architrave)	1 gang 10AX 1 Way Rocker	1 gang 10A Triple Pole Rocker
White	VWP R21 W	VWP R22 W	VWPR23 W	VWP R24 W	VWP R26 W	VWPR31 W	VWP AR21 W	VWP R11 W	VWP TP W
Nominal Size:	86mm x 86mm	86mm x 86mm	86mm x 86mm	146mm x 86mm	146mm x 86mm	86mm x 86mm	86mm x 40mm	86mm x 86mm	86mm x 86mm
Minimum Wall Box Depth:	25mm	25mm	25mm	25mm	25mm	25mm	47mm	25mm	25mm
Technical Insert Ref:	VWPR21	VWPR22	VWPR23	VWPR24	VWPR26	VWPR31	VWPAR21	VWPR11	VWPTP

Pull Cord Switches



VWP CS6A W



VWP CS45DPN W

	1 gang 6A 2 Way Pull Cord Switch	1 gang 45A Double Pole + Neon Pull Cord Switch
White	VWP CS6A W	VWP CS45DPN W
Technical Insert Ref:	PCS6A	PCS45DPN

Vogue Box Fix

Power Sockets



VWP SS1 W

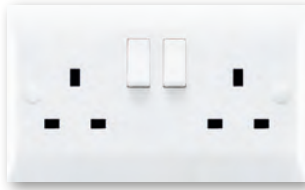

VWP SS2 W

	Shaver Dual Voltage Unswitched Socket (Vertically Mounted)	1 gang 13A Double Pole Switched Socket	2 gang 13A Double Pole Switched Socket	1 gang 13A Double Pole Switched Socket and Neon	1 gang 13A Double Pole Switched Socket (Deep Plate)	2 gang 13A Double Pole Switched Socket and Neon	2 gang 13A Double Pole Switched Socket (Deep Plate)	1 gang 5A Unswitched Socket	1 gang 13A Unswitched Socket	2 gang 13A Unswitched Socket
White	VWP SHS W	VWP SS1 W	VWP SS2 W	VWP SS1N W	VWP SS1 WD	VWP SS2N W	VWP SS2 WD	VWP US5 W	VWP US13 W	VWP US99 W
Nominal Size:	86mm x 146mm	86mm x 86mm	146mm x 86mm	86mm x 86mm	146mm x 86mm	146mm x 86mm	146mm x 86mm	86mm x 86mm	86mm x 86mm	146mm x 86mm
Minimum Wall Box Depth:	47mm	35mm	35mm	35mm	35mm	35mm	35mm	35mm	25mm	35mm
Technical Insert Ref:	VWP SHS	VWP SS1	VWP SS2	VWP SS1N	VWP SS1WD	VWP SS2N	VWP SS2WD	VWP US5	VWP US13	VWP US99

USB Power Sockets



VWP SS1USBX1 W



VWP SS2USBX2 W

	1 gang 13A Single Pole Switched Socket with 1 USB Outlets 1x2.1A	2 gang 13A Single Pole Switched Socket with 2 USB Outlets 1x1A 1x2.1A
White	VWP SS1USBX1 W	VWP SS2USBX2 W
Nominal Size:	86mm x 86mm	146mm x 86mm
Minimum Wall Box Depth:	35mm	35mm
Technical Insert Ref:	VWP SS1USBX1	VWP SS2USBX2

Vogue Box Fix

Television Coaxial Sockets



VWP TVW



VWP TV2 W

	1 gang Non-Isolated Television 1in/1out	2 gang Non-Isolated Television 2in/2out
White	VWP TV W	VWP TV2 W
Nominal Size:	86mm x 86mm	86mm x 86mm
Minimum Wall Box Depth:	25mm	25mm
Technical Insert Ref:	VWPTV	VWPTV2

Telephone and Data Outlets



VWP TCM W



VWP TCS W

	1 gang Telephone Master	1 gang Telephone Slave
White	VWP TCM W	VWP TCS W
Nominal Size:	86mm x 86mm	86mm x 86mm
Minimum Wall Box Depth:	25mm	25mm
Technical Insert Ref:	VWPTCM	VWPTCS

Double Pole Switches



VWP DPC W



VWP 45N W



VWP 45SS1N W

	1 gang 20AX Double Pole Rocker and Cable Outlet	1 gang 20AX Double Pole Rocker and Neon and Cable Outlet	1 gang 45A Double Pole Rocker and Neon	1 gang 45A Double Pole Rocker and Neon (Vertically Mounted)	45A Double Pole Rocker + Neon + 13A Switched Socket
White	VWP DPC W	VWP DPNC W	VWP 45N W	VWP 45V W	VWP 45SS1N W
	-	-	VWP 45N WH-W	-	VWP 45SS1N WH-W
Nominal Size:	86mm x 86mm	86mm x 86mm	86mm x 86mm	146mm x 86mm	146mm x 86mm
Minimum Wall Box Depth:	35mm	35mm	35mm	35mm	35mm
Technical Insert Ref:	VWPDPC	VWPDPC	VWP45N	VWP45V	VWP45SS1N

Connection Units



VWP SP W



VWP SPC W



VWP FOC W



VWP CO45 W

	1 gang 13A Double Pole Fused Spur	1 gang 13A Double Pole Fused Spur and Cable Outlet	1 gang 13A Double Pole Fused Spur and Neon and Cable Outlet	1 gang 13A Fuse and Cable Outlet	1 gang 20A Cable Outlet	1 gang 45A Cable Outlet White
White	VWP SP W	VWP SPC W	VWP SPNC W	VWP FOC W	VWP CO W	VWP CO45 W
Nominal Size:	86mm x 86mm	86mm x 86mm	86mm x 86mm	86mm x 86mm	86mm x 86mm	86mm x 86mm
Minimum Wall Box Depth:	35mm	35mm	35mm	35mm	35mm	35mm
Technical Insert Ref:	VWPSP	VWPSPC	VWPSPNC	VWPFOC	VWP CO	VWP CO45

Vogue Box Fix

LED Trailing/Leading Edge Push On/Off Rotary 2 Way Switching Dimmers



VWP 1XLEDITB100



VWP 2XLEDITB100



VWP 3XLEDITB100

	1 gang 100W LED 2 Way Push On/Off Rotary Dimmer	2 gang 100W LED 2 Way Push On/Off Rotary Dimmer	3 gang 100W LED 2 Way Push On/Off Rotary Dimmer	4 gang 100W LED 2 Way Push On/Off Rotary Dimmer
White	VWP 1XLEDITB100	VWP 2XLEDITB100	VWP 3XLEDITB100	VWP 4XLEDITB100
Nominal Size:	86mm x 86mm	86mm x 86mm	146mm x 86mm	146mm x 86mm
Minimum Wall Box Depth:	35mm	35mm	35mm	35mm
Technical Insert Ref:	1XLEDITB	2XLEDITB	3XLEDITB	4XLEDITB

LED Trailing/Leading Edge Push On-Off Rotary Multi-Way Dimmers



VWP 1X100LED



VWP 2X100LED



VWP 3X100LED

	1 gang 100W LED Trailing/Leading Edge Push On-Off Rotary Multi-Way Dimmer	2 gang 100W LED Trailing/Leading Edge Push On-Off Rotary Multi-Way Dimmers	3 gang 100W LED Trailing/Leading Edge Push On-Off Rotary Multi-Way Dimmers	4 gang 100W LED Trailing/Leading Edge Push On-Off Rotary Multi-Way Dimmers
White	VWP 1X100LED	VWP 2X100LED	VWP 3X100LED	VWP 4X100LED
Nominal Size:	86mm x 86mm	86mm x 86mm	146mm x 86mm	146mm x 86mm
Minimum Wall Box Depth:	35mm	35mm	35mm	35mm
Technical Insert Ref:	1X100LED	2X100LED	3X100LED	4X100LED

Resistive Leading Edge Push On/Off Rotary 2 Way Switching Dimmers



VWP 1X40



VWP 2X40



VWP 3X40

	1 gang 400W Resistive Leading Edge Push On-Off Rotary 2 Way Switching Dimmer	2x400W Resist Lead Edge Push On-Off Rotary 2 Way Switch Dimmer max 300W per gang	3 gang 400w Resistive Leading Edge Push On-Off Rotary 2 Way Switching Dimmers	4x400W Resist Lead Edge Push On-Off Rotary 2 Way Switch Dimmer max 300W per gang
White	VWP 1X40	VWP 2X40	VWP 3X40	VWP 4X40
Nominal Size:	86mm x 86mm	86mm x 86mm	146mm x 86mm	146mm x 86mm
Minimum Wall Box Depth:	35mm	35mm	35mm	35mm
Technical Insert Ref:	1X40	2X40	3X40	4X40

Vogue Box Fix

Blank Plates

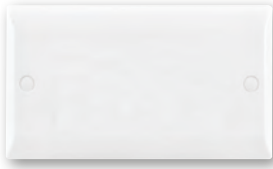

VWP BPD

	Single Blank Plate	Double Blank Plate
White	VWP BPS	VWP BPD
Nominal Size:	86mm x 86mm	146mm x 86mm
Minimum Wall Box Depth:	Any Box	Any Box
Technical Insert Ref:	VWPBPS	VWPBPD

EuroFix Apertured Plates complete with Fixing Grid



VWPEURO2

	Single Plate complete with 2 EuroFix Apertures 50x50mm and Grid	Double Plate complete with 4 EuroFix Apertures 100x50mm and Grid
White	VWP EURO2	VWP EURO4
Nominal Size:	86mm x 86mm	146mm x 86mm
Minimum Wall Box Depth:	As per Inserts	As per Inserts
Technical Insert Ref:	VWPEURO2	VWPEURO4

Vogue Micro Grid Fix

Rocker Switches



VWVG R21 W



VWVG R22 W



VWVG R23 W

	1 gang Micro Grid 10AX 2 Way Rocker	2 gang Micro Grid 10AX 2 Way Rocker	3 gang Micro Grid 10AX 2 Way Rocker	4 gang Micro Grid 10AX 2 Way Rocker
White	VWVG R21 W	VWVG R22 W	VWVG R23 W	VWVG R24 W
Nominal plate size:	86mm x 86mm	86mm x 86mm	86mm x 86mm	146mm x 86mm
Minimum Wall Depth:	25mm	25mm	25mm	25mm
Technical Insert Ref:	TRD-VMG-R21	TRD-VMG-R22	TRD-VMG-R23	TRD-VMG-R24

Micro Grid Fix Apertured Plates

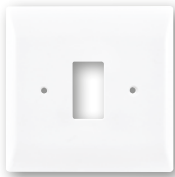

VWVG 1GP

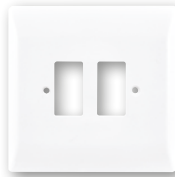

VWVG 2GP



VWVG 3GP



VWVG 4GP

	1 Gang Micro Grid Fix Aperture Plate with Grid	2 Gang Micro Grid Fix Aperture Plate with Grid	3 Gang Micro Grid Fix Aperture Plate with Grid	4 Gang Micro Grid Fix Aperture Plate with Grid
White	VWVG 1GP	VWVG 2GP	VWVG 3GP	VWVG 4GP
Nominal plate size:	86mm x 86mm as per insert	86mm x 86mm as per insert	86mm x 86mm as per insert	146mm x 86mm as per insert
Minimum Wall Depth:				
Technical Insert Ref:	TRD-VMG-1GP	TRD-VMG-2GP	TRD-VMG-3GP	TRD-VMG-4GP

Micro Grid Rocker Modules



10AX 2 Way Rocker Module



10AX Intermediate Rocker Module



10AX Push To Make Retractive
Rocker Module

10AX 1 Way Rocker Module

No Plate Colour	VWVG IR21 W	VWVG IR31 W	VWVG IRRT W	VWVG IR11 W
Technical Insert Ref:	TRD-VMG-IR21	TRD-VMG-IR31	TRD-VMG-IRRT	TRD-VMG-IR11

Vogue Grid Fix

Grid Fix Apertured Plates

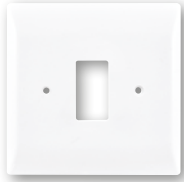

VW 1GP

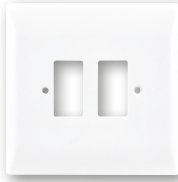

VW 2GP



VW 3GP

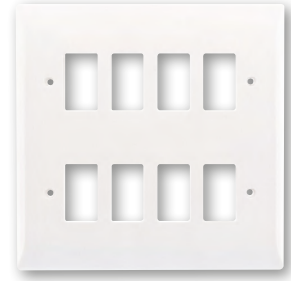

VW 8GP

	1 Gang Aperture Plate	2 Gang Aperture Plate	3 Gang Aperture Plate	4 Gang Aperture Plate	6 Gang Aperture Plate	8 Gang Aperture Plate	12 Gang Aperture Plate
	VW 1GP	VW 2GP	VW 3GP	VW 4GP	VW 6GP	VW 8GP	VW 12GP
Nominal Size:	86mm x 86mm as per insert	86mm x 86mm as per insert	146mm x 86mm as per insert	146mm x 86mm as per insert	146mm x 146mm as per insert	146mm x 146mm as per insert	146mm x 146mm as per insert
Technical Insert Ref:	TRD-VG-1GP	TRD-VG-2GP	TRD-VG-3GP	TRD-VG-4GP	TRD-VG-6GP	TRD-VG-8GP	TRD-VG-12GP

Fixing Grid



VW 1G-GRID



VW 2G-GRID



VW 4G-GRID

	Vogue 1 Gang Grid	Vogue 2 Gang Grid	Vogue 3 Gang Grid	Vogue 4 Gang Grid
Silver	VW 1G-GRID	VW 2G-GRID	VW 3G-GRID	VW 4G-GRID
Nominal Size:	86mm x 86mm as per insert	86mm x 86mm as per insert	146mm x 86mm as per insert	146mm x 86mm as per insert
Technical Insert Ref:	VW1G-GRID	VW2G-GRID	VW3G-GRID	VW4G-GRID

Resistive Leading Edge Push On/Off Rotary 2 Way Switching Dimmers Kit Module



VWG1D400-2

	1 gang 400W 2 Way Dimmer Module Full Kit
No Plate Colour	VWG1D400-2
Technical Insert Ref:	TRD-VG-ID400-2

Vogue Grid Fix Modules

Rocker Switches



VWGIR21 W



VWGI R31 W



VWGI RRT W



VWGI R212 W



VWGI R11 W

	10AX 2 Way Rocker Rocker	10AX Intermediate Rocker Module	10AX Push To Make Retractive Rocker Module	20AX 2 Way Rocker Rocker	10AX 1 Way Rocker Module
No Plate Colour	VWGI R21 W	VWGI R31 W	VWGI RRT W	VWGI R212 W	VWGI R11 W
Technical Insert Ref:	TRD-VG-IR21	TRD-VG-IR31	TRD-VG-IRRT	TRD-VG-IR212	TRD-VG-IR11

Key Switches



VWGI K21 W

	20AX 2 Way Key Switch Module	20AX Double Pole Key Switch Module
No Plate Colour	VWGI K21 W	VWGI KDP W
Technical Insert Ref:	TRD-VG-IK21	TRD-VG-IKDP

Double Pole Switches



VWGI DPN W

	20AX Double Pole Rocker Module	20AX Double Pole Rocker and Neon Module
No Plate Colour	VWGI DP W	VWGI DPN W
Technical Insert Ref:	TRD-VG-IDP	TRD-VG-IDPN

Blank Modules



VWGI 1BNK W

	Blank Grid Module
No Plate Colour	VWGI 1BNK W
Technical Insert Ref:	TRD-VG-I1BNK

Vogue Grid Fix

Connection Units



VWG1FO W



VWG1CO W

	Vogue White 13A Fuse Grid Module	20A Cable Outlet Module
White/White	VWG1FO W	VWG1CO W
Technical Insert Ref:	TRD-VG-IFO	TRD-VG-ICO

	Neon Only Module
Green/White	VWG1NG W
Orange/White	VWG1NO W
Red/White	VWG1NR W
Technical Insert Ref:	TRD-VG-INO

Vogue Box Fix

Vogue White Surface Mounted Pattress



VWP1G35PB



VWP1G43PB



VWP2G35PB



VWP2G43PB

White	VWP1G35PB	VWP1G43PB	VWP2G35PB	VWP2G43PB
Technical Insert Ref:	VBBOX1X35	VBBOX1X43	VBBOX2X35	VBBOX2X43
Nominal Size:	86mm x 86mm	86mm x 86mm	146mm x 86mm	146mm x 86mm
Minimum Wall Box Depth:	35mm Deep	43mm Deep	35mm Deep	43mm Deep

Vogue White Dimmer

Dimmer plate & knob only : no dimmer module included.



VWPD1



VWPD2



VWPD3

White	VWPD1	VWPD2	VWPD3	VWPD4
Technical Insert Ref:	VWPD1	VWPD2	VWPD3	VWPD4
Nominal Size:	86mm x 86mm	86mm x 86mm	146mm x 86mm	146mm x 86mm
Minimum Wall Box Depth:	35mm Deep	35mm Deep	35mm Deep	35mm Deep



Elemento

- Robust high impact UV stable housing
- Multiple gland entry positions
- IP66 rated when in use (excluding RCD outlets)
- Lockable 2 gang switched socket outlet as standard



Guarantee



Wireless Switching

- Wireless 4 channel switching system
- Can be used outside to control multiple lighting circuits, pond pumps and many other electrical devices
- Each circuits is controlled wirelessly using the supplied key fob and wallplate



Guarantee

Elemento IP

4 Channel Wireless Switching



IP56 Protected



LED Compatible



Wireless Switching



Range Distance 250m

Wireless 4 Channel Radio Receiver / Power Switch c/w MWM-4CHRC and MWM-4CHRT-WH-W
4 circuits each rated at 5 amps 1250 watts per circuit Total pack load MUST not exceed 4000 watts

MWM - 4CHPSKIT

IP66 Switched Power Socket Outlets



1 Gang 13A Double Pole Switched Socket Outlet

ELMSS1GY

Technical Ref:

TRD-ELM SS1



2 Gang 13A Double Pole Switched Socket Outlet

ELMSS2GY

TRD-ELM SS2



1 Gang 13A Unswitched Socket Outlet

ELMUS13GY

TRD-ELM US13



2 Gang Unswitched Socket Outlet

ELMUS99GY

TRD-ELM US99



2 Gang RCD Socket 13A 30mA

ELMRCDNLGY

TRD-ELM RCD

20AX 2 Way Rocker Switches



1 Gang 20AX 2 Way Rocker Switch + Neon

ELMR21NGY

Technical Ref:

TRD-ELM-R21N



2 Gang 20AX 2 Way Rocker Switch + Neon

ELMR22NGY

TRD-ELM-R22N

IP66 20AX Switch with Neon



1 Gang 20AX 2 Way Retractive Switch + Neon

ELMR2WNGY

Technical Ref:

TRD-ELM-R2WNGY



1 Gang 20AX Double Pole Switch + Neon

ELM20DPNGY

TRD-ELM-29DPNGY

IP66 Switched Connection Unit



Switched Connection Unit+Neon

ELMSPNGY

Technical Ref:

TRD-ELM-SPN

IP66 Enclosures



1 Gang Enclosure

ELM1MODGY

Technical Ref:

TRD-ELM-1MOD



2 Gang Enclosure

ELM2MODGY

TRD-ELM-2MOD

Junction Box



Junction Box Single

ELMSGJUNBOX

Technical Ref:

TRD-ELM-SGLJUNBOX



Elemento IP66 weatherproof accessories



Hamilton Air – IP56 wireless switching system

Add the all-weather touch to Gardens

Elemento –

a safe and reliable way to deliver power outdoors

- IP66 rated lockable casings
- Socket outlets, switches, connection units & enclosures
- Lockable 2 gang switched socket outlet as standard
- **NEW** RCD units, Retractive Switch, Double Pole Switch



Hamilton Air –

take remote control of multiple outdoor circuits

- IP56 rated, 4x 5A/1.25KW channel unit
- Ideal for garden lighting, ponds, garage doors and gates
- Wireless control using key fob & wall plates
- Operating Range: 250 metres



You need to be tough to survive outdoors!

Hamilton®

making connections beautifully

Wiring Accessories • Smart Lighting Control & Audio Solutions

www.hamilton-litestat.com

+44 (0)1747 860088

info@hamilton-litestat.com



BRITISH MANUFACTURER



Metalclad

- Upgraded Stylish grey finish
- Developed to ensure back boxes fit exactly
- Tough, impact resistant, durable & hard-wearing



Stylish
Design



Durable
Finish



10
YEAR Guarantee

Metalclad

Rocker Switches



MCR21 WH-W



MCR22 WH-W



MCR23 WH-W

	1 gang 10AX 2 Way Rocker	2 gang 10AX 2 Way Rocker	3 gang 10AX 2 Way Rocker
Grey	MCR21 WH-W	MCR22 WH-W	MCR23 WH-W
Nominal Size:	80.0mm x 80.0mm	80.0mm x 80.0mm	80.0mm x 80.0mm
Minimum Wall Box Depth:	40mm	40mm	40mm
Technical Ref:	MCR21	MCR22	MCR23

Power Sockets



MCSS1 WH-W



MCSS2 WH-W

	1 gang 13A Double Pole Switched Socket	2 gang 13A Double Pole Switched Socket
Grey	MCSS1 WH-W	MCSS2 WH-W
Nominal Size:	80.0mm x 80.0mm	142.0mm x 80.0mm
Minimum Wall Box Depth:	40mm	40mm
Technical Ref:	MCSS1	MCSS2

USB Power Sockets



MCSS2USB2 WH-W

	2 gang 13A Single Pole Switched Socket with 2 USB Outlets 1x1A 1x2.1A
Grey	MCSS2USB2 WH-W
Nominal Size:	142.0mm x 80.0mm
Minimum Wall Box Depth:	40mm
Technical Ref:	MCSS2USB2

Blank Plates + Back Box

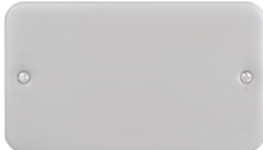

	Metalclad Single Blank Plate + Back Box	Metalclad Double Blank Plate + Back Box
Grey	MCBPS+BOX	MCBPD+BOX
Nominal Size:	80.0mm x 80mm	142.0mm x 80mm
Minimum Wall Box Depth:	40mm	40mm

Metalclad

Double Pole Switches



MC DP WH-W



MC DPC WH-W



MC DPN WH-W



MC DPNC WH-W



MC 45 W



MC 45N W

	1 gang 20AX Double Pole Rocker	1 gang 20AX Double Pole Rocker and Cable Outlet	1 gang 20AX Double Pole Rocker and Neon	1 gang 20AX Double Pole Rocker and Neon and Cable Outlet	1 gang 45A Double Pole Rocker	1 gang 45A Double Pole Rocker and Neon
Grey	MC DP WH-W	MC DPC WH-W	MC DPN WH-W	MC DPNC WH-W	MC 45 W	MC 45N W
Nominal Size:	80.0mm x 80mm	80.0mm x 80mm	80.0mm x 80mm	80.0mm x 80mm	80.0mm x 80mm	80.0mm x 80mm
Minimum Wall Box Depth:	40mm	40mm	40mm	40mm	40mm	40mm
Technical Ref:	MCDP	MCDPC	MCDPN	MCDPNC	MC45	MC45N

Connection Units



MC SP WH-W



MC SPC WH-W



MC SPN WH-W



MC FO W



MC FOC W



MCKSPNRD-W

	1 gang 13A Double Pole Fused Spur	1 gang 13A Double Pole Fused Spur and Cable Outlet	1 gang 13A Double Pole Fused Spur and Neon	1 gang 13A Double Pole Fused Spur and Neon and Cable Outlet	1 gang 13A Fuse Only	1 gang 13A Fuse and Cable Outlet	1 gang 13A Fuse and Neon	1 gang 13A Fuse and Neon and Cable Outlet	Metalclad Red 1 gang 13ADP Key Spur+N
Grey	MC SP WH-W	MC SPC WH-W	MC SPN WH-W	MC SPNC WH-W	MC FO W	MC FOC W	MC FON W	MC FOCN W	MCKSPNRD-W
Nominal Size:	80.0mm x 80mm	80.0mm x 80mm	80.0mm x 80mm	80.0mm x 80mm	80.0mm x 80mm	80.0mm x 80mm	80.0mm x 80mm	80.0mm x 80mm	80.0mm x 80mm
Minimum Wall Box Depth:	40mm	40mm	40mm	40mm	40mm	40mm	40mm	40mm	40mm
Technical Ref:	MCS P	MCS PC	MCS PN	MCS PNC	MCFO	MCFOC	MCFON	MCFONC	MCKSPN

EuroFix Apertured Plates + Back Box



MCEURO2 W



MCEURO4 W

	Single Enclosure complete with 2 EuroFix Apertures 50x50mm	Double Enclosure complete with 4 EuroFix Apertures 100x50mm
Grey	MC EURO2 W	MC EURO4 W
Nominal Size:	80.0mm x 80mm	142.0mm x 80mm
Minimum Wall Box Depth:	40mm	40mm
Technical Ref:	MCEURO2	MCEURO4

Metalclad Fixing grids



MC 1G-GRID



MC 2G-GRID

	Metalclad Grid Fix 1/2 Aperture Grid for Single c/w screws	Metalclad Grid Fix 3/4 Aperture Grid for Double c/w screws
Grey	MC EURO2 W	MC EURO4 W
Nominal Size:	80.0mm x 80mm as per insert	142.0mm x 80mm as per insert
Minimum Wall Box Depth:	40mm	40mm
Technical Ref:	MCEURO1/2	MCEURO3/4

Metalclad

Back Boxes



	Metalclad 40mm 1g Box With Terminal	Metalclad 50mm 1g Box With Terminal	Metalclad 40mm 2g Box With Terminal	Metalclad 50mm 2g Box With Terminal
Grey	MC1G40MM-BOX	MC1G50MM-BOX	MC2G40MM-BOX	MC2G50MM-BOX
Nominal Size:	80.0mm x 80mm	80.0mm x 80mm	142.0mm x 80mm	142.0mm x 80mm
Minimum Wall Box Depth:	40mm	50mm	40mm	50mm

Metalclad Grid Plates



	1 Aperture Plate - Single Plate c/w fixing Screws + 40mm Back Box	2 Aperture Plate - Single Plate c/w fixing Screws + 40mm Back Box	3 Aperture Plate - Double Plate c/w fixing Screws + 40mm Back Box	4 Aperture Plate - Double Plate c/w fixing Screws + 40mm Back Box	6 Aperture Plate - Double Plate c/w fixing Screws + 40mm Back Box	8 Aperture Plate - 150 x 150 c/w fixing Screws + 40mm Back Box
Grey	MCG1GP	MCG2GP	MCG3GP	MCG4GP	MCG6GP	MCG8GP
Nominal Size:	80.0mm x 80mm	142.0mm x 80mm	142.0mm x 80mm	142.0mm x 80mm	142.0mm x 142.0mm	142.0mm x 142.0mm
Minimum Wall Box Depth:	40mm	40mm	40mm	40mm	40mm	40mm

Metalclad Grid plates and modules sold separately

Metalclad Grid Modules



MC G/F Module Blank White/White	MC G/F Module 20A Cable Outlet White/White	MC G/F Module 20AX Double Pole Rocker White/White	MC G/F Module 13A Fuse Only White/White	MC G/F Module 20AX 2 Way Key + Key White/White	MC G/F Mod 20AX Double Pole Key "EM LGT"+ Key White	MC G/F Module 20AX Double Pole Key+Key White
MCG1BNKW	MCGICOW	MCGIDPW	MCGIFOW	MCGIK21W	MCGKDPETW	MCGIKDPW



MC G/F Spare Key for Key Switch Module	MC G/F Module Neon Only Green/White	MC G/F Module Neon Only Orange/White	MC G/F Module Neon Only Red/White	MC G/F Module 20AX 2 Way Rocker White/White	MC G/F Module 20AX Intermediate Rocker White/White	MC G/F Module 20A PTM Retract Rocker White/White
MCGIKEY	MCGINGW	MCGINOW	MCGINRW	MCGIR212W	MCGIR312W	MCGIRRTW

White Plastic Range

Quality Box Fix Dimmers on Stylish White Plastic Plates

A range of economy accessories on White Plastic plates to complement today's interiors.

- Clean, stylish and ideal for the nursery
- Standard Box-Fix Push On/Off Dimmers



White Plastic Dimmers ▶ Plate depth 6 mm

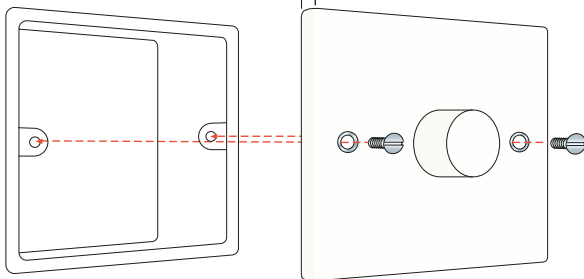



Box-Fix to Back Box

White Plastic



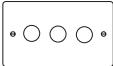
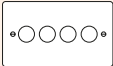

LED Trailing/Leading Edge Push On/Off Rotary Multi-Way Dimmers



				
	1 gang 100W LED Trailing/Leading Edge Push On/Off Rotary Multi-Way Dimmer	2 gang 100W LED Trailing/Leading Edge Push On/Off Rotary Multi-Way Dimmers	3 gang 100W LED Trailing/Leading Edge Push On/Off Rotary Multi-Way Dimmers	4 gang 100W LED Trailing/Leading Edge Push On/Off Rotary Multi-Way Dimmers
White	KP 1X100LED	KP 2X100LED	KP 3X100LED	KP 4X100LED
Nominal Size:	86.0mm x 86.0mm	86.0mm x 86.0mm	146.0mm x 86.0mm	146.0mm x 86.0mm
Minimum Wall Box Depth:	35mm	35mm	35mm	35mm
Technical Insert Ref:	1X100LED	2X100LED	3X100LED	4X100LED

LED Trailing/Leading Edge Push On/Off 2 Way Switching Dimmers







				
	1 gang 100W LED 2 Way Push On/Off Rotary Dimmer	2 gang 100W LED 2 Way Push On/Off Rotary Dimmer	3 gang 100W LED 2 Way Push On/Off Rotary Dimmer	4 gang 100W LED 2 Way Push On/Off Rotary Dimmer
White	KP 1XLEDITB100	KP 2XLEDITB100	KP 3XLEDITB100	KP 4XLEDITB100
Nominal Size:	86.0mm x 86.0mm	86.0mm x 86.0mm	146.0mm x 86.0mm	146.0mm x 86.0mm
Minimum Wall Box Depth:	35mm	35mm	35mm	35mm
Technical Insert Ref:	1XLEDITB	2XLEDITB	3XLEDITB	4XLEDITB

White Plastic

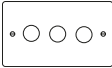
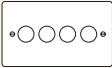

Resistive Leading Edge Push On/Off 2 Way Switching Dimmers



					
	1 gang 400W Resistive Leading Edge Push On/Off Rotary 2 Way Switching Dimmer	2x400W Resistive Leading Edge Push On/Off Rotary 2 Way Switch Dimmer max 300W per gang	3x400w Resistive Leading Edge Push On/Off Rotary 2 Way Switch Dimmer max 300W per gang	4x400W Resistive Leading Edge Push On/Off Rotary 2 Way Switch Dimmer max 250W per gang	1 gang 600W Resistive Leading Edge Push On/Off Rotary 2 Way Switching Dimmer
White	KP 1X40	KP 2X40	KP 3X40	KP 4X40	KP 1X60
Nominal Size:	86.0mm x 86.0mm	86.0mm x 86.0mm	146.0mm x 86.0mm	146.0mm x 86.0mm	86.0mm x 86.0mm
Minimum Wall Box Depth:	35mm	35mm	35mm	35mm	35mm
Technical Insert Ref:	1X40	2X40	P3X40	P4X40	1X60

Inductive Leading Edge Push On/Off Rotary 2 Way Switching Dimmers





		
	1 gang 200VA Inductive Leading Edge Push On/Off Rotary 2 Way Switching Dimmer	2 gang 200VA Inductive Leading Edge Push On/Off Rotary 2 Way Switching Dimmers
White	KP 1X2V	KP 2X2V
Nominal Size:	86.0mm x 86.0mm	86.0mm x 86.0mm
Minimum Wall Box Depth:	35mm	35mm
Technical Insert Ref:	1X2V	2X2V

White Plastic

Push On/Off Rotary Switches

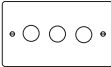
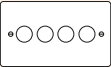

	 1 gang 5A Push On/Off Rotary Switch	 2 gang 5A Push On/Off Rotary Switch	 3 gang 5A Push On/Off Rotary Switch	 4 gang 5A Push On/Off Rotary Switch
White	KP 1XPS	KP 2XPS	KP 3XPS	KP 4XPS
Nominal Size:	86.0mm x 86.0mm	86.0mm x 86.0mm	146.0mm x 86.0mm	146.0mm x 86.0mm
Minimum Wall Box Depth:	35mm	35mm	35mm	35mm
Technical Insert Ref:	1X5A	2X5A	3X5A	4X5A

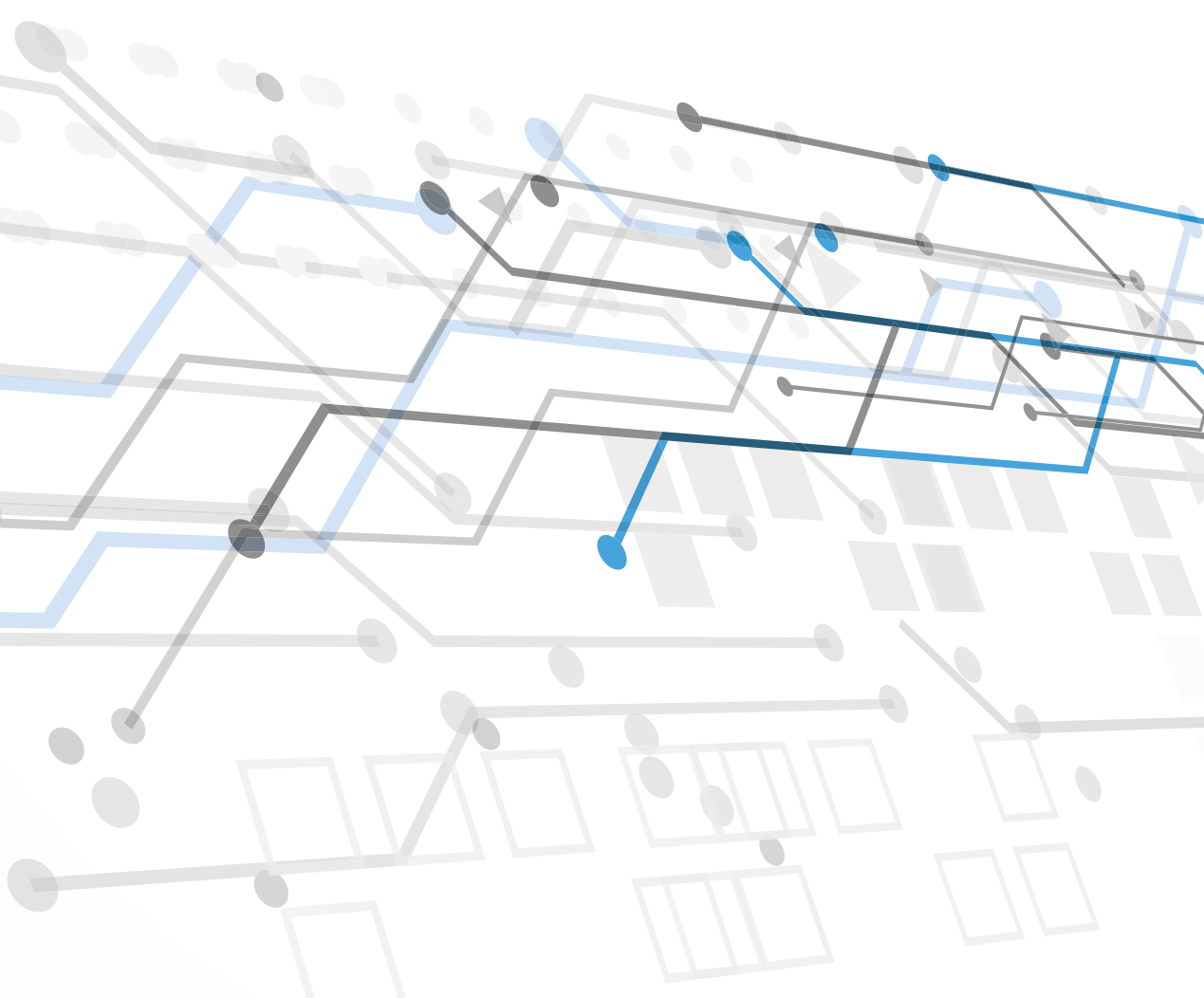

Technical Specifications



Rocker Switches/Key Switches

Category:

10AX Rocker Switch

Current Rating: 10AX
Max Load: 10 Amp inductive

Technical Insert Ref:	Description:
R21	1 gang 10AX 2 way Rocker
R22	2 gang 10AX 2 way Rocker
R23	3 gang 10AX 2 way Rocker
R24	4 gang 10AX 2 way Rocker
R26	6 gang 10AX 2 way Rocker
R31	1 gang 10AX Intermediate Rocker
R32	2 gang 10AX Intermediate Rocker
RRT	1 gang 10AX Push to Make Retractive Rocker
CFXRRT	1 gang 10AX PTM/PTB Retractive Rocker

Grid-IT 10AX Rocker Switch Modules

GRR2W	1 gang 10AX Retractive 2 way and Off Rocker
GR21	1 gang 10AX 2 way Rocker
GRRT	1 gang 10AX PTM/PTB Retractive Rocker

Grid-IT 20AX Rocker Switch Modules

Current Rating:	20AX
Max Load:	20 Amp inductive
GR2WO	1 gang 20AX Non-Retractive 2 way & Off Rocker
GR212	1 gang 20AX 2 way Rocker
GR312	1 gang 20AX Intermediate Rocker

20AX Rocker Switch

Current Rating: 20AX
Max Load: 20 Amp inductive

Technical Insert Ref:	Description:
R212	1 gang 20AX 2 way Rocker
R222	2 gang 20AX 2 way Rocker
R232	3 gang 20AX 2 way Rocker
R242	4 gang 20AX 2 way Rocker
R312	1 gang 20AX Intermediate Rocker
R322	2 gang 20AX Intermediate Rocker

20AX Key Switch

K21	1 gang 20AX 2 way Key Switch
KEL	1 gang 20AX 2 way Key Switch "EMG LTG TEST"

GRID-IT 20AX Key Switch Module

GK21	1 gang 20AX 2 way Key Switch
GKEL	1 gang 20AX 2 way Key Switch "EMG LTG TEST"

Note: For Double Pole Key Switch please see the Double Pole Switch page.

Technical Specification:

Voltage: 220/250V AC
IP Rating: IP2XD
Switched Poles: Single
Contact Gap Minimum: 3mm
Product Class 1: Must be earthed
GRID-IT Product Class 1: Face plate must be earthed

Ambient Operating Temperature: -5° to +40°C
Location: Internal Use Only
Max Installation Altitude: 2000m

Standard Hamilton manufactured electrical accessories are designed to be mounted on BS4662:2006 flush wall boxes.

Standards:

BS EN ISO Standard: BS EN 60669-1

Terminal Capacity:

	1mm ²	1.5mm ²	2.5mm ²	4mm ² Multi-Strand	6mm ²
Terminal Capacity 10AX	5	4	1	1	1
Earth Terminal Capacity 10AX	5	4	3	1	1
Terminal Capacity 20AX	5	4	2	2	1
Earth Terminal Capacity 20AX	6	5	3	2	1

Fixing Centres:

2 Way Rocker

Intermediate Rocker

Push to make Rocker

Key Switch

60.3mm



R21/R212



R22/R222



R23



R31/R312



R32/R322



RRT



CFXRRT



K21



KEL

120.6mm



R232



R24/R242



R26

GRID-IT SWITCH INSERTS Fits 1 Grid-IT aperture



GR2WO
GRR2W



GR212
GR312

GR21



GK21



GKEL



GRRT

Due to constant changes in regulations, etc. users should satisfy themselves there have been no amendments. E&OE.

Toggle and Bell Push Switches

Category:

20AX Toggle Switch

Current Rating: 20AX

Max Load: 20 Amp inductive

Technical Insert Ref:

Technical Insert Ref:	Description:
T21	1 gang 20AX 2 way Toggle
T22	2 gang 20AX 2 way Toggle
T23	3 gang 20AX 2 way Toggle
T24	4 gang 20AX 2 way Toggle
T31	1 gang 20AX Intermediate Toggle
T32	2 gang 20AX Intermediate Toggle
Only available in the Bloomsbury Range	
TDP	1 gang 20AX Double Pole Toggle
*Switched Poles: Double	

10AX Retractive Toggle Switch

Current Rating: 10AX

Max Load: 10 Amp inductive

Technical Insert Ref:

Technical Insert Ref:	Description:
TRT	1 gang 10AX Push to Make/Break Retractive Toggle

Technical Specification:

Voltage:	220/250V AC
IP Rating:	IP2XD
Switched Poles:	Single*
Contact Gap Minimum:	3mm
Product Class 1:	Must be earthed
Ambient Operating Temperature:	-5° to +40°C
Location:	Internal Use Only
Max Installation Altitude:	2000m

Standard Hamilton manufactured electrical accessories are designed to be mounted on BS4662:2006 flush wall boxes.

Standards:

BS EN ISO Standard:
Toggle Switch BS EN 60669-1

Terminal Capacity:

	1mm ²	1.5mm ²	2.5mm ²	4mm ² Multi-Strand	6mm ²
Terminal Capacity	5	4	2	2	1
Earth Terminal Capacity	6	5	3	2	1

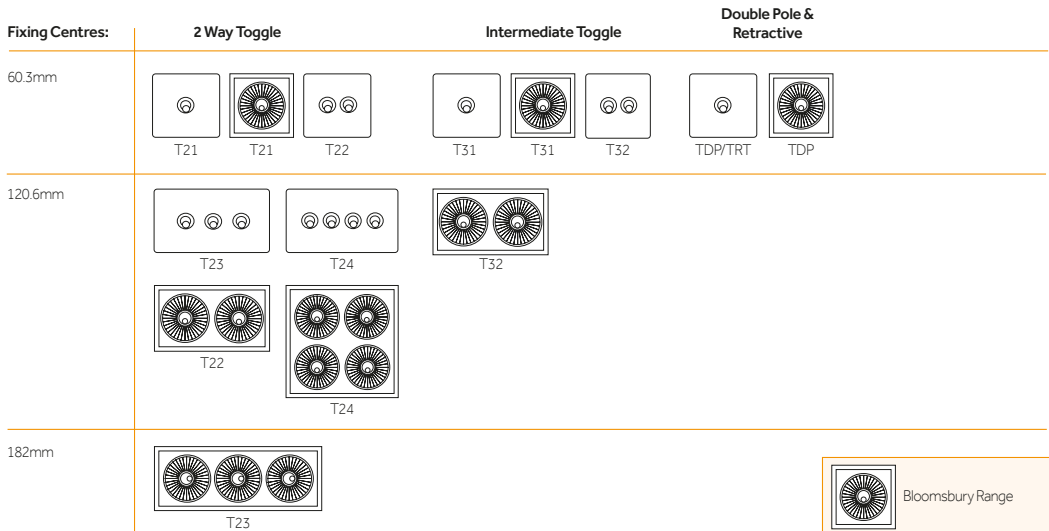

Double Pole Rocker Switches/Key Switches

Category:

20AX Double Pole Rocker Switch

Current Rating: 20AX
Max Load: 20 Amp inductive

Technical Insert Ref:	Description:
DP	1 gang 20AX Double Pole Rocker
DPN	1 gang 20AX Double Pole Rocker + Neon
DPNC	1 gang 20AX Double Pole Rocker + Neon + Cable Outlet

GRID-IT 20AX Double Pole Rocker Switch Module

GDP	1 gang 20AX Double Pole Rocker
-----	--------------------------------

GRID-IT 20AX DP Key Switch Module

GKDP	20AX Double Pole Key Switch
------	-----------------------------

45 Amp Double Pole Rocker Switch

Current Rating: 45 Amp
Max Load: 45 Amp

Technical Insert Ref:	Description:
45	1 gang 45A Double Pole Red Rocker
45N	1 gang 45A Double Pole Red Rocker + Neon
45V	45A Double Pole Red Rocker + Neon, Vertically Mounted

45 Amp Rocker Switch With 13Amp Socket

Current Rating: Switch 45 Amp/Socket 13 Amp
Max Load: Switch 45 Amp/Socket 13 Amp

Technical Insert Ref:	Description:
45SS1	45A Double Pole Red Rocker + Neon + 13A Switched Socket

Technical Specification:

Voltage: 220/250V AC
IP Rating: IP2XD
Switched Poles: Double
Contact Gap Minimum: 3mm
Product Class 1: Must be earthed
GRID-IT Product Class 1: Face plate must be earthed
Ambient Operating Temperature: -5° to +40°C
Location: Internal Use Only
Max Installation Altitude: 2000m

Standard Hamilton manufactured electrical accessories are designed to be mounted on BS4662:2006 flush wall boxes.

Standards:

BS EN ISO Standard:
20AX/45Amp Double Pole Rocker BS EN 60669-1
Double Pole Rocker with Socket BS 4177

Terminal Capacity:

	1mm ²	1.5mm ²	2.5mm ²	4mm ² Multi-Strand	6mm ²	10mm ²	16mm ²
20AX Terminal Capacity			3	2	1		
20AX Earth Terminal Capacity	6	5	3	2	1		
45Amp Terminal Capacity					3	2	1
45Amp Earth Terminal Capacity					3	2	1
GDP/GKDP Terminal Capacity	5	4	2	1	1		
GDP/GKDP Earth Terminal Capacity	6	5	3	2	1		

Fixing Centres:

60.3mm
DPNC Cable Outlet
Size: Min 0.75mm²
Max 2.5mm²

20Amp DP Rocker Switch



45Amp DP Rocker Switch

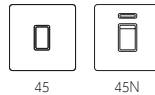

GRID-IT MODULE Fits 1 Grid-IT aperture

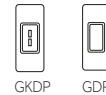

120.6mm

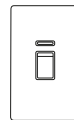

45V
Vertically mounted

DP ROCKER WITH SOCKET

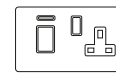

45SS1

Due to constant changes in regulations, etc. users should satisfy themselves there have been no amendments. E&OE.

Triple Pole Fan Isolator

Category:

FAN ISOLATOR

Technical Insert Ref:

TP

Description:

1 gang 10A Triple Pole Rocker

Technical Specification:

Current Rating:	10 Amp
Voltage:	220/250V AC
IP Rating:	IP2XD
Max Load:	10 Amp Resistive
Switched Poles:	Triple
Contact Gap Minimum:	3mm
Product Class 1:	Must be earthed
Ambient Operating Temperature:	-5° to +40°C
Location:	Internal Use Only
Max Installation Altitude:	2000m

Standard Hamilton manufactured electrical accessories are designed to be mounted on BS4662:2006 flush wall boxes.

Standards:

BS EN ISO Standard: BS EN 60669-1

Terminal Capacity:

	1mm ²	1.5mm ²	2.5mm ²	4mm ² Multi-Strand	6mm ²
Terminal Capacity 10AX	5	4	1	1	1
Earth Terminal Capacity	5	4	3	1	1

Fixing Centres:**Triple Pole Fan Isolator**

60.3mm



Hotel Card Switches

Category:

Hotel Card Switch

Current Rating: 10A (6AX)
Max Load: 10 Amp (6 Amp inductive)

Technical Insert Ref: C11
Description: 1 gang 10A (6AX) On/Off with Blue LED Locator
 Suitable for 44mm and 54mm width key cards

EuroFix Card Switch

MOD-C11 1 gang 10A (6AX) On/Off with Blue LED Locator
 Suitable for 44mm and 54mm width key cards

Technical Specification:

Voltage: 220/250V AC
KNX Voltage: 12-24V AC/DC
IP Rating: IP2XD
Switched Poles: Single
Contact Gap Minimum: 3mm
Product Class 1: Must be earthed
Eurofix Product Class 1: Face plate must be earthed
Ambient Operating Temperature: -5° to +40°C
Location: Internal Use Only
Max Installation Altitude: 2000m

Standard Hamilton manufactured electrical accessories are designed to be mounted on BS4662:2006 flush wall boxes.

Standards:
 BS EN ISO Standard: BS EN 60669-2-3

Terminal Capacity:

	1mm ²	1.5mm ²	2.5mm ²	4mm ² Multi-Strand	6mm ²
Terminal Capacity	3	2	1		
Earth Terminal Capacity	5	4	3	1	1

Fixing Centres:

Card Switch

Euro Card Switch

60.3mm



C11

Fits into one Euro2 aperture



MOD-C11

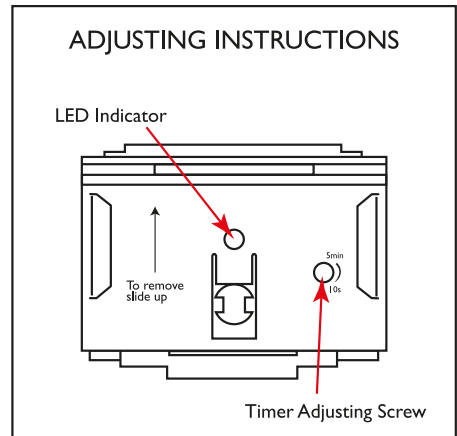

Due to constant changes in regulations, etc. users should satisfy themselves there have been no amendments. E&OE.

Switched Sockets

Category:

SWITCHED SOCKETS

Technical Insert Ref:	Description:
SS1	1 gang 13A Double Pole Switched Socket
SS2	2 gang 13A Double Pole Switched Socket

GRID-IT SWITCHED SOCKETS MODULES

Technical Insert Ref:	Description:
GSS1	1 gang 13A Double Pole Switched Socket
GSS2	2 gang 13A Double Pole Switched Socket

Technical Specification:

Current Rating:	13 Amp
Voltage:	220/250V AC
IP Rating:	IP2XD
Max Load:	13 Amp
Switched Poles:	Double
Contact Gap Minimum:	3mm
Product Class 1:	Must be earthed
GRID-IT Product Class 1:	Face plate must be earthed
Ambient Operating Temperature:	-5° to +40°C
Location:	Internal Use Only
Max Installation Altitude:	2000m
Dual Earth:	Yes

Standard Hamilton manufactured electrical accessories are designed to be mounted on BS4662:2006 flush wall boxes.

Standards:

BS EN ISO Standard:	BS 1363-2 Inc. amendment 1,2,3
ASTA Licence No:	1046 (SS1 and SS2 only)

Terminal Capacity:

	2.5mm ²	4mm ²	6mm ² Multi-Strand	10mm ²
Terminal Capacity	4	3	2	1
Earth Terminal Capacity	4	3	2	1

Fixing Centres:

13A Switched Sockets

60.3mm



SS1

120.6mm

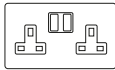

SS2

Fixing Centres:

60.3mm grid to wall box
49.2mm plate to grid

120.6mm grid to wall box
106.5mm plate to grid

Grid-IT Switched Sockets Modules



GSS1

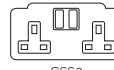

GSS2

Unswitched Sockets

Category:

2A Unswitched Sockets and Floor Sockets

Current Rating: 2 Amp
Max Load: 2 Amp

Technical Insert Ref: US2 **Description:** 1 gang 2A Unswitched Socket

5A Unswitched Sockets and Floor Sockets

Current Rating: 5 Amp
Max Load: 5 Amp

Technical Insert Ref: US5 **Description:** 1 gang 5A Unswitched Socket

13A Unswitched Sockets and Floor Sockets

Current Rating: 13 Amp
Max Load: 13 Amp

Technical Insert Ref: US13 **Description:** 1 gang 13A Unswitched Socket
US99 2 gang 13A Unswitched Socket

Eurofix 13A UK Unswitched Socket Module

MOD-ENG13A 1 gang 13A UK Unswitched Socket

Technical Specification:

Voltage: 220/250V AC
IP Rating: IP2XD
Switched Poles: None
Contact Gap Minimum: None
Product Class 1: Must be earthed
Ambient Operating Temperature: -5° to +40°C
Location: Internal Use Only
Max Installation Altitude: 2000m
Shuttered: Yes

Standard Hamilton manufactured electrical accessories are designed to be mounted on BS4662:2006 flush wall boxes.

Standards:

BS EN ISO Standard:
2A and 5A Unswitched BS 546
13A Unswitched BS 1363-2

Terminal Capacity:

	1mm ²	1.5mm ²	2.5mm ²	4mm ²	6mm ² Multi-strand	10mm ²
2A and 5A Terminal Capacity	5	4	2	1		
2A and 5A Earth Terminal Capacity	5	4	2	1		
13A Terminal Capacity			3	3	2	1
13A Earth Terminal Capacity			3	3	2	1

Eurofix 13A Unswitched Socket Module

Fixing Centres:

2A & 5A Unswitched Sockets

13A Unswitched Sockets

60.3mm

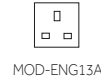
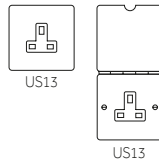
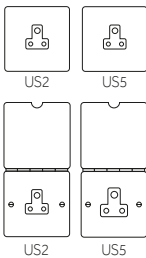

120.6mm

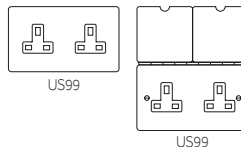

Due to constant changes in regulations, etc. users should satisfy themselves there have been no amendments. E&OE.

International Unswitched Sockets

Category:

American Sockets - NEMA 5

Current Rating: 15 Amp
Max Load: 15 Amp
Voltage: 110V AC

Technical Insert Ref:	Description:
5258	1 gang 15A Unswitched American Socket
5320	2 gang 15A Unswitched American Socket

EuroFix American Socket Module

MOD-USA 15A	1 gang 15A Unswitched American Socket
-------------	---------------------------------------

EuroFIX Universal Socket Module

Current Rating: 13 Amp
Max Load: 13 Amp

MOD-UNI 13A	1 gang 13A Universal Unswitched Socket
-------------	--

Schuko Sockets - CE7/4

Current Rating: 10/16 Amp
Max Load: 16 Amp
Voltage: 220/250V AC

Technical Insert Ref:	Description:
6126	1 gang 16A Unswitched German Sockets
26126	2 gang 16A Unswitched German Sockets

EuroFix German Socket Module

MOD-GER16A	1 gang 16A Unswitched German Socket
------------	-------------------------------------

Technical Specification:

IP Rating:	IP2XD
Switched Poles:	None
Contact Gap Minimum:	None
Product Class 1:	Face plate must be earthed
Ambient Operating Temperature:	-5° to +40°C
Location:	Internal Use Only
Max Installation Altitude:	2000m
Shuttered:	Yes

Standard Hamilton manufactured electrical accessories are designed to be mounted on BS4662:2006 flush wall boxes.

Standards:

BS EN ISO Standard: BS 5733
IEC 60884-1

Terminal Capacity:

	2.5mm ²	4mm ²	6mm ² Multi-stranded	10mm ²
13A and 16A Socket	3	3	2	1
15A Universal Socket Module	3	2	1	

Fixing Centres:

60.3mm

Socket Modules



120.6mm







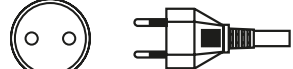
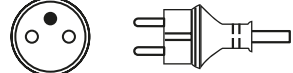
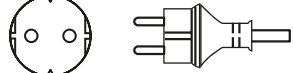

*Requires 47mm deep mounting box

Information relating to usage for non-uk sockets

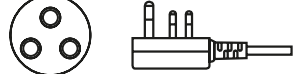
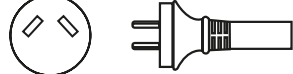
- It is permissible to sell and/or install non-UK BS type power sockets in the United Kingdom.
- It is the responsibility of the electrical contractor/installer to ensure that these products are installed correctly.
- The installation must be signed off by a qualified installer as a deviation to BS7671 wiring regulations.
- As these products fall outside the standards specified within the wiring regulations, additional measures must be taken to ensure safe, appropriate installation is effected.

Due to constant changes in regulations, etc. users should satisfy themselves there have been no amendments. E&OE.

International Socket Guide

Plug Type		Rating	Country	Visual
2-pin plug (Non-Earth)	Type A	2.5A, 250V	North America (United States) and in many other countries including Canada, Mexico, Guatemala, Jamaica and Venezuela	
2-pin plug (Euro)	Type C	2.5A, 250V	Most countries in continental Europe and also widely used in South Africa	
2-pin plug round	Type E	10/16A, 250V	Primarily used in France, Belgium, Poland, Slovakia, Czech Republic, Tunisia and Morocco	
2-pin plug (Non-Earth)	Type F	10/16A, 250V	Germany, Austria, the Netherlands, Sweden, Norway, Finland, Portugal, Spain and Eastern Europe	
3-pin plug BS	Type G	13A, 250V	Mainly used in the United Kingdom, Ireland, Cyprus, Malta, Malaysia, Singapore and Hong Kong	
3-pin plug round BS	Type D	5A, 250V	Used almost exclusively in India, Sri Lanka, Nepal and Nambia	
2-pin Australia plug	Type H	7.5A, 250V	Primarily used in Australia	
3-pin Australia plug	Type I	10A, 250V	Mainly used in Australia, New Zealand, Papa New Guinea and Argentina	
3-pin Australia plug	Type I	15A, 250V	Mainly used in Australia, New Zealand, Papa New Guinea and Argentina	
3-pin China plug	Type I	6/10A, 250V	China	
2-pin China plug	Type H	6/10A, 250V	China	
2-pin US plug	Type A	15A, 125V	North America (United States) and in many other countries including Canada, Mexico, Guatemala, Jamaica and Venezuela	

Due to constant changes in regulations, etc. users should satisfy themselves there have been no amendments. E&OE.

Dual Voltage Shaver Socket

Category:

SHAVER SOCKET

Technical Insert Ref:

Description:

SHS Shaver Dual Voltage Unswitched
Socket (Vertically Mounted)

Technical Specification:

Current Rating: 20VA
Voltage: 220/250V AC
Max Load Output: 115/230V
Max Load Input: 200/250V
IP Rating: IP2XD
Switched Poles: None
Contact Gap Minimum: None
Product Class 1: Must be earthed
Ambient Operating Temperature: -5° to +40°C
Location: Internal Use Only
Max Installation Altitude: 2000m
Shuttered: Yes
Box Depth: 47mm

Standard: Hamilton manufactured electrical accessories are designed to be mounted on BS4662:2006 flush wall boxes.

Standards:

BS EN ISO Standard: BS EN 61558
BS 4573

Terminal Capacity:

	1mm ²	1.5mm ²	2.5mm ²	4mm ² Multi-Strand	6mm ²
Terminal Capacity	5	4	3	2	1
Earth Terminal Capacity	9	6	4	2	1

Fixing Centres:

Shaver Socket

120.6mm
Vertically mounted

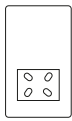

SHS

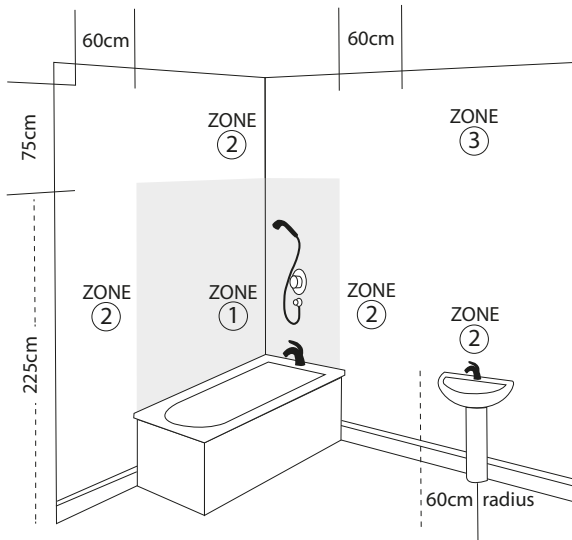

Bathroom Safety

Note: Generally, shaver sockets won't have an IP (ingress protection) rating, but if they comply with BS EN 61558 they can safely be installed in zone 2 - as long as they are away from the bath or shower unit and are unlikely to come into contact with shower spray.

Due to constant changes in regulations, etc. users should satisfy themselves there have been no amendments. E&OE.

Unswitched Sockets Plus Euro4 Aperture

Category:

Media Plate

Technical Insert Ref:	Description:
MED1	Media plate, Euro4 Apertured with 2 x 13A Unswitched Socket
MED2	Media plate, Euro4 Apertured with 4 x 13A Unswitched Socket

SPECIAL NOTE : When mains voltage and telecom/data/TV are mixed on the same plate a suitable phase barrier must be used in the wall box to shield the mains.

Technical Specification:

Current Rating:	13 Amp
Voltage:	220/250V AC
Max Load Output:	13 Amp Socket
IP Rating:	IP2XD
Switched Poles:	None
Contact Gap Minimum:	None
Product Class 1:	Must be earthed

Ambient Operating Temperature:	-5° to +40°C
Location:	Internal Use Only
Max Installation Altitude:	2000m
Shuttered:	Yes

Standards:	
BS EN ISO Standard:	(Socket) BS 1363-2

Terminal Capacity:

	2.5mm ²	4mm ²	6mm ² Multi-Strand	10mm ²
Terminal Capacity	3	3	2	1
Earth Terminal Capacity	3	3	2	1

Fixing Centres:

Media Plates EURO4 Apertured with 13A Unswitched Socket

120.6mm

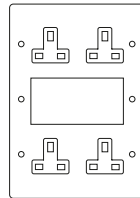
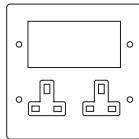

Connection Units

Category:

Switched Fused Connection Unit

Technical Insert Ref:	Description:
SP	1 gang 13A Double Pole Fused Spur
SPN	1 gang 13A DP Fused Spur + Neon
SPNC	1 gang 13A DP Fused Spur + Neon + Cable Outlet

13A Fuse with Red Neon Halo

FN	1 gang 13A Fuse with Red Neon Halo
----	------------------------------------

Grid-IT 13A Fuse with Neon Halo Module

GFN	13A Fuse with Neon Halo
-----	-------------------------

Cable Outlet

Current Rating:	20 Amp
Max Load:	20 Amp
Switched Poles:	None
Contact Gap Min:	None
Technical Insert Ref:	Description:
CO	Cable Outlet

Grid-It Cable Outlet Module

GC20	Cable Outlet
------	--------------

Unswitched Connection Unit

Switched Poles:	None
Contact Gap Min:	None
Technical Insert Ref:	Description:
FO	1 gang 13A Fuse Only
FOC	1 gang 13A Fuse + Cable Outlet

Technical Specification:

Current Rating:	13 Amp
Voltage:	220/250V AC
Max Load:	13 Amp
IP Rating:	IP2XD
Switched Poles (SP, SPN, SPNC):	Double
Contact Gap Minimum:	3mm
Product Class 1:	Must be earthed
Grid-IT Product Class 1:	Face plate must be earthed
Ambient Operating Temperature:	-5° to +40°C
Cable Outlet Size Flexible:	Min 0.75mm ² Max 2.5mm ²
Cable Outlets Fitted with Clamp:	Yes
Location:	Internal Use Only
Max Installation Altitude:	2000m









Standard Hamilton manufactured electrical accessories are designed to be mounted on BS4662:2006 flush wall boxes.

Standards:

BS EN ISO Standard:	
Switched Fuse/Unswitched	BS 1363-4
Fuse with halo	BS 5733
Fuse with halo + fuselink	BS 5733 and BS1362
Cable outlet	BS 5733

Terminal Capacity:

	1mm ²	1.5mm ²	2.5mm ²	4mm ² Multi-Strand	6mm ²
Switched/Fuse + Halo Terminal Capacity			3	2	1
Switched/Fuse + Halo Earth Terminal Capacity	6	5	3	2	1
Cable Outlet Terminal Capacity	5	4	2	2	
Cable Outlet Earth Terminal Capacity	6	5	3	2	1
FO/FOC Terminal Capacity	5	4	3	1	1
FO/FOC Earth Terminal Capacity	6	5	3	2	1

Fixing Centres:	Switched Fuse	Fuse with Halo	Cable Outlet	Fuse Unit
60.3mm	 SP  SPN  SPNC	 FN	 CO	 FO  FOC
Fits one Grid-IT aperture		 GFN	 GC20	

Due to constant changes in regulations, etc. users should satisfy themselves there have been no amendments. E&OE.

Television Coaxial and Data Sockets

Category:

TV/Data/Telephone Sockets and Floor Sockets

Technical Insert Ref:	Description:
TV	1 gang Non-Isolated Television 1 In/1 Out
TV2	2 gang Non-Isolated Television 2 In/2 Out
TVFM	Isolated TV/FM Diplexer 1 In/2 Out
TVI	1 gang Isolated Television 1 In/1 Out
TVSAT	2 gang Non-Isolated TV + Satellite 2 In/2 Out
SATN	1 gang Non-Isolated Satellite
SATI	1 gang Isolated Satellite
J12	1 gang RJ12 Outlet Unshielded
2J12	2 gang RJ12 Outlet Unshielded
J45	1 gang RJ45 CAT 5E Outlet Unshielded
2J45	2 gang RJ45 CAT 5E Outlet Unshielded
TCS	1 gang Telephone Slave
TCM	1 gang Telephone Master

EUROFIX TV/Data/Telephone Socket modules

Technical Insert Ref:	Description:
MOD-TV	1 gang Non-Isolated TV 1 In/1 Out
MOD-TV1	1 gang Isolated TV 1 In/1 Out
MOD-TVFM	Isolated TV/FM Diplexer 1 In/2 Out
MOD-SATI	1 gang Isolated Satellite
MOD-SATN	1 gang Non-Isolated Satellite
MOD-J12	1 gang RJ12 Outlet Unshielded
MOD-J45-C5	1 gang RJ45 CAT 5E Outlet Unshielded
MOD-J45-C6	1 gang RJ45 CAT 6 Outlet Unshielded
MOD-J45-C6S	1 gang RJ45 CAT 6S Outlet Shielded
MOD-TCS	1 gang Telephone Slave
MOD-TCM	1 gang Telephone Master

MOD-CAT6A and MOD-CAT7 are available on request

Technical Specification:

IP Rating:	IP2XD
Product Class 1:	Face plate must be earthed (ref BS7671 415.2.1)
Ambient Operating Temperature:	-5° to +40°C
Location:	Internal Use Only
Max Installation Altitude:	2000m



Note: Mains operated and extra low voltage products must not be installed in the same face plate aperture. When installing within the same back box a suitable barrier **MUST** be used to separate the two voltages. See BS 7671 Wiring regulations for further details.

Note for SATI only: Isolated F-type satellite outlet, where a DC signal back to the LNB unit on the satellite dish is not required.

Standard Hamilton manufactured electrical accessories are designed to be mounted on BS4662:2006 flush wall boxes.

Terminal Capacity:

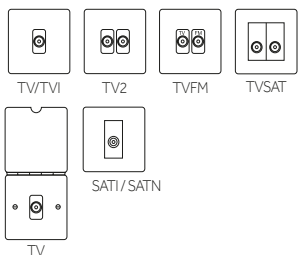
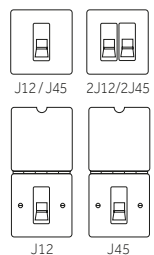
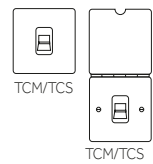
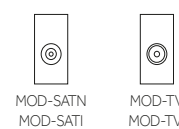
	1mm ²	1.5mm ²	2.5mm ²	4mm ² Multi-Strand	6mm ²
Earth Terminal Capacity	5	4	3	1	1

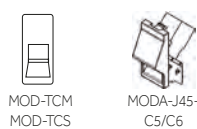
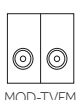
Fixing Centres:	Television Coaxial	Data Outlets	Telephone Socket
60.3mm			
Fits one Euro1 aperture			
Fits one Euro2 aperture			

New Angled RJ45 Sockets allow cables to enter from bottom for a neater installation

Due to constant changes in regulations, etc. users should satisfy themselves there have been no amendments. E&OE.

Digital Television Sockets - Screened Non-Isolated, DAB compatible

Category:

Digital TV Coaxial Sockets

Technical Insert Ref:	Description:
DENT	Non-Isolated TV/FM/Satellite 1/Satellite 2 Quadplex 2 In/ 4 Out
DSAT+	Non-Isolated TV/FM/Satellite 1/Satellite 2 Quadplex 2 In/ 4 Out + TVF + TCS
DTRID	Non-Isolated TV/FM/Satellite Triplexer 1 In/3 Out
DSAT	1 gang Non-Isolated Satellite
DTVf	1 gang Non-Isolated TV (female)
DTVM	1 gang Non-Isolated TV (male)

Eurofix Modules

Technical Insert Ref:	Description:
MOD-DENT	Non-Isolated TV/FM/Satellite 1/Satellite 2 Quadplex 2 In/ 4 Out
MOD-DSAT	1 gang Non-Isolated Satellite
MOD-DTRID	Non-Isolated TV/FM/Satellite Triplexer 1 In/3 Out
MOD-DTVf	1 gang Non-Isolated TV (female)
MOD-DTVM	1 gang Non-Isolated TV (male)

Technical Specification:

IP Rating:	IP2XD
Product Class 1:	Must be earthed (ref BS7671 415.2.1)
Ambient Operating Temperature:	-5° to +40°C
Location:	Internal Use Only
Max Installation Altitude:	2000m

Standard Hamilton manufactured electrical accessories are designed to be mounted on BS4662:2006 flush wall boxes.

Note: Mains operated and extra low voltage products must not be installed in the same face plate aperture. When installing within the same back box a suitable barrier MUST be used to separate the two voltages. See BS 7671 Wiring regulations for further details.

Terminal Capacity:

	1mm ²	1.5mm ²	2.5mm ²	4mm ² Multi-Strand	6mm ²
Earth Terminal Capacity	5	4	3	1	1

Frequencies:

DTVM	Frequency 1	FM DC	5-2200 MHz
DSAT	Frequency 1	SAT DC	5-2200 MHz
DTVf	Frequency 1	TV DC	5-2200 MHz
DENT/DTRID/DSAT+	Frequency 1	TV	5-68 MHz 125-860 MHz
	Frequency 2	FM	88-108 MHz
	Frequency 3	SAT DC	950-2200 MHz
DSAT+	Frequency 4	TV DC	5-2200 MHz

Fixing Centres:

Digital Television Sockets

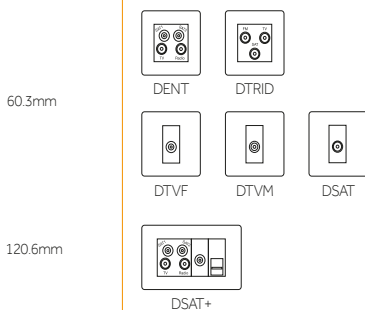

EUROFix Digital Tv Socket Modules

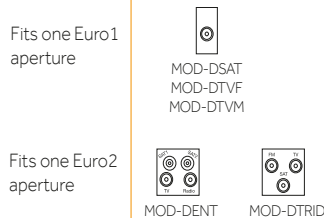

EuroFix AV/Audio/HDMI

Category:

EuroFix AV/Audio/HDMI Sockets

Technical Insert Ref:	Description:
MOD-HDMI	HDMI Chassis Mounted Socket Type A* (Female Mounted, Female Free)
MOD-USBAFF	USB2 Panel Mounted Socket Type A* (Female Mounted, Female Free)
MOD-USBAFM	USB2 Panel Mounted Socket Type A* (Female Mounted, Male Free)
MOD-MP3	3.5mm Stereo Socket (MP3) Screened*
MOD-DIN9	D-Range PC Socket 9 Pin*
MOD-SVGA	D-Range SVGA Socket 15 Pin*

Socket Type:	
MOD-BAN2	4mm Suitable for 'Banana' plugs 2 x Gold Binding Post Socket*

EuroFix AV/Audio/HDMI Sockets

Current Rating:	Mating connector dependent
Contact Resistance:	Mating connector dependent
Insulation Resistance:	>1GW
Dielectric Strength:	500V DC
Life Cycle:	5000
Cable OD:	4-9mm
Solder Compatibility:	IEC 68-2-20

Technical Insert Ref:	Description:
MOD-RCA1	1 x Gold Phone/Audio Socket**
MOD-RCA2	2 x Gold Phone/Audio Socket**
MOD-RCA3	3 x Gold Composite Video/Audio**

Current Rating:	15 Amp
Voltage:	120VAC
Contact Resistance:	5mW Max

MOD-XLR	Latching Audio Connector 3 Pin XLR Socket*
---------	--

Technical Specification:

IP Rating:	IP2XD
Ambient Operating Temperature:	-5° to +40°C* -25° to +70°C**
Location:	Internal Use Only
Max Installation Altitude:	2000m
Module Dimensions:	25 x 50mm

Note: Mains operated and extra low voltage products must not be installed in the same face plate aperture. When installing within the same back box suitable barrier **MUST** be used to separate the two voltages. See BS 7671 Wiring regulations for further details.

EuroFix Av/Audio/HDMI Modules

Fits a Euro1 aperture

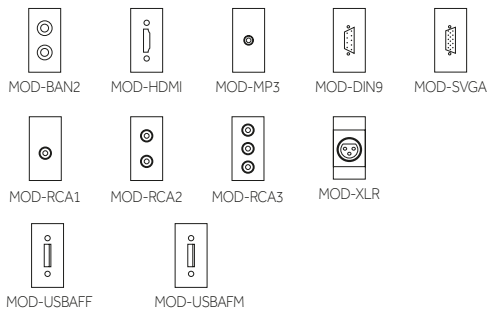

EuroFix USB Charger Module

Category:

EuroFix USBx2 Charger Module

Technical Insert Ref:

MOD-USBX2

Description:

Eurofix Twin USB Charger Module

Technical Specification:

Voltage (Twin): 180/250 Vac 50-60Hz**Current Rating (at full load):** 4.8A

2.4A per USB

2.0mA Twin

Standby Current: 1.0A per socketMax Load Output: 5Vdc \pm 5%

Charging Output: USB Type A

Output Connector: 5mm

Contact Gap Minimum:

Product Class 1: Must be earthed

Ambient Operating Temperature: 0° to +40°C

Location: Internal Use Only

Max Installation Altitude: 2000m

Module Dimensions: 50 x 50mm Twin

Standards:**BS EN ISO Standard:** IEC 60950-1
IEC 61000-6-1/3

Compliance:

EC Directive	MOD-USB2
Low Voltage	2006/95/EC
ROHS	2002/95/EC
WEEE	2002/95/EC
REACH	1907/2006
EMC	2004/108EC

Terminal Capacity

	1.0mm ²	1.5mm ²	2.5mm ²
Terminal Capacity	2	2	3

Ensure that the power is switched off or power is isolated before attempting to install or connect the charger.
The charger terminals will accept up to 2.5mm² conductor.

Eurofix USB TWIN Charger Module

Fits one Euro2
aperture

MOD-USBX2



USB Charging /Power Sockets

Category:

Charging /Power Sockets

Technical Insert Ref:	Description:
SS1USBX1	Single USB Charger 1 gang 13A Switched Socket, 5V 2.1A

Charging / Power Sockets

Technical Insert Ref:	Description:
SS2USBX2	Twin USB Chargers and 2 gang 13A Switched Socket, 5V 2.1 A & 5V 1.A

Ultra Charging /Power Sockets

Technical Insert Ref:	Description:
SS2USBX2ULT	Twin USB Charger and 2 gang 13A Switched Socket, 5V Dual 2.4A - 4.8A total

Ultra Charging /Power Sockets

Technical Insert Ref:	Description:
SS2USBC	Twin USB Charger and 2 gang 13A Switched Socket, 5V Dual 2.4A - 4.8A total

Technical Specification: SS1USBX1 / SS2USBX2

Socket Current Rating:	13A
USB Current Rating:	0.128A
Voltage:	AC 200-250V 50-60Hz
USB Max Load Output:	2.1A + 1A For SS2 2.1A For SS1
USB Charging Output:	5Vdc ± 5% 2.1A Max
Output Connector:	USB Type A
Contact Gap Minimum:	5mm
Product Class 1:	Must be earthed
Ambient Operating Temperature:	15 to +45°C
Location:	Internal Use Only
Max Installation Altitude:	2000m

Standard Hamilton manufactured electrical accessories are designed to be mounted on BS4662:2006 flush wall boxes.

Standards:

BS EN ISO Standard:	BS1363-2 BS5733 EN60950
---------------------	-------------------------------

Technical Specification: SS2USBX2ULT / SS2USBC

Socket Current Rating:	13A
USB Current Rating:	0.128A
Voltage:	AC 200-250V 50-60Hz
USB Max Load Output:	4.8A total for 2 outlets
USB Charging Output:	5Vdc ± 5% 4.8A Max
Output Connector:	X2 (Ultra) USB Type A + USB Type C (SS2USBC)
Contact Gap Minimum:	5mm
Product Class 1:	Must be earthed
Ambient Operating Temperature:	15 to +45°C
Location:	Internal Use Only
Max Installation Altitude:	2000m

Standard Hamilton manufactured electrical accessories are designed to be mounted on BS4662:2006 flush wall boxes.

Standards:

BS EN ISO Standard:	BS1363-2 BS5733 EN60950
---------------------	-------------------------------

Terminal Capacity for 13A Unswitched Socket:

	2.5mm ²	4mm ²	6mm ² Multi-Strand	10mm ²
Terminal Capacity	3	3	2	1
Earth Terminal Capacity	3	3	2	1

Twin USB/Power Socket

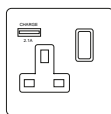

SS1USB

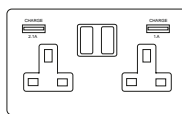

SS2USB

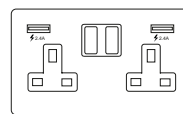

SS2USBULT

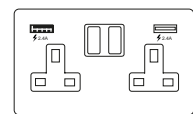

SS2USBC

Due to constant changes in regulations, etc. users should satisfy themselves there have been no amendments. E&OE.

Leading Edge Dimmer Information

Notes For Dimmers

Note A	Tungsten filament GU10 lamps must be branded with a fuse base.
Note B	When using mains voltage halogen lamps - dimmers should be de-rated by 25%.
Note C	When using mains voltage halogen load transformers - maximum rating is 210VA.
Note D	To only be used with Touch Master Dimmers.

Leading Edge Resistive Dimmers - Metal Plates								
Number of dimmer switches per plate	Nominal plate size mm	Dimmer type	Max plate load W (Watts)	Lamp type				
				Tungsten Filament including halogen (Watts)		Linea Halogen (Watts)	GU10 LED (Watts)	
				Min	Max	Max	Min	Max
1	88x88	1 x 40	400	40	400	300	10	100
2	88x88	2 x 40	600	40	300	300	10	100
3	88x146	3 x 40	1200	40	400	300	10	100
4	88x146	4 x 40	1200	40	300	250	10	100
6	150x150	6 x 40	1800	40	300	250	10	100
8	150x150	8 x 40	1800	40	300	250	10	100
9	150x210	9 x 40	2250	40	250	250	10	100
12	150x210	12 x 40	2250	40	200	150	10	100
12	210x280	12 x 40	3600	40	300	200	10	100
16	210x280	16 x 40	3600	40	225	200	10	100
1	88x88	1 x 60	600	100	600	450	15	150
1	88x146	1 x 1K	1000	150	1000	750	25	250

Leading Edge Resistive Dimmers - Wood Plates								
Number of dimmer switches per plate	Nominal plate size mm	Dimmer type	Max plate load W (Watts)	Lamp type				
				Tungsten Filament including halogen (Watts)		Linea Halogen (Watts)	GU10 LED (Watts)	
				Min	Max	Max	Min	Max
1	88x88	1 x 40	400	40	400	300	10	100
2	88x146	2 x 40	600	40	300	300	10	100
3	88x146	3 x 40	900	40	300	300	10	100
4	88x146	4 x 40	1000	40	250	200	10	100
6	150x150	6 x 40	1200	40	200	200	10	100
9	150x210	9 x 40	1800	40	200	200	10	100

Leading Edge Resistive Dimmers - Plastic Plates								
Number of dimmer switches per plate	Nominal plate size mm	Dimmer type	Max plate load W (Watts)	Lamp type				
				Tungsten Filament including halogen (Watts)		Linea Halogen (Watts)	GU10 LED (Watts)	
				Min	Max	Max	Min	Max
1	88x88	1 x 40	400	40	400	300	10	100
2	88x88	2 x 40	600	40	300	300	10	100
3	88x146	3 x 40	900	40	300	300	10	100
4	88x146	4 x 40	1000	40	250	250	10	100

Due to constant changes in regulations, etc. users should satisfy themselves there have been no amendments. E&OE.

Leading Edge Inductive Push on/Off Dimmers

Category:

200VA Inductive Dimmer

See Notes for Dimmers Page 436: Note E

Wattage: 200VA (low voltage) per gang
Current Rating: 0.8 Amp
Max Load: 200VA (low voltage) per gang
Min Load: 25VA

Technical Insert Ref:	Description:
1X2V	1 gang 200VA 2 way
2X2V	2 gang 200VA 2 way

Grid-IT 200VA Inductive Dimmer Module

See Notes for Dimmers Page 436: Note E

D2V	1 gang 200VA 2 way
-----	--------------------

300VA Inductive Dimmer

See Notes for Dimmers Page 436: Note E

Wattage: 300VA (low voltage)
Current Rating: 1.25 Amp
Max Load: 300VA (low voltage)
Min Load: 50VA

Technical Insert Ref:	Description:
1X3V	1 gang 300VA 2 way

Technical Specification:

Voltage: 220/250V AC
IP Rating: IP2XD
Switched Poles: Single
Contact Gap Minimum: None
Product Class 1: Face plate must be earthed

Ambient Operating Temperature: -5° to +40°C
Location: Internal Use Only
Max Installation Altitude: 2000m

Standard Hamilton manufactured electrical accessories are designed to be mounted on BS4662:2006 flush wall boxes.

Terminal Capacity:

	1mm ²	1.5mm ²	2.5mm ²	4mm ² Multi-Strand	6mm ²
200VA Terminal Capacity	2	2			
200VA Earth Terminal Capacity	5	4	3	1	1
300VA Terminal Capacity	2	2			

LEADING EDGE TECHNOLOGY DIMMERS for use with low voltage toroidal transformers and some LED lamps.

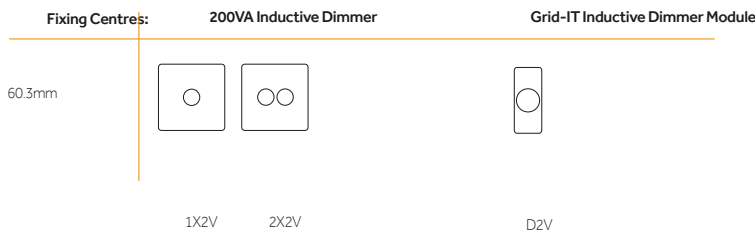

Note: It is recommended to contact the manufacturer of the transformer to confirm that it is dimmable and is considered to be an inductive load.

More information can found on our website, visit www.hamilton-litestat.com

LED Dimming

Technical Specification:

Category: 100LED	Category: LEDITB
<p>Intelligent LED Dimmer</p> <p>2 Operating Modes Trailing Edge: 100W Max Leading Edge: 75W Max Compatible With Retractive / Push To Make</p> <p>BUILT IN - Short Circuit Protection.</p> <p>Soft start up & down feature helps extend lamp life.</p>	<p>Intelligent LED Dimmer</p> <p>2 Operating Modes Trailing Edge: 100W Max Leading Edge: 100W Max 1 To 10 Leds Max</p> <p>BUILT IN - Short Circuit Protection.</p> <p>Soft Start up & down feature helps extends lamp life.</p> <p>Thermo Circuit protection activates if dimmer rises above 110°c, after cooling, dimmer resumes normal operation.</p> <p>Plastic Plates with 2 or more dimmers must be de rated to 70W per gang.</p>

LEDITB100 Compatibility Table

Dimmer:	H-LED/ITB100-GR	Insert Code:	1XLEDITB100 / LEDITB100
Rating:	5-100W (Halogen/Incandescent) 5-100W (LED / 10 Lamps Max)	Dimming Mode:	Leading Edge / Trailing Edge

LED Manufacturer	Description	Product Code	Wattage Quantity	Tested Quality	(0-5) Additional	Notes
All LED	GU10 Dimmable LED	AGU10007D	7W	1-10LEDs	4	
All LED	GU10 Dimmable LED	AGU5010	5.5W	1-10LEDs	4	
All LED	High Output COB GU10	AGU7000/30	7W	1-10LEDs	4	
All LED	Cobra Fire-Rated LED Downlight	ACFD80	8W	1-10LEDs	4	
All LED	350mA LED with All LED 14-25W Dimmable 350mA Driver	AGLD6AL-30	7W	1-2LEDs	4	
Aurora	MPRO Downlight	AU-MPRO	7W	1-10LEDs	4	
Aurora	GU10 Dimmable LED	AU-DP208/27	8W	1-10LEDs	5	Set minimum level
Aurora	GU10 Dimmable LED	AU-DGU107	7W	1-10LEDs	5	
Aurora	110 Downlight	AU-ALD05010	10W	1-10LEDs	4	
Aurora	M7 Downlight	AU-FRLD711	6W	1-10LEDs	4	
Aurora	M5 Downlight	AU-FRLD511	5W	1-10LEDs	4	Set minimum level
Bel Lighting	Halo Glass GU10	05963	5W	1-10LEDs	4	
Bel Lighting	Elite Halo GU10	05908	6W	1-10LEDs	5	
Bel Lighting	Halo GU10	05765	5W	1-10LEDs	5	
Bel Lighting	Firestry LED CCT Downlight	08187	7W	1-10LEDs	4	
Bel Lighting	E27 Candle LED	05146	4W	1-10LEDs	4	Better in Leading edge
Bel Lighting	Round Clear Ball LED	05188	4W	1-10LEDs	4	Better in Leading edge
Bel Lighting	Fire Rated Downlight	08100	8W	1-6LEDs	5	
Bel Lighting	6W GU10 LED		6W	1-8LEDs	4	Better in Leading edge
Collingwood	H5 Immess	DL282W-HW5DIM	5.5W	1-10LEDs	5	
Collingwood	Halers H2 Lite	DL388W/WS530	4.4W	1-10LEDs	4	
Collingwood	Halers H2 Pro 550	DL3566027	8.5W	1-10LEDs	4	
Collingwood	Halers H2 Pro 700	DL2425530	11W	1-9LEDs	4	
Crompton	Dimmable GU10	LGU105W/COB-DIM		1-10LEDs	4	
Enlite	Fire-Protection DE8 Downlight	EN-DE8	8W	1-10LEDs	5	
Enlite	Fire-Protection DE5 Downlight	EN-DE5	5W	1-10LEDs	5	
Enlite	Fire-Protection DE6 Pro Downlight	EN-DE6PRO/30	6W	1-10LEDs	4	
Enlite	GU10 Dimmable LED	EN-DGU005	5W	1-10LEDs	4	
Enlite	GU10 Dimmable LED	EN-DGU005H	5W	1-10LEDs	4	
Enlite	Fixed Round Integrated Downlight	EN-DDL1019	10W	1-10LEDs	4	
Enlite	Fixed Round Integrated Downlight	EN-DDL1016	8W	1-10LEDs	4	
GE	Energy Smart GU10	LEDGU104.4W/WW	5W	1-10LEDs	4	
Goodwin	GU10 Dimmable LED	GSP16G100S/827	5W	1-10LEDs	4	Better in Leading edge
Green Brook	Vela V7 1/4 Fire-Rated Downlight	V7T4000W	7W	1-6LEDs	4	
Green Brook	Vela Compact Fire-Rated Downlight	LEDLTC4000W	7W	1-5LEDs	4	
Integral LED	Low Profile Fire-Rated Downlight	ILDLPFR08010	8.5W	1-3LEDs	4	
JCC	Fire-Rated Downlight	FGLD6	6W	1-10LEDs	4	
JCC	Fire-Rated Downlight	FGLD10	10W	2-9LEDs	4	9LEDs Max
JCC	Hybrid 7 Downlight	JC94701	7.2W	1-10LEDs	4	Set minimum level
JCC	Hybrid 9 Downlight	JC94901	8.5W	1-10LEDs	4	Set minimum level
JCC	V50 Downlight	JC1001	7.5W	1-10LEDs	4	
KingsShield	Dimmable Downlight	LEDDLAC3000K	9W	1-6LEDs	4	
Kosmic	B22 Clear Candle	KDM5 SCND/B22-SLV-N27	5.5W	1-10LEDs	4	Set minimum level
KSR	GU10 Dimmable LED	KSRLP930	4.8W	1-10LEDs	4	Better in Leading edge
KSR	Fire-Rated Downlight	KSRRFD262	8W	1-10LEDs	4	
KSR	Firebreak QR4 LED Downlight	KSRRFD375	4.9W	1-10LEDs	4	
KSR	Firebreak QR5 LED Downlight	KSRRFD373	5W	1-10LEDs	4	
KSR	Firebreak QR10 LED Downlight	KSRRFD351	10W	1-10LEDs	4	
LAP	Edison Screw Dimmable Candle	1296T	5.9W	1-10LEDs	4	
LAP	GU10 Dimmable LED	LGDW5W37	5W	1-5LEDs	5	
LED/VANCE	Spot Dim 3000K 620m	Not Specified	8W	1-4LEDs	4	
Lucéco	Premium Dimmable GU10	LGDW5W37P	5W	1LED	4	
Lumifite	E14 Dimmable Candle	E14 5W	5W	1-10LEDs	4	Set minimum level
LLXNA	Dimmable GU10	LXLEDGU10/SNWD	5W	1-2LEDs	4	
Megaman	GU10 Dimmable LED	141490	6W	1-10LEDs	4	Better in Leading edge
Megaman	GU10 Dimmable LED	141751	7W	1-10LEDs	4	Better in Leading edge
Megaman	U-Dim LED Reflector GU10/PAR16	141324 (16W36)	5W	1-10LEDs	4	
Megaman	U-Dim LED Reflector GU10/PAR16	141726 (16W36)	5.5W	1-10LEDs	4	
Megaman	U-Dim LED Reflector GU10/PAR16	142202 (16W42)	7W	1-10LEDs	4	
Megaman	Dim-to-warm GU10/PAR16	141806 (15W53)	6W	1-10LEDs	4	
Megaman	E14 Clear Candle	143167	5W	1-10LEDs	4	Better in Leading edge
Megaman	E14 Candle	143424	3.2W	1-6LEDs	4	Use Leading Edge
Megaman	Dimmable Downlight	F29500RCv1-D Down Light	8W	1-10LEDs	4	Set minimum level
Modo by Megaman	GU10 Dimmable LED	141317	5W	1-10LEDs	4	Better in Leading edge
Osram	Parathom Advanced GU10	3W GU10	3W	1-10LEDs	5	Set minimum level
Osram	Parathom Advanced GU10	7.2W GU10	7.2W	1-10LEDs	4	
Osram	Parathom Advanced E14	E14 6W	6W	1-10LEDs	4	
Robus	Ultium Fire-Rated Downlight	RUL0730	7W	1-3LEDs	4	
Robus	Ramsada Fire-Rated Downlight	RR083060	8.5W	1-6LEDs	4	
Save Light	Dimmable LED GU10	Halo-DF5W-4K	5W	1-6LEDs	4	
Saxby	LED Downlight	73785	4W	1-5LEDs	4	Set minimum level
Scolmore	Interceptor Micro	LED4300WH7CD	7.5W	1-10LEDs	5	
Solo10	Dimmable LED Downlight	833839	10W	1-10LEDs	4	
Steeple (Denmans)	Fire-Rated LED Downlight IP65 4000K	STLEDL6CW	6W	1-10LEDs	4	Set minimum level
Taison Lighting	Recessed Fire-Rated IP65 LED Downlight	14GLB	13W	1-2LEDs	5	

Due to constant changes in regulations, etc. users should satisfy themselves there have been no amendments. E&OE.

Gridstat Kit

Technical Specification:

The Grid Kit enables the LED Dimmer range to be mounted to Hamilton Grid fix grids & front plates.

It also includes adaptors allowing Hamilton LED Dimmers to be mounted to third party grid systems including BG, Crabtree, Delta, Hager, Schneider Electric, MK & Wandsworth.

The Gridstat kit includes

- 8 Adaptors
- 2 Dimmer Knobs (2 sizes)
- 1 Dimmer nut tool

Hamilton LED Grid Kit includes two different sized dimmer knobs and compatible adapters for many popular grid based / clip-in switch plates detailed below

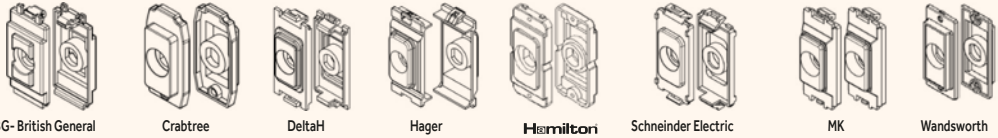

GRID100LED Compatibility Table

Dimmer:	H-LEDSTAT-GR	Insert Code:	1X100LED / GRID100LED
Rating:	5-100W (Halogen/Incandescent) 5-100W (LED Trailing Edge) 5-75W (LED Leading Edge)	Dimming Mode:	Leading Edge / Trailing Edge

LED Manufacturer	Description	Product Code	Wattage	Quantity Tested	(0-5) Additional	Notes
All LED	High Output LED GU10	AGU501D	5.5W	1-10 LEDs	4	
All LED	GU10 Retrofit LED	AGU10007D/30	7W	1-10 LEDs	4	Leading Edge is better
All LED	Dimmable Fire-Rated Downlight	AFD010D	10W	1-10 LEDs	3	
All LED	Cobra Fire-Rated IP65 Downlight	ACFD8/30	8W	1-10 LEDs	4	
Aurora	GU10 Retrofit LED	AU-DGU1077/30	7W	1-10 LEDs	4	
Aurora	LED Dimmable GU10 PAR20	AU-DP208	8W	1-10 LEDs	4	
Aurora	MPRO LED Downlight	AU-MPRO1	7W	1-10 LEDs	4	Set minimum level
Aurora	Dimmable Fire-Rated Downlight	AU-FRLD811	10W	1-10 LEDs	5	Set minimum level
Aurora	Dimmable LED Downlight	AU-DL10019AW/40	19W	1-5 LEDs	5	Set minimum level
Bell Lighting	LED Halo Glass GU10	05963	5W	1-15 LEDs	3	
Bell Lighting	LED Elite Halo GU10	05908	6W	1-15 LEDs	4	
Bell Lighting	LED Halo GU10	05763	5W	1-20 LEDs	4	
Bell Lighting	Firestay Downlight	08187	7W	1-15 LEDs	3	
Bell Lighting	Dimmable SES Candle	5139	4W	1-10 LEDs	4	Set minimum level
Bell Lighting	Firestay Downlight	8100	8W	1-10 LEDs	4	
Collingwood	Halers H2 Lite	DL388MW5530	5.5W	1-10 LEDs	5	
Collingwood	Halers H2 Pro 550	DL3566027	8.5W	1-10 LEDs	4	Set minimum level
Collingwood	Halers H2 Pro 700	DL2425530	11W	1-8 LEDs	4	
Collingwood	H5 Triless	DL282WH-WWDIM	5.5W	1-10 LEDs	4	
Enlite	Dimmable GU10 LED	EN-DGU005/30	5W	1-10 LEDs	4	Set minimum level
Enlite	Fixed Fire Protection Downlight E6 Pro	EN-DE6PRO/30	6W	1-10 LEDs	3	
Enlite	Fixed Fire Protection Downlight DE8	EN-DE8/30	8W	1-10 LEDs	4	
Enlite	Fixed Fire Protection Downlight DE5	EN-DE5/30	5W	1-10 LEDs	4	
Enlite	Fire-Rated Dimmable Downlight	EN-DE35N/40	9W	1-11 LEDs	4	Leading Edge is better
Green Brook	Tit Fire-Rated Downlight	V7T4000W	7W	1-6 LEDs	4	
Integral LED	Low Profile Fire-Rated Downlight	ILDFR708010	8.5W	1-3 LEDs	3	
JCC	V501 LED Downlight	JC1001	7.5W	1-10 LEDs	3	
Kingshield	Dimmable LED Downlight	LEDDL3000K	9W	1-6 LEDs	4	
Kosnic	BC Dimmable Candle	KDIM5.5CND/B22-SLV-N27	5.5W	1-10 LEDs	4	Set minimum level
KSR	GU10 Dimmable LED	KSRLP930	4.8W	1-10 LEDs	4	
KSR	Dimmable Fire-Rated Downlight	KSRFRD262	8W	1-10 LEDs	3	
KSR	Dimmable Fire-Rated Downlight	KSRFRD200	10W	1-10 LEDs	3	
KSR	Firebreak QR4 LED Downlight	KSRFRD375	4.9W	1-10 LEDs	3	
KSR	Firebreak QR5 LED Downlight	KSRFRD373	5W	1-10 LEDs	3	
KSR	Firebreak QR10 LED Downlight	KSRFRD351	10W	1-10 LEDs	4	
LAP	GU10 Retrofit LED	LGDW5W37	5W	1-5 LEDs	5	Set minimum level
LAP	Edison Screw Dimmable Candle	12967	5W	1-10 LEDs	3	
LEDVANCE	Spot Dim 3000K 620lm	Not Specified	8W	1-4 LEDs	4	
Lucaco	Parathom Dimmable GU10	LGDW5W37P	5W	1-10 LEDs	3	
LUXNA	Dimmable GU10	LXLEDGU10/5NWD	5W	1 LED	3	
Modo by Megaman	GU10 Dimmable LED	141317	5W	1-10 LEDs	4	
Megaman	GU10 Dimmable LED	141435	6W	1-10 LEDs	4	
Megaman	GU10 Dimmable LED	141751	7W	1-10 LEDs	4	
Megaman	U-Dim LED Reflector PAR16	141324	5W	1-10 LEDs	4	
Megaman	U-Dim LED Reflector PAR16	141726	5.5W	1-10 LEDs	4	
Megaman	U-Dim LED Reflector PAR16	142202	7W	1-10 LEDs	4	
Megaman	Dim-to-Warm GU10 PAR16	1141806	6W	1-10 LEDs	4	
Megaman	Fire-Rated Versa LED	F28851RC	8W	1-10 LEDs	4	
Megaman	Classic Dimmable Bulb	148136	13W	1-6 LEDs	4	Set minimum level
Megaman	E14 Candle Bulb	143167	5W	1-12 LEDs	4	Set minimum level
Megaman	E14 Candle Bulb	143424	3.2W	1-10 LEDs	4	Set minimum level
Osram	Parathom PAR 16 GU10	PAR16 20 35° Advanced	3W	1-10 LEDs	4	Set minimum level
Osram	Parathom PAR 16 GU10	PAR16 50 35° Advanced	5.5W	1-10 LEDs	4	Set minimum level
Save Light	Dimmable LED GU10	Halo-DF5W-4K	5W	1-6 LEDs	4	
Saxby	LED Downlight	73785	4W	1-5 LEDs	4	
Scolmore	Interceptor Fire-Rated Downlight	LED4400	8W	1-12 LEDs	4	
Solo10	Dimmable LED Downlight	833839	10W	1-7 LEDs	3	Maximum of 7 fittings
Steeple (Denmans)	Fire-Rated LED Downlight IP65 4000K	STLEDDL6CW	6W	1-10 LEDs	4	Set minimum level
Taison Lighting	Recessed Fire-Rated IP65 LED Downlight	T4GLB	13W	1-2 LEDs	4	
Tarnite	Starlite Fire-Rated Downlight	LED-444-3	8W	1-12 LEDs	4	Set minimum level
Vesta	GU10 Dimmable LED	VESCOBGU1052D860	5.2W	1-10 LEDs	4	Set minimum level

Due to constant changes in regulations, etc. users should satisfy themselves there have been no amendments. E&OE.

Leading Edge Push on/Off Resistive Dimmers

Category:

400W Push on/off Resistive Dimmer

See Notes for Dimmers Page 441: Note A,B,E

Wattage:	400W
Current Rating:	1.66 Amp
Max Load:	400W Resistive per gang
Technical Insert Ref:	Description:
1X40	1 gang 400W 2 Way
2X40	2 gang 400W 2 Way, max 300W per gang
3X40	3 gang 400W 2 Way
4X40	4 gang 400W 2 Way, max 300W per gang
WD2X40	2 gang 400W 2 way, max 300W per gang
W3X40	3 gang 400W 2 way, max 300W per gang
W4X40	4 gang 400W 2 way, max 250W per gang
P3X40	3 gang 400W 2 way, max 300W per gang
P4X40	4 gang 400W 2 way, max 250W per gang

Grid-It 400W Push on/off Resistive Dimmer Module

See Notes for Dimmers Page 411: Note A,B,E

D40	1 gang 400W 2 way Switched Poles: not applicable* Contact Gap Minimum: 3mm**
-----	--

600W Push on/off Resistive Dimmer

See Notes for Dimmers Page 441: Note A,B,E

Wattage:	600W
Current Rating:	2.5 Amp
Max Load:	600W Resistive per gang
Technical Insert Ref:	Description:
1X60	1 gang 600W 2 Way
WD1X60	1 gang 600W 2 Way

1KW Push on/off Resistive Dimmer

See Notes for Dimmers Page 441: Note A,B,E

Wattage:	1KW
Current Rating:	4.16 Amp
Max Load:	1KW Resistive per gang

Technical Specification:







Voltage:	220/250V AC
IP Rating:	IP2XD
Switched Poles:	Single*
Contact Gap Minimum:	N/A**
Product Class 1:	Face plate must be earthed
Ambient Operating Temperature:	-5° to +40°C
Location:	Internal Use Only
Max Installation Altitude:	2000m

Standard Hamilton manufactured electrical accessories are designed to be mounted on BS4662:2006 flush wall boxes.

STANDARDS:	
BS EN ISO Standard:	BS EN 60669-2-1
400W/600W Resistive Dimmer	

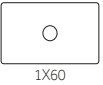
Terminal Capacity:

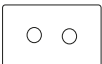
	1mm ²	1.5mm ²	2.5mm ²	4mm ² Multi-Strand	6mm ²
Terminal Capacity	2	2			
Earth Terminal Capacity	5	4	3	1	1

Fixing Centres:	400W Push on/off Dimmer	600W Push on/off Dimmer	1KW Push on/off Dimmer	GRID-IT 400W PUSH ON/OFF DIMMER MODULE
60.3mm	 1X40	 2X40	 1X60	
120.6mm	 3X40 / P3X40 W3X40	 4X40 / P4X40 W4X40		 WD2X40 Woods range
Fits one Grid-IT aperture				 D40

Due to constant changes in regulations, etc. users should satisfy themselves there have been no amendments. E&OE.

Trailing Edge Dimmer Information

Notes For Dimmers

Note A	Tungsten filament GU10 lamps must be branded with a fuse base.
Note B	When using mains voltage halogen lamps - dimmers should be de-rated by 25%.
Note C	When using mains voltage halogen load transformers - maximum rating is 210VA.
Note D	To only be used with Touch Master Dimmers.

Trailing Edge Resistive Dimmers - Metal Plates

Number of dimmer switches per plate	Nominal plate size mm	Dimmer type	Max plate load W (Watts)	Lamp type				
				Tungsten Filament including Halogen (Watts)		Linea Halogen (Watts)	GU10 LED (Watts)	
				Min	Max	Max	Min	Max
1	88x88	1XTE, 1XTM	250	25	250	200	7	62
2	88x88	2XTE, 2XTM	500	25	250	200	7	62
3	88x146	3XTE, 3XTM	750	25	250	200	7	62
4	88x146	4XTE, 4XTM	1000	25	250	200	7	62
6	150x150	6XTE, 6XTM	1500	25	250	200	7	62
8	150x150	8XTE, 8XTM	1800	25	225	200	7	62
9	150x210	9XTE, 9XTM	2250	25	250	200	7	62
12	150x210	12XTE, 12XTM	2250	25	200	200	7	62
12	210x280	12XTE, 12XTM	3000	25	250	200	7	62
16	210x280	16XTE, 16XTM	3600	25	225	200	7	62

Trailing Edge Resistive Dimmers - Wood Plates

Number of dimmer switches per plate	Nominal plate size mm	Dimmer type	Max plate load W (Watts)	Lamp type				
				Tungsten Filament including Halogen (Watts)		Linea Halogen (Watts)	GU10 LED (Watts)	
				Min	Max	Max	Min	Max
1	88x88	1XTE	250	25	250	200	7	62
2	88x88	2XTE	400	25	200	200	7	62
3	88x146	3XTE	750	25	250	150	7	62
4	88x146	4XTE	800	25	200	150	7	62
6	150x150	6XTE	1200	25	200	150	7	62
8	150x150	8XTE	1600	25	200	150	7	62
9	150x210	9XTE	1800	25	200	150	7	62
12	150x210	12XTE	2250	25	200	150	7	62

Trailing Edge Resistive Dimmers - Plastic Plates

Number of dimmer switches per plate	Nominal plate size mm	Dimmer type	Max plate load W (Watts)	Lamp type				
				Tungsten Filament including Halogen (Watts)		Linea Halogen (Watts)	GU10 LED (Watts)	
				Min	Max	Max	Min	Max
1	88x88	1XTE, 1XTM	250	25	250	200	7	62
2	88x88	2XTE, 2XTM	500	25	250	200	7	62
3	88x146	3XTE, 3XTM	750	25	250	150	7	62
4	88x146	4XTE, 4XTM	1000	25	250	150	7	62

Due to constant changes in regulations, etc. users should satisfy themselves there have been no amendments. E&OE.

Trailing Edge Push on/off Dimmers

Category:

Trailing Edge Dimmer

See Notes for Dimmers Page 441: Note A, B, C, E

Technical Insert Ref:	Description:
1XTE	1 gang 250W/210VA Multi-Way Dimmer
2XTE	2 gang 250W/210VA Multi-Way Dimmer
3XTE	3 gang 250W/210VA Multi-Way Dimmer
4XTE	4 gang 250W/210VA Multi-Way Dimmer
W2XTE	2 gang 250W/210VA Multi-Way Dimmer max 200W per gang
W4XTE	4 gang 250W/210VA Multi-Way Dimmer max 200W per gang

Grid-IT Trailing Edge Dimmer Module

See Notes for Dimmers Page 441: Note A, B, C, E

Technical Insert Ref:	Description:
DTE	1 gang 250W/210VA Multi-Way Dimmer Module

Technical Specification:

Wattage:	250W Resistive 210VA Inductive
Current Rating:	1.1 Amp per gang
Max Load:	250W Resistive 210VA Inductive
Minimum Load:	25W/25VA
Voltage:	220/250V AC
IP Rating:	IP2XD
Switched Poles:	Single
Contact Gap Minimum:	None
Product Class 1:	Face plate must be earthed
Ambient Operating Temperature:	-5° to +40°C
Location:	Internal Use Only
Max Installation Altitude:	2000m

Standard Hamilton manufactured electrical accessories are designed to be mounted on BS4662:2006 flush wall boxes.

Standards:

BS EN ISO Standard: BS EN 60669-2-1

Terminal Capacity:

	1mm ²	1.5mm ²	2.5mm ²	4mm ² Multi-Strand	6mm ²
Terminal Capacity	2	2			
Earth Terminal Capacity	5	4	3	1	1

TRAILING EDGE TECHNOLOGY DIMMERS. Are suitable for control of both resistive and inductive loads. When used for dimming low voltage electronic halogen transformers it must be noted that the dimmer controls the primary side of the transformer.

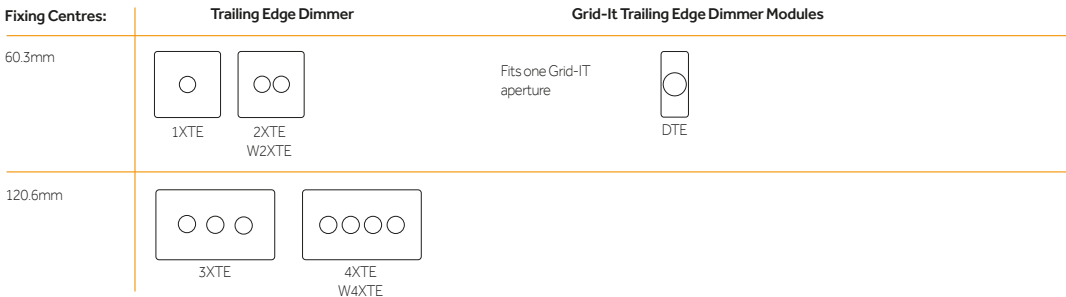

Note: For multi-way switching a push to make retractive switch should be installed in the other positions. (Note: standard two way switches will not work with this product).

Trailing Edge Touch Dimmers

Category:

Trailing Edge Touch Master Multi-Way Dimmer

See Notes for Dimmers Page 441: Note A,B,C,E

Technical Insert Ref:	Description:
1XTM	1 gang 250W/210VA Multi-Way Touch Master
2XTM	2 gang 250W/210VA Multi-Way Touch Master
3XTM	3 gang 250W/210VA Multi-Way Touch Master
4XTM	4 gang 250W/210VA Multi-Way Touch Master

Grid-IT Touch Master Multi-way Dimmer Module

See Notes for Dimmers Page 441: Note A,B,C,E

DTM	1 gang 250W/210VA Multi-Way Touch Master Module
-----	---

Touch Slave Controller

See Notes for Dimmers Page 441: Note A,B,C,D

Technical Insert Ref:	Description:
1XTS	1 gang Multi-Way Touch Slave
2XTS	2 gang Multi-Way Touch Slave
3XTS	3 gang Multi-Way Touch Slave
4XTS	4 gang Multi-Way Touch Slave

Grid-IT Touch Slave Controller Module

See Notes for Dimmers Page 441: Note A,B,C,D

DTS	1 gang Multi-Way Touch Slave Controller Module
-----	--

Touch slave controllers to be used only with touch master dimmers or ceiling dimmers. (Wattage and voltage will be the same as the dimmer).

Technical Specification:

Wattage:	250W Resistive 210VA Inductive
Current Rating:	1.1 Amps
Max Load:	250W Resistive 210VA Inductive
Minimum Load:	25W/VA
Voltage:	220/250V AC
IP Rating:	IP2XD
Product Class 1:	Face plate must be earthed
Ambient Operating Temperature:	-5° to +40°C
Location:	Internal Use Only
Max Installation Altitude:	2000m

Standard Hamilton manufactured electrical accessories are designed to be mounted on BS4662:2006 flush wall boxes.

Standards:

BS EN ISO Standard: BS EN 60669-2-1

Terminal Capacity:

	1mm ²	1.5mm ²	2.5mm ²	4mm ² Multi-Strand	6mm ²
Terminal Capacity	2	2	3	1	1
Earth Terminal Capacity	5	4	3	1	1

Fixing Centres:

60.3mm

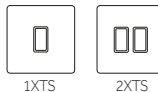
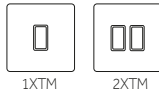

120.6mm

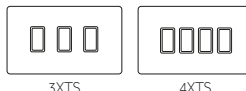
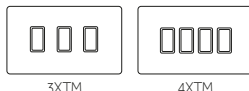

Grid-IT Touch Master Dimmer Module



Grid-IT Touch Slave Controller Module



Fits 1 Grid-IT aperture

Push on/off Switches and Ballast Controller

Category:

White Plastic Push on/off Switch

Current Rating: 5 Amps
Voltage: 230/240V AC

Technical Insert Ref:	Description:
1X5A	1 gang 5A Push On/Off Switch
2X5A	2 gang 5A Push On/Off Switch
3X5A	3 gang 5A Push On/Off Switch
4X5A	4 gang 5A Push On/Off Switch

Grid-IT Push on/off Switch Modules

Current Rating: 3 Amps

Technical Insert Ref:	Description:
DIP	3A Intermediate Push On/Off Module

Current Rating: 6 Amps
DPS 6A 2 way Push On/Off Switch Module

Grid-IT High frequency Ballast Control Module

Current Rating: 1-10V

Technical Insert Ref:	Description:
DHF	1-10V DC High Frequency Ballast Control Module (No Off)

Note: Normally used in conjunction with Hamilton 10 or 20amp rocker switch. The 1-10v module will not switch mains voltage. It is designed to control a 1-10volt signal only.

Technical Specification:

Voltage: 220/250V AC
IP Rating: IP2XD
Contact Gap Minimum: 3mm
Product Class 1: Face plate must be earthed
Ambient Operating Temperature: -5° to +40°C
Location: Internal Use Only
Max Installation Altitude: 2000m

Standard Hamilton manufactured electrical accessories are designed to be mounted on BS4662:2006 flush wall boxes.

Standards:

BS EN ISO Standard:
 Push on/off switch BS EN 60669-1

Terminal Capacity:

	1mm ²	1.5mm ²	2.5mm ²	4mm ² Multi-Strand	6mm ²
Terminal Capacity	2	2			
Earth Terminal Capacity	5	4	3	1	1

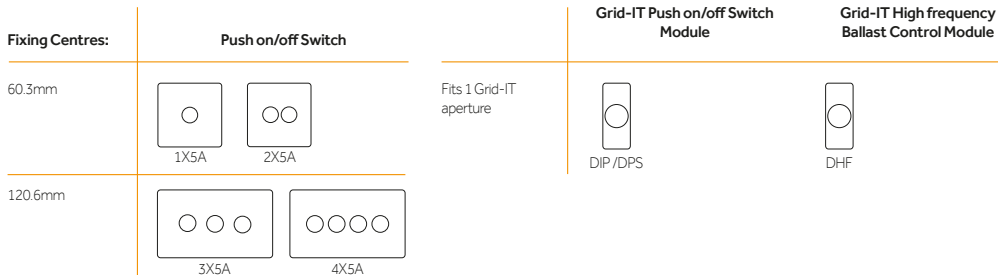

Due to constant changes in regulations, etc. users should satisfy themselves there have been no amendments. E&OE.

Grid-IT Neon and Neon Halo Modules

Category:

Grid-IT Neon Halo Modules

Technical Insert Ref:	Description:
GN	Neon Halo Modules

Grid-IT Neon Only Modules

Technical Insert Ref:	Description:
GNO	Neon Only Modules
GNH-PCR	Neon Only Module Horizontally Mounted Please Clean Room
GNH-DND	Neon Only Module Horizontally Mounted Do Not Disturb
GN-MAID	Neon Halo Module Maid
GN-BELL	Neon Halo Module Bell

Technical Specification:

Voltage:	220/250V AC
IP Rating:	IP2XD
Product Class 1:	Face plate must be earthed
Ambient Operating Temperature:	-5° to +40°C
Location:	Internal Use Only
Max Installation Altitude:	2000m

Standards:	
BS EN ISO Standard:	BS 5733

Terminal Capacity:

	1mm ²	1.5mm ²	2.5mm ²	4mm ² Multi-Strand	6mm ²
Terminal Capacity	5	4	2	2	1
Earth Terminal Capacity	6	5	3	2	1

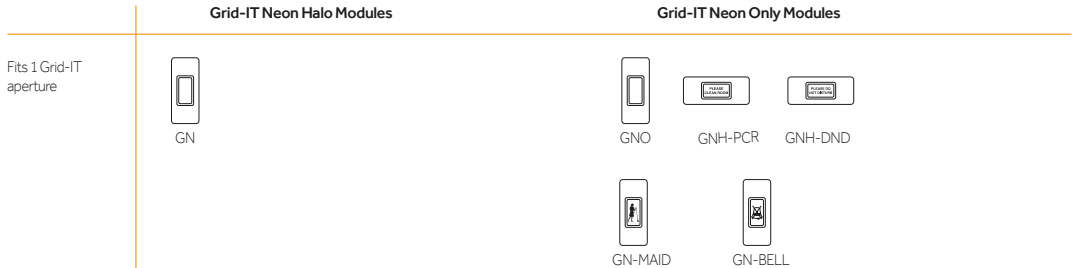

Due to constant changes in regulations, etc. users should satisfy themselves there have been no amendments. E&OE.

Large Plates Dimensions

Note: Large plastic not available in Perception CFX®, Hartland Colours CFX®, White Plastic.

Note: You can mix 'n' match dimmers as long as you don't go over the maximum wattage for the plate.

TECHNICAL SPECIFICATIONS

150mm

			Tungsten Filament including halogen	
No. Items per plate	Dimmer type	Max load per plate	Min load per gang	Max load per gang
Metal Plates				
6	400	1800	40	300
8	400	1800	40	300
6	TM, TE	1500	25	250
8	TM, TE	1800	25	225
4	600	1800	100	450
2	1000	1800	150	900
Wood Plates				
6	400	1200	40	200
6	TE	1200	25	200
8	TE	1600	25	200
All Plates				
6, 8	Grid rockers, toggle, touch slave			

150mm

210mm

			Tungsten Filament including halogen	
No. Items per plate	Dimmer type	Max load per plate	Min load per gang	Max load per gang
Metal Plates				
12	400	3600	40	300
16	400	3600	40	225
12	TM, TE	3000	25	250
16	TM, TE	3600	25	225
6	600	3600	100	600
3	1000	3600	150	1000
All Plates				
24	Grid rockers, toggle, touch slave			

280mm

150mm

			Tungsten Filament including halogen	
No. Items per plate	Dimmer type	Max load per plate	Min load per gang	Max load per gang
Metal Plates				
9	400	2250	40	250
12	400	2250	40	200
9	TM, TE	2250	25	250
12	TM, TE	2250	25	200
4	600	2250	100	550
3	1000	2250	150	750
Wood Plates				
9	400	1800	40	200
9	TE	1800	25	200
12	TE	2250	25	200
All Plates				
9,12	Grid rockers, toggle, touch slave			

210mm

210mm

			Tungsten Filament including halogen	
No. Items per plate	Dimmer type	Max load per plate	Min load per gang	Max load per gang
Metal Plates				
12	400	2400	40	200
12	TM, TE	2400	25	250
4	600	2400	100	550
3	1000	2400	150	800
All Plates				
18	Grid rockers, toggle, touch slave			

210mm

See dimmer information for Linea Halogen and GU10 LED

Due to constant changes in regulations, etc. users should satisfy themselves there have been no amendments. E&OE.

Grid-It/EuroFix/Blank Plate Dimensions

Grid-IT Grid Fix Plate Dimensions

	Dimension (mm)										
	Linea-CFX				Rondo / Scale	Hartland CFX	Hartland	Perception CFX	Sheer CFX	Sheer	Cheriton
	Duo	Georgian	Perlina								
1GP 1 gang aperture grid fix plate	86 x 86	95.5 x 95.5	92 x 92	91.5 x 91.5	86 x 86	88 x 88	86 x 86	86 x 86	86 x 86	88.5 x 88.5	
2GP 2 gang aperture grid fix plate	86 x 86	95.5 x 95.5	92 x 92	91.5 x 91.5	86 x 86	88 x 88	86 x 86	86 x 86	86 x 86	88.5 x 88.5	
3GP 3 gang aperture grid fix plate	145 x 86	154.5 x 95.5	151 x 92	150.5 x 91.5	145 x 86	144.5 x 85	145 x 86	145 x 86	146 x 86	146 x 86.5	
4GP 4 gang aperture grid fix plate	145 x 86	154.5 x 95.5	151 x 92	150.5 x 91.5	145 x 86	144.5 x 85	145 x 86	145 x 86	146 x 86	146 x 86.5	
6GP 6 gang aperture grid fix plate						146 x 146			146 x 146	146 x 146	
8GP 8 gang aperture grid fix plate						146 x 146			146 x 146	146 x 146	
9GP 9 gang aperture grid fix plate						146 x 210			146 x 210	146 x 210	
12GP 12 gang aperture grid fix plate						146 x 210			146 x 210	146 x 210	
SS1GP 1 gang 13A switched socket aperture grid fix plate	86 x 86	95.5 x 95.5	91 x 91		86 x 86	88 x 88	86 x 86	86 x 86	86 x 86	88.5 x 88.5	
SS2GP 2 gang 13A switched socket aperture grid fix plate	145 x 86	95.5 x 154.5	150 x 91		145 x 86	144.5 x 85	145 x 86	145 x 86	146 x 86	146 x 86.5	

EuroFix Plate Dimensions Plates must be earthed via the earth tag

	Dimension (mm)											
	Aperture Size	Linea-CFX				Rondo / Scale	Hartland CFX	Hartland	Perception CFX	Sheer CFX	Sheer	Cheriton
		Duo	Georgian	Perlina								
EURO1 1 Module Plate	25 x 50	86 x 86	95.5 x 95.5	92 x 92	91.5 x 91.5	86 x 86	88 x 88	86 x 86	86 x 86	86 x 86	88 x 88	
EURO2 2 Module Plate	50 x 50	86 x 86	95.5 x 95.5	92 x 92	91.5 x 91.5	86 x 86	88 x 88	86 x 86	86 x 86	86 x 86	88 x 88	
EURO3 3 Module Plate	75 x 50	145 x 86	154.5 x 95.5	151 x 92	150.5 x 91.5	145 x 86	144.5 x 85	145 x 86	145 x 86	146 x 86	146 x 86	
EURO4 4 Module Plate	100 x 50	145 x 86	154.5 x 95.5	151 x 92	150.5 x 91.5	145 x 86	144.5 x 85	145 x 86	145 x 86	146 x 86	146 x 86	

EuroFix Polycarbonate Plate Dimensions

	Nominal Plate Size	Aperture Size	Number of Modules Held
MOD-P2M 2 Module EuroFix Plate	86 x 86mm	50 x 50mm	One 50 x 50mm Module or Two 25 x 25mm Modules or One 25 x 50mm Module and two 12.5mm blanking modules
MOD-P4M 4 Module EuroFix Plate	146 x 86mm	100 x 50mm	One 100 x 50mm Module or Two 50 x 50mm Modules or One 50 x 50mm Module and two 25 x 50mm Modules or Four 25 x 50 Modules

Blank Plate Dimensions Plates must be earthed via the earth tag

	Dimension (mm)										
	Linea-CFX				Rondo / Scale	Hartland CFX	Hartland	Perception CFX	Sheer CFX	Sheer	Cheriton
	Duo	Georgian	Perlina								
BPS Single Blank Plate	86 x 86	95.5 x 95.5	92 x 92	91.5 x 91.5	86 x 86	88 x 88	86 x 86	86 x 86	86 x 86	88 x 88	
BPD Double Blank Plate	145 x 86	154.5 x 95.5	151 x 92	150.5 x 91.5	145 x 86	144.5 x 85	145 x 86	145 x 86	146 x 86	146 x 86	

Due to constant changes in regulations, etc. users should satisfy themselves there have been no amendments. E&OE.

Grid-IT and EuroFIX Ancillaries Dimensions

Blank Plate Module Dimensions

Technical Insert Ref:	Description	Nominal Size	Depth
MOD-HALFBLANK	EuroFix Half Blanking Plate Module	12.5 x 50mm	
MOD-1BLANK	EuroFix One Blanking Plate Module	25 x 50mm	
BMOD	Grid-IT Blank Module	23.2 x 51mm	9.2mm

Spare Module Grid For Sheer CFX and Hartland CFX

Sheer CFX Grid complete with gasket	8C1G	8C2G	8C3G	8C4G
Hartland CFX Grid complete with gasket	7C1G	7C2G	7C3G	7C4G
Dimensions (mm)	86 x 86mm	86 x 86mm	145 x 86mm	145 x 86mm

Spare Module Grid Dimensions For Sheer, Hartland and Cheriton front plates

	1G-GRID	2G-GRID	3G-GRID	4G-GRID
Spare Insert Grid (mm)	78 x 78mm	78 x 78mm	138 x 78mm	138 x 78mm

Spare Plate Screws Dimensions Box Quantity: 50

Technical Insert Ref:	Description	Size
SCREW-PSGR	Dome Headed Slotted Screws for Rocker Aperture Plates to Grid	M3 x 5mm
SCREW-PSGS	Countersunk Slotted Screws for Switched Socket Plates to Grid	M3 x 5mm

Spare Back Box Screws Dimensions Box Quantity: 50

Technical Insert Ref:	Description	Size
SCREW-SG25	Countersunk Slotted Screws for fixing Grids to Back Box	M3.5 x 25mm
SCREW-SG50	Countersunk Slotted Screws for fixing Grids to Back Box	M3.5 x 50mm

Spare Module Grid Screws Dimensions Box Quantity: 50

Technical Insert Ref:	Description	Size
SCREW-SINS	Countersunk Cross-Slotted Screws for fixing Module to Grid	M2.5 x 4mm

Surface Mounted Box Surrounds

Surface Mounted Box Surround Dimensions - For Woods Range Only

Technical Insert Ref:	Description	Nominal Size	Fits over mounted box size
BFS	Surface Mounting Box Single	93 x 93 x 30mm	25mm
BFD	Surface Mounting Box Double	150 x 93 x 30mm	25mm

Miscellaneous

Category:

Miscellaneous Items

Technical Insert Ref:	Description:	Technical Insert Ref:	Description:
GKEY	Spare Key for Key Switch	MOD-KEYSTONE	Suitable for Keystone type insert
DKIT	Dimmer Inlay + Knob Kit	MOD-TIDY	Cable Outlet Tidy with brushes

Contact Us

Production site and showrooms

BRISTOL - HEAD OFFICE PRODUCTION / SHOWROOM

Unit 10, Carrick Business Centre
4-5 Bonville Road
Brislington, Bristol
BS4 5NZ

T: +44 (0)1747 860088

E: uksales@hamilton-litestat.com

E: info@hamilton-litestat.com

MERE

Unit G, Quarry Industrial estate,
Mere, Wiltshire,
BA12 6LA

LONDON - OFFICE / SHOWROOM

City Pavilion
Cannon Green Building
27 Bush Lane
London
EC4R 0AA

BARCELONA, SPAIN - OFFICE / SHOWROOM

Avinguda Via Augusta 15-25
Esampling Showroom 4
08174 Sant Cugat del Vallès
Barcelona
SPAIN

T: (+34) 652 87 44 33

For Showroom centres opening please contact the head office



www.hamilton-litestat.com



All products listed conform to current British or European standards and the product information is correct at the time of going to press. It is the policy of the company to improve products as part of our development programme.

Therefore, we reserve the right to alter information, designs and dimensions without prior notice. Illustrations and diagrams are reproduced within the limitations of reproduction and printing process and are not binding.

Due to manufacturing processes we cannot guarantee an exact colour match and shadings of certain finishes. E&OE

www.hamilton-litestat.com