

CATALOG

# Electronic relays and controls

Offer overview and technical data



- Interface relays and optocouplers
- Time relays
- Primary switch mode power supplies
- Measuring and monitoring relays

---

**ABB has the industry's most comprehensive range of time relays measuring and monitoring relays, interface relays and power supplies – helping you to source all critical components from a single global supplier.**

**Increase the reliability of process equipment with control devices that provide intelligent signals and smart adjustments that help you achieve maximum system availability.**

---

# Electronic relays and controls

## Table of contents

<b>4</b>	<b>Overview</b>
<b>13</b>	<b>Time relays</b>
<b>73</b>	<b>Measuring and monitoring relays</b>
<b>247</b>	<b>Primary switch mode power supplies</b>
<b>361</b>	<b>Interface relays and optocouplers</b>
<b>458</b>	<b>Index</b>

# Interface relays and optocouplers

## A proven technology used worldwide

Relays are universally applicable and are utilized in a diverse array of applications. They are a significant element in contemporary industrial processes and are used in applications where galvanic isolation, signal separation, voltage coupling and signal amplification are required.

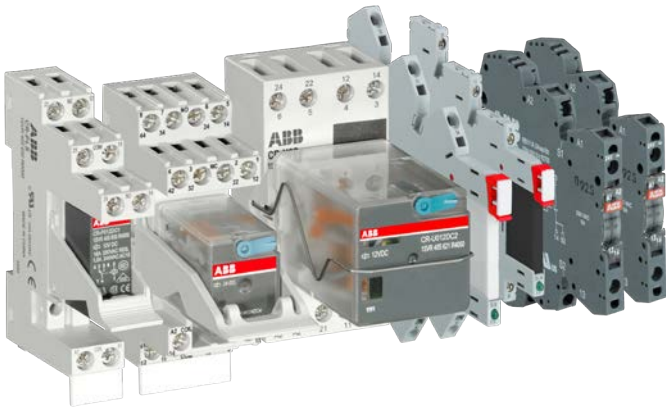

Optocouplers are predominantly used in applications where a high switching frequency is necessary. Furthermore, optocouplers do not contain any moving parts and are therefore bounce-free, immune to vibrations and possess a long electrical life. This wide selection of relays adheres to the highest global standards and satisfies the requirements for a diverse number of applications and needs.

ABB offers a complete range of interface relays and optocouplers for increased flexibility and choice. This portfolio includes pluggable relays for easy interchangeability and optocouplers for an extended electrical life. The portfolio includes electromechanical relays and optocouplers - the electromechanical relays operate using an electromagnetic field, whereas optocouplers use light.

**Billions**  
of relays operate and  
interface between control  
circuits and electrical loads

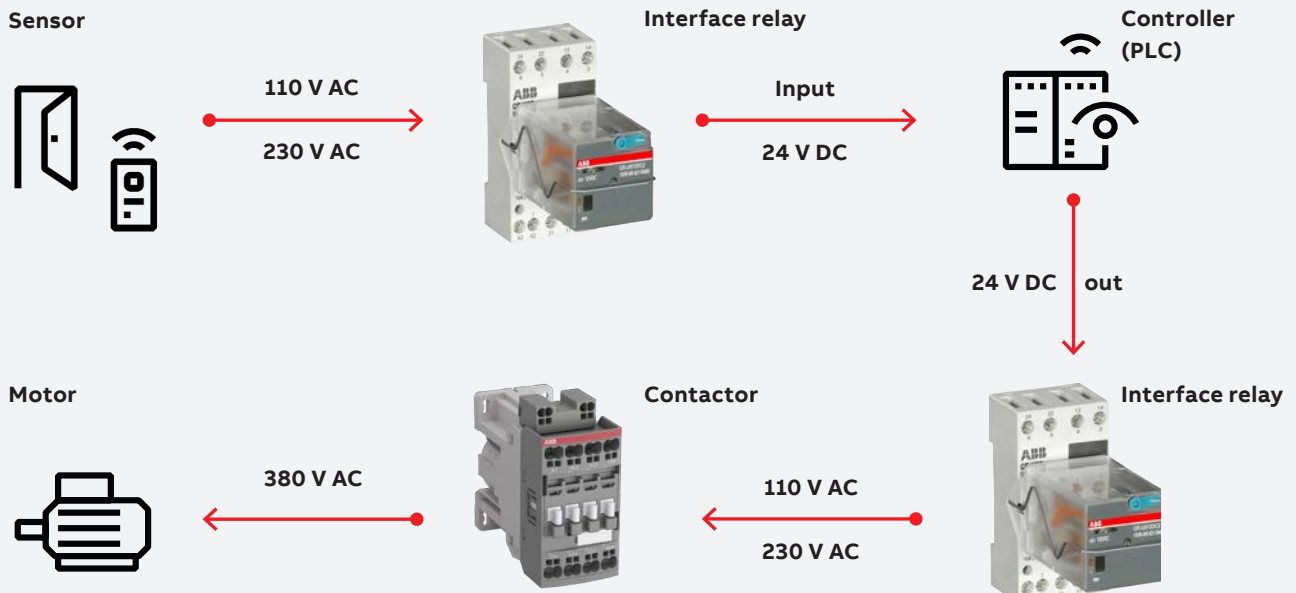

## Time relays

Have the perfect timing- everywhere

Available in three different ranges to cover every application, the CT range time relays are used to provide reliable timing functions worldwide. In both industrial and building applications, the time relays of the CT range have proven their excellent functionality in daily use under the toughest conditions.

Choose ABB as the partner for all your low voltage timing control needs to leverage our wide variety of product options. From economic to high-end solutions – the range offers maximum value. Time relays are found everywhere, for example in air conditioning systems, heaters and fans in industrial and in residential buildings. On-delay, off-delay and a range of other functions cover all requirements.



**Shock**  
and vibration resistant  
CT-S relays are perfect  
for use in rolling stock

- Control panels
- Pump controls
- Star-delta motor starting
- Movable equipment like cranes
- Machine tools
- Automatic doors
- Car park barriers
- Assembly machines
- HVAC
- Compressor controls
- Transportation
- Industrial refrigeration
- Packaging machines
- Baking ovens
- Water and wastewater
- Wind
- Industrial cleaning processes

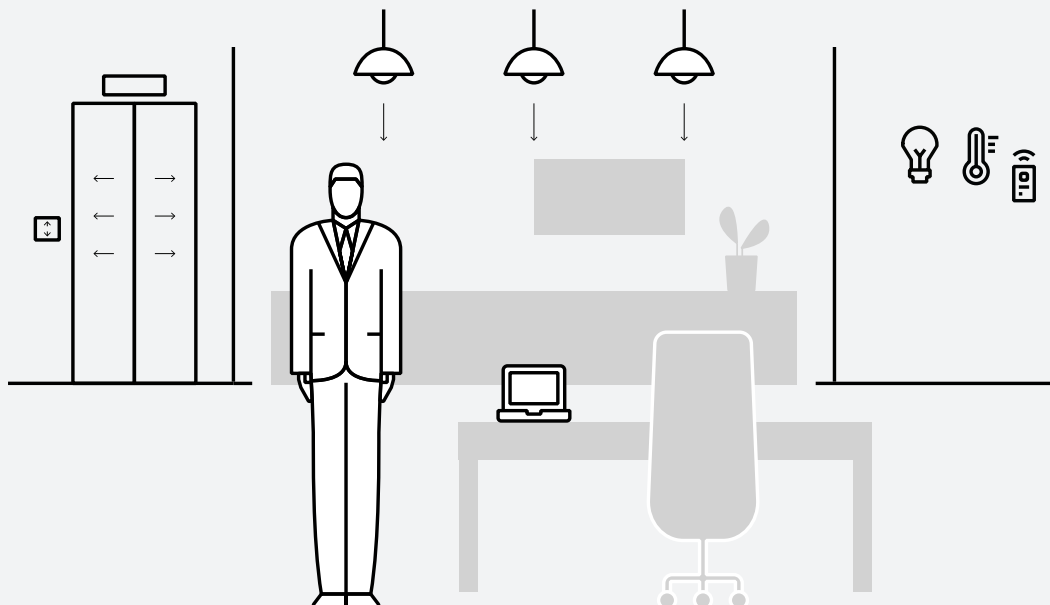

# Primary switch mode power supplies

## Excellent reliability in harsh environments

Available in four different ranges to cover every application requirement, ABB's CP range power supplies are used to power valuable assets worldwide.



E-mobility



Emergency lighting



LED lighting



Communication



Printing industry



Packaging industry



Food industry



Escalators



Elevators



Choose ABB as your power supply partner and leverage our wide variety of product options. From economic to high-end solutions, the CP range offers maximum value. Their excellent reliability in daily use is well proven even under the toughest of conditions.





## Measuring and monitoring relays

Increase process availability and take action

The relays inform users about abnormal conditions and allow them to take necessary corrective actions before severe and costly failures can occur.



Measuring and monitoring relays monitor and detect operating conditions with regard to phase, current, voltage, frequency, temperature, liquid level or insulation faults. The relays inform users about abnormal conditions and allow them to take necessary corrective actions before severe and costly failures can occur.

ABB offers the broadest range of measuring and monitoring relays in the industry - so you can source your critical components from a global supplier. Increase the reliability of your process equipment with controllers that deliver intelligent signals and settings to ensure maximum availability. Ensure continuous operation, engineer time savings and benefit from ABB's global support for measuring and monitoring relays.



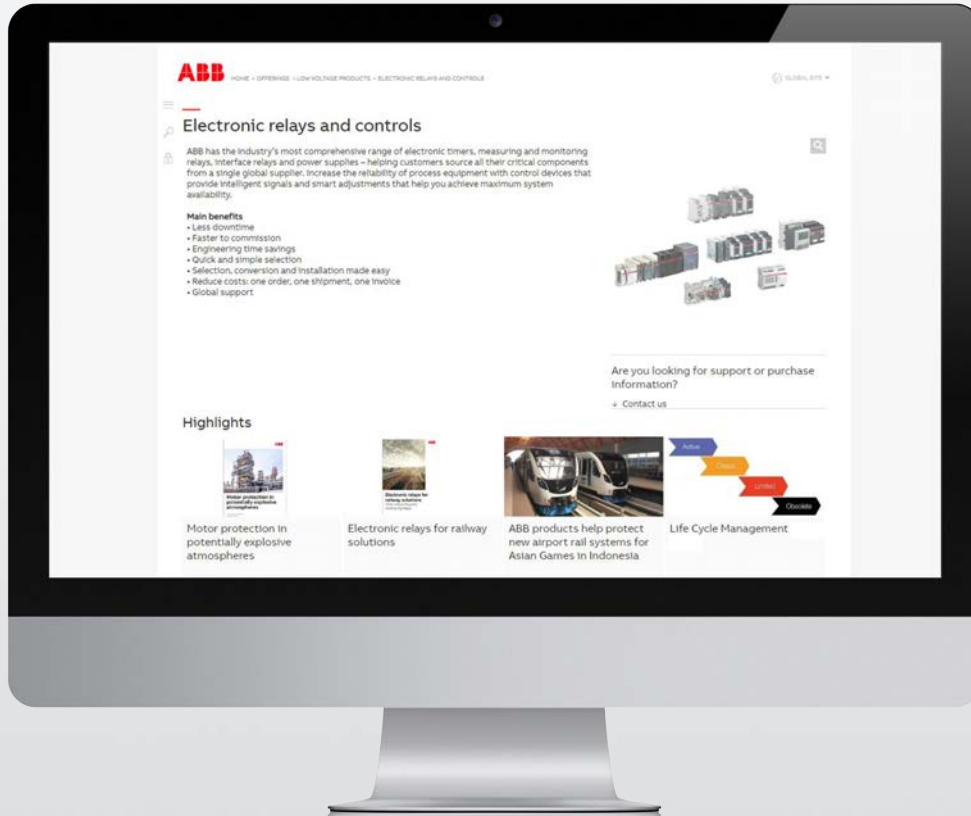

## Electronic relays and controls websites

Your one-stop shop for product information

On our web site you will also find the products in this catalog together with the current life cycle status, data sheets, certificates and tools.



3D data



Life cycle  
information



Coordination  
tables (SOC)



E-configure



Certificates

[new.abb.com/low-voltage/products/electronicrelays](http://new.abb.com/low-voltage/products/electronicrelays)



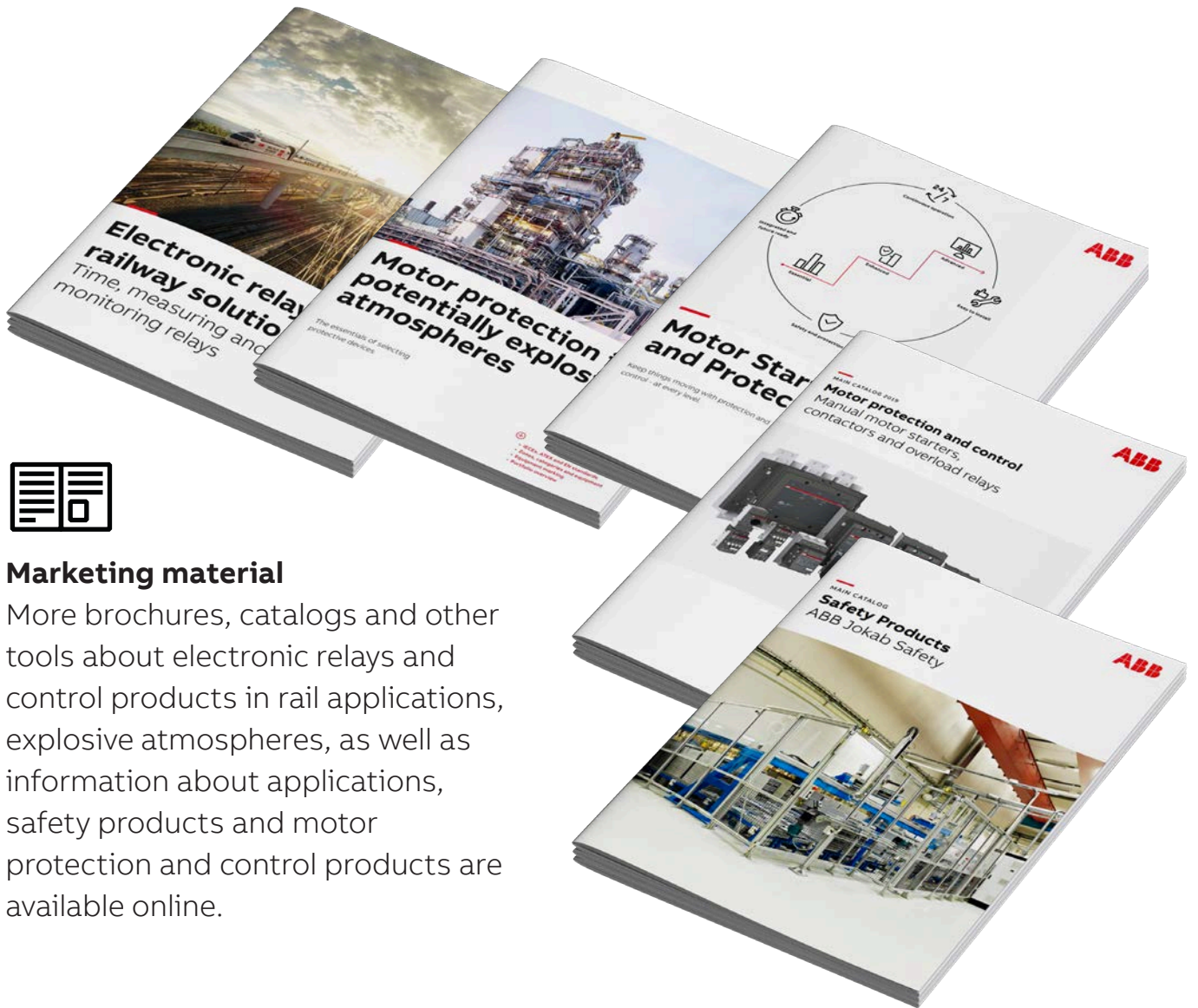

## Marketing material

More brochures, catalogs and other tools about electronic relays and control products in rail applications, explosive atmospheres, as well as information about applications, safety products and motor protection and control products are available online.



## Online data sheets

For detailed product information, use the order code to access the online data sheets as in the following example:

[new.abb.com/products/1SVR740110R3300](https://new.abb.com/products/1SVR740110R3300)

**ABB** POWERLINE

You can view this page in: EN DE SV FI CS DA EL ES FR HU IT JA KO NL NO PL PT RU SK TR ZH

### Detailed information for: CT-AHS.22P

This page contains technical data sheet, documents library and links to offering related to this product. If you require any other information, please contact us using form located at the bottom of the page. [Go Back](#) [Print to PDF](#)

[Data Sheet](#) [Downloads](#)

#### CT-AHS.22P

**General Information**

Extended Product Type:	CT-AHS.22P
Product ID:	1SVR740110R3300
SKU:	400079825008
Catalog Description:	CT-AHS.22P timer relay, ON-delay (S), 0.5-300 s, 24-48VDC, 0A-2A/0.5A

**Long Description**

The CT-AHS.22P is a single-function electronic time relay from the CT-S timer range. It provides an ON-delay (delay on break) function with 30 time ranges from 0.5 s to 300 s. This time relay operates with a rated control supply voltage of 24-48 V DC / 24-240 V AC and has a 2 CO (NO) output with contacts rated at 250 V / 5 A. A control input works with volt-free (floating) triggering. A sealable transparent cover for protection against unauthorized changes is available as accessory. The device offers maintenance free easy connect technology with push-in terminals.

**Categories**

Products - Low voltage products and systems - Control products - Electronic relays and controls - Time Delay Relays

**Ordering**

SKU:	400079825008
Minimum Order Quantity:	1 piece
Customs Tariff Number:	8506-8000

**Container Information**

Package Level 1 Units:	1 piece
Package Level 1 Width:	57 mm
Package Level 1 Depth / Length:	30 mm
Package Level 1 Height:	105 mm
Package Level 1 Gross Weight:	0.147 kg
Package Level 1 Code:	400079825008

**Dimensions**

Product Net Width:	22.5 mm
Product Net Height:	85.4 mm
Product Net Depth / Length:	103.7 mm
Product Net Weight:	0.145 kg

**Technical**

Timer Relay Type:	ON-Delay
Time Range:	0.05 s - 300 s

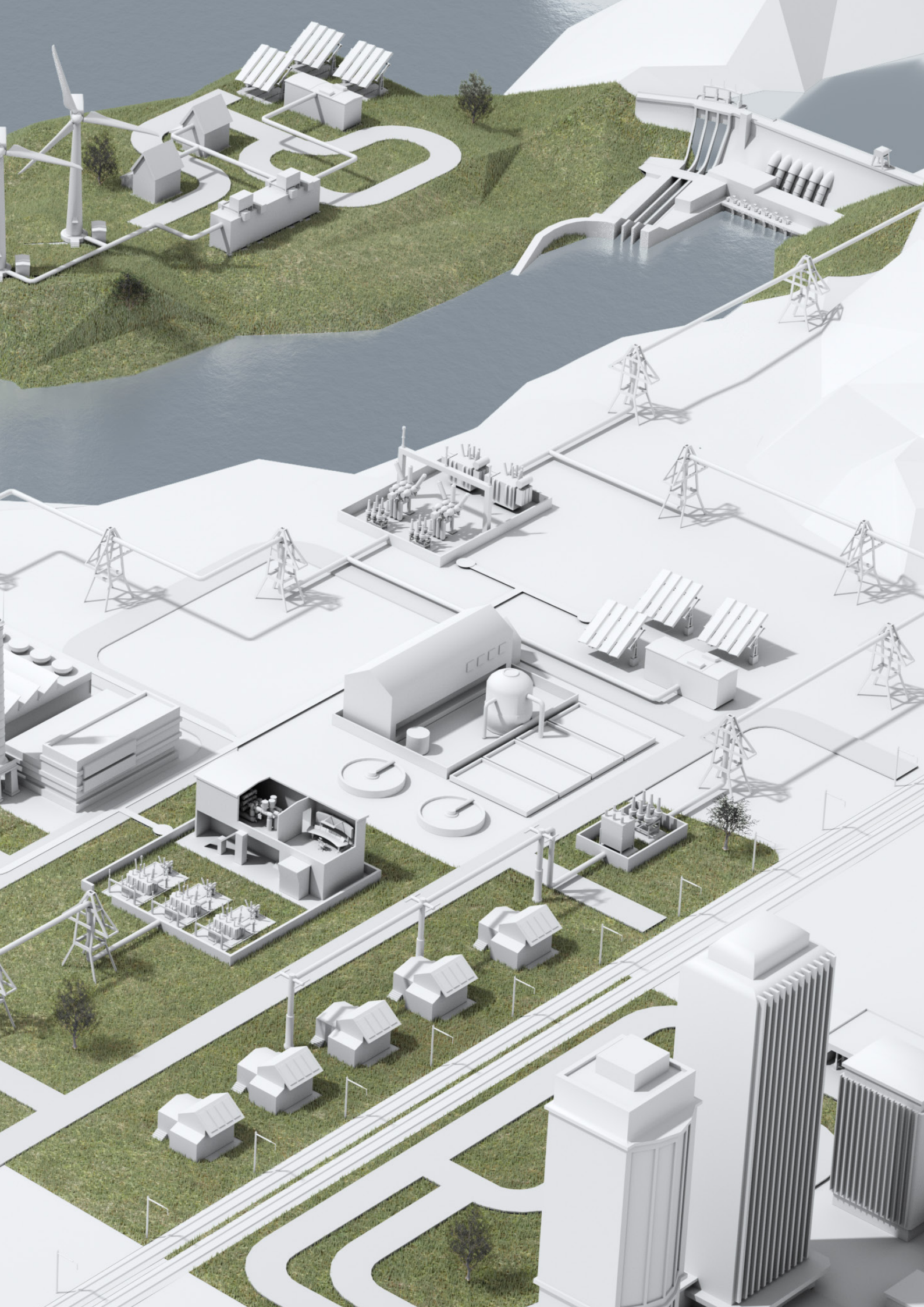

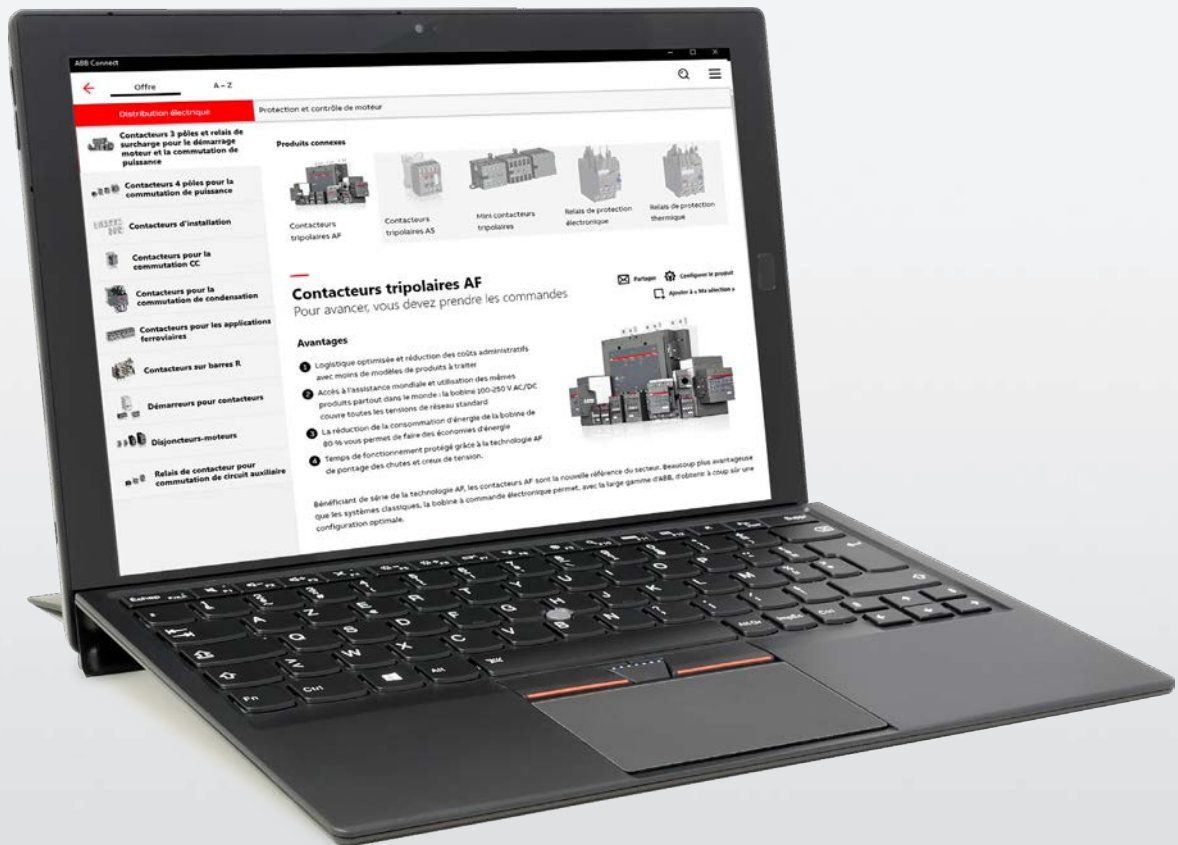

## ABB Connect

Your digital assistant

Connect to your electrification solutions with your digital assistant, access the latest news, and create your own digital workspace; search '**ABB Connect**' on the Apple App Store, Google Play Store or Microsoft Store and download today.



**Find the latest product details**



**Make your phone or tablet your workspace**



**Tap and stay connected to all the latest information**

[new.abb.com/low-voltage/service/abb-connect](https://new.abb.com/low-voltage/service/abb-connect)



---

# Time relays

## Table of contents

<b>15</b>	<b>Time relays for industrial applications</b>
21	CT-C range
33	CT-S range
<b>51</b>	<b>Time relays for building applications</b>
54	CT-D range
<b>65</b>	<b>Timing functions</b>



---

# Time relays for industrial applications

## Table of contents

<b>16</b>	<b>Offer overview</b>
<b>17</b>	<b>Type selection</b>
<b>19</b>	<b>Applications</b>
<b>21</b>	<b>CT-C range</b>
22	Benefits and advantages
23	Operating controls
24	Selection table
25	Ordering details
26	Technical data
30	Technical diagrams
<b>33</b>	<b>CT-S range</b>
34	Benefits and advantages
38	Selection table
39	Ordering details
42	Technical data
46	Technical diagrams

# Time relays for industrial applications

## Offer overview



### CT-C: the compact range

The CT-C range combines lower cost with higher value and performance by offering essential functions in a space-saving 17.5 mm housing. The range offers a choice of 11 devices, including single and multifunctional types, with timing functions that range from 0.05 seconds to 100 hours. Equipped with a wide voltage range, the CT-C range is suitable for a huge variety of applications worldwide.















### CT-S: the high-performance range

The advanced CT-S range is ABB's universal range of electronic timers. It includes 22 single-function devices and 16 multifunction time relays, offering flexibility in operation with up to 13 functions. The devices feature seven or ten time ranges, adjustable from 0.05 seconds to 300 hours. Additionally, every device is available in two different connection technologies: familiar double-chamber cage connection terminals (screw terminals) and ABB's vibration-resistant Easy Connect technology (push-in terminals).



# Time relays for industrial applications

## Type selection

	multi-functional	single-functional	multi-functional	single-functional
<b>Timing function</b>	<b>CT-C</b>		<b>CT-S</b>	
 ON-delay	CT-MFC, CT-MKC	CT-ERC	CT-MVS, CT-MFS, CT-MBS, CT-WBS	CT-ERS
 OFF-delay	CT-MFC, CT-MKC, CT-ARC	CT-AHC	CT-MVS, CT-MFS, CT-MBS	CT-APS, CT-AHS, CT-ARS
 ON- and OFF-delay			CT-MVS, CT-MXS, CT-MFS, CT-MBS	
 Impulse-ON	CT-MFC, CT-MKC	CT-VWC	CT-MVS, CT-MFS, CT-MBS, CT-WBS	
 Impulse-OFF	CT-MFC, CT-MKC, CT-ARC		CT-MVS, CT-MFS, CT-MBS	
 Impulse-ON and OFF			CT-MXS	
 Flasher starting with ON	CT-MFC, CT-MKC	CT-EBC	CT-MFS, CT-MBS, CT-WBS	
 Flasher starting with OFF	CT-MFC, CT-MKC	CT-EBC	CT-MFS, CT-MBS, CT-WBS	
 Flasher starting with ON or OFF			CT-MVS	
 Pulse generator starting with ON or OFF		CT-TGC	CT-MXS	
 Pulse former	CT-MFC, CT-MKC		CT-MVS, CT-MFS, CT-MBS	
 Star-delta change-over		CT-SDC, CT-SAC		CT-SDS
 Star-delta change-over with impulse			CT-MVS.2x, CT-MFS, CT-MBS	
 further functions (depending on device)			CT-MVS, CT-MXS, CT-MFS, CT-MBS, CT-WBS	

A detailed explanation of the different timing functions can be found in the chapter "Timing functions".

### Synonyms

Used expression	Alternative expression(s)
1 c/o contact	SPDT
2 c/o contacts	DPDT
voltage-related	wet / non-floating
volt-free	dry / floating

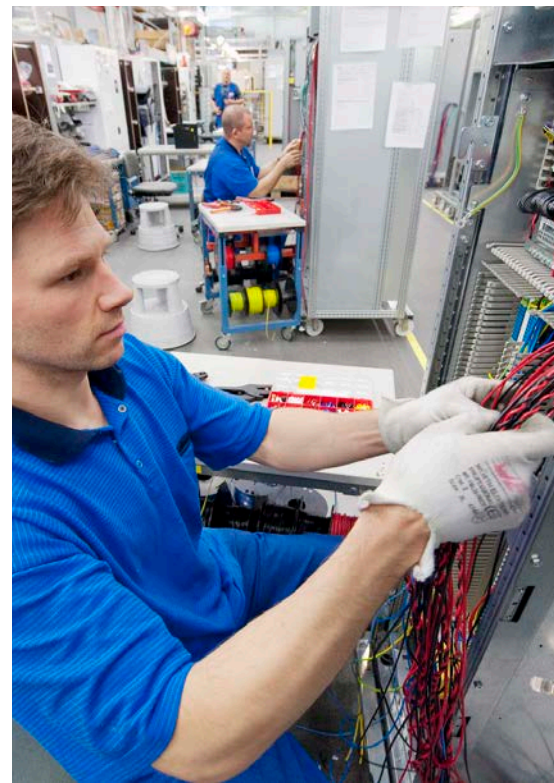
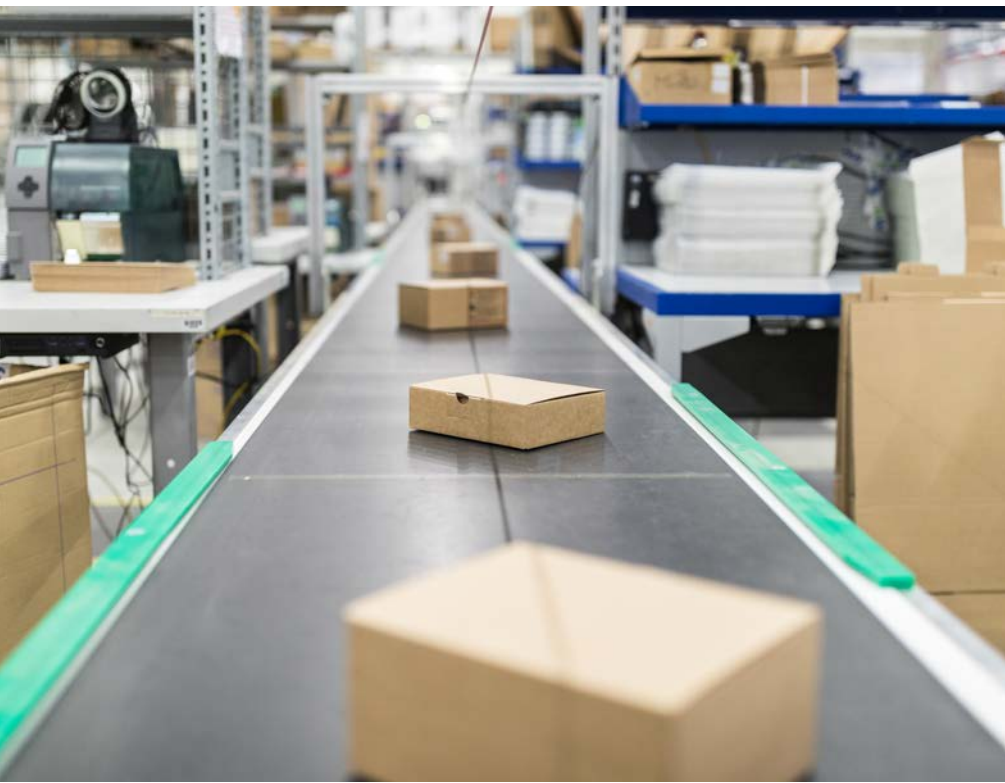
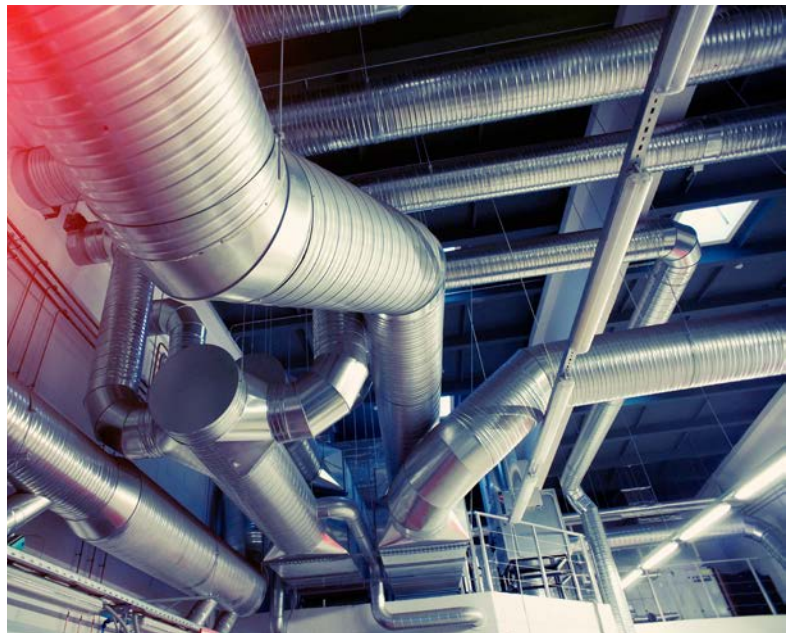

# Time relays for industrial applications

## Applications

ABB offers a wide selection of time relays – from economic to high-end – to suit every application for businesses worldwide. ABB time relays provide simple, reliable and economical control solutions in all types of panel. They are typically used in industrial applications and OEM equipment, providing time-delayed switching to start a motor, control a load or manage a process.



Remote control of time delays with a remote potentiometer.



Cyclic switching of machinery, for example the weekly startup of a fan to prevent them sticking or the flushing of pipes to keep them clear.



Lighting control, for example the delayed switching of multiple rows of lamps in production facilities or greenhouses.



Time controlled start up or shut down of machinery equipment, for example the delayed switch off of conveyor belts or the successive shut down of a plant.



Alarm triggering in case of fault detection, for example to allow the flashing of a lamp in industrial applications or rolling stock.



Star-delta motor starting to reduce starting current with changeover delay to prevent interphase short-circuits.

Have the perfect timing everywhere with ABB's time relays:

- Control panels
- Pump controls
- Star-delta motor starting
- Movable equipment e.g. cranes
- Machine tools
- Automatic doors
- Car park barriers
- Assembly machines
- HVAC
- Compressor controls
- Transportation
- Industrial refrigeration
- Packaging machines
- Baking ovens
- Water and wastewater
- Wind
- Industrial cleaning processes



---

## **CT-C range**

### Table of contents

<b>22</b>	<b>Benefits and advantages</b>
<b>23</b>	<b>Operating controls</b>
<b>24</b>	<b>Selection table</b>
<b>25</b>	<b>Ordering details</b>
<b>26</b>	<b>Technical data</b>
<b>30</b>	<b>Technical diagrams</b>

## CT-C range

### Benefits and advantages



The CT-C range combines lower cost with higher value and performance by offering essential functions in a 17.5 mm housing, freeing up room in any control cabinet. The range includes 11 devices, offering both single and multifunctional types, with a time range from 0.05 seconds to 100 hours. Equipped with wide voltage ranges, CT-C time relays allow for use across a huge variety of applications worldwide.

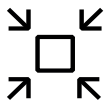

#### Space savings

With a width of just 17.5 mm, the CT-C range is 22% smaller than standard industrial housings for time relays. Its reduced overall footprint saves space in control cabinets. For more flexibility both 1 c/o and 2 c/o output versions are offered in the compact housing.



#### Cost effective solution

The CT-C range is an economical range that combines lower cost with higher value and performance. It suits basic applications where a time relay is needed, while offering improved functionality in each device.



#### Optimized logistics

By combining more functions into each device, the CT-C range makes it possible to reduce stock by up to 75% compared to other ranges. All devices in the CT-C range offer a wide supply voltage range as well as a wide time setting range from 0.05 seconds to 100 hours. This significantly reduces order code variance, making the range more compact with just 11 order codes covering every requirement.

# CT-C range

## Operating controls



### Connection terminals

Wide terminal spacing makes wiring connections easier: 2 x 1.5 mm<sup>2</sup> (2 x 16 AWG) with wire end ferrules or 2 x 2.5 mm<sup>2</sup> (2 x 14 AWG) without ferrules.



### Preselection of the time range



### Direct reading scales

Direct setting of the time delay without any additional calculation provides accurate time delay adjustment.



### Selection of the timing function

- ON-delay
- OFF-delay with aux. voltage
- Impulse-ON
- Impulse-OFF with aux. voltage
- Flasher starting with ON
- Flasher starting with OFF
- Pulse former

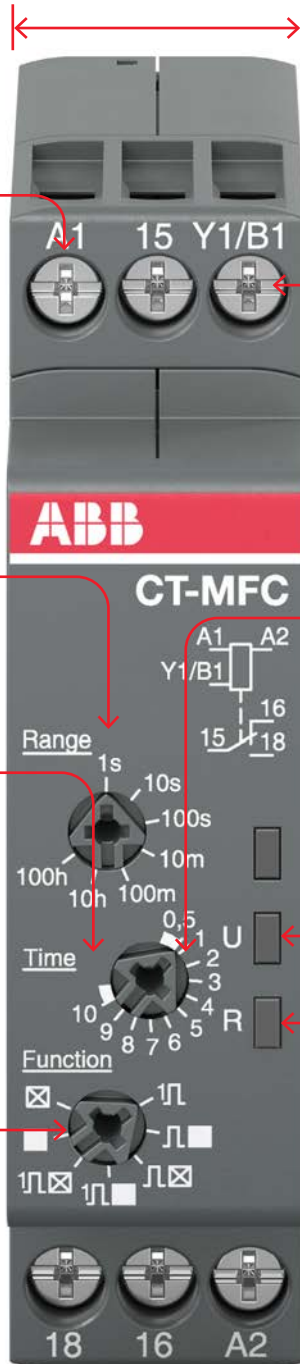

### Width 17.5 mm

With a width of just 17.5mm, CT-C time relays are ideal for installations with limited space.

### Control input to start timing



### Fine adjustment of the time delay



### LEDs for status indication

All actual operational states are displayed by front-facing LEDs, simplifying commissioning and troubleshooting.

- U - green LED: control supply voltage applied / timing
- R, R1, R2 - yellow LED: output relay energized





## CT-C range

### Ordering details



2CDC251030V0018

CT-MFC.12



2CDC251025V0018

CT-ERC.22

- Control input with voltage-related triggering
- No triggering

#### Description

The CT-C range combines lower cost with higher value and performance in a slim 17.5 mm-wide housing. All relays have a wide time setting range from 0.05 seconds up to 100 hours. Combined with a wide voltage range they are the perfect choice for applications worldwide.

#### Ordering details

Timing function	Rated control supply voltage	Time ranges	Control input	Output	Type	Order code	Weight (1 pc) kg (lb)
Multi <sup>1)</sup>	12-240 V AC/DC	7 (0.05 s - 100 h)	■	Solid state	CT-MKC.31	1SVR508010R1300	0.060 (0.132)
Multi <sup>1)</sup>	24-240 V AC 24-48 V DC		■	1 c/o	CT-MFC.12	1SVR508020R0000	0.060 (0.132)
Multi <sup>1)</sup>	12-240 V AC/DC		■	2 c/o	CT-MFC.21	1SVR508020R1100	0.065 (0.143)
Dual <sup>2)</sup>	24-240 V AC 24-48 V DC	7 (0.05 s - 10 min)	-	1 c/o	CT-ARC.12	1SVR508120R0000	0.060 (0.132)
ON-delay	24-240 V AC 24-48 V DC	7 (0.05 s - 100 h)	-	1 c/o	CT-ERC.12	1SVR508100R0000	0.060 (0.132)
			-	2 c/o	CT-ERC.22	1SVR508100R0100	0.065 (0.143)
OFF-delay			■	1 c/o	CT-AHC.12	1SVR508110R0000	0.060 (0.132)
			■	2 c/o	CT-AHC.22	1SVR508110R0100	0.065 (0.143)
Impulse-ON			-	1 c/o	CT-VWC.12	1SVR508130R0000	0.060 (0.132)
Flasher <sup>3)</sup>			-		CT-EBC.12	1SVR508150R0000	0.060 (0.132)
Pulse generator		2×7 (0.05 s - 100 h)	■		CT-TGC.12 <sup>4)</sup>	1SVR508160R0000	0.060 (0.132)
			■	2 c/o	CT-TGC.22 <sup>4)</sup>	1SVR508160R0100	0.065 (0.143)
Star-delta change-over		4 (0.05 s - 10 min)	-	2 n/o	CT-SDC.22 <sup>5)</sup>	1SVR508211R0100	0.065 (0.143)
			-		CT-SAC.22 <sup>6)</sup>	1SVR508210R0100	

<sup>1)</sup> Functions: ON-delay, OFF-delay with auxiliary voltage, Impulse-ON, Impulse-OFF with auxiliary voltage, Flasher starting with ON, Flasher starting with OFF, Pulse former

<sup>2)</sup> OFF-delay without aux. voltage (True OFF-delay), True Impulse-OFF

<sup>3)</sup> Flasher starting with ON, Flasher starting with OFF

<sup>4)</sup> ON and OFF times adjustable independently: 2 x 7 time ranges 0.05 s - 100 h



<sup>5)</sup> Transition time 50 ms fixed

<sup>6)</sup> Transition time adjustable

## CT-C range

### Technical data

Data at  $T_a = 25\text{ °C}$  and rated values, unless otherwise indicated

	CT-C with 1 c/o contact	CT-C with 2 c/o contacts	CT-MFC.21
<b>Input circuit - Supply circuit</b>			
Rated control supply voltage $U_s$	24-240 V AC / 24-48 V DC		12-240 V AC/DC
Rated control supply voltage $U_s$ tolerance	-15...+10 %		
Rated frequency	DC or 50/60 Hz		
Frequency range AC	47-63 Hz		
Typical power consumption	max. 3.5 VA		
Power failure buffering time	min. 20 ms		
Release voltage	> 10 % of the minimum rated control supply voltage $U_s$		
<b>Input circuit - Control circuit</b>			
Control input, control function	A1-Y1/B1	start timing external	
Kind of triggering	voltage-related triggering		
Resistance to reverse polarity	yes		
Parallel load / polarized	yes / yes		
Maximum cable length to the control inputs	50 m - 100 pF/m		
Minimum control pulse length	20 ms		
Control voltage potential	see rated control supply voltage		
<b>Timing circuit</b>			
Time ranges	7 time ranges 0.05 s - 100 h	1.) 0.05-1 s 2.) 0.5-10 s 3.) 5-100 s 4.) 0.5-10 min 5.) 5-100 min 6.) 0.5-10 h 7.) 5-100 h	
	4 time ranges 0.05 s - 10 min (CT-SDC, CT-SAC)	1.) 0.05-1 s 2.) 0.5-10 s 3.) 5-100 s 4.) 0.5-10 min	
Recovery time	< 50 ms		
Accuracy within the rated control supply voltage tolerance	$\Delta t < 0.005\%$ / V		
Accuracy within the temperature range	$\Delta t < 0.06\%$ / °C		
Repeat accuracy (constant parameters)	$\Delta t < \pm 0.5\%$		
Setting accuracy of time delay	$\pm 10\%$ of full-scale value		
Star-delta transition time	CT-SDC / CT-SAC	fixed 50 ms / adjustable: 20 ms, 30 ms, 40 ms, 50 ms, 60 ms, 80 ms or 100 ms	
Star-delta transition time tolerance	CT-SDC / CT-SAC	$\pm 3$ ms	
<b>Indication of operational states</b>			
Control supply voltage / timing	U: green LED	 : control supply voltage applied  : timing	
Relay energized	R, R1, R2: yellow LED	 : output relay energized	
<b>Operating elements and controls</b>			
Adjustment of the time range	front-face rotary switch, direct reading scales		
Fine adjustment of the time value	front-face potentiometer		
Preselection of the timing function at multifunction devices	front-face rotary switch, direct reading scales		
Adjustment of the transition time	CT-SAC	front-face potentiometer	

#### Note

Technical information for CT-ARC.12 and CT-MKC.31 on request.

## CT-C range

### Technical data

		CT-C with 1 c/o contact	CT-C with 2 c/o contacts	CT-MFC.21
<b>Output circuit</b>				
Kind of output	15-16/18	Relay, 1 c/o contact	-	
	15-16/18; 25-26/28	-	Relay, 2 c/o contacts	
	17-18; 17-28		Relay, 2 n/o contacts (CT-SDC, CT-SAC)	
Contact material		AgNi alloy, Cd free		
Rated operational voltage $U_e$		250 V		
Minimum switching voltage / minimum switching current		12 V / 100 mA		
Maximum switching voltage / maximum switching current		250 V AC / 6 A		250 V AC / 5 A
Rated operational current $I_e$	AC-12 (resistive) at 230 V	4 A	4 A	
	AC-15 (inductive) at 230 V	3 A	3 A	n/o: 3 A n/c: 0.75 A
	DC-12 (resistive) at 24 V	4 A	4 A	
	DC-13 (inductive) at 24 V	2 A	2 A	1 A
AC rating (UL 508)	utilization category (Control Circuit Rating Code)	B 300		n/o: B 300 n/c: C 300
	max. rated operational voltage	300 V AC		
	maximum continuous thermal current at B300	5 A		n/o: 5 A
	maximum continuous thermal current at C300	-		n/c: 2.5 A
	max. making/breaking apparent power at B300	3600 VA / 360 VA		n/o: 3600/360 VA
	max. making/breaking apparent power at C300	-		n/c: 1800/180 VA
	Mechanical lifetime	30 x 10 <sup>6</sup> switching cycles		
Electrical lifetime	0.1 x 10 <sup>6</sup> switching cycles			
Max. fuse rating to achieve short-circuit protection	n/c contact	6 A fast-acting		
	n/o contact	10 A fast-acting		6 A fast-acting
<b>General data</b>				
Mean time between failures (MTBF)		on request		
Duty cycle		100%		
Dimensions		see 'Dimensional drawings'		
Mounting		DIN rail (IEC/EN 60715), snap-mounting without any tool		
Mounting position		any		
Minimum distance to other units	horizontal / vertical	no / no		
Degree of protection	housing / terminals	IP50 / IP20		
<b>Electrical connection</b>				
Connecting capacity	fine-stranded with(out) wire and ferrule	2 x 0.5-1.5 mm <sup>2</sup> (2 x 20-16 AWG)		
		1 x 0.5-2.5 mm <sup>2</sup> (1 x 20-14 AWG)		
	rigid	2 x 0.5-1.5 mm <sup>2</sup> (2 x 20-16 AWG) 1 x 0.5-4 mm <sup>2</sup> (1 x 20-12 AWG)		
Stripping length		7 mm (0.28 in)		
Tightening torque		0.5-0.8 Nm (4.43-7.08 lb.in)		
<b>Environmental data</b>				
Ambient temperature range	operation / storage	-20 ... +60 °C / -40 ... +85 °C		
Climatic class	EC/EN 60068-2-30	3K3		
Relative humidity range		25-85%		
Vibration, sinusoidal	IEC/EN 60068-2-6	20 m/s <sup>2</sup> ; 10 cycles, 10...150...10 Hz		
Shock (half-sine)	IEC/EN 60068-2-27	150 m/s <sup>2</sup> , 11 ms		

#### Note

Technical information for CT-ARC.12 and CT-MKC.31 on request.

## CT-C range

### Technical data

		CT-C with 1 c/o contact	CT-C with 2 c/o contacts	CT-MFC.21
<b>Isolation data</b>				
Rated insulation voltage $U_i$	input circuit / output circuit	300 V		
	output circuit 1 / output circuit 2	not available	300 V	300 V
Rated impulse withstand voltage $U_{imp}$	between all isolated circuits	4 kV; 1.2/50 $\mu$ s		
Power-frequency withstand voltage test(test voltage)	between all isolated circuits	2.5 kV; 50 Hz; 60 s		
Basic insulation (IEC/EN 61140)	input circuit / output circuit	300 V		
Protective separation (IEC/EN 61140, EN 50178)	input circuit / output circuit	250 V		
Pollution degree		3		
Overvoltage category		III		
<b>Standards / Directives</b>				
Standards		IEC/EN 61812-1		
Low Voltage Directive		2014/35/EU		
EMC Directive		2014/30/EU		
RoHS Directive		2011/65/EU		
<b>Electromagnetic compatibility</b>				
Interference immunity to		IEC/EN 61000-6-2		
electrostatic discharge	IEC/EN 61000-4-2	Level 3 (6 kV / 8 kV)		
radiated, radio-frequency, electromagnetic field	IEC/EN 61000-4-3	Level 3 (10 V / m)		
electrical fast transient / burst	IEC/EN 61000-4-4	Level 3 (2 kV / 5 kHz)		
surge	IEC/EN 61000-4-5	Level 4 (2 kV L-L)		
conducted disturbances, induced by radio-frequency fields	IEC/EN 61000-4-6	Level 3 (10 V)		
Interference emission		IEC/EN 61000-6-3		
high-frequency radiated	IEC/CISPR 22, EN 55022	Class B		
high-frequency conducted	IEC/CISPR 22, EN 55022	Class B		



# CT-C range

## Technical diagrams

### Connection diagrams

**CT-MFC.21**

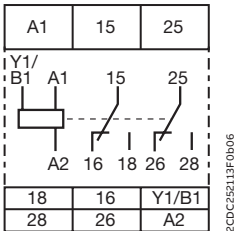

A1-A2	Supply: 12-240 V AC/DC
A1-Y1/B1	Control input
15-16/18	1st c/o contact
25-26/28	2nd c/o contact

**CT-MFC.12**

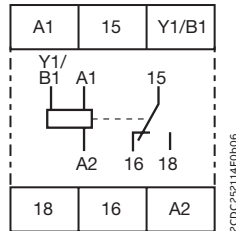

A1-A2	Supply: 24-48 V DC or 24-240 V AC
A1-Y1/B1	Control input
15-16/18	1st c/o contact

**CT-ERC.22**

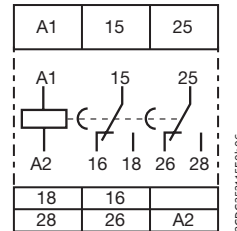

A1-A2	Supply: 24-48 V DC or 24-240 V AC
15-16/18	1st c/o contact
25-26/28	2nd c/o contact

**CT-ERC.12**

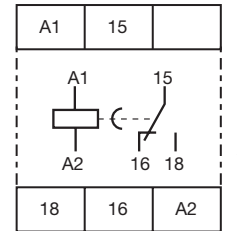

A1-A2	Supply: 24-48 V DC or 24-240 V AC
15-16/18	1st c/o contact

**CT-AHC.22**

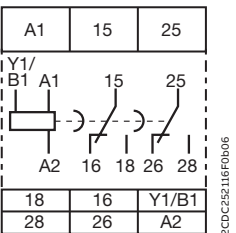

A1-A2	Supply: 24-48 V DC or 24- 240 V AC
A1-Y1/B1	Control input
15-16/18	1st c/o contact
25-26/28	2nd c/o contact

**CT-AHC.12**

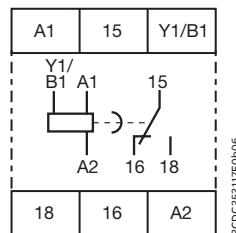

A1-A2	Supply: 24-48 V DC or 24- 240 V AC
A1-Y1/B1	Control input
15-16/18	1st c/o contact

**CT-VWC.12**

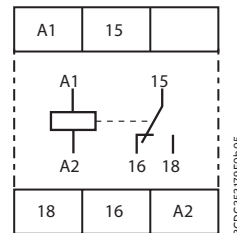

A1-A2	Supply: 24-48 V DC or 24- 240 V AC
15-16/18	1st c/o contact

**CT-TGC.22**

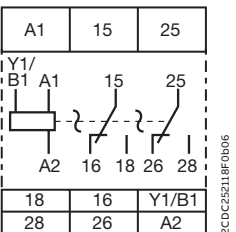

A1-A2	Supply: 24-48 V DC or 24-240 V AC
A1-Y1/B1	Control input
15-16/18	1st c/o contact
25-26/28	2nd c/o contact

**CT-TGC.12**

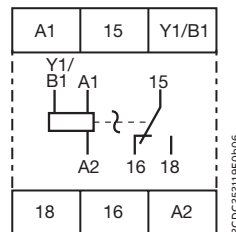

A1-A2	Supply: 24-48 V DC or 24- 240 V AC
A1-Y1/B1	Control input
15-16/18	1st c/o contact

**CT-SDC.22**

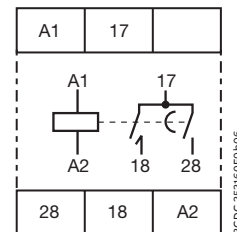

A1-A2	Supply: 24-48 V DC or 24-240 V AC
17-18	1st n/o contact (star contactor)
17-28	2nd n/o contact (delta contactor)

**CT-SAC.22**

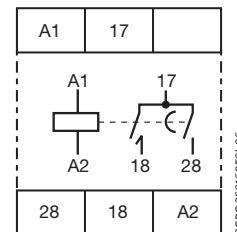

A1-A2	Supply: 24-48 V DC or 24-240 V AC
17-18	1st n/o contact (star contactor)
17-28	2nd n/o contact (delta contactor)

# CT-C range

## Technical diagrams

### Load limit curves

#### AC load (resistive)

##### CT-C.1x

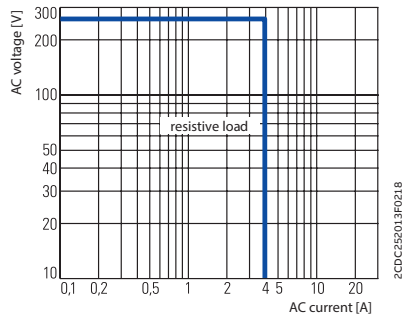

#### DC load (resistive)

##### CT-C.1x

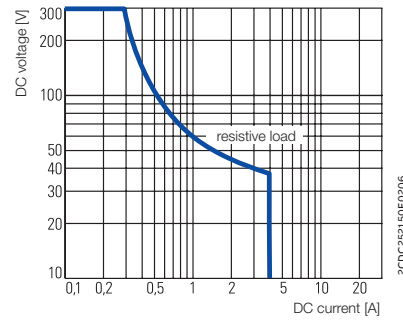

#### Derating factor F for inductive AC load

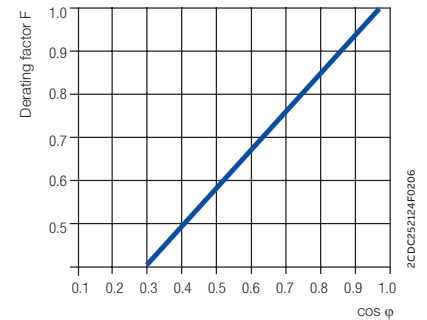

##### CT-C.2x

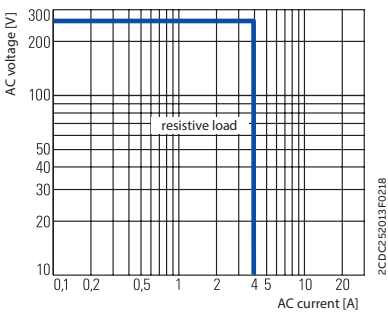

##### CT-C.2x

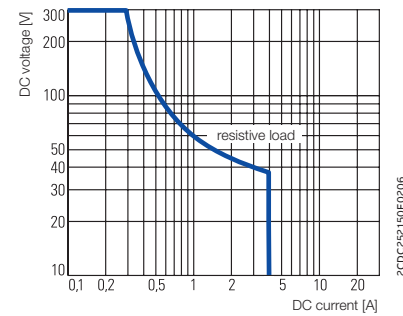

#### Contact lifetime

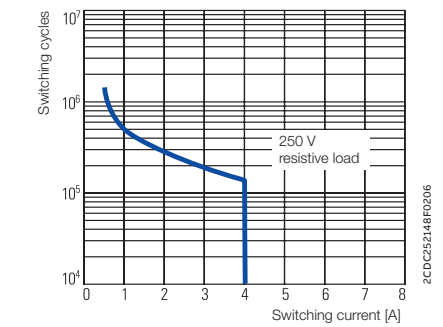

### Wiring notes for devices with control input

A parallel load to the control input is possible

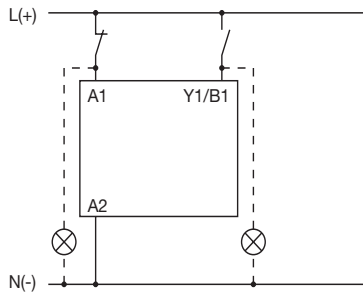

### Dimensional drawings in mm and inches

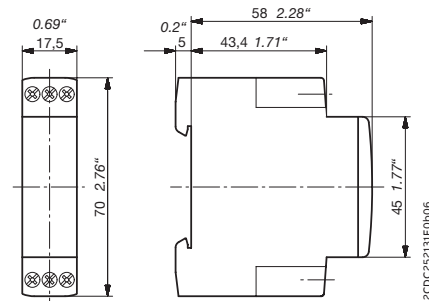

CT-C devices with 1 c/o contact or 2 n/o contacts

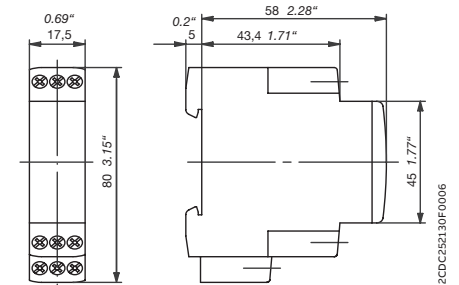

CT-C devices with 2 c/o contacts





---

## **CT-S range**

### Table of contents

<b>34</b>	<b>Benefits and advantages</b>
<b>38</b>	<b>Selection table</b>
<b>39</b>	<b>Ordering details - multifunctional devices</b>
<b>40</b>	<b>Ordering details - singlefunctional devices</b>
<b>41</b>	<b>Ordering details - Accessories</b>
<b>42</b>	<b>Technical data</b>
<b>46</b>	<b>Technical diagrams</b>

## CT-S range

### Benefits and advantages



The advanced CT-S range includes 22 single-function devices and 16 multifunction timers with up to 13 functions. The devices feature seven or ten time ranges, which are adjustable from 0.05 seconds to 300 hours. Every device is available in two different connection technologies: double-chamber cage connection terminals or ABB's vibration-resistant Push-in Technology.



#### Improve installation efficiency

The CT-S range allows simple tool free mounting and demounting on the DIN rail. Thanks to the easy connect and the double-chamber cage connection technology simplified wiring with or without wire end ferrules is no problem. Both allow simple and easy installation, even in case of different cable diameters.



#### Reliable in harsh conditions

The CT-S range's extended features make it especially suited for harsh environments. The housing material has the highest UL fire protection classification. All functions are available with Push-in terminals, making operations in environments with high vibrations possible without retightening. Additionally, the CT-S range offers devices with an extended temperature range, running operations in temperatures as low as -40 °C effortlessly. Specific types are tested according to the latest rail industry standards, making them a perfect solution for rolling stock and other rail applications



#### Global availability

Every device in the CT-S range is designed to provide a wide supply voltage range, making global differences irrelevant. Additionally, the CT-S range meets a broad range of standards and requirements. Together with ABB's global support and sales network, using CT-S gives customers the confidence of worldwide sourcing – no matter where they build, install or operate their equipment.

# CT-S range

## Operating controls

**Control input**  
Starts and pauses timing.



**Preselection of time range**  
Direct assignment of the pre-selected time range to the fine adjustment potentiometer scale by multicolor scales



**Fine adjustment of the time delay**



**Selection of the timing function**

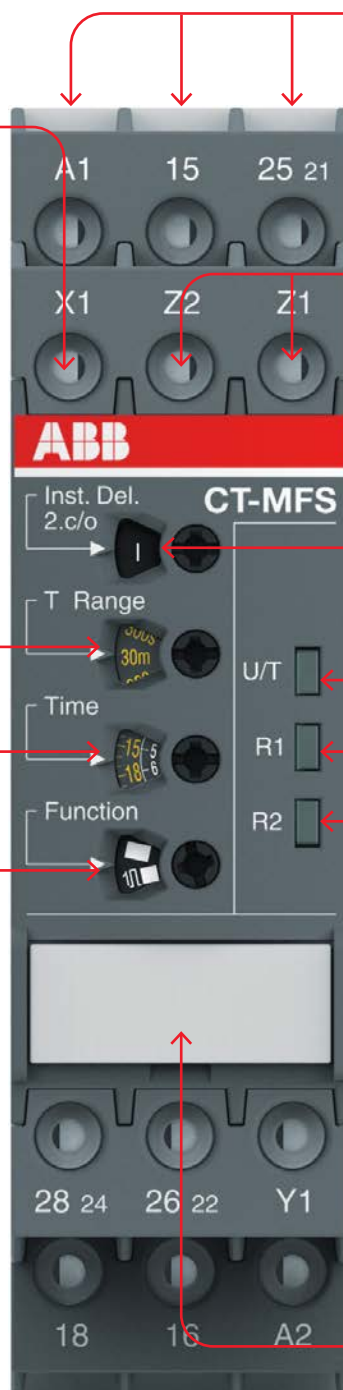

**Connection terminals**  
Screw or push-in connection available.

**Remote potentiometer connection possible**

**2nd contact selectable as an instantaneous contact**



**LEDs for status indication**  
All actual operational states are displayed by front-face LEDs, thus simplifying commissioning and troubleshooting.

- U/T - green LED:
  - ▭ control supply voltage applied /
  - ▭ timing
- R, R1, R2 - yellow LED:
  - ▭ Output relay energized



**Integrated marker label**  
Integrated marker labels allow the product to be marked quickly and simply. No additional marker labels are required.

# CT-S range

## Benefits and advantages



2CDC253026F0011

01 Tool-free mounting of wires

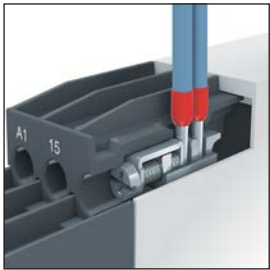

2CDC253026F0011

02 Wiring of double-chamber cage connection terminals with screw driver

### Easy Connect Technology

Tool-free wiring and excellent vibration resistance. Easy Connect (Push-in terminals) provide connection of wires up to  $2 \times 0.5 - 1.5 \text{ mm}^2$  ( $2 \times 20 - 16 \text{ AWG}$ ), rigid or fine-strand with or without wire end ferrules. The extended type designators for products with push-in terminals are indicated by a **P** following the extended type designator e.g. CT-xxS.xx**P**.

### Double-chamber cage connection terminals

According to IEC/EN 60947-1 double-chamber cage connection terminals provide connection of wires up to  $2 \times 0.5 - 2.5 \text{ mm}^2$  ( $2 \times 20 - 14 \text{ AWG}$ ) rigid or fine-strand, with or without wire end ferrules. Thanks to the technology, using different cable diameters in one terminal is easy and simple to install. Potential distribution does not require additional terminals. The extended type designators for products with double-chamber cage connection terminals (screw terminals) are indicated by an **S** following the extended type designator, e.g. CT-xxS.xx**S**.



## CT-S range

### Made for the most extreme conditions

Selected products of the CT-S range comply to the latest rail standards like EN50155. Designed for harsh environments, not only are standard screw type terminals offered – push-in terminals with excellent vibration resistance are also available. Perfect for use in rolling stock.



#### Conductor car

- In the event of the press switch not switching off the auxiliary release pumps of the breaking system, a delayed switch off is triggered by the time relays
- While switching between hold-on and start-up coil on the main switch, a time relay can prolong the pulse
- The reliable and safe functionality of the compressor is essential for trains

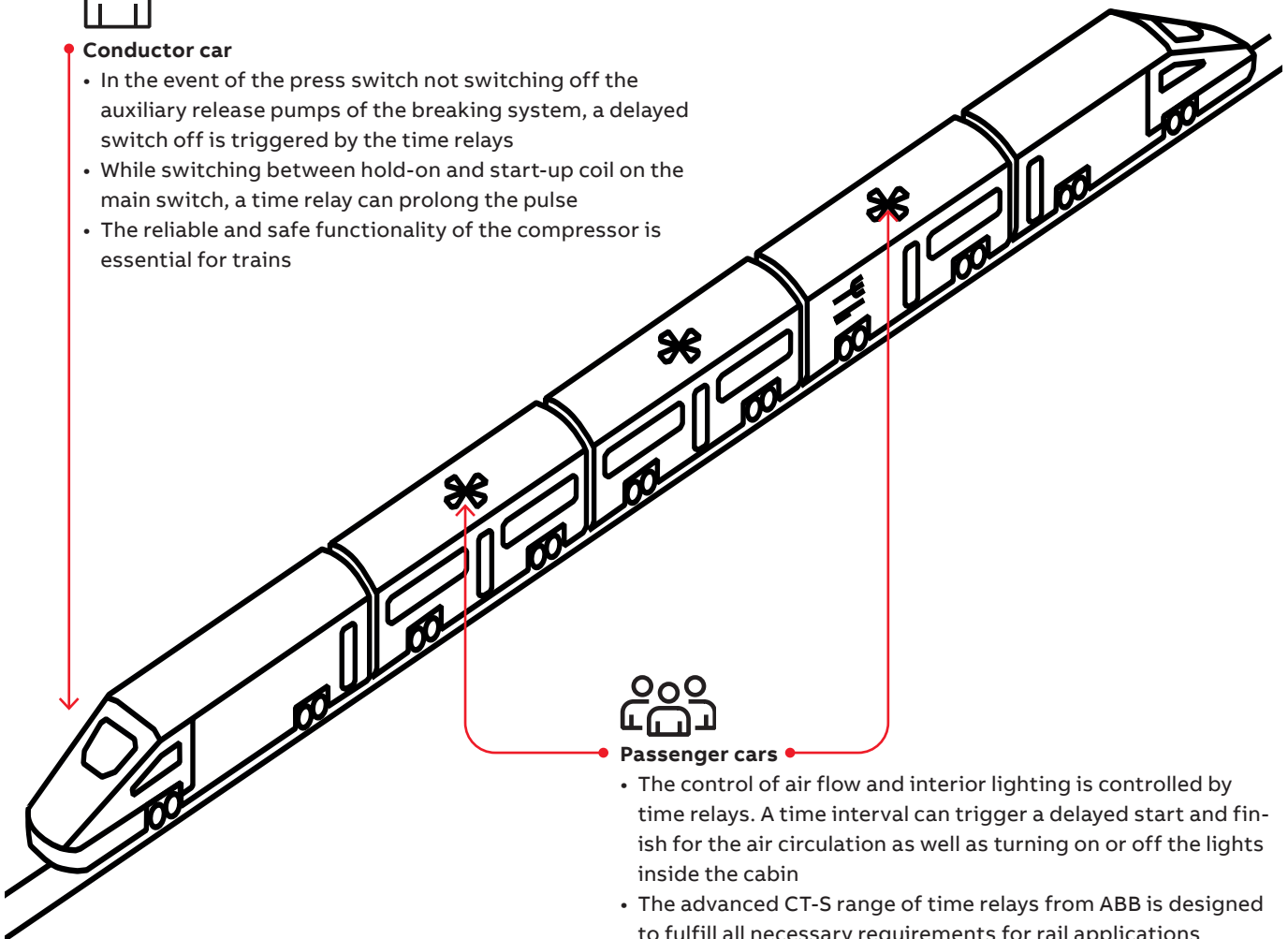

#### Passenger cars

- The control of air flow and interior lighting is controlled by time relays. A time interval can trigger a delayed start and finish for the air circulation as well as turning on or off the lights inside the cabin
- The advanced CT-S range of time relays from ABB is designed to fulfill all necessary requirements for rail applications

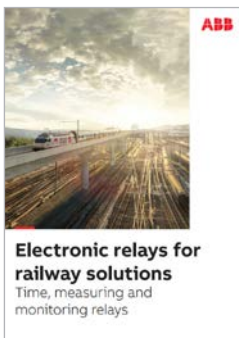

### Electronic relays for railway solutions brochure

For more information about time relays in rolling stock applications visit:

[new.abb.com/low-voltage/products/electronicrelays](http://new.abb.com/low-voltage/products/electronicrelays)

or scan the QR code





## CT-S range

### Ordering details - multifunctional devices



2CDC251.024 V0011

CT-MVS.21P



2CDC251.023 V0011

CT-MBS.22P

- Control input with voltage-related triggering
- Control input with volt-free triggering
- /□ Two control inputs with volt-free triggering
- No triggering

#### Description

The high-performance CT-S range is ideally suited for universal use and is available with two different connection technologies:

- Double-chamber cage connection terminals (Screw terminals)
- Easy Connect Technology (Push-in terminals)

#### Ordering details

Timing function <sup>5)</sup>	Rated control supply voltage	Time ranges	Control input	Output	Type	Order code	Weight (1 pc) kg (lb)
Multi	24- 240 V AC/DC	10 (0.05 s - 300 h)	■	2 c/o	CT-MVS.21S <sup>1) 2) 3)</sup>	1SVR730020R0200	0.148 (0.326)
					CT-MVS.21P <sup>1) 2) 3)</sup>	1SVR740020R0200	0.136 (0.30)
	CT-MVS.22S				1SVR730020R3300	0.142 (0.313)	
	CT-MVS.22P				1SVR740020R3300	0.131 (0.289)	
	CT-MVS.23S				1SVR730021R2300	0.144 (0.317)	
	CT-MVS.23P				1SVR740021R2300	0.133 (0.293)	
Multi	24-48 V DC, 24-240 V AC	10 (0.05 s - 300 h)	■	1 c/o	CT-MVS.12S	1SVR730020R3100	0.107 (0.236)
					CT-MVS.12P	1SVR740020R3100	0.102 (0.225)
Multi	24-48 V DC, 24-240 V AC	2×10 (0.05 s - 300 h)	■	2 c/o	CT-MXS.22S <sup>4)</sup>	1SVR730030R3300	0.142 (0.313)
					CT-MXS.22P <sup>4)</sup>	1SVR740030R3300	0.131 (0.289)
Multi	24- 240 V AC/DC	10 (0.05 s - 300 h)	□ / □	2 c/o	CT-MFS.21S <sup>1) 2) 3)</sup>	1SVR730010R0200	0.145 (0.32)
					CT-MFS.21P <sup>1) 2) 3)</sup>	1SVR740010R0200	0.133 (0.293)
	24-48 V DC, 24-240 V AC		□	CT-MBS.22S <sup>2) 3)</sup>	1SVR730010R3200	0.14 (0.309)	
				CT-MBS.22P <sup>2) 3)</sup>	1SVR740010R3200	0.129 (0.284)	
Multi	24-48 V DC, 24-240 V AC	10 (0.05 s - 300 h)	-	2 c/o	CT-WBS.22S	1SVR730040R3300	0.123 (0.271)
					CT-WBS.22P	1SVR740040R3300	0.115 (0.254)

<sup>1)</sup> Extended temperature range -40 °C

<sup>2)</sup> Remote potentiometer connection

<sup>3)</sup> 2nd c/o contact selectable as instantaneous contact

<sup>4)</sup> 2 remote potentiometer connections

<sup>5)</sup> See selection table on previous page

S: Screw connection

P: Push-in / easy connect

# CT-S range

## Ordering details - singlefunctional devices



CT-ERS.21P

2CDC 251 030 V0001



CT-AHS.22P

2CDC 251 033 V0001



CT-SDS.23P

2CDC 251 040 V0001

- Control input with voltage-related triggering
- Control input with volt-free triggering
- /□ Two control inputs with volt-free triggering
- No triggering

### Ordering details

Timing function	Rated control supply voltage	Time ranges	Control input	Output	Type	Order code	Weight (1 pc) kg (lb)			
ON-delay	24-240 V AC/DC	10 (0.05 s - 300 h)	-	2 c/o	CT-ERS.21S <sup>1)</sup>	1SVR730100R0300	0.13 (0.287)			
					CT-ERS.21P <sup>1)</sup>	1SVR740100R0300	0.121 (0.267)			
	CT-ERS.22S			1SVR730100R3300	0.121 (0.267)					
	CT-ERS.22P			1SVR740100R3300	0.113 (0.249)					
	-		1 c/o	CT-ERS.12S	1SVR730100R3100	0.106 (0.234)				
				CT-ERS.12P	1SVR740100R3100	0.101 (0.222)				
OFF-delay	24-240 V AC/DC	10 (0.05 s - 300 h)	■	2 c/o	CT-APS.21S <sup>1)</sup>	1SVR730180R0300	0.146 (0.322)			
					CT-APS.21P <sup>1)</sup>	1SVR740180R0300	0.125 (0.276)			
					CT-APS.22S	1SVR730180R3300	0.138 (0.304)			
					CT-APS.22P	1SVR740180R3300	0.127 (0.28)			
	-		1 c/o	CT-APS.12S	1SVR730180R3100	0.109 (0.24)				
				CT-APS.12P	1SVR740180R3100	0.103 (0.227)				
				□	2 c/o	CT-AHS.22S	1SVR730110R3300	0.136 (0.30)		
						CT-AHS.22P	1SVR740110R3300	0.125 (0.276)		
OFF-delay <sup>2)</sup>	24-240 V AC/DC	7 (0.05 s - 10 min)	-	1 c/o	CT-ARS.11S	1SVR730120R3100	0.106 (0.234)			
					CT-ARS.11P	1SVR740120R3100	0.10 (0.22)			
					-	2 c/o	CT-ARS.21S	1SVR730120R3300	0.124 (0.273)	
			CT-ARS.21P	1SVR740120R3300			0.115 (0.254)			
			Star-delta change-over <sup>3)</sup>	24-48 V DC, 24-240 V AC			7 (0.05 s - 10 min)	-	2 n/o	CT-SDS.22S
					CT-SDS.22P	1SVR740210R3300				0.108 (0.238)
CT-SDS.23S	1SVR730211R2300	0.118 (0.26)								
CT-SDS.23P	1SVR740211R2300	0.112 (0.247)								

<sup>1)</sup> Extended temperature range -40 °C

<sup>2)</sup> Without auxiliary voltage

<sup>3)</sup> 50 ms transition time

S: Screw connection  
P: Push-in / easy connect



## CT-S range

### Ordering details - Accessories



MT-x50B

1SFC 1B1 B39 V0001

The CT-S range offers the possibility of using accessories such as a remote potentiometer to adjust the time delay or a sealable, transparent cover to protect against unauthorized changes of time and threshold values.

#### Remote potentiometer

50 k $\Omega$   $\pm$ 20 % - 0.2  $\Omega$ , degree of protection IP66

Material	Diameter in mm	Type	Order code	Pack.- unit pieces	Weight 1 piece g / oz
Plastic, black	22.5	MT-150B	1SFA611410R1506	1	0.040
Plastic, chrome	22.5	MT-250B	1SFA611410R2506	1	0.040
Metal, chrome	22.5	MT-350B	1SFA611410R3506	1	0.048



30 mm adapters

2CDC 2B2 042 F0009

#### 30 mm adapter for attaching the potentiometer 22 mm in 30 mm mounting hole

Material	Type	Order code	Pack.- unit pieces	Weight 1 piece g / oz
Plastic, black	KA1-8029	1SFA616920R8029	1	
Metal, chrome	KA1-8030	1SFA616920R8030	1	

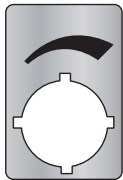

Marker label 29.6 x 44.5 mm

2CDC 2B2 043 F0209

#### Marker label

Caption	Type	Order code	Pack.- unit pieces	Weight 1 piece g / oz
Symbol (see illustration)	SK 615 562-87	GJD6155620R0087	1	0.002
Scale 0 - 10	SK 615 562-88	GJD6155620R0088	1	0.002
Scale 0 - 30	MA16-1060	1SFA611940R1060	1	0.002

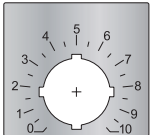
Marker label with scale 0-10  
48.5 x 44.5 mm

2CDC 2B2 044 F0209

#### Accessories for CT-S

Description	Type	Order code	Pack.- unit pieces	Weight 1 piece g / oz
Adapter for screw mounting	ADP.01	1SVR430029R0100	1	0.018 (0.040)
Sealable transparent cover	COV.11	1SVR730005R0100	1	0.004 (0.009)
Marker label for devices w/o DIP switches	MAR.01	1SVR366017R0100	10	0.001 (0.002)
Marker label for devices with DIP switches	MAR.12	1SVR730006R0000	10	0.001 (0.002)

Sealable transparent cover  
for CT-S in new housing

2CDC 2B5 006 S0011

## CT-S range

### Technical data





Data at  $T_a = 25\text{ °C}$  and rated values, unless otherwise indicated

		CT-S
<b>Input circuit - Supply circuit</b>		
Rated control supply voltage $U_s$	CT-xxx.x1	24-240 V AC/DC
	CT-xxx.x2	24-48 V DC, 24-240 V AC
	CT-xxx.x3	380-440 V AC
Rated control supply voltage $U_s$ tolerance		-15...+10 %
Rated frequency		DC or 50/60 Hz
Frequency range AC		47-63 Hz
Typical power consumption		max. 16 VA
Power failure buffering time	24 V DC	min. 15 ms
	230/400 V AC	min. 20 ms
Release voltage		> 10 % of the minimum rated control supply voltage $U_s$
Minimum energizing time		100 ms (CT-ARS)
Formatting time <sup>1)</sup>		5 min (CT-ARS)
<b>Input circuit - Control circuit</b>		
Kind of triggering	CT-MVS, CT-MXS, CT-APS	voltage-related triggering
Control input, Control function	A1-Y1/B1	start timing external
Parallel load / polarized		yes / no
Maximum cable length to the control input		50 m - 100 pF/m
Minimum control pulse length		20 ms
Control voltage potential		see rated control supply voltage
Current consumption of the control input	24 V DC	1.2 mA
	230 V AC	8 mA
	400 V AC	6 mA
Kind of triggering	CT-MFS, CT-MBS, CT-AHS	volt-free triggering
Control input, Control function	Y1-Z2	start timing external
	X1-Z2	pause timing / accumulative functions (CT-MFS)
Maximum switching current in the control circuit		1 mA
Maximum cable length to the control input		50 m - 100 pF/m
Minimum control pulse length		20 ms
No-load voltage at the control inputs		10-40 V DC
<b>Remote potentiometer</b>		
Remote potentiometer connections, resistance value	Z1-Z2	50 k $\Omega$ (CT-MFS, CT-MBS, CT-MVS.21, CT-MXS)
	Z3-Z2	50 k $\Omega$ (CT-MXS)
Maximum cable length to remote potentiometer		2 x 25 m, shielded with 100 pF/m
Shield connection		Z2
<b>Timing circuit</b>		
Time ranges	10 time ranges 0.05 s - 300 h	1.) 0.05-1 s 2.) 0.15-3 s 3.) 0.5-10 s 4.) 1.5-30 s 5.) 5-100 s 6.) 15-300 s 7.) 1.5-30 min 8.) 15-300 min 9.) 1.5-30 h 10.) 15-300 h
	7 time ranges 0.05 s - 10 min (CT-SDS, CT-ARS)	1.) 0.05-1 s 2.) 0.15-3 s 3.) 0.5-10 s 4.) 1.5-30 s 5.) 5-100 s 6.) 15-300 s 7.) 0.5-10 min
Recovery time	24-240 V AC/DC	< 50 ms
	24-48 V DC, 24-240 V AC	< 80 ms
	380-440 V AC	< 60 ms
Accuracy within the rated control supply voltage tolerance		$\Delta t < 0.004\%$ / V
Accuracy within the temperature range		$\Delta t < 0.03\%$ / °C
Repeat accuracy (constant parameters)		< $\pm 0.2\%$
Setting accuracy of time delay		$\pm 6\%$ of full-scale value
Star-delta transition time		fixed 50 ms (CT-SDS, CT-MBS, CT-MFS, CT-MVS.2x)
Star-delta transition time tolerance		$\pm 2\text{ ms}$

<sup>1)</sup> Prior to first commissioning and after a six-month stop in operation

## CT-S range

### Technical data

<b>Indication of operational states</b>			
Control supply voltage / timing	U/T: green LED	 : control supply voltage applied /  : timing	
Control supply voltage	U: green LED	 : control supply voltage applied	
Relay state	R, R1, R2: yellow LED	 : output relay energized	
<b>Output circuit</b>			
Kind of output	15-16/18	relay, 1 c/o contact	
	15-16/18; 25-26/28	relay, 2 c/o contacts	
	15-16/18; 25(21)-26(22)/28(24)	relay, 2 c/o contacts, 2nd c/o contact selectable as inst. contact	
	17-18; 17-28	relay, 2 n/o contacts (CT-SDS)	
Contact material		Cd-free, on request	
Rated operational voltage U <sub>e</sub>	IEC/EN 60947-1	250 V	
Minimum switching voltage / minimum switching current		12 V / 100 mA	
Maximum switching voltage / maximum switching current		see load limit curves	
Rated operational current I <sub>e</sub>	AC-12 (resistive) at 230 V	4 A	
	AC-15 (inductive) at 230 V	3 A	
	DC-12 (resistive) at 24 V	4 A	
	DC-13 (inductive) at 24 V	2 A (CT-ARS; 1.5 A)	
AC rating (UL 508)	utilization category (Control Circuit Rating Code)	B 300	
	max. rated operational voltage	300 V AC	
	maximum continuous thermal current at B300	5 A	
	max. making/breaking apparent power at B300	3600 VA / 360 VA	
Mechanical lifetime		30 x 10 <sup>6</sup> switching cycles	
Electrical lifetime	at AC-12, 230 V, 4 A	0.1 x 10 <sup>6</sup> switching cycles	
Frequency of operation	with/without load	360/72000 h <sup>-1</sup> CT-ARS: 1200/18000 h <sup>-1</sup>	
Max. fuse rating to achieve short-circuit protection	n/c contact	6 A fast-acting	
	n/o contact	10 A fast-acting	
<b>General data</b>			
MTBF		on request	
Duty cycle		100%	
Dimensions		see 'Dimensional drawings'	
Mounting		DIN rail (IEC/EN 60715), snap-on mounting without any tool	
Mounting position		any	
Minimum distance to other units	vertical / horizontal	not necessary / not necessary	
Material of housing		UL 94 V-0	
Degree of protection	housing / terminals	IP50 / IP20	
<b>Electrical connection</b>			
Connecting capacity	fine-strand with(out) wire end ferrule	Screw connection technology	Easy Connect Technology (Push-in)
		1 x 0.5-2.5 mm <sup>2</sup> (1 x 18-14 AWG) 2 x 0.5-1.5 mm <sup>2</sup> (2 x 18-16 AWG)	2 x 0.5-1.5 mm <sup>2</sup> (2 x 18-16 AWG)
	rigid	1 x 0.5-4 mm <sup>2</sup> (1 x 20-12 AWG) 2 x 0.5-2.5 mm <sup>2</sup> (2 x 20-14 AWG)	2 x 0.5-1.5 mm <sup>2</sup> (2 x 20-16 AWG)
Stripping length		8 mm (0.32 in)	
Tightening torque		0.6-0.8 Nm (7.08 lb.in)	-

## CT-S range

### Technical data

Environmental data		
Ambient temperature ranges	operation / storage	-25...+60 °C / -40...+85 °C, -40...+60 °C / -40...+85 °C for CT-MVS.21, CT-MFS.21, CT-ERS.21, CT-APS.21
Relative humidity range		25 % to 85 %
Vibration, sinusoidal (IEC/EN 60068-2-6)	functioning	40 m/s <sup>2</sup> , 10-58/60-150 Hz
	resistance	60 m/s <sup>2</sup> , 10-58/60-150 Hz, 20 cycles
Vibration, seismic (IEC/EN 60068-3-3)	functioning	20 m/s <sup>2</sup>
Shock, half-sine (IEC/EN 60068-2-27)	functioning	150 m/s <sup>2</sup> , 11 ms, 3 shocks/direction
	resistance	300 m/s <sup>2</sup> , 11 ms, 3 shocks/direction
Isolation data		CT-S with 1 c/o
Rated insulation voltage U <sub>i</sub>	input circuit / output circuit	500 V
	output circuit 1 / output circuit 2	not available
Rated impulse withstand voltage U <sub>imp</sub>	between all isolated circuits	4 kV; 1.2/50 μs except devices CT-xxx.23: input / output: 6 kV; 1.2/50 μs output 1 / output 2: 4 kV; 1.2/50 μs
	between all isolated circuits	2.0 kV; 50 Hz; 60 s
Power-frequency withstand voltage (test voltage)	between all isolated circuits	2.0 kV; 50 Hz; 60 s
Basic insulation (IEC/EN 61140)	input circuit / output circuit	500 V
Protective separation (IEC/EN 61140; EN 50178)	input circuit / output circuit	250 V
Pollution degree		3
Overvoltage category		III
Standards / Directives		
Standards		IEC/EN 61812-1
Low Voltage Directive		2014/35/EU
EMC Directive		2014/30/EU
RoHS Directive		2011/65/EU
Electromagnetic compatibility		
Interference immunity to		IEC/EN 61000-6-2
electrostatic discharge	IEC/EN 61000-4-2	Level 3, 6 kV / 8 kV
radiated, radio-frequency electromagnetic field	IEC/EN 61000-4-3	Level 3, 10 V/m (1 GHz) 3 V/m (2 GHz) 1 V/m (2.7 GHz)
electrical fast transient / burst	IEC/EN 61000-4-4	Level 3, 2 kV / 5 kHz
surge	IEC/EN 61000-4-5	Level 4, 2 kV A1-A2
conducted disturbances, induced by radio-frequency fields	IEC/EN 61000-4-6	Level 3, 10 V
harmonics and interharmonics	IEC/EN 61000-4-13	Class 3
Interference emission		IEC/EN 61000-6-3
high-frequency radiated	IEC/CISPR 22, EN 55022	Class B
high-frequency conducted	IEC/CISPR 22, EN 55022	Class B

# CT-S range

## Technical diagrams

### DIP switch configuration CT-MXS.22x

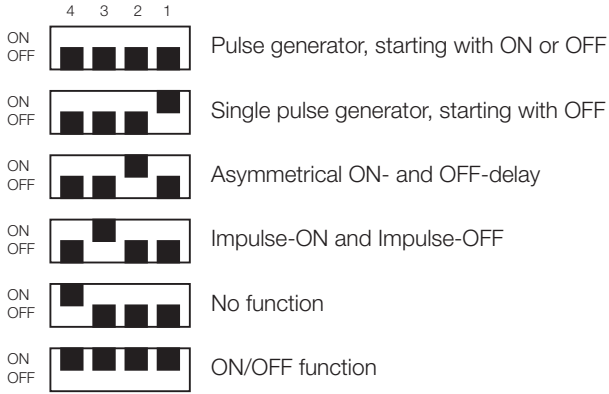

Default setting: all DIP switches in position OFF

### Example of application - Star-delta chageover

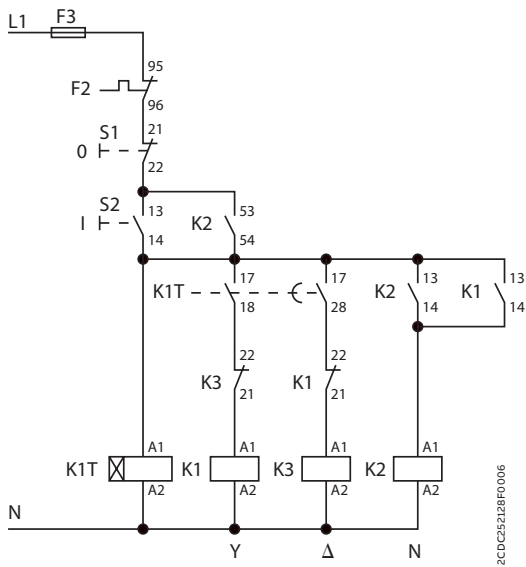

Control circuit diagram

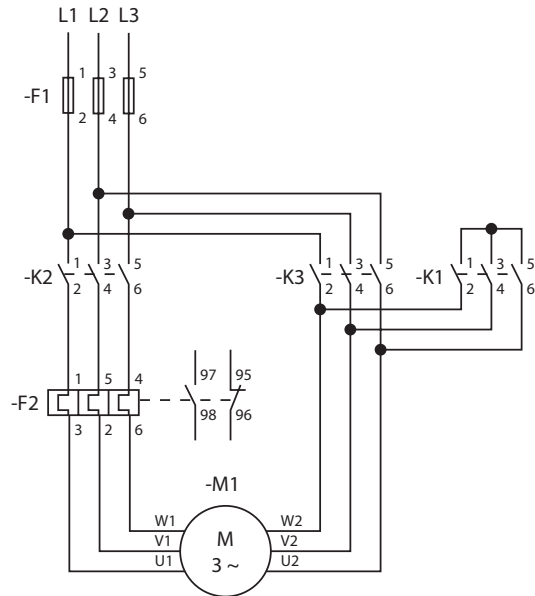

Power circuit diagram

# CT-S range

## Technical diagrams

### Connection diagrams

#### CT-MVS.21

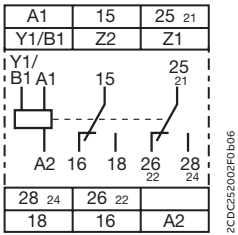

2CDC252002F0b06

- A1-A2 Supply: 24-240 V AC/DC

---

- A1-Y1/B1 Control input
- 15-16/18 1st c/o contact
- 25-26/28 2nd c/o contact
- 21-22/24 2nd c/o contact as instantaneous contact

---

- Z1-Z2 Remote potentiometer connection

#### CT-MVS.22

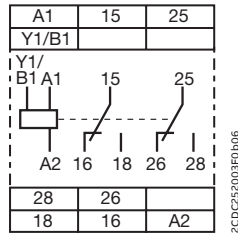

2CDC252003F0b06

- A1-A2 Supply: 224-48 V DC or 24-240 V AC

---

- A1-Y1/B1 Control input
- 15-16/18 1st c/o contact
- 25-26/28 2nd c/o contact

#### CT-MVS.23

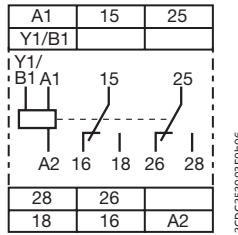

2CDC252003F0b06

- A1-A2 Supply: 380-440V AC

---

- A1-Y1/B1 Control input
- 15-16/18 1st c/o contact
- 25-26/28 2nd c/o contact

#### CT-MVS.12

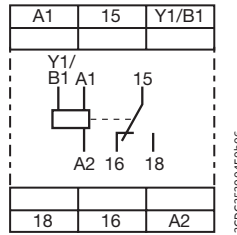

2CDC252004F0b06

- A1-A2 Supply: 24-48 V DC or 24-240 V AC

---

- A1-Y1/B1 Control input
- 15-16/18 1st c/o contact

#### CT-MXS.22

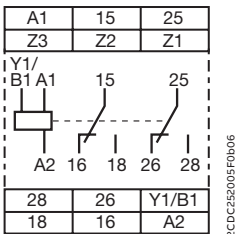

2CDC252005F0b06

- A1-A2 Supply: 24-48 V DC or 24-240 V AC

---

- A1-Y1/B1 Control input
- 15-16/18 1st c/o contact
- 25-26/28 2nd c/o contact
- Z1-Z2 Remote potentiometer connection

---

- Z3-Z2 Remote potentiometer connection

#### CT-MFS.21

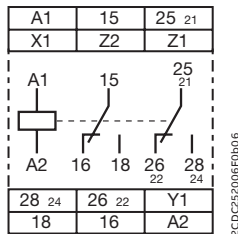

2CDC252006F0b06

- A1-A2 Supply: 24-240 V AC/DC

---

- 15-16/18 1st c/o contact
- 25-26/28 2nd c/o contact
- 21-22/24 2nd c/o contact as instantaneous contact

---

- Y1-Z2 Control input
- X1-Z2 Control input
- Z1-Z2 Remote potentiometer connection

#### CT-MBS.22

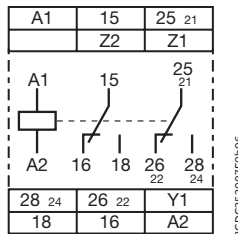

2CDC252007F0b06

- A1-A2 Supply: 24-48 V DC or 24-240 V AC

---

- 15-16/18 1st c/o contact
- 25-26/28 2nd c/o contact
- 21-22/24 2nd c/o contact as instantaneous contact

---

- Y1-Z2 Control input
- Z1-Z2 Remote potentiometer connection

#### CT-WBS.22

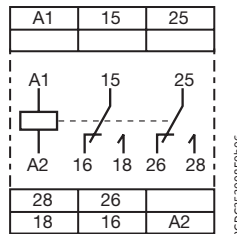

2CDC252008F0b06

- A1-A2 Supply: 24-48 V DC or 24-240 V AC

---

- 15-16/18 1st c/o contact
- 25-26/28 2nd c/o contact

# CT-S range

## Technical diagrams

### Connection diagrams

#### ☒ CT-ERS.21

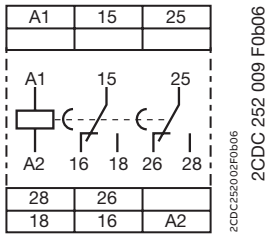

A1-A2 Supply: 24-240 V AC/DC

15-16/18 1st c/o contact  
25-26/28 2nd c/o contact

#### ☒ CT-ERS.22

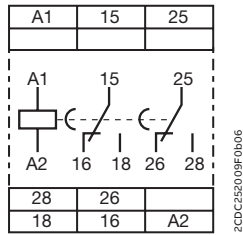

A1-A2 Supply: 24-48 V DC or 24-240 V AC

15-16/18 1st c/o contact  
25-26/28 2nd c/o contact

#### ☒ CT-ERS.12

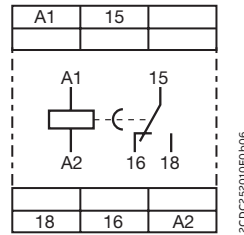

A1-A2 Supply: 24-48 V DC or 24-240 V AC

15-16/18 1st c/o contact

#### ■ CT-APS.21

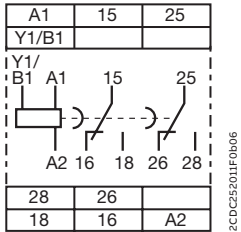

A1-A2 Supply: 24-240 V AC/DC

A1-Y1/B1 Control input  
15-16/18 1st c/o contact  
25-26/28 2nd c/o contact

#### ■ CT-APS.22

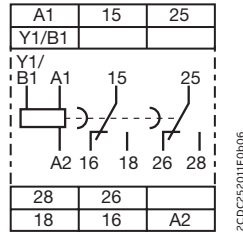

A1-A2 Supply: 24-48 V DC or 24-240 V AC

A1-Y1/B1 Control input  
15-16/18 1st c/o contact  
25-26/28 2nd c/o contact

#### ■ CT-APS.12

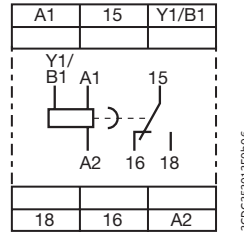

A1-A2 Supply: 24-48 V DC or 24-240 V AC

A1-Y1/B1 Control input  
15-16/18 1st c/o contact

#### ■ CT-AHS.22

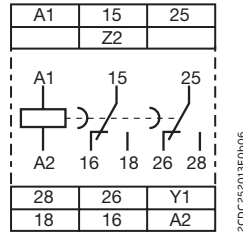

A1-A2 Supply: 24-48 V DC or 24-240 V AC

Y1-Z2 Control input  
15-16/18 1st c/o contact  
25-26/28 2nd c/o contact

#### ■ CT-ARS.11

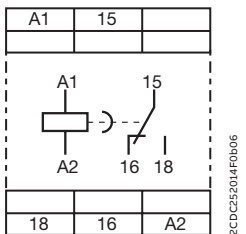

A1-A2 Supply: 24-240 V AC/DC

15-16/18 1st c/o contact

#### ■ CT-ARS.21

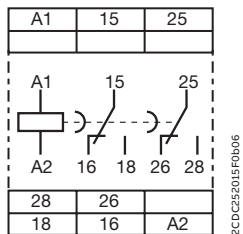

A1-A2 Supply: 24-240 V AC/DC

15-16/18 1st c/o contact  
25-26/28 2nd c/o contact

#### △ CT-SDS.22

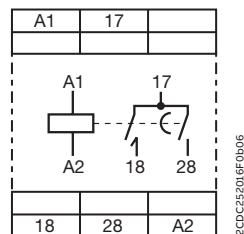

A1-A2 Supply: 24-48 V DC or 24-240 V AC

17-18 1st n/o contact  
17-28 2nd n/o contact

#### △ CT-SDS.23

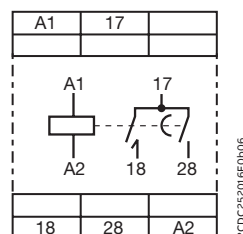

A1-A2 Supply: 380-440 V AC

17-18 1st n/o contact  
17-28 2nd n/o contact

# CT-S range

## Technical diagrams

### Load limit curves

#### AC load (resistive)

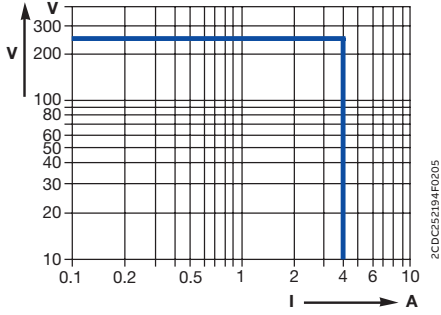

2CDC25219AF0205

#### DC load (resistive)

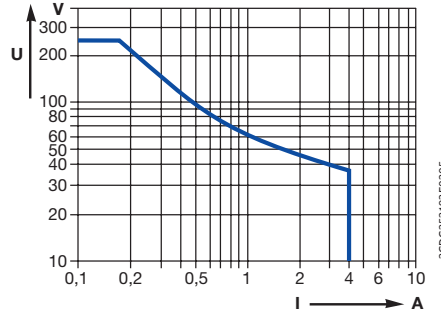

2CDC25219AF0205

### Derating factor F for inductive AC load

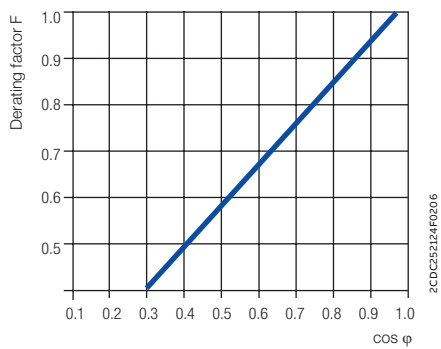

2CDC252124F0206

### Contact lifetime

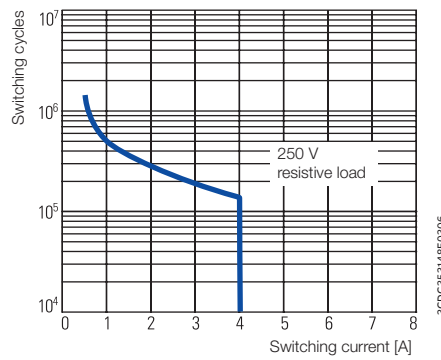

2CDC252148F0206

### Wiring notes

#### Control inputs (volt-free triggering)

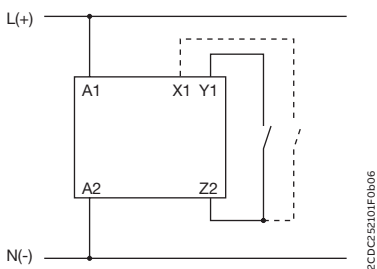

2CDC252105F0606

#### Triggering of the control inputs (volt-free) with a proximity switch (3 wire)

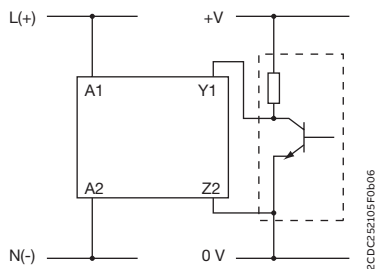

2CDC252105F0606



# CT-S range

## Technical diagrams

### Wiring notes

#### Control inputs (voltage-related triggering)

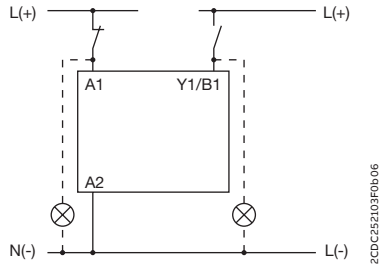
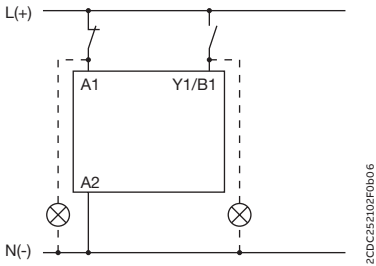

#### Remote potentiometer

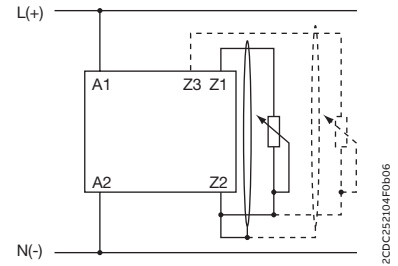

The control input Y1/B1 is triggered with electric potential against A2. It is possible to use the control supply voltage from terminal A1 or any other voltage within the rated control supply voltage range.

### Dimensional drawings in mm and inches

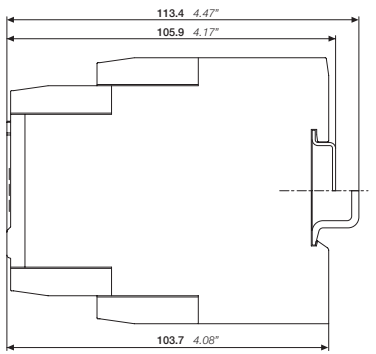

Main device

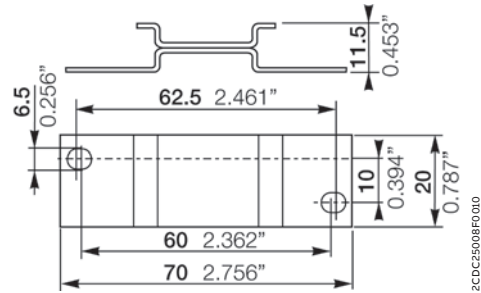

ADP.01 adapter for screw mounting

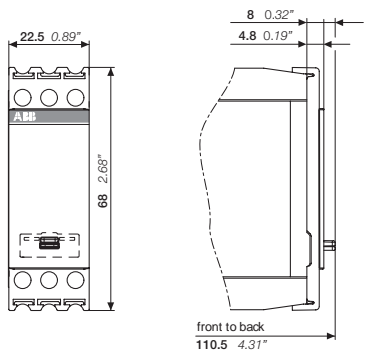

COV.11 sealable transparent cover

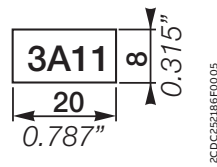

MAR.01 marker label



---

# Time relays for building applications

## Table of contents

<b>53</b>	<b>Applications</b>
<b>54</b>	<b>CT-D range</b>
54	Benefits and advantages
56	Selection table
57	Ordering details
58	Technical data
62	Technical diagrams

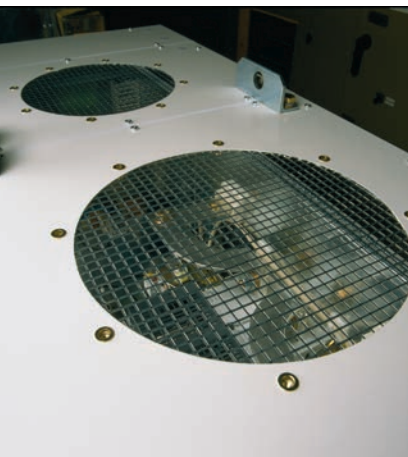
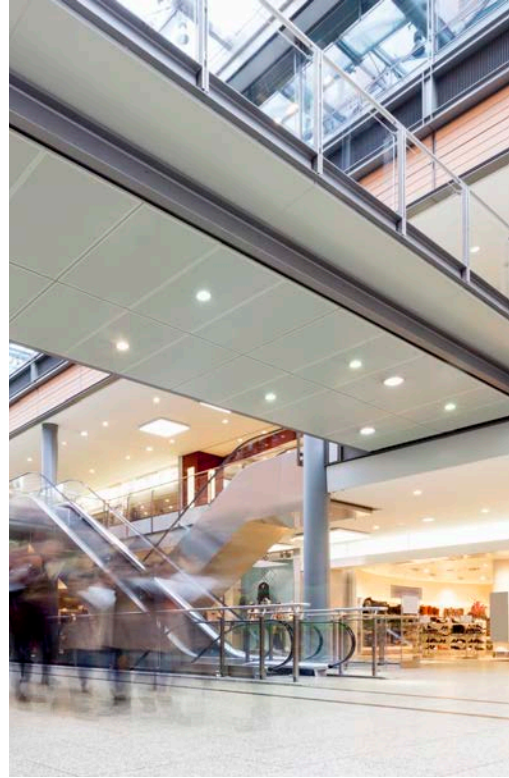

# Time relays for building applications

## Applications

The CT-D range is designed in a modular housing, making it well suited for building and residential applications. In just 12 order codes the CT-D range covers all the main timing functions needed for building automation, safely and reliably.



A typical application for timers is delayed switching. Switching several rows of lamps on and off in corridors, stairwells, staircases, etc, is a widespread application in which the excellent functionality of the CT-D timers is undisputed.



Air conditioning systems, heaters and fans can be found everywhere in buildings - just like the CT-D timers long used to switch them. On-delay, off-delay and a range of other functions cover all requirements.



Elevators, escalators, gates, compressors and doors - here too ABB timers ensure optimum and time-delayed opening as required. ABB's CT-D timers cover most functions with just 12 order codes.

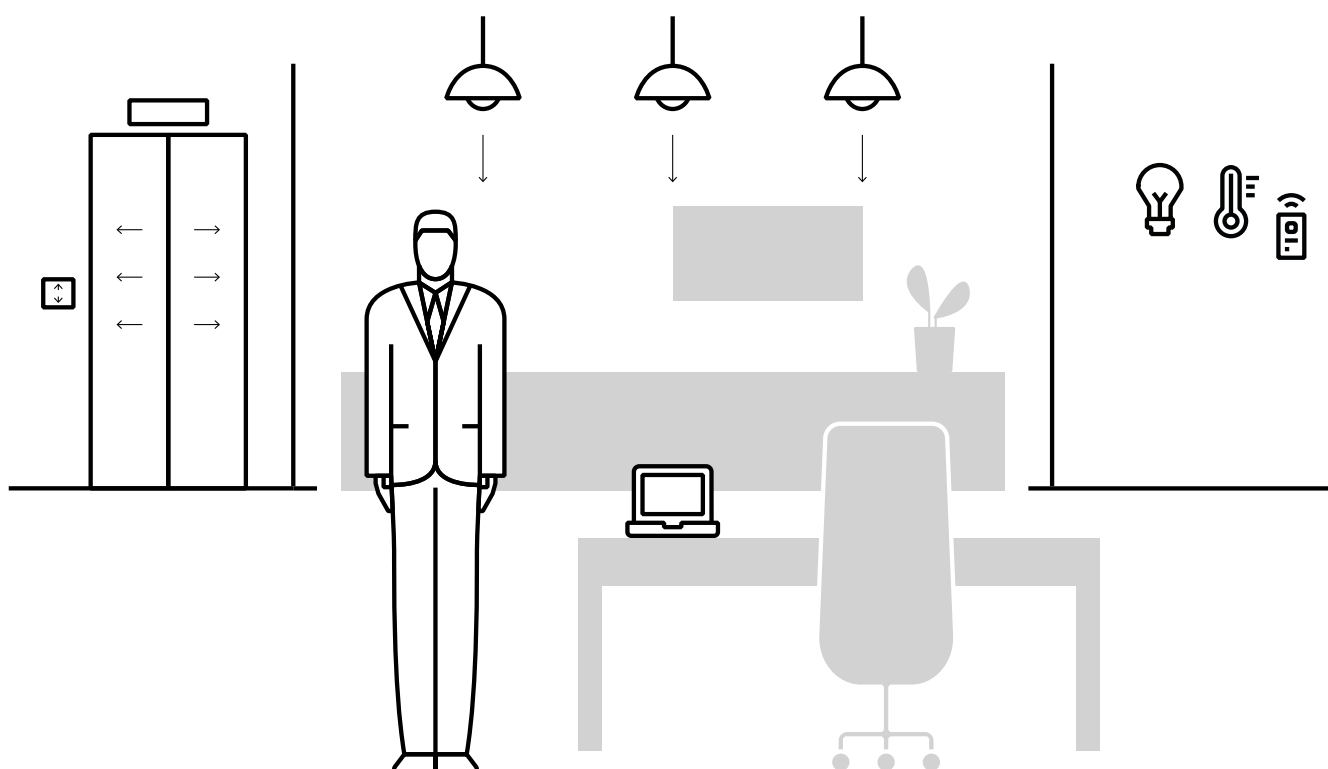

## CT-D range

### Benefits and advantages



The CT-D range is ideal for building applications and installation panels, due to its compact modular housing. For maximum flexibility in operation, nine single-function as well as two multifunction devices with seven timing functions are available. The devices offer four or seven time ranges from 0.05 seconds up to 100 hours. Their wide supply voltage range allows their use in applications worldwide.

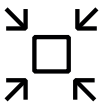

#### Space savings

The CT-D range is ideal for installation panels thanks to its compact modular housing. The housing's design helps make the status and configuration more clearly visible. The CT-D range also offers a higher output current than standard industrial types. As well as the 1 c/o contacts, ABB offers devices with 2 c/o contacts for maximum flexibility.



#### Easy to install

Direct reading scales help make time setting quick and easy. A pre-selection for the time range together with an additional scale for fine adjustments help improve installation efficiency. For more flexibility, the delay time can even be changed when processes are running, making optimization to fit the application even simpler. All devices can be mounted and demounted tool-free.



#### Global availability

The CT-D range fulfills various global standards and approvals, supporting business worldwide. Additionally, all devices from the CT-D range have a wide supply voltage from 24-48 V DC and 24-240 V AC, making it ideal for the use in installation panels around the world.

# CT-D range

## Operating controls



### Connection terminals

Wide terminal spacing makes connection of wires simpler: 2 x 1.5 mm<sup>2</sup> (2 x 16 AWG) with wire end ferrules or 2 x 2.5 mm<sup>2</sup> (2 x 14 AWG) without ferrules.



### Preselection of the time range



### Direct reading scales

Direct setting of the time delay without any additional calculation provides accurate time delay adjustment.



### Selection of the timing function

- ON-delay
- OFF-delay with aux. voltage
- Impulse-ON
- Impulse-OFF with aux. voltage
- Flasher starting with ON
- Flasher starting with OFF
- Pulse former

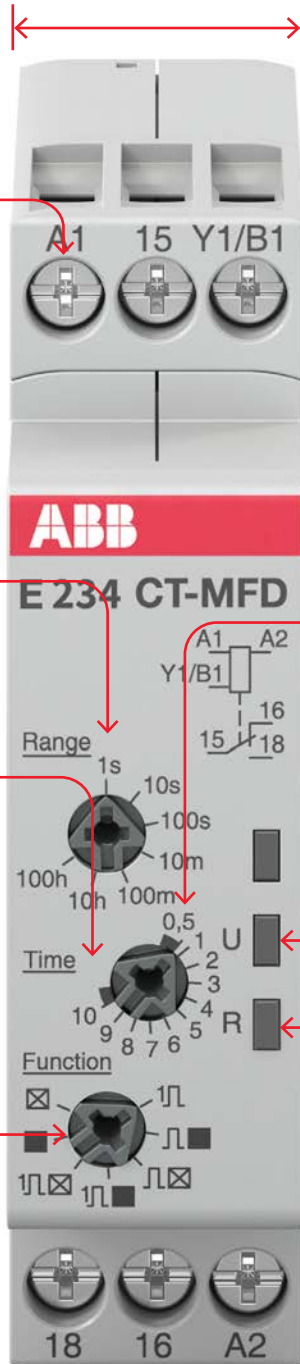

### Width 17.5 mm

With a width of just 17.5 mm, the CT-D range timers are ideally suited for installation in distribution panels.



### Fine adjustment of the time delay



### LEDs for status indication

All actual operational states are displayed by front-facing LEDs, thus simplifying commissioning and troubleshooting.

- U - green LED:
  - control supply voltage applied /
  - timing
- R, R1, R2 - yellow LED:
  - output relay energized





## CT-D range

### Ordering details



2CDC251002V0018

CT-MFD.12



2CDC251002V0018

CT-ERD.22

- Control input with voltage-related triggering
- No triggering

#### Description

The CT-D range with its modular design is a perfect solution for installation panels. For maximum flexibility in operation, 10 single-function as well as two multifunction devices with seven timing functions are available. The devices offer four or seven time ranges from 0.05 seconds up to 100 hours. Their wide input range allows their use in applications worldwide.

#### Ordering details

Timing function	Rated control supply voltage	Time ranges	Control input	Output	Type	Order code	Weight (1 pc) kg (lb)
Multi <sup>1)</sup>	24-240 V AC 24-48 V DC	7 (0.05 s - 100 h)	■	1 c/o	CT-MFD.12	1SVR500020R0000	0.060 (0.132)
Multi <sup>1)</sup>	12-240 V AC/DC	7 (0.05 s - 100 h)	■	2 c/o	CT-MFD.21	1SVR500020R1100	0.065 (0.143)
ON-delay	24-240 V AC 24-48 V DC	7 (0.05 s - 100 h)	-	1 c/o	CT-ERD.12	1SVR500100R0000	0.060 (0.132)
			-	2 c/o	CT-ERD.22	1SVR500100R0100	0.065 (0.143)
OFF-delay			■	1 c/o	CT-AHD.12	1SVR500110R0000	0.060 (0.132)
			■	2 c/o	CT-AHD.22	1SVR500110R0100	0.065 (0.143)
Impulse-ON			-	1 c/o	CT-VWD.12	1SVR500130R0000	0.060 (0.132)
Flasher starting with ON					CT-EBD.12	1SVR500150R0000	
Pulse generator		2×7 (0.05 s - 100 h)	■		CT-TGD.12 <sup>2)</sup>	1SVR500160R0000	0.060 (0.132)
			■	2 c/o	CT-TGD.22 <sup>2)</sup>	1SVR500160R0100	0.065 (0.143)
Star-delta change-over		4 (0.05 s - 10 min)	-	2 n/o	CT-SDD.22 <sup>3)</sup>	1SVR500211R0100	0.065 (0.143)
			-		CT-SAD.22 <sup>4)</sup>	1SVR500210R0100	

<sup>1)</sup> Functions: ON-delay, OFF-delay with auxiliary voltage, Impulse-ON, Impulse-OFF with auxiliary voltage, Flasher starting with ON, Flasher starting with OFF, Pulse former

<sup>2)</sup> ON and OFF times adjustable independently: 2 x 7 time ranges 0.05 s - 100 h



<sup>3)</sup> Transition time 50 ms fixed

<sup>4)</sup> Transition time adjustable

## CT-D range

### Technical data

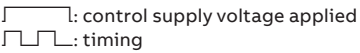
Data at  $T_a = 25\text{ °C}$  and rated values, unless otherwise indicated

	CT-D with 1 c/o contact	CT-D with 2 c/o contacts	CT-MFD.21
<b>Input circuit - Supply circuit</b>			
Rated control supply voltage $U_s$	24-240 V AC / 24-48 V DC		12-240 V AC/DC
Rated control supply voltage $U_s$ tolerance	-15...+10 %		
Rated frequency	DC or 50/60 Hz		
Frequency range AC	47-63 Hz		
Typical power consumption	max. 3.5 VA		
Power failure buffering time	min. 20 ms		
Release voltage	> 10 % of the minimum rated control supply voltage $U_s$		
<b>Input circuit - Control circuit</b>			
Control input, control function	A1-Y1/B1	start timing external	
Kind of triggering	voltage-related triggering		
Resistance to reverse polarity	yes		
Parallel load / polarized	yes / yes		
Maximum cable length to the control inputs	50 m - 100 pF/m		
Minimum control pulse length	20 ms		
Control voltage potential	see rated control supply voltage		
Current consumption of the control input	see data sheet		
<b>Timing circuit</b>			
Time ranges	7 time ranges 0.05 s - 100 h	1.) 0.05-1 s 2.) 0.5-10 s 3.) 5-100 s 4.) 0.5-10 min 5.) 5-100 min 6.) 0.5-10 h 7.) 5-100 h	
	4 time ranges 0.05 s - 10 min (CT-SDD, CT-SAD)	1.) 0.05-1 s 2.) 0.5-10 s 3.) 5-100 s 4.) 0.5-10 min	
Recovery time	< 50 ms		
Accuracy within the rated control supply voltage tolerance	$\Delta t < 0.005\% / V$		
Accuracy within the temperature range	$\Delta t < 0.06\% / \text{°C}$		
Repeat accuracy (constant parameters)	$\Delta t < \pm 0.5\%$		
Setting accuracy of time delay	$\pm 10\%$ of full-scale value		
Star-delta transition time	CT-SDD/ CT-SAD	fixed 50 ms / adjustable: 20 ms, 30 ms, 40 ms, 50 ms, 60 ms, 80 ms or 100 ms	
Star-delta transition time tolerance	CT-SDD / CT-SAD	$\pm 3\text{ ms}$	
<b>Indication of operational states</b>			
Control supply voltage / timing	U: green LED	 	
Relay energized	R, R1, R2: yellow LED		
<b>Operating elements and controls</b>			
Adjustment of the time range	front-face rotary switch, direct reading scales		
Fine adjustment of the time value	front-face potentiometer		
Preselection of the timing function at multifunction devices	front-face rotary switch, direct reading scales		
Adjustment of the transition time	CT-SAC	front-face potentiometer	

## CT-D range

### Technical data

		CT-D with 1 c/o contact	CT-D with 2 c/o contacts	CT-MFD.21
<b>Output circuit</b>				
Kind of output	15-16/18	Relay, 1 c/o contact	-	
	15-16/18; 25-26/28	-	Relay, 2 c/o contacts	
	17-18; 17-28		Relay, 2 n/o contacts (CT-SDC, CT-SAC)	
Contact material		AgNi alloy, Cd free		
Rated operational voltage $U_e$		250 V		
Minimum switching voltage / minimum switching current		12 V / 100 mA		
Maximum switching voltage / maximum switching current		250 V AC / 6 A	250 V AC / 5 A	
Rated operational current $I_e$	AC-12 (resistive) at 230 V	6 A	5 A	
	AC-15 (inductive) at 230 V	3 A	3 A	n/o: 3 A n/c: 0.75 A
	DC-12 (resistive) at 24 V	6 A	5 A	
	DC-13 (inductive) at 24 V	2 A	2 A	1 A
AC rating (UL 508)	utilization category (Control Circuit Rating Code)	B 300		n/o: B 300 n/c: C 300
	max. rated operational voltage	300 V AC		
	maximum continuous thermal current at B300	5 A		n/o: 5 A
	maximum continuous thermal current at C300	-		n/c: 2.5 A
	max. making/breaking apparent power at B300	3600 VA / 360 VA		n/o: 3600/360 VA
	max. making/breaking apparent power at C300	-		n/c: 1800/180 VA
	Mechanical lifetime	30 x 10 <sup>6</sup> switching cycles		
Electrical lifetime	0.1 x 10 <sup>6</sup> switching cycles			
Max. fuse rating to achieve short-circuit protection	n/c contact	6 A fast-acting		
	n/o contact	10 A fast-acting		6 A fast-acting
<b>General data</b>				
Mean time between failures (MTBF)	on request			
Duty cycle	100%			
Dimensions	see 'Dimensional drawings'			
Mounting	DIN rail (IEC/EN 60715), snap-mounting without any tool			
Mounting position	any			
Minimum distance to other units	horizontal / vertical	no / no		
Degree of protection	housing / terminals	IP50 / IP20		
<b>Electrical connection</b>				
Connecting capacity	fine-stranded with(out) wire and ferrule	2 x 0.5-1.5 mm <sup>2</sup> (2 x 20-16 AWG)		
		1 x 0.5-2.5 mm <sup>2</sup> (1 x 20-14 AWG)		
	rigid	2 x 0.5-1.5 mm <sup>2</sup> (2 x 20-16 AWG) 1 x 0.5-4 mm <sup>2</sup> (1 x 20-12 AWG)		
Stripping length	7 mm (0.28 in)			
Tightening torque	0.5-0.8 Nm (4.43-7.08 lb.in)			
<b>Environmental data</b>				
Ambient temperature range	operation / storage	-20 ... +60 °C / -40 ... +85 °C		
Climatic class	EC/EN 60068-2-30	3K3		
Relative humidity range	25-85%			
Vibration, sinusoidal	IEC/EN 60068-2-6	20 m/s <sup>2</sup> ; 10 cycles, 10...150...10 Hz		
Shock (half-sine)	IEC/EN 60068-2-27	150 m/s <sup>2</sup> , 11 ms		

## CT-D range

### Technical data

		CT-D with 1 c/o contact	CT-D with 2 c/o contacts	CT-MFC.21
<b>Isolation data</b>				
Rated insulation voltage $U_i$	input circuit / output circuit	300 V		
	output circuit 1 / output circuit 2	not available	300 V	300 V
Rated impulse withstand voltage $U_{imp}$	between all isolated circuits	4 kV; 1.2/50 $\mu$ s		
Power-frequency withstand voltage test(test voltage)	between all isolated circuits	2.5 kV; 50 Hz; 60 s		
Basic insulation (IEC/EN 61140)	input circuit / output circuit	300 V		
Protective separation (IEC/EN 61140, EN 50178)	input circuit / output circuit	250 V		
Pollution degree		3		
Overvoltage category		III		
<b>Standards / Directives</b>				
Standards		IEC/EN 61812-1		
Low Voltage Directive		2014/35/EU		
EMC Directive		2014/30/EU		
RoHS Directive		2011/65/EU		
<b>Electromagnetic compatibility</b>				
Interference immunity to		IEC/EN 61000-6-2		
electrostatic discharge	IEC/EN 61000-4-2	Level 3 (6 kV / 8 kV)		
radiated, radio-frequency, electromagnetic field	IEC/EN 61000-4-3	Level 3 (10 V / m)		
electrical fast transient / burst	IEC/EN 61000-4-4	Level 3 (2 kV / 5 kHz)		
surge	IEC/EN 61000-4-5	Level 4 (2 kV L-L)		
conducted disturbances, induced by radio-frequency fields	IEC/EN 61000-4-6	Level 3 (10 V)		
Interference emission		IEC/EN 61000-6-3		
high-frequency radiated	IEC/CISPR 22, EN 55022	Class B		
high-frequency conducted	IEC/CISPR 22, EN 55022	Class B		

# CT-D range

## Technical diagrams

### Example of application - Star-delta changeover

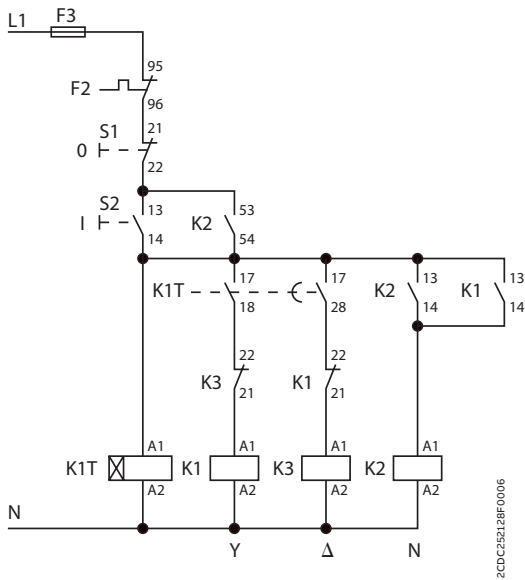

Control circuit diagram

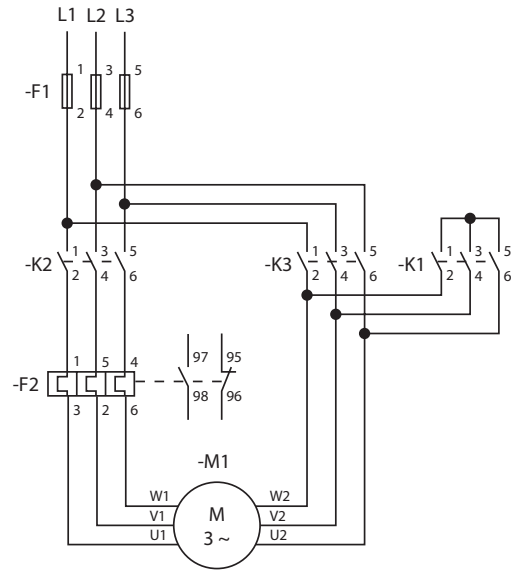

Power circuit diagram

# CT-D range

## Technical diagrams

### Connection diagrams

**CT-MFD.21**

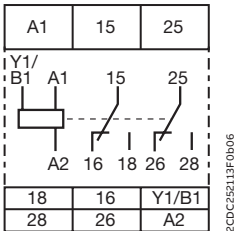

A1-A2	Supply: 12-240 V AC/DC
A1-Y1/B1	Control input
15-16/18	1st c/o contact
25-26/28	2nd c/o contact

**CT-MFD.12**

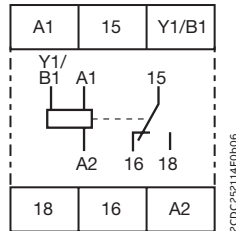

A1-A2	Supply: 24-48 V DC or 24-240 V AC
A1-Y1/B1	Control input
15-16/18	1st c/o contact

**CT-ERD.22**

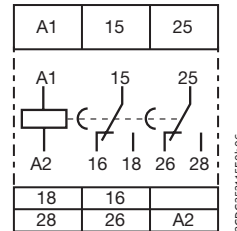

A1-A2	Supply: 24-48 V DC or 24-240 V AC
15-16/18	1st c/o contact
25-26/28	2nd c/o contact

**CT-ERD.12**

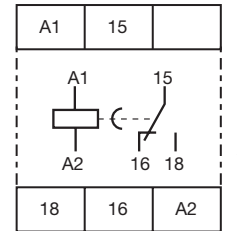

A1-A2	Supply: 24-48 V DC or 24-240 V AC
15-16/18	1st c/o contact

**CT-AHD.22**

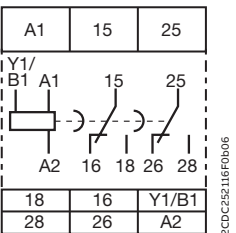

A1-A2	Supply: 24-48 V DC or 24- 240 V AC
A1-Y1/B1	Control input
15-16/18	1st c/o contact
25-26/28	2nd c/o contact

**CT-AHD.12**

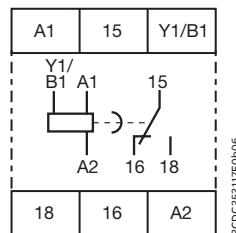

A1-A2	Supply: 24-48 V DC or 24- 240 V AC
A1-Y1/B1	Control input
15-16/18	1st c/o contact

**CT-VWD.12**

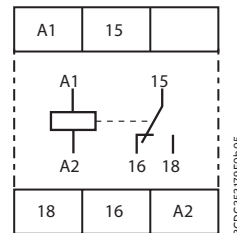

A1-A2	Supply: 24-48 V DC or 24- 240 V AC
15-16/18	1st c/o contact

**CT-TGD.22**

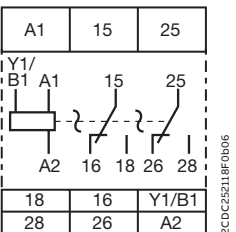

A1-A2	Supply: 24-48 V DC or 24-240 V AC
A1-Y1/B1	Control input
15-16/18	1st c/o contact
25-26/28	2nd c/o contact

**CT-TGD.12**

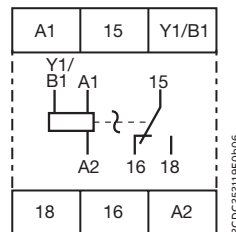

A1-A2	Supply: 24-48 V DC or 24- 240 V AC
A1-Y1/B1	Control input
15-16/18	1st c/o contact

**CT-SDD.22**

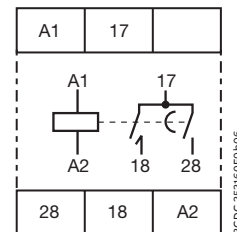

A1-A2	Supply: 24-48 V DC or 24-240 V AC
17-18	1st n/o contact (star contactor)
17-28	2nd n/o contact (delta contactor)

**CT-SAD.22**

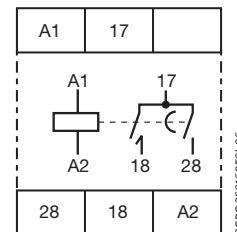

A1-A2	Supply: 24-48 V DC or 24-240 V AC
17-18	1st n/o contact (star contactor)
17-28	2nd n/o contact (delta contactor)

# CT-D range

## Technical diagrams

### Load limit curves

#### AC load (resistive)

##### CT-D.1x

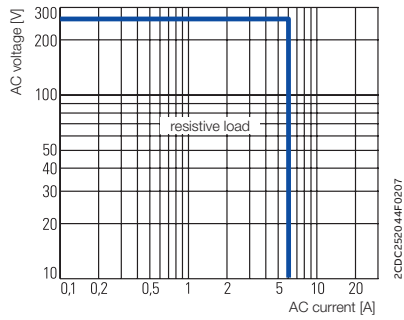

##### CT-D.2x

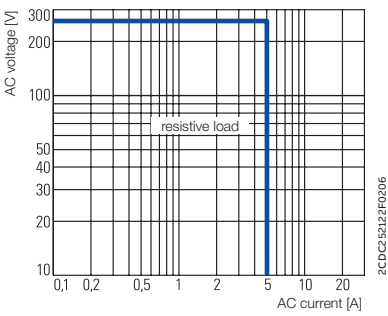

#### DC load (resistive)

##### CT-D.1x

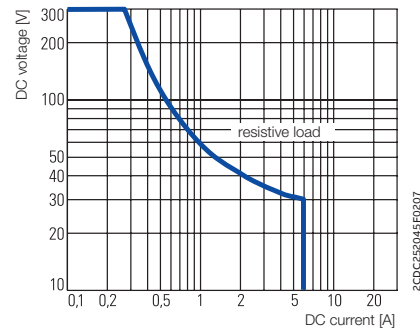

##### CT-D.2x

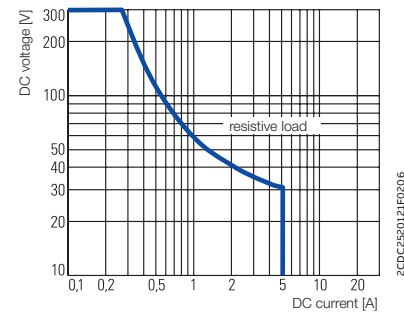

#### Derating factor F for inductive AC load

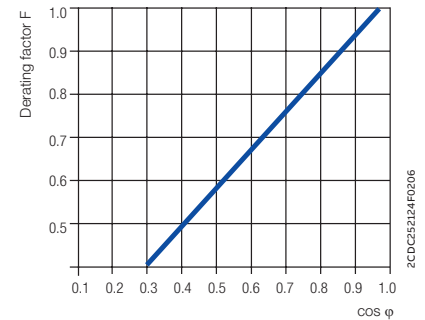

#### Contact lifetime

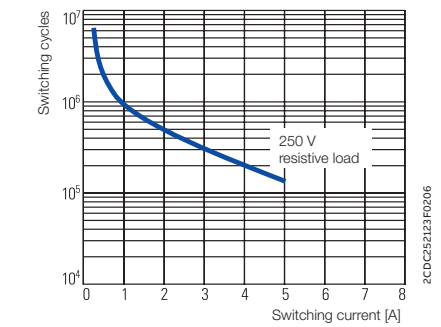

### Wiring notes for devices with control input

#### A parallel load to the control input is possible

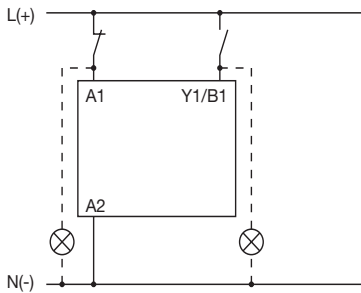

### Dimensional drawings in mm and inches

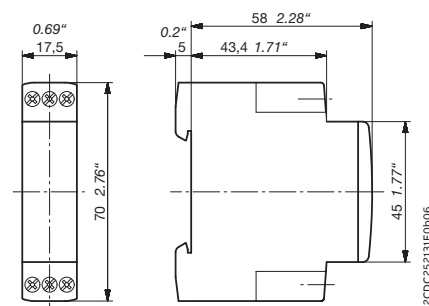

CT-D devices with 1 c/o contact or 2 n/o contacts

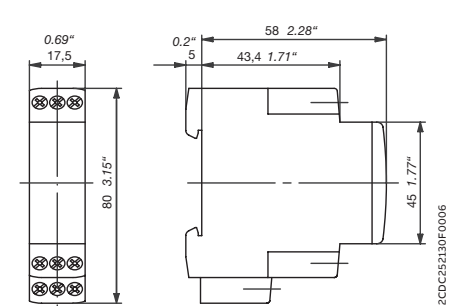

CT-D devices with 2 c/o contacts





---

# Timing functions

# Timing functions

## CT-C, CT-S, CT-D

### On delay functions (Delay on make) ☒

#### On-delay



This function requires a continuous control supply voltage for timing. Timing begins when a control supply voltage is applied. When the selected time delay is complete, the output relay energizes. If the control supply voltage is interrupted, the output relay de-energizes and the time delay is reset.

#### ON-delay accumulative



This function requires a continuous control supply voltage for timing. Timing begins when a control supply voltage is applied. When the selected time delay is complete, the output relay energizes. Timing can be paused by closing the control input.

The elapsed time  $t_1$  is stored and continues from this time value when the control input is re-opened. If the control supply voltage is interrupted, the output relay de-energizes and the time delay is reset.

### OFF delay functions (Delay on break) ■

#### OFF-delay with auxiliary voltage



This function requires a continuous control supply voltage for timing. If the control input is closed, the output relay energizes immediately. If the control input is opened, the time delay starts. When the selected time delay is complete, the output relay de-energizes.

If control input re-closes before the time delay is complete, the time delay is reset and the output relay does not change state. Timing starts again when the control input re-opens. If the control supply voltage is interrupted, the output relay de-energizes and the time delay is reset.

#### OFF-delay without auxiliary voltage



The OFF-delay function without auxiliary voltage does not require a continuous control supply voltage for timing. Applying a control supply voltage energizes the output relay. If the control supply voltage is interrupted, the OFF-delay starts. When timing is complete, the output relay de-energizes.

If a control supply voltage is re-applied before the time delay is complete, the time delay is reset and the output relay remains energized. A control supply voltage must be applied for the minimum energizing time (200 ms), for correct operation.

# Timing functions

## CT-C, CT-S, CT-D

### OFF-delay with auxiliary voltage, accumulative

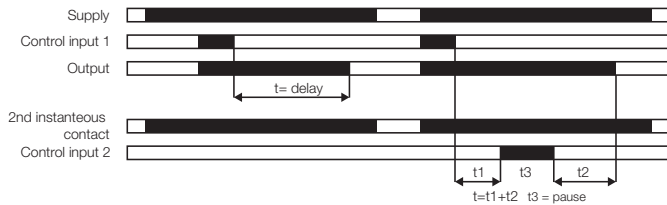

This function requires a continuous control supply voltage for timing. If the control input is closed, the output relay energizes immediately. If the control input is opened, the time delay starts. When the selected time delay is complete, the output relay de-energizes. If the control input closes before the time delay is complete, the time delay is reset and the output relay does not change state. Timing starts again when the control input reopens.

Pause timing / Accumulative OFF-delay: Timing can be paused by closing control 1. The elapsed time  $t_1$  is stored and continues from this time value when control input 1 is re-opened. This can be repeated as often as required. If the control supply voltage is interrupted, the output relay de-energizes and the time delay is reset.

### Impulse-ON functions

#### Impulse-ON (interval)



This function requires a continuous control supply voltage for timing. The output relay energizes immediately when the control supply voltage is applied and de-energizes after the set pulse time is complete. If the control supply voltage is interrupted, the output relay de-energizes and the time delay is reset.

#### Impulse-ON, accumulative



This function requires a continuous control supply voltage for timing. The output relay energizes immediately when the control supply voltage is applied and de-energizes after the set pulse time is complete. If control input 1 is open, timing begins when a control supply voltage is applied. Or, if control a supply voltage is already applied, opening control input 1 starts timing. When the selected pulse time is complete, the output relay de-energizes. Closing control input 1, before the pulse time is complete, de-energizes the output relay and resets the pulse time.

Pause timing / Accumulative impulse-ON: Timing can be paused by closing control input 2. The elapsed time  $t_1$  is stored and continues from this time value when control input 2 is re-opened. This can be repeated as often as required. If the control supply voltage is interrupted, the output relay de-energizes and the time delay is reset.

# Timing functions

## CT-C, CT-S, CT-D

### Impulse-OFF functions 1

#### Impulse-OFF with auxiliary voltage



This function requires a continuous control supply voltage for timing. The output relay energizes immediately when the control input is de-energized and the output de-energizes after the set pulse time is complete. If the control supply voltage is interrupted, the output relay de-energizes and the time delay is reset.

#### Impulse-OFF without auxiliary voltage

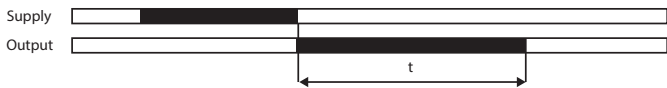

This function does not require a continuous control supply voltage for timing. If the control supply voltage is interrupted, the output relay energizes and the OFF time starts. When timing is complete, the output relay de-energizes. If a control supply voltage is re-applied before the time delay is complete, the time delay is reset and the output relay de-energizes. A control supply voltage must be applied for the minimum energizing time (200 ms), for proper operation.

#### Impulse-OFF with auxiliary voltage (Trailing edge interval) accumulative

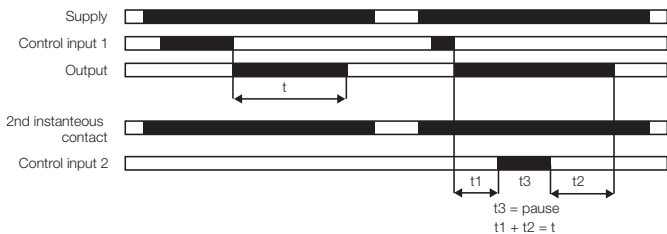

This function requires a continuous control supply voltage for timing. If a control supply voltage is applied, opening control input 1 energizes the output relay immediately and starts timing. When the selected pulse time is complete, the output relay de-energizes. Closing control input 1, before the pulse time is complete, de-energizes the output relay and resets the pulse time. Pause timing / Accumulative impulse-OFF: Timing can be paused by closing control input 2. The elapsed time t1 is stored and continues from this time value when control input 2 is re-opened. This can be repeated as often as required. If the control supply voltage is interrupted, the output relay de-energizes and the time delay is reset.

### Impulse-ON and Impulse-OFF functions 1

#### Impulse-ON and impulse-OFF

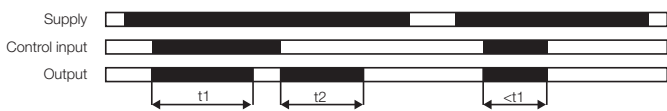

This function requires a continuous control supply voltage for timing. If a control supply voltage is applied, closing the control input energizes the output relay immediately and starts the pulse time t1. When t1 is complete, the output relay de-energizes. Re-opening the control input energizes the output relay immediately and starts the pulse time t2. When t2 is complete, the output relay de-energizes. t1 and t2 are independently adjustable. If the control input changes state before the pulse time is complete, the output relay de-energizes and the pulse time is reset. If the control input changes state again, the interrupted pulse time restarts. If the control supply voltage is interrupted, the output relay de-energizes and the time delay is reset.

# Timing functions

## CT-C, CT-S, CT-D

### Flasher starting with ON functions

#### Flasher starting with ON



Applying a control supply voltage starts timing with symmetrical ON & OFF times. The cycle starts with an ON time first. If the control supply voltage is interrupted, the output relay de-energizes and the time delay is reset.

#### Flasher with reset starting with ON

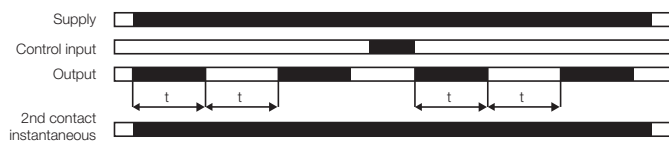

Applying a control supply voltage starts timing with symmetrical ON & OFF times. The cycle starts with an ON time first. The time delay can be reset by closing the control input. Opening the control input starts the timer pulsing again with symmetrical ON & OFF times. If the control supply voltage is interrupted, the output relay de-energizes and the time delay is reset.

### Flasher starting with OFF functions

#### Flasher starting with OFF



Applying a control supply voltage starts timing with symmetrical ON & OFF times. The cycle starts with an OFF time first. If the control supply voltage is interrupted, the output relay de-energizes and the time delay is reset.

#### Flasher with reset starting with OFF

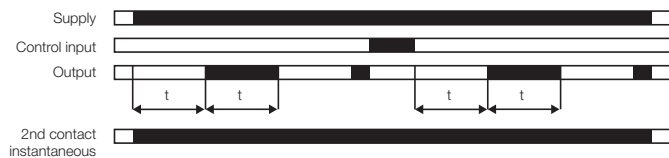

Applying a control supply voltage starts timing with symmetrical ON & OFF times. The cycle starts with an OFF time first. The time delay can be reset by closing the control input. Opening the control input starts the timer pulsing again with symmetrical ON & OFF times. If the control supply voltage is interrupted, the output relay de-energizes and the time delay is reset.

### Flasher starting with ON or OFF functions

#### Flasher starting with ON or OFF

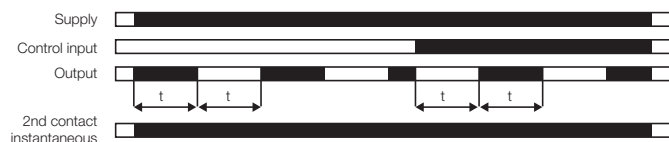

Applying a control supply voltage starts timing with symmetrical ON / OFF times. If the control input is open while supply voltage is connected the cycle starts with an ON time first. If the control input is closed while supply voltage is connected the cycle starts with an OFF time first.

# Timing functions

## CT-C, CT-S, CT-D

### Pulse former

Puls former (single shot)



This function requires a continuous control supply voltage for timing. Closing the control input energizes the output relay immediately and starts timing. Operating the control input during the time delay has no effect. When the selected ON time is complete, the output relay de-energizes. After the ON time is complete, it can be restarted by closing the control input. If control supply voltage is interrupted, the output relay de-energizes and the time delay is reset.

### Single-pulse generator

Single-pulse generator, starting with OFF



This function requires a continuous control supply voltage for timing. Applying a control supply voltage while the control input is open energizes the output relay after the OFF time  $t_1$  is complete. When the following ON time  $t_2$  is complete, the output relay de-energizes. Alternatively, when a control supply voltage is already applied, the timing process can be started by opening control input. Closing the control input with a control supply voltage applied, de-energizes the output relay and re-sets the time delay. The ON & OFF times are independently adjustable.

### Pulse generator

Starting with the ON or OFF time  
(Recycling unequal times, ON or OFF first)

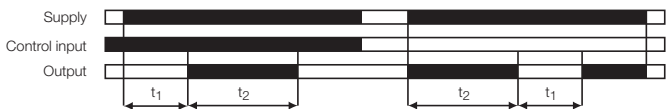

This function requires a continuous control supply voltage for timing. Applying a control supply voltage, with closed control input, starts timing with an OFF time first. Applying a control supply voltage, with open control input, starts timing with an ON time first. If the control supply voltage is interrupted, the output relay de-energizes and the time delay is reset.

### Impulse with delay

Fixed impulse with adjustable time delay



This function requires a continuous control supply voltage for timing. The time delay  $t_1$  starts when a control supply voltage is applied. When  $t_1$  is complete, the output relay energizes for the fixed impulse time  $t_2$  of 500 ms. If the control supply voltage is interrupted, the time delay is re-set. The output relay does not change state.

Adjustable impulse with fixed time delay



This function requires a continuous control supply voltage for timing. As soon as the control supply voltage is applied the output relay will close after 500 ms. When  $t_2$  is complete, the output relay energizes and the selected pulse time  $t_1$  starts. When  $t_1$  is complete, the output relay de-energizes. If the control supply voltage is interrupted, the pulse time is reset and the output relay de-energizes.

# Timing functions

## CT-C, CT-S, CT-D

### ON- and OFF-delay

#### Symmetrical ON- and OFF-delay <sup>1)</sup>

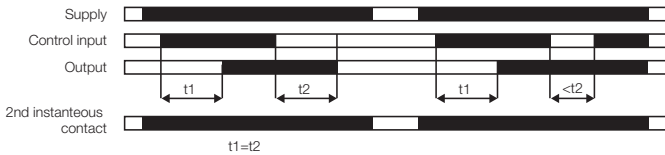

This function requires a continuous control supply voltage for timing. Closing the control input starts the ON-delay time  $t_1$ . When timing is complete, the output relay energizes. Opening the control input starts the OFF-delay time  $t_2$ . When the OFF-delay  $t_2$  is complete, the output relay de-energizes. If the control input opens before the ON-delay ( $<t_1$ ) is complete, the time delay is reset and the output relay remains de-energized. If control input closes before the OFF-delay time ( $<t_2$ ) is complete, the time delay is reset and the output relay remains energized.

1) Variant with 2nd control input for pause timing is available too.

#### Asymmetrical ON- and OFF-delay

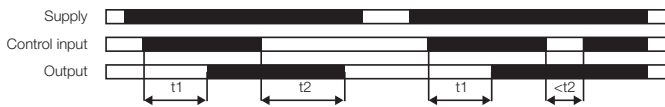

This function requires a continuous control supply voltage for timing. Closing the control input starts the ON-delay  $t_1$ . When timing is complete, the output relay energizes. Opening the control input starts the OFF-delay  $t_2$ . When the OFF-delay is complete, the output relay de-energizes. The ON-delay and OFF-delay are independently adjustable. If the control input opens before the ON-delay is complete ( $<t_1$ ), the time delay is reset and the output relay remains de-energized. If the control input closes before the OFF-delay is complete ( $<t_2$ ), the time delay is reset and the output relay remains energized. If the control supply voltage is interrupted, the output relay de-energizes and the time delay is reset.

### Star-Delta changeover



This function requires a continuous control supply voltage for timing. Applying a control supply voltage, energizes the star contactor connected to output 1 and begins the set starting time  $t_1$ . When the starting time is complete, the first output contact de-energizes the star contactor. When the transition time  $t_2$  is complete, the second output contact energizes the delta contactor. The delta contactor remains energized as long as the control supply voltage is applied.  $t_2$  is fixed to 50 ms or in some variants adjustable.

### Further functions

#### ON/OFF function



This function is used for test purposes during commissioning and troubleshooting. If the selected maximum value of the time range is smaller than 300 hours (front-face potentiometer "Time sector"  $\neq 300$  h), applying a control supply voltage energizes the output relay immediately. Interrupting the control supply voltage, de-energizes the output relay. If the selected maximum value of the time range is 300 hours (front-face potentiometer "Time sector" = 300 h) and a control supply voltage is applied the output relay does not energize.





---

# Measuring and monitoring relays

## Table of contents

<b>74</b>	<b>Benefits and advantages</b>
<b>76</b>	<b>Offer overview</b>
<b>79</b>	<b>Applications</b>
<b>81</b>	<b>Single-phase monitoring relays</b>
<b>105</b>	<b>Three-phase monitoring relays</b>
<b>137</b>	<b>Grid feeding monitoring relays</b>
<b>151</b>	<b>Insulation monitoring relays</b>
<b>181</b>	<b>Thermistor motor protection relays</b>
<b>203</b>	<b>Temperature monitoring relays</b>
<b>219</b>	<b>Liquid level monitoring relays</b>
<b>241</b>	<b>Accessories</b>

# Measuring and monitoring relays

## Benefits and advantages



**Higher utility class**  
The plastic housing material used meets the requirements for the highest flammability class. (UL94 V-0 rated)



**Snap-on housing**  
Tool-free DIN rail installation and deinstallation of the relay.



**Sealable transparent cover**  
Protection against unauthorized changes of time and threshold values.

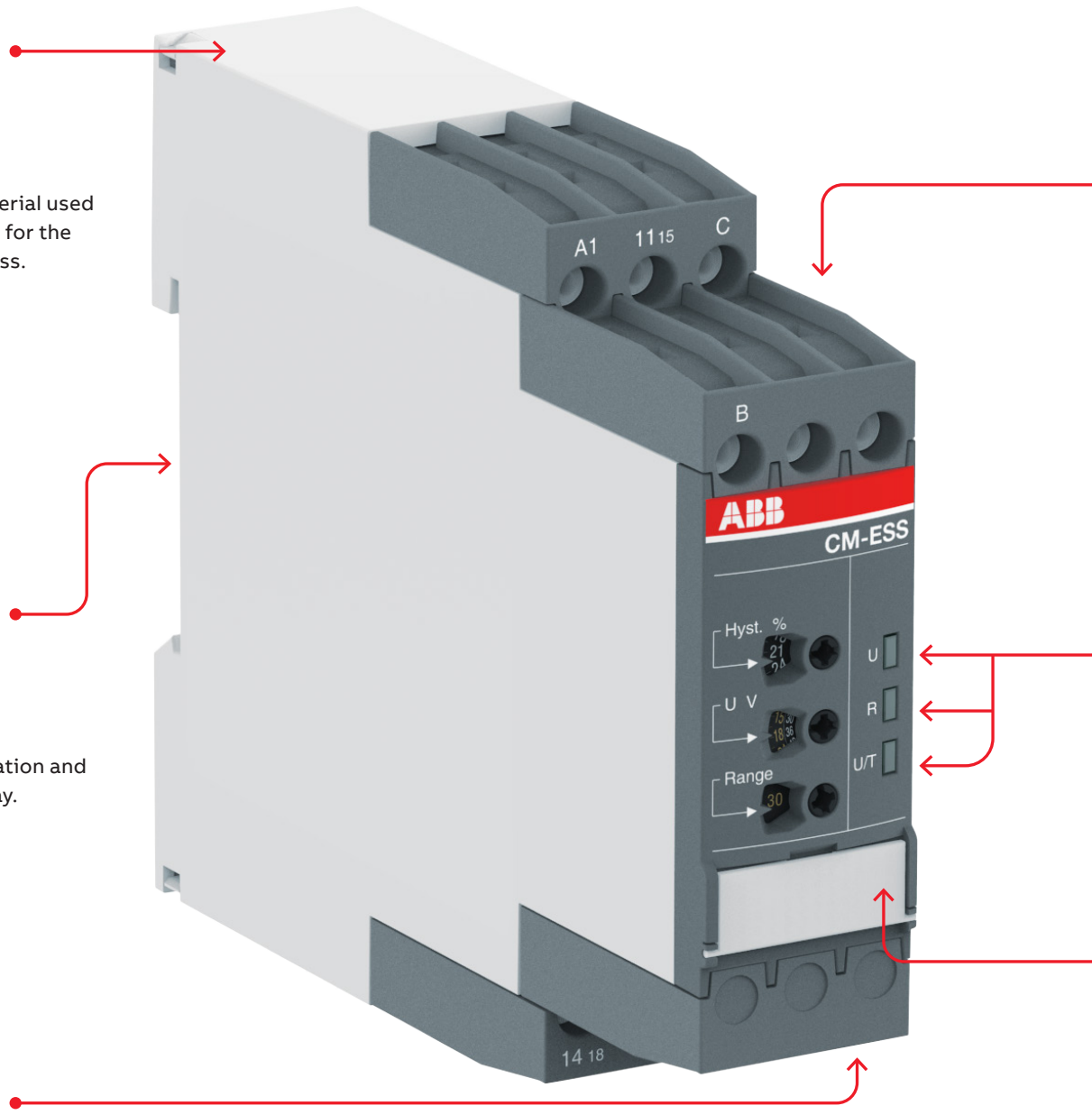

# Measuring and monitoring relays

## Benefits and advantages

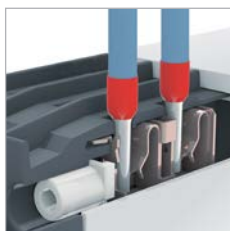

### Easy Connect technology

- Tool-free wiring and excellent vibration resistance.
- Push-in terminals provide connection of wires up to  $2 \times 0.5 - 1.5 \text{ mm}^2$  ( $2 \times 20 - 16 \text{ AWG}$ ), rigid or fine-strand with or without wire end ferrules.
- Excellent vibration resistance – the right solution for harsh environments.



### Double-chamber cage connection terminals

Double-chamber cage connection terminals provide connection of wires up to  $2 \times 0.5 - 2.5 \text{ mm}^2$  ( $2 \times 20 - 14 \text{ AWG}$ ) rigid or fine-strand, with or without wire end ferrules.

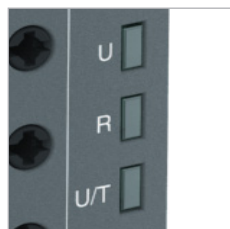

### LEDs for status indication

All actual operational states are displayed by front-face LEDs, simplifying commissioning and troubleshooting.

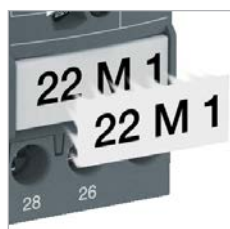

### Integrated marker label

Integrated marker labels allow the product to be marked quickly and simply. No additional marker labels are required.

# Measuring and monitoring relays

## Offer overview

Measuring and monitoring relays monitor and detect operating conditions with regard to phase, current, voltage, frequency, temperature, liquid level or insulation faults. The relays inform users about abnormal conditions and allow them to take necessary corrective actions before severe and costly failures can occur. Depending on the product model, measuring and monitoring relays are categorized into seven product families.

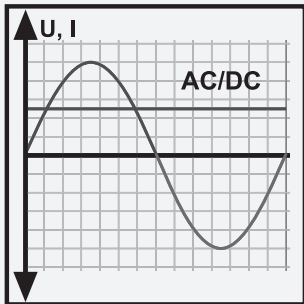

### Single-phase current monitoring relays

- Monitoring of motor current consumption
- Monitoring of lighting installations and heating circuits
- Monitoring of transportation equipment overload
- Monitoring of locking devices, electromechanical brake gear and locked rotors

### Single-phase voltage monitoring relays

- Speed monitoring of DC motors
- Monitoring of battery voltages and other supply networks

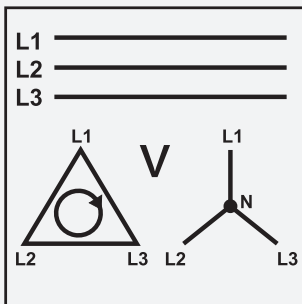

### Three-phase monitoring relays

- Voltage monitoring of mobile three-phase equipment
- Protection of personnel and installations against phase reversal
- Monitoring of the supply voltage of machines and installations
- Protection of equipment against damage caused by unstable supply voltage
- Switching to emergency or auxiliary supply
- Protection of motors against damage caused by unbalanced phase voltages and phase loss
- Suitable for HVAC applications

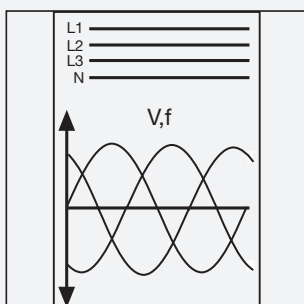

### Grid feeding monitoring relays

The CM-UFD.M\* range monitors all voltage and frequency parameters in a grid and ensures the safe feeding of decentrally produced electrical energy into the grid.

- Monitoring of the voltage with up to 2 thresholds for over- and undervoltage
- Monitoring of the frequency with up to 2 thresholds for over- and under-frequency
- ROCOF (rate of change of frequency) and vector shift detection
- In compliance with several local standards

# Measuring and monitoring relays

## Offer overview

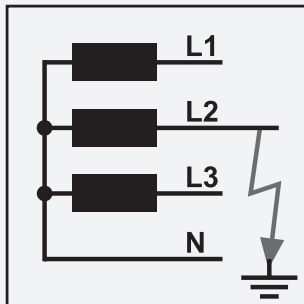

### Insulation monitoring relays

- Monitoring of electrically isolated supply mains for insulation resistance failure
- Detection of initial faults
- Protection against earth faults

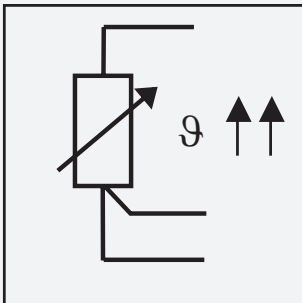

### Temperature monitoring relays

Acquisition, messaging and regulation of temperatures of solid, liquid and gaseous media in processes and machines

- Motor and system protection
- Control panel temperature monitoring
- Frost monitoring
- Temperature limits for process variables, e.g. in the packing or electroplating industry
- Control of systems and machines like heating, air-conditioning and ventilation systems, solar collectors, heat pumps or hot water supply systems
- Bearing, gear oil and coolant monitoring

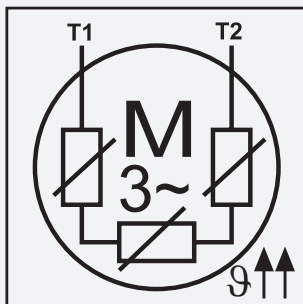

### Thermistor motor protection

CM-MSE and CM-MSS provide full protection of motors with integrated PTC resistor sensors.

Protection of motors against thermal overload, e. g. caused by insufficient cooling, heavy load starting conditions, undersized motors, etc.

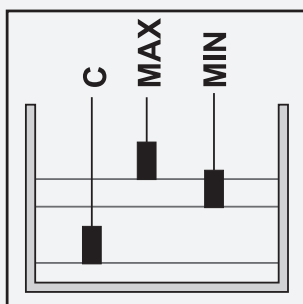

### Liquid level monitoring relays

- Protection of pumps against dry running
- Protection against container overflow
- Control of liquid levels
- Detection of leaks
- Control of mixing ratios

# Measuring and monitoring relays

## Offer overview



### CM-N range: Multifunctional range

- 45 mm wide housing
- Output contacts: 2 c/o (SPDT) contacts
- Continuous voltage range (24-240 V AC/DC) or single-supply
- Setting and operation via front-face operating controls
- Adjustment of threshold values and switching hysteresis via direct reading scale
- Adjustable time delays
- Integrated and snap-fitted front-face marker label
- Sealable transparent cover (accessory)



### CM-S range: Universal and multifunctional range

- Only 22.5 mm wide housing
- Output contacts: 1 or 2 c/o (SPDT) contacts
- One supply voltage range or supplied by measuring circuit
- Setting and operation via front-face operating controls
- Adjustment of threshold values and switching hysteresis via direct reading scale
- Integrated and snap-fitted front-face marker
- Snap-on housing: The relays can be placed on a DIN rail tool-free - just snap it on or remove it tool-free
- Sealable transparent cover (accessory)



### CM-E range: Economy range

- Only 22.5 mm wide housing
- Output contacts: 1 c/o contact or 1 n/o contact
- One supply voltage range
- One monitoring function
- Cost-efficient solution for OEM applications
- Preset monitoring ranges

# Measuring and monitoring relays

## Applications

ABB offers a wide selection of measuring and monitoring relays to suit a wide range of applications for businesses worldwide. Excellent vibration resistance with the Easy Connect terminal technology and railway certifications for selected products ensure the operability, even in harsh environments.



### Automation panels

- Textile industry - measuring and monitoring of motor voltage and current overload of, for example, looms.
- Packaging industry - measuring and monitoring of motor voltage and current overload of, for example, conveyor belts.



### Infrastructure

- Water and wastewater applications - monitoring the liquid level of water tanks and wastewater recycling plants.
- Lifts - status monitoring of the three phase mains of, for example, construction lifts, passenger lifts and escalators.
- Hoisting applications - construction cranes, harbor cranes.
- Railway.



### Renewable energy

- Solar - monitoring of the insulation resistance and the frequency and voltage of the public grid to keep electrical grids stable and meet local requirements.
- Wind - temperature, current and voltage supervision of automation panels and electrical motors.



### Buildings

- Lifts - status monitoring of the three phase mains of, for example, construction lifts, passenger lifts and escalators.
- HVAC - monitoring of grid parameters, control and protection of loads.







---

# Single-phase monitoring relays

## Table of contents

<b>82</b>	<b>Benefits and advantages</b>
<b>84</b>	<b>Operating controls</b>
<b>86</b>	<b>Single-phase current monitoring relays</b>
86	Selection table
87	Ordering details
<b>88</b>	<b>Single-phase voltage monitoring relays</b>
88	Selection table
89	Ordering details
<b>90</b>	<b>Technical data</b>
<b>96</b>	<b>Technical diagrams</b>
<b>98</b>	<b>Function diagrams</b>

# Single-phase monitoring relays

## Benefits and advantages



For the monitoring of currents and voltages in single-phase AC/DC systems, ABB's CM-range contains a wide selection of powerful and compact devices, all in an only 22.5 mm wide housing. This product range includes current and voltage monitoring relays for over- and undercurrent and voltage protection – from 3 mA to 15 A, and from 3 V to 600 V.



### Continuous operation

Read the status of the relay at a glance: clear visualization of the device status via LEDs. Easy to adjust with rotary wheels and variants with push-in terminals make a quick and easy installation and setting possible.



### Reliable in harsh conditions

All relays work reliably in environments with low temperatures down to  $-25\text{ }^{\circ}\text{C}$ . Additionally, the housing fulfills the UL 94 V-0 flammability standard requirements. Together with the vibration resistant push-in terminals, the relay is not only reliable, no matter the environment temperature, but is also durable to shock and vibration. Save time as retightening is no longer needed, and enhance the reliability and safety of the equipment.



### Easy installation

Like all devices from the measuring and monitoring portfolio, the single-phase monitoring relays are easily configurable via front facing potentiometers. Easy threshold configuration without calculation is accomplished by direct reading scales. For further configuration options, additional settings can be made via dip-switches, offering the flexibility to configure, for example, the working principle of the relays and the output configuration. The device can be set up before installation in the application and easy adjustments during the process are possible.

# Single-phase monitoring relays

## Benefits and advantages



### Characteristics current and voltage monitoring relays<sup>1)</sup>

- Monitoring of DC and AC currents: 3 mA to 15 A
- Monitoring of DC and AC voltages from 3-600 V
- TRMS measuring principle
- One device includes 3 current measuring ranges
- One device includes 4 voltage measuring ranges: 3-30 V; 6-60 V; 30-300 V; 60-600 V
- Over- and undercurrent monitoring
- Over- and undervoltage monitoring
- ON or OFF-delay configurable
- Open- or closed-circuit principle configurable
- Threshold values for >U and/or <U adjustable
- Latching function configurable
- Thresholds for >I and/or <I adjustable
- Fixed hysteresis of 5 %
- Start-up delay  $T_v$ , adjustable 0; 0.1-30 s
- Tripping delay  $T_v$ , adjustable 0; 0.1-30 s
- 1 x 2 c/o contacts (common signal) or 2 x 1 c/o contact (separate signals for >I and <I) configurable
- 1 x 2 c/o contacts (common signal) or 2 x 1 c/o contact (separate signals for >U and <U) configurable
- 22.5 mm width
- 3 LEDs for the indication of operational states
- Various approvals and marks

<sup>1)</sup> depending on device



### Applications

- Protection of electronic or electromechanical devices against over- and under voltage or over- and under current
- DC motor speed control
- Battery monitoring
- Monitoring of AC or DC supplies
- Monitoring of heating or lighting circuits



### Current monitoring, single-phase

The ABB current monitoring relays CM-SRS.xx reliably monitor the occurrence of currents that exceed or fall below the selected threshold value. The functions overcurrent or undercurrent monitoring can be preselected. Single- and multifunction devices for the monitoring of direct or alternating currents from 3 mA to 15 A are available.

### Current window monitoring ( $I_{min}$ , $I_{max}$ )

The window monitoring relay CM-SFS.2x is available if the application requires the simultaneous monitoring of over- and undercurrents.

### Voltage monitoring, single-phase

The ABB voltage monitoring relays CM-SRS.xx are used to monitor direct and alternating voltages within a range of 3-600 V. Over- or undervoltage detection can be preselected.

### Voltage window monitoring ( $U_{min}$ , $U_{max}$ )

For the simultaneous detection of over- and undervoltages, the window monitoring relay CM-EFS.2 can be used.

# Single-phase monitoring relays

## Operating controls

### Current monitoring relays

  
Adjustment of the threshold value  $>I$  for overcurrent

  
Adjustment of the tripping delay  $T_v$

-   
**DIP switches**
- ON-delay
  - OFF-delay
  - Closed-circuit principle
  - Open-circuit principle
  - Latching function activated
  - Latching function not activated
  - 2x1 c/o (SPDT) contact
  - 1x2 c/o (SPDT) contacts

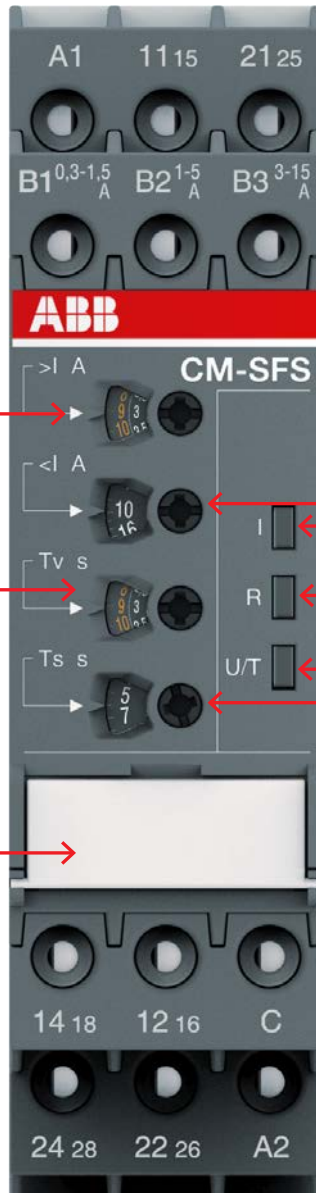

  
Adjustment of the threshold value  $<I$  for undercurrent

  
Indication of operational states  
I: red LED – over- / under-current  
R: yellow LED – relay status  
U/T: green LED – control supply voltage/timing

  
Adjustment of the start-up delay  $T_s$

# Single-phase monitoring relays

## Operating controls

### Voltage monitoring relays

  
Adjustment of the threshold value  $>U$  for overvoltage

  
Adjustment of the tripping delay  $T_v$

-   
**DIP switches**
- ON-delay
  - OFF-delay
  - Closed-circuit principle
  - Open-circuit principle
  - Latching function activated
  - Latching function not activated
  - 2x1 c/o (SPDT) contact
  - 1x2 c/o (SPDT) contacts

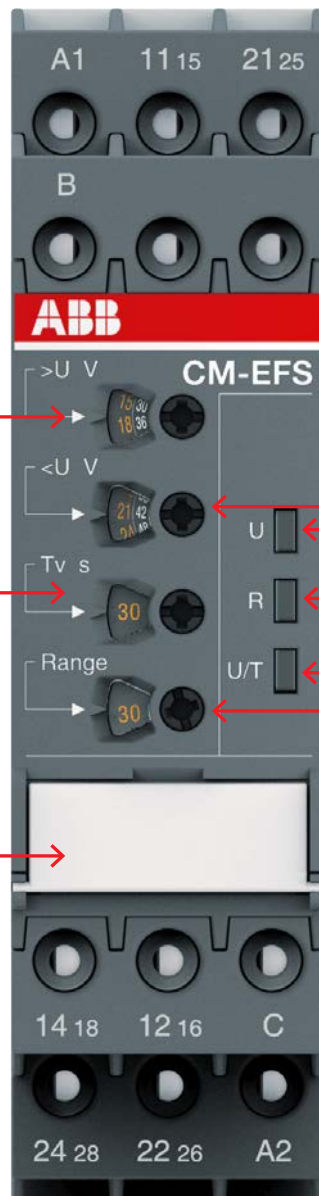

  
Adjustment of the threshold value  $<U$  for undervoltage

  
Indication of operational states  
U: red LED – over- / under-voltage  
R: yellow LED – relay status  
U/T: green LED – control supply voltage/timing

  
Adjustment of the measuring range



# Single-phase current monitoring relays

## Ordering details



CM-SRS.22S

2CDC 251 054 V0011



CM-SFS.22P

2CDC 251 056 V0011

### Description

The CM range current monitoring relays protect single-phase mains (DC or AC) from over- and undercurrent from 3 mA to 15 A.

### Ordering details

Description	Type	Order code	Weight (1 pc) kg (lb)
See selection table	CM-SRS.11S	1SVR730840R0200	0.145 (0.320)
		1SVR730841R0200	0.161 (0.355)
		1SVR730841R1200	0.161 (0.355)
	CM-SRS.11P	1SVR740840R0200	0.137 (0.302)
		1SVR740841R0200	0.153 (0.337)
		1SVR740841R1200	0.153 (0.337)
	CM-SRS.12S	1SVR730840R0300	0.137 (0.302)
		1SVR730841R0300	0.168 (0.370)
		1SVR730841R1300	0.168 (0.370)
	CM-SRS.21S	1SVR730840R0400	0.152 (0.335)
		1SVR730841R0400	0.179 (0.395)
		1SVR730841R1400	0.179 (0.395)
	CM-SRS.21P	1SVR740840R0400	0.141 (0.311)
		1SVR740841R0400	0.168 (0.370)
		1SVR740841R1400	0.168 (0.370)
	CM-SRS.22S	1SVR730840R0500	0.144 (0.399)
		1SVR730841R0500	0.181 (0.399)
		1SVR730841R1500	0.181 (0.399)
	CM-SRS.M1S	1SVR730840R0600	0.153 (0.337)
	CM-SRS.M1P	1SVR740840R0600	0.142 (0.313)
	CM-SRS.M2S	1SVR730840R0700	0.155 (0.342)
	CM-SFS.21S	1SVR730760R0400	0.150 (0.331)
	CM-SFS.21P	1SVR740760R0400	0.139 (0.306)
	CM-SFS.22S	1SVR730760R0500	0.158 (0.348)

S: screw connection  
P: push-in connection

# Single-phase voltage monitoring relays

## Selection table

	Type	Order number																
	CM-ESS.1S	1SVR730830R0300																
	CM-ESS.1P	1SVR740830R0300																
	CM-ESS.1S	1SVR730831R0300																
	CM-ESS.1P	1SVR740831R0300																
	CM-ESS.1S	1SVR730831R1300																
	CM-ESS.1P	1SVR740831R1300																
	CM-ESS.2S	1SVR730830R0400																
	CM-ESS.2P	1SVR740830R0400																
	CM-ESS.2S	1SVR730831R0400																
	CM-ESS.2P	1SVR740831R0400																
	CM-ESS.2S	1SVR730831R1400																
	CM-ESS.2P	1SVR740831R1400																
	CM-ESS.MS	1SVR730830R0500																
	CM-ESS.MP	1SVR740830R0500																
	CM-EFS.2S	1SVR730750R0400																
	CM-EFS.2P	1SVR740750R0400																
<b>Rated control supply voltage U<sub>s</sub></b>																		
24 - 240 V AC/DC			■	■														
110 - 130 V AC					■	■						■	■					
220 - 240 V AC							■	■						■	■			
<b>Measuring ranges AC/DC</b>																		
3 - 30 V			■	■	■	■	■	■	■	■	■	■	■	■	■	■	■	■
6 - 60 V			■	■	■	■	■	■	■	■	■	■	■	■	■	■	■	■
30 - 300 V			■	■	■	■	■	■	■	■	■	■	■	■	■	■	■	■
60 - 600 V			■	■	■	■	■	■	■	■	■	■	■	■	■	■	■	■
<b>Monitoring function</b>																		
Over- or undervoltage			■	■	■	■	■	■	■	■	■	■	■	■	■	■	■	■
Windows voltage monitoring																	■	■
Latching																	sel	sel
Open-circuit or closed-circuit principle																	sel	sel
<b>Timing functions for tripping delay</b>																		
ON-delay, 0.1 - 30 s										adj	adj	adj	adj	adj	adj	adj	adj	
ON- or OFF-delay, 0.1 - 30 s																		sel
<b>Output</b>																		
c/o contact			1	1	1	1	1	1	1	2	2	2	2	2	2	2	2	2
<b>Connection type</b>																		
Push-in terminals			■		■		■		■		■		■		■		■	■
Double-chamber cage connection terminals			■		■		■		■		■		■		■		■	■

adj: adjustable  
sel: selectable



# Single-phase voltage monitoring relays

## Ordering details



2CDC251 060 V0011

CM-ESS.MP



2CDC251 059 V0011

CM-EFS.2

### Description

The CM range voltage monitoring relays provide reliable monitoring of voltages, as well as the detection of phase loss in single-phase mains.









### Ordering details

Description	Type	Order code	Weight (1 pc) kg (lb)
See selection table	CM-ESS.1S	1SVR730830R0300	0.135 (0.298)
		1SVR730831R0300	0.164 (0.362)
		1SVR730831R1300	0.164 (0.362)
	CM-ESS.1P	1SVR740830R0300	0.126 (0.278)
		1SVR740831R0300	0.155 (0.342)
		1SVR740831R1300	0.155 (0.342)
	CM-ESS.2S	1SVR730830R0400	0.153 (0.337)
		1SVR730831R0400	0.181 (0.399)
		1SVR730831R1400	0.181 (0.399)
CM-ESS.2P	1SVR740830R0400	0.142 (0.313)	
	1SVR740831R0400	0.170 (0.375)	
	1SVR740831R1400	0.170 (0.375)	
CM-ESS.MS	1SVR730830R0500	0.154 (0.340)	
CM-ESS.MP	1SVR740830R0500	0.143 (0.320)	
CM-EFS.2S	1SVR730750R0400	0.157 (0.346)	
CM-EFS.2P	1SVR740750R0400	0.146 (0.322)	

S: screw connection  
P: push-in connection

## Single-phase current monitoring relays

### Technical data

Type	CM-SRS.1	CM-SRS.2	CM-SRS.M	CM-SFS.2			
<b>Input circuit - Supply circuit</b>		<b>A1-A2</b>					
Rated control supply voltage $U_s$	A1-A2	110-130 V AC					
	A1-A2	220-240 V AC					
	A1-A2	24-240 V AC/DC					
Rated control supply voltage $U_s$ tolerance		-15...+10 %					
Rated frequency	AC versions	50/60 Hz					
	AC/DC versions	50/60 Hz or DC					
Current / power consumption		see data sheets					
Power failure buffering time		20 ms					
Transient overvoltage protection		Varistors					
<b>Input circuit - Measuring circuit</b>		<b>B1/B2/B3-C</b>					
Monitoring function		over- or undercurrent monitoring configurable		over- and under-current monitoring			
Measuring method		True RMS measuring principle					
Measuring inputs		<b>CM-SxS.x1</b>			<b>CM-SxS.x2</b>		
	Terminal connection	B1-C	B2-C	B3-C	B1-C	B2-C	B3-C
	Measuring ranges AC/DC	3-30 mA	10-100 mA	0.1-1 A	0.3-1.5 A	1-5 A	3-15 A <sup>1)</sup>
	Input resistance	3.3 $\Omega$	1 $\Omega$	0.1 $\Omega$	0.05 $\Omega$	0.01 $\Omega$	0.0025 $\Omega$
	Pulse overload capacity $t < 1$ s	500 mA	1 A	10 A	15 A	50 A	100 A
	Continuous capacity	50 mA	150 mA	1.5 A	2 A	7 A	17 A
Threshold value(s)		adjustable within the indicated measuring range					
Setting accuracy of threshold value		10 % of full-scale value					
Hysteresis related to the threshold value		3-30 % adjustable				5 % fixed	
Measuring signal frequency range		DC / 15 Hz - 2 kHz					
Rated measuring signal frequency range		DC / 50-60 Hz					
Maximum response time		AC: 80 ms / DC: 120 ms					
Accuracy within the control supply voltage tolerance		$\Delta U \leq 0.5$ %					
Accuracy within the temperature range		$\Delta U \leq 0.06$ % / °C					
<b>Timing circuit</b>							
Start-up delay $T_s$		none			0 or 0.1-30 s adjustable		
Tripping delay $T_v$		none	0 or 0.1-30 s adjustable				
Repeat accuracy (constant parameters)		$\pm 0.07$ % of full scale					
Accuracy within the control supply voltage tolerance		-	$\Delta t \leq 0.5$ %				
Accuracy within the temperature range		-	$\Delta t \leq 0.06$ % / °C				
<b>Indication of operational states</b>							
Control supply voltage	U/T: green LED	 : control supply voltage applied,  : start-up delay $T_s$ active,  : tripping delay $T_v$ active					
Measured value	I: red LED	 : overcurrent,  : undercurrent					
Relay status	R: yellow LED	 : relay energized, no latching function  : relay energized, active latching function  : relay de-energized, active latching function					

## Single-phase current monitoring relays

### Technical data

Type	CM-SRS.1	CM-SRS.2	CM-SRS.M	CM-SFS.2
<b>Output circuits</b>	<b>11(15)-12(16)/14(18), 21(25)-22(26)/24(28) - Relays</b>			
Kind of output	1 c/o contact	2 c/o contacts		1x2 c/o contacts or 2x1 c/o contact configurable
Operating principle	open-circuit principle <sup>2)</sup>		open- or closed-circuit principle configurable <sup>2)</sup>	
Contact material	AgNi			
Minimum switching voltage / minimum switching current	24 V / 10 mA			
Maximum switching voltage / maximum switching current	250 V AC / 4 A AC			
Rated operational voltage U <sub>e</sub> and rated operational current I <sub>e</sub>	AC-12 (resistive) at 230 V	4 A		
	AC-15 (inductive) at 230 V	3 A		
	DC-12 (resistive) at 24 V	4 A		
	DC-13 (inductive) at 24 V	2 A		
AC rating (UL 508)	Utilization category (Control Circuit Rating Code)	B 300		
	max. rated operational voltage	300 V AC		
	max. continuous thermal current at B 300	5 A		
	max. making/breaking apparent power (Make/Break) at B 300	3600/360 VA		
Mechanical lifetime	30x10 <sup>6</sup> switching cycles			
Electrical lifetime (AC-12, 230 V, 4 A)	0.1x10 <sup>6</sup> switching cycles			
Max. fuse rating to achieve short-circuit protection	n/c contact	6 A fast-acting	10 A fast-acting	6 A fast-acting
	n/o contact	10 A fast-acting		

<sup>(1)</sup> In case of measured currents > 10 A, lateral spacing has to be min. 10 mm

<sup>(2)</sup> Open-circuit principle: output relay energizes if the measured value exceeds  $\square$  / falls below  $\square$  the adjusted threshold value  
 Closed-circuit principle: output relay de-energizes if measured value exceeds  $\square$  / falls below  $\square$  the adjusted threshold value







## Single-phase current monitoring relays

### Technical data

Type	CM-SRS.1	CM-SRS.2	CM-SRS.M	CM-SFS.2
<b>General data</b>				
MTBF	on request			
Duty cycle	100%			
Dimensions	see dimensional drawings			
Mounting	DIN rail (IEC/EN 60715), snap-on mounting without any tool			
Mounting position	any			
Minimum distance to other units	10 mm (0.39 in) at measured current > 10 A			
Material of housing	UL 94 V-0			
Degree of protection	housing / terminals	IP50 / IP20		
<b>Electrical connection</b>				
Connecting capacity	fine-strand with(out) wire end ferrule	<b>Screw connection technology</b>		<b>Easy Connect Technology (Push-in)</b>
		1 x 0.5-2.5 mm <sup>2</sup> (1 x 20-14 AWG)		2 x 0.5-1.5 mm <sup>2</sup> (2 x 20-16 AWG)
		2 x 0.5-1.5 mm <sup>2</sup> (2 x 20-16 AWG)		
Stripping length	rigid	1 x 0.5-4 mm <sup>2</sup> (1 x 20-12 AWG)		2 x 0.5-1.5 mm <sup>2</sup> (2 x 20-16 AWG)
		2 x 0.5-2.5 mm <sup>2</sup> (2 x 20-14 AWG)		
Tightening torque		0.6-0.8 Nm (7.08 lb.in)	-	
<b>Environmental data</b>				
Ambient temperature range	operation / storage	-20...+60 °C / -40...+85 °C		
Damp heat (IEC 60068-2-30)		55 °C, 6 cycles		
Vibration (sinusoidal)		class 2		
Shock		class 2		
<b>Isolation data</b>				
Rated insulation voltage	supply / measuring circuit / output	600 V		
	supply / output 1/2	250 V		
Rated impulse withstand voltage U <sub>imp</sub>	supply / measuring circuit / output	6 kV 1.2/50 μs		
	supply / output 1/2	4 kV 1.2/50 μs		
Pollution degree		3		
Overvoltage category		III		
<b>Standards / Directives</b>				
Standards		IEC/EN 60255-27, IEC/EN 60947-5-1, EN 50178		
Low Voltage Directive		2014/35/EU		
EMC Directive		2014/30/EU		
RoHS Directive		2011/65/EU		
<b>Electromagnetic compatibility</b>				
Interference immunity to		IEC/EN 61000-6-2		
electrostatic discharge	IEC/EN 61000-4-2	level 3		
radiated, radio-frequency, electromagnetic field	IEC/EN 61000-4-3	level 3		
electrical fast transient / burst	IEC/EN 61000-4-4	level 3		
surge	IEC/EN 61000-4-5	level 3		
conducted disturbances, induced by radio-frequency fields	IEC/EN 61000-4-6	level 3		
Interference emission		IEC/EN 61000-6-3		
high-frequency radiated	IEC/CISPR 22; EN 55022	Class B		
high-frequency conducted	IEC/CISPR 22; EN 55022	Class B		

# Single-phase voltage monitoring relays

## Technical data

Type	CM-ESS.1	CM-ESS.2	CM-ESS.M	CM-EFS.2	
<b>Input circuit - Supply circuit</b>					
<b>A1-A2</b>					
Rated control supply voltage $U_s$	A1-A2	110-130 V AC			
	A1-A2	220-240 V AC			
	A1-A2	24-240 V AC/DC			
Rated control supply voltage $U_s$ tolerance	-15...+10 %				
Rated frequency	AC versions	50/60 Hz			
	AC/DC versions	50/60 Hz or DC			
Current / power consumption	see data sheet				
Power failure buffering time	20 ms				
Transient overvoltage protection	varistors				
<b>Input circuit - Measuring circuit</b>					
<b>B-C</b>					
Monitoring function	over- or undervoltage monitoring configurable			over- and under voltage monitoring configurable	
Measuring method	True RMS measuring principle				
Measuring inputs	<b>CM-ExS</b>				
	Terminal connection	B-C	B-C	B-C	B-C
	Measuring range AC/DC	3-30 V	6-60 V	30-300 V	60-600 V
	Input resistance	600 k $\Omega$	600 k $\Omega$	600 k $\Omega$	600 k $\Omega$
	Pulse overload capacity $t < 1$ s	800 V	800 V	800 V	800 V
Continuous capacity	660 V	660 V	660 V	660 V	
Threshold value(s)	adjustable within the indicated measuring range				
Tolerance of the adjusted threshold value	10 % of full-scale value				
Hysteresis related to the threshold value	3-30 % adjustable			5 % fixed	
Measuring signal frequency range	DC / 15 Hz - 2 kHz				
Rated measuring signal frequency range	DC / 50-60 Hz				
Maximum response time	AC: 80 ms / DC: 120 ms				
Accuracy within the control supply voltage tolerance	$\Delta U \leq 0.5$ %				
Accuracy within the temperature range	$\Delta U \leq 0.06$ % / $^{\circ}\text{C}$				
Transient overvoltage protection	Varistors				
<b>Timing circuit</b>					
Delay time $T_v$	none	0 or 0.1-30 s adjustable			
Repeat accuracy (constant parameters)	$\pm 0.07$ % of full scale value				
Accuracy within the control supply voltage tolerance	-	$\Delta t \leq 0.5$ %			
Accuracy within the temperature range	-	$\Delta t \leq 0.06$ % / $^{\circ}\text{C}$			
<b>Indication of operational states</b>					
Control supply voltage	U/T: green LED	 : control supply voltage applied  : tripping delay $T_v$ active			
Measured value	U: red LED	 : overvoltage,  : undervoltage			
Relay status	R: yellow LED	 : relay energized, no latching function  : relay energized, active latching function  : relay de-energized, active latching function			

## Single-phase voltage monitoring relays

### Technical data

Type	CM-ESS.1	CM-ESS.2	CM-ESS.M	CM-EFS.2
<b>Output circuits</b>				
Kind of output	1 c/o contact	2 c/o contacts		1x2 c/o contacts or 2x1 c/o contact configurable
Operating principle	open-circuit principle <sup>1)</sup>		open- or closed-circuit principle configurable <sup>1)</sup>	
Contact material	AgNi			
Minimum switching voltage / minimum switching current	24 V / 10 mA			
Maximum switching voltage / maximum switching current	250 V AC / 4 A AC			
Rated operational voltage U <sub>e</sub> and rated operational current I <sub>e</sub>	AC-12 (resistive) at 230 V	4 A		
	AC-15 (inductive) at 230 V	3 A		
	DC-12 (resistive) at 24 V	4 A		
	DC-13 (inductive) at 24 V	2 A		
AC rating (UL 508)	Utilization category (Control Circuit Rating Code)	B 300		
	max. rated operational voltage	300 V AC		
	max. continuous thermal current at B 300	5 A		
	max. making/breaking apparent power (Make/Break) at B 300	3600/360 VA		
Mechanical lifetime	30x10 <sup>6</sup> switching cycles			
Electrical lifetime	AC-12, 230 V, 4 A	0.1x10 <sup>6</sup> switching cycles		
Max. fuse rating to achieve short-circuit protection	n/c contact	6 A fast-acting	10 A fast-acting	6 A fast-acting
	n/o contact	10 A fast-acting		

## Single-phase voltage monitoring relays

### Technical data

Type	CM-ESS.1	CM-ESS.2	CM-ESS.M	CM-EFS.2
<b>General data</b>				
MTBF	on request			
Duty cycle	100%			
Dimensions	see dimensional drawings			
Mounting	DIN rail (IEC/EN 60715), snap-on mounting without any tool			
Mounting position	any			
Minimum distance to other units	vertical / horizontal	not necessary / not necessary		
Material of housing	UL 94 V-0			
Degree of protection	housing / terminals	IP50 / IP20		
<b>Environmental data</b>				
Ambient temperature ranges	operation	-20...+60 °C		
	storage	-40...+85 °C		
Damp heat, cyclic (IEC/EN 60068-2-30)	55 °C, 6 cycle			
Vibration, sinusoidal	class 2			
Shock	class 2			
<b>Electrical connection</b>				
Wire size		<b>Screw connection technology</b>	<b>Easy Connect Technology (Push-in)</b>	
	fine-strand with(out) wire end ferrule	1 x 0.5-2.5 mm <sup>2</sup> (1 x 18-14 AWG) 2 x 0.5-1.5 mm <sup>2</sup> (2 x 18-16 AWG)	2 x 0.5-1.5 mm <sup>2</sup> (2 x 18-16 AWG)	
	rigid	1 x 0.5-4 mm <sup>2</sup> (1 x 20-12 AWG) 2 x 0.5-2.5 mm <sup>2</sup> (2 x 20-14 AWG)	2 x 0.5-1.5 mm <sup>2</sup> (2 x 20-16 AWG)	
Stripping length	8 mm (0.32 in)			
Tightening torque	0.6-0.8 Nm (7.08 lb.in)		-	
<b>Isolation data</b>				
Rated insulation voltage	supply / measuring circuit / output	600 V		
	supply / output 1/2	250 V		
Rated impulse withstand voltage U <sub>imp</sub>	supply / measuring circuit / output	6 kV 1.2/50 μs		
	supply / output 1/2	4 kV 1.2/50 μs		
Pollution degree	3			
Overvoltage category	III			
<b>Standards / Directives</b>				
Product standard	IEC/EN 60255-27, IEC/EN 60947-5-1, EN 50178			
Low Voltage Directive	2014/35/EU			
EMC Directive	2014/30/EU			
RoHS Directive	2011/65/EU			
<b>Electromagnetic compatibility</b>				
Interference immunity to	IEC/EN 61000-6-2			
electrostatic discharge	IEC/EN 61000-4-2	level 3		
radiated, radio-frequency, electromagnetic field	IEC/EN 61000-4-3	level 3		
electrical fast transient / burst	IEC/EN 61000-4-4	level 3		
surge	IEC/EN 61000-4-5	level 3		
conducted disturbances, induced by radio-frequency fields	IEC/EN 61000-4-6	level 3		
Interference emission	IEC/EN 61000-6-3			
high-frequency radiated	IEC/CISPR 22; EN 55022	class B		
high-frequency conducted	IEC/CISPR 22; EN 55022	class B		

1) Open-circuit principle: output relay energizes if the measured value exceeds  $\geq$  / falls below  $\leq$  the adjusted threshold value  
 Closed-circuit principle: output relay de-energizes if measured value exceeds  $\geq$  / falls below  $\leq$  the adjusted threshold value

# Single-phase current monitoring relays

## Technical diagrams

### Connection diagram

#### CM-SRS.1x, CM-SRS.2x

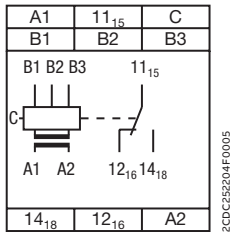

2CDC252204F0005

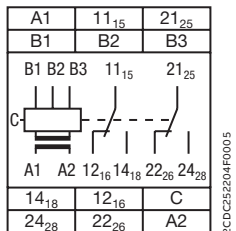

2CDC252204F0005

A1-A2	Control supply voltage
B1-C	Measuring range 1: 3-30 mA or 0.3-1.5 A
B2-C	Measuring range 2: 10-100 mA or 1-5 A
B3-C	Measuring range 3: 0.1-1 A or 3-15 A
11 <sub>15</sub> -12 <sub>16</sub> /14 <sub>18</sub> 21 <sub>25</sub> -22 <sub>26</sub> /24 <sub>28</sub>	Output contacts - open-circuit principle

#### CM-SRS.Mx

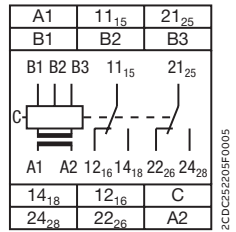

2CDC252205F0005

A1-A2	Control supply voltage
B1-C	Measuring range 1: 3-30 mA or 0.3-1.5 A
B2-C	Measuring range 2: 10-100 mA or 1-5 A
B3-C	Measuring range 3: 0.1-1 A or 3-15 A
11 <sub>15</sub> -12 <sub>16</sub> /14 <sub>18</sub> 21 <sub>25</sub> -22 <sub>26</sub> /24 <sub>28</sub>	Output contacts - open- or closed circuit principle

#### CM-SFS.2x

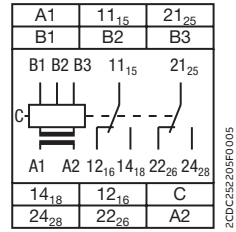

2CDC252205F0005

A1-A2	Control supply voltage
B1-C	Measuring range 1: 3-30 mA or 0.3-1.5 A
B2-C	Measuring range 2: 10-100 mA or 1-5 A
B3-C	Measuring range 3: 0.1-1 A or 3-15 A
11 <sub>15</sub> -12 <sub>16</sub> /14 <sub>18</sub> 21 <sub>25</sub> -22 <sub>26</sub> /24 <sub>28</sub>	Output contacts - open- or closed circuit principle

#### CM-SRS.2x

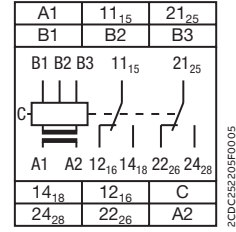

2CDC252205F0005

A1-A2	Control supply voltage
B1-C	Measuring range 1: 3-30 mA or 0.3-1.5 A
B2-C	Measuring range 2: 10-100 mA or 1-5 A
B3-C	Measuring range 3: 0.1-1 A or 3-15 A
11 <sub>15</sub> -12 <sub>16</sub> /14 <sub>18</sub> 21 <sub>25</sub> -22 <sub>26</sub> /24 <sub>28</sub>	Output contacts - open- or closed circuit principle

### DIP switch functions

#### CM-SRS.1x, CM-SRS.2x

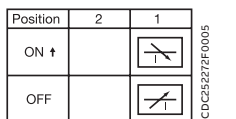

2CDC252272F0005

1	ON	Undercurrent monitoring
	OFF	Overcurrent monitoring

OFF = Default

#### CM-SRS.Mx

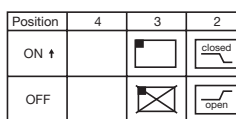

2CDC252273F0005

1	ON	Undercurrent monitoring
	OFF	Overcurrent monitoring
2	ON	Closed-circuit principle
	OFF	Open-circuit principle
3	ON	Latching function activated
	OFF	Latching function not activated

OFF = Default

#### CM-SFS.2x

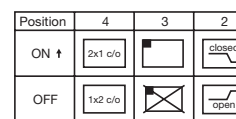

2CDC252274F0005

1	ON	OFF-delay
	OFF	ON-delay
2	ON	Closed-circuit principle
	OFF	Open-circuit principle
3	ON	Latching function activated
	OFF	Latching function not activated
4	ON	2x1 c/o contact
	OFF	1x2 c/o contacts

OFF = Default

#### CM-SRS.2x

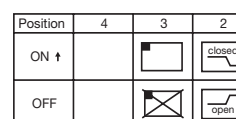

2CDC252273F0005

1	ON	Undercurrent monitoring
	OFF	Overcurrent monitoring
2	ON	Closed-circuit principle
	OFF	Open-circuit principle
3	ON	Latching function activated
	OFF	Latching function not activated

OFF = Default



# Single-phase voltage monitoring relays

## Technical diagrams

### Connection diagram

#### CM-ESS.1, CM-ESS.2

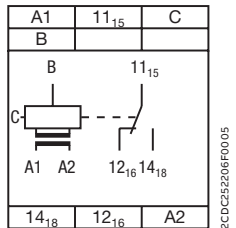

2CDC252207F0005

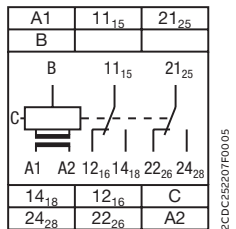

2CDC252207F0005

A1-A2	Control supply voltage
B-C	Measuring ranges AC/DC: 3-30 V; 6-60 V; 30-300 V; 60-600 V
11 <sub>15</sub> -12 <sub>16</sub> /14 <sub>18</sub> 21 <sub>25</sub> -22 <sub>26</sub> /24 <sub>28</sub>	Output contacts - open-circuit principle

#### CM-EFS.2

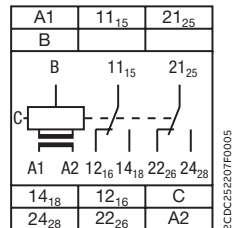

2CDC252207F0005

A1-A2	Control supply voltage
B-C	Measuring ranges AC/DC: 3-30 V; 6-60 V; 30-300 V; 60-600 V
11 <sub>15</sub> -12 <sub>16</sub> /14 <sub>18</sub> 21 <sub>25</sub> -22 <sub>26</sub> /24 <sub>28</sub>	Output contacts - open- or closed circuit principle

#### CM-ESS.M

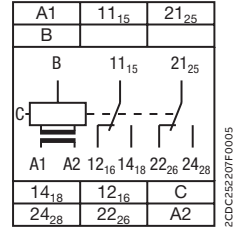

2CDC252207F0005

A1-A2	Control supply voltage
B-C	Measuring ranges AC/DC: 3-30 V; 6-60 V; 30-300 V; 60-600 V
11 <sub>15</sub> -12 <sub>16</sub> /14 <sub>18</sub> 21 <sub>25</sub> -22 <sub>26</sub> /24 <sub>28</sub>	Output contacts - open- or closed circuit principle

### DIP switch functions

#### CM-ESS.1, CM-ESS.2

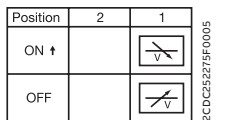

2CDC252276F0005

1	ON	Undervoltage monitoring
	OFF	Overvoltage monitoring
OFF = Default		

#### CM-EFS.2

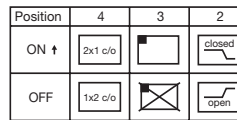

2CDC252276F0005

1	ON	ON-delay
	OFF	OFF-delay
2	ON	Closed-circuit principle
	OFF	Open-circuit principle
3	ON	Latching function activated
	OFF	Latching function not activated
4	ON	2x1 c/o contact
	OFF	1x2 c/o contacts
OFF = Default		

#### CM-ESS.M

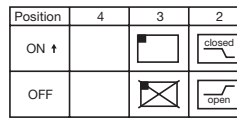

2CDC252276F0005

1	ON	Undervoltage monitoring
	OFF	Overvoltage monitoring
2	ON	Closed-circuit principle
	OFF	Open-circuit principle
3	ON	Latching function activated
	OFF	Latching function not activated
OFF = Default		

# Single-phase monitoring relays

## Function diagrams

### CM-SRS.1x and CM-SRS.2x

If the measured value exceeds resp. drops below the adjusted threshold value, the output relay(s) energize(s): on the CM-SRS.1x - immediately, on the CM-SRS.2x - after the set tripping delay  $T_v$ . If the measured value exceeds resp. drops below the threshold value plus resp. minus the adjusted hysteresis, the output relay(s) de-energize(s). The hysteresis is adjustable within a range of 3-30 % of the threshold value.

#### CM-SRS.1x

##### Overcurrent monitoring

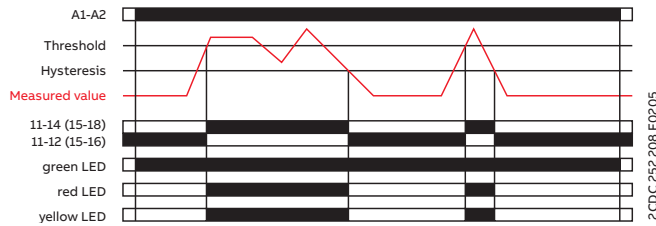

##### Undercurrent monitoring

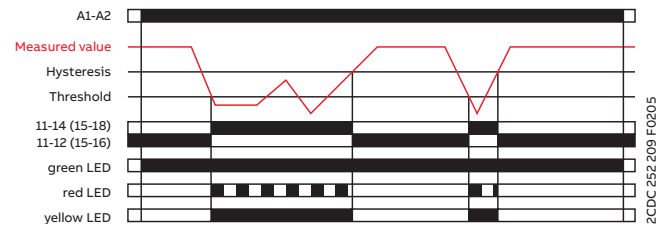

#### CM-SRS.2x

##### Overcurrent monitoring

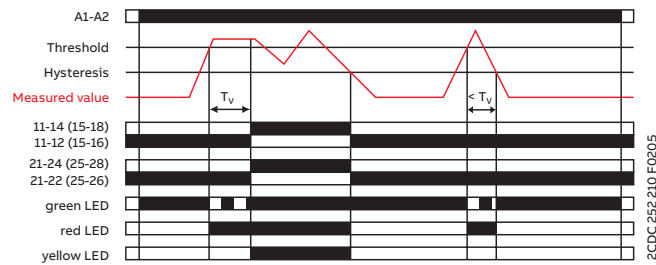

##### Undercurrent monitoring

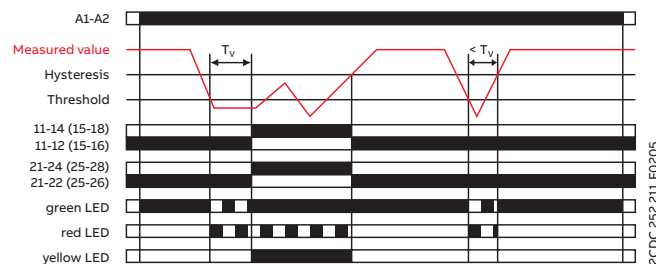

# Single-phase monitoring relays

## Function diagrams

### CM-SRS.Mx

If the measured value exceeds resp. drops below the adjusted threshold value before the set start-up delay  $T_s$  is complete, the output relays do not change their actual state. If the measured value exceeds resp. drops below the adjusted threshold value when  $T_s$  is complete, the tripping delay  $T_v$  starts. If  $T_v$  is complete and the measured value is still exceeding resp. below the threshold value plus resp. minus the set hysteresis, the output relays energize / de-energize.

If the measured value exceeds resp. drops below the threshold value minus resp. plus the set hysteresis and the latching function is not activated, the output relays de-energize / energize. With activated latching function the output relays remain energized and de-energize only when the supply voltage is interrupted / the output relays remain de-energized and energize only when the supply voltage is switched off and then again switched on = Reset. The hysteresis is adjustable within a range of 3-30 % of the threshold value.

Overcurrent monitoring with latching

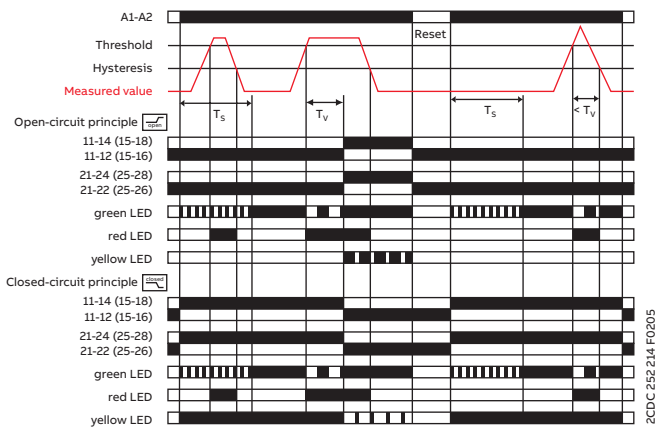

Overcurrent monitoring without latching

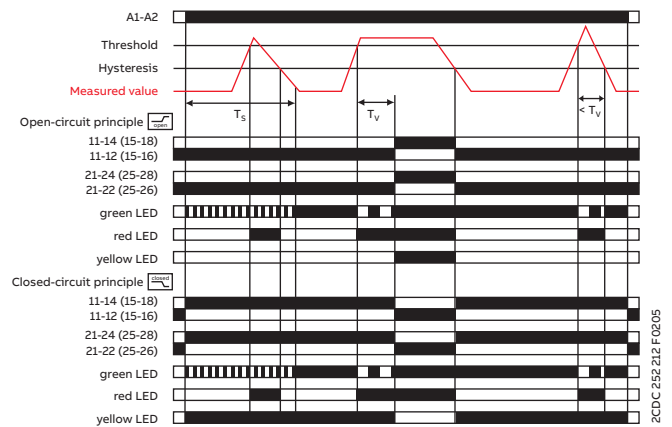

Undercurrent monitoring with latching

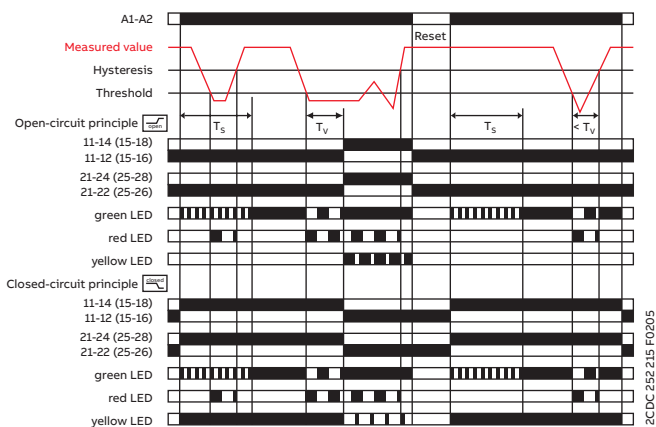

Undercurrent monitoring without latching

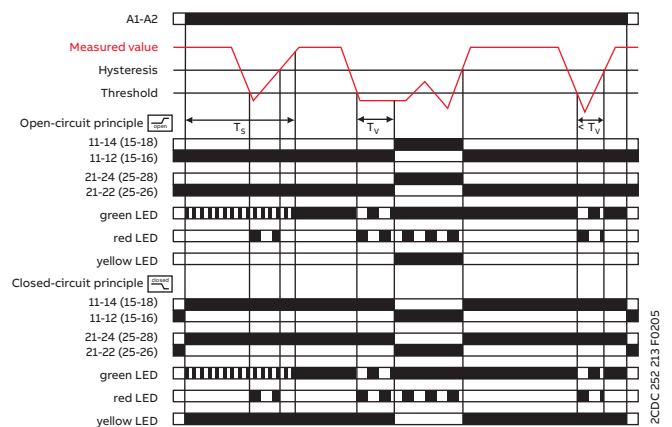

# Single-phase monitoring relays

## Function diagrams

### CM-SFS.2x

Current window monitoring 1x2 c/o contact

ON-delayed  without latching

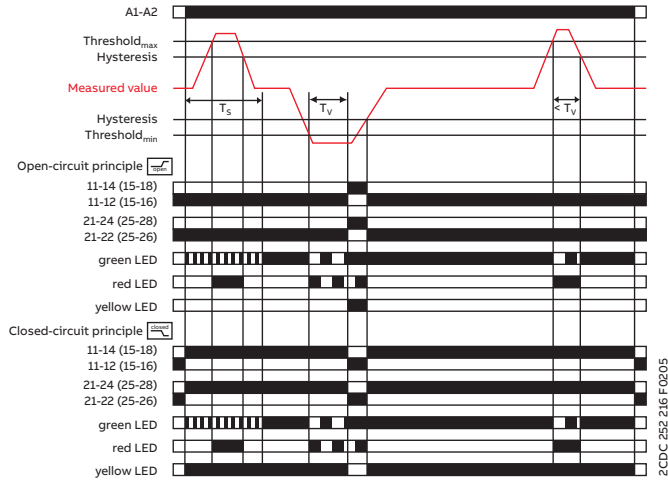

2CDC 252 216 F0205

### ON-delayed current window monitoring with parallel switching c/o contacts

If the measured value exceeds resp. drops below the adjusted threshold value before the set start-up delay  $T_s$  is complete, the output relays do not change their actual state.

If the measured value exceeds resp. drops below the adjusted threshold value when  $T_s$  is complete, the tripping delay  $T_v$  starts when  is configured. If  $T_v$  is complete and the measured value is still exceeding resp. below the threshold value minus resp. plus the fixed hysteresis (5%), the output relays energize  /de-energize .

If the measured value exceeds resp. drops below the threshold value plus resp. minus the hysteresis and the latching function is not activated , the output relays de-energize  / energize . With activated latching function  the output relays remain energized  and de-energize only when the supply voltage is interrupted / the output relays remain de-energized  and energize only when the supply voltage is switched off and then again switched on = Reset.

Current window monitoring 1x2 c/o contact

OFF-delayed  without latching

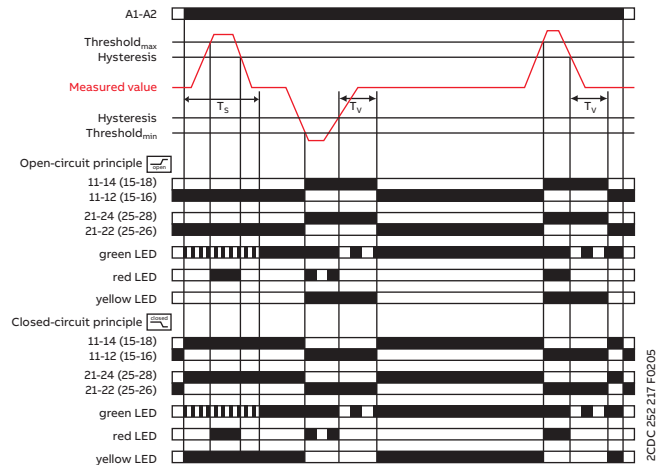

2CDC 252 217 F0205

### OFF-delayed current window monitoring with parallel switching c/o contacts



If the measured value exceeds resp. drops below the adjusted threshold value when the set start-up delay  $T_s$  is complete, the output relays energize  / de-energize , when  is configured, and remain in this position during the set tripping delay  $T_v$ . If the measured value exceeds resp. drops below the threshold value plus resp. minus the fixed hysteresis (5%) and the latching function is not activated , the tripping delay  $T_v$  starts. After completion of  $T_v$ , the output relays de-energize  / energize , provided that the latching function is not activated . With activated latching function  the output relays remain energized  and de-energize only when the supply voltage is interrupted / the output relays remain de-energized  and energize only when the supply voltage is switched off and then again switched on = Reset. When  is adjusted on the device, the functionality is equivalent to the one described above. In this case, instead of both output relays, only one output relay each will be switched.

">I" = 11<sub>15</sub>-12<sub>16</sub>/14<sub>18</sub> ; "<I" = 21<sub>25</sub>-22<sub>26</sub>/24<sub>28</sub>

# Single-phase monitoring relays

## Function diagrams

### CM-ESS.1x and CM-ESS.2x

Depending on the configuration, the voltage monitoring relays CM-ESS.1 and CM-ESS.2 can be used for over- or undervoltage monitoring  in single-phase AC and/or DC systems. The voltage to be monitored (measured value) is applied to terminals B-C. The devices work according to the open-circuit principle. If the measured value exceeds resp. drops below the adjusted threshold value, the output relay(s) energize(s): on the CM-ESS.1 - immediately, on the CM-ESS.2 - after the set tripping delay  $T_v$ . If the measured value exceeds resp. drops below the threshold value plus resp. minus the adjusted hysteresis, the output relay(s) de-energize(s). The hysteresis is adjustable within a range of 3-30 % of the threshold value.

#### CM-ESS.1x

##### Overvoltage monitoring

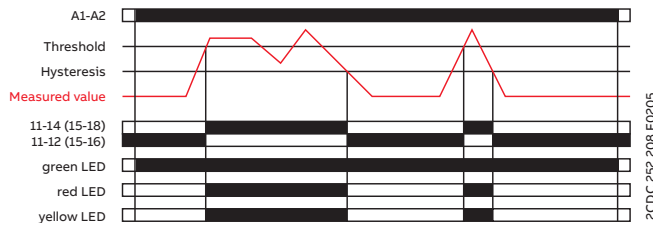

##### Undervoltage monitoring

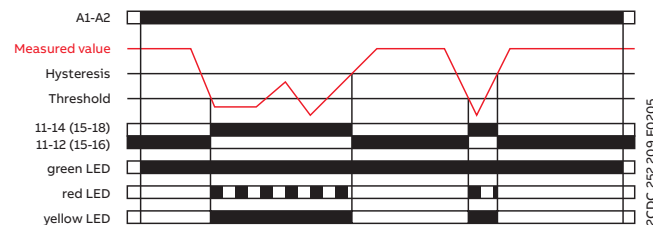

#### CM-ESS.2x

##### Overvoltage monitoring

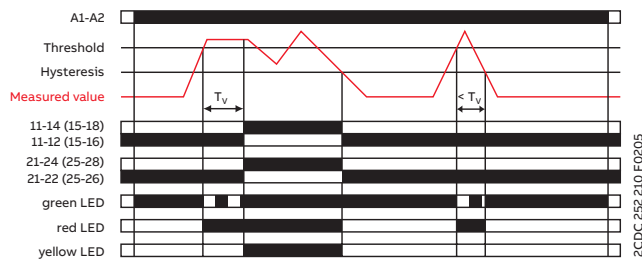

##### Undervoltage monitoring

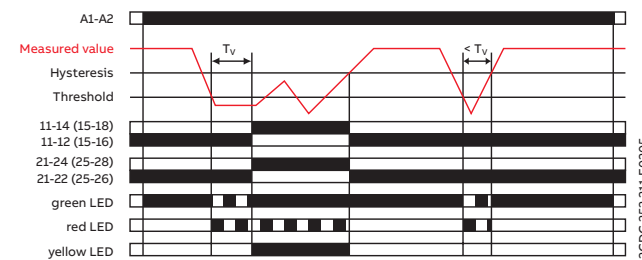

# Single-phase monitoring relays

## Function diagrams

### CM-ESS.Mx

If the measured value exceeds resp. drops below the adjusted threshold value, the tripping delay  $T_V$  starts. If  $T_V$  is complete and the measured value is still exceeding resp. below the threshold value plus resp. minus the set hysteresis, the output relays energize / de-energize.

If the measured value exceeds resp. drops below the threshold value plus resp. minus the set hysteresis and the latching function is not activated, the output relays de-energize / energize. With activated latching function the output relays remain energized and de-energize only when the supply voltage is interrupted / the output relays remain de-energized and energize only when the supply voltage is switched off and then again switched on = Reset. The hysteresis is adjustable within a range of 3-30 % of the threshold value.

Overvoltage monitoring without latching

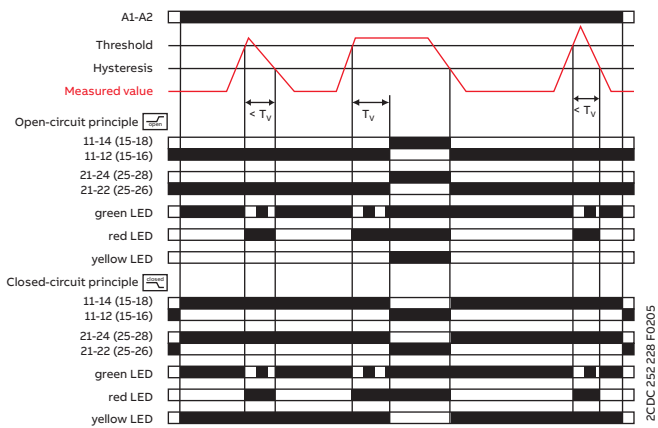

Overvoltage monitoring with latching

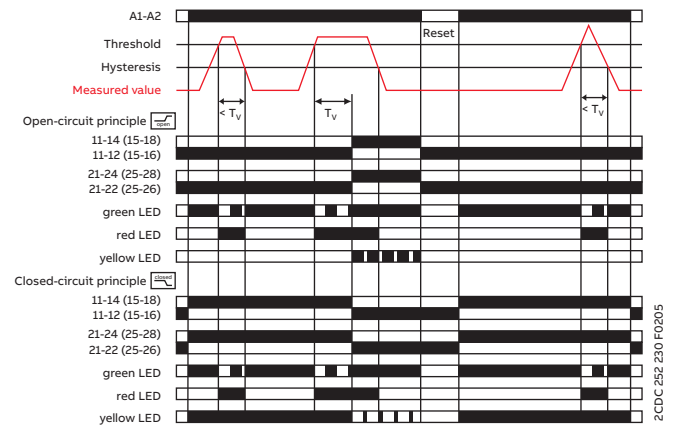

Undervoltage monitoring without latching

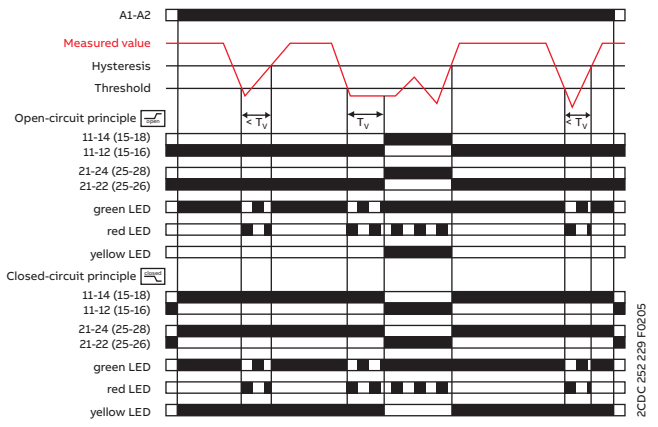

Undervoltage monitoring without latching

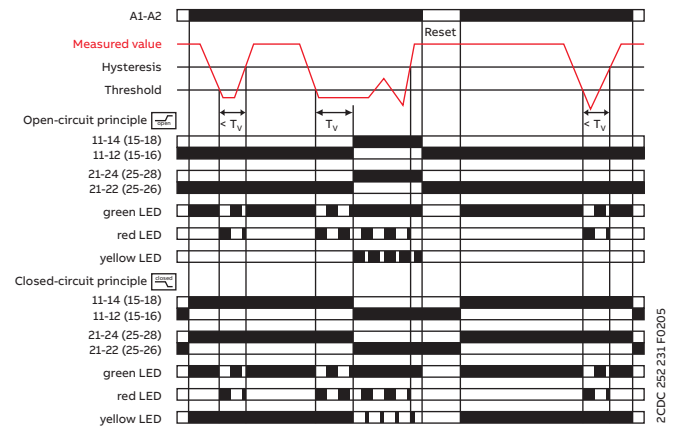

# Single-phase monitoring relays

## Function diagrams

### CM-EFS.2x

Voltage window monitoring 1x2 c/o contact [1x2 c/o]  
 ON-delayed [ON-Delayed] without latching [No Latching]

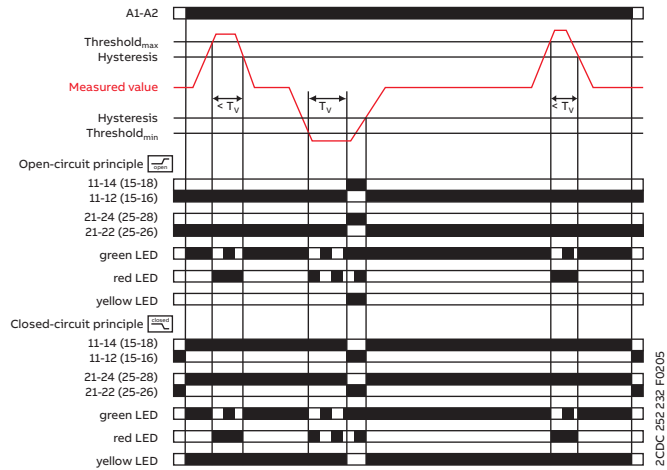

ZCDC 252.232 F0205

Voltage window monitoring 1x2 c/o contact [1x2 c/o]  
 OFF-delayed [OFF-Delayed] without latching [No Latching]

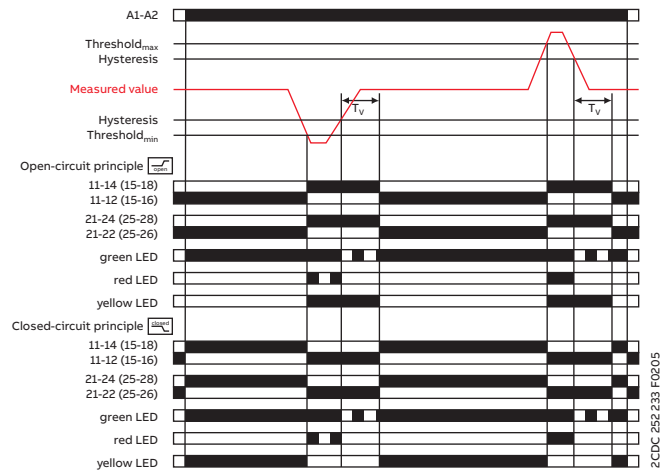

ZCDC 252.233 F0205

**ON-delayed [ON-Delayed] voltage window monitoring with parallel switching c/o contacts [1x2 c/o]:**

If the measured value exceeds resp. drops below the adjusted threshold value, the tripping delay  $T_v$  starts, when [ON-Delayed] is configured. If  $T_v$  is complete and the measured value is still exceeding resp. below the threshold value minus resp. plus the fixed hysteresis (5%), the output relays energize [ON-Delayed] / de-energize [ON-Delayed].

If the measured value exceeds resp. drops below the threshold value plus resp. minus the hysteresis and the latching function is not activated [No Latching], the output relays de-energize [ON-Delayed] / energize [ON-Delayed]. With activated latching function [Latching] the output relays remain energized [ON-Delayed] and de-energize only when the supply voltage is interrupted / the output relays remain de-energized [ON-Delayed] and energize only when the supply voltage is switched off and then again switched on = Reset.

**OFF-delayed [OFF-Delayed] voltage window monitoring with parallel switching c/o contacts [1x2 c/o]:**

If the measured value exceeds resp. drops below the adjusted threshold value, the output relays energize [OFF-Delayed] / de-energize [OFF-Delayed], when [OFF-Delayed] is configured, and remain in this position during the set tripping delay  $T_v$ .

If the measured value exceeds resp. drops below the threshold value plus resp. minus the fixed hysteresis (5%) and the latching function is not activated [No Latching], the tripping delay  $T_v$  starts.

After completion of  $T_v$ , the output relays de-energize [OFF-Delayed] / energize [OFF-Delayed], provided that the latching function is not activated [No Latching]. With activated latching function [Latching] the output relays remain energized [OFF-Delayed] and de-energize only when the supply voltage is interrupted / the output relays remain de-energized [OFF-Delayed] and energize only when the supply voltage is switched off and then again switched on = Reset. When [2x1 c/o] is adjusted on the device, the functionality is equivalent to the one described above. In this case, instead of both output relays, only one output relay each will be switched.

$$">U" = 11_{15}-12_{16}/14_{18}; "<U" = 21_{25}-22_{26}/24_{28}$$





---

# Three-phase monitoring relays

## Table of contents

<b>106</b>	<b>Benefits and advantages</b>
<b>109</b>	<b>Function</b>
<b>110</b>	<b>Operating controls</b>
<b>112</b>	<b>Selection table - singlefunctional</b>
<b>113</b>	<b>Ordering details - singlefunctional</b>
<b>114</b>	<b>Selection table - multifunctional</b>
<b>115</b>	<b>Ordering details - multifunctional</b>
<b>116</b>	<b>Technical data</b>
<b>127</b>	<b>Technical diagrams</b>
<b>129</b>	<b>Function diagrams</b>

# Three-phase monitoring relays

## Benefits and advantages



For the monitoring of voltages in a three-phase system or network, ABB's CM range contains a wide selection of powerful and compact devices. This product range includes voltage monitoring relays for phase sequence, phase loss, unbalance and monitoring of over- and under voltage from 160 V to 820 V.



### Continuous operation

Read the status of the relay at a glance: clear visualization of the device status via LEDs. Easy to adjust with rotary wheels and variants with push-in terminals make a quick and easy installation and setting possible.



### Reliable in harsh conditions

All relays work reliably in environments with low temperatures down to  $-25^{\circ}\text{C}$ . Additionally, the housing fulfills the UL 94 V-0 flammability standard requirements. Together with the vibration resistant push-in terminals, the relay is not only reliable no matter the environment temperature but is also durable to shock and vibration. Save time as retightening is no longer needed and enhance the reliability and safety not only for the equipment.



### Easy installation

Like all devices from the measuring and monitoring portfolio, the three-phase monitoring relays are easily configurable via front facing potentiometers. Easy threshold configuration without calculation is accomplished by direct reading scales. For further configuration options, additional settings can be made via dip-switches, offering the flexibility to configure, for example, the working principle of the relays and the output configuration. The device can be set up before installation in the application and easy adjustments during the process are possible.

# Three-phase monitoring relays

## Benefits and advantages



### Characteristics

- True RMS (TRMS) measuring principle
- Device for the use in mains with a frequency of 45-440 Hz and where harmonics are to be expected<sup>(1)</sup>
- Adjustable phase unbalance threshold value
- Adjustable ON-delay/OFF-delay time
- Powered by the measuring circuit
- 1 n/o contact, 1 or 2 c/o contacts
- LEDs for the indication of operational states
- Multifunctional and singlefunctional devices
- Phase failure detection
- Phase sequence monitoring
- Over- and undervoltage monitoring (fixed or adjustable)
- Wide-range operating voltage guarantees world-wide operation
- Various approvals and marks

<sup>(1)</sup> devices CM-MPS.23 and CM-MPS.43



### Applications

- Control for connection of moving equipment (e.g. air conditioning compressors, refrigerated trucks and containers, and cranes)
- Control against reverse motor operation (lifting, handling, elevators, escalators, etc.)
- Control of sensitive three-phase supplies
- Overheating of the motor due to asymmetrical voltage
- Protection of a plant against destruction due to overvoltage
- Direction of rotation of the drive



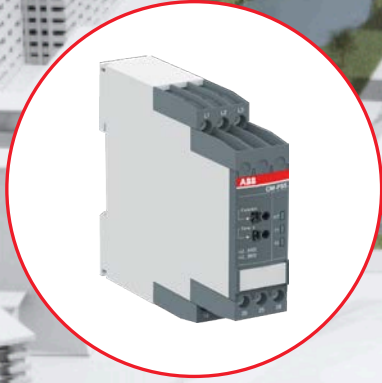
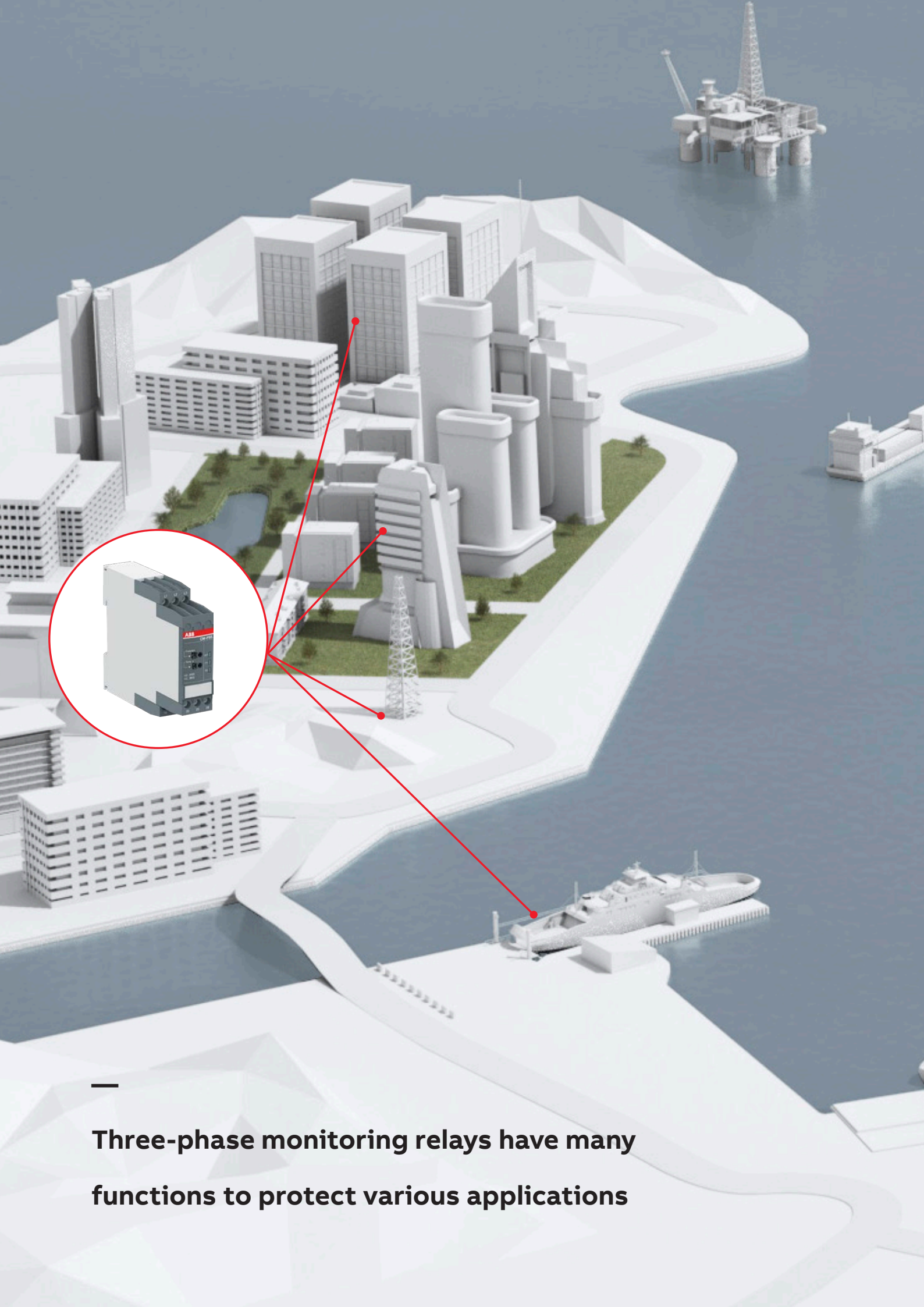

**Three-phase monitoring relays have many functions to protect various applications**

# Three-phase monitoring relays

## Function

### Phase unbalance monitoring

If the supply by the three-phase system is unbalanced due to an uneven distribution of the load, the motor will convert a part of the energy into reactive power. This energy gets lost unexploited; also the motor is exposed to higher thermal stress. Other thermal protection devices fail to detect continuing unbalances, which can lead to damage or destruction of the motor. The CM range three-phase monitors with phase unbalance monitoring can reliably detect this critical situation.

### Phase sequence

Changing the phase sequence during operation or a wrong phase sequence prior to startup causes a change of the rotational direction of the connected device. Generators, pumps or fans rotate in the wrong direction and the installation is no longer working properly. In particular, for moveable equipment, such as construction machinery, phase sequence detection prior to the startup process is highly reasonable.

### Phase loss

In case of phase loss, undefined states of the installation are likely to occur; e.g. the startup process of motors is disturbed. All three-phase monitors of the ABB CM range detect a phase loss as soon as the voltage of one phase drops below 60 % of its nominal value.

### Voltage monitoring

All electric devices can be damaged when operated continuously in a network with out-of-range voltages. For example, safe starting is not ensured in case of undervoltage. Also, the switching state of a contactor is not clearly defined when operated in a "forbidden" voltage range. This can lead to undefined states of the installation and cause damage or destruction of valuable parts.

### Selectable phase sequence monitoring

The phase sequence monitoring can be switched off by means of a rotary switch or a DIP switch. This enables monitoring of three-phase mains where phase sequence is not relevant for the application, for example in case of motors with forward and reverse rotation, heating applications, etc.

### Automatic phase sequence correction

The automatic phase sequence correction is activated by means of a DIP switch. With activated phase sequence correction, it is ensured that for any non-fixed or portable equipment, e.g. construction machinery, the correct phase sequence is always applied to the input terminals of the load. For details regarding the wiring, please see function description / diagrams.

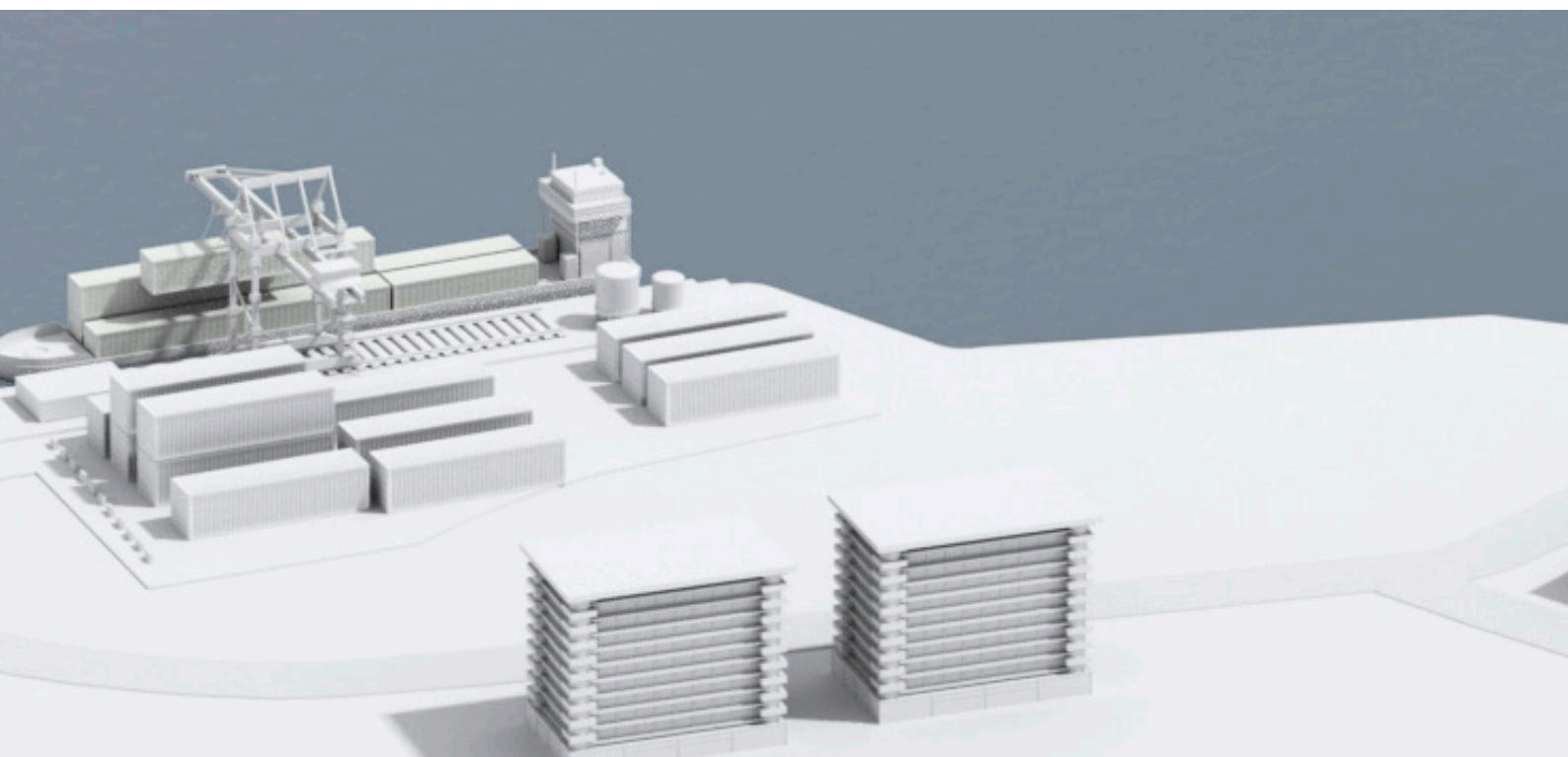

# Three-phase monitoring relays

## Operating controls

### S-range housing

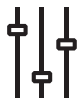

Adjustment of the threshold value  $>U$  for overvoltage

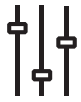

Adjustment of the threshold value Asymmetry for phase unbalance



**DIP switches**

- ON-delay
- OFF-delay
- Phase sequence monitoring deactivated
- Phase sequence monitoring activated
- Phase sequence correction activated
- Phase sequence correction deactivated
- 2x1 c/o (SPDT) contact
- 1x2 c/o (SPDT) contacts

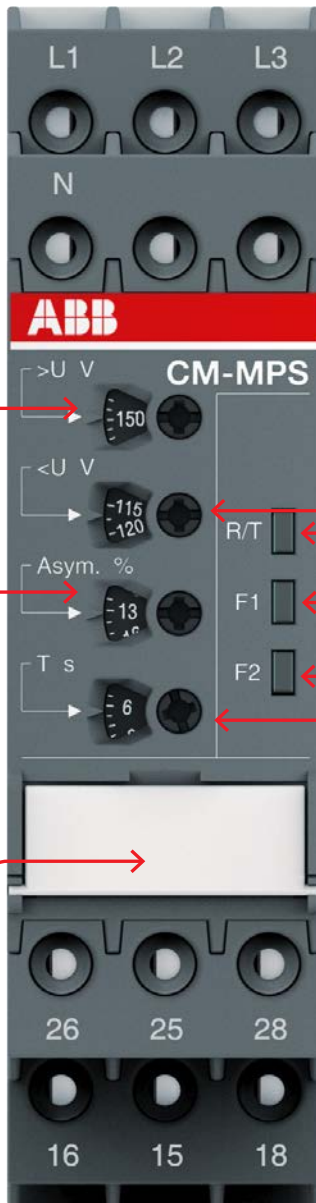

Adjustment of the threshold value  $<U$  for undervoltage



Indication of operational states  
 R/T: red LED – Relay status / timing  
 F1: yellow LED – Fault message  
 F2: yellow LED – Fault message

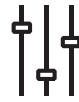

Adjustment of the tripping delay T

# Three-phase monitoring relays

## Operating controls

### N-range housing

**Adjustment of the threshold value  $>U$  for overvoltage**

**Adjustment of the threshold value  $<U$  for undervoltage**

**Adjustment of the threshold value Asymmetry for phase unbalance**

**Indication of operational states**  
 R/T: red LED – Relay status / timing  
 F1: yellow LED – Fault message  
 F2: yellow LED – Fault message

**Adjustment of the tripping delay T**

**DIP switches**

- ON-delay
- OFF-delay
- Phase sequence monitoring deactivated
- Phase sequence monitoring activated
- Phase sequence correction activated
- Phase sequence correction deactivated
- 2x1 c/o (SPDT) contact
- 1x2 c/o (SPDT) contacts

# Three-phase monitoring relays

## Selection table - singlefunctional

Type	Order number	CM-PBE	CM-PBE	CM-PVE	CM-PVE	CM-PFE	CM-PFE.2	CM-PFS.S	CM-PFS.P	CM-PSS.31S	CM-PSS.31P	CM-PSS.41S	CM-PSS.41P	CM-PVS.31S	CM-PVS.31P	CM-PVS.41S	CM-PVS.41P	CM-PVS.81S	CM-PVS.81P	CM-PAS.31S	CM-PAS.31P	CM-PAS.41S	CM-PAS.41P	
	1SVR550881R9400																							
	1SVR550882R9500																							
	1SVR550870R9400																							
	1SVR550871R9500																							
	1SVR550824R9100																							
	1SVR550826R9100																							
	1SVR730824R9300																							
	1SVR740824R9300																							
	1SVR730784R2300																							
	1SVR740784R2300																							
	1SVR730784R3300																							
	1SVR740784R3300																							
	1SVR730794R1300																							
	1SVR740794R1300																							
	1SVR730794R3300																							
	1SVR740794R3300																							
	1SVR730794R2300																							
	1SVR740794R2300																							
	1SVR730774R1300																							
	1SVR740774R1300																							
	1SVR730774R3300																							
	1SVR740774R3300																							
<b>Rated control supply voltage <math>U_s</math></b>																								
<b>Phase to phase</b>																								
160-300 V AC																								
200-400 V AC																								
200-500 V AC																								
208-440 V AC																								
300-500 V AC																								
320-460 V AC																								
380 V AC																								
380-440 V AC																								
400 V AC																								
<b>Phase to neutral</b>																								
185-265 V AC																								
220-240 V AC																								
<b>Rated frequency</b>																								
50/60 Hz																								
<b>Suitable for monitoring</b>																								
Single-phase mains																								
Three-phase mains																								
<b>Monitoring function</b>																								
Phase failure																								
Phase sequence																								
Overvoltage																								
Undervoltage																								
Unbalance																								
Neutral <sup>(1)</sup>																								
<b>Thresholds</b>																								
adjustable (adj) or fixed (fix)																								
<b>Timing functions for tripping delay</b>																								
ON delay																								
On and OFF delay																								
<b>Connection type</b>																								
Push-in terminals																								
Double-chamber cage connection terminals																								

(1) The external conductor voltage towards the neutral conductor is measured.

adj: adjustable  
 sel: selectable  
 fix: fixed



# Three-phase monitoring relays

## Ordering details - singlefunctional



CM-PBE



CM-PSS.41P



CM-PAS.31P

### Description

The three-phase monitoring relays are designed for use in three-phase mains for monitoring the phase parameters like phase sequence, phase failure, over- and undervoltage, as well as phase unbalance.

### Ordering details

Characteristics	Type	Order code	Weight (1 pc) kg (lb)
See selection table	CM-PBE	1SVR550881R9400	0.08 (0.17)
	CM-PBE	1SVR550882R9500	0.08 (0.17)
	CM-PVE	1SVR550870R9400	0.08 (0.17)
	CM-PVE	1SVR550871R9500	0.08 (0.17)
	CM-PFE	1SVR550824R9100	0.08 (0.17)
	CM-PFE.2	1SVR550826R9100	0.067 (0.147)

Characteristics	Type	Order code	Weight (1 pc) kg (lb)
See selection table	CM-PFS.S	1SVR730824R9300	0.127 (0.280)
	CM-PFS.P	1SVR740824R9300	0.119 (0.262)
	CM-PSS.31S	1SVR730784R2300	0.132 (0.291)
	CM-PSS.31P	1SVR740784R2300	0.123 (0.271)
	CM-PSS.41S	1SVR730784R3300	0.132 (0.291)
	CM-PSS.41P	1SVR740784R3300	0.123 (0.271)
	CM-PVS.31S	1SVR730794R1300	0.141 (0.311)
	CM-PVS.31P	1SVR740794R1300	0.132 (0.291)
	CM-PVS.41S	1SVR730794R3300	0.139 (0.306)
	CM-PVS.41P	1SVR740794R3300	0.131 (0.289)
	CM-PVS.81S	1SVR730794R2300	0.136 (0.300)
	CM-PVS.81P	1SVR740794R2300	0.128 (0.282)
	CM-PAS.31S	1SVR730774R1300	0.133 (0.293)
	CM-PAS.31P	1SVR740774R1300	0.124 (0.273)
	CM-PAS.41S	1SVR730774R3300	0.132 (0.291)
	CM-PAS.41P	1SVR740774R3300	0.123 (0.271)

S: screw connection  
P: push-in connection

# Three-phase monitoring relays

## Selection table - multifunctional

Type	Order number	CM-MPS.11S	CM-MPS.11P	CM-MPS.21S	CM-MPS.21P	CM-MPS.31S	CM-MPS.31P	CM-MPS.41S	CM-MPS.41P	CM-MPS.23S	CM-MPS.23P	CM-MPS.43S	CM-MPS.43P	CM-MPN.52S	CM-MPN.52P	CM-MPN.62S	CM-MPN.62P	CM-MPN.72S	CM-MPN.72P	
	1SVR730885R1300																			
	1SVR740885R1300																			
	1SVR730885R3300																			
	1SVR740885R3300																			
	1SVR730884R1300																			
	1SVR740884R1300																			
	1SVR730884R3300																			
	1SVR740884R3300																			
	1SVR730885R4300																			
	1SVR740885R4300																			
	1SVR730884R4300																			
	1SVR740884R4300																			
	1SVR750487R8300																			
	1SVR760487R8300																			
	1SVR750488R8300																			
	1SVR760488R8300																			
	1SVR750489R8300																			
	1SVR760489R8300																			
<b>Rated control supply voltage U<sub>s</sub></b>																				
<b>Phase to phase</b>																				
160-300 V AC																				
300-500 V AC																				
350-580 V AC																				
450-720 V AC																				
530-820 V AC																				
<b>Phase to neutral</b>																				
90-170 V AC																				
180-280 V AC																				
<b>Rated frequency</b>																				
50/60 Hz																				
50/60/400 Hz																				
<b>Suitable for monitoring</b>																				
Mains with harmonic content																				
Single-phase mains																				
Three-phase mains																				
<b>Monitoring function</b>																				
Phase failure																				
Phase sequence	sel	sel	sel	sel	sel	sel	sel	sel	adj	adj	adj	adj	adj	adj	adj	adj	adj	adj	adj	adj
Automatic phase sequence correction									adj	adj	adj	adj	adj	adj	adj	adj	adj	adj	adj	adj
Overvoltage																				
Undervoltage																				
Unbalance																				
Interrupted neutral monitoring <sup>1)</sup>																				
<b>Thresholds</b>																				
Adjustable (adj)	adj	adj	adj	adj	adj	adj	adj	adj	adj	adj	adj	adj	adj	adj	adj	adj	adj	adj	adj	adj
<b>Timing functions for tripping delay</b>																				
On- or OFF delay	adj	adj	adj	adj	adj	adj	adj	adj	adj	adj	adj	adj	adj	adj	adj	adj	adj	adj	adj	adj
<b>Connection type</b>																				
Push-in terminals																				
Double-chamber cage connection terminals																				

1) The relay detects by means of a phase unbalance the interruption of the neutral conductor. The external conductor voltage towards the neutral conductor is measured too.

adj: adjustable  
sel: selectable

# Three-phase monitoring relays

## Ordering details - multifunctional



CM-MPS.23P

2CDC251.065.V0011



CM-MPN.52P

2CDC251.062.V0011

### Description

The three-phase monitoring relays are designed for use in three-phase mains for monitoring the phase parameters, such as phase sequence, phase failure, over- and undervoltage, as well as phase unbalance.

### Ordering details

Characteristics	Type	Order code	Weight (1 pc) kg (lb)
See selection table	CM-MPS.11S	1SVR730885R1300	0.148 (0.326)
	CM-MPS.11P	1SVR740885R1300	0.137 (0.302)
	CM-MPS.21S	1SVR730885R3300	0.146 (0.322)
	CM-MPS.21P	1SVR740885R3300	0.135 (0.298)
	CM-MPS.31S	1SVR730884R1300	0.142 (0.313)
	CM-MPS.31P	1SVR740884R1300	0.133 (0.293)
	CM-MPS.41S	1SVR730884R3300	0.140 (0.309)
	CM-MPS.41P	1SVR740884R3300	0.132 (0.291)
	CM-MPS.23S	1SVR730885R4300	0.149 (0.328)
	CM-MPS.23P	1SVR740885R4300	0.138 (0.304)
	CM-MPS.43S	1SVR730884R4300	0.148 (0.327)
	CM-MPS.43P	1SVR740884R4300	0.137 (0.302)
	CM-MPN.52S	1SVR750487R8300	0.230 (0.507)
	CM-MPN.52P	1SVR760487R8300	0.226 (0.498)
	CM-MPN.62S	1SVR750488R8300	0.229 (0.505)
	CM-MPN.62P	1SVR760488R8300	0.225 (0.496)
	CM-MPN.72S	1SVR750489R8300	0.224 (0.494)
	CM-MPN.72P	1SVR760489R8300	0.220 (0.485)

**S:** screw connection  
**P:** push-in connection

## Three-phase monitoring relays

### Technical data

Type	CM-PBE <sup>1)</sup>	CM-PBE	CM-PVE <sup>1)</sup>	CM-PVE	CM-PFE	CM-PFE.2	CM-PFS
Input circuit - supply circuit	L1-L2-L3-N	L1-L2-L3	L1-L2-L3-N	L1-L2-L3			
Rated control supply voltage $U_s$ = measuring voltage	3x380-440 V AC, 220-240 V AC	3x380-440 V AC	3x320-460 V AC, 185-265 V AC	3x320-460 V AC	3x208-440 V AC	3x200-500 V AC	
Power consumption						13 mA / 9 VA	approx. 15 VA
Rated control supply voltage $U_s$ tolerance	-15...+15 %		-15...+10 %				
Rated frequency	50/60 Hz		50/60 Hz (-10...+10 %)		50/60 Hz		
Duty time	100 %						
Input circuit - measuring circuit	L1-L2-L3-N	L1-L2-L3	L1-L2-L3-N	L1-L2-L3			
Monitoring functions							
phase failure	■	■	■	■	■	■	■
phase sequence	-	-	-	-	■	■	■
over- / undervoltage	-	-	■	■	-	-	-
neutral	■	-	■	-	-	-	-
Measuring ranges	3x380-440 V AC, 220-240 V AC	3x380-440 V AC	3x320-460 V AC, 185-265 V AC	3x320-460 V AC	3x208-440 V AC	3x200-500 V AC	
Thresholds	$U_{min}$ 0.6 x $U_N$		fixed 185 V / 320 V	fixed 320 V	$0.6 \times U_N$		
	$U_{max}$ -		fixed 265 V / 460 V	fixed 460 V	-		
Hysteresis related to the threshold value	fixed 5 % (release value = 0.65 x $U_N$ )		fixed 5 %		-		
Measuring voltage frequency	50/60 Hz (-10 %...+10 %)				50/60 Hz		
Response time	40 ms		80 ms		500 ms		
Accuracy within the temperature range	-		$\Delta U \leq 0.06 \% / ^\circ C$				
Timing circuit							
Start-up delay $t_s$	fixed 500 ms ( $\pm 20 \%$ )				fixed 500 ms		
Tripping $t_v$	fixed 150 ms ( $\pm 20 \%$ )		at over- / undervoltage fixed 500 ms ( $\pm 20 \%$ )		fixed 500 ms		-
Indication of operational states							
Relay status	R: yellow LED	┌───┐ output relay energized					
Fault message	F: red LED	Only CM-PFS: ┌───┐ phase failure / ┌───┐ phase sequence error					

## Three-phase monitoring relays

### Technical data

Type	CM-PBE <sup>1)</sup>	CM-PBE	CM-PVE <sup>1)</sup>	CM-PVE	CM-PFE	CM-PFE.2	CM-PFS
Output circuits	13-14				11-12/14		11 <sub>15</sub> -12 <sub>16</sub> / 14 <sub>18</sub> , 21 <sub>25</sub> -22 <sub>26</sub> / 24 <sub>28</sub>
Kind of output	1 n/o contact				1 c/o contact		2 c/o contacts
Operating principle	closed-circuit principle <sup>2)</sup>						
Minimum switching voltage / Minimum switching current	24 V / 10 mA						
Maximum switching voltage / maximum switching voltage	see data sheets						
Rated operational voltage U <sub>e</sub> and rated operational current I <sub>e</sub>	AC-12 (resistive) 230 V	4 A					
	AC-15 (inductive) 230 V	3 A					
	DC-12 (resistive) 24 V	4 A					
	DC-13 (inductive) 24 V	2 A					
AC rating (UL 508)	Utilization category (Control Circuit Rating Code)	B 300 pilot duty, general purpose 250 V, 4 A, cos phi 0.75					
	max. rated operational voltage	300 V AC					
	max. continuous thermal current at B 300	5 A					
	max. making/breaking apparent power at B 300	3600/360 VA					
Mechanical lifetime	30 x 10 <sup>6</sup> switching cycles						
Electrical lifetime (AC-12, 230 V, 4 A)	0.1 x 10 <sup>6</sup> switching cycles						
Max. fuse rating to achieve short-circuit protection	n/c contact	10 A fast-acting				6 A fast-acting	
	n/o contact	10 A fast-acting					
Conventional thermal current I <sub>th</sub>					4 A		

1) Device with neutral monitoring: The external conductor voltage towards the neutral conductor is measured.

2) Closed-circuit principle: Output relay is de-energized if the measured value exceeds/drops below the adjusted threshold.

## Three-phase monitoring relays

### Technical data

Type		CM-PBE <sup>1)</sup>	CM-PBE	CM-PVE <sup>1)</sup>	CM-PVE	CM-PFE	CM-PFE.2	CM-PFS
<b>General data</b>								
Duty cycle		100 %						
Dimensions		see dimensional drawings						
Mounting		DIN rail (IEC/EN 60715)						
Mounting position		any						
Minimum distance to other unites	horizontal	not necessary				≥ 10 mm if ambient temperature > 50 °C and rated operational currents > 2 A		≥ 10 mm in case of continuous measuring voltage > 440 V
Degree of protection	housing / terminals	IP50 / IP20						
<b>Electrical connection</b>								
Connecting capacity	fine-strand with wire end ferrule	2 x 0.75-1.5 mm <sup>2</sup> (2 x 18-16 AWG)						Same as CM-PSS.31
	fine-strand without wire end ferrule	2 x 1-1.5 mm <sup>2</sup> (2 x 18-16 AWG)						
	rigid	2 x 0.75-1.5 mm <sup>2</sup> (2 x 18-16 AWG)						
Stripping length		10 mm (0.39 in)						Same as CM-PSS.31
Tightening torque		0.6-0.8 Nm						
<b>Environmental data</b>								
Ambient temperature range	operation / storage	-20...+60 °C / -40...+85 °C						
Climatic class		-				3K3		
Damp heat	IEC/EN 60068-2-30	40 °C, 93 % RH, 4 days				-		
Damp heat, cyclic	IEC/EN 60068-2-30					6 x 24 h cycle, 55 °C, 95 % RH		
Vibration withstand	IEC/EN 60068-2-6	10-57 Hz: 0.075 mm; 57-150 Hz: 1 g						
Vibration, sinusoidal		-				class 2		
Shock		-				class 2		
<b>Isolation data</b>								
Rated insulation voltage U <sub>i</sub>	between input, measuring and output circuits	400 V				-		
	input circuit / output circuit	-				600 V		
	output circuit 1 / output circuit 2	-				300 V		
Rated impulse withstand voltage U <sub>imp</sub>	between input, measuring and output circuits	4 kV / 1.2 -50 μs				-		
	input circuit / output circuit	-				6 kV		
	output circuit 1 / output circuit 2	-				4 kV		
Basic insulation	supply circuit / output circuit	-				600 V AC		
Pollution degree		3						
Overvoltage category		III						
<b>Standards / Directives</b>								
Standards		IEC/EN 60947-5-1, EN 50178				IEC/EN 60255-27, IEC/EN 60947-5-1, EN 50178		
Low Voltage Directive		2014/35/EU						
EMC Directive		2014/30/EU						
RoHS Directive		2011/65/EU						

## Three-phase monitoring relays

### Technical data

Type	CM-PBE <sup>(1)</sup>	CM-PBE	CM-PVE <sup>(1)</sup>	CM-PVE	CM-PFE	CM-PFE.2	CM-PFS
<b>Electromagnetic compatibility</b>							
Interference immunity to		IEC/EN 61000-6-2					
electrostatic discharge	IEC/EN 61000-4-2	level 3 - 6 kV/ 8 kV					
radiated, radio-frequency, electromagnetic field	IEC/EN 61000-4-3	level 3 - 10 V/m					level 3 - 10 V/m (1 GHz) 3 V/m (2 GHz) 1 V/m (2.7 GHz)
electrical fast transient / burst	IEC/EN 61000-4-4	level 3 - 2 kV / 5 kHz					
surge	IEC/EN 61000-4-5	level 4 - 2 kV L-L					
conducted disturbances, induced by radio-frequency fields	IEC/EN 61000-4-6	level 3 - 10 V					
voltage dips, short interruptions and voltage variations	IEC/EN 61000-4-11	-					class 3
harmonics and interharmonics	IEC/EN 61000-4-13	-					class 3
Interference emission		IEC/EN 61000-6-3					
high-frequency radiated	IEC/CISPR 22, EN 55022	Class B					
high-frequency conducted	IEC/CISPR 22, EN 55022	Class B					

(1) Device with neutral monitoring: The external conductor voltage towards the neutral conductor is measured.

## Three-phase monitoring relays

### Technical data

Type	CM-PSS.31	CM-PSS.41	CM-PVS.31	CM-PVS.41	CM-PVS.81	CM-PAS.31	CM-PAS.41
<b>Input circuit = Measuring circuit</b>	<b>L1, L2, L3</b>						
Rated control supply voltage $U_s$ = measuring voltage	3x380 V AC	3x400 V AC	3x160-300 V AC	3x300-500 V AC	3x200-400 V AC	3x160-300 V AC	3x300-500 V AC
Rated control supply voltage $U_s$ tolerance	-15...+10 %						
Rated frequency	50/60 Hz						
Frequency range	45-65 Hz						
Typical current / power consumption	25 mA / 18 VA (380 V AC)	25 mA / 18 VA (400 V AC)	25 mA / 10 VA (230 V AC)	25 mA / 18 VA (400 V AC)	19 mA / 10 VA (300 V AC)	25 mA / 10 VA (230 V AC)	25 mA / 18 VA (400 V AC)
<b>Measuring circuit</b>	<b>L1, L2, L3</b>						
Monitoring functions	Phase failure	■	■	■	■	■	■
	Phase sequence	can be switched off				■	■
	Automatic phase sequence correction	-	-	-	-	-	-
	Over- / undervoltage	■	■	■	■	-	-
	Phase unbalance	-	-	-	-	■	■
	Neutral	-	-	-	-	-	-
Measuring range	Overvoltage	3x418 V AC	3x440 V AC	3x220-300 V AC	3x420-500 V AC	3x300-400 V AC	-
	Undervoltage	3x342 V AC	3x360 V AC	3x160-230 V AC	3x300-380 V AC	3x210-300 V AC	-
	Phase unbalance	-	-	-	-	-	2-25 % of average of phase voltages
Thresholds	Overvoltage	fixed		adjustable within measuring range		-	-
	Undervoltage	fixed		adjustable within measuring range		-	-
	Phase unbalance (switch-off value)	-	-	-	-	-	adjust. within measuring range
Tolerance of the adjusted threshold value	6 % of full-scale value						
Hysteresis related to the threshold value	Over- / undervoltage	fixed 5 %				-	
	Phase unbalance	-	-	-	-	-	fixed 20 %
Maximum measuring cycle time	100 ms						
Accuracy within the temperature range	$\Delta U \leq 0.06 \% / ^\circ\text{C}$						
Measuring method	true RMS						
<b>Timing circuit</b>							
Start-up delay $t_s$	fixed 200 ms						
Tripping delay $t_v$	ON- or OFF-delay 0; 0.1-30 s adjustable					ON- delay 0; 0.1-30 s adjustable	
Repeat accuracy (constant parameters)	-	-	-	-	< $\pm 0.2 \%$	-	-
Accuracy within the rated control supply voltage tolerance	$\Delta t \leq 0.5 \%$						
Accuracy within the temperature range	$\Delta t \leq 0.06 \% / ^\circ\text{C}$						
<b>Indication of operational states</b>							
		1 yellow LED, 2 red LEDs					
	details see function description / -diagrams	details see operating mode and function description / -diagrams			details see function description / -diagrams		
<b>Output circuits</b>	<b>15-16/18, 25-26/28</b>						
Kind of output	relay, 2 x 1 c/o contact						
Operating principle	closed-circuit principle <sup>1)</sup>						
Contact material	AgNi alloy, Cd free						
Minimum switching power	24 V / 10 mA						
Maximum switching voltage	see "Load limit curves"						

1) Closed-circuit principle: Output relay(s) de-energize(s) if measured value exceeds or falls below the adjusted threshold value



## Three-phase monitoring relays

### Technical data

Type		CM-PSS.31	CM-PSS.41	CM-PVS.31	CM-PVS.41	CM-PVS.81	CM-PAS.31	CM-PAS.41	
Rated operational voltage $U_e$ and rated operational current $I_e$	AC-12 (resistive) 230 V	4 A							
	AC-15 (inductive) 230 V	3 A							
	DC-12 (resistive) 24 V	4 A							
	DC-13 (inductive) 24 V	2 A							
AC rating (UL 508)	Utilization category (Control Circuit Rating Code)	B 300							
	max. rated operational voltage	300 V AC							
	max. continuous thermal current at B 300	5 A							
	max. making/breaking apparent power at B 300	3600/360 VA							
Mechanical lifetime	30 x 10 <sup>6</sup> switching cycles								
Electrical lifetime (AC-12, 230 V, 4 A)	0.1 x 10 <sup>6</sup> switching cycles								
Max. fuse rating to achieve short-circuit protection	n/c contact	6 A fast-acting							
	n/o contact	10 A fast-acting							
<b>General data</b>									
MTBF	on request								
Duty cycle	100%								
Dimensions	see dimensional drawings								
Mounting	DIN rail (IEC/EN 60715), snap-on mounting without any tool								
Mounting position	any								
Minimum distance to other units	horizontal	10 mm (0.39 in) in case of continuous measuring voltages							
		> 400 V	> 400 V	> 220 V	> 400 V	-	> 220 V	> 400 V	
Material of housing	UL 94 V-0								
Degree of protection	housing / terminals	IP50 / IP20							
<b>Electrical connection</b>									
Wire size	fine-strand with(out) wire end ferrule	<b>Screw connection technology</b>				<b>Easy Connect Technology (Push-in)</b>			
		1 x 0.5-2.5 mm <sup>2</sup> (1 x 18-14 AWG) 2 x 0.5-1.5 mm <sup>2</sup> (2 x 18-16 AWG)				2 x 0.5-1.5 mm <sup>2</sup> (2 x 18-16 AWG)			
		rigid				2 x 0.5-1.5 mm <sup>2</sup> (2 x 20-16 AWG)			
Stripping length	8 mm (0.32 in)								
Tightening torque	0.6-0.8 Nm (7.08 lb.in)				-				
<b>Environmental data</b>									
Ambient temperature ranges	operation / storage	-25...+60 °C / -40...+85 °C							
Damp heat, cyclic (IEC 60068-2-30)	6 x 24 h cycle, 55 °C, 95 % RH								
Climatic class	3K3								
Vibration (sinusoidal)	class 2								
Shock	class 2								
<b>Isolation data</b>									
Rated insulation voltage $U_i$	input circuit / output circuit	600 V							
	output circuit 1 / output circuit 2	300 V							
Rated impulse withstand voltage $U_{imp}$	input circuit	6 kV; 1.2/50 μs							
	output circuit	4 kV; 1.2/50 μs							
Basic insulation	input circuit / output circuit	600 V							
Protective separation	input circuit / output circuit	-							
Pollution degree	3								
Overtoltage category	III								

## Three-phase monitoring relays

### Technical data

Type	CM-PSS.31	CM-PSS.41	CM-PVS.31	CM-PVS.41	CM-PVS.81	CM-PAS.31	CM-PAS.41
<b>Standards / Directives</b>							
Standards	IEC/EN 60255-27, IEC/EN 60947-5-1, EN 50178						
Low Voltage Directive	2014/35/EU						
EMC directive	2014/30/EU						
RoHS directive	2011/65/EU						
<b>Electromagnetic compatibility</b>							
Interference immunity to	EN 61000-6-1						
electrostatic discharge	IEC/EN 61000-4-2	Level 3 (6 kV / 8 kV)					
radiated, radio-frequency, electromagnetic field	IEC/EN 61000-4-3	Level 3 (10 V/m)					
electrical fast transient / burst	IEC/EN 61000-4-4	Level 3 (2 kV / 2 kHz)					
surge	IEC/EN 61000-4-5	Level 4 (2 kV L-L)					
conducted disturbances, induced by radio-frequency fields	IEC/EN 61000-4-6	Level 3 (10 V)					
Interference emission	IEC/EN 61000-6-3						
high-frequency radiated	IEC/CISPR 22, EN 55022	class B					
high-frequency conducted	IEC/CISPR 22, EN 55022	class B					

# Three-phase monitoring relays

## Technical data

Type	CM-MPS.11	CM-MPS.21	CM-MPS.31	CM-MPS.41
<b>Input circuit = Measuring circuit</b>	<b>L1, L2, L3, N</b>		<b>L1, L2, L3</b>	
Rated control supply voltage $U_s$ = measuring voltage	3x90-170 V AC	3x180-280 V AC	3x160-300 V AC	3x300-500 V AC
Rated control supply voltage $U_s$ tolerance	-15...+10 %			
Rated frequency	50/60 Hz			
Frequency range	45-65 Hz			
Typical current / power consumption	25 mA / 10 VA (115 V AC)	25 mA / 18 VA (230 V AC)	25 mA / 10 VA (230 V AC)	25 mA / 18 VA (400 V AC)
<b>Measuring circuit</b>	<b>L1, L2, L3, N</b>		<b>L1, L2, L3</b>	
Monitoring functions	Phase failure	■	■	■
	Phase sequence	can be switched off		
	Automatic phase sequence correction	-	-	-
	Over- / undervoltage	■	■	■
	Phase unbalance	■	■	■
	Interrupted neutral	■	-	-
Measuring range	Overvoltage	3x120-170 V AC	3x240-280 V AC	3x220-300 V AC
	Undervoltage	3x90-130 V AC	3x180-220 V AC	3x160-230 V AC
	Phase unbalance	2-25 % of average of phase voltages		
Thresholds	Overvoltage	adjustable within measuring range		
	Undervoltage	adjustable within measuring range		
	Phase unbalance (switch-off value)	adjustable within measuring range		
Tolerance of the adjusted threshold value	6 % of full-scale value			
Hysteresis related to the threshold value	Over- / undervoltage	fixed 5 %		
	Phase unbalance	fixed 20 %		
Accuracy within the temperature range	$\Delta U \leq 0.06 \% / ^\circ C$			
Measuring method	True RMS			
<b>Timing circuit</b>				
Start-up delay $t_s$	fixed 200 ms			
Tripping delay $t_v$	ON- or OFF-delay 0; 0.1-30 s adjustable			
Accuracy within the rated control supply voltage tolerance	$\Delta t \leq 0.5 \%$			
Accuracy within the temperature range	$\Delta t \leq 0.06 \% / ^\circ C$			
Indication of operational states	Details see function description / -diagrams			
<b>Output circuits</b>	<b>15-16/18, 25-26/28</b>			
Kind of output	relay, 1 x 2 c/o contacts			
Operating principle	closed-circuit principle <sup>1)</sup>			
Contact material	AgNi alloy, Cd free			
Minimum switching power	24 V / 10 mA			
Maximum switching voltage	see load limit curves			
Rated operational voltage $U_e$ and rated operational current $I_e$	AC-12 (resistive) 230 V	4 A		
	AC-15 (inductive) 230 V	3 A		
	DC-12 (resistive) 24 V	4 A		
	DC-13 (inductive) 24 V	2 A		
AC rating (UL 508)	Utilization category (Control Circuit Rating Code)	B 300		
	max. rated operational voltage	300 V AC		
	max. continuous thermal current at B 300	5 A		
	max. making/breaking apparent power at B 300	3600/360 VA		
Mechanical lifetime	30 x 10 <sup>6</sup> switching cycles			
Electrical lifetime (AC-12, 230 V, 4 A)	0.1 x 10 <sup>6</sup> switching cycles			
Max. fuse rating to achieve short-circuit protection	n/c contact	6 A fast-acting		
	n/o contact	10 A fast-acting		

1) Closed-circuit principle: Output relay(s) de-energize(s) if measured value exceeds or falls below the adjusted threshold value

## Three-phase monitoring relays

### Technical data

Type		CM-MPS.11	CM-MPS.21	CM-MPS.31	CM-MPS.41
<b>General data</b>					
MTBF		on request			
Duty time		100 %			
Dimensions		see dimension drawings			
Mounting		DIN rail (IEC/EN 60715), snap-on mounting without any tool			
Mounting position		any			
Minimum distance to other units	horizontal	10 mm (0.39 in) in case of continuous measuring voltages			
		> 120 V	> 240 V	> 220 V	> 400 V
Material of housing		UL 94 V-0			
Degree of protection	housing / terminals	IP50 / IP20			
<b>Electrical connection</b>					
Wire size		Screw connection technology		Easy Connect Technology (Push-in)	
	fine-strand with(out) wire end ferrule	1 x 0.5-2.5 mm <sup>2</sup> (1 x 18-14 AWG) 2 x 0.5-1.5 mm <sup>2</sup> (2 x 18-16 AWG)		2 x 0.5-1.5 mm <sup>2</sup> (2 x 18-16 AWG)	
	rigid	1 x 0.5-4 mm <sup>2</sup> (1 x 20-12 AWG) 2 x 0.5-2.5 mm <sup>2</sup> (2 x 20-14 AWG)		2 x 0.5-1.5 mm <sup>2</sup> (2 x 20-16 AWG)	
Stripping length		8 mm (0.32 in)			
Tightening torque		0.6-0.8 Nm (7.08 lb.in)		-	
<b>Environmental data</b>					
Ambient temperature ranges	operation / storage	-25...+60 °C / -40...+85 °C			
Damp heat, cyclic		6 x 24 h cycle, 55 °C, 65 % RH			
Climatic class		3K3			
Vibration		class 2			
Shock		class 2			
<b>Isolation data</b>					
Rated insulation voltage U <sub>i</sub>	input circuit / output circuit	600 V			
	output circuit 1 / output circuit 2	300 V			
Rated impulse withstand voltage U <sub>imp</sub>	input circuit	6 kV; 1.2/50 μs			
	output circuit	4 kV; 1.2/50 μs			
Test voltage between all isolated circuits (routine test)		2.5 kV, 50 Hz, 1 s			
Basic insulation	input circuit / output circuit	600 V			
Protective separation (IEC/EN 61140, EN 50178)	input circuit / output circuit	yes		-	
Pollution degree		3			
Overvoltage category		III			
<b>Standards / Directives</b>					
Standards		IEC/EN 60255-2, IEC/EN 60947-5-1, EN 50178			
Low Voltage Directive		2014/35/EU			
EMC directive		2014/30/EU			
RoHS directive		2011/65/EU			
<b>Electromagnetic compatibility</b>					
Interference immunity to		IEC/EN 61000-6-2			
electrostatic discharge	IEC/EN 61000-4-2	level 3 (6 kV / 8 kV)			
radiated, radio-frequency, electromagnetic field	IEC/EN 61000-4-3	level 3 (10 V/m)			
electrical fast transient / burst	IEC/EN 61000-4-4	level 3 (2 kV / 2 kHz)			
surge	IEC/EN 61000-4-5	level 4 (2 kV L-N)		Level 4 (2 kV L-L)	
conducted disturbances, induced by radio-frequency fields	IEC/EN 61000-4-6	level 3 (10 V)			
harmonics and interharmonics	IEC/EN 61000-4-13	class 3			
Interference emission		EN 61000-6-3, EN 61000-6-4			
high-frequency radiated	IEC/CISPR 22, EN 55022	class B			
high-frequency conducted	IEC/CISPR 22, EN 55022	class B			

## Three-phase monitoring relays

### Technical data

Type	CM-MPS.23	CM-MPS.43	CM-MPN.52	CM-MPN.62	CM-MPN.72	
<b>Input circuit = Measuring circuit</b>	<b>L1, L2, L3, N</b>	<b>L1, L2, L3</b>				
Rated control supply voltage $U_s$ = measuring voltage	3x180-280 V AC	3x300-500 V AC	3x350-580 V AC	3x450-720 V AC	3x530-820 V AC	
Rated control supply voltage $U_s$ tolerance	-15...+10 %					
Rated frequency	50/60/400 Hz		50/60 Hz			
Frequency range	45-440 Hz		45-65 Hz			
Typical current / power consumption	5 mA / 4 VA (230 V AC)	5 mA / 4 VA (400 V AC)	29 mA / 41 VA (480 V AC)	29 mA / 52 VA (600 V AC)	29 mA / 59 VA (690 V AC)	
<b>Measuring circuit</b>	<b>L1, L2, L3, N</b>	<b>L1, L2, L3</b>				
Monitoring functions	Phase failure	■	■	■	■	
	Phase sequence	can be switched off				
	Automatic phase sequence correction	configurable				
	Over- / undervoltage	■	■	■	■	■
	Phase unbalance	■	■	■	■	■
	Interrupted neutral	■	-	-	-	
Measuring range	Overvoltage	3x240-280 V AC	3x420-500 V AC	3x480-580 V AC	3x600-720 V AC	3x690-820 V AC
	Undervoltage	3x180-220 V AC	3x300-380 V AC	3x350-460 V AC	3x450-570 V AC	3x530-660 V AC
	Phase unbalance	2-25 % of average of phase voltages				
Thresholds	Overvoltage	adjustable within measuring range				
	Undervoltage	adjustable within measuring range				
	Phase unbalance (switch-off value)	adjustable within measuring range				
Tolerance of the adjusted threshold value	6 % of full-scale value					
Hysteresis related to the threshold value	Over- / undervoltage	fixed 5 %				
	Phase unbalance	fixed 20 %				
Maximum measuring cycle time	100 ms					
Accuracy within the temperature range	$\Delta U \leq 0.06 \% / ^\circ\text{C}$					
Measuring method	True RMS					
<b>Timing circuit</b>						
Start-up delay $t_s$ and $t_{s2}$	fixed 200 ms					
Start-up delay $t_{s1}$	fixed 250 ms					
Tripping delay $t_v$	ON- or OFF-delay 0; 0.1-30 s adjustable					
Accuracy within the rated control supply voltage tolerance	$\Delta t \leq 0.5 \%$					
Accuracy within the temperature range	$\Delta t \leq 0.06 \% / ^\circ\text{C}$					
Indication of operational states	Details see function description / -diagrams					
<b>Output circuits</b>	<b>15-16/18, 25-26/28</b>					
Kind of output	relay, 2 x 1 or 1 x 2 c/o contacts configurable					
Operating principle	closed-circuit principle <sup>1)</sup>					
Contact material	AgNi alloy, Cd free					
Minimum switching power	24 V / 10 mA					
Maximum switching voltage	see load limit curves					
Rated operational voltage $U_e$ and rated operational current $I_e$	AC-12 (resistive) 230 V	4 A				
	AC-15 (inductive) 230 V	3 A				
	DC-12 (resistive) 24 V	4 A				
	DC-13 (inductive) 24 V	2 A				
AC rating (UL 508)	Utilization category (Control Circuit Rating Code)	B 300				
	max. rated operational voltage	300 V AC				
	max. continuous thermal current at B 300	5 A				
	max. making/breaking apparent power at B 300	3600/360 VA				
Mechanical lifetime	30 x 10 <sup>6</sup> switching cycles					
Electrical lifetime (AC-12, 230 V, 4 A)	0.1 x 10 <sup>6</sup> switching cycles					
Max. fuse rating to achieve short-circuit protection	n/c contact	6 A fast-acting		10 A fast-acting		
	n/o contact	10 A fast-acting				

1) Closed-circuit principle: Output relay(s) de-energize(s) if measured value exceeds or falls below the adjusted threshold value

## Three-phase monitoring relays

### Technical data

Type	CM-MPS.23	CM-MPS.43	CM-MPN.52	CM-MPN.62	CM-MPN.72
<b>General data</b>					
MTBF	on request				
Duty time	100 %				
Dimensions	see dimensional drawings				
Mounting	DIN rail (IEC/EN 60715), snap-on mounting without any tool				
Mounting position	any				
Minimum distance to other units	horizontal	10 mm (0.39 in)	not necessary		
Material of housing	UL 94 V-0				
Degree of protection	housing / terminals	IP50 / IP20			
<b>Electrical connection</b>					
Wire size	<b>Screw connection technology</b>		<b>Easy Connect Technology (Push-in)</b>		
	fine-strand with(out) wire end ferrule	1 x 0.5-2.5 mm <sup>2</sup> (1 x 18-14 AWG) 2 x 0.5-1.5 mm <sup>2</sup> (2 x 20-16 AWG)	2 x 0.5-1.5 mm <sup>2</sup> (2 x 18-16 AWG)		
	rigid	1 x 0.5-4 mm <sup>2</sup> (1 x 20-12 AWG) 2 x 0.5-2.5 mm <sup>2</sup> (2 x 20-14 AWG)	2 x 0.5-1.5 mm <sup>2</sup> (2 x 20-16 AWG)		
Stripping length	8 mm (0.32 in)				
Tightening torque	0.6-0.8 Nm (7.08 lb.in)				-
<b>Environmental data</b>					
Ambient temperature ranges	operation / storage	-25...+60 °C / -40...+85 °C			
Damp heat, cyclic (IEC 60068-2-30)	6 x 24 h cycles, 55 °C, 95 % RH				
Climatic category	3K3				
Vibration (sinusoidal) (IEC/EN 60255-21-1)	class 2				
Shock (IEC/EN 60255-21-2)	class 2				
<b>Isolation data</b>					
Rated insulation voltage U <sub>i</sub>	input circuit / output circuit	600 V	1000 V		
	output circuit 1 / 2	300 V			
Rated impulse withstand voltage U <sub>imp</sub>	input circuit	6 kV; 1.2/50 μs	8 kV; 1.2/50 μs		
	output circuit	4 kV; 1.2/50 μs			
Basic insulation	input circuit / output circuit	600 V	1000 V		
Protective separation (IEC/EN 61140, EN 50148)	input circuit / output circuit	-			
Pollution degree	3				
Overvoltage category	III				
<b>Standards / Directives</b>					
Standards	IEC/EN 60255-27, IEC/EN 60947-5-1, EN 50178				
Low Voltage Directive	2014/35/EU				
EMC Directive	2014/30/EU				
RoHS Directive	2011/65/EU				
<b>Electromagnetic compatibility</b>					
Interference immunity to	IEC/EN 61000-6-2				
electrostatic discharge	IEC/EN 61000-4-2	level 3 (6 kV / 8 kV)			
radiated, radio-frequency, electromagnetic field	IEC/EN 61000-4-3	level 3 (10 V/m)			
electrical fast transient / burst	IEC/EN 61000-4-4	level 3 (2 kV / 2 kHz)			
surge	IEC/EN 61000-4-5	level 4 (2 kV L-N)	Level 4 (2 kV L-L)		
conducted disturbances, induced by radio-frequency fields	IEC/EN 61000-4-6	level 3 (10 V)			
harmonics and interharmonics	IEC/EN 61000-4-13	class 3			
Interference emission	IEC/EN 61000-6-3				
high-frequency radiated	IEC/CISPR 22, EN 55022	class B			
high-frequency conducted	IEC/CISPR 22, EN 55022	class B			

# Three-phase monitoring relays

## Technical diagrams

### Connection diagrams

#### CM-PBE, CM-PVE

with neutral

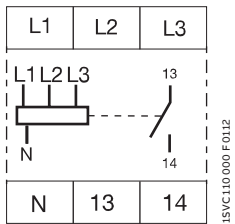

without neutral

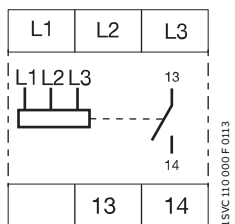

L1, L2, L3, (N) Control supply voltage = Measuring voltage  
13-14 Output contact - closed-circuit principle

#### CM-PFE

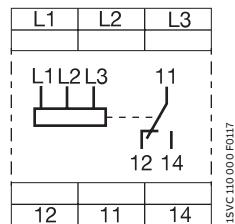

L1, L2, L3 Control supply voltage = Measuring voltage  
11-12/14 Output contact - closed-circuit principle

#### CM-PVS.x1, CM-PSS.x1, CM-PAS.x1

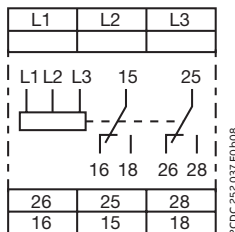

L1, L2, L3 Control supply voltage = Measuring voltage  
15-16/18 Output contact - closed-circuit principle  
25-26/28

#### CM-PFS

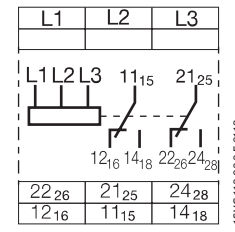

L1, L2, L3 Control supply voltage = Measuring voltage  
11<sub>15</sub>-12<sub>16</sub>/14<sub>18</sub> Output contact - closed-circuit principle  
21<sub>25</sub>-22<sub>26</sub>/24<sub>28</sub>

#### CM-MPS.11, CM-MPS.21, CM-MPS.23

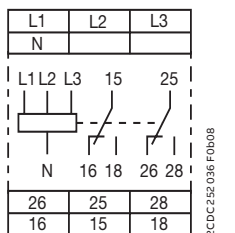

L1, L2, L3, (N) Control supply voltage = Measuring voltage  
15-16/18 Output contact - closed-circuit principle  
25-26/28

#### CM-MPS.31, CM-MPS.41, CM-MPS.43

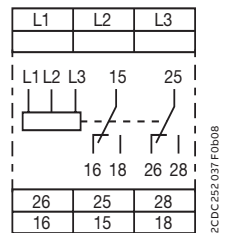

L1, L2, L3, (N) Control supply voltage = Measuring voltage  
15-16/18 Output contact - closed-circuit principle  
25-26/28

#### CM-MPN.x2

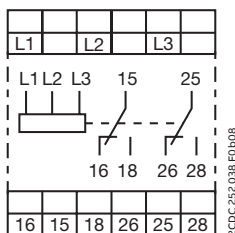

L1, L2, L3 Control supply voltage = Measuring voltage  
15-16/18 Output contact - closed-circuit principle  
25-26/28

## Three-phase monitoring relays

### Technical diagrams

#### Rotary switch "Function"

##### CM-PVS

	ON-delay with phase sequence monitoring
	OFF-delay with phase sequence monitoring
	ON-delay without phase sequence monitoring
	OFF-delay without phase sequence monitoring

##### CM-PSS

	ON-delay with phase sequence monitoring
	OFF-delay with phase sequence monitoring
	ON-delay without phase sequence monitoring
	OFF-delay without phase sequence monitoring

#### DIP switch functions

##### CM-MPS.x3 and CM-MPN.x2

Position	4	3	2	1
ON ↑				
OFF				

2CDC 252 0-40 F00B08

##### 1 Timing function

ON	ON-delayed
OFF	OFF-delayed

##### 2 Phase sequence monitoring

ON	deactivated
OFF	activated

##### 3 Operating principle of output

ON	2x1 c/o contact
OFF	1x2 c/o contact

##### 4 Phase sequence correction

ON	activated
OFF	deactivated

Output relay R1 is responsive to overvoltage, output relay R2 is responsive to undervoltage. In case of other faults, both output relays react synchronously.

##### CM-MPS.x1

Position	2	1
ON ↑		
OFF		

2CDC 252 0-40 F00B08

##### 1 Timing function

ON	ON-delayed
OFF	OFF-delayed

##### 2 Phase sequence monitoring

ON	deactivated
OFF	activated



# Three-phase monitoring relays

## Function diagrams

### CM-PBE

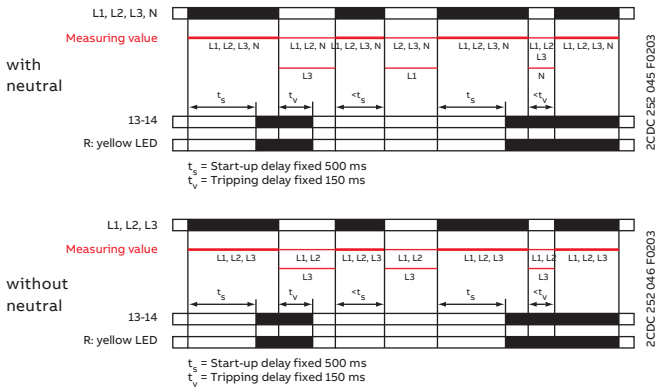

#### Phase failure detection

If all phases (and the neutral) are present, the output relay energizes after the start-up delay  $t_s$  is complete. If a phase failure occurs, the tripping delay  $t_v$  starts. When timing is complete, the output relay de-energizes. As soon as the voltage returns to the tolerance range, timing of  $t_s$  starts. When timing is complete, the output relay re-energizes automatically. The yellow LED glows when the output relay is energized.

### CM-PVE

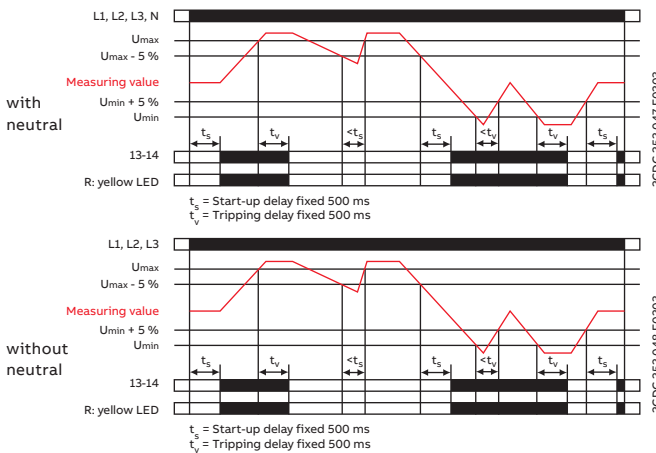

#### Phase failure, under- / overvoltage detection

If all phases (and the neutral) are present with correct voltage, the output relay energizes after the start-up delay  $t_s$  is complete. If the voltage exceeds or falls below the fixed threshold value or if a phase failure occurs, the tripping delay  $t_v$  starts. When timing is complete, the output relay de-energizes. As soon as the voltage returns to the tolerance range, timing of  $t_s$  starts. When timing is complete, the output relay re-energizes automatically. The yellow LED glows when the output relay is energized.

### CM-PFE, CM-PFE.2

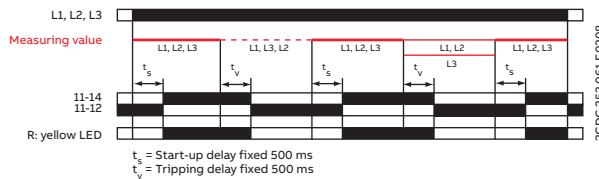

#### Phase failure detection, phase sequence monitoring

If all phases are present with the correct phase sequence, the output relay energizes after the start-up delay  $t_s$  is complete. If a phase failure or a phase sequence error occurs, the tripping delay  $t_v$  starts. When timing is complete, the output relay de-energizes. The yellow LED glows when the output relay is energized.

In case of motors which continue running with only two phases, the CM-PFE detects phase failure if the reverse fed voltage is less than 60 % of the originally applied voltage.

### CM-PFS

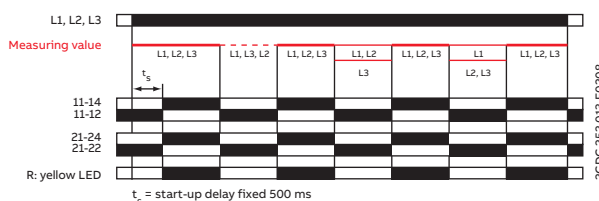

#### Phase failure detection, phase sequence monitoring

If all phases are present with the correct phase sequence, the output relay energizes after the start-up delay  $t_s$  is complete. If a phase failure or a phase sequence error occurs, the output relay de-energizes instantaneous. The yellow LED glows when the output relay is energized.

In case of motors which continue running with only two phases, the CM-PFS detects phase failure if the reverse fed voltage is less than 60 % of the originally applied voltage.

#### ATTENTION

If several CM-PFS units are placed side by side and the control supply voltage is higher than 415 V, spacing of at least 10 mm has to be kept between the individual units.

# Three-phase monitoring relays

## Function diagrams

### CM-PSS.xx, CM-PVS.xx, CM.PAS.xx, CM-MPS.xx, CM-MPN.xx

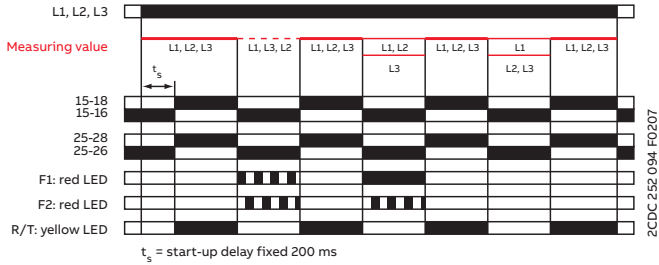

#### Phase sequence monitoring and phase failure detection

Applying control supply voltage begins the fixed start-up delay  $t_s$ . When  $t_s$  is complete and all phases are present with correct voltage, the output relays energize and the yellow LED R/T glows.

#### Phase sequence monitoring

If phase sequence monitoring is activated, the output relays de-energize as soon as a phase sequence error occurs. The fault is displayed by alternated flashing of the LEDs F1 and F2. The output relays re-energize automatically as soon as the phase sequence is correct again.

#### Phase failure detection

The output relays de-energize instantaneous if a phase failure occurs. The fault is indicated by lighting of LED F1 and flashing of LED F2. The output relays re-energize automatically as soon as the voltage returns to the tolerance range.

### CM-MPS.11, CM-MPS.21, CM-MPS.23

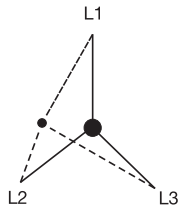

Displacement of the star point

#### Interrupted neutral monitoring

The interruption of the neutral in the main to be monitored is detected by means of phase unbalance evaluation. Determined by the system, in case of unloaded neutral (i.e. symmetrical load between all three phases) it may happen that an interruption of the neutral will not be detected. If the star point is displaced an asymmetrical load in the three-phase main, an interrupted neutral will be detected.

# Three-phase monitoring relays

## Function diagrams

### CM-MPS.x3, CM-MPN.x2

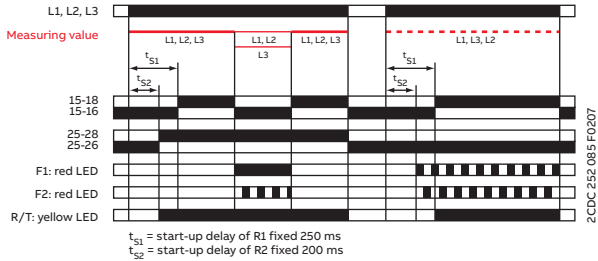

### Automatic phase sequence correction

This function can be selected only if phase sequence monitoring is activated  and operating mode 2x1 c/o (SPDT) contact  is selected.

Applying control supply voltage begins the fixed start-up delay  $t_{s1}$ . When  $t_{s1}$  is complete and all phases are present with correct voltage, output relay R1 energizes. Output relay R2 energizes when the fixed start-up delay  $t_{s2}$  is complete and all phases are present with the correct phase sequence. Output relay R2 remains de-energized if the phase sequence is incorrect.

If the voltage to be monitored exceeds or falls below the set threshold values for phase unbalance, over- or undervoltage or if a phase failure occurs, output relay R1 de-energizes and the LEDs F1 and F2 indicate the fault. Output relay R2 is responsive only to a false phase sequence. In conjunction with a reversing contactor combination, this enables an automatic correction of the rotation direction. See circuit diagrams on the right.

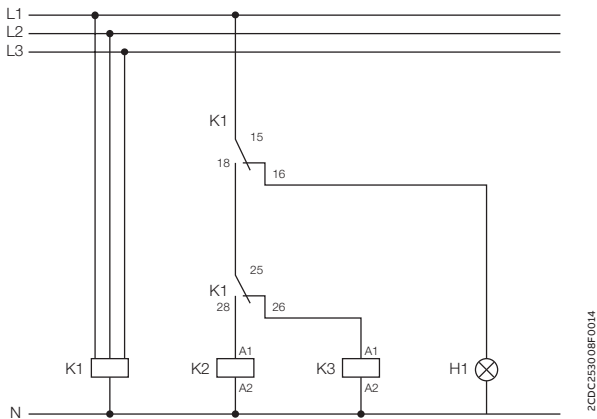

Control circuit diagram  
(K1 = CM-MPS.23)

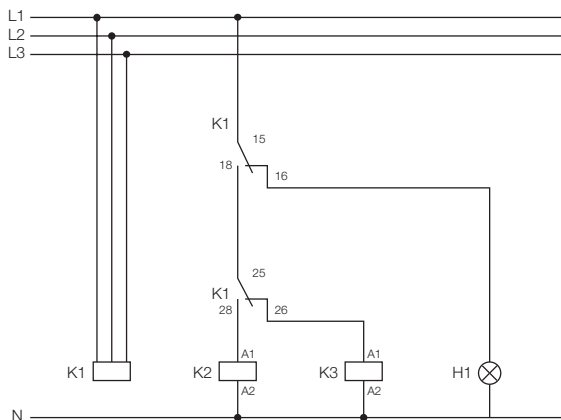

Control circuit diagram  
(K1 = CM-MPS.43 or CM-MPN.xx)

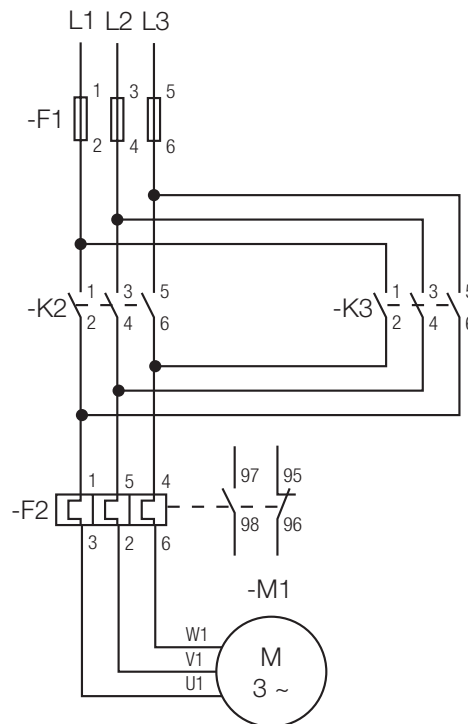

Power circuit diagram

# Three-phase monitoring relays

## Function diagrams

CM-PSS.xx (1), CM-PVS.xx (2), CM-MPS.xx (2), CM-MPN.xx (2)

### ON-delay ☒, 1x2 c/o contacts [1x2 c/o]

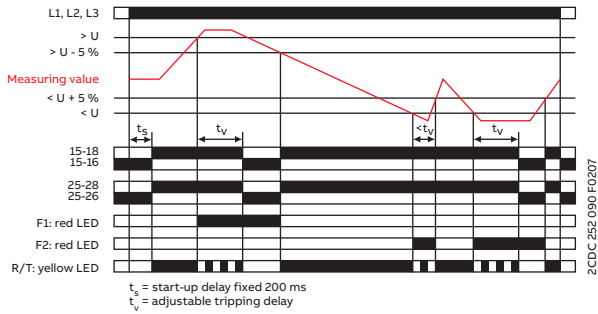

### Over- and undervoltage monitoring [1x2 c/o]

Applying control supply voltage begins the fixed start-up delay  $t_s$ . When  $t_s$  is complete and all phases are present with correct voltage and with the correct phase sequence, the output relays energize and the yellow LED R/T glows.

#### Type of tripping delay = ON-delay

If the voltage to be monitored exceeds or falls below the fixed (1) or set (2) threshold value, the output relays de-energize after the set tripping delay  $t_v$  is complete. The LED R/T flashes during timing and turns off as soon as the output relays de-energize.

The output relays re-energize automatically as soon as the voltage returns to the tolerance range, taking into account a fixed hysteresis of 5 % and the LED R/T glows.

### OFF-delay ■, 1x2 c/o contacts [1x2 c/o]

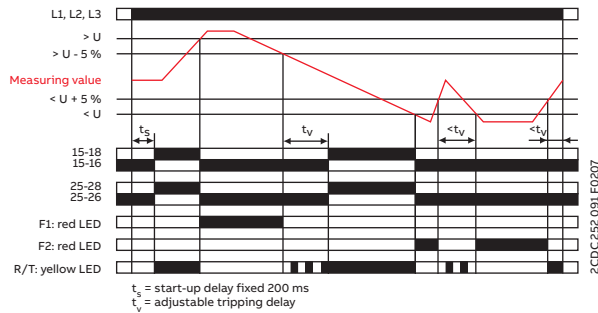

#### Type of tripping delay = OFF-delay

If the voltage to be monitored exceeds or falls below the fixed (1) or set (2) threshold value, the output relays de-energize instantaneously and the LED R/T turns off. As soon as the voltage returns to the tolerance range, taking into account a fixed hysteresis of 5 %, the output relays re-energize automatically after the set tripping delay  $t_v$  is complete. The LED R/T flashes during timing and turns steady when timing is complete.

# Three-phase monitoring relays

## Function diagrams

### CM-MPS.x3, CM-MPN.x2

#### ON-delay , 2x1 c/o contact

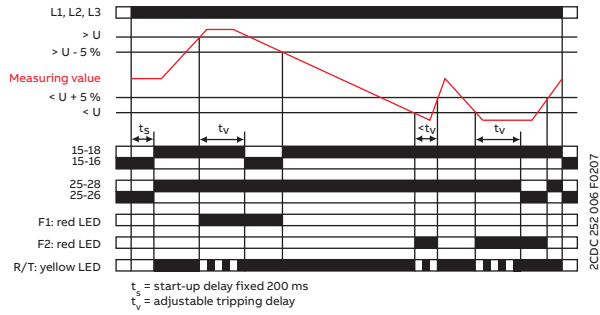

#### Over- and undervoltage monitoring

Applying control supply voltage begins the fixed start-up delay  $t_s$ . When  $t_s$  is complete and all phases are present with correct voltage and with the correct phase sequence, the output relays energize. The yellow LED R/T glows as long as at least one output relay is energized.

#### Type of tripping delay = ON-delay

If the voltage to be monitored exceeds or falls below the set threshold value, output relay R1 (overvoltage) or output relay R2 (undervoltage) de-energizes after the set tripping delay  $t_v$  is complete. The LED R/T flashes during timing.

The corresponding output relay re-energizes automatically as soon as the voltage returns to the tolerance range, taking into account a fixed hysteresis of 5 %.

#### OFF-delay , 2x1 c/o contact

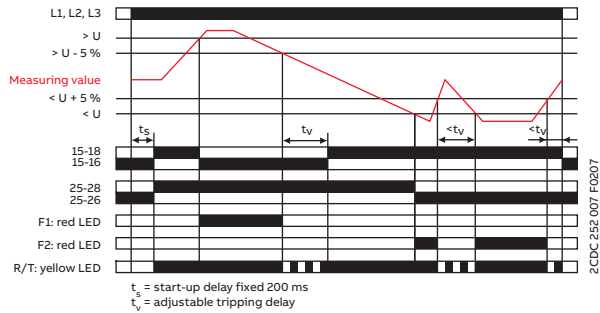

#### Type of tripping delay = OFF-delay

If the voltage to be monitored exceeds or falls below the set threshold value, output relay R1 (overvoltage) or output relay R2 (undervoltage) de-energizes instantaneously.

As soon as the voltage returns to the tolerance range, taking into account a fixed hysteresis of 5 %, the corresponding output relay re-energizes automatically after the set tripping delay  $t_v$  is complete. The LED R/T flashes during timing.

# Three-phase monitoring relays

## Function diagrams

CM-PAS.xx, CM-MPS.xx, CM-MPN.xx

### ON-delay ☒

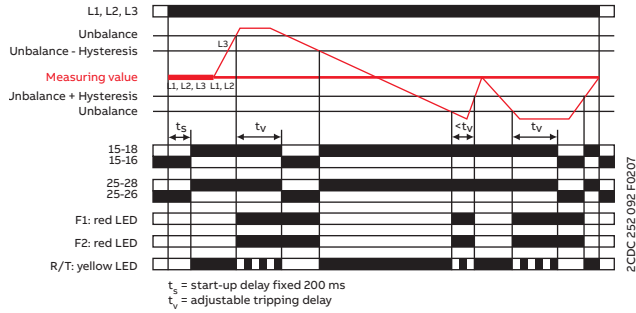

### Phase unbalance monitoring

Applying control supply voltage begins the fixed start-up delay  $t_s$ . When  $t_s$  is complete and all phases are present with correct voltage and with the correct phase sequence, the output relays energize and the yellow LED R/T glows.

### Type of tripping delay = ON-delay

If the voltage to be monitored exceeds or falls below the set phase unbalance threshold value, the output relays de-energize after the set tripping delay  $t_v$  is complete. The LED R/T flashes during timing and turns off as soon as the output relays de-energize.

The output relays re-energize automatically as soon as the voltage returns to the tolerance range, taking into account a fixed hysteresis of 20 % and the LED R/T glows.

### OFF-delay ■

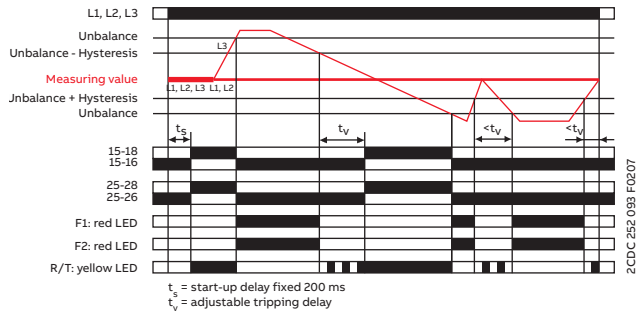

### Type of tripping delay = OFF-delay

If the voltage to be monitored exceeds or falls below the set phase unbalance threshold value, the output relays de-energize instantaneously and the LED R/T turns off. As soon as the voltage returns to the tolerance range, taking into account a fixed hysteresis of 20 %, the output relays re-energize automatically after the set tripping delay  $t_v$  is complete. The LED R/T flashes during timing and turns steady when timing is complete.

## Three-phase monitoring relays

### Function diagrams

CM-PSS.xx, CM-PSV.xx, CM-PAS.xx, CM-MPS.xx, CM-MPN.xx

#### LED functions

Function	R/T: yellow LED	F1: red LED	F2: red LED
Control supply voltage applied, output relay energized		-	-
Tripping delay t <sub>v</sub> active		-	-
Phase failure	-		
Phase sequence	-	alternating	
Overvoltage	-		-
Undervoltage	-	-	
Phase unbalance	-		
Interruption of the neutral	-		
Adjustment error			

#### Possible wrong adjustments of the front-facing operating controls

Overlapping of the threshold values:

- An overlapping of the threshold values is given if the threshold value for overvoltage is set to a smaller value than the threshold value for undervoltage.
- DIP switch 3 = OFF
- DIP switch 4 = ON: Automatic phase sequence correction is activated and selected operating mode is 1x2 c/o contacts
- DIP switch 2 and 4 = ON: Phase sequence detection is deactivated and the automatic phase sequence correction is activated

#### Type of tripping delay

The type of tripping delay / can be adjusted via a rotary (CM-PxS.xx) or a DIP switch (CM-MPx.xx).

#### Switch position ON-delay :

In case of a fault, the de-energizing of the output relays and the respective fault message are suppressed for the adjusted tripping delay t<sub>v</sub>.

#### Switch position OFF-delay :

In case of a fault, the output relays de-energize instantaneously and a fault message is displayed and stored for the length of the adjusted tripping delay t<sub>v</sub>. Thereby, also momentary undervoltage conditions are recognized.





---

# Grid feeding monitoring relays

## Table of contents

<b>138</b>	<b>Benefits and advantages</b>
<b>143</b>	<b>Operating controls</b>
<b>144</b>	<b>Selection table</b>
<b>145</b>	<b>Ordering details</b>
<b>146</b>	<b>Technical data</b>
<b>147</b>	<b>Technical diagrams</b>

# Grid feeding monitoring relays

## Benefits and advantages



ABB's grid feeding monitoring relays detect unusual events in the public power grid and keeps it stable by automatically disconnecting and reconnecting the renewable power plant. The CM-UFD displays all relevant measuring data and events and can communicate them via a build-in communication interface. The cloud-based service Ability™ EDCS enables customers to monitor the conditions in real-time, send the values into the cloud and access the diagnostics remotely.



### Optimum interface

#### Reduce downtime by up to 70%

Operate the device via LCD or remotely with the Modbus RTU. Users are informed immediately in case of an event in the public grid. Redundant microcontrollers ensure reliable measuring values and tripping.



### Global availability

#### Cut installation time by up to 60%

There's no need to learn every possible adjustment and its effects on your system – ABB's trained staff supports your business and answers your technical questions promptly.



### Easy installation

#### Commission & configure up to 60% faster

Simple instructions, presets for local grid feeding standards, and ABB's intuitive menu structure make installation quicker. Commissioning and troubleshooting errors are prevented.

# Grid feeding monitoring relays

## Benefits and advantages



ABB's CM-UFD range are multi-functional grid feeding monitoring relays, installed between the renewable energy system and the public grid. The innovative relays guarantee grid stability and prevent blackouts. If the public grid's voltage or frequency moves out of the permitted ranges, the device uses a decoupling unit (e.g. contactor or breaker Tmax XT) to separate the renewable energy system from the public grid. As soon as the grid is stable again, the system is automatically reconnected.

The CM-UFD range provides different monitoring functions in accordance with several local grid feeding standards to detect over-/undervoltage and over-/underfrequency.

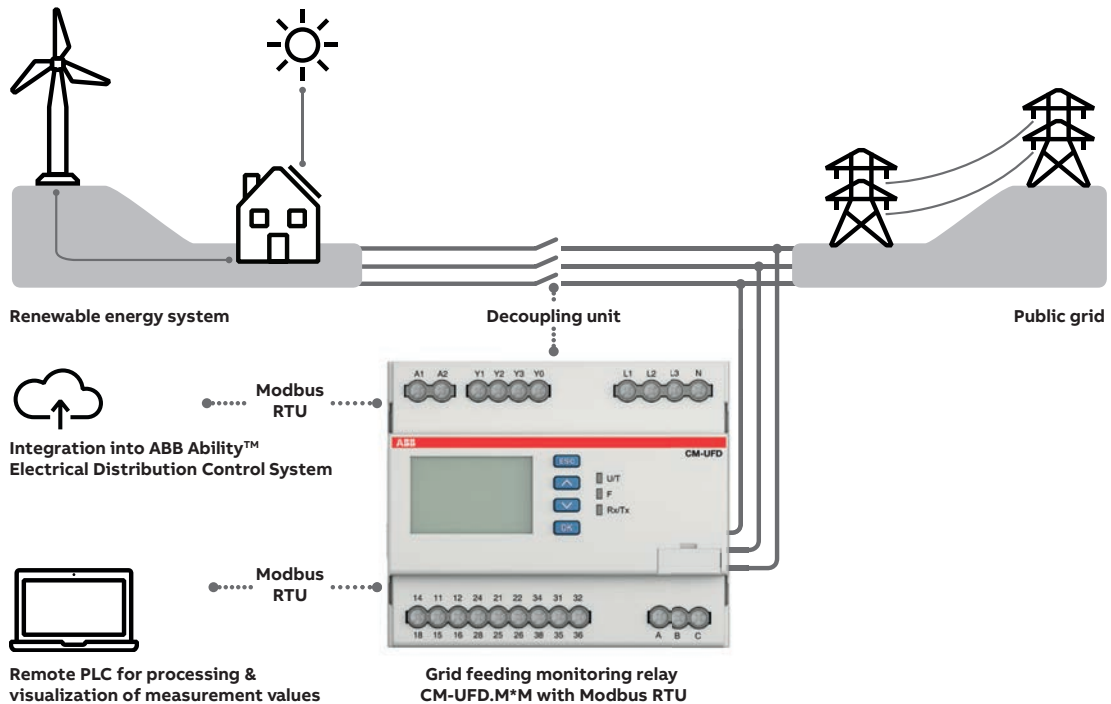

### Advantages

- Highly accurate measurement and setting
- Modbus RTU communication interface and ABB Ability™ EDCS connectivity
- Functional safety - single fault tolerances
- Clear multiline, backlit LCD
- Intuitive and user-friendly menu
- Event storage
- Pre-settings meet several local standards
- Type-tested to a number of local grid feeding standards by TÜV Süd



### Functionality

The device measures the ten-minute average value, voltage increases and decreases, as well as any changes in grid frequency. The rate of change of frequency (ROCOF) and vector shift monitoring to detect a loss of mains event can be easily configured.

---

ABB ABILITY™ EDCS

Monitor your renewable energy plant remotely with ABB's smart ABB Ability™ EDCS cloud platform.



# Grid feeding monitoring relays

## Benefits and advantages

The cloud-based service Ability™ EDCS enables customers to monitor the condition of CM-UFD.M\*M in real-time and access the diagnostics remotely. This functionality is very important when operating in the field of critical power. Parametrize with ABB Ekip Connect and access data no matter where you are.

### Example architecture

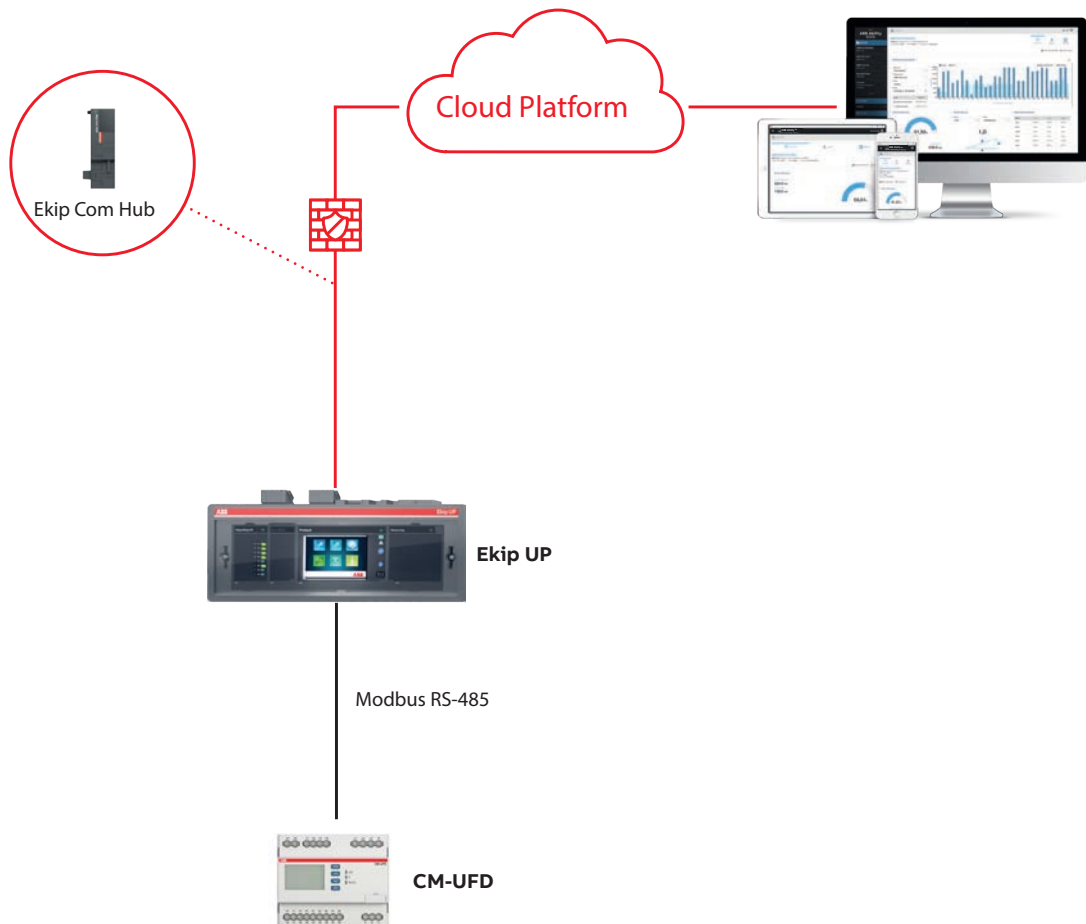

The grid feeding monitoring relays can be connected to the cloud directly by using Ekip Com Hub module. Another option is to connect via Modbus RTU when there is some other device equipped with the Ekip Com Hub like the Emax 2 air-circuit breaker.

In addition to the Ekip Connect 3 software, the following hardware is required:

- Ekip UP (min. firmware 2.23)
- Ekip Com Hub (min. firmware 1.18)
- Ekip Com Modbus RTU (min. firmware 2.28)
- Ekip Supply
- Ekip T&P cable
- CM-UFD.M\*M (min. firmware 1.0.1)



For further information regarding integration into ABB Ability™ EDCS, please use the application note "2CDC112280M0101 CM-UFD.M\*M integration into ABB Ability™ EDCS".

# Grid feeding monitoring relays

## Benefits and advantages

A reliable solution that takes country-specific requirements into account: the range is already pre-set to local requirements, making installation quick and simple. The devices can also be set manually with the display and used all over the world.



### Pre-set devices

In accordance with a number of local standards, the CM-UFD relays can be used in all low voltage plants and in medium voltage plants.



### Type-tested

To ensure reliability and compliance, the range is type-tested to local standards by the third party authority TÜV Süd.

— Countries with a dedicated local standard (in red)

— Countries referring to an existing local standard or using a product with reference to another dedicated standard (in grey)

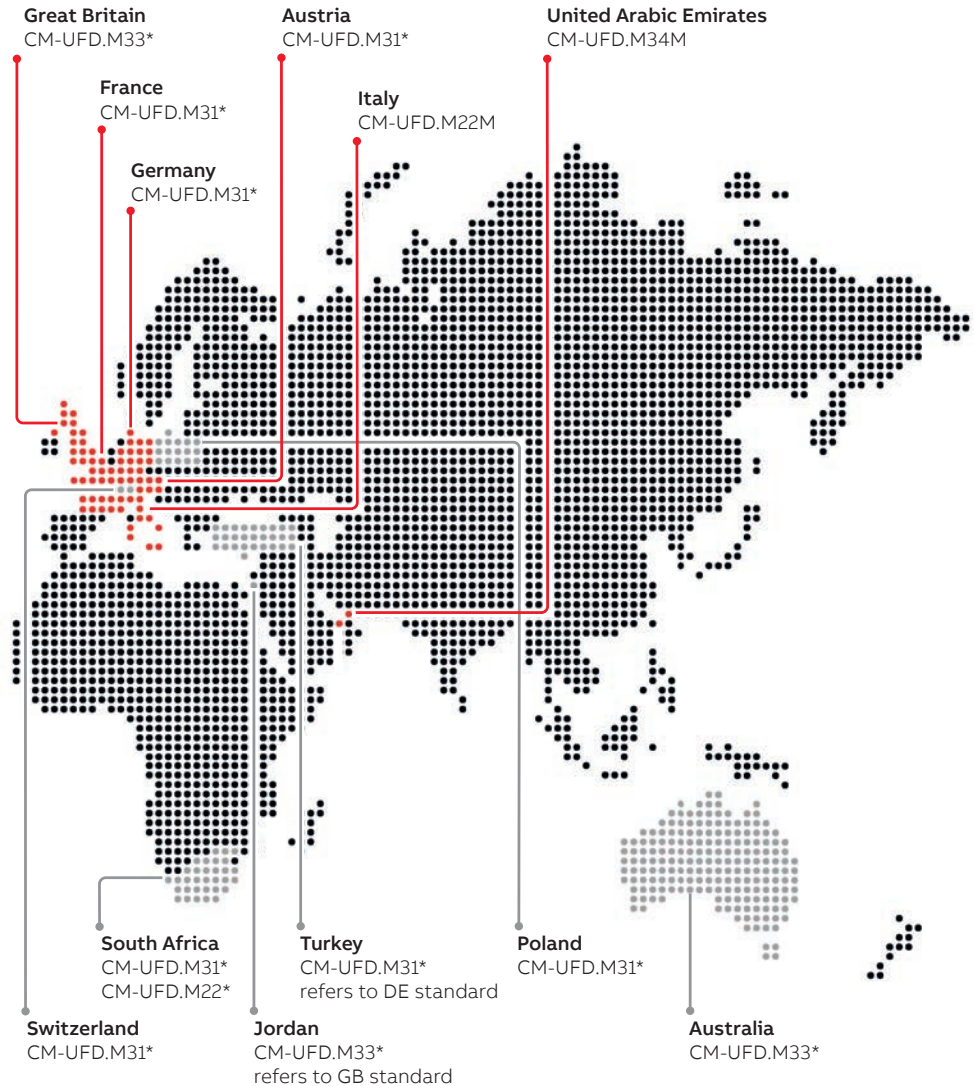

# Grid feeding monitoring relays

## Operating controls

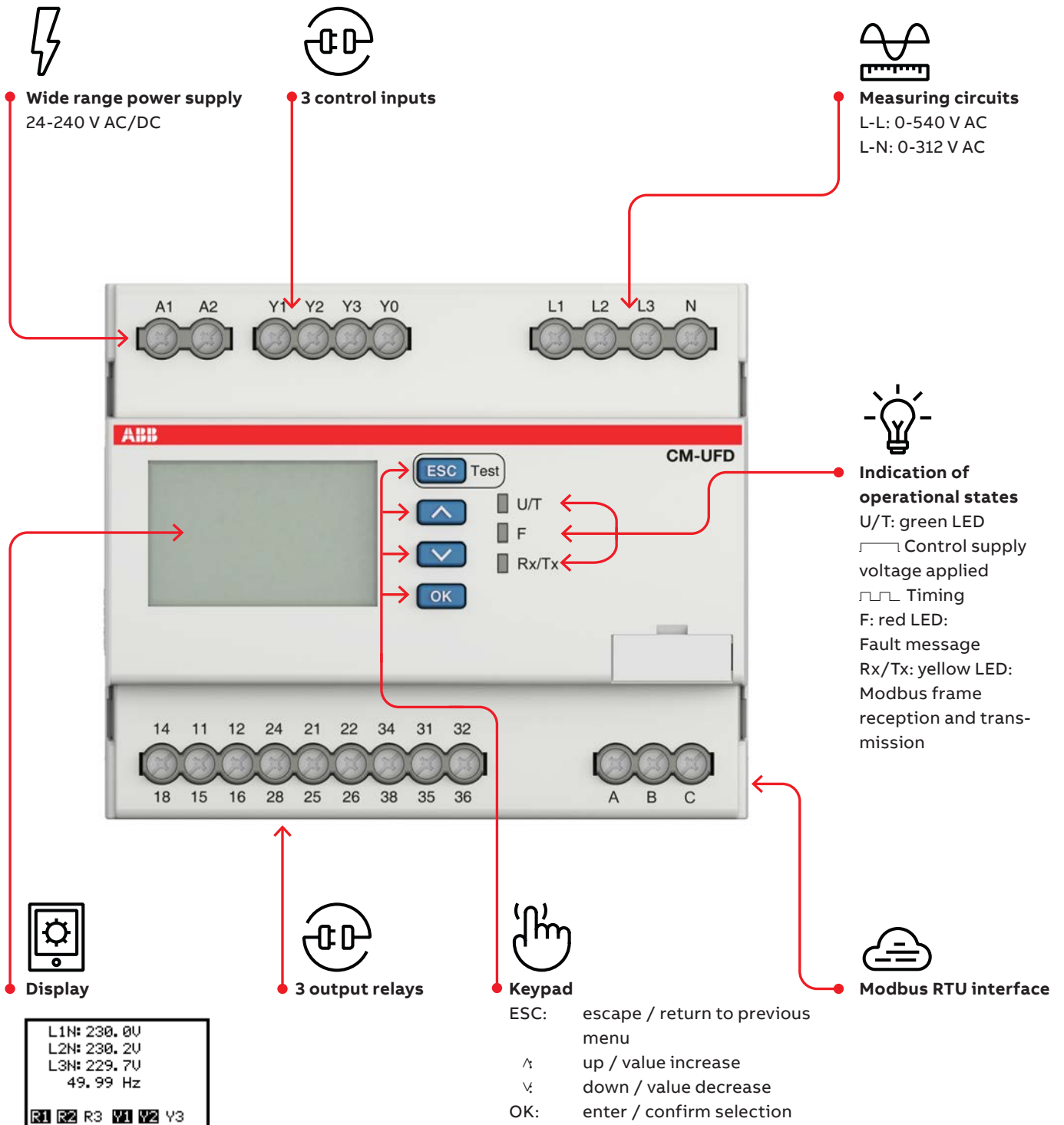

# Grid feeding monitoring relays

## Selection table

	Type	Order number				
	CM-UFD.M22M	1SVR560731R3700				
	CM-UFD.M31	1SVR560730R3401				
	CM-UFD.M31M	1SVR560731R3701				
	CM-UFD.M33	1SVR560730R3402				
	CM-UFD.M33M	1SVR560731R3702				
	CM-UFD.M34M	1SVR560731R3703				
<b>Rated control supply voltage <math>U_c</math></b>						
24-240 V AC/DC			■	■	■	■
<b>Standard</b>						
CEI 0-21			■			
VDE AR-N 4105, VDE AR-N 4110				■	■	
ENA G98, G99					■	■
DRRG standard of DEWA						■
<b>Rated frequency</b>						
DC or 50 Hz			■	■	■	
DC or 50/60 Hz					■	■
<b>Modbus RTU</b>						
			■		■	■
<b>Suitable for monitoring</b>						
Single-phase mains			■	■	■	■
Three-phase mains			■	■	■	■
<b>Monitoring function</b>						
Over-/undervoltage			■	■	■	■
Over-/underfrequency			■	■	■	■
ROCOF (rate of change of frequency)			■	■	■	■
10 minutes average value			■	■	■	■
Vector shift				■	■	■
<b>Thresholds</b>						
			adj	adj	adj	adj



## Grid feeding monitoring relays

### Ordering details



CM-UFD.M\*M

#### Description

The grid feeding monitoring relays CM-UFD.M\*M are designed to monitor the voltage and the frequency of the public low voltage or medium voltage grid. Whenever the measured values are not within the range of the adjusted threshold values, the CM-UFD.M\*M causes tripping of the section switch (consisting of 1 or 2 switching devices according to the applicable standard). This tripping disconnects the power generation, such as photovoltaic systems, wind turbines, block-type thermal power stations from the grid.

#### Ordering details

Description	Type	Order code	Weight (1 pc) kg (lb)
See selection table	CM-UFD.M22M	1SVR560731R3700	0.312 (0.688)
	CM-UFD.M31	1SVR560730R3401	0.304 (0.670)
	CM-UFD.M31M	1SVR560731R3701	0.312 (0.688)
	CM-UFD.M33	1SVR560730R3402	0.304 (0.670)
	CM-UFD.M33M	1SVR560731R3702	0.312 (0.688)
	CM-UFD.M34M	1SVR560731R3703	0.312 (0.688)

# Grid feeding monitoring relays

## Technical data

**ABB**

**DATA SHEET**

**Grid feeding monitoring according to CEI 0-21**  
CM-UFD.M22M with Modbus RTU

The CM-UFD.M22M with Modbus RTU is a multifunctional grid feeding monitoring relay. It provides different monitoring functions in accordance with CEI 0-21 to detect over- and under-voltage (30-minutes average value, voltage increase and decrease protection) as well as any changes in grid frequency (frequency increase and decrease protection).

The device is connected between the distributed generation and the public grid in order to disconnect the distributed generation in case of problems (e.g. unstable grid, faults or maintenance on the grid). Additionally, monitoring of ROCOF (rate of change of frequency) can be configured.



New with ABB Ability™

**Characteristics**

- Monitoring of voltage and frequency in single- and three-phase mains (2-wire, 3-wire or 4-wire AC systems)
- Type tested in accordance with CEI 0-21
- Pre-Settings in accordance with CEI 0-21
- Integrated management of redundancy function (acc. to CEI 0-21, mandatory in plants with PFC (DRM))
- Modbus RTU communication interface
- Multiline, backlit LCD display
- True RMS measuring principle
- Over- and under-voltage, 30-minutes average value as well as over- and under-frequency monitoring
- Two-level threshold settings for over/under-voltage and over/under-frequency
- ROCOF (rate of change of frequency) monitoring configurable
- Integrated neutral detection
- All threshold values and tripping delays adjustable
- Error memory for up to 99 errors (incl. cause of error, measured value, relative tripping)
- Autoreset Function
- Password setting protection
- 3 control inputs, e.g. for feedback signal, remote trip
- 3 I/O (DI/DO) contacts
- Can be connected to ABB Ability™ Electrical Distribution Control Systems (see EDCS Getting Started, document no. 1SDC2000080004)
- Various certifications and approvals (see overview, document no. 1SDC112280M0101)

**Ordering details**

Type	Rated control supply voltage	Measuring range	Order code
CM-UFD.M22M	230 V AC	0.5 kV to 24 kV AC, 0.5 kV to 24 kV AC	1SVR560731R3700

### Data sheets

For every product of the CM-UFD range, a technical data sheet is available.

- Operating control and mode
- Operating principles
- Modbus RTU functionality where available
- Electrical connection
- Configuration and settings
- Menu structure
- Display and failure messages
- Connection and wiring
- Technical data
- Technical diagrams
- CAS system files

### Ordering data and data sheet numbers

Description	Type	Order code	Data sheet number
	CM-UFD.M22M	1SVR560731R3700	2CDC112258D0201
	CM-UFD.M31	1SVR560730R3401	2CDC112208D0201
	CM-UFD.M31M	1SVR560731R3701	2CDC112270D0201
	CM-UFD.M33	1SVR560730R3402	2CDC112210D0201
	CM-UFD.M33M	1SVR560731R3702	2CDC112271D0201
	CM-UFD.M34M	1SVR560731R3703	2CDC112272D0201



For further information regarding integration into ABB Ability™ EDCS, please use the application note "2CDC112280M0101 CM-UFD.M\*M integration into ABB Ability™ EDCS".

# Grid feeding monitoring relays

## Technical diagrams

Example of a single-phase application

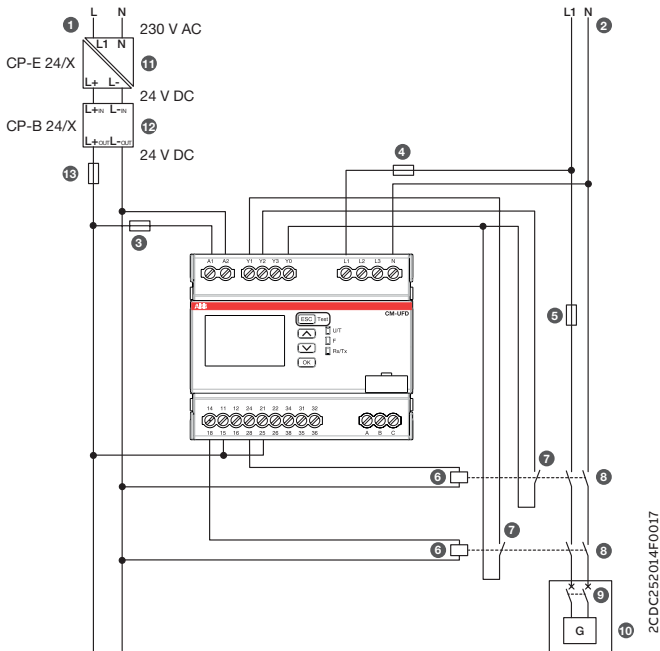

Example of a three-phase application

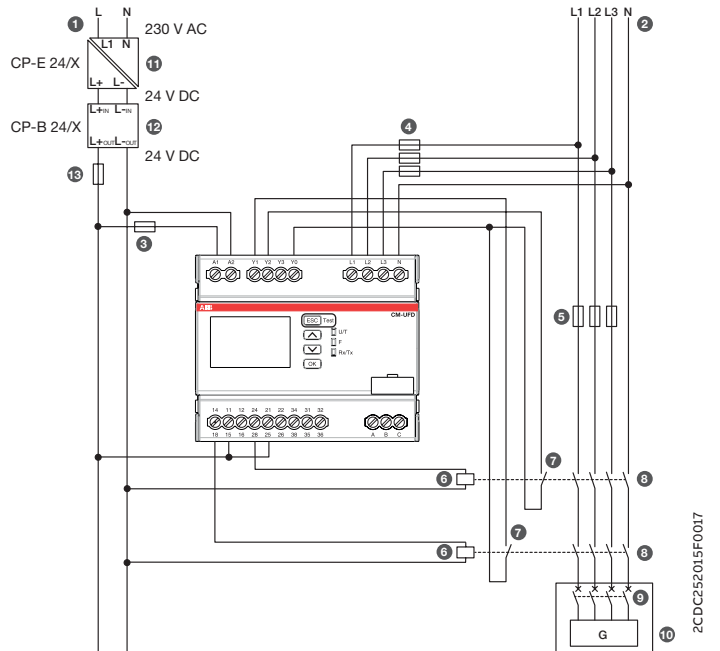

### Legend

1. Control supply voltage for CM-UFD.M\*M
2. Public grid
3. Protection fuse for the CM-UFD.M\*M
4. Protection fuse for the measuring circuit of the CM-UFD.M\*M (optional)
5. Short-circuit protection
6. Undervoltage release
7. Control input for feedback function
8. Switching device of the section switch
9. Switching device of the generator and/or inverter
10. Generator and/or inverter
11. Primary switch mode power supply unit CP-E (230 V AC / 24 V DC) for the buffer module CP-B
12. Ultra-capacitor based buffer module CP-B (24 V DC in/out)
13. Wire protection fuse for the output of the buffer module CP-B

# Grid feeding monitoring relays

## Technical diagrams

### Load limits curves

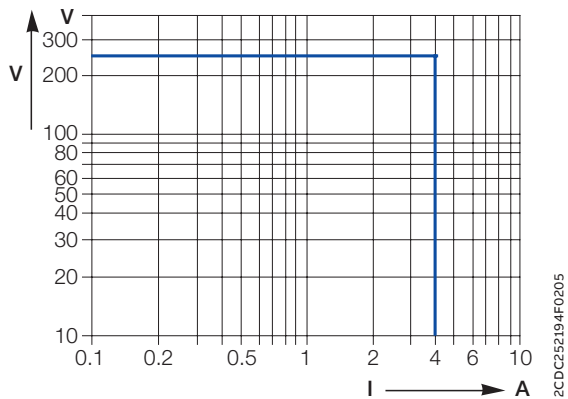

AC load (resistive)

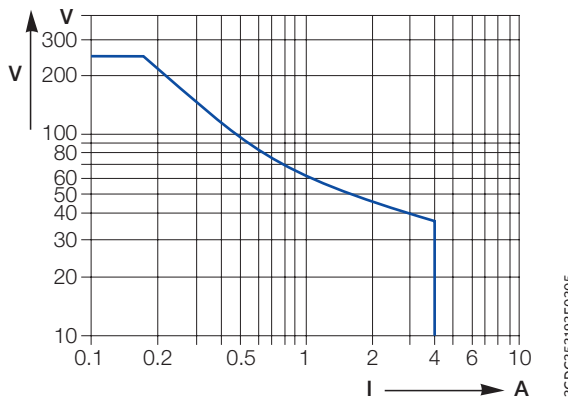

DC load (resistive)

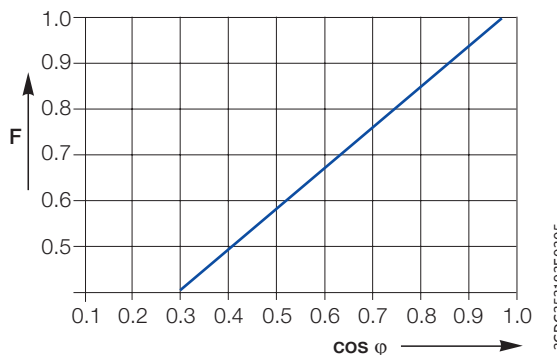

Derating factor F at inductive AC load

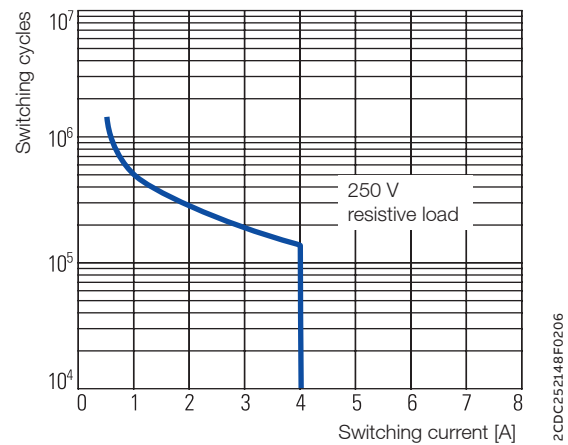

Contact lifetime

### Dimensional drawings in mm and inches

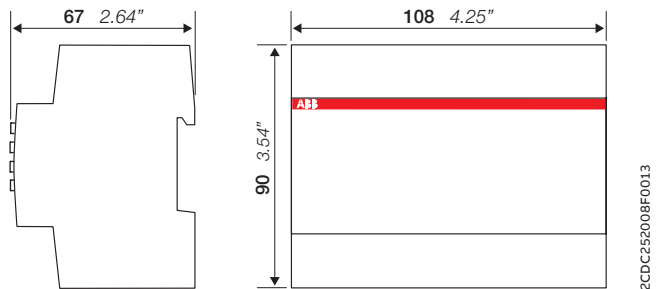





---

# Insulation monitoring relays for unearthed supply systems

## Table of contents

<b>152</b>	<b>Benefits and advantages</b>
<b>156</b>	<b>Applications</b>
<b>157</b>	<b>Operating controls</b>
<b>160</b>	<b>Selection table</b>
<b>161</b>	<b>Ordering details</b>
<b>162</b>	<b>Technical data</b>
<b>169</b>	<b>Technical diagrams</b>

# Insulation monitoring relays

## Benefits and advantages



The insulation monitoring relays of the CM-IWx range guarantee a continuous insulation monitoring of an IT system. The devices recognize insulation faults as they develop and warn immediately if the value has fallen below the minimum set threshold. This ensures a reliable operation of the system and prevents operational interruption caused by a second, more severe, insulation fault which may lead to a short circuit tripping the main circuit breaker.



### Continuous operation

Keep the system online and reduce downtime with early pre-warnings which enable time for maintenance planning. Monitor voltage free networks for early fault detection. Due to variants with rail and ship approval, the devices have a wide range of applications.



### Safety and protection

Safe and reliable detection of insulation faults according to the latest standards is what ABB's insulation monitoring relays deliver. The portfolio extends from standard to more challenging applications and can prevent fire due to fast and reliable earth fault detection. Built-in self-diagnosis and interrupted wire detection further ensure safety.



### Easy installation

Read the status of the relay at a glance: clear visualization of the device status via LEDs. Easy to adjust with rotary wheels and variants with push-in terminals make a quick and easy installation and setting possible.



# Insulation monitoring relays

## Benefits and advantages



### Overview

The CM-IWx product family offers a convincing solution for monitoring ungrounded AC, AC/DC and DC networks according to EN/IEC 61557-8. An IT network is supplied either by an isolating transformer or a voltage source, such as a battery or generator. In these systems, no active conductor is directly connected to earth potential.

The high reliability of an IT system is guaranteed thanks to continuous insulation monitoring. The insulation monitoring device recognizes insulation faults (at least one conductor has a galvanic connection to earth potential) as they develop and immediately reports if the insulation resistance has fallen below a given threshold. Therefore, maintenance activities can be scheduled and executed while the plant keeps running.



### Main benefits

- Increase plant availability and avoid costly unplanned stops of a plant / machine by quickly detecting faults first
- Prevents fires due to detection of a creeping deterioration of the insulation resistance
- The adjustment of the setting values is simple and done in a user-friendly way with rotary switches on the front of the device
- Device status is displayed with LEDs that are easy to read and understand
- Devices for standard and more challenging applications are available
- Variants with rail and ship approvals are available



# Insulation monitoring relays

## Benefits and advantages

### CM-IWS.1 – for unearthed pure AC systems



The CM-IWS.1 serves to monitor insulation resistance in accordance with IEC 61557-8 in unearthed IT AC systems, IT AC systems with galvanically connected DC circuits, or unearthed IT DC systems with a voltage up to 250 V AC and 300 V DC. It can be configured to the requirements of the applications and therefore has multi-functional uses. The device is available with two different terminal versions. You can choose between the proven screw connection technology (double-chamber cage connection terminals) and the completely tool-free Easy Connect Technology (push-in terminals).

- For monitoring the insulation resistance of unearthed IT systems up to  $U_n = 250$  V AC and 300 V DC
- Test function
- According to IEC/EN 61557-8
- Rated control supply voltage 24-240 V AC/DC
- Prognostic measuring principle with superimposed square wave signal
- One measuring range 1-100 k $\Omega$
- 1 c/o (SPDT) contact, closed-circuit principle
- Precise adjustment by front-face operating controls in 1 k $\Omega$  steps
- Interrupted wire detection
- Fault storage / latching configurable by control input
- Screw connection or Easy Connect Technology available
- Housing material for highest fire protection classification UL 94 V-0
- Tool-free mounting on DIN rail as well as demounting
- 22.5 mm width
- 3 LEDs for status indication

### CM-IWS.2 – for unearthed AC, DC or mixed AC/DC systems



The CM-IWS.2 serves to monitor insulation resistance in accordance with IEC 61557-8 in unearthed IT AC systems with a voltage up to 400 V AC. The CM-IWS.2 can be configured to the requirements of the applications and therefore has multi-functional uses. The device is available with two different terminal versions. You can choose between the proven screw connection technology (double-chamber cage connection terminals) and the completely tool-free Easy Connect Technology (push-in terminals).

- For monitoring the insulation resistance of unearthed IT systems up to  $U_n = 400$  V AC
- Test function
- According to IEC/EN 61557-8
- Rated control supply voltage 24-240 V AC/DC
- Measuring principle with superimposed DC voltage
- One measuring range 1-100 k $\Omega$
- Fault storage / latching configurable by control input
- Precise adjustment by front-face operating controls in 1 k $\Omega$  steps
- Screw connection or Easy Connect Technology available
- Housing material for highest fire protection classification UL 94 V-0
- Tool-free mounting on DIN rail as well as demounting
- 1 c/o (SPDT) contact, closed-circuit principle
- 22.5 mm width
- 3 LEDs for status indication

# Insulation monitoring relays

## Benefits and advantages

### CM-IWN.1 – for unearthed AC, DC or mixed AC/DC systems



The CM-IWN.1 serves to monitor insulation resistance in accordance with IEC 61557-8 in unearthed IT AC systems, IT AC systems with galvanically connected DC circuits, or unearthed IT DC systems with a voltage up to 400 V AC and 600 V DC. The measuring range can be extended up to 690 V AC and 1000 V DC by using the coupling unit CM-IVN. It can be configured to the requirements of the applications and therefore has multi-functional uses. The CM-IWN.1 is available with two different terminal versions. You can choose between the proven screw connection technology (double chamber cage connection terminals) and the completely tool-free Easy Connect Technology (push-in terminals).

- For monitoring the insulation resistance of unearthed IT systems up to  $U_n = 400$  V AC and 600 V DC, expansion to 690 V AC and 1000 V DC with CM-IVN
- Test function
- According to IEC/EN 61557-8
- Rated control supply voltage 24-240 V AC/DC
- Prognostic measuring principle with superimposed square wave signal
- Two measuring ranges 1-100 k $\Omega$  and 2-200 k $\Omega$
- Precise adjustment of the measuring value in 1 or 2 kW steps
- One (1 x 2 c/o) or two (2 x 1 c/o) threshold values  $R_{an1}/R_1$  (warning) and  $R_{an2}/R_2$  (pre-warning) configurable(1)
- Precise adjustment of the threshold values in 1 k $\Omega$  steps (R1) and 2 k $\Omega$  steps (R2)
- Interrupted wire detection configurable
- Non-volatile fault storage configurable
- Open- or closed-circuit principle configurable
- Screw connection or Easy Connect Technology available
- Housing material for highest fire protection classification UL 94 V-0
- Tool-free mounting on DIN rail as well as demounting
- 45 mm width
- 3 LEDs for status indication

### CM-IWM.10 and CM-IWM.11 – for unearthed AC, DC or mixed AC/DC systems with up to 1500 V measurement voltage



The insulation monitors CM-IWM.10 and CM-IWM.11 provide the best and up-to-date insulation monitoring of modern IT systems in an optimum and state-of-the-art way fulfilling the relevant standards. The devices can be used in the most flexible way for AC, DC and AC/DC systems even with large leakage capacity to earth (PE). The adjustment of the setting values is simple and done in a user-friendly way on two rotary switches on the front of the device. Via LEDs the measured value, device parameters and device status are indicated easy to read.

- Insulation monitoring according to IEC/EN 61557-8
- Detection of symmetric and asymmetric insulation faults
- 1 c/o contact each for pre-warning and warning
- Measuring circuits can be disconnected via control terminals, e.g. for mains couplings
- Pre-warning threshold setting range: 20 k $\Omega$  ... 2 M $\Omega$
- Warning threshold setting range: 1 k $\Omega$  ... 250 k $\Omega$
- Open- or closed-circuit principle configurable
- Setting the maximum earth leakage capacitance to shorten the response time
- Simple, clearly arranged adjustment of the device with screwdriver
- LED chain to indicate the current insulation resistance
- Display of active measuring circuits
- Automatic and manual device self-test
- Alarm storage selectable
- External test and reset push button can be connected
- 90 mm width

# Insulation monitoring relays

## Applications

The CM-IWS.x and CM-IWN.x series provide excellent insulation monitoring for general purpose supply networks, such as:

- Non-earthed AC, DC, AC/DC networks
- UPS systems
- Battery networks
- Hybrid and battery-powered vehicles
- Railway applications

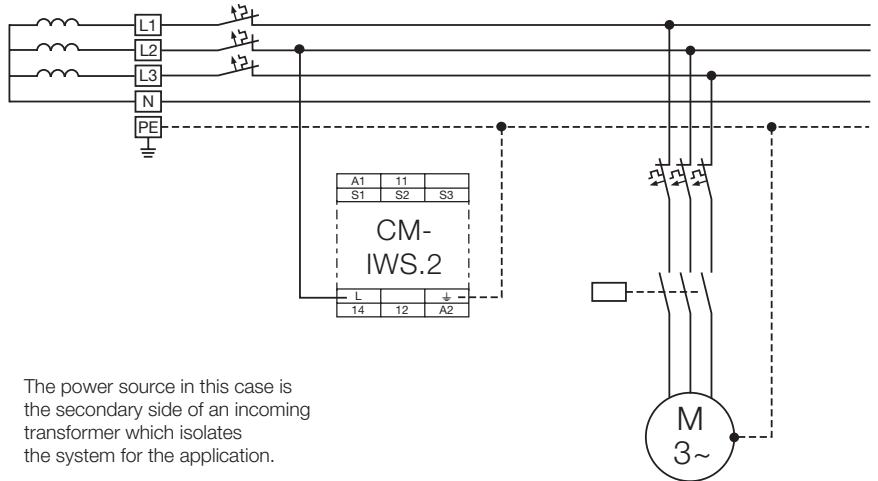

The power source in this case is the secondary side of an incoming transformer which isolates the system for the application.

Earth fault / insulation resistance monitoring of a 4-wire IT AC system with CM-IWS.2

CM-IWM.x can be additionally used in special applications, such as:

- Industrial networks with frequency inverters or direct current drives
- Photovoltaic systems with high system leakage capacitance
- Networks with system voltages up to 1500 V DC or 1100 V AC without requiring a coupling unit
- Installation on the AC or DC side of an inverter
- Networks which require measuring circuit deactivation in case two or more un-earthed networks are coupled

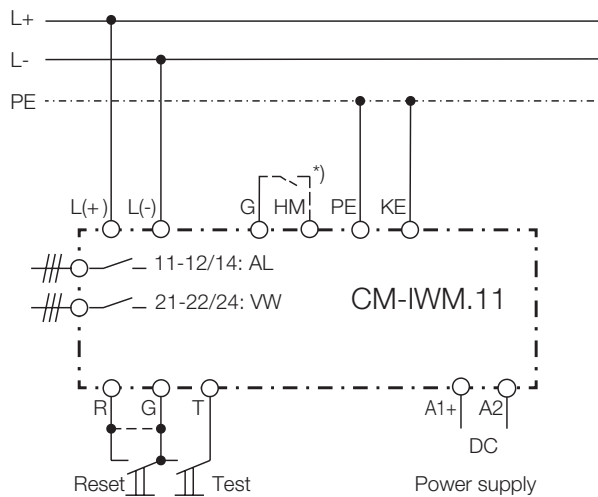

\*) G-HM connected: Measuring circuit is off

Example of a DC application with CM-IWM.11

Note:  
Only one insulation monitor must be connected and active in a network at the same time.

# Insulation monitoring relays

## Operating controls

### CM-IWM

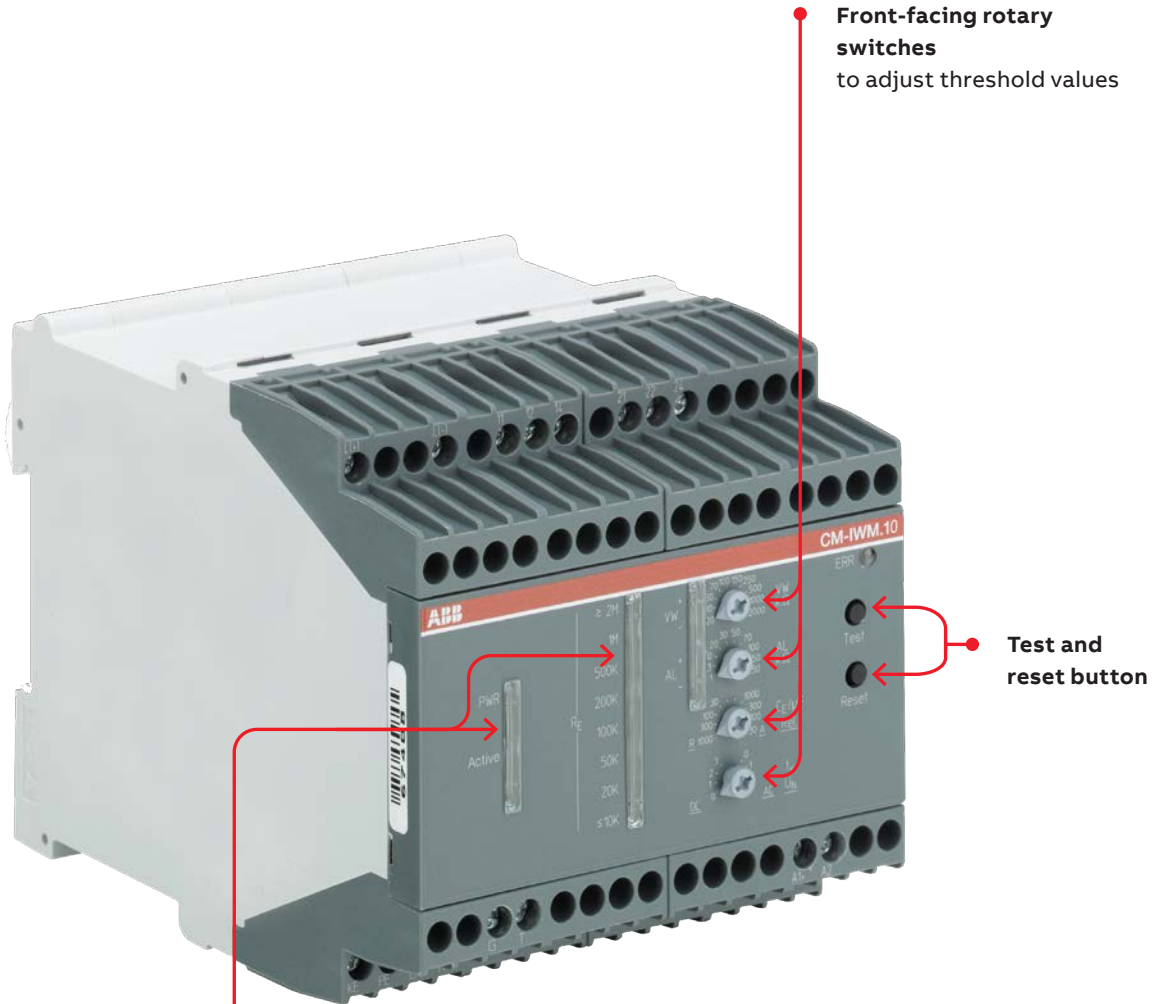

Indication of operational state and measured ground fault resistance

Front-facing rotary switches to adjust threshold values

Test and reset button

# Insulation monitoring relays

## Operating controls

### CM-IWS



Test and reset button



#### Configuration and setting

Front-face rotary switches for threshold value adjustment:

- R.1 for R1 tens figures: 0, 10, 20, 30, 40, 50, 60, 70, 80, 90 kΩ in ten kΩ steps
- R.2 for R1 units figures: 1, 2, 3, 4, 5, 6, 7, 8, 9, 10 kΩ in one kΩ steps

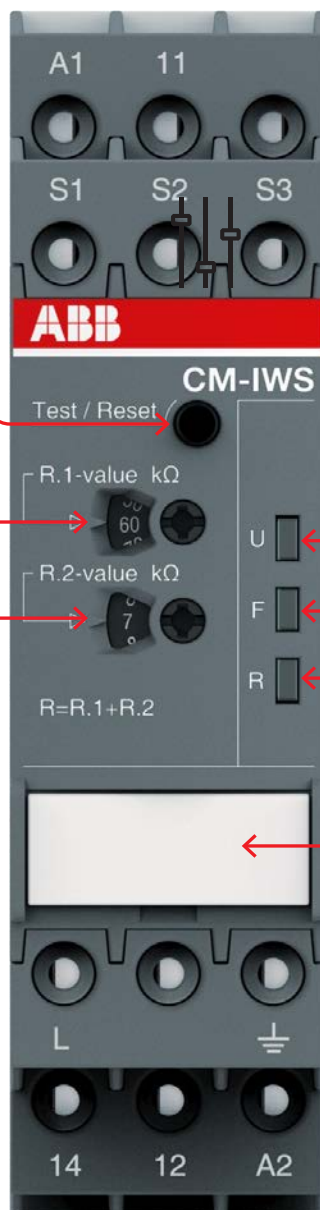

#### Indication of operational states

- U: green LED - control supply voltage
- F: red LED - fault message
- R: yellow LED - relay status



#### Marker label for devices without DIP switches

# Insulation monitoring relays

## Operating controls

### CM-IWN

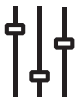

Front-face rotary switches to adjust the threshold value:

- R1.1 for R1 tens figure: 0, 10, 20, 30, 40, 50, 60, 70, 80, 90 kΩ in ten kΩ steps
- R1.2 for R1 units figure: 1, 2, 3, 4, 5, 6, 7, 8, 9, 10 kΩ in one kΩ steps
- R2.1 for R2 tens figure: 0, 20, 40, 60, 80, 100, 120, 140, 160, 180 kΩ in twenty kΩ steps
- R2.2 for R2 units figure: 2, 4, 6, 8, 10, 12, 14, 16, 18, 20 kΩ in two kΩ steps

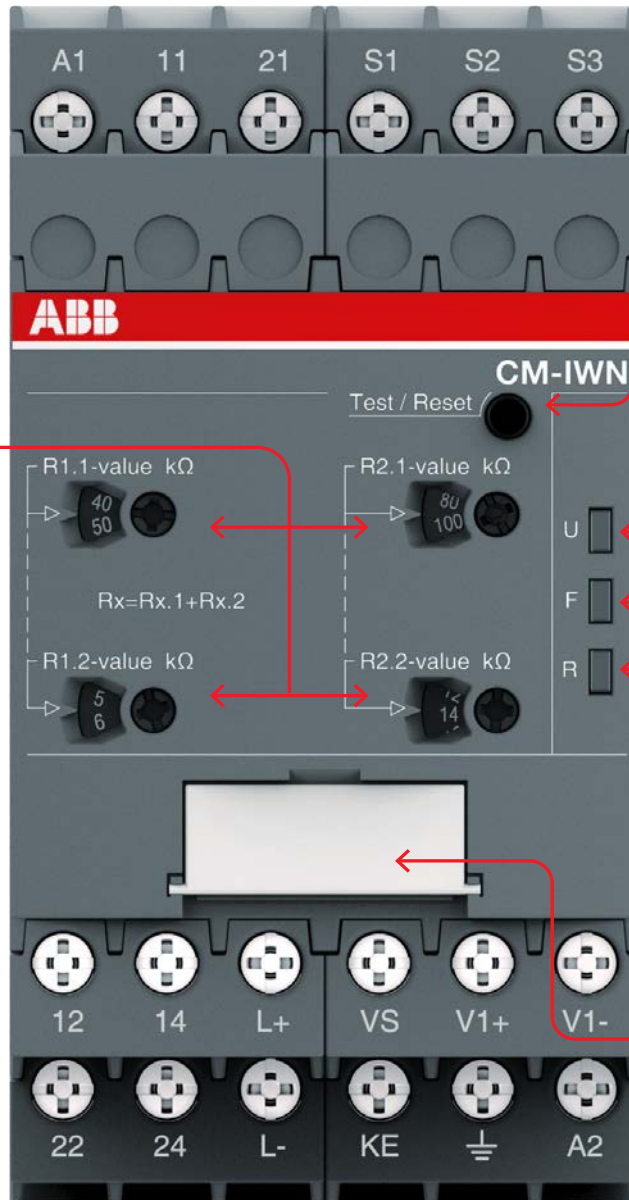

Test and reset button



Indication of operational states

- U: green LED – control supply voltage
- F1: red LED – fault message
- F2: yellow LED – relay status

DIP switches

(see DIP switch functions)

# Insulation monitoring relays

## Selection table

	Type	Order number							
	CM-IWS.2S	1SVR730670R0200							
	CM-IWS.2P	1SVR740670R0200							
	CM-IWS.1S	1SVR730660R0100							
	CM-IWS.1P	1SVR740660R0100							
	CM-IWN.1S	1SVR750660R0200							
	CM-IWN.1P	1SVR760660R0200							
	CM-IWM.10	1SVR470670R1000							
	CM-IWM.11	1SVR470670R1100							
<b>Rated control supply voltage U<sub>s</sub></b>									
24 - 240 V AC/DC			■	■	■	■	■	■	
24 V DC									■ ■
<b>Measuring voltages</b>									
250 V AC (L-PE)				■	■				
400 V AC (L-PE)		■	■			■	■		
690 V AC (L-PE)						■ (1)	■ (1)	■ (2)	
1000 V AC (L-PE)									■ (3)
300 V DC (L-PE)			■	■					
600 V DC (L-PE)						■	■		
690 V DC (L-PE)								■ (2)	
1000 V DC (L-PE)						■ (1)	■ (1)		■ (3)
<b>Measuring range</b>									
1 - 100 kΩ		■	■	■	■	■	■		
2 - 200 kΩ						■	■		
2 - 250 kΩ								■	■
<b>System leakage capacitance, max.</b>									
10 μF		■	■	■	■				
20 μF						■	■		
1000 μF								■	
3000 μF									■
<b>Output</b>									
1 c/o		■	■	■	■				
1 x 2 c/o or 2 x 1 c/o						■	■		
2 c/o								■	■
<b>Operating principle</b>									
Open-circuit principle		■	■	■	■			■	■
Open- or closed-circuit principle adjustable						■	■		
<b>Test</b>									
Front-face button or control input		■	■	■	■	■	■	■	■
<b>Reset</b>									
Front-face button or control input		■	■	■	■	■	■	■	■
Fault storage / latching configurable		■	■	■	■	■	■		
Non volatile storage configurable		■	■	■	■	■	■		
Interrupted wire detection						■	■	■	■
Threshold values configurable		1	1	1	1	2	2	2	2
Control input (measuring input deactivation)									■
<b>Connection type</b>									
Push-in terminals			■		■		■		
Double-chamber cage connection terminals		■		■		■			
Screw terminals								■	■

1) With coupling unit CM-IVN screw version CM-IVN.S: 1SVR750669R9400  
push-in version CM-IVN.P: 1SVR760669R9400

2) Allowed voltage range of the supervised network: 0-760 V AC / 0-1000 V

3) Allowed voltage range of the supervised network: 0-1100 V AC / 0-1500 V DC



# Insulation monitoring relays

## Ordering details



CM-IWS.1



CM-IWS.2



CM-IWN.1



CM-IVN

### Description

The CM-IWx serves to monitor insulation resistance in accordance with IEC 61557-8 in unearthed IT AC systems, IT AC systems with galvanically connected DC circuits, or IT DC systems. The devices are able to monitor control circuits (single-phase) and main circuits (3-phase).

The CM-IWM.x provides the best and up-to-date insulation monitoring of modern IT supply systems in an optimum and state-of-the-art way according to IEC 61558-8 including annex C. The device can be used in the most flexible way for AC, DC and AC/DC systems, even with a large leakage capacity to earth (PE) and under adverse conditions.

### Ordering details

Type	Rated control supply voltage	Nominal voltage $U_n$ of the distribution system to be monitored	System leakage capacitance, max.	Adjustment range of the specified response value $R_{an}$ (threshold)	Type	Order code	Weight (1 pc)  kg (lb)
CM-IWS.x	24-240 V AC/DC	0-250 V AC / 0-300 V DC	10 $\mu$ F	1-100 k $\Omega$	CM-IWS.1S	1SVR730660R0100	0.148 (0.326)
					CM-IWS.1P	1SVR740660R0100	0.137 (0.302)
		0-400 V AC			CM-IWS.2S	1SVR730670R0200	0.141 (0.311)
					CM-IWS.2P	1SVR740670R0200	0.130 (0.287)
CM-IWN.x		0-400 V AC / 0-600 V DC	20 $\mu$ F	1-100 k $\Omega$ 2-200 k $\Omega$	CM-IWN.1S	1SVR750660R0200	0.241 (0.531)
					CM-IWN.1P	1SVR760660R0200	0.217 (0.478)
CM-IWM.x	24 V DC	0-690 V AC/DC <sup>1)</sup>	1000 $\mu$ F	1-250 k $\Omega$ 20 k $\Omega$ -2 M $\Omega$	CM-IWM.10	1SVR470670R1000	0.500 (1.1)
		0-1000 V AC/DC <sup>2)</sup>			3000 $\mu$ F	CM-IWM.11	

1) Allowed voltage range of the supervised network: 0-760 V AC / 0-1000 V DC

2) Allowed voltage range of the supervised network: 0-1100 V AC / 0-1500 V DC

### Coupling unit

Rated control supply voltage = measuring voltage	Nominal voltage $U_n$ of the distribution system to be monitored	Type	Order code	Weight (1 pc)  kg (lb)
Passive device, no control supply voltage needed	0-690 V AC / 0-1000 V DC	CM-IVN.S	1SVR750669R9400	0.179 (0.395)
		CM-IVN.P	1SVR760669R9400	0.165 (0.364)

S: screw connection

P: push-in connection

## Insulation monitoring relays

### Technical data - CM-IWx

Data at  $T_a = 25^\circ\text{C}$  and rated values, unless otherwise indicated

		CM-IWS.2	CM-IWS.1	CM-IWN.1
<b>Input circuit - Supply circuit</b>		<b>A1 - A2</b>		
Rated control supply voltage $U_s$		24-240 V AC/DC		
Rated control supply voltage tolerance		-15...+10 %		
Typical current / power consumption		24 V DC	30 mA / 0.7 VA	35 mA / 0.9 VA
		115 V AC	12 mA / 1.4 VA	17 mA / 2.0 VA
		230 V AC	12 mA / 2.8 VA	14 mA / 3.2 VA
Rated frequency $f_s$		DC or 15-400 Hz		
Frequency range AC		13.5-440 Hz		
Power failure buffering time		min. 20 ms		
Start-up time $t_{s1}$ , fixed		min. 10 s	max. 15 s	min. 15 s
<b>Input circuit - Measuring circuit</b>		<b>L, <math>\pm</math></b>	<b>L<math>\pm</math>, L-, <math>\pm</math>, KE</b>	<b>L<math>\pm</math>, L-, <math>\pm</math>, KE</b>
Monitoring function		insulation resistance monitoring of IT systems		
Measuring principle		superimposed DC voltage	prognostic measuring principle with superimposed square wave signal	
Nominal voltage $U_n$ of the distribution system to be monitored		0-400 V AC	0-250 V AC / 0-300 V DC	0-400 V AC / 0-600 V DC
Voltage range of the distribution system to be monitored		0-460 V AC (tolerance +15 %)	0-287.5 V AC / 0-345 V DC (tolerance +15 %)	0-460 V AC / 0-690 V DC (tolerance +15 %)
Rated frequency $f_N$ of the distribution system to be monitored		50-60 Hz	DC or 15-400 Hz	DC or 15-400 Hz
System leakage capacitance $C_e$		max. 10 $\mu\text{F}$		20 $\mu\text{F}$
Tolerance of the rated frequency $f_N$		45-65 Hz	13.5-440 Hz	13.5-440 Hz
Extraneous DC voltage $U_{fg}$ (when connected to an AC system)		max. none	290 V DC	460 V DC
Number of possible response / threshold values		1		2
Adjustment range of the specified response value $R_{an}$ (threshold)		min.-max. 1-100 $\Omega$	-	
		min.-max. R1	1-100 k $\Omega$	
		min.-max. R2	2-200 k $\Omega$ (activated / deactivated by DIP-switch)	
Adjustment resolution		1 k $\Omega$	1 k $\Omega$	
		R1	1 k $\Omega$	
		R2	2 k $\Omega$	
Tolerance of the adjusted threshold value / Relative percentage uncertainty A at -5...+45 $^\circ\text{C}$ $U_n = 0-115\%$ $U_s = 85-110\%$ $f_N, f_s, C_e = 1\mu\text{F}$		at 1-10 k $\Omega$ $R_F$ (yellow marked scale)	$\geq 15\%$ , max. $\pm 0.5$ k $\Omega$	$\geq 15\%$ , max. $\pm 1$ kh, with CM-IVN $\pm 1.5$ kh
		at 10-100 k $\Omega$ $R_F$	$\pm 6\%$	-
		at 1-15 k $\Omega$ $R_F$	-	$\pm 1$ kh, with CM-IVN $\pm 1.5$ kh
		at 15-200 k $\Omega$ $R_F$	-	$\pm 8\%$
Hysteresis related to the threshold value		25 %; min. 2 k $\Omega$		
Internal impedance $Z_i$		at 50 Hz	135 k $\Omega$	100 k $\Omega$
Internal DC resistance $R_i$			185 k $\Omega$	115 k $\Omega$
Measuring voltage $U_m$			15 V	22 V
Tolerance of measuring voltage $U_m$			+10 %	
Measuring current $I_m$		max.	0.1 mA	0.3 mA
Response time $t_{an}$				
		pure AC system $0.5 \times R_{an}$ and $C_e = 1 \mu\text{F}$	max. 10 s	
		DC system or AC system with connected rectifiers	-	max. 15 s
Repeat accuracy (constant parameters)		< 0.1 % of full scale		
Accuracy of $R_a$ (measured value) within the rated control supply voltage tolerance		< 0.05 % of full scale		
Accuracy of $R_a$ (measured value) within the operation temperature range		at 1-10 k $\Omega$ $R_F$	5 $\Omega$ / K	-
		at 10-100 k $\Omega$ $R_F$	0.05 % / K	-
		at 10-200 k $\Omega$ $R_F$	-	0.05 % / K
Transient overvoltage protection ( $\pm$ - terminal)		Z-diode	avalanche diode	

# Insulation monitoring relays

## Technical data - CM-IWx

	CM-IWS.2	CM-IWS.1	CM-IWN.1
<b>Input circuit - Control circuits</b>			
Control inputs - volt free	S1-S3	remote test	
	S2-S3	remote reset	
Maximum switching current in the control circuit	1 mA		
Maximum cable length to the control inputs	50 m - 100 pF/m [164 ft - 30.5 pF/ft]		
Minimum control pulse length	150 ms		
No-load voltage at the control input	≤ 24 V ± 5 %	≤ 24 V DC	
<b>Indication of operational states</b>			
Control supply voltage	LED U (green)		
Fault message	LED F (red)		
Relay status	LED R (yellow)		
<b>Output circuits</b>			
Kind of output	relay, 1 c/o (SPDT) contact		2 x 1 or 1 x 2 c/o (SPDT) contacts configurable
Operating principle	closed-circuit principle <sup>1)</sup>		open- or closed circuit principle configurable <sup>1)</sup>
Contact material	AgNi alloy, Cd free		
Min. switching voltage / Min. switching current	24 V / 10 mA		
Max. switching voltage / Max. switching current	see data sheet		
Rated operational voltage U <sub>e</sub> and rated operational current I <sub>e</sub>	AC-12 (resistive) at 230 V	4 A	
	AC-15 (inductive) at 230 V	3 A	
	DC-12 (resistive) at 24 V	4 A	
	DC-13 (inductive) at 24 V	2 A	
AC rating (UL 508)	Utilization category (Control Circuit Rating Code)	B 300, pilot duty general purpose 250 V, 4 A, cos φ 0.75	
	max. rated operational voltage	250 V AC	
	max. continuous thermal current at B 300	4 A	
	max. making/breaking apparent power at B 300	3600/360 VA	
Mechanical lifetime	30 x 10 <sup>6</sup> switching cycles		
Electrical lifetime (AC-12, 230 V, 4 A)	0.1 x 10 <sup>6</sup> switching cycles		
Max. fuse rating to achieve short-circuit protection	n/c contact	6 A fast-acting	
	n/o contact	10 A fast-acting	
Conventional thermal current I <sub>th</sub>	4 A		
<b>General data</b>			
Duty cycle	100 %		
Dimensions	see dimensional drawings		
Mounting	DIN rail (IEC/EN 60715), snap-on mounting without any tool		
Mounting position	any		
Minimum distance to other units	vertical	not necessary	
	horizontal	10 mm (0.39 in) at U <sub>n</sub> > 240 V	not necessary
Material of housing	UL 94 V-0		
Degree of protection	housing / terminal	IP50 / IP20	
<b>Electrical connection</b>			
Wire size	fine-strand with(out) wire end ferrule	Screw connection technology	
		Easy Connect Technology (Push-in)	
		1 x 0.5-2.5 mm <sup>2</sup> (1 x 18-14 AWG) 2 x 0.5-1.5 mm <sup>2</sup> (2 x 18-16 AWG)	2 x 0.5-1.5 mm <sup>2</sup> (2 x 18-16 AWG)
	rigid	1 x 0.5-4 mm <sup>2</sup> (1 x 20-12 AWG) 2 x 0.5-2.5 mm <sup>2</sup> (2 x 20-14 AWG)	2 x 0.5-1.5 mm <sup>2</sup> (2 x 20-16 AWG)
Stripping length	8 mm (0.32 in)		
Tightening torque	0.6-0.8 Nm (5.31-7.08 lb.in)		

<sup>1)</sup> Closed-circuit principle: Output relay(s) de-energize(s) if a fault is occurring  
 Open-circuit principle: Output relay(s) energize(s) if a fault is occurring

## Insulation monitoring relays

### Technical data - CM-IWx

		CM-IWS.2	CM-IWS.1	CM-IWN.1
<b>Environmental data</b>				
Ambient temperature ranges	operation / storage / transport	-25...+60 °C/-40...+85 °C/-40...+85 °C		
Climatic class	IEC/EN 60721-3-3	3K5 (no condensation, no ice formation)		
Damp heat, cyclic	IEC/EN 60068-2-30	6 x 24 h cycle, 55 °C, 95 % RH		
Vibration, sinusoidal		25 Hz: 2.5 g		
<b>Isolation data</b>				
Rated impulse withstand voltage $U_{imp}$	supply / measuring circuit	6 kV		
	supply / output circuit	6 kV		
	measuring / output circuit	6 kV		
	output 1 / output circuit 2	4 kV		
Rated insulation voltage $U_i$	supply / measuring circuit	400 V	300 V	600 V
	supply / output circuit	300 V		
	supply / measuring circuit	400 V	300 V	600 V
	output 1 / output circuit 2	-	-	300 V
Basis insulation	supply / measuring circuit	400 V AC / 300 V DC	250 V AC / 300 V DC	400 V AC / 600 V DC
	supply / output circuit	250 V AC / 300 V DC		
	measuring / output circuit	400 V AC / 300 V DC	250 V AC / 300 V DC	400 V AC / 600 V DC
	output 1 / output 2	250 V AC / 300 V DC		
Protective separation (IEC/EN 61140)	supply / output circuit	250 V AC / 250 V DC		
	supply / measuring circuit	250 V AC / 250 V DC		
	measuring / output circuit	250 V AC / 250 V DC		
Pollution degree		3		
Overvoltage category		III		
<b>Standards / Directives</b>				
Standards		IEC/EN 60947-5-1, IEC/EN 61557-1, IEC/EN 61557-8		
Low Voltage Directive		2014/35/EU		
EMC Directive		2014/30/EU		
RoHS Directive		2011/65/EU		
<b>Electromagnetic compatibility</b>				
Interference immunity to		IEC/EN 61000-6-2, IEC/EN 61326-2-4		
electrostatic discharge	IEC/EN 61000-4-2	level 3, 6 kV / 8 kV		
radiated, radio-frequency, electromagnetic field	IEC/EN 61000-4-3	level 3, 10 V/m (1 GHz) / 3 V/m (2 GHz) / 1 V/m (2.7 GHz)		
electrical fast transient/burst	IEC/EN 61000-4-4	level 3, 2 kV / 5 kHz		
surge	IEC/EN 61000-4-5	level 3, installation class 3, supply circuit and measuring circuit 1 kV L-L, 2 kV L-earth		
conducted disturbances, induced by radio-frequency fields	IEC/EN 61000-4-6	level 3, 10 V		
voltage dips, short interruptions and voltage variations	IEC/EN 61000-4-11	class 3		
harmonics and interharmonics	IEC/EN 61000-4-13	class 3		
Interference emissions		IEC/EN 61000-6-3		
high-frequency radiated	IEC/CISPR 22, EN 55022	class B		
high-frequency conducted	IEC/CISPR 22, EN 55022	class B		

# Insulation monitoring relays

## Technical data - CM-IVN

		CM-IVN
<b>Input circuit - Measuring circuit</b>		<b>VL+, VL-, V±</b>
Function		expansion of the nominal voltage range of the insulation monitoring relay CM-IWN to 690 V AC or 1000 V DC, max. length of connection cable 40 cm
Measuring principle		see CM-IWN
Nominal voltage $U_n$ of the distribution system to be monitored		0-690 V AC / 0-1000 V DC
Voltage range of the distribution system to be monitored		0-793.5 V AC / 0-1150 V DC (tolerance +15 %)
Rated frequency $f_N$ of the distribution system to be monitored		DC or 15-400 Hz
Tolerance of the rated frequency $f_N$		13.5-440 Hz
System leakage capacitance $C_e$	max.	identical to that of the insulation monitoring relay used
Extraneous DC voltage $U_{fg}$ (when connected to an AC system)	max.	793.5 V DC
Tolerance of the adjusted threshold value / Relative percentage uncertainty A at -5...+45 °C, $U_n = 0-115\%$ , $U_s = 85-110\%$ , $f_N, f_s, C_e = 1 \mu F$	at 1-15 kΩ $R_f$ at 15-200 kΩ $R_f$	±1.5 kΩ ±8 %
Internal impedance $Z_i$	at 50 Hz	195 kΩ
Internal DC resistance $R_i$		200 kΩ
Measuring voltage $U_m$		24 V
Tolerance of measuring voltage $U_m$		+10 %
Measuring current $I_m$		0.15 mA
<b>General data</b>		
MTBF		on request
Duty cycle		100 %
Dimensions		see dimensional drawings
Mounting		DIN rail (IEC/EN 60715), snap-on mounting without any tool
Mounting position		any
Minimum distance to other units	vertical	not necessary
	horizontal	10 mm (0.39 in) at $U_n > 600 V$
Degree of protection		IP50 / IP20
<b>Electrical connection</b>		
Wire size	fine-strand with(out) wire end ferrule	2 x 0.75-2.5 mm <sup>2</sup> (2 x 18-14 AWG)
	rigid	2 x 0.5-4 mm <sup>2</sup> (2 x 20-12 AWG)
Stripping length		7 mm (0.28 in)
Tightening torque		0.6-0.8 Nm (5.31-7.08 lb.in)
Max. length of connection cable to CM-IWN		40 cm
<b>Environmental data</b>		
Ambient temperature ranges	operation / storage / transport	-25...+60 °C / -40...+85 °C / -40...+85 °C
Climatic category	IEC/EN 60721-3-3	3K5 (no condensation, no ice formation)
Damp heat, cyclic	IEC/EN 60068-2-30	6 x 24 h cycle, 55 °C, 95 % RH
Vibration, sinusoidal	IEC/EN 60255-21-1	Class 2
Shock, half-sine	IEC/EN 60255-21-2	Class 2
<b>Isolation data</b>		
Rated impulse withstand voltage $U_{imp}$	input circuit / PE	8 kV
Rated insulation voltage $U_i$	input circuit / PE	1000 V
Pollution degree		3
Overvoltage category		III
<b>Standards / Directives</b>		
Standards		IEC/EN 60947-5-1, IEC/EN 61557-1, IEC/EN 61557-8
Low Voltage Directive		2014/35/EU
EMC Directive		2014/30/EU
RoHS Directive		2011/65/EU

## Insulation monitoring relays

### Technical data - CM-IVN

		CM-IVN
<b>Electromagnetic compatibility</b>		
Interference immunity to		IEC/EN 61000-6-2, IEC/EN 61326-2-4
electrostatic discharge	IEC/EN 61000-4-2	level 3, 6 kV / 8 kV
radiated, radio-frequency, electromagnetic field	IEC/EN 61000-4-3	level 3, 10 V/m (1 GHz) / 3 V/m (2 GHz) / 1 V/m (2.7 GHz)
electrical fast transient/burst	IEC/EN 61000-4-4	level 3, 2 kV / 5 kHz
surge	IEC/EN 61000-4-5	level 3, installation class 3, supply circuit and measuring circuit 1 kV L-L, 2 kV L-earth
conducted disturbances, induced by radio-frequency fields	IEC/EN 61000-4-6	level 3, 10 V
voltage dips, short interruptions and voltage variations	IEC/EN 61000-4-11	level 3
harmonics and interharmonics	IEC/EN 61000-4-13	level 3
Interference emission		IEC/EN 61000-6-3
high-frequency radiated	IEC/CISPR 22, EN 50022	class B
high-frequency conducted	IEC/CISPR 22, EN 50022	class B

# Insulation monitoring relays

## Technical data - CM-IWM

	CM-IWM.10	CM-IWM.11
<b>Input circuit</b>		
Rated control supply voltage $U_s$	24 V DC	
Voltage range	20-30 V DC	
Typical power consumption	max. 5 W	
<b>Measuring circuit</b>		
	L(+) / L(-) to PE / KE	
Nominal voltage $U_N$	0-690 V AC/DC	0-1000 V AC/DC
Allowed voltage range of the supervised network	0-760 V AC / 0-1000 V DC	0-1100 V AC / 0-1500 V DC
Frequency range	DC or 16-1000 Hz	DC or 16-1000 Hz
Max. system leakage capacitance $C_e$	1000 $\mu$ F	3000 $\mu$ F
Internal resistance (AC/DC)	> 280 k $\Omega$	
Measuring voltage	approx. $\pm$ 95 V	
Max. measured current ( $R_e = 0$ )	< 0.35 mA	
Response values $R_e$ each adjustable via rotary switches		
	pre-warning ("VW")	warning ("AL")
	20 k $\Omega$	1 k $\Omega$
	30 k $\Omega$	3 k $\Omega$
	50 k $\Omega$	10 k $\Omega$
	70 k $\Omega$	20 k $\Omega$
	100 k $\Omega$	30 k $\Omega$
	150 k $\Omega$	50 k $\Omega$
	250 k $\Omega$	70 k $\Omega$
	500 k $\Omega$	100 k $\Omega$
	1000 k $\Omega$	150 k $\Omega$
	2000 k $\Omega$	250 k $\Omega$
Response inaccuracy	IEC/EN 61557-8	$\pm$ 15 % + 1.5 k $\Omega$
Response value hysteresis	at range 10 k $\Omega$ ... 700 k $\Omega$	approx. 25 %
	out of range:	approx. 40 % + 0.5 k $\Omega$
ON delay	at $C_e = 1 \mu$ F	< 10 s
	$R_e$ of $\infty$ to 0.5 * response value	
<b>Control input</b>		
	between T, R and G	between HM, T, R and G
Current flow	approx. 3 mA	
No-load voltage to ground	approx. 12 V	
Permissible wire length	< 50 m	
Min. activation time	0.5 s	
<b>Output</b>		
Contacts	2 x 1 c/o contacts for VW and AL	
Thermal current $I_{th}$	4 A	
Switching capacity to AC-15	n/o contact	3 A / AC 230 V acc. to IEC/EN 60947-5-1
	n/c contact	1 A / AC 230 V acc. to IEC/EN 60947-5-1
Electrical life	at 8 A, AC 250 V	1 x 10 <sup>4</sup> switching cycles
Short circuit strength max. fuse rating	4 A gL acc. to IEC/EN 60947-5-1	
Mechanical life	10 x 10 <sup>6</sup> switching cycles	

## Insulation monitoring relays

### Technical data - CM-IWM

	CM-IWM.10	CM-IWM.11
<b>General Data</b>		
Operating mode	continuous operation	
Temperature range	operation	- 25 ... + 60 °C
	storage	- 40 ... + 70 °C
Relative air humidity	93 % at 40 °C	
Atmospheric pressure	860-1600 mbar (86-106 kPa)	
Altitude	IEC/EN 60664-1	< 4000 m
Clearance and creepage distances		
Rated impulse voltage / pollution degree	IEC/EN 60664-1	
Measuring circuit L(+) / L(-) to	auxiliary voltage DC and relay contacts VW, AL	8 kV / 2
	auxiliary voltage DC to relay contacts VW, AL	8 kV / 2
	relay contacts VW to relay contact AL	4 kV / 2
Insulation test voltage, routine test	AC 5 kV; 1 s AC 2.5 kV; 1 s	
<b>Technical data</b>		
<b>EMC</b>		
Electrostatic discharge (ESD)	IEC/EN 61000-4-2	8 kV (air)
HF irradiation	IEC/EN 61000-4-3	80 MHz-2.7 GHz: 10 V/m
Fast transients	IEC/EN 61000-4-4	4 kV
Surge voltages	IEC/EN 61000-4-5	between A1 - A2: 1 kV L(+) - L(-): 2 kV A1, A2 - PE: 4 kV L(+), L(-) - PE: 4 kV control line: 0.5 kV control line and earth: 1 kV
HF-wire guided	IEC/EN 61000-4-6	10 V
Interference suppression	EN 55011	limit value class A when connected to a low voltage public system (Class B, EN 55011) radio interference can be generated. To avoid this, appropriate measures have to be taken
Degree of protection		
Housing	IEC/EN 60529	IP 40
Terminals	IEC/EN 60529	IP 20
Housing		thermoplastic with V0 behaviour according to UL subject 94
Vibration resistance	IEC/EN 60068-2-6	10-55 Hz: 0.35 mm 2-13.2 Hz: ± 1 mm 13.2-100 Hz: ± 7 g
Shock resistance	IEC/EN 60068-2-27	10 g / 11 ms, 3 pulses
Climate resistance	IEC/EN 60068-1	25 / 060 / 04
Terminal designation		EN 50005
Connecting capacity		1 x 4 mm <sup>2</sup> solid
		1 x 2.5 mm <sup>2</sup> stranded ferruled (isolated)
		2 x 1.5 mm <sup>2</sup> stranded ferruled (isolated) DIN 46228-1/-2/-3-4
		2 x 2.5 mm <sup>2</sup> stranded ferruled (isolated) DIN 46228-1/-2/-3
Stripping length		8 mm
Tightening torque		0.8 Nm
Wire fixing		plus-minus terminal screws M3.5 terminal with wire protection
Mounting	IEC/EN 60715	DIN rail
Dimensions	width x height x depth	90 x 90 x 121 mm



# Insulation monitoring relays

## Technical diagrams

### LEDs, status information and fault messages

#### CM-IWN.x

Operational state	LED U (green)	LED F (red)	LED R (yellow)
Start-up		OFF	OFF
No fault		OFF	(1)
Prewarning			
Insulation fault (below threshold value)			(1)
KE/± wire interruption			(1)
L+/L- wire interruption during system start-up / test function	 		(1)
System leakage capacitance too high / invalid measurement result			(1)
Internal system fault	(1)		(1)
Setting fault (2)			
Test function		OFF	(1)
No fault after fault storage (3)		(4)	

(1) Depending on the configuration.

(2) Possible faulty setting: The threshold value for final switch-off is set at a higher value than the threshold value for prewarning

(3) The device has triggered after an insulation fault. The fault has been stored and the insulation resistance has returned to a higher value than the threshold value plus hysteresis.

(4) Depending on the fault

#### CM-IWS.x

Operational state	LED U (green)	LED F (red)	LED R (yellow)
Start-up		OFF	OFF
No fault		OFF	
Insulation fault (below threshold value)			OFF
Invalid measuring result			OFF
KE/± wire interruption (only CM-IWS. (1))			OFF
CM-IWS.1: System leakage capacitance too high / invalid measurement result			OFF
CM-IWS.2: Invalid measurement result			OFF
Internal system fault	OFF		OFF
Test function		OFF	OFF
No fault after fault storage (3)		(4)	

#### CM-IWM.x

LED status	LED	Status
PWR: green LED		Control supply voltage applied
ERR: red LED		Internal device error
		Connection error L+/L-
		Connection error PE/KE
Active: green LED		Measuring phase with positive polarity
		Measuring phase with negative polarity
LED chain: yellow LED		8 LEDs indicate the current insulating resistance ( $\leq 10 \text{ k}\Omega \dots \geq 2 \text{ M}\Omega$ )
VW +: yellow LED		$R_e$ lower than prewarning value to + potential
VW -: yellow LED		$R_e$ lower than prewarning value to - potential
VW + and VW -: yellow LED		AC fault / symmetric fault
AL +: red LED		$R_e$ lower than warning value to + potential
AL -: red LED		$R_e$ lower than warning value to - potential
AL + and AL -: red LED		AC fault / symmetric fault

# Insulation monitoring relays

## Technical diagrams

### Connection diagrams

#### CM-IWS.2

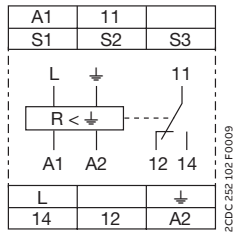

A1-A2	Control supply voltage
S1-S3	Remote test
S2-S3	Remote reset
L	Measuring circuit/input, system connection
⊥	Measuring circuit/input, earth connections
11-12/14	Output relay, closed-circuit principle

#### CM-IWS.1

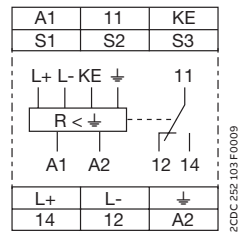

A1-A2	Control supply voltage
S1-S3	Remote test
S2-S3	Remote reset
L+, L-	Measuring circuit/input, system connection
⊥, KE	Measuring circuit/input, earth connections
1-12/14	Output relay, closed-circuit principle

#### CM-IWN.1

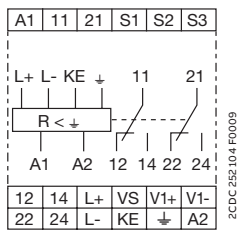

A1-A2	Control supply voltage
S1-S3	Remote test
S2-S3	Remote reset
L+, L-	Measuring circuit/input, system connection
⊥, KE	Measuring circuit/input, earth connections
VS, V1+, V1	Connections for the coupling unit (if used)
11-12/14	Output relay 1, open- or closed-circuit principle
21-22/24	Output relay 2, open- or closed-circuit principle

#### CM-IVN

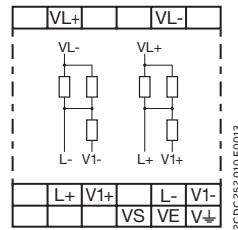

VE	Connection to CM-IWN.x - ⊥
VS	Connection to CM-IWN.x - VS
L+	Connection to CM-IWN.x - L+
V1+	Connection to CM-IWN.x - V1+
L-	Connection to CM-IWN.x - L-
V1-	Connection to CM-IWN.x - V1-
VL+	Measuring circuit / Measuring input, Connection to the system
VL-	Measuring circuit / Measuring input, Connection to the system
V⊥	Measuring circuit / Measuring input, Connection to earth

# Insulation monitoring relays

## Technical diagrams

### Connection diagrams

#### CM-IWM.10

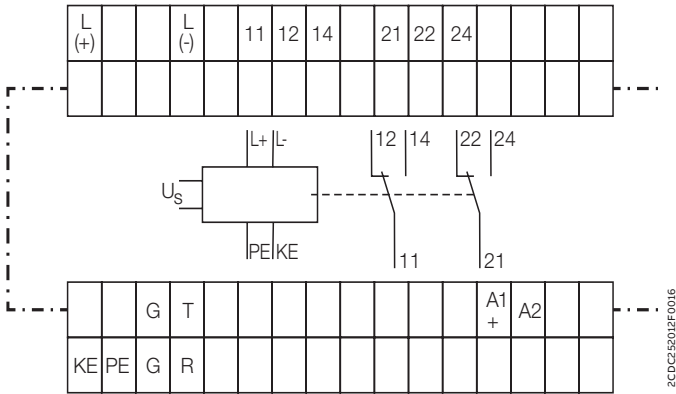

Terminal designation	Signal designation
A1+, A2	Control supply voltage
L(+), L(-)	Connection for measuring circuit
KE, PE	Connection for protective conductor
G, R	Control input (manual/auto reset) <ul style="list-style-type: none"> <li>• G/R not jumpered: manual reset</li> <li>• G/R jumpered: auto reset</li> </ul>
G, T	Control input (External test input) connection for an external device test pushbutton
11-12/14	Output relay 1 (warning)
21-22/24	Output relay 2 (prewarning)

#### CM-IWM.11

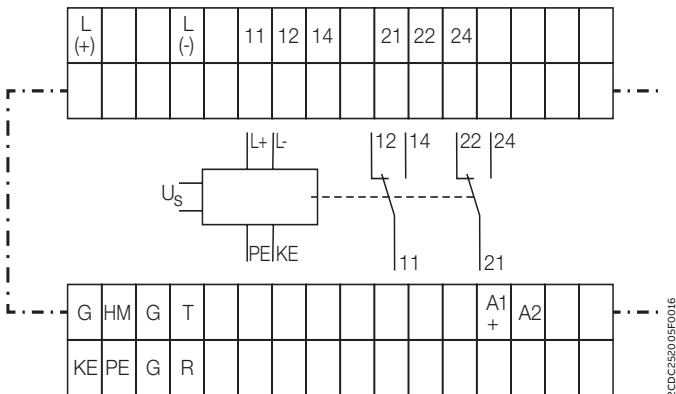

Terminal designation	Signal designation
A1+, A2	Control supply voltage
L(+), L(-)	Connection for measuring circuit
KE, PE	Connection for protective conductor
G, R	Control input (manual/auto reset) <ul style="list-style-type: none"> <li>• G/R not jumpered: manual reset</li> <li>• G/R jumpered: auto reset</li> </ul>
G, T	Control input (External test input) connection for an external device test pushbutton
G, HM	Control input (measuring circuit deactivation) <ul style="list-style-type: none"> <li>• G/HM not jumpered: measuring circuit activated</li> <li>• G/HM jumpered: measuring circuit deactivated</li> </ul>
11-12/14	Output relay 1 (warning)
21-22/24	Output relay 2 (prewarning)

## Insulation monitoring relays

### Technical diagrams

#### DIP switches

##### CM-IWN.1

Position	4	3	2	1
ON ↑				
OFF				

2CDC 252 050 F0009

	ON	OFF (default)
<b>DIP switch 1</b> Operating principle of the output relays	Closed-circuit principle If closed-circuit principle is selected, the output relays de-energize in case a fault is occurring. In non-fault state the relays are energized.	Open-circuit principle If open-circuit principle is selected, the output relays energize in case a fault is occurring. In non-fault state the relays are de-energized.
<b>DIP switch 2</b> Non-volatile fault storage	Fault storage activated (latching) If the fault storage function is activated, the output relays remain in tripped position until a reset is done either by the front-face button or by the remote reset connection S2-S3. This function is non-volatile.	Fault storage de-activated (non latching) If the fault storage function is de-activated, the output relays switch back to their original position as soon as the insulation fault no longer exists.
<b>DIP switch 3</b> Interrupted wire detection	Interrupted wire detection activated With this configuration, the CM-IWN.1 monitoring relays the wires connected to $\pm$ and KE for interruptions.	Interrupted wire detection de-activated With this configuration the interrupted wire detection is de-activated.
<b>DIP switch 4</b> 2 x 1 c/o, 1 x 2 c/o	2 x 1 c/o (SPDT) contact If operating principle 2 x 1 c/o contact is selected, the output relay R1 (11-12/14) reacts to threshold value R1 (final switch-off) and the output relay R2 (21-22/24) reacts to threshold value R2 (prewarning)	1 x 2 c/o (SPDT) contacts If operating principle 1 x 2 c/o contacts is selected, both output relays R1 (11-12/14) and R2 (21-22/24) react synchronously to threshold value R1. Settings of the threshold value R2 have no effect on the operation.

# Insulation monitoring relays

## Technical diagrams

### Wiring diagrams

#### CM-IWS.1

Always connect L+ and L- to different conductors. L+ and L- can be connected to any of the conductors.

$U_n \leq 250 \text{ V AC}; 300 \text{ V DC}$

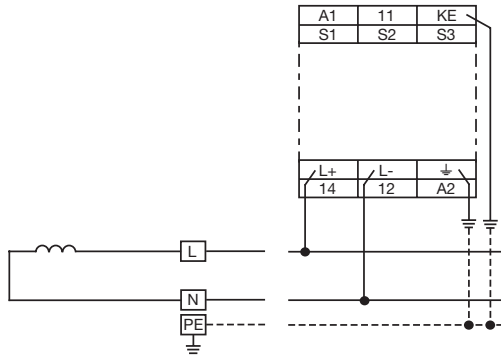

2CDC252085F0009, 2CDC252085F0009

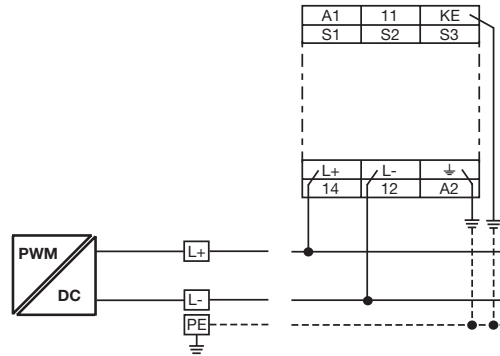

2CDC252085F0009, 2CDC252085F0009

2-wire AC system

2-wire DC system

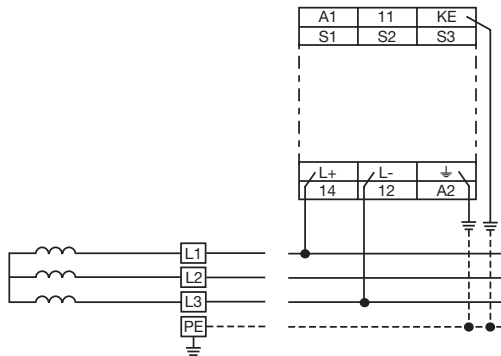

2CDC252098F0009, 2CDC252098F0009

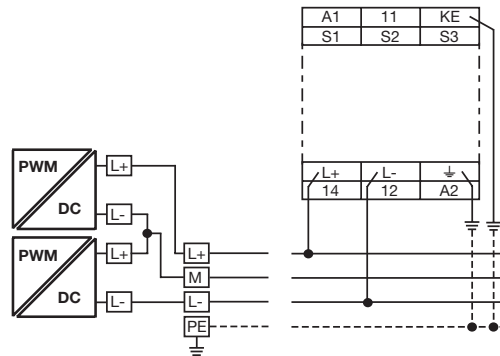

2CDC252098F0009, 2CDC252098F0009

3-wire AC system

3-wire DC system

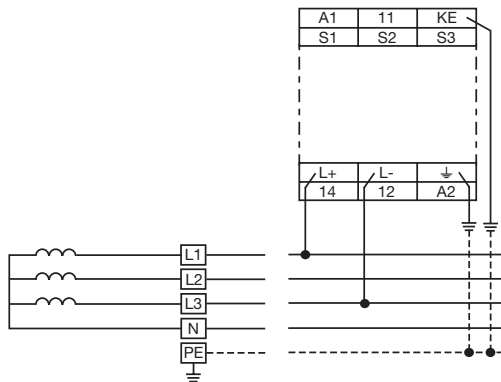

2CDC252099F0009, 2CDC252099F0009

4-wire AC system

# Insulation monitoring relays

## Technical diagrams

### Wiring diagrams

#### CM-IWS.2

L can be connected to any of the conductors.

$U_n \leq 400$  V AC

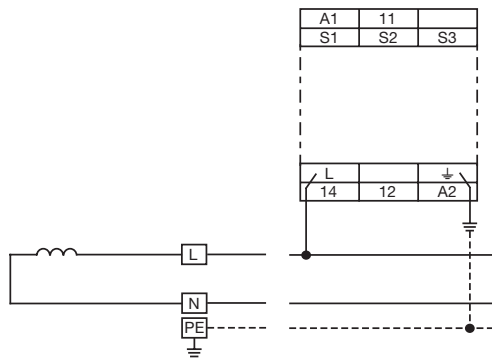

2CDC252083F0009, 2CDC252082F0009

2-wire AC system

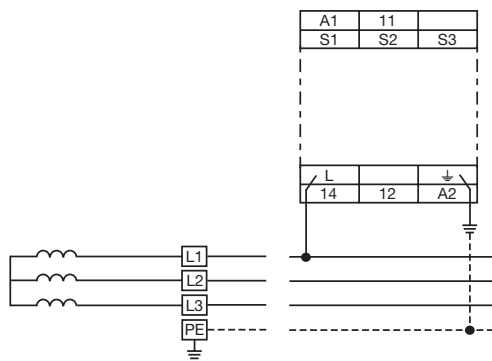

2CDC252090F0009, 2CDC252089F0009

3-wire AC system

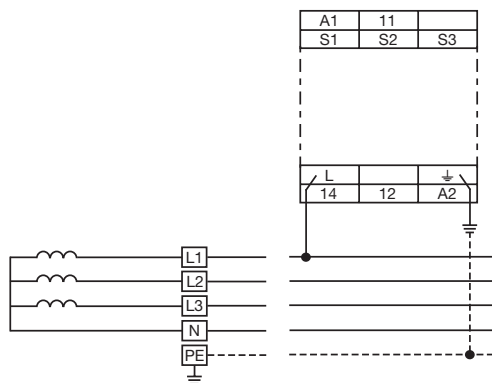

2CDC252097F0009, 2CDC252096F0009

4-wire AC system

# Insulation monitoring relays

## Technical diagrams

### Wiring diagrams

#### CM-IWN.1

Always connect L+ and L- to different conductors. L+ and L- can be connected to any of the conductors.  
 $U_n \leq 400 \text{ V AC}; 600 \text{ V DC}$  (For monitoring of systems with higher voltages, use coupling unit CM-IVN.)

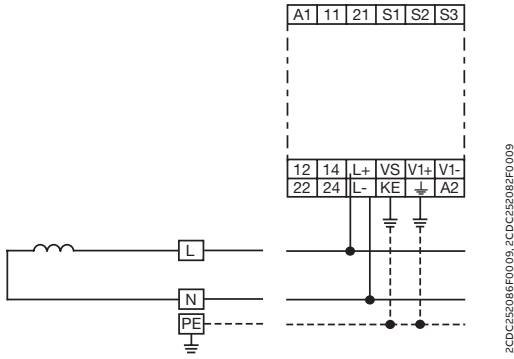

2-wire AC system

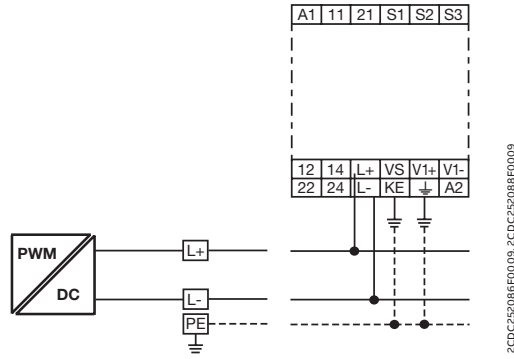

2-wire DC system

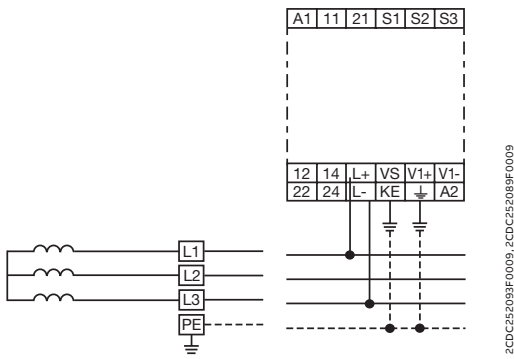

3-wire AC system

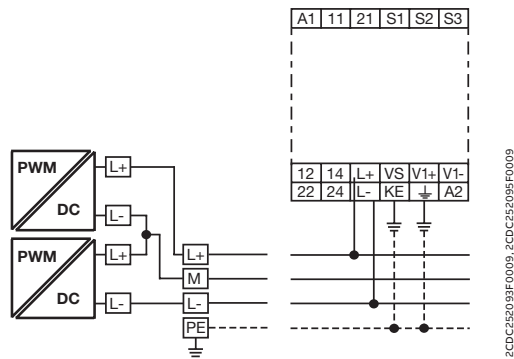

3-wire DC system

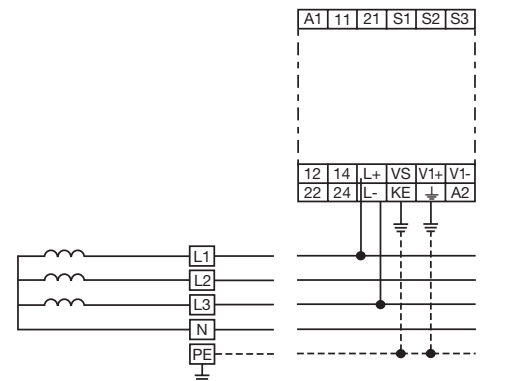

4-wire AC system

2CDC252086F0009, 2CDC252088F0009

2CDC252086F0009, 2CDC252088F0009

2CDC252098F0009, 2CDC252099F0009

2CDC252098F0009, 2CDC252099F0009

2CDC252100F0009, 2CDC252096F0009

# Insulation monitoring relays

## Technical diagrams

### Wiring diagrams

#### CM-IWM.10

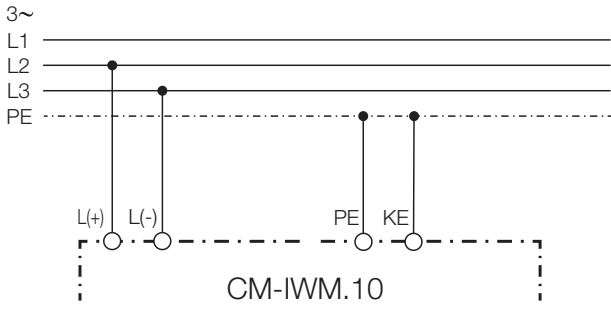

Example of a AC application

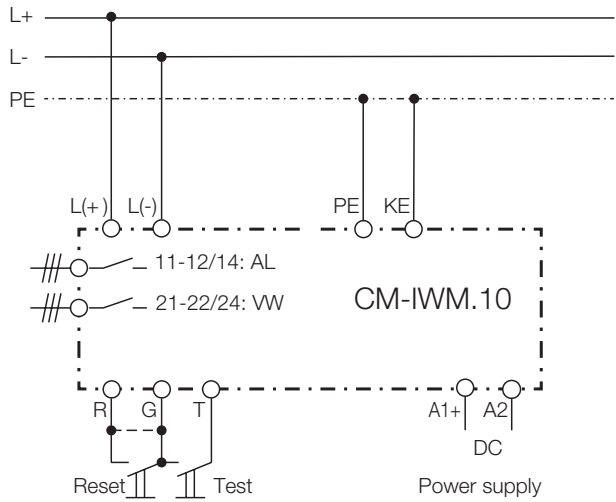

Example of a DC application

#### CM-IWM.11

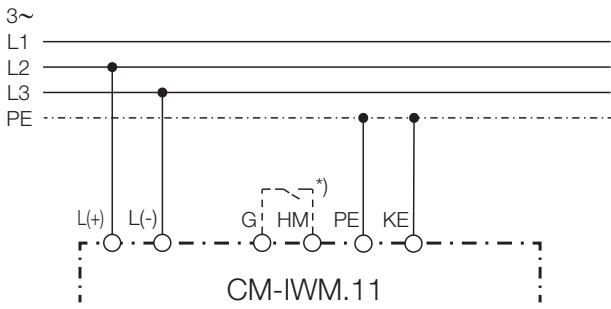

\*) G-HM connected: Measuring circuit is off

Example of a AC application

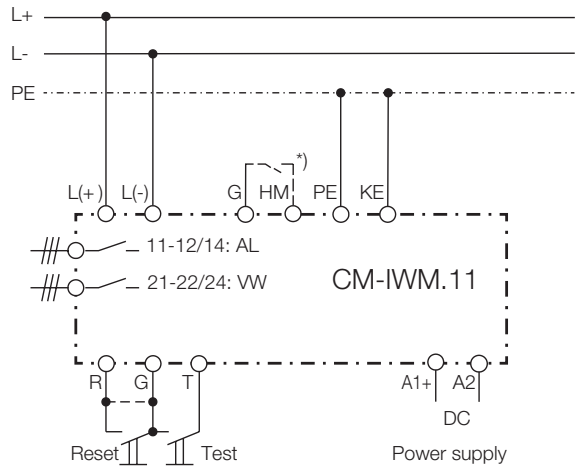

\*) G-HM connected: Measuring circuit is off

Example of a DC application

zCDC25011F0016

zCDC25010F0016

zCDC25007F0016

zCDC25008F0016



# Insulation monitoring relays

## Technical diagrams

### Dimensional drawings

in mm and inches

CM-IWS.x

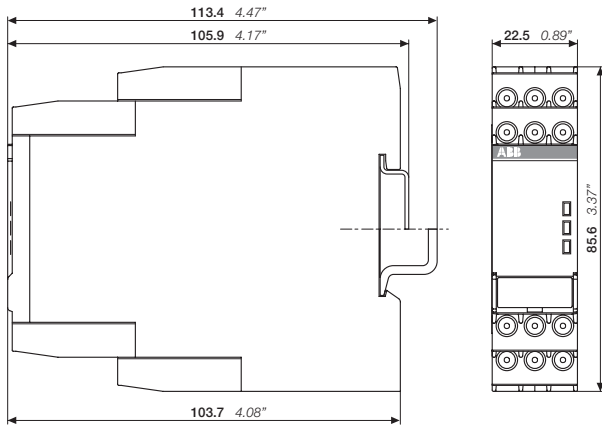

2CDC252009F0011

CM-IWS.x

### Accessories

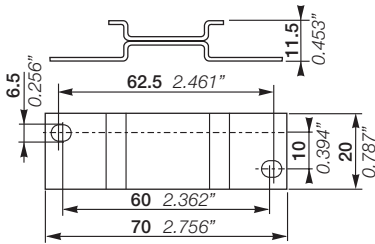

2CDC252008F0010

ADP.01 - Adapter for screw mounting

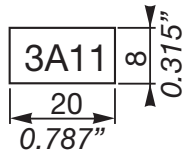

2CDC252186F0005

MAR.01 - Marker label for devices without DIP

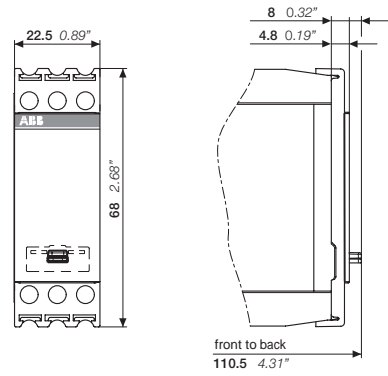

2CDC252010F0011

COV.11 - Sealable transparent cover switches

# Insulation monitoring relays

## Technical diagrams

### Dimensional drawings

in mm and inches

#### CM-IWN.x

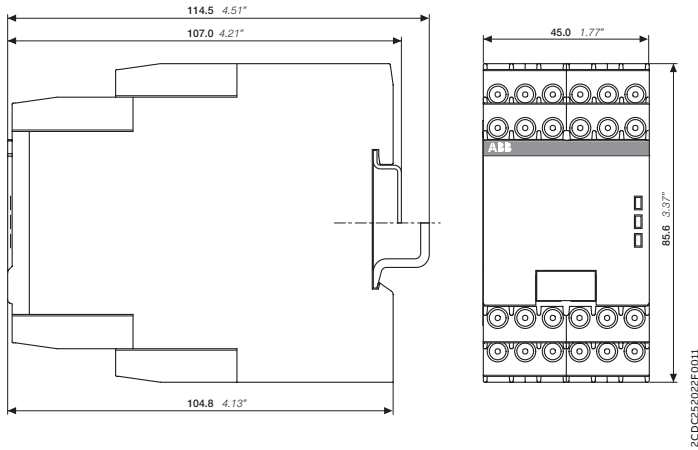

CM-IWN.x

### Accessories

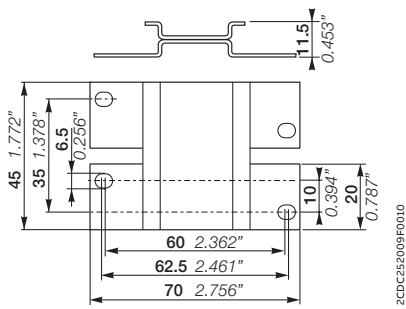

ADP.02 - Adapter for screw mounting

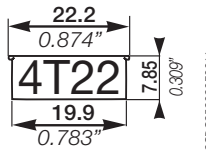

MAR.12 - Marker label for devices with DIP switches

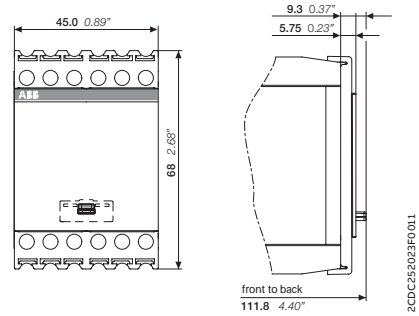

COV.12 - Sealable transparent cover





---

# Thermistor motor protection relays

## Table of contents

<b>182</b>	<b>Benefits and advantages</b>
<b>183</b>	<b>Applications</b>
<b>184</b>	<b>Features</b>
<b>186</b>	<b>Offer overview</b>
<b>188</b>	<b>Operating controls</b>
<b>189</b>	<b>Selection table</b>
<b>190</b>	<b>Ordering details</b>
<b>193</b>	<b>Technical data</b>
<b>199</b>	<b>Technical diagrams</b>

# Thermistor motor protection relays

## Benefits and advantages



The thermistor motor protection relays of the CM-MSx range protect motors with PTC sensors against high temperature. These sensors are incorporated in the motor windings, thus measuring the motor heat directly.



**Continuous operation**

By using thermistor motor protection relays from ABB, the down and commissioning time can be reduced. The relay is continuously monitoring the sensor circuit to detect short-circuit or interrupted i.e. wire faults, thus contributing to maintenance and time saving in case of faults. In addition, the clear error messages of the front LEDs makes it possible to distinguish between the various fault causes.



**Reliable in harsh conditions**

Direct motor protection through temperature monitoring of the motor winding offers 100 % motor protection, even under the most difficult ambient conditions. The ABB thermistor motor protection relays give you access to worldwide markets and are approved by local and international standards for many applications such as industry, renewable energies, the marine sector and dangerous and explosive environments. To prove that, the CM-MSS thermistor motor protection relays are certified according to ATEX Ex II (2) G and D for environments with explosive gas or dust loads.



**Easy installation**

Due to the compliance with the latest standards, there is no need to make any adjustments on the device. All relays come with two different connection possibilities - screw or push-in - to make any adjustments on the installation a breeze. Thanks to direct measurement of the motor temperature, dimensioning of the thermistor motor protection relay, considering the size of the motor, is not necessary.

# Thermistor motor protection relays

## Applications



### Direct temperature monitoring

Generally, motor damage caused by overload or overheating situations can be prevented in different ways. Compared to the indirect temperature measuring which monitors the motor current, the temperature inside the motor can be measured by direct temperature measuring. This enables direct control and evaluation of different operating conditions:

Therefore, the consequences from overheating, such as abrasion as well as electrical failures, can be prevented. The direct measuring principle is carried out by a combination of the thermistor motor protection relay and three PTC sensors which are installed directly in the motor by the manufacturer. Those 3 PTC sensors are placed directly at the thermal hotspots, the motor windings.

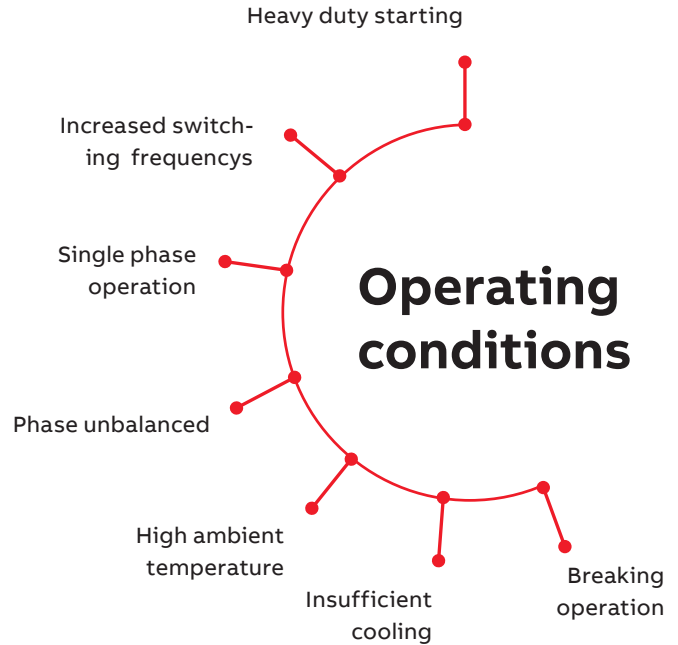

### Motor protection using current- and temperature-dependent protective devices

IEC 60204 stipulates that motors must be protected from overheating at a rating of 0.5 kW and higher. The protection can be provided or executed by overload protection, overtemperature protection or current limiting. For motors with frequent starting and braking, and in environments where cooling may be impaired (e.g. by dust), it is recommended to use the overtemperature protection option in the form of a protective device coordinated with this mode of operation.

On rotor-critical motors, overtemperature detection in the stator windings can lead to delayed and hence inadequate protection. In this case, the standards stipulate additional protection, e.g. by means of an overload relay. This combination of thermistor motor protection and an overload relay is recommended for full motor protection in case of frequent starting and braking of motors, irregular intermittent duty or excessive switching frequency.



### Operating mode

The thermistor motor protection relays are used to monitor the temperature of motors or generators equipped with PTC sensors type A according to the latest product standard IEC 60947-8. The sensors are built-in into the motor windings, measuring the motor heating. In case of an increase of the temperature in the motor, the resistance of the PTC sensors increases as well. If the motor heats-up excessively (>2.83 kΩ), the output relay(s) de-energize(s) and the corresponding LED displays the overtemperature. A short circuit and an interrupted wire within the sensor circuit can also be detected. A reset is only possible after cooling down of the motor (<1.1 kΩ) or after a wire interruption, or a short circuit within the sensor circuit has been removed. A reset after tripping can be done manually with the Test / Reset button, externally with a push button between S1 and 1T2/2T2, or automatically by jumpering S1-1T2/2T2.

# Thermistor motor protection relays

## Features



### Test function

The test function is only possible when there is no fault. By pressing the front-face combined Test / Reset button, a system test routine is executed. If the function „Remote Test / Reset“ (DIP switch 4) is activated, the system test routine is also possible via control input S1-T2 (S1-1T2/2T2\*).

After starting the test routine, the output relays de-energize. They remain de-energized until the Test / Reset button is pressed again or control input S1-T2 (S1-1T2/2T2\*) is closed (remote reset).

### Short-circuit detection

If a short circuit is detected between the two lines of a sensor circuit, the output relay(s) de-energize(s) and the LEDs will display the specific error code.

### Dynamic interrupted wire detection





During the operation, the device is permanently monitoring the measuring circuit. If the resistance in the measuring circuit rises, the device distinguishes if there is an overtemperature or an interrupted wire.



### Fault storage , reset function

The fault storage is designed as non-volatile (remanent). This means that after switch-off and return of the control supply voltage the device returns to the state it was prior to the switch-off. If there was no fault prior to the interruption of the control supply voltage, the device restarts automatically after re-applying control supply voltage.

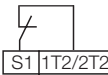
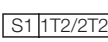
If there was a fault prior to the interruption, reset can be reset manually by the Test / Reset button or externally by remote reset between S1-T2 (S1-1T2/2T2\*). With deactivated fault storage, reset can be made manually by the Test / Reset button, automatically by jumpering S1-T2 (S1-1T2/2T2\*) or externally by remote reset between S1-T2 (S1-1T2/2T2\*). Depending on the configuration of DIP switch 1, there are several possibilities to reset the device as shown in the picture.

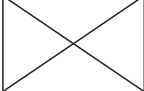
DIP switch 1		
 S1   1T2/2T2	1.) Front 2.) Remote 3.) A1-A2	1.) Front 2.) Remote
 S1   1T2/2T2	1.) Front 2.) A1-A2	1.) Front
 S1   1T2/2T2	1.) Auto-Reset	

\*CM-MSS.51

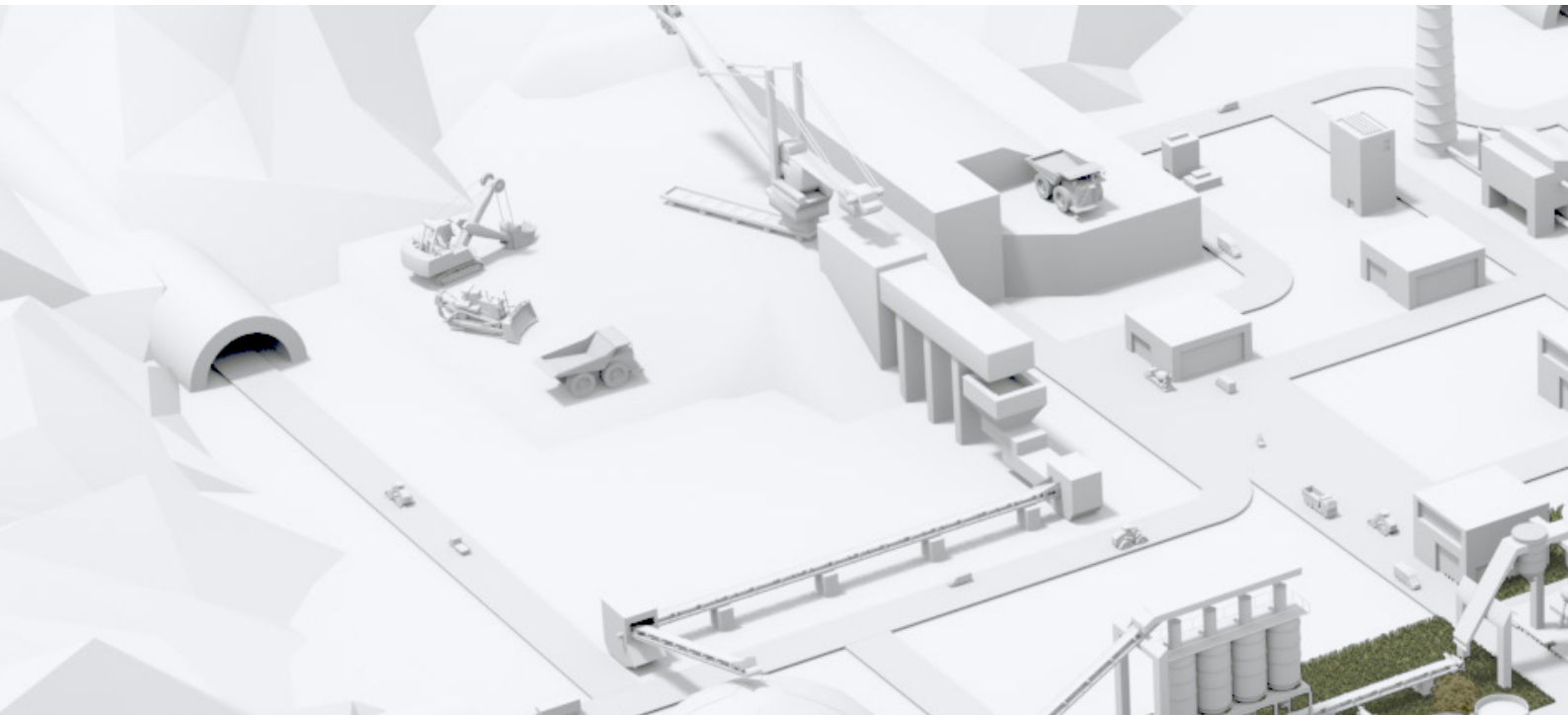



# Thermistor motor protection relays

## Features



### Single and accumulative evaluation

#### Single evaluation 2x1 c/o

If a fault occurs in the measuring circuit 1, output relay 1 (11-12/14) de-energizes. If a fault occurs in the measuring circuit 2, output relay 2 (21-22/24) de-energizes.

#### Accumulative evaluation 1x2 c/o

In case of a fault in one of the two measuring circuits, both output relays de-energize synchronously.

### Bimetallic switches

In some applications, bimetallic switches - such as Klixon - are used as sensors instead of PTC temperature sensors. Bimetallic switches are temperature and current dependent, normally closed contacts, and are available for different temperature ranges. Since bimetallic switches have almost no resistance below their opening temperature, short-circuit detection is not possible when bimetallic switches are used.



### ATEX certification

Suitably selected and adjusted devices are necessary for the safe operation of explosion-protected motors. Only the sensor line is conducted into the explosive atmosphere. The motor protection relay itself must be installed outside the potentially explosive atmospheres.

Marking:

- Ex II (2) G
- Ex II (2) D



### CM-MSS functionality video

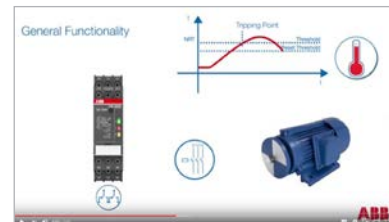

# Thermistor motor protection relays

## Offer overview



### CM-MSE

- Auto reset
- Connection of several sensors (max. 6 sensors connected in series)
- Monitoring of bimetals
- 1 n/o contact
- Excellent cost / performance ratio

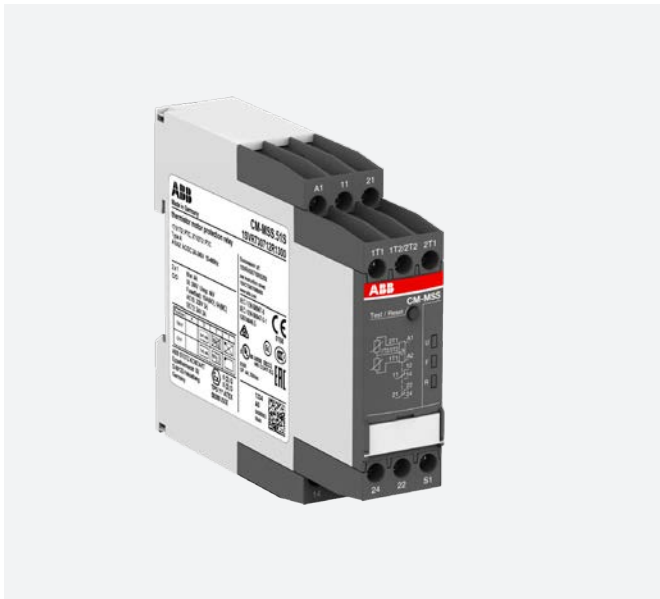

### CM-MSS<sup>1)</sup>

- Different types of contacts available
  - 1 x 2 c/o (SPDT) contacts
  - 2 x 1 c/o (SPDT) contact
  - 1 n/o and 1 n/c contact
- 1 or 2 measuring circuits
- Different types of reset functions
  - Automatic
  - Manual
  - Remote
- Rated control supply voltages
  - 24 V AC/DC
  - 24-240 V AC/DC
  - 110-130 V AC, 220-240 V AC
- Various approvals and marks

<sup>1)</sup> Depending on device the characteristics vary, for detailed overview see "Selection table" on page 189.



# Thermistor motor protection relays

## Operating controls



**Test / Reset button**  
 Test - only possible if/when the relay doesn't show any fault.  
 Reset - only possible if measured value < switch-on resistance



**Marker label / DIP switches (depending on device) e.g.**

- Single evaluation 2 x 1 c/o (SPDT) contact
- Accumulative evaluation 1 x 2 c/o (SPDT) contacts
- Short-circuit detection de-activated
- Short-circuit detection activated
- Non-volatile fault storage activated
- Non-volatile fault storage de-activated
- Remote Reset
- Remote Test/Reset

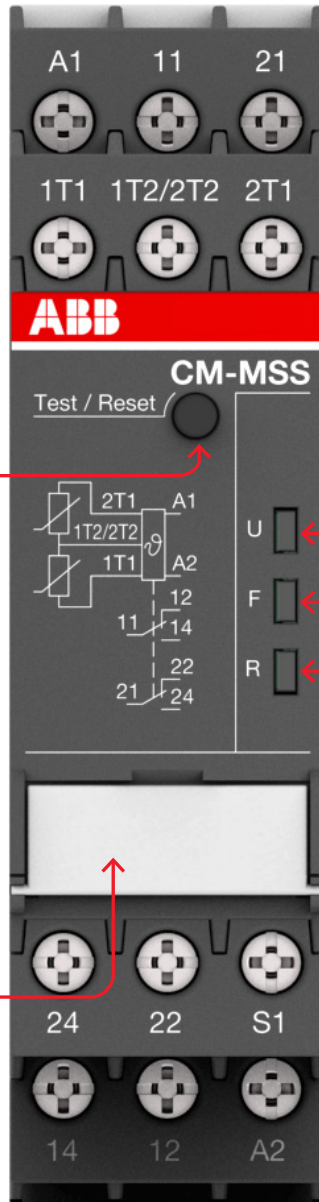

**Indication of operational states with LEDs**  
 U: green LED - Status indication of control supply voltage  
 Control supply voltage applied  
 F: red LED - Fault message  
 R: yellow LED - Status indication of the output relay

For detailed status and failure analysis, please see "LEDs, status information and fault messages".



## Thermistor motor protection relays

### Ordering details



CM-MSS.12S

2CDC 251 004 V0014



CM-MSS.41S

2CDC 251 013 V0014



CM-MSS.51S

2CDC 251 014 V0014

#### Description

The thermistor motor protection relay CM-MSS monitors the winding temperature and thus protects the motor from overheating, overload and insufficient cooling in accordance to the product standard IEC/EN 60947-8.

#### Ordering details

##### CM-MSx

Characteristics	Type	Order code	Weight (1 pc) kg (lb)
See selection table	CM-MSE	1SVR550805R9300	0.11 (0.24)
	CM-MSE	1SVR550800R9300	0.11 (0.24)
	CM-MSE	1SVR550801R9300	0.11 (0.24)
	CM-MSS.11P	1SVR740720R1400	0.119 (0.263)
	CM-MSS.11S	1SVR730720R1400	0.127 (0.280)
	CM-MSS.12P	1SVR740700R0100	0.105 (0.231)
	CM-MSS.12S	1SVR730700R0100	0.113 (0.249)
	CM-MSS.13P	1SVR740700R2100	0.147 (0.324)
	CM-MSS.13S	1SVR730700R2100	0.155 (0.342)
	CM-MSS.21P	1SVR740722R1400	0.118 (0.260)
	CM-MSS.21S	1SVR730722R1400	0.126 (0.278)
	CM-MSS.22P	1SVR740700R0200	0.121 (0.267)
	CM-MSS.22S	1SVR730700R0200	0.132 (0.291)
	CM-MSS.23P	1SVR740700R2200	0.163 (0.359)
	CM-MSS.23S	1SVR730700R2200	0.174 (0.384)
	CM-MSS.31P	1SVR740712R1400	0.120 (0.265)
	CM-MSS.31S	1SVR730712R1400	0.128 (0.282)
	CM-MSS.32P	1SVR740712R0200	0.120 (0.265)
	CM-MSS.32S	1SVR730712R0200	0.130 (0.287)
	CM-MSS.33P	1SVR740712R2200	0.162 (0.357)
	CM-MSS.33S	1SVR730712R2200	0.172 (0.379)
	CM-MSS.41P	1SVR740712R1200	0.130 (0.287)
	CM-MSS.41S	1SVR730712R1200	0.141 (0.311)
	CM-MSS.51P	1SVR740712R1300	0.135 (0.298)
	CM-MSS.51S	1SVR730712R1300	0.145 (0.320)

S: screw connection  
P: push-in connection

# Thermistor motor protection relays

## Ordering details - PTC temperature sensors C011



Temperature sensor example

15VC 110 000 F0531

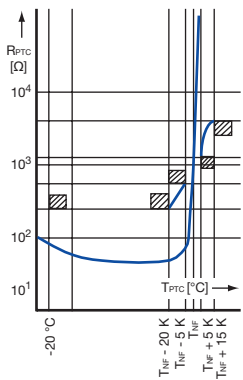

Temperature sensor characteristics

2CDC 252 068 F0208

### Description

The PTC temperature sensors (temperature-dependent with positive temperature coefficient) are selected by the manufacturer of the motor depending on:

- the motor insulation class according to IEC/EN 60034-11,
- the special characteristics of the motor, such as the conductor cross-section of the windings, the permissible overload factor, etc.
- special conditions prescribed by the user, such as the permissible ambient temperature, risks resulting from locked rotor, extent of permitted overload, etc.

One temperature sensor must be embedded in each phase winding. For instance, in case of three-phase squirrel cage motors, three sensors are embedded in the stator windings. For pole-changing motors with one winding (Dahlander connection), three sensors are also required. Pole-changing motors with two windings, however, require six sensors. If an additional warning is required before the motor is switched off, separate sensors for a correspondingly lower temperature must be embedded in the winding. They have to be connected to a second control unit.

The sensors are suitable for embedding in motor windings with rated operating voltages of up to 600 V AC. Conductor length: 500 mm per sensor. A 14 V varistor can be connected in parallel to protect the sensors from overvoltage. Due to their characteristics, the thermistor motor protection relays can also be used with PTC temperature sensors of other manufacturers which comply with DIN 44 081 and DIN 44 082.

### Ordering details

#### CM-MSS accessories

Rated response temperature $T_{NF}$	Color coding	Type	Order code	Weight (1 pc) kg (lb)
70 °C	white-brown	C011-70 <sup>1)</sup>	GHC0110003R0001	0.02 (0.044)
80 °C	white-white	C011-80 <sup>1)</sup>	GHC0110003R0002	0.02 (0.044)
90 °C	green-green	C011-90 <sup>1)</sup>	GHC0110003R0003	0.02 (0.044)
100 °C	red-red	C011-100 <sup>1)</sup>	GHC0110003R0004	0.02 (0.044)
110 °C	brown-brown	C011-110 <sup>1)</sup>	GHC0110003R0005	0.02 (0.044)
120 °C	gray-gray	C011-120 <sup>1)</sup>	GHC0110003R0006	0.02 (0.044)
130 °C	blue-blue	C011-130 <sup>1)</sup>	GHC0110003R0007	0.02 (0.044)
140 °C	white-blue	C011-140 <sup>1)</sup>	GHC0110003R0011	0.02 (0.044)
150 °C	black-black	C011-150 <sup>1)</sup>	GHC0110003R0008	0.02 (0.044)
160 °C	blue-red	C011-160 <sup>1)</sup>	GHC0110003R0009	0.02 (0.044)
170 °C	white-green	C011-170 <sup>1)</sup>	GHC0110003R0010	0.02 (0.044)
150 °C	black-black	C011-3-150 <sup>2)</sup>	GHC0110033R0008	0.05 (0.11)

1) Temperature sensor C011, standard version acc. to DIN 44081

2) Triple temperature sensor C011-3

## Thermistor motor protection relays

### Technical data - PTC temperature sensors C011

Characteristic data	Sensor type C011
Cold-state resistance	50 -100 $\Omega$ at 25 °C
Warm-state resistance $\pm 5$ up to 6 K of rated response temperature $T_{NF}$	10 000 $\Omega$
Thermal time constant, sensor open <sup>1)</sup>	< 5 s
Permitted ambient temperature	+180 °C

Rated response temperature $\pm$ tolerance $T_{NF} \pm \Delta T_{NF}$	PTC resistance R from -20 °C to $T_{NF} - 20$ K	PTC resistance R <sup>2)</sup> at PTC temperatures of:		
		$T_{NF} - iT_{NF}$ (UPTC $\leq 2.5$ V)	$T_{NF} + iT_{NF}$ (UPTC $\leq 2.5$ V)	$T_{NF} + 15$ K (UPTC $\leq 7.5$ V)
70 $\pm 5$ °C	$\leq 100 \Omega$	$\leq 570 \Omega$	$\geq 570 \Omega$	-
80 $\pm 5$ °C				
90 $\pm 5$ °C		$\leq 550 \Omega$	$\geq 1330 \Omega$	$\geq 4000 \Omega$
100 $\pm 5$ °C				
110 $\pm 5$ °C				
120 $\pm 5$ °C				
130 $\pm 5$ °C				
140 $\pm 5$ °C				
150 $\pm 5$ °C				
160 $\pm 5$ °C				
170 $\pm 7$ °C			$\leq 570 \Omega$	$\geq 570 \Omega$

1) Not embedded in windings.

2) For triple temperature sensor take values  $\times 3$ .



# Thermistor motor protection relays

## Technical data - CM-MSS

Data at T<sub>a</sub> = 25 °C and rated values, unless otherwise indicated

Type		CM-MSS.x1	CM-MSS.x2	CM-MSS.x3
<b>Supply circuit - Input circuit</b>				
Rated control supply voltage U <sub>s</sub>	A1-A2	24-240 V AC/DC	24 V AC/DC	220-240 V AC
	A2-A3	-	-	110-130 V AC
Rated control supply voltage U <sub>s</sub> tolerance		-15...+10 %		
Rated frequency		15-400 Hz	50-60 Hz	
Electrical insulation between supply circuit and measuring circuit		yes	no	yes
Power failure buffering time		20 ms		
<b>Supply circuit - Measuring circuit / Sensor circuit</b>				
Number of circuits		1 (CM-MSS.51: 2)		
Sensor type		PTC type A (DIN/EN 44081, DIN/EN 44082)		
Max. total resistance of sensors connected in series, cold state		< 750 Ω		
Overtemperature monitoring	switch-off resistance (relay de-energizes)	2.83 kΩ ± 1% (CM-MSS.12 /.13 /.22 /.23: 2.7 kΩ ± 5%)		
	switch-on resistance (relay energizes)	1.1 kΩ ± 1% (CM-MSS.12 /.13 /.22 /.23: 1.2 kΩ ± 5%)		
Maximum voltage in sensor circuit	1.33 kW	2.5 V		
	4 kW	3.7 V		
	∞ kW	5.5 V		
Maximum current in sensor circuit		3.7 mA		
Maximum sensor cable length		2 x 100 m at 0.75 mm <sup>2</sup> , 2 x 400 m at 2.5 mm <sup>2</sup>		
Accuracy within the rated control supply voltage tolerance		0.50 % (CM-MSS.12 /.13 /.22 /.23: 5 %)		
Accuracy within the temperature range		0.01 %/K (CM-MSS.12 /.13 /.22 /.23: 0.5 %/K)		
Repeat accuracy (constant parameters)		on request		
Reaction time of the safety function		< 100 ms		
Hardware fault tolerance (HFT)		0		
<b>Control circuit</b>				
Control function		see "Selection table CM-MSx range"		
Maximum no-load voltage		5.5 V		
Max. current		0.6 mA (CM-MSS.12 /.13 /.22 /.23: 1.2 mA)		
Maximum cable length		2 x 100 m at 0.75 mm <sup>2</sup> , 2 x 400 m at 2.5 mm <sup>2</sup>		
<b>Indication of operational states</b>				
Control supply voltage	U	LED green		
Relay status	R	LED yellow		
Fault message	F	LED red		
<b>Output circuit</b>				
Kind of output		see "Selection table CM-MSx range"		
Operating principle		closed-circuit principle		
Contact material		AgNi alloy, Cd free		
Rated operational voltage U <sub>e</sub> (IEC/EN 60947-1)		250 V AC		
Minimum switching voltage / Minimum switching current		24 V / 10 mA		
Maximum switching voltage / Maximum switching current		see data sheet		
Rated operating current I <sub>e</sub> (IEC/EN 60947-5-1)	AC-12 (resistive) at 230 V	4 A		
	AC-15 (inductive) at 230 V	3 A		
	DC-12 (resistive) at 24 V	4 A		
	DC-13 (inductive) at 24 V	2 A		
AC Rating (UL 508)	utilization category (Control Circuit Rating Code)	B 300		
	maximum rated operational voltage	300 V AC		
	maximum continuous thermal current at B 300	5 A		
	maximum making/breaking apparent power at B 300	3600/360 VA		
	general purpose rating	250 V AC - 4 A		
Mechanical lifetime		30 x 10 <sup>6</sup> switching cycles		
Electrical lifetime	at AC12, 230 V AC, 4 A	0.1 x 10 <sup>6</sup> switching cycles		
Maximum fuse rating to achieve short-circuit protection	n/c contact	10 A fast-acting (CM-MSS.12, CM-MSS.13, CM-MSS.51: 6 A)		
	n/o contact	10 A fast-acting		

## Thermistor motor protection relays

### Technical data - CM-MSS

Type	CM-MSS.x1	CM-MSS.x2	CM-MSS.x3
<b>General data</b>			
MTBF	on request		
Duty time	100 %		
Dimensions	see "Dimensional drawings"		
Mounting	DIN rail (IEC/EN 60715), snap-on mounting without any tool		
Mounting position	any		
Minimum distance to other units	vertical / horizontal	10 mm (0.394 in) if switching current > 2 A	
Material of housing	UL 94 V-0		
Degree of protection	housing	IP50	
	terminals	IP20	
<b>Electrical connection</b>		<b>Screw connection technology</b>	<b>Easy Connect Technology (push-in)</b>
Connection capacity	fine-strand with(out) wire end ferrule	1 x 0.5-2.5 mm <sup>2</sup> (1 x 18-14 AWG)	2 x 0.5-1.5 mm <sup>2</sup> (2 x 18-16 AWG)
		2 x 0.5-1.5 mm <sup>2</sup> (2 x 18-16 AWG)	
	rigid	1 x 0.5-4 mm <sup>2</sup> (1 x 20-12 AWG)	2 x 0.5-1.5 mm <sup>2</sup> (2 x 20-16 AWG)
		2 x 0.5-2.5 mm <sup>2</sup> (2 x 20-14 AWG)	
Stripping length	8 mm (0.32 in)		
Tightening torque	0.6-0.8 Nm (7.08 lb.in)		-
<b>Environmental data</b>			
Ambient temperature ranges	operation	-25...+60 °C (-13...+140 °F)	
	storage	-40...+85 °C (-40...+185 °F)	
Damp heat, cyclic (IEC/EN 60068-2-30)	6 x 24 h cycle, 55 °C, 95 % RH		
Climatic class (IEC/EN 60721-3-3)	3K5 (no condensation, no ice formation)		
Vibration, sinusoidal	5-13.2 Hz: ±1 mm; 13.2-100 Hz: 0.7 g		
Shock	Class 2		
<b>Isolation data</b>			
Rated insulation voltage U <sub>i</sub>	Supply circuit / Measuring circuit <sup>(1)</sup>	300 V AC (CM-MSS.x2: n/a)	
	Supply circuit / Output circuits	300 V AC	
	Measuring circuit (1) / Output circuits	300 V AC	
	Output circuit 1 / Output circuit 2	300 V AC	
Rated impulse withstand voltage U <sub>imp</sub>	Supply circuit / Measuring circuit <sup>(1)</sup>	4 kV (CM-MSS.x2: n/a)	
	Supply circuit / Output circuits	4 kV	
	Measuring circuit (1) / Output circuits	4 kV	
	Output circuit 1 / Output circuit 2	4 kV	
Basic insulation	Supply circuit / Measuring circuit <sup>(1)</sup>	600 V AC (CM-MSS.x2: n/a)	
	Supply circuit / Output circuits	600 V AC	
	Measuring circuit (1) / Output circuits	600 V AC	
	Output circuit 1 / Output circuit 2	300 V AC	
Protective separation (IEC/EN 61140, EN 50178)	Supply circuit / Measuring circuit <sup>(1)</sup>	yes, up to 300 V	
	Supply circuit / Output circuits	yes (CM-MSS.x2: n/a)	
	Measuring circuit (1) / Output circuits	yes	
	Output circuit 1 / Output circuit 2	no	
Pollution degree (IEC/EN 60664-1)	3		
Overvoltage category (IEC/EN 60664-1)	III		
<sup>(1)</sup> Potential of measuring circuit = Potential of control circuit			
<b>Standards</b>			
Product standard	EN 60947-5-1, EN 60947-8		
Low Voltage Directive	2014/35/EU		
EMC directive	2014/30/EU		
ATEX directive	2014/34/EU (only ATEX variants, see "Selection table CM-MSx range")		
RoHS directive	2011/65/EU		

## Thermistor motor protection relays

### Technical data - CM-MSS

Type	CM-MSS.x1	CM-MSS.x2	CM-MSS.x3
<b>Electromagnetic compatibility</b>			
Interference immunity to		IEC/EN 61000-6-2, IEC/EN 60947-8	
electrostatic discharge	IEC/EN 61000-4-2	Level 3, 6 kV contact discharge, 8 kV air discharge	
radiated, radio-frequency, electromagnetic field	IEC/EN 61000-4-3	Level 3, 10 V/m (1 GHz), 3 V/m (2 GHz), 1 V/m (2.7 GHz)	
electrical fast transient / burst	IEC/EN 61000-4-4	Level 3, 2 kV / 5 kHz	
surge	IEC/EN 61000-4-5	Level 3, Installation class 3, supply circuit and measuring circuit 1 kV L-L, 2 kV L-N	
conducted disturbances, induced by radio-frequency fields	IEC/EN 61000-4-6	Level 3, 0.15-80 MHz, 10 V, 80 % AM (1kHz)	
voltage dips, short interruptions and voltage variations	IEC/EN 61000-4-11	Class 3	
harmonics and interharmonics	IEC/EN 61000-4-13	Class 3	
Additional interference immunity according to product standard IEC/EN 60255-1 (reference on IEC/EN 60255-26)			
radiated, radio-frequency, electromagnetic field	IEC/EN 61000-4-3	10 V/m (80 MHz - 3 GHz)	
conducted disturbances, induced by radio-frequency fields	IEC/EN 61000-4-6	10 V at stated frequencies	
damped oscillatory waves	IEC/EN 61000-4-18	Signal lines, symmetric coupling: 1 kV peak voltage Power supply, asymmetric coupling: 2.5 kV peak voltage	
Interference emissions		IEC/EN 61000-6-3	
high-frequency radiated	IEC/CISPR 22, EN 55022	Class B	
high-frequency conducted	IEC/CISPR 22, EN 55022	Class B	
high-frequency radiated	Germanischer Lloyd	increased requirements in the emergency call frequency band	

## Thermistor motor protection relays

### Technical data - CM-MSE

Data at  $T_a = 25\text{ °C}$  and rated values, unless otherwise indicated

Type		CM-MSE
<b>Supply circuit - Input circuit</b>		
Rated control supply voltage $U_s$ power consumption	1SVR550805R9300	24 V AC approx. 1.5 A
	1SVR550800R9300	110-130 V AC approx. 1.5 A
	1SVR550801R9300	220-240 V AC approx. 1.5 A
Rated control supply voltage $U_s$ tolerance		-15...+10 %
Rated frequency		50-60 Hz
<b>Measuring circuit</b>		
Monitoring function	T1-T2	temperature monitoring by means of PTC sensors
Number of sensor circuits		1
<b>Sensor circuit</b>		
Sensor type		PTC type A (DIN/EN 44081, DIN/EN 44082)
Max. total resistance of sensors connected in series, cold state		$\leq 1.0\text{ k}\Omega$
Overtemperature monitoring	switch-off resistance (relay de-energizes)	2.0-3.0 $\text{k}\Omega$
	switch-on resistance (relay energizes)	1.2-1.65 $\text{k}\Omega$
Maximum voltage in sensor circuit	4 $\text{k}\Omega$	5 V
	$\infty\text{ k}\Omega$	15 V
Maximum current in sensor circuit		2 mA
Maximum sensor cable length		2 x 100 m at 0.75 mm <sup>2</sup> , 2 x 400 m at 2.5 mm <sup>2</sup>
Reaction time		<100 ms
<b>Output circuit</b>		
Kind of output	13-14	1 n/o contact
Operational principle		closed-circuit principle (output relay de-energizes if the measured value exceeds/drops below the adjusted threshold)
Maximum switching voltage		250 V
Rated operating voltage $U_e$ and rated operating current $I_e$	AC-12 (resistive) at 230 V	4 A
	AC-15 (inductive) at 230 V	3 A
	DC-12 (resistive) at 24 V	4 A
	DC-13 (inductive) at 24 V	2 A
AC Rating (UL 508)	utilization category (Control Circuit Rating Code)	B 300
	maximum rated operational voltage	300 V AC
	maximum continuous thermal current at B 300	5 A
	maximum making/breaking apparent power at B 300	3600/360 VA
	general purpose rating	250 V AC - 4 A
Mechanical lifetime		30 x 10 <sup>6</sup> switching cycles
Electrical lifetime	at AC12, 230 V AC, 4 A	0.1 x 10 <sup>6</sup> switching cycles
Maximum fuse rating to achieve short-circuit protection	n/c contact	10 A fast-acting
	n/o contact	10 A fast-acting
<b>General data</b>		
Dimensions		see "dimensional drawings"
Duty cycle		100 %
Mounting		DIN rail (IEC/EN 60715)
Mounting position		any
Degree of protection	housing / terminals	IP50 / IP20
<b>Electrical connection</b>		
Connecting capacity	fine strand with wire end ferrule	2 x 1.5 mm <sup>2</sup> (2 x 16 AWG)
	fine strand without wire end ferrule	2 x 0.75-1.5 mm <sup>2</sup> (2 x 18-16 AWG)
	rigid	2 x 1-1.5 mm <sup>2</sup> (2 x 18-16 AWG)
Stripping length		2 x 0.75-1.5 mm <sup>2</sup> (2 x 18-16 AWG)
Tightening torque		0.6-0.8 Nm (5.31-7.08 lb.in)
<b>Environmental data</b>		
Ambient temperature ranges	Operation	-20...+60 °C
	Storage	-40...+85 °C
Damp heat	IEC/EN 60068-2-30	40 °C, 93 % RH, 4 days
Vibration withstand	IEC/EN 60062-2-6	10-57 Hz: 0.075 mm; 57-150 Hz: 1 g

## Thermistor motor protection relays

### Technical data - CM-MSE























Type		CM-MSE
<b>Isolation data</b>		
Rated insulation voltage $U_i$	supply, measuring / output circuit	250 V
Rated impulse withstand voltage $U_{imp}$	between all isolated circuits	4 kV / 1.2 - 50 $\mu$ s
Pollution degree		3
Overvoltage category		III
<b>Standards / Directives</b>		
Standards		IEC/EN 60947-5-1, IEC/EN 60947-8
Low Voltage Directive		2014/35/EU
EMC Directive		2014/30/EU
RoHS Directive		2011/65/EU
<b>Electromagnetic compatibility</b>		
Interference immunity to		IEC/EN 61000-6-2, IEC/EN 60947-8
electrostatic discharge	IEC/EN 61000-4-2	Level 3, 6 kV contact discharge, 8 kV air discharge
radiated, radio-frequency, electromagnetic field	IEC/EN 61000-4-3	Level 3, 10 V/m (1 GHz), 3 V/m (2 GHz), 1 V/m (2.7 GHz)
electrical fast transient /burst	IEC/EN 61000-4-4	Level 3, 2 kV / 5 kHz
surge	IEC/EN 61000-4-5	Level 3, installation class 3, supply circuit and measuring circuit 1 kV L-L, 2 kV L-N
conducted disturbances, induced by radio-frequency fields	IEC/EN 61000-4-6	Level 3, 0.15-80 MHz, 10 V, 80 % AM (1kHz)
Interference emission		IEC/EN 61000-6-3
high-frequency radiated	IEC/CISPR 22, EN 55022	Class B
high-frequency conducted	IEC/CISPR 22, EN 55022	Class B

## Thermistor motor protection relays

### Technical data

#### LEDs, status information and fault messages

##### CM-MSS

Operational state	U: green LED	F: red LED	R: yellow LED
Absence of control supply voltage	OFF	OFF	OFF
Internal fault <sup>2)</sup>	OFF		
Internal fault <sup>2)</sup>			
Control supply voltage not within the tolerance range			OFF
Short circuit			OFF
Interrupted wire			OFF
Measuring circuit 2: Overtemperature			OFF
Measuring circuit 1: Overtemperature			OFF
Fault rectified but not confirmed		- <sup>1)</sup>	
Test function		OFF	OFF
Change of configuration not confirmed		OFF	
No fault		OFF	

1) Depending on the fault with the highest priority

2) Restart the device. If after restart the same fault is indicated, replace the device.

# Thermistor motor protection relays

## Technical diagrams

### Connection diagrams

#### CM-MSS.11x, CM-MSS.21x

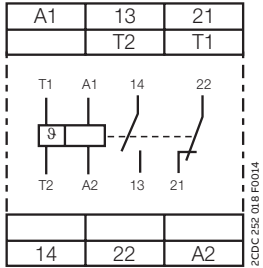

A1 – A2	Control supply voltage
13 – 14	n/o contact
21 – 22	n/c contact
T1 – T2	Measuring circuit

#### CM-MSS.12x

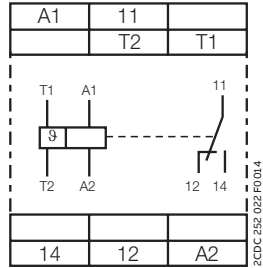

A1 – A2	Control supply voltage
11 – 12/14	c/o contact
T1 – T2	Measuring circuit

#### CM-MSS.13x

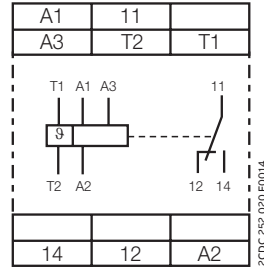

A1 – A2	Control supply voltage 220-240 V AC
A2 – A3	Control supply voltage 110-130 V AC
11 – 12/14	c/o contact
T1 – T2	Measuring circuit

#### CM-MSS.31x

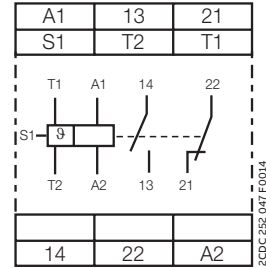

A1 – A2	Control supply voltage
13 – 14	n/o contact
21 – 22	n/c contact
S1 – T2	Automatic reset (jumpered)
T1 – T2	Measuring circuit

#### CM-MSS.22x, CM-MSS.32x, CM-MSS.41x

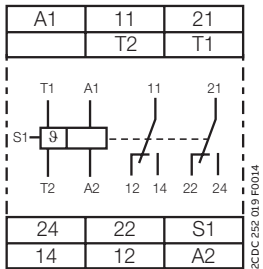

A1 – A2	Control supply voltage 24 V AC/DC
11 – 12/14	1st c/o (SPDT) contact
21 – 22/24	2nd c/o (SPDT) contact
S1 – T2	Automatic reset (jumpered)
T1 – T2	Measuring circuit

#### CM-MSS.23x, CM-MSS.33x

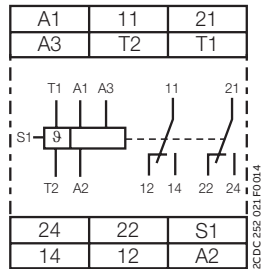

A1 – A2	Control supply voltage 220-240 V AC
A2 – A3	Control supply voltage 110-130 V AC
11 – 12/14	1st c/o (SPDT) contact
21 – 22/24	2nd c/o (SPDT) contact
S1 – T2	Automatic reset (jumpered)
T1 – T2	Measuring circuit

#### CM-MSS.51x

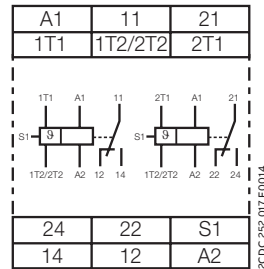

A1 – A2	Control supply voltage 220-240 V AC
11 – 12/14	1st c/o (SPDT) contact
21 – 22/24	2nd c/o (SPDT) contact
S1 – 1T2/2T2	Automatic reset (jumpered)
1T1 – 1T2/2T2	Measuring circuit 1
2T1 – 1T2/2T2	Measuring circuit 2

#### CM-MSE

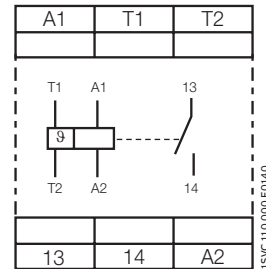

A1 – A2	Control supply voltage 24 V AC
T1-T2	Sensor circuit
13-14	Output contact - Closed circuit principle

# Thermistor motor protection relays

## Technical diagrams

### Circuit diagrams

**CM-MSS.11x, CM-MSS.21x**

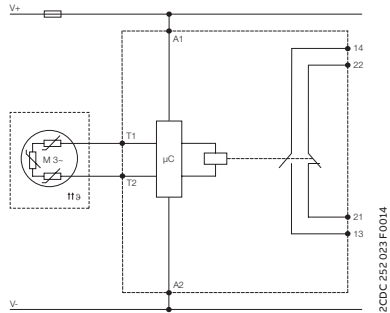

**CM-MSS.12x**

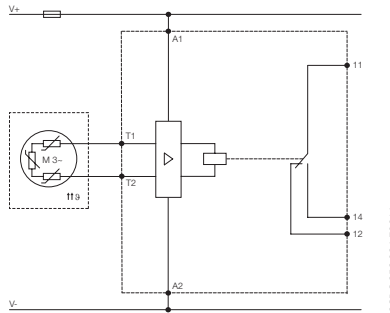

**CM-MSS.13x**

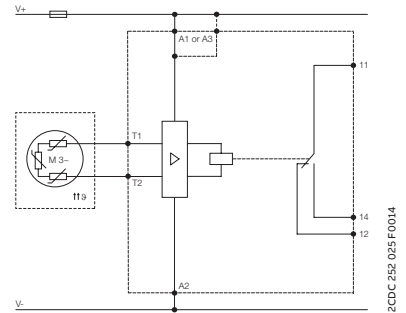

**CM-MSS.22x**

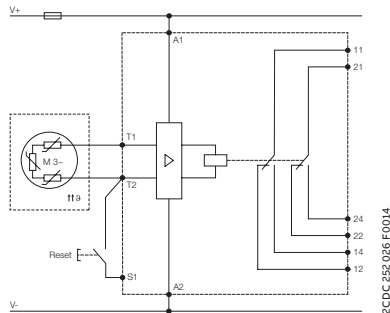

**CM-MSS.23x**

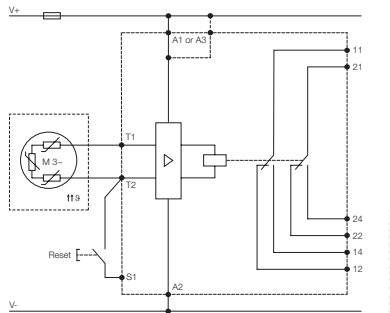

**CM-MSS.31x**

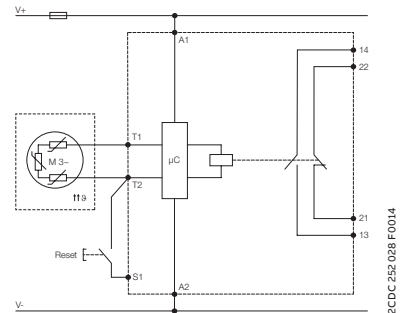

**CM-MSS.32x, CM-MSS.41x**

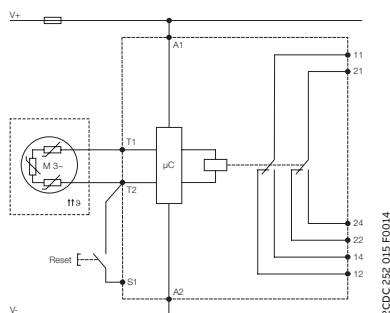

**CM-MSS.33x**

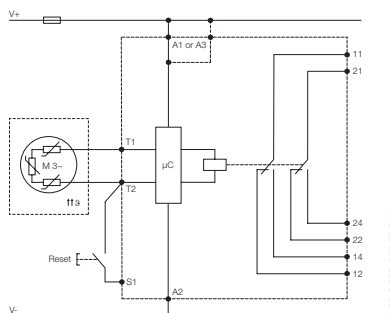

**CM-MSS.51x**

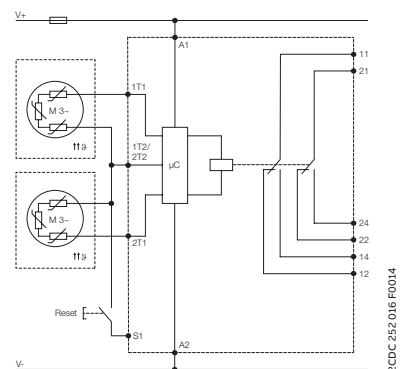

**CM-MSE**

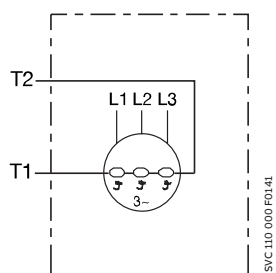







---

# Temperature monitoring relays

## Table of contents

<b>204</b>	<b>Benefits and advantages</b>
<b>205</b>	<b>Applications</b>
<b>207</b>	<b>Operating controls</b>
<b>208</b>	<b>Selection table</b>
<b>209</b>	<b>Ordering details</b>
<b>210</b>	<b>Configuration and setup</b>
<b>212</b>	<b>Technical data</b>
<b>215</b>	<b>Technical diagrams</b>
<b>216</b>	<b>Function diagrams</b>

# Temperature monitoring relays

## Benefits and advantages



The temperature monitoring relays of the CM-TCS range are able to measure temperatures of solids, liquids and gaseous media using PT100 sensors. Over-temperature and undertemperature monitoring, as well as open- or closed-circuit principle is configurable for all devices. As soon as the temperature falls below or exceeds the set threshold value, the output relays change their positions and the front-face LED's display the current status.

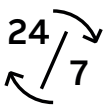

### Continuous operation

By using temperature monitoring relays, both the downtime and the commissioning time can be reduced. The relay is continuously monitoring the sensor circuit to detect short-circuit or interrupted wire faults. The high accuracy of the measuring input leads to a fast detection of exceeding threshold values. In case of fault, maintenance effort is reduced and time saved.



### Reliable in harsh conditions

All relays work reliably in environments with low temperatures down to -40 °C. Additionally, the housing fulfills the UL 94 V-0 flammability standard requirements. Together with the vibration resistant push-in terminals, the relay is not only reliable no matter the environment temperature but is also durable to shock and vibration. Save time as retightening is no longer needed and enhance the reliability and safety not only for the equipment.



### Easy installation

Like all devices from the measuring and monitoring portfolio, the CM-TCS relays are easily configurable via front facing potentiometers. Easy threshold configuration without calculation is accomplished by direct reading scales. For further configuration options, additional settings can be made via dip-switches, offering the flexibility to configure, for example, the working principle of the relays and the output configuration. The device can be set up before installation in the application and easy adjustments during the process are possible.

# Temperature monitoring relays

## Applications

The temperature monitoring relays CM-TCS monitor overtemperature, undertemperature, or temperatures between two threshold values (window monitoring) with a PT100 sensor.

As soon as the temperature falls below or exceeds the threshold value, the output relays change their positions according to the configured functionality.

The current status is displayed by front-faced LEDs. Regardless of the selected configuration, the device is monitoring its measuring circuit for interrupted wires or short-circuits.

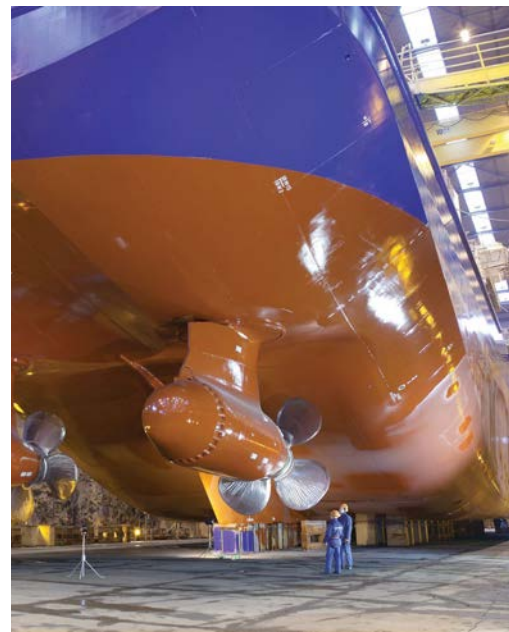
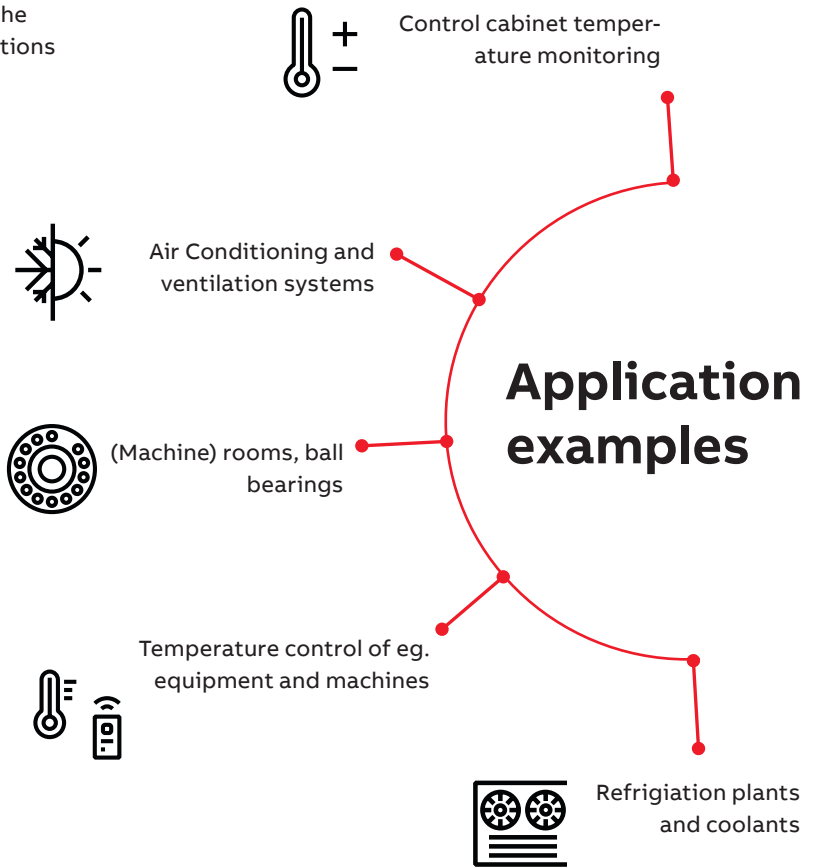



# Temperature monitoring relays

## Operating controls



Push-in and screw terminals



Measuring input: PT100



Adjustment of the threshold value  
 - 50 ... + 50 °C  
 0 ... + 100 °C  
 0 ... + 200 °C

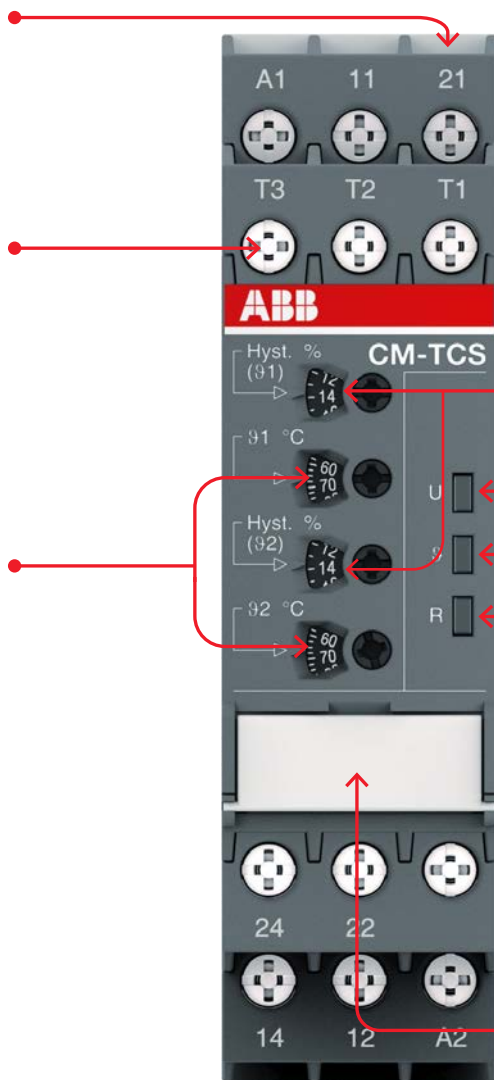

Adjustment of the hysteresis for threshold value 2 - 20 %



Indication of operational states  
 U: green LED – status indication of control supply voltage  
 9: red LED – fault message, state of measuring input  
 R: yellow LED – status indication of the output relays



DIP switch functions / marker label

- Overtemperature monitoring
- Undertemperature monitoring
- Temperature window monitoring activated
- Temperature window monitoring de-activated
- Closed-circuit principle
- Open-circuit principle
- 2x1 c/o (SPDT) contact
- 1x2 c/o (SPDT) contacts

## Temperature monitoring relays

### Selection table

Type	Order number	1SVR 730 740 R9100	1SVR 740 740 R9100	1SVR 730 740 R0100	1SVR 740 740 R0100	1SVR 730 740 R9200	1SVR 740 740 R9200	1SVR 730 740 R0200	1SVR 740 740 R0200	1SVR 730 740 R9300	1SVR 740 740 R9300	1SVR 730 740 R0300	1SVR 740 740 R0300
CM-TCS.21S		■	■			■	■			■	■		
CM-TCS.21P				■	■			■	■			■	■
CM-TCS.11S													
CM-TCS.11P													
CM-TCS.22S													
CM-TCS.22P													
CM-TCS.12S													
CM-TCS.12P													
CM-TCS.23S										■	■	■	■
CM-TCS.23P													
CM-TCS.13S													
CM-TCS.13P													
<b>Rated control supply voltage U<sub>c</sub></b>													
24 V AC/DC		■	■			■	■			■	■		
24-240 V AC/DC				■	■			■	■			■	■
<b>Sensor circuits (2 or 3 wire)</b>													
Number of temperature sensors		1	1	1	1	1	1	1	1	1	1	1	1
Number of thresholds		2	2	2	2	2	2	2	2	2	2	2	2
<b>Measuring temperature range</b>													
-50...+50 °C		■	■	■	■								
0...+100 °C						■	■	■	■				
0...+200 °C										■	■	■	■
<b>Monitoring function</b>													
Overtemperature		■	■	■	■	■	■	■	■	■	■	■	■
Undertemperature		■	■	■	■	■	■	■	■	■	■	■	■
Window temperature		■	■	■	■	■	■	■	■	■	■	■	■
<b>Operating principle</b>													
open or closed-circuit principle		■	■	■	■	■	■	■	■	■	■	■	■
<b>Output contacts</b>													
c/o		2	2	2	2	2	2	2	2	2	2	2	2

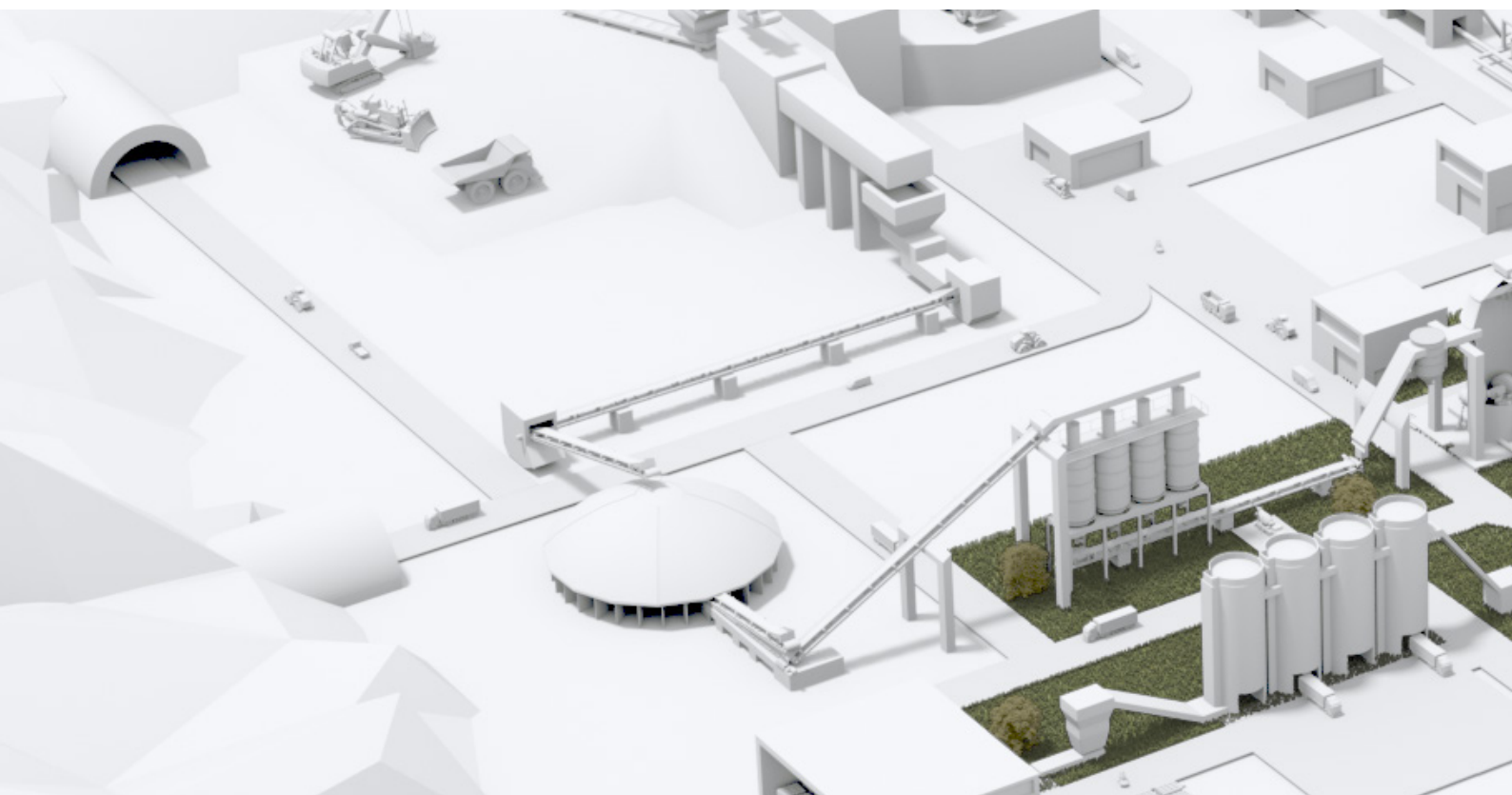



# Temperature monitoring relays

## Ordering details



CM-TCS

2CDC251031V0012

### Description CM-TCS

The temperature monitoring relays CM-TCS are able to measure temperatures of solids, liquids and gaseous media using PT100 sensors. Overtemperature and undertemperature monitoring, as well as open- or closed-circuit principle, is configurable for all devices. As soon as the temperature falls below or exceeds the set threshold value, the output relays change their positions according to the configured functionality and the front-face LEDs display the current status.

### Ordering details

#### Temperature monitoring relays CM-TCS

Rated control supply voltage	Measuring range	Temperature sensors	Type	Order code	Weight (1 pc) kg (lb)	
24-240 V AC/DC	-50...+50 °C	PT100	CM-TCS.11S	1SVR730740R0100	0.151 (0.333)	
			CM-TCS.11P	1SVR740740R0100	0.140 (0.309)	
			CM-TCS.12S	1SVR730740R0200	0.151 (0.333)	
	0...+100 °C		CM-TCS.12P	1SVR740740R0200	0.140 (0.309)	
			0...+200 °C	CM-TCS.13S	1SVR730740R0300	0.151 (0.333)
				CM-TCS.13P	1SVR740740R0300	0.140 (0.309)
24 V AC/DC	-50...+50 °C	CM-TCS.21S	1SVR730740R9100	0.138 (0.304)		
		CM-TCS.21P	1SVR740740R9100	0.127 (0.280)		
		CM-TCS.22S	1SVR730740R9200	0.138 (0.304)		
	0...+100 °C	CM-TCS.22P	1SVR740740R9200	0.127 (0.280)		
		0...+200 °C	CM-TCS.23S	1SVR730740R9300	0.138 (0.304)	
			CM-TCS.23P	1SVR740740R9300	0.127 (0.280)	

S: screw connection  
P: push-in connection

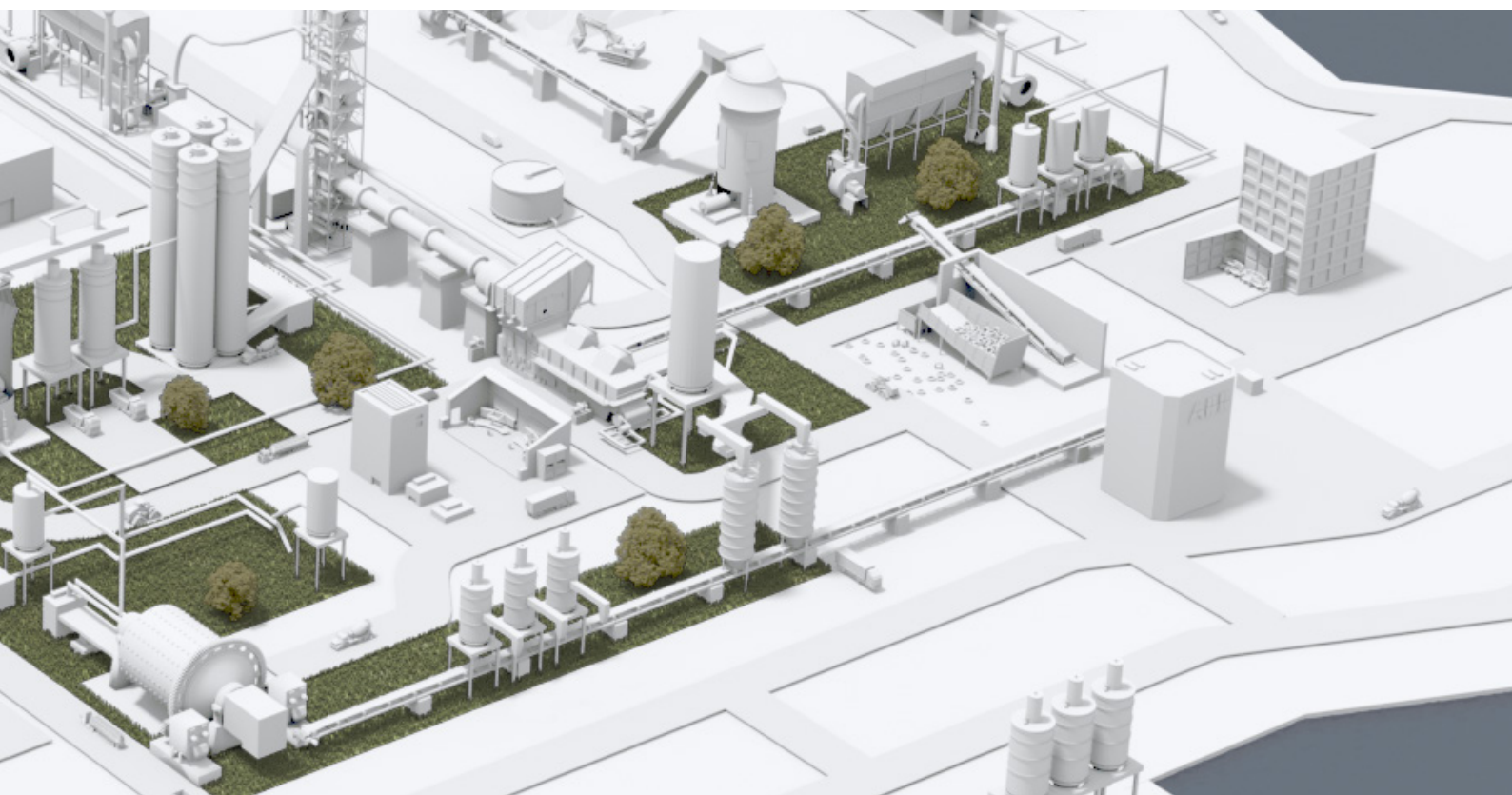

## Temperature monitoring relays

### Configuration and setup

#### DIP switches

Position	4	3	2	1
ON †				
OFF				

	ON	OFF (default)
<b>DIP switch 1</b> Monitoring principle	Overtemperature monitoring If overtemperature monitoring is selected, the CM-TCS recognizes temperatures above the selected threshold and trips the output relay according to the selected operating principle.	Undertemperature monitoring If undertemperature monitoring is selected, the CM-TCS recognizes temperatures below the selected threshold and trips the output relay according to the selected operating principle.
<b>DIP switch 2</b> Temperature window monitoring	Temperature window monitoring activated If temperature window monitoring is selected, the CM-TCS monitors over- and undertemperature. If temperature window monitoring is activated, DIP switch 1 is disabled.	Temperature window monitoring de-activated Temperature window monitoring is de-selected.
<b>DIP switch 3</b> Operating principle of the output relays	Closed-circuit principle If closed-circuit principle is selected, the output relays are energized. They de-energize if a fault is occurring.	Open-circuit principle If open-circuit principle is selected, the output relays are deenergized. They energize if a fault is occurring.
<b>DIP switch 4</b> 2 x 1 c/o contact, 1 x 2 c/o contacts	2 x 1 c/o (SPDT) contact If operating principle 2 x 1 c/o contact is selected, the output relay R1 (11-12/14) reacts to threshold value $\vartheta_1$ and the output relay R2 (21-22/24) reacts to threshold value $\vartheta_2$ .	1 x 2 c/o (SPDT) contacts If operating principle 1 x 2 c/o contacts is selected, both output relays R1 (11-12/14) and R2 (21-22/24) react synchronously to one threshold value. Overtemperature monitoring: Settings of the threshold value $\vartheta_2$ have no effect on the operation. Undertemperature monitoring: Settings of the threshold values $\vartheta_2$ have no effect on the operation.

# Temperature monitoring relays

## Configuration and setup

### Connection of resistance thermometer sensors

#### 2-wire measurement

When using 2-wire temperature sensors, the sensor resistance and the wire resistance are added together. The resulting systematic errors must be taken into account when adjusting the tripping device. A jumper must be connected between the terminals T2 and T3. The following table can be used for PT100 sensors to determine the temperature errors caused by the line length. When using resistance sensors with two-wire connection a bridge must be inserted between terminals T2 and T3.

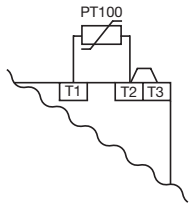

#### 3-wire measurement

To minimize the influence of the wire resistance, a three-wire connection is usually used. By means of the additional wire, two measuring circuits are created. One of these two circuits is used for reference. This way, the tripping device can calculate and take into account the wire resistance automatically.

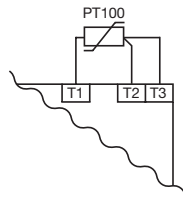

#### Temperature error

(depending on the line length and conductor cross section for PT100 sensors at an ambient temperature of 20 °C, in K)

Line length in m	Wire size mm <sup>2</sup>			
	0.50	0.75	1	1.5
0	0.0	0.0	0.0	0.0
10	1.8	1.2	0.9	0.6
25	4.5	3.0	2.3	1.5
50	9.0	6.0	4.5	3.0
75	13.6	9.0	6.8	4.5
100	18.1	12.1	9.0	6.0
200	36.3	24.2	18.1	12.1
500	91.6	60.8	45.5	30.2

#### Error caused by the line

The error resulting from the line resistance amounts to approx. 2.5 Kelvin/Ohm. If the resistance of the line is not known and it is not possible to measure it, the error caused by the line can be estimated using the following table.

## Temperature monitoring relays

### Technical data

Type		CM-TCS.11/12/13	CM-TCS.21/22/23
<b>Input circuit</b>			
Rated control supply voltage $U_s$	A1-A2	24-240 V AC/DC	24 V AC/DC
Rated control supply voltage $U_s$ tolerance		-15...+10 %	
Typical current / power / consumption	24 V DC	33 mA / 0.8 VA	18 mA / 0.45 VA
	115 V AC	12.5 mA / 1.5 VA	n/a
	230 V AC	13 mA / 2.9 VA	n/a
Rated frequency	AC	15-400 Hz	50/60 Hz
Frequency range	AC	13.5-440 Hz	45-65 Hz
Power failure buffering time	min.	20 ms	
<b>Measuring circuit</b>		<b>T1, T2, T3</b>	
Sensor type		PT100	
Connection of the sensor	2-wire	yes, jumper between T2-T3	
	3-wire	yes, use terminal T1, T2, T3	
Monitoring function		overtemperature, undertemperature or window monitoring	
Threshold values adjustable within the measuring range	CM-TCS.x1	-50...+50 °C	
	CM-TCS.x2	0...+100 °C	
	CM-TCS.x3	0...+200 °C	
Number of possible thresholds		2	
Tolerance of the adjusted threshold value		typ. ±5 % of the range end value	
Hysteresis related to the threshold value		2-20 % of threshold value, min. 1 °C	
Measuring principle		continuous current	
Typical current in the sensor circuit		0.8 mA	
Maximum current in sensor circuit		0.9 mA	
Interrupted wire detection		yes, indicated via LED status	
Short-circuit detection		yes, indicated via LED status	
Accuracy within the rated control supply voltage tolerance		< 0.2 °C / or < 0.01 %/K	
Accuracy within the temperature range		< 0.2 °C / or < 0.01 %/K	
Repeat accuracy (constant parameters)		< 0.2 % of full scale	
Maximum measuring cycle		320 ms	
<b>Output circuit</b>			
Kind of output		2 x 1 or 1 x 2 c/o (SPDT) contacts configurable	
Operating principle		open- or closed-circuit principle configurable (1)	
Contact material		AgNi alloy, Cd free	
Minimum switching voltage / Minimum switching current		24 V / 10 mA	
Maximum switching voltage / Maximum switching current		see 'Load limit curves'	
Rated operational voltage $U_e$ and rated operational current $I_e$	AC-12 (resistive) 230 V	4 A	
	AC-15 (inductive) 230 V	3 A	
	DC-12 (resistive) 24 V	4 A	
	DC-13 (inductive) 24 V	2 A	
AC Rating (UL508)	utilization category	B 300 pilot duty; general purpose 250 V, 4 A, $\cos \varphi$ 0.75	
	maximum rated operational voltage	250 V AC	
	maximum continuous thermal current at B 300	4 A	
	maximum making/breaking apparent power at B 300	3600/360 VA	
Mechanical lifetime		30 x 10 <sup>6</sup> switching cycles	
Electrical lifetime (AC-12, 230 V, 4 A)		0.1 x 10 <sup>6</sup> switching cycles	
Maximum fuse rating to achieve short-circuit protection	n/c contact	6 A fast-acting	
	n/o contact	10 A fast-acting	
Conventional thermal current $I_{th}$		4 A	

<sup>(1)</sup> Closed-circuit principle: Output relay(s) de-energize(s) if measured value exceeds or falls below the adjusted threshold value

## Temperature monitoring relays

### Technical data

Type	CM-TCS.11/12/13	CM-TCS.21/22/23	
<b>General data</b>			
Dimensions	see "dimensional drawings"		
Mounting	DIN rail (IEC/EN 60715), snap-on mounting without any tool		
Mounting position	any		
Degree of protection	enclosure / terminals	IP50 / IP20	
Ambient temperature range	operation	-40...+60 °C	
	storage /transport	-40...+85 °C	
<b>Electrical connection</b>			
Wire size	<b>Screw connection technology</b>	<b>Easy Connect Technology (Push-in)</b>	
fine-strand without wire end ferrule	A1, A2, 11, 12, 14, 21, 22, 24	1 x 0.5-2.5 mm <sup>2</sup> (1 x 20-14 AWG) 2 x 0.5-1.5 mm <sup>2</sup> (2 x 20-16 AWG)	2 x 0.5-1.5 mm <sup>2</sup> (2 x 20-16 AWG) connection with lever
	T1, T2, T3	1 x 0.2-2.5 mm <sup>2</sup> (1 x 24-14 AWG) 2 x 0.2-1.5 mm <sup>2</sup> (2 x 24-16 AWG)	2 x 0.2-1.5 mm <sup>2</sup> (2 x 24-16 AWG) connection with lever
fine-strand with wire end ferrule	A1, A2, 11, 12, 14, 21, 22, 24	1 x 0.5-2.5 mm <sup>2</sup> (1 x 20-14 AWG) 2 x 0.5-1.5 mm <sup>2</sup> (2 x 20-16 AWG)	2 x 0.5-1.5 mm <sup>2</sup> (2 x 20-16 AWG) connection: push-in
	T1, T2, T3	1 x 0.2-2.5 mm <sup>2</sup> (1 x 24-14 AWG) 2 x 0.2-1.5 mm <sup>2</sup> (2 x 24-16 AWG)	2 x 0.2-1.5 mm <sup>2</sup> (2 x 24-16 AWG) insulated ferrule (DIN 46228-4-E): connection: push-in ferrule (DIN 46228-1-A): < 0.5 mm <sup>2</sup> , connection with lever ≥ 0.5 mm <sup>2</sup> , connection: push-in
rigid	A1, A2, 11, 12, 14, 21, 22, 24	1 x 0.5-4 mm <sup>2</sup> (1 x 20-12 AWG) 2 x 0.5-2.5 mm <sup>2</sup> (2 x 20-14 AWG)	2 x 0.5-1.5 mm <sup>2</sup> (2 x 20-16 AWG) connection: push-in
	T1, T2, T3	1 x 0.2-4 mm <sup>2</sup> (1 x 24-12 AWG) 2 x 0.2-2.5 mm <sup>2</sup> (2 x 24-14 AWG)	2 x 0.2-1.5 mm <sup>2</sup> (2 x 24-16 AWG) < 0.5 mm <sup>2</sup> , connection with lever ≥ 0.5 mm <sup>2</sup> , connection: push-in
Stripping length	8 mm (0.32 In)		
Tightening torque	< 0.5 mm <sup>2</sup>	0.5 Nm (4.43 lb.In)	-
	≥ 0.5 mm <sup>2</sup>	0.6 - 0.8 Nm (5.31 - 7.08 lb.In)	-
<b>Standards / Directives</b>			
Standards	IEC/EN 60255-27, IEC/EN 60947-5-1		
Low Voltage Directive	2014/35/EU		
EMC Directive	2014/30/EU		
RoHS Directive	2011/65/EU		
<b>Environmental data</b>			
Ambient temperature ranges	operation/storage/ transport	-40...+60 °C/-40...+85 °C/-40...+85 °C	
Climatic class	IEC/EN 60721-3-3	3K5 (no condensation, no ice formation)	
Damp heat, cyclic	IEC/EN 600068-2-30	6 x 24 h cycle, 55 °C, 95 % RH	
Vibration, sinusoidal	Class 2		
Shock	Class 2		
<b>Isolation data</b>			
Rated impulse withstand voltage U <sub>imp</sub>	supply circuit / measuring circuit	4 kV	-
	supply circuit / output circuits	4 kV	
	measuring circuit / output circuits	4 kV	
	output circuit 1 / output circuit 2	4 kV	
Rated insulation voltage U <sub>i</sub>	supply circuit / measuring circuit	300 V	-
	supply circuit / output circuits	300 V	
	measuring circuit / output circuits	300 V	
	output circuit 1 / output circuit 2	300 V	

## Temperature monitoring relays

### Technical data

Type		CM_TCS.11/12/13	CM-TCS.21/22/23
Basis insulation	supply circuit / measuring circuit	250 V AC / 300 V DC	-
	supply circuit / output circuits	250 V AC / 300 V DC	
	measuring circuit / output circuits	250 V AC / 300 V DC	
	output circuit 1 / output circuit 2	250 V AC / 300 V DC	
Protective separation (IEC/EN 61140, EN 50178)	supply circuit / measuring circuit	250 V AC / 250 V DC	-
	supply circuit / output circuits	250 V AC / 300 V DC	250 V AC / 250 V DC
	measuring circuit / output circuits	250 V AC / 300 V DC	250 V AC / 250 V DC
Pollution degree		3	
Overvoltage category		III	
<b>Electromagnetic compatibility</b>			
Interference immunity to		IEC/EN 61000-6-2	
electrostatic discharge	IEC/EN 61000-4-2	Level 3, 6 kV / 8 kV	
radiated, radio-frequency, electromagnetic field	IEC/EN 61000-4-3	Level 3, 10 V/m (1 GHz) / 3 V/m (2 GHz) / 1 V/m (2.7 GHz)	
electrical fast transient/burst	IEC/EN 61000-4-4	Level 3, 2 kV / 5 kHz	
surge	IEC/EN 61000-4-5	Level 3, installation class 3, supply circuit and measuring circuit 1 kV L-L, 2 kV L-earth	
conducted disturbances, induced by radio-frequency fields	IEC/EN 61000-4-6	Level 3, 10 V	
voltage dips, short interruptions and voltage variations	IEC/EN 61000-4-11	Class 3	
harmonics and interharmonics	IEC/EN 61000-4-13	Class 3	
Interference emission		IEC/EN 61000-6-3	
high-frequency radiated	IEC/CISPR 22, EN 55022	Class B	
high-frequency conducted	IEC/CISPR 22, EN 55022	Class B	

# Temperature monitoring relays

## Technical diagrams

### Connection diagram

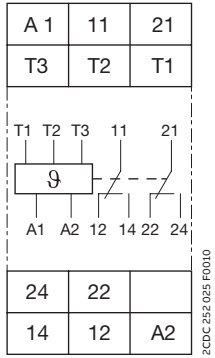

A1 – A2	Control supply voltage
11 – 12/14	Output relay R1
21 – 22/24	Output relay R2
T1, T2, T3	Measuring input, connection PT100

### Dimensional drawing in mm and inches

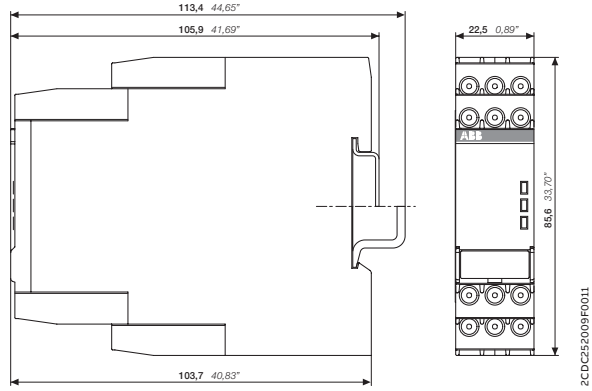

### Electrical isolation

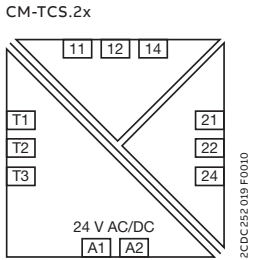

Electrical isolation

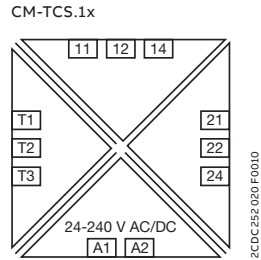

Protective separation acc. to IEC/EN 61140; EN 50178

# Temperature monitoring relays

## Function diagrams

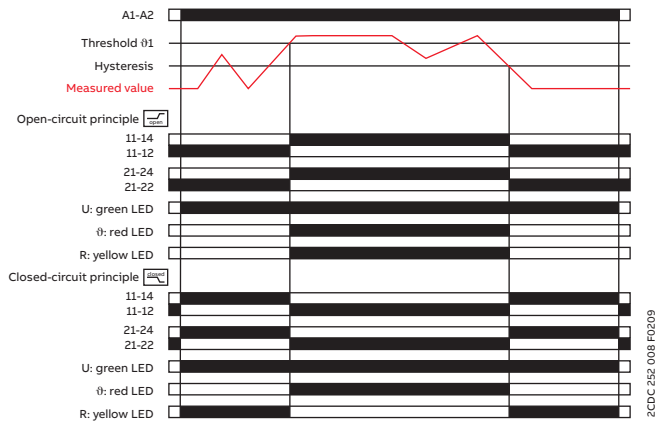

### Overtemperature monitoring, 1 x 2 c/o contacts [1x2 c/o]

With this configuration, settings via  $\vartheta 2$  have no influence on the operating function ( $\vartheta 2$  disabled).

#### Open-circuit principle:

If the measured value is correct, the output relays remain de-energized when control supply voltage is applied. If the measured value exceeds the adjusted threshold value  $\vartheta 1$ , the output relays energize. If the measured value drops again below the adjusted threshold value  $\vartheta 1$  minus the adjusted hysteresis, the output relays de-energize.

#### Closed-circuit principle:

The behavior is inverse to the one with open-circuit principle.

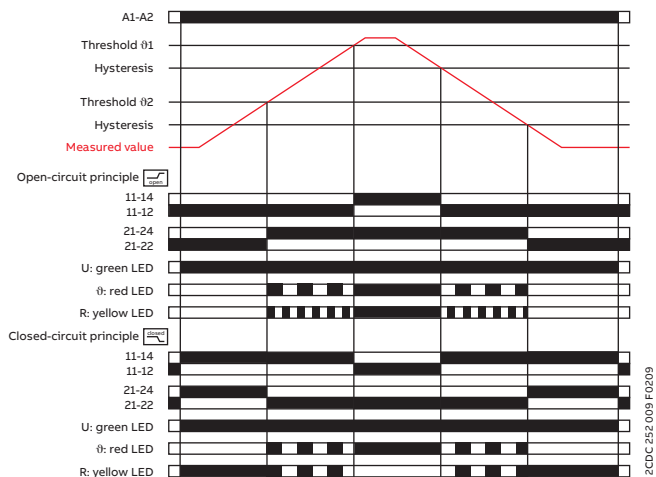

### Overtemperature monitoring, 2 x 1 c/o contact [2x1 c/o]

#### Open-circuit principle:

If the measured value is correct, the output relays remain de-energized when control supply voltage is applied. If the measured value exceeds the adjusted threshold value  $\vartheta 2$ , output relay R2 (prewarning) energizes. If the measured value exceeds the adjusted threshold value  $\vartheta 1$ , output relay R1 (final switch-off) energizes.

If the measured value drops again below the adjusted threshold value  $\vartheta 1$  minus the adjusted hysteresis, output relay R1 (final switch-off) de-energizes. If the measured value drops below the adjusted threshold value  $\vartheta 2$  minus the adjusted hysteresis, output relay R2 (prewarning) de-energizes.

#### Closed-circuit principle:

The behavior is inverse to the one with open-circuit principle.

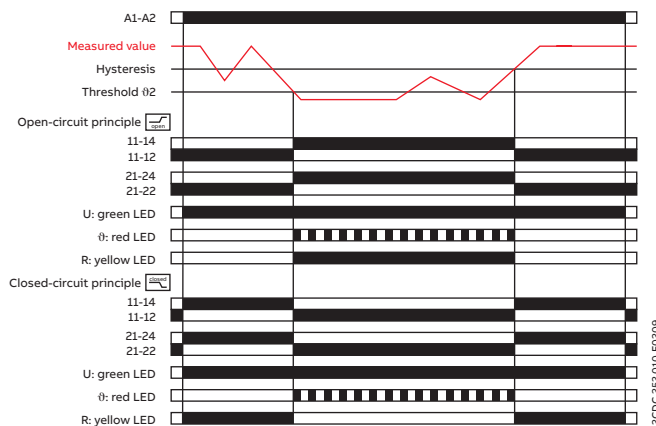

### Undertemperature monitoring, 1 x 2 c/o contacts [1x2 c/o]

With this configuration, settings via  $\vartheta 1$  have no influence on the operating function ( $\vartheta 1$  disabled).

#### Open-circuit principle:

If the measured value is correct, the output relays remain de-energized when control supply voltage is applied. If the measured value drops below the adjusted threshold value  $\vartheta 2$ , the output relays energize. If the measured value exceeds again the adjusted threshold value  $\vartheta 2$  plus the adjusted hysteresis, the output relays de-energize.

#### Closed-circuit principle:

The behavior is inverse to the one with open-circuit principle.



# Temperature monitoring relays

## Function diagrams

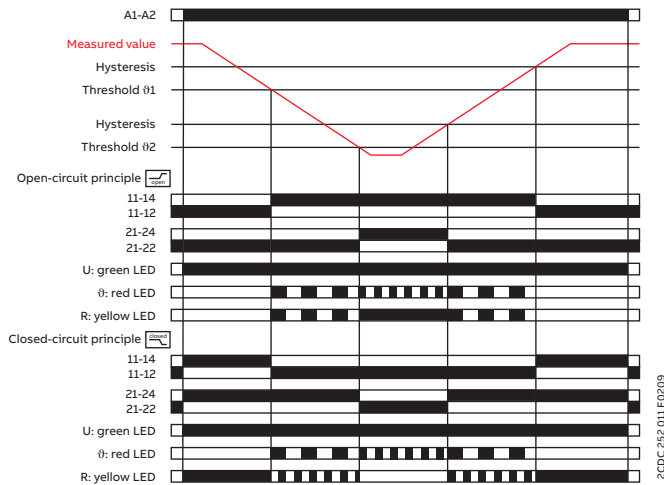

**Undertemperature monitoring, 2 x 1 c/o contact** 2x1 c/o

Open-circuit principle:  
 If the measured value is correct, the output relays remain de-energized when control supply voltage is applied. If the measured value drops below the adjusted threshold value  $\vartheta_1$ , output relay R1 (prewarning) energizes. If the measured value drops below the adjusted threshold value  $\vartheta_2$ , output relay R2 (final switch-off) energizes. If the measured value exceeds again the adjusted threshold value  $\vartheta_2$  plus the adjusted hysteresis, output relay R2 (final switch-off) de-energizes. If the measured value exceeds the adjusted threshold value  $\vartheta_1$  plus the adjusted hysteresis, output relay R1 (prewarning) de-energizes.

Closed-circuit principle:  
 The behavior is inverse to the one with open-circuit principle.

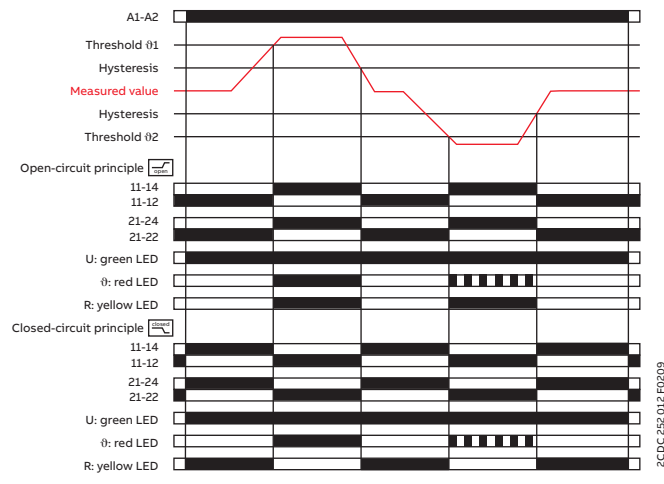

**Temperature window monitoring, 1 x 2 c/o contacts** 1x2 c/o

Open-circuit principle:  
 If the measured value is correct, the output relays remain de-energized when control supply voltage is applied. If the measured value exceeds the adjusted threshold value  $\vartheta_1$  or drops below the adjusted threshold value  $\vartheta_2$ , the output relays energize. If the measured value drops again below the adjusted threshold value  $\vartheta_1$  minus the adjusted hysteresis or exceeds again the adjusted threshold value  $\vartheta_2$  plus the adjusted hysteresis, the output relays de-energize.

Closed-circuit principle:  
 The behavior is inverse to the one with open-circuit principle.

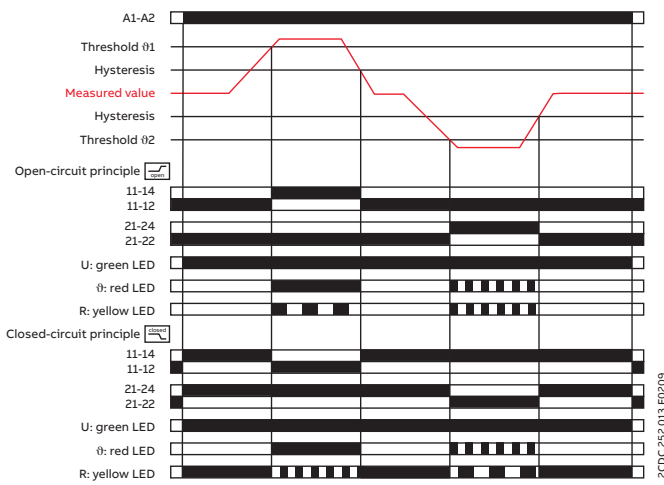

**Temperature window monitoring, 2 x 1 c/o contact** 2x1 c/o

Open-circuit principle:  
 If the measured value is correct, the output relays remain de-energized when control supply voltage is applied. If the measured value exceeds the adjusted threshold value  $\vartheta_1$  or drops below the adjusted threshold value  $\vartheta_2$ , output relay R1 ( $> \vartheta_1$ ) or R2 ( $< \vartheta_2$ ) respectively energizes. If the measured value drops again below the adjusted threshold value  $\vartheta_1$  minus the adjusted hysteresis or exceeds again the adjusted threshold value  $\vartheta_2$  plus the adjusted hysteresis, output relay R1 ( $> \vartheta_1$ ) or R2 ( $< \vartheta_2$ ) respectively de-energizes.

Closed-circuit principle:  
 The behavior is inverse to the one with open-circuit principle.



---

# Liquid level monitoring relays

## Table of contents

<b>220</b>	<b>Benefits and advantages</b>
<b>222</b>	<b>Applications</b>
<b>226</b>	<b>Operating controls</b>
<b>228</b>	<b>Selection table</b>
<b>229</b>	<b>Ordering details</b>
<b>230</b>	<b>Technical data</b>
<b>236</b>	<b>Function diagrams</b>
<b>237</b>	<b>Technical diagrams</b>

# Liquid level monitoring relays

## Benefits and advantages



ABB's liquid level monitoring relays are the ideal solution to regulate and control liquid levels and ratios of mixtures of conductive fluids. The assortment includes single- or multifunctional devices which can be used for overflow protection, dry-running protection of pumps, filling and draining applications as well as max. and min. level alarming.



### Global availability

The liquid level monitoring relays are designed to provide a wide supply voltage range, making global differences irrelevant. Additionally, the CM-ENS range meets a broad range of standards and requirements. Together with ABB's global support and sales network, using CM-ENS gives customers the confidence of worldwide sourcing – no matter where they build, install or operate their equipment.



### Reliable in harsh conditions

High immunity against electromagnetic disturbances is ensured due to advanced measuring technology. Additionally, the housing fulfills the UL 94 V-0 flammability standard requirements. Together with the vibration resistant push-in terminals, the relay is not only reliable no matter the environment temperature but is also durable to shock and vibration. Save time as re-tightening is no longer needed and enhance the reliability and safety not only for the equipment.



### Improve installation efficiency

Like all devices from the measuring and monitoring portfolio, the CM-ENS relays are easily configurable via front facing potentiometers. Easy threshold configuration without calculation is accomplished by direct reading scales. The device can be set up before installation in the application and easy adjustments during the process are possible.

# Liquid level monitoring relays

## Benefits and advantages



### Operating principle

Liquid level control relays CM-ENS are designed to monitor levels of conductive liquids and media and is used, for example, for liquid level control in pump systems. The measuring principle is based on the resistance change sensed by single-pole electrodes. To avoid electrolytic phenomena, an AC current runs across the probes.

A selector switch on the front panel allows selection of the required function and the sensitivity range.



### Suitability

Suitable for		Not suitable for	
spring water	acids, bases	chemically pure water	ethylene glycol
drinking water	liquid fertilizers	fuel	concentrated alcohol
sea water	milk, beer, coffee	oils	paraffin
sewage	non-concentrated alcohol	explosive areas (liquid gas)	lacquers



### Characteristics

#### CM-ENS.1x

- Control of one or two liquid levels (min/max)
- Fill or drain function
- Adjustable response sensitivity 5-100 kΩ

#### CM-ENS.2x

- Control of one or two liquid levels (min/max)
- Fill (UP) or Drain (DOWN), adjustable via front-face potentiometer
- Adjustable response sensitivity 0.1-1000 kΩ

#### CM-ENS.31

- Control of one or two liquid levels (min/max)
- Fill (UP) or Drain (DOWN), adjustable via front-face potentiometer
- Adjustable response sensitivity 0.1-1000 kΩ
- Selectable ON- or OFF-delay
- 2 c/o (SPDT) contacts

#### All CM-ENS devices

- Devices with wide rated control supply voltage 24-240 V AC/DC
- Cascadable
- High EMC immunity
- 3 LEDs for the indication of operational states
- Screw connection technology or Easy Connect Technology
- Housing material for highest fire protection classification UL 94 V-0
- Tool-free mounting and demounting on DIN rail
- 22.5 mm (0.89 in) width

# Liquid level monitoring relays

## Applications

Liquid level monitoring relays work in conjunction with, for example, suspension electrodes, and can be used either for direct liquid level control or also for cascading devices, as well as operation modes with several electrodes, or control of two liquid levels are possible.



Suspension electrode



# Liquid level monitoring relays

## Applications

### Cascading of several devices

With the CM-ENS it is possible to use two devices in one tank. This enables the possibility to realize a pre-warning with additional electrodes. In this way, two additional alarm outputs for exceeding or dropping below the normal level can be implemented in addition to the filling levels MAX and MIN. In addition, a reserve pump can be connected to the additional device.

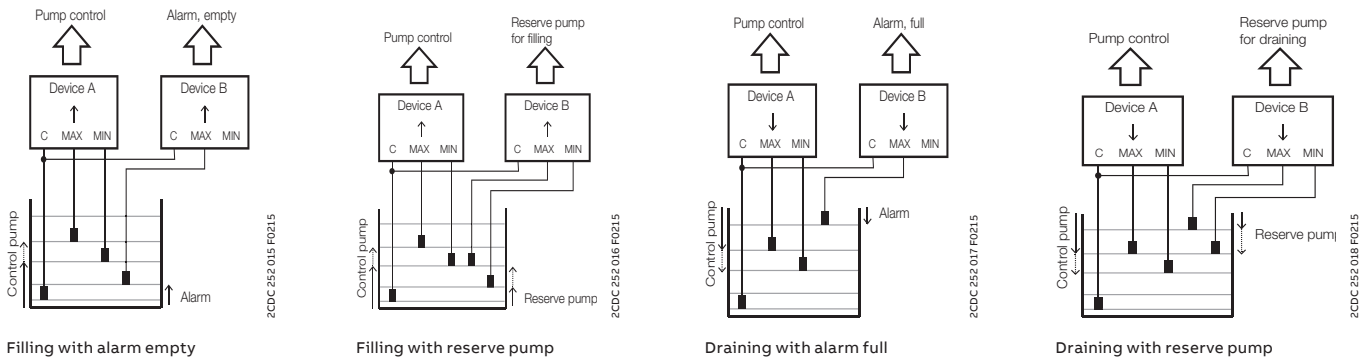

### Operating mode with three electrodes

The CM-ENS measures the electrical resistance of the liquid between two immersion electrodes and a reference electrode.

For CM-ENS.1x only: If the relay is connected to the rated control supply voltage, the output relay changes its switching state as soon as the liquid level reaches the MAX-electrode, while the minimum sensor is submerged. The relay returns to the original state as soon as the minimum sensor is no longer in contact with the monitored medium.

For CM-ENS.2x and CM-ENS.31 only: The function fill (Λ) or drain (∇) can be selected via a front-face potentiometer. If the fill function is selected, the output relay is energized until the MAX-electrode becomes wet. Then it is de-energized and not re-energized until the MIN-electrode becomes dry. If the drain function is selected, the output relay energizes as soon as the MAX-electrode becomes wet. It remains energized until the liquid level has dropped below the MIN-electrode.

### Operation mode with two electrodes

If only one level should be controlled, only the MAX-electrode shall be connected at the CM-ENS.

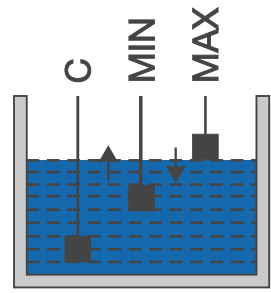

Operation mode with three electrodes

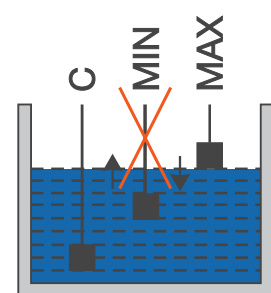

Operation mode with two electrodes

# Liquid level monitoring relays

## Applications

### Control of two liquid levels via liquid level monitoring relay CM-ENS

In combination with suspension electrodes CM-HC or CM-HCT (suitable for drinking water).

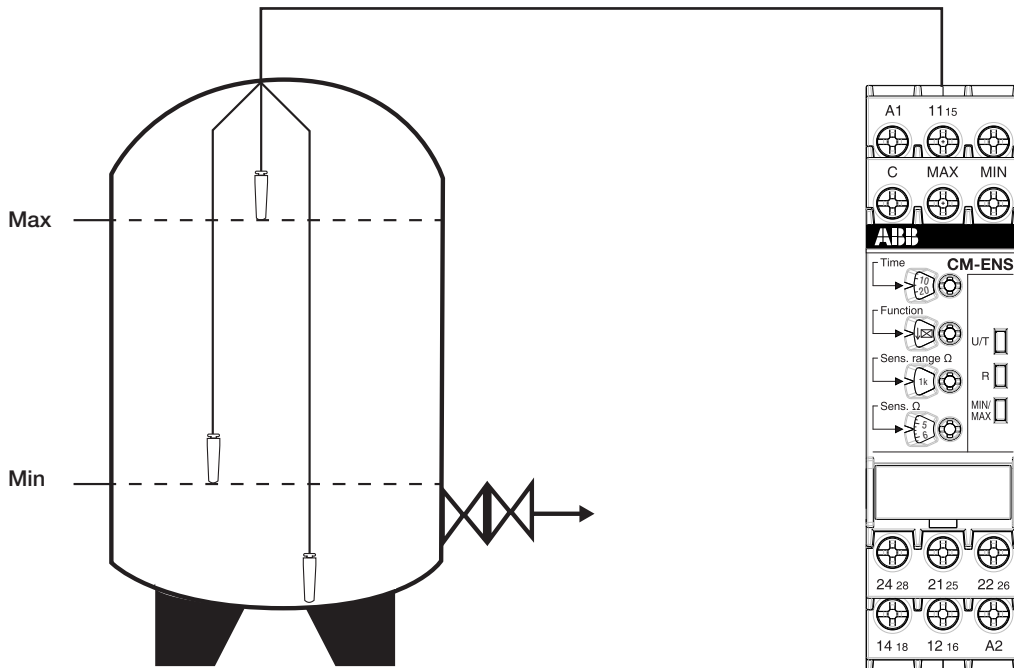



# Liquid level monitoring relays

## Applications

### Overflow protection via liquid level monitoring relay CM-ENS

In combination with the compact support CM-KH-3 and 3 bar electrodes CM-SE.

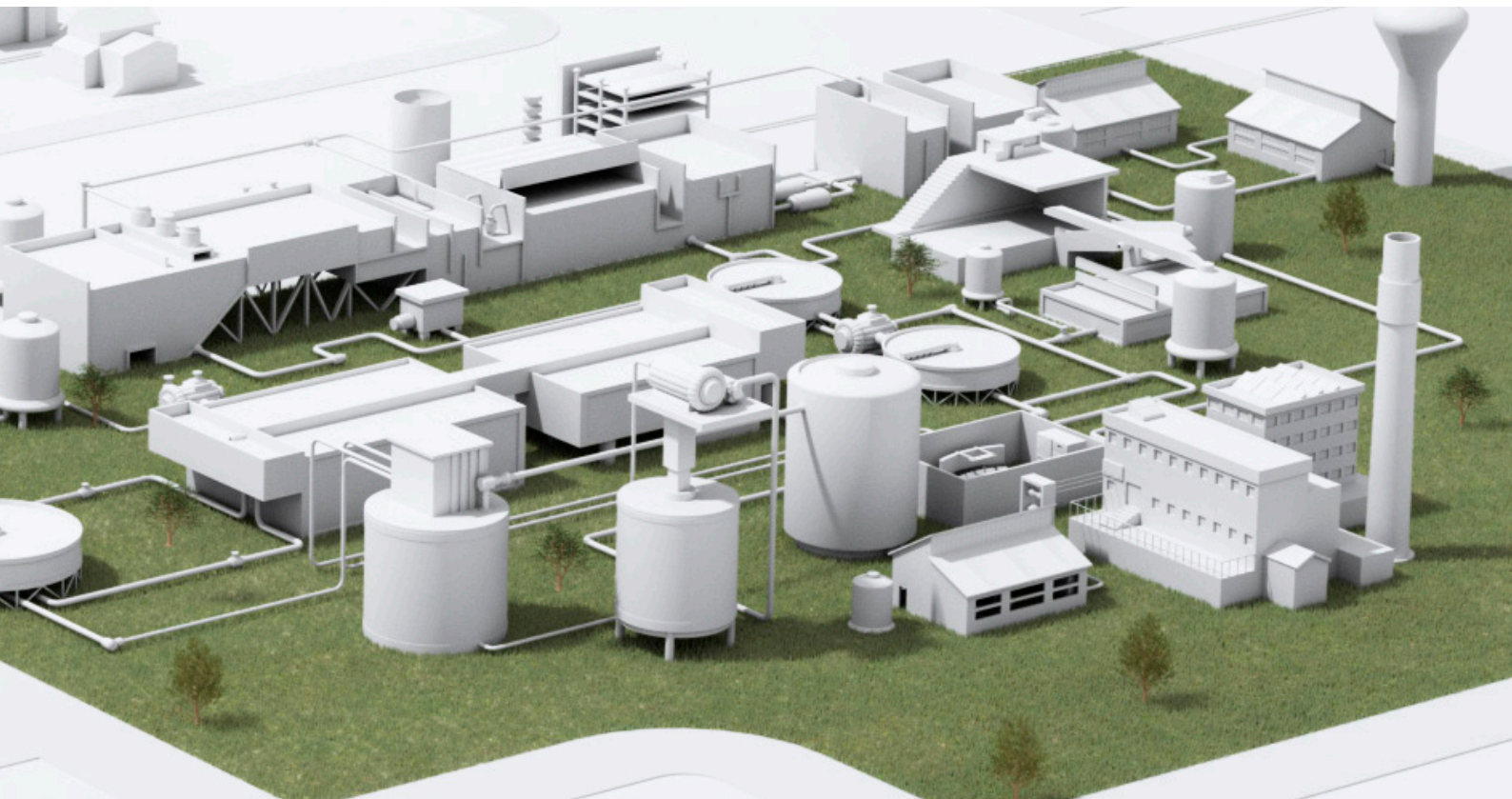
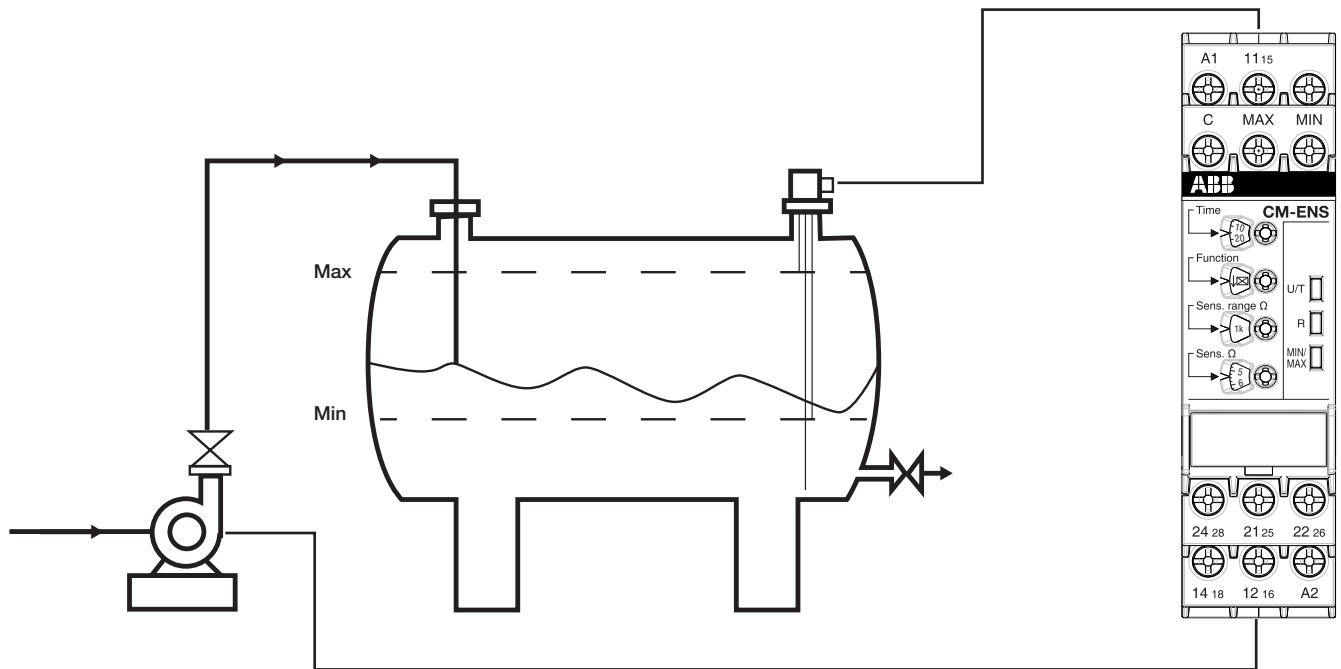

# Liquid level monitoring relays

## Operating controls

### CM-ENS.1x

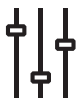

Adjustment of the response sensitivity



Marker label

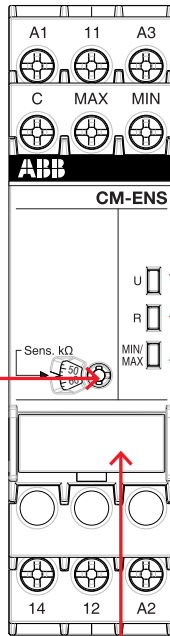

Indication of operational states with LEDs

- U: green LED - Status indication of control supply voltage
- [Symbol] control supply voltage applied
- R: yellow LED - Status indication of the output relays
- [Symbol] energized
- MIN/MAX: yellow LED - Status indication of the electrodes
- [Symbol] MIN and MAX wet
- [Symbol] MIN wet

### CM-ENS.2x

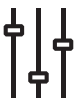

Adjustment of the function

- ↑ Fill
- ↓ Drain

Adjustment of the response sensitivity range

Adjustment of the response sensitivity



Marker label

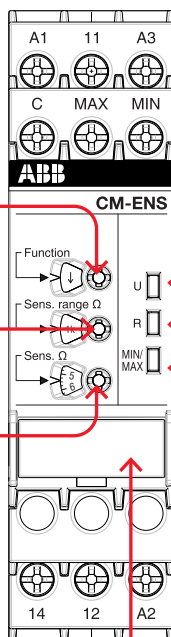

Indication of operational states with LEDs

- U: green LED - Status indication of control supply voltage
- [Symbol] control supply voltage applied
- R: yellow LED - Status indication of the output relays
- [Symbol] energized
- MIN/MAX: yellow LED - Status indication of the electrodes
- [Symbol] MIN and MAX wet
- [Symbol] MIN wet

# Liquid level monitoring relays

## Operating controls

### CM-ENS.31

Adjustment of the time delay



Adjustment of the function

- ↑ ☒ ON-delayed Fill
- ↓ ☒ ON-delayed Drain
- ↑ ■ OFF-delayed Fill
- ↓ ■ OFF-delayed Drain

Adjustment of the response sensitivity range

Adjustment of the response sensitivity



Marker label

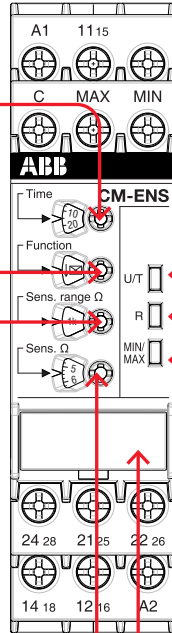

Indication of operational states with LEDs

- U: green LED - Status indication of control supply voltage
- ☐ control supply voltage applied
- ☐ time delay is running
- R: yellow LED - Status indication of the output relays
- ☐ energized
- MIN/MAX: yellow LED - Status indication of the electrodes
- ☐ MIN and MAX wet
- ☐ MIN wet

# Liquid level monitoring relays

## Selection table

	Type	Order code	CM-ENE MIN	CM-ENE MIN	CM-ENE MIN	CM-ENE MAX	CM-ENE MAX	CM-ENE MAX	CM-ENS.11S	CM-ENS.11P	CM-ENS.13S	CM-ENS.13P	CM-ENS.21S	CM-ENS.21P	CM-ENS.23S	CM-ENS.23P	CM-ENS.31S	CM-ENS.31P
<b>Rated control supply voltage Us</b>																		
24-240 V AC/DC									■	■			■	■			■	■
24 V AC			■			■												
110-130 V AC				■			■				■	■			■	■		
220-240 V AC					■			■			■	■			■	■		
<b>Sensor circuit</b>																		
Number of electrodes (including ground reference)			2	2	2	2	2	2	3	3	3	3	3	3	3	3	3	3
<b>Response sensitivity range</b>																		
0-100 kOhm			■	■	■	■	■	■										
5-100 kOhm									adj	adj	adj	adj						
0.1-1000 kOhm													adj	adj	adj	adj	adj	adj
<b>Monitoring function</b>																		
Dry running protection			■	■	■				■	■	■	■	■	■	■	■	■	■
Overflow protection						■	■	■	■	■	■	■	■	■	■	■	■	■
Liquid level control						■	■	■	■	■	■	■	■	■	■	■	■	■
<b>Operating principle</b>																		
Open-circuit principle			■	■	■				■	■	■	■						
Closed-circuit principle						■	■	■										
Open- or closed-circuit principle													sel	sel	sel	sel	sel	sel
<b>Adjustable ON-/OFF-delay</b>																		
0.1-10 s																	■	■
<b>Output contacts</b>																		
n/o			1	1	1	1	1	1										
c/o (SPDT)									1	1	1	1	1	1	1	1	2	2
<b>Connection type</b>																		
Push-in terminals										■		■		■		■		■
Double-chamber cage connection terminals									■		■		■		■		■	
Screw			■	■	■	■	■	■										

adj: adjustable  
sel: selectable

# Liquid level monitoring relays

## Ordering details



1SVR550851R9500

CM-ENE MIN



2CDC251004V0015

CM-ENS.3x

### Description

The liquid level monitoring relays CM-ENS and CM-ENE monitors and controls the liquid level and ratios of mixtures of conductive fluids. It is used for filling and draining applications, to protect pumps against dry-running, to protect tanks against overflow, and for signalization of the status of the monitored liquid level.

### Ordering details

Characteristics	Type	Order code	Weight (1 pc) kg (lb)
See selection table	CM-ENE MIN	1SVR550855R9500	0.15 (0.33)
		1SVR550850R9500	0.15 (0.33)
		1SVR550851R9500	0.15 (0.33)
	CM-ENE MAX	1SVR550855R9400	0.15 (0.33)
		1SVR550850R9400	0.15 (0.33)
		1SVR550851R9400	0.15 (0.33)
	CM-ENS.11S	1SVR730850R0100	0.124 (0.273)
	CM-ENS.11P	1SVR730850R2100	0.117 (0.258)
	CM-ENS.13S	1SVR740850R0100	0.153 (0.337)
	CM-ENS.13P	1SVR740850R2100	0.145 (0.320)
	CM-ENS.21S	1SVR730850R0200	0.125 (0.276)
	CM-ENS.21P	1SVR740850R0200	0.117 (0.258)
	CM-ENS.23S	1SVR730850R2200	0.154 (0.340)
	CM-ENS.23P	1SVR740850R2200	0.147 (0.324)
	CM-ENS.31S	1SVR730850R0300	0.143 (0.315)
	CM-ENS.31P	1SVR740850R0300	0.134 (0.295)

## Liquid level monitoring relays

### Technical data

Type		CM-ENE MIN	CM-ENE MAX
<b>Supply circuit</b>			
Rated control supply voltage $U_s$ - power consumption	A1-A2	24 V AC, approx. 1.5 VA	
	A1-A2	110-130 V AC, approx. 1.2 VA	
	A1-A2	220-240 V AC, approx. 1.4 VA	
Rated control supply voltage $U_s$ tolerance		-15...+15 %	
Rated frequency		50-60 Hz	
<b>Measuring circuit</b>		<b>MIN-C, MAX-C</b>	
Monitoring function		dry-running protection	overflow protection
Response sensitivity		0-100 k $\Omega$ , not adjustable	
Maximum electrode voltage		30 V AC	
Maximum electrode current		1.5 mA	
Electrode supply line	max. cable capacity	3 nF	
	max. cable length	30 m	
<b>Timing circuit</b>			
Tripping delay		fixed approx. 200 ms	
<b>Indication of operational states</b>			
Output relay energized		R: yellow LED	
<b>Output circuits</b>		<b>13-14</b>	
Kind of output		1 n/o contact	
Operational principle <sup>1)</sup>		open-circuit principle <sup>1)</sup>	closed-circuit principle <sup>1)</sup>
Rated operational voltage $U_e$ (IEC/EN 60947-1)		250 V	
Minimum switching voltage / minimum switching current		- / -	
Maximum switching voltage		250 V	
Rated operational voltage $U_e$ and rated operational current $I_e$	AC-12 (resistive) 230 V	4 A	
	AC-15 (inductive) 230 V	3 A	
	DC-12 (resistive) 24 V	4 A	
	DC-13 (inductive) 24 V	2 A	
AC rating (UL 508)	Utilization category (Control Circuit Rating Code)	B 300	
	max. rated operational voltage	300 V AC	
	max. continuous thermal current at B 300	5 A	
	max. making/breaking apparent power at B 300	3600/360 VA	
Mechanical lifetime		30 x 10 <sup>6</sup> switching cycles	
Electrical lifetime (AC-12, 230 V, 4 A)		0.3 x 10 <sup>6</sup> switching cycles	
Max. fuse rating to achieve short-circuit protection	n/c contact	-	
	n/o contact	10 A fast-acting	
<b>General data</b>			
Duty cycle		100 %	
Dimensions		see dimensional drawings	
Mounting		DIN rail (IEC/EN 60715)	
Mounting position		any	
Degree of protection	enclosure / terminals	IP50 / IP20	
Ambient temperature range	operation / storage	-20...+60 °C / -40...+85 °C	
<b>Electrical connection</b>			
Wire size	fine-strand with wire-end ferrule	2 x 0.75-1.5 mm <sup>2</sup> (2 x 18-16 AWG)	
	fine-strand without wire-end ferrule	2 x 1-1.5 mm <sup>2</sup> (2 x 18-16 AWG)	
	rigid	2 x 0.75-1.5 mm <sup>2</sup> (2 x 18-16 AWG)	
Stripping length		10 mm (0.39 inch)	
Tightening torque		0.6-0.8 Nm	

## Liquid level monitoring relays

### Technical data

Type	CM-ENE MIN	CM-ENE MAX
<b>Standards / Directives</b>		
Standard	IEC/EN 60947-5-1, EN 50178	
Low Voltage Directive	2014/35/EU	
EMC Directive	2014/35/EU	
RoHS Directive	2011/65/EU	
<b>Electromagnetic compatibility</b>		
Interference immunity to	EN 61000-6-2, EN 61000-6-4	
Electrostatic discharge	IEC/EN 61000-4-2	level 3 (6 kV / 8 kV)
Radiated, radio-frequency, electromagnetic field	IEC/EN 61000-4-3	level 3 (10 V/m)
Electrical fast transient / burst	IEC/EN 61000-4-4	level 3 (2 kV / 5 kHz)
Surge	IEC/EN 61000-4-5	level 4 (2 kV L-L)
Conducted disturbances, induced by radio-frequency fields	IEC/EN 61000-4-6	level 3 (10 V)
Interference emission		
high-frequency radiated	IEC/CISPR 22, EN 55022	class B
high-frequency conducted	IEC/CISPR 22, EN 55022	class B
<b>Environmental data</b>		
Ambient temperature ranges	operation/storage	-20...+60 °C / -40...+85 °C
Damp heat	IEC/EN 60068-2-30	40 °C, 93 % RH, 4 days
Vibration withstand	IEC/EN 60068-2-6	10-57 Hz: 0.075 mm; 57-150 Hz: 1 g
<b>Isolation data</b>		
Rat. insulation volt. betw. supply, measuring & output circuit	250 V	
Rated impulse withstand voltage $U_{imp}$ between all isolated circuits	4 kV / 1.2-50 $\mu$ s	
Pollution category	3	
Overvoltage category	III	

1) Open-circuit principle: Output relay energizes if the measured value exceeds/drops below the adjusted threshold.

Closed-circuit principle: Output relay de-energizes if the measured value exceeds/drops below the adjusted threshold.

## Liquid level monitoring relays

### Technical data

Type	CM-ENS.1x	CM-ENS.2x	CM-ENS.31				
<b>Supply circuit</b>							
Rated control supply voltage $U_s$	CM-ENS.11, CM-ENS.21, CM-ENS.31: A1-A2	24-240 V AC/DC					
	CM-ENS.13, CM-ENS.23: A1-A2	220-240 V AC					
	CM-ENS.13, CM-ENS.23: A3-A2	110-130 V AC					
Rated control supply voltage $U_s$ tolerance	-15...+10 %						
Rated frequency	50-60 Hz						
Frequency range	47-63 Hz						
Typical current / power consumption	24 V AC	25 mA / 0.6 W	25 mA / 0.6 W	25 mA / 0.6 W			
	110-130 V AC	20 mA / 2.6 VA	20 mA / 2.6 VA	8 mA / 1.1 VA			
	220-240 V AC	8.5 mA / 2.1 VA	8.5 mA / 2.1 VA	10 mA / 2.4 VA			
	24-240 V AC/DC	11 mA / 2.6 VA	11 mA / 2.6 VA	11 mA / 2.6 VA			
Power failure buffering time	min.	20 ms					
Start-up time $t_s$	Range 5-100 k $\Omega$	max. 1.3 s	-	-			
	Range 0.1-1 k $\Omega$	-	max. 900 ms	-			
	Range 1-10 k $\Omega$	-	max. 900 ms	-			
	Range 10-100 k $\Omega$	-	max. 1.3 s	-			
	Range 100-1000 k $\Omega$	-	max. 6.3 s	-			
<b>Measuring circuit</b>							
<b>MAX-MIN-C</b>							
Sensor type	electrode						
Monitoring function	fill or drain	fill or drain, selectable					
Measuring principle	conductivity measurement						
Number of electrodes	3						
Response sensitivity	adjustable: 5-100 k $\Omega$	adjustable: 0.1-1000 k $\Omega$					
Maximum electrode voltage	6 V AC						
Maximum electrode current	1 mA	2 mA					
Electrode supply line		<b>max cable capacity</b>	<b>max cable length</b>	<b>max cable capacity</b>	<b>max cable length</b>	<b>max cable capacity</b>	<b>max cable length</b>
	Range 5-100 k $\Omega$	10 nF	100 m	-	-	-	-
	Range 0.1-1 k $\Omega$	-	-	200 nF	1000 m	200 nF	1000 m
	Range 1-10 k $\Omega$	-	-	200 nF	1000 m	200 nF	1000 m
	Range 10-100 k $\Omega$	-	-	20 nF	100 m	20 nF	100 m
Range 100-1000 k $\Omega$	-	-	4 nF	20 m	4 nF	20 m	
Max. measuring cycle	Range 5-100 k $\Omega$	1000 ms		-	-		
	Range 0.1-1 k $\Omega$	-	-	700 ms		-	
	Range 1-10 k $\Omega$	-	-	700 ms		-	
	Range 10-100 k $\Omega$	-	-	1.1 s		-	
	Range 100-1000 k $\Omega$	-	-	5 s		-	
<b>Timing circuit</b>							
Time delay	-			0.1-30 s, adjustable, ON- or OFF-delay			
<b>Indication of operational states</b>							
Control supply voltage	U: green LED						
Output relay energized	R: Yellow LED						



## Liquid level monitoring relays

### Technical data

Type	CM-ENS.1x	CM-ENS.2x	CM-ENS.31
Electrode / alarm status	MAX/MIN: Yellow LED		
<b>Output circuits</b>			
Kind of output	11 <sub>15</sub> -12 <sub>16</sub> /14 <sub>18</sub>	relay, 1 c/o (SPDT) contact	
	21 <sub>15</sub> -22 <sub>16</sub> /24 <sub>18</sub>	-	
		relay, 1st c/o (SPDT) contact	relay, 2nd c/o (SPDT) contact
Operational principle	open-circuit principle	open- or closed-circuit principle (selectable)	
Contact material	AgNi alloy, Cd free		
Minimum switching voltage / minimum switching current	12 V / 10 mA		
Maximum switching voltage / Maximum switching current	see data sheets		
Rated operational voltage U <sub>o</sub> and rated operational current I <sub>e</sub> (IEC/EN 60947-5-1)	AC-12 (resistive) 230 V	4 A	
	AC-15 (inductive) 230 V	3 A	
	DC-12 (resistive) 24 V	4 A	
	DC-13 (inductive) 24 V	2 A	
AC rating (UL 508)	Utilization category (Control Circuit Rating Code)	B 300, pilot duty general purpose 250 V, 4 A, cos φ 0.75	
	max. rated operational voltage	300 V AC	
	max. continuous thermal current at B 300	5 A	
	max. making/breaking apparent power at B 300	3600/360 VA	
Mechanical lifetime	10 x 10 <sup>6</sup> switching cycles		
Electrical lifetime (AC-12, 230 V, 4 A)	0.1 x 10 <sup>6</sup> switching cycles		
Max. fuse rating to achieve short-circuit protection	n/c / n/o contact	6 A / 10 A fast-acting	10 A / 10 A fast-acting
Conventional thermal current I <sub>th</sub>	4 A		

## Liquid level monitoring relays

### Technical data

Type		CM-ENS.1x	CM-ENS.2x	CM-ENS.31
<b>General data</b>				
MTBF		on request		
Duty cycle		100 %		
Dimensions		see dimensional drawings		
Weight		see ordering details		
Mounting		DIN rail (IEC/EN 60715), snap-on mounting without any tool		
Mounting position		any		
Minimum distance to other units		CM-ENS.x1: not necessary CM-ENS.x3: 10 mm if contact current > 2 A		
Degree of protection	housing / terminals	IP50 / IP20		
Material of housing		UL 94 V-0		
<b>Electrical connection</b>				
		<b>Screw connection technology</b>		<b>Easy Connect Technology (push-in)</b>
Wire size	fine-strand with(out) wire end ferrule	1 x 0.5-2.5 mm <sup>2</sup> (1 x 18-14 AWG) 2 x 0.5-1.5 mm <sup>2</sup> (2 x 18-16 AWG)		2 x 0.5-1.5 mm <sup>2</sup> (2 x 18-16 AWG)
		rigid 1 x 0.5-4 mm <sup>2</sup> (1 x 20-12 AWG) 2 x 0.5-2.5 mm <sup>2</sup> (2 x 20-14 AWG)		2 x 0.5-1.5 mm <sup>2</sup> (2 x 20-16 AWG)
Stripping length		8 mm (0.32 in)		
Tightening torque		0.6 - 0.8 Nm (7.08 lb.in)		-
<b>Standards / Directives</b>				
Standard		IEC/EN 60255-27, IEC/EN 60947-5-1		
Low Voltage Directive		2014/35/EU		
RoHS Directive		2014/30/EU		
EMC Directive		2011/65/EU		
<b>Environmental data</b>				
Ambient temperature ranges	operation	-25...+60 °C		
	storage	-40...+85 °C		
Damp heat, cyclic (IEC/EN 60068-2-30)		6 x 24 h cycle, 55 °C, 95 % RH		
Climatic category (IEC/EN 60721-3-3)		3K5 (no condensation, no ice formation)		
Vibration, sinusoidal (IEC/EN 60255-21-1)		class 2		
Shock (IEC/EN 60255-21-2)		class 2		
<b>Isolation data</b>				
Rated impulse withstand voltage U <sub>imp</sub>	supply circuit / measuring circuit	4 kV		
	supply circuit / output circuits	4 kV		
	measuring circuit / output circuits	4 kV		
	output circuit 1 / output circuit 2	4 kV		
Pollution degree (IEC/EN 60664-1)		3		
Overvoltage category (IEC/EN 60664-1)		III		
Rated insulation voltage U <sub>i</sub>	supply circuit / measuring circuit	300 V		
	supply circuit / output circuits	300 V		
	measuring circuit / output circuits	300 V		
	output circuit 1 / output circuit 2	300 V		
Basic insulation	supply circuit / measuring circuit	250 V AC / 300 V DC		
	supply circuit / output circuits	250 V AC / 300 V DC		
	measuring circuit / output circuits	250 V AC / 300 V DC		
	output circuit 1 / output circuit 2	250 V AC / 300 V DC		

## Liquid level monitoring relays

### Technical data

Type		CM-ENS.1x	CM-ENS.2x	CM-ENS.31
Protective separation (IEC/EN 61140, EN 50178)	supply circuit / measuring circuit	250 V AC / 300 V DC		
	supply circuit / output circuits	250 V AC / 300 V DC		
	measuring circuit / output circuits	250 V AC / 300 V DC		
Pollution degree		3		
Overvoltage category		III		
<b>Electromagnetic compatibility</b>				
Interference immunity to		EN 61000-6-1, EN60255-26		
electrostatic discharge	IEC/EN 61000-4-2	level 3 (6 kV / 8 kV)		
radiated, radio-frequency, electromagnetic field	IEC/EN 61000-4-3	level 3 (10 V/m)		
electrical fast transient / burst	IEC/EN 61000-4-4	level 3, 2 kV / 5 kHz		
surge	IEC/EN 61000-4-5	level 3, installation class 3, supply circuit and measuring circuit 1 kV L-L, 2 kV L-earth		
conducted disturbances, induced by radio- frequency fields	IEC/EN 61000-4-6	level 3, 10 V		
voltage dips, short interruptions and voltage variations	IEC/EN 61000-4-11	class 3		
Interference emission		IEC/EN 61000-6-3, IEC/EN 61000-6-4		
high-frequency radiated	IEC/CISPR 22, EN 55022	class B		
high-frequency conducted	IEC/CISPR 22, EN 55022	class B		

# Liquid level monitoring relays

## Function diagrams

### CM-ENS

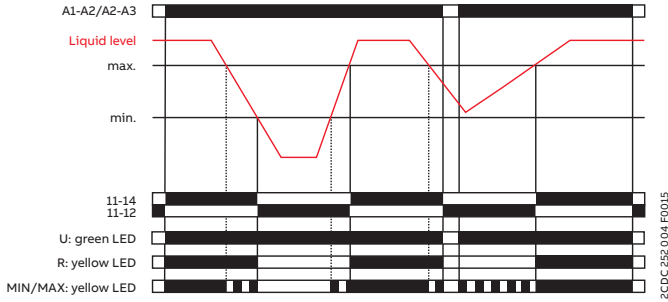

Drain: CM-ENS.1x, CM-ENS.2x

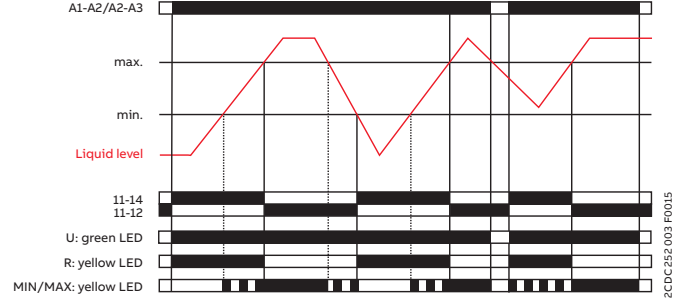

Fill: CM-ENS.2x

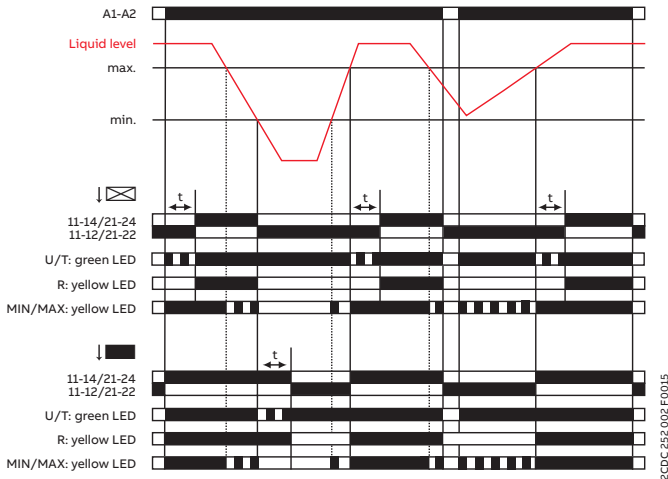

Drain: CM-ENS.31

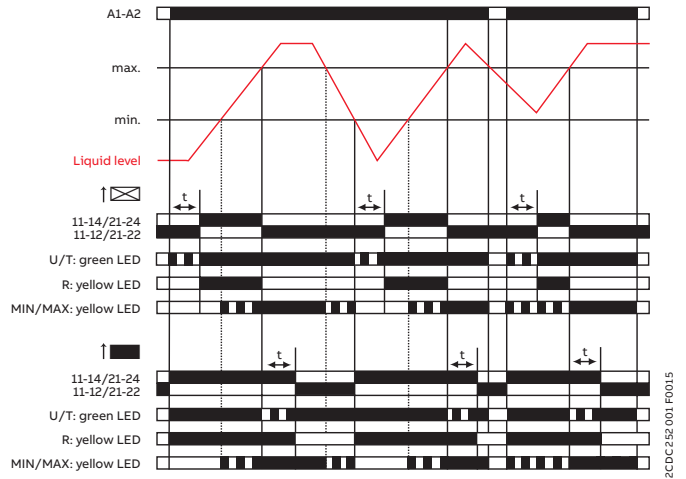

Fill: CM-ENS.31

### CM-ENE MIN

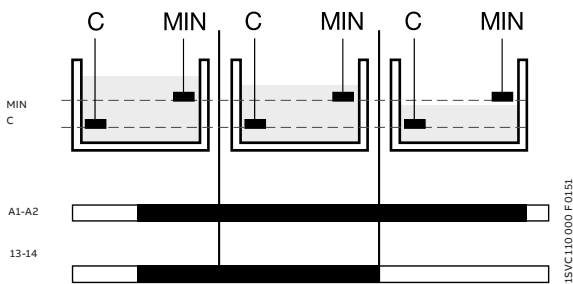

### CM-ENE MAX

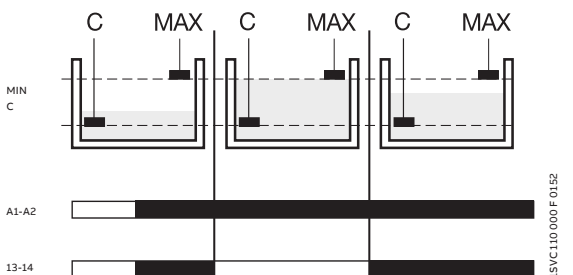

The liquid level relays CM-ENE MIN and CM-ENE MAX are used to monitor levels of conductive liquids, for example, in pump control systems for dry-running or overflow monitoring.

The measuring principle is based on the occurring resistance change when moistening single-pole electrodes. The single-pole electrodes (see also section Accessories) are connected to the terminals C and MIN or MAX.

If the supply voltage is applied to A1-A2 and the electrodes are wet, the output relay of the CM-ENE MIN is energized and the output relay of the CM-ENE MAX is de-energized.

The output relay of the CM-ENE MIN de-energizes if the electrodes are no longer wet. The output relay of the CM-ENE MAX energizes if the electrodes are no longer wet.

# Liquid level monitoring relays

## Technical diagrams

### Connection diagrams

#### CM-ENS.11x, CM-ENS.21x

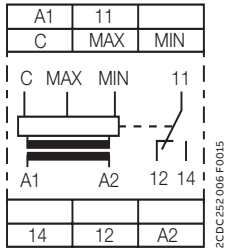

A1-A2	Control supply voltage
11-12/14	1 c/o (SPDT) contact
C	Reference electrode
MAX	Maximum level electrode
MIN	Minimum level electrode

#### CM-ENS.13x, CM-ENS.23x

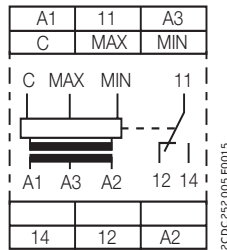

A1-A2	Control supply voltage 220-240 V AC
A3-A2	Control supply voltage 110-130 V AC
11-12/14	1 c/o (SPDT) contact
C	Reference electrode
MAX	Maximum level electrode
MIN	Minimum level electrode

#### CM-ENS.31x

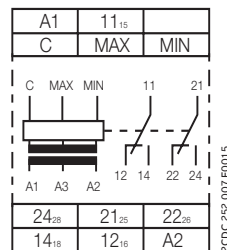

A1-A2	Control supply voltage
11 <sub>15</sub> -12 <sub>16</sub> /14 <sub>18</sub>	1 c/o (SPDT) contact
21 <sub>25</sub> -22 <sub>26</sub> /24 <sub>28</sub>	2nd c/o (SPDT) contact
C	Reference electrode
MAX	Maximum level electrode
MIN	Minimum level electrode

#### CM-ENE MIN

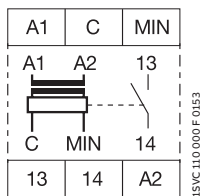

A1-A2	Rated control supply voltage
C	Reference electrode
MIN	Minimum level
13-14	Output contact -open-circuit principle

#### CM-ENE MAX

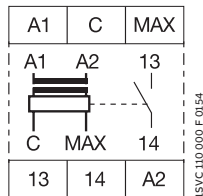

A1-A2	Rated control supply voltage
C	Reference electrode
MIN	Maximum level
13-14	Output contact -open-circuit principle

# Liquid level monitoring relays

## Technical diagrams

### CM-ENS.1x

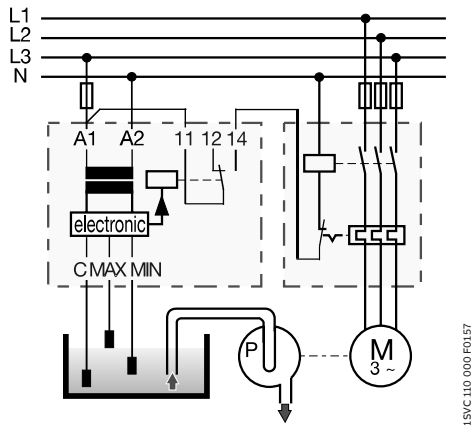

Liquid level control - drain

15VC.110.000.F0157

### CM-ENS.2x, CM-ENS.31x

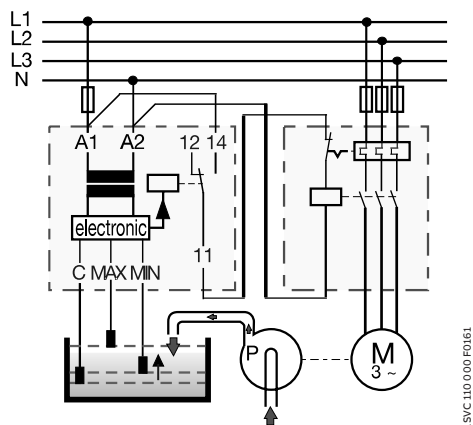

Liquid level control - fill - selected function "↑" (UP)

15VC.110.000.F0161

### CM-ENS.2x, CM-ENS.31x

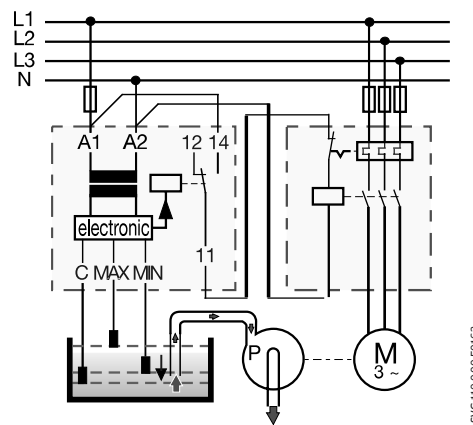

Liquid level control - drain - selected function "↓" (Down)

15VC.110.000.F0162

# Liquid level monitoring relays

## Technical diagrams

### Load limit curves

#### CM-S (22.5 mm), CM-E (22.5 mm)

AC load (resistive)

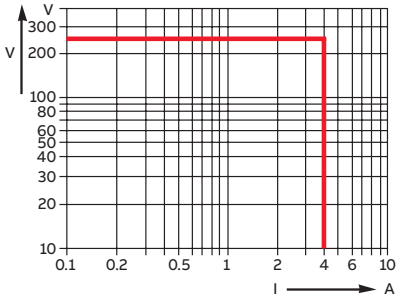

DC load (resistive)

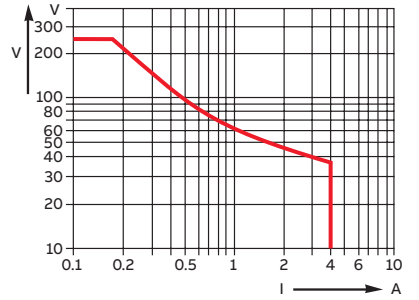

Derating factor F for inductive AC load

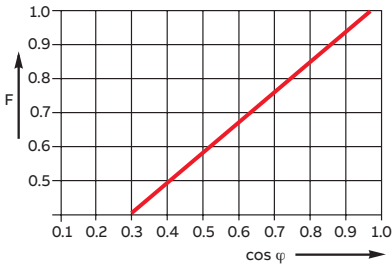

Contact lifetime

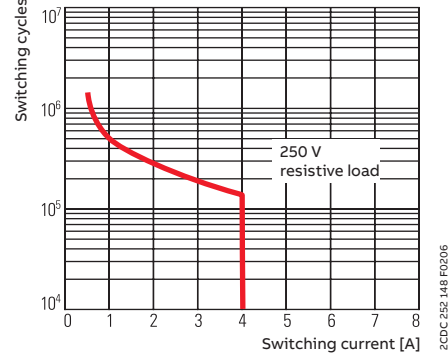

### Dimensional drawing

Dimension in mm and inches

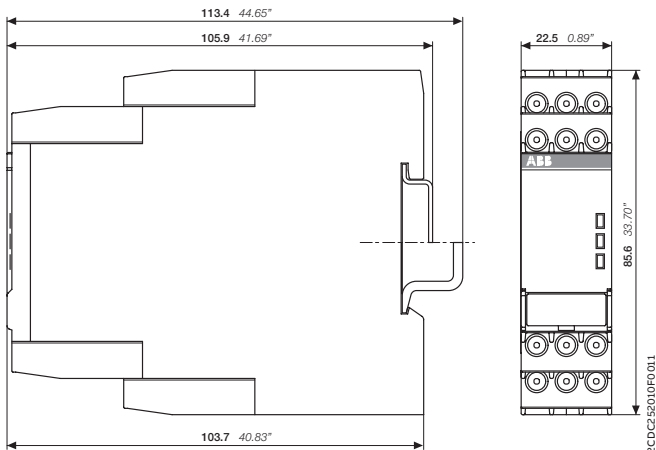

CM-xxS  
1SVR730xxxxxx, 1SVR740xxxxxx





---

## Accessories

### Table of contents

<b>242</b>	<b>Ordering details</b>
<b>244</b>	<b>Technical diagrams</b>
<b>245</b>	<b>Technical diagrams</b>

## Accessories

### Ordering details

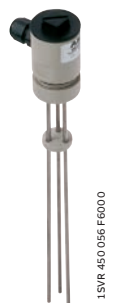

Bar electrode

1SVR 450 056 F6000



Suspension electrode

1SVC 110 000 F9478

#### Ordering details

#### Accessories

Description	For type	Width in mm	for devices	Type	Order code	Pkg qty	Weight (1 pc) g (oz)
Adapter for screw mounting	CM-S CM-S.S/P	22.5		ADP.01	1SVR430029R0100	1	18.4 (0.65)
	CM-N CM-N.S/P	45		ADP.02	1SVR440029R0100	1	36.7 (1.30)
Marker label	CM-S, CM-N CM-S.S/P CM-N.S/P		without DIP switches	MAR.01	1SVR366017R0100	10	0.19 (0.007)
	CM-S, CM-N		with DIP switches	MAR.02	1SVR430043R0000	10	0.13 (0.005)
	CM-S.S/P CM-N.S/P		with DIP switches	MAR.12	1SVR730006R0000	10	0.152 (0.335)
Sealable transparent cover	CM-S	22.5		COV.01	1SVR430005R0100	1	5.2 (0.18)
	CM-N	45		COV.02	1SVR440005R0100	1	7.7 (0.27)
	CM-S.S/P	22.5		COV.11	1SVR730005R0100	1	4.0 (0.129)
	CM-N.S/P	45		COV.12	1SVR750005R0100	1	7 (0.247)

#### Bar electrodes

Description	Material no.	Type	Order code	Weight (1 pc) kg (lb)
Compact support for 3 bar electrodes		CM-KH-3	1SVR450056R6000	0.06 (0.132)
Distance plate for 3 bar electrodes	-	CM-AH-3	1SVR450056R7000	0.06 (0.132)
Counter nut for 1" thread		CM-GM-1	1SVR450056R8000	0.06 (0.132)
Length: 300 mm	1.4301	CM-SE-300	1SVR450056R0000	0.08 (0.176)
Length: 600 mm	1.4301	CM-SE-600	1SVR450056R0100	0.08 (0.176)
Length: 1000 mm	1.4301	CM-SE-1000	1SVR450056R0200	0.08 (0.176)

#### Suspension electrodes

Description	Connec-tion	Material no.	Type	Order code	Weight (1 pc) kg (lb)
CM-HE suspension electrode high-alloy steel, material no. 1.4104 (according to EN 10088-1)	Screw	1.4104	CM-HE	1SVR402902R0000	0.074 (0.163)
CM-HC suspension electrode high-alloy steel, material no. 1.4104 (according to EN 10088-1)	Crimp	1.4104	CM-HC	1SVR402902R1000	0.09 (0.198)
CM-HCT suspension electrode suitable for drink water high-alloy steel, material no. 1.4301 (according to EN 10088-1)	Crimp	1.4301	CM-HCT	1SVR402902R2000	0.09 (0.198)

# Accessories

## Ordering details



CM-CT

2CDC251.002 F0005

### Plug-in current transformers CM-CT

- Without primary conductor though with foot angle, insulating protective cap and bar fastening screws
- Primary / rated current from 50 A to 600 A
- Secondary current of 1 A or 5 A
- Class 1

### Ordering details

Rated primary current	Secondary current	Burden class	Type	Order code	Weight (1 pc) g (oz)
50 A	1 A	1 VA / 1	CM-CT 50/1	1SVR450116R1000	0.31 (0.683)
75 A		1.5 VA / 1	CM-CT 75/1	1SVR450116R1100	0.31 (0.683)
100 A		2.5 VA / 1	CM-CT 100/1	1SVR450116R1200	0.276 (0.608)
150 A		2.5 VA / 1	CM-CT 150/1	1SVR450116R1300	0.32 (0.705)
200 A		2.5 VA / 1	CM-CT 200/1	1SVR450116R1400	0.222 (0.489)
300 A		5 VA / 1	CM-CT 300/1	1SVR450117R1100	0.29 (0.639)
400 A	5 A	5 VA / 1	CM-CT 400/1	1SVR450117R1200	0.27 (0.595)
500 A		5 VA / 1	CM-CT 500/1	1SVR450117R1300	0.29 (0.639)
600 A		5 VA / 1	CM-CT 600/1	1SVR450117R1400	0.24 (0.529)
50 A		1 VA / 1	CM-CT 50/5	1SVR450116R5000	0.3 (0.661)
75 A		1.5 VA / 1	CM-CT 75/5	1SVR450116R5100	0.31 (0.683)
100 A		2.5 VA / 1	CM-CT 100/5	1SVR450116R5200	0.31 (0.683)
150 A	5 A	2.5 VA / 1	CM-CT 150/5	1SVR450116R5300	0.28 (0.617)
200 A		5 VA / 1	CM-CT 200/5	1SVR450116R5400	0.29 (0.639)
300 A		5 VA / 1	CM-CT 300/5	1SVR450117R5100	0.252 (0.556)
400 A		5 VA / 1	CM-CT 400/5	1SVR450117R5200	0.26 (0.573)
500 A		5 VA / 1	CM-CT 500/5	1SVR450117R5300	0.208 (0.459)
600 A		5 VA / 1	CM-CT 600/5	1SVR450117R5400	0.21 (0.463)



CM-CT with mounted accessories

2CDC251.003 F0005



CM-CT-A mounted on DIN rail

2CDC251.159 F0006

### Accessories

Description	Type	Order code	Weight (1 pc) g (oz)
Snap-on fastener for DIN rail mounting of CM-CT	CM-CT A	1SVR450118R1000	0.009 (0.02)

# Accessories

## Technical diagrams

### Operating principle / circuit diagram

#### CM-CT

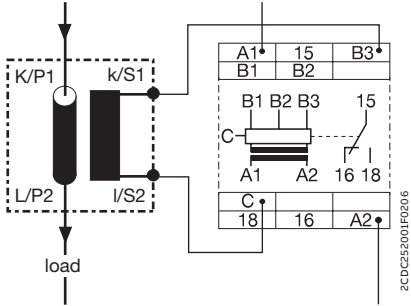

### Dimensional drawings

in mm and inches

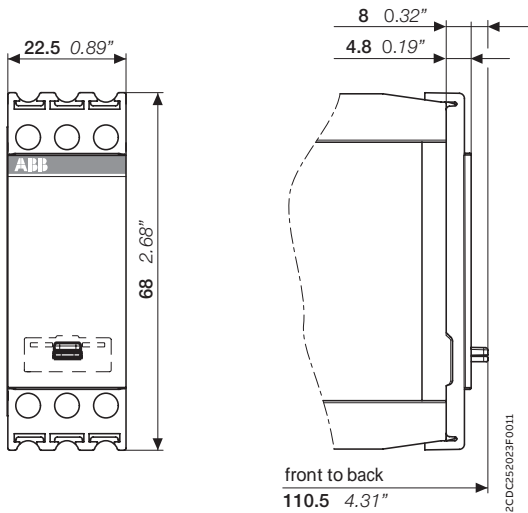

Sealable cover  
COV.11

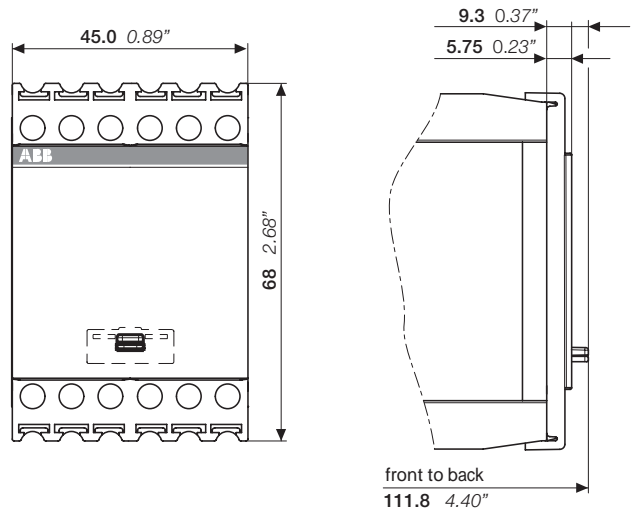

Sealable cover  
COV.12

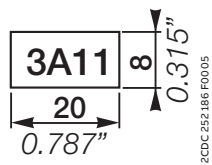

MAR.01

# Accessories

## Technical diagrams

### Dimensional drawings

in mm and inches

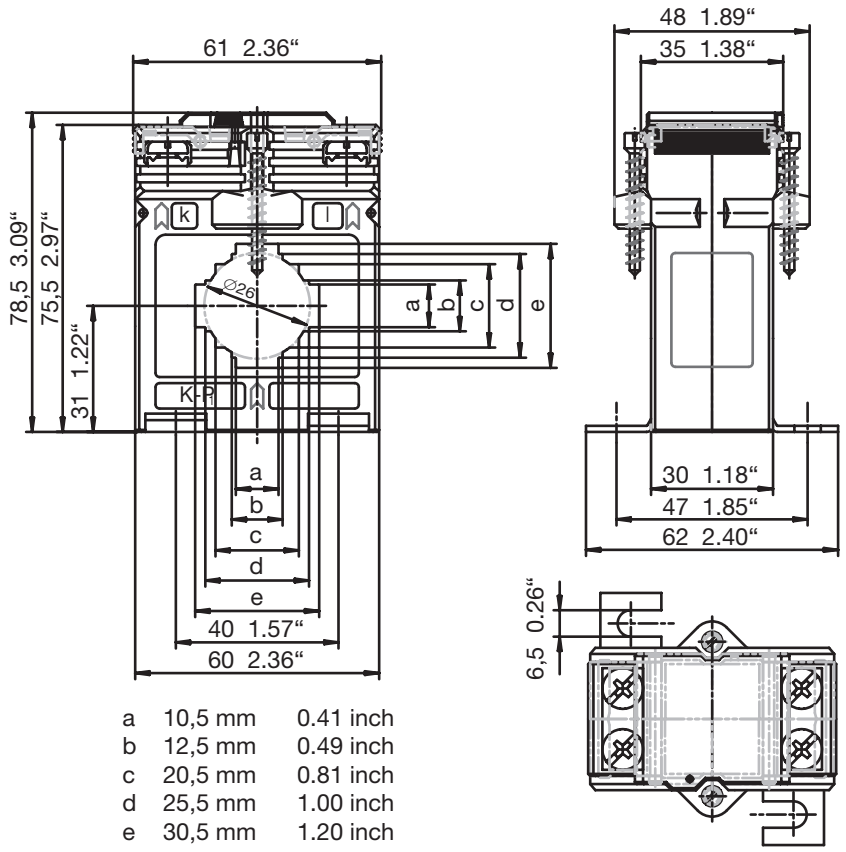

CM-CT

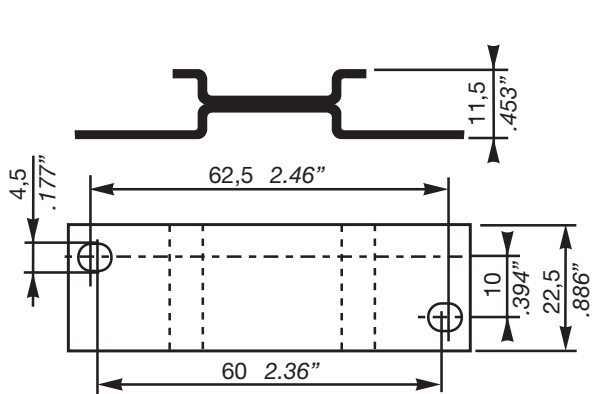

ADP.01

ZCDC 252.187 F0005

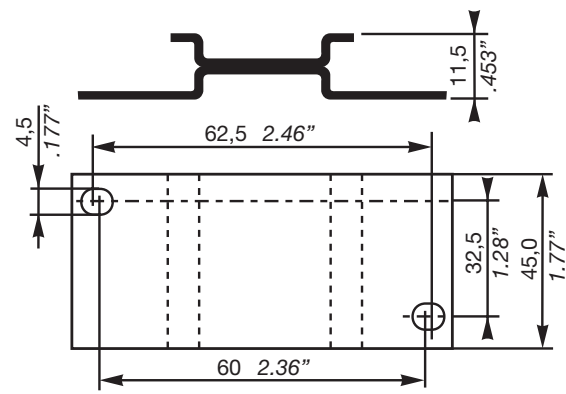

ADP.02

ZCDC252001F0009

ZCDC 252.153 F0006



---

# Power supplies

## Table of contents

<b>248</b>	<b>Overview</b>
<b>250</b>	<b>Selection table</b>
<b>253</b>	<b>Power supplies for industrial applications</b>
255	CP-E range
275	CP-T range
289	CP-C.1 range
<b>313</b>	<b>Power supplies for building applications</b>
314	CP-D range
<b>327</b>	<b>CP-B range buffer modules</b>
<b>339</b>	<b>Redundancy units</b>
<b>349</b>	<b>Electronic protection devices EPD24</b>

# Primary switch mode power supplies

## Overview

Modern power supply units are a vital component in energy management and automation technology. As your global partner in these areas, ABB pays the utmost attention to the resulting requirements. Innovation is the key to ABB's power supply product program.

### Power supplies for industrial applications



#### CP-E range: economy range

The CP-E range offers enhanced functionality while the number of different types has been considerably reduced. Now all power supply units can be operated at an ambient temperature of up to +70 °C. The CP-E range 24 V devices over 18 W offer an output/contact for monitoring of the output voltage and remote diagnosis. Optimized for worldwide applications, the CP-E power supplies can be supplied within a wide range of AC or DC voltages. The output voltage is continuously adjustable, ensuring optimal adaptation to the application, e.g. compensating the voltage drop caused by a long line length. For decoupling of parallel connected power supplies below or equal to 56 V, redundancy modules are available in order to achieve true redundancy.



#### CP-T range: three-phase range

The CP-T range of three-phase power supply units perfectly complements ABB's existing power supply offering in terms of design and functionality, giving you more advanced options for your three-phase applications. Solid state output for function monitoring and remote diagnostics is available. The range is to be used in 340 - 575 V AC or 480 - 820 V DC supply systems. Its continuously adjustable output voltage ensures optimal adaptation to the application, e.g. compensating the voltage drop caused by a long line length.



#### CP-C.1 range: high-performance range

The CP-C.1 power supplies are ABB's high-performance and most advanced range. With excellent efficiency, high reliability and innovative functionality, the CP-C.1 range is ready to take on the most demanding industrial applications. These power supplies have a 150 % integrated power reserve and operate at an efficiency of up to 94 %. They are equipped with overheat protection and active power factor correction. Combined with a broad AC and DC input range and extensive worldwide approvals, the CP-C.1 power supplies are the preferred choice for professional DC applications. Giving the power to control.



# Primary switch mode power supplies

## Overview

### Power supplies for industrial applications



#### CP-B range: short time buffers

ABB offers an innovative and completely maintenance-free product range for buffering the 24 V DC supply in case of interrupted mains on the primary side of the switch mode power supply.

- Ultra cap based buffer modules for short time UPS systems
- Rated input voltage 24 V DC
- Rated currents 3 A, 10 A and 20 A
- Expandable with CP-B EXT.2 module
- LEDs for status indication
- Higher than 90% efficiency
- Signaling and status outputs
- Buffering times at 100 % load current from 13 s to 38 s (depending on device)

### Power supplies for building applications



#### CP-D range: distribution panel design

The CP-D range of power supply units in MDRC design (modular DIN rail components) fits into all domestic installation and distribution panels. With their width of only 18 to 90 mm, the CP-D range switch mode power supplies are ideally suited for installation in distribution panels. The range is optimized for worldwide applications: The CP-D power supplies can be supplied with 90-264 V AC or 120-375 V DC. The continuously adjustable output voltage (CP-D > 10 W) ensures optimal adaption to the application, e.g. compensating the voltage drop caused by a long line length. An additional redundancy unit CP-RUD to establish true redundancy is available.



For certifications and approvals, please refer to the download section on the product web pages.

# Primary switch mode power supplies

## Selection table - Single-phase

	Order number	Single-phase																			
		CP-D					CP-E										CP-C.1				
Rated output voltage	5 V DC						■														
	12 V DC	■	■					■	■												
	24 V DC			■	■	■	■			■	■	■	■	■	■				■	■	■
	48 V DC																		■	■	■
Rated output current	0.42 A			■																	
	0.625 A																				
	0.75 A										■										
	0.83 A	■																			
	1.25 A																				
	1.3 A				■																
	2.1 A		■																		
	2.5 A					■															
	3 A						■														
	4.2 A							■													
	Rated output power	10 W	■		■																
15 W							■														
18 W																					
25 W			■																		
30 W					■																
60 W						■															
100 W							■														
120 W								■													
240 W																					
Rated input voltage	100-240 V AC	■	■	■	■	■	■	■	■	■	■	■	■	■	■	■	■	■	■	■	■
	115/230 V AC auto select																				
	115-230 V AC																				
DC input voltage range	90-300 V DC																				
	90-375 V DC							■													
	120-375 V DC	■	■	■	■	■	■			■											
	210-375 V DC																				
Features	Power reserve design																				
	Adjustable output voltage		■		■	■	■	■	■	■	■	■	■	■	■	■	■	■	■	■	■
	Integrated input fuse	■	■	■	■	■	■	■	■	■	■	■	■	■	■	■	■	■	■	■	■
	Short-circuit stable	■	■	■	■	■	■	■	■	■	■	■	■	■	■	■	■	■	■	■	■
	Fold-forward behavior (U/I)	■			■	■	■			■	■	■	■	■	■	■	■	■	■	■	■
	Fold-back behavior (hiccup)	■	■					■			■										
	Power factor correction																				
	Signalling contact																				
	Extended temp. range	■	■	■	■	■	■			■	■	■	■	■	■	■	■			■	■
	Parallel connection																				
	Serial connection	■	■	■	■	■	■	■	■	■	■	■	■	■	■	■	■	■	■	■	■
	Coated PCBA																				

pas = passive, act = active

# Primary switch mode power supplies

## Selection table - Three-phase

		Order number	Three-phase						
			CP-T						
Rated output voltage	24 V DC	■	■	■	■				
	48 V DC					■	■	■	
Rated output current	5 A	■				■			
	10 A		■				■		
	20 A			■				■	
	40 A				■				
Rated output power	120 W	■							
	240 W		■			■			
	480 W			■			■		
	960 W				■			■	
Rated input voltage	3 x 400-500 V AC	■	■	■	■	■	■	■	
DC input voltage range	480-820 V DC	■	■	■	■	■	■	■	
Features	Adjustable output voltage	■	■	■	■	■	■	■	
	Integrated input fuse	■	■	■	■	■	■	■	
	Short-circuit stable	■	■	■	■	■	■	■	
	Fold forward behavior (U/I)	■	■	■		■	■		
	Fold back behavior (hiccup)	■	■	■	■	■	■	■	
	Extended temp. range	■	■	■	■	■	■	■	
	Signalling contact	■	■	■	■				
	Parallel connection		2	2	2	2	2	2	
	Serial connection		2	2	2	2	2	2	



---

# Power supplies for industrial applications

## Table of contents

<b>255</b>	<b>CP-E range</b>
<b>275</b>	<b>CP-T range</b>
<b>289</b>	<b>CP-C.1 range</b>



---

## **CP-E range**

### Table of contents

<b>256</b>	<b>Benefits and advantages</b>
<b>258</b>	<b>Operating controls</b>
<b>259</b>	<b>Applications</b>
<b>260</b>	<b>Ordering details</b>
<b>261</b>	<b>Technical data</b>
<b>271</b>	<b>Technical diagrams</b>

## CP-E range

### Benefits and advantages



ABB's CP-E range offers enhanced functionality and a simpler, more rational selection process. All power supply units can be operated at an ambient temperature of up to +70 °C (158 °F).



**Affordable range**

Products with exactly the functions you require.  
Designed for best possible price-performance ratio.



**Global availability**

The product can be used in any installations in the world. Giving you the confidence of worldwide sourcing – no matter where you build, install or operate your equipment.



**Speed up your projects**

Data available for common planning software: Less engineering time required.



## CP-E range

### Benefits and advantages



#### Characteristics

- Output voltages 5 V, 12 V, 24 V, 48 V DC
- Adjustable output voltages
- Output currents 0.625 A / 0.75 A / 1.25 A / 2.5 A / 3 A / 5 A / 10 A / 20 A
- Power range 15 W, 18 W, 30 W, 60 W, 120 W, 240 W, 480 W
- High efficiency, up to 90 %
- Low power dissipation and low heating
- Free convection cooling (no forced cooling with ventilators)
- Open-circuit, overload and short-circuit stable
- Integrated input fuse
- U/I characteristic curve on devices > 18 W (fold-forward behavior at overload – no switch-off)
- Redundancy units offering true redundancy
- LED(s) for status indication
- Signalling output/contact for output voltage OK
  - Transistor on 24 V devices > 18 W and < 120 W
  - Solid-state on 24 V devices ≥ 120 W
- Various approvals and marks



#### Main benefits

##### Signalling output / contact

The CP-E range 24 V devices > 18 W offer an output/contact for monitoring of the output voltage and remote diagnosis.

##### Wide range input

Optimized for worldwide applications: The CP-E power supplies can be supplied with a wide range of AC or DC voltages.

##### Adjustable output voltage

A continuously adjustable output voltage ensures optimal adaptation to the application, e.g. compensating the voltage drop caused by a long line length.

##### Redundancy units

For decoupling of parallelized power supply units ≤ 40 A. Thus, true redundancy can be achieved.

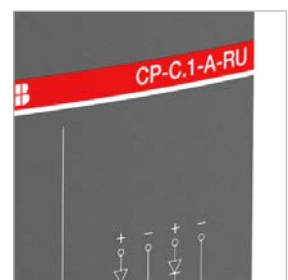
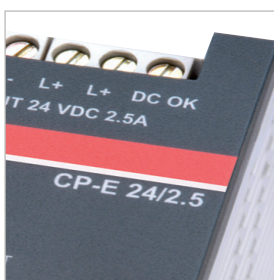

# CP-E range

## Operating controls

**OUTPUT Adjust:**  
Potentiometer -  
adjustment of  
output voltage

**Single/parallel:**  
Sliding switch -  
adjustment of  
single or parallel  
operation

**OUTPUT**  
**L+, L+, L-, L-:**  
Terminals - output  
5 V / 12 V / 24 V /  
48 V

**13-14:**  
Terminals -  
signalling contact  
(or solid-state)

**Indication of  
operational states:**  
OUTPUT OK:  
green LED - output  
voltage OK  
OUTPUT LOW:  
red LED - output  
voltage too low

**Circuit diagram**

**INPUT L, N, PE:**  
**terminals - input**  
90-132 V AC, 180-265 V AC / 210-375 V DC  
90-264 V AC / 120-375 V DC  
85-264 V AC / 90-375 V DC

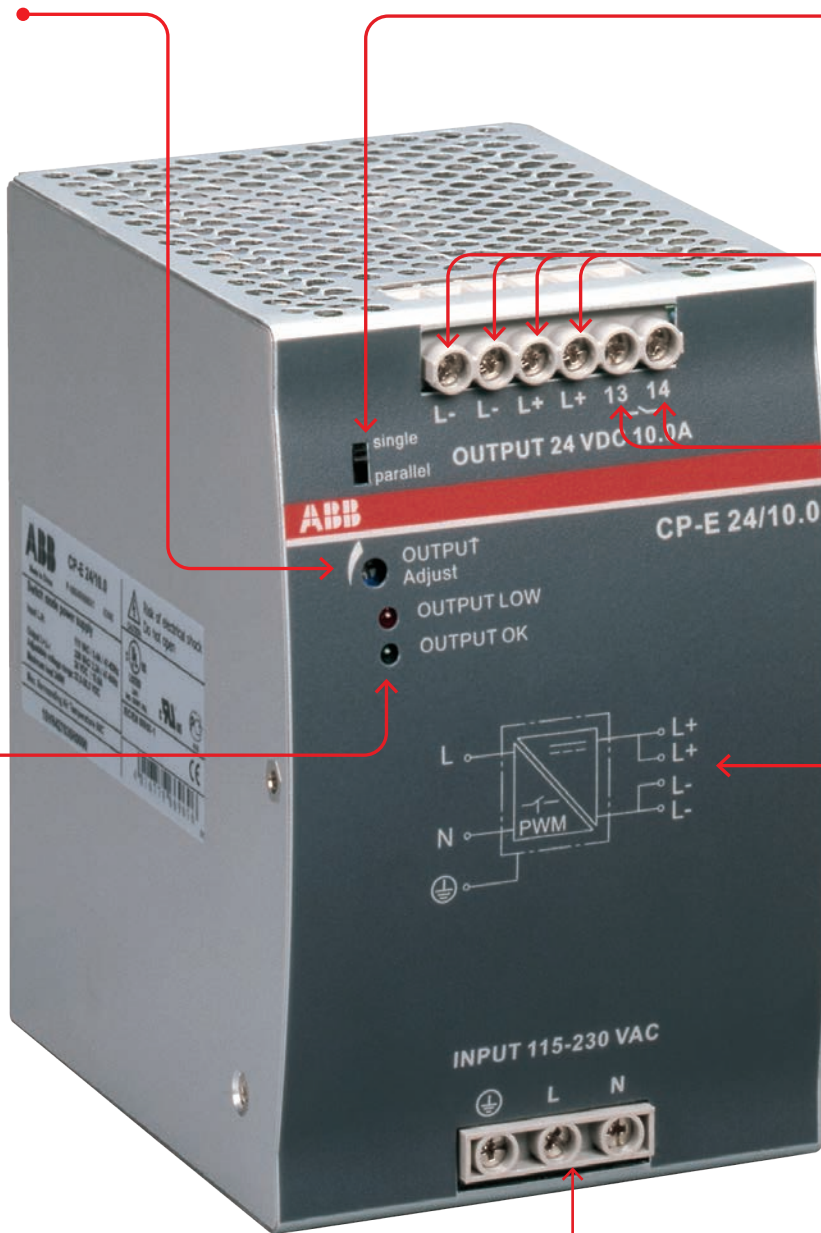

# CP-E range Applications



Tooling machines



Packaging industry



Food industry



Textile industry



Printing industry



Electro-mobility

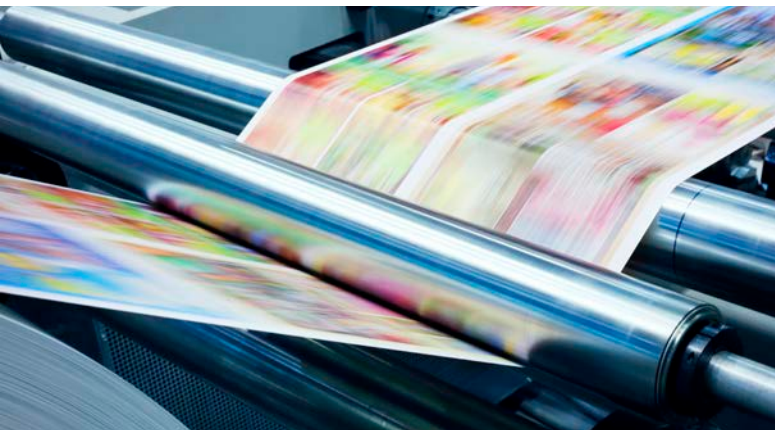

# CP-E range

## Ordering details



2CDC 271 017 F0006

CP-E 5/0.75



2CDC 271 013 F0006

CP-E 12/2.5



2CDC 271 028 F0008

CP-E 48/5.0



2CDC 271 027 F0008

CP-E 24/20.0

### Description

This range offers types with output voltages from 5 V DC to 48 V DC at output currents of 0.625 A to 20 A. With their high thermal efficiency of up to 90 %, these power supplies have very low power and heat dissipation and can be operated without forced cooling. The functionality has been enhanced while the number of different types has been considerably reduced. Of course, all power supplies of the CP-E range are approved in accordance with all relevant international standards.

### Ordering details - CP-E < 100 W

Input voltage range	Rated output voltage / current	Type	Order code	Weight (1 pc.) kg (lb)
90-264 V AC / 120-375 V DC	5 V DC / 3 A	CP-E 5/3.0	1SVR427033R3000	0.15 (0.33)
85-264 V AC / 90-375 V DC	12 V DC / 2.5 A	CP-E 12/2.5	1SVR427032R1000	0.29 (0.64)
90-132 V AC, 180-264 V AC / 210-375 V DC	12 V DC / 10 A	CP-E 12/10.0	1SVR427035R1000	1.00 (2.20)
90-264 V AC / 120-375 V DC	24 V DC / 0.75 A	CP-E 24/0.75	1SVR427030R0000	0.15 (0.33)
85-264 V AC / 90-375 V DC	24 V DC / 1.25 A	CP-E 24/1.25	1SVR427031R0000	0.29 (0.64)
85-264 V AC / 90-375 V DC	24 V DC / 2.5 A	CP-E 24/2.5	1SVR427032R0000	0.36 (0.79)





### Ordering details - CP-E ≥ 120 W

Input voltage range	Rated output voltage / current	Type	Order code	Weight (1 pc.) kg (lb)
90-132 V AC, 180-264 V AC / 210-375 V DC	24 V DC / 5 A	CP-E 24/5.0	1SVR427034R0000	1.00 (2.20)
90-132 V AC, 180-264 V AC / 210-375 V DC	24 V DC / 10 A	CP-E 24/10.0	1SVR427035R0000	1.36 (3.01)
90-264 V AC / 120-375 V DC	24 V DC / 20 A	CP-E 24/20.0	1SVR427036R0000	1.90 (4.18)
85-264 V AC / 90-375 V DC	48 V DC / 0.625 A	CP-E 48/0.62	1SVR427030R2000	0.29 (0.64)
85-264 V AC / 90-375 V DC	48 V DC / 1.25 A	CP-E 48/1.25	1SVR427031R2000	0.36 (0.79)
90-132 V AC, 180-264 V AC / 210-375 V DC	48 V DC / 5 A	CP-E 48/5.0	1SVR427034R2000	1.36 (3.01)
90-264 V AC / 120-375 V DC	48 V DC / 10 A	CP-E 48/10.0	1SVR427035R2000	1.90 (4.19)

## CP-E range

### Technical data

Data at  $T_a = 25\text{ °C}$ ,  $U_{in} = 230\text{ V AC}$  and rated values, unless otherwise indicated

Type		CP-E 5/3.0	CP-E 12/2.5	CP-E 12/10.0
<b>Input circuit</b>		<b>L, N</b>		
Rated input voltage $U_{in}$		100-240 V AC		115 / 230 V AC auto select
Input voltage range		90-264 V AC / 120-375 V DC	85-264 V AC / 90-375 V DC	90-132 V AC, 180-264 V AC / 210-375 V DC
Frequency range AC		47-63 Hz		
Typical input current	at 115 V AC	335 mA	560 mA	2.2 A
	at 230 V AC	210 mA	330 mA	0.83 A
Typical power consumption		19.8 W	35.9 W	143 W
Inrush current	at 115 V AC	15 A	20 A	24 A
	at 230 V AC	30 A	40 A	48 A
Discharge current	input / output	0.25 mA		
	input / PE	3.5 mA		
Power failure buffering time	at 115 V AC	min. 20 ms	min. 20 ms	min. 25 ms
	at 230 V AC	min. 75 ms	min. 30 ms	min. 30 ms
Internal input fuse		2 A slow-acting / 250 V AC		3.15 A slow-acting / 250 V AC
Power factor correction (PFC)		no		yes, passive, 0.7
<b>Indication of operational states</b>				
Output voltage	green LED	OK:  : output voltage OK	OUTPUT OK:  : output voltage OK	OUTPUT OK:  : output voltage OK
	red LED	LOW:  : output voltage too low	-	OUTPUT LOW:  : output voltage too low
<b>Output circuit</b>		<b>L+, L-</b>	<b>L+, L+, L-, L-</b>	
Rated output voltage		5 V DC	12 V DC	
Tolerance of the output voltage		0...+1 %		
Adjustment range of the output voltage		4.5-5.75 V DC	12-14 V DC	11.4-14.5 V DC
Rated output power		15 W	30 W	120 W
Rated output current $I_r$	$T_a \leq 60\text{ °C}$	3.0 A	2.5 A	10 A
Derating of the output current	$60\text{ °C} < T_a \leq 70\text{ °C}$	2.5 %/°C		2.5 %/°C
Maximum deviation with	load change statical	±2 %	±0.5 %	±1 % (single mode) ±5 % (parallel mode)
	change of output voltage within the input voltage range	±1 %	±0.5 %	±0.5 %
Recovery time $T_R$		< 2 ms		
Starting time after applying the supply voltage	at $I_r$	max. 1 s		
	with 3500 $\mu\text{F}$	-	max. 2 s	-
	with 7000 $\mu\text{F}$	max. 1.5 s	-	max. 1.5 s
Rise time	at rated load	max. 150 ms		
	with 3500 $\mu\text{F}$	-	max. 500 ms	-
	with 7000 $\mu\text{F}$	max. 500 ms	-	max. 500 ms
Fall time		max. 150 ms		
Residual ripple and switching peaks	BW = 20 MHz	50 mV		
Parallel connection		yes, to enable redundancy		configurable, to increase power, up to 3 devices, min. 0.1 $I_r$ - max. 0.9 $I_r$
Series connection		yes, to increase voltage		yes, to increase voltage, max. 2 devices
Resistance to reverse feed		1 s - max. 7.5 V DC	1 s - max. 18 V DC	max. 18 V DC
<b>Output circuit - No-load, overload and short-circuit behavior</b>				
Characteristic curve of output		hiccup-mode	U/I characteristic curve	
Short-circuit protection		continuous short-circuit proof		
Short-circuit behavior		Hiccup-mode	continuation with output power limiting	
Overload protection		output power limiting		
No-load protection		continuous no-load stability		
Starting of capacitive loads		7000 $\mu\text{F}$	3500 $\mu\text{F}$	7000 $\mu\text{F}$

## CP-E range

### Technical data

Data at  $T_a = 25\text{ °C}$ ,  $U_{in} = 230\text{ V AC}$  and rated values, unless otherwise indicated

Type		CP-E 5/3.0	CP-E 12/2.5	CP-E 12/10.0
<b>General data</b>				
Power loss		typ. 5 W	typ. 5.6 W	typ. 24 W
Efficiency		typ. 75 %	typ. 84 %	typ. 84 %
Duty cycle		100 %		
Dimensions		see "Dimensional drawings"		
Material of housing		plastic		metal
Mounting		DIN rail (IEC/EN 60715), snap-on mounting without any tool		
Mounting position		horizontal		
Minimum distance to other units	horizontal / vertical	25 mm / 25 mm (0.98 in / 0.98 in)		
Degree of protection	housing / terminals	IP20 / IP20		
Protection class		I		
<b>Electrical connection - input circuit / output circuit</b>				
Connecting capacity	fine-strand with wire end ferrule			0.2-4 mm <sup>2</sup> (24-11 AWG)
	fine-strand without wire end ferrule	0.2-2.5 mm <sup>2</sup> (24-14 AWG)		0.2-6 mm <sup>2</sup> (24-10 AWG)
	rigid			
Stripping length		6 mm (0.24 in)		8 mm (0.31 in)
Tightening torque	input / output	0.6 Nm (5 lb.in)		1.0 Nm (9 lb.in) / 0.62 Nm (5.5 lb.in)
<b>Environmental data</b>				
Ambient temperature range	operation	-20...+70 °C	-40...+70 °C	-35...+70 °C
	rated load	-20...+60 °C	-40...+60 °C	-35...+60 °C
	storage	-20...+85 °C	-40...+85 °C	-40...+85 °C
Damp heat (cyclic) (IEC/EN 60068-2-30)		95 RH, % without condensation		
Vibration (sinusoidal) (IEC/EN 60068-2-6)		10-500 Hz, 2 G, along X, Y, Z each axis, 60 min. for each axis		
Shock (half-sine) (IEC/EN 60068-2-27)		15 G, 11 ms, 3 axes, 6 faces, 3 times for each face		
<b>Isolation data</b>				
Rated insulation voltage $U_i$	input circuit / output circuit	3 kV AC		
	input / PE	1.5 kV AC		
	output / PE	0.5 kV AC; 0.71 kV DC		
Pollution degree		2		
Overvoltage category		II		
<b>Standards / Directives</b>				
Standards		IEC/EN 60950-1		
Low Voltage Directive		2014/35/EU		
EMC Directive		2014/30/EU		
RoHS Directive		2011/65/EU		
Protective low voltage		SELV (IEC/EN 60950-1)		
<b>Electromagnetic compatibility</b>				
Interference immunity to		IEC/EN 61000-6-2		
electrostatic discharge	IEC/EN 61000-4-2	level 4 (air discharge 15 kV / contact discharge 8 kV)		
radiated, radio-frequency, electromagnetic field	IEC/EN 61000-4-3	level 3 (10 V/m)		
electrical fast transient/burst	IEC/EN 61000-4-4	level 4 (4 kV / 2,5 kHz)	level 4 (4 kV / 5 kHz)	
surge	IEC/EN 61000-4-5	L-L level 3 (2 kV) / L-PE level 4 (4 kV)		
conducted disturbances, induced by radio-frequency fields	IEC/EN 61000-4-6	level 3 (10 V)		
power frequency magnetic fields	IEC/EN 61000-4-8	level 4 (30 A/m)		
voltage dips, short interruptions and voltage variations	IEC/EN 61000-4-11	dip: >95 % 10 ms / >30 % 500 ms interruptions: >95 % 5000 ms		
Interference emission		IEC/EN 61000-6-3		
high-frequency radiated		class B		
high-frequency conducted		class B		
limits for harmonic current emissions	IEC/EN 61000-3-2	class D	class A	class D

## CP-E range

### Technical data

Data at  $T_a = 25\text{ °C}$ ,  $U_{in} = 230\text{ V AC}$  and rated values, unless otherwise indicated

Type		CP-E 24/0.75	CP-E 24/1.25	CP-E 24/2.5
<b>Input circuit</b>		<b>L, N</b>		
Rated input voltage $U_{in}$		100-240 V AC		
Input voltage range		90-264 V AC / 120-375 V DC	85-264 V AC / 90-375 V DC	
Frequency range AC		47-63 Hz		
Typical input current	at 115 V AC	335 mA	560 mA	1060 mA
	at 230 V AC	210 mA	330 mA	590 mA
Typical power consumption		22.8 W	36.7 W	69.2 W
Inrush current	at 115 V AC	15 A	20 A (max. 3 ms)	30 A
	at 230 V AC	30 A	40 A (max. 3 ms)	60 A
Discharge current	input / output	0.25 mA		
	input / PE	3.5 mA		
Power failure buffering time	at 115 V AC	min. 20 ms	min. 20 ms	
	at 230 V AC	min. 75 ms	min. 30 ms	
Internal input fuse		2 A slow-acting / 250 V AC		
Power factor correction (PFC)		no		
<b>Indication of operational states</b>				
Output voltage	green LED	OK: : output voltage OK	OUTPUT OK: : output voltage OK	
	red LED	LOW: : output voltage too low	-	-
<b>Output circuit</b>		<b>L+,L-</b>	<b>L+, L+, L-, L-</b>	
Rated output voltage		24 V DC		
Tolerance of the output voltage		0 ... +1 %		
Adjustment range of the output voltage		21.6-28.8 V DC	24-28 V DC	
Rated output power		18 W	30 W	60 W
Rated output current $I_r$	$T_a \leq 60\text{ °C}$	0.75 A	1.25 A	2.5 A
Derating of the output current	$60\text{ °C} < T_a \leq 70\text{ °C}$	2.5 %/°C		
Signalling output for output voltage OK	DC OK	-	transistor	
Maximum deviation with	load change statical	±2 %	±0.5 %	
	change of output voltage within the input voltage range	±1 %	±0.5 %	
Recovery time $T_A$		< 2 ms		
Starting time after applying the supply voltage	at $I_r$	max. 1 s		
	with 3500 µF	-	max. 2 s	-
	with 7000 µF	max. 1.5 s	-	max. 1.5 s
Rise time	at rated load	max. 150 ms		
	with 3500 µF	-	max. 500 ms	-
	with 7000 µF	max. 500 ms	-	max. 500 ms
Fall time		max. 150 ms		
Residual ripple and switching peaks	BW = 20 MHz	50 mV		
Parallel connection		yes, to enable redundancy		
Series connection		yes, to increase voltage		
Resistance to reverse feed		1 s - max. 35 V DC		
<b>Output circuit - No-load, overload and short-circuit behavior</b>				
Characteristic curve of output		hiccup-mode	U/I characteristic curve	
Short-circuit protection		continuous short-circuit proof		
Short-circuit behavior		hiccup-mode	continuation with output power limiting	
Overload protection		output power limiting		
No-load protection		continuous no-load stability		
Starting of capacitive loads		7000 µF	3500 µF	7000 µF

## CP-E range

### Technical data

Data at  $T_a = 25\text{ °C}$ ,  $U_{in} = 230\text{ V AC}$  and rated values, unless otherwise indicated

Type		CP-E 24/0.75	CP-E 24/1.25	CP-E 24/2.5
<b>General data</b>				
Power loss		typ. 4.45 W	typ. 5.5 W	typ. 8.8 W
Efficiency		typ. 77 %	typ. 86 %	typ. 89 %
Duty cycle		100 %		
Dimensions		see "Dimensional drawings"		
Material of housing		plastic		
Mounting		DIN rail (IEC/EN 60715), snap-on mounting without any tool		
Mounting position		horizontal		
Minimum distance to other units	horizontal / vertical	25 mm / 25 mm (0.98 in / 0.98 in)		
Degree of protection	housing / terminals	IP20 / IP20		
Protection class		I		
<b>Electrical connection - input circuit / output circuit</b>				
Connecting capacity	fine-strand with wire end ferrule	0.2-2.5 mm <sup>2</sup> (24-14 AWG)		
	fine-strand without wire end ferrule			
	rigid			
Stripping length		6 mm (0.24 in)		
Tightening torque	input / output	0.6 Nm (5 lb.in)		
<b>Environmental data</b>				
Ambient temperature range	operation	-20...+70 °C	-40...+70 °C	
	rated load	-20...+60 °C	-40...+60 °C	
	storage	-20...+85 °C	-40...+85 °C	
Damp heat (cyclic) (IEC/EN 60068-2-30)		95 % RH, without condensation		
Vibration (sinusoidal) (IEC/EN 60068-2-6)		10-500 Hz, 2 G, along X, Y, Z each axis, 60 min. for each axis		
Shock (half-sine) (IEC/EN 60068-2-27)		15 G, 11 ms, 3 axes, 6 faces, 3 times for each face		
<b>Isolation data</b>				
Rated insulation voltage $U_i$	input circuit / output circuit	3 kV AC		
	input / PE	1.5 kV AC		
	output / PE	0.5 kV AC; 0.71 kV DC		
Pollution degree		2		
Overvoltage category		II		
<b>Standards / Directives</b>				
Standards		IEC/EN 60950-1		
Low Voltage Directive		2014/35/EU		
EMC Directive		2014/30/EU		
RoHS Directive		2011/65/EU		
Protective low voltage		SELV (IEC/EN 60950-1)		
<b>Electromagnetic compatibility</b>				
Interference immunity to		IEC/EN 61000-6-2		
electrostatic discharge	IEC/EN 61000-4-2	level 4 (air discharge 15 kV / contact discharge 8 kV)		
radiated, radio-frequency, electromagnetic field	IEC/EN 61000-4-3	level 3 (10 V/m)		
electrical fast transient/burst	IEC/EN 61000-4-4	level 4 (4 kV / 2.5 kHz)	level 4 (4 kV / 5 kHz)	
surge	IEC/EN 61000-4-5	L-L level 3 (2 kV) / L-PE level 4 (4 kV)		
conducted disturbances, induced by radio-frequency fields	IEC/EN 61000-4-6	level 3 (10 V)		
power frequency magnetic fields	IEC/EN 61000-4-8	level 4 (30 A/m)		
voltage dips, short interruptions and voltage variations	IEC/EN 61000-4-11	dip: >95 % 10 ms / >30 % 500 ms, interruptions: >95 % 5000 ms		
Interference emission		IEC/EN 61000-6-3		
high-frequency radiated		class B		
high-frequency conducted		class B		
limits for harmonic current emissions	IEC/EN 61000-3-2	class D	class A	



## CP-E range

### Technical data

Data at  $T_a = 25\text{ °C}$ ,  $U_{in} = 230\text{ V AC}$  and rated values, unless otherwise indicated

Type		CP-E 24/5.0	CP-E 24/10.0	CP-E 24/20.0
<b>Input circuit</b>		<b>L, N</b>		
Rated input voltage $U_{in}$		115 / 230 V AC auto select		115-230 V AC
Input voltage range		90-132 V AC, 180-264 V AC / 210-375 V DC	90-132 V AC, 180-264 V AC / 210-375 V DC	90-264 V AC, 120-375 V DC
Frequency range AC		47-63 Hz		
Typical input current	at 115 V AC	2.2 A	4.0 A	4.9 A
	at 230 V AC	0.83 A	1.55 A	2.5 A
Typical power consumption		140 W	270 W	539 W
Inrush current	at 115 V AC	24 A (max. 5 ms)	30 A (max. 5 ms)	25 A (max. 5 ms)
	at 230 V AC	48 A (max. 5 ms)	60 A (max. 5 ms)	50 A (max. 5 ms)
Discharge current	input / output	0.25 mA		
	input / PE	3.5 mA		
Power failure buffering time	at 115 V AC	min. 25 ms		
	at 230 V AC	min. 30 ms		
Internal input fuse		3.15 A slow-acting / 250 V AC	6.3 A slow-acting / 250 V AC	10 A slow-acting / 250 V AC
Power factor correction (PFC)		yes, passive, 0.7	yes, passive, 0.75	yes, active 115 V AC: 0.99 230 V AC: 0.97
<b>Indication of operational states</b>				
Output voltage	green LED	OUTPUT OK: <input type="checkbox"/> : output voltage OK		
	red LED	OUTPUT LOW: <input type="checkbox"/> : output voltage too low		
<b>Output circuit</b>		<b>L+, L+, L-, L-</b>		
Rated output voltage		24 V DC		
Tolerance of the output voltage		0...+1 %		
Adjustment range of the output voltage		22.5-28.5 V DC		
Rated output power		120 W	240 W	480 W
Rated output current $I_r$	$T_a \leq 60\text{ °C}$	5 A	10 A	-
	$T_a \leq 55\text{ °C}$	-	-	20 A
Derating of the output current	$60\text{ °C} < T_a \leq 70\text{ °C}$	2.5 %/°C		-
	$55\text{ °C} < T_a \leq 70\text{ °C}$	-	-	2.5 %/°C
Signalling contact for output voltage OK	13-14	solid-state (max. 60 V DC, 0.3 A)		
Minimum fuse rating to achieve short-circuit protection	13-14	$\geq 60\text{ V DC}$ , $\leq 0.3\text{ A}$ fast-acting		
Maximum deviation with	load change statical	$\pm 1\%$ (single mode), $\pm 5\%$ (parallel mode)		
	change of output voltage within the input voltage range	$\pm 0.5\%$		
Recovery time $T_R$		< 2 ms		
Starting time after applying the supply voltage	at $I_r$	max. 1 s	2.5 s (at $-40\text{ °C}$ / 90 V AC starting time >2.5 s has to be expected)	max. 1 s
	with 3500 $\mu\text{F}$	max. 1.5 s	-	-
	with 7000 $\mu\text{F}$	-	2.5 s	max. 1.5 s
Rise time	at rated load	max. 150 ms		
	with 3500 $\mu\text{F}$	max. 500 ms	-	-
	with 7000 $\mu\text{F}$	-	max. 500 ms	-
Fall time		max. 150 ms		
Residual ripple and switching peaks	BW = 20 MHz	50 mV	100 mV	
Parallel connection		configurable, to increase power, up to 3 devices, min. $0.1 I_r$ - max. $0.9 I_r$		
Series connection		yes, to increase voltage, max. 2 devices		
Resistance to reverse feed		max. 35 V DC		

## CP-E range

### Technical data

Data at  $T_a = 25\text{ °C}$ ,  $U_{in} = 230\text{ V AC}$  and rated values, unless otherwise indicated

Type	CP-E 24/5.0	CP-E 24/10.0	CP-E 24/20.0	
<b>Output circuit - No-load, overload and short-circuit behavior</b>				
Characteristic curve of output	U/I characteristic curve			
Short-circuit protection	continuous short-circuit proof			
Short-circuit behavior	continuation with output power limiting			
Overload protection	output power limiting			
No-load protection	continuous no-load stability			
Starting of capacitive loads	3500 $\mu\text{F}$	7000 $\mu\text{F}$		
<b>General data</b>				
Power loss	typ. 20 W	typ. 35 W	typ. 63 W	
Efficiency	typ. 86 %	typ. 89 %	typ. 89 %	
Duty cycle	100 %			
Dimensions	see "Dimensional drawings"			
Material of housing	metal			
Mounting	DIN rail (IEC/EN 60715), snap-on mounting without any tool			
Mounting position	horizontal			
Minimum distance to other units	horizontal / vertical	25 mm / 25 mm (0.98 in / 0.98 in)		
Degree of protection	housing / terminals	IP20 / IP20		
Protection class	I			
<b>Electrical connection - input circuit / output circuit</b>				
Connecting capacity	fine-strand with wire end ferrule	0.2-4 mm <sup>2</sup> (24-11 AWG)		
	fine-strand without wire end ferrule	0.2-6 mm <sup>2</sup> (24-10 AWG)		
	rigid			
Stripping length	8 mm (0.31 in)			
Tightening torque	input / output	1.0 Nm (9 lb.in) / 0.62 Nm (5.5 lb.in)		
<b>Environmental data</b>				
Ambient temperature range	operation	-35...+70 °C	-40...+70 °C	
	rated load	-35...+60 °C	-40...+60 °C	-40...+55 °C
	storage	-40...+85 °C	-40...+85 °C	
Damp heat (cyclic) (IEC/EN 60068-2-30)	95 % RH, without condensation			
Vibration (sinusoidal) (IEC/EN 60068-2-6)	10-500 Hz, 2 G, along X, Y, Z each axis, 60 min. for each axis			
Shock (half-sine) (IEC/EN 60068-2-27)	15 G, 11 ms, 3 axes, 6 faces, 3 times for each face			
<b>Isolation data</b>				
Rated insulation voltage $U_i$	input circuit / output circuit	3 kV AC		
	input / PE	1.5 kV AC		
	output / PE	0.5 kV AC; 0.71 kV DC		
	signalling contact / PE	0.5 kV DC		
Pollution degree	2			
Overvoltage category	II			
<b>Standards / Directives</b>				
Standards	IEC/EN 60950-1			
Low Voltage Directive	2014/35/EU			
EMC Directive	2014/30/EU			
RoHS Directive	2011/65/EU			
Protective low voltage	SELV (IEC/EN 60950-1)			

## CP-E range

### Technical data



Data at  $T_a = 25\text{ °C}$ ,  $U_{in} = 230\text{ V AC}$  and rated values, unless otherwise indicated

Type		CP-E 24/5.0	CP-E 24/10.0	CP-E 24/20.0
<b>Electromagnetic compatibility</b>				
Interference immunity to		IEC/EN 61000-6-2		
electrostatic discharge	IEC/EN 61000-4-2	level 4 (air discharge 15 kV / contact discharge 8 kV)		
radiated, radio-frequency, electromagnetic field	IEC/EN 61000-4-3	level 3 (10 V/m)		
electrical fast transient/burst	IEC/EN 61000-4-4	level 4 (4 kV / 5 kHz)	level 4 (4 kV / 2.5 kHz)	
surge	IEC/EN 61000-4-5	L-L level 3 (2 kV) / L-PE level 4 (4 kV)		
conducted disturbances, induced by radio-frequency fields	IEC/EN 61000-4-6	level 3 (10 V)		
power frequency magnetic fields	IEC/EN 61000-4-8	level 4 (30 A/m)		
voltage dips, short interruptions and voltage variations	IEC/EN 61000-4-11	dip: >95 % 10 ms / >30 % 500 ms interruptions: >95 % 5000 ms		
Interference emission		IEC/EN 61000-6-3		
high-frequency radiated		class B		
high-frequency conducted		class B		
limits for harmonic current emissions		class D		

## CP-E range

### Technical data

Data at  $T_a = 25\text{ °C}$ ,  $U_{in} = 230\text{ V AC}$  and rated values, unless otherwise indicated

Type	CP-E 48/0.62	CP-E 48/1.25	CP-E 48/5.0	CP-E 48/10.0
<b>Input circuit</b>	<b>L, N</b>			
Rated input voltage $U_{in}$	100-240 V AC		115 / 230 V AC auto select	115-230 V AC
Input voltage range	85-264 V AC / 90-375 V DC		90-132 V AC, 180-264 V AC / 210-375 V DC	90-264 V AC, 120-375 V DC
Frequency range AC	47-63 Hz			
Typical input current	at 115 V AC	560 mA	1060 mA	4.0 A
	at 230 V AC	330 mA	590 mA	1.55 A
Typical power consumption		35.7 W	69.0 W	267 W
Inrush current	at 115 V AC	20 A	30 A	30 A (max. 5 ms)
	at 230 V AC	40 A	60 A	60 A (max. 5 ms)
Discharge current	input / output	0.25 mA		
	input / PE	3.5 mA		
Power failure buffering time	at 115 V AC	min. 20 ms		min. 25 ms
	at 230 V AC	min. 30 ms		min. 25 ms
Internal input fuse	2 A slow-acting / 250 V AC		6.3 A slow-acting / 250 V AC	10 A slow-acting / 250 V AC
Power factor correction (PFC)	no		yes, passive, 0.7	yes, active 115 V AC: 0.99 230 V AC: 0.97
<b>Indication of operational states</b>				
Output voltage	green LED	OUTPUT OK:  : output voltage OK		
	red LED	-	-	OUTPUT LOW:  : output voltage too low
<b>Output circuit</b>	<b>L+, L+, L-, L-</b>			
Rated output voltage	48 V DC			
Tolerance of the output voltage	0...+1 %			
Adjustment range of the output voltage	48-55 V DC		47-56 V DC	
Rated output power	30 W	60 W	240 W	480 W
Rated output current $I_r$	$T_a \leq 60\text{ °C}$	0.625 A	1.25 A	5 A
	$T_a \leq 55\text{ °C}$	-	-	10 A
Derating of the output current	$60\text{ °C} < T_a \leq 70\text{ °C}$	2.5 %/°C		
	$55\text{ °C} < T_a \leq 70\text{ °C}$	-	-	2.5 %/°C
Signalling output for output voltage OK	DC OK	-	-	-
Maximum deviation with	load change statical	$\pm 0.5\%$		$\pm 1\%$ (single mode) $\pm 5\%$ (parallel mode)
	change of output voltage within the input voltage range	$\pm 0.5\%$		$\pm 0.5\%$
Recovery time $T_r$	< 2 ms			
Starting time after applying the supply voltage	at $I_r$	max. 1 s		
	with 3500 $\mu\text{F}$	max. 2 s	-	-
	with 7000 $\mu\text{F}$	-	max. 1.5 s	max. 1.5 s
Rise time	at rated load	max. 150 ms		
	with 3500 $\mu\text{F}$	max. 500 ms	-	-
	with 7000 $\mu\text{F}$	-	max. 500 ms	max. 500 ms
Fall time	max. 150 ms			
Residual ripple and switching peaks	BW = 20 MHz	50 mV		100 mV
Parallel connection	yes, to enable redundancy		configurable, to increase power, up to 3 devices, min. 0.1 $I_r$ - max. 0.9 $I_r$	
Series connection	yes, to increase voltage		yes, to increase voltage, max. 2 devices	
Resistance to reverse feed	1 s - max. 63 V DC			

## CP-E range

### Technical data

Data at  $T_a = 25\text{ °C}$ ,  $U_{in} = 230\text{ V AC}$  and rated values, unless otherwise indicated

Type	CP-E 48/0.62	CP-E 48/1.25	CP-E 48/5.0	CP-E 48/10.0
<b>Output circuit - No-load, overload and short-circuit behavior</b>				
Characteristic curve of output	U/I characteristic curve			
Short-circuit protection	continuous short-circuit proof			
Short-circuit behavior	continuation with output power limiting			
Overload protection	output power limiting			
No-load protection	continuous no-load stability			
Starting of capacitive loads	3500 $\mu\text{F}$	7000 $\mu\text{F}$	unlimited	7000 $\mu\text{F}$
<b>General data</b>				
Power loss	typ. 4.9 W	typ. 7.8 W	typ. 32 W	typ. 60 W
Efficiency	typ. 86 %	typ. 89 %	typ. 90 %	
Duty cycle	100 %			
Dimensions	see "Dimensional drawings"			
Material of housing	plastic		metal	
Mounting	DIN rail (IEC/EN 60715), snap-on mounting without any tool			
Mounting position	horizontal			
Minimum distance to other units	horizontal / vertical	25 mm / 25 mm (0.98 in / 0.98 in)		
Degree of protection	housing / terminals	IP/20 / IP20		
Protection class	I			
<b>Electrical connection - input circuit / output circuit</b>				
Connecting capacity	fine-strand with wire end ferrule	0.2-2.5 mm <sup>2</sup> (24-14 AWG)		0.2-4 mm <sup>2</sup> (24-11 AWG)
	fine-strand without wire end ferrule			0.2-6 mm <sup>2</sup> (24-10 AWG)
	rigid			
Stripping length		6 mm (0.24 in)	8 mm (0.31 in)	
Tightening torque	input / output	0.6 Nm (5 lb.in)	1.0 Nm (9 lb.in) / 0.62 Nm (5.5 lb.in)	
<b>Environmental data</b>				
Ambient temperature range	operation	-40...+70 °C		
	rated load	-40...+60 °C	-40...+55 °C	
	storage	-40...+85 °C		
Damp heat (cyclic) (IEC/EN 60068-2-30)	95 % RH, without condensation			
Vibration (sinusoidal) (IEC/EN 60068-2-6)	10-500 Hz, 2 G, along X, Y, Z each axis, 60 min. for each axis			
Shock (half-sine) (IEC/EN 60068-2-27)	15 G, 11 ms, 3 axes, 6 faces, 3 times for each face			
<b>Isolation data</b>				
Rated insulation voltage $U_i$	input circuit / output circuit	3 kV AC		
	input / PE	1.5 kV AC		
	output / PE	0.5 kV AC; 0.71 kV DC		
Pollution degree	2			
Overvoltage category	II			
<b>Standards / Directives</b>				
Standards	EN 61204-3			
Low Voltage Directive	2014/35/EU			
EMC Directive	2014/30/EU			
RoHS Directive	2011/65/EU			
Protective low voltage	SELV (IEC/EN 60950-1)			

## CP-E range

### Technical data

Data at  $T_a = 25\text{ °C}$ ,  $U_{in} = 230\text{ V AC}$  and rated values, unless otherwise indicated

Type	CP-E 48/0.62	CP-E 48/1.25	CP-E 48/5.0	CP-E 48/10.0
<b>Electromagnetic compatibility</b>				
Interference immunity to	IEC/EN 61000-6-2			
electrostatic discharge	IEC/EN 61000-4-2	level 4 (air discharge 15 kV / contact discharge 8 kV)		
radiated, radio-frequency, electromagnetic field	IEC/EN 61000-4-3	level 3 (10 V/m)		
electrical fast transient/burst	IEC/EN 61000-4-4	level 4 (4 kV / 5 kHz)	level 4 (4 kV / 2.5 kHz)	
surge	IEC/EN 61000-4-5	L-L level 3 (2 kV) / L-PE level 4 (4 kV)		
conducted disturbances, induced by radio-frequency fields	IEC/EN 61000-4-6	level 3 (10 V/m)		
power frequency magnetic fields	IEC/EN 61000-4-8	level 4 (30 A/m)		
voltage dips, short interruptions and voltage variations	IEC/EN 61000-4-11	dip: >95 % 10 ms / >30 % 500 ms, interruptions: >95 % 5000 ms		
Interference emission	IEC/EN 61000-6-3			
high-frequency radiated	class B			
high-frequency conducted	class B			
limits for harmonic current emissions	class A		class D	

# CP-E range

## Technical diagrams

### Output curve at $T_a = 25^\circ\text{C}$

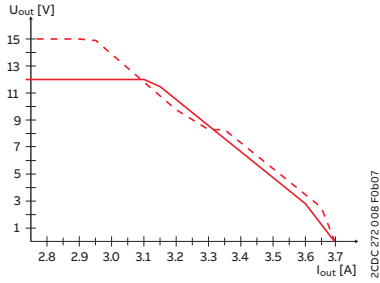

CP-E 12/2.5

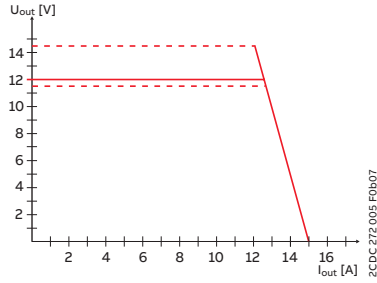

CP-E 12/10.0

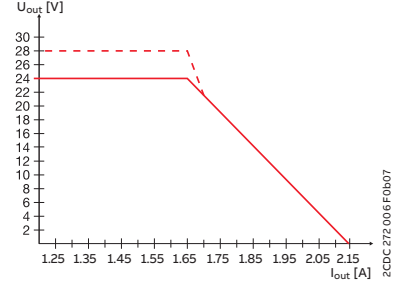

CP-E 24/1.25

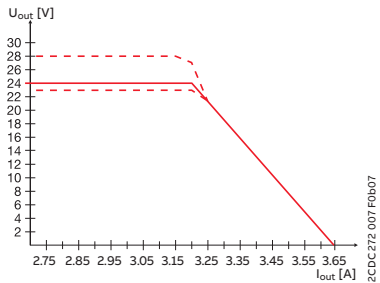

CP-E 24/2.5

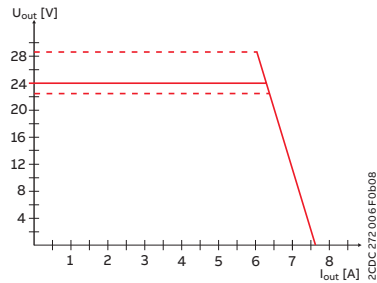

CP-E 24/5.0

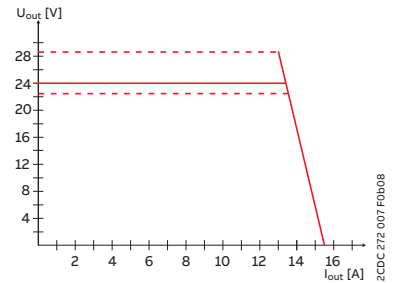

CP-E 24/10.0

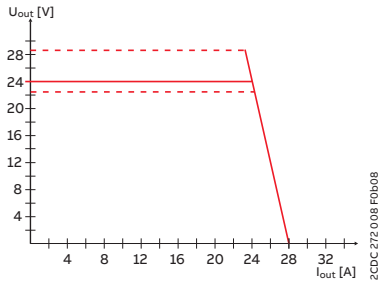

CP-E 24/20.0

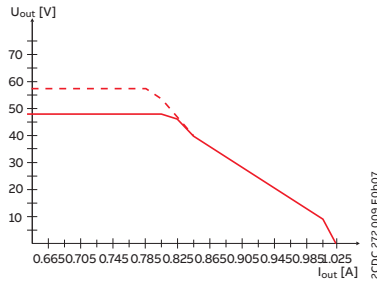

CP-E 48/0.62

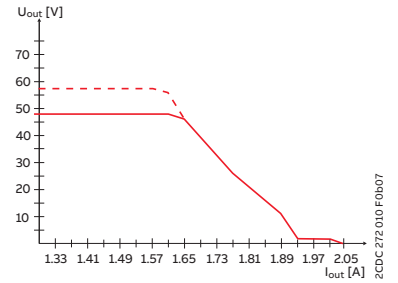

CP-E 48/1.25

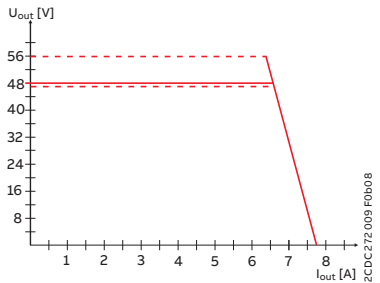

CP-E 48/5.0

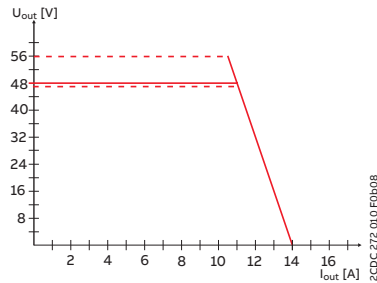

CP-E 48/10.0

# CP-E range

## Technical diagrams

### Temperature behavior at $T_a = 25\text{ }^\circ\text{C}$

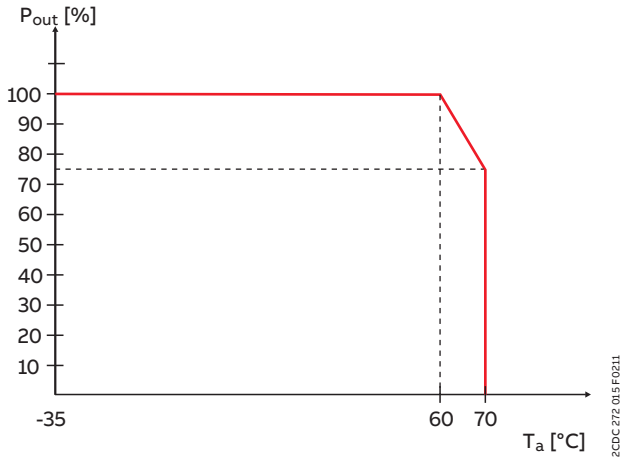

CP-E 12/10.0, CP-E 24/5.0

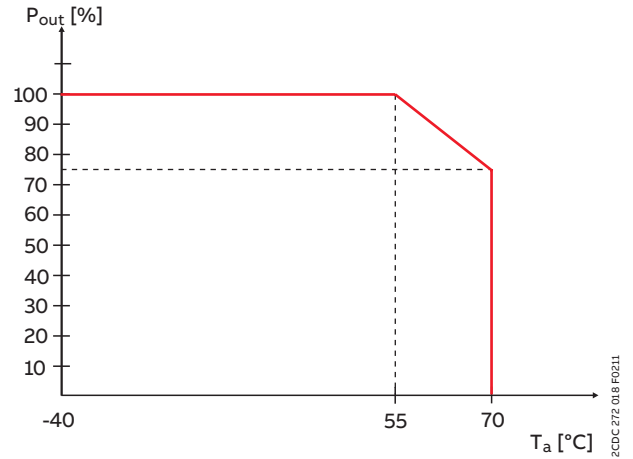

CP-E 24/20.0, CP-E 48/10.0

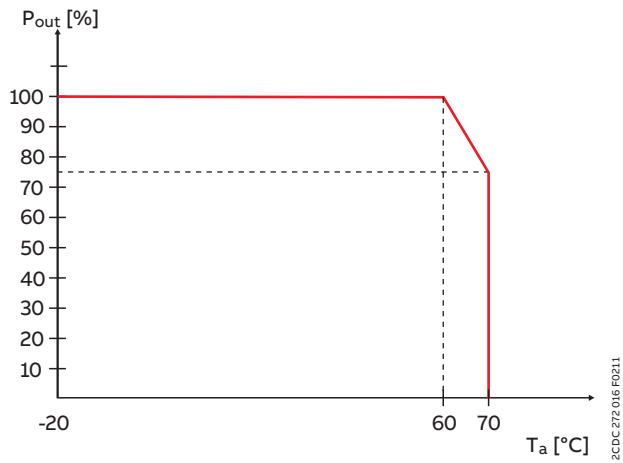

CP-E 5/3.0, CP-E 24/0.75

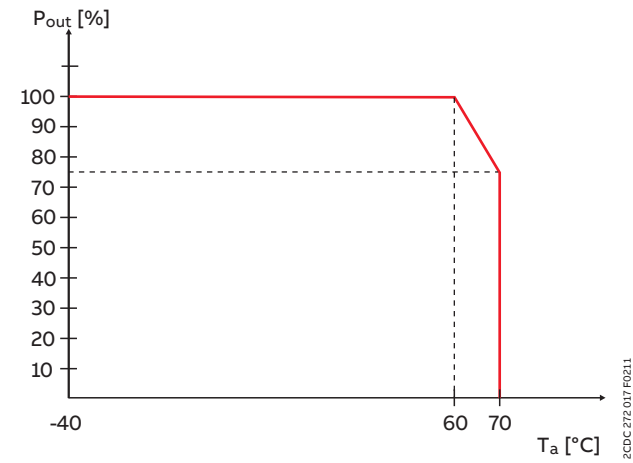

CP-E 12/2.5, CP-E 24/1.25, CP-E 48/0.62,  
CP-E 24/2.5, CP-E 48/1.25, CP-E 24/10.0, CP-E 48/5.0



# CP-E range

## Technical diagrams

### Wiring instructions

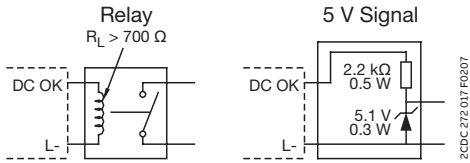

CP-E 24/1.25, CP-E 24/2.5

### Dimensional drawings

Dimensions in mm, inches

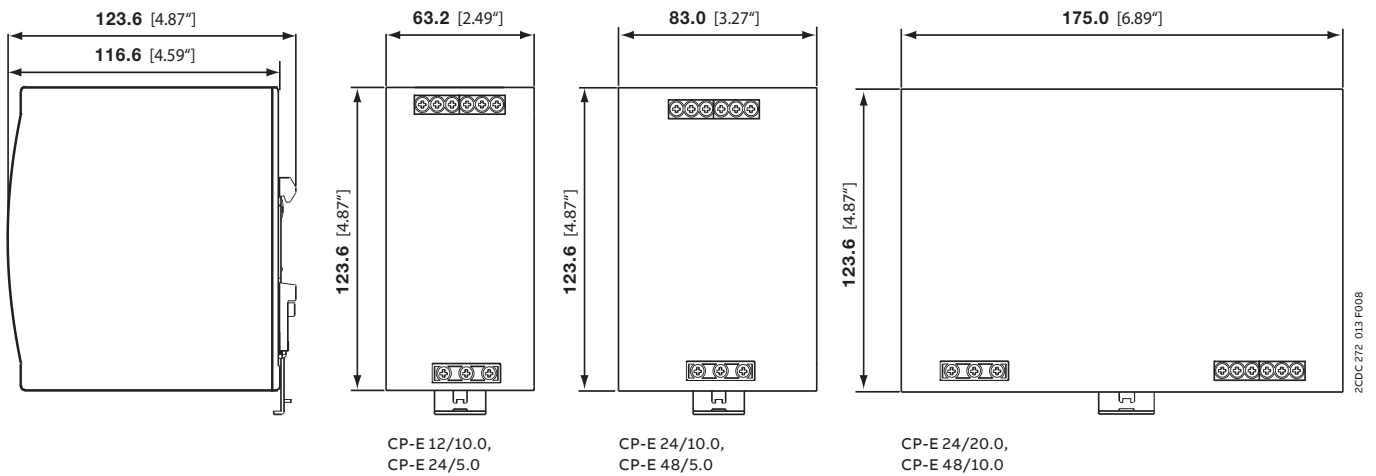
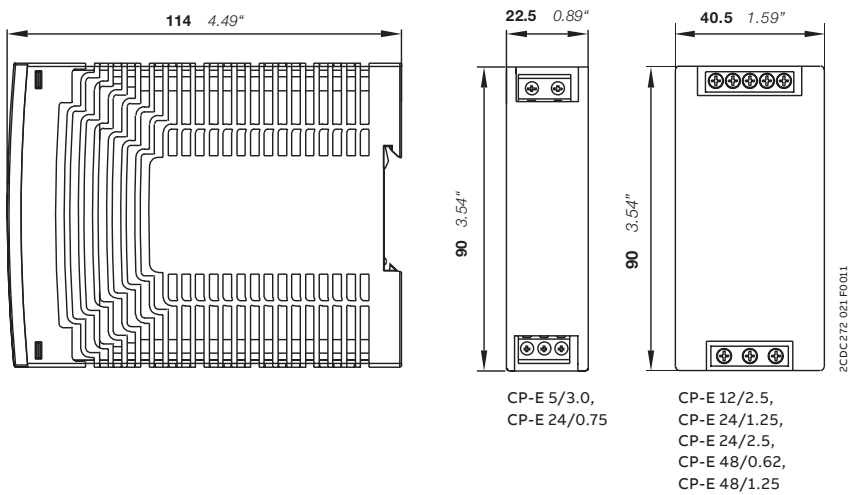



---

## **CP-T range**

### Table of contents

<b>276</b>	<b>Benefits and advantages</b>
<b>278</b>	<b>Operating controls</b>
<b>279</b>	<b>Applications</b>
<b>280</b>	<b>Ordering details</b>
<b>281</b>	<b>Technical data</b>
<b>285</b>	<b>Technical diagrams</b>

## CP-T range

### Benefits and advantages



ABB's CP-T range of three-phase power supply units perfectly complements our existing power supply offering in terms of design and functionality, giving you more advanced options for your three-phase applications.



**Affordable range**

Products with exactly the functions you require. Designed for best price-performance ratio.



**Global availability**

The product can be used in any installation in the world. Giving you the confidence of world-wide sourcing – no matter where you build, install or operate your equipment.



**Speed up your projects**

Data available for common planning software: Less engineering time required

# CP-T range

## Benefits and advantages



### Characteristics

- Rated output voltages 24 V, 48 V DC
- Output voltage adjustable via front-facing rotary potentiometer “OUTPUT Adjust”
- Rated output currents 5 A, 10 A, 20 A, 40 A
- Rated output powers 120 W, 240 W, 480 W, 960 W
- Three-phase operation (see derating note)
- Two-phase operation (25 % derating possible, see derating note)
- Supply range 3 x 400–500 V AC (3 x 340-575 V AC, 480-820 V DC)
- Typical efficiency of 93 %
- Low power dissipation and low heating
- Free convection cooling (no forced cooling with ventilators)
- Ambient temperature range during operation -40...+70 °C <sup>1)</sup>
- Open-circuit, overload and short-circuit stable
- Integrated input fuse
- Redundancy unit CP-C.1-A-RU (-C) offering true redundancy, available as accessory
- LEDs for status indication
- Signalling contact "13-14" (solid-state) for output voltage OK on 24 V devices
- Various approvals and marks

<sup>1)</sup> 480 W variants: -30...+70°C



### Main benefits

#### Signalling output

Some devices of the CP-T series offer a solid-state output for function monitoring and remote diagnostics.

#### Wide input range

Optimized for worldwide applications: The CP-T power supplies can be used in 340 - 575 V AC or 480 - 820 V DC supply systems.

#### Adjustable output voltage

The CP-T range features a continuously adjustable output voltage. Thus, they can be optimally adapted to the applications, e.g. compensating the voltage drop caused by a long line length.



# CP-T range

## Operating controls

**Indication of operational states**

- OUTPUT OK: green LED - green LED - output voltage OK
- OUTPUT LOW: red LED - output voltage too low

**Circuit diagram**

**INPUT L1, L2, L3, PE: Terminals - input**  
340-575 V AC / 480-820 V DC



**OUTPUT Adjust:** Potentiometer - adjustment of output voltage 22.5...28.5V DC

**Single/parallel:** Sliding switch - adjustment of single or parallel operation

**OUTPUT L+, L+, L-, L-: Terminals - output**  
24 V DC, 48 V DC

**13-14: Terminals - signalling contact**  
A solid-state output indicates the error-free operation of the output voltage



Tunnel drilling machines



Quality power management systems

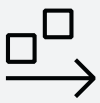

Floor conveyors

## CP-T range

### Ordering details



2CDC271.043.50009

CP-T 24/5.0



2CDC271.045.50009

CP-T 24/10.0, CP-T 48/5.0



2CDC271.047.50009

CP-T 24/20.0, CP-T 48/10.0

### Description

In terms of design and functionality, the CP-T range perfectly supplements the existing products and extends the range appropriately. The devices can be supplied with a three-phase voltage as well as with two-phase mains. Here, ABB offers power supply units with 24 V DC and 48 V DC outputs with 5 A, 10 A, 20 A and 40 A and efficiency of up to 93 %.

As in the case of all products, they are designed for an ambient temperature of up to 70 °C. All products can be supplied within an AC supply voltage range between 340 to 575 V AC and a DC supply voltage range between 480 to 820 V DC.

### Ordering details

Input voltage range	Rated output voltage / current	Type	Order code	Weight (1 pc.) kg (lb)
340-575 V AC / 480-820 V DC	24 V DC / 5 A	CP-T 24/5.0	1SVR427054R0000	0.80 (1.77)
340-575 V AC / 480-820 V DC	24 V DC / 10 A	CP-T 24/10.0	1SVR427055R0000	1.05 (2.31)
340-575 V AC / 480-820 V DC	24 V DC / 20 A	CP-T 24/20.0	1SVR427056R0000	1.75 (3.86)
340-575 V AC / 480-820 V DC	24 V DC / 40 A	CP-T 24/40.0	1SVR427057R0000	3.20 (7.05)
340-575 V AC / 480-820 V DC	48 V DC / 5 A	CP-T 48/5.0	1SVR427054R2000	1.05 (2.31)
340-575 V AC / 480-820 V DC	48 V DC / 10 A	CP-T 48/10.0	1SVR427055R2000	1.75 (3.86)
340-575 V AC / 480-820 V DC	48 V DC / 20 A	CP-T 48/20.0	1SVR427056R2000	3.40 (7.50)



## CP-T range

### Technical data

Data at  $T_a = 25\text{ °C}$ ,  $U_{in} = 3 \times 400\text{ V AC}$  and rated values, unless otherwise indicated

Type	CP-T 24/5.0	CP-T 24/10.0	CP-T 24/20.0	CP-T 24/40.0
<b>Input circuit</b>	<b>L1, L2, L3</b>			
Rated input voltage $U_{in}$	3 x 400-500 V AC			
Input voltage range	340-575 V AC 480-820 V DC			
Frequency range AC	47-63 Hz			
Typical input current	0.36 A	0.65 A	1.1 A	1.72 A
Typical power consumption	135 W	270 W	538 W	1058 W
Inrush current	typ. 10 A		20 A	
Power failure buffering time	min. 20 ms			min. 15 ms
Internal input fuse	per phase 2 A / 600 V AC		T 3.15 A / 500 V AC	T 5 A / 500 V AC
Recommended backup fuse	3 pole miniature circuit breaker ABB Type S203			
Power factor correction (PFC)	yes, passive			
Discharge current	towards PE		< 3.5 mA	
	input / output		< 0.25 mA	
<b>Indication of operational states</b>				
Output voltage	OUTPUT OK: green LED	output voltage OK when the output voltage > 75 % of the rated output voltage		
	OUTPUT LOW: red LED	output voltage too low when the output voltage < 70 % of the rated output voltage		
<b>Output circuit</b>	<b>L+, L+, L-, L-</b>			
Rated output voltage	24 V DC			
Tolerance of the output voltage	0...+1 %			
Adjustment range of the output voltage	22.5-28.5 V DC			
Rated output power	120 W	240 W	480 W	960 W
Rated output current $I_r$	$T_a \leq 60\text{ °C}$		5 A	
Derating of the output current	$60\text{ °C} < T_a \leq 70\text{ °C}$		2.5 %/°C	
Signalling contact for output voltage OK	13-14	solid-state (max. 60 V DC, 0.3 A)		
	Threshold	17.6-19.4 V		
	Insulation voltage	500 V DC		
Minimum fuse rating to achieve short-circuit protection	13-14	$\geq 60\text{ V DC}$ , $\leq 0.3\text{ A}$ fast-acting		
Maximum deviation with load change statical	$\pm 1\%$		$\pm 1\%$ (single mode)	
	change of output voltage within the input voltage range		$\pm 0.5\%$	
Recovery time $T_A$	at nominal load		< 2 ms	
Starting time after applying the supply voltage	at $I_r$		max. 1 s	
	with 3500 $\mu\text{F}$		max. 1.5 s	
Rise time	at nominal load		max. 150 ms	
	with 3500 $\mu\text{F}$		max. 500 ms	
Fall time	max. 150 ms			
Residual ripple and switching peaks	BW = 20 MHz		100 mV	
Parallel connection	not supported	configurable, to increase power, up to 2 devices, min. 0.1 $I_r$ - max 0.9 $I_r$		to increase power, up to 2 devices, min. 0.1 $I_r$ - max. 0.9 $I_r$ , use active current balancing
Series connection	not supported	yes, to increase voltage, max. 2 devices		
Resistance to reverse feed	approx. 35 V			
<b>Output circuit - No-load, overload and short-circuit behavior</b>				
Characteristic curve of output	combined U/I characteristic curve and hiccup mode		U/I- or hiccup-mode adjustable	hiccup / fold back behavior
Short-circuit protection	continuous short-circuit proof			
Short-circuit behavior	current limiting			
Overload protection	hiccup mode			
No-load protection	continuous no-load stability			
Overtemperature protection	yes, automatic recovery after temperature went down			
Starting of capacitive loads	3500 $\mu\text{F}$	7000 $\mu\text{F}$	7000 $\mu\text{F}$	7000 $\mu\text{F}$

## CP-T range

### Technical data

Data at  $T_a = 25\text{ °C}$ ,  $U_{in} = 3 \times 400\text{ V AC}$  and rated values, unless otherwise indicated

Type		CP-T 24/5.0	CP-T 24/10.0	CP-T 24/20.0	CP-T 24/40.0
<b>General data</b>					
Efficiency		typ. 89 %	typ. 90 %		typ. 92 %
Duty cycle		100 %			
Dimensions		see "Dimensional drawings"			
Material of housing		metal			
Mounting		DIN rail (IEC/EN 60715), snap-on mounting without any tool			
Mounting position		horizontal			
Minimum distance to other units	horizontal / vertical	25 mm / 25 mm (0.98 in / 0.98 in)			
Degree of protection	housing / terminals	IP20 / IP20			
Protection class		I			
<b>Electrical connection - input circuit / output circuit / signalling circuit</b>					
Connecting capacity	fine-strand with wire end ferrule	0.2-4 mm <sup>2</sup> (24-11 AWG)			
	fine-strand without wire end ferrule	0.2-6 mm <sup>2</sup> (24-10 AWG)			
	rigid	0.2-6 mm <sup>2</sup> (24-10 AWG)			
Stripping length		8 mm (0.31 in)			
Tightening torque	input / output	1 Nm (9 lb.in) / 0.6 Nm (5.5 lb.in)			1 Nm (9 lb.in) / 1.8 Nm (15.6 lb.in)
<b>Environmental data</b>					
Ambient temperature range	operation	-40...+70 °C	-30...+70 °C	-40...+70 °C	
	rated load	-40...+60 °C	-30...+60 °C	-40...+60 °C	
	storage	-40...+85 °C			
Altitude during operation	IEC/EN 60068-2-13	max. 5000 m			
Damp heat (cyclic) (IEC/EN 60068-2-30)		95 % without condensation			
Vibration (sinusoidal) (IEC/EN 60068-2-6)		10-500 Hz, 2G, each along X, Y, Z axes 60 min / cycle			
Shock (half-sine) (IEC/EN 60068-2-27)		15 g, 11 ms, 3 axes, 6 faces, 3 times for each face			
<b>Isolation data</b>					
Rated insulation voltage $U_i$	input circuit / output circuit	3 kV AC			
	input / PE	1.5 kV AC			
	output / PE	0.5 kV AC; 0.71 kV DC			
	signalling output / PE	0.5 kV DC			
Pollution degree		2			
<b>Standards / Directives</b>					
Standards		IEC/EN 60950-1			
Low Voltage Directive		2014/35/EU			
EMC Directive		2014/30/EU			
RoHS Directive		2011/65/EU			
Protective low voltage		SELV (IEC/EN 60950-1)			
<b>Electromagnetic compatibility</b>					
Interference immunity to		IEC/EN 61000-6-2			
electrostatic discharge	IEC/EN 61000-4-2	level 4 (air discharge 15 kV / contact discharge 8 kV)			
radiated, radio-frequency, electromagnetic field	IEC/EN 61000-4-3	level 3 (10 V/m)			
electrical fast transient/burst	IEC/EN 61000-4-4	level 4 (4 kV / 2.5 kHz)	level 4 (4 kV / 5 kHz)		
surge	IEC/EN 61000-4-5	L-L level 3 (2 kV) / L-PE level 4 (4 kV)			
conducted disturbances, induced by radio-frequency fields	IEC/EN 61000-4-6	level 3 (10 V)			
power frequency magnetic fields	IEC/EN 61000-4-8	level 4 (30 A/m)			
voltage dips, short interruptions and voltage variations	IEC/EN 61000-4-11	dips: >95 % 0.5 ms / >30 % 0.5 ms, interruptions: >95 % 250 ms			
Interference emission		IEC/EN 61000-6-3			
high-frequency radiated		class B			
high-frequency conducted		class B			
limits for harmonic current emissions	IEC/EN 61000-3-2	class A			

## CP-T range

### Technical data

Data at  $T_a = 25\text{ °C}$ ,  $U_{in} = 3 \times 400\text{ V AC}$  and rated values, unless otherwise indicated

Type	CP-T 48/5.0	CP-T 48/10.0	CP-T 48/20.0
<b>Input circuit</b>	<b>L1, L2, L3</b>		
Rated input voltage $U_{in}$	3 x 400-500 V AC		
Input voltage range	340-575 V AC 480-820 V DC		
Frequency range AC	47-63 Hz		
Typical input current	0.65 A	1.1 A	1.72 A
Typical power consumption	264 W	535 W	1050 W
Inrush current	typ. 20 A		30 A
Power failure buffering time	min. 20 ms		min. 15 ms
Internal input fuse	per phase 2 A / 600 V AC	T 3.15 A / 500 V AC	T 5 A / 500 V AC
Power factor correction (PFC)	yes, passive		
Discharge current	towards PE	< 3.5 mA	
	input / output	< 0.25 mA	
<b>Indication of operational states</b>			
Output voltage	OUTPUT OK: green LED	output voltage OK when the output voltage > 75 % of the rated output voltage	
	OUTPUT LOW: red LED	output voltage too low when the output voltage < 70 % of the rated output voltage	
<b>Output circuit</b>	<b>L+, L+, L-, L-</b>		
Rated output voltage	48 V DC		
Tolerance of the output voltage	0...+1 %		
Adjustment range of the output voltage	47-56 V DC		
Rated output power	240 W	480 W	960 W
Rated output current $I_r$	$T_a \leq 60\text{ °C}$ 5 A	10 A	20 A
Derating of the output current	$60\text{ °C} < T_a \leq 70\text{ °C}$	2.5 %/°C	
Maximum deviation with	load change statical	$\pm 1\%$ (single mode) $\pm 5\%$ (parallel mode)	
	change of output voltage within the input voltage range	$\pm 0.5\%$	
Recovery time $T_A$	at rated load	< 2 ms	
Starting time after applying the supply voltage	at $I_r$	max. 1 s	
	with 7000 $\mu\text{F}$	max. 1.5 s	
Rise time	at rated load	max. 150 ms	
	with 7000 $\mu\text{F}$	max. 500 ms	
Fall time		max. 150 ms	
Residual ripple and switching peaks	BW = 20 MHz	100 mV	80 mV
Parallel connection		configurable, to increase power, up to 2 devices, min. 0.1 $I_r$ - max 0.9 $I_r$	to increase power, up to 2 devices, min. 0.1 $I_r$ - max. 0.9 $I_r$ , use active current balancing
Series connection		yes, to increase voltage, max. 2 devices	
Resistance to reverse feed		approx. 35 V	approx. 63 V
		approx. 63 V	approx. 63 V
<b>Output circuit - No-load, overload and short-circuit behavior</b>			
Characteristic curve of output	combined U/I and hiccup mode	U/I or hiccup mode, configurable	hiccup mode / fold back behavior
Short-circuit protection	continuous short-circuit proof		
Short-circuit behavior	current limiting		
Overload protection	hiccup mode		
No-load protection	continuous no-load stability		
Over temperature protection	yes, automatic recovery after temperature went down		
Starting of capacitive loads	7000 $\mu\text{F}$		

## CP-T range

### Technical data

Data at  $T_a = 25\text{ °C}$ ,  $U_{in} = 3 \times 400\text{ V AC}$  and rated values, unless otherwise indicated

Type		CP-T 48/5.0	CP-T 48/10.0	CP-T 48/20.0
<b>General data</b>				
Efficiency		typ. 91 %		typ. 93 %
Duty cycle		100%		
Dimensions		see "Dimensional drawings"		
Material of housing		Metal		
Mounting		DIN rail (IEC/EN 60715), snap-on mounting without any tool		
Mounting position		horizontal		
Minimum distance to other units	horizontal / vertical	25 mm / 25 mm (0.98 in / 0.98 in)		
Degree of protection	housing / terminals	IP20 / IP20		
Protection class		I		
<b>Electrical connection - input circuit / output circuit</b>				
Connecting capacity	fine-strand with wire end ferrule	0.2-4 mm <sup>2</sup> (24-11 AWG)		0.2-4 mm <sup>2</sup> (24-11 AWG) / 0.5-10 mm <sup>2</sup> (20-8 AWG)
		0.2-6 mm <sup>2</sup> (24-10 AWG)		
	rigid			
Stripping length		8 mm (0.31 in)		
Tightening torque	input / output	1 Nm (9 lb.in) / 0.6 Nm (5.5 lb.in)		1 Nm (9 lb.in) / 1.8 Nm (15.6 lb.in)
<b>Environmental data</b>				
Ambient temperature range	operation	-40...+70 °C	-30...+70 °C	-40...+70 °C
	rated load	-40...+60 °C	-30...+60 °C	-40...+60 °C
	storage	-40...+85 °C	-40...+85 °C	-40...+85 °C
Altitude during operation	IEC/EN 60068-2-13	max. 5000 m		
Damp heat (cyclic) (IEC/EN 60068-2-30)		95 % without condensation		
Vibration (sinusoidal) (IEC/EN 60068-2-6)		10-500 Hz, 2G, each along X, Y, Z axes 6 min / cycle		
Shock (half-sine) (IEC/EN 60068-2-27)		15G, 11 ms, 3 axes, 6 Faces, 3 times for each face		
<b>Isolation data</b>				
Rated insulation voltage $U_i$	input circuit / output circuit	3 kV AC		
	input / PE	1.5 kV AC		
	output / PE	0.5 kV AC; 0.71 kV DC		
Pollution degree		2		
<b>Standards / Directives</b>				
Standards		IEC/EN 60950-1		
Low Voltage Directive		2014/35/EU		
EMC Directive		2014/30/EU		
RoHS Directive		2011/65/EU		
Protective low voltage		SELV (IEC/EN 60950-1)		
<b>Electromagnetic compatibility</b>				
Interference immunity to		IEC/EN 61000-6-2		
electrostatic discharge	IEC/EN 61000-4-2	level 4 (air discharge 15 kV / contact discharge 8 kV)		
radiated, radio-frequency, electromagnetic field	IEC/EN 61000-4-3	level 3 (10 V/m)		
electrical fast transient/burst	IEC/EN 61000-4-4	level 4 (4 kV / 5 kHz)		
surge	IEC/EN 61000-4-5	L-L level 3 (2 kV) / L-PE level 4 (4 kV)		
conducted disturbances, induced by radio-frequency fields	IEC/EN 61000-4-6	level 3 (10 V)		
power frequency magnetic fields	IEC/EN 61000-4-8	level 4 (30 A/m)		
voltage dips, short interruptions and voltage variations	IEC/EN 61000-4-11	dips: >95 % 0.5 ms / >30 % 0.5 ms interruptions: >95 % 250 ms		
Interference emission		IEC/EN 61000-6-3		
high-frequency radiated		class B		
high-frequency conducted		class B		
limits for harmonic current emissions	IEC/EN 61000-3-2	class A		

# CP-T range

## Technical diagrams

### Output curves at $T_a = 25^\circ\text{C}$

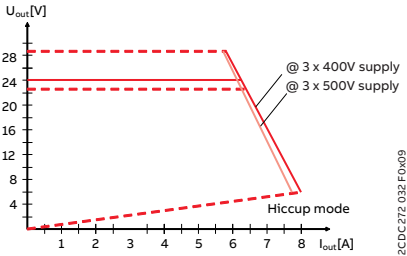

CP-T 24/5.0

2CDC272.032.F0x09

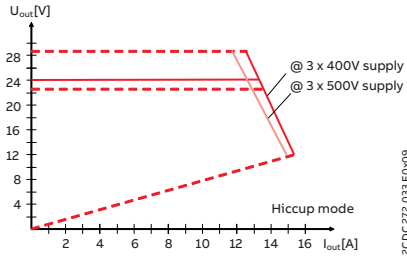

CP-T 24/10.0

2CDC272.033.F0x09

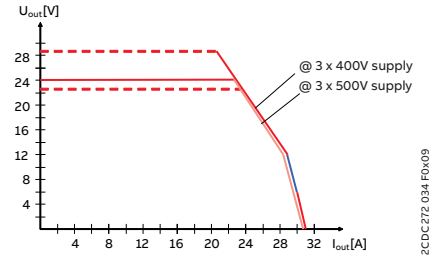

CP-T 24/20.0 U/I curve

2CDC272.034.F0x09

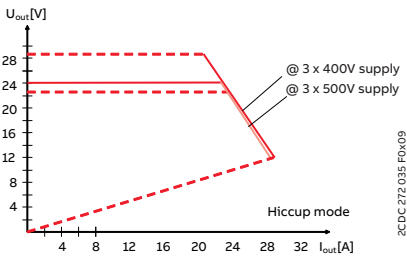

CP-T 24/20.0 Hiccup mode

2CDC272.035.F0x09

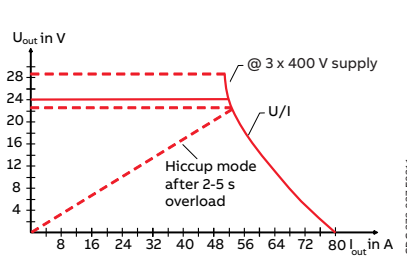

CP-T 24/40.0

2CDC272.027.F0211

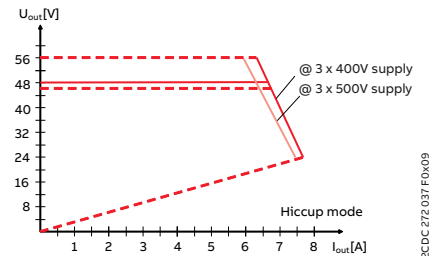

CP-T 48/5.0

2CDC272.037.F0x09

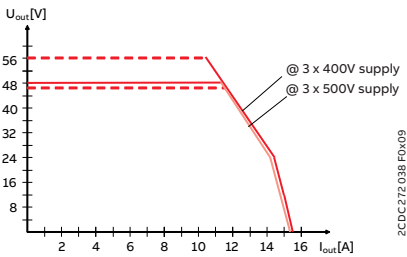

CP-T 48/10.0 U/I curve

2CDC272.038.F0x09

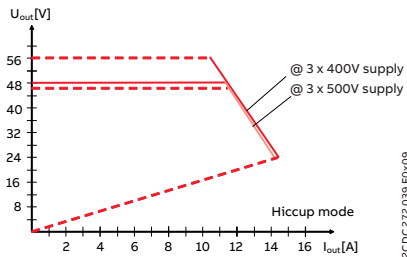

CP-T 48/10.0 Hiccup mode

2CDC272.039.F0x09

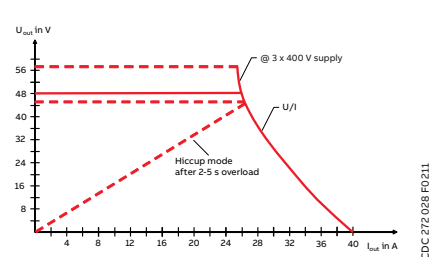

CP-T 48/20.0

2CDC272.038.F0211

### Temperature curves at rated load

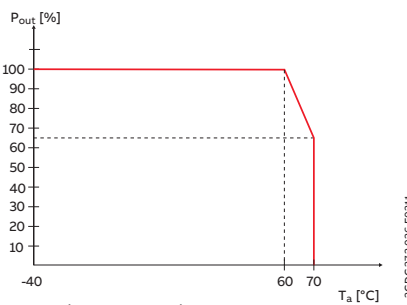

CP-T 24/40.0, CP-T 48/20.0

2CDC272.026.F0211

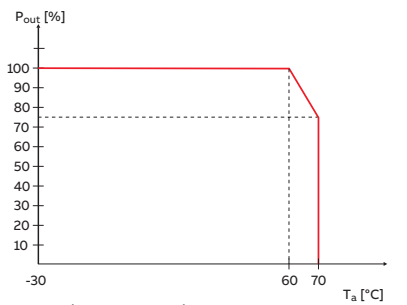

CP-T 24/20.0, CP-T 48/10.0

2CDC272.030.F0211

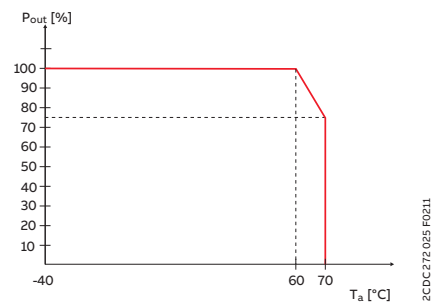

CP-T 24/5.0, CP-T 24/10.0, CP-T 48/5.0

2CDC272.025.F0211

# CP-T range

## Technical diagrams

### Dimensional drawings

Dimensions in mm, inches

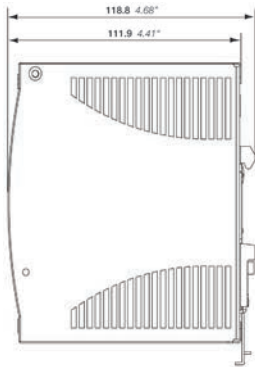

CP-T 24/5.0

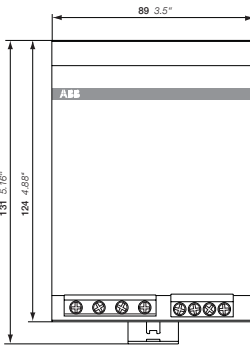
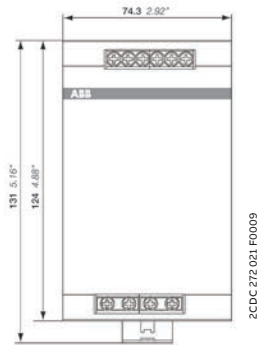

CP-T 24/10.0, CP-T 48/5.0

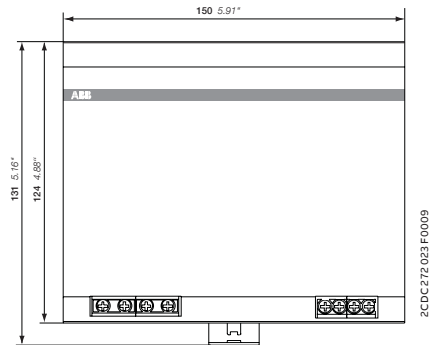

CP-T 24/20.0, CP-T 48/10.0

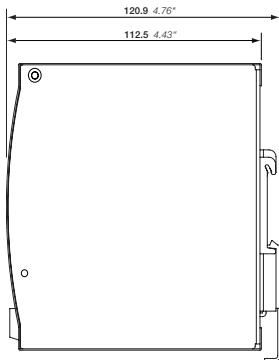

CP-T 24/40.0, CP-T 48/20.0

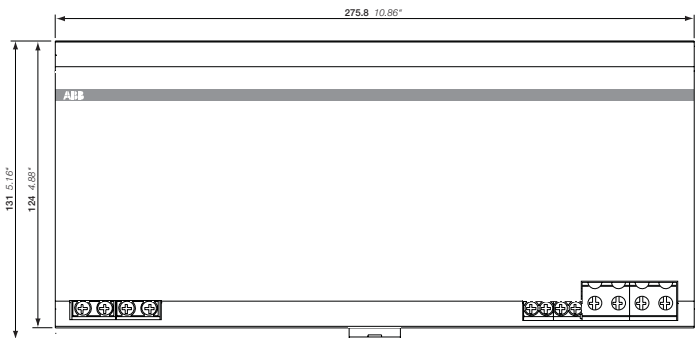

2CDC272 011 F0016







---

## **CP-C.1 range**

### Table of contents

<b>290</b>	<b>Benefits and advantages</b>
<b>292</b>	<b>Operating controls</b>
<b>293</b>	<b>Applications</b>
<b>294</b>	<b>Ordering details</b>
<b>295</b>	<b>Technical data</b>
<b>307</b>	<b>Technical diagrams</b>

# CP-C.1 range

## Benefits and advantages



The high-performance CP-C.1 power supplies are ABB’s most advanced range. With excellent efficiency, high reliability and innovative functionality, it is ready to take on the most demanding of industrial applications. These power supplies have a 150 % integrated power reserve, operate at an efficiency of up to 94 % and are equipped with overheat protection and active power factor correction. Combined with a broad AC and DC input range and extensive worldwide approvals, CP-C.1 power supplies are the preferred choice for professional DC applications. ATEX and IECEx approvals are available for the use in hazardous areas.



### Continuous operation

- Power reserve design to allow performance with up to 150 % more current
- Redundancy setup of the application possible to allow parallel operation
- Long lifetime
- High peak currents for switching on capacitive loads are supported



### Project cost reduction

- Up to 94 % efficiency saves money for energy during operation
- Less need for external cooling in the cabinet
- Small size to reduce space needed in panel



### Reliable in harsh conditions

- Extended ambient temperature range during operation -40...+70 °C with coated PCBA version
- IECEx/ATEX approvals for hazardous locations available
- High MTBF values

## CP-C.1 range

### Benefits and advantages



#### Characteristics

- Rated output voltage 24 V DC
- Power reserve design delivers up to 150 % at  $T_a \leq 40 \text{ }^\circ\text{C}$
- Output voltage adjustable via front-facing rotary potentiometer "OUTPUT Adjust", 22.5-28.5 V
- High efficiency of up to 94 %
- Low power dissipation and low heating
- Free convection cooling (no forced cooling)
- Devices with coated PCBAs for harsh environments and with extended temperature range
- Open-circuit, overload and short-circuit stable
- Integrated input fuse
- OUTPUT OK - signaling output "13-14" (relay), Power reserve signaling output " $I > I_r$ " (transistor)
- Redundancy unit offers true redundancy, available as accessory
- Various approvals and marks



#### Main benefits

The primary switch mode power supply CP-C.1 has a wide range of AC and DC input voltages. Furthermore, the CP-C.1 is equipped with capacitors that ensure a hold-up time of at least 50 ms. This enables worldwide usage and permits safe operation in fluctuating networks and battery-powered applications.

With their robust metallic housing and the reliable construction, CP-C.1 power supplies are suitable for applications in industrial environments. The CP-C.1-C units have coated PCBAs, which enables their use in harsh industrial environments. The power reserve of up to 150 % enables trouble-free starting of heavy loads eliminating the need for an oversized power supply.

#### Signaling output

To communicate the status of the power supply, the CP-C.1 is equipped with a relay output to signal OUTPUT OK as well as a transistor output  $I > I_r$  to indicate when the power reserve is active. These signals can be used for communication with a higher level control system, e.g. a PLC.

Depending on the logic of the higher level control system, an appropriate action is initiated by forwarding the signal. The receptor of this signal could be a contactor, a signal tower, or an interface relay.

# CP-C.1 range

## Operating controls

13-14: Relay output to signal 'Output OK'

$I > I_R$ : Power reserve transistor output to signal 'Power reserve is active'

OUTPUT L+, L-: Output terminals 24 V DC

Indication of operational states  
OUTPUT OK: Green LED  
POWER RESERVE  $I > I_R$ : Yellow LED

Circuit diagram

INPUT L(+), N(-), PE: Input terminals 85-264 V AC / 90 - 300 V DC

Side mounting screw holes for DIN rail adapter / lateral mounting

OUTPUT Adjust: Rotary potentiometer - Adjustment of output voltage 22.5-28.5 V DC



# CP-C.1 range

## Applications



### Application

The primary switch mode power supply CP-C.1 has a wide range of AC and DC input voltages. Furthermore, the CP-C.1 is equipped with capacitors that ensure a hold-up time of at least 50 ms. This enables worldwide usage and permits safe operation in fluctuating networks and battery-powered applications. With their robust metallic housing and reliable construction, CP-C.1 power supplies are suitable for applications in industrial environments. The CP-C.1-C units have coated PCBAs, which enables their use in the harshest of industrial environments. usage in even harsh industrial environments. The power reserve of up to 150 % enables trouble-free starting of heavy loads eliminating the need for an oversized power supply.



### Adjustable output voltage

The CP-C.1 range power supplies feature a continuously adjustable output voltage of 22.5 to 28.5 V DC. Thus, they can be optimally adapted to the applications, e.g. compensating the voltage drop caused by a long line length.



### Signaling output

To communicate the status of the power supply, the CP-C.1 is equipped with a relay output to signal OUTPUT OK as well as a transistor output  $I > I_R$  to indicate when the power reserve is active. These signals can be used for communication with a higher level control system, e.g. a PLC.



### Power reserve

The primary switch mode power supply CP-C.1 is equipped with a power reserve functionality to handle the start-up of particularly heavy loads (e.g. of a capacitive load or a motor). To ensure that heavy loads are started up, the CP-C.1 delivers additionally up to 150 % of the rated output current to secure the operation of the application. This status is displayed by the yellow LED labelled POWER RESERVE  $I > I_R$ .

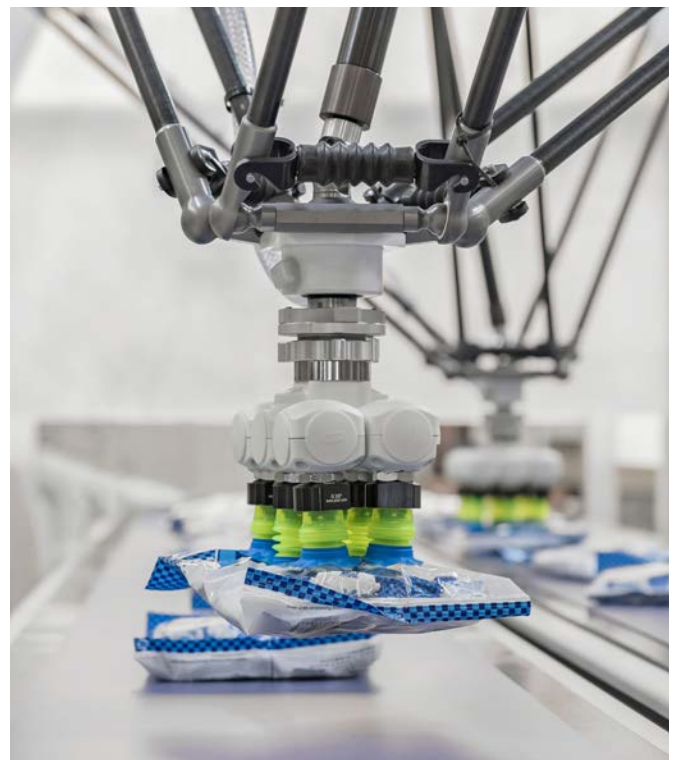

# CP-C.1 range

## Ordering details



2CDC271009 FO07

CP-C.1 24/5.0  
CP-C.1 24/5.0-C



2CDC271010 V0017

CP-C.1 24/10.0  
CP-C.1 24/10.0-C



2CDC271011 V0017

CP-C.1 24/20.0  
CP-C.1 24/20.0-C



CP-C.1 24/5.0  
light grey



CP-C.1 24/10.0  
light grey

### Description

High-performance CP-C.1 power supplies are ABB's most advanced range. With excellent efficiency, high reliability, and innovative functionality, it is ready to take on the most demanding industrial applications. These power supplies have up to 50 % integrated power reserve and operate at an efficiency of up to 94 %. They are equipped with overheat protection and active power factor correction. Combined with a broad AC and DC input range and extensive worldwide approvals, the CP-C.1 power supplies are the preferred choice for professional DC applications.

### Ordering details - CP-C.1

Input voltage range	Rated output voltage / current	PCBA	Color	Type	Order code	Weight (1 pc.) kg (lb)
85-264 V AC, 90-300 V DC	24 V DC / 5 A	uncoated	dark grey	CP-C.1 24/5.0	1SVR360563R1001	0.87 (1.92)
	24 V DC / 10 A			CP-C.1 24/10.0	1SVR360663R1001	1.21 (2.67)
	24 V DC / 20 A			CP-C.1 24/20.0	1SVR360763R1001	1.70 (3.75)
	24 V DC / 5 A	coated		CP-C.1 24/5.0-C	1SVR360563R2001	0.87 (1.92)
	24 V DC / 10 A			CP-C.1 24/10.0-C	1SVR360663R2001	1.24 (2.73)
	24 V DC / 20 A			CP-C.1 24/20.0-C	1SVR360763R2001	1.72 (3.79)
	24 V DC / 5 A	uncoated	light grey	CP-C.1 24/5.0-L	1SVR361563R1001	0.87 (1.92)
	24 V DC / 10 A			CP-C.1 24/10.0-L	1SVR361663R1001	1.21 (2.67)
	24 V DC / 20 A			CP-C.1 24/20.0-L	1SVR361763R1001	1.70 (3.75)

## CP-C.1 range

### Technical data

Data at  $T_a = 25\text{ °C}$ ,  $U_{in} = 230\text{ V AC}$  and rated values, unless otherwise indicated

Type	CP-C.1 24/5.0, CP-C.1 24/5.0-L		CP-C.1 24/5.0-C
<b>Input circuit - Supply circuit</b>			
		<b>L (+), N (-)</b>	
Rated input voltage $U_{in}$		100-240 V AC, 90-300 V DC	
Input voltage range	AC	85-264 V AC	
	DC	90-300 V DC	
Typical input current	at 115 V AC	1.1 A	
	at 230 V AC	0.6 A	
Typical power consumption	at 230 V AC	132 W	
Rated frequency		DC, 50/60 Hz	
Frequency range	AC	45-65 Hz	
Inrush current, cold state		< 8 A	
Let-through energy $I^2t$ , cold state	at 230 V AC	< 1 A <sup>2</sup> s	
Discharge current towards PE		< 3.5 mA	
Hold-up time	at 115 V AC	min. 50 ms	
	at 230 V AC	min. 50 ms	
Internal input fuse		T4.0 A, not exchangeable	
Recommended backup fuse for wire protection at 1.5 mm <sup>2</sup>		1 pole miniature circuit breaker ABB type S 200	
	characteristic	B or C	
	max. rating	16 A	
Power factor correction (PFC)		yes, active	
Transient overvoltage protection		yes, varistor	
<b>User interface</b>			
<b>Indication of operational states</b>			
Output voltage	LED 'OUTPUT OK' (green)	ON	92 % adjusted $U_{out}$
		flashing	90 % adjusted $U_{out}$
Power reserve	LED 'I > I <sub>R</sub> ' (yellow)	OFF	$I \leq I_R$
		ON	$I > I_R$
<b>Output circuit - Power output</b>			
		<b>L+, L-</b>	
Rated output voltage		24 V DC	
Tolerance of the output voltage		± 1 %	
Adjustment range of the output voltage		22.5-28.5 V DC	
Rated output power		120 W	
Rated output current $I_R$	- 25 °C ≤ $T_a$ ≤ 60 °C	5.0 A	-
	- 40 °C ≤ $T_a$ ≤ 60 °C	-	5.0 A
Reserve output current	- 25 °C ≤ $T_a$ ≤ 40 °C	7.5 A continuously	-
	- 40 °C ≤ $T_a$ ≤ 40 °C	-	7.5 A continuously
Short-circuit current limiting		7.6 A	
Derating of the output current	60 °C < $T_a$ ≤ 70 °C	2.5 %/°C	
Deviation width of output voltage	static output voltage deviation 25-100 %	< 1%, class C	
	dynamical 0-100 %	< 2%, class A	
	change of input voltage within the rated input voltage	< 1 ms, class A	
Recovery time $T_A$		< 1 ms, class A	
Starting time after applying the supply voltage		< 500 ms, class C	
Rise time		< 10 ms	
Residual ripple and switching peaks	BW = 20 MHz	< 120 mV <sub>pp</sub> , class A	
Parallel connection		yes, up to 5 devices, to enable redundancy and to increase power, current not symmetrical	
Series connection		yes, max. 2 devices to increase voltage	

## CP-C.1 range

### Technical data

Type	CP-C.1 24/5.0, CP-C.1 24/5.0-L	CP-C.1 24/5.0-C
<b>No-load, overload and short-circuit behavior</b>		
Characteristic curve of output	U/I characteristic curve with power reserve	
Short-circuit protection	continuous short-circuit stability	
Short-circuit behavior	current limiting	
Resistance to reverse feed	≤ 35 V DC	
Overload protection	constant current limitation	
Overtemperature protection	protection by switch off in case of overtemperature (thermal protection), automatic restart	
No-load protection	continuous no-load stability	
Starting of capacitive loads	yes	
<b>Signaling outputs</b>		
<b>OUTPUT OK signaling output</b>		
Type of output	13-14	relay, n/o contact
ON (contact closed)	92 % adjusted $U_{out}$	
OFF (contact open)	90 % adjusted $U_{out}$	
Contact ratings	max. switching voltage / current	30 V AC - 0.5 A / 24 V DC - 1 A (resistive load)
	min. switching voltage / current	5 V DC / 1 mA
<b>POWER RESERVE signaling output</b>		
Type of output	$I > I_R$	transistor, short-circuit proof
Active / ON (closed)	$I > I_R$	
Inactive / OFF (open)	$I \leq I_R$	
Ratings	voltage/current	24 V DC / ≤ 20 mA
<b>General data</b>		
Efficiency	at rated output power	up to 93 %
Power loss	at rated output power	12 W
	at 50% of rated output power	8 W
	at no load	< 3.6 W
Duty cycle		100 %
MTBF	acc. to MIL 217 HDBK	on request
Dimensions		see "Dimensional drawings"
Material of housing	cover	zinc-coated sheet-steel
	housing shell	aluminium
	front	plastic, PA6, V-0
Mounting		DIN rail (IEC/EN 60715), snap-on mounting
Mounting position		see "Mounting positions" in the data sheet
Minimum distance to other units	horizontal	25 mm (0.98 in)
	vertical	25 mm (0.98 in)
Degree of protection (IEC/EN 60529)	housing / terminals	IP20 / IP20
Protection class (IEC/EN 61140)		I
<b>Electrical connection</b>		
<b>Input circuits (L(+), N(-), PE)</b>		
Connecting capacity	rigid	0.5-4.0 mm <sup>2</sup> (20-10 AWG)
	fine-strand with(out) wire end ferrule	0.5-2.5 mm <sup>2</sup> (20-12 AWG)
Stripping length		8 mm (0.315 in)
Tightening torque		0.5 Nm (4.4 lb.in)
Recommended screw driver		PH1 / Ø 4.0 x 0.8 mm
<b>Output circuits (L+, L+, L-, L-)</b>		
Connecting capacity	rigid	0.5-4.0 mm <sup>2</sup> (20-10 AWG)
	fine-strand with(out) wire end ferrule	0.5-2.5 mm <sup>2</sup> (20-12 AWG)
Stripping length		8 mm (0.315 in)
Tightening torque		0.5 Nm (4.4 lb.in)
Recommended screw driver		PH1 / Ø 4.0 x 0.8 mm



## CP-C.1 range

### Technical data

Type		CP-C.1 24/5.0, CP-C.1 24/5.0-L	CP-C.1 24/5.0-C
<b>Signaling output (13-14, I &gt; IR)</b>			
Connecting capacity	rigid	0.5-4.0 mm <sup>2</sup> (20-10 AWG)	
	fine-strand with(out) wire end ferrule	0.5-2.5 mm <sup>2</sup> (20-12 AWG)	
Stripping length		8 mm (0.315 in)	
Tightening torque		0.5 Nm (4.4 lb.in)	
Recommended screw driver		PH1 / Ø 4.0 x 0.8 mm	
Maximum cable length (applicable for I>IR)		30 m	
<b>Environmental data</b>			
Ambient temperature range	operation	-25...+70 °C (-13... +158 °F)	-40...+70 °C (-40...+158 °F)
	rated output power	-25...+60 °C (-13... +140 °F)	-40...+60 °C (-40...+140 °F)
	storage	-40...+85 °C (-40...+185 °F)	
	transportation	-40...+85 °C (-40...+185 °F)	
Climatic class (IEC/EN 60721-3-1)	storage	1K2 (-40...+85 °C / -40...+185 °F)	
Climatic class (IEC/EN 60721-3-2)	transportation	2K2 (-40...+85 °C / -40...+185 °F)	
Climatic class (IEC/EN 60721-3-3)	operation	3K3 (-25...+70 °C / -13...+158 °F)	3K3 (-40...+70 °C / -40...+158 °F)
Damp heat, cyclic (IEC/EN 60068-2-30)		test Db: 55 °C, 2 cycles	
Vibration (IEC/EN 60068-2-6)		test Fc: 10-58 Hz, amplitude ±0.15 mm, 58-150 Hz, 2 g, 10 sweep cycles each axis	
Shock, half-sine (IEC/EN 60068-2-27)		test Ea: 30 g, 6 ms, 3 pulses each axis; bump 20 g, 11 ms, 100 pulses each axis	
Coated PCBA		no	yes
Gaseous corrosive environment withstand test (IEC/EN 60068-2-60)		-	testing method: 4 testing period: 21 days ambient conditions: 25 °C, 75 % r.h. air/volume change rate per hour: 3-6 sample not energized during exposure gas concentrations acc. ISA-S71.04.2013 Harsh Group A, G3 IEC 60721-3.3 acc. 3C2/3C3 - H2S ≥ 100 ± 10 ppb - SO2/SO3 ≥ 300 ± 20 ppb - Cl2 ≥ 100 ± 10 ppb - NOx ≥ 1250 ± 20 ppb
<b>Isolation data</b>			
Rated impulse withstand voltage U <sub>imp</sub> (EN 50178)	input circuit / output circuit	4 kV (1.2/50 μs)	
	input circuit / PE	4 kV (1.2/50 μs)	
	input circuit / relay contact	4 kV (1.2/50 μs)	
	output circuit / relay contact	0.5 kV (1.2/50 μs)	
	relay contact / PE	0.5 kV (1.2/50 μs)	
	output circuit / PE	0.5 kV (1.2/50 μs)	
Rated insulation voltage U <sub>i</sub> (EN 50178)	input circuit / output circuit	300 V	
	input circuit / PE	300 V	
	input circuit / relay contact	300 V	
	output circuit / relay contact	50 V	
	relay contact / PE	50 V	
	output circuit / PE	50 V	
Overvoltage category (EN 50178)	< 2000 m	III	
	2000...5000 m	II	
Overvoltage category (IEC/EN 60950-1)	< 2000 m	II	
	2000...5000 m	I	
Pollution degree		2	
Protective separation (IEC/EN 60950-1)	input circuit / output circuit	yes	
	input circuit / relay contact	yes	

## CP-C.1 range

### Technical data

Type	CP-C.1 24/5.0, CP-C.1 24/5.0-L	CP-C.1 24/5.0-C
<b>Standards / Directives</b>		
Standards	IEC/EN 61204	
Low Voltage Directive	2014/35/EU	
EMC Directive	2014/30/EU	
ATEX Directive	-	2014/34/EU
RoHS Directive	2011/65/EU	
Electrical safety	IEC/EN 60950-1	
Industrial control equipment	UL 508 / CSA 22.2 No 107.1	
Electronic equipment for use in power installations	EN 50178	
Protective extra low voltage	PELV (EN 50178)	
Safety extra low voltage	SELV (IEC/EN 60950-1)	
Limitation of harmonic line currents	IEC/EN 61000-3-2	
<b>Electromagnetic compatibility</b>		
Low-voltage power supplies, d.c. output – Part 3: Electromagnetic compatibility (EMC)	IEC/EN 61204-3	
Interference immunity to	IEC/EN 61000-6-2	
electrostatic discharge (ESD)	IEC/EN 61000-4-2	level 4, 8 kV / 15 kV (criterion A)
radiated, radio-frequency, electromagnetic field	IEC/EN 61000-4-3	level 3, 10 V/m (criterion A)
electrical fast transient / burst	IEC/EN 61000-4-4	level 4, 4 kV / 2 kV (criterion A)
surge	IEC/EN 61000-4-5	level 4, L/N 2 kV (criterion A) level 4, L,N/PE 4 kV (criterion A)
conducted disturbances, induced by radio-frequency fields	IEC/EN 61000-4-6	level 3, 10 V (criterion A)
voltage dips, short interruptions and voltage variations	IEC/EN 61000-4-11	class 3
harmonics and interharmonics	IEC/EN 61000-4-13	class 3 (criterion A)
conducted, common mode disturbances in the frequency range 0 Hz to 150 kHz	IEC/EN 61000-4-16	level 3, 10 V
Interference emission	IEC/EN 61000-6-3	
limits for harmonic current emissions	IEC/EN 61000-3-2	class A
limitation of voltage changes etc.	IEC/EN 61000-3-3	compliant
Information technology equipment radio disturbance characteristics limits and methods of measurement	IEC/CISPR 22, EN 55022	class B
Industrial scientific and medical (ISM) radio-frequency equipment electromagnetic disturbance characteristics limits and methods of measurement	IEC/CISPR 11, EN 55011	class B
Voltage sags	SEMI F47	passed
Federal Communications Commission	FCC15	compliant

## CP-C.1 range

### Technical data

Data at  $T_a = 25\text{ °C}$ ,  $U_{in} = 230\text{ V AC}$  and rated values, unless otherwise indicated

Type	CP-C.1 24/10.0, CP-C.1 24/10.0-L	CP-C.1 24/10.0-C	
<b>Input circuit - Supply circuit</b>			
	<b>L (+), N (-)</b>		
Rated input voltage $U_{in}$	100-240 V AC, 90-300 V DC		
Input voltage range	AC	85-264 V AC	
	DC	90-300 V DC	
Typical input current	at 115 V AC	2.3 A	
	at 230 V AC	1.2 A	
Typical power consumption	at 230 V AC	256 W	
Rated frequency	DC, 50/60 Hz		
Frequency range	AC	45-65 Hz	
Inrush current, cold state	< 11 A		
Let-through energy $I^2t$ , cold state	at 230 V AC	< 1,5 A <sup>2</sup> s	
Discharge current towards PE	< 3.5 mA		
Hold-up time	at 115 V AC	min. 40 ms	
	at 230 V AC	min. 40 ms	
Internal input fuse	T6.3 A, not exchangeable		
Recommended backup fuse for wire protection at 1.5 mm <sup>2</sup>	1 pole miniature circuit breaker ABB type S 200		
	characteristic	B or C	
	max. rating	16 A	
Power factor correction (PFC)	yes, active		
Transient overvoltage protection	yes, varistor		
<b>User interface</b>			
<b>Indication of operational states</b>			
Output voltage	LED 'OUTPUT OK' (green)	ON	92 % adjusted $U_{out}$
		flashing	90 % adjusted $U_{out}$
Power reserve	LED 'I > I <sub>R</sub> ' (yellow)	OFF	$I \leq I_R$
		ON	$I > I_R$
<b>Output circuit - Power output</b>			
	<b>L+, L-</b>		
Rated output voltage	24 V DC		
Tolerance of the output voltage	±1 %		
Adjustment range of the output voltage	22.5-28.5 V DC		
Rated output power	240 W		
Rated output current $I_R$	- 25 °C ≤ $T_a$ ≤ 60 °C	10.0 A	-
	- 40 °C ≤ $T_a$ ≤ 60 °C	-	10.0 A
Reserve output current	- 25 °C ≤ $T_a$ ≤ 40 °C	15.0 A continuously	-
	- 40 °C ≤ $T_a$ ≤ 60 °C	-	15.0 A continuously
Short-circuit current limiting	15.5 A		
Derating of the output current	60 °C < $T_a$ ≤ 70 °C	2.5 %/°C	2.5 %/°C
Deviation width of output voltage	static output voltage deviation 25-100 %	< 1%, class C	
	dynamic 0-100 %	< 5 %, class B	
	change of input voltage within the rated input voltage	< 1 ms, class A	
Recovery time $T_A$	< 1 ms, class A		
Starting time after applying the supply voltage	< 500 ms, class C		
Rise time	< 10 ms		
Residual ripple and switching peaks	BW = 20 MHz	< 120 mV <sub>pp</sub> , class A	
Parallel connection	yes, up to 5 devices, to enable redundancy and to increase power, current not symmetrical		
Series connection	yes, max. 2 devices to increase voltage		

## CP-C.1 range

### Technical data

Type	CP-C.1 24/10.0, CP-C.1 24/10.0-L	CP-C.1 24/10.0-C
<b>No-load, overload and short-circuit behavior</b>		
Characteristic curve of output	U/I characteristic curve with power reserve	
Short-circuit protection	continuous short-circuit stability	
Short-circuit behavior	current limiting	
Resistance to reverse feed	≤ 35 V DC	
Overload protection	constant current limitation	
Overtemperature protection	protection by switch off in case of overtemperature (thermal protection), automatic restart	
No-load protection	continuous no-load stability	
Starting of capacitive loads	yes	
<b>Signaling outputs</b>		
<b>OUTPUT OK signaling output</b>		
Type of output	13-14	relay, n/o contact
ON (contact closed)	92 % adjusted $U_{out}$	
OFF (contact open)	90 % adjusted $U_{out}$	
Contact ratings	max. switching voltage / current	30 V AC - 0.5 A / 24 V DC - 1 A (resistive load)
	min. switching voltage / current	5 V DC / 1 mA
<b>POWER RESERVE signaling output</b>		
Type of output	$I > I_R$	transistor, short-circuit proof
Active / ON (closed)	$I > I_R$	
Inactive / OFF (open)	$I \leq I_R$	
Ratings	voltage/current	24 V DC / ≤ 20 mA
<b>General data</b>		
Efficiency	at rated output power	up to 94 %
Power loss	at rated output power	16 W
	at 50% of rated output power	12 W
	at no load	< 3.6 W
Duty cycle	100 %	
MTBF	acc. to MIL 217 HDBK	on request
Dimensions	see "Dimensional drawings"	
Material of housing	cover	zinc-coated sheet-steel
	housing shell	aluminium
	front	plastic, PA6, V-0
Mounting	DIN rail (IEC/EN 60715), snap-on mounting	
Mounting position	see "Mounting positions" in the data sheet	
Minimum distance to other units	horizontal	25 mm (0.98 in)
	vertical	25 mm (0.98 in)
Degree of protection (IEC/EN 60529)	housing / terminals	IP20 / IP20
Protection class (IEC/EN 61140)	I	
<b>Electrical connection</b>		
<b>Input circuits (L(+), N(-), PE)</b>		
Connecting capacity	rigid	0.5-4.0 mm <sup>2</sup> (20-10 AWG)
	fine-strand with(out) wire end ferrule	0.5-2.5 mm <sup>2</sup> (20-12 AWG)
Stripping length	8 mm (0.315 in)	
Tightening torque	0.5 Nm (4.4 lb.in)	
Recommended screw driver	PH1 / Ø 4.0 x 0.8 mm	
<b>Output circuits (L+, L+, L-, L-)</b>		
Connecting capacity	rigid	0.5-4.0 mm <sup>2</sup> (20-10 AWG)
	fine-strand with(out) wire end ferrule	0.5-2.5 mm <sup>2</sup> (20-12 AWG)
Stripping length	8 mm (0.315 in)	
Tightening torque	0.5 Nm (4.4 lb.in)	
Recommended screw driver	PH1 / Ø 4.0 x 0.8 mm	

## CP-C.1 range

### Technical data

Type	CP-C.1 24/10.0, CP-C.1 24/10.0-L	CP-C.1 24/10.0-C
<b>Signaling output (13-14, I &gt; IR)</b>		
Connecting capacity	rigid	0.5-4.0 mm <sup>2</sup> (20-10 AWG)
	fine-strand with(out) wire end ferrule	0.5-2.5 mm <sup>2</sup> (20-12 AWG)
Stripping length	8 mm (0.315 in)	
Tightening torque	0.5 Nm (4.4 lb.in)	
Recommended screw driver	PH1 / Ø 4.0 x 0.8 mm	
Maximum cable length (applicable for I>I <sub>R</sub> )	30 m	
<b>Environmental data</b>		
Ambient temperature range	operation	-25...+70 °C (-13...+158 °F)
	rated output power	-25...+60 °C (-13...+140 °F)
	storage	-40...+85 °C (-40...+185 °F)
	transportation	-40...+85 °C (-40...+185 °F)
Climatic class (IEC/EN 60721-3-1)	storage 1K2 (-40...+85 °C / -40...+185 °F)	
Climatic class (IEC/EN 60721-3-2)	transportation 2K2 (-40...+85 °C / -40...+185 °F)	
Climatic class (IEC/EN 60721-3-3)	operation	3K3 (-25...+70 °C / -13...+158 °F)
Damp heat, cyclic (IEC/EN 60068-2-30)	test Db: 55 °C, 2 cycles	
Vibration (IEC/EN 60068-2-6)	test Fc: 10-58 Hz, amplitude ±0.15 mm, 58-150 Hz, 2 g, 10 sweep cycles each axis	
Shock, half-sine (IEC/EN 60068-2-27)	test Ea: 30 g, 6 ms, 3 pulses each axis; bump 20 g, 11 ms, 100 pulses each axis	
Coated PCBA	no	yes
Gaseous corrosive environment withstand test (IEC/EN 60068-2-60)	-	testing method: 4 testing period: 21 days ambient conditions: 25 °C, 75 % r.h. air/volume change rate per hour: 3-6 sample not energized during exposure gas concentrations acc. ISA-S71.04.2013 Harsh Group A, G3 IEC 60721-3.3 acc. 3C2/3C3 - H2S ≥ 100 ± 10 ppb - SO2/SO3 ≥ 300 ± 20 ppb - Cl2 ≥ 100 ± 10 ppb - NOx ≥ 1250 ± 20 ppb
<b>Isolation data</b>		
Rated impulse withstand voltage U <sub>imp</sub> (EN 50178)	input circuit / output circuit	4 kV (1.2/50 μs)
	input circuit / PE	4 kV (1.2/50 μs)
	input circuit / relay contact	4 kV (1.2/50 μs)
	output circuit / relay contact	0.5 kV (1.2/50 μs)
	relay contact / PE	0.5 kV (1.2/50 μs)
	output circuit / PE	0.5 kV (1.2/50 μs)
Rated insulation voltage U <sub>i</sub> (EN 50178)	input circuit / output circuit	300 V
	input circuit / PE	300 V
	input circuit / relay contact	300 V
	output circuit / relay contact	50 V
	relay contact / PE	50 V
	output circuit / PE	50 V
Overvoltage category (EN 50178)	< 2000 m	III
	2000...5000 m	II
Overvoltage category (IEC/EN 60950-1)	< 2000 m	II
	2000...5000 m	I
Pollution degree	2	
Protective separation (IEC/EN 60950-1)	input circuit / output circuit	yes
	input circuit / relay contact	yes

## CP-C.1 range

### Technical data

Type	CP-C.1 24/10.0, CP-C.1 24/10.0-L	CP-C.1 24/10.0-C
<b>Standards / Directives</b>		
Standards	IEC/EN 61204	
Low Voltage Directive	2014/35/EU	
EMC Directive	2014/30/EU	
ATEX Directive	-	2014/34/EU
RoHS Directive	2011/65/EU	
Electrical safety	IEC/EN 60950-1	
Industrial control equipment / General Use Power Supplies	UL 508 / CSA 22.2 No 107.1	
Electronic equipment for use in power installations	EN 50178	
Protective extra low voltage	PELV (EN 50178)	
Safety extra low voltage	SELV (IEC/EN 60950-1)	
Limitation of harmonic line currents	IEC/EN 61000-3-2	
<b>Electromagnetic compatibility</b>		
Low-voltage power supplies, d.c. output – Part 3: Electromagnetic compatibility (EMC)	IEC/EN 61204-3	
Interference immunity to	IEC/EN 61000-6-2	
electrostatic discharge (ESD)	IEC/EN 61000-4-2	level 4, 8 kV / 15 kV (criterion A)
radiated, radio-frequency, electromagnetic field	IEC/EN 61000-4-3	level 3, 10 V/m (criterion A)
electrical fast transient / burst	IEC/EN 61000-4-4	level 4, 4 kV / 2 kV (criterion A)
surge	IEC/EN 61000-4-5	level 4, L/N 2 kV (criterion A) level 4, L,N/PE 4 kV (criterion A)
conducted disturbances, induced by radio-frequency fields	IEC/EN 61000-4-6	level 3, 10 V (criterion A)
voltage dips, short interruptions and voltage variations	IEC/EN 61000-4-11	class 3
harmonics and interharmonics	IEC/EN 61000-4-13	class 3 (Criterion A)
conducted, common mode disturbances in the frequency range 0 Hz to 150 kHz	IEC/EN 61000-4-16	level 3, 10 V
Interference emission	IEC/EN 61000-6-3	
limits for harmonic current emissions	IEC/EN 61000-3-2	class A
limitation of voltage changes etc.	IEC/EN 61000-3-3	compliant
Information technology equipment radio disturbance characteristics limits and methods of measurement	IEC/CISPR 22, EN 55022	class B
Industrial scientific and medical (ISM) radio-frequency equipment electromagnetic disturbance characteristics limits and methods of measurement	IEC/CISPR 11, EN 55011	class B
Voltage sags	SEMI F47	passed
Federal Communications Commission	FCC15	compliant

## CP-C.1 range

### Technical data

Data at  $T_a = 25\text{ °C}$ ,  $U_{in} = 230\text{ V AC}$  and rated values, unless otherwise indicated

Type	CP-C.1 24/20.0, CP-C.1 24/20.0-L		CP-C.1 24/20.0-C
<b>Input circuit - Supply circuit</b>			
		<b>L (+), N (-)</b>	
Rated input voltage $U_{in}$		100-240 V AC, 90-300 V DC	
Input voltage range	AC	85-264 V AC	
	DC	90-300 V DC	
Typical input current	at 115 V AC	4.6 A	
	at 230 V AC	2.3 A	
Typical power consumption	at 230 V AC	508 W	
Rated frequency		DC, 50/60 Hz	
Frequency range	AC	45-65 Hz	
Inrush current, cold state		< 11 A	
Let-through energy $I^2t$ , cold state	at 230 V AC	< 3 A <sup>2</sup> s	
Discharge current towards PE		< 3.5 mA	
Hold-up time	at 115 V AC	min. 40 ms	
	at 230 V AC	min. 40 ms	
Internal input fuse		T12 A, not exchangeable	
Recommended backup fuse for wire protection at 1.5 mm <sup>2</sup>		1 pole miniature circuit breaker ABB type S 200	
	characteristic	B or C	
	max. rating	16 A	
Power factor correction (PFC)		yes, active	
Transient overvoltage protection		yes, varistor	
<b>User interface</b>			
<b>Indication of operational states</b>			
Output voltage	LED 'OUTPUT OK' (green)	ON	92 % adjusted $U_{out}$
		flashing	90 % adjusted $U_{out}$
Power reserve	LED 'I > I <sub>R</sub> ' (yellow)	OFF	$I \leq I_R$
		ON	$I > I_R$
<b>Output circuit - Power output</b>			
		<b>L+, L-</b>	
Rated output voltage		24 V DC	
Tolerance of the output voltage		± 1 %	
Adjustment range of the output voltage		22.5-28.5 V DC	
Rated output power		480 W	
Rated output current $I_R$	$-25\text{ °C} \leq T_a \leq 60\text{ °C}$	20 A	-
	$-40\text{ °C} \leq T_a \leq 60\text{ °C}$	-	20 A
Reserve output current	$-25\text{ °C} \leq T_a \leq 40\text{ °C}$	26.0 A continuously	-
	$-40\text{ °C} \leq T_a \leq 60\text{ °C}$	-	26.0 A continuously
Short-circuit current limiting		27.7 A	
Derating of the output current	$60\text{ °C} < T_a \leq 70\text{ °C}$	2.5 %/°C	
Deviation width of output voltage	static output voltage deviation 25-100 %	< 1 %, class C	
	dynamical 0-100 %	< 5 %, class B	
	change of input voltage within the rated input voltage	< 5 ms, class B	
Recovery time $T_A$		< 1 ms, class A	
Starting time after applying the supply voltage		< 500 ms, class C	
Rise time		< 10 ms	
Residual ripple and switching peaks	BW = 20 MHz	< 120 mV <sub>pp</sub> , class A	
Parallel connection		yes, up to 5 devices, to enable redundancy and to increase power, current not symmetrical	
Series connection		yes, max. 2 devices to increase voltage	

## CP-C.1 range

### Technical data

Type	CP-C.1 24/20.0, CP-C.1 24/20.0-L		CP-C.1 24/20.0-C
<b>No-load, overload and short-circuit behavior</b>			
Characteristic curve of output	U/I characteristic curve with power reserve		
Short-circuit protection	continuous short-circuit stability		
Short-circuit behavior	current limiting		
Resistance to reverse feed	≤ 35 V DC		
Overload protection	constant current limitation		
Overtemperature protection	protection by switch off in case of overtemperature (thermal protection), automatic restart		
No-load protection	continuous no-load stability		
Starting of capacitive loads	yes		
<b>Signaling outputs</b>			
<b>OUTPUT OK signaling output</b>			
Type of output	13-14	relay, n/o contact	
ON (contact closed)	92 % adjusted $U_{out}$		
OFF (contact open)	90 % adjusted $U_{out}$		
Contact ratings	max. switching voltage / current	30 V AC - 0.5 A / 24 V DC - 1 A (resistive load)	
	min. switching voltage / current	5 V DC / 1 mA	
<b>POWER RESERVE signaling output</b>			
Type of output	$I > I_R$	transistor, short-circuit proof	
Active / ON (closed)	$I > I_R$		
Inactive / OFF (open)	$I \leq I_R$		
Ratings	voltage/current	24 V DC / ≤ 20 mA	
<b>General data</b>			
Efficiency	at rated output power	up to 94 %	
Power loss	at rated output power	28 W	
	at 50 % of rated output power	17 W	
	at no load	< 3.6 W	
Duty cycle	100 %		
MTBF	acc. to MIL 217 HDBK	on request	
Dimensions	see "Dimensional drawings"		
Material of housing	cover	zinc-coated sheet-steel	
	housing shell	aluminium	
	front	plastic, PA6, V-0	
Mounting	DIN rail (IEC/EN 60715), snap-on mounting		
Mounting position	see "Mounting positions" in the data sheet		
Minimum distance to other units	horizontal	25 mm (0.98 in)	
	vertical	25 mm (0.98 in)	
Degree of protection (IEC/EN 60529)	housing / terminals	IP20 / IP20	
Protection class (IEC/EN 61140)	I		
<b>Electrical connection</b>			
<b>Input circuits (L(+), N(-), PE)</b>			
Connecting capacity	rigid	0.5-4.0 mm <sup>2</sup> (20-10 AWG)	
	fine-strand with(out) wire end ferrule	0.5-2.5 mm <sup>2</sup> (20-12 AWG)	
Stripping length	8 mm (0.315 in)		
Tightening torque	0.5 Nm (4.4 lb.in)		
Recommended screw driver	PH1 / Ø 4.0 x 0.8 mm		



## CP-C.1 range

### Technical data

Type	CP-C.1 24/20.0, CP-C.1 24/20.0-L	CP-C.1 24/20.0-C
<b>Output circuits (L+, L+, L-, L-)</b>		
Connecting capacity	rigid	2.5-16.0 mm <sup>2</sup> (12-6 AWG)
	fine-strand with(out) wire end ferrule	2.5-10 mm <sup>2</sup> (12-8 AWG)
Stripping length	10 mm (0.394 in)	
Tightening torque	1.2 Nm (10.5 lb-in)	
Recommended screw driver	PH1 / Ø 4.0 x 0.8 mm	
<b>Signaling output (13-14, I &gt; IR)</b>		
Connecting capacity	rigid	0.5-4.0 mm <sup>2</sup> (20-10 AWG)
	fine-strand with(out) wire end ferrule	0.5-2.5 mm <sup>2</sup> (20-12 AWG)
Stripping length	8 mm (0.315 in)	
Tightening torque	0.5 Nm (4.4 lb.in)	
Recommended screw driver	PH1 / Ø 4.0 x 0.8 mm	
Maximum cable length (applicable for I>I <sub>R</sub> )	30 m	
<b>Environmental data</b>		
Ambient temperature range	operation	-25...+70 °C (-13...+158 °F)
	rated output power	-25...+60 °C (-13...+140 °F)
	storage	-40...+85 °C (-40...+185 °F)
	transportation	-40...+85 °C (-40...+185 °F)
Climatic class (IEC/EN 60721-3-1)	storage	1K2 (-40...+85 °C / -40...+185 °F)
Climatic class (IEC/EN 60721-3-2)	transportation	2K2 (-40...+85 °C / -40...+185 °F)
Climatic class (IEC/EN 60721-3-3)	operation	3K3 (-25...+70 °C / -13...+158 °F)
Damp heat, cyclic (IEC/EN 60068-2-30)	test Db: 55 °C, 2 cycles	
Vibration (IEC/EN 60068-2-6)	test Fc: 10-58 Hz, amplitude ±0.15 mm, 58-150 Hz, 2 g, 10 sweep cycles each axis	
Shock, half-sine (IEC/EN 60068-2-27)	test Ea: 30 g, 6 ms, 3 pulses each axis; bump 20 g, 11 ms, 100 pulses each axis	
Coated PCBA	no	yes
Gaseous corrosive environment withstand test (IEC/EN 60068-2-60)	-	testing method: 4 testing period: 21 days ambient conditions: 25 °C, 75 % r.h. air/volume change rate per hour: 3-6 sample not energized during exposure gas concentrations acc. ISA-S71.04.2013 Harsh Group A, G3 IEC 60721-3.3 acc. 3C2/3C3 - H2S ≥ 100 ± 10 ppb - SO2/SO3 ≥ 300 ± 20 ppb - Cl2 ≥ 100 ± 10 ppb - NOx ≥ 1250 ± 20 ppb

## CP-C.1 range

### Technical data

Type	CP-C.1 24/20.0, CP-C.1 24/20.0-L		CP-C.1 24/20.0-C
<b>Isolation data</b>			
Rated impulse withstand voltage $U_{imp}$ (EN 50178)	input circuit / output circuit	4 kV (1.2/50 $\mu$ s)	
	input circuit / PE	4 kV (1.2/50 $\mu$ s)	
	input circuit / relay contact	4 kV (1.2/50 $\mu$ s)	
	output circuit / relay contact	0.5 kV (1.2/50 $\mu$ s)	
	relay contact / PE	0.5 kV (1.2/50 $\mu$ s)	
	output circuit / PE	0.5 kV (1.2/50 $\mu$ s)	
Rated insulation voltage $U_i$ (EN 50178)	input circuit / output circuit	300 V	
	input circuit / PE	300 V	
	input circuit / relay contact	300 V	
	output circuit / relay contact	50 V	
	relay contact / PE	50 V	
	output circuit / PE	50 V	
Overvoltage category (EN 50178)	< 2000 m	III	
	2000...5000 m	II	
Overvoltage category (IEC/EN 60950-1)	< 2000 m	II	
	2000...5000 m	I	
Pollution degree	2		
Protective separation (IEC/EN 60950-1)	input circuit / output circuit	yes	
	input circuit / relay contact	yes	
<b>Standards / Directives</b>			
Standards	IEC/EN 61204		
Low Voltage Directive	2014/35/EU		
EMC Directive	2014/30/EU		
ATEX Directive	-	2014/34/EU	
RoHS Directive	2011/65/EU		
Electrical safety	IEC/EN 60950-1		
Industrial control equipment / General Use Power Supplies	UL 508 / CSA 22.2 No 107.1		
Electrical equipment for use in power installations	EN 50178		
Protective extra low voltage	PELV (EN 50178)		
Safety extra low voltage	SELV (IEC/EN 60950-1)		
Limitation of harmonic line currents	IEC/EN 61000-3-2		
<b>Electromagnetic compatibility</b>			
Low-voltage power supplies, d.c. output – Part 3: Electromagnetic compatibility (EMC)	IEC/EN 61204-3		
Interference immunity to	IEC/EN 61000-6-2		
electrostatic discharge (ESD)	IEC/EN 61000-4-2	level 4, 8 kV / 15 kV (criterion A)	
radiated, radio-frequency, electromagnetic field	IEC/EN 61000-4-3	level 3, 10 V/m (criterion A)	
electrical fast transient / burst	IEC/EN 61000-4-4	level 4, 4 kV / 2 kV (criterion A)	
surge	IEC/EN 61000-4-5	level 4, L/N 2 kV (criterion A) level 4, L,N/PE 4 kV (criterion A)	
conducted disturbances, induced by radio-frequency fields	IEC/EN 61000-4-6	level 3, 10 V (criterion A)	
voltage dips, short interruptions and voltage variations	IEC/EN 61000-4-11	class 3	
harmonics and interharmonics	IEC/EN 61000-4-13	class 3 (Criterion A)	
conducted, common mode disturbances in the frequency range 0 Hz to 150 kHz	IEC/EN 61000-4-16	level 3, 10 V	
Interference emission	IEC/EN 61000-6-3		
limits for harmonic current emissions	IEC/EN 61000-3-2	class A	
limitation of voltage changes etc.	IEC/EN 61000-3-3	compliant	
Information technology equipment radio disturbance characteristics limits and methods of measurement	IEC/CISPR 22, EN 55022	class B	
Industrial scientific and medical (ISM) radio-frequency equipment electromagnetic disturbance characteristics limits and methods of measurement	IEC/CISPR 11, EN 55011	class B	
Voltage sags	SEMI F47	passed	
Federal Communications Commission	FCC15	compliant	

# CP-C.1 range

## Technical diagrams

### CP-C.1 24/5.0, CP-C.1 24/5.0-L and CP-C.1 24/5.0-C

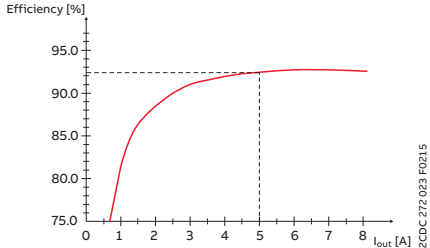

Typical efficiency over output current

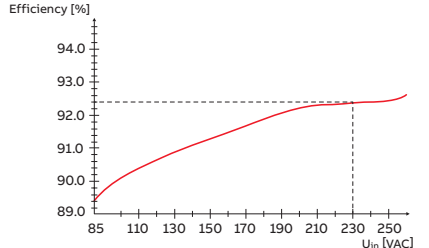

Typical efficiency over AC input voltage

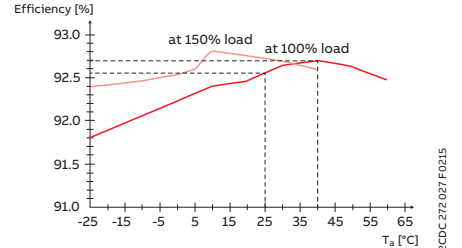

Typical efficiency over ambient temperature

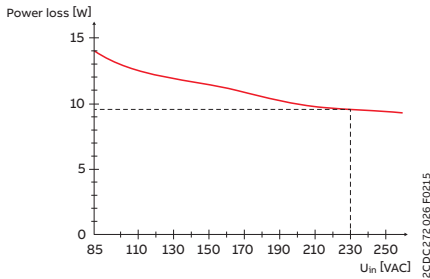

Typical power loss over AC input voltage

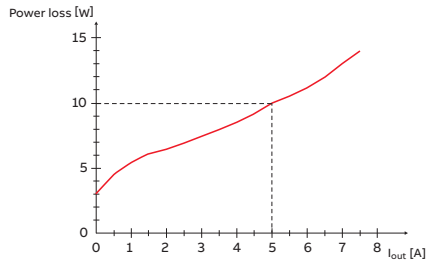

Typical power loss over output current

### CP-C.1 24/10.0, CP-C.1 24/10.0-L and CP-C.1 24/10.0-C

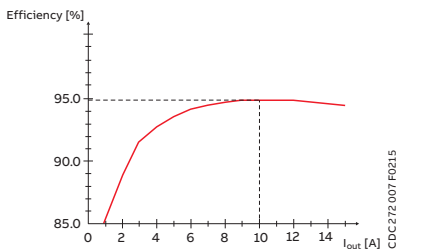

Typical efficiency over output current

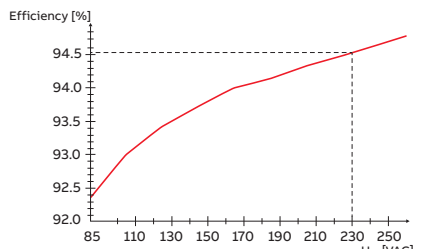

Typical efficiency over AC input voltage

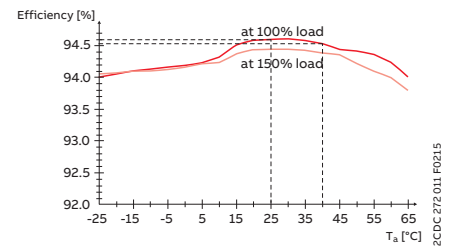

Typical efficiency over ambient temperature

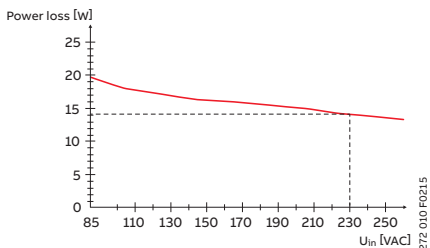

Typical power loss over AC input voltage

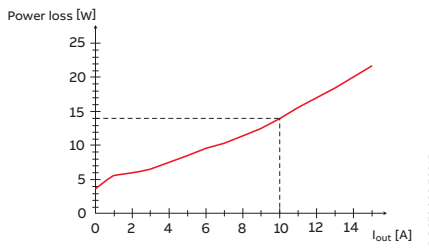

Typical power loss over output current

# CP-C.1 range

## Technical diagrams

### CP-C.1 24/20.0, CP-C.1 24/20.0-L and CP-C.1 24/20.0-C

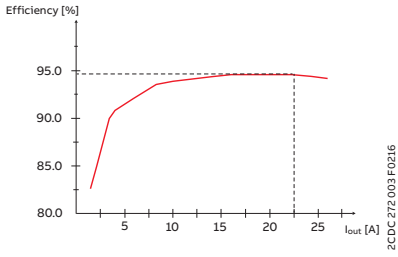

Typical efficiency over output current

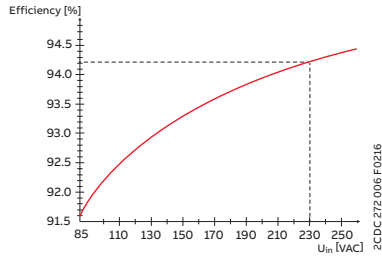

Typical efficiency over AC input voltage

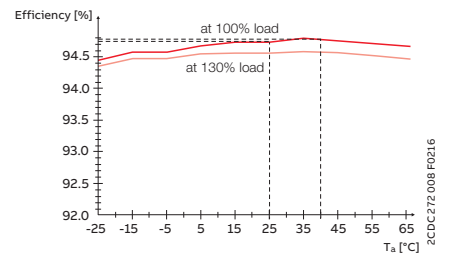

Typical efficiency over ambient temperature

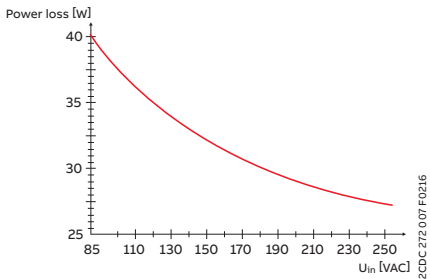

Typical power loss over AC input voltage

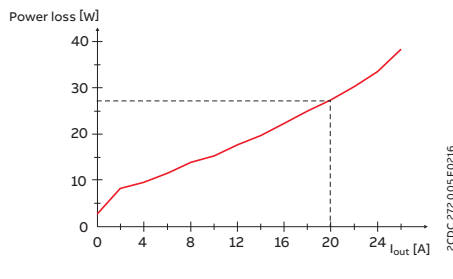

Typical power loss over output current

# CP-C.1 range

## Technical diagrams

### Characteristic curve of output at $T_a = 25^\circ\text{C}$

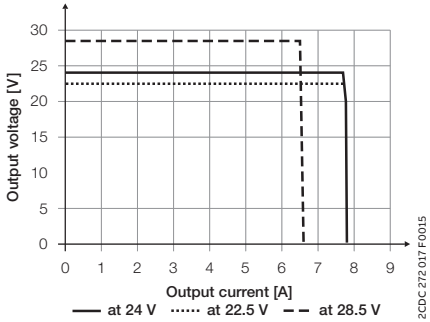

CP-C.1 24/5.0, CP-C.1 24/5.0-L  
CP-C.1 24/5.0-C

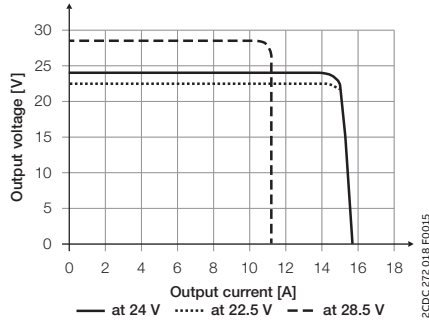

CP-C.1 24/10.0, CP-C.1 24/10.0-L  
CP-C.1 24/10.0-C

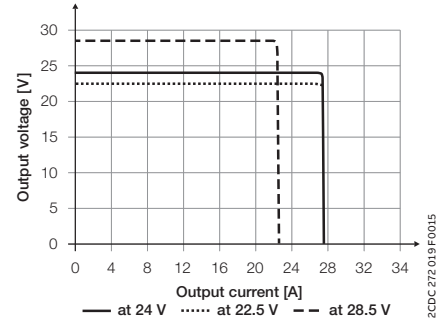

CP-C.1 24/20.0, CP-C.1 24/20.0-L  
CP-C.1 24/20.0-C

### Characteristic curve of temperature at $U_{out} = 24\text{ V}$

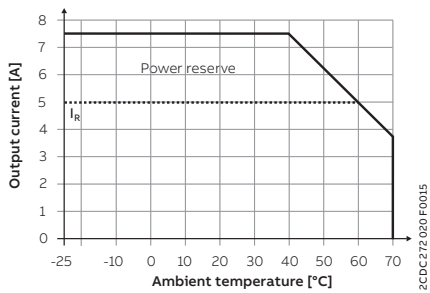

CP-C.1 24/5.0, CP-C.1 24/5.0-L

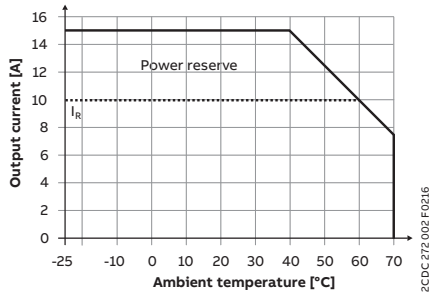

CP-C.1 24/10.0, CP-C.1 24/10.0-L

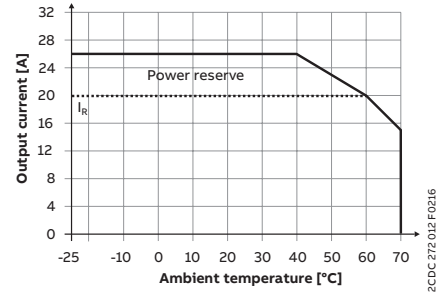

CP-C.1 24/20.0, CP-C.1 24/20.0-L

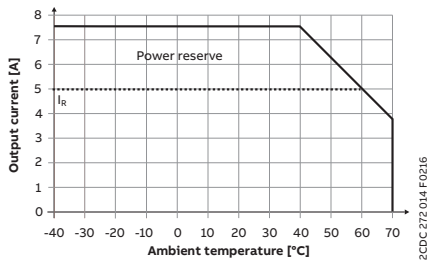

CP-C.1 24/5.0-C

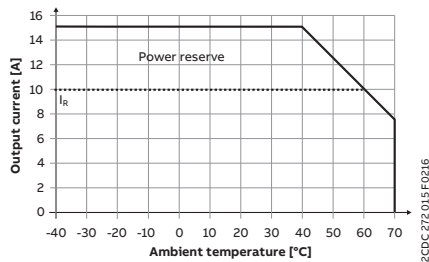

CP-C.1 24/10.0-C

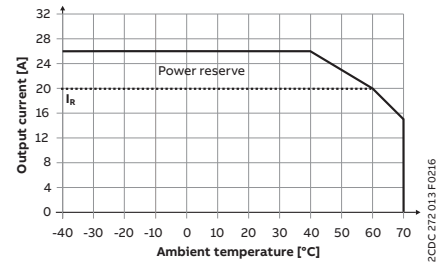

CP-C.1 24/20.0-C

# CP-C.1 range

## Technical diagrams

### Dimensional drawings

Dimensions in mm, inches

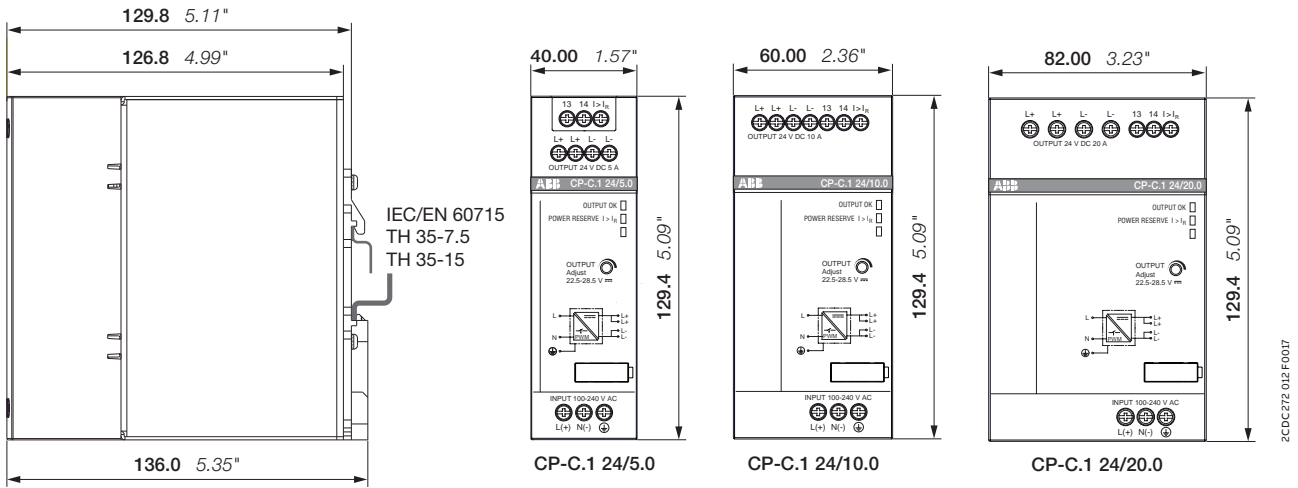







---

# Power supplies for building applications

## Table of contents

<b>314</b>	<b>CP-D range</b>
<b>314</b>	<b>Benefits and advantages</b>
<b>316</b>	<b>Operation controls</b>
<b>317</b>	<b>Applications</b>
<b>318</b>	<b>Ordering details</b>
<b>319</b>	<b>Technical data</b>
<b>323</b>	<b>Technical diagrams</b>

## CP-D range

### Benefits and advantages



Thanks to its compact modular housing, the CP-D range is ideal for building applications and installation. For maximum flexibility in operation, six different versions are available, from 10 W up to 100 W. Their wide input voltage range allows their use in global applications.



#### Easy to install

The CP-D range is easy to adjust and ideally suited for installation in distribution panels due to its width being only 18 to 90 mm.



#### Global availability

The product can be used in any installation in the world. Giving you the confidence of worldwide sourcing – no matter where you build, install or operate your equipment.



#### Speed up your projects

Data available for common planning software: Less engineering time required.

## CP-D range

### Benefits and advantages



#### Characteristics

- Output voltages 12 V, 24 V DC
- Adjustable output voltages (devices > 10 W)
- Output currents 0.42 A / 0.83 A / 1.3 A / 2.1 A / 2.5 A / 4.2 A
- Power range 10 W, 25 W, 30 W, 60 W, 100 W
- Wide range input 100-240 V AC (90-264 V AC, 120-375 V DC)
- High efficiency of up to 89 %
- Low power dissipation and low heating
- Free convection cooling (no forced cooling with ventilators)
- Ambient temperature range during operation -40...+70 °C
- Open-circuit, overload and short-circuit stable
- Integrated input fuse
- LEDs for status indication
- Light-grey housing in RAL 7035
- Various approvals and marks



#### Main benefits

##### Adjustable output voltage

The CP-D range types > 10 W feature a continuously adjustable output voltage. Thus, they can be optimally adapted to the application, for example compensating the voltage drop caused by a long line length.

##### Wide range input

Optimized for world-wide applications: The CP-D power supplies can be supplied with 90-264 V AC or 120-375 V DC.

##### Width and structural form

With their width being only 18 to 90 mm, the CP-D range switch mode power supplies are ideally suited for installation in distribution panels.

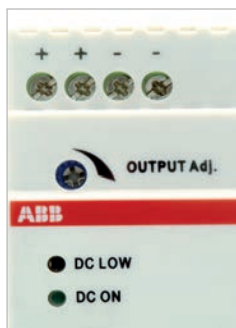

# CP-D range

## Operation controls

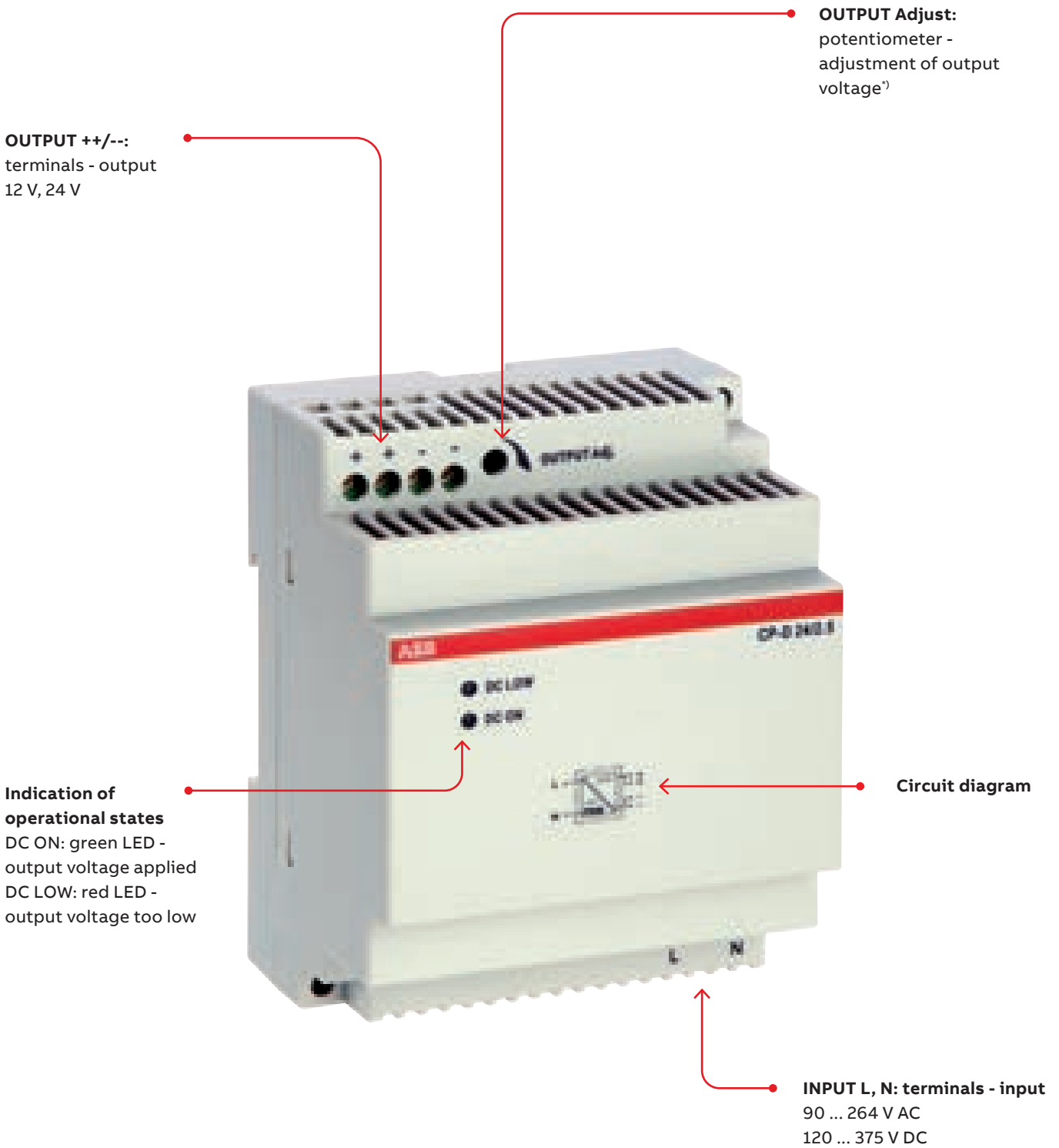

<sup>\*)</sup> only for devices > 10 W. 12 V version: 12...14 V DC, 24 V version: 24 ... 28 V DC.

## CP-D range Applications



Emergency  
lighting



Communication



Escalators



Elevators



LED  
lighting

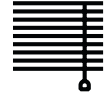

Venetian blind  
drives



## CP-D range

### Ordering details



CP-D 12/0.83, CP-D 24/0.42



CP-D 12/2.1, CP-D 24/1.3



CP-D 24/2.5

### Description

The CP-D range of modular power supply units in MDRC design (modular DIN rail components) is ideally suited for installation in distribution panels. This range offers devices with output voltages of 12 V DC and 24 V DC at output currents of 0.42 A to 4.2 A. Thanks to their high thermal efficiency, these power supplies have very low power and heat dissipation and can be operated without forced cooling. All power supply units in the CP-D range are approved according to all relevant international standards.



### Ordering details

Input voltage range	Rated output voltage / current	Type	Order code	Weight (1 pc.) kg (lb)
90-264 V AC/ 120-375 V DC	12 V DC / 0.83 A	CP-D 12/0.83	1SVR427041R1000	0.06 (0.13)
90-264 V AC/ 120-375 V DC	12 V DC / 2.1 A	CP-D 12/2.1	1SVR427043R1200	0.19 (0.41)
90-264 V AC/ 120-375 V DC	24 V DC / 0.42 A	CP-D 24/0.42	1SVR427041R0000	0.06 (0.13)
90-264 V AC/ 120-375 V DC	24 V DC / 1.3 A	CP-D 24/1.3	1SVR427043R0100	0.19 (0.41)
90-264 V AC/ 120-375 V DC	24 V DC / 2.5 A	CP-D 24/2.5	1SVR427044R0200	0.25 (0.56)
90-264 V AC/ 120-375 V DC	24 V DC / 4.2 A	CP-D 24/4.2	1SVR427045R0400	0.32 (0.71)

## CP-D range

### Technical data

Data at  $T_a = 25\text{ °C}$ ,  $U_{in} = 230\text{ V AC}$  and rated values, unless otherwise indicated

Type	CP-D 12/0.83	CP-D 12/2.1
<b>Input circuit - supply circuit</b>	<b>L, N</b>	
Rated input voltage $U_{in}$	100-240 V AC	
Input voltage range	90-264 V AC / 120-375 V DC	
Frequency range AC	47-63 Hz	
Typical input current / typical power consumption	at 115 V AC 200 mA / 12.68 W	502 mA / 31.14 W
	at 230 V AC 128.3 mA / 13.01 W	277 mA / 31.2 W
Inrush current	at 115 / 230 V AC 16 A / 32 A	
Power failure buffering time	min. 30 ms	
Internal input fuse	1 A slow-acting / 250 V AC	2 A slow-acting / 250 V AC
Power factor correction (PFC)	no	
<b>Indication of operational states</b>		
Output voltage	DC ON: green LED  : output voltage applied	
	DC LOW: red LED  : output voltage too low	
<b>Output circuit</b>	<b>+, -</b>	<b>++, --</b>
Rated output voltage	12 V DC	
Tolerance of the output voltage	±1 %	
Adjustment range of the output voltage	-	12-14 V DC
Rated output power	10 W	25 W
Rated output current $I_r$	$T_a \leq 60\text{ °C}$ 0.83 A	2.1 A
Derating of the output current	$60\text{ °C} < T_a \leq 70\text{ °C}$ 2.5 %/°C	
Maximum deviation with change of output voltage within the input voltage range	load change statical max. 1 %	
Recover time $T_A$	< 1 ms	
Starting time after applying the supply voltage	at $I_r$ 1000 ms	
Rise time	at rated load typ. 1 ms	
Residual ripple and switching peaks	BW = 20 MHz 50 mV	
Parallel connection	yes, using CP-D RU	
Series connection	yes, to increase voltage	
Resistance to reverse feed	18 V / 1 s	
<b>Output circuit - No-load, overload and short-circuit behavior</b>		
Characteristic curve of output	hiccup-mode	U/I characteristic curve
Short-circuit protection	continuous short-circuit stability	
Short-circuit behavior	continuation with output power limiting	
Current limiting at short circuit	typ. 1.4 A	typ. 5.9 A
Overload protection	output power limiting	
Overvoltage protection	15-16.5 V DC	
No-load protection	continuous no-load stability	
Starting of capacitive loads	unlimited	
<b>General data</b>		
Efficiency	typ. 78 %	typ. 82 %
Duty cycle	100 %	
Dimensions	see "Dimensional drawings"	
Material of housing	plastic	
Mounting	DIN rail (IEC/EN 60715), snap-on mounting without any tool	
Mounting position	horizontal	
Minimum distance to other units	horizontal / vertical	25 mm / 25 mm (0.98 in / 0.98 in)
Degree of protection	housing / terminals	IP20 / IP20
Protection class	II	

## CP-D range

### Technical data

Data at  $T_a = 25\text{ °C}$ ,  $U_{in} = 230\text{ V AC}$  and rated values, unless otherwise indicated

Type		CP-D 12/0.83	CP-D 12/2.1
<b>Electrical connection - Input circuit / Output circuit</b>			
Connecting capacity	fine-strand with wire end ferrule	0.2-1.5 mm <sup>2</sup> (24-16 AWG)	0.2-2.5 mm <sup>2</sup> (24-14 AWG)
	rigid	0.2-2.5 mm <sup>2</sup> (26-12 AWG)	0.2-2.5 mm <sup>2</sup> (24-12 AWG)
Stripping length		4-5 mm (0.16-0.2 in)	7 mm (0.28 in)
Tightening torque		0.6 Nm (5 lb.in)	0.7 Nm (6 lb.in)
<b>Environmental data</b>			
Ambient temperature range	operation	-40...+70 °C (-40...+158 °F)	
	rated load	-40...+60 °C (-40...+131 °F)	
	storage	-40...+85 °C (-40...+185 °F)	
Altitude during operation	IEC/EN 60068-2-13	max. 4850 m	
Damp heat (cyclic) (IEC/EN 60068-2-30)		4 x 24 cycles, 40 °C, 95 % RH	
Vibration (sinusoidal) (IEC/EN 60068-2-6)		50 m/s <sup>2</sup> , 10 Hz - 2 kHz	
Shock (half-sine) (IEC/EN 60068-2-27)		40 m/s <sup>2</sup> , 22 ms	
<b>Isolation data</b>			
Rated insulation voltage $U_i$	input circuit / output circuit	3 kV AC	
Pollution degree		2	
Overvoltage category		II	
<b>Standards / Directives</b>			
Standards		IEC/EN 60950-1	
Low Voltage Directive		2014/35/EU	
EMC Directive		2014/30/EU	
RoHS Directive		2011/65/EU	
Protective low voltage		SELV (IEC/EN 60950-1)	
<b>Electromagnetic compatibility</b>			
Interference immunity to		IEC/EN 61000-6-2	
electrostatic discharge	IEC/EN 61000-4-2	level 4 (4 kV / 8 kV)	level 4 (4 kV / 15 kV)
radiated, radio-frequency, electromagnetic field	IEC/EN 61000-4-3	level 3 (10 V/m)	
electrical fast transient/burst	IEC/EN 61000-4-4	level 4 (4 kV)	
surge	IEC/EN 61000-4-5	level 3 (2 kV L-L)	
conducted disturbances, induced by radio-frequency fields	IEC/EN 61000-4-6	level 3 (10 V)	
Interference emission		IEC/EN 61000-6-3	
high-frequency radiated		class B	
high-frequency conducted		class B	



## CP-D range

### Technical data

Data at  $T_a = 25\text{ °C}$ ,  $U_{in} = 230\text{ V AC}$  and rated values, unless otherwise indicated

Type	CP-D 24/0.42	CP-D 24/1.3	CP-D 24/2.5	CP-D 24/4.2
<b>Input circuit - supply circuit</b>	<b>L, N</b>			
Rated input voltage $U_{in}$	100-240 V AC			
Input voltage range	90-264 V AC / 120-375 V DC			
Frequency range AC	47-63 Hz			
Typical input current / typical power consumption	at 115 V AC 184 mA / 11.62 W	600 mA / 37.92 W	1120 mA / 69.3 W	1800 mA / 117.3 W
	at 230 V AC 120.6 mA / 12 W	344 mA / 38.16 W	660 mA / 70.1 W	900 mA / 114.4 W
Inrush current	at 115 / 230 V AC max. 16 A / 32 A		max. 25 A / 50 A	
Power failure buffering time	min. 30 ms		min. 60 ms	
Internal input fuse	1 A slow-acting / 250 V AC	2 A slow-acting / 250 V AC		3.15 A slow- acting / 250 V AC
Power factor correction (PFC)	no			
<b>Indication of operational states</b>				
Output voltage	DC ON: green LED	[ ]: output voltage applied		
	DC LOW: red LED	[ ]: output voltage too low		
<b>Output circuit</b>	+, -		++, --	
Rated output voltage	24 V DC			
Tolerance of the output voltage	±1 %			
Adjustment range of the output voltage	-		24-28 V DC	
Rated output power	10 W	30 W	60 W	100 W
Rated output current $I_r$	$T_a \leq 60\text{ °C}$ : 0.42 A	$T_a \leq 60\text{ °C}$ : 1.3 A	$T_a \leq 55\text{ °C}$ : 2.5 A	$T_a \leq 60\text{ °C}$ : 4.2 A
Derating of the output current	$60\text{ °C} < T_a \leq 70\text{ °C}$ : 2.5 %/°C	$60\text{ °C} < T_a \leq 70\text{ °C}$ : 2.5 %/°C	$55\text{ °C} < T_a \leq 70\text{ °C}$ : 2.5 %/°C	$60\text{ °C} < T_a \leq 70\text{ °C}$ : 2.5 %/°C
Maximum deviation with load change statical change of output voltage within the input voltage range	max. 1 %			
	max. 1 %			
Recover time $T_A$	< 1 ms			
Starting time after applying the supply voltage	at $I_r$ 1000 ms			
Rise time	at rated load typ. 1 ms			
Residual ripple and switching peaks	BW = 20 MHz 50 mV			
Parallel connection	yes, using CP-D RU			
Series connection	yes, to increase voltage			
Resistance to reverse feed	35 V / 1 s			
<b>Output circuit - No-load, overload and short-circuit behavior</b>				
Characteristic curve of output	hiccup-mode	U/I characteristic curve		
Short-circuit protection	continuous short-circuit stability			
Short-circuit behavior	continuation with output power limiting			
Current limiting at short circuit	typ. 0.78 A	typ. 4.2 A	typ. 6.05 A	typ. 11.5 A
Overload protection	output power limiting			
Overvoltage protection	30-33 V DC			
No-load protection	continuous no-load stability			
Starting of capacitive loads	unlimited			
<b>General data</b>				
Efficiency	typ. 80 %	typ. 83 %	typ. 86 %	typ. 89 %
Duty cycle	100 %			
Dimensions	see "Dimensional drawings"			
Material of housing	plastic			
Mounting	DIN rail (IEC/EN 60715), snap-on mounting without any tool			
Mounting position	horizontal			
Minimum distance to other units	horizontal / vertical	25 mm / 25 mm (0.98 in / 0.98 in)		
Degree of protection	housing / terminals	IP20 / IP20		
Protection class	II			

## CP-D range

### Technical data

Data at  $T_a = 25\text{ °C}$ ,  $U_{in} = 230\text{ V AC}$  and rated values, unless otherwise indicated

Type		CP-D 24/0.42	CP-D 24/1.3	CP-D 24/2.5	CP-D 24/4.2
<b>Electrical connection - Input circuit / Output circuit</b>					
Connecting capacity	fine-strand with wire end ferrule	0.2-1.5 mm <sup>2</sup> (24-16 AWG)	0.2-2.5 mm <sup>2</sup> (24-14 AWG)		
	rigid	0.2-2.5 mm <sup>2</sup> (26-12 AWG)	0.2-2.5 mm <sup>2</sup> (24-12 AWG)		
Stripping length		4-5 mm (0.16-0.2 in)		7 mm (0.28 in)	
Tightening torque		0.6 Nm (5 lb.in)		0.7 Nm (6 lb.in)	
<b>Environmental data</b>					
Ambient temperature range	operation	-40...+70 °C			
	rated load	-40...+60 °C		-40...+55 °C	-40...+60 °C
	storage	-40...+85 °C			
Altitude during operation	IEC/EN 60068-2-13	max. 4850 m			
Damp heat (cyclic) (IEC/EN 60068-2-30)		4 x 24 cycles, 40 °C, 95 % RH			
Vibration (sinusoidal) (IEC/EN 60068-2-6)		50 m/s <sup>2</sup> , 10 Hz - 2 kHz			
Shock (half-sine) (IEC/EN 60068-2-27)		40 m/s <sup>2</sup> , 22 ms			
<b>Isolation data</b>					
Rated insulation voltage $U_i$	input circuit / output circuit	3 kV AC		4 kV AC	3 kV AC
Pollution degree		2			
Overvoltage category		II			
<b>Standards / Directives</b>					
Standards		IEC/EN 60950-1			
Low Voltage Directive		2014/35/EU			
EMC Directive		2014/30/EU			
RoHS Directive		2011/65/EU			
Protective low voltage		SELV (IEC/EN 60950-1)			
<b>Electromagnetic compatibility</b>					
Interference immunity to		IEC/EN 61000-6-2			
electrostatic discharge	IEC/EN 61000-4-2	level 4 (4 kV / 8 kV)	level 4 (4 kV / 15 kV)		level 4 (4 kV / 8 kV)
		radiated, radio-frequency, electromagnetic field	IEC/EN 61000-4-3	level 3 (10 V/m)	
electrical fast transient/burst	IEC/EN 61000-4-4	level 4 (4 kV)			
surge	IEC/EN 61000-4-5	level 3 (2 kV L-L)			
conducted disturbances, induced by radio-frequency fields	IEC/EN 61000-4-6	level 3 (10 V)			
Interference emission		IEC/EN 61000-6-3			
high-frequency radiated		class B			
high-frequency conducted		class B			

# CP-D range

## Technical diagrams

### Characteristic curve of output at $T_a = 25^\circ\text{C}$

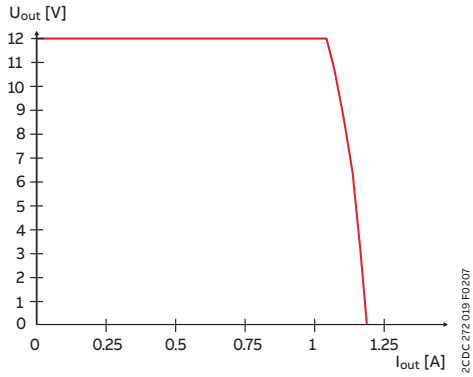

CP-D 12/0.83

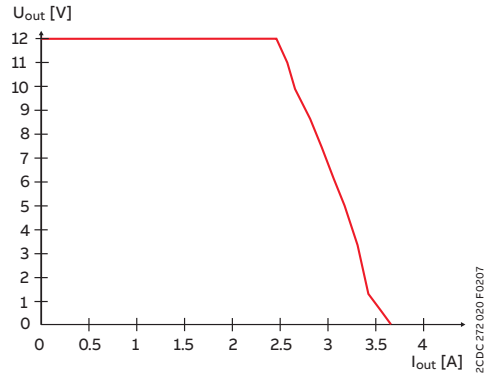

CP-D 12/2.1

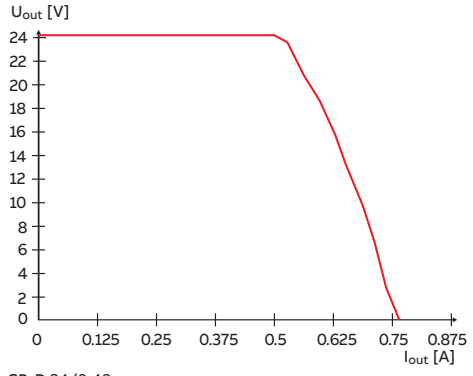

CP-D 24/0.42

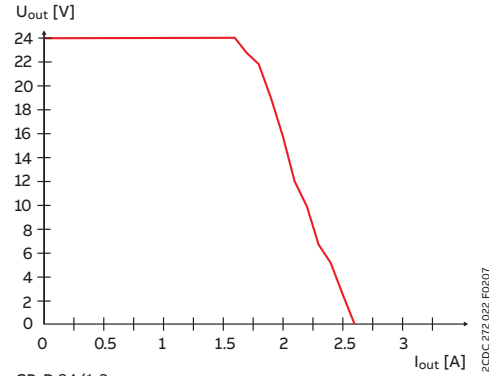

CP-D 24/1.3

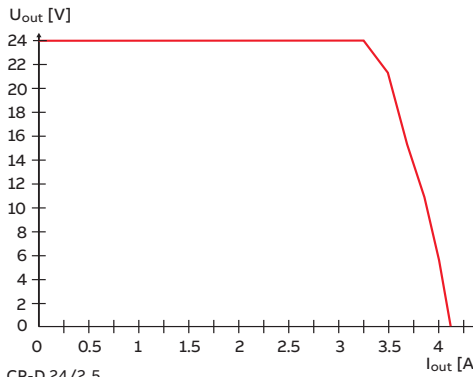

CP-D 24/2.5

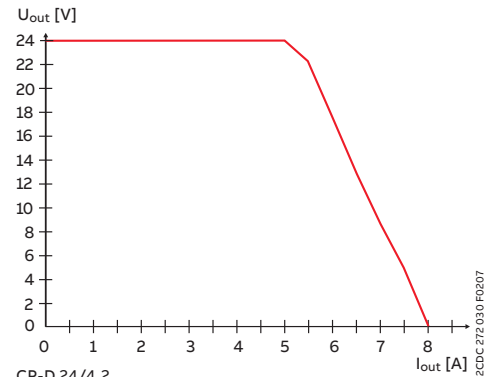

CP-D 24/4.2

### Characteristic curve of temperature at rated output voltage

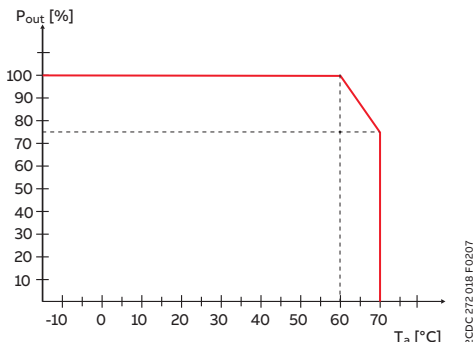

CP-D except CP-D 24/2.5

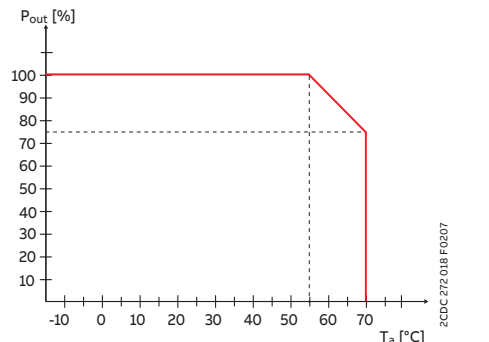

CP-D 24/2.5

# CP-D range

## Technical diagrams

### Dimensional drawings

Dimensions in mm

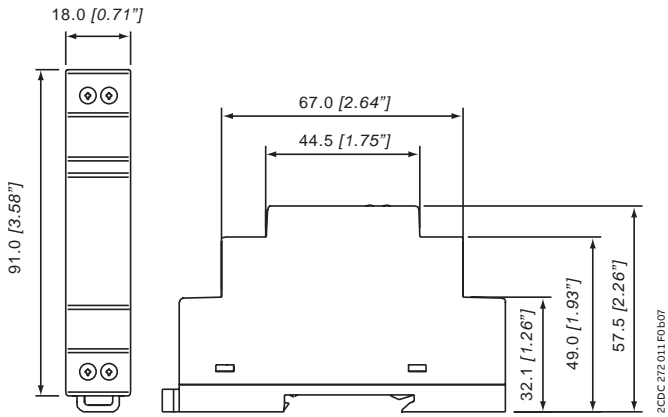

CP-D 12/0.83, CP-D 24/0.42

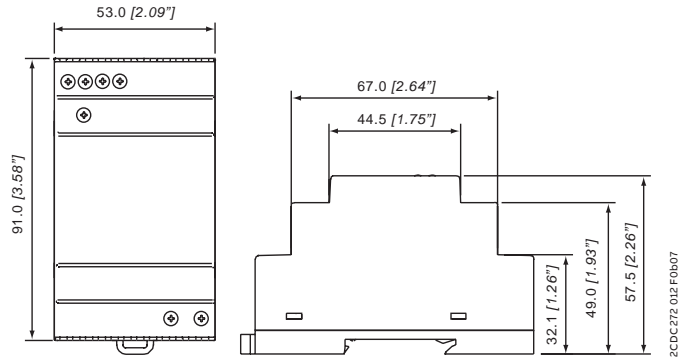

CP-D 12/2.1, CP-D 24/1.3

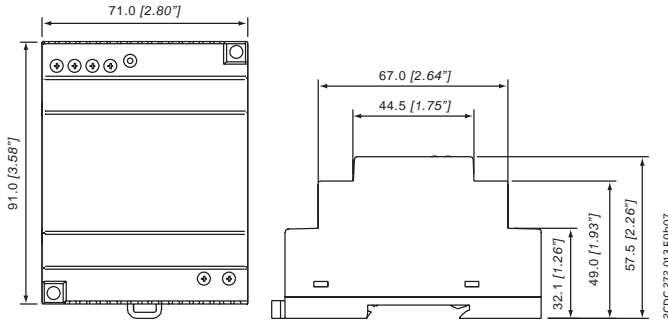

CP-D 24/2.5

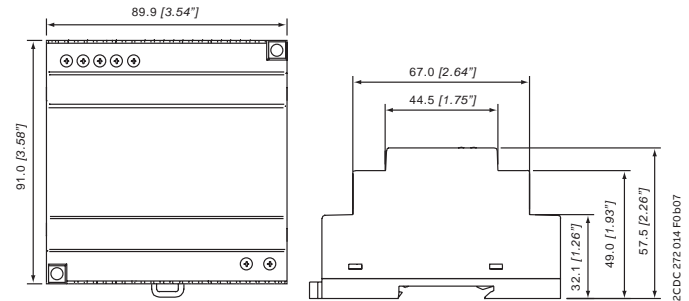

CP-D 24/4.2





---

## **CP-B range**

### Table of contents

<b>328</b>	<b>Benefits and advantages</b>
<b>330</b>	<b>Operation controls</b>
<b>331</b>	<b>Applications</b>
<b>332</b>	<b>Ordering details</b>
<b>333</b>	<b>Technical data</b>
<b>336</b>	<b>Technical diagrams</b>

# CP-B range

## Benefits and advantages



ABB’s ultra-capacitor based CP-B buffer modules serve to ensure a short-term uninterrupted power supply system with a voltage of 24 V DC by buffering the load in case of power loss.

The buffer modules feature a technology for storing energy: the use of ultra-capacitors obviates the need for maintenance and exempts deep discharge in comparison to batteries.

Energy storage can be expanded with additional extension modules for longer buffering times and is therefore extremely adaptable.

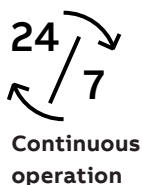

- Buffering 24 V DC supply of up to 380 s
- Maintenance-free, ultra-capacitor technology
- Temperature resistant
- No deep charge
- Small footprint



# CP-B range

## Benefits and advantages

Power supply systems have to be highly reliable in most areas of energy management and automation technology. Often, batteries are used for supporting the supply system in case of mains failures. Batteries have limited lifetimes depending on environmental parameters and have to be maintained regularly, which causes extra work and costs.

Using the ultra-capacitor technology, ABB offers an innovative and completely maintenance-free new product for buffering the 24 V DC supply in case of interrupted mains on the primary side of the switch mode power supply.

The CP-B range is an ultra-capacitor buffer energy storage system for power supply units which ensures a short term uninterrupted power supply system. In case of power loss, the energy stored in the capacitor guarantees that the load is continually provided for up to several hundred seconds depending on the load current.



### Characteristics

- 3 buffer modules for buffering 24 V DC:
  - CP-B 24/3.0 (3 A / 1 kW<sup>s</sup><sup>1)</sup>)
  - CP-B 24/10.0 (10 A / 10 kW<sup>s</sup><sup>1)</sup>)
  - CP-B 24/20.0 (20 A / 8 kW<sup>s</sup><sup>1)</sup>)
- CP-B 24/3.0 and CP-B 24/20.0 expandable with additional extension module(s)
  - CP-B EXT.2 (2 kW<sup>s</sup><sup>1)</sup>)
- LEDs for status indication
- Relay contacts for status messaging
- Very high backup times (e.g. with CP-B 24/10.0 up to 8 minutes at 1 A load current)
- Short charging times
- High efficiency, higher than 90 %
- Wide temperature range
- DIN rail mountable, compact housing
- Extended temperature range -40...60 °C

<sup>1)</sup> internal energy buffer

		CP-B 24/3.0	CP-B 24/10.0	CP-B 24/20.0	CP-B EXT.2
Order code		1SVR427060R0300	1SVR427060R1000	1SVR427060R2000	1SVR427065R0000
Rated input voltage		24 V DC	24 V DC	24 V DC	–
Rated current		3 A DC	10 A DC	20 A DC	3 A DC
Energy storage (min.)		1.000 Ws	10.000 Ws	8.000 Ws	2.000 Ws
Typical charging time at load current	100 %	65 s	134 s	135 s	
	0 %	56 s	82 s	62 s	
Typical buffering time <sup>1)</sup> at load current	100 %	13 s	38 s	15 s	
	50 %	28 s	76 s	30 s	
	25 %	66 s	140 s	60 s	
	10 %	148 s	380 s	150 s	

<sup>1)</sup> buffering time  $\approx \frac{\text{energy storage} \times 0.9}{\text{current} \times \text{output voltage}}$

# CP-B range

## Operation controls

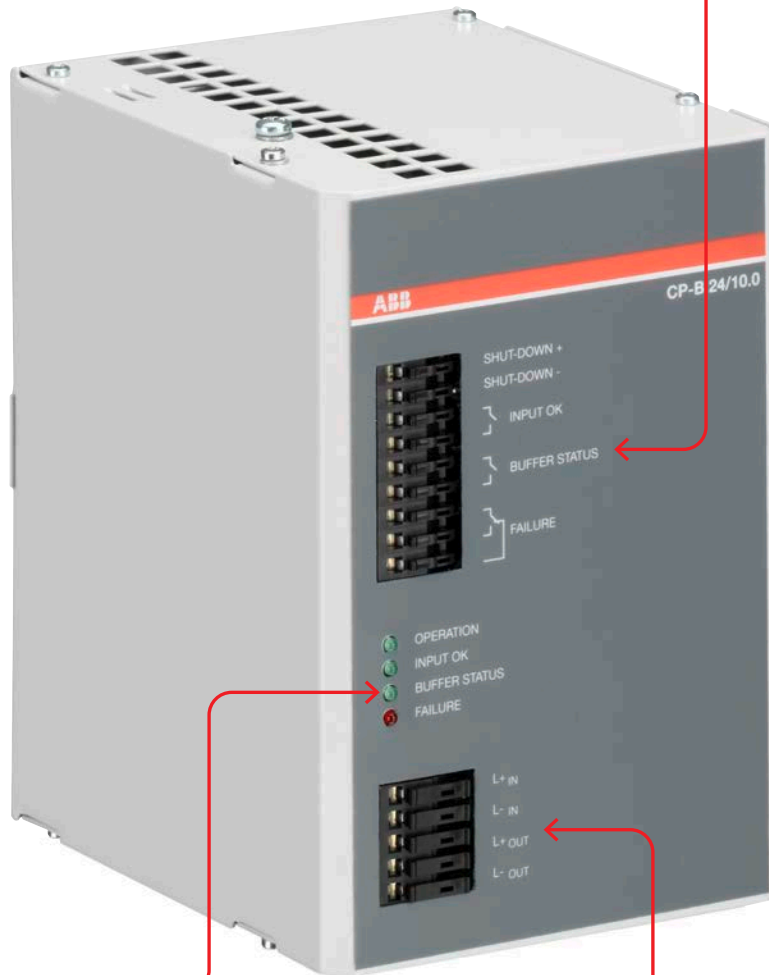

**Input terminals**  
 SHUT-DOWN+,  
 SHUT-DOWN-:  
 Input signal terminals  
 INPUT OK,  
 BUFFER STATUS,  
 FAILURE:  
 Signalling contact –  
 terminals  
 L+<sub>IN</sub>, L-<sub>IN</sub>: Input voltage  
 terminals

**Indication of operational states**  
 OPERATION:  
 Buffer module in operation  
 (standby or buffering)  
 INPUT OK:  
 Input voltage applied

**Output terminals**  
 L+<sub>OUT</sub>, L-<sub>OUT</sub>, L-<sub>OUT</sub>:  
 Output voltage  
 terminals

# CP-B range Applications

## Example of application

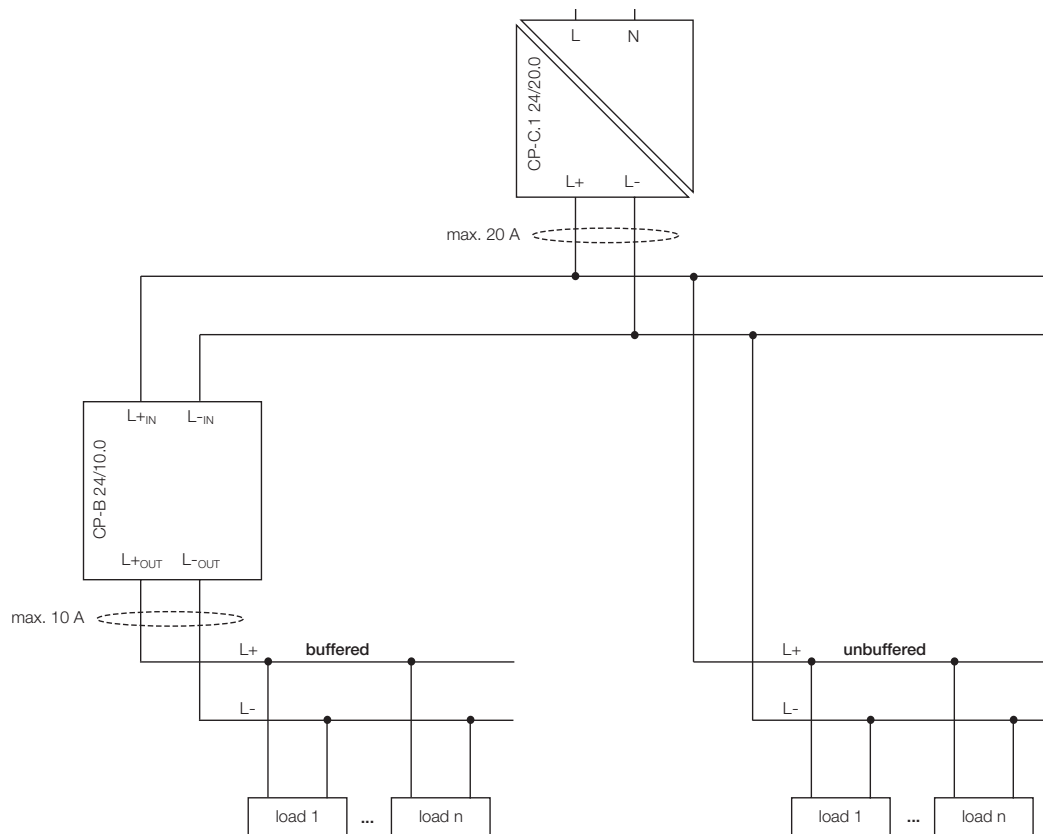

## CP-B range

### Ordering details



2CDC271.004.S0010

CP-B 24/3.0



2CDC271.002.S0010

CP-B 24/10.0



2CDC271.003.S0010

CP-B 24/20.0

#### Description

Ultra capacitor based buffer units of the CP-B range offer the highest reliability also in harsh environments. Thanks to their ultra-cap based technology, the units are maintenance free, there will be no deep discharge and these products offer a very wide operational ambient temperature range. CP-B range buffer units are an excellent solution for avoiding voltage drops in solar applications, for example.

#### Ordering details

Rated input voltage	Rated current	Type	Order code	Weight (1 pc.) kg (lb)
24 V DC	3 A DC	CP-B 24/3.0	1SVR427060R0300	0.59 (1.31)
	10 A DC	CP-B 24/10.0	1SVR427060R1000	2.10 (4.63)
	20 A DC	CP-B 24/20.0	1SVR427060R2000	2.20 (4.85)

#### Ordering details - Extension unit for CP-B 24/3.0 and CP-B 24/20.0

Rated voltage	Voltage range	Type	Order code	Weight (1 pc.) kg (lb)
24 V DC	0-26.4 V DC	CP-B EXT.2	1SVR427065R0000	1.04 (2.30)

## CP-B range

### Technical data

Type		CP-B 24/3.0	CP-B 24/10.0	CP-B 24/20.0
<b>Input circuit - Supply circuit</b>		<b>L<sub>IN</sub> L<sub>-IN</sub></b>		
Rated input voltage U <sub>in</sub>		24 V DC		
Input voltage range		23.7-26.4 V DC	23.9-27 V DC	23.4-29 V DC
Minimum charging potential		23.7 V DC	23.9 V DC	23.4 V DC
Rated input current		3 A DC	10 A DC	20 A DC
Inrush current limiting		50 A / 1 ms	35 A / 2 ms	35 A / 2 ms
Transient overvoltage protection		suppressor diode	varistor / suppressor diode	varistor / suppressor diode
Internal input fuse (apparatus protection, not accessible)		4 A slow acting	15 A (FK2)	30 A (FK2)
Internal fuse capacitors circuit (not accessible)			25 A (FK2)	
Kind of input	SHUT-DOWN	-	control input	control input
	rated voltage	-	24 V DC	24 V DC
	voltage range	-	6-45 V DC	6-45 V DC
<b>Output circuit</b>		<b>L<sub>OUT</sub> L<sub>-OUT</sub> L<sub>-OUT</sub></b>		
Rated output power		69 W	240 W	480 W
Rated output voltage U <sub>out</sub>		24 V DC		
Output voltage (buffer mode)		23.0 V DC	23.2 V DC	23.2 V DC
Tolerance of the output voltage		+2...-10 %		
Rated output current I <sub>r</sub>	T <sub>a</sub> ≤ 60 °C	3 A DC	10 A DC	20 A DC
Peak output current (fully loaded capacitors required)	T <sub>a</sub> ≤ 60 °C	6 A DC (min. 1.5 s)	20 A DC (10 A power supply + 10 A CP-B, min. 1.5 s)	40 A DC (min. 1.5 s)
Control of limiting current		-	10.3 A DC ±0.1A	-
Shut-down if limiting current is exceeded		-	after 1.5 s	-
Short-circuit protection (only via external fuse)		no continuous short-circuit stability		
Internal output fuse (not accessible)		-	15 A (FK2)	-
Required external fuse		3.15 A slow acting	10 A slow acting	25 A slow acting
Current limiting at output circuit		-	1.05...1.2 × I <sub>r</sub>	-
Breaking capacity of output circuit	t = 2.5 ms	-	24 V DC, 10 A	-
Power failure buffering time <sup>1)</sup>		load-dependent, min. 13 s at 100 % load	load-dependent, min. 38 s at 100 % load	load-dependent, min. 15 s at 100 % load
Overload protection		thermal protection		
Kind of output	INPUT OK	n/o contact		
	BUFFER STATUS	-	n/o contact	
	FAILURE	-	c/o contact	
Contact material		Ag + Au-clad		
Minimum switching voltage / Minimum switching current		5 V DC / 1 mA		
Maximum switching voltage / Maximum switching current		50 V AC / 1.0 A, 30 V DC / 0.5 A		
Mechanical lifetime		5 × 10 <sup>6</sup> switching cycles		
Electrical lifetime		0.1 × 10 <sup>6</sup> switching cycles		
Maximum fuse rating to achieve short-circuit protection	n/o or n/c contact	1.0 A AC / 0.5 A DC		

## CP-B range

### Technical data

Type		CP-B 24/3.0	CP-B 24/10.0	CP-B 24/20.0
<b>General data</b>				
Maximum internal power consumption		7 W	20 W	40 W
Power consumption with unloaded output		0.75 W	3 W	1.6 W
Energy storage (min.)		1000 Ws	10000 Ws	8000 Ws
Typical charging time at load current	100 %	65 s	134 s	135 s
	0 %	56 s	82 s	62 s
Typical buffering time at load current <sup>1)</sup>	100 %	13 s	38 s	15 s
	50 %	28 s	76 s	30 s
	25 %	66 s	140 s	60 s
	10 %	148 s	380 s	150 s
Efficiency		> 90 %		
Dimensions		see "Dimensional drawings"		
Material	cover / housing shell	steel sheet powdered		
Mounting		DIN rail (IEC/EN 60715), snap-on mounting		
Mounting position		horizontal		
Minimum distance to other units	horizontal	not necessary		
	vertical	40 mm (1.58 in)		80 mm (3.15 in)
Pollution degree		2		
Degree of protection	housing / terminal	IP20		
Protection class (IEC/EN 61140)		III SELV / PELV (condition: power supply fulfills class III)		
<b>Electrical connection - Input circuit / Output circuit</b>		<b>pull spring terminals</b>	<b>pull spring terminals</b>	<b>pluggable screw type terminals</b>
Connecting capacity	fine-strand with(out) wire end ferrule	0.08-1.0 mm <sup>2</sup> (28-18 AWG)	0.08-1.5 mm <sup>2</sup> (28-18 AWG)	0.2-4.0 mm <sup>2</sup> (24-12 AWG)
	rigid	0.08-1.5 mm <sup>2</sup> (28-16 AWG)	0.08-4.0 mm <sup>2</sup> (28-16 AWG)	0.2-6.0 mm <sup>2</sup> (24-10 AWG)
Stripping length		6.0 mm (0.24 in)		7.0 mm (0.28 in)
<b>Signaling circuit</b>				
Connecting capacity	fine-strand with(out) wire end ferrule	0.08-1.0 mm <sup>2</sup> (28-18 AWG)		0.14-1.0 mm <sup>2</sup> (26-16 AWG)
	rigid	0.08-1.5 mm <sup>2</sup> (28-16 AWG)		0.14-1.5 mm <sup>2</sup> (28-16 AWG)
Stripping length		6.0 mm (0.24 in)		7.0 mm (0.28 in)
<b>Environmental data</b>				
Ambient temperature	operation	-40...+60 °C		
	storage	-40...+60 °C		
<b>Standards / Directives</b>				
Standards		EN 50178, IEC/EN 60950-1, IEC/EN 62040-2		
Low Voltage Directive		2014/35/EU		
EMC Directive		2014/30/EU		
RoHS Directive		2011/65/EC		
<b>Electromagnetic compatibility</b>				
Interference immunity to		IEC/EN 61000-6-2		
electrostatic discharge	IEC/EN 61000-4-2	level 3, 6 kV / 8 kV		
radiated, radio-frequency, electromagnetic field	IEC/EN 61000-4-3	level 3, 10 V/m (27-1000 MHz) / level 2, 3 V/m (1400-2700 MHz)		
electrical fast transient/burst	IEC/EN 61000-4-4	level 3, 2(1) kV / 5 kHz		
surge	IEC/EN 61000-4-5	level 1, 0.5 kV		
conducted disturbances, induced by radio-frequency fields	IEC/EN 61000-4-6	level 3, 10 V (150 kHz-80 MHz)		
voltage dips, short interruptions and voltage variations	IEC/EN 61000-4-11	buffered by ultra-capacitors		
Interference emission		EN 61000-6-4		
high-frequency radiated	DIN EN 55011	B/C1		
high-frequency conducted	DIN EN 55011	B/C1		

<sup>1)</sup> buffering time  $\approx \frac{\text{energy storage} \times 0.9}{\text{current} \times \text{output voltage}}$

## CP-B range

### Technical data

Data at  $T_a = 25\text{ °C}$  and rated values, unless otherwise indicated

<b>Type</b>	<b>CP-B EXT 2.0</b>	
<b>Extension circuit</b>	<b>EXT+ EXT+ EXT- EXT-</b>	
Rated voltage	24 V DC	
Voltage range	0-26.4 V DC	
Rated current	3 A DC	
Internal input fuse (apparatus protection, not accessible)	4 A slow acting (PTC)	
Short-circuit protection	via internal 3 A fuse	
Overload protection	only in combination with CP-B 24/3.0 or CP-B 24/20.0	
<b>Indication of operational states</b>	status information and fault messages of the buffer module apply	
<b>General data</b>		
Power consumption without load	0.5 W	
Energy storage (min.)	2000 Ws	
Material	cover / housing shell	steel sheet powdered
Mounting	DIN rail (IEC/EN 60715), snap-on mounting	
Mounting position	horizontal	
Minimum distance to other units	horizontal	not necessary
	vertical	40 mm (1.58 in)
Pollution degree	2	
Degree of protection	housing / terminal	IP20
Protection class (IEC/EN 61140)	III SELV / PELV (condition: power supply fulfills class III)	
Electrical connection - Extension circuit	pull spring terminals	
Connecting capacity	fine-strand with(out) wire end ferrule	0.08-1.0 mm <sup>2</sup> (28-18 AWG)
	rigid	0.08-1.5 mm <sup>2</sup> (28-16 AWG)
Stripping length	6.0 mm (0.24 in)	
<b>Environmental data</b>		
Ambient temperature	operation	-40...+60 °C
	storage	-40...+60 °C
Vibration, sinusoidal	IEC/EN 60068-2-6	1.5 mm, 3-57.55 Hz; 2 g, 57.55-500 Hz, 10 cycles
Shock, half-sine	IEC/EN 60068-2-27	15 g, 11 ms, 3 axes, 6 faces, 3 times for each face
<b>Standards / Directives</b>		
Standards	EN 50178, IEC/EN 60950-1, IEC/EN 62040-2	
Low Voltage Directive	2014/35/EU	
EMC Directive	2014/30/EU	
RoHS Directive	2011/65/EU	
<b>Electromagnetic compatibility</b>		
Interference immunity to	IEC/EN 61000-6-2	
electrostatic discharge	IEC/EN 61000-4-2	level 3, 6 kV / 8 kV
radiated, radio-frequency, electromagnetic field	IEC/EN 61000-4-3	level 3, 10 V/m (27-1000 MHz) / level 2, 3 V/m (1400-2700 MHz)
electrical fast transient/burst	IEC/EN 61000-4-4	level 3, 2(1) kV / 5 kHz
surge	IEC/EN 61000-4-5	level 1, 0.5 kV
conducted disturbances, induced by radio-frequency fields	IEC/EN 61000-4-6	level 3, 10 V (150 kHz-80 MHz)
voltage dips, short interruptions and voltage variations	IEC/EN 61000-4-11	buffered by ultra-capacitors
Interference emission	EN 61000-6-4	
high-frequency radiated	DIN EN 55011	B/C1
high-frequency conducted	DIN EN 55011	B/C1

# CP-B range

## Technical diagrams

Characteristic curve of the temperature at rated load

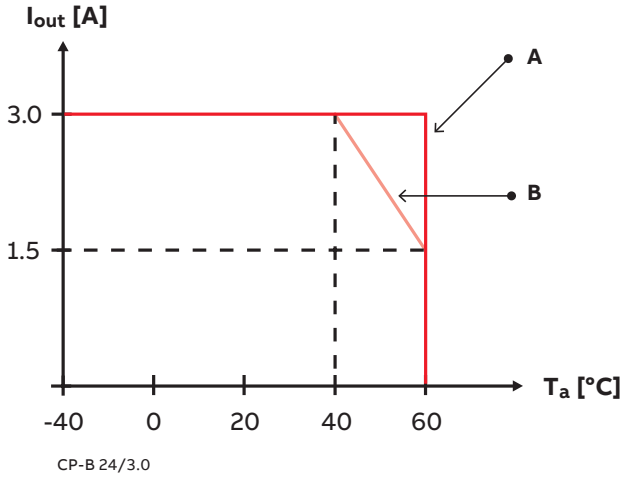

Capacitors life span over temperature

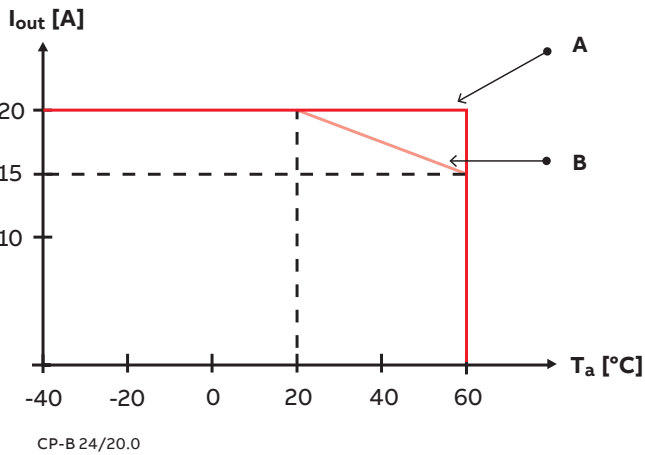
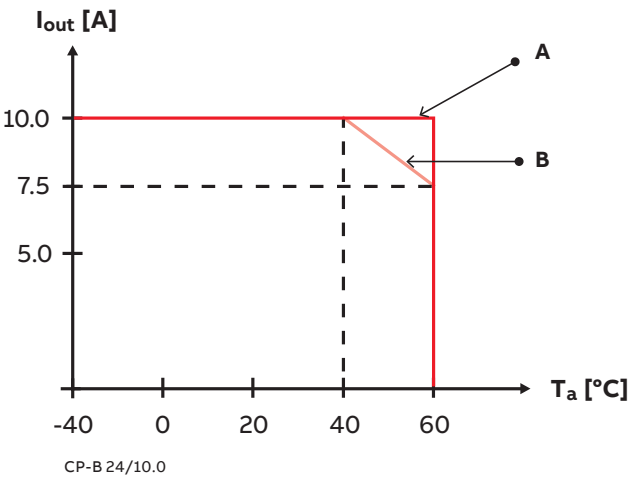
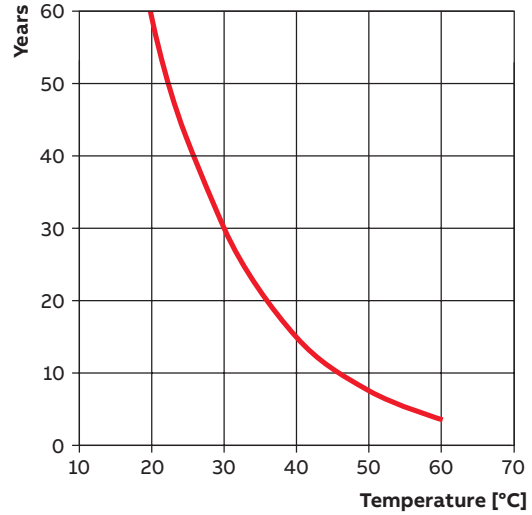

- A Normal application (up to 50 % buffer mode, 5 charging and discharging cycles in direct series)
- B Continuous charging and discharging in direct series. As this is not typical of a real application, this should be considered as theoretical indication



# CP-B range

## Technical diagrams

### Dimensional drawings

Dimensions in mm, inches

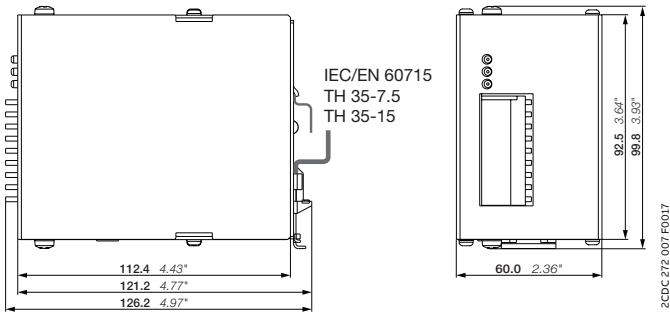

CP-B 24/3.0

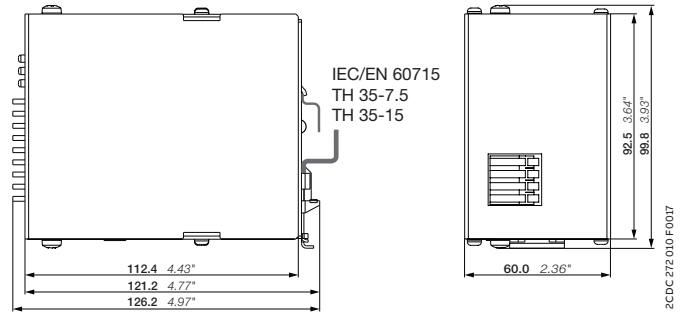

CP-B EXT.2

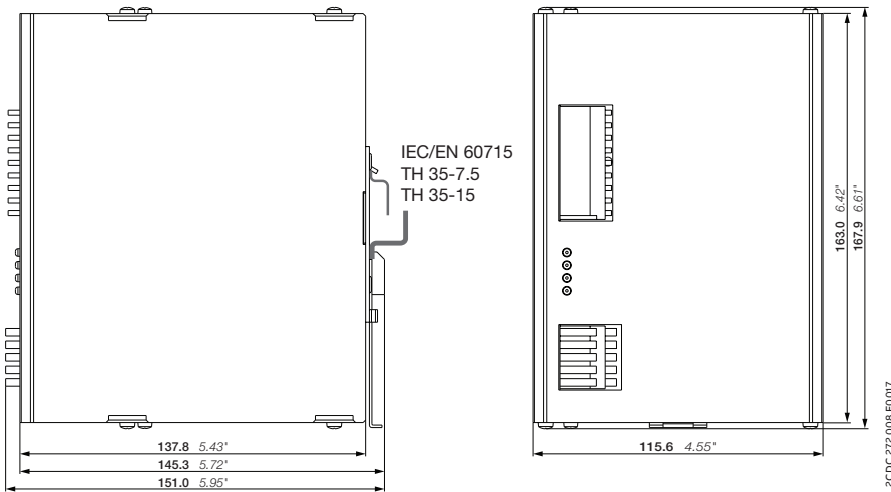

CP-B 24/10.0

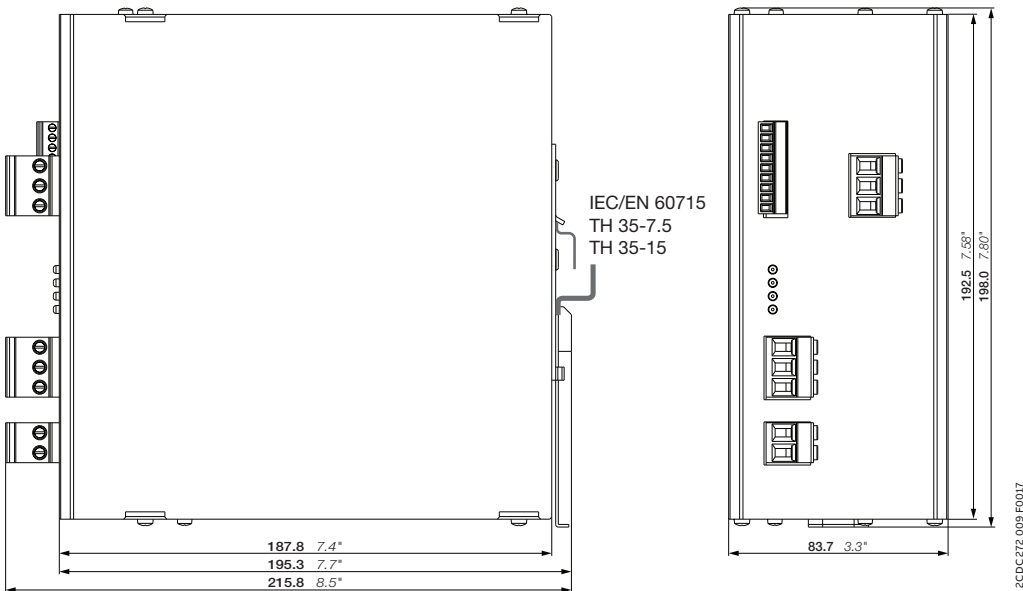

CP-B 24/20.0



---

## **Redundancy units**

### Table of contents

<b>341</b>	<b>Benefits and advantages</b>
<b>342</b>	<b>Ordering details</b>
<b>343</b>	<b>Technical data</b>
<b>347</b>	<b>Technical diagrams</b>

—  
**Establish true redundancy  
where it really matters with  
ABB's power supply  
redundancy units.**



# Redundancy units

## Benefits and advantages



ABB's redundancy units are used to establish true redundancy, which increases the availability of electrical systems significantly. Three versions are available with different output currents and power supply housings:

- CP-D RU in MDRC housing
- CP-RUD for a true redundant setup of two 24 V DC power supplies with a max. output current of 2.5 A per channel
- CP-C.1-A-RU for a true redundant setup of two 24 V DC power supplies of the CP range



**Continuous  
operation**

### **Highest system reliability**

- Redundancy setup of the application possible to allow parallel operation
- Long lifetime

# Redundancy units

## Ordering details



CP-C.1-A-RU



CP-C.1-A-RU-L



CP-D RU



CP-RUD

### Description

Whenever the highest availability and reliability are key requirements, a true redundancy setup with two power supplies connected to a redundancy unit is the best solution. In case one power supply fails, the other one keeps supplying the load. Furthermore, even a short circuit in one power supply will not affect the other one, which keeps supplying the load. The CP-C.1-A-RU is also available with coated PCBA (CP-C.1-A-RU-C) for harsh environments.

### Ordering details - CP-C.1-A-RU for decoupling of CP power supplies up to 20 A per input / channel

Input voltage range	Rated input current per channel	Rated output voltage / current		Type	Order code	Weight (1 pc.) kg (lb)
10 - 28.5 V DC	20 A	24 V DC / 2 x 20 A or 1 x 40 A	uncoated	CP-C.1-A-RU	1SVR360060R1001	1.04 (2.29)
			coated	CP-C.1-A-RU-C	1SVR360060R2001	1.04 (2.29)
			uncoated	CP-C.1-A-RU-L	1SVR361060R1001	1.04 (2.29)

### Ordering details - CP-D RU for decoupling of two CP-D power supply units

Input voltage range	Rated input current	Rated output voltage / current	Type	Order code	Weight (1 pc.) kg (lb)
9-35 V DC	2 x 5 A	24 V DC / 1 x 10 A	CP-D RU	1SVR427049R0000	0.075 (0.165)

### Ordering details - CP-RUD for decoupling of two CP-E power supply units ≤ 35 V and < 5 A

Input voltage range	Rated input current	Rated output voltage / current	Type	Order code	Weight (1 pc.) kg (lb)
5-35 V DC	0.5 - 2.5 A	24 V DC / 5 A	CP-RUD	1SVR423418R9000	0.088 (0.195)

## Redundancy units

### Technical data

Data at  $T_a = 25\text{ °C}$ ,  $U_{in} = 230\text{ V AC}$  and rated values, unless otherwise indicated

Type		CP-C.1-A-RU, CP-C.1-A-RU-L	CP-C.1-A-RU-C
<b>Input circuit - Supply circuit</b>			
<b>(+/, -/-)</b>			
Rated input voltage $U_{in}$		24 V DC	
Input voltage range		10-28.5 V DC	
Rated input current $I_{in}$ per channel	$-25\text{ °C} \leq T_a \leq 60\text{ °C}$	20 A	
Maximum input current per channel	$-25\text{ °C} \leq T_a \leq 40\text{ °C}$	30 A	
	$-40\text{ °C} \leq T_a \leq 40\text{ °C}$	-	30 A
Transient overvoltage protection		yes, varistor	
<b>Output circuit</b>			
<b>(+/-)</b>			
Rated output voltage $U_{out}$		24 V DC	
Voltage drop input/output		typ. 0.6 V, max. 0.9 V	
Rated output current $I_o$	$-25\text{ °C} \leq T_a \leq 60\text{ °C}$	2 x 20 A or 1 x 40 A	
Max. output current (Power reserve)	$-25\text{ °C} \leq T_a \leq 40\text{ °C}$	2 x 30 A or 1 x 60 A	
	$-40\text{ °C} \leq T_a \leq 40\text{ °C}$	-	2 x 30 A or 1 x 60 A
Derating of the output current	$60\text{ °C} < T_a \leq 70\text{ °C}$	2.5 % per Kelvin temperature increase	
Resistance to reverse feed		< 60 V	
<b>General data</b>			
Power loss	input 2 x 20 A	23.0 W	
	input 2 x 10 A	9.4 W	
	input 2 x 5 A	4.1 W	
MTBF	acc. to MIL 217 HDBK	on request	
Dimensions		see "Dimensional drawings"	
Material of housing	cover / housing shell / front	aluminium / zinc-coated sheet steel / plastic	
Mounting		DIN rail (IEC/EN 60715), snap-on mounting	
Mounting position		1 and 7	
Minimum distance to other units	horizontal / vertical	25 mm (0.98 in) / 25 mm (0.98 in)	
Degree of protection (IEC/EN 60529)	housing / terminals	IP20 / IP20	
Protection class (IEC/EN 61140)		III	
<b>Electrical connection - Input circuit / Output circuit</b>			
Connecting capacity	fine-strand with(out) wire end ferrule	2.5-10 mm <sup>2</sup> (12-8 AWG)	
	rigid	2.5-16 mm <sup>2</sup> (12-6 AWG)	
Stripping length		10 mm (0.39 in)	
Tightening torque		1.2 Nm (10.5 lb.in)	
Recommended screw driver		PH1 / Ø 4.0 x 0.8 mm (0.16 x 0.03 in)	

## Redundancy units

### Technical data

Type		CP-C.1-A-RU, CP-C.1-A-RU-L	CP-C.1-A-RU-C
<b>Environmental data</b>			
Ambient temperature range	operation	-25...+70 °C (-13... +158 °F)	-40...+70 °C (-40...+158 °F)
	rated load	-25...+60 °C (-13... +140 °F)	-40...+60 °C (-40...+140 °F)
	storage	-40...+85 °C (-40...+185 °F)	
	transportation	-40...+85 °C (-40...+185 °F)	
Climatic class (IEC/EN 60721-3-1)	storage	1K2 (-40...+85 °C / -40...+185 °F)	
Climatic class (IEC/EN 60721-3-2)	transportation	2K2 (-40...+85 °C / -40...+185 °F)	
Climatic class (IEC/EN 60721-3-3)	operation	3K3 (-25...+70 °C / -13...+158 °F)	3K3 (-40...+70 °C / -40...+158 °F)
Damp heat, cyclic (IEC/EN 60068-2-30)	test Db: 55 °C, 2 cycles		
Vibration (IEC/EN 60068-2-6)	test Fc: 10-58 Hz, amplitude ±0.15 mm, 58-150 Hz, 2 g, 10 sweep cycles each axis		
Shock, half-sine (IEC/EN 60068-2-27)	test Ea: 30 g, 6 ms, 3 pulses each axis; bump 20 g, 11 ms, 100 pulses each axis		
Coated PCBA	no		yes
Gaseous corrosive environment withstand test (IEC/EN 60068-2-60)	-		testing method: 4 testing period: 21 days ambient conditions: 25 °C, 75 % r.h. air/volume change rate per hour: 3-6 sample not energized during exposure gas concentrations acc. ISA-S71.04.2013 Harsh Group A, G3 IEC 60721-3.3 acc. 3C2/3C3 - H2S ≥ 100 ± 10 ppb - SO2/SO3 ≥ 300 ± 20 ppb - Cl2 ≥ 100 ± 10 ppb - NOx ≥ 1250 ± 20 ppb
<b>Isolation data</b>			
Rated impulse withstand voltage $U_{imp}$ (EN 50178)	input / housing	1.5 kV (1.2/50 μs)	
	output / housing	1.5 kV (1.2/50 μs)	
Pollution degree	2		
<b>Standards / Directives</b>			
Standards	IEC/EN 61204		
EMC Directive	2014/30/EU		
ATEX Directive	-	2014/34/EU	
RoHS Directive	2011/65/EU		
Electrical safety	IEC/EN 60950-1		
Industrial control equipment / General Use Power Supplies	UL 508 / CSA 22.2 No 107.1		
<b>Electromagnetic compatibility</b>			
Interference immunity to			
electrostatic discharge	IEC/EN 61000-4-2	Level 4, contact discharge ±8 kV, air discharge ±15 kV (criterion B)	
electrical fast transient / burst	IEC/EN 61000-4-4	Level 3, DC mains inputs and output ±2 kV (criterion B)	
surge	IEC/EN 61000-4-5	Level 1, DC mains inputs and output ±0.5 kV, input and output vs. PE ±1 kV (criterion B)	



## Redundancy units

### Technical data

<b>Type</b>	<b>CP-D RU</b>	
<b>Input circuit - Supply circuit</b>	<b>IN 1 + + -, IN 2 + + -</b>	
Rated input voltage $U_{in}$	24 V DC	
Input voltage range	9-35 V DC	
Rated input current $I_{in}$ per channel	5 A	
Maximum input current per channel	10 A for 300 s	
Transient overvoltage protection	no	
<b>Output circuit</b>	<b>OUT + + +, - - -</b>	
Rated output voltage $U_{out}$	24 V DC	
Voltage drop	typ. 0.5 V	
Rated output current $I_{out}$	10 A	
Resistance to reverse feed	< 35 V	
<b>General data</b>		
MTBF	on request	
Duty cycle	100 %	
Dimensions	see "Dimensional drawings"	
Material of housing	plastic	
Mounting	DIN rail, snap-on mounting without any tool	
Mounting position	1, 7	
Minimum distance to other units	horizontal / vertical	25 mm (0.98 in) / 25 mm (0.98 in)
<b>Electrical connection - Input circuit / Output circuit</b>		
Connecting capacity	fine-strand with (out)wire end ferrule	0.2-2.5 mm <sup>2</sup> (24-14 AWG)
	rigid	0.2-2.5 mm <sup>2</sup> (24-12 AWG)
Stripping length	7.0 mm (0.28 in)	
Tightening torque	0.67 Nm (6 lb.in)	
<b>Environmental data</b>		
Ambient temperature range	operation	-40...+70 °C
	storage	-40...+85 °C
Relative humidity	RH at 40 °C	20-95 %, no condensation
Vibration (IEC/EN 60068-2-6)	mounting by rail: 10-500 Hz, 2 G, along X, Y, Z each axis, 60 min for each axis	
Shock (IEC/EN 60068-2-27)	15 G, 11 ms, 3 axis, 6 faces, 3 times for each face	
<b>Standards / Directives</b>		
Standards	IEC/EN 61204-3, IEC/EN 60950-1	
RoHS Directive	2011/65/EU	
<b>Electromagnetic compatibility</b>		
Interference immunity to	EN 55024	
electrostatic discharge	IEC/EN 61000-4-2	level 3, air discharge 8 kV, contact discharge 4 kV
radiated, radio-frequency, electromagnetic field	IEC/EN 61000-4-3	level 3, 10 V/m
electrical fast transient/burst	IEC/EN 61000-4-4	level 3, 2 kV / 5 kHz
conducted disturbances, induced by radio-frequency fields	IEC/EN 61000-4-6	level 3, 10 V
Interference emission	EN 55022	
high-frequency radiated	IEC/CISPR 22 / EN 55022	class B
high-frequency conducted	IEC/CISPR 22 / EN 55022	class B

## Redundancy units

### Technical data

<b>Type</b>	<b>CP-RUD</b>	
<b>Input circuit - Supply circuit</b>	<b>A: U1+/-U ; B: U2+/-U</b>	
Rated input voltage $U_{in}$	24 V DC	
Input voltage range	5-35 V DC	
Rated input current $I_{in}$ per channel	0.5-2.5 A	
Maximum input current per channel	10 A for 300 s	
Transient overvoltage protection	no	
<b>Output circuit</b>	<b>L+, L+, L+, L-, L-, L-</b>	
Rated output voltage $U_{out}$	24 V DC	
Voltage drop	typ. 0.6 V, max. 0.7 V	
Rated output current $I_{out}$	0.5-5 A	
Peak output current	20 A for 150 s	
Resistance to reverse feed	< 35 V	
<b>General data</b>		
Dimensions	see "Dimensional drawings"	
Minimum distance to other units	horizontal / vertical	10 mm / 10 mm (0.39 in / 0.39 in)
Degree of protection	housing / terminals	IP20 / IP20
Material of housing	housing shell / cover	plastic / plastic
Protection class	-	
Mounting	DIN rail (IEC/EN 60715)	
Mounting position	horizontal	
<b>Electrical connection - Input circuit / Output circuit</b>		
Connecting capacity	fine-strand with wire end ferrule	2 x 0.75-2.5 mm <sup>2</sup> (2 x 18-14 AWG)
	fine-strand without wire end ferrule	
	rigid	2 x 0.5-4 mm <sup>2</sup> (2 x 20-12 AWG)
Stripping length	7 mm (0.28 in)	
Tightening torque	0.6-0.8 Nm	
<b>Environmental data</b>		
Ambient temperature range	operation	-20...+60 °C
	rated load	-20...+60 °C
	storage	-40...+85 °C
Damp heat (IEC/EN 60068-2-3)	93 % at 40 °C, no condensation	
<b>Isolation data</b>		
Insulation voltage	input / output / housing	-
Pollution degree (EN 50178)	2	
<b>Standards / Directives</b>		
Electrical safety	EN 50178	
RoHS Directive	2011/65/EU	
<b>Electromagnetic compatibility</b>		
Interference immunity to	IEC/EN 61000-6-2	
electrostatic discharge	IEC/EN 61000-4-2	level 3 (air discharge ±8 kV, contact discharge ±6 kV)
radiated, radio-frequency, electromagnetic field	IEC/EN 61000-4-3	level 3 (10 V/m)
electrical fast transient/burst	IEC/EN 61000-4-4	level 3 (±2 kV)
surge	IEC/EN 61000-4-5	level 1 (±0.5 kV)
conducted disturbances, induced by radio-frequency fields	IEC/EN 61000-4-6	level 3 (10 V)
Interference emission	IEC/EN 61000-6-3	
high-frequency radiated	class B	
high-frequency conducted	class B	

# Redundancy units

## Technical diagrams

### Dimensional drawings

Dimensions in mm, inches

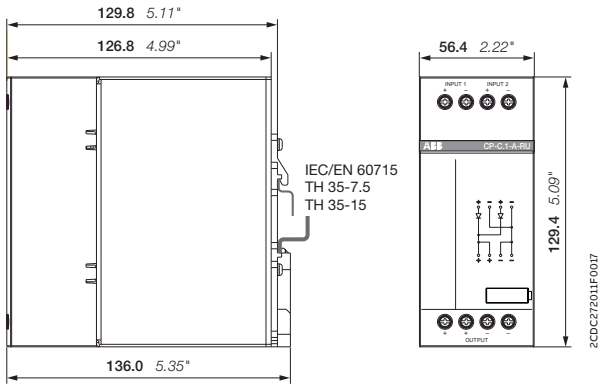

CP-C.1-A-RU, CP-C.1-A-RU-L  
CP-C.1-A-RU-C

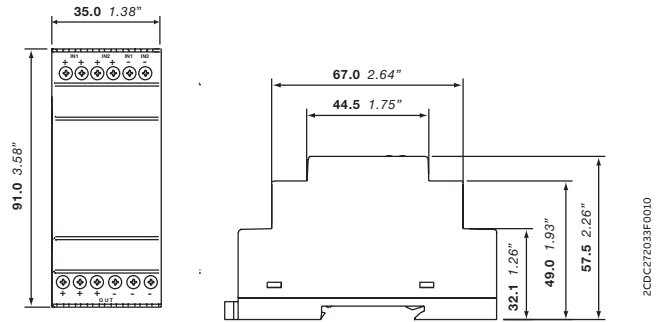

CP-D RU

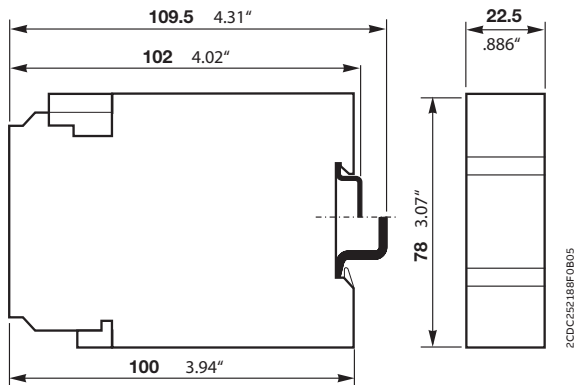

CP-RUD

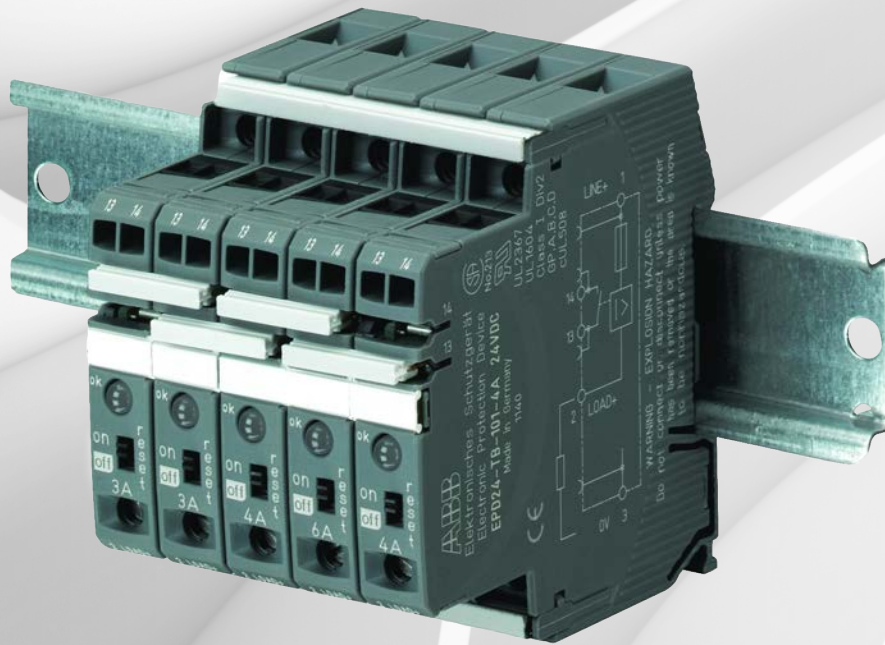

---

# Electronic protection devices EPD24

## Table of contents

<b>350</b>	<b>Benefits and advantages</b>
<b>351</b>	<b>Applications</b>
<b>352</b>	<b>Ordering details</b>
<b>353</b>	<b>Operating data</b>
<b>354</b>	<b>Technical data</b>
<b>355</b>	<b>Technical information</b>
<b>356</b>	<b>Technical diagrams</b>
<b>357</b>	<b>Approvals, Safety instructions</b>
<b>358</b>	<b>Installation guidelines</b>

# Electronic protection devices EPD24

## Benefits and advantages

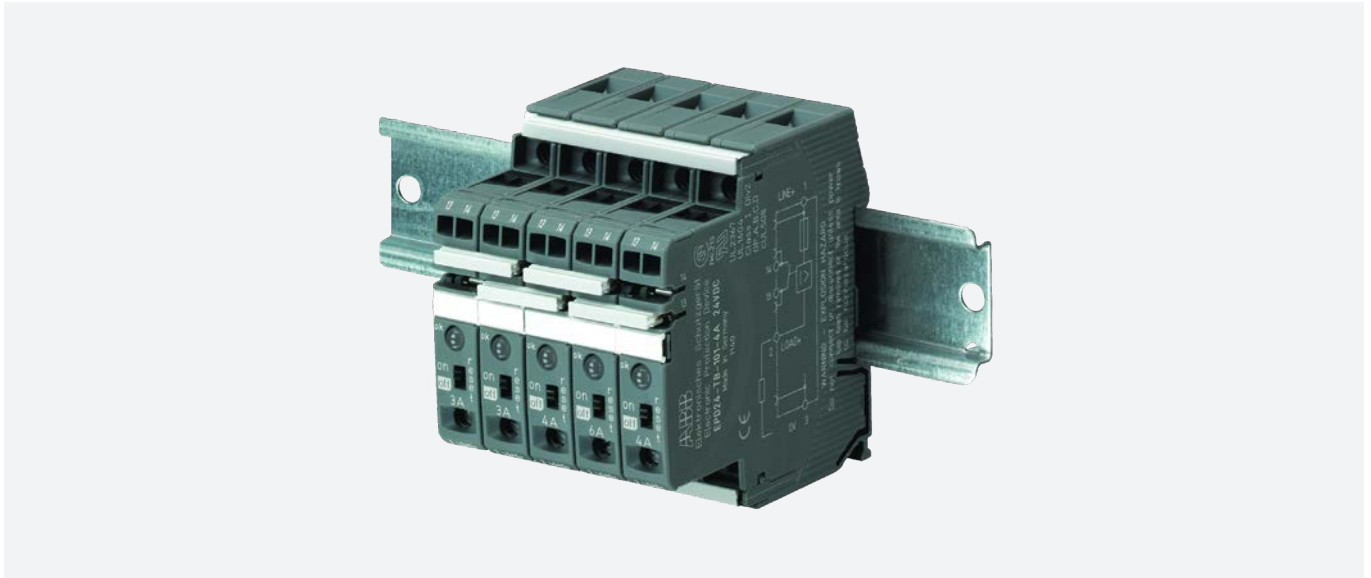

With its narrow width of only 12.5 mm, EPD24 can fit everywhere – it can even be mounted side-by-side.

Its adjustable and fixed current ratings, projectable protection through current limitation as well as a single trip curve for all types of loads allow for use in a wide field of applications.



**Continuous  
operation**

### Highlights

- Safety and reliability
- Operational continuity
- Worldwide use thanks to relevant certifications
- Compact and effective

# Electronic protection devices EPD24

## Applications



### Features

- Selective load protection, one electronic tripping characteristic.
- Active current limitation for safe connection of capacitive loads up to 20,000  $\mu\text{F}$  and on overload/short circuit
- Current ratings 0.5...12 A
- Reliable overload disconnection with  $1.1 \times I_N$
- Manual ON/OFF button
- Clear status and failure indication through LED and integrated auxiliary contact
- Integral fail-safe element adjusted to current rating
- Width per unit only 12.5 mm
- Rail mounting
- Ease of wiring through busbar LINE+ and 0 V as well as signal bars
- UL- and CSA-approvals allow international use of the devices



### Applications

- Packaging machines
- Automation
- Automation & Process Control
- Automotive Manufacturing
- Chemical, Oil & Gas
- Medical Equipment
- Pharmaceutical & Food
- Power Engineering DC 24 V
- Renewable Energy
- Steel Production



## Electronic protection devices EPD24

### Ordering details



EPD24-TB-101-3A

2CDC 051 001 S0010

#### Description

The protection devices EPD24 extend the ABB product range of modular DIN rail components by electronic overcurrent protection modules for selective protection of 24 V DC load circuits. This protection is achieved by a combination of active electronic current limitation in the case of a short circuit and an overload deactivation from  $1.1 \times I_n$  upwards.

If a fault occurs in a load circuit, the protection device EPD24 will detect this rapidly and reliably, then disable the power output transistor and hence interrupt the current flow in the defective circuit. The maximum possible overcurrent is always limited to 1.3...1.8 times the selected rated current. An activation of capacitive loads up to 20,000  $\mu\text{F}$  is possible, deactivation only occurring in the case of overloads or short circuits. Selective deactivation of the defective current circuit means undefined error states and a complete system stop are prevented.

#### Ordering details

Rated current IN A	bbn 40 16779 EAN	Type	Order code	Pkg qty	Weight (1 pc.) kg (lb)
0.5	829960	EPD24-TB-101-0.5A	2CDE601101R2905	4	0.065 (1.433)
1	829984	EPD24-TB-101-1A	2CDE601101R2001	4	0.065 (1.433)
2	830003	EPD24-TB-101-2A	2CDE601101R2002	4	0.065 (1.433)
3	830027	EPD24-TB-101-3A	2CDE601101R2003	4	0.065 (1.433)
4	830041	EPD24-TB-101-4A	2CDE601101R2004	4	0.065 (1.433)
6	830065	EPD24-TB-101-6A	2CDE601101R2006	4	0.065 (1.433)
8	830089	EPD24-TB-101-8A	2CDE601101R2008	4	0.065 (1.433)
10	830102	EPD24-TB-101-10A	2CDE601101R2010	4	0.065 (1.433)
12	830126	EPD24-TB-101-12A	2CDE601101R2012	4	0.065 (1.433)

Description	bbn 40 16779 EAN	Type	Order code	Pkg qty	Weight (1 pc.) kg (lb)
Busbars for LINE+ and 0 V, grey insulation, length 500 mm <sup>1)</sup>	830140	EPD-BB500	2CDE605100R0500	10	0.2 (0.441)
Signal bars for aux. contacts, grey insulation, length 21 mm	830164	EPD-SB21	2CDE605200R0021	10	0.4 (0.882)

<sup>1)</sup> Max. load with one line entry  $I_{\text{max}} = 50 \text{ A}$  (recommended: mid line entry)  
Max. load with two line entries  $I_{\text{max}} = 63 \text{ A}$



## Electronic protection devices EPD24

### Operating data

<b>Operating data</b>	
Operating voltage $U_b$	24 V DC (18...32 V)
Current rating $I_N$	fixed current: ratings: 0.5, 1, 2, 3, 4, 6, 8, 10, 12 A
Closed current $I_o$	ON condition: typically 20...30 mA depending on signal output
Status indication by means of	Green: unit is ON load circuit / Power-MOSFET is switched on Orange: in the event of overload or short circuit until electronic disconnection Red: unit electronically disconnected load circuit/Power-MOSFET OFF undervoltage ( $U_b < 8$ V) after switch-on till the end of the delay period OFF: manually switched off or device is dead potential-free auxiliary contact F ON/OFF/ condition of switch
<b>Load circuit</b>	
Load output	Power-MOSFET switching output (high side switch)
Overload disconnection	typically $1.1 \times I_N$ (1.05...1.35 $\times I_N$ )
Short-circuit current $I_k$	active current limitation
Trip time	see time/current characteristics
For electronic disconnection	typically 3 s at $I_{Load} > 1.1 \times I_N$ typically 100 ms...3 s at $I_{Load} > 1.8 \times I_N$ (or $1.5 \times I_N/1.3 \times I_N$ )
Temperature disconnection	internal temperature monitoring with electronic disconnection
Low voltage monitoring load output	with hysteresis, no reset required: load »OFF« at $U_b < 8$ V
Starting delay $t_{Start}$	typically 0.5 sec after every switch-on and after applying $U_b$
Disconnection of load circuit	electronic disconnection
Free-wheeling circuit	suitable external free-wheeling circuit to be used with inductive load
Several load outputs must not be connected in parallel	
<b>Signal output</b>	
Electrical data	potential-free auxiliary contact max. 30 V DC/0.5 A, min. 10 V DC/10 mA
ON condition LED green	voltage $U_b$ applied, switch is in ON position no overload, no short circuit
OFF condition LED off	device switched off (switch is in OFF position) no voltage $U_b$ applied
Fault condition LED orange	overload condition $> 1.1 \times I_N$ up to electronic disconnection
Fault condition LED red	electronic disconnection upon overload or short circuit Device switched off with control signal (switch is in ON position)
Aux. contact	single signal, make contact contact open, terminal 13-14
Fault	signal output fault conditions no operating voltage $U_b$ ON/OFF switch is in OFF position red LED lighted (electronic disconnection)

## Electronic protection devices EPD24

### Technical data

General data	
Fail-Safe element	backup fuse for EPD24 not required because of the integral redundant fail-safe element
Housing material	moulded
Mounting	symmetrical rail to EN 50022-35x7.5
Ambient temperature	0...+50 °C (without condensation, see EN 60204-1)
Storage temperature	-20...+70 °C
Humidity	96 hrs/95 % RH/40 °C to IEC 60068-2-78, test Cab. climate class 3K3 to EN 60721
Vibration	3 g, test to IEC 60068-2-6 test Fc
Degree of protection	housing: IP20 DIN 40050 terminals: IP20 DIN 40050
EMC (EMC directive, CE logo)	emission: EN 61000-6-3 susceptibility: EN 61000-6-2
Isolations coordination (IEC 60934)	0.5 kV/pollution degree 2 reinforced insulation in operating area
Dielectric strength	max. 32 V DC (load circuit)
Isolation resistance (OFF condition)	n/a, only electronic disconnection
Approvals/Declarations of conformity	UL 2367 Solid State Overcurrent Protectors UL 1604, (class I, division 2, groups A, B, C, D) UL 508 CSA C22.2 No. 213 (class I, division 2) CSA C22.2 No. 142 CE logo
Dimensions (B x H x T)	12.5 x 80 x 83 mm
Weight	approx. 65 g
Terminals	
<b>Line+/LOAD+/0V</b>	
Screw terminals	M4
Max. cable cross section flexible with wire end ferrule w/wo plastic sleeve	0.5 – 10 mm <sup>2</sup>
Multi-lead connection (2 identical cables) rigid/flexible	0.5 – 4 mm <sup>2</sup>
Flexible with wire end ferrule without plastic sleeve	0.5 – 2.5 mm <sup>2</sup>
Flexible with TWIN wire end ferrule with plastic sleeve	0.5 – 6 mm <sup>2</sup>
Wire stripping length	10 mm
Tightening torque (EN 60934)	1.5 – 1.8 Nm
Terminals	
<b>aux. contacts</b>	
Screw terminals	M3
Max. cable cross section flexible with wire end ferrule w/wo plastic sleeve	0.25 - 2.5 mm <sup>2</sup>
Wire stripping length	8 mm
Tightening torque (EN 60934)	0.5 Nm

**Table 1: voltage drop, current limitation, max. load current**

current rating $I_N$	typically voltage drop $U_{ON}$ at $I_N$	active current limitation (typically)	max. load current at 100 % ON duty	
			$T_{ambient} = 40\text{ °C}$	$T_{ambient} = 40\text{ °C}$
0.5 A	70 mV	$1.8 \times I_N$	0.5 A	0.5 A
1 A	80 mV	$1.8 \times I_N$	1 A	1 A
2 A	130 mV	$1.8 \times I_N$	2 A	2 A
3 A	80 mV	$1.8 \times I_N$	3 A	3 A
4 A	100 mV	$1.8 \times I_N$	4 A	4 A
6 A	130 mV	$1.8 \times I_N$	6 A	5 A
8 A	120 mV	$1.5 \times I_N$	8 A	7 A
10 A	150 mV	$1.5 \times I_N$	10 A	9 A
12 A	180 mV	$1.3 \times I_N$	12 A	10.8 A

Attention: when mounted side-by-side without convection, the ERD24 should carry no more than 80 % of its rated load with 100 % ON duty due to thermal effects.

## Electronic protection devices EPD24

### Technical information

#### Time/Current characteristic curve (T<sub>ambient</sub> = 25 °C)

The trip time is typically 3 s in the range between  $1.1 \times I_N^{1)}$  and  $1.8 \times I_N^{1)}$ .

Electronic current limitation occurs at typically  $1.8 \times I_N^{1)}$  which means that under all overload conditions (independent of the power supply and the resistance of the load circuit) the max. overload before disconnection will not exceed  $1.8 \times I_N^{1)}$  times the current rating. Trip time is between 100 ms and 3 sec (depending on overload or at short circuit).

Without this current limitation a considerably higher overload current would flow in the event of an overload or short circuit.

#### Maximum cable lengths

EPD24 reliably trips from 0 Ω up to max. circuit resistance  $R_{max}$ .

#### Calculation of $R_{max}$

Selected rating $I_N$ (A)	3	6
Operating voltage $U_g$ (V DC) (= 80 % of 24 V) <sup>2)</sup>	19.2	19.2
Trip current $I_{ab} = 1.25 \times I_N$ (A) (EPD24 trips after 3 s)	3.75	7.50
$R_{max}$ (Ω) = $(U_g / I_{ab}) - 0.050$	5.07	2.51

<sup>2)</sup> Voltage drop of EPD24 and tolerance of trip point (typically  $1.1 \times I_N = 1.05 \dots 1.35 \times I_N$ ) have been taken into account

#### Selection table for the incoming cable lengths with different cable cross-sections

Cable cross section A (mm <sup>2</sup> )	0.14	0.25	0.34	0.5	0.75	1.00	1.50
Cable length L (m) (= single length)	cable resistance (Ω) = $(\rho_0 \times 2 \times L) / A^{3)}$						
5	1.27	0.71	0.52	0.36	0.24	0.18	0.12
10	2.54	1.42	1.05	0.71	0.47	0.36	0.24
15	3.81	2.14	1.57	1.07	0.71	0.53	0.36
20	5.09	2.85	2.09	1.42	0.95	0.71	0.47
25	6.36	3.56	2.62	1.78	1.19	0.89	0.59
30	7.63	4.27	3.14	2.14	1.42	1.07	0.71
35	8.90	4.98	3.66	2.49	1.66	1.25	0.83
40	10.17	5.70	4.19	2.85	1.90	1.42	0.95
45	11.44	6.41	4.71	3.20	2.14	1.60	1.07
50	12.71	7.12	5.24	3.56	2.37	1.78	1.19
75	19.07	10.68	7.85	5.34	3.56	2.67	1.78
100	25.34	14.24	10.47	7.12	4.75	3.56	2.37
125	31.79	17.80	13.09	8.90	5.93	4.45	2.97
150	38.14	21.36	15.71	10.68	7.12	5.34	3.56
175	44.50	24.92	18.32	12.46	8.31	6.23	4.15
200	50.86	28.48	20.94	14.24	9.49	7.12	4.75
225	57.21	32.04	23.56	16.02	10.68	8.01	5.34
250	63.57	35.60	26.18	17.80	11.87	8.90	5.93

<sup>3)</sup> Resistivity of copper  $\rho_0 = 0.0178$  (Ω x mm<sup>2</sup>)/m

Example 1: max. length for 1.5 mm<sup>2</sup> and 3 A: 214 m

Example 2: max. length for 1.5 mm<sup>2</sup> and 6 A: 106 m

Example 3: mixed wiring: (Control cabinet --- sensor/actuator level)

R1 = 40 m for 1.5 mm<sup>2</sup> and R2 = 5 m for 0.25 mm<sup>2</sup>:

R1 = 0.95 Ω, R2 = 0.71 Ω, total (R1 + R2) = 1.66 Ω

# Electronic protection devices EPD24

## Technical diagrams

### Time/Current characteristic curve

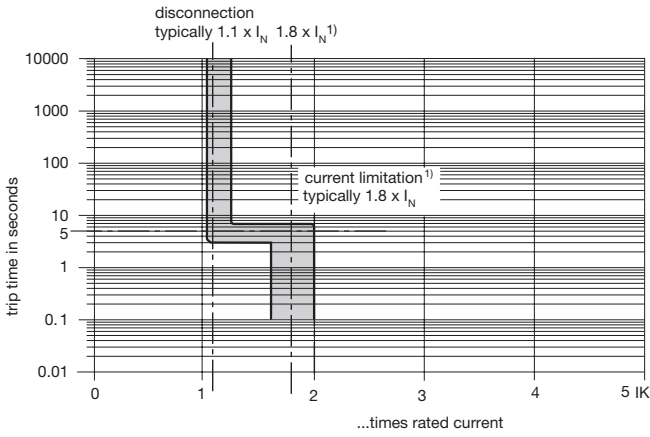

<sup>1)</sup> Current limitation typically  $1.8 \times I_N$  at  $I_N = 0.5 \text{ A} \dots 6 \text{ A}$   
Current limitation typically  $1.5 \times I_N$  at  $I_N = 8 \text{ A}$  or  $10 \text{ A}$   
Current limitation typically  $1.3 \times I_N$  at  $I_N = 12 \text{ A}$

### Wiring diagram

EPD24-TB-101  
without signal input  
with signal output F  
(Single signal, N/O)

Operating condition: 13-14 closed  
Fault condition: 13-14 open

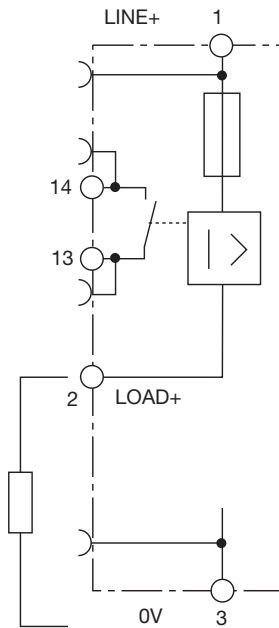

## Electronic protection devices EPD24

### Approvals, Safety instructions

#### Please note

The user must ensure that the cable cross sections of the relevant load circuit are suitable for the current rating of the EPD24 used. Automatic start-up of machinery after shut down must be prevented (Machinery Directive 2006/42/EU and IEC/EN 60204-1). In the event of a short circuit or overload the load circuit will be disconnected electronically by the EPD24.

#### Information on UL approvals/CSA approvals



UL1604  
UL File # E 339238



CSA C22.2 No. 213 (Class I, Division 2)  
CSA File # 2305929

#### Operating Temperature Code T5

- This equipment is suitable for use in Class I, Division 2, Groups A, B, C and D or non-hazardous locations only

#### WARNING:

- Exposure to some chemicals may degrade the sealing properties of materials used in the following device: relay  
Sealant Material:
  - Generic Name: Modified diglycidyl ether of bisphenol A
  - Supplier: Fine Polymers Corporation
  - Type: Epi Fine 4616L-160PK
- Casing Material:
  - Generic Name: Liquid Crystal Polymer
  - Supplier: Sumitomo Chemical
  - Type: E4008, E4009, or E6008

#### RECOMMENDATION:

- Periodically inspect the device named above for any degradation of properties and replace if degradation is found

#### WARNING – EXPLOSION HAZARD:

- Do not disconnect equipment unless power has been removed or the area is known to be non-hazardous
- Substitution of any components may impair suitability for Class I, Division 2



UL2367  
Non-hazardous use - UL File # E 339236



UL 508  
Non-hazardous use - UL File # E 149922



CSA C22.2 No. 14  
CSA C22.2 No. 142 - CSA File # E 2305929

Class 2

Meets requirement for Class 2 current limitation (EPD24 ... -0,5 A/1 A/2 A/3 A)

# Electronic protection devices EPD24

## Installation guidelines

The EPD24 features an integral power distribution system.

The following wiring modes are possible with various pluggable current and signal busbars:

- LINE+ (24 V DC)
- 0 V
- Caution: The electronic devices EPD24 require a 0 V connection
- Auxiliary contacts

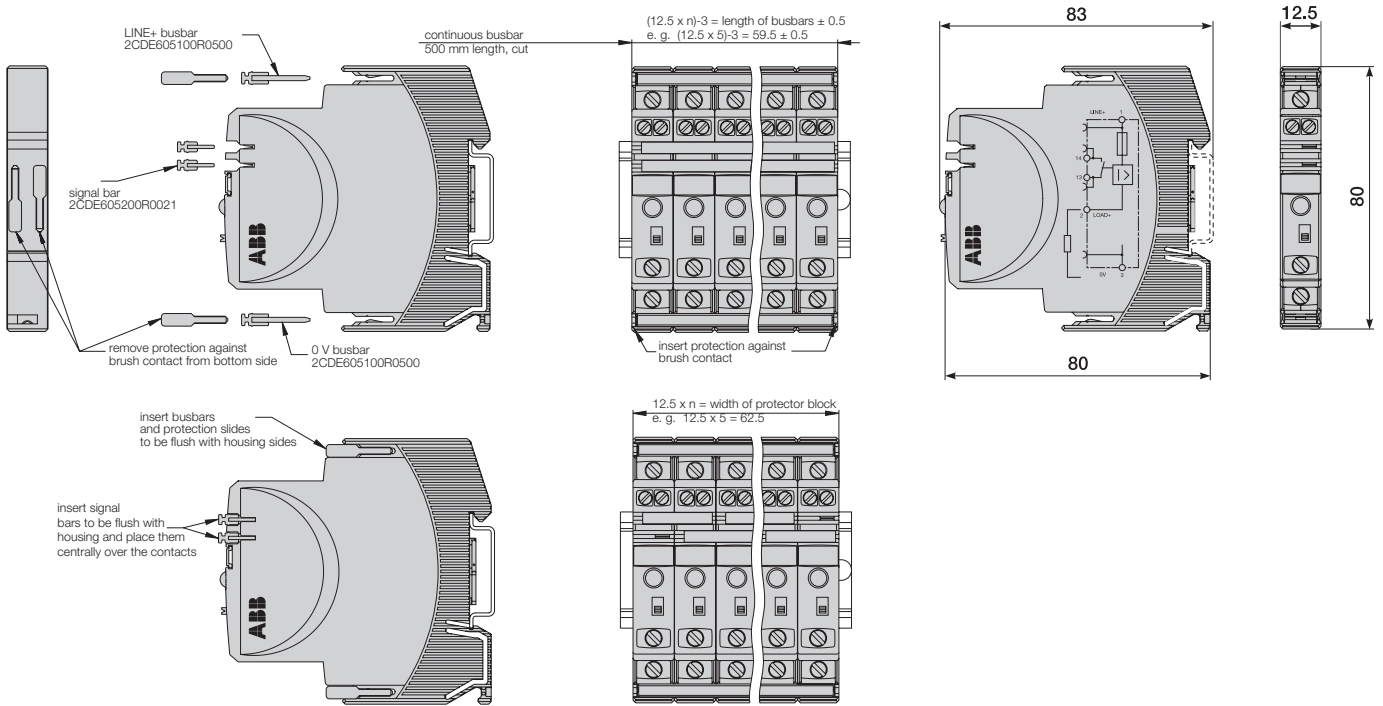

### Mounting procedure

Before wiring insert busbars into protector block. A maximum of 10 connection cycles are permissible using connecting busbars.

### Recommendation

After 10 units the busbars should be interrupted and receive a new entry live.

### Table of length for busbars

(Order code 2CDE605100R0500)

No. of units	2	3	4	5	6	7	8	9	10
Length of busbar (mm) ± 0.5 mm	22	34.5	47	59.5	72	84.5	97	109.5	122



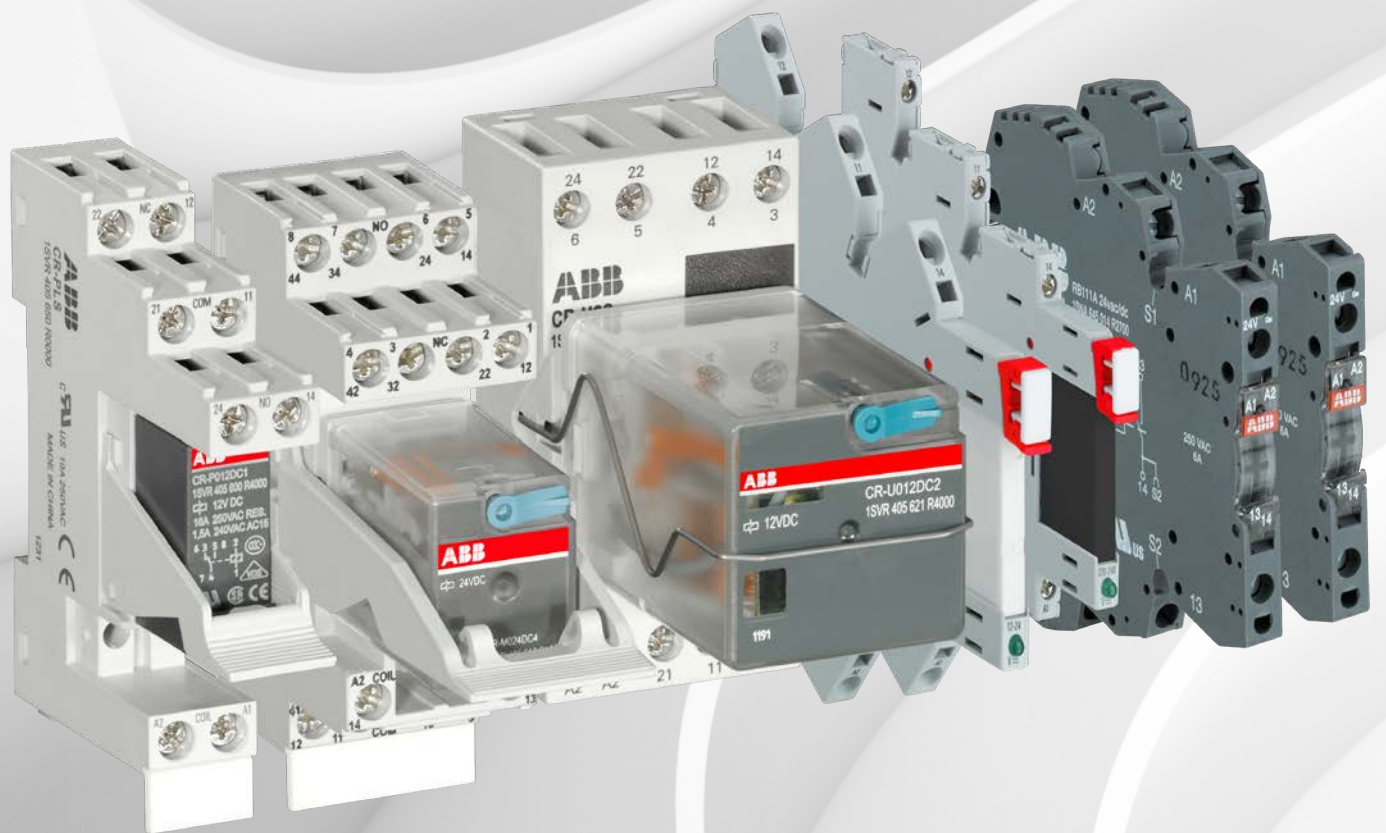



---

# Interface relays and optocouplers

## Table of contents

<b>362</b>	<b>Offer overview</b>
<b>365</b>	<b>Applications</b>
<b>367</b>	<b>Pluggable interface relays and optocouplers</b>
368	Selection tables
370	List of components
385	Benefits and advantages
386	Socket & terminal connection types
387	Relay components
389	Ordering details
410	Technical data
424	Technical diagrams
<b>437</b>	<b>Boxed interface relays and optocouplers R600 range</b>
438	Overview
<b>440</b>	<b>Boxed interface relays R600 range</b>
440	Selection table
442	Ordering details
444	Technical data
448	Technical diagrams
<b>450</b>	<b>Boxed optocouplers R600 range</b>
450	Selection table
451	Ordering details
453	Technical data
456	Technical diagrams

# Interface relays and optocouplers

## Offer overview

Relays are universally applicable and are utilized in a diverse array of applications. They are a significant element in contemporary industrial processes and are used in applications where galvanic isolation, signal separation, voltage coupling and signal amplification are required.

The ABB portfolio includes electromechanical relays and optocouplers. The electromechanical relays operate using an electromagnetic field whereas optocouplers use light. Optocouplers are predominantly used in applications where a high switching frequency is necessary. Furthermore, optocouplers do not contain any moving parts and are therefore bounce-free, immune to vibrations and possess a long electrical life.



### CR-S range

#### The slim line of interface relays and optocouplers

The pluggable interface relays and optocouplers of the CR-S range are used for electrical isolation, amplification and signal matching between the electronic controlling, e.g. PLC, iPC or field bus systems and the sensor / actuator level. The CR-S range combines the flexibility of a modular system and the ability of switching high currents on a small footprint thus can be used in applications where space saving is essential. The CR-S range also includes complete versions consisting of a relay, socket and marker.



### CR-P range

#### The pluggable pcb interface relays and optocouplers

The pluggable interface relays of the CR-P range are used for electrical isolation, amplification and signal matching between the electronic controlling, e.g. PLC, iPC or field bus systems and the sensor / actuator level. The CR-P range offers highest current switching in an IP67 rated relay housing. Furthermore, nine different coil voltages are available to suit world wide applications and even gold contact versions are available which is essential when it comes to switch sensitive signals. The CR-P range also includes complete versions consisting of a relay, socket, holder, marker and function module.

# Interface relays and optocouplers

## Offer overview



### CR-M range

#### The pluggable miniature interface relays

The pluggable interface relays of the CR-M range are used for electrical isolation, amplification and signal matching between the electronic controlling, e.g. PLC, iPC or field bus systems and the sensor / actuator level. The CR-M range offers up to 4 contacts in one relay and a built in test button which makes a circuit check fast and easy. 12 different coil voltages are available to suit world wide applications and even gold contact versions are available which is essential when it comes to switch sensitive signals. The CR-M range also includes complete versions consisting of a relay, socket, holder, marker and where applicable a function module.



### CR-U range

#### The pluggable universal interface relays

The pluggable interface relays of the CR-U range are used for electrical isolation, amplification and signal matching between the electronic controlling, e.g. PLC, iPC or field bus systems and the sensor / actuator level. The CR-U range offers up to 3 contacts in one relay and a built in test button which makes a circuit check fast and easy. 12 different coil voltages are available to suit world wide applications.



### R600 range

#### Boxed interface relays and optocouplers

Boxed interface relays of the R600 range are used for electrical isolation, amplification and signal matching between the electronic controlling, e.g. PLC, iPC or field bus systems and the sensor / actuator level. The relay itself is built in thus the perfect solution because this design fulfills highest vibration requirements. The compact design and different connection terminal possibilities further optimize your panel installation.

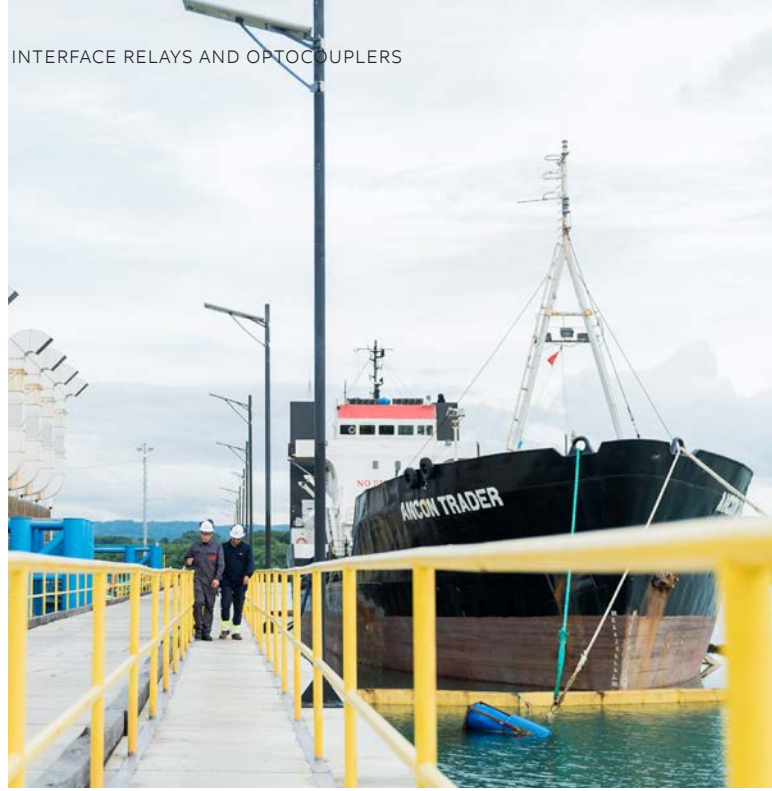

# Applications of interface relays

A proven technology used worldwide

Relays are universally applicable and are utilized in a diverse array of applications. They are a significant element in contemporary industrial processes and are used in applications where galvanic isolation, signal separation, voltage coupling and signal amplification are required.

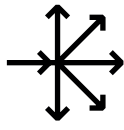

## Circuit multiplication

A single voltage signal may be used to simultaneously perform up to four different switching operations. Each output contact can be used to switch load circuits with different voltage and current levels.

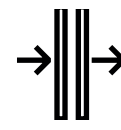

## Galvanic isolation

Interface relays are excellently suited to ensure safe galvanic isolation, i.e. separation between control circuit and load circuit.

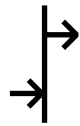

## Voltage conversion

Interface relays allow for small voltage signals to switch much larger loads. For example: a 24 V DC 10 mA signal can be used to switch a 230 V AC 16 A load.

**Billions**  
of relays operate and interface  
between control circuits and electrical  
loads.

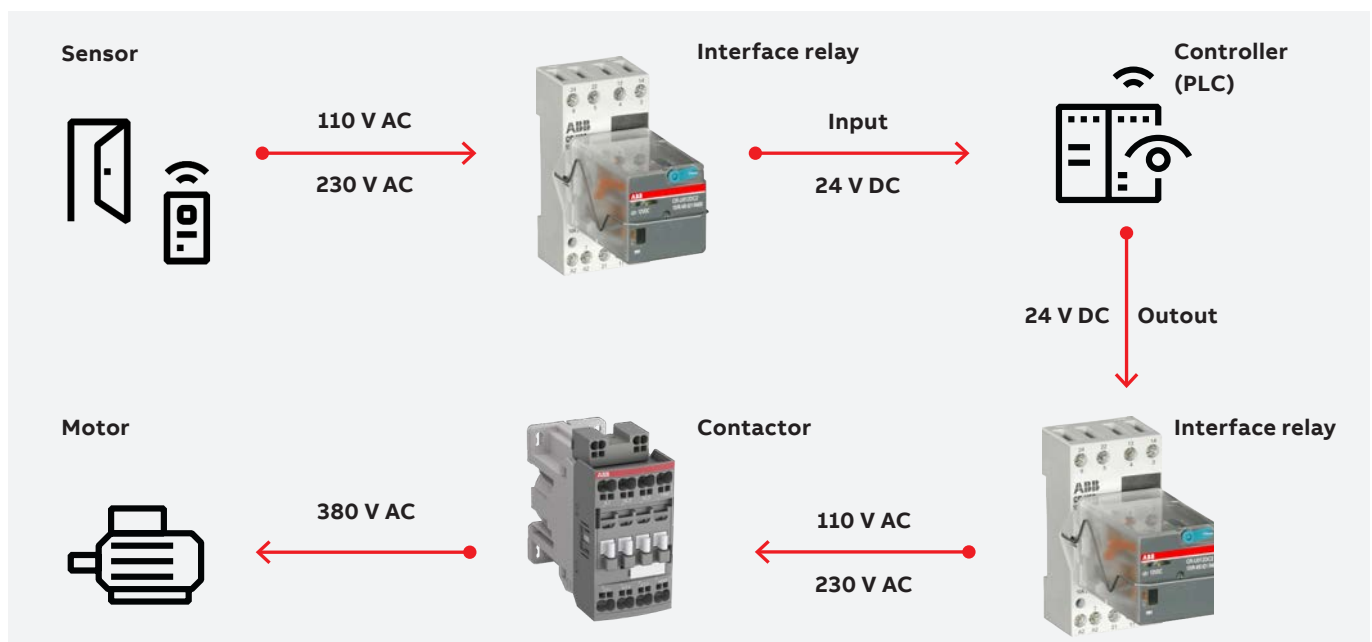



---

# Pluggable interface relays and optocouplers

## Table of contents

<b>368</b>	<b>Selection tables</b>
<b>370</b>	<b>List of components</b>
<b>385</b>	<b>Benefits and advantages</b>
<b>386</b>	<b>Socket &amp; terminal connection types</b>
<b>387</b>	<b>Relay components</b>
<b>389</b>	<b>Ordering details</b>
389	CR-S range
393	CR-P range
397	CR-M range
404	CR-P/M function modules
406	CR-U range
408	CR-U function modules
<b>410</b>	<b>Technical data</b>
410	CR-S interface relays
411	CR-S optocouplers
412	CR-S sockets
413	CR-S jumper bars
414	CR-P, CR-M, CR-U
418	CR-P optocouplers
419	CR-P and CR-M sockets
420	CR-P and CR-M jumper bars
421	CR-P and CR-M function modules
422	CR-U sockets
423	CR-U function modules
<b>424</b>	<b>Technical diagrams</b>

# Pluggable interface relays

## Selection table CR-S range



### How to use the selection table

Choose the desired control supply voltage from the column "Control voltage", e.g. "5 V DC".

Choose the desired kind of connection terminal from the column "Connection terminal", e.g. "spring".

Choose the desired material of contact from the column "Contact Material" e.g. "gold plated".

Control voltage	Connection terminal	Contact material	Socket type	Socket order code	Relay type	Relay order code
5 V DC	screw	standard	CR-S006/024VDC1SS	1SVR405521R1100	CR-S005VDC1R	1SVR405501R1010
		gold plated	CR-S006/024VDC1SS	1SVR405521R1100	CR-S005VDC1RG	1SVR405501R1020
	spring	standard	CR-S006/024VDC1SZ	1SVR405521R1200	CR-S005VDC1R	1SVR405501R1010
		gold plated	<b>CR-S006/024VDC1SZ</b>	<b>1SVR405521R1200</b>	<b>CR-S005VDC1RG</b>	<b>1SVR405501R1020</b>
12 V AC	screw	standard	CR-S012/024VADC1SS	1SVR405521R3100	CR-S012VDC1R	1SVR405501R2010
		gold plated	CR-S012/024VADC1SS	1SVR405521R3100	CR-S012VDC1RG	1SVR405501R2020
	spring	standard	CR-S012/024VADC1SZ	1SVR405521R3200	CR-S012VDC1R	1SVR405501R2010
		gold plated	CR-S012/024VADC1SZ	1SVR405521R3200	CR-S012VDC1RG	1SVR405501R2020



### Example

When you have chosen 5 V DC as control supply voltage, spring connection as connection terminal and gold plated as contact material the following order codes and type designators are valid:

Socket: CR-S006/024VDC1SZ, 1SVR405521R1200

Relay: CR-S005VDC1RG, 1SVR405501R1020



—  
CR-S range relay assemblies

Control voltage	Connection terminal	Contact material	Socket type	Socket order code	Relay type	Relay order code
5 V DC	screw	standard	CR-S006/024VDC1SS	1SVR405521R1100	CR-S005VDC1R	1SVR405501R1010
		gold plated	CR-S006/024VDC1SS	1SVR405521R1100	CR-S005VDC1RG	1SVR405501R1020
	spring	standard	CR-S006/024VDC1SZ	1SVR405521R1200	CR-S005VDC1R	1SVR405501R1010
		gold plated	CR-S006/024VDC1SZ	1SVR405521R1200	CR-S005VDC1RG	1SVR405501R1020
12 V DC	screw	standard	CR-S006/024VDC1SS or CR-S012/024VADC1SS	1SVR405521R1100 or 1SVR405521R3100	CR-S012VDC1R	1SVR405501R2010
		gold plated	CR-S006/024VDC1SS or CR-S012/024VADC1SS	1SVR405521R1100 or 1SVR405521R3100	CR-S012VDC1RG	1SVR405501R2020
	spring	standard	CR-S006/024VDC1SZ or CR-S012/024VADC1SZ	1SVR405521R1200 or 1SVR405521R3200	CR-S012VDC1R	1SVR405501R2010
		gold plated	CR-S006/024VDC1SZ or CR-S012/024VADC1SZ	1SVR405521R1200 or 1SVR405521R3200	CR-S012VDC1RG	1SVR405501R2020
12 V AC	screw	standard	CR-S012/024VADC1SS	1SVR405521R3100	CR-S012VDC1R	1SVR405501R2010
		gold plated	CR-S012/024VADC1SS	1SVR405521R3100	CR-S012VDC1RG	1SVR405501R2020
	spring	standard	CR-S012/024VADC1SZ	1SVR405521R3200	CR-S012VDC1R	1SVR405501R2010
		gold plated	CR-S012/024VADC1SZ	1SVR405521R3200	CR-S012VDC1RG	1SVR405501R2020
24 V DC	screw	standard	CR-S006/024VDC1SS or CR-S012/024VADC1SS	1SVR405521R1100 or 1SVR405521R3100	CR-S024VDC1R	1SVR405501R3010
		gold plated	CR-S006/024VDC1SS or CR-S012/024VADC1SS	1SVR405521R1100 or 1SVR405521R3100	CR-S024VDC1RG	1SVR405501R3020
	spring	standard	CR-S006/024VDC1SZ or CR-S012/024VADC1SZ	1SVR405521R1200 or 1SVR405521R3200	CR-S024VDC1R	1SVR405501R3010
		gold plated	CR-S006/024VDC1SZ or CR-S012/024VADC1SZ	1SVR405521R1200 or 1SVR405521R3200	CR-S024VDC1RG	1SVR405501R3020
24 V AC	screw	standard	CR-S012/024VADC1SS	1SVR405521R3100	CR-S024VDC1R	1SVR405501R3010
		gold plated	CR-S012/024VADC1SS	1SVR405521R3100	CR-S024VDC1RG	1SVR405501R3020
	spring	standard	CR-S012/024VADC1SZ	1SVR405521R3200	CR-S024VDC1R	1SVR405501R3010
		gold plated	CR-S012/024VADC1SZ	1SVR405521R3200	CR-S024VDC1RG	1SVR405501R3020
48 V AC/DC	screw	standard	CR-S048/060VADC1SS	1SVR405521R5100	CR-S048VDC1R	1SVR405501R4010
		gold plated	CR-S048/060VADC1SS	1SVR405521R5100	CR-S048VDC1RG	1SVR405501R4020
	spring	standard	CR-S048/060VADC1SZ	1SVR405521R5200	CR-S048VDC1R	1SVR405501R4010
		gold plated	CR-S048/060VADC1SZ	1SVR405521R5200	CR-S048VDC1RG	1SVR405501R4020
60 V AC/DC	screw	standard	CR-S048/060VADC1SS	1SVR405521R5100	CR-S060VDC1R	1SVR405501R5010
		gold plated	CR-S048/060VADC1SS	1SVR405521R5100	CR-S060VDC1RG	1SVR405501R5020
	spring	standard	CR-S048/060VADC1SZ	1SVR405521R5200	CR-S060VDC1R	1SVR405501R5010
		gold plated	CR-S048/060VADC1SZ	1SVR405521R5200	CR-S060VDC1RG	1SVR405501R5020
110-125 V AC/DC	screw	standard	CR-S110/125VADC1SS	1SVR405521R6100	CR-S060VDC1R	1SVR405501R5010
		gold plated	CR-S110/125VADC1SS	1SVR405521R6100	CR-S060VDC1RG	1SVR405501R5020
	spring	standard	CR-S110/125VADC1SZ	1SVR405521R6200	CR-S060VDC1R	1SVR405501R5010
		gold plated	CR-S110/125VADC1SZ	1SVR405521R6200	CR-S060VDC1RG	1SVR405501R5020
220-240 V AC/DC	screw	standard	CR-S220/240VADC1SS	1SVR405521R7100	CR-S060VDC1R	1SVR405501R5010
		gold plated	CR-S220/240VADC1SS	1SVR405521R7100	CR-S060VDC1RG	1SVR405501R5020
	spring	standard	CR-S220/240VADC1SZ	1SVR405521R7200	CR-S060VDC1R	1SVR405501R5010
		gold plated	CR-S220/240VADC1SZ	1SVR405521R7200	CR-S060VDC1RG	1SVR405501R5020

—  
CR-S optocoupler range relay assemblies

Control voltage	Connection terminal	Output characteristics	Socket type	Socket order code	Opto type	Opto order code
24 V DC	screw	Transistor 100 mA - 48 V DC	CR-S012/024VADC1SS	1SVR405521R3100	CR-S024VDC1TRA	1SVR405510R3050
			CR-S012/024VADC1SZ	1SVR405521R3200	CR-S024VDC1TRA	1SVR405510R3050
	spring	MOS-FET 2 A - 24 V DC	CR-S012/024VADC1SS	1SVR405521R3100	CR-S024VDC1MOS	1SVR405510R3060
			CR-S012/024VADC1SZ	1SVR405521R3200	CR-S024VDC1MOS	1SVR405510R3060
	screw	Triac 2 A - 240 V AC	CR-S012/024VADC1SS	1SVR405521R3100	CR-S024VDC1TRI	1SVR405510R3070
			CR-S012/024VADC1SZ	1SVR405521R3200	CR-S024VDC1TRI	1SVR405510R3070

# List of components

## Selection table CR-S range complete versions



The complete versions of the CR-S range comprise of a pluggable interface relay, socket and marker.

### CR-S complete versions

Complete versions	Type	Order code	Relay				Socket				
			CR-S024VDC1R	CR-S024VDC1RG	CR-S060VDC1R	CR-S060VDC1RG	CR-S012/024VADC1S	CR-S012/024VADC1SZ	CR-S110/125VADC1S	CR-S110/125VADC1SZ	CR-S220/240VADC1S
1SVR405541R3110	CR-S024VADC1CRS	1SVR405501R3010	■				■				
1SVR405541R3120	CR-S024VADC1CRGS	1SVR405501R3020		■			■				
1SVR405541R3210	CR-S024VADC1CRZ	1SVR405501R5010	■				■				
1SVR405541R3220	CR-S024VADC1CRGZ	1SVR405501R5020		■			■				
1SVR405541R6110	CR-S110VADC1CRS	1SVR405521R3100			■			■			
1SVR405541R6120	CR-S110VADC1CRGS	1SVR405521R3200			■			■			
1SVR405541R6210	CR-S110VADC1CRZ	1SVR405521R6100		■					■		
1SVR405541R6220	CR-S110VADC1CRGZ	1SVR405521R6200		■					■		
1SVR405541R7110	CR-S230VADC1CRS	1SVR405521R7100		■						■	
1SVR405541R7120	CR-S230VADC1CRGS	1SVR405521R7200		■						■	
1SVR405541R7210	CR-S230VADC1CRZ			■							■
1SVR405541R7220	CR-S230VADC1CRGZ			■							■











# Pluggable interface relays and optocouplers

## Selection table CR-M range

CR-M pluggable relays with LED

Type	Order code
CR-M012DC3L	1SVR405612R4100
CR-M012DC3LD	1SVR405612R4400
CR-M024DC3L	1SVR405612R1100
CR-M024DC3LD	1SVR405612R1400
CR-M048DC3L	1SVR405612R6100
CR-M048DC3LD	1SVR405612R6400
CR-M060DC3L	1SVR405612R4300
CR-M110DC3L	1SVR405612R8100
CR-M110DC3LD	1SVR405612R8400
CR-M125DC3L	1SVR405612R8300
CR-M125DC3LD	1SVR405612R8500
CR-M220DC3L	1SVR405612R9100
CR-M220DC3LD	1SVR405612R9400
CR-M012AC3L	1SVR405612R0300
CR-M024AC3L	1SVR405612R0100
CR-M048AC3L	1SVR405612R5100
CR-M110AC3L	1SVR405612R7100
CR-M120AC3L	1SVR405612R2100
CR-M230AC3L	1SVR405612R3100

Input voltage	CR-M012DC3L	CR-M012DC3LD	CR-M024DC3L	CR-M024DC3LD	CR-M048DC3L	CR-M048DC3LD	CR-M060DC3L	CR-M110DC3L	CR-M110DC3LD	CR-M125DC3L	CR-M125DC3LD	CR-M220DC3L	CR-M220DC3LD	CR-M012AC3L	CR-M024AC3L	CR-M048AC3L	CR-M110AC3L	CR-M120AC3L	CR-M230AC3L
12 V DC	■	■																	
24 V DC			■	■															
48 V DC					■	■													
60 V DC							■												
110 V DC								■	■										
125 V DC										■	■								
220 V DC												■	■						
12 V AC														■					
24 V AC															■				
48 V AC																■			
60 V AC																	■		
110 V AC																		■	
120 V AC																			■
230 V AC																			■

Output rating	CR-M012DC3L	CR-M012DC3LD	CR-M024DC3L	CR-M024DC3LD	CR-M048DC3L	CR-M048DC3LD	CR-M060DC3L	CR-M110DC3L	CR-M110DC3LD	CR-M125DC3L	CR-M125DC3LD	CR-M220DC3L	CR-M220DC3LD	CR-M012AC3L	CR-M024AC3L	CR-M048AC3L	CR-M110AC3L	CR-M120AC3L	CR-M230AC3L
250 V 6 A																			
250 V 10 A	■	■	■	■	■	■	■	■	■	■	■	■	■	■	■	■	■	■	■
250 V 12 A																			

Output contacts	CR-M012DC3L	CR-M012DC3LD	CR-M024DC3L	CR-M024DC3LD	CR-M048DC3L	CR-M048DC3LD	CR-M060DC3L	CR-M110DC3L	CR-M110DC3LD	CR-M125DC3L	CR-M125DC3LD	CR-M220DC3L	CR-M220DC3LD	CR-M012AC3L	CR-M024AC3L	CR-M048AC3L	CR-M110AC3L	CR-M120AC3L	CR-M230AC3L
c/o	3	3	3	3	3	3	3	3	3	3	3	3	3	3	3	3	3	3	3
Gold plated contacts																			

Additional features	CR-M012DC3L	CR-M012DC3LD	CR-M024DC3L	CR-M024DC3LD	CR-M048DC3L	CR-M048DC3LD	CR-M060DC3L	CR-M110DC3L	CR-M110DC3LD	CR-M125DC3L	CR-M125DC3LD	CR-M220DC3L	CR-M220DC3LD	CR-M012AC3L	CR-M024AC3L	CR-M048AC3L	CR-M110AC3L	CR-M120AC3L	CR-M230AC3L
LED	■	■	■	■	■	■	■	■	■	■	■	■	■	■	■	■	■	■	■
Free-wheeling diode		■		■		■			■		■		■						





# Pluggable interface relays and optocouplers

## Selection table CR-M range

CR-M pluggable relays with Gold Plated Contacts

Type	Order code
CR-M024DC4G	1SVR405618R1000
CR-M024AC4G	1SVR405618R0000
CR-M110AC4G	1SVR405618R7000
CR-M230AC4G	1SVR405618R3000
CR-M230AC4G	1SVR405618R3000
CR-M012DC4LG	1SVR405618R4100
CR-M024DC4LG	1SVR405618R1100
CR-M048DC4LG	1SVR405618R6100
CR-M060DC4LG	1SVR405618R4300
CR-M110DC4LG	1SVR405618R8100
CR-M125DC4LG	1SVR405618R8300
CR-M220DC4LG	1SVR405618R9100
CR-M024AC4LG	1SVR405618R0100
CR-M048AC4LG	1SVR405618R5100
CR-M110AC4LG	1SVR405618R7100
CR-M120AC4LG	1SVR405618R2100
CR-M230AC4LG	1SVR405618R3100
CR-M012DC4LDG	1SVR405618R4400
CR-M024DC4LDG	1SVR405618R1400

Input voltage	
12 V DC	■
24 V DC	■
48 V DC	■
60 V DC	■
110 V DC	■
125 V DC	■
220 V DC	■
24 V AC	■
48 V AC	■
60 V AC	■
110 V AC	■
120 V AC	■
230 V AC	■

Output rating	
250 V 6 A	■
250 V 10 A	■
250 V 12 A	■

Output contacts	
c/o	4 4 4 4 4 4 4 4 4 4 4 4 4 4 4 4 4 4
Gold plated contacts	■ ■ ■ ■ ■ ■ ■ ■ ■ ■ ■ ■ ■ ■ ■ ■ ■ ■

Additional features	
LED	■ ■ ■ ■ ■ ■ ■ ■ ■ ■ ■ ■ ■ ■ ■ ■ ■ ■
Free-wheeling diode	■ ■

# Pluggable interface relays and optocouplers

## Selection table CR-M range complete versions

### CR-M range complete versions

	Type	Order code
	CR-M012DC4LDGSS	15VR405618R4410
	CR-M024DC4SS42V	15VR405613R1010
	CR-M024DC4LS42V	15VR405613R1011
	CR-M024DC4LC42	15VR405613R1012
	CR-M024DC4GSS42V	15VR405618R1011
	CR-M024DC4GLC62CV	15VR405618R1010
	CR-M024DC4LGLC22	15VR405618R1110
	CR-M024DC4LDGSS	15VR405618R1410
	CR-M024AC4LS62CV	15VR405613R0010
	CR-M230AC4SS92CV	15VR405613R3110
	CR-M230AC4LS92CV	15VR405613R3011
	CR-M230AC4LC92	15VR405613R3012
	CR-M230AC4GSS92CV	15VR405618R3112
	CR-M230AC4LGLC	15VR405618R3110
	CR-M230AC4LGSS	15VR405618R3111

Input voltage		
12 V DC	■	
24 V DC	■	■
48 V DC		
60 V DC		
110 V DC		
125 V DC		
220 V DC		
24 V AC		■
48 V AC		
60 V AC		
110 V AC		
120 V AC		
230 V AC		■

Output rating		
250 V 6 A	■	■
250 V 10 A		
250 V 12 A		

Output contacts		
c/o	4	4
Gold plated contacts	■	■

Socket type		
Standard socket	■	■
Logical socket		■

Additional features		
LED	■	■
Free-wheeling diode	■	■

# List of components

## Selection table CR-M range complete versions



The complete versions of the CR-M range comprise of a pluggable interface relay, socket, holder, marker and where applicable a function module.

### CR-M complete versions

Complete versions		Relay	Socket	Function module	Holder
Order code	Type	Order code	Order code	Order code	Order code
1SVR405618R4410	CR-M012DC4LDGSS	1SVR405618R4400	CR-M012DC4LDG	1SVR405651R0000	1SVR405659R1000
1SVR405613R1010	CR-M024DC4SS42V	1SVR405613R1000	CR-M024DC4	1SVR405652R0000	
1SVR405613R1011	CR-M024DC4LS42V	1SVR405618R1000	CR-M024DC4G	1SVR405652R1000	
1SVR405613R1012	CR-M024DC4LC42	1SVR405618R1100	CR-M024DC4LG	1SVR405652R9100	
1SVR405618R1011	CR-M024DC4GSS42V	1SVR405618R1400	CR-M024DC4LDG	1SVR405655R1000	
1SVR405618R1010	CR-M024DC4GLC62CV	1SVR405613R0000	CR-M024AC4	1SVR405654R0100	
1SVR405618R1110	CR-M024DC4LGLC22	1SVR405613R3000	CR-M230AC4	1SVR405655R1100	
1SVR405618R1410	CR-M024DC4LDGSS	1SVR405618R3000	CR-M230AC4G		
1SVR405613R0010	CR-M024AC4LS62CV	1SVR405618R3100	CR-M230AC4LG		
1SVR405613R3110	CR-M230AC4SS92CV	1SVR405618R3200			
1SVR405613R3011	CR-M230AC4LS92CV	1SVR405651R3000	CR-M4SS		
1SVR405613R3012	CR-M230AC4LC92	1SVR405651R3100	CR-M4LS		
1SVR405618R3112	CR-M230AC4GSS92CV	1SVR405651R3200	CR-M4LC		
1SVR405618R3110	CR-M230AC4LGLC	1SVR405651R0000	CR-P/M 22		
1SVR405618R3111	CR-M230AC4LGSS	1SVR405651R0000	CR-P/M 42		
		1SVR405652R0000	CR-P/M 42V		
		1SVR405652R1000	CR-P/M 42CV		
		1SVR405655R1000	CR-P/M 62CV		
		1SVR405654R0100	CR-P/M 92		
		1SVR405655R1100	CR-P/M 92CV		
		1SVR405659R1000	CR-MH		







# Pluggable interface relays and optocouplers

## Selection table CR-U function modules

CR-U function modules

	Type	Order code
	CR-U 21	1SVR405661R0000
	CR-U 41	1SVR405662R0000
	CR-U 41V	1SVR405662R1000
	CR-U 41B	1SVR405662R4000
	CR-U 41BV	1SVR405662R4100
	CR-U 41C	1SVR405662R9000
	CR-U 41CV	1SVR405662R9100
	CR-U 51B	1SVR405663R0000
	CR-U 51D	1SVR405663R4000
	CR-U 51C	1SVR405663R1000
	CR-U 61	1SVR405664R0000
	CR-U 61V	1SVR405664R1000
	CR-U 61E	1SVR405664R4000
	CR-U 61EV	1SVR405664R4100
	CR-U 91	1SVR405664R0100
	CR-U 91V	1SVR405664R1100
	CR-U 61C	1SVR405665R0000
	CR-U 61CV	1SVR405665R1000
	CR-U 61D	1SVR405665R4000
	CR-U 61DV	1SVR405665R4100
	CR-U 91C	1SVR405665R0100
	CR-U 91CV	1SVR405665R1100
	CR-U 71	1SVR405666R0000
	CR-U 71A	1SVR405666R1000
	CR-U 81	1SVR405666R2000
	CR-U T	1SVR405677R0000
<b>Related control supply voltage</b>		
6-220 V DC	■	
6-24 V DC	■	■
24-60 V DC		■
110 V DC		■
110-230 V DC		■
6-24 V AC		■
24-60 V AC		■
110-230 V AC		■
24 V AC		■
115 V AC		■
230 V AC		■
24-240 V AC/DC		■
<b>Function</b>		
Diode - reverse polarity protection / free wheeling diode	■	
Diode and LED - Reverse polarity protection / free-wheeling diode and LED to indicate energized coil	■	■
RC element - Spark quenching		■
Diode and LED - LED to indicate energized coil		■
Varistor and LED - Overvoltage protection and LED to indicate energized coil		■
Varistor - Overvoltage protection		■
Multi-function time module		■
LED red	■	■
LED green	■	■



# Pluggable interface relays and optocouplers

## Benefits and advantages

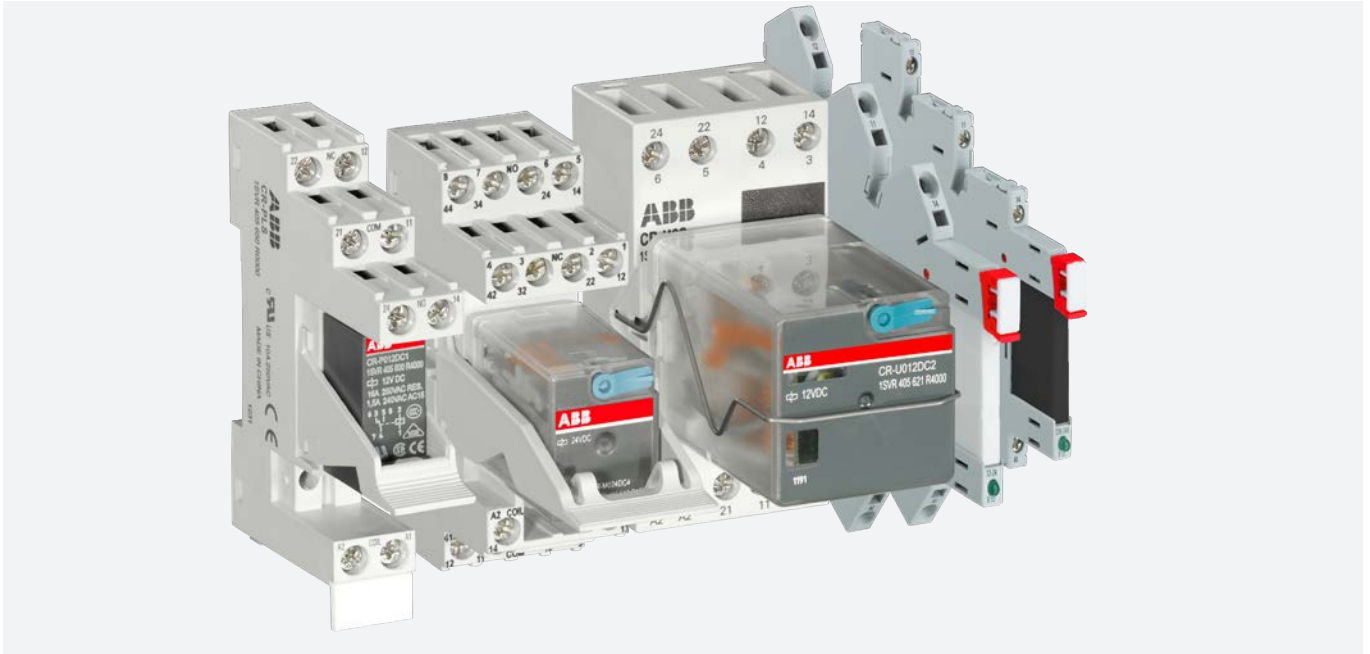

ABB's interface relays and optocouplers ensure a reliable voltage conversion between process peripherals and higher level control systems. These relays ensure reliable signal switching and provide electrical isolation for sensitive electronics such as PLCs. The wide variety of pluggable interface relays with accompanied by standard or logic sockets may be used for switching AC or DC loads. Suitable for extreme environments, ABB's interface relays are offered across a wide spectrum of coil voltages, with a variety of optional function modules.



**Continuous operation**

The interface relay portfolio incorporates a large assortment of relays. It includes both electro-mechanical relays and optocouplers. Optocouplers allow for continuous operation without any mechanical wear-and-tear.



**Easy to install**

The interface relay includes both pluggable and non-pluggable relays. The pluggable relays allow for the easy and seamless exchange of relay modules.



**Global availability**

The ABB interface relays and optocouplers are approved for a large variety of applications, comply to the highest global approvals and are available world-wide.

# Pluggable interface relays and optocouplers

## Socket and terminal connection types

### Standard sockets



01 Standard socket CR-P

2CDC291040F0004

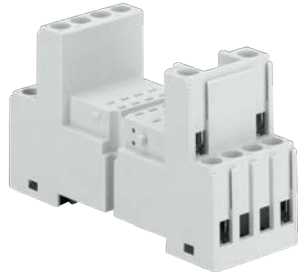

02 Standard socket CR-M

2CDC29100950011

Position of connection terminals:  
 Coil connection (A1-A2) on lower side of the socket, contact connections (n/o and n/c contacts) on the lower and upper side of the socket.

### Logical sockets



03 Logical socket CR-P

2CDC29100650011



04 Logical socket CR-M

2CDC291042F0004

Position of connection terminals:  
 Coil connection (A1-A2) on lower side of the socket, all contact connections (common contacts, n/o and n/c contacts) on the upper side of the socket.

### Terminal connection types

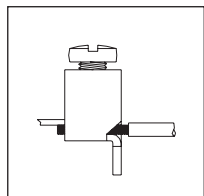

05 Screw type

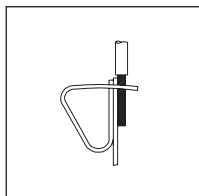

06 Spring type

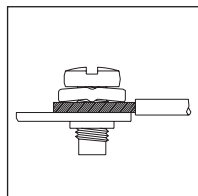

07 Fork type

A variety of sockets are available for interface relays and optocouplers to meet the needs of different applications such as vibration-intensive environments.

# Pluggable interface relays and optocouplers

## Relay components

### CR-S range

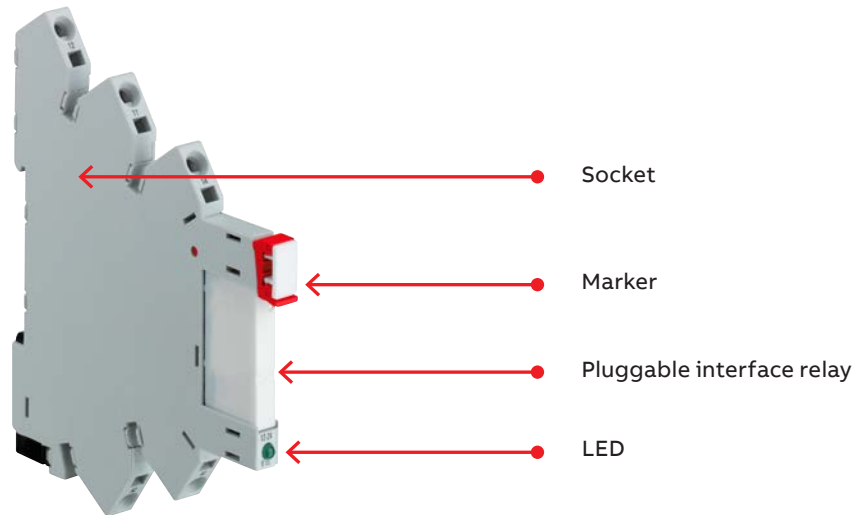

### CR-P range

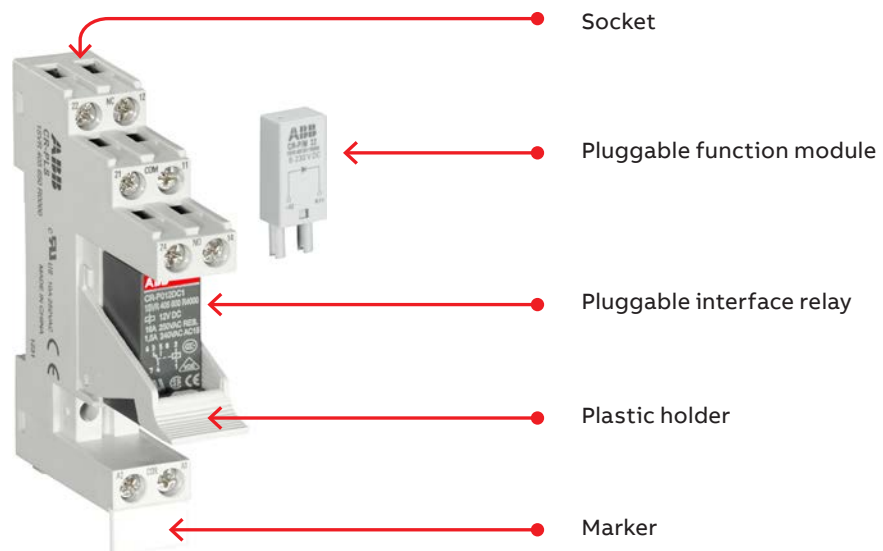



## Pluggable interface relays and optocouplers

### Ordering details – CR-S range



CR-S relay

The slim pluggable interface relays and optocouplers of the CR-S range may be used for electrical isolation, amplification and signal matching. The CR-S relays are 6.2 mm wide and therefore allow for the switching high currents on a small footprint.

#### Ordering details - CR-S range pluggable interface relays

Rated control supply voltage	Outputs	Contact ratings	Type	Order code	Pkg qty	Weight (1 pc.) kg (lb)
5 V DC	1 c/o (SPDT) standard contacts	250 V, 6 A	CR-S005VDC1R	1SVR405501R1010	10	0.005 (0.011)
12 V DC			CR-S012VDC1R	1SVR405501R2010		
24 V DC			CR-S024VDC1R	1SVR405501R3010		
48 V DC			CR-S048VDC1R	1SVR405501R4010		
60 V DC			CR-S060VDC1R	1SVR405501R5010		
5 V DC	1 c/o (SPDT) gold plated contacts	12 V, 250 mA (3W) <sup>1)</sup>	CR-S005VDC1RG	1SVR405501R1020	10	0.005 (0.011)
12 V DC			CR-S012VDC1RG	1SVR405501R2020		
24 V DC			CR-S024VDC1RG	1SVR405501R3020		
48 V DC			CR-S048VDC1RG	1SVR405501R4020		
60 V DC			CR-S060VDC1RG	1SVR405501R5020		

#### Ordering details - CR-S range pluggable optocouplers

Rated control supply voltage	Outputs	Type	Order code	Pkg qty	Weight (1 pc.) kg (lb)
24 V DC	Transistor, 100 mA - 48 V DC	CR-S024VDC1TRA	1SVR405510R3050	10	0.004 (0.009)
	MOS-FET, 2 A - 24 V DC	CR-S024VDC1MOS	1SVR405510R3060		
	Triac, 2 A - 240 V AC	CR-S024VDC1TRI	1SVR405510R3070		



CR-S optocoupler

#### Ordering details - CR-S range complete interface relays (relay + socket)

Rated control supply voltage	Outputs	Contact ratings	Type	Order code	Pkg qty	Weight (1 pc.) kg (lb)
24 V AC/DC	1 c/o (SPDT) standard contacts	250 V, 6 A	CR-S024VADC1CRS	1SVR405541R3110	10	0.03 (0.066)
			CR-S024VADC1CRZ	1SVR405541R3210		
110 V AC/DC			CR-S110VADC1CRS	1SVR405541R6110		
			CR-S110VADC1CRZ	1SVR405541R6210		
230 V AC/DC			CR-S230VADC1CRS	1SVR405541R7110		
			CR-S230VADC1CRZ	1SVR405541R7210		
24 V AC/DC	1 c/o (SPDT) gold plated contacts	12 V, 250 mA (3W) <sup>1)</sup>	CR-S024VADC1CRGS	1SVR405541R3120	10	0.03 (0.066)
110 V AC/DC			CR-S024VADC1CRGZ	1SVR405541R3220		
			CR-S110VADC1CRGS	1SVR405541R6120		
230 V AC/DC			CR-S110VADC1CRGZ	1SVR405541R6220		
			CR-S230VADC1CRGS	1SVR405541R7120		
			CR-S230VADC1CRGZ	1SVR405541R7220		



CR-S complete interface relay

<sup>1)</sup> If specified maximum values exceeded, the gold plating is destroyed. The maximum values of the standard contacts are then valid.

## Pluggable interface relays and optocouplers

### Ordering details – CR-S range



CR-S socket

2CDC292008F0016

#### Ordering details - CR-S range sockets

Rated control supply voltage	Connection type	Type	Order code	Pkg qty	Weight (1 pc.) kg (lb)
6-24 V DC	screw	CR-S006/024VDC1SS	1SVR405521R1100	10	0.025 (0.055)
	spring	CR-S006/024VDC1SZ	1SVR405521R1200		
12-24 V AC/DC	screw	CR-S012/024VADC1SS	1SVR405521R3100		
	spring	CR-S012/024VADC1SZ	1SVR405521R3200		
48-60 V AC/DC	screw	CR-S048/060VADC1SS	1SVR405521R5100		
	spring	CR-S048/060VADC1SZ	1SVR405521R5200		
110-125 V AC/DC	screw	CR-S110/125VADC1SS	1SVR405521R6100		
	spring	CR-S110/125VADC1SZ	1SVR405521R6200		
220-240 V AC/DC	screw	CR-S220/240VADC1SS	1SVR405521R7100		
	spring	CR-S220/240VADC1SZ	1SVR405521R7200		

#### Ordering details - CR-S range accessories

Version	Type	Order code	Pkg qty	Weight (1 pc.) kg (lb)
Jumper bar 20 pole, blue color	CR-SJB20-BLUE	1SVR405598R0700	10	0.008 (0.018)
Jumper bar 20 pole, red color	CR-SJB20-RED	1SVR405598R0800		
Jumper bar 20 pole, black color	CR-SJB20-BLACK	1SVR405598R0900		
Separator	CR-SSEP	1SVR405599R0000	10	0.012 (0.026)

## Pluggable interface relays and optocouplers

### Ordering details – CR-S range

#### Relay assemblies

Control voltage	Connection terminal	Contact material	Socket type	Socket order code	Relay type	Relay order code
5 V DC	screw	standard	CR-S006/024VDC1SS	1SVR405521R1100	CR-S005VDC1R	1SVR405501R1010
		gold plated	CR-S006/024VDC1SS	1SVR405521R1100	CR-S005VDC1RG	1SVR405501R1020
	spring	standard	CR-S006/024VDC1SZ	1SVR405521R1200	CR-S005VDC1R	1SVR405501R1010
		gold plated	CR-S006/024VDC1SZ	1SVR405521R1200	CR-S005VDC1RG	1SVR405501R1020
12 V DC	screw	standard	CR-S006/024VDC1SS or CR-S012/024VADC1SS	1SVR405521R1100 or 1SVR405521R3100	CR-S012VDC1R	1SVR405501R2010
		gold plated	CR-S006/024VDC1SS or CR-S012/024VADC1SS	1SVR405521R1100 or 1SVR405521R3100	CR-S012VDC1RG	1SVR405501R2020
	spring	standard	CR-S006/024VDC1SZ or CR-S012/024VADC1SZ	1SVR405521R1200 or 1SVR405521R3200	CR-S012VDC1R	1SVR405501R2010
		gold plated	CR-S006/024VDC1SZ or CR-S012/024VADC1SZ	1SVR405521R1200 or 1SVR405521R3200	CR-S012VDC1RG	1SVR405501R2020
12 V AC	screw	standard	CR-S012/024VADC1SS	1SVR405521R3100	CR-S012VDC1R	1SVR405501R2010
		gold plated	CR-S012/024VADC1SS	1SVR405521R3100	CR-S012VDC1RG	1SVR405501R2020
	spring	standard	CR-S012/024VADC1SZ	1SVR405521R3200	CR-S012VDC1R	1SVR405501R2010
		gold plated	CR-S012/024VADC1SZ	1SVR405521R3200	CR-S012VDC1RG	1SVR405501R2020
24 V DC	screw	standard	CR-S006/024VDC1SS or CR-S012/024VADC1SS	1SVR405521R1100 or 1SVR405521R3100	CR-S024VDC1R	1SVR405501R3010
		gold plated	CR-S006/024VDC1SS or CR-S012/024VADC1SS	1SVR405521R1100 or 1SVR405521R3100	CR-S024VDC1RG	1SVR405501R3020
	spring	standard	CR-S006/024VDC1SZ or CR-S012/024VADC1SZ	1SVR405521R1200 or 1SVR405521R3200	CR-S024VDC1R	1SVR405501R3010
		gold plated	CR-S006/024VDC1SZ or CR-S012/024VADC1SZ	1SVR405521R1200 or 1SVR405521R3200	CR-S024VDC1RG	1SVR405501R3020
24 V AC	screw	standard	CR-S012/024VADC1SS	1SVR405521R3100	CR-S024VDC1R	1SVR405501R3010
		gold plated	CR-S012/024VADC1SS	1SVR405521R3100	CR-S024VDC1RG	1SVR405501R3020
	spring	standard	CR-S012/024VADC1SZ	1SVR405521R3200	CR-S024VDC1R	1SVR405501R3010
		gold plated	CR-S012/024VADC1SZ	1SVR405521R3200	CR-S024VDC1RG	1SVR405501R3020
48 V AC/DC	screw	standard	CR-S048/060VADC1SS	1SVR405521R5100	CR-S048VDC1R	1SVR405501R4010
		gold plated	CR-S048/060VADC1SS	1SVR405521R5100	CR-S048VDC1RG	1SVR405501R4020
	spring	standard	CR-S048/060VADC1SZ	1SVR405521R5200	CR-S048VDC1R	1SVR405501R4010
		gold plated	CR-S048/060VADC1SZ	1SVR405521R5200	CR-S048VDC1RG	1SVR405501R4020
60 V AC/DC	screw	standard	CR-S048/060VADC1SS	1SVR405521R5100	CR-S060VDC1R	1SVR405501R5010
		gold plated	CR-S048/060VADC1SS	1SVR405521R5100	CR-S060VDC1RG	1SVR405501R5020
	spring	standard	CR-S048/060VADC1SZ	1SVR405521R5200	CR-S060VDC1R	1SVR405501R5010
		gold plated	CR-S048/060VADC1SZ	1SVR405521R5200	CR-S060VDC1RG	1SVR405501R5020
110-125 V AC/DC	screw	standard	CR-S110/125VADC1SS	1SVR405521R6100	CR-S060VDC1R	1SVR405501R5010
		gold plated	CR-S110/125VADC1SS	1SVR405521R6100	CR-S060VDC1RG	1SVR405501R5020
	spring	standard	CR-S110/125VADC1SZ	1SVR405521R6200	CR-S060VDC1R	1SVR405501R5010
		gold plated	CR-S110/125VADC1SZ	1SVR405521R6200	CR-S060VDC1RG	1SVR405501R5020
220-240 V AC/DC	screw	standard	CR-S220/240VADC1SS	1SVR405521R7100	CR-S060VDC1R	1SVR405501R5010
		gold plated	CR-S220/240VADC1SS	1SVR405521R7100	CR-S060VDC1RG	1SVR405501R5020
	spring	standard	CR-S220/240VADC1SZ	1SVR405521R7200	CR-S060VDC1R	1SVR405501R5010
		gold plated	CR-S220/240VADC1SZ	1SVR405521R7200	CR-S060VDC1RG	1SVR405501R5020

## Pluggable interface relays and optocouplers

Ordering details – CR-S range

### Optocoupler assemblies

Control voltage	Connection terminal	Output characteristics	Socket type	Socket order code	Opto type	Opto order code
24 V DC	screw	Transistor 100 mA - 48 V DC	CR-S012/024VADC1SS	1SVR405521R3100	CR-S024VDC1TRA	1SVR405510R3050
	spring		CR-S012/024VADC1SZ	1SVR405521R3200	CR-S024VDC1TRA	1SVR405510R3050
	screw	MOS-FET 2 A - 24 V DC	CR-S012/024VADC1SS	1SVR405521R3100	CR-S024VDC1MOS	1SVR405510R3060
	spring		CR-S012/024VADC1SZ	1SVR405521R3200	CR-S024VDC1MOS	1SVR405510R3060
	screw	Triac 2 A - 240 V AC	CR-S012/024VADC1SS	1SVR405521R3100	CR-S024VDC1TRI	1SVR405510R3070
	spring		CR-S012/024VADC1SZ	1SVR405521R3200	CR-S024VDC1TRI	1SVR405510R3070



## Pluggable interface relays and optocouplers

### Ordering details – CR-P range

The CR-P range offers the highest current switching in an IP67 rated relay housing. This range comprises of pluggable interface relays and optocouplers offered in 10 different control supply voltages. Additionally, gold plated contacts are available for applications where sensitive signals are to be switched. The CR-P range also includes complete versions consisting of a relay, socket, holder, marker and function module.

#### Ordering details - CR-P range relays



CR-P relay

2CDC291.045.F0004

Rated control supply voltage	Outputs	Contact ratings	Type	Order code	Pkg qty	Weight (1 pc.) kg (lb)
12 V DC	1 c/o (SPDT)	250 V, 16 A	CR-P012DC1	1SVR405600R4000	10	0.014 (0.031)
24 V DC			CR-P024DC1	1SVR405600R1000		
48 V DC			CR-P048DC1	1SVR405600R6000		
110 V DC			CR-P110DC1	1SVR405600R8000		
24 V AC			CR-P024AC1	1SVR405600R0000		
48 V AC			CR-P048AC1	1SVR405600R5000		
110 V AC			CR-P110AC1	1SVR405600R7000		
120 V AC			CR-P120AC1	1SVR405600R2000		
230 V AC			CR-P230AC1	1SVR405600R3000		
12 V DC			2 c/o (SPDT)	250 V, 8 A		
24 V DC	CR-P024DC2	1SVR405601R1000				
48 V DC	CR-P048DC2	1SVR405601R6000				
110 V DC	CR-P110DC2	1SVR405601R8000				
12 V AC	CR-P012AC2	1SVR405601R0200				
24 V AC	CR-P024AC2	1SVR405601R0000				
48 V AC	CR-P048AC2	1SVR405601R5000				
110 V AC	CR-P110AC2	1SVR405601R7000				
120 V AC	CR-P120AC2	1SVR405601R2000				
230 V AC	CR-P230AC2	1SVR405601R3000				

#### Ordering details - CR-P range relays with gold contacts

Rated control supply voltage	Outputs	Contact ratings	Type	Order code	Pkg qty	Weight (1 pc.) kg (lb)
24 V DC	2 c/o (SPDT) gold contact	250 V, 8 A	CR-P024DC2G	1SVR405606R1000	10	0.014 (0.031)
24 V AC			CR-P024AC2G	1SVR405606R0000		
110 V AC			CR-P110AC2G	1SVR405606R7000		
230 V AC			CR-P230AC2G	1SVR405606R3000		

#### Ordering details - CR-P range pluggable optocouplers



CR-P optocoupler

2CDC291.006.S0016

Rated control supply voltage (Us)	Outputs	Type	Order code	Pkg qty	Weight (1 pc.) kg (lb)
10-32 V DC	MOS-FET, 5 A - 35 V DC	CR-P024MOS1	1SVR405610R4060	10	0.011 (0.618)
	Triac, 3 A - 275 V AC	CR-P024TRI1	1SVR405610R4070		

# Pluggable interface relays and optocouplers

## Ordering details – CR-P range



CR-PLSX



CR-PSS

Standard and logical sockets for CR-P interface relays are suitable for snap-on mounting onto a DIN rail. Optional function modules for the CR-P range are plugged into both standard and logical sockets.

### Ordering details - Sockets\*

Version	Connection terminal	Type	Order code	Pkg qty	Weight (1 pc.) kg (lb)
Logical socket with protective separation	screw	CR-PLS	1SVR405650R0000	10	0.045 (0.099)
Logical socket	screw	CR-PLSX	1SVR405650R0100		0.043 (0.095)
	spring	CR-PLC	1SVR405650R0200		0.042 (0.093)
Standard socket	screw	CR-PSS	1SVR405650R1000		0.038 (0.084)

\*All CR-P socket packages include a set of markers.

### Standard sockets

Position of connection terminals: coil connection (A1-A2) on lower side of the socket, contact connections (n/o and n/c contacts) on the lower and upper side of the socket.

### Logical sockets

Position of connection terminals: coil connection (A1-A2) on lower side of the socket, all contact connections (common contacts, n/o and n/c contacts) on the upper side of the socket.

### Ordering details - Accessories

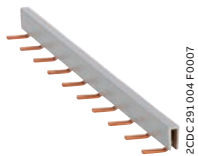

CR-PJ

Version	Type	Order code	Pkg qty	Weight (1 pc.) kg (lb)
Plastic holder for socket	CR-PH	1SVR405659R0000	10	0.002 (0.004)
Metal holder for socket	CR-PH1	1SVR405659R0100		0.4g
Jumper bar for sockets with screw connection	CR-PJ	1SVR405658R5000		0.018 (0.040)
Marker	CR-PM	1SVR405658R0000	10	0.0002 (0.0004)

## Pluggable interface relays and optocouplers

### Ordering details – CR-P range



CR-P complete version

2CDC29.001F0019

#### Ordering details - CR-P range complete versions

Rated control supply voltage	Out-puts	Description	Socket type	Connection terminal	Type	Order code	Pkg qty	Weight (1 pc.) kg (lb)
12 V DC	1 c/o	Reverse polarity protection and freewheeling diode, LED green, holder	standard	screw	CR-P012DC1SS42V	<a href="#">1SVR405600R4010</a>	10	0.057 (0.126)
24 V DC	1 c/o	Reverse polarity protection and freewheeling diode, LED green, holder	standard	screw	CR-P024DC1SS42V	<a href="#">1SVR405600R1010</a>	10	0.057 (0.126)
		Reverse polarity protection and freewheeling diode, LED green, holder	logical	spring	CR-P024DC1LC42V	<a href="#">1SVR405600R1011</a>	10	0.057 (0.126)
		Varistor and LED red, holder	logical	spring	CR-P024DC1LC62C	<a href="#">1SVR405600R1013</a>	10	0.057 (0.126)
110 V DC	1 c/o	Reverse polarity protection and freewheeling diode, LED green, holder	standard	screw	CR-P110DC1SS42CV	<a href="#">1SVR405600R8010</a>	10	0.057 (0.126)
24 V AC	1 c/o	Varistor and LED green, holder	standard	screw	CR-P024AC1SS62CV	<a href="#">1SVR405600R0010</a>	10	0.057 (0.126)
120 V AC	1 c/o	Varistor and LED green, holder	standard	screw	CR-P120AC1SS92CV	<a href="#">1SVR405600R2010</a>	10	0.057 (0.126)
230 V AC	1 c/o	Reverse polarity protection and freewheeling diode, LED green, holder	standard	screw	CR-P230AC1SS92CV	<a href="#">1SVR405600R3110</a>	10	0.057 (0.126)
		Holder	logical	screw	CR-P230AC1LS	<a href="#">1SVR405600R3011</a>	10	0.057 (0.126)
		Varistor and LED green, holder	logical	spring	CR-P230AC1LC92CV	<a href="#">1SVR405600R3010</a>	10	0.057 (0.126)

# Pluggable interface relays and optocouplers

## Ordering details – CR-P range



CR-P complete version

2DC291001F0019

### Ordering details - CR-P range complete versions

Rated control supply voltage	Out-puts	Description	Socket type	Conne-ction terminal	Type	Order code	Pkg qty	Weight (1 pc.) kg (lb)
12 V DC	2 c/o	Reverse polarity protection and freewheeling diode, LED green, holder	standard	screw	CR-P012DC2SS42V	<a href="#">1SVR405601R4010</a>	10	0.057 (0.126)
24 V DC	2 c/o	Reverse polarity protection and freewheeling diode, LED green, holder	standard	screw	CR-P024DC2SS42V	<a href="#">1SVR405601R1010</a>	10	0.057 (0.126)
		Reverse polarity protection and freewheeling diode, LED red, holder	logical	screw	CR-P024DC2LS42	<a href="#">1SVR405601R1013</a>	10	0.057 (0.126)
		Reverse polarity protection and freewheeling diode, LED green, holder	logical	screw	CR-P024DC2LS42V	<a href="#">1SVR405601R1011</a>	10	0.057 (0.126)
		Reverse polarity protection and freewheeling diode, LED red, holder	logical	spring	CR-P024DC2LC42	<a href="#">1SVR405601R1012</a>	10	0.057 (0.126)
24 V DC	2 c/o gold plated	Reverse polarity protection and freewheeling diode, LED green, holder	logical	spring	CR-P024DC2GLC42V	<a href="#">1SVR405606R1010</a>	10	0.057 (0.126)
		Varistor and LED red, holder	logical	spring	CR-P024DC2GLC62C	<a href="#">1SVR405606R1013</a>	10	0.057 (0.126)
		Varistor and LED green, holder	logical	spring	CR-P024DC2GLC62CV	<a href="#">1SVR405606R1011</a>	10	0.057 (0.126)
110 V DC	2 c/o	Reverse polarity protection and freewheeling diode, LED green, holder	standard	screw	CR-P110DC2SS42CV	<a href="#">1SVR405601R8010</a>	10	0.057 (0.126)
24 V AC	2 c/o	Varistor and LED green, holder	standard	screw	CR-P024AC2SS62CV	<a href="#">1SVR405601R0010</a>	10	0.057 (0.126)
120 V AC	2 c/o	Varistor and LED green, holder	standard	screw	CR-P120AC2SS92CV	<a href="#">1SVR405601R2010</a>	10	0.057 (0.126)
230 V AC	2 c/o	Reverse polarity protection and freewheeling diode, LED green, holder	standard	screw	CR-P230AC2SS92CV	<a href="#">1SVR405601R3110</a>	10	0.057 (0.126)
		Varistor and LED green, holder	logical	screw	CR-P230AC2LS92CV	<a href="#">1SVR405601R3011</a>	10	0.057 (0.126)
		Diode and LED red, holder	logical	spring	CR-P230AC2LC92	<a href="#">1SVR405601R3012</a>	10	0.057 (0.126)
230 V AC	2 c/o gold plated	Diode and LED red, holder	logical	spring	CR-P230AC2GLC92	<a href="#">1SVR405606R3013</a>	10	0.057 (0.126)
		Varistor and LED red, holder	logical	spring	CR-P230AC2GLC92C	<a href="#">1SVR405606R3012</a>	10	0.057 (0.126)
		Varistor and LED green, holder	logical	spring	CR-P230AC2GLC92CV	<a href="#">1SVR405606R3010</a>	10	0.057 (0.126)

## Pluggable interface relays and optocouplers

### Ordering details – CR-M range



CR-M

The CR-M range offers the possibility of switching up to 4 different circuits with a single relay. The integrated LED and test button\* allow for easy testing and commissioning. This range of relays are available at a wide range of different coil voltages and are accompanied by a wide variety of function modules. The CR-M range also includes complete versions consisting of a relay, socket, holder, marker and where applicable, function module.

#### Ordering details - CR-M range without LED

Rated control supply voltage	Outputs	Contact ratings	Type	Order code	Pkg qty	Weight (1 pc.) kg (lb)				
12 V DC	2 c/o (SPDT)	250 V, 12 A	CR-M012DC2	1SVR405611R4000	10	0.033 (0.073)				
24 V DC			CR-M024DC2	1SVR405611R1000						
48 V DC			CR-M048DC2	1SVR405611R6000						
60 V DC			CR-M060DC2	1SVR405611R4200						
110 V DC			CR-M110DC2	1SVR405611R8000						
125 V DC			CR-M125DC2	1SVR405611R8200						
220 V DC			CR-M220DC2	1SVR405611R9000						
24 V AC			CR-M024AC2	1SVR405611R0000						
48 V AC			CR-M048AC2	1SVR405611R5000						
110 V AC			CR-M110AC2	1SVR405611R7000						
120 V AC			CR-M120AC2	1SVR405611R2000						
230 V AC			CR-M230AC2	1SVR405611R3000						
12 V DC			3 c/o (SPDT)	250 V, 10 A			CR-M012DC3	1SVR405612R4000	10	0.033 (0.073)
24 V DC							CR-M024DC3	1SVR405612R1000		
48 V DC	CR-M048DC3	1SVR405612R6000								
60 V DC	CR-M060DC3	1SVR405612R4200								
110 V DC	CR-M110DC3	1SVR405612R8000								
125 V DC	CR-M125DC3	1SVR405612R8200								
220 V DC	CR-M220DC3	1SVR405612R9000								
24 V AC	CR-M024AC3	1SVR405612R0000								
48 V AC	CR-M048AC3	1SVR405612R5000								
60 V AC	CR-M060AC3	1SVR405612R5200								
110 V AC	CR-M110AC3	1SVR405612R7000								
120 V AC	CR-M120AC3	1SVR405612R2000								
230 V AC	CR-M230AC3	1SVR405612R3000								
12 V DC	4 c/o (SPDT)	250 V, 6 A			CR-M012DC4	1SVR405613R4000	10	0.033 (0.073)		
24 V DC			CR-M024DC4	1SVR405613R1000						
48 V DC			CR-M048DC4	1SVR405613R6000						
60 V DC			CR-M060DC4	1SVR405613R4200						
110 V DC			CR-M110DC4	1SVR405613R8000						
125 V DC			CR-M125DC4	1SVR405613R8200						
220 V DC			CR-M220DC4	1SVR405613R9000						
24 V AC			CR-M024AC4	1SVR405613R0000						
48 V AC			CR-M048AC4	1SVR405613R5000						
110 V AC			CR-M110AC4	1SVR405613R7000						
120 V AC			CR-M120AC4	1SVR405613R2000						
230 V AC			CR-M230AC4	1SVR405613R3000						

\* Note: During the operation of the relay, the temperature of the test button will increase. In order to manually operate the test button, the supply voltage should first be disconnected. The test button is only safe to operate once it has cooled down or by using protective gloves and insulated tools. During operation, the test button should be pressed smoothly and quickly. When the test button is depressed, the n/o contacts will close and remain closed. Once the button is released, the n/o contacts change status and open. A 90 degree rotation of the test button closes and holds the n/o contacts in a closed position. Reverse rotation of the test button will once again change the status of the n/o contacts to their default open position.

## Pluggable interface relays and optocouplers

### Ordering details – CR-M range



CR-M

#### Ordering details - CR-M range with LED

Rated control supply voltage	Outputs	Contact ratings	Type	Order code	Pkg qty	Weight (1 pc.) kg (lb)				
12 V DC	2 c/o (SPDT)	250 V, 12 A	CR-M012DC2L	1SVR405611R4100	10	0.033 (0.073)				
24 V DC			CR-M024DC2L	1SVR405611R1100						
48 V DC			CR-M048DC2L	1SVR405611R6100						
60 V DC			CR-M060DC2L	1SVR405611R4300						
110 V DC			CR-M110DC2L	1SVR405611R8100						
125 V DC			CR-M125DC2L	1SVR405611R8300						
220 V DC			CR-M220DC2L	1SVR405611R9100						
12 V AC			CR-M012AC2L	1SVR405611R0300						
24 V AC			CR-M024AC2L	1SVR405611R0100						
48 V AC			CR-M048AC2L	1SVR405611R5100						
110 V AC			CR-M110AC2L	1SVR405611R7100						
120 V AC			CR-M120AC2L	1SVR405611R2100						
230 V AC			CR-M230AC2L	1SVR405611R3100						
12 V DC			3 c/o (SPDT)	250 V, 10 A			CR-M012DC3L	1SVR405612R4100	10	0.033 (0.073)
24 V DC							CR-M024DC3L	1SVR405612R1100		
48 V DC							CR-M048DC3L	1SVR405612R6100		
60 V DC	CR-M060DC3L	1SVR405612R4300								
110 V DC	CR-M110DC3L	1SVR405612R8100								
125 V DC	CR-M125DC3L	1SVR405612R8300								
220 V DC	CR-M220DC3L	1SVR405612R9100								
12 V AC	CR-M012AC3L	1SVR405612R0300								
24 V AC	CR-M024AC3L	1SVR405612R0100								
48 V AC	CR-M048AC3L	1SVR405612R5100								
110 V AC	CR-M110AC3L	1SVR405612R7100								
120 V AC	CR-M120AC3L	1SVR405612R2100								
230 V AC	CR-M230AC3L	1SVR405612R3100								
12 V DC	4 c/o (SPDT)	250 V, 6 A			CR-M012DC4L	1SVR405613R4100	10	0.033 (0.073)		
24 V DC					CR-M024DC4L	1SVR405613R1100				
48 V DC					CR-M048DC4L	1SVR405613R6100				
60 V DC			CR-M060DC4L	1SVR405613R4300						
110 V DC			CR-M110DC4L	1SVR405613R8100						
125 V DC			CR-M125DC4L	1SVR405613R8300						
220 V DC			CR-M220DC4L	1SVR405613R9100						
12 V AC			CR-M012AC4L	1SVR405613R0300						
24 V AC			CR-M024AC4L	1SVR405613R0100						
48 V AC			CR-M048AC4L	1SVR405613R5100						
110 V AC			CR-M110AC4L	1SVR405613R7100						
120 V AC			CR-M120AC4L	1SVR405613R2100						
230 V AC			CR-M230AC4L	1SVR405613R3100						

## Pluggable interface relays and optocouplers

### Ordering details – CR-M range



CR-M

2CDC291002 F0015

#### Ordering details - CR-M range with LED and free-wheeling diode

Rated control supply voltage	Outputs	Contact ratings	Type	Order code	Pkg qty	Weight (1 pc.) kg (lb)
12 V DC	2 c/o (SPDT)	250 V, 6 A	CR-M012DC2LD	1SVR405611R4400	10	0.033 (0.073)
24 V DC			CR-M024DC2LD	1SVR405611R1400	10	0.033 (0.073)
48 V DC			CR-M048DC2LD	1SVR405611R6400	10	0.033 (0.073)
110 V DC			CR-M110DC2LD	1SVR405611R8400	10	0.033 (0.073)
125 V DC			CR-M125DC2LD	1SVR405611R8500	10	0.033 (0.073)
220 V DC			CR-M220DC2LD	1SVR405611R9400	10	0.033 (0.073)
12 V DC	3 c/o (SPDT)	250 V, 10 A	CR-M012DC3LD	1SVR405612R4400	10	0.033 (0.073)
24 V DC			CR-M024DC3LD	1SVR405612R1400	10	0.033 (0.073)
48 V DC			CR-M048DC3LD	1SVR405612R6400	10	0.033 (0.073)
110 V DC			CR-M110DC3LD	1SVR405612R8400	10	0.033 (0.073)
125 V DC			CR-M125DC3LD	1SVR405612R8500	10	0.033 (0.073)
220 V DC			CR-M220DC3LD	1SVR405612R9400	10	0.033 (0.073)
12 VDC	4 c/o (SPDT)	250 V, 6 A	CR-M012DC4LD	1SVR405613R4400	10	0.033 (0.073)
24 V DC			CR-M024DC4LD	1SVR405614R1100	10	0.033 (0.073)
48 V DC			CR-M048DC4LD	1SVR405613R6400	10	0.033 (0.073)
110 V DC			CR-M110DC4LD	1SVR405613R8400	10	0.033 (0.073)
125 V DC			CR-M125DC4LD	1SVR405613R8500	10	0.033 (0.073)
220 V DC			CR-M220DC4LD	1SVR405613R9400	10	0.033 (0.073)

#### Ordering details - CR-M range with gold contacts

Rated control supply voltage	Outputs	Contact ratings	Type	Order code	Pkg qty	Weight (1 pc.) kg (lb)
24 V DC	4 c/o (SPDT)	250 V, 6 A	CR-M024DC4G	1SVR405618R1000	10	0.033 (0.073)
24 V AC			CR-M024AC4G	1SVR405618R0000		
110 V AC			CR-M110AC4G	1SVR405618R7000		
230 V AC			CR-M230AC4G	1SVR405618R3000		

## Pluggable interface relays and optocouplers

### Ordering details – CR-M range



CR-M

#### Ordering details – CR-M range with gold contacts and LED

Rated control supply voltage	Outputs	Contact ratings	Type	Order code	Pkg qty	Weight (1 pc.) kg (lb)
12 V DC	4 c/o (SPDT)	250 V / 6 A	CR-M012DC4LG	1SVR405618R4100	10	0.033 (0.073)
24 V DC			CR-M024DC4LG	1SVR405618R1100		
48 V DC			CR-M048DC4LG	1SVR405618R6100		
60 V DC			CR-M060DC4LG	1SVR405618R4300		
110 V DC			CR-M110DC4LG	1SVR405618R8100		
125 V DC			CR-M125DC4LG	1SVR405618R8300		
220 V DC			CR-M220DC4LG	1SVR405618R9100		
24 V AC			CR-M024AC4LG	1SVR405618R0100		
48 V AC	CR-M048AC4LG	1SVR405618R5100				
110 V AC	CR-M110AC4LG	1SVR405618R7100				
120 V AC	CR-M120AC4LG	1SVR405618R2100				
230 V AC	CR-M230AC4LG	1SVR405618R3100				

#### Ordering details – CR-M range with gold contacts, LED and free-wheeling diode

Rated control supply voltage	Outputs	Contact ratings	Type	Order code	Pkg qty	Weight (1 pc.) kg (lb)
12 V DC	4 c/o (SPDT)	250 V / 6 A	CR-M012DC4LDG	1SVR405618R4400	10	0.033 (0.073)
24 V DC			CR-M024DC4LDG	1SVR405618R1400		



## Pluggable interface relays and optocouplers

### Ordering details – CR-M range



CR-M complete version

2CDC291002F0019

#### Ordering details – CR-M range complete version

Rated control supply voltage	Out-puts	Description	Socket type	Connection terminal	Type	Order code	Pkg	Weight
							qty	(1 pc.) kg (lb)
12 V DC	4 c/o gold-plated	LED red, holder	standard	screw	CR-M012DC4LDGSS	<a href="#">1SVR405618R4410</a>	10	0.0109 (0.024)
24 V DC	4 c/o	Reverse polarity protection and free-wheeling diode, LED green, holder	standard	screw	CR-M024DC4SS42V	<a href="#">1SVR405613R1010</a>	10	0.0109 (0.024)
		Reverse polarity protection and free-wheeling diode, LED green, holder	logical	screw	CR-M024DC4LS42V	<a href="#">1SVR405613R1011</a>	10	0.0109 (0.024)
		Reverse polarity protection and free-wheeling diode, LED red, holder	logical	spring	CR-M024DC4LC42	<a href="#">1SVR405613R1012</a>	10	0.0109 (0.024)
24 V DC	4 c/o gold-plated	Reverse polarity protection and free-wheeling diode, LED green, holder	standard	screw	CR-M024DC4GSS42V	<a href="#">1SVR405618R1011</a>	10	0.0109 (0.024)
		Varistor, LED green, holder	logical	spring	CR-M024DC4GLC62CV	<a href="#">1SVR405618R1010</a>	10	0.0109 (0.024)
		LED, free-wheeling diode, holder	logical	spring	CR-M024DC4LGLC22	<a href="#">1SVR405618R1110</a>	10	0.0109 (0.024)
		LED red, free-wheeling diode, holder	standard	screw	CR-M024DC4LDGSS	<a href="#">1SVR405618R1410</a>	10	0.0109 (0.024)
24 V AC	4 c/o	Varistor and LED green, holder	logical	screw	CR-M024AC4LS62CV	<a href="#">1SVR405613R0010</a>	10	0.0109 (0.024)

## Pluggable interface relays and optocouplers

Ordering details – CR-M range



CR-M complete version

2CDCR31002F0019

### Ordering details – CR-M range complete version

Rated control supply voltage	Out-puts	Description	Socket type	Connection terminal	Type	Order code	Pkg	Weight
							qty	(1 pc.) kg (lb)
230 V AC	4 c/o	Varistor, LED green, holder	standard	screw	CR-M230AC4SS92CV	<a href="#">1SVR405613R3110</a>	10	0.0109 (0.024)
		Varistor, LED green, holder	logical	screw	CR-M230AC4LS92CV	<a href="#">1SVR405613R3011</a>	10	0.0109 (0.024)
		Diode and LED red, holder	logical	spring	CR-M230AC4LC92	<a href="#">1SVR405613R3012</a>	10	0.0109 (0.024)
230 V AC	4 c/o gold-plated	Reverse polarity protection and free-wheeling diode, LED green, holder	standard	screw	CR-M230AC4GSS92CV	<a href="#">1SVR405618R3112</a>	10	0.0109 (0.024)
		LED red, holder	logical	screw	CR-M230AC4LGLC	<a href="#">1SVR405618R3110</a>	10	0.0109 (0.024)
		LED red, holder	standard	screw	CR-M230AC4LGSS	<a href="#">1SVR405618R3111</a>	10	0.0109 (0.024)

## Pluggable interface relays and optocouplers

### Ordering details – CR-M range



CR-M2LS

2CDC291042F0004



CR-M4SS

2CDC291009F0011

Standard and logical sockets for CR-M interface relays are suitable for snap-on mounting onto a DIN rail. Optional function modules for the CR-M range are plugged into both standard and logical sockets.

#### Ordering details - Sockets\*

Version	Connection terminal	Type	Order code	Pkg qty	Weight (1 pc.) kg (lb)
Logical socket for 2 c/o	screw	CR-M2LS	1SVR405651R1100	10	0.055 (0.121)
Logical socket for 3 c/o		CR-M3LS	1SVR405651R2100		0.062 (0.137)
Logical socket for 2/4 c/o		CR-M4LS	1SVR405651R3100		0.066 (0.146)
Logical socket for 2 c/o	spring	CR-M2LC	1SVR405651R1200	10	0.065 (0.143)
Logical socket for 2/4 c/o		CR-M4LC	1SVR405651R3200		0.066 (0.146)
Standard socket for 2 c/o	screw	CR-M2SS	1SVR405651R1000	10	0.066 (0.146)
Standard socket for 3 c/o		CR-M3SS	1SVR405651R2000		0.068 (0.150)
Standard socket for 2/4 c/o		CR-M4SS	1SVR405651R3000		0.070 (0.154)
Standard socket for 2 c/o	fork type	CR-M2SF	1SVR405651R1300	10	0.040 (0.088)
Standard socket for 2/4 c/o		CR-M4SF	1SVR405651R3300		0.048 (0.106)

\*All CR-M socket packages include a set of markers.

#### Standard sockets

Position of connection terminals: coil connection (A1-A2) on lower side of the socket, contact connections (n/o and n/c contacts) on the lower and upper side of the socket.

#### Logical sockets

Position of connection terminals: coil connection (A1-A2) on lower side of the socket, all contact connections (common contacts, n/o and n/c contacts) on upper side of the socket.

#### Ordering details - Accessories



CR-MJ

2CDC291005F0007

Version	Type	Order code	Pkg qty	Weight (1 pc.) kg (lb)
Plastic holder for socket	CR-MH	1SVR405659R1000	10	0.003 (0.007)
Metal holder for socket	CR-MH1	1SVR405659R1100	10	0.0005 (0.001)
Jumper bar for sockets with screw connection	CR-MJ	1SVR405658R6000	10	0.029 (0.064)
Marker for CR-M standard sockets	CR-MM	1SVR405658R1000	10	0.0005 (0.001)
Plug for test button replacement	CR-MP	1SVR405658R2000	100	0.001 (0.002)

## Pluggable interface relays and optocouplers

### Ordering details – CR-P/M function modules



CR-P/M ...

#### Ordering details - Diode - Reverse polarity protection / free-wheeling diode

Rated control supply voltage $U_s$	Version	Type	Order code	Pkg qty	Weight (1 pc.) kg (lb)
6-220 V DC	A1+, A2-	CR-P/M 22	1SVR405651R0000	10	0.003 (0.007)

#### Ordering details - Diode and LED - Reverse polarity protection / free-wheeling diode and LED to indicate energized coil

Rated control supply voltage $U_s$	Version	Type	Order code	Pkg qty	Weight (1 pc.) kg (lb)
6-24 V DC	red, A1+, A2-	CR-P/M 42	1SVR405652R0000	10	0.003 (0.007)
6-24 V DC	green, A1+, A2-	CR-P/M 42 V	1SVR405652R1000		
24-60 V DC	red, A1+, A2-	CR-P/M 42 B	1SVR405652R4000		
24-60 V DC	green, A1+, A2-	CR-P/M 42 BV	1SVR405652R4100		
110 V DC	red, A1+, A2-	CR-P/M 42 C	1SVR405652R9000		
110 V DC	green, A1+, A2-	CR-P/M 42 CV	1SVR405652R9100		

#### Ordering details - RC element - Spark quenching

Rated control supply voltage $U_s$	Version	Type	Order code	Pkg qty	Weight (1 pc.) kg (lb)
6-24 V AC/DC		CR-P/M 52B	1SVR405653R0000	10	0.003 (0.007)
24-60 V AC/DC		CR-P/M 52D	1SVR405653R4000		
110-230 V AC/DC		CR-P/M 52C	1SVR405653R1000		

#### Ordering details - Diode and LED - LED to indicate energized coil

Rated control supply voltage $U_s$	Version	Type	Order code	Pkg qty	Weight (1 pc.) kg (lb)
6-24 V AC/DC	red, for DC: A1+, A2-	CR-P/M 62	1SVR405654R0000	10	0.003 (0.007)
6-24 V AC/DC	green, for DC: A1+, A2-	CR-P/M 62 V	1SVR405654R1000		
24-60 V AC/DC	red, for DC: A1+, A2-	CR-P/M 62 E	1SVR405654R4000		
24-60 V AC/DC	green, for DC: A1+, A2-	CR-P/M 62 EV	1SVR405654R4100		
110-230 V AC/DC	red, for DC: A1+, A2-	CR-P/M 92	1SVR405654R0100		
110-230 V AC/DC	green, for DC: A1+, A2-	CR-P/M 92 V	1SVR405654R1100		

## Pluggable interface relays and optocouplers

### Ordering details – CR-P/M function modules



CR-P/M ...

#### Ordering details - Varistor and LED - Overvoltage protection and LED to indicate energized coil

Rated control supply voltage $U_c$	Version	Type	Order code	Pkg qty	Weight (1 pc.) kg (lb)
6-24 V AC/DC	red, for DC: A1+, A2-	CR-P/M 62 C	1SVR405655R0000	10	0.003 (0.007)
6-24 V AC/DC	green, for DC: A1+, A2-	CR-P/M 62 CV	1SVR405655R1000		
24-60 V AC/DC	red, for DC: A1+, A2-	CR-P/M 62 D	1SVR405655R4000		
24-60 V AC/DC	green, for DC: A1+, A2-	CR-P/M 62 DV	1SVR405655R4100		
110-230 V AC/DC	red, for DC: A1+, A2-	CR-P/M 92 C	1SVR405655R0100		
110-230 V AC/DC	green, for DC: A1+, A2-	CR-P/M 92 CV	1SVR405655R1100		

#### Ordering details - Varistor - Overvoltage protection

Rated control supply voltage $U_c$	Version	Type	Order code	Pkg qty	Weight (1 pc.) kg (lb)
24 V AC		CR-P/M 72	1SVR405656R0000	10	0.002 (0.004)
115 V AC		CR-P/M 72 A	1SVR405656R1000		
230 V AC		CR-P/M 82	1SVR405656R2000		

## Pluggable interface relays and optocouplers

### Ordering details – CR-U range



CR-U

2CDC291 047 F0004

The CR-U range offers up to 3 change over contacts in single relay. The integrated LED and test button\* allow for easy testing and commissioning. This robust range of relays are available at a wide range of different coil voltages and are accompanied by a wide variety of function modules.

#### Ordering details - CR-U range without LED

Rated control supply voltage	Outputs	Contact ratings	Type	Order code	Pkg qty	Weight (1 pc.) kg (lb)				
12 V DC	2 c/o (SPDT)	250 V, 10 A	CR-U012DC2	1SVR405621R4000	10	0.083 (0.183)				
24 V DC			CR-U024DC2	1SVR405621R1000						
48 V DC			CR-U048DC2	1SVR405621R6000						
110 V DC			CR-U110DC2	1SVR405621R8000						
220 V DC			CR-U220DC2	1SVR405621R9000						
24 V AC			CR-U024AC2	1SVR405621R0000						
48 V AC			CR-U048AC2	1SVR405621R5000						
110 V AC			CR-U110AC2	1SVR405621R7000						
120 V AC			CR-U120AC2	1SVR405621R2000						
230 V AC			CR-U230AC2	1SVR405621R3000						
12 V DC			3 c/o (SPDT)	250 V, 10 A			CR-U012DC3	1SVR405622R4000	10	0.083 (0.183)
24 V DC							CR-U024DC3	1SVR405622R1000		
48 V DC							CR-U048DC3	1SVR405622R6000		
110 V DC							CR-U110DC3	1SVR405622R8000		
125 V DC	CR-U125DC3	1SVR405622R8200								
220 V DC	CR-U220DC3	1SVR405622R9000								
24 V AC	CR-U024AC3	1SVR405622R0000								
48 V AC	CR-U048AC3	1SVR405622R5000								
60 V AC	CR-U060AC3	1SVR405622R5200								
110 V AC	CR-U110AC3	1SVR405622R7000								
120 V AC	CR-U120AC3	1SVR405622R2000								
230 V AC	CR-U230AC3	1SVR405622R3000								

\* Note: During the operation of the relay, the temperature of the test button will increase. In order to manually operate the test button, the supply voltage should first be disconnected. The test button is only safe to operate once it has cooled down or by using protective gloves and insulated tools. During operation, the test button should be pressed smoothly and quickly. When the test button is depressed, the n/o contacts will close and remain closed. Once the button is released, the n/o contacts change status and open. A 90 degree rotation of the test button closes and holds the n/o contacts in a closed position. Reverse rotation of the test button will once again change the status of the n/o contacts to their default open position.

#### Ordering details - CR-U range with LED

Rated control supply voltage	Outputs	Contact ratings	Type	Order code	Pkg qty	Weight (1 pc.) kg (lb)
12 V DC	2 c/o (SPDT)	250 V, 10 A	CR-U012DC2L	1SVR405621R4100	10	0.083 (0.183)
24 V DC			CR-U024DC2L	1SVR405621R1100		
48 V DC			CR-U048DC2L	1SVR405621R6100		
110 V DC			CR-U110DC2L	1SVR405621R8100		
220 V DC			CR-U220DC2L	1SVR405621R9100		
12 V AC			CR-U012AC2L	1SVR405621R0300		
24 V AC			CR-U024AC2L	1SVR405621R0100		
48 V AC			CR-U048AC2L	1SVR405621R5100		
110 V AC			CR-U110AC2L	1SVR405621R7100		
120 V AC			CR-U120AC2L	1SVR405621R2100		
230 V AC			CR-U230AC2L	1SVR405621R3100		

## Pluggable interface relays and optocouplers

### Ordering details – CR-U range

#### Ordering details - CR-U range with LED

Rated control supply voltage	Outputs	Contact ratings	Type	Order code	Pkg qty	Weight (1 pc.) kg (lb)
12 V DC	3 c/o (SPDT)	250 V, 10 A	CR-U012DC3L	1SVR405622R4100	10	0.083 (0.183)
24 V DC			CR-U024DC3L	1SVR405622R1100		
48 V DC			CR-U048DC3L	1SVR405622R6100		
110 V DC			CR-U110DC3L	1SVR405622R8100		
220 V DC			CR-U220DC3L	1SVR405622R9100		
12 V AC			CR-U012AC3L	1SVR405622R0300		
24 V AC			CR-U024AC3L	1SVR405622R0100		
48 V AC			CR-U048AC3L	1SVR405622R5100		
110 V AC			CR-U110AC3L	1SVR405622R7100		
120 V AC			CR-U120AC3L	1SVR405622R2100		
230 V AC			CR-U230AC3L	1SVR405622R3100		

#### Ordering details - CR-U range with LED and free-wheeling diode

Rated control supply voltage	Outputs	Contact ratings	Type	Order code	Pkg qty	Weight (1 pc.) kg (lb)
12 V DC	2 c/o (SPDT)	250 V, 10 A	CR-U012DC2LD	<u>1SVR405621R4400</u>	10	0.033 (0.073)
24 V DC			CR-U024DC2LD	<u>1SVR405621R1400</u>	10	0.033 (0.073)
48 V DC			CR-U048DC2LD	<u>1SVR405621R6400</u>	10	0.033 (0.073)
110 V DC			CR-U110DC2LD	<u>1SVR405621R8400</u>	10	0.033 (0.073)
12 V DC	3 c/o (SPDT)	250 V, 10 A	CR-U012DC3LD	<u>1SVR405622R4400</u>	10	0.033 (0.073)
24 V DC			CR-U024DC3LD	<u>1SVR405623R1100</u>	10	0.033 (0.073)
48 V DC			CR-U048DC3LD	<u>1SVR405622R6400</u>	10	0.033 (0.073)
110 V DC			CR-U110DC3LD	<u>1SVR405622R8400</u>	10	0.033 (0.073)



CR-U

2CDC 291 047 F0004

The sockets for CR-U interface relays have screw connection terminals and are suitable for snap-on mounting onto a DIN rail. Optional function modules for the CR-U range may only be plugged into compatible standard sockets.

#### Ordering details - Sockets and Accessories

Version	Type	Order code	Pkg qty	Weight (1 pc.) kg
Socket for 2 c/o and function module	CR-U2S	1SVR405670R0000	10	0.065
Socket for 3 c/o and function module	CR-U3S	1SVR405660R0000		0.065
Socket for 3 c/o	CR-U3E	1SVR405660R0100		0.065
Small socket for 2 c/o	CR-U2SM	1SVR405670R1100		0.054
Small socket for 3 c/o	CR-U3SM	1SVR405660R1100		0.058
Metal holder for socket	CR-UH	1SVR405669R0000		0.001



CR-U2S

2CDC 291 007 S0011

#### CR-U sockets

Position of connection terminals: coil connection (A1-A2) on lower side of socket, contact connections (n/o and n/c contacts) on the lower and upper side of socket.

## Pluggable interface relays and optocouplers

### Ordering details – CR-U function modules



CR-U...

2CDC291.004.S0011

CR-U function modules are compatible with the CR-U2S and CR-U3S sockets only.

#### Diode - Reverse polarity protection / free-wheeling diode

Rated control supply voltage	Version	Type	Order code	Pkg qty	Weight (1 pc.) kg (lb)
6-220 V DC	A1+, A2-	CR-U 21	1SVR405661R0000	10	0.007 (0.015)

#### Diode and LED - Reverse polarity protection / free-wheeling diode and LED to indicate energized coil

Rated control supply voltage	Version	Type	Order code	Pkg qty	Weight (1 pc.) kg (lb)
6-24 V DC	red, A1+, A2-	CR-U 41	1SVR405662R0000	10	0.007 (0.015)
6-24 V DC	green, A1+, A2-	CR-U 41V	1SVR405662R1000		
24-60 V DC	red, A1+, A2-	CR-U 41B	1SVR405662R4000		
24-60 V DC	green, A1+, A2-	CR-U 41BV	1SVR405662R4100		
110 V DC	red, A1+, A2-	CR-U 41C	1SVR405662R9000		
110 V DC	green, A1+, A2-	CR-U 41CV	1SVR405662R9100		

#### RC element - Spark quenching

Rated control supply voltage	Version	Type	Order code	Pkg qty	Weight (1 pc.) kg (lb)
6-24 V AC/DC		CR-U 51B	1SVR405663R0000	10	0.007 (0.015)
24-60 V AC/DC		CR-U 51D	1SVR405663R4000		
110 -230 V AC/DC		CR-U 51C	1SVR405663R1000		

#### Diode and LED - LED to indicate energized coil

Rated control supply voltage	Version	Type	Order code	Pkg qty	Weight (1 pc.) kg (lb)
6-24 V AC/DC	red, for DC A1+, A2-	CR-U 61	1SVR405664R0000	10	0.007 (0.015)
6-24 V AC/DC	green, for DC A1+, A2-	CR-U 61V	1SVR405664R1000		
24-60 V AC/DC	red, for DC A1+, A2-	CR-U 61E	1SVR405664R4000		
24-60 V AC/DC	green, for DC A1+, A2-	CR-U 61EV	1SVR405664R4100		
110-230 V AC/DC	red, for DC A1+, A2-	CR-U 91	1SVR405664R0100		
110-230 V AC/DC	green, for DC: A1+, A2-	CR-U 91V	1SVR405664R1100		



## Pluggable interface relays and optocouplers

### Ordering details – CR-U function modules



CR-U...

2CDC291 004 50011

#### Varistor and LED - Overvoltage protection and LED to indicate energized coil

Rated control supply voltage	Version	Type	Order code	Pkg qty	Weight (1 pc.) kg (lb)
6-24 V AC/DC	red, for DC A1+, A2-	CR-U 61C	1SVR405665R0000	10	0.007 (0.015)
6-24 V AC/DC	green, for DC A1+, A2-	CR-U 61CV	1SVR405665R1000		
24-60 V AC/DC	red, for DC A1+, A2-	CR-U 61D	1SVR405665R4000		
24-60 V AC/DC	green, for DC A1+, A2-	CR-U 61DV	1SVR405665R4100		
110-230 V AC/DC	red, for DC A1+, A2-	CR-U 91C	1SVR405665R0100		
110-230 V AC/DC	green, for DC A1+, A2-	CR-U 91CV	1SVR405665R1100		



CR-U T

2CDC291 039 F0005

#### Varistor - Overvoltage protection

Rated control supply voltage	Version	Type	Order code	Pkg qty	Weight (1 pc.) kg (lb)
24 V AC		CR-U 71	1SVR405666R0000	10	0.007 (0.015)
115 V AC		CR-U 71A	1SVR405666R1000		
230 V AC		CR-U 81	1SVR405666R2000		

#### Multi-function time module\*

Rated control supply voltage	Version	Type	Order code	Pkg qty	Weight (1 pc.) kg (lb)
24-240 V AC/DC	green LED	CR-U T	1SVR405667R0000	10	0.014 (0.031)

\* For more details, refer to the [CR-U T datasheet](#).

## Pluggable interface relays and optocouplers

### Technical data - CR-S interface relays

Input circuit							
	Rated control supply voltage $U_s$	Make voltage (at 23 °C)	Maximum voltage (at 55 °C)	Break voltage	Rated power	Coil resistance (at 23 °C)	Tolerance of coil resistance
CR-S005VDC1R(G)	5 V DC	3.75 V DC	7.5 V DC	0.25 V DC	170 mW	147 $\Omega$	$\pm 10\%$
CR-S012VDC1R(G)	12 V DC	9 V DC	18 V DC	0.6 V DC	170 mW	848 $\Omega$	$\pm 10\%$
CR-S024VDC1R(G)	24 V DC	18 V DC	36 V DC	1.2 V DC	170 mW	3390 $\Omega$	$\pm 15\%$
CR-S048VDC1R(G)	48 V DC	36 V DC	72 V DC	2.4 V DC	210 mW	10600 $\Omega$	$\pm 15\%$
CR-S060VDC1R(G)	60 V DC	45 V DC	90 V DC	3 V DC	210 mW	16600 $\Omega$	$\pm 15\%$
Output circuits							
Output circuit(s)	11-12/14						
Kind of output	1 c/o (SPDT)						
Contact material	AgSnO <sub>2</sub> or AgSnO <sub>2</sub> /Au						
Rated operational voltage $U_e$ (IEC/EN 60947-1)	250 V AC						
Minimum switching voltage	5 V at 100 mA (AgSnO <sub>2</sub> ) / 5 V at 12 mA (AgSnO <sub>2</sub> /Au)						
Maximum switching voltage	400 V AC / 250 V DC						
Minimum switching current	10 mA at 10 V (AgSnO <sub>2</sub> ) / 3 mA at 20 V (AgSnO <sub>2</sub> /Au)						
Rated free air thermal current $I_{th}$	5 A						
Rated operational current (IEC/EN 60947-5-1)	AC12 (resistive)	230 V	6 A				
	AC15 (inductive)	230 V	1.5 A				
	AC15 (inductive)	120 V	3 A				
	DC12 (resistive)	24 V	6 A				
	DC13 (inductive)	24 V	1 A				
	DC13 (inductive)	120 V	0.22 A				
	DC13 (inductive)	250 V	0.11 A				
AC rating (UL 508; NEMA ICS-5)	utilization category (pilot duty) (contact rating code designation)		B300				
DC rating (UL 508; NEMA ICS-5)	utilization category (pilot duty) (contact rating code designation)		R300				
Maximum making (inrush) current	15 A, 240 V AC						
Minimum switching power	100 mA/12 V (AgSnO <sub>2</sub> ) / 50 mW (AgSnO <sub>2</sub> /Au)						
Maximum switching (breaking) power	AC1 (resistive)	1500 VA, 250 V AC					
Contact resistance	100 m $\Omega$ (at 1 A/ 6 V DC)						
Maximum operating frequency	rated load AC1	360 switching cycles/h					
	without load	18000 switching cycles/h					
Mechanical lifetime	1 x 10 <sup>7</sup> switching cycles						
Electrical lifetime	AC1 (resistive)	(n/c) 3 x 10 <sup>4</sup> switching cycles (at +85 °C) (n/o) 1 x 10 <sup>4</sup> switching cycles (at +85 °C)					
Response time	8 ms						
Release time	4 ms						
Isolation data							
Rated insulation voltage	250 V AC						
Rated impulse withstand voltage $U_{imp}$	between coil and contacts	4000 V 1 min					
	between open contacts	1000 V 1 min					
Clearance	between coil and contacts	5.5 mm (0.217 in)					
Creepage distance	between coil and contacts	8 mm (0.315 in)					
Overvoltage category	III						
Pollution degree	2						
General data							
Dimensions	see 'Dimensional drawings'						
Mounting	on socket						
Mounting position	any						
Degree of protection	RT II and RT III						

## Pluggable interface relays and optocouplers

### Technical data - CR-S interface relays and CR-S optocouplers

Electrical connection		
Connection	by socket	
Environmental data		
Ambient temperature range	operation	-40...+85 °C
	storage	-40...+85 °C
Vibration resistance (10-150 Hz)	n/o contact	10 Hz to 55 Hz 1 mm DA
	n/c contact	10 Hz to 55 Hz 1 mm DA
Shock resistance	n/o contact	function 49 m/s <sup>2</sup> / destructive 980 m/s <sup>2</sup>
	n/c contact	function 49 m/s <sup>2</sup> / destructive 980 m/s <sup>2</sup>
Standards/directives		
Standards	IEC/EN 61810-1	
RoHS Directive	2011/65/EU	

### Technical data - CR-S optocouplers

Input circuit	CR-S024VDC1TRA	CR-S024VDC1MOS	CR-S024VDC1TRI
Input resistance	3400 Ohm		
Rated control voltage	24 V DC*		
Pull-in voltage	15 V DC		
Maximum input voltage	30 V DC		
Nominal input current	7 mA		
Input power	168 mW		
Typical switching-on time	< 40 ms	< 60 ms	< 1/2 cycle
Typical switch-off time	< 600 ms	< 600 ms	< 1/2 cycle
Output circuits			
Output circuit(s)	11 (13+) - 14	11 (13+) - 14	11 (13+) - 14
Kind of output	Transistor	MOS-FET	Triac
Rated operational voltage	48 V DC	24 V DC	240 V AC
Maximum switching voltage	48 V DC	24 V DC	275 V AC
Minimum switching current	50 mA	50 mA	22 mA
Maximum switching current continuously	100 mA	2 A	2 A
Leakage current at maximum switching voltage	<1 mA	<1 mA	< 1.5 mA
Voltage drop at rated current	< 120 mV DC	< 120 mV DC	< 1.6 V AC
Isolation data			
Rated insulation voltage	input/output	2.5 kV	
Insulation class		2	
Clearance	input/output	14 mm	
Creepage distance	input/output	14 mm	
Overtoltage category		III	
Pollution degree		2	
General data			
Dimensions	see 'Dimensional drawings'		
Weight	3.5 g (0.007 lb)		
Mounting	on socket		
Environmental data			
Ambient temperature	operation	-30...+80 °C	
	storage	-40...+100 °C	
Standards / Directives			
Standards	IEC/EN 62314		
EMC Directive	2014/30/EN		
RoHS Directive	2011/65/EN		

\* The output circuit should not exceed 30 m.

## Pluggable interface relays and optocouplers

### Technical data - CR-S sockets

Input circuit	CR-S 6-24 V	CR-S 12-24 V	CR-S 48-60 V	CR-S 110-125 V	CR-S 220-240 V
Rated control supply voltage $U_s$	6-24 V DC	12-24 V AC/DC*	48-60 V AC/DC	110-125 V AC/DC	220-240 V AC/DC
Rated control supply voltage $U_s$ tolerance	(0.8-1.2) $U_n$	(0.8-1.1) $U_n$			
Typical current	11-29 mA	11-16 mA	3.6-4.5 mA	3.6 mA	3.6 mA
Response time	8 ms				
Release time	4 ms				
Status device	green LED				
Protective circuit	yes				
<b>Output circuits</b>					
Output circuit(s)	11-12/14				
Number of poles	1				
Rated voltage	250 V AC				
Rated current	6 A				
<b>General data for CR-S with screw connection terminal</b>					
Dimensions	see 'Dimensional drawings'				
Degree of protection (EN 60529)	Degree of protection (EN 60529) IP20 (terminals)				
Temperature range	operation	-40...+70 °C			-40...+55 °C
	storage	-40...+85 °C			
Connection type	Screw				
Maximum number of wires per connection terminal	2				
Connecting capacity	rigid	2 x 0.5 - 1.5 mm <sup>2</sup> (2 x 20 - 16 AWG)			
	fine-strand				
	with wire end ferule	2 x 0.5 - 1 mm <sup>2</sup> (2 x 20 - 18 AWG)			
Tightening torque	0.5 Nm (4.426 lb.in)				
Stripping length	7 mm (0.28 in)				
Minimum clamping force for fine-strand wire	with 0.2 mm <sup>2</sup>	10 N			
	with 1.5 mm <sup>2</sup>	40 N			
Mounting (IEC/EN 60715)	DIN rail				
Material	socket	PA6 +GF-V2			
	contacts	CuZn36			
	contact surface	3 μ Ni/Sn			
	terminals	CuZn40, 3 μ Ni			
	combi screw M3	Fe			
<b>General data for CR-S with spring connection terminal</b>					
Dimensions without holder (L x W x H)	see 'Dimensional drawings'				
Degree of protection (EN 60529)	Degree of protection (EN 60529) IP20 (terminals)				
Temperature range	operation	-40...+70 °C			-40...+55 °C
	storage	-40...+85 °C			
Connection type	Spring				
Maximum number of wires per connection terminal	1				
Connecting capacity	0.75 - 2.5 mm <sup>2</sup> (20 - 14 AWG) rigid, fine-strand and with wire end ferrule				
Stripping length	7 mm (0.28 in)				
Mounting (IEC/EN 60715)	DIN rail				
Material	socket	PA6 +GF-V2			
	contacts	CuZn36			
	contact surface	3 μ Ni/Sn			
	spring terminals	SUS301			
<b>Isolation data</b>					
Isolation between coil and contacts	5000 V AC				
Resistance to shock coil to contact	1000 MΩ				
Clearance and creepage distance	IEC/EN 61984				
<b>Standards / Directives</b>					
Standard	IEC/EN 61984				
Low Voltage Directive	2014/35/EU				
RoHS Directive	2011/65/EU				

\* In combination with optocouplers, only DC supply is allowed

## Pluggable interface relays and optocouplers

### Technical data - CR-S jumper bars

Rated operational voltage / current		CR-SJB20-BLUE	CR-SJB20-RED	CR-SJB20-BLACK
Rated operational voltage		250 V AC		
Rated operational current		36 A		
<b>Electrical connection</b>				
Jumper bar cross section		123.2 mm (4.850 in)		
Step distance		6.3 mm (0.248 in)		
Rail length		with isolation 16.7 mm (0.657 in)		
		without isolation 6.7 mm (0.264 in)		
Stripping length of a connection wire that is used in combination with a jumper bar		7 mm (0.276 in)		
<b>Environmental data</b>				
Ambient temperature range		operation -40 ... +70 °C		
<b>General data</b>				
Material of rail		Cu		
Number of pins		20		
Flammability		V0		

## Pluggable interface relays and optocouplers

Technical data – CR-P, CR-M, CR-U

### Input circuit - coil data

#### CR-P range

	Rated control supply voltage $U_s$	Rated frequency	Make voltage (at 20 °C)	Maximum voltage (at 55 °C)	Break voltage	Rated power	Coil resistance (at 20 °C)	Tolerance of coil resistance
DC coils	12 V DC	-	8.4 V DC	30.6 V DC	$\geq 0.1 U_s$	0.4-0.48 W	360 $\Omega$	$\pm 10\%$
	24 V DC	-	16.8 V DC	61.2 V DC	$\geq 0.1 U_s$	0.4-0.48 W	1440 $\Omega$	$\pm 10\%$
	48 V DC	-	33.6 V DC	122.4 V DC	$\geq 0.1 U_s$	0.4-0.48 W	5700 $\Omega$	$\pm 10\%$
	110 V DC	-	77 V DC	280 V DC	$\geq 0.1 U_s$	0.4-0.48 W	25200 $\Omega$	$\pm 10\%$
AC coils	24 V AC	50 / 60 Hz	19.2 V AC	28.8 V AC	$\geq 0.15 U_s$	0.75 VA	400 $\Omega$	$\pm 10\%$
	48 V AC	50 / 60 Hz	38.4 V AC	57.6 V AC	$\geq 0.15 U_s$	0.75 VA	1550 $\Omega$	$\pm 10\%$
	110 V AC	50 / 60 Hz	88 V AC	132 V AC	$\geq 0.15 U_s$	0.75 VA	8900 $\Omega$	$\pm 10\%$
	120 V AC	50 / 60 Hz	96 V AC	144 V AC	$\geq 0.15 U_s$	0.75 VA	10200 $\Omega$	$\pm 10\%$
	230 V AC	50 / 60 Hz	184 V AC	276 V AC	$\geq 0.15 U_s$	0.75 VA	38500 $\Omega$	$\pm 10\%$

#### CR-P optocouplers range

Input circuit	CR-P024MOS1	CR-P024TRI1
Input resistance	2200 $\Omega$	1950 $\Omega$
Rated control voltage	24 V DC	24 V DC
Pull-in voltage	10 V DC	10 V DC
Maximum input voltage	32 V DC	32 V DC
Nominal input current	10 mA	12 mA
Input power	260 mW	295 mW
Typical switching-on time	50 ms	< 1/2 cycle
Typical switch-off time	250 ms	< 1/2 cycle

#### CR-M range

	Rated control supply voltage $U_s$	Rated frequency	Make voltage (at 20 °C)	Maximum voltage (at 55 °C)	Break voltage	Rated power	Coil resistance (at 20 °C)	Tolerance of coil resistance
DC coils	12 V DC	-	9.6 V DC	13.2 V DC	$\geq 0.1 U_s$	0.9 W	160 $\Omega$	$\pm 10\%$
	24 V DC	-	19.2 DC	26.4 V DC	$\geq 0.1 U_s$	0.9 W	640 $\Omega$	$\pm 10\%$
	48 V DC	-	38.4 V DC	52.8 V DC	$\geq 0.1 U_s$	0.9 W	2600 $\Omega$	$\pm 10\%$
	60 V DC	-	48 V DC	66 V DC	$\geq 0.1 U_s$	0.9 W	4000 $\Omega$	$\pm 10\%$
	110 V DC	-	88 V DC	121 V DC	$\geq 0.1 U_s$	0.9 W	13600 $\Omega$	$\pm 10\%$
	125 V DC	-	100 V DC	137.5 V DC	$\geq 0.1 U_s$	0.9 W	16000 $\Omega$	$\pm 10\%$
	220 V DC	-	176 V DC	242 V DC	$\geq 0.1 U_s$	0.9 W	54000 $\Omega$	$\pm 10\%$
AC coils	24 V AC	50 / 60 Hz	19.2 V AC	26.4 V AC	$\geq 0.2 U_s$	1.6 VA	158 $\Omega$	$\pm 10\%$
	48 V AC	50 / 60 Hz	38.4 V AC	52.8 V AC	$\geq 0.2 U_s$	1.6 VA	640 $\Omega$	$\pm 10\%$
	60 V AC	50 / 60 Hz	48 V AC	66 V AC	$\geq 0.2 U_s$	1.6 VA	930 $\Omega$	$\pm 10\%$
	110 V AC	50 / 60 Hz	88 V AC	121 V AC	$\geq 0.2 U_s$	1.6 VA	3450 $\Omega$	$\pm 10\%$
	120 V AC	50 / 60 Hz	96 V AC	132 V AC	$\geq 0.2 U_s$	1.6 VA	3770 $\Omega$	$\pm 10\%$
	230 V AC	50 / 60 Hz	184 V AC	253 V AC	$\geq 0.2 U_s$	1.6 VA	16100 $\Omega$	$\pm 10\%$

## Pluggable interface relays and optocouplers

Technical data – CR-P, CR-M, CR-U

### CR-U range

	Rated control supply voltage $U_s$	Rated frequency	Make voltage (at 20 °C)	Maximum voltage (at 55 °C)	Break voltage	Rated power	Coil resistance (at 20 °C)	Tolerance of coil resistance
DC coils	12 V DC	-	9.6 V DC	13.2 V DC	$\geq 0.1 U_s$	1.5 W	110 $\Omega$	$\pm 10 \%$
	24 V DC	-	19.2 V DC	26.4 V DC	$\geq 0.1 U_s$	1.5 W	430 $\Omega$	$\pm 10 \%$
	48 V DC	-	38.4 V DC	52.8 V DC	$\geq 0.1 U_s$	1.5 W	1750 $\Omega$	$\pm 10 \%$
	110 V DC	-	88.0 V DC	121.0 V DC	$\geq 0.1 U_s$	1.5 W	9200 $\Omega$	$\pm 10 \%$
	125 V DC	-	100 V DC	137.5 V DC	$\geq 0.1 U_s$	1.5 W	11000 $\Omega$	$\pm 10 \%$
	220 V DC	-	176.0 V DC	242.0 V DC	$\geq 0.1 U_s$	1.5 W	37000 $\Omega$	$\pm 10 \%$
AC coils	24 V AC	50 / 60 Hz	19.2 V AC	26.4 V AC	$\geq 0.15 U_s$	2.8 VA (50 Hz) 2.5 VA (60 Hz)	75 $\Omega$	$\pm 10 \%$
	48 V AC	50 / 60 Hz	38.4 V AC	52.8 V AC	$\geq 0.15 U_s$	2.8 VA (50 Hz) 2.5 VA (60 Hz)	305 $\Omega$	$\pm 10 \%$
	60 V AC	50 / 60 Hz	48.0 V AC	66.0 V AC	$\geq 0.15 U_s$	2.8 VA (50 Hz) 2.5 VA (60 Hz)	475 $\Omega$	$\pm 10 \%$
	110 V AC	50 / 60 Hz	88.0 V AC	121.0 V AC	$\geq 0.15 U_s$	2.8 VA (50 Hz) 2.5 VA (60 Hz)	1700 $\Omega$	$\pm 10 \%$
	120 V AC	50 / 60 Hz	96.0 V AC	132.0 V AC	$\geq 0.15 U_s$	2.8 VA (50 Hz) 2.5 VA (60 Hz)	1910 $\Omega$	$\pm 10 \%$
	230 V AC	50 / 60 Hz	184.0 V AC	253.0 V AC	$\geq 0.15 U_s$	2.8 VA (50 Hz) 2.5 VA (60 Hz)	7080 $\Omega$	$\pm 10 \%$

## Pluggable interface relays and optocouplers

Technical data – CR-P, CR-M, CR-U

Type	CR-P...1	CR-P...2	CR-M...2	CR-M...3	CR-M...4	CR-U...2	CR-U...3	
Output circuit(s)	11-12/14	11-12/14 21-22/24	11-12/14 21-22/24	11-12/14 21-22/24 31-32/34	11-12/14 21-22/24 31-32/34 41-42/44	11-12/14 31-32/34	11-12/14 21-22/24 31-32/34	
Kind of output	Relay, 1 c/o	Relay, 2 c/o	Relay, 2 c/o	Relay, 3 c/o	Relay, 4 c/o	Relay, 2 c/o	Relay, 3 c/o	
Contact material	AgNi	AgNi AgNi/Au 5 µm	AgNi	AgNi	AgNi AgNi/Au 5 µm	AgNi		
Rated operational voltage $U_e$ (VDE 0110, IEC 60947-1)	250 V							
Minimum switching voltage	5 V		10 V (AgNi); 5 V (AgNi/Au)			10 V		
Maximum switching voltage	DC 300 V DC		250 V DC					
	AC 440 V AC		250 V AC				440 V AC	
Minimum switching current	5 mA (AgNi), 2 mA (AgNi/Au)		5 mA (AgNi)	5 mA (AgNi)	2 mA (AgNi/Au)	5 mA		
Rated free air thermal current $I_{th}$	16 A	8 A	12 A	10 A	6 A	10 A		
Rated operational current (IEC 60947-5-1)	AC-12 (resistive) 230 V	16 A	8 A	12 A	10 A	6 A	10 A	
	AC-15 (inductive) 230 V	1.5 A	1.5 A	1.5 A	1.5 A	1 A	1.5 A	
	AC-15 (inductive) 120 V	3 A			1.5 A		3 A	
	DC-12 (resistive) 24 V	16 A	8 A	12 A	10 A	6 A	10 A	
	DC-13 (inductive) 24 V	2.5 A	2 A	2.5 A	2.5 A	2 A	2 A	
	DC-13 (inductive) 120 V	0.22 A						
AC rating (UL 508)	utilization category (pilot duty) (contact rating code designation)	B300		B300			B300	
	max. rated operational voltage	300 V AC		300 V AC			300 V AC	
	max. continuous thermal current at utilization category	5 A		5 A	5 A	2.5 A	5 A	
	max. making / breaking apparent power at utilization category	3600 / 360 VA		3600 / 360 VA			1800 / 180 VA	3600/360 VA
	utilization category (resistive) (CSA22.2 No.14....)	16 A, 250 V AC	8 A, 250 V AC	10 A, 250 V AC 12 A, 150 V AC	6 A, 250 V AC 10 A, 150 V AC	5 A, 250 V AC 10 A, 150 V AC	10 A, 250 V AC (resistive + single-phase)	
	DC rating * (UL 508; NEMA ICS-5)	utilization category (pilot duty) (contact rating code designation)	R300					
max. rated operational voltage		300 V DC						
max. continuous thermal current at utilization category		1 A						
max. making / breaking apparent power at utilization category		28 VA						
utilization category (resistive) (CSA22.2 No.14....)		-	10 A, 24 V DC	-			10 A, 28 V DC	
Maximum making (inrush) current	30 A	15 A	24 A	20 A	12 A	20 A		
Minimum switching power	0.3 W (AgNi), 0.05 W (AgNi/Au)		0.3 W (AgNi), 0.1 W (AgNi/Au)			0.3 W		
Maximum switching (breaking) power	AC1 (resistive)	4000 VA	2000 VA	3000 VA	2500 VA	1500 VA	2500 VA	
Contact resistance	≤ 100 mΩ							
Maximum operating frequency	rated load AC-1	600 switching cycles/h		1200 switching cycles/h				
	without load	72000 switching cycles/h		18000 switching cycles/h			12000 switching cycles/h	



## Pluggable interface relays and optocouplers

### Technical data – CR-P, CR-M, CR-U

Type		CR-P...1	CR-P...2	CR-M...2	CR-M...3	CR-M...4	CR-U...2	CR-U...3
Mechanical lifetime		> 3 x 10 <sup>7</sup> switching cycles		> 2 x 10 <sup>7</sup> switching cycles				
Electrical lifetime	electrical AC1 (resistive)	> 0.7 x 10 <sup>5</sup> switching cycles (16 A, 250 V)	> 10 <sup>5</sup> switching cycles (8 A, 250 V)	> 10 <sup>5</sup> switching cycles (12 A, 250 V) (10 A, 250 V) (6 A, 250 V)			> 10 <sup>5</sup> switching cycles (12 A, 250 V)	
	cos φ	see reduction factor F						
Response time		typ. 7 ms		typ. 13 ms (DC), 10 ms (AC)			typ. 18 ms (DC), 12 ms (AC)	
Release time		typ. 3 ms		typ. 3 ms (DC), 8 ms (AC)			typ. 7 ms (DC), 10 ms (AC)	
<b>Isolation data</b>								
Rated insulation voltage		400 V AC		250 V AC				
Insulation class (In accordance to VDE 0110b)		C250 / B400		C250 / B250			C250	
Rated impulse withstand voltage U <sub>imp</sub>	between coil and contacts	5 kV		2.5 kV				
	between open contacts	1 kV		1.5 kV				
	between c/o (SPDT) contacts	-	2.5 kV	2.5 kV		≥ 2 kV	2 kV	
Clearance between coil and contacts		≥ 10 mm		≥ 2.5 mm		≥ 1.6 mm	≥ 3 mm	
Creepage distance between coil and contacts		≥ 10 mm		≥ 4 mm		≥ 3.2 mm	≥ 4.2 mm	
Overvoltage category		III		III		II	III	
Pollution degree		3		3		2	3	
<b>General data</b>								
Dimensions		see 'Dimensional drawings'						
Mounting		on socket (see accessories)						
Mounting position		any						
Degree of protection		IP 67		IP 40				
<b>Electrical connection</b>								
Connection		by socket						
<b>Environmental data</b>								
Ambient temperature range	operation	DC: -40...+85 °; AC: -40...+70 °C		DC: -40...+70 °; AC: -40...+55 °C				
	storage	-40 ... +85 °C						
Vibration resistance 10-150 Hz	n/o contact	10 g		5 g			5 g	
	n/c contact	10 g	5 g	5 g		5 g		
Shock resistance	n/o contact	30 g	20 g	10 g		10 g		
	n/c contact	30 g	20 g	5 g		10 g		
<b>Standards / Directives</b>								
Standards		IEC/EN 61810-1						
Low Voltage Directive		-		2014/35/EU				
RoHS Directive		2011/65/EU						

\* These ratings are based on different type tests which are not covered by the cULus or CSA approvals.

## Pluggable interface relays and optocouplers

### Technical data – CR-P optocouplers

<b>Output circuits</b>		<b>CR-P024MOS1</b>	<b>CR-P024TRI1</b>
Output circuit(s)		11 (13+) - 14	11 (13+) - 14
Kind of output		MOS-FET	Triac
Rated operational voltage		24 V DC	240 V AC
Maximum switching voltage		35 V DC	275 V AC
Minimum switching current		1 mA	50 mA
Maximum switching current continuously		5 A	3,5 A
Leakage current at maximum switching voltage		10 uA	1 mA
Voltage drop at rated current		300 mV	1.1 V
<b>Isolation data</b>			
Rated insulation voltage	input/output	2.5 kV	2.5 kV
Insulation class		2	2
Clearance	input/output	19 mm	19 mm
Creepage distance	input/output	19 mm	19 mm
Overvoltage category		III	III
Pollution degree		2	2
<b>General data</b>			
Dimensions		see 'Dimensional drawings'	
Weight		11 g (0.618 lbs)	11 g (0.618 lbs)
Mounting		on socket	on socket
<b>Environmental data</b>			
Ambient temperature	operational	-20...+80 °C	-20...+80 °C
	storage	-40...+100 °C	-40...+100 °C
<b>Standards / Directives</b>			
Standards		IEC/EN 62314	IEC/EN 62314
EMC Directive		2014/30/EU	2014/30/EU
RoHS Directive		2011/65/EU	2011/65/EU

## Pluggable interface relays and optocouplers

### Technical data - CR-P and CR-M sockets

Output circuits		CR-PLS	CR-PLSx	CR-PSS	CR-PLC	CR-MxLS	CR-MxSS	CR-MxSF	CR-MxLC
Output circuit(s)		11-12/14, 21-22/24				11-12/14, 21-22/24, ...			
Number of poles		2				2, 3 or 4		2 or 4	
Rated voltage		250 V AC/DC	300 V AC/DC	250 V AC/DC		250 V AC/DC			300 V AC/DC
Rated current		2 x 10 A <sup>1)</sup>	2 x 12 A <sup>1)</sup>	2 x 10 A <sup>1)</sup>		7 A			10 A
<b>General data</b>									
Dimensions without holder and module (L x W x H)		76 x 15.8 x 62 mm (2.992 x 0.622 x 2.441 in)	78.5 x 15.5 x 61 mm (3.011 x 0.610 x 2.402 in)	76 x 15.8 x 42.8 mm (2.992 x 0.622 x 1.685 in)	97.5 x 16.3 x 45.2 mm (3.839 x 0.642 x 1.780 in)	75 x 27.2 x 60.8 mm (2.952 x 1.071 x 2.394 in)	75.2 x 27.2 x 42.6 mm (2.961 x 1.071 x 1.677 in)	66.7 x 30.3 x 29 mm (2.626 x 1.193 x 1.142 in)	95 x 31 x 42.5 mm (3.74 x 1.22 x 1.67 in)
Degree of protection		IP 20 B (EN 60529)							
Temperature range		operation		-40...+70 °C		-40...+70 °C		-25...+85 °C	
		storage		-40...+70 °C		-40...+70 °C		-40...+70 °C	
Connection type		screw connection			spring connection	screw connection		fork type screw	spring connection
Maximum number of wires per connecting terminal		2			2 (one per connection point)	2		-	2 (one per connection point)
Connecting capacity		rigid			2 x 0.5 - 2.5 mm <sup>2</sup> (2 x 20 - 14 AWG)	2 x 0.2 - 1.5 mm <sup>2</sup> (2 x 24 - 16 AWG)	2 x 0.5 - 2.5 mm <sup>2</sup> (2 x 20 - 14 AWG)		2 x 0.5 - 1.5 mm <sup>2</sup> (2 x 20 - 16 AWG)
		fine-strand			2 x 0.5 - 1.5 mm <sup>2</sup> (2 x 20 - 16 AWG)	2 x 1.5 mm <sup>2</sup> (2 x 16 AWG)	2 x 0.5 - 1.5 mm <sup>2</sup> (2 x 20 - 16 AWG)		2 x 1.5 mm <sup>2</sup> (2 x 16 AWG)
Stripping length		7 mm (0.28 in)			11 mm (0.43 in)	7 mm (0.28 in)		10 mm (0.39 in)	
Tightening torque		0.6 Nm	0.8 Nm	0.6 Nm		0.6 Nm (5.31 lb.in)			
Maximum clamping force		with 0,2 mm <sup>2</sup>		-	-	10 N	-	-	10 N
		with 1,5 mm <sup>2</sup>		-	-	40 N	-	-	40 N
		with wire end ferrule		-			-	-	-
Mounting		DIN rail (IEC/EN 60715)							
Material		socket				PA 6+GF - V2			
		contacts				CuZn33			
contact surface		5 μ Ni	5 μ tinned	5 μ Ni		5 μ Ni	6 μ Ni	5 μ tinned	
terminals		8 μ Ni	8 μ galvanized	8 μ Ni	XCrNi Steel	8 μ Ni		CCSC	
combi screw M3		8.8 Steel, 5μ Ni			-	8.8 Steel, 5μ Ni			-
<b>Isolation data</b>									
Insulation voltage		> 5 kV	> 3 kV	> 5 kV		> 3 kV		> 4 kV	
Isolation between coil and contacts		IEC/EN 61984							
Clearance and creepage distance		IEC/EN 61984							
<b>Standards / Directives</b>									
Standards		IEC/EN 61984							
Low Voltage Directive		2014/35/EU							
RoHS Directive		2011/65/EU							

<sup>1)</sup> Loads >10 A (>12 A for CR-PLSx) require jumpering of terminal 11 with 21, 12 with 22, and 14 with 24

## Pluggable interface relays and optocouplers

### Technical data - CR-P and CR-M jumper bars

Rated operational voltage / Rated current	CR-PJ	CR-MJ
Rated operational voltage (VDE 0660 / part 500)	400 V	
Rated current (VDE 0660 / part 500)	25 A	
<b>Electrical connection</b>		
Bus bar diameter	6 mm <sup>2</sup> (0.0093 in <sup>2</sup> )	
Step distance	15.5 mm (0.610 in)	27.2 mm (1.071 in)
Rail length	with isolation	150 mm (5.906 in)
	without isolation	141.5 mm (5.571 in)
Stripping length of a connection wire that is used in combination with a jumper bar	6 mm (0.236 in)	
<b>Environmental data</b>		
Ambient temperature range	operation	-40... +55 °C
<b>Isolation data</b>		
Rated impulse withstand voltage U <sub>imp</sub> (VDE 0660 / part 500)	4 kV	
Overvoltage category (IEC/EN 60664)	III	
Polution degree (IEC/EN 60664)	2	
<b>General data</b>		
Material of rail	E-Cu-F25	
Type of rail	pin type	
Number of pins	10	
Number of phases	1	
Color of insulating material	RAL 7035	
Flammability (UL 94)	V0	

## Pluggable interface relays and optocouplers

### Technical data - CR-P and CR-M function modules

<b>CR-P/M 22</b>										
Type	CR-P/M 22									
Version	Diode									
Function	Reverse polarity protection									
Control supply voltage	6-220 V DC									
Component data	diode	1 A, 1000 V								
Polarized	yes (A1+, A2-)									
Material	enclosure / base	PA6 + GF V2								
<b>CR-P/M 42</b>										
Type	CR-P/M 42	CR-P/M 42V	CR-P/M 42B	CR-P/M 42BV	CR-P/M 42C	CR-P/M 42CV				
Version	Diode and LED									
Function	Reverse polarity protection, applied supply voltage indicated via LED									
Control supply voltage	6-24 V DC			24-60 V DC		110 V DC				
Component data	diode	1 A, 1000 V								
	LED	red	green	red	green	red	green			
	resistance	3 k $\Omega$ , 0.25 W		15 k $\Omega$ , 0.25 W		200 k $\Omega$ , 0.25 W				
Polarized	yes (A1+, A2-)									
Material	enclosure / base	PA6 + GF V2								
<b>CR-P/M 52</b>										
Type	CR-P/M 52B			CR-P/M 52D		CR-P/M 52C				
Version	RC element									
Function	Arc elimination									
Control supply voltage	6-24 V AC/DC			24-60 V AC/DC		110-230 V AC/DC				
Component data	capacitor	0.1 $\mu$ F, 63 V DC		0.1 $\mu$ F, 100 V DC		0.082 $\mu$ F, 400 V DC				
	resistance	10 $\Omega$ , 0.25 W		47 $\Omega$ , 0.25 W		100 $\Omega$ , 0.25 W				
Polarized	no									
Material	enclosure / base	PA6 + GF V2								
<b>CR-P/M 62</b>										
Type	CR-P/M 62	CR-P/M 62V	CR-P/M 62E	CR-P/M 62EV	CR-P/M 62C	CR-P/M 62CV	CR-P/M 62D	CR-P/M 62DV		
Version	Diode and LED				Varistor and LED					
Control supply voltage	6-24 V AC/DC		24-60 V AC/DC		6-24 V AC/DC		24-60 V AC/DC			
Component data	diode	1 A, 1000 V								
	LED	red	green	red	green	red	green	red	green	
	varistor	25 V AC		75 V AC		25 V AC		75 V AC		
	resistance	3 k $\Omega$ , 0.25 W		15 k $\Omega$ , 0.25 W		3 k $\Omega$ , 0.25 W		15 k $\Omega$ , 0.25 W		
Polarized	AC: no, DC: yes (A1+, A2-)									
Material	enclosure / base	PA6 + GF V2								
<b>CR-P/M 72, 82</b>										
Type	CR-P/M 72			CR-P/M 72A		CR-P/M 82				
Version	Varistor									
Function	Overvoltage protection									
Control supply voltage	24 V AC			115 V AC		230 V AC				
Component data	varistor	25 V AC		115 V AC		275 V AC				
Polarized	no									
Material	enclosure / base	PA6 + GF V2								
<b>CR-P/M 92</b>										
Type	CR-P/M 92			CR-P/M 92V		CR-P/M 92C		CR-P/M 92CV		
Version	Diode and LED				Varistor and LED					
Control supply voltage	110-230 V AC / 110 V DC									
Component data	diode	1 A, 1000 V								
	LED	red		green		red		green		
	varistor	275 V AC								
	resistance	120 k $\Omega$ , 0.25 W								
Polarized	AC: no, DC: yes (A1+, A2-)									
Material	enclosure / base	PA6 + GF V2								
<b>Standards / Directives</b>										
Standards	IEC/EN 61984									
Low Voltage Directive	2014/35/EU									
RoHS Directive	2011/65/EU									

## Pluggable interface relays and optocouplers

### Technical data - CR-U sockets and function modules

Output circuits		CR-U2S	CR-U3S	CR-U3E	CR-UxSM
Output circuit(s)		11-12/14, 21-22/24,...			
Number of poles		2	3		2 or 3
Rated voltage		250 V AC		300 V AC	250 V
Rated current		10 A			
<b>General data</b>					
Dimensions		see 'Dimensional drawings'			
Degree of protection		IP 20 B (EN 60529)			
Temperature range		operation		-40...+70 °C	-40...+70 °C
		storage		-40...+70 °C	-40...+70 °C
Connecting capacity		rigid 2 x 2 x 0,5 - 2,5 mm <sup>2</sup> (2 x 20 - 14 AWG)			
		fine-strand			
		with wire end ferrule		2 x 0.5 - 1.5 mm <sup>2</sup> (2 x 20 - 16 AWG)	2 x 0.5 - 1.5 mm <sup>2</sup> (2 x 20 - 16 AWG)
Stripping length		7 mm (0.28 in)			
Tightening torque		0.6 Nm		0.8 Nm	0.6 Nm
Mounting		DIN rail (IEC/EN 60715)			
Material		socket PA 6+GF - V2			
		contacts CuZn33			
		contact surface		6 μ Ni	3 μ Ni
		terminals		8 μ Ni	10 μ Ni
		combi screw M3		8.8 steel, 5μ Ni	Steel, 8 μ Ni
<b>Isolation data</b>					
Insulation voltage		> 2 kV			
Isolation between coil and contacts		IEC/EN 61984			
Clearance and creepage distance		IEC/EN 61984			
<b>Standards/Directives</b>					
Standards		IEC/EN 61984			
Low Voltage Directive		2014/35/EU			
RoHS Directive		2011/65/EU			

### Technical data - CR-U function modules

CR-U 21						
Type	CR-U 21					
Version	Diode					
Function	Reverse polarity protection and elimination of the converse current					
Control supply voltage	6-220 V DC					
Component data	Diode	1 A, 1000 V				
Polarized	yes (A1+, A2-)					
Material	Enclosure / Base	PA6 + GF V2				
CR-U 41						
Type	CR-U 41	CR-U 41V	CR-U 41B	CR-U 41BV	CR-U 41C	CR-U 41CV
Version	Diode and LED					
Function	Reverse polarity protection and elimination of the converse current. LED to indicate the energization of coil					
Control supply voltage	6-24 V DC		24-60 VDC		110 V DC	
Component data	Diode	1 A, 1000 V				
	LED	red	green	red	green	red
	Resistance	3 kΩ, 0.25 W		15 kΩ, 0.25 W		200 kΩ, 0.25 W
Polarized	yes (A1+, A2-)					
Material	Enclosure / Base	PA6 + GF V2				

## Pluggable interface relays and optocouplers

### Technical data - CR-U function modules

<b>CR-U 51</b>										
Type	CR-U 51B			CR-U 51D			CR-U 51C			
Version	RC element									
Function	Arc elimination									
Control supply voltage	6-24 V AC/DC			24-60 V AC/DC			110-230 V AC/DC			
Component data	Capacitor	0.1 $\mu$ F, 63 V DC			0.1 $\mu$ F, 100 V DC			0.082 $\mu$ F, 400 V DC		
	Resistance	10 $\Omega$ , 0.25 W			47 $\Omega$ , 0.25 W			100 $\Omega$ , 0.25 W		
Polarized	no									
Material	Enclosure / Base	PA6 + GF V2								
<b>CR-U 61</b>										
Type	CR-U 61	CR-U 61V	CR-U 61E	CR-U 61EV	CR-U 61C	CR-U 61CV	CR-U 61D	CR-U61DV		
Version	Diode and LED				Varistor and LED					
Function	Reverse polarity protection and elimination of the converse current. LED to indicate the energization of coil.				Overvoltage protection, LED to indicate the energized of coil					
Control supply voltage	6-24 V AC/DC			24-60 V AC/DC		6-24 V AC/DC		24-60 V AC/DC		
Component data	Diode	1 A, 1000 V								
	LED	red	green	red	green	red	green	red	green	
	Resistance	3 k $\Omega$ , 0.25 W			15 k $\Omega$ , 0.25 W		3 k $\Omega$ , 0.25 W		15 k $\Omega$ , 0.25 W	
Polarized	AC: no, DC: yes (A1+, A2-)									
Material	Enclosure / Base	PA6 + GF V2								
<b>CR-U 71, 81</b>										
Type	CR-U 71			CR-U 71A			CR-U 81			
Version	Varistor									
Function	Overvoltage protection									
Control supply voltage	24 V AC			115 V AC			230 V AC			
Component data	Varistor	25 V AC			115 V AC			275 V AC		
Polarized	no									
Material	Enclosure / Base	PA6 + GF V2								
<b>CR-U 91</b>										
Type	CR-U 91			CR-U 91V			CR-U 91C		CR-U 91CV	
Version	Diode and LED				Varistor and LED					
Function	Reverse polarity protection and elimination of the converse current. LED to indicate the energization of coil.				Overvoltage protection, LED to indicate the energized of coil					
Control supply voltage	110-230 V AC / 110 V DC									
Component data	Diode	1 A, 1000 V								
	LED	red			green		red		green	
	Resistance	120 k $\Omega$ , 0.25 W								
Polarized	AC: no, DC: yes (A1+, A2-)									
Material	Enclosure / Base	PA6 + GF V2								
<b>Standards / Directives</b>										
Standards	IEC/EN 61984									
Low Voltage Directive	2014/35/EU									
RoHS Directive	2011/65/EU									

# Pluggable interface relays and optocouplers

## Technical diagrams

### Connection diagrams

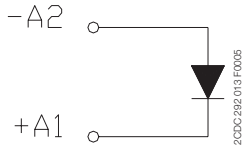

CR-P/M 22

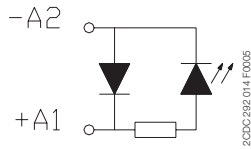

CR-P/M 42, CR-P/M 42B,  
CR-P/M 42C, CR-P/M 42V,  
CR-P/M 42BV, CR-P/M 42CV

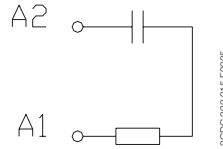

CR-P/M 52B, CR-P/M 52C  
CR-P/M 52D,

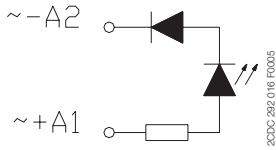

CR-P/M 62, CR-P/M 62E,  
CR-P/M 92, CR-P/M 62V,  
CR-P/M 62EV, CR-P/M 92V

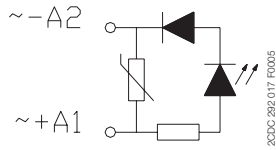

CR-P/M 62C, CR-P/M 62D,  
CR-P/M 92C, CR-P/M 62CV,  
CR-P/M 62DV, CR-P/M 92CV

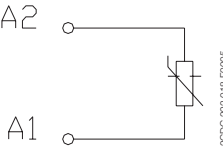

CR-P/M 72, CR-P/M 82  
CR-P/M 72A,

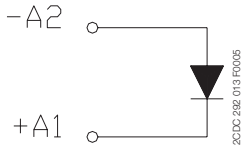

CR-U 21

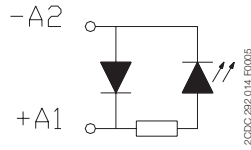

CR-U 41, CR-U 41B, CR-U 41C,  
CR-U 41V, CR-U 41BV, CR-U 41CV

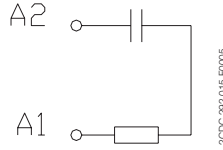

CR-U 51B, CR-U 51C CR-U 51D

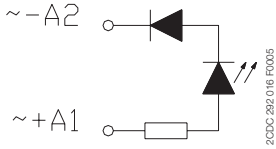

CR-U 61, CR-U 61E, CR-U 91,  
CR-U 61V, CR-U 61EV, CR-U 91V

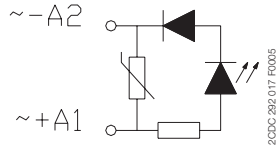

CR-U 61C, CR-U 61CV, CR-U 61D,  
CR-U 61DV, CR-U 91C, CR-U 91CV

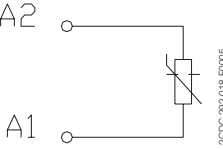

CR-U 71, CR-U 71A, CR-U 81



# Pluggable interface relays and optocouplers

## Technical diagrams

### Connection diagrams

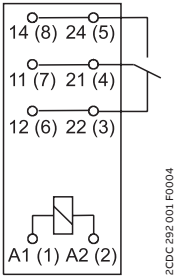

2CDC 292 001 F0004

CR-P with 1 c/o contact

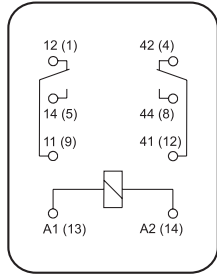

2CDC 292 011 F0004

CR-M with 2 c/o contacts

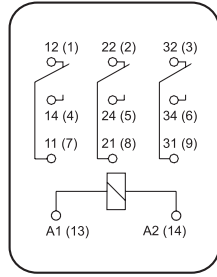

2CDC 292 016 F0004

CR-M with 3 c/o contacts

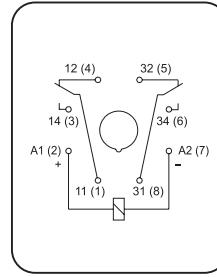

2CDC 292 024 F0004

CR-U with 2 c/o contacts

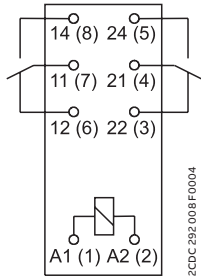

2CDC 292 008 F0004

CR-P with 2 c/o contacts

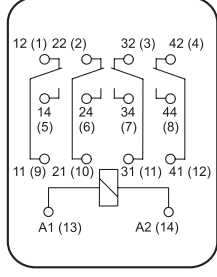

2CDC 292 020 F0004

CR-M with 4 c/o contacts

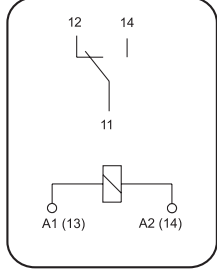

2CDC 292 001 F0014

CR-S

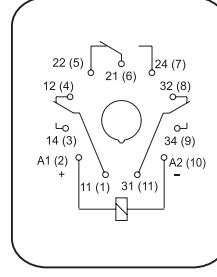

2CDC 292 030 F0004

CR-U with 3 c/o contacts

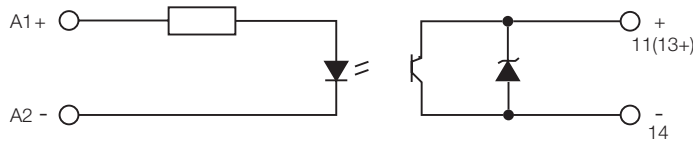

2CDC 292 001 F0016

CR-S optocoupler with Transistor

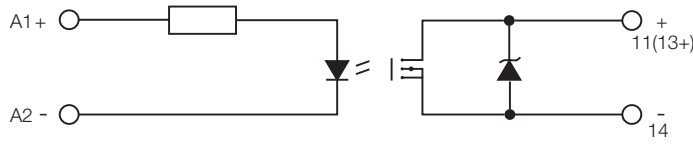

2CDC 292 002 F0016

CR-S optocoupler with MOSFET

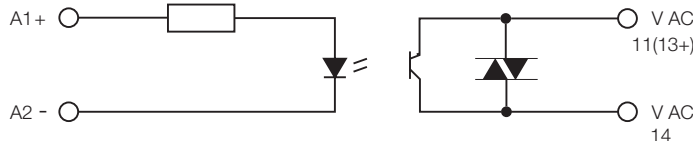

2CDC 292 001 F0016

CR-S optocoupler with Triac

# Pluggable interface relays and optocouplers

## Technical diagrams

### CR-P: Operating range of coils

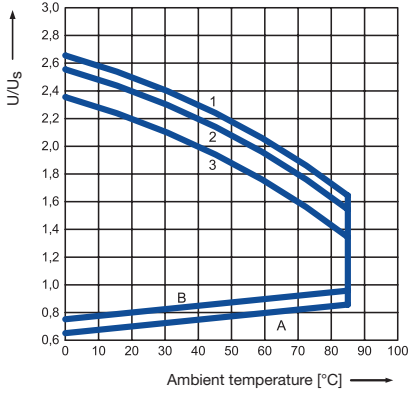

Operating range of DC coil

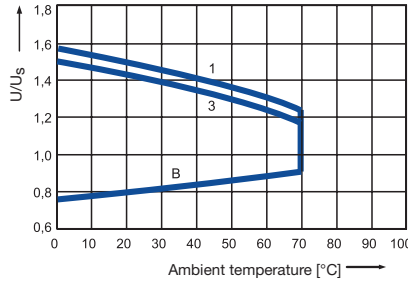

Operating range of AC coil

- A unloaded contacts, coil temperature = ambient temperature
- B continued with  $I_{th}$  (16 A at CR-P ... 1 and 8 A at CR-P ... 2) loaded contacts coil heated with  $1,1 \times U_s$
- 1 at unloaded contacts
- 2 at 50 % rated load
- 3 at rated load

### Electrical connection

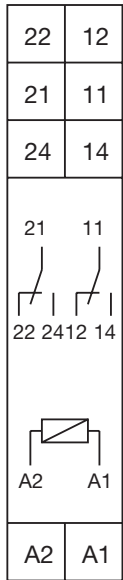

CR-PLS

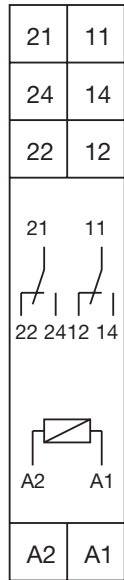

CR-PLSx, CR-PLC

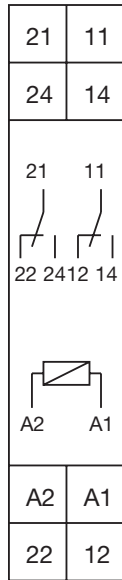

CR-PSS

A1-A2	Supply voltage
11-12/14,	Relay outputs
21-22/24	Relay outputs

# Pluggable interface relays and optocouplers

## Technical diagrams

### Mounting and removal of sockets

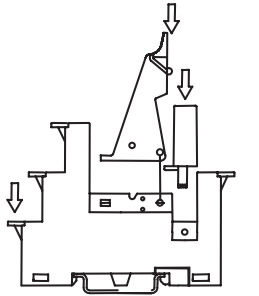

2CDC 292 061 F0004

Mounting

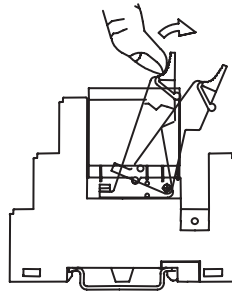

2CDC 292 062 F0004

Removal

### Electrical connection

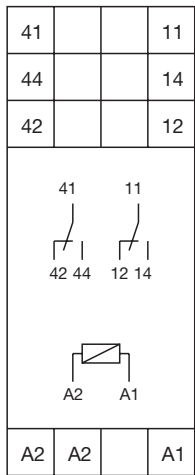

2CDC 292 075 F0004

CR-M2LS

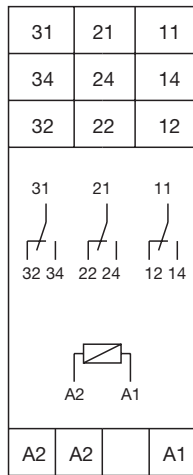

2CDC 292 074 F0004

CR-M3LS

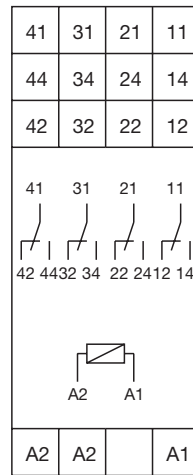

2CDC 292 073 F0004

CR-M4LS

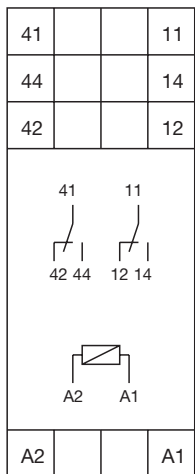

2CDC 292 008 F0004

CR-M2LC

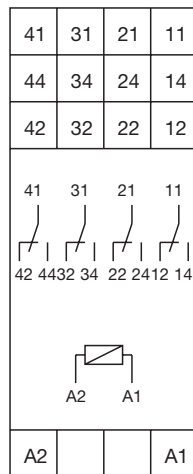

2CDC 292 008 F0004

CR-M4LC

# Pluggable interface relays and optocouplers

## Technical diagrams

### Electrical connection

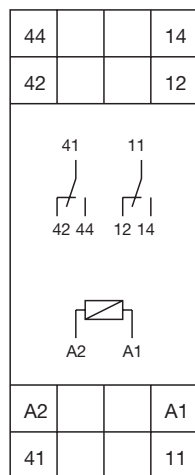

2CDC 232 070 F0004

CR-M2SS,  
CR-M2SF

A1-A2	Supply voltage
11-12/14,	Relay outputs
41-42/44	Relay outputs

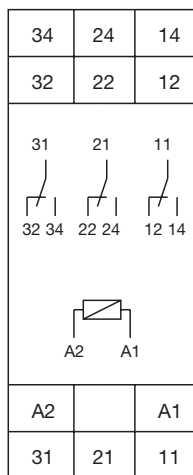

2CDC 232 069 F0004

CR-M3SS

A1-A2	Supply voltage
11-12/14,	Relay outputs
21-22/24,	Relay outputs
31-32/34	Relay outputs

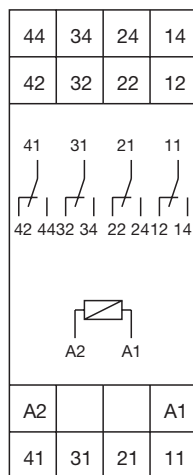

2CDC 232 068 F0004

CR-M4SS,  
CR-M4SF

A1-A2	Supply voltage
11-12/14,	Relay outputs
21-22/24	Relay outputs
31-32/34	Relay outputs
41-42/44	Relay outputs

# Pluggable interface relays and optocouplers

## Technical diagrams

### Technical diagrams CR-S interface relays

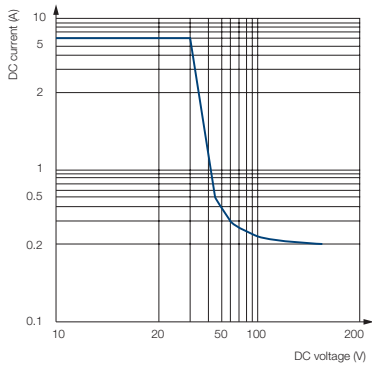

2CDC292.012 F0214

Max. DC load breaking capacity

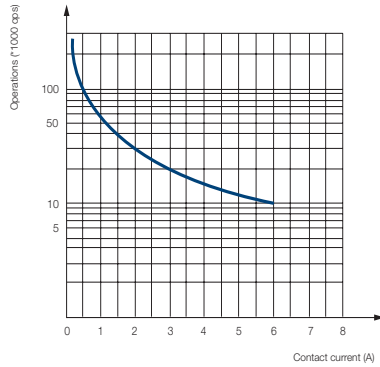

2CDC292.013 F0214

Endurance curve

### Load limit curves CR-P, CR-M and CR-U - Electrical lifetime at resistive AC load

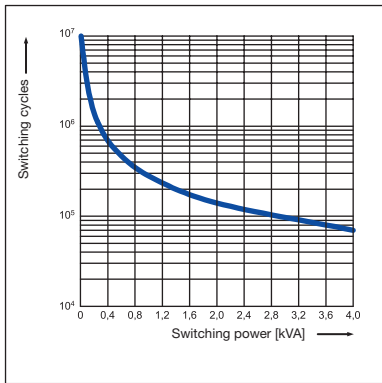

2CDC92009F0204

CR-P with 1 c/o contact

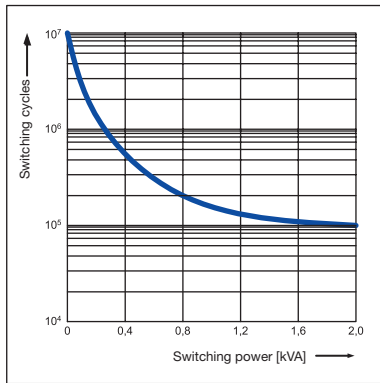

2CDC92009F0204

CR-P with 2 c/o contacts

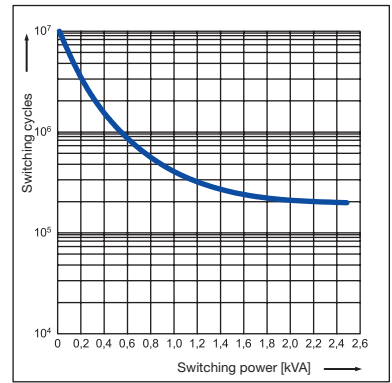

2CDC92027F0204

CR-U with 2 and 3 c/o contacts

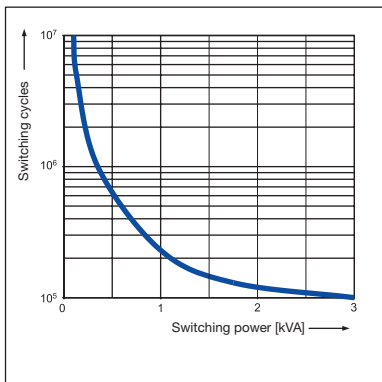

2CDC29203F0204

CR-M with 2 c/o contacts

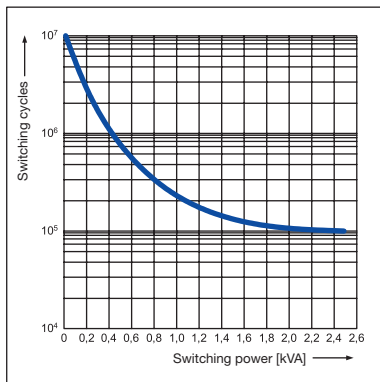

2CDC292018F0204

CR-M with 3 c/o contacts

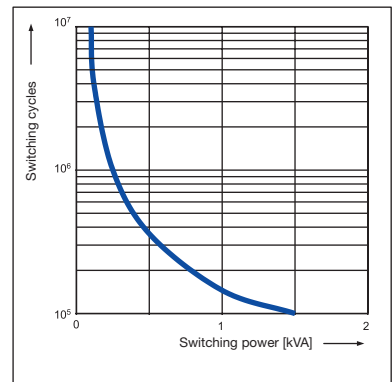

2CDC92022F0204

CR-M with 4 c/o contacts

# Pluggable interface relays and optocouplers

## Technical diagrams

### Load limit curves CR-P, CR-M and CR-U - Maximum switching power at resistive DC load

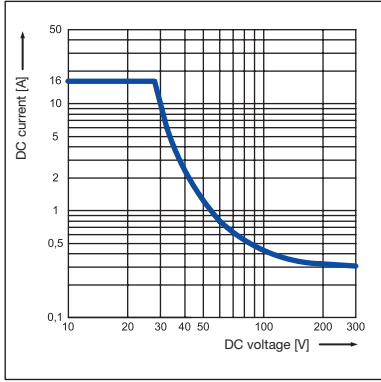

2CDC292009F0204

CR-P with 1 c/o contact

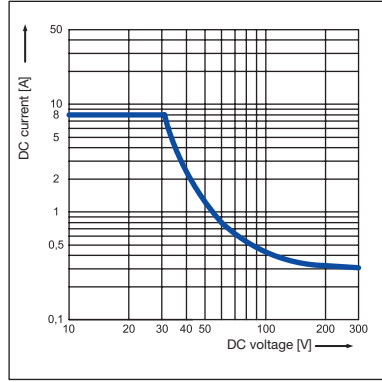

2CDC292010F0204

CR-P with 2 c/o contacts

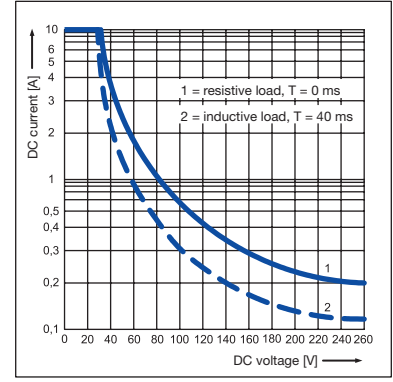

2CDC292029F0204

CR-U with 2 and 3 c/o contacts

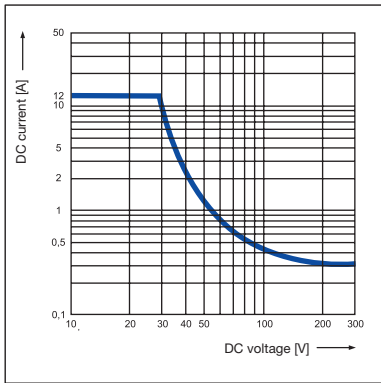

2CDC292015F0204

CR-M with 2 c/o contacts

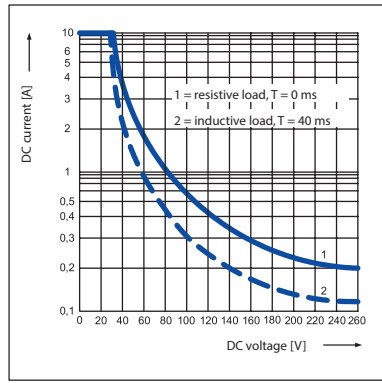

2CDC292019F0204

CR-M with 3 c/o contacts

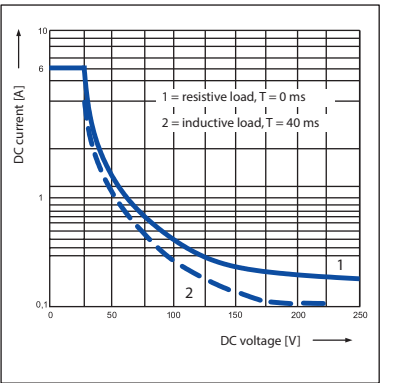

2CDC292023F0204

CR-M with 4 c/o contacts

### Reduction factor CR-P, CR-M and CR-U – F at inductive AC load

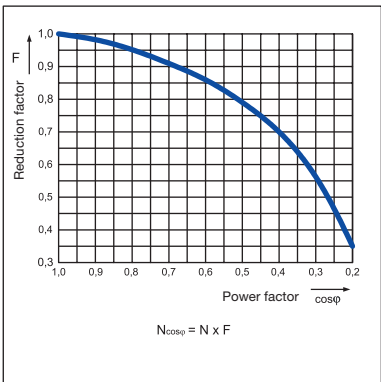

2CDC292004F0204

CR-P

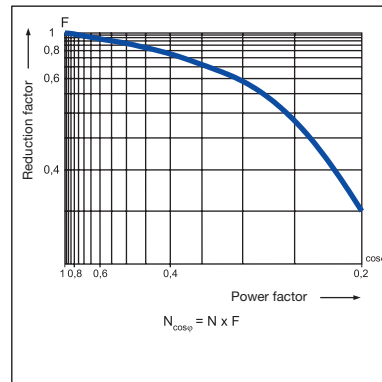

2CDC292014F0204

CR-M

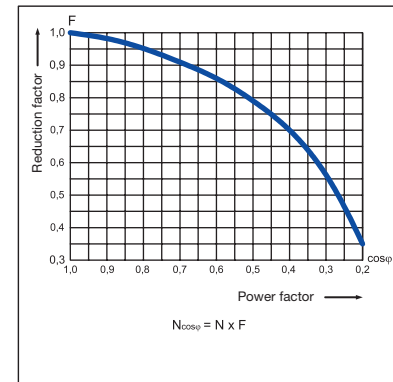

2CDC292029F0204

CR-U

# Pluggable interface relays and optocouplers

## Technical diagrams

### Derating curves

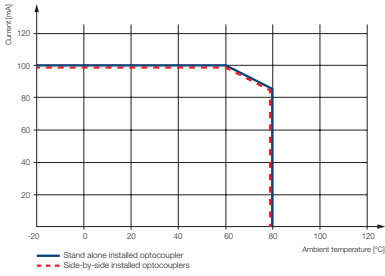

Derating curve Transistor output CR-S

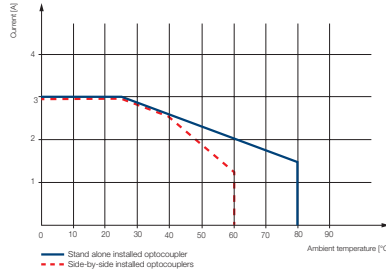

Derating curve MOS-FET output CR-S

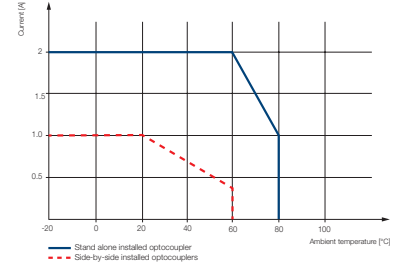

Derating curve Triac output CR-S

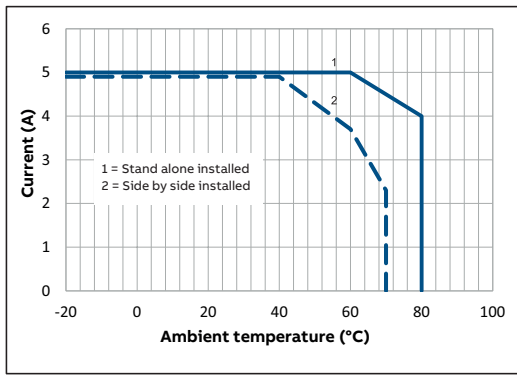

MOS-FET output CR-P

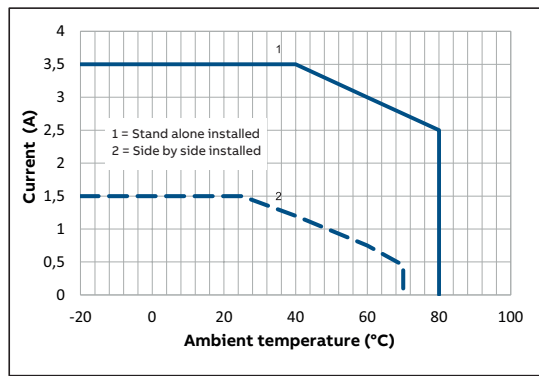

Triac output CR-P

# Pluggable interface relays and optocouplers

## Technical diagrams

### Dimensional drawings in mm and inches

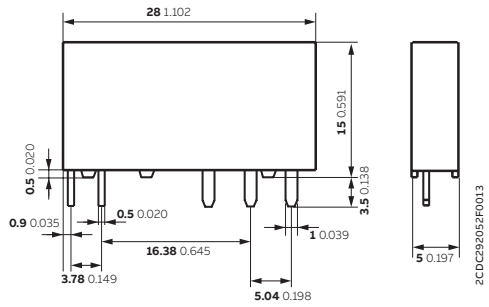

CR-S relay

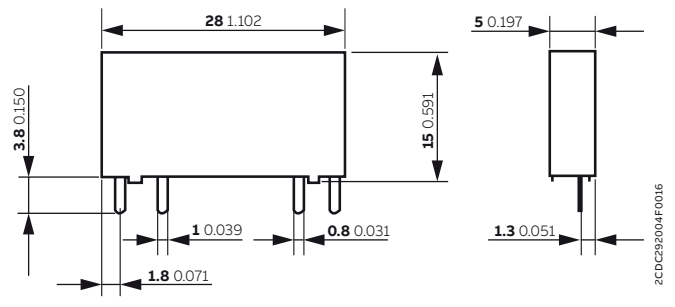

CR-S optocoupler

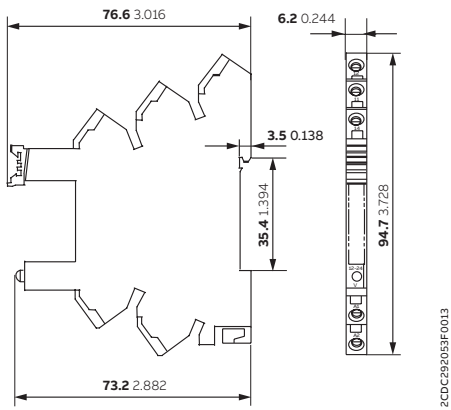

CR-S socket - spring connection

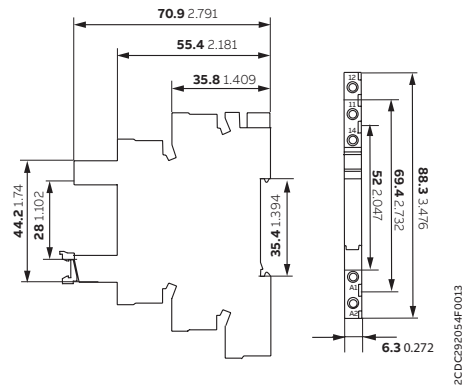

CR-S socket - screw connection

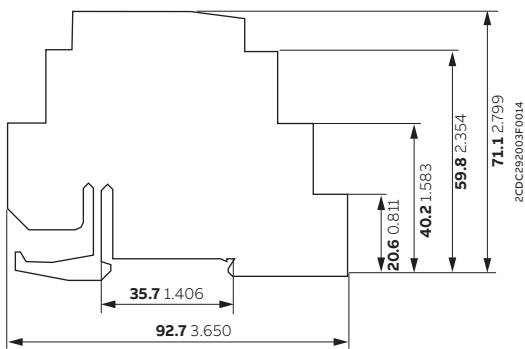

CR-S separator

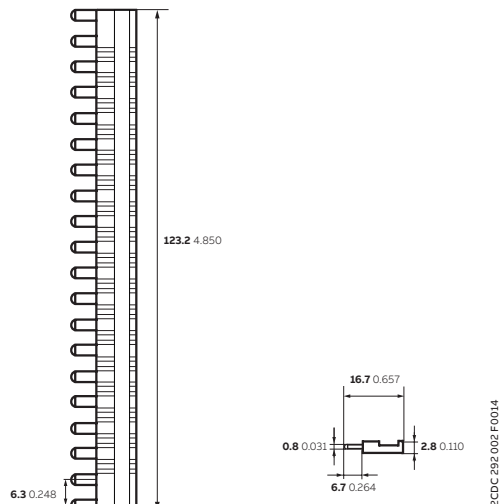

CR-SJB20 - blue, CR-SJB20 - red, CR-SJB20 - black jumper bar



# Pluggable interface relays and optocouplers

## Technical diagrams

### Dimensional drawings in mm and inches

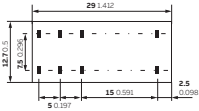

2CDC292002F0004

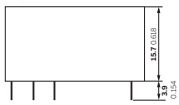

CR-P relay

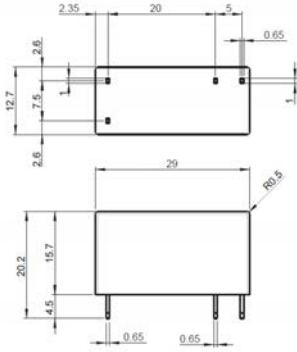

2CDC292003F0017

CR-P optocoupler

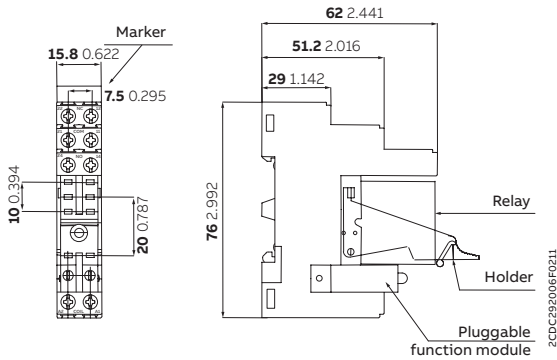

2CDC292006F0211

CR-PLS - screw connection

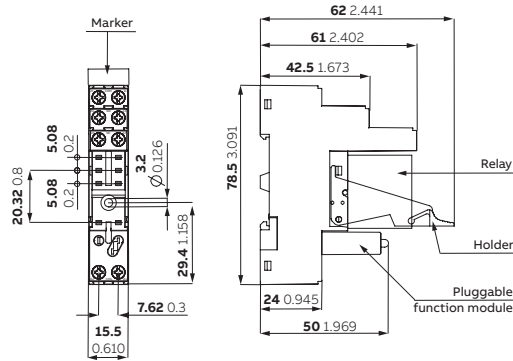

2CDC292033F0004

CR-PLSx - screw connection

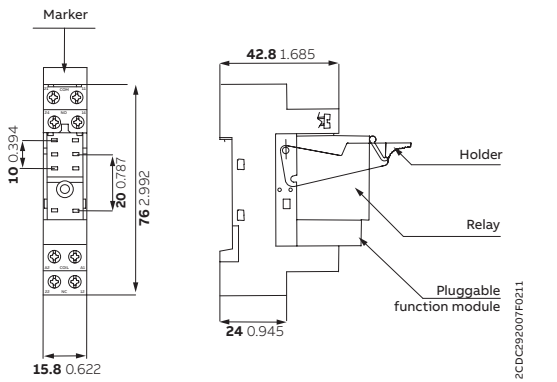

2CDC292007F0211

CR-PSS - screw connection

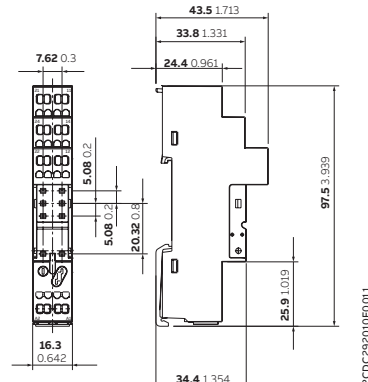

2CDC292010F0011

CR-PLC - spring connection

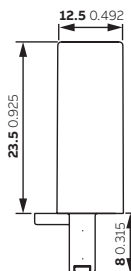

CR- P/Mxx function module

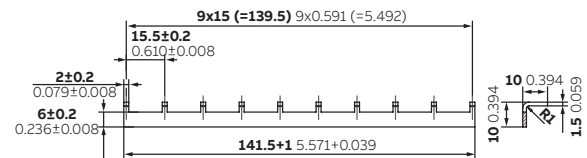

2CDC292012F0011

CR-PJ jumper bar

# Pluggable interface relays and optocouplers

## Technical diagrams

### Dimensional drawings in mm and inches

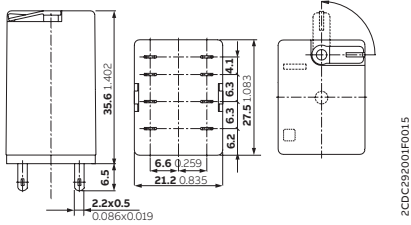

CR-M relay with 2 c/o contacts

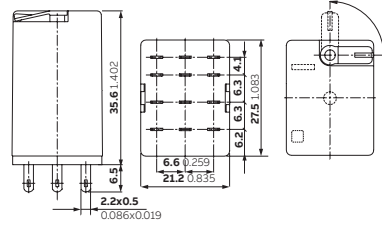

CR-M relay with 3 c/o contacts

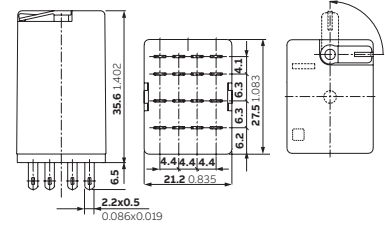

CR-M relay with 4 c/o contacts

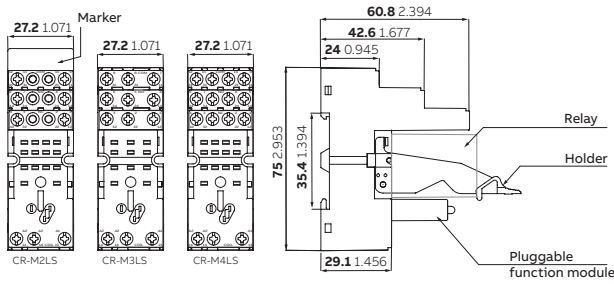

CR-M2LS - CR-M3LS - CR-M4LS - screw connection

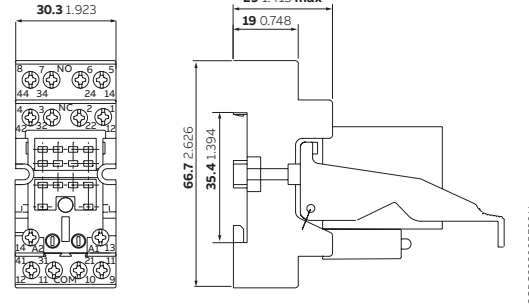

CR-MxSF - screw connection

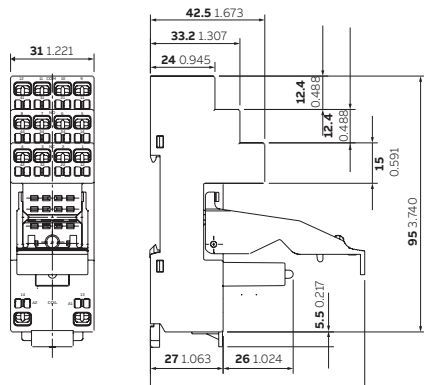

CR-M2LC, CR-M4LC - spring connection

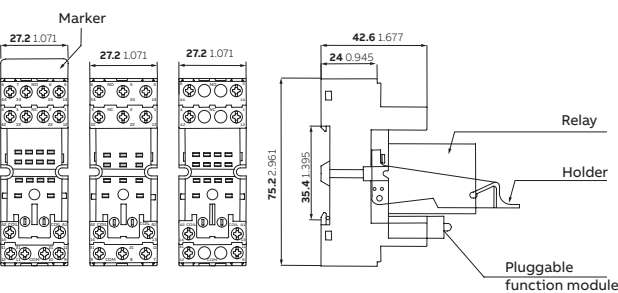

CR-M2SS - CR-M3SS - CR-M4SS - screw connection

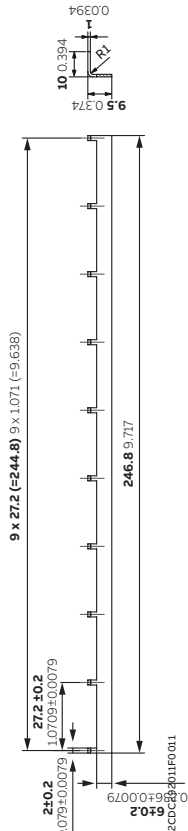

CR-MJ jumper bar

# Pluggable interface relays and optocouplers

## Technical diagrams

### Dimensional drawings in mm and inches

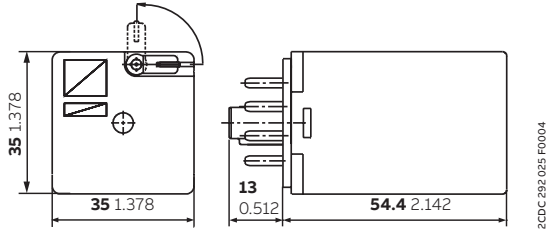

CR-U relay with 2 c/o contacts

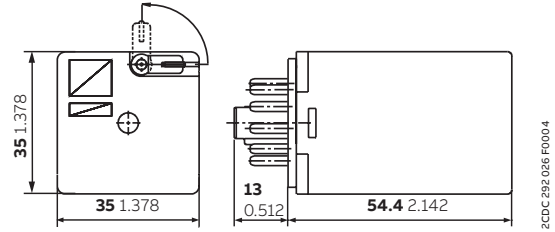

CR-U relay with 3 c/o contacts

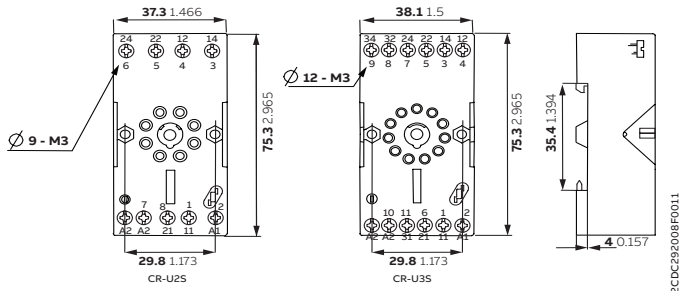

CR-U25 - CR-U35 - screw connection

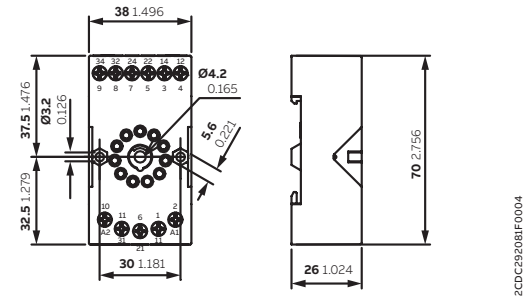

CR-U3E - screw connection

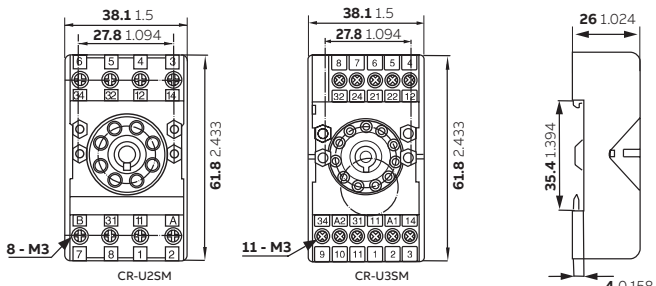

CR-U2SM - CR-U3SM - screw connection

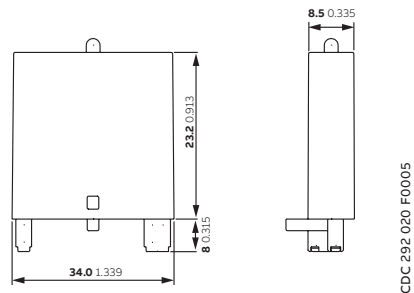

CR-Uxx function module



---

# Boxed interface relays and optocouplers R600 range

## Table of contents

<b>438</b>	<b>Overview</b>
<b>440</b>	<b>Boxed interface relays R600 range</b>
440	Selection table
442	Ordering details
444	Technical data
448	Technical diagrams
<b>450</b>	<b>Boxed optocouplers R600 range</b>
450	Selection table
451	Ordering details
453	Technical data
456	Technical diagrams

# Boxed interface relays and optocouplers R600 range

## Overview



ABB's R600 range may be used in applications where electrical isolation, amplification and signal matching are required. The slim, compact design, incorporated with the variety of terminal connections available allow for the optimization of space within a control panel. This broad portfolio allows for the flexibility of choice and includes both electromagnetic relays and optocouplers.



**Continuous operation**

The ABB boxed interface relays portfolio incorporates a large assortment of non-pluggable relays. It includes both electro-mechanical relays and optocouplers. The R600 Optocouplers allow for continuous operation without any mechanical wear-and-tear.

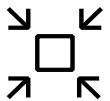

**Space saving**

The 6 mm slim housing of the R600 boxed interface relays provides the possibility of space saving within control cabinets. The 75 mm depth of these relays allows for the use in compact cabinets.



**Global availability**

The ABB boxed interface relays are approved for a large variety of applications and adhere to highest levels of global approvals (UL, CSA, VDE, CCC).

# Boxed interface relays and optocouplers R600 range

## Overview

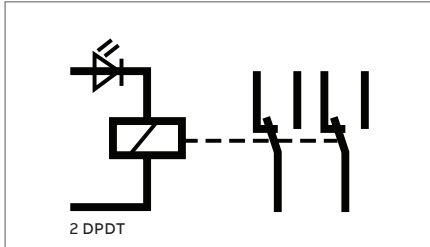

### Complete product line

1 n/o, 1 n/c, 1 c/o, 2 c/o output configuration. Standard contact material for switching high current signals as well as gold-plated contacts for reliable switching of low current signals.



### Marine certification

The R600 range offers the LR approval, which allows usage of the boxed interface relays and optocouplers in many applications around the marine segment. The performance of the R600 range has been proven by successfully passing tests required for operating under harsh conditions.

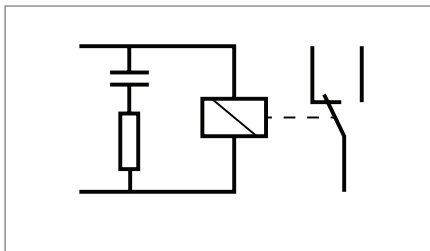

### Safe operation

High resistance to vibration and shock thanks to the relay soldered inside of the housing. Wrong relay replacement or relay lose not possible. Devices with immunity to leakage currents.

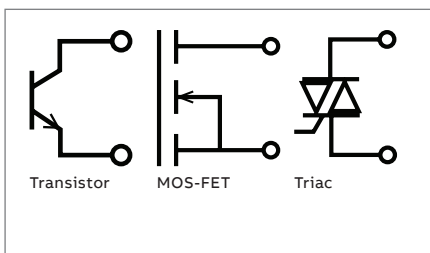

### Longevity

Optocoupler with transistor, MOS-FET and Triac output ensure a longer lifetime, higher reliability and quiet operation.

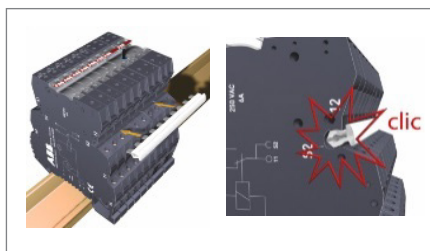

### Easy to mount

The R600 interface relays and optocouplers are easy to mount by snapping onto a DIN-rail according to IEC/EN 60715. Time saving wiring thanks to a jumper bar.







## Boxed interface relays R600 range

### Ordering details



R600 - 6 mm

The R600 range comprises of boxed interface relays and optocouplers. In this range, the relay is soldered into device housing, fulfilling the highest vibration requirements. This compact range of relays are 6 mm wide and provide the possibility of switching AC and DC circuits with the same relay. All the sockets in this range are equipped with an indicator LED and available with screw or spring terminals.

#### Ordering details - 1 n/c contact: 250 V, 10 mA - 6 A, width 12 mm

Rated control supply voltage	Connection type	Particularities	Type	Order code	Pkg qty	Weight (1 pc.) kg (lb)
24 V AC/DC	screw	RC circuit parallel to output contact	RB101R-24VUC	1SNA645019R0400	5	0.04 (0.088)
	spring		RBR101R-24VUC	1SNA645519R0600		

#### Ordering details - 1 n/o contact: 250 V, 10 mA - 6 A, width 6 mm

Rated control supply voltage	Connection type	Particularities	Type	Order code	Pkg qty	Weight (1 pc.) kg (lb)
24 V AC/DC	screw		RB111-24VUC	1SNA645014R2700	10	0.02 (0.044)
115 V AC/DC	screw		RB111-115VUC	1SNA645016R2100		
230 V AC/DC	screw		RB111-230VUC	1SNA645017R2200		
24 V AC/DC	spring		RBR111-24VUC	1SNA645514R2100		

#### Ordering details - 1 n/o contact: 250 V, 10 mA - 6 A, width 12 mm

Rated control supply voltage	Connection type	Particularities	Type	Order code	Pkg qty	Weight (1 pc.) kg (lb)
24 V AC/DC	screw	RC circuit parallel to output contact	RB111R-24VUC	1SNA645018R0300	5	0.04 (0.088)
	spring		RBR111R-24VUC	1SNA645518R0500		

#### Ordering details - 1 c/o (SPDT) contact: 250 V, 10 mA - 6 A, width 6 mm

Rated control supply voltage	Connection type	Particularities	Type	Order code	Pkg qty	Weight (1 pc.) kg (lb)
5 V DC	screw	A1-A2 polarized	RB121P-5VDC	1SNA645034R2300	10	0.02 (0.044)
12 V DC	screw	A1-A2 polarized	RB121P-12VDC	1SNA645035R2400		
12 V DC	screw		RB121-12VDC	1SNA645073R0000		
24 V DC	screw		RB121-24VDC	1SNA645071R0000		
24 V AC/DC	screw		RB121-24VUC	1SNA645001R0300		
48-60 V AC/DC	screw		RB121-48-60VUC	1SNA645002R0400		
115 V AC/DC	screw		RB121-115VUC	1SNA645003R0500		
230 V AC/DC	screw		RB121-230VUC	1SNA645004R0400		
5 V DC	spring	A1-A2 polarized	RBR121P-5VDC	1SNA645534R2500		
12 V DC	spring	A1-A2 polarized	RBR121P-12VDC	1SNA645535R2600		
24 V DC	spring		RBR121-24VDC	1SNA645571R0000		
24 V AC/DC	spring		RBR121-24VUC	1SNA645501R0500		
48-60 V AC/DC	spring		RBR121-48-60VUC	1SNA645502R0600		
115 V AC/DC	spring		RBR121-115VUC	1SNA645503R0700		
230 V AC/DC	spring		RBR121-230VUC	1SNA645504R0000		

## Boxed interface relays R600 range

### Ordering details

#### Ordering details - 1 c/o (SPDT) contact: 250 V, 3 mA - 6 A, gold-plated contacts, width 6 mm

Rated control supply voltage	Connection type	Particularities	Type	Order code	Pkg qty	Weight (1 pc.) kg (lb)
5 V DC	screw	A1-A2 polarized	RB121PG-5VDC	1SNA645036R2500	10	0.02 (0.044)
12 V DC	screw		RB121G-12VDC	1SNA645075R0000		
24 V DC	screw		RB121G-24VDC	1SNA645072R0000		
24 V AC/DC	screw		RB121G-24VUC	1SNA645005R0700		
48-60 V AC/DC	screw		RB121G-48-60VUC	1SNA645006R0000		
115 V AC/DC	screw		RB121G-115VUC	1SNA645007R0100		
230 V AC/DC	screw		RB121G-230VUC	1SNA645008R1200		
24 V DC	spring		RBR121G-24VDC	1SNA645572R0000		
24 V AC/DC	spring		RBR121G-24VUC	1SNA645505R0100		
48-60 V AC/DC	spring		RBR121G-48-60VUC	1SNA645506R0200		
115 V AC/DC	spring		RBR121G-115VUC	1SNA645507R0300		
230 V AC/DC	spring		RBR121G-230VUC	1SNA645508R1400		

#### Ordering details - 1 c/o (SPDT) contact: 250 V, 10 mA - 6 A, width 12 mm

Rated control supply voltage	Connection type	Particularities	Type	Order code	Pkg qty	Weight (1 pc.) kg (lb)
60-230 V AC/DC	screw		RB121-60-230VUC	1SNA645020R0100	5	0.04 (0.088)
115 V AC/DC	screw	Leakage current protection, RC circuit parallel to input	RB121R-115VUC	1SNA645046R0700		
230 V AC/DC	screw		RB121R-230VUC	1SNA645011R2400		
60-230 V AC/DC	spring		RBR121-60-230VUC	1SNA645520R0300		
230 V AC/DC	spring	Leakage current protection, RC circuit parallel to input	RBR121R-230VUC	1SNA645511R2600		



R600 - 12 mm

2CDC29H 013 50013

#### Ordering details - 2 c/o (SPDT) contacts: 250 V, 1 mA - 8 A, gold-plated contacts, width 12 mm

Rated control supply voltage	Connection type	Type	Order code	Pkg qty	Weight (1 pc.) kg (lb)
24 V AC/DC	screw	RB122G-24VUC	1SNA645012R2500	5	0.04 (0.088)
48-60 V AC/DC	screw	RB122G-48-60VUC	1SNA645040R1500		
115 V AC/DC	screw	RB122G-115VUC	1SNA645041R0200		
230 V AC/DC	screw	RB122G-230VUC	1SNA645013R2600		
24 V AC/DC	spring	RBR122G-24VUC	1SNA645512R2700		
48-60 V AC/DC	spring	RBR122G-48-60VUC	1SNA645540R1700		
115 V AC/DC	spring	RBR122G-115VUC	1SNA645541R0400		
230 V AC/DC	spring	RBR122G-230VUC	1SNA645513R2000		

#### Ordering details - Accessories

Description	Type	Order code	Pkg qty	Weight (1 pc.) kg (lb)
Jumper bar, 10 poles * (replacement of BJ612-10 - 1SNA290488R0100)	RB-JB10	1SVR406570R0000	10	0.05 (0.11)
Jumper bar, 20 poles * (replacement of BJ612-20 - 1SNA206754R0000)	RB-JB20	1SVR406580R0000		0.10 (0.22)
Separator end section	SC612	1SNA290474R0200		0.05 (0.11)

\* - Before the first and after the last jumpered R600 relay, a separator end section shall be used.

- The sum of the current for jumpered devices shall not exceed 6 A on 6 mm devices and 8 A on 12 mm devices.

## Boxed interface relays R600 range

### Technical data

		RB(R)101R-		RB(R)111R-	
		24 V UC		24 V UC	
<b>Input circuit</b>					
Rated control supply voltage $U_s$		24 V AC/DC			
Rated control supply voltage $U_s$ tolerance	DC	-15 %, +20 %			
	AC	-/+ 10 %			
Rated frequency		50/60 Hz			
Typical power consumption		0.24 W			
Typical current		10 mA			
Drop-out voltage	at 20 °C	4.5 V			
Indication of operational states	green LED	 : control supply voltage applied			
<b>Output circuit</b>					
Kind of output	11-12	relay, 1 n/c contact		-	
	13-14	-		relay, 1 n/o contact	
Rated operational voltage $U_e$		250 V AC			
Minimum switching voltage		5 V			
Maximum switching voltage		250 V AC			
Minimum switching current		60 mA			
Rated free air thermal current $I_{th}$		6 A			
Rated operational current $I_e$	AC-12 (resistive) 230 V	6 A			
	AC-15 (inductive) 230 V	1.5 A			
	AC-15 (inductive) 120 V	3 A			
	DC-12 (resistive) 24 V	6 A			
	DC-13 (inductive) 24 V	1 A			
	DC-13 (inductive) 110 V	0.2 A			
	DC-13 (inductive) 220 V	0.1 A			
AC rating (UL 508; NEMA ICS-5)	utilization category (pilot duty)	B300			
DC rating (UL 508; NEMA ICS-5)	utilization category (pilot duty)	R300			
Minimum switching power		300 mW			
Mechanical lifetime		1 x 10 <sup>7</sup> switching cycles			
Electrical lifetime	at AC-15	1 x 10 <sup>5</sup> switching cycles			
Max. fuse rating to achieve short-circuit protection		6 A fast			
Response time		5 ms			
Release time		8 ms			

		RB(R)111-		
		24 V UC	115 V UC	230 V UC
<b>Input circuit</b>				
Rated control supply voltage $U_s$		24 V AC/DC	115 V AC/DC	230 V AC/DC
Rated control supply voltage $U_s$ tolerance	DC	-15 %, +20 %		-15 %, +10 %
	AC	-/+ 10 %		
Rated frequency		50/60 Hz		
Typical power consumption		0.24 W	0.46 W	0.8 W
Typical current		10 mA	4 mA	3.5 mA
Drop-out voltage	at 20 °C	4.5 V	17 V	27 V
Indication of operational states	green LED	 : control supply voltage applied		
<b>Output circuit</b>				
Kind of output	13-14	relay, 1 n/o contact		
Rated operational voltage $U_e$		250 V AC		
Minimum switching voltage		12 V		
Maximum switching voltage		250 V AC		
Minimum switching current		10 mA		
Rated free air thermal current $I_{th}$		6 A		

## Boxed interface relays R600 range

### Technical data

		RB(R)111-		
		24 V UC	115 V UC	230 V UC
Rated operational current $I_e$	AC-12 (resistive) 230 V	6 A		
	AC-15 (inductive) 230 V	1.5 A		
	AC-15 (inductive) 120 V	3 A		
	DC-12 (resistive) 24 V	6 A		
	DC-13 (inductive) 24 V	1 A		
	DC-13 (inductive) 110 V	0.2 A		
	DC-13 (inductive) 220 V	0.1 A		
AC rating (UL 508; NEMA ICS-5)	utilization category (pilot duty)	B300		
DC rating (UL 508; NEMA ICS-5)	utilization category (pilot duty)	R300		
Minimum switching power		300 mW		
Mechanical lifetime		1 x 10 <sup>7</sup> switching cycles		
Electrical lifetime		at AC-15 1 x 10 <sup>5</sup> switching cycles		
Max. fuse rating to achieve short-circuit protection		6 A fast		
Response time		5 ms	6 ms	7 ms
Release time		8 ms	15 ms	15 ms

		RB(R)121(P)(G)-							
		5 V DC	12 V DC	24 V DC	24 V UC	48-60 V UC	115 V UC	230 V UC	
<b>Input circuit</b>									
Rated control supply voltage $U_s$		5 V DC	12 V DC	24 V DC	24 V AC/DC	48 V AC/DC	60 V AC/DC	115 V AC/DC	230 V AC/DC
Rated control supply voltage		DC -15 %, +20 %							-15 %, +10 %
$U_s$ tolerance		AC -			-/+ 10 %				
Rated frequency		-			50/60 Hz				
Typical power consumption		0.2 W	0.2 W	0.24 W	0.33 W	0.54 W	0.46 W	0.8 W	
Typical current		40 mA	16 mA	10 mA	7 mA	9 mA	4 mA	3.5 mA	
Drop-out voltage		at 20 °C 1.2 V 2.2 V 4.5 V			8 V	8 V	17 V	27 V	
Indication of operational states		green LED control supply voltage applied							
<b>Output circuit</b>									
Kind of output		11-12/14 relay, 1 c/o (SPDT) contact							
Rated operational voltage $U_e$		250 V AC							
Minimum switching voltage		5 V / gold-plated contacts: 5 V							
Maximum switching voltage		250 V AC							
Minimum switching current		60 mA / gold-plated contacts: 10 mA							
Rated free air thermal current $I_{th}$		6 A							
Rated operational current $I_e$	AC-12 (resistive) 230 V	6 A							
	AC-15 (inductive) 230 V	1.5 A							
	AC-15 (inductive) 120 V	3 A							
	DC-12 (resistive) 24 V	6 A							
	DC-13 (inductive) 24 V	1 A							
	DC-13 (inductive) 110 V	0.2 A							
	DC-13 (inductive) 220 V	0.1 A							
AC rating (UL 508; NEMA ICS-5)	utilization category (pilot duty)	B300							
DC rating (UL 508; NEMA ICS-5)	utilization category (pilot duty)	R300							
Minimum switching power		300 mW / gold-plated contacts: 50 mW							
Mechanical lifetime		1 x 10 <sup>7</sup> switching cycles							
Electrical lifetime		at AC-15 1 x 10 <sup>5</sup> switching cycles							
Max. fuse rating to achieve short-circuit protection		6 A fast							
Response time		5 ms	5 ms	5 ms	5 ms	5 ms	6 ms	7 ms	
Release time		8 ms	8 ms	8 ms	8 ms	8 ms	15 ms	16 ms	

## Boxed interface relays R600 range

### Technical data

		RB(R)121R-	
		115 V UC	230 V UC
<b>Input circuit</b>			
Rated control supply voltage $U_s$		115 V AC/DC	230 V AC/DC
Rated control supply voltage $U_s$ tolerance	DC	-20%, +15%	-10%, +15%
	AC	-/+ 10 %	
Rated frequency		50/60 Hz	
Typical power consumption		2 W	2.8 W
Typical current		18 mA	12 mA
Drop-out voltage	at 20 °C	17 V	27 V
Indication of operational states	green LED	: control supply voltage applied	
<b>Output circuit</b>			
Kind of output	11-12/14	relay, 1 c/o (SPDT) contact	
Rated operational voltage $U_e$		250 V AC	
Minimum switching voltage		5 V	
Maximum switching voltage		250 V AC	
Minimum switching current		60 mA	
Rated free air thermal current $I_{th}$		6 A	
Rated operational current $I_e$	AC-12 (resistive) 230 V	6 A	
	AC-15 (inductive) 230 V	1.5 A	
	AC-15 (inductive) 120 V	3 A	
	DC-12 (resistive) 24 V	6 A	
	DC-13 (inductive) 24 V	1 A	
	DC-13 (inductive) 110 V	0.2 A	
	DC-13 (inductive) 220 V	0.1 A	
AC rating (UL 508; NEMA ICS-5)	utilization category (pilot duty)	B300	
DC rating (UL 508; NEMA ICS-5)	utilization category (pilot duty)	R300	
Minimum switching power		300 mW	
Mechanical lifetime		1 x 10 <sup>7</sup> switching cycles	
Electrical lifetime	at AC-15	1 x 10 <sup>5</sup> switching cycles	
Max. fuse rating to achieve short-circuit protection		6 A fast	
Response time		6 ms	7 ms
Release time		15 ms	16 ms

## Boxed interface relays R600 range

### Technical data

		RB(R)122G				
		24 V UC	48-60 V UC		115 V UC	230 V UC
<b>Input circuit</b>						
Rated control supply voltage $U_s$		24 V AC/DC	48 V AC/DC	60 V AC/DC	115 V AC/DC	230 V AC/DC
Rated control supply voltage $U_s$ tolerance	DC	-15 %, +20 %				-15 %, +10 %
	AC	-/+ 10 %				
Rated frequency		50/60 Hz				
Typical power consumption		0.48 W	0.62 W	0.96 W	0.58 W	1.15 W
Typical current		20 mA	13 mA	16 mA	5 mA	5 mA
Drop-out	at 20 °C	5.4 V	8.8 V	8.8 V V	20 V	10 V
Indication of operational states	green LED	□: control supply voltage applied				
<b>Output circuit</b>						
Kind of output	11-12/14	relay, 1st c/o (SPDT) contact				
	21-22/24	relay, 2nd c/o (SPDT) contact				
Rated operational voltage $U_e$		250 V AC				
Minimum switching voltage		5 V / gold-plated contacts: 5 V				
Maximum switching voltage		250 V				
Minimum switching current		60 mA / gold-plated contacts: 10 mA				
Rated free air thermal current $I_{th}$		8 A				
Rated operational current $I_e$	AC-12 (resistive) 230 V	8 A				
	AC-15 (inductive) 230 V	1.5 A				
	DC-12 (resistive) 24 V	8 A				
	DC-13 (inductive) 24 V	1 A				
	DC-13 (inductive) 110 V	0.2 A				
	DC-13 (inductive) 220 V	0.1 A				
Minimum switching power		300 mW / gold-plated contacts: 50 mW				
Mechanical lifetime		2 x 10 <sup>7</sup> switching cycles				
Electrical lifetime	at AC-15	1 x 10 <sup>5</sup> switching cycles				
Max. fuse rating to achieve short-circuit protection		10 A fast				
Response time		6 ms	10 ms	10 ms	6 ms	6 ms
Release time		10 ms	14 ms	14 ms	15 ms	15 ms

### General technical data - Interface relays

		RB	RBR
<b>General data</b>			
Material of housing		UL 94 V0	
Mounting		DIN rail	
Degree of protection	housing / terminals	IP20 NEMA1	
<b>Electrical connection</b>			
Connecting capacity	fine-strand	0.22-2.5 mm <sup>2</sup> (24-14 AWG)	
	rigid	0.2-4 mm <sup>2</sup> (24-12 AWG)	0.2-2.5 mm <sup>2</sup> (24-14 AWG)
Stripping length		9 mm (0.354 in)	
Tightening torque		0.4-0.6 Nm (3.5-5.3 lb.in)	n/a
<b>Environmental data</b>			
Ambient temperature ranges	storage	-40...+80 °C (-40...+176 °F)	
	operation	-20...+70 °C (-4...+158 °F) <sup>1)</sup>	
<b>Isolation data</b>			
Rated insulation voltage $U_i$		250 V	
Rated impulse withstand voltage $U_{imp}$	input / output	4 kV	
	shock coil / output	4 kV	
	output / output	1 kV	
Overvoltage category		III	
Pollution degree		2	
<b>Standards/Directives</b>			
Standards		IEC/EN 60947-5-1	
Low Voltage Directive		2014/35/EC	
RoHS Directive		2011/65/EC	

<sup>1)</sup> Over 55 °C, blocks have to be mounted on horizontal rail with 10 mm spacing between each block. For vertical rail mounting max. operation temperature is 15 °C lower.

# Boxed interface relays R600 range

## Technical diagrams

### Load limit curves

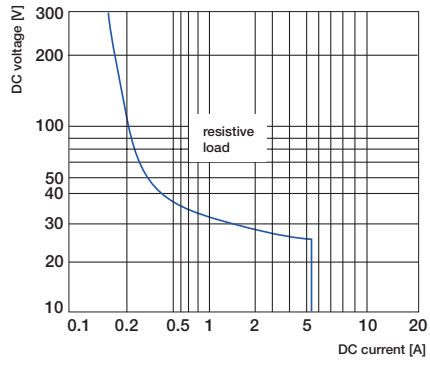

2CDC292028F0212

Versions with 1 n/o, 1 n/c or 1 c/o contact

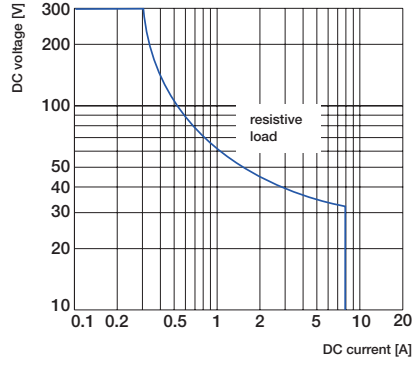

2CDC292028F0213

Versions with 2 c/o contacts

### Dimensional drawings

in mm and inches

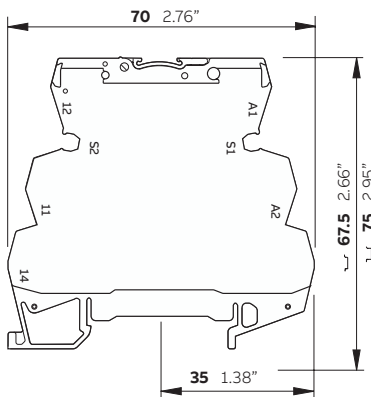

2CDC292028F0013

R600 - screw connection

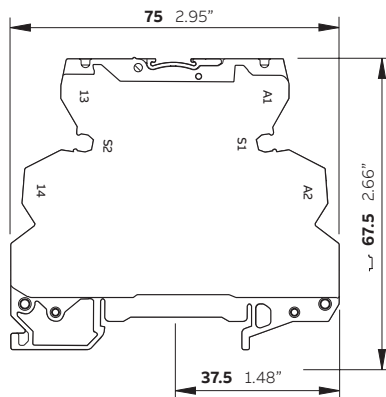

2CDC292028F0013

R600 - spring connection



# Boxed interface relays R600 range

## Technical diagrams

### Connection diagrams

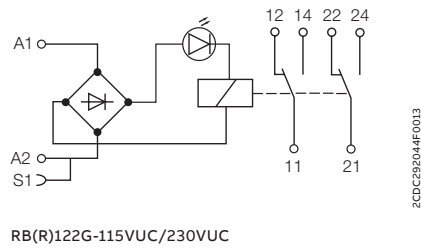
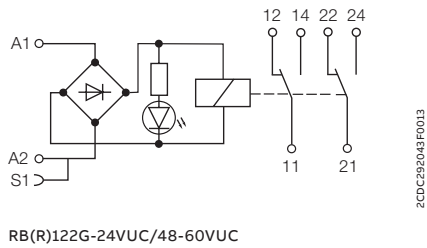
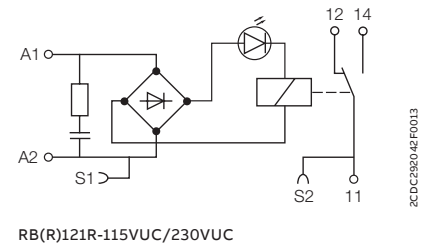
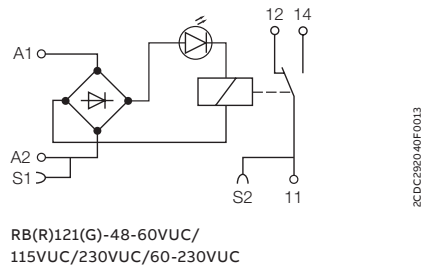
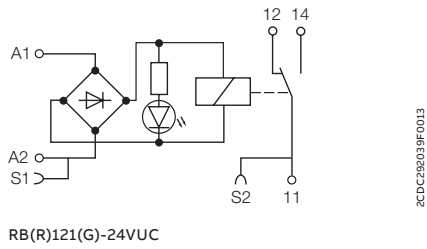
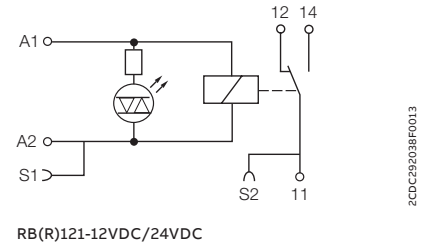
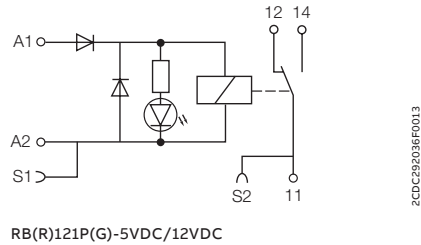
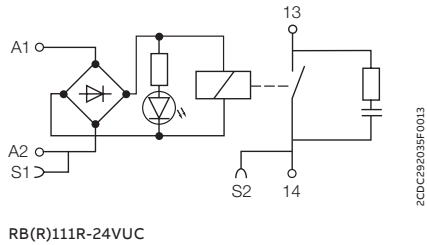
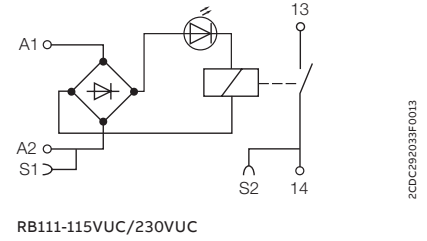
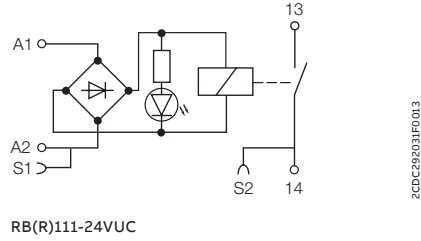
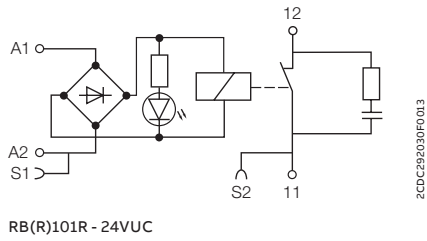



## Boxed optocouplers R600 range

### Ordering details



R600 - 6 mm

#### Ordering details - Transistor output, 58 V DC, 100 mA, width 6 mm

Rated control supply voltage	Connection type	Type	Order code	Pkg qty	Weight (1 pc.) kg (lb)
5 - 12 V DC	screw	OBIC0100-5-12VDC	1SNA645047R0000	10	0.02 (0.044)
24 V DC	screw	OBIC0100-24VDC	1SNA645021R2600		
48 - 60 V AC/DC	screw	OBIC0100-48-60VUC	1SNA645049R1200		
115 - 230 V AC/DC	screw	OBIC0100-115-230	1SNA645022R2700		
5 - 12 V DC	spring	OBRIC0100-5-12VDC	1SNA645547R0200	10	0.02 (0.044)
24 V DC	spring	OBRIC0100-24VDC	1SNA645521R2000		
48 - 60 V AC/DC	spring	OBRIC0100-48-60VUC	1SNA645549R1400		
115 - 230 V AC/DC	spring	OBRIC0100-115-230	1SNA645522R2100		

#### Ordering details - MOS-FET output, 58 V DC, 2 A, width 6 mm

Rated control supply voltage	Connection type	Type	Order code	Pkg qty	Weight (1 pc.) kg (lb)
5 - 12 V DC	screw	OBOC2000-5-12VDC	1SNA645050R1700	10	0.02 (0.044)
24 V DC	screw	OBOC2000-24VDC	1SNA645051R0400		
24 V AC/DC	screw	OBOC2000-24VUC	1SNA645025R2200		
48 - 60 V AC/DC	screw	OBOC2000-48-60VUC	1SNA645053R0600		
115 V AC/DC	screw	OBOC2000-115VUC	1SNA645054R0700		
230 V AC/DC	screw	OBOC2000-230VUC	1SNA645026R2300		
5 - 12 V DC	spring	OBROC2000-5-12VDC	1SNA645550R1100	10	0.02 (0.044)
24 V DC	spring	OBROC2000-24VDC	1SNA645551R0600		
24 V AC/DC	spring	OBROC2000-24VUC	1SNA645525R2400		
48 - 60 V AC/DC	spring	OBROC2000-48-60VUC	1SNA645553R0000		
230 V AC/DC	spring	OBROC2000-230VUC	1SNA645526R2500		

#### Ordering details - MOS-FET output, 58 V DC, 5 A, width 6 mm

Rated control supply voltage	Connection type	Type	Order code	Pkg qty	Weight (1 pc.) kg (lb)
24 V DC	screw	OBOC5000-24VDC	1SNA645024R2100	10	0.02 (0.044)
115 V AC/DC	screw	OBOC5000-115VUC	1SNA645058R1300		
24 V DC	spring	OBROC5000-24VDC	1SNA645524R2300	10	0.02 (0.044)
230 V AC/DC	spring	OBROC5000-230VUC	1SNA645559R1600		

#### Ordering details - Triac output, 400 V AC, 1 A, width 6 mm

Rated control supply voltage	Connection type	Type	Order code	Pkg qty	Weight (1 pc.) kg (lb)
24 V DC	screw	OBOA1000-24VDC	1SNA645027R2400	10	0.03 (0.066)
115 V AC/DC	screw	OBOA1000-115VUC	1SNA645062R0700		
230 V AC/DC	screw	OBOA1000-230VUC	1SNA645028R0500		
24 V DC	spring	OBROA1000-24VDC	1SNA645527R2600	10	

## Boxed optocouplers R600 range

### Ordering details



R600 - 12 mm

2CDC291 013 S0013

#### Ordering details - Triac output, 230 V AC, 2 A, width 12 mm

Rated control supply voltage	Connection type	Type	Order code	Pkg qty	Weight (1 pc.) kg (lb)
24 V DC	screw	OBOA2000-24VDC	1SNA645029R0600	5	0.03
24 V DC	spring	OBROA2000-24VDC	1SNA645529R0000	5	(0.066)

#### Ordering details - Accessories

Description	Type	Order code	Pkg qty	Weight (1 pc.) kg (lb)
Jumper bar, 10 poles * (replacement of BJ612-10 - 1SNA290488R0100)	RB-JB10	1SVR406570R0000	10	0.05 (0.11)
Jumper bar, 20 poles * (replacement of BJ612-20 - 1SNA206754R0000)	RB-JB20	1SVR406580R0000		0.10 (0.22)
Separator end section	SC612	1SNA290474R0200		0.05 (0.11)

\* - Before the first and after the last jumpered R600 optocoupler, a separator end section shall be used.  
 - The sum of the current for jumpered devices shall not exceed 6 A on 6 mm devices and 8 A on 12 mm devices.

## Boxed optocouplers R600 range

### Technical data

	OB(R)IC0100-...						
	5-12 V DC		24 V DC	48-60 V UC		115-230	
<b>Input circuit</b>							
Input voltage	5 V DC	12 V DC	24 V DC	48 V AC/DC	60 V AC/DC	115 V AC/DC	230 V AC/DC
Frequency	-			50/60 Hz			
Input current	5 mA	9 mA	4 mA	4 mA	5 mA	7 mA (AC) 16 mA (DC)	11.5 mA (AC) 25 mA (DC)
Pull-in voltage	4 V		15 V	25 V		60 V AC / 70 V DC	
Typ. switch-on time	10 µs			5 ms			
Typ. switch-off time	500 µs			20 ms			
Operating frequency	1000 Hz				20 Hz		
Permissible leakage current	0.9 mA		1.0 mA	0.9 mA		1.6 mA	
<b>Output circuit</b>							
	11(13+)- 14						
Kind of output	Transistor						
Rated operational voltage	4.5-58 V DC						
Minimum switching current	1 mA						
Maximum switching current	100 mA						
Leakage current at max. switching voltage	< 50 µA						
Rated operational current I <sub>e</sub> (IEC/EN 60947-5-1)	DC-12 (resistive) 58 V		0.1 A				
Residual voltage	typical		1 V				
	maximum		1.3 V				
Max. fuse rating to achieve short-circuit protection	100 mA fast						
<b>Isolation data</b>							
Rated insulation voltage U <sub>i</sub>	250 V						
Rated impulse withstand voltage U <sub>imp</sub>	2.5 kV						
Overvoltage category	II						
Pollution degree	2						

	OB(R)OC2000-...							
	5-12 V DC		24 V DC	24 V UC	48-60 V UC		115 V UC	230 V UC
<b>Input circuit</b>								
Input voltage	5 V DC	12 V DC	24 V DC	24 V AC/DC	48 V AC/DC	60 V AC/DC	115 V AC/DC	230 V AC/DC
Frequency	-			50/60 Hz				
Input current	5 mA	9 mA	5.4 mA	6.3 mA	4 mA	5.1 mA	4.2 mA	4 mA
Pull-in voltage	4 V		12 V	15 V	27 V		50 V	80 V
Typ. switch-on time	15 µs		30 µs	1 ms	5 ms		500 µs	1 ms
Typ. switch-off time	250 µs		400 µs	7 ms	20 ms		10 ms	15 ms
Operating frequency	2000 Hz		1000 Hz	60 Hz	20 Hz		50 Hz	35 Hz
Permissible leakage current	1 mA		0.8 mA	0.9 mA	1 mA		0.3 mA	
<b>Output circuit</b>								
	11(13+)- 14							
Kind of output	MOS-FET							
Rated operational voltage	4.5-58 V DC							
Minimum switching current	1 mA							
Maximum switching current	2 A							
Leakage current at max. switching voltage	< 50 µA							
Rated operational current I <sub>e</sub> (IEC/EN 60947-5-1)	DC-12 (resistive) 58 V		2 A					
Residual voltage	typical		0.1 V					
	maximum		0.5 V					
Max. fuse rating to achieve short-circuit protection	2 A ultra-fast							
<b>Isolation data</b>								
Rated insulation voltage U <sub>i</sub>	250 V							
Rated impulse withstand voltage U <sub>imp</sub>	2.5 kV							
Overvoltage category	II							
Pollution degree	2							

## Boxed optocouplers R600 range

### Technical data

		OB(R)OC5000-...		
		24 V DC	115 V UC	230 V UC
<b>Input circuit</b>				
Input voltage		24 V DC	115 V AC/DC	230 V AC/DC
Frequency		-	50/60 Hz	
Input current		5.4 mA	4.2 mA	4 mA
Pull-in voltage		12 V	50 V	80 V
Typ. switch-on time		30 µs	500 µs	1 ms
Typ. switch-off time		400 µs	10 ms	15 ms
Operating frequency		1000 Hz	50 Hz	35 Hz
Permissible leakage current		0.8 mA	0.3 mA	0.3 mA
<b>Output circuit</b>		11(13+)- 14		
Kind of output		MOS-FET		
Rated operational voltage		4.5-58 V DC		
Minimum switching current		1 mA		
Maximum switching current		5 A		
Leakage current at max. switching voltage		< 50 µA		
Rated operational current I <sub>e</sub>	DC-12 (resistive) 58 V	5 A		
Residual voltage	typical	0.1 V		
	maximum	0.5 V		
Max. fuse rating to achieve short-circuit protection		6 A ultra-fast		
<b>Isolation data</b>				
Rated insulation voltage U <sub>i</sub>		250 V		
Rated impulse withstand voltage U <sub>imp</sub>		2.5 kV		
Overvoltage category		II		
Pollution degree		2		

		OB(R)OA1000-...			OB(R)OA2000-...
		24 V DC	115 V UC	230 V UC	24 V DC
<b>Input circuit</b>					
Input voltage		24 V DC	115 V AC/DC	230 V AC/DC	24 V DC
Frequency		-	50/60 Hz		-
Input current		3.6 mA	4.15 mA	4.6 mA	3.6 mA
Pull-in voltage		14 V	60 V	135 V	14 V
Typ. switch-on time		150 µs	2.2 ms	2.5 ms	150 µs
Typ. switch-off time		1 ms	18 ms	25 ms	1 ms
Operating frequency		500 Hz	25 Hz	20 Hz	500 Hz
Permissible leakage current		1 mA			1 mA
<b>Output circuit</b>		11(13+)- 14			
Kind of output		Triac			Triac
Rated operational voltage		24-400 V AC			10-230 V AC
Minimum switching current		25 mA			25 mA
Maximum switching current		1 A			2 A
Leakage current at max. switching voltage		< 500 µA			< 500 µA
Rated operational current I <sub>e</sub>	AC-12 (resistive) 400 V	1 A			-
	AC-12 (resistive) 230 V	-			2A
Residual voltage	typical	1 V			1 V
	maximum	1.6 V			1.6 V
Max. fuse rating to achieve short-circuit protection		4 A ultra-fast			4 A ultra-fast
<b>Isolation data</b>					
Rated insulation voltage U <sub>i</sub>		400 V			230 V
Rated impulse withstand voltage U <sub>imp</sub>		4 kV			4 kV
Overvoltage category		II			II
Pollution degree		2			2

## Boxed optocouplers R600 range

### Technical data

#### General technical data - Optocouplers

		OB	OBR
<b>General data</b>			
Material of housing		UL 94 V0	
Mounting		DIN Rail	
Degree of protection	housing / terminals	IP20 NEMA1	
<b>Electrical connection</b>		<b>Screw terminal</b>	<b>Spring-type terminal</b>
Connecting capacity	fine-strand	0.22-2.5 mm <sup>2</sup> (24-14 AWG)	
	rigid	0.2-4 mm <sup>2</sup> (24-12 AWG)	0.2-2.5 mm <sup>2</sup> (24-14 AWG)
Stripping length		9 mm (0.354 in)	
Tightening torque		0.4-0.6 Nm (3.5-5.3 lb.in)	n/a
<b>Environmental data</b>			
Ambient temperature ranges	storage	-40...+80 °C (-40...+176 °F)	
	operation	-20...+70 °C (-4...+158 °F)	
<b>Standards/Directives</b>			
Standards		IEC/EN 60947-5-1	
Low Voltage Directive		2014/35/EU	
RoHS Directive		2011/65/EU	

# Boxed optocouplers R600 range

## Technical diagrams

### Dimensional drawings in mm and inches

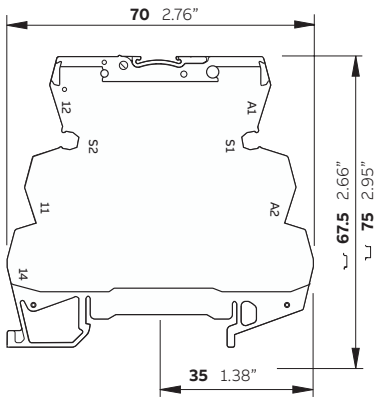

R600 - screw connection

2CDC29025F0013

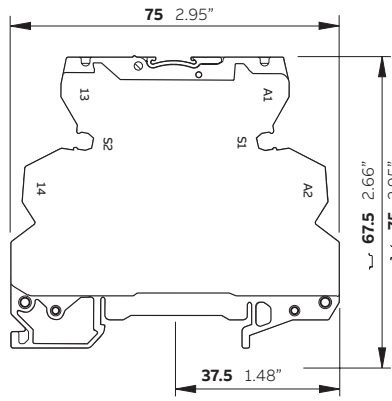

R600 - spring connection

2CDC29026F0013

### Connection diagrams

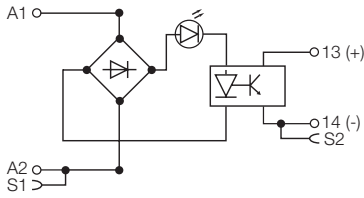

OB(R)OC, OB(R)IC  
except 5-12 V DC versions

2CDC292019F0016

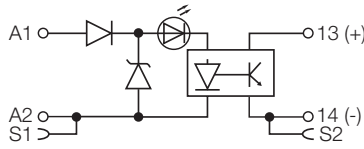

OB(R)IC0100-5-12 V DC  
OB(R)OC2000-5-12 V DC

2CDC292017F0016

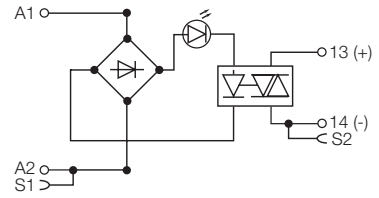

OB(R)OA

2CDC292018F0016





# Index

## Product type

Type	Order code	Page
ADP.01	1SVR430029R0100	41
ADP.01	1SVR430029R0100	242
ADP.02	1SVR440029R0100	242
C011-100	GHC0110003R0004	191
C011-110	GHC0110003R0005	191
C011-120	GHC0110003R0006	191
C011-130	GHC0110003R0007	191
C011-140	GHC0110003R0011	191
C011-150	GHC0110003R0008	191
C011-160	GHC0110003R0009	191
C011-170	GHC0110003R0010	191
C011-3-150	GHC0110033R0008	191
C011-70	GHC0110003R0001	191
C011-80	GHC0110003R0002	191
C011-90	GHC0110003R0003	191
CM-AH-3	1SVR450056R7000	242
CM-CT 100/1	1SVR450116R1200	243
CM-CT 100/5	1SVR450116R5200	243
CM-CT 150/1	1SVR450116R1300	243
CM-CT 150/5	1SVR450116R5300	243
CM-CT 200/1	1SVR450116R1400	243
CM-CT 200/5	1SVR450116R5400	243
CM-CT 300/1	1SVR450117R1100	243
CM-CT 300/5	1SVR450117R5100	243
CM-CT 400/1	1SVR450117R1200	243
CM-CT 400/5	1SVR450117R5200	243
CM-CT 50/1	1SVR450116R1000	243
CM-CT 50/5	1SVR450116R5000	243
CM-CT 500/1	1SVR450117R1300	243
CM-CT 500/5	1SVR450117R5300	243
CM-CT 600/1	1SVR450117R1400	243
CM-CT 600/5	1SVR450117R5400	243
CM-CT 75/1	1SVR450116R1100	243
CM-CT 75/5	1SVR450116R5100	243
CM-CT A	1SVR450118R1000	243
CM-EFS.2P	1SVR740750R0400	89
CM-EFS.2S	1SVR730750R0400	89
CM-ENE MAX	1SVR550855R9400	229
CM-ENE MAX	1SVR550850R9400	229
CM-ENE MAX	1SVR550851R9400	229
CM-ENE MIN	1SVR550855R9500	229
CM-ENE MIN	1SVR550850R9500	229
CM-ENE MIN	1SVR550851R9500	229
CM-ENS.11P	1SVR730850R2100	229
CM-ENS.11S	1SVR730850R0100	229
CM-ENS.13P	1SVR740850R2100	229
CM-ENS.13S	1SVR740850R0100	229
CM-ENS.21P	1SVR740850R0200	229
CM-ENS.21S	1SVR730850R0200	229
CM-ENS.23P	1SVR740850R2200	229
CM-ENS.23S	1SVR730850R2200	229

Type	Order code	Page
CM-ENS.31P	1SVR740850R0300	229
CM-ENS.31S	1SVR730850R0300	229
CM-ESS.1P	1SVR740830R0300	89
CM-ESS.1P	1SVR740831R0300	89
CM-ESS.1P	1SVR740831R1300	89
CM-ESS.1S	1SVR730830R0300	89
CM-ESS.1S	1SVR730831R0300	89
CM-ESS.1S	1SVR730831R1300	89
CM-ESS.2P	1SVR740830R0400	89
CM-ESS.2P	1SVR740831R0400	89
CM-ESS.2P	1SVR740831R1400	89
CM-ESS.2S	1SVR730830R0400	89
CM-ESS.2S	1SVR730831R0400	89
CM-ESS.2S	1SVR730831R1400	89
CM-ESS.MP	1SVR740830R0500	89
CM-ESS.MS	1SVR730830R0500	89
CM-GM-1	1SVR450056R8000	242
CM-HC	1SVR402902R1000	242
CM-HCT	1SVR402902R2000	242
CM-HE	1SVR402902R0000	242
CM-IVN.P	1SVR760669R9400	161
CM-IVN.S	1SVR750669R9400	161
CM-IWM.10	1SVR470670R1000	161
CM-IWM.11	1SVR470670R1100	161
CM-IWN.1P	1SVR760660R0200	161
CM-IWN.1S	1SVR750660R0200	161
CM-IWS.1P	1SVR740660R0100	161
CM-IWS.1S	1SVR730660R0100	161
CM-IWS.2P	1SVR740670R0200	161
CM-IWS.2S	1SVR730670R0200	161
CM-KH-3	1SVR450056R6000	242
CM-MPN.52P	1SVR760487R8300	115
CM-MPN.52S	1SVR750487R8300	115
CM-MPN.62P	1SVR760488R8300	115
CM-MPN.62S	1SVR750488R8300	115
CM-MPN.72P	1SVR760489R8300	115
CM-MPN.72S	1SVR750489R8300	115
CM-MPS.11P	1SVR740885R1300	115
CM-MPS.11S	1SVR730885R1300	115
CM-MPS.21P	1SVR740885R3300	115
CM-MPS.21S	1SVR730885R3300	115
CM-MPS.23P	1SVR740885R4300	115
CM-MPS.23S	1SVR730885R4300	115
CM-MPS.31P	1SVR740884R1300	115
CM-MPS.31S	1SVR730884R1300	115
CM-MPS.41P	1SVR740884R3300	115
CM-MPS.41S	1SVR730884R3300	115
CM-MPS.43P	1SVR740884R4300	115
CM-MPS.43S	1SVR730884R4300	115
CM-MSE	1SVR550805R9300	190
CM-MSE	1SVR550800R9300	190

# Index

## Product type

Type	Order code	Page	Type	Order code	Page
CM-MSE	1SVR550801R9300	190	CM-SRS.11P	1SVR740840R0200	87
CM-MSS.11P	1SVR740720R1400	190	CM-SRS.11P	1SVR740841R0200	87
CM-MSS.11S	1SVR730720R1400	190	CM-SRS.11P	1SVR740841R1200	87
CM-MSS.12P	1SVR740700R0100	190	CM-SRS.11S	1SVR730840R0200	87
CM-MSS.12S	1SVR730700R0100	190	CM-SRS.11S	1SVR730841R0200	87
CM-MSS.13P	1SVR740700R2100	190	CM-SRS.11S	1SVR730841R1200	87
CM-MSS.13S	1SVR730700R2100	190	CM-SRS.12S	1SVR730840R0300	87
CM-MSS.21P	1SVR740722R1400	190	CM-SRS.12S	1SVR730841R0300	87
CM-MSS.21S	1SVR730722R1400	190	CM-SRS.12S	1SVR730841R1300	87
CM-MSS.22P	1SVR740700R0200	190	CM-SRS.21P	1SVR740840R0400	87
CM-MSS.22S	1SVR730700R0200	190	CM-SRS.21P	1SVR740841R0400	87
CM-MSS.23P	1SVR740700R2200	190	CM-SRS.21P	1SVR740841R1400	87
CM-MSS.23S	1SVR730700R2200	190	CM-SRS.21S	1SVR730840R0400	87
CM-MSS.31P	1SVR740712R1400	190	CM-SRS.21S	1SVR730841R0400	87
CM-MSS.31S	1SVR730712R1400	190	CM-SRS.21S	1SVR730841R1400	87
CM-MSS.32P	1SVR740712R0200	190	CM-SRS.22S	1SVR730840R0500	87
CM-MSS.32S	1SVR730712R0200	190	CM-SRS.22S	1SVR730841R0500	87
CM-MSS.33P	1SVR740712R2200	190	CM-SRS.22S	1SVR730841R1500	87
CM-MSS.33S	1SVR730712R2200	190	CM-SRS.M1P	1SVR740840R0600	87
CM-MSS.41P	1SVR740712R1200	190	CM-SRS.M1S	1SVR730840R0600	87
CM-MSS.41S	1SVR730712R1200	190	CM-SRS.M2S	1SVR730840R0700	87
CM-MSS.51P	1SVR740712R1300	190	CM-TCS.11P	1SVR740740R0100	209
CM-MSS.51S	1SVR730712R1300	190	CM-TCS.11S	1SVR730740R0100	209
CM-PAS.31P	1SVR740774R1300	113	CM-TCS.12P	1SVR740740R0200	209
CM-PAS.31S	1SVR730774R1300	113	CM-TCS.12S	1SVR730740R0200	209
CM-PAS.41P	1SVR740774R3300	113	CM-TCS.13P	1SVR740740R0300	209
CM-PAS.41S	1SVR730774R3300	113	CM-TCS.13S	1SVR730740R0300	209
CM-PBE	1SVR550881R9400	113	CM-TCS.21P	1SVR740740R9100	209
CM-PBE	1SVR550882R9500	113	CM-TCS.21S	1SVR730740R9100	209
CM-PFE	1SVR550824R9100	113	CM-TCS.22P	1SVR740740R9200	209
CM-PFE.2	1SVR550826R9100	113	CM-TCS.22S	1SVR730740R9200	209
CM-PFS.P	1SVR740824R9300	113	CM-TCS.23P	1SVR740740R9300	209
CM-PFS.S	1SVR730824R9300	113	CM-TCS.23S	1SVR730740R9300	209
CM-PSS.31P	1SVR740784R2300	113	CM-UFD.M22M	1SVR560731R3700	145
CM-PSS.31S	1SVR730784R2300	113	CM-UFD.M31	1SVR560730R3401	145
CM-PSS.41P	1SVR740784R3300	113	CM-UFD.M31M	1SVR560731R3701	145
CM-PSS.41S	1SVR730784R3300	113	CM-UFD.M33	1SVR560730R3402	145
CM-PVE	1SVR550870R9400	113	CM-UFD.M33M	1SVR560731R3702	145
CM-PVE	1SVR550871R9500	113	CM-UFD.M34M	1SVR560731R3703	145
CM-PVS.31P	1SVR740794R1300	113	COV.01	1SVR430005R0100	242
CM-PVS.31S	1SVR730794R1300	113	COV.02	1SVR440005R0100	242
CM-PVS.41P	1SVR740794R3300	113	COV.11	1SVR730005R0100	41
CM-PVS.41S	1SVR730794R3300	113	COV.11	1SVR730005R0100	242
CM-PVS.81P	1SVR740794R2300	113	COV.12	1SVR750005R0100	242
CM-PVS.81S	1SVR730794R2300	113	CP-B 24/10.0	1SVR427060R1000	332
CM-SE-1000	1SVR450056R0200	242	CP-B 24/20.0	1SVR427060R2000	332
CM-SE-300	1SVR450056R0000	242	CP-B 24/3.0	1SVR427060R0300	332
CM-SE-600	1SVR450056R0100	242	CP-B EXT.2	1SVR427065R0000	332
CM-SFS.21P	1SVR740760R0400	87	CP-C.1 24/10.0	1SVR360663R1001	294
CM-SFS.21S	1SVR730760R0400	87	CP-C.1 24/10.0-C	1SVR360663R2001	294
CM-SFS.22S	1SVR730760R0500	87	CP-C.1 24/10.0-L	1SVR361663R1001	294

# Index

## Product type

Type	Order code	Page
CP-C.1 24/20.0	1SVR360763R1001	294
CP-C.1 24/20.0-C	1SVR360763R2001	294
CP-C.1 24/20.0-L	1SVR361763R1001	294
CP-C.1 24/5.0	1SVR360563R1001	294
CP-C.1 24/5.0-C	1SVR360563R2001	294
CP-C.1 24/5.0-L	1SVR361563R1001	294
CP-C.1-A-RU	1SVR360060R1001	342
CP-C.1-A-RU-C	1SVR360060R2001	342
CP-C.1-A-RU-L	1SVR361060R1001	342
CP-D 12/0.83	1SVR427041R1000	318
CP-D 12/2.1	1SVR427043R1200	318
CP-D 24/0.42	1SVR427041R0000	318
CP-D 24/1.3	1SVR427043R0100	318
CP-D 24/2.5	1SVR427044R0200	318
CP-D 24/4.2	1SVR427045R0400	318
CP-D RU	1SVR427049R0000	342
CP-E 12/10.0	1SVR427035R1000	260
CP-E 12/2.5	1SVR427032R1000	260
CP-E 24/0.75	1SVR427030R0000	260
CP-E 24/1.25	1SVR427031R0000	260
CP-E 24/10.0	1SVR427035R0000	260
CP-E 24/2.5	1SVR427032R0000	260
CP-E 24/20.0	1SVR427036R0000	260
CP-E 24/5.0	1SVR427034R0000	260
CP-E 48/0.62	1SVR427030R2000	260
CP-E 48/1.25	1SVR427031R2000	260
CP-E 48/10.0	1SVR427035R2000	260
CP-E 48/5.0	1SVR427034R2000	260
CP-E 5/3.0	1SVR427033R3000	260
CP-RUD	1SVR423418R9000	342
CP-T 24/10.0	1SVR427055R0000	280
CP-T 24/20.0	1SVR427056R0000	280
CP-T 24/40.0	1SVR427057R0000	280
CP-T 24/5.0	1SVR427054R0000	280
CP-T 48/10.0	1SVR427055R2000	280
CP-T 48/20.0	1SVR427056R2000	280
CP-T 48/5.0	1SVR427054R2000	280
CR-M012AC2L	1SVR405611R0300	398
CR-M012AC3L	1SVR405612R0300	398
CR-M012AC4L	1SVR405613R0300	398
CR-M012DC2	1SVR405611R4000	397
CR-M012DC2L	1SVR405611R4100	398
CR-M012DC2LD	1SVR405611R4400	399
CR-M012DC3	1SVR405612R4000	397
CR-M012DC3L	1SVR405612R4100	398
CR-M012DC3LD	1SVR405612R4400	399
CR-M012DC4	1SVR405613R4000	397
CR-M012DC4L	1SVR405613R4100	398
CR-M012DC4LD	1SVR405613R4400	399
CR-M012DC4LDG	1SVR405618R4400	400
CR-M012DC4LDGSS	1SVR405618R4410	401

Type	Order code	Page
CR-M012DC4LG	1SVR405618R4100	400
CR-M024AC2	1SVR405611R0000	397
CR-M024AC2L	1SVR405611R0100	398
CR-M024AC3	1SVR405612R0000	397
CR-M024AC3L	1SVR405612R0100	398
CR-M024AC4	1SVR405613R0000	397
CR-M024AC4G	1SVR405618R0000	399
CR-M024AC4L	1SVR405613R0100	398
CR-M024AC4LG	1SVR405618R0100	400
CR-M024AC4LS62CV	1SVR405613R0010	401
CR-M024DC2	1SVR405611R1000	397
CR-M024DC2L	1SVR405611R1100	398
CR-M024DC2LD	1SVR405611R1400	399
CR-M024DC3	1SVR405612R1000	397
CR-M024DC3L	1SVR405612R1100	398
CR-M024DC3LD	1SVR405612R1400	399
CR-M024DC4	1SVR405613R1000	397
CR-M024DC4G	1SVR405618R1000	399
CR-M024DC4GLC62CV	1SVR405618R1010	401
CR-M024DC4GSS42V	1SVR405618R1011	401
CR-M024DC4L	1SVR405613R1100	398
CR-M024DC4LC42	1SVR405613R1012	401
CR-M024DC4LD	1SVR405614R1100	399
CR-M024DC4LDG	1SVR405618R1400	400
CR-M024DC4LDGSS	1SVR405618R1410	401
CR-M024DC4LG	1SVR405618R1100	400
CR-M024DC4LGLC22	1SVR405618R1110	401
CR-M024DC4LS42V	1SVR405613R1011	401
CR-M024DC4SS42V	1SVR405613R1010	401
CR-M048AC2	1SVR405611R5000	397
CR-M048AC2L	1SVR405611R5100	398
CR-M048AC3	1SVR405612R5000	397
CR-M048AC3L	1SVR405612R5100	398
CR-M048AC4	1SVR405613R5000	397
CR-M048AC4L	1SVR405613R5100	398
CR-M048AC4LG	1SVR405618R5100	400
CR-M048DC2	1SVR405611R6000	397
CR-M048DC2L	1SVR405611R6100	398
CR-M048DC2LD	1SVR405611R6400	399
CR-M048DC3	1SVR405612R6000	397
CR-M048DC3L	1SVR405612R6100	398
CR-M048DC3LD	1SVR405612R6400	399
CR-M048DC4	1SVR405613R6000	397
CR-M048DC4L	1SVR405613R6100	398
CR-M048DC4LD	1SVR405613R6400	399
CR-M048DC4LG	1SVR405618R6100	400
CR-M060AC3	1SVR405612R5200	397
CR-M060DC2	1SVR405611R4200	397
CR-M060DC2L	1SVR405611R4300	398
CR-M060DC3	1SVR405612R4200	397
CR-M060DC3L	1SVR405612R4300	398

# Index

## Product type

Type	Order code	Page	Type	Order code	Page
CR-M060DC4	1SVR405613R4200	397	CR-M230AC3L	1SVR405612R3100	398
CR-M060DC4L	1SVR405613R4300	398	CR-M230AC4	1SVR405613R3000	397
CR-M060DC4LG	1SVR405618R4300	400	CR-M230AC4G	1SVR405618R3000	399
CR-M110AC2	1SVR405611R7000	397	CR-M230AC4GSS92CV	1SVR405618R3112	402
CR-M110AC2L	1SVR405611R7100	398	CR-M230AC4L	1SVR405613R3100	398
CR-M110AC3	1SVR405612R7000	397	CR-M230AC4LC92	1SVR405613R3012	402
CR-M110AC3L	1SVR405612R7100	398	CR-M230AC4LG	1SVR405618R3100	400
CR-M110AC4	1SVR405613R7000	397	CR-M230AC4LGLC	1SVR405618R3110	402
CR-M110AC4G	1SVR405618R7000	399	CR-M230AC4LGSS	1SVR405618R3111	402
CR-M110AC4L	1SVR405613R7100	398	CR-M230AC4LS92CV	1SVR405613R3011	402
CR-M110AC4LG	1SVR405618R7100	400	CR-M230AC4SS92CV	1SVR405613R3110	402
CR-M110DC2	1SVR405611R8000	397	CR-M2LC	1SVR405651R1200	403
CR-M110DC2L	1SVR405611R8100	398	CR-M2LS	1SVR405651R1100	403
CR-M110DC2LD	1SVR405611R8400	399	CR-M2SF	1SVR405651R1300	403
CR-M110DC3	1SVR405612R8000	397	CR-M2SS	1SVR405651R1000	403
CR-M110DC3L	1SVR405612R8100	398	CR-M3LS	1SVR405651R2100	403
CR-M110DC3LD	1SVR405612R8400	399	CR-M3SS	1SVR405651R2000	403
CR-M110DC4	1SVR405613R8000	397	CR-M4LC	1SVR405651R3200	403
CR-M110DC4L	1SVR405613R8100	398	CR-M4LS	1SVR405651R3100	403
CR-M110DC4LD	1SVR405613R8400	399	CR-M4SF	1SVR405651R3300	403
CR-M110DC4LG	1SVR405618R8100	400	CR-M4SS	1SVR405651R3000	403
CR-M120AC2	1SVR405611R2000	397	CR-MH	1SVR405659R1000	403
CR-M120AC2L	1SVR405611R2100	398	CR-MH1	1SVR405659R1100	403
CR-M120AC3	1SVR405612R2000	397	CR-MJ	1SVR405658R6000	403
CR-M120AC3L	1SVR405612R2100	398	CR-MM	1SVR405658R1000	403
CR-M120AC4	1SVR405613R2000	397	CR-MP	1SVR405658R2000	403
CR-M120AC4L	1SVR405613R2100	398	CR-P/M 22	1SVR405651R0000	404
CR-M120AC4LG	1SVR405618R2100	400	CR-P/M 42	1SVR405652R0000	404
CR-M125DC2	1SVR405611R8200	397	CR-P/M 42 B	1SVR405652R4000	404
CR-M125DC2L	1SVR405611R8300	398	CR-P/M 42 BV	1SVR405652R4100	404
CR-M125DC2LD	1SVR405611R8500	399	CR-P/M 42 C	1SVR405652R9000	404
CR-M125DC3	1SVR405612R8200	397	CR-P/M 42 CV	1SVR405652R9100	404
CR-M125DC3L	1SVR405612R8300	398	CR-P/M 42 V	1SVR405652R1000	404
CR-M125DC3LD	1SVR405612R8500	399	CR-P/M 52B	1SVR405653R0000	404
CR-M125DC4	1SVR405613R8200	397	CR-P/M 52C	1SVR405653R1000	404
CR-M125DC4L	1SVR405613R8300	398	CR-P/M 52D	1SVR405653R4000	404
CR-M125DC4LD	1SVR405613R8500	399	CR-P/M 62	1SVR405654R0000	404
CR-M125DC4LG	1SVR405618R8300	400	CR-P/M 62 C	1SVR405655R0000	405
CR-M220DC2	1SVR405611R9000	397	CR-P/M 62 CV	1SVR405655R1000	405
CR-M220DC2L	1SVR405611R9100	398	CR-P/M 62 D	1SVR405655R4000	405
CR-M220DC2LD	1SVR405611R9400	399	CR-P/M 62 DV	1SVR405655R4100	405
CR-M220DC3	1SVR405612R9000	397	CR-P/M 62 E	1SVR405654R4000	404
CR-M220DC3L	1SVR405612R9100	398	CR-P/M 62 EV	1SVR405654R4100	404
CR-M220DC3LD	1SVR405612R9400	399	CR-P/M 62 V	1SVR405654R1000	404
CR-M220DC4	1SVR405613R9000	397	CR-P/M 72	1SVR405656R0000	405
CR-M220DC4L	1SVR405613R9100	398	CR-P/M 72 A	1SVR405656R1000	405
CR-M220DC4LD	1SVR405613R9400	399	CR-P/M 82	1SVR405656R2000	405
CR-M220DC4LG	1SVR405618R9100	400	CR-P/M 92	1SVR405654R0100	404
CR-M230AC2	1SVR405611R3000	397	CR-P/M 92 C	1SVR405655R0100	405
CR-M230AC2L	1SVR405611R3100	398	CR-P/M 92 CV	1SVR405655R1100	405
CR-M230AC3	1SVR405612R3000	397	CR-P/M 92 V	1SVR405654R1100	404

# Index

## Product type

Type	Order code	Page	Type	Order code	Page
CR-P012AC2	1SVR405601R0200	393	CR-P230AC2SS92CV	1SVR405601R3110	396
CR-P012DC1	1SVR405600R4000	393	CR-PH	1SVR405659R0000	394
CR-P012DC1SS42V	1SVR405600R4010	395	CR-PH1	1SVR405659R0100	394
CR-P012DC2	1SVR405601R4000	393	CR-PJ	1SVR405658R5000	394
CR-P012DC2SS42V	1SVR405601R4010	396	CR-PLC	1SVR405650R0200	394
CR-P024AC1	1SVR405600R0000	393	CR-PLS	1SVR405650R0000	394
CR-P024AC1SS62CV	1SVR405600R0010	395	CR-PLSX	1SVR405650R0100	394
CR-P024AC2	1SVR405601R0000	393	CR-PM	1SVR405658R0000	394
CR-P024AC2G	1SVR405606R0000	393	CR-PSS	1SVR405650R1000	394
CR-P024AC2SS62CV	1SVR405601R0010	396	CR-S005VDC1R	1SVR405501R1010	389
CR-P024DC1	1SVR405600R1000	393	CR-S005VDC1RG	1SVR405501R1020	389
CR-P024DC1LC42V	1SVR405600R1011	395	CR-S006/024VDC1SS	1SVR405521R1100	390
CR-P024DC1LC62C	1SVR405600R1013	395	CR-S006/024VDC1SZ	1SVR405521R1200	390
CR-P024DC1SS42V	1SVR405600R1010	395	CR-S012/024VADC1SS	1SVR405521R3100	390
CR-P024DC2	1SVR405601R1000	393	CR-S012/024VADC1SZ	1SVR405521R3200	390
CR-P024DC2G	1SVR405606R1000	393	CR-S012VDC1R	1SVR405501R2010	389
CR-P024DC2GLC42V	1SVR405606R1010	396	CR-S012VDC1RG	1SVR405501R2020	389
CR-P024DC2GLC62C	1SVR405606R1013	396	CR-S024VADC1CRGS	1SVR405541R3120	389
CR-P024DC2GLC62CV	1SVR405606R1011	396	CR-S024VADC1CRGZ	1SVR405541R3220	389
CR-P024DC2LC42	1SVR405601R1012	396	CR-S024VADC1CRS	1SVR405541R3110	389
CR-P024DC2LS42	1SVR405601R1013	396	CR-S024VADC1CRZ	1SVR405541R3210	389
CR-P024DC2LS42V	1SVR405601R1011	396	CR-S024VDC1MOS	1SVR405510R3060	389
CR-P024DC2SS42V	1SVR405601R1010	396	CR-S024VDC1R	1SVR405501R3010	389
CR-P024MOS1	1SVR405610R4060	393	CR-S024VDC1RG	1SVR405501R3020	389
CR-P024TRI1	1SVR405610R4070	393	CR-S024VDC1TRA	1SVR405510R3050	389
CR-P048AC1	1SVR405600R5000	393	CR-S024VDC1TRI	1SVR405510R3070	389
CR-P048AC2	1SVR405601R5000	393	CR-S048/060VADC1SS	1SVR405521R5100	390
CR-P048DC1	1SVR405600R6000	393	CR-S048/060VADC1SZ	1SVR405521R5200	390
CR-P048DC2	1SVR405601R6000	393	CR-S048VDC1R	1SVR405501R4010	389
CR-P110AC1	1SVR405600R7000	393	CR-S048VDC1RG	1SVR405501R4020	389
CR-P110AC2	1SVR405601R7000	393	CR-S060VDC1R	1SVR405501R5010	389
CR-P110AC2G	1SVR405606R7000	393	CR-S060VDC1RG	1SVR405501R5020	389
CR-P110DC1	1SVR405600R8000	393	CR-S110/125VADC1SS	1SVR405521R6100	390
CR-P110DC1SS42CV	1SVR405600R8010	395	CR-S110/125VADC1SZ	1SVR405521R6200	390
CR-P110DC2	1SVR405601R8000	393	CR-S110VADC1CRGS	1SVR405541R6120	389
CR-P110DC2SS42CV	1SVR405601R8010	396	CR-S110VADC1CRGZ	1SVR405541R6220	389
CR-P120AC1	1SVR405600R2000	393	CR-S110VADC1CRS	1SVR405541R6110	389
CR-P120AC1SS92CV	1SVR405600R2010	395	CR-S110VADC1CRZ	1SVR405541R6210	389
CR-P120AC2	1SVR405601R2000	393	CR-S220/240VADC1SS	1SVR405521R7100	390
CR-P120AC2SS92CV	1SVR405601R2010	396	CR-S220/240VADC1SZ	1SVR405521R7200	390
CR-P230AC1	1SVR405600R3000	393	CR-S230VADC1CRGS	1SVR405541R7120	389
CR-P230AC1LC92CV	1SVR405600R3010	395	CR-S230VADC1CRGZ	1SVR405541R7220	389
CR-P230AC1LS	1SVR405600R3011	395	CR-S230VADC1CRS	1SVR405541R7110	389
CR-P230AC1SS92CV	1SVR405600R3110	395	CR-S230VADC1CRZ	1SVR405541R7210	389
CR-P230AC2	1SVR405601R3000	393	CR-SJB20-BLACK	1SVR405598R0900	390
CR-P230AC2G	1SVR405606R3000	393	CR-SJB20-BLUE	1SVR405598R0700	390
CR-P230AC2GLC92	1SVR405606R3013	396	CR-SJB20-RED	1SVR405598R0800	390
CR-P230AC2GLC92C	1SVR405606R3012	396	CR-SSEP	1SVR405599R0000	390
CR-P230AC2GLC92CV	1SVR405606R3010	396	CR-U 21	1SVR405661R0000	408
CR-P230AC2LC92	1SVR405601R3012	396	CR-U 41	1SVR405662R0000	408
CR-P230AC2LS92CV	1SVR405601R3011	396	CR-U 41B	1SVR405662R4000	408

# Index

## Product type

Type	Order code	Page	Type	Order code	Page
CR-U 41BV	1SVR405662R4100	408	CR-U060AC3	1SVR405622R5200	406
CR-U 41C	1SVR405662R9000	408	CR-U110AC2	1SVR405621R7000	406
CR-U 41CV	1SVR405662R9100	408	CR-U110AC2L	1SVR405621R7100	406
CR-U 41V	1SVR405662R1000	408	CR-U110AC3	1SVR405622R7000	406
CR-U 51B	1SVR405663R0000	408	CR-U110AC3L	1SVR405622R7100	407
CR-U 51C	1SVR405663R1000	408	CR-U110DC2	1SVR405621R8000	406
CR-U 51D	1SVR405663R4000	408	CR-U110DC2L	1SVR405621R8100	406
CR-U 61	1SVR405664R0000	408	CR-U110DC2LD	1SVR405621R8400	407
CR-U 61C	1SVR405665R0000	409	CR-U110DC3	1SVR405622R8000	406
CR-U 61CV	1SVR405665R1000	409	CR-U110DC3L	1SVR405622R8100	407
CR-U 61D	1SVR405665R4000	409	CR-U110DC3LD	1SVR405622R8400	407
CR-U 61DV	1SVR405665R4100	409	CR-U120AC2	1SVR405621R2000	406
CR-U 61E	1SVR405664R4000	408	CR-U120AC2L	1SVR405621R2100	406
CR-U 61EV	1SVR405664R4100	408	CR-U120AC3	1SVR405622R2000	406
CR-U 61V	1SVR405664R1000	408	CR-U120AC3L	1SVR405622R2100	407
CR-U 71	1SVR405666R0000	409	CR-U125DC3	1SVR405622R8200	406
CR-U 71A	1SVR405666R1000	409	CR-U220DC2	1SVR405621R9000	406
CR-U 81	1SVR405666R2000	409	CR-U220DC2L	1SVR405621R9100	406
CR-U 91	1SVR405664R0100	408	CR-U220DC3	1SVR405622R9000	406
CR-U 91C	1SVR405665R0100	409	CR-U220DC3L	1SVR405622R9100	407
CR-U 91CV	1SVR405665R1100	409	CR-U230AC2	1SVR405621R3000	406
CR-U 91V	1SVR405664R1100	408	CR-U230AC2L	1SVR405621R3100	406
CR-U T	1SVR405667R0000	409	CR-U230AC3	1SVR405622R3000	406
CR-U012AC2L	1SVR405621R0300	406	CR-U230AC3L	1SVR405622R3100	407
CR-U012AC3L	1SVR405622R0300	407	CR-U2S	1SVR405670R0000	407
CR-U012DC2	1SVR405621R4000	406	CR-U2SM	1SVR405670R1100	407
CR-U012DC2L	1SVR405621R4100	406	CR-U3E	1SVR405660R0100	407
CR-U012DC2LD	1SVR405621R4400	407	CR-U3S	1SVR405660R0000	407
CR-U012DC3	1SVR405622R4000	406	CR-U3SM	1SVR405660R1100	407
CR-U012DC3L	1SVR405622R4100	407	CR-UH	1SVR405669R0000	407
CR-U012DC3LD	1SVR405622R4400	407	CT- MXS.22S	1SVR730030R3300	39
CR-U024AC2	1SVR405621R0000	406	CT-AHC.12	1SVR508110R0000	25
CR-U024AC2L	1SVR405621R0100	406	CT-AHC.22	1SVR508110R0100	25
CR-U024AC3	1SVR405622R0000	406	CT-AHD.12	1SVR500110R0000	57
CR-U024AC3L	1SVR405622R0100	407	CT-AHD.22	1SVR500110R0100	57
CR-U024DC2	1SVR405621R1000	406	CT-AHS.22P	1SVR740110R3300	40
CR-U024DC2L	1SVR405621R1100	406	CT-AHS.22S	1SVR730110R3300	40
CR-U024DC2LD	1SVR405621R1400	407	CT-APS.12P	1SVR740180R3100	40
CR-U024DC3	1SVR405622R1000	406	CT-APS.12S	1SVR730180R3100	40
CR-U024DC3L	1SVR405622R1100	407	CT-APS.21P	1SVR740180R0300	40
CR-U024DC3LD	1SVR405623R1100	407	CT-APS.21S	1SVR730180R0300	40
CR-U048AC2	1SVR405621R5000	406	CT-APS.22P	1SVR740180R3300	40
CR-U048AC2L	1SVR405621R5100	406	CT-APS.22S	1SVR730180R3300	40
CR-U048AC3	1SVR405622R5000	406	CT-ARC.12	1SVR508120R0000	25
CR-U048AC3L	1SVR405622R5100	407	CT-ARS.11P	1SVR740120R3100	40
CR-U048DC2	1SVR405621R6000	406	CT-ARS.11S	1SVR730120R3100	40
CR-U048DC2L	1SVR405621R6100	406	CT-ARS.21P	1SVR740120R3300	40
CR-U048DC2LD	1SVR405621R6400	407	CT-ARS.21S	1SVR730120R3300	40
CR-U048DC3	1SVR405622R6000	406	CT-EBC.12	1SVR508150R0000	25
CR-U048DC3L	1SVR405622R6100	407	CT-EBD.12	1SVR500150R0000	57
CR-U048DC3LD	1SVR405622R6400	407	CT-ERC.12	1SVR508100R0000	25

# Index

## Product type

Type	Order code	Page	Type	Order code	Page
CT-ERC.22	1SVR508100R0100	25	EPD24-TB-101-8A	2CDE601101R2008	352
CT-ERD.12	1SVR500100R0000	57	EPD-BB500	2CDE605100R0500	352
CT-ERD.22	1SVR500100R0100	57	EPD-SB21	2CDE605200R0021	352
CT-ERS.12P	1SVR740100R3100	40	KA1-8029	1SFA616920R8029	41
CT-ERS.12S	1SVR730100R3100	40	KA1-8030	1SFA616920R8030	41
CT-ERS.21P	1SVR740100R0300	40	MA16-1060	1SFA611940R1060	41
CT-ERS.21S	1SVR730100R0300	40	MAR.01	1SVR366017R0100	41
CT-ERS.22P	1SVR740100R3300	40	MAR.01	1SVR366017R0100	242
CT-ERS.22S	1SVR730100R3300	40	MAR.02	1SVR430043R0000	242
CT-MBS.22P	1SVR740010R3200	39	MAR.12	1SVR730006R0000	41
CT-MBS.22S	1SVR730010R3200	39	MAR.12	1SVR730006R0000	242
CT-MFC.12	1SVR508020R0000	25	MT-150B	1SFA611410R1506	41
CT-MFC.21	1SVR508020R1100	25	MT-250B	1SFA611410R2506	41
CT-MFD.12	1SVR500020R0000	57	MT-350B	1SFA611410R3506	41
CT-MFD.21	1SVR500020R1100	57	OBIC0100-115-230	1SNA645022R2700	451
CT-MFS.21P	1SVR740010R0200	39	OBIC0100-24VDC	1SNA645021R2600	451
CT-MFS.21S	1SVR730010R0200	39	OBIC0100-48-60VUC	1SNA645049R1200	451
CT-MKC.31	1SVR508010R1300	25	OBIC0100-5-12VDC	1SNA645047R0000	451
CT-MVS.12P	1SVR740020R3100	39	OBOA1000-115VUC	1SNA645062R0700	451
CT-MVS.12S	1SVR730020R3100	39	OBOA1000-230VUC	1SNA645028R0500	451
CT-MVS.21P	1SVR740020R0200	39	OBOA1000-24VDC	1SNA645027R2400	451
CT-MVS.21S	1SVR730020R0200	39	OBOA2000-24VDC	1SNA645029R0600	452
CT-MVS.22P	1SVR740020R3300	39	OBOC2000-115VUC	1SNA645054R0700	451
CT-MVS.22S	1SVR730020R3300	39	OBOC2000-230VUC	1SNA645026R2300	451
CT-MVS.23P	1SVR740021R2300	39	OBOC2000-24VDC	1SNA645051R0400	451
CT-MVS.23S	1SVR730021R2300	39	OBOC2000-24VUC	1SNA645025R2200	451
CT-MXS.22P	1SVR740030R3300	39	OBOC2000-48-60VUC	1SNA645053R0600	451
CT-SAC.22	1SVR508210R0100	25	OBOC2000-5-12VDC	1SNA645050R1700	451
CT-SAD.22	1SVR500210R0100	57	OBOC5000-115VUC	1SNA645058R1300	451
CT-SDC.22	1SVR508211R0100	25	OBOC5000-24VDC	1SNA645024R2100	451
CT-SDD.22	1SVR500211R0100	57	OBRIC0100-115-230	1SNA645522R2100	451
CT-SDS.22P	1SVR740210R3300	40	OBRIC0100-24VDC	1SNA645521R2000	451
CT-SDS.22S	1SVR730210R3300	40	OBRIC0100-48-60VUC	1SNA645549R1400	451
CT-SDS.23P	1SVR740211R2300	40	OBRIC0100-5-12VDC	1SNA645547R0200	451
CT-SDS.23S	1SVR730211R2300	40	OBROA1000-24VDC	1SNA645527R2600	451
CT-TGC.12	1SVR508160R0000	25	OBROA2000-24VDC	1SNA645529R0000	452
CT-TGC.22	1SVR508160R0100	25	OBROC2000-230VUC	1SNA645526R2500	451
CT-TGD.12	1SVR500160R0000	57	OBROC2000-24VDC	1SNA645551R0600	451
CT-TGD.22	1SVR500160R0100	57	OBROC2000-24VUC	1SNA645525R2400	451
CT-VWC.12	1SVR508130R0000	25	OBROC2000-48-60VUC	1SNA645553R0000	451
CT-VWD.12	1SVR500130R0000	57	OBROC2000-5-12VDC	1SNA645550R1100	451
CT-WBS.22P	1SVR740040R3300	39	OBROC5000-230VUC	1SNA645559R1600	451
CT-WBS.22S	1SVR730040R3300	39	OBROC5000-24VDC	1SNA645524R2300	451
EPD24-TB-101-0.5A	2CDE601101R2905	352	RB101R-24VUC	1SNA645019R0400	442
EPD24-TB-101-10A	2CDE601101R2010	352	RB111-115VUC	1SNA645016R2100	442
EPD24-TB-101-12A	2CDE601101R2012	352	RB111-230VUC	1SNA645017R2200	442
EPD24-TB-101-1A	2CDE601101R2001	352	RB111-24VUC	1SNA645014R2700	442
EPD24-TB-101-2A	2CDE601101R2002	352	RB111R-24VUC	1SNA645018R0300	442
EPD24-TB-101-3A	2CDE601101R2003	352	RB121-115VUC	1SNA645003R0500	442
EPD24-TB-101-4A	2CDE601101R2004	352	RB121-12VDC	1SNA645073R0000	442
EPD24-TB-101-6A	2CDE601101R2006	352	RB121-230VUC	1SNA645004R0400	442



# Index

## Product type

Type	Order code	Page
RB121-24VDC	1SNA645071R0000	442
RB121-24VUC	1SNA645001R0300	442
RB121-48-60VUC	1SNA645002R0400	442
RB121-60-230VUC	1SNA645020R0100	443
RB121G-115VUC	1SNA645007R0100	443
RB121G-12VDC	1SNA645075R0000	443
RB121G-230VUC	1SNA645008R1200	443
RB121G-24VDC	1SNA645072R0000	443
RB121G-24VUC	1SNA645005R0700	443
RB121G-48-60VUC	1SNA645006R0000	443
RB121P-12VDC	1SNA645035R2400	442
RB121P-5VDC	1SNA645034R2300	442
RB121PG-5VDC	1SNA645036R2500	443
RB121R-115VUC	1SNA645046R0700	443
RB121R-230VUC	1SNA645011R2400	443
RB122G-115VUC	1SNA645041R0200	443
RB122G-230VUC	1SNA645013R2600	443
RB122G-24VUC	1SNA645012R2500	443
RB122G-48-60VUC	1SNA645040R1500	443
RB-JB10	1SVR406570R0000	452
RB-JB20	1SVR406580R0000	452
RBR101R-24VUC	1SNA645519R0600	442
RBR111-24VUC	1SNA645514R2100	442
RBR111R-24VUC	1SNA645518R0500	442
RBR121-115VUC	1SNA645503R0700	442
RBR121-230VUC	1SNA645504R0000	442
RBR121-24VDC	1SNA645571R0000	442
RBR121-24VUC	1SNA645501R0500	442
RBR121-48-60VUC	1SNA645502R0600	442
RBR121-60-230VUC	1SNA645520R0300	443
RBR121G-115VUC	1SNA645507R0300	443
RBR121G-230VUC	1SNA645508R1400	443
RBR121G-24VDC	1SNA645572R0000	443
RBR121G-24VUC	1SNA645505R0100	443
RBR121G-48-60VUC	1SNA645506R0200	443
RBR121P-12VDC	1SNA645535R2600	442
RBR121P-5VDC	1SNA645534R2500	442
RBR121R-230VUC	1SNA645511R2600	443
RBR122G-115VUC	1SNA645541R0400	443
RBR122G-230VUC	1SNA645513R2000	443
RBR122G-24VUC	1SNA645512R2700	443
RBR122G-48-60VUC	1SNA645540R1700	443
SC612	1SNA290474R0200	443
SK 615 562-87	GJD6155620R0087	41
SK 615 562-88	GJD6155620R0088	41

# Index

## Order code

Type	Order code	Page	Type	Order code	Page
MT-150B	1SFA611410R1506	41	RBR121-48-60VUC	1SNA645502R0600	442
MT-250B	1SFA611410R2506	41	RBR121-115VUC	1SNA645503R0700	442
MT-350B	1SFA611410R3506	41	RBR121-230VUC	1SNA645504R0000	442
MA16-1060	1SFA611940R1060	41	RBR121G-24VUC	1SNA645505R0100	443
KA1-8029	1SFA616920R8029	41	RBR121G-48-60VUC	1SNA645506R0200	443
KA1-8030	1SFA616920R8030	41	RBR121G-115VUC	1SNA645507R0300	443
SC612	1SNA290474R0200	443	RBR121G-230VUC	1SNA645508R1400	443
RB121-24VUC	1SNA645001R0300	442	RBR121R-230VUC	1SNA645511R2600	443
RB121-48-60VUC	1SNA645002R0400	442	RBR122G-24VUC	1SNA645512R2700	443
RB121-115VUC	1SNA645003R0500	442	RBR122G-230VUC	1SNA645513R2000	443
RB121-230VUC	1SNA645004R0400	442	RBR111-24VUC	1SNA645514R2100	442
RB121G-24VUC	1SNA645005R0700	443	RBR111R-24VUC	1SNA645518R0500	442
RB121G-48-60VUC	1SNA645006R0000	443	RBR101R-24VUC	1SNA645519R0600	442
RB121G-115VUC	1SNA645007R0100	443	RBR121-60-230VUC	1SNA645520R0300	443
RB121G-230VUC	1SNA645008R1200	443	OBRIC0100-24VDC	1SNA645521R2000	451
RB121R-230VUC	1SNA645011R2400	443	OBRIC0100-115-230	1SNA645522R2100	451
RB122G-24VUC	1SNA645012R2500	443	OBROC5000-24VDC	1SNA645524R2300	451
RB122G-230VUC	1SNA645013R2600	443	OBROC2000-24VUC	1SNA645525R2400	451
RB111-24VUC	1SNA645014R2700	442	OBROC2000-230VUC	1SNA645526R2500	451
RB111-115VUC	1SNA645016R2100	442	OBROA1000-24VDC	1SNA645527R2600	451
RB111-230VUC	1SNA645017R2200	442	OBROA2000-24VDC	1SNA645529R0000	452
RB111R-24VUC	1SNA645018R0300	442	RBR121P-5VDC	1SNA645534R2500	442
RB101R-24VUC	1SNA645019R0400	442	RBR121P-12VDC	1SNA645535R2600	442
RB121-60-230VUC	1SNA645020R0100	443	RBR122G-48-60VUC	1SNA645540R1700	443
OBRIC0100-24VDC	1SNA645021R2600	451	RBR122G-115VUC	1SNA645541R0400	443
OBRIC0100-115-230	1SNA645022R2700	451	OBRIC0100-5-12VDC	1SNA645547R0200	451
OBROC5000-24VDC	1SNA645024R2100	451	OBRIC0100-48-60VUC	1SNA645549R1400	451
OBROC2000-24VUC	1SNA645025R2200	451	OBROC2000-5-12VDC	1SNA645550R1100	451
OBROC2000-230VUC	1SNA645026R2300	451	OBROC2000-24VDC	1SNA645551R0600	451
OBOA1000-24VDC	1SNA645027R2400	451	OBROC2000-48-60VUC	1SNA645553R0000	451
OBOA1000-230VUC	1SNA645028R0500	451	OBROC5000-230VUC	1SNA645559R1600	451
OBOA2000-24VDC	1SNA645029R0600	452	RBR121-24VDC	1SNA645571R0000	442
RB121P-5VDC	1SNA645034R2300	442	RBR121G-24VDC	1SNA645572R0000	443
RB121P-12VDC	1SNA645035R2400	442	CP-C.1-A-RU	1SVR360060R1001	342
RB121PG-5VDC	1SNA645036R2500	443	CP-C.1-A-RU-C	1SVR360060R2001	342
RB122G-48-60VUC	1SNA645040R1500	443	CP-C.1 24/5.0	1SVR360563R1001	294
RB122G-115VUC	1SNA645041R0200	443	CP-C.1 24/5.0-C	1SVR360563R2001	294
RB121R-115VUC	1SNA645046R0700	443	CP-C.1 24/10.0	1SVR360663R1001	294
OBRIC0100-5-12VDC	1SNA645047R0000	451	CP-C.1 24/10.0-C	1SVR360663R2001	294
OBRIC0100-48-60VUC	1SNA645049R1200	451	CP-C.1 24/20.0	1SVR360763R1001	294
OBROC2000-5-12VDC	1SNA645050R1700	451	CP-C.1 24/20.0-C	1SVR360763R2001	294
OBROC2000-24VDC	1SNA645051R0400	451	CP-C.1-A-RU-L	1SVR361060R1001	342
OBROC2000-48-60VUC	1SNA645053R0600	451	CP-C.1 24/5.0-L	1SVR361563R1001	294
OBROC2000-115VUC	1SNA645054R0700	451	CP-C.1 24/10.0-L	1SVR361663R1001	294
OBROC5000-115VUC	1SNA645058R1300	451	CP-C.1 24/20.0-L	1SVR361763R1001	294
OBOA1000-115VUC	1SNA645062R0700	451	MAR.01	1SVR366017R0100	41
RB121-24VDC	1SNA645071R0000	442	MAR.01	1SVR366017R0100	242
RB121G-24VDC	1SNA645072R0000	443	CM-HE	1SVR402902R0000	242
RB121-12VDC	1SNA645073R0000	442	CM-HC	1SVR402902R1000	242
RB121G-12VDC	1SNA645075R0000	443	CM-HCT	1SVR402902R2000	242
RBR121-24VUC	1SNA645501R0500	442	CR-S005VDC1R	1SVR405501R1010	389

# Index

## Order code

Type	Order code	Page	Type	Order code	Page
CR-S005VDC1RG	1SVR405501R1020	389	CR-P012DC1SS42V	1SVR405600R4010	395
CR-S012VDC1R	1SVR405501R2010	389	CR-P048AC1	1SVR405600R5000	393
CR-S012VDC1RG	1SVR405501R2020	389	CR-P048DC1	1SVR405600R6000	393
CR-S024VDC1R	1SVR405501R3010	389	CR-P110AC1	1SVR405600R7000	393
CR-S024VDC1RG	1SVR405501R3020	389	CR-P110DC1	1SVR405600R8000	393
CR-S048VDC1R	1SVR405501R4010	389	CR-P110DC1SS42CV	1SVR405600R8010	395
CR-S048VDC1RG	1SVR405501R4020	389	CR-P024AC2	1SVR405601R0000	393
CR-S060VDC1R	1SVR405501R5010	389	CR-P024AC2SS62CV	1SVR405601R0010	396
CR-S060VDC1RG	1SVR405501R5020	389	CR-P012AC2	1SVR405601R0200	393
CR-S024VDC1TRA	1SVR405510R3050	389	CR-P024DC2	1SVR405601R1000	393
CR-S024VDC1MOS	1SVR405510R3060	389	CR-P024DC2SS42V	1SVR405601R1010	396
CR-S024VDC1TRI	1SVR405510R3070	389	CR-P024DC2LS42V	1SVR405601R1011	396
CR-S006/024VDC1SS	1SVR405521R1100	390	CR-P024DC2LC42	1SVR405601R1012	396
CR-S006/024VDC1SZ	1SVR405521R1200	390	CR-P024DC2LS42	1SVR405601R1013	396
CR-S012/024VADC1SS	1SVR405521R3100	390	CR-P120AC2	1SVR405601R2000	393
CR-S012/024VADC1SZ	1SVR405521R3200	390	CR-P120AC2SS92CV	1SVR405601R2010	396
CR-S048/060VADC1SS	1SVR405521R5100	390	CR-P230AC2	1SVR405601R3000	393
CR-S048/060VADC1SZ	1SVR405521R5200	390	CR-P230AC2LS92CV	1SVR405601R3011	396
CR-S110/125VADC1SS	1SVR405521R6100	390	CR-P230AC2LC92	1SVR405601R3012	396
CR-S110/125VADC1SZ	1SVR405521R6200	390	CR-P230AC2SS92CV	1SVR405601R3110	396
CR-S220/240VADC1SS	1SVR405521R7100	390	CR-P012DC2	1SVR405601R4000	393
CR-S220/240VADC1SZ	1SVR405521R7200	390	CR-P012DC2SS42V	1SVR405601R4010	396
CR-S024VADC1CRS	1SVR405541R3110	389	CR-P048AC2	1SVR405601R5000	393
CR-S024VADC1CRGS	1SVR405541R3120	389	CR-P048DC2	1SVR405601R6000	393
CR-S024VADC1CRZ	1SVR405541R3210	389	CR-P110AC2	1SVR405601R7000	393
CR-S024VADC1CRGZ	1SVR405541R3220	389	CR-P110DC2	1SVR405601R8000	393
CR-S110VADC1CRS	1SVR405541R6110	389	CR-P110DC2SS42CV	1SVR405601R8010	396
CR-S110VADC1CRGS	1SVR405541R6120	389	CR-P024AC2G	1SVR405606R0000	393
CR-S110VADC1CRZ	1SVR405541R6210	389	CR-P024DC2G	1SVR405606R1000	393
CR-S110VADC1CRGZ	1SVR405541R6220	389	CR-P024DC2GLC42V	1SVR405606R1010	396
CR-S230VADC1CRS	1SVR405541R7110	389	CR-P024DC2GLC62CV	1SVR405606R1011	396
CR-S230VADC1CRGS	1SVR405541R7120	389	CR-P024DC2GLC62C	1SVR405606R1013	396
CR-S230VADC1CRZ	1SVR405541R7210	389	CR-P230AC2G	1SVR405606R3000	393
CR-S230VADC1CRGZ	1SVR405541R7220	389	CR-P230AC2GLC92CV	1SVR405606R3010	396
CR-SJB20-BLUE	1SVR405598R0700	390	CR-P230AC2GLC92C	1SVR405606R3012	396
CR-SJB20-RED	1SVR405598R0800	390	CR-P230AC2GLC92	1SVR405606R3013	396
CR-SJB20-BLACK	1SVR405598R0900	390	CR-P110AC2G	1SVR405606R7000	393
CR-SSEP	1SVR405599R0000	390	CR-P024MOS1	1SVR405610R4060	393
CR-P024AC1	1SVR405600R0000	393	CR-P024TRI1	1SVR405610R4070	393
CR-P024AC1SS62CV	1SVR405600R0010	395	CR-M024AC2	1SVR405611R0000	397
CR-P024DC1	1SVR405600R1000	393	CR-M024AC2L	1SVR405611R0100	398
CR-P024DC1SS42V	1SVR405600R1010	395	CR-M012AC2L	1SVR405611R0300	398
CR-P024DC1LC42V	1SVR405600R1011	395	CR-M024DC2	1SVR405611R1000	397
CR-P024DC1LC62C	1SVR405600R1013	395	CR-M024DC2L	1SVR405611R1100	398
CR-P120AC1	1SVR405600R2000	393	CR-M024DC2LD	1SVR405611R1400	399
CR-P120AC1SS92CV	1SVR405600R2010	395	CR-M120AC2	1SVR405611R2000	397
CR-P230AC1	1SVR405600R3000	393	CR-M120AC2L	1SVR405611R2100	398
CR-P230AC1LC92CV	1SVR405600R3010	395	CR-M230AC2	1SVR405611R3000	397
CR-P230AC1LS	1SVR405600R3011	395	CR-M230AC2L	1SVR405611R3100	398
CR-P230AC1SS92CV	1SVR405600R3110	395	CR-M012DC2	1SVR405611R4000	397
CR-P012DC1	1SVR405600R4000	393	CR-M012DC2L	1SVR405611R4100	398

# Index

## Order code

Type	Order code	Page	Type	Order code	Page
CR-M060DC2	1SVR405611R4200	397	CR-M024AC4	1SVR405613R0000	397
CR-M060DC2L	1SVR405611R4300	398	CR-M024AC4LS62CV	1SVR405613R0010	401
CR-M012DC2LD	1SVR405611R4400	399	CR-M024AC4L	1SVR405613R0100	398
CR-M048AC2	1SVR405611R5000	397	CR-M012AC4L	1SVR405613R0300	398
CR-M048AC2L	1SVR405611R5100	398	CR-M024DC4	1SVR405613R1000	397
CR-M048DC2	1SVR405611R6000	397	CR-M024DC4SS42V	1SVR405613R1010	401
CR-M048DC2L	1SVR405611R6100	398	CR-M024DC4LS42V	1SVR405613R1011	401
CR-M048DC2LD	1SVR405611R6400	399	CR-M024DC4LC42	1SVR405613R1012	401
CR-M110AC2	1SVR405611R7000	397	CR-M024DC4L	1SVR405613R1100	398
CR-M110AC2L	1SVR405611R7100	398	CR-M120AC4	1SVR405613R2000	397
CR-M110DC2	1SVR405611R8000	397	CR-M120AC4L	1SVR405613R2100	398
CR-M110DC2L	1SVR405611R8100	398	CR-M230AC4	1SVR405613R3000	397
CR-M125DC2	1SVR405611R8200	397	CR-M230AC4LS92CV	1SVR405613R3011	402
CR-M125DC2L	1SVR405611R8300	398	CR-M230AC4LC92	1SVR405613R3012	402
CR-M110DC2LD	1SVR405611R8400	399	CR-M230AC4L	1SVR405613R3100	398
CR-M125DC2LD	1SVR405611R8500	399	CR-M230AC4SS92CV	1SVR405613R3110	402
CR-M220DC2	1SVR405611R9000	397	CR-M012DC4	1SVR405613R4000	397
CR-M220DC2L	1SVR405611R9100	398	CR-M012DC4L	1SVR405613R4100	398
CR-M220DC2LD	1SVR405611R9400	399	CR-M060DC4	1SVR405613R4200	397
CR-M024AC3	1SVR405612R0000	397	CR-M060DC4L	1SVR405613R4300	398
CR-M024AC3L	1SVR405612R0100	398	CR-M012DC4LD	1SVR405613R4400	399
CR-M012AC3L	1SVR405612R0300	398	CR-M048AC4	1SVR405613R5000	397
CR-M024DC3	1SVR405612R1000	397	CR-M048AC4L	1SVR405613R5100	398
CR-M024DC3L	1SVR405612R1100	398	CR-M048DC4	1SVR405613R6000	397
CR-M024DC3LD	1SVR405612R1400	399	CR-M048DC4L	1SVR405613R6100	398
CR-M120AC3	1SVR405612R2000	397	CR-M048DC4LD	1SVR405613R6400	399
CR-M120AC3L	1SVR405612R2100	398	CR-M110AC4	1SVR405613R7000	397
CR-M230AC3	1SVR405612R3000	397	CR-M110AC4L	1SVR405613R7100	398
CR-M230AC3L	1SVR405612R3100	398	CR-M110DC4	1SVR405613R8000	397
CR-M012DC3	1SVR405612R4000	397	CR-M110DC4L	1SVR405613R8100	398
CR-M012DC3L	1SVR405612R4100	398	CR-M125DC4	1SVR405613R8200	397
CR-M060DC3	1SVR405612R4200	397	CR-M125DC4L	1SVR405613R8300	398
CR-M060DC3L	1SVR405612R4300	398	CR-M110DC4LD	1SVR405613R8400	399
CR-M012DC3LD	1SVR405612R4400	399	CR-M125DC4LD	1SVR405613R8500	399
CR-M048AC3	1SVR405612R5000	397	CR-M220DC4	1SVR405613R9000	397
CR-M048AC3L	1SVR405612R5100	398	CR-M220DC4L	1SVR405613R9100	398
CR-M060AC3	1SVR405612R5200	397	CR-M220DC4LD	1SVR405613R9400	399
CR-M048DC3	1SVR405612R6000	397	CR-M024DC4LD	1SVR405614R1100	399
CR-M048DC3L	1SVR405612R6100	398	CR-M024AC4G	1SVR405618R0000	399
CR-M048DC3LD	1SVR405612R6400	399	CR-M024AC4LG	1SVR405618R0100	400
CR-M110AC3	1SVR405612R7000	397	CR-M024DC4G	1SVR405618R1000	399
CR-M110AC3L	1SVR405612R7100	398	CR-M024DC4GLC62CV	1SVR405618R1010	401
CR-M110DC3	1SVR405612R8000	397	CR-M024DC4GSS42V	1SVR405618R1011	401
CR-M110DC3L	1SVR405612R8100	398	CR-M024DC4LG	1SVR405618R1100	400
CR-M125DC3	1SVR405612R8200	397	CR-M024DC4LGLC22	1SVR405618R1110	401
CR-M125DC3L	1SVR405612R8300	398	CR-M024DC4LDG	1SVR405618R1400	400
CR-M110DC3LD	1SVR405612R8400	399	CR-M024DC4LDGSS	1SVR405618R1410	401
CR-M125DC3LD	1SVR405612R8500	399	CR-M120AC4LG	1SVR405618R2100	400
CR-M220DC3	1SVR405612R9000	397	CR-M230AC4G	1SVR405618R3000	399
CR-M220DC3L	1SVR405612R9100	398	CR-M230AC4LG	1SVR405618R3100	400
CR-M220DC3LD	1SVR405612R9400	399	CR-M230AC4LGLC	1SVR405618R3110	402

# Index

## Order code

Type	Order code	Page	Type	Order code	Page
CR-M230AC4LGSS	1SVR405618R3111	402	CR-U048AC3L	1SVR405622R5100	407
CR-M230AC4GSS92CV	1SVR405618R3112	402	CR-U060AC3	1SVR405622R5200	406
CR-M012DC4LG	1SVR405618R4100	400	CR-U048DC3	1SVR405622R6000	406
CR-M060DC4LG	1SVR405618R4300	400	CR-U048DC3L	1SVR405622R6100	407
CR-M012DC4LDG	1SVR405618R4400	400	CR-U048DC3LD	1SVR405622R6400	407
CR-M012DC4LDGSS	1SVR405618R4410	401	CR-U110AC3	1SVR405622R7000	406
CR-M048AC4LG	1SVR405618R5100	400	CR-U110AC3L	1SVR405622R7100	407
CR-M048DC4LG	1SVR405618R6100	400	CR-U110DC3	1SVR405622R8000	406
CR-M110AC4G	1SVR405618R7000	399	CR-U110DC3L	1SVR405622R8100	407
CR-M110AC4LG	1SVR405618R7100	400	CR-U125DC3	1SVR405622R8200	406
CR-M110DC4LG	1SVR405618R8100	400	CR-U110DC3LD	1SVR405622R8400	407
CR-M125DC4LG	1SVR405618R8300	400	CR-U220DC3	1SVR405622R9000	406
CR-M220DC4LG	1SVR405618R9100	400	CR-U220DC3L	1SVR405622R9100	407
CR-U024AC2	1SVR405621R0000	406	CR-U024DC3LD	1SVR405623R1100	407
CR-U024AC2L	1SVR405621R0100	406	CR-PLS	1SVR405650R0000	394
CR-U012AC2L	1SVR405621R0300	406	CR-PLSX	1SVR405650R0100	394
CR-U024DC2	1SVR405621R1000	406	CR-PLC	1SVR405650R0200	394
CR-U024DC2L	1SVR405621R1100	406	CR-PSS	1SVR405650R1000	394
CR-U024DC2LD	1SVR405621R1400	407	CR-P/M 22	1SVR405651R0000	404
CR-U120AC2	1SVR405621R2000	406	CR-M2SS	1SVR405651R1000	403
CR-U120AC2L	1SVR405621R2100	406	CR-M2LS	1SVR405651R1100	403
CR-U230AC2	1SVR405621R3000	406	CR-M2LC	1SVR405651R1200	403
CR-U230AC2L	1SVR405621R3100	406	CR-M2SF	1SVR405651R1300	403
CR-U012DC2	1SVR405621R4000	406	CR-M3SS	1SVR405651R2000	403
CR-U012DC2L	1SVR405621R4100	406	CR-M3LS	1SVR405651R2100	403
CR-U012DC2LD	1SVR405621R4400	407	CR-M4SS	1SVR405651R3000	403
CR-U048AC2	1SVR405621R5000	406	CR-M4LS	1SVR405651R3100	403
CR-U048AC2L	1SVR405621R5100	406	CR-M4LC	1SVR405651R3200	403
CR-U048DC2	1SVR405621R6000	406	CR-M4SF	1SVR405651R3300	403
CR-U048DC2L	1SVR405621R6100	406	CR-P/M 42	1SVR405652R0000	404
CR-U048DC2LD	1SVR405621R6400	407	CR-P/M 42 V	1SVR405652R1000	404
CR-U110AC2	1SVR405621R7000	406	CR-P/M 42 B	1SVR405652R4000	404
CR-U110AC2L	1SVR405621R7100	406	CR-P/M 42 BV	1SVR405652R4100	404
CR-U110DC2	1SVR405621R8000	406	CR-P/M 42 C	1SVR405652R9000	404
CR-U110DC2L	1SVR405621R8100	406	CR-P/M 42 CV	1SVR405652R9100	404
CR-U110DC2LD	1SVR405621R8400	407	CR-P/M 52B	1SVR405653R0000	404
CR-U220DC2	1SVR405621R9000	406	CR-P/M 52C	1SVR405653R1000	404
CR-U220DC2L	1SVR405621R9100	406	CR-P/M 52D	1SVR405653R4000	404
CR-U024AC3	1SVR405622R0000	406	CR-P/M 62	1SVR405654R0000	404
CR-U024AC3L	1SVR405622R0100	407	CR-P/M 92	1SVR405654R0100	404
CR-U012AC3L	1SVR405622R0300	407	CR-P/M 62 V	1SVR405654R1000	404
CR-U024DC3	1SVR405622R1000	406	CR-P/M 92 V	1SVR405654R1100	404
CR-U024DC3L	1SVR405622R1100	407	CR-P/M 62 E	1SVR405654R4000	404
CR-U120AC3	1SVR405622R2000	406	CR-P/M 62 EV	1SVR405654R4100	404
CR-U120AC3L	1SVR405622R2100	407	CR-P/M 62 C	1SVR405655R0000	405
CR-U230AC3	1SVR405622R3000	406	CR-P/M 92 C	1SVR405655R0100	405
CR-U230AC3L	1SVR405622R3100	407	CR-P/M 62 CV	1SVR405655R1000	405
CR-U012DC3	1SVR405622R4000	406	CR-P/M 92 CV	1SVR405655R1100	405
CR-U012DC3L	1SVR405622R4100	407	CR-P/M 62 D	1SVR405655R4000	405
CR-U012DC3LD	1SVR405622R4400	407	CR-P/M 62 DV	1SVR405655R4100	405
CR-U048AC3	1SVR405622R5000	406	CR-P/M 72	1SVR405656R0000	405

# Index

## Order code

Type	Order code	Page	Type	Order code	Page
CR-P/M 72 A	1SVR405656R1000	405	CP-E 12/2.5	1SVR427032R1000	260
CR-P/M 82	1SVR405656R2000	405	CP-E 5/3.0	1SVR427033R3000	260
CR-PM	1SVR405658R0000	394	CP-E 24/5.0	1SVR427034R0000	260
CR-MM	1SVR405658R1000	403	CP-E 48/5.0	1SVR427034R2000	260
CR-MP	1SVR405658R2000	403	CP-E 24/10.0	1SVR427035R0000	260
CR-PJ	1SVR405658R5000	394	CP-E 12/10.0	1SVR427035R1000	260
CR-MJ	1SVR405658R6000	403	CP-E 48/10.0	1SVR427035R2000	260
CR-PH	1SVR405659R0000	394	CP-E 24/20.0	1SVR427036R0000	260
CR-PH1	1SVR405659R0100	394	CP-D 24/0.42	1SVR427041R0000	318
CR-MH	1SVR405659R1000	403	CP-D 12/0.83	1SVR427041R1000	318
CR-MH1	1SVR405659R1100	403	CP-D 24/1.3	1SVR427043R0100	318
CR-U3S	1SVR405660R0000	407	CP-D 12/2.1	1SVR427043R1200	318
CR-U3E	1SVR405660R0100	407	CP-D 24/2.5	1SVR427044R0200	318
CR-U3SM	1SVR405660R1100	407	CP-D 24/4.2	1SVR427045R0400	318
CR-U 21	1SVR405661R0000	408	CP-D RU	1SVR427049R0000	342
CR-U 41	1SVR405662R0000	408	CP-T 24/5.0	1SVR427054R0000	280
CR-U 41V	1SVR405662R1000	408	CP-T 48/5.0	1SVR427054R2000	280
CR-U 41B	1SVR405662R4000	408	CP-T 24/10.0	1SVR427055R0000	280
CR-U 41BV	1SVR405662R4100	408	CP-T 48/10.0	1SVR427055R2000	280
CR-U 41C	1SVR405662R9000	408	CP-T 24/20.0	1SVR427056R0000	280
CR-U 41CV	1SVR405662R9100	408	CP-T 48/20.0	1SVR427056R2000	280
CR-U 51B	1SVR405663R0000	408	CP-T 24/40.0	1SVR427057R0000	280
CR-U 51C	1SVR405663R1000	408	CP-B 24/3.0	1SVR427060R0300	332
CR-U 51D	1SVR405663R4000	408	CP-B 24/10.0	1SVR427060R1000	332
CR-U 61	1SVR405664R0000	408	CP-B 24/20.0	1SVR427060R2000	332
CR-U 91	1SVR405664R0100	408	CP-B EXT.2	1SVR427065R0000	332
CR-U 61V	1SVR405664R1000	408	COV.01	1SVR430005R0100	242
CR-U 91V	1SVR405664R1100	408	ADP.01	1SVR430029R0100	41
CR-U 61E	1SVR405664R4000	408	ADP.01	1SVR430029R0100	242
CR-U 61EV	1SVR405664R4100	408	MAR.02	1SVR430043R0000	242
CR-U 61C	1SVR405665R0000	409	COV.02	1SVR440005R0100	242
CR-U 91C	1SVR405665R0100	409	ADP.02	1SVR440029R0100	242
CR-U 61CV	1SVR405665R1000	409	CM-SE-300	1SVR450056R0000	242
CR-U 91CV	1SVR405665R1100	409	CM-SE-600	1SVR450056R0100	242
CR-U 61D	1SVR405665R4000	409	CM-SE-1000	1SVR450056R0200	242
CR-U 61DV	1SVR405665R4100	409	CM-KH-3	1SVR450056R6000	242
CR-U 71	1SVR405666R0000	409	CM-AH-3	1SVR450056R7000	242
CR-U 71A	1SVR405666R1000	409	CM-GM-1	1SVR450056R8000	242
CR-U 81	1SVR405666R2000	409	CM-CT 50/1	1SVR450116R1000	243
CR-U T	1SVR405667R0000	409	CM-CT 75/1	1SVR450116R1100	243
CR-UH	1SVR405669R0000	407	CM-CT 100/1	1SVR450116R1200	243
CR-U2S	1SVR405670R0000	407	CM-CT 150/1	1SVR450116R1300	243
CR-U2SM	1SVR405670R1100	407	CM-CT 200/1	1SVR450116R1400	243
RB-JB10	1SVR406570R0000	452	CM-CT 50/5	1SVR450116R5000	243
RB-JB20	1SVR406580R0000	452	CM-CT 75/5	1SVR450116R5100	243
CP-RUD	1SVR423418R9000	342	CM-CT 100/5	1SVR450116R5200	243
CP-E 24/0.75	1SVR427030R0000	260	CM-CT 150/5	1SVR450116R5300	243
CP-E 48/0.62	1SVR427030R2000	260	CM-CT 200/5	1SVR450116R5400	243
CP-E 24/1.25	1SVR427031R0000	260	CM-CT 300/1	1SVR450117R1100	243
CP-E 48/1.25	1SVR427031R2000	260	CM-CT 400/1	1SVR450117R1200	243
CP-E 24/2.5	1SVR427032R0000	260	CM-CT 500/1	1SVR450117R1300	243

# Index

## Order code

Type	Order code	Page	Type	Order code	Page
CM-CT 600/1	1SVR450117R1400	243	CM-UFD.M22M	1SVR560731R3700	145
CM-CT 300/5	1SVR450117R5100	243	CM-UFD.M31M	1SVR560731R3701	145
CM-CT 400/5	1SVR450117R5200	243	CM-UFD.M33M	1SVR560731R3702	145
CM-CT 500/5	1SVR450117R5300	243	CM-UFD.M34M	1SVR560731R3703	145
CM-CT 600/5	1SVR450117R5400	243	COV.11	1SVR730005R0100	41
CM-CT A	1SVR450118R1000	243	COV.11	1SVR730005R0100	242
CM-IWM.10	1SVR470670R1000	161	MAR.12	1SVR730006R0000	41
CM-IWM.11	1SVR470670R1100	161	MAR.12	1SVR730006R0000	242
CT-MFD.12	1SVR500020R0000	57	CT-MFS.21S	1SVR730010R0200	39
CT-MFD.21	1SVR500020R1100	57	CT-MBS.22S	1SVR730010R3200	39
CT-ERD.12	1SVR500100R0000	57	CT-MVS.21S	1SVR730020R0200	39
CT-ERD.22	1SVR500100R0100	57	CT-MVS.12S	1SVR730020R3100	39
CT-AHD.12	1SVR500110R0000	57	CT-MVS.22S	1SVR730020R3300	39
CT-AHD.22	1SVR500110R0100	57	CT-MVS.23S	1SVR730021R2300	39
CT-VWD.12	1SVR500130R0000	57	CT-MXS.22S	1SVR730030R3300	39
CT-EBD.12	1SVR500150R0000	57	CT-WBS.22S	1SVR730040R3300	39
CT-TGD.12	1SVR500160R0000	57	CT-ERS.21S	1SVR730100R0300	40
CT-TGD.22	1SVR500160R0100	57	CT-ERS.12S	1SVR730100R3100	40
CT-SAD.22	1SVR500210R0100	57	CT-ERS.22S	1SVR730100R3300	40
CT-SDD.22	1SVR500211R0100	57	CT-AHS.22S	1SVR730110R3300	40
CT-MKC.31	1SVR508010R1300	25	CT-ARS.11S	1SVR730120R3100	40
CT-MFC.12	1SVR508020R0000	25	CT-ARS.21S	1SVR730120R3300	40
CT-MFC.21	1SVR508020R1100	25	CT-APS.21S	1SVR730180R0300	40
CT-ERC.12	1SVR508100R0000	25	CT-APS.12S	1SVR730180R3100	40
CT-ERC.22	1SVR508100R0100	25	CT-APS.22S	1SVR730180R3300	40
CT-AHC.12	1SVR508110R0000	25	CT-SDS.22S	1SVR730210R3300	40
CT-AHC.22	1SVR508110R0100	25	CT-SDS.23S	1SVR730211R2300	40
CT-ARC.12	1SVR508120R0000	25	CM-IWS.1S	1SVR730660R0100	161
CT-VWC.12	1SVR508130R0000	25	CM-IWS.2S	1SVR730670R0200	161
CT-EBC.12	1SVR508150R0000	25	CM-MSS.12S	1SVR730700R0100	190
CT-TGC.12	1SVR508160R0000	25	CM-MSS.22S	1SVR730700R0200	190
CT-TGC.22	1SVR508160R0100	25	CM-MSS.13S	1SVR730700R2100	190
CT-SAC.22	1SVR508210R0100	25	CM-MSS.23S	1SVR730700R2200	190
CT-SDC.22	1SVR508211R0100	25	CM-MSS.32S	1SVR730712R0200	190
CM-MSE	1SVR550800R9300	190	CM-MSS.41S	1SVR730712R1200	190
CM-MSE	1SVR550801R9300	190	CM-MSS.51S	1SVR730712R1300	190
CM-MSE	1SVR550805R9300	190	CM-MSS.31S	1SVR730712R1400	190
CM-PFE	1SVR550824R9100	113	CM-MSS.33S	1SVR730712R2200	190
CM-PFE.2	1SVR550826R9100	113	CM-MSS.11S	1SVR730720R1400	190
CM-ENE MAX	1SVR550850R9400	229	CM-MSS.21S	1SVR730722R1400	190
CM-ENE MIN	1SVR550850R9500	229	CM-TCS.11S	1SVR730740R0100	209
CM-ENE MAX	1SVR550851R9400	229	CM-TCS.12S	1SVR730740R0200	209
CM-ENE MIN	1SVR550851R9500	229	CM-TCS.13S	1SVR730740R0300	209
CM-ENE MAX	1SVR550855R9400	229	CM-TCS.21S	1SVR730740R9100	209
CM-ENE MIN	1SVR550855R9500	229	CM-TCS.22S	1SVR730740R9200	209
CM-PVE	1SVR550870R9400	113	CM-TCS.23S	1SVR730740R9300	209
CM-PVE	1SVR550871R9500	113	CM-EFS.2S	1SVR730750R0400	89
CM-PBE	1SVR550881R9400	113	CM-SFS.21S	1SVR730760R0400	87
CM-PBE	1SVR550882R9500	113	CM-SFS.22S	1SVR730760R0500	87
CM-UFD.M31	1SVR560730R3401	145	CM-PAS.31S	1SVR730774R1300	113
CM-UFD.M33	1SVR560730R3402	145	CM-PAS.41S	1SVR730774R3300	113

# Index

## Order code

Type	Order code	Page	Type	Order code	Page
CM-PSS.31S	1SVR730784R2300	113	CT-ARS.21P	1SVR740120R3300	40
CM-PSS.41S	1SVR730784R3300	113	CT-APS.21P	1SVR740180R0300	40
CM-PVS.31S	1SVR730794R1300	113	CT-APS.12P	1SVR740180R3100	40
CM-PVS.81S	1SVR730794R2300	113	CT-APS.22P	1SVR740180R3300	40
CM-PVS.41S	1SVR730794R3300	113	CT-SDS.22P	1SVR740210R3300	40
CM-PFS.S	1SVR730824R9300	113	CT-SDS.23P	1SVR740211R2300	40
CM-ESS.1S	1SVR730830R0300	89	CM-IWS.1P	1SVR740660R0100	161
CM-ESS.2S	1SVR730830R0400	89	CM-IWS.2P	1SVR740670R0200	161
CM-ESS.MS	1SVR730830R0500	89	CM-MSS.12P	1SVR740700R0100	190
CM-ESS.1S	1SVR730831R0300	89	CM-MSS.22P	1SVR740700R0200	190
CM-ESS.2S	1SVR730831R0400	89	CM-MSS.13P	1SVR740700R2100	190
CM-ESS.1S	1SVR730831R1300	89	CM-MSS.23P	1SVR740700R2200	190
CM-ESS.2S	1SVR730831R1400	89	CM-MSS.32P	1SVR740712R0200	190
CM-SRS.11S	1SVR730840R0200	87	CM-MSS.41P	1SVR740712R1200	190
CM-SRS.12S	1SVR730840R0300	87	CM-MSS.51P	1SVR740712R1300	190
CM-SRS.21S	1SVR730840R0400	87	CM-MSS.31P	1SVR740712R1400	190
CM-SRS.22S	1SVR730840R0500	87	CM-MSS.33P	1SVR740712R2200	190
CM-SRS.M1S	1SVR730840R0600	87	CM-MSS.11P	1SVR740720R1400	190
CM-SRS.M2S	1SVR730840R0700	87	CM-MSS.21P	1SVR740722R1400	190
CM-SRS.11S	1SVR730841R0200	87	CM-TCS.11P	1SVR740740R0100	209
CM-SRS.12S	1SVR730841R0300	87	CM-TCS.12P	1SVR740740R0200	209
CM-SRS.21S	1SVR730841R0400	87	CM-TCS.13P	1SVR740740R0300	209
CM-SRS.22S	1SVR730841R0500	87	CM-TCS.21P	1SVR740740R9100	209
CM-SRS.11S	1SVR730841R1200	87	CM-TCS.22P	1SVR740740R9200	209
CM-SRS.12S	1SVR730841R1300	87	CM-TCS.23P	1SVR740740R9300	209
CM-SRS.21S	1SVR730841R1400	87	CM-EFS.2P	1SVR740750R0400	89
CM-SRS.22S	1SVR730841R1500	87	CM-SFS.21P	1SVR740760R0400	87
CM-ENS.11S	1SVR730850R0100	229	CM-PAS.31P	1SVR740774R1300	113
CM-ENS.21S	1SVR730850R0200	229	CM-PAS.41P	1SVR740774R3300	113
CM-ENS.31S	1SVR730850R0300	229	CM-PSS.31P	1SVR740784R2300	113
CM-ENS.11P	1SVR730850R2100	229	CM-PSS.41P	1SVR740784R3300	113
CM-ENS.23S	1SVR730850R2200	229	CM-PVS.31P	1SVR740794R1300	113
CM-MPS.31S	1SVR730884R1300	115	CM-PVS.81P	1SVR740794R2300	113
CM-MPS.41S	1SVR730884R3300	115	CM-PVS.41P	1SVR740794R3300	113
CM-MPS.43S	1SVR730884R4300	115	CM-PFS.P	1SVR740824R9300	113
CM-MPS.11S	1SVR730885R1300	115	CM-ESS.1P	1SVR740830R0300	89
CM-MPS.21S	1SVR730885R3300	115	CM-ESS.2P	1SVR740830R0400	89
CM-MPS.23S	1SVR730885R4300	115	CM-ESS.MP	1SVR740830R0500	89
CT-MFS.21P	1SVR740010R0200	39	CM-ESS.1P	1SVR740831R0300	89
CT-MBS.22P	1SVR740010R3200	39	CM-ESS.2P	1SVR740831R0400	89
CT-MVS.21P	1SVR740020R0200	39	CM-ESS.1P	1SVR740831R1300	89
CT-MVS.12P	1SVR740020R3100	39	CM-ESS.2P	1SVR740831R1400	89
CT-MVS.22P	1SVR740020R3300	39	CM-SRS.11P	1SVR740840R0200	87
CT-MVS.23P	1SVR740021R2300	39	CM-SRS.21P	1SVR740840R0400	87
CT-MXS.22P	1SVR740030R3300	39	CM-SRS.M1P	1SVR740840R0600	87
CT-WBS.22P	1SVR740040R3300	39	CM-SRS.11P	1SVR740841R0200	87
CT-ERS.21P	1SVR740100R0300	40	CM-SRS.21P	1SVR740841R0400	87
CT-ERS.12P	1SVR740100R3100	40	CM-SRS.11P	1SVR740841R1200	87
CT-ERS.22P	1SVR740100R3300	40	CM-SRS.21P	1SVR740841R1400	87
CT-AHS.22P	1SVR740110R3300	40	CM-ENS.13S	1SVR740850R0100	229
CT-ARS.11P	1SVR740120R3100	40	CM-ENS.21P	1SVR740850R0200	229



# Index

## Order code

Type	Order code	Page
CM-ENS.31P	1SVR740850R0300	229
CM-ENS.13P	1SVR740850R2100	229
CM-ENS.23P	1SVR740850R2200	229
CM-MPS.31P	1SVR740884R1300	115
CM-MPS.41P	1SVR740884R3300	115
CM-MPS.43P	1SVR740884R4300	115
CM-MPS.11P	1SVR740885R1300	115
CM-MPS.21P	1SVR740885R3300	115
CM-MPS.23P	1SVR740885R4300	115
COV.12	1SVR750005R0100	242
CM-MPN.52S	1SVR750487R8300	115
CM-MPN.62S	1SVR750488R8300	115
CM-MPN.72S	1SVR750489R8300	115
CM-IWN.1S	1SVR750660R0200	161
CM-IVN.S	1SVR750669R9400	161
CM-MPN.52P	1SVR760487R8300	115
CM-MPN.62P	1SVR760488R8300	115
CM-MPN.72P	1SVR760489R8300	115
CM-IWN.1P	1SVR760660R0200	161
CM-IVN.P	1SVR760669R9400	161
EPD24-TB-101-1A	2CDE601101R2001	352
EPD24-TB-101-2A	2CDE601101R2002	352
EPD24-TB-101-3A	2CDE601101R2003	352
EPD24-TB-101-4A	2CDE601101R2004	352
EPD24-TB-101-6A	2CDE601101R2006	352
EPD24-TB-101-8A	2CDE601101R2008	352
EPD24-TB-101-10A	2CDE601101R2010	352
EPD24-TB-101-12A	2CDE601101R2012	352
EPD24-TB-101-0.5A	2CDE601101R2905	352
EPD-BB500	2CDE605100R0500	352
EPD-SB21	2CDE605200R0021	352
C011-70	GHC0110003R0001	191
C011-80	GHC0110003R0002	191
C011-90	GHC0110003R0003	191
C011-100	GHC0110003R0004	191
C011-110	GHC0110003R0005	191
C011-120	GHC0110003R0006	191
C011-130	GHC0110003R0007	191
C011-150	GHC0110003R0008	191
C011-160	GHC0110003R0009	191
C011-170	GHC0110003R0010	191
C011-140	GHC0110003R0011	191
C011-3-150	GHC0110033R0008	191
SK 615 562-87	GJD6155620R0087	41
SK 615 562-88	GJD6155620R0088	41

---

**ABB STOTZ-KONTAKT GmbH**

Eppelheimer Strasse 82  
69123 Heidelberg  
Germany

**You can find the address of your local  
sales organization on the ABB homepage**



**[abb.com/lowvoltage](http://abb.com/lowvoltage)**

---

We reserve the right to make technical changes or modify the contents of this document without prior notice. With regard to purchase orders, the agreed particulars shall prevail. ABB AG does not accept any responsibility whatsoever for potential errors or possible lack of information in this document.

We reserve all rights in this document and in the subject matter and illustrations contained therein. Any reproduction, disclosure to third parties or utilization of its contents – in whole or in parts – is forbidden without prior written consent of ABB AG Copyright© 2020 ABB AG All rights reserved