



Universal Enclosures and Thermal Management

Catalog 2023

Panel**SeT**, Spacial, Thalassa
Actassi, ClimaSys

More than 60 years protecting your equipment



se.com/enclosures

Life Is On

Schneider
Electric

Life Is On

Contents

Overview	4
Services / Software / General Information	6
PanelSeT and Spacial	
1 Steel Industrial Boxes	8
2 Steel Wall-Mounted Enclosures	20
3 Steel Floor-Standing Enclosures	74
4 Stainless-Steel Industrial Boxes	112
5 Stainless-Steel Wall-Mounted Enclosures	124
6 Stainless-Steel Floor-Standing Enclosures	136
Thalassa	
7 Insulated Boxes	146
8 Insulated Wall-Mounted Enclosures	172
9 Insulated Floor-Standing Enclosures	190
Accessories	
10 Accessories	218
Applicative Solutions	
11 Applicative Solutions	280
Customized Solutions	
12 Customized Solutions	474
Actassi	
13 Actassi	486
ClimaSys	
14 Thermal Management System	564
Technical Guides	
15 Technical Guides	638
Spare Parts	
16 Spare Parts	652
Index	
17 Index of References	670

Universal Enclosures

Our Ranges, Solutions for Each Application

PanelSeT and Spacial



Metal Enclosures and Boxes

From our small boxes to large suitable floor-standing enclosures, the ranges of PanelSeT and Spacial products offers the perfect fit for your applications. Our extensive range of easy-to-use accessories helps you save time during your projects. Select between steel or stainless-steel to better suit the installation environment. Our stainless-steel products represent the optimal solution where cleanliness is required, or for highly corrosive environments.

Thalassa



Insulated Enclosures

Operating the equipment under adverse ambient conditions may expose your installation to chemical or aggressive substances. Our Thalassa range, from boxes to floor-standing enclosures, has been developed to efficiently protect your equipment. The products are made of fiberglass-reinforced polyester to resist harsh conditions and outdoor use. The Thalassa industrial boxes in ABS or polycarbonate are strong, easy to install and designed to be used in highly demanding environments.

ClimaSys



Thermal Management

Maintaining the right temperature inside your enclosure is vital for maximising the lifetime of your installed devices. Our ClimaSys range offers you the right solution: airing, connected cooling or heating, including control units for temperature, humidity and many other parameters.

Actassi



19" Enclosures Designed for all Cabling + Network Applications

With the Actassi system you can create a seamless end-to-end network connectivity solution for all needs. Installations in small, medium or critical buildings, for edge computing (micro data centers) or small offices have specific demands and represent different operating conditions. To this end, the Actassi system offers a variety of sizes of wall-mounted and floor-standing enclosures, from 6 to 47 units in different widths, depths, colors, with customized configurations. You can always find an Actassi enclosure with aesthetic design and accessories easy to use for all Cabling and Networking applications.

Industry and Infrastructure Offer

A Material for Every Environment

Steel

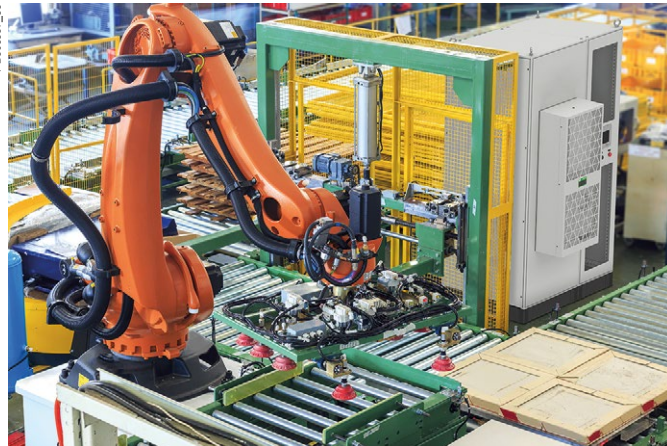

Indoor non-clean industrial environment

The industrial environment in mechanical plants is especially demanding as regards the protection of electric and electronic components against dust, splashing with oil and impacts. Such ambient conditions require a range that is suited to the application and easy to implement.

- Standard range for industrial applications.
- E.M.C. just available for WM (S3HF)
- Range of ATEX enclosures, for potentially explosive atmospheres.

Solution:

The PanelSeT and Spacial ranges in steel (wall-mounted, monobloc and suitable floor-standing enclosures).

304L - 316L Stainless-Steel



Demanding industrial environment

Food and beverage, pharmaceutical, petrochemical and infrastructure industries are particularly demanding in terms of hygiene and resistance to corrosion. Our products are available with two grades of stainless-steel:

- 304L stainless-steel: Corrosion resistance and cleanability (often used in food production).
- 316L stainless-steel: Also known as "marine stainless-steel". Very high resistance to corrosion (saline or chlorinated environment).

Solution:

The Spacial range in stainless-steel (wall-mounted, monobloc and suitable floor-standing enclosures).

Insulated Polyester and Plastic Materials (Abs, Polycarbonate)

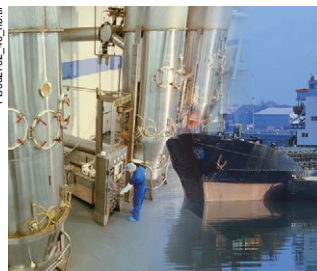

Infrastructures and industrial environments

Outdoor infrastructures and electrical installations are exposed to direct sunlight, rain, saline mist, extreme temperatures, oil splashes, chemical and corrosive agents.

- Standard range for industry and infrastructures.

Solution:

The Thalassa range (boxes, wall-mounted and floor-standing enclosures).

Heavy-Duty Materials



Severe outdoor environments, generally requested by OEMs, the telecommunication, water treatment and transportation industry

Heavy-Duty polyester units are suitable for outdoor public areas thanks to its multiple benefits:

- Resistant against pressure and shock (IEC 61439-5: 2010),
 - Door with ribbed surface against posting,
 - Insulated (prepared for Class II according to IEC 61439-1: 2011).
- Heavy-Duty steel enclosures are designed for outdoor private areas:
- Resistant against aggressive environments (anti-corrosion certification class C4H, ISO 12944:2018).

Solution:

The Thalassa PHD and Spacial S3HD and SFHD ranges (wall-mounted and floor-standing).



Selection and Configuration Tools

Selection Tools

www.se.com

Our web site allows you to access all Schneider Electric products with just two clicks with direct links to:

- A complete library of technical documents, catalogues, FAQs brochures, etc.
- Certificates.
- 2D and 3D drawings.
- Selection Guides from the e-catalogue.
- Product discovery sites.

You may also find illustrated overviews, news to which you can subscribe, a list of contacts in your country and other useful information.

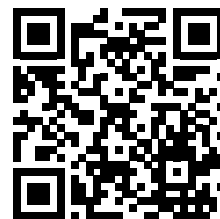

Scan or click

Product Selection Tool

Find the accessories that suit your enclosure

The digital rules allow you to select the best components from the current product range. There will be no risk of mistake since product and accessory selection take place automatically, saving you time and money.



Quick Selection Guide

The Quick Selection Guide is a streamlined alternative to the catalogue, offering an overview of the Universal enclosures ranges and a table of the most frequently used product references.

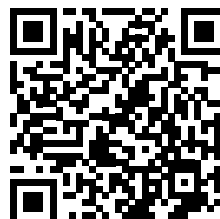

Scan or click

Thermal Management

ProClima

Find the best thermal solution for your enclosure

Select and calculate your thermal management requirements according to the environment and the electrical/electronic devices installed in the enclosure.



Custom Enclosure Configurator

Get your enclosure pre-engineered for your special needs

The Custom Enclosure Configurator software gives you total autonomy to configure and quote enclosures with services (cut-outs, painting, accessory mounting) in less than 3 minutes. Custom Enclosure Configurator is designed to create orders quickly and conveniently, without any errors.



The Customized Solutions

Enclosure Preparation Takes Precious Time Away from Actual Panel Building

Preparing your Enclosure can take a significant amount of time and manual labor.

Not only that, achieving a high-quality final result can be challenging.

This work can make you lose time on tasks such as:

- Drilling cut-outs for push-buttons, light indicators and cable entries
- Adding device fitting plates and cable glands
- Milling
- Deburring
- Painting

That's where Schneider Electric's PanelSeT, Spacial and Thalassa enclosure customization services fit in. We can insource the low-value customization work and get it done quickly for you. That way, your enclosures are ready for wiring when they arrive, saving you time and reducing costs, whilst also improving the quality of your panels.



Time Savings

Delivered with cut-outs and painting: no waste of time



Logistics

- Flexible management of your logistics option (scheduled delivery service for on-going orders)
- Special packaging



Simplified Installation
Enclosures delivered with cut-outs: no special tools required



Ergonomic Design
Customized project dedicated to your personal requirements



Increased Life-Time

- Cut-outs made before painting ensure corrosion protection and reliable sealing
- Painting service for better protection



Improved Quality

- No burrs on edges of cut-outs
- Guaranteed manufacturing tolerances



Aesthetics

- Large choice of colors
- No scratches in external surfaces



Higher Performance

- Adapted thermal management
- Higher-grade stainless-steel

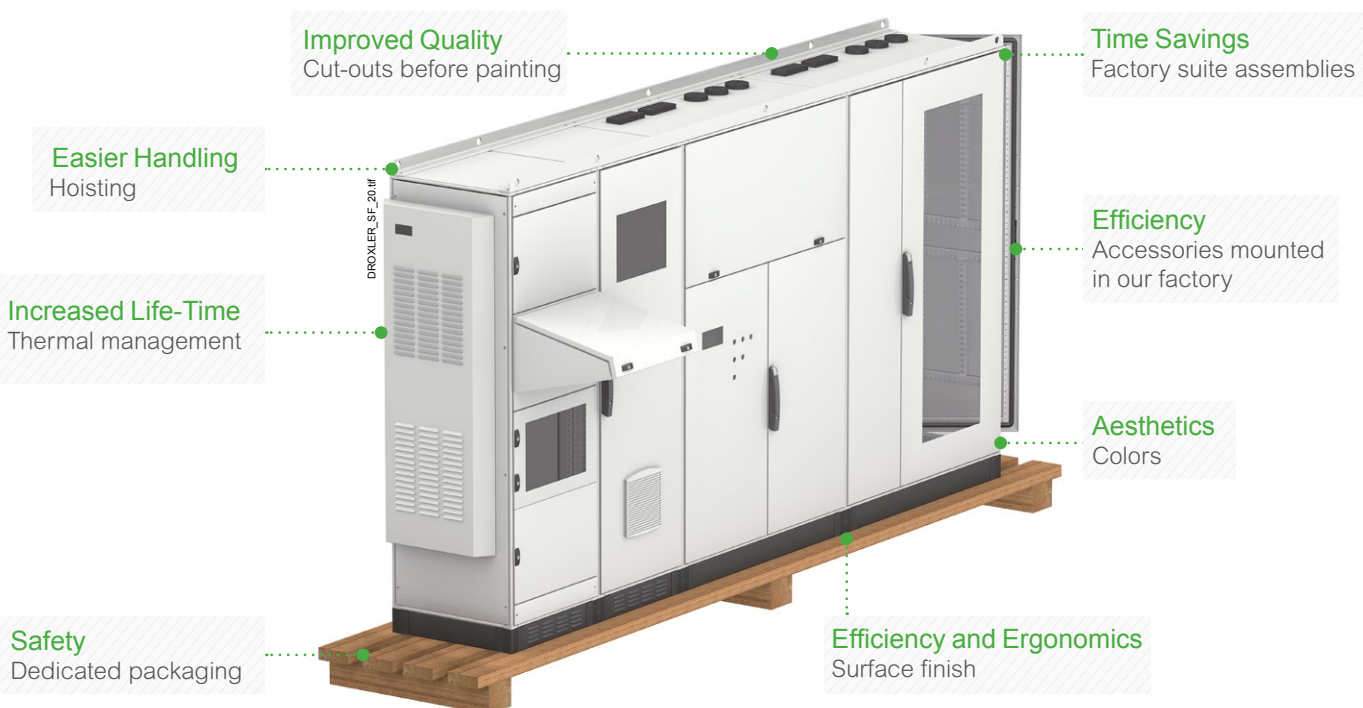

Technical changes reserved. Information provided without guarantee. Images are for illustrative purposes only.

Steel Industrial Boxes

Spacial SDB Metal Junction Boxes



Steel Industrial Boxes



Spacial SDB

Metal Junction Boxes	10
-----------------------------	-----------

Spacial SBM

Introduction	12
Characteristics	13
Spacial SBM Overview	14
Fixing Accessories	16

Dimensions

Dimensions	19
-------------------	-----------

Metal Junction Boxes

- PVC sealing gasket for sizes up to 20/15 and a rubber gasket for sizes > 25/20.
- Back ready for threaded drill holes for fixing equipment. From size 15/10 and up, there are four M4 threaded holes fitted with removable plugs for direct fixing of the mounting plate.
- With low cover.
- The SDB series consists of 2 basic models:
- Without knock-outs: **NSYDB●●●**
- With knock-outs: **NSYDB●●●M**
- Material: Sheet steel
- Finish: Structured finish, epoxy polyester powder
- Color: RAL 7035 gray
- Ingress protection rating: IP55 according to IEC 60529
- Mechanical protection rating: IK07 according to IEC 62262
- Installation: Indoor installation: Direct wall-mounted by means of drill holes fitted with plastic plugs to ensure sealing compliant with IEC 62208 regarding type tests specified in §9.12 (resistance to ultra-violet (UV) radiation) and §9.13 (resistance to corrosion).

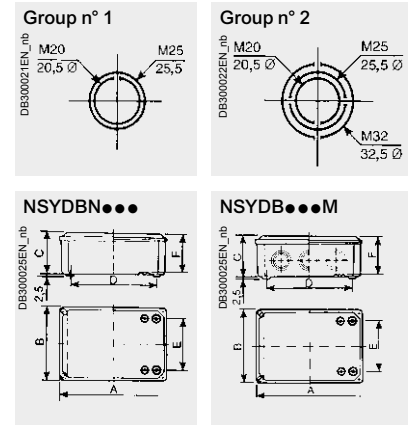

Low Cover Models without Knock-Outs



NSYDBN1510

	External dimensions (mm)			Dimensions (mm)			Weight (kg)	References
	Height (A)	Width (B)	Depth (C)	D	E	F		
85	85	49	58	58	-		0.18	NSYDBN88
105	105	49	76	76	-		0.25	NSYDBN1010
155	105	61	124	74	56		0.38	NSYDBN1510
206	156	83	172	122	78		1.00	NSYDBN2015
256	206	93	220	170	88		1.5	NSYDBN2520
307	257	116	268	218	110		3.3	NSYDBN3025

Low Cover Models with Knock-Outs



NSYDB2015M

	External dimensions (mm)			Dimensions (mm)			Knock-outs		Weight (kg)	References
	Height (A)	Width (B)	Depth (C)	D	E	F	Height (A)	Width (B)		
85	85	49	58	58	-		1 n° 1	1 n° 1	0.18	NSYDB88M
105	105	49	76	76	-		2 n° 1	1 n° 1	0.25	NSYDB1010M
155	105	61	124	74	56		3 n° 1	1 n° 1	0.38	NSYDB1510M
206	156	83	172	122	78		3 n° 2	2 n° 2	1.00	NSYDB2015M

Plain Mounting Plates for SDB Junction Boxes

for models without knock-outs	for models with knock-outs	References
NSYDBN1510	NSYDB1510M	NSYPMD1510
NSYDBN2015	NSYDB2015M	NSYPMD2015
NSYDBN2520	-	NSYPMD2520
NSYDBN3025	-	NSYPMD3025

Simplicity, Ergonomics and Versatility, It's All in the Box

This range can be configured according to your needs

4 different services available:



Assemble to Order



Mounting of Standard Accessories



Painting



Machining



Modularity
• 28 sizes available.

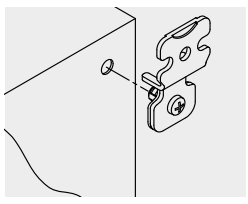

Easy Installation
• Direct mounting through the rear.
• Mounting with versatile external lugs.



Added Value to your Work
• Quality and aesthetics.
Sturdy and Good Ingress Protection
• Mechanical protection rating up to IK10.
• Ingress protection rating up to IP66.

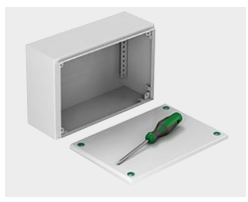

Ergonomics
• Cover opening and accessory mounting with just a screwdriver.



Characteristics	Spacial SBM - Flat box with plain cover
Box body	Single-piece body (cross-shaped structure). Front design incorporating folded gutters. Flat rear. 2 (or 3 profiles for width 800 mm) drilled profiles for installing mounting plates and DIN rails, with mounting centers of 12.5 mm.
Box cover	Equipped with 4 or 6 half-turn thread screws, according to the version (6 screws for width greater than 400 mm) to ensure maximum watertightness. Polyurethane sealing gasket.
Protection of personnel	Ground connection mandatory for all boxes: Spacial SBM steel boxes are equipped with a M6 x 16 ground stud welded in the cover, to be linked with the body for equipotential connection. Grounding strap to be ordered separately (Ø 6.4 mm terminal).
Material	Sheet steel
Finish	Structured finish, epoxy polyester powder
Color	RAL 7035 gray
Ingress protection rating	<ul style="list-style-type: none"> • IP66 according to IEC 60529 • Types 4, 4X according to UL50E
Mechanical protection rating	IK10 according to IEC 62262
Standard	Compliance with enclosure standard IEC 62208 and the RoHS directive
Certifications (see page 640)	<ul style="list-style-type: none"> • UL (cULus), BVM, LR, DNV, TUV
Indoor installation	Direct wall-mounted (4 x Ø 10 mm holes) or with mounting lugs installed from the outside (to be ordered separately, see specific accessory pages).
Maximum load	Loading capacity on the body: 50 kg/m ²
Vibration constraints	Specific construction of the Spacial SBM - single-piece body (rectangular structure). The rear is flat without added parts - this ensures compliance with certain vibration constraints.
Seismic behaviour	The seismic behavior of the the industrial boxes Spacial SBM have been qualified according to MRI spectra "big material" specified in the standard IEC 60068-2-6 and IEC 60068-2-57 (see page 388 for more details). Tested enclosure configuration: <ul style="list-style-type: none"> • Plain door, • Plain mounting plate with a load of 200 kg/m² uniformly distributed on the mounting plate, • Fixing to the wall with M8 screws (tightening torque: 12 Nm ± 1 Nm). Level of the seismic behavior obtained: <ul style="list-style-type: none"> • 2.5G for boxes of height and width (both) equal to or less than 400 mm and depth equal to or less than 200 mm, • 1G for other dimensions.

SBM



Standard Bus box phased out

Dimensions (mm)			Cover screws Bus Boxes phased out divide by 2	Flat box	Mounting plate without screws	DIN rail 10 rails, supplied without screws	Post mounting
Height	Width	Depth					
150	150	80	4	NSYSBM15158	NSYMM11SB	NSYAMRD15357SB	-
150	150	120	4	NSYSBM151512	NSYMM11SB	NSYAMRD15357SB	-
150	200	80	4	NSYSBM15208	NSYMM12SB	NSYAMRD20357SB	-
150	200	120	4	NSYSBM152012	NSYMM12SB	NSYAMRD20357SB	-
150	300	80	4	NSYSBM15308	NSYMM13SB	NSYAMRD30357SB	NSYSFPSC30
150	300	120	4	NSYSBM153012	NSYMM13SB	NSYAMRD30357SB	NSYSFPSC30
150	400	80	4	NSYSBM15408	NSYMM14SB	NSYAMRD40357SB	NSYSFPSC40
150	400	120	4	NSYSBM154012	NSYMM14SB	NSYAMRD40357SB	NSYSFPSC40
200	200	80	4	NSYSBM20208	NSYMM22SB	NSYAMRD20357SB	-
200	200	120	4	NSYSBM202012	NSYMM22SB	NSYAMRD20357SB	-
200	300	80	4	NSYSBM20308	NSYMM23SB	NSYAMRD30357SB	NSYSFPSC30
200	300	120	4	NSYSBM203012	NSYMM23SB	NSYAMRD30357SB	NSYSFPSC30
200	400	80	4	NSYSBM20408	NSYMM24SB	NSYAMRD40357SB	NSYSFPSC40
200	400	120	4	NSYSBM204012	NSYMM24SB	NSYAMRD40357SB	NSYSFPSC40
200	500	80	6	NSYSBM20508	NSYMM25SB	NSYAMRD50357SB	NSYSFPSC50
200	500	120	6	NSYSBM205012	NSYMM25SB	NSYAMRD50357SB	NSYSFPSC50
200	600	80	6	NSYSBM20608	NSYMM26SB	NSYAMRD60357SB	NSYSFPSC60
200	600	120	6	NSYSBM206012	NSYMM26SB	NSYAMRD60357SB	NSYSFPSC60
200	800	120	6	NSYSBM208012	NSYMM28SB	NSYAMRD80357SB	NSYSFPSC80
300	300	120	4	NSYSBM303012	NSYMM33SB	NSYAMRD30357SB	NSYSFPSC30
300	400	120	4	NSYSBM304012	NSYMM34SB	NSYAMRD40357SB	NSYSFPSC40
300	500	120	6	NSYSBM305012	NSYMM35SB	NSYAMRD50357SB	NSYSFPSC50
300	600	120	6	NSYSBM306012	NSYMM36SB	NSYAMRD60357SB	NSYSFPSC60
300	800	120	6	NSYSBM308012	NSYMM38SB	NSYAMRD80357SB	NSYSFPSC80
400	400	120	4	NSYSBM404012	NSYMM44SB	NSYAMRD40357SB	NSYSFPSC40
400	500	120	6	NSYSBM405012	NSYMM45SB	NSYAMRD50357SB	NSYSFPSC50
400	600	120	6	NSYSBM406012	NSYMM46SB	NSYAMRD60357SB	NSYSFPSC60
400	800	120	6	NSYSBM408012	NSYMM48SB	NSYAMRD80357SB	NSYSFPSC80

Head screws							Dimensions (mm)		
Mounting lugs	Self-tapping screws	Hinges	Double-bar shaped head screw	Triangular shaped head screw	Sealing kit	Height	Width	Depth	
						NSYAEFPFSB	NSYAMFSB	NSYAEDHSB	NSYAEDSBSB
NSYAEFPFSB	NSYAMFSB	NSYAEDHSB	NSYAEDSBSB	NSYAEDSTSB	NSYPPSB	150	150	120	
NSYAEFPFSB	NSYAMFSB	NSYAEDHSB	NSYAEDSBSB	NSYAEDSTSB	NSYPPSB	150	200	80	
NSYAEFPFSB	NSYAMFSB	NSYAEDHSB	NSYAEDSBSB	NSYAEDSTSB	NSYPPSB	150	200	120	
NSYAEFPFSB	NSYAMFSB	NSYAEDHSB	NSYAEDSBSB	NSYAEDSTSB	NSYPPSB	150	300	80	
NSYAEFPFSB	NSYAMFSB	NSYAEDHSB	NSYAEDSBSB	NSYAEDSTSB	NSYPPSB	150	300	120	
NSYAEFPFSB	NSYAMFSB	NSYAEDHSB	NSYAEDSBSB	NSYAEDSTSB	NSYPPSB	150	400	80	
NSYAEFPFSB	NSYAMFSB	NSYAEDHSB	NSYAEDSBSB	NSYAEDSTSB	NSYPPSB	150	400	120	
NSYAEFPFSB	NSYAMFSB	NSYAEDHSB	NSYAEDSBSB	NSYAEDSTSB	NSYPPSB	200	200	80	
NSYAEFPFSB	NSYAMFSB	NSYAEDHSB	NSYAEDSBSB	NSYAEDSTSB	NSYPPSB	200	200	120	
NSYAEFPFSB	NSYAMFSB	NSYAEDHSB	NSYAEDSBSB	NSYAEDSTSB	NSYPPSB	200	300	80	
NSYAEFPFSB	NSYAMFSB	NSYAEDHSB	NSYAEDSBSB	NSYAEDSTSB	NSYPPSB	200	300	120	
NSYAEFPFSB	NSYAMFSB	NSYAEDHSB	NSYAEDSBSB	NSYAEDSTSB	NSYPPSB	200	400	80	
NSYAEFPFSB	NSYAMFSB	NSYAEDHSB	NSYAEDSBSB	NSYAEDSTSB	NSYPPSB	200	400	120	
NSYAEFPFSB	NSYAMFSB	NSYAEDHSB	NSYAEDSBSB	NSYAEDSTSB	NSYPPSB	200	500	80	
NSYAEFPFSB	NSYAMFSB	NSYAEDHSB	NSYAEDSBSB	NSYAEDSTSB	NSYPPSB	200	500	120	
NSYAEFPFSB	NSYAMFSB	NSYAEDHSB	NSYAEDSBSB	NSYAEDSTSB	NSYPPSB	200	600	80	
NSYAEFPFSB	NSYAMFSB	NSYAEDHSB	NSYAEDSBSB	NSYAEDSTSB	NSYPPSB	200	600	120	
NSYAEFPFSB	NSYAMFSB	NSYAEDHSB	NSYAEDSBSB	NSYAEDSTSB	NSYPPSB	200	800	120	
NSYAEFPFSB	NSYAMFSB	NSYAEDHSB	NSYAEDSBSB	NSYAEDSTSB	NSYPPSB	300	300	120	
NSYAEFPFSB	NSYAMFSB	NSYAEDHSB	NSYAEDSBSB	NSYAEDSTSB	NSYPPSB	300	400	120	
NSYAEFPFSB	NSYAMFSB	NSYAEDHSB	NSYAEDSBSB	NSYAEDSTSB	NSYPPSB	300	500	120	
NSYAEFPFSB	NSYAMFSB	NSYAEDHSB	NSYAEDSBSB	NSYAEDSTSB	NSYPPSB	300	600	120	
NSYAEFPFSB	NSYAMFSB	NSYAEDHSB	NSYAEDSBSB	NSYAEDSTSB	NSYPPSB	300	800	120	
NSYAEFPFSB	NSYAMFSB	NSYAEDHSB	NSYAEDSBSB	NSYAEDSTSB	NSYPPSB	400	400	120	
NSYAEFPFSB	NSYAMFSB	NSYAEDHSB	NSYAEDSBSB	NSYAEDSTSB	NSYPPSB	400	500	120	
NSYAEFPFSB	NSYAMFSB	NSYAEDHSB	NSYAEDSBSB	NSYAEDSTSB	NSYPPSB	400	600	120	
NSYAEFPFSB	NSYAMFSB	NSYAEDHSB	NSYAEDSBSB	NSYAEDSTSB	NSYPPSB	400	800	120	

Technical changes reserved. Information provided without guarantee. Images are for illustrative purposes only.

Flat Boxes (SBM)



NSYSBM15158

Characteristics	Height (mm)	Width (mm)	Depth (mm)	Power dissipation	Sheet thickness	References
Flat box IP66 IK10 RAL 7035, 4 screws f. cover	150	150	80	13.5	10/10°	NSYSBM15158
Flat box IP66 IK10 RAL 7035, 4 screws f. cover	150	150	120	17.2	10/10°	NSYSBM151512
Flat box IP66 IK10 RAL 7035, 4 screws f. cover	150	200	80	16.6	10/10°	NSYSBM15208
Flat box IP66 IK10 RAL 7035, 4 screws f. cover	150	200	120	20.8	10/10°	NSYSBM152012
Flat box IP66 IK10 RAL 7035, 4 screws f. cover	150	300	80	22.8	10/10°	NSYSBM15308
Flat box IP66 IK10 RAL 7035, 4 screws f. cover	150	300	120	28.1	10/10°	NSYSBM153012
Flat box IP66 IK10 RAL 7035, 4 screws f. cover	150	400	80	29.0	10/10°	NSYSBM15408
Flat box IP66 IK10 RAL 7035, 4 screws f. cover	150	400	120	35.3	10/10°	NSYSBM154012
Flat box IP66 IK10 RAL 7035, 4 screws f. cover	200	200	80	20.6	10/10°	NSYSBM20208
Flat box IP66 IK10 RAL 7035, 4 screws f. cover	200	200	120	25.6	10/10°	NSYSBM202012
Flat box IP66 IK10 RAL 7035, 4 screws f. cover	200	300	80	28.2	10/10°	NSYSBM20308
Flat box IP66 IK10 RAL 7035, 4 screws f. cover	200	300	120	34.2	10/10°	NSYSBM203012
Flat box IP66 IK10 RAL 7035, 4 screws f. cover	200	400	80	35.7	10/10°	NSYSBM20408
Flat box IP66 IK10 RAL 7035, 4 screws f. cover	200	400	120	42.8	10/10°	NSYSBM204012
Flat box IP66 IK10 RAL 7035, 6 screws f. cover	200	500	80	43.3	12/10°	NSYSBM20508
Flat box IP66 IK10 RAL 7035, 6 screws f. cover	200	500	120	51.4	12/10°	NSYSBM205012
Flat box IP66 IK10 RAL 7035, 6 screws f. cover	200	600	80	50.8	12/10°	NSYSBM20608
Flat box IP66 IK10 RAL 7035, 6 screws f. cover	200	600	120	60.1	12/10°	NSYSBM206012
Flat box IP66 IK10 RAL 7035, 6 screws f. cover	200	800	120	77.3	12/10°	NSYSBM208012
Flat box IP66 IK10 RAL 7035, 4 screws f. cover	300	300	120	46.4	10/10°	NSYSBM303012
Flat box IP66 IK10 RAL 7035, 4 screws f. cover	300	400	120	57.8	10/10°	NSYSBM304012
Flat box IP66 IK10 RAL 7035, 6 screws f. cover	300	500	120	69.1	12/10°	NSYSBM305012
Flat box IP66 IK10 RAL 7035, 6 screws f. cover	300	600	120	80.4	12/10°	NSYSBM306012
Flat box IP66 IK10 RAL 7035, 6 screws f. cover	300	800	120	103.0	12/10°	NSYSBM308012
Flat box IP66 IK10 RAL 7035, 4 screws f. cover	400	400	120	72.7	10/10°	NSYSBM404012
Flat box IP66 IK10 RAL 7035, 6 screws f. cover	400	500	120	86.7	12/10°	NSYSBM405012
Flat box IP66 IK10 RAL 7035, 6 screws f. cover	400	600	120	100.7	12/10°	NSYSBM406012
Flat box IP66 IK10 RAL 7035, 6 screws f. cover	400	800	120	128.7	12/10°	NSYSBM408012

Mounting Plate

- Material: Galvanized steel
- Installation: Mounting by means of 2* or 4 x Ø 5 mm self-tapping screws, Pozidriv head, ref. **NSYAMFSB**. Attachment points compatible with many other brands of accessories

Supply:
1 unit, supplied without screws



NSYMM11SB

Characteristics	Height (mm)	Width (mm)	References
Mounting plate	125	135	NSYMM11SB
Mounting plate	125	185	NSYMM12SB
Mounting plate	125	285	NSYMM13SB
Mounting plate	125	385	NSYMM14SB
Mounting plate	175	185	NSYMM22SB
Mounting plate	175	265	NSYMM23SB
Mounting plate	175	385	NSYMM24SB
Mounting plate	175	485	NSYMM25SB
Mounting plate	175	585	NSYMM26SB
Mounting plate	175	785	NSYMM28SB
Mounting plate	275	285	NSYMM33SB
Mounting plate	275	385	NSYMM34SB
Mounting plate	275	485	NSYMM35SB
Mounting plate	275	585	NSYMM36SB
Mounting plate	275	785	NSYMM38SB
Mounting plate	375	385	NSYMM44SB
Mounting plate	375	485	NSYMM45SB
Mounting plate	375	585	NSYMM46SB
Mounting plate	375	785	NSYMM48SB

Symmetrical DIN Rails 35 x 7.5 mm

- Material: Galvanized steel
- Installation: Mounting by means of 2 x Ø 5 mm self-tapping screws, Pozidriv head, ref. **NSYAMFSB**
- All boxes are delivered with 5 x Ø 5 mm self-tapping screws.

Supply:
10 rails, supplied without screws



NSYAMRD15357SB

Characteristics	Height (mm)	Width (mm)	References
Symmetrical DIN rail	35	150	NSYAMRD15357SB
Symmetrical DIN rail	35	200	NSYAMRD20357SB
Symmetrical DIN rail	35	300	NSYAMRD30357SB
Symmetrical DIN rail	35	400	NSYAMRD40357SB
Symmetrical DIN rail	35	200	NSYAMRD20357SB
Symmetrical DIN rail	35	300	NSYAMRD30357SB
Symmetrical DIN rail	35	400	NSYAMRD40357SB
Symmetrical DIN rail	35	500	NSYAMRD50357SB
Symmetrical DIN rail	35	600	NSYAMRD60357SB
Symmetrical DIN rail	35	800	NSYAMRD80357SB
Symmetrical DIN rail	35	300	NSYAMRD30357SB
Symmetrical DIN rail	35	400	NSYAMRD40357SB
Symmetrical DIN rail	35	500	NSYAMRD50357SB
Symmetrical DIN rail	35	600	NSYAMRD60357SB
Symmetrical DIN rail	35	800	NSYAMRD80357SB
Symmetrical DIN rail	35	400	NSYAMRD40357SB
Symmetrical DIN rail	35	500	NSYAMRD50357SB
Symmetrical DIN rail	35	600	NSYAMRD60357SB
Symmetrical DIN rail	35	800	NSYAMRD80357SB

Post Mounting

- Material: Zinc-plated steel
- Rail mounted externally to the rear of the box with 8 mm screws for installation on posts with diameters between 150 mm and 215 mm.
- For steel boxes with widths of 150, 200, 300, 400, 500, 600 and 800 mm.
- Maximum load: 100 kg

Supply:
1 unit



NSYSFPSC15

Characteristics	Height (mm)	Width (mm)	References
Post mounting	45	300	NSYSFPSC30
Post mounting	45	400	NSYSFPSC40
Post mounting	45	500	NSYSFPSC50
Post mounting	45	600	NSYSFPSC60
Post mounting	45	800	NSYSFPSC80

Mounting Lugs

- Wall-mounted lugs to be mounted directly on the rear of the box, either in horizontal or vertical position. Their versatile design complies with the mounting dimensions of many other enclosures.
- Ingress protection rating: IP66 according to IEC 60529
- Installation: Horizontal or vertical position, distance between wall and enclosure: 12 mm, only requires a screw driver
- Maximum load: 70 kg

Supply:

4 wall-mounted lugs, screws and pre-mounted sealing gaskets



NSYAEFFFSB

Characteristics	References
wall-mounted lugs	NSYAEFFFSB

Self-Tapping Screws

- Same reference for all enclosure dimensions
- Self-tapping, Pozidriv head, screws, for Ø 5 mm holes.

Supply:

100 units



NSYAMFSB

Characteristics	References
Self-tapping screws	NSYAMFSB

Hinges

- The hinges allow the cover to be opened by more than 180°.
 - They can be installed on all covers of the range.
 - Ingress protection rating: IP66 according to IEC 60529
- Installation:**
- The box must be drilled before installing the 2 or 3 hinges on the body.
 - 3 hinges are required for boxes of width more than 500 mm
 - A specific mark on the body helps to locate where the hole should be drilled
 - Maximum load: 30 kg/m² on the hinged cover
 - Same reference for all enclosure dimensions

Supply:

Set of 6 hinges delivers with fixing hardware



NSYAEHHSB

Characteristics	References
Hinges SBM	NSYAEHHSB

Head Screws

- The standard Pozidriv head screws can be replaced with the Double-bar or triangular shaped head screws, to discourage unauthorised opening of the cover with normal screwdrivers.
- Ingress protection rating: IP66 according to IEC 60529
- Installation: Simply replace the standard screw on the box
- Same reference for all enclosure dimensions

Supply:

1 unit



NSYAEDSBSB

NSYAEDTSB

Characteristics	References
Double-bar shaped head 3 mm screw	NSYAEDSBSB
Triangular shaped head 6.5 mm screw	NSYAEDTSB

Sealing Kit

- The sealing kit helps to set up a lead-sealed cable of cover opening.
- Color: Green
- Ingress protection rating: IP66 according to IEC 60529
- Installation: Replaces the standard sealing washer on the box
- Same reference for all enclosure dimensions

Supply:

1 unit



NSYPPSB

Characteristics	References
Sealing kit SBM	NSYPPSB

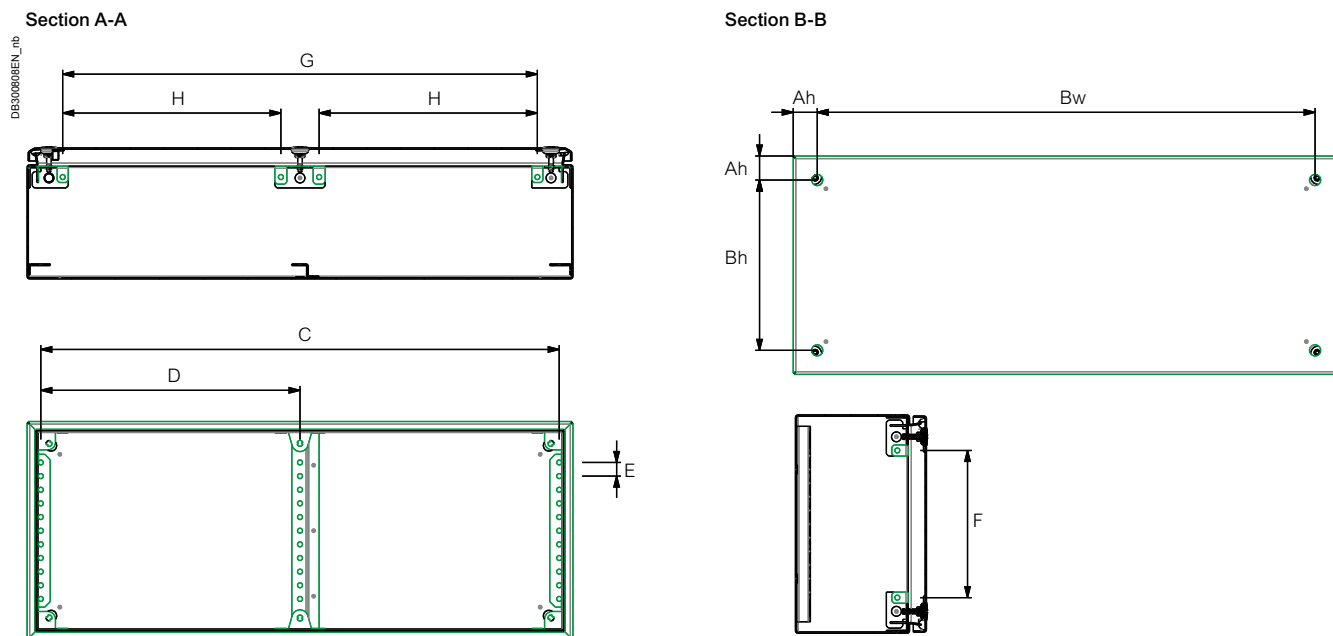

External Mounting of the Box and Mounting Accessories

Box		Mounting								
Height	Width	Ah	Bh	Bw	C	D	E	F	G	H
150 mm	150 mm	20.5 mm	109 mm	109 mm	125 mm	-	12.5 mm	85 mm	85 mm	-
	200 mm	20.5 mm	109 mm	159 mm	175 mm	-	12.5 mm	85 mm	135 mm	-
	300 mm	20.5 mm	109 mm	259 mm	275 mm	-	12.5 mm	85 mm	235 mm	-
	400 mm	20.5 mm	109 mm	359 mm	375 mm	-	12.5 mm	85 mm	335 mm	-
200 mm	200 mm	20.5 mm	159 mm	159 mm	175 mm	-	12.5 mm	135 mm	135 mm	-
	300 mm	20.5 mm	159 mm	259 mm	275 mm	-	12.5 mm	135 mm	235 mm	-
	400 mm	20.5 mm	159 mm	359 mm	375 mm	-	12.5 mm	135 mm	335 mm	-
	500 mm	20.5 mm	159 mm	459 mm	475 mm	-	12.5 mm	135 mm	435 mm	200 mm
	600 mm	20.5 mm	159 mm	559 mm	575 mm	-	12.5 mm	135 mm	535 mm	250 mm
	800 mm	20.5 mm	159 mm	759 mm	775 mm	387.5 mm	12.5 mm	135 mm	735 mm	350 mm
300 mm	300 mm	20.5 mm	259 mm	259 mm	275 mm	-	12.5 mm	235 mm	235 mm	-
	400 mm	20.5 mm	259 mm	359 mm	375 mm	-	12.5 mm	235 mm	335 mm	-
	500 mm	20.5 mm	259 mm	459 mm	475 mm	-	12.5 mm	235 mm	435 mm	200 mm
	600 mm	20.5 mm	259 mm	559 mm	575 mm	-	12.5 mm	235 mm	535 mm	250 mm
	800 mm	20.5 mm	259 mm	759 mm	775 mm	387.5 mm	12.5 mm	235 mm	735 mm	350 mm
400 mm	400 mm	20.5 mm	359 mm	359 mm	375 mm	-	12.5 mm	335 mm	335 mm	-
	500 mm	20.5 mm	359 mm	459 mm	475 mm	-	12.5 mm	335 mm	435 mm	200 mm
	600 mm	20.5 mm	359 mm	559 mm	575 mm	-	12.5 mm	335 mm	535 mm	250 mm
	800 mm	20.5 mm	359 mm	759 mm	775 mm	387.5 mm	12.5 mm	335 mm	735 mm	350 mm

Steel Wall-Mounted Enclosures

Spacial CRN

Enclosure for Indoor
Non-Clean Industrial Environment



Spacial S3D

Enclosure for Indoor
Non-Clean Industrial Environment



Spacial CRN

Introduction	22
Characteristics	23
Selection Guide	24
Accessories	29
Dimensions	38

Spacial S3D

Introduction	42
Characteristics	43
Selection Guide	44
Fixing Accessories	49
Plinth	51
Coupling Accessories	52
Protection Canopy	53
Handles	54
Locks	55
Accessories	56
Dimensions	66

Enclosure for Indoor Non-Clean Industrial Environment

This range can be configured according to your needs

4 different services available:



Assemble to Order



Mounting of Standard Accessories



Painting



Machining



Built to Last

- Industrial welding process.
- Epoxy-polyester painting.
- Molded polyurethane gasket.

These features ensure quality as well as water and dust tightness for years. Front folded gutter prevents the entry of water, oil or liquids, ensuring IP66 protection



Sealed

- Door glazed with tempered glass, water- and dust-tight, IP66 and IK08 protection



Safe

For people:

- Two welded M6 x 15 earth studs welded to the back and one M6 x 15 stud on the door

For your installation:

- Water and dust tightness IP66
- Ruggedness IK10 to protect your components from external impact
- Concealed hinges to prevent removal of the door



Practical

- 4 welded M8 x 15 back studs with 10-mm collar for direct installation of mounting plate



Smart

- Welded door reinforcement profile allowing the fixing of equipment in models from 500 mm in height



Convenient

- Large embedded cable-entry plate with a neoprene gasket, flush with the back of the enclosure
- Direct fixing or using the brackets fixed from outside

See [page 474](#) for details or consult our web site www.se.com



Characteristics	Spacial CRN
	56 dimensions for this metal monobloc, 14 of them with three-point locking system. Back piece joined to the sides using a special profile forming a protected sealed area.
Material	Steel
Finish	Structured finish, epoxy-polyester powder
Color	RAL 7035 gray
Ingress protection rating	<ul style="list-style-type: none"> • IP66 for one-door enclosures • IP55 for two-door enclosures according to IEC 62208
Mechanical protection rating	IK10 for plain door and IK08 for glazed door according to IEC 62208
Standards	IEC 62208
Certifications	<ul style="list-style-type: none"> • UL (cULus), CUL • Types 12 and 13 according UL50E • RoHS compliance
Installation	<ul style="list-style-type: none"> • Given their strength, metal enclosures are particularly well suited to indoor areas where they may experience impacts
Supply	<p>Body</p> <ul style="list-style-type: none"> • 4 holes for direct fixing • Wall-fixing drill holes sealed with plastic plugs to ensure the degree of protection (supplied as standard) • Wall-fixing bracket fixed from outside (brackets to be ordered separately) • Direct cable entry • Built-in cable-entry plate, flush with the back of the enclosure (without foamed-in gasket to facilitate machining) • Insulated cable entries with knock-outs, available as an accessory • Easy to equip with 4 welded back studs shouldered 10 mm <p>Door</p> <ul style="list-style-type: none"> • 3-mm standard double-bar lock as standard. (Wide choice of inserts as accessories and three-point locking system for heights from 1200 mm and widths from 1000 mm with standard 5-mm double-bar lock. Door-centering piece on two-door enclosures to ensure proper door alignment) • Foamed-in polyurethane gasket on the doors to guarantee water and dust tightness • Easily reversible door, fixed with two or three invisible metal hinges allowing the door to open to 120° • Reinforcement on plain doors with welded perforated door profiles for equipment fixing from models NSYCRN54150 • Welded earth studs on door and body • Delivered with a reusable packaging and technical instructions

Dimensions			Enclosures				Mounting plates				
Height (A) (mm)	Width (B) (mm)	Depth (C) (mm)	Doors	IP	Weight (kg) ⁽¹⁾	with plain door, with mounting plate	with plain door, without mounting plate	with glazed door, without mounting plate	Plain	Microperforated	Telequick
200	200	150	1	66	2.5	-	NSYCRN22150 (2)	-	NSYMM22	-	-
200	300	150	1	66	3.9	-	NSYCRN23150 (2)	-	NSYMM32	NSYMF32	-
250	200	150	1	66	3.2	NSYCRN252150P	NSYCRN252150	-	NSYMM2520	-	-
300	250	150	1	66	4.2	NSYCRN325150P	NSYCRN325150	NSYCRN325150T	NSYMM3025	-	NSYMR3025
300	250	200	1	66	4.9	NSYCRN325200P	NSYCRN325200	NSYCRN325200T	NSYMM3025	-	NSYMR3025
300	300	150	1	66	5.0	NSYCRN33150P	NSYCRN33150	NSYCRN33150T	NSYMM33	NSYMF33	NSYMR33
300	300	200	1	66	6.0	NSYCRN33200P	NSYCRN33200	NSYCRN33200T	NSYMM33	NSYMF33	NSYMR33
300	400	200	1	66	6.4	-	NSYCRN34200	NSYCRN34200T	NSYMM43	NSYMF43	NSYMR34
300	450	150	1	66	6.7	-	NSYCRN345150	-	NSYMM3045	-	-
400	300	150	1	66	6.0	NSYCRN43150P	NSYCRN43150	NSYCRN43150T	NSYMM43	NSYMF43	NSYMR43
400	300	200	1	66	6.8	NSYCRN43200P	NSYCRN43200	NSYCRN43200T	NSYMM43	NSYMF43	NSYMR43
400	400	200	1	66	8.0	NSYCRN44200P	NSYCRN44200	NSYCRN44200T	NSYMM44	NSYMF44	NSYMR44
400	600	250	1	66	10.0	NSYCRN46250P	NSYCRN46250	NSYCRN46250T	NSYMM64	NSYMF64	NSYMR46
400	600	300	1	66	11.2	-	NSYCRN46300	-	NSYMM64	NSYMF64	NSYMR46
500	400	150	1	66	8.7	NSYCRN54150P	NSYCRN54150	NSYCRN54150T	NSYMM54	NSYMF54	NSYMR54
500	400	200	1	66	9.8	NSYCRN54200P	NSYCRN54200	NSYCRN54200T	NSYMM54	NSYMF54	NSYMR54
500	400	250	1	66	11.0	NSYCRN54250P	NSYCRN54250	NSYCRN54250T	NSYMM54	NSYMF54	NSYMR54
500	500	250	1	66	12.8	NSYCRN55250P	NSYCRN55250	NSYCRN55250T	NSYMM55	NSYMF55	NSYMR55
600	400	150	1	66	9.3	NSYCRN64150P	NSYCRN64150	NSYCRN64150T	NSYMM64	NSYMF64	NSYMR64
600	400	200	1	66	10.8	NSYCRN64200P	NSYCRN64200	NSYCRN64200T	NSYMM64	NSYMF64	NSYMR64
600	400	250	1	66	12.3	NSYCRN64250P	NSYCRN64250	NSYCRN64250T	NSYMM64	NSYMF64	NSYMR64
600	500	150	1	66	11.3	NSYCRN65150P	NSYCRN65150	-	NSYMM65	NSYMF65	NSYMR65
600	500	200	1	66	14.3	NSYCRN65200P	NSYCRN65200	NSYCRN65200T	NSYMM65	NSYMF65	NSYMR65
600	500	250	1	66	16.2	NSYCRN65250P	NSYCRN65250	NSYCRN65250T	NSYMM65	NSYMF65	NSYMR65
600	600	200	1	66	16.3	NSYCRN66200P	NSYCRN66200	NSYCRN66200T	NSYMM66	NSYMF66	NSYMR66
600	600	250	1	66	18.2	NSYCRN66250P	NSYCRN66250	NSYCRN66250T	NSYMM66	NSYMF66	NSYMR66
600	600	300	1	66	19.8	NSYCRN66300P	NSYCRN66300	NSYCRN66300T	NSYMM66	NSYMF66	NSYMR66
600	800	300	1	66	26.0	-	NSYCRN68300	NSYCRN68300T	NSYMM86	NSYMF86	NSYMR68
700	500	200	1	66	17.3	NSYCRN75200P	NSYCRN75200	NSYCRN75200T	NSYMM75	NSYMF75	NSYMR75
700	500	250	1	66	19.3	NSYCRN75250P	NSYCRN75250	NSYCRN75250T	NSYMM75	NSYMF75	NSYMR75
800	600	200	1	66	21.8	NSYCRN86200P	NSYCRN86200	NSYCRN86200T	NSYMM86	NSYMF86	NSYMR86
800	600	250	1	66	24.8	NSYCRN86250P	NSYCRN86250	NSYCRN86250T	NSYMM86	NSYMF86	NSYMR86
800	600	300	1	66	26.3	NSYCRN86300P	NSYCRN86300	NSYCRN86300T	NSYMM86	NSYMF86	NSYMR86
800	600	400	1	66	30.0	-	NSYCRN86400	NSYCRN86400T	NSYMM86	NSYMF86	NSYMR86
800	800	200	1	66	29.5	NSYCRN88200P	NSYCRN88200	-	NSYMM88	NSYMF88	NSYMR88
800	800	300	1	66	32.5	NSYCRN88300P	NSYCRN88300	NSYCRN88300T	NSYMM88	NSYMF88	NSYMR88
800	1000	300	2	55	40.0	-	NSYCRN810300D	-	NSYMM108	NSYMF108	NSYMR810
800	1200	300	2	55	46.0	-	NSYCRN812300D	-	NSYMM128	NSYMF128	2x NSYMR86 (4)
1000	600	250	1	66	28.4	NSYCRN106250P	NSYCRN106250	NSYCRN106250T	NSYMM106	NSYMF106	NSYMR106
1000	600	300	1	66	30.6	NSYCRN106300P	NSYCRN106300	NSYCRN106300T	NSYMM106	NSYMF106	NSYMR106
1000	600	400	1	66	36.0	-	NSYCRN106400	NSYCRN106400T	NSYMM106	NSYMF106	NSYMR106
1000	800	250	1	66	34.5	NSYCRN108250P	NSYCRN108250	NSYCRN108250T	NSYMM108	NSYMF108	NSYMR108
1000	800	300	1	66	37.4	NSYCRN108300P	NSYCRN108300	NSYCRN108300T	NSYMM108	NSYMF108	NSYMR108
1000	800	400	1	66	43.0	-	NSYCRN108400	NSYCRN108400T	NSYMM108	NSYMF108	NSYMR108
1000	1000	300	2 (3)	55	47.0	-	NSYCRN1010300D	NSYCRN1010300T	NSYMM1010	NSYMF1010	NSYMR1010 (5)
1000	1200	300	2	55	55.0	-	NSYCRN1012300D	-	NSYMM1210	NSYMF1210	NSYMR1012 (5)
1000	1200	400	2	55	60.0	-	NSYCRN1012400D	-	NSYMM1210	NSYMF1210	NSYMR1012 (5)
1200	600	300	1	66	37.0	-	NSYCRN126300	NSYCRN126300T	NSYMM126	NSYMF126	NSYMR126
1200	600	400	1	66	42.0	-	NSYCRN126400	NSYCRN126400T	NSYMM126	NSYMF126	NSYMR126
1200	800	300	1	66	45.0	-	NSYCRN128300	NSYCRN128300T	NSYMM128	NSYMF128	NSYMR128
1200	800	400	1	66	50.0	-	NSYCRN128400	NSYCRN128400T	NSYMM128	NSYMF128	NSYMR128
1200	1000	300	2	55	56.0	-	NSYCRN1210300D	-	NSYMM1210	NSYMF1210	NSYMR1210 (5)
1200	1000	400	2	55	61.0	-	NSYCRN1210400D	-	NSYMM1210	NSYMF1210	NSYMR1210 (5)
1200	1200	300	2	55	64.0	-	NSYCRN1212300D	-	NSYMM1212	2x NSYMF126 (4)	2x NSYMR126 (4)
1200	1200	400	2	55	90.0	-	NSYCRN1212400D	-	NSYMM1212	2x NSYMF126 (4)	2x NSYMR126 (4)
1400	1000	300	2	55	80.0	-	NSYCRN1410300D	-	NSYMM1410	-	NSYMR1410 (5)





(1) Enclosure without mounting plate.

(2) Two cable gland plates, one on the top, one on the bottom.

(3) Except glazed door in single-door.

(4) Order **NSYCRNSDR** to mount double mounting plate.

(5) Ref. **NSYEMR** mandatory.

			Cable entries			Dimensions		
			Type of cable entry	Cable gland plate standard	Cable gland plate insulated	Height (A) (mm)	Width (B) (mm)	Depth (C) (mm)
								
Bakelite	DIN rail chassis							
-	-	-	0	NSYTLCRNO	-	200	200	150
NSYMB32	-	-	B	NSYTLCRNB	-	200	300	150
-	-	-	0	NSYTLCRNO	-	250	200	150
NSYMB3025	-	-	A	NSYTLCRNA	-	300	250	150
NSYMB3025	-	-	A	NSYTLCRNA	-	300	250	200
NSYMB33	NSYMD33	-	B	NSYTLCRNB	NSYTSACRNB	300	300	150
NSYMB33	NSYMD33	-	B	NSYTLCRNB	NSYTSACRNB	300	300	200
NSYMB43	-	-	C	NSYTLCRNC	NSYTSACRNC	300	400	200
NSYMB43	-	-	B	NSYTLCRNB	NSYTSACRNB	300	450	150
NSYMB43	NSYMD43	-	B	NSYTLCRNB	NSYTSACRNB	400	300	150
NSYMB43	NSYMD43	-	B	NSYTLCRNB	NSYTSACRNB	400	300	200
-	-	-	C	NSYTLCRNC	NSYTSACRNC	400	400	200
NSYMB64	-	-	D	NSYTLCRND	NSYTSACRND	400	600	250
NSYMB64	-	-	D	NSYTLCRND	NSYTSACRND	400	600	300
NSYMB54	NSYMD54	-	B	NSYTLCRNB	NSYTSACRNB	500	400	150
NSYMB54	NSYMD54	-	C	NSYTLCRNC	NSYTSACRNC	500	400	200
NSYMB54	NSYMD54	-	C	NSYTLCRNC	NSYTSACRNC	500	400	250
-	-	-	D	NSYTLCRND	NSYTSACRND	500	500	250
NSYMB64	NSYMD64	-	B	NSYTLCRNB	NSYTSACRNB	600	400	150
NSYMB64	NSYMD64	-	C	NSYTLCRNC	NSYTSACRNC	600	400	200
NSYMB64	NSYMD64	-	C	NSYTLCRNC	NSYTSACRNC	600	400	250
NSYMB65	-	-	B	NSYTLCRNB	NSYTSACRNB	600	500	150
NSYMB65	-	-	D	NSYTLCRND	NSYTSACRND	600	500	200
NSYMB65	-	-	D	NSYTLCRND	NSYTSACRND	600	500	250
-	NSYMD66	-	D	NSYTLCRND	NSYTSACRND	600	600	200
-	NSYMD66	-	D	NSYTLCRND	NSYTSACRND	600	600	250
-	NSYMD66	-	D	NSYTLCRND	NSYTSACRND	600	600	300
-	-	-	E	NSYTLCRNC (7)	NSYTSACRNC	600	800	300
NSYMB75	NSYMD75	-	D	NSYTLCRND	NSYTSACRND	700	500	200
NSYMB75	NSYMD75	-	D	NSYTLCRND	NSYTSACRND	700	500	250
NSYMB86	NSYMD86	-	D	NSYTLCRND	NSYTSACRND	800	600	200
NSYMB86	NSYMD86	-	D	NSYTLCRND	NSYTSACRND	800	600	250
NSYMB86	NSYMD86	-	D	NSYTLCRND	NSYTSACRND	800	600	300
NSYMB86	NSYMD86	-	D	NSYTLCRND	NSYTSACRND	800	600	400
-	-	-	E	NSYTLCRNC (7)	NSYTSACRNC (8)	800	800	200
-	-	-	E	NSYTLCRNC (7)	NSYTSACRNC (8)	800	800	300
-	-	-	D	2 x NSYTLCRND	2 x NSYTSACRND	800	1000	300
-	-	-	D	2 x NSYTLCRND	2 x NSYTSACRND	800	1200	300
-	-	-	D	NSYTLCRND	NSYTSACRND	1000	600	250
-	-	-	D	NSYTLCRND	NSYTSACRND	1000	600	300
-	-	-	D	NSYTLCRND	NSYTSACRND	1000	600	400
NSYMB108	NSYMD108	-	E	NSYTLCRNC (7)	NSYTSACRNC (8)	1000	800	250
NSYMB108	NSYMD108	-	E	NSYTLCRNC (7)	NSYTSACRNC (8)	1000	800	300
NSYMB108	NSYMD108	-	C	2 x NSYTLCRNC	2 x NSYTSACRNC	1000	800	400
NSYMB1210	-	-	D	2 x NSYTLCRND	2 x NSYTSACRND	1000	1000	300
NSYMB1210	-	-	D	2 x NSYTLCRND	2 x NSYTSACRND	1000	1200	300
-	-	-	D	2 x NSYTLCRND	2 x NSYTSACRND	1000	1200	400
-	-	-	D	NSYTLCRND	NSYTSACRND	1200	600	300
-	-	-	D	NSYTLCRND	NSYTSACRND	1200	600	400
-	NSYMD128	-	C	2 x NSYTLCRNC	2 x NSYTSACRNC	1200	800	300
-	NSYMD128	-	C	2 x NSYTLCRNC	2 x NSYTSACRNC	1200	800	400
NSYMB1210	-	-	D	2 x NSYTLCRND	2 x NSYTSACRND	1200	1000	300
NSYMB1210	-	-	D	2 x NSYTLCRND	2 x NSYTSACRND	1200	1000	400
-	-	-	D	2 x NSYTLCRND	2 x NSYTSACRND	1200	1200	300
-	-	-	D	2 x NSYTLCRND	2 x NSYTSACRND	1200	1200	400
-	-	-	D	2 x NSYTLCRND	2 x NSYTSACRND	1400	1000	300



(6) Order NSYAMCSF, NSYMDV12 in steel.
(7) With two holes.

(8) For flange openings type E, two NSYTSACRNC are required.
(9) Cable entry FlexiCable IP55

• For other dimensions, see our application offer.

Dimensions			Electric distribution							
Height (mm)	Width (mm)	Depth (mm)	Doors	DLA insulated Distribution chassis	DL metal distribution chassis	DLM metal distribution chassis	Plain cover plate for DLM	Mounting plate for DLM	Blanking plate	
200	200	150	1	-	-	-	-	-	-	
200	300	150	1	-	-	-	-	-	-	
250	200	150	1	-	-	-	-	-	-	
300	250	150	1	-	NSYDLCR18	-	-	-	-	
300	250	200	1	-	NSYDLCR18	-	-	-	-	
300	300	150	1	-	-	-	-	-	-	
300	300	200	1	-	-	-	-	-	-	
300	400	200	1	-	-	-	-	-	-	
300	450	150	1	-	-	-	-	-	-	
400	300	150	1	NSYDLA24G	NSYDLCR24	NSYDLM24	-	-	NSYATP72M	
400	300	200	1	NSYDLA24G	NSYDLCR36	NSYDLM24	-	-	NSYATP72M	
400	400	200	1	-	NSYDLCR24 (1)	-	-	-	-	
400	600	250	1	-	NSYDLCR36 (1)	-	-	-	-	
400	600	300	1	-	-	-	-	-	-	
500	400	150	1	NSYDLA48G	-	NSYDLM48	-	-	NSYATP72M	
500	400	200	1	NSYDLA48G	-	NSYDLM48	-	-	NSYATP72M	
500	400	250	1	NSYDLA48G	NSYDLCR48	NSYDLM48	-	-	NSYATP72M	
500	500	250	1	-	NSYDLCR48 (1)	-	-	-	-	
600	400	150	1	NSYDLA48PG	-	NSYDLM48P	-	-	NSYATP72M	
600	400	200	1	NSYDLA48PG	-	NSYDLM48P	-	-	NSYATP72M	
600	400	250	1	NSYDLA48PG	NSYDLCR64	NSYDLM48P	-	-	NSYATP72M	
600	500	150	1	-	NSYDLCR64	-	-	-	-	
600	500	200	1	-	-	-	-	-	-	
600	500	250	1	-	NSYDLCR88	-	-	-	-	
600	600	200	1	-	NSYDLCR88	NSYDLM84P	NSYCTL600DLM	-	NSYATP72M	
600	600	250	1	-	-	NSYDLM84P	NSYCTL600DLM	-	-	
600	600	300	1	-	-	NSYDLM84P	NSYCTL600DLM	-	NSYATP72M	
600	800	300	1	-	-	-	-	-	-	
700	500	200	1	NSYDLA66G / NSYDLA88G	-	NSYDLM66 / NSYDLM88	NSYCTL500DLM	NSYPMP500DLM	NSYATP72M	
700	500	250	1	NSYDLA66G / NSYDLA88G	-	NSYDLM66 / NSYDLM88	NSYCTL500DLM	NSYPMP500DLM	NSYATP72M	
800	600	200	1	NSYDLA84G / NSYDLA112G	NSYDLCR110	NSYDLM84 / NSYDLM112	NSYCTL600DLM	NSYPMP600DLM	NSYATP72M	
800	600	250	1	NSYDLA84G / NSYDLA112G	-	NSYDLM84 / NSYDLM112	NSYCTL600DLM	NSYPMP600DLM	NSYATP72M	
800	600	300	1	NSYDLA84G / NSYDLA112G	NSYDLCR135	NSYDLM84 / NSYDLM112	NSYCTL600DLM	NSYPMP600DLM	NSYATP72M	
800	600	400	1	NSYDLA84G / NSYDLA112G	-	NSYDLM84 / NSYDLM112	NSYCTL600DLM	NSYPMP600DLM	NSYATP72M	
800	800	200	1	-	-	-	-	-	-	
800	800	300	1	-	-	-	-	-	-	
800	1000	300	2	-	-	-	-	-	-	
800	1200	300	2	-	-	-	-	-	-	
1000	600	250	1	-	-	NSYDLM168	NSYCTL600DLM	NSYPMP600DLM	NSYATP72M	
1000	600	300	1	-	-	NSYDLM168	NSYCTL600DLM	NSYPMP600DLM	NSYATP72M	
1000	600	400	1	-	-	NSYDLM168	NSYCTL600DLM	NSYPMP600DLM	NSYATP72M	
1000	800	250	1	NSYDLA234G	-	NSYDLM240	NSYCTL800DLM	NSYPMP800DLM	NSYATP72M	
1000	800	300	1	NSYDLA234G	-	NSYDLM240	NSYCTL800DLM	NSYPMP800DLM	NSYATP72M	
1000	800	400	1	NSYDLA234G	-	NSYDLM240	NSYCTL800DLM	NSYPMP800DLM	NSYATP72M	
1000	1000	300	2	-	-	-	-	-	-	
1000	1200	300	2	-	-	-	-	-	-	
1000	1200	400	2	-	-	-	-	-	-	
1200	600	300	1	-	-	-	-	-	-	
1200	600	400	1	-	-	-	-	-	-	
1200	800	300	1	-	-	-	-	-	-	
1200	800	400	1	-	-	-	-	-	-	
1200	1000	300	2	-	-	-	-	-	-	
1200	1000	400	2	-	-	-	-	-	-	
1200	1200	300	2	-	-	-	-	-	-	
1200	1200	400	2	-	-	-	-	-	-	
1400	1000	300	2	-	-	-	-	-	-	

Technical changes reserved. Information provided without guarantee. Images are for illustrative purposes only.

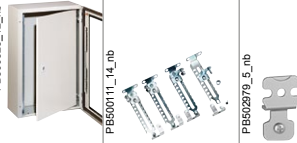
Electronic and network		Plinths (100 mm)		Plinths (200 mm)		Installation system			Dimensions		
Fixed 19" rack	Swing 19" rack	Single plinths side plate ⁽¹⁾	Single plinths front plate ⁽¹⁾	Single plinths side plate ⁽¹⁾	Single plinths front plate ⁽¹⁾	Inner door	Step slides	Wall-fixing lugs	Height (mm)	Width (mm)	Depth (mm)
											
-	-	-	-	-	-	-	-	NSYPFCR	200	200	150
-	-	-	-	-	-	-	-	NSYPFCR	200	300	150
-	-	-	-	-	-	-	-	NSYPFCR	250	200	150
-	-	-	-	-	-	-	-	NSYPFCR	300	250	150
-	-	-	-	-	-	-	NSYSDCR200	NSYPFCR	300	250	200
-	-	-	-	-	-	-	-	NSYPFCR	300	300	150
-	-	-	-	-	-	-	NSYSDCR200	NSYPFCR	300	300	200
-	-	-	-	-	-	-	NSYSDCR200	NSYPFCR	300	400	200
-	-	-	-	-	-	-	-	NSYPFCR	300	450	150
-	-	-	-	-	-	NSYPIN43	-	NSYPFCR	400	300	150
-	-	-	-	-	-	NSYPIN43	NSYSDCR200	NSYPFCR	400	300	200
-	-	-	-	-	-	-	NSYSDCR200	NSYPFCR	400	400	200
NSYVDM8UF	-	-	-	-	-	-	NSYSDCR250	NSYPFCR	400	600	250
NSYVDM8UF	-	NSYSPS3100SD	NSYSPF6100	NSYSPS3200SD	NSYSPF6200	-	NSYSDCR300	NSYPFCR	400	600	300
-	-	-	-	-	-	NSYPIN54	-	NSYPFCR	500	400	150
-	-	-	-	-	-	NSYPIN54	NSYSDCR200	NSYPFCR	500	400	200
-	-	-	-	-	-	NSYPIN54	NSYSDCR250	NSYPFCR	500	400	250
-	-	-	-	-	-	-	NSYSDCR250	NSYPFCR	500	500	250
-	-	-	-	-	-	NSYPIN64	-	NSYPFCR	600	400	150
-	-	-	-	-	-	NSYPIN64	NSYSDCR200	NSYPFCR	600	400	200
-	-	-	-	-	-	NSYPIN64	NSYSDCR250	NSYPFCR	600	400	250
-	-	-	-	-	-	-	-	NSYPFCR	600	500	150
-	-	-	-	-	-	-	NSYSDCR200	NSYPFCR	600	500	200
NSYVDM12UF	NSYVDM11UP	-	-	-	-	-	NSYSDCR250	NSYPFCR	600	500	250
NSYVDM12UF	NSYVDM11UP	-	-	-	-	-	NSYSDCR200	NSYPFCR	600	600	200
NSYVDM12UF	NSYVDM11UP	NSYSPS3100SD	NSYSPF6100	NSYSPS3200SD	NSYSPF6200	-	NSYSDCR250	NSYPFCR	600	600	250
-	-	NSYSPS3100SD	NSYSPF8100	NSYSPS3200SD	NSYSPF8200	-	NSYSDCR300	NSYPFCR	600	600	300
-	-	-	-	-	-	NSYPIN75	NSYSDCR200	NSYPFCR	700	500	200
-	-	-	-	-	-	NSYPIN75	NSYSDCR250	NSYPFCR	700	500	250
NSYVDM17UF	-	-	-	-	-	NSYPIN86	NSYSDCR200	NSYPFCR	800	600	200
NSYVDM17UF	NSYVDM16UP	-	-	-	-	NSYPIN86	NSYSDCR250	NSYPFCR	800	600	250
NSYVDM17UF	NSYVDM16UP	NSYSPS3100SD	NSYSPF6100	NSYSPS3200SD	NSYSPF6200	NSYPIN86	NSYSDCR300	NSYPFCR	800	600	300
NSYVDM17UF	NSYVDM16UP	NSYSPS4100SD	NSYSPF6100	NSYSPS4200SD	NSYSPF6200	NSYPIN86	NSYSDCR400	NSYPFCR	800	600	400
-	-	-	-	-	-	-	NSYSDCR200	NSYPFCR	800	800	200
-	-	NSYSPS3100SD	NSYSPF8100	NSYSPS3200SD	NSYSPF8200	-	NSYSDCR300	NSYPFCR	800	800	300
-	-	NSYSPS3100SD	NSYSPF10100	NSYSPS3200SD	NSYSPF10200	-	NSYSDCR300	NSYPFCR	800	1000	300
-	-	NSYSPS3100SD	NSYSPF12100	NSYSPS3200SD	NSYSPF12200	-	NSYSDCR300	NSYPFCR	800	1200	300
NSYVDM21UF	NSYVDM20UP	-	-	-	-	NSYPIN106	NSYSDCR250	NSYPFCR	1000	600	250
NSYVDM21UF	NSYVDM20UP	NSYSPS3100SD	NSYSPF6100	NSYSPS3200SD	NSYSPF6200	NSYPIN106	NSYSDCR300	NSYPFCR	1000	600	300
NSYVDM21UF	NSYVDM20UP	NSYSPS4100SD	NSYSPF6100	NSYSPS4200SD	NSYSPF6200	NSYPIN106	NSYSDCR400	NSYPFCR	1000	600	400
-	NSYVDM20U8P	-	-	-	-	NSYPIN108	NSYSDCR250	NSYPFCR	1000	800	250
-	NSYVDM20U8P	NSYSPS3100SD	NSYSPF8100	NSYSPS3200SD	NSYSPF8200	NSYPIN108	NSYSDCR300	NSYPFCR	1000	800	300
-	NSYVDM20U8P	NSYSPS4100SD	NSYSPF8100	NSYSPS4200SD	NSYSPF8200	NSYPIN108	NSYSDCR400	NSYPFCR	1000	800	400
-	-	NSYSPS3100SD	NSYSPF10100	NSYSPS3200SD	NSYSPF10200	-	NSYSDCR300	NSYPFCR	1000	1000	300
-	-	NSYSPS3100SD	NSYSPF12100	NSYSPS3200SD	NSYSPF12200	-	NSYSDCR300	NSYPFCR	1000	1200	300
-	-	NSYSPS4100SD	NSYSPF12100	NSYSPS4200SD	NSYSPF12200	-	NSYSDCR400	NSYPFCR	1000	1200	400
-	-	NSYSPS3100SD	NSYSPF6100	NSYSPS3200SD	NSYSPF6200	NSYPIN126	NSYSDCR300	NSYPFCR	1200	600	300
-	-	NSYSPS4100SD	NSYSPF6100	NSYSPS4200SD	NSYSPF6200	NSYPIN126	NSYSDCR400	NSYPFCR	1200	600	400
-	NSYVDM25U8P	NSYSPS3100SD	NSYSPF8100	NSYSPS3200SD	NSYSPF8200	NSYPIN128	NSYSDCR300	NSYPFCR	1200	800	300
-	NSYVDM25U8P	NSYSPS4100SD	NSYSPF8100	NSYSPS4200SD	NSYSPF8200	NSYPIN128	NSYSDCR400	NSYPFCR	1200	800	400
-	-	NSYSPS3100SD	NSYSPF10100	NSYSPS3200SD	NSYSPF10200	-	NSYSDCR300	NSYPFCR	1200	1000	300
-	-	NSYSPS4100SD	NSYSPF10100	NSYSPS4200SD	NSYSPF10200	-	NSYSDCR400	NSYPFCR	1200	1000	400
-	-	NSYSPS3100SD	NSYSPF12100	NSYSPS3200SD	NSYSPF12200	-	NSYSDCR300	NSYPFCR	1200	1200	300
-	-	NSYSPS4100SD	NSYSPF12100	NSYSPS4200SD	NSYSPF12200	-	NSYSDCR400	NSYPFCR	1200	1200	400
-	-	NSYSPS3100SD	NSYSPF10100	NSYSPS3200SD	NSYSPF10200	-	NSYSDCR300	NSYPFCR	1400	1000	300

⁽¹⁾ To install the plinth to a wall-mounted enclosure, order ref. NSYAPFWM.

Dimensions			Post-fixing	Supporting pole	Canopies	Support bracket
Height (mm)	Width (mm)	Depth (mm)	Post-fixing device	Supporting pole	Canopies	Support bracket for enclosure with anti-tilt kit and reinforcement 1400 mm ⁽²⁾
200	200	150	-	-	-	NSYCOCNS1400
200	300	150	-	-	-	NSYCOCNS1400
250	200	150	-	-	NSYTJ2015	NSYCOCNS1400
300	250	150	-	NSYCOCN80	-	NSYCOCNS1400
300	250	200	-	NSYCOCN80	-	NSYCOCNS1400
300	300	150	NSYSFPSC30	NSYCOCN80	NSYTJ3015	NSYCOCNS1400
300	300	200	NSYSFPSC30	NSYCOCN80	NSYTJ3020	NSYCOCNS1400
300	400	200	NSYSFPSC40	NSYCOCN80	NSYTJ4020	NSYCOCNS1400
300	450	150	-	-	-	NSYCOCNS1400
400	300	150	NSYSFPSC30	NSYCOCN80	NSYTJ3015	NSYCOCNS1400
400	300	200	NSYSFPSC30	NSYCOCN80	NSYTJ3020	NSYCOCNS1400
400	400	200	NSYSFPSC40	NSYCOCN80	NSYTJ4020	NSYCOCNS1400
400	600	250	NSYSFPSC60	NSYCOCN80	NSYTJ6025	NSYCOCNS1400
400	600	300	NSYSFPSC60	NSYCOCN80	NSYTJ6030	NSYCOCNS1400
500	400	150	NSYSFPSC40	NSYCOCN80	NSYTJ4015	NSYCOCNS1400
500	400	200	NSYSFPSC40	NSYCOCN80	NSYTJ4020	NSYCOCNS1400
500	400	250	NSYSFPSC40	NSYCOCN80	NSYTJ4025	NSYCOCNS1400
500	500	250	NSYSFPSC50	NSYCOCN80	NSYTJ5025	NSYCOCNS1400
600	400	150	NSYSFPSC40	NSYCOCN80	NSYTJ4015	NSYCOCNS1400
600	400	200	NSYSFPSC40	NSYCOCN80	NSYTJ4020	NSYCOCNS1400
600	400	250	NSYSFPSC40	NSYCOCN80	NSYTJ4025	NSYCOCNS1400
600	500	150	NSYSFPSC50	NSYCOCN80	-	NSYCOCNS1400
600	500	200	NSYSFPSC50	NSYCOCN80	NSYTJ5020	NSYCOCNS1400
600	500	250	NSYSFPSC50	NSYCOCN80	NSYTJ5025	NSYCOCNS1400
600	600	200	NSYSFPSC60	NSYCOCN80	NSYTJ6020	NSYCOCNS1400
600	600	250	NSYSFPSC60	NSYCOCN80	NSYTJ6025	NSYCOCNS1400
600	600	300	NSYSFPSC60	NSYCOCN80	NSYTJ6030	NSYCOCNS1400
600	800	300	NSYSFPSC80	-	NSYTJ8030	NSYCOCNS1400
700	500	200	NSYSFPSC50	NSYCOCN80	NSYTJ5020	NSYCOCNS1400
700	500	250	NSYSFPSC50	NSYCOCN80	NSYTJ5025	NSYCOCNS1400
800	600	200	NSYSFPSC60	NSYCOCN80	NSYTJ6020	NSYCOCNS1400
800	600	250	NSYSFPSC60	NSYCOCN80	NSYTJ6025	NSYCOCNS1400
800	600	300	NSYSFPSC60	NSYCOCN80	NSYTJ6030	NSYCOCNS1400
800	600	400	NSYSFPSC60	-	NSYTJ6040	-
800	800	200	NSYSFPSC80	-	-	NSYCOCNS1400
800	800	300	NSYSFPSC80	-	NSYTJ8030	NSYCOCNS1400
800	1000	300	-	-	NSYTJ10030	-
800	1200	300	-	-	NSYTJ12030	-
1000	600	250	-	NSYCOCN80	NSYTJ6025	NSYCOCNS1400
1000	600	300	-	NSYCOCN80	NSYTJ6030	NSYCOCNS1400
1000	600	400	-	-	NSYTJ6040	-
1000	800	250	-	-	NSYTJ8025	NSYCOCNS1400
1000	800	300	-	-	NSYTJ8030	NSYCOCNS1400
1000	800	400	-	-	NSYTJ8040	-
1000	1000	300	-	-	NSYTJ10030	-
1000	1200	300	-	-	NSYTJ12030	-
1000	1200	400	-	-	NSYTJ12040	-
1200	600	300	-	-	NSYTJ6030	-
1200	600	400	-	-	NSYTJ6040	-
1200	800	300	-	-	NSYTJ8030	-
1200	800	400	-	-	NSYTJ8040	-
1200	1000	300	-	-	NSYTJ10030	-
1200	1000	400	-	-	NSYTJ10040	-
1200	1200	300	-	-	NSYTJ12030	-
1200	1200	400	-	-	NSYTJ12040	-
1400	1000	300	-	-	NSYTJ10030	-

⁽¹⁾ 2 coupling plates and supporting poles are required.

⁽²⁾ Available in version 1800 mm: Ref. **NSYCOCNS1800**.

Wall-Fixing Lugs for Spacial CRN Enclosures

- Set of 4 wall-fixing lugs.
- Mounted directly on the rear of the enclosure, either in horizontal or vertical position.
- Wall-to-enclosure spacing separation of 10 mm.
- Maximum load: 250 kg
- Not suitable for dynamic loads.
- For weights of the Spacial CRN enclosures without mounting plate refer to the selection guide

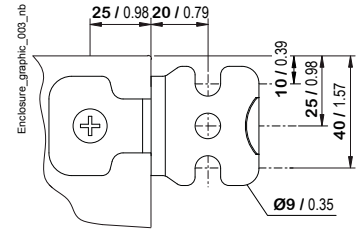

Wall-Fixing Lugs for Spacial CRN Enclosures



NSYPFCR

- Material: Passivated zinc-coated steel

Characteristics

Set of 4 wall fixing lugs for Spacial CRN enclosure

References

NSYPFCR

Supply:

Supplied with fixing screws and pre-mounted sealing gaskets

Wall-Fixing Lugs for Spacial CRN Enclosures



NSYPFCX

- Material: Stainless-steel AISI 304L

Characteristics

Set of 4 wall fixing brackets in stainless-steel AISI 304L

References

NSYPFCX

Supply:

Supplied with fixing screws and pre-mounted sealing gaskets

Wall-Fixing Lugs for Spacial CRN Enclosures



NSYPFC2X

- Material: Stainless-steel AISI 316L

Characteristics

Set of 4 wall fixing brackets in stainless-steel AISI 316L

References

NSYPFC2X

Supply:

Supplied with fixing screws and pre-mounted sealing gaskets

Covers for wall fixing brackets



NSYCAEFPF

- Material: PA

Characteristics

Set of 4 covers for wall fixing brackets for Spacial S3D/CRN

References

NSYCAEFPF

Supply:

Kit of 4 covers

Post-Fixing Device for Spacial Steel Enclosure

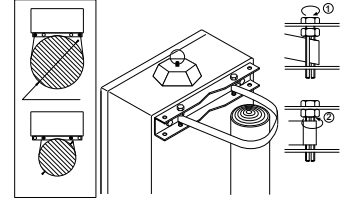
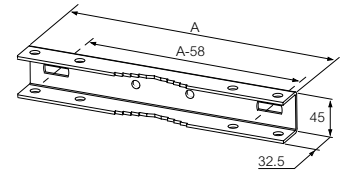

For more details see [page 40](#)

- For indoor installations on posts with a maximum circumference of 675 mm (minimum diameter 150 mm and maximum diameter 215 mm).
- Rail fixed to the inserts in the rear of the enclosure with 8-mm screws.
- They allow the mounting of protection canopies.
- Material: Galvanized steel
- Maximum load: 100 kg



NSYFPSC30

Characteristics	Width (mm)	A (mm)	References
Post-fixing device for Spacial steel enclosure	300	295	NSYFPSC30
Post-fixing device for Spacial steel enclosure	400	395	NSYFPSC40
Post-fixing device for Spacial steel enclosure	500	495	NSYFPSC50
Post-fixing device for Spacial steel enclosure	600	595	NSYFPSC60
Post-fixing device for Spacial steel enclosure	800	795	NSYFPSC80

Support Pillar

- The support pillar is fixed directly to the bottom face of the Spacial steel enclosure by means of an adapter plate. The latter, to be ordered in addition to the pillar, replaces the cable gland plate.
- Overall height of the support foot: 800 mm.
- Mounting possible on all enclosures with dimensions up to 600 x 400 x 250 mm (except 200 x 200 x 150 and 250 x 200 x 150 enclosures).
- Material: Extruded aluminum
- Finish: Epoxy-polyester paint
- Color: RAL 7035 gray



NSYCOCN80

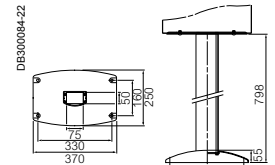

Characteristics	Height (mm)	References
Support pillar	800	NSYCOCN80

Support Bracket for Enclosure with Anti-Tilt Kit and Reinforcement

- The support bracket is used when the enclosure cannot be hung from a wall or a post.
- Maximum enclosure dimensions: 1000 x 800 x 300 mm.
- Floor attachment by standard M12 fastenings.
- Material: Steel
- Finish: Epoxy-polyester paint
- Color: RAL 7035 gray
- Maximum load: 120 kg



NSYCOCN1400

Characteristics	Height (mm)	References
Support bracket for enclosure with anti-tilt kit and reinforcement	1400	NSYCOCN1400
Support bracket for enclosure with anti-tilt kit and reinforcement	1800	NSYCOCN1800

Front and Rear Plinths



Stainless-steel plinths (standard plinths [page 131](#), ventilated plinths [page 379](#)) are compatible with steel wall-mounted S3D enclosures using an earthing cable (description [page 278](#)) to be ordered separately.

- The front and rear of the plinth consists of 4 corners with 2 or 4 panels.
- Material: Folded sheet steel, corner with a thickness of 25/10° mm
- Finish: Structured finish, epoxy-polyester powder
- Color: RAL 7022 gray
- Ingress protection rating: IP30 according to IEC 60529
- Mechanical protection rating: IK10 according to IEC 62262

Installation:

It is necessary to order separately the plinth fixing kit (ref. [NSYAPFWM](#)) composed by fixing hardware and drilling jig

Note:

For more information see [page 89](#)

Supply:

Height 100 mm: 4 corners, 2 panels (front and rear), 4 corner covers and fixing elements. Height 200 mm: 4 corners, 4 panels (2 front and 2 rear), 4 corner covers and fixing elements



NSYSPPF6100

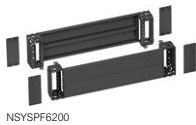

NSYSPPF6200

Characteristics	Width (mm)	Height (mm)	References
Front and rear plinths for Spacial	600	100	NSYSPPF6100
Front and rear plinths for Spacial	800	100	NSYSPPF8100
Front and rear plinths for Spacial	1000	100	NSYSPPF10100
Front and rear plinths for Spacial	1200	100	NSYSPPF12100
Front and rear plinths for Spacial	600	200	NSYSPPF6200
Front and rear plinths for Spacial	800	200	NSYSPPF8200
Front and rear plinths for Spacial	1000	200	NSYSPPF10200
Front and rear plinths for Spacial	1200	200	NSYSPPF12200

Plinth Side Panels



NSYSPPS3100SD



NSYSPPS3200SD

- They are fixed to the corner of the plinth by 2 fixing screws.
- Folded sheet steel
- Finish: Structured finish, epoxy-polyester powder
- Color: RAL 7022 gray
- Ingress protection rating: IP30 according to IEC 60529
- Mechanical protection rating: Mechanical protection rating

Supply:

Height 100 mm: 2 side panels, 4 corner covers and fixing elements. Height 200 mm: 4 side panels (height of 100 mm, 2 for each side), 4 corner covers and fixing elements

Characteristics	Depth (mm)	Height (mm)	References
Side plinths for Spacial	300	100	NSYSPPS3100SD
Side plinths for Spacial	400	100	NSYSPPS4100SD
Side plinths for Spacial	300	200	NSYSPPS3200SD
Side plinths for Spacial	400	200	NSYSPPS4200SD

Plinth

- Material: Stainless-steel, AISI 304L or AISI 316L
- Finish: Scotch-Brite® brushing, to guarantee the durability in application where the contact with the floor increases the risk of corrosion



NSYSPPFX8100

Characteristics	Width	Height (mm)	References
Plinth height 100 mm, Kit (4 corners + front and back), AISI 304L	800	100	NSYSPPFX8100
Plinth height 100 mm, Kit (4 corners + front and back), AISI 304L	1000	100	NSYSPPFX10100
Plinth height 100 mm, Kit (4 corners + front and back), AISI 316L	800	100	NSYSPPFX8100H
Plinth height 100 mm, Kit (4 corners + front and back), AISI 316L	1000	100	NSYSPPFX10100H



NSYSPPSX3100

Characteristics	Depth	Height (mm)	References
Plinth height 100 mm, Set of 2 side panels, AISI 304L	300	100	NSYSPPSX3100



NSYSPPFX8200

Characteristics	Width	Height (mm)	References
Plinth height 200 mm, Kit (4 corners + front and back), AISI 304L	800	200	NSYSPPFX8200
Plinth height 200 mm, Kit (4 corners + front and back), AISI 304L	1000	200	NSYSPPFX10200
Plinth height 200 mm, Kit (4 corners + front and back), AISI 316L	800	200	NSYSPPFX8200H
Plinth height 200 mm, Kit (4 corners + front and back), AISI 316L	1000	200	NSYSPPFX10200H



NSYSPPSX3200

Characteristics	Depth	Height (mm)	References
Plinth height 200 mm, Set of 2 side panels (x2), AISI 304L	300	200	NSYSPPSX3200

Coupling of Spacial Steel Enclosures

- Available in 2 versions:
 - Coupling version without cable entry.
 - Version with coupling frame allowing the entry of cables.
- Separation of 17 mm between 2 coupled enclosures, allowing full opening of the doors.
- Allows lateral coupling of 2 enclosures.
- These frames allow the door to open to 120°.
- Material: Fiberglass-reinforced polyester, self-extinguishing
- Ingress protection rating: IP66 according to IEC 60529

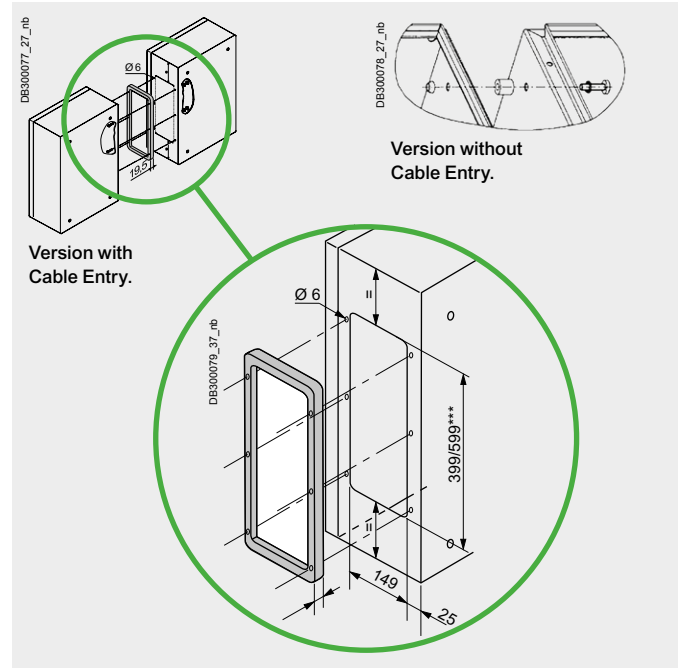

Supply:
Set of 4 spacers and their fixings. Mounting by screws, included

Coupling Spacers



NSYAEUBUSC

Characteristics	References
Set of 4 coupling spacers	NSYAEUBUSC

Coupling Frame



NSYAEUBU41SC

Characteristics	References
Coupling frame, 435 x 185 mm	NSYAEUBU41SC
Coupling frame, 635 x 185 mm	NSYAEUBU61SC

Eyebolts



NSYAELYTCRG8

- Set of two M8 eyebolts. They are fixed directly to the body of the floor-standing enclosure. Cannot be installed with the canopy in place or if it is planned to put one.
- Material: Zinc-coated molded steel
- Maximum load: 200 kg per enclosure when slinging at 60°

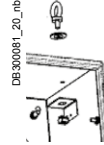

Supply:
Reinforcing brackets attached to the rings (these brackets also act as a drilling template)

Characteristics	References
Set of 2 M8 eyebolts	NSYAELYTCRG8

Protection Canopy



NSYTJ2015

- Direct fixing to the body of the enclosure by 4 M6 screws.
- Material: Sheet steel
- Finish: Epoxy-polyester paint
- Color: RAL 7035 gray

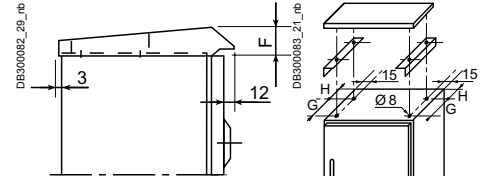

Supply:
Delivered with the fixings required for installation

Characteristics	Width (mm)	Depth (mm)	F (mm)	G (mm)	H (mm)	References
Protection canopy	200	150	36	75	23	NSYTJ2015
Protection canopy	300	150	36	75	23	NSYTJ3015
Protection canopy	400	150	36	75	23	NSYTJ4015
Protection canopy	500	200	36	130	23	NSYTJ5020
Protection canopy	600	200	36	130	23	NSYTJ6020
Protection canopy	300	200	36	130	23	NSYTJ3020
Protection canopy	400	200	36	130	23	NSYTJ4020
Protection canopy	400	250	42	150	48	NSYTJ4025
Protection canopy	500	250	42	150	48	NSYTJ5025
Protection canopy	600	250	42	150	48	NSYTJ6025
Protection canopy	800	250	42	150	48	NSYTJ8025
Protection canopy	600	300	42	200	48	NSYTJ6030
Protection canopy	800	300	42	200	48	NSYTJ8030
Protection canopy	1000	300	42	200	48	NSYTJ10030
Protection canopy	1200	300	42	200	48	NSYTJ12030
Protection canopy	600	400	42	300	48	NSYTJ6040
Protection canopy	800	400	42	300	48	NSYTJ8040
Protection canopy	1000	400	42	300	48	NSYTJ10040
Protection canopy	1200	400	42	300	48	NSYTJ12040

Number of Modules Per Chassis (Every 18 mm)

Chassis reference	NSYDLM24	NSYDLM48	NSYDLM48P	NSYDLM84P	NSYDLM66*	NSYDLM88	NSYDLM84*	NSYDLM112	NSYDLM168	NSYDLM240
Enclosure height (mm)	400	500	600	600	700	700	800	800	1000	1000
Enclosure width (mm)	300	400	400	600	500	500	600	600	600	800
Number of rows	2	3	3	3	3	4	3	4	6	6
Modules per row	12	16	16	28	22	22	28	28	28	39
Total n. of modules	24	48	48	84	66	88	84	112	168	234

Note:

References **NSYDLM48**, **NSYDLM48P** and **NSYDLM84P**, the central row cannot receive modules at the height of the lock (check our technical instructions) when installed at the front of the enclosure. In this case, 1 module is sealed up. DLM modular chassis. The provided dimensions are with the modular chassis, which is the most commonly used accessory with this enclosure.

* Chassis with a plain front plate includes a partial mounting plate.

Simple lock for Spacial CRN Enclosure

- **NSYCDB3** 3 mm Ø standard double-bar lock for heights below 1200 mm and widths below 1000 mm.
- By fixing the wing nut to the lock, the double-bar lock becomes a handle lock.
- Operation using:
wing key ref.: **NSYDBP**
key **NSYLDB5** (according to DIN 43668)
- **NSYTDBCRN** delivered with 1 metal key

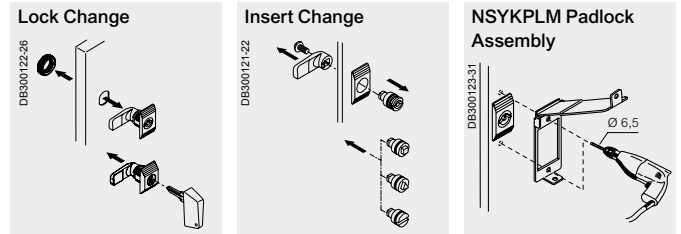
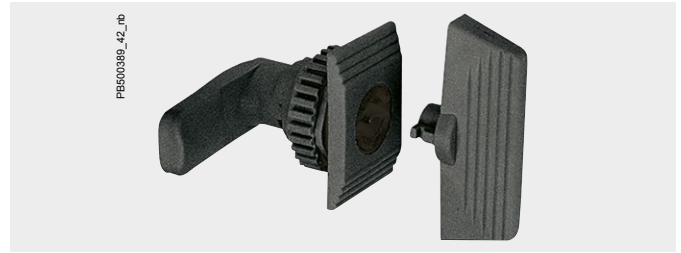

Inserts



Characteristics	Key references	References
3-mm double-bar	NSYLDB5	NSYTDBCRN
6 mm square	NSYLC7	NSYTC6CRN
7 mm square	NSYLC7	NSYTC7CRN
8 mm square	NSYLC8	NSYTC8CRN
6.5 mm triangular	NSYLT8	NSYTT6CRN
8 mm triangular	NSYLT8	NSYTT8CRN
Screw driver lock		NSYAEDLSD

Keys



- Insert without keys (unless indicated)

Characteristics	References
Metal key for 5-mm double-bar insert	NSYLDB5
Metal key for 7 mm square insert	NSYLC7
Metal key for 8 mm square insert	NSYLC8
Metal key for 8 mm triangle insert	NSYLT8

Complete Locks

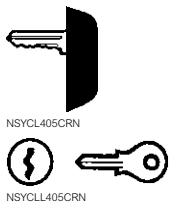

Characteristics	References
Complete manual handle lock, operated with key 405	NSYCL405CRN
Complete manual handle lock, operated with key 220	NSYCL220CRN
Complete metal lock, operated with key 405E	NSYCLL405CRN
Lock TJIS	NSYTJIS

Padlocks



Characteristics	References
Padlock device for WM enclosures, Ø 8 mm, stainless-steel	NSYKPLM
Padlock for Spacial CRN enclosure, Ø 7.5 mm / Ø 10 mm	NSYCBCRN

Lock for Spacial CRN Enclosure Three-Point Lock

- Standard 5-mm double-bar lock for CRN for heights from 1200 mm and widths from 1000 mm.
- Operation using: Key **NSYLDB5** (according to DIN 43668)

Transformation of the Standard Lock to Standardised Variations in Enclosures with Three-Point Locks

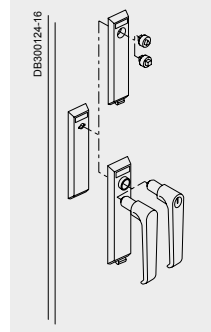

Transformation of the Standard Lock to a Retractable Three-Point Lock with Various Types of Inserts

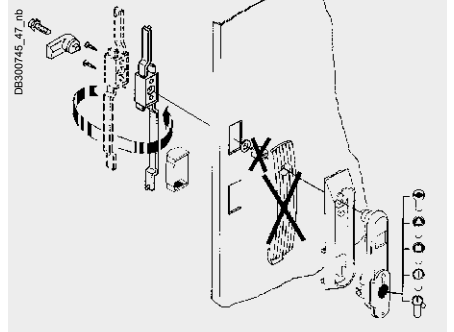

Handle Locks for Transformation of the Standard Lock to Standardised Variations in Enclosures with Three-Point Locks



NSYTL405SML

Characteristics	References
Handle lock	NSYTSML
Handle lock operated using key 405 (included)	NSYTL405SML

Transformation of the Standard Lock to a Retractable Three-Point Lock with Various Types of Inserts



NSYTEL405ML

Characteristics	Key references	References
Key operated bar lock	NSYLDB5	NSYTEDB5ML
Lock operated with key type 405		NSYTEL405ML
Lock operated with reinforced key		NSYTERML

Keys

- Insert without keys (unless indicated)



NSYLDB5



NSYLC8



NSYLT8

Characteristics	References
Metal key for 5-mm double-bar insert	NSYLDB5
Metal key for 7 mm square insert	NSYLC7
Metal key for 8 mm square insert	NSYLC8
Metal key for 8 mm triangle insert	NSYLT8

Padlocking Accessories

- Padlocking system, positioned around the long rectangular escutcheon of the enclosures, to block access to the lock, for a Ø 9 mm padlock.



NSYBCPL

Characteristics	References
Padlock device for large rectangular escutcheon of PLM 108 and PL	NSYBCPL

- Padlocking system, to block access to the retractable handle, for a Ø 9 mm padlock.



NSYBCME

Characteristics	References
Spacial SFX - SMX enclosures - padlocking device for retractable handle	NSYBCME

Standard Cable Gland Plates

- The cable gland plate for Spacial CRN guarantees water and dust tightness.
- Material: Steel
- Color: RAL 7035 gray
- Installation: Fixing with screws, it is flattened with the body
- Type E: Enclosure with 2 entries

Supply:

Included as a standard with the Spacial CRN enclosure. It is delivered with a separate seal. It allows easy cut-outs with no risk of damaging the seal and can be easily repainted.



NSYTLCRNO

Characteristics	Width (mm)	Depth (mm)	To be coupled with entry	References
Standard cable gland plate	200	150	0	NSYTLCRNO
Standard cable gland plate	250	150/200	A	NSYTLCRNA
Standard cable gland plate	300	150/200	B	NSYTLCRNB
Standard cable gland plate	400/500	150	B	NSYTLCRNB
Standard cable gland plate	400	200/250	C	NSYTLCRNC
Standard cable gland plate	500/600	200/250/300	D	NSYTLCRND
Standard cable gland plate	800	200/250/300	E	NSYTLCRNC

Insulated Cable Gland Plates

- With a polyurethane sealing gasket.
- Excellent thermal resistance.
- Pre-marked holes for cable entry plates.
- Material: Self-extinguishing ABS with 30% fiberglass
- Color: RAL 7035 gray
- Installation: Pre-marked holes with diameter Pg for coupling of cable glands, membrane glands, tubes, etc
- For type E cable entry, use two **NSYTSACRNC**.

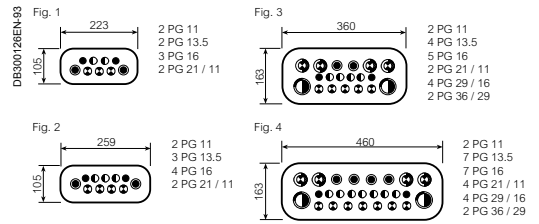

For more details see [page 41](#)



NSYTSACRNB

Characteristics	Fig.	Width (mm)	Depth (mm)	To be coupled with entry	References
Insulated cable gland plate	2	300	150/200	B	NSYTSACRNB
Insulated cable gland plate	3	400/500	150	B	NSYTSACRNB
Insulated cable gland plate	3	400	200/250	C	NSYTSACRNC
Insulated cable gland plate	4	500/600	200/250/300	D	NSYTSACRND
Insulated cable gland plate	3	800	200/250/300	E ⁽²⁾	NSYTSACRNC

Internal Door

- Locking with 3-mm double-bar lock.
- The internal door can be installed directly on the front face of the enclosure or on the step slides (not supplied as standard).
- To mount an inner door and a mounting plate at the same time on the step slides is possible as standard.
- Incompatible with the installation of the door stop and door switch.
- For further details, please consult us.
- Material: Steel
- Color: RAL 7035 gray
- Maximum load: 30 kg/m²

Note:

⁽¹⁾ Equipped with welded vertical profiles in order to facilitate cable management.



NSYPIN43

Characteristics	High (mm)	Width (mm)	References
Internal door	400	300	NSYPIN43
Internal door	500	400	NSYPIN54
Internal door	600	400	NSYPIN64
Internal door	700	500	NSYPIN75
Internal door	800	600	NSYPIN86 ⁽¹⁾
Internal door	1000	600	NSYPIN106 ⁽¹⁾
Internal door	1000	800	NSYPIN108 ⁽¹⁾
Internal door	1200	600	NSYPIN126
Internal door	1200	800	NSYPIN128 ⁽¹⁾

Mounting Rail

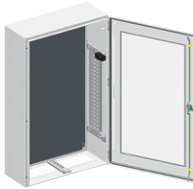

NSYSUCR200WM

- Accessory designed to optimize the available space in the enclosure.
- It is intended for the installation of switchgear complementing the chassis.
- Mounting possible after installing the mounting plate.
- It is mounted horizontally, with a single screw, on the side panels.
- Door switch mounting option.
- It is possible to vertically fasten **NSYSLCR●●** light cross-rails (description on [page 238](#)) and **NSYSQCR●●** quick-fixing cross-rails (description on [page 237](#)).
- Material: Galvanized steel
- Maximum load: Static load: 6 kg (sides) and 1,5 kg (top); Dynamic load (transport horizontally): 2 kg according to ASTM D-4169-16
- Installation: In order to ensure the electrical continuity in all cases we recommend using an earthing cable **NSYEL●●●D6** or **NSYEL●●●D8**, see [page 278](#)



Supply:

Set of 2 cross-rails

Characteristics	Enclosure depth (mm)	References
Mounting rail for wall-mounted enclosure S3D/CRN	200	NSYSUCR200WM
Mounting rail for wall-mounted enclosure S3D/CRN	250	NSYSUCR250WM
Mounting rail for wall-mounted enclosure S3D/CRN	300	NSYSUCR300WM
Mounting rail for wall-mounted enclosure S3D/CRN	400	NSYSUCR400WM

Door Switch for Wall-Mounted Enclosures



NSYINLCRN

- Switch/commutator unit equipped with support and fixings for direct fixing to the enclosure.
- Can be used to control lighting, air-conditioning units, etc.
- It is not compatible with installing the 19" swing rack and the internal door.
- NC + NO contact, 240 V AC / 3 A (IEC 60947-5-1) 250 V DC / 0,1 A (IEC 0947-5-1).

Supply:

1 door switch and fixing elements

Characteristics	References
Door switch	NSYINLCRN

Wall-Mounted Door Retainer Steel

- To block the door in the open position.
- It is installed on enclosures with heights from 400 mm and widths from 300 mm.
- Door opening angle: 120°.
- Earthing connection of the enclosure by means of the reinforcement rail.
- Earthing accessories supplied with the enclosure (earth-connection cable to be ordered separately), for more information see [page 278](#)
- Material: Steel

Comment:

It is not compatible with installing the 19" swing rack and the internal door.



NSYAEDRSCST

Characteristics	References
Wall-mounted door retainer Steel	NSYAEDRSCST

Dimensions

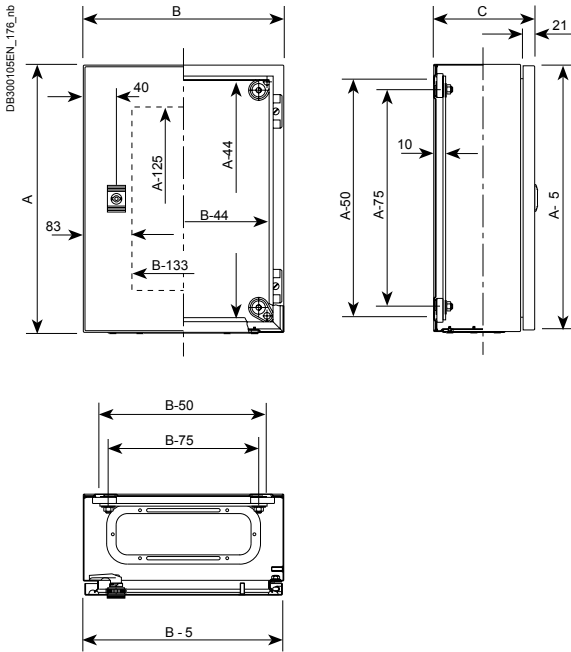

Fig. 1

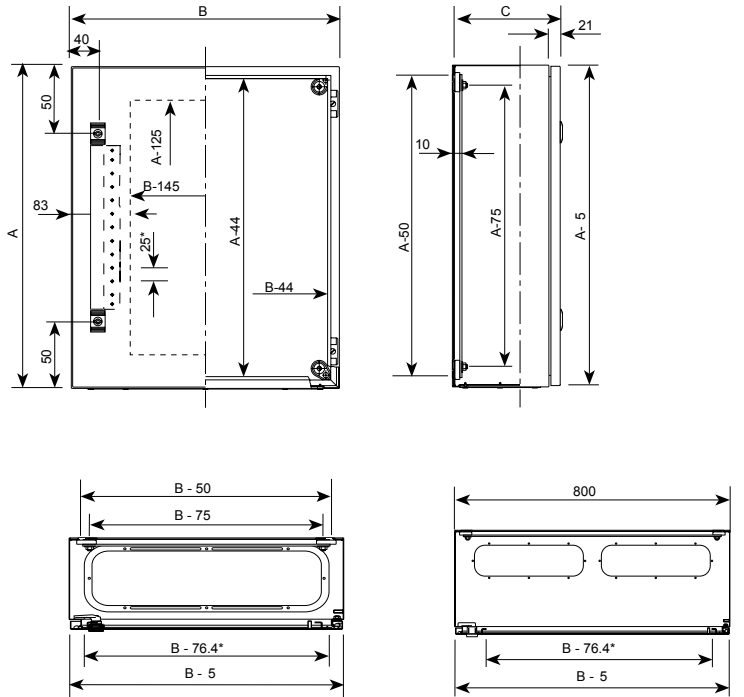
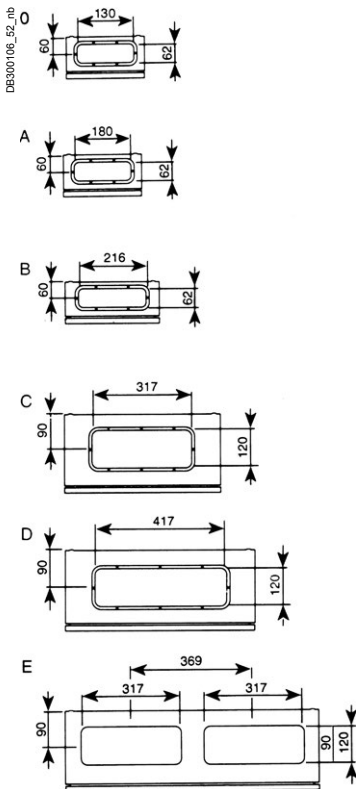

Fig. 2

A: Enclosure height
 B: Enclosure width
 C: Enclosure depth

Spacial CRN Cable Entry Dimensions and Type



None of the T Glazed-Door Enclosures Have Door Reinforcement Profiles.

Our DXF Diagrams and Technical Instruction Sheets Can Be Downloaded from our Websites.

Technical changes reserved. Information provided without guarantee. Images are for illustrative purposes only.

Dimensions

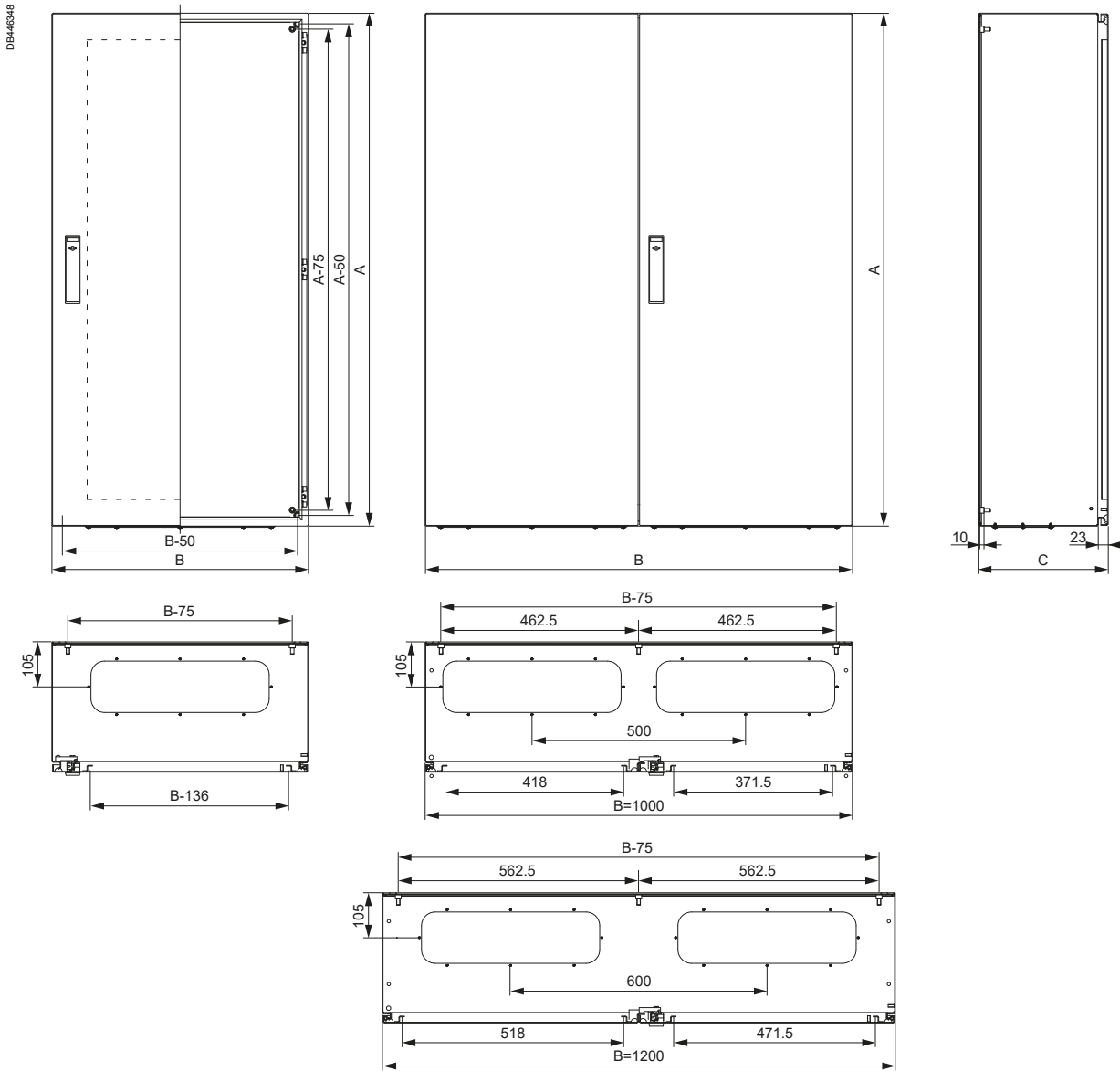

Dimensions of the Door-Reinforcement Profiles, the T Doors Only Include Vertical Profiles

1-door enclosure		Reinforcement profile			
Height (A)	Width (B)	E	D		
800	600	519	525		
1000	600	519	725		
	800	719	725		
1200	600	464	1075		
	800	664	1075		
2-door enclosure		Reinforcement profile			
Height (A)	Width (B)	Rt. Door		Lft. Door	
		E	D	E	D
800	1000	372	675	419	675
	1200	472	675	519	675
1000	1000	372	875	419	875
	1200	472	875	519	875
1200	1000	372	1075	419	1075
	1200	472	1075	519	1075
1400	1000	372	1275	419	1275

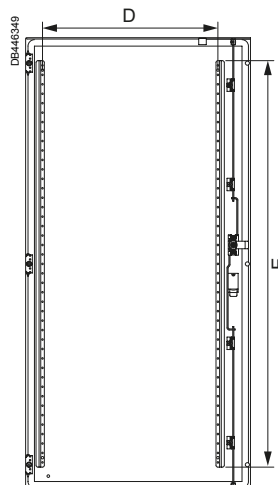

Technical changes reserved. Information provided without guarantee. Images are for illustrative purposes only.

Post-Fixing Device for Spacial Steel Enclosure

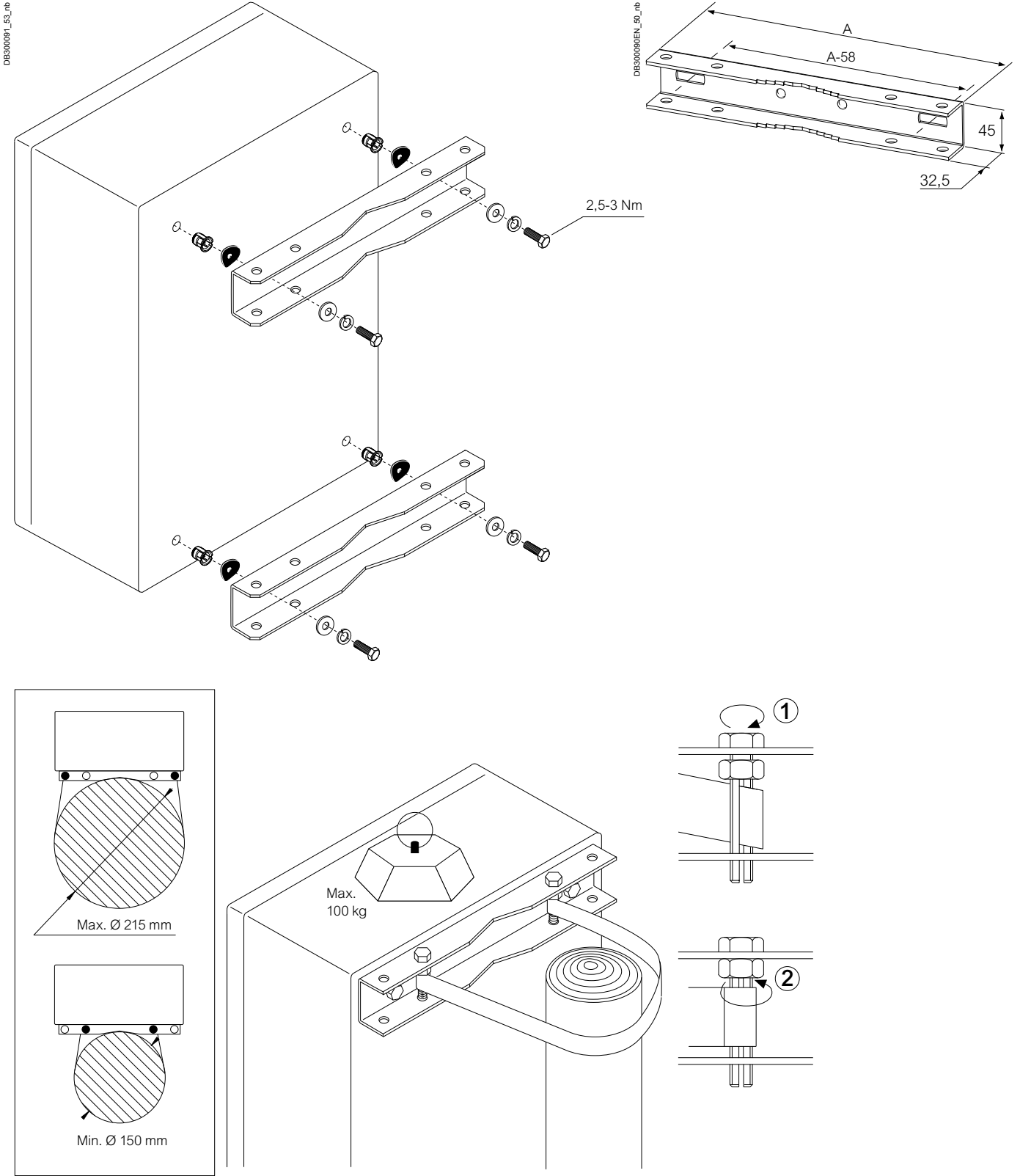

Technical changes reserved. Information provided without guarantee. Images are for illustrative purposes only.

Insulated Cable Gland Plates

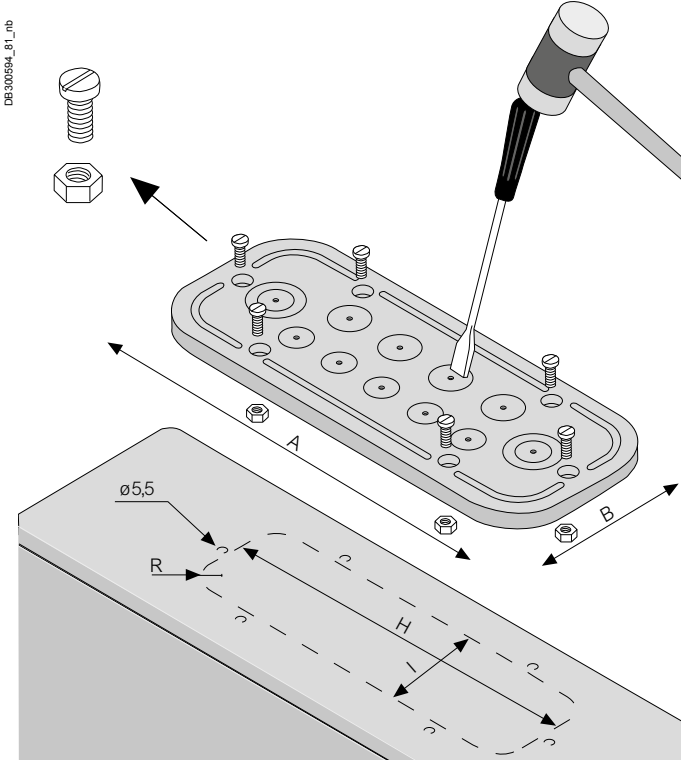
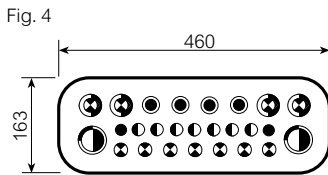
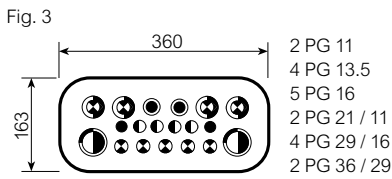
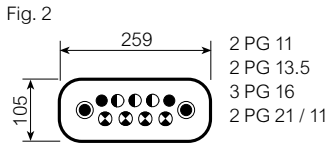
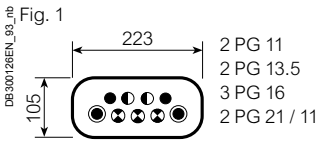

- PG 11 (18,6 mm)
- PG 16 (20,4 mm)
- PG 16 / 22,5 mm
- PG 21 / 11 (28,3 / 18,6 mm)
- PG 29 / 16 (37 / 22,5 mm)
- PG 36 / 29 (47 / 37 mm)

Internal Door

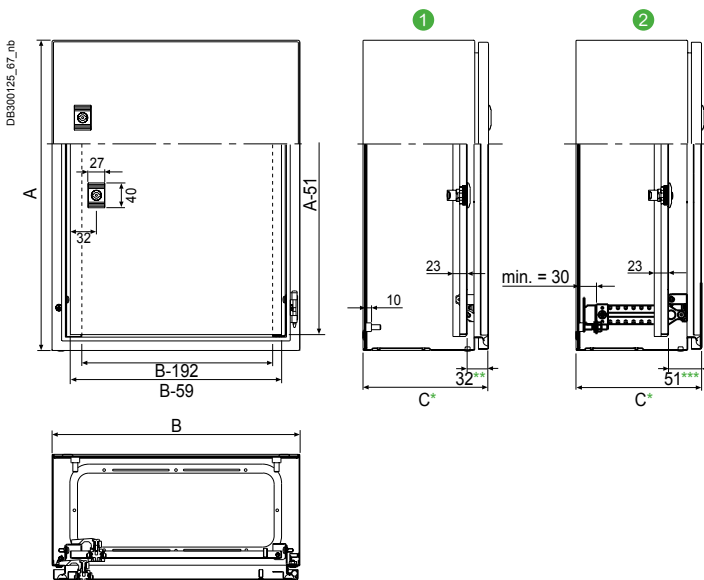

- 1 NSYPIN●●● internal door fixed directly to the enclosure.
- 2 NSYPIN●●● internal door fixed to the adjustable NSYSDCR support. In this case, both the internal door and the mounting plate may be depth adjustable.

* Dimension C according to general table on [page 24](#).

** Except H 1200 x W 600: 38.3.

*** Except H 1200 x W 600: 59 and H 1200 x W 800: 50

The Steel Enclosure with the Greatest Range of Available Dimensions on the Market!

This range can be configured according to your needs

4 different services available:



Assemble to order



Mounting of standard accessories



Painting



Machining



Service Life

- Quality of the welding and the painting.



Personnel Safety

- Earthing studs welded to the body and door.

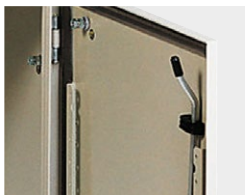

Component Protection

- Water and dust tightness and impact resistance.
- EMC and ATEX offer.



Added Value to your Work

- Quality and aesthetics.



Increased Choice

- Large range of universal dimensions.
- Application offer with special dimensions.



Easy Equipping

- 4 10 mm shouldered welded studs.
- Broad range of mounting plates.
- Broad range of cable gland plates.
- Cable guides welded to the door from the height of 400 mm.

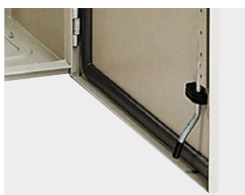

Easy Maintenance

- Removable hinges.
- 1-lock system for heights below 600 mm.
- 3-point lock for heights from 600 mm.

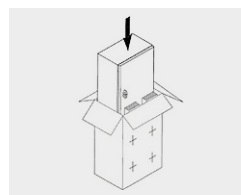

Easy Handling

- Reusable, eco-friendly packaging.
- No sharp edges.

See [page 474](#) for details or consult our web site www.se.com



Characteristics	Spacial S3D
	<p>Three steel enclosure configurations are available:</p> <ul style="list-style-type: none"> • Enclosure with plain door. • Enclosure with plain door delivered with a galvanized plain mounting plate, not installed. • Enclosure with glazed door, 4 mm-thick Securit® glass.
Personnel protection	<ul style="list-style-type: none"> • Earth connection: Spacial S3D steel enclosures are equipped with M6 x 16 earth studs welded in the body and the door for equipotential connection. Earth braid to be ordered separately (see page 278). • Closing the enclosure: The enclosures are equipped from the height of 600 mm with three locking points with linkage, with a single control point, helping prevent the enclosures from being left ajar. Locks and inserts, page 54.
Material	Steel
Finish	Structured finish, epoxy polyester powder
Color	RAL 7035 gray
Ingress protection rating	<ul style="list-style-type: none"> • IP66 for the single-door enclosures and IP55 for the double-door enclosures, according to IEC 60529. • cUL : Types 4, 4x and 13 for single-door enclosure and 12 and 13
Mechanical protection rating	IK10 for the plain-door enclosures and IK08 for the glazed-door enclosures according to IEC 62262 Types 4, 4X and 13 for single-door and Types 12 and 13 according UL508A and CAN C22.2 No 14
Standards	Compliance with enclosure standards IEC 62208 The Spacial S3D wall-mounted enclosures are compliant with the RoHS directive
Certifications (see page 640)	<ul style="list-style-type: none"> • UL (cULus), BVM, DNV, LR. For Atex see page 428 • Types 4, 4X and 13 for the single-door enclosures and Types 12, 13 for the double-door enclosures. according to UL508A. Information on NEMA and UL classification on page 645 and 646 <p>Nuclear decontamination: RAL 7035 gray and AFNOR A550 tests available on demand. More information on painting properties on page 647 and 648</p> <ul style="list-style-type: none"> • Seismic behavior: 2.5G (details page 70)
Fixing	4 (or 6 studs for widths 1000 and 1200 (see page 68 and 69)) M8 x 25 collared studs for installing mounting plates and step slides, leaving a space of 10 mm behind them.
Supply	<p>Body</p> <ul style="list-style-type: none"> • Single-piece body (cross-shaped structure). Gutter-shaped front profile with double fold. <p>Flat rear</p> <ul style="list-style-type: none"> • M6 x 16 earthing screws for equipotential connection between the door and the body of the enclosure • Cable gland plate with marking for easy drilling and to enable the maximum access surface; Delivered with the enclosure. This plate is flush with the body of the enclosure (detail and other options on page 57) • Direct wall-mounted (4 Ø 10 holes for the sealing plugs for the the IP) or with the help of fixing lugs installed from the outside (to be ordered separately, see page 49) <p>Door</p> <ul style="list-style-type: none"> • Wall-mounted enclosure supplied with 3-mm double-bar lock as standard • Polyurethane door gasket • M6 x 16 earthing screws for equipotential connection between the door and the body of the enclosure • Easily removable and reversible, with 20 mm return with double thickness granting excellent rigidity, opening to 120°, equipped with 2 or 3 invisible hinges (from the height of 800 mm) • Door opening to 180° with optional hinges (page 56) • For heights from 600 mm, three locking points with linkage, with a single control point. Simple reversal of linkage. Maximum load: 50 kg/m² • A handle is delivered which provides 2 functions: <ul style="list-style-type: none"> - Operating key - Tool for loosening the stud protection caps. This handle can be solidly attached to the locking system by means of a captive element • Perforated rails on the door, with drill holes with a diameter of 4.2 mm in steps of 25 mm: <ul style="list-style-type: none"> - 2 vertical rails from the height of 400 mm - 2 vertical rails and 2 horizontal rails from the width of 800 mm

• Ingress protection rating: IP66 for the single-door enclosures and IP55 for the double-door enclosures, according to IEC 60529.

• Rating according UL50E: Types 4, 4X and 13 for single-door enclosures and Types 12 and 13 for double-door enclosures.

Dimensions ⁽¹⁾			Door				Mounting plates			
Height (mm)	Width (mm)	Depth (mm)	Doors	IP	Weight (kg) ⁽²⁾	Plain without mounting plate	Plain with mounting plate	Glazed without mounting plate	Plain	Microperforated
300	200	150	1	66	3.02	NSYS3D3215	NSYS3D3215P	-	NSYMM32	NSYMF32
300	250	150	1	66	3.48	NSYS3D32515	NSYS3D32515P	NSYS3D32515T	NSYMM3025	-
300	300	150	1	66	3.90	NSYS3D3315	NSYS3D3315P	NSYS3D3315T	NSYMM33	NSYMF33
300	300	200	1	66	4.50	NSYS3D3320	NSYS3D3320P	NSYS3D3320T	NSYMM33	NSYMF33
300	400	150	1	66	4.82	NSYS3D3415	NSYS3D3415P	NSYS3D3415T	NSYMM43	NSYMF43
300	400	200	1	66	5.60	NSYS3D3420	NSYS3D3420P	NSYS3D3420T	NSYMM43	NSYMF43
400	300	150	1	66	4.90	NSYS3D4315	NSYS3D4315P	NSYS3D4315T	NSYMM43	NSYMF43
400	300	200	1	66	5.00	NSYS3D4320	NSYS3D4320P	NSYS3D4320T	NSYMM43	NSYMF43
400	400	200	1	66	6.50	NSYS3D4420	NSYS3D4420P	NSYS3D4420T	NSYMM44	NSYMF44
400	600	200	1	66	10.50	NSYS3D4620	NSYS3D4620P	NSYS3D4620T	NSYMM64	NSYMF64
400	600	250	1	66	12.00	NSYS3D4625	NSYS3D4625P	NSYS3D4625T	NSYMM64	NSYMF64
500	300	200	1	66	7.50	NSYS3D5320	NSYS3D5320P	NSYS3D5320T	NSYMM53	NSYMF53
500	400	200	1	66	9.30	NSYS3D5420	NSYS3D5420P	NSYS3D5420T	NSYMM54	NSYMF54
500	400	250	1	66	10.20	NSYS3D5425	NSYS3D5425P	NSYS3D5425T	NSYMM54	NSYMF54
500	500	200	1	66	11.18	NSYS3D5520	NSYS3D5520P	NSYS3D5520T	NSYMM55	NSYMF55
500	500	250	1	66	12.06	NSYS3D5525	NSYS3D5525P	NSYS3D5525T	NSYMM55	NSYMF55
600	400	200	1	66	11.00	NSYS3D6420	NSYS3D6420P	NSYS3D6420T	NSYMM64	NSYMF64
600	400	250	1	66	12.00	NSYS3D6425	NSYS3D6425P	NSYS3D6425T	NSYMM64	NSYMF64
600	500	250	1	66	16.20	NSYS3D6525	NSYS3D6525P	NSYS3D6525T	NSYMM65	NSYMF65
600	600	200	1	66	14.00	NSYS3D6620	NSYS3D6620P	NSYS3D6620T	NSYMM66	NSYMF66
600	600	250	1	66	15.00	NSYS3D6625	NSYS3D6625P	NSYS3D6625T	NSYMM66	NSYMF66
600	600	300	1	66	17.00	NSYS3D6630	NSYS3D6630P	NSYS3D6630T	NSYMM66	NSYMF66
600	600	400	1	66	19.00	NSYS3D6640	NSYS3D6640P	NSYS3D6640T	NSYMM66	NSYMF66
600	800	300	1	66	25.50	NSYS3D6830	NSYS3D6830P	NSYS3D6830T	NSYMM86	NSYMF86
700	500	250	1	66	15.00	NSYS3D7525	NSYS3D7525P	NSYS3D7525T	NSYMM75	NSYMF75
800	600	200	1	66	21.00	NSYS3D8620	NSYS3D8620P	NSYS3D8620T	NSYMM86	NSYMF86
800	600	250	1	66	23.00	NSYS3D8625	NSYS3D8625P	NSYS3D8625T	NSYMM86	NSYMF86
800	600	300	1	66	25.00	NSYS3D8630	NSYS3D8630P	NSYS3D8630T	NSYMM86	NSYMF86
800	600	400	1	66	29.00	NSYS3D8640	NSYS3D8640P	NSYS3D8640T	NSYMM86	NSYMF86
800	800	250	1	66	30.00	NSYS3D8825	NSYS3D8825P	NSYS3D8825T	NSYMM88	NSYMF88
800	800	300	1	66	32.00	NSYS3D8830	NSYS3D8830P	NSYS3D8830T	NSYMM88	NSYMF88
800	1000	300	1	66	38.00	NSYS3D81030	NSYS3D81030P	-	NSYMM108	NSYMF108
800	1000	300	2	55	43.50	NSYS3D81030D	NSYS3D81030DP	-	NSYMM108	NSYMF108
800	1200	300	2	55	46.00	NSYS3D81230D	NSYS3D81230DP	-	NSYMM128	NSYMF128
1000	600	250	1	66	28.00	NSYS3D10625	NSYS3D10625P	NSYS3D10625T	NSYMM106	NSYMF106
1000	600	300	1	66	30.60	NSYS3D10630	NSYS3D10630P	NSYS3D10630T	NSYMM106	NSYMF106
1000	600	400	1	66	33.00	NSYS3D10640	NSYS3D10640P	NSYS3D10640T	NSYMM106	NSYMF106
1000	800	250	1	66	35.00	NSYS3D10825	NSYS3D10825P	NSYS3D10825T	NSYMM108	NSYMF108
1000	800	300	1	66	38.00	NSYS3D10830	NSYS3D10830P	NSYS3D10830T	NSYMM108	NSYMF108
1000	800	400	1	66	42.00	NSYS3D10840	NSYS3D10840P	NSYS3D10840T	NSYMM108	NSYMF108
1000	1000	300	1	66	46.00	NSYS3D101030	NSYS3D101030P	NSYS3D101030T	NSYMM1010	NSYMF1010
1000	1000	300	2	55	46.00	NSYS3D101030D	NSYS3D101030DP	NSYS3D101030DT	NSYMM1010	NSYMF1010
1000	1200	300	2	55	53.00	NSYS3D101230D	NSYS3D101230DP	-	NSYMM1210	NSYMF1210
1000	1200	400	2	55	60.00	NSYS3D101240D	NSYS3D101240DP	-	NSYMM1210	NSYMF1210
1200	600	300	1	66	37.00	NSYS3D12630	NSYS3D12630P	NSYS3D12630T	NSYMM126	NSYMF126
1200	600	400	1	66	42.00	NSYS3D12640	NSYS3D12640P	NSYS3D12640T	NSYMM126	NSYMF126
1200	800	300	1	66	45.00	NSYS3D12830	NSYS3D12830P	NSYS3D12830T	NSYMM128	NSYMF128
1200	800	400	1	66	49.00	NSYS3D12840	NSYS3D12840P	NSYS3D12840T	NSYMM128	NSYMF128
1200	1000	300	1	66	53.00	NSYS3D121030	NSYS3D121030P	NSYS3D121030T	NSYMM1210	NSYMF1210
1200	1000	300	2	55	54.00	NSYS3D121030D	NSYS3D121030DP	NSYS3D121030DT	NSYMM1210	NSYMF1210
1200	1000	400	2	55	61.00	NSYS3D121040D	NSYS3D121040DP	-	NSYMM1210	NSYMF1210
1200	1200	300	2	55	64.00	NSYS3D121230D	NSYS3D121230DP	-	NSYMM1212	2x NSYMF126 (4)
1200	1200	400	2	55	90.00	NSYS3D121240D	NSYS3D121240DP	-	NSYMM1212	2x NSYMF126 (4)
1400	1000	300	2	55	80.00	NSYS3D141030D	NSYS3D141030DP	-	NSYMM1410	-

⁽¹⁾ For other dimensions, see our application offer, [page 280](#).

⁽²⁾ Enclosure without mounting plate.

⁽³⁾ In inverted use, the marking is inverted.





⁽⁴⁾ Order **NSYCRNGSDR** for double mounting of the mounting plates

⁽⁵⁾ Order nuts ref. **NSYAMCSF**. Steel siderail ref. **NSYMDVR12**.

⁽⁶⁾ When width ≥ 1000 ref. **NSYEMR** is mandatory (see on [page 68](#)).

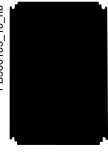
⁽⁷⁾ Possible assembling to ref. **NSYDLM84** or **NSYDLM112**.

- For other dimensions, see our application offer.
- Enclosure without mounting plate.

		Modular mounting plate					Cross-rails		Dimensions ⁽¹⁾		
								Height (mm)	Width (mm)	Depth (mm)	
	Telequick	Bakelite	Module	Modular chassis DLM Steel	Modular chassis DLA Insulated	DIN rail chassis	Type	Door cross-rails			
NSYMR32		NSYMB32	-	-	-	-	-	-	300	200	150
NSYMR3025		NSYMB3025	-	-	-	-	-	-	300	250	150
NSYMR33	-	-	-	-	-	NSYMD33	B	-	300	300	150
NSYMR33	-	-	-	-	-	NSYMD33	B	-	300	300	200
NSYMR34		NSYMB43	-	-	-	-	-	-	300	400	150
NSYMR34		NSYMB43	-	-	-	-	-	-	300	400	200
NSYMR43		NSYMB43	24	NSYDLM24	-	NSYMD43	B	-	400	300	150
NSYMR43		NSYMB43	24	NSYDLM24	NSYDLA24G	NSYMD43	B	-	400	300	200
NSYMR44	-	-	-	-	-	-	-	NSYTFPCR4	400	400	200
NSYMR46		NSYMB64	-	-	-	-	-	NSYTFPCR6	400	600	200
NSYMR46		NSYMB64	-	-	-	-	-	NSYTFPCR6	400	600	250
NSYMR53	-	-	-	-	-	-	-	-	500	300	200
NSYMR54		NSYMB54	48	NSYDLM48	NSYDLA48G	NSYMD54	B	NSYTFPCR4	500	400	200
NSYMR54		NSYMB54	48	NSYDLM48	-	NSYMD54	B	NSYTFPCR4	500	400	250
NSYMR55	-	-	-	-	-	-	-	NSYTFPCR5	500	500	200
NSYMR55	-	-	-	-	-	-	-	NSYTFPCR5	500	500	250
NSYMR64		NSYMB64	48	NSYDLM48P	NSYDLA48PG	NSYMD64	B	NSYTFPCR4	600	400	200
NSYMR64		NSYMB64	48	NSYDLM48P	NSYDLA48PG	NSYMD64	B	NSYTFPCR4	600	400	250
NSYMR65		NSYMB65	-	-	-	-	-	NSYTFPCR5	600	500	250
NSYMR66	-	-	84	NSYDLM84P	-	NSYMD66	A	NSYTFPCR6	600	600	200
NSYMR66	-	-	84	NSYDLM84P	-	NSYMD66	A	NSYTFPCR6	600	600	250
NSYMR66	-	-	84	NSYDLM84P	-	NSYMD66	A	NSYTFPCR6	600	600	300
NSYMR66	-	-	84	NSYDLM84P	-	NSYMD66	A	NSYTFPCR6	600	600	400
NSYMR68		NSYMB86	-	-	-	NSYMD86	A	NSYTFPCR8	600	800	300
NSYMR75		NSYMB75	66	NSYDLM66	NSYDLA66G	NSYMD75	B	NSYTFPCR5	700	500	250
NSYMR86		NSYMB86	84 (6)	NSYDLM84	NSYDLA84G / NSYDLA112G	NSYMD86	A	NSYTFPCR6	800	600	200
NSYMR86		NSYMB86	112 (6)	NSYDLM112	NSYDLA84G / NSYDLA112G	NSYMD86	A	NSYTFPCR6	800	600	250
NSYMR86		NSYMB86	112 (6)	NSYDLM112	NSYDLA84G / NSYDLA112G	NSYMD86	A	NSYTFPCR6	800	600	300
NSYMR86		NSYMB86	112 (6)	NSYDLM112	NSYDLA84G / NSYDLA112G	NSYMD86	A	NSYTFPCR6	800	600	400
NSYMR88	-	-	-	-	-	-	-	NSYTFPCR8	800	800	250
NSYMR88	-	-	-	-	-	-	-	NSYTFPCR8	800	800	300
NSYMR810		NSYMB108	-	-	-	-	-	NSYTFPCR10	800	1000	300
NSYMR810		NSYMB108	-	-	-	-	-	-	800	1000	300
2x NSYMR86 (4)		2x NSYMB86 (4)	-	-	-	2x NSYMD86 (4)	A	-	800	1200	300
NSYMR106	-	-	168	NSYDLM168	-	-	-	NSYTFPCR6	1000	600	250
NSYMR106	-	-	168	NSYDLM168	-	-	-	NSYTFPCR6	1000	600	300
NSYMR106	-	-	168	NSYDLM168	-	-	-	NSYTFPCR6	1000	600	400
NSYMR108		NSYMB108	234	NSYDLM240	NSYDLA234G	NSYMD108	A	NSYTFPCR8	1000	800	250
NSYMR108		NSYMB108	234	NSYDLM240	NSYDLA234G	NSYMD108	A	NSYTFPCR8	1000	800	300
NSYMR108		NSYMB108	234	NSYDLM240	NSYDLA234G	NSYMD108	A	NSYTFPCR8	1000	800	400
NSYMR1012	-	-	-	-	-	-	-	NSYTFPCR10	1000	1000	300
NSYMR1012	-	-	-	-	-	-	-	-	1000	1000	300
NSYMR1012		NSYMB1210	-	-	-	-	-	-	1000	1200	300
NSYMR1012		NSYMB1210	-	-	-	-	-	-	1000	1200	400
-	-	-	-	-	-	-	-	-	1200	600	300
-	-	-	-	-	-	-	-	-	1200	600	400
NSYMR128	-	-	-	-	-	NSYMD128	A	NSYTFPCR8	1200	800	300
NSYMR128	-	-	-	-	-	NSYMD128	A	NSYTFPCR8	1200	800	400
NSYMR1210		NSYMB1210	-	-	-	-	-	NSYTFPCR10	1200	1000	300
NSYMR1210		NSYMB1210	-	-	-	-	-	-	1200	1000	300
NSYMR1210		NSYMB1210	-	-	-	-	-	-	1200	1000	400
2x NSYMR126 (4)	-	-	-	-	-	-	-	-	1200	1200	300
2x NSYMR126 (4)	-	-	-	-	-	-	-	-	1200	1200	400
NSYMR1410	-	-	-	-	-	-	-	-	1400	1000	300

Wall fixing lugs: [page 49](#)
 Steel: **NSYAEFPFSC**
 Stainless-steel: **NSYAEFPFXSC**

Reinforcement for heavy loads: [page 49](#)
NSYAEFAHLBSC
 Locking accessories: [page 55](#)

Door accessories: [page 273](#)
 Clip-on nuts: [page 248](#)
 Self-tapping screw: **NSYS13M5HS** / [page 249](#)

- Ingress protection rating: IP66 for the single-door enclosures and IP55 for the double-door enclosures, according to IEC 60529

- For other dimensions, see our application offer.
- Enclosure without mounting plate.

Dimensions ⁽¹⁾				Electronics and networks, 19" racks			Cable entry accessories, Cable gland plates				
Height (mm)	Width (mm)	Depth (mm)	Fixed	No. of U	Swing	No. of U	Entry type	Standard steel	Aluminum	Steel with cut-out for FL membrane ⁽²⁾	FlexiCable ⁽⁶⁾
300	200	150	-	-	-	-	A	NSYTLA	-	-	-
300	250	150	-	-	-	-	A	NSYTLA	-	-	-
300	300	150	-	-	-	-	B	NSYTLB	NSYTLBU	-	-
300	300	200	-	-	-	-	C	NSYTLC	-	NSYTLCFL	NSYTLCME
300	400	150	-	-	-	-	B	NSYTLB	NSYTLBU	-	-
300	400	200	-	-	-	-	D	NSYTLD	-	NSYTLDLDFL	NSYTLDME
400	300	150	-	-	-	-	B	NSYTLB	NSYTLBU	-	-
400	300	200	-	-	-	-	C	NSYTLC	-	NSYTLCFL	NSYTLCME
400	400	200	-	-	-	-	D	NSYTLD	-	NSYTLDLDFL	NSYTLDME
400	600	200	NSYVDM8UF	8	-	200	F	NSYTTF	NSYTTFU	NSYTTFFL	NSYTTFME
400	600	250	NSYVDM8UF	8	-	-	F	NSYTTF	NSYTTFU	NSYTTFFL	NSYTTFME
500	300	200	-	-	-	-	C	NSYTLC	-	NSYTLCFL	NSYTLCME
500	400	200	-	-	-	-	D	NSYTLD	-	NSYTLDLDFL	NSYTLDME
500	400	250	-	-	-	-	D	NSYTLD	-	NSYTLDLDFL	NSYTLDME
500	500	200	-	-	-	-	E	NSYTLE	-	NSYTLEFL	NSYTLEME
500	500	250	-	-	-	-	E	NSYTLE	-	NSYTLEFL	NSYTLEME
600	400	200	-	-	-	-	D	NSYTLD	-	NSYTLDLDFL	NSYTLDME
600	400	250	-	-	-	-	D	NSYTLD	-	NSYTLDLDFL	NSYTLDME
600	500	250	-	-	-	-	E	NSYTLE	-	NSYTLEFL	NSYTLEME
600	600	200	NSYVDM12UF	12	NSYVDM11UP	11	F	NSYTTF	NSYTTFU	NSYTTFFL	NSYTTFME
600	600	250	NSYVDM12UF	12	NSYVDM11UP	11	F	NSYTTF	NSYTTFU	NSYTTFFL	NSYTTFME
600	600	300	NSYVDM12UF	12	NSYVDM11UP	11	G	NSYTLG	NSYTLGU	NSYTLG2FL ⁽⁵⁾	NSYTLGME
600	600	400	NSYVDM12UF	12	NSYVDM11UP	11	G	NSYTLG	NSYTLGU	NSYTLG2FL ⁽⁵⁾	NSYTLGME
600	800	300	-	-	-	-	D ⁽⁴⁾	NSYTLD	-	NSYTLDLDFL	2x NSYTLDME
700	500	250	-	-	-	-	E	NSYTLE	-	NSYTLEFL	NSYTLEME
800	600	200	NSYVDM17UF	17	NSYVDM16UP	16	F	NSYTTF	NSYTTFU	NSYTTFFL	NSYTTFME
800	600	250	NSYVDM17UF	17	NSYVDM16UP	16	F	NSYTTF	NSYTTFU	NSYTTFFL	NSYTTFME
800	600	300	NSYVDM17UF	17	NSYVDM16UP	16	G	NSYTLG	NSYTLGU	NSYTLG2FL ⁽⁵⁾	NSYTLGME
800	600	400	NSYVDM17UF	17	NSYVDM16UP	16	G	NSYTLG	NSYTLGU	NSYTLG2FL ⁽⁵⁾	NSYTLGME
800	800	250	-	-	-	-	D ⁽⁴⁾	NSYTLD	-	NSYTLDLDFL	2x NSYTLDME
800	800	300	-	-	-	-	D ⁽⁴⁾	NSYTLD	-	NSYTLDLDFL	2x NSYTLDME
800	1000	300	-	-	-	-	E ⁽⁴⁾	NSYTLE	-	NSYTLEFL	2x NSYTLEME
800	1000	300	-	-	-	-	E ⁽⁴⁾	NSYTLE	-	NSYTLEFL	2x NSYTLEME
800	1200	300	-	-	-	-	E ⁽⁴⁾	NSYTLE	-	NSYTLEFL	2x NSYTLEME
1000	600	250	NSYVDM21UF	21	NSYVDM20UP	20	F	NSYTTF	NSYTTFU	NSYTTFFL	NSYTTFME
1000	600	300	NSYVDM21UF	21	NSYVDM20UP	20	G	NSYTLG	NSYTLGU	NSYTLG2FL ⁽⁵⁾	NSYTLGME
1000	600	400	NSYVDM21UF	21	NSYVDM20UP	20	G	NSYTLG	NSYTLGU	NSYTLG2FL ⁽⁵⁾	NSYTLGME
1000	800	250	-	-	NSYVDM20U8P	20	D ⁽⁴⁾	NSYTLD	-	NSYTLDLDFL	2x NSYTLDME
1000	800	300	-	-	NSYVDM20U8P	20	D ⁽⁴⁾	NSYTLD	-	NSYTLDLDFL	2x NSYTLDME
1000	800	400	-	-	NSYVDM20U8P	20	D ⁽⁴⁾	NSYTLD	-	NSYTLDLDFL	2x NSYTLDME
1000	1000	300	-	-	-	-	E ⁽⁴⁾	NSYTLE	-	NSYTLEFL	2x NSYTLEME
1000	1000	300	-	-	-	-	E ⁽⁴⁾	NSYTLE	-	NSYTLEFL	2x NSYTLEME
1000	1200	300	-	-	-	-	E ⁽⁴⁾	NSYTLE	-	NSYTLEFL	2x NSYTLEME
1000	1200	400	-	-	-	-	E ⁽⁴⁾	NSYTLE	-	NSYTLEFL	2x NSYTLEME
1200	600	300	-	-	-	-	G	NSYTLG	NSYTLGU	NSYTLG2FL ⁽⁵⁾	NSYTLGME
1200	600	400	-	-	-	-	G	NSYTLG	NSYTLGU	NSYTLG2FL ⁽⁵⁾	NSYTLGME
1200	800	300	-	-	NSYVDM25U8P	25	D ⁽⁴⁾	NSYTLD	-	NSYTLDLDFL	2x NSYTLDME
1200	800	400	-	-	NSYVDM25U8P	25	D ⁽⁴⁾	NSYTLD	-	NSYTLDLDFL	2x NSYTLDME
1200	1000	300	-	-	-	-	E ⁽⁴⁾	NSYTLE	-	NSYTLEFL	2x NSYTLEME
1200	1000	300	-	-	-	-	E ⁽⁴⁾	NSYTLE	-	NSYTLEFL	2x NSYTLEME
1200	1000	400	-	-	-	-	E ⁽⁴⁾	NSYTLE	-	NSYTLEFL	2x NSYTLEME
1200	1200	300	-	-	-	-	E ⁽⁴⁾	NSYTLE	-	NSYTLEFL	2x NSYTLEME
1200	1200	400	-	-	-	-	E ⁽⁴⁾	NSYTLE	-	NSYTLEFL	2x NSYTLEME
1400	1000	300	-	-	-	-	E ⁽⁴⁾	NSYTLE	-	NSYTLEFL	2x NSYTLEME

⁽¹⁾ For other dimensions, see our application offer, [page 280](#).

⁽²⁾ FL13 for entry type A and B FL21 for all other entries.

⁽³⁾ To adjust the depth of the internal door, please order the step slides.

⁽⁴⁾ 2 plates.

⁽⁵⁾ Exists with 1 cut-out **NSYTLGFL**.

⁽⁶⁾ Cable entry FlexiCable IP55

Composition accessories					Plinths				Dimensions ⁽¹⁾		
Internal door ⁽³⁾	Step slides	Canopy	Fixing on post	Full width wall fixing lugs	Single plinths front plate ⁽⁹⁾	Single plinths side plate ⁽⁹⁾	Single plinths front plate ⁽⁷⁾⁽⁹⁾	Single plinths side plate ⁽⁷⁾⁽⁹⁾	Height (mm)	Width (mm)	Depth (mm)
-	-	NSYTJ2015	-	-	-	-	-	-	300	200	150
-	-	NSYTJ2515	-	-	-	-	-	-	300	250	150
-	-	NSYTJ3015	NSYSFPSC30	-	-	-	-	-	300	300	150
-	NSYSDCR200	NSYTJ3020	NSYSFPSC30	-	-	-	-	-	300	300	200
-	-	NSYTJ4015	NSYSFPSC40	NSYAEFPFS3DW40	-	-	-	-	300	400	150
-	NSYSDCR200	NSYTJ4020	NSYSFPSC40	NSYAEFPFS3DW40	-	-	-	-	300	400	200
NSYPIN43	-	NSYTJ3015	NSYSFPSC30	-	-	-	-	-	400	300	150
NSYPIN43	NSYSDCR200	NSYTJ3020	NSYSFPSC30	-	-	-	-	-	400	300	200
-	NSYSDCR200	NSYTJ4020	NSYSFPSC40	NSYAEFPFS3DW40	-	-	-	-	400	400	200
-	NSYSDCR200	NSYTJ6020	NSYSFPSC60	NSYAEFPFS3DW60	-	-	-	-	400	600	200
-	NSYSDCR250	NSYTJ6025	NSYSFPSC60	NSYAEFPFS3DW60	-	-	-	-	400	600	250
-	NSYSDCR200	NSYTJ3020	NSYSFPSC30	-	-	-	-	-	500	300	200
NSYPIN54	NSYSDCR200	NSYTJ4020	NSYSFPSC40	NSYAEFPFS3DW40	-	-	-	-	500	400	200
NSYPIN54	NSYSDCR250	NSYTJ4025	NSYSFPSC40	NSYAEFPFS3DW40	-	-	-	-	500	400	250
-	NSYSDCR200	NSYTJ5020	NSYSFPSC50	-	-	-	-	-	500	500	200
-	NSYSDCR250	NSYTJ5025	NSYSFPSC50	-	-	-	-	-	500	500	250
NSYPIN64	NSYSDCR200	NSYTJ4020	NSYSFPSC40	NSYAEFPFS3DW40	-	-	-	-	600	400	200
NSYPIN64	NSYSDCR250	NSYTJ4025	NSYSFPSC40	NSYAEFPFS3DW40	-	-	-	-	600	400	250
-	NSYSDCR250	NSYTJ5025	NSYSFPSC50	-	-	-	-	-	600	500	250
-	NSYSDCR200	NSYTJ6020	NSYSFPSC60	NSYAEFPFS3DW60	-	-	-	-	600	600	200
-	NSYSDCR250	NSYTJ6025	NSYSFPSC60	NSYAEFPFS3DW60	-	-	-	-	600	600	250
-	NSYSDCR300	NSYTJ6030	NSYSFPSC60	NSYAEFPFS3DW60	NSYSPPF6100	NSYSPPS3100SD	NSYSPPF6200	NSYSPPS3200SD	600	600	300
-	NSYSDCR400	NSYTJ6040	NSYSFPSC60	NSYAEFPFS3DW60	NSYSPPF6100	NSYSPPS4100SD	NSYSPPF6200	NSYSPPS4200SD	600	600	400
-	NSYSDCR300	NSYTJ8030	NSYSFPSC80	NSYAEFPFS3DW80	NSYSPPF8100	NSYSPPS3100SD	NSYSPPF8200	NSYSPPS3200SD	600	800	300
NSYPIN75	NSYSDCR250	NSYTJ5025	NSYSFPSC50	-	-	-	-	-	700	500	250
NSYPIN86	NSYSDCR200	NSYTJ6020	NSYSFPSC60	NSYAEFPFS3DW60	-	-	-	-	800	600	200
NSYPIN86	NSYSDCR250	NSYTJ6025	NSYSFPSC60	NSYAEFPFS3DW60	-	-	-	-	800	600	250
NSYPIN86	NSYSDCR300	NSYTJ6030	NSYSFPSC60	NSYAEFPFS3DW60	NSYSPPF6100	NSYSPPS3100SD	NSYSPPF6200	NSYSPPS3200SD	800	600	300
NSYPIN86	NSYSDCR400	NSYTJ6040	NSYSFPSC60	NSYAEFPFS3DW60	NSYSPPF6100	NSYSPPS4100SD	NSYSPPF6200	NSYSPPS4200SD	800	600	400
-	NSYSDCR250	NSYTJ8025	NSYSFPSC80	NSYAEFPFS3DW80	-	-	-	-	800	800	250
-	NSYSDCR300	NSYTJ8030	NSYSFPSC80	NSYAEFPFS3DW80	NSYSPPF8100	NSYSPPS3100SD	NSYSPPF8200	NSYSPPS3200SD	800	800	300
-	NSYSDCR300	NSYTJ10030	-	NSYAEFPFS3DW100	NSYSPPF10100	NSYSPPS3100SD	NSYSPPF10200	NSYSPPS3200SD	800	1000	300
-	NSYSDCR300	NSYTJ10030	-	NSYAEFPFS3DW100	NSYSPPF10100	NSYSPPS3100SD	NSYSPPF10200	NSYSPPS3200SD	800	1000	300
-	NSYSDCR300 ⁽⁶⁾	NSYTJ12030	-	-	-	-	-	-	800	1200	300
NSYPIN106	NSYSDCR250	NSYTJ6025	-	NSYAEFPFS3DW60	-	-	-	-	1000	600	250
NSYPIN106	NSYSDCR300	NSYTJ6030	-	NSYAEFPFS3DW60	NSYSPPF6100	NSYSPPS3100SD	NSYSPPF6200	NSYSPPS3200SD	1000	600	300
NSYPIN106	NSYSDCR400	NSYTJ6040	-	NSYAEFPFS3DW60	NSYSPPF6100	NSYSPPS4100SD	NSYSPPF6200	NSYSPPS4200SD	1000	600	400
NSYPIN108	NSYSDCR250	NSYTJ8025	-	NSYAEFPFS3DW80	-	-	-	-	1000	800	250
NSYPIN108	NSYSDCR300	NSYTJ8030	-	NSYAEFPFS3DW80	NSYSPPF8100	NSYSPPS3100SD	NSYSPPF8200	NSYSPPS3200SD	1000	800	300
NSYPIN108	NSYSDCR400	NSYTJ8040	-	NSYAEFPFS3DW80	NSYSPPF8100	NSYSPPS4100SD	NSYSPPF8200	NSYSPPS4200SD	1000	800	400
-	NSYSDCR300	NSYTJ10030	-	NSYAEFPFS3DW100	NSYSPPF10100	NSYSPPS3100SD	NSYSPPF10200	NSYSPPS3200SD	1000	1000	300
-	NSYSDCR300	NSYTJ10030	-	NSYAEFPFS3DW100	NSYSPPF10100	NSYSPPS3100SD	NSYSPPF10200	NSYSPPS3200SD	1000	1000	300
-	NSYSDCR300 ⁽⁶⁾	NSYTJ12030	-	-	NSYSPPF12100	NSYSPPS3100SD	NSYSPPF12200	NSYSPPS3200SD	1000	1200	300
-	NSYSDCR400 ⁽⁶⁾	NSYTJ12040	-	-	NSYSPPF12100	NSYSPPS4100SD	NSYSPPF12200	NSYSPPS4200SD	1000	1200	400
NSYPIN126	NSYSDCR300	NSYTJ6030	-	NSYAEFPFS3DW60	NSYSPPF6100	NSYSPPS3100SD	NSYSPPF6200	NSYSPPS3200SD	1200	600	300
NSYPIN126	NSYSDCR400	NSYTJ6040	-	NSYAEFPFS3DW60	NSYSPPF6100	NSYSPPS4100SD	NSYSPPF6200	NSYSPPS4200SD	1200	600	400
NSYPIN128	NSYSDCR300	NSYTJ8030	-	NSYAEFPFS3DW80	NSYSPPF8100	NSYSPPS3100SD	NSYSPPF8200	NSYSPPS3200SD	1200	800	300
NSYPIN128	NSYSDCR400	NSYTJ8040	-	NSYAEFPFS3DW80	NSYSPPF8100	NSYSPPS4100SD	NSYSPPF8200	NSYSPPS4200SD	1200	800	400
-	NSYSDCR300	NSYTJ10030	-	NSYAEFPFS3DW100	NSYSPPF10100	NSYSPPS3100SD	NSYSPPF10200	NSYSPPS3200SD	1200	1000	300
-	NSYSDCR300	NSYTJ10030	-	NSYAEFPFS3DW100	NSYSPPF10100	NSYSPPS3100SD	NSYSPPF10200	NSYSPPS3200SD	1200	1000	300
-	NSYSDCR400	NSYTJ10040	-	NSYAEFPFS3DW100	NSYSPPF10100	NSYSPPS4100SD	NSYSPPF10200	NSYSPPS4200SD	1200	1000	400
-	NSYSDCR300 ⁽⁶⁾	NSYTJ12030	-	-	NSYSPPF12100	NSYSPPS3100SD	NSYSPPF12200	NSYSPPS3200SD	1200	1200	300
-	NSYSDCR400 ⁽⁶⁾	NSYTJ12040	-	-	NSYSPPF12100	NSYSPPS4100SD	NSYSPPF12200	NSYSPPS4200SD	1200	1200	400
-	NSYSDCR300	NSYTJ10030	-	NSYAEFPFS3DW100	NSYSPPF10100	NSYSPPS3100SD	NSYSPPF10200	NSYSPPS3200SD	1400	1000	300

⁽⁷⁾ Also available in ventilated version with cable gland for widths of 600 and 800, see page 90.

⁽⁶⁾ For the double mounting plates,

⁽⁹⁾ To install the plinth to a wall-mounted enclosure, order ref. NSYAPFWM.

Composition accessories

PB50031_15_nb



PB50032_9_nb



PB501821_9_nb



Dimensions			Support pillar adaption plate	Support pillar	Support bracket for enclosure with anti-tilt kit and reinforcement 1400 mm (1)
Height (mm)	Width (mm)	Depth (mm)			
300	200	150	-	-	NSYCOCNS1400
300	250	150	-	-	NSYCOCNS1400
300	300	150	-	NSYCOCN80	NSYCOCNS1400
300	300	200	-	NSYCOCN80	NSYCOCNS1400
300	400	150	-	NSYCOCN80	NSYCOCNS1400
300	400	200	NSYAEFP42S3D	NSYCOCN80	NSYCOCNS1400
400	300	150	-	NSYCOCN80	NSYCOCNS1400
400	300	200	-	NSYCOCN80	NSYCOCNS1400
400	400	200	NSYAEFP42S3D	NSYCOCN80	NSYCOCNS1400
400	600	200	-	-	NSYCOCNS1400
400	600	250	-	-	NSYCOCNS1400
500	300	200	-	NSYCOCN80	NSYCOCNS1400
500	400	200	NSYAEFP42S3D	NSYCOCN80	NSYCOCNS1400
500	400	250	NSYAEFP42S3D	NSYCOCN80	NSYCOCNS1400
500	500	200	-	-	NSYCOCNS1400
500	500	250	-	-	NSYCOCNS1400
600	400	200	NSYAEFP42S3D	NSYCOCN80	NSYCOCNS1400
600	400	250	NSYAEFP42S3D	NSYCOCN80	NSYCOCNS1400
600	500	250	-	-	NSYCOCNS1400
600	600	200	-	-	NSYCOCNS1400
600	600	250	-	-	NSYCOCNS1400
600	600	300	-	-	NSYCOCNS1400
600	600	400	-	-	NSYCOCNS1400
600	800	300	-	-	NSYCOCNS1400
700	500	250	-	-	NSYCOCNS1400
800	600	200	-	-	NSYCOCNS1400
800	600	250	-	-	NSYCOCNS1400
800	600	300	-	-	NSYCOCNS1400
800	600	400	-	-	NSYCOCNS1400
800	800	250	-	-	NSYCOCNS1400
800	800	300	-	-	NSYCOCNS1400
800	1000	300	-	-	NSYCOCNS1400
800	1000	300	-	-	NSYCOCNS1400
800	1200	300	-	-	NSYCOCNS1400
1000	600	250	-	-	NSYCOCNS1400
1000	600	300	-	-	NSYCOCNS1400
1000	600	400	-	-	NSYCOCNS1400
1000	800	250	-	-	NSYCOCNS1400
1000	800	300	-	-	NSYCOCNS1400

(1) Available in version 1800 mm: ref. NSYCOCNS1800.

Comment:

You will find the weights of the Spacial S3D enclosures without mounting plate in the selection guide on [page 44](#).

Wall Fixing Lugs



NSYAEFFFC

- Set of 4 wall fixing lugs.
- Mounted directly on the rear of the enclosure, either in horizontal or vertical position.
- Wall-enclosure separation of 12 mm.
- Do not use for dynamic loads.
- Maximum load: 250 kg

Characteristics	References
Wall fixing lugs, passivated zinc-coated steel, for indoor enclosure	NSYAEFFFC
Wall fixing lugs, 304L stainless-steel	NSYAEFFXC

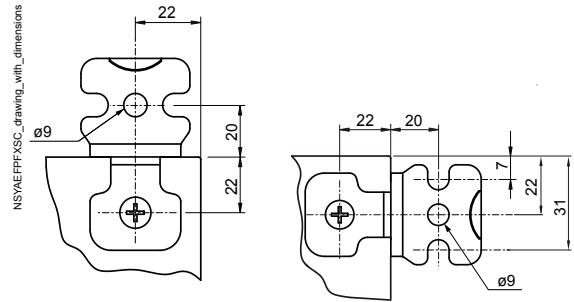

Supply:
Supplied with fixing screws and pre-mounted sealing gaskets



NSYAEFFFC2

Characteristics	References
Wall fixing lugs + cover, passivated zinc-coated steel + PA	NSYAEFFFC2

Supply:
4 fixing brackets + covers



NSYCAEFPF

Characteristics	References
Cover for wall fixing brackets, PA	NSYCAEFPF

Supply:
Kit of 4 covers

Kit For Heavy Loads



NSYAEFAHLBSC

- Set of 2 reinforcement pieces.
- To be mounted before installing the mounting plate in top position with the standard lugs (to be ordered separately).
- This kit is mandatory for wall-mounted enclosures bigger than 800 x 800 mm.
- Material: Passivated zinc-coated steel
- Maximum load: 400 kg

Characteristics	References
Kit for heavy loads	NSYAEFAHLBSC

Wall Fixing Lugs with Wall-Enclosure Separation



NSYAEFF40SC

- Set of 4 wall fixing lugs.
- Separation of 40 mm from the wall at the rear of the enclosure.
- Requires a drilled hole to prevent rotation.
- Material: Passivated zinc-coated steel
- Maximum load: 100 kg

Characteristics	References
Wall fixing lugs with wall-enclosure separation	NSYAEFF40SC

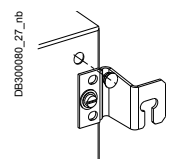

Full-Width Wall Fixing Lugs



NSYAEFFFS3DW40

- Kit made of 2 parts (top and bottom).
- Screwed from the inside.
- Material: Passivated zinc-coated steel
- Maximum load: 350 kg

Characteristics	Width (mm)	A (mm)	References
Heavy load reinforcement	400	395	NSYAEFFFS3DW40
Heavy load reinforcement	600	595	NSYAEFFFS3DW60
Heavy load reinforcement	800	795	NSYAEFFFS3DW80
Heavy load reinforcement	1000	-	NSYAEFFFS3DW100

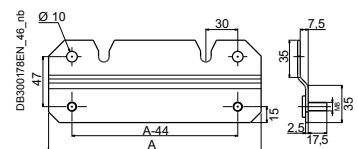

Comment:
For more information see [page 71](#)

Post Fixing Device for Spacial Steel Enclosure

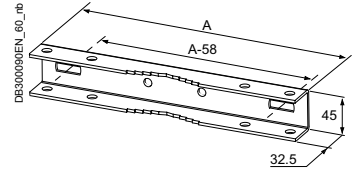

- For indoor installations on posts with a maximum circumference of 675 mm (minimum diameter 150 mm and maximum diameter 215 mm).
- Rail fixed to the inserts in the rear of the enclosure with 8 mm screws.
- They allow the mounting of protection canopies.
- Material: Passivated zinc-coated steel
- Maximum load: 100 kg

Supply:
2 pieces

Comment:
For more information see [page 71](#)



NSYSFPSC30

Characteristics	Width (mm)	A (mm)	References
Post fixing	300	295	NSYSFPSC30
Post fixing	400	395	NSYSFPSC40
Post fixing	500	495	NSYSFPSC50
Post fixing	600	595	NSYSFPSC60
Post fixing	800	795	NSYSFPSC80

Support Pillar

- The support pillar is fixed directly to the bottom face of the Spacial steel enclosure by means of an adapter plate.
- The adapter plate, to be ordered in addition to the pillar, replaces the cable gland plate.
- Overall height of the support foot: 800 mm.
- Mounting possible on all enclosures with dimensions up to 600 x 400 x 250 mm (except 200 x 200 x 150 mm and 250 x 200 x 150 mm enclosures).
- Material: Extruded aluminum
- Finish: Epoxy polyester paint
- Color: RAL 7035 gray

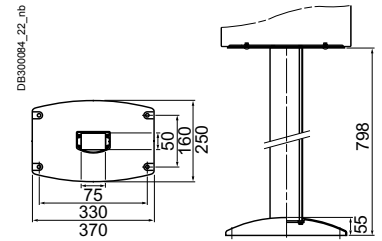

NSYCOCN80

Characteristics	Height (mm)	References
Support pillar	800	NSYCOCN80

Support Pillar Adaptation Plate

- Description: Plate for fixing the support pillar on the enclosure.
- This plate replaces the cable gland plate delivered with the enclosure.
- Material: Steel
- Finish: Polyester powder
- Color: RAL 7035 gray



NSYAEFP42S3D

Characteristics	For enclosure width (mm)	For enclosure depth (mm)	References
Support pillar adaptation plate	400	200-250	NSYAEFP42S3D

Support Bracket for Enclosure with Anti-Tilt Kit and Reinforcement

- The support bracket is used when the enclosure cannot be hung from a wall or a post.
- Maximum enclosure dimensions: 1000 x 800 x 300 mm.
- Floor attachment by standard M12 fastenings.
- Material: Steel
- Finish: Epoxy polyester paint
- Color: RAL 7035 gray
- Maximum load: 120 kg



NSYCOCN1400

Characteristics	Height (mm)	References
Support bracket for enclosure with anti-tilt kit and reinforcement	1400	NSYCOCN1400
Support bracket for enclosure with anti-tilt kit and reinforcement	1800	NSYCOCN1800

Front and Rear Plinths



- The front and rear of the plinth consists of 4 corners with 2 or 4 panels.
- Material: Folded sheet steel, corner with a thickness of 25/10° mm
- Finish: Structured finish, epoxy polyester powder
- Color: RAL 7022 gray
- Ingress protection rating: IP30 according to IEC 60529
- Mechanical protection rating: IK10 according to IEC 62262

Characteristics	Width (mm)	Height (mm)	References
Front plinths for Spacial	600	100	NSYSPF6100
Front plinths for Spacial	800	100	NSYSPF8100
Front plinths for Spacial	1000	100	NSYSPF10100
Front plinths for Spacial	1200	100	NSYSPF12100
Front plinths for Spacial	600	200	NSYSPF6200
Front plinths for Spacial	800	200	NSYSPF8200
Front plinths for Spacial	1000	200	NSYSPF10200
Front plinths for Spacial	1200	200	NSYSPF12200

Installation:

It is necessary to order separately the plinth fixing kit (ref. **NSYAPFWM**) composed by fixing hardware and drilling jig

Comment:

For more information see [page 89](#)

Supply:

Height 100 mm: 4 corners, 2 panels (front and rear), 4 corner covers and fixing elements. Height 200 mm: 4 corners, 4 panels (2 front and 2 rear), 4 corner covers and fixing elements

Plinth Side Panels



- They are fixed to the corner of the plinth by 2 fixing screws.
- Folded sheet steel
- Finish: Structured finish, epoxy polyester powder
- Color: RAL 7022 gray
- Ingress protection rating: IP30 according to IEC 60529
- Mechanical protection rating: Mechanical protection rating

Characteristics	Depth (mm)	Height (mm)	References
Side plinths for Spacial	300	100	NSYSPS3100SD
Side plinths for Spacial	400	100	NSYSPS4100SD
Side plinths for Spacial	300	200	NSYSPS3200SD
Side plinths for Spacial	400	200	NSYSPS4200SD

Supply:

Height 100 mm: 2 side panels, 4 corner covers and fixing elements. Height 200 mm: 4 side panels (height of 100 mm, 2 for each side), 4 corner covers and fixing elements



Stainless-steel plinths (standard plinths [page 131](#), ventilated plinths [page 379](#)) are compatible with steel wall-mounted S3D enclosures using an earthing cable (description [page 278](#)) to be ordered separately.

Coupling of S3D Steel Enclosures

- Available in 2 versions:
 - Coupling version without cable entry.
 - Version with coupling frame allowing the entry of cables.
- Spacing of 17 mm between 2 coupled enclosures, allowing full opening of the doors.
- Allows lateral coupling of 2 enclosures.
- These frames allow the door to open to 120°.
- Material: Fiberglass-reinforced polyester, self-extinguishing
- Ingress protection rating: IP66 according to IEC 60529

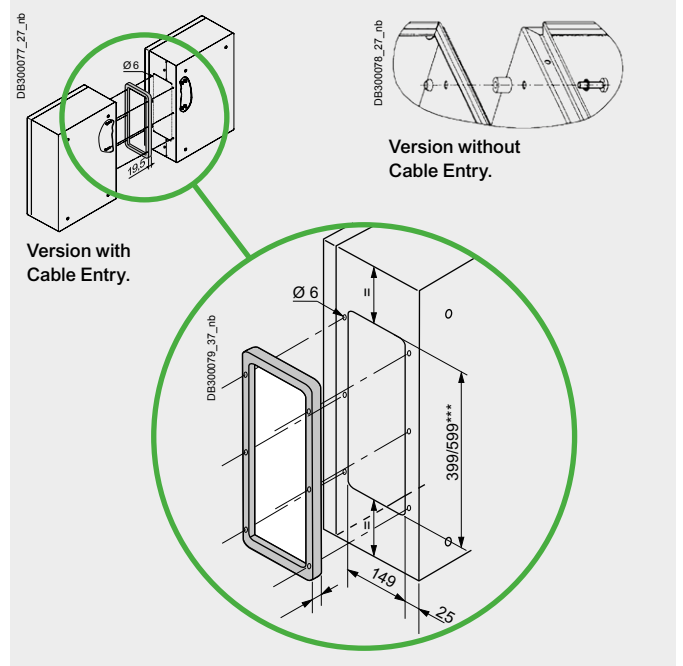

Supply:
Set of 4 spacers and their fixings. Mounting by screws, included

Coupling Spacers



NSYAEUBUSC

Characteristics	References
Set of 4 coupling spacers	NSYAEUBUSC

Coupling Frame



NSYAEUBU41SC

Characteristics	References
Coupling frame, 435 x 185 mm	NSYAEUBU41SC
Coupling frame, 635 x 185 mm	NSYAEUBU61SC

Eyebolts



NSYAELYTCRG8

- Set of two M8 eyebolts. They are fixed directly to the body of the floor-standing enclosure. Cannot be installed with the canopy in place or if it is planned to put one.
- Material: Zinc-coated molded steel
- Maximum load: 200 kg per enclosure when slinging at 60°

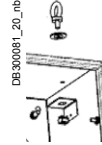

Supply:
Reinforcing brackets attached to the rings (these brackets also act as a drilling template)

Characteristics	References
Set of 2 M8 eyebolts	NSYAELYTCRG8

Protection Canopy



NSYTJ2015

- Direct fixing to the body of the enclosure by four M6 screws.
- Material: Sheet steel
- Finish: Epoxy polyester paint
- Color: RAL 7035 gray

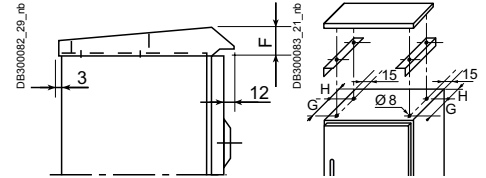

Supply:
Delivered with the fixings required for installation

Characteristics	Width (mm)	Depth (mm)	F (mm)	G (mm)	H (mm)	References
Protection canopy	200	150	36	75	23	NSYTJ2015
Protection canopy	300	150	36	75	23	NSYTJ3015
Protection canopy	400	150	36	75	23	NSYTJ4015
Protection canopy	500	200	36	130	23	NSYTJ5020
Protection canopy	600	200	36	130	23	NSYTJ6020
Protection canopy	300	200	36	130	23	NSYTJ3020
Protection canopy	400	200	36	130	23	NSYTJ4020
Protection canopy	400	250	42	150	48	NSYTJ4025
Protection canopy	500	250	42	150	48	NSYTJ5025
Protection canopy	600	250	42	150	48	NSYTJ6025
Protection canopy	800	250	42	150	48	NSYTJ8025
Protection canopy	600	300	42	200	48	NSYTJ6030
Protection canopy	800	300	42	200	48	NSYTJ8030
Protection canopy	1000	300	42	200	48	NSYTJ10030
Protection canopy	1200	300	42	200	48	NSYTJ12030
Protection canopy	600	400	42	300	48	NSYTJ6040
Protection canopy	800	400	42	300	48	NSYTJ8040
Protection canopy	1000	400	42	300	48	NSYTJ10040
Protection canopy	1200	400	42	300	48	NSYTJ12040

Mounting Rail

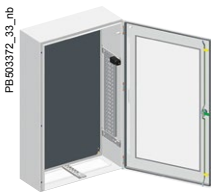

PB503372_30_nb

- Accessory designed to optimize the available space inside the enclosure.
- It is intended for the installation of switchgear to extend the chassis.
- Mounting possible after installing the mounting plate.
- It is mounted horizontally, with a single screw, on the side panels.
- Door switch mounting option.
- It is possible to vertically fasten **NSYSLCR●●** light cross-rails (description on [page 238](#)) and **NSYSQCR●●** quick-fixing cross-rails (description on [page 237](#)).
- Material: Galvanized steel
- Maximum load: Static load: 6 kg (sides) and 1.5 kg (top); Dynamic load (transport horizontally): 2 kg according to ASTM D-4169-16
- Installation: In order to ensure the electrical continuity in all cases it is recommended to use an earthing cable **NSYEL●●●D6** or **NSYEL●●●D8**, see [page 278](#)

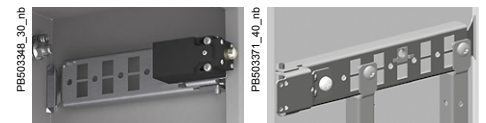

Supply:
Set of 2 cross-rails



NSYSUCR200WM

Characteristics	Enclosure depth (mm)	References
Mounting rail for wall-mounted enclosure S3D/CRN	200	NSYSUCR200WM
Mounting rail for wall-mounted enclosure S3D/CRN	250	NSYSUCR250WM
Mounting rail for wall-mounted enclosure S3D/CRN	300	NSYSUCR300WM
Mounting rail for wall-mounted enclosure S3D/CRN	400	NSYSUCR400WM

Standard Handle

- Operating handle delivered with the enclosure.
- It can be attached to the locking system by means of a fixing element.
- It can also be used to loosen the caps helping protect the studs when painting.



NSYAEDLS3DKDB3

Characteristics	References
Standard handle	NSYAEDLS3DKDB3

Standard Handles with Keys

- Attractive and ergonomic bi-material handle.
- Large range of barrels covering all the most common needs.
- The installation of the standard handle does not require the escutcheon to be removed.
- Locks may only be operated using the supplied keys.
- Delivery: Delivered with 2 keys

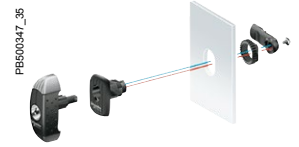

NSYAEDL1242S3D

Characteristics	References
405	NSYAEDL405S3D
421	NSYAEDL421S3D
455	NSYAEDL455S3D
520	NSYAEDL520S3D
601	NSYAEDL601S3D
610E	NSYAEDL610S3D
1242	NSYAEDL1242S3D
1332E	NSYAEDL1332S3D
2124E	NSYAEDL2124S3D
2131A	NSYAEDL2131S3D
2132A	NSYAEDL2132S3D
2133A	NSYAEDL2133S3D
2241A	NSYAEDL2241S3D
2331A	NSYAEDL2331S3D
2432E	NSYAEDL2432S3D
2433A	NSYAEDL2433S3D
3113A	NSYAEDL3113S3D
3123E	NSYAEDL3123S3D
3131A	NSYAEDL3131AS3D
3132A	NSYAEDL3132S3D
3432E	NSYAEDL3432S3D
3524E	NSYAEDL3524S3D
4322A	NSYAEDL4322S3D
4324E	NSYAEDL4324S3D
5124A	NSYAEDL5124S3D

Standard Locks

- Spacial S3D wall-mounted enclosures are supplied with a 3-mm double-bar lock as **standard**.
- Spare lock: Order ref. **NSYAEDLS3DRL** (escutcheon + cam + washer).
- Large range of standardised inserts covering all the most common needs.
- Installation and removal with a single screw.
- Material: Zamack + polyamide
- Ingress protection rating: IP66 according to IEC 60529

Supply:
Delivered with 1 plastic key



NSYAEDLS6S3D

Characteristics	References
7 mm square	NSYAEDLS7S3D
8 mm square	NSYAEDLS8S3D
3-mm double-bar	NSYAEDLB3S3D
5-mm double-bar	NSYAEDLB5S3D
CNOMO 6.5 mm triangular	NSYAEDLT6S3D
8 mm triangular	NSYAEDLT8S3D

Barrel DIN Kit

- Mounting of half-cylinder according to DIN 18252 (EN1303). Cam can be turned every 45°.
- Easy mounting instead of standard lock.
- Compatible with PLM barrels offer. See [page 141](#). (Example: **NSYTL1242EME**).
- Material: Polyamide GF
- Ingress protection rating: IP66 according to IEC 60529

Supply:
Delivered with metal cam 1 point and metal cam 3 points



NSYAEDDINS3D

Characteristics	References
Barrel DIN kit	NSYAEDDINS3D

Double-Bar 3 mm Metal Lock

- Easy mounting instead of standard lock.
- Material: Zamak
- Ingress protection rating: IP66 according to IEC 60529

Supply:
Delivered with metal cam 1 point and metal cam 3 points



NSYAEDLB3MS3D

Characteristics	References
Double-bar 3 mm metal lock	NSYAEDLB3MS3D

Metal Cam Kit 1 Point and 3 Points

- To adapt other locks.
- Material: Zinc-coated metal

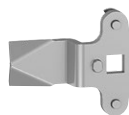

NSYAEDLMETS3D

Characteristics	References
Metal cam kit 1 point and 3 points	NSYAEDLMETS3D

Padlock

- Easy mounting instead of the standard lock.
- Padlockable, diameter 8 mm
- Material: Zamak
- Ingress protection rating: IP66 (IEC 60529)

Supply:
Delivered with metal key



NSYAEDLPADS3D

Characteristics	References
Padlock	NSYAEDLPADS3D

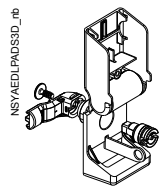

Other Locks with Keys

- Material: Zamak
- Ingress protection rating: IP66 (IEC 60529)

Supply:
Delivered with metal cam 1 point and metal cam 3 points



NSYAEDLEDF13S3D

Characteristics	References
EDF 900	NSYAEDLEDF9S3D
EDF 1300	NSYAEDLEDF13S3D
EDF 1400	NSYAEDLEDF14S3D

Door Hinges

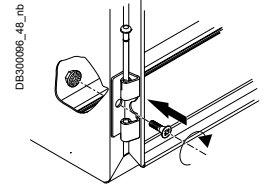

NSYAEDH180S3D NSYAEDH120S3D

- Captive pin, indexed by a spring.
- Material: Zamak body for ref. **NSYAEDH180S3D**, treated sheet steel body for ref. **NSYAEDH120S3D**, aluminum pin
- Maximum load: For the 180° hinge, the maximum admissible load on the door is 20 kg/m²
- For the 120° hinge, the maximum admissible load on the door is 50 kg/m²

Supply:
Set of 1 hinge, delivered with fixings

Characteristics	References
180° hinge for S3D enclosure	NSYAEDH180S3D
Standard 120° hinge for S3D	NSYAEDH120S3D

Door Switch for Wall-Mounted Enclosures



NSYINLCRN

- Switch/commutator unit equipped with support and fixings for direct fixing to the enclosure.
- Can be used to control lighting, air-conditioning units, etc.
- It is not compatible with installing the 19" swing rack and the internal door.
- NC + NO contact, 240 V AC / 3 A (IEC 60947-5-1) 250 V DC / 0,1 A (IEC 0947-5-1).

Supply:
1 door switch and fixing elements

Characteristics	References
Door switch	NSYINLCRN

Wall-Mounted Door Retainer Steel



NSYAEDRSCST

- To block the door in the open position.
- It is installed on enclosures with heights from 400 mm and widths from 300 mm.
 - Door opening angle: 120°.
 - Earthing connection of the enclosure by means of the reinforcement rail.
 - Earthing accessories supplied with the enclosure (earth-connection cable to be ordered separately), for more information see [page 278](#)
 - Material: Steel

Comment:
It is not compatible with installing the 19" swing rack and the internal door.

Characteristics	References
Wall-mounted door retainer Steel	NSYAEDRSCST

Wall-Mounted Door Retainer Polyamide



NSYAEDRS3DPA6

- To block the door in the open position.
- It is installed on the perforated rails of the enclosure doors at the required height.
 - Material: Polyamide 6 (PA6)

Comment:
It is only installed on enclosures with a height of less than 400 mm (no perforated rails).

Characteristics	References
Wall-mounted door retainer polyamide	NSYAEDRS3DPA6

Internal Door



NSYPIN43

- Locking with 3-mm double-bar lock.
- The internal door can be installed directly on the front face of the enclosure or on the step slides (not supplied as standard).
- To mount an inner door and a mounting plate at the same time on the step slides is possible as standard.
- Incompatible with the installation of the door stop and door switch. For further details, please consult us.
- Material: Steel
- Color: RAL 7035 gray
- Maximum load: 30 kg/m²

Comment:
For more information see [page 73](#)
(¹) Equipped with welded vertical profiles in order to facilitate cable management.

Characteristics	High (mm)	Width (mm)	References
Internal door	400	300	NSYPIN43
Internal door	500	400	NSYPIN54
Internal door	600	400	NSYPIN64
Internal door	700	500	NSYPIN75
Internal door	800	600	NSYPIN86
Internal door	1000	600	NSYPIN106 ⁽¹⁾
Internal door	1000	800	NSYPIN108 ⁽¹⁾
Internal door	1200	600	NSYPIN126 ⁽¹⁾
Internal door	1200	800	NSYPIN128 ⁽¹⁾

Standard Cable Gland Plate

- Plate delivered as standard with the Spacial S3D universal enclosure.
- Drilling marks with 25 mm spacing.
- Material: Steel, structured finish RAL 7035 gray
- Thickness: 15/10° mm
- Ingress protection rating: IP66 according to IEC 60529
- Fixing: Fixing by 4, 6, 8, 10 or 12 screws, according to the model

Comment:

For more information see [page 73](#)

Supply:

Delivered with sealing gasket and fixing hardware



NSYTLA

Characteristics	Enclosures width (mm)	Enclosures depth (mm)	Type	Width (A)	Depth (B)	No. of markings	No. of Ø 6 holes	References
Standard	200-250	150	A	140	80	4	4	NSYTLA
Standard	300-400	150	B	245	80	7	4	NSYTLB
Standard	300	200	C	245	130	21	6	NSYTLC
Standard	400	200-250	D	345	130	33	8	NSYTLD
Standard	500	200-250	E	445	130	45	8	NSYTLE
Standard	600	200-250	F	545	130	57	10	NSYTLF
Standard	600	300-400	G	495	220	102	12	NSYTLG
Standard	800	250-300-400	D	345	130	-	-	2x NSYTLD
Standard	1000-1200	300-400	E	445	130	-	-	2x NSYTLE

Aluminum Cable Gland Plate

- Suitable for non-magnetic applications.
- Material: Brushed-finish aluminum
- Thickness: 30/10° mm
- Ingress protection rating: IP66 according to IEC 60529
- Fixing: Fixing by 4, 6, 8, 10 or 12 screws, according to the model

Supply:

Delivered with sealing gasket and fixing hardware



NSYTLAU

Characteristics	Enclosures width (mm)	Enclosures depth (mm)	Type	Width (A)	Depth (B)	No. of markings	No. of Ø 6 holes	References
Aluminum	300-400	150	B	245	80	7	4	NSYTLBU
Aluminum	600	200-250	F	545	130	57	10	NSYTLFU
Aluminum	600	300-400	G	495	220	102	12	NSYTLGU

Cable Gland Plates with FL-Type Cut-Out for Cable Gland Membranes

- Mounting replaces the Spacial S3D plate.
- Cut-outs for installation of membranes type FL 21 (Cut-out FL13 for depth 150 mm; And cut-out FL21 for other depths.), [page 73](#).
- Material: Steel, structured finish RAL 7035 gray
- Thickness: 15/10° mm
- Fixing: Fixing by 4, 6, 8, 10 or 12 screws, according to the model
- **NSYTLG2FL** with 2 FL21 cut-outs
- **NSYTLG4FL** with 4 FL21 cut-outs
- **NSYTLAFL** cannot be mounted on enclosure width 200 and depth 150
- **NSYTLBFL** with FL13 cut-out

Comment:

For more information see [page 73](#)

Supply:

Delivered with sealing gasket and fixing hardware



NSYTLAFL

Characteristics	Enclosures width (mm)	Enclosures depth (mm)	Type	Width (A)	Depth (B)	No. of markings	No. of Ø 6 holes	References
Cut-out	200-250	150	A	140	80	4	4	NSYTLAFL
Cut-out	300	200	C	245	130	21	6	NSYTL CFL
Cut-out	400	200-250	D	345	130	33	8	NSYTL DFL
Cut-out	500	200-250	E	445	130	45	9	NSYTL EFL
Cut-out	600	200-250	F	545	130	57	10	NSYTL FFL
Cut-out	600	200-250	F	545	130	57	10	NSYTL F2FL
Cut-out	600	300-400	G	495	220	102	12	NSYTL GFL
Cut-out	600	300-400	G	495	220	102	12	NSYTL G2FL
Cut-out	800	250-300-400	D	345	130	-	-	2x NSYTL DFL
Cut-out	1000-1200	300-400	E	445	130	-	-	2x NSYTL EFL

FlexiCable Cable Entries

FlexiCable is an innovative cable gland plate for simple and fast cable entry.

There is no need to drill holes: The creation of the cable entrances takes a few seconds.

- Installation options: Replaces cable gland plate (S3D) or directly on enclosure.
- Cable diameter: Up to 26 mm.
- Ingress protection rating: IP55 according to IEC 60529
- Fixing: By 4, 6, 8, 10 or 12 screws, according to the model

Other characteristics:

- Exists in 5 sizes matching 46 sizes (132 models) of Spacial S3D steel wall-mounted enclosures
- Fire resistant 650 °C following IEC 60695-2-11
- Tested on short-circuit effect 250 A, 25 kA following IEC 61439-1

FlexiCable Cable Entries

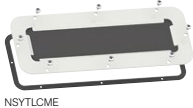

Characteristics	Enclosures width (mm)	Enclosures depth (mm)	Type	Width (A)	Depth (B)	Effective cable entrance dimensions (mm)	References
Standard	300	200	C	245	130	178 x 63	NSYTLME
Standard	400	200-250	D	345	130	278 x 63	NSYTLME
Standard	500	200-250	E	445	130	378 x 63	NSYTLME
Standard	600	200-250	F	545	130	478 x 63	NSYTLME
Standard	600	300-400	G	495	220	428 x 153	NSYTLME
Standard	800	250-300-400	D	345	130	-	NSYTLME
Standard	1000-1200	300-400	E	445	130	-	NSYTLME

Mount FlexiCable on Your S3D Enclosure

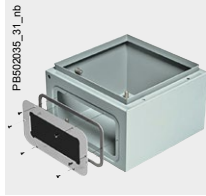

Create a Hole with a Screw Driver

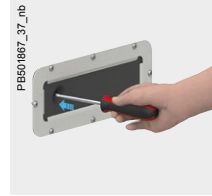



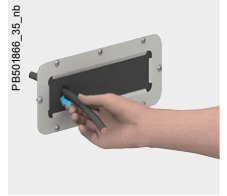

Push the Cable through Flexicable and Complete Your Installation





Supply:





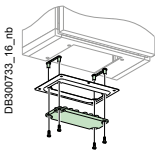

- 1 metal frame with pre-mounted membrane,
- 1 gasket, Fixing hardware

• For details enter the reference into the search engine of www.se.com

Multi-A	Multi-C	Multi-R	Multi-CS	Multi-T
				
FL13 and FL21 type membranes	Circular connector-free entries	Rectangular connector-free entries	Modular entry allowing the passing of up to 48 pre-assembled cables.	FL21-type membranes
NSYAECFLA25 NSYAECFLA33	NSYTSAM508SE NSYTSAM638SE	NSYTSA2414SE NSYTSA2417SE NSYTSA2422SE NSYTSA2423SE NSYTSA2429SE	NSYDCD2412 NSYDCD244 NSYDCD248 NSYDCD249	NSYAECFLBP ⁽¹⁾ NSYAECFLT7 NSYAECFLT25 NSYAECFLT35

⁽¹⁾ Metal plate

PrismaSeT	Multi-H
	
FL21 or rectangular.	FL21 insulated flange with ISO knock-outs.
LVS08881 LVS08892 LVS08895 LVS08897 LVS08898 LVS08899	NSYTSAKFL

Simple-1	Simple-2	Simple-3	Simple-5	Synthetic snap-in cable gland	Stainless-steel cable gland with lamellar insert	
						
Mixed membrane entries for enclosure thickness 20/10° - 32/10° mm.	PVC adjustable cone-shaped entries for enclosure thickness 30/10° - 32/10° mm.	Quick cable entries for enclosure thickness 10/10e - 40/10e mm (5/10° - 20/10° mm for ref. IMT36179).	ISO cable gland	Without thread. Easy assembly and disassembly. Suitable for walls from 0.5 to 4 mm thick.	Lamellar technology provides excellent resistance to traction as well as excellent torsional protection. For outdoor use, or for aggressive environments.	
					AISI 304L	AISI 316L
ISM71071 ISM71072 ISM71073 ISM71074	NSYECPC3 NSYECPC5 NSYECPC6 NSYECPC9 NSYECPC15	IMT36179 IMT36180 IMT36181 IMT36182 IMT36183 IMT36184 IMT36185	ISM71501 ISM71502 ISM71503 ISM71504 ISM71505 ISM71506 IMT36150	NSYCGSP16 NSYCGSP20 NSYCGSP25 NSYCGSP32 NSYCGSP40	NSYCGX12 NSYCGX16 NSYCGX20 NSYCGX25 NSYCGX32 NSYCGX40	NSYCGX12H NSYCGX16H NSYCGX20H NSYCGX25H NSYCGX32H NSYCGX40H

Technical changes reserved. Information provided without guarantee. Images are for illustrative purposes only.

Multi-A

- Material: TPE, SBS, SEBS and PP co-polymer - halogen-free
- Color: RAL 7035 gray
- Cable entry material: Combined
- Cable glands to be fitted: Optional: Specific cable clamp ref. **NSYAECPLACA●●** to be used
- Installation options: On cable gland plate adapter or directly on enclosure
- Flexibility of the installation: Medium
- Reversibility: Medium
- Ingress protection rating: IP55 according to IEC 60529
- Cable retention: High with cable clamp, (up to 18 daN)
- Cable diameter (mm): From 14 to 30
- Cable Installation time: Moyenne
- Quantity of cables to be fitted for a given surface: ++
- Cable entries for cables with connectors: No
- Cut-out dimensions (mm): 134 x 52 (FL13); 214 x 90 (FL21)
- External dimensions (mm): 216 x 84
- Certificates: Cable anchorage pull test: EN 50262. Long term UV resistance: ASTM G 154-06
- Flame resistance: 750 °C
- Temperature range: -40 °C to +85 °C



NSYAECPLA33

Characteristics	Height (mm)	Width (mm)	Depth (mm)	Diameter of the cable entry (Ø mm)								References
				No.	13	14	15	16	18	21	30	
FL13 and FL21 type membranes	25	215	86	25	-	16	-	-	6	-	3	NSYAECPLA25
FL13 and FL21 type membranes	25	215	86	33	-	24	-	-	9	-	-	NSYAECPLA33

Multi-C

- Order by multiples of 10 (10, 20, 30...)
- Material: Polyamide
- Cable entry material: Soft membrane
- Cable glands to be fitted: No
- Installation options: On modified cable gland plate or directly on enclosure
- Flexibility of the installation: Medium
- Reversibility: Full
- Ingress protection rating: IP55 according to IEC 60529, UL recognized (UR)
- Cable retention: Medium
- Cable diameter (mm): From 3 to 15.9
- Cable Installation time: Fast
- Quantity of cables to be fitted for a given surface: ++
- Cable entries for cables with connectors: No
- Cut-out dimensions (mm): Ø 50.5; Ø 63.5
- External dimensions (mm): Ø 58; Ø 71
- Certificates: UL 94 V-0
- Flame resistance: 650 °C



NSYTSAM508SE

Characteristics	Cut-out Ø (mm)	No.	Diameter of the cable entry (Ø mm)						References
			3-5.5	3-6.5	3.6-6.5	5-9.2	6-10	9.6-15.9	
Circular connector-free entries	50.5	8	-	-	7	-	1	-	NSYTSAM508SE
Circular connector-free entries	63.5	8	-	2	-	4	-	2	NSYTSAM638SE

Multi-R

- Material: Polyamide
- Cable entry material: Soft membrane
- Cable glands to be fitted: No
- Installation options: On cable gland plate with special cut-out or directly on enclosure
- Flexibility of the installation: Medium
- Reversibility: Full
- Ingress protection rating: IP55 according to IEC 60529, UL recognized (UL)
- Cable retention: Medium
- Cable diameter (mm): From 4.3 to 15.9
- Cable Installation time: Fast
- Quantity of cables to be fitted for a given surface: ++
- Cable entries for cables with connectors: No
- Cut-out dimensions (mm): 112 x 36
- External dimensions (mm): 146 x 14 x 58
- Certificates: UL 94 V-0
- Flame resistance: 650 °C

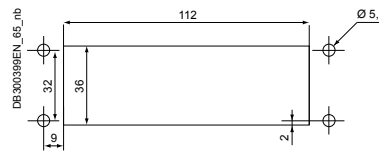

Supply:
1 unit



NSY TSA2414SE

Characteristics	Cut-out Ø (mm)	No.	Diameter of the cable entry (Ø mm)					References
			4.3-8.1	3-6.5	5-9.2	8-12.5	9.6-15.9	
Rectangular connector-free entries	112 x 36	14	-	6	4	-	-	NSY TSA2414SE
Rectangular connector-free entries	112 x 36	17	-	-	17	-	-	NSY TSA2417SE
Rectangular connector-free entries	112 x 36	22	-	16	4	2	-	NSY TSA2422SE
Rectangular connector-free entries	112 x 36	23	23	-	-	-	-	NSY TSA2423SE
Rectangular connector-free entries	112 x 36	29	-	29	-	-	-	NSY TSA2429SE

Multi-CS

- Material: Reinforced polypropylene and TPE, halogen-free
- Color: Black
- Cable entry material: Soft membrane
- Cable glands to be fitted: No
- Installation options: On cable gland plate adapter or directly on enclosure
- Flexibility of the installation: Full
- Reversibility: Full
- Ingress protection rating: IP65 according to IEC 60529
- Cable retention: Medium
- Cable diameter (mm): Up to 22
- Cable Installation time: Fast
- Quantity of cables to be fitted for a given surface: +++
- Cable entries for cables with connectors: Yes
- Cut-out dimensions (mm): 112 x 36
- External dimensions (mm): 148 x 58 x 15; 148 x 58 x 18
- Certificates: UL recognized (UR)
- Temperature range: -30 °C to +100 °C



NSYDCD2412

Characteristics	References
Modular entry allowing the passing of up to 48 pre-assembled cables	NSYDCD2412
Modular entry allowing the passing of up to 48 pre-assembled cables	NSYDCD244
Modular entry allowing the passing of up to 48 pre-assembled cables	NSYDCD248
Modular entry allowing the passing of up to 48 pre-assembled cables	NSYDCD249

Technical changes reserved. Information provided without guarantee. Images are for illustrative purposes only.

Multi-T

- Material: TPE
- Color: RAL 7035 gray
- Cable entry material: Soft membrane
- Cable glands to be fitted: No
- Installation options:
 - On cable gland plate adapter or directly on enclosure
- Flexibility of the installation: Medium
- Reversibility: Medium
- Ingress protection rating: IP66 according to IEC 60529 (IP65 for **NSYAECPLBP**)
- Cable retention: Low
- Cable diameter (mm): From 5 to 60
- Cable Installation time: Fast
- Quantity of cables to be fitted for a given surface: ++
- Cable entries for cables with connectors: No
- Cut-out dimensions (mm): 214 x 90 (FL21)
- External dimensions (mm): 214 x 88
- Flame resistance: 650 °C
- Temperature range: -40 °C to +100 °C

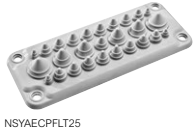

NSYAECPLT25

Characteristics	Diameter of the cable entry (Ø mm)												References
	No.	5-7	6-10	8-12	8-16	10-14	12-18	14-20	17-32	20-26	24-54	30-60	
metal plate	0	-	-	-	-	-	-	-	-	-	-	-	NSYAECPLBP
FL21 membranes	7	-	-	-	4	-	-	-	-	-	2	1	NSYAECPLT7
FL21 membranes	27	4	-	4	-	13	-	4	-	2	-	-	NSYAECPLT25
FL21 membranes	37	-	4	14	-	16	2	-	1	-	-	-	NSYAECPLT35

PrismaSeT

- Material: Insulated material
- Color: RAL 9003
- Cable entry material: Soft membrane
- Cable glands to be fitted: No
- Installation options:
 - On cable gland plate adapter or directly on enclosure
- Flexibility of the installation: Medium
- Reversibility: Medium
- Ingress protection rating: IP55 according to IEC 60529
- Cable retention: Low
- Cable diameter (mm): From 28 to 60 (FL21), From 7 to 72 (rectangular)
- Cable Installation time: Fast
- Quantity of cables to be fitted for a given surface: ++
- Cable entries for cables with connectors: No
- Cut-out dimensions (mm): 214 x 90 (FL21)
- External dimensions (mm): 216 x 84

PrismaSeT, Plain

- Solid cable gland plates



08881

Characteristics	Type	References
PrismaSeT	FL21	LVS08881

PrismaSeT, Pre-Drilled

- Suitable for receiving cable glands with metric pitch

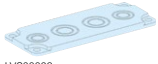

LVS08892



LVS08895



LVS08898



LVS08899

Characteristics	Type	References
Pre-drilled, 2 x M20 or M32 + 2 x M25 or M40	FL21	LVS08892
Pre-drilled, 5 x M16 or M25 + 8 x M20	FL21	LVS08895
Pre-drilled, 39 x Ø 7 - 26 mm	opening 225 x 137 mm	LVS08898
Pre-drilled, 2 x Ø 33 - 72 mm	opening 225 x 137 mm	LVS08899

PrismaSeT, Membrane

- Membrane to be drilled according to the required diameter

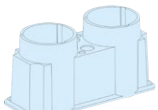

LVS08897

Characteristics	Type	References
Membrane, 2 x Ø 28 - 60 mm	FL21	LVS08897

Multi-H

- Material: Fiberglass-reinforced polycarbonate
- Color: RAL 7035 gray
- Cable entry material: Hard-plastic
- Cable glands to be fitted: Yes
- Installation options:
 - On cable gland plate adapter or directly on enclosure
- Flexibility of the installation: Low
- Reversibility: Medium
- Ingress protection rating: IP65 according to IEC 60529
- Cable retention: High (with cable clamp)
- Cable diameter (mm): From 12 to 25
- Cable Installation time: Slow
- Quantity of cables to be fitted for a given surface: ++
- Cable entries for cables with connectors: No
- Cut-out dimensions (mm): 214 x 90 (FL21)
- External dimensions (mm): 215 x 85
- Flame resistance: 750 °C
- Temperature range: For normal operation: -40 °C to +80 °C; For a short time: -40 °C to +120 °C



NSYTSAKFL

Characteristics	Height (mm)	Width (mm)	Depth (mm)	Diameter of the cable entry (Ø mm)				References
				No.	M12	M12 or M20	M16 oder M25	
FL21 insulated flange with ISO knock-outs	10	215	85	12	4	4	4	NSYTSAKFL

Simple-1

- Mixed membrane entries for enclosure thickness 20/10° - 32/10° mm.
- Material: SBS
- Color: RAL 7035 gray or RAL 9010 white
- Cable entry material: Soft membrane
- Cable glands to be fitted: Not applicable
- Installation options: On cable gland plate or directly on enclosure
- Flexibility of the installation: Low
- Reversibility: Medium
- Ingress protection rating: IP55 according to IEC 60529
- Cable retention: Low
- Cable diameter (mm): From 20 to 40
- Cable Installation time: Fast
- Quantity of cables to be fitted for a given surface: +
- Cable entries for cables with connectors: No
- Cut-out dimensions (mm): Various circular hole diameters according to cable diameter
- External dimensions (mm): From Ø 23 to 44
- Flame resistance: 750 °C

Supply:

Minor packaging of 10 pieces



ISM71074

Characteristics	Drill hole Ø (mm)	Cable / conduit Ø (mm)	References
Mixed membrane entries for IP55 direct cable entries, RAL 7035	23	4 - 20	ISM71071
Mixed membrane entries for IP55 direct cable entries, RAL 7035	29	4 - 25	ISM71072
Mixed membrane entries for IP55 direct cable entries, RAL 7035	36	4 - 32	ISM71073
Mixed membrane entries for IP55 direct cable entries, RAL 7035	44	4 - 40	ISM71074

Simple-2

- PVC adjustable cone-shaped entries for enclosure thickness 30/10° - 32/10° mm.
- Material: PVC
- Cable entry material: Soft membrane
- Cable glands to be fitted: Not applicable
- Installation options: On cable gland plate or directly on enclosure
- Flexibility of the installation: Low
- Reversibility: Medium
- Ingress protection rating: IP55 according to IEC 60529
- Cable retention: Low
- Cable diameter (mm): From 5 to 37
- Cable Installation time Fast
- Quantity of cables to be fitted for a given surface: +
- Cable entries for cables with connectors: No
- Cut-out dimensions (mm): Various circular hole diameters according to cable diameter
- External dimensions (mm): From Ø 25 to 98

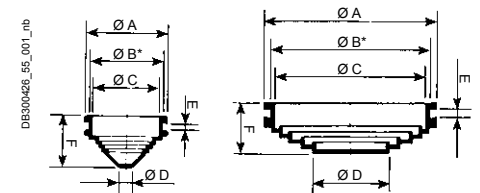

Supply:

NSYECPC3 50 cable entries, NSYECPC5 and NSYECPC6 each 25 cable entries, NSYECPC9 and NSYECPC15 each 10 cable entries



NSYECPC15

Characteristics	Dimensions (mm)						Capacity		References
	Ø A	Ø B	Ø C	Ø D	E	F	Cable (Ø mm)	Tube	
PVC adjustable cone-shaped entries	25	21.5	18	5	3.2	13	5-18	PG 9-11	NSYECPC3
PVC adjustable cone-shaped entries	33	29.5	26	5	3.2	20	5-26	PG 9-16	NSYECPC5
PVC adjustable cone-shaped entries	43	38.5	36	5	3.2	22	5-36	PG 9-21	NSYECPC6
PVC adjustable cone-shaped entries	70	63	60	28	3	20	28-60	PG 21-48	NSYECPC9
PVC adjustable cone-shaped entries	98	90	87	28	3	23	28-87	PG 21-48	NSYECPC15

Simple-3

- Quick cable entries for enclosure thickness 10/10° - 40/10° mm (5/10° - 20/10° mm for ref. IMT36179).
- Material: EPDM plastic
- Color: Gray cable entries: NCS 5500; Black cable entries: NCS 9000
- Cable entry material: Combined
- Cable glands to be fitted: Not applicable
- Installation options: On cable gland plate or directly on enclosure
- Flexibility of the installation: Low
- Reversibility: Medium
- Ingress protection rating: IP67 according to IEC 60529
- Cable retention: Medium
- Cable diameter (mm): From 12 to 50
- Cable Installation time: Fast
- Quantity of cables to be fitted for a given surface: +
- Cable entries for cables with connectors: No
- Cut-out dimensions (mm):
Various circular hole diameters according to cable diameter
- External dimensions (mm): From Ø 12.5 to 50.7
- Flame resistance: 750 °C

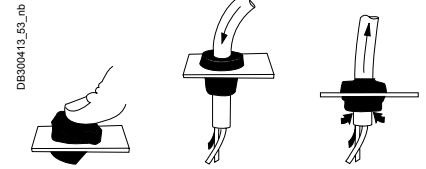

Supply:
50 (M12 to M32)
25 (M40 and M50)



IMT36179

Characteristics	Dimensions			References
	ISO	Drill hole (Ø mm)	Cable (Ø mm)	
Quick cable entries	M12	12.5	3 - 5	IMT36179
Quick cable entries	M16	16	5 - 7	IMT36180
Quick cable entries	M20	20.3	7 - 10	IMT36181
Quick cable entries	M25	25.3	10 - 14	IMT36182
Quick cable entries	M32	32.4	14 - 20	IMT36183
Quick cable entries	M40	40.7	20 - 26	IMT36184
Quick cable entries	M50	50.7	26 - 35	IMT36185

Simple-5

- ISO cable gland.
- Material: PA6 Polyamide, neoprene gasket
- Color: RAL 7035 gray
- Cable entry material: Combined
- Installation options: On cable gland plate or directly on enclosure
- Flexibility of the installation: Low
- Reversibility: Medium
- Ingress protection rating: IP68
- Cable retention: High
- Cable diameter (mm): From 12 to 40
- Cable Installation time: Slow
- Quantity of cables to be fitted for a given surface: +
- Cable entries for cables with connectors: No
- Cut-out dimensions (mm): Various circular hole diameters according to cable diameter
- External dimensions (mm): From Ø 15 to 46
- Certificate: VDE, UL Recognized (UR)
- Flame resistance: 750 °C

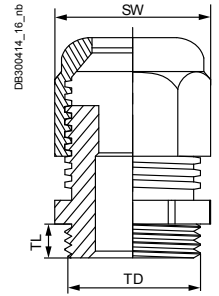

Supply:

The cable glands are supplied with nuts
Pack of 20 (M12 to M20), of 10 (M25 and M32), of 5 (M40)



ISM71503

Characteristics	Dimensions					References
	Cable (Ø mm)	Drill hole (Ø mm)	TD	TL	SW	
Cable gland	3 / 6.5	12.2 (0 + 0.2)	12	6	15	ISM71501
Cable gland	4 / 8	16.2 (0 + 0.2)	16	8	19	ISM71502
Cable gland	6 / 12	20.2 (0 + 0.2)	20	10	24	ISM71503
Cable gland with high resistance to fire	6 / 12	20.2 (0 + 0.2)	20	10	24	IMT36150
Cable gland	11 / 17	25.2 (0 + 0.2)	25	8	29	ISM71504
Cable gland	15 / 21	32.2 (0 + 0.3)	32	10	36	ISM71505
Cable gland	19 / 28	40.5 (0 + 0.3)	40	10	46	ISM71506

Synthetic Snap-In Cable Gland

- Without thread.
- Easy assembly and disassembly.
- Suitable for walls from 0.5 to 4 mm thick.
- Material: PA6 Polyamide, neoprene gasket
- Color: RAL 7035 gray, RAL 7001, RAL 9005. Other colors on demand
- Cable entry material: Non-armoured
- Installation options: On cable gland plate or directly on enclosure
- Flexibility of the installation: Low
- Reversibility: Medium
- Ingress protection rating: IP66
- Cable retention: High
- Cable diameter (mm): From 16 to 40
- Cable Installation time: Slow
- Quantity of cables to be fitted for a given surface: +
- Cable entries for cables with connectors: No
- Thread type: Metric EN 60423
Other types are available on demand
- Cut-out dimensions (mm): Various circular hole diameters according to cable diameter
- External dimensions (mm): From Ø 22 to 46
- Certificates: UR (cURus) Type 4x except for the size M40
- Standard: DIN EN 62444, UL 514B, UL 514B§8.26.7
- Temperature range: -20 °C to + 100 °C

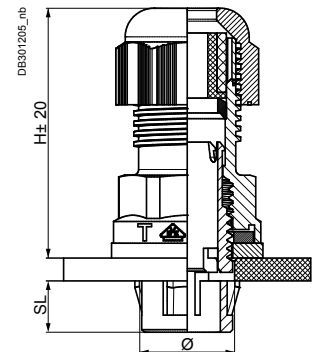

Supply:

The cable glands are supplied with nuts
Pack of 20 (M16 and M20), of 10 (M25 and M32), of 5 (M40)



NSYCGSP16

Characteristics	Dimensions						References	
	Ø	Ø min / max	Drill Ø	SL	SD	H		
Synthetic snap-in cable gland	M16	5/10	16.2 to 16.4	9	15.9	42.5	22	NSYCGSP16
Synthetic snap-in cable gland	M20	6/12	20.2 to 20.4	9	19.9	41.5	24	NSYCGSP20
Synthetic snap-in cable gland	M25	11/17	25.2 to 25.4	9	24.9	43.5	29	NSYCGSP25
Synthetic snap-in cable gland	M32	15/21	32.2 to 32.4	9	31.9	49.5	36	NSYCGSP32
Synthetic snap-in cable gland	M40	19/28	40.2 to 40.4	11.5	39.9	56	46	NSYCGSP40

Stainless-Steel Cable Gland with Lamellar Insert

- Lamellar technology provides excellent resistance to traction as well as excellent torsional protection. For aggressive environments.
- Material: Stainless-steel AISI 304L or AISI 316L, neoprene gasket
- Cable entry material: Non armoured
- Installation options:
 - On cable gland plate or directly on enclosure
- Flexibility of the installation: Low
- Reversibility: Medium
- Ingress protection rating: IP68
- Cable retention: High
- Cable diameter (mm): From 12 to 40
- Cable Installation time: Slow
- Quantity of cables to be fitted for a given surface: +
- Cable entries for cables with connectors: No
- Thread type: Metric EN 60423
- Cut-out dimensions (mm):
 - Various circular hole diameters according to cable diameter
- External dimensions (mm): From Ø 14 to 43
- Certificates: UL recognized (cURus). Rated Type 4, 4X according UL50E
- Standard: DIN EN 62444, UL 514
- Temperature range: -20 °C to + 100 °C

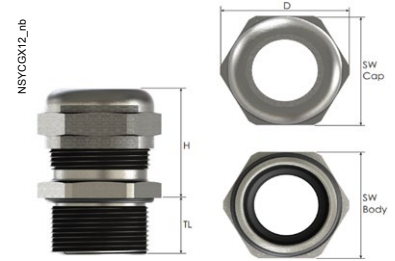

Supply:
The cable glands are supplied with nuts
Pack of 5 (M12 and M16), of 4 (M20 and M25),
of 2 (M32 and M40)



NSYCGX12

Characteristics	Dimensions							References
	Ø	Ø min-max mm	Thread Length TL mm	SW Cap mm	SW Body mm	Outer Ø D mm	max. Height H mm	
AISI 304L	M12x1.5	3.0 - 6.5	6	14	14	15.5	24	NSYCGX12
AISI 304L	M16x1.5	4.0 - 8.0	7	17	19	21	25.5	NSYCGX16
AISI 304L	M20x1.5	10.0 - 14.0	8	24	24	26.5	30	NSYCGX20
AISI 304L	M25x1.5	10.0 - 14.0	8	24	27	30	30	NSYCGX25
AISI 304L	M32x1.5	13.0 - 18.0	9	30	36	39.8	35	NSYCGX32
AISI 304L	M40x1.5	18.0 - 25.0	9	41	46	51.4	40.5	NSYCGX40
AISI 316L	M12x1.5	3.0 - 6.5	6	14	14	15.5	24	NSYCGX12H
AISI 316L	M16x1.5	4.0 - 8.0	7	17	19	21	25.5	NSYCGX16H
AISI 316L	M20x1.5	10.0 - 14.0	8	24	24	26.5	30	NSYCGX20H
AISI 316L	M25x1.5	10.0 - 14.0	8	24	27	30	30	NSYCGX25H
AISI 316L	M32x1.5	13.0 - 18.0	9	30	36	39.8	35	NSYCGX32H
AISI 316L	M40x1.5	18.0 - 25.0	9	41	46	51.4	40.5	NSYCGX40H

Single-Door Enclosure

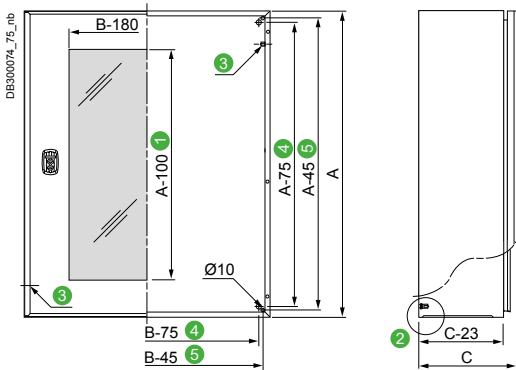

Double-Door Enclosure

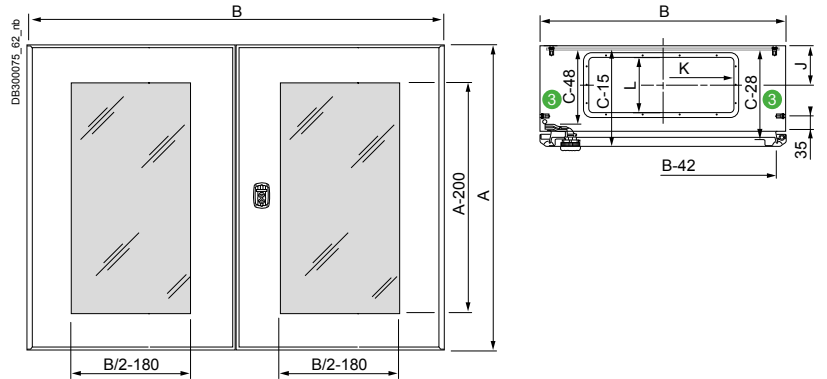

- A: Enclosure height
- B: Enclosure width
- C: Enclosure depth

- 1 A-200 from the height of 800 mm.
- 2 4 or 6 (widths 1000 - 1200 mm) M8 x 25 mm backstuds.
- 3 2 M6 x 17.5 mm earthing studs
- 4 Stud center-to-center distance.
- 5 Center-to-center distance of the holes for direct fixing.

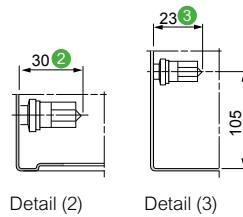

Comment:

The DXF diagrams can be downloaded from our websites.

Enclosure		Cable gland plate						
Width (mm)	Depth (mm)	Dim. (mm)	Type	No.	J	K	L	References
200 - 250	150 - 250	140 x 80	A	1	57	115	55	NSYTLA
300 - 400	150	245 x 80	B	1	57	220	55	NSYTLB
300	200	245 x 130	C	1	80	220	105	NSYTLC
400	200 - 250	345 x 130	D	1	80	320	105	NSYTLD
500	200 - 250	445 x 130	E	1	80	420	105	NSYTLE
600	200 - 250	545 x 130	F	1	80	520	105	NSYTLF
600	300 - 400	495 x 220	G	1	126*	470	195	NSYTLG
800	250 - 300 - 400	345 x 130	D	2	95**	320	105	2 x NSYTLD
1000 - 1200	300 - 400	445 x 130	E	2	95	420	105	2 x NSYTLE

* Except enclosure 1000 x 600 x 400 mm, J = 140 mm.

** Except enclosure 600 x 800 x 300 mm, J = 80 mm.

Perforated Rails on Plain Door*

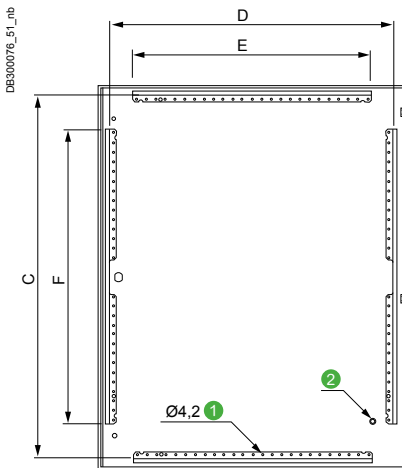

- 1 Perforations with 25 mm spacing
- 2 1 M6 x 17.5 mm earthing stud.

* The glazed doors are equipped with a vertical cable guide on the hinge side.

Enclosure**	Height (mm)	Width (mm)	Perforated rails on the door				Perforated rails on the double-door				Perforated rails on the internal door			
			Vertical (mm)		Horizontal (mm)		Vertical (mm)		Horizontal (mm)		Vertical (mm)		Horizontal (mm)	
			F	D	E	C	F	D	E	C	F	D	E	C
400	300	300	320	237	-	-	-	-	-	-	-	-	-	-
400	400	300	320	337	-	-	-	-	-	-	-	-	-	-
400	600	300	320	537	-	-	-	-	-	-	-	-	-	-
500	300	300	370	237	-	-	-	-	-	-	-	-	-	-
500	400	300	370	337	-	-	-	-	-	-	-	-	-	-
500	500	300	370	437	-	-	-	-	-	-	-	-	-	-
600	400	300	370	337	-	-	-	-	-	-	-	-	-	-
600	500	300	370	437	-	-	-	-	-	-	-	-	-	-
600	600	300	370	537	-	-	-	-	-	-	-	-	-	-
600	800	300	370	737	-	-	-	-	-	-	-	-	-	-
700	500	300	470	437	-	-	-	-	-	-	-	-	-	-
800	600	300	570	537	-	-	-	-	-	-	-	-	-	-
800	800	300	570	737	620	749	-	-	-	-	-	-	-	-
800	1000	300	570	937	820	749	570	437	320	749	620	437	320	749
800	1200	300	-	-	-	-	570	537	420	749	620	537	420	749
1000	600	300	770	537	420	949	-	-	-	-	-	-	-	-
1000	800	300	770	737	620	949	-	-	-	-	-	-	-	-
1000	1000	300	770	937	820	949	770	437	320	949	820	437	320	949
1000	1200	300	-	-	-	-	770	537	420	949	820	537	420	949
1200	600	300	970	537	420	1149	-	-	-	-	-	-	-	-
1200	800	300	970	737	620	1149	-	-	-	-	-	-	-	-
1200	1000	300	970	937	820	1149	970	437	320	1149	1020	437	320	1149
1200	1200	300	-	-	-	-	970	537	420	1149	1020	537	420	1149
1400	1000	300	-	-	-	-	970	437	320	1349	1020	437	320	1349

** The doors of enclosures with dimensions of less than 800 x 600 mm do not have horizontal cable guides.



Download the configuration sheets and DXF diagrams from www.se.com
Send them back to your local Schneider Electric office.
Take advantage of a shorter delivery time!

Installation of 2 Mounting Plates in the Enclosures with Width of 1000 or 1200 mm and Depth of 300 or 400 mm

Step slides, [page 224](#).



1 On the 6 backstuds

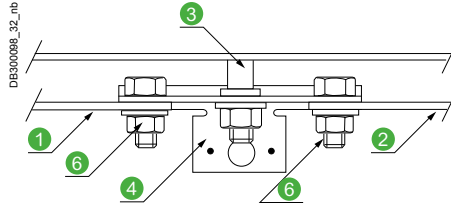

2 Two offset mounting plates with depthwise adjustment

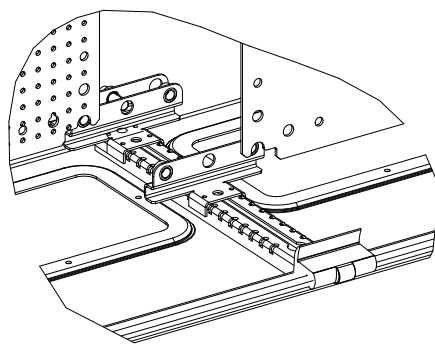
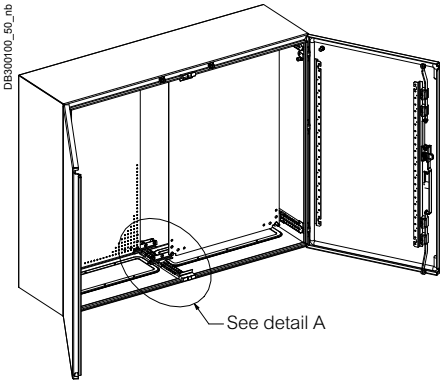
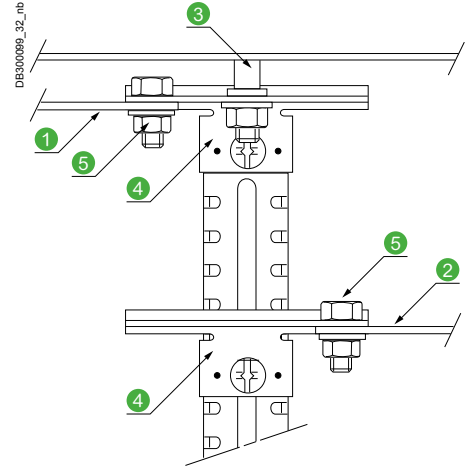

Detail A

- 1 Left mounting plate
- 2 Right mounting plate
- 3 Central backstud
- 4 Bracket ref. NSYCRNGSDR with 2 M8 x 20 mm screws
- 5 M8 x 20 mm screw

Installation of Telequick Mounting Plates

Spacers for raising the mounting plate in the enclosures equipped with 6 studs.

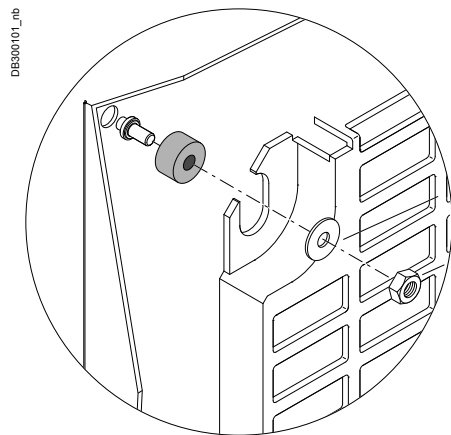

Reference NSYEMR

Acceptable Loads on the Mounting Plates, Bases and Doors



Spacial 3D wall-mounted enclosures

Acceptable loads (kg)					References
On plain mounting plates	On base	On door *	On vertical lug	On horizontal lug	
60	135	50	350	190	NSYS3D3215 to NSYS3D5320
90	135	50	350	190	NSYS3D5420 to NSYS3D6425
135	135	50	350	190	NSYS3D6620 to NSYS3D8630
150	135	50	350	190	NSYS3D10625 to NSYS3D10830
180	135	50	350	190	NSYS3D101030D to NSYS3D141030D

* On a sheet door with a thickness of 20/10⁶ mm: 60 kg of maximum acceptable load (please consult us).

Areas without Cut-Outs

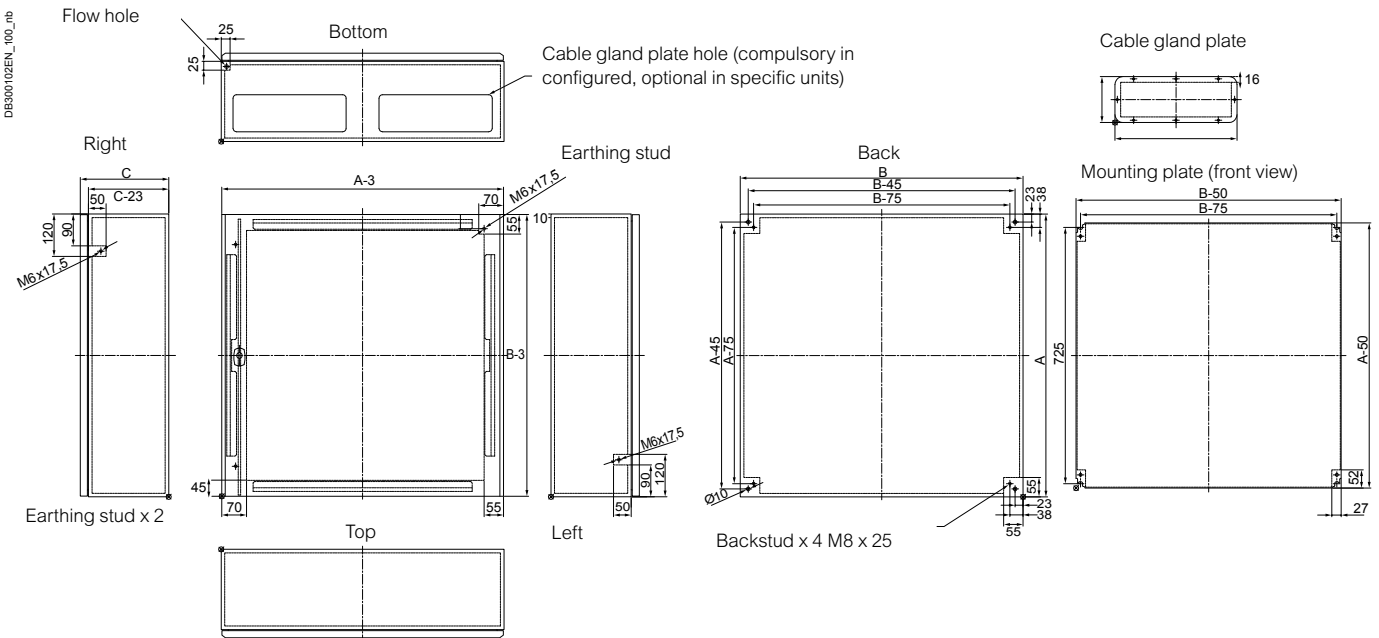

- For 800, 1000 and 1200 mm widths, 2 cable gland plates: See previous page.
- Vertical cable guides from 400 mm height.
- Horizontal cable guides from 800 mm width.
- Download our DXF diagrams from our websites.

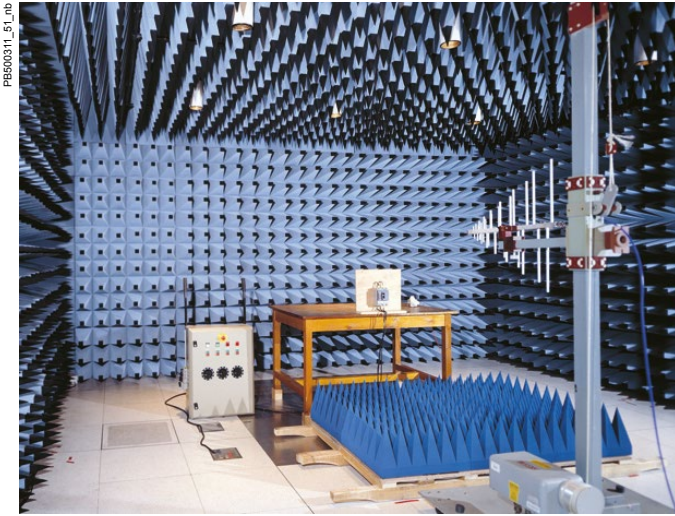

Standard Spacial S3D enclosures are tested against electromagnetic interference. Since the enclosure is tested empty, it is advisable to rerun the tests with the enclosure completely equipped in its final configuration.

Earth braids to be ordered separately, see [page 278](#).

Another solution and information on electromagnetic compatibility: Spacial S3HF enclosure, [page 424](#).

Attenuation Curve of the Spacial S3D Compared with the Spacial S3HF

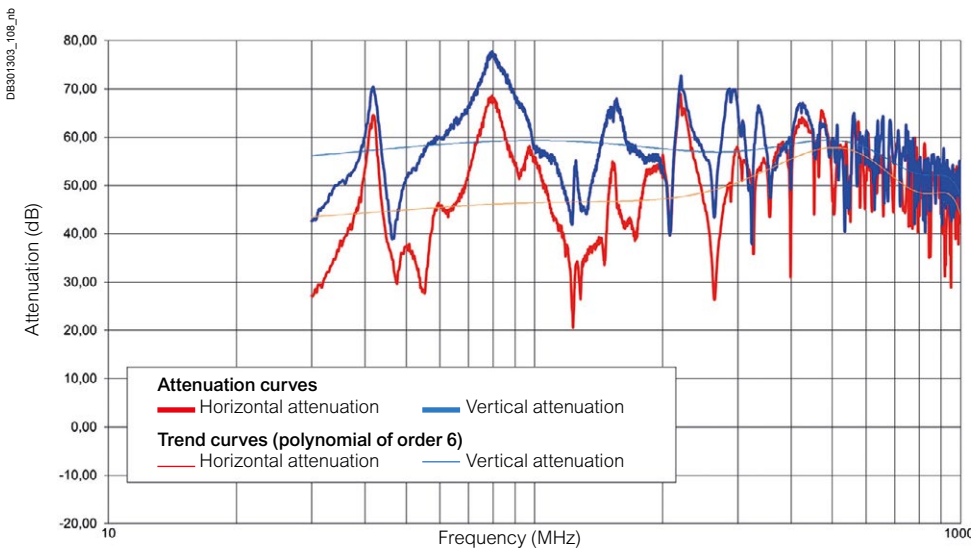

Frequency: 3 - 13.2 Hz
 Amplitude: 1 mm/sec below 22 Hz
 Frequency: 3 - 100 Hz
 Acceleration: 0.7 g above 30 Hz

Vibration constraints

Specific construction of the Spacial S3D - single-piece body (cross-shaped structure). The rear is flat without added parts - this allows it to comply with certain vibration constraints. The tests were conducted according to the "rules for ships" by "Det Norske Veritas". Enclosures labelled "DNV" have undergone these tests and obtained classification "A". Since the enclosure is tested empty, it is advisable to rerun the tests with the enclosure completely equipped in its final configuration.

Seismic constraint

The seismic behavior of the the wall-mounted enclosure Spacial S3D has been qualified according to MRI spectra "big material" specified in the standard IEC 60068-2-6 and IEC 60068-2-57 (see [page 388](#) for more details).

Tested enclosure configuration:

- Plain door,
- Plain mounting plate with a load of 250 kg/m² uniformly distributed on the mounting plate,
- Fixing to the wall with M8 screws (tightening torque: 12 Nm ± 1 Nm).

ATEX compliance

The Spacial S3D enclosure (with adaptation) is ATEX-certified by the LCIE.

Environmental properties

Compliance with RoHS standard.



Post Fixing Device for Spacial Steel Enclosure

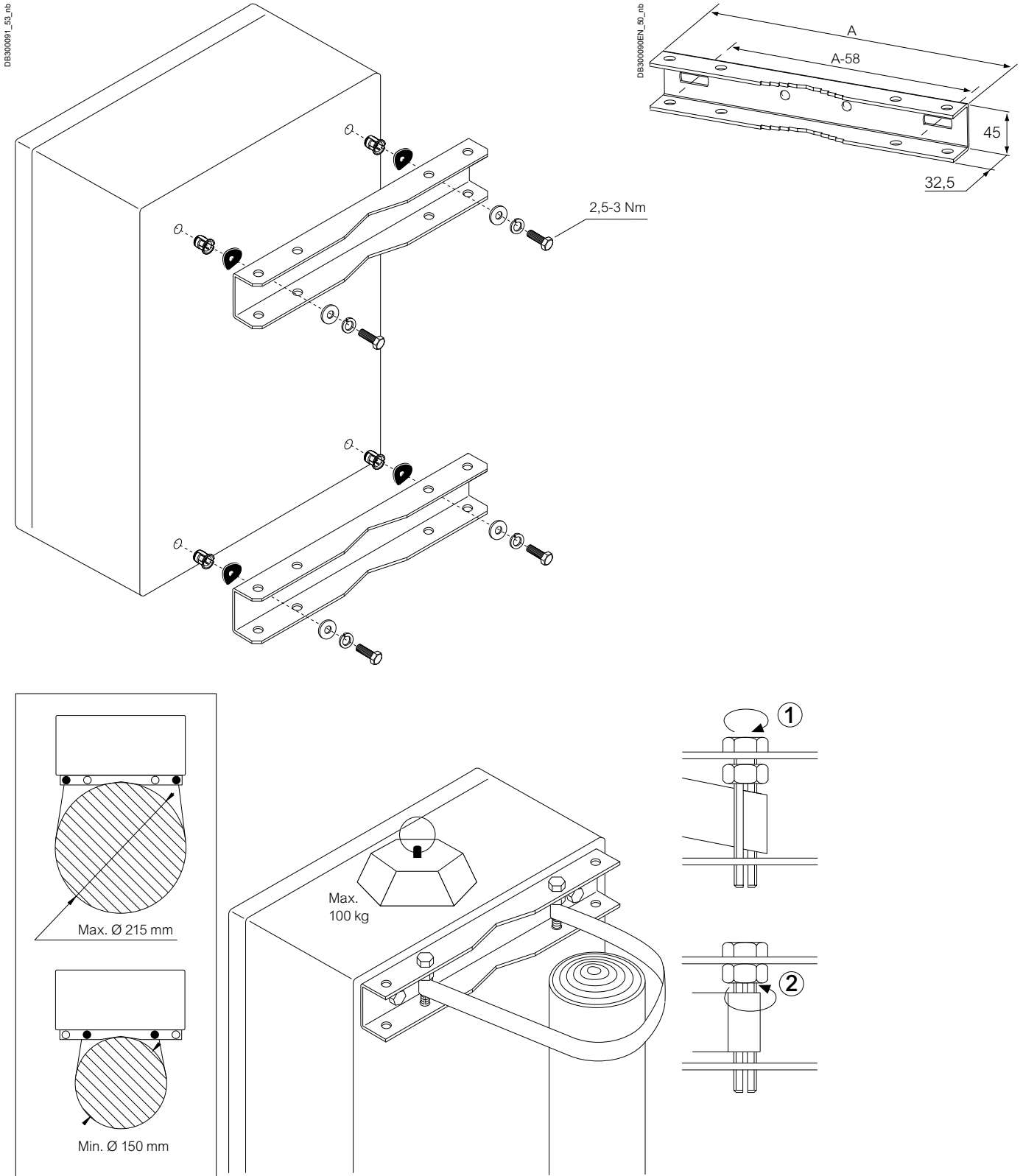

Mounting Rail



Quick-Fixing Cross-Rails

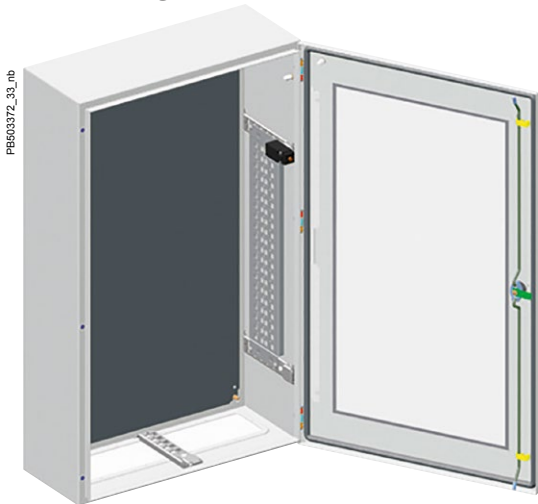

Ease of Installation



Door Switch Mounting Option

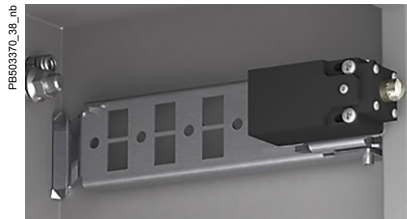

With Din Rail

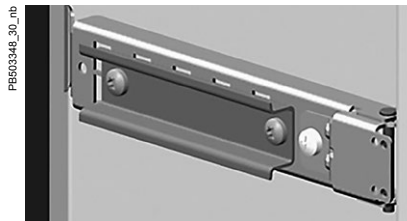

With Light Cross-Rails and Cage Nut

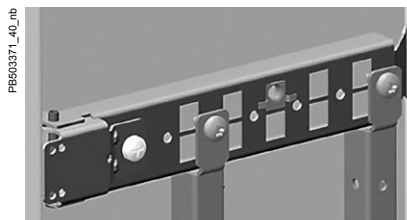

Standard Cable Gland Plate

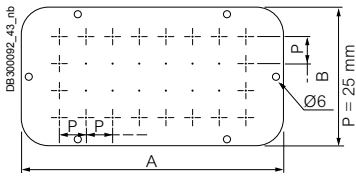

Width (A)	Depth (B)	Standard References	Aluminum References
140	80	NSYTLA	NSYTLAU
245	80	NSYTLB	NSYTLBU
245	130	NSYTLC	NSYTLCU
345	130	NSYTLD	NSYTLDU
445	130	NSYTLE	NSYTLEU
545	130	NSYTLF	NSYTLFU
495	220	NSYTLG	NSYTLGU
345	130	2x NSYTLD	2x NSYTLDU
445	130	2x NSYTLE	2x NSYTLEU

Cable Gland Plates with FL-Type Cut-Out for Cable Gland Membranes

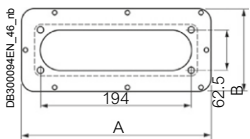

NSYTLBFL, NSYTL CFL, NSYTLDFL,
NSYTLEFL, NSYTLFFL, NSYTLGBFL

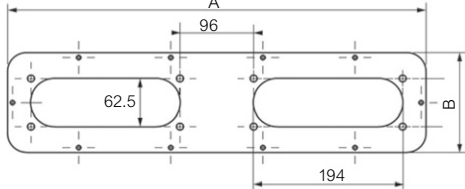

NSYTLBFL, NSYTLG2FL

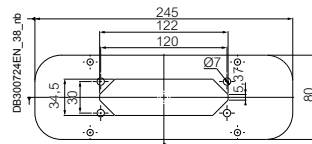

NSYTLBFL

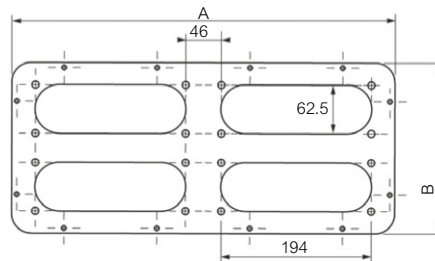

NSYTLBFL

Width (A)	Depth (B)	References
140	80	NSYTLAFL
245	80	NSYTLBFL
245	130	NSYTL CFL
345	130	NSYTLDFL
445	130	NSYTLEFL
545	130	NSYTLFFL
545	130	NSYTLF2FL
495	220	NSYTLGFL
495	220	NSYTLG2FL
495	220	NSYTLG4FL
345	130	2x NSYTLDFL
445	130	2x NSYTLEFL

Internal Door

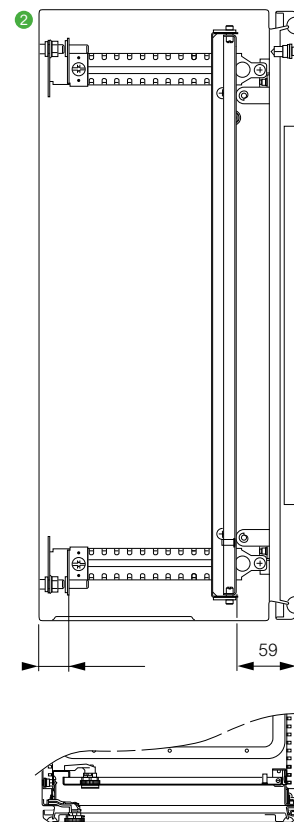
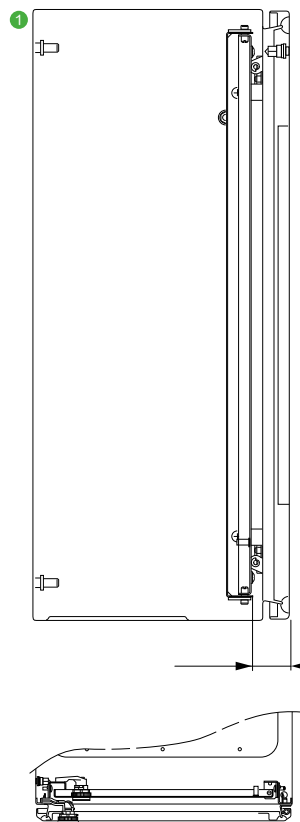
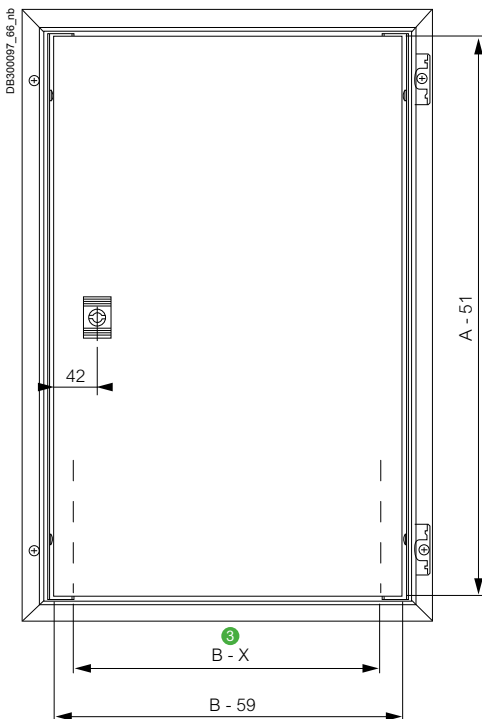

- 1 Installation on the front of the enclosure or
- 2 installation on step slides
- 3 Dimension resulting from installation on step slides: B-83 mm.
Dimension resulting from direct installation (without step slides): B-91 mm

Technical changes reserved. Information provided without guarantee. Images are for illustrative purposes only.

Steel Floor-Standing Enclosures

3

Compact Enclosures Spacial SM



Modular Enclosures PanelSet SFN



Spacial SM - PanelSeT SFN

Introduction	76
Characteristics	78
Selection Guide	80
Accessories	86
Dimensions	110

Multi-Purpose IP55 Compact Steel Enclosure for Fast and Simple Solutions

This range can be configured according to your needs

4 different services available:



Assemble to Order



Mounting of Standard Accessories



Painting



Machining



Robust

- Body made as a single piece with welded rear panel.
- Front part forming a rigid frame with welded corners.



Protection

- IP guaranteed by the rigidity of the enclosure, the expanded-polyurethane sealing gasket of the enclosure and the subsequent welding.
- Double-door enclosures with inner lock on the left door.



Practical

- Height-adjustable door rails suitable for cable fixing.
- Can be installed with adapter profile in the front and rear of the enclosure, the universal 40-mm cross-rail (1 row) in the rear provides the same fixing points as the modular enclosure.



Comfort

- Handle with sturdy design for easily activating the locking system, allowing the installation of any shape insert and any cylindrical combination key.
- Easily interchangeable insert with one click.

See page 474 for details or consult our web site www.se.com

PanelSeT SFN Modular Floor-Standing Decarbonized Steel Enclosures



Sustainable

Structure contains recycled steel manufactured with renewable energy sources with significant reduction of CO₂ emissions.

Reusable eco-friendly packaging composed mainly by cardboard.



Robust

New patented frame and fixation corner system in a bolted structure. Uprights fixed by 8 screws, one at each corner of the enclosure.

Capable of withstanding a static load of up to 1500 kg throughout its volume.

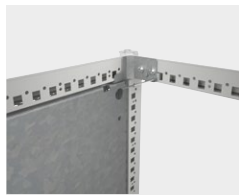

Efficient

- Quick system for the mounting plate allowing faster assembly.
- Most accessories to be installed using the same self-tapping Torx T30 screws or nuts.



- Quick door removal and installation to facilitate assembly.

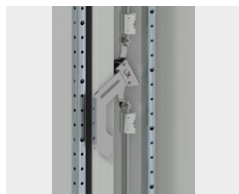

- Second door handle for easy and ergonomic open-close operation.

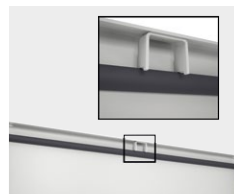

- Panels include self-centering piece and captive screws for easier assembly and dismantling.



Aesthetics

- Extended roof and panels giving a new smoother appearance with less fixation points.



- Ergonomic and convenient main handle, which features a label that can be used for customizing a signature or identification tag.



Flexible

- Delivered assembled, with or without plate, with plain or glazed door, as a kit or customized to adapt to all spaces and needs.



Compatible

- Fully couplable with the previous Spatial SF version and compatible with its accessories.



Modular

- The design allows enclosures to be coupled in any direction and layout, adapting to all installation surfaces.

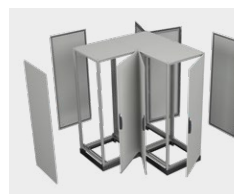

Accessible

- The symmetric design of the profile allows doors to be installed on any side of the enclosure, opening right or left and providing full accessibility to the enclosure.

Technical changes reserved. Information provided without guarantee. Images are for illustrative purposes only.



Characteristics	Compact enclosures Spatial SM
	<ul style="list-style-type: none"> • Compact body with a front rigid frame with welded corners and rear panel supports installed in depth to adjust and fix the equipment with a pitch of 25 mm
Basic composition	<ul style="list-style-type: none"> • The double doors are overlapping, with system for fixing the left door • Door reversible, 120° opening • Welded rear panel • System with 4 locking points with handle and 5-mm double-bar insert • Cable gland plate 1 entry • Mounting plate support brackets
Versions / Configurations	<ul style="list-style-type: none"> • Compact enclosure with plain door and mounting plate • Compact enclosure with plain door and without mounting plate • Compact enclosure with transparent Securit® glass door and without mounting plate
Protection of personnel	Earthing accessories needed to ensure the grounding continuity, page 278
Material	Steel
Finish	Structured finish, epoxy polyester powder
Color	RAL 7035 gray
Ingress protection rating	IP55 according to IEC 60529
Mechanical protection rating	IK10 for plain door and IK08 for transparent door according to IEC 62262
Standards	Compliance with enclosure standard IEC 62208 and RoHS and REACH directive
Certifications	BV Marine, UL (cULus), Rating according UL50E : single-door enclosures : Types 1, 2, 3R, 5 and 13. Double-door enclosures Types 1, 12
Installation	* Compliant with IEC 62208 regarding type tests specified in §9.12 (resistance to UV radiation) and §9.13 (resistance to corrosion) Canopy needed to avoid water stagnation on the upper part of the enclosure, page 100
Maximum load	500 kg
Options	<ul style="list-style-type: none"> • Plinths, heights 100 mm and 200 mm, page 91 • Lifting eyebolts, page 99 • Internal door, page 103 • Door accessories, page 105 • Other locking options, page 108 • Mounting plates and Telequick system, page 226



SFN

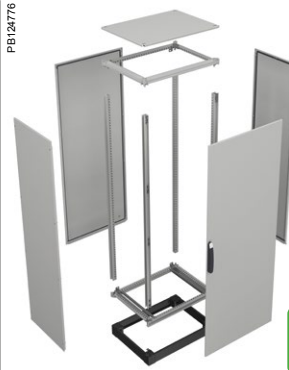

SFN
kit

Suitable enclosures PanelSet SFN - supplied assembled

- Structure made up of vertical uprights joined with top and bottom frames
- Panels and doors built into the structure
- Formed from a single section and perforated structure with a pitch of 25 mm
- Front door with a reinforcement frame (horizontal rails height-adjustable) and bottom trim
- The double doors are overlapping, with a central handle on the left door
- Door reversible, 120° opening
- Extended rear panel screwed on with captive screws
- Removable extended roof
- System with 4 locking points with handle and 5-mm double-bar insert
- Mounting plate support brackets (for widths from 600 mm) and quick-fixation system
- Mounting plate sliding rails (for widths from 600 mm)

- Modular enclosure with plain door and mounting plate
- Modular enclosure with plain door and without mounting plate
- Modular enclosure with transparent Securit® glass door and without mounting plate

Earthing accessories needed to ensure grounding continuity

Decarbonized steel

Structured finish, epoxy polyester powder

RAL 7035 gray

IP55 according to IEC 60529 (with side panels and plain cable gland plate with gasket)

IK10 for plain door and IK08 for transparent door according to IEC 62262

Compliance with enclosure standard IEC 62208 and RoHS and REACH directive

BV, DNV, UL (cULus) Rating according to UL50E: Types 1, 3R, 12

1500 kg

- Side panels options, [page 87](#)
- Enclosure suites options, [page 88](#)
- Plinths, heights 100 mm and 200 mm, [page 89](#)
- Cable gland plates, [page 95](#)
- Lifting systems, [page 99](#)
- Roof options, [page 101](#)
- Door accessories, [page 105](#)
- Other locking options, [page 108](#)
- Mounting plates and Telequick system, [page 226](#)

Suitable enclosures PanelSet SFN - supplied as a kit

- Separate door, panels, frames and vertical uprights

- Front door with a reinforcement frame (horizontal rails height-adjustable) and bottom trim
- The double doors are overlapping, with a central handle on the left door
- Door reversible, 120° opening
- Extended rear panel to be screwed on with captive screws
- Removable extended roof delivered with top and bottom frame
- System with 4 locking points with handle and 5-mm double-bar insert
- Mounting plate support brackets delivered with top and bottom frame kit (for widths from 600 mm) and quick-fixation system
- Mounting plate sliding rails delivered with top and bottom frame kit (for widths from 600 mm)

- Uprights kit
- Top and bottom frame kit
- Rear panel kit
- Door kit (plain or transparent)





- Side panels options, [page 87](#)
- Enclosure suites options, [page 88](#)
- Plinths, heights 100 mm and 200 mm, [page 89](#)
- Cable gland plates, [page 95](#)
- Lifting systems, [page 99](#)
- Roof options, [page 101](#)
- Other locking options, [page 108](#)
- Mounting plates and Telequick system, [page 226](#)

Dimensions			Enclosures			Plinth (H 100 mm)		
Height (mm)	Width (mm)	Depth (mm)	Doors	Plain door, without mounting plate	Plain door, with mounting plate	Transparent door, without mounting plate	Front kit (corners + front panels)	Side panels, 2 u.
1200	800	300	1	NSYSM12830	NSYSM12830P	-	NSYSPPF8100	NSYSPPS3100
1200	1000	300	2	NSYSM1210302D	NSYSM1210302DP	-	NSYSPPF10100	NSYSPPS3100
1200	1200	400	2	NSYSM1212402D	NSYSM1212402DP	-	NSYSPPF12100	NSYSPPS4100
1400	600	300	1	NSYSM14630	NSYSM14630P	-	NSYSPPF6100	NSYSPPS3100
1400	600	400	1	NSYSM14640	NSYSM14640P	-	NSYSPPF6100	NSYSPPS4100
1400	800	300	1	NSYSM14830	NSYSM14830P	-	NSYSPPF8100	NSYSPPS3100
1400	800	400	1	NSYSM14840	NSYSM14840P	NSYSM14840T	NSYSPPF8100	NSYSPPS4100
1400	1000	400	2	NSYSM1410402D	NSYSM1410402DP	-	NSYSPPF10100	NSYSPPS4100
1400	1200	400	2	NSYSM1412402D	NSYSM1412402DP	-	NSYSPPF12100	NSYSPPS4100
1600	600	300	1	NSYSM16630	NSYSM16630P	-	NSYSPPF6100	NSYSPPS3100
1600	600	400	1	NSYSM16640	NSYSM16640P	NSYSM16640T	NSYSPPF6100	NSYSPPS4100
1600	800	300	1	NSYSM16830	NSYSM16830P	-	NSYSPPF8100	NSYSPPS3100
1600	800	400	1	NSYSM16840	NSYSM16840P	NSYSM16840T	NSYSPPF8100	NSYSPPS4100
1600	1000	300	2	NSYSM1610302D	NSYSM1610302DP	-	NSYSPPF10100	NSYSPPS3100
1600	1000	400	2	NSYSM1610402D	NSYSM1610402DP	-	NSYSPPF10100	NSYSPPS4100
1600	1200	300	2	NSYSM1612302D	NSYSM1612302DP	-	NSYSPPF12100	NSYSPPS3100
1600	1200	400	2	NSYSM1612402D	NSYSM1612402DP	-	NSYSPPF12100	NSYSPPS4100
1800	600	300	1	NSYSM18630	NSYSM18630P	-	NSYSPPF6100	NSYSPPS3100
1800	600	400	1	NSYSM18640	NSYSM18640P	NSYSM18640T	NSYSPPF6100	NSYSPPS4100
1800	600	500	1	NSYSM18650	NSYSM18650P	-	NSYSPPF6100	NSYSPPS5100
1800	800	300	1	NSYSM18830	NSYSM18830P	NSYSM18830T	NSYSPPF8100	NSYSPPS3100
1800	800	400	1	NSYSM18840	NSYSM18840P	NSYSM18840T	NSYSPPF8100	NSYSPPS4100
1800	800	500	1	NSYSM18850	NSYSM18850P	NSYSM18850T	NSYSPPF8100	NSYSPPS5100
1800	800	600	1	NSYSM18860	NSYSM18860P	-	NSYSPPF8100	NSYSPPS6100
1800	1000	400	1	NSYSM181040	NSYSM181040P	-	NSYSPPF10100	NSYSPPS4100
1800	1000	400	2	NSYSM1810402D	NSYSM1810402DP	-	NSYSPPF10100	NSYSPPS4100
1800	1000	500	2	NSYSM1810502D	NSYSM1810502DP	-	NSYSPPF10100	NSYSPPS5100
1800	1200	400	2	NSYSM1812402D	NSYSM1812402DP	-	NSYSPPF12100	NSYSPPS4100
1800	1200	500	2	NSYSM1812502D	NSYSM1812502DP	-	NSYSPPF12100	NSYSPPS5100
1800	1600	400	2	NSYSM1816402D	NSYSM1816402DP	-	NSYSPPF16100	NSYSPPS4100
1800	1600	500	2	NSYSM1816502D	NSYSM1816502DP	-	NSYSPPF16100	NSYSPPS5100
2000	600	300	1	NSYSM20630	NSYSM20630P	-	NSYSPPF6100	NSYSPPS3100
2000	600	400	1	NSYSM20640	NSYSM20640P	NSYSM20640T	NSYSPPF6100	NSYSPPS4100
2000	600	500	1	NSYSM20650	NSYSM20650P	-	NSYSPPF6100	NSYSPPS5100
2000	800	300	1	NSYSM20830	NSYSM20830P	NSYSM20830T	NSYSPPF8100	NSYSPPS3100
2000	800	400	1	NSYSM20840	NSYSM20840P	NSYSM20840T	NSYSPPF8100	NSYSPPS4100
2000	800	500	1	NSYSM20850	NSYSM20850P	NSYSM20850T	NSYSPPF8100	NSYSPPS5100
2000	800	600	1	NSYSM20860	NSYSM20860P	NSYSM20860T	NSYSPPF8100	NSYSPPS6100
2000	1000	400	2	NSYSM2010402D	NSYSM2010402DP	-	NSYSPPF10100	NSYSPPS4100
2000	1000	500	2	NSYSM2010502D	NSYSM2010502DP	-	NSYSPPF10100	NSYSPPS5100
2000	1200	400	2	NSYSM2012402D	NSYSM2012402DP	-	NSYSPPF12100	NSYSPPS4100
2000	1200	500	2	NSYSM2012502D	NSYSM2012502DP	-	NSYSPPF12100	NSYSPPS5100
2000	1200	600	2	NSYSM2012602D	NSYSM2012602DP	-	NSYSPPF12100	NSYSPPS6100
2000	1600	400	2	NSYSM2016402D	NSYSM2016402DP	-	NSYSPPF16100	NSYSPPS4100
2000	1600	500	2	NSYSM2016502D	NSYSM2016502DP	-	NSYSPPF16100	NSYSPPS5100
2000	1600	600	2	NSYSM2016602D	NSYSM2016602DP	-	NSYSPPF16100	NSYSPPS6100

Plinth (H 200 mm)		Inner door	Mounting plate	Vertical uprights		19" swing rack		Dimensions		
Front kit (corners + front panels)	Side panels, 4 u.	Plain door	Galvanized	Standard	Technical	Off-center	Centered	Height (mm)	Width (mm)	Depth (mm)
NSYSPF8200	NSYSPS3200	-	NSYMP128	-	NSYTVR12	-	-	1200	800	300
NSYSPF10200	NSYSPS3200	-	NSYMP1210	-	NSYTVR12	-	-	1200	1000	300
NSYSPF12200	NSYSPS4200	-	NSYMP1212	-	NSYTVR12	-	-	1200	1200	400
NSYSPF6200	NSYSPS3200	-	NSYMP146	-	NSYTVR14	-	-	1400	600	300
NSYSPF6200	NSYSPS4200	-	NSYMP146	-	NSYTVR14	-	-	1400	600	400
NSYSPF8200	NSYSPS3200	-	NSYMP148	-	NSYTVR14	NSYRSW27	-	1400	800	300
NSYSPF8200	NSYSPS4200	-	NSYMP148	-	NSYTVR14	NSYRSW27	-	1400	800	400
NSYSPF10200	NSYSPS4200	-	NSYMP1410	-	NSYTVR14	-	-	1400	1000	400
NSYSPF12200	NSYSPS4200	-	NSYMP1412	-	NSYTVR14	-	-	1400	1200	400
NSYSPF6200	NSYSPS3200	NSYID166	NSYMP166	-	NSYTVR16	-	-	1600	600	300
NSYSPF6200	NSYSPS4200	NSYID166	NSYMP166	-	NSYTVR16	-	-	1600	600	400
NSYSPF8200	NSYSPS3200	NSYID168	NSYMP168	-	NSYTVR16	NSYRSW31	-	1600	800	300
NSYSPF8200	NSYSPS4200	NSYID168	NSYMP168	-	NSYTVR16	NSYRSW31	-	1600	800	400
NSYSPF10200	NSYSPS3200	-	NSYMP1610	-	NSYTVR16	-	-	1600	1000	300
NSYSPF10200	NSYSPS4200	-	NSYMP1610	-	NSYTVR16	-	-	1600	1000	400
NSYSPF12200	NSYSPS3200	-	NSYMP1612	-	NSYTVR16	-	-	1600	1200	300
NSYSPF12200	NSYSPS4200	-	NSYMP1612	-	NSYTVR16	-	-	1600	1200	400
NSYSPF6200	NSYSPS3200	NSYID186	NSYMP186	NSYVR18	NSYTVR18	-	-	1800	600	300
NSYSPF6200	NSYSPS4200	NSYID186	NSYMP186	NSYVR18	NSYTVR18	-	-	1800	600	400
NSYSPF6200	NSYSPS5200	NSYID186	NSYMP186	NSYVR18	NSYTVR18	-	-	1800	600	500
NSYSPF8200	NSYSPS3200	NSYID188	NSYMP188	NSYVR18	NSYTVR18	NSYRSW36	NSYRSWC36	1800	800	300
NSYSPF8200	NSYSPS4200	NSYID188	NSYMP188	NSYVR18	NSYTVR18	NSYRSW36	NSYRSWC36	1800	800	400
NSYSPF8200	NSYSPS5200	NSYID188	NSYMP188	NSYVR18	NSYTVR18	NSYRSW36	NSYRSWC36	1800	800	500
NSYSPF8200	NSYSPS6200	NSYID188	NSYMP188	NSYVR18	NSYTVR18	NSYRSW36	NSYRSWC36	1800	800	600
NSYSPF10200	NSYSPS4200	NSYID1810	NSYMP1810	NSYVR18	NSYTVR18	-	-	1800	1000	400
NSYSPF10200	NSYSPS4200	NSYID1810	NSYMP1810	NSYVR18	NSYTVR18	-	-	1800	1000	400
NSYSPF10200	NSYSPS5200	NSYID1810	NSYMP1810	NSYVR18	NSYTVR18	-	-	1800	1000	500
NSYSPF12200	NSYSPS4200	-	NSYMP1812	NSYVR18	NSYTVR18	-	-	1800	1200	400
NSYSPF12200	NSYSPS5200	-	NSYMP1812	NSYVR18	NSYTVR18	-	-	1800	1200	500
NSYSPF16200	NSYSPS4200	-	NSYMP1816	NSYVR18	NSYTVR18	-	-	1800	1600	400
NSYSPF16200	NSYSPS5200	-	NSYMP1816	NSYVR18	NSYTVR18	-	-	1800	1600	500
NSYSPF6200	NSYSPS3200	NSYID206	NSYMP206	NSYVR20	NSYTVR20	-	-	2000	600	300
NSYSPF6200	NSYSPS4200	NSYID206	NSYMP206	NSYVR20	NSYTVR20	-	-	2000	600	400
NSYSPF6200	NSYSPS5200	NSYID206	NSYMP206	NSYVR20	NSYTVR20	-	-	2000	600	500
NSYSPF8200	NSYSPS3200	NSYID208	NSYMP208	NSYVR20	NSYTVR20	NSYRSW40	NSYRSWC40	2000	800	300
NSYSPF8200	NSYSPS4200	NSYID208	NSYMP208	NSYVR20	NSYTVR20	NSYRSW40	NSYRSWC40	2000	800	400
NSYSPF8200	NSYSPS5200	NSYID208	NSYMP208	NSYVR20	NSYTVR20	NSYRSW40	NSYRSWC40	2000	800	500
NSYSPF8200	NSYSPS6200	NSYID208	NSYMP208	NSYVR20	NSYTVR20	NSYRSW40	NSYRSWC40	2000	800	600
NSYSPF10200	NSYSPS4200	NSYID2010	NSYMP2010	NSYVR20	NSYTVR20	-	-	2000	1000	400
NSYSPF10200	NSYSPS5200	NSYID2010	NSYMP2010	NSYVR20	NSYTVR20	-	-	2000	1000	500
NSYSPF12200	NSYSPS4200	-	NSYMP2012	NSYVR20	NSYTVR20	-	-	2000	1200	400
NSYSPF12200	NSYSPS5200	-	NSYMP2012	NSYVR20	NSYTVR20	-	-	2000	1200	500
NSYSPF12200	NSYSPS6200	-	NSYMP2012	NSYVR20	NSYTVR20	-	-	2000	1200	600
NSYSPF16200	NSYSPS4200	-	NSYMP2016	NSYVR20	NSYTVR20	-	-	2000	1600	400
NSYSPF16200	NSYSPS5200	-	NSYMP2016	NSYVR20	NSYTVR20	-	-	2000	1600	500
NSYSPF16200	NSYSPS6200	-	NSYMP2016	NSYVR20	NSYTVR20	-	-	2000	1600	600

Technical changes reserved. Information provided without guarantee. Images are for illustrative purposes only.

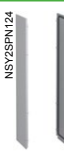
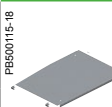
3
SFN

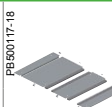
Dimensions			Enclosures			Side panels	Cable entry plates			
(A) Height (mm)	(B) Width (mm)	(C) Depth (mm)	Doors	 NSYSFN12640	 NSYSFN12640P	 NSYSFN18640T	 NSY2SPN124	 PB60015-16	 PB60016-16	 PB60017-16
				Plain door, without mounting plate	Plain door, with mounting plate	Transparent door, without mounting plate	Plain	Plain	1 entry	2 entries
1200	600	400	1	NSYSFN12640	NSYSFN12640P	-	NSY2SPN124	NSYEC64	NSYEC641	-
1200	600	600	1	NSYSFN12660	NSYSFN12660P	-	NSY2SPN126	NSYEC66	NSYEC661	NSYEC662
1200	800	400	1	NSYSFN12840	NSYSFN12840P	-	NSY2SPN124	NSYEC84	NSYEC841	-
1200	800	600	1	NSYSFN12860	NSYSFN12860P	-	NSY2SPN126	NSYEC86	NSYEC861	NSYEC862
1400	600	400	1	NSYSFN14640	NSYSFN14640P	-	NSY2SPN144	NSYEC64	NSYEC641	-
1400	800	400	1	NSYSFN14840	NSYSFN14840P	-	NSY2SPN144	NSYEC84	NSYEC841	-
1600	600	600	1	NSYSFN16660	NSYSFN16660P	-	NSY2SPN166	NSYEC66	NSYEC661	NSYEC662
1600	600	800	1	NSYSFN16680	NSYSFN16680P	-	NSY2SPN168	NSYEC68	NSYEC681	NSYEC682
1600	800	600	1	NSYSFN16860	NSYSFN16860P	-	NSY2SPN166	NSYEC86	NSYEC861	NSYEC862
1600	800	800	1	NSYSFN16880	NSYSFN16880P	-	NSY2SPN168	NSYEC88	NSYEC881	NSYEC882
1800	400	400	1	NSYSFN18440	-	-	NSY2SPN184	NSYEC44	NSYEC441	-
1800	400	500	1	NSYSFN18450	-	-	NSY2SPN185	NSYEC45	NSYEC451	-
1800	400	600	1	NSYSFN18460	-	-	NSY2SPN186	NSYEC46	NSYEC461	NSYEC462
1800	600	400	1	NSYSFN18640	NSYSFN18640P	NSYSFN18640T	NSY2SPN184	NSYEC64	NSYEC641	-
1800	600	500	1	NSYSFN18650	NSYSFN18650P	NSYSFN18650T	NSY2SPN185	NSYEC65	NSYEC651	-
1800	600	600	1	NSYSFN18660	NSYSFN18660P	-	NSY2SPN186	NSYEC66	NSYEC661	NSYEC662
1800	600	800	1	-	-	NSYSFN18680T	NSY2SPN188	NSYEC68	NSYEC681	NSYEC682
1800	800	400	1	NSYSFN18840	NSYSFN18840P	NSYSFN18840T	NSY2SPN184	NSYEC84	NSYEC841	-
1800	800	500	1	NSYSFN18850	NSYSFN18850P	NSYSFN18850T	NSY2SPN185	NSYEC85	NSYEC851	-
1800	800	600	1	NSYSFN18860	NSYSFN18860P	NSYSFN18860T	NSY2SPN186	NSYEC86	NSYEC861	NSYEC862
1800	800	600	2	NSYSFN188602D	NSYSFN188602DP	-	NSY2SPN186	NSYEC86	NSYEC861	NSYEC862
1800	1000	400	1	NSYSFN181040	NSYSFN181040P	-	NSY2SPN184	NSYEC104	NSYEC1041	-
1800	1000	400	2	NSYSFN1810402D	NSYSFN1810402DP	-	NSY2SPN184	NSYEC104	NSYEC1041	-
1800	1000	500	1	NSYSFN181050	NSYSFN181050P	-	NSY2SPN185	NSYEC105	NSYEC1051	-
1800	1000	600	1	NSYSFN181060	NSYSFN181060P	-	NSY2SPN186	NSYEC106	NSYEC1061	NSYEC1062
1800	1000	600	2	NSYSFN1810602D	NSYSFN1810602DP	-	NSY2SPN186	NSYEC106	NSYEC1061	NSYEC1062
1800	1200	400	2	NSYSFN1812402D	NSYSFN1812402DP	-	NSY2SPN184	NSYEC124	NSYEC1241	-
1800	1200	500	2	NSYSFN1812502D	NSYSFN1812502DP	-	NSY2SPN185	NSYEC125	NSYEC1251	-
1800	1200	600	2	NSYSFN1812602D	NSYSFN1812602DP	-	NSY2SPN186	NSYEC126	NSYEC1261	NSYEC1262
2000	300	500	1	NSYSFN20350	-	-	NSY2SPN205	NSYEC35	NSYEC351	-
2000	300	600	1	NSYSFN20360	-	-	NSY2SPN206	NSYEC36	NSYEC361	-
2000	300	800	1	NSYSFN20380	-	-	NSY2SPN208	-	NSYEC381	-
2000	400	400	1	NSYSFN20440	-	-	NSY2SPN204	NSYEC44	NSYEC441	-
2000	400	500	1	NSYSFN20450	-	-	NSY2SPN205	NSYEC45	NSYEC451	-
2000	400	600	1	NSYSFN20460	-	-	NSY2SPN206	NSYEC64	NSYEC461	NSYEC462
2000	400	800	1	NSYSFN20480	-	-	NSY2SPN208	NSYEC84	NSYEC481	NSYEC482
2000	600	400	1	NSYSFN20640	NSYSFN20640P	NSYSFN20640T	NSY2SPN204	NSYEC64	NSYEC641	-
2000	600	500	1	NSYSFN20650	NSYSFN20650P	NSYSFN20650T	NSY2SPN205	NSYEC65	NSYEC651	-
2000	600	600	1	NSYSFN20660	NSYSFN20660P	-	NSY2SPN206	NSYEC66	NSYEC661	NSYEC662
2000	600	800	1	NSYSFN20680	NSYSFN20680P	-	NSY2SPN208	NSYEC68	NSYEC681	NSYEC682
2000	800	400	1	NSYSFN20840	NSYSFN20840P	NSYSFN20840T	NSY2SPN204	NSYEC84	NSYEC841	-
2000	800	500	1	NSYSFN20850	NSYSFN20850P	NSYSFN20850T	NSY2SPN205	NSYEC85	NSYEC851	-
2000	800	600	1	NSYSFN20860	NSYSFN20860P	NSYSFN20860T	NSY2SPN206	NSYEC86	NSYEC861	NSYEC862
2000	800	600	2	NSYSFN208602D	NSYSFN208602DP	-	NSY2SPN206	NSYEC86	NSYEC861	NSYEC862
2000	800	800	1	NSYSFN20880	NSYSFN20880P	NSYSFN20880T	NSY2SPN208	NSYEC88	NSYEC881	NSYEC882
2000	1000	400	1	NSYSFN201040	NSYSFN201040P	NSYSFN201040T	NSY2SPN204	NSYEC104	NSYEC1041	-
2000	1000	400	2	NSYSFN2010402D	NSYSFN2010402DP	-	NSY2SPN204	NSYEC104	NSYEC1041	-
2000	1000	500	1	NSYSFN201050	NSYSFN201050P	NSYSFN201050T	NSY2SPN205	NSYEC105	NSYEC1051	-
2000	1000	500	2	NSYSFN2010502D	NSYSFN2010502DP	-	NSY2SPN205	NSYEC105	NSYEC1051	-
2000	1000	600	1	NSYSFN201060	NSYSFN201060P	NSYSFN201060T	NSY2SPN206	NSYEC106	NSYEC1061	NSYEC1062
2000	1000	600	2	NSYSFN2010602D	NSYSFN2010602DP	-	NSY2SPN206	NSYEC106	NSYEC1061	NSYEC1062
2000	1000	800	1	NSYSFN201080	NSYSFN201080P	-	NSY2SPN208	NSYEC108	NSYEC1081	NSYEC1082
2000	1200	400	2	NSYSFN2012402D	NSYSFN2012402DP	-	NSY2SPN204	NSYEC124	NSYEC1241	-
2000	1200	500	2	NSYSFN2012502D	NSYSFN2012502DP	-	NSY2SPN205	NSYEC125	NSYEC1251	-
2000	1200	600	2	NSYSFN2012602D	NSYSFN2012602DP	-	NSY2SPN206	NSYEC126	NSYEC1261	NSYEC1262
2000	1200	800	2	NSYSFN2012802D	NSYSFN2012802DP	-	NSY2SPN208	NSYEC128	NSYEC1281	NSYEC1282
2000	1600	400	2	NSYSFN2016402D	NSYSFN2016402DP	-	NSY2SPN204	NSYEC164	NSYEC1641	-
2000	1600	500	2	NSYSFN2016502D	NSYSFN2016502DP	-	NSY2SPN205	NSYEC165	NSYEC1651	-
2000	1600	600	2	NSYSFN2016602D	NSYSFN2016602DP	-	NSY2SPN206	NSYEC166	NSYEC1661	NSYEC1662
2200	400	600	1	NSYSFN22460	-	-	NSY2SPN226	NSYEC64	NSYEC461	-
2200	600	600	1	NSYSFN22660	NSYSFN22660P	-	NSY2SPN226	NSYEC66	NSYEC661	NSYEC662
2200	600	800	1	NSYSFN22680	NSYSFN22680P	-	NSY2SPN228	NSYEC68	NSYEC681	NSYEC682
2200	800	600	1	NSYSFN22860	NSYSFN22860P	-	NSY2SPN226	NSYEC86	NSYEC861	NSYEC862
2200	800	800	1	NSYSFN22880	NSYSFN22880P	NSYSFN22880T	NSY2SPN228	NSYEC88	NSYEC881	NSYEC882
2200	1000	600	1	NSYSFN221060	NSYSFN221060P	-	NSY2SPN226	NSYEC106	NSYEC1061	NSYEC1062
2200	1200	600	2	NSYSFN2212602D	NSYSFN2212602DP	-	NSY2SPN226	NSYEC126	NSYEC1261	NSYEC1262
2200	1200	800	2	NSYSFN2212802D	NSYSFN2212802DP	-	NSY2SPN228	NSYEC128	NSYEC1281	NSYEC1282

Technical changes reserved. Information provided without guarantee. Images are for illustrative purposes only.

3
SFN



Dimensions			Doors	Vertical uprights		Bottom frame and top frame with roof		Panels		Doors		Mounting plate
(A) Height (mm)	(B) Width (mm)	(C) Depth (mm)		Standard	Frames	Rear panel	Side panel	Plain	Transparent	Standard		
1200	600	400	1	NSYSFNV12	NSYSFNC64	NSYBPN126	NSY2SPN124	NSYSFND126	NSYSFND126T	NSYMP126		
1200	600	500	1	NSYSFNV12	NSYSFNC65	NSYBPN126	NSY2SPN125	NSYSFND126	NSYSFND126T	NSYMP126		
1200	600	600	1	NSYSFNV12	NSYSFNC66	NSYBPN126	NSY2SPN126	NSYSFND126	NSYSFND126T	NSYMP126		
1200	600	800	1	NSYSFNV12	NSYSFNC68	NSYBPN126	NSY2SPN128	NSYSFND126	NSYSFND126T	NSYMP126		
1200	800	400	1	NSYSFNV12	NSYSFNC84	NSYBPN128	NSY2SPN124	NSYSFND128	NSYSFND128T	NSYMP128		
1200	800	500	1	NSYSFNV12	NSYSFNC85	NSYBPN128	NSY2SPN125	NSYSFND128	NSYSFND128T	NSYMP128		
1200	800	600	1	NSYSFNV12	NSYSFNC86	NSYBPN128	NSY2SPN126	NSYSFND128	NSYSFND128T	NSYMP128		
1200	800	800	1	NSYSFNV12	NSYSFNC88	NSYBPN128	NSY2SPN128	NSYSFND128	NSYSFND128T	NSYMP128		
1400	600	400	1	NSYSFNV14	NSYSFNC64	NSYBPN146	NSY2SPN144	NSYSFND146	NSYSFND146T	NSYMP146		
1400	600	500	1	NSYSFNV14	NSYSFNC65	NSYBPN146	NSY2SPN145	NSYSFND146	NSYSFND146T	NSYMP146		
1400	600	600	1	NSYSFNV14	NSYSFNC66	NSYBPN146	NSY2SPN146	NSYSFND146	NSYSFND146T	NSYMP146		
1400	600	800	1	NSYSFNV14	NSYSFNC68	NSYBPN146	NSY2SPN148	NSYSFND146	NSYSFND146T	NSYMP146		
1400	800	400	1	NSYSFNV14	NSYSFNC84	NSYBPN148	NSY2SPN144	NSYSFND148	NSYSFND148T	NSYMP148		
1400	800	500	1	NSYSFNV14	NSYSFNC85	NSYBPN148	NSY2SPN145	NSYSFND148	NSYSFND148T	NSYMP148		
1400	800	600	1	NSYSFNV14	NSYSFNC86	NSYBPN148	NSY2SPN146	NSYSFND148	NSYSFND148T	NSYMP148		
1400	800	800	1	NSYSFNV14	NSYSFNC88	NSYBPN148	NSY2SPN148	NSYSFND148	NSYSFND148T	NSYMP148		
1600	600	400	1	NSYSFNV16	NSYSFNC64	NSYBPN166	NSY2SPN164	NSYSFND166	NSYSFND166T	NSYMP166		
1600	600	500	1	NSYSFNV16	NSYSFNC65	NSYBPN166	NSY2SPN165	NSYSFND166	NSYSFND166T	NSYMP166		
1600	600	600	1	NSYSFNV16	NSYSFNC66	NSYBPN166	NSY2SPN166	NSYSFND166	NSYSFND166T	NSYMP166		
1600	600	800	1	NSYSFNV16	NSYSFNC68	NSYBPN166	NSY2SPN168	NSYSFND166	NSYSFND166T	NSYMP166		
1600	800	400	1	NSYSFNV16	NSYSFNC84	NSYBPN168	NSY2SPN164	NSYSFND168	NSYSFND168T	NSYMP168		
1600	800	500	1	NSYSFNV16	NSYSFNC85	NSYBPN168	NSY2SPN165	NSYSFND168	NSYSFND168T	NSYMP168		
1600	800	600	1	NSYSFNV16	NSYSFNC86	NSYBPN168	NSY2SPN166	NSYSFND168	NSYSFND168T	NSYMP168		
1600	800	800	1	NSYSFNV16	NSYSFNC88	NSYBPN168	NSY2SPN168	NSYSFND168	NSYSFND168T	NSYMP168		
1800	400	400	1	NSYSFNV18	NSYSFNC44	NSYBPN184	NSY2SPN184	NSYSFND184	-	NSYMP184		
1800	400	500	1	NSYSFNV18	NSYSFNC45	NSYBPN184	NSY2SPN185	NSYSFND184	-	NSYMP184		
1800	400	600	1	NSYSFNV18	NSYSFNC46	NSYBPN184	NSY2SPN186	NSYSFND184	-	NSYMP184		
1800	400	800	1	NSYSFNV18	NSYSFNC48	NSYBPN184	NSY2SPN188	NSYSFND184	-	NSYMP184		
1800	600	400	1	NSYSFNV18	NSYSFNC64	NSYBPN186	NSY2SPN184	NSYSFND186	NSYSFND186T	NSYMP186		
1800	600	500	1	NSYSFNV18	NSYSFNC65	NSYBPN186	NSY2SPN185	NSYSFND186	NSYSFND186T	NSYMP186		
1800	600	600	1	NSYSFNV18	NSYSFNC66	NSYBPN186	NSY2SPN186	NSYSFND186	NSYSFND186T	NSYMP186		
1800	600	800	1	NSYSFNV18	NSYSFNC68	NSYBPN186	NSY2SPN188	NSYSFND186	NSYSFND186T	NSYMP186		
1800	800	400	1	NSYSFNV18	NSYSFNC84	NSYBPN188	NSY2SPN184	NSYSFND188	NSYSFND188T	NSYMP188		
1800	800	500	1	NSYSFNV18	NSYSFNC85	NSYBPN188	NSY2SPN185	NSYSFND188	NSYSFND188T	NSYMP188		
1800	800	600	1	NSYSFNV18	NSYSFNC86	NSYBPN188	NSY2SPN186	NSYSFND188	NSYSFND188T	NSYMP188		
1800	800	600	2	NSYSFNV18	NSYSFNC86	NSYBPN188	NSY2SPN186	NSYSFND1882D	-	NSYMP188		
1800	800	800	1	NSYSFNV18	NSYSFNC88	NSYBPN188	NSY2SPN188	NSYSFND188	NSYSFND188T	NSYMP188		
1800	800	800	2	NSYSFNV18	NSYSFNC88	NSYBPN188	NSY2SPN188	NSYSFND1882D	-	NSYMP188		
1800	1000	400	1	NSYSFNV18	NSYSFNC104	NSYBPN1810	NSY2SPN184	NSYSFND1810	NSYSFND1810T	NSYMP1810		
1800	1000	400	2	NSYSFNV18	NSYSFNC104	NSYBPN1810	NSY2SPN184	NSYSFND18102D	-	NSYMP1810		
1800	1000	500	1	NSYSFNV18	NSYSFNC105	NSYBPN1810	NSY2SPN185	NSYSFND1810	NSYSFND1810T	NSYMP1810		
1800	1000	600	1	NSYSFNV18	NSYSFNC106	NSYBPN1810	NSY2SPN186	NSYSFND1810	NSYSFND1810T	NSYMP1810		
1800	1000	600	2	NSYSFNV18	NSYSFNC106	NSYBPN1810	NSY2SPN186	NSYSFND18102D	-	NSYMP1810		
1800	1000	800	1	NSYSFNV18	NSYSFNC108	NSYBPN1810	NSY2SPN188	NSYSFND1810	NSYSFND1810T	NSYMP1810		
1800	1000	800	2	NSYSFNV18	NSYSFNC108	NSYBPN1810	NSY2SPN188	NSYSFND18102D	-	NSYMP1810		
1800	1200	400	2	NSYSFNV18	NSYSFNC124	NSYBPN1812	NSY2SPN184	NSYSFND18122D	NSYSFND18122DT	NSYMP1812		
1800	1200	500	2	NSYSFNV18	NSYSFNC125	NSYBPN1812	NSY2SPN185	NSYSFND18122D	NSYSFND18122DT	NSYMP1812		
1800	1200	600	2	NSYSFNV18	NSYSFNC126	NSYBPN1812	NSY2SPN186	NSYSFND18122D	NSYSFND18122DT	NSYMP1812		
1800	1200	800	2	NSYSFNV18	NSYSFNC128	NSYBPN1812	NSY2SPN188	NSYSFND18122D	NSYSFND18122DT	NSYMP1812		

Technical changes reserved. Information provided without guarantee. Images are for illustrative purposes only.

Dimensions			Doors	Vertical uprights	Bottom frame and top frame with roof	Panels		Doors		Mounting plate
(A) Height (mm)	(B) Width (mm)	(C) Depth (mm)		NSYSFNV20	NSYSFNC36	NSYBPN203	NSYBPN224	NSYSFND203	NSYSFND2010T	PS60047-7
				Standard	Frames	Rear panel	Side panel	Plain	Transparent	Standard
2000	300	500	1	NSYSFNV20	NSYSFNC35	NSYBPN203	NSY2SPN205	NSYSFND203	-	-
2000	300	600	1	NSYSFNV20	NSYSFNC36	NSYBPN203	NSY2SPN206	NSYSFND203	-	-
2000	300	800	1	NSYSFNV20	NSYSFNC38	NSYBPN203	NSY2SPN208	NSYSFND203	-	-
2000	400	400	1	NSYSFNV20	NSYSFNC44	NSYBPN204	NSY2SPN204	NSYSFND204	-	NSYMP204
2000	400	500	1	NSYSFNV20	NSYSFNC45	NSYBPN204	NSY2SPN205	NSYSFND204	-	NSYMP204
2000	400	600	1	NSYSFNV20	NSYSFNC46	NSYBPN204	NSY2SPN206	NSYSFND204	-	NSYMP204
2000	400	800	1	NSYSFNV20	NSYSFNC48	NSYBPN204	NSY2SPN208	NSYSFND204	-	NSYMP204
2000	600	400	1	NSYSFNV20	NSYSFNC64	NSYBPN206	NSY2SPN204	NSYSFND206	NSYSFND206T	NSYMP206
2000	600	500	1	NSYSFNV20	NSYSFNC65	NSYBPN206	NSY2SPN205	NSYSFND206	NSYSFND206T	NSYMP206
2000	600	600	1	NSYSFNV20	NSYSFNC66	NSYBPN206	NSY2SPN206	NSYSFND206	NSYSFND206T	NSYMP206
2000	600	800	1	NSYSFNV20	NSYSFNC68	NSYBPN206	NSY2SPN208	NSYSFND206	NSYSFND206T	NSYMP206
2000	800	400	1	NSYSFNV20	NSYSFNC84	NSYBPN208	NSY2SPN204	NSYSFND208	NSYSFND208T	NSYMP208
2000	800	500	1	NSYSFNV20	NSYSFNC85	NSYBPN208	NSY2SPN205	NSYSFND208	NSYSFND208T	NSYMP208
2000	800	600	1	NSYSFNV20	NSYSFNC86	NSYBPN208	NSY2SPN206	NSYSFND208	NSYSFND208T	NSYMP208
2000	800	600	2	NSYSFNV20	NSYSFNC86	NSYBPN208	NSY2SPN206	NSYSFND2082D	-	NSYMP208
2000	800	800	1	NSYSFNV20	NSYSFNC88	NSYBPN208	NSY2SPN208	NSYSFND208	NSYSFND208T	NSYMP208
2000	800	800	2	NSYSFNV20	NSYSFNC88	NSYBPN208	NSY2SPN208	NSYSFND2082D	-	NSYMP208
2000	1000	400	1	NSYSFNV20	NSYSFNC104	NSYBPN2010	NSY2SPN204	NSYSFND2010	NSYSFND2010T	NSYMP2010
2000	1000	400	2	NSYSFNV20	NSYSFNC104	NSYBPN2010	NSY2SPN204	NSYSFND20102D	-	NSYMP2010
2000	1000	500	1	NSYSFNV20	NSYSFNC105	NSYBPN2010	NSY2SPN205	NSYSFND2010	NSYSFND2010T	NSYMP2010
2000	1000	500	2	NSYSFNV20	NSYSFNC105	NSYBPN2010	NSY2SPN205	NSYSFND20102D	-	NSYMP2010
2000	1000	600	1	NSYSFNV20	NSYSFNC106	NSYBPN2010	NSY2SPN206	NSYSFND2010	NSYSFND2010T	NSYMP2010
2000	1000	600	2	NSYSFNV20	NSYSFNC106	NSYBPN2010	NSY2SPN206	NSYSFND20102D	-	NSYMP2010
2000	1000	800	1	NSYSFNV20	NSYSFNC108	NSYBPN2010	NSY2SPN208	NSYSFND2010	NSYSFND2010T	NSYMP2010
2000	1000	800	2	NSYSFNV20	NSYSFNC108	NSYBPN2010	NSY2SPN208	NSYSFND20102D	-	NSYMP2010
2000	1200	400	2	NSYSFNV20	NSYSFNC124	NSYBPN2012	NSY2SPN204	NSYSFND20122D	NSYSFND20122DT	NSYMP2012
2000	1200	500	2	NSYSFNV20	NSYSFNC125	NSYBPN2012	NSY2SPN205	NSYSFND20122D	NSYSFND20122DT	NSYMP2012
2000	1200	600	2	NSYSFNV20	NSYSFNC126	NSYBPN2012	NSY2SPN206	NSYSFND20122D	NSYSFND20122DT	NSYMP2012
2000	1200	800	2	NSYSFNV20	NSYSFNC128	NSYBPN2012	NSY2SPN208	NSYSFND20122D	NSYSFND20122DT	NSYMP2012
2000	1600	400	2	NSYSFNV20	NSYSFNC164	NSYBPN2016	NSY2SPN204	NSYSFND20162D	-	NSYMP2016
2000	1600	500	2	NSYSFNV20	NSYSFNC165	NSYBPN2016	NSY2SPN205	NSYSFND20162D	-	NSYMP2016
2000	1600	600	2	NSYSFNV20	NSYSFNC166	NSYBPN2016	NSY2SPN206	NSYSFND20162D	-	NSYMP2016
2200	400	400	1	NSYSFNV22	NSYSFNC44	NSYBPN224	NSY2SPN224	NSYSFND224	-	NSYMP224
2200	400	500	1	NSYSFNV22	NSYSFNC45	NSYBPN224	NSY2SPN225	NSYSFND224	-	NSYMP224
2200	400	600	1	NSYSFNV22	NSYSFNC46	NSYBPN224	NSY2SPN226	NSYSFND224	-	NSYMP224
2200	400	800	1	NSYSFNV22	NSYSFNC48	NSYBPN224	NSY2SPN228	NSYSFND224	-	NSYMP224
2200	600	400	1	NSYSFNV22	NSYSFNC64	NSYBPN226	NSY2SPN224	NSYSFND226	NSYSFND226T	NSYMP226
2200	600	500	1	NSYSFNV22	NSYSFNC65	NSYBPN226	NSY2SPN225	NSYSFND226	NSYSFND226T	NSYMP226
2200	600	600	1	NSYSFNV22	NSYSFNC66	NSYBPN226	NSY2SPN226	NSYSFND226	NSYSFND226T	NSYMP226
2200	600	800	1	NSYSFNV22	NSYSFNC68	NSYBPN226	NSY2SPN228	NSYSFND226	NSYSFND226T	NSYMP226
2200	800	400	1	NSYSFNV22	NSYSFNC84	NSYBPN228	NSY2SPN224	NSYSFND228	NSYSFND228T	NSYMP228
2200	800	500	1	NSYSFNV22	NSYSFNC85	NSYBPN228	NSY2SPN225	NSYSFND228	NSYSFND228T	NSYMP228
2200	800	600	1	NSYSFNV22	NSYSFNC86	NSYBPN228	NSY2SPN226	NSYSFND228	NSYSFND228T	NSYMP228
2200	800	800	1	NSYSFNV22	NSYSFNC88	NSYBPN228	NSY2SPN228	NSYSFND228	NSYSFND228T	NSYMP228
2200	1000	400	1	NSYSFNV22	NSYSFNC104	NSYBPN2210	NSY2SPN224	NSYSFND2210	NSYSFND2210T	NSYMP2210
2200	1000	500	1	NSYSFNV22	NSYSFNC105	NSYBPN2210	NSY2SPN225	NSYSFND2210	NSYSFND2210T	NSYMP2210
2200	1000	600	1	NSYSFNV22	NSYSFNC106	NSYBPN2210	NSY2SPN226	NSYSFND2210	NSYSFND2210T	NSYMP2210
2200	1000	800	1	NSYSFNV22	NSYSFNC108	NSYBPN2210	NSY2SPN228	NSYSFND2210	NSYSFND2210T	NSYMP2210
2200	1200	400	2	NSYSFNV22	NSYSFNC124	NSYBPN2212	NSY2SPN224	NSYSFND22122D	NSYSFND22122DT	NSYMP2212
2200	1200	500	2	NSYSFNV22	NSYSFNC125	NSYBPN2212	NSY2SPN225	NSYSFND22122D	NSYSFND22122DT	NSYMP2212
2200	1200	600	2	NSYSFNV22	NSYSFNC126	NSYBPN2212	NSY2SPN226	NSYSFND22122D	NSYSFND22122DT	NSYMP2212
2200	1200	800	2	NSYSFNV22	NSYSFNC128	NSYBPN2212	NSY2SPN228	NSYSFND22122D	NSYSFND22122DT	NSYMP2212

Technical changes reserved. Information provided without guarantee. Images are for illustrative purposes only.

Side Door

3
SFN



- Door for the side of the enclosure, can replace the panels.
- Installation directly on the structure of the enclosure, opening 120°.
- Lock with handle and 5-mm double-bar insert. 4 locking points.
- Reinforcement frame, cut-out with a pitch of 25 mm.
- Opening to right or left.
- Material: Steel
- Finish: Structured finish, epoxy polyester powder
- Color: RAL 7035 gray

Supply:
One side door, four hinges, four catches, bottom trim and handle lock



NSYSFND168

Characteristics	Height (mm)	Depth (mm)	References
PanelSet SFN Side door	1200	600	NSYSFND126
PanelSet SFN Side door	1200	800	NSYSFND128
PanelSet SFN Side door	1400	600	NSYSFND146
PanelSet SFN Side door	1400	800	NSYSFND148
PanelSet SFN Side door	1600	600	NSYSFND166
PanelSet SFN Side door	1600	800	NSYSFND168
PanelSet SFN Side door	1800	400	NSYSFND184
PanelSet SFN Side door	1800	500	NSYSFND185
PanelSet SFN Side door	1800	600	NSYSFND186
PanelSet SFN Side door	1800	800	NSYSFND188
PanelSet SFN Side door	2000	400	NSYSFND204
PanelSet SFN Side door	2000	500	NSYSFND205
PanelSet SFN Side door	2000	600	NSYSFND206
PanelSet SFN Side door	2000	800	NSYSFND208
PanelSet SFN Side door	2200	400	NSYSFND224
PanelSet SFN Side door	2200	500	NSYSFND225
PanelSet SFN Side door	2200	600	NSYSFND226
PanelSet SFN Side door	2200	800	NSYSFND228

External Fixing



- Set of 2 side panels fixed from the outside of the enclosure.
- Material: Steel
- Finish: Structured finish, epoxy polyester powder
- Color: RAL 7035 gray

Supply:
2 side panels, with sealing gasket and captive screws

Characteristics	Height (mm)	Depth (mm)	References
Set of 2 side panels fixed from the outside of the enclosure	1200	400	NSY2SPN124
Set of 2 side panels fixed from the outside of the enclosure	1200	500	NSY2SPN125
Set of 2 side panels fixed from the outside of the enclosure	1200	600	NSY2SPN126
Set of 2 side panels fixed from the outside of the enclosure	1200	800	NSY2SPN128
Set of 2 side panels fixed from the outside of the enclosure	1400	400	NSY2SPN144
Set of 2 side panels fixed from the outside of the enclosure	1400	500	NSY2SPN145
Set of 2 side panels fixed from the outside of the enclosure	1400	600	NSY2SPN146
Set of 2 side panels fixed from the outside of the enclosure	1400	800	NSY2SPN148
Set of 2 side panels fixed from the outside of the enclosure	1600	400	NSY2SPN164
Set of 2 side panels fixed from the outside of the enclosure	1600	500	NSY2SPN165
Set of 2 side panels fixed from the outside of the enclosure	1600	600	NSY2SPN166
Set of 2 side panels fixed from the outside of the enclosure	1600	800	NSY2SPN168
Set of 2 side panels fixed from the outside of the enclosure	1800	400	NSY2SPN184
Set of 2 side panels fixed from the outside of the enclosure	1800	500	NSY2SPN185
Set of 2 side panels fixed from the outside of the enclosure	1800	600	NSY2SPN186
Set of 2 side panels fixed from the outside of the enclosure	1800	800	NSY2SPN188
Set of 2 side panels fixed from the outside of the enclosure	2000	400	NSY2SPN204
Set of 2 side panels fixed from the outside of the enclosure	2000	500	NSY2SPN205
Set of 2 side panels fixed from the outside of the enclosure	2000	600	NSY2SPN206
Set of 2 side panels fixed from the outside of the enclosure	2000	800	NSY2SPN208
Set of 2 side panels fixed from the outside of the enclosure	2200	400	NSY2SPN224
Set of 2 side panels fixed from the outside of the enclosure	2200	500	NSY2SPN225
Set of 2 side panels fixed from the outside of the enclosure	2200	600	NSY2SPN226
Set of 2 side panels fixed from the outside of the enclosure	2200	800	NSY2SPN228

Partition Panel



- Partition panel for direct fixing to the structure, helps guarantee a water/dustproof protection of IP10 between enclosure suites.
- Material: Galvanized steel

Supply:
1 partition panel, sealing gasket and fixing elements

Characteristics	Height (mm)	Depth (mm)	References
PanelSet SFN partition panel	1800	400	NSYPPS184
PanelSet SFN partition panel	1800	500	NSYPPS185
PanelSet SFN partition panel	1800	600	NSYPPS186
PanelSet SFN partition panel	2000	400	NSYPPS204
PanelSet SFN partition panel	2000	500	NSYPPS205
PanelSet SFN partition panel	2000	600	NSYPPS206
PanelSet SFN partition panel	2000	800	NSYPPS208

Accessories



- Trim cap for external fixing panels, both sides and rear
- Material: Polyamide 6
- Color: RAL 7035 gray

Supply:
50 units

Characteristics	References
Trim cap for external fixing panels	NSYCSP

SFN Standard Coupling Kit



NSYSFBK

- Used for joining enclosures side-to-side or depthwise.
- Fixing from the inside of the enclosure.
- Material: Flat connectors and brackets: Zinc-coated steel
Sealing gasket: EPDM
- Ingress protection rating: IP55 according to IEC 60529

Supply:

4 brackets, 2 flat connectors, sealing gasket, fixing elements and 16 caps

Characteristics	References
PanelSet SFN Standard coupling kit	NSYSFBK

SFN Swing 19" Rack or PrismaSet HD Coupling Kit

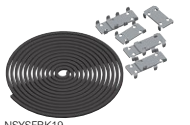

NSYSFBK19

- Used for joining enclosures equipped with swing 19" rack, side-to-side or depthwise.
- Fixing from the inside of the enclosures.
- Material: Flat connectors: Zinc-coated steel
Sealing gasket: EPDM
- Ingress protection rating: IP55 according to IEC 60529

Supply:

8 flat connectors, sealing gasket, fixing elements and 16 caps

Characteristics	References
PanelSet SFN-19" Swing 19" rack coupling kit	NSYSFBK19

SFN Reinforced Coupling



NSYSFBKR

- It is used together with the coupling kit to reinforce the connection between 2 enclosures when they carry heavy loads.
- Fixing from the inside of the enclosures.
- Material: Zinc-coated steel

Supply:

4 reinforced connectors and fixing elements

Characteristics	References
PanelSet SFN Reinforced coupling	NSYSFBKR

SFN Quick Coupling

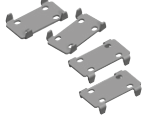

NSYSFBKF

- Used for quickly joining 2 enclosures.
- Fixing from the inside of the enclosures.
- Material: Zinc-coated steel

Supply:

4 flat links and fixing elements

Characteristics	References
PanelSet SFN Quick coupling	NSYSFBKF

SFN External Coupling



NSYSFBKE

- Allows two enclosures to be joined by their structure.
- To be used with the standard coupling kit in those cases where front and back uprights are not accessible.
- The mounting plate or vertical uprights fixed to the back of the enclosure help prevent the assembly and dismantling of the kit.
- It can be combined with the reinforced or the quick coupling kit.
- Material: External connectors: Zinc-coated steel

Supply:

4 external connectors and fixing elements

Characteristics	References
PanelSet SFN External coupling	NSYSFBKE

SM Enclosure Coupling Kit for Spacial SM

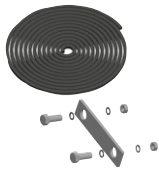

NSYSMBK

- Used for joining enclosure side-to-side.
- Enclosures fixed from the inside.
- Material: 3 x 10 mm sealing gasket: EPDM
- Ingress protection rating: IP55 according to IEC 60529

Supply:





1 sealing gasket and fixing elements

Characteristics	References
Spacial SM Enclosure coupling kit for Spacial SM	NSYSMBK

Plinth as a Kit

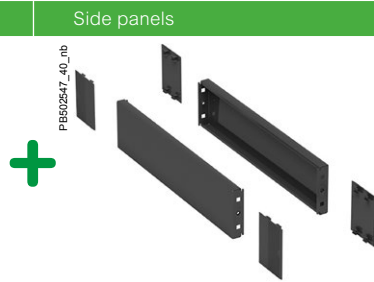
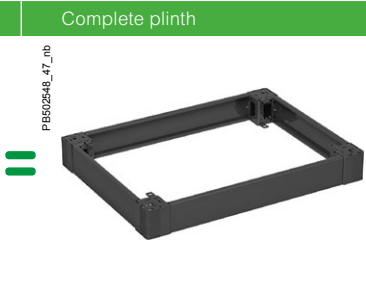
The complete plinth consists of two elements, one is the front and rear kit, determined by the width of the enclosure, and the other consists of the side panels which determine the depth of the enclosure. The number of side panels required depends on the plinth combination.

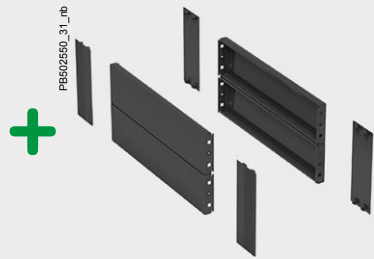
- + Robust design.
- + The modular plinth system makes it possible to reduce the number of references in stock.

Characteristics	Front and rear kit	Side panels	Complete plinth
Plinth height 100 mm	 <p>PB502546_50_nb</p>	 <p>PB502547_40_nb</p>	 <p>PB502548_47_nb</p>
Plinth height 200 mm	 <p>PB502549_50_nb</p>	 <p>PB502550_31_nb</p>	 <p>PB502551_47_nb</p>

Floor

Examples of Solutions

Plinth Cross-Rail Fixed in Position B, Requires 2 Cross-Rails Fixed in Position A.

- They are fixed to the plinth cross-rails, both the universal and the quick-fixing types.
- Their depth is adjustable in increments of 25 mm.

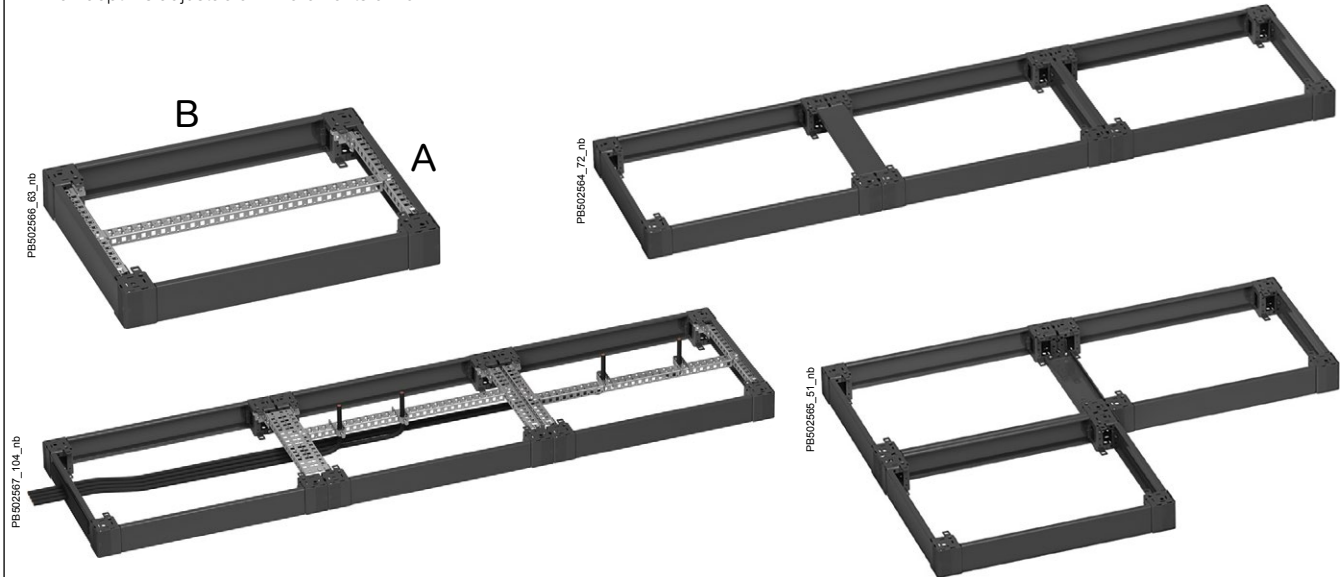

Comment: Universal and quick-fixing cross-rail references, [page 236](#)

3
SM
SFN

Possibility of Joining Plinths

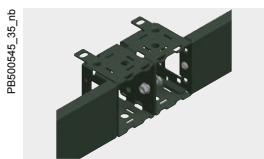

The surfaces between corners are always in contact.
They are joined by a M8 screw and nut, not included in the standard supply.

- + Longitudinally free space for passing cables
- + Greater rigidity of the resulting assembly unit

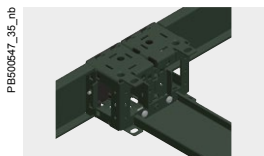
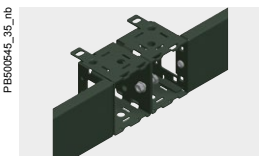

Side panels are secured by M6 screws and caged nuts, not included in the standard supply, reference **NSYSMP6** and reference **NSYCN9M625**, which can be mounted above and/or below.

- + Improves rigidity in the depthwise direction during transport

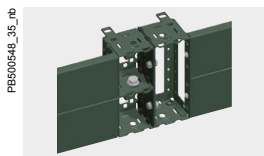

Vertical plinth assembly are secured by means of M12 screws and nuts, not included in the standard supply.

Possibility of Fixing the Enclosure to the Plinth



Fixing from the inside of the enclosure by means of an M12 screw, screwing directly into the corner of the plinth.

- + Fixing convenience and speed



Fixing from the outside of the enclosure with a M12 screw, screwing directly onto the vertical upright.

- + Maximum rigidity of the enclosure-plinth assembly

Options to Fix the Plinth to the Floor

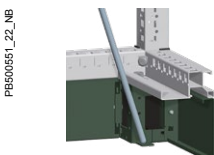

Fixing from the inside of the enclosure.
The machining angle varies according to the plinth model:

- Plinth height 100 mm $\phi = 18^\circ$.
- Plinth height 200 mm $\phi = 9^\circ$.

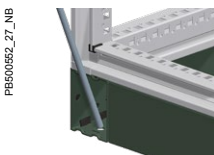

Fixing from the outside of the enclosure, optimal point for the rigidity of the assembly.
The machining angle varies according to the plinth model:

- Plinth height 100 mm $\phi = 22^\circ$.
- Plinth height 200 mm $\phi = 11^\circ$.

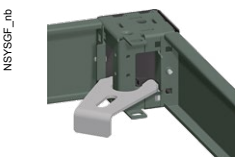

Floor-fixing supports can be used as well.
Brackets **NSYSGF** for fixing plinth to the floor if the drillholes made in the plinth cannot be used.
It can be to the corner, or between corner and panel.

Fixing the Enclosure to the Plinth

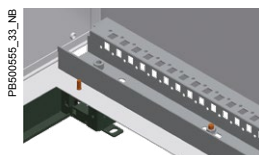

Fixing from the inside of the enclosure by means of a M12 screw, screwing directly into the corner of the plinth

- Fixing convenience and speed.

Fixing the Enclosure Against a Wall



Enclosure against a wall.
Thanks to the design of the corners, when the enclosure is installed against the wall, the external fixing point can still be accessible by removing the plinth side panels and turning the back corners.

Assembly of the Plinth Panels

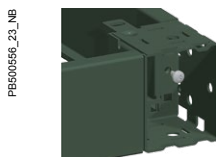

The panels are fixed with an M6 screw to the corner included in the standard supply of the side panels.

- The front and rear panels are delivered with the corners mounted.

Front and Rear Plinths

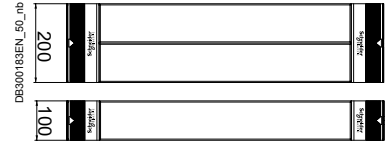
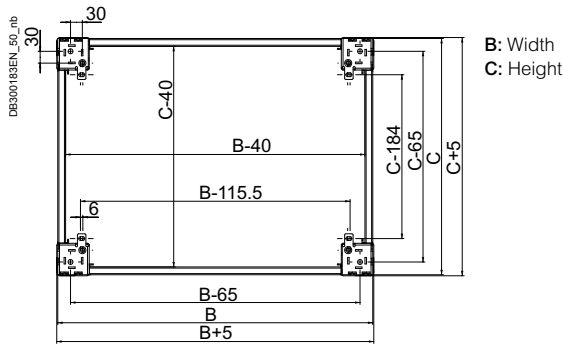

3
SM
SFN

- The front and rear of the plinth consists of 4 corners with 2 or 4 panels.
- Material: Folded sheet steel, corner with a thickness of 25/10° mm
- Finish: Structured finish, epoxy polyester powder
- Color: RAL 7022 gray
- Ingress protection rating: IP20 according to IEC 60529
- Mechanical protection rating: IK10 according to IEC 62262

Supply:

Height 100 mm: 4 corners, 2 panels (front and rear), 4 corner covers and fixing elements
 Height 200 mm: 4 corners, 4 panels (2 front and 2 rear), 4 corner covers and fixing elements

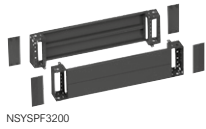

Characteristics	Height (mm)	Width (mm)	References
Front plinths for Spacial	100	300	NSYSPPF3100
Front plinths for Spacial	100	400	NSYSPPF4100
Front plinths for Spacial	100	600	NSYSPPF6100
Front plinths for Spacial	100	800	NSYSPPF8100
Front plinths for Spacial	100	1000	NSYSPPF10100
Front plinths for Spacial	100	1200	NSYSPPF12100
Front plinths for Spacial	100	1600	NSYSPPF16100
Front plinths for Spacial	200	300	NSYSPPF3200
Front plinths for Spacial	200	400	NSYSPPF4200
Front plinths for Spacial	200	600	NSYSPPF6200
Front plinths for Spacial	200	800	NSYSPPF8200
Front plinths for Spacial	200	1000	NSYSPPF10200
Front plinths for Spacial	200	1200	NSYSPPF12200
Front plinths for Spacial	200	1600	NSYSPPF16200

Plinth side panels

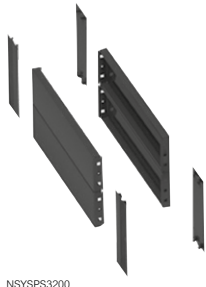

- They are fixed to the corner of the plinth by 2 fixing screws.
- Material: Folded sheet steel
- Finish: Structured finish, epoxy polyester powder
- Color: RAL 7022 gray
- Ingress protection rating: IP20 according to IEC 60529
- Mechanical protection rating: IK10 according to IEC 62262

Supply:

Height 100 mm: 2 side panels, 4 corner covers and fixing elements
 Height 200 mm: 4 side panels (height of 100 mm, 2 for each side), 4 corner covers and fixing elements

Characteristics	Height (mm)	Depth (mm)	References
Side plinths for Spacial	100	300	NSYSPPS3100
Side plinths for Spacial	100	400	NSYSPPS4100
Side plinths for Spacial	100	500	NSYSPPS5100
Side plinths for Spacial	100	600	NSYSPPS6100
Side plinths for Spacial	100	800	NSYSPPS8100
Side plinths for Spacial	200	300	NSYSPPS3200
Side plinths for Spacial	200	400	NSYSPPS4200
Side plinths for Spacial	200	500	NSYSPPS5200
Side plinths for Spacial	200	600	NSYSPPS6200
Side plinths for Spacial	200	800	NSYSPPS8200

Ventilated Front Plinth



NSYSPFV6100

- The front and rear of the ventilated plinth is made up of 4 corners with 2 front panels.
- Material: Folded sheet steel, corner with a thickness of 25/10° mm
- Finish: Structured finish, epoxy polyester powder
- Color: RAL 7022 gray
- Ingress protection rating: IP20 according to IEC 60529
- Mechanical protection rating: IK10 according to IEC 62262

Supply:
Height 100 mm: 4 corners, 2 ventilated panels (front and rear), 4 corner covers and fixing elements

Characteristics	Height (mm)	Width (mm)	References
Ventilated front plinth for PanelSeT SFN-Spacial SM	100	600	NSYSPFV6100
Ventilated front plinth for PanelSeT SFN-Spacial SM	100	800	NSYSPFV8100

Ventilated Side Panels

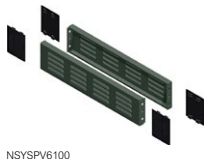

NSYSPV6100

- They are fixed to the corner of the plinth by fixing screws.
- Material: Folded sheet steel
- Finish: Structured finish, epoxy polyester powder
- Color: RAL 7022 gray
- Ingress protection rating: IP20 according to IEC 60529
- Mechanical protection rating: IK10 according to IEC 62262

Supply:
Height 100 mm: 2 ventilated side panels, 4 corner covers and fixing elements

Characteristics	Height (mm)	Depth (mm)	References
Ventilated side panels for PanelSeT SFN-Spacial SM	100	600	NSYSPV6100
Ventilated side panels for PanelSeT SFN-Spacial SM	100	800	NSYSPV8100

Panels with Brush

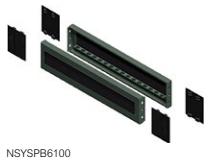

NSYSPB6100

- They allow the entry and fixing of cables inside the enclosure, through the plinth.
- Material: Folded sheet steel
- Finish: Structured finish, epoxy polyester powder
- Color: RAL 7022 gray
- Ingress protection rating: IP20 according to IEC 60529
- Mechanical protection rating: IK10 according to IEC 62262

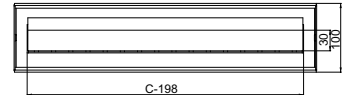

Supply:
Height 100 mm: 2 panels with brushes, 4 corner covers and fixing elements

Characteristics	Height (mm)	Depth (mm)	References
Panels with brush for PanelSeT SFN-Spacial SM	100	600	NSYSPB6100
Panels with brush for PanelSeT SFN-Spacial SM	100	800	NSYSPB8100



Stainless-steel plinths (standard plinths [page 140](#), ventilated plinths [page 379](#)) are compatible with steel floor-standing enclosure SM and SFN using an earthing cable section 6 mm², length 220 mm, eyelet hole 13 mm. Not included in the delivery of the plinths.

Fixing to the Floor



- Part for fixing the plinth to the floor if the drillholes made in the plinth cannot be used.
- Material: Steel
- Finish: Zinc-coated

Characteristics

PanelSeT SFN-Fixing to the floor

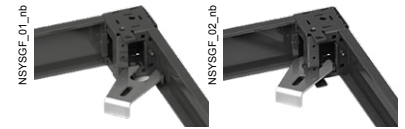

Supply:

4 pieces, fixing element not supplied

References

NSYSGF

3
SM
SFN

Plinth Cross-Rail Support



- Support for fixing a cross-rail inside the plinth.
- Material: Steel
- Finish: Zinc-coated

Characteristics

PanelSeT SFN-Plinth cross-rail support, 100 mm

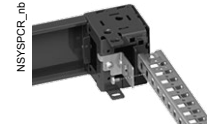

Comment:

Reference by unit Order by multiples of 12 (12, 24, 36...)

Supply:

12 pieces and fixing elements

References

NSYSPCR

Plinth Cross-Rails

3
SM
SFN

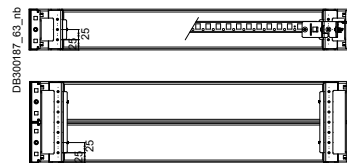

Supply:
2 cross-rails and fixing elements

- They are fixed across the width and/or depth between the corners of the plinth.
- The plinth cross-rail supports are required for its assembly.
- Material: Steel
- Finish: Zinc-coated



NSYSUCR4030

Characteristics	Cross-rails	Width (mm)	Depth (mm)	References
Plinth cross-rails for PanelSeT SFN-Spacial SM	1 row (40)	400	-	NSYSUCR4030
Plinth cross-rails for PanelSeT SFN-Spacial SM	1 row (40)	600	-	NSYSUCR4050
Plinth cross-rails for PanelSeT SFN-Spacial SM	1 row (40)	800	-	NSYSUCR4070
Plinth cross-rails for PanelSeT SFN-Spacial SM	1 row (40)	1000	-	NSYSUCR4090
Plinth cross-rails for PanelSeT SFN-Spacial SM	1 row (40)	1200	-	NSYSUCR40110
Plinth cross-rails for PanelSeT SFN-Spacial SM	3 row (90)	400	-	NSYSUCR9030
Plinth cross-rails for PanelSeT SFN-Spacial SM	3 row (90)	600	-	NSYSUCR9050
Plinth cross-rails for PanelSeT SFN-Spacial SM	3 row (90)	800	-	NSYSUCR9070
Plinth cross-rails for PanelSeT SFN-Spacial SM	1 row (40)	-	500	NSYSUCR4040
Plinth cross-rails for PanelSeT SFN-Spacial SM	3 row (90)	-	500	NSYSUCR9040

Fixing Options, Screw M6



NSYSMP6

- M6 x 10 mm

Supply:
50 screws

Characteristics	References
Screw M6	NSYSMP6

Fixing Options, Caged Nuts



NSYCN9M625

- M6 caged nuts.

Supply:
100 caged nuts.

Characteristics	References
Caged nuts	NSYCN9M625

Fixing Options, Levelling the Plinth

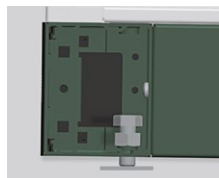

NSYSPLK

- The plinth allows levelling by means of a M12 screw.

Characteristics	References
Levelling the plinth	NSYSPLK

Plain Cable Gland Plate

- Cable-gland plate to be placed on top or bottom of the enclosure
- The design of the compact cable gland plate, coupled with the use of the sealing gasket **NSYCEK** enable maximum dust/water tightness
- Material: Steel painted with epoxy polyester resin
- Color: RAL 7035 gray
- Thicknesses: 10/10⁺ mm

Supply:
Plain plate and fixing elements

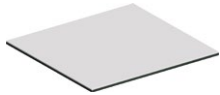

NSYSMEC63

Characteristics	Width (mm)	Depth (mm)	References
Spacial SM Plain cable gland plate	600	300	NSYSMEC63
Spacial SM Plain cable gland plate	600	400	NSYSMEC64
Spacial SM Plain cable gland plate	600	500	NSYSMEC65
Spacial SM Plain cable gland plate	800	300	NSYSMEC83
Spacial SM Plain cable gland plate	800	400	NSYSMEC84
Spacial SM Plain cable gland plate	800	500	NSYSMEC85
Spacial SM Plain cable gland plate	800	600	NSYSMEC86
Spacial SM Plain cable gland plate	1000	400	NSYSMEC104
Spacial SM Plain cable gland plate	1200	300	2x NSYSMEC63
Spacial SM Plain cable gland plate	1200	400	2x NSYSMEC64
Spacial SM Plain cable gland plate	1200	500	2x NSYSMEC65
Spacial SM Plain cable gland plate	1600	400	2x NSYSMEC84
Spacial SM Plain cable gland plate	1600	500	2x NSYSMEC85
Spacial SM Plain cable gland plate	1600	600	2x NSYSMEC86

Cable Entries

Possibilities of Cable Gland Plate Adjustment

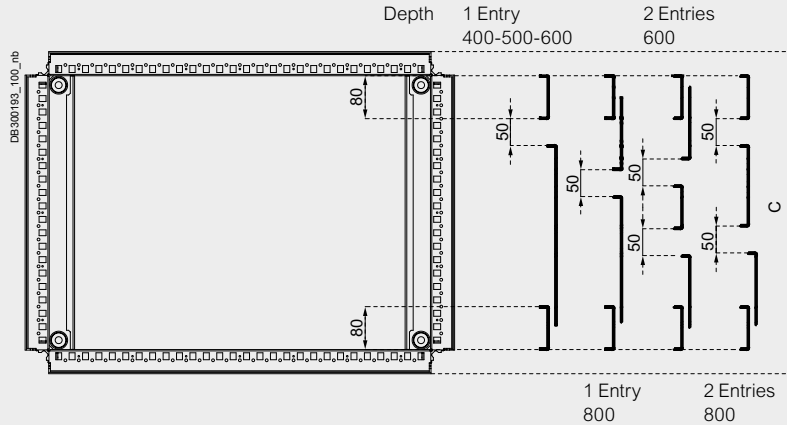

3
SFN

Plain Cable Gland Plate

- The design of the compact cable gland plate, coupled with the use of the sealing gasket **NSYCEK** provide IP55.
- Material: Galvanized steel
- Thicknesses: 15/10^a mm
- Ingress protection rating: IP55 according to IEC 60529 (with the gasket)

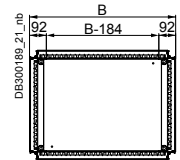

Supply:
Plain plate and fixing elements

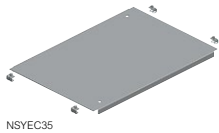

Characteristics	(B) Width (mm)	(C) Depth (mm)	References
PanelSet SFN Plain cable gland plate	300	500	NSYEC35
PanelSet SFN Plain cable gland plate	300	600	NSYEC36
PanelSet SFN Plain cable gland plate	400	400	NSYEC44
PanelSet SFN Plain cable gland plate	400	500	NSYEC45
PanelSet SFN Plain cable gland plate	400	600	NSYEC64
PanelSet SFN Plain cable gland plate	400	800	NSYEC84
PanelSet SFN Plain cable gland plate	600	400	NSYEC64
PanelSet SFN Plain cable gland plate	600	500	NSYEC65
PanelSet SFN Plain cable gland plate	600	600	NSYEC66
PanelSet SFN Plain cable gland plate	600	800	NSYEC68
PanelSet SFN Plain cable gland plate	800	400	NSYEC84
PanelSet SFN Plain cable gland plate	800	500	NSYEC85
PanelSet SFN Plain cable gland plate	800	600	NSYEC86
PanelSet SFN Plain cable gland plate	800	800	NSYEC88
PanelSet SFN Plain cable gland plate	1000	400	NSYEC104
PanelSet SFN Plain cable gland plate	1000	500	NSYEC105
PanelSet SFN Plain cable gland plate	1000	600	NSYEC106
PanelSet SFN Plain cable gland plate	1000	800	NSYEC108
PanelSet SFN Plain cable gland plate	1200	400	NSYEC124
PanelSet SFN Plain cable gland plate	1200	500	NSYEC125
PanelSet SFN Plain cable gland plate	1200	600	NSYEC126
PanelSet SFN Plain cable gland plate	1200	800	NSYEC128
PanelSet SFN Plain cable gland plate	1600	400	NSYEC164
PanelSet SFN Plain cable gland plate	1600	500	NSYEC165
PanelSet SFN Plain cable gland plate	1600	600	NSYEC166

Plate with 1 Entry

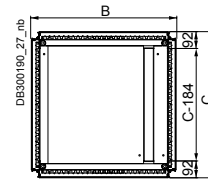

Enclosures of 300 and 400 mm width.

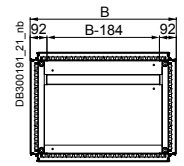

Enclosures of 600, 800, 1000 and 1200 mm width.

3
SFN

- Facilitates the entry of cables thanks to a longitudinal opening.
- Material: Galvanized steel
- Thicknesses: 15/10° mm

Supply:

Plate with 1 entry; Self-extinguishing polyurethane adhesive gasket with cross-section of 15 x 25 mm (helps guarantee good sealing) and fixing elements



NSYEC351

Characteristics	(B) Width (mm)	(C) Depth (mm)	References
PanelSeT SFN Plate with 1 entry	300	500	NSYEC351
PanelSeT SFN Plate with 1 entry	300	600	NSYEC361
PanelSeT SFN Plate with 1 entry	400	400	NSYEC441
PanelSeT SFN Plate with 1 entry	400	500	NSYEC451
PanelSeT SFN Plate with 1 entry	400	600	NSYEC461
PanelSeT SFN Plate with 1 entry	400	800	NSYEC481
PanelSeT SFN Plate with 1 entry	600	400	NSYEC641
PanelSeT SFN Plate with 1 entry	600	500	NSYEC651
PanelSeT SFN Plate with 1 entry	600	600	NSYEC661
PanelSeT SFN Plate with 1 entry	600	800	NSYEC681
PanelSeT SFN Plate with 1 entry	800	400	NSYEC841
PanelSeT SFN Plate with 1 entry	800	500	NSYEC851
PanelSeT SFN Plate with 1 entry	800	600	NSYEC861
PanelSeT SFN Plate with 1 entry	800	800	NSYEC881
PanelSeT SFN Plate with 1 entry	1000	400	NSYEC1041
PanelSeT SFN Plate with 1 entry	1000	500	NSYEC1051
PanelSeT SFN Plate with 1 entry	1000	600	NSYEC1061
PanelSeT SFN Plate with 1 entry	1000	800	NSYEC1081
PanelSeT SFN Plate with 1 entry	1200	400	NSYEC1241
PanelSeT SFN Plate with 1 entry	1200	500	NSYEC1251
PanelSeT SFN Plate with 1 entry	1200	600	NSYEC1261
PanelSeT SFN Plate with 1 entry	1200	800	NSYEC1281
PanelSeT SFN Plate with 1 entry	1600	400	NSYEC1641
PanelSeT SFN Plate with 1 entry	1600	500	NSYEC1651
PanelSeT SFN Plate with 1 entry	1600	600	NSYEC1661

Plate with 2 Entries

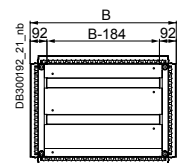

- Cable entry for very deep enclosures (600 and 800 mm).
- Two longitudinal openings allowing a large number of cables through.
- Material: Galvanized steel
- Thicknesses: 15/10° mm

Supply:

1 plate with 2 entries; Polyurethane adhesive gasket with cross-section of 15 x 25 mm (helps guarantee good sealing) and fixing elements



NSYEC662

Characteristics	(B) Width (mm)	(C) Depth (mm)	References
PanelSeT SFN Plate with 2 entries	400	600	NSYEC462
PanelSeT SFN Plate with 2 entries	400	800	NSYEC482
PanelSeT SFN Plate with 2 entries	600	600	NSYEC662
PanelSeT SFN Plate with 2 entries	600	800	NSYEC682
PanelSeT SFN Plate with 2 entries	800	600	NSYEC862
PanelSeT SFN Plate with 2 entries	800	800	NSYEC882
PanelSeT SFN Plate with 2 entries	1000	600	NSYEC1062
PanelSeT SFN Plate with 2 entries	1000	800	NSYEC1082
PanelSeT SFN Plate with 2 entries	1200	600	NSYEC1262
PanelSeT SFN Plate with 2 entries	1200	800	NSYEC1282
PanelSeT SFN Plate with 2 entries	1600	600	NSYEC1662

3
SM
SFN

SFN Brush-Type Cable Entry Gasket

- For plates with 1 or 2 cable entries.
- The cables can have different diameters.
- No IP degree of protection

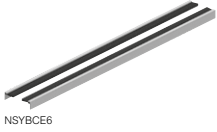

Characteristics	Width (mm)	References
PanelSeT SFN Brush-type cable entry gasket	600	NSYBCE6
PanelSeT SFN Brush-type cable entry gasket	800	NSYBCE8
PanelSeT SFN Brush-type cable entry gasket	1000	NSYBCE10
PanelSeT SFN Brush-type cable entry gasket	1200	NSYBCE12
PanelSeT SFN Brush-type cable entry gasket	1600	NSYBCE16

SM Brush-Type Cable Entry Gasket

- Brush-type gasket for installation on the cable gland plates.
- The cables can have different diameters.
- No IP degree of protection



Characteristics	Width (mm)	References
Spacial SM-Brush-type cable entry gasket	600	NSYSMBCE6
Spacial SM-Brush-type cable entry gasket	800	NSYSMBCE8
Spacial SM-Brush-type cable entry gasket	1000	NSYSMBCE10
Spacial SM-Brush-type cable entry gasket	1200	2x NSYSMBCE6
Spacial SM-Brush-type cable entry gasket	1600	2x NSYSMBCE8

SFN Foam Cable Entry Gasket

- Spare gasket, made from self-extinguishing expanded polyurethane with a cross-section of 15 x 25 mm, for fixing on cable gland plates.

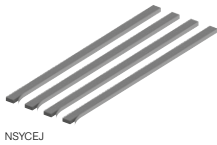

Characteristics	References
PanelSeT SFN Foam cable entry gasket	NSYCEJ

SFN Sealing Gasket

- Sealing gasket, made from ethylene-propylene with a cross-section of 3 x 10 mm, for mounting on the perimeter of the cable gland plates. Adhesive to help guarantee good sealing.



Characteristics	References
PanelSeT SFN Sealing gasket	NSYCEK

Steel Floor-Standing Enclosures

Spacial SM - PanelSeT SFN, Accessories

Lifting Systems

SFN Eyebolts



NSYSFEB

- Set of M12 lifting eyebolts, which screw directly into the structure of the enclosure, in the axis of the uprights.
- Material: Galvanized cast steel
- Maximum load: 1360 kg at 90° using 4 units (340 kg at 90° per unit)
- Maximum amount of assembled enclosures to be lifted: 1

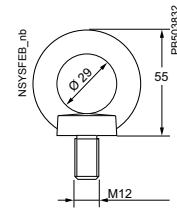

Supply:
4 eyebolts

Characteristics	Enclosures to be lifted	Max. load (kg)	References
PanelSeT SFN Eyebolts	1	340	NSYSFEB

3
SM
SFN

SM Eyebolts



NSYSMEB

- Set of M12 lifting eyebolts, fixed to the enclosure by fixing nuts.
- Material: Galvanized cast steel
- Maximum load: 1360 kg at 90° using 4 units (340kg at 90° per unit)
- Maximum amount of assembled enclosures to be lifted: 1

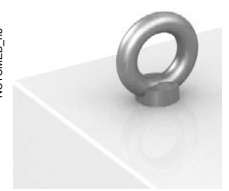
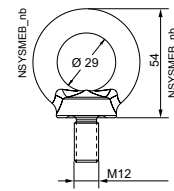

Supply:
4 eyebolts and
4 fixing nuts

Characteristics	Enclosures to be lifted	Max. load (kg)	References
Spacial SM Eyebolts	1	340	NSYSMEB

SFN Lifting Brackets



NSYSFELB

- Set of lifting and transport brackets, fixed to the structure between two coupled enclosures, in the axis of the uprights.
- Material: Zinc-coated steel
- Maximum load: 500 kg at 90° per unit
- Maximum amount of assembled enclosures to be lifted with 2 brackets: 2

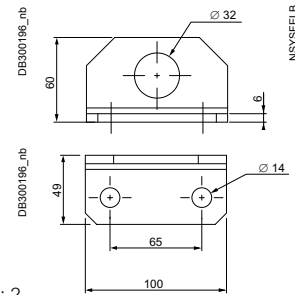

Supply:
4 brackets and fixing
elements (M12 screws)

Characteristics	Enclosures to be lifted	Max. load (kg)	References
PanelSeT SFN Lifting brackets	2	500	NSYSFELB

SFN Lifting Bar



NSYSFTB16

- Set of bars for lifting and transporting enclosures suites.
- They are fixed to the structure of the enclosure, in the axis of the uprights.
- Material: Zinc-plated steel

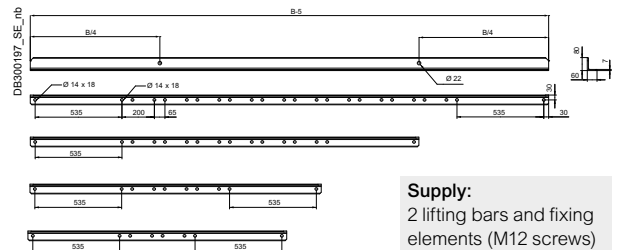

Supply:
2 lifting bars and fixing
elements (M12 screws)

Characteristics	B - Length (mm)	Enclosures to be lifted	Max. load (kg)	References
PanelSeT SFN Lifting bar	1600	2	2000	NSYSFTB16
PanelSeT SFN Lifting bar	1800	3	3000	NSYSFTB18
PanelSeT SFN Lifting bar	2400	4	3000	NSYSFTB24
PanelSeT SFN Lifting bar	3200	5	4000	NSYSFTB32

Roof Canopy

3
SM
SFN

- Provides excellent protection against splashes from rainwater.
- Canopy cannot be used together with lifting fixtures.
- PanelSeT SFN: It is possible to use a single canopy with combinations of modular enclosures (example: one 1600-mm canopy with two coupled 800-mm enclosures).
- Material: Galvanized steel
- Finish: Structured finish, epoxy polyester powder
- Color: RAL 7035 gray

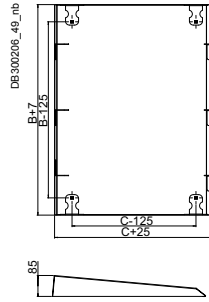

Fixing:

PanelSeT SFN: Fixing by holes to be made in the roof of the enclosure
 Spacial SM: Fixing by holes already made in the roof

Supply:

One canopy, drilling template and fixing elements



NSYSC630

Characteristics	(B) Width (mm)	(C) Depth (mm)	References
PanelSeT SFN/Spacial SM Canopy	600	300	NSYSC630
PanelSeT SFN/Spacial SM Canopy	600	400	NSYSC640
PanelSeT SFN/Spacial SM Canopy	600	600	NSYSC660
PanelSeT SFN/Spacial SM Canopy	800	300	NSYSC830
PanelSeT SFN/Spacial SM Canopy	800	400	NSYSC840
PanelSeT SFN/Spacial SM Canopy	800	500	NSYSC850
PanelSeT SFN/Spacial SM Canopy	800	600	NSYSC860
PanelSeT SFN/Spacial SM Canopy	1000	300	NSYSC1030
PanelSeT SFN/Spacial SM Canopy	1000	400	NSYSC1040
PanelSeT SFN/Spacial SM Canopy	1000	500	NSYSC1050
PanelSeT SFN/Spacial SM Canopy	1000	600	NSYSC1060
PanelSeT SFN/Spacial SM Canopy	1200	300	NSYSC1230
PanelSeT SFN/Spacial SM Canopy	1200	400	NSYSC1240
PanelSeT SFN/Spacial SM Canopy	1200	500	NSYSC1250
PanelSeT SFN/Spacial SM Canopy	1200	600	NSYSC1260
PanelSeT SFN/Spacial SM Canopy	1600	400	NSYSC1640
PanelSeT SFN/Spacial SM Canopy	1600	500	NSYSC1650

Airing Elevators for Roof



- Allows the roof to be raised, providing natural airing.
- They are screwed onto the structure at the roof fixing point.
- Material: Zinc-coated steel.
- Can't be used for lifting.

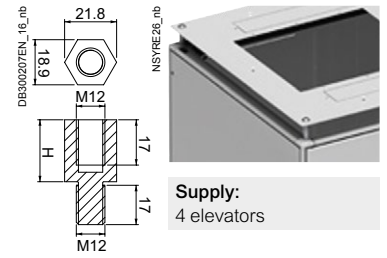

Supply:
4 elevators

Characteristics	(H) Height (mm)	IP	References
PanelSet SFN Airing elevators for roof	23	10	NSYRE26
PanelSet SFN Airing elevators for roof	60	00	NSYRE60

FL21 Cable Entry Membranes



- Membrane plate for watertight cable entries made from insulated material (fireresistance level UL 94 V-0).
- Direct installation in the FL21 cable entry plate adapter.
- 4 models: Plain plate and membrane plates from 7 to 37 cable entries.
- Material: Gray plastic
- Ingress protection rating: IP55 according to IEC 60529

Comment:
For more information see [page 262](#)

Supply:
Membrane plate and fixing elements.

Characteristics	No. of entries	References
FL21 plain metal plate	0	NSYAECPFLBP
FL21 cable entry membranes	7	NSYAECPFLT7
FL21 cable entry membranes	27	NSYAECPFLT25
FL21 cable entry membranes	37	NSYAECPFLT35

Standard Cable Entry Plate



- Thickness: 15/10° mm

Comment:
For more information see [page 262](#)

Characteristics	References
Standard cable entry plate	NSYTLCL

FlexiCable



Characteristics
FlexiCable

References
NSYTLCLME

Adapter for FL21 Cable Entry Plate



- Thickness: 15/10° mm

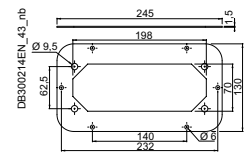

Characteristics	References
Adapter for FL21 cable entry plate	NSYTLCLFL

Wall Fixing

SFN Wall Fixing Support

3
SM
SFN

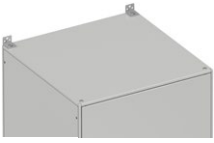

NSYSFWFIX

- Supports for fixing the enclosure on the wall and helping prevent it from turning over.
- They cannot be used for hanging the enclosure.
- They are installed using the roof mounting screws.
- Material: Zinc-coated steel sheet

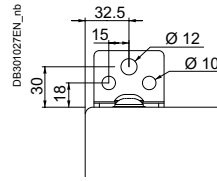

Supply:
2 supports

Characteristics

PanelSet SFN Wall fixing support

References

NSYSFWFIX

SM Wall Fixing Support



NSYSMWFIX

- Supports for fixing the enclosure on the wall and helping prevent it from turning over.
- They are installed using the drill holes in the back of the enclosure.
- Mounted directly on the rear of the enclosure, either in horizontal or vertical position
- Material: Zinc-coated steel sheet

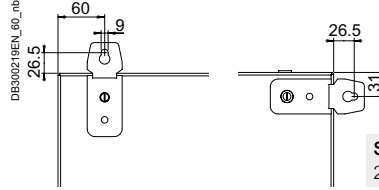

Supply:
2 supports

Characteristics

Spacial SM Wall fixing support

References

NSYSMWFIX

Doors **SFN** **SM**

Inner Door

SFN



NSYID166

- Door for additional protection. Helps prevent the switchgear from being manipulated by unauthorised personnel.
- Allows the installation of switchgear mounted directly on the door.
- Mounting on the top and bottom frame of the enclosure.
- Depth adjustable with a pitch of 25 mm, from the first fixing point.
- Opening to right or left, with two locks, 3-mm double-bar, with central handle.
- Reinforcement frames on the rear, cut-outs with a 25 mm pitch, for equipping the door.
- Maximum acceptable load: 15 kg.
- Inner doors can be mounted in our stainless-steel floor-standing enclosures (SFX and SMX).
- Material: Steel
- Finish: Structured finish, epoxy polyester powder
- Color: RAL 7035 gray

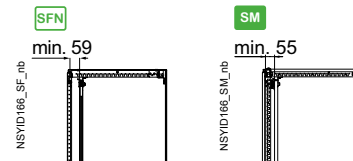

Comment:

For dimensions see [page 80](#)

Supply:

One inner door and fixing elements

SM



NSYID166

Characteristics	Height (mm)	Width (mm)	References
PanelSeT SFN/Spacial SM Inner door	1600	600	NSYID166
PanelSeT SFN/Spacial SM Inner door	1600	800	NSYID168
PanelSeT SFN/Spacial SM Inner door	1800	600	NSYID186
PanelSeT SFN/Spacial SM Inner door	1800	800	NSYID188
PanelSeT SFN/Spacial SM Inner door	1800	1000	NSYID1810
PanelSeT SFN/Spacial SM Inner door	2000	600	NSYID206
PanelSeT SFN/Spacial SM Inner door	2000	800	NSYID208
PanelSeT SFN/Spacial SM Inner door	2000	1000	NSYID2010

SFN Side Door

PE124779



NSYSFND126

- Door for all sides of the enclosure, can replace the panels.
- Installation directly on the structure of the enclosure, opening 120°.
- Lock with handle and 5-mm double-bar insert.
- 4 locking points.
- Reinforcement frame, cut-out with a pitch of 25 mm.
- Opening to right or left.
- Material: Steel
- Finish: Structured finish, epoxy polyester powder
- Color: RAL 7035 gray

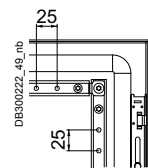

Comment:

For dimensions see [page 84](#)

Supply:

One side door, four hinges, four catches, bottom trim and handle lock

Characteristics	Height (mm)	Width (mm)	References
PanelSeT SFN Side door	1200	600	NSYSFND126
PanelSeT SFN Side door	1200	800	NSYSFND128
PanelSeT SFN Side door	1400	600	NSYSFND146
PanelSeT SFN Side door	1400	800	NSYSFND148
PanelSeT SFN Side door	1600	600	NSYSFND166
PanelSeT SFN Side door	1600	800	NSYSFND168
PanelSeT SFN Side door	1800	400	NSYSFND184
PanelSeT SFN Side door	1800	500	NSYSFND185
PanelSeT SFN Side door	1800	600	NSYSFND186
PanelSeT SFN Side door	1800	800	NSYSFND188
PanelSeT SFN Side door	2000	300	NSYSFND203
PanelSeT SFN Side door	2000	400	NSYSFND204
PanelSeT SFN Side door	2000	500	NSYSFND205
PanelSeT SFN Side door	2000	600	NSYSFND206
PanelSeT SFN Side door	2000	700	NSYSFND207
PanelSeT SFN Side door	2000	800	NSYSFND208
PanelSeT SFN Side door	2200	400	NSYSFND224
PanelSeT SFN Side door	2200	500	NSYSFND225
PanelSeT SFN Side door	2200	600	NSYSFND226
PanelSeT SFN Side door	2200	800	NSYSFND228



Enclosure ingress protection rating decreases to IP54 according to IEC 60529 when installing any type of partial door.

Partial Doors

Front Fix Panel for Modularity

- Top and bottom fix panel to obtain modularity required to install partial doors.
- It is needed to purchase **NSYMICN6** and **NSYMICN8**.
- Height 100 mm fixed panels are delivered as standard for PanelSeT SFN compartmentalized enclosures for Motor Control Centers.
- Option to order it separately for PanelSeT SFN framework in kit supply.
- Available in 2 heights (mm).
- Color: RAL 7035 gray.
- Finish: Epoxy-polyester powder.



NSYMFP2M6

Supply:
2 crossbars with 2 front fix panels

Characteristics	Height (mm)	Width (mm)	References
Front Fix panel for modularity	100	600	NSYMFP2M6
Front Fix panel for modularity	250	600	NSYMFP5M6
Front Fix panel for modularity	100	800	NSYMFP2M8
Front Fix panel for modularity	250	800	NSYMFP5M8

Frontal Partial Doors

- Plain partial door with lock 5-mm double-bar insert.
- They are fixed to the uprights of the framework by means of hinges.
- Drilling template for uprights ref. **NSYMDT** (only one drilling template required per order).
- Opening to right or left.
- 1, 2 or 4 locking points depending on height.
- Option to replace locking insert.
- Available in following heights (mm).
- Color: RAL 7035 gray.
- Finish: Epoxy-polyester powder.



NSYMPD3M6

Characteristics	Height (mm)	Width (mm)	References
Frontal partial door	150	600	NSYMPD3M6
Frontal partial door	200	600	NSYMPD4M6
Frontal partial door	250	600	NSYMPD5M6
Frontal partial door	300	600	NSYMPD6M6
Frontal partial door	400	600	NSYMPD8M6
Frontal partial door	450	600	NSYMPD9M6
Frontal partial door	600	600	NSYMPD12M6
Frontal partial door	800	600	NSYMPD16M6
Frontal partial door	900	600	NSYMPD18M6
Frontal partial door	1000	600	NSYMPD20M6
Frontal partial door	1200	600	NSYMPD24M6
Frontal partial door	150	800	NSYMPD3M8
Frontal partial door	200	800	NSYMPD4M8
Frontal partial door	250	800	NSYMPD5M8
Frontal partial door	300	800	NSYMPD6M8
Frontal partial door	400	800	NSYMPD8M8
Frontal partial door	450	800	NSYMPD9M8
Frontal partial door	600	800	NSYMPD12M8
Frontal partial door	800	800	NSYMPD16M8
Frontal partial door	900	800	NSYMPD18M8
Frontal partial door	1000	800	NSYMPD20M8
Frontal partial door	1200	800	NSYMPD24M8

Frontal Transparent Partial Doors

- Glazed (Securit glass) partial door with lock 5-mm double-bar insert.
- They are fixed to the uprights of the framework by means of hinges.
- Opening to right or left.
- 1 or 2 locking points according different heights.
- Available in following heights (mm).
- Color: RAL 7035 gray.
- Finish: Epoxy-polyester powder.



NSYMPD46T

Characteristics	Height (mm)	Width (mm)	References
Frontal Transparent partial doors	400	600	NSYMPD46T
Frontal Transparent partial doors	600	600	NSYMPD66T
Frontal Transparent partial doors	800	600	NSYMPD86T
Frontal Transparent partial doors	1000	600	NSYMPD106T
Frontal Transparent partial doors	400	800	NSYMPD48T
Frontal Transparent partial doors	600	800	NSYMPD68T
Frontal Transparent partial doors	800	800	NSYMPD88T
Frontal Transparent partial doors	1000	800	NSYMPD108T

Technical changes reserved. Information provided without guarantee. Images are for illustrative purposes only.

Intermediate Crossbar



- Mounted between partial doors or between doors and control desk, guaranteeing IP54 according to IEC 60529.
- Crossbar with direct fixing to the structure.
- Available in 2 widths (mm).
- Color: RAL 7035 gray.
- Finish: Epoxy-polyester powder.



Supply:
2 crossbars with fixing elements.

Characteristics	Width (mm)	References
PanelSeT SFN-Intermediate Crossbar	600	NSYMICN6
PanelSeT SFN-Intermediate Crossbar	800	NSYMICN8

Metal Document Pocket



- Direct mounting on the reinforcement frame of the door.
- Adjustable depth with a pitch of 25 mm.
- Material: Steel
- Finish: Structured finish, epoxy polyester powder
- Color: RAL 7035 gray

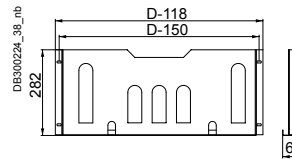

Supply:
1 metal document pocket and fixing elements

Characteristics	(D) Width (mm)	References
PanelSeT SFN/Spacial SM Metal document pocket	600	NSYSDP6M
PanelSeT SFN/Spacial SM Metal document pocket	800	NSYSDP8M

Plastic Document Pocket



- Attachment by adhesive tape.
- Material: Polystyrene (PS)
- Color: RAL 7035 gray (**NSYDPA4**: RAL 9001 white)

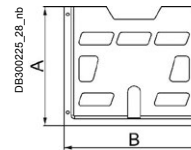

Comment:
NSYDPA44 not compatible with 19" chassis or modular distribution.

Supply:
1 plastic document pocket

Characteristics	Doc. format	A (mm)	B (mm)	C (mm)	References
PanelSeT SFN/Spacial SM Plastic document pocket	A5	174	188	22	NSYDPA5
PanelSeT SFN/Spacial SM Plastic document pocket	A4	230	247	23	NSYDPA4
PanelSeT SFN/Spacial SM Plastic document pocket	A4	234	278	40	NSYDPA44
PanelSeT SFN/Spacial SM Plastic document pocket	A3	285	476	35	NSYDPA3

3
SM
SFN

Folding Support Tray



NSYSDT5

- Adjustable horizontal support for laptop computers, documents or any other element.
- Installation on the reinforcement frame of the door.
- Can also be installed on the door cross-rails, see [page 274](#).
- 4 positions: 45°, 60°, 75° and 90°.
- Maximum load: 30 kg
- Material: Steel
- Finish: Structured finish, epoxy polyester powder
- Color: RAL 7035 gray

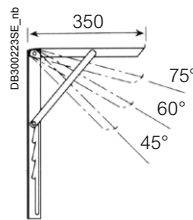

Supply:
1 folding support tray and fixing elements



NSYSDT8

Characteristics	Width of enclosure (mm)	Width of tray (mm)	References
PanelSeT SFN/Spacial SM-Folding support tray	500	325	NSYSDT5
PanelSeT SFN/Spacial SM-Folding support tray	600	425	NSYSDT6
PanelSeT SFN/Spacial SM-Folding support tray	800	625	NSYSDT8

180° Hinge



- Hinge with opening of 180°.
- Intended to replace the 120° hinges installed as standard.
- They are compatible with the transparent door and can be installed even with enclosure suites.
- Maximum load: 60 kg on the door
- Material: Aluminum and zamak
- Finish: Painted RAL 9005 black
- UL-certified (cULus):
 - SFN: Types 1, 3R, 12 according UL50E
 - SM: Types 1, 2, 3R, 5 and 13 for single-door enclosures

Supply:
4 hinges

Characteristics	References
PanelSeT SFN/Spacial SM 180° hinge	NSYSH180NC

Door-Centering Caster

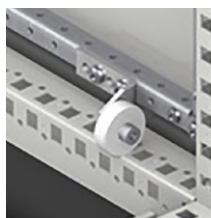

NSYSDRC

- Allows the door to be raised when closing.
- Direct mounting on the reinforcement frame.
- Maximum load: 92 kg
- Spacial SM: installation only possible with horizontal adaptation profile NSYSMHR• (see [page 239](#))

Supply:
One centering roller and fixing elements

Characteristics	References
PanelSeT SFN/Spacial SM Door-centering caster	NSYSDRC

Door Switch



NSYDCM20

- The switch is fixed to the structure of the enclosure.
- Drilled M20 cable entry for cable gland.
- NC + NO contact, 240 V AC / 3 A (IEC 60947-5-1)
250 V DC / 0,1 A (IEC 60947-5-1)



Supply:
1 door switch and fixing elements

Characteristics	References
PanelSeT SFN/Spacial SFX Door switch	NSYDCM20
Spacial SM Door switch	NSYMDCM20

Locking System Padlock Locking

Coming soon

3
SM
SFN



NSYBLKHN123

- Padlock locking system, for installation in all the handles of the PanelSeT SFN and Spacial SM enclosures.
- Screw with 7.5 mm drill hole.

Supply:
One cut-out handle, screw for padlock and screw fixing screw

Characteristics	References
PanelSeT SFN/Spacial SM Padlock locking	NSYBLKHN123

CNOMO Kit



NSYCNOH123

- Locking system to be installed on the central locking bar of the door.
- It works as a locking bar immobiliser, helping prevent the handle from closing while the door is still open.
- It is compatible with all handle lock versions, except the flat lock and the small flat lock.



Supply:
One mechanism and fixing elements

Characteristics	References
PanelSeT SFN/Spacial SM CNOMO kit	NSYCNOH123

Handle for Shaped Inserts and Cylindrical Barrels



NSYSFNHS1

- Easy to change the opening direction of the door, right/left.
- Space reserved for enclosure identification, 21 x 27 mm, protected by a label frame.
- Handle material: Polyamide 6 with 30% fiberglass
- Color: RAL 9005
- Mechanical protection rating: IK10 according to IEC 62262
- Fire resistance: 650 °C

Supply:
Standard handle and fixing elements (insert not included)

Characteristics	References
PanelSeT SFN/Spacial SM Handle for shaped inserts and cylindrical barrels	NSYSFNHS1

Push-Button



NSYINPULS1

Characteristics	References
Push-button	NSYINPULS1

Shape Inserts

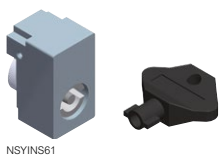

NSYINS61

Characteristics	References
6 mm square insert	NSYINS61
7 mm square insert	NSYINS71
8 mm square insert	NSYINS81
6.5 mm triangular insert	NSYINT61
7 mm triangular insert	NSYINT71
8 mm triangular insert	NSYINT81
9 mm triangular insert	NSYINT91
3-mm double-bar insert	NSYINDB31
5-mm double-bar insert	NSYINDB51

Cylindrical Barrels

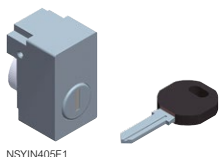

NSYIN405E1

Characteristics	References
405E key lock	NSYIN405E1
421E key lock	NSYIN421E1
455 key lock	NSYIN4551
1242E key lock	NSYIN1242E1
2131A key lock	NSYIN2131A1
2132A key lock	NSYIN2132A1
2433A key lock	NSYIN2433A1
2452E key lock	NSYIN2452E1
3113A key lock	NSYIN3113A1
EDF1300 key lock	NSYINF1301
Michelin 8133 keyless lock	NSYINICHEL8131
Michelin 8376 keyless lock	NSYINICHEL8371
E1 keyless lock	NSYINE11

Handles for Insert Types DIN, KABA, ASSA, Insert Handle

Coming soon



NSYSFNHD2

- The inserts are easily and quickly mounted without any screws and allow the installation of profiled DIN, KABA and ASSA locks.
- To install shaped inserts or cylindrical barrels, it is necessary to add adapter ref. **NSYLADP**.
- Easy to change the opening direction of the door, right/left.
- Space reserved for enclosure identification, 21 x 27 mm, protected by a label frame.
- Handle material: Polyamide 6 with fiberglass
- Color: RAL 9005 black
- Mechanical protection rating: IK10 according to IEC 62262
- Glow wire resistance: 650 °C

Supply:

One handle for DIN, KABA and ASSA inserts and fixing elements (insert not included)

Characteristics	References
PanelSeT SFN/Spacial SM Insert handle	NSYSFNHD2

Handles for Insert Types DIN, KABA, ASSA, Double-Insert Handle

Coming soon



NSYSFNHD3

- The double-insert handle can perform the "AND" and "OR" functions (are supplied with the handle).
 - "AND" function: One insert blocks the activation of the other insert.
 - "OR" function: Either insert can release the handle.
- Easy to change the opening direction of the door, right/left.
- Space reserved for enclosure identification, 21 x 27 mm, protected by a label frame.
- To install shaped inserts or cylindrical barrels, it is necessary to add adapter ref. **NSYLADP**.
- Handle material: Polyamide 6 with fiberglass
- Color: RAL 9005 black
- Mechanical protection rating: IK10 according to IEC 62262
- Glow wire resistance: 650 °C.

Supply:

One handle for DIN, KABA and ASSA inserts and fixing elements (insert not included)

Characteristics	References
PanelSeT SFN/Spacial SM Double-insert handle	NSYSFNHD3

Lock System: DIN, KABA and ASSA



NSYINDIN2

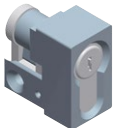

NSYIN1242E2

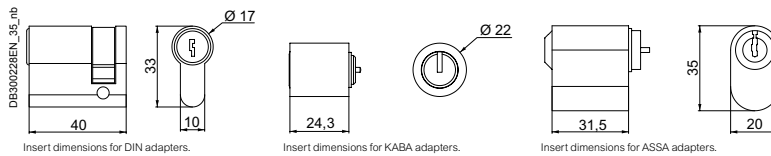
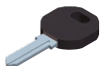

Comment:

NSYINKBA2: Adapter for receiving the KABA8, KABA20 and KABA start cylinders.

Characteristics	References
PanelSeT SFN/Spacial SM Adapter for DIN cylinder	NSYINDIN2
PanelSeT SFN/Spacial SM Adapter for KABA cylinder	NSYINKBA2
PanelSeT SFN/Spacial SM Adapter for ASSA cylinder	NSYINASSA2
PanelSeT SFN/Spacial SM 1242E key lock	NSYIN1242E2
PanelSeT SFN/Spacial SM Reinforced key lock	NSYINKR2
PanelSeT SFN/Spacial SM JIS key lock	NSYINKJIS2
PanelSeT SFN/Spacial SM FAC key lock	NSYINKFAC2

Adapter for Shaped Inserts and Cylindrical Barrels



NSYLADP

- Plastic adapter for installing shaped inserts and cylindrical barrels in handle lock types DIN, KABA, ASSA.
- See shaped inserts and cylindrical barrels.
- See insert types DIN, KABA, ASSA.

Supply:

1 unit

Characteristics	References
PanelSeT SFN/Spacial SM Adapter for shaped inserts and cylindrical barrels	NSYLADP

DB30018BEN-176

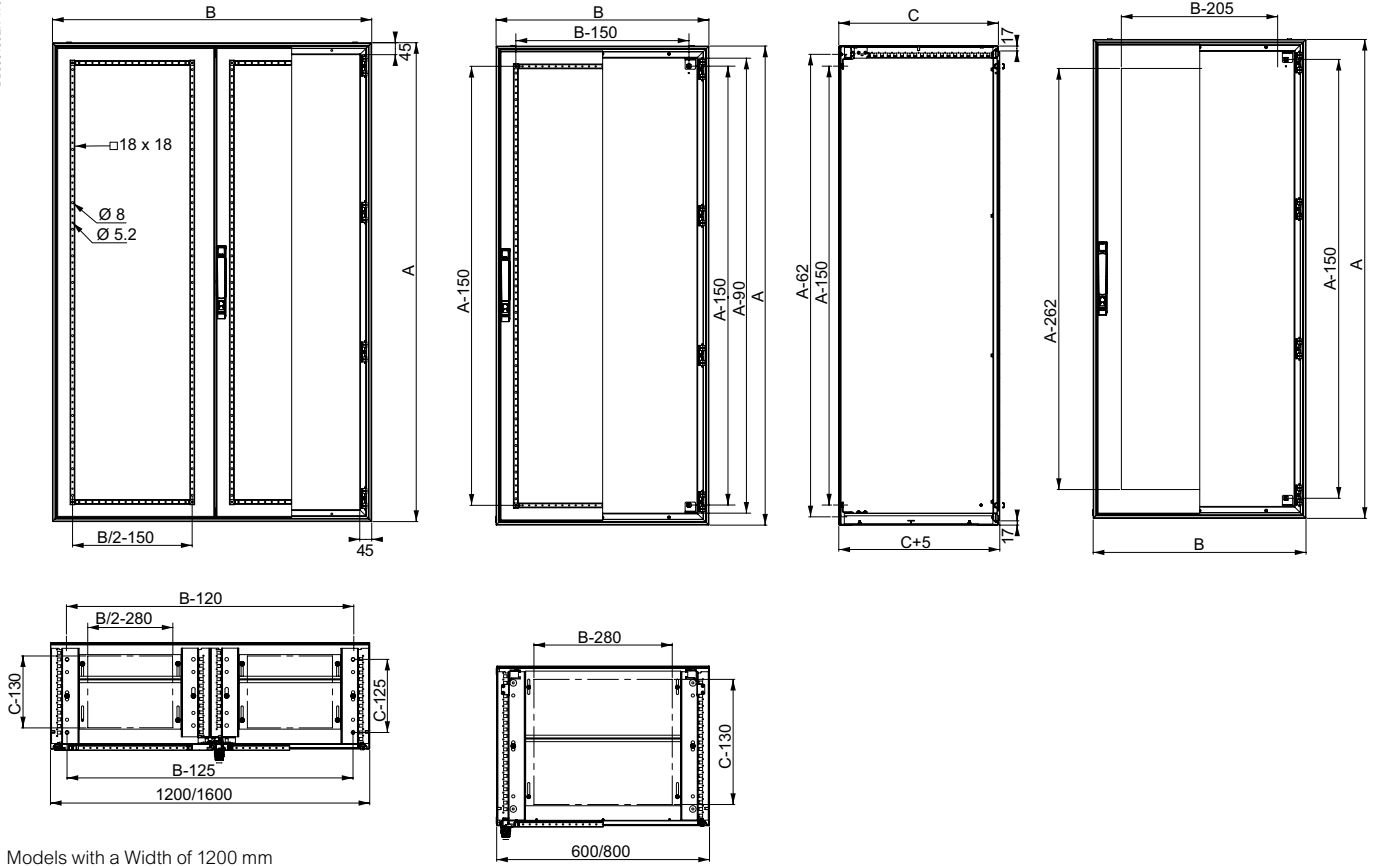

Models with a Width of 1200 mm without Top/Bottom Adjustment Rails

Inner Door

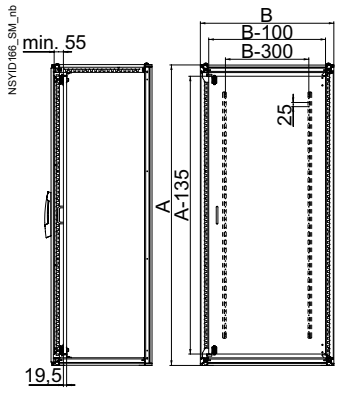

DE301024EN-SFNok

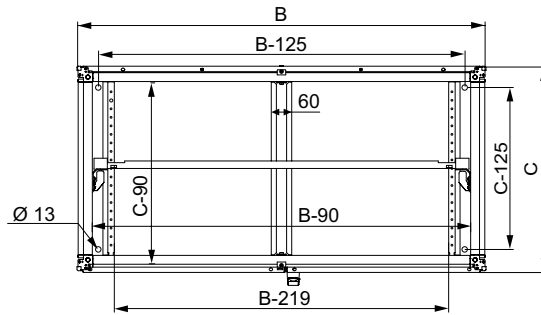
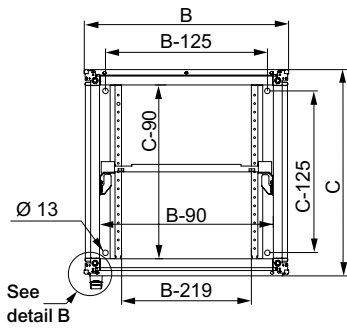
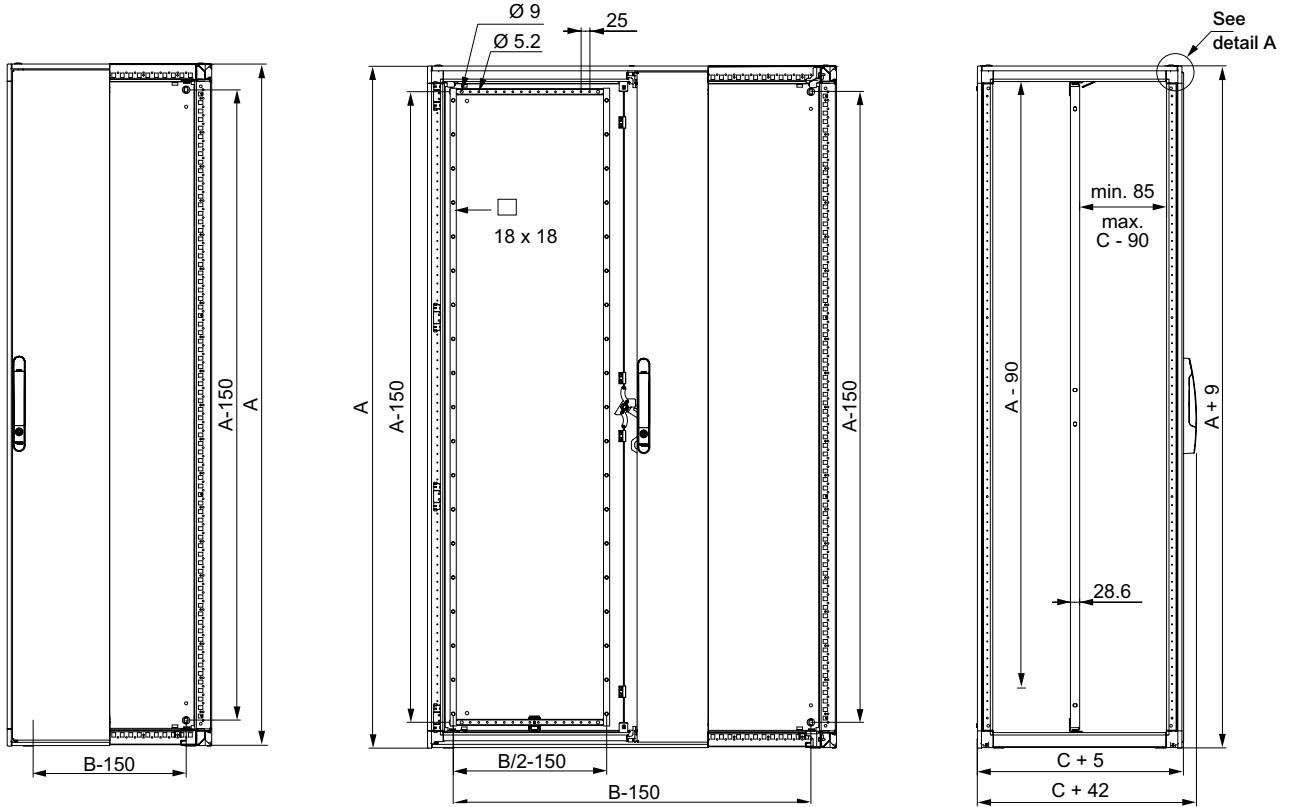

Inner Door

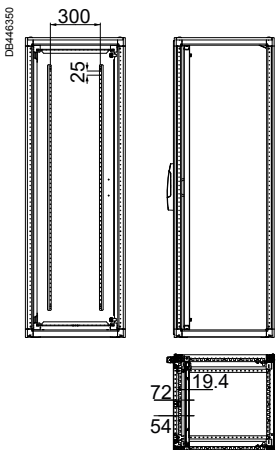

Side Door

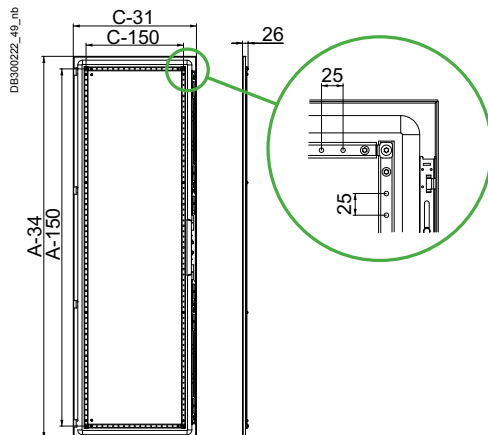

Stainless-Steel Industrial Boxes

Spacial SBX

4

PB030875_06_nb



Spacial SBX

Introduction	114
Characteristics	117
Accessories	118
Dimensions	122

What Is Stainless-Steel?

How Is the Grade of Stainless-Steel Determined?

These enclosures have been specially designed for the chemical, oil and food and beverage industries, among others, which are particularly demanding in terms of hygiene and resistance to corrosion.

Elaborate Material Composition

The following table shows the percentages of the main alloy elements that make up stainless-steels. The resistance of the material to aggressive agents in the environment depends mainly on these alloys.



PB501229_nb

4
SBX

Choosing a Grade

Stainless-steel type		Chemical composition (%)			
AISI grade	N. Europe	Carbon	Chromium	Nickel	Molybdenum
304L	1.4307	< 0.03	17 - 19	8 - 10	0
316L	1.4404	< 0.03	17 - 19	10 - 13	2 - 2.25



PB501230_nb

AISI 304L Stainless-Steel

The most commonly used type in the food and beverage industry because of its resistance to corrosion and ease of cleaning.

- Prevention against corrosion, especially in the presence of organic acids.
- Resistance to the effects of nitrous gas in the presence of condensed water and in most aggressive environments.



PB501231_nb

AISI 316L Stainless-Steel

Recommended in salty or chlorinated environments because of its very high resistance to corrosion created by molybdenum.

- Improved resistance to corrosion.
- Particularly well adapted to environments with acidity, bromine and saline halides or very corrosive additives and solvents.

The Finish

The Finish: Three Solutions for Protection Against Aggressive Substances

Surface condition plays an important role in the fight against bacteria. The lower the roughness, the fewer bacteria become incrustated. Reduced roughness means fewer bacteria, less adhesion, and a finish that's impeccable. The choice of finish determines the appearance of the enclosures that matches the environment of other machines and equipment.



Solution 1: Scotch-Brite® Brushing

The method uses brushing as defined by the ASTM (American Society for Testing and Material).

- Finish very commonly used for the chemical and food and beverage industries.
- Surface roughness is improved thanks to an additional polishing process which offers more efficient characteristics against polluting elements.
- Surface roughness: $Ra \leq 0.8 \mu m$.



Solution 2: Micro-Beading (on Request)

Exclusiveness, an impeccable finish with silky-smooth appearance.

The method:

- Bombardment with miniscule ceramic balls of the entire surface to be treated at very high speed.
- Closes micro-cracks caused during lamination by flattening the surface.

The result:

- Increased hardness.
- Reduced surface roughness: $Ra \approx 0.8 \mu m$.
- A perfectly even surface, with a silky appearance (no scratches and no burrs).
- Reduces the adhesion of materials.
- Allows disinfection.
- Typical application: Pharmaceutical and food and beverage industries.

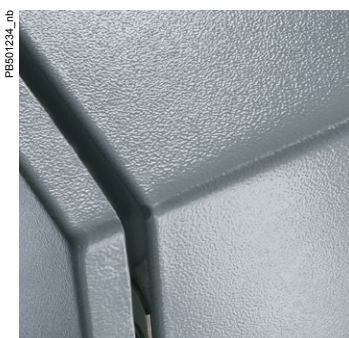

Solution 3: Protective Painting (on Request)

The highest protection against aggressive substances, external pollution and projections of metal particles.

- Provides ultimate protection against corrosion.
- Typical applications: Marine, seaside, off-shore.

Simplicity, Ergonomics and Quality

4
SBX



Save Time



Get the Best
Esthetic



Get a High Quality
Cut-Outs



Customized Cut-Outs



- Enclosure delivered with cut-outs so you can focus on your added-value work
- Cut-outs made with an industrial laser machine for a perfect result, burr-free, with high accuracy and minimal machining tolerances
- Scotch-Brite®-brushed
- External surfaces with no scratches

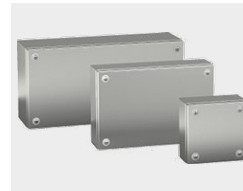

Selection

- 6 sizes
- 80 mm and 120 mm in depth.



Sturdy with High Ingress Protection

- Thickness of 1.2 mm
- Mechanical protection rating up to IK10.
- Ingress protection rating up to IP66.



Added-Value for Your Work

- Quality and esthetics.
- Same dimensions as steel boxes (SBM range).
- Mounting with versatile external brackets.
- Certification (on request):
UL, Veritas and BVM.



Ergonomics

- Cover opening and accessory mounting with just a screwdriver.

See [page 474](#) for details or consult our web site www.se.com



Characteristics	Spacial SBX Flat box
	<p>Box with plain faces Single-piece body (rectangular structure). Front design incorporating folded gutters. Flat rear. 2 drilled profiles for installing mounting plates and DIN rails, with mounting centers of 12.5 mm. Equipped with 4 half-turn thread screws to ensure maximum watertightness. Polyurethane sealing gasket.</p> <p>Protection of personnel Earthing connection mandatory for all boxes: Spacial SBX Stainless-Steel boxes are equipped with an M6 x 10 mm earthing stud welded on the cover, to be linked with the body for equipotential connection. Earthing braid to be ordered separately (Ø 6.4 mm terminal).</p>
Material	AISI 304L stainless-steel, thickness of 1.2 mm.
Finish	Scotch-Brite® brushed.
Ingress protection rating	IP66
Mechanical protection rating	IK10
Compliance with standards	IEC 62208 and the RoHS directive.
Certifications	<ul style="list-style-type: none"> • UL (cULus), BV, BVM • Rating according UL50E: Types 4, 4X and 13
Installation	<p>Indoor installation Direct wall-mounted (4 x Ø 10 mm holes with sealing plugs to maintain the IP rating) or with the help of fixing lugs installed from the outside (to be ordered separately, see the specific accessory pages). Distance between mounting holes enables the installation of the box in the same locations as many existing enclosures.</p> <p>Outdoor installation Compliant with IEC 62208 regarding type tests specified in §9.12 resistance to ultra-violet (UV) radiation and §9.13 resistance to corrosion. It is always advisable to place the box under shelter to avoid water stagnation on the upper part of the enclosure.</p>
Maximum load capacity	On the body: 50 kg/m ²
Other characteristics	<p>Vibration constraints Specific construction of the Spacial SBX - single-piece body (rectangular structure). The rear is flat without added parts - this helps ensure compliance with certain vibration constraints. The tests were conducted according to the marine application by Bureau Veritas Marine.</p>

Technical changes reserved. Information provided without guarantee. Images are for illustrative purposes only.

4
SBX

Dimensions			Box	Mounting plate	DIN rail	Fixing lugs	Sealing kit
Height (mm)	Width (mm)	Depth (mm)	Supply: 1 piece	Supply: 1 piece	Supply: 10 pieces	Supply: 4 pieces	Supply: 1 piece
References			References	References	References	References	References
150	150	80	NSYSBX15158	NSYMM11SB	NSYAMRD15357SB	NSYAEFFSBX	NSYPPSB
150	300	80	NSYSBX15308	NSYMM13SB	NSYAMRD30357SB		
200	200	80	NSYSBX20208	NSYMM22SB	NSYAMRD20357SB		
200	300	80	NSYSBX20308	NSYMM23SB	NSYAMRD30357SB		
200	400	120	NSYSBX204012	NSYMM24SB	NSYAMRD40357SB		
300	300	120	NSYSBX303012	NSYMM33SB	NSYAMRD30357SB		

Mounting Plate

- Material: Galvanized steel
- Installation: Mounting by means of 2* or 4 x Ø 5 mm self-tapping screws, Pozidriv head, ref. **NSYAMFSB**. Mounting plate installation points compatible with many other brands of accessories.

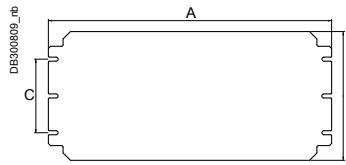

Comment:
* Only 2 screws for mounting plates with height of 150 mm

Supply:
1 unit, supplied without screws

Characteristics	Dimensions		Mounting plate, Dimensions			Thickness (mm)	References
	Height (mm)	Width (mm)	A (mm)	B (mm)	C (mm)		
Mounting plate	150	150	135	135	-	1.5	NSYMM11SB
Mounting plate	150	300	135	285	-	1.5	NSYMM13SB
Mounting plate	200	200	185	185	100	1.5	NSYMM22SB
Mounting plate	200	300	185	285	100	1.5	NSYMM23SB
Mounting plate	200	400	185	385	100	2.0	NSYMM24SB
Mounting plate	300	300	185	185	200	1.5	NSYMM33SB

Symmetrical DIN Rails 35 x 7.5 mm

- Material: Galvanized steel
- Installation: Mounting by means of 2 x Ø 5 mm self-tapping screws, Pozidriv head, ref. **NSYAMFSB** (All boxes are delivered with 5 x Ø 5 mm self-tapping screws).

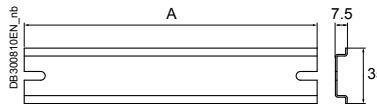

Supply:
10 rails, supplied without screws

Characteristics	Box Width (mm)	DIN rail Length A (mm)	References
Symmetrical DIN rail	150	135	NSYAMRD15357SB
Symmetrical DIN rail	200	185	NSYAMRD20357SB
Symmetrical DIN rail	300	285	NSYAMRD30357SB
Symmetrical DIN rail	400	385	NSYAMRD40357SB

Self-Tapping Screws



NSYAMFSB

- Same reference for all dimensions
- Self-tapping, Pozidriv head, screws, for Ø 5 mm holes.

Supply:
100 units

Characteristics	References
Self-tapping screws	NSYAMFSB

Sealing Kit



NSYPFSB

- The sealing kit helps to set up a lead-sealed cable of cover opening.
- Color: Green
- Ingress protection rating: IP66 according to IEC 60529
- Installation: Replaces the standard sealing washer on the box
- Same reference for all dimensions

Supply:
1 unit

Characteristics	References
Sealing kit SBM	NSYPFSB

Mounting Lugs



NSYAEFFFSBX

- Wall-mounted lugs to be mounted directly on the rear of the box, either in horizontal or vertical position. Their versatile design complies with the mounting dimensions of many other enclosures.
- Installation: Horizontal or vertical position, distance between wall and enclosure: 12 mm
- Maximum load: 70 kg

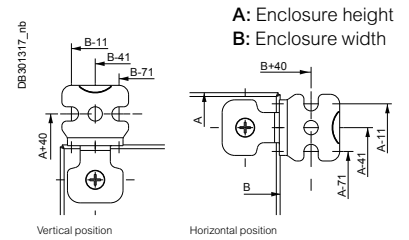

Supply:
4 wall-mounted lugs, screws and pre-mounted sealing gaskets

Characteristics	References
Wall-mounted lugs	NSYAEFFFSBX

4
SBX

Simple-5

- ISO cable gland.
- Material: PA6 Polyamide, neoprene gasket
- Color: RAL 7035 gray
- Cable entry material: Combined
- Installation options: On cable gland plate or directly on enclosure
- Flexibility of the installation: Low
- Reversibility: Medium
- Ingress protection rating: IP68
- Cable retention: High
- Cable diameter (mm): From 12 to 40
- Cable Installation time: Slow
- Quantity of cables to be fitted for a given surface: +
- Cable entries for cables with connectors: No
- Cut-out dimensions (mm): Various circular hole diameters according to cable diameter
- External dimensions (mm): From Ø 15 to 46
- Glow wire resistance 960 °C
- Certified by VDE and UL
- Flame resistance: 750 °C

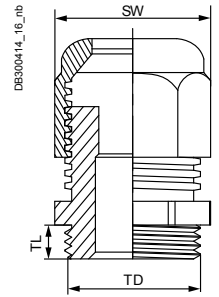

Supply:

The cable glands are supplied with nuts
Pack of 20 (M12 to M20), of 10 (M25 and M32), of 5 (M40)



ISM71503

Characteristics	Dimensions					References
	Cable (Ø mm)	Drill hole (Ø mm)	TD	TL	SW	
Cable gland M12, RAL 7035	3 / 6.5	12.2 (0 + 0.2)	12	6	15	ISM71501
Cable gland M16, RAL 7035	4 / 8	16.2 (0 + 0.2)	16	8	19	ISM71502
Cable gland M20, RAL 7035	6 / 12	20.2 (0 + 0.2)	20	10	24	ISM71503
Safety Cable gland M20, RAL 3000	6 / 12	20.2 (0 + 0.2)	20	10	24	IMT36150
Cable gland M25, RAL 7035	11 / 17	25.2 (0 + 0.2)	25	8	29	ISM71504
Cable gland M32, RAL 7035	15 / 21	32.2 (0 + 0.3)	32	10	36	ISM71505
Cable gland M40, RAL 7035	19 / 28	40.5 (0 + 0.3)	40	10	46	ISM71506

Synthetic Snap-In Cable Gland

- Without thread.
- Easy assembly and disassembly.
- Suitable for walls from 0.5 to 4 mm thick.
- Material: PA6 Polyamide, neoprene gasket
- Color: RAL 7035 gray, RAL 7001, RAL 9005. Other colors on demand
- Cable entry material: Non armoured
- Installation options: On cable gland plate or directly on enclosure
- Flexibility of the installation: Low
- Reversibility: Medium
- Ingress protection rating: IP66
- Cable retention: High
- Cable diameter (mm): From 16 to 40
- Cable Installation time: Slow
- Quantity of cables to be fitted for a given surface: +
- Cable entries for cables with connectors: No
- Thread type: Metric EN 60423
Other types are available on demand
- Cut-out dimensions (mm): Various circular hole diameters according to cable diameter
- External dimensions (mm): From Ø 22 to 46
- Certificates: UL Certified (cULus)
- Temperature range: -20 °C to + 100 °C

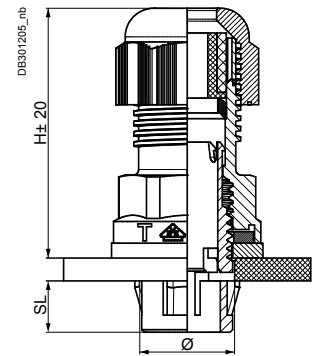

Supply:

The cable glands are supplied with nuts
Pack of 20 (M16 and M20), of 10 (M25 and M32), of 5 (M40)



NSYCGSP16

Characteristics	Dimensions						References	
	Ø	Ø min / max	Drill Ø	SL	SD	H		
Synthetic snap-in cable gland	M16	5/10	16.2 to 16.4	9	15.9	42.5	22	NSYCGSP16
Synthetic snap-in cable gland	M20	6/12	20.2 to 20.4	9	19.9	41.5	24	NSYCGSP20
Synthetic snap-in cable gland	M25	11/17	25.2 to 25.4	9	24.9	43.5	29	NSYCGSP25
Synthetic snap-in cable gland	M32	15/21	32.2 to 32.4	9	31.9	49.5	36	NSYCGSP32
Synthetic snap-in cable gland	M40	19/28	40.2 to 40.4	11.5	39.9	56	46	NSYCGSP40

Stainless-Steel Cable Gland with Lamellar Insert

- Lamellar technology provides excellent resistance to traction as well as excellent torsional protection. For outdoor use, or for aggressive environments.
- Material: Stainless-steel AISI 304L or AISI 316L, neoprene gasket
- Cable entry material: Non armoured
- Installation options:
 - On cable gland plate or directly on enclosure
- Flexibility of the installation: Low
- Reversibility: Medium
- Ingress protection rating: IP68
- Cable retention: High
- Cable diameter (mm): From 12 to 40
- Cable Installation time: Slow
- Quantity of cables to be fitted for a given surface: +
- Cable entries for cables with connectors: No
- Thread type: Metric EN 60423

- Cut-out dimensions (mm): Various circular hole diameters according to cable diameter
- External dimensions (mm): From Ø 14 to 43
- Certificate: UL (cULus)
- Standard: DIN EN 62444
- Temperature range: -20 °C to + 100 °C



Supply:

The cable glands are supplied with nuts
Pack of 5 (M12 and M16), of 4 (M20 and M25), of 2 (M32 and M40)



NSYCGX12

Characteristics	Dimensions							References
	Ø	Ø min-max mm	Thread Length TL mm	SW Cap mm	SW Body mm	Outer Ø D mm	max. Height H mm	
AISI 304L	M12x1.5	3.0 - 6.5	6	14	14	15.5	24	NSYCGX12
AISI 304L	M16x1.5	4.0 - 8.0	7	17	19	21	25.5	NSYCGX16
AISI 304L	M20x1.5	10.0 - 14.0	8	24	24	26.5	30	NSYCGX20
AISI 304L	M25x1.5	10.0 - 14.0	8	24	27	30	30	NSYCGX25
AISI 304L	M32x1.5	13.0 - 18.0	9	30	36	39.8	35	NSYCGX32
AISI 304L	M40x1.5	18.0 - 25.0	9	41	46	51.4	40.5	NSYCGX40
AISI 316L	M12x1.5	3.0 - 6.5	6	14	14	15.5	24	NSYCGX12H
AISI 316L	M16x1.5	4.0 - 8.0	7	17	19	21	25.5	NSYCGX16H
AISI 316L	M20x1.5	10.0 - 14.0	8	24	24	26.5	30	NSYCGX20H
AISI 316L	M25x1.5	10.0 - 14.0	8	24	27	30	30	NSYCGX25H
AISI 316L	M32x1.5	13.0 - 18.0	9	30	36	39.8	35	NSYCGX32H
AISI 316L	M40x1.5	18.0 - 25.0	9	41	46	51.4	40.5	NSYCGX40H

Earth Braids

- They help guarantee the earth connection for high frequencies, avoiding the disturbing electric currents that are produced.
- Material: Tinned copper.

Supply:

10 earth braids
(nuts and washers not included)
Reference by unit. Order by multiples of 10 (10, 20, 30...)



NSYEB156D6

Characteristics	Section (mm ²)	Terminal Ø (mm)	Length (mm)	Width (mm)	References
Earth braids	6	6.5	150	12	NSYEB156D6
Earth braids	10	6.5	150	17	NSYEB1510D6

Earth Cables

- Make it easier to install a safe earth connection, with a perfect contact, with optimized length.
- Material: Brass and copper alloy terminal, green and yellow PVC insulated sheath

Supply:

10 earth cables (nuts and washers not included).
Reference by unit. Order by multiples of 10 (10, 20, 30...)



NSYEL136D6

Characteristics	Section (mm ²)	Terminal Ø (mm)	Length (mm)	References
Earth cables	6	6.4	130	NSYEL136D6
Earth cables	6	6.4	160	NSYEL166D6
Earth cables	6	8.3	160	NSYEL166D8
Earth cables	6	6.4	220	NSYEL226D6
Earth cables	25	8.3	220	NSYEL2225D8
Earth cables	10	6.4	250	NSYEL2510D6
Earth cables	25	8.3	350	NSYEL3525D8

Earthing Strip

- Perforated brass bar, 15 x 3 mm.
- 1 m long.
- 87 connection points, M5 drill holes

Supply:

• 1 earthing strip
and fixing elements



NSYECB1M153

Characteristics	References
Earthing strip	NSYECB1M153

Section A-A

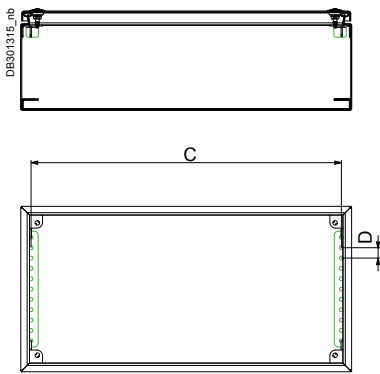

Section B-B

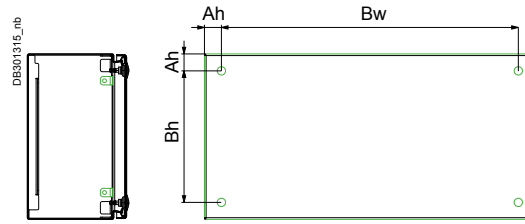

4
SBX

Dimensions Height (mm)	Width (mm)	Depth (mm)	Sheet thickness (mm)	Box installation Ah (mm)	Bh (mm)	Bw (mm)	Mounting C (mm)	D (mm)
150	150	80	1.2	20.5	109	109	125	12.5
150	300	80	1.2	20.5	109	259	275	12.5
200	200	80	1.2	20.5	159	159	175	12.5
200	300	80	1.2	20.5	159	259	275	12.5
200	400	120	1.2	20.5	159	359	375	12.5
300	300	120	1.2	20.5	259	259	275	12.5

Cut-Out Zone Limits

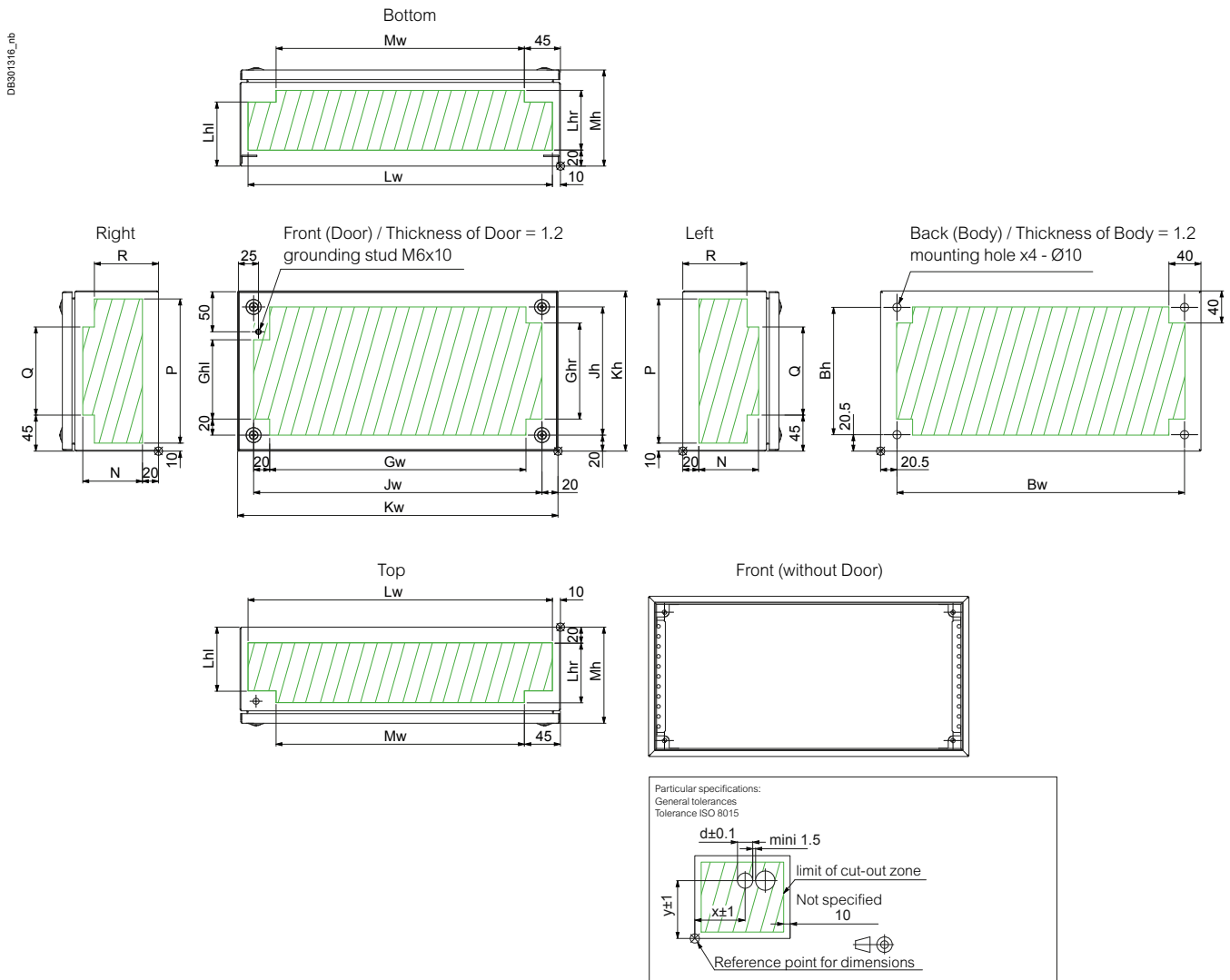

4
SBX

Dimensions			References	Dimensions of permissible cut-out zone																	
Height (mm)	Width (mm)	Depth (mm)		Bh (mm)	Bw (mm)	Ghr (mm)	Ghl (mm)	Gw (mm)	Jh (mm)	Jw (mm)	Kh (mm)	Kw (mm)	Lhl (mm)	Lhr (mm)	Lw (mm)	Mh (mm)	Mw (mm)	N (mm)	P (mm)	Q (mm)	R (mm)
150	150	80	NSYSBX15158	109	109	70	49	70	110	110	150	150	40	34.5	130	80	60	34.5	130	60	40
150	300	80	NSYSBX15308	109	259	70	49	220	110	260	150	300	40	34.5	280	80	210	34.5	130	60	40
200	200	80	NSYSBX20208	159	159	120	99	120	160	160	200	200	40	34.5	180	80	110	34.5	180	110	40
200	300	80	NSYSBX20308	159	259	120	99	220	160	260	200	300	40	34.5	280	80	210	34.5	180	110	40
200	400	120	NSYSBX204012	159	359	120	99	320	160	360	200	400	80	74.5	380	120	310	74.5	180	110	80
300	300	120	NSYSBX303012	259	259	220	199	220	260	260	300	300	80	74.5	280	120	210	74.5	280	210	80

Stainless-Steel Wall-Mounted Enclosures

Stainless-Steel Wall-Mounted Enclosures

PB650075_40_nb

5



Spacial S3X, Stainless-Steel Wall-Mounted Enclosures

Introduction	126
Characteristics	128
Selection Guide	130
Accessories	131
Dimensions	135

What Is Stainless-Steel?

How Is the Grade of Stainless-Steel Determined?

These enclosures have been specially designed for the chemical, oil and food and beverage industries, among others, which are particularly demanding in terms of hygiene and resistance to corrosion.

Elaborate Material Composition

The following table shows the percentages of the main alloy elements that make up stainless-steels. The resistance of the material to aggressive agents in the environment depends mainly on these alloys.



5
S3X

Choosing a Grade

Stainless-steel type		Chemical composition (%)			
AISI grade	N. Europe	Carbon	Chromium	Nickel	Molybdenum
304L	1.4307	< 0.03	17 - 19	8 - 10	0
316L	1.4404	< 0.03	17 - 19	10 - 13	2 - 2.25

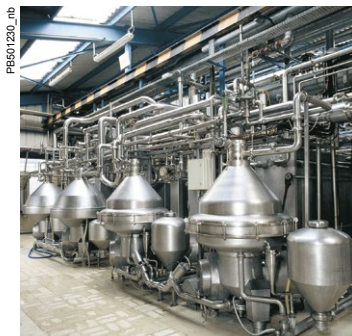

AISI 304L Stainless-Steel

The most commonly used type in the food and beverage industry because of its resistance to corrosion and ease of cleaning.

- Prevention against corrosion, especially in the presence of organic acids.
- Resistance to the effects of nitrous gas in the presence of condensed water and in most aggressive environments.



AISI 316L Stainless-Steel

Recommended in salty or chlorinated environments because of its very high resistance to corrosion created by molybdenum.

- Improved resistance to corrosion.
- Particularly well adapted to environments with acidity, bromine and saline halides or very corrosive additives and solvents.

The Finish

The Finish: Three Solutions for Protection Against Aggressive Substances

Surface condition plays an important role in the fight against bacteria. The lower the roughness, the fewer bacteria become incrustated. Reduced roughness means fewer bacteria, less adhesion, and a finish that's impeccable. The choice of finish determines the appearance of the enclosures that matches the environment of other machines and equipment.



Solution 1: Scotch-Brite® Brushing

The method uses brushing as defined by the ASTM (American Society for Testing and Material).

- Finish very commonly used for the chemical and food and beverage industries.
- Surface roughness is improved thanks to an additional polishing process which offers more efficient characteristics against polluting elements.
- Surface roughness: $Ra \leq 0.8 \mu m$.



Solution 2: Micro-Beading (on Request)

Exclusiveness, an impeccable finish with silky-smooth appearance.

The method:

- Bombardment with miniscule ceramic balls of the entire surface to be treated at very high speed.
- Closes micro-cracks caused during lamination by flattening the surface.

The result:

- Increased hardness.
- Reduced surface roughness: $Ra \approx 0.8 \mu m$.
- A perfectly even surface, with a silky appearance (no scratches and no burrs).
- Reduces the adhesion of materials.
- Allows disinfection.
- Typical application: Pharmaceutical and food and beverage industries.

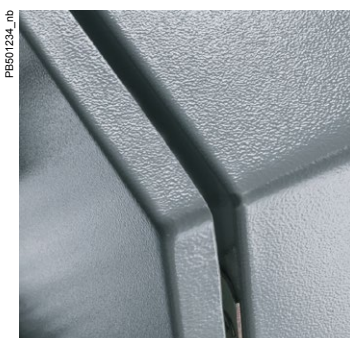

Solution 3: Protective Painting (on Request)

The highest protection against aggressive substances, external pollution and projections of metal particles.

- Provides ultimate protection against corrosion.
- Typical applications: Marine, seaside, off-shore.

These Enclosures Have Been Specially Designed for the Chemical, Oil and Food and Beverage Industries, Among Others, Which Are Particularly Demanding in Terms of Hygiene and Resistance to Corrosion

5
S3X

This range can be configured according to your needs

4 different services available:



Assemble to Order



Mounting of Standard Accessories



Painting



Machining



Finishes

- Two types of steel offered as standard: 304L and 316L, with Scotch-Brite® brushed finish.
- Painted or micro-beaded finish (on request).



Robustness and Durability

Resistance to external mechanical impacts:

- IK10: Plain door, IK08: Glazed door.
- Door reinforcement frame or profile.
- Stainless-steel hinges.



Large Range of Accessories

- Stainless-steel accessories: canopy, wall fixing lugs.
- Standard accessories: mounting plate, inner door, modular chassis and step slides.
- Large selection of locks made of 100% stainless-steel.



Time Savings and Convenience

- 304L or 316L stainless-steel wall fixing lugs.
- Vertical reinforcement perforated profiles, which make it easier to equip the door.
- Reversible door opening to 120°.
- Easy installation directly on the machine thanks to the 4 rear drilled holes.



Sealing

- Protection rating of IP66 (1 door) or IP55 (2 doors) according to IEC 60529: Complete protection against dust and water sprays.
- Polyurethane gasket.
- Gutter-shaped front profile.
- Three locking points for the double-door.

See page 474 for details or consult our web site www.se.com

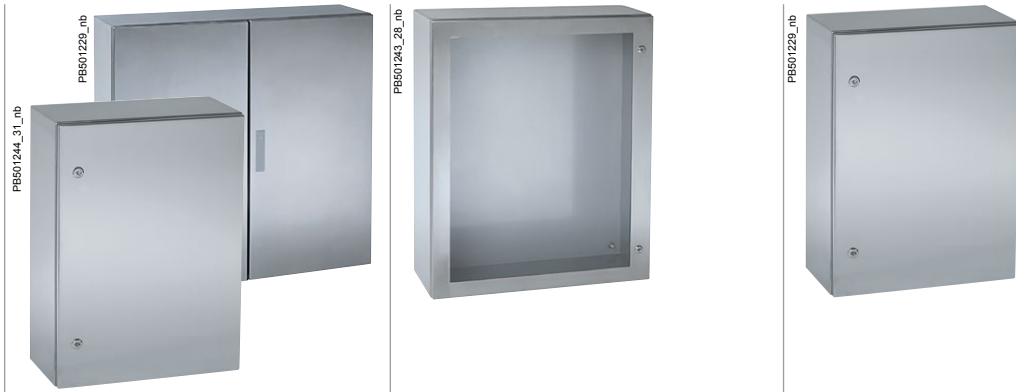

Comment:
For more information see [page 135](#)

Characteristics	NSYS3X●●●●	NSYS3X●●●●T	NSYS3X●●●●H
	304L stainless-steel Enclosure with plain door.	304L stainless-steel Enclosure with glazed door, Securit® glass, 4 mm thick.	316L stainless-steel Enclosure with plain door.
Material	AISI 304L		AISI 316L
Finish	Scotch-Brite® brushed		
Thickness	10/10° - 15/10° mm		
Ingress protection rating	<ul style="list-style-type: none"> • IP66 (1 door) or IP55 (2 doors) according to IEC 60529 • Rating according to UL50e: Types 4,4X and 13 for single-door and Types 1 and 12 for double-door enclosures. 		
Mechanical protection rating	IK10 according to IEC 62262	IK08 according to IEC 62262	IK10 according to IEC 62262
Standards and certifications	See technical guide on page 640		
Installation	Outdoor installation: Compliant with IEC 62208 regarding type tests specified in §9.12 (resistance to ultra-violet (UV) radiation) and §9.13 (resistance to corrosion). It is always advisable to install a canopy to avoid water stagnation on the upper part of the enclosure		
Other characteristics	<ul style="list-style-type: none"> • Single-piece body (cross-shaped structure). Gutter-shaped front profile • 4 rear studs for fixing the material • 2 cut-out vertical profiles on the door (from a height of 600 mm), with drill holes with a diameter of 4.25 mm and a pitch of 25 mm for installing accessories • Door reinforcement frame (from a height of 1000 mm), cross-section of 20 mm x 15 mm, with drilled holes with a diameter of 5 mm and a pitch of 25 mm • Standard lock with 3-mm double-bar lock (chrome-plated zamak) • 2 locking points for heights of more than 500 mm or three points for two-door enclosures • Stainless-steel hinges screwed to the body of the enclosure. They make it easier to remove and invert the door. Opening angle: 120° • Maximum load on the door: 50 kg/m² • Polyurethane gasket • M6 x 16 mm screws on the door and on the body, allowing equipotential connection between the earth connections (on request) • 4 holes for fixing to the wall directly or with the help of mounting lugs (on request), sealed by sealing plugs 		

External dimensions					304L stainless-steel	316L stainless-steel	
Height (mm)	Width (mm)	Depth (mm)	No. of locks	No. of doors	Plain door	Glazed door. The glazed door has no reinforcement.	Plain door
300	200	150	1	1	NSYS3X3215	-	NSYS3X3215H
300	250	150	1	1	NSYS3X302515	-	NSYS3X302515H
300	300	150	1	1	NSYS3X3315	-	NSYS3X3315H
400	300	150	1	1	NSYS3X4315	-	NSYS3X4315H
400	300	200	1	1	NSYS3X4320	NSYS3X4320T	NSYS3X4320H
400	400	200	1	1	NSYS3X4420	-	NSYS3X4420H
400	600	200	1	1	NSYS3X4620	-	NSYS3X4620H
500	400	200	2	1	NSYS3X5420	NSYS3X5420T	NSYS3X5420H
600	400	200	2	1	NSYS3X6420	NSYS3X6420T	NSYS3X6420H
600	600	250	2	1	NSYS3X6625	-	NSYS3X6625H
600	1000	300	-	2	NSYS3X601030	-	-
600	1200	300	-	2	NSYS3X601230	-	-
700	500	250	2	1	NSYS3X7525	NSYS3X7525T	NSYS3X7525H
800	600	250	2	1	NSYS3X8625	NSYS3X8625T	NSYS3X8625H
800	800	300	2	1	NSYS3X8830	-	NSYS3X8830H
800	1000	300	-	2	NSYS3X801030	-	-
800	1200	300	-	2	NSYS3X801230	-	-
1000	800	300	2	1	NSYS3X10830	NSYS3X10830T	NSYS3X10830H
1000	1000	300	-	2	NSYS3X101030	-	NSYS3X101030H
1200	800	300	2	1	NSYS3X12830	-	NSYS3X12830H
1200	1000	300	-	2	NSYS3X121030	-	NSYS3X121030H

(1) Three-point locking system system.

Accessories

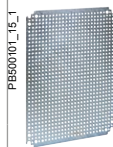
External dimensions									
Height (mm)	Width (mm)	Depth (mm)	No. of modules	Mounting plate Plain	Mounting plate Microperforated	Mounting plate Telequick	Modular Chassis	Step slides	
300	200	150	-	NSYMM32	NSYMF32	NSYMR32	-	-	
300	250	150	-	NSYMM3025	-	NSYMR3025	-	-	
300	300	150	-	NSYMM33	NSYMF33	NSYMR33	-	-	
400	300	150	24	NSYMM43	NSYMF43	NSYMR43	NSYDLM24	-	
400	300	200	24	NSYMM43	NSYMF43	NSYMR43	NSYDLM24	NSYSDCR200	
400	400	200	-	NSYMM44	NSYMF44	NSYMR44	-	NSYSDCR200	
400	600	200	-	NSYMM64	NSYMF64	NSYMR46	-	NSYSDCR200	
500	400	200	48	NSYMM54	NSYMF54	NSYMR54	NSYDLM48	NSYSDCR200	
600	400	200	48	NSYMM64	NSYMF64	NSYMR64	NSYDLM48P	NSYSDCR200	
600	600	250	84	NSYMM66	NSYMF66	NSYMR66	NSYDLM84P	NSYSDCR250	
600	1000	300*	-	NSYMM106	NSYMF106	NSYMR106	-	NSYSDCR300	
600	1200	300*	-	NSYMM126	NSYMF126	-	-	NSYSDCR300	
700	500	250	66	NSYMM75	NSYMF75	NSYMR75	NSYDLM66	NSYSDCR250	
700	500	250	88	-	-	-	NSYDLM88	-	
800	600	250	84	NSYMM86	NSYMF86	NSYMR86	NSYDLM84	NSYSDCR250	
800	600	250	112	-	-	-	NSYDLM112	-	
800	800	300	-	NSYMM88	NSYMF88	NSYMR88	-	NSYSDCR300	
800	1000	300 ⁽¹⁾	-	NSYMM108	NSYMF108	NSYMR108	-	NSYSDCR300	
800	1200	300 ⁽¹⁾	-	NSYMM128	NSYMF128	NSYMR128	-	NSYSDCR300	
1000	800	300	234	NSYMM108	NSYMF108	NSYMR108	NSYDLM240	NSYSDCR300	
1000	1000	300	-	NSYMM1010	NSYMF1010	NSYMR1010	-	NSYSDCR300	
1200	800	300	-	NSYMM128	NSYMF128	NSYMR128	-	NSYSDCR300	
1200	1000	300	-	NSYMM1210	NSYMF1210	NSYMR1210	-	NSYSDCR300	

(1) Three-point locking system system.

Stainless-Steel Wall-Mounted Enclosures Spacial S3X, Accessories

Plinth

- Material: Stainless-steel, AISI 304L or AISI 316L
- Finish: Scotch-Brite® brushing, to help guarantee the durability in applications where contact to the floor increases the risk of corrosion
- Installation: Plinth fixing kit must be ordered separately (ref. **NSYAPFXWM**) composed by fixing elements and drilling jig



Characteristics	Width	References
Plinth height 100 mm, Kit (4 corners + front and back), AISI 304L	800	NSYSFPFX8100
Plinth height 100 mm, Kit (4 corners + front and back), AISI 304L	1000	NSYSFPFX10100
Plinth height 100 mm, Kit (4 corners + front and back), AISI 316L	800	NSYSFPFX8100H
Plinth height 100 mm, Kit (4 corners + front and back), AISI 316L	1000	NSYSFPFX10100H



Characteristics	Depth	References
Plinth height 100 mm, Set of 2 side panels, AISI 304L	300	NSYSFPSX3100



Characteristics	Width	References
Plinth height 200 mm, Kit (4 corners + front and back), AISI 304L	800	NSYSFPFX8200
Plinth height 200 mm, Kit (4 corners + front and back), AISI 304L	1000	NSYSFPFX10200
Plinth height 200 mm, Kit (4 corners + front and back), AISI 316L	800	NSYSFPFX8200H
Plinth height 200 mm, Kit (4 corners + front and back), AISI 316L	1000	NSYSFPFX10200H



Characteristics	Depth	References
Plinth height 200 mm, Set of 2 side panels (x2), AISI 304L	300	NSYSFPSX3200
Plinth height 200 mm, Set of 2 side panels (x2), AISI 316L	300	NSYSFPSX3200H

Plain Mounting Plate Screw



Characteristics	Supply	References
Plain mounting plate screw, Self-tapping screw M5 x 13	100	NSYS13M5HS
Plain mounting plate screw, Self-tapping screw M5 x 16	100	NSYS16M5HS
Plain mounting plate screw, Self-tapping screw M6 x 16	100	NSYS16M6HS



5
S3X

Accessories

Clip-on nuts: [page 248](#)
Reference: **AF1EA6**
Cable entries: [page 250](#)
Reference: **NSYSAM504SE**

Stainless-steel cable gland with lamellar insert: [page 252](#)
Reference: **NSYCGX12**
Lighting: [page 269](#)
Reference: **NSYLAMLDS**

Adhesive plastic document pocket: [page 273](#)
Reference: **NSYDPA44**
Door switch: [page 273](#)
Reference: **NSYINLCRN**

Technical changes reserved. Information provided without guarantee. Images are for illustrative purposes only.

Stainless-Steel Wall-Mounted Enclosures Spacial S3X, Accessories

Canopy

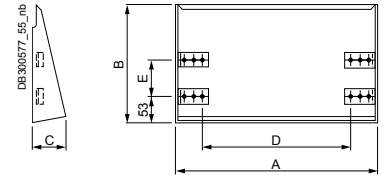

- Material: 304L stainless-steel sheet
- Finish: Scotch-Brite® brushed
- Thickness: 15/10° mm
- Installation: Direct fixing to the body of the enclosure

Supply:

Delivered with the fixings required for installation



NSYTX2015

Dimensions

Characteristics	Width (mm)	Depth (mm)	A (mm)	B (mm)	C (mm)	D (mm)	E (mm)	References
Canopy	200	150	205	183	51	120	-	NSYTX2015
Canopy	250	150	205	183	51	120	-	NSYTX2515
Canopy	300	150	305	183	51	220	-	NSYTX3015
Canopy	300	200	305	233	51	220	70	NSYTX3020
Canopy	400	200	405	233	70	320	70	NSYTX4020
Canopy	600	200	605	233	70	520	70	NSYTX6020
Canopy	600	250	605	283	70	520	120	NSYTX6025
Canopy	1000	300	1005	333	70	920	170	NSYTX10030
Canopy	1200	300	1205	333	70	1120	120	NSYTX12030
Canopy	500	250	505	283	70	420	120	NSYTX5025
Canopy	800	300	805	333	70	720	170	NSYTX8030

5
S3X

Wall Fixing Lugs

- A: Enclosure height
- B: Enclosure width

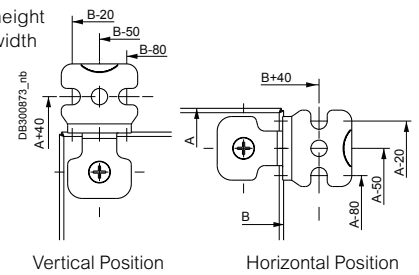

NSYPFCX

Installation:

Mounting of the wall fixing lugs in horizontal or vertical position. Fixing from the outside.

- Wall-enclosure separation of 12 mm
- Maximum load: 250 kg

Supply:

Set of four wall fixing lugs

Characteristics	References
Wall fixing-lug, 304L stainless-steel	NSYPFCX
Wall fixing-lug, 316L stainless-steel	NSYPFC2X

Support Bracket for Enclosure with Anti-Tilt Kit and Reinforcement

- Material: Steel
- The support bracket is used when the enclosure cannot be hung from a wall or a post.
- Maximum enclosure dimensions: 1000 x 800 x 300 mm.
- Floor attachment by standard M12 fastenings.
- Finish: Epoxy polyester paint
- Color: RAL 7035 gray
- Maximum load: 120 kg



NSYCOCS1400

Characteristics	Height (mm)	References
Support bracket for enclosure with anti-tilt kit and reinforcement	1400	NSYCOCS1400
Support bracket for enclosure with anti-tilt kit and reinforcement	1800	NSYCOCS1800

1-Point-Lock Options

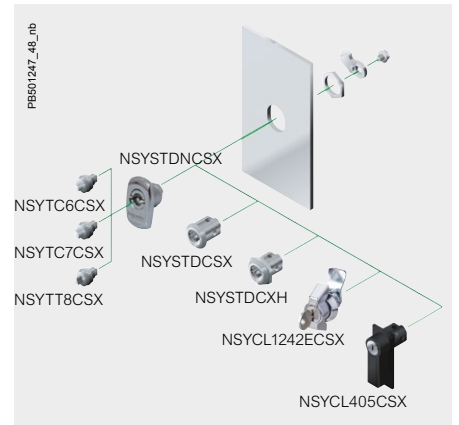

- Protection rating: IP66
- For locks for double-door enclosures please contact us



Characteristics	Type	Material	References
Double-bar lock	Escutcheon with insert, 3 mm	Chrome-plated zamak	NSYSTDNC SX
Insert	triangular, 8 mm	304L stainless-steel	NSYTT8CSX
Insert	square, 7 mm	304L stainless-steel	NSYTC7CSX
Insert	square, 6 mm	304L stainless-steel	NSYTC6CSX
Round lock	round, 3 mm (spare)	Chromeplated zamak	NSYSTDCSX
Round lock	round, 3 mm	304L stainless-steel	NSYSTDCXH
Round lock	round	316 stainless-steel, please contact us for availability	NSYSTDCX2H
Handle lock	Padlock	316 stainless-steel, please contact us for availability	NSYCBXHC RN
Handle lock	1242E	Chrome-plated zamak	NSYCL1242ECSX
Handle lock	405	Polyamide	NSYCL405CSX
Handle lock	610	Polyamide	NSYCL610CSX

5
S3X

3-Point-Lock Options



- Protection rating: IP66
- Compatible with Spacial S3X double-door enclosures

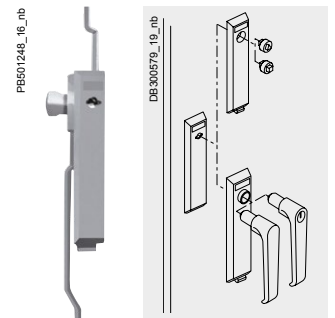

Type	References
Handle lock	NSYT SML

Wall-Mounted Door Retainer, Steel

- To block the door in open position.
- It is installed on enclosures with heights from 400 mm and widths from 300 mm
 - Door opening angle: 120°
 - Earthing connection of the enclosure by means of the reinforcement rail
 - Earthing accessories supplied with the enclosure (earth-connection cable to be ordered separately), see [page 278](#)
 - Material: Steel

Comment:
It is not compatible with the 19" swing rack and the internal door.



Characteristics	References
Wall-mounted door retainer, steel	NSYAEDRSCST

Stainless-Steel Wall-Mounted Enclosures Spacial S3X, Accessories

Eyebolts, Consult Us for Availability

- Material: Stainless-steel 304L
- Maximum load: 210 kg per enclosure when slinging at 60°
- Supply reinforcing brackets attached to therings (these brackets also act as a drilling template)



NSYAELYTCRXG8

Characteristics	References
Set of 2 M8 eyebolts	NSYAELYTCRXG8

Inner Door

- 3-mm double-bar lock.
- Not compatible with door retainer and door switch. Consult us.
- Maximum load: 30 kg/m²

Installation: As standard it can be mounted an inner door and a mounting plate, on the step slides, at the same time

- Can be mounted either on the front side of the enclosure or on step slides (not supplied with standard)

Supply:
1 inner door



NSYPIN43

Characteristics	Height (mm)	Width (mm)	D (mm)	E (mm)	G (mm)	H (mm)	I min. (mm)	References
Inner door for wall-mounted enclosures	400	300	349	241	208	32	51	NSYPIN43
Inner door for wall-mounted enclosures	500	400	449	341	308	32	51	NSYPIN54
Inner door for wall-mounted enclosures	600	400	549	341	308	32	51	NSYPIN64
Inner door for wall-mounted enclosures	700	500	649	441	408	32	51	NSYPIN75
Inner door for wall-mounted enclosures	800	600	749	541	508	32	51	NSYPIN86
Inner door for wall-mounted enclosures	1000	800	949	741	708	32	51	NSYPIN108
Inner door for wall-mounted enclosures	1200	800	1149	741	708	32	52	NSYPIN128

DB9300890_43_nb

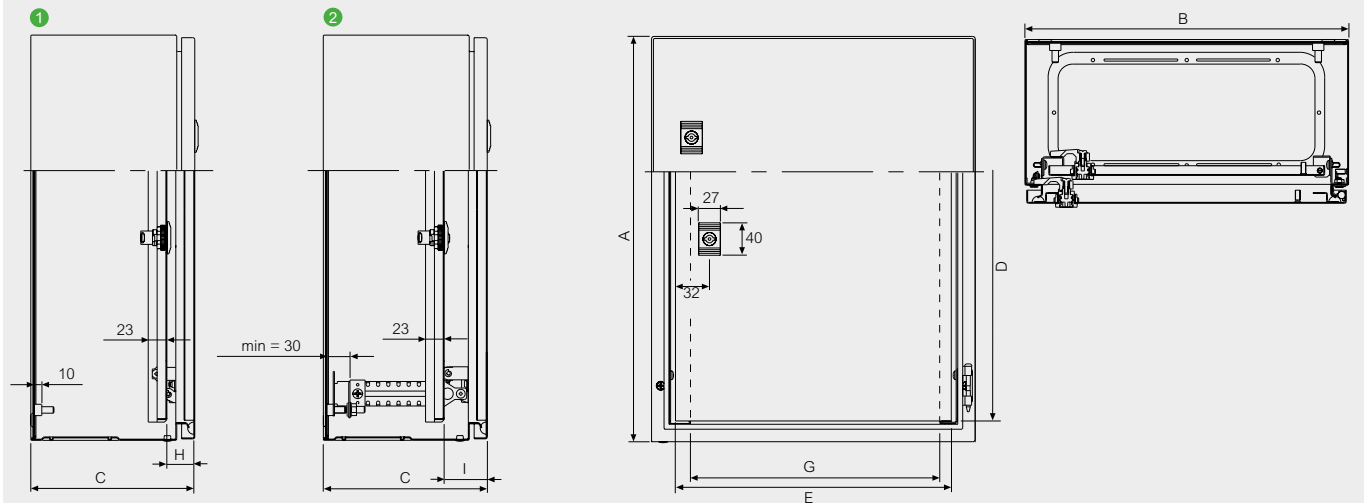

● **NSYPIN** inner door fixed directly to the enclosure.

● **NSYPIN** inner door fixed to the adjustable **NSYSDCR** support. In this case, inner door and mounting plate can be adjusted in depth.

Height (mm)	Width (mm)	D (mm)	E (mm)	G (mm)	H (mm)	I min. (mm)	References
400	300	349	241	208	32	51	NSYPIN43
500	400	449	341	308	32	51	NSYPIN54
600	400	549	341	308	32	51	NSYPIN64
700	500	649	441	408	32	51	NSYPIN75
800	600	749	541	508	32	51	NSYPIN86
1000	800	949	741	708	32	51	NSYPIN108
1200	800	1149	741	708	32	52	NSYPIN128

Stainless-Steel Wall-Mounted Enclosures Spatial S3X, Dimensions

Fig. 1

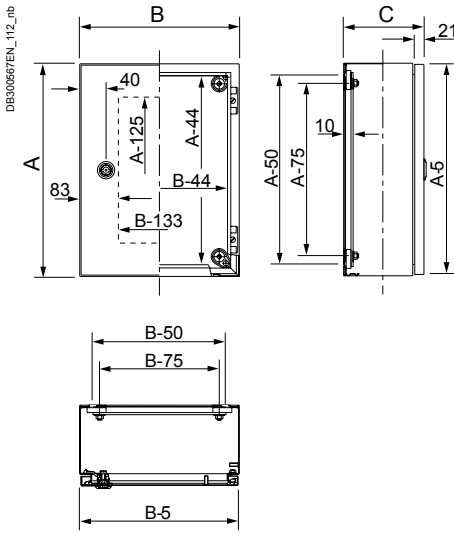
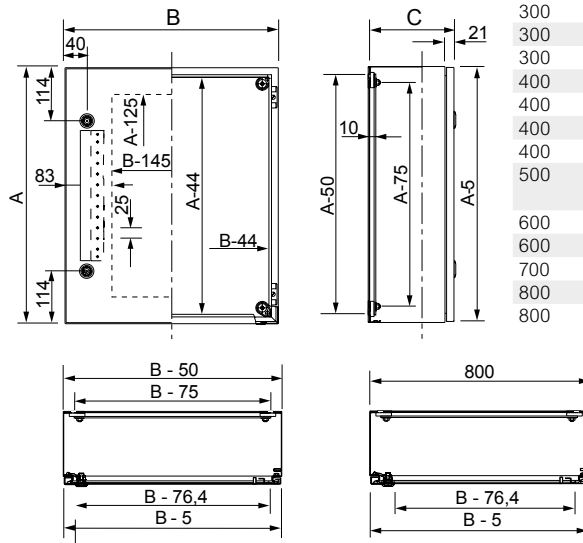

Fig. 2



External dimensions (mm)			Fig.
A	B	C	
300	200	150	1
300	250	150	1
300	300	150	1
400	300	150	1
400	300	200	1
400	400	200	1
400	600	200	1
500	400	200	2 Without door reinforcement
600	400	200	2
600	600	250	2
700	500	250	2
800	600	250	2
800	800	300	2

Fig. 3

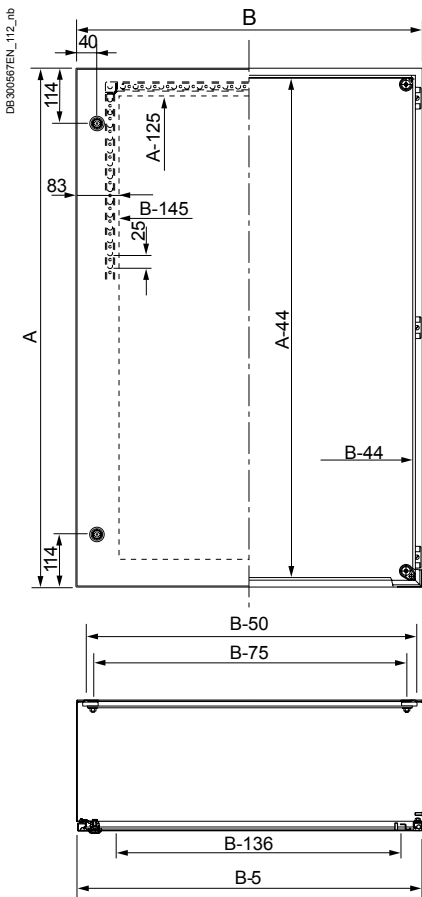
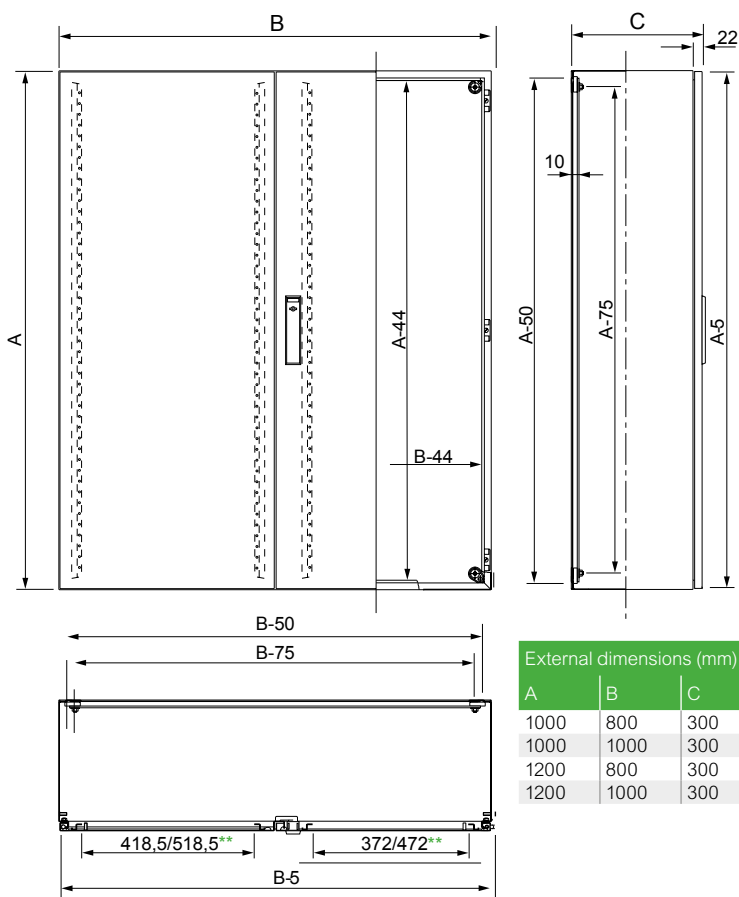

Fig. 4



External dimensions (mm)			Fig.
A	B	C	
1000	800	300	3
1000	1000	300	4
1200	800	300	3
1200	1000	300	4

** For glazed door.

5
S3X

Stainless-Steel Floor-Standing Enclosures

Spacial SMX



Spacial SFX



6

Spacial SMX - SFX

Introduction	138
Characteristics	139
Accessories	140
Dimensions	144

Stainless-Steel Floor-Standing Enclosures

These Enclosures Have Been Specially Designed for the Chemical, Oil and Food and Beverage Industries, Among Others, Which Are Particularly Demanding in Terms of Hygiene and Resistance to Corrosion

This range can be configured according to your needs

4 services are available:

6
SMX
SFX



Assemble
to Order



Mounting
of Standard
Accessories



Painting



Machining



Material and Finishes

- AISI 304L as standard in Spacial SMX and SFX.
- AISI 316L as standard in Spacial SMX and on request in Spacial SFX.
- Finishes:
 - Scotch-Brite® brushed (standard).
 - Micro-beaded (on request).
 - Painted (on request).

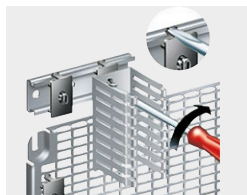

Time Savings and Convenience

- Complete range of accessories for installation, cable management, etc.
- 316L stainless-steel plinth: easy cable entry.
- 304L or 316L stainless-steel plinth: easy cable entry (Spacial SFX and SMX).
- Reversible door opening to 120°.
- Padlock lock with key or shaped insert.
- Adjustment rails perforated with a pitch of 25 mm.
- Perforated reinforcement frame allowing accessories to be mounted on the door.



Sealing

- Protection rating against dust and water IP66 or IP55 depending model according to IEC 60529.
- 3-point locking system.
- Canopy (optional):
 - Protects the door sealing,
 - Helps guarantee correct water drainage,
 - No stagnation on the top.
- Single-piece cable gland plate with polyurethane gasket.



Compatible with the Other Ranges

- The mounting plates and other accessories of the Spacial SM and SF can be combined with metal products.



Hygiene

- The high quality of the standard finish enables very easy maintenance while avoiding contamination.
- The hygienic feet made from 316L stainless-steel, adjustable between 140 mm and 200 mm in height, make it easier to clean under the enclosures.



Robustness and Durability

- Resistance to external mechanical impacts: IK10 according to IEC 62262.
- 3 hinges made entirely from stainless-steel.
- Door reinforcement frame.



Resistance to Corrosion

- High resistance to corrosion. 304L and 316L stainless-steels provide the best solutions for applications in extremely demanding environments.

See page 474 for details or consult our web site www.se.com



Characteristics	Spacial SMX	Spacial SFX
	<ul style="list-style-type: none"> Stainless-steel floor-standing enclosure, folded and welded. Single and double front door, with reinforcement frame. 	<ul style="list-style-type: none"> Enclosure made up of a structure, consisting of top and bottom, rear panel and vertical profiles. Single and double front door, with reinforcement frame.
Material	304L stainless-steel, 316L stainless-steel	304L stainless-steel, 316L version (on request)
Finish	Scotch-Brite® brushed finish Micro-beaded and painted finishes (on request)	
Thickness	15/10* mm	Consult us
Ingress protection rating	IP66 according to IEC 62208 (single-door enclosure)	
Mechanical protection rating	IK10 according to IEC 62262	
Standards and certifications	See technical guides page 640	
Installation	Outdoor installation: Compliant with IEC 62208 regarding type tests specified in §9.12 (resistance to ultra-violet (UV) radiation) and §9.13 (resistance to corrosion). Comment: SMX and SFX units do not require a canopy for outdoor use.	
Other characteristics	<ul style="list-style-type: none"> Plain front door. Opening to left or right to 120° with reinforcement frame installed: 3 stainless-steel hinges 3-point locking system with handle made from painted zamak, 5-mm double-bar Acceptable load of 50 kg 	
Supply	<ul style="list-style-type: none"> Welded compact body Single-piece cable gland plate with sealing gasket Welded mounting plate support brackets 	<ul style="list-style-type: none"> Welded rear panel 4 mounting plate-supporting brackets Single-piece cable gland plate with sealing gasket

Comment:
Dimensions,
see [page 144](#)

	304L	316L	304L
--	------	------	------



External dimensions				Stainless-steel enclosure	Stainless-steel enclosure	Stainless-steel suitable enclosure
Height (mm)	Width (mm)	Depth (mm)	Number of front doors			
1400	1000	300	2	NSYSMX141030	-	-
1600	800	400	1	NSYSMX16840	-	-
1800	600	400	1	NSYSMX18640	-	NSYSFX18640
1800	800	400	1	NSYSMX18840	NSYSMX18840H	NSYSFX18840
1800	1200	400	2	NSYSMX181240	-	NSYSFX181240
1800	1600	400	2	NSYSMX181640	NSYSMX181640H	-
2000	600	500	1	-	-	NSYSFX20650
2000	800	400	1	-	-	NSYSFX20840
2000	800	500	1	NSYSMX20850	-	-
2000	800	600	1	-	-	NSYSFX20860
2000	1000	400	2	NSYSMX201040	NSYSMX201040H	-
2000	1000	600	2	-	-	NSYSFX201060
2000	1200	500	2	NSYSMX201250	NSYSMX201250H	-
2000	1200	600	2	-	-	NSYSFX201260
2000	1600	600	2	NSYSMX201660	NSYSMX201660H	-

Stainless-Steel Floor-Standing Enclosures

Spacial SMX - SFX, Accessories

SMX



Plinth height 100 mm
(4 corners + front and back)



Plinth height 100 mm
(Set of 2 side panels)

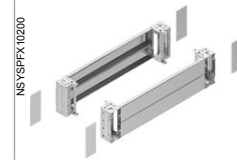

Plinth height 200 mm
(4 corners + front and back)

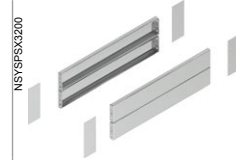

Plinth height 200 mm
(Set of 2 side panels)

Characteristics		Stainless-steel plinths								
Material		Stainless-steel, AISI 304L				Stainless-steel, AISI 316L				
Finish		Scotch-Brite®-brushing to ensure durability in applications where contact with the floor increases the risk of corrosion								
External dimensions (mm)		Plinth height 100 mm		Plinth height 200 mm		Plinth height 100 mm		Plinth height 200 mm		
Height (A)	Width (B)	Depth (C)	Kit (4 corners + front and back)	Set of 2 side panels	Kit (4 corners + front and back)	Set of 2 side panels (x2)	Kit (4 corners + front and back)	Set of 2 side panels	Kit (4 corners + front and back)	Set of 2 side panels (x2)
1400	1000	300	NSYSFPFX10100	NSYSFPSX3100	NSYSFPFX10200	NSYSFPSX3200	NSYSFPFX10100H	NSYSFPSX3100H	NSYSFPFX10200H	NSYSFPSX3200H
1600	800	400	NSYSFPFX8100	NSYSFPSX4100	NSYSFPFX8200	NSYSFPSX4200	NSYSFPFX8100H	NSYSFPSX4100H	NSYSFPFX8200H	NSYSFPSX4200H
1800	600	400	NSYSFPFX6100	NSYSFPSX4100	NSYSFPFX6200	NSYSFPSX4200	NSYSFPFX6100H	NSYSFPSX4100H	NSYSFPFX6200H	NSYSFPSX4200H
1800	800	400	NSYSFPFX8100	NSYSFPSX4100	NSYSFPFX8200	NSYSFPSX4200	NSYSFPFX8100H	NSYSFPSX4100H	NSYSFPFX8200H	NSYSFPSX4200H
1800	1200	400	NSYSFPFX12100	NSYSFPSX4100	NSYSFPFX12200	NSYSFPSX4200	NSYSFPFX12100H	NSYSFPSX4100H	NSYSFPFX12200H	NSYSFPSX4200H
1800	1600	400	NSYSFPFX16100	NSYSFPSX4100	NSYSFPFX16200	NSYSFPSX4200	NSYSFPFX16100H	NSYSFPSX4100H	NSYSFPFX16200H	NSYSFPSX4200H
2000	600	500	NSYSFPFX6100	NSYSFPSX5100	NSYSFPFX6200	NSYSFPSX5200	NSYSFPFX6100H	NSYSFPSX5100H	NSYSFPFX6200H	NSYSFPSX5200H
2000	800	400	NSYSFPFX8100	NSYSFPSX4100	NSYSFPFX8200	NSYSFPSX4200	NSYSFPFX8100H	NSYSFPSX4100H	NSYSFPFX8200H	NSYSFPSX4200H
2000	800	500	NSYSFPFX8100	NSYSFPSX5100	NSYSFPFX8200	NSYSFPSX5200	NSYSFPFX8100H	NSYSFPSX5100H	NSYSFPFX8200H	NSYSFPSX5200H
2000	800	600	NSYSFPFX8100	NSYSFPSX6100	NSYSFPFX8200	NSYSFPSX6200	NSYSFPFX8100H	NSYSFPSX6100H	NSYSFPFX8200H	NSYSFPSX6200H
2000	1000	400	NSYSFPFX10100	NSYSFPSX4100	NSYSFPFX10200	NSYSFPSX4200	NSYSFPFX10100H	NSYSFPSX4100H	NSYSFPFX10200H	NSYSFPSX4200H
2000	1000	600	NSYSFPFX10100	NSYSFPSX6100	NSYSFPFX10200	NSYSFPSX6200	NSYSFPFX10100H	NSYSFPSX6100H	NSYSFPFX10200H	NSYSFPSX6200H
2000	1200	500	NSYSFPFX12100	NSYSFPSX5100	NSYSFPFX12200	NSYSFPSX5200	NSYSFPFX12100H	NSYSFPSX5100H	NSYSFPFX12200H	NSYSFPSX5200H
2000	1200	600	NSYSFPFX12100	NSYSFPSX6100	NSYSFPFX12200	NSYSFPSX6200	NSYSFPFX12100H	NSYSFPSX6100H	NSYSFPFX12200H	NSYSFPSX6200H
2000	1600	600	NSYSFPFX16100	NSYSFPSX6100	NSYSFPFX16200	NSYSFPSX6200	NSYSFPFX16100H	NSYSFPSX6100H	NSYSFPFX16200H	NSYSFPSX6200H

SFX



Plinth height 100 mm
(4 corners + front and back)



Plinth height 100 mm
(Set of 2 side panels)

Characteristics		Stainless-steel plinths				
Material		Stainless-steel, AISI 304L				
Finish		Scotch-Brite®-brushing to ensure durability in applications where contact with the floor increases the risk of corrosion				
Installation		Mounting in the holes for fixing the enclosures to the floor. Suitable for steel floor-standing enclosures (SF and SM)				
External dimensions (mm)		Plinth height 100 mm		Plinth height 200 mm		
Height (A)	Width (B)	Depth (C)	Kit (4 corners + front and back)	Set of 2 side panels	Kit (4 corners + front and back)	Set of 2 side panels (x2)
1400	1000	300	NSYSFPFX10100	-	NSYSFPFX10200	-
1600	800	400	NSYSFPFX8100	NSYSFPSX4100SF	NSYSFPFX8200	NSYSFPSX4200SF
1800	600	400	NSYSFPFX6100	NSYSFPSX4100SF	NSYSFPFX6200	NSYSFPSX4200SF
1800	800	400	NSYSFPFX8100	NSYSFPSX4100SF	NSYSFPFX8200	NSYSFPSX4200SF
1800	1200	400	NSYSFPFX12100	NSYSFPSX4100SF	NSYSFPFX12200	NSYSFPSX4200SF
1800	1600	400	-	NSYSFPSX4100SF	-	NSYSFPSX4200SF
2000	600	500	NSYSFPFX6100	NSYSFPSX5100SF	NSYSFPFX6200	NSYSFPSX5200SF
2000	800	400	NSYSFPFX8100	NSYSFPSX4100SF	NSYSFPFX8200	NSYSFPSX4200SF
2000	800	500	NSYSFPFX8100	NSYSFPSX5100SF	NSYSFPFX8200	NSYSFPSX5200SF
2000	800	600	NSYSFPFX8100	NSYSFPSX6100SF	NSYSFPFX8200	NSYSFPSX6200SF
2000	1000	400	NSYSFPFX10100	NSYSFPSX4100SF	NSYSFPFX10200	NSYSFPSX4200SF
2000	1000	600	NSYSFPFX10100	NSYSFPSX6100SF	NSYSFPFX10200	NSYSFPSX6200SF
2000	1200	500	NSYSFPFX12100	NSYSFPSX5100SF	NSYSFPFX12200	NSYSFPSX5200SF
2000	1200	600	NSYSFPFX12100	NSYSFPSX6100SF	NSYSFPFX12200	NSYSFPSX6200SF
2000	1600	600	-	NSYSFPSX6100SF	-	NSYSFPSX6200SF

Comment:

Ventilated plinths made of stainless-steel for heavy-duty outdoor enclosures (page 379) are compatible to Spacial SMX stainless-steel compact enclosures.

SMX Canopy



NSYSCMX10030

- Helps guarantee very high protection of the enclosure when used outdoors.
- Material: 304L stainless-steel sheet
Other types of stainless-steel, contact us
- Finish: Scotch-Brite® brushed
- Other finishes, contact us
- Thickness 15/10°
- Installation: It is fixed in the same holes as the eyebolt.

Supply:

Delivered with fixings. Other dimensions and canopy for sets, contact us

Characteristics	Width (mm)	Depth (mm)	References
Top-mounted	800	400	NSYSCMX8040
Top-mounted	800	500	NSYSCMX8050
Top-mounted	1000	300	NSYSCMX10030
Top-mounted	1000	400	NSYSCMX10040
Top-mounted	1200	400	NSYSCMX12040
Top-mounted	1600	400	NSYSCMX16040
Top-mounted	1600	600	NSYSCMX16060

SFX Canopy



NSYSCX6040

Supply:

Delivered with fixings. Other dimensions and canopy for sets, contact us

Characteristics	Width (mm)	Depth (mm)	References
Top-mounted	600	400	NSYSCX6040
Top-mounted	800	400	NSYSCX8040
Top-mounted	800	600	NSYSCX8060
Top-mounted	1000	600	NSYSCX10060
Top-mounted	1200	400	NSYSCX12040
Top-mounted	1200	600	NSYSCX12060
Top-mounted (used when coupling 2 SFX together)	1200	500	NSYSCX12050
Top-mounted (used when coupling 2 SFX together)	1600	400	NSYSCX16040
Top-mounted (used when coupling 2 SFX together)	1600	600	NSYSCX16060

Locking Options



NSYTDB5ME



NSYTDB5ME



NSYBCME

- The enclosures Spacial SMX and SFX are delivered as standard with a retractable handle made from
- Painted zamak with 5-mm double-bar insert, ref. **NSYMCSX**
- Standard inserts can be replaced by shaped inserts or barrels according the following table:

Door switch for Spacial SF and SFX: [page 273](#)

Reference: **NSYDCM20**

Door switch for Spacial SM: [page 273](#)

Reference: **NSYDPCM20**

Characteristics	Type	Supply	References
Shape insert	5 mm doublebar insert.	Insert with key	NSYTDB5ME
Padlocking system	Padlocking device	1 pack	NSYBCME
Barrels	Manual	1 pack	NSYTMME
Barrels	Barrel and key 405E	Barrels with 1 key	NSYTCL405ME
Barrels	Barrel and key 1242E	Barrels with 1 key	NSYTL1242EME

SFX Side Panels



NSY2SPX184

- Side panels including a polyurethane sealing gasket.
- Their special design helps guarantee the protection of the door gasket
- 304L stainless-steel sheet

Characteristics	Height of the enclosure (mm)	Depth of the enclosure (mm)	References
Set of 2 side panels	1800	400	NSY2SPX184
Set of 2 side panels	2000	400	NSY2SPX204
Set of 2 side panels	2000	500	NSY2SPX205
Set of 2 side panels	2000	600	NSY2SPX206

SMX Plain Mounting Plate



NSYMP1410

Characteristics	Height of the enclosure (mm)	Width of the enclosure (mm)	Height (mm)	Width (mm)	References
Plain mounting plate	1400	1000	1297	896	NSYMP1410
Plain mounting plate	1600	800	1497	696	NSYMP168
Plain mounting plate	1800	600	1697	496	NSYMP186
Plain mounting plate	1800	800	1697	696	NSYMP188
Plain mounting plate	1800	1200	1697	1096	NSYMP1812
Plain mounting plate	1800	1600	1697	1496	NSYMP1816
Plain mounting plate	2000	800	1897	696	NSYMP208
Plain mounting plate	2000	1000	1897	896	NSYMP2010
Plain mounting plate	2000	1200	1897	1096	NSYMP2012
Plain mounting plate	2000	1600	1897	1496	NSYMP2016

SFX Plain Mounting Plate



NSYMP186

Characteristics	Height of the enclosure (mm)	Width of the enclosure (mm)	Height (mm)	Width (mm)	References
Plain mounting plate	1800	600	1697	496	NSYMP186
Plain mounting plate	1800	800	1697	696	NSYMP188
Plain mounting plate	1800	1200	1697	1096	NSYMP1812
Plain mounting plate	2000	600	1897	496	NSYMP206
Plain mounting plate	2000	800	1897	696	NSYMP208
Plain mounting plate	2000	1000	1897	896	NSYMP2010
Plain mounting plate	2000	1200	1897	1096	NSYMP2012

SMX SFX Uprights Vertical

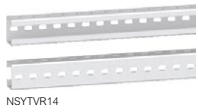

Characteristics	Height (mm)	References
Uprights vertical, Standard	1800	NSYVR18
Uprights vertical, Standard	2000	NSYVR20
Uprights vertical, Technical	1400	NSYTVR14
Uprights vertical, Technical	1600	NSYTVR16
Uprights vertical, Technical	1800	NSYTVR18
Uprights vertical, Technical	2000	NSYTVR20

Eyebolts



- Material: Stainless-steel 304L
- Installation: By the fixing nuts supplied
- Maximum load: 340 kg for 1 eyebolt in vertical direction

Supply:
Set of four M12 eyebolts

Characteristics	References
Eyebolt	NSYSMXEB

SFX Lifting Bracket



- Material: Treated steel
- Installation: They are fixed instead of the eyebolts on two suitable enclosures side-by-side, helping guarantee the rigidity of the enclosure when lifted
- Maximum load: 1300 kg when slinging at 60°

Supply:
Set of four lifting brackets

Characteristics	References
Lifting bracket for SFX	NSYPUNX

SMX Wall Fixing Lugs



- Material: Stainless-steel 304L
- Installation: Mounting of the wall fixing lugs in horizontal or vertical position; Fixing from the outside

Supply:
Set of four wall fixing lugs

Characteristics	References
Wall fixing lugs for SMX	NSYFCMX

Hygienic Feet



- Recommended for applications that require special hygiene conditions.
- Material: 316L stainless-steel
- Installation: Adjustable between 140 mm and 200 mm in height
- Maximum load: 200 kg per foot.

Supply:
Set of 4 adjustable feet

Characteristics	References
Hygienic feet	NSYPHX200

SFX Coupling Kit

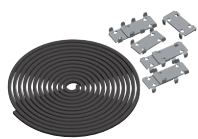

- Used for joining enclosures side by side.
- Material: Flat connectors and brackets: Zinc-coated steel (**NSYSFBK19**); Sealing gasket: EPDM (**NSYSFXJG**)
- Ingress protection rating: IP55
- Installation: Fixing from the inside of the enclosures

Characteristics	References
Coupling kit for SFX	NSYSFBK19
Coupling kit for SFX	NSYSFXJG

6
SMX
SFX

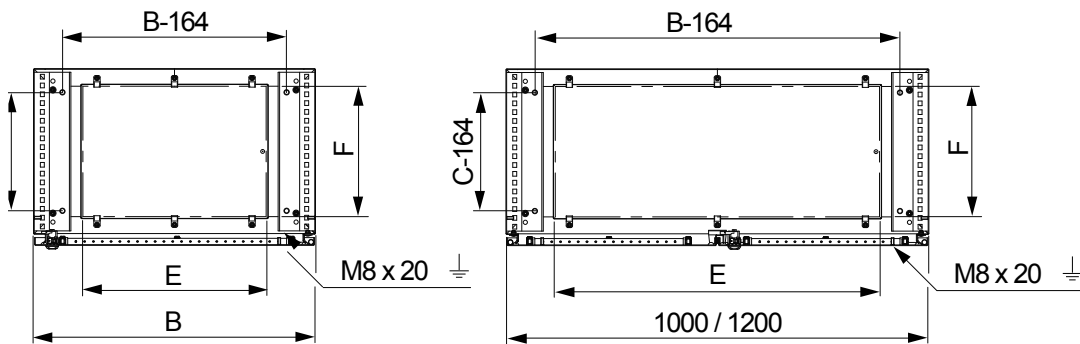
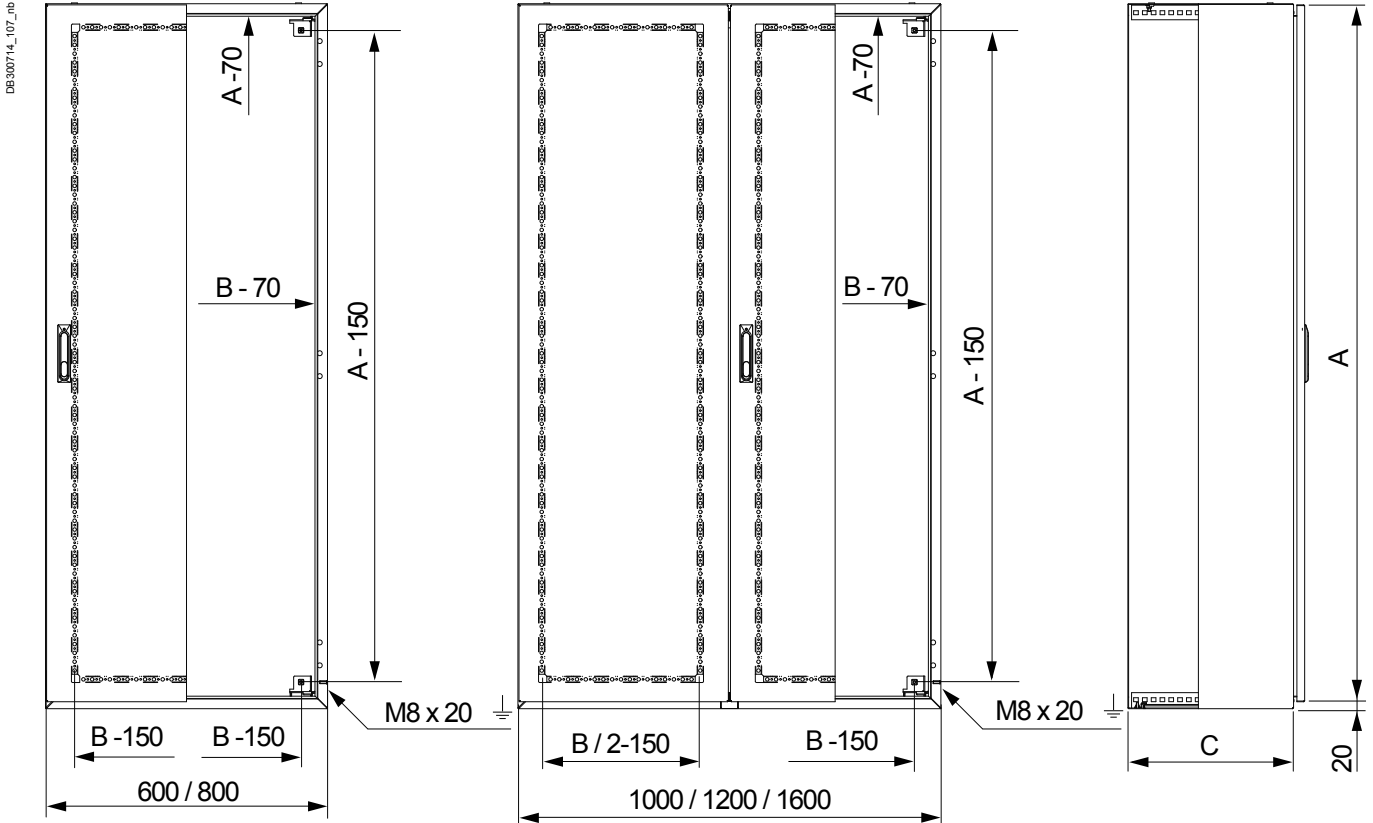

Enclosure width of 1000 and 1200 mm

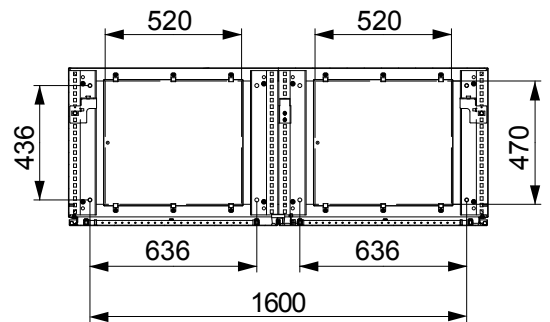

Enclosure width of 1600 mm

Floor-standing enclosure			No. of front doors	No. of cable gland plates	Dimensions	
Height (A) (mm)	Width (B) (mm)	Depth (C) (mm)			E (mm)	F (mm)
1400	1000	300	1	1	720	270
1600	800	400	1	1	520	270
1800	600	400	1	1	520	270
1800	800	400	1	1	520	270
1800	1200	400	2	1	920	270
1800	1600	400	2	2	1320	270
2000	800	500	1	1	520	370
2000	1000	400	2	1	720	270
2000	1200	500	2	1	920	370
2000	1600	600	2	2	1320	470

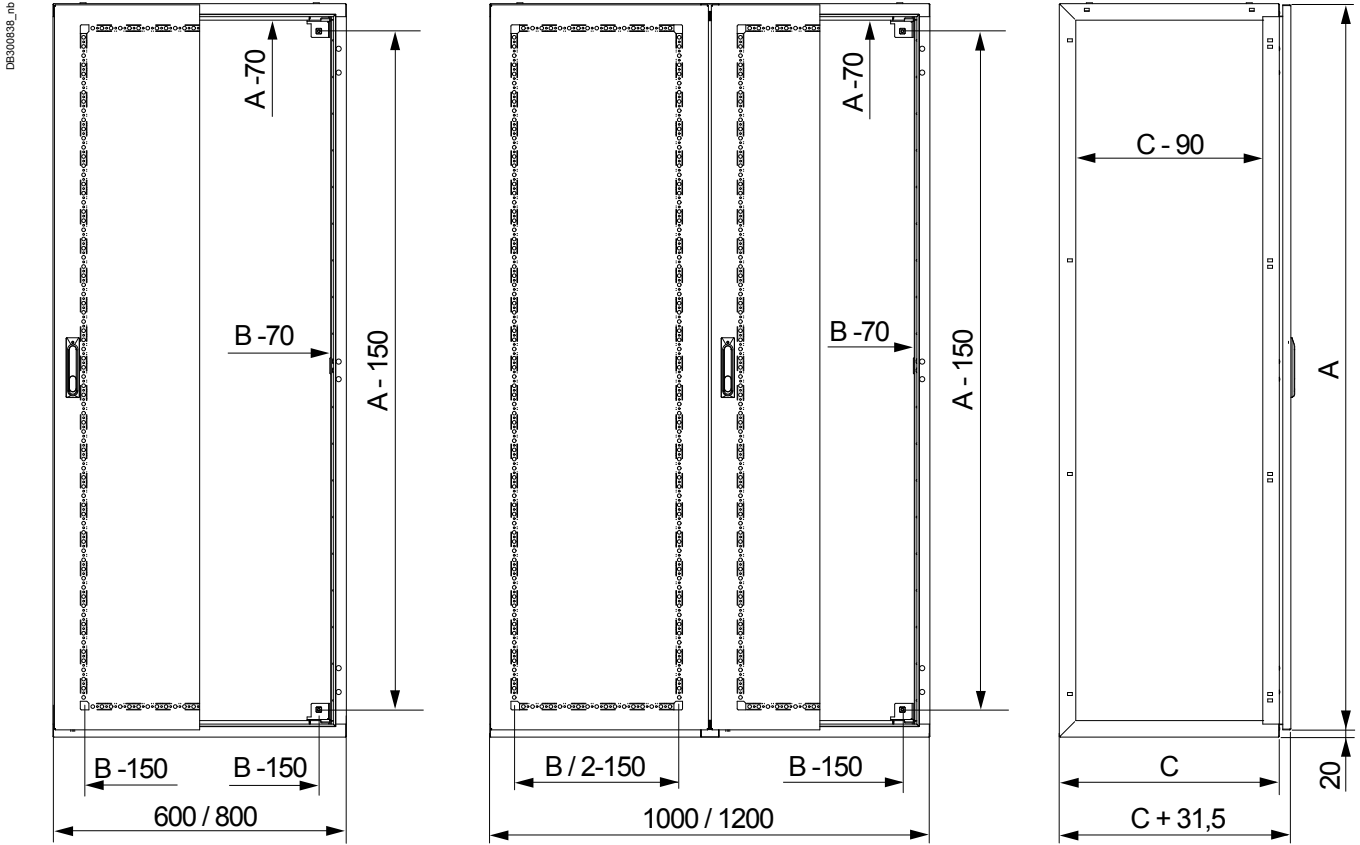

6
SMX
SFX

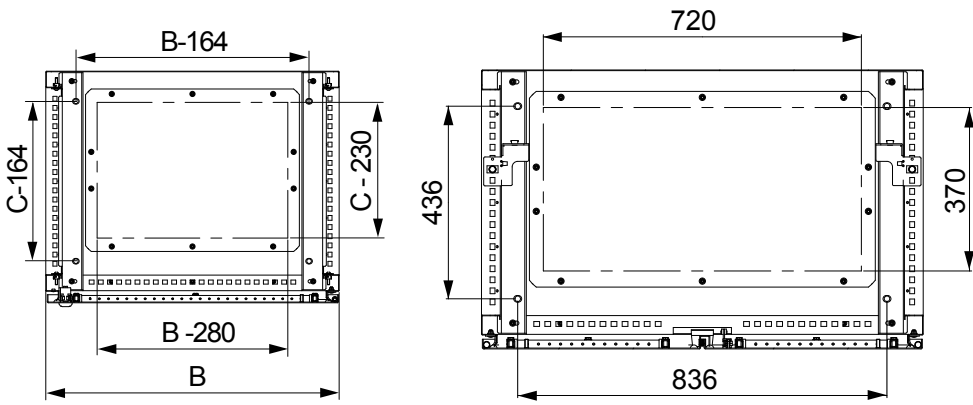

Enclosure width 1000

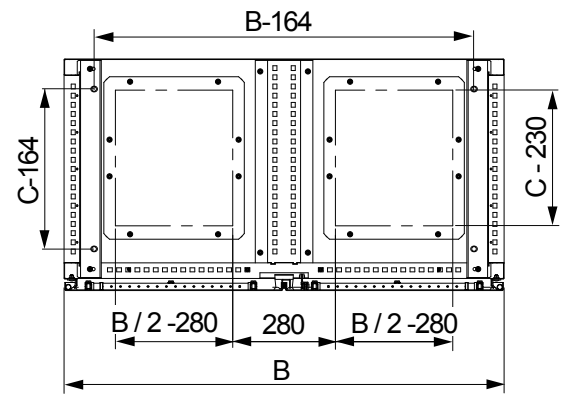

Enclosure width 1200 mm

External dimensions			Number of front doors	No. of cable gland plates
Height (A) (mm)	Width (B) (mm)	Depth (C) (mm)		
1800	600	400	1	1
1800	800	400	1	1
1800	1200	400	2	2
2000	600	500	1	1
2000	800	400	1	1
2000	800	600	1	1
2000	1000	600	2	1
2000	1200	600	2	2

Technical changes reserved. Information provided without guarantee. Images are for illustrative purposes only.

Insulated Boxes

Thalassa TBS

PB500080_4



Thalassa TBP

PB500081_32



7

Thalassa PLS

PB502791_61_r0



Thalassa TBS - TBP Insulated Industrial Boxes

Introduction	148
Characteristics	149
Selection Guide	150
Specific Accessories	152
Common Accessories	155

Thalassa PLS Insulated Modular Boxes



Introduction	158
Characteristics	161
Selection Guide	162
Accessories	164

Technical Guide

Insulated Industrial Boxes Dimensions	166
--	------------

Insulated industrial boxes:

- ABS for conventional applications (IK07) in regular operating conditions,
- polycarbonate for enhanced impact resistance (IK08) and for outdoor applications or applications directly exposed to UV,
- polycarbonate with certified UL (cULus) rating according to UL50E: type 4 4X, IP66 rating for all ranges, protection against electrical impacts of Class II.

This range can be configured according to your needs

4 different services available:



Assemble to Order



Mounting of Standard Accessories



Painting



Machining



7
TBS
TBP



Easy to Install

- 3 methods of fixing the box to its support



Smart

- Fixing studs on the cover.



Easy to Use

- Only one tool is required: A flat-bladed screwdriver.

See page 474 for details or consult our web site www.se.com

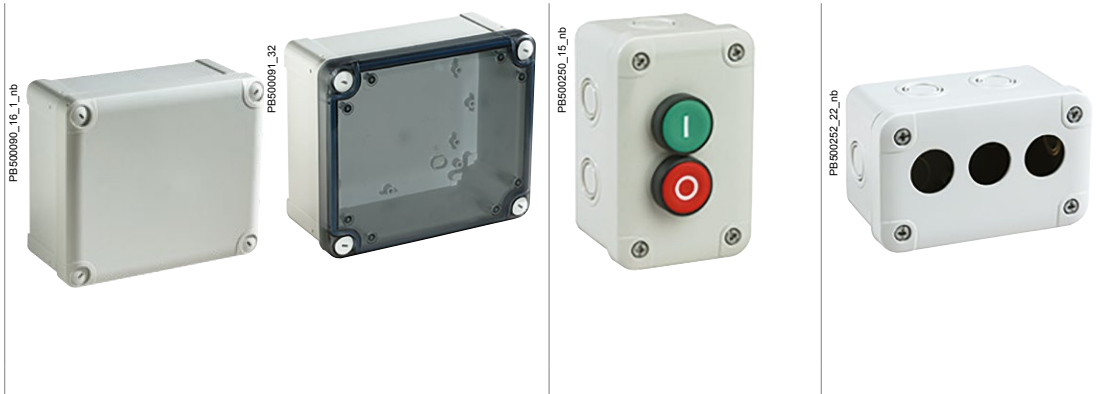

Characteristics	Universal boxes rated IP66	ABS boxes with push-buttons rated IP54	ABS boxes prepared for push-buttons
	Boxes can be coupled (exactly the same dimensions) with kit ref. 13934 . Locks from box size of 116 x 116 x 62 mm: <ul style="list-style-type: none"> • Cover locking by 4 plastic captive screws with coarse thread outside the sealed area, • Plumbable lock. Locks from box size of 138 x 93 x 72 mm: <ul style="list-style-type: none"> • The standard screws (flat-bladed screwdriver) can be replaced with other standardised screws. The 4 reinforced edges of the cover ensure its robustness and perfect support during customization operations. Adaptable hinges on all the 20 and 40 mm covers.		
Material	ABS boxes: <ul style="list-style-type: none"> • Transparent cover made of polycarbonate • Glow wire resistance: 650 °C according to IEC 60695-2-11 • Operating temperature: -25 °C...+60 °C • Installation temperature: -15 °C...+40 °C Polycarbonate boxes: <ul style="list-style-type: none"> • Glow wire resistance: 960 °C • Operating temperature: -25 °C...+80 °C • Installation temperature: -15 °C...+60 °C 	ABS boxes: <ul style="list-style-type: none"> • Glow wire resistance: 650 °C according to IEC 60695-2-11 • Operating temperature: -25 °C...+60 °C • Installation temperature: -15 °C...+40 °C 	
Color	<ul style="list-style-type: none"> • Body: RAL 7035 gray • Cover: RAL 7035 gray or transparent 		
Ingress protection rating	IP66 according to IEC 60529	IP54 according to IEC 60529	–
Mechanical protection rating	ABS: IK07 according to IEC 62262 Polycarbonate: IK08 according to IEC 62262	ABS: IK07 according to IEC 62262	
Standards	IEC 62208		
Certifications	<ul style="list-style-type: none"> • IEC 62208 certified by TÜV • UL (cULus) : Polycarbonate Range • Product Environmental Profile • Class II according to IEC 61140 Polycarbonate range: <ul style="list-style-type: none"> • Rating according UL50E : Types 4, 4X • Self-extinguishing 	<ul style="list-style-type: none"> • IEC 62208 certified by TÜV • Product Environmental Profile • Class II according to IEC 61140 	
Installation	Fixing the box: <ul style="list-style-type: none"> • Outside the sealed sensitive volume by the 4 chimneys in the corners from box size of 138 x 93 x 72 mm • Through the rear of the box by 2 or 4 elongated holes to be perforated • With fixing lugs from box size of 116 x 116 x 62 mm (ref. NSYAEFTB) Outdoor installation, only for polycarbonate range: Compliant with IEC 62208 regarding type tests specified in §9.12 (resistance UV radiation) and §9.13 (resistance to corrosion). Equipment installation: <ul style="list-style-type: none"> • Studs for fixing the equipment in the body and the cover of the box by means of a Ø 4 mm self-tapping screw (ref. NSYAMFSTB, screw Ø 4 x 10 mm with Pozidriv and slotted head) • Option of installing rails, plates or other types of supports (card, etc.) • Spacers and stand-offs to be installed on the studs for adjusting the height of the equipment 		







Comment:

For outdoor use and based on the configuration of the installation, a canopy must be installed on the top of the boxes or the boxes should be installed under a shelter to protect them against the different weather conditions and to avoid water stagnation between body and lid. Anti-condensation valves must be installed to prevent condensation and deformations of the boxes.

Comment:

For dimensions see [page 166](#)

Overall external dimensions			Overall internal dimensions			Body (mm)	Cover (mm)	Minor pack.	Cover screw	Universal boxes with IP66											
Height (mm)	Width (mm)	Depth (mm)	Height (mm)	Width (mm)	Depth (mm)					ABS IP66 IK07	PC-UL IP66 IK08	References	References	References	References						
74	74	54	65	65	47	37	10	5	Metal					Opaque cover	Transparent cover	Opaque cover	Transparent cover				
74	74	54	65	65	47	37	10	5	Metal	NSYTBS775	-	NSYTBP775	-								
89	89	54	80	80	47	37	10	5	Metal	NSYTBS885	-	NSYTBP885	-								
116	74	62	105	65	55	45	10	5	Metal	NSYTBS1176	-	NSYTBP1176	-								
116	74	94	105	65	85	45	40	3	Metal	NSYTBS1179H	-	-	-								
116	116	62	105	105	55	45	10	5	Plastic	NSYTBS11116	-	NSYTBP11116	-								
116	116	133	105	105	125	45	80	2	Plastic	NSYTBS111113H	-	-	-								
138	93	72	125	80	65	45	20	2	Plastic	NSYTBS1397	NSYTBS1397T	NSYTBP1397	NSYTBP1397T								
164	121	87	150	105	80	60	20	2	Plastic	NSYTBS16128	NSYTBS16128T	NSYTBP16128	NSYTBP16128T								
192	121	87	175	105	80	60	20	2	Plastic	NSYTBS19128	NSYTBS19128T	NSYTBP19128	NSYTBP19128T								
192	121	105	175	105	100	60	40	2	Plastic	NSYTBS191210H	NSYTBS191210HT	NSYTBP191210H	NSYTBP191210HT								
192	164	87	175	150	80	60	20	1	Plastic	NSYTBS19168	NSYTBS19168T	NSYTBP19168	NSYTBP19168T								
192	164	105	175	150	100	60	40	1	Plastic	NSYTBS191610H	NSYTBS191610HT	NSYTBP191610H	NSYTBP191610HT								
241	194	87	225	175	80	60	20	1	Plastic	NSYTBS24198	NSYTBS24198T	NSYTBP24198	NSYTBP24198T								
241	194	107	225	175	100	80	20	1	Plastic	NSYTBS241910	NSYTBS241910T	NSYTBP241910	NSYTBP241910T								
241	194	107	225	175	100	60	40	1	Plastic	NSYTBS241910H	NSYTBS241910HT	NSYTBP241910H	NSYTBP241910HT								
241	194	127	225	175	120	80	40	1	Plastic	NSYTBS241912H	NSYTBS241912HT	NSYTBP241912H	NSYTBP241912HT								
291	241	88	275	225	80	60	20	1	Plastic	NSYTBS29248	NSYTBS29248T	NSYTBP29248	NSYTBP29248T								
291	241	128	275	225	120	100	20	1	Plastic	NSYTBS292412	NSYTBS292412T	NSYTBP292412	NSYTBP292412T								
291	241	128	275	225	120	60	60	1	Plastic	NSYTBS292412H	NSYTBS292412HT	NSYTBP292412H	NSYTBP292412HT								
291	241	168	275	225	160	100	60	1	Plastic	NSYTBS292416H	NSYTBS292416HT	NSYTBP292416H	NSYTBP292416HT								
341	291	128	325	275	120	100	20	1	Plastic	NSYTBS342912	NSYTBS342912T	NSYTBP342912	NSYTBP342912T								
341	291	168	325	275	160	100	60	1	Plastic	NSYTBS342916H	NSYTBS342916HT	NSYTBP342916H	NSYTBP342916HT								

7
TBS
TBP



Mounting Plates for Adjustment to Mounting Surface

Installation:

- Fixing by means of Ø 4 mm self-tapping screws, Pozidrive and slotted head, ref. **NSYAMFSTB**

Supply:

Plates supplied without screws

Box Height (mm)	Box Width (mm)	Mounting plate dimensions		Minor pack.	Mounting plates	
		A (mm)	B (mm)		Material:	Material:
192	164	168.5	140	1		
241	194	215	168.5	1	Material: Galvanized steel	Material: Insulated polyester plate reinforced with fiberglass, halogen-free: Glow wire resistance 750 °C according to IEC 60695-2-11.
291	241	265	215	1	Thickness: 15/10 ^e mm	Thickness: 25/10 ^e mm
341	291	315	265	1	References	References
					NSYAMP1916TB	NSYAMPA1916TB
					NSYAMP2419TB	NSYAMPA2419TB
					NSYAMP2924TB	NSYAMPA2924TB
					NSYAMP3429TB	NSYAMPA3429TB

Button Description

- Emergency-off function with a red, O 40 mm, turn-to-unlock palm button.
- Start/stop function with 2 push-buttons.
- Up/down/stop function with 3 push buttons.

Technical Features of the Switches:

- NC switch with positive opening maneuver according to IEC 60947-5-1 appendix K,
- Mechanical durability of the emergency switch: 0.1 million cycles,
- Mechanical durability of the NC and NO switches: 5 million cycles,
- Protection against short circuits: 10 A.

- Ref. **XALEK1702** houses an emergency switching off palm button with mechanical locking according to standards IEC 60364-5-53 and 60947-5-5.

Comment:

For dimensions see [page 166](#)

Overall external dimensions			Overall internal dimensions			Body (mm)	Cover (mm)	Minor pack.	No. of holes	Function	References	References
Height (mm)	Width (mm)	Depth (mm)	Height (mm)	Width (mm)	Depth (mm)							
74	74	83	-	-	-	-	-	1	-	Emergency switching off	XALEK170	-
116	74	62	105	65	55	45	10, Gray	5	2	-	-	XALE2
116	74	62	105	65	55	45	10, Gray	5	3	-	-	XALE3
116	74	75	-	-	-	-	-	1	-	Up/down/stop	XALE3255	-



Function	Push-button type	Type NO	
Emergency switching off	Locking, red	1	
Start/stop			
Start	Flush, green	1	
Stop	Projecting, red	-	
Up/down/stop			
Up	Flush, black	-	
Down	Flush, white	-	
Stop	Projecting, red	-	
Function	Push-button type	Type NC	
Emergency switching off	Locking, red	1	
Start/stop			
Start	Flush, green	-	
Stop	Projecting, red	1	
Up/down/stop			
Up	Flush, black	-	
Down	Flush, white	-	
Stop	Projecting, red	1	
Function	Push-button type	Type C/O	
Emergency switching off	Locking, red	-	
Start/stop			
Start	Flush, green	-	
Stop	Projecting, red	-	
Up/down/stop			
Up	Flush, black	1	
Down	Flush, white	1	
Stop	Projecting, red	-	

Coupling Kit



13934

The coupling kit allows you to join several boxes with dimensions from 138 x 93 mm.

- Material: Polystyrene, glow wire resistance: 650 °C according to IEC 60695-2-11
- Ingress protection rating: IP66 according to IEC 60529
- Installation: The kit is installed by drilling a hole with Ø 32 mm in the boxes to be coupled

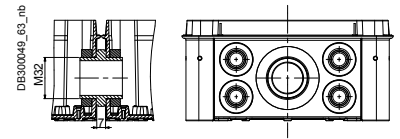

Supply:
The kit consists of 2 linking parts, nuts and seals

Characteristics	Drilling Ø	Minor pack.	Reference
Coupling kit	32 mm	1	13934

Sealed Pressure Balance Valve



NSYCAG12LPH1

Balances the pressure to avoid condensation and/or deformations of the boxes due to internal temperature changes. Protection of equipment for luminaires, industrial control, transportation, pumps, etc.

- Material: PA6-V2, acrylic co-polymer membrane, water and oil repellent
- Ingress protection rating: IP68
- Installation: The valve is installed by drilling a hole with Ø 12 mm in the box
- Operating temperature: -40...+105 °C
- Permeability: Air flow under $\Delta P = 0.7$ bar
- Pressure difference: Condition for IP68

Supply:
10 valves, nuts and seals

Characteristics	Permeability	Pressure difference	Drilling Ø	Minor pack.	Reference
Sealed pressure balance valve IP68	16 litres/h	$\Delta P < 1$ bar	12 mm	1	NSYCAG12LPH1
Sealed pressure balance valve IP68	120 litres/h	$\Delta P < 0.1$ bar	12 mm	1	NSYCAG12LPH2

Cover Accessories Set

- The Thalassa boxes are delivered as standard with slotted-head screws for flat-bladed screwdriver from 4 to 5.5 mm.
- With box sizes from 138 x 93 x 72 mm, these screws can be replaced for screws with different standardised heads to comply with most cases.
- After removing the standard screw, simply position the new screw by pressing on it.
- The adapter clips (intermediate parts for tightening the cover on the body of the box) are the same as those for the standard screws. They are not delivered with the shaped screws.
- A single key for opening the boxes as well as the other enclosures of your installation.

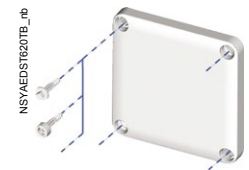

Supply:
Set of 4 shape screws



NSYAEDS8520TB

Characteristics	Minor pack.	Reference
Spare standard plastic screw for Thalassa boxes, Height of the lid 20 mm	1	NSYAEDS20TB
Spare standard plastic screw for Thalassa boxes, Height of the lid 40 mm	1	NSYAEDS40TB
Spare standard plastic screw for Thalassa boxes, Height of the lid 60 mm	1	NSYAEDS60TB

Hinges, Set of 2 Hinges



- The hinges can be adapted to all covers with a height of 20 and 40 mm with dimensions from 138 x 93 mm.
- The hinge allows the lid to open fully to 200°.
- Ingress protection rating: IP66 according to IEC 60529
- Installation: The hinge does not require any machining and is installed easily even with the box already equipped
- Maximum load: Hinged cover: 10 kg/m²

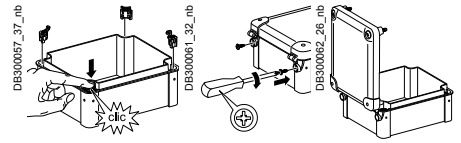

Supply:
The hinges (2 per set) are delivered with the fixings, minor pack 1

Characteristics	Height of the lid (mm)	References
Set of 2 hinges	20	NSYAEDH20TB
Set of 2 hinges	40	NSYAEDH40TB

Hinges, Set of 4 Fixing Lugs



- Plastic fixing lugs for installation on boxes with dimensions from 116 x 116 mm.
- Option of vertical or horizontal installation.
- Installation: Installation by a single screw at the last moment, with the box closed and equipped
- Maximum load: Body: 30 kg/m², Cover: 10 kg/m²

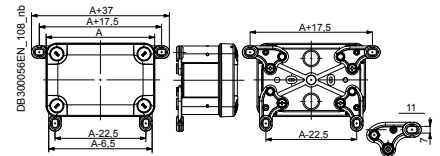

Supply:
4 lugs + screws, minor pack 1

Characteristics	Reference
Set of 4 fixing lugs	NSYAEFTB

Mounting Plates



- Mounting plates made to adapt to all usage scenarios.
- Material: Galvanized steel
- Thickness: 15/10^e mm
- Installation: Fixing by means of Ø 4 mm self-tapping screws, Pozidrive and slotted head, ref. **NSYAMFSTB**

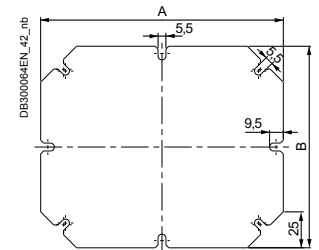

Supply:
Plates supplied without screws

Characteristics	Box		Dimensions			References
	Height (mm)	Width (mm)	A (mm)	B (mm)	Minor pack.	
Mounting plate	192	164	168.5	140	1	NSYAMPM1916TB
Mounting plate	241	194	215	168.5	1	NSYAMPM2419TB
Mounting plate	291	241	265	215	1	NSYAMPM2924TB
Mounting plate	341	291	315	265	1	NSYAMPM3429TB

NSYAMPM1916TB

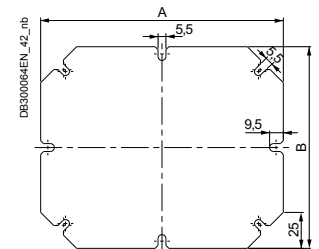

Supply:
Plates supplied without screws

- Mounting plates made to adapt to all usage scenarios.
- Material: Insulated polyester plate reinforced with fiberglass, halogen-free: Glow wire resistance 750 °C.
- Thickness: 25/10^e mm
- Installation: Fixing by means of Ø 4 mm self-tapping screws, Pozidrive and slotted head, ref. **NSYAMFSTB**

Characteristics	Box		Dimensions			References
	Height (mm)	Width (mm)	A (mm)	B (mm)	Minor pack.	
Insulated mounting plate	192	164	168.5	140	1	NSYAMPA1916TB
Insulated mounting plate	241	194	215	168.5	1	NSYAMPA2419TB
Insulated mounting plate	291	241	265	215	1	NSYAMPA2924TB
Insulated mounting plate	341	291	315	265	1	NSYAMPA3429TB

NSYAMPA1916TB

Symmetric DIN Rails

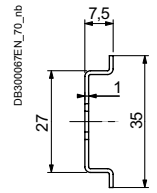

- Installation: Fixing of the rails with \varnothing 4 mm self-tapping screws, (not included), Pozidrive and slotted head, ref. **NSYAMFSTB**

Supply:
Supplied without screws



NSYAMRD11357TB

Characteristics	Height (mm)	Depth (mm)	Length (mm)	Box (mm)	References
Symmetric DIN rail	35	7.5	97	105	NSYAMRD11357TB
Symmetric DIN rail	35	7.5	140	150	NSYAMRD16357TB
Symmetric DIN rail	35	7.5	168	175	NSYAMRD19357TB
Symmetric DIN rail	35	7.5	214	225	NSYAMRD24357TB
Symmetric DIN rail	35	7.5	264	275	NSYAMRD29357TB
Symmetric DIN rail	35	7.5	316	325	NSYAMRD34357TB

Screws for Rails



NSYAMFSTB

- \varnothing 4 x 10 mm

Supply:
Pack of 100 screws

Characteristics	References
Screws \varnothing 4 mm, height 10 mm	NSYAMFSTB

Simple-1	Simple-2	Simple-3	Simple-5	Synthetic snap-in cable gland
 <p>ISM71074</p>	 <p>NSYECPC15</p>	 <p>IMT36179</p>	 <p>ISM71503</p>	 <p>NSYCGSP16</p>
Mixed membrane entries for enclosure thickness 20/10° - 32/10° mm.	PVC adjustable cone-shaped entries for enclosure thickness 30/10° - 32/10° mm.	Quick cable entries for enclosure thickness 10/10° - 40/10° mm (5/10° - 20/10° mm for ref. IMT36179).	ISO cable gland	Without thread. Easy assembly and disassembly. Suitable for walls from 0.5 to 4 mm thick.
ISM71071	NSYECPC3	IMT36179	ISM71501	NSYCGSP16
ISM71072	NSYECPC5	IMT36180	ISM71502	NSYCGSP20
ISM71073	NSYECPC6	IMT36181	ISM71503	NSYCGSP25
ISM71074	NSYECPC9	IMT36182	ISM71504	NSYCGSP32
	NSYECPC15	IMT36183	ISM71505	NSYCGSP40
		IMT36184	ISM71506	
		IMT36185	IMT36150	

Accessories Bag for Enclosure TBS/TBP



NSYTBPASBS

Simple-1

Characteristics	References
Spare Parts	NSYTBPASBS

- Mixed membrane entries for enclosure thickness 20/10° - 32/10° mm.
- Material: SBS
- Color: RAL 7035 gray
- Cable entry material: Soft membrane
- Cable glands to be fitted: Not applicable
- Installation options: On cable gland plate or directly on enclosure
- Flexibility of the installation: Low
- Reversibility: Medium
- Ingress protection rating: IP55 according to IEC 60529

- Cable retention: Low
- Cable diameter (mm): From 20 to 40
- Cable Installation time: Fast
- Quantity of cables to be fitted for a given surface: +
- Cable entries for cables with connectors: No
- Cut-out dimensions (mm): Various circular hole diameters according to cable diameter
- External dimensions (mm): From Ø 23 to 44
- Flame resistance: 750 °C

Supply:
Minor packaging of 10 pieces



ISM71074

Characteristics	Drill hole Ø (mm)	Cable / conduit Ø (mm)	References
Mixed membrane entries for IP55 direct cable entries, RAL 7035	23	4 - 20	ISM71071
Mixed membrane entries for IP55 direct cable entries, RAL 7035	29	4 - 25	ISM71072
Mixed membrane entries for IP55 direct cable entries, RAL 7035	36	4 - 32	ISM71073
Mixed membrane entries for IP55 direct cable entries, RAL 7035	44	4 - 40	ISM71074

Simple-2

- PVC adjustable cone-shaped entries for enclosure thickness 30/10° - 32/10° mm.
- Material: PVC
- Cable entry material: Soft membrane
- Cable glands to be fitted: Not applicable
- Installation options:
 - On cable gland plate or directly on enclosure
- Flexibility of the installation: Low
- Reversibility: Medium
- Ingress protection rating: IP55 according to IEC 60529
- Cable retention: Low
- Cable diameter (mm): From 5 to 87
- Cable Installation time Fast
- Quantity of cables to be fitted for a given surface: +
- Cable entries for cables with connectors: No
- Cut-out dimensions (mm): Various circular hole diameters according to cable diameter
- External dimensions (mm): From Ø 25 to 98

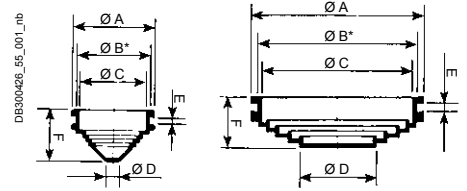

Supply:
NSYECPC3 50 cable entries, **NSYECPC5** and **NSYECPC6** each 25 cable entries, **NSYECPC9** and **NSYECPC15** each 10 cable entries



NSYECPC15

7
TBS
TBP

Characteristics	Dimensions (mm)						Capacity		References
	Ø A	Ø B	Ø C	Ø D	E	F	Cable (Ø mm)	Tube	
PVC adjustable cone-shaped entrie 25x3 mm	25	21.5	18	5	3.2	13	5-18	PG 9-11	NSYECPC3
PVC adjustable cone-shaped entrie 32x3 mm	33	29.5	26	5	3.2	20	5-26	PG 9-16	NSYECPC5
PVC adjustable cone-shaped entrie 43x3 mm	43	38.5	36	5	3.2	22	5-36	PG 9-21	NSYECPC6
PVC adjustable cone-shaped entrie 70x3 mm	70	63	60	28	3	20	28-60	PG 21-48	NSYECPC9
PVC adjustable cone-shaped entrie 98x3 mm	98	90	87	28	3	23	28-87	PG 21-48	NSYECPC15

Simple-3

- Quick cable entries for enclosure thickness 10/10° - 40/10° mm (5/10° - 20/10° mm for ref. **IMT36179**).
- Material: EPDM plastic
- Color: Gray cable entries: NCS 5500; Black cable entries: NCS 9000
- Cable entry material: Combined
- Cable glands to be fitted: Not applicable
- Installation options: On cable gland plate or directly on enclosure
- Flexibility of the installation: Low
- Reversibility: Medium
- Ingress protection rating: IP67 according to IEC 60529
- Cable retention: Medium
- Cable diameter (mm): From 12 to 50
- Cable Installation time: Fast
- Quantity of cables to be fitted for a given surface: +
- Cable entries for cables with connectors: No3
- Cut-out dimensions (mm): Various circular hole diameters according to cable diameter
- External dimensions (mm): From Ø 12.5 to 50.7
- Flame resistance: 750 °C

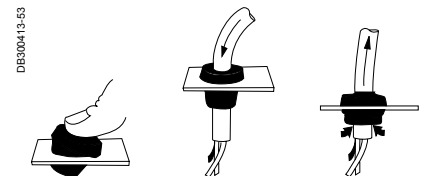

Supply:
 50 (M12 to M32)
 25 (M40 and M50)



IMT36179

Characteristics	Dimensions			References
	ISO	Drill hole (Ø mm)	Cable (Ø mm)	
Quick cable entries	M12	12.5	3 - 5	IMT36179
Quick cable entries	M16	16	5 - 7	IMT36180
Quick cable entries	M20	20.3	7 - 10	IMT36181
Quick cable entries	M25	25.3	10 - 14	IMT36182
Quick cable entries	M32	32.4	14 - 20	IMT36183
Quick cable entries	M40	40.7	20 - 26	IMT36184
Quick cable entries	M50	50.7	26 - 35	IMT36185

Simple-5

- ISO cable gland
- Material: PA6 Polyamide, neoprene gasket
- Color: RAL 7035 gray
- Cable entry material: Combined
- Installation options:
 - On cable gland plate or directly on enclosure
- Flexibility of the installation: Low
- Reversibility: Medium
- Ingress protection rating: IP68
- Cable retention: High
- Cable diameter (mm): From 12 to 40
- Cable Installation time: Slow
- Quantity of cables to be fitted for a given surface: +
- Cable entries for cables with connectors: No
- Cut-out dimensions (mm): Various circular hole diameters according to cable diameter
- External dimensions (mm): From Ø 15 to 46
- Certificates: UL
- Flame resistance: 750 °C

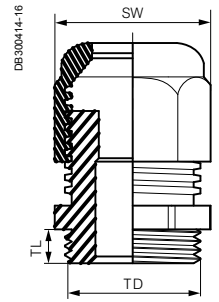

Supply:

The cable glands are supplied with nuts Pack of 20 (M12 to M20), of 10 (M25 and M32), of 5 (M40)



ISM71503

Characteristics	Dimensions					References
	Cable (Ø mm)	Drill hole (Ø mm)	TD	TL	SW	
Cable gland M12, RAL 7035	3 / 6.5	12.2 (0 + 0.2)	12	6	15	ISM71501
Cable gland M16, RAL 7035	4 / 8	16.2 (0 + 0.2)	16	8	19	ISM71502
Cable gland M20, RAL 7035	6 / 12	20.2 (0 + 0.2)	20	10	24	ISM71503
Safety Cable gland M20, RAL 3000	6 / 12	20.2 (0 + 0.2)	20	10	24	IMT36150
Cable gland M25, RAL 7035	11 / 17	25.2 (0 + 0.2)	25	8	29	ISM71504
Cable gland M32, RAL 7035	15 / 21	32.2 (0 + 0.3)	32	10	36	ISM71505
Cable gland M40, RAL 7035	19 / 28	40.5 (0 + 0.3)	40	10	46	ISM71506

7
TBS
TBP

Synthetic Snap-In Cable Gland

- Without thread.
- Easy assembly and disassembly.
- Suitable for walls from 0.5 to 4 mm thick.
- Material: PA6 Polyamide, neoprene gasket
- Color: RAL 7035 gray, RAL 7001, RAL 9005. Other colors on demand
- Cable entry material: Non armoured
- Installation options:
 - On cable gland plate or directly on enclosure
- Flexibility of the installation: Low
- Reversibility: Medium
- Ingress protection rating: IP66
- Cable retention: High
- Cable diameter (mm): From 16 to 40
- Cable Installation time: Slow
- Quantity of cables to be fitted for a given surface: +
- Cable entries for cables with connectors: No
- Thread type: Metric EN 60423
 - Other types are available on demand
- Cut-out dimensions (mm): Various circular hole diameters according to cable diameter
- External dimensions (mm): From Ø 22 to 46
- Certificates: UL 94 V-2 (except for the size M40)
- Standard: DIN EN 62444, UL 514B, UL 514B§8.26.7
- Temperature range: -20 °C to + 100 °C

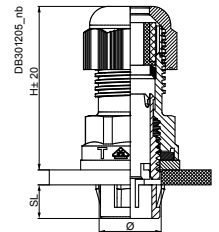

Supply:

The cable glands are supplied with nuts Pack of 20 (M16 and M20), of 10 (M25 and M32), of 5 (M40)



NSYCGSP16

Characteristics	Dimensions (mm)							References
	Ø	Ø min / max	Drill Ø	SL	SD	H	🔧	
Synthetic snap-in cable gland	M16	5/10	16.2 to 16.4	9	15.9	42.5	22	NSYCGSP16
Synthetic snap-in cable gland	M20	6/12	20.2 to 20.4	9	19.9	41.5	24	NSYCGSP20
Synthetic snap-in cable gland	M25	11/17	25.2 to 25.4	9	24.9	43.5	29	NSYCGSP25
Synthetic snap-in cable gland	M32	15/21	32.2 to 32.4	9	31.9	49.5	36	NSYCGSP32
Synthetic snap-in cable gland	M40	19/28	40.2 to 40.4	11.5	39.9	56	46	NSYCGSP40



7
PLS

Technical changes reserved. Information provided without guarantee. Images are for illustrative purposes only.

PLS Boxes: Polyester Rear and PC Transparent Cover with Wing Screws for Manual Opening

This range can be configured according to your needs

4 different services available:



Assemble to Order



Mounting of Standard Accessories



Painting



Machining

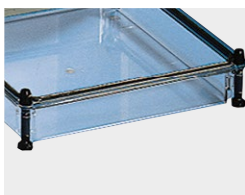

Protection

IP66.
Gasket between body and cover.
IK09.
Insulation Class II.

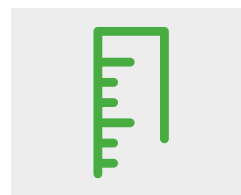

Modular

The dimensions of the sides, multiples of 9 cm, allow the creation of assemblies.



Easy

Bosses with inserts, at the rear of the body, for fixing plates or various supports.

See [page 474](#) for details or consult our web site www.se.com



Prolonged exposure to UV radiation, wind and rain can cause aesthetics changes in the external surface of the enclosure. Without affecting the technical properties according to IEC 62208. For long exposure applications, it is recommended to use painted enclosures available through the P&S offer.



Class II



Characteristics	NSYPLS5454AG	NSYPLS1827G	NSYPLSC5472AG	NSYPLSC1827G	NSYPLSP1827G
Complete box					
	<ul style="list-style-type: none"> Insulated boxes that can be coupled by all their side surfaces, allowing the creation of the greatest variety of modular assemblies. The product references show the two lateral dimensions in cm. 14 sizes of insulated boxes; The sides are multiples of 9 cm. Body made from polyester reinforced with fiberglass, molded by hot compression, 9 sizes. 3 types of cover available according to the sizes: Standard cover, made from transparent polycarbonate with neoprene gasket, 45 mm high, or 95 mm high (final index A) according to the sizes, Opaque polycarbonate cover (index C), with neoprene gasket, 45 mm high, or 95 mm high (final index A) according to the sizes, Polyester reinforced with fiberglass cover (index P) with PUR gasket, 45 mm high. Complete box includes body, cover, locking screws and sealing device. The bodies (prefix F) and the covers (prefix T) are supplied separately as standard references. The separate covers are supplied without locking screws or sealing accessories. The PLS enclosures with transparent cover are also offered in sets; The reference refers to the complete set. Excellent resistance to corrosion; withstands most chemical substances. Full insulation to create Class II assemblies. Standard lock with slot screws outside the volume of the boxes. Delivered with sealing system. External wall-mounted by 4 lugs, to be ordered separately. Service temperature: -40 to +80 °C. Bosses with M6 inserts for fixing the mounting plate. Halogen-free and compliant with the RoHS directive. 				
Color	RAL 7035 gray (opaque bodies and cover)				
Ingress protection rating	IP66				
Mechanical protection rating	IK09				
Certifications	<ul style="list-style-type: none"> Certification according to standard IEC 62208 to ensure compliance with IP, IK, resistance to heat and fire (self-extinguishing), insulation to 5000 V, and load of the mounting plate, 100 kg/m² Certified UL (cULus). Rating according UL50E Type 1, 2, 3, 3R, 4, 4X, 12 and 13 				
Installation	Outdoor installation: Compliant with IEC 62208 regarding type tests specified in §9.12 (resistance to UV radiation) and §9.13 (resistance to corrosion). It is always advisable to install a canopy to avoid water stagnation on the top of the enclosure and to protect against UV radiation.				
Options	-				
Supply	-				

NSYPLS, NSYPLSP and NSYPLSC followed by suffixes.



Modular distribution chassis

NSYDLS12

Built-in DLS modular chassis, made up of an insulated protection panel, RAL 7011 color, 35-mm DIN rails and a 2 x 16 + 5 x 6 mm² neutral/earth connection strip.

-
- IP43
- IK09
-
- Indoor
-
-

Complete box



Dimensions			Transparent cover	Polycarbonate cover	Polyester cover
Height (mm)	Width (mm)	Depth (mm)	References	References	References
180	270	180	NSYPLS1827G	NSYPLSC1827G	NSYPLSP1827G
270	270	180	NSYPLS2727G	NSYPLSC2727G	NSYPLSP2727G
270	270	230	NSYPLS2727AG	NSYPLSC2727AG	-
270	360	180	NSYPLS2736G	NSYPLSC2736G	NSYPLSP2736G
270	360	230	NSYPLS2736AG	NSYPLSC2736AG	-
270	540	180	NSYPLS2754G	NSYPLSC2754G	NSYPLSP2754G
270	540	230	NSYPLS2754AG	NSYPLSC2754AG	-
360	270	180	-	-	-
360	270	180	-	-	-
360	360	180	NSYPLS3636G	NSYPLSC3636G	NSYPLSP3636G
360	540	180	NSYPLS3654G	NSYPLSC3654G	NSYPLSP3654G
360	540	230	NSYPLS3654AG	NSYPLSC3654AG	-
360	720	230	NSYPLS3672AG	NSYPLSC3672AG	-
540	270	180	-	-	-
540	540	180	NSYPLS5454G	NSYPLSC5454G	NSYPLSP5454G
540	540	230	NSYPLS5454AG	NSYPLSC5454AG	-
540	720	230	NSYPLS5472AG	NSYPLSC5472AG	-

7
PLS

Rear Low covers: 45 mm

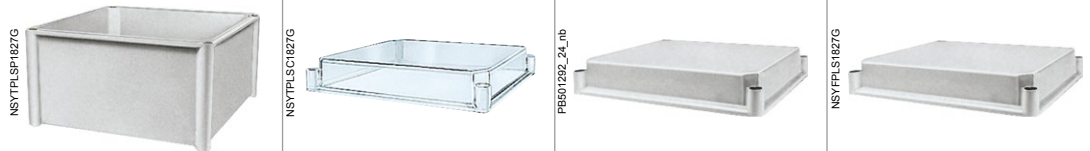

Dimensions			Rear 135 mm	Transparent	Polycarbonate	Polyester
Height (mm)	Width (mm)	Depth (mm)	References	References	References	References
180	270	180	NSYFPLS1827G	NSYTPLS1827	NSYTPLSC1827G	-
270	270	180	NSYFPLS2727G	NSYTPLS2727	NSYTPLSC2727G	NSYTPLSP2727G
270	270	230	NSYFPLS2727G	-	-	-
270	360	180	NSYFPLS2736G	NSYTPLS2736	NSYTPLSC2736G	-
270	360	230	NSYFPLS2736G	-	-	-
270	540	180	NSYFPLS2754G	NSYTPLS2754	NSYTPLSC2754G	NSYTPLSP2754G
270	540	230	NSYFPLS2754G	-	-	-
360	360	180	NSYFPLS3636G	NSYTPLS3636	NSYTPLSC3636G	-
360	540	180	NSYFPLS3654G	NSYTPLS3654	NSYTPLSC3654G	NSYTPLSP3654G
360	540	230	NSYFPLS3654G	-	-	-
360	720	230	NSYFPLS3672G	-	-	-
540	540	180	NSYFPLS5454G	NSYTPLS5454	NSYTPLSC5454G	-
540	540	230	NSYFPLS5454G	-	-	-
540	720	230	NSYFPLS5472G	-	-	-

Insulated modular boxes with modular distribution chassis				Modular distribution chassis			
				References	Dimensions		
No. of 18 mm modules	No. of rows	Approximate weight (kg)	Height (mm)		Width (mm)	Depth (mm)	
12	1	1.7	180	NSYDLS12	270	180	
24	2	2.5	270	NSYDLS24	270	180	
-	-	-	270	-	270	230	
-	-	-	270	-	360	180	
-	-	-	270	-	360	230	
-	-	-	270	-	540	180	
-	-	-	270	-	540	230	
24	2	2.7	360	NSYDLS242	270	180	
36	3	2.8	360	NSYDLS36	270	180	
-	-	-	360	-	360	180	
-	-	-	360	-	540	180	
-	-	-	360	-	540	230	
-	-	-	360	-	720	230	
-	4	3.8	540	NSYDLS48	270	180	
48	-	-	540	-	540	180	
-	-	-	540	-	540	230	
-	-	-	540	-	720	230	



7
PLS

High covers: 95 mm		Metal mounting plates		Insulated mounting plates			
References	References	References	References	References	Dimensions		
					Height (mm)	Width (mm)	Depth (mm)
-	-	NSYPMM1827	NSYPMR1827	NSYPMA1827G	180	270	180
-	-	NSYPMM2727	NSYPMR2727	NSYPMA2727G	270	270	180
NSYTPLS2727A	NSYTPLSC2727AG	NSYPMM2727	NSYPMR2727	NSYPMA2727G	270	270	230
-	-	NSYPMM2736	NSYPMR2736	NSYPMA2736G	270	360	180
NSYTPLS2736A	NSYTPLSC2736AG	NSYPMM2736	NSYPMR2736	NSYPMA2736G	270	360	230
-	-	NSYPMM2754	NSYPMR2754	NSYPMA2754G	270	540	180
NSYTPLS2754A	NSYTPLSC2754AG	NSYPMM2754	NSYPMR2754	NSYPMA2754G	270	540	230
-	-	NSYPMM3636	-	NSYPMA3636G	360	360	180
-	-	NSYPMM3654	NSYPMR3654	NSYPMA3654G	360	540	180
NSYTPLS3654A	NSYTPLSC3654AG	NSYPMM3654	NSYPMR3654	NSYPMA3654G	360	540	230
NSYTPLS3672A	NSYTPLSC3672AG	NSYPMM3672	-	NSYPMA3672G	360	720	230
-	-	NSYPMM5454	-	NSYPMA5454G	540	540	180
NSYTPLS5454A	NSYTPLSC5454AG	NSYPMM5454	-	NSYPMA5454G	540	540	230
NSYTPLS5472A	NSYTPLSC5472AG	NSYPMM5472	-	NSYPMA5472G	540	720	230

Technical changes reserved. Information provided without guarantee. Images are for illustrative purposes only.

Wall Fixing Lugs



NSYPF27N

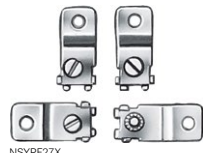

NSYPF27X

- Passivated zinc-coated steel
- Stainless-steel

Characteristics	References
Wall fixing lug, passivated zinc-coated steel	NSYPF27N
Wall fixing lug, stainless-steel	NSYPF27X

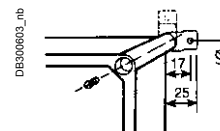

Supply:
Set of 4 lugs and fixings

Plastic Carrying Handle



NSYATM27

- Material: Plastic
- Ingress protection rating: IP43

Characteristics	References
Plastic carrying handle	NSYATM27

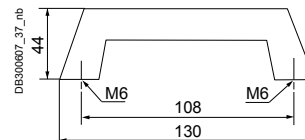

7
PLS

Coupling Frames



NSYUM27180

- Ingress protection rating: Frame with full opening: IP65 between enclosures

Characteristics	For surfaces (mm)	Opening (mm)	References
Full-opening frame	180	110	NSYUM27180
Full-opening frame	270	200	NSYUM27270
Full-opening frame	360	290	NSYUM27360

Comment:
Use the dimensional drawings of the boxes to identify which coupling frame you need. Consider the sides and surfaces you will join. Not UL-certified.



NSYUCC270

- Ingress protection rating: Frame with full opening: IP44 between enclosures

Characteristics	For surfaces (mm)	Opening (mm)	References
Partial-opening frame	270	200	NSYUCC270
Partial-opening frame	360	290	NSYUCC360

Comment:
Use the dimensional drawings of the boxes to identify which coupling frame you need. Consider the sides and surfaces you will join. Not UL-certified.

Supply:
References by unit. Order by multiples of 10 units (10, 20, 30, etc.).

Side Plates

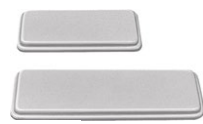

NSYTL27270G

- Ingress protection rating: IP65

Characteristics	For surfaces (mm)	Width (mm)	References
Side plate	270	200	NSYTL27270G
Side plate	360	290	NSYTL27360G

Box Coupling Unit Piece



NSYPS2C27

- For coupling 2, 3 or 4 boxes, with optional wall-mounted.
- M6 x 8 mm screw with cylindrical head.

Characteristics	References
Box coupling unit piece for coupling 2 boxes	NSYPS2C27
Box coupling unit piece for coupling 3 or 4 boxes	NSYPS4C27

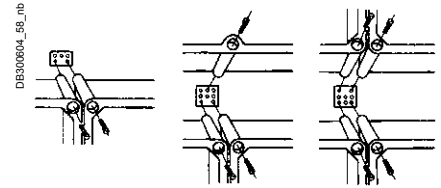

Supply:
To be ordered in multiples of 25

Closures for PLS Boxes

- Slotted screw: Included in the standard references of boxes **NSYPLS●●●**.
- Wing screw: Included in the standard references of modular distribution boxes **NSYPLS●●●DLS●●●**.

Supply:
Set of 4, 6 or 8 screws.
The references also include 4 M6 screws for fixing mounting plates and 2 steel sealing accessories



NSYTC274



NSYTCM274

Characteristics	Tool	References
Set of 4 slotted screws	Flat-blade screwdriver	NSYTC274
Set of 6 slotted screws	Flat-blade screwdriver	NSYTC276
Set of 8 slotted screws	Flat-blade screwdriver	NSYTC278
Set of 4 wing screws	Manual	NSYTCM274

Closing Locks



NSYCL27M

- Option of installing a side lock on the opposite side to where the hinges are installed
- Ingress protection rating: IP43



NSYCL27L405

Characteristics	Tool	References
Double-bar side lock and handle	NSYDBP	NSYCL27M
Side lock with key 405	Key 405	NSYCL27L405

External Hinges



NSYBE27G

- To open the door to 180°.
- Material: Plastic

Comment:
IP level cannot be guaranteed due to type of application and installation

Supply:
Set of 2 hinges

Characteristics	References
External hinges, plastic	NSYBE27G

Internal Hinges



NSYBL27

- To open the door to 180°.
- Material: Brass

Comment:
IP level cannot be guaranteed due to type of application and installation

Supply:
Set of 2 hinges

Characteristics	References
Internal hinges, brass	NSYBL27

7
PLS

Box of 74 x 74 x 54 mm (external dimensions) **NSYTB●●●775**

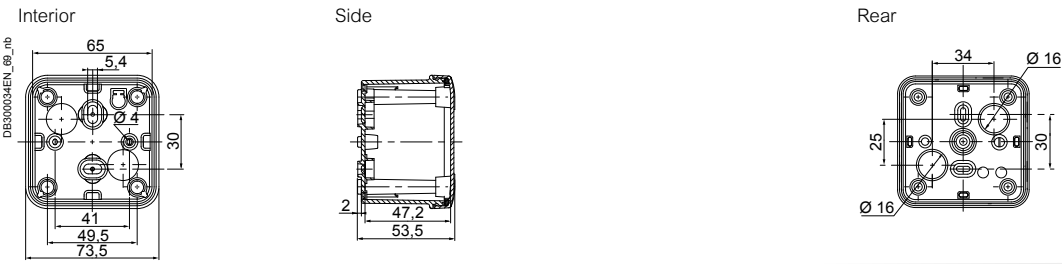

Box of 89 x 89 x 54 mm (external dimensions) **NSYTB●●●885**

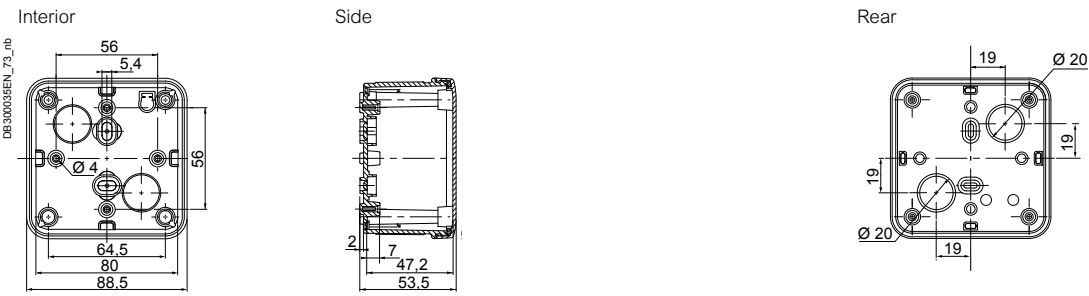

Box of 116 x 74 x 62 or 94 mm (external dimensions) **NSYTB●●●1176** or **NSYTB●●●1179**

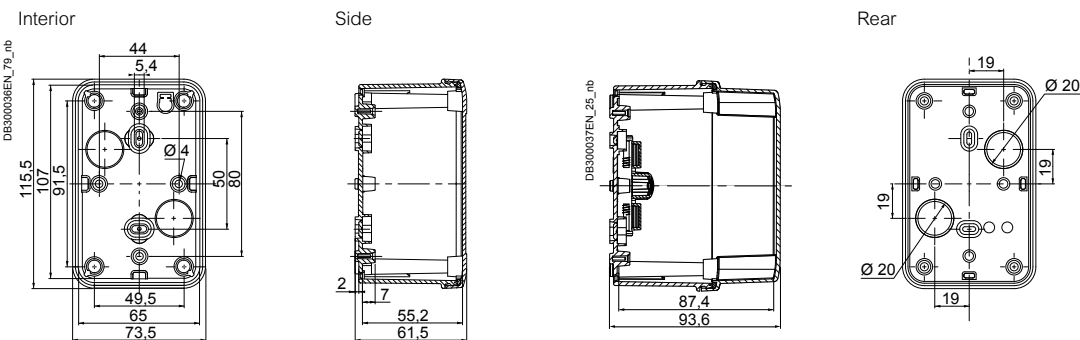

Box of 116 x 116 x 62 or 133 mm (external dimensions) **NSYTB●●●11116** or **NSYTB●●●11113**

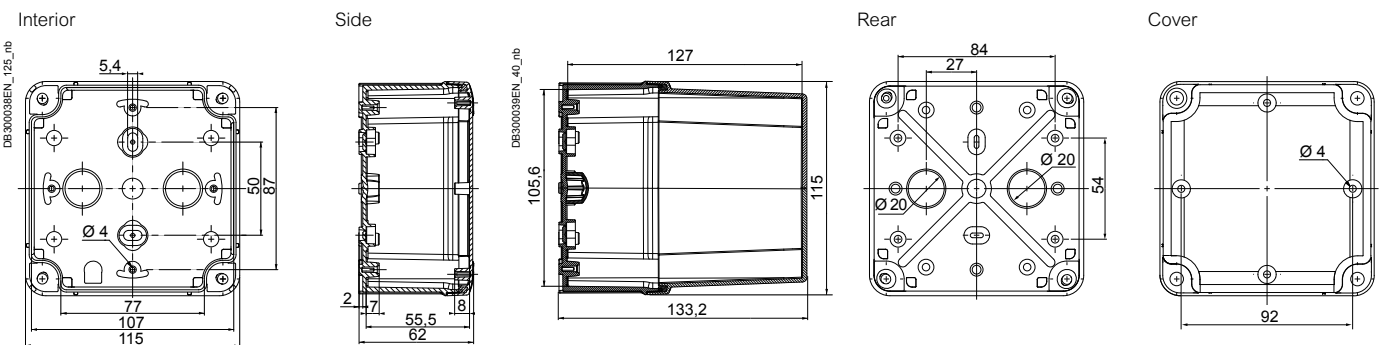

Box of 138 x 93 x 72 mm (external dimensions) **NSYTB●●●1397**



Technical changes reserved. Information provided without guarantee. Images are for illustrative purposes only.

Box of 164 x 121 x 87 mm (external dimensions) **NSYTB●●●16128**

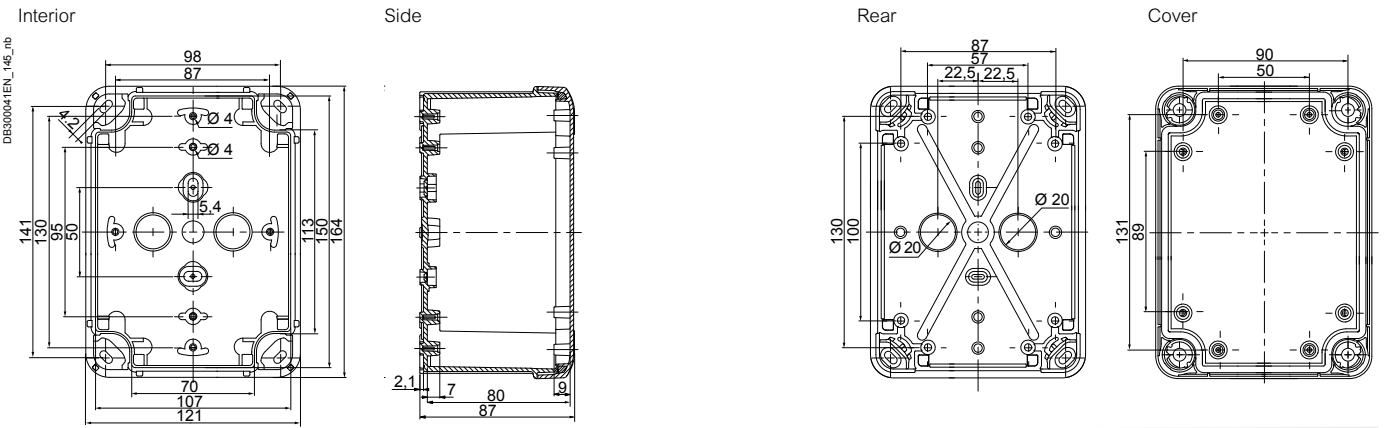

Box of 192 x 121 x 87 or 105 mm (external dimensions) **NSYTB●●●19128** or **NSYTB●●●191210**

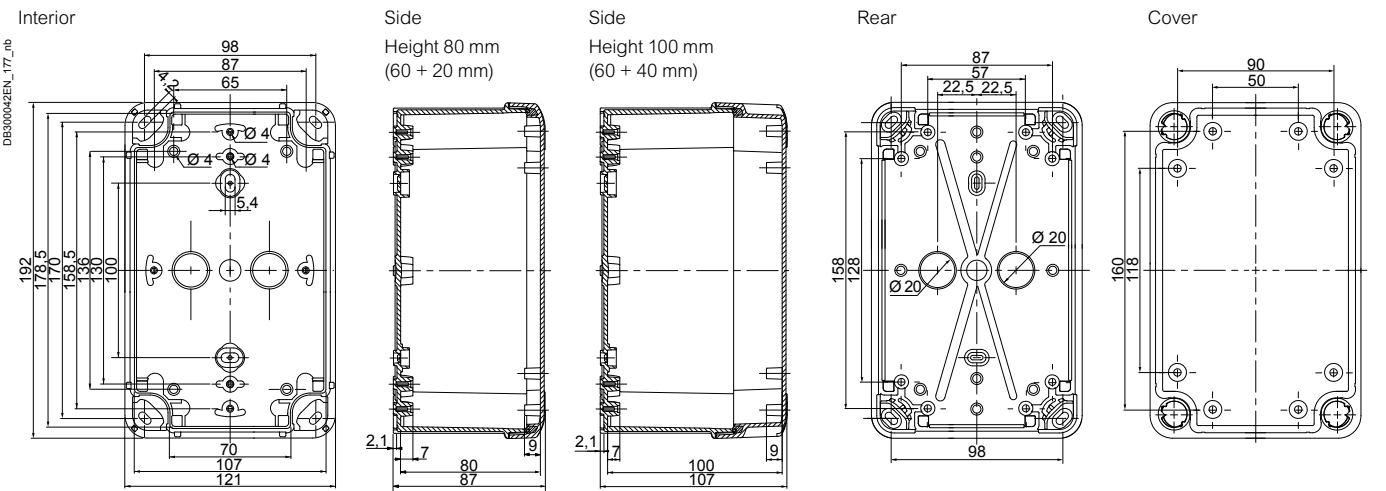

7
TBS
TBP

Box of 192 x 164 x 87 or 105 mm (external dimensions) **NSYTB●●●19168** or **NSYTB●●●191610**

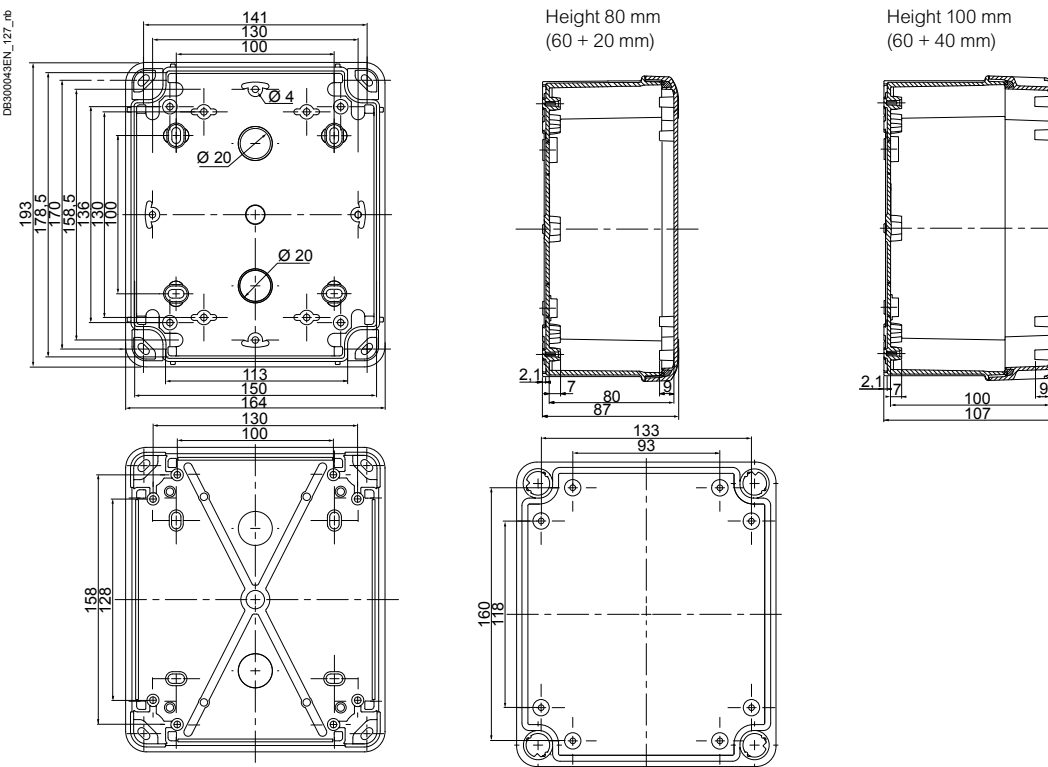

Technical changes reserved. Information provided without guarantee. Images are for illustrative purposes only.

Box of 241 x 194 x 87, 107 or 127 mm (external dimensions)
NSYTB●●●24198, NSYTB●●●241910 or NSYTB●●●241912

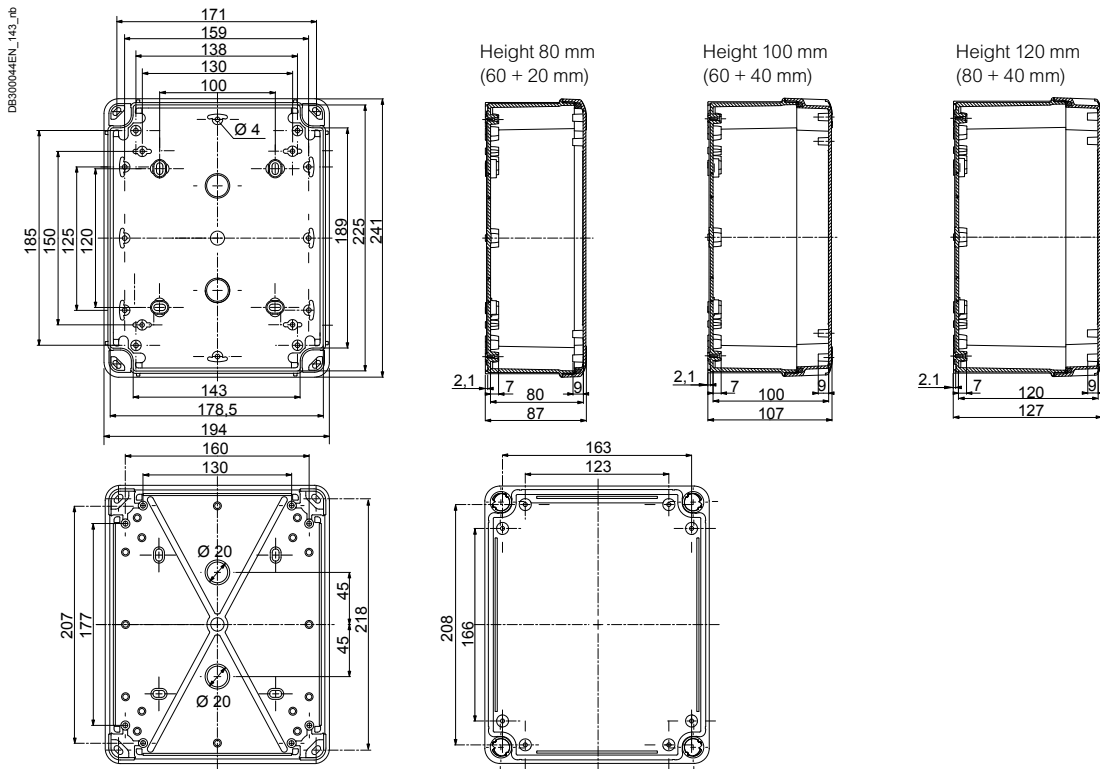

Box of 291 x 241 x 88, 128 or 168 mm (external dimensions)
NSYTB●●●29248, NSYTB●●●292412 or NSYTB●●●292416

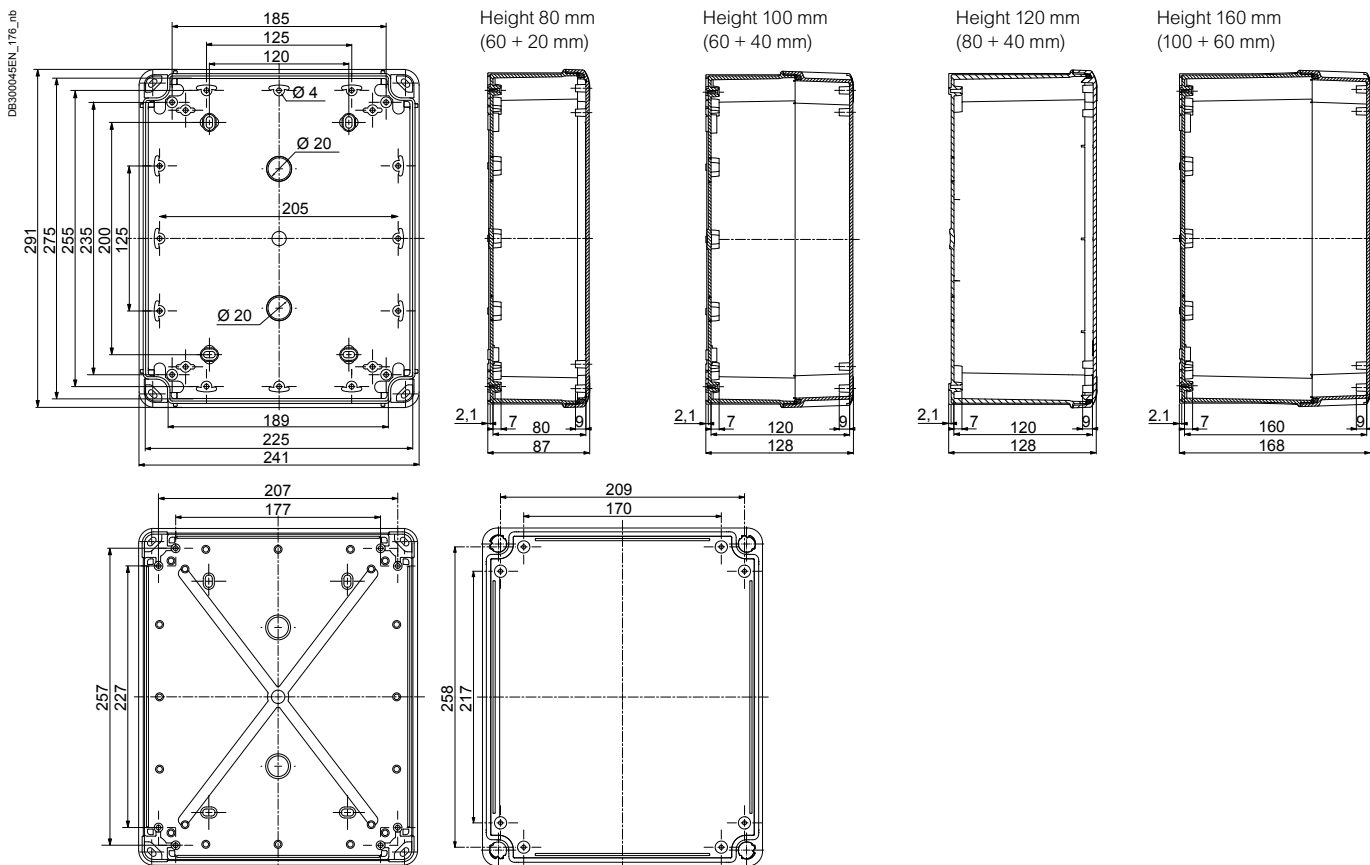

Technical changes reserved. Information provided without guarantee. Images are for illustrative purposes only.

Box of 341 x 291 x 128 or 168 mm (external dimensions)
NSYTB●●●342912 or **NSYTB●●●342916**

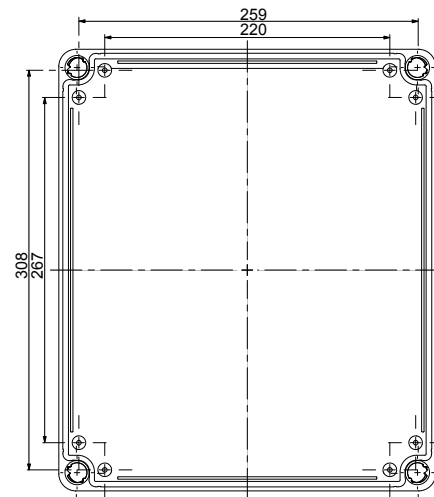
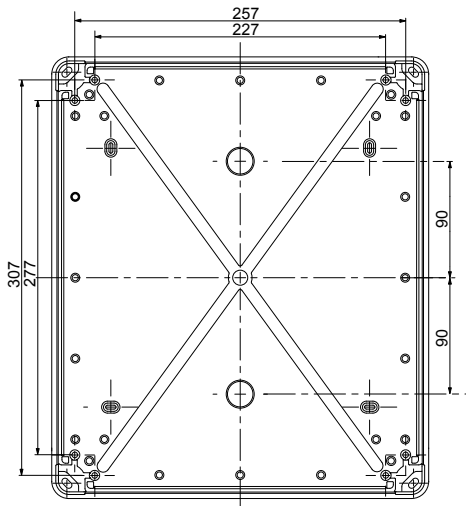
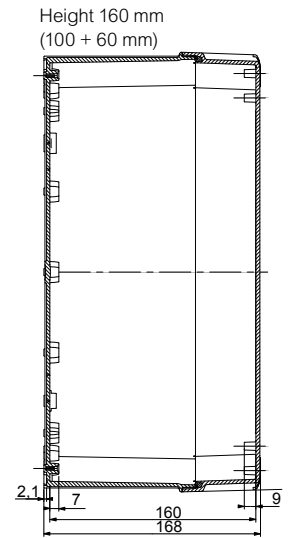
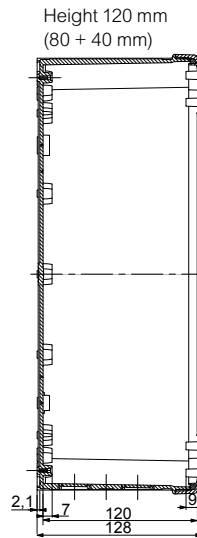
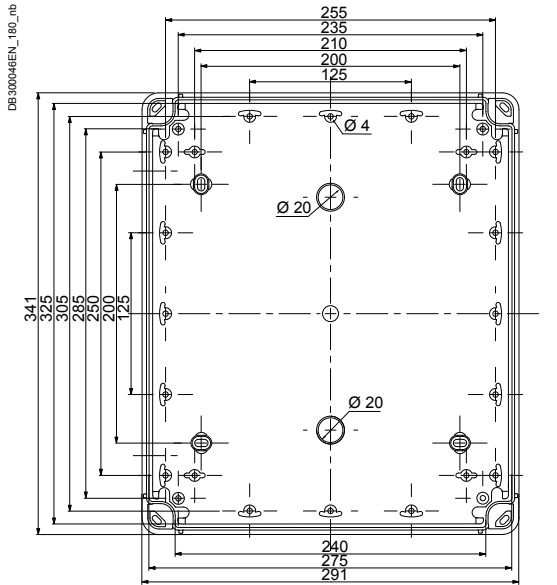

Technical changes reserved. Information provided without guarantee. Images are for illustrative purposes only.

The Surfaces Are Numbered to Enable Identification of the Surfaces to Be Drilled in the Customized Offer

NSYPLS●●●1827G

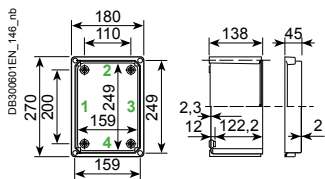

NSYPLS●●●3654G

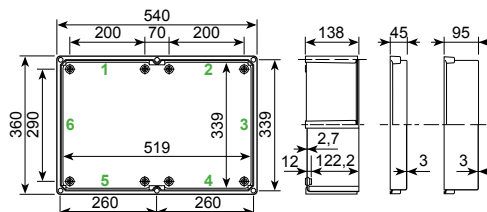

NSYPLS●●●2727G

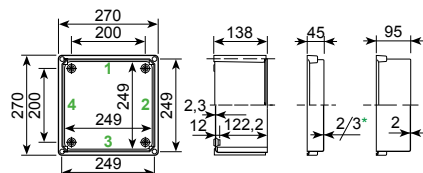

NSYPLS●●●5454G

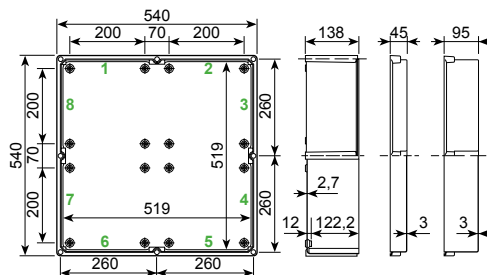

NSYPLS●●●2736G

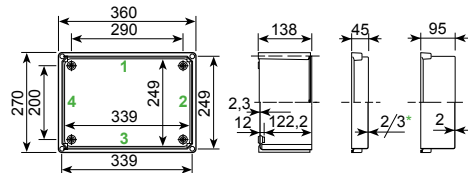

NSYPLS●●●3672G

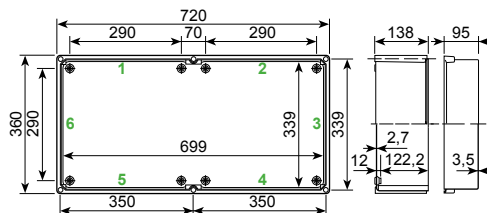

NSYPLS●●●3636G

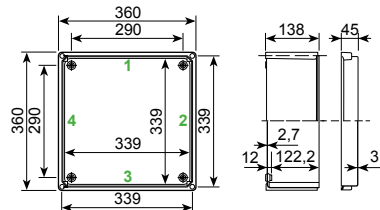

NSYPLS●●●5472G

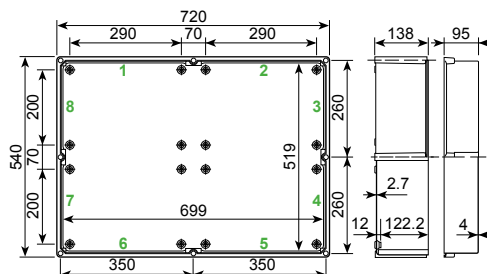

NSYPLS●●●2754G

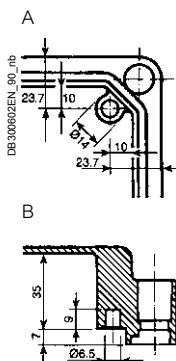
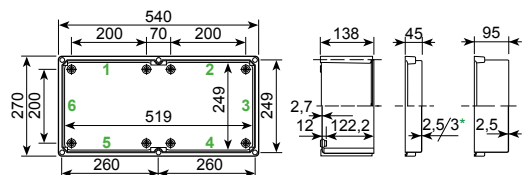

A - B: Internal view of the corners of the polyester covers with bosses for inserts ref. **NSYTEX5** for M5 screws.

7
PLS

* Thickness of 30/10^o mm for the polyester cover.

Examples of Assembly

All the boxes can be joined by their lateral surfaces using the coupling frames **NSYUM●●●** or **NSYUCC●●●**, and the joining and fixing pieces **NSYPS2C27** and **NSYPS4C27**.

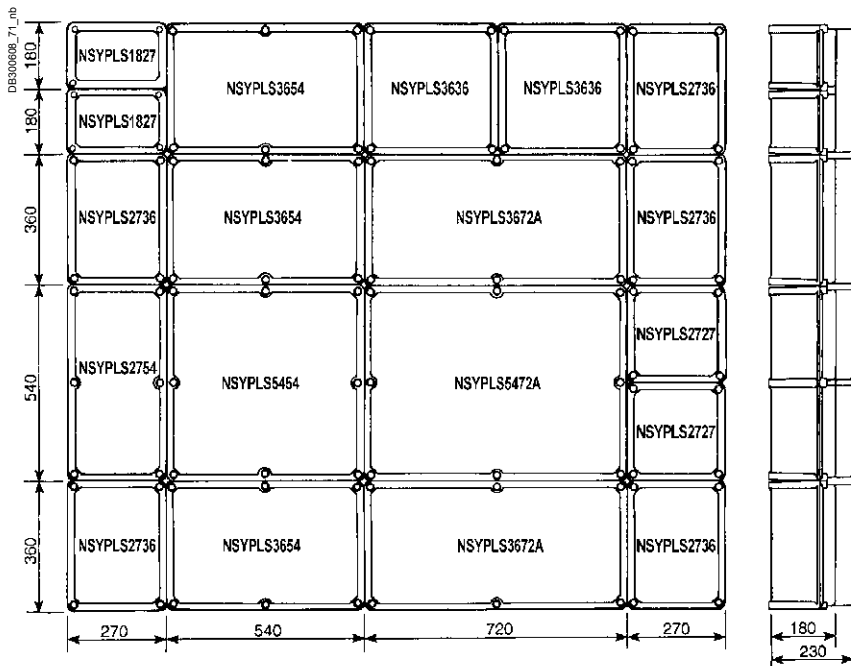

7
PLS

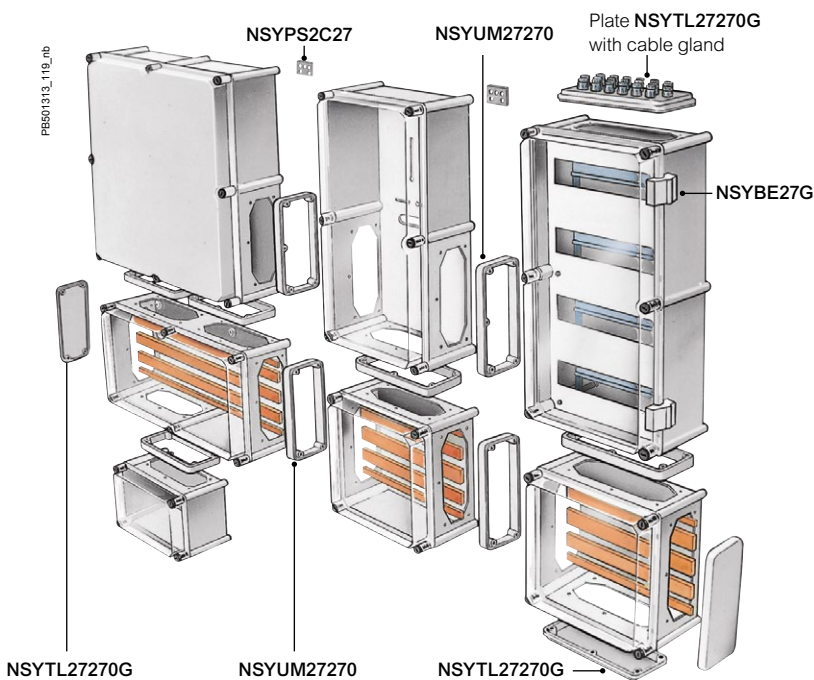

Technical changes reserved. Information provided without guarantee. Images are for illustrative purposes only.

Insulated Wall-Mounted Enclosures

Polyester Wall-Mounted Enclosures



Thalassa PLM



Introduction	174
Characteristics	175
Selection Guide	176
Specific Accessories	177
Dimensions	188

Monobloc wall-mounted enclosure, made of polyester reinforced with fiberglass, molded by hot compression. Degree of protection IP66, impact resistance IK10 for plain doors and surfaces, and IK08 for glazed doors of polyester versions, UL certification (cULus), rating according to UL50E 4x and 13 for polyester wall-mounted enclosures. Full insulation to produce Class II-units compliant with RoHS and REACH directives

This range can be configured according to your needs

4 different services available:



Assemble to Order



Mounting of Standard Accessories



Painting



Machining



8 PLM



Easy Installation

- Door easily reversible by turning it over.
- Opening to 120° or 180°.
- Easy machining with no corrosion.
- Lightness.
- Polyamide hinge pin, easily removable and captive.



Service Life

- High resistance to corrosion in harsh environments, maintaining mechanical properties and insulation.



Smart Interior

- Notches for easy fixing of DIN rails.
- Grid pattern on the rear of the door for marking the machining operations.



Landscape Enclosures

- Horizontal enclosures for photovoltaic and multiple applications
- Easily and quickly removable door system (without removing hinges and pins)
- For more details see [page 386](#)

See [page 474](#) for details or consult our web site www.se.com







Prolonged exposure to UV radiation, wind and rain can cause aesthetics changes in the external surface of the enclosure. Without affecting the technical properties according to IEC 62208. For long exposure applications, it is recommended to use painted enclosures available through the P&S offer.







Characteristics	ABS/PC wall-mounted enclosures	Polyester wall-mounted enclosures								
	<ul style="list-style-type: none"> • Monobloc wall-mounted enclosure. • Version with transparent polycarbonate door. • Door opening: 180°. • Supplied with a lock with double-bar insert as standard 	<ul style="list-style-type: none"> • Monobloc wall-mounted enclosure. • Version with transparent tempered-glass door. • Door opening angle: 120°. • Grid pattern with a pitch of 50 mm on the back of the door. • Supplied with one lock with a double-bar insert as standard. 	<ul style="list-style-type: none"> • Monobloc wall-mounted enclosure. • Version with transparent tempered-glass door. • Locking device outside the sealed area to ensure long-term tightness according to IP66. • Locking system: enclosure height ≤ 847 mm: 2 locks with double-bar insert ref. NSYCDBPLM or 1 handle with key lock and 3-point locking system, enclosure height 1056 mm: 1 lock with double-bar insert and 4-point locking system ref. NSYVPLM108. • Door opening angle: 180°. • Bosses for accessory-fixing inserts: M6 inside the enclosure, M5 in the door for enclosure heights of 430 and 530 mm, M6 in the door for enclosure heights ≥ 647 mm. • Grid pattern with a pitch of 25 mm on the back of the door. 							
Material	ABS/PC	Polyester reinforced with fiberglass, molded by hot compression								
Temperature range - Gasket	-40 °C to +80 °C									
Color	RAL 7035 gray									
Ingress protection rating	IP66 according to IEC 60529									
Mechanical protection rating	<ul style="list-style-type: none"> • IK10 plain door • IK08 glazed door 									
Certifications (see page 640)	<ul style="list-style-type: none"> • IEC 62208 • Bureau Veritas Marine 	<ul style="list-style-type: none"> • IEC 62208 • Marine • UL (cULus). Rating according to UL50E: 1, 2, 3, 3R, 4, 4X, 5, 12 and 13. • Certifications exclude range NSYPLM...VG or TVG 	<ul style="list-style-type: none"> • IEC 62208 • Marine 							
Installation	<ul style="list-style-type: none"> • Direct fixing of symmetrical rails ref. NSYCS200PLM with plastic nuts ref. NSYTCSPML, to be installed in the notches on the rear of the body, with a pitch of 25 mm • Fixing of installation plates on the studs at the rear of the enclosure 	<ul style="list-style-type: none"> • Fixing of rear accessories on 4 M8 x 18 studs 	<ul style="list-style-type: none"> • Fixing of rear accessories on 4 M8 studs, included in the standard supply • Direct fixing of symmetrical rails ref. NSYCS●●●PLM, with plastic nuts, ref. NSYTCSPML, to be installed in the notches on the rear of the body, with a pitch of 25 mm 							
External dimensions	References of wall-mounted enclosures with door									
Height (mm)	Width (mm)	Depth (mm)	Plain (3)	Transparent (4)	Plain (3)	Transparent (4)	Plain (3)	Transparent (4)	Plain (1)	Transparent (1) (4)
308	255	160	-	-	NSYPLM3025G	NSYPLM3025TG	-	-	-	-
310	215	160	NSYPLM32G	NSYPLM32TG	-	-	-	-	-	-
430	330	200	-	-	-	-	NSYPLM43G	NSYPLM43TG	NSYPLM43VG	NSYPLM43TVG
530	430	200	-	-	-	-	NSYPLM54G	NSYPLM54TG	NSYPLM54VG	NSYPLM54TVG
647	436	250	-	-	-	-	NSYPLM64G	NSYPLM64TG	NSYPLM64VG	NSYPLM64TVG
747	536	300	-	-	-	-	NSYPLM75G	NSYPLM75TG	NSYPLM75VG	NSYPLM75TVG
847	636	300	-	-	-	-	NSYPLM86G	NSYPLM86TG	NSYPLM86VG	NSYPLM86TVG
1056	852	350	-	-	-	-	NSYPLM108G (2)	NSYPLM108TG (2)	-	-





(1) Wall-mounted enclosure with handle and lock with 3-point locking system and key 1242 E delivered as standard.
 (2) Wall-mounted enclosure with standard 5-mm double-bar lock and lock with 4-point locking system.
 (3) These enclosures are also available equipped with metal or insulated mounted plates.
 (4) Must be protected against UV radiation.



Comment:
NSYPLMRS108GA is also certified by UL (cULus)

ABS/PC wall-mounted enclosures with door				Polyester wall-mounted enclosures with door			
Comment: For dimensions see page 188							
External dimensions				Plain (3)	Transparent (4)	Plain (3)	Transparent (4)
Height (mm)	Width (mm)	Depth (mm)	References	References	References	References	References
310	215	160	NSYPLM32G	NSYPLM32TG	-	-	-
308	255	160	-	-	NSYPLM3025G	NSYPLM3025TG	-

Polyester wall-mounted enclosures with door							
Comment: For dimensions see page 188							
							
Plain (3)		Transparent (4)		Plain (1)		Transparent (1) (4)	
External dimensions		References		References		References	
Height (mm)	Width (mm)	Depth (mm)	References	References	References	References	References
430	330	200	NSYPLM43G	NSYPLM43TG	NSYPLM43VG	NSYPLM43TVG	NSYPLM43TVG
530	430	200	NSYPLM54G	NSYPLM54TG	NSYPLM54VG	NSYPLM54TVG	NSYPLM54TVG
647	436	250	NSYPLM64G	NSYPLM64TG	NSYPLM64VG	NSYPLM64TVG	NSYPLM64TVG
747	536	300	NSYPLM75G	NSYPLM75TG	NSYPLM75VG	NSYPLM75TVG	NSYPLM75TVG
847	636	300	NSYPLM86G	NSYPLM86TG	NSYPLM86VG	NSYPLM86TVG	NSYPLM86TVG
1056	852	350	NSYPLM108G (2)	NSYPLM108TG (2)	-	-	-

⁽¹⁾ Wall-mounted enclosure with handle and lock with 3-point locking system and key 1242 E delivered as standard.
⁽²⁾ Wall-mounted enclosure with standard 5-mm double-bar lock and lock with 4-point locking system.
⁽³⁾ These enclosures are also available equipped with metal or insulated mounted plates.
⁽⁴⁾ Must be protected against UV radiation.

Wall-mounted enclosures with plain door and mounted plate (not mounted)							
Comment: For dimensions see page 188							
							
Plain		Bakelite		Plain		Bakelite	
External dimensions		References		References		References	
Height (mm)	Width (mm)	Depth (mm)	References	References	References	References	References
310	215	160	NSYPLM32PG	NSYPLM32BG	-	-	-
308	255	160	-	-	NSYPLM3025PG	NSYPLM3025BG	-

Wall-mounted enclosures with plain door and mounted plate (not mounted)							
Comment: For dimensions see page 188							
							
Plain		Bakelite		Bakelite			
External dimensions		References		References			
Height (mm)	Width (mm)	Depth (mm)	References	References	References	References	References
430	330	200	NSYPLM43PG	NSYPLM43BG	NSYPLM43BG	NSYPLM43BG	NSYPLM43BG
530	430	200	NSYPLM54PG	NSYPLM54BG	NSYPLM54BG	NSYPLM54BG	NSYPLM54BG
647	436	250	NSYPLM64PG	NSYPLM64BG	NSYPLM64BG	NSYPLM64BG	NSYPLM64BG
747	536	300	NSYPLM75PG	NSYPLM75BG	NSYPLM75BG	NSYPLM75BG	NSYPLM75BG
847	636	300	NSYPLM86PG	NSYPLM86BG	NSYPLM86BG	NSYPLM86BG	NSYPLM86BG
1056	852	350	-	NSYPLM108BG	NSYPLM108BG	NSYPLM108BG	NSYPLM108BG



Characteristics	ZM plinth for PLM enclosure <ul style="list-style-type: none"> Designed to support and raise enclosures NSYPLM75G, NSYPLM86G and NSYPLM108G. Plinth height of 200 mm; stackable to obtain a 400 mm plinth. Four floor attachment points; symmetry of the parts prevents incorrect assembly. <p>The front parts of the plinth (front and rear) have two stainless-steel screws protected by a plastic cap; these screws make it possible (using an Allen key) to open and remove the front parts for easier cable installation. In stacked position, the bottom plinth can be partially buried. It is provided with one transverse reinforcement rail, adjustable to adapt to the position of the cables. The reference of the plinth contains all the accessories required for attaching the enclosure to the plinth and for stacking two plinths.</p>
Material	Polyester reinforced with fiberglass, molded by hot compression
Ingress protection rating	IP44
Mechanical protection rating	IK10
Standards	Helps guarantee full insulation according to IEC 61439-1

Plinth



NSYZM253G

Kit for IP54



NSYAEPZM

Characteristics	PLM enclosure	Height (mm)	Width (mm)	Depth (mm)	Reference
Plinth	NSYPLM75G	200	456	302	NSYZM253G
Plinth	NSYPLM86G	200	556	302	NSYZM263G
Plinth	NSYPLM108G	200	772	352	NSYZM283G

Required to obtain IP54 for the plinth and the plinth enclosure coupling.

Characteristics	Reference
Kit for IP54	NSYAEPZM

Feet for Partially Buried Installation



NSYAEBFZ

Allows the partially buried installation of plinths before completion of the floor. The plinths are attached by four feet with a standard length of 750 mm. Option of horizontal adjustment of the plinth. The reference includes a kit made up of four feet and fixings.

Characteristics	Reference
Feet for partially buried installation	NSYAEBFZ

8
PLM

Insulated Wall-Mounted Enclosures

Floor-Mounted Pillar

To protect cables entering the enclosure in outdoor installations.
Cable entry section: 165 x 100 mm.
For enclosures ref. **NSYPLM54G**, **NSYPLM54TG**, **NSYPLM64G** and **NSYPLM64TG**.



NSYSFPLMG

- Material: Polyester reinforced with fiberglass
- Color: RAL 7035 gray

Supply:
Delivered with steel frame for secure fixing to the floor

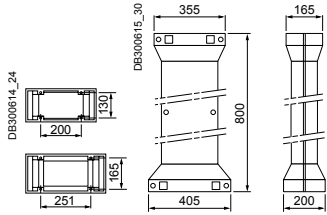

Characteristics	Reference
Floor-mounted pillar	NSYSFPLMG

Wall Fixing Lugs

Set of 4 wall fixing lugs. Mounted directly on the enclosure, either in horizontal position or in vertical position.

- Material: Polyamide reinforced with fiberglass
- Color: RAL 7035 gray
- **Maximum load:**
On PLM32: Vertical or horizontal: 10 kg
Other PLM models: Vertical position: 200 kg, horizontal position: 100 kg

Supply:
Delivered with fixings



NSYFPPLMG

NSYFPPLM32G

Characteristics	Reference
Wall fixing lugs	NSYFPPLMG
Wall fixing lugs, exclusively for enclosures ref. NSYPLM32G and NSYPLM32TG.	NSYFPPLM32G

Wall Fixing Lugs

Set of 4 wall fixing lugs. Mounted directly on the enclosure, either in horizontal position or in vertical position.

- Material: Stainless-steel
- Color: RAL 7035 gray
- **Maximum load:**
Other PLM models: Vertical position: 200 kg, horizontal position: 100 kg

Supply:
Delivered with fixings



NSYFPXPLM

Characteristics	Reference
Wall fixing lugs	NSYFPXPLM

Post Fixing Device

For outdoor installations on a post with a maximum circumference of 675 mm, Ø 215 mm.

- Material: Galvanized steel
- Maximum load: 100 kg

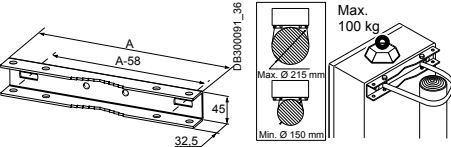

Supply:
Supply of 2 rails, the strips and the fixings



NSYSFP300

Characteristics	For wall-mounted enclosure	Reference
Post fixing device	NSYPLM43G	NSYSFP300
Post fixing device	NSYPLM54G and NSYPLM64G	NSYSFP400
Post fixing device	NSYPLM75G	NSYSFP500
Post fixing device	NSYPLM86G	NSYSFP600

Blanking Plates

Aesthetic Accessory. They are positioned on the rear surface of the enclosures to block the openings in the corners in order to improve their appearance or prevent the entry of unwanted elements in the airing shaft. Supplied as standard for enclosure, ref. **NSYPLM108G**.

- Material: Thermoplastic
- Color: RAL 7035 gray
- Ingress protection rating: IP40

Accessory is mounted outside the IP66-protected area.



NSYCEPLMAG

Characteristics	For wall-mounted enclosure	Reference
Blanking plates	NSYPLM32G	NSYCEPLMAG
Blanking plates	NSYPLM43G and NSYPLM54G	NSYCEPLMBG
Blanking plates	NSYPLM64G, 75G and 86G	NSYCEPLMCG

Insulated Wall-Mounted Enclosures

Support Bracket for Enclosure with Anti-Tilt Kit and Reinforcement



NSYCOCONS1400

- The support bracket is used when the enclosure cannot be hung from a wall or a post.
- Maximum enclosure dimensions: 1000 x 800 x 300 mm.
- Floor attachment by standard M12 fasteners.
- Material: Steel
- Finish: Epoxy polyester paint
- Color: RAL 7035 gray
- Maximum load: 120 kg

Characteristics	Height (mm)	References
Support bracket for enclosure with anti-tilt kit and reinforcement	1400	NSYCOCONS1400
Support bracket for enclosure with anti-tilt kit and reinforcement	1800	NSYCOCONS1800

Internal Door

- Reversible door.
- Grid pattern with a pitch of 25 mm for easier marking before drilling.
- Closes with 2 double-bar locks.
- Door handle.
- Steel internal door, without grid pattern and locking by a screw, for enclosures ref. **NSYPLM3025G**.
- Incompatible with the modular distribution chassis.
- Material: Polyester reinforced with fiberglass, self-extinguishing
- Color: RAL 7035 gray



NSYPA3025PLMG

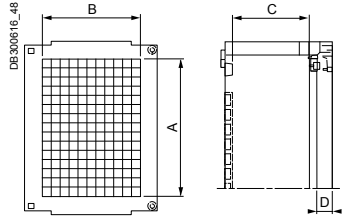

Supply:
Delivered with fixings and brass inserts

Characteristics	Height (mm)	Width (mm)	A (mm)	B (mm)	C (mm)	D Plain door (mm)	D Transp. door (mm)	Reference
Internal door	308	255	248	165	62	76	71	NSYPA3025PLMG
Internal door	430	330	315	205	152	26	21	NSYPAP43G
Internal door	530	430	415	305	152	26	21	NSYPAP54G
Internal door	645	435	515	305	194	32	27	NSYPAP64G
Internal door	745	535	615	405	244	32	27	NSYPAP75G
Internal door	845	635	715	505	244	32	27	NSYPAP86G
Internal door	1055	850	850	650	269	37	32	NSYPAP108G

8
PLM

New

PLM Landscape (Horizontal) Range for Photovoltaic and Multiple Applications with Removable Door System [see page 386](#)



PLM86G_Closed_ISO (1)

NSYCSA08_ISO



PLM86G_Dismounted_ISO

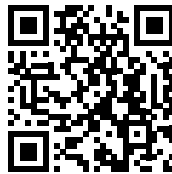

Scan or click for video

Metal mounted Plate

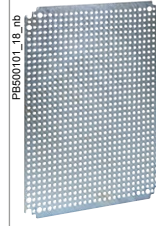

Characteristics	Plain	Microperforated
-----------------	-------	-----------------

Model	Enclosure Dimensions			MP Dimension		Reference	Reference
	Height (mm)	Width (mm)	Depth (mm)	Height (mm)	Width (mm)		
NSYPLM32	310	215	160	250	150	NSYMM32	-
NSYPLM3025	308	255	160	250	200	NSYMM3025	-
NSYPLM43	430	330	200	230	350	NSYMM43	NSYMF43
NSYPLM54	530	430	200	450	350	NSYMM54	NSYMF54
NSYPLM64	647	436	250	550	350	NSYMM64	NSYMF64
NSYPLM75	747	536	300	650	450	NSYMM75	NSYMF75
NSYPLM86	847	636	300	750	550	NSYMM86	NSYMF86
NSYPLM108	1056	852	350	950	750	NSYMM108	NSYMF108



Height (mm)	Width (mm)	# of perforation H	# of perforation W	Reference	Height (mm)	Width (mm)	Thick. (mm)	Reference	Height (mm)	Width (mm)	Thick. (mm)	Reference
255	153.7	16	5	NSYMR32	265	150	4	NSYMB32	265	150	4	NSYMPP32
253	228	16	8	NSYMR3025	265	200	4	NSYMB3025	265	200	4	-
348.7	251	22	9	NSYMR43	325	250	4	NSYMB43	325	250	4	NSYMPP43
450	351	31	11	NSYMR54	465	350	4	NSYMB54	465	350	4	NSYMPP54
555	351	38	11	NSYMR64	565	350	4	NSYMB64	565	350	4	NSYMPP64
645	451	44	14	NSYMR75	665	450	4	NSYMB75	665	450	4	NSYMPP75
750	551	51	17	NSYMR86	765	550	4	NSYMB86	765	550	5	NSYMPP86
945	751	64	24	NSYMR108	965	750	4	NSYMB108	965	750	5	NSYMPP108

Insulated Wall-Mounted Enclosures

Options to Convert the Locks to Double-Bar Inserts **NSYPLM32G** to **NSYPLM86G**



NSYTC8CRN



NSYTT8CRN



NSYTL405PLM

- Changing the shaped inserts for locks with keys according to the following table.

Characteristics	Operated with a key	References
Square insert 6 mm □	LC-7	NSYTC6CRN
Square insert 7 mm □	LC-7	NSYTC7CRN
Square insert 8 mm □	LC-8	NSYTC8CRN
Triangular insert 6 mm ▲	LT-8	NSYTT6CRN
Triangular insert 8 mm ▲	LT-8	NSYTT8CRN
Lock and key 405		NSYTL405PLM
Lock and key 220		NSYTL220PLM

Options to Convert the Locks to Double-Bar Inserts **NSYPLM32G** to **NSYPLM86G**

- Replacement for locking handle with cylindrical barrel, delivered with all the parts required to change the lock.



NSYTHL1242EPLM

Characteristics	References
Key 1242 E	NSYTHL1242EPLM
Key 405	NSYTHL405PLM
Key 421	NSYTHL421PLM
Key 455	NSYTHL455PLM
Key 2433 A	NSYTHL2433APLM
Key 3113 A	NSYTHL3113APLM
Manual	NSYTHPLM

Options to Convert Versions **NSYPLM●●V**, with Retractable Handle and 3-Point Locking System

- Conversion of the standard insert (barrel for key 1242E, ref. **NSYTL1242EME**) to other shaped inserts or barrels according to the following table.

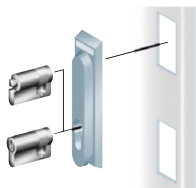

NSYTDB5ME

Characteristics	References
5-mm double-bar	NSYTDB5ME
Barrel and key 405	NSYTCL405ME
Manual	NSYTMME

Insulated Wall-Mounted Enclosures

Locks and Inserts for Enclosures **NSYPLM108/T**

- Options to convert the insert
- The standard insert can be replaced with other shaped inserts according to the following table.

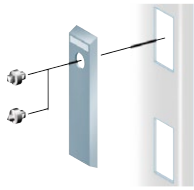

NSYTDB5PL

Characteristics	References
Double-bar insert	NSYTDB5PL

Locks and Inserts for Enclosures **NSYPLM108/T**

- Options to convert to a retractable handle
- The escutcheon and rosette assembly can be replaced with a lock with retractable handle equipped with inserts or barrels according to the following table.

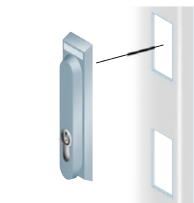

NSYTEDB5PL

Characteristics	References
5-mm double-bar	NSYTEDB5PL
8 mm male triangle	NSYTET8PL
Lock key 1242 E	NSYTEL1242EPL
Barrel and key 405	NSYTEL405PL
JIS key and barrel	NSYTELJISPL
Manual	NSYTEMPL

Padlocking Accessories

Padlocking system positioned around the rectangular escutcheon of the enclosures with a height of ≤ 847 mm to block access to the lock; For a $\varnothing 9$ mm padlock.



NSYKPLM

Characteristics	References
Padlocking accessories	NSYKPLM

Padlocking Accessories

Padlocking system positioned around the long rectangular escutcheon of the enclosures ref. **NSYPLM108G/TG** to block access to the lock; For $\varnothing 9$ mm padlock.



NSYBCPL

Characteristics	References
Padlocking accessories	NSYBCPL

Padlocking Accessories

Padlocking system to block access to the retractable handle, for the versions **NSYPLM●●V** or optionally for enclosures ref. **NSYPLM108G/TG**, for a $\varnothing 9$ mm padlock.



NSYBCME

Characteristics	References
Padlocking accessories	NSYBCME

8
PLM

Insulated Wall-Mounted Enclosures

Step Slides

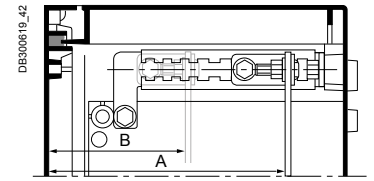

NSYDPLM200

Kit allowing depth adjustment with a pitch of 12.5 mm, and the fixings required for the installation. Incompatible with the modular distribution chassis.

Supply:
4 step slides with brackets

Characteristics (Material: Galvanized steel)	For wall-mounted enclosure depth (mm)	Depth adjustment A (mm)	Depth adjustment B (mm)	References
Step slides	200	156	94	NSYDPLM200
Step slides	250	200	100	NSYDPLM250
Step slides	300	250	100	NSYDPLM300
Step slides	350	306	106	NSYDPLM350

Plastic Nuts for Rail Fixing

They slide directly into the notches, with a pitch of 25 mm, which are located on the rear of the enclosures, except enclosure ref. **NSYPLM3025G/TG**. They allow direct fixing of symmetrical DIN rails by self-tapping screws. Option of raising the rails with an M6 spacer using a plastic nut containing an M6 nut.

Supply:
References by unit. Order by multiples of 20 units (20, 40, 60, etc.)



NSYTCSPLM

Characteristics	References
Plastic nut with self-tapping screw	NSYTCSPLM
Plastic nut containing an M6 metal nut	NSYTCSM6PLM

35-mm Symmetrical DIN Rails

They are fixed to the rear of the enclosure without uprights, with a pitch of 25 mm for the notches on the rear of the enclosure using direct-fixing nuts ref. **NSYTCSPLM** or **NSYTCSM6PLM**.

- Material: Galvanized steel

Supply:
References by unit. Order by multiples of 2 units (2, 4, 6, etc.)



NSYCS200PLM

Characteristics	For wall-mounted enclosure width (mm)	Rail length (mm)	References
35 mm symmetrical DIN rails	215	180	NSYCS200PLM
35 mm symmetrical DIN rails	330	280	NSYCS300PLM
35 mm symmetrical DIN rails	430 / 436	380	NSYCS400PLM
35 mm symmetrical DIN rails	536	480	NSYCS500PLM
35 mm symmetrical DIN rails	636	580	NSYCS600PLM
35 mm symmetrical DIN rails	852	795	NSYCS800PLM

Insulated Wall-Mounted Enclosures

Fixing Inserts



Expanding inserts for addition to the M6 bosses of the enclosure, the M5 or M6 bosses of the door and the M8 bosses of the external rear part of the enclosure.

Supply:

References by unit. Order by multiples of 8 units (8, 16, 24, etc.). M5 and M6 inserts to be ordered in multiples of 20

Characteristics	Insert size	For wall-mounted enclosure	References
Fixing inserts	M5	NSYPLM43G and NSYPLM54G	NSYTEX5
Fixing inserts	M6	NSYPLM64G to NSYPLM108G	NSYTEX6
Fixing inserts	M8	For the rear of the enclosure	NSYTEX8PLM

Airing Louvres



- They can be positioned inside the wall-mounted enclosures with heights from 430 to 846 mm, allowing airing through the channels of the enclosure.

Supply:

References by unit. Order by multiples of 2 units (2, 4, 6, etc.)

Characteristics	References
Airing louvres	NSYCAG35LP

Water Drain Plug



- For drainage of condensed water. (Condensation should be eliminated using ClimaSys solution.) It is placed in the Ø 8.5 mm (8.2 mm for wall-mounted enclosures **NSYPLM32G**, **NSYPLM32TG**, **NSYPLM32PG** and **NSYPLM32BG**, diverse accessories) housing at the bottom of the enclosure.
- Ingress protection rating: IP53

Supply:

References by unit. Order by multiples of 10 units (10, 20, 30, etc.)

Characteristics	References
Water drain plug	NSYVEA9

Renovation and Anti-Graffiti Paint



- Paint kit with two components (base 80% + hardener 20%)
- Specially designed for polyester enclosures, for their renovation and/or as prevention to allow easy removal of graffiti.
- Color: RAL 7035 gray

Supply: NSYAUPG1G

The 1 kg reference includes 1 pot with 800 g of base paint and 200 g of hardener (It is enough to paint a surface of around 5 m²)

Characteristics	References
Renovation and anti-graffiti paint	NSYAUPG1G

Insulated Wall-Mounted Enclosures

Thalassa PLM, S3D, S3X,
Specific Accessories

DLA Modular Chassis for Distribution



S3D* **S3X** **PLM**

Characteristics	DLA modular chassis
	<ul style="list-style-type: none"> • Front panels and covers installed in the front part, not depth adjustable. • Rigid structure for the installation of modular devices. • Open front panels with 35-mm DIN rail and plain front panels with mounted plate, according to the model. • Front plates are quickly installed with no fixings. • Rail depth adjustable from 40 to 85 mm. • System for standard circuit marking. • Incompatible with the internal doors and the step slides. • Neutral/earth strip: 2 x 16 mm² + 5 x 6 mm².
Material	Front panels and finish covers: Polystyrene Rigid structure: Galvanized steel
Color	Front panels and finish covers: RAL 7035 gray

8
PLM



NSYDLA24G

Characteristics	No. of rows	No. of 18 mm modules per row	No. of 18 mm modules	No. of plates	PLM enclosure References	S3D enclosure (depth ≥ 200 mm) Height (mm) Width (mm)	Reference
DLA modular chassis	2	12	24	-	NSYPLM43G NSYPLM43TG	400 300	NSYDLA24G
DLA modular chassis	3	16	48	-	NSYPLM54G NSYPLM54TG	500 400	NSYDLA48G
DLA modular chassis	3	16	48	-	NSYPLM64G NSYPLM64TG	600 400	NSYDLA48PG
DLA modular chassis	3	22	66	1	NSYPLM75G NSYPLM75TG	700 500	NSYDLA66G *
DLA modular chassis	4	22	88	-	NSYPLM75G NSYPLM75TG	700 500	NSYDLA88G
DLA modular chassis	3	28	84	1	NSYPLM86G NSYPLM86TG	800 600	NSYDLA84G *
DLA modular chassis	4	28	112	-	NSYPLM86G NSYPLM86TG	800 600	NSYDLA112G
DLA modular chassis	6	39	234	-	NSYPLM108G NSYPLM108TG	1000 800	NSYDLA234G

DB300620_SE

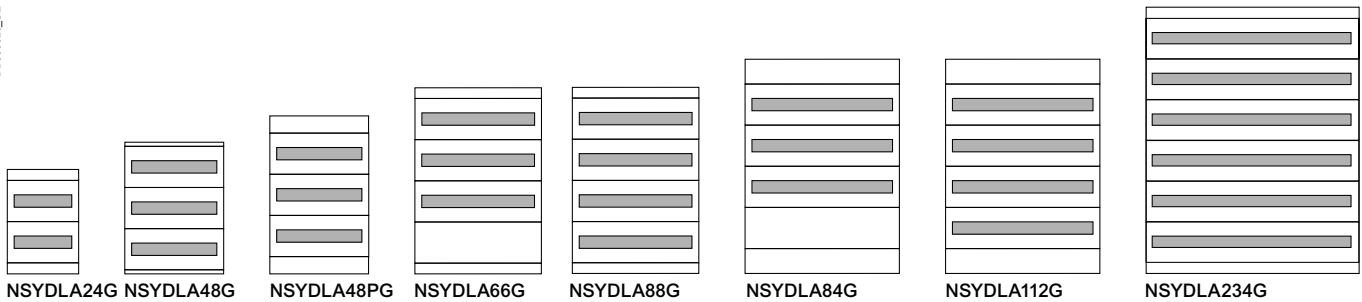

* Chassis with a plain front plate includes a partial mounting plate.

DB300621_72_nb

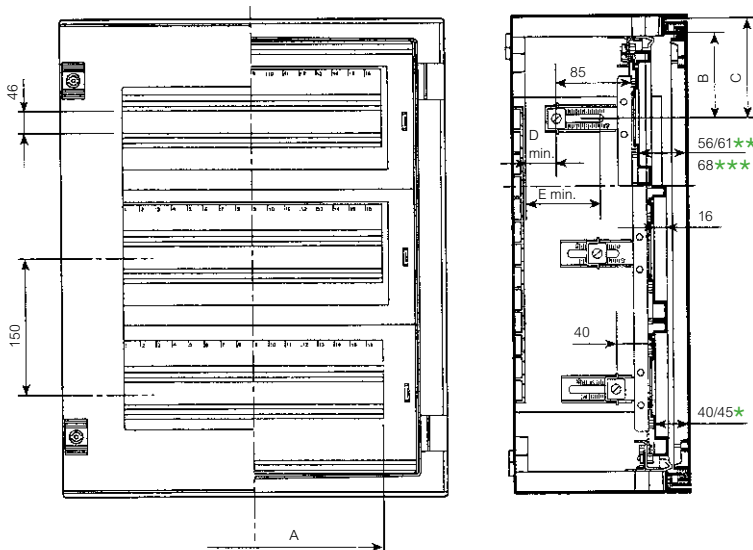

** Models NSYDLA48PG, 66G, 88G, 84G and 112G.
*** Models NSYDLA234G.

Technical changes reserved. Information provided without guarantee. Images are for illustrative purposes only.

Plain Front Panels for DLA Modular Chassis

- Front panel for non-modular device protection on one row.
- To be ordered in multiples of two.
- Material: Polystyrene
- Color: RAL 7035 gray



NSYCTL300DLAG

Characteristics	Width (mm)	For installing on the chassis	Reference
Plain front panels for DLA modular chassis	456	NSYDLA66G and NSYDLA88G	NSYCTL500DLAG
Plain front panels for DLA modular chassis	555	NSYDLA84G and NSYDLA112G	NSYCTL600DLAG
Plain front panels for DLA modular chassis	755	NSYDLA234G	NSYCTL800DLAG

Modular Distribution Chassis

- For mounted modular devices on two rows of nine 18-mm modules.
- Material:
Chassis: Metal Protective
Plate: Insulated material



NSYDLPLM18G

Characteristics	For enclosure	Reference
Modular distribution chassis	NSYPLM3025G/TG	NSYDLPLM18G

ABS/PC Wall-Mounted Enclosures

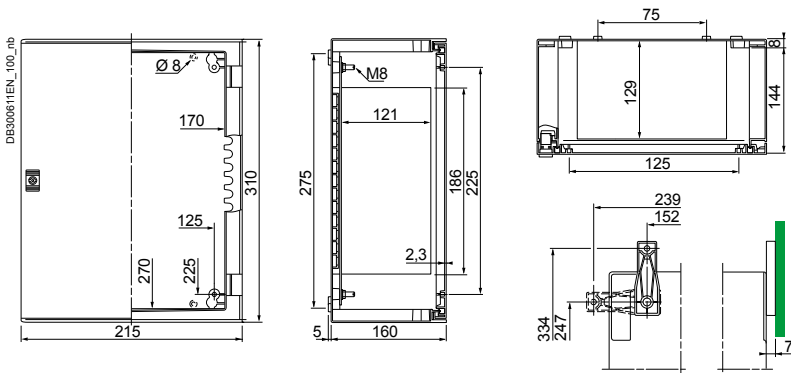

Polyester Wall-Mounted Enclosures 308 x 255 mm

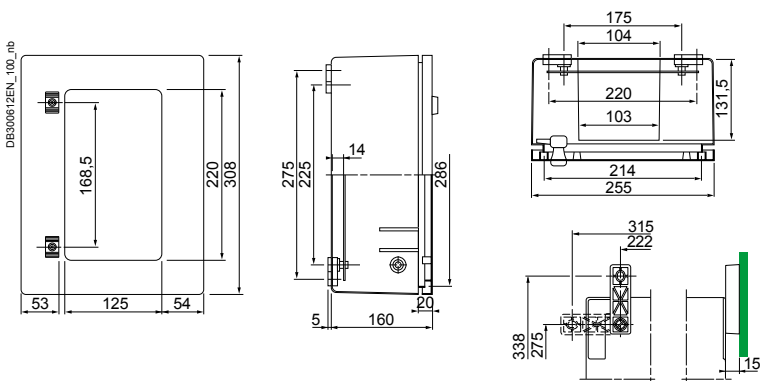

 Warning! This model is available with only one lock!

8
PLM

Other Polyester Wall-Mounted Enclosures

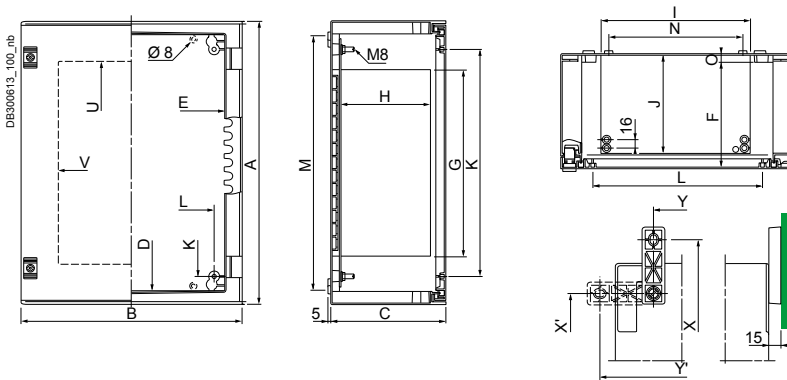

External fixing with lugs (mm)				
References	Vertical		Horizontal	
	X	Y	X'	Y'
NSYPLM43G	490	225	355	360
NSYPLM54G	590	325	455	460
NSYPLM64G	690	330	555	465
NSYPLM75G	790	430	655	565
NSYPLM86G	890	530	755	665
NSYPLM108G	1090	750	955	885

Glazed door opening (mm)		
References	U	V
NSYPLM43TG	273	194
NSYPLM43TVG	273	151
NSYPLM54TG	373	294
NSYPLM54TVG	373	251
NSYPLM64TG	463	294
NSYPLM64TVG	463	252
NSYPLM75TG	563	394
NSYPLM75TVG	563	352
NSYPLM86TG	663	494
NSYPLM86TVG	663	452
NSYPLM108TG	854	661

References	Dimensions (mm)										Bottom screw and door bosses (mm)		Internal fixing (mm)		
	A	B	C	D	E	F	G	H	I	J	K	L	M	N	O
NSYPLM43G	430	330	200	380	260	181	247	247	179	168	325	225	225	150	13
NSYPLM54G	530	430	200	480	360	181	347	347	279	168	425	325	325	250	13
NSYPLM64G	647	436	250	580	360	228	388	388	279	212	525	325	325	250	13
NSYPLM75G	747	536	300	680	460	278	487	487	379	261	625	425	425	350	15
NSYPLM86G	847	636	300	780	560	278	587	587	479	261	725	525	525	450	15
NSYPLM108G	1056	852	350	980	760	327	775	775	680	300	925	725	725	650	15

8
PLM

Insulated Floor-Standing Enclosures

PLA Version



PLAT Version



PLAZ Version



PLAZT Version



Thalassa PLA Polyester Floor-Standing Enclosures

Introduction	192
Characteristics	193
Selection Guide	194
Specific Accessories	196
Dimensions	209

Polyester Floor-Standing Enclosures

Thalassa PLA, PLAT, PLAZ, PLA ZT, Introduction

The **floor-standing enclosures** are made of **polyester reinforced with fiberglass**, molded by hot compression. High resistance to corrosion in harsh environments, it maintains its mechanical and insulation properties.

This range can be configured according to your needs

4 different services available:



Assemble to Order



Mounting of Standard Accessories



Painting



Machining



9
PLA

New Bigger dimensions

Enclosures with a height of 2000 mm and a depth of 620 mm have been included to suit the demands of industry and infrastructure for the integration of motor controllers, power distribution, electronic or telecommunication devices

PLAT version



Airing

- Open top with canopy allows passive airing.



Easy Mounting

- Various bosses for M8 inserts.

PLAZ version



Open Bottom

- Big open bottom to be mounted directly on the floor or on a plinth.



Smart Interior

- Plain mounting plate installed on step slides and compulsory adapter plates in all the enclosures with open bottom part.

PLAZT version



Easy Installation

- Door opening to 180°.



Resistant

- Anti lever security system..

See page 474 for details or consult our web site www.se.com



Prolonged exposure to UV radiation, wind and rain can cause aesthetics changes in the external surface of the enclosure. Without affecting the technical properties according to IEC 62208. For long exposure applications, it is recommended to use painted enclosures available through the P&S offer.



Class II

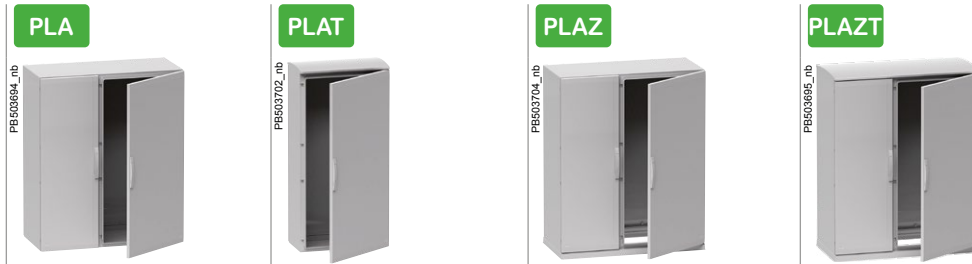

Characteristics	PLA version	PLAT version	PLAZ version	PLAZT version
	<p>Completely sealed enclosure Enclosure obtained by assembling:</p> <ul style="list-style-type: none"> • 1 sealed top part, • 1 sealed bottom part, • 2 side parts, • 1 or 2 rear panels (depending on width), • 1 or 2 doors (depending on width). • Locking system with handle with a 5-mm double-bar insert block, included in the standard supply. Other blocks with inserts or barrels and keys optionally available. • Door opening to 120°. 	<p>Enclosure with ventilated canopy Enclosure obtained by assembling:</p> <ul style="list-style-type: none"> • 1 open top part with canopy, • 1 sealed bottom part, • 2 side parts, • 1 or 2 rear panels (depending on width), • 1 or 2 doors (depending on width). • Locking system with handle with a 5-mm double-bar insert block, included in the standard supply. Other blocks with inserts or barrels and keys optionally available. • Door opening to 120°. 	<p>Enclosure with open bottom Enclosure obtained by assembling:</p> <ul style="list-style-type: none"> • 1 sealed top part, • 1 plinth-type open bottom part, • 2 side parts, • 1 or 2 rear panels (depending on width), • 1 or 2 doors (depending on width). • Locking system with handle with a 5-mm double-bar insert block, included in the standard supply. Other blocks with inserts or barrels and keys optionally available. • Door opening to 120°. 	<p>Enclosure with open bottom and ventilated canopy</p> <ul style="list-style-type: none"> • Enclosure obtained by assembling: • 1 open top part with canopy, • 1 plinth-type open bottom part, • 2 side parts, • 1 or 2 rear panels (depending on width), • 1 or 2 doors (depending on width). • Locking system with handle with a 5-mm double-bar insert block. Other blocks with inserts or barrels and keys optionally available. • Door opening to 180°. • Anti-lever system to help prevent forcing of the door.
Material	<ul style="list-style-type: none"> • Polyester reinforced with fiberglass 			
Finish	<ul style="list-style-type: none"> • Molded by hot compression: The pieces have an excellent finish on both sides and can include numerous bosses for accommodating inserts and mounting or cable management accessories 			
Color	<ul style="list-style-type: none"> • RAL 7035 gray 			
Ingress protection rating	IP65 according to IEC 60529	<ul style="list-style-type: none"> • IP44 according to IEC 60529 • IP54 with 1 or 2 internal grilles, ref. NSYCAG125LPF, to be ordered separately. 	IP54 according to IEC 60529	<ul style="list-style-type: none"> • IP44 according to IEC 60529 • IP54 with 1 or 2 internal grilles, ref. NSYCAG125LPF, to be ordered separately
Mechanical protection rating	IK10 (20 joules) plain door - IEC62262 and IK08 glazed door			
Insulation	<ul style="list-style-type: none"> • Class II according to IEC 60950-1 if the mounting process follows the included mounting instructions sheet 			
Certifications	<ul style="list-style-type: none"> • UL (cULus). • Rating according UL50E: Types 1, 2, 3, 3X, 3R, 3RX, 5, 12 and 13. • Bureau Veritas Marine • IEC 62208 	<ul style="list-style-type: none"> • IEC 62208 		
Installation	<ul style="list-style-type: none"> • Indoor use only. For outdoor use, must install a canopy 	<ul style="list-style-type: none"> • Outdoor or indoor installation 		
	<ul style="list-style-type: none"> • Direct fixing to the floor or by means of a plinth with a height of 60 mm, as an option, see page 198 • Option of fixing on a semi-embedded plinth, see page 198 • Optional wall fixing lugs 		<ul style="list-style-type: none"> • The open bottom part forms a 60 mm plinth which is fixed to the floor directly or by means of an optional fixing frame, see page 200, or else it is installed on a semi-embedded plinth, see page 200 	
Options	<ul style="list-style-type: none"> • The versions with glassed door must be protected against the direct sunlight to avoid overheating. • Anti-posting door upon request 			

PHD - Applicative and customized solutions:

See the Polyester Heavy-Duty offer in the Applicative and customized solutions, [page 372](#).

Polyester Floor-Standing Enclosures

Thalassa PLA, PLAZ,
Selection Guide



Indoor and Outdoor:
Outdoor use requires the
installation of a canopy.

Completely sealed enclosures, IP65

Enclosures with open bottom part, IP54

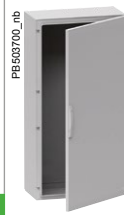

PLA



PLA



PLAZ

Dimensions (mm)

Height	Width	Depth	N° of doors	Plain	Glazed**	Plain
500	500	320	1	NSYPLA553G	NSYPLA553TG	NSYPLAZ553G
500	500	420	1	NSYPLA554G	NSYPLA554TG	NSYPLAZ554G
500	750	320	1	NSYPLA573G	NSYPLA573TG	NSYPLAZ573G
500	750	420	1	NSYPLA574G	NSYPLA574TG	NSYPLAZ574G
500	1000	320	2	NSYPLA5103G	-	-
500	1000	420	2	NSYPLA5104G	-	-
500	1250	320	2	NSYPLA5123G	-	-
500	1250	420	2	NSYPLA5124G	-	-
750	500	320	1	NSYPLA753G	NSYPLA753TG	NSYPLAZ753G
750	500	420	1	NSYPLA754G	NSYPLA754TG	NSYPLAZ754G
750	750	320	1	NSYPLA773G	NSYPLA773TG	NSYPLAZ773G
750	750	420	1	NSYPLA774G	NSYPLA774TG	NSYPLAZ774G
750	750	620	1	NSYPLA776G	NSYPLA776TG	NSYPLAZ776G
750	1000	320	2	NSYPLA7103G	NSYPLA7103TG	NSYPLAZ7103G
750	1000	420	2	NSYPLA7104G	NSYPLA7104TG	NSYPLAZ7104G
750	1250	320	2	NSYPLA7123G	NSYPLA7123TG	NSYPLAZ7123G
750	1250	420	2	NSYPLA7124G	NSYPLA7124TG	NSYPLAZ7124G
1000	500	320	1	NSYPLA1053G	NSYPLA1053TG	NSYPLAZ1053G
1000	500	420	1	NSYPLA1054G	NSYPLA1054TG	NSYPLAZ1054G
1000	750	320	1	NSYPLA1073G	NSYPLA1073TG	NSYPLAZ1073G
1000	750	420	1	NSYPLA1074G	NSYPLA1074TG	NSYPLAZ1074G
1000	1000	320	2	NSYPLA10103G	NSYPLA10103TG	NSYPLAZ10103G
1000	1000	420	2	NSYPLA10104G	NSYPLA10104TG	NSYPLAZ10104G
1000	1250	320	2	NSYPLA10123G	NSYPLA10123TG	NSYPLAZ10123G
1000	1250	420	2	NSYPLA10124G	NSYPLA10124TG	NSYPLAZ10124G
1250	500	320	1	NSYPLA1253G	NSYPLA1253TG	NSYPLAZ1253G
1250	500	420	1	NSYPLA1254G	NSYPLA1254TG	NSYPLAZ1254G
1250	750	320	1	NSYPLA1273G	NSYPLA1273TG	NSYPLAZ1273G
1250	750	420	1	NSYPLA1274G	NSYPLA1274TG	NSYPLAZ1274G
1250	750	620	1	NSYPLA1276G	NSYPLA1276TG	NSYPLAZ1276G
1250	1000	320	2	NSYPLA12103G	NSYPLA12103TG	NSYPLAZ12103G
1250	1000	420	2	NSYPLA12104G	NSYPLA12104TG	NSYPLAZ12104G
1250	1250	320	2	NSYPLA12123G	NSYPLA12123TG	NSYPLAZ12123G
1250	1250	420	2	NSYPLA12124G	NSYPLA12124TG	NSYPLAZ12124G
1250	1250	620	2	NSYPLA12126G	NSYPLA12126TG	NSYPLAZ12126G
1500	500	320	1	NSYPLA1553G	NSYPLA1553TG	NSYPLAZ1553G
1500	500	420	1	NSYPLA1554G	NSYPLA1554TG	NSYPLAZ1554G
1500	750	320	1	NSYPLA1573G	NSYPLA1573TG	NSYPLAZ1573G
1500	750	420	1	NSYPLA1574G	NSYPLA1574TG	NSYPLAZ1574G
1500	750	620	1	NSYPLA1576G	NSYPLA1576TG	NSYPLAZ1576G
1500	1000	320	2	NSYPLA15103G	NSYPLA15103TG	NSYPLAZ15103G
1500	1000	420	2	NSYPLA15104G	NSYPLA15104TG	NSYPLAZ15104G
1500	1250	320	2	NSYPLA15123G	NSYPLA15123TG	NSYPLAZ15123G
1500	1250	420	2	NSYPLA15124G	NSYPLA15124TG	NSYPLAZ15124G
1500	1250	620	2	NSYPLA15126G	NSYPLA15126TG	NSYPLAZ15126G
2000	750	420	2*	NSYPLA2074G	NSYPLA2074TG	NSYPLAZ2074G

*Two doors in vertical.

**Recommended to protect against the direct UV radiation.

PHD - Applicative and customized solutions:

See the Polyester Heavy-Duty offer in the applicative and customized solutions, [page 372](#).

Technical changes reserved. Information provided without guarantee. Images are for illustrative purposes only.

Enclosures with ventilated canopy, IP44 | Enclosures with open bottom part and ventilated canopy, IP44



PLAT



PLAZT

Dimensions (mm)				Plain	Plain
Height	Width	Depth	N° of doors		
500	500	320	1	NSYPLAT553G	NSYPLAZT553G
500	500	420	1	NSYPLAT554G	NSYPLAZT554G
500	750	320	1	NSYPLAT573G	NSYPLAZT573G
500	750	420	1	NSYPLAT574G	NSYPLAZT574G
500	1000	320	2	-	-
500	1000	420	2	-	-
500	1250	320	2	-	-
500	1250	420	2	-	-
750	500	320	1	NSYPLAT753G	NSYPLAZT753G
750	500	420	1	NSYPLAT754G	NSYPLAZT754G
750	750	320	1	NSYPLAT773G	NSYPLAZT773G
750	750	420	1	NSYPLAT774G	NSYPLAZT774G
750	750	620	1	NSYPLAT776G	NSYPLAZT776G
750	1000	320	2	NSYPLAT7103G	NSYPLAZT7103G
750	1000	420	2	NSYPLAT7104G	NSYPLAZT7104G
750	1250	320	2	NSYPLAT7123G	NSYPLAZT7123G
750	1250	420	2	NSYPLAT7124G	NSYPLAZT7124G
1000	500	320	1	NSYPLAT1053G	NSYPLAZT1053G
1000	500	420	1	NSYPLAT1054G	NSYPLAZT1054G
1000	750	320	1	NSYPLAT1073G	NSYPLAZT1073G
1000	750	420	1	NSYPLAT1074G	NSYPLAZT1074G
1000	1000	320	2	NSYPLAT10103G	NSYPLAZT10103G
1000	1000	420	2	NSYPLAT10104G	NSYPLAZT10104G
1000	1250	320	2	NSYPLAT10123G	NSYPLAZT10123G
1000	1250	420	2	NSYPLAT10124G	NSYPLAZT10124G
1250	500	320	1	NSYPLAT1253G	NSYPLAZT1253G
1250	500	420	1	NSYPLAT1254G	NSYPLAZT1254G
1250	750	320	1	NSYPLAT1273G	NSYPLAZT1273G
1250	750	420	1	NSYPLAT1274G	NSYPLAZT1274G
1250	750	620	1	NSYPLAT1276G	NSYPLAZT1276G
1250	1000	320	2	NSYPLAT12103G	NSYPLAZT12103G
1250	1000	420	2	NSYPLAT12104G	NSYPLAZT12104G
1250	1250	320	2	NSYPLAT12123G	NSYPLAZT12123G
1250	1250	420	2	NSYPLAT12124G	NSYPLAZT12124G
1250	1250	620	2	NSYPLAT12126G	NSYPLAZT12126G
1500	500	320	1	NSYPLAT1553G	NSYPLAZT1553G
1500	500	420	1	NSYPLAT1554G	NSYPLAZT1554G
1500	750	320	1	NSYPLAT1573G	NSYPLAZT1573G
1500	750	420	1	NSYPLAT1574G	NSYPLAZT1574G
1500	750	620	1	NSYPLAT1576G	NSYPLAZT1576G
1500	1000	320	2	NSYPLAT15103G	NSYPLAZT15103G
1500	1000	420	2	NSYPLAT15104G	NSYPLAZT15104G
1500	1250	320	2	NSYPLAT15123G	NSYPLAZT15123G
1500	1250	420	2	NSYPLAT15124G	NSYPLAZT15124G
1500	1250	620	2	NSYPLAT15126G	NSYPLAZT15126G
2000	750	420	Two doors in vertical	NSYPLAT2074G	NSYPLAZT2074G

PHD - Applicative and customized solutions:
See the Polyester Heavy-Duty offer in the applicative and customized solutions, [page 372](#).

Technical changes reserved. Information provided without guarantee. Images are for illustrative purposes only.

Horizontal Coupling Kits, 15 mm, Joining Two Enclosures Mounted on ZA Plinths

- For coupling two enclosures side by side.
- Coupling frame kit: Made up of a coupling kit and the fixings required for installation.
- Trim kit: Made up of two frames for aesthetic fitting of the two coupled enclosures
- Coupling kit widths: 15 mm, joining two enclosures mounted on ZA plinths
- Ingress protection rating: IP55 at the coupling point

Note:
Not valid for coupling two enclosures using ZZ or ZH type plinth.

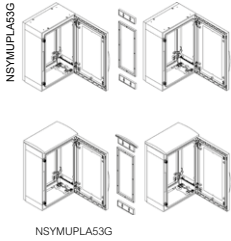

Characteristics	Depth (mm)	Height (mm)	References
Coupling frame kit 15 mm	320	500	NSYMUPLA53G
Coupling frame kit 15 mm	320	750	NSYMUPLA73G
Coupling frame kit 15 mm	320	1000	NSYMUPLA103G
Coupling frame kit 15 mm	320	1250	NSYMUPLA123G
Coupling frame kit 15 mm	320	1500	NSYMUPLA153G
Coupling frame kit 15 mm	420	500	NSYMUPLA54G
Coupling frame kit 15 mm	420	750	NSYMUPLA74G
Coupling frame kit 15 mm	420	1000	NSYMUPLA104G
Coupling frame kit 15 mm	420	1250	NSYMUPLA124G
Coupling frame kit 15 mm	420	1500	NSYMUPLA154G
Coupling frame kit 15 mm	420	2000	NSYMUPLA204G
Trim kit for enclosure without canopy	320	-	NSYSUPLA3G
Trim kit for enclosure with canopy	320	-	NSYSUPLA3TG
Trim kit for enclosure without canopy	420	-	NSYSUPLA4G
Trim kit for enclosure with canopy	420	-	NSYSUPLA4TG

Vertical Coupling Kit

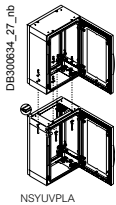

- For coupling two enclosures on top of one another.
- Set of 3.5 m of adhesive seal and the fixings required for mounting.
- Ingress protection rating: IP55 at the coupling point

Characteristics	References
Vertical coupling kit	NSYUPLA

Canopy

- Can be installed in all enclosure models.
- High resistance to impacts, temperature and bad weather.
- Increases the height (A) of the enclosure by 38 mm without modifying its width or depth.
- Material: Polyester reinforced with fiberglass
- Color: RAL 7035 gray
- Installation: Essential for outdoor use

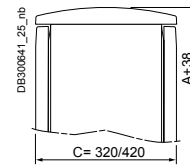

Supply:
Delivered with the fixings required for installation



NSYTJPLA53G

Characteristics	Width (mm)	Depth (mm)	References
Canopy	500	320	NSYTJPLA53G
Canopy	500	420	NSYTJPLA54G
Canopy	750	320	NSYTJPLA73G
Canopy	750	420	NSYTJPLA74G
Canopy	750	620	NSYTJPLA76G
Canopy	1000	320	NSYTJPLA103G
Canopy	1000	420	NSYTJPLA104G
Canopy	1250	320	NSYTJPLA123G
Canopy	1250	420	NSYTJPLA124G
Canopy	1250	620	NSYTJPLA126G

Wall Fixing Lugs

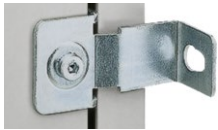

NSYFMPLA

- Drilling positions and marks inside the side panels.
- Material: Passivated zinc-coated steel
 - Maximum load: 180 kg including weight of enclosure
- Fixing:** Fixing on the sides by four or six lugs in horizontal position (six lugs for enclosures with height ≥ 1000 mm)
10 mm fixing distance on the rear of the enclosure plane

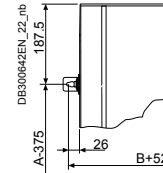

Supply:
Set of six lugs and fixings

Characteristics	References
Wall fixing lugs	NSYFMPLA

PLAZ PLAZT Cable Entry Plate

- Easy drilling in specific customized version.
- Not compatible with: Adapter plates, step slides, internal door and chassis for modular distribution.
- Material: Polyester reinforced with fiberglass
- Thickness: 4 mm

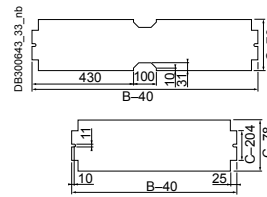

Supply:
Delivered with the fixings required for installation



NSYECPLAZ53G

Characteristics	Width (mm)	Depth (mm)	References
Cable entry plate	500	320	NSYECPLAZ53G
Cable entry plate	500	420	NSYECPLAZ54G
Cable entry plate	750	320	NSYECPLAZ73G
Cable entry plate	750	420	NSYECPLAZ74G
Cable entry plate	1000	320	NSYECPLAZ103G
Cable entry plate	1000	420	NSYECPLAZ104G
Cable entry plate	1250	320	NSYECPLAZ123G
Cable entry plate	1250	420	NSYECPLAZ124G

Renovation and Anti-Graffiti Paint

Supply: NSYAUPG1G

The 1 kg reference includes one pot with 800 g of base paint and 200 g of hardener
(It is enough to paint a surface of around 5 m²)

- Paint kit with two components (base 80% + hardener 20%)
- Specially developed for the renovation of polyester enclosures and/or to facilitate the easy removal of graffiti.
- Color: RAL 7035 gray



NSYAUPG1G

Characteristics	References
Renovation and anti-graffiti paint	NSYAUPG1G



Characteristics	ZA plinths for PLA and PLAT versions
	<ul style="list-style-type: none"> The front parts of the plinth (front and rear) have two stainless-steel screws protected by a plastic cap; these screws, which can be accessed from the outside, make it possible (using an Allen key) to open and remove the front parts for easier cable installation. In stacked position, the bottom plinth can be partially buried. It is provided with one or two reinforcement cross-rails, adjustable to adjust to the position of the cables.
Material	Polyester reinforced with fiberglass
Color	RAL 7035 gray
Ingress protection rating	IP44
Mechanical protection rating	IK10
Fixing	Four floor attachment points; symmetry of the parts prevents incorrect assembly
Supply	The reference of the plinth contains all the accessories required for attaching the enclosure to the plinth and for stacking two plinths

For floor-standing enclosure			Plinth		Cable gland area		Height 200 mm
Width (mm)	Depth (mm)	References	Width (mm)	Depth (mm)	Width (mm)	Depth (mm)	References
500	320	NSYPLA(T)●53G	494	250	360	205	NSYZA253G
750	320	NSYPLA(T)●73G	744	250	610	205	NSYZA273G
1000	320	NSYPLA(T)●103G	994	250	860	205	NSYZA2103G
1250	320	NSYPLA(T)●123G	1244	250	1100	205	NSYZA2123G
500	420	NSYPLA(T)●54G	494	350	360	305	NSYZA254G
750	420	NSYPLA(T)●74G	744	350	610	305	NSYZA274G
1000	420	NSYPLA(T)●104G	994	350	860	305	NSYZA2104G
1250	420	NSYPLA(T)●124G	1244	350	1110	305	NSYZA2124G
750	620	NSYPLA(T)●76G	744	550	610	505	NSYZA276G
1250	620	NSYPLA(T)●126G	1244	550	1110	505	NSYZA2126G

9
PLA

Feet for Partially Buried Installation



NSYAEBFZ

Description: Allows the partially buried installation of plinths before completion of the floor. The plinths are attached by four feet with a standard length of 750 mm. Option of horizontal adjustment of the plinth.

Supply:
Kit includes four feet and fixings.

Characteristics	References
Feet for partially buried installation	NSYAEBFZ

N Plinths

Designed to be installed under the closed bottom enclosures (version PLA or PLAT).

- Material: Polyester reinforced with fiberglass
- Color: RAL 7035 gray
- Height 60 mm

Supply:
Delivered with fixings required for installation



NSYZNPLA53G

Characteristics	References
N plinths	NSYZNPLA53G
N plinths	NSYZNPLA73G
N plinths	NSYZNPLA103G
N plinths	NSYZNPLA123G
N plinths	NSYZNPLA54G
N plinths	NSYZNPLA74G
N plinths	NSYZNPLA104G
N plinths	NSYZNPLA124G

Connectors Between Plinths

Description: Designed to allow the adaptation of a closed bottom enclosure + N plinth on a H-type partially buried plinth.

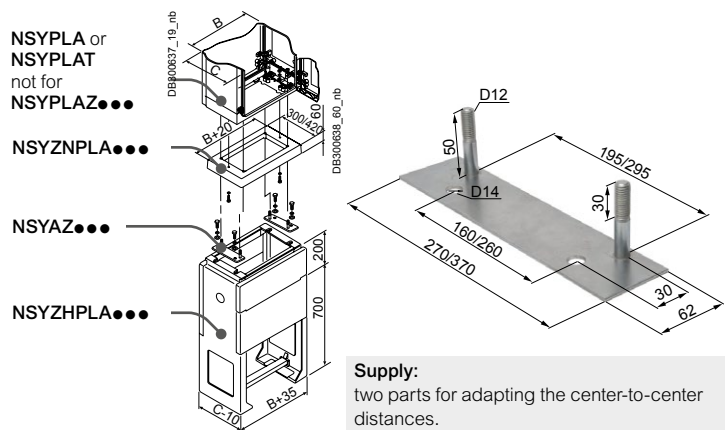

NSYAZ3PLA

Characteristics	For floor-standing enclosure Depth (mm)	References
Linking parts for N plinth on 320 mm H plinth	320	NSYAZ3PLA
Linking parts for N plinth on 420 mm H plinth	420	NSYAZ4PLA



(1) For enclosures using ZZ or ZH type plinths the coupling kit to use is the **NSYMUPLA●●●W**.

Characteristics	ZZ plinths for PLAZ and PLAZT versions⁽¹⁾
	<ul style="list-style-type: none"> The front parts (front and rear) are removed from the inside. Removing them makes it easier to install the cables. The 500-mm plinth can be partially buried. It is provided with one or two reinforcement cross-rails, adjustable to adapt to the position of the cables.
Material	Polyester reinforced with fiberglass
Color	RAL 7035 gray
Ingress protection rating	IP44
Mechanical protection rating	IK10
Fixing	Four floor attachment points; symmetry of the parts prevents incorrect assembly
Supply	The reference of the plinth contains all the accessories required for attaching the enclosure to the plinth

For floor-standing enclosure			Plinth		Cable gland area		Height 200 mm	Height 500 mm
Width (mm) (B)	Depth (mm) (C)	References	Width (mm)	Depth (mm)	Width (mm)	Depth (mm)	References	References
500	320	NSYPLAZ(T)●53G	535	310	419	252	NSYZZ253G	NSYZZ553G
750	320	NSYPLAZ(T)●73G	785	310	669	252	NSYZZ273G	NSYZZ573G
1000	320	NSYPLAZ(T)●103G	1035	310	919	252	NSYZZ2103G	NSYZZ5103G
1250	320	NSYPLAZ(T)●123G	1285	310	1169	252	NSYZZ2123G	NSYZZ5123G
500	420	NSYPLAZ(T)●54G	535	410	419	352	NSYZZ254G	NSYZZ554G
750	420	NSYPLAZ(T)●74G	785	410	669	352	NSYZZ274G	NSYZZ574G
1000	420	NSYPLAZ(T)●104G	1035	410	919	352	NSYZZ2104G	NSYZZ5104G
1250	420	NSYPLAZ(T)●124G	1285	410	1169	352	NSYZZ2124G	NSYZZ5124G
750	620	NSYPLAZ(T)●76G	785	610	669	552	NSYZZ276G	-
1250	620	NSYPLAZ(T)●126G	1285	610	1169	552	NSYZZ2126G	-

Outside Opening Kit



NSYAELZ

- Description: The 200 mm front part of the 200 and 500 mm plinths can be opened from the outside, after installing a set of two locks with double-bar insert.

Characteristics	References
Outside opening kit	NSYAELZ

Buriable H Plinths



NSYZHPLA53G

- Front panel with a height of 170 mm, retractable, providing easy access to the inside.
- Fixed front panel with a height of 305 mm, corresponding to the finished floor height area.
- The height above the floor after built-in varies between 200 and 500 mm.
- A metal rail helps to fix the entry cables.
- Lateral uprights with knock-out auxiliary output with Ø Pg 36 (48 mm).
- A knock-out area is provided at the bottom of the lateral uprights for cable entry, if necessary.
- Material: Polyester reinforced with fiberglass
- Color: RAL 7035 gray

Supply:
Delivered with the fixings required for installation

Note:
For dimensions see [page 214](#)



NSYZHPLA53G

Characteristics	References
Buriable H plinths	NSYZHPLA53G
Buriable H plinths	NSYZHPLA73G
Buriable H plinths	NSYZHPLA103G
Buriable H plinths	NSYZHPLA123G
Buriable H plinths	NSYZHPLA54G
Buriable H plinths	NSYZHPLA74G
Buriable H plinths	NSYZHPLA104G
Buriable H plinths	NSYZHPLA124G

Internal Door

- Designed for direct installation in enclosures with sealed bottom part. In the enclosures with the bottom part open, installation can be performed by ordering the necessary adapter plates, ref. **NSYPTZ●●●●**.
- Two depthwise mounting positions (two positions for depthwise installation) according to the chosen M8 impressions, on the top and bottom parts of the enclosure, for fixing.
- Lock with 5-mm double-bar inserts.
- Not compatible with: Modular distribution chassis, 19" chassis, cable entry plate and door retainer, ref. **NSYRETPLAU**.
- Material: Aluminum
- Color: RAL 7035 gray

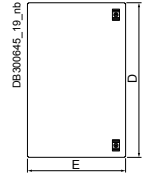

Supply:

Delivered with M8 brass inserts and fixings

Note:

For dimensions see [page 214](#)



Dimensions		Internal door dimensions		References
Height (mm)	Width (mm)	D (mm)	E (mm)	
500	500	398	398	NSYPAPLA55G
500	750	398	648	NSYPAPLA57G
500	1000	398	796 (2 x 398)	2 x NSYPAPLA55G
500	1250	398	1046 (398 + 648)	NSYPAPLA55G + NSYPAPLA57G
750	500	648	398	NSYPAPLA75G
750	750	648	648	NSYPAPLA77G
750	1000	648	796 (2 x 398)	2 x NSYPAPLA75G
750	1250	648	1046 (398 + 648)	NSYPAPLA75G + NSYPAPLA77G
1000	500	898	398	NSYPAPLA105G
1000	750	898	648	NSYPAPLA107G
1000	1000	898	796 (2 x 398)	2 x NSYPAPLA105G
1000	1250	898	1046 (398 + 648)	NSYPAPLA105G + NSYPAPLA107G
1250	500	1148	398	NSYPAPLA125G
1250	750	1148	648	NSYPAPLA127G
1250	1000	1148	796 (2 x 398)	2 x NSYPAPLA125G
1250	1250	1148	1046 (398 + 648)	NSYPAPLA125G + NSYPAPLA127G
1500	500	1398	398	NSYPAPLA155G
1500	750	1398	648	NSYPAPLA157G
1500	1000	1398	796 (2 x 398)	2 x NSYPAPLA155G
1500	1250	1398	1046 (398 + 648)	NSYPAPLA155G + NSYPAPLA157G

9
PLA

Door Retainer



- Designed to adapt directly to the enclosure
- Can be installed on a door opening to the left or right indistinctly
- Material: Galvanized steel

Supply:

Delivered with the fixings required for installation

Note:

ref. **NSYRETPLAU** is incompatible with internal doors, modular distribution chassis, step slides, adapter plates and cable entry plates. If not compatible, use ref. **NSYRETPLA**.

Characteristics	References
 <p>Door retainer, PLA, PLAZ, PLAT versions, opening to 110°</p>	NSYRETPLA
 <p>Door retainer, PLA, PLAZ, PLAT, PLAZT versions*, with 2 positions, 90° and 120°</p>	NSYRETPLAU

Door Switch

- NC + NO switch.
- Incompatible with the rear door and modular distribution chassis

Supply:

Switch, fixing bracket and fixings

Characteristics	References
 <p>Door switch</p>	NSYSNLPLA

Technical changes reserved. Information provided without guarantee. Images are for illustrative purposes only.

Polyester Floor-Standing Enclosures

Lock with Handle

- Ergonomic locking system with pivoting handle installed as standard on enclosures with ventilated canopy and/or open bottom part, with a 5-mm double-bar insert block.
- Material: PA6
- Color: RAL 7035 gray

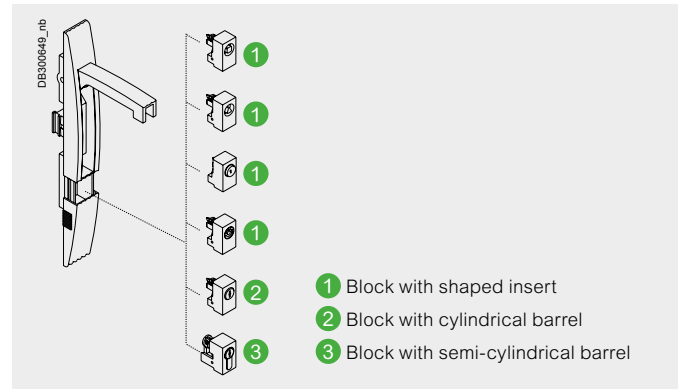

Options for Converting the Form-Insert Blocks



Characteristics	References
6 mm square insert	NSYINS61
7 mm square insert	NSYINS71
8 mm square insert	NSYINS81
6.5 mm triangular insert	NSYINT61
8 mm triangular insert	NSYINT81
Push-button	NSYTSPLA
Double-bar	NSYINDB51

Options for Converting the Blocks to Cylindrical Barrels

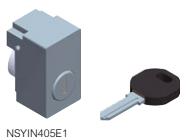

Characteristics	References
405E key lock	NSYIN405E1
421E key lock	NSYIN421E1
455 key lock	NSYIN4551
1242E key lock	NSYIN1242E1
2131A key lock	NSYIN2131A1
2132A key lock	NSYIN2132A1
2433A key lock	NSYIN2433A1
2452E key lock	NSYIN2452E1
3113A key lock	NSYIN3113A1

Options for Converting the Blocks to Semi-Cylindrical Barrels

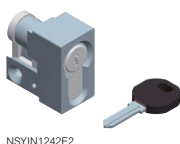

Characteristics	References
PanelSet SFN and Spacial SM 1242E key lock	NSYIN1242E2
PanelSet SFN and Spacial SM Adapter for DIN cylinder	NSYINDIN2
PanelSet SFN and Spacial SM JIS key lock	NSYINKJIS2
PanelSet SFN and Spacial SM Reinforced key lock	NSYINKR2
PanelSet SFN and Spacial SM FAC key lock	NSYINKFAC2

Options for Converting the Handle Lock

- Changing the handle for a handle including a padlocking device (Ø 10 mm) allowing the handle to be locked. The handle is delivered without barrel or insert block.



NSYBCMPLAG

Options for Converting the Handle Lock

- Spare handle lock without barrel or insert blocks. The insert or barrel are to be chosen from the option table.



NSYEBMPLAG

Characteristics	References
Options for converting the handle lock	NSYBCMPLAG

Characteristics	References
Options for converting the handle lock	NSYEBMPLAG

19" Fixed Chassis

Installation: For heights from 750 to 1500 mm, the installation requires ordering one set of two matching uprights. If a chassis is installed in an enclosure with a greater height, it is necessary to use the suitable uprights for the size of the enclosure

- Very sturdy 19" metal chassis, designed for installation in enclosures with a width of 750 and 1250 mm.
In enclosures with a width of 1250 mm, the chassis is installed in the 750-mm part with an intermediate support, ref. **NSYSBPLA**.
- These chassis can be used as partial mounting plates in enclosures with a height greater than the nominal height.
- Incompatible with the internal doors and the step slides.
- Fixed chassis made up of two uprights with fixings
- Material: Galvanized steel
- Finish: Epoxy polyester paint
- Color: RAL 7035 gray
- Maximum load: 3 kg per unit

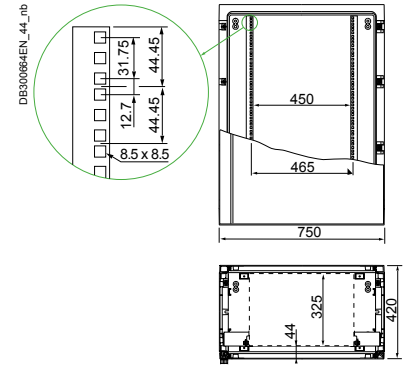

Note:
For dimensions see [page 217](#)



NSYBRF8PLAG

Characteristics	Height (mm)	Width (mm)	# of units	References
19" fixed chassis	500	750	8	NSYBRF8PLAG
19" fixed chassis	750	750	12	NSYBRF12PLAG
19" fixed chassis	1000	750	17	NSYBRF17PLAG
19" fixed chassis	1250	750	21	NSYBRF21PLAG
19" fixed chassis	1500	750	26	NSYBRF26PLAG
19" fixed chassis	2000	750	2 x 17	2 x NSYBRF17PLAG + NSYPTZ4
Set of two uprights	750	750	12	NSYSPLA75
Set of two uprights	1000	750	17	NSYSPLA100
Set of two uprights	1250	750	21	NSYSPLA125
Set of two uprights	1500	750	26	NSYSPLA150*
Set of two uprights	2000	750	2 x 17	2 x NSYSPLA100

* Not compatible with **NSYCAAPVHD**.

Metal mounting plate

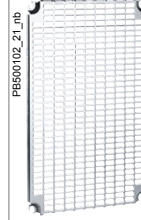





Note:
For dimensions see [page 215](#)

Characteristics	Plain mounting plate	Telequick mounting plate
	<ul style="list-style-type: none"> Direct installation on M8 inserts at the rear of the enclosure or on step slides for depth adjustment (see page 210). The enclosures with height of ≥ 1000 mm have intermediate impressions for installing mounting plates of a lesser height (M8 inserts, ref. NSYTEX8, to be ordered separately). In the two door enclosures, it is possible to install one complete mounting plate or two individual mounting plates. 	<ul style="list-style-type: none"> Grille with 11 x 26 mm drill holes, with a step of 15 x 30 mm, for direct installation, with clip nuts, of all the devices with fixing at 2, 3 or 4 points, by screws with diameters of 3, 4, 5 or 6 mm. Direct installation on M8 inserts at the rear of the enclosure or on step slides for depth adjustment (see page 210). The enclosures with height of ≥ 1000 mm have intermediate impressions for installing mounting plates of a lesser height (M8 inserts, ref. NSYTEX8, to be ordered separately).
Material	Galvanized sheet steel	Galvanized steel
Finish	-	-
Color	-	-
Thickness	2.5 mm	-
Maximum load	150 kg/m ²	150 kg/m ²
Supply	One mounting plate	One mounting plate

9 PLA

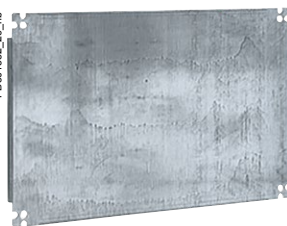
Dimensions					Dimensions			
Height (A) (mm)	Width (B) (mm)	H (mm)	Surface (dm ²)	References	E (mm)	D (mm)	Surface (dm ²)	References
500	500	-	14	NSYPMM55	350	350	13	NSYPMR55
500	750	-	24	NSYPMM75	350	600	23	NSYPMR57
500	1000	437.5	32	NSYPMM510	350	2 x 350	26	2 x NSYPMR55
500	1250	-	38	NSYPMM55 + NSYPMM75	350	350 + 600	36	NSYPMR55 + NSYPMR57
750	500	-	24	NSYPMM75	600	350	23	NSYPMR75
750	750	-	40	NSYPMM77	600	600	38	NSYPMR77
750	1000	437.5	54	NSYPMM710	600	2 x 350	46	2 x NSYPMR75
750	1250	687.5	70	NSYPMM712	600	350 + 600	61	NSYPMR75 + NSYPMR77
1000	500	-	33	NSYPMM105	850	350	32	NSYPMR105
1000	750	-	55	NSYPMM107	850	600	54	NSYPMR107
1000	1000	437.5	74	NSYPMM1010	850	2 x 350	64	2 x NSYPMR105
1000	1250	687.5	96	NSYPMM1012	850	350 + 600	86	NSYPMR105 + NSYPMR107
1250	500	-	42	NSYPMM125	1100	350	42	NSYPMR125
1250	750	-	70	NSYPMM127	1100	600	70	NSYPMR127
1250	1000	437.5	96	NSYPMM1210	1100	2 x 350	84	2 x NSYPMR125
1250	1250	687.5	124	NSYPMM1212	1100	350 + 600	112	NSYPMR125 + NSYPMR127
1500	500	-	51	NSYPMM155	1350	350	51	NSYPMR155
1500	750	-	85	NSYPMM157	1350	600	85	NSYPMR157
1500	1000	437.5	118	NSYPMM1510	1350	2 x 350	102	2 x NSYPMR155
1500	1250	687.5	152	NSYPMM1512	1350	350 + 600	136	NSYPMR155 + NSYPMR157
2000	750	-	115	NSYPMM207	2 x 850	2 x 600	108	2 x NSYPMR107

Insulated mounting plate		Partial plain mounting plate	Technical uprights
			
<ul style="list-style-type: none"> Direct installation on M8 inserts at the rear of the enclosure or on step slides for depth adjustment (see page 210). The enclosures with height of ≥ 1000 mm have intermediate impressions for installing mounting plates of a lesser height (M8 inserts, ref. NSYTEX8, to be ordered separately). In the two door enclosures, it is possible to install one complete mounting plate or two individual mounting plates. 		<ul style="list-style-type: none"> Direct fixing on the uprights with the notched sliding nuts or pivoting nuts, see common accessories section. 	<ul style="list-style-type: none"> Supports for fixing rails, perforated grilles and plain partial mounting plates. Details in the common accessory section. Fixing at the rear on the M8 inserts or on the step slides.
Bakelite	Polyester	Galvanized sheet steel	Zinc-coated steel
–	–	–	–
4 mm	<ul style="list-style-type: none"> 4 mm up to 700 mm height 5 mm from 800 mm height 	2.5 mm	2 mm
100 kg/m ²	100 kg/m ²	150 kg/m ²	
One mounting plate	One mounting plate	One mounting plate	Two technical uprights

		Height 247 mm (H)	Height 397 mm (H)		
References	References	References	References	Dimensions (mm)	References
NSYPMB55	NSYPMA55	-	-	-	-
NSYPMB75	NSYPMA75	-	-	-	-
NSYPMB510	-	NSYSPMP25100	NSYSPMP40100	-	-
NSYPMB55 + NSYPMB75	NSYPMA55 + NSYPMA75	-	-	-	-
NSYPMB75	NSYPMA75	-	-	625	NSYTVR7
NSYPMB77	NSYPMA77	-	-	625	NSYTVR7
NSYPMB710	-	NSYSPMP25100	NSYSPMP40100	625	NSYTVR7
NSYPMB712	-	-	-	625	NSYTVR7
NSYPMB105	NSYPMA105	-	-	875	NSYTVR10
NSYPMB107	NSYPMA107	-	-	875	NSYTVR10
NSYPMB1010	-	NSYSPMP25100	NSYSPMP40100	875	NSYTVR10
NSYPMB1012	-	-	-	875	NSYTVR10
NSYPMB125	-	-	-	1125	NSYTVR125
NSYPMB127	NSYPMA127	-	-	1125	NSYTVR125
NSYPMB1210	-	NSYSPMP25100	NSYSPMP40100	1125	NSYTVR125
NSYPMB1212	-	-	-	1125	NSYTVR125
NSYPMB155	-	-	-	1375	NSYTVR15
NSYPMB157	-	-	-	1375	NSYTVR15
NSYPMB1510	-	NSYSPMP25100	NSYSPMP40100	1375	NSYTVR15
NSYPMB1512	-	-	-	1375	NSYTVR15
2 x NSYPMB107	2 x NSYPMA107	-	-	1875	2 x NSYTVR10

Note: Enclosures with widths of 1000 and 1250 allow the installation of four uprights to integrate two mounting plates of 500 mm or of 500 and 750 mm.

Modular Distribution Chassis

- Chassis for modular switchgear, installed directly in the sealed enclosures (PLA version).
For installation in enclosures with open bottom part (PLAZ version) it is necessary to use a set of adapter plates (ref. **NSYPTZ●●●**).
- Chassis made up of cover plates on a rigid structure.
- Quick installation without fixings.
- Distance between rail and front panel with adjustable depth from 40 to 85 mm.
- System for identifying electrical circuits supplied.
- Neutral/earth strip: 2 x 16 mm² + 5 x 6 mm² included in the standard offer.
- Incompatibility with: Cable entry plate, internal door, door switch and door retainer (ref. **NSYRETPLAU**).
- Material: Rigid structure: Galvanized steel, Cover plates: Self-extinguishing insulated
- Color: Cover plates: RAL 7035 gray

Note:

For dimensions see [page 209](#)
Other modular distribution accessories on [page 210](#)



Dimensions (mm)		No. of doors	No. of rows	Rows for module	No. of modules 18 mm	No. of plates	References
Height (A)	Width (B)						
750	500	1	4	4	76	-	NSYDLP76G
750	500	1	4	3	57	1	NSYDLP57G *
750	750	1	4	4	132	-	NSYDLP132G
750	750	1	4	3	99	1	NSYDLP99G *
750	1000	2	4 + 4	4 + 4	152	-	2 x NSYDLP76G
750	1000	2	4 + 4	3 + 3	114	1 + 1	2 x NSYDLP57G *
750	1250	2	4 + 4	4 + 4	208	-	NSYDLP76G + NSYDLP132G
750	1250	2	4 + 4	3 + 3	156	1 + 1	NSYDLP57G * + NSYDLP99G *
1000	500	1	6	6	114	-	NSYDLP114G
1000	500	1	6	5	95	1	NSYDLP95G *
1000	750	1	6	6	198	-	NSYDLP198G
1000	750	1	6	5	165	1	NSYDLP165G *
1000	1000	2	6 + 6	6 + 6	228	-	2 x NSYDLP114G
1000	1000	2	6 + 6	5 + 5	190	1 + 1	2 x NSYDLP95G *
1000	1250	2	6 + 6	6 + 6	312	-	NSYDLP114G + NSYDLP198G
1000	1250	2	6 + 6	5 + 5	260	1 + 1	NSYDLP95G * + NSYDLP165G *
1250	500	1	7	7	133	-	NSYDLP133G
1250	500	1	7	6	114	1	NSYDLP114PG *
1250	750	1	7	7	231	-	NSYDLP231G
1250	750	1	7	6	198	1	NSYDLP198PG *
1250	1000	2	7 + 7	7 + 7	266	-	2 x NSYDLP133G
1250	1000	2	7 + 7	6 + 6	228	1 + 1	2 x NSYDLP114PG *
1250	1250	2	7 + 7	7 + 7	364	-	NSYDLP133G + NSYDLP231G
1250	1250	2	7 + 7	6 + 6	312	1 + 1	NSYDLP114PG * + NSYDLP198PG *
1500	500	1	9	9	171	-	NSYDLP171G
1500	500	1	9	8	152	1	NSYDLP152G *
1500	750	1	9	9	297	-	NSYDLP297G
1500	750	1	9	8	264	1	NSYDLP264G *
1500	1000	2	9 + 9	9 + 9	342	-	2 x NSYDLP171G
1500	1000	2	9 + 9	8 + 8	304	-	2 x NSYDLP152G *
1500	1250	2	9 + 9	9 + 9	468	1 + 1	NSYDLP171G + NSYDLP297G
1500	1250	2	9 + 9	8 + 8	416	1 + 1	NSYDLP152G * + NSYDLP264G *

* Chassis with a plain front plate includes a partial mounting plate.

Modular Distribution Chassis



DB300660_71_nb

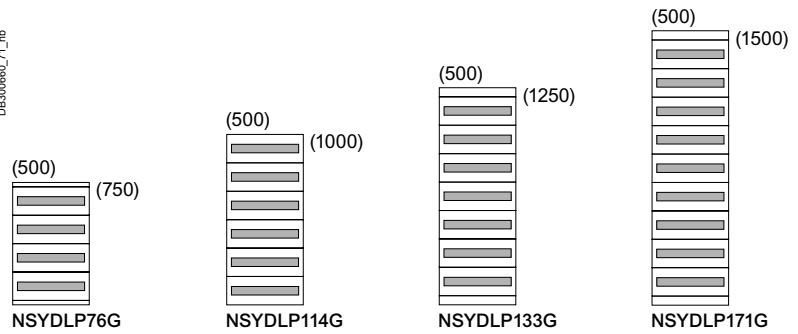

Details of the Depth Adjustment

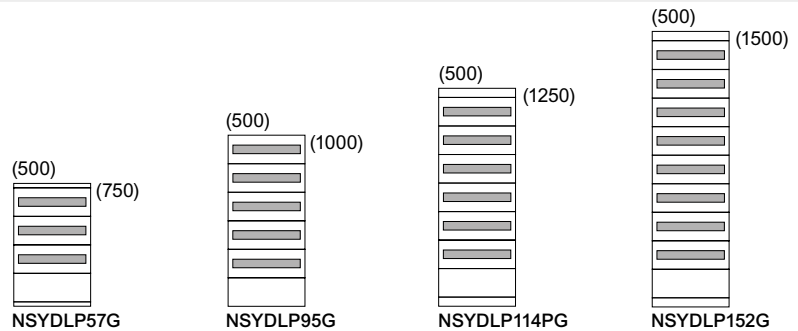

Detail from Front Panel Mounting

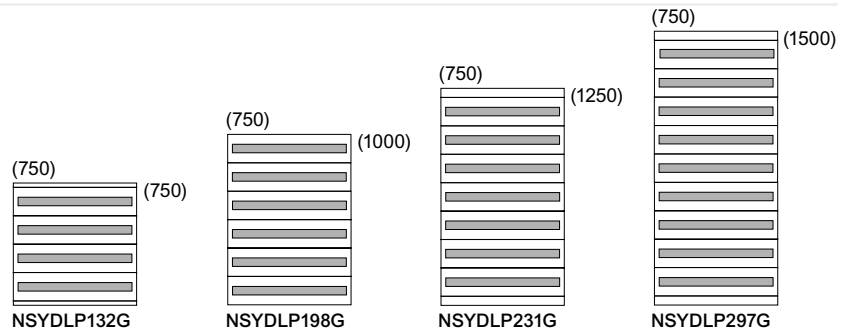

Detail from the Circuit Marking System

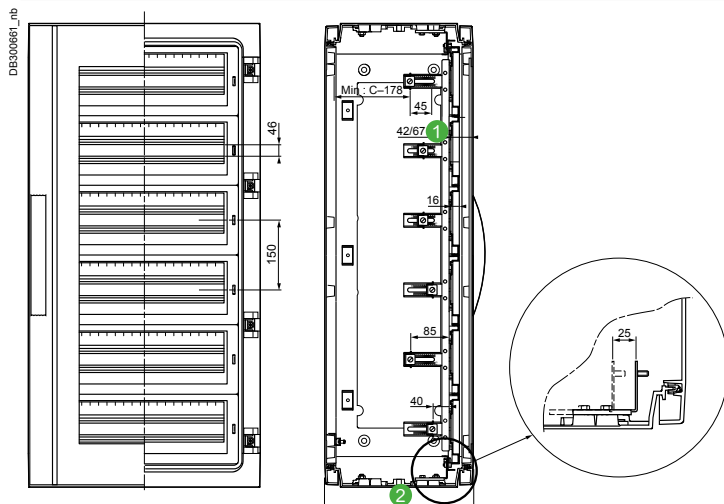
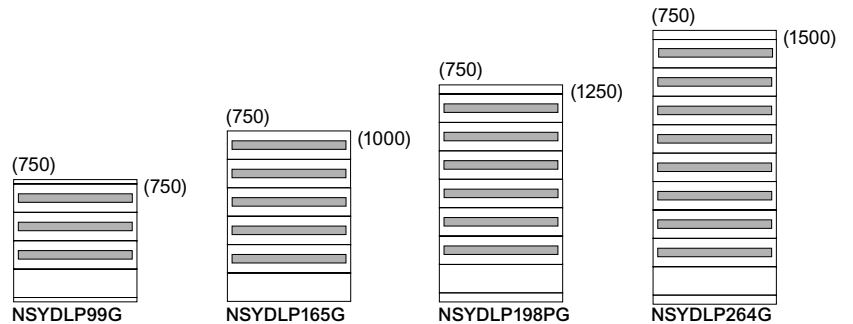

- 1 Dimensions of 42 or 67 mm or a pitch of 25 mm, according to the M8 boss chosen for the installation. See details in the enlarged image on the right. In enclosures with glazed doors, the two dimensions are reduced by 5 mm.
- 2 C = Depth of the enclosure.

Step Slides

- Set of four step slides with brackets allowing continuous depth adjustment of the mounting plate, with a pitch of 25 mm.
- Designed for direct installation in the enclosures with sealed bottom part (versions PLA or PLAT).
- In the enclosures with open bottom part (versions PLAZ or PLAZT), installation is made possible by adding the relevant adapter plates.
- Incompatibility with: Internal door, modular distribution chassis, 19" chassis, cable entry plate and door retainer, ref. **NSYRETPLAU**.
- Material: Bracket with steel M8 stud on aluminum rail
- Fixing: Fixing on the top and bottom parts of the enclosure by means of M8 inserts and screws (supplied)



Note:
For dimensions see [page 215](#)



NSYDPLA3

Characteristics	Depth (mm)	No. of doors	References
Step slides	320	1	NSYDPLA3
Step slides	320	2	2 x NSYDPLA3
Step slides	420	1	NSYDPLA4
Step slides	420	2	2 x NSYDPLA4
Step slides	620	1	NSYDPLA6
Step slides	620	2	2 x NSYDPLA6

Adapter Plates

- The enclosures with open bottom part (versions PLAZ and PLAZT) require a set of adapter plates for mounting: An internal door, step slides, modular chassis and 19" chassis.
- **NSYPTZ●●●** for one door enclosures
- **NSYPTX●●●** 2P for two door enclosures
- Material: Galvanized steel
- Fixing: Fixing on the bottom part of the enclosure by means of M8 inserts and screws (supplied)



NSYPTZ3

Characteristics	Depth (mm)	No. of doors	References
Adapter plates	320	1	NSYPTZ3
Adapter plates	320	2	NSYPTZ32P
Adapter plates	420	1	NSYPTZ4
Adapter plates	420	2	NSYPTZ42P
Adapter plates	620	1	NSYPTZ6
Adapter plates	620	2	NSYPTZ62P

PDA

Additional Support

- Set of four additional brackets, to be slid into the step slides, for the installation of an additional mounting plate.



NSYEDPLA

Characteristics	Reference
Additional support	NSYEDPLA

Plain Cover Plate

- Plain cover plate for non-modular switchgear protection.
- Can be cutted out according to needs.
- Material: Polystyrene (PS) (for 146 mm high)
- Fiberglass reinforced polyester (for 298 mm high)
- Color: RAL 7035 gray

Supply:
Order by multiples of 2 (2, 4, 6...)

Note:
Dimensions, [page 216](#)



NSYCTL500DLP

Characteristics	For enclosure - Width (mm)	Height A (mm)	Thickness (mm)	References
Plain cover plate	500	146	2	NSYCTL500DLP
Plain cover plate	500	298	4	NSYCTL500DLP2
Plain cover plate	750	146	2	NSYCTL750DLP
Plain cover plate	750	298	4	NSYCTL750DLP2

Plain Mounting Plate

- Plate for fixing non-modular devices.
- Depth-adjustable fixing on the supports from 40 to 85 mm..
- Material: Galvanized steel 2 mm thick

Supply:
Order by multiples of 2 (2, 4, 6...)

Note:
Dimensions, [page 216](#)



NSYPMP500DLP

Characteristics	For enclosure - Width (mm)	Height - A (mm)	Thickness (mm)	References
Plain mounting plate 146 for width 500	500	149	2	NSYPMP500DLP
Plain mounting plate 298 for width 500	500	298	2	NSYPMP500DLP2
Plain mounting plate 146 for width 750	750	149	2	NSYPMP750DLP
Plain mounting plate 298 for width 750	750	298	2	NSYPMP750DLP2

Support Plate



NSYSPLA75

Installation:

It is installed directly on the bottom part of the enclosure.

For the installation of one or several support plates, use two sets of two uprights suitable for the height (to be ordered separately). These uprights offer the option of adjusting the height with a step of 50 mm

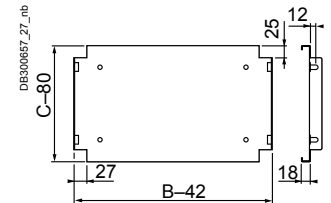
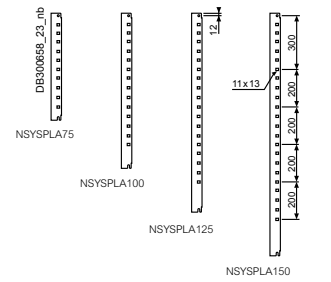

- Designed to support assorted equipment or simply to install a separation.
- In the two door enclosures, the installation of the plate or the uprights requires the prior installation of an intermediate support, ref. **NSYSBPLA**, presented beside.
- Material: Galvanized steel

Supply:

Delivered with the fixings required for installation

Height	Depth	Upright No. of adjustments	References
750	320 / 420	2	2 x NSYSPLA75
1000	320 / 420	3	2 x NSYSPLA100
1250	320 / 420	4	2 x NSYSPLA125
1500	–	5	2 x NSYSPLA150
2000	420	6	2 x NSYSPLA100

Depth (C)	Width (B)	Plate Max. load	References
320	500	60 kg	NSYBANPLA53
420	500	50 kg	NSYBANPLA54
420	750	50 kg	NSYBANPLA74
620	750	50 kg	NSYBANPLA76

M8 Inserts



NSYTEX8

- To be placed in the bosses molded on the doors, uprights, rear panels and bottom and top parts, for fixing accessories and assorted devices.
- Material: Brass

Supply:

References by unit. Order by multiples of 8 units (8, 16, 24, etc.)

Characteristics	References
Fixing inserts	NSYTEX8

Intermediate Support in the Two Door Enclosures



NSYSBPLA

- Required accessory for installing support plates, ref. **NSYBANPLA●●●** or uprights, ref. **NSYSPLA●●●** in the two door enclosures
- Material: Galvanized steel

Supply:

Two support kits

Characteristics	References
Intermediate support in the two door enclosures	NSYSBPLA

Recommendation

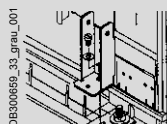

Intermediate support

Accessory required for installing uprights, ref. **NSYSPLA●●●**.
Only for two door enclosures.
Supply: one (including two supports)
ref. **NSYSBPLA**

Polyester Floor-Standing Enclosures

Thalassa PLA, PLAT, PHD,
Dimensions

Sealed Enclosure or Enclosure with Ventilated Canopy

For enclosures without canopy, please just disregard the related 38 mm.

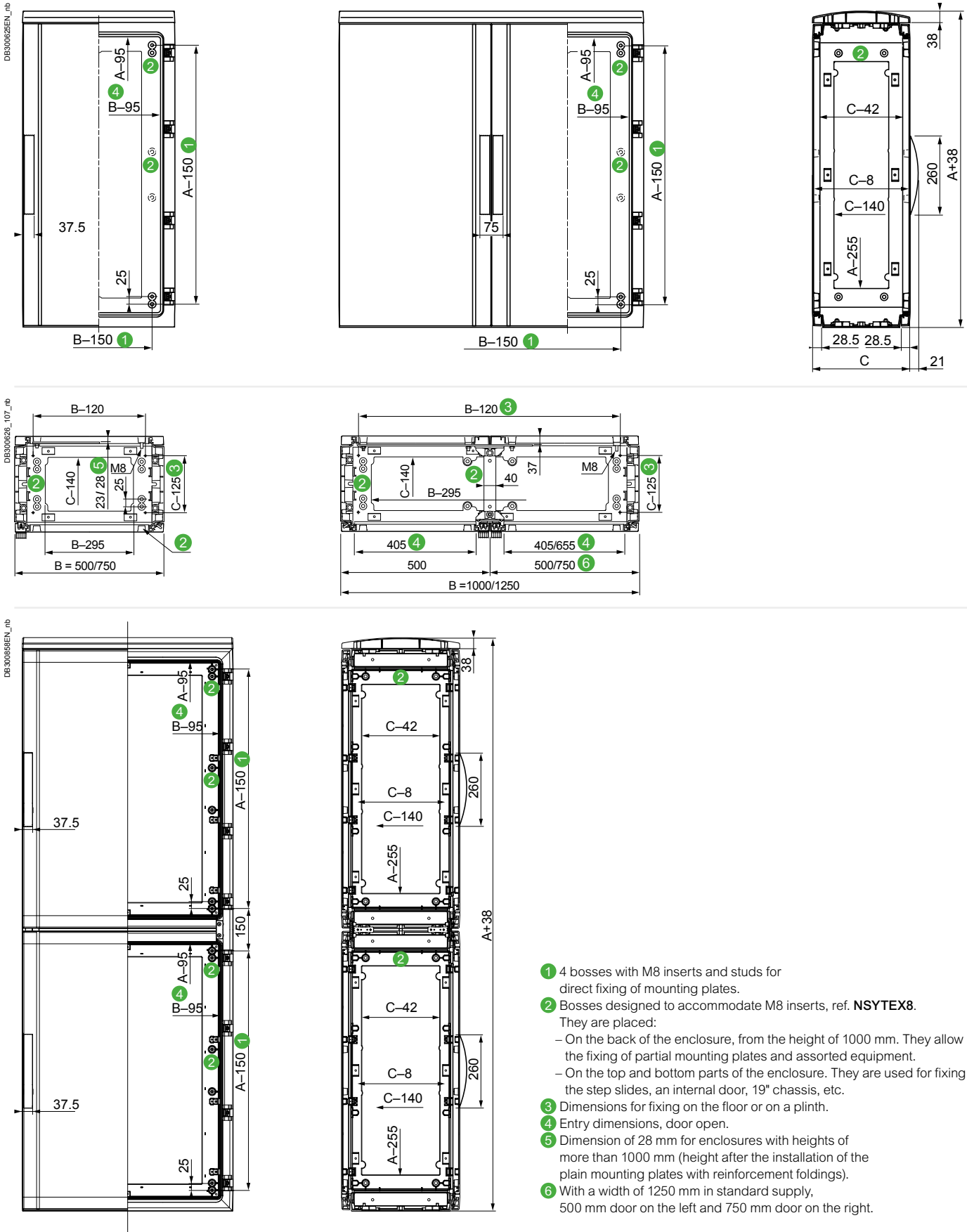

- ① 4 bosses with M8 inserts and studs for direct fixing of mounting plates.
- ② Bosses designed to accommodate M8 inserts, ref. **NSYTEX8**. They are placed:
 - On the back of the enclosure, from the height of 1000 mm. They allow the fixing of partial mounting plates and assorted equipment.
 - On the top and bottom parts of the enclosure. They are used for fixing the step slides, an internal door, 19" chassis, etc.
- ③ Dimensions for fixing on the floor or on a plinth.
- ④ Entry dimensions, door open.
- ⑤ Dimension of 28 mm for enclosures with heights of more than 1000 mm (height after the installation of the plain mounting plates with reinforcement foldings).
- ⑥ With a width of 1250 mm in standard supply, 500 mm door on the left and 750 mm door on the right.

Technical changes reserved. Information provided without guarantee. Images are for illustrative purposes only.

Enclosures with Open Bottom - Plinth Type with or without Ventilated Canopy

For enclosures without canopy, please disregard the corresponding 38 mm.



- 1 4 bosses with M8 inserts and studs for direct fixing of mounting plates.
- 2 Bosses designed to accommodate M8 inserts, ref. **NSYTEX8**. They are placed:
 - On the back of the enclosure, from the height of 1000 mm. They allow the fixing of partial mounting plates and assorted equipment.
 - On the top and bottom parts of the enclosure. They are used for fixing the step slides, an internal door, 19" chassis, etc.
- 3 Dimensions for fixing on the floor or on a plinth.
- 4 Entry dimensions, door open.
- 5 Dimension of 28 mm for enclosures with heights of more than 1000 mm (height after the installation of the plain mounting plates with reinforcement foldings).
- 6 With a width of 1250 mm in standard supply, 500 mm door on the left and 750 mm door on the right.

Connectors Between Plinths

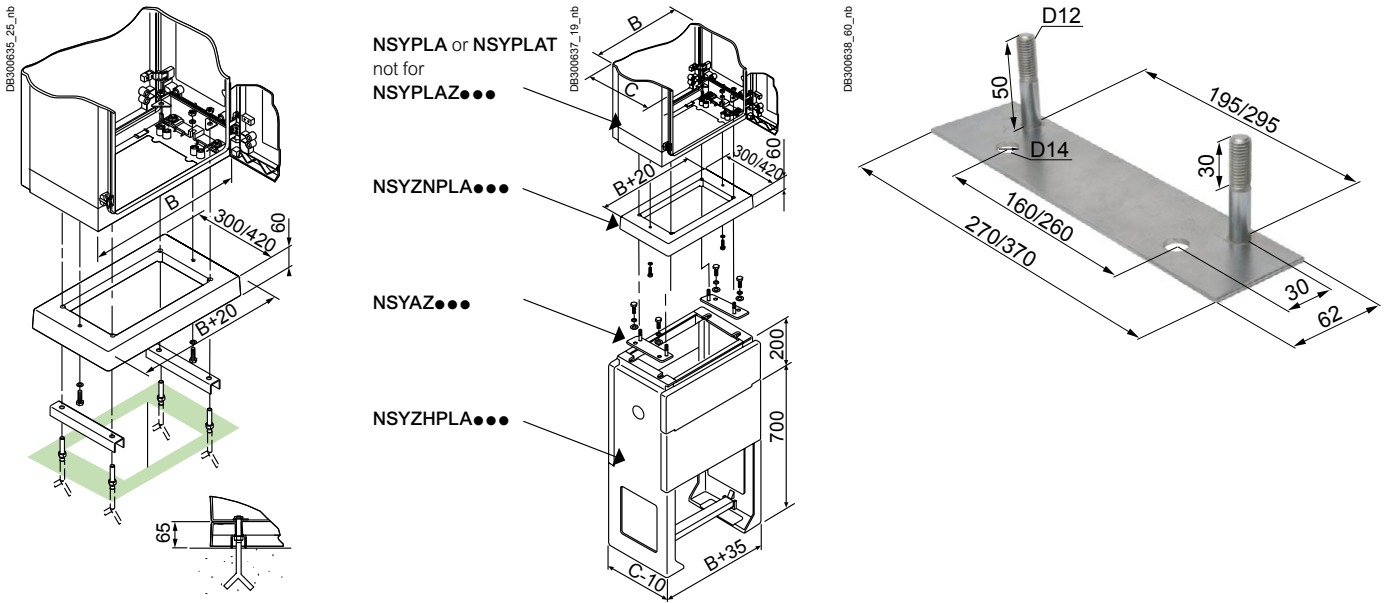

H-Plinths for Partially Buried Installation

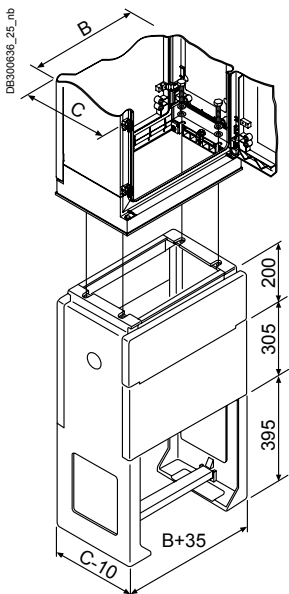

Floor-Standing Frame

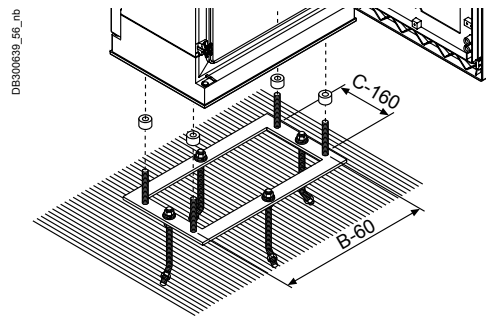

9
PLA

Internal Door

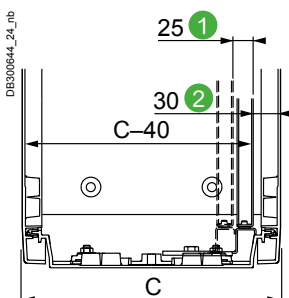

- 1 Two positions for depthwise installation
- 2 The 2nd position moves the position of the internal door back by 25 mm

Plain Mounting Plate

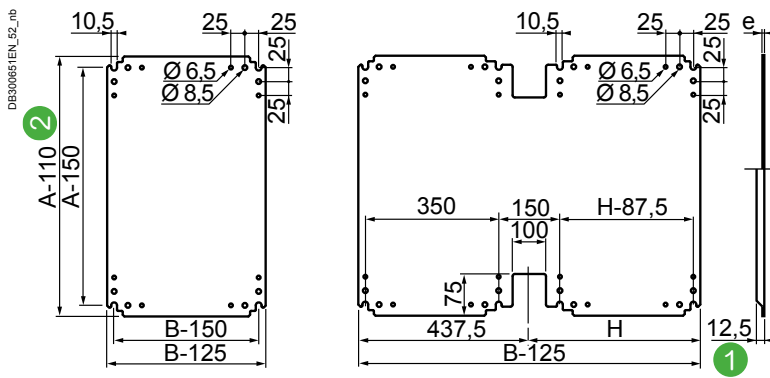

Telequick Mounting Plate

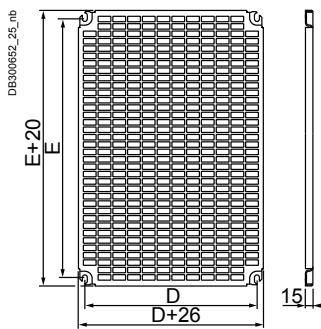

Insulated Mounting Plate

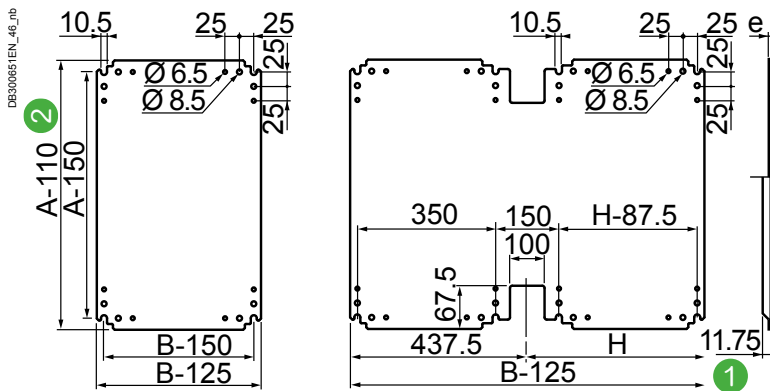

- ① Reinforcing fold for steel mounting plate NSYPMM1010 to NSYPMM1512
- ② A-125 for references NSYPMM1010 to NSYPMM1512, A-120 for the polyester mounting plate, ref. NSYPMA●●●.

Step Slides

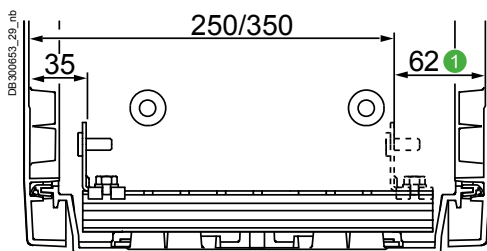

Installation of step slide ref. NSYDPLA●●●,
① 57 mm with one transparent door.

Step Slides

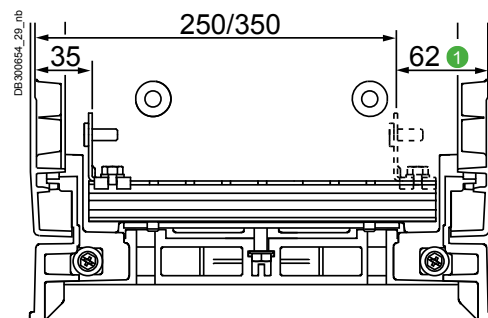

Installation of step slide ref. NSYDPLA●●●, with adapter plate
ref. NSYPTZ●●●, ① 57 mm with one transparent door.

Technical changes reserved. Information provided without guarantee. Images are for illustrative purposes only.

Upright

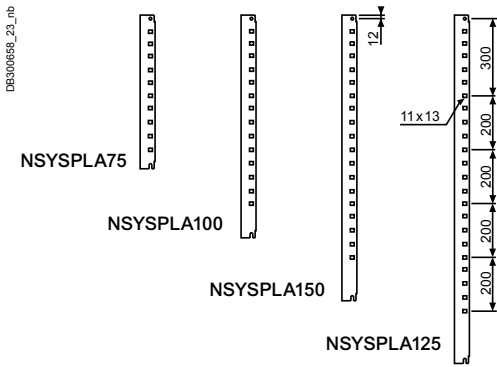

Plate

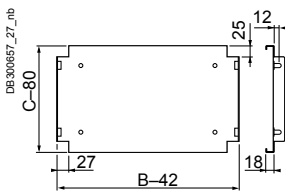

Plain Cover Plate

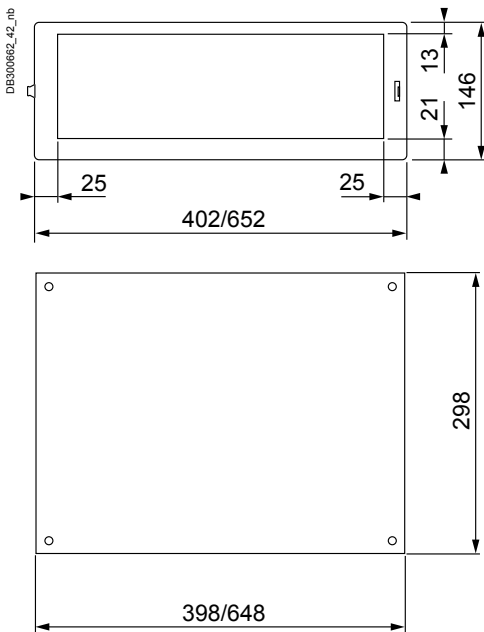

Plain Mounting Plate

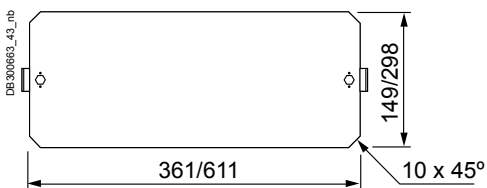

9
PLA

Technical changes reserved. Information provided without guarantee. Images are for illustrative purposes only.

19" Fixed Chassis

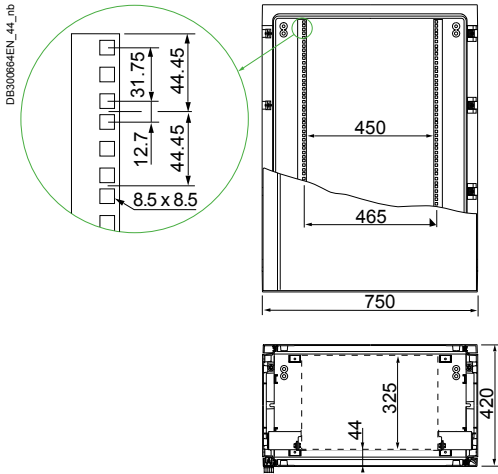

19" Swing Chassis

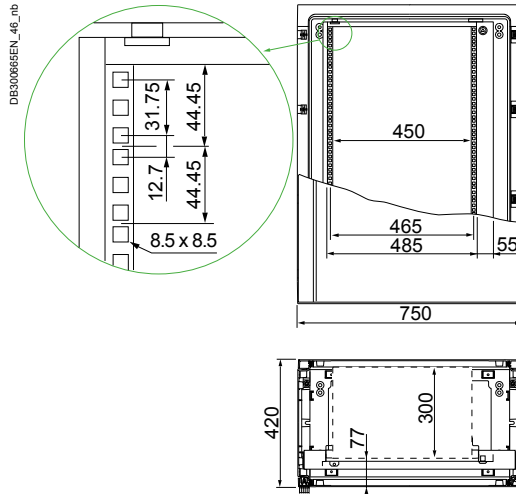

Accessories

Mounting



Cable Management

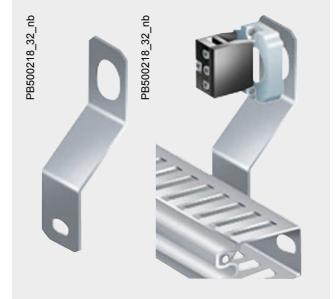

Terminal Blocks

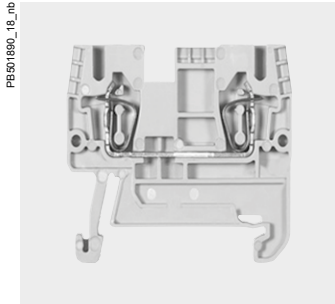

Lighting and Power Sockets



Floor Accessories



10

Door Accessories



Other Accessories



Content

Mounting	220
Cable Management	250
Lighting and Power Sockets	269
Floor Accessories	272
Door Accessories	273
Other Accessories	278

Mounting Plates for Wall-Mounted Enclosures

- S3D
- CRN
- S3X
- PLM

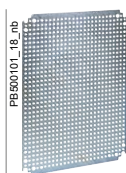



Characteristics				Mounting plates, plain	Mounting plates, microperforated**	Telequick Mounting plate**		
Material				Galvanized steel	Galvanized steel	Zinc-coated steel		
Maximum load				PLM: 150 kg/m ² S3D, S3X, CRN: 250 kg/m ²		PLM: 150 kg/m ² S3D, S3X, CRN: 250 kg/m ²		
Supply				One mounting plate without fixing elements		One mounting plate without fixing elements		
For enclosures (mm)	Dimensions (mm)			References	References	No. of perforations in		References
	Height	Width	H			W	H	
200	200	150	150	NSYMM22	-	-	-	-
250	200	200	150	NSYMM2520	-	-	-	-
250	300	250	200	NSYMM3025	-	-	-	-
250	400	200	350	NSYMM2540	-	-	-	-
250	500	200	450	NSYMM2550	-	-	-	-
300	200	250	150	NSYMM32	NSYMF32	16	5	NSYMR32
300	250	250	200	NSYMM3025*	-	16	8	NSYMR3025
300	300	250	250	NSYMM33	NSYMF33	16	9	NSYMR33
300	400	250	350	NSYMM43*	NSYMF43*	18	11	NSYMR34
300	450	250	400	NSYMM3045	-	-	-	-
300	500	450	250	NSYMM53*	-	-	-	-
300	600	250	550	NSYMM36	-	-	-	-
400	300	230	350	NSYMM43*	NSYMF43	22	9	NSYMR43
400	400	350	350	NSYMM44	NSYMF44	24	11	NSYMR44
400	600	350	550	NSYMM64*	-	24	19	NSYMR46
400	800	350	750	NSYMM48	-	-	-	-
500	300	450	250	NSYMM53*	NSYMF53	29	9	NSYMR53
500	400	450	350	NSYMM54	NSYMF54	31	11	NSYMR54
500	500	450	450	NSYMM55*	NSYMF55	31	14	NSYMR55
500	600	550	450	NSYMM65	-	-	-	-
600	400	550	350	NSYMM64	NSYMF64*	38	11	NSYMR64
600	500	550	450	NSYMM65	NSYMF65	38	14	NSYMR65
600	600	550	550	NSYMM66	NSYMF66	38	17	NSYMR66
600	800	-	-	-	-	36	24	NSYMR68
700	500	650	450	NSYMM75	NSYMF75	44	14	NSYMR75
700	600	650	550	NSYMM76	-	44	17	NSYMR76
800	600	750	550	NSYMM86*	NSYMF86*	51	17	NSYMR86
800	800	750	750	NSYMM88	NSYMF88	51	24	NSYMR88
800	1000	-	-	NSYMM108	NSYMF108	49	31	NSYMR810
800	1200	-	-	NSYMM128	NSYMF128			2 x NSYMR86
1000	600	950	550	NSYMM106	NSYMF106	64	17	NSYMR106
1000	800	950	750	NSYMM108*	NSYMF108*	64	24	NSYMR108
1000	1000	950	950	NSYMM1010	NSYMF1010	62	31	NSYMR1010
1000	1200	-	-	-	-	62	37	NSYMR1012
1200	600	1150	550	NSYMM126	NSYMF126	75	17	NSYMR126
1200	800	1150	750	NSYMM128*	NSYMF128	75	24	NSYMR128
1200	1000	1150	950	NSYMM1210*	NSYMF1210*	75	31	NSYMR1210
1200	1200	1150	1150	NSYMM1212	2 x NSYMF126	-	-	2 x NSYMR126
1400	1000	1350	950	NSYMM1410	-	88	31	NSYMR1410

10

* Plate with reversible dimensions; It can be installed in enclosures with inverted dimensions. Example: Plate ref. **NSYMM64** can be used for the following enclosures: H 600 x W 400 mm or H 400 x W 600 mm. For plain and silkscreened mounting plates: In wall-mounted enclosures with widths of 1000 and 1200 mm, it is possible to install two mounting plates at different depths using an additional central step slide **NSYSDRSDCR***** (more information on [page 224](#)).

** To install two mounting plates in a single enclosure, also order reference **NSYCRNGSDR**. See details on [page 224](#).
To install the plate in an enclosure with six studs, also order reference **NSYEMR**.

Mounting Plates for Wall-Mounted Enclosures

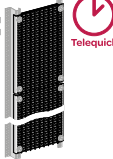
	S3D	CRN	S3X	PLM											
Characteristics	Bakelite mounting plate**		Polyester mounting plate**		DIN rail chassis		Joinable Telequick mounting plate								
	<ul style="list-style-type: none"> They are coupled directly to the rear of the actual enclosure or to the sliding plate supports. Double-door enclosures offer the option of installing two plates. 				Components supplied with a DIN rail chassis: <ul style="list-style-type: none"> Aluminum uprights. DIN rails (symmetric section A or B, according to the reference). Screws, washers and nuts need to mount the DIN rails to the uprights. Set of four adapters, ref. NSYAMCSF, needed to fix the uprights to the enclosure. 		<ul style="list-style-type: none"> 20/10e mm Telequick mounting plates. These mounting plates are suitable for mounting vertically multiple plates. 11 x 26 mm slots. Switchgear fixing by clip-on nuts. 								
Material	Bakelite		Polyester reinforced with fiberglass		Aluminum - Zinc-coated steel		Zinc-coated steel								
Color	RAL 9005 black		RAL 7035 gray		-		-								
Maximum load	100 kg/m ²		150 kg/m ²		-		-								
Supply	One mounting plate without fixing elements				One DIN rail chassis		One mounting plate and fixing elements								
For enclosures (mm)	Dimensions (mm)					Dimensions (mm)					Dimensions (mm)				
Height	Width	H (P)	W (S)	Thick.	References	H (P)	W (S)	Thick.	References	Type of rails	No. of rails	References	H	W	References
300	150	-	-	-	-	-	-	-	-	-	-	-	349	228	AM1PA3015
300	195	-	-	-	-	-	-	-	-	-	-	-	349	258	AM1PA3020
300	200	265	150	4	NSYMB32	265	150	4	NSYMPP32	-	-	-	-	-	-
300	250	265	200	4	NSYMB3025	-	-	-	-	-	-	-	-	-	-
300	300	-	-	-	-	-	-	-	-	B	4	NSYMD33	-	-	-
300	700	-	-	-	-	-	-	-	-	-	-	-	360	734	AM1PA3070
400	300	325	250	4	NSYMB43	325	250	4	NSYMPP43	B	4	NSYMD43	-	-	-
405	300	-	-	-	-	-	-	-	-	-	-	-	465	334	AM1PA4030
500	400	465	350	4	NSYMB54	465	350	4	NSYMPP54	B	4	NSYMD54	-	-	-
600	400	565	350	4	NSYMB64	565	350	4	NSYMPP64	B	6	NSYMD64	660	434	AM1PA6040
600	500	565	450	4	NSYMB65	-	-	-	-	-	-	-	660	534	AM1PA6050
600	600	-	-	-	-	-	-	-	-	A	6	NSYMD66	660	634	AM1PA6060
700	500	665	450	4	NSYMB75	665	450	4	NSYMPP75	B	6	NSYMD75	-	-	-
800	600	765	550	4	NSYMB86	765	550	5	NSYMPP86	A	6	NSYMD86	-	-	-
800	1000	-	-	-	NSYMB108	-	-	-	-	-	-	-	-	-	-
800	1200	-	-	-	2 x NSYMB86	-	-	-	-	-	-	2 x NSYMD86	-	-	-
900	600	-	-	-	-	-	-	-	-	-	-	-	960	634	AM1PA9060
900	700	-	-	-	-	-	-	-	-	-	-	-	960	734	AM1PA9070
1000	800	965	750	4	NSYMB108	965	750	5	NSYMPP108	A	6	NSYMD108	-	-	-
1200	800	-	-	-	-	-	-	-	-	A	7	NSYMD128	-	-	-
1200	1000	1150	950	4	NSYMB1210	-	-	-	-	-	-	-	-	-	-

* Plate with reversible dimensions; It can be installed in enclosures with inverted dimensions. Example: Plate ref. **NSYMM64** can be used for the following enclosures: H 600 x W 400 mm or H 400 x W 600 mm. For plain and silkscreened mounting plates: In wall-mounted enclosures with widths of 1000 and 1200 mm, it is possible to install two mounting plates at different depths using an additional central step slide **NSYSDRSDCR**** (more information on [page 224](#)).

** To install two mounting plates in a single enclosure, also order reference **NSYCRNGSDR**. See details on [page 224](#).
To install the plate in an enclosure with six studs, also order reference **NSYEMR**.

Plain Mounting Plates

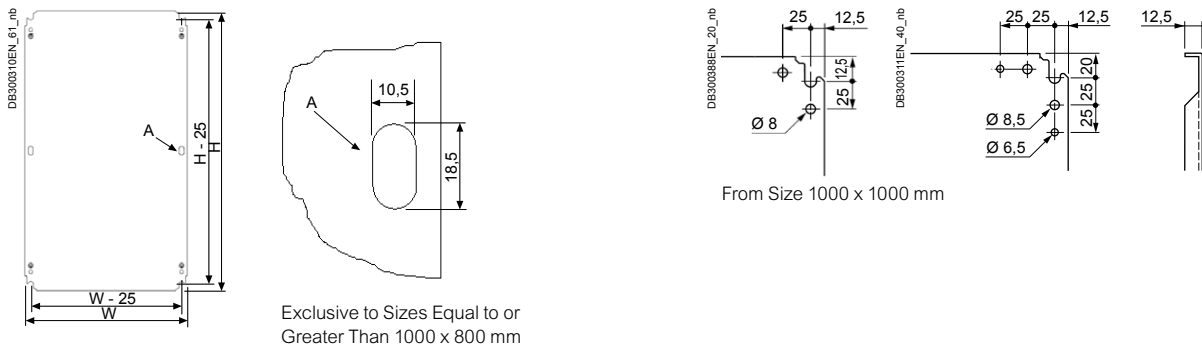

Microperforated Mounting Plate

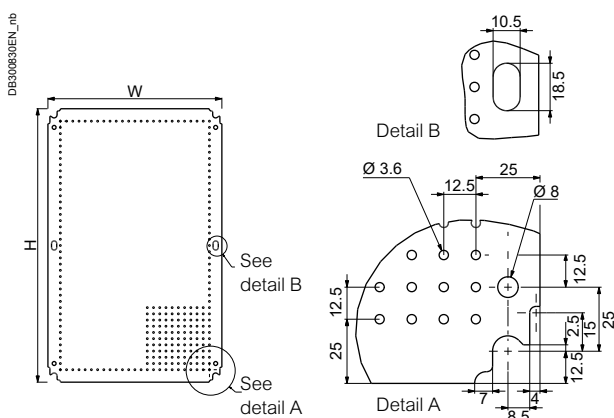

Telequick Mounting Plate

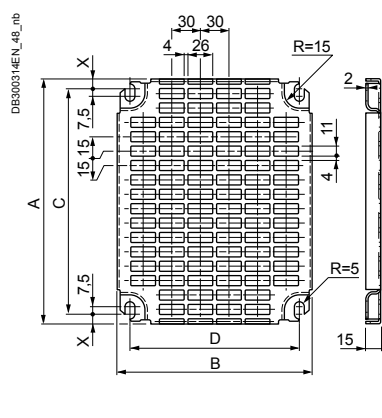

10

Joinable Telequick Mounting Plate

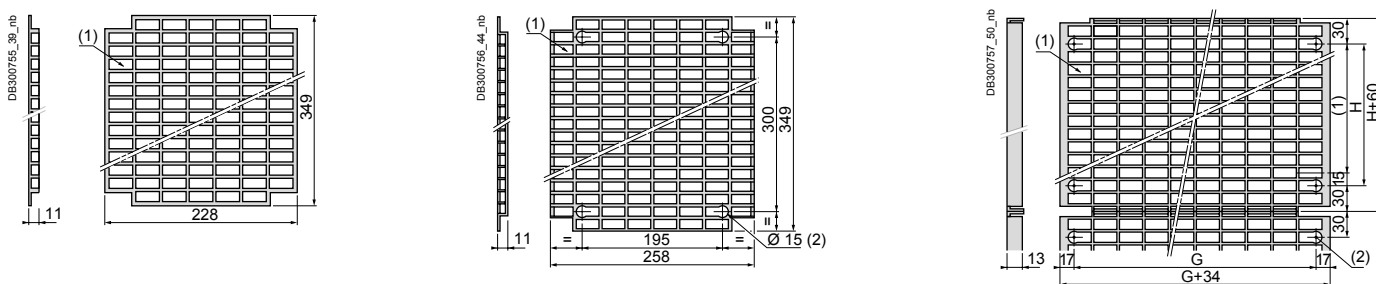

Bakelite and Polyester Mounting Plate

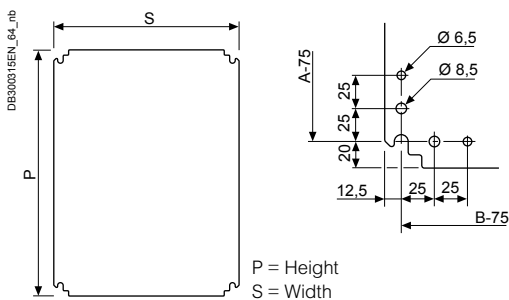

DIN Rail Chassis

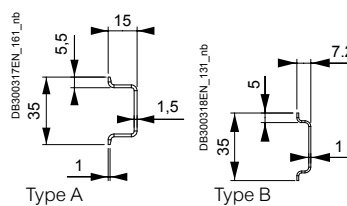

S3D S3X PLM Elevator for Microperforated Mounting Plate



AZ1CA04

- Mounting plate elevator to mount the microperforated mounting plate on the same level as the other Telequick system components.

Supply:
Four units

Characteristics	Reference
Elevator for microperforated mounting plate	AZ1CA04

Clip-On Nuts for Telequick Mounting Plate



AF1EA3

- Used to easily fix devices on the Telequick mounting plate with the option of converting the layout as much as needed.

Supply:
100 units. Reference by unit. Order by multiples of 100 (100, 200, 300...)

Characteristics	Reference
Clip-on nuts for Telequick mounting plate, Model M3	AF1EA3
Clip-on nuts for Telequick mounting plate, Model M4	AF1EA4
Clip-on nuts for Telequick mounting plate, Model M5	AF1EA5
Clip-on nuts for Telequick mounting plate, Model M6	AF1EA6

S3D S3X Step Slides for Mounting Plate



- Set of four supports intended for installation in enclosures with depths of 200 and 250 mm.
- The rail allows the depth of the plate and other accessories to be adjusted in steps of 12.5 mm.

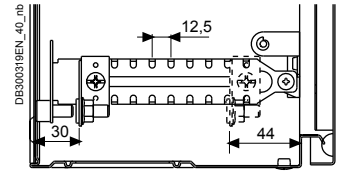

Supply:
Four step slides

Characteristics	Enclosure depth (mm)	Reference
Step slides for mounting plate	200	NSYSDCR200
Step slides for mounting plate	250	NSYSDCR250
Step slides for mounting plate	300	NSYSDCR300
Step slides for mounting plate	400	NSYSDCR400

Step slides for 2 mounting plates in one enclosure

S3D S3X Slide Bracket for Two Mounting Plates at Different Depths



- Additional slide bracket to be installed on the central step slides in order to mount two mounting plates, side by side, in 300 and 400 mm depth.

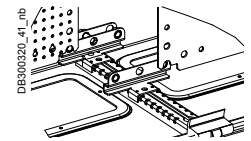

Supply:
Two slide brackets

Characteristics	Reference
Slide bracket for two mounting plates at different depths	NSYCRNGSDR

Vertical Rails for Wall-Mounted Enclosures

Accessories - Mounting

S3D S3X PLM PLA Aluminum Vertical Rails

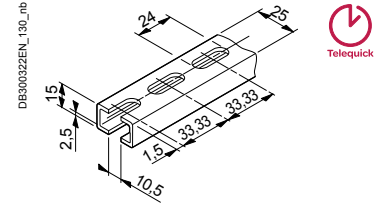

NSYMDVR12

- Fixing in the enclosure with M8 nuts, ref. **NSYAMCSF** (set of 4 adapters to be ordered separately).

Characteristics	Height (mm)	Supply (units)	References
Aluminum vertical rail, steel	1200	2	NSYMDVR12
Aluminum vertical rail, aluminum	3000	10	NSYMDVR3M

S3D S3X PLM 20/10^e mm Zinc-Coated Pre-Drilled Uprights



DZ6MZ211

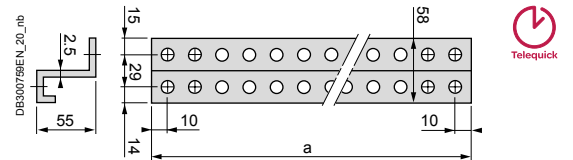

- Ø 11 mm holes enable to adjust the rows of equipment by 20 mm steps.

Characteristics	Height (mm)	Weight (g)	References
20/10e mm zinc-coated pre-drilled uprights	1920	4000	DZ6MZ211

Sliding Nuts



NSYNM5

- Sliding nuts to be used on aluminum vertical rails.

Supply:
100 Sliding nuts

Characteristics	Type	References
Sliding Nut	M4	NSYNM4
Sliding Nut	M5	NSYNM5
Sliding Nut	M6	NSYNM6

Brass Nuts to Fix the Upright to the Enclosures



NSYAMCSF

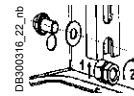

Supply:
Four Brass nuts

Characteristics	References
Brass nuts for screws M8 to fix the upright to the enclosures	NSYAMCSF

Notched Clamp Nuts

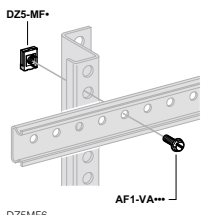

DZ5MF6

- Specially designed for pre-drilled uprights.

Supply:
100 units. References per unit. To be ordered in multiples of 100 (100, 200, 300, etc).

Characteristics	Type	Weight (g)	References
Notched clamp nuts	M6	7.0	DZ5MF6
Notched clamp nuts	M8	8.0	DZ5MF8

10

Mounting Plates for Floor-Standing Enclosures

SM SMX SFN SFX Plain Mounting Plate

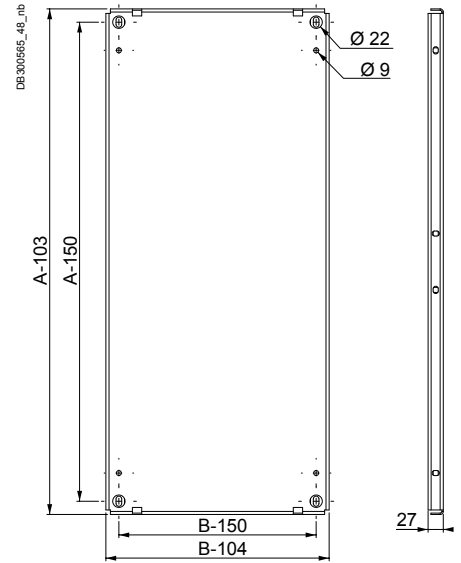

- Depth adjustable with a pitch of 25 mm, provided with plastic shoe for easier sliding.
- Once the plate is fixed, in advanced position, the sliding shoe can be easily removed to increase the available plate surface.
- In sets made up of two or more enclosures with mounting plates, it is possible to obtain a continuous plate surface using intermediate mounting plates (see page 228).
- Load: 300 kg/ m²
- Maximum load: 600 kg in the back of the enclosure and 500 kg in the intermediate position
- Material: Galvanized steel

Fixing options:

- At the sides of the enclosure with the orthogonal brackets (see page 230)
- Back-to-back, with the brackets for fixing the mounting plates in back-to-back position (see page 231)
- For 400 mm wide plates: with sliding rails and brackets, orthogonal brackets when mounted at back position, or with standard fixing brackets when mounted at middle position.

Note:

Accessories must be purchased separately (depending on the fixation at the back or in the mid position).

- NSYSMPs** rails always needed
- NSYSMPB** brackets for intermediate position
- NSYSMPsB** brackets for back position

Supply:

One mounting plate and sliding shoes.



10

Characteristics	Width of the enclosure (mm)	Height of the enclosure (mm)	Width (mm)	Height (mm)	References
Plain mounting plate	400	1800	296	1697	NSYMP184
Plain mounting plate	400	2000	296	2097	NSYMP204
Plain mounting plate	400	2200	296	1897	NSYMP224
Plain mounting plate	600	1200	496	1097	NSYMP126
Plain mounting plate	600	1400	496	1297	NSYMP146
Plain mounting plate	600	1600	496	1497	NSYMP166
Plain mounting plate	600	1800	496	1697	NSYMP186
Plain mounting plate	600	2000	496	1897	NSYMP206
Plain mounting plate	600	2200	496	2097	NSYMP226
Plain mounting plate	800	1200	696	1097	NSYMP128
Plain mounting plate	800	1400	696	1297	NSYMP148
Plain mounting plate	800	1600	696	1497	NSYMP168
Plain mounting plate	800	1800	696	1697	NSYMP188
Plain mounting plate	800	2000	696	1897	NSYMP208
Plain mounting plate	800	2200	696	2097	NSYMP228
Plain mounting plate	1000	1200	896	1097	NSYMP1210
Plain mounting plate	1000	1400	896	1297	NSYMP1410
Plain mounting plate	1000	1600	896	1497	NSYMP1610
Plain mounting plate	1000	1800	896	1697	NSYMP1810
Plain mounting plate	1000	2000	896	1897	NSYMP2010
Plain mounting plate	1000	2200	896	2097	NSYMP2210
Plain mounting plate	1200	1200	1096	1097	NSYMP1212
Plain mounting plate	1200	1400	1096	1297	NSYMP1412
Plain mounting plate	1200	1600	1096	1497	NSYMP1612
Plain mounting plate	1200	1800	1096	1697	NSYMP1812
Plain mounting plate	1200	2000	1096	1897	NSYMP2012
Plain mounting plate	1200	2200	1096	2097	NSYMP2212
Plain mounting plate	1600	1800	1496	1697	NSYMP1816
Plain mounting plate	1600	2000	1496	1897	NSYMP2016

Mounting Plates for Floor-Standing Enclosures

SM SMX SFN SFX SD Perforated Mounting Plate Telequick

- Allows the installation of switchgear without drilling or screwing.
- Plate designed for quick-fixing of switchgear by means of clip-on nuts ref. **AF1EA3** to **AF1EA6**.
- To ensure vertical continuity, multiple Telequick plates can be installed consecutively in a stacked arrangement..
- The top plate must be fixed in the third hole, 80 mm from the top frame.
- Load: 150 kg/m²
- Material: Zinc-coated steel

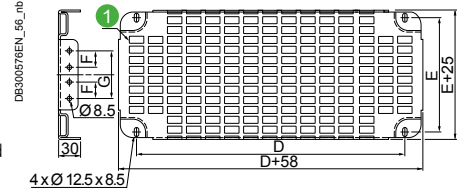

1 Cut-outs 11 x 26 with a pitch of 15 x 30.

Fixing options:

- Directly to the vertical uprights of the structure, by means of self-tapping screws (only PanelSeT SFN)
- To the technical vertical uprights, by means of sliding nuts, see [page 233](#);
- To standard uprights by means of flat nuts, see [page 233](#) or self-tapping screws, and to cross-rails

Comment:

Examples of combination see below.

Supply:

One perforated mounting plate and fixing elements for technical uprights and screws for fixing to the structure or cross-rails.



Characteristics	Width (mm)	Plate height (mm)				Useful surface (dm ²)	References
		D	E	F	G		
Perforated mounting plate Telequick	600	450	200	-	100	11.4	NSYSTMP2260
Perforated mounting plate Telequick	600	450	425	-	325	22.8	NSYSTMP4560
Perforated mounting plate Telequick	600	450	575	125	475	30.4	NSYSTMP6060
Perforated mounting plate Telequick	600	450	800	250	700	11.9	NSYSTMP8260
Perforated mounting plate Telequick	800	650	200	-	100	15.9	NSYSTMP2280
Perforated mounting plate Telequick	800	650	425	-	325	31.8	NSYSTMP4580
Perforated mounting plate Telequick	800	650	575	125	475	42.4	NSYSTMP6080
Perforated mounting plate Telequick	800	650	800	250	700	58.4	NSYSTMP8280
Perforated mounting plate Telequick	1000	850	200	-	100	20.4	NSYSTMP22100
Perforated mounting plate Telequick	1000	850	425	-	325	40.8	NSYSTMP45100
Perforated mounting plate Telequick	1000	850	575	125	475	54.4	NSYSTMP60100
Perforated mounting plate Telequick	1000	850	800	250	700	74.9	NSYSTMP82100
Perforated mounting plate Telequick	1200	1050	200	-	100	24.9	NSYSTMP22120
Perforated mounting plate Telequick	1200	1050	425	-	325	49.9	NSYSTMP45120
Perforated mounting plate Telequick	1200	1050	575	125	475	66.5	NSYSTMP60120
Perforated mounting plate Telequick	1200	1050	800	250	700	91.5	NSYSTMP82120

Examples of perforated mounting plate installation

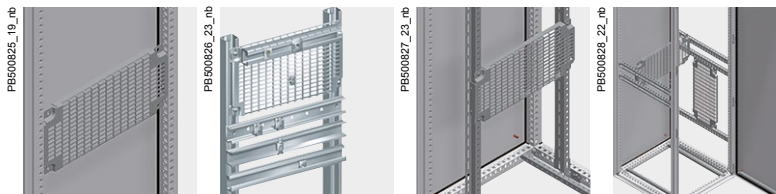

- Perforated plate mounted on structure.
- Perforated plate mounted on technical vertical uprights.
- Perforated plate mounted on standard vertical uprights.
- Perforated plate mounted on cross-rails.

Examples of Mounting Plates Combination

Length of joined PanelSeT SFN enclosures (mm)	Example of PanelSeT SFN enclosure combination width (mm) (B)	Example of combining mounting plates by width (mm)	Useful length (mm)
1200	1200	600 + 800	1192
1400	600 + 800	600 + 1000	1392
1600	2 x 800	800 + 1000	1592
1800	3 x 600	800 + 1200	1792
2000	2 x 1000	1000 + 1200	1992
2200	600 + 2 x 800	1200 + 1200	2192
2400	3 x 800	1600 + 1000	2392
2400	3 x 800	3 x 600 + 1000	2384
2600	2 x 1000 + 600	1600 + 1200	2592
2600	2 x 1000 + 600	3 x 600 + 1200	2584
2800	2 x 1000 + 800	4 x 800	2784
3000	3 x 1000	3 x 800 + 1000	2984
3200	2 x 1000 + 1200	3 x 800 + 1200	3184
3400	3 x 800 + 1000	800 + 3 x 1000	3384
3600	3 x 1200	4 x 1000	3584
3800	800 + 3 x 1000	600 + 3 x 1200	3784
4000	4 x 1000	800 + 3 x 1200	3984

Technical changes reserved. Information provided without guarantee. Images are for illustrative purposes only.

Mounting Plates for Floor-Standing Enclosures

SM **SFN** **SFX** Partial Mounting Plate

- Partial mounting plate, provided with reinforcement flange on its four sides.
- Load: 250 kg/m²
- Material: Galvanized steel

Fixing options:

PanelSeT SFN and Spacial SFX:

- Fixing to the vertical uprights of the structure
- Fixing to the technical or standard vertical uprights, see [page 233](#)
- For installations in advanced position, fixing to cross-rails, see [page 236](#)

Spacial SM:

- Fixing by means of adaptation profiles and 40 mm universal cross-rails (one row) in vertical position, or also on horizontal universal cross-rails
- It can be mounted horizontally, as a tray, by means of depthwise cross-rails, see [page 236](#)

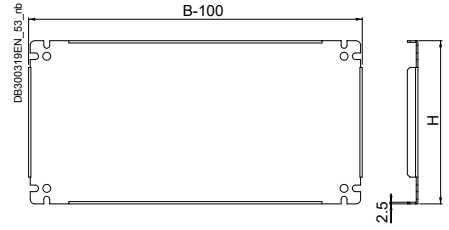

Supply:
Partial mounting plate and fixing elements



NSYSMP2560

Characteristics	Width (mm) B	Plate height (mm) H	Plate length (mm) B-100	References
Partial mounting plate	600	247	500	NSYSMP2560
Partial mounting plate	600	397	500	NSYSMP4060
Partial mounting plate	600	597	500	NSYSMP6060
Partial mounting plate	800	247	700	NSYSMP2580
Partial mounting plate	800	397	700	NSYSMP4080
Partial mounting plate	800	597	700	NSYSMP6080
Partial mounting plate	1000	247	900	NSYSMP25100
Partial mounting plate	1000	397	900	NSYSMP40100
Partial mounting plate	1200	247	1100	NSYSMP25120
Partial mounting plate	1200	397	1100	NSYSMP40120
Partial mounting plate	1200	597	1100	NSYSMP60120

SFN **SFX** Intermediate Mounting Plate

- Obtains a continuous surface of the mounting plate at enclosure suites.
- Adjustable depth with a pitch of 25 mm. When the mounting plates are located in the back of the enclosure, the vertical profiles of the structure are flush with the plates, acting as an intermediate mounting plate. In this case the intermediate plate cannot be installed.
- Material: Galvanized steel

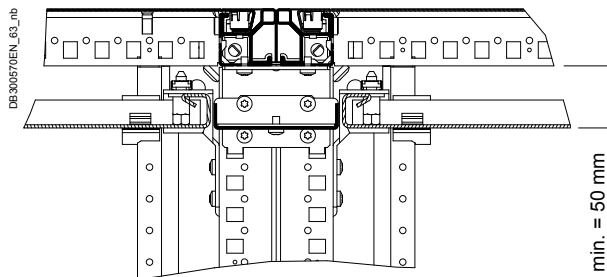

Supply:
One intermediate plate and fixing elements

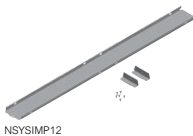

NSYSIMP12

Characteristics	Height (mm)	References
Intermediate mounting plate	1200	NSYSIMP12
Intermediate mounting plate	1400	NSYSIMP14
Intermediate mounting plate	1600	NSYSIMP16
Intermediate mounting plate	1800	NSYSIMP18
Intermediate mounting plate	2000	NSYSIMP20
Intermediate mounting plate	2200	NSYSIMP22

SFN **SFX** Intermediate Fixing of the Mounting Plate, Located in the Back of the Enclosure

- Support for additional fixing of the mounting plate, at any height of the plate when the plate is mounted in the back of the enclosure.
- The supports minimize the vibration of the plate during the transport and operation of the panel.
- Material: Zinc-coated steel
- **Fixing:** The supports are fixed to the structure when the plate is already located in the back of the enclosure
 Spacial SM: Fixing to 40 mm universal cross-rails (one row), installed vertically in the back of the enclosure, see [page 236](#)

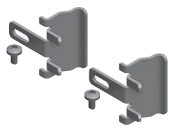

NSYSMPFB



Supply:
 Ten units and fixing elements.
 Reference by unit. Order by multiples of 10 (10, 20, 30...)

Characteristics	References
Intermediate fixing of the mounting plate, located in the back of the enclosure	NSYSMPFB

SFN **SFX** Intermediate Fixing of the Mounting Plate, in Advanced Position

- Support for additional fixing of the mounting plate, at any height of the plate when the plate is mounted in advanced position.
- The supports minimize the vibration of the plate during the transport and operation of the panel.
- Material: Zinc-coated steel
- **Fixing:** The supports are mounted on light cross-rails or on 40 mm (one row) universal or quick-fixing cross-rails (not supplied), see [page 236](#)

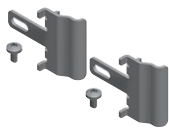

NSYSMPFA



Supply:
 Ten units and fixing elements.
 Reference by unit. Order by multiples of 10 (10, 20, 30...)

Characteristics	References
Intermediate fixing of the mounting plate, in advanced position	NSYSMPFA

SFN **SFX** Reinforcement for Mounting Plate

- Reinforcement kit for transversal mounting plate.
- Provides extra rigidity to the mounting plates and absorbs vibrations.
- Can be used as a support for fixing very heavy elements.
- Material: Zinc-coated steel
- Thickness: 15/10^e mm



NSYMPRK8

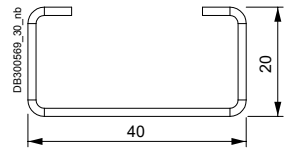

Supply:
 Two profiles, four supports for fixing to the mounting plate and fixing elements

Characteristics	Width (mm)	References
Reinforcement for mounting plate	800	NSYMPRK8
Reinforcement for mounting plate	1000	NSYMPRK10
Reinforcement for mounting plate	1200	NSYMPRK12
Reinforcement for mounting plate	1600	NSYMPRK16

Mounting Plate Accessories

Self-Tapping Screw

- Hexagonal head, 4.8 x 16 mm thread.
- Drilling capacity: Thicknesses between 17.5/10^e and 40/10^e mm.



NSYS16M5HS

Supply:
 100 units. To be ordered in multiples of 100 (100, 200, 300, etc.).

Characteristics	References
Self-tapping screw	NSYS16M5HS

SM SMX SFN SFX Mounting Plate Fixing Brackets

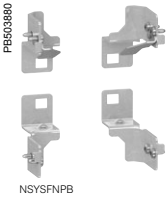

- For direct mounting on the structure of the enclosure.
- Adjustable depth with a pitch of 25 mm.
- Material: Zinc-coated steel
- Maximum load: Four brackets: 600 kg

Supply:
Four brackets and fixing elements

Characteristics	References
PanelSeT SFN Mounting plate fixing brackets	NSYSFNPB
Spacial SM/SMX/SFX Mounting plate fixing brackets	NSYSMPB

SFN SFX Orthogonal Brackets



- Designed for the installation of mounting plates on the sides of the enclosure.
- When installing one plate in the back of the enclosure and one plate at the side, they must both be installed using orthogonal brackets.
- Spacial SFX: Mounting the lateral mounting plate requires the removal of the one on the back and its fixing brackets.
- Material: Zinc-coated steel
- Maximum load: Four brackets: 600 kg

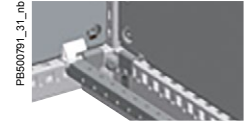

Supply:
Four brackets and fixing elements

Characteristics	References
PanelSeT SFN and Spacial SFX Orthogonal brackets	NSYSMPSB

SFN Mounting Plate Sliding Rails



- Rail in which the mounting plate slides along when inserted in the enclosure.
- Once the mounting plate is installed and fixed to the brackets, the sliding rails can be removed to maximize the cable passage surface, and can be installed depthwise in other positions.
- Material: Galvanized steel

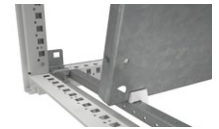

Supply:
Four brackets and fixing elements

Characteristics	Depth (mm)	References
PanelSeT SFN Mounting plate sliding rails	400	NSYSMPS4
PanelSeT SFN Mounting plate sliding rails	500	NSYSMPS5
PanelSeT SFN Mounting plate sliding rails	600	NSYSMPS6
PanelSeT SFN Mounting plate sliding rails	800	NSYSMPS8

Mounting Plate Brackets for Floor-Standing Enclosures

Brackets for Fixing Mounting Plates in Back-to-Back Position

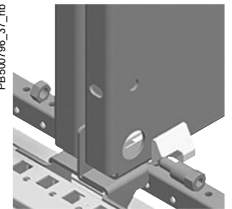
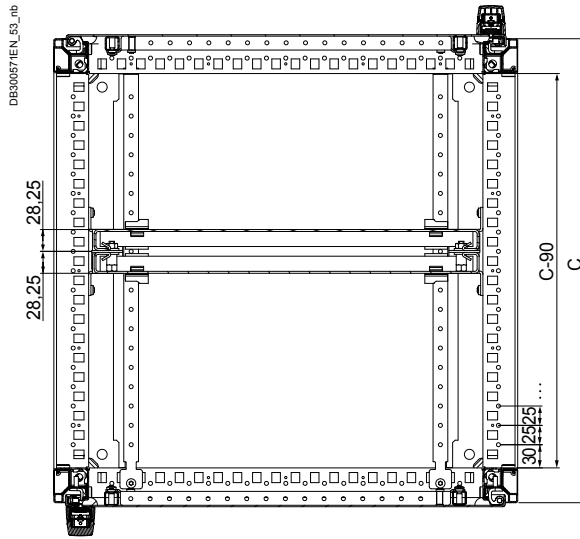

Supply:
Four brackets for fixing back-to-back and fixing elements

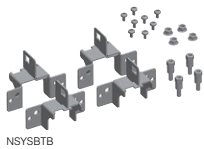

- Doubling the mounting surface.
- Adjustable with a pitch of 25 mm.
- Material: Zinc-coated steel

Characteristics
Brackets for fixing mounting plates in back-to-back position

References
NSYSBTB

SM SMX SFN SFX Brackets for Fixing Intermediate Mounting Plates in Back-to-Back Position

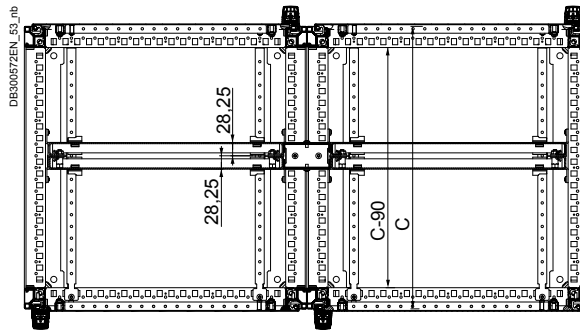

Supply:
2 brackets for fixing intermediate plates back-to-back and fixing elements

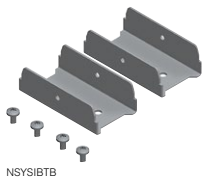

- Doubling the mounting surface.
- Adjustable with a pitch of 25 mm.
- Material: Zinc-coated steel

Characteristics
PanelSet SFN and Spacial SM/SMX Brackets for fixing intermediate mounting plates in back-to-back position

References
NSYSIBTB

10

SFN **SFX** Side Entry Rails for the Mounting Plate

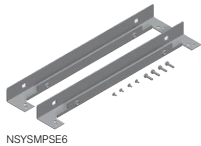

- Side entry device for the mounting plates when coupling PanelSeT SFN enclosures or Spacial SFX.
- The mounting plates can be coupled with one another, and are fixed to the side entry guide by pressure.
- Material: Zinc-coated steel

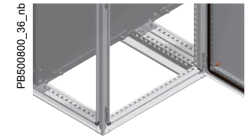

Supply:
Two rails (top and bottom) and fixing elements

Characteristics	Width (mm)	References
PanelSeT SFN and Spacial SFX Side entry rails for the mounting plate	600	NSYSMPSE6
PanelSeT SFN and Spacial SFX Side entry rails for the mounting plate	800	NSYSMPSE8
PanelSeT SFN and Spacial SFX Side entry rails for the mounting plate	1000	NSYSMPSE10
PanelSeT SFN and Spacial SFX Side entry rails for the mounting plate	1200	NSYSMPSE12

SM Top/Bottom Adjustment Rails



- Allows the installation of two mounting plates or vertical uprights in enclosures with a width of 1200 mm and 1600 mm, as if in two independent enclosures.
- A set of mounting plate fixing brackets ref. **NSYSMPB** is required.
- Optional installation of an intermediate mounting plate.
- Material: Galvanized steel

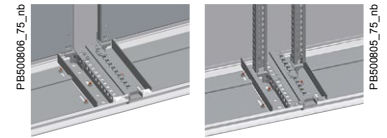

Supply:
Two rails, top and bottom

Characteristics	Depth (mm)	References
Spacial SM Top/bottom adjustment rails	300	NSYSTBR3
Spacial SM Top/bottom adjustment rails	400	NSYSTBR4
Spacial SM Top/bottom adjustment rails	500	NSYSTBR5
Spacial SM Top/bottom adjustment rails	600	NSYSTBR6

SFN Kit for Adapting Two-Door Enclosures

- Allows the installation of two mounting plates as if in two independent enclosures.
- A set of brackets for fixing mounting plates ref. **NSYSMPB** is required.
- Option of installing an intermediate mounting plate.
- Valid for enclosures with widths of 1200 and 1600 mm.
- If installing a cable gland plate for a width of 1200 mm, it is necessary to install two with a width of 600 mm, and for widths of 1600 mm, two with a width of 800 mm.

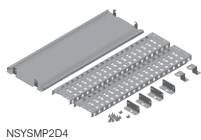

Characteristics	Depth (mm)	References
PanelSeT SFN Kit for adapting two-door enclosures	400	NSYSMP2D4
PanelSeT SFN Kit for adapting two-door enclosures	500	NSYSMP2D5
PanelSeT SFN Kit for adapting two-door enclosures	600	NSYSMP2D6
PanelSeT SFN Kit for adapting two-door enclosures	800	NSYSMP2D8

SM SMX SFN SFX Technical Uprights

SD PLA PHD

- Vertical uprights for fixing plates and rails.
- They can be fixed to the fixing brackets of the mounting plate or to the uprightfixing bracket (ref. **NSYMFB**).
- Adjustable height in steps of 2.5 mm (with quarter-turn nuts, ref. **NSYSNM6** or **NSYSNM8**) or 25 mm (with cage nuts, ref. **NSYCNM6** or **NSYCNM8**).
- Material: Galvanized steel
- Thickness: 20/10^e mm

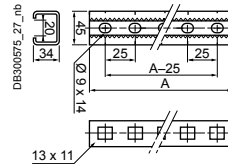

Comment:
NSYTVR20 is not compatible with PLA or PHD 2000 mm high enclosures. Use 2 x **NSYTVR10**.

Supply:
 Set of two uprights



Characteristics	Height (mm)	A (mm)	References
SM/SMX/SFN/SFX/SD/PLA/PHD Technical uprights	750	625	NSYTVR7
SM/SMX/SFN/SFX/SD/PLA/PHD Technical uprights * Control desk.	1000*	675	NSYTVR8
SM/SMX/SFN/SFX/SD/PLA/PHD Technical uprights	1000	875	NSYTVR10
SM/SMX/SFN/SFX/SD/PLA/PHD Technical uprights	1200	1075	NSYTVR12
SM/SMX/SFN/SFX/SD/PLA/PHD Technical uprights	1250	1125	NSYTVR125
SM/SMX/SFN/SFX/SD/PLA/PHD Technical uprights	1400	1275	NSYTVR14
SM/SMX/SFN/SFX/SD/PLA/PHD Technical uprights	1500	1375	NSYTVR15
SM/SMX/SFN/SFX/SD/PLA/PHD Technical uprights	1600	1475	NSYTVR16
SM/SMX/SFN/SFX/SD/PLA/PHD Technical uprights	1800	1675	NSYTVR18
SM/SMX/SFN/SFX/SD Technical uprights	2000	1875	NSYTVR20
SM/SMX/SFN/SFX/SD/PLA/PHD Technical uprights	2200	2075	NSYTVR22

SM SMX SFN SFX Standard Uprights

- Vertical uprights for fixing plates and rails.
- They can be fixed on the mounting plate fixing brackets or on the upright fixing bracket, ref. **NSYMFB**.
- Adjustable height with a pitch of 25 or 50 mm.
- Material: Galvanized steel
- Thickness: 20/10^e mm

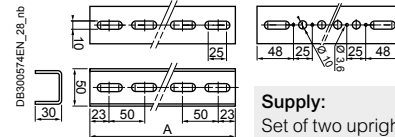

Supply:
 Set of two uprights



Characteristics	Height (mm)	A (mm)	References
SM/SMX/SFN/SFX Standard uprights	1800	1696	NSYVR18
SM/SMX/SFN/SFX Standard uprights	2000	1896	NSYVR20
SM/SMX/SFN/SFX Standard uprights	2200	2096	NSYVR22

Nuts and Screws for Technical Uprights



Characteristics	Supply (units)	References
M6 quarter-turn sliding nut	10	NSYSNM6
M8 quarter-turn sliding nut	10	NSYSNM8
M6 quarter-turn serrated sliding nut	10	NSYSNSM6
M8 quarter-turn serrated sliding nut	10	NSYSNSM8
M6 renewable nut	50	NSYCNM6
M8 renewable nut	50	NSYCNM8
M6 x 12 screw	100	AF1VA612
M6 x 18 screw	100	AF1VA618
M8 x 20 screw	100	AF1VC820

Nuts and Screws for Standard Uprights



Characteristics	Supply (units)	References
M6 flat nut	50	NSYFNM6
M8 flat nut	50	NSYFNM8
M6 x 12 screw	100	AF1VA612
M6 x 18 screw	100	AF1VA618
M8 x 20 screw	100	AF1VC820

Bracket for Fixing Uprights

- Brackets for fixing the uprights, standard or technical, at the same level as the structure, obtaining a greater working surface inside the enclosure.
- They allow two pairs of uprights to be fixed back-to-back, doubling the working surface.
- The brackets are fixed to the structure by means of M6 self-tapping screws.
- Adjustable depth with a pitch of 25 mm.
- Material: Zinc-coated steel.

Supply:
 Four brackets for fixing uprights and fixing elements.



Characteristics	References
Bracket for fixing uprights	NSYMFB

Technical changes reserved. Information provided without guarantee. Images are for illustrative purposes only.

SM SMX SFN SFX SD Rail Support Bracket

- Bracket for fixing rails at an angle of 45°.
- Material: Zinc-coated steel
- Installation: PanelSet SFN: Mounted on the structure and/or mounting plates
Spacial SM: Mounted on the bottom mounting rail and/or mounting plates



NSYFB45



PB600829_33_nb

Supply:
Ten units and fixing elements.
Reference by unit. Order by multiples of 10 (10, 20, 30...)



Characteristics	References
Rail support bracket	NSYFB45

Combined Support Bracket

- Allows the installation of a DIN rail and an earthing strip on different planes to minimize the cable radiuses.
- Material: Zinc-coated steel
- Installation: PanelSet SFN: Directly on the structure and/or using mounting plates
Spacial SM: On the bottom adjustment rails and/or on mounting plates



NSYETF

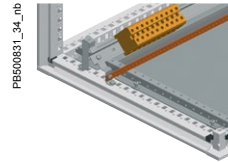

PB600031_34_nb

Supply:
Ten combined support brackets and fixing elements.
Reference by unit. Order by multiples of 10 (10, 20, 30...)

Characteristics	References
Combined support bracket	NSYETF

Terminal-Block Support Bracket

- Allow the mounting of a DIN rail.
- Tilted to 30°.
- Material: Treated steel



NSYEDCO

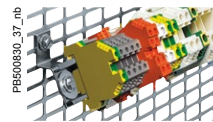

PB600830_37_nb

Supply:
Two lugs and fixings



Characteristics	References
Terminal-block support bracket	NSYEDCO

Combined Fixing Lugs for the Earthing Strip

- Allows the mounting of an earth collector rail and a DIN rail.
- Tilted to 30°.
- Earthing strip, ref. **NSYECB1M153**. See [page 278](#).



NSYEDCOC

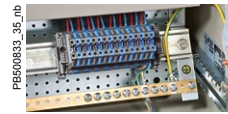

PB600833_35_nb

Supply:
Two fixing lugs and fixing elements



Characteristics	References
Combined fixing lugs for the earthing strip	NSYEDCOC

Combined Support Bracket (Vertical)

- Allow the installation of a DIN rail and an earthing strip on different planes, to minimize the cable radiuses.
- Material: Zinc-coated steel
- Installation: PanelSet SFN and Spacial SM: Directly on the vertical structure and/or using mounting plates



DZ5MS10



PB602727_68_nb

Supply:
10 brackets

Characteristics	References
Combined support bracket (vertical)	DZ5MS10

Clicked Support Plate

- For screw mounted equipment.
- For mounting on 35 mm symmetric and double profile DIN rails or Telequick mounting plate.
- Material: Zinc-plate coated



AX2DL01

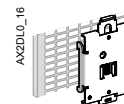

AX2DL01_16

Supply:
Ten units and fixing elements.
Reference by unit. Order by multiples of 10 (10, 20, 30...)



Characteristics	References
Clicked support plate, 44 x 65 - 9 screws	AX2DL01
Clicked support plate, 49 x 65 - 4 screws	AX2DL02

Bracket for Fixing Control Units (Ø 22)

- To mount any 22 mm diameter device directly on mounting plates.



DX1AP52

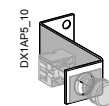

DX1AP52_10

Supply:
Ten units and fixing elements.
Reference by unit. Order by multiples of 10 (10, 20, 30...)



Characteristics	References
Bracket for fixing control units (Ø 22)	DX1AP52

Cross-Rails and Profiles for Floor-Standing Enclosures



- SM
- SMX
- SFN
- SFX
- SD

In the PanelSeT SFN and Spacial SM, SFX and SMX enclosures, it is possible to create a fixing at any point of the inner volume, providing mounting planes with different widths, heights and depths. In the case of the Spacial SM, it may be necessary to install vertical/horizontal adaptation profiles and 40-mm universal cross-rails (one row).

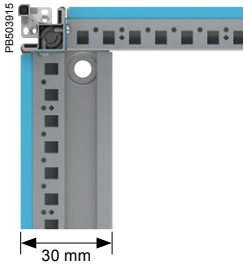

Four types of cross-rails are available to create fixing points:

- Universal cross-rails (see page 236)
- Quick-fixing cross-rails (see page 237)
- Integrated cross-rails (see page 238)
- Light cross-rails (see page 238)

Universal, quick-fixing and integrated cross-rails are available in 3 sizes:

- 40 mm (1 row)
- 65 mm (2 rows)
- 90 mm (3 rows)

Cross-rails for specific applications are also available:

- Cross-rails for heavy loads (see page 238) to be fixed on the bottom part of the enclosure or to be combined with a "heavy load kit" (see page 241) to be used at any height in the enclosure

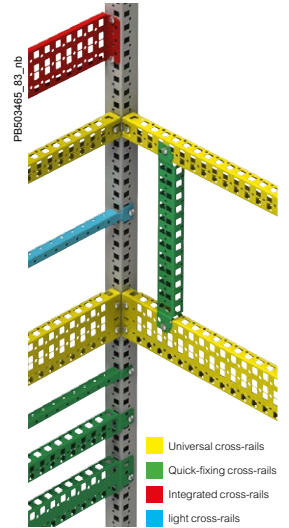
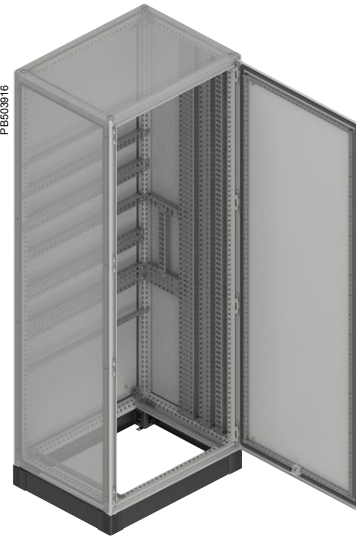
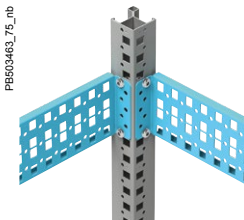

Combination Examples

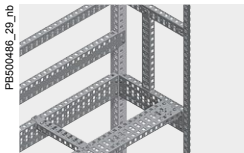

PanelSeT SFN and Spacial SFX: The cross-rails can be fixed to the structure and among each other, offering multiple options.

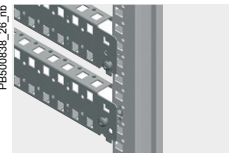

The quick-fixing cross-rails can be fixed directly to the structure, quickly and easily. PanelSeT SFN and Spacial SFX*:

- They clip onto the structure and are fixed by M6 self-tapping screws, or optionally with M6 caged nuts.

Spacial SM:

- Option of clipping onto the adaptation profile or another cross-rail.
- Fixing by means of M6 self-tapping screws.
- Fixing by means of M6 caged nuts.

* In Spacial SFX enclosures, it cannot be mounted depthwise.



Universal cross-rails and integrated cross-rails can be simultaneously mounted at the same height, on all the sides of the enclosure. To perform this type of installation in a Spacial SM enclosure, the vertical adaptation profile and the vertical 40 mm universal cross-rail (one row) are required, mounted in the back of the enclosure.

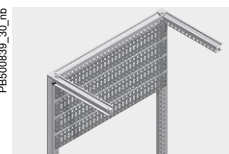

Quick-fixing cross-rails can be used to support equipments at the back of the enclosure or be fixed every 25 mm on two cross-rails (universal or integrated) in vertical position.



PanelSeT SFN: Universal cross-rails and integrated cross-rails can be mounted in vertical position.

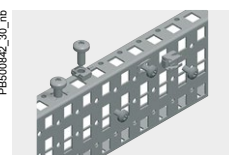

The main fixing point to the quick-fixing cross-rails is the 5.2 mm drill hole for M6 self-tapping screw, although they can also receive M6 and M8 caged nuts.

10

Cross-Rails for Floor-Standing Enclosures Accessories - Mounting

SM SMX SFN SFX SD Universal Cross-Rails

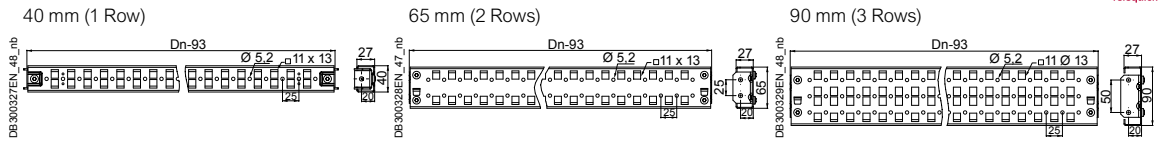

- Used for the creation of structures inside the enclosure.
- Cross-rails available in three sizes: 40 mm (one row), 65 mm (two rows) and 90 mm (three rows).
- Each row is perforated every 25 mm with a 5.2 mm diameter hole and a 11x13 mm cutout which enables fixing by means of M6 self-tapping screws, ref **NSYST30M6S**.
- Equipment is fixed by means of caged nuts or self-tapping screws.
- Material: Galvanized steel
- Thickness: 15/10^e mm

Fixing to the structure:

Fixing accordingly to uprights axis.
Option to mount cross-rails simultaneously on all sides, at the same height of the enclosure.

Comment:

- (1) For vertical assembly only.
- (2) Cross-rails only for fixing cables.
- (3) These cross-rails have not been sized to be used in the width, depth or height of the enclosure, but to be mounted in other positions or in between cross-rails.

Supply:

Two cross-rails, four supports for cross-rails and fixing elements

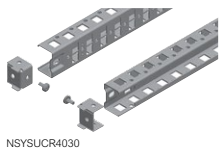

Characteristics	Width of the cross-rails (mm)	H / W / D (Dn) of enclosure (mm)	Maximum load by rail (kg)	References
Universal cross-rails	40 (1 row)	300	70	NSYSUCR4030
Universal cross-rails	40 (1 row)	400	60	NSYSUCR4040
Universal cross-rails	40 (1 row)	500	60	NSYSUCR4050
Universal cross-rails	40 (1 row)	600	50	NSYSUCR4060
Universal cross-rails	40 (1 row)	700 (3)	50	NSYSUCR4070
Universal cross-rails	40 (1 row)	800	40	NSYSUCR4080
Universal cross-rails	40 (1 row)	900 (3)	40	NSYSUCR4090
Universal cross-rails	40 (1 row)	1000	30	NSYSUCR40100
Universal cross-rails	40 (1 row)	1100 (3)	30	NSYSUCR40110
Universal cross-rails	40 (1 row)	1200	20	NSYSUCR40120
Universal cross-rails	40 (1 row)	1400	(1)	NSYSUCR40140
Universal cross-rails	40 (1 row)	1600	(1)	NSYSUCR40160
Universal cross-rails	40 (1 row)	1800	(1)	NSYSUCR40180
Universal cross-rails	40 (1 row)	2000	(1)	NSYSUCR40200
Universal cross-rails	40 (1 row)	2200	(1)	NSYSUCR40220
Universal cross-rails	65 (2 rows)	300	110	NSYSUCR6530
Universal cross-rails	65 (2 rows)	400	100	NSYSUCR6540
Universal cross-rails	65 (2 rows)	500	90	NSYSUCR6550
Universal cross-rails	65 (2 rows)	600	80	NSYSUCR6560
Universal cross-rails	65 (2 rows)	800	70	NSYSUCR6580
Universal cross-rails	65 (2 rows)	1000	50	NSYSUCR65100
Universal cross-rails	65 (2 rows)	1200	50	NSYSUCR65120
Universal cross-rails	65 (2 rows)	1400	(1)	NSYSUCR65140
Universal cross-rails	65 (2 rows)	1600	(1)	NSYSUCR65160
Universal cross-rails	65 (2 rows)	1800	(1)	NSYSUCR65180
Universal cross-rails	65 (2 rows)	2000	(1)	NSYSUCR65200
Universal cross-rails	90 (3 rows)	300	130	NSYSUCR9030
Universal cross-rails	90 (3 rows)	400	120	NSYSUCR9040
Universal cross-rails	90 (3 rows)	500	120	NSYSUCR9050
Universal cross-rails	90 (3 rows)	600	110	NSYSUCR9060
Universal cross-rails	90 (3 rows)	700 (3)	110	NSYSUCR9070
Universal cross-rails	90 (3 rows)	800	100	NSYSUCR9080
Universal cross-rails	90 (3 rows)	1000	70	NSYSUCR90100
Universal cross-rails	90 (3 rows)	1200	70	NSYSUCR90120
Universal cross-rails	90 (3 rows)	1400	(1)	NSYSUCR90140
Universal cross-rails	90 (3 rows)	1600	(1)	NSYSUCR90160
Universal cross-rails	90 (3 rows)	1800	(1)	NSYSUCR90180
Universal cross-rails	90 (3 rows)	2000	(1)	NSYSUCR90200
Universal cross-rails	90 (3 rows)	2200	(1)	NSYSUCR90220

Cross-Rails for Floor-Standing Enclosures Accessories - Mounting

SM SMX SFN SFX SD Quick-Fixing Cross-Rails

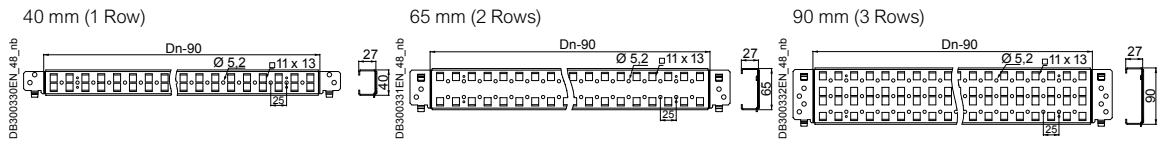

- Used for the creation of structures inside the enclosure.
- Cross-rails available in three sizes: 40 mm (one row), 65 mm (two rows) and 90 mm (three rows).
- Each row is perforated every 25 mm with a 5.2 mm diameter hole and a 11x13 mm cutout which enables fixing by means of M6 self-tapping screws, ref **NSYST30M6S**.
- Equipment are fixed by means of caged nuts or self-tapping screws.
- Material: Galvanized steel
- Thickness: 15/10^e mm

Comment:

- (1) For vertical assembly only.
- (2) Cross-rails only for fixing cables.
- (3) These cross-rails have not been sized to be used in the width, depth or height of the enclosure, but to be mounted in other positions or in between cross-rails.

Supply:

Two cross-rails and fixing elements

Fixing to the structure:

Fixing accordingly to uprights axis.

It is not possible to mount two cross-rails on one level with an upright

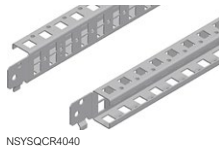

NSYSQCR4040

Characteristics	Width of the cross-rails (mm)	H / W / D (Dn) of enclosure (mm)	Maximum load by rail (kg)	References
Quick-fixing cross-rails	40 (1 row)	400	60	NSYSQCR4040
Quick-fixing cross-rails	40 (1 row)	500	60	NSYSQCR4050
Quick-fixing cross-rails	40 (1 row)	600	50	NSYSQCR4060
Quick-fixing cross-rails	40 (1 row)	800	40	NSYSQCR4080
Quick-fixing cross-rails	40 (1 row)	1000	30	NSYSQCR40100
Quick-fixing cross-rails	40 (1 row)	1200	20	NSYSQCR40120
Quick-fixing cross-rails	65 (2 rows)	400	100	NSYSQCR6540
Quick-fixing cross-rails	65 (2 rows)	500	90	NSYSQCR6550
Quick-fixing cross-rails	65 (2 rows)	600	80	NSYSQCR6560
Quick-fixing cross-rails	65 (2 rows)	800	70	NSYSQCR6580
Quick-fixing cross-rails	65 (2 rows)	1000	50	NSYSQCR65100
Quick-fixing cross-rails	65 (2 rows)	1200	50	NSYSQCR65120
Quick-fixing cross-rails	90 (3 rows)	400	120	NSYSQCR9040
Quick-fixing cross-rails	90 (3 rows)	500	120	NSYSQCR9050
Quick-fixing cross-rails	90 (3 rows)	600	110	NSYSQCR9060
Quick-fixing cross-rails	90 (3 rows)	800	100	NSYSQCR9080
Quick-fixing cross-rails	90 (3 rows)	1000	70	NSYSQCR90100
Quick-fixing cross-rails	90 (3 rows)	1200	70	NSYSQCR90120
Set of 2 quick cross-rails 120 x 400 mm	120 (4 rows)	400	120	NSYSQCR12040
Set of 2 quick cross-rails 120 x 500 mm	120 (4 rows)	500	120	NSYSQCR12050
Set of 2 quick cross-rails 120 x 600 mm	120 (4 rows)	600	110	NSYSQCR12060
Set of 2 quick cross-rails 120 x 800 mm	120 (4 rows)	800	100	NSYSQCR12080

Cross-Rails for Floor-Standing Enclosures Accessories - Mounting

Integrated Cross-Rails

- Used for the creation of structures inside the enclosure.
- Cross-rails available in three sizes: 40 mm (one row), 65 mm (two rows) and 90 mm (three rows).
- Each row is perforated every 25 mm with a 5.2 mm diameter hole and a 11x13 mm cutout which enables fixing by means of M6 self-tapping screws, ref **NSYST30M6S**.
- Equipment are fixed by means of caged nuts or self-tapping screws
- Material: Galvanized steel
- Thickness: 15/10° mm

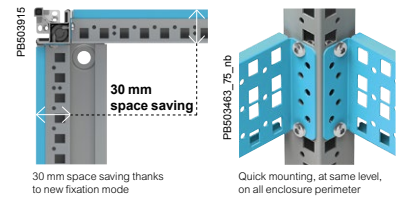

Fixing to the structure:

Fixing is shifted by 30 mm relatively to uprights axis.
Option to mount cross-rails simultaneously on all sides, at the same height of the enclosure.

Supply:

Two cross-rails and fixing elements



NSYSICR4040

Characteristics	Width of the cross-rails (mm)	H / W / D (Dn) of enclosure (mm)	Maximum load by rail (kg)	References
Integrated cross-rails	40 (1 row)	400	60	NSYSICR4040
Integrated cross-rails	40 (1 row)	500	60	NSYSICR4050
Integrated cross-rails	40 (1 row)	600	50	NSYSICR4060
Integrated cross-rails	40 (1 row)	800	40	NSYSICR4080
Integrated cross-rails	65 (2 rows)	600	80	NSYSICR6560
Integrated cross-rails	65 (2 rows)	800	70	NSYSICR6580
Integrated cross-rails	65 (2 rows)	1000	50	NSYSICR65100
Integrated cross-rails	90 (3 rows)	400	120	NSYSICR9040
Integrated cross-rails	90 (3 rows)	600	110	NSYSICR9060
Integrated cross-rails	90 (3 rows)	800	100	NSYSICR9080
Integrated cross-rails	90 (3 rows)	1000	70	NSYSICR90100

SM SFN SFX Light Cross-Rails

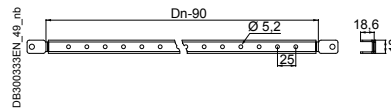

- **PanelSet SFN and Spacial SFX:** Direct fixing to the structure or between cross-rails.
- **Spacial SM:** Fixing by means of adaptation profiles and 40 mm universal cross-rails (one row), or between cross-rails in any other position.
- Adjustable with a pitch of 25 mm.
- The light cross-rails are equipped with a row of drill holes with a diameter of 5.2 mm and a pitch of 25 mm, which allows fixing with an M6 self-tapping screw, ref. **NSYST30M6S**.
- Material: Galvanized steel

Supply:

Two light cross-rails and fixing elements



NSYSLCR40

Characteristics	Width/Depth (mm)	References
PanelSet SFN and Spacial SFX/SM Light cross-rails	400	NSYSLCR40
PanelSet SFN and Spacial SFX/SM Light cross-rails	500	NSYSLCR50
PanelSet SFN and Spacial SFX/SM Light cross-rails	600	NSYSLCR60
PanelSet SFN and Spacial SFX/SM Light cross-rails	800	NSYSLCR80

SFN Rails for Heavy Loads

- They can be mounted with a cable gland plate or with a previously mounted mounting plate.
- Laterally adjustable with a pitch of 25 mm.
- Elongated holes, for adjusting the center-to-center distance of the switchgear.
- Fixing to the structure: Directly fixed on the bottom frame of the enclosure
- Thickness: 30/10° mm
- Material: Galvanized steel



Supply:

Two rails for heavy loads and fixing elements



NSYHLCR40

Characteristics	Maximum load (kg)	Depth (mm)	References
Rail for heavy loads	575	400	NSYHLCR40
Rail for heavy loads	525	500	NSYHLCR50
Rail for heavy loads	500	600	NSYHLCR60
Rail for heavy loads	475	800	NSYHLCR80

SM Vertical Adaptation Profiles



NSYSMVR12

- The vertical adaptation profiles provide fixing points at the entrance to the enclosure.
- Fixing on the screws of the hinge and catches of the lock.
- Allows the depthwise fixing of cross-rails, etc.
- Thickness: 15/10^e mm
- Material: Galvanized steel

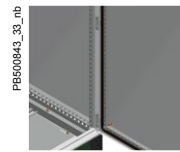

PB600845_30_nb

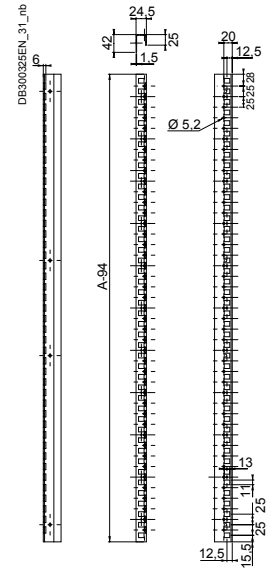

Supply:
2 vertical adaptation profiles and fixing screws

Characteristics	Height (mm)	References
Vertical adaptation profiles	1200	NSYSMVR12
Vertical adaptation profiles	1400	NSYSMVR14
Vertical adaptation profiles	1600	NSYSMVR16
Vertical adaptation profiles	1800	NSYSMVR18
Vertical adaptation profiles	2000	NSYSMVR20

SM Horizontal Adaptation Profiles



NSYSMHR6

- The horizontal adaptation profiles provide fixing points at the entrance to the enclosure.
- Thickness: 15/10^e mm
- Material: Galvanized steel

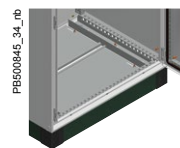

PB600845_34_nb

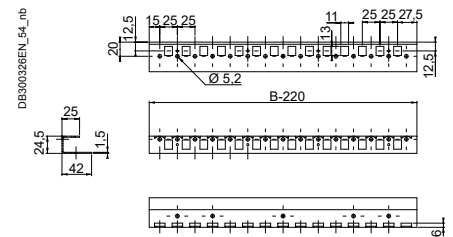

Supply:
2 horizontal adaptation profiles and fixing screws

Characteristics	Width (mm)	References
Horizontal adaptation profiles	600	NSYSMHR6
Horizontal adaptation profiles	800	NSYSMHR8
Horizontal adaptation profiles	1000	NSYSMHR10
Horizontal adaptation profiles	1200	NSYSMHR12
Horizontal adaptation profiles	1600	NSYSMHR16

SM SFN Fixed Tray

- Provided with cut-outs for improving air circulation inside.
- Material: Steel
- Finish: Painted with epoxy polyester resin
- Color: RAL 7035 gray
- Maximum load: 150 kg direct fixed to the structure, 40 kg when universal cross-rails are used

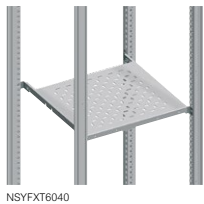

Options for fixing the tray to the enclosure:

- If the tray has the same dimensions as the enclosure:
- PanelSeT SFN: Direct fixing to the structure.
 - Spacial SFX: Installation possible only with universal cross-rails, see [page 236](#).
 - Spacial SM: Fixing by means of adaptation profiles and 40 mm universal cross-rails (1 row) in vertical position.
- If the tray is smaller than the dimensions of the enclosure:
- Fixing on depth cross-rails.
 - Depth-adjustable tray with a pitch of 25 mm.

Supply:
1 fixed tray and fixing elements

Characteristics	Width (mm)	Depth (mm)	References
Fixed tray	600	400	NSYFXT6040
Fixed tray	800	400	NSYFXT8040
Fixed tray	600	500	NSYFXT6050
Fixed tray	800	500	NSYFXT8050
Fixed tray	600	600	NSYFXT6060
Fixed tray	800	600	NSYFXT8060
Fixed tray	800	800	NSYFXT8080

SM SFN Telescopic Rails

- Mechanical stop of the rails in open and closed position.
- Material: Galvanized steel
- Finish: Painted with epoxy polyester resin
- Maximum load: 25 kg evenly distributed



Options for fixing the tray to the enclosure:

- PanelSeT SFN: Installation directly on the structure of the enclosure or on universal cross-rails.
- Spacial SFX: Installation possible only with universal cross-rails, see [page 236](#).
- Spacial SM: Installation by means of adaptation profiles and 40 mm universal cross-rails (1 row) in vertical position, or on horizontal universal cross-rails.

The installation of a telescopic tray consists of the following:

- 1 fixed tray.
- 2 telescopic rails.

Supply:
2 telescopic rails and fixing elements

Characteristics	Width (mm)	Depth (mm)	References
Telescopic rails	600/800	400	NSYTTG40
Telescopic rails	600/800	500	NSYTTG50
Telescopic rails	600/800	600/800	NSYTTG60

10

Handle for Telescopic Trays

- Designed for easy extraction of the sliding trays.
- Material: Polyamide 6 (black).



Supply:
2 units and fixing elements

Characteristics	References
Handle for telescopic trays	NSY1TH

SM SMX SFN SFX Tray Cross-Rails

- Allow the installation of fixed trays and telescopic rails.
Quick and universal cross-rails, see [page 236 - 237](#)

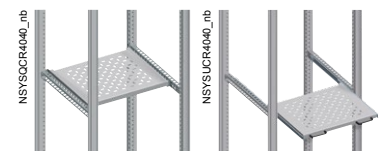
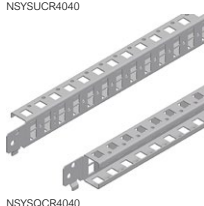
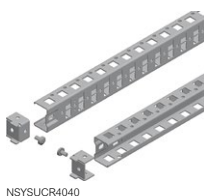

Characteristics	Depth (mm)	References
Tray cross-rails, Universal cross-rail, 40 mm (1 row)	400	NSYSUCR4040
Tray cross-rails, Universal cross-rail, 40 mm (1 row)	500	NSYSUCR4050
Tray cross-rails, Universal cross-rail, 40 mm (1 row)	600	NSYSUCR4060
Tray cross-rails, Universal cross-rail, 40 mm (1 row)	800	NSYSUCR4080
Tray cross-rails, Quick-fixing cross-rail, 40 mm (1 row)	400	NSYSQCR4040
Tray cross-rails, Quick-fixing cross-rail, 40 mm (1 row)	500	NSYSQCR4050
Tray cross-rails, Quick-fixing cross-rail, 40 mm (1 row)	600	NSYSQCR4060
Tray cross-rails, Quick-fixing cross-rail, 40 mm (1 row)	800	NSYSQCR4080

SFN Ventilated Shelf

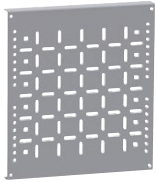

NSYDHLT8080

- Airing is ensured by two cut-out sizes: 11 x 13 mm rectangles for fixation on both sides with self-tapping screws, 40 x 8.5 mm rectangles.
- The ventilated shelf must be fixed in the enclosure with a heavy load kit.
- Material: Steel
- Color: RAL 7035 gray
- Maximum load: 350 kg



PB603486_42_nb

Supply:
1 tray and fixing elements

Characteristics	Tray dimensions W x D x H (mm)	Width (mm)	Depth (mm)	References
Ventilated shelf	700 x 759 x 50	800	800	NSYDHLT8080

SFN Heavy Load Cross-Rails

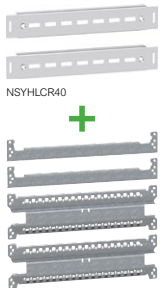

NSYHLCR40

NSYSHLT6040

- Can be fixed anywhere in the enclosure with a heavy load kit.
- Free space useful for thermal management.
- Nominal width of cross-rails must be 100 mm shorter than the associated heavy load kit width.
- Material: Galvanized steel

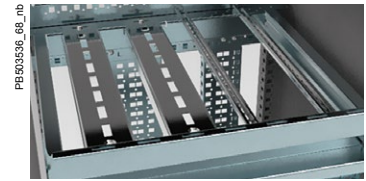

PB603536_68_nb

Supply:
2 cross-rails and fixing elements

Characteristics	Associated heavy load kit references	Maximum load (kg)	Nominal width (mm)	References
Heavy load cross-rails	Not usable with heavy load kit	575	400	NSYHLCR40
Heavy load cross-rails	NSYSHLT6040 NSYSHLT6060 NSYSHLT6080	525	500	NSYHLCR50
Heavy load cross-rails	Not usable with heavy load kit	500	600	NSYHLCR60
Heavy load cross-rails	Not usable with heavy load kit	475	800	NSYHLCR80

Heavy Load Supports

PB603918



Combination Examples

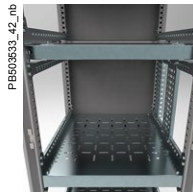

PB603533_42_nb

- Heavy Load Kit + Ventilated Shelf

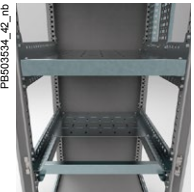

PB603534_42_nb

- Heavy Load Kit + Partially Ventilated Shelf



PB603535_42_nb

- Heavy Load Kit + Plain Shelf For Battery



PB603536_68_nb

- Heavy Load Kit + Heavy Load Cross-Rails

S3D S3X PLM Symmetric Mounting Rail for the Wall-Mounted Enclosures



- 2 types: Type A: 35 x 15 mm, Type B: 35 x 7.5 mm
- Material: Zinc-coated steel
- Standards: DIN 715
- Thickness: Type A: 15/10^e mm, Type B: 10/10^e mm
- Fixing: Fixed to mounting plates or another fixing elements, uprights not included in the supply

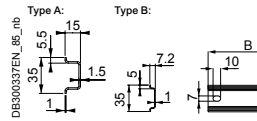

Supply:
10 rails and fixings for direct assembling to the structure. References by unit. Order by multiples of 10 units(10, 20, etc.)



NSYSDR30B

Characteristics	Type	Enclosure width (mm)	Rail length (mm)	References
Symmetric mounting rail for the wall-mounted enclosures	B	300	250	NSYSDR30B
Symmetric mounting rail for the wall-mounted enclosures	B	400	350	NSYSDR40B
Symmetric mounting rail for the wall-mounted enclosures	A	500	450	NSYSDR50A
Symmetric mounting rail for the wall-mounted enclosures	A	600	550	NSYSDR60A
Symmetric mounting rail for the wall-mounted enclosures	A	800	750	NSYSDR80A
Symmetric mounting rail for the wall-mounted enclosures	A	1000	950	NSYSDR100A

Serrated C-Shaped Rail for Heavy Loads

- Marked in steps of 25 mm to facilitate switchgear positioning.
- Material: Zinc-coated steel
- Thickness: 20/10^e mm

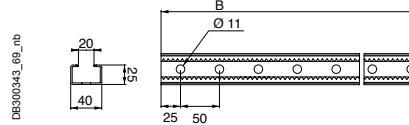

Supply:
2 rails with a length of 2 m



AM1EC200

Characteristics	Rail length (mm)	References
Serrated C-shaped rail for heavy loads	2000	AM1EC200

Symmetric C-Shaped Rails

- Rails for supporting and fixing switchgear on panels and enclosures, formation of chassis, racks and panel reinforcements.
- Material: Galvanized steel
- Fixing: They are fixed to the structure and to one another by means of fixing elements

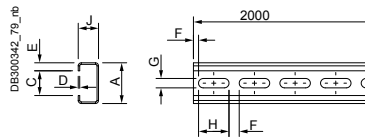

Supply:
References by unit. Order by multiples of 10 units(10, 20, etc.)



NSYCN20

Characteristics	Dimensions (mm)								Rail length (mm)	References
	A	J	C	D	E	F	G	H		
Symmetric C-shaped rails 21x11x10, not perforated	21	11	10	1.5	5.5	-	-	-	2000	NSYCN20
Symmetric C-shaped rails 21x11x10, perforated	21	11	10	1.5	5.5	5	6.2	15	2000	NSYCN20
Symmetric C-shaped rails 40x20x24, not perforated	40	20	24	1.5	8	-	-	-	2000	NSYCN40
Symmetric C-shaped rails 40x20x24, perforated	40	20	24	1.5	8	10	8.5	30	2000	NSYCN40

Combiplas Nut for Symmetric C-Shaped Rails



NSYBN206

Characteristics	Rail type	Nuts type	Supply	References
Combiplas nut for symmetric C-shaped rails	C20	M4	100	NSYBN204
Combiplas nut for symmetric C-shaped rails	C20	M6	100	NSYBN206
Combiplas nut for symmetric C-shaped rails	C40	M4	50	NSYBN404
Combiplas nut for symmetric C-shaped rails	C40	M6	50	NSYBN406
Combiplas nut for symmetric C-shaped rails	C40	M8	50	NSYBN408
Combiplas nut for symmetric C-shaped rails	C60	M6	20	NSYBN606

Metal Sliding Nut for Symmetric C-Shaped Rails



NSYB406

Characteristics	Rail type	Nuts type	Supply	References
Metal sliding nut for symmetric C-shaped rails	C40	M6	-	NSYB406

Symmetric Rails

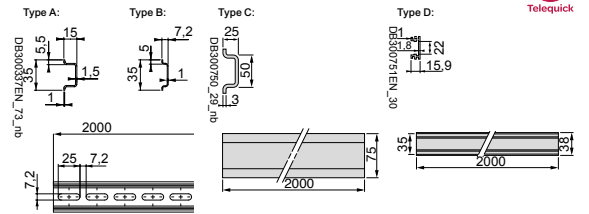

- Material: Galvanized steel, zinc-coated steel or aluminum
- Length: 2000 mm



NSYSDR200D

Characteristics	Type	Order by Multiples	Perforations	References
Symmetric rail, Galvanized steel	A	10	Perforated	NSYSDR200D
Symmetric rail, Galvanized steel	B	10	Perforated	NSYSDR200BD
Symmetric rail, Galvanized steel	A	10	Not perforated	NSYSDR200
Symmetric rail, Galvanized steel	B	10	Not perforated	NSYSDR200B
Symmetric rail, Zinc-coated steel	C	6	Not perforated	AM1DL201
Symmetric rail, Aluminum	D	10	Not perforated	AM1EA200

Asymmetric DIN Rails

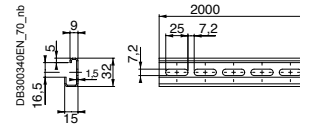

- Material: Galvanized steel
- Length: 2000 mm



NSYADR200D

Supply:
10 rails with a length of 2 m.
References by unit. Order by multiples of 10 units (10, 20, etc.)

Characteristics	Perforations	References
Asymmetric DIN rail	Perforated	NSYADR200D
Asymmetric DIN rail	Not perforated	NSYADR200

Double-Profile DIN Rails

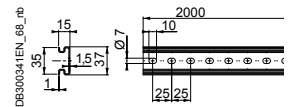

- Material: Galvanized steel
- Length: 2000 mm



NSYDPR200D

Supply:
10 rails with a length of 2 m.
References by unit. Order by multiples of 10 units (10, 20, etc.)
ref. **NSYDPR200T** multiples 20

Characteristics	Thickness (mm)	Perforations	Order by Multiples	References
Double-profile DIN rail	15/10°	Perforated	10	NSYDPR200D
Double-profile DIN rail	10/10°	Perforated	20	NSYDPR200T
Double-profile DIN rail	15/10°	Not perforated	10	NSYDPR200



Nuts for Symmetric Rails



AF1GC4

- Clip-on nut.

Characteristics	Type	References
Nuts for symmetric rails	M4	AF1GC4
Nuts for symmetric rails	M5	AF1GC5
Nuts for symmetric rails	M6	AF1GC6

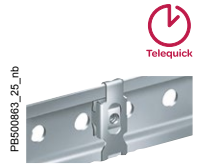

PB5C0983_25_nb

Supply:
100 nuts

Nuts for Asymmetric DIN Rails, 2000 mm Version



DZ5ME5

- Quarter-turn sliding nut.

Characteristics	Type	References
Nuts for asymmetric DIN rails, 2000 mm version	M4	DZ5ME5
Nuts for asymmetric DIN rails, 2000 mm version	M5	DZ5ME8
Nuts for asymmetric DIN rails, 2000 mm version	M6	DZ5ME9

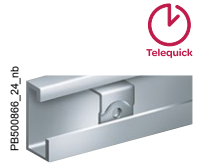

PB5C0986_24_nb

Supply:
100 nuts

Nuts for Double-Profile DIN Rails



AF1CF34

- Quarter-turn sliding nut.

Characteristics	Type	References
Nuts for double-profile DIN rails	M3 + M4	AF1CF34
Nuts for double-profile DIN rails	M5 + M6	AF1CF56

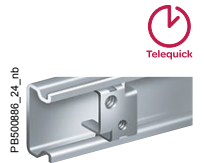

PB5C0986_24_nb

Supply:
100 nuts

10

Nuts for Serrated C-Shaped Rails



NSYSNM6

- Quarter-turn sliding nuts.

Characteristics	Type	References
M6 quarter-turn sliding nut	M6	NSYSNM6
M8 quarter-turn sliding nut	M8	NSYSNM8
M6 quarter-turn serrated sliding nut	M6	NSYSNSM6
M8 quarter-turn serrated sliding nut	M8	NSYSNSM8

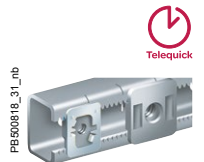

PB5X0818_31_nb

Supply:
10 nuts



NSYSNSM6

Connectors for Symmetric C-Shaped Rails Accessories - Mounting

- The connectors enable the formation of chassis or frames and structures for fixing switchgear, in any position inside the enclosures, allowing the fixing of DIN rails or other elements.
- See symmetric C-shaped rails.

EVA Connectors



NSYEVA20

- To join two symmetric C-shaped rails, C20 and C40 types, forming an overlapping assembly with plane change, or also at right angles for the formation of spacers or supports at a different level.
- Material: Zinc-coated steel

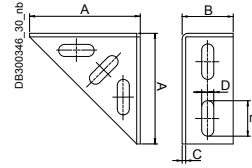

Supply:
20 units. References by unit. Order by multiples of 20 units (20, 40, 60, etc.)

Characteristics	Dimensions (mm)					References
	A	B	C	D	E	
EVA connectors	43	19	2	6.2	15	NSYEVA20

EN Connectors



NSYEN20

- To create L-shaped assemblies with plane change in the symmetric C-shaped rails, between them or with any other section.
- Material: Zinc-coated steel

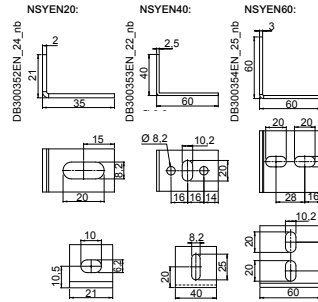

Supply:
20 units. References by unit. Order by multiples of 20 units (20, 40, 60, etc.)

Characteristics	References
EN connectors	NSYEN20
EN connectors	NSYEN40

Examples



Combinations with connectors for symmetric C-shaped rails

Spacers

Hexagonal Spacers

- Hexagonal spacers for raising switchgear, mounting plates, etc. They can be linked to achieve variable heights with gradual elevation.
- Their assembly requires M6 or M8 caged nuts.
- Material: Zinc-coated steel
- Installation: If used to raise a mounting plate, the maximum load of the mounting plate is decreased

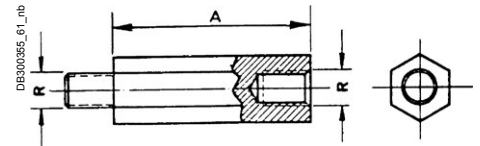

Supply:
100 hexagonal connectors.
References by unit.
Order by multiples of 100 units (100, 200, 300, etc.)



10

Characteristics	Thread type	Spacer height (mm)	References
Hexagonal spacers	M5	10	NSYE1025
Hexagonal spacers	M5	15	NSYE1525
Hexagonal spacers	M5	20	NSYE2025
Hexagonal spacers	M6	10	NSYEX106
Hexagonal spacers	M6	14	NSYEX146
Hexagonal spacers	M6	16	NSYEX166
Hexagonal spacers	M6	20	NSYEX206
Hexagonal spacers	M6	30	NSYEX306
Hexagonal spacers	M6	40	NSYEX406
Hexagonal spacers	M6	50	NSYEX506
Hexagonal spacers	M6	100	NSYEX1006
Hexagonal spacers	M8	15	NSYEX158
Hexagonal spacers	M8	20	NSYEX208
Hexagonal spacers	M8	30	NSYEX308
Hexagonal spacers	M8	40	NSYEX408
Hexagonal spacers	M8	50	NSYEX508
Hexagonal spacers	M8	60	NSYEX608
Hexagonal spacers	M8	100	NSYEX1008

S3D S3X 19" Fixed Chassis for Wall-Mounted Enclosure

- 19" fixed chassis comprising 2 19" uprights with fixing.
- Adjustable in depth by fixing on the step slides available as accessory.
- Material: Galvanized steel
- Thickness: 20/10° mm
- Maximum load: 3 kg per unit



Characteristics	Enclosure dimensions (mm)		Unit number	References
	Height	Width		
19" fixed chassis for wall-mounted enclosure	400	600	8	NSYVDM8UF
19" fixed chassis for wall-mounted enclosure	600	600	12	NSYVDM12UF
19" fixed chassis for wall-mounted enclosure	800	600	17	NSYVDM17UF
19" fixed chassis for wall-mounted enclosure	1000	600	21	NSYVDM21UF

S3D S3X 19" Swing Chassis for Wall-Mounted Enclosure

- 19" swing chassis opening to 120° with locking system by 3-mm double-bar insert.
- Material: Steel
- Finish: Structured finish, epoxy polyester powder
- Color: RAL 7035 gray
- Maximum load: 3 kg per unit



Characteristics	Enclosure dimensions (mm)		Unit number	References
	Height	Width		
19" swing chassis for wall-mounted enclosure	600	600	11	NSYVDM11UP
19" swing chassis for wall-mounted enclosure	800	600	16	NSYVDM16UP
19" swing chassis for wall-mounted enclosure	1000	600	20	NSYVDM20UP
19" swing chassis for wall-mounted enclosure	1000	800	20	NSYVDM20U8P
19" swing chassis for wall-mounted enclosure	1200	800	25	NSYVDM25U8P

Fixings for 19" Rack

- They allow 19" accessories to be mounted.
- Caged nut compatible with 8.5 x 8.5 mm and 9.5 x 9.5 mm holes.



Characteristics	Set of	References
M6 screws + washers + nuts 8,5 mm	30	NSYGFR95M63
M6 x 16 screws and washers	50	NSYGFR166P
M6 caged nuts 9,5 mm	100	NSYCN9M625
M6 screws + washers + nuts 9,5 mm	50	NSYGFR95M65
M5 screws + washers + nuts 9,5 mm	50	NSYGFR95M55
M6 12 mm	50	NSYGFR12M65









Nuts and Screws Overview

Characteristics		Clip-on nuts	Combiplas slide nuts				Screws with captive washer				
											
Usage		For Telequick mounting plates	C - shaped rail - 20/40/60 mm				All nuts				
											
Type	Supply	References	Rail type	Supply	References	Supply	References	Models	Supply	References	
M3	100	AF1EA3	-	-	-	-	-	-	-	-	
M4	100	AF1EA4	C20	100	NSYBN204	-	-	M4 x 10 mm	100	AF1VA410	
M4	100	AF1EA4	C40	100	NSYBN404	-	-	M4 x 16 mm	100	AF1VA416	
M5	100	AF1EA5	-	-	-	-	-	M5 x 12 mm	100	AF1VA512	
M5	100	AF1EA5	-	-	-	-	-	M5 x 18 mm	100	AF1VA518	
M6	100	AF1EA6	C20	100	NSYBN206	-	-	M6 x 12 mm	100	AF1VA612	
M6	100	AF1EA6	C40	100	NSYBN406	-	-	M6 x 18 mm	100	AF1VA618	
M6	100	AF1EA6	-	-	-	100	NSYB406	-	-	-	
M8	-	-	C40	100	NSYBN408	-	-	M8 x 20 mm	100	AF1VC820	

Supply:

References by unit. Order by multiples of the units specified in the supply.



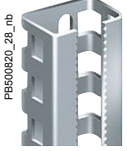
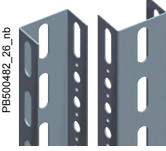



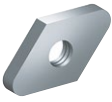

10

Characteristics		Fixings and nuts for serrated uprights				Nuts for uprights and cross-rails				
										
Usage		2 x serrated mounting uprights for floor-standing enclosures								
										
Type	Supply	References	Supply	References	References	Supply	References	Supply	References	
M4	4	NSYMF8	-	-	-	-	-	-	-	
M5	-	-	-	-	-	-	-	-	-	
M6	-	-	10	NSYSNM6	NSYSNSM6	50	NSYCNM6	50	NSYCNFM6	
M8	-	-	10	NSYSNM8	NSYSNSM8	50	NSYCNM8	50	NSYCNFM8	
-	-	-	-	-	-	-	-	-	-	
-	-	-	-	-	-	-	-	-	-	

Supply:







References by unit. Order by multiples of the units specified in the supply.

Torx screws			Self-tapping screw			Fixings and nuts for aluminum uprights				
										
Nuts and 6 mm Spacial enclosures holes						Mounting uprights for wall-mounted enclosures				
										
Models	Supply	References	Models	Supply	References	Supply	References	Supply	References	Type
-	-	-	-	-	-	-	-	4	NSYAMCSF	M3
-	-	-	-	-	-	100	NSYNM4	-	-	M4
-	-	-	-	-	-	-	-	-	-	M4
-	-	-	M5 x 13 mm	100	NSYS13M5HS	100	NSYNM5	-	-	M5
-	-	-	M5 x 16 mm	100	NSYS16M5HS	-	-	-	-	M5
T30 M6 x 16 mm	100	NSYST30M6	M6 x 16 mm	100	NSYS16M6HS	100	NSYNM6	-	-	M6
T30 M6 x 12 mm self-tapping	100	NSYST30M6S	-	-	-	-	-	-	-	M6
-	-	-	-	-	-	-	-	-	-	M6
T40 M8 x 16 mm	100	NSYST40M8	-	-	-	-	-	-	-	M8

Flat nuts for standard uprights		Clip nut for symmetric DIN rail		Quarter turn nut for double profile DIN rail		Quarter turn nut for asymmetric DIN rail			
									
2 x standard mounting uprights for floor-standing enclosures		35 x 15 mm symmetric DIN rail		35 mm double profile DIN rail		35 mm asymmetric DIN rail			
									
Supply	References	Supply	References	Models	Supply	References	Supply	References	Type
-	-	100	AF1CG4	-	-	-	100	DZ5ME5	M4
-	-	100	AF1CG5	-	-	-	100	DZ5ME8	M5
50	NSYFNM6	100	AF1CG6	-	-	-	100	DZ5ME9	M6
50	NSYFNM8	-	-	-	-	-	-	-	M8
-	-	-	-	M3 + M4	100	AF1CF34	-	-	-
-	-	-	-	M5 + M6	100	AF1CF56	-	-	-

10

• For details enter the reference into the search engine of www.se.com



Characteristics	FlexiCable	Multi-A	Multi-C	Multi-R	Multi-CS	Multi-T
						
	Full membrane cable gland plate	FL21 type membranes	Circular connector-free entries	Rectangular connector-free entries	Modular entry allowing the passing of up to 48 pre-assembled cables	FL21-type membranes
Material	HCE for membrane. Steel for frame	TPE, SBS, SEBS and PP co-polymer - halogen-free	Polyamide	Polyamide	Reinforced polypropylene and TPE. halogen-free	TPE
Color	Frame: RAL 7035 gray	RAL 7035 gray	-	-	Black	RAL 7035 gray
Cable entry material	Soft membrane	Combined	Soft membrane			
Cable glands to be fitted	No	Optional: Specific cable clamp ref. NSYAECPLACA●● to be used	No	No	No	No
Installation options	Replaces cable gland plate (S3D) or directly on enclosure	On cable gland plate adapter or directly on enclosure	On modified cable gland plate or directly on enclosure	On cable gland plate with special cut-out or directly on enclosure	On cable gland plate adapter or directly on enclosure	
Flexibility of the installation	Full	Medium	Medium	Medium	Full	Medium
Reversibility	Medium	Medium	Full	Full	Full	Medium
Ingress protection rating	IP55 according to IEC 60529	IP65 according to IEC 60529	IP65 according to IEC 60529	IP65 according to IEC 60529	IP65 according to IEC 60529	IP66 according to IEC 60529*
Cable retention	Low	High with cable clamp, (up to 18 daN)	Medium	Medium	Medium	Low
Cable diameter (mm)	Up to 26	From 16 to 30	From 3 to 15.9	From 4.3 to 15.9	Up to 22	From 5 to 60
Cable Installation time	Fast	Medium	Fast	Fast	Fast	Fast
Quantity of cables to be fitted for a given surface	+++	++	++	++	+++	++
Cable entries for cables with connectors	No	No	No	No	Yes	No
Cut-out dimensions (mm)	178 x 63 to 478 x 63	214 x 90 (FL21)	Ø 50.5 Ø 63.5	112 x 36	112 x 36	214 x 90 (FL21)
External dimensions (mm)	245 x 130 to 545 x 130 or 495 x 220	216 x 84	Ø 58 Ø 71	146 x 14 x 58	148 x 58 x 15 148 x 58 x 18	214 x 88
Certificates	Tested on short-circuit effect 250 A, 25 kA following IEC 61439-1	Cable anchorage pull test: EN 50262. Long term UV- resistance: ASTM G 154-06	UL recognized (UsR)	UL recognized (UsR)	-	-
Fire resistance	650 °C	750 °C	650 °C	650 °C	-	650 °C
Temperature range	-	-40 °C to +85 °C	-	-	-30 °C to +100 °C	-40 °C to +100 °C
References	See page 258 NSYTL●●●	See page 258 NSYAECPLA●●	See page 258 NSYTSAM●●●●●	See page 259 NSYSA24●●●●●	See page 260 NSYDCD24●●	See page 259 NSYAECPL●●●●●

10

* IP65 for **NSYAECPLBP**.

Technical changes reserved. Information provided without guarantee. Images are for illustrative purposes only.

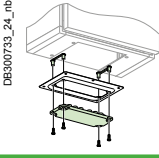

• For further information please have a look on the next page

Characteristics	PrismaSeT	Multi-H
	 <p>DE300723_24_10</p>	 <p>PE500944_17_10</p>
	FL21 or rectangular	FL21 insulated flange with ISO knock-outs
Material	Insulated material	Polycarbonate glass-fiber reinforced
Color	RAL 9003	RAL 7035 gray
Cable entry material	Soft membrane	
Cable glands to be fitted	No	Yes
Installation options	On cable gland plate adapter or directly on enclosure	
Flexibility of the installation	Medium	Low
Reversibility	Medium	Medium
Ingress protection rating	IP55 according to IEC 60529	IP65 according to IEC 60529
Cable retention	Low	High (with cable clamp)
Cable diameter (m)	From 28 to 60 (FL21) From 7 to 72 (rectangular)	From 12 to 25
Cable Installation time	Fast	Slow
Quantity of cables to be fitted for a given surface	++	++
Cable entries for cables with connectors	No	No
Cut-out dimensions (mm)	214 x 90 (FL21)	214 x 90 (FL21)
External dimensions (mm)	216 x 84	215 x 85
Certificates	-	-
Flame resistance	-	750 °C
Temperature range	-	<ul style="list-style-type: none"> • For normal operation: -40 °C to +80 °C • For a short time: -40 °C to +120 °C
References	See page 261 LVS088●●	See page 260 NSYTSAKFL





• For details enter the reference into the search engine of www.se.com

Characteristics	Simple-1	Simple-2	Simple-3	Simple-5
				
	Mixed membrane entries for enclosure thickness 20/10° - 32/10° mm.	PVC adjustable cone-shaped entries for enclosure thickness 30/10° - 32/10° mm.	Quick cable entries for enclosure thickness 10/10° - 40/10° mm (5/10° - 20/10° mm for ref. IMT36179).	ISO cable gland.
Material	SBS	PVC	EPDM plastic	PA6 Polyamide, neoprene gasket
Color	RAL 7035 gray or RAL 9010 white	-	Gray cable entries: NCS 5500 Black cable entries: NCS 9000	RAL 7035 gray
Cable entry material	Soft membrane		Combined	
Cable glands to be fitted	Not applicable			
Installation options	On cable gland plate or directly on enclosure			
Flexibility of the installation	Low			
Reversibility	Medium			
Ingress protection rating	IP55 according to IEC 60529	IP55 according to IEC 60529	IP67 according to IEC 60529	IP66 o IP68-5BARS TYPE 4X (cULus) UL50E
Cable retention	Low	Low	Medium	High
Cable diameter (mm)	From 20 to 40	From 5 to 87	From 12 to 50	From 12 to 40
Cable Installation time	Fast	Fast	Fast	Slow
Quantity of cables to be fitted for a given surface	+	+	+	+
Cable entries for cables with connectors	No	No	No	No
Cut-out dimensions (mm)	Various circular hole diameters according to cable diameter			
External dimensions (mm)	From Ø 23 to 44	From Ø 25 to 98	From Ø 12.5 to 50.7	From Ø 15 to 46
Certificates	-	-	-	-
Standard	-	-	-	Compliance with UL
Flame resistance	750 °C	-	750 °C	750 °C
References	See page 262 IMT36●●●/ISM71●●●	See page 262 NSYECPC●●	See page 262 IMT361●●	See page 262 ISM71●●●

10

Characteristics	Synthetic snap-in cable gland	Stainless-steel cable gland with lamellar insert
		
	Without thread. Easy assembly and disassembly. Suitable for walls from 0.5 to 4 mm thick.	Lamellar technology provides excellent resistance to traction as well as excellent torsional protection. For outdoor use, or for aggressive environments.
Material	PA6 Polyamide, neoprene gasket	Stainless-steel AISI 304L or AISI 316L, neoprene gasket
Color	RAL 7035 gray, RAL 7001, RAL 9005. Other colors on demand	-
Cable entry material	Non armoured	Non armoured
Installation options	On cable gland plate or directly on enclosure	
Flexibility of the installation	Low	
Reversibility	Medium	
Ingress protection rating	IP68	IP68
Cable retention	High	High
Cable diameter (mm)	From 16 to 40	From 12 to 40
Cable Installation time	Slow	Slow
Quantity of cables to be fitted for a given surface	+	+
Cable entries for cables with connectors	No	No
Thread type	Metric EN 60423, other types are available on demand	Metric EN 60423
Cut-out dimensions (mm)	Various circular hole diameters according to cable diameter	
External dimensions (mm)	From Ø 22 to 46	From Ø 14 to 43
Certificates	UL recognized (cURus). Rated Type 4X according UL50E	UL recognized (cURus). Rated Type 4X according UL50E
Standard	DIN EN 62444, UL 514B, UL 514B§8.26.7	DIN EN 62444, UL 514
Temperature range	-20 °C to + 100 °C	-20 °C to + 100 °C
References	See page 263, NSYCGSP●●	See page 263 NSYCGX●●●

Technical changes reserved. Information provided without guarantee. Images are for illustrative purposes only.

Characteristics	Multi-cable disc	Cable gland gasket	Blanking plug	Transport plug	
	 <p>IMT36157</p>	 <p>IMT36151</p>	 <p>PB650265_25_nb</p>	 <p>PB650070_19_nb</p>	
	The multi-cable bushing permits several cables to be passed through a single cable gland.		It is screwed into the cable gland's plate.	It is installed to block the cable gland during transport or during maintenance operations.	
Material	EDPM rubber	EDPM rubber	PA6	PA6	
Color	Black	Black	RAL 7035 gray	Black	
Ingress protection rating	-	IP68	-	-	
Standards	-	-	-	-	
Other characteristics	-	-	-	-	
Supply	Set of 40 (M16 and M20), 20 (M25 and M32)	Set of 100 (M12 to M20), 50 (M25 and M32), 25 (M40)	Pack of 40 plugs (M12 to M20), 20 plugs (M25 and M32), 10 plugs (M40)	Pack of 40 plugs (M16 to M20), pack of 20 (M25 and M32), pack of 10 (M40)	
Ø	Number / Ø (mm)	References	References	References	
M12	-	-	IMT36151	IMT36161	-
M16	-	-	IMT36152	IMT36162	IMT36167
M20	3 x Ø 4	IMT36158	IMT36153	IMT36163	IMT36168
M25	-	-	IMT36154	IMT36164	IMT36169
M32	-	-	IMT36155	-	-

Key Features When Selecting a Cable Entry (1/4)

1



Multiple

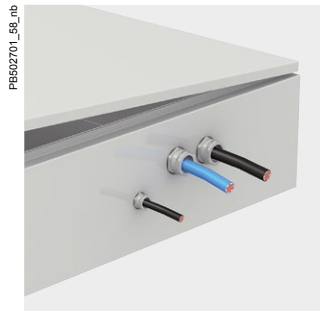

Single

Multiple Cable Entries or Single Cable Entries?

- This choice depends on the number of cables going through the cable entry: Generally, for 3 or more cables, choose a multiple cable entry. This will make your installation faster and more economical.
- In other words, your final costs will not necessarily be lower if you use single cable entry!
- Flexibility of installation: For high flexibility, multiple cable entry is the right choice.

2

Cable Entry Material

- **Soft membranes** allow cables to be easily pushed through, but still offer a good IP rating and protection from moisture and physical intrusion. Cable retention force, however, is lower than with other alternatives.



Push the Membrane into a Standard Hole



Make a Small Hole in the Membrane

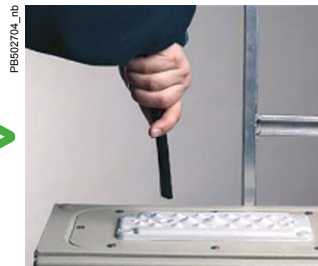

Push the Cable or Tube through the Guide Hole

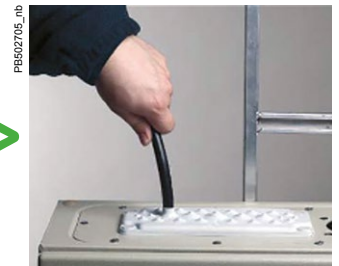

Pull the Cable or Tube Back Some 20 mm to Lock It

10

- **Hard-plastic cable entry plates** require tools to create the opening (drill or knife) but, thanks to the cable gland, they offer a very high retention force. Another use of this solution is for public places, since the hard surface prevents objects being pushed in.

- **Combined:** The material of the cable entry plate is hard-plastic, but the cable is pushed through a soft membrane. In this case you have the advantages of both soft membranes (easy and fast installation, flexibility) and hard-plastic membranes (high retention force when using specific cable clamps).

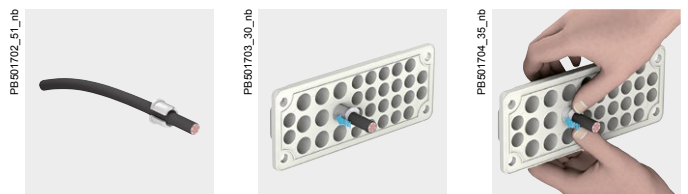

3



Cable Glands to Be Fitted

- Some multiple cable entries require a cable gland to be able to retain the cables and ensure the degree of protection

Key Features When Selecting a Cable Entry (2/4)

4



Installation Options

There are 4 ways to install your cable entries on the enclosure:

- **Using a cable entry:**

The standard cable gland plate of your S3D wall-mounted enclosure is unscrewed and replaced by the cable entry. A gasket between enclosure and cable entry will ensure good water and dust tightness.



- **Modifying the standard cable gland plate:**

The standard cable gland plate is unscrewed and machined. A cut-out is made.

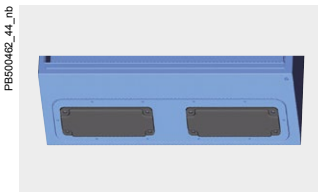

- **On cable gland plate adapter:**

This plate, which has the outer dimensions of a standard cable gland plate, has one or more pre-cut cut-outs of standard dimensions (FL13 and FL21).

On steel wall-mounted enclosures, the plate can replace the standard cable gland plate once the cable entry is fitted into it. On polyester enclosures, a cut-out must be created. Schneider Electric provides this service: a precise laser cut-out can be made at the factory upon request.

On steel floor-standing enclosures, you may either use the specific cable gland roof or create a cut-out (see expert's tip 1 - page 257).

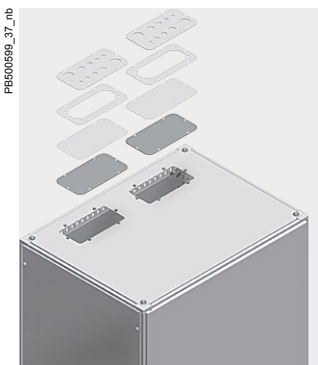

Cable gland plate adapters

Enclosure range	1 membrane	2 membranes	3 membranes	4 membranes
Spacial S3D	 <p>NSYTL●FL</p>	 <p>NSYTL●2FL</p>	-	 <p>NSYTLG4FL</p>

- **Drilling directly the enclosure:** A cut-out is created on the enclosure's side according to the cable entry's dimensions (see expert's tip 1 - page 257).



Spotlight On...

FL13 and FL21 are standard cut-out dimensions frequently used in northern European countries and also used by our enclosures for several years now.

Key Features When Selecting a Cable Entry (3/4)



Full Flexibility

5 Flexibility of the installation

- **Full flexibility:** This means that cables can be added/removed easily, changing:
 - quantity
 - diameter
 - position
 (see expert's tip 2, page 257)
- **Medium flexibility:**
 - The amount, diameter or position of cables can be changed to a limited extent.
- **Low flexibility:**
 - It is not possible to change the above parameters.



Medium Flexibility

6 Reversibility

- **Full reversibility:** This means that cables can be added/ removed easily without losing their initial characteristics, such as water tightness.
- **Medium reversibility:** For soft membranes, once the cable has been removed, there may be a loss of IP degree depending on the size of the cable and the cut. For hard-plastic entries or combined material entries, initial characteristics are regained by adding plugs.
- **Low reversibility:** The cable entry must be completely replaced in order to regain the initial characteristics.

7 Degree of Protection (IP)

- If an enclosure is to be used in a clean, dry and well insulated environment, lower levels of IP may be acceptable (IP54 or IP55).
- In a dusty environment, a higher IP level such as IP65 or IP68 may be required (see expert's tip 4, page 257).

8 Cable Retention

- Choose the right level of cable retention according to your needs. For locations accessible to the public, preferably choose a high level of cable retention.

9 Cable Diameter

- Choose the cable entry seal according to the cable diameter. Take into account cable diameter tolerances.

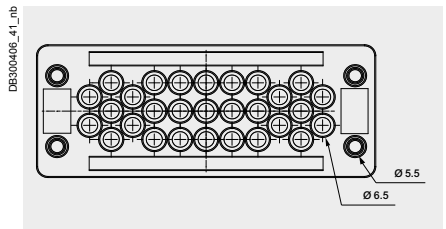
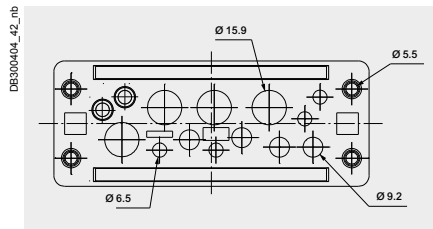

10 Cable Installation Time

- Each cable entry has different installation characteristics. Some can be installed easily and quickly thanks to the soft membrane. Take this into account depending on labour costs in your region.

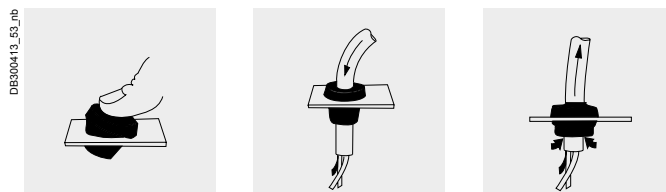

Key Features When Selecting a Cable Entry (4/4)



11 Number of Cables for a Given Surface

- For some installations, a large quantity of cables must go through the cable entry. Some cable entries can handle a high density of cables, which can result in a more economical installation (fewer cable entries to be purchased). For small enclosures, it may simply be impossible to install too many cable entries due to the available space on the enclosure's wall (see expert's tip 3, page 257).



12 Cable Entries for Cables with Connectors

- Some cables have large connectors which cannot be pushed through tight cable clamps or cable seals. These cable entries have the unique advantage of not requiring the cable to be cut, thanks to the snap-fitting system.

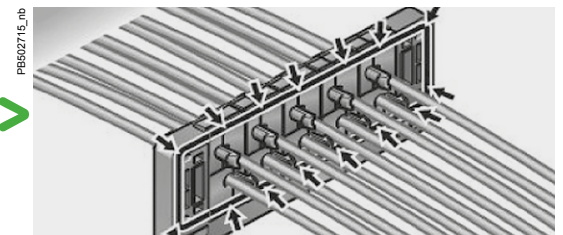
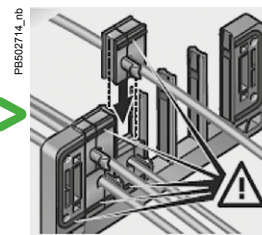
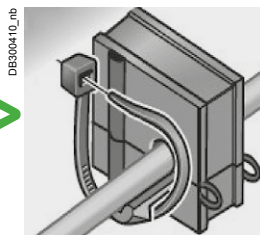
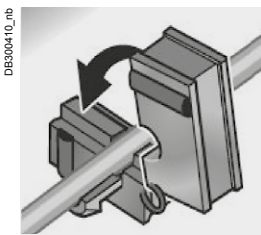

A High Cable Retention Force Is Provided Thanks to the Integrated Cable Fastener

Expert's Tip



Specific



Configured

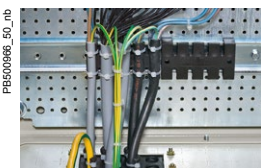
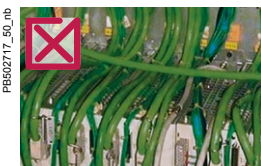

- Some cable entries require cut-outs to be machined on the enclosure or cable gland plate. Our customized offer provides this service. The quality of your enclosure will therefore be improved since the painting operation is performed after creating the cut-outs.

- Installing a cable entry with full flexibility is the solution when a large number of enclosures is being prepared for different types of installations. By using one combination of enclosure cable entries, you can cover a large variety of installations!

- When the cable entry has been defined, the next step is cable management inside the enclosure. For correct thermal management, all cables must be fitted and attached so as not to create an obstacle for correct air flow. Consult our Universal Enclosures catalog for cable management accessories (such as cable ducts) and consumables (such as cable ties).

- If your environment requires a high IP level for your installation, make sure you have an appropriate thermal management system to avoid condensation or overheating problems. Consult our Thermal Management offer in our Universal Enclosures catalog and our Control Panel Technical Guide related to this issue.

FlexiCable Cable Entries

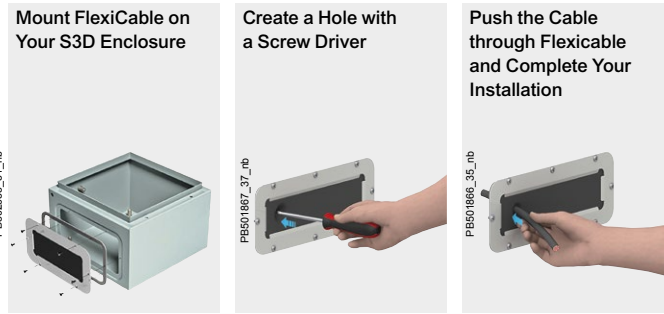

Note:
Details see [page 250](#)

Supply:
1 metal frame with pre-mounted membrane, 1 gasket, fixing hardware

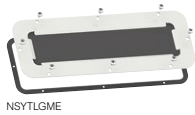

Characteristics	Type	Plate width (mm)	Plate depth (mm)	Effective cable entrance dimensions (mm)	References
FlexiCable cable entries	C	245	130	178 x 63	NSYTLGME
FlexiCable cable entries	D	345	130	278 x 63	NSYTLGME
FlexiCable cable entries	E	445	130	378 x 63	NSYTLGME
FlexiCable cable entries	F	545	130	478 x 63	NSYTLGME
FlexiCable cable entries	G	495	220	428 x 153	NSYTLGME
FlexiCable cable entries for enclosure with 2 cable gland plates	D	345	130	-	2x NSYTLGME
FlexiCable cable entries for enclosure with 2 cable gland plates	E	445	130	-	2x NSYTLGME

Multi-A

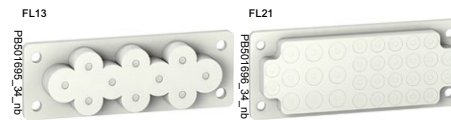

Note:
Details see [page 250](#)



Characteristics	Height (mm)	Width (mm)	Depth (mm)	Diameter of the cable entry (Ø mm)						References		
				No.	13	14	15	16	18		21	30
Multi-A Type FL21	25	215	86	25	-	16	-	-	6	-	3	NSYAECPFLA25
Multi-A Type FL21	25	215	86	33	-	24	-	-	9	-	-	NSYAECPFLA33

10

Multi-C

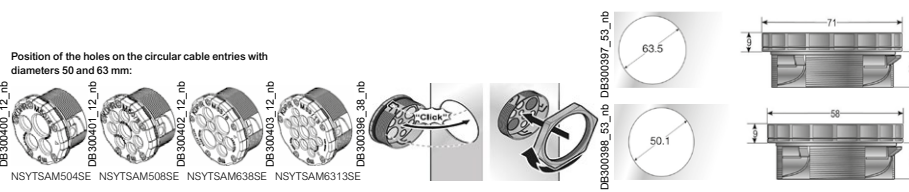

Note:
Details see [page 250](#)

Supply:
10 units.
Reference by unit.
Order by multiples of 10 (10, 20, 30...)

Characteristics	Cut-out Ø (mm)	Diameter of the cable entry (Ø mm)						References	
		No.	3-5.5	3-6.5	3.6-6.5	5-9.2	6-10		9.6-15.9
Multi-C	50.5	8	-	-	7	-	1	-	NSYTSAM508SE
Multi-C	63.5	8	-	2	-	4	-	2	NSYTSAM638SE

Multi-R

- Material: Polyamide
- Cable entry material: Soft membrane
- Cable glands to be fitted: No
- Installation options: On cable gland plate with special cut-out or directly on enclosure
- Flexibility of the installation: Medium
- Reversibility: Full
- Ingress protection rating: IP65 according to IEC 60529
- Cable retention: Medium
- Cable diameter (mm): From 4.3 to 15.9
- Cable Installation time: Fast
- Quantity of cables to be fitted for a given surface: ++
- Cable entries for cables with connectors: No

- Cut-out dimensions (mm): 112 x 36
- External dimensions (mm): 146 x 14 x 58
- Certificates: UR Certified
- Flame resistance: 650 °C

Note:
Dimensions and positions of the holes on a rectangular cable entry see below. Details see [page 250](#)

Supply:
1 unit

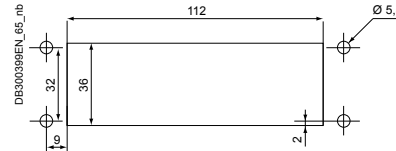

NSYTSA2414SE

Characteristics	Cut-out Ø (mm)	Diameter of the cable entry (Ø mm)						References
		No.	4.3-8.1	3-6.5	5-9.2	8-12.5	9.6-15.9	
Multi-R	112 x 36	14	-	6	4	-	-	NSYTSA2414SE
Multi-R	112 x 36	17	-	-	17	-	-	NSYTSA2417SE
Multi-R	112 x 36	22	-	16	4	2	-	NSYTSA2422SE
Multi-R	112 x 36	23	23	-	-	-	-	NSYTSA2423SE
Multi-R	112 x 36	29	-	29	-	-	-	NSYTSA2429SE

NSYTSA2414SE

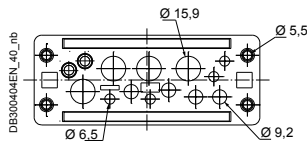

KDP 24/14

NSYTSA2417SE

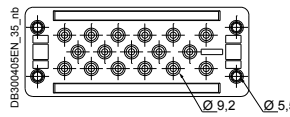

KDP 24/17

NSYTSA2429SE

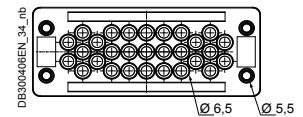

KDP 24/29

NSYTSA2422SE

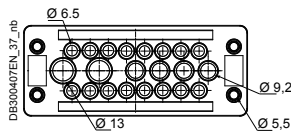

KDP 24/22

NSYTSA2423SE

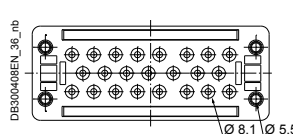

KDP 24/23

Multi-T

- Type FL21

Note:
Details see [page 250](#)



NSYAECPFLT25

Characteristics	Diameter of the cable entry (Ø mm)											References	
	No.	5-7	6-10	8-12	8-16	10-14	12-18	14-20	17-32	20-26	24-54		30-60
Multi-T, metal plate	0	-	-	-	-	-	-	-	-	-	-	-	NSYAECPFLBP
Multi-T	7	-	-	-	4	-	-	-	-	-	2	1	NSYAECPFLT7
Multi-T	27	4	-	4	-	13	-	4	-	2	-	-	NSYAECPFLT25
Multi-T	37	-	4	14	-	16	2	-	1	-	-	-	NSYAECPFLT35

NSYAECPFLBP

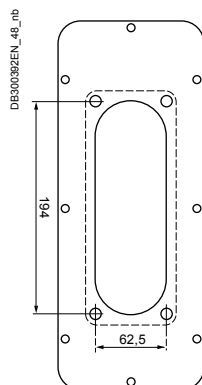

NSYAECPFLT7

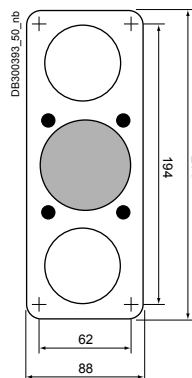

NSYAECPFLT25

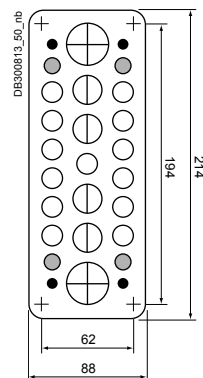

NSYAECPFLT35

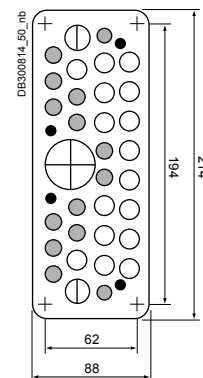

Multi-H

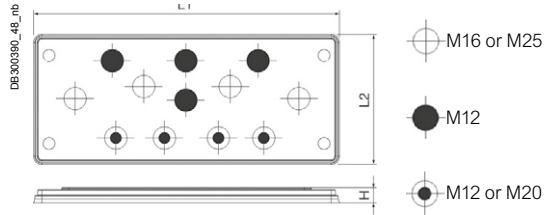

• Type FL21

Note:
Details see [page 251](#)



NSYTSAKFL

Characteristics	L1 (mm)	L2 (mm)	H (mm)	Diameter of the cable entry (Ø mm)			References
				M12	M12 or M20	M16 or M25	
Multi-H	10	215	85	4	4	4	NSYTSAKFL

Multi-CS

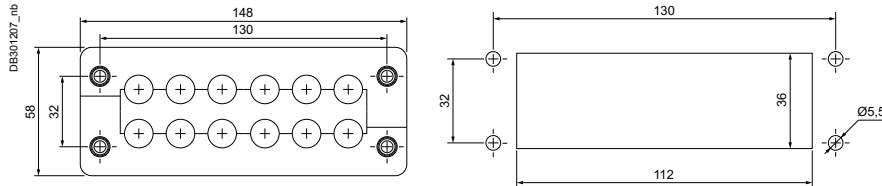

Note:
Details see [page 250](#)

Supply:
1 unit



NSYDCD2412

Characteristics	Cut-out (mm)	Diameter of the cable entry (Ø mm)	References		
			No.	2-12	12-24
Multi-CS	112 x 36	12	12	-	NSYDCD2412
Multi-CS	112 x 36	4	-	4	NSYDCD244
Multi-CS	112 x 36	8	6	2	NSYDCD248
Multi-CS	112 x 36	9	8	1	NSYDCD249

Cable Gland

Supply:

Small ... plugs: 12 units. Reference per unit.
To be ordered in multiples of 12 (12,24,36, etc.).
Large ... plugs: 4 units. Reference per unit.
To be ordered in multiples of 4 (4,8,12, etc.)



NSYCEJDS2

10

Characteristics	Cable Ø (mm)	References
Cable gland, small	2-3	NSYCEJDS2
Cable gland, small	3-4	NSYCEJDS3
Cable gland, small	4-5	NSYCEJDS4
Cable gland, small	5-6	NSYCEJDS5
Cable gland, small	6-7	NSYCEJDS6
Cable gland, small	7-8	NSYCEJDS7
Cable gland, small	8-9	NSYCEJDS8
Cable gland, small	9-10	NSYCEJDS9
Cable gland, small	10-11	NSYCEJDS10
Cable gland, small	11-12	NSYCEJDS11
Cable gland, large	12-13	NSYCEJDL12
Cable gland, large	13-14	NSYCEJDL13
Cable gland, large	14-15	NSYCEJDL14
Cable gland, large	15-16	NSYCEJDL15
Cable gland, large	16-17	NSYCEJDL16
Cable gland, large	17-18	NSYCEJDL17
Cable gland, large	18-19	NSYCEJDL18
Cable gland, large	19-20	NSYCEJDL19
Cable gland, large	20-21	NSYCEJDL20
Cable gland, large	21-22	NSYCEJDL21

Blanking Plugs

Supply:

Small ... plugs: 12 units. Reference per unit.
To be ordered in multiples of 12 (12,24,36, etc.).
Large ... plugs: 4 units. Reference per unit.
To be ordered in multiples of 4 (4,8,12, etc.)



NSYCEJDS0

Characteristics	References
Blanking plugs, small	NSYCEJDS0
Blanking plugs, large	NSYCEJDL0

PrismaSeT, Plain

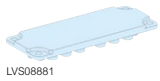

- Solid cable gland plates

Characteristics	Type	References
PrismaSeT, plain	FL21	LVS08881

Note:
Details see [page 251](#)

PrismaSeT, Pre-Drilled

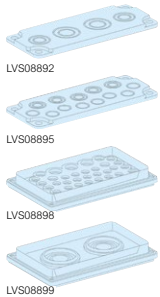

- Suitable for receiving cable glands with metric pitch

Characteristics	Type	References
PrismaSeT, pre-drilled, with 4 entries 2 x M20 or M32 + 2 x M25 or M40	FL21	LVS08892
PrismaSeT, pre-drilled, with 13 entries 5 x M16 or M25 + 8 x M20	FL21	LVS08895
PrismaSeT, pre-drilled, with 39 entries Ø 7 - 26 mm	opening 225 x 137 mm	LVS08898
PrismaSeT, pre-drilled, with 2 entries Ø 33 - 72 mm	opening 225 x 137 mm	LVS08899

Note:
Reference LVS08898 is made up of:
3 cables with diameters from 14 to 26.
4 cables with diameters from 10 to 20.
32 cables with diameters from 7 to 16.
Details see [page 251](#)

PrismaSeT, Membrane

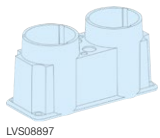

- Membrane to be drilled according to the required diameter

Characteristics	Type	References
PrismaSeT, membrane, 2 entries, 2 x Ø 28 - 60 mm	FL21	LVS08897

Note:
Details see [page 251](#)

Steel Adapter Plate for FL21 Membranes

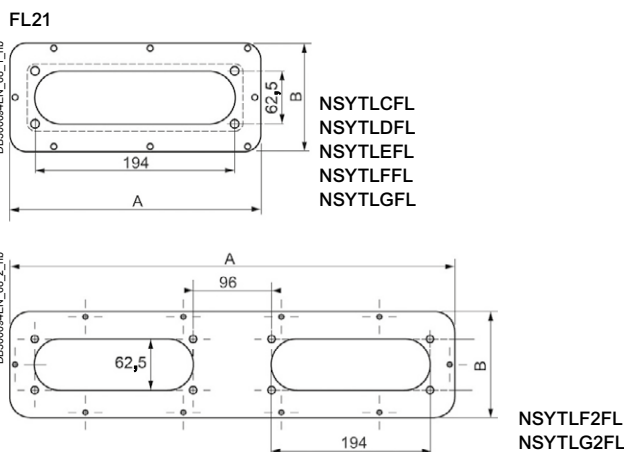

Application Example

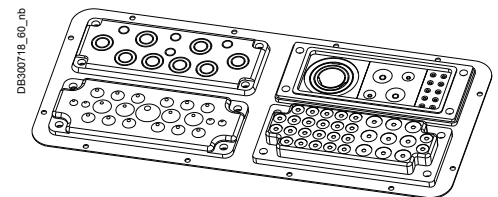

Our membrane can be easily adapted to fit onto all our metal enclosures using the adapter plate.

- Allows the mounting of FL13 and FL21 membranes on every type of enclosure.
- Our membrane can be easily adapted to fit onto all our metal enclosures using the adapter plate.
- Ingress protection rating IP55 according to IEC 60529

Supply:
Delivered with fixing screws and gasket



Characteristics	Type	Plate dimensions (mm)		Cut-out dimensions (mm)		References
		A	B	H	I	
Steel adapter plate for FL21 membranes	C	245	130	212	97	NSYTLDFL
Steel adapter plate for FL21 membranes	D	345	130	312	97	NSYTLDFL
Steel adapter plate for FL21 membranes	E	445	130	412	97	NSYTLDFL
Steel adapter plate for FL21 membranes	F	545	130	512	97	NSYTLDFL
Steel adapter plate for FL21 membranes	F	545	130	512	97	NSYTLF2FL
Steel adapter plate for FL21 membranes	G	495	220	462	187	NSYTLGFL
Steel adapter plate for FL21 membranes	G	495	220	462	187	NSYTLG2FL

Mixed Membrane Entries for IP55 Direct Cable Entries

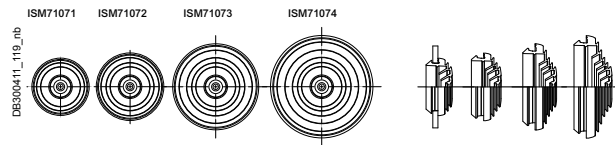

Note:
Details see [page 252](#)

Supply:
Minimal packaging of 10 pieces



ISM71074

Characteristics	Drill hole Ø (mm)	Cable / conduit Ø (mm)	References
Mixed membrane entries for IP55 direct cable entries, RAL 7035	23	4 - 20	ISM71071
Mixed membrane entries for IP55 direct cable entries, RAL 7035	29	4 - 25	ISM71072
Mixed membrane entries for IP55 direct cable entries, RAL 7035	36	4 - 32	ISM71073
Mixed membrane entries for IP55 direct cable entries, RAL 7035	44	4 - 40	ISM71074

PVC Adjustable Cone-Shaped Entries

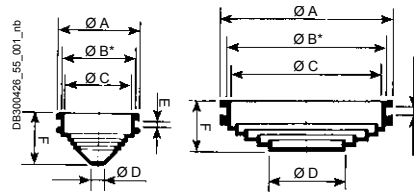

Note:
* Drill-hole for mounting.
Details see [page 252](#)

Supply:
NSYECPC3 50 cable entries,
NSYECPC5 and **NSYECPC6**
each 25 cable entries,
NSYECPC9 and **NSYECPC15**
each 10 cable entries



NSYECPC15

Characteristics	Dimensions (mm)						Capacity		References
	Ø A	Ø B*	Ø C	Ø D	E	F	Cable (Ø mm)	Tube	
PVC adjustable cone-shaped entries	25	21.5	18	5	3.2	13	5-18	PG 9-11	NSYECPC3
PVC adjustable cone-shaped entries	33	29.5	26	5	3.2	20	5-26	PG 9-16	NSYECPC5
PVC adjustable cone-shaped entries	43	38.5	36	5	3.2	22	5-36	PG 9-21	NSYECPC6
PVC adjustable cone-shaped entries	70	63	60	28	3	20	28-60	PG 21-48	NSYECPC9
PVC adjustable cone-shaped entries	98	90	87	28	3	23	28-87	PG 21-48	NSYECPC15

ISO Cable Gland

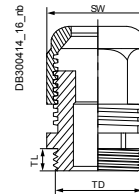

Note:
* In brackets: Tolerance.
Details see [page 252](#)

Supply:
The cable glands are supplied with nuts. Pack of 20 (M12 to M20), 10 (M25 and M32), 5 (M40)

- The cable gland (ref. **IMT36150**) is especially recommended for security circuits.



ISM71503

Characteristics	Dimensions						References
	ISO	Cable Ø (mm)	Drill hole* Ø (mm)	TD	TL		
Cable gland	M12	3 / 6.5	12.2 (0 + 0.2)	12	6	15	ISM71501
Cable gland	M16	4 / 8	16.2 (0 + 0.2)	16	8	19	ISM71502
Cable gland	M20	6 / 12	20.2 (0 + 0.2)	20	10	24	ISM71503
Cable gland with high resistance to fire	M20	6 / 12	20.2 (0 + 0.2)	20	10	24	IMT36150
Cable gland	M25	11 / 17	25.2 (0 + 0.2)	25	8	29	ISM71504
Cable gland	M32	15 / 21	32.2 (0 + 0.3)	32	10	36	ISM71505
Cable gland	M40	19 / 28	40.5 (0 + 0.3)	40	10	46	ISM71506

Quick Cable Entries

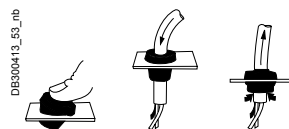

Note:
Details see [page 252](#)

Supply:
50 (M12 to M32), 25 (M40 and M50)



IMT36179

Characteristics	Dimensions			References
	Ø	Drill hole Ø (mm)	Cable Ø (mm)	
Quick cable entries	M12	12.5	3 - 5	IMT36179
Quick cable entries	M16	16	5 - 7	IMT36180
Quick cable entries	M20	20.3	7 - 10	IMT36181
Quick cable entries	M25	25.3	10 - 14	IMT36182
Quick cable entries	M32	32.4	14 - 20	IMT36183
Quick cable entries	M40	40.7	20 - 26	IMT36184
Quick cable entries	M50	50.7	26 - 35	IMT36185

Synthetic Snap-In Cable Gland



NSYCGSP16

- Wall thickness : E = 0.5 à 4 mm.

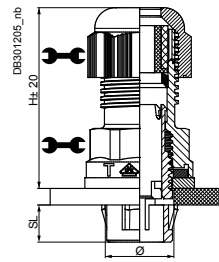

Note:
Details see [page 252](#)

Supply:
The cable glands are supplied with nuts. Pack of 20 (M16 and M20), of 10 (M25 and M32), of 5 (M40)

Characteristics	Dimensions								References
	Ø	Ø min / max	Drill Ø	SL	SD	H			
Synthetic snap-in cable gland	M16	5/10	16.2 to 16.4	9	15.9	42.5	22	NSYCGSP16	
Synthetic snap-in cable gland	M20	6/12	20.2 to 20.4	9	19.9	41.5	24	NSYCGSP20	
Synthetic snap-in cable gland	M25	11/17	25.2 to 25.4	9	24.9	43.5	29	NSYCGSP25	
Synthetic snap-in cable gland	M32	15/21	32.2 to 32.4	9	31.9	49.5	36	NSYCGSP32	
Synthetic snap-in cable gland	M40	19/28	40.2 to 40.4	11.5	39.9	56	46	NSYCGSP40	

Stainless-Steel Cable Gland with Lamellar Insert

- Lamellar technology provides excellent resistance to traction as well as excellent torsional protection. For aggressive environments.
- Material: Stainless-steel AISI 304L or AISI 316L, neoprene gasket
- Cable entry material: Non armoured
- Installation options:
 - On cable gland plate or directly on enclosure
- Flexibility of the installation: Low
- Reversibility: Medium
- Ingress protection rating: IP68
- Cable retention: High
- Cable diameter (mm): From 12 to 40
- Cable Installation time: Slow
- Quantity of cables to be fitted for a given surface: +
- Cable entries for cables with connectors: No
- Thread type: Metric EN 60423
- Cut-out dimensions (mm):
 - Various circular hole diameters according to cable diameter
- External dimensions (mm): From Ø 14 to 43
- Certificates: UL recognized (cURus). Rated Type 4, 4X according UL50E
- Standard: DIN EN 62444, UL 514
- Temperature range: -20 °C to + 100 °C



NSYCGX12

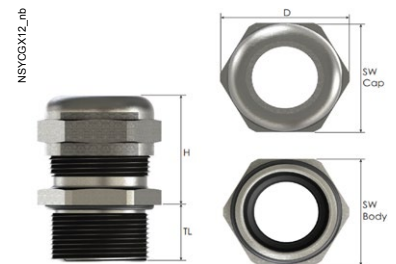

Supply:
The cable glands are supplied with nuts Pack of 5 (M12 and M16), of 4 (M20 and M25), of 2 (M32 and M40)

Characteristics	Dimensions							References
	Ø	Ø min-max mm	Thread Length TL mm	SW Cap mm	SW Body mm	Outer Ø D mm	max. Height H mm	
AISI 304L	M12x1.5	3.0 - 6.5	6	14	14	15.5	24	NSYCGX12
AISI 304L	M16x1.5	4.0 - 8.0	7	17	19	21	25.5	NSYCGX16
AISI 304L	M20x1.5	10.0 - 14.0	8	24	24	26.5	30	NSYCGX20
AISI 304L	M25x1.5	10.0 - 14.0	8	24	27	30	30	NSYCGX25
AISI 304L	M32x1.5	13.0 - 18.0	9	30	36	39.8	35	NSYCGX32
AISI 304L	M40x1.5	18.0 - 25.0	9	41	46	51.4	40.5	NSYCGX40
AISI 316L	M12x1.5	3.0 - 6.5	6	14	14	15.5	24	NSYCGX12H
AISI 316L	M16x1.5	4.0 - 8.0	7	17	19	21	25.5	NSYCGX16H
AISI 316L	M20x1.5	10.0 - 14.0	8	24	24	26.5	30	NSYCGX20H
AISI 316L	M25x1.5	10.0 - 14.0	8	24	27	30	30	NSYCGX25H
AISI 316L	M32x1.5	13.0 - 18.0	9	30	36	39.8	35	NSYCGX32H
AISI 316L	M40x1.5	18.0 - 25.0	9	41	46	51.4	40.5	NSYCGX40H

SM SMX SFN SFX Lower Cable-Guide Cross-Rail

- It allows the quick fixing of cables entering and exiting the enclosure.
- Depth adjustable every 25 mm.
- Material: Galvanized steel

Fixing:

- PanelSeT SFN: for suitable enclosures with widths of 1200 and 1600 mm, use the adaptation kit for two-door suitable enclosures, see [page 232](#)
- Spacial SM: for floor-standing enclosures with a width of 1200 mm, a top/bottom mounting rail installed in central position is required
- Spacial SFX: no adaptation piece is required for the 1200 mm suitable enclosures
- Spacial SMX: no adaptation piece is required for the 1600 mm floor-standing enclosures



NSYCFP60

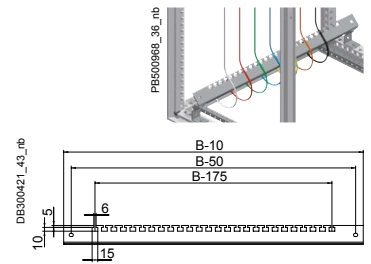

Supply:

1 cable-guide cross-rail and fixing elements

Characteristics	Width (mm)	References
Lower cable-guide cross-rail	600	NSYCFP60
Lower cable-guide cross-rail	800	NSYCFP80
Lower cable-guide cross-rail	1000	NSYCFP100
Lower cable-guide cross-rail	1200	2x NSYCFP60
Lower cable-guide cross-rail	1600	2x NSYCFP80

SM SMX SFN SFX Cable-Guide Cross-Rails for Framework

Support types:

- Angle support at 90°: For vertical cable fixing.
- Angle support at 120°: For fixing cables near the cable entry.
- Material: Galvanized steel



NSYCF96

Fixing:

- PanelSeT SFN and Spacial SFX: support for direct mounting on the framework, cross-rails or rails
- Spacial SM: fixing on the bottom mounting rail, or on the floor-standing enclosure by means of adaptation rails and 40 mm universal cross-rails (1 row) in vertical position
- Spacial SMX: fixing on the bottom mounting rail and 40 mm universal cross-rails (1 row) in vertical position

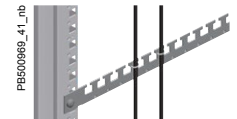
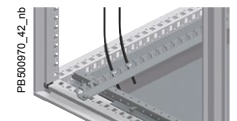

Supply:

2 supports and fixing elements

Characteristics	Support angle	Width (mm)	References
Cable-guide cross-rails for framework	90°	600	NSYCF96
Cable-guide cross-rails for framework	120°	600	NSYCF126
Cable-guide cross-rails for framework	90°	800	NSYCF98
Cable-guide cross-rails for framework	120°	800	NSYCF128

SM SMX SFN SFX L-Rail for Fixing Cables

- Rail for fixing cables entering from the bottom.
- Adjustable depth with a pitch of 25 mm.
- It is not possible to mount it on a plinth cross-rail.
- Material: Galvanized steel

Fixing:

- PanelSeT SFN and Spacial SFX: fixing to the bottom frame, above the cable entry, or else to the plinth, using the plinth cross-rails, see [page 89](#)
- Spacial SM/SMX: fixing to the bottom adjustment rails, above the cable entry, or else to the plinth, using the plinth cross-rails, see [page 89](#)
- The cables are fixed to the rail by means of metal clamps



NSYFCG60

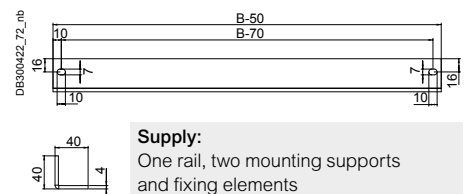

Supply:

One rail, two mounting supports and fixing elements

Characteristics	Width (mm)	References
L-rail for fixing cables	600	NSYFCG60
L-rail for fixing cables	800	NSYFCG80
L-rail for fixing cables	1000	NSYFCG100

SM SMX SFN SFX Door Cable-Guide Cross-Rail

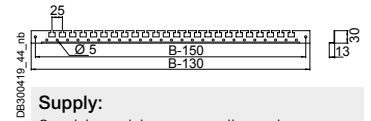
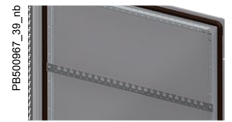

- Recommended for fixing cables in the internal equipment of the door.
- Height adjustable every 25-mm.
- Material: Galvanized steel
- Fixing: Direct fixing on the reinforcement frame

Supply:
2 cable-guide cross-rails and fixing elements



Characteristics	Width (mm)	References
Door cable-guide cross-rail	600	NSYSDGCR5
Door cable-guide cross-rail	600	NSYSDGCR6
Door cable-guide cross-rail	800	NSYSDGCR8

Plastic Cable Support

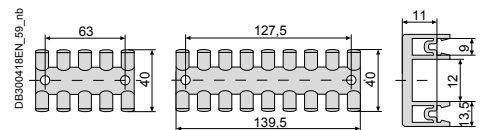

- It clips or screws onto 35-mm symmetric rails or a C-shaped rail.
- Fixing: Quick and easy fixing of cables using cable ties

Supply:
10 units. Reference by unit. Order by multiples of 10 (10, 20, 30...)

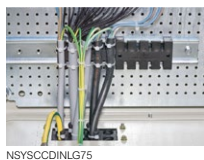

Characteristics	Max. no. of cables	Width (mm)	References
Plastic cable support	5	75	NSYSCCDINLG75
Plastic cable support	9	140	NSYSCCDINLG140

CRN S3D S3X Door Cable-Guide Cross-Rails for Wall-Mounted Enclosures

- They are installed on wall-mounted enclosures with heights from 400 mm for Spacial S3D and 500 mm for Spacial S3X.
- They make it easy to equip the inside of the door.
- Installation cable ties.
- Fixing: They are fixed to the door reinforcement frame by 2 self-tapping screws. The angle can be directed towards the body of the enclosure or towards the door

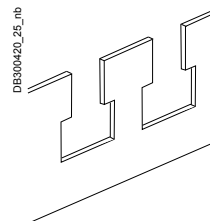

Supply:
2 cable-guide cross-rails and fixing elements



Characteristics	Width (mm)	References
Door cable-guide cross-rails for wall-mounted enclosures	400	NSYTFPCR4
Door cable-guide cross-rails for wall-mounted enclosures	500	NSYTFPCR5
Door cable-guide cross-rails for wall-mounted enclosures	600	NSYTFPCR6
Door cable-guide cross-rails for wall-mounted enclosures	800	NSYTFPCR8
Door cable-guide cross-rails for wall-mounted enclosures	1000	NSYTFPCR10

10

Corrugated Cable Tube



NSYCPT37

- Corrugated tube allowing cable entry between the structure and the door.
- Free from halogens and heavy metals.
- UV protection.
- Material: Low-density polyethylene (LDPE)
- Color: Black

Supply:
One 25 m reel

Characteristics	Ø Nominal (mm)	Ø Inner (mm)	Ø Outer (mm)	References
Corrugated cable tube	37	36	42.4	NSYCPT37

Fixing Support for Corrugated Tube



NSYCPTS37

- Mounting options: Directly on the enclosure, on a 19" swing rack and/or on cross-rails, by means of a fixing point.
- The supports can be assembled with one another to form sets of tubes that allow a better arrangement of the cables.
- It allows the rotation of the tube once it is fixed on the support and prevents the corrugated tube from coming loose if subject to pulling movements.
- Material: Polyamide (PA), black.



NSYCPTS17_06

Supply:
10 units and fixing elements.
The support is supplied with its cover.

Characteristics	Model (nominal Ø)	References
Fixing support for corrugated tube	37	NSYCPTS37

Spiral Cable Duct



NSYTC12100

- Spiral strip for bundling cables.
- Allows cables to enter between the body and the door.
- Color: Colorless

Supply:
One 50 m reel

Characteristics	Tightening range (mm)	Ø Inner (mm)	Ø Outer (mm)	References
Corrugated cable tube	12 to 100	9	12	NSYTC12100

Steel Wired Cable Tray



NSYBPC3

- Mounting on the cable supports.
- Dimensions (2 types):
1845 x 200 x 35 mm.
1845 x 200 x 54 mm.
- Material: Zinc-coated steel wire

Supply:
1 vertical steel wired cable tray
and fixing elements

Characteristics	Necessary depth (mm)	References
Steel wired cable tray	35	NSYBPC3
Steel wired cable tray	54	NSYBPC5

Cable-Duct

- Temperature resistance: -5 ... +60 °C
- Behaviour in fire: Material V0 according to UL 94
- Fire resistance: 960 °C according to IEC 60695-2-1/1
- Maximum capacity of H07.V.K 1.5 mm² flexible cable (filling factor: 0.6)
- With lateral through slots and rear perforations.
- Material: Rigid PVC
- Color: RAL 7030 gray or RAL 5000 blue
- Standards: Compliance with standards VDE 0660/506 and DIN 43659

Supply:
8 units. Supplied in lengths of 2 m



AK2GD7550



AK2GA65

Characteristics	Width (mm)	Height (mm)	Color	References
Cable-duct	25	25	Gray	AK2GD2525
Cable-duct	25	50	Gray	AK2GD2550
Cable-duct	37.5	50	Gray	AK2GD3750
Cable-duct	37.5	75	Gray	AK2GD3775
Cable-duct	50	50	Gray	AK2GD5050
Cable-duct	50	75	Gray	AK2GD5075
Cable-duct	75	50	Gray	AK2GD7550
Cable-duct	75	75	Gray	AK2GD7575
Cable-duct	100	75	Gray	AK2GD10075
Cable-duct	125	75	Gray	AK2GD12575
Cable-duct	30	35	Blue	AK2GA33
Cable-duct	30	55	Blue	AK2GA35
Cable-duct	30	90	Blue	AK2GA39
Cable-duct	30	144	Blue	AK2GA315
Cable-duct	60	55	Blue	AK2GA65
Cable-duct	60	90	Blue	AK2GA69
Cable-duct	60	144	Blue	AK2GA615

Covers for Cable-Duct

- Temperature resistance: -5 ... +60 °C
- Behaviour in fire: Material V0 according to UL 94
- Fire resistance: 960 °C according to IEC 60695-2-1/1
- Maximum capacity of H07.V.K 1.5 mm² flexible cable (filling factor: 0.6)
- Replacement covers.
- Material: Rigid PVC
- Color: RAL 7030 gray or RAL 5000 blue
- Standards: Compliance with standards VDE 0660/506 and DIN 43659

Supply:
8 units. Supplied in lengths of 2 m



AK2CD75



AK2CA6

Characteristics	Width (mm)	Height (mm)	Color	For Cable-duct Ref.	References
Covers for cable-duct	25	25	Gray	AK2GD2525	AK2CD25
Covers for cable-duct	25	50	Gray	AK2GD2550	AK2CD25
Covers for cable-duct	37.5	50	Gray	AK2GD3750	AK2CD37
Covers for cable-duct	37.5	75	Gray	AK2GD3775	AK2CD37
Covers for cable-duct	50	50	Gray	AK2GD5050	AK2CD50
Covers for cable-duct	50	75	Gray	AK2GD5075	AK2CD50
Covers for cable-duct	75	50	Gray	AK2GD7550	AK2CD75
Covers for cable-duct	75	75	Gray	AK2GD7575	AK2CD75
Covers for cable-duct	100	75	Gray	AK2GD10075	AK2CD100
Covers for cable-duct	125	75	Gray	AK2GD12575	AK2CD125
Covers for cable-duct	30	35	Blue	AK2GA33	AK2CA3
Covers for cable-duct	30	55	Blue	AK2GA35	AK2CA3
Covers for cable-duct	30	90	Blue	AK2GA39	AK2CA3
Covers for cable-duct	30	144	Blue	AK2GA315	AK2CA3
Covers for cable-duct	60	55	Blue	AK2GA65	AK2CA6
Covers for cable-duct	60	90	Blue	AK2GA69	AK2CA6
Covers for cable-duct	60	144	Blue	AK2GA615	AK2CA6

S3D SM SFN S3X Ø 22 mm Cable-Duct Support
SFX PLA



- Installed on the door of the wall-mounted or floor-standing enclosure combined with Ø 22 mm elements.
- Material: Treated steel

Characteristics
Ø 22 mm cable-duct support

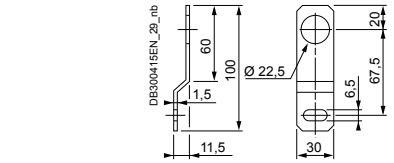

Supply:
10 units. Reference by unit.
Order by multiples of 10 (10, 20, 30...)

References
NSYSPCP

SM SFN SD SMX Cable-duct Support on Technical Upright
SFX PLA

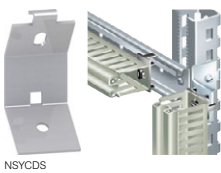

- Allows cable ducts to be installed on technical uprights, while increasing the usable surface of the equipment (up to 20% according to the width of the cable duct).
- Material: Galvanized steel

Characteristics
Cable-duct support on technical upright

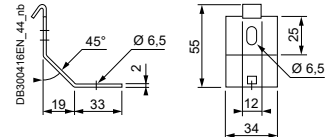

Supply:
10 units. Reference by unit.
Order by multiples of 10 (10, 20, 30...)

References
NSYCDS

Plastic Cable-Duct Support



- Clips onto the Telequick mounting plate or the 35-mm DIN rail.
- Includes a screw for fixing the cable ducts through the 6.5 x 14 mm drill holes made in the back.
- The 2 functions, clipping and bolting, provide considerable time savings.
- Respects electrical insulation.
- Material: Black polyamide.

Characteristics
Plastic cable-duct support

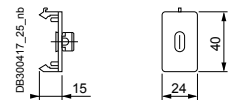

Supply:
20 units. Reference by unit.
Order by multiples of 20 (20, 40, 60...)

References
NSYSPC

Note:
For dimensions see below



Characteristics	Multi-Fixing LED Lamps
	These LED lamps are designed to optimize the life time, consumption, space and accessibility inside the enclosure, they are available with three fixing options as standard.
Color	Black RAL 9005
Ingress protection rating	IP20 according to IEC60529
Standards	<ul style="list-style-type: none"> IEC 60598 UL 94: For plastic components UL508A: Control Panel UL153: Lamps UL8750: LED for lighting EN55015: EMC
Other characteristics	<ul style="list-style-type: none"> Built-in switch Power consumption: 10 W Frequency: 50/60 Hz Power factor: <ul style="list-style-type: none"> V AC lamps: 0.9 V DC lamps: 1 Luminosity: 640 lm* Light temperature: 4000 K* LED service life: 25000 h* Casing: Plastic UL94 Degree of insulation: <ul style="list-style-type: none"> Class I - Lamps with socket according to ENEC certificate Class II - Lamps without socket according to ENEC certificate NSYLAMLDVDC is Class III according to ENEC Certificate Compliant with RoHS and Reach Ambient temperature: <ul style="list-style-type: none"> Operation: -16 °C to +65 °C (-3 °F to +149 °F) Storage: -10 °C to +60 °C (-14 °F to +140 °F) Max. 2 Amps and 5 lamps in serial connection
Connections	<ul style="list-style-type: none"> 3 m power black or orange cable with quick connector (Not supplied. See reference below) 1.5 m interconnection black or orange cable with quick connectors (Not supplied. See reference below) According to the directive IEC 60204-1: <ul style="list-style-type: none"> Black cables: Power circuits for switch or DC voltage. Orange cables: External voltage that may be present even if the cabinet is turned off.
Supply	1 lamp and fixing elements

Lamp model	Lamps		Cables			
	Socket	References	Black cables		Orange cables	
			Power (3 m) References	Interconnection (1.5 m) References	Power (3 m) References	Interconnection (1.5 m) References
With socket 120 / 230 V AC	SCHUKO	NSYLAMLDS	NSYLAM3M	NSYLAM1M	NSYLAM3MN	NSYLAM1MN
With socket 120 / 230 V AC	UTE	NSYLAMLDF	NSYLAM3M	NSYLAM1M	NSYLAM3MN	NSYLAM1MN
With socket 120 / 230 V AC	British	NSYLAMLDB	NSYLAM3M	NSYLAM1M	NSYLAM3MN	NSYLAM1MN
With socket 120 V AC	USA	NSYLAMLDU	NSYLAM3MUL	-	-	-
Without socket 120 / 230 V AC	-	NSYLAML	NSYLAM3M	NSYLAM1M	NSYLAM3MN	NSYLAM1MN
Without socket 120 / 230 V AC	-	-	NSYLAM3MUL	-	-	-
Without socket	-	NSYLAMLDD	NSYLAM3M	NSYLAM1M	NSYLAM3MN	NSYLAM1MN
Without socket	-	-	NSYLAM3MUL	-	-	-
Without socket - DC 24-48 V DC	-	NSYLAMLDVDC	NSYLAM3MDC	-	-	-
Without socket - DC 24-48 V DC	-	-	NSYLAM3MDCUL	-	-	-

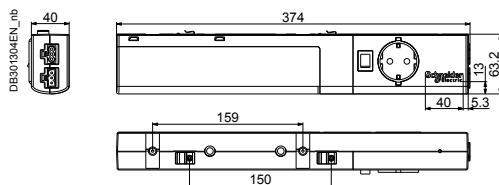

Fixing Options

Fixing by Sliding Brackets



Magnetic Fixing

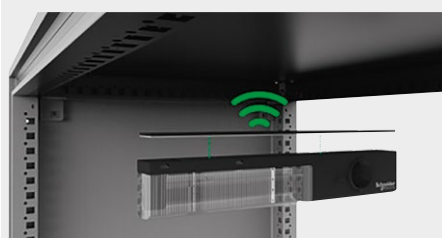

Fixing to DIN Rail

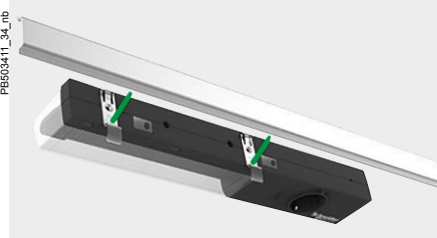

Technical changes reserved. Information provided without guarantee. Images are for illustrative purposes only.

Rack for VDI



- 1 U, 19" rack. For lamp installation in VDI enclosures.

Supply:
supplied with fixing elements.

Characteristics	References
Rack for VDI	NSYLAM1U

3-Pole Connectors

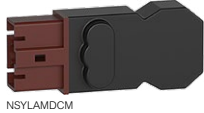
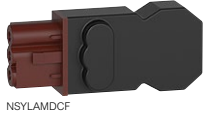

- Designed to connect Multi-Fixing LED Lamps.
- Color:
AC: Black
DC: Black (body) and brown (head)
- Ingress protection rating: IP20
- Rated current: 16 A
- Rated voltage: 250 V
- Strain relief: Yes
- Connection type for cabling: Screw connection
- Material: Polyamide
- Dimensions:
Length: 53.2 mm
Width: 23 mm
Height: 13.8 mm

- **Connection data:**
Cable diameter: 9 mm
Cable diameter 2: 5.5 mm
Cross section solid: 2.5 mm²
Cross section solid 2: 0.5 mm²
Connection cross section stranded (max.): 2.5 mm²
Cross section stranded 2: 0.5 mm²

Characteristics	References
3-pole female connectors AC model	NSYLAMACF
3-pole female connectors DC model	NSYLAMDCE
3-pole male connectors AC model	NSYLAMACM
3-pole male connectors DC model	NSYLAMDCM

Cost-Effective LED Lamps

- This LED lamp is designed to optimize costs and can be used in almost all enclosures respecting the dimensions. It can be interconnected using a single power source:
 - 5 W lamps: Max. 10 lamps interconnected,
 - 10 W lamps: Max. 5 lamps interconnected.
- Built-in switch
- Light temperature: 4000 K*
- LED service life: 25000 h*
- Casing:
 - Plastic for transparent cover and connectors
 - Aluminum for body
- Degree of insulation: Class I
- Compliant with RoHS and Reach
- Ambient temperature:
 - Operating: -10 °C to +60 °C (-14 °F to +140 °F)
 - Storage: -16 °C to +65 °C (-3 °F to +149 °F)
- Color: Aluminum
- Ingress protection rating: IP20 according to IEC60529
- Standards: IEC 60598

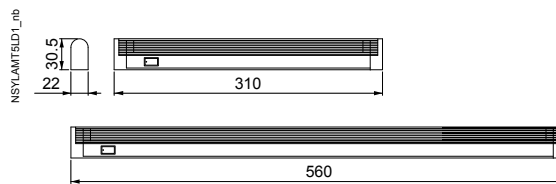

Supply:
 1 lamp and fixing elements
 3 m connection cable with quick connector
 1 m interconnection cable with quick connectors

* Approximate values.



Characteristics	Voltage (V)	Power (W)	Power factor	Frequency (Hz)	Luminous flux (lm)*	References
Cost-effective LED lamps	120/230 V AC	5	0.8	50-60	500	NSYLAMT5LD1
Cost-effective LED lamps	120/230 V AC	10	0.9	50-60	1100	NSYLAMT5LD2
Cost-effective LED lamps	24/48 V DC	5	1	-	470	NSYLAMT5LD1VDC

Portable LED Lamp

- This LED portable lamp is designed to be installed as
 - Enclosure lamp or maintenance lamp providing mobility,
 - Resistance, versatility and durability.
- Double function:
 - internal enclosure lamp,
 - maintenance lamp.
- E27 LED lamp
- Built-in recessed switch
- Light temperature: 4000 K*
- LED service life: 25000 h*
- Power cable 3 m long with male plug (European standard type)
- Casing: Plastic
- Degree of insulation: Class II
- Compliant with RoHS and Reach
- Ambient temperature:
 - Operating: -16 °C to +65 °C (-3 °F to +149 °F)
 - Storage: -10 °C to +60 °C (-14 °F to +140 °F)
- Color: Black RAL 9005
- Ingress protection rating: IP20 according to IEC60529
- Standards:
 - IEC 60598
 - UL 94: For plastic components

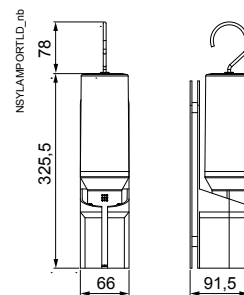

Supply:
 1 lamp with 3 m power cable with European universal plug
 1 fix base
 Fixing elements

* Approximate values.



Characteristics	Voltage (V)	Power (W)	Power factor	Frequency (Hz)	Luminous flux (lm)*	References
Portable LED lamp	120/230 V AC	10	0.5	50-60	1100	NSYLAMPORLTD

10

Fixing Options

Possible uses

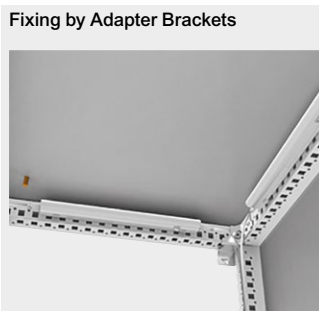
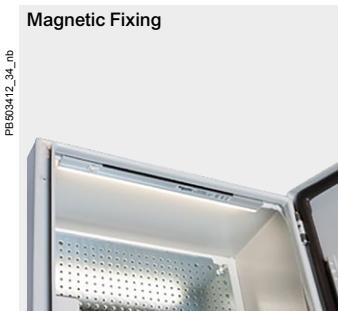

Casters and Feet for Floor-Standing Enclosures

SM **SFN** **SD** Transport Casters*



- Quick installation on plinths with heights of 100 and 200 mm, except the plinth for enclosure sets.
- They can be installed in front or side position.
- Clipping and fixing to the corner by screws.
- For use on flat surfaces.
- Height: 110 mm.
- Maximum load: 200 kg per caster.

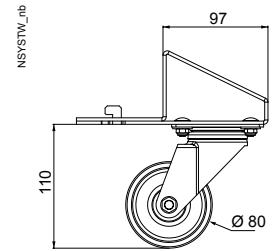

Supply:
4 transport casters
(2 with a blocking system)
and fixing elements

Characteristics
Transport casters

References
NSYSW

NSYSW

SM **SFN** **SD** Enclosure Casters

SMX **SFX**



- Double casters.
- Height: 92 mm.
- Diameter: 64 mm.
- Maximum load:
180 kg per caster
720 kg when it is installed directly on the upright,
400 kg when it is installed on the frame.

Supply:
4 casters and fixing elements

Characteristics
Enclosure casters

References
NSYSW

NSYSW

SM **SFN** **SD** Levelling Feet

SMX **SFX**



- Height: 42 mm.
- Material: Steel.
- Maximum load: 400 kg per foot.

Supply:
Set of 4 floor feet

Characteristics
Levelling feet fixed

References
NSYSPSJ

NSYSPSJ

SM **SFN** **SD** Levelling Feet

SMX **SFX**



- Height: 22 mm.
- Maximum load: 400 kg per foot.

Supply:
Set of 4 floor feet

Characteristics
Levelling feet adjustable

References
NSYSPRJ

NSYSPRJ

SM **SFN** **SD** Hygienic Stainless-Steel Feet

SMX **SFX**



- Recommended for applications that require special hygiene conditions.
- Material: 316L stainless-steel.
- Installation: Adjustable between 140 mm and 200 mm in height.
- Maximum load: 200 kg per foot.

Supply:
Set of 4 hygienic feet

Characteristics
Hygienic stainless-steel feet

References
NSYPHX200

NSYPHX200

10

CRN S3D S3X Door Switch for Wall-Mounted Enclosures



- Switch/commutator unit equipped with support and fixings for direct fixing to the enclosure.
- Can be used to control lighting, air-conditioning units, etc.
- Not compatible with the 19" swing rack and the internal door.
- NC + NO contact, 240 V AC / 3 A.

Supply:
1 door switch and fixing elements

Characteristics
Door switch for wall-mounted enclosures

References
NSYINLCRN

SM SFN SFX Door Switch for Floor-Standing Enclosures



- The switch is fixed to the structure of the enclosure.
- Drilled M20 cable entry for cable gland.
- NC + NO contact, 240 V AC / 3 A (IEC 60947-5-1) 250 V DC / 0,1 A (IEC 0947-5-1).

Supply:
1 door switch and fixing elements

Characteristics	For ranges	References
Door switch for floor-standing enclosures	SFN and SFX	NSYDCM20
Door switch for floor-standing enclosures	SM	NSYMDCM20



SFN SM Metal Document Pocket

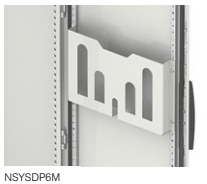

- Direct mounting on the reinforcement frame of the door.
- Adjustable depth with a pitch of 25 mm.
- Material: Steel
- Finish: Structured finish, epoxy polyester powder
- Color: RAL 7035 gray

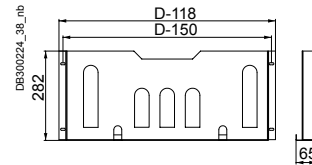

Supply:
1 metal document pocket and fixing elements

Characteristics	Width (mm)	References
PanelSet SFN and Spacial SM Metal document pocket	600	NSYSDP6M
PanelSet SFN and Spacial SM Metal document pocket	800	NSYSDP8M

SFN SM PLA PLM Plastic Document Pocket

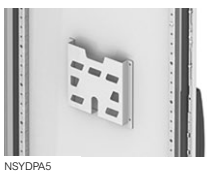

- Attachment by adhesive tape.
- Material: Polystyrene (PS)
- Color: RAL 7035 gray (NSYDPA4: RAL 9001)

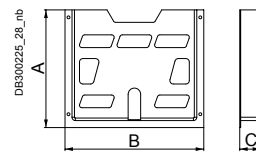

Note:
NSYDPA44 not compatible with 19" chassis or modular distribution.

Supply:
1 plastic document pocket

Characteristics	Doc. format	A (mm)	B (mm)	C (mm)	References
PanelSet SFN and Spacial SM Plastic document pocket	A5	174	188	22	NSYDPA5
PanelSet SFN and Spacial SM Plastic document pocket	A4	230	247	23	NSYDPA4
PanelSet SFN and Spacial SM Plastic document pocket	A4	234	278	40	NSYDPA44
PanelSet SFN and Spacial SM Plastic document pocket	A3	285	476	35	NSYDPA3

SFN SM Folding Support Tray



NSYSDT5

- Adjustable horizontal support for laptop computers, documents or any other element.
- Installation on the reinforcement frame of the door.
- Can also be installed on the door cross-rails.
- 4 positions: 45°, 60°, 75° and 90°.
- Maximum load: 30 kg
- Material: Steel
- Finish: Structured finish, epoxy polyester powder
- Color: RAL 7035 gray

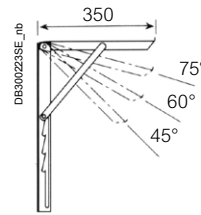

Supply:
1 folding support tray and fixing elements

Characteristics	Width of enclosure (mm)	Width of tray (mm)	References
PanelSet SFN and Spacial SM-Folding support tray	500	325	NSYSDT5
PanelSet SFN and Spacial SM-Folding support tray	600	425	NSYSDT6
PanelSet SFN and Spacial SM-Folding support tray	800	625	NSYSDT8



NSYSDT8

Door Cross-Rails

- Direct mounting cross-rails on the profiles of the reinforcement frame of the door.
- Adjustable height with a pitch of 25 mm.
- Material: Galvanized steel
- Thickness: 20/10° mm

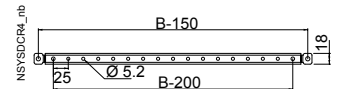

Supply:
2 cross-rails and bag of fixings



NSYSDCR4

Characteristics	Width (B)	References
Door cross-rails	400	NSYSDCR4
Door cross-rails	500	NSYSDCR5
Door cross-rails	600	NSYSDCR6
Door cross-rails	800	NSYSDCR8
Door cross-rails	1000	NSYSDCR10

SM Door Retainer for Floor-Standing Enclosure



NSYSMDR

- Door retainer locking the door in open position.
- It is fixed directly to the front frame of them enclosure and to the reinforcement frame of the door.
- It can be installed on doors that open both to the right and to the left.

Supply:
Door stop and fixing elements

Characteristics	Limit	References
Door retainer for floor-standing enclosure	90°	NSYSMDR
Door retainer for floor-standing enclosure, compatible with SFX	90° and 120°	NSYSMNR

SFN Door Retainer for Floor-Standing Enclosure



NSYSFNR

- Door retainer locking the door in open position
- It is fixed directly to the front frame of them enclosure and to the reinforcement frame of the door.
- It can be installed on doors that open both to the right and to the left.

Supply:
Door stop and fixing elements

Characteristics	Limit	References
Floor-standing door retainer	90° and 120°	NSYSFMR
Floor-standing door retainer	120°	NSYSFNR



CRN S3D S3X Door Retainer for Wall-Mounted Steel Enclosure

Door retainer locking the door in open position

- It is installed on enclosures with heights from 400 mm and widths from 300 mm.
- Door opening angle: 120°.
- Earthing connection of the enclosure by means of the reinforcement rail.
- Earthing accessories supplied with the enclosure (earth-connection cable to be ordered separately), see [page 278](#).
- Material: Steel

Note:

Cannot be installed on 19" mounting plates or on enclosures equipped with internal door.



NSYAEDRSCST

Characteristics	References
Door retainer for wall-mounted steel enclosure	NSYAEDRSCST

S3D Door Retainer for Wall-Mounted Polyamide Enclosure

Door retainer locking the door in open position

- It is installed on the perforated rails of the enclosure doors at the required height.
- Material: Polyamide 6 (PA6)

Note:

It is only installed on enclosures with a height of less than 400 mm (no perforated rails).



NSYAEDRS3DPA6

Characteristics	References
Door retainer for wall-mounted polyamide enclosure	NSYAEDRS3DPA6

Window for Modular Equipment

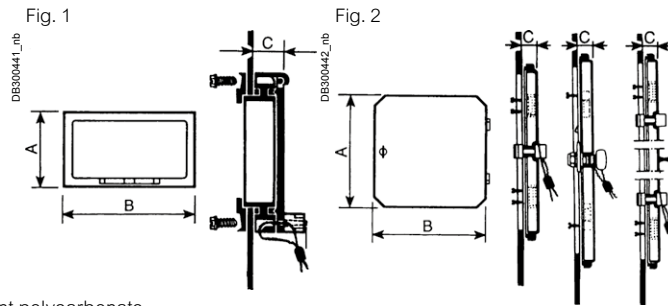

- Material: Transparent polycarbonate

Supply:
1 window



NSYVA2728M

Characteristics	N.° of modules	Fig. n.°	A	B	C	References
Window for modular equipment, Low cover	2	1	78	60	15	NSYVA2722M
Window for modular equipment, Low cover	4	1	78	95	15	NSYVA2744M
Window for modular equipment, Low cover	6	1	78	130	15	NSYVA2766M
Window for modular equipment, Low cover	8	1	78	165	15	NSYVA2788M
Window for modular equipment, Low cover	10	1	78	200	15	NSYVA2710M
Window for modular equipment, Low cover	12	1	78	235	15	NSYVA2712M
Window for modular equipment, High cover	2	1	78	60	25	NSYVA2722MA
Window for modular equipment, High cover	4	1	78	95	25	NSYVA2744MA
Window for modular equipment, High cover	6	1	78	130	25	NSYVA2766MA
Window for modular equipment, High cover	8	1	78	165	25	NSYVA2788MA
Window for modular equipment, High cover	10	1	78	200	25	NSYVA2710MA
Window for modular equipment, High cover	12	1	78	235	25	NSYVA2712MA
Window for modular equipment, Low cover	16	2	195	165	13	NSYVA2716M
Window for modular equipment, Low cover	24 in 2 rows	2	196	235	13	NSYVA2724M



NSYVA2724M

Plastic Window

- Plastic window with hinged cover for installation in front panel.
- External dimensions: 213 x 133 mm.
- Internal dimensions of the window: 180 x 78 mm.
- Material:
Cover: Polycarbonate
Body: PVC

Supply:
1 plastic window delivered with a drilling template



NSYMW10M

Characteristics	References
Plastic window	NSYMW10M

Plastic Window for Modular Equipment

- Frame with transparent hinged cover for mounting modular switchgear on the front panel.
- Opening: 46 x 180 mm (10 modules).
- Material:
Cover: Polycarbonate
Body: PVC

Supply:
1 modular front panel



NSYMW10MK

Characteristics	References
Plastic window for modular equipment	NSYMW10MK

Kit for Fixing the Switchgear

- The unit is delivered assembled.

Supply:
1 DIN rail and two supports.



NSYMW10MR

Characteristics	References
Kit for fixing the switchgear	NSYMW10MR

Mounting Example

NSYMW10MK + NSYMW10MR.



Control Window

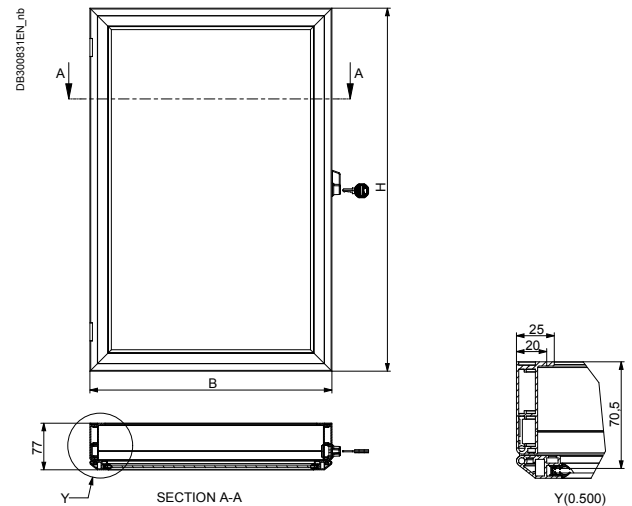

- To prevent accidental operation of the control units by any unauthorised person.
- Allows the displayed information to be read without opening the door.
- Equipped with hinges for opening (180°).
- Locked by a n° 2233X lock.
- Indoor installation.
- Material: Aluminum frame and 3 mm acrylic window

Supply:
1 window, fixings
and instruction sheet



NSYCW33

Characteristics	Dimensions A (mm)	Dimensions B (mm)	References
Control window	300	300	NSYCW33
Control window	400	400	NSYCW44
Control window	400	500	NSYCW45
Control window	400	600	NSYCW46
Control window	500	400	NSYCW54
Control window	500	500	NSYCW55
Control window	500	600	NSYCW56
Control window	600	500	NSYCW65
Control window	600	600	NSYCW66
Control window	800	600	NSYCW86

Earthing Strip

- Perforated brass bar, 15 x 3 mm.
- 1 m long.
- 87 connection points, M5 drill holes



Characteristics
Earthing strip

Supply:
1 earthing strip and fixing elements

References

NSYECB1M153

S3D S3X Fixing Lugs for the Earthing Strip



- They allow the mounting of an earth collector rail or a DIN rail at the top and bottom of an enclosure.
- Mounting incompatible with certain accessories. Please consult us.
- Fixing: On holes made in the gutter of the enclosure.

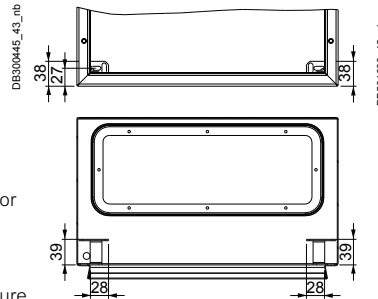

Supply:
2 lugs and fixings.

References

NSYEDCOS

SM SFN SD Central Earthing Point

SMX SFX



- Connects earthing braids and cables to the structure of the enclosure.
- The earth connection is made by means of the M8 x 18 mm screw.
- Fixing: Fixing to the structure by means of self-tapping screws

Characteristics

Central earthing point

Supply:
1 central earthing point, elements for fixing to the structure, and fixings for fixing to the screw

References

NSYCEP

Earth Braids

- They guarantee the earth connection for high frequencies, avoiding the disturbing electric currents that are produced.
- Material: Tinned copper.



Characteristics	Section (mm ²)	Terminal Ø (mm)	Length (mm)	Width (mm)	References
Earth braids	6	7	150	12	NSYEB156D6
Earth braids	10	6.5	150	17	NSYEB1510D6
Earth braids	16	8.5	155	17	NSYEB1516D8
Earth braids	25	8.5	200	27	NSYEB2025D8
Earth braids	50	8.5	200	33	NSYEB2050D8

Supply:
10 earth braids (nuts and washers not included)

Earth Cables

- Make it easier to install a safe earth connection, with a perfect contact, with optimized length.
- Material: Brass and copper alloy terminal, green and yellow PVC insulated sheath



Characteristics	Section (mm ²)	Terminal Ø (mm)	Length (mm)	References
Earth cables	6	6.4	130	NSYEL136D6
Earth cables	6	6.4	160	NSYEL166D6
Earth cables	6	8.3	160	NSYEL166D8
Earth cables	6	6.4	220	NSYEL226D6
Earth cables	25	8.3	220	NSYEL2225D8
Earth cables	10	6.4	250	NSYEL2510D6
Earth cables	25	8.3	350	NSYEL3525D8

Supply:
10 earth cables (nuts and washers not included). Reference by unit. Order by multiples of 10 (10, 20, 30...)

Aerosol Paint Can



NSYBPA7032

- Air-drying paint.
- Content: 150 g.

Note:

Not available for destinations outside Europe.
NSYBPA703* expires 10 years after its production.

Characteristics	References
Aerosol paint can, RAL 7032	NSYBPA7032
Aerosol paint can, RAL 7035 gray	NSYBPA7035

Touch-Up Paint



NSYTUP7035

- Paint for touching up with a brush.
- Air-drying paint.

Characteristics	References
Touch-up paint, RAL 7035 gray	NSYTUP7035

Renovation and Anti-Graffiti Paint



NSYAUPG1G

- Paint kit with 2 components (base 80% + hardener 20%)
- Specially designed for polyester enclosures, for their renovation and/or as prevention to allow easy removal of graffiti.
- Color: RAL 7035 gray

Supply: NSYAUPG1G

The 1 kg reference includes 1 pot with 800 g of base paint and 200 g of hardener (It is enough to paint a surface of around 5 m²).

Characteristics	References
Renovation and anti-graffiti paint	NSYAUPG1G

Applicative Solutions

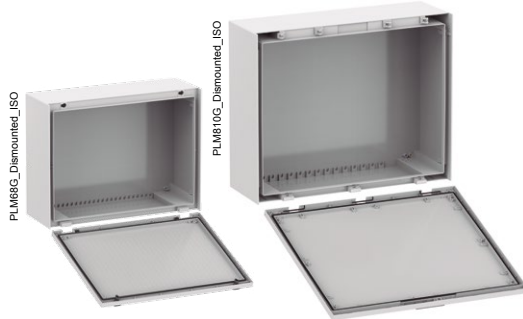
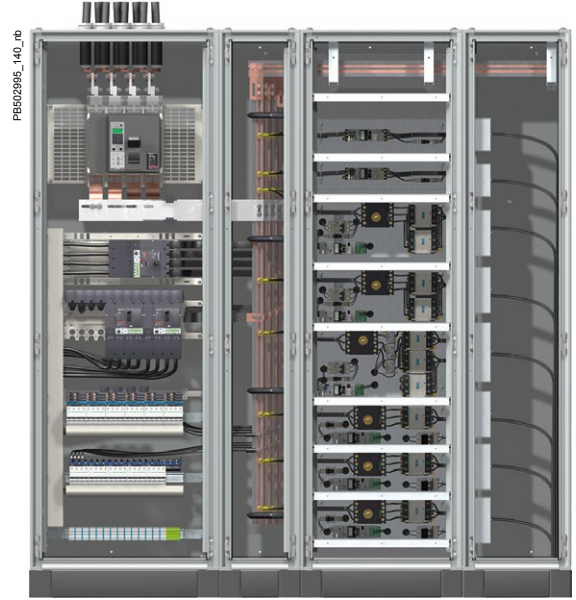

Contents

Solutions for Electrical Distribution	282
Terminal Blocks	282
Modular Wall-Mounted Enclosures	285
Accessories for Modular Floor-Standing Enclosures	289
Accessories for Low-Voltage Switchboards	296
PrismaSet Functional System	320
Solutions for Motor Control Centers	340
Outdoor Heavy-Duty Enclosures	372
Thalassa PLM Landscape Enclosures	386
Seismic Enclosures	388
Electronic Applications	402
Steel Enclosures with Protection Against Electromagnetic Interference (EMC)	420
Enclosures for Explosive Atmospheres (ATEX)	428
Human-Machine Interface Control Enclosure, PC Racks and Control Desks	436
Variable-Speed Drive Flush-Mounting Kits	468
Automotive Applications	472

The **Spacial S3DB** Enclosure Is Made to Be Equipped with Terminal Blocks.

It is ready to be equipped with a ladder mounting plate and a symmetrical DIN rail (to be ordered separately). The body does not have cable gland openings. The Spacial S3DB enclosure is the ideal coupling enclosure with FL21 cut-outs.

Spacial S3DB



Vertical Position

Horizontal Position

11

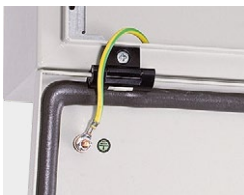

Safe

Welded studs on door and body
(earth cables to be ordered separately).



Smart

Example of installation with the ladder mounting plate.

Spacial S3DB

Body

Single-piece body, folded and welded. Front rail with double sheet thickness, guttershaped.

- Depth 150 mm
- The terminal enclosure can be installed vertically (width becoming height, and vice versa)
- Wall-mounted directly or by means of fixing lugs (to be ordered separately).
- 4 M8 x 25 shouldered backstuds.
- Body without cable gland openings.

Door

- Easily removable and reversible door, with 20 mm return with double sheet thickness granting excellent rigidity; equipped with 2 hinges opening to 180°.
- Door opening to more than 180° for maximum accessibility (the door comes to rest on the body of the enclosure in top position).
- Maximum acceptable load on the door: 20 kg/m².
- Wall-mounted enclosure supplied with 3-mm double-bar lock as standard.
- M6 x 16 earthing screw for equipotential connection between the door and the body of the enclosure.

Dedicated accessories

The terminal enclosure, with a depth of 150 mm, can be equipped:

- With 2 rails to be installed on the 4 M8 x 25 shouldered backstuds.
- With a symmetrical rail to be installed on the rails.
- With a 6 mm² earth braid to be placed between the body and the door.
- It can also be equipped with a plain mounting plate, see [page 220](#).
- Finish: Structured finish, epoxy polyester powder
- Color: RAL 7035 gray
- Ingress protection rating: IP66 according to IEC 60529
- Mechanical protection rating: IK10 according to IEC 62262

For more details see [page 284](#)



NSYS3DB25315

Characteristics	Height (mm)	Width (mm)	Depth (mm)	References
Spacial S3DB	250	300	150	NSYS3DB25315
Spacial S3DB	250	400	150	NSYS3DB25415
Spacial S3DB	250	500	150	NSYS3DB25515
Spacial S3DB	300	400	150	NSYS3DB3415
Spacial S3DB	300	500	150	NSYS3DB3515
Spacial S3DB	300	600	150	NSYS3DB3615
Spacial S3DB	400	800	150	NSYS3DB4815
Spacial S3DB	600	400	150	NSYS3DB6415

Spacial S3DB

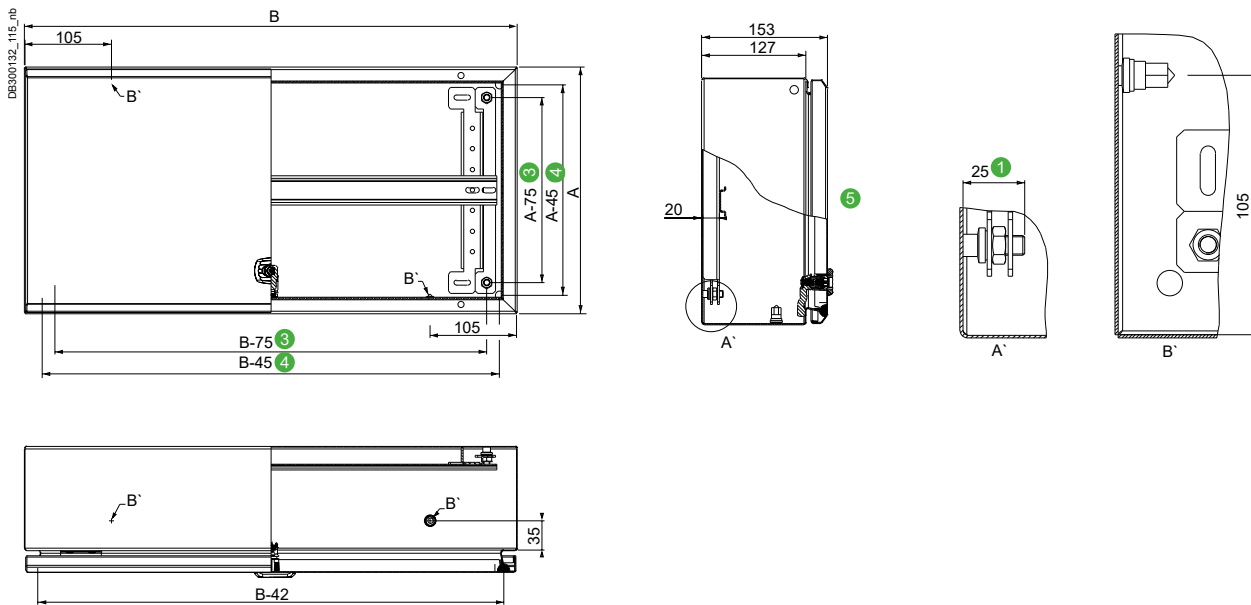

- A:** Enclosure height
- B:** Enclosure width
- C:** Enclosure depth

- ① With ladder mounting plate installed.
- ② M6 x 17.5 mm earthing stud.
- ③ Stud center-to-center distance.
- ④ Center-to-center distance of the holes for direct fixing.
- ⑤ Drop-leaf door.

The dimensions provided include the ladder mounting plate which is the most commonly used accessory with this enclosure.

The **Spacial S3DM** Enclosure for Modular Switchgear Can Be Equipped with:

- a modular chassis (**NSYDLM...**) with cut-out front panels for 24 to 234 modules according to the dimensions and references,
- a 6 mm² earth connection placed between the body and the door.

The enclosure can be equipped with accessories from the Spacial standard wall-mounted range.

Spacial S3DM



S3DM Enclosure (Standard Delivery)



S3DM Enclosure Equipped with a DLM Modular Chassis



Easily Removable and Reversible Door

- With 20 mm return with double thickness granting excellent rigidity, opening to 120°, equipped with 2 or 3 invisible hinges.
- Three locking points for heights of more than 600 mm.
- Perforated rails on the hinge side of the door, with drill holes with a diameter of 4.2 mm in steps of 25 mm.



Dedicated Accessories

- The DLM modular chassis consists of metal cut-out front panels which can clip on with any screws. Rigid structure made from galvanized steel. The depth of the chassis can be adjusted from 40 to 85 mm between the rail and the front panel, allowing the installation of all types of devices.
- For enclosures with a depth of 150 mm, the chassis can be installed at the front or on the backstuds at the rear. It is possible to adjust its depth using the adjustable supports (**NSYSDCR...** type).
- It can also be equipped with a plain mounting plate, see [page 220](#).

Spacial S3DM

- Single-piece body, folded and welded.
- Front rail with double sheet thickness, gutter-shaped.
- 4 M8 x 25 mm shouldered backstuds for installing chassis and step slides, leaving a space of 10 mm behind them.
- Cable gland plate (245 x 80) at the top and bottom of the enclosure, guaranteeing the maximum access surface (also available in plain door).
- Finish: Structured finish, epoxy polyester powder
- Color: RAL 7035 gray
- Ingress protection rating: IP66 according to IEC 60529
- Mechanical protection rating: IK08 according to IEC 62262

Supply:

Wall-mounted enclosure supplied with 3-mm double-bar lock as standard



NSYS3DM10615T

Characteristics	Height (mm)	Width (mm) (B)	Depth (mm) (C)	References
Spacial S3DM	400	300	150	NSYS3DM4315T
Spacial S3DM	500	400	150	NSYS3DM5415T
Spacial S3DM	600	400	150	NSYS3DM6415T
Spacial S3DM	600	600	150	NSYS3DM6615T
Spacial S3DM	700	500	150	NSYS3DM7515T
Spacial S3DM	800	600	150	NSYS3DM8615T
Spacial S3DM	1000	600	150	NSYS3DM10615T
Spacial S3DM	1000	800	150	NSYS3DM10815T

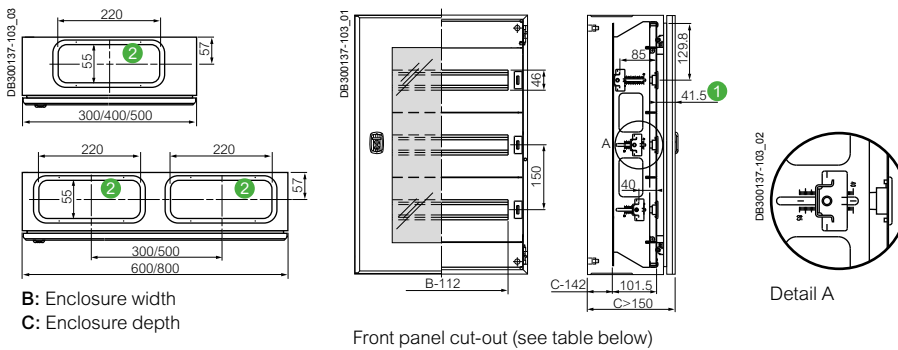

- ① Front face of the modular chassis / front face of the door
- ② Cable gland plates at the top and bottom of the enclosure.

Number of Modules per Chassis** (Every 18 mm)

1 module = 2 steps = 18 mm

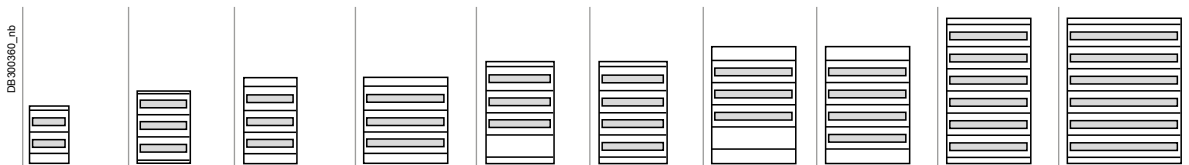

Chassis reference	NSYDLM24	NSYDLM48	NSYDLM48P	NSYDLM84P	NSYDLM66*	NSYDLM88	NSYDLM84*	NSYDLM112	NSYDLM168	NSYDLM240
Enclosure height (mm)	400	500	600	600	700	700	800	800	1000	1000
Enclosure width (mm)	300	400	400	600	500	500	600	600	600	800
Number of rows	2	3	3	3	3	4	3	4	6	6
Modules per row	12	16	16	28	22	22	28	28	28	39
Total n. of modules	24	48	48	84	66	88	84	112	168	234

Note:

References **NSYDLM48**, **NSYDLM48P** and **NSYDLM84P**: the central row cannot receive modules at the height of the lock (check our technical instructions) when installed at the front of the enclosure. In this case, 1 module is sealed up. ** DLM modular chassis. The dimensions provided include the modular chassis which is the most commonly used accessory with this enclosure.

* Chassis with a plain front plate includes a partial mounting plate.

DLM Modular Chassis

- The chassis consists of metal cut-out front panels, which can be clipped on without screws.
- The depth of the chassis can be adjusted from 40 to 85 mm, between the rail and the front panel, allowing the installation of all types of devices.
- Material: Rigid galvanized steel structure
- Finish: Structured finish, epoxy polyester powder
- Color: RAL 7035 gray

Note:
1 module = 2 steps = 18 mm



NSYDLM24

Characteristics	Number of modules	Height (mm)	Width (mm) (B)	References
DLM modular chassis	24	400	300	NSYDLM24
DLM modular chassis	48	500	400	NSYDLM48
DLM modular chassis	48	600	400	NSYDLM48P
DLM modular chassis	84	600	600	NSYDLM84P
DLM modular chassis	66	700	500	NSYDLM66 *
DLM modular chassis	88	700	500	NSYDLM88
DLM modular chassis	84	800	600	NSYDLM84 *
DLM modular chassis	112	800	600	NSYDLM112
DLM modular chassis	168	1000	600	NSYDLM168
DLM modular chassis	234	1000	800	NSYDLM240

* Chassis with a plain front plate includes a partial mounting plate.

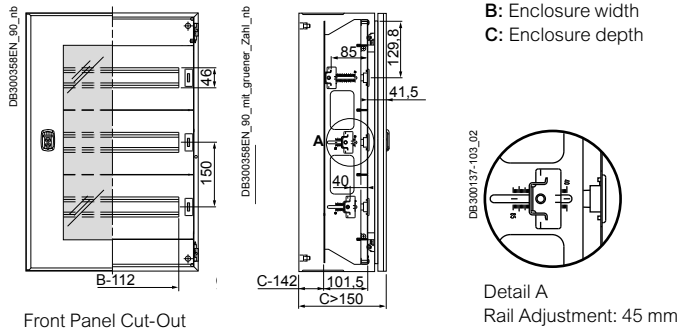

Plain Front Panel

- Metal front panels to be clipped on without screws.
- Finish: Structured finish, epoxy polyester powder
- Color: RAL 7035 gray

Supply:
2 plain front panel and fixings



NSYCTL300DLM

Characteristics	Width (mm)	References
Plain front panel	500	NSYCTL500DLM
Plain front panel	600	NSYCTL600DLM
Plain front panel	800	NSYCTL800DLM

DL Modular Chassis

- Modular chassis designed for devices with heights of 53 and 68 mm, which can be coupled directly to the enclosure plate-support screws.
- Distance between device rail and protective cover plate: 45 mm.
- One-piece modular chassis
- The depth of the chassis can't be adjustable
- Material: Steel
- Finish: Metal protective cover plate
- Color: RAL 7035 gray

Note:
For Spacial S3D please consult us
Depth 150 mm: For coupling to enclosures with a depth of 200 mm, the stand-offs (ref. **NSYEX608**) are to be ordered separately (4 per chassis).



NSYDLCR24

Characteristics	Height (mm)	Width (mm)	Depth (mm)	References
DL modular chassis	300	250	150	NSYDLCR18
DL modular chassis	400	300	150	NSYDLCR24
DL modular chassis	400	300	150	NSYDLCR36
DL modular chassis	500	400	150	NSYDLCR48
DL modular chassis	600	400	150/200	NSYDLCR64
DL modular chassis	600	500	150/200	NSYDLCR88
DL modular chassis	700	500	200	NSYDLCR110
DL modular chassis	800	600	200	NSYDLCR135

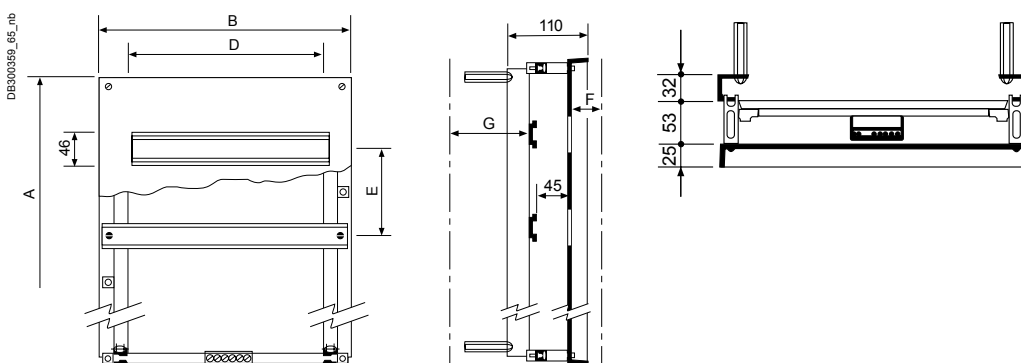

Dimension F: Distance from the protective cover plate to the inside of the door.
Dimension G: Distance from the device-support rail to the rear of the enclosure.

References	Dimensions (mm)						No. of 18 mm modules	No. of rows	Approx. weight (kg)
	A	B	D	E	F	G			
NSYDLCR18	255	205	162	120	41	51	18	2	1.2
NSYDLCR24	355	255	216	160	41	51	24	2	1.7
NSYDLCR36	355	255	216	110	41	51	36	3	1.7
NSYDLCR48	455	355	288	130	41	51	48	3	2.4
NSYDLCR64	555	355	288	130	41	51/101	64	4	3.3
NSYDLCR88	555	455	396	130	41	51/101	88	4	4.5
NSYDLCR110	655	455	396	125	41	101	110	5	5.1
NSYDLCR135	755	555	486	140	41	101	135	5	7.5

Note: For enclosures with transparent door, the F dimension is reduced by 4 mm

Blanking Plate

- Blanking plate for full or partial covering of the circuit-breaker windows; it can easily be cut to the required size.
- Material: PVC (polyvinyl chloride)



NSYATP72M

Characteristics	Number of modules	Color	Length (mm)	References
Blanking plate	4	RAL 7035 gray	72	NSYATP72M
Blanking plate	24	RAL 7035 gray	432	NSYATP24DTM
Blanking plate	61	RAL 7035 gray	1100	NSYATPUND

Modular Distribution System Based on Accessories to Create Electric Panels with High Distribution Capacity

The accessories are installed on a chassis mounted at the front of the enclosure, such as:

- cover plates for enclosures with widths of 600 and 800 mm, solid or cut-out, screw-mounted or hinged. They cover 24 or 36 modules per row, depending on the width of the enclosure,
- material support rails, fixed or with adjustable depth,
- mounting plate supports for coupling non-modular equipment,
- supports for fixing cable-distribution cable ducts.
- the summatory of the height of all the covers that complete a chassis must be the height of the cabinet minus 200 mm.

Sets of accessories made up of material-supporting frames with chassis and cover plates are offered for the construction of double or busbar modular chassis. All accessories of the individual chassis system can also be combined in the same way with a double chassis or with a chassis with busbar area.



Single-Chassis Coupling Set

- Chassis made up of vertical uprights and horizontal crossbars:
- PanelSeT SFN: They are screwed to the front frame of the enclosure.
- Spacial SM: They are screwed to the front frame of the enclosure by means of vertical adaptation profiles, see [page 239](#).
- Easy access to the inside for component installation.
- Material: Steel
- Finish: Structured finish, epoxy polyester powder
- Color: RAL 7035 gray

Note:
Installation example: See [page 291](#).

Supply:
2 vertical uprights, 2 horizontal crossbars and fixing elements

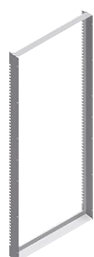

NSYCSH166

Characteristics	Maximum no. of 18 mm modules	Height (mm)	Width (mm)	References
Single-chassis coupling set	216	1600	600	NSYCSH166
Single-chassis coupling set	324	1600	800	NSYCSH168
Single-chassis coupling set	240	1800	600	NSYCSH186
Single-chassis coupling set	360	1800	800	NSYCSH188
Single-chassis coupling set	288	2000	600	NSYCSH206
Single-chassis coupling set	432	2000	800	NSYCSH208

Double-Chassis Coupling Set

- Mounting on enclosures with widths of 1200 and 1600 mm.
- PanelSeT SFN: The double-door enclosure adaptation kit is required for enclosure widths of 1200 and 1600 mm, see [page 232](#).
- Spacial SM: They are screwed to the front frame of the enclosure by means of the vertical adaptation profiles, see [page 239](#). For enclosures with a width of 1200 mm the top/bottom adjustment rails are necessary.
- Set made up of two modular chassis with an intermediate central upright.
- Material: Steel
- Finish: Structured finish, epoxy polyester powder
- Color: RAL 7035 gray

Note:
Installation example: See [page 291](#).

Supply:
2 single-chassis coupling sets,
1 intermediate central upright and fixing elements

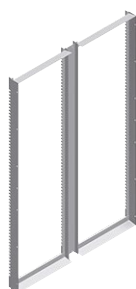

NSYDCSH2012

Characteristics	Maximum no. of 18 mm modules	Set made up of columns with a width (mm)	Height (mm)	Width (mm)	References
Double-chassis coupling set	576	600 + 600	2000	600	NSYDCSH2012

Chassis-Coupling Set with Zone For Busbars

- Set for mounting on enclosures with widths of 1000 and 1200 mm.
- PanelSeT SFN: They are screwed to the front frame enclosure.
- Spacial SM: They are screwed to the front frame of the enclosure by means of the vertical and horizontal adaptation profiles, see [page 239](#).
- Assembly made up of a modular chassis with an intermediate central upright and a blanking cover plate for busbars (width 300 mm).
- Material: Steel
- Finish: Structured finish, epoxy polyester powder
- Color: RAL 7035 gray

Note:
Installation example: See [page 291](#).

Supply:
1 single-chassis coupling set,
1 intermediate central upright,
1 busbar blanking cover plate and fixing elements

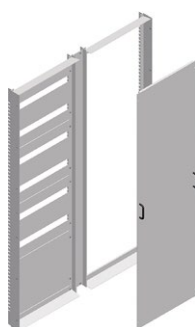

NSYCSHB2010

Characteristics	Maximum no. of 18 mm modules	Set made up of columns with a width (mm)	Height (mm)	Width (mm)	References
Chassis-coupling set with zone for busbars	288	600 + 400	2000	1000	NSYCSHB2010
Chassis-coupling set with zone for busbars	432	800 + 400	2000	1200	NSYCSHB2012

Combination of Cut-Out Screw-Mounted Cover Plates and Single-Chassis Coupling Set

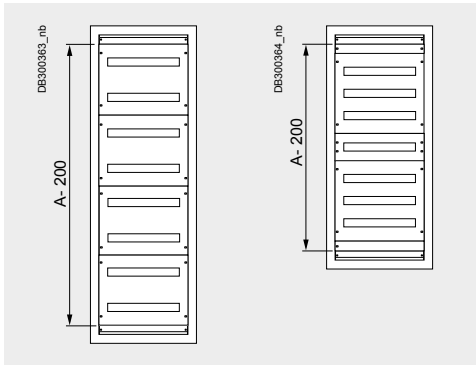

Dimensions (mm)		No. of 18 mm modules	1 single-chassis coupling set	5 screwed-on cut-out cover plates	2 adjustment cover plates
H (A)	W (B)				
1800	600	240	1 x NSYCSH186	5 x NSYMUC306	1 x NSYADC16

Single-Chassis Coupling Set

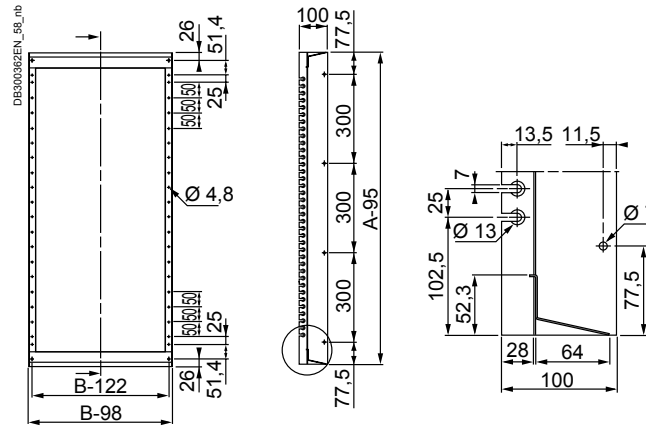

Combination of Cut-Out Screw-Mounted Cover Plates and Double-Chassis Coupling Set

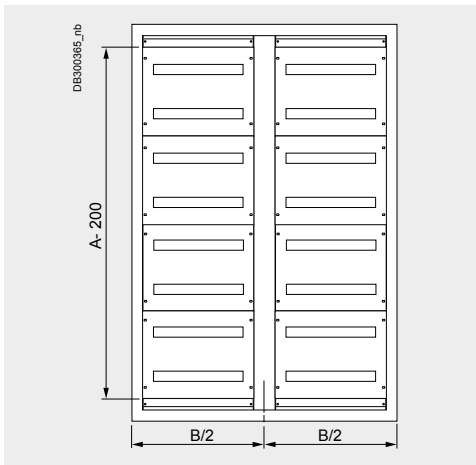

Dimensions (mm)			No. of 18 mm modules	1 double-chassis coupling set	12 screwed-on cut-out 300 mm cover plates	Double-door enclosure adaptation kit
H (A)	W (B)	D (C)				
2000	1200	500	576	1 x NSYDCSH2012	12 x NSYMUC306	NSYSMP2D5
2000	1600	500	864	-	12 x NSYMUC308	-

Screwed-On Plain Cover Plate

- Metal cover plates for protecting control devices.
- The cut-outs in non-modular control devices are at user's request.
- Suitable by modules of 150 or 200 mm.
- Material: Steel
- Finish: Structured finish, epoxy polyester powder
- Color: RAL 7035 gray

Versions:

- Screwed-on plain cover plate.
- Hinged plain cover plate.
- 120° opening with flat hinge.

Supply:

1 plain cover plate and fixing elements

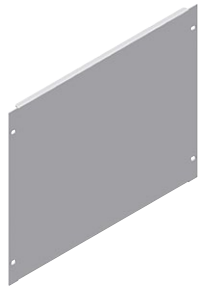

NSYMPC156

Characteristics	Height (mm) (A)	Width (mm) (B)	References
Screwed-on plain cover plate	150	600	NSYMPC156
Screwed-on plain cover plate	150	800	NSYMPC158
Screwed-on plain cover plate	200	600	NSYMPC206
Screwed-on plain cover plate	200	800	NSYMPC208
Screwed-on plain cover plate	300	600	NSYMPC306
Screwed-on plain cover plate	300	800	NSYMPC308
Screwed-on plain cover plate	400	600	NSYMPC406
Screwed-on plain cover plate	400	800	NSYMPC408
Screwed-on plain cover plate	450	600	NSYMPC456
Screwed-on plain cover plate	450	800	NSYMPC458
Screwed-on plain cover plate	600	600	NSYMPC606
Screwed-on plain cover plate	600	800	NSYMPC608

Hinged Plain Cover Plate

- Metal cover plates for protecting control devices.
- The cut-outs in non-modular control devices are at user's request.
- Suitable by modules of 150 or 200 mm.
- Material: Steel
- Finish: Structured finish, epoxy polyester powder
- Color: RAL 7035 gray

Versions:

- Screwed-on plain cover plate.
- Hinged plain cover plate.
- 120° opening with flat hinge.

Supply:

1 plain cover plate and fixing elements

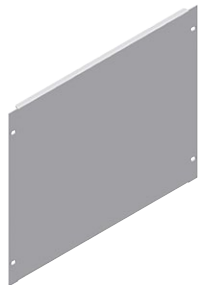

NSYMPCH156

Characteristics	Height (mm) (A)	Width (mm) (B)	References
Hinged plain cover plate	150	600	NSYMPCH156
Hinged plain cover plate	150	800	NSYMPCH158
Hinged plain cover plate	200	600	NSYMPCH206
Hinged plain cover plate	200	800	NSYMPCH208
Hinged plain cover plate	300	600	NSYMPCH306
Hinged plain cover plate	300	800	NSYMPCH308
Hinged plain cover plate	400	600	NSYMPCH406
Hinged plain cover plate	400	800	NSYMPCH408
Hinged plain cover plate	450	600	NSYMPCH456
Hinged plain cover plate	450	800	NSYMPCH458
Hinged plain cover plate	600	600	NSYMPCH606
Hinged plain cover plate	600	800	NSYMPCH608

Plain Cover Plates

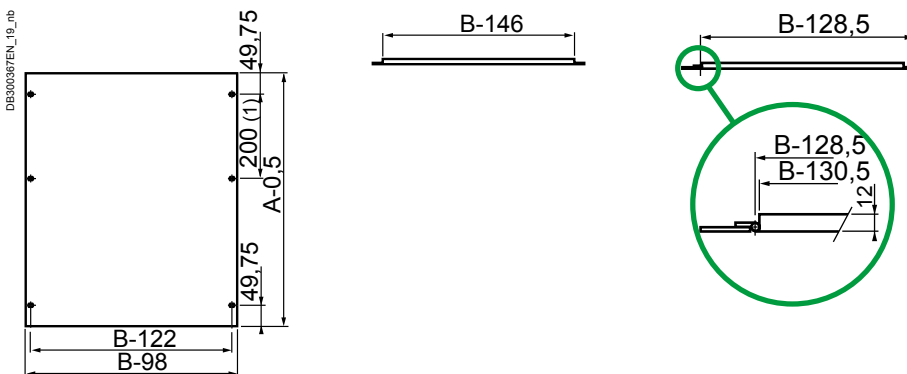

Screwed-On Cut-Out Cover Plate

- Cut-out metal cover plates for modular switchgear (1 module = 18 mm).
- Suitable by modules of 150 or 200 mm.
- Cover plates for 600 mm width enclosures: 24 modules per row,
- Cover plates for 800 mm width enclosures: 36 modules per row.
- Material: Steel
- Finish: Structured finish, epoxy polyester powder
- Color: RAL 7035 gray
- To close the unoccupied DIN rail spaces, use the blanking plate **NSYATPUND**

Versions:

- Screwed-on cut-out cover plate,
- Hinged cut-out cover plate. 120° opening with flat hinge.

Supply:

1 cut-out cover plate and fixing elements

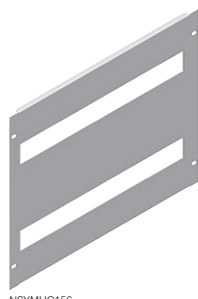

NSYMUC156

Characteristics	Maximum no. of 18 mm modules	No. of cut-outs	Height (mm) (A)	Width (mm) (B)	References
Screwed-on cut-out cover plate	24	1	150	600	NSYMUC156
Screwed-on cut-out cover plate	36	1	150	800	NSYMUC158
Screwed-on cut-out cover plate	24	1	200	600	NSYMUC206
Screwed-on cut-out cover plate	36	1	200	800	NSYMUC208
Screwed-on cut-out cover plate	48	2	300	600	NSYMUC306
Screwed-on cut-out cover plate	72	2	300	800	NSYMUC308
Screwed-on cut-out cover plate	48	2	400	600	NSYMUC406
Screwed-on cut-out cover plate	72	2	400	800	NSYMUC408

Hinged Cut-Out Cover Plate

- Cut-out metal cover plates for modular switchgear (1 module = 18 mm).
- Suitable by modules of 150 or 200 mm.
- Cover plates for 600 mm width enclosures: 24 modules per row,
- Cover plates for 800 mm width enclosures: 36 modules per row.
- Material: Steel
- Finish: Structured finish, epoxy polyester powder
- Color: RAL 7035 gray
- To close the unoccupied DIN rail spaces, use the blanking plate **NSYATPUND**

Versions:

- Screwed-on cut-out cover plate,
- Hinged cut-out cover plate. 120° opening with flat hinge.

Supply:

1 cut-out cover plate and fixing elements



NSYMUCH156

Characteristics	Maximum no. of 18 mm modules	No. of cut-outs	Height (mm) (A)	Width (mm) (B)	References
Hinged cut-out cover plate	24	1	150	600	NSYMUCH156
Hinged cut-out cover plate	36	1	150	800	NSYMUCH158
Hinged cut-out cover plate	24	1	200	600	NSYMUCH206
Hinged cut-out cover plate	36	1	200	800	NSYMUCH208
Hinged cut-out cover plate	48	2	300	600	NSYMUCH306
Hinged cut-out cover plate	72	2	300	800	NSYMUCH308
Hinged cut-out cover plate	48	2	400	600	NSYMUCH406
Hinged cut-out cover plate	72	2	400	800	NSYMUCH408

Cut-Out Cover Plates

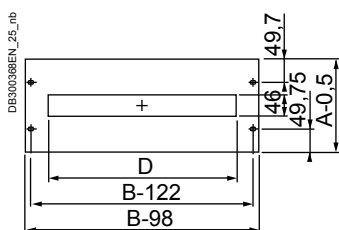

A = 150 and 200 mm

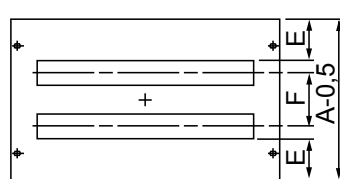

A = 300 and 400 mm

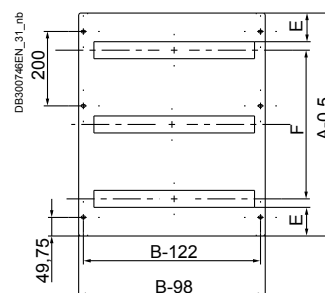

Cut-out at 200 mm when A = 600

Dimensions (mm)

D	E	F
432	51.75	150
642	51.75	150
432	76.75	200
642	76.75	200
432	51.75	150
642	51.75	150
432	76.75	200
642	76.75	200

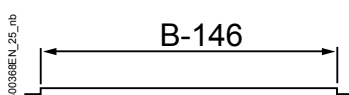

Screwed-On Cover Plate

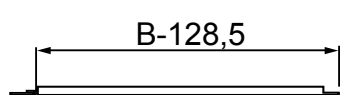

Hinged Cover Plate

Adjustment Cover Plates

- Metal adjustment cover plates designed to complete the front of the modular chassis according to the combinations made by modules of 150 or 200 mm.
- Material: Steel
- Finish: Structured finish, epoxy polyester powder
- Color: RAL 7035 gray

Supply:
2 adjustment cover plates and fixing elements



Characteristics	Height (mm)	Width (mm)	References
Adjustment cover plates	50	600	NSYADC16
Adjustment cover plates	50	800	NSYADC18

Set of Fixed Rail with Supports

- Set made up of a galvanized symmetric DIN rail, 35 x 15 mm, and fixed mounting supports, for the installation of modular devices or not.
- Material: Zinc-coated steel
- Fixing: Mounting by screws directly on the uprights of the chassis-coupling set

Maximum number of 18 mm modules:

- Enclosure width 600 mm: 24 modules,
- Enclosure width 800 mm: 36 modules.

Supply:
1 DIN rail, 2 fixed supports and fixing elements



Characteristics	Width (mm)	References
Set of fixed rail with supports	600	NSYMFSC60
Set of fixed rail with supports	800	NSYMFSC80

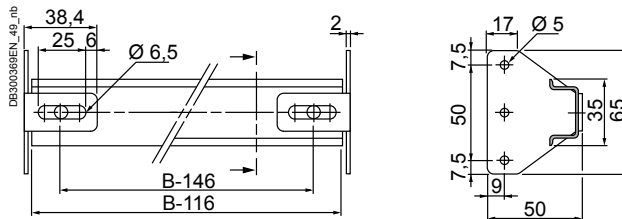

Set of Depth-Adjustable Rail with Supports

- Set made up of a galvanized symmetric DIN rail, 35 x 15 mm, and depth adjustable mounting supports, for the installation of modular devices or not.
- Material: Zinc-coated steel (mounting support)
- Fixing: Mounting by screws directly on the uprights of the modular chassis-coupling set

Maximum number of 18 mm modules:

- Enclosure width 600 mm: 24 modules,
- Enclosure width 800 mm: 36 modules.

Supply:
1 DIN rail, 2 adjustable supports and fixing elements



Characteristics	Width (mm)	References
Set of depth-adjustable rail with supports	600	NSYMFSC60D
Set of depth-adjustable rail with supports	800	NSYMFSC80D

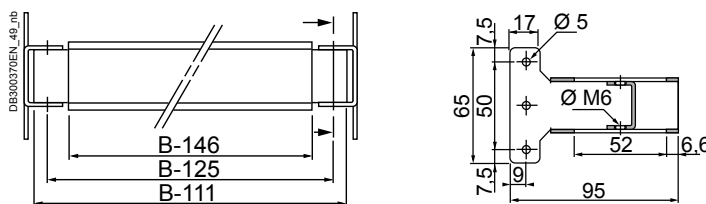

Cable Duct Fixing Supports

- Supports for fixing cable-distribution gutters in the modular chassis.
- Allows the fixing of gutters in horizontal and vertical position on the same plane to facilitate cable distribution.
- Material: Zinc-coated steel

Fixing: Installation by screws directly on the rail supplied with the fixed or adjustable rail

Supply:

6 supports (3 on the right and 3 on the left) and fixing elements



Characteristics	References
Cable duct fixing supports	NSYMCDFIX

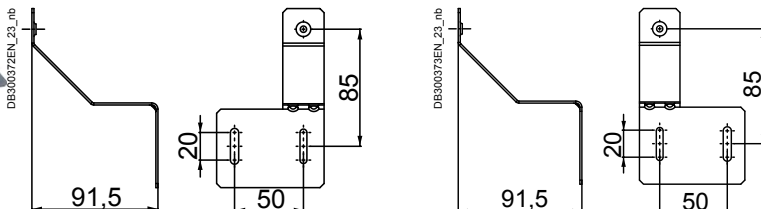

Reinforced Plate Supports

- Supports for fixing the partial mounting plate for small non-modular equipment or material-supporting cross-rails for heavy equipment. See partial mounting plate, [page 227](#).
- Material: Zinc-coated steel

Fixing: Direct fixing by screws to the vertical uprights of the modular chassis-coupling set and at the rear directly to the structure (PanelSet SFN) and on universal or quick-fixing cross-rails (see [page 237](#)) installed vertically in the back of the enclosure (Spacial SM)

Supply:

2 supports and fixing elements



Characteristics	No. of cut-outs (Ø 5.2 mm)	Depth (mm)	References
Reinforced plate supports	16	600	NSYMPS60
Reinforced plate supports	24	800	NSYMPS80

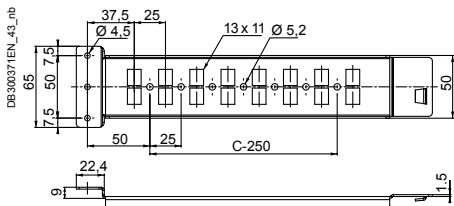

Top Busbar Chamber

- Chamber which protects and supports the sets of horizontal bars.
- Enables new switchgear by tapping and isolates the sets of bars from the rest of the equipment.
- It is only installed at the top of the enclosure.
- Material: Steel
- Finish: Structured finish, epoxy polyester powder
- Color: RAL 7035 gray
- Ingress protection rating: IP55 according to IEC 60529

Supply:

One structure of the busbar chamber as a kit
Two front panels
Reinforced coupling kit
One sealing gasket



NSYTBCN345

Characteristics	Height (mm)	Width (mm) (B)	Depth (mm) (C)	References
Top busbar chamber	300	400	500	NSYTBCN345
Top busbar chamber	300	400	600	NSYTBCN346
Top busbar chamber	300	400	800	NSYTBCN348
Top busbar chamber	300	600	500	NSYTBCN365
Top busbar chamber	300	600	600	NSYTBCN366
Top busbar chamber	300	600	800	NSYTBCN368
Top busbar chamber	300	800	500	NSYTBCN385
Top busbar chamber	300	800	600	NSYTBCN386
Top busbar chamber	300	800	800	NSYTBCN388
Top busbar chamber	300	1000	500	NSYTBCN3105
Top busbar chamber	300	1000	600	NSYTBCN3106
Top busbar chamber	300	1000	800	NSYTBCN3108
Top busbar chamber	300	1200	500	NSYTBCN3125
Top busbar chamber	300	1200	600	NSYTBCN3126
Top busbar chamber	300	1200	800	NSYTBCN3128

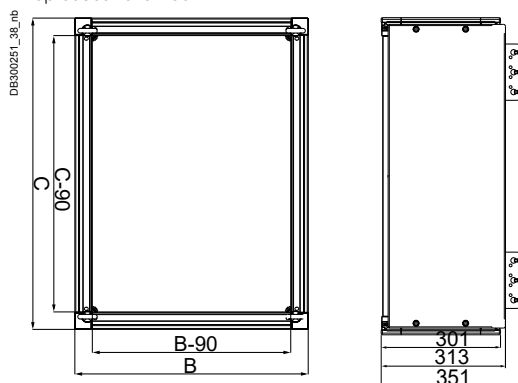

Side Panels for the Top Busbar Chamber

- Set of two side panels for coupling with the busbar chamber.
- Captive screws.
- Material: Steel
- Finish: Structured finish, epoxy polyester powder
- Color: RAL 7035 gray

Supply:

Two side panels and fixing elements

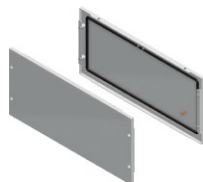

NSYSPBCN35

Characteristics	Depth (mm)	References
Side panels for the top busbar chamber	500	NSYSPBCN35
Side panels for the top busbar chamber	600	NSYSPBCN36
Side panels for the top busbar chamber	800	NSYSPBCN38

Side Busbar Chamber

- Protects and supports the sets of vertical bars.
- Enables new switchgear by tapping and isolates the sets of bars from the rest of the equipment.
- It can be installed on either of the two sides of the enclosure.
- Material: Steel
- Finish: Structured finish, epoxy polyester powder
- Color: RAL 7035 gray
- Ingress protection rating: IP55 according to IEC 60529
- UL-certified (cULus): Rating according UL50E: Type 1,12 AND 3R

Supply:

One structure of the busbar chamber
One roof
One rear panel
One door with handle (5 mm DB lock)



NSYSFN18440

Characteristics	Height (mm)	Width (mm)	Depth (mm)	References
Side busbar chamber	1800	400	400	NSYSFN18440
Side busbar chamber	1800	400	500	NSYSFN18450
Side busbar chamber	1800	400	600	NSYSFN18460
Side busbar chamber	2000	300	500	NSYSFN20350
Side busbar chamber	2000	300	600	NSYSFN20360
Side busbar chamber	2000	300	800	NSYSFN20380
Side busbar chamber	2000	400	400	NSYSFN20440
Side busbar chamber	2000	400	500	NSYSFN20450
Side busbar chamber	2000	400	600	NSYSFN20460
Side busbar chamber	2000	400	800	NSYSFN20480
Side busbar chamber	2200	400	600	NSYSFN22460

Side Panels for the Side Busbar Chamber

- Set of 2 side panels fixed to the outside.
- Captive screws.
- Material: Steel
- Finish: Structured finish, epoxy polyester powder
- Color: RAL 7035 gray

Supply:

Two side panels with external fixing
and fixing elements



NSY2SPN184

Characteristics	Height (mm)	Depth (mm)	References
Side panels	1800	400	NSY2SPN184
Side panels	1800	500	NSY2SPN185
Side panels	1800	600	NSY2SPN186
Side panels	2000	400	NSY2SPN204
Side panels	2000	500	NSY2SPN205
Side panels	2000	600	NSY2SPN206
Side panels	2000	800	NSY2SPN208
Side panels	2200	600	NSY2SPN226

Accessories for Low Voltage Switchboards

Spacial SM - PanelSeT SFN - Spacial SFX
Copper Bar Support Up To 630 A

630-A Bar Support

PanelSeT SFN:

- Support prepared for coupling directly to the structure of the enclosure.

Spacial SFX:

- A universal cross-rail is needed, in some cases, to replace the 400 mm quick-fixing cross-rail.

Spacial SM:

- Installation by means of a vertical adaptation profile and 40 mm universal cross-rails (1 row).
- Maximum nominal rating 630 A.
- Determine according to the enclosed table the cross-section of the bars and the distance between supports, according to the nominal and short-circuit current respectively.

Supply:

One 630-A bar support, one 40 mm quick-fixing cross-rail and fixing elements



Characteristics	Width (mm)	References
630-A bar support	400	NSYBS400
630-A bar support	500	NSYBS500
630-A bar support	600	NSYBS600
630-A bar support	800	NSYBS800

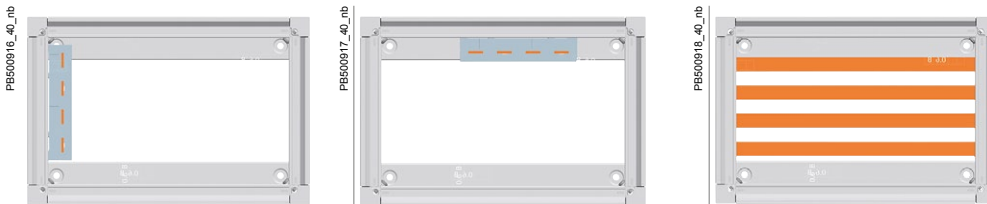
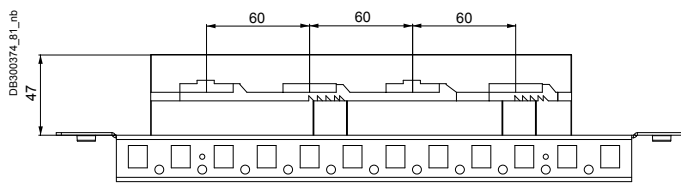

Nominal rating IP55 NR (A)	No. of bars per phase	Bar cross-section (mm)	Bar cross-section (mm ²)	Maximum distance between bar supports according to the short-circuit current (mm) I _{cc} kA								Neutral (mm)	Earth (mm)
				12	23	30	39	52	66	69			
200	1	12 x 5	60	525	525	525	400	250	-	-	-	-	
250	1	15 x 5	75	575	575	575	450	325	-	-	-	-	
320	1	20 x 5	100	600	600	600	475	350	150	-	12 x 5-10	-	
390	1	25 x 5	125	600	600	600	475	350	150	-	12 x 5-10	6 x 3	
440	1	30 x 5	150	650	650	650	650	525	400	350	20 x 5-10	10 x 3	
500	1	20 x 10	200	675	675	675	525	350	150	-	25 x 5-10	10 x 6	
600	1	30 x 10	300	675	675	675	600	475	325	275	30 x 5-10	10 x 6	

630-A Multi-Stage Bar Support

- Support for fixing bars with cross-sections: 15 x 5, 20 x 5, 32 x 5, 32 x 8.
- The orientation of the copper bars makes tightening easier and allows better circulation of the cables.
- It can be 3-pole or 4-pole, with gauges from 160 to 630 A.

Electrical characteristics:

- Rated peak withstand current I_{pk} (kA):
- 30 kA for 160 A busbar,
- 40 kA for 250 A busbar,
- 55 kA for 400 A and 630 A busbar.
- Rated insulation voltage $U_i = 750$ V.
- Material: Insulated plastic
- Fixing: Mounting on mounting plates (see page 227) or cross-rails (see page 237) M6 x 25 self-tapping screws are required for fixing on the cross-rails, not included

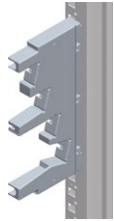

LVS04192

Supply:

1 multi-stage bar support and fixing elements

Characteristics	References
630-A multi-stage bar support	LVS04192

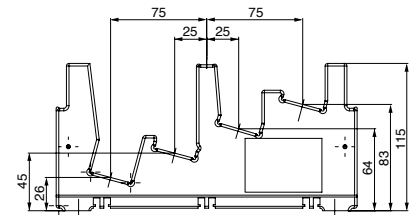
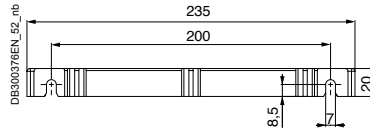
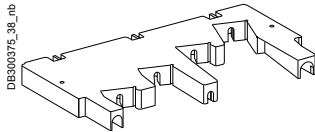

The following table shows:

- The cross-section of the bars that will be used according to the current-carrying capacity in the busbar.
- The distance between the bar supports that will be installed according to the rated short-time withstand current: I_{cw} .

Rating (A)	Bar cross-section (mm)	Center-to-center distance of the supports (mm) I_{cw} (kA eff/1 s)				
		10	13	15	20	25
160	15 x 5	450	–	–	–	–
250	20 x 5	450	450	–	–	–
400	32 x 5	450	450	450	300	300 I_{cw} (kA eff/0.6 s)
630	32 x 8	450	450	450	300	300

Display for 630-A Multi-Stage Busbar



LVS04197

- Protects against direct contact from the front in the connections of the busbar.
- Length: 1500 mm.
- Fixing: Direct mounting on the actual support

Supply:

1 display for multi-stage busbar and fixing elements

Characteristics	References
Display for 630-A multi-stage busbar	LVS04197

Vertical Bar Support

- Support prepared for fixing bars in vertical position, mounted directly on the structure of the enclosure. Adjustable height with a pitch of 25 mm.
- For a nominal rating $I_n \geq 3000$ A and ≤ 4000 A you must add one spacer ref. **LVS04646**.

Supply:
2 insulated bar supports,
1 metal vertical support and fixing elements



NSYBVS400

Characteristics	Width / Depth (B) (mm)	References
Vertical bar support	400	NSYBVS400
Vertical bar support	500	NSYBVS500
Vertical bar support	600	NSYBVS600
Vertical bar support	800	NSYBVS800

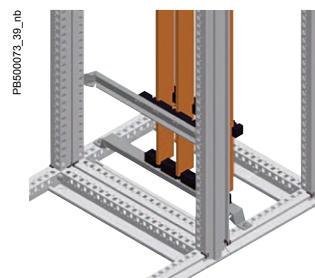
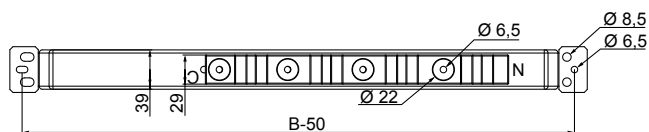
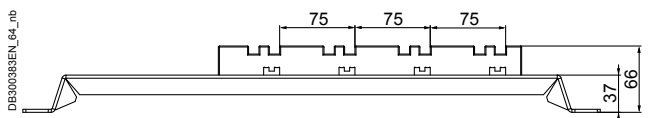

Setting Support

- Bottom support for bars in vertical position.
- It is fixed to the bottom frame of the enclosure.
- It is required for supporting the bars.
- It is not considered a bar support when calculating the number of supports

Supply:
1 insulated bar support,
1 metal vertical support and fixing elements



NSYAS500

Characteristics	Width / Depth (B) (mm)	References
Setting support	500	NSYAS500
Setting support	600	NSYAS600
Setting support	800	NSYAS800

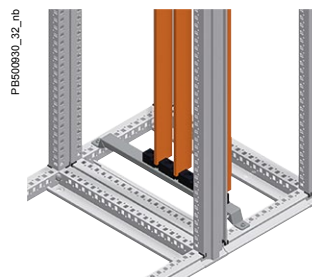
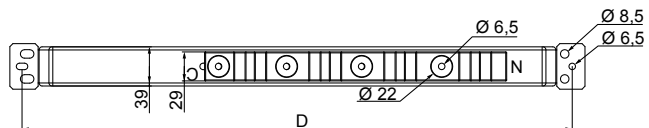
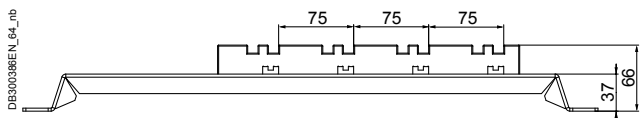

Accessories for Low Voltage Switchboards

PanelSet SFN - Spacial SFX Horizontal Bar Support

Horizontal Bar Support

- Support prepared for fixing bars in horizontal position.
- Direct mounting to the structure of the enclosure, on the vertical uprights, at any height, adjustable with a pitch of 25 mm.
- For a nominal rating $I_n \geq 3000$ A and ≤ 4000 A you must add one spacer ref.

Supply:

2 insulated bar supports,
1 metal horizontal support and fixing elements



Characteristics	Width / Depth (B) (mm)	References
Horizontal bar support	500	NSYBHS500
Horizontal bar support	600	NSYBHS600
Horizontal bar support	800	NSYBHS800

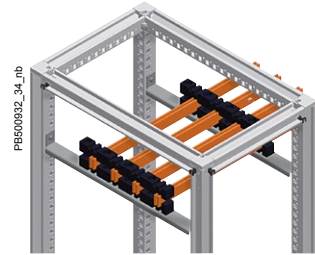
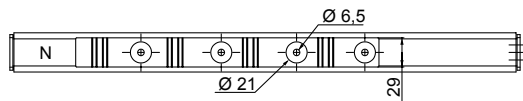
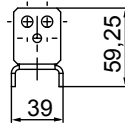
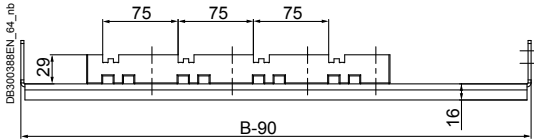

Bar Support Arm

- Support without fixing to the enclosure, required to guarantee the distance between the bars.
- It is used on bars in both vertical and horizontal position.
- For a nominal rating $I_n \geq 3000$ A and ≤ 4000 A you must add one spacer ref. **LVS04646**.

Supply:

2 insulated bar supports and fixing elements



Characteristics	Width / Depth (B) (mm)	References
Bar support arm	500	NSYBSA

Overview of the Offer MasterPacT NT and NW

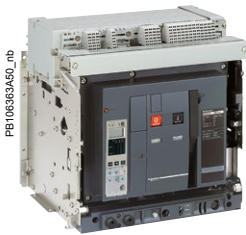

Circuit Breakers

Ratings:

- MasterPacT NT: 630 to 1600 A
- MasterPacT NW: 800 to 4000 A.
- Circuit breakers type N1, H1, H2, H3, L1.
- Switch-disconnectors type NA, HA, HF, HH.
- 3 or 4 poles.
- Fixed or drawout versions.
- Option with neutral on the right.
- Protection derating.



Micrologic Control Units

Ammeter A and Energy E

- 2.0 basic protection
- 5.0 selective protection
- 6.0 selective + earth-fault protection
- 7.0 selective + earth-leakage protection (Only for ammeter A).

Power meter P

- 5.0 selective protection
- 6.0 selective + earth-fault protection
- 7.0 selective + earth-leakage protection

Harmonic meter H

- 5.0 selective protection
- 6.0 selective + earth-fault protection
- 7.0 selective + earth-leakage protection
- External sensor for earth-fault protection.
- Rectangular sensor for earth-leakage protection.
- Setting options (long-time rating plug):
- Low setting 0.4 to 0.8 x Ir
- High setting 0.8 to 1 x Ir
- Without long-time protection.
- External AD power-supply module.
- Battery module.



Power Meter Functions

MasterPacT equipped with Micrologic 2 / 5 / 6 / 7 trip units offer type A (ammeter) or E (energy) metering functions as well as communication. Using Micrologic sensors and intelligence, MasterPacT provides access to measurements of all the main electrical parameters on the built-in display, on a dedicated FDM display unit or via the communication system.



Operating Assistance Functions

Integration of measurement functions provides operators with operating assistance functions including alarms tripped by user-selected measurement values, time-stamped event tables and histories, and maintenance indicators.



Communication

- COM option in MasterPacT.
- MasterPacT in a communication network.
- IFM: Modbus interface module.
- IFE: Ethernet interface module.
- I/O application module.
- Electrical Asset Manager.



Overview of the Offer MasterPacT MTZ



Circuit Breakers

MTZ1
From 630 to 1600 A



MTZ2
From 800 to 4000 A

Micrologic™ X control units

2.0X | 5.0X | 6.0X | 7.0X |

Only four references



Digital Modules



Protection



Measurement



Diagnostics and Maintenance

DB408827_nb



Five Performance Levels N1, H1, H2, H3, L1

I_{cu} (kA rms)
at 415V AC

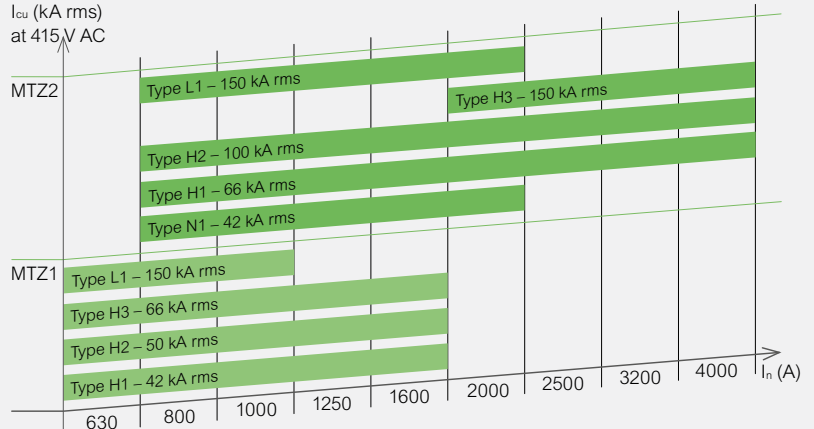

MasterPacT MTZ1

Find all functions and technical characteristics in:
MasterPacT MTZ catalog
LVPED216026EN

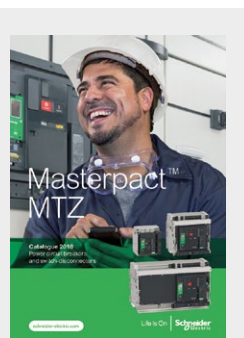

MasterPacT Support

Introduction

Installation of a MasterPacT in a SFN switchboard requires:

- Lateral cross-rails (**NSYSQCR65**, **NSYSUCR90**) (See table below)
- 1 specific transversal MasterPacT support (**NSYFXMN65**) fixed to the lateral cross-rails
- Bar supports to reduce bar movements due to constraints

MasterPacT Supports

Dedicated offer to secure and facilitate MasterPacT positioning in the switchboard

- Less distortion
- Reduced installation time



MasterPacT Supports W600

- Cut-outs already defined (available in the Schneider CAD library)
- Material: Galvanized steel
- Mounting instructions (screwdriver: T30, Tightening torque: 4.5 Nm/39.82 lb-in)

Supply:

1 support delivered with fixing elements (self tapping screws and cage nuts: M6)



Characteristics	MasterPacT combination	References
MasterPacT MTZ1 and NT	Fixed	NSYFXMNT60F
MasterPacT MTZ1 and NT	Withdrawable	NSYFXMNWT60FW
MasterPacT MTZ2 and NW	Fixed	NSYFXMNWT60FW
MasterPacT MTZ2 and NW	Withdrawable	NSYFXMNWT60FW

MasterPacT Supports W800

- Cut-outs already defined (available in the Schneider CAD library)
- Material: Galvanized steel
- Mounting instructions (screwdriver: T30, Tightening torque: 4.5 Nm/39.82 lb-in)

Supply:

1 support delivered with fixing elements (self tapping screws and cage nuts: M6)



Characteristics	MasterPacT combination	References
MasterPacT MTZ1 and NT	Fixed	NSYFXMNT80F
MasterPacT MTZ1 and NT	Withdrawable	NSYFXMNT80W
MasterPacT MTZ2 and NW	Fixed	NSYFXMNW80F
MasterPacT MTZ2 and NW	Withdrawable	NSYFXMNW80W

Associated Cross-Rails

- Material: Zinc-coated steel

Supply:

2 cross-rails and fixing elements (see cross-rail section [page 235](#) for more information)

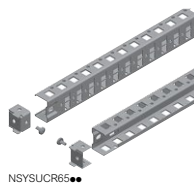

Characteristics	References
in MasterPacT combination: MTZ1 and NT	NSYSUCR65
in MasterPacT combination: MTZ2 and NW	NSYSUCR90

Associated Cross-Rails

- Material: Zinc-coated steel

Supply:

2 cross-rails and fixing elements (see cross-rail section [page 235](#) for more information)

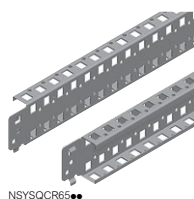

Characteristics	References
in MasterPacT combination: MTZ1 and NT	NSYSQCR65
in MasterPacT combination: MTZ2 and NW	NSYSQCR90

Bar Supports

Supports for MasterPacT MTZ1 and NT

- Fixing by screw with hexagonal head.
- Material: Metal support: Zinc-coated steel, Isolating supports: thermosetting painting

Supply:
2 insulated bar supports,
1 metal horizontal support and fixing element



NSYBHNT600

Characteristics	Width (mm)	References
Fixed support	600	NSYBHNT600
Fixed support	800	NSYBHNT800

Supports for MasterPacT MTZ1 and NT

- Fixing by screw with hexagonal head.
- Material: Isolating supports: Thermosetting painting

Supply:
2 insulated bar supports and fixing elements



NSYBSA70

Characteristics	References
Free support	NSYBSA70

Supports for MasterPacT MTZ2 and NW

- Fixing by screw with hexagonal head.
- Material: Metal support: Zinc-coated steel, Isolating supports: thermosetting painting

Supply:
2 insulated bar supports,
1 metal horizontal support and fixing element



NSYBHNW600

Characteristics	Width (mm)	References
Fixed support	600	NSYBHNW600
Fixed support	800	NSYBHNW800

Supports for MasterPacT MTZ2 and NW

- Fixing by screw with hexagonal head.
- Material: Isolating supports: Thermosetting painting

Supply:
2 insulated bar supports and fixing elements









LVS04678

Characteristics	References
Free support	LVS04678







Accessories for Low Voltage Switchboards

PanelSet SFN - Spacial SFX Distribution Blocks

Quick-Connection Distribution Blocks

Linergy DX					
					
	04040	04041	04045	04046	04031
					
	064947d_nb			04046	
	63 A	63 A	125 A	160 A	160 A
Characteristics	LVS04040	LVS04041	LVS04045 + LVS04047	LVS04046	LVS04031
	<ul style="list-style-type: none"> Incoming through the top. Clip-on to rail. 	<ul style="list-style-type: none"> Incoming through the bottom. Clip-on to rail. 	<ul style="list-style-type: none"> Set of 4 35 mm² flexible connections, length 210 mm to be ordered separately (cat. no. 04047). Clip-on to rail. 	<ul style="list-style-type: none"> Set of 4 prefabricated flexible connections supplied, for connection with an INS100/160 or NSA160 switch, installed on the right or left. Clip-on to rail 	Clip-on to rail.
Number of poles	4P		4P		1P
Total connection capacity (dia. for flexible cables)					
4 mm ²	-		7		-
6 mm ²	12 per phase + 12 neutral		3		6
10 mm ²	-		2		-
16 mm ²	-		1 tunnel terminal		6
25 mm ²	4 tunnel terminals per phase + 1 neutral		-		-
35 mm ²	-		1 tunnel terminal		-
70 mm ²	-		-		1 tunnel terminal
Size in 9 mm- modules	8		12		4.5
Size in 18 mm- modules	4		6		2.5

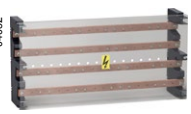

Screw Distribution Blocks

Linergy DS								Linergy BS				
												
	LGY112510	LGY116013	LGY125014	LGY410028	LGY412548	LGY412560	LGY416048	04052				
	125 A	160 A	250 A	100 A	125 A		160 A	160 A	250 A	400 A	630 A	
Characteristics	LGY112510	LGY116013	LGY125014	LGY410028	LGY412548	LGY412560	LGY416048	LVS04052	LVS04053	LVS04054	LVS04055	
	Clip-on to rail.			Clip-on to rail.				<ul style="list-style-type: none"> To be screwed on back. 13 M6 tapped holes + 4 plain holes of diameter 12.2 mm. 				
Number of poles	1P			4P				4P				
Total connection capacity	10	13	14	4 x 7	4 x 12	4 x 15	4 x 12	4 + 13 (dia. for flexible cables: 50 mm ²)				
Size in 9 mm- modules	3	4	5	8	14	20	18	-	-	-	-	
Neutral terminal strip (optional)	-	-	-	LGYN1007	LGYN12512	LGYN12515	LGYN12512	-	-	-	-	

Quick Device Feeders

Linergy FM: For cable links							
							
	63 A	80 A	160 A	200 A			
Characteristics	LVS04008	LVS04000	LVS04018	LVS04012	LVS04013	LVS04014	LVS04026
	4P Cable to be used without ferrules.	4P -	4P Cable to be used without ferrules.	2P.	3P	4P	4P
Length in 9-mm modules	24	48	24	48			72
Length in 18-mm modules	12	24	12	24			36
Supply at incoming terminals	Enclosed terminals for cables up to 25 mm ²	Enclosed terminals for flexible cables 6 to 25 mm ² or rigid cables 10 to 35 mm ²	Direct onto the row by cable 70 mm ² with crimped lug, or flexible bar 20 x 3 from busbar with prefabricated connection				
Downstream connection capacity							
Max. 4 mm ² , Phase	6	-	-	-	-	-	-
Max. 4 mm ² , Neutral	4	-	-	-	-	-	-
Max. 6 mm ² , Phase	6	18	-	-	-	-	-
Max. 6 mm ² , Neutral	4	18	-	-	-	-	-
Max. 10 mm ² , Phase	-	-	18	12	36	36	54
Max. 10 mm ² , Neutral	-	-	9	12	-	18	27
Accessories included							
Pre-stripped copper connections	10 of 4 mm ² + 6 of 6 mm ² (L=100 mm)	12 blue + 12 black	12 of 10 mm ² (L=100 mm)	24 of 10 mm ²			36 of 10 mm ²
Protective cover	-	-	For pads (IPxxB)	-	-	-	-
Screws and nuts	-	-	For pads	-	-	-	-

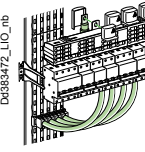
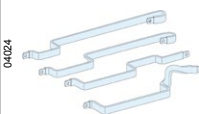
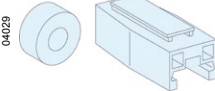
Linergy FM with Upstream Device

Connection of Linergy FM with upstream device					
					
Characteristics	LVS04021 + LVS04150 insulated covers	LVS04024	LVS04029	LVS04030	LVS04743
Upstream device	Linergy BW busbar	Multi-stage Linergy BS busbar	Rear Linergy BS busbar	Device 160 A	Busbar
Connection hardware	4P 200 A connection (supplied with fixing accessories)	4P 200 A connection (supplied with fixing accessories)	4P 200 A connection (supplied with fixing accessories)	4P 160 A connection for Linergy FM 1/2 row	200 A connection (20 x 3 mm) for Linergy FM

Feeders for ComPacT NSX et INS

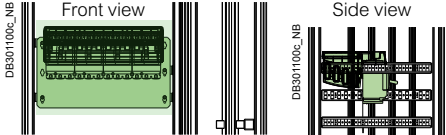
Linery FC	
 <p>04407</p> <p>ComPacT NSX100/250 and INS/INV250 - All controls, fixed and withdrawable</p>	 <p>DB301100c_NB</p> <p>Front view</p> <p>Side view</p>
Characteristics	LVS04407
	<p>LVS04408</p> <ul style="list-style-type: none"> Linery FC without prefabricated connections: The connection of a Linery FC distribution block using pre-wired connectors or insulated flexible bars is not compatible with Form 2 partitioning (LVS04922). In this case, use the form 2 restoration kit (LVS04924). For the connection, use insulated flexible bars, 32 x 8 mm (LVS04753). Each connection must not be longer than 500 mm. This size is validated with Schneider Electric insulated flexible bars.
Number of poles	3P
Connection to	Linery BS, Linery LGY or Linery LGYE busbars
Number of devices	4
Composition	Self-adhesive labels to mark the phases for connections to the busbars.

Accessories

Tooth Caps

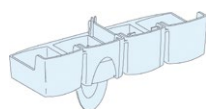

- The caps block off the reserve terminals on a Linery FC distribution block.
- Made of an insulated material, they simply clip on from the front.

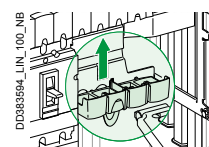

Characteristics	References
Tooth caps	LVS04809

Sigma Safety Terminals

- Safety terminals made from self-extinguishing Polyamide-6, with matt black base, MS-58 brass terminal (DIN 17660), tempered, zinc-plated and dichromated steel ring, and cover made from orange-colored self-extinguishing polypropylene.
- Anti-shearing: The connection is made by means of a tightening mechanism which distributes the pressure across the entire contact surface, avoiding friction and occasional stress that can damage the conductors.
- Unloosenable: The ring that surrounds the brass body guarantees that the pressure exerted by the actual conductors cannot open the terminal and loosen the connection.
- Full insulation: All SIGMA "S" terminals are supplied with a terminal-covering cap, avoiding any accidental contact with live parts. All the gauges can be coupled together, forming strips of any length. Operating voltage: 500 V.

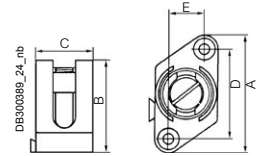

Note:
Each terminal accepts up to 2 conductors with the specified section.
20 units
(except for ref. **NSYS95100**: 10 units)



NSYS16

Characteristics	Section (mm ²)	A	B	C	D	E	References
Sigma safety terminals	1 x 4	30	20	13	21	4	NSYS04
Sigma safety terminals	1 x 6	33	25	16	24	7	NSYS06
Sigma safety terminals	1 x 10	38	28	16	28	6	NSYS10
Sigma safety terminals	1 x 16	42	32	19	32	9	NSYS16
Sigma safety terminals	1 x 35	46	38	23	34	11	NSYS2535
Sigma safety terminals	1 x 50	52	45	27	40	15	NSYS50
Sigma safety terminals	1 x 70	55	50	30	40	15	NSYS70
Sigma safety terminals	1 x 100	58	54	33	40	20	NSYS95100

Bimetal Terminals

Earthing Strips

- For the junction of neutral and earth cables.
- Models **NSYRBL●●** (Fig. 3) for installation in boxes with insulated rear or by means of insulators, not supplied.

Supply:
10 earthing strips

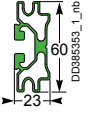
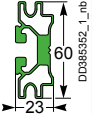
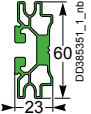
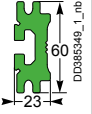
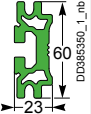
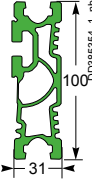

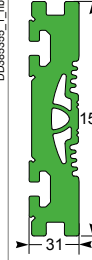

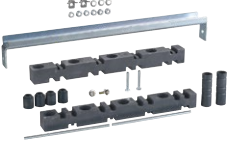

Fig. 3



NSYRBL21656M

Characteristics	Number of terminals x section	Fig	References
Earthing strips	2 x 16 mm ² + 5 x 6 mm ²	3	NSYRBL21656M
Earthing strips	2 x 16 mm ² + 8 x 6 mm ²	3	NSYRBL21686M
Earthing strips	2 x 16 mm ² + 14 x 6 mm ²	3	NSYRBL216146M
Earthing strips	2 x 16 mm ² + 29 x 6 mm ²	3	NSYRBL216296M

Linery LGYE - Horizontal Profiles up to 4000 A

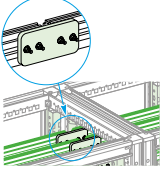
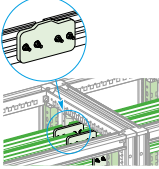
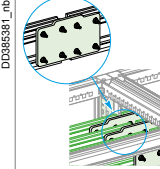
Installation in PanelSet SFN		Up to 1600 A					Up to 4000 A				
Linery profiles, 2000 mm length											
Permissible current for an ambient temperature of 35 °C around the switchboard		530 A	680 A	850 A	1050 A	1480 A	1650 A	2100 A	2800 A	3350 A	
Number of profiles per phase		1									
Height available (mm)		150					150		200		
References		LVS04560	LVS04561	LVS04562	LVS04563	LVS04564	LVS04565	LVS04566	LVS04567	LVS04568	
Busbar supports											
		Fixed Support NSYBHS ●●		Free Support NSYBSA		2 supports shall mandatorily be fastened to the structure of the 800 mm wide PanelSet SFN enclosure. If the width is greater, add a NSYSUCR40●● cabinet cross-rail to add a third fixed support. 1 support shall mandatorily be fastened to the structure of the enclosures of width 300 mm and 400 mm. If more supports are required, use free supports.					
Number of supports depending on I _{cw} (kA rms/1 s)		≤ 15	2 x NSYBHS ●● *								
		≤ 25	2 x NSYBHS ●● *								
		≤ 30	2 x NSYBHS ●● *								
		≤ 40	-		2 x NSYBHS ●● *						
		≤ 50	-		2 x NSYBHS ●● *						
		≤ 60	-		2+1 **		2 x NSYBHS ●● *				
		≤ 65	-		-		2+1 **				
		≤ 75	-		-		2+1 **				
		≤ 85	-		-		2+1 **				
		≤ 100	-		-		2+4 ***				
References Fixed support		NSYBHS ●●					NSYBHS ●● + LVS04646				
References Free support		NSYBSA					NSYBSA + LVS04646				
		* If spacing between supports > 800 mm add 1 NSYBSA free support. ** If spacing between supports > 300 mm add 1 NSYBSA free support. *** If spacing between supports > 135 mm add 1 NSYBSA free support.									
Joints		Up to 1600 A					Up to 4000 A				
		630 A	800 A	1000 A	1250 A	1600 A	2000 A	2500 A	3200 A	4000 A	
References (3P)		3x LVS04620					3x LVS04621		3x LVS04623		
References (4P)		4x LVS04620					4x LVS04621		4x LVS04623		
Note:		If insulation clearance < 20 mm add an insulated shield between the busbar and the metal part of the cabinet.									
											
		LVS04620			LVS04621				LVS04623		

Linery BS - Horizontal Busbars up to 4000 A

Installation in PanelSeT SFN		Up to 1600 A				Up to 4000 A					
Copper without holes, 2000 mm length											
Permissible current for an ambient temp. of 35 °C around the switchboard	IP > 31	750 A	900 A	1250 A	1600 A	1600 A	1800 A	2000 A	2500 A	2900 A	3340 A
Size of bars (mm)		60 x 5	80 x 5	60 x 5	80 x 5	80 x 10	50 x 10	60 x 10	80 x 10	100 x 10	120 x 10
Number of bars per phase		1	1	2	2	1	2	2	2	2	2
Height available (mm)		150									200
References		LVS04536	LVS04538	LVS04536	LVS04538	LVS04548	LVS04545	LVS04546	LVS04548	LVS04550	LVS04552
Busbar supports		 Fixed Support NSYBHS				 Free Support NSYBSA					
2 supports shall mandatorily be fastened to the structure of the 800 mm wide PanelSeT SFN enclosure. If the width is greater, add a NSYSUCR40 cabinet cross-rail to add a third fixed support. 1 support shall mandatorily be fastened to the structure of the enclosures of width 300 mm and 400 mm. If more supports are required, use free supports.											
Number of supports depending on I _{cw} (kA rms/1 s)	≤ 15	2 x NSYBHS *									
	≤ 25	2+1 **	2 x NSYBHS *								
	≤ 30	2+1 **	2 x NSYBHS *								
	≤ 40	2+1 **					2 x NSYBHS *				
	≤ 50	-	2+1 **					2 x NSYBHS *			
	≤ 60	-					2+1 **				
	≤ 65	-					2+1 **				
	≤ 75	-					2+4 ***	2+1 **			
≤ 85	-									2+1 **	
References Fixed support		NSYBHS									NSYBHS + LVS04646
References Free support		NSYBSA									NSYBSA + LVS04646











* If spacing between supports > 800 mm add 1 **NSYBSA** free support.
 ** If spacing between supports > 300 mm add 1 **NSYBSA** free support.
 *** If spacing between supports > 135 mm add 1 **NSYBSA** free support.

11

Joints Installation dans PanelSeT SFN		Up to 1600 A				Up to 4000 A					
		1 vertical bar per phase		2 vertical bars per phase		1 vert. bar per phase	2 vertical bars per phase				
Size of bars (mm)		60 x 5	80 x 5	60 x 5	80 x 5	80 x 10	50 x 10	60 x 10	80 x 10	100 x 10	120 x 10
References		LVS04640	LVS04641	LVS04640	LVS04641	LVS04641	LVS04640	LVS04640	LVS04641	LVS04641	LVS04643
Sliding joints with torque nut		 LVS04640		 LVS04641							

Accessories for Low Voltage Switchboards

Linery LGY - Lateral Profiles up to 1600 A

Installation in PanelSet SFN		L 300				
		 DD381233_LIN_7_nb	 DD381234_LIN_7_nb	 DD381235_LIN_7_nb	 DD381236_LIN_7_nb	 DD381237_LIN_7_nb
		 630 A	 800 A	 1000 A	 1250 A	 1600 A
Permissible current for an ambient temp. of 35 °C around the switchboard	IP ≤ 31	590 A	760 A	950 A	1170 A	1480 A
Number of profiles per phase		1				
References		LVS04502	LVS04503	LVS04504	LVS04505	LVS04506

Busbar supports

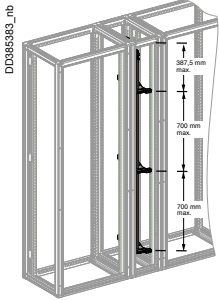

Number depending on I_{cw} (kA rms/1 s)

≤ 25	3
≤ 30	3
≤ 40	3
≤ 50	4
≤ 60	5
≤ 65	
≤ 75	7
≤ 85	8

Only for enclosures with a depth ≥ 500 mm

References: DD380741_LIN_nb, DD380742_LIN_12_nb

Fixed Support LVS04651

Note: An end stop must be fitted on the bottom support: LVS01109 (sold in lots of 12)

References

LVS04651 + upright adapters NSYSFPAED + NSYSUCR40●●

Connections to the Linery BS horizontal busbar

DD3885409_nb

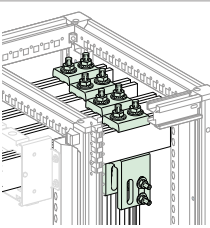

Note: Supplied with mounting hardware. Reference include 1 connection only. Order 1 connection per phase.

References according to horizontal busbar size	5 mm thick	LVS04634	LVS04635
	10 mm thick Width ≤ 80 mm	LVS04636	
	10 mm thick Width > 80 mm	LVS04636 + LVS04642 LVS04638 + LVS04642	

Connections to the Linery LGYE horizontal busbar

DD3885387_nb

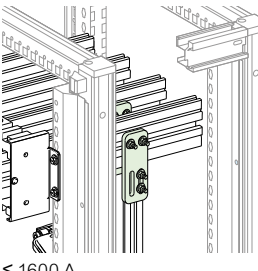







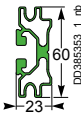
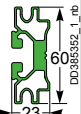
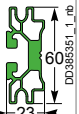
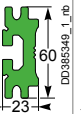
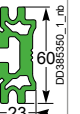
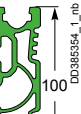

≤ 1600 A

Note: Supplied with mounting hardware. Reference include 1 connection only. Order 1 connection per phase.

References (vertical connection)	LVS04602
References (vertical shifted connection)	LVS04603

Linery LGYE - Lateral Profiles up to 4000 A

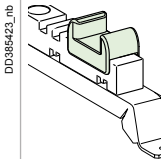
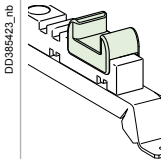
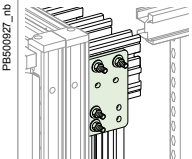
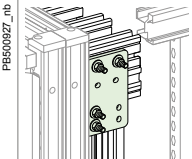
Installation in PanelSet SFN		L 300										
Linery profile, 2000 mm length												
		630 A	800 A	1000 A	1250 A	1600 A	2000 A	2500 A	3200 A	4000 A	4000 A	
Permissible current for an ambient temperature of 35 °C around the switchboard	IP > 31	530 A	680 A	850 A	1050 A	1480 A	1650 A	2100 A	2800 A	3350 A	3350 A	
Number of profiles per phase		1										
Height available (mm)		150						150		200		
References		LVS04560	LVS04561	LVS04562	LVS04563	LVS04564	LVS04565	LVS04566	LVS04567	LVS04568		
Busbar supports		 Fixed Support NSYBVS ●●			 Free Support NSYBSA			 Bottom Support NSYAS ●●				
		3 fixed supports are compulsory to hold the busbar in position. If more than 3 supports are needed, use free supports (in addition).										
Number depending on I _{ew} (kA rms/1 s)	≤ 30	3										
	≤ 40	-			3+2 *			3				
	≤ 50	-			3+2 *			3				
	≤ 60	-			3+2 *			3				
	≤ 65	-			3+2 *			3				
	≤ 75	-			3+4 **			3+2 *				
	≤ 85	-			3+4 **			3+2 *				
	≤ 100	-			-			3+6 ***				
References Fixed support		NSYBVS●●							NSYBHS●● + LVS04646			
References Bottom support		NSYAS●●							NSYAS●● + LVS04646			
References Free support		NSYBSA							NSYBSA + LVS04646			
		* If spacing between supports > 400 mm add 1 NSYBSA free support. ** If spacing between supports > 250 mm add 1 NSYBSA free support. *** If spacing between supports > 130 mm add 1 NSYBSA free support.										
Wedging busbars in position		 Wedge Fitted on Bottom Support					 Wedge Fitted on Bottom Support					
		The bottom support NSYAS●● + LVS0465● is used to place profiles and ensure they are in the correct position. It is not considered to be a busbar support.										
References		LVS04658 (set of 12 wedges)					LVS04659 (set of 12 wedges)					
Connections to the Linery LGYE horizontal busbar		 2000/2500 A						 3200/4000 A				
		Supplied with mounting hardware. Reference include 1 connection only. Order 1 connection per phase.										
References (short connection)		LVS04604						LVS04607				
References (long connection)		LVS04605										

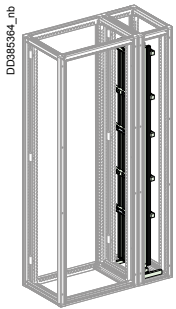

Linery BS - Lateral Flat Busbars up to 3200 A

Installation in PanelSet SFN	Up to 1600 A	Up to 3200 A									
Pre-slotted copper, 1675 mm length 											
Permissible current for an ambient temp. of 35 °C around the switchboard IP > 31	750 A	900 A	1250 A	1600 A	1080 A	1250 A	1600 A	1850 A	2000 A	2500 A	2820 A
Busbar cross-section (mm)	60 x 5	80 x 5	60 x 5	80 x 5	50 x 10	60 x 10	80 x 10	50 x 10	60 x 10	80 x 10	100 x 10
Number of profiles per phase	1		2		1			2			
References	LVS04516	LVS04518	LVS04516	LVS04518	LVS04525	LVS04526	LVS04528	LVS04525	LVS04526	LVS04528	LVS04550

Busbar supports	Up to 1600 A	Up to 3200 A
	Fixed Support NSYBVS●●	Free Support NSYBSA

3 fixed supports are compulsory to hold the busbar in position.
 If more than 3 supports are needed, use free supports (in addition).
 The bottom wedge support is used to place the busbar and ensure it is in the correct position.
 It does not count as a busbar support.

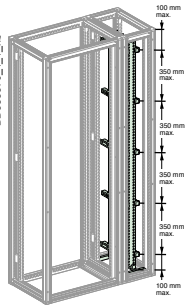

Number of supports depending on I _{cr} (kA rms/1 s)	≤ 15	≤ 25	≤ 30	≤ 40	≤ 50	≤ 60	≤ 65	≤ 75	≤ 85
	3 *	3+2 *	3 *	3+4	3+4	3+2 *	3+4	3+2 *	3+4

References Fixed support	NSYBVS●●
References Bottom support	NSYAS●●
References Free support	NSYBSA

* If spacing between supports > 350 mm add 1 NSYBSA free support.

Connections to the Linery BS horizontal busbar	Up to 1600 A	Up to 3200 A									
	For a busbar with 75 mm distance between bars, the bars must be completely covered. Staggered assembly points between one bar and the next, to maintain the necessary clearance distances.(3)	References LVS04636 , LVS04637 , LVS04638 are supplied individually: 1 connection per phase. Reference LVS04642 consists of 2 M8 x 140 screws which can replace the original M8 x 120 screws.									
	1 bar per phase	2 bars per phase	1 bar per phase	2 bars per phase	1 bar per phase	2 bars per phase	1 bar per phase	2 bars per phase	1 bar per phase	2 bars per phase	1 bar per phase
	60 x 5	80 x 5	60 x 5	80 x 5	50 x 10	60 x 10	80 x 10	50 x 10	60 x 10	80 x 10	100 x 10
References depending on horizontal busbar size	Width ≤ 80 mm	LVS04645		LVS04636			LVS04637			LVS04645	
	Width > 80 mm	LVS04645		LVS04636 + LVS04642			LVS04637 + LVS04642			LVS04645	

(1) Drill Hole Dimensions for 5 mm Thick Horizontal Busbars

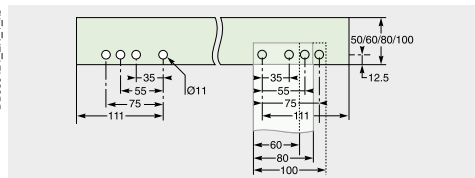

Drill Hole Dimensions for 10 mm Thick Horizontal Busbars

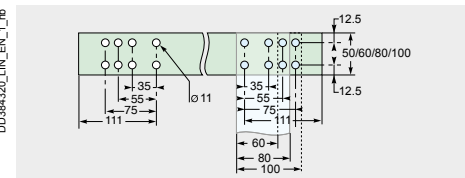

Technical changes reserved. Information provided without guarantee. Images are for illustrative purposes only.

Linery TB

PE conductor									
		DB301153_nb			DB301154_nb		DB301155_nb		
Characteristics		Vertical PE conductor with Linery LGY profile (W = 1670 mm)			Vertical PE conductor with Linery BS busbar (W = 1675 mm)		Horizontal PE conductor with Linery BS busbar		
Rated short-time current (Isc)	(A)	≤ 65	> 65... ≤ 80	= 100	≤ 40	> 40	≤ 40	> 40	
Permissible current	(A)	630	800	1250	-	-	-	-	
Bar size	(mm)	-	-	-	25 x 5	50 x 5	25 x 5	50 x 5	
Characteristics		-	-	-	Drilled flat bar Ø10.6 mm (one 10.6 mm hole every 25 mm along the entire length)	Drilled flat bar Ø10.6 mm (two 10.6 mm hole every 25 mm along the entire length)	-	-	
References		LVS04502	LVS04503	LVS04505	LVS04512	LVS04515	LVS04512	LVS04512	

Connection Between PE Conductors

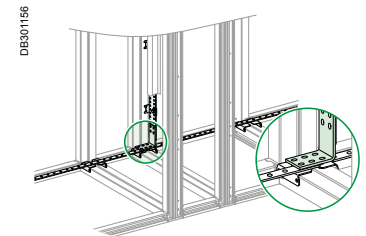
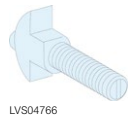
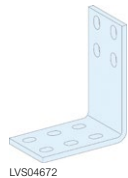

Characteristics	Composition	References
Connection plates for horizontal/vertical PE bars	2 copper angle brackets	LVS04672
Linery connection hardware	20 M8 screws (W = 25 mm) + 20 nuts + 20 contact washers for connection to cable lugs or flexible bars	LVS04766

PEN Conductor

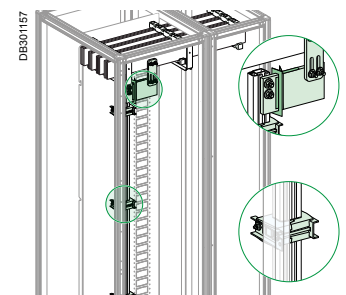
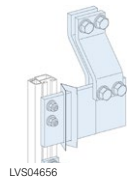

Characteristics	References
Linery TB PEN installation kit with LGY vertical profile	LVS04656
1600-A connection 10-mm horizontal busbar with Linery LGY profile	LVS04636
Linery LGYE vertical connection 1600 A	LVS04602

Connection Between Device and Busbars

- The flexible bars are determined taking into account the connected device, whatever the internal temperature of the switchboard.
- The bar sizes indicated below take into account the derating curves of devices.
- Width: 1800 mm
- Rated insulation voltage (Ui): 1000 V
- Maximum withstand temperature for the insulated material: 125 °C



04742

Characteristics	Size (mm)	References
NSX100	20 x 2	LVS04742
NSX160/250	20 x 3	LVS04743
NSX400	32 x 5	LVS04751
NSX630	32 x 8	LVS04753
FM 200 A Linergy	20 x 3	LVS04743
FC 3P Linergy	32 x 8	LVS04753
FC 4P Linergy	32 x 8	LVS04753
Fupact 250	24 x 5	LVS04746
Fupact 400	32 x 5	LVS04751
Fupact 630	32 x 8	LVS04753

Accessories for Low Voltage Switchboards

PanelSeT SFN Assemblies with IEC 61439-2 Certification

Introduction

Because low-voltage switchboards must comply with the IEC 61439-2 standard, we have tested the most unfavourable and the most representative configurations (§ 10.10.2 of IEC 61439-1 ed2 2011) ranging up to 4000 A. We offer the entire product range, based on the PanelSeT SFN universal assembly system, allowing you to comply with all requirements of the standard.

Whether you are an OEM or a panelbuilder using universal enclosures and looking for advice on how to flexibly and reliably assemble and integrate the equipment: In this guide you can learn how to build up an electrical switchboard fitted with Schneider Electric products.

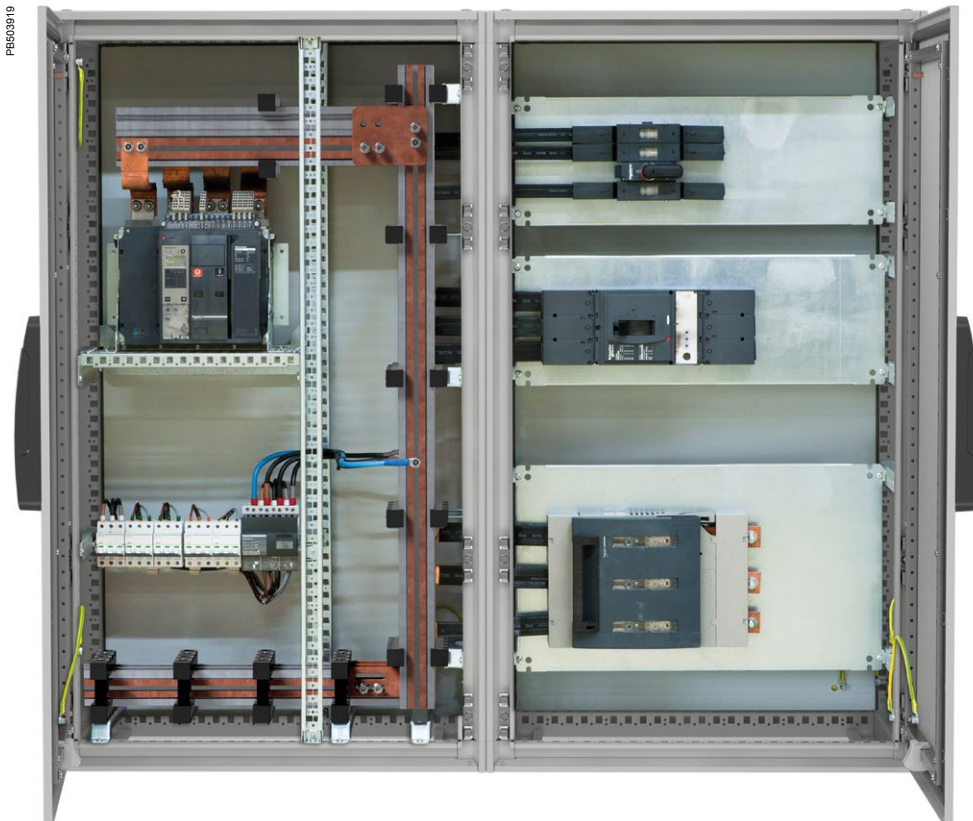

11

To ensure continuity of service and compliance with electrical safety requirements, we provide you with certificates based on assemblies tested by a third-party organization in accordance with the IEC 61439-2 standard. These tests have been performed with the most commonly used configurations to assist you finalize your switchboard with complete confidence, based on useful, reliable and verified information.

These tests cover the entire PanelSeT SFN range of dimensions. They supplement our range of tested PrismaSeT HD enclosures based on the functional unit system of PrismaSeT and PanelSeT SFN for Motor Control Center applications. This guide may also be used to brush up the knowhow of the fundamental rules of how to use an enclosure and how to install devices in PanelSeT SFN enclosures.

Accessories for Low Voltage Switchboards

PanelSeT SFN IEC 61439-2 Certified Assemblies

Compatibility table

Dimensions			Intensity (A)					
Height (mm)	Width (mm)	Depth (mm)	≤ 800 A	≤ 1250 A	≤ 1600 A	≤ 2500 A	≤ 4000 A	
1200	600	400	●					
	600	600	●					
	800	400	●					
	800	600	●					
1400	600	400	●	●				
	800	400	●	●				
1600	600	600	●	●				
	600	800	●	●				
	800	600	●	●				
	800	800	●	●				
1800	600	400	●	●	●			
	600	500	●	●	●			
	600	600	●	●	●	●		
	600	800	●	●	●	●		
	800	400	●	●	●			
	800	500	●	●	●			
	800	600	●	●	●	●		
	1000	400	●	●	●			
	1000	500	●	●	●			
	1000	600	●	●	●	●		
	1200	400	●	●	●			
	1200	500	●	●	●			
	1200	600	●	●	●	●		
	2000	600	400	●	●	●		
		600	500	●	●	●		
		600	600	●	●	●	●	
600		800	●	●	●	●	●	
800		400	●	●	●			
800		500	●	●	●			
800		600	●	●	●	●		
800		800	●	●	●	●	●	
1000		400	●	●	●			
1000		500	●	●	●			
1000		600	●	●	●	●		
1000		800	●	●	●	●	●	
1200		400	●	●	●			
1200		500	●	●	●			
1200		600	●	●	●	●		
1200		800	●	●	●	●	●	
1600	400	●	●	●				
1600	500	●	●	●				
1600	600	●	●	●	●			
2200	600	600	●	●	●	●		
	600	800	●	●	●	●	●	
	800	600	●	●	●	●		
	800	800	●	●	●	●	●	
	1000	600	●	●	●	●		
	1200	600	●	●	●	●		
	1200	800	●	●	●	●	●	
	1200	800	●	●	●	●	●	

●: Certified dimensions for indicated intensity

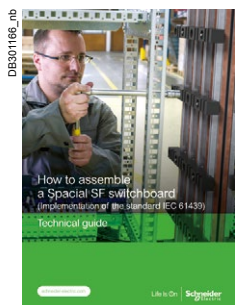

How to assemble a PanelSeT SFN switchboard
 (Implementation of the standard IEC 61439) Technical guide
 Ref : UE17MK01EN



IEC 61439-2 certification (IECEE CB scheme issued by DEKRA) is valid only once installation has been carried out, according to the recommendations indicated in the technical guide, "how to assemble a PanelSeT SFN switchboard", with the Schneider Electric devices featured in this guide.

Technical changes reserved. Information provided without guarantee. Images are for illustrative purposes only.

The PrismaSeT system can be used for all types of low-voltage distribution switchboards up to 6300 A for harsh environments.



Switchboard Design Is Very Simple



1 Metal structure

Made up of one or more pre-assembled frameworks combined side-by-side or back-to-back.

2 Distribution system

Horizontal busbars running on the top or bottom and vertical busbars positioned in a lateral compartment or at the rear of the enclosure are used to distribute electricity throughout the switchboard.

3 Complete functional units

- Dedicated mounting plate for device installation
- Front plate to block direct access to live parts
- Devices for on-site connections.

Each functional unit contributes to a function in the switchboard. The functional units are modular and are arranged rationally. The system includes everything required for functional unit mounting, supply and onsite connection. The components of the PrismaSeT HD and those of the functional units in particular have been designed and tested taking into account device characteristics. This design approach ensures a high degree of reliability in system operation and optimal safety for personnel.



Advantages of Prisma System Switchboards



1 Safe electrical installation

The total compatibility of Schneider Electric devices with the PrismaSeT HD system is a key advantage in ensuring a high level of installation dependability.

2 Upgradeable electrical installation

Thanks to modular design, PrismaSeT HD switchboards can be modified easily to integrate new functional units as needed or to be combined with your PanelSeT SFN control panel cabinets.

3 Safety for personnel

Work in a switchboard must only be carried out by authorised persons in compliance with all applicable safety regulations. To increase the safety of personnel, devices are installed behind protective front plates; only the operating handles are accessible. Additional internal protection (partitions, barriers) is available for protection against direct contact with live parts according to form of separation 2, 3 or 4. Terminal shields are mandatory for installation of ComPacT NSX and INS/INV devices in PrismaSeT HD enclosures.

4 Connected solution up to 4000 A

- Fire prevention
- Power availability
- Energy management

Components in the PrismaSeT HD system ensure the compliance of switchboards with standards IEC 61439-1 + 2.

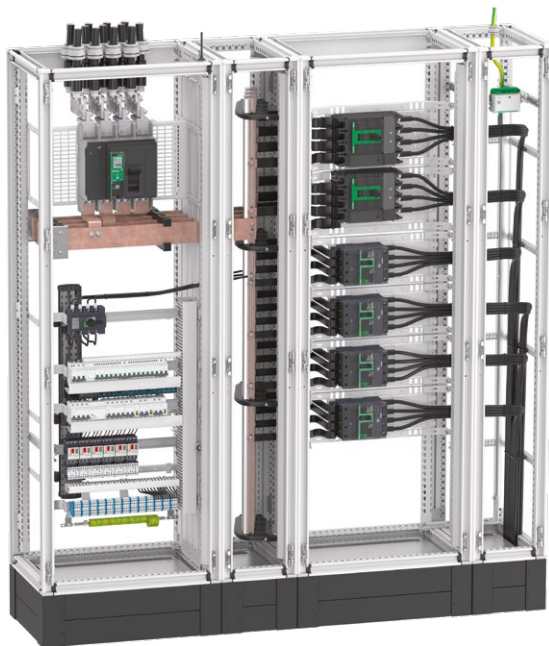

Mechanical Characteristics up to 4000 A*



- Steel sheet metal.
- Structured finish, epoxy polyester powder.
- Two options:
 - White color RAL 9003 outside and inside
 - Gray color RAL 7035 and white color inside (for the PrismaSeT references)
- Can be dismantled.
- Can be combined side-by-side and back-to-back.
- Degree of protection: IP55 according to IEC 60529.
- Degree of protection against mechanical impacts: IK10 (IK08 for the glazed-door) according to IEC 62262.

Framework dimensions

Two widths:

- W 300: Cable management or vertical busbar compartment
- W 700: Device compartment

Three depths:

- D500 up to 1600 A with incoming MasterPacT NT and MTZ1 only
- D600 up to 1600 A with incoming MasterPacT NT and MTZ1 only. Option to connect with cables from rear
- D800 up to 4000 A with incoming MasterPacT NT and MTZ1 or NW and MTZ2. Option to connect to cables from rear or to connect to rear vertical busbars
- Height: 2000 mm
- Enclosures for indoor installation.



* For more information about PrismaSeT 6300 and for solutions up to 6300 A see the catalog PrismaSeT 6300 UEMKCAT008EN

Electrical Characteristics



- Rated insulation level of main busbars: 1000 V.
- Rated operational current I_e : 4000 A.
- Rated peak withstand current I_{pk} : 220 kA.
- Rated short-time withstand current I_{cw} : 100 kA rms/1 second.
- Frequency: 50/60 Hz.



Electrical switchboards built using the PrismaSeT functional system and Schneider Electric recommendations fully comply with international standard IEC 61439-2.

Forms According to IEC 61439-2

Decisions concerning the form of separation and the degree of protection are subject to a joint agreement between manufacturer and client.

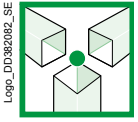

In most installations, PrismaSet HD enclosures do not require partitioning. In this case, the switchboard is a Form 1. Safety being one of its foremost goals, Schneider Electric offers options and features that go well beyond the recommendations of the standard.

The protection of life and property is a standard feature due to:

- Front plates that require a tool to be removed
- Keylock on doors providing access to live parts
- The systematic installation of terminal shields on ComPacT NSX circuit breakers and ComPacT INS and INV switch-disconnectors
- Covering of the upstream and downstream terminals on the incoming device so that operators are perfectly safe at all points in the switchboard when the incoming device is off (open).

What is more, PrismaSet HD offers different levels of partitioning to create separations inside the enclosures, thereby creating Form 2b, 3b, 4a and 4b electrical switchboards. Electrical switchboards must meet the IP2X degree of protection to comply with standard IEC 61439-2

Form 1

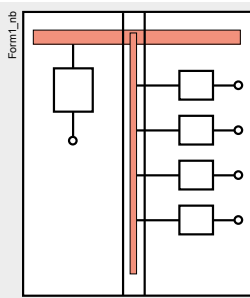

In most installations, PrismaSet HD enclosures do not require partitioning. In this case, the switchboard is a Form 1. Safety being one of its foremost goals, Schneider Electric offers options and features that go well beyond the recommendations of the standard.

Form 2b

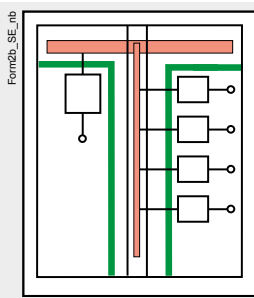

- Terminals for external conductors separated from busbars.
- The functional units and the terminals are separated from the busbars.

Form 3b

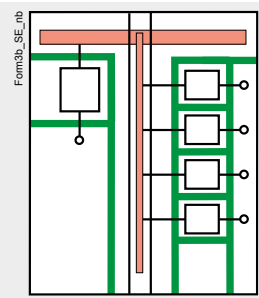

- Terminals for external conductors separated from busbars.
- The functional units are separated from each other and from the busbars.
- The terminals are separated from the busbars, but not from each other.

Form 4a

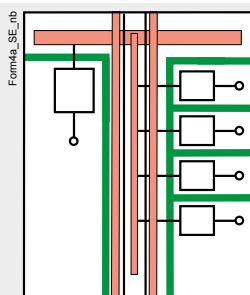

Terminals for external conductors in the same compartment as the associated functional unit.

Form 4b

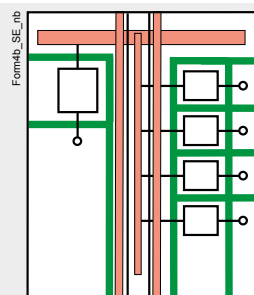

Terminals for external conductors not in the same compartment as the associated functional unit, but in individual, separate, enclosed protected spaces or compartments.

Upgradeable Functional Units

Functional units include switchgear mounting plates, front plates, connection supports, barriers, etc.



MasterPacT MTZ2
from 800 to 4000 A



MasterPacT MTZ1
from 600 to 1600 A



ComPacT NSX
up to 630 A



ComPacT NS
from 630b to 1600 A



ComPacT NS
up to 3200 A



EasyPact
from 100 to 630 A

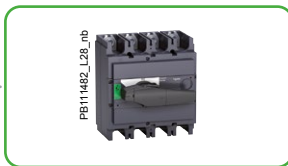

ComPacT INS-INV250-630 A



ComPacT INS-INV630-2500 A



Source changeover systems
ComPacT/MasterPacT



Source changeover systems
ComPacT INS





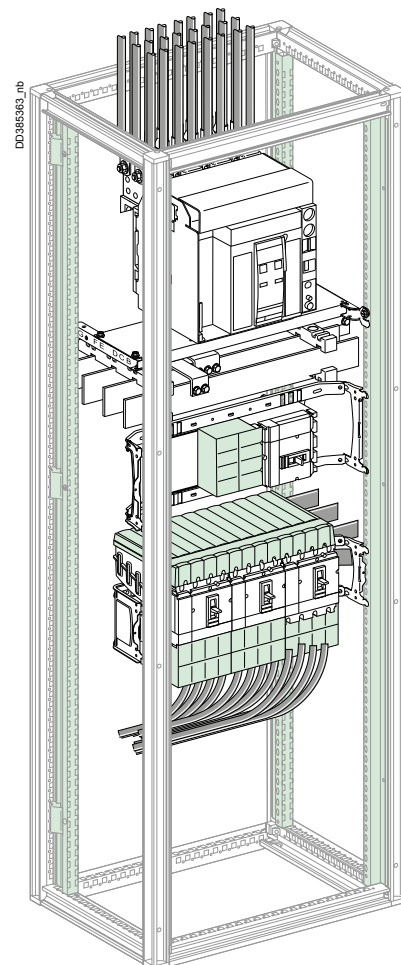





FuPact from 32 to 1250 A

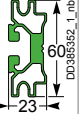
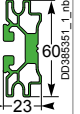
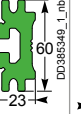
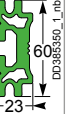
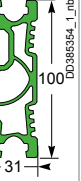

For more information see catalog PrismaSeT P **DESW024EN**

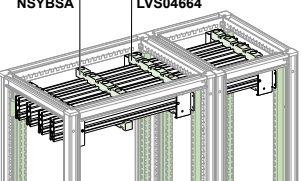
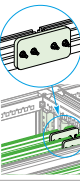
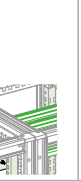
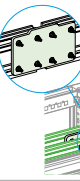
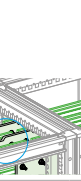

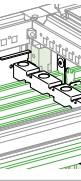
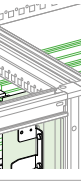
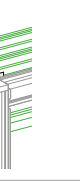
Linery LGYE - Horizontal Profiles up to 4000 A

Installation in PrismaSet HD		Up to 1600 A					Up to 4000 A					
Linery profile, 2000 mm length												
		630 A	800 A	1000 A	1250 A	1600 A	2000 A	2500 A	3200 A	4000 A		
Permissible current for an ambient temperature of 35 °C around the switchboard	IP ≤ 31	630 A	800 A	1000 A	1250 A	1650 A	2000 A	2440 A	3200 A	3620 A		
	IP > 31	530 A	680 A	850 A	1050 A	1480 A	1650 A	2100 A	2800 A	3350 A		
Number of profiles per phase		1										
Total number of vertical modules (50 mm)		3					3		4			
References		LVS04560	LVS04561	LVS04562	LVS04563	LVS04564	LVS04565	LVS04566	LVS04567	LVS04568		
Busbar supports		 Fixed Support LVS04664 Free Support NSYBSA 2 fixed supports for PrismaSet HD 700 wide frame are compulsory. 1 fixed support for 300/400 wide frame are compulsory. If more supports are needed, add free supports.										
In enclosure: W700 Busbar supports 75 mm distance between bars	Number of supports depending on I _{cw} (kA rms/1 s)	≤ 15	2									
		≤ 25	2									
		≤ 30	2									
		≤ 40	2									
		≤ 50	2									
		≤ 60	2+1					2				
		≤ 65						2+1				
		≤ 75						2+1				
≤ 85						2+1						
≤ 100							2+2					
References Fixed support		LVS04664				LVS04664 + LVS04671 (order 1 per support)		LVS04664 + LVS04646 (sold in lots of 12 spacers)				
References Free support		NSYBSA				NSYBSA + LVS04671 (order 1 per support)		NSYBSA + LVS04646 (sold in lots of 12 spacers)				
In duct: W300 Busbar supports 75 mm distance between bars	Number of supports depending on I _{cw} (kA rms/1 s)	≤ 15	1									
		≤ 25	1									
		≤ 30	1									
		≤ 40	1									
		≤ 50	1									
		≤ 60	1									
		≤ 65	1 + 1									
		≤ 75	1 + 1									
≤ 85	1 + 1											
≤ 100							1 + 1					
References Fixed support		LVS04664				LVS04664 + LVS04671 (order 1 per support)		LVS04664 + LVS04646 (sold in lots of 12 spacers)				
References Free support		NSYBSA				NSYBSA + LVS04671 (order 1 per support)		NSYBSA + LVS04646 (sold in lots of 12 spacers)				
Joints		Up to 1600 A					Up to 4000 A					
												
		LVS04620		LVS04623			LVS04624					
References (3P)		3x LVS04620					3x LVS04621		3x LVS04623			
References (4P)		4x LVS04620 + LVS04624					4x LVS04621 + LVS04624		4x LVS04623 + LVS04624			
		Reference LVS04624 is compulsory when installing jointed Linery LGYE 4P busbars and must be fitted where the frames meet. When installed at the bottom of an enclosure, the busbar must be partitioned.										

Linery BS - Horizontal Flat Busbars up to 4000 A

Installation in PrismaSet HD		Up to 1600 A				Up to 4000 A						
Copper bar, 2000 mm length Note: When installed at the bottom of an enclosure, the busbar must be partitioned.												
Permissible current for an ambient temp. of 35 °C around the switchboard	IP ≤ 31	800 A	1000 A	1400 A	1800 A	1800 A	2050 A	2300 A	2820 A	3300 A	3760 A	
	IP > 31	750 A	900 A	1250 A	1600 A	1600 A	1850 A	2000 A	2500 A	2900 A	3340 A	
Busbar cross-section (mm)		60 x 5	80 x 5	60 x 5	80 x 5	80 x 10	50 x 10	60 x 10	80 x 10	100 x 10	120 x 10	
Number of busbars per phase		1	1	2	2	1	2	2	2	2	2	
Total number of vertical modules (50 mm)		3										
References		LVS04536	LVS04538	LVS04536	LVS04538	LVS04548	LVS04545	LVS04546	LVS04548	LVS04550	LVS04552	
Busbar supports		<p>Fixed Support LVS04664 Free Support NSYBSA</p> <p>2 fixed supports for PrismaSet HD 700 wide frame are compulsory. 1 fixed support for 300/400 wide frame are compulsory. If more supports are needed, add free supports.</p>										
In enclosure: W700 with 75 mm distance between bars	Number of supports depending on I_{cw} (kA rms/1 s)	≤ 15	2									
		≤ 25	2+1	2								
		≤ 30	2+1	2								
		≤ 40	2+1	2								
		≤ 50	-	2+1	2							
		≤ 60	-			2+1						
		≤ 65	-			2+1						
		≤ 75	-			2+2	2+1					
≤ 85	-					2+1						
References Fixed support		LVS04664				LVS04664		LVS04664 + LVS04671				
References Free support		NSYBSA				NSYBSA		NSYBSA + LVS04671				
In duct: W300 with 75 mm distance between bars	Number of supports depending on I_{cw} (kA rms/1 s)	≤ 30	1									
		≤ 50	1+1		1							
		≤ 85			2							
References (depending on depth) Fixed support		NSYBHS500 (D500) or NSYBHS600 (D600) or NSYBHS800 (D800)				NSYBHS500 (D500) or NSYBHS600 (D600) or NSYBHS800 (D800)		NSYBHS500 (D500) or NSYBHS600 (D600) or NSYBHS800 (D800) + LVS04671				
References (depending on depth) Free support		NSYBSA				NSYBSA		NSYBSA + LVS04671				
Joints		Up to 1600 A				Up to 4000 A						
		1 vertical bar per phase		2 vertical bars per phase		1 vert. bar per phase		2 vertical bars per phase				
Busbar cross-section (mm)		60 x 5	80 x 5	60 x 5	80 x 5	80 x 10	50 x 10	60 x 10	80 x 10	100 x 10	120 x 10	
Sliding joints with self-breaking lock nut		<p>LVS04640 LVS04641</p>										
References		LVS04640	LVS04641	LVS04640	LVS04641	LVS04641	LVS04640	LVS04640	LVS04641	LVS04641	LVS04643	

Linery LGY - Lateral Profiles up to 1600 A

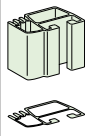
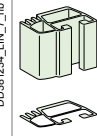
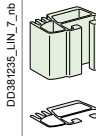
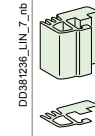
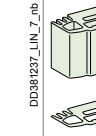
In PrismaSet HD duct		W300				
		 DD381233_LIN_T_nb 630 A	 DD381234_LIN_T_nb 800 A	 DD381235_LIN_T_nb 1000 A	 DD381236_LIN_T_nb 1250 A	 DD381237_LIN_T_nb 1600 A
Permissible current for an ambient temp. of 35 °C around the switchboard	IP ≤ 31	590 A	760 A	950 A	1170 A	1480 A
	IP > 31	590 A	760 A	950 A	1170 A	1480 A
Number of profiles per phase		1				
References		LVS04502	LVS04503	LVS04504	LVS04505	LVS04506

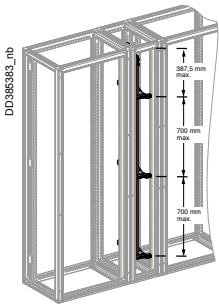

Number depending on I_{cw} (kA rms/1 s)

≤ 25	3
≤ 30	3
≤ 40	3
≤ 50	4
≤ 60	5
≤ 65	5
≤ 75	7
≤ 85	8

Only for enclosures with a depth ≥ 500 mm

References



Fixed Support LVS04651

Note:
An end stop must be fitted on the bottom support: LVS01109 (sold in lots of 12)

LVS04651 (set of 2 upright adapters NSYSFPAED for installation in PrismaSet HD enclosure)

Connections to the Linery BS horizontal busbar

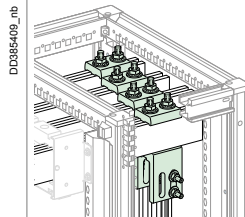

Note:
Supplied with mounting hardware. Reference include 1 connection only. Order 1 connection per phase.

References according to horizontal busbar size	5 mm thick	LVS04634	LVS04635
	10 mm thick Width ≤ 80 mm	LVS04636	
	10 mm thick Width > 80 mm	LVS04636 + LVS04642 LVS04638 + LVS04642	

Connections to the Linery LGYE horizontal busbar

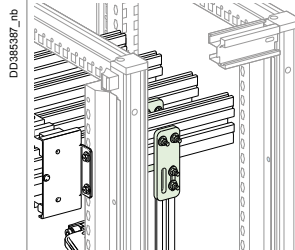







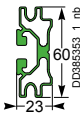
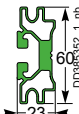

Note:
Supplied with mounting hardware. Reference include 1 connection only. Order 1 connection per phase.

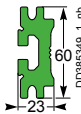
References (vertical connection)	LVS04602
References (vertical shifted connection)	LVS04603

(1) Dedicated connection LVS04603 for Linery LGYE busbar in 150 mm duct with horizontal jointing.

Linery LGYE - Lateral Profiles up to 4000 A

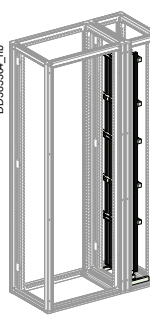
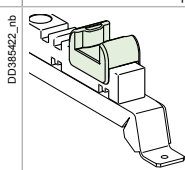
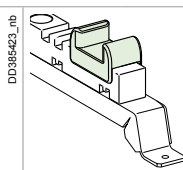
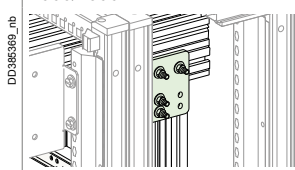
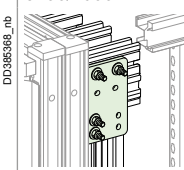
In PrismaSet HD duct		W300									
Linery profile, 2000 mm length											
		630 A	800 A	1000 A	1250 A	1600 A	2000 A	2500 A	3200 A	4000 A	
Permissible current for an ambient temperature of 35 °C around the switchboard	IP ≤ 31	630 A	800 A	1000 A	1250 A	1650 A	2000 A	2440 A	3200 A	3620 A	
	IP > 31	530 A	680 A	850 A	1050 A	1480 A	1650 A	2100 A	2800 A	3350 A	
Length to cut for side-mounted		1675 mm							1625 mm		
Number of profiles per phase		1									
Height available (mm)		150						150		200	
References		LVS04560	LVS04561	LVS04562	LVS04563	LVS04564	LVS04565	LVS04566	LVS04509	LVS04510	
 Number depending on I _{cw} (kA rms/1 s)	≤ 30	3									
	≤ 40	-	3+2 *				3				
	≤ 50	-	3+2 *			3					
	≤ 60	-	3+2 *			3					
	≤ 65	-	3+2 *				3				
	≤ 75	-	3+4 **				3+2 *				
≤ 85	-	3+4 **				3+2 *					
≤ 100	-	3+6 ***				3+6 ***					
References* 75 mm distance between bars		W300, D500	NSYBVS500 (fixed) + NSYBSA (free) + NSYAS500 (spacer) (1)								
		W300, D600	NSYBVS600 (fixed) + NSYBSA (free) + NSYAS600 (spacer) (1)								
		W300, D800	NSYBVS800 (fixed) + NSYBSA (free) + NSYAS800 (spacer) (1)								
References* 115 mm distance between bars		W300, D800	NSYBVS800L (fixed) + LVS04678 (free) + NSYAS800L (spacer) (1)								
* References of supports depending on distance between bars and duct depth		(1) If using a 100 x 10 bars, add a pack of screws ref. LVS04671 for each fixed support and free support.									
Wedging busbars in position											
		Wedge Fitted on Bottom Support LVS04658				Wedge Fitted on Bottom Support LVS04659					
		The bottom support is used to place profiles and ensure they are in the correct position. It is not considered to be a busbar support.									
References Wedge		LVS04658					LVS04659				
Connections to the Linery LGYE horizontal busbar		2000/2500 A							3200/4000 A		
											
		Supplied with mounting hardware. Reference include 1 connection only. Order 1 connection per phase.									
References (short connection)		LVS04604							LVS04607		
References (long connection)		LVS04605									

Linery BS - Lateral Flat Busbars up to 3200 A

In PrismaSeT HD duct		W300											
Pre-slotted copper, 1675 mm length													
Permissible current for an ambient temp. of 35 °C around the switchboard	IP ≤ 31	800 A	1000 A	1400 A	1800 A	1200 A	1400 A	1800 A	2050 A	2300 A	2820 A	3200 A	
	IP > 31	750 A	900 A	1250 A	1600 A	1080 A	1250 A	1600 A	1850 A	2000 A	2500 A	2820 A	
Busbar cross-section (mm)		60 x 5	80 x 5	60 x 5	80 x 5	50 x 10	60 x 10	80 x 10	50 x 10	60 x 10	80 x 10	100 x 10	
Number of profiles per phase		1			2			1			2		
References		LVS04516	LVS04518	LVS04516	LVS04518	LVS04525	LVS04526	LVS04528	LVS04525	LVS04526	LVS04528	LVS04550 (1)	

Busbar supports
 3 fixed supports are compulsory to hold the busbar in position.
 If more than 3 supports are needed, use free supports (in addition).
 The bottom wedge support is used to place the busbar and ensure it is in the correct position.
 It does not count as a busbar support.

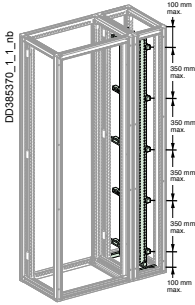

Number of supports depending on I_{cw} (kA rms/1 s)	≤ 15	3 *											
	≤ 25	3+2 *			3 *								
	≤ 30	3+2 *									3 *		
	≤ 40	3+4			3+2 *								
	≤ 50				3+4			3+2 *					
	≤ 60							3+4			3+2 *		
	≤ 65							3+4			3+2 *		
	≤ 75							3+6			3+4		
≤ 85										3+4			

References* 75 mm distance betw. bars	W300, D500	NSYBVS500 (fixed) + NSYBSA (free) + NSYAS500 (spacer) ⁽²⁾											
	W300, D600	NSYBVS600 (fixed) + NSYBSA (free) + NSYAS600 (spacer) ⁽²⁾											
	W300, D800	NSYBVS800 (fixed) + NSYBSA (free) + NSYAS800 (spacer) ⁽²⁾											
References* 115 mm distance betw. bars	W300, D800	NSYBVS800L (fixed) + LVS04678 (free) + NSYAS800L (spacer) ⁽²⁾											

* References. of supports depending on distance between bars and duct depth
⁽¹⁾ Copper bar without holes.
⁽²⁾ If using a 100 x 10 bars, add a pack of screws ref. LVS04671 for each fixed support and free support.

Connections to the Linery BS horizontal busbar											
		For a busbar with 75 mm distance between bars, the bars must be completely covered. Staggered assembly points between one bar and the next, to maintain the necessary clearance distances ⁽³⁾				References LVS04636, LVS04637, LVS04638 are supplied individually: 1 connection per phase. Reference LVS04642 consists of 2 M8 x 140 screws which can replace the original M8 x 120 screws.					
References depending on horizontal busbar size	≤ 80 mm	LVS04645		LVS04636		LVS04637		LVS04637		LVS04645	
	> 80 mm	LVS04645		LVS04636 + LVS04642		LVS04637 + LVS04642		LVS04637 + LVS04642		LVS04645	



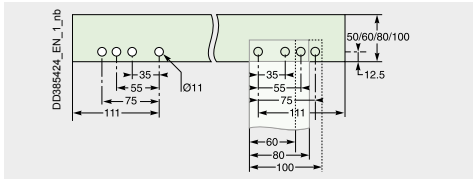

⁽¹⁾ Drill Hole Dimensions for 5 mm Thick Horizontal Busbars

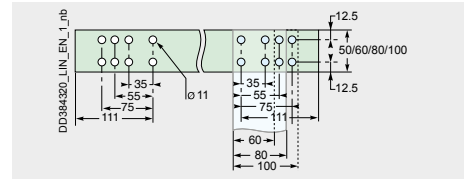

Drill Hole Dimensions for 10 mm Thick Horizontal Busbars

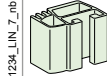

Linergy LGYE - Rear Profiles up to 1600 A

At the rear of a PrismaSeT HD enclosure		W700				
		 <small>DD381233_LIN_7_nb</small> 630 A	 <small>DD381234_LIN_7_nb</small> 800 A	 <small>DD381235_LIN_7_nb</small> 1000 A	 <small>DD381236_LIN_7_nb</small> 1250 A	 <small>DD381237_LIN_7_nb</small> 1600 A
Permissible current for an ambient temp. of 35 °C around the switchboard	IP ≤ 31	680 A	840 A	1040 A	1290 A	1650 A
	IP > 31	590 A	760 A	950 A	1170 A	1480 A
Number of profiles per phase		1				
References		LVS04502	LVS04503	LVS04504	LVS04505	LVS04506

Busbar supports

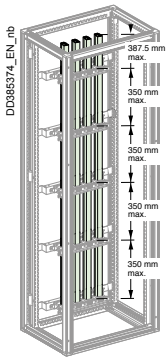

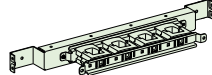
		 <small>DD381242_LIN_nb</small> Fixed Support LVS04652
Number depending on I _{cw} (kA rms/1 s)	≤ 25	3
	≤ 30	4
	≤ 40	5
	≤ 50	7

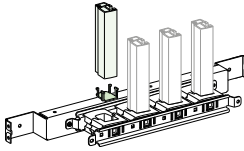

Note:
An end stop must be fitted on the bottom support LVS01109 (sold in lots of 12)

References	LVS04652
------------	----------

Connections to the Linergy BS horizontal flat busbar

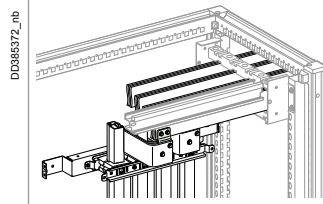

LVS04635 Connection to 5 mm Thick Horizontal Busbar

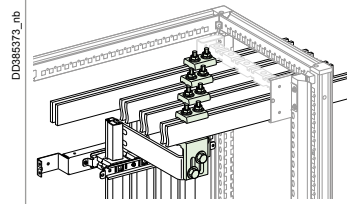

LVS04636 Connection to 10 mm Thick Horizontal Busbar

Fixings supplied, order 1 connection per phase.
Some parts of the connection require flexible insulated busbars.

References according to horizontal busbar size	5 mm thick	LVS04635
	10 mm thick Width ≤ 80 mm	LVS04636
	10 mm thick Width > 80 mm	LVS04636 + LVS04642

Connections to the Linergy LGYE horizontal flat busbar

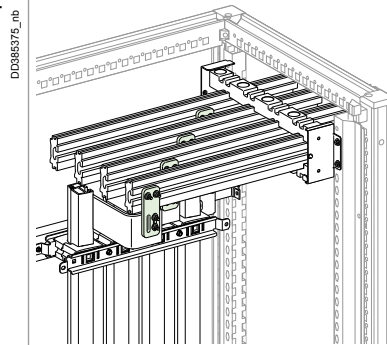

LVS04602 Connection to the Linergy LGYE Horizontal Flat Busbar

Fixings supplied, order 1 connection per phase.
Some parts of the connection require flexible insulated busbars.

References	LVS04602
------------	----------

Linery BS - Rear Flat Busbars up to 1600 A

At the rear of a PrismaSeT HD enclosure			W700						
Pre-slotted copper, 1670 mm length									
Permissible current for an ambient temperature of 35 °C around the switchboard			IP ≤ 31	800 A	1000 A	1400 A	-	-	-
			IP > 31	750 A	900 A	1250 A	1080 A	1250 A	1600 A
Busbar cross-section (mm)				60 x 5	80 x 5	60 x 5	50 x 10	60 x 10	80 x 10
Number of busbars per phase				1		2	1		
References				LVS04516	LVS04518	LVS04516	LVS04525	LVS04526	LVS04528
Busbar supports									
			<p>3 fixed supports ref. LVS04653 are compulsory to keep the busbar vertical. If more than 3 supports are needed, use free support ref. NSYBSA (in addition). Metal shim ref. LVS04669 (sold in lots of 100), 5 mm thick, is screwed onto the busbar. It rests on a fixed support and is used to wedge the busbar in position.</p>						
			<p>Wedging: 1 busbar/phase</p>						
			<p>Wedging: 2 busbars/phase</p>						
Number depending on I _{cw} (kA rms/1 s)			≤ 15	3			3		
			≤ 25	3+2			3		
			≤ 30	3+2			3+2		
			≤ 40	3+4		3+2	3+2		
			≤ 50	3+4			3+2		
			≤ 60				3+4		
			≤ 65				3+4		
			≤ 75				3+6		
			≤ 85						
References			LVS04653 (fixed) + NSYBSA (free) + LVS04669 (spacer)						
Connections to the Linery BS horizontal flat busbar									
			<p>For part of the connection, flexible insulated busbars are needed. References LVS04635, LVS04636 are supplied individually = 1 connection per phase. Reference LVS04642 consists of 2 M8 x 140 screws which can replace the original M8 x 120 screws.</p>						
References according to horizontal busbar size			5 mm thick	LVS04635					
			10 mm thick	Width ≤ 80 mm		LVS04636 ⁽¹⁾			
			10 mm thick	Width > 80 mm		LVS04636 + LVS04642 ⁽¹⁾			
			⁽¹⁾ To be made.						

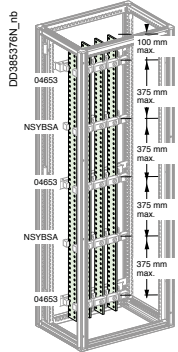

Linery LGYE - Accessories

Linery Screw

- Sold in lots of 20: 20 screws + 20 nuts + 20 contact washers, grade 8.8. The screws slide into the profile and are then locked in the desired position.

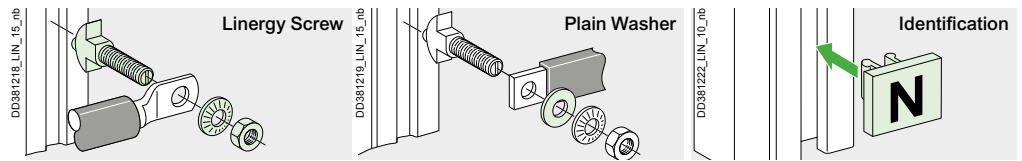

Characteristics	AD	References
Steel plain washers	M8 sold in lots of 20	20 mm LVS04772
Brass plain washers	M8 sold in lots of 20	24 mm LVS04773
	M8 sold in lots of 20	28 mm LVS04774
Identification	M8 sold in lots of 20 for connection of $\leq 25 \text{ mm}^2$ lugs to Linery	20 mm LVS04775
	12 clip-on supports + N, L1, L2, L3, PE, PEN labels	LVS04794
	Linery LGYE busbar screw plate kit after sales service	LVS01130

M8 Screws

- Set of 20 screws + 20 nuts + 40 contact washers.

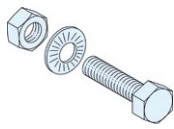

LVS04782

Characteristics	References
Linery BS, 20 screws grade 8.8, M8 x 20	LVS04782
Linery BS, 20 screws grade 8.8, M8 x 25	LVS04783
Linery BS, 20 screws grade 8.8, M8 x 30	LVS04784
Linery BS, 20 screws grade 8.8, M8 x 35	LVS04785
Linery BS, 20 screws grade 8.8, M8 x 40	LVS04786
Linery BS, 20 screws grade 8.8, M8 x 45	LVS04787
Linery BS, 20 screws grade 8.8, M8 x 50	LVS04788

Torque Nuts

- Can be used to obtain the correct tightening torque (28 Nm) recommended by the manufacturer, without using a torque wrench. Torque nuts may be used for all electrical connections.



LVS04759

Characteristics	References
20 M8 torque nuts	LVS04759

Voltage Tap-Offs

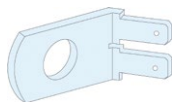

LVS04229

- For small lugs (on low-current cables or measurement tap-offs), insert a conducting washer (ref. **LVS04775**) between the busbar and the lug.

Characteristics	References
20 M10 voltage tap-offs for two 6.35 mm tab connectors	LVS04229

Connections on Linery LGYE and LGY

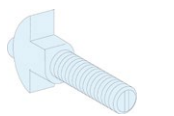

LVS04766



LVS04768



LVS04769

Characteristics	InA	bar	Utilisation	References
Use the 25 mm Linery screw	0 A to 630 A	Cable Insulated flexible bar	Recommended	LVS04766
Use the 39 mm Linery screw is only compatible with Linery LGY.	0 A to 630 A	Cable Insulated flexible bar	Possible	LVS04767
Use the 25 mm Linery screw	800 A to 1250 A	5 mm thick bar	Recommended	LVS04766
Use the 39 mm Linery screw is only compatible with Linery LGY.	800 A to 1250 A	5 mm thick bar	Possible	LVS04767
Use the flat plate screw with 2 studs	800 A to 1250 A	5 mm thick bar	Possible	LVS04768
Use the flat plate screw with 2 studs	1600 A to 2500 A	5 or 10 mm thick bar	Recommended	LVS04768
Use the 39 mm Linery screw is only compatible with Linery LGY.	1600 A to 2500 A	5 or 10 mm thick bar	Possible	LVS04767
Use the flat plate screw with 3 studs	3200 A to 4000 A	10 mm thick bar	Recommended	LVS04769

Form 1 Partitioning

Presentation:

Decisions concerning the form of separation and the degree of protection are the subject of an agreement between the manufacturer and the user.

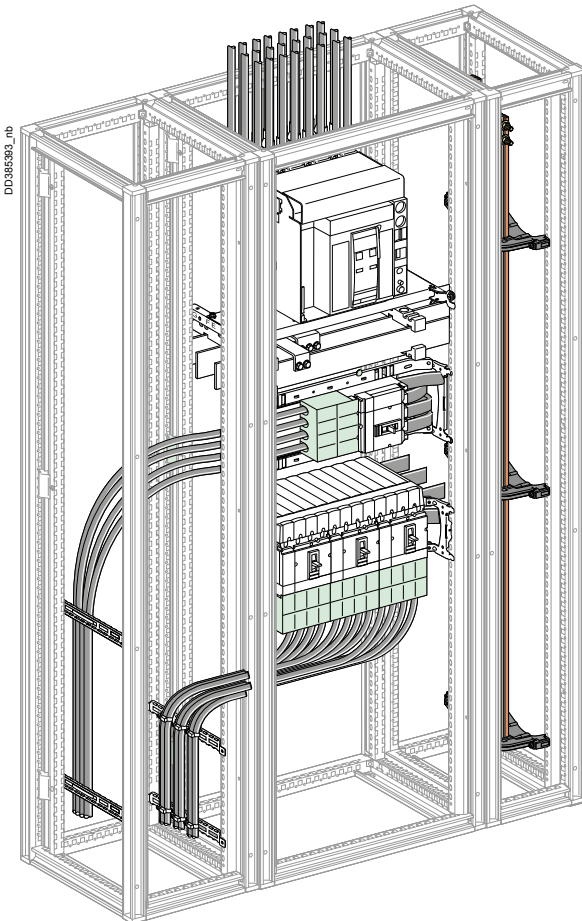

The protection of life and property is ensured by the systematic installation of terminal shields on ComPact NSX circuit breakers and on ComPact INS and INV switch-disconnectors (see the pages on the functional units).

11

In most installations, PrismaSeT HD enclosures do not require partitioning. In this case, the switchboard is a Form 1. Safety being one of its foremost goals, Schneider Electric offers options and features that go well beyond the requirements of the standard.

The Protection of Life and Property Is a Standard Feature Due to:

- Front plates that require a tool to be removed
- Keylocks on doors, some of which provide access to live parts
- The systematic installation of terminal shields on ComPact NSX circuit breakers and ComPact INS and INV switch-disconnectors.

What is more, PrismaSeT HD offers different levels of partitioning to create separations inside the enclosures and thus create Form 2b, 3b, 4a and 4b electrical switchboards.

Electrical switchboards must meet the IP2X degree of protection to comply with standard IEC 61439-2

Form 2b Partitioning

Note:
If the busbars are at the bottom of the enclosure, gland plates are mandatory.

Separation of busbars from the functional units:

- Protection against contact with live parts upstream of the outgoing circuits
- Protection against penetration by foreign solid bodies.

Lateral Partitioning; Form 2 Restoration for Side-Barrier Cut-Out

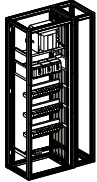

LVS06545

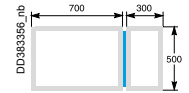

Characteristics	References
Lateral partitioning <ul style="list-style-type: none"> • Vertical barrier made of insulated slats. • Can be installed on both sides of Linergy and flat busbars. • The space between the slats is sufficient for prefabricated connections (one copper bar, 5 or 10 mm thick, or insulated flexible bars) or for cables up to 35 mm², while maintaining the IP2X degree of protection in compliance with standard IEC 60695.2.1 concerning fire resistance. 	LVS06545
Form 2 restoration for side-barrier cut-out <ul style="list-style-type: none"> • This kit enables the passage of the connection between a device > 1600 A (MTZ2, INS) and lateral vertical busbars. • It is made up of an insulated plate (six modules H 300 mm) that can be cut as required, supplied with supports and the necessary hardware. 	LVS04924

Partitioning Extension

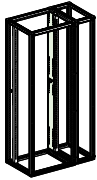

LVS06541

- The partitioning extension is required for PrismaSeT system switchboards with a depth of 600 or 800 mm.

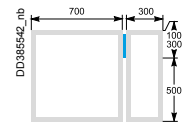

Characteristics	References
D600	LVS06541
D800	LVS06543

Front and Rear Barrier

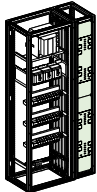

LVS06540

Characteristics	References
<ul style="list-style-type: none"> • Front protection is realized by the combination of door W300 and this barrier. • Metal barrier, composed of 2 parts H850, pre-cut at both ends. • Rear protection, a barrier is required at the rear of the busbar compartment in enclosures that are 800, 1000 or 1300 mm deep. 	LVS06540

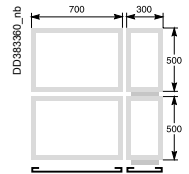

Inter-Enclosure Partitioning

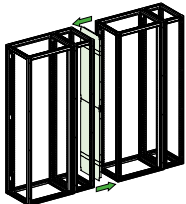

LVS06555

- Metal partition, used to separate two adjacent enclosures.
- It is made up of two panels, each 850 mm high.
- The top and bottom ends have knock-outs for horizontal busbars.
- Supplied with the necessary supports and hardware, the partition is mounted on the framework and does not hinder installation of the functional mounting plates.

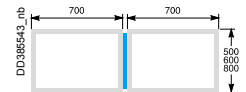

Characteristics	References
D500	LVS06555
D600	LVS06555 + LVS06541
D800	LVS06555 + LVS06543

Partitioning of Horizontal Busbars

- Set of two barriers (front and rear), plus a slotted rear panel for efficient natural convection in the switchboard.
- The set can be used to partition horizontal busbars installed at the top or bottom of the enclosure.
- The space required for the busbars is not increased.

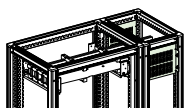

LVS06560

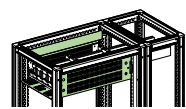

LVS06570

Characteristics	References
3M-busbar, W300, D500	LVS06560
3M-busbar, W300, D600	LVS06561
3M-busbar, W300, D800	LVS06563
4M-busbar, W300, D500 or D600 or D800	LVS06568
3M-busbar, W700, D500 or D600 or D800	LVS06570
4M-busbar, W700, D500 or D600 or D800	LVS06567

Technical changes reserved. Information provided without guarantee. Images are for illustrative purposes only.

Form 3b Partitioning

Separation of busbars from the functional units and separation of all functional units from one another.
 Separation of the terminals for external conductors from the functional units, but not from each other.

- Protection against contact with live parts
- Reduction in the risk of faults between the functional units (propagation of electrical arcs, etc.).

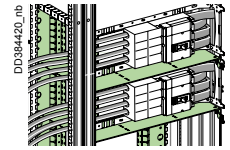

Front Connection

- A horizontal metal partition can be used to physically separate functional units from one another.

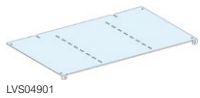

LVS04901

Characteristics	References
Horizontal metal partition, W650 mm	LVS04901

- It is fixed at the rear by a support (two uprights) secured to the framework (500 mm deep) or to the intermediate uprights (800 mm deep frameworks).



LVS04943

Characteristics	References
Rear support for partitions, W650 mm	LVS04943

- A set of brackets can be used to install partial Form 3 partitioning in the enclosure.
- It does not take up any useful space in the switchboard.



LVS03583

Characteristics	References
6 universal angle brackets	LVS03583

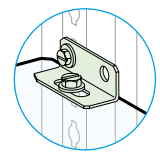

DD384422_nb

Rear Connection

- Vertical partitions (two cat. no. per functional unit)

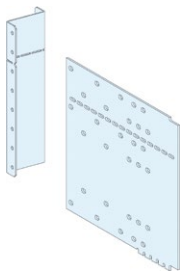

LVS04955

Characteristics	References
3 to 4 modules	LVS04955
5 to 6 modules	LVS04956

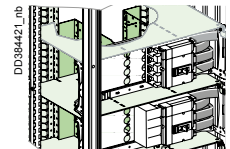

DD384421_nb

Form 4 Partitioning

Separation of busbars from the functional units and separation of all functional units from one another, including the terminals for external conductors which are an integral part of the functional unit.

- Protection against contacts with live parts and reduction in the risk of faults between the functional units (propagation of electrical arcs, etc.).
- Form 4a: Terminal for external conductors in the same compartment as the associated.
- Form 4b: Terminals for external conductors not in the same compartment as the associated functional unit, but in individual, separate, enclosed protected spaces or compartments.

Form 4a Partition for Front Connection

- Backplate (one cat. no. per enclosure) made up to two metal half panels mounted on the rear supports for Form 3 partitions. This backplate is not indispensable for 500 mm deep frameworks.

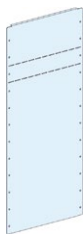
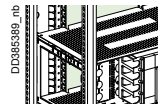

LVS04946

Characteristics	References
Form 4a backplate (one cat. no. per enclosure)	LVS04946

Form 4a Gland Plate

- Gland plate that can be easily cut-out (one for each functional unit) and is mounted on the framework.

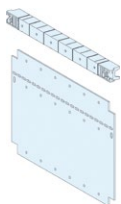
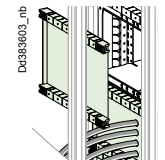

LVS04951

Characteristics	References
3 or 4 modules	LVS04951
5 or 6 modules	LVS04952

Form 4b Partition

- Cover with metal gland plates that can be easily cut-out on the side and bottom. It is available in two heights:

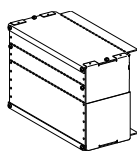
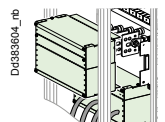

LVS06600

Characteristics	References
3 to 5 modules	LVS06600
4 to 6 modules	LVS06601

Connection Transfer Assembly, 3 to 5 Modules, 250 A

- Transfer assembly without connections to simplify cable installation.

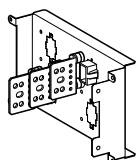

LVS06606

Characteristics	References
3P	LVS06606
4P	LVS06604

Connection Transfer Assembly, 4 to 6 Modules, 630 A

- Transfer assembly without connections to simplify cable installation.

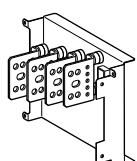



LVS06605

Characteristics	References
3P	LVS06607
4P	LVS06605

Common Characteristics

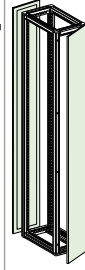
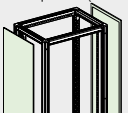
- Roof characteristics:
 - equipped with a factory-mounted polyurethane (PUR) gasket
 - supplied with mounting hardware
 - with markings for clear identification of cable-running zones
- The cable compartment can be mounted on the right or left.
- Can be combined side-by-side or back-to-back.
- Receive the IP55 cover panels.

Mounting			W700			W300		
								
Depth			D500	D600	D800	D500*	D600	D800
Enclosures for front connection H2000	Plain-door enclosure	White RAL 9003	NSYSFPN20750ED	-	NSYSFPN20780ED	NSYSFN20350ED	-	NSYSFN20380ED
		Gray RAL 7035	NSYSFPN20750G	NSYSFPN20760G	NSYSFPN20780G	NSYSFN20350	NSYSFN20360	NSYSFN20380
	Transparent-door enclosure	White RAL 9003	NSYSFPN20750TED	-	NSYSFPN20780TED	-	-	-
		Gray RAL 7035	NSYSFPN20750TG	NSYSFPN20760TG	NSYSFPN20780TG	-	-	-
Additional enclosure for rear connection H2000	Vertical up-rights	White RAL 9003	NSYSFNV20ED	-	-	NSYSFNV20ED	-	-
		Gray RAL 7035	NSYSFNV20	-	-	NSYSFNV20	-	-
	Bottom and top frame with roof	White RAL 9003	NSYSFNC75ED	-	-	NSYSFNC35ED	-	-
		Gray RAL 7035	NSYSFNC75	-	-	NSYSFNC35	-	-
Adapter uprights for busbar installation in vertical on Linergy LGY			-	-	-	NSYSFPAED	NSYSFPAED + NSYSUCR40200	NSYSFPAED + NSYSUCR40200
Side panel (Set of 2)**		White RAL 9003	NSY2SPN205ED	-	NSY2SPN208ED	NSY2SPN205ED	-	NSY2SPN208ED
		Gray RAL 7035	NSY2SPN205	NSY2SPN206	NSY2SPN208	NSY2SPN205	NSY2SPN206	NSY2SPN208
Hinged front plate support frame***			LVS08566	LVS08566	LVS08566	-	-	-

* For cables and to install Linergy LGY, LGYE, BS Busbars.

** An earthing braid must be installed between the lateral panels and the frame.

*** Reversible for left or right-hand opening.

Accessories

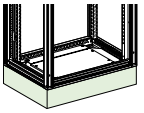
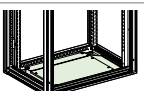
Width			W700			W300		
Depth			D500	D600	D800	D500	D600	D800
	Plinth H100*	Front and rear cross-pieces	NSYSPF7100	NSYSPF7100	NSYSPF7100	NSYSPF3100	NSYSPF3100	NSYSPF3100
		Lateral cross-pieces	NSYSPS5100	NSYSPS6100	NSYSPS8100	NSYSPS5100	NSYSPS6100	NSYSPS8100
	Plinth H200*	Front and rear cross-pieces	NSYSPF7200	NSYSPF7200	NSYSPF7200	NSYSPF3200	NSYSPF3200	NSYSPF3200
Lateral cross-pieces		NSYSPS5200	NSYSPS6200	NSYSPS8200	NSYSPS5200	NSYSPS6200	NSYSPS8200	
	Single-entry gland-plates		NSYEC751	NSYEC761	NSYEC781	NSYEC351	NSYEC361	NSYEC381

* The plinth is made up of two catalog numbers: Front and rear cross-pieces + lateral cross-pieces.

Technical changes reserved. Information provided without guarantee. Images are for illustrative purposes only.

Coupling Kit

- Side-by-side combination
- Back-to-back combination: D500+D500, D800+D500
- Back-to-back combination must be shipped individually and combined during on-site installation

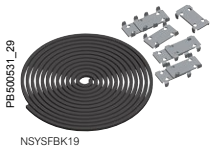

PR600831_29

NSYSFBK19

Characteristics	References
PrismaSet SFN coupling kit for PrismaSeT HD or SFN enclosures equipped with swinging 19" rack, IP55	NSYSFBK19

4 Lifting Rings

- Use a set of lifting rings for each framework for one framework (W700 mm) containing devices



NSYSFEB

Characteristics	References
PanelSeT SFN M12 lifting eyebolt, galvanized cast steel	NSYSFEB

4 Lifting Brackets

- When two enclosures with devices have been combined, use a lifting beam.

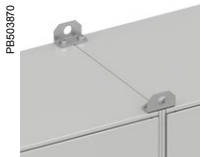

PR603870

NSYSFELB

Characteristics	References
Set of 4 PanelSeT SFN lifting bracket, zinc-coated steel	NSYSFELB

Set of 20 Screws + M6 Nuts



LVS06461

Characteristics	References
20 screws and M6 nuts	LVS06461

Earthing Cable, 6 mm²

The cable is equipped with a 4 mm diameter lug at one end and a 6 mm diameter lug on the other.

The earthing cable is used to earth:

- A door or wicket door with devices
- A front-plate support frame equipped with switchgear in an enclosure.



LVS08911

Characteristics	References
Earthing cable 6 mm	LVS08911

Earthing Braid

- An earthing braid must be installed between the roof and the frame.
- For NSYEL166D8: Length 160 mm, Section 6 mm², Terminal 8.3 mm.
- For NSYEL3525D8: Length 350 mm, Section 25 mm², Terminal 8.3 mm.



NSYEL166D8

Characteristics	References
Earth leads section 6 mm ² , length 160 mm	NSYEL166D8
Earth leads section 25 mm ² , length 350 mm	NSYEL3525D8

Ground Fastening

Note:

Incoming by pre-fabricated busbar trunking is forbidden for seismic applications.

Seismic Plinth H100 mm for Seismic Application 3G Withstand

1600 A configuration *	Height (mm)	Width (mm)	Depth (mm)	References
PrismaSeT HD	2000	700	500	NSYS5GPC75
Busbar duct	2000	300	500	NSYS5GPC35
configuration 3200 A	Height (mm)	Width (mm)	Depth (mm)	References
PrismaSeT HD	2000	700	800	NSYS5GPC78
Busbar duct	2000	300	800	NSYS5GPC38

* Not compatible for depth 600 mm.

Ground Fastening

Front Connection

(Example: device enclosure W700 mm + compartment W300 mm)

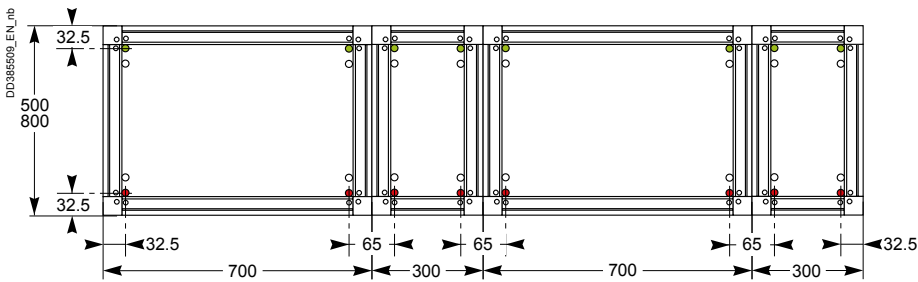

Rear Connection D1000

(Example: device enclosure + compartment D500 + D500 mm)

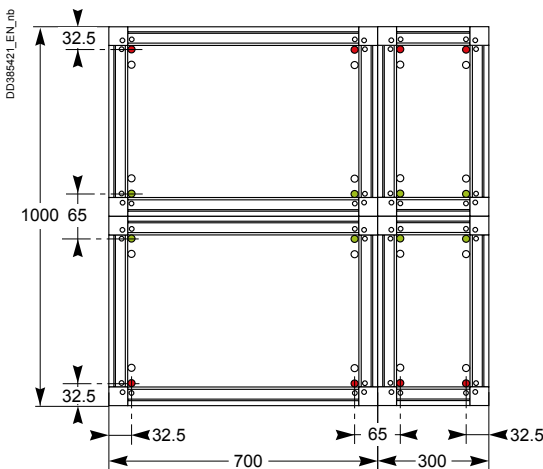

Rear Connection D1300

(Example: device enclosure + compartment D800 + D500 mm)

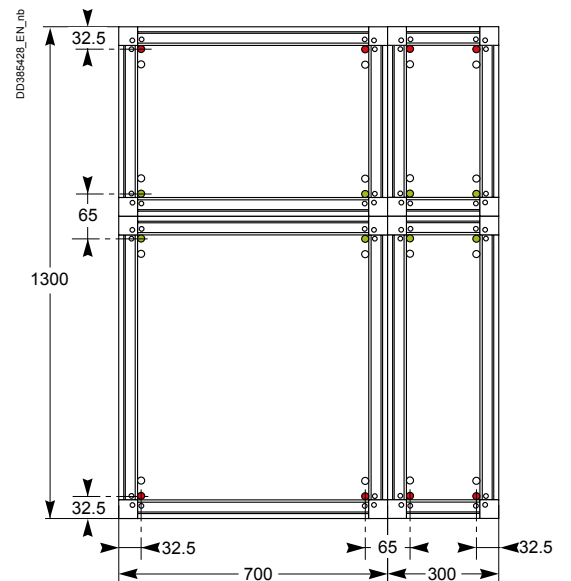

- compulsory fixing point
- optional fixing point

8.8-class screws: Screw M10 TH
 + washers (external Ø 25 mm, thickness 3 mm)
 + CS contact washers Ø 10 mm.

Enclosures

Profile

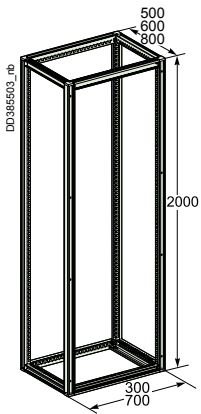

Cover Panels, Plain or Transparent Door, Lateral Panel

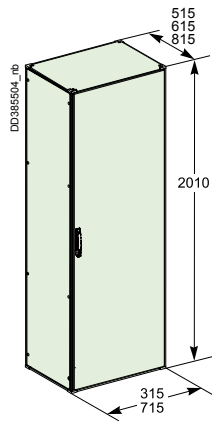

Standard Plinth

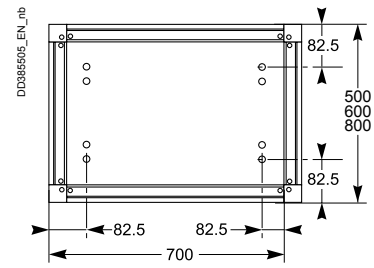

Gland Plates

W300

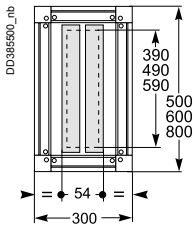

W700

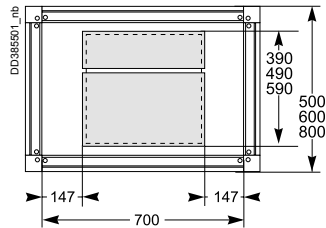

Functional System in PrismaSeT HD Switchboards, Enclosure Mounting

D500, D600, D800

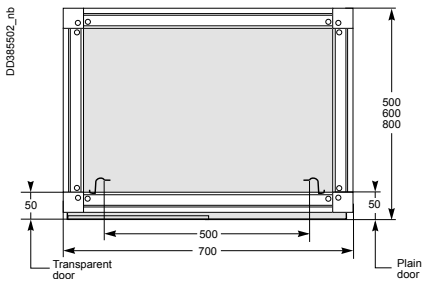

Busbars Mounting, Lateral Vertical Busbars

1600 A

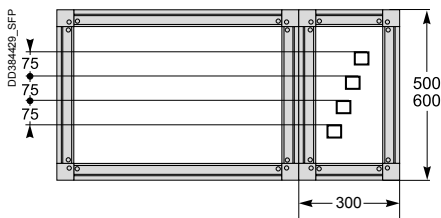

2000

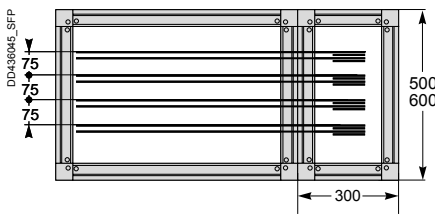

2500 A up to 4000 A

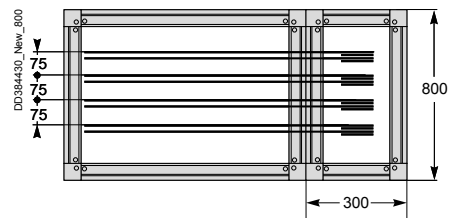

PanelSeT SFN compartmentalized enclosures for Motor Control Centers

Enclosure with Compartments for Motor Control Centers

PanelSeT SFN enclosures can host compartments for Motor Control Centers in industrial environments (IP54), thanks to a full assortment of dedicated accessories and solutions, such as:

- Lynergy distribution systems
- Motor starter solutions
- Partial doors and front fixing panels
- Partitioning forms accessories

They have been tested considering the device characteristics what ensures a high degree of reliability in system operation and optimal safety.

Fixed functional system for Motor Control

The fixed functional system for Motor Control Centers is designed for installation of motor starters up to 250 kW.



In addition to the motor power and the starter type (direct, reversing, star-delta...), 4 main criteria must be considered when choosing a motor starter:

- The operating voltage,
- The type of thermal protection, electro-mechanical or electronic,
- The type of magnetic protection according to the switchboard's Isc,
- The type of installation according to the required availability level.

Operating Voltage

A network's operating voltage is a decisive parameter in the choice of motor protection. The operating voltage will have an impact on the device performance and the installation constraints.

For instance, the voltage will influence:

- The breaking performances,
- The safety areas.

Motor Protection

Protecting the motors to extend their lifetime

- Overheating in electric motors is caused by copper and ferro-magnetic losses:
 - the current I is proportional to the motor's load. Copper losses are proportional to I^2 (stator and rotor),
 - hysteresis cycles in ferro-magnetic materials and the induced Foucault currents cause overheating, which is in particular proportional to frequency.
- The consequence of abnormal overheating is a reduced isolation capacity of the materials, thus leading to a significant shortening of the motor lifetime, as shown in the opposite diagram.
- In continuous or semi-continuous processes, availability is a major issue. It is therefore decisive to observe accurately the operating conditions of the motors.
- Motor protection relays are the components dedicated to this task. They provide various levels of accuracy and functionalities, in order to meet the expectations of the process manager.

Supervising finely the motors to improve process availability

- An electric motor converts electric energy into mechanical energy. When voltage, current and frequency change, the speed and torque of the motor change as well. And conversely, any changes in charge have a direct impact on the electrical parameters.
- Electromechanical thermal relays protect the motor against overloads.
- Electronic relays protect the motor against overloads on the basis of very sophisticated and highly accurate thermal patterns.
- These relays can identify motor overload conditions and transmit the information, alerting the operator of problems,
- These relays transmit many complementary parameters, providing information to operators and allowing them to take action against motor stops or to restart a motor quickly if a stop has occurred.

Examples:

- Motor underload may indicate pump cavitation,
- Phase inversion may indicate a maintenance fault that would be difficult to diagnose without such information.
- In addition to the current, electronic relays can also monitor voltage, and consequently power and power factor. They can also monitor leakage current and measure coil temperature if a sensor is integrated. These data can be used for preventive maintenance and are helpful when resolving problems.
- Finally, electronic relays assume information processing functions such as state and fault statistics. They are also able to provide logical solutions and to respond to process-specific requirements.

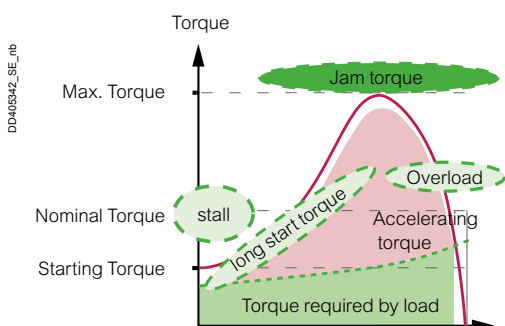
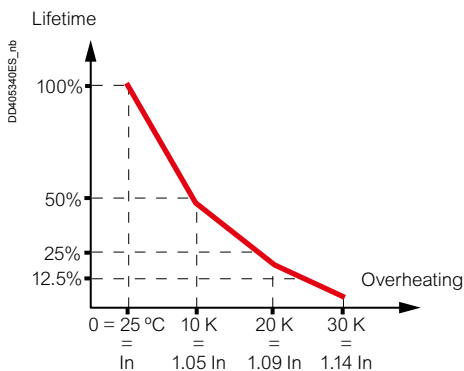
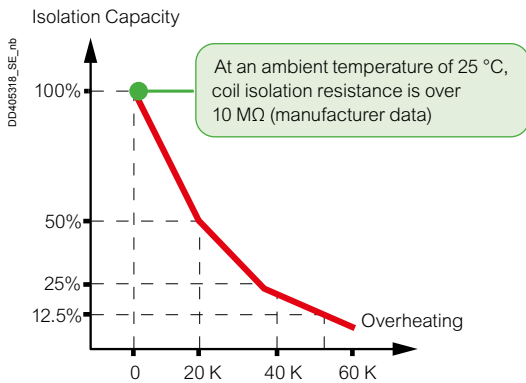

Motor Protection

Magnetic Protection: Circuit-Breakers and Fuses

Schneider Electric have chosen to promote circuit-breakers wherever possible because of their advantages in terms of maintenance and quick reactivation.

Universal solution that can be exported to all countries, unlike fuses which must differ national standards,

- Reduced dimensions,
- Limited temperature rise,
- Faster maintenance,
- No risk of over-rating the fuse cartridge (causing motor destruction) or underrating (untimely tripping).

PanelSeT SFN: a Combination for Motor Starter Control

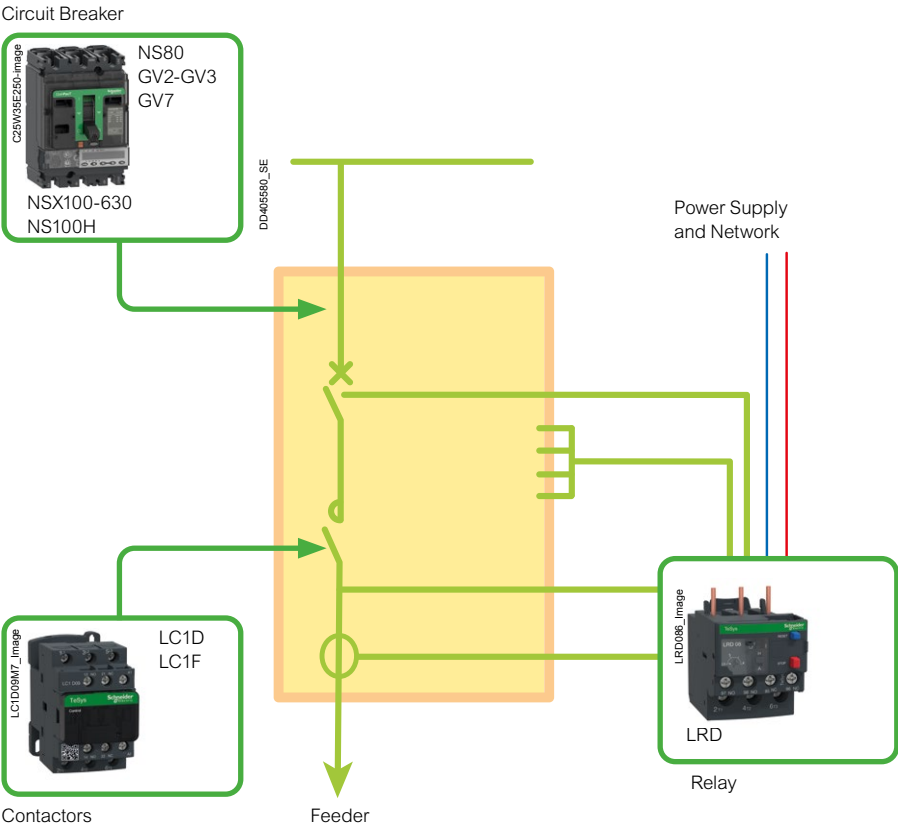

Type 1 Coordination

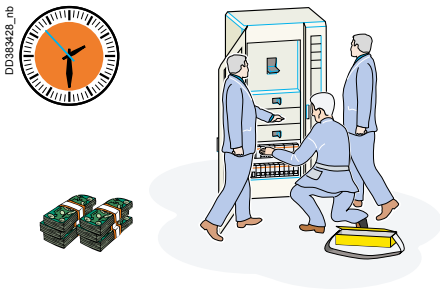

Type 2 Coordination

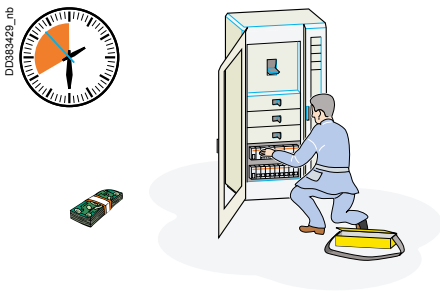

Total Coordination

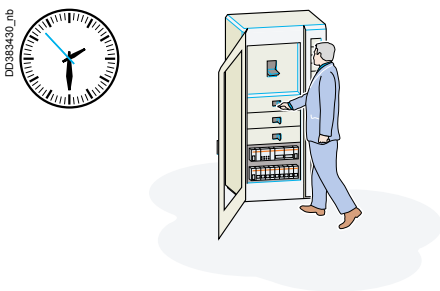

Coordination, What Is It About?

A motor starter can be made up of 1, 2, or 3 different devices. They have to be coordinated in a way they ensure an optimal operation of the installation.

Aims of Coordination

In the case of a fault, coordination serves the following purposes:

- To protect persons and equipment,
- To ensure continuity of service,
- To reduce maintenance costs (manpower and replacement equipment).

Types of Coordination as Per IEC 60947-4-1

- Type 1 coordination: Basic solution
 - no continuity of service,
 - high maintenance costs in case of a fault (manpower and equipment).
- Type 2 coordination: Solution ensuring continuity of service
 - reduced machine downtime,
 - reduced cost of replacement equipment.
- Total coordination: Withdrawable solutions as per IEC 60947-6-2:
 - no damage nor resetting of devices following a fault,
 - installation immediate return to operation.

Schneider Electric's Choice as Regards Coordination

For Motor Control Centers availability switchboard, Schneider Electric applies:

- Type 2 coordination because of:
 - Low cost for repairing the equipment,
 - Reduced machine downtime,

and does no longer apply:

- Type 1 coordination and non-coordinated feeders because of:
 - Expensive return to operation,
 - Extended machine shutdowns.



2-Component Motor Starter
Thermomagnetic circuit-breaker + contactor

Advantages

- Very economic solutions.
- Suitable for all types of diagrams.
- Manual reset following a thermal fault.
- Type 2 coordination.

Applications

- Manufacturing and continuous and semi-continuous processes.



3-Component Motor Starter

Advantages

- Wide choice of solutions.
- Suitable for all types of diagrams.
- Manual or automatic reset following a thermal fault.
- 2 starting classes (10 and 20).
- Type 2 coordination.
- Separation of thermal and magnetic faults.

Magnetic circuit-breaker + contactor + thermal protection

- For manufacturing and continuous and semi-continuous processes.

Switch-disconnector fuse + contactor + thermal protection

- For all types of machines.
- For manufacturing and continuous and semi-continuous processes.





Presentation

The PanelSeT SFN system of enclosures with compartments used for MCC purposes is based on the PanelSeT SFN range.

They offer the same functions:

- Various configuration options, combined side-by-side or back-to-back.
- The built-in partial doors and panels ensure the required degree of protection.

And the same advantages:

- Save time through all assembly phases.
- Enclosure robustness.

Modularity and Versatility

The enclosures feature offer 36 vertical modules, each 50 mm high, of usable space. They are available in 4 sizes and with 2 additional chambers for distribution busbars or cabling management. They can also be coupled with PrismaSeT HD for power distribution switchboards.

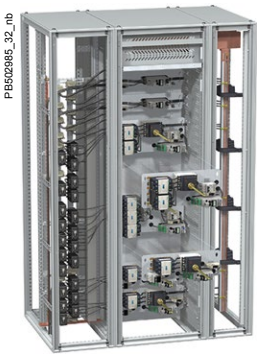

The Functional System

Metal structure

The switchboard is made up of one or more frameworks combined side-by-side or back-to-back, on which a complete selection of cover panels and partial doors can be mounted.

They are used to build IP54 configurations and can be fitted with ClimaSys options for airing.

Electrical continuity is achieved using earthing braids.

Plain partial doors are reversible for quick left or right-hand mounting by a single person, 120° opening.

The robustness of the locking system ensure the accurate alignment of the assembly. A system with 1 to 4 locking points and 5-mm double-bar inserts are standard, other shaped inserts are available as options.

Distribution system

Vertical busbars positioned in a lateral compartment and horizontal busbars are used to distribute electricity inside the switchboard.

Complete functional units

Functional units comprise the following components:

- Motor control and protection devices,
- A dedicated plain mounting plate for device installation,
- Gland boxes for terminal isolation on the back of the switchboard or on the side of the cabling chamber to obtain form 4b,
- Devices for on-site connections.

The functional units are modular and designed for stacked installation.

The system includes everything needed for the mounting, supply and onsite connection of the functional unit. The components of the PanelSeT SFN compartment system and those of the functional units in particular have been designed and tested in accordance with device characteristics. This design approach ensures a high degree of reliability in system operation and optimal safety for personnel. Electrical switchboards built according to Schneider Electric's recommendations fully comply with international standards IEC 61439-2 and IEC 62208.



Resistant to the Most Demanding Environments

- IP54 degree of protection for dusty and/or damp industrial environments.
- Seismic resistance.
- Optional forced-airing for environments with ambient temperatures above 45 °C or for devices with considerable heat loss (see ClimaSys offer options).



Type-Tested

The PanelSeT SFN enclosures equipped for Motor Control Centers are fully tested in accordance with IEC 61439-2.

- Certified by independent laboratories.
- Permanent quality control through Schneider Electric testing laboratories.

Type-testing includes the following tests:

- Temperature-rise limit,
- Dielectric properties,
- Short-circuit withstand,
- Effectiveness of protective circuit,
- Conformity of the clearance and creepage distances,
- Mechanical operation,
- Degree of protection.

Partitioning

Partitioning is essential to ensure the utmost protection of the installation and the personnel carrying out work in the switchboard.

Used in conjunction with the standard protection (terminal shields, factory-built connections), partitioning prevents any direct contact with live parts.

Form 2b

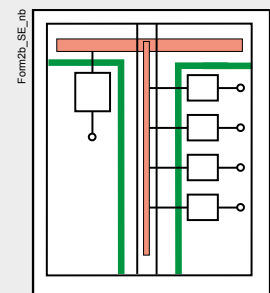

- Terminals for external conductors separated from busbars.
- The functional units and the terminals are separated from the busbars.

Form 3b

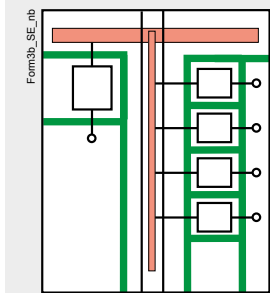

- Separation of busbars from the functional units and separation of all functional units from one another. Separation of the terminals for external conductors from the functional units, but not from each other.
- Protection against contact with live parts.
 - Reduction in the risk of faults between the functional units (propagation of electrical arcs, etc.).

Form 4a

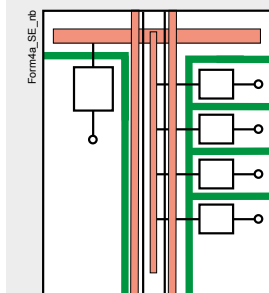

- Terminals for external conductors in the same compartment as the associated functional unit.

Form 4b

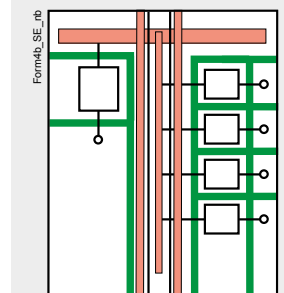

- Terminals for external conductors not in the same compartment as the associated functional unit, but in individual, separate, enclosed protected spaces or compartments.

Image 07



General data	
Applications	MCC
Standards	IEC 61439-2
Internal	No
Installation	Indoor

Mechanical data	
Cable inlet	Top / Bottom
Access	Front / Rear Side
IP	54
IK	10
Form	4b type 7
Withdrability	FFF
Dimensions	H 2000 / W 600 and 800 / D 600 and 800
Color	RAL 7035 gray

Electrical data	
Insulation voltage (Ui)	1000 V
Rated voltage (Ue)	415 V
Coordination	Type 2
Frequency	50/60 Hz
Auxiliary circuit voltage	230 V
Degree of pollution	3
Rated current (IP>31)	2500 A (with Copper and Linergy)
Short circuit (I _{cw} - 1s)	85 kA

Mounting Plates for Fixed MCC Switchboards

Motor Control Functional Units

The plain mounting plates can be used to install all the devices making up an MCC motor starter on a single support.

Easy installation

Motor feeders can be prepared on a bench making the cut-outs needed. The quick-fixing system allows holding the mounting plate during device installation and wiring. The mounting plate can be fixed on the side partitions in adjustable depth with a pitch of 50 mm.

Switchboard upgradeability

- Functional units with partitioning of Form 3b and 4b.
- Access from sides and rear.
- Separation panels with pre-cuts for cable glands ref. **LVS01215**.

Functional unit reliability

- 3 to 24 module (150 to 1200 mm) mounting plates are installed in 600 and 800 mm wide enclosures.
- Capacity of PanelSet SFN enclosures equipped for Motor Control Centers: 36 modules (50 mm each).
- Cables are routed in dedicated 300 or 400 mm wide lateral compartments.

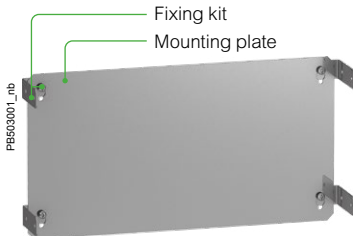

Plain Mounting Plates

Dimension of the compartment				
Number of modules	Height (mm)	Width (mm)	Mounting plate	Fixing kit
3M	150	600	NSYMP3M6	NSYMPFIX
3M	150	800	NSYMP3M8	
4M	200	600	NSYMP4M6	
4M	200	800	NSYMP4M8	
5M	250	600	NSYMP5M6	
5M	250	800	NSYMP5M8	
6M	300	600	NSYMP6M6	
6M	300	800	NSYMP6M8	
8M	400	600	NSYMP8M6	
8M	400	800	NSYMP8M8	
9M	450	600	NSYMP9M6	
9M	450	800	NSYMP9M8	
12M	600	600	NSYMP12M6	
12M	600	800	NSYMP12M8	
16M	800	600	NSYMP16M6	
16M	800	800	NSYMP16M8	
18M	900	600	NSYMP18M6	
18M	900	800	NSYMP18M8	
20M	1000	600	NSYMP20M6	
20M	1000	800	NSYMP20M8	
24M	1200	600	NSYMP24M6	
24M	1200	800	NSYMP24M8	

2-Component Motor Starter

PanelSeT SFN compartmentalized enclosures for Motor Control Centers

2-Component Motor Starter, Direct on Line and Reversing, GV2, GV3 And GV7

Selection of Recommended Combinations

GV2							
I _q (kA)		Motor characteristics		Motor starter solution		Number of modules on mounting plate (1M = 50 mm)	
Without limiter	With GV1L3	P _{max} (kW)	I _{max} (A)	Circuit breaker	Contactor ^①	DOL	Reversing
85	-	0.18	0.6	GV2-P04	LC1D09	3M	3M
85	-	0.25	0.9	GV2-P05	LC1D09	3M	3M
85	-	0.37	1.1	GV2-P06	LC1D09	3M	3M
85	-	0.55	1.5	GV2-P06	LC1D09	3M	3M
85	-	0.75	1.8	GV2-P07	LC1D09	3M	3M
85	-	1.1	2.6	GV2-P08	LC1D09	3M	3M
85	-	1.5	3.4	GV2-P08	LC1D09	3M	3M
85	-	2.2	4.8	GV2-P10	LC1D09	3M	3M
85	-	3	6.5	GV2-P14	LC1D09	3M	3M
85	-	4	8.2	GV2-P14	LC1D18	3M	3M
50	85	5.5	11	GV2-P16	LC1D25	3M	3M
50	85	7.5	14	GV2-P20	LC1D25	3M	3M
50	85	10	19	GV2-P21	LC1D32	3M	3M
50	85	11	21	GV2-P22	LC1D32	3M	3M
50	85	15	28	GV2-P32	LC1D32	3M	3M
50	-	18.5	34	GV3-P40	LC1D50A	3M	4M
50	-	22	40	GV3-P50	LC1D50A	3M	4M
50	-	30	55	GV3-P65	LC1D65	3M	4M
70	-	15	28	GV7-RS40	LC1D40	3M	6M
70	-	18.5	34	GV7-RS40	LC1D50	3M	6M
70	-	22	40	GV7-RS50	LC1D80	3M	6M
70	-	30	55	GV7-RS80	LC1D80	3M	6M
70	-	37	66	GV7-RS80	LC1D80	3M	6M
70	-	45	80	GV7-RS100	LC1D115	4M	9M
70	-	55	100	GV7-RS150	LC1D150	6M	9M
70	-	75	135	GV7-RS150	LC1F185	9M	12M
70	-	90	160	GV7-RS220	LC1F225	9M	12M
70	-	110	200	GV7-RS220	LC1F265	9M	12M

① 2xLC1-D for reversing

Plain Mounting Plates

Dimension of compartment			Mounting plate	Fixing kit
Number of modules	Height (mm)	Width (mm)	References	References
3M	150	600	NSYMP3M6	NSYMPFIX
3M	150	800	NSYMP3M8	
4M	200	600	NSYMP4M6	
4M	200	800	NSYMP4M8	
6M	300	600	NSYMP6M6	
6M	300	800	NSYMP6M8	
9M	450	600	NSYMP9M6	
9M	450	800	NSYMP9M8	
12M	600	600	NSYMP12M6	
12M	600	800	NSYMP12M8	

3-Component Motor Starter

PanelSeT SFN compartmentalized enclosures for Motor Control Centers

3-Component Motor Starter Direct on Line and Reversing GV2 and GV3

U _e	IP	Ambient temperature
415 V	≤ IP54	35 °C

Selection of Recommended Combinations

I _q (kA)		Motor characteristics		Motor starter solution			Number of modules on mounting plate (1M = 50 mm)	
Without limiter	With LA9LB920	P _{max} (kW)	I _{max} (A)	Circuit breaker	Contactors ¹	Thermal relay	DOL	Reversing
85	-	0.18	0.6	GV2-L04	LC1D09	LRD04	3M	3M
85	-	0.25	0.9	GV2-L05	LC1D09	LRD05	3M	3M
85	-	0.37	1.1	GV2-L06	LC1D09	LRD06	3M	3M
85	-	0.55	1.5	GV2-L06	LC1D09	LRD06	3M	3M
85	-	0.75	1.8	GV2-L07	LC1D09	LRD07	3M	3M
85	-	1.1	2.6	GV2-L08	LC1D09	LRD08	3M	3M
85	-	1.5	3.4	GV2-L08	LC1D09	LRD08	3M	3M
85	-	2.2	4.8	GV2-L10	LC1D09	LRD10	3M	3M
85	-	3	6.5	GV2-L14	LC1D09	LRD12	3M	3M
85	-	4	8.2	GV2-L14	LC1D18	LRD14	3M	3M
50	85	5.5	11	GV2-L16	LC1D25	LRD16	3M	3M
50	85	7.5	14	GV2-L20	LC1D25	LRD21	3M	3M
50	85	10	19	GV2-L21	LC1D32	LRD22	3M	3M
50	85	11	21	GV2-L22	LC1D32	LRD22	3M	3M
50	85	13	24	GV2-L32	LC1D32	LRD32	3M	3M
50	-	18.5	34	GV3-L40	LC1D50A	LRD340	3M	4M
50	-	22	40	GV3-L50	LC1D50A	LRD350	3M	4M
50	-	26	49	GV3-L65	LC1D65A	LRD365	3M	4M

¹ 2xLC1-D for reversing

Selection of the Mounting Plate

Dimension of the compartment			Mounting plate	Fixing kit
Number of modules	Height (mm)	Width (mm)	References	References
3M	150	600	NSYMP3M6	NSYMPFIX
3M	150	800	NSYMP3M8	
4M	200	600	NSYMP4M6	
4M	200	800	NSYMP4M8	

3-Component Motor Starter

PanelSeT SFN compartmentalized enclosures for Motor Control Centers

3-Component Motor Starter, Direct on Line and Reversing, NS80H and NSX

U _e	IP	Ambient temperature
415 V	≤ IP54	35 °C

Selection of Recommended Combinations

I _q (kA)	Motor characteristics		Motor starter solution			Number of modules on mounting plate (1M = 50 mm)	
	P _{max} (kW)	I _{max} (A)	Circuit breaker	Contactor ¹	Thermal relay	DOL	Reversing
70	18.5	34	NS80H-MA	LC1D50	LRD3355	3M	6M
70	22	40	NS80H-MA	LC1D50	LRD3357	3M	6M
70	30	55	NS80H-MA	LC1D65	LRD3359	3M	6M
70	37	66	NS80H-MA	LC1D80	LRD3363	3M	6M
NSX...F = 36 kA	18.5	34	NSX100 MA	LC1D80	LRD3355	3M	6M
NSX...N = 50 kA	22	40	NSX100 MA	LC1D80	LRD3357	3M	6M
NSX...H = 70 kA	30	55	NSX100 MA	LC1D80	LRD3359	3M	6M
NSX...S = 85 kA	37	64	NSX100 MA	LC1D80	LRD3363	3M	6M
NSX400L = 150 kA	45	80	NSX100 MA	LC1D115	LR9D5367	6M	9M
NSX630L = 150 kA	55	100	NSX160 MA	LC1D150	LR9D5369	6M	9M
	75	135	NSX160 MA	LC1F185	LR9F5369	9M	12M
	90	160	NSX250 MA	LC1F225	LR9F5371	9M	12M
	100	187	NSX250 MA	LC1F265	LR9F5371	9M	12M
	132	230	NSX400 1.3-M	LC1F330	LR9F7375	12M	16M
	160	270	NSX400 1.3-M	LC1F330	LR9F7375	12M	16M
	200	361	NSX630 1.3-M	LC1F500	LR9F7379	16M	16M
	220	380	NSX630 1.3-M	LC1F500	LR9F7379	16M	16M
	250	430	NSX630 1.3-M	LC1F500	LR9F7379	16M	16M

¹ 2xLC1-D for reversing

Selection of the Mounting Plate

Dimension of the compartment			Mounting plate	Fixing kit
Number of modules	Height (mm)	Width (mm)	References	References
3M	150	600	NSYMP3M6	NSYMPFIX
3M	150	800	NSYMP3M8	
6M	300	600	NSYMP6M6	
6M	300	800	NSYMP6M8	
9M	450	600	NSYMP9M6	
9M	450	800	NSYMP9M8	
12M	600	600	NSYMP12M6	
12M	600	800	NSYMP12M8	
16M	800	600	NSYMP16M6	
16M	800	800	NSYMP16M8	

3-Component Motor Starter

PanelSeT SFN compartmentalized enclosures for Motor Control Centers

2-Component Motor Starter, Star-Delta, GV2, GV3 and GV7

U _e	IP	Ambient temperature
415 V	≤ IP54	35 °C

Selection of Recommended Combinations

I _q (kA)		Motor characteristics		Motor starter solution		Number of modules on mounting plate (1M = 50 mm)
Without limiter	With GV1L3	P _{max} (kW)	I _{max} (A)	Circuit breaker	Contactors	Star-delta
85	-	0,37	1,1	GV2-P06	3xLC1D09	4M
85	-	0,55	1,5	GV2-P06	3xLC1D09	4M
85	-	0,75	1,8	GV2-P07	3xLC1D09	4M
85	-	1,1	2,6	GV2-P08	3xLC1D09	4M
85	-	1,5	3,4	GV2-P08	3xLC1D09	3M
85	-	2,2	4,8	GV2-P10	3xLC1D18	4M
85	-	3	6,5	GV2-P14	3xLC1D18	3M
85	-	4	8,2	GV2-P14	3xLC1D18	4M
50	85	5,5	11	GV2-P16	3xLC1D25	4M
50	85	7,5	14	GV2-P20	3xLC1D25	4M
50	85	10	19	GV2-P21	3xLC1D32	5M
50	85	11	21	GV2-P22	3xLC1D32	4M
35	85	15	28	GV2-P32	3xLC1D32	4M
50	-	18,5	34	GV3-P40	3xLC1D50A	5M
50	-	22	40	GV3-P50	3xLC1D50A	5M
50	-	30	55	GV3-P65	3xLC1D65A	5M
70	-	15	28	GV7-RS40	3xLC1D80	9M
70	-	18,5	34	GV7-RS40	3xLC1D50	9M
70	-	22	40	GV7-RS50	3xLC1D80	9M
70	-	30	55	GV7-RS80	3xLC1D80	9M
70	-	45	80	GV7-RS100	3xLC1D115	12M
70	-	55	100	GV7-RS150	3xLC1D150	12M
70	-	75	135	GV7-RS150	3xLC1F185	16M
70	-	90	160	GV7-RS220	3xLC1F225	16M
70	-	110	200	GV7-RS220	3xLC1F265	16M

Selection of the Mounting Plate

Dimension of the compartment			Mounting plate	Fixing kit
Number of modules	Height (mm)	Width (mm)	References	References
3M	150	600	NSYMP3M6	NSYMPFIX
3M	150	800	NSYMP3M8	
4M	200	600	NSYMP4M6	
4M	200	800	NSYMP4M8	
5M	250	600	NSYMP5M6	
5M	250	800	NSYMP5M8	
9M	450	600	NSYMP9M6	
9M	450	800	NSYMP9M8	
12M	600	600	NSYMP12M6	
12M	600	800	NSYMP12M8	
16M	800	600	NSYMP16M6	
16M	800	800	NSYMP16M8	

11

3-Component Motor Starter

PanelSeT SFN compartmentalized enclosures for Motor Control Centers

3-Component Motor Starter, Star-Delta, GV2 and GV3

U _e	IP	Ambient temperature
415 V	≤ IP54	35 °C

Selection of Recommended Combinations

I _q (kA)		Motor characteristics		Motor starter solution			Number of modules on mounting plate (1M = 50 mm)
Without limiter	With LA9LB920	P _{max} (kW)	I _{max} (A)	Circuit breaker	Contactors	Thermal relay	Star-delta
85	-	0,37	1,1	GV2-L06	3xLC1D09	LRD06	4M
85	-	0,55	1,5	GV2-L06	3xLC1D09	LRD06	4M
85	-	0,75	1,8	GV2-L07	3xLC1D09	LRD07	4M
85	-	1,1	2,6	GV2-L08	3xLC1D09	LRD08	4M
85	-	1,5	3,4	GV2-L08	3xLC1D09	LRD08	4M
85	-	2,2	4,8	GV2-L10	3xLC1D18	LRD10	4M
85	-	3	6,5	GV2-L14	3xLC1D18	LRD12	4M
85	-	4	8,2	GV2-L14	3xLC1D18	LRD14	4M
50	85	5,5	11	GV2-L16	3xLC1D25	LRD16	4M
50	85	7,5	14	GV2-L20	3xLC1D25	LRD21	4M
50	85	10	19	GV2-L21	3xLC1D32	LRD22	4M
50	85	11	21	GV2-L22	3xLC1D32	LRD22	4M
35	85	15	24	GV2-L32	3xLC1D32	LRD32	4M
50	-	18,5	34	GV3-L40	3xLC1D50A	LRD340	5M
50	-	22	40	GV3-L50	3xLC1D50A	LRD350	5M
50	-	30	49	GV3-L65	3xLC1D65A	LRD365	5M

Selection of the Mounting Plate

Dimension of the compartment			Mounting plate	Fixing kit
Number of modules	Height (mm)	Width (mm)	References	References
4M	200	600	NSYMP4M6	NSYMPFIX
4M	200	800	NSYMP4M8	
5M	250	600	NSYMP5M6	
5M	250	800	NSYMP5M8	

3-Component Motor Starter, Star-Delta, NS80H and NSX

U _e	IP	Ambient temperature
415 V	≤ IP54	35 °C

Selection of Recommended Combinations

I _q (kA)	Motor characteristics		Motor starter solution			Number of modules on mounting plate (1M = 50 mm)
	P _{max} (kW)	I _{max} (A)	Circuit breaker	Contactors	Thermal relay	Star-delta
70	18.5	34	NS80H-MA	3xLC1D50	LRD3355	9M
70	22	40	NS80H-MA	3xLC1D50	LRD3357	9M
70	30	55	NS80H-MA	3xLC1D65	LRD3359	9M
70	37	66	NS80H-MA	3xLC1D80	LRD3363	9M
NSX...F = 36 kA	18.5	34	NSX100 MA	3xLC1D80	LRD3355	9M
NSX...N = 50 kA	22	40	NSX100 MA	3xLC1D80	LRD3357	9M
NSX...H = 70 kA	30	55	NSX100 MA	3xLC1D80	LRD3359	9M
NSX...S = 85 kA	37	64	NSX100 MA	3xLC1D80	LRD3363	9M
NSX400L = 150 kA	45	80	NSX100 MA	3xLC1D115	LR9D5367	12M
NSX630L = 150 kA	55	100	NSX160 MA	3xLC1D150	LR9D5369	12M
	75	135	NSX160 MA	3xLC1F185	LR9F5369	16M
	90	160	NSX250 MA	3xLC1F225	LR9F5371	16M
	110	187	NSX250 MA	3xLC1F265	LR9F5371	16M
	132	230	NSX400 1.3-M	3xLC1F330	LR9F7375	20M
	160	270	NSX400 1.3-M	3xLC1F330	LR9F7375	20M
	200	361	NSX630 1.3-M	3xLC1F500	LR9F7379	24M
	220	380	NSX630 1.3-M	3xLC1F500	LR9F7379	24M
	250	430	NSX630 1.3-M	3xLC1F500	LR9F7379	24M

Selection of the Mounting Plate

Dimension of the compartment			Mounting plate	Fixing kit
Number of modules	Height (mm)	Width (mm)	References	References
9M	450	600	NSYMP9M6	NSYMPFIX
9M	450	800	NSYMP9M8	
12M	600	600	NSYMP12M6	
12M	600	800	NSYMP12M8	
16M	800	600	NSYMP16M6	
16M	800	800	NSYMP16M8	
20M	1000	600	NSYMP20M6	
20M	1000	800	NSYMP20M8	
24M	1200	600	NSYMP24M6	
24M	1200	800	NSYMP24M8	

Linergy LGYE-LGY a Breakthrough in Busbar Systems

Safe, reliable, flexible and with the highest level of performance

The Linergy LGYE-LGY busbar system now includes horizontal busbars for greater performance, reliability and costeffectiveness of the switchboard enclosure.

Manufactured using a revolutionary process, patented Linergy busbars are unique on the market, taking your electrical switchboard installations a giant leap into the future.



Discover how Linergy LGYE-LGY can place the next generation of low-voltage switchboards in your hands.



Innovative Technology

From an Energy Expert You Can Trust

Patented Linery LGYE-LGY is backed by Schneider Electric's decades of expertise in electrical distribution systems and is certified IEC 61439-2 compliant by ASEFA.

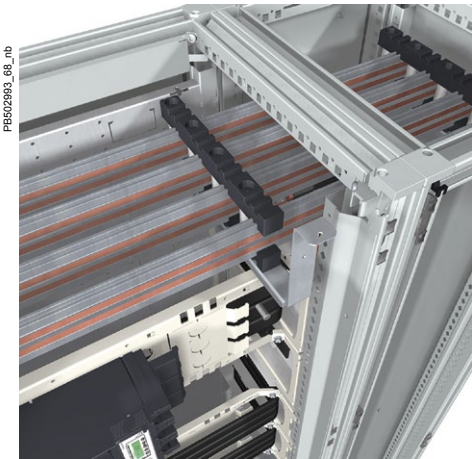

Linery Unique Profile

Was designed with the ratings you need, a commitment to performance backed by regular testing up to 4000 A.

Heat Is Dissipated by Conduction

And radiation for performance only a market leader can provide.

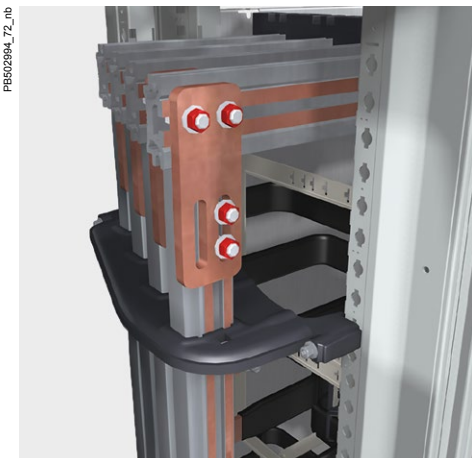

Linery LGYE-LGY Busbars

Performances are identical or better than traditional Linery BS busbars.

Unlike Tin-Plated Aluminum Busbars, Rugged Linery LGYE-LGY Busbars are resistant to scratching during assembly to ensure optimal connection quality and reliability.



High-Velocity Oxy-Fuel, Unique on the Busbar Market
Patented Linery LGYE-LGY uses a supersonic high-temperature painting process for a robust copper contact surface.

A Revolutionary Design for Greater Efficiency

The Linergy line now includes horizontal busbars, helping you achieve better electrical switchboard performance while optimizing busbar layout and facilitating assembly.

Schneider Electric™ has drawn upon 30 years of expertise in electrical distribution systems and a decade of hands-on experience with the proven and reliable Linergy line of products. It brings you a revolutionary design featuring a high-quality copper contact surface that delivers even better results than traditional Linergy BS-to-Linergy BS connections. Linergy LGYE-LGY busbars offer a number of benefits to help you enhance performance and boost your competitiveness.

Lightweight

Linergy is half the weight of equivalently rated Linergy BS bars for more fuel-efficient transport, easier handling, and smoother installation.

Higher Capacity

A single Linergy LGYE bar can withstand ratings up to 2500 A. It would take two or three Linergy BS bars per pole to achieve similar ratings.

Robust and Flexible

Linergy LGYE bars are extruded for a unique profile that includes both closed and ribbed sections, improving rigidity, thermal dissipation, and resistance to short circuits, with a shortcircuit withstand capacity (I_{cw}) of 85 kA/1s for PanelSeT SFN enclosures equipped for Motor Control Centers and 100 kA/1s for PrismaSeT HD.

Attractive

The revolutionary copper contact strips, anodized aluminum surface, and unique shapes give a modern appearance and a soft touch.

IEC Standards-Compliant

The latest standards were factored in from the early design stages to ensure that temperatures are kept below the values specified in standard IEC 61439-2 for optimal performance regardless of the switchboard configuration.

Environmentally-Friendly

Instead of increasingly-scarce copper, Linergy LGYE is made from 70% recycled raw materials offering the same performance as primary raw materials.

Cost-Effective

Linergy LGYE-LGY helps you achieve cost savings now and provides protection against fluctuating copper prices in the future, plus all the advantages of a raw material that is easy to purchase and store.



Linergy LGYE is 50% lighter than Linergy BS

Reduce costs and assembly times over Linergy BS busbars

Linery Accessories Are Evolving as Well!

Linery LGYE is a full-featured busbar system that includes all the connections, screws, isolating supports, and other accessories you need for drill-free assembly.

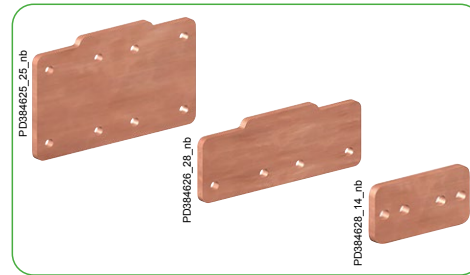
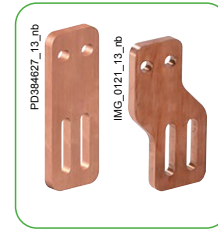
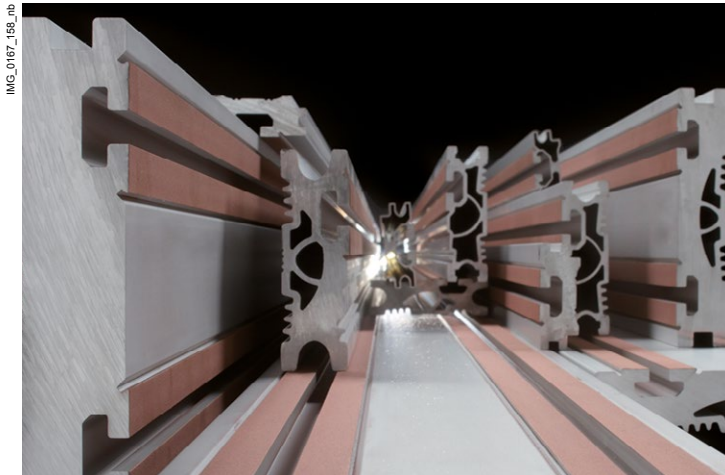

Panel Builders, We've Thought of Everything to Make Your Life Easier!

IMG_5857_48_nb



- Linery LGYE-LGY busbars are lightweight, making them easy to transport and handle in the workshop.
- With Linery LGYE-LGY, you can continue to use the familiar PrismaSeT HD busbar supports you already know from Linery BS bars. There's no new system to learn.
- Linery LGYE-LGY offers single bars for each rating, making handling during installation faster and more convenient.
- Linery LGYE-LGY bars are fast and easy to position without drilling, thanks to a sliding screw and track system.
- Linery screws let you add extra outgoing connections without drilling new holes or dismantling previous connections or busbar supports, saving you time and giving you greater flexibility in the event of last-minute changes.
- Linery LGYE-LGY busbars offer a unique shape with no sharp edges for safer, smoother handling and installation the bars simply slide right in to the busbar supports.
- Existing Linery LGY vertical busbars are easy to connect to Linery LGYE with ready-to-install accessories like vertical connectors.
- Linery materials are easy to recycle via well-established aluminum recycling services already in use for materials like aluminum cans, coffee capsules, door and window frames, and engine blocks.

Linergy Also Offers the Most Advanced Busbar Solutions While Remaining Simple

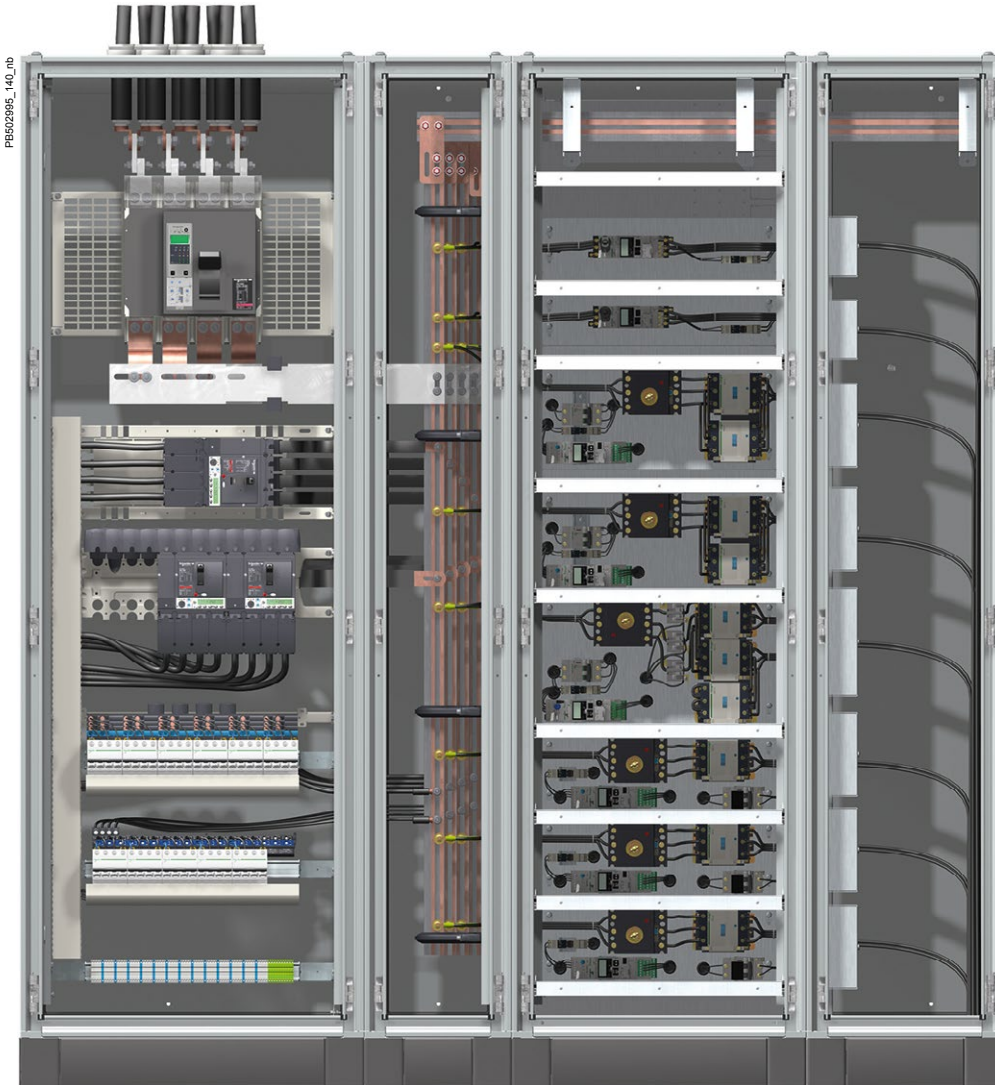

Linergy LGYE / LGY /BS

Power busbars

- > Solutions available up to 2500 A for PanelSet SFN equipped for Motor Control Centers and up to 4 000 A for PrismaSet HD.
- > Connection everywhere without drilling (with LGY and LGYE profile).



Lateral Linery Busbars up to 1600 A

Busbar Calculation

The following table indicates:

- The catalog numbers of the bars to be used, depending on the permissible current level in the busbars,
- The number of supports required, depending on the rated short-time withstand current (I_{cw} in kA rms / 1 second).

Linery busbars	Permissible current at 35 °C for switchboard		No. of supports I_{cw} (kA effrms / 1 s)								References
	IP ≤ 31	IP > 31	≤ 25	≤ 30	≤ 40	≤ 50	≤ 60	≤ 65	≤ 75	≤ 85	
Linery 630	680	590	3								LVS04502
Linery 800	840	760	3	3							LVS04503
Linery 1000	1040	950	3	3	3						LVS04504
Linery 1250	1290	1170	3	3	3	4	5				LVS04505
Linery 1600	1650	1480	3	3	3	4	5	5	7	8	LVS04506

Note: The permissible current values for the busbars are given for an ambient temperature of 35 °C around the switchboard. The bottom support also maintains the bars in position. Each catalog number represents one bar.

Busbar Selection

Linery busbars, L = 1670 mm

Cat. no. selection: See the table below.

Each bar is supplied with a stop for the bottom support.

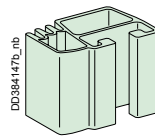
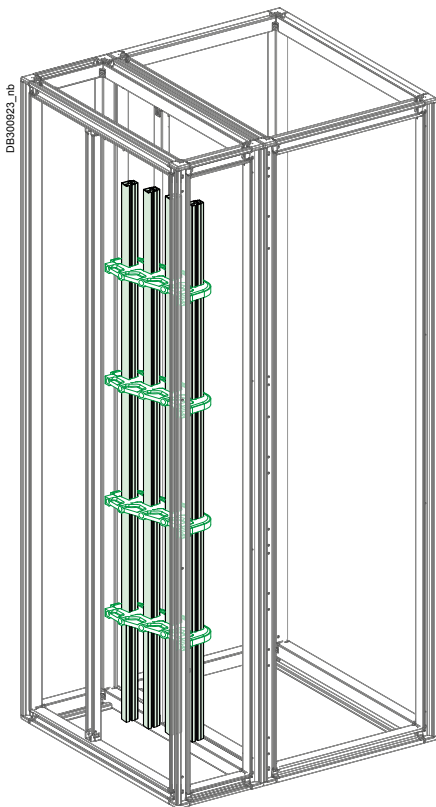

Bar 630 A.
LVS04502

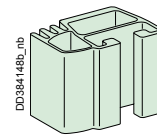

Bar 800 A.
LVS04503

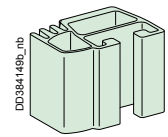

Bar 1000 A.
LVS04504

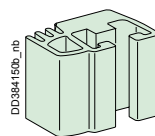

Bar 1250 A.
LVS04505

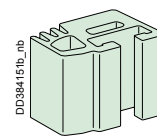



Bar 1600 A.
LVS04506

Busbars up to 1600 A.

The bottom support is used for wedging busbars in position.

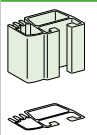
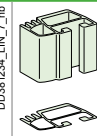
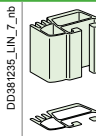
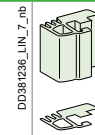
Linery LGY - Lateral Profiles up to 1600 A

In PanelSeT SFN duct		W300				
Linery profile, 1670 mm length		 DD381233_LIN_7_nb 630 A	 DD381234_LIN_7_nb 800 A	 DD381235_LIN_7_nb 1000 A	 DD381236_LIN_7_nb 1250 A	 DD381237_LIN_7_nb 1600 A
Permissible current for an ambient temp. of 35 °C around the switchboard	IP ≤ 31	680 A	840 A	1040 A	1290 A	1650 A
	IP > 31	590 A	760 A	950 A	1170 A	1480 A
Number of profiles per phase		1				
References		LVS04502	LVS04503	LVS04504	LVS04505	LVS04506

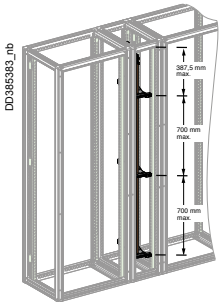

The bottom wedge support is used to place the busbar and ensure it is in the correct position. It is counted as a busbar support (included in the number of supports).		
 DD380741_LIN_nb DD680742_LIN_12_nb Fixed support LVS04651		
Note: An end stop must be fitted on the bottom support: LVS01109 (sold in lots of 12)		
Number depending on I _{cw} (kA rms/1 s)	≤ 25	3
	≤ 30	3
	≤ 40	3
	≤ 50	4
	≤ 60	5
	≤ 65	5
	≤ 75	7
	≤ 85	8

Only for enclosures with a depth ≥ 500 mm

References	LVS04651 (set of 2 upright adapters NSYSFPAED and set of 2 40 mm universal cross-rail NSYSUCR40200 for installation in PanelSeT SFN busbar chamber)
------------	---

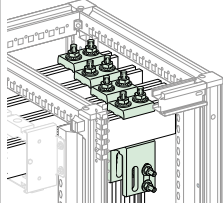
Connections to the Linery BS horizontal busbar	 DD385408_nb	Note: Supplied with mounting hardware. Reference includes 1 connection only. Order 1 connection per phase.
--	--	--



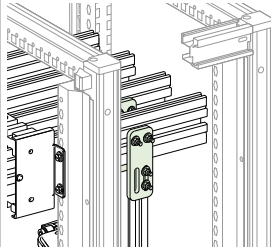

References according to horizontal busbar size	5 mm thick	LVS04634	LVS04635
	10 mm thick, width ≤ 80 mm	LVS04636	

Connections to the Linery LGYE horizontal busbar	 DD385387_nb	Note: Supplied with mounting hardware. Reference includes 1 connection only. Order 1 connection per phase.
--	--	--

References (vertical connection)	LVS04602
References (vertical shifted connection)	LVS04603

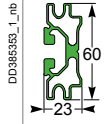
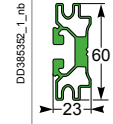
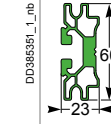
Linery LGYE - Horizontal Profiles up to 2500 A

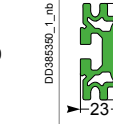
Note:
For accessories, see page 365.

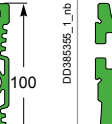
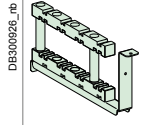
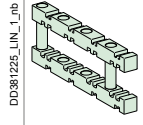
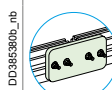
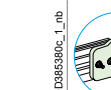
Installation in PanelSeT SFN compartmentalized		Up to 1600 A					Up to 2500 A		
Linery profile, 2000 mm length									
		630 A	800 A	1000 A	1250 A	1600 A	2000 A	2500 A	
Permissible current for an ambient temp. of 35 °C around the switchboard		530 A	680 A	850 A	1050 A	1480 A	1650 A	2100 A	
Number of profiles per phase		1							
Total number of vertical modules (50 mm)		3					3		
References		LVS04560	LVS04561	LVS04562	LVS04563	LVS04564	LVS04565	LVS04566	
Busbar supports									
		Fixed support		Free support					
		2 fixed supports for PanelSeT SFN wide enclosure are compulsory according compartment depth (400 or 500 mm). 1 fixed support for PanelSeT SFN 300/400 wide chamber are compulsory. Fixed directly on framework. If more supports are needed, add free supports.							
In a PanelSeT SFN W600/800 Busbar supports 75 mm distance between bars	Number of supports depending on I_{ew} (kA rms/1 s)	≤ 15	2						
		≤ 25	2						
		≤ 30	2						
		≤ 40	-			2			
		≤ 50	-			2			
		≤ 60	-			2+1		2	
		≤ 65	-					2+1	
		≤ 75	-					2+1	
References Fixed support		D400	NSYBHS4						
References Fixed support		D500	NSYBHS5						
References Free support		NSYBSA							
In busbar chamber SFN: W300/400 Busbar supports 75 mm distance between bars	Number of supports depending on I_{ew} (kA rms/1 s)	≤ 15	1						
		≤ 25	1						
		≤ 30	1						
		≤ 40	-			1			
		≤ 50	-			1			
		≤ 60	-			1			
		≤ 65	-					1 + 1	
		≤ 75	-					1 + 1	
References Fixed support		D600	NSYBHS600				NSYBHS600		
References Fixed support		D800	NSYBHS800				NSYBHS800		
References Free support		NSYBSA						NSYBSA	
Joints		Up to 1600 A					Up to 2500 A		
		630 A	800 A	1000 A	1250 A	1600 A	2000 A	2500 A	
									
		LVS04620					LVS04621		
References (3P)		3x LVS04620					3x LVS04621		
References (4P)		4x LVS04620					4x LVS04621		

Linery BS - Lateral Flat Busbars up to 2500 A

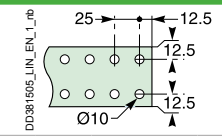
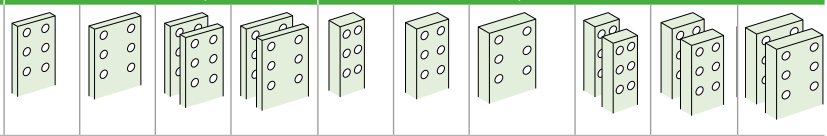
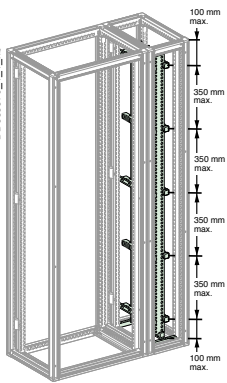
In PanelSet SFN busbar chamber		W300 D500/600/800, up to 1600 A				W300 D500/600/800, up to 2500 A								
Pre-slotted copper, 1675 mm length														
Permissible current for an ambient temp. of 35 °C around the switchboard	IP > 31	750 A	900 A	1250 A	1600 A	1080 A	1250 A	1600 A	1850 A	2000 A	2500 A			
Busbar cross-section (mm)		60 x 5	80 x 5	60 x 5	80 x 5	50 x 10	60 x 10	80 x 10	50 x 10	60 x 10	80 x 10			
Number of busbars per phase		1		2		1			2					
References		LVS04516	LVS04518	LVS04516	LVS04518	LVS04525	LVS04526	LVS04528	LVS04525	LVS04526	LVS04528			
Busbar supports		3 fixed supports are compulsory to hold the busbar in position. If more than 3 supports are needed, use free supports (in addition). The bottom wedge support is used to place the busbar and ensure it is in the correct position. It does not count as a busbar support.												
	Number of supports depending on I _{ow} (kA rms/1 s)	≤ 15	3			3								
		≤ 25	3+2		3		3							
		≤ 30	3+2								3			
		≤ 40	3+4			3+2		3+2						
		≤ 50	3+4						3+2					
		≤ 60							3+4				3+2	
		≤ 65							3+4				3+2	
		≤ 85							3+6		3+4		3+4	
References* PanelSet SFN busbar chamber 75 mm distance between bars	W300, D600	NSYBVS600 (fixed) + NSYBSA (free) + NSYAS600 (end stop support)												
	W300, D800	NSYBVS800 (fixed) + NSYBSA (free) + NSYAS800 (end stop support)												

Connections to the Linery BS horizontal busbar

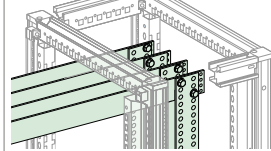
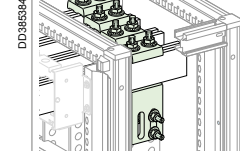
											
		For a busbar with 75 mm distance between bars, the bars must be completely covered. Staggered assembly points between one bar and the next, to maintain the necessary clearance distances. ⁽¹⁾				References LVS04636, LVS04637 are supplied individually: 1 connection per phase. Reference LVS04642 consists of 2 M8 x 140 screws which can replace the original M8 x 120 screws.					
		1 vertical bar per phase		2 vertical bars per phase		1 vertical bar per phase		2 vertical bars per phase			
		60 x 5	80 x 5	60 x 5	80 x 5	50 x 10	60 x 10	80 x 10	50 x 10	60 x 10	80 x 10
References*	≤ 80 mm	LVS04645				LVS04636		LVS04637		LVS04637	

⁽¹⁾ Drill hole dimensions for 5 mm thick horizontal busbars.

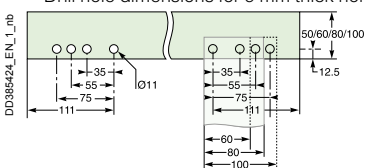

Drill hole dimensions for 10 mm thick horizontal busbars.

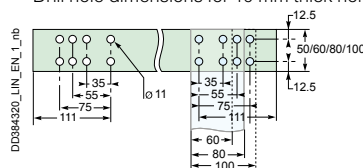

Linery BS - Horizontal Flat Busbars up to 2500 A

Note:

When installed at the bottom of an enclosure, the busbar must be partitioned.

Installation in PanelSeT SFN compartmentalized		Up to 1600 A				Up to 2500 A			
Copper bar, 2000 mm length									
Permissible current for an ambient temp. of 35 °C around the switchboard		750 A	900 A	1250 A	1600 A	1600 A	1850 A	2000 A	2500 A
Busbar cross-section (mm)		60 x 5	80 x 5	60 x 5	80 x 5	80 x 10	50 x 10	60 x 10	80 x 10
Number of busbars per phase		1	1	2	2	1	2	2	2
Total number of vertical modules (50 mm)		3							
References		LVS04536	LVS04538	LVS04536	LVS04538	LVS04548	LVS04545	LVS04546	LVS04548
Busbar supports		 Fixed support		 Free support					
		2 fixed supports for PanelSeT SFN wide enclosure are compulsory according compartment depth (400 or 500 mm). 1 fixed support for PanelSeT SFN 300/400 wide chamber are compulsory. Fixed directly on framework. If more supports are needed, add free supports.							
In a PanelSeT SFN W600/800 with 75 mm distance between bars	Number of supports depending on I_{cw} (kA rms/1 s)	≤ 15	2						
		≤ 25	2+1	2					
		≤ 30	2+1	2					
		≤ 40	2+1			2			
		≤ 50	-	2+1				2	
		≤ 60	-			2+1			
		≤ 65	-			2+1			
		≤ 85	-			2+2	2+1		
References Fixed support		NSYMBHS4 (D400) or NSYMBHS5 (D500)							
References Free support		NSYBSA							
In busbar chamber SFN: W300/400 with 75 mm distance between bars	Number depending on I_{cw} (kA rms/1 s)	≤ 30	1						
		≤ 50	1+1				1		
		≤ 85	-				2		
References* Fixed support		NSYBHS600 (D600) or NSYBHS800 (D800)				NSYBHS600 (D600) or NSYBHS800 (D800)			
References* Free support		NSYBSA				NSYBSA			
* References depending on depth									
Joins, Installation in PanelSeT SFN		Up to 1600 A				Up to 2500 A			
		1 vertical bar per phase		2 vertical bars per phase		1 vert. bar per phase		2 vertical bars per phase	
Busbar cross-section (mm)		60 x 5	80 x 5	60 x 5	80 x 5	80 x 10	50 x 10	60 x 10	80 x 10
Sliding joints with self-breaking lock nut		 LVS04640		 LVS04641					
References		LVS04640	LVS04641	LVS04640	LVS04641	LVS04641	LVS04640	LVS04640	LVS04641

Linergy LGYE - Accessories

Linergy Screw

- Sold in lots of 20: 20 screws + 20 nuts + 20 contact washers, grade 8.8. The screws slide into the profile and are then locked in the desired position.

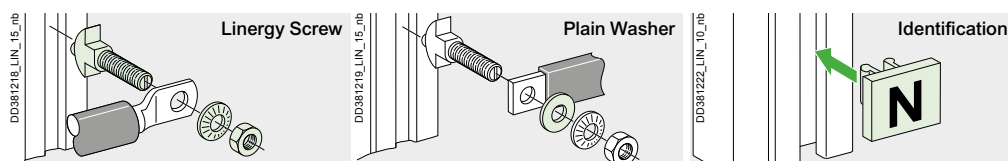

Characteristics	AD	References
Steel plain washers	M8 sold in lots of 20	20 mm LVS04772
Brass plain washers	M8 sold in lots of 20	24 mm LVS04773
	M8 sold in lots of 20	28 mm LVS04774
Identification	M8 sold in lots of 20 for connection of $\leq 25 \text{ mm}^2$ lugs to Linergy	20 mm LVS04775
	12 clip-on supports + N, L1, L2, L3, PE, PEN labels	LVS04794
	Linergy LGYE busbar screw plate kit after sales service	LVS01130

M8 Screws

- Set of 20 screws + 20 nuts + 40 contact washers.

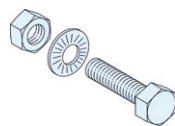

Characteristics	References
Linergy BS, 20 screws grade 8.8, M8 x 20	LVS04782
Linergy BS, 20 screws grade 8.8, M8 x 25	LVS04783
Linergy BS, 20 screws grade 8.8, M8 x 30	LVS04784
Linergy BS, 20 screws grade 8.8, M8 x 35	LVS04785
Linergy BS, 20 screws grade 8.8, M8 x 40	LVS04786
Linergy BS, 20 screws grade 8.8, M8 x 45	LVS04787
Linergy BS, 20 screws grade 8.8, M8 x 50	LVS04788

Torque Nuts

- Can be used to obtain the correct tightening torque (28 Nm) recommended by the manufacturer without using a torque wrench. Torque nuts may be used for all electrical connections.



Characteristics	References
20 M8 torque nuts	LVS04759

Voltage Tap-Offs

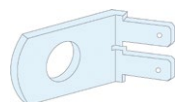

- For small lugs (on low-current cables or measurement tap-offs), insert a conducting washer (ref. LVS04775) between the busbar and the lug.

Characteristics	References
20 M10 voltage tap-offs for two 6.35 mm tab connectors	LVS04229

Connections on Linergy LGYE and LGY



Characteristics	InA	bar	Use	References
Use the 25 mm Linergy screw	0 A to 630 A	Cable Insulated flexible bar	Recommended	LVS04766
Use the 39 mm Linergy screw is only compatible with Linergy LGY.	0 A to 630 A	Cable Insulated flexible bar	Possible	LVS04767
Use the 25 mm Linergy screw	800 A to 1250 A	5 mm thick bar	Recommended	LVS04766
Use the 39 mm Linergy screw is only compatible with Linergy LGY.	800 A to 1250 A	5 mm thick bar	Possible	LVS04767
Use the flat plate screw with 2 studs	800 A to 1250 A	5 mm thick bar	Possible	LVS04768
Use the flat plate screw with 2 studs	1600 A to 2500 A	5 or 10 mm thick bar	Recommended	LVS04768
Use the 39 mm Linergy screw is only compatible with Linergy LGY.	1600 A to 2500 A	5 or 10 mm thick bar	Possible	LVS04767
Use the flat plate screw with 3 studs	3200 A to 4000 A	10 mm thick bar	Recommended	LVS04769

Partitioning Form 2

PanelSeT SFN compartmentalized enclosures for Motor Control Centers

Partitioning Form 2

Separation of busbars from the functional units:

- Protection against contact with live parts upstream of the outgoing circuits,
- Protection against penetration by foreign solid bodies.

Note:

When the busbars are at the bottom of the enclosure, gland plates are mandatory.

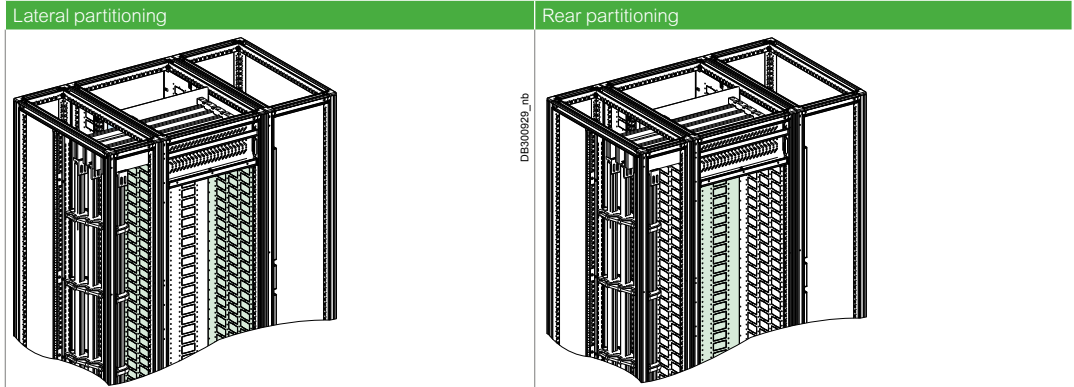

Diagrams

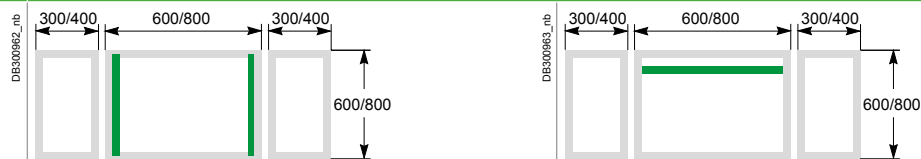

Characteristics	<ul style="list-style-type: none"> • Set of 2 vertical metal separation which guarantees good insulation of the sides of the compartment (IP2x). • Top and bottom ends have knock-outs for installation of horizontal busbars and pre-cuts of 40 x 70 mm for cable glands using grommets ref. LVS01215 when Form 4b is required. • Partition extension required for D800 mm. • Direct fixing on structure of enclosure. 	<ul style="list-style-type: none"> • Vertical metal separation which guarantee good insulation of the back of the compartment (IP2x). • Pre-cuts of 40 x 70 mm for cable glands using grommets ref. LVS01215 when Form 4b is required on back installation. • Direct fixing on structure of enclosure.
	References	D600: NSYMSC206 D800: NSYMSC206 + NSYMSC202 + NSYSUCR40200

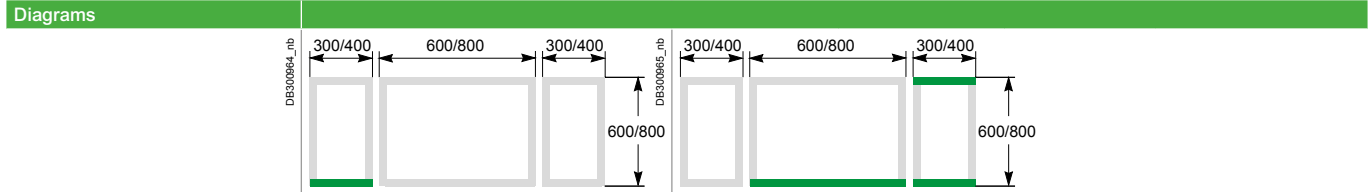
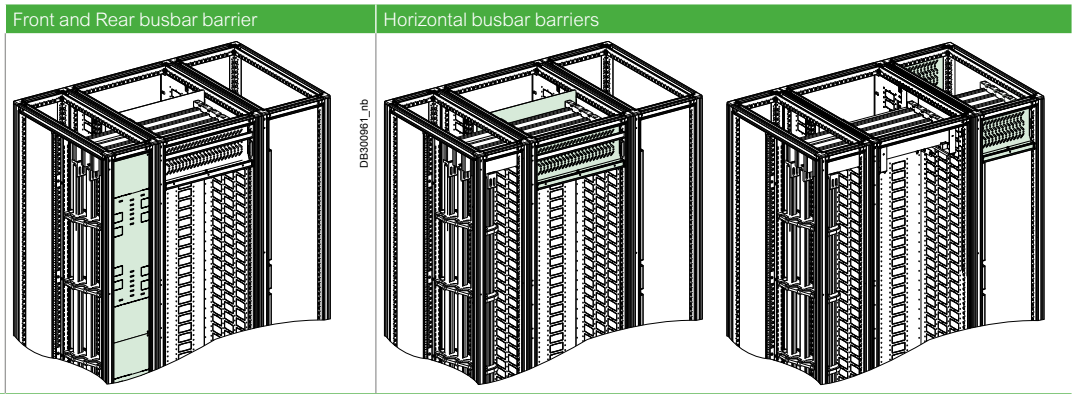

Characteristics	<ul style="list-style-type: none"> • Front protection is realized by the combination of the door W300 and this barrier. Metal barrier, composed of 2 parts H850, pre-cut at both ends • Rear protection is realized by the combination of the back panel of the enclosure. 	<ul style="list-style-type: none"> • Horizontal protection by the combination of slotted front barrier and horizontal partition for efficient natural convection in the switchboard. • The set can be used to partition horizontal busbar at the top or bottom of the enclosure. • The space required for the busbars is not increased. 	<ul style="list-style-type: none"> • Set of 2 slotted barriers (front and rear), plus horizontal panel to be used when busbars cross the cable chamber. 		
	References	W300: LVS06540 W400: NSYVPFN2B4	D600 ①: NSYHPF2B3M64 D800 ①: NSYHPF2B3M65	D600 ①: NSYHPF2B3M84 D800 ①: NSYHPF2B3M85	D600: LVS06561 D800: LVS06563

① For an enclosure with a depth of 600 mm the compartment depth is 400 mm. For an enclosure with a depth of 800 mm the compartment depth is 500 mm

Technical changes reserved. Information provided without guarantee. Images are for illustrative purposes only.

Accessories for Partitioning Form 2

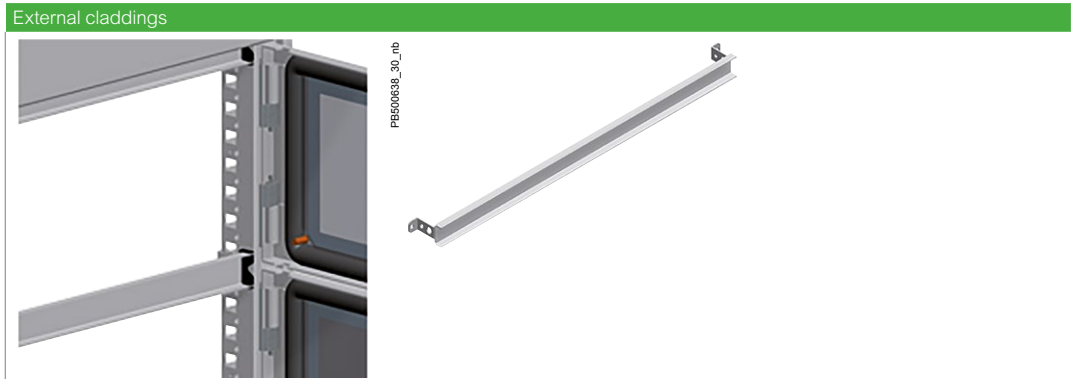

Intermediate Crossbar	
Characteristics	<ul style="list-style-type: none"> • It is mounted between partial doors, guaranteeing good sealing. • It is included inside of Horizontal busbar barriers and form 3 partitioning • To be used in the absence of the partition tray. • Direct fixing to the structure. • Available in 2 widths (mm).
Supply	<ul style="list-style-type: none"> • 2 crossbars with fixing elements
References	W600: NSYMICN6 W800: NSYMICN8

Partitioning Form 3

Separation of busbars from the functional units and separation of all functional units from one another.

Separation of the terminals for external conductors from the functional units, but not from each other.

- Protection against contact with live parts
- Reduction in the risk of faults between the functional units (propagation of electrical arcs, etc.).

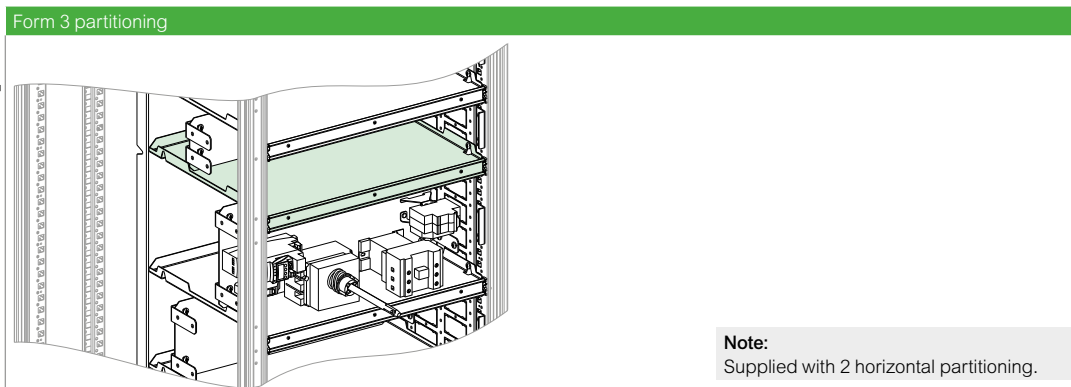

Horizontal partitioning	W600	W800
Characteristics	<ul style="list-style-type: none"> • A horizontal metal partition to separate functional units from one another and guarantees insulation of the compartments (IP2X). • It is fixed to the front uprights of the enclosure and the side partitions. • Quick-fixing system with intermediate crossbar to ensure the degree of protection of the partial doors. • Order by multiples of 2 (2, 4, 6...). 	
References	D600 ①: NSYMTRN64 D800 ①: NSYMTRN65	D600 ①: NSYMTRN84 D800 ①: NSYMTRN85

① For an enclosure with a depth of 600 mm the compartment depth is 400 mm. For an enclosure with a depth of 800 mm the compartment depth is 500 mm.

Partitioning Form 4

Separation of busbars from the functional units and separation of all functional units from one another, including the terminals for external conductors which are an integral part of the functional unit:

- Protection against contacts with live parts and reduction in the risk of faults between the functional units (propagation of electrical arcs, etc.).
- Form 4a: Terminal for external conductors in the same compartment as the associated.
- Form 4b: Terminals for external conductors not in the same compartment as the associated functional unit, but in individual, separate, enclosed protected spaces or compartments.

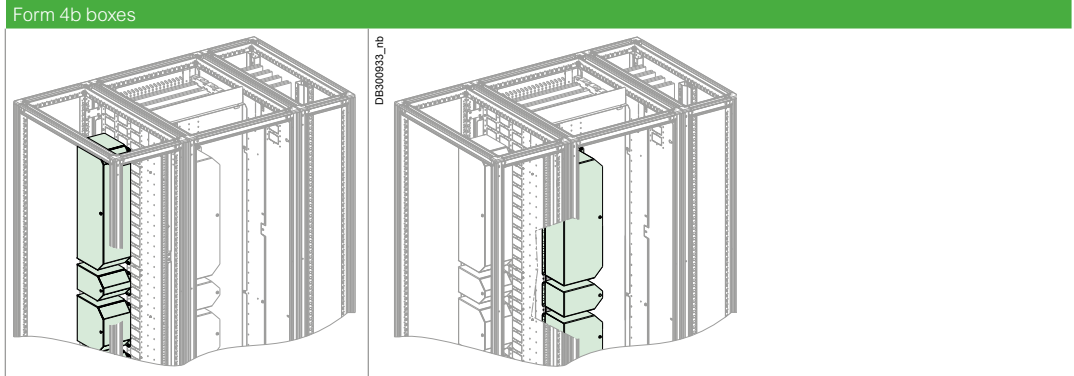

Characteristics	<ul style="list-style-type: none"> • Metal plain box composed by 2 parts that can be easily installed for side or rear connection to separate the terminals for external conductors of the functional unit. • Quick-fixing system on the side or on the back partition. • Available in 6 heights: 					
References	3M: NSYBF4B3M	4M: NSYBF4B4M	5M: NSYBF4B5M	6M: NSYBF4B6M	8M: NSYBF4B8M	9M: NSYBF4B9M

Rail Support Bracket

- SM**
- SFN**
- SD**
- SFX**

- Bracket for fixing rails at an angle of 45°.
- Material: Zinc-coated steel
- PanelSeT SFN: Mounted on the structure and/or mounting plates
- Spacial SM: Mounted on the bottom mounting rail and/ or mounting plates



Characteristics	References
Rail support bracket	NSYFB45

Other Common Accessories

Mounting and Cable management acc.	Grommets
Characteristics	Grommets
-	5 square grommets 70 x 40
References	LVS01215
See on Universal Enclosure catalog	

Common Characteristics

- PanelSeT SFN framework with compartment system that can be combined side-by-side with busbar and cable chambers.
- Receive the cover panels and partial doors IP54.
- Material: Steel.
- Finish: Painted with epoxy polyester resin.
- Color: RAL 7035 gray.
- Available as kit.



Compartmentalised enclosure	W600	W800
Characteristics	<ul style="list-style-type: none"> • Structure: Top and bottom frame and vertical uprights with a height of 2000 mm. • Useful height for doors with a height of 1800 mm/36M if top and bottom fix panels are installed for modularity (mandatory for installation of partial doors). • Equipped with removable roof, external fixing rear panel and top and bottom fixed panels (H100 mm) to allow modularity of partial doors. • 4 dimensions available. 	
References	-	-
Vertical uprights, height 2000 mm	NSYSFNV20	NSYSFNV20
Top and Bottom frame with roof	D600: NSYSFNC66 D800: NSYSFNC68	D600: NSYSFNC86 D800: NSYSFNC88
Rear panel	NSYBPN206	NSYBPN208
Fixed panels for modularity, height 100 mm/2M (intermediate crossbars included)	See table below	See table below

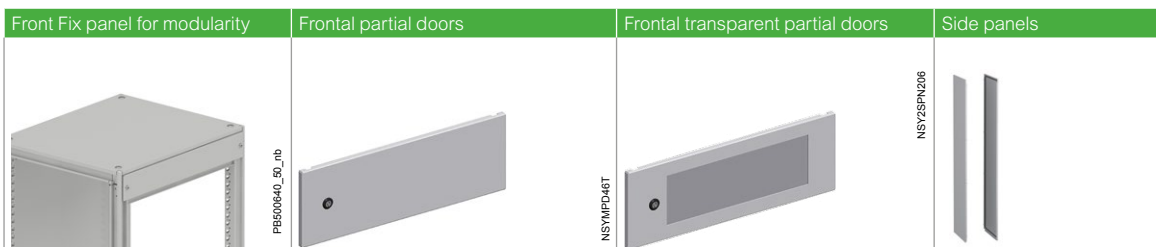

External claddings	Front Fix panel for modularity		Frontal partial doors		Frontal transparent partial doors		Side panels	
	W600	W800	W600	W800	W600	W800	D600	D800
Characteristics	<ul style="list-style-type: none"> • Top and bottom fix panel to obtain modularity required to install partial doors. • Supplied with a bottom trim. • If there is no horizontal partitioning on top or bottom, the intermediate crossbar has to be ordered separately, ref. NSYMICN6 (W600 mm) or NSYMICN8 (W800 mm). • Available in 2 heights(M) Heights according modularity (1M = 50 mm). 		<ul style="list-style-type: none"> • Plain partial door with lock with 5-mm double-bar insert. • They are fixed to the uprights of the framework by means of hinges. • Drilling template for uprights ref. NSYMDT (Only 1 drilling template by order is needed). • Opening to right or left. • 1, 2 or 4 locking points depending on height. • Replaceable locking insert (see page 371). • Available in following heights(M) Heights according modularity (1M = 50 mm). 		<ul style="list-style-type: none"> • Glazed (Securit glass) partial door with lock 5-mm double-bar insert. • They are fixed to the uprights of the framework by means of hinges. • Opening to right or left. • 1 or 2 locking points according different heights. • Available in following heights (mm). • Ingress protection rating: IP54 according to IEC 60529 		<ul style="list-style-type: none"> • Set of 2 side panels fixed to the outside of the enclosure. • Captive screws pre-mounted on • The panels. • Available in 2 depths (mm). 	
References	2M: NSYMF2M6 5M: NSYMF2M6	2M: NSYMF2M8 5M: NSYMF2M8	3M: NSYMPD3M6 4M: NSYMPD4M6 5M: NSYMPD5M6 6M: NSYMPD6M6 8M: NSYMPD8M6 9M: NSYMPD9M6 12M: NSYMPD12M6 16M: NSYMPD16M6 18M: NSYMPD18M6 20M: NSYMPD20M6 24M: NSYMPD24M6	3M: NSYMPD3M8 4M: NSYMPD4M8 5M: NSYMPD5M8 6M: NSYMPD6M8 8M: NSYMPD8M8 9M: NSYMPD9M8 12M: NSYMPD12M8 16M: NSYMPD16M8 18M: NSYMPD18M8 20M: NSYMPD20M8 24M: NSYMPD24M8	8M: NSYMPD46T 12M: NSYMPD66T 16M: NSYMPD86T 20M: NSYMPD106T	8M: NSYMPD48T 12M: NSYMPD68T 16M: NSYMPD88T 20M: NSYMPD108T	NSY2SPN206	NSY2SPN208

Selection of PanelSeT Enclosures

PanelSeT SFN compartmentalized enclosures for Motor Control Centers

Selection of PanelSeT Enclosures for Motor Control Centers

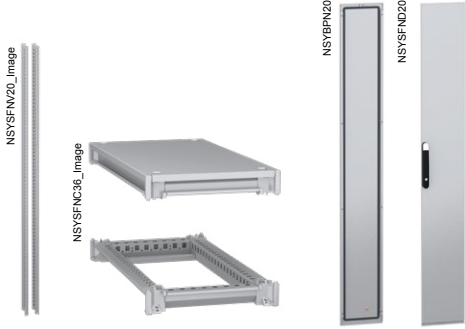
	Assembled supply		Kit supply	
				
Busbar and cabling chambers	W300	W400	W300	W400
Characteristics	<ul style="list-style-type: none"> • Structure: Top and bottom frame and vertical uprights with a height of 2000 mm. • Equipped with removable roof, external fixing rear panel and front plain door with 4-point locking system with handle and DB 5 mm insert. • 4 dimensions available. 			
References	D600: NSYSFN20360 D800: NSYSFN20380	D600: NSYSFN20460 D800: NSYSFN20480	-	-
Vertical uprights, height 2000 mm	-	-	NSYSFNV20	NSYSFNV20
Top and Bottom frame with roof	-	-	D600: NSYSFNC36 D800: NSYSFNC38	D600: NSYSFNC46 D800: NSYSFNC48
Rear panel	-	-	NSYBPN203	NSYBPN204
Front plain door	-	-	NSYSFND203	NSYSFND204

Other Assembly Accessories

			Cable gland plates			Plinth (100 mm height)		Plinth (200 mm height)	
H (mm)	W (mm)	D (mm)	Plain	1 entry	2 entries	Front kit	Side kit	Front kit	Side kit
2000	600	600	NSYEC66	NSYEC661	NSYEC662	NSYSPPF6100	NSYSPS6100	NSYSPPF6200	NSYSPS6200
2000	600	800	NSYEC68	NSYEC681	NSYEC682	NSYSPPF6100	NSYSPS8100	NSYSPPF6200	NSYSPS8200
2000	800	600	NSYEC86	NSYEC861	NSYEC862	NSYSPPF8100	NSYSPS6100	NSYSPPF8200	NSYSPS6200
2000	800	800	NSYEC88	NSYEC881	NSYEC882	NSYSPPF8100	NSYSPS8100	NSYSPPF8200	NSYSPS8200
2000	300	600	NSYEC36	NSYEC361	-	NSYSPPF3100	NSYSPS6100	NSYSPPF3200	NSYSPS6200
2000	300	800	-	NSYEC381	-	NSYSPPF3100	NSYSPS8100	NSYSPPF3200	NSYSPS8200
2000	400	600	NSYEC64	NSYEC461	-	NSYSPPF4100	NSYSPS6100	NSYSPPF4200	NSYSPS6200
2000	400	800	NSYEC84	NSYEC481	-	NSYSPPF4100	NSYSPS8100	NSYSPPF4200	NSYSPS8200

	Coupling kit	4 lifting eyebolts	4 lifting brackets	Earth braids	Earthing cables
Characteristics	<ul style="list-style-type: none"> Side-by-side combination. Back-to-back combination (back-to-back combination must be shipped individually and combined during on-site installation). 	<ul style="list-style-type: none"> Use a set of lifting eyebolts rings for each framework ①. 	<ul style="list-style-type: none"> When two enclosures with devices have been combined, use lifting brackets. ② 	NSYEB1516D8: <ul style="list-style-type: none"> Length 155 mm, Section 16 mm², Terminal Ø8.5 mm. NSYEB2025D8: <ul style="list-style-type: none"> Length 200 mm, Section 25 mm², Terminal Ø 8.5 mm. NSYEB2050D8: <ul style="list-style-type: none"> Length 200 mm, Section 50 mm², Terminal Ø 8.5 mm. 	NSYEL166D8: <ul style="list-style-type: none"> Length 160 mm, Section 6 mm², Terminal Ø 8.3 mm. NSYEL2225D8: <ul style="list-style-type: none"> Length 220 mm, Section 25 mm², Terminal Ø 8.3 mm. NSYEL3525D8: <ul style="list-style-type: none"> Length 350 mm, Section 25 mm², Terminal Ø 8.3 mm.
References	NSYSFBK19	NSYSFEB	NSYSFELB	NSYEB1516D8 NSYEB2025D8 NSYEB2050D8	NSYEL166D8 NSYEL2225D8 NSYEL3525D8

① For 2 columns:

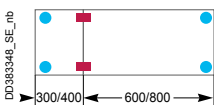

② For 3 columns:

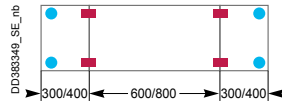

- Lifting eyebolts
- Lifting brackets

For more than 3 columns, lengths > 1600 mm, see Lifting bars options on Universal Enclosures catalog.

Locks for Partial Doors

Standard insert can be replaced by a lock from the table below (CRN range), keeping the standard latch.

Type of lock	Insert references	Key references
3-mm double-bar	NSYTDBCRN*	NSYLDDB5
6 mm	NSYTC6CRN	NSYLC7
7 mm	NSYTC7CRN	NSYLC7
8 mm	NSYTC8CRN	NSYLC8
6.5 mm	NSYTT6CRN	NSYLT8
8 mm	NSYTT8CRN	NSYLT8

* Delivered with 1 metal key.

Thalassa PHD enclosures are suitable for outdoor public areas thanks to their multiple features:

- pressure and shock resistant (IEC 61439-5: 2010),
- anti-posting surface thanks to the special ribbed door surface,
- insulated (ready for Class II according to IEC 61439-1: 2011).

This range can be configured according to your needs

4 different services available:



Assemble to Order



Mounting of Standard Accessories



Painting



Machining



Tough

- PHD: Heavy-Duty polyester reinforced with a double layer of fiberglass. Ultra-resistant.



Upper Airming Module

- The newly engineered roof airming accessory
- Prevents condensation (one of the causes of corrosion).

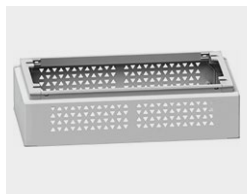

Heavy-Duty Accessories

- Dedicated accessories to resist harsh outdoor environments.



Anti-Vandalism

- PHD and SFHD: The handle with keylock and additional padlock hole (padlock not included)
- Protects the equipment inside.
- It is standard equipment.



Simplicity

- Installation simplified: Easy lifting even when loaded with up to 1000 kg of equipment. HD lifting accessories also available.



Fully Equipped

- Standard, pre-installed equipment includes:
- A curved canopy to avoid water stagnation
 - A door retainer to keep the door open even with strong wind or when a vehicle passes by
 - An aluminum cable gland plate to easily drill holes and avoid corrosion
 - A document pocket to hold your documents in a practical place.

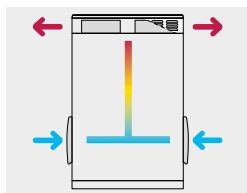

Thermal Management Solutions

- 3 airming architectures help protecting the equipment installed inside from overheating and humidity.

See page 474 for details or consult our web site www.se.com



Prolonged exposure to UV radiation, wind and rain can cause aesthetics changes in the external surface of the enclosure. Without affecting the technical properties according to IEC 62208. For long exposure applications, it is recommended to use painted enclosures available through the P&S offer.



Polyester outdoor Heavy-Duty enclosures

Steel outdoor Heavy-Duty enclosures

Characteristics	Wall-mounted enclosure	Floor-standing enclosure	Wall-mounted enclosure	Floor-standing enclosure
	Outdoor Heavy-Duty (HD) enclosures made of polyester insulated material. Suitable to be installed in public areas thanks to its features: <ul style="list-style-type: none"> • Pressure and shock-resistant • Posting-deterrent for floor standing • Insulated. 		Outdoor Heavy-Duty (HD) enclosures made of coated steel. Suitable to be installed in private areas with harsh environments thanks to its capacity to resist: <ul style="list-style-type: none"> • Corrosion (up to C4H level according ISO 12944:2018) • UV. 	
Material	HD Polyester reinforced with fiberglass to meet standard EN 439-5		HD steel with anti-corrosive painting	
Finish	-		Structured finish, 100% polyester powder	
Color	RAL 7035 gray		RAL 7035 gray	
Conditions of use	Outdoor and/or harsh environments		Outdoor and/or harsh environments	
Temperature range	-40...80 °C		-40...80 °C	
Ingress protection rating	IP65 according to IEC 60529	IP55 according to IEC 60529	IP66 according to IEC 60529	IP55 according to IEC 60529
Mechanical protection rating	IK10 according to IEC 62262		IK10 according to IEC 62262	
Standards	IEC 61439-5: 2010, IEC 62208: 2011, IEC 61439-1: 2011, IEC 61969-3: 2011, IEC 60297-3-100: 2009		IEC 61439-5: 2010, IEC 62208: 2011, IEC 61969-3: 2011, IEC 60297-3-100: 2009, ISO 12.944: 2018 (C4H)	
Certifications	See table page 384		See table page 384	
Fixing	On wall by means of optional wall fixing accessory	Option for installation on floor: <ul style="list-style-type: none"> • With additional ZZ plinths (ventilated or non-ventilated) available as accessory (200 mm) (see page 375) 	<ul style="list-style-type: none"> • On wall by means of optional stainless-steel wall fixing lugs • On post by means of optional HD post fixing device 	<ul style="list-style-type: none"> • Directly on floor by means of optional plinth (see page 379)
Maximum load according to IEC 62208	500 kg		200 kg	1000 kg
Other characteristics	<ul style="list-style-type: none"> • Fire resistant (EN 1794-2:2011) • Lifting possible from top with eyebolt accessory • New dedicated airing solutions to be integrated in roof, lateral or plinth. 3 airing architectures proposed (see page 382 and 383) 		New dedicated airing solutions to be integrated in roof, side or plinth	
Options	Plain door	Plain or ribbed door	-	
Supply	<ul style="list-style-type: none"> • Curved canopy • Handle with keylock (1242E type) and padlock • Door retainer • Plastic document pocket (A4 size) 	<ul style="list-style-type: none"> • Curved canopy • Integrated plinth • Handle with keylock (1242E type) and padlock • Aluminum cable gland plate • Door retainer • Plastic document pocket (A4 size) 	<ul style="list-style-type: none"> • Curved canopy • 3-mm double-bar lock • Plastic document pocket (A4 size) • Door retainer • Aluminum cable gland plate 	<ul style="list-style-type: none"> • Curved canopy • Rear panel • Handle with keylock (1242E type) and padlock • Aluminum cable gland plate • Door retainer • Plastic document pocket (A4 size)

Polyester Outdoor Heavy-Duty Enclosures

- Outdoor Heavy-Duty (HD) enclosures made of polyester insulated material. Suitable to be installed in public areas thanks to its features: Pressure and shock-resistant, posting-deterrent, insulated.
 - Material: HD Polyester reinforced with fiberglass to meet standard EN 439-5
 - Color: RAL 7035 gray
 - Conditions of use: Outdoor and/or harsh environments
 - Temperature range: -40...80 °C
 - Mechanical protection rating: IK10 according to IEC 62262
 - Standards: IEC 61439-5: 2010, IEC 62208: 2011, IEC 61439-1: 2011, IEC 61969-3: 2011, IEC 60297-3-100: 2009
- Certifications: See table [page 384](#)
- Maximum load according to IEC 62208: 500 kg
 - Other characteristics: Fire resistant (EN 1794-2:2011), Lifting possible from top with eyebolt accessory, new dedicated airing solutions to be integrated in roof, lateral or plinth.
 - 3 airing architectures proposed (see [page 382](#) and [383](#))
 - Options: Plain door or ribbed door

Wall-Mounted Enclosure



NSYPHDT553P

- Ingress protection rating: IP65 according to IEC 60529
- Fixing: On wall by means of optional wall fixing accessory

Supply:

- Curved canopy
- Handle with keylock (1242E type) and padlock
- Door retainer
- Plastic document pocket (A4 size)

Characteristics	Door type	No. of doors	Dimensions (H x W x D)	References
Wall-mounted enclosure	Plain	1	538 x 500 x 320	NSYPHDT553P
Wall-mounted enclosure	Plain	1	788 x 500 x 320	NSYPHDT753P

Floor-Standing Enclosure



NSYPHDZT774

- Ingress protection rating: IP55 according to IEC 60529
- Fixing: 2 options for installation on floor:
- With floor fixing kit **NSYMF2PLAZ4** or **NSYMF2PLAZ6** for integrated plinth (50 mm)
- With additional ZZ plinths (ventilated or non-ventilated) available as accessory (200 mm) (see [page 375](#))

Supply:

- Curved canopy
- Integrated plinth
- Handle with keylock (1242E type) and padlock
- Aluminum cable gland plate
- Door retainer
- Plastic document pocket (A4 size)

Characteristics	Door type	No. of doors	Dimensions (H x W x D)	References
Floor-standing enclosure	Anti-posting	1	843 x 750 x 420	NSYPHDZT774
Floor-standing enclosure	Anti-posting	1	843 x 750 x 620	NSYPHDZT776
Floor-standing enclosure	Anti-posting	1	1093 x 500 x 420	NSYPHDZT1054
Floor-standing enclosure	Anti-posting	1	1093 x 750 x 420	NSYPHDZT1074
Floor-standing enclosure	Anti-posting	1	1343 x 500 x 420	NSYPHDZT1254
Floor-standing enclosure	Anti-posting	1	1343 x 750 x 420	NSYPHDZT1274
Floor-standing enclosure	Anti-posting	1	1343 x 750 x 620	NSYPHDZT1276
Floor-standing enclosure	Anti-posting	2	1343 x 1250 x 420	NSYPHDZT12124
Floor-standing enclosure	Anti-posting	2	1343 x 1250 x 620	NSYPHDZT12126
Floor-standing enclosure	Anti-posting	1	1593 x 750 x 420	NSYPHDZT1574
Floor-standing enclosure	Anti-posting	1	1593 x 750 x 620	NSYPHDZT1576
Floor-standing enclosure	Anti-posting	2	1593 x 1250 x 420	NSYPHDZT15124
Floor-standing enclosure	Anti-posting	2	1593 x 1250 x 620	NSYPHDZT15126
Floor-standing enclosure	Anti-posting	2 Vertical	2093 x 750 x 420	NSYPHDZT2074
Floor-standing enclosure	Plain	1	843 x 750 x 420	NSYPHDZT774P
Floor-standing enclosure	Plain	1	843 x 750 x 620	NSYPHDZT776P
Floor-standing enclosure	Plain	1	1093 x 500 x 420	NSYPHDZT1054P
Floor-standing enclosure	Plain	1	1093 x 750 x 420	NSYPHDZT1074P
Floor-standing enclosure	Plain	1	1343 x 500 x 420	NSYPHDZT1254P
Floor-standing enclosure	Plain	1	1343 x 750 x 420	NSYPHDZT1274P
Floor-standing enclosure	Plain	1	1343 x 750 x 620	NSYPHDZT1276P
Floor-standing enclosure	Plain	2	1343 x 1250 x 420	NSYPHDZT12124P
Floor-standing enclosure	Plain	2	1343 x 1250 x 620	NSYPHDZT12126P
Floor-standing enclosure	Plain	1	1593 x 750 x 420	NSYPHDZT1574P
Floor-standing enclosure	Plain	1	1593 x 750 x 620	NSYPHDZT1576P
Floor-standing enclosure	Plain	2	1593 x 1250 x 420	NSYPHDZT15124P
Floor-standing enclosure	Plain	2	1593 x 1250 x 620	NSYPHDZT15126P
Floor-standing enclosure	Plain	2 Vertical	2093 x 750 x 420	NSYPHDZT2074P



NSYPHDZT774P

Eyebolts



NSYPLHD

- Top lifting accessory for polyester outdoor Heavy-Duty enclosure.
- Maximum load per enclosure: 500 kg.
- Material: Galvanized cast steel



PB502891_22_nb

Supply:
4

Characteristics	References
Eyebolts	NSYPLHD

Wall Fixing Accessory



NSYFMPHD

- Wall fixing support for polyester outdoor Heavy-Duty enclosure.
- No change in ingress protection rate.
- Maximum load per enclosure: 180 kg
- Material: Zinc-coated steel
- Finish: Zinc painting



PB502892_31_nb

Supply:
6

Characteristics	References
Wall fixing accessory	NSYFMPHD

Ventilated ZZ Plinth 200 mm

- Height: 200 mm.
- The front part can be removed with a 1242 key.
- Includes a polyester anti-insect filter.
- Material: Glass-reinforced polyester
- Color: RAL 7035 gray

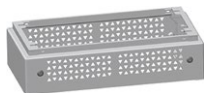

NSYZZ254VHD



PB502830_22_nb

Note:
The coupling kit **NSYMUPLA●●●** is not applicable for enclosures using ZZ or ZH type plinths.

Supply:
1

Characteristics	Dimensions (W x D)	References
Ventilated ZZ plinth 200 mm	500 x 420	NSYZZ254VHD
Ventilated ZZ plinth 200 mm	750 x 420	NSYZZ274VHD
Ventilated ZZ plinth 200 mm	750 x 620	NSYZZ276VHD
Ventilated ZZ plinth 200 mm	1250 x 420	NSYZZ2124VHD
Ventilated ZZ plinth 200 mm	1250 x 620	NSYZZ2126VHD

ZZ Plinth 200 mm

- Height: 200 mm.
- The front and back plates can only be removed from the inside.
- It is provided with one or two reinforcement cross-rails, adjustable to adapt to the position of the cables.
- Material: Glass-reinforced polyester
- Color: RAL 7035 gray



NSYZZ254G



PB502830hns_24_nb

Note:
The coupling kit **NSYMUPLA●●●** is not applicable for enclosures using ZZ or ZH type plinths.

Supply:
1

Characteristics	Depth (mm)	References
ZZ plinth 200 mm	500 x 420	NSYZZ254G
ZZ plinth 200 mm	750 x 420	NSYZZ274G
ZZ plinth 200 mm	750 x 620	NSYZZ276G
ZZ plinth 200 mm	1250 x 420	NSYZZ2124G
ZZ plinth 200 mm	1250 x 620	NSYZZ2126G

Plain Mounting Plate

- The enclosures with height of ≥ 1000 mm have intermediate bosses to fix the mounting plate (M8 inserts, ref. **NSYTEX8**, to be ordered separately).
- Material: Galvanized steel

Installation:

- Direct installation on M8 inserts at the rear of the enclosure or on step slides for depth adjustment (see [page 210](#))
- In the 2-door enclosures, it is possible to install 1 complete mounting plate or 2 individual mounting plates

Supply:
1



NSYPMM55

Characteristics	Dimensions (H x W)	References
Plain mounting plate	538 x 500	NSYPMM55
Plain mounting plate	788 x 500	NSYPMM75
Plain mounting plate	843 x 750	NSYPMM77
Plain mounting plate	1093 x 500	NSYPMM105
Plain mounting plate	1093 x 750	NSYPMM107
Plain mounting plate	1343 x 500	NSYPMM125
Plain mounting plate	1343 x 750	NSYPMM127
Plain mounting plate	1343 x 1250	NSYPMM1212
Plain mounting plate	1583 x 750	NSYPMM157
Plain mounting plate	1583 x 1250	NSYPMM1512
Plain mounting plate (or 2 x NSYPMM107)	2093 x 750	NSYPMM207

Roof Airing Module

- Airing module to enable airing from the top of the enclosure (H = 95 mm).
- Material: Steel with anti-corrosive painting (C4H according ISO 12.944: 2018)
- Finish: Structured finish, 100% polyester powder
- Color: RAL 7035 gray



PE502830_22_1

Supply:
1



NSYPCVR54HD

Characteristics	Dimensions (W x D)	References
Roof airing module	500 x 420	NSYPCVR54HD
Roof airing module	750 x 420	NSYPCVR74HD
Roof airing module	750 x 620	NSYPCVR76HD
Roof airing module	1250 x 420	NSYPCVR124HD
Roof airing module	1250 x 620	NSYPCVR126HD

Steel Outdoor HD Enclosures

- Outdoor Heavy-Duty (HD) enclosures made of coated steel.
- Suitable to be installed in private areas with harsh environments thanks to its capacity to resist: corrosion (up to C4H level according to ISO 12944:2018), UV
- Material: HD steel with anti-corrosive painting
- Finish: Structured finish, 100% polyester powder
- Color: RAL 7035 gray
- Conditions of use: Outdoor and/or harsh environments
- Temperature range: -40...80 °C
- Mechanical protection rating: IK10 according to IEC 62262
- Standards: IEC 61439-5: 2010, IEC 62208: 2011, IEC 61969-3: 2011, IEC 60297-3-100: 2009, ISO 12.944: 2018 (C4H)
- Certifications: See table [page 384](#)
- Other characteristics: New dedicated airing solutions to be integrated in roof, side or plinth

Supply:
 Curved canopy
 Plastic document pocket (A4 size)
 Door retainer
 Aluminum cable gland plate

Wall-Mounted Enclosure

- Ingress protection rating: IP66 according to IEC 60529
- Fixing: On wall by means of optional stainless-steel wall fixing lugs, on post by means of optional HD post fixing device
- Maximum load according to IEC 62208: 200 kg
- cUL according to 508A CSA C.22.2 N° 14 .
- Environmental rating according to UL50E 4, 4x and 13

Supply:
 3-mm double-bar lock



NSYS3HD3215

Characteristics	Dimensions (H x W x D)	References
Wall-mounted enclosure	343 x 200 x 180	NSYS3HD3215
Wall-mounted enclosure	448 x 300 x 230	NSYS3HD4320
Wall-mounted enclosure	548 x 400 x 230	NSYS3HD5420
Wall-mounted enclosure	653 x 400 x 280	NSYS3HD6425
Wall-mounted enclosure	658 x 600 x 330	NSYS3HD6630
Wall-mounted enclosure	753 x 500 x 280	NSYS3HD7525
Wall-mounted enclosure	858 x 600 x 330	NSYS3HD8630
Wall-mounted enclosure	862 x 800 x 430	NSYS3HD8840
Wall-mounted enclosure	1062 x 600 x 430	NSYS3HD10640
Wall-mounted enclosure	1062 x 800 x 430	NSYS3HD10840

Floor-Standing Enclosure

- Ingress protection rating: IP55 according to IEC 60529
- Fixing: Directly on floor by means of optional plinth
- Maximum load according to IEC 62208: 1000 kg
- Coupling possible up to 2,2 meters, and up to 5 meters if coupled by Schneider Electric
- cUL according to UL508a
- Environmental ratings according to UL50E,12 and 3R

Supply:
 Rear panel
 Handle with keylock (1242E type) and padlock



NSYSFHD12640

Characteristics	Dimensions (H x W x D)	References
Floor-standing enclosure	1262 x 600 x 430	NSYSFHD12640
Floor-standing enclosure	1262 x 800 x 430	NSYSFHD12840
Floor-standing enclosure	1262 x 1200 x 430	NSYSFHD1212402D
Floor-standing enclosure	1281 x 600 x 630	NSYSFHD12660
Floor-standing enclosure	1281 x 800 x 630	NSYSFHD12860
Floor-standing enclosure	1281 x 1200 x 630	NSYSFHD1212602D
Floor-standing enclosure	1662 x 800 x 430	NSYSFHD16840
Floor-standing enclosure	1662 x 1200 x 430	NSYSFHD1612402D
Floor-standing enclosure	1681 x 600 x 630	NSYSFHD16660
Floor-standing enclosure	1681 x 800 x 630	NSYSFHD16860
Floor-standing enclosure	1681 x 1200 x 630	NSYSFHD1612602D
Floor-standing enclosure	2062 x 800 x 430	NSYSFHD20840

Side Panels for Floor-Standing Enclosures



NSY2SPHD124

- Side panel fixing for SFHD.
- Material: Steel with anti-corrosive painting (C4H according ISO 12.944: 2018)
- Finish: Structured finish, 100% polyester powder
- Color: RAL 7035 gray

Supply:
2 side panels with fixing elements and sealing gasket

Characteristics	Dimensions (H x D)	References
Side panels, external fixing	1262 x 430	NSY2SPHD124
Side panels, external fixing	1281 x 630	NSY2SPHD126
Side panels, external fixing	1662 x 430	NSY2SPHD164
Side panels, external fixing	1681 x 630	NSY2SPHD166
Side panels, external fixing	2060 x 430	NSY2SPHD204
Side panels, internal fixing	1262 x 430	NSY2SPIHD124
Side panels, internal fixing	1281 x 630	NSY2SPIHD126
Side panels, internal fixing	1662 x 430	NSY2SPIHD164
Side panels, internal fixing	1681 x 630	NSY2SPIHD166
Side panels, internal fixing	2060 x 430	NSY2SPIHD204

Stainless-Steel Wall Fixing Lugs



NSYAEFFXSC

- Set of 4 wall fixing lugs.
- Mounted directly on the rear of the enclosure, either in horizontal or vertical position.
- Wall-enclosure separation of 12 mm.
- Do not use for dynamic loads.
- Maximum load: 250 kg

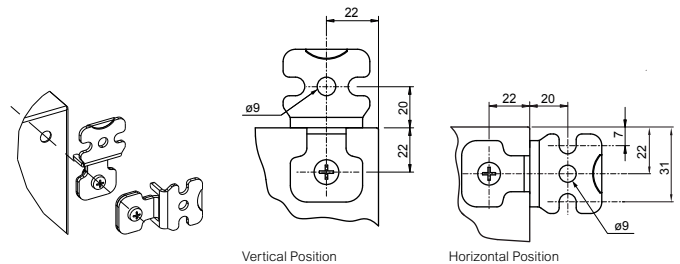

Supply:
Supplied with fixing screws and pre-mounted sealing gaskets

Characteristics	References
Wall fixing lugs, 304L stainless-steel, for outdoor enclosure	NSYAEFFXSC

Heavy-Duty Padlockable Double Lock, for Wall-Mounted Enclosures



NSYAEDLPADS3DHD

- Easy mounting instead of the standard lock.
- Material: Zamak
- Finish: Anti-corrosive painting

Supply:
Delivered with 3-mm double-bar metal key

Characteristics	References
Heavy-Duty padlockable double lock	NSYAEDLPADS3DHD

Stainless-Steel Plinths 200 mm

- Material: Stainless-steel AISI 304L
- Finish: Scotch-Brite® brushing

Installation: For wall-mounted enclosure: It is necessary to order separately the plinth fixing kit (ref. **NSYAPFXWM**) composed by fixing hardware and drilling template, for floor-standing enclosure: Mounting in the holes for fixing the enclosures to the floor

Ventilated Plinths, Front and Rear Kit



NSYSPFVX6200

- The front and rear of the plinth consists of 4 corners with 2 panels.

Supply:
1 kit

Characteristics	Width (mm)	References
Ventilated plinths, front and rear kit	600	NSYSPFVX6200
Ventilated plinths, front and rear kit	800	NSYSPFVX8200
Ventilated plinths, front and rear kit	1200	NSYSPFVX12200

Ventilated Plinths, Lateral Kit



NSYSPLVX4200SF

- They are fixed to the corner of the plinth by fixing screws.

Supply:
1 kit

Characteristics	Depth (mm)	References
Ventilated plinths, for floor-standing enclosure	430	NSYSPLVX4200SF
Ventilated plinths, for floor-standing enclosure	630	NSYSPLVX6200SF

Standard Plinths, Front and Rear Kit



NSYSPFX6200

- The front and rear of the plinth consists of 4 corners with 2 panels.

Supply:
1 kit

Characteristics	Width (mm)	References
Plinth height 200 mm, Kit (4 corners + front and back), AISI 304L	600	NSYSPFX6200
Plinth height 200 mm, Kit (4 corners + front and back), AISI 304L	800	NSYSPFX8200
Plinth height 200 mm, Kit (4 corners + front and back), AISI 304L	1200	NSYSPFX12200

Standard Plinths, Lateral Kit



NSYSPSX3200

- They are fixed to the corner of the plinth by fixing screws.

Supply:
1 kit

Characteristics	Depth (mm)	References
Standard plinths height 200 mm, for wall-mounted enclosure, AISI 304L	330	NSYSPSX3200
Standard plinths height 200 mm, for wall-mounted enclosure, AISI 304L	430	NSYSPSX4200
Standard plinths height 200 mm, for floor-standing enclosure, AISI 304L	430	NSYSPSX4200SF
Standard plinths height 200 mm, for floor-standing enclosure, AISI 304L	630	NSYSPSX6200SF

Plain Mounting Plate



- Material: Galvanized steel

Supply:
1 mounting plate

Characteristics	Dimensions (H x W)	References
Plain mounting plate, for wall-mounted enclosure	300 x 200	NSYMM32
Plain mounting plate, for wall-mounted enclosure	400 x 300	NSYMM43
Plain mounting plate, for wall-mounted enclosure	500 x 400	NSYMM54
Plain mounting plate, for wall-mounted enclosure	600 x 400	NSYMM64
Plain mounting plate, for wall-mounted enclosure	600 x 600	NSYMM66
Plain mounting plate, for wall-mounted enclosure	700 x 500	NSYMM75
Plain mounting plate, for wall-mounted enclosure ⁽¹⁾	800 x 600	NSYMM86
Plain mounting plate, for wall-mounted enclosure	800 x 800	NSYMM88
Plain mounting plate, for wall-mounted enclosure	1000 x 600	NSYMM106
Plain mounting plate, for wall-mounted enclosure ⁽¹⁾	1000 x 800	NSYMM108
Plain mounting plate, for floor-standing enclosure	1200 x 600	NSYMP126
Plain mounting plate, for floor-standing enclosure	1200 x 800	NSYMP128
Plain mounting plate, for floor-standing enclosure	1200 x 1200	NSYMP1212
Plain mounting plate, for floor-standing enclosure	1600 x 600	NSYMP168
Plain mounting plate, for floor-standing enclosure	1600 x 800	NSYMP1612
Plain mounting plate, for floor-standing enclosure	1600 x 1200	NSYMP166
Plain mounting plate, for floor-standing enclosure	2000 x 800	NSYMP208

Roof Airing Module



- Airing module to enable airing from the top of the enclosure (H = 95 mm).
- Material: Steel with anticorrosive painting
- Finish: Structured finish, 100% polyester powder
- Color: RAL 7035 gray

Supply:
1

Characteristics	For enclosure dimensions (W x D)	References
Roof airing module, for floor-standing enclosure	600 x 430	NSYSFCVR64HD
Roof airing module, for floor-standing enclosure	600 x 630	NSYSFCVR66HD
Roof airing module, for floor-standing enclosure	800 x 430	NSYSFCVR84HD
Roof airing module, for floor-standing enclosure	800 x 630	NSYSFCVR86HD
Roof airing module, for floor-standing enclosure	1200 x 430	NSYSFCVR124HD
Roof airing module, for floor-standing enclosure	1200 x 630	NSYSFCVR126HD

Airing System Heavy-Duty

Fanbox



NSYCVF550M24FB

- Free flow rate: 550 m³/h (50/60 Hz).
- Minimal depth inside the enclosure (90 mm).
- Allows multiple cooling architectures (see page 382 and 383).
- Material: Plastic
- Color: RAL 7016 dark gray

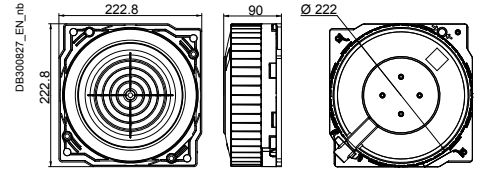

Supply:
1 (grille not included)

Characteristics	Voltage	References
Fanbox	24 V DC	NSYCVF550M24FB
Fanbox	115 V AC	NSYCVF550M115FB
Fanbox	230 V AC	NSYCVF550M230FB

Filter



NSYCAF223T

- Replacement G3 M1 type synthetic filter for HD metal grille.
- Dimensions: 215 x 215 mm.
- Material: 100% polyester fibers
- Color: White

Supply:
5

Characteristics	Height (mm)	Width (mm)	Depth (mm)	Cut-out (mm)	References
G3 M1 synthetic fine filters	268	248	18	223 x 223	NSYCAF223T

Roof Filter for Fanbox



NSYCAF190

- Roof G2 round synthetic filter designed to cover the fanbox. Covers completely the fanbox and helps to protect it from dust and humidity. Mandatory for fanbox installation in the roof airing module for IP55 configurations.
- Material: 100% polyester fibers
- Color: White

Supply:
1

Characteristics	References
Roof filter for fanbox	NSYCAF190

IP55 HD Metal Grille



NSYCAAG223LFHD

- Slim grille (35 mm external depth).
- Includes a G3 M1
- Material: Steel with anti-corrosive painting + plastic PA6 / GF25 for fixing frame
- Finish: Structured finish, 100% polyester powder
- Color: RAL 7035 gray
- Ingress protection rating: IP55 according to IEC 60529
- Mechanical protection rating: IK10 according to IEC 62262

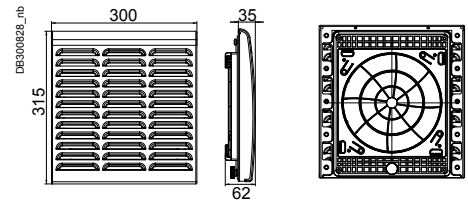

Supply:
1 grille delivered with G3 M1 type synthetic filter (215 x 215 mm) and fixings

Characteristics	References
IP55 HD Metal Grille	NSYCAAG223LFHD

Anti-Vandalism Kit for HD Metal Grille



NSYCAAPVHD

- Fixings that help to prevent to open the grille from the outside with standard tools (EN 1627-1630:2011 Class 2).
- Quick installation without tools.
- Material: Steel with anticorrosive painting + plastic for fixing screws

Note:
not compatible with NSYSPLA150

Supply:
4 grip knob
4 clip nuts

Characteristics	References
Anti-vandalism kit for HD metal grille	NSYCAAPVHD

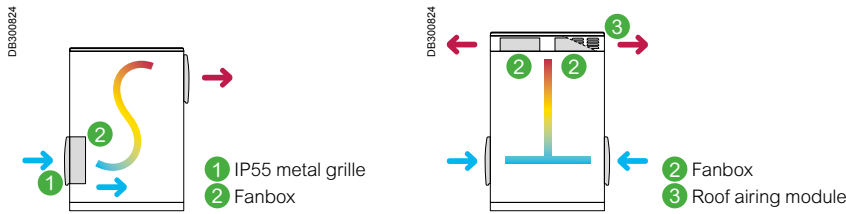

	S-Line				T-Line				
Architecture benefits	<ul style="list-style-type: none"> • Most common and competitive architecture • Maximum heat dissipation to extract 800 W-1000 W • ΔT° of 5 $^\circ\text{C}$ • Easy access to mount-dismount fanbox • Air flow in horizontal axis 				<ul style="list-style-type: none"> • High thermal extraction capacity up to 1500 W • Noise level with 1 fan: 55 dB when installed inside the upper airing module • ΔT° of 5 $^\circ\text{C}$ • Air flow in vertical axis 				
	IP55 metal grille		Fanbox		IP55 metal grille		Fanbox (1 filter NSYCAF190 for each Fanbox)		Roof airing module
	Door	Side	Door	Side	Door	Side			

Polyester outdoor HD enclosure									
References	Amount to be installed				Amount to be installed				References
NSYPHDZT553P	-	-	-	-	-	-	-	-	-
NSYPHDZT753P	1 to 2	-	1 to 2	-	1 to 2	-	-	-	-
NSYPHDZT774	-	1 to 2	-	1 to 2	-	1 to 2	1 to 2	1	NSYPCVR74HD
NSYPHDZT774P	1 to 2	1 to 2	1 to 2	1 to 2	1 to 2	1 to 2	1 to 2	1	NSYPCVR74HD
NSYPHDZT776	-	1 to 2	-	1 to 2	-	1 to 2	1 to 2	1	NSYPCVR76HD
NSYPHDZT776P	1 to 2	1 to 2	1 to 2	1 to 2	1 to 2	1 to 2	1 to 2	1	NSYPCVR76HD
NSYPHDZT1054	-	1	-	1	-	1	1	1	NSYPCVR54HD
NSYPHDZT1054P	1 to 2	1	1 to 2	1	1 to 2	1	1	1	NSYPCVR54HD
NSYPHDZT1074	-	1 to 2	-	1 to 2	-	1 to 2	1 to 2	1	NSYPCVR74HD
NSYPHDZT1074P	1 to 4	1 to 2	1 to 4	1 to 2	1 to 4	1 to 2	1 to 2	1	NSYPCVR74HD
NSYPHDZT12124	-	1 to 3	-	1 to 3	-	1 to 3	1 to 3	1	NSYPCVR124HD
NSYPHDZT12124P	1 to 4	1 to 3	1 to 4	1 to 3	1 to 4	1 to 3	1 to 3	1	NSYPCVR124HD
NSYPHDZT12126	-	1 to 3	-	1 to 3	-	1 to 3	1 to 3	1	NSYPCVR126HD
NSYPHDZT12126P	1 to 4	1 to 3	1 to 4	1 to 3	1 to 4	1 to 3	1 to 3	1	NSYPCVR126HD
NSYPHDZT1254	-	1	-	1	-	1	1	1	NSYPCVR54HD
NSYPHDZT1254P	1 to 3	1	1 to 3	1	1 to 3	1	1	1	NSYPCVR54HD
NSYPHDZT1274	-	1 to 2	-	1 to 2	-	1 to 2	1 to 2	1	NSYPCVR74HD
NSYPHDZT1274P	1 to 4	1 to 2	1 to 4	1 to 2	1 to 4	1 to 2	1 to 2	1	NSYPCVR74HD
NSYPHDZT1276	-	1 to 2	-	1 to 2	-	1 to 2	1 to 2	1	NSYPCVR76HD
NSYPHDZT1276P	1 to 4	1 to 2	1 to 4	1 to 2	1 to 4	1 to 2	1 to 2	1	NSYPCVR76HD
NSYPHDZT15124	-	1 to 3	-	1 to 3	-	1 to 3	1 to 3	1	NSYPCVR124HD
NSYPHDZT15124P	1 to 4	1 to 3	1 to 4	1 to 3	1 to 4	1 to 3	1 to 3	1	NSYPCVR124HD
NSYPHDZT15126	-	1 to 3	-	1 to 3	-	1 to 3	1 to 3	1	NSYPCVR126HD
NSYPHDZT15126P	1 to 4	1 to 3	1 to 4	1 to 3	1 to 4	1 to 3	1 to 3	1	NSYPCVR126HD
NSYPHDZT1574	-	1 to 2	-	1 to 2	-	1 to 2	1 to 2	1	NSYPCVR74HD
NSYPHDZT1574P	1 to 4	1 to 2	1 to 4	1 to 2	1 to 4	1 to 2	1 to 2	1	NSYPCVR74HD
NSYPHDZT1576	-	1 to 2	-	1 to 2	-	1 to 2	1 to 2	1	NSYPCVR76HD
NSYPHDZT1576P	1 to 4	1 to 2	1 to 4	1 to 2	1 to 4	1 to 2	1 to 2	1	NSYPCVR76HD
NSYPHDZT2074	-	1 to 2	-	1 to 2	-	1 to 2	1 to 2	1	NSYPCVR74HD
NSYPHDZT2074P	1 to 4	1 to 2	1 to 4	1 to 2	1 to 4	1 to 2	1 to 2	1	NSYPCVR74HD

Steel outdoor HD enclosure									
NSYS3HD8630	1 to 2	-	1 to 2	-	1 to 2	-	-	-	-
NSYS3HD8840	1 to 2	1 to 2	1 to 2	1 to 2	1 to 2	1 to 2	1 to 2	1	-
NSYS3HD10640	1 to 2	1 to 2	1 to 2	1 to 2	1 to 2	1 to 2	1	1	-
NSYS3HD10840	1 to 4	1 to 2	1 to 4	1 to 2	1 to 4	1 to 2	1 to 2	1	-
NSYSFHD12640	1 to 3	1 to 3	1 to 3	1 to 3	1 to 3	1 to 3	1	1	NSYSFCVR64HD
NSYSFHD12660	1 to 3	1 to 3	1 to 3	1 to 3	1 to 3	1 to 3	1	1	NSYSFCVR66HD
NSYSFHD12840	1 to 4	1 to 3	1 to 4	1 to 3	1 to 4	1 to 3	1 to 2	1	NSYSFCVR84HD
NSYSFHD12860	1 to 4	1 to 3	1 to 4	1 to 3	1 to 4	1 to 3	1 to 2	1	NSYSFCA66HD
NSYSFHD16660	1 to 4	1 to 4	1 to 4	1 to 4	1 to 4	1 to 4	1	1	NSYSFCVR66HD
NSYSFHD16840	1 to 4	1 to 4	1 to 4	1 to 3	1 to 4	1 to 3	1 to 2	1	NSYSFCVR84HD
NSYSFHD16860	1 to 4	1 to 4	1 to 4	1 to 4	1 to 4	1 to 4	1 to 2	1	NSYSFCA66HD
NSYSFHD20840	1 to 4	1 to 4	1 to 4	1 to 4	1 to 4	1 to 4	1 to 2	1	NSYSFCVR84HD
NSYSFHD1212402D	1 to 4	1 to 3	1 to 4	1 to 2	1 to 4	1 to 2	1 to 3	1	NSYSFCVR124HD
NSYSFHD1212602D	1 to 4	1 to 3	1 to 4	1 to 3	1 to 4	1 to 2	1 to 3	1	NSYSFCVR126HD
NSYSFHD1612402D	1 to 4	1 to 4	1 to 4	1 to 3	1 to 4	1 to 3	1 to 3	1	NSYSFCVR124HD
NSYSFHD1612602D	1 to 4	1 to 4	1 to 4	1 to 3	1 to 4	1 to 3	1 to 3	1	NSYSFCVR126HD

Technical changes reserved. Information provided without guarantee. Images are for illustrative purposes only.

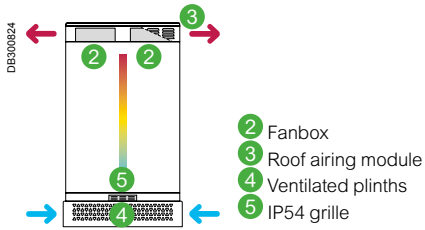

This table helps to configure thermal architectures, but it is highly recommended to use ProClima Software to ensure the right thermal solution according to the selected architecture.

I-Line

- Integrated architecture particularly suitable for public areas
- High thermal extraction capacity up to 1500 W
- Noise level with 1 fan: 55 dB when installed inside the upper airing module
- Good extraction flow rate power
- Air flow in vertical axis

IP54 outlet grille
(NSYCAG223LPF +
G3 filter NSYCAF223T)

Ventilated plinths

Fanbox
(1 filter NSYCAF190
for each Fanbox)

Roof airing module

Amount to be installed		References		Amount to be installed		References	
-	-	-	-	-	-	-	-
-	-	-	-	-	-	-	-
1 to 2	1	NSYZZ274VHD	-	1 to 2	1	NSYPCVR74HD	-
1 to 2	1	NSYZZ274VHD	-	1 to 2	1	NSYPCVR74HD	-
1 to 2	1	NSYZZ276VHD	-	1 to 2	1	NSYPCVR76HD	-
1 to 2	1	NSYZZ276VHD	-	1 to 2	1	NSYPCVR76HD	-
1	1	NSYZZ254VHD	-	1	1	NSYPCVR54HD	-
1	1	NSYZZ254VHD	-	1	1	NSYPCVR54HD	-
1 to 2	1	NSYZZ274VHD	-	1 to 2	1	NSYPCVR74HD	-
1 to 2	1	NSYZZ274VHD	-	1 to 2	1	NSYPCVR74HD	-
1 to 3	1	NSYZZ2124VHD	-	1 to 3	1	NSYPCVR124HD	-
1 to 3	1	NSYZZ2124VHD	-	1 to 3	1	NSYPCVR124HD	-
1 to 3	1	NSYZZ2126VHD	-	1 to 3	1	NSYPCVR126HD	-
1 to 3	1	NSYZZ2126VHD	-	1 to 3	1	NSYPCVR126HD	-
1	1	NSYZZ254VHD	-	1	1	NSYPCVR54HD	-
1	1	NSYZZ254VHD	-	1	1	NSYPCVR54HD	-
1 to 2	1	NSYZZ274VHD	-	1 to 2	1	NSYPCVR74HD	-
1 to 2	1	NSYZZ274VHD	-	1 to 2	1	NSYPCVR74HD	-
1 to 2	1	NSYZZ276VHD	-	1 to 2	1	NSYPCVR76HD	-
1 to 2	1	NSYZZ276VHD	-	1 to 2	1	NSYPCVR76HD	-
1 to 3	1	NSYZZ2124VHD	-	1 to 3	1	NSYPCVR124HD	-
1 to 3	1	NSYZZ2124VHD	-	1 to 3	1	NSYPCVR124HD	-
1 to 3	1	NSYZZ2126VHD	-	1 to 3	1	NSYPCVR126HD	-
1 to 3	1	NSYZZ2126VHD	-	1 to 3	1	NSYPCVR126HD	-
1 to 2	1	NSYZZ274VHD	-	1 to 2	1	NSYPCVR74HD	-
1 to 2	1	NSYZZ274VHD	-	1 to 2	1	NSYPCVR74HD	-
1 to 2	1	NSYZZ276VHD	-	1 to 2	1	NSYPCVR76HD	-
1 to 2	1	NSYZZ276VHD	-	1 to 2	1	NSYPCVR76HD	-
1 to 2	1	NSYZZ274VHD	-	1 to 2	1	NSYPCVR74HD	-
1 to 2	1	NSYZZ274VHD	-	1 to 2	1	NSYPCVR74HD	-

1	1	NSYSPFVX6200	NSYSPSX3200	-	-	-
1 to 2	1	NSYSPFVX8200	-	1 to 2	1	-
1	1	NSYSPFVX6200	-	1	1	-
1	1	NSYSPFVX8200	-	1 to 2	1	-
1	1	NSYSPFVX6200	-	1	1	NSYSFCVR64HD
1	1	NSYSPFVX6200	NSYSPLVX6200	1	1	NSYSFCVR66HD
1 to 2	1	NSYSPFVX8200	-	1 to 2	1	NSYSFCVR84HD
1 to 2	1	NSYSPFVX8200	NSYSPLVX6200	1 to 2	1	NSYSFECA66HD
1	1	NSYSPFVX6200	NSYSPLVX6200	1	1	NSYSFCVR66HD
1 to 2	1	NSYSPFVX8200	-	1 to 2	1	NSYSFCVR84HD
1 to 2	1	NSYSPFVX8200	NSYSPLVX6200	1 to 2	1	NSYSFECA66HD
1 to 2	1	NSYSPFVX8200	-	1 to 2	1	NSYSFCVR84HD
1 to 3	1	NSYSPFVX12200	-	1 to 3	1	NSYSFCVR124HD
1 to 3	1	NSYSPFVX12200	NSYSPLVX6200	1 to 3	1	NSYSFCVR126HD
1 to 3	1	NSYSPFVX12200	-	1 to 3	1	NSYSFCVR124HD
1 to 3	1	NSYSPFVX12200	NSYSPLVX6200	1 to 3	1	NSYSFCVR126HD

Technical changes reserved. Information provided without guarantee. Images are for illustrative purposes only.

POLYESTER Thalassa PHD				
Test description	Standard	Standard title	Certification	Declaration
IP55, IK10, lifting: 500 kg max. (IP65 for wall-mounted)	IEC 62208: 2011	Empty enclosures for low-voltage switchgear and controlgear assemblies - General requirements	●	-
Class II Insulation	IEC 61439-1: 2011	Low-voltage switchgear and controlgear assemblies Part 1: General rules	-	✓
Strength of materials and parts	IEC 61439-5: 2010	Low-voltage switchgear and controlgear assemblies Part 5: Assemblies for power distribution in public networks	●	-
Corrosion resistance C4H. It affects the painted accessories (ventilated roof, anti-burglary kit). All other metal parts have special treatment to pass the same test.	ISO 12.944: 2018	Paints and varnishes-corrosion protection of steel structures by protective paint systems Part 6: laboratory performance testing methods	-	✓
Climatic test, Biological Test, Resistance against chemically and mechanical active substances. Mechanical test, Lifting and stiffness test	IEC 61969-3: 2011	Electronic "Mechanical structures for electronic equipment - Outdoor enclosures" Part 3: Environmental requirements, tests and safety aspects	●	-
Space for electronics	IEC 60297-3-100: 2009	Mechanical structures for electronic equipment Dimensions of mechanical structures of the 482.6 mm (19 in) series - Part 3-100: Basic dimensions of front panels, subracks, chassis, racks and cabinets	-	✓
Dimensional	EIA-310-E	Cabinets, Racks, Panels, and associated equipment	-	✓
Fire resistance	EN 1794-2:2011	Vandalism: Fire resistance	-	✓
Posting	Internal test	Door anti-posting internal test	-	✓
Single-door: types 1, 2, 3, 3R, 4, 4X, 5, 12 and 13 Double-door: types 1, 2, 3, 3R, 5, 12 and 13	UL 508 A CSA c.22.2 No 14	Standard for Industrial Control Panels. Standard for Industrial Control Equipment.	●	-
Spacial SFHD (floor-standing enclosures)				
IP55, IK10, lifting: 1000 kg max.	IEC 62208: 2011	Empty enclosures for low-voltage switchgear and controlgear assemblies - General requirements	●	-
Strength of materials and parts	IEC 61.439-5: 2010	Low-voltage switchgear and controlgear assemblies Part 5: Assemblies for power distribution in public networks	●	-
Corrosion resistance C4H	ISO 12.944: 2018	Paints and varnishes-corrosion protection of steel structures by protective paint systems Part 6: laboratory performance testing methods	●	-
Climatic test, Biological Test, Resistance against chemically and mechanical active substances. Mechanical test, Lifting and stiffness test	IEC 61969-3: 2011	Electronic "Mechanical structures for electronic equipment - Outdoor enclosures" Part 3: Environmental requirements, tests and safety aspects	●	-
Space for electronics	IEC 60297-3-100: 2009	Mechanical structures for electronic equipment Dimensions of mechanical structures of the 482.6 mm (19 in) series - Part 3-100: Basic dimensions of front panels, subracks, chassis, racks and cabinets	-	✓
Dimensional	EIA-310-E	Cabinets, Racks, Panels, and associated equipment	-	✓
Single-door: Types 1, 3R, 12 Double-door: Types 1, 3R, 12	UL 508 A CSA C.22 No 14-18 UL50E	Standard for Industrial Control Panels. Standard for Industrial Control Equipment.	●	-
Spacial S3HD (wall-mounted enclosures)				
IP66, IK10, lifting: 200 kg max.	IEC 62208: 2011	Empty enclosures for low-voltage switchgear and controlgear assemblies - General requirements	●	-
Strength of materials and parts	IEC 61.439-5: 2010	Low-voltage switchgear and controlgear assemblies Part 5: Assemblies for power distribution in public networks	●	-
Corrosion resistance C4H	ISO 12.944: 2018	Paints and varnishes-corrosion protection of steel structures by protective paint systems Part 6: Laboratory performance testing methods	●	-
Climatic test, Biological Test, Resistance against chemically and mechanical active substances. Mechanical test, Lifting and stiffness test	IEC 61969-3: 2011	Electronic "Mechanical structures for electronic equipment - Outdoor enclosures" Part 3: Environmental requirements, tests and safety aspects	●	-
Space for electronics	IEC 60297-3-100: 2009	Mechanical structures for electronic equipment Dimensions of mechanical structures of the 482.6 mm (19 in) series - Part 3-100: Basic dimensions of front panels, subracks, chassis, racks and cabinets	-	✓
Dimensional	EIA-310-E	Cabinets, Racks, Panels, and associated equipment	-	✓
Single-door: Types 1, 2, 3, 3R, 4, 4X, 5, 12 and 13	UL 508 A: 2007 CSA c.22.2 No 14	Standard for Industrial Control Panels. Standard for Industrial Control Equipment.	●	-

HD ACCESSORIES HD THERMAL Management, Fanbox				
Test description	Standard	Standard title	Certification	Declaration
NSYCVF Series are intended for mounting on the flat surface of a Type 12 or 12K enclosure	UL 508A CAN/CSA-C22.2 No. 14, CAN/CSA C22.2 No. 94-M91 CAN/CSA C22.2 No. 73	Industrial Control Panels Industrial Control Equipment Special Purpose Enclosures Electrically Equipped Machine Tools	●	-
IP55 HD Metal grille (NSYCAG223LFHD)				
IP55 (in conditions of use)	IEC 60529: 2013	Degrees of protection provided by enclosures (IP Code)	-	✓
Corrosion resistance C4H	ISO 12.944: 2018	Paints and varnishes-corrosion protection of steel structures by protective paint systems - part 6: Laboratory performance testing methods	●	-
Anti-vandalism kit for HD metal grille (NSYCAAPVHD)				
Resistance Class 2	ENV 1627:2011	Burglar resistance - Requirements and classification	●	-
Upper airing module (PHD / SFHD / S3HD)				
IP55 (in conditions of use)	IEC 60529: 2013	Degrees of protection provided by enclosures (IP Code)	-	✓
Corrosion resistance at level C4H	ISO 12.944: 2018	Paints and varnishes-corrosion protection of steel structures by protective paint systems Part 6: Laboratory performance testing methods	●	-
HD POLYESTER ENCLOSURES				
Corrosion resistance at level C4H	ISO 12.944: 2018	Paints and varnishes-corrosion protection of steel structures by protective paint systems Part 6: Laboratory performance testing methods	●	-
ZZ plinths (NSYZZ... and NSYZZ...VHD)				
ZZ Plinth: IP44 (in conditions of use) Ventilated ZZ Plinth: IP43 (in conditions of use)	IEC 60.529:2013	Degrees of protection provided by enclosures (IP Code)	-	✓
Eyebolts (NSYPLHD)				
Maximum load 500 kg	IEC 62208: 2011	Empty enclosures for low-voltage switchgear and controlgear assemblies - General requirements	-	✓
HD STEEL ENCLOSURES				
Stainless-steel plinths (NSYSFVX... / NSYSPLVX... / NSYSPSX... / NSYSXSX...)				
Ventilated plinth: IP20 (in conditions of use) Standard plinth: IP30 (in conditions of use)	IEC 60.529:2013	Degrees of protection provided by enclosures (IP Code)	-	✓

Horizontal Wall-Mounted Enclosures Designed for Photovoltaic and Multiple Outdoor Applications Installed in Harsh Environments

New

- Wall-mounted enclosures made of **fiberglass reinforced polyester** molded by hot compression.
- Monobloc body with polyurethane gasket.
- **Wider sizes with more space available in the bottom of the enclosure** to install additional cable entries.
- **Impact resistance IK10**, IEC 62262.
- **Protection degree IP 66**, IEC 60529.
- Class II insulation.
- Certifications: **IEC 62208 and UL 508A - NEMA type: 1, 2, 3, 3R, 3S, 4, 4X, 5, 12 and 13.**
- Reach and RoHs compliance.
- Color: **RAL 7035**.

Removable Door System

- Removable door system that allows:
 - Total access without limitations to the internal part of the enclosure.
 - Easy and quick assembly/disassembly of the door. (without dismantling the hinges and removing the pin)



Self-Adhesive and Fixable Canopy

- Self-adhesive and fixable canopy made of PVC available as an accessory - black RAL 9005 Color. Die-cut to be easily fixed by two screws. IP degree is maintained.
- For outdoor use, the canopy must be installed to protect the door gasket against water stagnation.



Wall Fixing Lugs

- Set of 4 wall fixing lugs (plastic or stainless-steel) available as an accessory.
- Quick and easy assembly through the inserts, without drilling the enclosure. IP guaranteed.



Landscape Enclosures - RAL 7035



NSYS3HD3215



NSYPLM810G

Characteristics	Height (mm)	Width (mm)	Depth (mm)	Number of locks	References
Landscape enclosures. RAL 7035	536	747	300	2	NSYPLM57G New
Landscape enclosures. RAL 7035	636	847	300	2	NSYPLM68G New
Landscape enclosures. RAL 7035	852	1056	350	1	NSYPLM810G New

Canopy PVC - RAL 9005

- Self-adhesive and fixable by screws
- Holes pre die-cut
- IP is maintained



NSYS3HD3215

Characteristics	Height (mm)	Width (mm)	Depth (mm)	Enclosure	References
Canopy PVC - RAL 9005	5	747	62	NSYPLM57G	NSYCSA57 New
Canopy PVC - RAL 9005	5	847	62	NSYPLM68G	NSYCSA68 New
Canopy PVC - RAL 9005	5	1056	62	NSYPLM810G	NSYCSA810 New

Plain Mounting Plate



NSYMM75

- Material: Galvanized steel

Characteristics	Dimensions (H x W)	Enclosure	References
Plain mounting plate, for wall-mounted enclosure	700 x 500	NSYPLM57G	NSYMM75
Plain mounting plate, for wall-mounted enclosure	800 x 600	NSYPLM68G	NSYMM86
Plain mounting plate, for wall-mounted enclosure	1000 x 800	NSYPLM810G	NSYMM108

Plain Mounting Plate



NSYMP75

- Material: Polyester

Characteristics	Dimensions (H x W)	Enclosure	References
Plain mounting plate, for wall-mounted enclosure	700 x 500	NSYPLM57G	NSYMP75
Plain mounting plate, for wall-mounted enclosure	800 x 600	NSYPLM68G	NSYMP86
Plain mounting plate, for wall-mounted enclosure	1000 x 800	NSYPLM810G	NSYMP108

Wall Fixing Lugs



NSYFPPLMG

Set of 4 wall fixing lugs. Mounted directly on the enclosure, either in horizontal position or in vertical position.

- Material: Fiberglass-reinforced polyamide
- Color: RAL 7035 gray
- **Maximum load:**

On PLM32: Vertical or horizontal: 10 kg

Other PLM models: Vertical position: 200 kg, horizontal position: 100 kg

Supply:

Delivered with fixings

Characteristics	Reference
Wall fixing lugs	NSYFPPLMG

Wall Fixing Lugs



NSYFPXPLM

Set of 4 wall fixing lugs. Mounted directly on the enclosure, either in horizontal position or in vertical position.

- Material: Stainless-steel
- Color: RAL 7035 gray
- **Maximum load:**

Other PLM models: Vertical position: 200 kg, horizontal position: 100 kg

Supply:

Delivered with fixings

Characteristics	Reference
Wall fixing lugs	NSYFPXPLM



PLM108-PAP free



Customized Service

Machining service available. Please consult your Universal Enclosure sales representative.



Scan or click for video



The Seismic Risk

The seismic risk is present everywhere on the surface of the globe, its intensity varies from one region to another. In order to assess the seismic risk of a region, 6 zones (0, 1, 2A, 2B, 3, 4 and 5) have been defined by the UBC (Uniform Building Code) based on ground acceleration. The map below, taken from the IEC 60721-2-6 (figure 5), shows the distribution of these zones on the 5 continents (for greater clarity zones 2A and 2B have been grouped in zone 2).

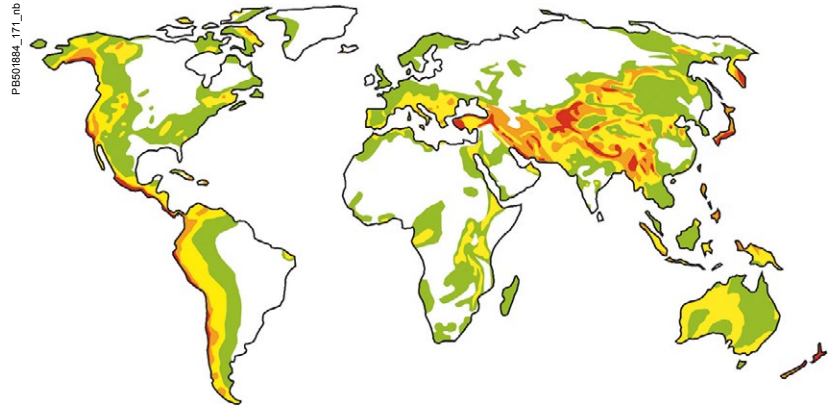
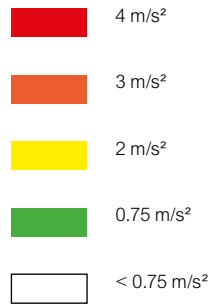

Spacial Enclosures and the Seismic Constraint

Spacial standard range solutions

Standard offer Spacial SBM, S3D, PrismaSet HD, enclosures have been qualified for use in areas subject to medium-intensity earthquakes (zone 3 from UBC). The results are presented in each corresponding pages. Seismic applications being an expert domain, it is strongly recommended to consult us for all projects with seismic constraints.

Enclosures for strong earthquakes

To meet the requirements of areas with high seismic risk (UBC zone 4), Schneider Electric has developed 2 offers:

- SF6G cells
- The S3D 6G enclosure to meet the specific constraints of the nuclear industry.

These 2 offers are Spacial SF cubicles and S3D enclosures whose following elements have been strengthened:

- Sheet thickness,
- Lock system,
- Wall mounting brackets,
- Frame fixing.

Certificate

- All tests have been carried out in accordance with the following regulations techniques:
- IEC 60068-3-3 (first edition): international standard
- M12D0168610 (EDF): specified earthquake resistance tests for the nuclear industry.
- This document is the update of document CRT 91-C-112-00 carried out following the Fukushima accident.

SF **S3D**

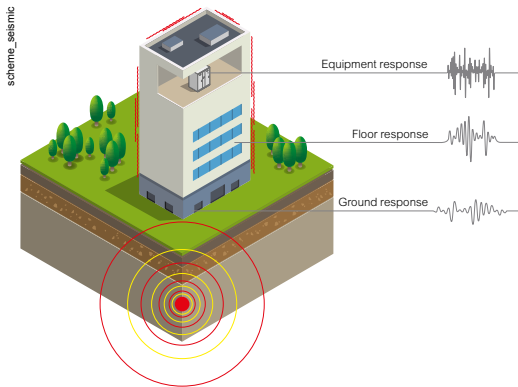

Technical Information

Seismic Standards

There is no single international standard. The standards depend on each country/zone and are linked to civil engineering standards.

The main ones are:

- International Building Code (I.B.C. Ex UBC)
- IEC 60068-3-3
- EDF specification CRT 91C11200 (ex-HN-20-E-53)
- GR Core 63 Telcordia

The Spacial enclosures have been tested according to standards IEC 60068-3-3 and CRT 91-C-112-00. CRT 91-C-112-00 is one of the most restrictive specifications, and for which it is therefore more difficult to obtain certification.

To define the seismic resistance of equipment, it is necessary to take into account the geological characteristics of the earthquake and the behavior of the building, and compare these with the equipment's seismic performance.

Geology
Equivalence between scales characterizing the earthquake

MSK	Richter	IEC 60068-3-3 (ground acc.)
<VIII	< 5.5	2 m/s ²
VIII to IX	≥ 5.5 and ≤ 7	3 m/s ²
>IX	> 7	5 m/s ²

Civil engineering
Example acceleration levels on the floor of a building (RRS)

All types of building (IEC 60068-3-3)	EDF specification for a power plant nuclear. Anticipate the increase potential of the RRS level in a later revision of CRT 91 C 112
6 m/s ²	-
9 m/s ²	10 m/s ² - 8 m/s ²
15 m/s ²	20 m/s ² - 24 m/s ²

Equipment performance tested according to CRT 91 C 112 00

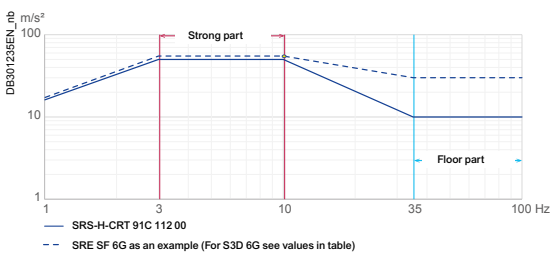

Products	Floor part acc	Strong part acc
SF 6G*	30 m/s ²	50 m/s ²
S3D 6G*	30 m/s ²	55 m/s ²

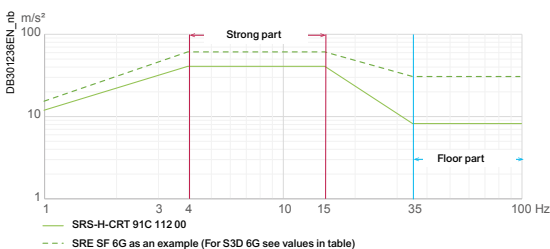

Products	Floor part acc	Strong part acc
SF 6G*	30 m/s ²	60 m/s ²
S3D 6G*	30 m/s ²	80 m/s ²

Definitions

Ground acceleration: Ground acceleration resulting from an earthquake. Note: In practice, ground acceleration can be broken down into horizontal and vertical components.

Floor acceleration: Ground acceleration measured on a particular floor in a building (at the location of an equipment item).

Note: In practice, floor acceleration can be broken down into horizontal and vertical components.

Required response spectrum (RRS): Representation of the amplification of the ground acceleration caused by the structure or equipment according to the wave frequency. Used for determining equipment dimensions and qualifying the equipment.

Test response spectrum (TRS): Representation of the amplification of tested products during tests on vibrating table.

Two parts are defined in the response spectra:

- **Floor part:** On the product zone in contact with the vibrating table there is no amplification of the acceleration. The acceleration value recorded for the spectrum is that measured on the ground.
- **Strong part:** The acceleration value recorded for the spectrum is the maximum amplified acceleration expected at the center of gravity of the equipment. This is not a measurable quantity but a mathematical representation.

Conclusion: The TRS values must be compared to the RRS values. If they are greater, the equipment will resist the effects of the earthquake.

The **Spacial SF 6G** Enclosures Have Been Designed to Withstand Earthquakes Corresponding to UBC Zone 4.

Spacial SF 6G for Seismic Risks



11



Panel Mounting

- 12 fastening points by M6 screws per panel..



Security Locking System

- Seismic locking system.
- Special connecting rods and handle to prevent any accidental door opening under severe vibration conditions.



Plinths

- Enhanced mechanical strength (monobloc structure).
- Assembled on the enclosure.
- Floor fixing: 10 fastening points by M12 screws.

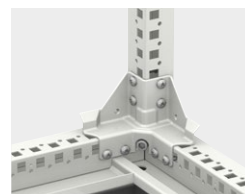

Multi-Purpose Corners

- To strengthen the enclosure and respond to seismic risks.
- To strengthen fastening of the side panels and rear panel.
- To fasten the door connecting rods.

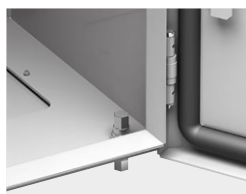

Optional on Request

- Continuity of masses between interior and exterior by 2 studs welded opposite each other.



Decontaminable Smooth Paint PID 100 Series

- Complies with CCTR 91.C.031.08 Double layer of paint (minimum thickness: 60 µ).
- PIA/PIB/PID and PIC REP 100.
- Powder system according to FNP 1125.

Technical changes reserved. Information provided without guarantee. Images are for illustrative purposes only.

Spacial SF 6G for Seismic Risks



NSYSF6G20680

- Enclosures designed to be installed in UBC Zone 4.
- They have been tested with a plain mounting plate and 19" rack.
- Integrated plinth.
- Material: Steel
- Ingress protection rating: IP55 according to IEC 60529
- Mechanical protection rating: IK10 according to IEC 62262
- Maximum load: 80 kg/m² on plain mounting plate, 250 kg on fix upright 19" compliant with IEC 61587-2
- Standards: IEC 62208 (enclosure) - IEC 60068-3-3 (seismic methods to apply for materials)
- Certifications: 6G certification as per CRT 91-C-112-00 (EDF) - UL50E types 1, 12

Supply:

Framework

- 1 upper frame with roof
- 1 lower frame
- 1 rear panel
- 4 uprights
- 8 multi-purpose reinforcement corners
- 8 cross-rails fastened to the framework contributing to the seismic resistance (3 left, 3 right, 2 rear)

Plinth

- Monobloc base 4 mm thick, 100 mm high (enclosure without plinths on demand)

Door

- Plain door with EDF 1600 captive key lock
- 3 fastening points with connecting rods
- Door hinges on right (opposite direction available on request)

Coupling

- Option to couple SF 6G enclosures with the coupling kits ref. **NSYSFBK19 + NSYSFBKR**
- Option to couple plinth with the ref. **NSYPLK6G**

Characteristics	Height (mm)	Width (mm)	Depth (mm)	References
Spacial SF 6G	2000	600	800	NSYSF6G20680
Spacial SF 6G	2000	800	600	NSYSF6G20860
Spacial SF 6G	2000	800	800	NSYSF6G20880

Side Panels



NSY6G2SP204

- Enclosures designed to be installed in UBC Zone 4.
- They have been tested with a plain mounting plate and 19" rack.
- Integrated plinth.
- Material: Steel
- Installation: 12 fastening points

Supply:

2 side panels and fasteners

Characteristics	Height (mm)	Depth (mm)	References
Side panel	2000	600	NSY6G2SP206
Side panel	2000	800	NSY6G2SP208

Mounting Plate



NSYMP206

- Material: Galvanized steel
- Installation: Mounting plate to be installed with **NSYSFPB6G** fastening kit + **NSYHLCR●●** cross-rails

Supply:

1 mounting plate and sliding shoes

Characteristics	Height of the enclosure (mm)	Width of the enclosure (mm)	Height (mm)	Depth (mm)	References
Mounting plate	2000	600	1897	496	NSYMP206
Mounting plate	2000	800	1897	696	NSYMP208

Rails for Heavy Load

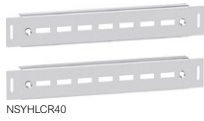

NSYHLCR40

- Material: Zinc-coated steel

Supply:
2 cross-rails and fixing elements

Characteristics	Depth (mm)	References
Rails for heavy load	400	NSYHLCR40
Rails for heavy load	600	NSYHLCR60
Rails for heavy load	800	NSYHLCR80

Reinforced Fixing Kit for Mounting Plate

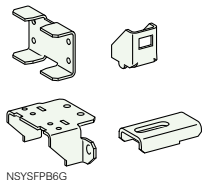

NSYSFPB6G

- Material: Steel

Supply:
6 anti-vibration supports
4 mounting brackets
4 supports
2 connectors and fixing elements

Characteristics	References
Reinforced fixing kit for mounting plate	NSYSFPB6G

Trim Cap for SF 6G Panels



NSYCSP6G

- Material: Plastic

Supply:
50 units

Characteristics	References
Trim cap for SF 6G panels	NSYCSP6G

19" Fixed Uprights

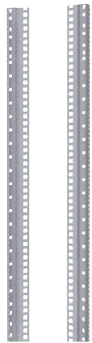

NSYRCK42

- Uprights designed to be assembled on enclosures 800 mm wide and 800 mm deep.
- Material: Zinc-coated steel
- Fixing: To fasten the 19" uprights, it is necessary to use the fixing kit **NSYRCK19KIT6G**

Note:
For a 19" seismic configuration, 4 uprights must be used

Supply:
2 uprights and fasteners,

Characteristics	References
19" fixed uprights	NSYRCK42

19" Fixed Uprights

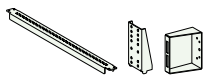

NSYRCK19KIT6G

- Material: Steel

Supply:
4 cross-rails
8 fastening brackets
4 reinforcements
Fixing elements

Characteristics	References
19" fixed uprights	NSYRCK19KIT6G

Optional Locks for Enclosure



NSYAEDLEDF9K33

- With captive key.
- Material: Polyamide handle, metal connecting rods and cam

Supply:
3-point lock with
1 lock button and
1 cremone screw

Characteristics	References
Optional lock for enclosure, EDF 900	NSYAEDLEDF9K33
Optional lock for enclosure, EDF 1300	NSYAEDLEDF13K33
Optional lock for enclosure, EDF 1400	NSYAEDLEDF14K33
Optional lock for enclosure, 1242E	NSYAEDL1242K33
Optional lock for enclosure, 405E	NSYAEDL405K33
Optional lock for enclosure, 455E	NSYAEDL455K33

Local Seismic Standards: Conformity with Acceleration Severity Levels (Only Orientative Values, Not Considered Other Aspects)

Standards	Specifications
EDF book of technical rules CRT 91C11200	Spectrum of response specified: <ul style="list-style-type: none"> • horizontally: <ul style="list-style-type: none"> - acceleration at the floor = 1 g - maximum acceleration. amplified at the center of gravity = 5 g • vertically: <ul style="list-style-type: none"> - acceleration at the floor = 0.8 g - maximum acceleration. amplified at the center of gravity = 4 g
EAK 2000 Greece	Seismic risk zone: IV Importance category: S4
ENDESA 1986	All seismic categories Ground acceleration = 0.5 g
RPA 99 2003 Algeria	All types of soil class Ground acceleration factor A = 0.36 Behavior factor R = 2 Quality factor Q = 1.35
Turkish Seismic Code 2009	All types of site class Importance factor = 1.5 Ground acceleration factor: A0 = 0.4
GOST 17516.1-90 Russia	Civil market: MSK intensity 9, level 3. Nuclear market: MSK intensity 9, level 0
Eurocode 8	All soil types agR = 3 m/s ² Importance factor = 1.3
Core GR 63	Zone 4

Spacial SF 6G for Seismic Risks

Enclosure Equipped with Plain Mounting Plate, Available Depths

Height	Width 300	400	600	800
2200	-	-	800	600 / 800
1800	-	-	600 / 800	600
1600	-	-	600 / 800	600 / 800
1200	-	-	400 / 600	400 / 600

SF Enclosures for Seismic Risks Compatibility Of Accessories

Accessories		SF 6G compatibility	PrismaSet HD 5G compatibility (PrismaSet system)	Comments
Trade references impacted	Description			
NSYSDT●	Folding mounting shelf	Please contact us	Compatible	Depends on size
NSYSDP●M	Metal document holder	Please contact us	Compatible	Depends on size
NSYDPA●●	Plastic document holder	Compatible	Compatible	-
NSYMP●●●	Mounting plate	Compatible	-	Position 200 mm mini from the rear panel
NSYSUCR●●	Universal cross-rail	Compatible	-	-
NSYSQCR●●	Quick cross-rail	Compatible	-	-
NSYSICR●●	Integrated cross-rail	Compatible	-	-
NSYHLCR●●	Cross-rail for heavy loads	Compatible	-	-
NSYSLCR●●	Light cross-rail	Compatible	-	-
NSYFXT●●●●	Fixed Trays	Compatible	-	-
NSYSPMP●	Partial plain mounting plate	Compatible	-	-
NSYSTMP●●	Telequick mounting plate	Compatible	-	-
NSYSDCR●●	Door cable-guide cross-rail	Compatible	Compatible	Select the smaller-sized cross-rail

Spacial SF 6G for Seismic Risks

Cut-Outs

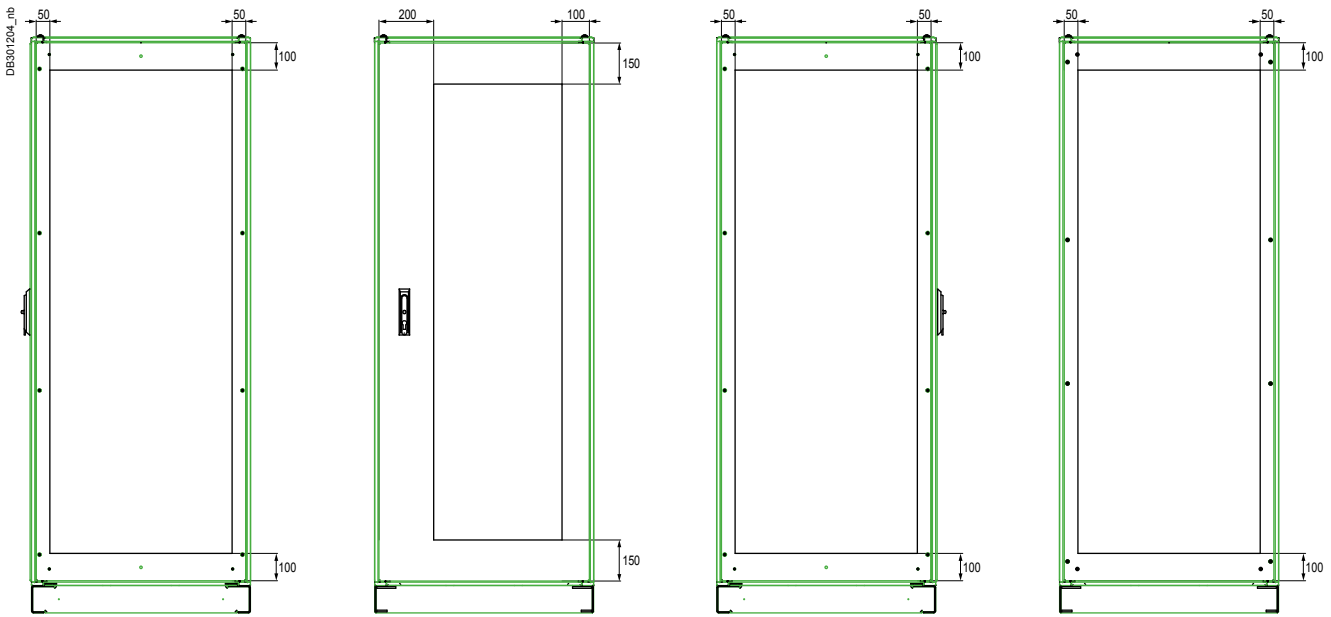

Top View

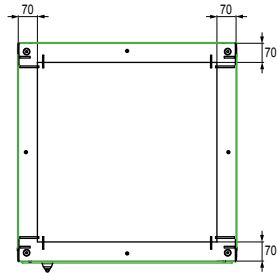

Note:
Customization areas guaranteeing 6G resistance

Spacial S3D 6G Enclosures Are Designed to Withstand Earthquakes up to UBC Zone 4.



11



Strength
Panel thickness:

- Casing + door: 20/10 mm;
- Entry flange: 15/10 mm.



Reinforced Mounting Plate

- Mounting plate reinforcement.
- Increased number of attachment points.



Security Locking System

- EDF 1600 security locking system with captive key.



Wall-Mounted

- Reinforced bracket for wall-mounted.

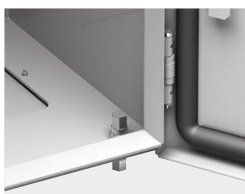

Optional on Request

- Continuity of masses between interior and exterior by 2 studs welded opposite each other.



Decontaminable Smooth Paint PID 100 Series

- Complies with CCTR 91.C.031.08 Double layer of paint (minimum thickness: 60 µ).
- PIA/PIB/PID and PIC REP 100.
- Powder system according to FNP 1125.

Technical changes reserved. Information provided without guarantee. Images are for illustrative purposes only.

Spacial S3D 6G Solutions for Seismic Risks

- Seismic applications up to UBC zone 4.
- Material: Steel
- Ingress protection rating: IP65 according to IEC 60529
- Mechanical protection rating: IK10 according to IEC 62262
- Maximum load: 80 kg/m² on plain mounting plate, 250 kg on 19" fixed uprights
- Standards: IEC 62208 (enclosure) - IEC 60068-3-3 (seismic methods to apply for materials)
- Certifications: 6G certification as per CRT 91-C-112-00 (EDF)

Supply:

Body

- Monobloc casing (cross structure). Gutter-shaped front profile. Flat back
- M6 x 16 earthing screws and earth strap for equipotential connection between the enclosure door and casing
- Entry flange
- Maximum load: 10 kg

Door

- Plain door with EDF 1600 captive key lock
 - H < 600: 1 fastening point
 - H ≥ 600: 3 fastening points
- Non-reversible door (for reversibility, please contact us)
- M6 x 16 earthing screws and earth strap for equipotential connection between the enclosure door and casing
- 120° door opening
- Maximum load: 10 kg

Mounting plate

- Mounting plate galvanized before mounting
- Maximum load: 80 kg/m²
- Two wall-mounted brackets



NSYS3D6G32515P

Characteristics	Height (mm)	Width (mm)	Depth (mm)	References
Spacial S3D seismic plain door with mount.plate	300	250	150	NSYS3D6G32515P
Spacial S3D seismic plain door with mount.plate	400	300	200	NSYS3D6G4320P
Spacial S3D seismic plain door with mount.plate	700	500	250	NSYS3D6G7525P
Spacial S3D seismic plain door with mount.plate	800	600	300	NSYS3D6G8630P
Spacial S3D seismic plain door with mount.plate	1200	800	400	NSYS3D6G12840P

Locks for Enclosure

- < H 600
- With captive key.
- Material: Zamak lock and metal cam

Supply:

- 1- or 3-point lock with 1 lock button and 1 cremone screw



NSYAEDLEDF9K31

Characteristics	Key lock	References
Lock for enclosure	EDF 900	NSYAEDLEDF9K31
Lock for enclosure	EDF 1300	NSYAEDLEDF13K31
Lock for enclosure	EDF 1400	NSYAEDLEDF14K31
Lock for enclosure	1242E	NSYAEDL1242K31
Lock for enclosure	405E	NSYAEDL405K31
Lock for enclosure	455E	NSYAEDL455K31

Locks for Enclosure

- > H 600
- With captive key.
- Material: Polyamide handle, metal connecting rods and cam

Supply:

- 3-point lock with 1 lock button and 1 cremone screw



NSYAEDLEDF9K33

Characteristics	Key lock	References
Lock for enclosure	EDF 900	NSYAEDLEDF9K33
Lock for enclosure	EDF 1300	NSYAEDLEDF13K33
Lock for enclosure	EDF 1400	NSYAEDLEDF14K33
Lock for enclosure	1242E	NSYAEDL1242K33
Lock for enclosure	405E	NSYAEDL405K33
Lock for enclosure	455E	NSYAEDL455K33

Padlocking Lug

- Securing of enclosure access.
- Material: White galvanized steel



NSYAEDLPADS3DK3

Characteristics	References
Padlocking lug	NSYAEDLPADS3DK3

Local Seismic Standards: Conformity with Acceleration Severity Levels, Not Considered Other Aspects

Standards	Specifications
EDF book of technical rules CRT 91C11200	<p>Large equipment" MRI RRS:</p> <p>Horizontal:</p> <ul style="list-style-type: none"> • Floor acceleration = 2 g • Amplified max. acceleration at center of gravity = 5 g <p>Vertical:</p> <ul style="list-style-type: none"> • Floor acceleration = 2.4 g • Amplified max. acceleration at center of gravity = 6 g
EAK 2000 Greece	<p>Seismic risk zone: IV</p> <p>Importance category: S4</p>
ENDESA 1986	<p>All seismic categories</p> <p>Ground acceleration = 0.5 g</p>
RPA 99 2003 Algeria	<p>All types of soil class</p> <p>Ground acceleration factor A = 0.36</p> <p>Behavior factor R = 2</p> <p>Quality factor Q = 1.35</p>
Turkish Seismic Code 2009	<p>All types of site class</p> <p>Importance factor = 1.5</p> <p>Ground acceleration factor: A0 = 0.4</p>
GOST 17516.1-90 Russia	<p>Civil market:</p> <p>MSK intensity 9, level 3.</p>
Eurocode 8	<p>All soil types</p> <p>agR = 3 m/s²</p> <p>Importance factor = 1.3</p>

Table of Compatibility of Accessories in 6G Seismic S3D Enclosures

Accessories		Compatibility	Comments	Trade references impacted
 PE500322_11_nb	19" rack	Limited	Conditions: Drilling by customization department to be provided for	NSYVDM●●●●
 ISPA011_010_43_nb	Door switch	Limited	Conditions: Drilling by customization department to be provided for	NSYINLCRN
 PB500083_29_nb	Diagram holder	Yes	-	NSYDPA●●
 PB500338_24_nb	Lifting rings	Limited	Conditions: Drilling by customization department to be provided for	NSYAELYTCRG8

Comment: None of the accessories is certified 6G.

Table of Compatibility of Accessories in 6G Seismic S3D Enclosures

Accessories		Compatibility	Comments	Trade references impacted
 PE500322_11_nb	19" rack	Limited	Conditions: Drilling by customization department to be provided for	NSYVDM●●●●
 ISPA011_010_43_nb	Door switch	Limited	Conditions: Drilling by customization department to be provided for	NSYINLCRN
 PE500083_20_nb	Diagram holder	Yes	-	NSYDPA●●
 PE500338_24_nb	Lifting rings	Limited	Conditions: Drilling by customization department to be provided for	NSYAELYTCRG8

Comment: None of the accessories is certified 6G.

Special Dimensions

Height	Width					
	250	300	400	500	600	800
1200	-	-	-	-	200/250/300/400	200/250/300/400
1000	-	-	-	-	200/250/300/400	200/250/300/400
800	-	-	200/250/300	200/250/300	200/250/400	200/250/300
700	-	-	200/250/300	200/300	200/250/300/400	-
600	-	-	200/250/300	200/300	200/250/300/400	-
500	200	150/200/250	200/250/300	200/250/300	-	-
400	150/200	150/250	-	-	-	-
300	150/200	150/200/250	-	-	-	-

Cut-Outs

Customization Areas

Door

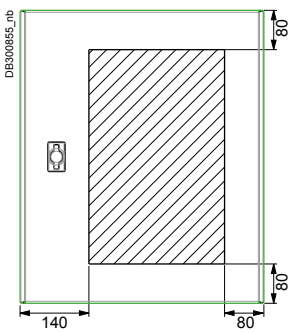

Entry Flange

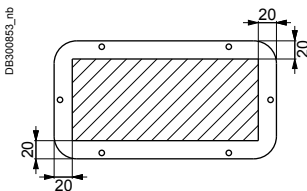

Casing

DB300854_nb

Hinge Side View

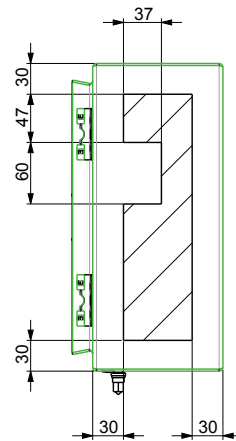

Bottom View

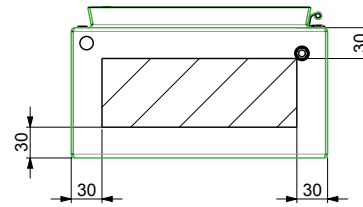

Closing Lock Side View

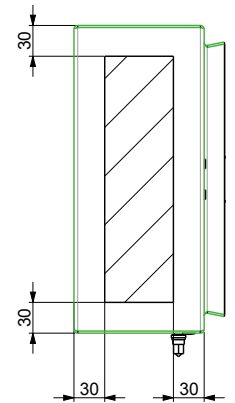



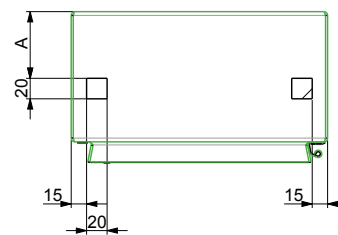

Top View



Depth	A
150	65
200	82
250	98
300	115
400	148

This range can be configured according to your needs

4 different services available:

	
Assemble to Order	Mounting of Standard Accessories
	
Painting	Machining

Spacial SF

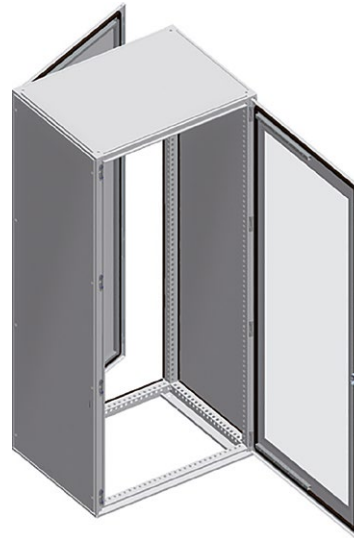

Spacial S3D



Practical

- Cable gland plates at top and bottom:
- On the rear part (2-body enclosure),
- On the body (1-body enclosure).

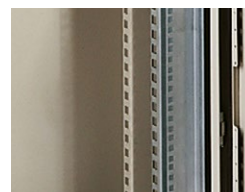

Simplified Installation

- Pre-installed fixed or swing rack; Earth connection placed between the door and the body; The enclosure is ready to use; The cardboard packaging can be reused after cabling.

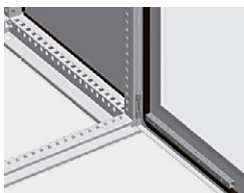

Suitable Metal Enclosure

- Enclosure prepared for the installation of standard 19" racks in professional telecommunication, voice, data and electronic facilities, by means of 19" fixed and swing racks, see [page 411](#).

See [page 474](#) for details or consult our web site www.se.com

Spacial S3D Empty Enclosure

- Single-piece body (cross-shaped structure). Gutter-shaped front profile with double fold. Flat rear.
- Cable gland plate with marking for easy drilling and to guarantee the maximum access surface; Delivered with the enclosure. This plate is flush with the body of the enclosure.
- Glazed door, 4 mm-thick Securit® glass, easily removable and reversible, with 20 mm return with double thickness granting excellent rigidity, opening to 120°, equipped with 2 or 3 invisible hinges (From the height of 800 mm).
- Material: Steel
- Finish: Structured finish, epoxy polyester powder
- Color: RAL 7035 gray
- Ingress protection rating according to IEC 60529: IP66 for the single-door enclosures, IP55 for the double-door enclosures
- Mechanical protection rating according to IEC 62262: IK10 for the plain-door enclosures, IK08 for the glazed-door enclosures
- Maximum load: 50 kg/m²
- Fixing: Direct wall-mounted (4 Ø 10 holes for the sealing plugs guaranteeing the IP) or with the help of fixing lugs installed from the outside (to be ordered separately, see [page 46](#))
- Other characteristics: For heights from 600 mm, three locking points with linkage, with a single control point. Simple reversal of linkage

Delivery includes a handle with two functions:

- Operating key
- Tool for loosening the stud protection caps.

This handle can be solidly attached to the locking system by means of a captive element.

Perforated rails on the door, with drill holes with a diameter of 4.2 mm in steps of 25 mm:

- 2 vertical rails from the height of 400 mm
- 2 vertical rails and 2 horizontal rails from the width of 800 mm

Note:

Door opening to 180° with optional hinges ([page 56](#))

Supply:

Wall-mounted enclosure supplied with 3-mm double-bar lock as standard

Glazed Door



NSYS3D4620T

Characteristics	Fixed rack	Swing rack	Height (mm)	Width (mm)	Depth (mm)	References
Glazed door	NSYVDM8UF	NSYVDM7UP	400	600	200	NSYS3D4620T
Glazed door	NSYVDM8UF	NSYVDM7UP	400	600	250	NSYS3D4625T
Glazed door	NSYVDM12UF	NSYVDM11UP	600	600	200	NSYS3D6620T
Glazed door	NSYVDM12UF	NSYVDM11UP	600	600	250	NSYS3D6625T
Glazed door	NSYVDM12UF	NSYVDM11UP	600	600	300	NSYS3D6630T
Glazed door	NSYVDM12UF	NSYVDM11UP	600	600	400	NSYS3D6640T
Glazed door	NSYVDM17UF	NSYVDM16UP	800	600	200	NSYS3D8620T
Glazed door	NSYVDM17UF	NSYVDM16UP	800	600	250	NSYS3D8625T
Glazed door	NSYVDM17UF	NSYVDM16UP	800	600	300	NSYS3D8630T
Glazed door	NSYVDM17UF	NSYVDM16UP	800	600	400	NSYS3D8640T
Glazed door	NSYVDM21UF	NSYVDM20UP	1000	600	250	NSYS3D10625T
Glazed door	-	-	1000	600	300	NSYS3D10630T
Glazed door	NSYVDM21UF	NSYVDM20UP	1000	600	400	NSYS3D10640T
Glazed door	-	NSYVDM20U8P	1000	800	250	NSYS3D10825T
Glazed door	-	NSYVDM20U8P	1000	800	300	NSYS3D10830T
Glazed door	-	NSYVDM20U8P	1000	800	400	NSYS3D10840T
Glazed door	-	NSYVDM25U8P	1200	800	300	NSYS3D12830T
Glazed door	-	NSYVDM25U8P	1200	800	400	NSYS3D12840T

Plain Door



NSYS3D4620

Characteristics	Fixed rack	Swing rack	Height (mm)	Width (mm)	Depth (mm)	References
Plain door	NSYVDM8UF	NSYVDM7UP	400	600	200	NSYS3D4620
Plain door	NSYVDM8UF	NSYVDM7UP	400	600	250	NSYS3D4625
Plain door	NSYVDM12UF	NSYVDM11UP	600	600	200	NSYS3D6620
Plain door	NSYVDM12UF	NSYVDM11UP	600	600	250	NSYS3D6625
Plain door	NSYVDM12UF	NSYVDM11UP	600	600	300	NSYS3D6630
Plain door	NSYVDM12UF	NSYVDM11UP	600	600	400	NSYS3D6640
Plain door	NSYVDM17UF	NSYVDM16UP	800	600	200	NSYS3D8620
Plain door	NSYVDM17UF	NSYVDM16UP	800	600	250	NSYS3D8625
Plain door	NSYVDM17UF	NSYVDM16UP	800	600	300	NSYS3D8630
Plain door	NSYVDM17UF	NSYVDM16UP	800	600	400	NSYS3D8640
Plain door	NSYVDM21UF	NSYVDM20UP	1000	600	250	NSYS3D10625
Plain door	-	-	1000	600	300	NSYS3D10630
Plain door	NSYVDM21UF	NSYVDM20UP	1000	600	400	NSYS3D10640
Plain door	-	NSYVDM20U8P	1000	800	250	NSYS3D10825
Plain door	-	NSYVDM20U8P	1000	800	300	NSYS3D10830
Plain door	-	NSYVDM20U8P	1000	800	400	NSYS3D10840
Plain door	-	NSYVDM25U8P	1200	800	300	NSYS3D12830
Plain door	-	NSYVDM25U8P	1200	800	400	NSYS3D12840

Spacial S3D Fixed Rack (Racks to Be Ordered Separately)

- 19" fixed chassis composed by 2 19" uprights with fixing hardware.
- Thickness: 20/10° mm.
- Material: Galvanized steel
- Maximum load: 3 kg per unit

Note:

Adjustable in depth by fixing on the step slides in accessories (see [page 46](#)).

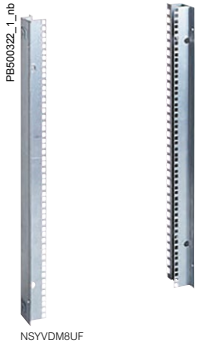

Characteristics	Number of U	Height (mm)	Width (mm)	Depth (mm)	References
Fixed rack	8	400	600	200	NSYVDM8UF
Fixed rack	8	400	600	250	NSYVDM8UF
Fixed rack	12	600	600	200	NSYVDM12UF
Fixed rack	12	600	600	250	NSYVDM12UF
Fixed rack	12	600	600	300	NSYVDM12UF
Fixed rack	12	600	600	400	NSYVDM12UF
Fixed rack	17	800	600	200	NSYVDM17UF
Fixed rack	17	800	600	250	NSYVDM17UF
Fixed rack	17	800	600	300	NSYVDM17UF
Fixed rack	17	800	600	400	NSYVDM17UF
Fixed rack	21	1000	600	250	NSYVDM21UF
Fixed rack	21	1000	600	400	NSYVDM21UF

Spacial S3D Swing Rack (Racks to Be Ordered Separately)

- 19" swing chassis opening to 120° with locking system by 3-mm double-bar insert.
- Material: Steel
- Finish: Epoxy polyester powder
- Color: RAL 7035 gray
- Maximum load: 3 kg per unit



Characteristics	Number of U	Height (mm)	Width (mm)	Depth (mm)	References
Swing rack	11	600	600	200	NSYVDM11UP
Swing rack	11	600	600	250	NSYVDM11UP
Swing rack	11	600	600	300	NSYVDM11UP
Swing rack	11	600	600	400	NSYVDM11UP
Swing rack	16	800	600	200	NSYVDM16UP
Swing rack	16	800	600	250	NSYVDM16UP
Swing rack	16	800	600	300	NSYVDM16UP
Swing rack	16	800	600	400	NSYVDM16UP
Swing rack	20	1000	600	250	NSYVDM20UP
Swing rack	20	1000	600	400	NSYVDM20UP
Swing rack	20	1000	800	250	NSYVDM20U8P
Swing rack	20	1000	800	300	NSYVDM20U8P
Swing rack	20	1000	800	400	NSYVDM20U8P
Swing rack	25	1200	800	300	NSYVDM25U8P
Swing rack	25	1200	800	400	NSYVDM25U8P

Spacial SF 19" Electronic Enclosure

- Structure: Top and bottom frame and vertical uprights.
- Transparent front door with Securit® glass.
- Plain rear door.
- Standard locking system with handle and 5-mm double-bar insert.
- Removable roof.
- External fixing of double-folded side panels to increase rigidity, captive fixing screws that reduce installation time.
- In enclosures with widths of 600 and 800 mm, it is possible to install fixed or swing racks, to be ordered separately.
- Material: Steel
- Finish: Structured finish, epoxy polyester powder
- Color: RAL 7035 gray
- Certifications: UL (cULus) Rated type 1 and 12 according to UL50E

For more details see [page 418](#)

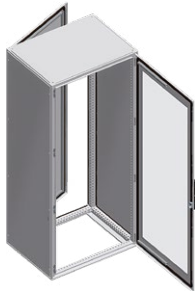

NSYSF12660E

Characteristics	Height (mm)	Width (mm)	Depth (mm)	References
Spacial SF 19" electronic enclosure	1200	600	600	NSYSF12660E
Spacial SF 19" electronic enclosure	1200	600	800	NSYSF12680E
Spacial SF 19" electronic enclosure	1200	800	600	NSYSF12860E
Spacial SF 19" electronic enclosure	1200	800	800	NSYSF12880E
Spacial SF 19" electronic enclosure	2000	600	600	NSYSF20660E
Spacial SF 19" electronic enclosure	2000	600	800	NSYSF20680E
Spacial SF 19" electronic enclosure	2000	800	600	NSYSF20860E
Spacial SF 19" electronic enclosure	2000	800	800	NSYSF20880E
Spacial SF 19" electronic enclosure	2000	800	1000	NSYSF208100E
Spacial SF 19" electronic enclosure	2200	600	600	NSYSF22660E
Spacial SF 19" electronic enclosure	2200	600	800	NSYSF22680E
Spacial SF 19" electronic enclosure	2200	600	1000	NSYSF226100E
Spacial SF 19" electronic enclosure	2200	800	600	NSYSF22860E
Spacial SF 19" electronic enclosure	2200	800	800	NSYSF22880E
Spacial SF 19" electronic enclosure	2200	800	1000	NSYSF228100E

Single Ventilated Door for 19" Racks

- Door designed to achieve natural airing of the enclosure.
- Installation on enclosures with a width of 800 mm, equipped with centered fixed or swing racks. Opening of 120°.
- Standard locking system with handle and 5-mm double-bar insert.
- Material: Steel
- Finish: Structured finish, epoxy polyester powder
- Color: RAL 7035 gray

Supply:
1 ventilated door for racks



NSYPCVD126

Characteristics	Height (mm)	Width (mm)	References
Single ventilated door	1200	600	NSYPCVD126
Single ventilated door	1200	800	NSYPCVD128
Single ventilated door	1800	800	NSYPCVD188
Single ventilated door	2000	600	NSYPCVD206
Single ventilated door	2000	800	NSYPCVD208
Single ventilated door	2200	600	NSYPCVD226
Single ventilated door	2200	800	NSYPCVD228

Front and Rear Plinths

- The front and rear of the plinth consists of 4 corners with 2 or 4 panels.
- Material: Folded sheet steel, corner with a thickness of 25/10° mm
- Finish: Epoxy polyester paint
- Color: RAL 7022 gray
- Ingress protection rating: IP30 according to IEC 60529
- Mechanical protection rating: IK10 according to IEC 62262

Note:

For more information see [page 89](#)

Supply:

Height 100 mm: 4 corners, 2 panels (front and rear), 4 corner covers and fixing elements. Height 200 mm: 4 corners, 4 panels (2 front and 2 rear), 4 corner covers and fixing elements



Characteristics	Width (mm)	Height (mm)	References
Front plinths for Spacial	600	100	NSYSPF6100
Front plinths for Spacial	800	100	NSYSPF8100
Front plinths for Spacial	600	200	NSYSPF6200
Front plinths for Spacial	800	200	NSYSPF8200

Plinth Side Panels

- They are fixed to the corner of the plinth by 2 fixing screws.
- Folded sheet steel
- Finish: Epoxy polyester paint
- Color: RAL 7022 gray
- Ingress protection rating: IP30 according to IEC 60529
- Mechanical protection rating: IK10 according to IEC 62262

Supply:

Height 100 mm: 2 side panels, 4 corner covers and fixing elements. Height 200 mm: 4 side panels (height of 100 mm, 2 for each side), 4 corner covers and fixing elements



Characteristics	Depth (mm)	Height (mm)	References
Side plinths for Spacial	600	100	NSYSPS6100
Side plinths for Spacial	800	100	NSYSPS8100
Side plinths for Spacial	1000	100	NSYSPS10100
Side plinths for Spacial	600	200	NSYSPS6200
Side plinths for Spacial	800	200	NSYSPS8200
Side plinths for Spacial	1000	200	NSYSPP10200

Ventilated Front Plinth



- The front and rear of the ventilated plinth is made up of 4 corners with 2 front panels.
- Material: Folded sheet steel, corner with a thickness of 25/10° mm
- Finish: Structured finish, epoxy polyester powder
- Color: RAL 7022 gray
- Ingress protection rating: IP20 according to IEC 60529
- Mechanical protection rating: IK10 according to IEC 62262

Supply:
Height 100 mm: 4 corners, 2 ventilated panels (front and rear), 4 corner covers and fixing elements

Characteristics	Height (mm)	Width (mm)	References
Ventilated front plinth for Spacial SF-SM	100	600	NSYSPFV6100
Ventilated front plinth for Spacial SF-SM	100	800	NSYSPFV8100

Ventilated Side Panels

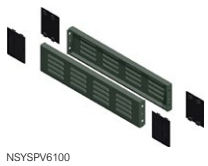

- They are fixed to the corner of the plinth by fixing screws.
- Material: Folded sheet steel
- Finish: Structured finish, epoxy polyester powder
- Color: RAL 7022 gray
- Ingress protection rating: IP20 according to IEC 60529
- Mechanical protection rating: IK10 according to IEC 62262

Supply:
Height 100 mm: 2 ventilated side panels, 4 corner covers and fixing elements

Characteristics	Height (mm)	Depth (mm)	References
Ventilated side panels for Spacial SF-SM	100	600	NSYSPV6100
Ventilated side panels for Spacial SF-SM	100	800	NSYSPV8100

Plain Cable Gland Plate

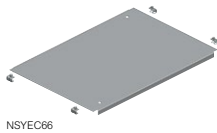

- The design of the compact cable gland plate, coupled with the use of the sealing gasket **NSYCEK** enable the maximum dust/water tightness.
- Material: Galvanized steel
- Thicknesses: 15/10° mm

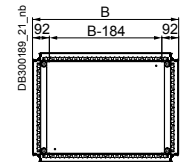

Supply:
Plain plate and fixing elements

Characteristics	(B) Width (mm)	(C) Depth (mm)	References
Spacial SF Plain cable gland plate	600	600	NSYEC66
Spacial SF Plain cable gland plate	600	800	NSYEC68
Spacial SF Plain cable gland plate	600	1000	NSYEC610
Spacial SF Plain cable gland plate	800	600	NSYEC86
Spacial SF Plain cable gland plate	800	800	NSYEC88
Spacial SF Plain cable gland plate	800	1000	NSYEC810

Plate with 1 Entry



- Facilitates the entry of cables thanks to a longitudinal opening.
- Material: Galvanized steel
- Thicknesses: 15/10° mm

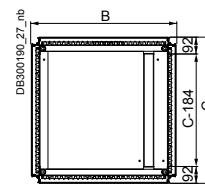

Enclosures of 300 and 400 mm width.

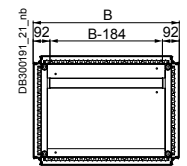

Enclosures of 600, 800, 1000 and 1200 mm width.

Supply:
Plate with 1 entry; Self-extinguishing polyurethane adhesive gasket with cross-section of 15 x 25 mm (guarantees good sealing) and fixing elements

Characteristics	(B) Width (mm)	(C) Depth (mm)	References
Spacial SF Plate with 1 entry	600	600	NSYEC661
Spacial SF Plate with 1 entry	600	800	NSYEC681
Spacial SF Plate with 1 entry	600	1000	NSYEC6101
Spacial SF Plate with 1 entry	800	600	NSYEC861
Spacial SF Plate with 1 entry	800	800	NSYEC881
Spacial SF Plate with 1 entry	800	1000	NSYEC8101

Plate with 2 Entries

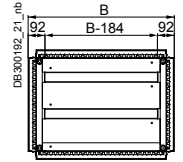

- Cable entry for very deep enclosures (600 and 800 mm).
- Two longitudinal openings allowing a large number of cables through.
- Material: Galvanized steel
- Thicknesses: 15/10^e mm

Supply:

1 plate with 2 entries; Polyurethane adhesiv gasket with cross-section of 15 x 25 mm (guarantee good sealing) and fixing elements



NSYEC662

Characteristics	(B) Width (mm)	(C) Depth (mm)	References
Spacial SF Plate with 2 entries	600	600	NSYEC662
Spacial SF Plate with 2 entries	600	800	NSYEC682
Spacial SF Plate with 2 entries	600	1000	NSYEC6102
Spacial SF Plate with 2 entries	800	600	NSYEC862
Spacial SF Plate with 2 entries	800	800	NSYEC882
Spacial SF Plate with 2 entries	800	1000	NSYEC8102

Actassi Plain Plate for Roof

- Removable plate made from folded sheet steel
- Option of installing roof elevators for aeration, ref. **NSYEX206**, and cable glands
- Material: Steel
- Finish: Structured finish, epoxy polyester powder
- Color: RAL 7035 gray

Supply:
1 plain plate and fixing elements



NSYTSPC450

Characteristics	References
Actassi plain plate for roof	NSYTSPC450

Actassi Plate with Brush Gasket for Roof

- Removable folded sheet steel plate, equipped with a gasket with cable gland brush
- Optional installation of roof elevators for aeration, ref. **NSYEX206**, and cable gland plates
- Material: Steel
- Finish: Structured finish, epoxy polyester powder
- Color: RAL 7035 gray

Supply:
1 plate with brush gasket and fixing elements



NSYTSP450

Characteristics	References
Actassi plate with brush gasket for roof	NSYTSP450

Roof Plate Elevators for Aeration

- Columns with a height of 20 mm.
- Fixing: Between the roofplate and the roof.

Supply:
100 units. Reference by unit.
Order by multiples of 100 (100, 200, 300...).



NSYEX206

Characteristics	References
Roof plate elevators for aeration	NSYEX206

Actassi Ventilated Support with Filter

- Fixing: To be mounted on the cable gland plate with or without fan or on the self-ventilated cable gland plate.
- Color: RAL 9011

Supply:
1 mounting support and filter



NSYFECVT440

Characteristics	References
Actassi ventilated support with filter	NSYFECVT440

Actassi Plain Cable Gland Plate

- Material: Galvanized steel
- Fixing: Fixing on the outside of the roof and bottom support plate
Can be combined with other types of cable gland plates

Supply:
1 plain cable gland plate and fixing elements



NSYEC440

Characteristics	References
Actassi plain cable gland plate	NSYEC440

Actassi Cable Gland Plate with Brush

- Material: Galvanized steel
- Fixing: Fixing on the outside of the roof and bottom support plate
Can be combined with other types of cable gland plates

Supply:
1 cable gland plate with brush and fixing elements



NSYEC440

Characteristics	References
Actassi cable gland plate with brush	NSYEC440

Actassi Self-Ventilated Cable Gland Plate

- Material: Galvanized steel
- Fixing: Fixing on the outside of the roof and bottom support plate
Can be combined with other types of cable gland plates

Supply:
1 self-ventilated cable gland plate and fixing elements



NSYEC4V440

Characteristics	References
Actassi self-ventilated cable gland plate	NSYEC4V440

Actassi Airing Plate with or without Fans, Symbol Diameter Before 120 mm

- Fixing: Fixing on the outside of the roof and bottom support plate
Can be combined with other types of cable gland plates
- Other characteristics: Sound level: 34 dB (A)

Supply:
1 cable gland plate with or without fans, 2-m power cord (version with fans) and fixing elements
Versions with 2 or 3 fans: Each of them has an output capacity of 170 m³/h, 220 V-50/60 Hz, installed and wired to a terminal strip. A 2-m power cord is supplied connected



NSYECVT3V440

Characteristics	Description	References
Actassi airing plate with or without fans, symbol diameter before 120 mm	With 3 fans	NSYECVT3V440
Actassi airing plate with or without fans, symbol diameter before 120 mm	With 2 fans	NSYECVT2V440

Top frame - 3 blanking plates					
Width	Depth	Example 1	Example 2	Example 3	Example 4
600 mm 800 mm	600 mm 800 mm 1000 mm	<p>400 mm</p>	<p>400 mm</p>	<p>400 mm</p>	<p>400 mm</p>
Cut-out = 400 x 450 mm					
Top frame - 2 Blanking plates					
Width	Depth	Example 1	Example 2	Example 3	Example 4
600 mm 800 mm	600 mm	<p>400 mm</p>	<p>400 mm</p>	<p>400 mm</p>	<p>400 mm</p>
Cut-out = 400 x 300 mm					

Technical changes reserved. Information provided without guarantee. Images are for illustrative purposes only.

Ventilated Roof



NSYSVR608

- Roof for providing natural airing for the enclosure, with IP30 protection.
- Height: An extra 63 mm in relation to the structure.
- Material: Steel
- Finish: Structured finish, epoxy polyester powder
- Color: RAL 7035 gray

Supply:
1 ventilated roof and fixing elements

Characteristics	Width (mm)	Depth (mm)	References
Spacial SF Ventilated roof	600	800	NSYSVR608
Spacial SF Ventilated roof	800	800	NSYSVR808

Partial 19" Fixed Rack

- Rack designed for coupling in enclosures with a width of 600 mm.
- Adjustable depth with a pitch of 25 mm.
- Material: Zinc-coated steel
- Maximum load: 2 kg/U

Installation:

- **Spacial SF:** Installation at the top front of the enclosure, no cross-rails needed⁽¹⁾
- Depth adjustment of the partial rack: two cross-rails need to be installed, see [page 237](#)
- For installation at any other height, four cross-rails are required⁽²⁾

Spacial SM:

- At the front of the enclosure⁽¹⁾: Install two front vertical adaptation profiles, see [page 239](#)
- For depth adjustment⁽²⁾: Install two front vertical adaptation profiles, see [page 239](#) and two rear vertical 40 mm (1 row) cross-rails and four cross-rails, see [page 237](#)

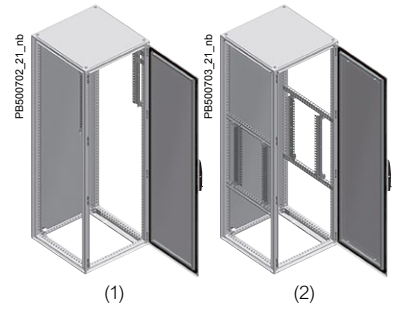

Supply:
2 uprights and fixing elements

Characteristics	No. of units	Height (mm)	References
Partial 19" fixed rack	4	200	NSYRCKP4
Partial 19" fixed rack	8	400	NSYRCKP8
Partial 19" fixed rack	12	600	NSYRCKP12
Partial 19" fixed rack	17	800	NSYRCKP17
Partial 19" fixed rack	21	1000	NSYRCKP21
Partial 19" fixed rack	26	1200	NSYRCKP26



NSYRCKP4

19" Fixed Rack

- Rack designed for installation in enclosures with a width of 600 mm.
- Adjustable depth with a pitch of 25 mm.
- Material: Zinc-coated steel
- Maximum load: 400 kg for 4 uprights
- Maximum load: 200 kg for 2 uprights

Installation:

Spacial SF:

- Direct fixing on the structure of the enclosures:
- For installation on enclosures with a width of 800 mm, use the 19" fixed-rack support brackets,
- To reinforce the rigidity of the uprights in enclosures with a width of 800 mm, it is advisable to use the central fixing kit, for enclosure heights above 1800 mm, ref. **NSYRCK19KIT**.

Spacial SM:

- Fixing on the top/bottom adjustment rails.

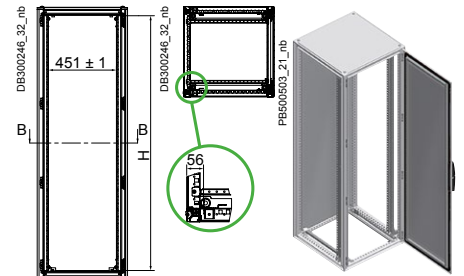

Supply:
2 uprights and fixing elements

Characteristics	No. of units	Height (mm)	References
19" fixed rack	24	1200	NSYRCK24
19" fixed rack	29	1400	NSYRCK29
19" fixed rack	33	1600	NSYRCK33
19" fixed rack	38	1800	NSYRCK38
19" fixed rack	42	2000	NSYRCK42
19" fixed rack	47	2200	NSYRCK47

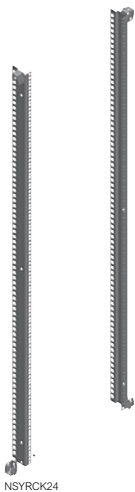

NSYRCK24

Support Brackets for 19" Fixed Rack with a Width of 800 mm

- Support brackets for coupling the fixed rack to enclosures with a width of more than 600 mm.
- They allow the depth of the fixed rack to be adjusted with a pitch of 25 mm.
- The fixed sizes are delivered in pairs.
- Material: Zinc-coated steel
- Maximum load: 400 kg

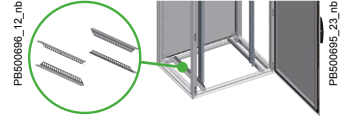

NSYRCKS6

Characteristics	Depth (mm)	References
Support brackets for 19" fixed rack	600	NSYRCKS6
Support brackets for 19" fixed rack	800	NSYRCKS8
Support brackets for 19" fixed rack	1000	NSYRCKS10

Supply:
4 support brackets and fixing elements

Side Plates of the Centered Fixed Rack for a Width of 800 mm

- Side plates for coupling to the fixed rack in enclosures with a width of 800 mm.
- Direct installation on the rack by screws.
- The fixed sizes are delivered in pairs.
- Material: Steel
- Finish: Structured finish, epoxy polyester powder
- Color: RAL 7035 gray

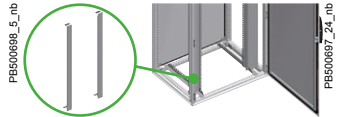

NSYRC12

Characteristics	Height (mm)	References
Side plates of the centered fixed rack	1200	NSYRC12
Side plates of the centered fixed rack	1800	NSYRC18
Side plates of the centered fixed rack	2000	NSYRC20
Side plates of the centered fixed rack	2200	NSYRC22

Supply:
2 side plates and fixing elements

Central Fixing Kit

- To reinforce the rigidity of the 19" fixed racks in enclosures with a width of 800 mm.
- Fixing to the enclosure by cross-rails or light cross-rails installed depthwise. See [page 238](#).
- Material: Zinc-coated steel

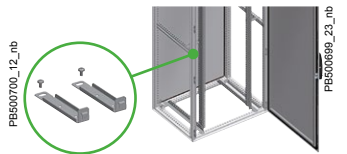

NSYRCK19KIT

Characteristics	References
Central fixing kit	NSYRCK19KIT

Supply:
2 supports and fixing elements

Partial 19" Swing Rack for 600 and 800 mm Enclosures

- Rack for coupling to enclosures with widths of 600 and 800 mm.
- In enclosures with a width of 800 mm, the rack can be installed centered or off-center.
- Maximum opening: 120°.
- Reversible opening direction: Left/right.
- Locking system, top and bottom, with 5-mm double-bar key.
- The 6 and 9 units racks only with bottom lock.
- Maximum equipment installation depth: 180 mm, in enclosures with a width of 600 mm.
- Material: Zinc-coated steel

Installation:

Spacial SF:

- To install at the front at any height of the enclosure: directly to the framework by rack fixing elements
- For depth adjustment: Install two (for top height) or four (for any height) 65 mm (2 rows) cross-rails, see [page 237](#)

Spacial SM:

- To install at the front at any height of the enclosure: install two front vertical adaptation profiles, see [page 239](#)
- For depth adjustment: Install two front vertical adaptation profiles, see [page 239](#) and two rear vertical 40 mm cross-rails and four 65 mm (2 rows) cross-rails, see [page 237](#)
- Maximum load: 2 kg/U

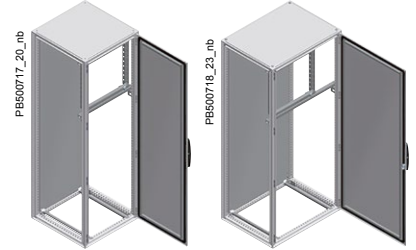

For more details see [page 418](#)

⁽¹⁾ Optional installation in enclosures with height of 1200 mm.

Supply:

1 partial 19" swing rack



NSYRSWP6

Characteristics	No. of units (H)	Height (mm)	References
Partial 19" swing rack	6	355	NSYRSWP6
Partial 19" swing rack	9	468	NSYRSWP9
Partial 19" swing rack	12	601	NSYRSWP12
Partial 19" swing rack	15	735	NSYRSWP15
Partial 19" swing rack	18	868	NSYRSWP18
Partial 19" swing rack ⁽¹⁾	21	1002	NSYRSWP21

Partial 19" Swing Rack Support for 600 and 800 mm Enclosures

- Supports for coupling the partial swing rack to enclosures with widths of 600 and 800 mm.
- Height or depth adjustment, with a pitch of 25 mm, by two 65 mm (2 rows) universal cross-rails and a 19" multiple bracket, ref. **NSYMBR19**.
- Spacial SF: Direct fixing to the structure.
- Spacial SM: Fixing to the enclosure by means of the vertical adaptation profile, see [page 239](#).
- Material: Zinc-coated steel

Installation:

- Installation of the rack in centered or off-center position, for enclosures with a width of 800 mm

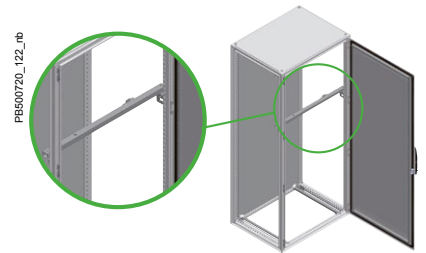

Supply:

2 supports and fixing elements



NSYRSWSP6

Characteristics	Width (mm)	References
Partial 19" swing rack support	600	NSYRSWSP6
Partial 19" swing rack support	800	NSYRSWSP8

19" Multiple Bracket

- Bracket for fixing 65 mm universal cross-rails (2 rows), depthwise, to position the partial 19" swing rack in any direction, up and down and/or depthwise.
- Material: Zinc-coated steel.

Supply:

4 brackets and fixing elements



NSYMBR19

Characteristics	Width (mm)	References
19" multiple bracket	600	NSYMBR19

19" Swing Rack for 600 mm Enclosures

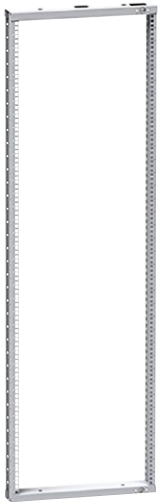

NSYRSW636

- To be coupled to enclosures with widths of 600 mm.
- Can be moved depthwise with a pitch of 25 mm.
- Reversible opening direction: Left/right.
- Locking system, top and bottom, with 5-mm double-bar key.
- Maximum opening: 130°.
- Maximum equipment installation depth: 180 mm.
- Not compatible with 120° mechanical retainer **NSYRCDR12**

Fixing to the enclosure structure:

Spacial SF:

- Fixing to the enclosure structure.

Spacial SM:

- Fixing to the enclosure on top/bottom adjustment rails.

Components:

- Zinc-coated steel central structure.
- Mounting cross-rail on structure made from steel painted with epoxy polyester resin, textured RAL 7035 gray. Fixed to the central structure by screws.

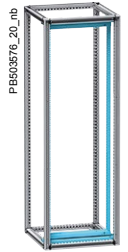

PB603576_20L_nb

For more details see [page 418](#)

Supply:

1 19" swing rack with no panels

Characteristics	No. of units (H)	Height (mm)	References
19" swing rack	36	1800	NSYRSW636
19" swing rack	40	2000	NSYRSW640
19" swing rack	45	2200	NSYRSW645

19" Swing Rack for 800 mm Enclosures, Off-Center



NSYRSW27

- To be coupled to enclosures with widths of 800 mm.
- Can be moved depthwise with a pitch of 25 mm.
- Reversible opening direction: Left/right.
- Locking system, top and bottom, with 5-mm double-bar key.
- Maximum opening: 130° (option of opening to 180° using 180° hinges).
- Material: Zinc-coated steel and steel painted
- Maximum load: 3.75 kg/unit with a max of 150 kg

Installation:

- Spacial SF - SM
- Other mounting options: Consult us

Maximum equipment installation depth:

- Off-center 19" swing rack: 470 mm
- Centered 19" swing rack: 390 mm

Fixing to the enclosure structure:

- Spacial SF: Fixing to the entire height of the enclosure structure.
- Spacial SM: Fixing to the enclosure on top/bottom adjustment rails.

Components:

- Zinc-coated steel central structure.
- Mounting cross-rail on structure made from steel painted with epoxy polyester resin, textured RAL 7035 gray.
- Fixed to the central structure by screws.
- Side plate made from steel painted with epoxy polyester resin, textured RAL 7035 gray. Fixed to the central structure by screws.

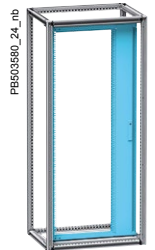

PB603580_24_nb

For more details see [page 418](#)

Spare handle:

Order ref. **NSYTEDB5ML** (handle) + **NSYTMME** (blind barrel).

Supply:

Centered and off-center 19" swing rack: hinged rack, 800 mm swing rack supports, side plates with locking system double-bar and fixing elements

Characteristics	No. of units (H)	Height (mm)	References
19" swing rack, off-center	27	1400	NSYRSW27
19" swing rack, off-center	31	1600	NSYRSW31
19" swing rack, off-center	36	1800	NSYRSW36
19" swing rack, off-center	40	2000	NSYRSW40
19" swing rack, off-center	45	2200	NSYRSW45

19" Swing Rack for 800 mm Enclosures, Centered

- To be coupled to enclosures with widths of 800 mm.
- Can be moved depthwise with a pitch of 25 mm.
- Reversible opening direction: Left/right.
- Locking system, top and bottom, with 5-mm double-bar key.
- Maximum opening: 130° (option of opening to 180° using 180° hinges).
- Material: Zinc-coated steel and steel painted
- Maximum load: 3.75 kg/unit with a max of 150 kg

Installation:

- Spacial SF - SM
- Other mounting options: Consult us

Maximum equipment installation depth:

- Off-center 19" swing rack: 470 mm
- Centered 19" swing rack: 390 mm

Fixing to the enclosure structure:

- Spacial SF: Fixing to the entire height of the enclosure structure.
- Spacial SM: Fixing to the enclosure on top/bottom adjustment rails.

Components:

- Zinc-coated steel central structure.
- Mounting cross-rail on structure made from steel painted with epoxy polyester resin, textured RAL 7035 gray.
- Fixed to the central structure by screws.
- Side plate made from steel painted with epoxy polyester resin, textured RAL 7035 gray. Fixed to the central structure by screws.

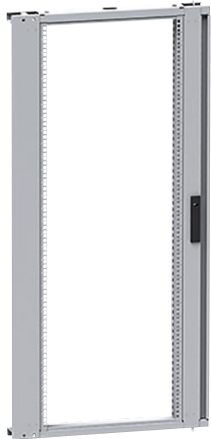

NSYRSWC36

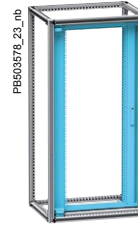

PB500578_23_nb

For more details see [page 418](#)

Supply:

Centered and off-center 19" swing rack: hinged rack, 800 mm swing rack supports, side plates with locking system double-bar and fixing elements

Characteristics	No. of units (H)	Height (mm)	References
19" swing rack, centered	36	1800	NSYRSWC36
19" swing rack, centered	40	2000	NSYRSWC40
19" swing rack, centered	45	2200	NSYRSWC45

180° Hinge

- Hinge for installation on centered and off-center 19" swing racks.
- Allows the swing rack to be opened to 180°.
- Fixing by M8 screws directly to the swing rack.
- Material: Zamak 5

Maximum equipment installation depth:

- Off-center 19" swing rack: 425 mm,
- Centered 19" swing rack: 345 mm.



NSYRSWH180

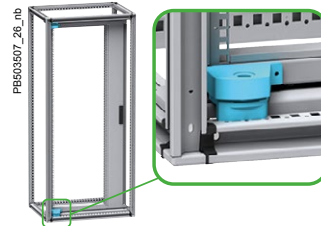

PB500507_26_nb

Supply:

2 hinges and fixing elements

Characteristics	References
180° hinge	NSYRSWH180

1 U / 3 U Support

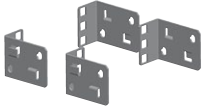

NSYRC1U

- Support prepared for installing equipment 1 U or 3 U high.
- Designed with quick-locking for easy installation.
- **Spacial SF:** Direct fixing to the structure.
- **Spacial SM:** Fixing to the enclosure by means of the vertical adapter section, see [page 239](#).
- Material Zinc-coated steel

Characteristics

1 U / 3 U support

References

NSYRC1U

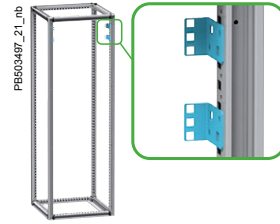

For more details see [page 418](#)

Supply:

4 1 U/3 U supports (2 units right and 2 units left) and fixing elements

19" Partial Single Slides



NSYGB140

- Rails for installation on fixed or swing racks.
- Direct fixing on the structure of the enclosure, by quick-locking.
- Material: Zinc-coated steel
- Thickness: 12/10e mm
- Maximum load: 15 kg

Characteristics

19" partial single slides

References

NSYGB140

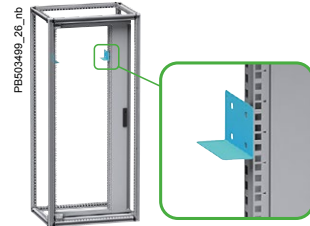

Supply:

2 rails and fixing elements

Fixing of Cable Ducts on 19" Racks



NSYRCDFIX

- Allows vertical fixing of cable ducts for cable guide.
- Service depth: 150 mm.
- Fixed by quick-locking to the 19" rack profile.
- Material: Zinc-coated steel

Characteristics

Fixing of cable ducts on 19" racks

References

NSYRCDFIX

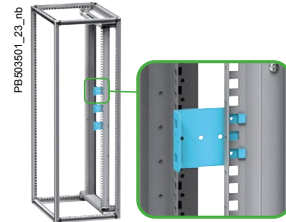

Supply:

3 units and fixing elements

Rear Cable-Guide Support



NSYRCSUP15

- Supports used for installation on the rear of the swing racks.
- Suitable for fixing cable-guide accessories.
- Allow vertical fixing of cable ducts: Adjustable depth with a pitch of 44.45 mm.
- Material: Zinc-coated steel

Characteristics

Rear cable-guide support	150	NSYRCSUP15
Rear cable-guide support	250	NSYRCSUP25

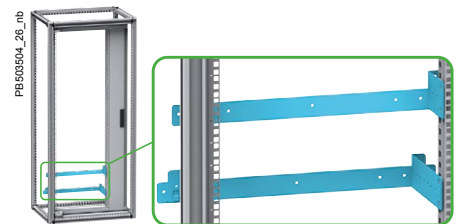

Supply:

2 cable-guide supports, crossbar and fixing elements

120° Mechanical Retainer

- Retainer for installation on the swing racks.
- Maximum opening: 120°.
- Not compatible with the 19" swing racks for 600 mm enclosures (NSYRSW6*)

Fixing:

Direct fixing to the rack support and the 19" rack



NSYRCDR12

Supply:

1 mechanical door stop and fixing elements

Characteristics	References
120° mechanical retainer	NSYRCDR12

180° Pneumatic Retainer

- Retainer for installation on the swing racks installed with 180° hinges, in enclosures with a depth of 600, 800 or 1000 mm.
- Maximum opening: 180°.

Fixing:

Spacial SF:

Fixing to the base of the structure and to the rack.

Spacial SM:

Direct fixing to the rack support and to the 19" rack.



NSYRCDR18

Supply:

1 pneumatic door stop and fixing elements

Characteristics	References
180° pneumatic retainer	NSYRCDR18

Flat Escutcheon for Swing 19" Rack



NSYRCLOCK

- Flat escutcheon with 5-mm double-bar insert lock, for installation on swing 19" racks

Supply:

1 flat escutcheon, 5-mm double-bar insert and fixing elements

Characteristics	References
Flat escutcheon for swing 19" rack	NSYRCLOCK

Switch for Swing 19" Rack

- Switch for direct fixing on the bottom or top support of the swing rack.
- M20 connection.
- NO + NC contact, 10 A/500 V.



NSYRCINT

Supply:

1 19" rack switch and fixing elements

Characteristics	References
Switch for swing 19" rack	NSYRCINT

Fixings for 19" Rack

- They allow 19" accessories to be mounted.
- Caged nut compatible with 8.5 x 8.5 mm and 9.5 x 9.5 mm holes.



NSYGFR95M63



Characteristics	Set of	References
M6 screws + washers + nuts	30	NSYGFR95M63
M6 x 16 screws and washers	50	NSYGFR166P
M6 caged nuts	100	NSYCN9M625
M6 screws + washers + nuts	50	NSYGFR95M65
M5 screws + washers + nuts	50	NSYGFR95M55

Spacial SF 19" Electronic Enclosure

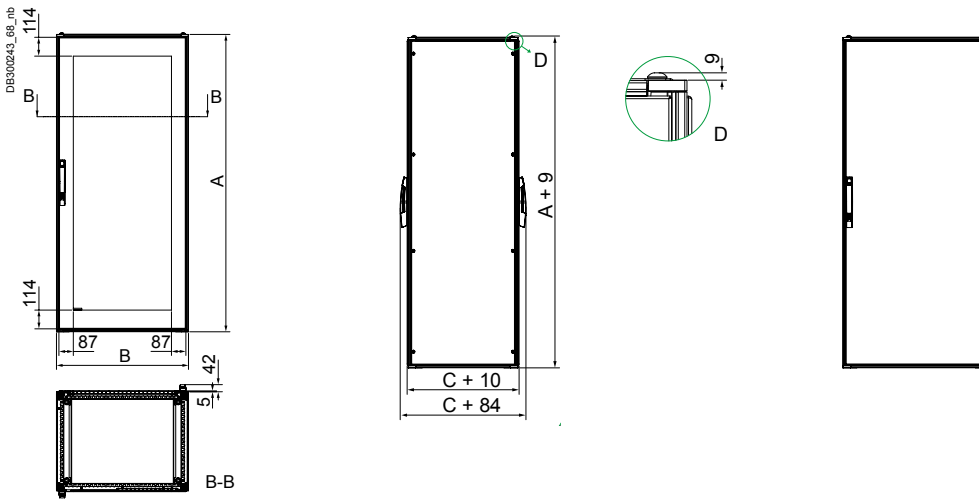

Partial 19" Swing Rack for 600 and 800 mm Enclosures



Partial 19" Swing Rack for Enclosures with a Width of 600 mm

Partial 19" Swing Rack, Off-Centered, Centered, for Enclosures with a Width of 800 mm

19" Swing Rack for 600 mm Enclosures

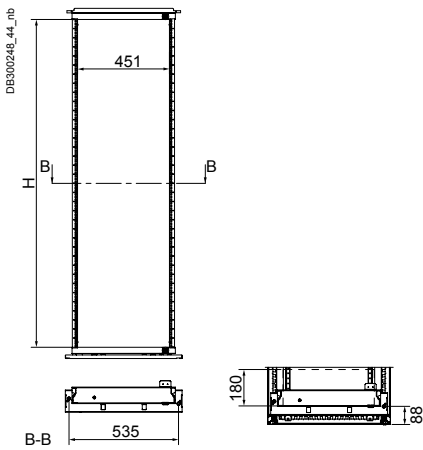

19" Swing Racks for 800 mm Enclosures

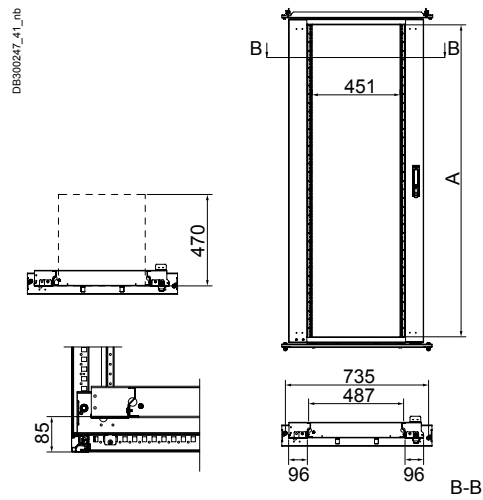

11

1 U / 3 U Support

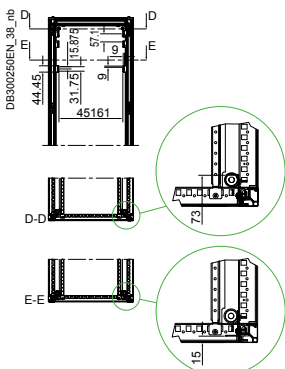

Technical changes reserved. Information provided without guarantee. Images are for illustrative purposes only.

EcoStruxure™ Micro Data Center for Rugged Environments

Spacial Sf 19" Electronic Enclosure

Solution at a Glance

IOT and Industry 4.0 transformations mean that critical IT and OT equipment is moving closer to where it's used. That's why Schneider Electric™ has expanded its EcoStruxure™ Micro Data Center R-series to include all new NEMA and IP ratings for harsh environments. It's everything you already love about EcoStruxure Micro Data Center – a complete, simple-to-deploy, simple-to-manage solution – fine-tuned for industrial use.



Up and Running in Weeks, Not Months.



Costs 42-48% Less Than Typical Data Center Build!



Securely Manage from Anywhere.



Secure Physically to Ensure Cybersecurity

- NEMA and IP rating for harsh environments
- Essential access control
- Environmental monitoring and alerts
- Remote video surveillance

Enclosure Description



- Structure: Top and bottom frame and vertical uprights.
- Plain front door
- Plain rear door.
- Locking system with handle and insert key NSYIN405E1
- Removable roof assembled
- External fixing of double-folded side panels to increase rigidity, captive fixing screws that reduce installation time.
- Side panels mounted
- Plinth H=100mm mounted
- Gland plate mounted
- 4 crossrails mounted (2 on each side) for 1200mm heights
- 6 crossrails mounted (3 on each side) for 2000mm heights
- 4 x 19" upright mounted
- Enclosure width 800 with support bracket NSYCRKS.... and NSYRCK19KIT in order to mount 19" upright
- 5 earthcable NSYEL2225D8 mounted
- Material: Steel
- Finish: Structured finish, epoxy polyester powder
- Color: RAL 7035 gray
- UL, CUL according to UL 508A and CSA C22.2 NO.14
- Nema 1 and 12 according to NEMA 250
- RoHS and REACH directive compliance.

For more details Please consult us

Characteristics	Height (mm)	Width (mm)	Depth (mm)	References
Spacial SF 12x8x6 Solution Edge Micro data center	1200	600	800	NSYSFRSEDC1268E
Spacial SF 20x6x8 Solution Edge Micro data center	2000	600	800	NSYSFRSEDC268E
Spacial SF 20x8x10 Solution Edge Micro data center	2000	800	1000	NSYSFRSEDC281E
Spacial SF 20x6x10 Solution Edge Micro data center	2000	600	1000	NSYSFRSEDC261E
Spacial SF 20x8x12 Solution Edge Micro data center	2000	800	1200	NSYSFRSEDC2812E

Technical changes reserved. Information provided without guarantee. Images are for illustrative purposes only.

Electromagnetic Interference

Introduction

LV networks are highly polluted and subject to a large number of aggressions. Electrotechnical equipment and in particular electronic devices, which are increasingly numerous and process ever lower signals, must withstand a harsh electromagnetic environment. At the same time availability requirements, whether for production, management or commerce, are steadily increasing.

Definition

Electromagnetic interference is defined as any electromagnetic phenomenon capable of impairing the performance of a device, equipment or system, etc. An electromagnetic disturbance can be electromagnetic noise, an unwanted signal or a change in the propagation medium itself.

An electromagnetic disturbance, as its name suggests, consists of an electric field \vec{E} generated by a potential difference and a magnetic field \vec{H} difference caused by the flow of a current I along a conductor.

Unwanted electromagnetic interference is simply an unwanted electrical signal that is added to the useful signal.

This unwanted signal is propagated via conductors and by radiation.

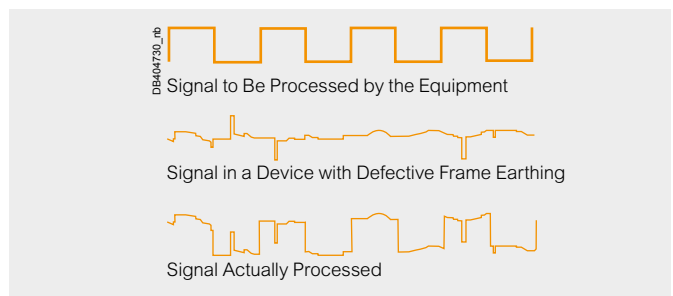
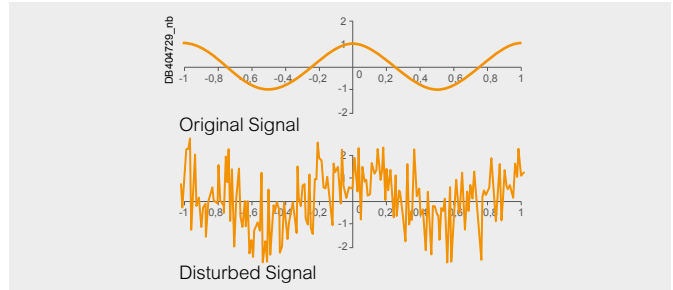

Examples of Sources of Electromagnetic Interference

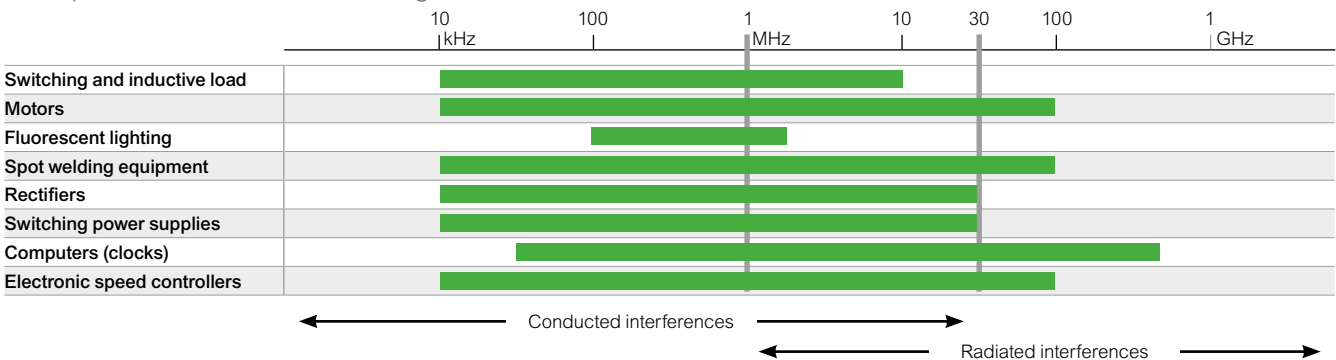

EMC Standards

The standards define electromagnetic compatibility (EMC) as "the ability of a device, equipment or a system to function satisfactorily in its electromagnetic environment without introducing intolerable disturbances to that environment or to other equipment".

Classification

In an electrical switchboard, the signals coming from these sources of disturbance will coexist with more sensitive devices. These signals may be classified as follows (sources: standards IEC 61000-5-2 and IEC 60364-4-44):

Class	Examples
1 Sensitive	<ul style="list-style-type: none"> Low-power devices with analog output, transducers etc. Instrument circuits (probe, sensors...)
2 Not very sensitive	<ul style="list-style-type: none"> Control/command circuits with resistive load Digitalized low-level circuits (Bus...) Low-level circuits with on-off output unit (sensors...) Low-level direct power supply
3 Not very disturber	<ul style="list-style-type: none"> Control/command circuits with inductive load (relay, contactors, coils, inverters...) with adapted protection Alternating power supply Main power supply connected to power devices
4 Disturber	<ul style="list-style-type: none"> Welding machines Power circuits Drives, switched-mode power supplies ...

How to Obtain EMC

Rules to Be Followed: General Description

Electromagnetic interference generated by devices is classified in 2 categories according to its frequency:

- Low frequency (up to 30 MHz): Interference conducted by sensor cables;
- High frequency (above 1 MHz): Interference radiated by a device.

The rules to be followed concern the selection and installation of the electrical installation's components. Overall, they break down as follows:

Conducted interferences

- Importance of the choice of architecture for the power supplies and associated protective devices.
- Use of filters.

Radiated interferences

- Specification of installation rules: grounding, length and cross-section of cables, cabling rules, choice of cable tray, connections, choice and installation of the enclosure.
- Use of filters.

Shielding Connection

- Shielding connections eliminate interference by conducting them to earth. The decision to connect one or both ends to earth means priority is given to protection against low or high frequencies:
- If one end is earthed, 50-Hz stray current cannot flow, HF protection is moderate;
- if both ends are earthed, 50-Hz current may occur but the barrier against higher frequencies is enhanced.

Isolation Transformers

Isolation transformers are used to guard against high-frequency disturbances generated by the network power supply (primary circuit). An electrostatic shield is connected to earth by a short link. This link must be free of paint and any other insulated material. Physical separation of the cables of the primary circuit (network power supply) and those of the secondary circuit (power distribution) is also essential.

Earth Connection of Metal Raceways

Increasing shielding efficiency of highly disturbing cables

The radiation from a shielded variable speed drive/motor connecting cable will be further reduced if it runs in a closed metal raceway or, even better, in a metal conduit. The raceway and tube need to be connected to earth at either end.

Enclosures

The interfering and sensitive components, cables etc. should be installed in separate enclosures or located at some distance from each other.

Note:

For further information, consult your local sales office or our educational leaflet entitled "Electromagnetic compatibility" - ref. **UE17MK08FR**.

Connect The Shielding

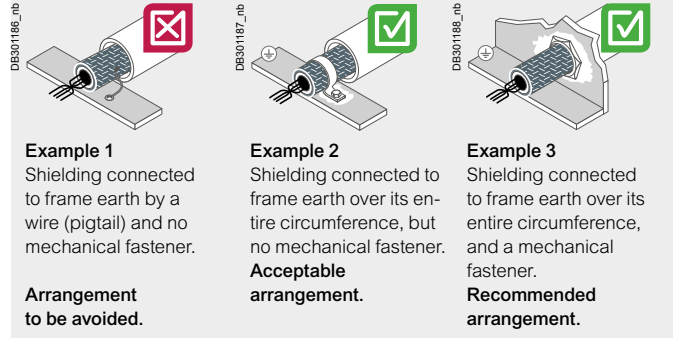

Isolation Transformers

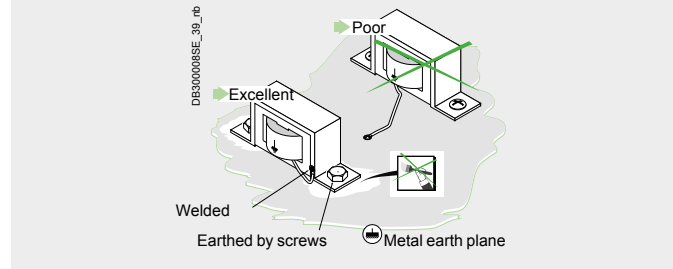

Earth Connection Of Metal Raceways

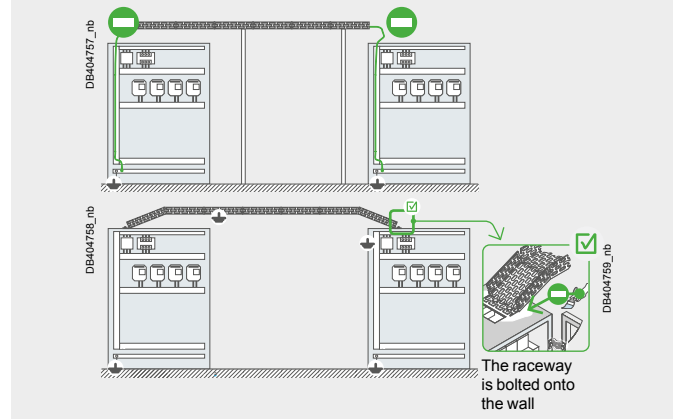

Enclosures

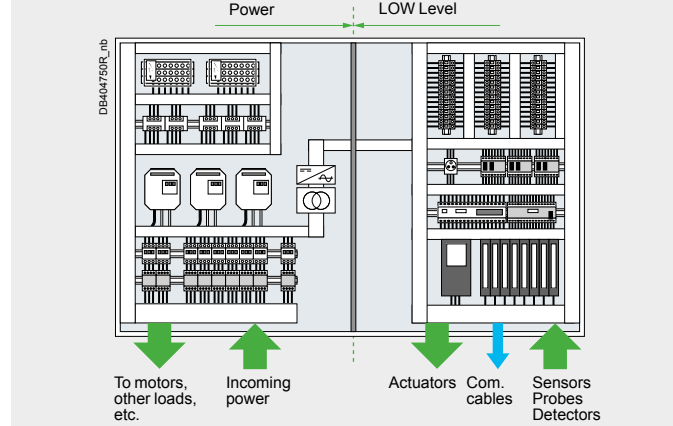

Technical changes reserved. Information provided without guarantee. Images are for illustrative purposes only.

EMC Offer of Schneider Electric

This range can be configured according to your needs

4 different services available:



Assemble
to Order



Mounting
of Standard
Accessories



Painting



Machining



Spacial S3HF Wall-Mounted Enclosure, IP55, IK10

From 400 x 300 x 200 mm to 1200 x 800 x 300 mm (W x D x H)

- Metal monobloc enclosures constructed from special ALU-ZINC 150 sheet.
- Body constructed from single folded and welded sheet.
- The enclosure surface, comprising 55% aluminum, ensures good reflection of radiated electromagnetic interference.
- Ingress protection rating: IP55.
- Mechanical protection rating: IK10.
- Structured finish, exclusively epoxy polyester paint on the outside
- RAL 7035 gray

Spacial SFHF Suitable Enclosure IP55 IK10

From 1800 x 600 x 600 mm to 2200 x 800 x 800 mm (W x D x H)

- Metal, extendable enclosure constructed from a closed triangular profile, door and panel from special ALU-ZINC 150 sheet.
- The enclosure surface, comprising 55% aluminum, ensures good reflection of radiated electromagnetic interference.
- Ingress protection rating: IP55.
- Mechanical protection rating: IK10.
- Structured finish, exclusively epoxy polyester paint on the outside
- RAL 7035 gray

See [page 474](#) for details or consult our web site www.se.com

Attenuation of Electromagnetic Interference

The next illustrations indicates the attenuation (dB) curves related to the frequency (MHz).

Attenuation of the Spacial S3HF Enclosure

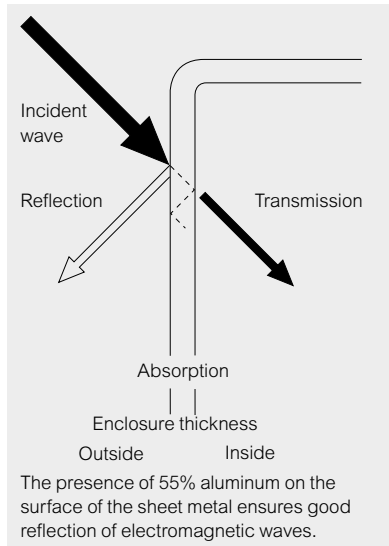
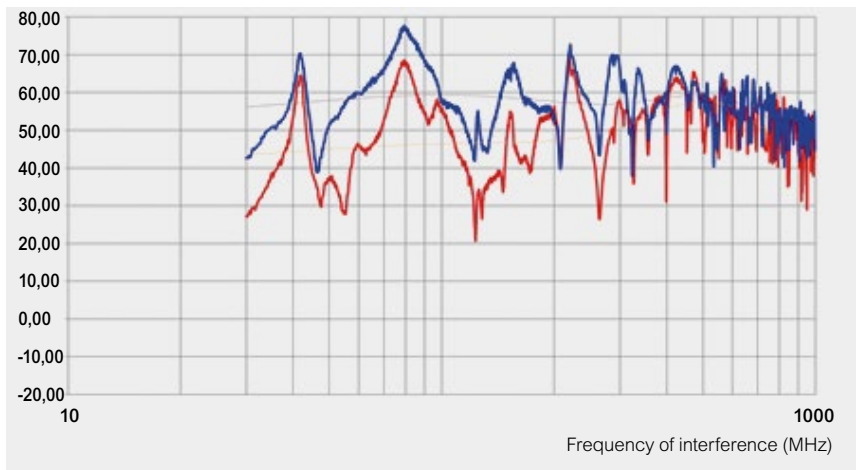

Attenuation of the Spacial SFHF Suitable Enclosure

Enclosure is tested with its sides panels and earth braids mounted on all claddings (test performed following IEC 61587-3).

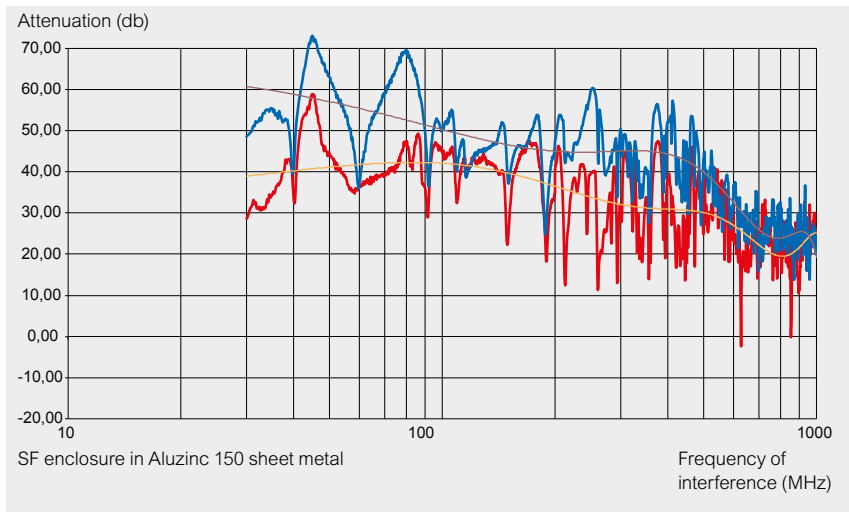

Attenuation Curves

- Horizontal attenuation
- Vertical attenuation

Trend Curves (Polynomial of Order 6)

- Horizontal attenuation
- Vertical attenuation

Spacial S3HF

- Single-piece metal enclosures made from special sheets of ALUZINC 150.
- The presence of 55% aluminum on the surface of the sheet metal ensures good reflection of electromagnetic waves.

Body

- Single-piece body, folded and welded,
- Entirely sealed body with no cable entry and no opening,
- Equipped with four shouldered backstuds allowing direct fixing of the mounting plate,
- Low resistivity for good earth continuity
- Direct fixing or using wall fixing lugs, ref. **NSYPFCR** (to be ordered separately).

Door

- The special body-door gasket (IP + EMC) provides, in addition to water and dust tightness, electric continuity between the door and the body of the enclosure,
- The metal lock with earth continuity helps improve the general shielding,
- An earthing braid added to the enclosure between the body and the door guarantees a good earth connection and, consequently, good electromagnetic compatibility,
- 3-mm double-bar lock as standard delivery (if a 405 key is needed it is possible to mount ref. **NSYCLL405CRN**).
- Other sizes: Consult us.
- Finish: Structured finish, epoxy polyester powder (inside not painted)
- Color: RAL 7035 gray
- Ingress protection rating: IP55 according to IEC 60529
- Mechanical protection rating: IK10 according to IEC 62262
- Certifications and declarations: UL, CE declaration
- Fixing: Fixing lugs, ref. **NSYPFCR** to be ordered separately (1 set of 4 lugs)

For more details see [page 427](#)

Supply:

Enclosure delivered with galvanized mounting plate.



NSYS3HF4320P

Characteristics	Fig.	Weight (kg)	Width (mm)	Height (mm)	Depth (mm)	References
Spacial S3HF	1	7.5	300	400	200	NSYS3HF4320P
Spacial S3HF	2	13.0	400	600	200	NSYS3HF6420P
Spacial S3HF	2	20.5	600	600	250	NSYS3HF6625P
Spacial S3HF	2	32.8	600	800	300	NSYS3HF8630P
Spacial S3HF	2	53.2	800	1000	300	NSYS3HF10830P

Support Bracket for Enclosure with Anti-Tilt Kit and Reinforcement

- The support bracket is used when the enclosure cannot be mounted to a wall or post.
- Maximum enclosure dimensions: 1000 x 800 x 300 mm.
- Floor attachment by standard M12 fasteners.
- Material: Steel
- Finish: Painted
- Color: RAL 7035 gray
- Maximum load: 120 kg



NSYCOENS1400

Characteristics	Height (mm)	References
Support bracket for enclosure with anti-tilt kit and reinforcement	1400	NSYCOENS1400
Support bracket for enclosure with anti-tilt kit and reinforcement	1800	NSYCOENS1800

Spacial SFHF

Structure

- Galvanized steel structure,
- Top and bottom frame, vertical upright.

Claddings

- Enclosure with screwed panels (on side and rear) and front plain door (with reinforcement frame) made from Aluzinc steel,
- Side panels to be ordered separately,
- Special gasket (IP + EMC) between body, door and panels.
- Finish: Epoxy polyester paint on the outside (inside not painted)
- Color: RAL 7035 gray
- Ingress protection rating: IP55
- Mechanical protection rating: IK10
- Certifications: RoHS compliant
- Dimensions manufacturing on demand

Note:

Only available on demand.
For more details see [page 427](#)

Supply:

- 1 single plain door with door-reinforcement frame (double-door on request, please consult us).
- Left or right opening to 120°.
- Delivered with standard locking system handle and 5-mm double-bar insert.
- 1 rear panel screwed from the outside.
- 1 removable roof.
- 1 part cable gland plate with special gasket (IP + EMC).



Characteristics	Height (mm)	Width (mm)	Depth (mm)
Spacial SFHF	1800	600	600
Spacial SFHF	1800	800	400
Spacial SFHF	1800	800	600
Spacial SFHF	2000	600	400
Spacial SFHF	2000	600	600
Spacial SFHF	2000	600	800
Spacial SFHF	2000	600	1000
Spacial SFHF	2000	800	400
Spacial SFHF	2000	800	600
Spacial SFHF	2000	800	800
Spacial SFHF	2000	800	1000
Spacial SFHF	2200	600	600
Spacial SFHF	2200	800	600
Spacial SFHF	2200	800	800

Side panel

- Finish: Epoxy polyester paint on the outside (inside not painted)
- Color: RAL 7035 gray
- Dimensions manufacturing on demand

Note:

Only available on demand.

Characteristics	Height (mm)	Width (mm)
Side panel	1800	600
Side panel	1800	400
Side panel	2000	400
Side panel	2000	600
Side panel	2000	800
Side panel	2000	1000
Side panel	2200	600
Side panel	2200	800

All mounting accessories are compatible with the SF and SM standard range.

- Mounting plate (see page 226).
- Rails (see page 235).
- 19" frame (fixed and swing-out) (see page 411).

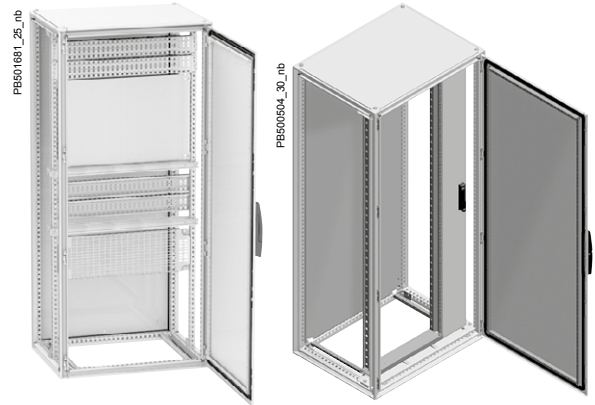

Earth Braids

- They guarantee the earth connection for high frequencies, avoiding the disturbing electric currents that are produced.
- Material: Tinned copper.

Supply:

10 earth braids (nuts and washers not included)



NSYEB156D6

Characteristics	Section (mm ²)	Terminal Ø (mm)	Length (mm)	Width (mm)	References
Earth braids	6	6.5	150	12	NSYEB156D6
Earth braids	10	6.5	150	17	NSYEB1510D6
Earth braids	16	8.5	155	17	NSYEB1516D8
Earth braids	25	8.5	200	27	NSYEB2025D8
Earth braids	50	8.5	200	33	NSYEB2050D8

Emc Coupling Kit

- Used to join enclosures side-by-side or back-to-back. Special gasket for EMC solution.
- Attenuation level is decreased by 5 db when enclosures are joined (please consult us).
- Ingress protection rating: IP55.

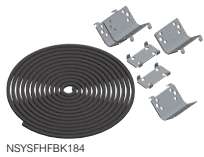

NSYSFHFBK184

Characteristics	Height (mm)	Depth (mm)	References
EMC coupling kit	1800	400	NSYSFHFBK184
EMC coupling kit	1800	600	NSYSFHFBK186
EMC coupling kit	2000	400	NSYSFHFBK204
EMC coupling kit	2000	600	NSYSFHFBK206
EMC coupling kit	2000	800	NSYSFHFBK208
EMC coupling kit	2000	1000	NSYSFHFBK2010
EMC coupling kit	2200	600	NSYSFHFBK226
EMC coupling kit	2200	800	NSYSFHFBK228

Emc Cable Gland with Contact Spring

- Thread type: Metric EN 60423, other types are available upon request
- Material: Nickel-plated brass, neoprene gasket
- Ingress protection rating: IP66
- Flame resistance: UL94 V-2
- Temperature range: -20 °C to + 100 °C
- Cable type: Unshielded

Supply:

The cable glands are supplied with nuts.
Pack of 10 (M12 and M16), of 5 (M20 and M25), of 4 (M32 and M40)



NSYCGHF12

Characteristics	Ø	Ø min/max	Drill Ø	TD	TL	Wrench width	References
New EMC cable gland with contact spring	M12	3/6.5	12 to 12.2	12	6	14	NSYCGHF12
New EMC cable gland with contact spring	M16	5/10	16 to 16.2	16	7	20	NSYCGHF16
New EMC cable gland with contact spring	M20	6/12	20 to 20.2	20	8	22	NSYCGHF20
New EMC cable gland with contact spring	M25	11/17	25 to 25.2	25	8	27	NSYCGHF25
New EMC cable gland with contact spring	M32	15/21	32 to 32.3	32	8	34	NSYCGHF32
New EMC cable gland with contact spring	M40	19/28	40 to 40.3	40	9	43	NSYCGHF40

Electromagnetic Protected Steel Enclosures

Spacial S3HF - SFHF
Dimensions

Spacial S3HF

Fig. 1

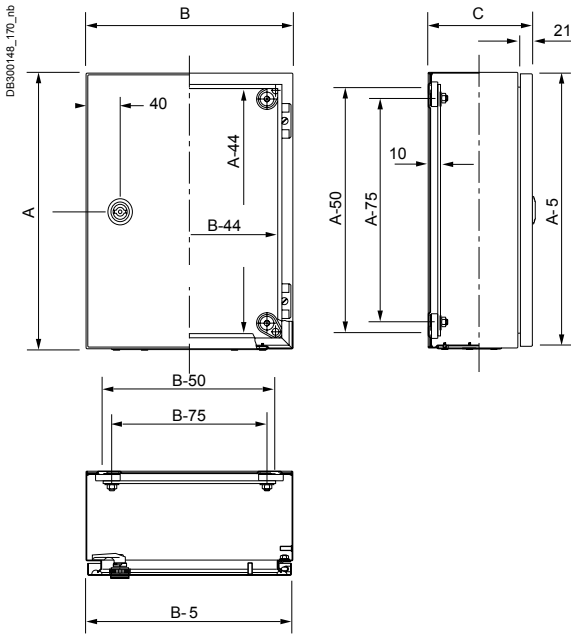
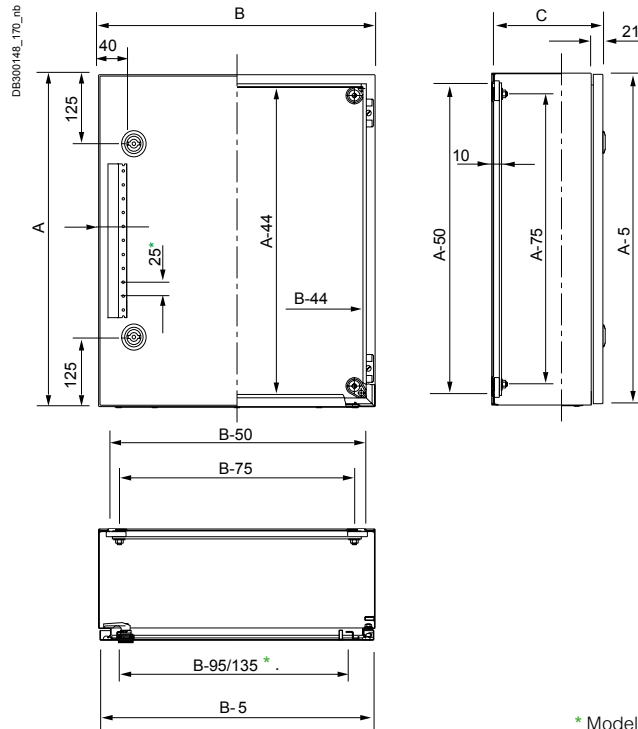

Fig. 2



A: Height.
B: Width.
C: Depth.

* Model 1200 x 800.

Spacial SFHF

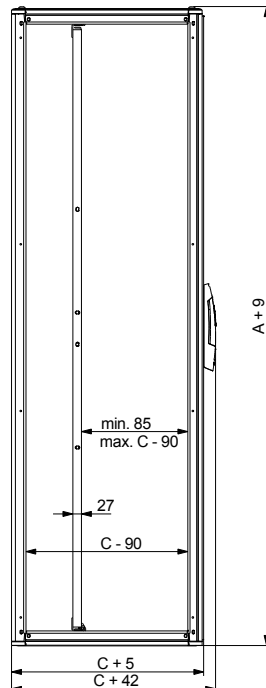
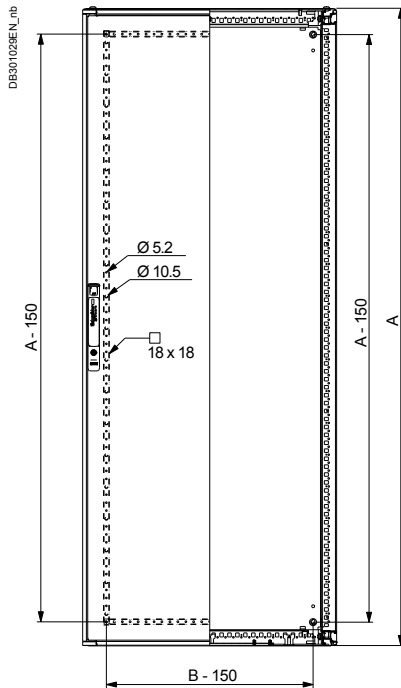

A: Height.
B: Width.
C: Depth.

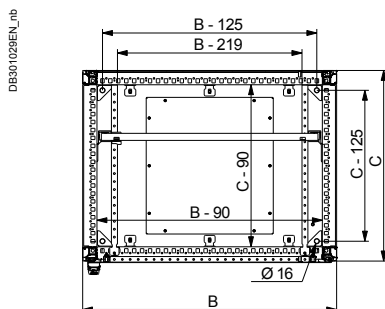

Industrial Environments, Equipment Rooms

Spacial S3DEX Steel Enclosure

The Spacial S3DEX steel enclosure is certified by the LCIE with no. LCIE 02ATEX0037U (component certification).

- Ten sizes: From 300 x 200 x 150 mm to 1000 x 800 x 300 mm.
- Degree of protection: IP66 according to IEC 60529.
- Ambient temperature range: $-20\text{ °C} \leq T_a \leq +40\text{ °C}$.
- Resistance to external mechanical impacts: IK10.
- Structured finish, epoxy polyester powder paint, RAL 7035 gray.



Safety

- Blind nut for external earth connection.



- The 4 fixing holes are blocked by 4 crimped blind nuts.



- Earthing studs welded to the door and inside the body.

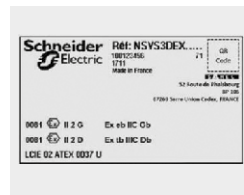

Label

- Example of specific ATEX marking (description: [Page 651](#)).

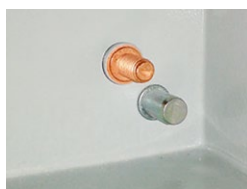

Robust

- The chassis is mounted on four 10 mm shouldered backstuds.

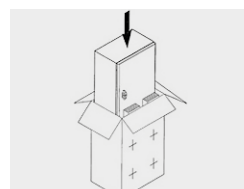

Easy Handling

- Reusable, eco-friendly packaging.
- No sharp edges.



In accordance with the ATEX directive

- The enclosures bear the marking shown on [page 651](#).
- The enclosures offer a degree of protection of IP66 according to EN 60529, reaching the highest dust protection according to ATEX standards.
- The certification of our production sites and inspection procedures guarantees the observance and regularity of the quality level.

Protection of all applications in ATEX II2 or II3 areas

- Surface installations with occasional or accidental
- Thanks to ATEX-certified steel.

ATEX Enclosures from Schneider Electric



Steel enclosures

- All the wall-mounted enclosures presented in this brochure comply with standards for protection against the potential risk of explosion in atmospheres containing gas (G) or dust (D).
- The Schneider Electric offer, designed to be used in group II, is classified as category 2.

Protection of equipment against explosion			ATEX	
Group *	Category	Level	Probability	Zone
I	M1	Very high	Permanent	0 / 20
I	M2	High	Occasional	1 / 21
II	1	Very high	Permanent	0 / 20
II	2	High	Occasional	1 / 21
II	3	Normal	Accidental	2 / 22

* I = equipment designed to be used in the mining and quarrying industries
 II = equipment designed to be used in surface industries

Zone of application of Schneider Electric ATEX wall-mounted enclosures.

- Products of category 2 can be used as category 3.

Our products are certified:

- For gas environments: Increased safety "e" (Ex e) but not flameproof safety "d" (Ex d);
- For dust environments: Protection by enclosure "t" or "tb".
- The wall-mounted enclosures offer a degree of protection of IP66 according to IEC 60529, exceeding the recommendations of the ATEX directive.
- Certification of our production sites and inspection procedures guarantees observance and consistency of the quality level.

Potentially Explosive Atmospheres (ATEX)

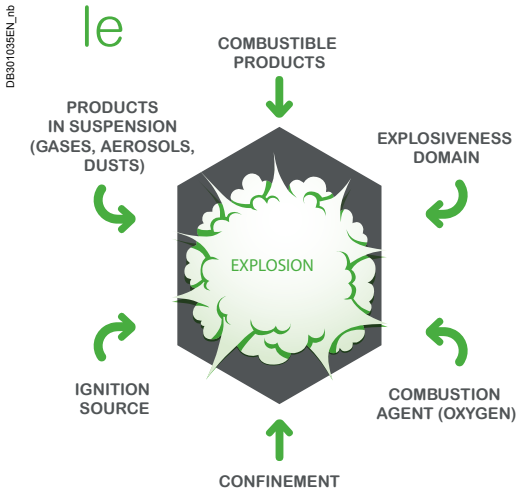

Explosion Hexagon

Process Leading to an Explosion in an Explosive Atmosphere

For an explosion to occur, six conditions must be met simultaneously (see explosion hexagon opposite). The process is as follows:

- Mixing combustible substances (gases, dusts) with air whose oxygen acts as combustion agent;
- Dosing of combustible products and combustion agents in precise proportions; thereby obtaining a potentially explosive atmosphere;
- Confining the explosive atmosphere thus obtained in a place conducive to explosion;
- Exposing it to an ignition source having sufficient energy to cause an explosion.

ATEX Regulations

Two EU directives and an international standard regulate potentially explosive atmospheres:

- The objective of the two EU directives (the so-called ATEX directives) is to enhance protection from explosions by making various technical and organizational measures compulsory;
- The 2014/34/EU directive (a revision of the 94/9/EC directive) came into application on 20 April 2016. It describes the requirements that must be met by protection devices and systems, and the conformity assessment procedures;
- The 99/92/EC directive, a labour relations supplement to the preceding one, presents the minimum requirements to be met to improve the protection of workers liable to be exposed to ATEX-related risks.



Definition



Product directive 2014/34/UE: defines the manufacturers' obligations.



Personal protection directive 99/92/CE: defines the users' obligations.

Degree of protection:

In hazardous areas, equipment is required to offer a minimum degree of protection of IP54, but it can be tested or certified for a higher degree of protection.

- An IEC international standard harmonized with the European standard EN:
- IEC 60079: electrical equipment for potentially explosive gaseous atmospheres.

Classification

Locations liable to be in the presence of an explosive atmosphere have been classified according to 2 criteria:

- The probability assessed on a scale comprising 3 levels;
- The nature of the combustible product.

The following 6 ATEX zones are obtained:

Probability of an explosive atmosphere	Gas / vapor or mist	Dust
Place in which an explosive atmosphere is present constantly , or for long periods or frequently	Zone 0	Zone 20
Place in which an explosive atmosphere is likely to occur occasionally in normal operation	Zone 1	Zone 21
Place in which an explosive atmosphere is not likely to occur in normal operation or, if it does occur, will persist for a short period only	Zone 2	Zone 22

11

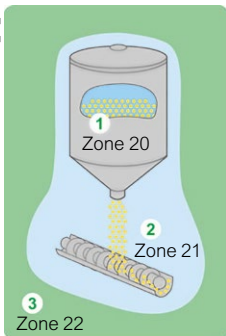
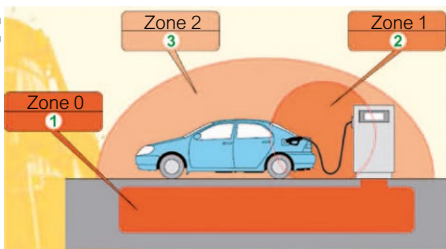

Equipment installed in an explosive-atmosphere zone must be protected against the risk of explosion. Three levels of protection have been defined, corresponding to the three probabilities of existence of an explosive atmosphere. They are broken down into 5 categories depending on the type of industry.

Protection of equipment against explosions			ATEX	
Group *	Category	Level	Probability	Zone
I	M1	Very high	Permanent	0 / 20
I	M2	High	Occasional	1 / 21
II	1	Very high	Permanent	0 / 20
II	2	High	Occasional	1 / 21
II	3	Normal	Accidental	2 / 22

* I = equipment designed to be used in the mining and quarrying industries
 II = equipment designed to be used in surface industries

Protection of Electrical Equipment

The standards define various methods of protection for electrical equipment according to the application in explosive atmospheres containing gas or dust.

Electrical equipment		ATEX	Methods of protection	
CENELEC	IEC		Symbol	Title
EN 50015	IEC 60079-6	G, D	o	Immersion in oil
EN 50016	IEC 60079-2	G, D	p	Enclosures with internal overpressure
EN 50017	IEC 60079-5	G, D	q	Filling with powder product
EN 60079-1	IEC 60079-1	G, D	d	Explosion-proof enclosures
EN 60079-7	IEC 60079-7	G, D	e	Increased safety "e"
EN 50020	IEC 60079-11	G, D	i	Intrinsic safety
EN 60079-15	IEC 60079-15	G, D	n	Product design
EN 60079-31	IEC 60079-31	G, D	tD	Protection by enclosure "t"

G = gas / vapor or mist
D = dust

ATEX Certification of Electrical Switchboards

- Since 1 July 2003, the European Union has made it compulsory to use certified equipment (electrical or non-electrical) when it is to be installed in areas where the atmosphere is potentially explosive.
- The certification must be established by an approved organization in accordance with the 2014/34/EU directive.
- The organization certifies that the product complies with the health and safety requirements defined in the European directive and the international standards.
- The certificate indicates, via the marking, the product's category and accordingly the zone and the atmosphere in which it may be used.
- Enclosures are certified as components. They will be assembled with other ATEX components (electrical, pneumatic, hydraulic, etc.), to form a final solution which must itself be ATEX-certified and covered by a declaration of conformity.

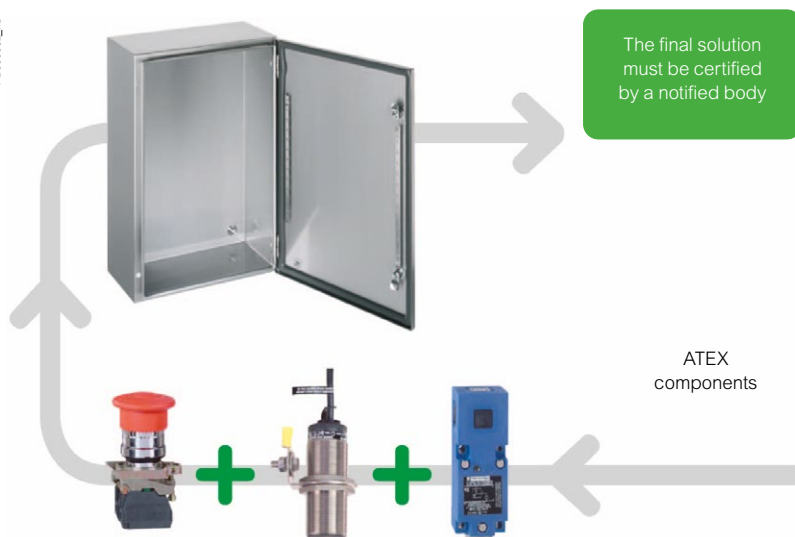

Spacial S3DEX

Protection for users

- Earthing: The Spacial S3DEX steel enclosures are provided with M6 x 16 earth studs welded to the casing and door for equipotential connection. Earth strap to be ordered separately.
- Closing: Enclosures higher than 600 mm are provided with three locking points with connecting rods, with a single control point preventing the enclosures from being left half-open.

Casing

- Monobloc casing (cross-structure). Gutter-shaped front profile.
- 4 bottom shoulder studs M8 x 25 for mounting the chassis and notched bars to provide a space of 10 mm at the rear.

Door

- Standard fastening by 3-mm double-bar lock
- Polyurethane door seal
- Double-thickness 20 mm return conferring excellent rigidity;
- 2 concealed hinges (3 above H = 800 mm) to facilitate dismantling and reversibility of the door. Opening angle: 120°
- Maximum load: 50 kg/m².
- Perforated sections on the door, with holes of diameter 4.2 mm every 25 mm for mounting accessories:
- 2 vertical sections from H = 400 mm;
- 2 vertical sections and 2 horizontal sections from L = 800 mm.

Specific ATEX features

- 4 fastening holes closed by 4 crimped blind nuts.
- One crimped M8 blind nut for an external frame earth link (strap not provided)
- Ambient temperature: -20 °C ≤ Ta ≤ +40 °C
- Marking: See [page 651](#).
- Material: Steel
- Finish: Structured finish, epoxi-polyester powder painting
- Color: RAL 7035 gray
- Ingress protection rating: IP66 (enclosures with single-door) according to IEC 60529
- Mechanical protection rating: IK10 (enclosures with plain door) according to IEC 62262
- Fixing: Wall fixing lugs:

Passivated zinc-coated steel: Reference **NSYAEFPFSC**

304L stainless-steel: Reference **NSYAEFPFXSC**



NSYS3DEX3215

Characteristics	Height (mm)	Width (mm)	Depth (mm)	References
Spacial S3DEX	300	200	150	NSYS3DEX3215
Spacial S3DEX	300	300	200	NSYS3DEX3320
Spacial S3DEX	400	300	200	NSYS3DEX4320
Spacial S3DEX	400	400	200	NSYS3DEX4420
Spacial S3DEX	500	400	200	NSYS3DEX5420
Spacial S3DEX	600	400	250	NSYS3DEX6425
Spacial S3DEX	600	600	250	NSYS3DEX6625
Spacial S3DEX	700	500	250	NSYS3DEX7525
Spacial S3DEX	800	600	300	NSYS3DEX8630
Spacial S3DEX	1000	800	300	NSYS3DEX10830



The accessories of the Spacial standard wall-mounted enclosures can be installed in the Spacial S3DEX wall-mounted enclosures. However, plastic accessories should not be used due to the risk of a static charge.

Mounting Plate Plain



NSYMM32

Characteristics	Height (mm)	Width (mm)	References
Mounting plate Plain	300	200	NSYMM32
Mounting plate Plain	300	300	NSYMM33
Mounting plate Plain	308	255	NSYMM3025
Mounting plate Plain	400 / 430	300 / 330	NSYMM43
Mounting plate Plain	400	400	NSYMM44
Mounting plate Plain	500 / 530	400 / 430	NSYMM54
Mounting plate Plain	600 / 647	400 / 436	NSYMM64
Mounting plate Plain	600	600	NSYMM66
Mounting plate Plain	700 / 747	500 / 536	NSYMM75
Mounting plate Plain	800 / 847	600 / 636	NSYMM86
Mounting plate Plain	1000 / 1056	800 / 852	NSYMM108

Mounting Plate Microperforated

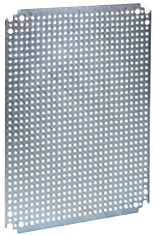

NSYMF33

Characteristics	Height (mm)	Width (mm)	References
Mounting plate Microperforated	300	300	NSYMF33
Mounting plate Microperforated	400 / 430	300 / 330	NSYMF43
Mounting plate Microperforated	400	400	NSYMF44
Mounting plate Microperforated	500 / 530	400 / 430	NSYMF54
Mounting plate Microperforated	600 / 647	400 / 436	NSYMF64
Mounting plate Microperforated	600	600	NSYMF66
Mounting plate Microperforated	700 / 747	500 / 536	NSYMF75
Mounting plate Microperforated	800 / 847	600 / 636	NSYMF86
Mounting plate Microperforated	1000 / 1056	800 / 852	NSYMF108

Mounting Plate Telequick



NSYMR32

Characteristics	Height (mm)	Width (mm)	References
Mounting plate Telequick	300	200	NSYMR32
Mounting plate Telequick	300	300	NSYMR33
Mounting plate Telequick	308	255	NSYMR3025
Mounting plate Telequick	400 / 430	300 / 330	NSYMR43
Mounting plate Telequick	500 / 530	400 / 430	NSYMR54
Mounting plate Telequick	600 / 647	400 / 436	NSYMR64
Mounting plate Telequick	600	600	NSYMR66
Mounting plate Telequick	700 / 747	500 / 536	NSYMR75
Mounting plate Telequick	800 / 847	600 / 636	NSYMR86
Mounting plate Telequick	1000 / 1056	800 / 852	NSYMR108

Mixed Symmetrical Chassis



NSYMD33

Characteristics	Height (mm)	Width (mm)	References
Mixed symmetrical chassis	300	300	NSYMD33
Mixed symmetrical chassis	400	300	NSYMD43
Mixed symmetrical chassis	500	400	NSYMD54
Mixed symmetrical chassis	600	400	NSYMD64
Mixed symmetrical chassis	600	600	NSYMD66
Mixed symmetrical chassis	700	500	NSYMD75
Mixed symmetrical chassis	800	600	NSYMD86
Mixed symmetrical chassis	1000	800	NSYMD108

Step Slides



NSYSDCR200

Characteristics	Depth (mm)	References
Step slides	200	NSYSDCR200
Step slides	250	NSYSDCR250
Step slides	300	NSYSDCR300

Enclosures for Explosive Atmospheres Spacial S3DEX, Dimensions

Single-Door Enclosure

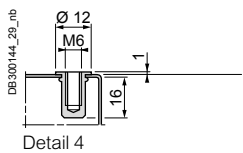
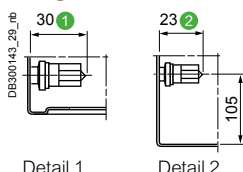

4 Crimped Blind Nuts for Direct Fixing of the Fixing Lugs

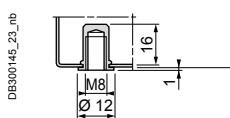

1 Crimped Blind Nut for the External Earth

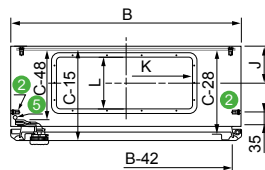
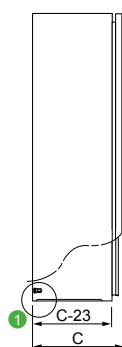
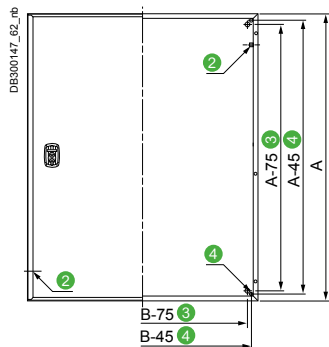

- 1 4 M8 x 25 mm backstuds.
- 2 2 M6 x 17.5 mm earthing studs.
- 3 Stud center-to-center distance.
- 4 Crimped blind nut center-to-center distance.
- 5 Blind nut for external earth.

A: Height
B: Width
C: Depth

Perforated Rails on the Door

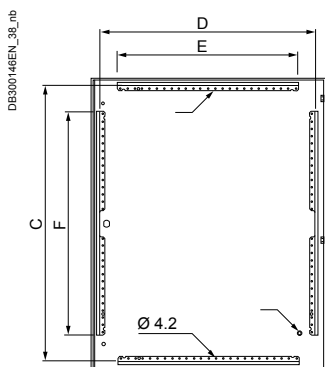

Enclosure (8)		Perforated rails on the door (mm)			
Height (A) (mm)	Width (B) (mm)	Vertical F	Vertical D	Horizontal E	Horizontal C
400	300	320	237	-	-
400	400	320	337	-	-
600	400	370	337	-	-
600	600	370	537	-	-
700	500	470	437	-	-
800	600	570	537	-	-
1000	800	770	737	620	949

- 6 Perforations with a pitch of 25 mm.
- 7 1 M6 x 17.5 mm earthing stud.
- 8 The doors of enclosures with dimensions less than 800 x 600 mm do not have horizontal cable guides.

Human-Machine Interface Solutions

Indoor Non-Clean Industrial Environments

Steel



11

Demanding Industrial Environments

Stainless-Steel



Technical changes reserved. Information provided without guarantee. Images are for illustrative purposes only.

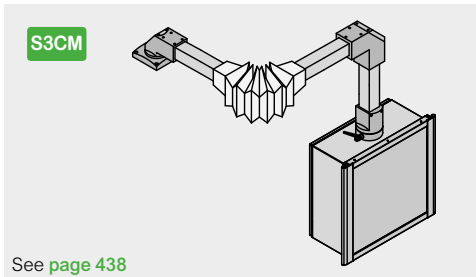

Spacial S3CM Control Enclosure with Suspension System

The Spacial S3CM offer for human-machine interface combines robustness with aesthetics and ergonomics. Consist of:

- Control enclosure,
- A keyboard-box,
- A suspension system of arms and joints, for a fixed or rotating solutions, and support accessories.



Spacial SD Control Desks

The range of Spacial SD control desks provides all functions required of a workstation intended for industrial and infrastructure applications. Spacial SD products offer two distinct solutions:

- The SD ComPacT control desk,
- The SD Control desk with console.

The range has protection ratings of IP55 and IK10 guaranteeing the safety and the protection of the installed devices.



Spacial SF Suitable PC Rack

The Spacial SF PC rack is designed to protect and control computer equipment in industrial environments. Access to various functions and working heights, guaranteeing optimal comfort. The roof and panels, fixed from the inside, prevent access by unauthorized personnel.

The Spacial S3CM Offer for Human-Machine Dialogue Consists of:

control enclosures, a box keyboard, a system of fixed or swiveling arms and joints, accessories.
The global dialogue system combines robustness with aesthetics and ergonomics.

This range can be configured according to your needs

4 different services available:



Assemble to Order



Mounting of Standard Accessories



Painting



Machining

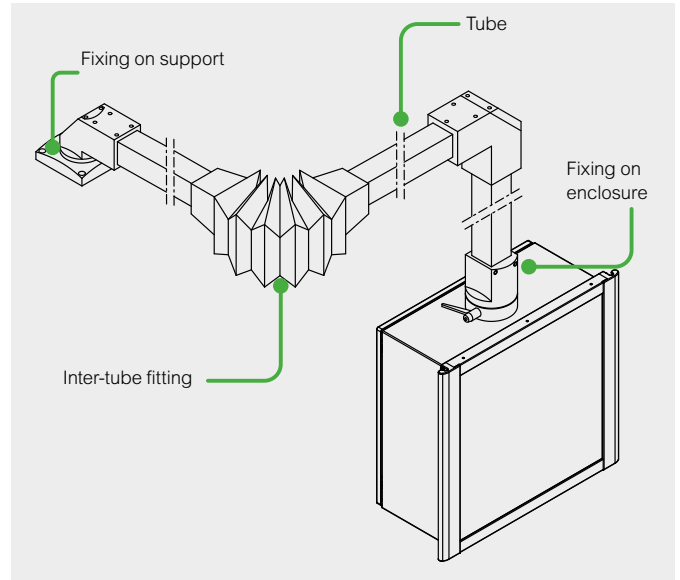

Human-Machine Interface Solutions



Robust

2 tube sizes in extruded steel, 50 and 80 mm square, thickness 40/10e mm. Top wall reinforced by a plate with a thickness of 30/10e mm.



Ease of Use

Easy access to the equipment by a rear door, opening to 120°. Direct installation of accessories on the enclosure frame rail:
- vertical document support,
- keyboard support,
- laptop computer support.
A box keyboard is installed directly on the enclosure.

11



Aesthetics

Extruded aluminum rail frame.
Frame: RAL 7040 Window gray
Enclosure: RAL 7035 Light gray
Customization to your image or the aesthetics of your machine: Consult us.

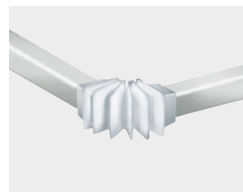

Flexibility

Flexibility



Ergonomics

Frame designed to facilitate the handling and usage of the enclosure by the operator.

See page 474 for details or consult our web site www.se.com

Every model is suitable for tubes with a cross-section of:

- 50 mm for medium loads,
- 80 mm for heavy loads
(see selection table on [page 440](#)).

Steps to Choose the Suspension System (Medium or Heavy Loads)

- 1 - Define the total load of the system*: a + b + enclosure + installed equipment (Y-axis).
- 2 - Define the length of arm L (X-axis).
- 3 - Define the configuration:

Suspension System without Intermediate Joint.

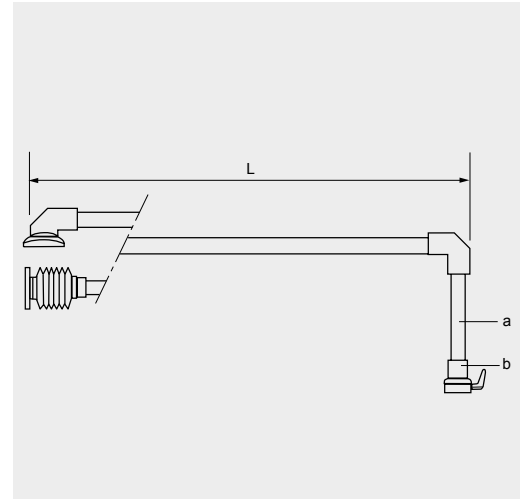
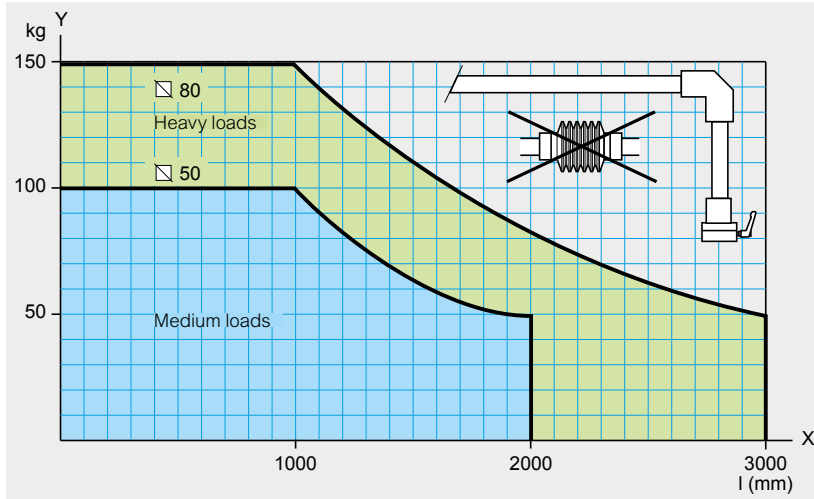

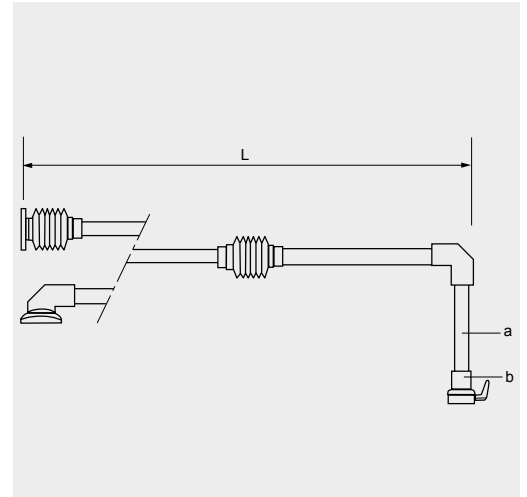
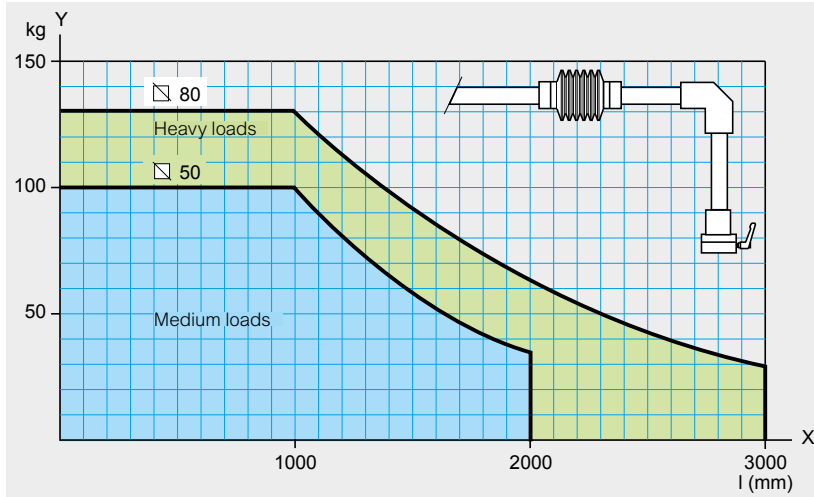

Suspension System with Intermediate Joint.



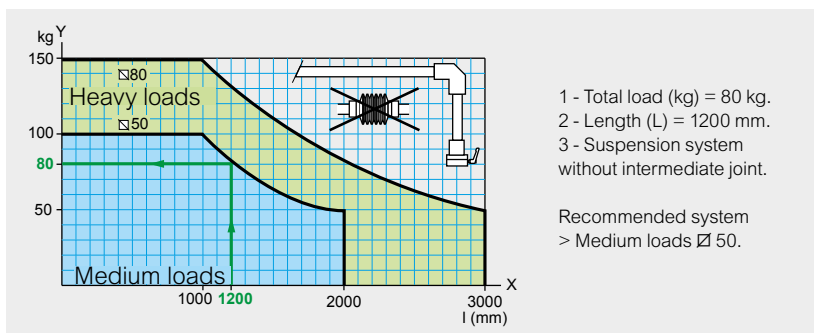

* The load (a + b + enclosure + installed equipment) must be less than the maximum load.



Example





Enclosure dimensions (mm)				Tube section U 50 mm	Tube section U 80 mm
	H (mm)	W (mm)	D (mm)	References	References
 PB500421_24_nb	300	300	200	NSYS3CM303020	-
	300	400	200	NSYS3CM304020	-
	400	400	200	NSYS3CM404020	-
	400	600	250	NSYS3CM406025*	-
	500	500	250	NSYS3CM505025	-
	600	600	200	NSYS3CM606020*	-
	600	800	300	-	NSYS3CM608030
	800	600	300	-	NSYS3CM806030*

Tube	Length (m)	Tube section U 50 mm	Tube section U 80 mm
		References	References
 PB500422_33_nb	0.5	NSYCMT5005	NSYCMT8005
	1	NSYCMT5010	NSYCMT8010
	1.5	NSYCMT5015	NSYCMT8015
	2	NSYCMT5020	NSYCMT8020

Fixing on support (steel material)		Tube section U 50 mm	Tube section U 80 mm
		References	References
 NSYCMUMR50	1 Fixed base	NSYCMUMR50	NSYCMUMR80
	 PB500424_25_nb	2 Wall fixing with joint	NSYCMUMA50
 PB500425_30_nb		3 Rotating straight fitting	NSYCMUMC50

Inter-tube fitting (aluminum material)		Tube section U 50 mm	Tube section U 80 mm
		References	References
 PB500426_28_nb	4 Horizontal inter-tube joint	NSYCMUIA50	NSYCMUIA80
	 PB500427_24_nb	5 Fixed bracket	NSYCMUTC50

Fixing on enclosure (aluminum material)		Tube section U 50 mm	Tube section U 80 mm
		References	References
 PB500428_18_nb	6 Rotating fixing on enclosure	NSYCMUCR50	NSYCMUCR80
	 PB500429_28_nb	7 Rotating fixing in bracket on enclosure	NSYCMUCC50
 NSYCMUCF50		8 Tilting fixing on enclosure	NSYCMUCP50

* Enclosure equipped with a cable gland plate.

(1) Installation on an enclosure D300 requires plate ref. NSYCMUCPAD87 (see page 444).

Technical changes reserved. Information provided without guarantee. Images are for illustrative purposes only.

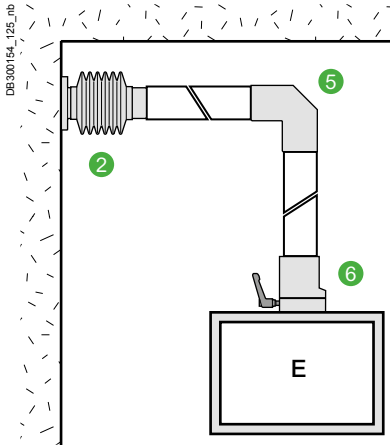

Fixing on support
 2 See page 443

Inter-tube fitting
 5 See page 444

Fixing on enclosure
 6 See page 444

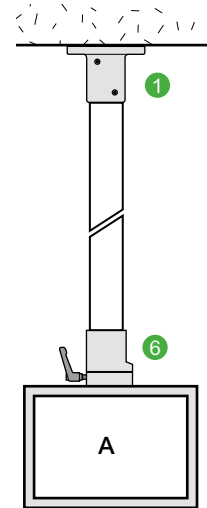

Fixing on support
 1 See page 443

Inter-tube fitting

Fixing on enclosure
 6 See page 444

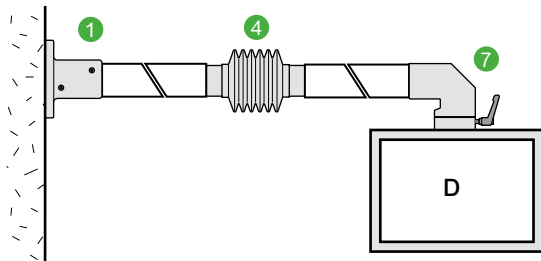

Fixing on support
 1 See page 443

Inter-tube fitting
 4 See page 443

Fixing on enclosure
 7 See page 444

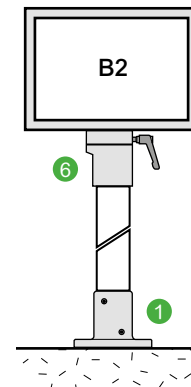

Fixing on support
 1 See page 443

Inter-tube fitting

Fixing on enclosure
 6 See page 444

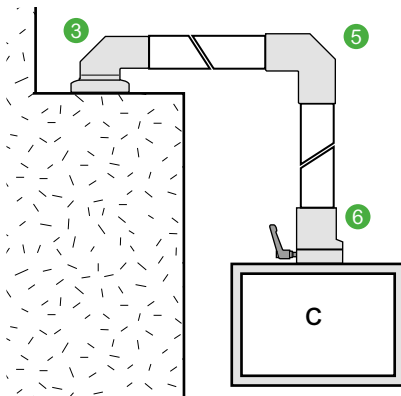

Fixing on support
 3 See page 443

Inter-tube fitting
 5 See page 444

Fixing on enclosure
 6 See page 444

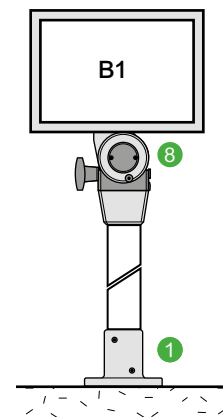

Fixing on support
 1 See page 443

Inter-tube fitting

Fixing on enclosure
 8 See page 444

Spacial S3CM

The control enclosures consist of:

A steel body equipped with:

- Reinforcement plate: The top wall is reinforced by a plate (3 mm) and pierced with a hole Ø 54 or 87 mm (according to the reference) to allow hanging installation of the enclosure,
- 4 welded studs on the 2 inner vertical walls, for fixing the rails,
- 2 rails (with drill holes) for installing equipment,
- A rear door, opening to 120° and closing with double-bar lock.

⁽¹⁾ Enclosure equipped with a cable gland plate

An aluminum front face (2.5 mm thick):

- This surface is protected on both sides by a plastic film, allowing the installation of the dialogue elements,
- A trim frame made from 4 extruded-aluminum rails.
- Structured finish, epoxy polyester powder, RAL 7040 gray color (other colors on demand).
- The design of these rails takes into account the accessory mounting functions (lamp, document support, keyboard support, laptop support, etc.), the ergonomics for handling the enclosure and its overall aesthetics.
- Finish: Structured finish, epoxy polyester powder
- Color: RAL 7035 gray
- Ingress protection rating: IP54 according to IEC 60529
- Mechanical protection rating: IK10 according to IEC 62262
- UL (cULus) certification with rating 1, 2, 3R, 12 and 13 according to UL50E

For more details see [page 460](#)



NSYS3CM303020

Characteristics	Enclosure load (kg)	Tube section (mm)	Height (mm)	Width (mm)	Depth (mm)	References
HMI encl. Spacial S3CM	8.6	50	300	300	200	NSYS3CM303020
HMI encl. Spacial S3CM	9.5	50	300	400	200	NSYS3CM304020
HMI encl. Spacial S3CM	11.4	50	400	400	200	NSYS3CM404020
HMI encl. Spacial S3CM ⁽¹⁾	17.9	50	400	600	250	NSYS3CM406025
HMI encl. Spacial S3CM	20.2	50	500	500	250	NSYS3CM505025
HMI encl. Spacial S3CM ⁽¹⁾	26.5	50	600	600	200	NSYS3CM606020
HMI encl. Spacial S3CM	34.9	80	600	800	300	NSYS3CM608030
HMI encl. Spacial S3CM ⁽¹⁾	33.6	80	800	600	300	NSYS3CM806030

Human-Machine Interface - Specific Accessories

Box Keyboard for Control Enclosure

- The box is installed on the control enclosures with a width of 600 mm. It then has an angle of 120° with its front face. All the accessories required for installation are delivered with 2 brackets and 1 trim rail, 1 hose for cable entry.

The box consists of:

- A steel body, structured finish, epoxy polyester powder, RAL 7035 gray color, with a screwed cover, an aluminum front face (2.5 mm thick) for installing a keyboard,

- A trim frame made from 2 extruded-aluminum rails guaranteeing ergonomic handling of the box and the aesthetics of the unit. The frame and the front face are delivered assembled. Structured finish, epoxy polyester powder painting, RAL 7040 gray color.
- Ingress protection rating: IP54
- Mechanical protection rating: IK10
- Weight: 8 kg

For more details see [page 461](#)



NSYCMT2560110

Characteristics	Height (mm)	Width (mm)	References
Box-keyboard for control enclosure	250	600	NSYCMT2560110

11

Support

- Installation on the left or right rail of the frame of the control enclosure.
- Material: Sheet steel
- Finish: Structured finish, epoxy polyester powder
- Color: RAL 7035 gray
- Thickness: 15/10° mm

For more details see [page 461](#)



NSYCMBPT

Characteristics	References
Support for Keyboard	NSYCMBPT

Tube

The tubes are available in:

- 2 sizes: Square of 50 and 80 mm,
- 4 lengths: 0.5, 1, 1.5 and 2 m
- Material: Extruded steel
- Finish: structured finish, powder
- Color: RAL 7035 gray
- Thickness: 40/10e mm



NSYCMT5005

Characteristics	Square (mm)	Length (m)	Weight (kg/m)	References
Tube	50	0.5	6.5	NSYCMT5005
Tube	50	1	6.5	NSYCMT5010
Tube	50	1.5	6.5	NSYCMT5015
Tube	50	2	6.5	NSYCMT5020
Tube	80	0.5	10.5	NSYCMT8005
Tube	80	1	10.5	NSYCMT8010
Tube	80	1.5	10.5	NSYCMT8015
Tube	80	2	10.5	NSYCMT8020

Fixed Base



NSYCMUMR50

- Support foot for direct horizontal or vertical connection.
- Material: Molded steel
- Color: RAL 7040 gray

For more details see [page 462](#)

Characteristics	Square (mm)	Weight (kg)	References
Fixed base	50	3.25	NSYCMUMR50
Fixed base	80	7	NSYCMUMR80

Wall Fixing with Joint



NSYCMUMA50

- Device allowing rotation through 170° of a horizontal tube, with a square section of 50 or 80 mm, and its fixing on a vertical surface.
- Protection by bellows, RAL 7035 gray color.
- Option of passing cables through the inside of the joint.
- Material: Molded steel
- Color: RAL 7040 gray

For more details see [page 462](#)

Characteristics	Square (mm)	Weight (kg)	References
Wall fixing with joint	50	4.35	NSYCMUMA50
Wall fixing with joint	80	9.45	NSYCMUMA80

Rotating Straight Fitting



NSYCMUMC50

- Device allowing the fixing and rotation through 295° of tubes, with a square section of 50 or 80 mm, in horizontal position.
- Without blocking the chosen position.
- Fixing by 4 screws, not included.
- Material: Molded steel
- Color: RAL 7040 gray

For more details see [page 462](#)

Characteristics	Square (mm)	Weight (kg)	References
Rotating straight fitting	50	5.4	NSYCMUMC50
Rotating straight fitting	80	15.7	NSYCMUMC80

Horizontal Inter-Tube Joint



NSYCMUIA50

- Device allowing the linking and rotation through 170° of 2 horizontal tubes, with a square section of 50 or 80 mm.
- Protection by bellows, RAL 7035 gray color.
- Option of passing cables through the inside of the joint.
- Material: Molded steel
- Color: RAL 7040 gray

For more details see [page 462](#)

Characteristics	Square (mm)	Weight (kg)	References
Horizontal inter-tube joint	50	4.25	NSYCMUIA50
Horizontal inter-tube joint	80	10	NSYCMUIA80

Adapter Part for Enclosure D300 / Ø 80 mm



NSYCMUCPAD87

Fixed Bracket

Characteristics	Square (mm)	Weight (kg)	References
Adapter part for enclosure D300 / Ø 80 mm	80	0.5	NSYCMUCPAD87



NSYCMUTC50

- Our system of tubes and joints, fixed or rotating, enables all the solutions to respond to the installation needs of the control enclosures for human-machine dialogue.
- Device allowing the combination and fixing of a horizontal tube with a vertical tube.
- Material: Aluminum
- Color: RAL 7040 gray

For more details see [page 463](#)

Characteristics	Square (mm)	Weight (kg)	References
Fixed bracket	50	1.35	NSYCMUTC50
Fixed bracket	80	2.4	NSYCMUTC80

Rotating Fixing on Enclosure



NSYCMUCR50

- Device allowing the fixing and rotation through 300° of tubes, with a square section of 50 or 80 mm, in vertical position.
- System for blocking in the chosen position.
- Fixing through the support surface by 4 screws.
- Material: Aluminum
- Color: RAL 7040 gray

For more details see [page 463](#)

Characteristics	Square (mm)	Weight (kg)	References
Rotating fixing on enclosure	50	1.25	NSYCMUCR50
Rotating fixing on enclosure	80	3.1	NSYCMUCR80

Rotating Fixing in Bracket on Enclosure



NSYCMUCC50

- Devices allowing the fixing and rotation through 300° of tubes, with a square section of 50 or 80 mm, in horizontal position.
- System for blocking in the chosen position.
- Fixing through the support surface by 4 screws.
- Material: Aluminum
- Color: RAL 7040 gray

For more details see [page 463](#)

Characteristics	Square (mm)	Weight (kg)	References
Rotating fixing in bracket on enclosure	50	2	NSYCMUCC50
Rotating fixing in bracket on enclosure	80	6.55	NSYCMUCC80

Tilting Fixing on Enclosure



NSYCMUCP50

- This fixing allows the enclosures to be tilted up to 30°.
- System for blocking in the chosen position.
- It is installed on enclosures with depths of 200 and 250 mm.
- The installation on enclosures with a depth of 300 mm requires an adapter plate.
- Material: Aluminum + PA
- Color: RAL 7040 gray + PA black

For more details see [page 463](#)

Characteristics	Square (mm)	Weight (kg)	References
Tilting fixing on enclosure	50	2.98	NSYCMUCP50
Tilting fixing on enclosure	80	3.10	NSYCMUCP80

Adapter for Signalling Beacon



NSYCMACS50

- It is installed on fixed brackets ref. NSYCMUTC50 and NSYCMUTC80.
- Material: Aluminum.
- Finish: Structured finish, powder.
- Color: RAL 7040 gray

For more details see [page 463](#)

Characteristics	Square (mm)	Weight (kg)	References
Adapter for signalling beacon	50	0.025	NSYCMACS50
Adapter for signalling beacon	80	0.08	NSYCMACS80

The Range of **Spacial SD** Control Desks Provides All Functions Required of a Workstation Intended for Industrial and Infrastructure Applications.

This range can be configured according to your needs

4 different services available:



Assemble to Order



Mounting of Standard Accessories



Painting



Machining



Steel Control Desks



Accessibility

There are two versions of the ComPacT control desk:

- Front accessibility: Designed for straightforward solutions.
- Front and rear accessibility through a removable panel: Enables the installation of two adjoining plates and to work at the rear. The control desk with console offers full accessibility since it is fully accessible from the rear thanks to the 3-point locking system door it includes. For Spacial SD, the accessibility which allows quick and easy work is one of its main priorities. For this reason, its design excludes the central upright.



Convenience

The option of connecting the modular control desk to the modular consoles affords multiple combinations. The opening direction of the door can be changed quickly thanks to the included hinges.



Ease of Use

The console opens easily and safely thanks to the installed pneumatic opening lid stays. Cable entry is optimized because all the models of the range include a cable gland plate with two adjustable parts.



Compatibility

Furthermore, the Spacial SD control desk is compatible with most of the accessories of the Spacial SF and SM ranges.

See page 474 for details or consult our web site www.se.com

ComPacT Control Desk



NSYSDB6

- This range is available in 4 widths with fixed rear panel.
- Full accessibility is provided from the front (no central upright).
- Easy removable and reversible door opening to 120°.
- Locking by 3 mm doublebar lock (other inserts or cylinders also available, to be ordered separately, see [page 452](#)).
- Desk lid equipped with a pneumatic opening stay.
- Opens to 75°. Perforated reinforcement rails with a pitch of 25 mm.
- Control desk equipped with adjustment rails with a pitch of 25 mm and brackets allowing adjustment of the mounting plate depth.
- Cable gland plate with 2 adjustable parts, with polyurethane gasket.
- M8 x 18 mm earthing screw for equipotential connection between the door and the body.
- Material: Welded folded steel
- Finish: Structured finish, epoxy polyester powder
- Color: RAL 7035 gray
- Thickness: 15/10° mm
- Ingress protection rating according to IEC 60529: IP55
- Mechanical protection rating according to IEC 62262: IK10

Options:
It can also be equipped with a mounting plate, see [page 453](#)

For more details see [page 464](#)

Characteristics	No. doors	Width (mm)	Height (mm)	Depth (mm)	References
ComPacT control desk	1	600	1000	469	NSYSDB6
ComPacT control desk	1	800	1000	469	NSYSDB8
ComPacT control desk	2	1000	1000	469	NSYSDB10
ComPacT control desk	2	1200	1000	469	NSYSDB12

Control Desk with Console

- Full accessibility is provided from the front and rear.
- Easy removable and reversible front door, opening to 120°.
- Locking by two-point locks with 3-mm double-bar insert.
- Desk lid equipped with a pneumatic opening stay. Opens to 75°.
- Perforated reinforcement rails with a pitch of 25 mm for quick installation of cables and cable ducts.
- Locking by two-point locks with 3-mm double-bar insert.
- Hinged console cover equipped with a pneumatic opening stay.
- Opens to 75°.
- Locking by two-point locks with 3-mm double-bar insert.
- Easy removable and reversible rear door, opening to 120°.
- Locking by three-point lock with flat escutcheon, 5-mm double-bar insert.
- One entry cable gland plate, with polyurethane gasket.
- Control desk equipped with adjustment rails with a pitch of 25 mm and brackets allowing adjustment of the mounting plate depth.
- M8 x 18 mm earthing screw for equipotential connection between the door and the body.
- Material: Welded folded steel
- Finish: Structured finish, epoxy polyester powder
- Color: RAL 7035 gray
- Thickness: 15/10° mm
- Ingress protection rating according to IEC 60529: IP55
- Mechanical protection rating according to IEC 62262: IK10

Options:
Plinth options see [page 451](#).
It can also be equipped with a mounting plate, see [page 453](#).
Locking system: Other inserts or cylinders also available, see [page 452](#).
The console can support the installation of a 14" display with an optional PC support plate, see [page 453](#).

For more details see [page 464](#)



NSYSDF88

Characteristics	No. Front doors	No. Rear doors	No. cable gland plates	Width (mm)	Height (mm)	Depth (mm)	References
Control desk with console	1	1	1	800	1400	845	NSYSDF88
Control desk with console	1	1	1	800	1400	1045	NSYSDF810
Control desk with console	2	2	1	1000	1400	845	NSYSDF108
Control desk with console	2	2	1	1000	1400	1045	NSYSDF1010
Control desk with console	2	2	1	1200	1400	845	NSYSDF128
Control desk with console	2	2	1	1200	1400	1045	NSYSDF1210
Control desk with console	2	2	2	1600	1400	845	NSYSDF168
Control desk with console	2	2	2	1600	1400	1045	NSYSDF1610

ComPacT Control Desk with Rear Panel

- Removable rear panel. It enables the installation of two mounting plates back-to-back, allowing the installation of a large number of devices, while ensuring full accessibility from the front and the rear.
- At the top, these control desks are equipped with cable entry cut-outs, that allows the installation of one or more modular consoles.
- Easy removable and reversible door, opening to 120°.
- Locking by 3 mm doublebar lock (other inserts or cylinders also available, to be ordered separately, see [page 452](#)).
- Desk lid equipped with a pneumatic opening stay.
- Opens to 75°. Perforated reinforcement rails with a pitch of 25 mm.
- Top cable entry cut-outs covered by a entire blanking cover.
- Control desk equipped with adjustment rails with a pitch of 25 mm and brackets allowing adjustment of the mounting plate depth.
- Cable gland plate with 2 adjustable parts, with polyurethane gasket.
- M8 x 18 mm earthing screw for equipotential connection between the door and the body.
- Material: Welded folded steel
- Finish: Structured finish, epoxy polyester powder paint
- Color: RAL 7035 gray
- Thickness: 15/10° mm
- Ingress protection rating according to IEC 60529: IP55
- Mechanical protection rating according to IEC 62262: IK10

Options:

Modular consoles to be installed on top of compact control desk. See details and combinations [page 448](#). It can also be equipped with a mounting plate, see [page 453](#).

For more details see [page 465](#)



NSYSD6R

Characteristics	No. doors	Width (mm)	Height (mm)	Depth (mm)	References
ComPacT control desk with rear panel	1	600	1000	600	NSYSD6R
ComPacT control desk with rear panel	1	800	1000	600	NSYSD8R
ComPacT control desk with rear panel	2	1000	1000	600	NSYSD10R
ComPacT control desk with rear panel	2	1200	1000	600	NSYSD12R

Modular Consoles

- Hinged modular console cover equipped with a pneumatic opening stay.
- Opens to 75°. Locking of the hinged modular console cover by two 3-mm double-bar locks (other inserts or barrels also available, to be ordered separately, see [page 452](#)).
- Screw fixed rear panel equipped with step slides in the version with a depth of 300 mm.
- Material: Welded folded steel
- Finish: Structured finish, epoxy polyester powder
- Color: RAL 7035 gray
- Thickness: 15/10^o mm
- Ingress protection rating: IP55 according to IEC 60529
- Mechanical protection rating: IK10 according to IEC 62262

Options:

The link between the control desk and the modular console requires, in certain cases, the addition of one or several blanking covers (to be ordered separately).
Optional galvanized mounting plate.



NSYSDC42

Characteristics	No. of cable entry cut-outs	Width (mm)	Height (mm)	Depth (mm)	References
Modular consoles	2	400	483	200	NSYSDC42
Modular consoles	2	400	483	300	NSYSDC43
Modular consoles	3	600	483	200	NSYSDC62
Modular consoles	3	600	483	300	NSYSDC63

Blanking Cover

- To conceal the free space of the control desk when the width of the console or consoles is less than the width of the control desk.
- In any case, it is necessary to first remove the top plate delivered with the control desk.
- Material: Steel
- Finish: Structured finish, epoxy polyester powder
- Color: RAL 7035 gray
- Thickness: 15/10^o mm
- Fixing: Fixing by screws



NSYRP2

Characteristics	Width (mm)	Height (mm)	References
Blanking cover	200	40	NSYRP2

Mounting Plates for Modular Consoles

- Steel mounting plates can be installed at the back of modular consoles (F).
- Material: 304L Galvanized Steel

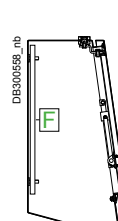

Example Installation of a Mounting Plate in a Console Depth 200 mm.

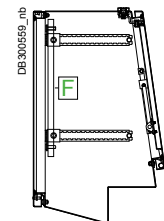

Example Installation of a Mounting Plate in a Console Depth 300 mm.



NSYMM44

Characteristics	Modular console Width (mm)	Fixing center-to-center distance (mm)		References
		Height (mm)	Width (mm)	
Mounting plate	400	325	325	NSYMM44
Mounting plate	600	625	325	NSYMM64













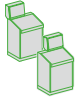





NSYMF44

Characteristics	Modular console Width (mm)	Fixing center-to-center distance (mm)		References
		Height (mm)	Width (mm)	
Mounting plate Microperforated	400	325	325	NSYMF44
Mounting plate Microperforated	600	625	325	NSYMF64

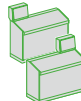

NSYMR44

Characteristics	Modular console Width (mm)	Fixing center-to-center distance (mm)		References
		Height (mm)	Width (mm)	
Mounting plate Telequick	400	325	325	NSYMR44
Mounting plate Telequick	600	625	325	NSYMR64

Combination examples of modular consoles installation		ComPacT control desk	Modular console	Blanking cover
600		Spacial SD	Spacial SD	Spacial SD
		NSYSD6R	NSYSDC42 / NSYSDC43	NSYRP2
		NSYSD6R	NSYSDC62 / NSYSDC63	-
800		Spacial SD	Spacial SD	Spacial SD
		NSYSD8R	NSYSDC42 / NSYSDC43	2 x NSYRP2
		NSYSD8R	2 x NSYSDC42 / 2 x NSYSDC43	-
		NSYSD8R	NSYSDC62 / NSYSDC63	NSYRP2
1000		Spacial SD	Spacial SD	Spacial SD
		NSYSD10R	NSYSDC42 / NSYSDC43	3 x NSYRP2
		NSYSD10R	NSYSDC62 / NSYSDC63	2 x NSYRP2
		NSYSD10R	NSYSDC62 / NSYSDC63	2 x NSYRP2
		NSYSD10R	NSYSDC42 + NSYSDC62 / NSYSDC43 + NSYSDC63	-
1200		Spacial SD	Spacial SD	Spacial SD
		NSYSD12R	NSYSDC42 / NSYSDC43	4 x NSYRP2
		NSYSD12R	NSYSDC62 / NSYSDC63	3 x NSYRP2
		NSYSD12R	NSYSDC62 / NSYSDC63	3 x NSYRP2
		NSYSD12R	2 x NSYSDC62 / 2 x NSYSDC63	-
		NSYSD12R	NSYSDC42 + NSYSDC62 / NSYSDC43 + NSYSDC63	NSYRP2

Floor

SD

For more information, see [page 89](#).



Front and rear plinth

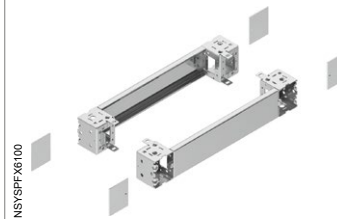

NSYSPPFX6100

Characteristics	NSYSPPF6100		NSYSPPFX6100	
	<ul style="list-style-type: none"> The front and rear of the plinth consists of 4 corners with 2 or 4 panels. 			
Material	Folded sheet steel, corner with a thickness of 25/10e mm		304L stainless-steel	
Finish	Painted with epoxy polyester resin		-	
Color	RAL 7022 gray		-	
Ingress protection rating	IP30		IP30	
Mechanical protection rating	IK10		IK10	
Supply	<ul style="list-style-type: none"> Height 100 mm: 4 corners, 2 panels (front and rear), 4 corner covers and fixing elements Height 200 mm: 4 corners, 4 panels (2 front and 2 rear), 4 corner covers and fixing elements The use of 304L stainless-steel plinths on an SD control desk requires an earthing cable (description page 278) to be ordered separately. 			
Control desk references	Plinths references			
ComPacT control desks with fixed rear panel	100 mm	200 mm	100 mm	200 mm
	References	References	References	References
	NSYSDD6	NSYSPPF6100	NSYSPPF6200	NSYSPPFX6100
	NSYSDD8	NSYSPPF8100	NSYSPPF8200	NSYSPPFX8100
	NSYSDD10	NSYSPPF10100	NSYSPPF10200	NSYSPPFX10100
	NSYSDD12	NSYSPPF12100	NSYSPPF12200	NSYSPPFX12100
ComPacT control desks with removable rear panel Sheet steel	100 mm	200 mm	100 mm	200 mm
	References	References	References	References
	NSYSDD6R	NSYSPPF6100	NSYSPPF6200	NSYSPPFX6100
	NSYSDD8R	NSYSPPF8100	NSYSPPF8200	NSYSPPFX8100
	NSYSDD10R	NSYSPPF10100	NSYSPPF10200	NSYSPPFX10100
	NSYSDD12R	NSYSPPF12100	NSYSPPF12200	NSYSPPFX12100
Control desk with console	100 mm	200 mm	100 mm	200 mm
	References	References	References	References
	NSYSDF88	NSYSPPF8100	NSYSPPF8200	-
	NSYSDF108	NSYSPPF10100	NSYSPPF10200	-
	NSYSDF128	NSYSPPF12100	NSYSPPF12200	-
	NSYSDF168	NSYSPPF16100	NSYSPPF16200	-
	NSYSDF810	NSYSPPF8100	NSYSPPF8200	-
	NSYSDF1010	NSYSPPF10100	NSYSPPF10200	-
	NSYSDF1210	NSYSPPF12100	NSYSPPF12200	-
	NSYSDF1610	NSYSPPF16100	NSYSPPF16200	-

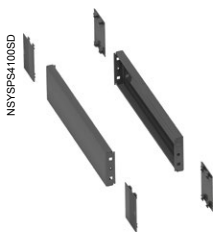

Plinth side panels



NSYSPSX5100

NSYSPS4100SD

- They are fixed to the corner of the plinth by 2 fixing screws.

Folded sheet steel

Painted with epoxy polyester resin

RAL 7022 gray

IP30

IK10

- Height 100 mm: 2 side panels, 4 corner covers and fixing elements
- Height 200 mm: 4 side panels (height of 100 mm, 2 for each side), 4 corner covers and fixing elements
- The use of 304L stainless-steel plinths on an SD control desk requires an earthing cable (description [page 278](#)) to be ordered separately.

NSYSPSX5100

304L stainless-steel

-

-

IP30

IK10

100 mm

200 mm

100 mm

200 mm

References

References

References

References

NSYSPS4100SD

NSYSPS4200SD

NSYSPSX5100

NSYSPSX5200

NSYSPS4100SD

NSYSPS4200SD

NSYSPSX5100

NSYSPSX5200

NSYSPS4100SD

NSYSPS4200SD

NSYSPSX5100

NSYSPSX5200

NSYSPS4100SD

NSYSPS4200SD

NSYSPSX5100

NSYSPSX5200

100 mm

200 mm

100 mm

200 mm

NSYSPS5100SD

NSYSPS5200SD

NSYSPSX5100

NSYSPSX5200

NSYSPS5100SD

NSYSPS5200SD

NSYSPSX5100

NSYSPSX5200

NSYSPS5100SD

NSYSPS5200SD

NSYSPSX5100

NSYSPSX5200

NSYSPS5100SD

NSYSPS5200SD

NSYSPSX5100

NSYSPSX5200

100 mm

200 mm

100 mm

200 mm

NSYSPS4100SD

NSYSPS4200SD

-

-

NSYSPS4100SD

NSYSPS4200SD

-

-

NSYSPS4100SD

NSYSPS4200SD

-

-

NSYSPS4100SD

NSYSPS4200SD

-

-

NSYSPS6100SD

NSYSPS6200SD

-

-

NSYSPS6100SD

NSYSPS6200SD

-

-

NSYSPS6100SD

NSYSPS6200SD

-

-

NSYSPS6100SD

NSYSPS6200SD

-

-

Door

Pneumatic opening stay

- Holds the desk lid in open position at an angle of 75°.



Nominal load per stay (N)	Max. load on lid (kg)	Control desk references			Standard supply stay
		With fixed rear panel	With removable rear panel	With console	
		References	Sheet steel References	References	References
244	13	NSYSD6	NSYSD6R	NSYSDF88	NSYPLS24
244	13	NSYSD8	NSYSD8R	NSYSDF810	NSYPLS24
300	11	-	-	NSYSDF168	NSYPLS30
300	11	-	-	NSYSDF1610	NSYPLS30
300	15	NSYSD12	NSYSD12R	NSYSDF128	NSYPLS30
300	15	-	-	NSYSDF1210	NSYPLS30
300	17	NSYSD10	NSYSD10R	NSYSDF108	NSYPLS30
300	17	-	-	NSYSDF1010	NSYPLS30

Pneumatic Opening Stay

- Holds the desk lid in open position at an angle of 75°.

Supply:
delivered with fixings

Characteristics	Nominal load per stay (N)	Max. load on lid (kg)	References
Pneumatic opening stay	244	13	NSYPLS24
Pneumatic opening stay	300	17	NSYPLS30

Shape Inserts

Option to replace the standard shape insert:

- 8 mm triangular insert,
- 8 mm male square insert,
- 7 mm male square insert.
- Material: Zamack

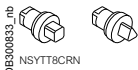

Characteristics	References
8 mm triangular insert	NSYTT8CRN
8 mm male square insert	NSYTC8CRN
7 mm male square insert	NSYTC7CRN

Escutcheon with Key Lock

- Insert breakage torque: 15 daN.
- Material: Polyamide PA 6 material charged with 30% fiberglass
- Color: RAL 7011 gray
- Mechanical protection rating according to IEC 62262: IK10
- Fire resistance: 650 °C



Characteristics	References
405E key	NSYML405SD

ComPacT Control Desks

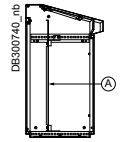

Characteristics	Width (mm)	Surface (dm ²)	References
Mounting plate plain	600	42	NSYPMP8560
Mounting plate plain	800	59	NSYPMP8580
Mounting plate plain	1000	76	NSYPMP85100
Mounting plate plain	1200	93	NSYPMP85120

Control Desk with Console

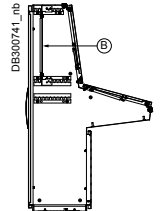

Characteristics	Width (mm)	Surface (dm ²)	References
Mounting plate plain	800	31	NSYPMP4580
Mounting plate plain	1000	40	NSYPMP45100
Mounting plate plain	1200	77	NSYPMP45120
Mounting plate plain	1600	67	NSYPMP45160

Control Desk with Console

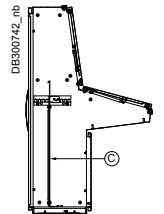

Characteristics	Width (mm)	Surface (dm ²)	References
Mounting plate plain	800	49	NSYPMP8580
Mounting plate plain	1000	63	NSYPMP85100
Mounting plate plain	1200	77	NSYPMP85120
Mounting plate plain	1600	105	NSYPMP85160

ComPacT Control Desks



NSYMP148

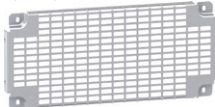

NSYSTMP6080

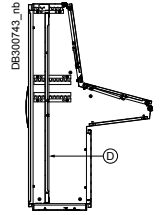

Characteristics	Width (mm)	Surface (dm ²)	References
Mounting plate plain	800	90	NSYMP148
Mounting plate plain	1000	116	NSYMP1410
Mounting plate plain	1200	142	NSYMP1412
Mounting plate Telequick (2 items needed)	800	84	NSYSTMP6080
Mounting plate Telequick (2 items needed)	1000	108	NSYSTMP60100
Mounting plate Telequick (2 items needed)	1200	132	NSYSTMP60120

ComPacT Control Desks



NSYSPMP4080

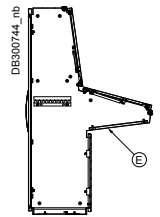

Characteristics	Width (mm)	Surface (dm ²)	References
Mounting plate plain	800	28	NSYSPMP4080
Mounting plate plain	1000	36	NSYSPMP40100
Mounting plate plain	1200	44	NSYSPMP40120

Fixing Brackets

- Set of 4 fixing brackets.
- Depth adjustment on 25 mm pitch.
- Included as standard with desk (all versions).
- To be ordered separately when required for installation of two back-to-back mounting plates in control desks with rear access.
- Material: Galvanized steel
- Thickness: 40/10^e mm
- Maximum load: 250 kg



NSYMPBSD

Characteristics	For desk width (mm)	References
Fixing brackets	600	NSYMPBSD
Fixing brackets	800	NSYMPBSD
Fixing brackets	1000	NSYMPBSD
Fixing brackets	1200	NSYMPBSD
Fixing brackets	1600	NSYMPBSD

Adjustment Rails and Fixing Brackets

- Set of 4 rails and 4 fixing brackets.
- To install a plain mounting plate or a Telequick mounting plate, either at the top or across the height of the monobloc control desk with console.
- For positioning 2 plates (back-to-back), order fixing brackets ref. **NSYMPBSD**.



NSYMPB4SD

Characteristics	For control desks with console Depth (mm)	References
Adjustment rails and fixing brackets	400	NSYMPB4SD
Adjustment rails and fixing brackets	600	NSYMPB6SD

Technical Uprights

- Set of 2 equipment uprights.
- Support for fixing Telequick mounting plates and rails.
- Material: Zinc-coated
- Thickness: 20/10° mm



Characteristics	For control desk height (mm)	Center-to-center distance (mm)	References
Technical uprights	1000	650	NSYTVR8
Technical uprights	1400	1250	NSYTVR14

The **Spacial SF** PC Rack Is Designed to Protect and Control Computer Equipment in Industrial Environments.

This range can be configured according to your needs

4 different services available:



Assemble to Order



Mounting of Standard Accessories



Painting



Machining



Steel PC Racks

11



Convenience

- Anti-glare glazed door designed for viewing screens up to 25.5"
- Cable entry made easier by a two-piece cable-land plate.

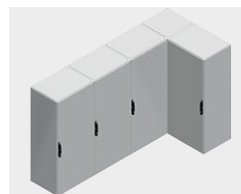

Simplicity

The Spacial SF design allows enclosures to be coupled in any direction, adapting to all installation surfaces.



Ergonomics

- Access to the various functions and working heights, guaranteeing optimal comfort.
- Partial doors delimit the access to each function with a 3-mm double-bar lock.
- Built-in display and CPU support.
- Built-in keyboard and mouse support.



Detail of 5 mm DB lock on rear door.

Locking System

- Locking system with flat escutcheon, made from polyamide 6 with 30% fiberglass, RAL 9005 black, with 5-mm double-bar insert for the plain rear door, and small flat escutcheon with 3 mm double-bar insert for the partial front doors.

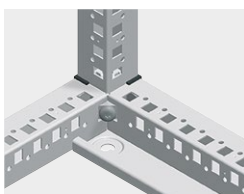

Robust

- Spacial SF structure formed from a single 1.5 mm galvanized steel section, with a high moment of inertia.
- Vertical uprights joined with top and bottom frames, screwed together with connections of sintered steel.
- Panels built into the structure.

See page 474 for details or consult our web site www.se.com

Spacial SF PC Rack



- Partial door for PC display, with Securit® anti-glare glass.
- Plain partial door for CPU (enclosures with height of 1800 mm).
- Hinged plain door for keyboard.
- Plain partial door for optional installation of A4 printer support.
- Partial front doors opening to the right.
- Plain rear door, reversible opening direction (right or left).
- Roof and side panels fixed from the inside.
- Cable gland plate with 1 entry.
- Finish: Structured finish, epoxy polyester powder
- Color: RAL 7035 gray
- Ingress protection rating according to IEC 60529: IP40
- Mechanical protection rating according to IEC 62262: IK10
- Certifications: UL (cULus). Rated 1, 12 according to UL50E

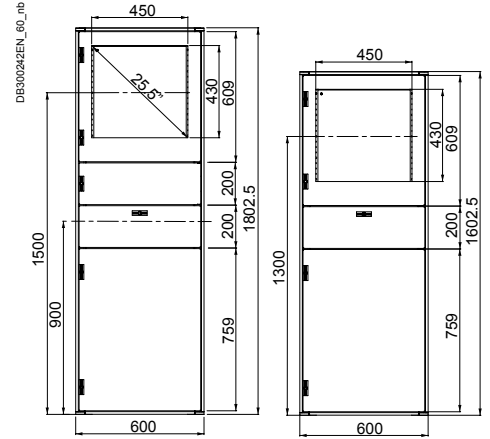

For more details see [page 465](#)

Characteristics	No. of compartments	Height (mm)	Width (mm)	Depth (mm)	References
Spacial SF PC rack	3	1600	600	600	NSYSF16660PC
Spacial SF PC rack	3	1600	600	800	NSYSF16680PC
Spacial SF PC rack	4	1800	600	600	NSYSF18660PC
Spacial SF PC rack	4	1800	600	800	NSYSF18680PC

Front and Rear Plinths



- The front and rear of the plinth consists of 4 corners with 2 or 4 panels.
- Material: Folded sheet steel, corner with a thickness of 25/10^o mm
- Finish: Structured finish, epoxy polyester powder
- Color: RAL 7022 gray
- Ingress protection rating: IP30 according to IEC 60529
- Mechanical protection rating: IK10 according to IEC 62262

Supply:

Height 100 mm: 4 corners, 2 panels (front and rear), 4 corner covers and fixing elements
 Height 200 mm: 4 corners, 4 panels (2 front and 2 rear), 4 corner covers and fixing elements

Characteristics	Height (mm)	Width (mm)	References
Front plinths for Spacial	100	600	NSYSPF6100
Front plinths for Spacial	200	600	NSYSPF6200

Plinth Side Panels



- They are fixed to the corner of the plinth by 2 fixing screws.
- Material: Folded sheet steel
- Finish: Structured finish, epoxy polyester powder
- Color: RAL 7022 gray
- Ingress protection rating: IP30 according to IEC 60529
- Mechanical protection rating: IK10 according to IEC 62262

Supply:

Height 100 mm: 2 side panels, 4 corner covers and fixing elements
 Height 200 mm: 4 side panels (height of 100 mm, 2 for each side), 4 corner covers and fixing elements

Characteristics	Height (mm)	Depth (mm)	References
Side plinths for Spacial	100	600	NSYSPS6100
Side plinths for Spacial	100	800	NSYSPS8100
Side plinths for Spacial	200	600	NSYSPS6200
Side plinths for Spacial	200	800	NSYSPS8200

Fixed Trays



- Optional installation of a supplement fixed or telescopic tray directly on structure or on cross-rails.
- Acceptable load: 150 kg for fixed trays and 50 kg for telescopic rails, both evenly distributed.
- Installation: On structure / On cross-rails

For more details and other options on Mounting see [page 240](#).

Characteristics	Width (mm)	Depth (mm)	References
Fixed Tray	600	600	NSYFXT6060

Universal Cross-Rail 40 mm (1 Row)



Characteristics	Enclosure Depth (mm)	References
Universal cross-rail 40 mm (1 row)	600	NSYSUCR4060
Universal cross-rail 40 mm (1 row)	800	NSYSUCR4080

Telescopic Rails



Characteristics	Enclosure Depth (mm)	References
Telescopic rails	600	NSYTTG60
Telescopic rails	800	NSYTTG60

Handle for Telescopic Trays



- Handle designed for easy extraction of the sliding trays.
- Material: Polyamide 6 (black)

Supply:

2 units and fixing elements

Characteristics	References
Handle for telescopic trays	NSY1TH

Locks for Partial Doors

Locks to replace the 3-mm double-bar lock supplied with the partial doors.

Models:

- Transformation of lock with shaped inserts, triangular 6.5 mm and square 6 mm.
- Lock with 2233X key for partial doors.
- Lock with 2233X key, exclusive for hinged keyboard door.

Supply:

Lock with shaped inserts, triangular 6.5 mm and square 6 mm: Metal body, shape insert and safety washer.

Lock with 2233X key for partial doors:

metal body, insert, screw, safety washer and key.

Lock with 2233X key, exclusive for hinged

keyboard door: Metal body, insert, special screw, safety washer and key.



NSYMLT6

Characteristics	References
With 6.5 mm triangular insert for partial and hinged door	NSYMLT6
With 6 mm square insert for partial and hinged door	NSYMLS6
With 2233X key for partial door	NSYML23
With 2233X key for hinged keyboard door	NSYMLCD23

HMI Enclosure Spacial S3CM

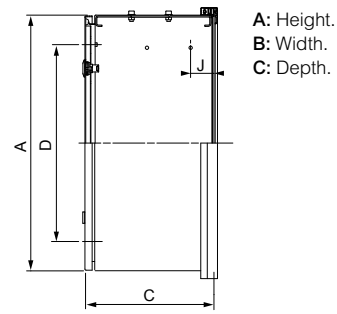
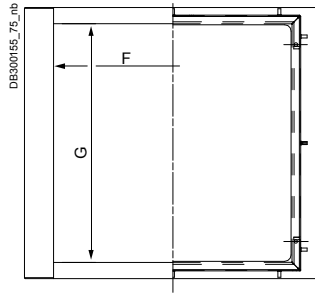
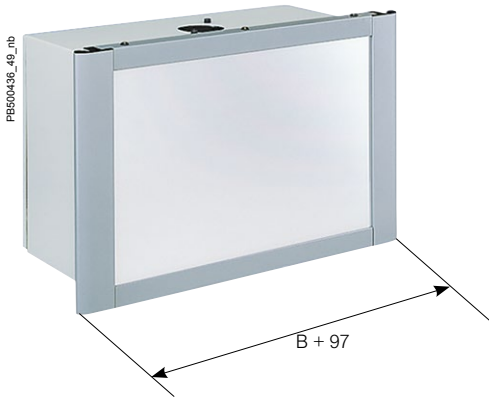

W600 enclosure + box keyboard installation

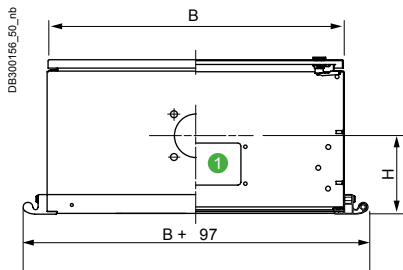

1 Cable gland plate.

Figure 1
Enclosure depth from 200 to 250

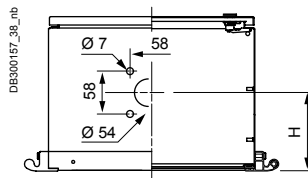
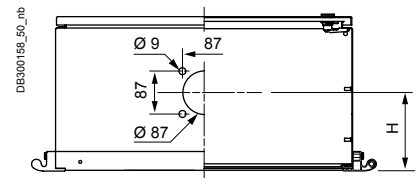

Figure 2
Enclosure depth 300



Enclosure dimensions (mm)								Cable gland plate	Ø Top hole (mm)	Fig.	Enclosure References
Height (mm)	Width (mm)	Depth (mm)	D	F	G	H	J				
300	300	200	162	262	262	100	45	-	54	1	NSYS3CM303020
300	400	200	162	362	262	100	45	-	54	1	NSYS3CM304020
400	400	200	262	362	362	100	45	-	54	1	NSYS3CM404020
400	600	250	262	562	362	125	75	●	54	1	NSYS3CM406025*
500	500	250	362	462	462	125	75	-	54	1	NSYS3CM505025
600	600	200	462	562	562	100	45	●	54	1	NSYS3CM606020*
600	800	300	462	762	562	150	100	-	87	2	NSYS3CM608030
800	600	300	662	562	762	150	100	●	87	2	NSYS3CM806030*

* Enclosure equipped with a cable gland plate.



Perforated Rails Installed on Lateral Studs.



Detail of the Reinforcement Plate.



Rear Door with Double-Bar Lock.



Fixing of the Trim Frame by Screws.

Box Keyboard for Control Enclosure

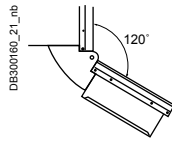
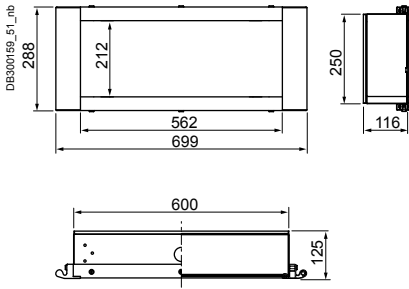

Detail from the Installation of the Box Keyboard on the Control Enclosure.

Support



Laptop Computer

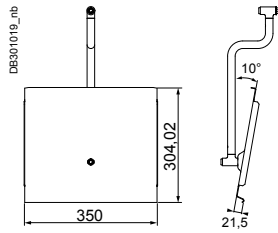

Keyboard

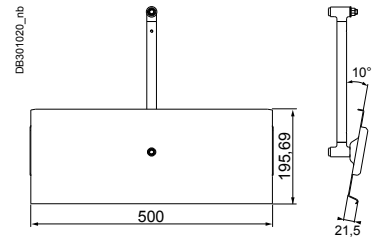



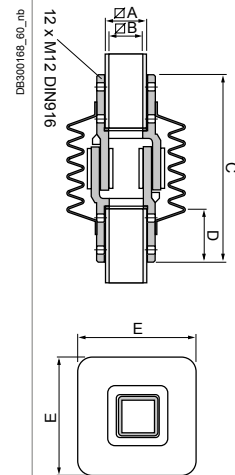
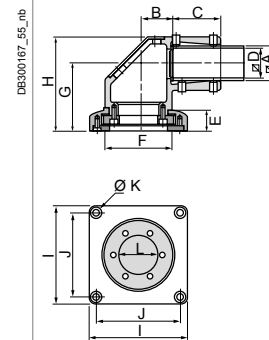
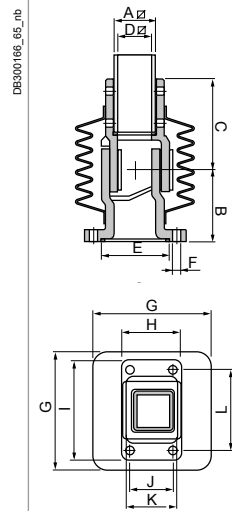
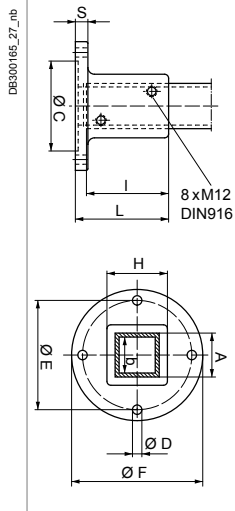

Suspension System

	NSYCMUMR80		PB900424_40_nb		PB900425_46_nb		PB900426_46_nb	
Characteristics	Fixed base		Wall fixing with joint		Rotating straight fitting		Horizontal inter-tube joint	
	Support foot for direct horizontal or vertical connection.		Device allowing rotation through 170° of a horizontal tube, with a cross-section of 50 or 80 mm, and its fixing on a vertical surface. Protection by bellows, RAL 7035 gray color. Option of passing cables through the inside of the joint.		Device allowing the fixing and rotation through 295° of tubes, with a cross-section of 50 or 80 mm, in horizontal position. Without locking the chosen position. Fixing by 4 screws, not included.		Device allowing the linking and rotation through 170° of 2 horizontal tubes, with a cross-section of 50 or 80 mm. Protection by bellows, RAL 7035 gray color. Option of passing cables through the inside of the joint.	
Material	Molded steel		Molded steel		Molded steel		Molded steel	
Color	RAL 7040 gray		RAL 7040 gray		RAL 7040 gray		RAL 7040 gray	
Weight (kg)	3.25	7	4.35	9.45	5.4	15.7	4.25	10
Dimensions (mm)								
∅ A	50 mm ²	80 mm ²	50 mm ²	80 mm ²	50 mm ²	80 mm ²	50 mm ²	80 mm ²
B	42	72	92	115	50	74	42	72
C	105	134	118	160	68	98	236	320
D	11	11	42	72	42	72	67	94
E	125	173	85	130	30	45	148	190
F	152	201	11	11	96	144	-	-
G	-	-	148	190	96	141.5	-	-
H	72	111	80	115	134	195.5	-	-
I	97	126	130	175	140	210	-	-
J	-	-	55	90	120	180	-	-
K	-	-	68	103	9	13	-	-
L	110	140	105	150	55	84	-	-
S	15	16	-	-	-	-	-	-
References	NSYCMUMR50	NSYCMUMR80	NSYCMUMA50	NSYCMUMA80	NSYCMUMC50	NSYCMUMC80	NSYCMUIA50	NSYCMUIA80

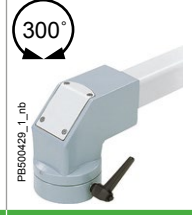

Suspension System

								
Characteristics	Fixed bracket	Rotating fixing on enclosure	Rotating fixing in bracket on enclosure					
	Our system of tubes and joints, fixed or rotating, enables all the solutions to respond to the installation needs of the control enclosures for human-machine dialogue. Device allowing the combination and fixing of a horizontal tube with a vertical tube.	Device allowing the fixing and rotation through 310° of tubes, with a square section of 50 or 80 mm, in vertical position. System for locking in the chosen position. Fixing through the support surface by 4 screws.	Devices allowing the fixing and rotation through 310° of tubes, with a square section of 50 or 80 mm, in horizontal position. System for locking in the chosen position. Fixing through the support surface by 4 screws.	This fixing allows the enclosures to be tilted up to 30°. System for locking in the chosen position. It is installed on enclosures with depths of 200 and 250 mm. The installation on enclosures with a depth of 300 mm requires an adapter plate.				
Material	Aluminum		Aluminum					
Color	RAL 7040 gray		RAL 7040 gray					
Weight (kg)	1.35	2.4	1.25	3.1	2	6.55	2.98	3.10
Dimensions (mm)								
∅ A	50 mm ²	80 mm ²	50 mm ²	80 mm ²	50 mm ²	80 mm ²	50 mm ²	80 mm ²
B	46	56	42	72	46	56	55	55
C	60	83	115	145	60	83	100	100
D	60	83	96	139	147	190	44	44
E	46	56	52.3	85	96	139	121	121
F	42	70	58	87	42	72	182	182
G	144	193	-	-	154	208.5	50	50
H	-	-	-	-	42	70	100	100
I	-	-	-	-	58	87	50	50
M	-	-	M6	M8	M6	M8	-	-
References	NSYCMUTC50	NSYCMUTC80	NSYCMUCR50	NSYCMUCR80	NSYCMUCC50	NSYCMUCC80	NSYCMUCP50	NSYCMUCP80

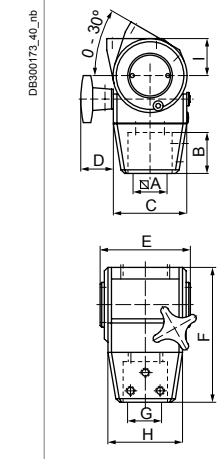
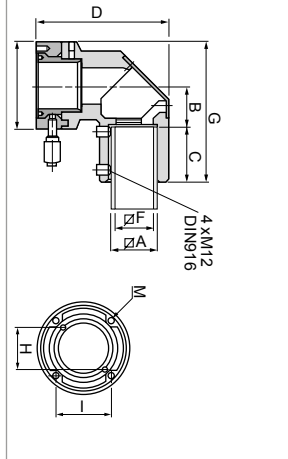
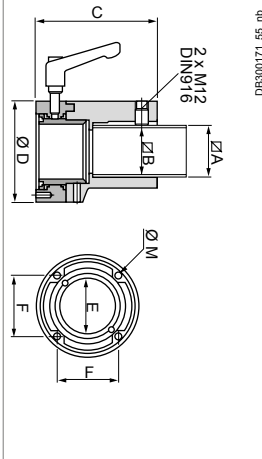
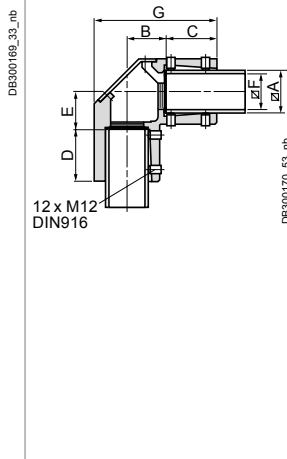

Adapter for Signalling Beacon

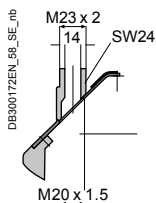

Technical changes reserved. Information provided without guarantee. Images are for illustrative purposes only.

ComPacT Control Desk

1 door

2 doors

DE300557EN_102_nb

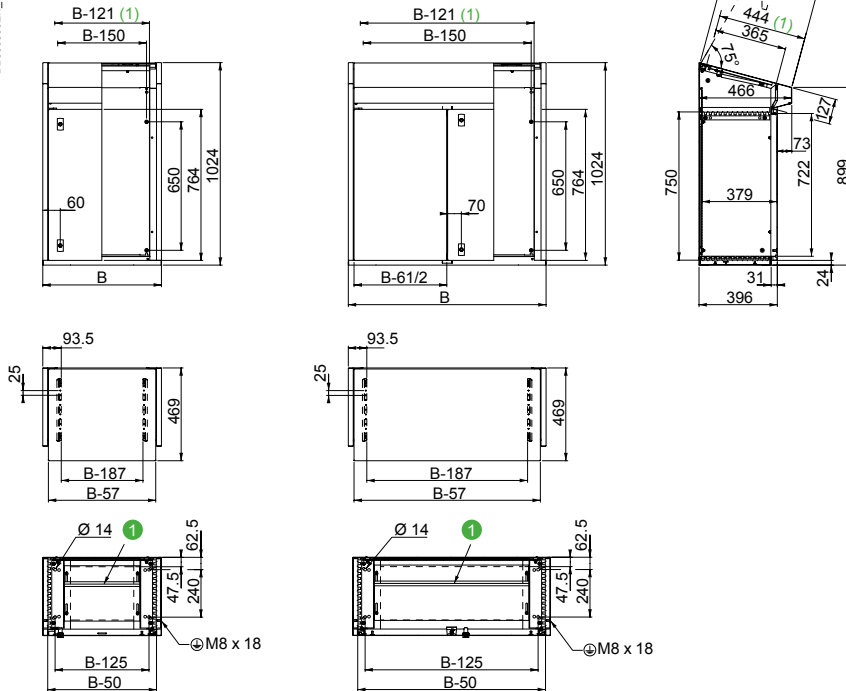

Cable gland plate clearance dimensions (mm)	
Width	Maximum opening.
B-280	56

Common side view.
 (1) Usable clearance.

ComPacT Control Desks with Rear Panel

1 door

2 doors

DE300557EN_108_nb

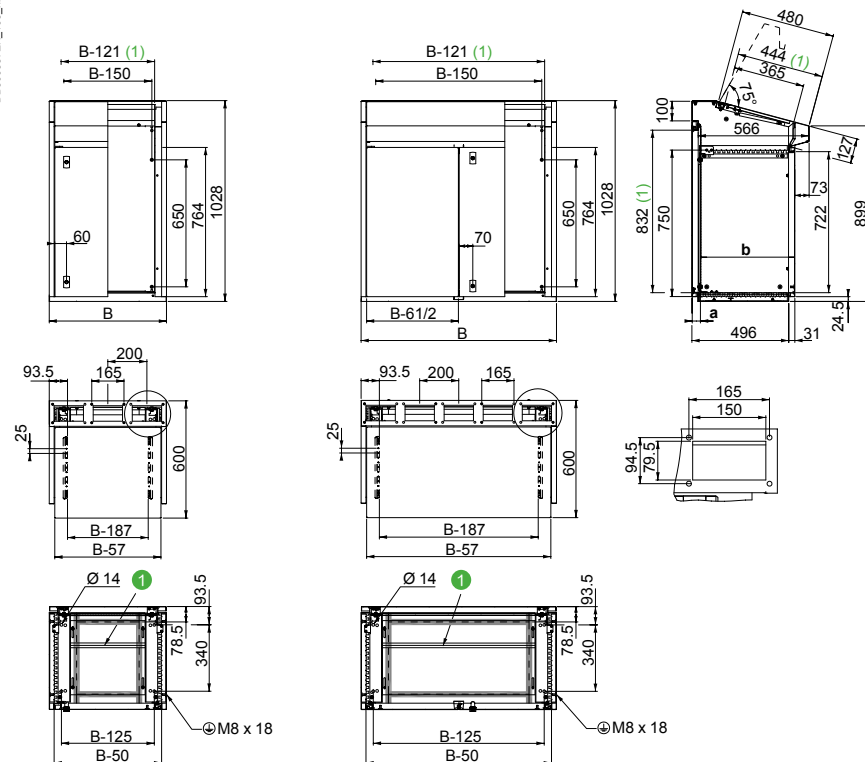

Cable gland plate clearance dimensions (mm)	
Width	Maximum opening.
B-280	56

Adjustment of the depth of the mounting plate (mm)

Depth	Min.	Max.
a	42	392
b	129	479

Common side view.
 (1) Usable clearance.

Control desk with console

1 door

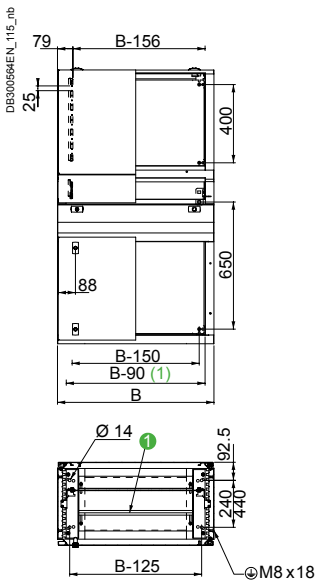

2 doors

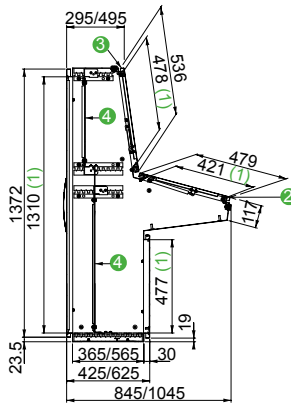
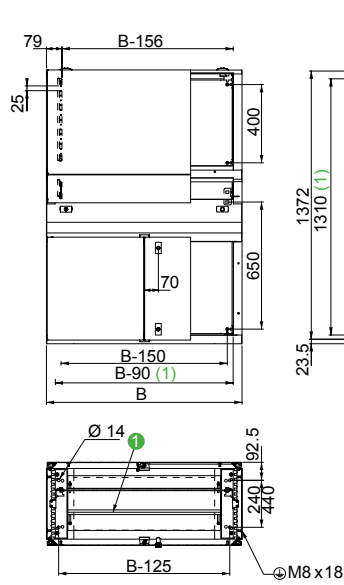

Cable gland plate clearance dimensions (mm)

Width	Maximum opening.
B-280	56

Notes

- 1 1 entry cable gland plate
- 2 Maximum opening of the hinged desk lid: 75°
- 3 Maximum opening of the hinged console cover: 75°
- 4 Optional mounting plate installation, see page 453

Common side view.
(1) Usable clearance.

Modular console

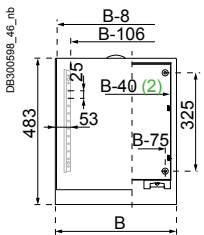

Depth 200 mm

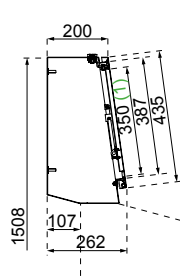

Depth 300 mm

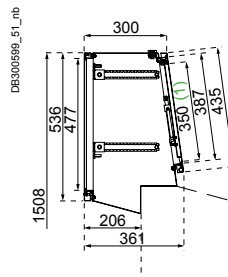

(1) Usable clearance.
(2) Same dimensions for the rear panel.

Spacial SF PC Rack

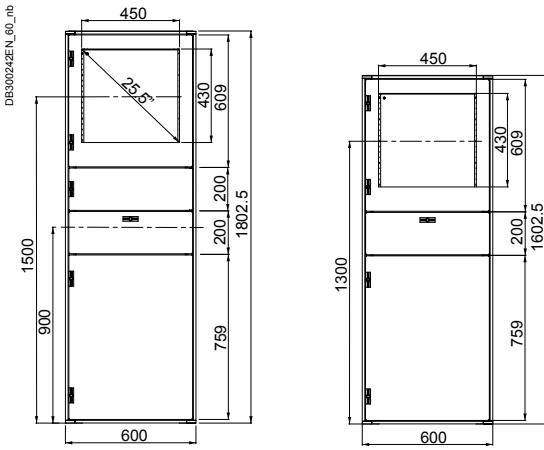

PC Rack with a Height of 1800 mm.

PC Rack with a Height of 1600 mm.

304L Stainless-Steel PC Racks

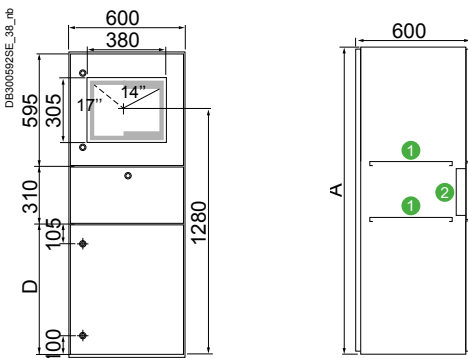

- (1) Screwed shelf, adjustable height.
- (2) Sealed case for keyboard.

A	D
1600	690
1800	890

The variable-speed drives flush-mounting kits have been designed to isolate the power part, which is an important source of heat. They are mounted in the Spacial range of steel enclosures (floor-standing and wall-mounted enclosures) and have been approved for Altivar Process variable-speed drives of the ATV630 and ATV930 ranges (power range: 0.75 to 45 kW at 200/240 V, 0.75 to 90 kW at 380/480 V).

The kits are available in five sizes and offer two methods of mounting variable-speed drives:

- slide-rail mounting for sizes 1, 2 and 3
- bracket mounting for sizes 4 and 5.

The kits can be installed:

- at the back of the enclosure.

This installation provides full thermal insulation.

- inside the enclosure on a mounting plate.

This installation may require additional thermal control.



Tightness

- IP55 according to IEC 60529 with polyurethane seal provided.



Services

Option of cut-outs (enclosure and frame) by Schneider Electric: No risk of corrosion and cuts (cut-out made before painting).

11



Ease of Installation

- Set of slide-rails allowing the variable-speed drive to be mounted quickly and efficiently.



Strength

- The rigidity of the kit allows it to be installed on Spacial S3D, SF and SM enclosures.

Earth Continuity

- Earth continuity is ensured by tightening the M6 nuts combined with pin washers.



Maintenance of the Variable-Speed Drive Fan (Kit Sizes 4 and 5)

- Easy front panel maintenance for fan servicing.



Sizes 1, 2 and 3

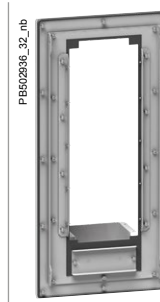

Sizes 4 and 5

Note:
For dimensions see [page 470](#)

Characteristics	Mounting kits
	Variable-speed drive installation kits allowing the hot part to be isolated.
Material	Steel
Finish	Structured finish, epoxy polyester powder
Color	RAL 7035 gray
Ingress protection rating according to IEC 60529	IP55
Certifications	UL (cULus). Rated 1, 3R and 12 according to UL50E

Supply	<p>Sizes 1, 2 and 3:</p> <ul style="list-style-type: none"> • Painted steel plate with cut-out fitted with two slide-rails + adhesive seal + 7 to 9 M6 studs for kit mounting • Protection seal profile supplied for frame cut-out • Enclosure drilling template 	<p>Sizes 4 and 5:</p> <ul style="list-style-type: none"> • Painted steel plates with cut-out fitted with painted mounting brackets + screws and nuts for fixing the brackets and the kit • Protection seal supplied for frame cut-out
--------	--	--

Dimensions (mm)			Sizes	Compatibilities							
				Enclosures	Variable-speed drives					Kits	
H	L	P			ATV340 380/480 V References	ATV630 200/240 V References	380/480 V References	ATV930 200/240 V References	380/480 V References	References	
360	235	22	1	S3D, SFN, SM	-	ATV630U07M3	ATV630U07N4	ATV930U07M3	ATV930U07N4	NSYPTDS1	
360	235	22	1	S3D, SFN, SM	-	ATV630U15M3	ATV630U15N4	ATV930U15M3	ATV930U15N4	-	
360	235	22	1	S3D, SFN, SM	-	ATV630U22M3	ATV630U22N4	ATV930U22M3	ATV930U22N4	-	
360	235	22	1	S3D, SFN, SM	-	ATV630U30M3	ATV630U30N4	ATV930U30M3	ATV930U30N4	-	
360	235	22	1	S3D, SFN, SM	-	ATV630U40M3	ATV630U40N4	ATV930U40M3	ATV930U40N4	-	
360	235	22	1	S3D, SFN, SM	-	-	ATV630U55N4	-	ATV930U55N4	-	
420	265	22	2	S3D, SFN, SM	-	ATV630U55M3	ATV630U75N4	ATV930U55M3	ATV930U75N4	NSYPTDS2	
420	265	22	2	S3D, SFN, SM	-	-	ATV630D11N4	-	ATV930D11N4	-	
555	295	22	3	S3D, SFN, SM	-	ATV630U75M3	ATV630D15N4	ATV930U75M3	ATV930D15N4	NSYPTDS3	
555	295	22	3	S3D, SFN, SM	-	ATV630D11M3	ATV630D18N4	ATV930D11M3	ATV930D18N4	-	
555	295	22	3	S3D, SFN, SM	-	-	ATV630D22N4	-	ATV930D22N4	-	
800	385	151.5	4	SFN, SM	ATV340D30N4E	ATV630D15M3	ATV630D30N4	ATV930D15M3	ATV930D30N4	NSYPTDS4	
800	385	151.5	4	SFN, SM	ATV340D37N4E	ATV630D18M3	ATV630D37N4	ATV930D18M3	ATV930D37N4	-	
800	385	151.5	4	SFN, SM	-	ATV630D22M3	ATV630D45N4	ATV930D22M3	ATV930D45N4	-	
975	427	205.5	5	SFN, SM	ATV340D45N4E	ATV630D30M3	ATV630D55N4	ATV930D30M3	ATV930D55N4	NSYPTDS5	
975	427	205.5	5	SFN, SM	ATV340D55N4E	ATV630D37M3	ATV630D75N4	ATV930D37M3	ATV930D75N4	-	
975	427	205.5	5	SFN, SM	ATV340D75N4E	ATV630D45M3	ATV630D90N4	ATV930D45M3	ATV930D90N4	-	

Variable Speed Drive Flush-Mounting Kits

Spacial S3D, SF and SM
Dimensions

NSYPTDS1

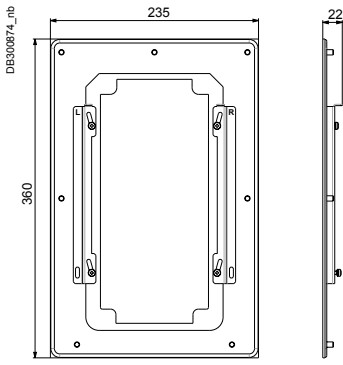

NSYPTDS2

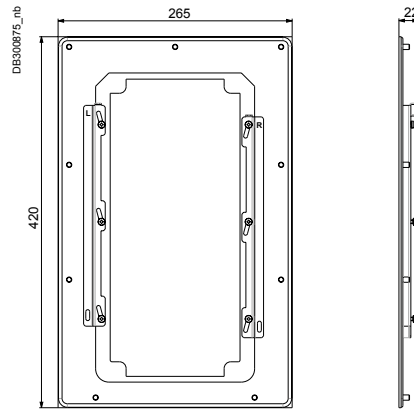

NSYPTDS3

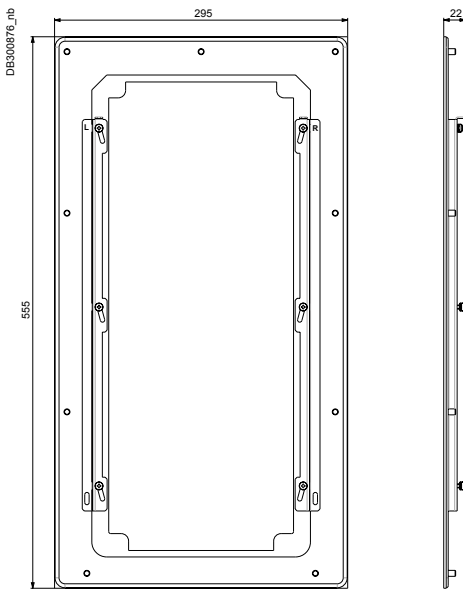

NSYPTDS4

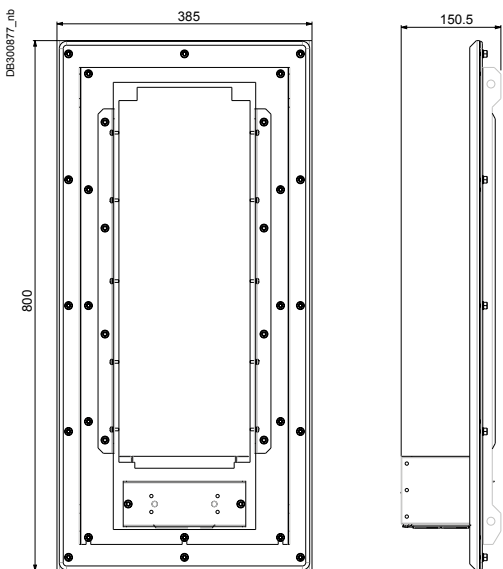

NSYPTDS5

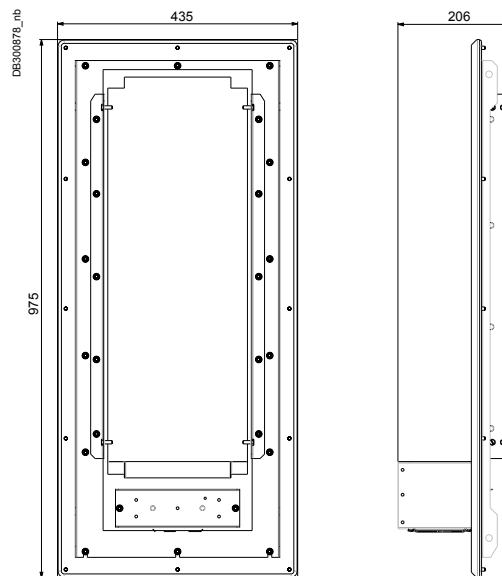

The Door of the "Incoming" Enclosure Is Interlocked by the Control of the Main Switch or Circuit Breaker. A Built-In Interlocking System with Runner Rods Prevents the Opening of the "Outgoing" Enclosure Doors. Access Is Only Allowed When the Main Switch or Circuit Breaker Is in "O" Position and the Main Door Is Open. Manual Activation of the Rods Unlocks the Other Doors and Allows Access.

Designed to be Combined with Specific Circuit Breakers or Switches:

- Square D (9422 A1).
- Schneider Electric.

The System is Limited for Configurations up to 4 Columns.

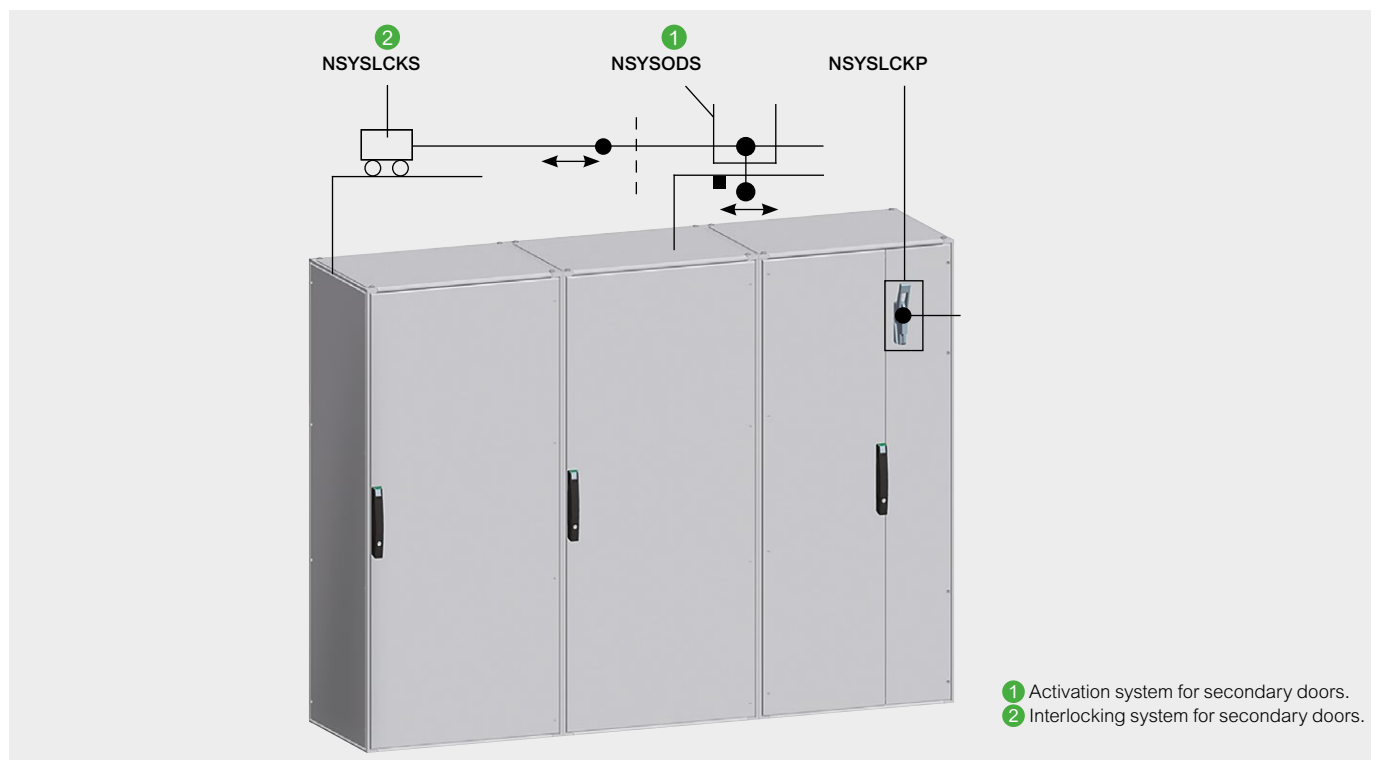

Safety

- The built-in safety interlocking system for the door (on demand) of the incoming/outgoing enclosures allows Spacial SF enclosures to be adapted to the requirements of the American automotive industry.

Interlocking System for Main Door

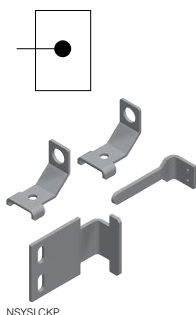

NSYSLCKP

System for unlocking the main door adapted to the switches:

- Allen Bradley (1494 VH11).
- Square D (9422 A1).
- Siemens (FH0H).
- Schneider Electric.

Unlocks the main door when the switch is in the open position "O".

The main door interlocking system requires ordering both references:

- 1 Activation system for secondary doors.
- 2 Interlocking system for secondary doors.

- Material: Steel
- Finish: Zinc-coated

Note:

The fixed panel in this example must be ordered through our customized service.

Supply:

2 brackets for fixing the configured panel, interlocking elements, switch and fixings. Configured panel and switch not included.

Characteristics	References
Interlocking system for main door	NSYSLCKP

Activation System for Secondary Doors

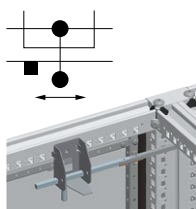

NSYSODS

- System installed in the main enclosure.
- Activated by manual operation, preventing the opening of the secondary enclosures connected to one another by runner rods.
- Safety function consisting of a part that forces the system into the position in which the secondary enclosures are locked in order to lock the main door.
- Material: Mechanism: Zinc-coated steel, Activation handle: Black plastic

Supply:

Elements for activating the main door and fixings.

For the complete function, both activation

- 1 and interlocking systems
- 2 need to be ordered.

Characteristics	References
Activation system for secondary doors	NSYSODS

Interlocking System for Secondary Doors

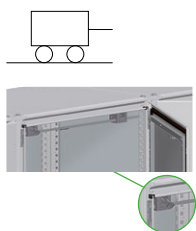

NSYSLCKS6

- System for interlocking the outgoing enclosures connected to one another by runner rods that lock their doors.
- Material: Steel
- Finish: Zinc-coated
- Fixing: Fixing to the structure of the enclosures by screws

Supply:

Elements for interlocking the secondary doors and fixings.

For the complete function, both activation

- 1 and interlocking systems
- 2 need to be ordered according to the enclosure Larg..

Characteristics	Width (mm)	References
Interlocking system for secondary doors	600	NSYSLCKS6
Interlocking system for secondary doors	800	NSYSLCKS8
Interlocking system for secondary doors	1000	NSYSLCKS10

Customized Solutions

Examples of Specific Solutions

Customised_solutions_001



- Custom dimensions
- Cut-outs in the body and the doors

Customised_solutions_002



- Cable entry and door adaptation
- Custom door shape

Customised_solutions_003



Customised_solutions_004



19" SFE for micro-edge data center application

Customized Solutions

Save Time and Costs on Your Enclosure	476
Which Enclosures Can You Customize?	477
Different Available Customization Options	478
Quick Overview on How to Define Your Enclosure	481
Defining Basic Customization Projects	483
Defining Complex Customization Projects	484
Customization Benefits	485

Enclosure Preparation Takes Precious Time Away from Actual Panel Building

Preparing your Enclosure can take a significant amount of time and manual labor. Not only that, achieving a high-quality final result can be challenging. This work can make you lose time on tasks such as:

- Drilling cut-outs for push-buttons, light indicators and cable entries
- Adding device fitting plates and cable glands
- Milling
- Deburring
- Painting

That's where Schneider Electric's PanelSet, Spacial, and Thalassa enclosure customization services fit in. We can insource the low-value customization work and get it done quickly for you. That way, your enclosures are ready for wiring when they arrive, saving you time and reducing costs, whilst also improving the quality of your panels.



Customization services are offered for a wide selection of enclosures made with a variety of materials, for applications ranging from electrical distribution and industrial automation to data networks.

PanelSeT and Spacial Steel Enclosures

- Includes enclosures ranging in size from small boxes to large, floor-standing units
- Robust design for indoor industrial environments
- Help protect electrical equipment from dust, oil splashes, impacts, and more
- An extensive assortment of accessories available



Spacial Stainless-Steel Enclosures

An optimal solution for environments with hygiene requirements, and for harsh, highly corrosive environments, available in two alloys:

- 340L – corrosion-resistant and easy to clean, suitable for the food and pharmaceutical industries
- 316L – offering the highest corrosion resistance, designed for saline and chlorinated environments



Thalassa Insulating-Material Enclosures

Designed to help protect electrical equipment from highly demanding environments:

- Made with fiberglass-reinforced polyester for outdoor operation (panels exposed to direct sunlight, rain, salt mist, or extreme temperatures)
- Made with ABS or polycarbonate for aggressive industrial atmospheres (oil splashes, chemical and corrosive agents)
- Made with heavy-duty polyester for public outdoor areas



What Are the Different Customizations Options Available for Your Enclosure?

We offer a wide variety of customization options that you can choose from. To achieve the highest quality and precision, the same consistent look and feel across different enclosures in a series, as well as quick lead times, all of the customization work is done with high-performance industrial equipment.

Cut-outs

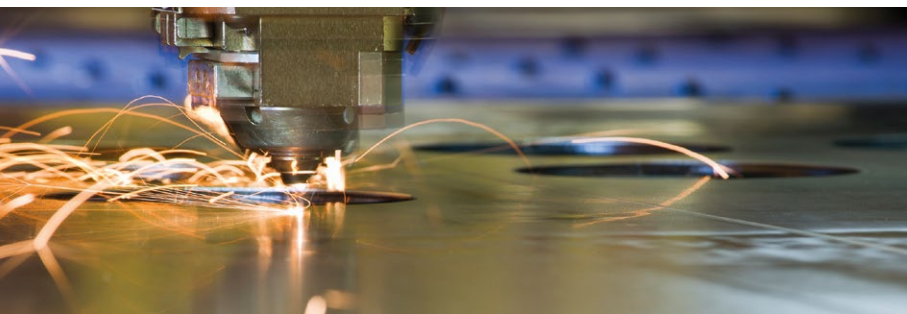

Gettyimages-189344693

Cut-outs are created with digitally-controlled laser or punching machines. This helps ensure that the position and dimensions of cut-outs are accurate and strictly identical across all the enclosures with the same configuration. The cut-out edges don't require any touch-ups.

Painting

Painting takes place after the cut-outs are created, to help ensure flawless coating and anti-rust protection. Gaskets and other accessories are attached after the painting process is complete, which helps ensure the reliability and durability of the protective layer.

You can choose nearly any color of paint, select textures, or add serigraphy printing. Surface treatments includes:

- Anti-corrosion primer layer
- 100% polyester powder for outdoor or harsh industrial environments

Gettyimages-15285795



The fully automated painting process takes 2h 30 min.

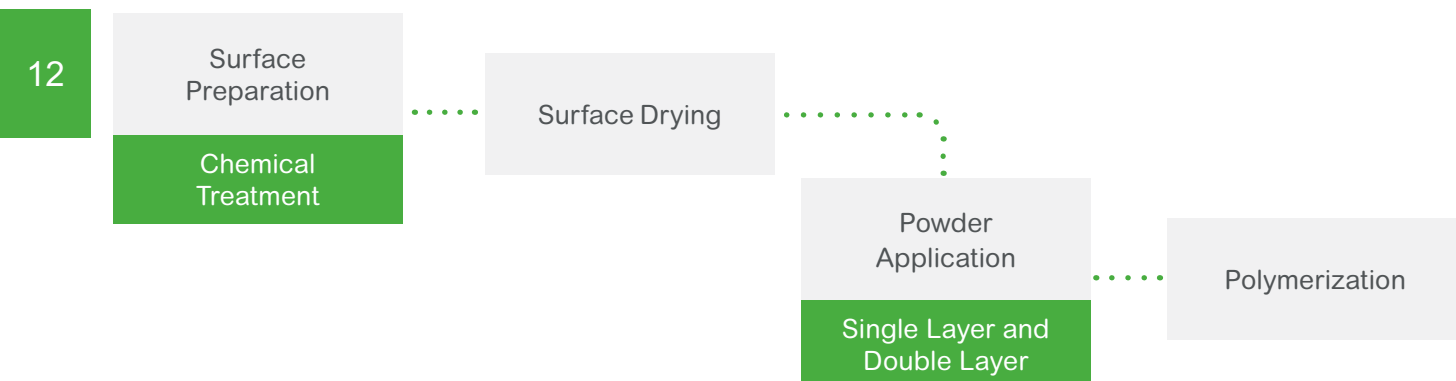

Accessories

After the painting process is finished, enclosures can be equipped with the desired accessories, saving you even more time.

To see the full list of available accessories for each of the ranges, refer to the dedicated selection guide:

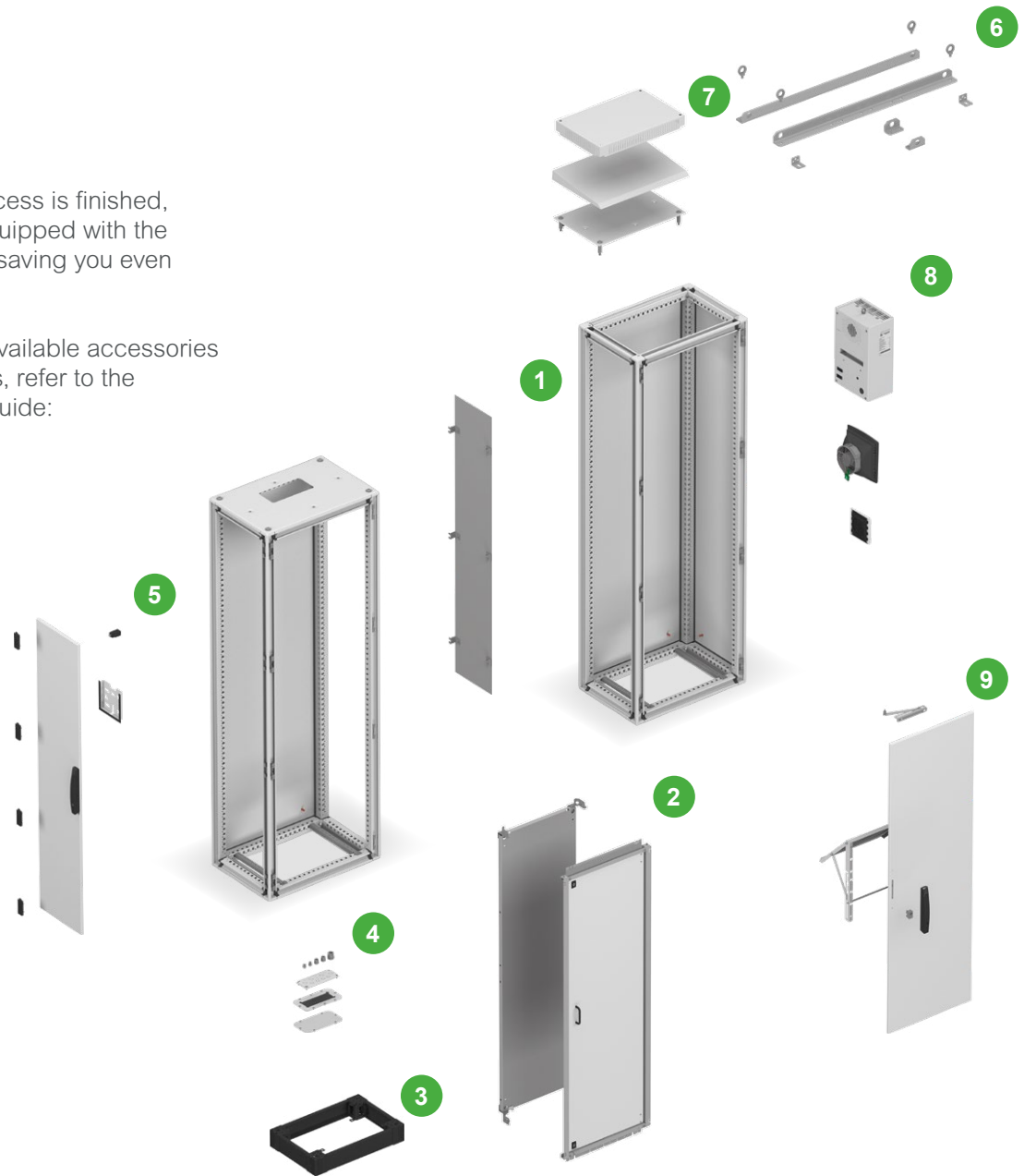

1 Composition Accessories
e.g. Coupling spacers, frames

2 Internal Accessories
e.g. mounting plates, chassis, rails, internal doors

3 Settling Accessories
e.g. plinths, pillars, floorstanding kits, wall-fixing lugs

4 Cable Entries
e.g. gland plates, cable glands, membranes, cable guides

5 Side or Rear Panels and Doors
e.g. internally fixed, externally fixed

6 Hoisting Accessories
e.g. eyebolts, brackets, bars

7 Roof and Roof Accessories
e.g., canopies, ventilated canopies, airing elevators

8 Thermal Protection Accessories
e.g. airing grids, fans, cooling units, thermostats

9 Doors and Door Accessories
e.g. hinges, handles, locks

Specific Dimensions

Unlike the catalog-listed enclosures, width, height and depth can be supplied in any multiple of 10 mm for small enclosures, and any multiple of 100 mm for large enclosures (only applicable to the PanelSeT and Spacial range).

Assembled Enclosures

For electrical panels comprising several cubicles placed side by side, enclosures can be delivered fully assembled, with or without cable paths.

Thermal Studies

At your request, Schneider Electric experts can help ensure the enclosures will provide suitable temperature and humidity conditions for your electrical equipment. To achieve that, the enclosures will be equipped with airing grids, fans, cooling units, or heaters and their controllers.

Quality Control, Audits, and Certifications

All our enclosure manufacturing sites are ISO 9000 certified, which means strict quality controls throughout all the industrial processes. Additional quality checks and audits can be set up too, depending on your project's requirements. Conformity declarations or certificates are available on request.

Packaging and Delivery

Manufacturing batches can be sized and deliveries scheduled to match your stock and flow requirements. Transportation conditions can be assessed, and reinforced packaging opted for.

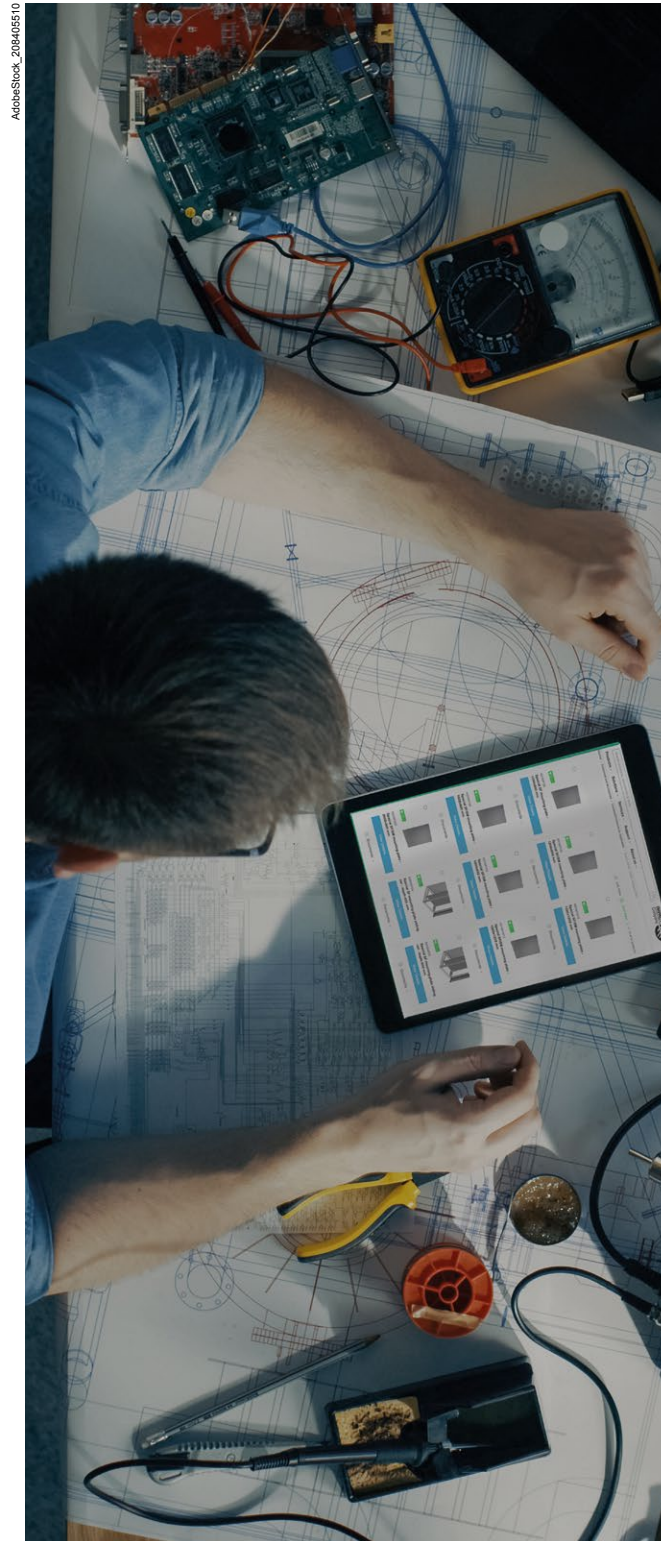



Step 1: Define your environment

Installation

- Indoor or outdoor
- Outdoor under shelter
- Clean or not clean environment
- IP level
- IK level



Step 2: Check certification and homologation

Certification

- UL
- ATEX

Control Report

- During manufacturing
- Before shipping

Performance

- Nema
- Marine
- Seismic
- Others



Step 3: Specify technical characteristics

Offer Type

- Wall mounted
- Floor standing

Dimensions

- Height
- Width
- Depth

Door⁽¹⁾

- Plain door
- Glazed door
- Opening: right (default) / left
- Door lock⁽²⁾ (mounted / not mounted)

Cable Entries Cut-Out

- Side
- Top
- Bottom

⁽¹⁾On floor standing offer (SFN) a door can also be mounted on the back and on the sides

⁽²⁾ Choose from a range of the most common locks on the market

Step 3: Specify Technical Characteristics (cont.)

Plinth

- Yes
- No
- Reinforced

Accessories

- Filterfans
- Ventilation grid
- Door locks

Some accessories can be ordered mounted and other will be delivered along with the enclosure; this possibility is indicated in the Custom Enclosure Configurator.

Fixing of the Enclosure

- On the wall
- On the floor
- Other

Installation of Device Inside the Enclosure

- Mounting plate
 - Plain
 - Microperforated
 - Telequick
- Load inside the enclosure (load in kg)

Handling and Transport

- Lifting ring for hoisting
- Plinth for pallet truck

Step 4: Choose other services

Colors

- Metallic range
 - Standard color (RAL 7035)
 - Other color, to be specified (17 colors in the online configurator, more with our offline support)
- For polyester and plastic ranges
 - Standard color (RAL 7035)
 - Other colors possible for large quantities

Machining

- Define the size, shape and number of holes on the body and on the door
- For a quote, only the number of holes on the body and on the door is required, but to place an order, a drawing is required

Assembly

- Some accessories can be ordered mounted and other will be delivered along with the enclosure; this possibility is indicated in the Custom Enclosure Configurator.
- Possibility of coupling
- A wide range of accessories is also available with the help of our offline support



To Define Your Basic Customization Projects, Choose the Online Configurator

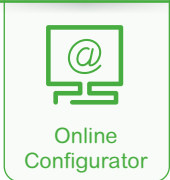

Specify Settings and Get a Quote in a Single Tool, Then Email Your Order In.

For basic customization work (see next page for advanced customization), the Custom Enclosure Configurator allows you to adjust the enclosure to your specifications in a couple of minutes. And it provides you with a price quote and delivery lead time.

It's a convenient, simple-to-use tool that gives you a wide variety of options to choose from, from different cut-out shapes to paint colors and accessory fittings.

Follow These 5 Easy Steps to Use the Custom Enclosure Configurator



The Custom Enclosure Configurator is a fully automated tool, so your project will be automatically sent to production. It is an online tool that is always up to date, and allows an easier transmission for ordering. To access the configurator, scan the QR code or go to <https://custom-enclosures.se.com/>



1



Select the Enclosure from the Catalog

Choose height, width, depth.

2



Select Accessories and Mounting Options

Some accessories can be ordered mounted and other will be delivered along with the enclosure.



Specify Cut-Outs

Choose the cut-out locations, shapes and dimensions.



Select Your Color

Pick from 17 available shades.

3



Get a Price Quote and Lead Time

Confirm your order and send it by email right away.



Place Your Order

Confirm and place your order right away, without waiting for a confirmation by email or phone

To Define Complex Customization Projects, Contact Our Experts

Customized Solutions



Offline Support

For Complex Projects Requiring Advanced Customization, a Dedicated Team of Schneider Electric Experts Will Guide You through the Process.

Here's an outline of our advanced customization process:

- Provide your specifications
- Get a feasibility study and quotation
- Confirm and place your order
- Manufacturing starts
- A quality assessment is performed
- Your product is delivered

Gettyimages-1301827337



12



Discover how Otech, a French OEM, takes advantage of PanelSeT and Spacial, and Thalassa customization services.





Time Savings

Delivered with cut-outs and painting: no waste of time



Logistics

- Flexible management of your logistics option (scheduled delivery service for on going orders)
- Special packaging



Simplified Installation

Enclosures delivered with cut-outs: no special tools required



Ergonomic Design

Customized project dedicated to your personal requirements



Increased Life-Time

- Cut-outs made before painting help ensure corrosion protection and reliable sealing
- Painting service for better protection



Improved Quality

- No burrs on edges of cut-outs
- Help guaranty manufacturing tolerances



Aesthetics

- Large choice of colors
- No scratches in external surfaces



Higher Performance

- Adapted thermal management
- Higher-grade stainless-steel

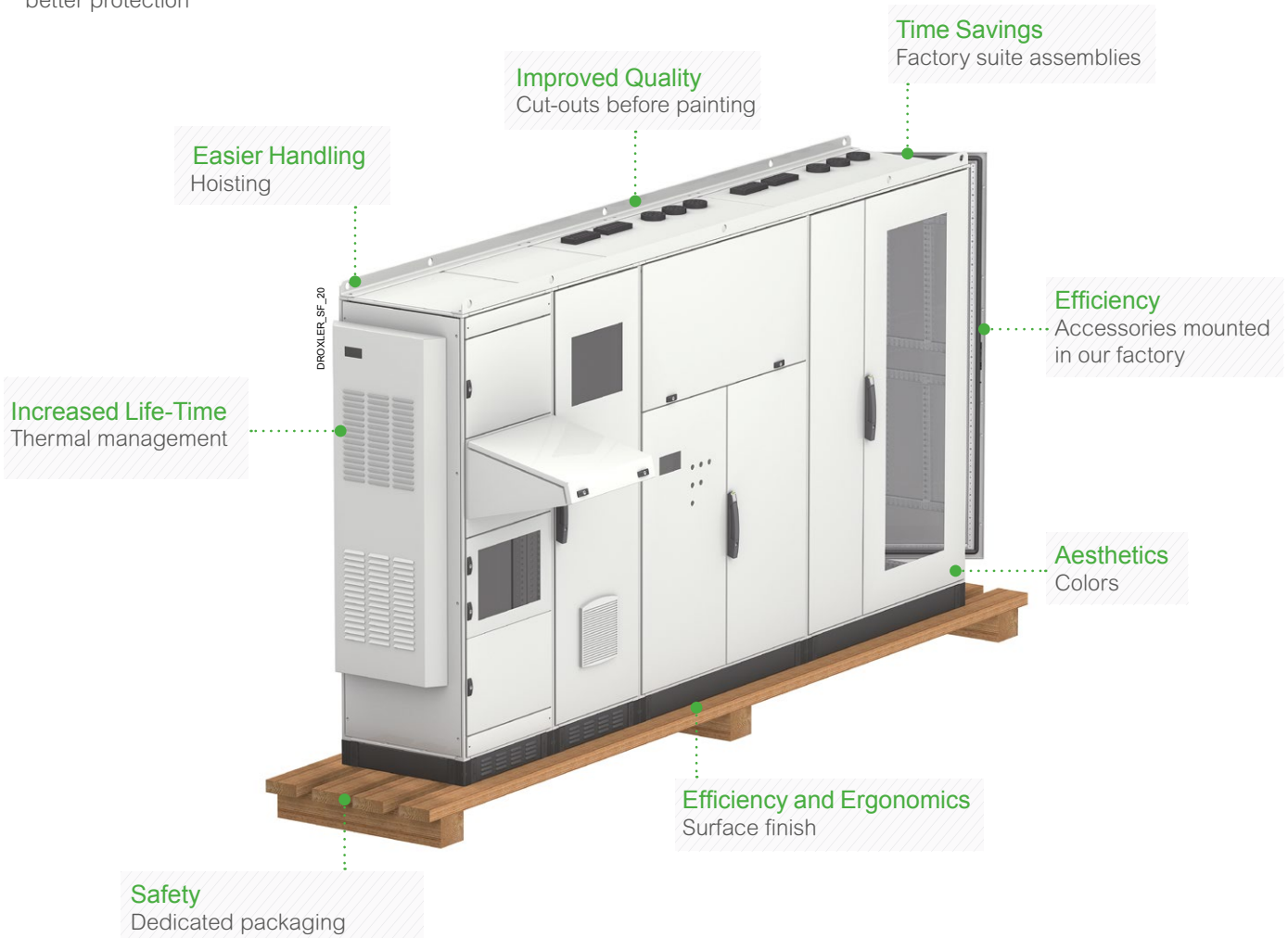

Actassi

Enclosures for Indoor Needs

Wall-Mounted



Floor-Standing

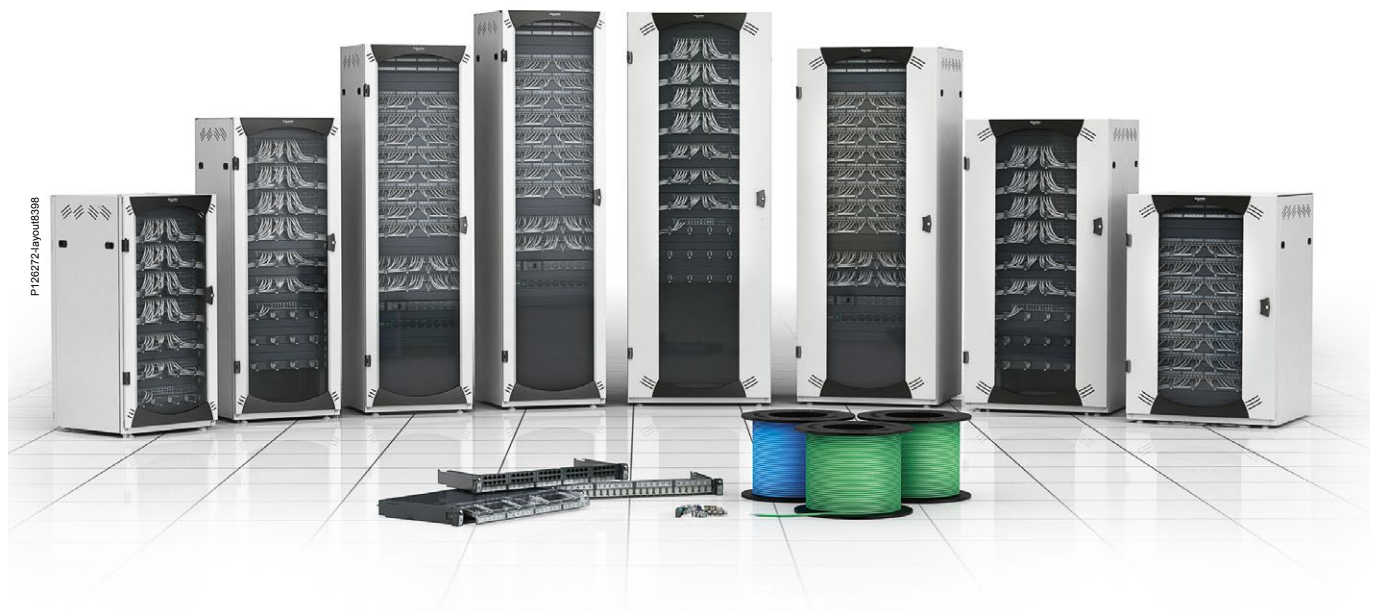

13

OPB	
19" Wall-Mounted Open Box	491
19" Wall-Mounted Open Box with Swing Rack	492
19" Wall-Mounted Open Box with Fixed Rack	493
19" Mobile Open Box	496
Roof Accessories	498
Base Accessories	499
KDB	
19" Wall Knock-Down Box	503
Thermal Management	504
VDA	
Easy to Install and to Integrate	506
VDA/VDS Racks Overview	508
VDA-B	
Simple and Functional	509
VDA-E	
Equipped and Ready to Use	513
VDA-L	
Prepared for Ruko Locking System	517
VDS	
19" Server Enclosure	520
Patching Frame	525
Overhead Patching Frame	525
VDA/VDS	
EA Accessories	527
EA Base Accessories	536
Universal Accessories	538
Earth Connection	539
Fixing Components	540
Shelves (Compatible Only with Floor-Standing Enclosures)	541
Equipment Support	544
Electrical Power Distribution Rails	545
Power Distribution	548
Cable Management (Compatible Only with Floor-Standing)	549
Cable Management	551
Plates	552
Thermal Management	552
19-E Universal Accessories Lighting	
Customized Offer	554
VDA/VDS	556
Customization Services	556
Technical Information	
Technical Information	562
Spare Parts	
VDA-VDS Floor-Standing Enclosures	563

Actassi Enclosures

With the Actassi system you can create a seamless end-to-end network connectivity solution for all needs. There are different conditions and demands on the installations in buildings, data centers and small offices. That is why Actassi includes all possible sizes of wall-mounted and floor-standing enclosures, from 6 to 47 units in different widths, depths, colors and compositions. You can always find an Actassi enclosure that gives a perfect result.



Do You Want to Have Other Enclosures than Standard? No Problem. With Actassi Enclosures It's Possible to Customize Color, Accessories, Specific Lining Etc. According to Your Personal Needs.



The Digital Rule Helps You Select Products Hard to select the Actassi enclosures, RJ45 connectors, patch panels and cables? Visit se.com and try our Digital Rule. It's an intelligent online e-catalog which will facilitate your choices and helps ensuring an error-free specification.



13

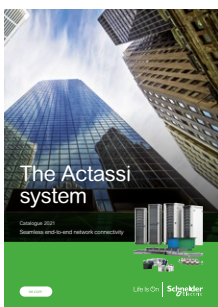

The Actassi system – Network Connectivity

Actassi is Schneider Electric's new global state-of-the-art range for networking and connectivity infrastructure solutions for buildings. It consists of the best performing features from local Schneider Electric brands such as LexCom, Infracplus, Clipsal Datacomms, Sarel and Himel. From RJ45 connectors to network enclosures, the Actassi system offers every installer around the world the best of the best solutions.

Ref: LSB02659EN
09/2021



Scan or click

Technical changes reserved. Information provided without guarantee. Images are for illustrative purposes only.

Actassi Wall-Mounted Enclosures

The Actassi wall-mounted OPB OpenBox enclosures allow you to easily integrate patch panels, cables, switches and digital recorders. All the lining can be removed without tools, and with the swing-rack version of OPB, with a quick-locking system, you'll get access to the connections from the back to handle the maintenance in a convenient way. Too hot in the enclosure? No problem, it's easy to integrate a blanking plate with two fans. With Actassi KDB, the new flat-pack knock-down boxes, you save 60% of space in the stock. And it takes only 5 minutes to assemble.



Actassi OPB and KDB



Actassi OPB
Open Box with swing
rack



Actassi KDB
Knock-Down Box



Actassi OPB
Mobile Open Box



Actassi Wall-Mounted



Actassi OPB
Open Box with fixed
rack

Maximized Capacity and Swift Maintenance with Actassi OPB

Time for adjustments? Just open the sides and fold out the swing rack. Replace and add whatever parts you need, no tools required. Fold back the rack, close the sides and you are done. To increase the flexibility of the entire installation, use the Actassi OPB as a distributed solution.



The Actassi Opb Serves Perfectly as a Distributed Solution. In a Hospital for Instance, the Need for Quick, Reliable and Easily Expandable Network Connectivity Can Be Crucial.

Actassi OPB – Open for Installation
The Actassi OPB is wide open for a swift and struggle-free installation. Steady as a rock, even with the side panels and the door dismantled.

The Swing Rack Makes All the Difference
When making the first installation, as well as continuous upgrades, you will find that the swing rack makes all the difference for you as an installer. Access from all sides, pre-cut cable entries and minimum usage of tools are some of the other features that make the OPB truly open for installation and maintenance.

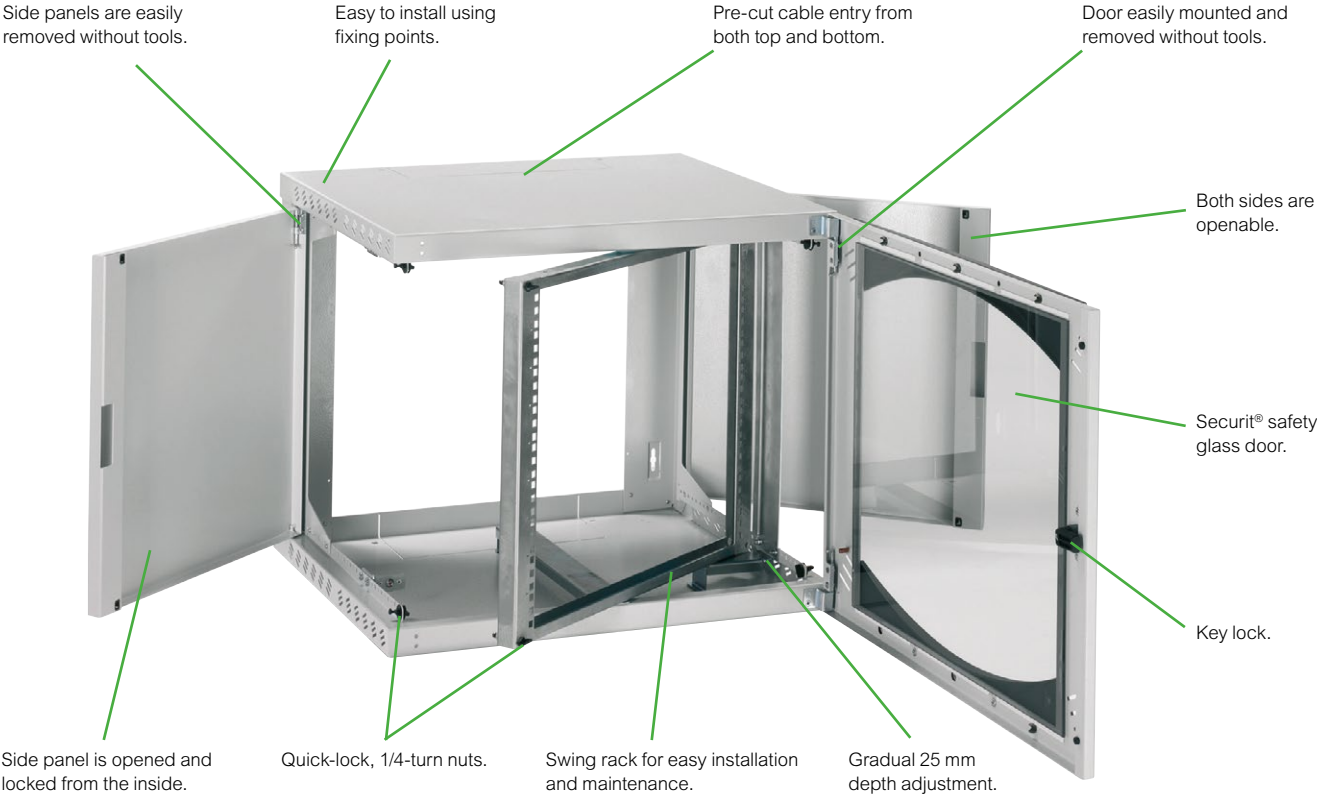

13

Technical changes reserved. Information provided without guarantee. Images are for illustrative purposes only.

19" Wall-Mounted Open Box Ergonomic and Adaptable



Actassi OPB is Assembled at Delivery, Ready to Use.



Side Panels, Swing Rack and Door Can Be Opened and Removed without Tools. Quick and Easy.

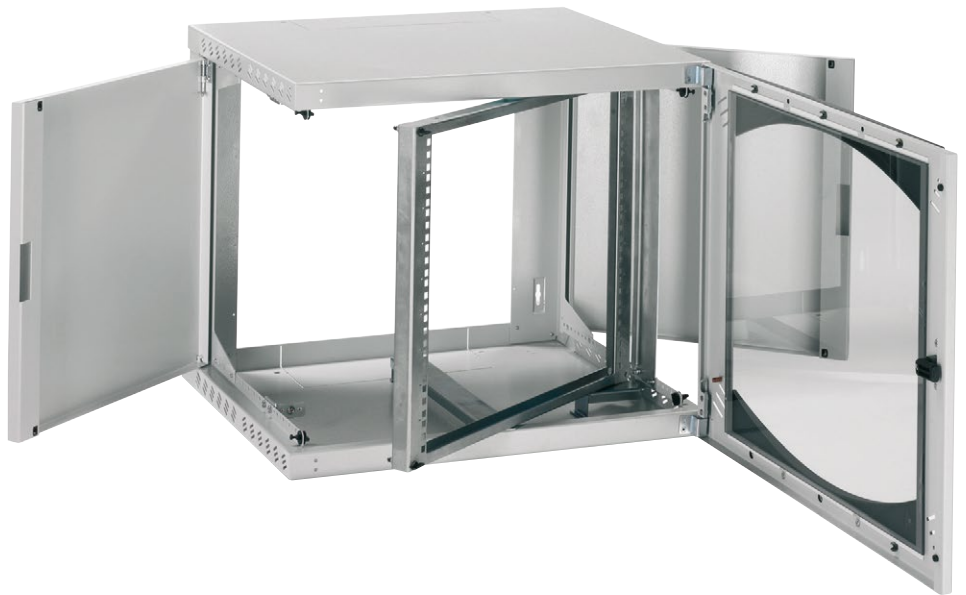

50 kg

The Body Allows Mounting of Components up to 50 kg.



Easy to Install

The Actassi OPB enclosure can be wall-mounted by a single person using the fixing points intended for the passage of holding screw heads into the wall.



Adaptable

The 19" uprights are designed to be depth-adjustable with a step of 25 mm. Their fixing with screws helps guaranteeing the rigidity of the Actassi OPB enclosure.



Ergonomics

The side panels swing through 120° and can be easily removed without tools. Rear access is easy. Door easily removable without tools.



Easy to Install and to Reverse

Its drilling template on the packaging and its 4 wall-mounted points enable quick and efficient installation while guaranteeing reversibility by simply turning the enclosure around.



Easy to Cable

The cable entries, top or bottom, are pre-cut and open into the rear of the Actassi OPB enclosure. The enclosure fits around those cables that are already in place (rear blanking plate optional).



Ergonomics

The side panels are locked from the inside by two 1/4-turn nuts, accessible only when the door is open.

19" Wall-Mounted Open Box with Swing Rack

Actassi, OPB

Open for Easy Installation and Maintenance
Introduction and Selection Guides

- Wall-mounted enclosure made from folded and welded sheet steel, powder paint, leather-grain finish, RAL 7035 light gray epoxy-polyester
- Enclosure made up of a body, 2 hinged and removable side panels, a 19" swing rack and a Securit® glass transparent door with key no. 333
- Protection rating: IP20
 - protection against objects > 12.5 mm
 - no protection against liquids
- Impact Protection: IK08
- Impact energy = 5 joules
- Available enclosures:
 - 5 heights: 6, 9, 12, 15, 18U
 - 3 depths: 400, 500 and 600 mm
- Swing rack: acceptable load of 25 kg (Include 25% of margin load rating according to IEC 62208)
- Certifications: in compliance with directive RoHs, with 19" standard IEC 60297-3-100 and EIA-310-E.



Installed enclosures

Number of U	Dimensions (mm)			Enclosure reference	Blanking plate	Cable-gland plate with brush gasket	Blanking plate with 2 fans, cannot be used directly with UK PDU
	Height	Width	Depth				
6	380	600	400	NSYOPB6U4P	NSYOPB6UTPN	NSYECP300	NSYECVT300
6	380	600	500	NSYOPB6U5P	NSYOPB6UTPN		
9	515	600	400	NSYOPB9U4P	NSYOPB9UTPN		
9	515	600	500	NSYOPB9U5P	NSYOPB9UTPN		
12	650	600	500	NSYOPB12U5P	NSYOPB12UTPN		
12	650	600	600	NSYOPB12U6P	NSYOPB12UTPN		
15	780	600	500	NSYOPB15U5P	NSYOPB15UTPN		
15	780	600	600	NSYOPB15U6P	NSYOPB15UTPN		
18	915	600	500	NSYOPB18U5P	NSYOPB18UTPN		



Total accessibility with the swing rack and the swingable and removable side panels and door.

19" Wall-Mounted Open Box with Fixed Rack

Actassi, OPB

Ergonomic and Adaptable Introduction and Selection Guides

- Wall-mounted enclosure made from folded and welded sheet steel, powder paint, leather-grain finish, RAL 7035 light gray epoxy-polyester
- Enclosure made up of a body, 2 hinged and removable side panels, 19" fixed uprights and a Securit® glass transparent door or plain sheet steel door with key no. 333
- Protection rating: IP20
 - protection against objects > 12.5 mm
 - no protection against liquids
- Impact Protection: IK08 (for glazed door)
 - impact energy = 5 joules
- Impact Protection: IK10 (for plain door)
 - impact energy = 20 joules
- Available enclosures:
 - 6 heights: 6, 9, 12, 15, 18, 21U
 - 3 depths: 400, 500 and 600 mm
- Fixed 19" rack. Acceptable load: 3 kg/U; max. 50 kg per enclosure (Include 25% of margin load rating according to IEC 62208)
- Certifications: in compliance with directive RoHs, with 19" standard IEC 60297-3-100 and EIA-310-E.

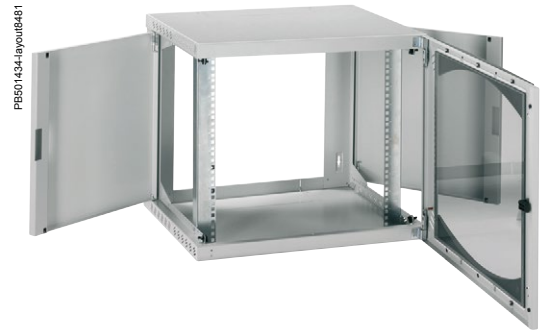

Installed enclosures

Number of U	Dimensions (mm)			Enclosure reference	Blanking plate	Cable-gland plate with brush gasket	Blanking plate with 2 fans, cannot be used directly with UK PDU
	Height	Width	Depth				
6	380	600	400	NSYOPB6U4F	NSYOPB6UTPN	NSYECP300	NSYECVT300
6	380	600	500	NSYOPB6U5F	NSYOPB6UTPN		
9	515	600	400	NSYOPB9U4F	NSYOPB9UTPN		
9	515	600	500	NSYOPB9U5F	NSYOPB9UTPN		
9	515	600	600	NSYOPB9U6F	NSYOPB9UTPN		
12	650	600	400	NSYOPB12U4F	NSYOPB12UTPN		
12	650	600	500	NSYOPB12U5F	NSYOPB12UTPN		
12	650	600	600	NSYOPB12U6F	NSYOPB12UTPN		
15	780	600	400	NSYOPB15U4F	NSYOPB15UTPN		
15	780	600	500	NSYOPB15U5F	NSYOPB15UTPN		
15	780	600	600	NSYOPB15U6F	NSYOPB15UTPN		
18	915	600	400	NSYOPB18U4F	NSYOPB18UTPN		
18	915	600	500	NSYOPB18U5F	NSYOPB18UTPN		
21	1050	600	500	NSYOPB21U5F	NSYOPB21UTPN		
21	1050	600	600	NSYOPB21U6F	NSYOPB21UTPN		

Enclosure with plain door

Number of U	Dimensions (mm)			Enclosure reference	Blanking plate	Blanking plate with 2 fans, cannot be used directly with UK PDU
	Height	Width	Depth			
9	515	600	400	NSYOPB9U4FR	NSYOPB9UTPN	NSYECVT300
12	650	600	400	NSYOPB12U4FR	NSYOPB12UTPN	
15	780	600	500	NSYOPB15U5FR	NSYOPB15UTPN	
18	915	600	500	NSYOPB18U5FR	NSYOPB18UTPN	



2U extra space "for free", 1U in the top and 1U in the bottom. Can be used for example for power rails.

19" Wall-Mounted Open Box with Swing Rack

- Wall-mounted enclosure made from folded and welded sheet steel, powder paint, leather-grain finish, RAL 7035 light gray epoxy-polyester
- Enclosure made up of a body, 2 hinged and removable side panels, a 19" swing rack and a Securit® glass transparent door with key no. 333
- Protection rating: IP20
 - protection against objects > 12.5 mm
 - no protection against liquids
- Impact Protection: IK08
- Impact energy = 5 joules

Available enclosures:

- 5 heights: 6, 9, 12, 15, 18U
- 3 depths: 400, 500 and 600 mm
- Swing rack: acceptable load of 25 kg (Include 25% of margin load rating according to IEC 62208)
- Certifications: in compliance with directive RoHs, with 19" standard IEC 60297-3-100 and EIA-310-E.

Cable-gland plate with brush gasket, ref. **NSYECB300**, see [page 498](#)
 Blanking plate with 2 fans, cannot be used directly with UK PDU, ref. **NSYECVT300**, see [page 498](#)



NSYOPB6U4P

Characteristics	Number of U	Height (mm)	Width (mm)	Depth (mm)	References
19" Wall-Mounted Open Box with swing rack, glazed door	6	380	600	400	NSYOPB6U4P
19" Wall-Mounted Open Box with swing rack, glazed door	6	380	600	500	NSYOPB6U5P
19" Wall-Mounted Open Box with swing rack, glazed door	9	515	600	400	NSYOPB9U4P
19" Wall-Mounted Open Box with swing rack, glazed door	9	515	600	500	NSYOPB9U5P
19" Wall-Mounted Open Box with swing rack, glazed door	12	650	600	500	NSYOPB12U5P
19" Wall-Mounted Open Box with swing rack, glazed door	12	650	600	600	NSYOPB12U6P
19" Wall-Mounted Open Box with swing rack, glazed door	15	780	600	500	NSYOPB15U5P
19" Wall-Mounted Open Box with swing rack, glazed door	15	780	600	600	NSYOPB15U6P
19" Wall-Mounted Open Box with swing rack, glazed door	18	915	600	500	NSYOPB18U5P

19" Wall-Mounted Open Box with Fixed Rack

- Wall-mounted enclosure made from folded and welded sheet steel, powder paint, leather-grain finish, RAL 7035 light gray epoxy-polyester
- Enclosure made up of a body, 2 hinged and removable side panels, 19" fixed uprights and a Securit® glass transparent door or plain sheet steel door with key no. 333
- Protection rating: IP20
 - protection against objects > 12.5 mm
 - no protection against liquids
- Impact Protection: IK08 (for glazed door)
 - impact energy = 5 joules
- Impact Protection: IK10 (for plain door)
 - impact energy = 20 joules

Available enclosures:

- 6 heights: 6, 9, 12, 15, 18, 21U
- 3 depths: 400, 500 and 600 mm
- Fixed 19" rack. Acceptable load: 3 kg/U; max. 50 kg per enclosure (Include 25% of margin load rating according to IEC 62208)
- Certifications: in compliance with directive RoHs, with the 19" standard IEC 60297-3-100 and EIA-310-E.

Cable-gland plate with brush gasket, ref. **NSYEC300**, see [page 498](#)
 Blanking plate with 2 fans, cannot be used directly with UK PDU, ref. **NSYECVT300**, see [page 498](#)



NSYOPB6U4F

Characteristics	Number of U	Height (mm)	Width (mm)	Depth (mm)	References
19" Wall-Mounted Open Box with fixed rack, glazed door	6	380	600	400	NSYOPB6U4F
19" Wall-Mounted Open Box with fixed rack, glazed door	6	380	600	500	NSYOPB6U5F
19" Wall-Mounted Open Box with fixed rack, glazed door	9	515	600	400	NSYOPB9U4F
19" Wall-Mounted Open Box with fixed rack, glazed door	9	515	600	500	NSYOPB9U5F
19" Wall-Mounted Open Box with fixed rack, glazed door	9	515	600	600	NSYOPB9U6F
19" Wall-Mounted Open Box with fixed rack, glazed door	12	650	600	400	NSYOPB12U4F
19" Wall-Mounted Open Box with fixed rack, glazed door	12	650	600	500	NSYOPB12U5F
19" Wall-Mounted Open Box with fixed rack, glazed door	12	650	600	600	NSYOPB12U6F
19" Wall-Mounted Open Box with fixed rack, glazed door	15	780	600	400	NSYOPB15U4F
19" Wall-Mounted Open Box with fixed rack, glazed door	15	780	600	500	NSYOPB15U5F
19" Wall-Mounted Open Box with fixed rack, glazed door	15	780	600	600	NSYOPB15U6F
19" Wall-Mounted Open Box with fixed rack, glazed door	18	915	600	400	NSYOPB18U4F
19" Wall-Mounted Open Box with fixed rack, glazed door	18	915	600	500	NSYOPB18U5F
19" Wall-Mounted Open Box with fixed rack, glazed door	21	1050	600	500	NSYOPB21U5F
19" Wall-Mounted Open Box with fixed rack, glazed door	21	1050	600	600	NSYOPB21U6F

Enclosure with Plain Door

Blanking plate with 2 fans, cannot be used directly with UK PDU, ref. **NSYECVT300**, see [page 498](#)



NSYOPB9U4FR

Characteristics	Number of U	Height (mm)	Width (mm)	Depth (mm)	References
19" Wall-Mounted Open Box with fixed rack, plain door	9	515	600	400	NSYOPB9U4FR
19" Wall-Mounted Open Box with fixed rack, plain door	12	650	600	400	NSYOPB12U4FR
19" Wall-Mounted Open Box with fixed rack, plain door	15	780	600	500	NSYOPB15U5FR
19" Wall-Mounted Open Box with fixed rack, plain door	18	915	600	500	NSYOPB18U5FR

Made for Audiovisual Applications

Technical Characteristics

- The body of the enclosure has cut-outs at the top and bottom to allow natural airing
- Cable entry through rear opening and through pre-cut areas on the top and bottom of the enclosure
- 4 cut-outs are provided for wall-mounted
- The 2 side panels can be opened very easily by means of two 1/4-turn nuts. The panels can be removed without tools
- The 19" uprights in zinc-coated steel are depth-adjustable on a 25 mm step
- The Securit® glass door is completely reversible. It is equipped with a handle and a locking system with key no. 333. It is easily removed without tools
- Certifications: in compliance with directive RoHs, with 19" standard IEC 60297-3-100 and EIA-310-E.

Composition

- Actassi OPB with top and bottom cut-outs
- 1 glazed front door with a lock, key no. 333
- 1 rear plate, reference: **NSYOPB6UTPN** to **NSYOPB21UTPN**
- 4 depth-adjustable 19" uprights. Additional uprights available
- 4 wheels, reference **NSYRUFOPB**
- Option of installing a plinth instead of the wheels.



Rear Blanking Plate



NSYOPB6UTPN

- Blanking plate made from sheet steel, powder paint, leather-grain finish, RAL 7035 light gray epoxy-polyester

Supply:
Delivered with the fixings required for installation

Characteristics	Number of U	References
Rear blanking plate	6	NSYOPB6UTPN
Rear blanking plate	9	NSYOPB9UTPN
Rear blanking plate	12	NSYOPB12UTPN
Rear blanking plate	15	NSYOPB15UTPN
Rear blanking plate	18	NSYOPB18UTPN
Rear blanking plate	21	NSYOPB21UTPN

Additional 19" Uprights



NSYOPB6UF

- Material: zinc-coated sheet steel, 20/10 mm thick
- Maximum load: 3 kg/U; max. 50 kg per enclosure
- Unit marking.

Supply:
Set of two 19" uprights delivered with the fixings required for installation

Characteristics	Number of U	References
Additional 19" uprights	6	NSYOPB6UF
Additional 19" uprights	9	NSYOPB9UF
Additional 19" uprights	12	NSYOPB12UF
Additional 19" uprights	15	NSYOPB15UF
Additional 19" uprights	18	NSYOPB18UF
Additional 19" uprights	21	NSYOPB21UF

19" Uprights, Rear, 2U



NSYSSOPB

- Allows to save 2U on the front and to fix Power Distribution Unit on the back of the enclosure
- It is fixed to the rear of the enclosure
- It allows the installation of products in 19" format
- Height adjustment with a step of 44.45 mm (1U)
- Material: zinc-coated sheet steel.

Supply:
Set made up of 2 partial 2U 19" uprights delivered with the fixings required for installation

Characteristics	Number of U	References
19" uprights, rear, 2U	2	NSYSSOPB

Cable Support for Enclosure, Rear



NSYSPBOPB

- Allows to help securing and guide the cables on the back of the enclosure
- Fixed to the rear of the enclosure to support and fix the cables
- Height adjustable with a step of 44.45 mm (1U)
- Material: zinc-coated steel

Supply:
Delivered with the fixings required for installation.

Characteristics	References
Cable support for enclosure, rear	NSYSPBOPB

Top or Bottom Blanking Plate

- Plain blanking plate
- Material: zinc-coated steel sheet

Supply:
Delivered with the fixings required for installation.



NSYEC300

Characteristics	References
Top or bottom blanking plate	NSYEC300

Blanking Plate with Brush Gasket

- Fixing to the top or bottom openings of the enclosures
- Material: zinc-coated steel sheet

Supply:
Delivered with the fixings required for installation.



NSYEC300

Characteristics	Dimensions (mm)	References
Blanking plate with brush gasket	35 x 300	NSYEC300

Total Brush Gasket

- It is fixed to the top and bottom cable entries.



NSYECPT300

Characteristics	Dimensions (mm)	References
Total brush gasket	100 x 300	NSYECPT300

Top Or Bottom Blanking Plate with Airing Louvres

- Fixing to the top or bottom openings of the enclosures
- Material: zinc-coated sheet steel

Supply:
Delivered with the fixings required for installation.



NSYECAV300

Characteristics	References
Top or bottom blanking plate with airing louvres	NSYECAV300

Top or Bottom Blanking Plate with 2 Fans

- 2 fans installed and wired to on the terminal block, including a protection grille.
- A power supply cable of 2 m in length is supplied connected
- Free flow of 35 m³/h each
- Fixing to the top or bottom openings of the enclosures
- Material: zinc-coated sheet steel
- Delivered with the fixings required for installation
- Sound level: 35 dB (A)
- Cannot be used directly with UK PDU.

Supply:
Delivered with the fixings required for installation.



NSYECVT300

Characteristics	References
Top or bottom blanking plate with 2 fans	NSYECVT300

See also the 19-E Universal accessories



NSYQRTM1UVTG Thermal management [page 552](#)

Levelling Feet



NSYPNOPB

- Require drilling of the enclosure at the knock-out point for direct installation
- Set of 4 parts.

Supply:
Delivered with the fixings required for installation.

Characteristics	References
Levelling feet	NSYPNOPB

Wheels



NSYRUFOPB

- Require drilling of the enclosure at the knock-out point for direct installation
- Installation possible on the plinth
- Set of 4 parts.

Supply:
Delivered with the fixings required for installation.

Characteristics	References
Wheels	NSYRUFOPB

Plinths



NSYZUN65OPB

- Material: sheet steel, 15/10 mm thick, powder paint, leather grain finish, RAL 7011 dark gray epoxy-polyester
- Height 100 mm
- Removable surfaces
- Knock-out entries on the side and rear surfaces for cable entry.

Supply:
Delivered with the fixings required for installation.

Characteristics	Width (mm)	Depth (mm)	References
Plinths	600	500	NSYZUN65OPB
Plinths	600	600	NSYZUN66OPB

Brush Gasket for the Cable Entries through the Plinth



NSYJPSVD

- It is fixed to the knock-out areas for the cable entries
- Delivery as a unit.

Characteristics	Entry width (mm)	References
Brush gasket for the cable entries through the plinth	75 x 400	NSYJPSVD

Wall-Mounted Kit for Actassi Enclosures

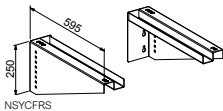

NSYCFRS

- Allows wall-mounted of enclosures from 6U to 29U, with a depth of 600 mm
- Maximum load inside the enclosure: 50 kg
- The kit includes 2 brackets

Supply:
Delivered with the fixings required for installation.

Characteristics	Depth (mm)	References
Wall-mounted kit for Actassi enclosures	600	NSYCFRS

Partial Fixed Slides



NSYGF140OPB

- Set of 2 slides for supporting a drawer, a shelf or 19" hardware
- Fixing by attachment on the front 19" uprights
- Material: zinc-coated steel
- Acceptable load: 15 kg.

Characteristics	Width (mm)	References
Partial fixed slides	140	NSYGF140OPB

Fixed Slides



NSYGF200OPB

- Set of 2 slides for supporting a drawer, a shelf or 19" hardware
- Fixing by attachment between the front and rear 19" uprights
- Material: zinc-coated steel
- Heel of 0 mm
- Acceptable load: 15 kg.

Characteristics	Center-to-center distance (mm)	References
Fixed slides	200	NSYGF200OPB

Rear Cable Support on 19" Uprights



NSYSRCOPB

- Fixing to the rear of the 19" uprights to support the cables
- Material: zinc-coated steel

Supply:
Delivered with the fixings required for installation.

Characteristics	References
Rear cable support on 19" uprights	NSYSRCOPB

Earthing Kit for Actassi OPB



NSYCTOPB

- To earth all the covering components.

Characteristics	References
Earthing kit for Actassi OPB	NSYCTOPB

Actassi KDB Knock-Down Boxes – Ideal for Smaller Businesses

Imagine providing excellent equipment for network, telephone, security and audio/video while saving up to 60% on stock space. Add smart benefits like the flat-package and the exceptional mounting time of 5 minutes, and you have the major advantages of the KDB enclosure in a little box.



The Actassi KDB Boxes Are Available at Your Wholesaler. Always Quick and Easy to Find an Enclosure for Your Needs.

Actassi KDB Knock-Down Box

A sturdy, robust enclosure made of welded sheet steel, with great opportunities for several kinds of installations, would probably save lots of time and mounting space during installation. Not the Actassi KDB knock-down boxes. The keyword is "easy".

Easy to Stock, Assemble and Manage

Let's start with the package. The clever flat-pack will help save up to 60% on storage space. It's easy to stock – just grab a couple of packages from the shelf, load them into the your car and you are ready to go.

On site, the enclosure can be put up, wall-mounted and prepared for the components in just a few minutes. In addition, there are a number of handy features that provide equal easiness: the tool-less door with spring hinges for optimized access to the patch panels, the brush panel for swift cable management and the fan plates for smart airing.



Save 60% on stock space

The KDB enclosure is easy to stock and load. The flat-pack allows you to save up to 60% on space, which means you can make more installations in less time.



5 Minutes 1 Person 1 Tool

Actassi KDB Enclosures Offer Exceptional Simplicity in Terms of Mounting and Installation. One Person Can Set up the KDB in Less than 5 Minutes. And the Only Tool Needed Is a Regular Screwdriver.



13

Technical changes reserved. Information provided without guarantee. Images are for illustrative purposes only.

19" Wall-Mounted Open Box Ergonomic and Adaptable



5 minutes

You Need Only Five Minutes to Mount the Actassi KDB enclosure.



Easy to Assemble. You Only Need One Single Tool. A Drilling Template Facilitates the Fixation on the Wall.



40 kg

The Body Allows Mounting of Components up to 40 kg.



Easy to Stock and Ship

The flat-pack architecture of KDB enclosure helps saving 60% of space in the stock. It is also very easy to ship and carry.



Easy Cable Management (Option)

Use the 19" brush panel to easily manage the entry of cables supress into the top and bottom.



Easy to Assemble

The symmetric construction of the top, bottom and side panels gives easy and helps assembling.



Smart Airing (Option)

Helps protecting the installed components like switches and PABX. Use the 19" smart fan plates equipped with a thermostat adjustable from 0 °C to 55 °C

13

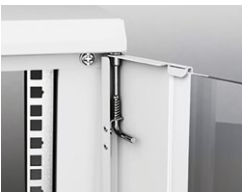

Easy to Use

Tool-less door with spring hinges facilitates the access to the patch panels.



Easy to Adapt

If you need more space at the front of the enclosure, you can easily move the 19" uprights each 25 mm.

19" Wall Knock-Down Box

Simple and Space-Saving

Introduction and Selection Guides

- Flat-pack wall-mounted enclosure dismantled in 1 package
- Symmetric enclosure made from welded sheet steel, powder-painted, leather-grain finish, RAL 7035 light gray epoxy-polyester.
- Enclosure made up of a body, one pair of 19" fixed uprights and a Securit® glass transparent door with key no. 333.
- Top and bottom 19" knock-down plates for entry cables and fans – 0U
- Protection rating: IP20
 - protection against objects > 12.5 mm
 - no protection against liquids
- Impact Protection: IK08
 - impact energy = 5 joules
- Acceptable load: 3 kg/U; max. 40 kg per enclosure.
- (Include 25% of margin load rating according to IEC 62208)
- Certifications: in compliance with directive RoHs, with 19" standard IEC 60297-3-100 and EIA-310-E
- Brush entry cables NSYCRTM1U1PS (in option)
- Smart fan NSY1FAN230T for temperature control from 0 °C to 55 °C (option).



60%

The Flat-Pack Helps Saving up to 60% of Space in the Stock.

Flat-pack enclosures

Number of U	Dimensions (mm)			Enclosure reference	Brush entry cables	Smart fan
	Height	Width	Depth			
6	352	600	400	NSYKDB6U4F	NSYCRTM1U1PS	NSY1FAN230T
9	485	600	400	NSYKDB9U4F		
12	618	600	400	NSYKDB12U6F		
15	752	600	400	NSYKDB15U6F		



Smart Fans



- 19" fan plate
 - 0U on top and bottom of the box
 - 3U fixed on the 19" uprights
- Equipped with 1 or 2 fans
 - 90 CFM per fan (155 m³/h)
 - 230 V - AC
 - plugs IEC 14 to power
 - Mains input: socket IEC C14 - for connection with IEC C13 plug power cable
- Equipped with 1 adjustable thermostat 0 °C to 55 °C
- Equipped with 1 led switch On/Off.



NSY1FAN230T



NSY2FAN230T

Supply:
Delivered without cable.

Characteristics	Type	References
Smart fans	1 Fan	NSY1FAN230T
Smart fans	2 Fans	NSY2FAN230T

Cables for Smart and Basic Fan Plates

- Black power cables of 3 m to power the fan plates.



NSYIEC13SCH



NSYIEC13IEC14

Characteristics	Plug Out	Plug In	References
Cables for smart and basic fan plates	IEC C13	Schuko/FR	NSYIEC13SCH
Cables for smart and basic fan plates	IEC C13	IEC C14	NSYIEC13IEC14

Actassi Floor-Standing Enclosures

Are you looking for an enclosure that is robust and very quick to install? Actassi VDA should be your choice. Smart details and an option to choose pre-installed accessories reduce the installation time. If you need a top-of-the-line server enclosure, Actassi VDS is hard to beat. It can be mounted with up to 750 kg of 19" components, and the micro-perforated door helps ensuring superior air flow (above 80%).



Actassi VDA-B
Cabling enclosure



Actassi VDA-E
Cabling enclosure



Actassi VDA-L
Cabling enclosure.
Prepared for Ruko locking system



Actassi VDS
Server enclosure

VDA Easy to Install and to Integrate 19" Cabling Enclosure

Adaptable

The configured offer allows you to equip the rack according to your needs:

- 2 framework models,
- 13 door models,
- 2 side panel models.

Aesthetics and Customization

3 models referenced:

VDA-B, VDA-E, VDA-L (Ruko).

2 color variants:

- 2 colors light gray (RAL7035) or dark gray (RAL9011)



Time Saving

All doors can be installed and removed quickly. The cladding can be installed and removed by one person.

The feet can be adjusted from the inside.



Rigidity and Sturdiness

400 kg of acceptable static load. Option of increasing to 500 kg using a rigidity kit.

VDA Easy to Install and to Integrate 19" Cabling Enclosure



The Airing Is Adjustable and Does Not Take Up Any Units (1 to 9 Fans).



Panels and Doors Can Be Installed and Removed Quickly by One Person.



Innovation

The side cable entry is the most ergonomic and efficient solution on the market. The top and bottom openings, flush with the structure, allow the cables to be prepared before installing the rack. These openings also allow for easy maintenance and are closed when the side panels are installed.



Safety

Helps securing installed components such as switches. The latches of the panels can be equipped with a key locking system (the key is identical for all the doors).



Accessories

The central openings on the roof and the base support multiple blanking plate combinations (plain, with brush gasket or ventilated). Optional installation of the blanking plates with the roof plate thanks to the roof stand-offs.



Smart

The pivot and guide system allows the panels to be returned to their place quickly, with maximum safety.



Harmonious Design

With modern aesthetics: strip, handle, hinge, in rounded shape.



Practical

Marking of the units on the front panel and on the side for quick installation of the equipment. The 19" uprights are easily adjusted in depth on site.



Ergonomics

The routing of the cable glands is easier:

- Knock-out side cable glands at top and bottom.
- Knock-out rear cable glands at top and bottom.
- Large opening on the roof, offset towards the rear and equipped with a removable plate. Allows the integration of live equipment at the top and the entry of cables by the rear.
- Large opening at the bottom.



Adjustable Airing

The roof airing is depth-adjustable and does not take up any units. Option of installing 1 to 9 fans according to the size of your enclosure.

VDA/VDS Racks Overview



VDA B/E/L Enclosures



VDS - Server Enclosure

		Colors	19" Uprights		Lining specificities			Acceptable Static Load	Equipments
			Front	Rear	Door	Side Panel	Rear		
VDA-B	Simply and functionally designed for cabling applications with switches and routers	Ral7035 - Light Gray	x2	No	glazed (1-point locking system)	locking by latches	Panel (locking by latches)	400 kg (882 lbs)	Earthing kit (NSYCTVDA) must be ordered separately
VDA-E	Equipped and ready to use for IT and VIDEO applications	Ral7035 - Light Gray	x2	x2	glazed (2-point locking system)		Full plain door (1-point locking system)		Earthing kit is pre-installed + bag of 30 cage nuts M6 and 30 screws and washers
		Ral9011 - Black	x2	x2	glazed (2-point locking system)		Full plain door (1-point locking system)		Earthing kit is pre installed + Bag of 30 cage nuts M6 and 30 screws and washers
VDA-L	Prepared and ready to use for network applications with Ruko Locking System	24U Ral7035 - Light Gray	x2	No	glazed (1-point locking system)		Panel (locking by latches)		Cover (NSYAEDKRUVD) must be ordered separately for Ruko locking system
		42U Ral9011 - Black	x2	x2	glazed or plain (2-point locking system)		Panel (locking by latches)		Adapter (NSYAEDN1DVD) is supplied with the rack for Ruko locking system
VDS	19" Server enclosure, robust and ventilated for micro data centers	Ral9011 - Black	x2	x2	ventilated (2-point locking system)	Ventilated Door (2-point locking system)	750 kg (1654 lbs)	Earthing kit is pre-installed	

13

VDA-B

Simple and Functional

Introduction

VDA-B rack

- Designed for circulation applications with switches and routers
- 6 heights: 24U, 29U, 33U, 38U, 42U and 47U
- 2 widths: 600 and 800 mm
- 3 depths: 600, 800 and 1000 mm
- Acceptable static load: 400 kg
- Dynamic load: 250 kg
- Color: light Gray (RAL 7035) for lining
- Protection rating: IP20
 - protection against objects > 12.5 mm
 - no protection against liquids
- Impact Protection: IK08
 - impact energy = 5 joules
- Certifications: in compliance with directive RoHs, with 19° standard IEC 60297-3-100 and EIA-310D.

Rack Composition

- Top and bottom frames, mechanically assembled by Torx screws to the vertical structure uprights, thus forming a rigid framework
- Base without blanking plate
- Cut-out roof, closed with a removable blanking plate
- Glazed reversible front door, 4 mm Securit® glass, opening to 180°, 1-point lock with a key no. 333. Hinges on the right as standard
- Rear panel with quick installation and removal, locking by latches
- Side panels with quick installation and removal, locking by latches
- Top and bottom side cable glands flush with the structure
- Top and bottom side knock-out areas for cable entry, with a width of 800 mm
- Large opening on the bottom and large knock-out area on the rear for cable entry.
- Levelling feet installed
- Two 19° uprights made from treated steel, installed 100 mm back from the front surface and depth-adjustable in steps of 25 mm
- Delivered on a pallet wrapped with film.

Composition of the Rack without Side Panels

- Exactly the same composition as the above rack, but without the side panels
- Coupling kit not supplied
- If coupling is required, use the coupling kit (ref. **NSYCUNVDA**) and the brush gasket (ref. **NSYCUNPL800** or **NSYCUNPL1000**) to close the cable entry left by the 2 side panels.



Selection Guide

- VDA-B racks, RAL 7035 Light Gray

Installed enclosures									
Number of U	Dimensions (mm)			Rack with side panels	Rack without side panels	19" uprights	100 mm plinth	Handling wheels	Cable-gland trim
	Height	Width	Depth						
24	1200	600	600	NSYVDA24U66B	-	NSYBR9F24	NSYZUN66VDA	NSYRUFVDA	-
24	1200	600	800	NSYVDA24U68B	-	NSYBR9F24	NSYZUN68VDA	NSYRUFVDA	-
24	1200	600	1000	NSYVDA24U610B	-	NSYBR9F24	NSYZUN610VDA	NSYRUFVDA	-
24	1200	800	800	NSYVDA24U88B	-	NSYBR9F24	NSYZUN88VDA	NSYRUFVDA	-
24	1200	800	1000	NSYVDA24U810B	-	NSYBR9F24	NSYZUN810VDA	NSYRUFVDA	-
29	1400	600	600	NSYVDA29U66B	-	NSYBR9F29	NSYZUN66VDA	NSYRUFVDA	-
33	1600	600	600	NSYVDA33U66B	-	NSYBR9F33	NSYZUN66VDA	NSYRUFVDA	-
33	1600	600	800	NSYVDA33U68B	-	NSYBR9F33	NSYZUN68VDA	NSYRUFVDA	-
33	1600	800	800	NSYVDA33U88B	-	NSYBR9F33	NSYZUN88VDA	NSYRUFVDA	-
38	1800	600	600	NSYVDA38U66B	-	NSYBR9F38	NSYZUN66VDA	NSYRUFVDA	-
38	1800	600	800	NSYVDA38U68B	-	NSYBR9F38	NSYZUN68VDA	NSYRUFVDA	-
42	2000	600	600	NSYVDA42U66B ⁽¹⁾	-	NSYBR9F42	NSYZUN66VDA	NSYRUFVDA	-
42	2000	600	800	NSYVDA42U68B	-	NSYBR9F42	NSYZUN68VDA	NSYRUFVDA	-
42	2000	600	1000	NSYVDA42U610B	-	NSYBR9F42	NSYZUN610VDA	NSYRUFVDA	-
42	2000	800	600	NSYVDA42U86B	-	NSYBR9F42	NSYZUN86VDA	NSYRUFVDA	NSYPV42
42	2000	800	800	NSYVDA42U88B ⁽¹⁾	NSYVDAC42U88B	NSYBR9F42	NSYZUN88VDA	NSYRUFVDA	NSYPV42
42	2000	800	1000	NSYVDA42U810B ⁽¹⁾	-	NSYBR9F42	NSYZUN810VDA	NSYRUFVDA	NSYPV42
47	2200	600	600	NSYVDA47U66B	-	NSYBR9F47	NSYZUN66VDA	NSYRUFVDA	-
47	2200	800	800	NSYVDA47U88B	-	NSYBR9F47	NSYZUN88VDA	NSYRUFVDA	-

⁽¹⁾ This size exists in kit version (delivered disassembled)

Only 2 people and 10 mn is needed.
 Same Reference but + „K" at the end
 > NSYVDA42U66BK
 > NSYVDA42U810BK
 > NSYVDA42U88BK

Rack with Side Panels



NSYVDA24U66B

Characteristics	Number of U	Height (mm)	Width (mm)	Depth (mm)	References
Rack with side panels	24	1200	600	600	NSYVDA24U66B
Rack with side panels	24	1200	600	800	NSYVDA24U68B
Rack with side panels	24	1200	600	1000	NSYVDA24U610B
Rack with side panels	24	1200	800	800	NSYVDA24U88B
Rack with side panels	24	1200	800	1000	NSYVDA24U810B
Rack with side panels	29	1400	600	600	NSYVDA29U66B
Rack with side panels	33	1600	600	600	NSYVDA33U66B
Rack with side panels	33	1600	600	800	NSYVDA33U68B
Rack with side panels	33	1600	800	800	NSYVDA33U88B
Rack with side panels	38	1800	600	600	NSYVDA38U66B
Rack with side panels	38	1800	600	800	NSYVDA38U68B
Rack with side panels	42	2000	600	600	NSYVDA42U66B
Rack with side panels, kit version (delivered disassembled)	42	2000	600	600	NSYVDA42U66BK
Rack with side panels	42	2000	600	800	NSYVDA42U68B
Rack with side panels	42	2000	600	1000	NSYVDA42U610B
Rack with side panels	42	2000	800	600	NSYVDA42U86B
Rack with side panels	42	2000	800	800	NSYVDA42U88B
Rack with side panels, kit version (delivered disassembled)	42	2000	800	800	NSYVDA42U88BK
Rack with side panels	42	2000	800	1000	NSYVDA42U810B
Rack with side panels, kit version (delivered disassembled)	42	2000	800	1000	NSYVDA42U810BK
Rack with side panels	47	2200	600	600	NSYVDA47U66B
Rack with side panels	47	2200	800	800	NSYVDA47U88B

Rack without Side Panels



NSYVDAC42U88B

Characteristics	Number of U	Height (mm)	Width (mm)	Depth (mm)	References
Rack without side panels	42	2000	800	800	NSYVDAC42U88B

Additional 19" Uprights

- Assembly on the depthwise supports
- Depth adjustable in steps of 25 mm
- Set of 2 uprights and the fixings required for assembly
- For partial assembly use depth-support references **NSYSBRF66** to **NSYSBRF88**
- 9.5 mm square holes in the front panel.



NSYBR9F12

Characteristics	Number of U	References
Additional 19" uprights	24U	NSYBR9F24
Additional 19" uprights	29U	NSYBR9F29
Additional 19" uprights	33U	NSYBR9F33
Additional 19" uprights	38U	NSYBR9F38
Additional 19" uprights	42U	NSYBR9F42
Additional 19" uprights	47U	NSYBR9F47

Plinths (F1)



NSYZUN66VDA

- Plinth made from folded sheet steel, RAL 7011 dark gray, epoxy-polyester, textured, powder paint
- Plinth height: 100 mm
- Allows the assembly of standard levelling feet compatible with handling wheels reference **NSYRUFNPVDA**
- Option of removing the 4 strips
- Side and rear strips equipped with a knock-out area for cable entry
- Front strip equipped with airing louvres.

Characteristics	Width (mm)	Depth (mm)	References
Plinths (F1)	600	600	NSYZUN66VDA
Plinths (F1)	600	800	NSYZUN68VDA
Plinths (F1)	600	1000	NSYZUN610VDA
Plinths (F1)	800	600	NSYZUN86VDA
Plinths (F1)	800	800	NSYZUN88VDA
Plinths (F1)	800	1000	NSYZUN810VDA

Handling Wheels (M3)



NSYRUFVDA

- Set of 4 swivel wheels, 2 of which are equipped with a locking system
- Direct fixing under the bottom frame of the rack by M12 screws
- Height of the wheels: 105 mm.

Characteristics	References
Handling wheels (M3)	NSYRUFVDA

Vertical Trim Strips with Cable Entries (H2)



NSYPV24

- For enclosures with a width of 800 mm only
- Side cut-outs allowing the entry of cables every 250 mm. Knock-out entries on the front plate every 250 mm
- Assembly on the framework uprights providing aesthetic continuity between the framework and the 19" uprights positioned at least 100 mm away from the door
- RAL 7011 dark gray paint
- Cable-protection strips (not supplied) to be ordered separately
- Dismounting by 1/4-turn screws
- Set of 2 trim strips.

Characteristics	Number of U	References
Vertical trim strips with cable entries (H2)	42U	NSYPV42

VDA-E

Equipped and Ready to Use

Introduction

VDA-E Rack

- Designed for IT and video applications, among others
- 4 heights: 24U, 38U, 42U and 47U
- 2 widths: 600 and 800 mm
- 3 depths: 600, 800 and 1000 mm.
- Acceptable static load: 400 kg
- Dynamic load: 250 kg
- Color:
 - light Gray (RAL 7035) for lining
 - black (RAL 9011)
- Protection rating: IP20
 - protection against objects > 12.5 mm
 - no protection against liquids
- Impact Protection: IK08
 - impact energy = 5 joules
- Certifications: in compliance with directive RoHs, with 19" standard IEC 60297-3-100 and EIA-310D

Rack Composition

- Top and bottom frames, mechanically assembled by Torx screws to the vertical structure uprights, thus forming a rigid framework
- Base without blanking plate
- Cut-out roof, closed with a removable plain sheet
- Glazed reversible front door, 4 mm Securit® glass, opening to 180°, 2-point lock with a key no. 333 and handle. Hinges on the right as standard. Option of adding a third central locking point as an accessory, with reference **NSYAEDN3PVD**
- Reversible full plain rear door, 1-point lock with a key no. 333, opening to 180°
- Side panels with quick installation and removal, locking by latches
- Top and bottom side cable glands flush with the structure
- Top and bottom side knock-out areas for cable entry, with a width of 800 mm
- Large opening on the bottom and large knock-out area on the rear for cable entry
- Leveling feet installed
- Four 19" uprights made from treated steel, installed 100 mm back from the front plate and depth-adjustable in steps of 25 mm
- Delivered on a pallet wrapped with film
- Earthing kit pre-installed
- 1 bag of fixings with 30 M6 screws + washers + caged nuts.

Composition of the Rack without Side Panels

- Exactly the same composition as the above rack
- Coupling kit not supplied
- If coupling is required, use the coupling kit (ref. **NSYCUNVDA**) and the brush gasket (ref. **NSYCUNPL800** or **NSYCUNPL1000**) to close the cable entry left by the 2 side panels.

VDA-E Racks, RAL 9011 Black Cladding

- 1 height: 42U
- 2 widths: 600 and 800 mm
- 3 depths: 600, 800 and 1000 mm
- Rack composition
- Delivered assembled.



Selection Guide

- VDA-E racks, RAL 7035 Light Gray

Installed enclosures								
Number of U	Dimensions (mm)			Rack with side panels	Rack without side panels	100 mm plinth	Handling wheels	Cable-gland trim
	Height	Width	Depth					
24	1200	600	600	NSYVDA24U66E	-	NSYZUN66VDA	NSYRUFVDA	-
24	1200	600	800	NSYVDA24U68E	-	NSYZUN68VDA	NSYRUFVDA	-
24	1200	600	1000	NSYVDA24U610E	-	NSYZUN610VDA	NSYRUFVDA	-
42	2000	600	600	NSYVDA42U66E	-	NSYZUN66VDA	NSYRUFVDA	-
42	2000	600	800	NSYVDA42U68E	-	NSYZUN68VDA	NSYRUFVDA	-
42	2000	800	800	NSYVDA42U88E	NSYVDAC42U88E	NSYZUN88VDA	NSYRUFVDA	NSYPV42
42	2000	800	1000	NSYVDA42U810E	-	NSYZUN810VDA	NSYRUFVDA	NSYPV42
47	2200	800	800	NSYVDA47U88E	-	NSYZUN88VDA	NSYRUFVDA	-

Selection Guide

- VDA-E racks, RAL 9011 black

Installed enclosures								
Number of U	Dimensions (mm)			Rack with side panels	Rack without side panels	100 mm plinth	Handling wheels	Cable-gland trim
	Height	Width	Depth					
42	2000	800	800	NSYVDA42U88EN	-	NSYZUN88VDA	NSYRUFVDA	NSYPV42
42	2000	800	1000	NSYVDA42U810EN	-	NSYZUN810VDA	NSYRUFVDA	NSYPV42

Rack with Side Panels

- VDA-E racks,
- RAL 7035 Light Gray



NSYVDA24U66E

Characteristics	Number of U	Height (mm)	Width (mm)	Depth (mm)	References
Rack with side panels	24	1200	600	600	NSYVDA24U66E
Rack with side panels	24	1200	600	800	NSYVDA24U68E
Rack with side panels	24	1200	600	1000	NSYVDA24U610E
Rack with side panels	42	2000	600	600	NSYVDA42U66E
Rack with side panels	42	2000	600	800	NSYVDA42U68E
Rack with side panels	42	2000	800	800	NSYVDA42U88E
Rack with side panels	42	2000	800	1000	NSYVDA42U810E
Rack with side panels	47	2200	800	800	NSYVDA47U88E

Rack without Side Panels

- VDA-E racks,
- RAL 7035 Light Gray



NSYVDAC42U88E

Characteristics	Number of U	Height (mm)	Width (mm)	Depth (mm)	References
Rack without side panels	42	2000	800	800	NSYVDAC42U88E

Rack with Side Panels

- VDA-E racks,
- RAL 9011 black



NSYVDA42U66EN

Characteristics	Number of U	Height (mm)	Width (mm)	Depth (mm)	References
Rack with side panels	42	2000	800	800	NSYVDA42U88EN
Rack with side panels	42	2000	800	1000	NSYVDA42U810EN

Plinths (F1)



NSYZUN66VDA

- Plinth made from folded sheet steel, RAL 7011 dark gray, epoxy-polyester, textured, powder paint
- Plinth height: 100 mm
- Allows the assembly of standard levelling feet compatible with handling wheels reference **NSYRUFNPVDA**
- Option of removing the 4 strips
- Side and rear strips equipped with a knock-out area for cable entry
- Front strip equipped with airing louvres.

Characteristics	Width (mm)	Depth (mm)	References
Plinths (F1)	600	600	NSYZUN66VDA
Plinths (F1)	600	800	NSYZUN68VDA
Plinths (F1)	600	1000	NSYZUN610VDA
Plinths (F1)	800	600	NSYZUN86VDA
Plinths (F1)	800	800	NSYZUN88VDA
Plinths (F1)	800	1000	NSYZUN810VDA

Handling Wheels (M3)



NSYRUFVDA

- Set of 4 swivel wheels, 2 of which are equipped with a locking system
- Direct attachment under the bottom frame of the rack by M12 screws
- Height of the wheels: 105 mm.

Characteristics	References
Handling wheels (M3)	NSYRUFVDA

Vertical Trim Strips with Cable Entries (H2)



NSYPV24

- For enclosures with a width of 800 mm only
- Side cut-outs allowing the entry of cables every 250 mm. Knock-out entries on the front plate every 250 mm
- Assembly on the framework uprights providing aesthetic continuity between the framework and the 19" uprights positioned at least 100 mm away from the door
- RAL 7011 dark gray paint
- Cable-protection strips (not supplied) to be ordered separately
- Dismounting by 1/4-turn screws
- Set of 2 trim strips.

Characteristics	Number of U	References
Vertical trim strips with cable entries (H2)	42U	NSYPV42

VDA-L

Prepared for Ruko Locking System

Introduction

VDA-L Rack, RAL 7035 Light Gray

- Designed for IT and video applications among others
- Height: 24U - 42U
- 2 widths: 600 and 800 mm
- 2 depths: 600 and 800
- Acceptable static load: 400 kg
- Dynamic load: 250 kg
- Color:
 - light Gray (RAL 7035) for lining
 - black (RAL 9011)
- Protection rating: IP20
 - protection against objects > 12.5 mm
 - no protection against liquids
- Impact Protection: IK08
 - impact energy = 5 joules
- Certifications: in compliance with directive RoHs, with 19" standard IEC 60297-3-100 and EIA-310D

Rack Composition

- Top and bottom frames, mechanically assembled by Torx screws to the vertical structure uprights, thus forming a rigid framework
- Base without blanking plate
- Cut-out roof, closed with a removable plate equipped with a brush gasket
- Glazed or front door, 4 mm Securit® glass, opening to 180°, 2-point lock with a key no. EK333 and handle. Hinges on the right as standard. Option of adding a third central locking point as an accessory, with reference **NSYAEDN3PVD**
- Single rear panel
- Side panels with quick installation and removal, locking by latches
- Top and bottom side cable glands flush with the structure
- Top and bottom side knock-out areas for cable entry, with a width of 800 mm
- Large opening on the bottom and large knock-out area on the rear for cable entry
- Levelling feet
- One pair of 19" uprights made from treated steel, installed 100 mm back from the front plate and depth-adjustable in steps of 25 mm
- Delivered on a pallet wrapped with film.

Composition of the Rack without Side Panels

- Exactly the same composition as the above rack, but without the side panels.
- Coupling kit not supplied
- If coupling is required, use the coupling kit (ref. **NSYCUNVDA**) and the brush gasket (ref. **NSYCUNPL800** or **NSYCUNPL1000**) to close the cable entry left by the 2 side panels.

VDA-L Racks, RAL 9011 Black

- 1 height: 42U
- 1 width: 600 mm
- 1 depths: 1000 mm

Rack Composition

- Same composition to the above rack with glazed door
- Two pairs of 19" uprights made from treated steel, installed 100 mm back from the front plate and depth-adjustable in steps of 25 mm
- Delivered assembled.



Selection Guide

- VDA-L racks, RAL 7035 Light Gray

Installed enclosures								
Number of U	Dimensions (mm)			Rack with glazed door	Rack with plain door	19" uprights	100 mm plinth	Handling wheels
	Height	Width	Depth					
24	1200	600	800	NSYVDA24U68L	-	NSYBR9F24	NSYZUN68VDA	NSYRUFVDA
42	2000	600	600	NSYVDA42U66L	NSYVDA42U66LR	NSYBR9F42	NSYZUN66VDA	NSYRUFVDA
42	2000	600	800	NSYVDA42U68L	-	NSYBR9F42	NSYZUN68VDA	NSYRUFVDA
42	2000	800	800	NSYVDA42U88L	NSYVDA42U88LR	NSYBR9F42	NSYZUN88VDA	NSYRUFVDA
42	2000	800	600	NSYVDA42U86L	-	NSYBR9F42	NSYZUN86VDA	NSYRUFVDA

Selection Guide

- VDA-L racks, RAL 9011 black

Installed enclosures						
Number of U	Dimensions (mm)			Rack with glazed door	100 mm plinth	Handling wheels
	Height	Width	Depth			
42	2000	800	1000	NSYVDA42U810LN	NSYZUN810VDA	NSYRUFVDA

Rack with Glazed Door



NSYVDA24U68L

- VDA-L racks,
- RAL 7035 Light Gray

Characteristics	Number of U	Height (mm)	Width (mm)	Depth (mm)	References
Rack with glazed door	24	1200	600	800	NSYVDA24U68L
Rack with glazed door	42	2000	600	600	NSYVDA42U66L
Rack with glazed door	42	2000	600	800	NSYVDA42U68L
Rack with glazed door	42	2000	800	800	NSYVDA42U88L
Rack with glazed door	42	2000	800	600	NSYVDA42U86L

Rack with Plain Door



NSYVDA42U66LR

- VDA-L racks,
- RAL 7035 Light Gray

Characteristics	Number of U	Height (mm)	Width (mm)	Depth (mm)	References
Rack with plain door	42	2000	600	600	NSYVDA42U66LR
Rack with plain door	42	2000	800	800	NSYVDA42U88LR

Rack with Glazed Door



NSYVDA42U610LN

- VDA-L racks,
- RAL 9011 black

Characteristics	Number of U	Height (mm)	Width (mm)	Depth (mm)	References
Rack with glazed door	42	2000	800	1000	NSYVDA42U810LN

Plinths (F1)



NSYZUN66VDA

- Plinth made from folded sheet steel, RAL 7011 dark gray, epoxy-polyester, textured, powder paint
- Plinth height: 100 mm
- Allows the assembly of standard levelling feet compatible with handling wheels reference **NSYRUFNPVDA**
- Option of removing the 4 strips
- Side and rear strips equipped with a knock-out area for cable entry
- Front strip equipped with airing louvres.

Characteristics	Width (mm)	Depth (mm)	References
Plinths (F1)	600	600	NSYZUN66VDA
Plinths (F1)	600	800	NSYZUN68VDA
Plinths (F1)	600	1000	NSYZUN610VDA
Plinths (F1)	800	600	NSYZUN86VDA
Plinths (F1)	800	800	NSYZUN88VDA
Plinths (F1)	800	1000	NSYZUN810VDA

Handling Wheels (M3)



NSYRUFVDA

- Set of 4 swivel wheels, 2 of which are equipped with a locking system
- Direct fixing under the bottom frame of the rack by M12 screws
- Height of the wheels: 105 mm.

Characteristics	References
Handling wheels (M3)	NSYRUFVDA

Additional 19" Uprights

- Assembly on the depthwise supports
- Depth adjustable in steps of 25 mm
- Set of 2 uprights and the fixings required for assembly
- For partial assembly use depth-support references **NSYSBRF66** to **NSYSBRF88**
- 9.5 mm square holes in the front panel.



NSYBR9F12

Characteristics	Number of U	References
Additional 19" uprights	24U	NSYBR9F24
Additional 19" uprights	42U	NSYBR9F42

VDS 19" Server Enclosure

Robust and Ventilated



Ventilated

The front and rear doors are microperforated across the width of the 19" uprights to guide the air flow through the equipment. They allow above 80% of air through for optimal airing of the live components that equip the 19" rack.



Vertical Cable Manager (Option)

Efficient vertical cable managers can be used to duct, support and hide fiber and copper cables in improving airflow.



Rigidity and Robustness

750 kg of acceptable static load.

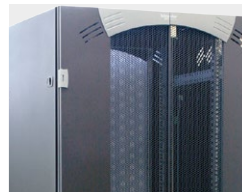

Adaptation and Customization

The configured offer allows you to equip the rack according to your needs:

- 2 framework models.
- 13 door models (microperforated double-door, etc.).
- 2 side panel models.

VDS 19" Server Enclosure

Robust and Ventilated



The Airing Is Adjustable and Does Not Take Up Any Units (1 to 9 Fans).



Panels and Doors Can Be Installed and Removed Quickly by A Single Operator.



Innovating

The side cable entry is the most ergonomic and efficient solution on the market. The top and bottom openings, flush with the structure, allow the strands to be prepared before installing the rack. These openings also allow for easy maintenance and are closed when the side panels are installed.



Safety

The latches of the panels can be equipped with a key locking system (the key is identical for all the doors).



Accessories

The central openings on the roof and the base support allow multiple blanking plate combinations (plain, with brush or ventilated). Option of installing the blanking plates with the roof plate thanks to the roof stand-offs.

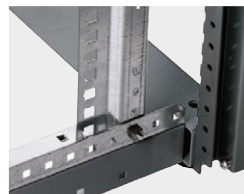

Smart

The pivot and guide system allows the panels to be returned to their place quickly, with maximum safety.



Time Saving

All the doors and panels can be installed and removed quickly. The cladding can be installed and removed by a single person. The feet can be adjusted from the inside.



Practical

Marking of the units on the front panel and on the side for quick installation of the equipment. The 19" uprights are easily depth-adjustable on the site.

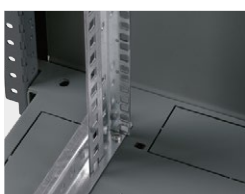

Ergonomic

The routing of the cable entries is easier:

- Side cable entries at top and bottom, pre-cut.
- Rear cable entries at the bottom, pre-cut.
- Large opening on the roof, offset towards the rear and equipped with a blanking plate.
- Allows the integration of live equipment at the top and the entry of cables from the rear.
- Large opening at the bottom.



Adaptable Airing

The roof airing is depth adjustable and does not result in the loss of any units. Option of installing 1 to 9 fans according to the size of your enclosure.

VDS 19" Server Enclosure

Robust and Ventilated

Introduction

Technical Characteristics

- Folded and welded sheet-steel enclosure, textured, RAL 9011 black epoxy-polyester powder paint
- Earth continuity guaranteed, according to the standard
- Allowed air flow above 80%
- Acceptable static load: 750 kg
- Color: black (RAL 9011)
- Protection rating: IP20
 - protection against objects > 12.5 mm
 - no protection against liquids
- Impact Protection: IK10
 - impact energy = 20 joules
- Certifications: in compliance with directive RoHs, with 19" standard IEC 60297-3-100 and EIA-310D

Rack Composition

- Top and bottom frames, mechanically assembled by Torx screws to the vertical structure uprights, thus forming a rigid framework
- Base without blanking plate
- Cut-out roof, closed with a blanking plate with dismountable brush gasket
- Reversible microperforated front and rear door, opening to 180°, 2-point locking system with a handle and a key no. 333. Hinges on the right as standard
- Side panels, with quick installation and removal, closing by latches
- Top and bottom side cable entries flush with the structure
- Top and bottom side knock-out areas for cable entry, with a width of 800 mm
- Large opening on the bottom and large knock-out area on the rear for cable entry
- Leveling feet installed
- Four 19" uprights made from treated steel, installed 100 mm back from the front plate and depth-adjustable in steps of 25 mm
- Earthing kit installed
- Delivered on a pallet wrapped with film
- Composition of the rack without side panels
- Exactly the same composition as the above rack, but without the side panels
- Coupling kit not supplied
- If coupling is required, use coupling kit ref. **NSYCUNVDA** and brush gasket (ref. **NSYCUNPL800** or **NSYCUNPL1000**) to close the cable entry left by the 2 side panels.





19" Server Enclosure Robust and Ventilated, Overview

Actassi, VDS

Selection Guide

- Server rack with and without side panels

Installed enclosures						
Number of U	Dimensions (mm)			Rack with side panels	100 mm plinth	Stand-off plinth for raised floor
	Height	Width	Depth			
42	2000	600	1000			
42	2000	800	800	NSYVDS42U610N	NSYZUN610VDA	NSYAEBP2F610
42	2000	800	800	NSYVDS42U88N	NSYZUN88VDA	NSYAEBP2F88
42	2000	800	1000	NSYVDS42U810N	NSYZUN810VDA	NSYAEBP2F810



Configured

- Configuration service: save time and rather remain focussed on your installation, letting us configure the product, color and accessories and their installation.
- One single order, one single delivery

See [page 555](#)



Specific

- Specific service: tailor-made enclosures; we specify the enclosure dimensions (15U rack, 400 mm depth, etc.), knock-outs, configuration, color and accessories and their installation for you.
- One single order, one single delivery.

See [page 555](#)

Technical changes reserved. Information provided without guarantee. Images are for illustrative purposes only.

Rack with Side Panels



NSYVDS42U610N

Characteristics	Number of U	Height (mm)	Width (mm)	Depth (mm)	References
Rack with side panels	42	2000	600	1000	NSYVDS42U610N
Rack with side panels	42	2000	800	800	NSYVDS42U88N
Rack with side panels	42	2000	800	1000	NSYVDS42U810N

Plinths (F1)



NSYZUN66VDA

- Plinth made from folded sheet steel, RAL 7011 dark gray, epoxy-polyester, textured, powder paint
- Plinth height: 100 mm
- Allows the assembly of standard levelling feet compatible with handling wheels reference **NSYRUFNPVDA**
- Option of removing the 4 strips
- Side and rear strips equipped with a knock-out area for cable entry
- Front strip equipped with airing louvres.

Characteristics	Width (mm)	Depth (mm)	References
Plinths (F1)	600	800	NSYZUN68VDA
Plinths (F1)	600	1000	NSYZUN610VDA
Plinths (F1)	800	800	NSYZUN88VDA
Plinths (F1)	800	1000	NSYZUN810VDA

Stand-Off Plinth for Raised Floor



NSYAEBP2F68

- Folded and welded sheet-steel frame, RAL 9005 black, epoxy-polyester, textured, powder paint
- Delivered with feet adjustable from 0 to 60 mm with holes for fixing to the floor
- Can support Actassi VDA, Actassi VDS, Spacial SM and PanelSeT SFN enclosures
- Standard adjustment for heights from 200 mm to a maximum of 300 mm in steps of 25 mm
- Acceptable static load: 1000 kg
- To adjust heights from 335 to 435 mm, use feet reference **NSYAEBP2F4F**.

Characteristics	Width (mm)	Depth (mm)	References
Stand-off plinth for raised floor	600	800	NSYAEBP2F68
Stand-off plinth for raised floor	600	1000	NSYAEBP2F610
Stand-off plinth for raised floor	800	800	NSYAEBP2F88
Stand-off plinth for raised floor	800	1000	NSYAEBP2F810

Overhead Patching Frame

The Actassi 19" overhead patching frame allows you to use the empty space above the enclosure. Just mount the frame onto the tray, either vertically or at an angle. For mounting on Defem mesh trays, use the Defem B1 fitting. Install patch panels and make the entire enclosure beneath available for server hosting. The patching frame now works as a consolidation point, enabling flexible cabling layout as well as convenient addition of new enclosures and servers.

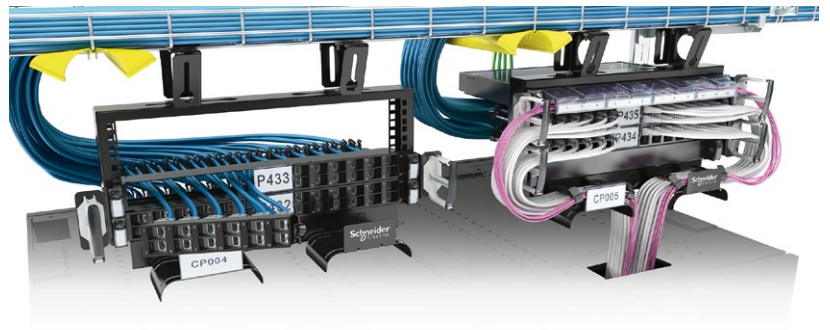

Robust cord managers for bending radius protection.



For maximum convenience, the brackets enable vertical or angled mounting of the frame.



Large label for clear visibility from the ground.

Actassi 19" Overhead Patching Frame 4U



VDIM33174

- 19" frame
- Designed to be mounted in a mesh tray or cable ladder to provide 4U patching positions and to save space in the enclosure below
- 4U height
- In compliance with directive RoHS and with 19" standards EIA 310-D and IEC 60297-3-100
- Dimensions: 500 x 350 x 160 mm
- Material: steel AN10130 DC01 painted in Raven Black
- Holds up to 15 Kg
- Equipped with two cable managers that helps securing the bending radius of the cables going down to the enclosure.
It includes 4 fastening strips of 30 cm
- Equipped with a large label holder for easy readability from the ground.

Characteristics	References
Overhead 19" patching frame 4U	VDIM33174

Locking System (P1)



NSYSTVDA

- Allows the locking of a side panel and the rear panel.
- Lock with key no. 333 with escutcheon plate
- It is installed on the opening latches of the side and rear panels
- Delivery of 2 locks per panel.

Characteristics	References
Locking system (P1)	NSYSTVDA

Adapter for 2-Point Locking System Handle



NSYAEDN1DVD

- Assembly on the rear of the handle for doors with 2-point locking system as standard on Actassi VDA-E or Actassi VDS
- Adapter supplied without the insert.

Characteristics	Adapter	References
Adapter for 2-point locking system handle	DIN half-cylinder	NSYAEDN1DVD
Adapter for 2-point locking system handle	ASSA	NSYAEDN1AVD
Adapter for 2-point locking system handle	KABA	NSYAEDN1KVD

Key Insert for 2-Point Locking System



NSYAEDNH2124EVD

- Assembly on the handle for doors with 2-point locking system as standard on the Actassi
- VDA-E front door or on Actassi VDS.

Characteristics	Key no.	References
Key insert for 2-point locking system	2124E	NSYAEDNH2124EVD

3rd Locking Point for Handle



NSYAEDN3PVD

- Assembly on the handle for doors with 2-point locking system as standard on the Actassi
- VDA-E front door or on Actassi VDS
- Provides a 3rd locking point (central).

Characteristics	References
3rd locking point for handle	NSYAEDN3PVD

Key Insert for 1-Point Locking System



NSYAEDN2124EVD

- Assembly on the handle for doors with 1-point locking system as standard on the Actassi
- VDA or on Actassi VDA-B or on the Actassi VDA-E rear door.

Characteristics	Key no.	References
Key insert for 1-point locking system	2124E	NSYAEDN2124EVD

Side Panels



NSY2PLVDC42U6



NSY2PLVDC42U8N

- Panels made from folded sheet steel with plastic obturators at the ends, epoxy-polyester, textured, powder paint
- Panels with quick assembly and removal by latches
- Unit of 2 panels delivered in cardboard packaging
- Option of installing a lock with key ref. **NSYSTVDA**.

Characteristics	Number of U	Height (mm)	Depth (mm)	References
Side panel, RAL 7035 light gray	42U	2000	600	NSY2PLVDC42U6
Side panel, RAL 7035 light gray	42U	2000	800	NSY2PLVDC42U8
Side panel, RAL 7035 light gray	42U	2000	1000	NSY2PLVDC42U10
Side panel, RAL 9011 black	42U	2000	800	NSY2PLVDC42U8N
Side panel, RAL 9011 black	42U	2000	1000	NSY2PLVDC42U10N

100 mm Rear Extension Kit (D20)

- Frame made from folded sheet steel, RAL 7035 light gray, epoxy-polyester, textured, powder paint
- Assembly on the rear of the enclosure framework
- Allows the assembly of a door or a panel
- Allows depths of 700, 900 and 1100 mm
- Delivered with assembly instructions
- Please consult us for other sizes.



NSYAEPX42U8

Characteristics	Number of U	Width (mm)	References
100 mm rear extension kit (D20)	42U	800	NSYAEPX42U8

To order your enclosure elements, please consult the configuration sheet on [page 554](#).

Coupling Kit (R1)

- Kit to be used when coupling two racks side by side
- Kit of 4 flanges and the fixings required for assembly.

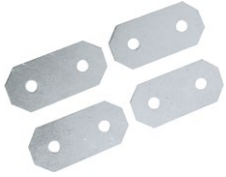

NSYCUNVDA

Characteristics	References
Coupling kit (R1)	NSYCUNVDA

Blanking Brush Gasket for the Cable Entries Between Coupled Racks

- Blanking plate with brush gasket
- Assembly on the top or bottom frame between two coupled racks, on the cable entry left by the 2 side panels

Supply:
Delivered with the fixings required for installation.



NSYCUNPL800

Characteristics	Depth (mm)	References
Blanking brush gasket for the cable entries between coupled racks	800	NSYCUNPL800
Blanking brush gasket for the cable entries between coupled racks	1000	NSYCUNPL1000

Vertical Trim Strips with Cable Entries (H2)



- For enclosures with a width of 800 mm only
- Side cut-outs allowing the entry of cables every 250 mm. Knock-out entries on the front plate every 250 mm
- Assembly on the framework uprights providing aesthetic continuity between the framework and the 19" uprights positioned at least 100 mm away from the door
- RAL 7011 dark gray paint
- Cable-protection strips (not supplied) to be ordered separately
- Dismounting by 1/4-turn screws
- Set of 2 trim strips.

Characteristics	Number of U	References
Vertical trim strips with cable entries (H2)	42U	NSYPV42

Fixing Kit



NSYCFM

- Allows the rack to be fixed to the floor and/or to the wall

Supply:
Delivered with assembly instructions.

Characteristics	References
Fixing kit	NSYCFM

Wall-Mounted Kit for Actassi Enclosures

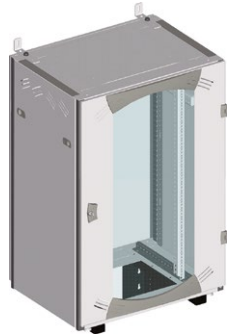

NSYCFRS

- Allows wall-mounted of enclosures from 6U to 29U, with a depth of 600 mm
- The kit includes 2 brackets
- Maximum load inside the rack: 100 kg.

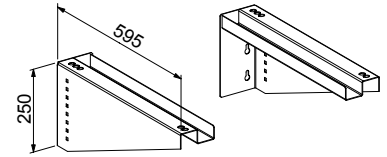

Supply:
Delivered with the fixings required for installation.

Characteristics	Depth (mm)	References
Wall-mounted kit for Actassi enclosures	600	NSYCFRS

Plain Roof Plate (E1)



NSYTSPC450

- Removable plate made from folded sheet steel, RAL 7035 light gray, epoxy-polyester, textured, powder paint
- Plate delivered assembled on the framework
- Option of installing roof stand-offs (reference **NSYEX206**) and blanking plates.

Characteristics	References
Plain roof plate (E1)	NSYTSPC450

Roof Plate with Brush Gasket (E2)



NSYTSP450

- Removable plate made from folded sheet steel, RAL 7035 light gray, epoxy-polyester, textured, powder paint, equipped with a brush gasket for cable entry
- Plate delivered assembled on the framework
- Option of installing roof stand-offs (reference **NSYEX206**) and blanking plates.

Characteristics	Dimensions (mm)	References
Roof plate with brush gasket (E2)	75 x 400	NSYTSP450

Roof Plate Elevators for Aeration (Q1)



NSYEX206

- Direct fixing between the roof and the roof plate
- Stand-offs to be ordered with a minimum of 100 pieces.

Characteristics	Height (mm)	References
Roof plate elevators for aeration (Q1)	20	NSYEX206

Plain Blanking Plate (J1) (K1)



NSYEC440

- Fixing on the internal surface of the base or roof
- Can be combined with other types of blanking plates
- Treated sheet steel

Supply:
Delivered with the fixings required for installation.

Characteristics	References
Plain blanking plate (J1) (K1)	NSYEC440

Blanking Plate with Brush Gasket (J2) (K2) (L1)



NSYEC440

- Fixing on the internal surface of the base or roof or on a 6U knock-out panel of the reduced rear door
- Can be combined with other types of blanking plates
- Treated sheet steel

Supply:
Delivered with the fixings required for installation.

Characteristics	Dimensions (mm)	References
Blanking plate with brush gasket (J2) (K2) (L1)	75 x 400	NSYEC440

Blanking Plate with Airing Louvres (J5) (K3) (L4)

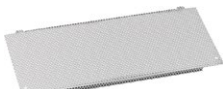

NSYEC440

- Fixing on the internal surface of the base or roof or on a 6U knock-out panel of the reduced rear door
- Can be combined with other types of blanking plates
- Treated sheet steel

Supply:
Delivered with the fixings required for installation.

Characteristics	References
Blanking plate with airing louvres (J5) (K3) (L4)	NSYEC440

Brush Gaskets for Cable Entry on the Side Panels

- Set of 2 brush gaskets
- Assembly instead of the plastic obturators, at the top or bottom of the side panels
- Cable-entry width: 35 mm.



NSYECPL600

Characteristics	Depth (mm)	References
Brush gaskets for cable entry on the side panels	600	NSYECPL600
Brush gaskets for cable entry on the side panels	800	NSYECPL800
Brush gaskets for cable entry on the side panels	1000	NSYECPL1000

Brush Gasket for a Knock-Out Area

- Assembly on the knock-out areas for cable entry
- Cable-entry width: 75 mm.



NSYJPSVD

Characteristics	References
Brush gasket for a knock-out area	NSYJPSVD

Sheet-Edge Protection Strip

- 10-m roll of rubber protection strip.



NSYTPV

Characteristics	References
Sheet-edge protection strip	NSYTPV

Hoisting Accessories, Lifting Eyes

- Set of 4 lifting eyes
- Fixing to the framework of the rack
- Maximum load: 360 kg for 4 eyes (slinging at 60°)
- Ø M12.



NSYAELYM12VD

Characteristics	References
Hoisting accessories	NSYAELYM12VD

Blanking Plates with or without Fans, Ø 120 mm (J3) (J4) (L2) (L3)

- Fixing on the internal surface of the base or roof or on a 6U knock-out panel of the reduced rear door
- Equipped with 2 or 3 fans, free flow of 170 m³/h each, 220 V-50/60 Hz, installed wired with terminal board. A 3-m power cord is supplied, installed
- Can be combined with other types of blanking plates
- Treated sheet steel
- Noise level: 34 dB (A)
- 1U front panel with thermostat
- Cannot be used directly with UK PDU.

Supply:
Delivered with the fixings required for installation.



NSYECVT2440

Characteristics	References
2 positions with 2 fans	NSYECVT2V440
3 positions with 3 fans	NSYECVT3V440

Filter for Ventilated Blanking Plate

- It is fixed on top of the ventilated plates or the plates with airing louvres.



NSYFECVT440

Characteristics	References
Filter for ventilated blanking plate	NSYFECVT440

Filter for Ventilated Blanking Plate

Top frame - 3 blanking plates					
Width	Depth	Example 1	Example 2	Example 3	Example 4
600 mm 800 mm	600 mm 800 mm 1000 mm	<p>400 mm</p>	<p>400 mm</p>	<p>400 mm</p>	<p>400 mm</p>
Cut-out => 400 x 450 mm					
Bottom frame - 2 Blanking plates					
Width	Depth	Example 1	Example 2	Example 3	Example 4
600 mm 800 mm	600 mm	<p>400 mm</p>	<p>400 mm</p>	<p>400 mm</p>	<p>400 mm</p>
Cut-out => 400 x 300 mm					
Bottom frame - 3 Blanking plates					
Width	Depth	Example 1	Example 2	Example 3	Example 4
600 mm 800 mm	800 mm 1000 mm	<p>400 mm</p>	<p>400 mm</p>	<p>400 mm</p>	<p>400 mm</p>
Cut-out => 400 x 450 mm					

Additional 19" Uprights

- Assembly on the depthwise supports
- Depth adjustable in steps of 25 mm
- Set of 2 uprights and the fixings required for assembly
- For partial assembly use depth-support references **NSYSBRF66** to **NSYSBRF88**
- 9.5 mm square holes in the front panel.



Characteristics	Number of U	References
Additional 19" uprights	12U	NSYBR9F12
Additional 19" uprights	21U	NSYBR9F21
Additional 19" uprights	24U	NSYBR9F24
Additional 19" uprights	29U	NSYBR9F29
Additional 19" uprights	33U	NSYBR9F33
Additional 19" uprights	38U	NSYBR9F38
Additional 19" uprights	42U	NSYBR9F42
Additional 19" uprights	47U	NSYBR9F47

Adhesive Strip for Marking the U

- Set of 10 self-adhesive strips
- Attached on the front panel of the 19" upright
- Allows the units to be numbered
- Length: 42U.



Characteristics	References
Adhesive strip for marking the U	NSYENU

Additional 19" Upright Supports

- Assembly in intermediate position on the framework to reinforce the rigidity of the 19" rack and/or to support the cables
- Set of 2 supports and the fixings required for assembly.



Characteristics	Rack width (mm)	Rack depth (mm)	References
Additional 19" upright supports	600	600	NSYSBRF66
Additional 19" upright supports	600	800	NSYSBRF68
Additional 19" upright supports	600	1000	NSYSBRF610
Additional 19" upright supports	800	600	NSYSBRF86
Additional 19" upright supports	800	800	NSYSBRF88
Additional 19" upright supports	800	1000	NSYSBRF810

Cable-Support Cross-Rails on Framework (N)

- Direct assembly on the framework of the enclosure
- Allow cables to be secured using cable ties
- Treated sheet steel
- Set of 2 cross-rails and the fixings required for assembly.



Characteristics	Rack width (mm)	Rack depth (mm)	References
Cable-support cross-rails on framework (N)	600	-	NSYTVPSL6
Cable-support cross-rails on framework (N)	800	-	NSYTVPSL8
Cable-support cross-rails on framework (N)	-	600	NSYTVPSP6
Cable-support cross-rails on framework (N)	-	800	NSYTVPSP8
Cable-support cross-rails on framework (N)	-	1000	NSYTVPSP10

Standard Levelling Feet (M1)



NSYPNVDA

- Set of 4 feet
- Steel feet, height adjustable, from the inside of the rack
- Direct fixing, under the bottom frame or under the plinth of the rack, by M12 screws
- Height: 30 mm.

Characteristics	References
Standard levelling feet (M1)	NSYPNVDA

Anti-Vibration Levelling Feet (M2)



NSYPRVDA

- Set of 4 feet
- Steel feet, height adjustable, with rubber collar for absorbing vibrations
- Direct fixing, under the bottom frame by M12 screws
- Height 80 mm.

Characteristics	References
Anti-vibration levelling feet (M2)	NSYPRVDA

Handling Wheels (M3)



NSYRUFVDA

- Set of 4 swivel wheels, 2 of which are equipped with a locking system
- Direct fixing under the bottom frame of the rack by M12 screws
- Height of the wheels: 105 mm.

Characteristics	References
Handling wheels (M3)	NSYRUFVDA

Foot-Wheels Adaptation Kit for Plinth (M4)



NSYRUFNPVDA

- Set of 4 adaptation parts, 4 wheels without brakes and fixings
- Allows simultaneous assembly of wheel reference **NSYRUFVDA** and levelling foot reference **NSYRUFNPVDA**
- Direct assembly on the base of an enclosure equipped with a plinth
- Use the levelling feet installed as standard on the rack
- Material: treated sheet steel.

Characteristics	References
Foot-wheels adaptation kit for plinth (M4)	NSYRUFNPVDA

Foot and Wheels Kit for Rack



NSYRUFNPVDA

- Set of 4 wheels without brakes and supports for accommodating the positioning feet
- Allows direct assembly on the base of the rack.
- Allows simultaneous assembly of wheels and levelling feet
- Use the levelling feet installed as standard on the rack
- Height of the wheels: 105 mm.

Characteristics	References
Foot and wheels kit for rack	NSYRUFNPVDA

Plinths (F1)



NSYZUN66VDA

- Plinth made from folded sheet steel, RAL 7011 dark gray, epoxy-polyester, textured, powder paint
- Plinth height: 100 mm
- Allows the assembly of standard levelling feet compatible with handling wheels reference **NSYRUFNPVDA**
- Option of removing the 4 strips
- Side and rear strips equipped with a knock-out area for cable entry
- Front strip equipped with airing louvres.

Characteristics	Width (mm)	Depth (mm)	References
Plinths (F1)	600	600	NSYZUN66VDA
Plinths (F1)	600	800	NSYZUN68VDA
Plinths (F1)	600	1000	NSYZUN610VDA
Plinths (F1)	800	600	NSYZUN86VDA
Plinths (F1)	800	800	NSYZUN88VDA
Plinths (F1)	800	1000	NSYZUN810VDA

Brush Gasket for the Cable Entries of the Plinth



NSYJPSVD

- It is fixed to the knock-out areas for the cable entries
- Delivery by unit.

Characteristics	Entry width (mm) x L	References
Brush gasket for the cable entries of the plinth	75 x 400	NSYJPSVD

Stand-Off Plinth for Raised Floor



NSYAEBP2F68

- Folded and welded sheet-steel frame, RAL 9005 black, epoxy-polyester, textured, powder paint
- Delivered with feet adjustable from 0 to 60 mm with holes for fixing to the floor
- Can support Actassi VDA, Actassi VDS, Spacial SM and PanelSeT SFN enclosures
- Standard adjustment for heights from 200 mm to a maximum of 300 mm in steps of 25 mm
- Acceptable static load: 1000 kg
- To adjust heights from 335 to 435 mm, use feet reference **NSYAEBP2F4F**.

Characteristics	Width (mm)	Depth (mm)	References
Stand-off plinth for raised floor	600	800	NSYAEBP2F68
Stand-off plinth for raised floor	600	1000	NSYAEBP2F610
Stand-off plinth for raised floor	800	800	NSYAEBP2F88
Stand-off plinth for raised floor	800	1000	NSYAEBP2F810

Set of 4 Feet for Stand-Off Plinths



NSYAEBP2F4F

- Folded and welded sheet-steel feet, textured, RAL 9005 black epoxy-polyester powder paint
- They are installed on the stand-off plinths for raised floor, reusing the levelling feet delivered with the plinth
- Acceptable static load: 1000 kg on 4 feet.

Characteristics	References
Set of 4 feet for stand-off plinths	NSYAEBP2F4F

Floor-Panel Support Bracket



NSYAEBP2FS6

- Set of 2 brackets made from folded sheet steel painted RAL 9005 black
- They are installed across the width and/or depth on the stand-off plinth to support the panels of the raised floor
- Height adjustment ± 30 mm.

Characteristics	Width (mm)	Depth (mm)	References
Floor-panel support bracket	600	600	NSYAEBP2FS6
Floor-panel support bracket	800	800	NSYAEBP2FS8
Floor-panel support bracket	1000	1000	NSYAEBP2FS10

Mounting Components

Equipment support



Fixings for 19" racks

See page 540



Fixed 19" trays

See page 542

Equipment support



Telescopic 19" trays

See page 542

Power Distribution

Current distribution



19" distribution rail with or without protection

See page 545

Modular distribution



19" front plates for modular circuit breakers

See page 548

Cable Management Plates

19" cover plate



19" cover plates
Painted steel: 1.5 mm

See page 552

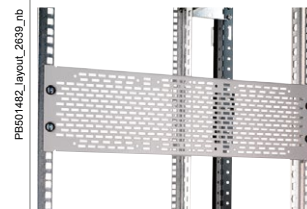

19" cover plates with
airing louvres
Steel 1.5 mm

See page 552

Cable Management

Cable distribution



1U or 2U 19" front panels
with cable-gland openings

See page 551



1U 19" cable-gland
front panels with brush gasket

See page 551

Cable management



1U 19" front panels
with insulated guides

See page 551



1U 19" front panels with metal
guides or with cable ducting

See page 556

Thermal management

19" thermostats



1U front panel
with switch and thermostat

See page 552



1U front panel
with digital thermostat

See page 552

Lighting Management

Lighting



Lamp to be fixed on 19"

See page 553

Technical changes reserved. Information provided without guarantee. Images are for illustrative purposes only.

Earthing Strip (Y)

- Two models available:
 - insulated: 10 x 5 mm brass bar with 40 connection points by screws for lugs (screws not installed)
 - non-insulated: stainless-steel bar ref. **NSYAEEC1UF**, connection by Faston lug 6.5 or by copper bar with caged terminal ref. **NSYAEEC1UN**
- Fixing to the 19" rack or to the framework
- Length: 480 mm
- Delivered with fixings
- Strip reference **NSYAEEC1UN** is equipped with caged terminal blocks.



NSYAEECS

Characteristics	Insulated	References
Earthing strip (Y)	Yes	NSYAEECS
Earthing strip (Y)	No	NSYAEEC1UF
Earthing strip (Y)	No	NSYAEEC1UN

Earthing Claws



NSYAEEC100C

- Set of 100 pieces
- Provides earthing continuity of the front panels and blanking plates.

Note:

it is the installer's responsibility to help ensuring earth continuity and connection.

Characteristics	References
Earthing claws	NSYAEEC100C

Earthing Kit for Actassi VDA / VDS

- Kit for earthing the cladding pieces of the enclosure
- Assembly on all the doors of the enclosure to comply with standard IEC 62208, Section 9.10 regarding the continuity of the protection circuit
- Brass and copper lugs
- Green-yellow PVC insulated sheath.

Note:

it is the installer's responsibility to help ensuring earth continuity and connection.



NSYCTVDA

Characteristics	References
Earthing kit for Actassi VDA / VDS	NSYCTVDA

For Fixing Components to the Rear of the 19" Uprights.

Nuts for 19" Uprights



NSYGFR12M65

- Set of 50 M6 caged nuts
- Bag of M6 caged nuts for 12 mm square holes (holes on the rear of the 19" uprights).

Characteristics	Set of	References
Nuts for 19" uprights	50	NSYGFR12M65

Fixings for 19" Rack



NSYGFR95M63

- They allow 19" accessories to be mounted
- Caged nut compatible with 8.5 x 8.5 mm and 9.5 x 9.5 mm holes.

Characteristics	Set of	References
M6 screws + washers + nuts	30	NSYGFR95M63
M6 caged nuts	100	NSYCN9M625
M6 screws + washers + nuts	50	NSYGFR95M65
M5 screws + washers + nuts	50	NSYGFR95M55

Compatible Only with Floor-Standing Enclosures

Fixed Perforated and Plain 19" Trays, 1U

- Fixing by attachment without tools between the front and rear 19" uprights
- Sheet steel, RAL 7035 or RAL 7016 gray paint
- Acceptable load: 100 kg
- Option of installing a handle reference **NSYASR3U** on the front panel and a guide reference **NSYGCA46** on the rear panel [page 549](#).

Note:
⁽¹⁾ -100 ...+50 mm, adjustable in steps of 25 mm.



Characteristics	Rack depth (mm)	Fixing center-to-center distance (mm)	Color	References
Perforated 19" tray	600-800-1000	258 ⁽¹⁾	RAL 7035	NSYBBF1U40P
Perforated 19" tray	800-1000	458 ⁽¹⁾	RAL 7035	NSYBBF1U60P
Perforated 19" tray	1000	658 ⁽¹⁾	RAL 7035	NSYBBF1U80P
Plain 19" tray	600-800-1000	258 ⁽¹⁾	RAL 7035	NSYBBF1U40
Plain 19" tray	800-1000	458 ⁽¹⁾	RAL 7035	NSYBBF1U60
Plain 19" tray	1000	658 ⁽¹⁾	RAL 7035	NSYBBF1U80
Perforated 19" tray	600-800-1000	258 ⁽¹⁾	RAL 7016	NSYBBF1U40PG
Perforated 19" tray	800-1000	458 ⁽¹⁾	RAL 7016	NSYBBF1U60PG
Perforated 19" tray	1000	658 ⁽¹⁾	RAL 7016	NSYBBF1U80PG

Telescopic Perforated and Plain 19" Trays, 1U

- Fixing by attachment without tools between the front and rear 19" uprights
- Fixing on the telescopic slides supplied
- Sheet steel, RAL 7035 or RAL 7016 gray paint
- Acceptable load: 45 kg
- Option of installing a handle reference **NSYASR3U** on the front panel and a guide reference **NSYGCA46** on the rear panel [page 549](#).

Note:
⁽¹⁾ Slides delivered with the tray.
⁽²⁾ -100 ...+50 mm, adjustable in steps of 50 mm.



Characteristics	Mounting on slides ⁽¹⁾	Rack depth (mm)	Fixing center-to-center distance (mm)	Color	References
Perforated 19" tray	NSYGT40	600-800-1000	258 ⁽²⁾	RAL 7035	NSYBBT1U40P
Perforated 19" tray	NSYGT60	800-1000	458 ⁽²⁾	RAL 7035	NSYBBT1U60P
Perforated 19" tray	NSYGT80	1000	658 ⁽²⁾	RAL 7035	NSYBBT1U80P
Plain 19" tray	NSYGT40	600-800-1000	258 ⁽²⁾	RAL 7035	NSYBBT1U40
Plain 19" tray	NSYGT60	800-1000	458 ⁽²⁾	RAL 7035	NSYBBT1U60
Plain 19" tray	NSYGT80	1000	658 ⁽²⁾	RAL 7035	NSYBBT1U80
Perforated 19" tray	NSYGT40	600-800-1000	258 ⁽¹⁾	RAL 7016	NSYBBT1U40PG
Perforated 19" tray	NSYGT60	800-1000	458 ⁽¹⁾	RAL 7016	NSYBBT1U60PG
Perforated 19" tray	NSYGT80	1000	658 ⁽¹⁾	RAL 7016	NSYBBT1U80PG

Handle for Telescopic 19" Tray

- Plastic material, RAL 7011 dark gray

Supply:
 Delivered with fixings.



Characteristics	References
Handle for telescopic 19" tray	NSYASR3U

Compatible Only with Floor-Standing Enclosures

1U and 2U Fixed 19" Tray

- Fixing to the front or rear uprights of the 19" rack
- Heel of 5 mm
- Sheet steel, RAL 7035 or RAL 7016 gray paint

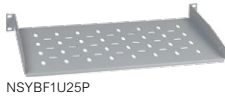

NSYBF1U25P

Characteristics	Number of U	Depth (mm)	Load (kg)	Color	References
Fixed 19" tray	1U	250	15	RAL 7035	NSYBF1U25P
Fixed 19" tray	2U	250	20	RAL 7035	NSYBF2U25P
Fixed 19" tray	2U	380	20	RAL 7035	NSYBF2U40P
Fixed 19" tray	2U	250	20	RAL 7016	NSYBF2U25PG
Fixed 19" tray	2U	380	20	RAL 7016	NSYBF2U40PG

2U Telescopic 19" Tray



NSYBT2U25P

- Fixing to the front uprights of the 19" rack
- Sheet steel, RAL 7035 or RAL 7016 gray paint
- Acceptable load: 5 kg
- Heel of 5 mm.

Supply:
Delivered with the telescopic slides assembled

Characteristics	Number of U	Depth (mm)	Load (kg)	Color	References
Telescopic 19" tray	2U	250	5	RAL 7035	NSYBT2U25P
Telescopic 19" tray	2U	250	5	RAL 7016	NSYBT2U25PG

19" Screen-Support Tray

- Fixing by attachment without tools between the front and rear 19" uprights
- Sheet steel, RAL 7035 light gray paint

Supply:
Delivered with all the necessary fixings



NSYBSM80

Characteristics	Rack depth (mm)	Load (kg)	Color	References
19" screen-support tray	800-1000	45	RAL 7035	NSYBSM80

19" Keyboard-Support Tray

- Sheet steel, RAL 7035 light gray paint
- Fixing by attachment without tools between the front and rear 19" uprights
- Fixing on the telescopic slides supplied
- Optional installation of handle reference **NSYASR3U**.

Supply:
Delivered with all the necessary fixings



NSYBST80

Characteristics	Rack depth (mm)	Load (kg)	Color	References
19" keyboard-support tray	800-1000	45	RAL 7035	NSYBST80

Compatible Only with Floor-Standing Enclosures

Fixed 19" Slides

- Set of 2 slides for the 19" hardware
- Material: treated steel
- Acceptable load: 60 kg
- Heel 0 mm: fixing by attachment between the front and rear 19" uprights
- Heel ± 5 mm: fixing by screws between the front and rear 19" uprights; supplied with the slides.

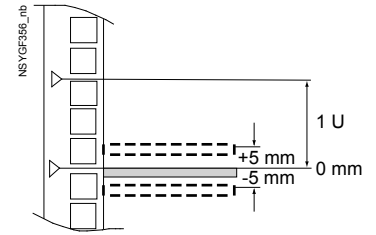

Characteristics	Rack depth (mm)	Distance between the front and rear uprights	Fixing center-to-center distance (mm)	Heel height (mm)	References
Fixed 19" slides	600-800-1000	350	258	0	NSYGF356
Fixed 19" slides	800-1000	450	358	0	NSYGF456
Fixed 19" slides	800-1000	550	458	0	NSYGF556
Fixed 19" slides	1000	650	558	0	NSYGF656
Fixed 19" slides	1000	750	658	0	NSYGF756
Fixed 19" slides	600-800-1000	350	258	± 5	NSYGF356H5
Fixed 19" slides	800-1000	550	458	± 5	NSYGF556H5
Fixed 19" slides	1000	750	658	± 5	NSYGF756H5

1U/2U Partial Fixed 19" Slides



- Set of 2 slides
- Fixing by attachment on the front or rear 19" uprights
- Material: treated steel
- Acceptable load: 30 kg.

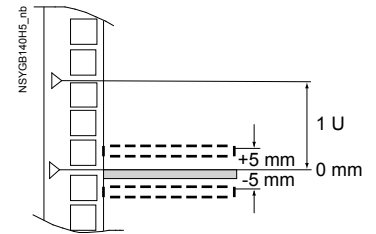

Characteristics	Number of U	Heel height (mm)	References
Partial fixed 19" slides	1U	± 5	NSYGB140H5
Partial fixed 19" slides (length=150 mm)	2U	0	NSYGB140

Full Telescopic 19" Slides



- Set of 2 slides for the 19" hardware
- Material: treated steel
- Acceptable load: 60 kg
- Heel 0 mm: fixing by attachment between the front and rear 19" uprights
- Heel ± 5 mm: fixing by screws between the front and rear 19" uprights; supplied with the slides.

Characteristics	Rack depth (mm)	Fixing center-to-center distance (mm)	References
Full telescopic 19" slides	600-800-1000	258, -100 ...+50 mm, adjustable in steps of 50 mm	NSYGT40
Full telescopic 19" slides	800-1000	458, -100 ...+50 mm, adjustable in steps of 50 mm	NSYGT60
Full telescopic 19" slides	1000	658, -100...+50mm, adjustable in steps of 50 mm	NSYGT80

Rear Cable Support

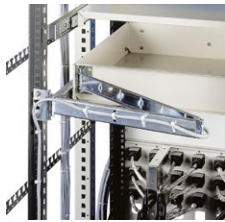

NSYBTSCS

- Fixing of cables through an opening without effort
- Direct fixing to the framework and the rear part of the tray.

Characteristics	References
Rear cable support	NSYBTSCS

Universal Fixing Plate



NSYEUV D

- Fixing to the 19" uprights or to the framework uprights for mounting accessories
- Delivery by unit.

Characteristics	References
Universal fixing plate	NSYEUV D

UTE - 16 A/230 V~ with Pin-Earthened Outlets

- Sockets set at 35° with child protection
- Aluminum profile silver - height 1U
- Material: fiberglass polyamide plastic that helps ensuring fire resistance up to 850 °C
- Equipped with power cord (3G 1.5 mm²) type H05 VVF, equipped with a molded right-angle plug with earthing contact system
- According to NF C 61314, IEC 60884 and NBNC61112-1 standards
- Could be used in: France, Belgium, Poland, Monaco, Slovakia, Czech Republic.

Note:

- ⁽¹⁾ A: rail of sockets without protection
- ⁽²⁾ B: rail of sockets with recessed green LED switch
- ⁽³⁾ C: rail of sockets with bi-polar magnetothermal circuit-breaker C16 type C60N 16 A curve C
- ⁽⁴⁾ D: suppression filter for interferences up to 30 MHz, guaranteed frequency 400 Hz, attenuation 20 dB per decade.
- ⁽⁵⁾ E: rail of sockets with interference filter and surge suppressor, 6.5 kA short-circuit protection. Protection level Up 1.5 kV, test voltage Uoc 5 kV Uc 255 V, 50 Hz. Operation indicator light, interfaces 30 MHz. Frequency nominal 400 Hz, attenuation 20 dB per decade.
- ⁽⁶⁾ F: rail of sockets with differential protection 30 mA, 2 poles 25 A type NC



NSYAPU19F9



NSYAPU19F8S



NSYAPU19F6CB



NSYAPU19F7FA



NSYAPU19F6F



NSYAPU19F6FT



NSYAPUF10S



NSYAPUF12CB

Characteristics	Width (mm)	Depth (mm)	Type	References
19" Adapted				
9 sockets outlets	19"	44	A ⁽¹⁾	NSYAPU19F9
8 sockets outlets with recessed green led switch	19"	44	B ⁽²⁾	NSYAPU19F8S
6 sockets outlets with Overvoltage protection 16 A	19"	76	C ⁽³⁾	NSYAPU19F6CB
7 sockets outlets with Overvoltage protection 16 A + frequency filters	19"	44	D ⁽⁴⁾	NSYAPU19F7FA
6 sockets outlets with interference filter and surge suppressor	19"	76	F ⁽⁶⁾	NSYAPU19F6F
6 sockets outlets with overvoltage protection 30mA	19"	44	E ⁽⁵⁾	NSYAPU19F6FT
Vertical – 0U				
10 sockets outlets with recessed green led switch (D. 968 mm)	968	44	B ⁽²⁾	NSYAPUF10S
12 sockets outlets with Overvoltage protection 16 A (D. 1232 mm)	1232	76	C ⁽³⁾	NSYAPUF12CB

VDE - 16 A/230 V~ with Pin-Earthen Outlets

- Sockets set at 35° with child protection
- Aluminum profile silver - height 1U
- Material: fiberglass polyamide plastic that helps ensuring fire resistance up to 850 °C
- Equipped with power cord (3G 1.5 mm²) type H05 VVF, equipped with a molded right-angle plug with earthing contact system
- According to DIN49 440, VDE0620-1, IEC 60884 and UNE20315 standards
- Could be used in: Germany, Austria, Netherlands, Italy (partial), Spain, Portugal, Sweden, Norway, Finland, Slovenia, Romania, Hungary, Afghanistan, Andorra, Vatican City, San Marino, Estonia, South Korea, Indonesia, Iceland, Chile, Bulgaria.

Note:

- ⁽¹⁾ A: rail of sockets without protection
- ⁽²⁾ B: rail of sockets with recessed green LED switch
- ⁽³⁾ C: rail of sockets with bi-polar magnetothermal circuit-breaker C16 type C60N 16 A curve C
- ⁽⁴⁾ D: suppression filter for interferences up to 30 MHz, guaranteed frequency 400 Hz, attenuation 20 dB per decade.
- ⁽⁵⁾ E: rail of sockets with Interference filter and surge suppressor, 6.5 kA short-circuit protection. Protection level Up 1.5 kV, test voltage Uoc 5 kV Uc 255 V, 50 Hz. Operation indicator light, interfaces 30 MHz. Frequency nominal 400 Hz, attenuation 20 dB per decade.
- ⁽⁶⁾ F: rail of sockets with differential protection 30 mA, 2 poles 25 A type NC



NSYAPU10S3



NSYAPU10S3S



NSYAPU19S9



NSYAPU19S8S



NSYAPU19S6CB



NSYAPU19S7FA



NSYAPU19S6F



NSYAPU19S6FT



NSYAPUS10S



NSYAPUS12CB

Characteristics	Width (mm)	Depth (mm)	Type	References
10" Adapted				
3 sockets outlets	10"	44	A ⁽¹⁾	NSYAPU10S3
3 sockets outlets with recessed green led switch	10"	44	B ⁽²⁾	NSYAPU10S3S
19" Adapted				
9 sockets outlets	19"	44	A ⁽¹⁾	NSYAPU19S9
8 sockets outlets with recessed green led switch	19"	44	B ⁽²⁾	NSYAPU19S8S
6 sockets outlets with Overvoltage protection 16 A	19"	76	C ⁽³⁾	NSYAPU19S6CB
7 sockets outlets with Overvoltage protection 16 A + frequency filters	19"	44	D ⁽⁴⁾	NSYAPU19S7FA
6 sockets outlets with overvoltage protection 30mA	19"	76	F ⁽⁶⁾	NSYAPU19S6F
6 sockets outlets with interference filter and surge suppressor	19"	44	E ⁽⁵⁾	NSYAPU19S6FT
Vertical				
10 sockets outlets with recessed green led switch (D. 968 mm)	968	44	B ⁽²⁾	NSYAPUS10S
12 sockets outlets with Overvoltage protection 16 A (D. 1232 mm)	1232	76	C ⁽³⁾	NSYAPUS12CB

Technical changes reserved. Information provided without guarantee. Images are for illustrative purposes only.

UK - 13 A/240 V~ with BS Standard Outlets

- Sockets set at 90° with child protection
- Aluminum profile silver - height 1U
- Material: fiberglass polyamide plastic that helps ensuring fire resistance up to 850 °C
- Equipped with power cord (3G 1.5 mm²) type H05 VVF, equipped with a molded right-angle plug with earthing contact system.

Note:
⁽¹⁾ A: rail of sockets without protection

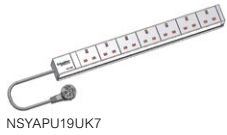

NSYAPU19UK7

Characteristics	Width (mm)	Depth (mm)	Type	References
19" Adapted				
7 sockets outlets	19"	44	A ⁽¹⁾	NSYAPU19UK7

Fixing Brackets

- For vertical assembly of distribution rails
- Set of 2 brackets, adaptable to all rails, delivered with fixings
- Material: treated steel, thickness 10/10 mm
- Fixing to the ends of the rail: reference
- Fixing with an orientation of 90°: reference **NSYAPUB**.



NSYAPUBV



NSYAPUB

Characteristics	Fixing	References
Fixing brackets	End of the rail	NSYAPUBV
Fixing brackets	Orientation of 90°	NSYAPUB

19" Front Plate for Modular Circuit-Breakers

- Front plates for mounting 22 modules
- Fixing to the 19" rack
- Front panel made from sheet steel, 15/10 mm thick, RAL 7035 or RAL 7016 gray paint
- Front panel made from 3 mm anodised aluminum.

Supply:
Delivered with steel DIN rail



NSYCRTM3UD



NSYCRTM3UDG



NSYCRTA4UD



NSYCRTA3UD

Characteristics	Number of U	Color	References
19" front plate for modular circuit-breakers	3U	RAL 7035	NSYCRTM3UD
19" front plate for modular circuit-breakers	3U	RAL 7016	NSYCRTM3UDG
19" front plate for modular circuit-breakers	3U	Aluminum	NSYCRTA4UD
19" front plate for modular circuit-breakers	3U	Aluminum	NSYCRTA3UD

19" DIN Rail

- DIN rail for fixing on the front surface of the 19" uprights

Supply:
Delivery by unit.



NSYR19DN

Characteristics	References
19" DIN rail	NSYR19DN

Compatible Only with Floor-Standing Enclosures

Side Cable-Support Cross-Rails on 19" Uprights

- For mounting between the front and rear 19" uprights
- Allow cables to be flanged using cable ties
- Set of 2 pieces.

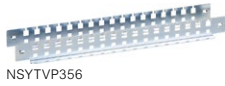

Characteristics	Rack depth (mm)	Distance between the front and rear 19" uprights (mm)	Fixing center-to-center distance (mm)	References
Side cable-support cross-rails on 19" uprights	600-800-1000	350	258	NSYTVP356
Side cable-support cross-rails on 19" uprights	600-800	550	458	NSYTVP556
Side cable-support cross-rails on 19" uprights	800-1000	750	658	NSYTVP756

Rear Cable-Support Cross-Rails on Fixed 19"

- Mounting on the rear of the 19" uprights of the rack
- Allow cables to be fixed and guided at the rear of the circulation panels
- Delivered with the fixings required for installation.



Characteristics	References
Rear cable-support cross-rails on fixed 19"	NSYTVAR

Guides (X)



NSYGCA46



NSYGCA410



NSYGCA1010

Mounting on:

- The 19" uprights (laterally)
- All the cable-support cross-rails
- At the rear of the 19" shelves
 - on the framework uprights, with the help of intermediate support reference **NSYADGCA**
- Material: plastic, RAL 7035 light gray
- Guides and supports: set of 10.

Characteristics	Dimensions (mm)	References
Guides (X)	40 x 60	NSYGCA46
Guides (X)	40 x 100	NSYGCA410
Guides (X)	100 x 100	NSYGCA1010

Metal Guides

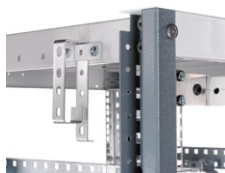

NSYGC1010

- Installation on the 19" rack, laterally on the framework uprights inside the rack
- Set of 10 pieces.

Supply:

Delivered with the mounting elements (screw, nut)

Characteristics	Dimensions (mm)	References
Metal guides	100 x 100 guide	NSYGC1010
Metal guides	40 x 100 guide	NSYGC410

Steel Wired Cable Tray

- Mounting on the cable supports.
- Dimensions (2 types):
 - 1845 x 200 x 35 mm.
 - 1845 x 200 x 54 mm.
- Material: Zinc-coated steel wire



NSYBPC3

Supply:

1 vertical steel wired cable tray and fixing elements

Characteristics	Necessary depth (mm)	References
Steel wired cable tray	35	NSYBPC3
Steel wired cable tray	54	NSYBPC5

Compatible Only with Floor-Standing Enclosures

Wired Guides

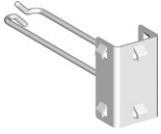

NSYGCH213

- Set of 10 wired guides
- Side-mounted on the 19" uprights
- Material: treated steel.

Characteristics	Dimensions (mm)	References
Wired guides	24 x 130	NSYGCH213

19" Vertical Cable Guides



NSYGC1US19

- Fixing on the 19" uprights
- Material: nickel steel
- Delivery by unit.

Characteristics	Number of U	Depth (mm)	References
19" vertical cable guides	1.5U	120	NSYGC1US19

Self-Grip Strips



NSYACC2N

- For holding the cables on the supports
- Models available in 3 shapes:
 - cable tie 13 mm wide, 225 mm long; set of 10 pieces
 - strap in a roll 16 mm wide and 5 metres long, black color
 - adhesive cable strap, 50 x 20 mm, black color, in a set of 10 pieces.



NSYACC50N

Characteristics	Color	References
225 mm strips	Black	NSYACC2N
5 m strips	Black	NSYACC50N
Adhesive strap	Black	NSYACCA

NSYACCA

Support for the Management of Cable Surplus



NSYACGCS

- Used for winding cable surplus
- Delivered with the fixings required for installation.

Characteristics	References
Cable management surplus	NSYACGCS

1U 19" Front Panels with Metal Guides

- Channels the cables over the front panel of the rack
- Fixing to the 19" rack
- Sheet steel, RAL 7035 or RAL 7016 gray paint.



Characteristics	Number of guides Vert.	Number of guides Horiz.	References
1U 19" front panels with metal guides, RAL 7035	3	2	NSYCRTM1U32B
1U 19" front panels with metal guides, RAL 7035	4	0	NSYCRTM1U40B
1U 19" front panels with metal guides, RAL 7016	4	0	NSYCRTM1U40BG

1U 19" Front Panel with Cable-Gland Openings

- Fixing on the 19" uprights
- Cable openings protected by a gasket
- Sheet steel, RAL 7035 or RAL 7016 gray paint.



Characteristics	References
1U 19" front panel with cable-gland openings, RAL 7035	NSYCRTM1U2

1U 19" Front Panels with Cable-Gland and Brush Gasket

- Fixing on the 19" uprights
- Sheet steel, RAL 7035 or RAL 7016 paint
- 150 mm cable support.

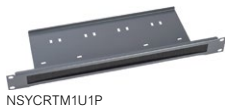

Characteristics	References
With cable support at the rear, RAL 7035	NSYCRTM1U1P
With cable support at the rear, RAL 7016	NSYCRTM1U1PG
Without cable support at the rear, RAL 7035	NSYCRTM1U1PS

1U 19" Front Panel with Insulated Guides

- Channels the cables over the front panel of the rack
- Fixing on the 19" uprights
- Steel front panel, RAL 7035 light gray paint
- Equipped with 5 guides (reference **NSYGCA46**) in horizontal, vertical and 45° positions.



Characteristics	References
1U 19" front panel with insulated guides	NSYCRTM1U5GCA

2U 19" Front Panel with Cable-Gland Openings

- Fixing to the 19" rack
- Cable openings protected by a gasket
- Sheet steel, RAL 7035 light gray paint.



Characteristics	References
2U 19" front panel with cable-gland openings	NSYCRTM2U3

2U Depth-Adjustable 19" Support

- Fixing on the 19" uprights
- Depth-adjustable from 50 to 200 mm; it allows the installation of non-19" devices or the fixing of cables, ducting, etc.
- Sheet steel, RAL 7035 light gray paint



Characteristics	References
2U depth-adjustable 19" support	NSYCRTM2US

Supply:
Delivered with assembly fixings.

Frontal 19" Cable-Support Cross-Rails

- For frontal assembly on the 19" uprights
- Allow cables to be flanged using cable ties
- Set of 2 pieces.



Characteristics	References
Frontal 19" cable-support cross-rails	NSYTVA

Plain 19" Front Panel

- Fixing to the 19" rack
- Front panel made from sheet steel, 15/10 mm thick, RAL 7035 or RAL 7016 gray paint
- Front panel made from 3 or 4 mm anodised aluminum
- Fixing by screws reference **NSYGFR95M65**
- Earthing claws reference **NSYAEEC100C**.



Characteristics	Number of U	RAL 7035 steel References	RAL 7016 steel References	Aluminum 3 mm References	Aluminum 4 mm References
Plain 19" front panel	1U	NSYCRTM1U	NSYCRTM1UG	NSYCRTA1U	NSYCRT4A1U
Plain 19" front panel	2U	NSYCRTM2U	NSYCRTM2UG	NSYCRTA2U	NSYCRT4A2U
Plain 19" front panel	3U	NSYCRTM3U	NSYCRTM3UG	NSYCRTA3U	NSYCRT4A3U
Plain 19" front panel	4U	NSYCRTM4U		NSYCRTA4U	NSYCRT4A4U
Plain 19" front panel	5U	NSYCRTM5U		NSYCRTA5U	NSYCRT4A5U
Plain 19" front panel	6U	NSYCRTM6U		NSYCRTA6U	NSYCRT4A6U
Plain 19" front panel	9U	NSYCRTM9U		NSYCRTA9U	NSYCRT4A9U
Plain 19" front panel	10U	NSYCRTM10U		NSYCRTA10U	
Plain 19" front panel	12U	NSYCRTM12U		NSYCRTA12U	

Plain 19" Front Panel

- Direct fixing to the 19" rack
- Sheet steel, 15/10 mm thick, RAL 7035 light gray paint
- Allow the entry of air for natural airing of the installations
- Option of installing reference **NSYCRTMR3U** with 3 fans reference: **NSYCVF65M230PF** as accessories
- Fixing by screws reference **NSYGFR95M65**
- Earthing claws reference **NSYAEEC100C**.



Characteristics	Number of U	Color	References
Plain 19" front panel	1U	RAL 7035	NSYCRTMR1U
Plain 19" front panel	3U	RAL 7035	NSYCRTMR3U

1U 19" Front Panel with Airing Switch and Thermostat

- Direct fixing to the 19" rack
- Switch ON/OFF with LED
- Thermostat contact open, operating temperature -20 °C ... +80 °C, temperature setting range 0 ... +60 °C, In 10 A/250 V
- Front panel made from RAL 7035 or RAL 7016 sheet.



Characteristics	Number of U	Color	References
19" front panel with airing switch and thermostat	1U	RAL 7035	NSYCRTM1UVT
19" front panel with airing switch and thermostat	1U	RAL 7016	NSYCRTM1UVTG



Characteristics		Multi-Fixing LED Lamps
Color		Black RAL 9005
Protection rating		IP20 according to IEC60529
Standards		<ul style="list-style-type: none"> • IEC 60598 • UL 94: For plastic components • UL508A: Control Panel • UL1598: Lamps • UL8750: LED for lighting • EN55015: EMC
Other characteristics		<ul style="list-style-type: none"> • Built-in switch • Power consumption: 10 W • Frequency: 50/60 Hz • Power factor: <ul style="list-style-type: none"> V AC lamps: 0.9 V DC lamps: 1 • Luminosity: 640 lm* • Light temperature: 4000 K* • LED service life: 25000 h* • Casing: Plastic UL94 • Degree of insulation: <ul style="list-style-type: none"> Class I - Lamps with socket Class II - Lamps without socket • Except NSYLAMLDVDC rated Class III • Compliant with RoHS and Reach • Ambient temperature: <ul style="list-style-type: none"> Operation: -16 °C to +65 °C (-3 °F to +149 °F) Storage: -10 °C to +60 °C (-14 °F to +140 °F) • Max. 2 Apsms and 5 lamps in serial connection
Connections		<ul style="list-style-type: none"> • 3 m black or orange power cable with quick connector (Not supplied. See reference below) • 1.5 m black or orange interconnection cable with quick connectors (Not supplied. See reference below) According to the directive IEC 60204-1: <ul style="list-style-type: none"> • Black cables: Power circuits for switch or DC voltage. • Orange cables: External voltage that may be present even if the cabinet is turned off.
Supply		• 1 lamp and fixing elements

Lamp model	Lamps		Cables			
	Socket	References	Black cables		Orange cables	
			Power (3 m) References	Interconnection (1.5 m) References	Power (3 m) References	Interconnection (1.5 m) References
With socket 120 / 230 V AC	SCHUKO	NSYLAMLDS	NSYLAM3M	NSYLAM1M	NSYLAM3MN	NSYLAM1MN
With socket 120 / 230 V AC	UTE	NSYLAMLDF	NSYLAM3M	NSYLAM1M	NSYLAM3MN	NSYLAM1MN
With socket 120 / 230 V AC	British	NSYLAMLDB	NSYLAM3M	NSYLAM1M	NSYLAM3MN	NSYLAM1MN
With socket 120 V AC	USA	NSYLAMLDU	NSYLAM3MUL	-	-	-
Without socket 120 / 230 V AC	-	NSYLAML	NSYLAM3M	NSYLAM1M	NSYLAM3MN	NSYLAM1MN
Without socket 120 / 230 V AC	-	-	NSYLAM3MUL	-	-	-
Without socket	-	NSYLAMLDD	NSYLAM3M	NSYLAM1M	NSYLAM3MN	NSYLAM1MN
With presence detection 230 V AC	-	-	NSYLAM3MUL	-	-	-
Without socket	-	-	NSYLAM3MUL	-	-	-
With presence detection 230 V AC	-	-	-	-	-	-
Without socket - DC 24-48 V DC	-	NSYLAMLDVDC	NSYLAM3MDC	-	-	-
Without socket - DC 24-48 V DC	-	-	NSYLAM3MDCUL	-	-	-

Fixing Options

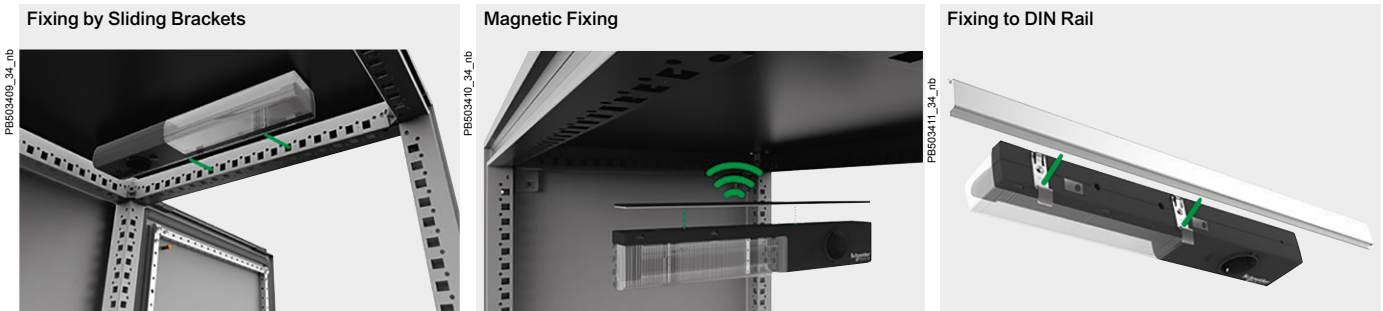

Rack for VDI

- 1 U, 19" rack. For lamp installation in VDI enclosures.



Characteristics	References
Rack for VDI	NSYLAM1U

Supply:
supplied with fixing elements.

Technical changes reserved. Information provided without guarantee. Images are for illustrative purposes only.

The Customized Offer

Do you want to have other enclosures than standard? No problem.

With Actassi enclosures it's possible to customize color, accessories, specific lining, etc. according to your personal needs.

Two Levels of Customization

At Schneider Electric we have developed two levels of customized services based on more than 50 years of experience in the market:

- Configured offer (standard, modified)
- Specific offer (custom-built enclosures).



We Perform Machining, Mounting of Accessories and Painting.



We Manufacture Customized Solutions with Our Industrial Tools.
Example: Cut-Outs Made before Painting.

Flexibility
Several types of side panels

Functionality
Defined thermal management

Time-Saving
Factory-made assemblies



Aesthetics
Color

Mounting
Accessories mounted in our factories

Efficiency and Ergonomics
Several types of doors

Examples of Customized Solutions

Configured Offer



Make Your Own Definition Based on Our Standard Claddings.

Example: Actassi VDA Enclosure in RAL 9011
Equipped with:

- Double front door with two-point locking system. Airflow above 80%
- Double rear door with two-point locking system. Airflow above 80%
- Two side doors with locks
- Roof equipped with 6 fans and 1 cable entry with brush seal

Specific Offer















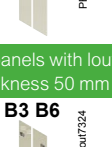
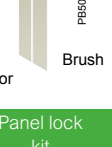

Built Exactly According to Your Needs

Custom-Made Actassi VDA-VDS Enclosure

- Specify yours needs on VDA-VDS enclosures or spare parts.
- This enclosure is delivered equipped, machined and ready to use.

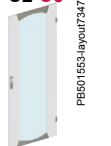
Definition Example

Number of	Size guide	
	Width (mm)	Depth (mm)
24	600	600
		800
		1000
29	600	600
		800
		1000
33	600	600
		800
		1000
38	600	600
		800
		1000
42	600	600
		800
		1000
47	600	600
		800
		1000

Rack elements		Front door		
Framework	Side panels	Single (1)	Double (2)	Single-door (1)
		A1  With cut-out entries A4  Without cut-out entries A5  With cut-out entries on the top frame, rigidity of 500 kg A6  Without cut-out entries on the top frame, rigidity of 500 kg	B1 B2 Plastic obturator  With louvres / Without louvres B4 B5 Brush gasket  Without cut-out entries B3 B6 Lateral panels with louvres, thickness 50 mm  With cut-out entries on the top frame, rigidity of 500 kg P1 Plastic obturator gasket  R1 Panel lock kit  Coupling kit 	C1 C5 Plain  C2 C6 Glazed  C9 C10 Microperforated  C8 Plain  C7 Glazed  C11 Microperforated 

(1) In red: doors with 2-point locking system
(2) In blue: double doors with 3-point locking system

S T	
1	RAL 7035
2	RAL 5015
3	RAL 3003
4	RAL 9001
5	RAL 7011
6	RAL 1021
7	RAL 9011
Other colors, consult us	

Simplified Order
Tick here to show whether this is an order or a price request (estimate).

Please specify the reference number of your request.

Easy
Please specify the dimensions of the required rack.

Order Estimate

Your ref.

Configure your rack

Number of identical racks required

No.	U	Width	Depth	A	B	C	D	E	F	G	H	J	K	L	M	N	P	Q	R	S	T	U	V	W	X	Y	Z	
29		600	800					2			1	1	3	2														

Company Name
 Address Telephone
 Postcode - Town Fax
 Photocopy this form and fax it to your sales office E-mail

Smart
If your order is only for spare parts, please use the configuration sheet on page XXX.

Please specify the reference of the chosen element.
Example: E2 is a roof plate with brush gasket.

Choice
Your choice of colors.
Example: gray uprights and yellow cladding.

Rack elements							
Rear		Rear panel	Roof plate	Plinth	19" upright	Escutcheon	Top blanking plate
D6 Plain PB501552-layout4063	D4 Plain PB501558-layout4081	E1 Plain PB501559-layout4059	F1 Plain PB501562-layout541	G1 Front PB501564-layout576	H2 Cable gland width 800 mm PB501573	J2 J1 Plain Brush gasket PB501568-layout600	
D7 Glazed PB501554-layout4089		E2 Brush gasket PB501560-layout629	F2 Anti-tilt PB501563-layout547	G2 Front and rear PB501565-layout653		J3 J4 3 fans 2 fans PB501569-layout606	
D10 Microperforated PB501552-layout4075	D20 Rear extension kit, 100 mm thick PB501485-layout4086	E3 Perforated PB501561-layout636	Q1 Roof stand-offs PB500083	M1 Levelling feet PB501446-layout653	G3 Partial 19" uprights PB501566-layout688	J5 Airing louvres PB501570-layout612	J4 Bottom blanking plate PB501570-layout612
	Z3 Panel earthing PB500217-layout4092			M2 Anti-vibration feet PB501489-layout659	G4 12U partial front and rear PB501567-layout684	K2 K1 Brush gasket PB501568-layout617	K3 Airing louvres PB501570-layout623
				M3 Wheels PB501501-layout666		L1 Rear blanking plate PB501571-layout623	L2 L3 3 fans 2 fans PB501569-layout634
				M4 Foot-wheels adaptation kit PB501560-layout671		L4 Airing louvres PB501570-layout640	

Non-mounted accessories description

Non-mounted accessories description	Ref. No	Amount
1U 19" front plate	NSYCRTM1U32B	2
5U front panel	NSYCRTM5U	1
1U fixed shelf	NSYBBF1U40	2
2U adjustable support	NSYCRTM2US	1
.....
.....

Smart

To order exactly identical racks, please specify the number of racks required.
To order different racks, fill in a separate form for each type of rack.

Please specify the required rack accessories.

Practical

Choose the door opening direction.

Elements of a Rack

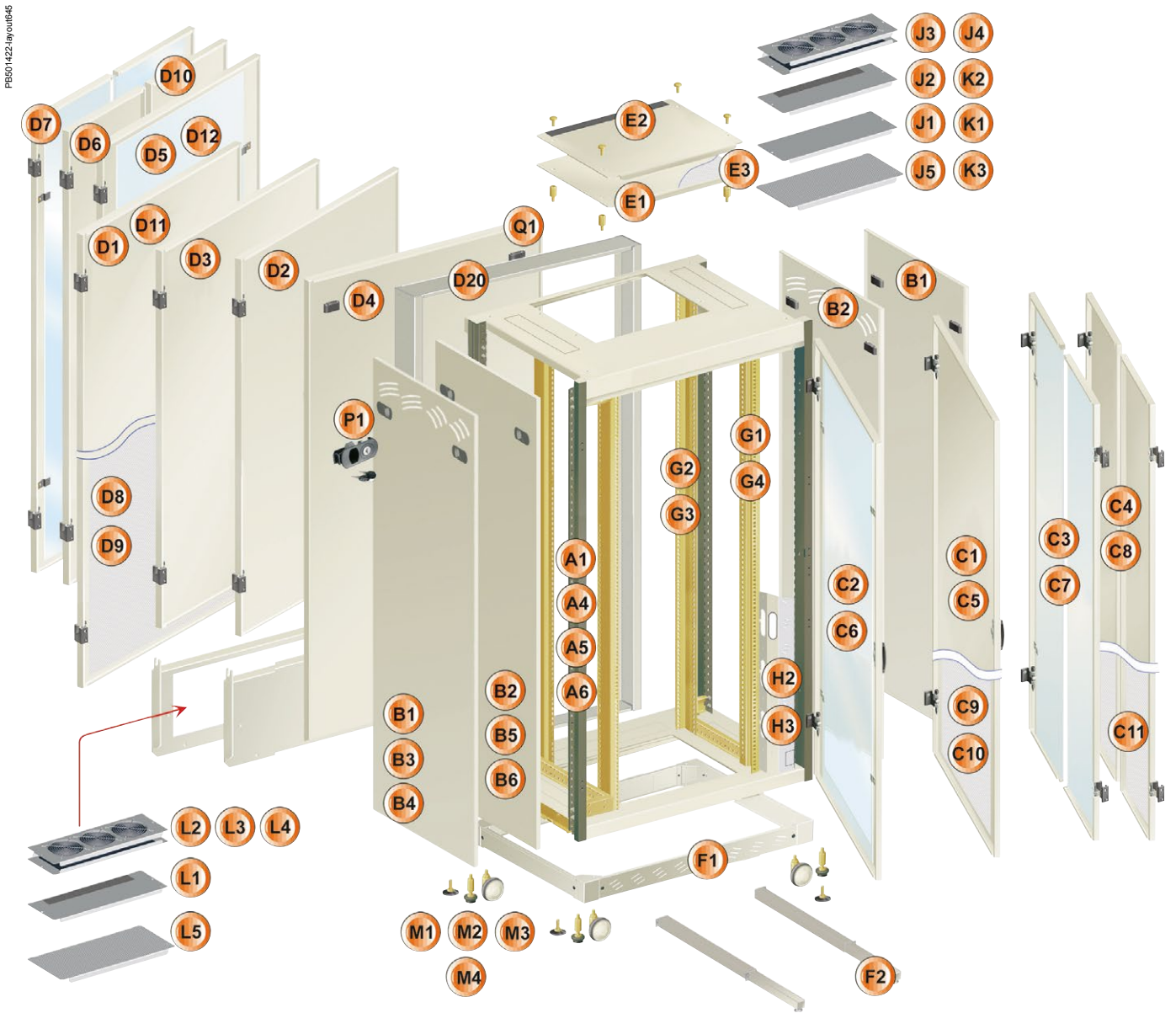

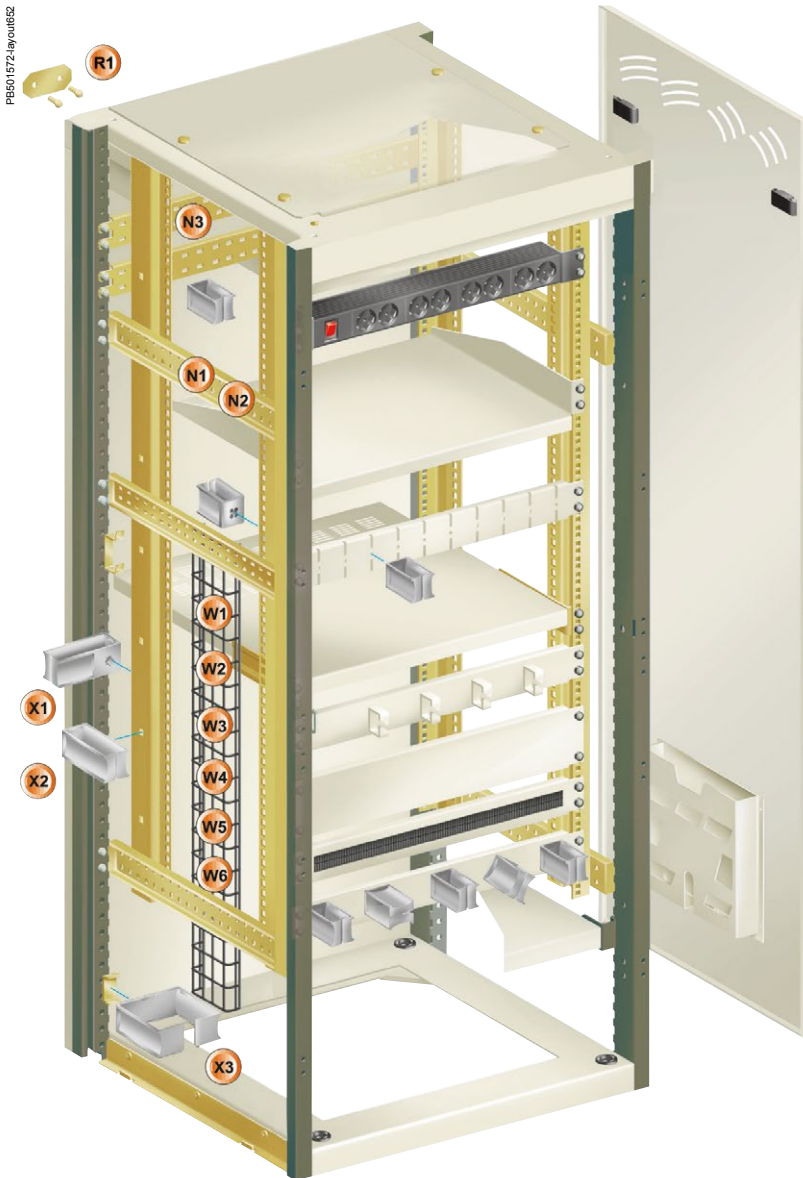

- A Framework
- B Side panels
- C Front doors
- D Rear doors or panels
- E Plain roof plate
- F Plinths
- G 19" uprights
- H Trim strips
- J Blanking plates for the top of the rack
- K Blanking plates for the bottom of the rack ⁽¹⁾
- W Blanking plates for the rear of the rack (1 plate)
- M Standard levelling feet
- N Cable-support cross-rails
- D Lock kit for rear and side panels
- Q Roof stand-offs
- R Coupling kit
- S Color of the paint on the structure uprights
- T Color of the paint on the cladding elements
- W Steel wired cable trays
- X Cable-gland guides
- Y Earthing strips
- Z Door switch, fixings, earthing kit

⁽¹⁾ Number of plates

Rack depth (mm)	Number of plates at the top	Number of plates at the bottom
600	3	2
800	3	3
1000	3	3

Definition Example

Rack elements	
A1	Framework with knock-out entries (top frame)
A4	Framework without knock-out entries (top frame)
A5	Framework with knock-out entries (top frame) rigidity 500 kg
A6	Framework without knock-out entries (top frame) rigidity 500 kg

Cladding accessories	
B1	Side panels with airing louvres
B2	Side panels without airing louvres
B3	Side panels, with 50 mm airing louvres
B4	Side panels, with airing louvres and brush gasket
B5	Side panels, without airing louvres and brush gasket
B6	Side panels with 50 mm airing louvres and brush gasket
R1	Coupling kit
P1	Lock kit for rear and side panels
C5	C1 Plain front door (1)
C6	C2 Glazed front door (1)
C7	Front door with double leaf, glazed (2)
C8	Front door with double leaf, plain (2)
C10	C9 Microperforated front door (1)
C11	Front door with double leaf, microperforated (2)
	H3 Structure trim strips (rack without door)
D11	D1 Plain rear door (1)
	D2 Partial rear door with plain 6U panel
	D3 Partial rear door with cut-out 6U panel
	D4 Rear panel
D12	D5 Glazed rear door (1)
D6	Rear door with double leaf, plain (2)
D7	Rear door with double leaf, glazed (2)
D9	D8 Microperforated rear door (1)
D10	Rear door with double leaf, microperforated (2)
	D20 Rear extension kit
	E1 Plain roof plate
	E2 Roof plate with brush gasket
	E3 Perforated roof plate
	Q1 Roof stand-offs
	Z3 Panel earthing kit
	S Color of the structure upright paint
	T Color of the paint of the cladding elements

Base accessories	
F1	Plinth
F2	Anti-tilt plinth
M1	Standard levelling feet
M2	Anti-vibration levelling feet
M3	Handling wheels
M4	Wheel adaptation kit

Blanking plates for the top of the rack (3)	
J1	Plain blanking plate
J2	Blanking plate with brush gasket
J3	Blanking plate with 3 fans
J4	Blanking plate with 2 fans
J5	Blanking plate with airing louvres

Blanking plates for the bottom of the rack (3)	
K1	Plain blanking plate
K2	Blanking plate with brush gasket
K3	Blanking plate with airing louvres

Blanking plates for the rear of the rack (1 plate)	
L1	Blanking plate with brush gasket
L2	Blanking plate with 3 fans
L3	Blanking plate with 2 fans
L4	Blanking plate with airing louvres

Installation accessories	
G1	Front 19" uprights and depth supports
G2	Front/rear 19" uprights and depth supports
G3	12U partial 19" uprights
G4	Front/rear 12U partial 19" uprights installed at the top
Z2	Bag of 19" fixings (30 pieces)

Cable-management accessories	
H2	Trim strips with cable glands (rack width 800 mm)
N1	Cable-support cross-rails on framework, on the left
N2	Cable-support cross-rails on framework, on the right
N3	Cable-support cross-rails on framework, on the rear
W1	Wired cable tray, 35 mm deep, on the left
W2	Wired cable tray, 35 mm deep, on the right
W3	Wired cable tray, 35 mm deep, on the rear
W4	Wired cable tray, 70 mm deep, on the left
W5	Wired cable tray, 70 mm deep, on the right
W6	Wired cable tray, 70 mm deep, on the rear
X1	40 x 60 mm guides mounted on the 19" uprights
X2	40 x 100 mm guides mounted on the 19" uprights
X3	100x 100 mm guides mounted on the 19" uprights

Complementary accessories	
Y1	Insulated earthing strip
Y2	Non-insulated earthing strip
Z1	Door switch (corresponding to NSYAEDWVD)
Z2	Bag of fixings (50 screws + nuts)
Z3	Panel earthing kit

⁽¹⁾ Code in red: doors with 2-point locking system.

⁽²⁾ Code in blue: double-door with 3-point locking system.

⁽³⁾ Top frame: always 3 plates; bottom frame depth 600 mm: 2 plates; depth 800 and 1000 mm: 3 plates.

Example of Realisations



Colocation 19" Enclosure
Enclosure separated in 4 parts to give different access to each customer. Each hosted customer has his own secured access and cannot make some operation to the other part of the enclosure



Branded 19" Enclosure
Equipped with Saloon Glazed Doors Enclosure totally customized with the customer requirements. 42U enclosure equipped with double glazed doors permits to open the doors when you don't have space.



Ventilated 19" Enclosure with Fans Mounted on the Doors
Enclosure dedicated to extract a lot of heat. Mainly dedicated to server application. This configuration permits to help ensuring the stability of the installation



19" Enclosure – Depth 400 mm
19" enclosure with a very limited depth (Depth 400 mm) for cabling application. Required by the customer to reduce the size of the installation.



Racks Structure Merged with a Center Zone Cabling
Totally dedicated for cabling, this structure permits to easily manage the cables and to give the best access to install the components.













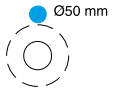
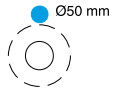

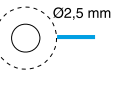
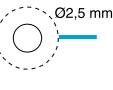

Wall-Mounted Enclosure – Depth 1000 mm
Enclosure totally customized with the customer requirements. 12U – Width 600 mm and Depth 1000 mm.

Degree of Protection

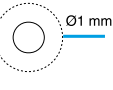
Standard IEC 60364-5-51 lists and codifies a large number of external influences to which electrical installations can be subjected, including the presence of water, solid objects, shocks, vibrations, corrosive substances, etc.

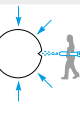
IP Code

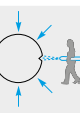
Standard IEC 60529 (IP code, February 2001) indicates the degrees of protection provided by an enclosure for electrical devices against access to hazardous parts, against penetration of solid foreign objects and against penetration of water. These standards do not apply for the protection against the risks of explosion or conditions such as a humidity, corrosive vapor, fungus or vermin. The IP code is made up of two characteristic numerals and can include an additional letter when the actual protection for persons against access to the hazardous parts is better than that indicated by the first numeral. The first numeral characterises the protection provided against the ingress of solid foreign objects and the protection of persons. The second numeral characterises the protection provided against the ingress of water with harmful effects.

1 st numeral Protection of persons		Protection against ingress of solid objects		2 nd numeral Protection against ingress of water	
1	Helps protecting against access with back of hand Dc381959 	Protection against solid foreign objects larger than 50 mm Dc381959 	1	Helps protecting against vertically dripping water (condensation) Dc381966 	
2	Helps protecting against access with a finger Dc381960 	Protection against solid foreign objects larger than 12.5 mm Dc381963 	2	Helps protecting against dripping water up to 15° from vertical Dc381967 	
3	Helps protecting against access with a tool Dc381961 	Protection against solid foreign objects larger than 2.5 mm Dc381961 	3	Helps protecting against spraying water up to 60° from vertical Dc381968 	
4	Helps protecting against access with a wire Dc381962 	Protection against solid foreign objects larger than 1 mm Dc381962 	4	Helps protecting against splashing water from all directions Dc381969 	
5	Helps protecting against access with a wire Dc381962 	Helps protecting against dust (dust protected) Dc381964 	5	Helps protecting against water jets from all directions Dc381970 	
6	Helps protecting against access with a wire Dc381962 	Dust tight Dc381965 	6	Helps protecting against powerful water jets from all directions Dc381971 	
			7	Helps protecting against the effects of temporary immersion in water Dc381972 	
			8	Helps protecting against the effects of continuous immersion in water Dc381973 	

IK Code

Standard IEC 62262 defines an IK code characterising the capacity of products to resist mechanical impacts from all sides.

IK code	Impact energy (joules)
01	0.14
02	0.2
03	0.35
04	0.5
05	0.7
06	1
07	2
08	5
09	10
10	20

IK codes can be selected according to the risks of impacts on a given site.

Risk	Site	Recommended IK
No risk of major impact	Technical premises	07
Significant risk of impact that can damage devices	Hallways	08 (switchboard with door)
Maximum risk of impact that can damage the switchboard	Workshops	10

Technical changes reserved. Information provided without guarantee. Images are for illustrative purposes only.

VDA-VDS Floor-Standing Enclosures
OPB Wall-Mounted Enclosures

Commercialized CR

Description	Complement	References
2 points locking system VDA 42U		NSYVDA42ULS2P
Kit SAV VDA		NSYVDASAVKIT
Glazed door VDA R7035 42U W600		NSYVDA42U6GGD
Glazed door VDA R7035 42U W800		NSYVDA42U8GGD
Ventillated door VDA/VDS R9011 42U W800		NSYVDA42U8BVD
Doble ventillated door VDA/VDS R9011 42U W800		NSYVDA42U8DBVD
Actassi - key - set of 2 - n° 333		NSYLL333

Some spare-parts are part of customized offer: services can answer your needs

Description	Customized offer	For
Rear panel VDA R7035 24U W600	Be ordered by Configured offer (CTO) or Specific offer (ETO)	VDA24U
Rear panel VDA R7035 24U W800	Be ordered by Configured offer (CTO) or Specific offer (ETO)	VDA24U
Rear panel VDA R7035 29U W600	Be ordered by Configured offer (CTO) or Specific offer (ETO)	VDA29U
Rear panel VDA R7035 29U W800	Be ordered by Configured offer (CTO) or Specific offer (ETO)	VDA29U
Rear panel VDA R7035 33U W600	Be ordered by Configured offer (CTO) or Specific offer (ETO)	VDA33U
Rear panel VDA R7035 33U W800	Be ordered by Configured offer (CTO) or Specific offer (ETO)	VDA33U

Commercialized CR

Description	Customized offer	For
Rear panel VDA R7035 38U W600	Be ordered by Configured offer (CTO) or Specific offer (ETO)	VDA38U
Rear panel VDA R7035 38U W800	Be ordered by Configured offer (CTO) or Specific offer (ETO)	VDA38U
Rear panel VDA R7035 42U W600	Be ordered by Configured offer (CTO) or Specific offer (ETO)	VDA42U
Rear panel VDA R7035 42U W800	Be ordered by Configured offer (CTO) or Specific offer (ETO)	VDA42U
Rear panel VDA R7035 47U W600	Be ordered by Configured offer (CTO) or Specific offer (ETO)	VDA47U
Rear panel VDA R7035 47U W800	Be ordered by Configured offer (CTO) or Specific offer (ETO)	VDA47U
Glazed door VDA R7035 24U W600	Be ordered by Configured offer (CTO) or Specific offer (ETO)	VDA24U
Glazed door VDA R7035 24U W800	Be ordered by Configured offer (CTO) or Specific offer (ETO)	VDA24U
Glazed door VDA R7035 47U W600	Be ordered by Configured offer (CTO) or Specific offer (ETO)	VDA47U
Glazed door VDA R7035 47U W800	Be ordered by Configured offer (CTO) or Specific offer (ETO)	VDA47U

Description	Customized offer	For
2 points locking system VDA 24U	Be ordered by Specific offer (ETO)	VDA24UP
2 points locking system VDA 38U	Be ordered by Specific offer (ETO)	VDA38U
2 points locking system VDA 47U	Be ordered by Specific offer (ETO)	VDA47U

Technical changes reserved. Information provided without guarantee. Images are for illustrative purposes only.

ClimaSys Thermal Management System

Thermal Management System

PE503912



Introduction

Presentation	566
ClimaSys Smart Airing Systems	572
ClimaSys CV Airing Systems	584
ClimaSys CA Natural Airing	598
ClimaSys CE Exchangers	600
ClimaSys CU Cooling Units	610
ClimaSys CRS Ultra-Thin Resistance Heaters	626
ClimaSys CR Resistance Heaters	628
ClimaSys CC Thermal Control	632
ProClima Web Software	636

Thermal Problems in Enclosures

Make your manufacturing processes more dependable by reducing downtime and production losses.

Evolution of the electrical switchboard

An electrical switchboard is an assembly formed of the following components:

- The enclosure;
- Switchgear and controlgear;
- Electrical conductors; and
- Miscellaneous functions (displays, controls, information processing).

It has evolved in three directions:

- Enclosures increasingly made of insulated materials;
- Switchgear and controlgear incorporating more and more electronics which concentrates a growing number of functions in an increasingly small volume;
- An increasingly high density ratio.



Industrial safety studies, a concept which covers:

- The safety of personnel and equipment;
- The availability of electric power;

These two aspects are the critical point of all industrial and service-sector activities.

Operation must therefore be perfectly under control; and this control must concern not only the operation of the components but also their operating conditions in a given environment.

Temperature and humidity in the enclosure

Analysis of the malfunctions and downtimes of an electrical installation shows that they are mostly of thermal origin: Temperature/humidity ratio too high or too low inside the enclosure.

The rise of the average temperature above the limits tolerated by the equipment is often caused by changes to the electrical switchboard:

- Use of insulated materials for the enclosure impairing heat dissipation,
- An increasing number of electronic devices and a higher filling rate increase the temperature.

Such overheating may only occur at certain points of the installation called 'hot spots'.

Excessively low temperatures occur when the electrical switchboard is installed in a very cold environment. These low temperatures, in case of too high humidity ratio may cause the formation of water condensate (harmful to electrical equipment).

Consequences

The presence of humidity or excessively high temperatures inside the enclosure can cause numerous malfunctions:

- Nuisance tripping of protective devices;
- Fire inside the enclosure;
- Burns for the users;
- Premature equipment ageing;

These malfunctions lead to an increase in the installation's operating costs:

- Maintenance costs,
- Costs entailed by installation downtimes.

Solution: Thermal Management

Objective

The thermal management solution adopted shall:

- Maintain the temperature and humidity level inside the enclosure at values corresponding to normal operation of the equipment.
- Establish a uniform temperature to prevent hot spots.

Choice of solution

The products constituting the thermal management solution are selected to obtain a thermal balance of the installation. This comprises 2 parts:

- Thermal balance inside the enclosure;
- Evaluation of the ambient climatic conditions (temperature, humidity level) or environmental conditions (pollution) of the location of the electrical switchboard.





The Schneider Electric solutions

With the ClimaSys range, Schneider Electric proposes a comprehensive offer meeting all needs:

- Natural airing and forced ventilation
- Homogenizing (air circulation)
- Heat Exchangers and Cooling Units
2023 novelties: The new Cooling Unit range will natively be able to communicate to any supervision system
- Heating resistances
- Regulating controllers

Schneider Electric also proposes a thermal design software, ProClima Web, which calculates the thermal balance and proposes one or more thermal management solutions, perfectly adapted to the customers environment.

2023 novelties: To simplify user experience during electrical switchboard design phase, ProClima Web is now fully integrated with SEE Electrical Software suits.

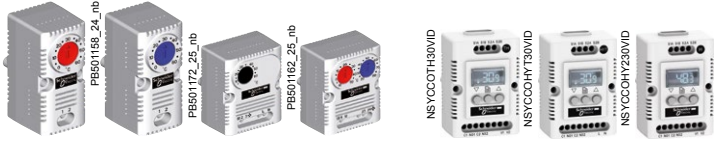
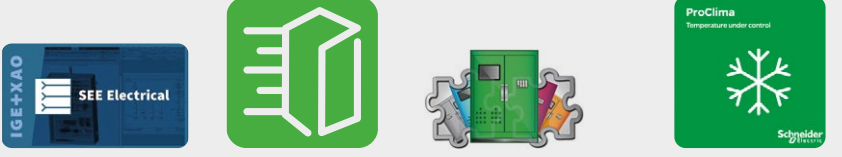
Characteristics	Smart Climasys	Climasys
Cooling	 <p>PB503526_34_nb</p> <p>Smart airing systems</p>	 <p>PB501021_35_nb</p> <p>PB502618_9_1_nb</p> <p>PB502596_11_nb</p> <p>PB502593_1_nb</p> <p>PB502606_16_nb</p> <p>NSYUUK06_image</p> <p>NSYUJHD1K32P40S_image.eps</p> <p>Forced-airing systems Air-to-air exchangers Air-to-water exchangers Cooling units</p>
Heating		 <p>PB501026_12_nb</p> <p>PB501027_12_nb</p> <p>PB501029_8_nb</p> <p>PB502042_4_nb</p> <p>Resistance heaters</p>
Controlling	 <p>PB503549_nb</p> <p>PB503558_nb</p> <p>Smart thermal control accessories</p>	 <p>PB501160_24_nb</p> <p>PB501169_24_nb</p> <p>PB501172_25_nb</p> <p>PB501162_25_nb</p> <p>NSYCO0TH30VID</p> <p>NSYCO0HY30VID</p> <p>NSYCO0HY230VID</p> <p>Thermal control accessories</p>
Softwares		 <p>SEE electrical Product Selector Customization Offers ProClima Web software</p>

14

Technical changes reserved. Information provided without guarantee. Images are for illustrative purposes only.

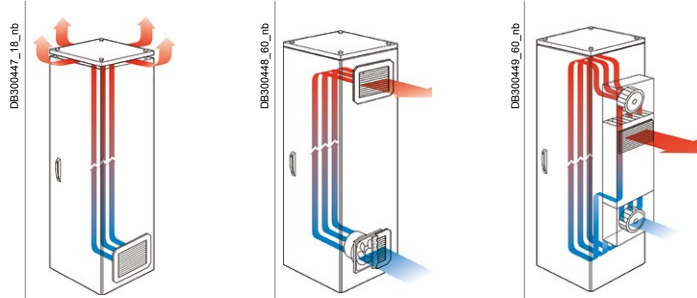

	Homogenize	Cooling	Cooling	Cooling
Solution	Air circulation	Natural airming	Forced-airing	Air-to-air exchanger
Description	Circulation fan inside the enclosure	Air circulation achieved by installing grids (side or roof-mounted) with or without filter, or by elevating the roof.	A fan (with or without filter) feeds fresh external air into the enclosure. This creates a slight overpressure, forcing the warm air out of the enclosure through an outlet grid. The air flow balances the temperature, and the overpressure prevents dust ingress. Side or roof-mounted. Can be combined with a thermostat.	Cooling system comprising an aluminum heat exchanger and separate internal and external air circuits and two centrifugal fans circulating the air, and a thermostat for temperature control. Side or roof-mounted.
Use	To prevent hot spots	Low power to be dissipated. Dusty environment	High heat dissipation performance, suitable for dusty and non-hazardous environments. Prevents hot spots.	Medium heat dissipation performance, suitable for corrosive environments (food processing) and relatively cold environments (approx. 25 °C)
Temperature conditions	None	$T_d > T_a + 5\text{ °C}$	$T_d > T_a + 5\text{ °C}$ $3\text{ °C} < T_a \leq 35\text{ °C}$	$T_d > T_a + 10\text{ °C}$
Ta = ambient temperature (outside the enclosure) Td = desired temperature inside the enclosure				
Independent internal and external air circuits?	No	No	No	Yes
Advantages	<ul style="list-style-type: none"> Uniform temperature inside the enclosure 	<ul style="list-style-type: none"> Very economical solution No maintenance Easy, fast installation. 	<ul style="list-style-type: none"> Economical solution Easy maintenance Easy, fast installation Uniform temperature inside the enclosure Guaranteed level of protection: IP54 (IP55 with cover) 	<ul style="list-style-type: none"> Easy maintenance (no filter) Far lower maintenance frequency than for fans IP55 guaranteed between the enclosure and the air-to-air exchanger.
Disadvantages		<ul style="list-style-type: none"> Low power dissipated Reduction of IP rating Risk of ingress of particles and dust if no filter. 	<ul style="list-style-type: none"> Internal temperature always higher than external temperature Maintenance required: filter change. 	<ul style="list-style-type: none"> Internal temperature always higher than external temperature.
Illustration	<p>PB501087_37_nb</p>	<p>PB501020_28_nb PB500916_16_nb</p> <p>Outlet grids</p>	<p>PB501021_53_nb PB503528_34_nb</p> <p>Fans</p>	<p>PB502019_9_1_nb PB502596_11_nb</p> <p>Air-to-air exchangers</p>

<p>DE300450_24_nb</p>	<p>DE300451_67_nb</p>	<p>DE300452_60_nb</p>
<p>Cooling Air-to-water exchanger</p>	<p>Cooling Cooling unit</p>	<p>Heating Resistor heaters</p>
<p>Cooling system using an exchanger coil supplied with cold water, separated from the internal air circuit, a centrifugal fan for air circulation, and a thermostat to regulate the temperature inside the enclosure. Side-mounting.</p>	<p>Operates like a heat pump: A condenser dissipates the calorific energy absorbed by an evaporator to the ambient air, thereby cooling and drying the air in the enclosure. Mounted on Side (surface, half flush, flush) or Roof. Connected Cooling Units Provides data related to alarming, operations, and setting, locally and remotely, in any process SCADA, supervision, including EcostruXure SE Software Ware and Application and services.</p>	<p>The heating resistors Help prevent the formation of condensation and ensure an ideal temperature inside the enclosure.</p>
<p>Dissipation of large quantities of heat. Suitable for difficult environments (cement plants, production lines, etc.) or humid environments (sewage plants, bottling lines, etc.). Calorific energy is not discharged to the environment.</p>	<p>Filter recommendation:</p> <ul style="list-style-type: none"> • Office environment (no dust, no grease): filter free, • Industrial environment (dust, grease, not explosive): G3 fiber filter is recommended, • Outdoor (not explosive) : aluminum filter is recommended, Indoor CU are delivered without any filter by default. Outdoor CU are delivered with Aluminum filter by default. 	<p>To heat the inside of the enclosure and prevent condensation.</p>
<p>Ta > Td</p>	<p>Ta > Td and Ta ≤ 55 °C</p>	<p>Ta < Td</p>
<p>Yes</p>	<p>Yes</p>	<p>-</p>
<ul style="list-style-type: none"> • Internal temperature independent of external temperature • Protection system against any leaks • Calorific energy dissipated externally. • Guaranteed level of protection: IP55. 	<ul style="list-style-type: none"> • Internal temperature independent of external temperature • Even temperature inside the enclosure. • Guaranteed level of protection: IP54 for roof, IP55 for side-mounted models • Drainage system for condensed water from evaporator 	<ul style="list-style-type: none"> • Small size (1.6 mm thick for the ultra-thin version) • Low surface temperature (< 70 °C for insulated version, 75 °C for aluminum version) • Even temperature inside the enclosure with the version equipped with a fan.
<ul style="list-style-type: none"> • Cold-water circuit with stabilized temperature and flow rate required • Installation of special piping. 	<ul style="list-style-type: none"> • Water condensation evaporation unit integrated in side-mounted models from 0.6 kW to 4 kW • Maintenance required: filter change. 	
<p>PE502806_16_nb PE502893_11_nb PE502816_nb</p> <p>Air-to-water exchangers</p>	<p>NSYCU1KD0G_image.eps NSYCU1HD1K62P4D0G_image.eps</p> <p>Cooling units</p>	<p>PB501025_33_nb PB501028_17_nb PB501027_17_nb PB502042_6_nb</p> <p>Heating resistors</p>

Large range of fans:
flow rate efficiency, high protection rating, quick installation and easier maintenance to secure all the applications.

Airing Systems

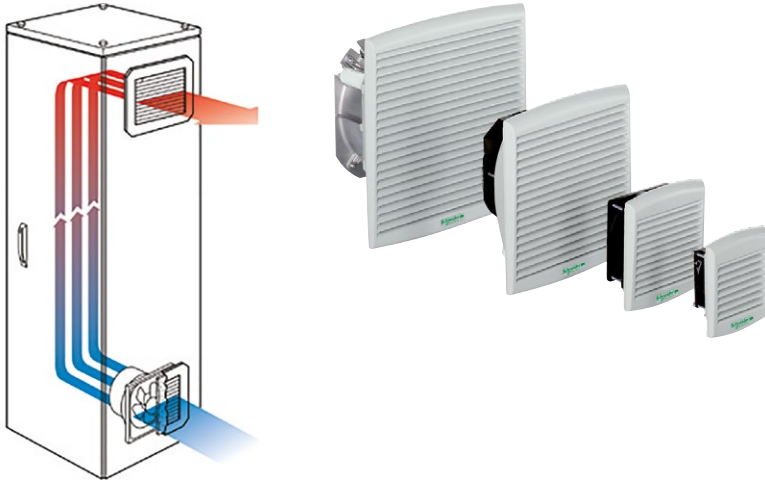

Easy Maintenance

Quick filter replacement

- Quick, easy and safe replacement of the filter installed in the fan, even during operation.



Certifications

- UL



Quality of Components

Selection of motors

- Improved flow rate and longer service life.
- Large range of input voltages available on all motors delivered as standard, with 50/60-Hz alternating current or direct current

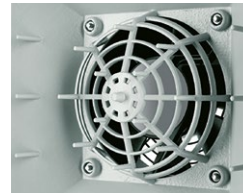

Optimized Flow Rate: Average Increase of 50%

- Maximum use of surface.
- Minimal loss of pressure.



Easy Installation

Quick installation

- Safe, reliable fixing with the assisted fixing device and the system of multi-thickness fixing-clips.
- Easy to invert.
- To operate as extractors, all the motors can be inverted by simply removing four screws.

Innovation



Smart Airing Systems

The smartest way to keep critical equipment cool

- Smart filter.
- Adaptable to any new or existing enclosures.

High Protection Rating: IP54 as Standard

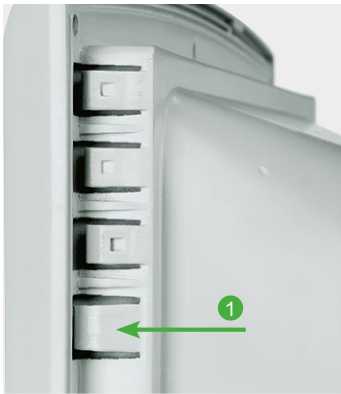

- 1 Fixing Guide**
- To center the body of the fan on the wall of enclosure.
 - To correct machining faults.
 - To facilitate the correct operation of the fixing "clips".

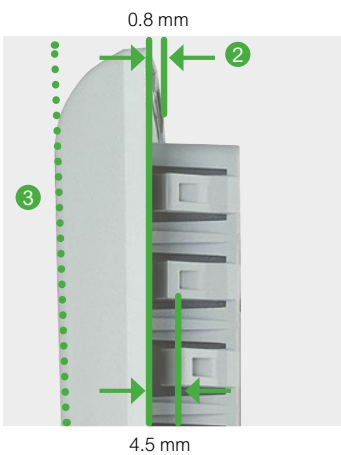

- 2 Multi-Thickness Fixing-Clips**
- To help guarantee easy and reliable fixing of the airing system.
 - With a thickness of 0.8 to 4.5 mm, with no fixings.

- 3 Inclined Profile of the Grille**
- To protect the filter against vertical spraying: each slat is protected by the slat above it, with the external dimensions remaining small.

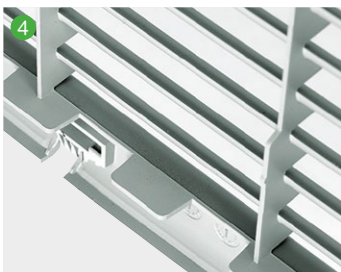

- 4 IP54 (IP55 with the cover)** A patented system allows the evacuation of water absorbed by the filter,
- In particular during high-pressure spraying.



- 5 Hot-Fitted Sealing Gasket**
- The polyurethane gasket, hot cast, helps guarantee a long-lasting seal.



- 6 Effective Filter-Retaining System**
- The system for holding the synthetic filter in the cavity of the filter holder ensures a protection rating of IP54, even under the most difficult conditions.

Innovation

Problems Generated by Dirty Filters

60% of installations face quality issues caused by dirty filters

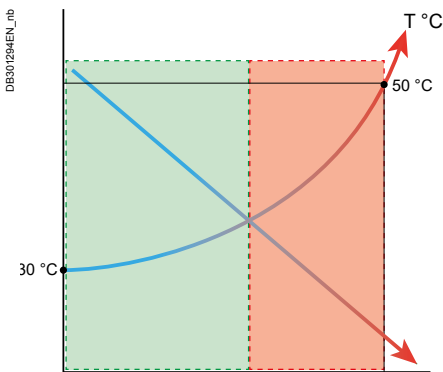

- > Product Malfunction or Breakdown of the Panel
 - Overheating issues
 - Conductivity issues due to dust
 - Damage to internal moving parts
- > Reduced Lifespan of Installed Equipment
- > Low energy Efficiency of the Panel
 - Overconsumption of the fan
- > Safety Issues
 - Risk of fire/burning

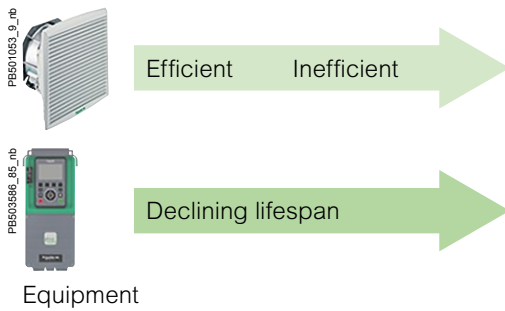

All these issues are due to the presence of dust and/or airing malfunction; They can be avoided by using a smart airing system.

 HEALTH OF EQUIPMENT = FILTER'S DUST LEVEL

The Concept of the ClimaSys Smart Airing System (CSVS)

The ClimaSys Smart Airing System is a smart, closely integrated network that makes your life easier.

- > Use Corrective and Predictive Maintenance of the Airing System to:
 - Improve CAPEX and OPEX of the installation
 - Improve maintenance and operation of the installation
 - Improve peace of mind

Reduce maintenance cost for new and existing installations.



- > Functions of the CSVS Systems:
 - Detect general poor health of the enclosure by monitoring:**
 - Input/output temperature
 - Detect fan issues by monitoring:**
 - Air flow temperature
 - Current level, consumed energy
 - Blade speed measurement
 - Used and remaining (approximate) lifespan
 - Detect grid filter issues:**
 - Air flow temperature
 - Dust level (0% clean – 100% dirty)
 - Number of replacements
 - Remaining time to next replacement

90% Savings on Filter Maintenance

Innovation The Technical Solution

2 Sensors...

PB503557_30_nb



Dust sensor (patented)
NSYCCAFSDUST

Composed of an optical sensor which detects the filter dirt level + temperature sensor

PB503552_30_nb



Fan Sensor
NSYCCARPM

Composed of:
RPM sensor to control fan rotation and transported air temperature
Toroidal sensor to measure fan consumption



... Connected to a Controller Relaying Information and Alarms

Filterstat™ Controller ClimaSys CC DG **NSYCCOFST•••V**
Information displayed on Filterstat's controller display

- **Detect general poor health of enclosure by monitoring:**
 - Input/output temperature
- **Detect fan issues by monitoring:**
 - Air flow temperature
 - Current level, consumed energy
 - Blade speed measurement
 - Used and remaining (approximate) lifespan
- **Detect grid filter issues:**
 - Air flow temperature
 - Dust level (0% clean – 100% dirty)
 - Number of replacements
 - Remaining time before next replacement

The alarms

The system offers different types of alarms for notification when something is not right:

Alarms

Dust filter alarm: Filter capacity below user-defined level. 0%-60% (LED green), 60%-80% (LED orange), >80% (LED flashing red)

No power supply to fan: Fan is running (there is an rpm reading but the current sensor shows a 0 mA reading).

Fan rpm slow: Fan speed is below a user-predefined level.

Fan flaps blocked: Consumption in a fan is detected but the rpm speed is zero.

Over-temperature alarm on airflow: Fan exceeds a user-defined threshold.

Over-temperature or under-temperature alarm: On inlet or outlet air from grids.

Fan lifespan over: The fan lifetime has almost expired and it should be replaced (front LEDs light up purple).

Δt deviation: Δt deviation is greater than a user-predefined threshold.

Remote sensor not connected/broken: A device in the network is disconnected.

Thermal Network Architecture

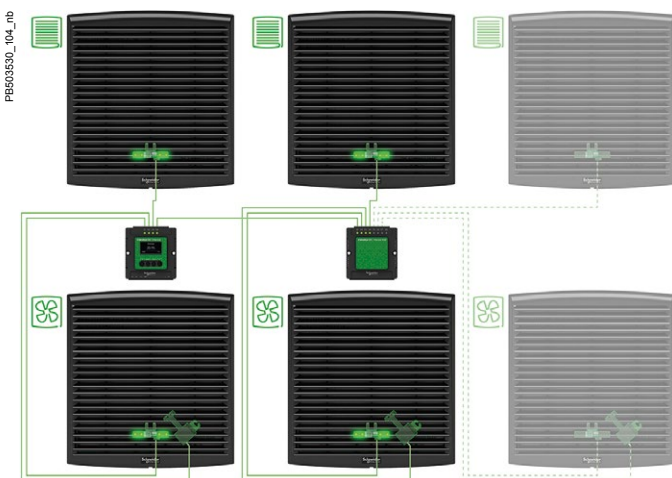

> The Greenfield Solution for New Installations

We offer a range of digital devices that can be connected together and optionally also to a remote supervisor.

See [page 574](#)

> The Brownfield Kit for Retrofit Installations

Easy upgrading of an existing installation to a digital one.

See [page 575](#)

Innovation Build your Greenfield Solution for a New Installation

The nucleus of the system is the ClimaSys Filterstat™ controller that collects information from filter and fan sensors across all of your enclosures.



Easy Product Selection with the ProClima Selection Tool

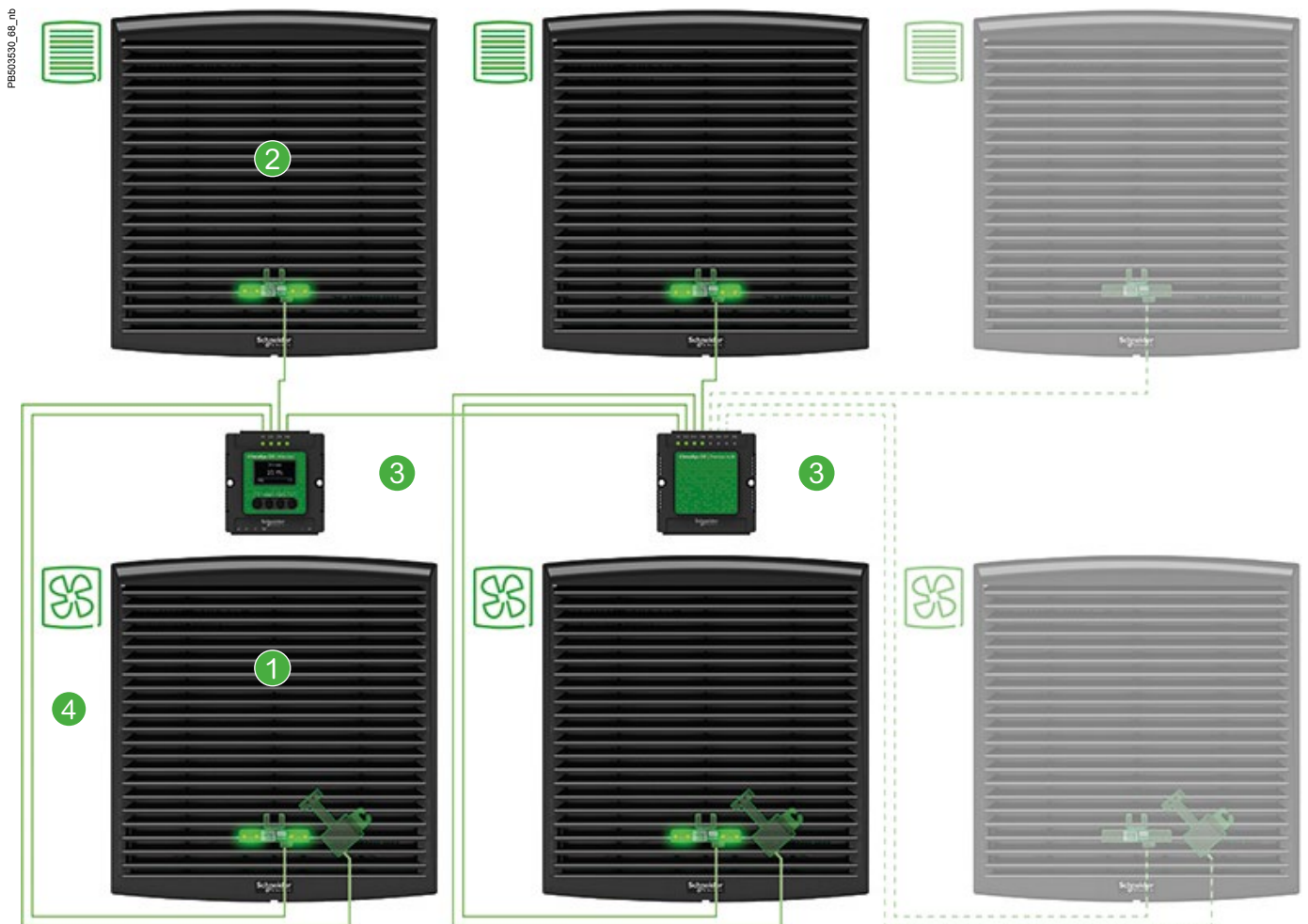

14 CV

Technical changes reserved. Information provided without guarantee. Images are for illustrative purposes only.

Select Your Smart Fan



Select Your Smart Grid



Select Your Controller and Potential Thermal Hubs to Digitalize More Than 1 Enclosure



Select Your Communication Cables



New ClimaSys Smart Grid Offer

Complete Smart Grid that includes:

- A dust Sensor
- A smart Filter G2, G3 smart filter to be order separately (see [page 576](#)).

Grid cut-out (mm ²)	References
92x92	NSYCAG92DG
125x125	NSYCAG125DG
223x223	NSYCAG223DG
291x291	NSYCAG291DG

Filterstat Controllers (4 Ports) and Thermal Hubs (8 Ports)

- Trim frame IP55 for installing the Filterstat Controller and thermal hub on enclosure doors, side panels etc.

Voltage (V)	References
30 V AC/DC	NSYCCOFST30V
90-250 V AC	NSYCCOFST90250V
30 V AC/DC	NSYCCOFSEM8U1
90-250 V AC	NSYCCOFSEM8U2

Modular frame IP55

Material and color	References
same as controller	NSYCCOFR55

Filterstat Communication Cable

Black unshielded cable with 2 connectors on each end.
Material: PVC.

Length (mm)	References
500	NSYCCA50MFST
1000	NSYCCA100MFST
1500	NSYCCA150MFST
2000	NSYCCA200MFST
3000	NSYCCA300MFST
4000	NSYCCA400MFST
5000	NSYCCA500MFST



Control devices (thermostat, hygostat, hydrotherm) must be ordered separately.

Innovation

Select Your Brownfield Kit for an Existing Installation

To select Brownfield components separately:

Smart filters



Set of 5 Smart filters for replacement on Smart Fans and Smart Grids. See details [page 582](#).

Dimensions Grid cut-out size (mm)	Filter type		References
92 x 92	M1	G2	NSYCAF92DG
125 x 125	M1	G2	NSYCAF125DG
125 x 125	M1	G3	NSYCAF125G3DG
223 x 223	M1	G2	NSYCAF223DG
223 x 223	M1	G3	NSYCAF223G3DG
291 x 291	M1	G2	NSYCAF291DG
291 x 291	M1	G3	NSYCAF291G3DG

Dust Sensor 10 stickers and retainer flaps mini-tool kit Fan Sensor



Individual Dust Sensor ready to be implemented on any existing ClimaSys CV fan or ClimaSys CA grids in the Brownfield installation or used as spare part.

References
NSYCCAFSDUST

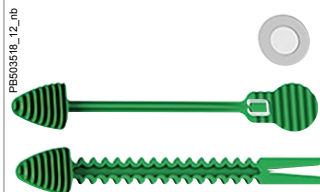

Tool kit for digitalizing fans in Brownfield installations without opening fan motor rear grids.

References
NSYCCABLK

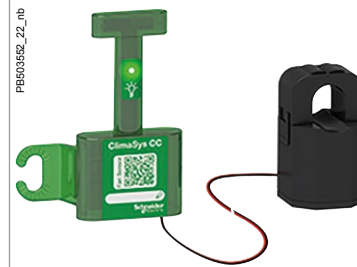

Individual Fan Sensor ready to be implemented on any existing fan in the Brownfield installation or used as spare part.

References
NSYCCARPM



- Characteristics: The Smart fans are equipped with an axial motor, a protective housing on the front, rear surfaces, and a Smart filter with Dust sensor and a Fan sensor with infrared technology. The external smokey-colored grid displays the status of the airing functions through the LED colors of the Dust sensor. This Smart filter can be replaced for maintenance during operation without risk of contact with the rotating element.
- Material of external grids: Injected thermoplastic (ASA PC). self-extinguishing according to UL 94 V-0.
- Color of external grids: Smokey black RAL 9005
- Conditions of use: The external temperature must not exceed 30 °C and must be more than 5 °C lower than the temperature required in the enclosure. The Smart filters that equip the Smart fans must be replaced when the alarm is triggered by the Filterstat controller (see more details [page 573](#))
Storage Temperature: -40...+ 70 °C
- Ingress protection rating (according to IEC 60529): IP54
- If the enclosure contains electronics, material sensitive to dust deposits or if it is needed to use several fans and grills in the same enclosure, we highly recommend using ProClima and a solution with better filtering using a G3 filter or a higher IP (cooling option as example). In any case, do not hesitate to contact our sales teams to collaborate on your project.
- Mechanical protection rating (according to IEC 62262): IK08
- Installation: The cut-out template supplied with the device avoids the need for marking and helps protect the surface of the enclosure during handling.
- Options: For maintenance replacement of Smart filters please see spare parts references, [page 576](#)

Free flow rate with standard filter (m³/h)	Flow rate with outlet grille(s) (m³/h)		Voltage range (nominal voltage)	Absorbed power (max. intensity)	Noise level	External dimensions (cut-out)	Weight	Operating temperature	Max. static pressure
	1	2							
34 (50 Hz)	21 (50 Hz)	29 (50 Hz)	150 V...250 V (230 V)	4.5/4.8 W (0.16/0.17 A)	40/41 dB (A)	137 x 117 x 49 (92 x 92)	0.220 kg	-10...+ 70 °C	29 Pa
35 (60 Hz)	22 (60 Hz)								
74 (50 Hz)	52 (50 Hz)	60 (50 Hz)	175 V...253 V (230 V)	17/15 W (0.121/0.097 A)	46/49 dB (A)	170 x 150 x 62 (125)	0.780 kg	-20...+60 °C	50 Pa
87 (60 Hz)	61 (60 Hz)								
142 (50 Hz)	130 (50 Hz)	138 (50 Hz)	175 V...253 V (230 V)	16.3/14.3 W (0.12/0.94 A)	50/51 dB (A)	268 x 248 x 104 (223 x 223)	1.140 kg	-20...+60 °C	50 Pa
170 (60 Hz)	151 (60 Hz)	152 (60 Hz)							
259 (50 Hz)	209 (50 Hz)	218 (50 Hz)	145 V...253 V (230 V)	36/37 W (0.17/0.16 A)	55/56 dB (A)	268 x 248 x 116 (223 x 223)	1.3 kg	-10...+ 70 °C	158 Pa
307 (60 Hz)	251 (60 Hz)								
502 (50 Hz)	412 (50 Hz)	420 (50 Hz)	207 V...244 V (230 V)	68/85 W (0.52/0.370 A)	59/59 dB (A)	336 x 316 x 161 (291 x 291)	3.2 kg	-15...+60 °C	140 Pa
526 (60 Hz)	448 (60 Hz)								
638 (50 Hz)	500 (50 Hz)	528 (50 Hz)	207 V...244 V (230 V)	150/195 W (0.65/0.85 A)	76/75 dB (A)	336 x 316 x 162 (291 x 291)	4.1 kg	-15...+60 °C	170 Pa
603 (60 Hz)	462 (60 Hz)								
731 (50 Hz)	598 (50 Hz)	609 (50 Hz)	396 V...466 V (400 V)	126/126 W (0.226/0.232 A)	77/75 dB (A)	336 x 316 x 162 (291 x 291)	4.1 kg	-15...+60 °C	170 Pa
603 (60 Hz)	368 (60 Hz)								

How to Identify Whether Your ClimaSys CV Fan Has Been Upgraded to Install the CSVS Solution

Your installation		Installation of CSVS solution	
Greenfield	NSYCV...DG		<input checked="" type="checkbox"/> It's possible to install the CSVS solution
Brownfield	NSYCV...LPF		<input type="checkbox"/> You need to order NSYCCABLK
	NSYCV...LPF		<input checked="" type="checkbox"/> It's possible to install the CSVS solution

14 CV

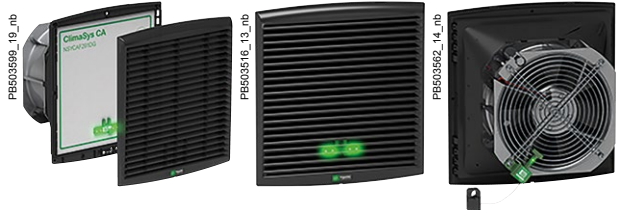

Type of connection				
by cable ★ Forced-airing fan 38 m³/h	by faston (1) Forced-airing fan 85 m³/h	by faston (1) Forced-airing fan 165 m³/h	by faston (1) Forced-airing fan 300 m³/h	by terminal block Forced-airing fan 560-850 m³/h
NSYCVF38M230DG	-	-	-	-
-	NSYCVF85M230DG	-	-	-
-	-	NSYCVF165M230DG	-	-
-	-	-	NSYCVF300M230DG	-
-	-	-	-	NSYCVF560M230DG
-	-	-	-	NSYCVF850M230DG
-	-	-	-	NSYCVF850M400DG

(1) Fan models with connection are delivered with the connection cord included (2 metres).

★ Warning: The fan **NSYCVF38M230DG** MUST NOT be connected to a power conversion module, an inverter or UPS!

High-Visibility LED Indicators



Dust filter alarm
0%-60%



Dust filter alarm
60%-80%



Dust filter alarm
>80%



Fan lifespan
exhausted



PING function
Identification of the
sensor on the panel
(flashing blue color)

Filterstat Controllers (4 Ports) and Thermal Hubs (8 Ports)

- Trim frame IP55 for installing the Filterstat Controller and thermal hub on enclosure doors, side panels etc.



NSYCCOFST30V

Characteristics	Voltage	References
Filterstat Controllers	30 V AC/DC	NSYCCOFST30V
Filterstat Controllers	90-250 V AC	NSYCCOFST90250V



NSYCCOFSEM8U1

Characteristics	Voltage	References
Thermal Hub	30 V AC/DC	NSYCCOFSEM8U1
Thermal Hub	90-250 V AC	NSYCCOFSEM8U2

Modular frame IP55



NSYCCOFR55

Characteristics	References
Modular frame	NSYCCOFR55

Filterstat Communication Cable

- Black unshielded cable with 2 connectors on each side.
- Material: PVC.



NSYCCA50MFST

Characteristics	References
Filterstat communication cable	NSYCCA100MFST
Filterstat communication cable	NSYCCA200MFST
Filterstat communication cable	NSYCCA300MFST
Filterstat communication cable	NSYCCA400MFST
Filterstat communication cable	NSYCCA500MFST

Smart Airing Systems



NSYCVF38M115DG

Characteristics	References
Smart airing system, 38 m³/h 230 V IP54	NSYCVF38M230DG
Smart airing system, 85 m³/h 230 V IP54	NSYCVF85M230DG
Smart airing system, 165 m³/h 230 V IP54	NSYCVF165M230DG
Smart airing system, 300 m³/h 230 V IP54	NSYCVF300M230DG
Smart airing system, 582 m³/h 230 V IP54	NSYCVF560M230DG
Smart airing system, 850 m³/h 230 V IP54	NSYCVF850M230DG
Smart airing system, 850 m³/h 400 V IP54	NSYCVF850M400DG

ClimaSys (CSVS) General Wiring Diagram

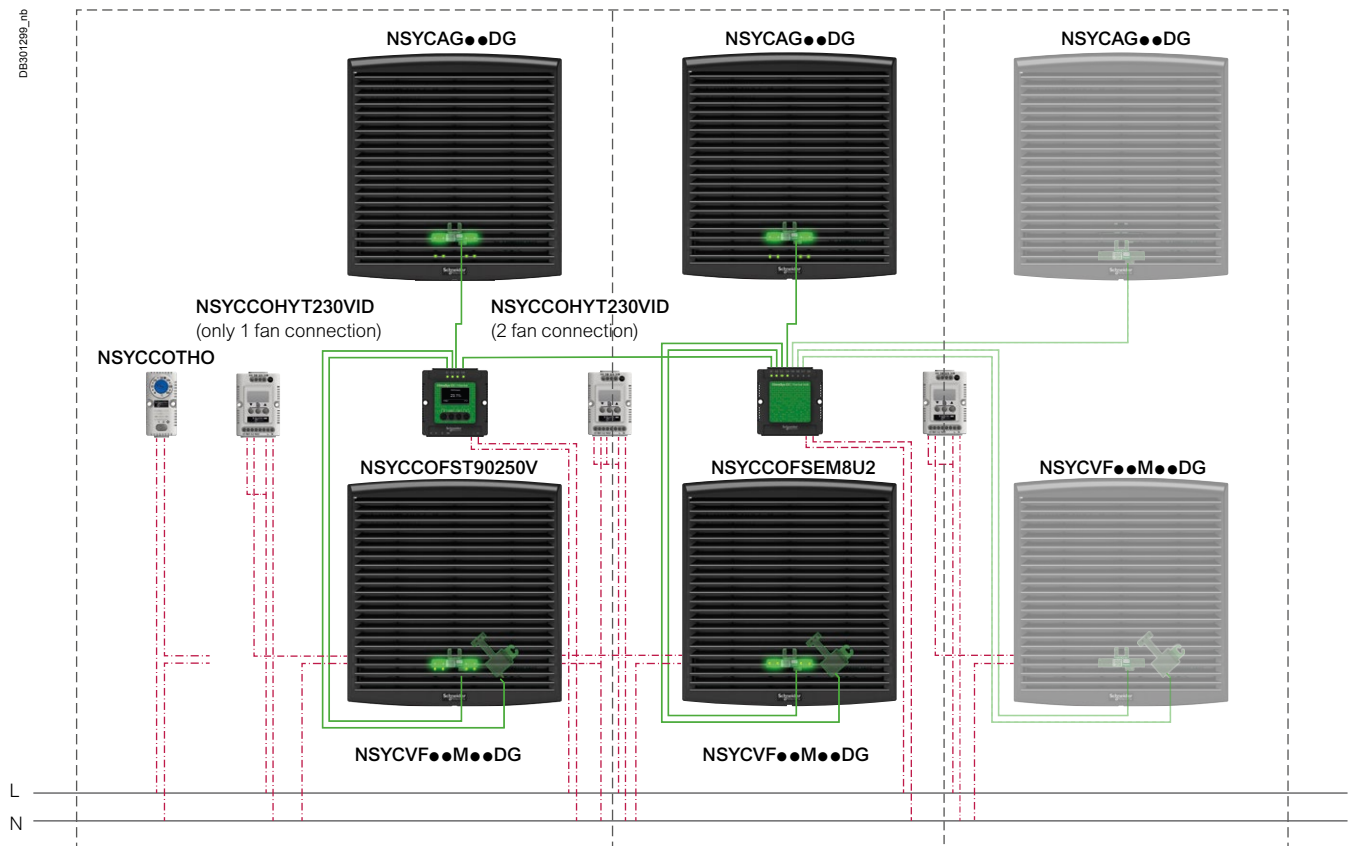

Smart Grid Systems

Complete Smart Grids

- A Dust Sensor
- A SmartFilter G2
- Material: Injected thermoplastic (PC), self-extinguishing according to UL 94 V-0
- Color: Smokey black RAL 9005
- Ingress protection rating (according to IEC 60529): IP54



NSYCAG92DG

Characteristics	Height (mm)	Width (mm)	Depth (mm)	Cut-out (mm)	References
Complete Smart Grid	137	117	13	92 x 92	NSYCAG92DG
Complete Smart Grid	170	150	15	125 x 125	NSYCAG125DG
Complete Smart Grid	268	248	18	223 x 223	NSYCAG223DG
Complete Smart Grid	336	316	18	291 x 291	NSYCAG291DG

Smart Filters

- Set of 5 Smart filters for replacement on Smart Fans and Smart Grids. For fans and grilles.
- Material: Polyester.
- Filters according to ISO 16890.
- Color: White with green lettering



NSYCAF92DG

Characteristics	Height (mm)	Width (mm)	Cut-out (mm)	References
External Smart Grid, G2 M1 filters	137	117	92 x 92	NSYCAF92DG
External Smart Grid, G2 M1 filters	170	150	125 x 125	NSYCAF125DG
External Smart Grid, G2 M1 filters	268	248	223 x 223	NSYCAF223DG
External Smart Grid, G2 M1 filters	336	316	291 x 291	NSYCAF291DG
External Smart Grid, G3 M1 filters	170	150	125 x 125	NSYCAF125G3DG
External Smart Grid, G3 M1 filters	268	248	223 x 223	NSYCAF223G3DG
External Smart Grid, G3 M1 filters	336	316	291 x 291	NSYCAF291G3DG

Dust Sensor

- Individual Dust Sensor ready to be implemented on any existing ClimaSys CV fan or ClimaSys CA grids in the Brownfield installation or used as spare part.



NSYCCAFSDUST

Characteristics	References
Dust Sensor	NSYCCAFSDUST

Fan Sensor

- Individual Fan Sensor ready to be implemented on any existing fan in the Brownfield installation or used as spare part.



NSYCCARPM

Characteristics	References
Fan Sensor	NSYCCARPM

10 Stickers and Retainer Flaps Mini-Tool Kit

- Tool kit for digitalizing fans in Brownfield installations without opening fan motor rear grids.



NSYCCABLK

Characteristics	References
10 stickers and retainer flaps mini-tool kit	NSYCCABLK

Anti-Vandalism Kit



NSYCAAPV

- Prevents the grid from being opened from the outside.
- The unlocking thumbwheel is accessed from the inside of the enclosure.
- Color: RAL 7011

Characteristics	References
Anti-vandalism kit	NSYCAAPV

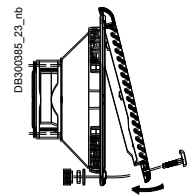

Supply:
Minor packaging 2

Filter Pocket



NSYDPA5

- Fixed by adhesive tape
- Material: Polystyrene (PS)
- Color: RAL 7035 gray (**NSYDPA4**: RAL 9001)
- ⁽¹⁾ Not compatible with 19" chassis or modular distribution installation.

Characteristics	Smart filter references	Dimensions			References
		A (mm)	B (mm)	C (mm)	
Pocket A5	NSYCAF92•DG and NSYCAF125•DG	137	117	13	NSYDPA5
Pocket A4	NSYCAF223•DG	170	150	15	NSYDPA4
Pocket A4 ⁽¹⁾	NSYCAF223•DG	268	248	18	NSYDPA44
Pocket A3	NSYCAF291•DG	336	316	18	NSYDPA3

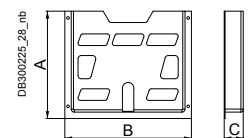

Supply:
1 plastic document pocket

- Characteristics: The fans comprise an axial motor, a protective housing on the front and rear surfaces and a filter designed to retain dust particles. This filter can be replaced during operation without risk of contact with the rotating element.
- Material of external grids: Injected thermoplastic (ASA PC). self-extinguishing according to UL 94 V-0
- Color external grids: RAL 7035 gray as standard
- Conditions of use: The external temperature must not exceed 30 °C and must be more than 5 °C lower than the temperature wanted in the enclosure. The filters that equip the fans must be cleaned and replaced regularly. The ambient air must be relatively clean and overfrequent filter replacement should be avoided. Bear in mind the pressure losses caused by the outlet element (grille with filter, airing louvre or simple opening) when determining the fan flow rate
- Storage Temperature: -40...+ 70 °C
- Ingress protection rating (according to IEC 60529): IP54
- If the enclosure contains electronics, material sensitive to dust deposits or if it is needed to use several fans and grills in the same enclosure, we highly recommend using ProClima and a solution with better filtering using a G3 filter or a higher IP (cooling option as example). In any case, do not hesitate to contact our sales teams to collaborate on your project.
- Mechanical protection rating (according to IEC 62262): IK08
- UL recognized (cURus). Rated Type 12 according to UL50E.
- Installation: The cut-out template supplied with the device avoids the need for marking and helps protect the surface of the enclosure during handling
- All fan references are also delivered with one anti-insect filter
- Options: The device can be equipped with a filter that provides even more efficient protection for your sensitive facilities against dust particles

Free flow rate with standard filter (m³/h)	Flow rate with outlet grille(s) (m³/h)		Voltage range (nominal voltage)	Absorbed power (max. intensity)	Noise level	External dimensions (cut-out)	Weight	Operating temperature	Max. static pressure
	1	2							
38 (50 Hz)	25 (50 Hz)	33 (50 Hz)	150 V...250 V (230 V)	4.5/4.8 W (0.16/0.17 A)	40/41 dB (A)	137 x 117 x 49 (92 x 92)	0.220 kg	-10...+ 70 °C	29 Pa
39 (60 Hz)	26 (60 Hz)								
38 (50 Hz)	27 (50 Hz)	35 (50 Hz)	75 V...125 V (115 V)	3.3/3.5 W (0.16/0.16 A)	40/41 dB (A)	137 x 117 x 49 (92 x 92)	0.220 kg	-10...+ 70 °C	29 Pa
39 (60 Hz)	28 (60 Hz)								
58	39	47	10 V...27.6 V (24 V DC)	3.6 W (0.18 A)	40/41 dB (A)	137 x 117 x 49 (92 x 92)	0.230 kg	-10...+ 70 °C	29 Pa
44	34	41	36 V...56 V (48 V DC)	3.6 W (70 mA)	40/41 dB (A)	137 x 117 x 49 (92 x 92)	0.230 kg	-10...+ 70 °C	29 Pa
85 (50 Hz)	63 (50 Hz)	71 (50 Hz)	175 V...253 V (230 V)	17/15 W (0.121/0.097 A)	46/49 dB (A)	170 x 150 x 62 (125)	0.780 kg	-20...+60 °C	50 Pa
98 (60 Hz)	72 (60 Hz)								
79 (50 Hz)	65 (50 Hz)	73 (50 Hz)	75 V...126 V (115 V)	16/15 W (0.207/0.179 A)	46/49 dB (A)	170 x 150 x 62 (125)	0.780 kg	-20...+60 °C	50 Pa
92 (60 Hz)	74 (60 Hz)								
80	57	77	10 V...27.6 V (24 V DC)	7.6 W (0.30 A)	46/49 dB (A)	170 x 150 x 62 (125)	0.480 kg	-10...+ 70 °C	50 Pa
79	59	68	25 V...55.2 V (48 V DC)	8 W (0.173 A)	46/49 dB (A)	170 x 150 x 62 (125)	0.480 kg	-10...+ 70 °C	50 Pa
165 (50 Hz)	153 (50 Hz)	161 (50 Hz)	175 V...253 V (230 V)	16.3/14.3 W (0.12/0.094 A)	50/51 dB (A)	268 x 248 x 104 (223 x 223)	1.140 kg	-20...+60 °C	50 Pa
193 (60 Hz)	171 (60 Hz)	175 (60 Hz)							
164 (50 Hz)	153 (50 Hz)	161 (50 Hz)	75 V...126 V (115 V)	15.5/14.4 W (0.20/0.18 A)	50/51 dB (A)	268 x 248 x 104 (223 x 223)	1.140 kg	-20...+60 °C	50 Pa
193 (60 Hz)	171 (60 Hz)	179 (60 Hz)							
188	171	179	10 V...27.6 V (24 V DC)	8 W (0.3 A)	50/51 dB (A)	268 x 248 x 104 (223 x 223)	0.810 kg	-10...+ 70 °C	50 Pa
193	171	179	25 V...55.2 V (48 V DC)	8.7 W (0.18 A)	50/51 dB (A)	268 x 248 x 104 (223 x 223)	0.810 kg	-10...+ 70 °C	50 Pa
302 (50 Hz)	260 (50 Hz)	268 (50 Hz)	145 V...253 V (230 V)	36/37 W (0.17/0.16 A)	55/56 dB (A)	268 x 248 x 116 (223 x 223)	1.3 kg	-10...+ 70 °C	158 Pa
350 (60 Hz)	307 (60 Hz)								
302 (50 Hz)	263 (50 Hz)	271 (50 Hz)	75 V...126 V (115 V)	36/36 W (0.35/0.32 A)	55/56 dB (A)	268 x 248 x 116 (223 x 223)	1.3 kg	-10...+70 °C	158 Pa
350 (60 Hz)	307 (60 Hz)								
262	221	229	12 V...30 V (24 V DC)	13 W (0.53 A)	55/56 dB (A)	268 x 248 x 103.4 (223 x 223)	1.1 kg	-10...+ 70 °C	158 Pa
247	210	218	25 V...60 V (48 V DC)	11 W (0.24 A)	55/56 dB (A)	268 x 248 x 103.4 (223 x 223)	1.1 kg	-10...+70 °C	158 Pa
562 (50 Hz)	473 (50 Hz)	481 (50 Hz)	207 V...244 V (230 V)	68/85 W (0.52/0.370 A)	59/59 dB (A)	336 x 316 x 161 (291 x 291)	3.2 kg	-15...+60 °C	140 Pa
586 (60 Hz)	477 (60 Hz)								
582 (50 Hz)	485 (50 Hz)	494 (50 Hz)	103 V...122 V (115 V)	65/83 W (0.60/0.72 A)	59/59 dB (A)	336 x 316 x 161 (291 x 291)	3.2 kg	-15...+60 °C	140 Pa
586 (60 Hz)	477 (60 Hz)								
838 (50 Hz)	718 (50 Hz)	728 (50 Hz)	207 V...244 V (230 V)	150/195 W (0.65/0.85 A)	76/75 dB (A)	336 x 316 x 162 (291 x 291)	4.1 kg	-15...+60 °C	170 Pa
803 (60 Hz)	568 (60 Hz)								
983 (50 Hz)	843 (50 Hz)	854 (50 Hz)	103 V...122 V (115 V)	145/182 W (1.279/1.6 A)	78/77 dB (A)	336 x 316 x 162 (291 x 291)	4.1 kg	-15...+60 °C	170 Pa
944 (60 Hz)	642 (60 Hz)								
931 (50 Hz)	798 (50 Hz)	809 (50 Hz)	400 V (-15% / +10%)	126/126 W (0.21/0.26 A)	77/75 dB (A)	336 x 316 x 162 (291 x 291)	4.1 kg	-15...+60 °C	170 Pa
803 (60 Hz)	568 (60 Hz)								

14
CV



Type of connection				
by cable Forced-airing fan 38 m³/h	by faston ⁽¹⁾ Forced-airing fan 85 m³/h	by faston ⁽¹⁾ Forced-airing fan 165 m³/h	by faston ⁽¹⁾ Forced-airing fan 300 m³/h	by terminal block Forced-airing fan 560-850 m³/h
NSYCVF38M230PF *	-	-	-	-
NSYCVF38M115PF *	-	-	-	-
NSYCVF38M24DPF	-	-	-	-
NSYCVF38M48DPF	-	-	-	-
-	NSYCVF85M230PF	-	-	-
-	NSYCVF85M115PF	-	-	-
-	NSYCVF85M24DPF	-	-	-
-	NSYCVF85M48DPF	-	-	-
-	-	NSYCVF165M230PF	-	-
-	-	NSYCVF165M115PF	-	-
-	-	NSYCVF165M24DPF	-	-
-	-	NSYCVF165M48DPF	-	-
-	-	-	NSYCVF300M230PF	-
-	-	-	NSYCVF300M115PF	-
-	-	-	NSYCVF300M24DPF	-
-	-	-	NSYCVF300M48DPF	-
-	-	-	-	NSYCVF560M230PF
-	-	-	-	NSYCVF560M115PF
-	-	-	-	NSYCVF850M230PF
-	-	-	-	NSYCVF850M115PF
-	-	-	-	NSYCVF850M400PF

⁽¹⁾ Fan models with connection are delivered with the connection cord included (2 metres).



★ Warning: The fan **NSYCVF38M230PF** and **NSYCVF38M115PF** MUST NOT be connected to a power conversion module, an inverter or UPS!

Airing Systems, IP54 Outlet Grilles

- Delivered G2 M1 synthetic standard filter according to ISO 16890 and **NSYCAG125LPF**, **NSYCAG223LPF**, **NSYCAG291LPF** are also delivered with anti-insect filter.
- Material: Injected thermoplastic polycarbonate.
- Color: RAL 7035 gray
- Ingress protection rating (according to IEC 60529): IP54
- UL recognized (cURus), rated Type 12 according to UL50E



NSYCAG92LPF

Characteristics	Height (mm)	Width (mm)	Depth (mm)	Cut-out (mm)	References
IP54 outlet grilles	137	117	13	92 x 92	NSYCAG92LPF
IP54 outlet grilles	170	150	15	125 x 125	NSYCAG125LPF
IP54 outlet grilles	268	248	18	223 x 223	NSYCAG223LPF
IP54 outlet grilles	336	316	18	291 x 291	NSYCAG291LPF

Filters

- For fans and grilles.
- Filters according to ISO 16890.



NSYCAF223T

Characteristics	Height (mm)	Width (mm)	Cut-out (mm)	References
G2 M1 synthetic standard filters	137	117	92 x 92	NSYCAF92
G2 M1 synthetic standard filters	170	150	125 x 125	NSYCAF125
G2 M1 synthetic standard filters	268	248	223 x 223	NSYCAF223
G2 M1 synthetic standard filters	336	316	291 x 291	NSYCAF291
Filters for greasy environments G2 M1	170	150	125 x 125	NSYCAF125O
Filters for greasy environments G2 M1	268	248	223 x 223	NSYCAF223O
Filters for greasy environments G2 M1	336	316	291 x 291	NSYCAF291O
G3 M1 synthetic fine filters	170	150	125 x 125	NSYCAF125T
G3 M1 synthetic fine filters	268	248	223 x 223	NSYCAF223T
G3 M1 synthetic fine filters	336	316	291 x 291	NSYCAF291T
Stainless-steel anti-insect filters	137	117	92 x 92	NSYCAF92M
Stainless-steel anti-insect filters	170	150	125 x 125	NSYCAF125M
Stainless-steel anti-insect filters	268	248	223 x 223	NSYCAF223M
Stainless-steel anti-insect filters	336	316	291 x 291	NSYCAF291M

Supply:

- G2 M1 synthetic standard filters, Filters for greasy environments G2 M1, G3 M1 synthetic fine filters: 5 units
- Stainless-steel anti-insect filters: 1 unit

Anti-Vandalism Kit



NSYCAAPV

- Prevents the grid from being opened from the outside.
- The unlocking thumbwheel is accessed from the inside of the enclosure.
- Color: RAL 7011

Characteristics	References
Anti-vandalism kit	NSYCAAPV

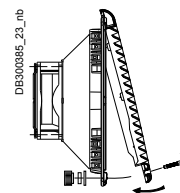

Supply:

2 items per kit

Covers IP55

- This solution protects the fan or grille from any direct spray.
- The cover is the preferred solution to ensure the following:
 - an efficient air flow for cooling,
 - IP55 rating.
- Material: 2 materials available:
 - steel painted with epoxy polyester powder (RAL 7035 gray) for outdoor applications
 - stainless-steel 304L for food and beverage applications
- Ingress protection rating (according to IEC 60529): IP55
- Mechanical protection rating (according to IEC 62262): IK10
- Certifications: UL Recognized (cURus). Rated 12 and 3R according to UL 50E
- Installation: Double insulation maintained if installed in an insulated enclosure. The cover is placed over the fan or the grille with a filter located at the bottom of the cover to prevent the entry of particles. Easy access to the filter: Only two screws needed. When mounting: Remove the external part of the fan or the grille as well as the filter.

⁽¹⁾ Values given for a fan powered at 230 V. For other voltages, the values are similar

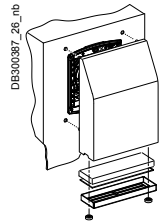

Supply:
It is necessary to order 1 fan + 1 grille + 2 covers to have a complete system



NSYCAP125LZF

Characteristics	Flow rate (m³/h) with cover ⁽¹⁾		Dimensions		References
	Free	With 1 outlet grille	External (mm)	Cut-out (mm)	
Steel painted RAL 7035 gray	74	53	240 x 180 x 60	125 x 125	NSYCAP125LZF
Steel painted RAL 7035 gray	110	82	350 x 305 x 80	223 x 223	NSYCAP223LZF
Steel painted RAL 7035 gray	165	123	350 x 305 x 80	223 x 223	NSYCAP223LZF
Steel painted RAL 7035 gray	316	265	430 x 373 x 105	291 x 291	NSYCAP291LZF
Steel painted RAL 7035 gray	502	430	430 x 373 x 105	291 x 291	NSYCAP291LZF
Stainless-steel 304L	74	53	240 x 180 x 60	125 x 125	NSYCAP125LXF
Stainless-steel 304L	110	82	350 x 305 x 80	223 x 223	NSYCAP223LXF
Stainless-steel 304L	165	123	350 x 305 x 80	223 x 223	NSYCAP223LXF
Stainless-steel 304L	316	265	430 x 373 x 105	291 x 291	NSYCAP291LXF
Stainless-steel 304L	502	430	430 x 373 x 105	291 x 291	NSYCAP291LXF

Spare Filter for Cover

Supply:
5 items per kit



NSYCAF125L55

Characteristics	Flow rate (m³/h) with cover ⁽¹⁾		Dimensions		References
	Free	With 1 outlet grille	External (mm)	Cut-out (mm)	
Spare filter for cover	74	53	240 x 180 x 60	125 x 125	NSYCAF125L55
Spare filter for cover	110	82	350 x 305 x 80	223 x 223	NSYCAF223L55
Spare filter for cover	165	123	350 x 305 x 80	223 x 223	NSYCAF223L55
Spare filter for cover	316	265	430 x 373 x 105	291 x 291	NSYCAF291L55
Spare filter for cover	502	430	430 x 373 x 105	291 x 291	NSYCAF291L55

Characteristics				Fan	Grille
				 NSYCVF85M230PF	 NSYCAG291LZF
				RAL 7035 gray	RAL 7035 gray
Flow rate (m³/h) with cover ⁽¹⁾		Dimensions (mm)		References	References
Free	With 1 outlet grille	External	Cut-out		
74	53	240 x 180 x 60	125 x 125	NSYCVF85M230PF	NSYCAG125LZF
110	82	350 x 305 x 80	223 x 223	NSYCVF165M230PF	NSYCAG223LZF
165	123	350 x 305 x 80	223 x 223	NSYCVF300M230PF	NSYCAG223LZF
316	265	430 x 373 x 105	291 x 291	NSYCVF560M230PF	NSYCAG291LZF
502	430	430 x 373 x 105	291 x 291	NSYCVF850M230PF	NSYCAG291LZF

Airing System, Heavy-Duty

Fanbox



NSYCVF550M24FB

- Free flow rate: 550 m³/h (50/60 Hz).
- UL Recognized (cURus). Rated Type 12
- Minimal depth inside the enclosure (90 mm).
- Allows multiple cooling architectures (see page 590 and 591).
- Material: polyamide
- Color: RAL 7016 dark gray

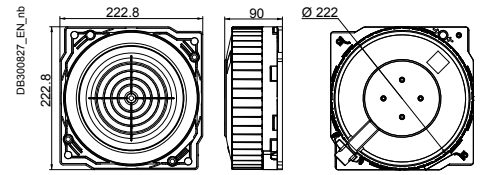

Supply:
1 (grille not included)

Characteristics	Voltage	References
Fanbox	24 V DC	NSYCVF550M24FB
Fanbox	115 V AC	NSYCVF550M115FB
Fanbox	230 V AC	NSYCVF550M230FB

IP55 HD Metal Grille



NSYACG223LFHD

- Slim grille (35 mm external depth).
- UL Recognized (cURus). Rated Type 12 according UL 50e
- Includes a G3 M1
- Material: Steel with anti-corrosive painting + plastic PA6 / GF25 for fixing frame
- Finish: Structured finish, 100% polyester powder
- Color: RAL 7035 gray
- Ingress protection rating: IP55 according to IEC 60529
- Mechanical protection rating: IK10 according to IEC 62262

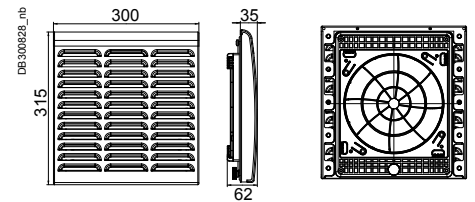

Supply:
1 grille delivered with G3 M1 type synthetic filter (215 x 215 mm) and fixings

Characteristics	References
IP55 HD Metal Grille	NSYACG223LFHD

Roof Filter for Fanbox (Extraction Mode)



NSYCAF190

- Roof G2 round synthetic filter designed to cover the fanbox. Covers completely the fanbox to protect it from dust and humidity. Mandatory for fanbox installation in the roof airing module for IP55 configurations.
- Material: 100% polyester fibers
- Color: White

Supply:
1

Characteristics	References
Roof filter for fanbox	NSYCAF190

Filter



NSYCAF223T

- Replacement G3 M1-type synthetic filter for HD metal grille.
- Dimensions: 215 x 215 mm.
- Material: 100% polyester fibers
- Color: White

Supply:
5

Characteristics	Height (mm)	Width (mm)	Depth (mm)	Cut-out (mm)	References
G3 M1 synthetic fine filters	268	248	18	223 x 223	NSYCAF223T

Anti-Vandalism Kit for HD Metal Grille



NSYCAAPVHD

- Fixings that help to prevent to open the grille from the outside with standard tools (EN 1627-1630:2011 Class 2).
- Quick installation without tools.
- Material: Steel with anticorrosive painting + plastic for fixing screws

Comment:
Not compatible with NSYSPLA150

Supply:
4 grip knob
4 clip nuts

Characteristics	References
Anti-vandalism kit for HD metal grille	NSYCAAPVHD

PR0303012



ProClima: Free Online Tool



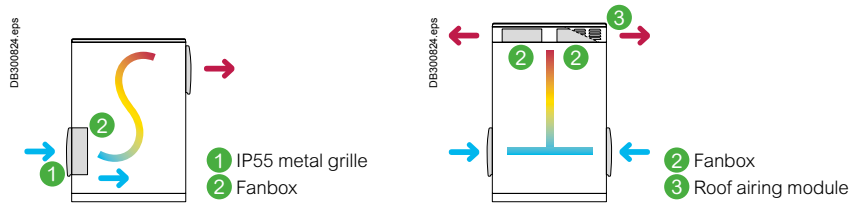

	S-Line				T-Line				
Architecture benefits	<ul style="list-style-type: none"> • Most common and competitive architecture • Maximum heat dissipation to extract 800 W-1000 W • ΔT° of 5 $^\circ\text{C}$ • Easy access to mount-dismount fanbox • Air flow in horizontal axis 				<ul style="list-style-type: none"> • High thermal extraction capacity up to 1500 W • Noise level with 1 fan: 55 dB when installed inside the upper airing module • ΔT° of 5 $^\circ\text{C}$ • Air flow in vertical axis 				
	IP55 metal grille		Fanbox		IP55 metal grille		Fanbox (1 filter NSYCAF190 for each Fanbox)		Roof airing module Rated Type 12 according to UL 50 E
	Door	Side	Door	Side	Door	Side			

Polyester outdoor HD enclosure									
References	Quantity to be installed				Quantity to be installed				References
NSYPHDZT553P	-	-	-	-	-	-	-	-	-
NSYPHDZT753P	1 to 2	-	1 to 2	-	1 to 2	-	-	-	-
NSYPHDZT774	-	1 to 2	-	1 to 2	-	1 to 2	1 to 2	1	NSYPCVR74HD
NSYPHDZT774P	1 to 2	1 to 2	1 to 2	1 to 2	1 to 2	1 to 2	1 to 2	1	NSYPCVR74HD
NSYPHDZT776	-	1 to 2	-	1 to 2	-	1 to 2	1 to 2	1	NSYPCVR76HD
NSYPHDZT776P	1 to 2	1 to 2	1 to 2	1 to 2	1 to 2	1 to 2	1 to 2	1	NSYPCVR76HD
NSYPHDZT1054	-	1	-	1	-	1	1	1	NSYPCVR54HD
NSYPHDZT1054P	1 to 2	1	1 to 2	1	1 to 2	1	1	1	NSYPCVR54HD
NSYPHDZT1074	-	1 to 2	-	1 to 2	-	1 to 2	1 to 2	1	NSYPCVR74HD
NSYPHDZT1074P	1 to 4	1 to 2	1 to 4	1 to 2	1 to 4	1 to 2	1 to 2	1	NSYPCVR74HD
NSYPHDZT12124	-	1 to 3	-	1 to 3	-	1 to 3	1 to 3	1	NSYPCVR124HD
NSYPHDZT12124P	1 to 4	1 to 3	1 to 4	1 to 3	1 to 4	1 to 3	1 to 3	1	NSYPCVR124HD
NSYPHDZT12126	-	1 to 3	-	1 to 3	-	1 to 3	1 to 3	1	NSYPCVR126HD
NSYPHDZT12126P	1 to 4	1 to 3	1 to 4	1 to 3	1 to 4	1 to 3	1 to 3	1	NSYPCVR126HD
NSYPHDZT1254	-	1	-	1	-	1	1	1	NSYPCVR54HD
NSYPHDZT1254P	1 to 3	1	1 to 3	1	1 to 3	1	1	1	NSYPCVR54HD
NSYPHDZT1274	-	1 to 2	-	1 to 2	-	1 to 2	1 to 2	1	NSYPCVR74HD
NSYPHDZT1274P	1 to 4	1 to 2	1 to 4	1 to 2	1 to 4	1 to 2	1 to 2	1	NSYPCVR74HD
NSYPHDZT1276	-	1 to 2	-	1 to 2	-	1 to 2	1 to 2	1	NSYPCVR76HD
NSYPHDZT1276P	1 to 4	1 to 2	1 to 4	1 to 2	1 to 4	1 to 2	1 to 2	1	NSYPCVR76HD
NSYPHDZT15124	-	1 to 3	-	1 to 3	-	1 to 3	1 to 3	1	NSYPCVR124HD
NSYPHDZT15124P	1 to 4	1 to 3	1 to 4	1 to 3	1 to 4	1 to 3	1 to 3	1	NSYPCVR124HD
NSYPHDZT15126	-	1 to 3	-	1 to 3	-	1 to 3	1 to 3	1	NSYPCVR126HD
NSYPHDZT15126P	1 to 4	1 to 3	1 to 4	1 to 3	1 to 4	1 to 3	1 to 3	1	NSYPCVR126HD
NSYPHDZT1574	-	1 to 2	-	1 to 2	-	1 to 2	1 to 2	1	NSYPCVR74HD
NSYPHDZT1574P	1 to 4	1 to 2	1 to 4	1 to 2	1 to 4	1 to 2	1 to 2	1	NSYPCVR74HD
NSYPHDZT1576	-	1 to 2	-	1 to 2	-	1 to 2	1 to 2	1	NSYPCVR76HD
NSYPHDZT1576P	1 to 4	1 to 2	1 to 4	1 to 2	1 to 4	1 to 2	1 to 2	1	NSYPCVR76HD
NSYPHDZT2074	-	1 to 2	-	1 to 2	-	1 to 2	1 to 2	1	NSYPCVR74HD
NSYPHDZT2074P	1 to 4	1 to 2	1 to 4	1 to 2	1 to 4	1 to 2	1 to 2	1	NSYPCVR74HD

Steel outdoor HD enclosure									
NSYS3HD8630	1 to 2	-	1 to 2	-	1 to 2	-	-	-	-
NSYS3HD8840	1 to 2	1 to 2	1 to 2	1 to 2	1 to 2	1 to 2	1 to 2	1	-
NSYS3HD10640	1 to 2	1 to 2	1 to 2	1 to 2	1 to 2	1 to 2	1	1	-
NSYS3HD10840	1 to 4	1 to 2	1 to 4	1 to 2	1 to 4	1 to 2	1 to 2	1	-
NSYSFHD12640	1 to 3	1 to 3	1 to 3	1 to 3	1 to 3	1 to 3	1	1	NSYSFCVR64HD
NSYSFHD12660	1 to 3	1 to 3	1 to 3	1 to 3	1 to 3	1 to 3	1	1	NSYSFCVR66HD
NSYSFHD12840	1 to 4	1 to 3	1 to 4	1 to 3	1 to 4	1 to 3	1 to 2	1	NSYSFCVR84HD
NSYSFHD12860	1 to 4	1 to 3	1 to 4	1 to 3	1 to 4	1 to 3	1 to 2	1	NSYSFECA66HD
NSYSFHD16660	1 to 4	1 to 4	1 to 4	1 to 4	1 to 4	1 to 4	1	1	NSYSFCVR66HD
NSYSFHD16840	1 to 4	1 to 4	1 to 4	1 to 3	1 to 4	1 to 3	1 to 2	1	NSYSFCVR84HD
NSYSFHD16860	1 to 4	1 to 4	1 to 4	1 to 4	1 to 4	1 to 4	1 to 2	1	NSYSFECA66HD
NSYSFHD20840	1 to 4	1 to 4	1 to 4	1 to 4	1 to 4	1 to 4	1 to 2	1	NSYSFCVR84HD
NSYSFHD1212402D	1 to 4	1 to 3	1 to 4	1 to 2	1 to 4	1 to 2	1 to 3	1	NSYSFCVR124HD
NSYSFHD1212602D	1 to 4	1 to 3	1 to 4	1 to 3	1 to 4	1 to 2	1 to 3	1	NSYSFCVR126HD
NSYSFHD1612402D	1 to 4	1 to 4	1 to 4	1 to 3	1 to 4	1 to 3	1 to 3	1	NSYSFCVR124HD
NSYSFHD1612602D	1 to 4	1 to 4	1 to 4	1 to 3	1 to 4	1 to 3	1 to 3	1	NSYSFCVR126HD

14 CV

Technical changes reserved. Information provided without guarantee. Images are for illustrative purposes only.

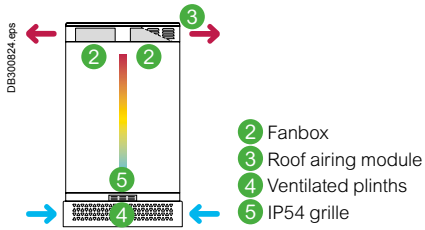

This table helps to configure thermal architectures, but it is highly recommended to use the ProClima Software to ensure the right thermal solution according to the selected architecture.

I-Line	
<ul style="list-style-type: none"> Integrated architecture particularly suitable for public areas High thermal extraction of calorific energy up to 1500 W Noise level with 1 fan: 55 dB when installed inside the upper airing module High flow rate and extraction performance Air flow in vertical axis 	

IP54 outlet grille (NSYCAG223LPF + G3 filter NSYCAF223T)	Ventilated plinths	Fanbox (1 filter NSYCAF190 for each Fanbox)	Roof airing module
--	--------------------	---	--------------------

Quantity to be installed		References		Quantity to be installed		References	
-	-	-	-	-	-	-	-
-	-	-	-	-	-	-	-
1 to 2	1	NSYZZ274VHD	-	1 to 2	1	NSYPCVR74HD	-
1 to 2	1	NSYZZ274VHD	-	1 to 2	1	NSYPCVR74HD	-
1 to 2	1	NSYZZ276VHD	-	1 to 2	1	NSYPCVR76HD	-
1 to 2	1	NSYZZ276VHD	-	1 to 2	1	NSYPCVR76HD	-
1	1	NSYZZ254VHD	-	1	1	NSYPCVR54HD	-
1	1	NSYZZ254VHD	-	1	1	NSYPCVR54HD	-
1 to 2	1	NSYZZ274VHD	-	1 to 2	1	NSYPCVR74HD	-
1 to 2	1	NSYZZ274VHD	-	1 to 2	1	NSYPCVR74HD	-
1 to 3	1	NSYZZ2124VHD	-	1 to 3	1	NSYPCVR124HD	-
1 to 3	1	NSYZZ2124VHD	-	1 to 3	1	NSYPCVR124HD	-
1 to 3	1	NSYZZ2126VHD	-	1 to 3	1	NSYPCVR126HD	-
1 to 3	1	NSYZZ2126VHD	-	1 to 3	1	NSYPCVR126HD	-
1	1	NSYZZ254VHD	-	1	1	NSYPCVR54HD	-
1	1	NSYZZ254VHD	-	1	1	NSYPCVR54HD	-
1 to 2	1	NSYZZ274VHD	-	1 to 2	1	NSYPCVR74HD	-
1 to 2	1	NSYZZ274VHD	-	1 to 2	1	NSYPCVR74HD	-
1 to 2	1	NSYZZ276VHD	-	1 to 2	1	NSYPCVR76HD	-
1 to 2	1	NSYZZ276VHD	-	1 to 2	1	NSYPCVR76HD	-
1 to 3	1	NSYZZ2124VHD	-	1 to 3	1	NSYPCVR124HD	-
1 to 3	1	NSYZZ2124VHD	-	1 to 3	1	NSYPCVR124HD	-
1 to 3	1	NSYZZ2126VHD	-	1 to 3	1	NSYPCVR126HD	-
1 to 3	1	NSYZZ2126VHD	-	1 to 3	1	NSYPCVR126HD	-
1 to 2	1	NSYZZ274VHD	-	1 to 2	1	NSYPCVR74HD	-
1 to 2	1	NSYZZ274VHD	-	1 to 2	1	NSYPCVR74HD	-
1 to 2	1	NSYZZ276VHD	-	1 to 2	1	NSYPCVR76HD	-
1 to 2	1	NSYZZ276VHD	-	1 to 2	1	NSYPCVR76HD	-
1 to 2	1	NSYZZ274VHD	-	1 to 2	1	NSYPCVR74HD	-
1 to 2	1	NSYZZ274VHD	-	1 to 2	1	NSYPCVR74HD	-

1	1	NSYSPFVX6200	NSYSPSX3200	-	-	-
1 to 2	1	NSYSPFVX8200	-	1 to 2	1	-
1	1	NSYSPFVX6200	-	1	1	-
1	1	NSYSPFVX8200	-	1 to 2	1	-
1	1	NSYSPFVX6200	-	1	1	NSYSFCVR64HD
1	1	NSYSPFVX6200	NSYSPLVX6200	1	1	NSYSFCVR66HD
1 to 2	1	NSYSPFVX8200	-	1 to 2	1	NSYSFCVR84HD
1 to 2	1	NSYSPFVX8200	NSYSPLVX6200	1 to 2	1	NSYSFECA66HD
1	1	NSYSPFVX6200	NSYSPLVX6200	1	1	NSYSFCVR66HD
1 to 2	1	NSYSPFVX8200	-	1 to 2	1	NSYSFCVR84HD
1 to 2	1	NSYSPFVX8200	NSYSPLVX6200	1 to 2	1	NSYSFECA66HD
1 to 2	1	NSYSPFVX8200	-	1 to 2	1	NSYSFCVR84HD
1 to 3	1	NSYSPFVX12200	-	1 to 3	1	NSYSFCVR124HD
1 to 3	1	NSYSPFVX12200	NSYSPLVX6200	1 to 3	1	NSYSFCVR126HD
1 to 3	1	NSYSPFVX12200	-	1 to 3	1	NSYSFCVR124HD
1 to 3	1	NSYSPFVX12200	NSYSPLVX6200	1 to 3	1	NSYSFCVR126HD

EMC Airing Systems

EMC IP54 Fan

- To effectively protect the equipment against electromagnetic interference, the EMC fan is equipped with:
 - a steel frame covering the plastic elements (self-extinguishing ABS according to standard UL94 V0),
 - a metal grille attached to the frame,
 - a beryllium gasket to ensure conductivity between the perimeter of the fan unit and the enclosure
- Ingress protection rating (according to IEC 60529): IP54

For more details see [page 596](#)



NSY17990

Characteristics	Flow rate (m³/h)		Voltage (V)		Dimensions		References
	Free	With 1 outlet grille	External (mm)	Cut-out (mm)			
EMC IP54 fan	61	82	145 x 145 x 70	126 x 126	NSY17990		
EMC IP54 fan	156	123	252 x 252 x 97	224 x 224	NSY17991		
EMC IP54 fan	480	265	320 x 320 x 150	292 x 292	NSY17992		

EMC IP54 Fan

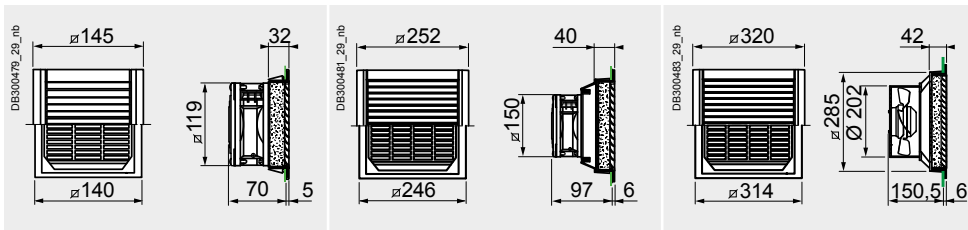

EMC IP54 Outlet Grille

- Grille equipped with:
 - a steel frame covering the plastic elements (self-extinguishing ABS according to standard UL 94 V-0),
 - a metal grille attached to the frame,
 - a beryllium gasket to ensure conductivity between the perimeter of the fan unit and the enclosure
- Ingress protection rating (according to IEC 60529): IP54



NSY17996

Characteristics	Dimensions		References
	External (mm)	Cut-out (mm)	
EMC IP54 outlet grille	145 x 145 x 70	126 x 126	NSY17996
EMC IP54 outlet grille	252 x 252 x 97	224 x 224	NSY17997
EMC IP54 outlet grille	320 x 320 x 150	292 x 292	NSY17998

EMC IP55 Cover

- This solution provides protection against electromagnetic interference and ensures IP55 ingress protection.
- The EMC cover is installed on the fans or standard IP54 outlet grilles.
- The cover is made of painted steel for outdoor use and completely covers the fan or outlet grille.
- Conductivity is obtained by means of:
 - a conductive painting (2 Ω),
 - a conductive copper braid.
- Color: RAL 7035 gray
- Ingress protection rating (according to IEC 60529): IP55
- Mechanical protection rating (according to IEC 62262): IK10

⁽¹⁾ Values given for a fan powered at 230 V. For other voltages, the values are similar

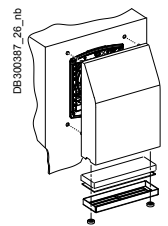

NSYCAP223LE

Characteristics	Flow rate (m³/h) with cover ⁽¹⁾		Dimensions		References
	Free	With 1 outlet grille	External (mm)	Cut-out (mm)	
Sheet steel painted for outdoor applications, RAL 7035 gray	110	82	350 x 305 x 80	223 x 223	NSYCAP223LE
Sheet steel painted for outdoor applications, RAL 7035 gray	165	123	350 x 305 x 80	223 x 223	NSYCAP223LE
Sheet steel painted for outdoor applications, RAL 7035 gray	316	265	430 x 373 x 105	291 x 291	NSYCAP291LE
Sheet steel painted for outdoor applications, RAL 7035 gray	502	430	430 x 373 x 105	291 x 291	NSYCAP291LE

Dimensions of IP54 and EMC Covers

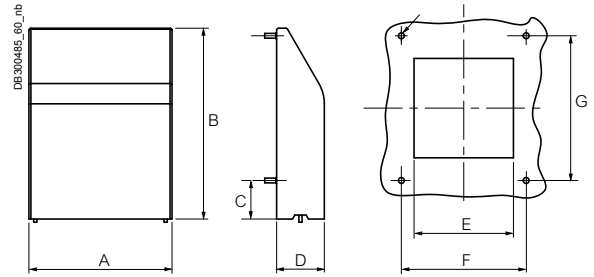

Dimensions (mm)							Cover references			
A	B	C	D	E	F	G	No. of fixing points	IP55	EMC	
180	240	49	49	49	157	182	4	NSYCAP125LZF	NSYCAP125LXF	NSYCAP125LE
305	350	61	61	61	283	280	8	NSYCAP223LZF	NSYCAP223LXF	NSYCAP223LE
373	430	73	73	73	351	348	8	NSYCAP291LZF	NSYCAP291LXF	NSYCAP291LE

Spare Filter for Cover

⁽¹⁾ Values given for a fan powered at 230 V.
For other voltages, the values are similar

Supply:
5 items per kit



NSYCAF125L55

Characteristics	Flow rate (m³/h) with cover ⁽¹⁾		Dimensions		References
	Free	With 1 outlet grille	External (mm)	Cut-out (mm)	
Spare filter for cover	74	53	240 x 180 x 60	125 x 125	NSYCAF125L55
Spare filter for cover	110	82	350 x 305 x 80	223 x 223	NSYCAF223L55
Spare filter for cover	165	123	350 x 305 x 80	223 x 223	NSYCAF223L55
Spare filter for cover	316	265	430 x 373 x 105	291 x 291	NSYCAF291L55
Spare filter for cover	502	430	430 x 373 x 105	291 x 291	NSYCAF291L55

Fan

⁽¹⁾ Values given for a fan powered at 230 V.
For other voltages, the values are similar

- Color: RAL 7035 gray



NSYCVF85M230PF

Characteristics	Flow rate (m³/h) with cover ⁽¹⁾		Dimensions		References
	Free	With 1 outlet grille	External (mm)	Cut-out (mm)	
Fan	74	53	240 x 180 x 60	125 x 125	NSYCVF85M230PF
Fan	110	82	350 x 305 x 80	223 x 223	NSYCVF165M230PF
Fan	165	123	350 x 305 x 80	223 x 223	NSYCVF300M230PF
Fan	316	265	430 x 373 x 105	291 x 291	NSYCVF560M230PF
Fan	502	430	430 x 373 x 105	291 x 291	NSYCVF850M230PF

Grille

⁽¹⁾ Values given for a fan powered at 230 V.
For other voltages, the values are similar

- Color: RAL 7035 gray



NSYCAG125L55

Characteristics	Flow rate (m³/h) with cover ⁽¹⁾		Dimensions		References
	Free	With 1 outlet grille	External (mm)	Cut-out (mm)	
Grille	74	53	240 x 180 x 60	125 x 125	NSYCAG125L55
Grille	110	82	350 x 305 x 80	223 x 223	NSYCAG223L55
Grille	165	123	350 x 305 x 80	223 x 223	NSYCAG223L55
Grille	316	265	430 x 373 x 105	291 x 291	NSYCAG291L55
Grille	502	430	430 x 373 x 105	291 x 291	NSYCAG291L55

Fans by Components

Fans

- Two models according to the input voltage: 230 and 115 V, 50-60 Hz.
- Ingress protection rating: IP20 according to IEC 60529.
- Options: IP20 outlet grille (ABS, black) and filter (black polyurethane foam).
- UL (cURus). Rated 12 according to UL50E

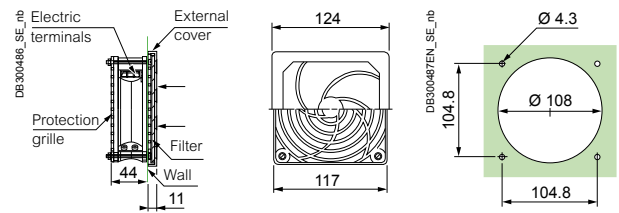

NSYCVF65M115PF

Characteristics	Free air flow (m³/h)	Air flow with fan and outlet grilles and filters (m³/h)	Voltage (V)	References
Fan	170	Fan: 65	115	NSYCVF65M115PF
Fan	170	Fan: 65	230	NSYCVF65M230PF

Fan Accessories



NSYCAF108

Characteristics	Dimensions External (mm)	References
Outlet grille	124 x 124 x 11	NSYCAF108LP
Filter	124 x 124	NSYCAF108

Airing Kit

- Ingress protection rating: IP33 according to IEC 60529.
- Mechanical protection rating: IK10 according to IEC 62262.
- Overall flow rate: 54 m³/h.

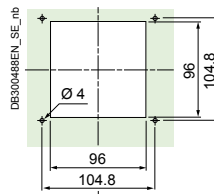

Supply:

- One 120 x 120 x 38 mm fan, 230 V - 50/60 Hz, free flow rate 170 m³/h,
- Two 120 x 120 mm metal grilles, RAL 7035 gray,
- Two 115 x 98 mm anti-insect filters, stainless-steel 304L cable Ø 0.32 mm braided,
- 1.07 mm meshes,
- 1 power cord,
- The fixings required for installation.



NSYCVF54M230MM2

Characteristics	Flow rate (m³/h)	Voltage (V)	References
Airing kit	54	230	NSYCVF54M230MM2

Top Hood with Fan and Cover

- Ingress protection rating: IP54 according to IEC 60529.
- Installation: Installation and removal from the outside.
- Electric power: 85 W.
- Noise level: 64 dB (A).

Comment:

Flow rate measured without counter-pressure

Supply:

Delivered with fixings and connection terminal block.



NSYCVF570M115MF

Characteristics	Weight (kg)	Flow rate (m³/h)	Voltage (V)	References
Top hood with fan and cover	5.8	570	115	NSYCVF570M115MF
Top hood with fan and cover	5.8	575	230	NSYCVF575M230MF

Fan Motor



NSYCVF156M230



NSYCVF156M115

- Turbine-type fan motor for airing/extraction.

Characteristics	Flow rate (m³/h)	Voltage (V/Hz)	Absorbed power (W)	Noise level (dB)	External dimensions (mm)	References
Fan motor	156	230/50-60	17/15	42	120 x 120 x 38	NSYCVF156M230
Fan motor	156	115/50-60	17/15	42	120 x 120 x 38	NSYCVF156M115
Fan motor	35	230/50-60	16/14	32	80 x 80 x 25	NSYCVF35M230
Fan motor	35	115/50-60	16/14	32	80 x 80 x 25	NSYCVF35M115

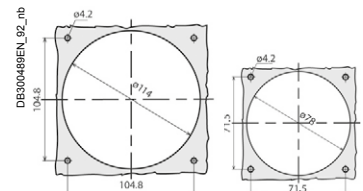

Fan Accessories

Outlet Grille

- Outlet filter kit for enclosure airing.
- For coupling to fans use **NSYCVF156M●●●** and **NSYCVF35M●●●**.



NSYCAG114LPF

Characteristics	External dimensions (mm)	References
Outlet grille	120 x 120 x 38	NSYCAG114LPF
Outlet grille	80 x 80 x 25	NSYCAG78LPF

Rear Protective Grille

- Protective grille for enclosure fan motor
- For coupling to fans use **NSYCVF156M●●●** and **NSYCVF35M●●●**.

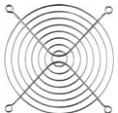

NSYCVA114M



NSYCVA78M

Characteristics	External dimensions (mm)	References
Rear protective grille	120 x 120 x 38	NSYCVA114M
Rear protective grille	80 x 80 x 25	NSYCVA78M

Fan Connection Cable

- For coupling to the connection terminal of the fan motors.



NSYCVAC100

Characteristics	References
Fan connection cable, length = 1 m	NSYCVAC100

Air Circulation for Internal Forced Convection

Circulation Fan

User protection according to DIN 31001.

Dimensions:

- Fan: 119 x 119 x 38 mm.
- Collar: Length: 140 mm; Fixing center-to-center distance: 130 mm.
- Motor mounted on ball bearing

Comment:

⁽¹⁾ Free flow.



NSYCVF170M115

Characteristics	Flow rate (m³/h) ⁽¹⁾	Voltage (V)	Weight. (kg)	P (W)	dB (A)	References
Circulation fan	170	115	0.82	17	41	NSYCVF170M115
Circulation fan	170	230	0.82	17	41	NSYCVF170M230

Tangential Fan, 19" 2 U

- Air is sucked in from the front, filtered and forced vertically through the equipment.

Comment:

⁽¹⁾ Flow rate measured without counter-pressure.

Supply:

Delivered with fixings and connection terminal block.



NSYAVG2U300

Characteristics	Flow rate (m³/h) ⁽¹⁾	Voltage (V)	P (W)	References
Tangential fan, 19" 2 U	300	230 (50-60 Hz)	37	NSYAVG2U300

- Increases the speed of upward air flow, in particular between trays with cards.
- Frontal operation LED.
- It is advisable to install slides, ref. **NSYGB140** to guarantee optimal support of the fan.

Comment:

Flow rate measured without counter-pressure. ⁽¹⁾ Direct current.

Supply:

Delivered without connection cord



NSYAVD1U480

Characteristics	Flow rate (m³/h)	Voltage (V)	No.	Weight. (kg)	P (W)	I (mA)	dB (A)	Depth (mm)	References
Circulation fan, 19" 1 U D210	486	230	3	3.3	45	300	43	208	NSYAVD1U480



NSYAVD1U970

Technical changes reserved. Information provided without guarantee. Images are for illustrative purposes only.

Smart Airing Systems

Fan 38 m³/h

Comment: Adding the Dust Sensor will decrease the flow rate by nearly 10%.



★ Warning: The fan NSYCVF38M230DG and NSYCVF38M115DG and NSYCVF38M230PF MUST NOT be connected to a power conversion module, an inverter or UPS!

Flow Curves

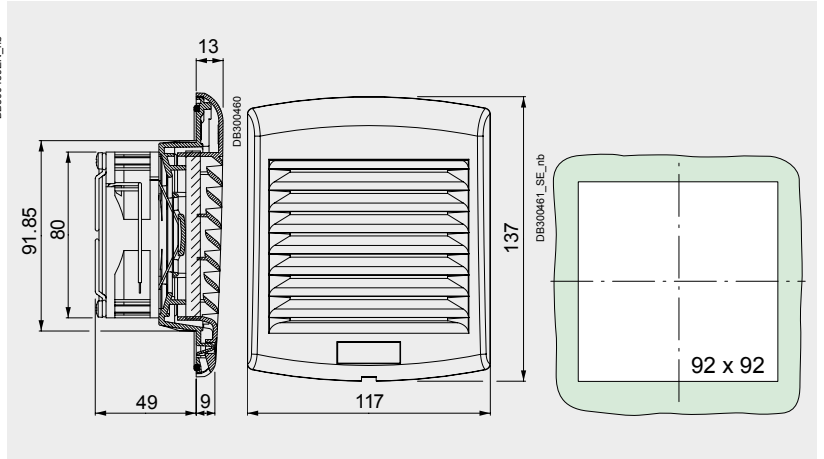
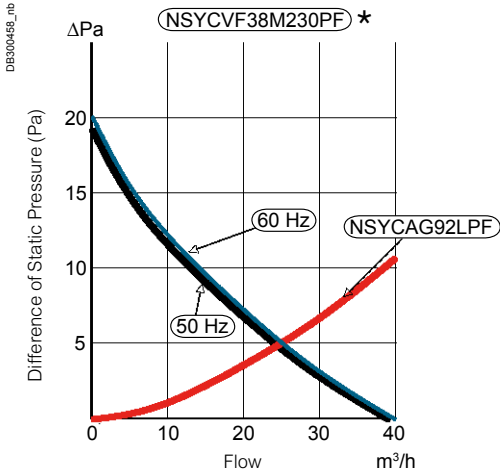

Fan 85 m³/h

Comment: Adding the Dust Sensor will decrease the flow rate by nearly 5%.

Flow Curves

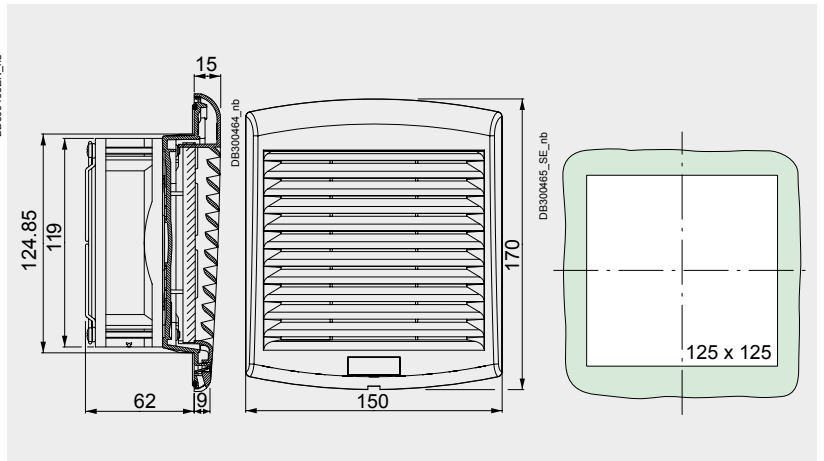
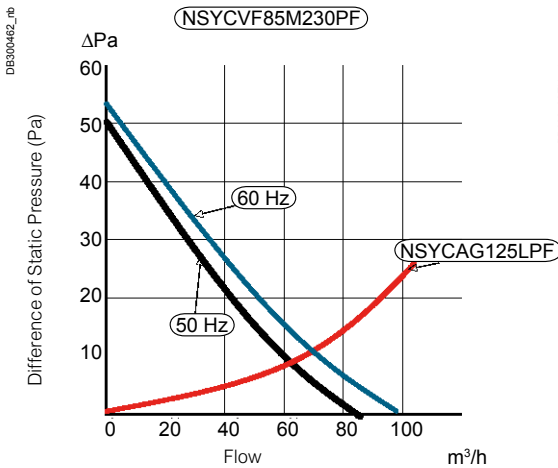

Fan 165 m³/h

Comment: Adding the Dust Sensor will decrease the flow rate by nearly 5%.

Flow Curves

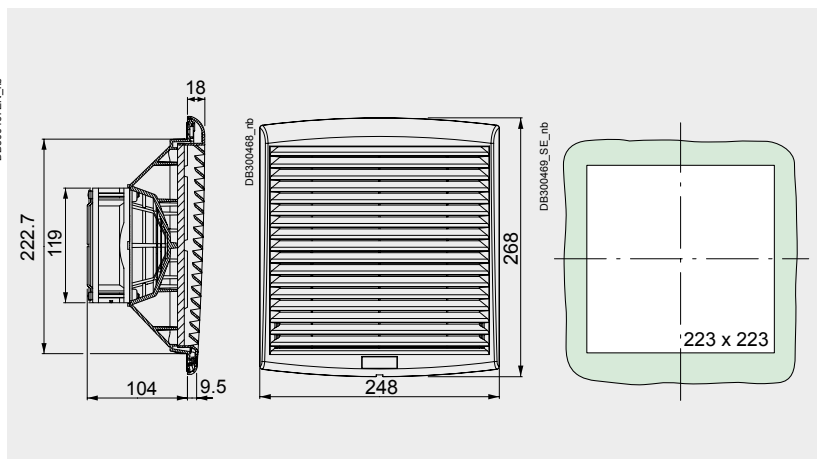
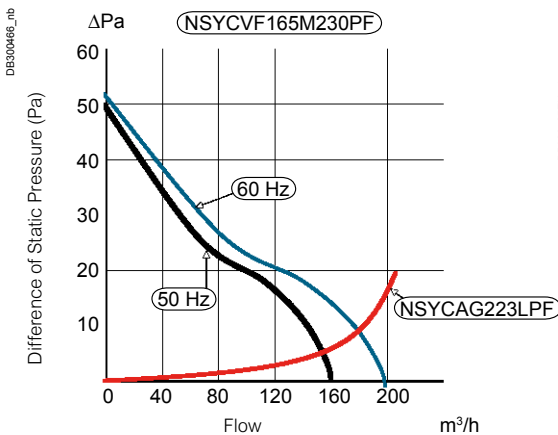

14
CV

Smart Airing Systems

Fan 300 m³/h

Comment: Adding the Dust Sensor will decrease the flow rate by nearly 5%.

Flow Curves

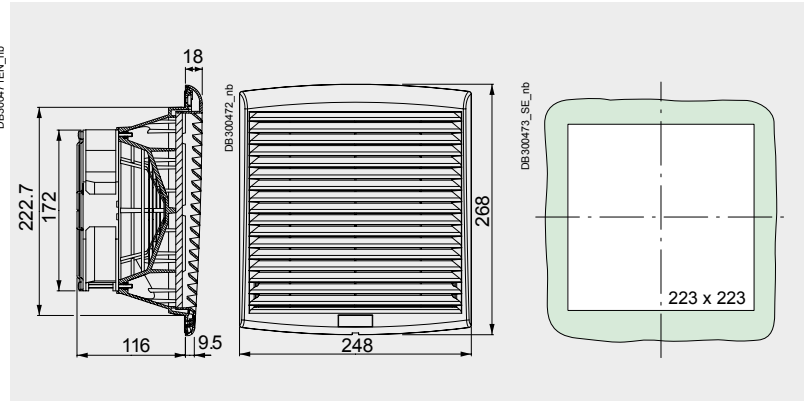
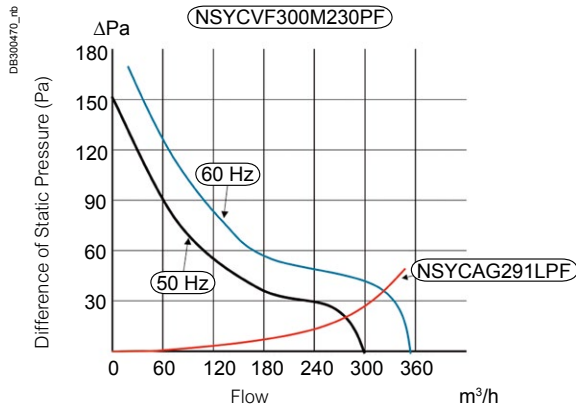

Fan 560-850 m³/h

Comment: Adding the Dust Sensor will decrease the flow rate by nearly 5%.

Flow Curves

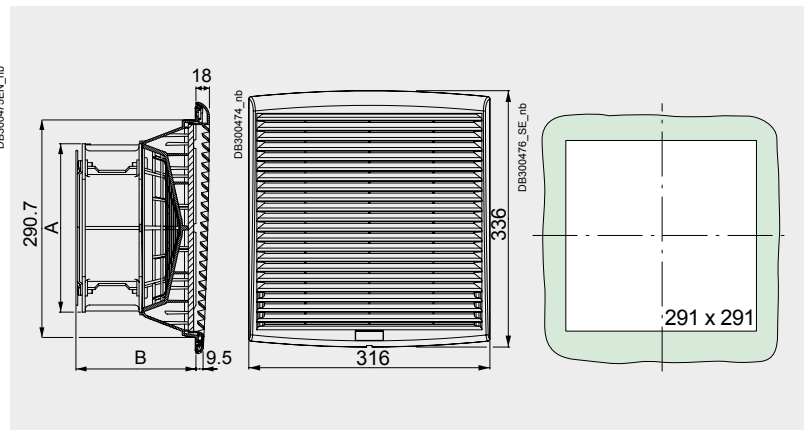
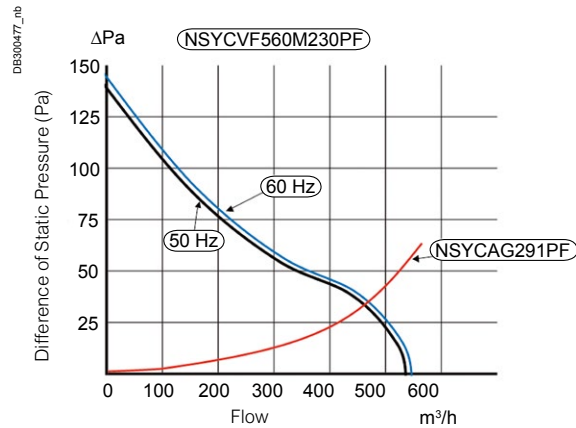

Flow Curves

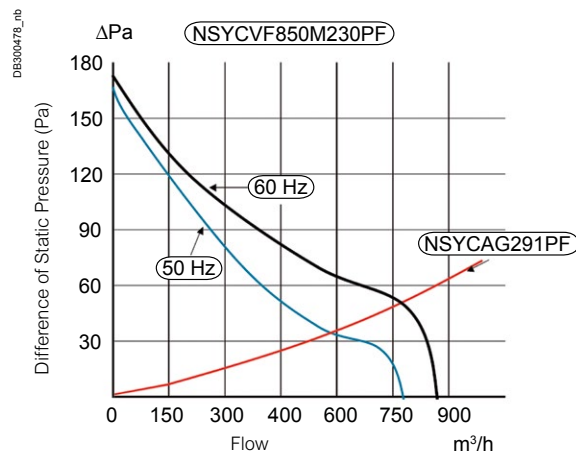

References	A	B
NSYCVF560M230PF	225	160.5
NSYCVF560M115PF	225	160.5
NSYCVF850M230PF	280	162
NSYCVF850M115PF	280	162

Metal Louvre Plate, Rectangular

- Material: Steel
- Structured finish, epoxy polyester painting, RAL 7035 gray
- Ingress protection rating (according to IEC 60529): IP20
- Installation: On the sides of the enclosure. Fixing by screws.

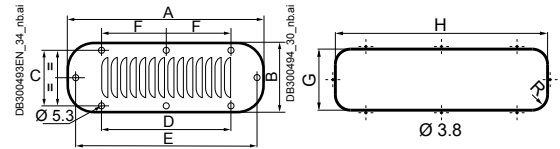

Supply:
One metal louvre and fixing elements



NSYCAG110X46M

Characteristics	A (mm)	B (mm)	C (mm)	D (mm)	E (mm)	F (mm)	G (mm)	H (mm)	R (mm)	References
Metal louvre plate, rectangular	144	62	36	110	-	-	94	46	10	NSYCAG110X46M
Metal louvre plate, rectangular	208	90	72	94	190	-	62	180	18	NSYCAG180X62M
Metal louvre plate, rectangular	244	90	72	130	226	-	62	216	18	NSYCAG216X62M
Metal louvre plate, rectangular	345	118	100	231	327	115.5	90.5	317	30	NSYCAG317X91M
Metal louvre plate, rectangular	345	148	130	231	327	115.5	120	317	30	NSYCAG317X120M
Metal louvre plate, rectangular	445	148	130	267	427	148.5	120	417	30	NSYCAG417X120M

Metal Louvre Plate, Square

- Ingress protection rating (according to IEC 60529): IP23

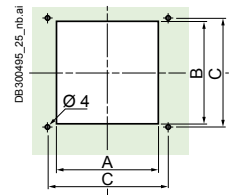

Supply:
One metal louvre



NSYCAG104X95LM

Characteristics	Dimensions (mm)	A (mm)	B (mm)	C (mm)	Slot width (mm)	No. of slots	References
Metal louvre plate, square	120 x 120	95	90	104.8	90	5	NSYCAG104X95LM
Metal louvre plate, square	160 x 160	110	130	140	100	5	NSYCAG130X110LM
Metal louvre plate, square	220 x 220	190	170	200	180	5	NSYCAG170X190LM

Anti-Insect Filters for Metal Louvre Plate, Square

- Material: Stainless-steel 304L Ø 0.32 mm wire mesh, 1.07 mm, thickness 0.6 mm
- Ingress protection rating (according to IEC 60529): IP33
- Installation: Between the enclosure and the metal louvre

Supply:
One anti-insect filter



NSYCAF104X95X

Characteristics	External dimensions (mm)	Weight	References
Anti-insect filters for metal louvre plate, square	98 x 115	0.8 kg/m ²	NSYCAF104X95X
Anti-insect filters for metal louvre plate, square	133 x 158	0.8 kg/m ²	NSYCAF130X110X
Anti-insect filters for metal louvre plate, square	197 x 215	0.8 kg/m ²	NSYCAF170X190X

Roof Elevators

Allow the roof to be raised, providing natural airing.

- Material: Zinc-coated steel
- They are screwed onto the structure of SF enclosures at the roof fixing points

Supply:
4 elevators



NSYRE26

Characteristics	Top elevation (mm)	References
Roof elevators	26	NSYRE26
Roof elevators	60	NSYRE60

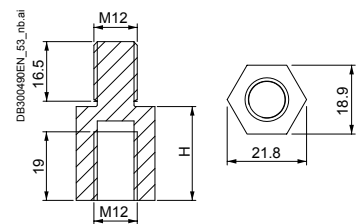

Hood for Natural Airing



NSYCAC228RMF

Natural airing device for coupling to the top of metal floor-standing enclosures. Solution for combination with the airing slots.

- Material: Steel
- Finish: Structured finish, epoxy polyester painting, RAL 7035 gray
- Ingress protection rating (according to IEC 60529): IP54
- Installation: Fixing to the top by means of caged nuts and special screws

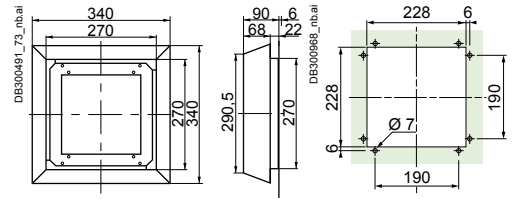

Supply:

1 hood for natural airing and fixing elements

Characteristics	Weight	References
Hood for natural airing	4.6 (kg)	NSYCAC228RMF
Spare filter	-	NSYCAF228R

Plastic Airing Louvres

Four models available according to IP rating, in vertical position.



NSYCAG45LP

NSYCAG35LP

NSYCAG38LP

NSYCAG33LP

NSYCAG19LP

Characteristics	Ingress protection rating	Cut-out Ø (mm)	References
Plastic airing louvres	IP22	45.5	NSYCAG45LP
Plastic airing louvres	IP30/44	35	NSYCAG35LP
Plastic airing louvres	IP45	38	NSYCAG38LP
Plastic airing louvres	IP44	33	NSYCAG33LP
	IP45	19	NSYCAG19LP

Supply:

References by unit. Order by multiples of 2 units (2, 4, 6, etc)

Sealed pressure balance valve

Controls the pressure to avoid condensation following internal temperature increase.

- Material: PA6-V2, acrylic co-polymer membrane, water- and oil-repelling
- Ingress protection rating: IP68
- Permeability: Air flow under $\Delta P = 0.7$ bar



NSYCAG12LPH2

Characteristics	Cut-out Ø (mm)	Permeability	Pressure difference	Minor pack.	References
Sealed pressure balance valve	M12	16 litres/h	$\Delta P < 1$ bar	10	NSYCAG12LPH1
Sealed pressure balance valve	M12	120 litres/h	$\Delta P < 0.1$ bar	10	NSYCAG12LPH2

Choose air-to-air exchangers to take advantage of cooler ambient temperatures, such as in food and beverage plants, to evacuate large amounts of heat while retaining the independence of the internal and external air circuits.



Air-to-Air Exchangers: A New Range Energy Efficient



Higher Efficiency through Improved Design

- With an updated external grill design, and by positioning cooling closer to critical equipment, such as speed drives, ClimaSys now provides better flow, better cooling, and higher energy efficiency.



Protection

- All side-mounted models are IP55 internally according to EN 60529.



Faster Installation

- A number of design improvements reduce installation time. Mounting requires single cut-outs and a minimum of screws. Wiring is accomplished with smart interconnects.



New Certifications and Declarations

- CE
- EAC



Simplicity Saves You Time

- Our free ProClima thermal calculation software makes specification simple and fast. A new thermal solutions module integrates calculation for cooling and control devices, helping you maximize the energy efficiency of your systems.

Air-to-Air Exchangers, Side-Mounted Models



Characteristics	Side-mounted models			
	<ul style="list-style-type: none"> The air-to-air exchanger can be used in heavily polluted environments provided that the ambient temperature is at least 10 °C lower than the internal temperature wanted. Main components: Thermostat adjustment system, exchanger cassette, fans for internal and external circuits of the enclosure. 			
Material	Painted zinc-coated steel			
Color	RAL 7035 gray			
Ingress protection rating (according to IEC 60529)	IP55			
Certifications and declarations	CE, EAC			
Installation	Indoor. For outdoor applications or other surface finishes please consult us.			
Cooling characteristics				
Specific power	22 W/K	36 W/K	50 W/K	80 W/K
Air flow of the internal circuit (enclosure)	280 m³/h	570 m³/h	600 m³/h	1050 m³/h
Air flow of the external circuit (ambient)	280 m³/h	570 m³/h	600 m³/h	1050 m³/h
Thermostat type	-	Mechanical	Mechanical	Mechanical
Temperature setting range	-	+5 ... +60 °C	+5 ... +60 °C	+5 ... +60 °C
Temperature range of external circuit (ambient)	-5 ... +55 °C	-5 ... +55 °C	-5 ... +55 °C	-5 ... +55 °C
Type of fluid	Air	Air	Air	Air
Electric characteristics				
Input voltage	1 x 230 V / 50-60 Hz	1 x 230 V / 50-60 Hz	1 x 230 V / 50-60 Hz	1 x 230 V / 50-60 Hz
Rated current	0.5 A	0.7 A	0.7 A	1.1 A
Power consumption	72 W	160 W	160 W	240 W
Thermal protection recommended (fuse)	T1 A	T1 A	T1 A	T2 A
Physical characteristics				
External dimensions (H x W x D)	413 x 189 x 149 mm	771 x 316 x 103 mm	771 x 316 x 103 mm	1260 x 317 x 148 mm
Protection degree IP internal /external (according to IEC 60529)	IP55 / IP22	IP55 / IP22	IP55 / IP22	IP55 / IP22
Noise level	59 dB	62 dB	62 dB	64 dB
Weight of unit	7 kg	10 kg	10 kg	17 kg
References	NSYCEA22E	NSYCEA36	NSYCEA50	NSYCEA80

Choose air-to-water exchangers for especially difficult environments where there is no external air circuit available but a stable cold-water circuit can be supplied.



Air-to-Water Exchangers: For Highly Polluted Environments

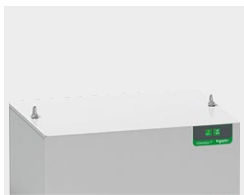

Many Mounting Options Give You the Right Fit

- Air-to-water exchangers offer roof and side-mounted options.



Certifications and Declarations

- CE
- EAC

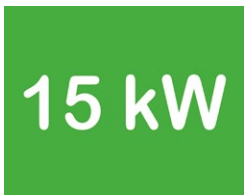

Extended Ratings to Meet Any Challenge

- Provide options for up to 15 kW of cooling power, among the world's highest power ratings for air-to-water exchangers.



Protection

- All side-mounted models are IP55-protected internally and externally according EN 60529. Top-mounted models are IP54.



New Material Options Adapt to Any Application

- Air-to-water exchangers can be provided in the same material as electrical enclosures (for example stainless-steel) for a homogeneous appearance and thermal performance.

Air-to-Water Exchangers, Side-Mounted Models



Characteristics		Side-mounted models				
		<ul style="list-style-type: none"> Main components: Thermostat adjustment system, Exchange cassette, fans for internal circuits of the enclosure, protection device against possible leaks. Eyebolts included in all models. 				
Material	RAL 7035 gray painted zinc-coated steel or stainless-steel					
Ingress protection rating (according to IEC 60529)	IP55					
Certifications and declarations	<ul style="list-style-type: none"> CE declaration UL (only references ending with UL) EAC 					
Installation	Indoor. For outdoor applications or other surface finishes please consult us.					
Cooling characteristics						
Cooling power W10A35	1000 W	1750 W	2500 W	3500 W	4500 W	
Hydraulic circuit maximum pressure	5 bar	5 bar	5 bar	5 bar	5 bar	
Internal airflow	330 m³/h	570 m³/h	860 m³/h	1050 m³/h	1450 m³/h	
Thermostat type	Mechanical	Mechanical	Mechanical	Mechanical	Mechanical	
Temperature setting range	+20 ... +46 °C	+20 ... +46 °C	+20 ... +46 °C	+20 ... +46 °C	+20 ... +46 °C	
Temperature range of external circuit (ambient)	+1 ... +70 °C	+1 ... +70 °C	+1 ... +70 °C	+1 ... +70 °C	+1 ... +70 °C	
Type of fluid	Filtered water or glycolised water	Filtered water or glycolised water	Filtered water or glycolised water	Filtered water or glycolised water	Filtered water or glycolised water	
Water flow	150 l/h	150 l/h	500 l/h	500 l/h	500 l/h	
Pressure drop	0.1 bar	0.1 bar	0.3 bar	0.2 bar	0.2 bar	
Hydraulic connection	3/8" G	1/2" G	1/2" G	1/2" G	1/2" G	
Electric characteristics						
Input voltage	1 x 230 V / 50-60 Hz*	1 x 230 V / 50-60 Hz*	1 x 230 V / 50-60 Hz*	1 x 230 V / 50-60 Hz*	1 x 230 V / 50-60 Hz*	
Rated Intensity	0.17 A	0.36 A	0.33 A	0.55 A	0.71 A	
Power consumption absorbed W10A35	29 W	75 W	80 W	130 W	160 W	
Thermal protection recommended (fuse)	T2 A	T2 A	T2 A	T2 A	T2 A	
Physical characteristics						
External dimensions (H x W x D)	450 x 310 x 115 mm	901 x 398 x 137 mm	901 x 398 x 137 mm	1148 x 398 x 163 mm	1148 x 398 x 163 mm	
Protection degree IP internal / external (according to IEC 60529)	IP55 / IP55	IP55 / IP55	IP55 / IP55	IP55 / IP55	IP55 / IP55	
Noise level	55 dB (A)	58 dB (A)	58 dB (A)	64 dB (A)	69 dB (A)	
Weight of unit	12 kg	18 kg	19 kg	29 kg	30 kg	
References						
Steel	NSYCEW1K	NSYCEW1K8	NSYCEW2K5	NSYCEW3K5	NSYCEW4K5	
Stainless-steel	NSYCEWX1K	NSYCEWX1K8	NSYCEWX2K5	-	-	

Technical changes reserved. Information provided without guarantee. Images are for illustrative purposes only.

Side-Mounting Model



Top Mounting Model

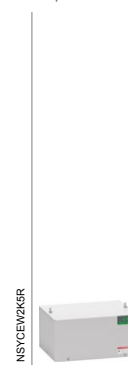

Characteristics	Side-mounted models		Top mounting model
	<ul style="list-style-type: none"> Main components: Thermostat adjustment system, Exchange cassette, fans for internal circuits of the enclosure, protection device against possible leaks. Eyebolts included in all models. 		
Material	RAL 7035 gray painted zinc-coated steel or stainless-steel		
Ingress protection rating (according to IEC 60529)	IP55		IP54
Certifications and declarations	<ul style="list-style-type: none"> CE declaration UL (only references ending with UL) EAC 		
Installation	Indoor. For outdoor applications or other surface finishes please consult us.		
Cooling characteristics			
Cooling power W10A35	6000 W	6000 W	2500 W
Hydraulic circuit maximum pressure	5 bar	8 bar	5 bar
Internal airflow	1450 m³/h	1450 m³/h	750 m³/h
Thermostat type	Mechanical	Mechanical	Mechanical
Temperature setting range	+20 ... +46 °C	+20 ... +46 °C	+20 ... +46 °C
Temperature range of external circuit (ambient)	+1 ... +70 °C	+1 ... +70 °C	+1 ... +70 °C
Type of fluid	Filtered water or glycolised water	Filtered water or glycolised water	Filtered water or glycolised water
Water flow	800 l/h	800 l/h	500 l/h
Pressure drop	0.5 bar	0.5 bar	0.3 bar
Hydraulic connection	1/2" G	1/2" G	1/2" G
Electric characteristics			
Input voltage	1 x 230 V / 50-60 Hz*	2 x 400-440 V / 50-60 Hz	1 x 230 V / 50-60 Hz
Rated Intensity	0.71 A	0.4 A	0.30 A
Power consumption absorbed W10A35	160 W	170 W	65 W
Thermal protection recommended (fuse)	T2 A	T1 A	T2 A
Physical characteristics			
External dimensions (H x W x D)	1500 x 450 x 163 mm	1500 x 450 x 163 mm	270 x 400 x 542 mm
Protection degree IP internal / external (according to IEC 60529)	IP55 / IP55	IP55 / IP55	IP54 / IP55
Noise level	69 dB (A)	69 dB (A)	58 dB (A)
Weight of unit	40 kg	42 kg	19 kg
References			
Steel	NSYCEW6K	NSYCEW6K2P4	NSYCEW2K5R

Accessories

PB502593_20_nb



References	Air-to-air and air-to-water exchangers CE Steel
Air- air exchangers	
Side-mounted models	NSYCEA36 NSYCEA50 NSYCEA80
Air-to-water exchangers	
Side-mounted models	NSYCEW1K NSYCEW1K8 NSYCEW2K5 NSYCEW3K5 NSYCEW4K5 NSYCEW6K NSYCEW6K2P4
Top-mounted model	NSYCEW2K5R

Air-to-Air Exchangers, Side-Mounted Models

NSYCEA22E

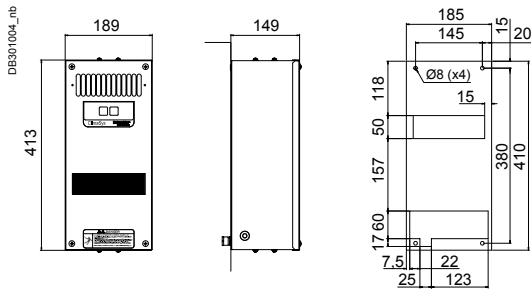

NSYCEA36 / NSYCEA50

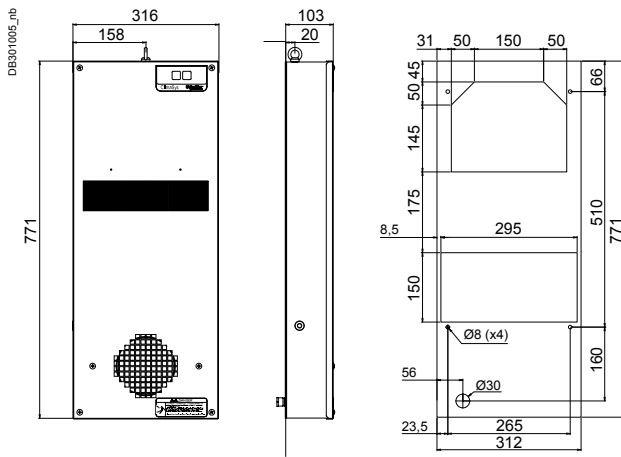

NSYCEA80

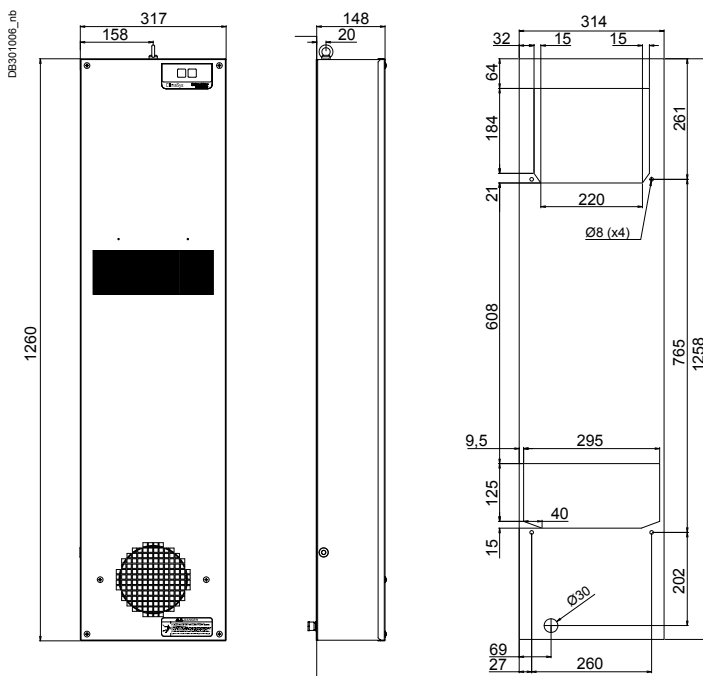

Air-to-Water Exchangers, Side-Mounted Models

Performance Curves

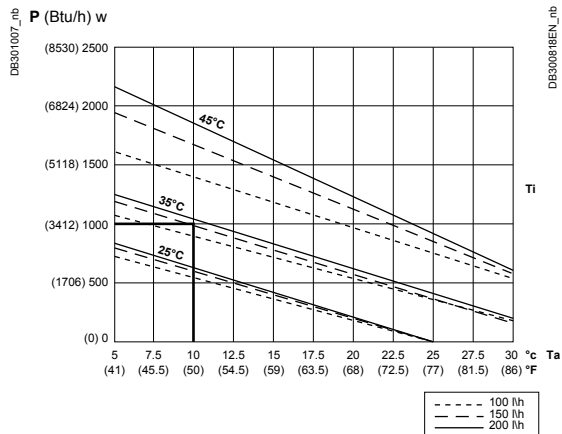

NSYCEW●●1K●●

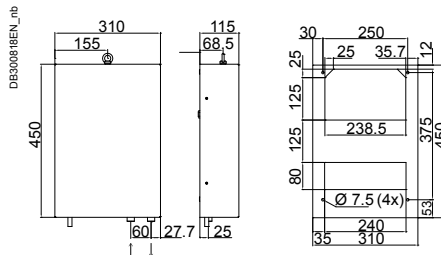

Performance Curves

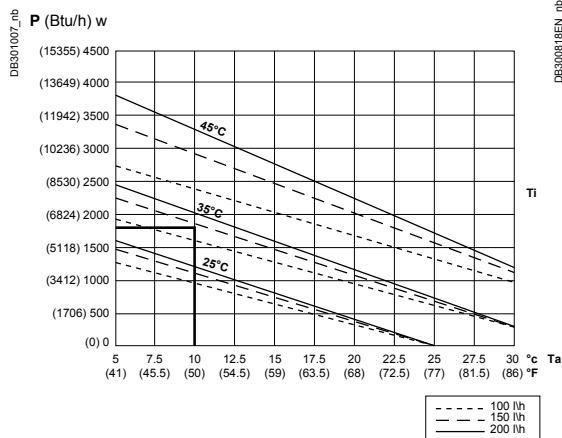

NSYCEW●●1K8●● - NSYCEW●●2K5●●

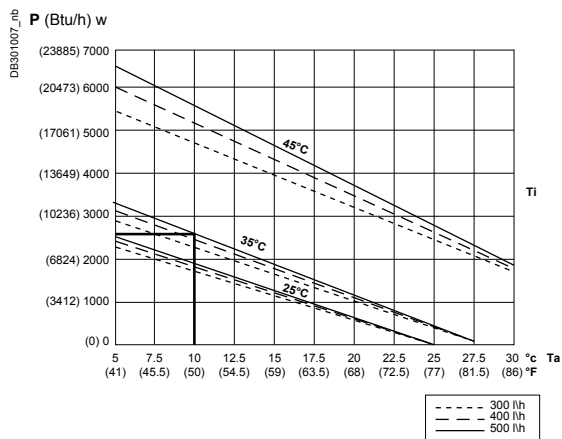
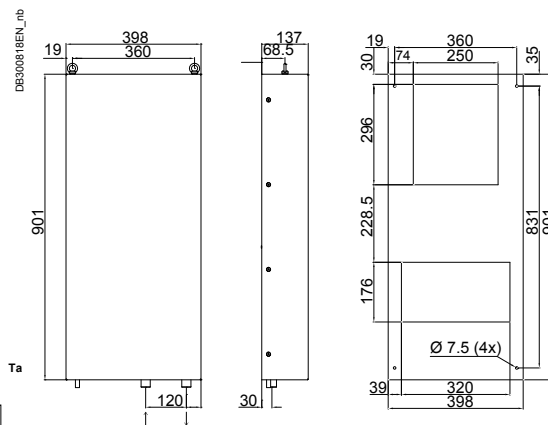

P = Cooling power
Ta = Inlet water temperature
Ti = Target internal temperature of the enclosure

Technical changes reserved. Information provided without guarantee. Images are for illustrative purposes only.

Air-to-Water Exchangers, Side-Mounted Models

Performance Curves

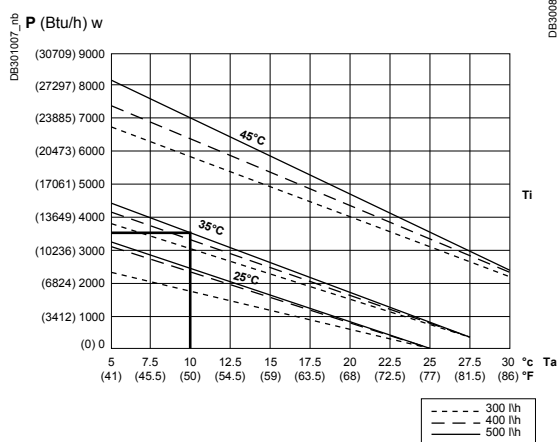

NSYCEW●●3K5●● - NSYCEW●●4K5●●

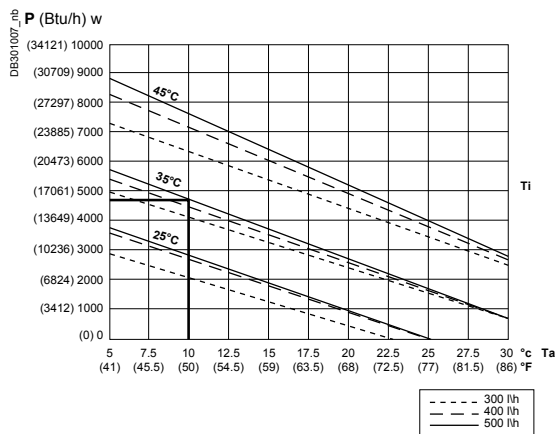
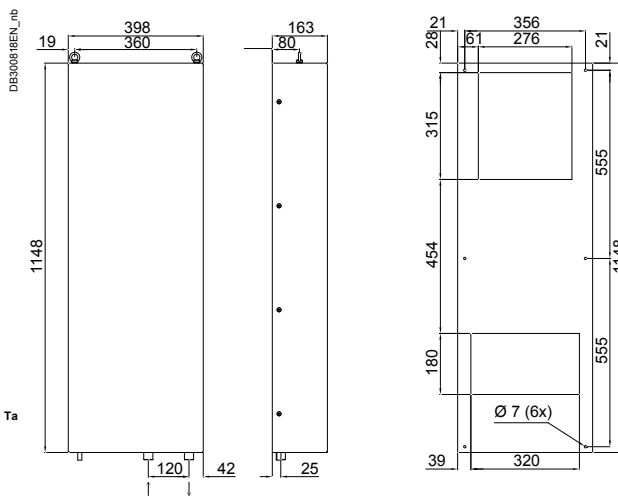

NSYCEW●●6K●●

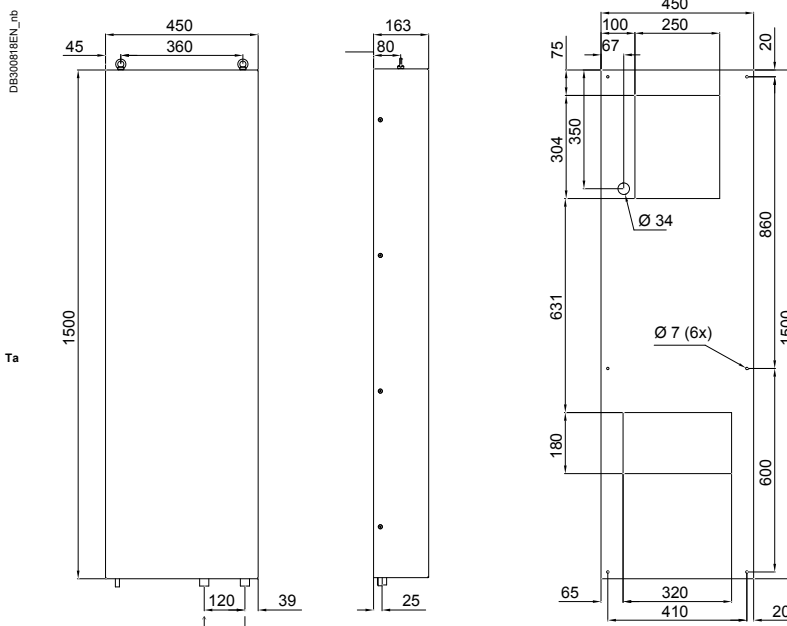

Performance Curves

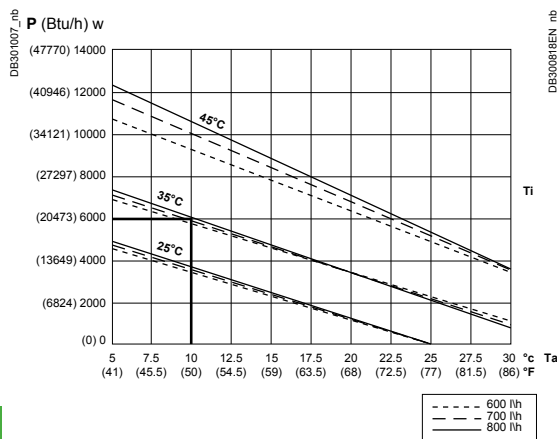

14
CE

P = Cooling power
Ta = Inlet water temperature
Ti = Desired internal temperature of the enclosure

Technical changes reserved. Information provided without guarantee. Images are for illustrative purposes only.

Air-to-Water Exchangers, Side-Mounted Models

Performance Curves

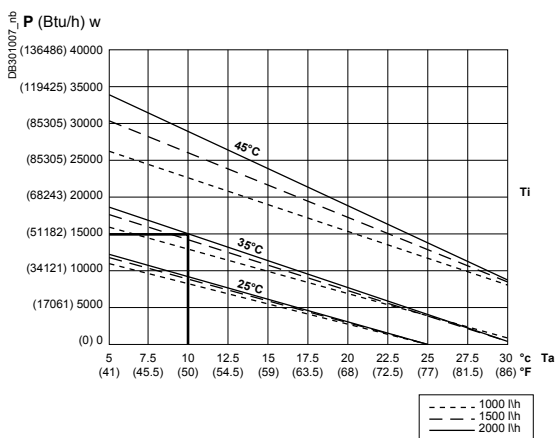
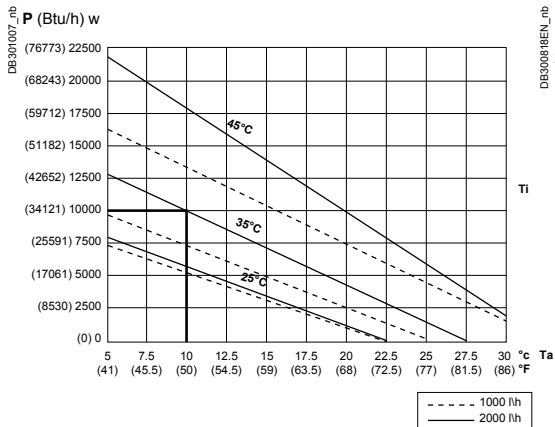

NSYCEW●●3K5●● - NSYCEW●●4K5●●

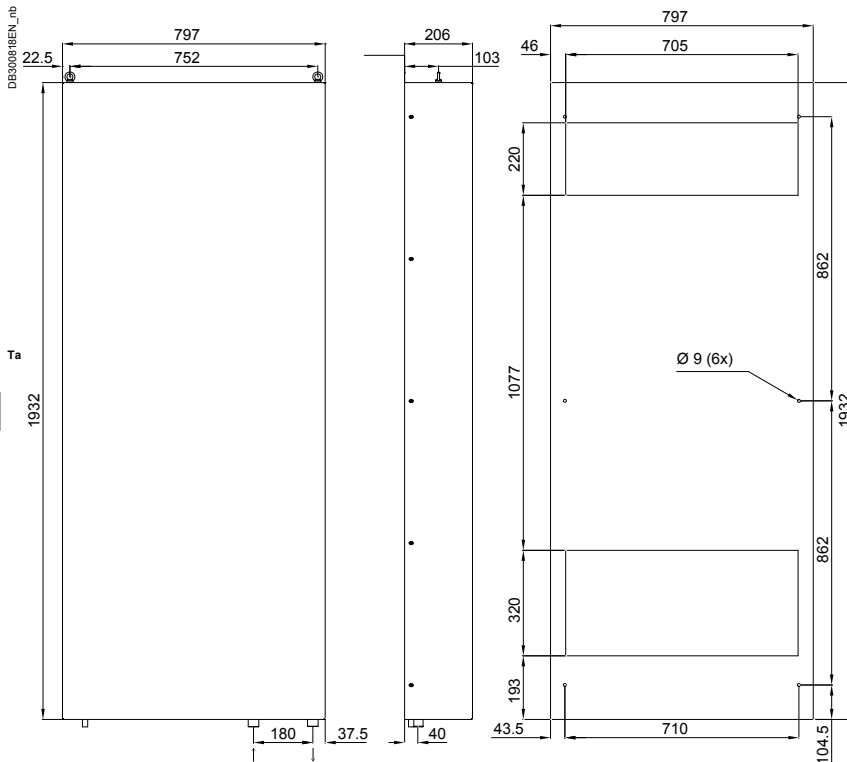

Performance Curves

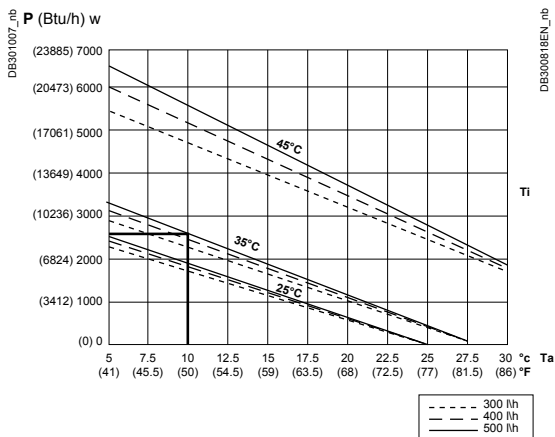

NSYCEW●●6K●●

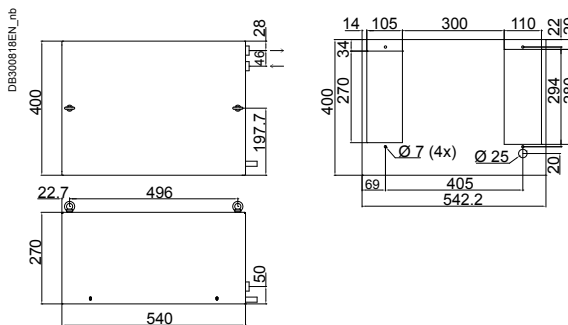

P = Cooling power
 Ta = Inlet water temperature
 Ti = Desired internal temperature of the enclosure

Technical changes reserved. Information provided without guarantee. Images are for illustrative purposes only.



14
CU

Technical changes reserved. Information provided without guarantee. Images are for illustrative purposes only.

This range of Cooling units is the ideal solution for electrical cabinets with :

- High power dissipation generated inside (ex.: VSD - Variable Speed Drive),
- High ambient temperature or humidity (ex.: Steel industry, Specific geographical location),
- Environmental dust or pollution (to avoid air flow from ambient to internal atmosphere).

The unit's integrated alarm and communication system keeps you informed about the operating status of your cooling systems and any temperature conditions.



RELIABILITY FOR GREATER PEACE OF MIND



Connectivity New

- Remote visibility for alarms, operating status, and setting data
- Native feature with no specific option / configuration to be defined



Certificates and Declarations

- Cooling capacity compliant with EN14511 (L35L35 and L35L50)
- Dual compliance with IEC and UL
- Cybersecurity certified according with IEC62443

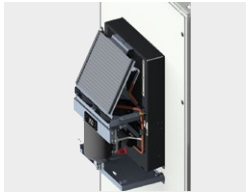

Hardware Features

- IP55 for all side cooling units
- Ambient temperature up to 55 °C
- Optimized condensation water management with no clogging pipe solution
- Top of the art components from the automotive industry: Rotary compressors, micro-channel condenser heat exchanger



Redundancy Modes for Critical Applications

- 3 redundant mode options: serial, back-up, sequential
- Native feature



Robust Design in Every Situation

- Indoor and outdoor
- Side and roof
- Steel / Stainless Steel

EFFICIENCY FOR EASIER PRODUCT SELECTION AND QUICKER MOUNTING



Product Selection

Easy, optimized product selection with "ProClima Web" combined with SEE Electrical

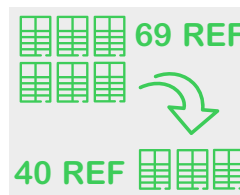

Offer Portfolio

- All cooling unit functions in 40 references
- Possible customization if required
- 3 mounting options for the Side Indoor Cooling Units: Surface, Half-flush, Flush



Mounting and Cabling

- Small sizes Cooling Unit
- Mounting bracket and lifting eyebolts
- 4 independent connectors (Power supply, Signal and Alarm, Modbus, Synchronization)



Simplicity

- Roof screw fixing from inside (by default) or from outside if required
- Retrofit kits available when required
- Schneider EcoStruxure integration in edge software and cloud advisors

SUSTAINABILITY



Qualification

- Green premium qualification
- Compliant with RoHS and REACH regulation
- Product Environmental Profile available



Sustainability Features

- Unique combination of optimized Energy Efficiency Ratio and reduced sizes and weight
- Less refrigerant gas per cooling unit -40%
- Lighter Instruction Sheet with digital link to user manual

Side Cooling Units



Characteristics		Side-mounted models			
		<ul style="list-style-type: none"> Alarm, operation and setting info available remotely and locally Simple, open and easy, native connectivity with Modbus RTU communication Electronic thermostat with touch screen display Alarm signal for door contact included in all References Internal IP55 Passive water condensate evaporator for all Side Cooling Units strictly above 800 W Unique combination of optimized Energy Efficiency Ratio and reduced sizes and weight Easy product selection with ProClima Web associated with SEE Electrical Filter recommendation: <ul style="list-style-type: none"> Office environment (no dust, no grease) : filter free, Industrial environment (dust, grease, not explosive) : G3 fiber filter is recommended, Indoor CU are delivered without any filter by default. 			
Material	Galvanized steel painted in gray RAL 7035 or stainless-steel				
Certifications and declarations	CE and UL Registered (for all references)				
Installation	Indoor				
Cooling characteristics					
Cooling power L35-L35 according to EN 14511	350 W	650 W	900 W	900 W	
Cooling power L35-L50 according to EN 14511	186 W	500 W	700 W	700 W	
Air flow of the internal circuit	117 m³/h	117 m³/h	550 m³/h	550 m³/h	
Air flow of the external circuit	166 m³/h	174 m³/h	850 m³/h	850 m³/h	
Thermostat type	Electronic	Electronic	Electronic	Electronic	
Temperature range of circuit	+20... +50 °C	+20... +50 °C	+20... +50 °C	+20... +50 °C	
Maximum outside temperature	+55 °C	+55 °C	+55 °C	+55 °C	
Temperature range of external circuit	+5... +55 °C	+5... +55 °C	+5... +55 °C	+5... +55 °C	
Type of cooling gas	R134a	R134a	R134a	R134a	
Cooling gas weight	0.126 kg	0.110 kg	0.120 kg	0.120 kg	
Maximum pressure of cooling circuit	28 bar	28 bar	28 bar	28 bar	
External filter	Optional, see page 620	Optional, see page 620	Optional, see page 620	Optional, see page 620	
Electric characteristics					
Input voltage	1 x 230 V / 50-60 Hz	1 x 230 V / 50-60 Hz	1 x 230 V / 50-60 Hz	2 x 400-460 V / 50-60 Hz	
Starting / rated current	3.8 A / 1.4 A	6 A / 2.3 A	6 A / 3 A	4 A / 2 A	
Power consumption L35-L35 according to EN 14511	240 W	350 W	480 W	500 W	
Power consumption L35-L50 according to EN 14511	270 W	410 W	530 W	530 W	
Energy efficiency ratio L35-L35 according to EN 14511	1.4	1.8	1.8	1.8	
Thermal protection recommended (circuit breaker)	M9F22116	M9F22116	M9F22116	M9F22116	
Thermal protection recommended (fuse)	T15 A	T15 A	T15 A	T15 A	
Physical characteristics					
External dimensions (H x W x D)	460 x 290 x 190 mm	460 x 290 x 190 mm	780 x 345 x 215 mm	780 x 345 x 215 mm	
Protection degree IP internal/external according to IEC	IP55 / IP24	IP55 / IP24	IP55 / IP24	IP55 / IP24	
Noise level	55 dB	55 dB	70 dB	70 dB	
Weight of Unit	11.7 kg	11.7 kg	22.4 kg	27.4 kg	
References					
Steel	NSYCU350DG	NSYCU600DG	NSYCU800DG	NSYCU800P4DG	
Stainless Steel	NSYCUX350DG	NSYCUX600DG	-	-	



1000 W	1000 W	1200 W	1200 W	1650 W	1650 W	2000 W
870 W	870 W	1050 W	1050 W	1400 W	1400 W	1900 W
550 m³/h	550 m³/h	850 m³/h	850 m³/h	850 m³/h	850 m³/h	850 m³/h
850 m³/h	850 m³/h	1200 m³/h	1200 m³/h	1200 m³/h	1200 m³/h	1200 m³/h
Electronic	Electronic	Electronic	Electronic	Electronic	Electronic	Electronic
+20... +50 °C	+20... +50 °C	+20... +50 °C	+20... +50 °C	+20... +50 °C	+20... +50 °C	+20... +50 °C
+55 °C	+55 °C	+55 °C	+55 °C	+55 °C	+55 °C	+55 °C
+5... +55 °C	+5... +55 °C	+5... +55 °C	+5... +55 °C	+5... +55 °C	+5... +55 °C	+5... +55 °C
R134a	R134a	R134a	R134a	R134a	R134a	R134a
0.145 kg	0.145 kg	0.255 kg	0.255 kg	0.323 kg	0.323 kg	0.410 kg
28 bar	28 bar	28 bar	28 bar	28 bar	28 bar	28 bar
Optional, see page 620	Optional, see page 620	Optional, see page 620	Optional, see page 620	Optional, see page 620	Optional, see page 620	Optional, see page 620
1 x 230 V / 50-60 Hz	2 x 400-460 V / 50-60 Hz	1 x 230 V / 50-60 Hz	2 x 400-460 V / 50-60 Hz	1 x 230 V / 50-60 Hz	2 x 400-460 V / 50-60 Hz	1 x 230 V / 50-60 Hz
6 A / 3 A	4 A / 2 A	16 A / 6 A	8 A / 2.8 A	16 A / 6 A	8 A / 2.8 A	22 A / 7.5 A
480 W	480 W	700 W	700 W	770 W	770 W	900 W
530 W	530 W	790 W	790 W	880 W	880 W	1100 W
2.1	2.1	1.8	1.8	2.2	2.2	2.2
M9F22116	M9F22216	M9F22116	M9F22216	M9F22116	M9F22216	M9F22116
T15 A	T15 A	T15 A	T15 A	T15 A	T15 A	T15 A
780 x 345 x 215 mm	780 x 345 x 215 mm	1000 x 405 x 225 mm	1000 x 405 x 225 mm	1000 x 405 x 225 mm	1000 x 405 x 225 mm	1000 x 405 x 225 mm
IP55 / IP24	IP55 / IP24	IP55 / IP24	IP55 / IP24	IP55 / IP24	IP55 / IP24	IP55 / IP24
70 dB	70 dB	72 dB	72 dB	72 dB	72 dB	72 dB
22.4 kg	27.4 kg	39 kg	44.5 kg	39 kg	44.5 kg	40.4 kg
NSYCU1KDG NSYCUX1KDG	NSYCU1K2P4DG NSYCUX1K2P4DG	NSYCU1K2DG -	NSYCU1K22P4DG -	NSYCU1K6DG NSYCUX1K6DG	NSYCU1K62P4DG -	NSYCU2KDG -

Side Cooling Units



Characteristics	Side-mounted models	
	<ul style="list-style-type: none"> • Alarm, operation and setting info available remotely and locally • Simple, open and easy, native connectivity with Modbus RTU communication • Electronic thermostat with touch screen display • Alarm signal for door contact included in all References • Internal IP55 • Passive water condensate evaporator for all Side Cooling Units strictly above 800 W • Unique combination of optimized Energy Efficiency Ratio and reduced sizes and weight • Easy product selection with ProClima Web associated with SEE Electrical • Filter recommendation: <ul style="list-style-type: none"> - Office environment (no dust, no grease) : filter free, - Industrial environment (dust, grease, not explosive) : G3 fiber filter is recommended, Indoor CU are delivered without any filter by default. 	
Material	Galvanized steel painted in gray RAL 7035 or stainless-steel	
Certifications and declarations	CE and UL Registered (for all references)	
Installation	Indoor	
Cooling characteristics		
Cooling power L35-L35 according to EN 14511	2000 W	3200 W
Cooling power L35-L50 according to EN 14511	1900 W	2600 W
Air flow of the internal circuit	850 m³/h	1200 m³/h
Air flow of the external circuit	1200 m³/h	1400 m³/h
Thermostat type	Electronic	Electronic
Temperature range of circuit	+20... +50 °C	+20... +50 °C
Maximum outside temperature	55 °C	55 °C
Temperature range of external circuit	+5... +55 °C	+5... +55 °C
Type of cooling gas	R134a	R134a
Cooling gas weight	0.390 kg	0.482 kg
Maximum pressure of cooling circuit	28 bar	32 bar
External filter	Optional, see page 620	Optional, see page 620
Electric characteristics		
Input voltage	3 x 400-460 V / 50-60 Hz	1 x 230 V / 50-60 Hz
Starting/rated current	13 A / 2.5 A	30 A / 9 A
Power consumption L35-L35 according to EN 14511	900 W	1200 W
Power consumption L35-L50 according to EN 14511	1000 W	1400 W
Energy efficiency ratio L35-L35 according to EN 14511	2.2	2.6
Thermal protection recommended (circuit breaker)	M9F22316	M9F22116
Thermal protection recommended (fuse)	T15 A	T15 A
Physical characteristics		
External dimensions (H x W x D)	1000 x 405 x 225 mm	1300 x 490 x 250 mm
Protection degree IP internal /external according to IEC 60529	IP55 / IP24	IP55 / IP24
Noise level	72 dB	72 dB
Weight of unit	40.4 kg	59.6 kg
References		
Steel	NSYCU2K3P4DG	NSYCU3K2DG
Stainless-steel	NSYCU2K3P4DG	-



NSYCU3K23P4DG_image

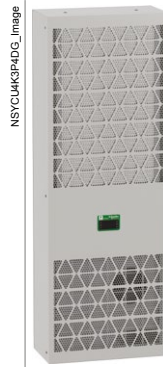

NSYCU4K3P4DG_image

3200 W	4000 W
2600 W	3200 W
1200 m³/h	1200 m³/h
1400 m³/h	1400 m³/h
Electronic	Electronic
+20... +50 °C	+20... +50 °C
55 °C	55 °C
+5... +55 °C	+5... +55 °C
R134a	R134a
0.482 kg	0.673 kg
32 bar	32 bar
Optional, see page 620	Optional, see page 620
3 x 400-460 V / 50-60 Hz	3 x 400-460 V / 50-60 Hz
20 A / 3.5 A	15 A / 5 A
1200 W	1700 W
1400 W	2800 W
2.6	2.3
M9F22316	M9F22316
T15 A	T15 A
1300 x 490 x 250 mm	1300 x 490 x 250 mm
IP55 / IP24	IP55 / IP24
72 dB	72 dB
59 kg	62.2 kg
NSYCU3K23P4DG	NSYCU4K3P4DG
-	-

Roof Cooling Units



Characteristics		Roof-mounted models			
		<ul style="list-style-type: none"> Alarm, operation and setting info available remotely and locally Simple, open and easy, native connectivity with Modbus RTU communication Electronic thermostat with touch screen display Alarm signal for door contact included in all References Passive water condensate evaporator for all Side Cooling Units strictly above 800 W Unique combination of optimized Energy Efficiency Ratio and reduced sizes and weight Easy product selection with ProClima Web associated with SEE Electrical Filter recommendation: <ul style="list-style-type: none"> Office environment (no dust, no grease) : filter free, Industrial environment (dust, grease, not explosive) : G3 fiber filter is recommended, Indoor CU are delivered without any filter by default. 			
Material	Galvanized steel painted in gray RAL 7035 or stainless-steel				
Certifications and declarations	CE and UL Registered (for all references)				
Installation	Indoor				
Cooling characteristics					
Cooling power L35-L35 according to EN 14511	650 W	850 W	850 W	1250 W	
Cooling power L35-L50 according to EN 14511	580 W	600 W	600 W	800 W	
Air flow of the internal circuit	180 m³/h	850 m³/h	850 m³/h	850 m³/h	
Air flow of the external circuit	408 m³/h	850 m³/h	850 m³/h	850 m³/h	
Thermostat type	Electronic		Electronic		Electronic
Temperature range of circuit	+20... +50 °C		+20... +50 °C		+20... +50 °C
Maximum outside temperature	55 °C		55 °C		55 °C
Temperature range of external circuit	5... +55 °C		5... +55 °C		5... +55 °C
Type of cooling gas	R134a		R134a		R134a
Cooling gas weight	0.120 kg		0.132 kg		0.156 kg
Maximum pressure of cooling circuit	28 bar		28 bar		32 bar
External filter	Optional, see page 620		Optional, see page 620		Optional, see page 620
Electric characteristics					
Input voltage	1 x 230 V / 50-60 Hz	1 x 230 V / 50-60Hz	2 x 400-460 V / 50-60 hz	1 x 230 V / 50-60Hz	
Starting/rated current	6 A / 2.2 A	6 A / 3 A	4 A / 1.9 A	16 A / 4.3 A	
Power consumption L35-L35 according to EN 14511	340 W	490 W	530 W	650 W	
Power consumption L35-L50 according to EN 14511	390 W	550 W	580 W	700 W	
Energy efficiency ratio L35-L35 according to EN 14511	1.9	1.7	1.6	1.9	
Thermal protection recommended (circuit breaker)	M9F22116	M9F22116	M9F22216	M9F22116	
Thermal protection recommended (fuse)	T15 A	T15 A	T15 A	T15 A	
Physical characteristics					
External dimensions (H x W x D)	368 x 400 x 325 mm	412 x 595 x 395 mm	412 x 595 x 395 mm	412 x 595 x 395 mm	
Protection degree IP internal /external according to IEC 60529	IP54 / IP24	IP54 / IP24	IP54 / IP24	IP54 / IP24	
Noise level	55 dB	70 dB	70 dB	70 dB	
Weight of unit	16.8 kg	27.5 kg	32 kg	34.5 kg	
References					
Steel	NSYCU600RDG	NSYCU800RDG	NSYCU800P4RDG	NSYCU1K2RDG	

Evaporation device for condensation water (external installation)

- Device allowing the evaporation of water condensate from the internal heat exchanger (evaporator).
- Accessory compatible for all Indoor Cooling Unit (Side and Roof).

Heat sink

NSYCUACC009DG

Characteristics	Value
Mechanical data	
Height x Width x Depth	103 x 164 x 148 mm (4.1 x 6.5 x 5.8 in)
Weight	1.2 kg (2.2 lb)
Implementation	External mounting of the Cooling Unit
Electrical data	
Voltage / Frequency	1 x 230 V / 50-60 Hz
Starting current	2 A
Power consumption	
During operation (max. heater fully immersed)	230 W
Stabdry (dry)	25 W
Performance	
Evaporation rate	0.25l/h)

Technical changes reserved. Information provided without guarantee. Images are for illustrative purposes only.



1250 W	1550 W	1550 W	2100 W	2100 W	3200 W	4000 W
800 W	1200 W	1200 W	1600 W	1600 W	2640 W	3300 W
850 m³/h	850 m³/h	850 m³/h	850 m³/h	850 m³/h	1200 m³/h	1200 m³/h
850 m³/h	850 m³/h	850 m³/h	1200 m³/h	1200 m³/h	1400 m³/h	1400 m³/h
Electronic	Electronic	Electronic	Electronic	Electronic	Electronic	Electronic
+20... +50 °C	+20... +50 °C	+20... +50 °C	+20... +50 °C	+20... +50 °C	+20... +50 °C	+20... +50 °C
55 °C	55 °C	55 °C	55 °C	55 °C	55 °C	55 °C
+5... +55 °C	+5... +55 °C	+5... +55 °C	+5... +55 °C	+5... +55 °C	+5... +55 °C	+5... +55 °C
R134a	R134a	R134a	R134a	R134a	R134a	R134a
0.156 kg	0.267 kg	0.267 kg	0.320 kg	0.420 kg	0.482 kg	0.545 kg
32 bar	32 bar	32 bar	32 bar	32 bar	32 bar	32 bar
Optional, see page 620	Optional, see page 620	Optional, see page 620	Optional, see page 620	Optional, see page 620	Optional, see page 620	Optional, see page 620
2 x 400-460 V / 50-60 Hz	1 x 230 V / 50-60Hz	2 x 400-460 V / 50-60 Hz	1 x 230 V / 50-60Hz	3 x 400-460 V / 50-60 hz	3 x 400-460 V / 50-60 hz	3 x 400-460 V / 50-60 h
8 A / 2.2 A	16 A / 6.1 A	8 A / 3 A	22 A / 6.4 A	13 A / 2.4 A	20 A / 3.2 A	28 A / 4.1 A
700 W	700 W	760 W	870 W	840 W	1170 W	1480 W
750 W	800 W	860 W	1030 W	1010 W	1400 W	1770 W
1.8	2.1	2.0	2.4	2.4	2.7	2.7
M9F22216	M9F22116	M9F22216	M9F22116	M9F22316	M9F22316	M9F22316
T15 A	T15 A	T15 A	T15 A	T15 A	T15 A	T15 A
412 x 595 x 395 mm	412 x 595 x 395 mm	412 x 595 x 395 mm	435 x 595 x 475 mm	435 x 595 x 475 mm	456 x 795 x 575 mm	456 x 795 x 575 mm
IP54 / IP24	IP54 / IP24	IP54 / IP24	IP54 / IP24	IP54 / IP24	IP54 / IP24	IP54 / IP24
70 dB	70 dB	70 dB	72 dB	72 dB	72 dB	72 dB
39 kg	34.5 kg	39 kg	38.1 kg	40.1 kg	54.2 kg	57.2 kg
NSYCU1K22P4RDG	NSYCU1K5RDG	NSYCU1K52P4RDG	NSYCU2KRDG	NSYCU2K3P4RDG	NSYCU3K3P4RDG	NSYCU4K3P4RDG

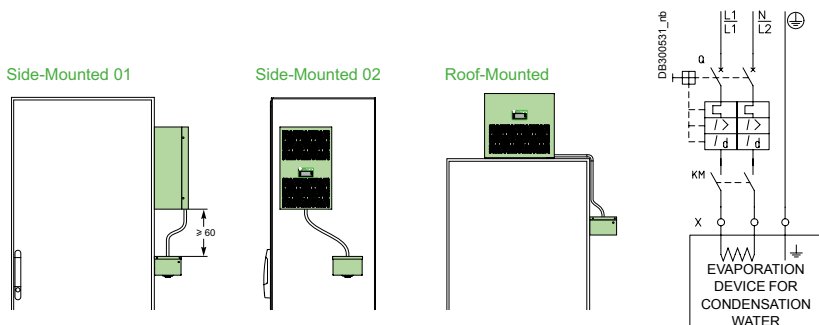

Technical changes reserved. Information provided without guarantee. Images are for illustrative purposes only.

Outdoor Cooling Units



Characteristics	Side-mounted models		
	<ul style="list-style-type: none"> Alarm, operation and setting info available remotely and locally Simple, open and easy, native connectivity with Modbus RTU communication Electronic thermostat with touch screen display mounter in the enclosure side Alarm signal for door contact included in all References Internal IP55 Unique combination of optimized Energy Efficiency Ratio and reduced sizes and weight Easy product selection with ProClima Web associated with SEE Electrical Anti-corrosion protection (class C3H) External screws are safety Torx head Aluminum filter re placement access is closed with a lid Minimum ambient temperature range reaches -20 °C adding a heater to the compressor body Filter recommendation: <ul style="list-style-type: none"> - Office environment (no dust, no grease): filter free, - Industrial environment (dust, grease, not explosive): G3 fiber filter is recommended, - Outdoor (not explosive) : aluminum filter is recommended, Indoor CU are delivered without any filter by default Outdoor CU are delivered with Aluminum filter by default. 		
Material	Galvanized steel painted in gray RAL 7035		
Certifications and declarations	CE and UL Registered (for all references)		
Installation	Indoor or outdoor		
Cooling characteristics			
Cooling power L35-L35 according to EN 14511	350 W	650 W	900 W
Cooling power L35-L50 according to EN 14511	186 W	500 W	700 W
Air flow of the internal circuit	117 m³/h	117 m³/h	550 m³/h
Air flow of the external circuit	166 m³/h	174 m³/h	850 m³/h
Thermostat type	Electronic	Electronic	Electronic
Temperature range of circuit	+20... +50 °C	+20... +50 °C	+20... +50 °C
Maximum outside temperature	55 °C	55 °C	55 °C
Temperature range of external circuit	-20 °C... +55 °C	-20 °C... +55 °C	-20 °C... +55 °C
Type of cooling gas	R134a	R134a	R134a
Cooling gas weight	0.124 kg	0.110 kg	0.120 kg
Maximum pressure of cooling circuit	28 bar	28 bar	28 bar
External filter	Aluminum filter included	Aluminum filter included	Aluminum filter included
Electric characteristics			
Input voltage	1 x 230 V / 50-60 Hz	1 x 230 V / 50-60 Hz	1 x 230 V / 50-60 Hz
Starting/rated current	3.8 A / 1.4 A	6 A / 2.3 A	6 A / 3 A
Power consumption L35-L35 according to EN 14511	240 W	350 W	480 W
Power consumption L35-L50 according to EN 14511	270 W	410 W	530 W
Energy efficiency ratio L35-L35 according to EN 14511	1.4	1.8	1.8
Thermal protection recommended (circuit breaker)	M9F22116	M9F22116	M9F22116
Thermal protection recommended (fuse)	T15 A	T15 A	T15 A
Physical characteristics			
External dimensions (H x W x D)	460 x 290 x 190 mm	460 x 290 x 190 mm	780 x 345 x 215 mm
Protection degree IP internal/external according to IEC	IP55 / IP24	IP55 / IP24	IP55 / IP24
Noise level	55 dB	55 dB	70 dB
Weight of Unit	11.7 kg	11.7 kg	22.4 kg
References	NSYCUHD350DG	NSYCUH600DG	NSYCUHD800DG



1000 W	1000 W	1650 W	1650 W	2000 W
870 W	870 W	1400 W	1400 W	1900 W
550 m³/h	550 m³/h	850 m³/h	850 m³/h	850 m³/h
850 m³/h	850 m³/h	1200 m³/h	1200 m³/h	1200 m³/h
Electronic	Electronic	Electronic	Electronic	Electronic
+20... +50 °C	+20... +50 °C	+20... +50 °C	+20... +50 °C	+20... +50 °C
55 °C	55 °C	55 °C	55 °C	55 °C
-20 °C... +55 °C	-20 °C... +55 °C	-20 °C... +55 °C	-20 °C... +55 °C	-20 °C... +55 °C
R134a	R134a	R134a	R134a	R134a
0.174 kg	0.174 kg	0.323 kg	0.323 kg	0.390 kg
28 bar	28 bar	28 bar	28 bar	28 bar
Aluminum filter included	Aluminum filter included	Aluminum filter included	Aluminum filter included	Aluminum filter included
1 x 230 V / 50-60 Hz	2 x 400-460 V / 50-60 Hz	1 x 230 V / 50-60 Hz	2 x 400-460 V / 50-60 Hz	3 x 400-460 V / 50-60 Hz
6 A / 3 A	4 A / 2 A	16 A / 6 A	8 A / 2.8 A	13 A / 2.5 A
480 W	480 W	770 W	770 W	900 W
530 W	530 W	880 W	880 W	1000 W
2.1	2.1	2.2	2.2	2.2
M9F22116	M9F22216	M9F22116	M9F22216	M9F22316
T15 A	T15 A	T15 A	T15 A	T15 A
780 x 345 x 215 mm	780 x 345 x 215 mm	1000 x 405 x 225 mm	1000 x 405 x 225 mm	1000 x 405 x 225 mm
IP55 / IP24	IP55 / IP24	IP55 / IP24	IP55 / IP24	IP55 / IP24
70 dB	70 dB	72 dB	72 dB	72 dB
22.4 kg	27.4 kg	39 kg	44.5 kg	40.4 kg
NSYCUHD1KDG	NSYCUHD1K2P4DG	NSYCUHD1K6DG	NSYCUHD1K62P4DG	NSYCUHD2K3P4DG

Technical changes reserved. Information provided without guarantee. Images are for illustrative purposes only.

Accessories

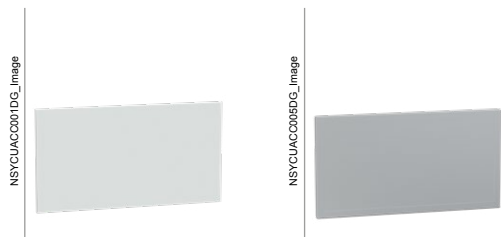

Characteristics	Material		Filter	
	Steel	Stainless-steel	Fiber filter	Aluminum filter
			Filter not recommended for outdoor models	Filter recommended for outdoor models
Color				
Supply			5 units	1 unit
References				
Cooling units				
Side Indoor CU	NSYCU350DG NSYCU600DG NSYCU800DG NSYCU8002P4DG NSYCU1KDG NSYCU1K2P4DG NSYCU1K2DG NSYCU1K22P4DG NSYCU1K6DG NSYCU1K62P4DG NSYCU2KDG NSYCU2K3P4DG NSYCU3K2DG NSYCU3K23P4DG NSYCU4K3P4DG	NSYCUX350DG NSYCUX600DG NSYCUX1KDG NSYCUX1K2P4DG NSYCUX1K6DG NSYCUX2K3P4DG	NSYCUACC001DG NSYCUACC001DG NSYCUACC002DG NSYCUACC002DG NSYCUACC002DG NSYCUACC002DG NSYCUACC003DG NSYCUACC003DG NSYCUACC003DG NSYCUACC003DG NSYCUACC003DG NSYCUACC004DG NSYCUACC004DG NSYCUACC004DG	NSYCUACC005DG NSYCUACC005DG NSYCUACC006DG NSYCUACC006DG NSYCUACC006DG NSYCUACC006DG NSYCUACC007DG NSYCUACC007DG NSYCUACC007DG NSYCUACC007DG NSYCUACC007DG NSYCUACC007DG NSYCUACC008DG NSYCUACC008DG
Roof indoor CU	NSYCU600RDG NSYCU800RDG NSYCU8002P4RDG NSYCU1K2RDG NSYCU1K22P4RDG NSYCU1K5RDG NSYCU1K52P4RDG NSYCU2KRDG NSYCU2K3P4RDG NSYCU3K3P4RDG NSYCU4K3P4RDG		NSYCUACC010DG NSYCUACC011DG NSYCUACC011DG NSYCUACC011DG NSYCUACC011DG NSYCUACC011DG NSYCUACC011DG NSYCUACC011DG NSYCUACC011DG NSYCUACC013DG NSYCUACC013DG	NSYCUACC014DG NSYCUACC015DG NSYCUACC015DG NSYCUACC015DG NSYCUACC015DG NSYCUACC015DG NSYCUACC015DG NSYCUACC015DG NSYCUACC015DG NSYCUACC017DG NSYCUACC017DG
Side outdoor CU	NSYCUHD350DG NSYCUHD600DG NSYCUHD800DG NSYCUHD1KDG NSYCUHD1K2P4DG NSYCUHD1K6DG NSYCUHD1K62P4DG NSYCUHD2K3P4DG			NSYCUACC005DG NSYCUACC005DG NSYCUACC006DG NSYCUACC006DG NSYCUACC006DG NSYCUACC007DG NSYCUACC007DG NSYCUACC007DG

Technical changes reserved. Information provided without guarantee. Images are for illustrative purposes only.



External condensate evaporator	Half-flush kit		Retrofit kit	
	Steel	Stainless-steel	Steel	Stainless-steel
For water condensate evaporation			Kit to mount a new Cooling Unit in place of an existing Schneider Electric Cooling Unit from the previous range	Kit to mount a new Cooling Unit in place of an existing Schneider Electric Cooling Unit from the previous range
	RAL 7035 gray		RAL 7035 gray	
1 unit	1 unit	1 unit	1 unit	1 unit

NSYCUACC009DG	NSYCUACC034DG	NSYCUACC038DG		
NSYCUACC009DG	NSYCUACC034DG	NSYCUACC038DG	NSYCUACC032DG	NSYCUACC022DG
NSYCUACC009DG	NSYCUACC035DG			
NSYCUACC009DG	NSYCUACC035DG			
NSYCUACC009DG	NSYCUACC035DG	NSYCUACC039DG		
NSYCUACC009DG	NSYCUACC035DG	NSYCUACC039DG		
NSYCUACC009DG	NSYCUACC036DG		NSYCUACC023DG - Flush NSYCUACC024DG - Half-flush NSYCUACC025DG - Surface	
NSYCUACC009DG	NSYCUACC036DG		NSYCUACC023DG - Flush NSYCUACC024DG - Half-flush NSYCUACC025DG - Surface	
NSYCUACC009DG	NSYCUACC036DG	NSYCUACC040DG	NSYCUACC023DG - Flush NSYCUACC024DG - Half-flush NSYCUACC025DG - Surface	NSYCUACC029DG - Flush NSYCUACC030DG - Half-flush NSYCUACC031DG - Surface
NSYCUACC009DG	NSYCUACC036DG		NSYCUACC023DG - Flush NSYCUACC024DG - Half-flush NSYCUACC025DG - Surface	
NSYCUACC009DG	NSYCUACC036DG		NSYCUACC023DG - Flush NSYCUACC024DG - Half-flush NSYCUACC025DG - Surface	
NSYCUACC009DG	NSYCUACC036DG	NSYCUACC040DG	NSYCUACC023DG - Flush NSYCUACC024DG - Half-flush NSYCUACC025DG - Surface	NSYCUACC029DG - Flush NSYCUACC030DG - Half-flush NSYCUACC031DG - Surface
NSYCUACC009DG	NSYCUACC037DG		NSYCUACC026DG - Flush NSYCUACC027DG - Half-flush NSYCUACC028DG - Surface	
NSYCUACC009DG	NSYCUACC037DG		NSYCUACC026DG - Flush NSYCUACC027DG - Half-flush NSYCUACC028DG - Surface	
NSYCUACC009DG	NSYCUACC037DG			
NSYCUACC009DG			NSYCUACC033DG	
NSYCUACC009DG			NSYCUACC018DG	
NSYCUACC009DG			NSYCUACC018DG	
NSYCUACC009DG			NSYCUACC019DG	
NSYCUACC009DG			NSYCUACC019DG	
NSYCUACC009DG			NSYCUACC019DG	
NSYCUACC009DG			NSYCUACC019DG	
NSYCUACC009DG			NSYCUACC020DG	
NSYCUACC009DG			NSYCUACC020DG	
NSYCUACC009DG			NSYCUACC021DG	
NSYCUACC009DG			NSYCUACC021DG	

14
CU

Side-Mounted Models: Dimensions and Cut-Outs

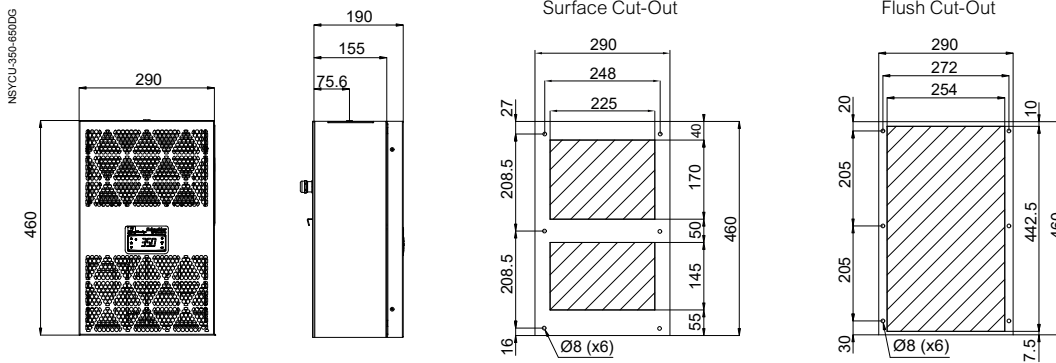

The Half-flush drawings are available on se.com

NSYCU350DG / NSYCUX350DG / NSYCUHD350DG / NSYCU600DG / NSYCUX600DG / NSYCUHD600DG

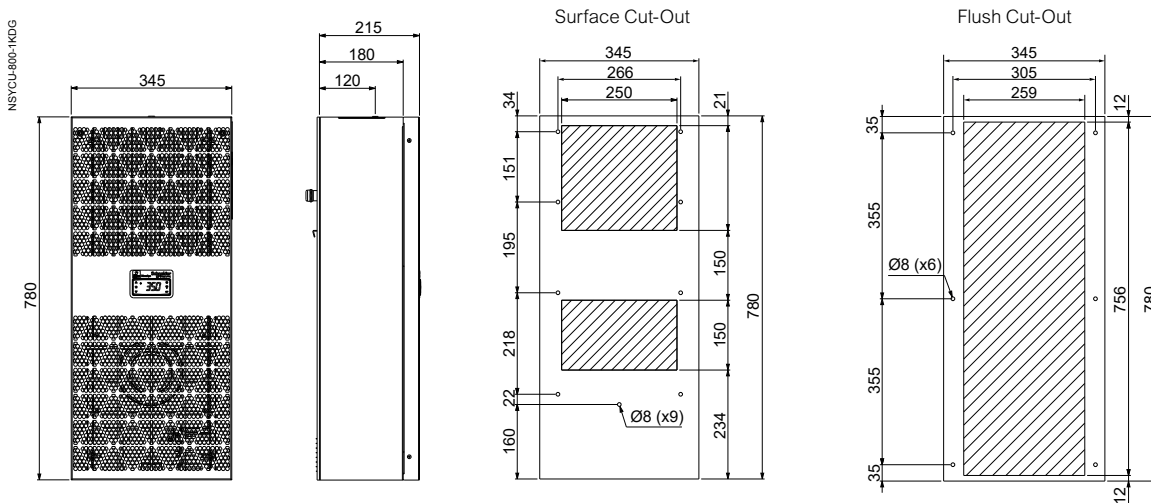

The Half-flush drawings are available on se.com

NSYCU800DG / NSYCU8002P4DG / NSYCUHD800DG / NSYCU1KDG / NSYCUX1KDG / NSYCUHD1KDG / NSYCU1K2P4DG / NSYCUX1K2P4DG / NSYCUHD1K2P4DG

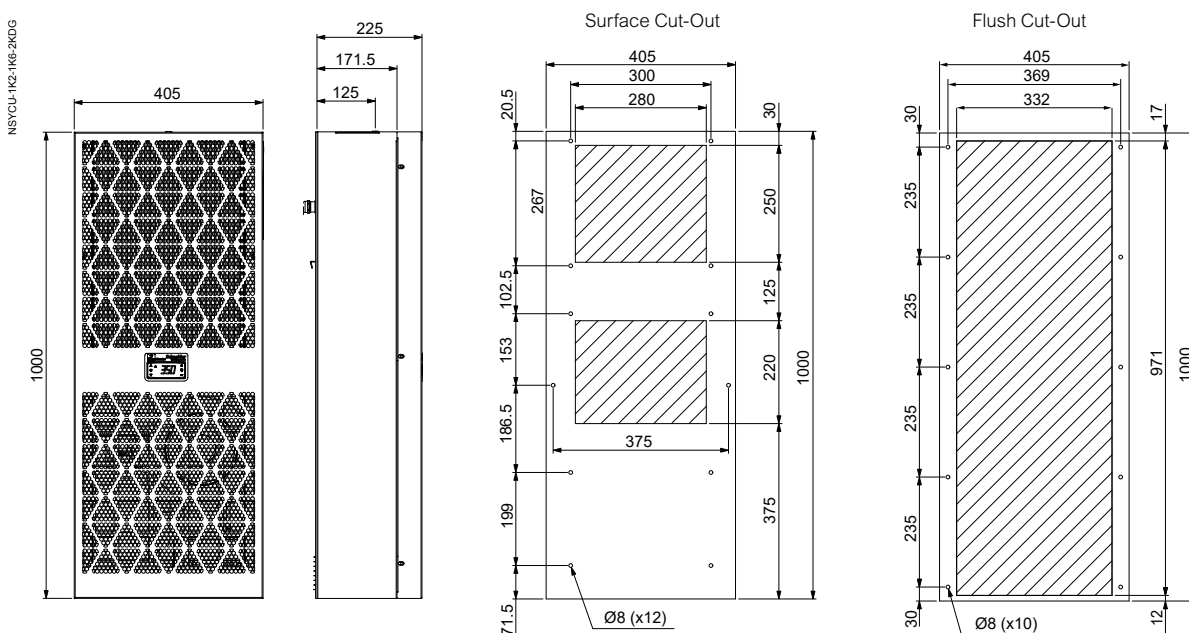

The Half-flush drawings are available on se.com

NSYCU1K2DG / NSYCU1K22P4DG / NSYCU1K6DG / NSYCUX1K6DG / NSYCUHD1K6DG / NSYCU1K62P4DG / NSYCUHD1K62P4DG / NSYCU2KDG / NSYCU2K3P4DG / NSYCUX2K3P4DG / NSYCUHD2K3P4DG

Indoor Side Cooling Unit Mounting Types Could Be either Surface, Half-Flush or Flush, and Out-Door Side Cooling Unit Mounting Type Is Only Surface.
Units of Measurement Are mm

Technical changes reserved. Information provided without guarantee. Images are for illustrative purposes only.

Side-Mounted Models: Dimensions and Cut-Outs

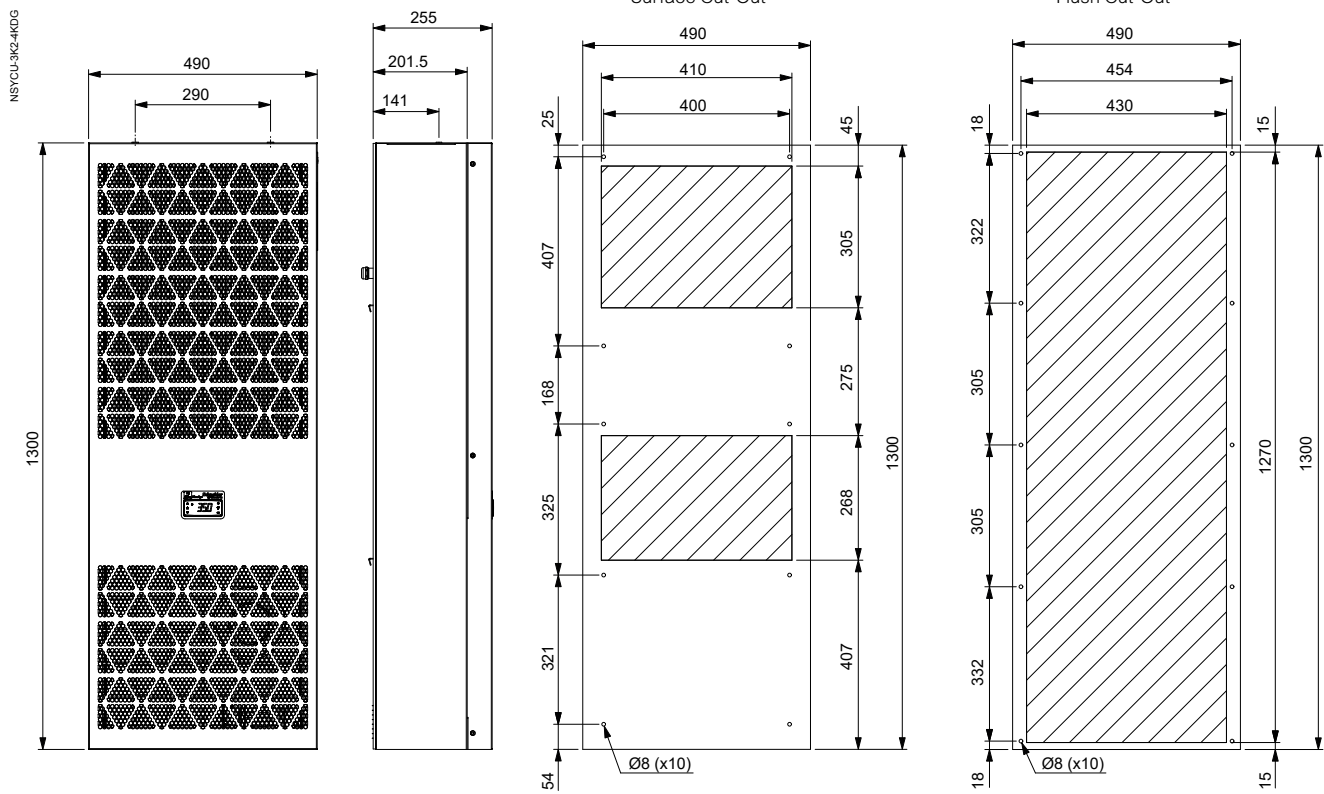

The Half-flush drawings are available on se.com

NSYCU3K2DG / NSYCU3K23P4DG / NSYCU4K3P4DG

Indoor Side Cooling Unit Mounting Types Could Be either Surface, Half-Flush or Flush, and Out-Door Side Cooling Unit Mounting Type Is Only Surface.
Units of Measurement Are mm

Roof-Mounted Models: Dimensions and Cut-Outs

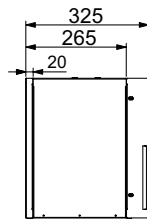
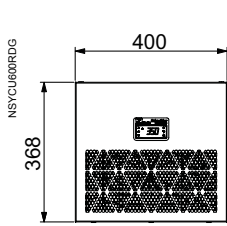

Internal Mounting Cut-Out

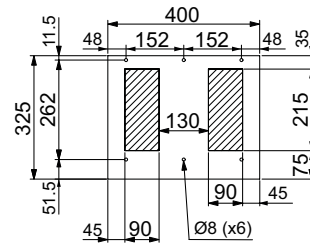

NSYCU600RDG

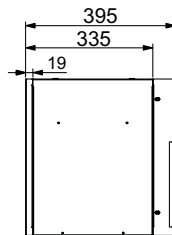
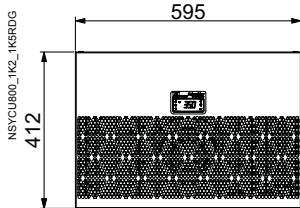

Internal Mounting Cut-Out

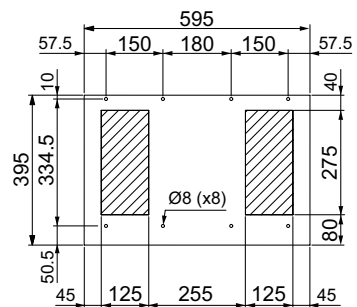

NSYCU800RDG / NSYCU8002P4RDG / NSYCU1K2RDG / NSYCU1K22P4RDG / NSYCU1K5RDG / NSYCU1K52P4RDG

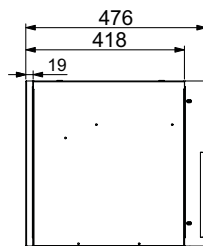
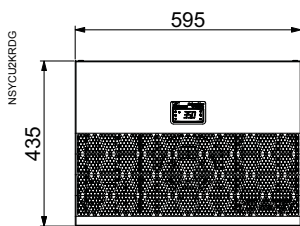

Internal Mounting Cut-Out

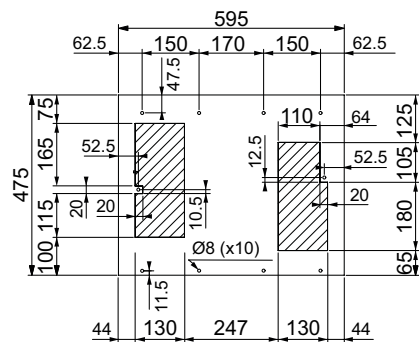

NSYCU2KRDG / NSYCU2K3P4RDG

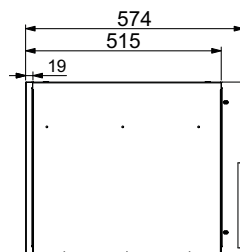
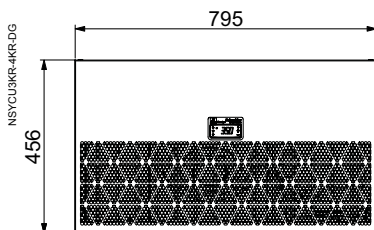

Internal Mounting Cut-Out

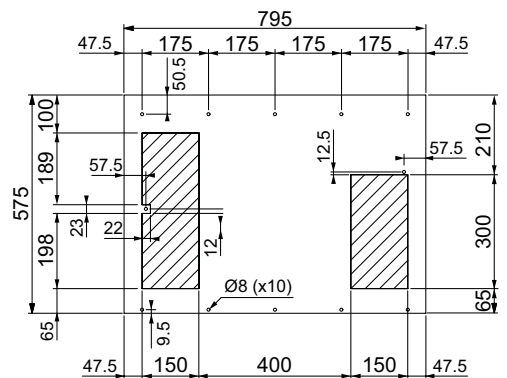

NSYCU3K3P4RDG / NSYCU4K3P4RDG

Units of Measurement Are mm

Technical changes reserved. Information provided without guarantee. Images are for illustrative purposes only.

Ultra-thin resistance heaters have been designed to resolve condensation problems in the most complex installations.
Is your enclosure short of space?
Does your mounting plate make it impossible to install a conventional heater?
Do you not want to take out the equipment?
Discover the benefits of this new offer and its numerous mounting solutions.

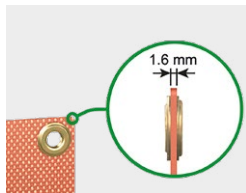
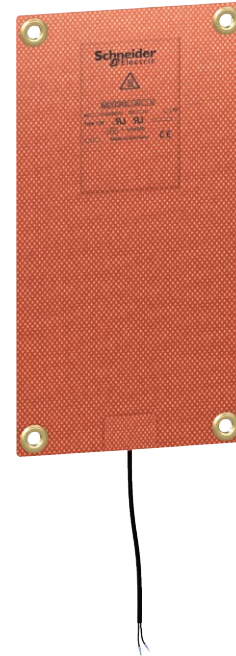

Small Size (Thickness = 1.6 mm)

- The space saving available for the equipment compared with a conventional resistor can be up to 30%.



Numerous Positions for Installation

- These heaters are so slim and flexible they can be installed in a variety of positions:
- Vertically on side panels
- On the mounting plate.



Heat and Safety

- The heat is distributed over the whole surface and does not exceed 70 °C. This temperature allows devices next to the heater to be handled safely.



Energy Efficiency

- Ultra-thin resistance heaters have a low starting current.



Multiple Options for Fixing

- Innovative quick-fixing system using Velcro pads (no need for a tool!) or with basic fixing accessories (screw + spacer). These systems make it easy to move the heater if necessary.



No Electromagnetic Emissions

- These resistors can be installed near electronic equipment to ensure an optimal temperature.

Other Characteristics - Electrical Circuit Diagram

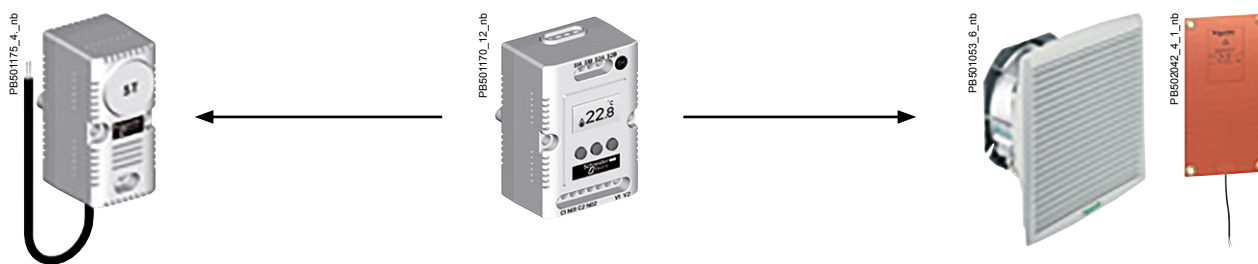

	PB502046_17_nb	PB502047_17_nb	PB502048_17_nb	PB502049_17_nb	PB502052_35_nb
5 mounting solutions:	On a Telequick mounting plate	On plain or micro-perforated mounting plate with fixing hardware	On DIN rail	On plain mounting plate with self-adhesive Velcro pads	On wall with self-adhesive Velcro pads
	<ul style="list-style-type: none"> A Telequick mounting plate, ref. NSYMR●●●● B Telequick nuts, ref. AF1EA●, supplied with the mounting kit 	<ul style="list-style-type: none"> A Mounting plate, ref. NSYMM●●●● B Fixing hardware included in the mounting kit 	<ul style="list-style-type: none"> A Mounting plate, ref. NSYMM●●●● B Symmetrical DIN rail, ref. NSYSDR●●●● C Clip-on nuts, ref. AF1CG●, supplied with the mounting kit 	<ul style="list-style-type: none"> A Mounting plate, ref. NSYMM●●●● B Self-adhesive Velcro pad and plastic fixings supplied with the mounting kit 	<ul style="list-style-type: none"> A Self-adhesive Velcro pads and plastic fixings supplied in the mounting kit
Characteristics	Flexible, ultra-thin resistance heaters to be installed inside the enclosure				
Material	Silicon reinforced with fiberglass				
Color	Red (heaters), black (cables)				
Certification	UL				
Supply	<ul style="list-style-type: none"> • 6 self-adhesive Velcro pads • 6 plastic fixings • 4 Telequick nuts • 4 clip-on nuts • Fixing hardware 				

Ultra-Thin Resistance Heaters

Flexible, ultra-thin resistance heaters to be installed inside the enclosure

- Material: Silicon reinforced with fiberglass
- Color: Red (heaters), black (cables)
- Certification: UL (cURus)

Comment:

Ultra-thin resistance heaters can be manufactured with other dimensions and power ratings than those indicated above. Please contact us.



NSYCRS10W240V

Characteristics	Power (W)	Voltage (V)	Inrush current (A)	Height (mm)	Width (mm)	Depth (mm)	References
Ultra-thin resistance heaters	10	240	0.04	110	140	1.6	NSYCRS10W240V
Ultra-thin resistance heaters	25	240	0.10	110	230	1.6	NSYCRS25W240V
Ultra-thin resistance heaters	50	240	0.21	200	320	1.6	NSYCRS50W240V
Ultra-thin resistance heaters	100	240	0.42	260	440	1.6	NSYCRS100W240V
Ultra-thin resistance heaters	200	240	0.83	380	650	1.6	NSYCRS200W240V

Resistance heaters prevent the formation of condensation and help guarantee the correct temperature for the correct operation of the electronic components in the enclosure.

Insulated PTC Heaters

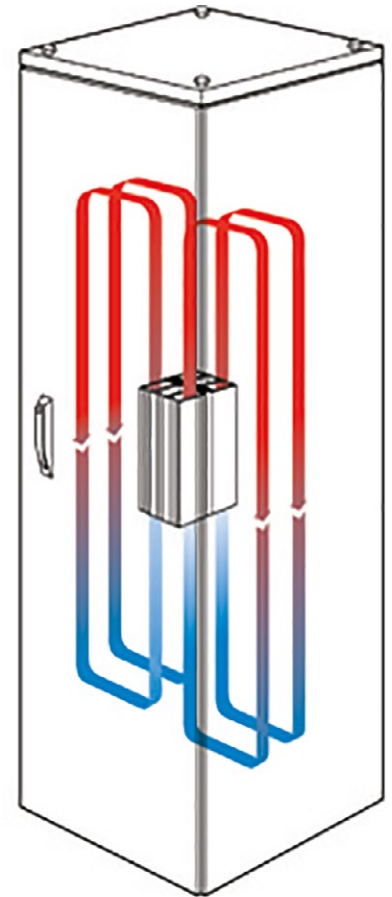

Large Range of Power Levels

- 2 versions: By natural convection or by fan.
- AC or DC power supply.
- 7 power levels from 10 W to 550 W.



Easy Installation and Connection

- Reduced dimensions.
- Quick electric connection by terminal board.
- No maintenance required.
- Direct clipping onto a 35-mm DIN rail.



Innovating Design



Safety

- The protection prevents direct contact with the aluminum radiator.
- Electric protection device with terminal block cover.
- Equipped with a PTC-type heater.
- Surface temperature lower than 70 °C.



Models with Fan

- The heaters equipped with a fan helps to ensure circulation of the air and a uniform temperature inside the enclosure.
- High-flow, silent fan.

High Thermal Efficiency

- The configuration of the aluminum profile produces a "chimney" effect: high natural convection.
- Low power consumption thanks to self-control of the PTC-type heater.



Certifications

- CE marking.
- Range compliant with UL and VDE, UL (*only the marked references)

14
CR

Aluminum PTC Heaters

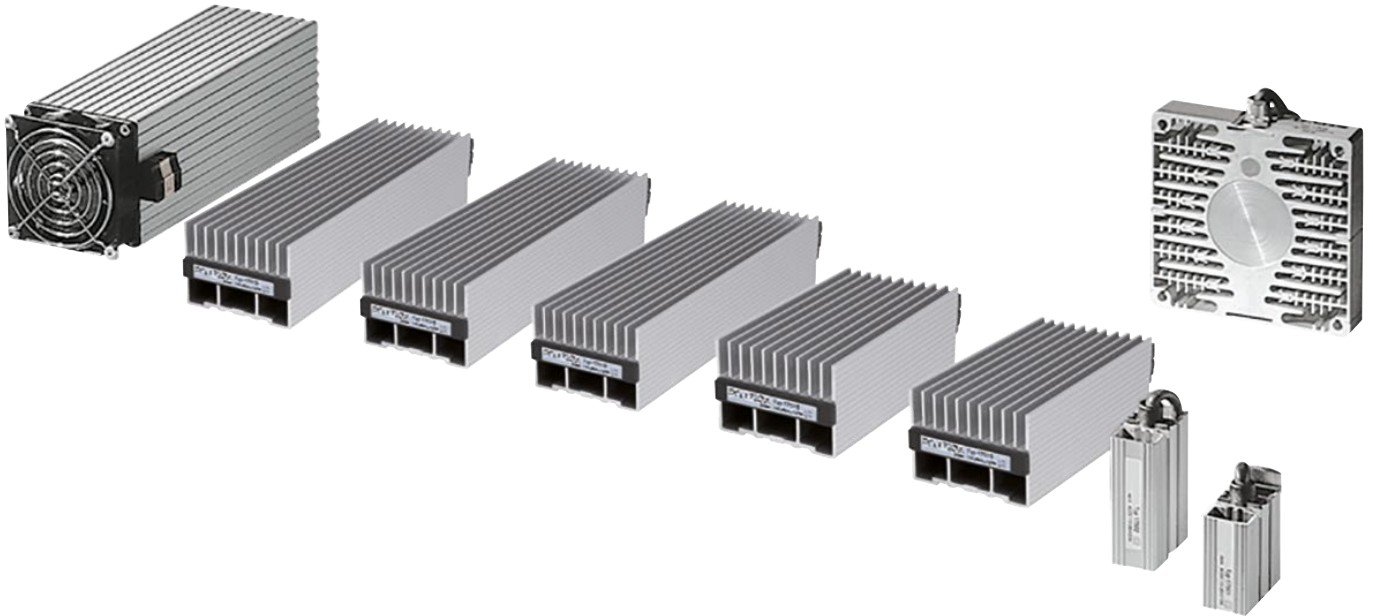

Models with Fan

- Models of 250 to 400 W with fan.



Connection Cables

- The 10 and 20-W heaters are equipped with a 2 x 0.75 x 300 mm power cord.

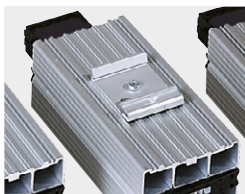

Quick-Fixing

- The resistance heaters are fixed by means of fixing clips to a 35-mm DIN rail.



Connection Terminal Boards

- Heaters with a power of more than 20 W are equipped with a connection terminal board.

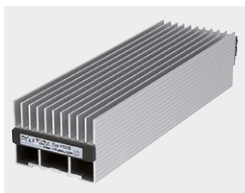

Resistance Heaters Equipped with a PTC-Type Sensor

The resistance heaters for electrical and electronic enclosures are equipped with PTC-type heating devices (Positive Temperature Coefficient). Thanks to these heaters:

- The surface temperature stabilises at 75 °C when the ambient temperature is -5 °C.
- Power consumption is reduced.

Improved Convection

- The design of the profile of the resistance heaters produces a "chimney" effect, leading to increased natural convection and maintaining an even temperature inside the enclosure.

Insulated PTC Resistance Heaters



NSYCR10WU2C



NSYCR50WU2C

- Compact resistance heater preventing the formation of condensation or frost.
- Designed to ensure natural convection and high thermal efficiency.
- Material: Extruded aluminum body
- Conditions of use: The heaters must be installed with a thermal controller (see selection table on [page 632](#) and [633](#)) to control the temperature or the humidity inside the enclosure
- The enclosure must be sealed to prevent the entry of air from the outside
- An electrical protection device must be installed on the supply side of the unit
- Operating position: Vertical
- Operating temperature: -40...+70 °C; -10...+158 °F
- Surface temperature: <70 °C, except for the top protection grille
- Ingress protection rating: IP20
- Certifications: UL (cURus) only the reference marked with (*), Class II (double insulated)
- Mounting: By clip on a 35-mm DIN rail

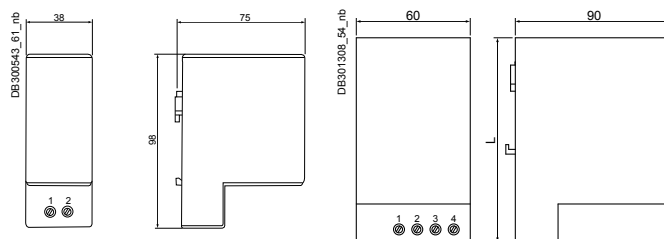

Characteristics	Heating power at 0 °C (W)	Voltage (V)	Electric connection	References
Insulated PTC resistance heater	10	12-24 DC	2 screw terminals, 2.5 mm ²	NSYCR10WU1C
Insulated PTC resistance heater	10	110-250 AC	2 screw terminals, 2.5 mm ²	NSYCR10WU2C *
Insulated PTC resistance heater	20	12-24 DC	2 screw terminals, 2.5 mm ²	NSYCR20WU1C
Insulated PTC resistance heater	20	110-250 AC	2 screw terminals, 2.5 mm ²	NSYCR20WU2C *
Insulated PTC resistance heater	55	12-24 DC	4 screw terminals, 2.5 mm ²	NSYCR50WU1C
Insulated PTC resistance heater	55	110-250 AC	4 screw terminals, 2.5 mm ²	NSYCR50WU2C *
Insulated PTC resistance heater	55	270-420 AC	4 screw terminals, 2.5 mm ²	NSYCR50WU3C
Insulated PTC resistance heater	100	12-24 DC	4 screw terminals, 2.5 mm ²	NSYCR100WU1C
Insulated PTC resistance heater	100	110-250 AC	4 screw terminals, 2.5 mm ²	NSYCR100WU2C *
Insulated PTC resistance heater	100	270-420 AC	4 screw terminals, 2.5 mm ²	NSYCR100WU3C
Insulated PTC resistance heater	147	12-24 DC	4 screw terminals, 2.5 mm ²	NSYCR150WU1C
Insulated PTC resistance heater	147	110-250 AC	4 screw terminals, 2.5 mm ²	NSYCR150WU2C *

Insulated Ventilated PTC Heaters

- Compact resistance heater preventing the formation of condensation or frost.
- Designed to ensure good natural convection and high thermal efficiency.
- Material: Extruded aluminum body
- Conditions of use: The heaters must be installed with a thermal controller (see selection table on [page 632](#) and [633](#)) to control the temperature or the humidity inside the enclosure
- The enclosure must be sealed to prevent the entry of air from the outside
- An electrical protection device must be installed on the supply side of the unit
- Operating position: Vertical
- Operating temperature: -40...+70 °C; -10...+158 °F
- Surface temperature: Max. 50 °C in the enclosure, 100 °C on the top protection grille, (for an ambient temperature of 20 °C / 68 °F)
- Ingress protection rating: IP20
- Certifications: VDE and UL, Cover: UL 94 V-0 plastic, Class II (double insulated)
- Mounting: By clip on a 35-mm DIN rail

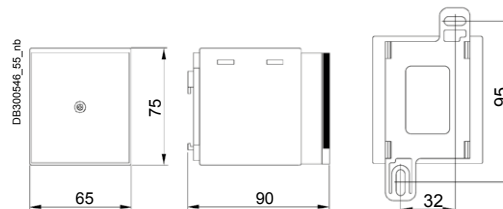

Characteristics	Heating power at 0 °C (W)	Voltage (V)	Electric connection	References
Insulated ventilated PTC heater	177	230 AC / 50-60 HZ	2 poles, 2.5 mm ²	NSYCR170W230VVC



NSYCR170W230VVC

Aluminum PTC Heaters

- Extruded aluminum body.
- Surface temperature limited to 75 °C when the ambient temperature is -5 °C.
- Heaters equipped with a power cable with a length of 500 mm with silicon insulation, or with a connection terminal block.

Conditions of use:

- The heaters must be installed with a thermal controller to control the temperature or the humidity inside the enclosure
- The enclosure must be sealed to prevent the entry of air from the outside
- An electrical protection device must be installed on the supply side of the unit

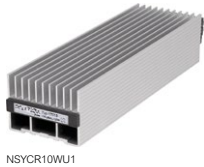

NSYCR10WU1



NSYCR250W115V

Characteristics	Power (W)	Voltage (V)	References
Aluminum PTC heater	10	12-24 DC	NSYCR10WU1
Aluminum PTC heater	10	110-250 AC	NSYCR10WU2
Aluminum PTC heater	20	12-24 DC	NSYCR20WU1
Aluminum PTC heater	20	110-250 AC	NSYCR20WU2
Aluminum PTC heater	20	270-420 AC	NSYCR20WU3
Aluminum PTC heater	55	12-24 DC	NSYCR55WU1
Aluminum PTC heater	55	110-250 AC	NSYCR55WU2
Aluminum PTC heater	55	270-420 AC	NSYCR55WU3
Aluminum PTC heater	90	12-24 DC	NSYCR100WU1
Aluminum PTC heater	90	110-250 AC	NSYCR100WU2
Aluminum PTC heater	90	270-420 AC	NSYCR100WU3
Aluminum PTC heater	150	12-24 DC	NSYCR150WU1
Aluminum PTC heater	150	110-250 AC	NSYCR150WU2
Aluminum PTC heater	150	270-420 AC	NSYCR150WU3
Aluminum PTC heater with fan	250	230 AC	NSYCR250W230VV
Aluminum PTC heater with fan	400	230 AC	NSYCR400W230VV
Resistive heater	200	230 AC	NSYCRS200W230V

Thermofan



NSYCRP1W120VTVC

Combination of a resistance heater and an axial fan to ensure uniform heating of the enclosure.

- Fixing by clip on a DIN rail.
- Thermostat adjustable from 0...+60 °C.
- Visual operation indicator.

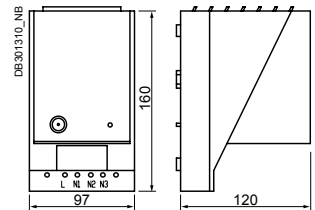

Characteristics	Power (W)	Voltage (V)	References
Thermofan	350/550	120 AC	NSYCRP1W120VTVC
Thermofan	350/550	230 AC	NSYCRP1W230VTVC

Mechanical Thermostats

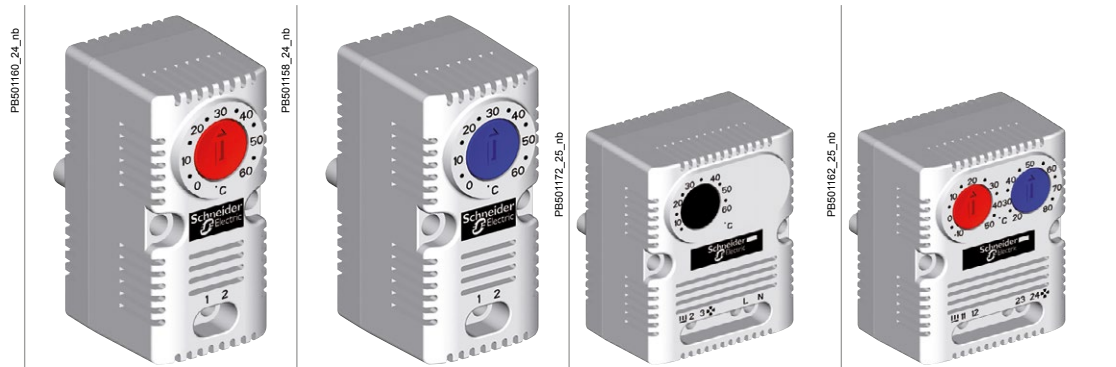

Thermostat with NC contact

Thermostat with NO contact

Thermostat with NO/NC contact

Double Thermostat

Characteristics	NSYCCOTHC (NSYCCOTHCF)	NSYCCOTHO (NSYCCOTHOF)	NSYCCOTH I	NSYCCOTH D (NSYCCOTHDF)
	Thermostat with NC Contact: <ul style="list-style-type: none"> To control the stopping of a resistance heater when the temperature exceeds the displayed value. Thermostat with NO Contact: <ul style="list-style-type: none"> To control the starting of a fan when the temperature exceeds the displayed maximum value, To control the temperature inside the enclosure by only starting the fan when necessary, thus increasing the service life of the fan and reducing the clogging of the filter. 			
Button color	Red	Blue	Black	Red and blue
Ingress protection rating	IP20	IP20	IP20	IP20
Sensor element	Bimetal	Bimetal	Bimetal	Bimetal
Contact	NC, forced rupture	NC, forced rupture	Inverse, forced rupture	NO/NC, forced rupture
Contact resistance	< 10 mΩ	< 10 mΩ	< 10 mΩ	< 10 mΩ
Service life	> 100,000 cycles	> 100,000 cycles	> 100,000 cycles	> 100,000 cycles
Switching capacity	<ul style="list-style-type: none"> 250 V AC; 10 A (resistive load) 120 V AC; 15 A (resistive load) 250 V AC/120 V AC 2 A (inductive load cos φ = 0.6) 30 W DC 	<ul style="list-style-type: none"> 250 V AC; 10 A (resistive load) 120 V AC; 15 A (resistive load) 250 V AC/120 V AC 2 A (inductive load cos φ = 0.6) 30 W DC 	<ul style="list-style-type: none"> 250 V AC; 10 A (resistive load) 	<ul style="list-style-type: none"> 250 V AC; 10 A (resistive load) 120 V AC; 15 A (resistive load) 250 V AC/120 V AC 2 A (inductive load cos φ = 0.6) 30 W DC
Max interrupting capacity with direct current	NC	NO	250 V AC 4 A (inductive load cos φ = 0.6) 30 W DC	NA
Connection	Two 2.5-mm ² terminals	Two 2.5-mm ² terminals	Four 2.5-mm ² terminals	Six 2.5-mm ² terminals
Mounting	By clip on 35-mm DIN rail	By clip on 35-mm DIN rail	By clip on 35-mm DIN rail	By clip on 35-mm DIN rail
Enclosure	UL 94 V-0 plastic, light gray	UL 94 V-0 plastic, light gray	UL 94 V-0 plastic, light gray	UL 94 V-0 plastic, light gray
Dimensions	60 x 33 x 43 mm	60 x 33 x 43 mm	67 x 50 x 44 mm	60 x 33 x 43 mm
Weight	40 g	40 g	100 g	40 g
Mounting position	Indifferent	Indifferent	Indifferent	Indifferent
Operating temperature	-20...+80 °C (-4...+176 °F)	-20...+80 °C (-4...+176 °F)	-20...+80 °C (-4...+176 °F)	-20...+80 °C (-4...+176 °F)
Hysteresis	7± 4°K	7± 4°K	7± 4°K	7± 4°K
Temperature setting range	0...+60 °C	0...+60 °C	+5...+60 °C	0...+60 °C
Display	°C (°F)	°C (°F)	°C (°F)	°C (°F)
Max. command intensity	10 A 250 V	10 A 250 V	(NO) 5 A (NC) 10 A	(NO) 5 A (NC) 10 A

Thermal control

14 CC

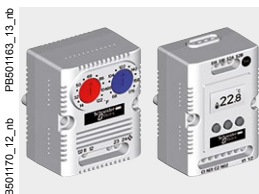

Mechanical and Electronic Thermostats

- Large range of temperature control.
- Small dimensions.
- Easily accessible terminals.



Operational Temperature Range

- For mechanical thermostats: 0 °C ... +60 °C
- For electronic thermostats: -40 °C ... +80 °C



LED Display

- Display visible even in the dark.

Technical changes reserved. Information provided without guarantee. Images are for illustrative purposes only.

Electronic Thermostats with LED Display



Electronic thermostat With LED display



Electronic hygrothermostat With LED display



Electronic hygrometer With LED display

Characteristics	NSYCCOTH30VID NSYCCOTH120VID NSYCCOTH230VID	NSYCCOHYT30VID NSYCCOHYT120VID NSYCCOHYT230VID	- - NSYCCOHY230VID
	Electronic temperature controller	Electronic temperature and humidity controller	Electronic humidity controller
Ingress protection rating	IP20	IP20	IP20
Certification	UL / UR	UL / UR	UL / UR
Internal sensor element	Temperature sensor	Temperature sensor and humidity sensor	Humidity sensor
Contact	Free with zero potential	Free with zero potential	Free with zero potential
Connection	2 x 2.5 mm ² (input voltage) + 2 relays (2 x 2.5 mm ² + 2 x 2.5 mm ²)	2 x 2.5 mm ² (input voltage) + 2 relays (2 x 2.5 mm ² + 2 x 2.5 mm ²)	2 x 2.5 mm ² (input voltage) + 1 relay (2 x 2.5 mm ²)
Mounting	4 different methods: By DIN rail, PanelSet SFN profile, on VDI cross-rail or on mounting plate		
Enclosure	UL 94 V-0 plastic, light gray		
Operating temperature	-40 °C...+70 °C		
Hysteresis	Programmed 2 K	Programmed 2 K and 3%	3%
Temperature setting range	-40 °C...+80 °C		
Humidity setting range	-	20%...80%	20%...80%
Display	°C or °F		
Max. command: Alternative current	Motor: 4.0 A / 13.1 A - FLA / LRA 250 V AC Resistive load: 4 A - 50 V DC		
Max. command: Direct current	Resistive load: 4 A - 50 V DC		

Input Current

Characteristics	References
9...30 V AC/CC, 50/60 Hz, SELV/Class 2 source, 15 W or less	NSYCCO***30VID
90-140 V AC, 50/60 Hz, 1 VA	NSYCCO***120VID
200-240 V AC, 50/60 Hz, 3.5 VA	NSYCCO***230VID

The New Quick-Fixing Systems

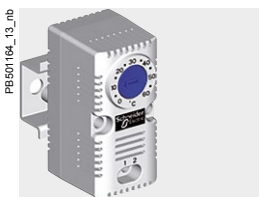

- On 35-mm DIN rail.

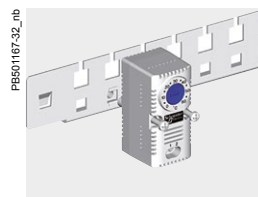

- On cross-rail.

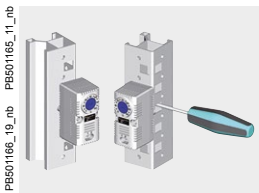

- On PanelSet and Spacial upright.



- On mounting plate.

Certifications and Declarations



- UL
- CE

Mechanical Thermostats

- Ingress protection rating according to IEC 60529: IP20
- Sensor element: Bimetal
- Contact resistance: < 10 mΩ
- Service life: > 100,000 cycles
- Mounting: By clip on 35-mm DIN rail
- Enclosure: UL 94 V-0 plastic, light gray
- Mounting position: Indifferent
- Operating temperature: -20...+80 °C (-4...+176 °F)
- Hysteresis: 7± 4°K

Thermostat with NC Contact



NSYCCOTHC

- Button color: Red
- Contact: NC, forced rupture
- Switching capacity: 250 V AC; 10 A (resistive load)
120 V AC; 15 A (resistive load)
250 V AC/120 V AC 2 A (inductive load cos = 0.6)
30 W DC
- Max interrupting capacity with direct current: NC
- Connection: Two 2.5-mm² terminals
- Weight: 40 g
- Temperature setting range: 0...+60 °C

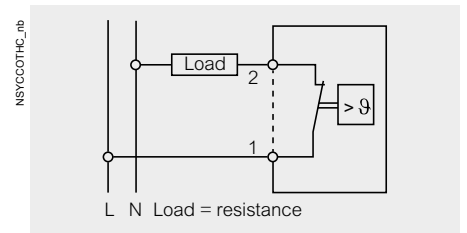

Characteristics	Display	Max. command intensity	Dimensions (H x W x D)	References
Thermostat with NC contact	°C	10 A 250 V	60 x 33 x 43 mm	NSYCCOTHC
Thermostat with NC contact	°F	10 A 250 V	60 x 33 x 43 mm	NSYCCOTHCF

Thermostat with NO Contact

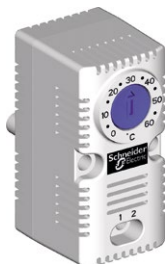

NSYCCOTH0

- Button color: Blue
- Contact: NO, forced rupture
- Switching capacity: 250 V AC; 10 A (resistive load)
120 V AC; 15 A (resistive load)
250 V AC/120 V AC 2 A (inductive load cos = 0.6)
30 W DC
- Max interrupting capacity with direct current: NO
- Connection: Two 2.5-mm² terminals
- Weight: 40 g
- Temperature setting range: 0...+60 °C

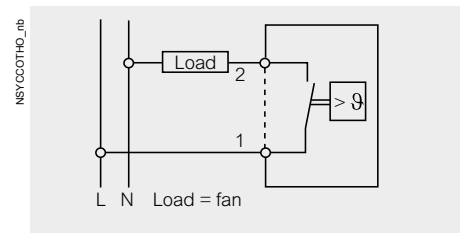

Characteristics	Display	Max. command intensity	Dimensions (H x W x D)	References
Thermostat with NO contact	°C	10 A 250 V	60 x 33 x 43 mm	NSYCCOTH0
Thermostat with NO contact	°F	10 A 250 V	60 x 33 x 43 mm	NSYCCOTH0F

Thermostat with NO/NC Contact



NSYCCOTH1

- Button color: Black
- Contact: Inverse, forced rupture
- Switching capacity: 250 V AC; 10 A (resistive load)
- Max interrupting capacity with direct current: 250 V AC 4 A (inductive load cos = 0.6) 30 W DC
- Connection: Four 2.5-mm² terminals
- Weight: 100 g
- Temperature setting range: +5...+60 °C

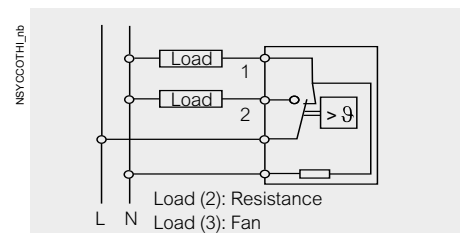

Characteristics	Display	Max. command intensity	Dimensions (H x W x D)	References
Thermostat with NO/NC contact	°C	(NO) 5 A (NC) 10 A	67 x 50 x 44 mm	NSYCCOTH1

Double Thermostat



NSYCCOTH0

- Button color: Red and blue
- Contact: NO / NC, forced rupture
- Switching capacity: 250 V AC; 10 A (resistive load)
120 V AC; 15 A (resistive load)
250 V AC/120 V AC 2 A (inductive load cos = 0.6)
30 W DC
- Max interrupting capacity with direct current: NA
- Connection: Six 2.5-mm² terminals
- Weight: 40 g
- Temperature setting range: 0...+60 °C

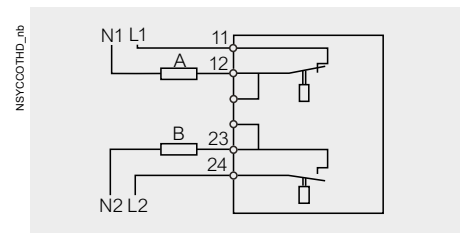

Characteristics	Display	Max. command intensity	Dimensions (H x W x D)	References
Double Thermostat	°C	(NO) 5 A (NC) 10 A	60 x 33 x 43 mm	NSYCCOTH0
Double Thermostat	°F	(NO) 5 A (NC) 10 A	60 x 33 x 43 mm	NSYCCOTH0F

Electronic Thermostats

- Ingress protection rating according to IEC 60529: IP20
- Certification: UL / UR
- Contact resistance: Free with zero potential
- Mounting: 4 methods: By DIN rail, PanelSeT SFN profile, on VDI cross-rail or on mounting plate

- Enclosure: UL 94 V-0 plastic, light gray
- Operating temperature: -40 °C...+70 °C
- Hysteresis: 7 K
- Max. command intensity: Motor: 4 / 13.1 A, FLA / LRA, 250 Vac
Resistive load: 4 A, 250 Vdc

Electronic Thermostats with LED Display



NSYCCOTH30VID

- Internal sensor element: Temperature sensor
- Connection: 2 x 2.5 mm² (input voltage) + 2 relays (2 x 2.5 mm² + 2 x 2.5 mm²)
- Hysteresis: Programmed 2 K
- Temperature setting range: -40 °C...+80 °C

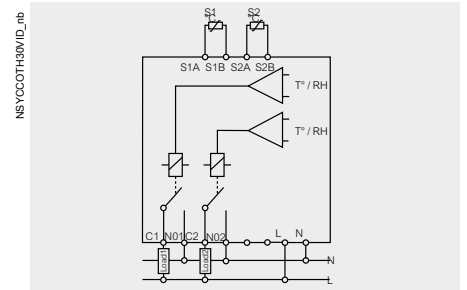

Characteristics	Display	Voltage (type of current)	References
Electronic thermostats, with LED display	°C or °F	9-30 V (AC/DC)	NSYCCOTH30VID
Electronic thermostats, with LED display	°C or °F	90-140 V (AC)	NSYCCOTH120VID
Electronic thermostats, with LED display	°C or °F	200-240 V (AC)	NSYCCOTH230VID

Electronic Hygrotherm



NSYCCOHYT30VID

- Internal sensor element: Temperature sensor and humidity sensor
- Connection: 2 x 2.5 mm² (input voltage) + 2 relays (2 x 2.5 mm² + 2 x 2.5 mm²)
- Hysteresis: Programmed 2 K and 3%
- Temperature setting range: -40 °C...+80 °C
- Humidity setting range: 20%...80%

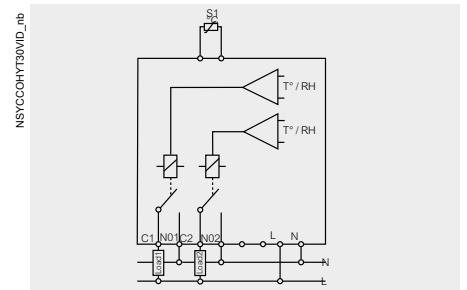

Characteristics	Display	Voltage (type of current)	References
Electronic hygrotherm	°C or °F or % RH	9-30 V (AC/DC)	NSYCCOHYT30VID
Electronic hygrotherm	°C or °F or % RH	90-140 V (AC)	NSYCCOHYT120VID
Electronic hygrotherm	°C or °F or % RH	200-240 V (AC)	NSYCCOHYT230VID

Electronic Hygrostat



NSYCCOHY230VID

- Internal sensor element: Humidity sensor
- Connection: 2 x 2.5 mm² (input voltage) + 1 relay (2 x 2.5 mm²)
- Hysteresis: 3%
- Humidity setting range: 20%...80%

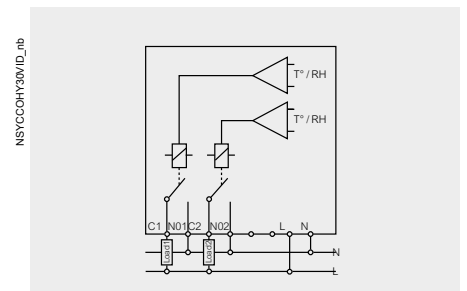

Characteristics	Display	Voltage (type of current)	References
Electronic hygrostat	% RH	200-240 V (AC)	NSYCCOHY230VID

External Temperature Sensor (Double Insulation)



NSYCCASTE

Sensor operation or reading range: -40 °C...+150 °C. Thermostat installation tips: The thermostat should be installed at the top of the enclosure (the hottest place). See the various operating modes of each thermostat to choose the one that best meets your needs. Hygrostat installation tips: The hygrostat should be installed at the bottom of the enclosure. 60% RH is the optimal value in the enclosure.

- Ingress protection rating: IP67
- Fixing: On DIN rail, on PanelSeT SFN profile, on VDI cross-rail, on mounting plate

Characteristics	Length of cable supplied	References
External temperature sensor	3 m	NSYCCASTE

Thermal Conditions: A Hot Topic for Enclosures

Temperature, humidity, and dew point all affect the performance of your electrical and electronic enclosures. Problem is, unless these environments are sized properly, thermal conditions will compromise reliability, safety, and efficiency, as well as the lifetime of your panels.

The precise knowledge of the thermal conditions is therefore indispensable to choose the most appropriate thermal management solution.

Proclima Web Software



ProClima Web Software provides the user with an optimized thermal management solution for:

- Automation and control panels.
- Motor Control Center panels (generally with Variable Speed Drives).

ProClima Web Software takes into account variables such as temperature, humidity, sun radiation and indoor or outdoor settings, in a nominal environment (without any dust, sand or corrosion). If the actual conditions involve a risk of dust, sand or corrosion, please adapt the proposed thermal solution. You can refer to the Control Panel Technical Guide CPTG001_EN and do not hesitate to contact your regular Schneider Electric sales point of contact.

The ProClima Web Software:

- Draws up a heat balance and defines the optimized ventilation, control, heating and cooling system to match your installed equipment temperature and humidity nominal characteristics.
- Optimizes your thermal management solution to minimize under- or over- sizing of designs.

The ProClima Web Software is recommended for panel architecture without any segregation of the compartments. The heat which is taken into account is calculated for volume. This is especially adapted for automation and control, and Motor Control Center applications

Benefits of ProClima Web Software

- Web software with regular and constant online updates
- Intuitive navigation available in all browser languages
- Reports are available in English, French, Spanish, German, Polish, Russian and Italian
- Cybersecurity level A
- Energy efficiency criteria used
- Analyze different thermal options in one enclosure
- CAD files available for enclosures, cooling units and heat exchangers devices
- Enclosure drawings illustrate the design of your installation
- A dimensional checklist is drawn up to help ensure the solution is compatible with your enclosure size
- Download useful technical documentations
- Get a complete final thermal report and add your own company logo to it

Applications of the software

- Indoor and outdoors installations
- Infrastructures
- Automotive industries
- Original Equipment Manufacturers (OEMs)

Download ProClima Free Software



ProClima Web Software User Guide

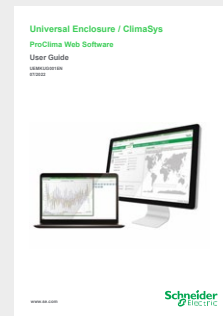

Technical Guides

Introduction

Enclosures and Thermal Management Systems Certifications	640
International Enclosure Standard	641
Selection of Enclosures	643
Degrees of Protection Provided by Enclosures	644
Classification of Electrical Equipment Enclosures According to NEMA and UL	645
Polyester Base-Painting Properties	647
Properties of the Plastic Materials	649
Description of the Marking Label Affixed to ATEX Certified Wall-Mounted Enclosures	651

Range	Empty assemblies					Equipped assemblies
	Empty assemblies for low-voltage switchgear	Standards for industrial equipment and UL classification	Marine environment classification or approval for protection and resistance to vibrations	Enclosures installed in a potentially explosive atmosphere	Outdoor heavy-duty enclosures	Low-voltage switchgear and controlgear assemblies
	Standard/Directive					
	IEC 62208	UL508A and CAN CSA C22-2 no. 14	Compliance with requirements of certified bodies	European directive no. 2014/34/UE EN60079-0 / EN60079-7 EN60079-3 / EN60529	IEC 61439-5 ISO 12944-6 IEC 61969-3	IEC61439-1&2
Spacial						
SBM	●	●	● ●			
S3D	● ● ⁽⁶⁾	●	● ● ●			
CRN	● ⁽⁶⁾	●	●			
S3DEX		●		●		
S3HF		●				
S3HD	● ⁽⁶⁾	●			●	
S3CM		●				
SM	● ● ⁽⁶⁾	●	●			
SFN	● ● ⁽⁶⁾	●	●			●
SFHD	● ● ⁽⁶⁾	●			●	●
PrismaSeT HD	● ⁽⁶⁾					●
SBX	●	●	●			
S3X	●	●	●			
SMX	●	●	● ⁽³⁾			
SFX	● ⁽³⁾	●	● ⁽³⁾			
Thalassa						
TBS/TBP	●	● ⁽¹⁾				
PLS	●	●				
PLM	● ● ⁽⁶⁾	●	●			
PLA	● ● ⁽⁶⁾	●	●			
PLAT	● ● ⁽⁶⁾					
PLAZ	● ● ⁽⁶⁾					
PLAZT	● ● ⁽⁶⁾					
PLD						
PHD	● ⁽⁶⁾				● ⁽²⁾	
ClimaSys⁽⁴⁾						
CV		●				
CU		●				
CE		●				
CR		● ⁽⁵⁾				
CC		●				

⁽¹⁾ Only TBP.

⁽²⁾ ISO 12944-6 only applies to the Spacial enclosures.

⁽³⁾ Only for single-door versions

⁽⁴⁾ EAC-compliant

⁽⁵⁾ The insulated and aluminum resistance heaters of 12-24 V DC and 270-420 V AC are not certified

⁽⁶⁾ Certificate by DEKRA

For other certifications and declarations of conformity please consult us.

Official Certification Body

Bureau Veritas	LCIE (Bureau Veritas)	Bureau Veritas Marine Division	TUV Rheinland Group	Underwriters Laboratories	Laboratorio Oficial J.M. Madariaga	DNV-GL	Lloyd's Register	Dekra	Asefa
●	●	●	●	●	●	●	●	●	●

Technical changes reserved. Information provided without guarantee. Images are for illustrative purposes only.

The Main 10 Functions of Standard IEC 61439

For each of the following 10 functions, the standard IEC 61439 requires design verifications from the system manufacturer - mainly through type-tests defined in IEC 62208 - and routine verifications on each panel from the panel builder to achieve 3 basic goals: Safety, continuity of service and compliance with end-user requirements.



Safety

Voltage stresses withstand capability

- To withstand long term voltages, and transient and temporary overvoltages according to the insulation coordination principles and requirements.

Current-carrying capability

To help protect against fire and to withstand temperature rise:

- When any circuit is continuously loaded, alone, to the specified current
- When the assembly is loaded to the specified current according to the specified load pattern (between circuits and/or as a function of the time).

Short-circuit withstand capability

- To withstand the stresses resulting from the prospective short-circuit current and from the associated data (high forces between conductors, temp. rise in a very short time, air ionization, overpressure).

Protection against electric shock

- Hazardous live parts not to be accessible (basic protection).
- Accessible conductive parts not to become hazardous-live (fault protection).

Protection against risk of fire or explosion

- Resistance to internal glowing elements.

Comment: Protection of persons, and optional protection of the assembly, against arcing due to internal fault can be specified through a "special test" according to IEC 61641.



Continuity of Service

Maintenance and modification capability

Capability to preserve continuity of supply without impairing safety during assembly, maintenance or modification.

- Electrical condition of the assembly or various circuits.
- Speed of exchange of the functional units.
- Test facilities...

Electro-Magnetic Compatibility

To properly function (immunity) and not to generate EM interference (emission) in specified environmental conditions:

- Industrial networks or locations (Environment A).
- Domestic, commercial, and light industrial locations (Environment B).



Compliance with End-User Requirements

Capability to operate the electrical installation

To properly function, according to:

- The electrical diagram of the overall system and related information (voltages, coordination...),
- The specified operating facilities (e.g. free or restricted access to man-machine interfaces, isolation of the outgoing circuits...).

Capability to be installed on site

- To withstand handling, transport, storage and installation constraints.
- Capability to be set up and connected (type of enclosure, type, material and cross-sectional areas of external conductors).

Protection of the assembly against mechanical and atmospheric ambient conditions

- Presence of water or solid foreign bodies (IP according to IEC 60529).
- External mechanical impacts (optional IK according to IEC 62262).
- Indoor or outdoor installation (humidity, UV).

Both the Point of Arrival of Energy and a Device for Distribution to the Site Applications, the LV Switchboard Is the Intelligence of the System, Central to the Electrical Installation.

It plays an essential role in the availability of electric power, while meeting the needs of personal and property safety. Its definition, design and installation are based on precise rules; There is no space for improvisation. The IEC 61439 standard aims to better define "low-voltage switchgear and controlgear assemblies", helping ensure that the specified performances are reached. It specifies in particular:

- The responsibilities of each player, distinguishing those of the original equipment manufacturer; the organization that performed the original design and associated verification of an assembly in accordance with the standard, and of the assembly manufacturer - the organization taking responsibility for the finished assembly
- The design and verification rules, constituting a benchmark for product certification All the component parts of the electrical switchboard are concerned by the IEC 61439 standard. Equipment produced in accordance with the requirements of this switchboard standard helps ensure the safety and reliability of the installation.

International Enclosure Standards

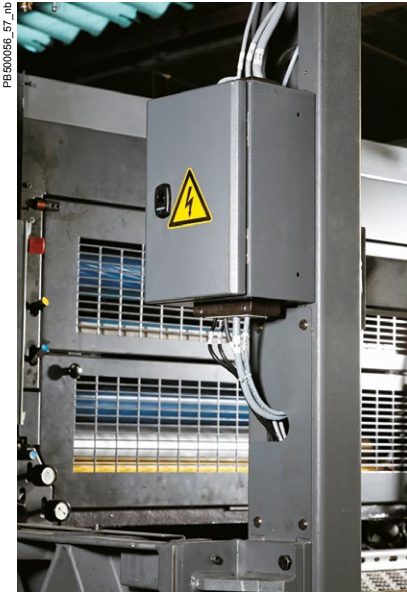

Comment:

European standard EN 62208 is identical to IEC 62208. European countries publish this standard according to the body in each country (for example BS EN 62208 in the UK).

Empty Enclosures for Low-Voltage Switchgear and Controlgear Assemblies. General Rules.

Application

For empty enclosures before adding the user's switchgear, in the condition as supplied by the manufacturer.

Field of application

Demands for testing the enclosures to be used as part of the switchgear assemblies for voltages of less than 1000 V alternating current and 1500 V direct current in accordance with IEC 61439.

Information supplied by the manufacturer

- Commercial trademark of the manufacturer: Schneider Electric.
- Mechanical characteristics, materials, conditions for use.
- Conditions for use: Ambient air temperature for outdoor installations: -25 to +40 °C.
- Atmospheric conditions for outdoor installations: The humidity may temporarily reach 100% at a temperature of 25 °C.
- Transport and storage conditions: From -25 to +55 °C; For limited periods not exceeding 24 h: Up to +70 °C.



Standard Tests of Standard IEC 62208

- Static loads: Test 1.25 x maximum admissible load during 1 hour.
- Lifting: Applicable to enclosures with lifting accessories.
- Axial loads of metal inserts: 500 N for 10 seconds for M8 inserts.
- IK code: Test according to standard IEC 62262 with pendulum impact tester. The enclosure must maintain its IP rating after the test.
- IP rating: Test according to standard IEC 60529. Degree of protection against access to dangerous parts and the penetration of solid bodies and against the penetration of water.
- Thermal stability at a temperature of 70 °C: 7 days.
- Resistance to heat: Ball test at 70 °C.
Information required for enclosures made from insulated material.
- Resistance to abnormal heat and to fire: Glow wire test according to IEC 60695-2-10 and IEC 60695-2-11.
Information required for enclosures made from insulated material.
- Dielectric strength: 5000 V
Information required for enclosures made from insulated material.
- Protection circuit continuity for metal enclosures: Resistance not to exceed 0.1 ohm.
- Weather resistance: Duration 500 h (cycle: Rain 5 minutes + UV lamp 25 minutes).

Corrosion resistance:

For indoor enclosures:

- 6 cycles of 24 hours of the damp heat test at 40 °C and relative humidity of 95%.
- 2 cycles of 24 hours of the salt mist test at 35 °C.

For outdoor enclosures:

2 identical 12 day periods. Each one with:

- 5 cycles of 24 hours of the damp heat test at 40 °C and relative humidity of 95%.
- 7 cycles of 24 hours of the salt mist test at 35 °C.

Our empty enclosures are CE-marked according to the Low-Voltage Directive (LVD). It is the responsibility of the final equipment manufacturer to respect regulations in force.

Selection According to the IP Protection Degrees

The degrees of protection, explained on the next page, is an important element when selecting the enclosures. The following table shows the protection degrees of the enclosures.

Name	Range	IP43	IP44	IP54	IP55	IP65 ⁽⁷⁾	IP66
Metal industrial boxes	Spacial SBM						●
Metal derivation boxes	Spacial SDB				●		
Stainless-steel boxes	Spacial SBX						●
Steel wall-mounted enclosures	Spacial S3D				● ⁽¹⁾		●
Steel modular distribution wall-mounted enclosures	Spacial S3DM						●
Terminal wall-mounted enclosures	Spacial S3DB						●
Steel wall-mounted enclosures	Spacial S3HF				●		
Steel wall-mounted enclosures	Spacial CRN				● ⁽¹⁾		●
EMC steel floor-standing enclosures	Spacial SFHF				●		
HMI control enclosures	Spacial S3CM			●			
ATEX steel wall-mounted enclosures	Spacial S3DEX						●
Steel outdoor wall-mounted enclosures	Spacial S3HD						●
Stainless-steel wall-mounted enclosures	Spacial S3X				● ⁽¹⁾		●
Seismic and nuclear enclosures	Spacial S3D6G / Spacial S3D6GK3					●	
Terminal enclosures with FL21 cut-out	Spacial S3DBFL					● ⁽⁶⁾	
Steel floor-standing enclosures	Spacial SM				●		
Steel suitable enclosures	PanelSeT SFN				●		
Steel outdoor floor-standing enclosures	Spacial SFHD				●		
Stainless-steel floor-standing enclosures	Spacial SMX						● ⁽⁷⁾
Stainless-steel suitable enclosures	Spacial SFX						● ⁽⁷⁾
Functional steel floor-standing enclosures	PrismaSeT HD				●		
Steel control desks	Spacial SD				●		
Thermoplastic industrial boxes	Thalassa TBS-TBP				● ⁽⁴⁾		● ⁽⁵⁾
Polyester modular boxes	Thalassa PLS						●
Polyester wall-mounted enclosures	Thalassa PLM						●
Polyester outdoor wall-mounted enclosures	Thalassa PHD					●	
Polyester floor-standing enclosures	Thalassa PLA ⁽²⁾		●	●		●	
Polyester floor-standing enclosures	Thalassa PLD	●		● ⁽³⁾			
Polyester outdoor floor-standing enclosures	Thalassa PHD				●		

⁽¹⁾ Double-door.

⁽²⁾ Different IP depending on the version. See introduction in Thalassa section: PLA: IP65, PLAT / PLA2T: IP44, PLAZ / PLAT / PLA2T with grille: IP54.

⁽³⁾ With gasket.

⁽⁴⁾ Button boxes.

⁽⁵⁾ Universal boxes.

⁽⁶⁾ With membrane mounted.

⁽⁷⁾ Single-door enclosure.

The Universal Offer

> **3** Material Options

Steel

Stainless-Steel

Plastic and Polyester

Selection According to Ambient Conditions

The location of the enclosures and the physical, chemical and climatic conditions to which they are exposed will determine the model to be used.

- Steel enclosures are particularly well suited to indoor use in industrial environments.
- Stainless-steel enclosures are particularly well suited to corrosive environments or areas where specific hygiene demands are applicable.
- Polyester enclosures are particularly well suited to severe corrosive atmospheres, indoors or outdoors.

Enclosures made from insulated materials ensure total insulation, reducing electric hazards for persons.



























The main characteristics of the plastic materials of our enclosures and their chemical strength are given on [page 649](#).

Further help for making the selection is given by the NEMA or UL classification of the enclosure, see [page 646](#).

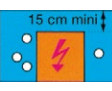
- The degrees of protection provided by the enclosures are defined by standards IEC 60529 (IP) and IEC 62262 (IK).
- Degrees of protection are indicated by the letters IP followed by two characteristic numerals. The numerals show the degree of protection offered by the enclosure against access to hazardous parts, the penetration by solid bodies (1st numeral), and against the penetration of liquids (2nd numeral).
- The protection against external mechanical impact is indicated by the letters IK followed by a characteristic group numeral.

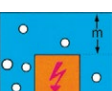
Comment:

Many EN European standards are harmonized with international IEC standards. This is the case with enclosure protection standards:
 - EN 60529 = IEC 60529.
 - EN 62262 = IEC 62262.

First numeral Protection against solid bodies	IP Second numeral Protection against liquids	IK Mechanical protection
<p>0 </p> <p>No protection</p>	<p>0 </p> <p>No protection</p>	<p>0 </p> <p>No protection</p>
<p>1 </p> <p>Protected against solid bodies larger than 50 mm (e.g.: Incidental contact with the hand)</p>	<p>1 </p> <p>Protected against vertically falling water droplets (condensation)</p>	<p>1 </p> <p>Impact energy: 0.150 Joules</p>
<p>2 </p> <p>Protected against solid bodies larger than 12 mm (e.g.: Finger contact)</p>	<p>2 </p> <p>Protected against water droplets deflected at up to 15° from vertical</p>	<p>2 </p> <p>Impact energy: 0.200 Joules</p>
<p>3 </p> <p>Protected against solid bodies larger than 2.5 mm (tools, cables)</p>	<p>3 </p> <p>Protected against rainwater at up to 60° from vertical</p>	<p>3 </p> <p>Impact energy: 0.350 Joules</p>
<p>4 </p> <p>Protected against solid bodies larger than 1 mm (fine tools, small cables)</p>	<p>4 </p> <p>△ Protection against water spray from all directions</p>	<p>4 </p> <p>Impact energy: 0.500 Joules</p>
<p>5 </p> <p>◆ Protected against dust (no harmful deposits)</p>	<p>5 </p> <p>△△ Protected against low-pressure water jets from all directions</p>	<p>5 </p> <p>Impact energy: 0.700 Joules</p>
<p>6 </p> <p>◆ Totally dust tight</p>	<p>6 </p> <p>Protected against powerful water jets from all directions</p>	<p>6 </p> <p>Impact energy: 1.00 Joules</p>
	<p>7 </p> <p>⋯ Protected against the effects of immersion</p>	<p>7 </p> <p>Impact energy: 2.00 Joules</p>
	<p>8 </p> <p>⋯... m Protected against prolonged effects of immersion under pressure</p>	<p>8 </p> <p>Impact energy: 5.00 Joules</p>
		<p>9 </p> <p>Impact energy: 10.00 Joules</p>
		<p>10 </p> <p>Impact energy: 20.00 Joules</p>

Classification of Electrical Equipment Enclosures According to NEMA and UL

NEMA and UL are standardization bodies, commonly recognized in North America, which have issued classifications of enclosures according to the protection offered in various environments.

These classifications are similar.

The 1st table below summarizes these classifications which do not include potentially explosive areas.

The detailed recommendations of these classifications are given on the next page.

The 2nd table indicates the classification of our enclosures.

These classifications appear in our UL certifications (see Certification technical annex on [page 646](#)).

Certification according to the UL classification helps guarantee the corresponding NEMA classification by equivalence.

Environment and protection	Classification												
	1	2	3	3R	3S	4	4X	5	6	6P	12	13	
Indoor use	●	●	●	●	●	●	●	●	●	●	●	●	
Outdoor use			●	●	●	●	●		●				
Incidental contact with the equipment	●	●	●	●	●	●	●	●	●	●	●	●	
Dirt	●	●	●	●	●	●	●	●	●	●	●	●	
Drips and gentle splashes of non-corrosive liquids		●	●	●	●	●	●	●	●	●	●	●	
Rain, frost* and snow			●	●	●	●	●		●	●			
Frost**					●								
Dust, fibers and particles in suspension			●		●	●	●		●	●	●	●	
Accumulated dust, fibers and particles in suspension			●		●	●	●	●	●	●	●	●	
Clouds of dust			●		●	●	●		●	●			
Splashes and spray of water						●	●		●	●			
Gentle splashes and leaks of oil or non-corrosive coolants											●	●	
Drips, splashing and spraying of oil or non-corrosive coolants												●	
Corrosive agents							●			●			
Occasional temporary immersion									●	●			
Occasional prolonged immersion										●			

* The operation of the external mechanisms is not required when the enclosure is covered with frost.

** The operation of the external mechanisms is required when the enclosure is covered with frost.

Enclosures		Type of protection ⁽¹⁾													
Name	Range	1	2	3	3R	3S	3X	3RX	3SX	4	4X	5	6	12	13
Metal industrial boxes	SBM									●	●				
Stainless-steel industrial boxes	SBX									●	●				●
HMI control enclosures	S3CM	●	●		●									●	●
Steel wall-mounted enclosures	S3D ⁽¹⁾	●	● ⁽²⁾	● ⁽²⁾	● ⁽²⁾					● ⁽²⁾	● ⁽²⁾	● ⁽²⁾		●	●
Steel wall-mounted enclosures	S3HF	●	●	●	●									●	●
Steel outdoor wall-mounted enclosures	S3HD	●	●	●	●					●	●	●		●	●
Steel wall-mounted enclosures	CRN	●	●	●	●					●	●	●		●	●
Stainless-steel wall-mounted enclosures	S3X	●	● ⁽²⁾	● ⁽²⁾	● ⁽²⁾					● ⁽²⁾	● ⁽²⁾	● ⁽²⁾		●	● ⁽²⁾
Steel floor-standing enclosures	SM	●	● ⁽²⁾	● ⁽²⁾	●							● ⁽²⁾		●	●
Polyester outdoor wall-mounted enclosures	PHD	●	●	●	●					● ⁽²⁾	● ⁽²⁾	●		●	●
Steel suitable enclosures	SFN	●			●									●	
Steel outdoor floor-standing enclosures	SFHD	●			●									●	
Stainless-steel floor-standing enclosures	SMX	●	● ⁽²⁾	● ⁽²⁾	● ⁽²⁾					● ⁽²⁾	● ⁽²⁾	● ⁽²⁾		●	●
Stainless-steel floor-standing enclosures	SFX	● ⁽²⁾	● ⁽²⁾	● ⁽²⁾	● ⁽²⁾					● ⁽²⁾	● ⁽²⁾	● ⁽²⁾			● ⁽²⁾
Thermoplastic boxes	TBP	●		●		●				●	●				
Polyester modular boxes	PLS	●	●	●	●	●				●	●			●	●
Polyester wall-mounted enclosures	PLM	●	●	●	●	●				●	●	●		●	●
Polyester floor-standing enclosures	PLA	●	●	● ⁽²⁾	● ⁽²⁾	● ⁽²⁾	● ⁽²⁾	● ⁽²⁾	● ⁽²⁾			● ⁽²⁾		●	●

⁽¹⁾ Also S3DM, S3DEX and S3DC.

⁽²⁾ 1 door.

Components		Type of protection ⁽⁵⁾													
Name	Range	1	2	3	3R	3S	4	4X	5	6	6P	12	13		
Airing system	CV											●			
Thermal control system	CC	●													

⁽⁵⁾ In some ranges the classification depends on the model and version. The detailed protection types are indicated in the UL certifications.

Classification of Electrical Equipment Enclosures According to NEMA and UL

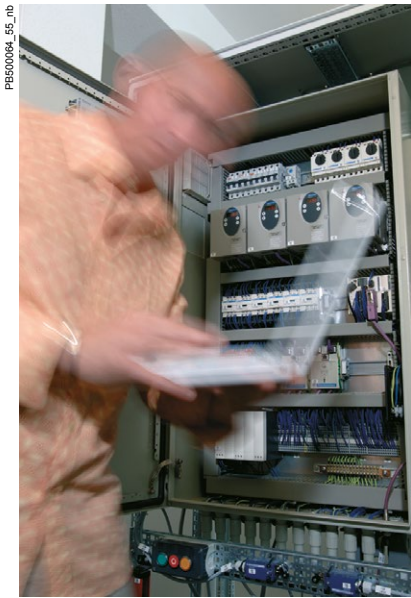

The enclosures must protect the equipment against environmental conditions and help protect persons against the risk of incidental contact with the equipment. The following classifications (Type) are applied according to the required uses and prescriptions:

Type	Use	Prescription
1	Indoor use	The enclosure provides protection for persons against incidental contact with the internal equipment and protects said equipment against dirt.
2	Indoor use	It provides protection for persons against incidental contact with the internal equipment and protects said equipment against dirt, drips and gentle splashes of non-corrosive liquids.
3	Indoor and outdoor use	The enclosure provides protection for persons against incidental contact with the internal equipment and protects said equipment against dirt, rain, sleet, snow, windblown and resists the formation of ice on the outside.
3R	Indoor and outdoor use	The enclosure provides protection for persons against incidental contact with the internal equipment and protects said equipment against dirt, rain, sleet, snow and resists the formation of ice on the outside.
3S	Indoor and outdoor use	The enclosure provides protection for persons against incidental contact with the internal equipment and protects said equipment against dirt, rain, sleet, snow and windblown dust. The external mechanism must continue to work even when layers of ice are formed.
3X	Indoor and outdoor use	The enclosure provides a degree of protection to personnel against access to hazardous parts; To provide a degree of protection of the equipment inside the enclosure against ingress of solid foreign objects (falling dirt and windblown dust); To provide a degree of protection with respect to harmful effects on the equipment due to the ingress of water (rain, sleet, snow); To provide an additional level of protection against corrosion and that will be undamaged by the external formation of ice on the enclosure.
3RX	Indoor and outdoor use	The enclosure provides a degree of protection to personnel against access to hazardous parts; To provide a degree of protection of the equipment inside the enclosure against ingress of solid foreign objects (falling dirt); To provide a degree of protection with respect to harmful effects on the equipment due to the ingress of water (rain, sleet, snow); To prevent damage by the external formation of ice on the enclosure and to provide an additional level of protection against corrosion.
3SX	Indoor and outdoor use	The enclosure provides a degree of protection to personnel against access to hazardous parts; To provide a degree of protection of the equipment inside the enclosure against ingress of solid foreign objects (falling dirt and windblown dust); To provide a degree of protection with respect to harmful effects on the equipment due to the ingress of water (rain, sleet, snow); To provide an additional level of protection against corrosion; To ensure that external mechanism(s) remain operable when ice laden.
4	Indoor and outdoor use	The enclosure provides protection for persons against incidental contact with the internal equipment and protects said equipment against dirt, rain, sleet, snow, windblown dust, splashes and hose-directed water and resists the formation of frost on the outside.
4x	Indoor and outdoor use	The enclosure provides protection for persons against incidental contact with the internal equipment and protects said equipment against dirt, rain, sleet, snow, windblown dust, splashes, hose-directed water and resists corrosion and the formation of ice on the outside.
5	Indoor use	The enclosure provides protection for persons against incidental contact with the internal equipment and protects said equipment against dirt, settling airborne dust, lint, fibers, flyings, drips and gentle splashes of non-corrosive liquids.
6	Indoor and outdoor use	The enclosure provides protection for persons against incidental contact with the internal equipment and protects said equipment against dirt, rain, sleet, snow, hose-directed water, the entry of water during occasional temporary submersion to a limited depth and resists the formation of ice on the outside.
6P	Indoor and outdoor use	The enclosure provides protection for persons against incidental contact with the internal equipment and protects said equipment against dirt, rain, sleet, snow, hose-directed water, the entry of water during prolonged submersion to a limited depth and resists corrosion and the formation of ice on the outside.
12	Indoor use (without knock-outs)	The enclosure provides protection for persons against incidental contact with the internal equipment and protects said equipment against dirt, dust, fluff, fibers, particles in suspension, drips and gentle splashes of non-corrosive liquids as well as gentle splashes or leaks of oil and non-corrosive coolants.
13	Indoor use	The enclosure provides protection for persons against incidental contact with the internal equipment and protects said equipment against dirt, dust, lint, fibers flyings and the spraying, splashing, and seepage leaks of water, oil or non-corrosive coolants.

Note:
The above recommendations aim to explain the NEMA and UL classifications, but are not the official texts of NEMA or UL. The exact definitions provided by the Organisations are those of standards NEMA 250 and UL 50E.

Polyester Base-Painting Properties



Product type

Thermosetting polyester resins based powder painting modified by epoxy resins and designed for decoration and to help prevent corrosion. The performance of this painting is superior to conventional epoxy powders in terms of color stability, temperature resistance and weather resistance. RAL 7035 gray; Surface finish: Structured.

Mechanical properties

Testing conditions: Steel samples with a thickness of 10/10^e mm. Degreasing using biodegradable surface-active agents. Film thickness: 60 microns.

Test	Standard	Result
Bonding (scratching and adhesive tape)	ISO 2409	≥ to Class 1
Ericksen stamping	ISO 1520	≥ 7 mm
Direct impact resistance	ISO 6272	> 1 kg/70 cm
Indirect impact resistance	ISO 6272	> 1 kg/20 cm
Bending around conical mandrel	ISO 6860 - ASTM D 522-88	Maximum cracking of 70 mm, without the paint coming loose

Chemical properties

Tests conducted at ambient temperature on phosphated samples covered with a 70 to 100 micron film:

- Film intact.
- Film attacked (blistering, yellowing, loss of gloss).

Number of months		2	4	6	8	10	12	
Acid	Acetic	20%	[Blue bar]					
	Sulphuric	30%	[Blue bar]					
	Nitric	30%	[Blue bar]		[Red bar]			
	Phosphoric	30%	[Blue bar]					
	Hydrochloric	30%	[Blue bar]				[Red bar]	
	Lactic	10%	[Blue bar]					
	Citric	10%	[Blue bar]				[Red bar]	
Base	Soda	10%	[Blue bar]		[Red bar]			
	Ammonia	10%	[Blue bar]		[Red bar]			
Water	Distilled water		[Blue bar]				[Red bar]	
	Sea water		[Blue bar]					
	Tap water		[Blue bar]					
	Diluted chloride bleach		[Blue bar]		[Red bar]			
Solvents	Petrol		[Blue bar]		[Red bar]			
	Higher-grade alcohols		[Blue bar]				[Red bar]	
	Aliphatics		[Blue bar]		[Red bar]			
	Aromatics		[Blue bar]		[Red bar]			
	Ketone-ester		[Red bar]					
	Tri-perchlorethylene		[Red bar]					

Physical properties

Temperature resistance: -40 °C and 100 hours at +150 °C (color: White). Gloss retention: Good.

Resistance to corrosion

Compliance with standard IEC 62208 for outdoor installations: 288 h of humid heat and 336 h of salt mist.

Polyester Base-Painting Properties

Nuclear decontamination

Applicable to colors RAL 7035 gray and AFNOR A550.
Standard NFT 30901. Percentage of decontamination for contamination by fission products. Please consult us for further details.

Accelerated aging

Standard IEC 62208: 500 h UV according to ISO 4892 (method A)
(adherence of the painting with minimum retention of 50% on the grid according to ISO 2409).

Fire behaviour

Class M1 (self-extinguishing material).
Class M0 (for painting on a metal base).

Manufacturing process



Properties of Plastic Materials - Mechanical, Electrical, Physical and Fire-Resistance Properties

Plastic materials generally used to manufacture our products:

- ABS.
- Polycarbonate.
- PVC (polyvinyl chloride).
- Bayblend® = PC + ABS.
- Polyester reinforced with fiberglass.
- Altuglas.
- Polypropylene.
- Polystyrene.
- Polyamide 6 and 12.
- SBS.

Comment:

For other chemical agents, please contact us.

All information provided here is taken from the best sources and provided for information purposes only, with no commitment on our behalf.

Specifications	Standards	Units	ABS	Polycarbonate	PVC	Bayblend®	Polyester	SBS
Mechanical properties								
Tensile strength	ISO 257	MPa	44	> 65	45	35	85	5
Tensile strain	ISO 527	%	12	> 110	120 bis 150	40	0	600
Impact resistance	ISO 179	kJ/m ²	125	No breakage	25	No breakage	60	No breakage
Notching resistance	ISO 179	kJ/m ²	19	25	20	25	50	-
Electrical properties								
Stress point	IEC 60112	-	-	250-300	> 600	> 550	> 600	-
Surface strength	IEC 60093	Ω	1015	> 1015	> 1013	> 1014	≥1012	> 1013
Dielectric strength	IEC 60243	kV/mm	16.5	> 30	30	24	18-20	20
Specific resistivity	IEC 60093	Ω ² cm	1015	> 1016	≥ 1015	1016	≥ 1012	> 1016
Physical properties								
Softening temperature (Vicat B)	ISO 306	°C	95	145-150	79-80	115	⁽¹⁾	80
Temperature resistance	-	°C	-40...+90	-50...+125	-20...+65	-35...+90	-50...+150	-40...+120
Water absorption	ISO 62	%	0.2 - 0.45	0.15	< 0.1	0.2	0.2	-
Specific weight	ISO 1183	kg/dm ³	1.04	1.21	1.4	1.12	1.85	0.3 in 24 h
Fire resistance								
Oxygen index	ISO 4589	%	19	26	45-50	22	24.4	18
Glow wire resistance, 2 mm	IEC 60695-2-10	°C	650	960	960	750	960	750° (1.5 mm)
Glow wire resistance, 3 mm	IEC 60695-2-10	°C	650	960	960	750	960	NA

⁽¹⁾No softening of the polyester.

Specifications	Standards	Units	Altuglas	Polypropylene	Polystyrene	Polyamide 6	Polyamide 12
Mechanical properties							
Tensile strength	ISO 257	MPa	30	35	24	40	30
Tensile strain	ISO 527	%	5	400	36	200	300
Impact resistance	ISO 179	kJ/m ²	20	20	63	No breakage	No breakage
Notching resistance	ISO 179	kJ/m ²	3	5	50	31.2	15
Electrical properties							
Stress point	IEC 60112	-	-	-	KB175	KB175	KB180
Surface strength	IEC 60093	Ω	≥ 1014	-	> 1013	1012	5 x 1010
Dielectric strength	IEC 60243	kV/mm	13-15	20	≤ 40	23	55
Specific resistivity	IEC 60093	Ω ² cm	> 1015	> 1016	> 1015	1011	3 x 1011
Physical properties							
Softening temperature (Vicat B)	ISO 306	°C	120-122	75 (vicat A)	79	230	140
Temperature resistance	-	°C	-20...+80	-10...+80	-15...+60	-20...+100	-50...+125
Water absorption	ISO 62	%	< 0.5	0.1 in 24 h	0.1 in 24 h	1.6	1.5
Density	ISO 1183	kg/dm ³	1.18	0.91	1.06	1.14	1.03
Fire resistance							
Oxygen index	ISO 4589	%	18.5	18	18	24	22
Glow wire resistance, 2 mm	IEC 60695-2-10	°C	-	650	650	750	650
Glow wire resistance, 3 mm	IEC 60695-2-10	°C	960	650	650	850	650

Properties of Plastic Materials - Resistance to Chemical Agents

Plastic materials generally used to manufacture our products:

- ABS.
- Polycarbonate.
- PVC (polyvinyl chloride).
- Bayblend® = PC + ABS.
- Polyester.
- Altuglas.
- Polypropylene.
- Polystyrene.
- Polyamide 6 and 12.
- SBS.

The table shows:

The concentration of the chemical agent in %;

- Sat = saturation.

The resistance of the material:

- +: Resistant.
- O: Limited resistance.
- -: Not resistant.

Resistance to	ABS	Polycarbonate	PVC	Bayblend®	Polyester	Altuglas	Polypropylene	Polystyrene	Polyamide 6	Polyamide 12	SBS											
Acetone	-	-	-	-	-	O	100	+	-	100	+											
Hydrochloric acid	15	+	10	+	30	+	20	+	30	+	sat	+	10	+	O	10	-	10	+	10	+	
Citric acid			10	+	sat	+	10	+	100	+	sat	+	+	10	O			+	+	10	+	
Lactic acid	80	+	10	+	90	+	10	-	100	+	20	+	90	+	O	50	O		+	+	sat	+
															90	-			+			
Nitric acid	30	+	10	+	50	+	10	+	20	+	10	+	25/		O	2	O		-		50	+
			100	-					+	100	-	50			10	-						
Phosphoric acid	85	+	100	+	sat	+		+	100	+	10	+	sat	+	O	2	O	50	+			+
										95	-				10	-						
Sulphuric acid	50	+	50	+	96	+	30	+	70	+	30	+	96	+	O	3	-	10	+		96	+
			100	-																		
Alcohol	O	96	+	96	+		-	50	O	50	O	96	+	+	96	O	96	+				+
Pure aniline	O		-	100	-		-		O		-	100	+		100	O	100	O				
Benzene	+	100	-		-		+		-		O	100	O		100	+		+				-
Liquid bromine		100	-		-		-					100	-					100	-			-
Liquid chlorine			-	100	-		-	sat	+		-	100	-		100	O		-		50	+	
Sea water	+	100	+	100	+		+	100	+	100	+			100	+		100	+		100	+	sat
Petrol	+	100	+	100	O		-	100	+	100	O		-		100	+		+				-
Ether	-	100	O	100	-		-	100	O		+				100	+	100	+				-
Hexane	O		+		O		O		-			100	+		100	+	100	+				-
Oil and greases	+	100	+	100	+		O	100	+	100	O	100	+		-		+	100	+			-
Aromatic hydrocarbon	O		-		-		-		-		+	-			-		-		+			-
Fuel oil	O	100	O	100	+		-	100	+	100	-	100	+		100	+	100	+				-
Naphthalene				100	O		-	100	+	100	-	100	+		100	+	100	+				-
Nitrobenzene	-		-	100	-		-				-	100	O			-			O			-
Phenol	-		-	sat	O		-	20	O		-	sat	+			-			-	10	O	
Mineral salts			+		+		+		+		+		+						+			+
Iodine solution			O		-		+				-							+				
Toluene	-		-	100	-		-		+		O	100	O		-	100	+	100	+			-
Trichloroethylene	-		-	100	-		-		-		-	100	O		-	100	-	100	O			-
Urea			sat	+	sat	+		+				sat	+				10	+	sat	+	sat	O

Comment:

For other chemical agents please contact us.

All information provided here is taken from the best sources and provided for information purposes only, with no commitment on our behalf.

Description of Marking Labels on ATEX-Certified Wall-Mounted Enclosures

Spacial S3DEX

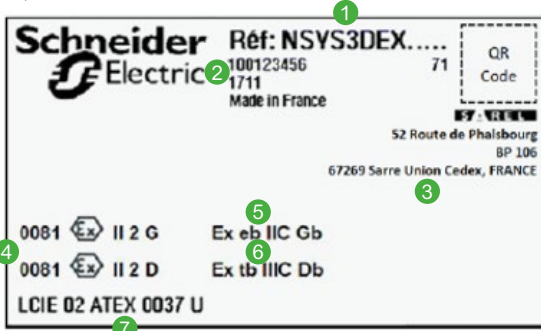

1

- Range of the product with its dimensions

2

- 100123456 71: exemple of the serial number
- 1711: exemple of the year and the month of the manufacturing

3

- Address of manufacturer

4

- 0081: identification number of the notified body for the application of the ATEX directive
- Ex: distinctive mark indicating that the product is authorized in an explosive atmosphere
- II: Industry group (II = surface industries)
- 2: device category (2 = occasional presence, Zone 1 or 21)
- G: atmosphere type (G = gases and vapors)
- D: atmosphere type (D = dust)

5

- Ex: symbol that indicates the product complies with one or several protection modes
- eb: protection level of type of protection "e" for increased safety (EN 60079-7)
- II C: group of gaz (hydrogen/acetylene)
- Gb: type of protection for non-electric material (control of power supply) G = gaz

6

- Ex: symbol indicating that the product complies with one or several protection types
- tb: protection level of type of protection "t" per enclosure (EN 60079-31)
- III C: type of dust (conductive dust)
- Db: type of protection for non-electric material (control of power supply) D = dust

7

- Number of the EC type examination certificate (Included the name of the certification body)



Download our ATEX certificates from our site.

Spare Parts

Content

Spare Parts - Selection Table	654
Spare Parts ClimaSys	665

Steel Industrial Boxes SBM



NSYSBMABS4

Accessories	References
Bag of acces. SBM boxes 4 screws	NSYSBMABS4
Bag of acces. SBM boxes 6 screws	NSYSBMABS6

Steel Wall-Mounted Enclosures S3D



NSYDS3D32

Single doors	References	Door accessories	References
Plain door 300 x 200	NSYDS3D32	Gasket double-door enclosure (previous version before May 2023)	NSYGDD
Plain door 300 x 250	NSYDS3D325	Set of 5 taps and latches	NSYS3DRTL
Plain door 300 x 300	NSYDS3D33	Hinge 120°	NSYAEDH120S3D
Plain door 300 x 400	NSYDS3D34	Hinge 180°	NSYAEDH180S3D
Plain door 400 x 300	NSYDS3D43	Earthing accessories	References
Plain door 400 x 400	NSYDS3D44	Set of 500 earthing labels	NSYSWMEL
Plain door 400 x 600	NSYDS3D46	Fixing hardware cable Gland plate	References
Plain door 500 x 300	NSYDS3D53	100 screws	NSYS3DCGSB
Plain door 500 x 400	NSYDS3D54	standard screw bag	NSYS3DCGPSTDSB
Plain door 500 x 500	NSYDS3D55	Locking accessories	References
Plain door 600 x 400	NSYDS3D64	Set of 10 linkage guides	NSYS3DLG
Plain door 600 x 500	NSYDS3D65	Standard key DB3	NSYAEDLS3DKDB3
Plain door 600 x 600	NSYDS3D66	Lock + standard key DB3 neutral	NSYAEDLS3DRLN
Plain door 600 x 800	NSYDS3D68	3 point lock linkage H 600 mm	NSYBTAS3D60
Plain door 700 x 500	NSYDS3D75	3 point lock linkage H 700 mm	NSYBTAS3D70
Plain door 800 x 600	NSYDS3D86	3 point lock linkage H 800 mm	NSYBTAS3D80
Plain door 800 x 800	NSYDS3D88	3 point lock linkage H 1000 mm	NSYBTAS3D100
Plain door 800 x 1000	NSYDS3D810	3 point lock linkage H 1200 mm	NSYBTAS3D120
Plain door 1000 x 600	NSYDS3D106	3 point lock linkage H 1400 mm	NSYBTAS3D140
Plain door 1000 x 800	NSYDS3D108	Lock with key type 3131A	NSYAEDL3131AS3D
Plain door 1000 x 1000	NSYDS3D1010	3 point lock linkage (H = 650 mm)	NSYBTAS3D65
Plain door 1200 x 1000	NSYDS3D1210	3 point lock linkage (H = 900 mm)	NSYBTAS3D90
Plain door 1200 x 600	NSYDS3D126	Panels	References
Plain door 1200 x 800	NSYDS3D128	50 caps for holes of hinges WM	NSYSWMCH
		Set of 50 back plugs WM	NSYSWMBP
Double door (new design from April 2023)	References	Double door (previous design before April 2023)	References
Plain door 800 x 500 right	NSYDNS3D85R	Plain door 800 x 500 right	NSYDS3D85R
Plain door 800 x 500 left	NSYDNS3D85L	Plain door 800 x 500 left	NSYDS3D85L
Plain door 800 x 600 right	NSYDNS3D86R	Plain door 800 x 600 right	NSYDS3D86R
Plain door 800 x 600 left	NSYDNS3D86L	Plain door 800 x 600 left	NSYDS3D86L
Plain door 1000 x 500 right	NSYDNS3D105R	Plain door 1000 x 500 right	NSYDS3D105R
Plain door 1000 x 500 left	NSYDNS3D105L	Plain door 1000 x 500 left	NSYDS3D105L
Plain door 1000 x 600 right	NSYDNS3D106R	Plain door 1000 x 600 right	NSYDS3D106R
Plain door 1000 x 600 left	NSYDNS3D106L	Plain door 1000 x 600 left	NSYDS3D106L
Plain door 1200 x 500 right	NSYDNS3D125R	Plain door 1200 x 500 right	NSYDS3D125R
Plain door 1200 x 500 left	NSYDNS3D125L	Plain door 1200 x 500 left	NSYDS3D125L
Plain door 1200 x 600 right	NSYDNS3D126R	Plain door 1200 x 600 right	NSYDS3D126R
Plain door 1200 x 600 left	NSYDNS3D126L	Plain door 1200 x 600 left	NSYDS3D126L
Plain door 1400 x 500 right	NSYDNS3D145R	Plain door 1400 x 500 right	NSYDS3D145R
Plain door 1400 x 500 left	NSYDNS3D145L	Plain door 1400 x 500 left	NSYDS3D145L

Steel Wall-Mounted Enclosures S3DM



NSYS3DCGSB

Fixing hardware	References
100 screws for cable gland plate	NSYS3DCGSB
Standard screw bag cable gland plate	NSYS3DCGPSTDSB
Earthing accessories	References
Set of 500 earthing labels	NSYSWMEL
Locking accessories	References
Set of 10 linkage guides	NSYS3DLG
Standard key DB3	NSYAEDLS3DKDB3
3 point lock linkage H 600 mm	NSYBTAS3D60
3 point lock linkage H 700 mm	NSYBTAS3D70
3 point lock linkage H 800 mm	NSYBTAS3D80
3 point lock linkage H 1000 mm	NSYBTAS3D100
Panels WM	References
50 caps for holes of hinges	NSYSWMCH
Set of 50 back plugs	NSYSWMBP

Steel Wall-Mounted Enclosures S3DC



NSYSWMEL

Earthing accessories	References
Set of 500 earthing labels	NSYSWMEL
Locking accessories	References
Set of 10 linkage guides	NSYS3DLG
Standard lock enclosures	NSYAEDLS3DC
3 point lock linkage H 600 mm	NSYBTAS3D60
3 point lock linkage H 700 mm	NSYBTAS3D70
3 point lock linkage H 800 mm	NSYBTAS3D80
3 point lock linkage H 1000 mm	NSYBTAS3D100
3 point lock linkage H 1200 mm	NSYBTAS3D120
Panels WM	References
50 caps for holes of hinges	NSYSWMCH
Set of 50 back plugs	NSYSWMBP

Steel Wall-Mounted Enclosures S3DB



NSYSWMEL

Earthing accessories	References
Set of 500 earthing labels	NSYSWMEL
Locking accessories	References
Standard key DB3	NSYAEDLS3DKDB3
Panels	References
50 caps for holes of hinges WM	NSYSWMCH
Set of 50 back plugs WM	NSYSWMBP

Steel Wall-Mounted Enclosures CRN



NSYDCRN22

Doors	References	Door accessories	References
Plain door H 200 x W 200	NSYDCRN22	Standard Spacial hinge	NSYBICRN
Plain door H 200 x W 300	NSYDCRN23	Earthing accessories	References
Plain door H 250 x W 200	NSYDCRN2520	Set of 500 earthing labels	NSYSWMEL
Plain door H 300 x W 250	NSYDCRN3025	Locking accessories	References
Plain door H 300 x W 300	NSYDCRN33	TCRE1 Lock	NSYTCRE1
Plain door H 300 x W 400	NSYDCRN34	TCRE12 Lock	NSYTCRE12
Plain door H 300 x W 450	NSYDCRN3045	Panels	References
Plain door H 400 x W 300	NSYDCRN43	Set of 50 back plugs WM	NSYSWMBP
Plain door H 400 x W 400	NSYDCRN44	Fixing hardware	References
Plain door H 400 x W 600	NSYDCRN46	Screw bag for CRN cable gland plate	NSYCRNCGPSTDSB
Plain door H 500 x W 400	NSYDCRN54	Sealing	References
Plain door H 500 x W 500	NSYDCRN55	Adhesive sealing gasket 18 x 10 2M	NSYADG2M
Plain door H 600 x W 400	NSYDCRN64	Adhesive sealing gasket 18 x 10 3M	NSYADG3M
Plain door H 600 x W 500	NSYDCRN65	Adhesive sealing gasket 18 x 10 5M	NSYADG5M
Plain door H 600 x W 600	NSYDCRN66	Adhesive sealing gasket 18 x 10 20M	NSYADG20M
Plain door H 600 x W 800	NSYDCRN68		
Plain door H 700 x W 500	NSYDCRN75		
Plain door left H 800 x W 500	NSYDCRN85L		
Plain door right H 800 x W 500	NSYDCRN85R		
Plain door H 800 x W 600	NSYDCRN86		
Plain door left H 800 x W 600	NSYDCRN86L		
Plain door right H 800 x W 600	NSYDCRN86R		
Plain door H 800 x W 800	NSYDCRN88		
Plain door left H 1000 x W 500	NSYDCRN105L		
Plain door right H 1000 x W 500	NSYDCRN105R		
Plain door H 1000 x W 600	NSYDCRN106		
Plain door right H 1000 x W 600	NSYDCRN106R		
Plain door left H 1000 x W 600	NSYDCRN106L		
Plain door H 1000 x W 800	NSYDCRN108		
Plain door right H 1200 x W 500	NSYDCRN125R		
Plain door left H 1200 x W 500	NSYDCRN125L		
Plain door H 1200 x W 600	NSYDCRN126		
Plain door right H 1200 x W 600	NSYDCRN126R		
Plain door left H 1200 x W 600	NSYDCRN126L		
Plain door H 1200 x W 800	NSYDCRN128		
Plain door H 1200 x W 800	NSYDCRN128		
Plain door right H 1400 x W 500	NSYDCRN145R		
Plain door left H 1400 x W 500	NSYDCRN145L		





Steel wall-mounted enclosures CRNG



NSYDCRNG86

Doors	References	Door accessories	References
Plain door H 800 x W 600	NSYDCRNG86	Hinge 120°	NSYAEDH120S3D
Plain door left H 800 x W 500	NSYDCRNG85L	Hinge 180°	NSYAEDH180S3D
Plain door right H 800 x W 500	NSYDCRNG85R	Locking accessories	References
Plain door left H 800 x W 600	NSYDCRNG86L	3 point lock linkage for Spacial CRNG (H = 800 mm)	NSYBTACRNG80
Plain door right H 800 x W 600	NSYDCRNG86R	3 point lock linkage for Spacial CRNG (H = 1000 mm)	NSYBTACRNG100
Plain door H 1000 x W 600	NSYDCRNG106	3 point lock linkage for Spacial CRNG (H = 1200 mm)	NSYBTACRNG120
Plain door H 1000 x W 800	NSYDCRNG108	3 point lock linkage for Spacial CRNG (H = 1400 mm)	NSYBTACRNG140
Plain door left H 1000 x W 500	NSYDCRNG105L	Earthing accessories	References
Plain door right H 1000 x W 500	NSYDCRNG105R	Set of 500 earthing labels	NSYSWMEL
Plain door right H 1000 x W 600	NSYDCRNG106R	Fixing hardware cable gland plate	References
Plain door left H 1000 x W 600	NSYDCRNG106L	100 screws	NSYS3DCGSB
Plain door right H 1000 x W 600	NSYDCRNG106R	Standard screw bag	NSYS3DCGPSTDSB
Plain door left H 1000 x W 600	NSYDCRNG106L	Panels	References
Plain door H 1200 x W 600	NSYDCRNG126	50 caps for holes of hinges WM	NSYSWMCH
Plain door H 1200 x W 600	NSYDCRNG126	Set of 50 back plugs WM	NSYSWMBP
Plain door H 1200 x W 800	NSYDCRNG128	Others accessories	References
Plain door H 1200 x W 800	NSYDCRNG128	Screw bag for CRN cable gland plate	NSYCRNCGPSTDSB
Plain door right H 1200 x W 500	NSYDCRNG125R		
Plain door left H 1200 x W 500	NSYDCRNG125L		
Plain door right H 1200 x W 500	NSYDCRNG125R		
Plain door left H 1200 x W 500	NSYDCRNG125L		
Plain door H 1200 x W 600	NSYDCRNG126R		
Plain door left H 1200 x W 600	NSYDCRNG126L		
Plain door H 1200 x W 600	NSYDCRNG126R		
Plain door left H 1200 x W 600	NSYDCRNG126L		
Plain door right H 1400 x W 500	NSYDCRNG145R		
Plain door left H 1400 x W 500	NSYDCRNG145L		

Steel Floor-Standing Enclosures SFN

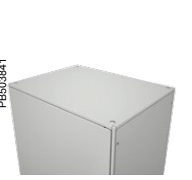
		Door accessories	References	Fixing hardware	References
PB124775 		Set of 4 Hinges and fixing elements	NSYDHSF	Captive screws for panels external fixing	NSYCSSF
		Double-door stoppers (2 pieces)	NSYDSSF2D	Plinth accessories	References
NSYSFD207 		Locking accessories	References	H 100 mm Plastic covers for plinth corners	NSYPC100
		Locking system for enclosures, single-door version 1200H (right side door for double-door version)	NSYLCK12SF	H 200 mm Plastic covers for plinth corners	NSYPC200
PB503844 NSYTDSSF2D 		Locking system for enclosures, single-door version 1400H	NSYLCK14SF	Panels	References
		Locking system for enclosures, single-door version 1600H (right side door for double-door version)	NSYLCK16SF	PrismaSeT back panel H 2000 x W 700 mm	NSYBP207
PB503844 NSYTDSSF2D 		Locking system for enclosures, single-door version 1800H (right side door for double-door version)	NSYLCK18SF	Doors	References
		Locking system for enclosures, single-door version 2000H (right side door for double-door version)	NSYLCK20SF	Plain door PrismaSeT RAL9003 2000 x 700 mm	NSYSFND207ED
PB503841 NSYRSF64L 		Locking system for enclosures, single-door version 2200H (right side door for double-door version)	NSYLCK22SF	Plain door PrismaSeT RAL7035 2000 x 700 mm	NSYSFND207G
		Handle neutral trim	NSYSFHNTRIM	Glazed door PrismaSeT RAL9003 2000 x 700 mm	NSYSFND207TED
	Handle SFN	NSYSFHS1	Glazed door PrismaSeT RAL7035 2000 x 700 mm	NSYSFND207TG	
	Roof	New roof (expanded)	Glazed door PrismaSeT RAL7035 2000 x 700 mm	NSYSFND207TG	
	Roof W 600 x D 400 mm	NSYRSF64L	Plain door PrismaSeT RAL9003 2000 x 300	NSYSFND203ED	
	Roof W 600 x D 600 mm	NSYRSF66L	SFN std enlarged roof W 1000 x D 400mm	NSYRSFN104L	
	Roof W 800 x D 400 mm	NSYRSF84L	SFN std enlarged roof W 1000 x D 500mm	NSYRSFN105L	
	Roof W 800 x D 500 mm	NSYRSF85L	SFN std enlarged roof W 1000 x D 600mm	NSYRSFN106L	
	Roof W 800 x D 600 mm	NSYRSF86L	SFN std enlarged roof W 1000 x D 800mm	NSYRSFN108L	
	Roof W 800 x D 800 mm	NSYRSF88L	SFN std enlarged roof W 1200 x D 400mm	NSYRSFN124L	
	Roof W 1000 x D 400 mm	NSYRSF104L	SFN std enlarged roof W 1200 x D 500mm	NSYRSFN125L	
	Roof W 1000 x D 500 mm	NSYRSF105L	SFN std enlarged roof W 1200 x D 600mm	NSYRSFN126L	
	Roof W 1000 x D 600 mm	NSYRSF106L	SFN std enlarged roof W 600 x D 400mm	NSYRSFN64L	
	Roof W 1000 x D 800 mm	NSYRSF108L	SFN std enlarged roof W 600 x D 600mm	NSYRSFN66L	
	Roof W 1200 x D 400 mm	NSYRSF124L	SFN std enlarged roof W 800 x D 400mm	NSYRSFN84L	
	Roof W 1200 x D 500 mm	NSYRSF125L	SFN std enlarged roof W 800 x D 500mm	NSYRSFN85L	
	Roof W 1200 x D 600 mm	NSYRSF126L	SFN std enlarged roof W 800 x D 600mm	NSYRSFN86L	
			SFN std enlarged roof W 800 x D 800mm	NSYRSFN88L	
			Two door stop double door SFN	NSYTDSSFN2D	

Steel Floor-Standing Enclosures SM



NSYSMEC1041

Cable gland plates	References	Door accessories	References
1 entry W 1000 x D 400 mm	NSYSMEC1041	Set of 4 hinges and fixing elements	NSYDHSF
1 entry W 1000 x D 300 mm	NSYSMEC1031	Spacial SM hinges and 2D door stop	NSYDHSM2D
1 entry W 1000 x D 500 mm	NSYSMEC1051	Double-door stoppers (2 pieces)	NSYTDSSF2D
1 entry W 600 x D 300 mm	NSYSMEC631	Locking accessories	References
1 entry W 600 x D 400 mm	NSYSMEC641	Locking system for enclosures, single-door version 1200H (right side door for double-door version)	NSYLCK12SF
1 entry W 600 x D 600 mm	NSYSMEC661	Locking system for enclosures, single-door version 1600H (right side door for double-door version)	NSYLCK16SF
1 entry W 800 x D 300 mm	NSYSMEC831	Locking system for enclosures, single-door version 1800H (right side door for double-door version)	NSYLCK18SF
1 entry W 800 x D 400 mm	NSYSMEC841	Locking system for enclosures, single-door version 2000H (right side door for double-door version)	NSYLCK20SF
1 entry W 800 x D 500 mm	NSYSMEC851	Locking system for enclosures, single-door version 2200H (right side door for double-door version)	NSYLCK22SF
1 entry W 800 x D 600 mm	NSYSMEC861	Locking system for enclosures 1 single-door version 1400H	NSYLCK14SF
Doors	Old roof integrated)	Door locking system toothed washer	NSYLCKWSF
Double plain door H 1200 x W 1000 mm	NSYSMD12102D	Handle neutral trim	NSYSFHNTRIM
Double plain door H 1200 x W 1200 mm	NSYSMD12122D	Plinth accessories	References
Double plain door H 1400 x W 1000 mm	NSYSMD14102D	H 100 mm Plastic covers for plinth corners	NSYPC100
Double plain door H 1400 x W 1200 mm	NSYSMD14122D	H 200 mm Plastic covers for plinth corners	NSYPC200
Double plain door H 1600 x W 1000 mm	NSYSMD16102D		
Double plain door H 1600 x W 1200 mm	NSYSMD16122D		
Double plain door H 1800 x W 1600 mm	NSYSMD18162D		

Stainless-Steel Enclosures S3X (Wall-Mounted)



NSYDS3X1010L

Doors	References
Left door 304L for enclosure H1000 x W1000 mm	NSYDS3X1010L
Left door 316L for enclosure H1000 x W1000 mm	NSYDS3X1010LH
Right door 304L for enclosure H1000 x W1000 mm	NSYDS3X1010R
Right door 316L for enclosure H1000 x W1000 mm	NSYDS3X1010RH
Plain door 304L for enclosure H1000 x W800 mm	NSYDS3X108
Plain door 316L for enclosure H1000 x W800 mm	NSYDS3X108H
Left door 304L for enclosure H1200 x W1000 mm	NSYDS3X1210L
Left door 316L for enclosure H1200 x W1000 mm	NSYDS3X1210LH
Right door 304L for enclosure H1200 x W1000 mm	NSYDS3X1210R
Right door 316L for enclosure H1200 x W1000 mm	NSYDS3X1210RH
Plain door 304L for enclosure H1200 x W800 mm	NSYDS3X128
Plain door 316L for enclosure H1200 x W800 mm	NSYDS3X128H
Plain door 304L for enclosure H300 x W200 mm	NSYDS3X32
Plain door 304L for enclosure H300 x W250 mm	NSYDS3X325
Plain door 316L for enclosure H300 x 250 mm	NSYDS3X325H
Plain door 316L for enclosure H300 x W200 mm	NSYDS3X32H
Plain door 304L for enclosure H300 x W300 mm	NSYDS3X33
Plain door 316L for enclosure H300 x W300 mm	NSYDS3X33H
Plain door 304L for enclosure H400 x W300 mm	NSYDS3X43
Plain door 316L for enclosure H400 x W300 mm	NSYDS3X43H
Plain door 304L for enclosure H400 x W400 mm	NSYDS3X44
Plain door 316L for enclosure H400 x W400 mm	NSYDS3X44H
Plain door 304L for enclosure H400 x W600 mm	NSYDS3X46

Doors	References
Plain door 316L 400 x 600 mm	NSYDS3X46H
Plain door 304L 500 x 400 mm	NSYDS3X54
Plain door 316L 500 x 400 mm	NSYDS3X54H
Plain door 304L 600 x 400 mm	NSYDS3X64
Plain door 316L 600 x 400 mm	NSYDS3X64H
Plain door 304L 600 x 600 mm	NSYDS3X66
Plain door 316L 600 x 600 mm	NSYDS3X66H
Plain door 304L 700 x 500 mm	NSYDS3X75
Plain door 316L 700 x 500 mm	NSYDS3X75H
Plain door 304L 800 x 600 mm	NSYDS3X86
Plain door 316L 800 x 600 mm	NSYDS3X86H
Plain door 304L 800 x 800 mm	NSYDS3X88
Plain door 316L 800 x 800 mm	NSYDS3X88H
Transp. door 304L 1000 x 800 mm	NSYDS3X108T
Transp. door 304L 400 x 300 mm	NSYDS3X43T
Transp. door 304L 500 x 400 mm	NSYDS3X54T
Transp. door 304L 600 x 400 mm	NSYDS3X64T
Transp. door 304L 700 x 500 mm	NSYDS3X75T
Transp. door 304L 800 x 600 mm	NSYDS3X86T
Door accessories	References
Set of 2 hinges	NSYHS3X
Locking accessories	References
Locking system 1000 mm	NSYLSS3X10
Locking system 1200 mm	NSYLSS3X12

Stainless-Steel Enclosures SMX (Floor-Standing)



NSYDSFX1410L

Doors	References
Left door 304L for enclosure H1400 x W1000 mm	NSYDSFX1410L
Right door 304L for enclosure H1400 x W1000 mm	NSYDSFX1410R
Door 304L for enclosure H1600 x W800 mm	NSYDSFX168
Door 304L for enclosure H1800 x W600 mm	NSYDSFX186
Left door for enclosure H1800 x W1200 mm	NSYDSFX1812L
Left door 316L for enclosure H1800 x W1200 mm	NSYDSFX1812LH
Right door for enclosure H1800 x W1200 mm	NSYDSFX1812R
Right door 316L for enclosure H1800 x W1200 mm	NSYDSFX1812RH
Door 304L for enclosure H1800 x W800 mm	NSYDSFX188
Door 316L for enclosure H1800 x W800 mm	NSYDSFX188H
Left door 304L for enclosure H1800 x W1600 mm	NSYDSFX1816L
Left door 316L for enclosure H1800 x W1600 mm	NSYDSFX1816LH
Right door 304L for enclosure H1800 x W1600 mm	NSYDSFX1816R
Right door 316L for enclosure H1800 x W1600 mm	NSYDSFX1816RH
Left door for enclosure H2000 x W1000 mm	NSYDSFX2010L
Left door 316L for enclosure H2000 x W1000 mm	NSYDSFX2010LH
Right door for enclosure H2000 x W1000 mm	NSYDSFX2010R
Right door 316L for enclosure H2000 x W1000 mm	NSYDSFX2010RH
Door for enclosure H1800 x W800 mm	NSYDSFX206
Left door for enclosure H2000 x W1200 mm	NSYDSFX2012L
Left door 316L for enclosure H2000 x W1200 mm	NSYDSFX2012LH
Right door for enclosure H2000 x W1200 mm	NSYDSFX2012R
Right door 316L for enclosure H2000 x W1200 mm	NSYDSFX2012RH
Door for enclosure H2000 x W800 mm	NSYDSFX208
Left for enclosure door H2000 x W1600 mm	NSYDSFX2016L
Left door 316L for enclosure H2000 x W1600 mm	NSYDSFX2016LH
Right door for enclosure H2000 x W1600 mm SMX	NSYDSFX2016R
Right door 316L for enclosure H2000 x W1600 mm	NSYDSFX2016RH

Locking system	References
Locking system H = 1400 mm	NSYLSSF14
Locking system H = 1600 mm	NSYLSSF16
Locking system H = 1800 mm	NSYLSSF18
Locking system H = 2000 mm	NSYLSSF20
Door accessories	References
Double-door stoppers (2 pieces)	NSYTDSSF2D

Stainless-Steel Enclosures SFX (Floor-Standing)



NSYDSFX186

Doors	References
Door 304L for enclosure H1800 x W600 mm	NSYDSFX186
Left door for enclosure H1800 x W1200 mm	NSYDSFX1812L
Right door for enclosure H1800 x W1200 mm	NSYDSFX1812R
Door 304L for enclosure H1800 x W800 mm	NSYDSFX188
Left door for enclosure H2000 x W1000 mm	NSYDSFX2010L
Right door for enclosure H2000 x W1000 mm	NSYDSFX2010R
Door for enclosure H1800 x W800 mm	NSYDSFX206
Left door for enclosure H2000 x W1200 mm	NSYDSFX2012L
Right door for enclosure H2000 x W1200 mm	NSYDSFX2012R
Door for enclosure H2000 x W800 mm	NSYDSFX208
Left door for enclosure H2000 x W1600 mm	NSYDSFX2016L
Right door for enclosure H2000 x W1600 mm	NSYDSFX2016R

Door accessories	References
Set of 3 hinges	NSYHSMX
Double-door stoppers (2 pieces)	NSYTDSSF2D
Locking accessories	References
Locking system H = 1400 mm	NSYLSSF14
Locking system H = 1600 mm	NSYLSSF16
Locking system H = 1800 mm	NSYLSSF18
Locking system H = 2000 mm	NSYLSSF20

Insulated Materials PLA (Floor-Standing)



NSYDPLA55G

- For RAL 7035

Doors	References
Door 500 x 500 Lock handle type. Door opening 120°	NSYDPLA55G
Door 500 x 750 Lock handle type. Door opening 120°	NSYDPLA57G
Door 750 x 500 Lock handle type. Door opening 120°	NSYDPLA75G
Door 750 x 750 Lock handle type. Door opening 120°	NSYDPLA77G
Door 1000 x 500 Lock handle type. Door opening 120°	NSYDPLA105G
Door 1000 x 750 Lock handle type. Door opening 120°	NSYDPLA107G
Door 1250 x 500 Lock handle type. Door opening 120°	NSYDPLA125G
Door 1250 x 750 Lock handle type. Door opening 120°	NSYDPLA127G
Door 1500 x 500 Lock handle type. Door opening 120°	NSYDPLA155G
Door 1500 x 750 Lock handle type. Door opening 120°	NSYDPLA157G
Door 500 x 500 Lock handle type. Door opening 180° + Accessory bag 120° hinge	NSYDPLA55HG
Door 500 x 750 Lock handle type. Door opening 180° + Accessory bag 120° hinge	NSYDPLA57HG
Door 750 x 500 Lock handle type. Door opening 180° + Accessory bag 120° hinge	NSYDPLA75HG
Door 750 x 750 Lock handle type. Door opening 180° + Accessory bag 120° hinge	NSYDPLA77HG
Door 1000 x 500 Lock handle type. Door opening 180° + Accessory bag 120° hinge	NSYDPLA105HG
Door 1000 x 750 Lock handle type. Door opening 180° + Accessory bag 120° hinge	NSYDPLA107HG
Door 1250 x 500 Lock handle type. Door opening 180° + Accessory bag 120° hinge	NSYDPLA125HG
Door 1250 x 750 Lock handle type. Door opening 180° + Accessory bag 120° hinge	NSYDPLA127HG

- For RAL 7035

Doors	References
Door 1500 x 500 Lock handle type. Door opening 180° + Accessory bag 120° hinge	NSYDPLA155HG
Door 1500 x 750 Lock handle type. Door opening 180° + Accessory bag 120° hinge	NSYDPLA157HG
Door accessories	References
One hinge + axe for PLA (120° opening)	NSYAEPLA004
Kit of axes of door PLAZT (180° opening)	NSYAEPLA005
Rod guide inside the door PLA (set of 2)	NSYAEPLA001
Rod guide on 1 door PLA (set of 2)	NSYAEPLA002G
Rod guide on 2 doors PLA (set of 2)	NSYAEPLA003G
Fixing hardware	References
Acc. bag for 1 door H = 500-1000 mm	NSYASPLA001
Acc. bag for 2 door H = 1250-1500 mm	NSYASPLA002
Acc. bag for 2 door	NSYASPLA003
Locking accessories	References
5mm double bar insert for large escucheon for old PLA without handle	NSYTDB5PLA
Handle locking and rods H = 500 mm	NSYVPLA5MG
Handle locking and rods H = 750 mm	NSYVPLA7MG
Handle locking and rods H = 1000 mm	NSYVPLA10MG
Handle locking and rods H = 1250 mm	NSYVPLA12MG
Handle locking and rods H = 1500 mm	NSYVPLA15MG

Insulated Materials PLM (Wall-Mounted)

- For RAL 7035



NSYDPLM32G

Complete door (door + lock system)	References	Door accessories	References
Door with locking for PLM32	NSYDPLM32G	Door hinge for NSYPLM32	NSYAEDHPLM32
Door with locking for 2 locks PLM3025	NSYDPLM3025G	Door hinge for NSYPLM3025 for 2 locks door	NSYAEDHPLM3025
Door with locking for PLM43	NSYDPLM43G	Door hinge for NSYPLM43 to 86	NSYAEDHPLM
Door with locking for PLM54	NSYDPLM54G	Door hinge for NSYPLM108	NSYAEDHPLM108
Door with locking for PLM64	NSYDPLM64G	Rod guides (4 pieces) for PLM108	NSYAEDPLM108
Door with locking for PLM75	NSYDPLM75G	Fixing hardware	References
Door with locking for PLM86	NSYDPLM86G	Acc. bag NSYPLM43 to 86	NSYASPLM
Door with locking for PLM108	NSYDPLM108G	Locking accessories	References
Glazed door with locking for PLM3025T	NSYDPLM3025TG	Locking and rods for NSYPLM108	NSYVPLM108
Glazed door with locking for PLM43T	NSYDPLM43TG	Double-bar lock for PLM enclosures from 430 to 847 mm high	NSYCDBPLM
Glazed door with locking for PLM54T	NSYDPLM54TG		
Glazed door with locking for PLM64T	NSYDPLM64TG		
Glazed door with locking for PLM75T	NSYDPLM75TG		
Glazed door with locking for PLM86T	NSYDPLM86TG		
Glazed door with locking for PLM108T	NSYDPLM108TG		

Applicative and Customized Solutions: HMI SD



NSYCCSDF8

Doors	References	Door accessories	References
Desk lid W 600 mm	NSYDLSDF6	Hinges compact control desk	NSYHSD
Desk lid W 800 mm	NSYDLSDF8	Hinges control desk w/console	NSYHSDF
Desk lid W 1000 mm	NSYDLSDF10	Locking accessories	References
Desk lid W 1200 mm	NSYDLSDF12	Standard handle in RAL 7011 (previous version)	NSYSDH
Desk lid for w/console W 800 mm	NSYDLSDF8	Handle rear door (new version)	NSYBTACRNG140
Desk lid for w/console W 1000 mm	NSYDLSDF10	Lock w/DB 3 mm for frontal doors	NSYFDLSD
Desk lid for w/console W 1200 mm	NSYDLSDF12	Lock w/DB 3 mm desk lids and covers	NSYDLSDF
Desk lid for w/console W 1600 mm	NSYDLSDF16	Flat escutcheon with DB 5 mm	NSYDFFLOCKDB5
Folding console cover W 800 mm	NSYCCSDF8		
Folding console cover W 1000 mm	NSYCCSDF10		
Folding console cover W 1200 mm	NSYCCSDF12		
Folding console cover W 1600 mm	NSYCCSDF16		

Applicative and Customized Solutions: HMI

Door accessories	References
Locking system	NSYLSSDX

Applicative and Customized Solutions: S3CM

Doors	References	Door accessories	References
Plain door H 200 x W 200	NSYDCRN22	Standard Spacial hinge	NSYBICRN
Plain door H 200 x W 300	NSYDCRN23	Earthing accessories	References
Plain door H 250 x W 200	NSYDCRN2520	Set of 500 earthing labels	NSYSWMEL
Plain door H 300 x W 250	NSYDCRN3025		
Plain door H 300 x W 300	NSYDCRN33		
Plain door H 300 x W 400	NSYDCRN34		
Plain door H 300 x W 450	NSYDCRN3045		
Plain door H 400 x W 300	NSYDCRN43		
Plain door H 400 x W 400	NSYDCRN44		
Plain door H 400 x W 600	NSYDCRN46		
Plain door H 500 x W 500	NSYDCRN55		
Plain door H 600 x W 600	NSYDCRN66		
Plain door H 600 x W 800	NSYDCRN68		
Plain door H 800 x W 600	NSYDCRN86		

Applicative and Customized Solutions: EMC, S3HF



NSYSWMEL

Earthing accessories	References
Set of 500 earthing labels	NSYSWMEL
Locking accessories	References
Standard Locking system	NSYAEDLS3HFDB3

Applicative and Customized Solutions: ATEX S3DEX



NSYDS3D32

Doors	References
Plain door 300 x 200	NSYDS3D32
Plain door 300 x 300	NSYDS3D33
Plain door 400 x 300	NSYDS3D43
Plain door 400 x 400	NSYDS3D44
Plain door 500 x 400	NSYDS3D54
Plain door 600 x 400	NSYDS3D64
Plain door 600 x 600	NSYDS3D66
Plain door 700 x 500	NSYDS3D75
Plain door 800 x 600	NSYDS3D86
Plain door 1000 x 800	NSYDS3D108
Earthing accessories	References
Set of 500 earthing labels	NSYSWMEL

Locking accessories	References
Set of 10 linkage guides	NSYS3DLG
Standard key DB3	NSYAEDLS3DKDB3
3 point lock linkage H 600 mm	NSYBTAS3D60
3 point lock linkage H 700 mm	NSYBTAS3D70
3 point lock linkage H 800 mm	NSYBTAS3D80
3 point lock linkage H 1000 mm	NSYBTAS3D100
Panels	References
50 caps for holes of hinges WM	NSYSWMCH
Set of 50 back plugs WM	NSYSWMBP

Outdoor Heavy-Duty Enclosures Thalassa PHD



NSYPPC74HD

Plain doors (door + lock + hinges + door retainer)	Unic door or right door References	Left door References
H 538 x W 500	NSYDPHD55P	-
H 788 x W 500	NSYDPHD75P	-
H 843 x W 750	NSYDPHD77P	-
H 1093 x W 500	NSYDPHD105P	-
H 1093 x W 750	NSYDPHD107P	-
H 1343 x W 500	NSYDPHD125P	-
H 1343 x W 750	NSYDPHD127P	-
H 1343 x W 1250	NSYDPHD127P	NSYDPHD125LP
H 1593 x W 750	NSYDPHD157P	-
H 1593 x W 1250	NSYDPHD157P	NSYDPHD155LP
H 2093 x W 750	2 x NSYDPHD107P	-
Ribbed doors (door + lock + hinges + door retainer)	References	References
H 538 x W 500	NSYDPHD55R	-
H 788 x W 500	NSYDPHD75R	-
H 843 x W 750	NSYDPHD77R	-
H 1093 x W 500	NSYDPHD105R	-
H 1093 x W 750	NSYDPHD107R	-
H 1343 x W 500	NSYDPHD125R	-
H 1343 x W 750	NSYDPHD127R	-
H 1343 x W 1250	NSYDPHD127R	NSYDPHD125LR
H 1593 x W 750	NSYDPHD157R	-
H 1593 x W 1250	NSYDPHD157R	NSYDPHD155LR
H 2093 x W 750	2 x NSYDPHD107R	-

Aluminum cable gland plate	References
For enclosure W 750 x D 420	NSYPPC74HD
For enclosure W 750 x D 620	NSYPPC76HD
For enclosure W 500 x D 420	NSYPPC54HD
For enclosure W 1250 x D 420	NSYPPC54HD + NSYPPC74HD
For enclosure W 1250 x D 620	NSYPPC56HD + NSYPPC76HD
Screws and nuts for PHD gland plate (10 units)	NSYPPCPHDSN
Door accessories	References
Set of 4 complete hinges for PHD	NSYAEDPHD
Locking accessories	References
Complete lock system for PHD H 1000	NSYVPHD10
Complete lock system for PHD H 1500	NSYVPHD15
Complete lock system for PHD H 2000	2 x NSYVPHD10





Outdoor Heavy-Duty Enclosures Spacial S3HD

Heavy-Duty cable gland plate for enclosure	References	Hinge	References
H 343 x W 200 x D 180	NSYTLAUHD	S3HD hinge	NSYAEDH120S3HD
H 448 x W 300 x D 230	NSYTLCUHD	Canopy	References
H 548 x W 400 x D 230	NSYTLDUHD	Canopy for S3HD 200 (W) x 150 (P)	NSYTJ2015HD
H 653 x W 400 x D 280	NSYTLDUHD	Canopy for S3HD 300 (W) x 200 (P)	NSYTJ3020HD
H 658 x W 600 x D 330	NSYTLGUHD	Canopy for S3HD 400 (W) x 200 (P)	NSYTJ4020HD
H 753 x W 500 x D 280	NSYTLGUHD	Canopy for S3HD 400 (W) x 250 (P)	NSYTJ4025HD
e H 858 x W 600 x D 330	NSYTLGUHD	Canopy for S3HD 600 (W) x 300 (P)	NSYTJ6030HD
H 862 x W 800 x D 430	2 x NSYTLDUHD	Canopy for S3HD 500 (W) x 250 (P)	NSYTJ5025HD
H 1062 x W 600 x D 430	NSYTLGUHD	Canopy for S3HD 800 (W) x 400 (P)	NSYTJ8040HD
H 1062 x W 800 x D 430	2 x NSYTLDUHD	Canopy for S3HD 600 (W) x 400 (P)	NSYTJ6040HD
Door	References	Lock	References
Door 300 x 200 S3HD, without handle	NSYDS3HD32	Lock S3HD DB 3 mm (Escutcheon+cam+washer)	NSYAEDLS3HDRL
Door 400 x 300 S3HD, without handle	NSYDS3HD43		
Door 500 x 400 S3HD, without handle	NSYDS3HD54		
Door 600 x 400 S3HD + linkage locking syst	NSYDS3HD64		
Door 600 x 600 S3HD + linkage locking syst	NSYDS3HD66		
Door 700 x 500 S3HD + linkage locking syst	NSYDS3HD75		
Door 800 x 600 S3HD + linkage locking syst	NSYDS3HD86		
Door 800 x 800 S3HD + linkage locking syst	NSYDS3HD88		
Door 1000 x 600 S3HD + linkage locking syst	NSYDS3HD106		
Door 1000 x 800 S3HD + linkage locking syst	NSYDS3HD108		



Outdoor Heavy-Duty Enclosures Spacial SFHD

Heavy-Duty cable gland plate for enclosure	References	Back Panel	References
H 1262 x W 600 x D 430	NSYSFECA64HD	SFHD 1200 x 600 mm	NSYBPHD126
H 1262 x W 800 x D 430	NSYSFECA64HD	SFHD 1200 x 800 mm	NSYBPHD128
H 1262 x W 1200 x D 430	2 x NSYSFECA64HD	SFHD 1200 x 1200 mm	NSYBPHD12122D
H 1281 x W 600 x D 630	NSYSFECA66HD	SFHD 1600 x 600 mm	NSYBPHD166
H 1281 x W 800 x D 630	NSYSFECA66HD	SFHD 1600 x 800 mm	NSYBPHD168
H 1281 x W 1200 x D 630	2 x NSYSFECA66HD	SFHD 1600 x 1200 mm	NSYBPHD1612
H 1662 x W 800 x D 430	NSYSFECA64HD	SFHD 2000 x 800 mm	NSYBPHD208
H 1662 x W 1200 x D 430	2 x NSYSFECA64HD	Canopy	References
H 1681 x W 600 x D 630	NSYSFECA66HD	SFHD 600 x 400 mm	NSYSC64HD
H 1681 x W 800 x D 630	NSYSFECA66HD	SFHD 600 x 600 mm	NSYSC66HD
H 1681 x W 1200 x D 630	2 x NSYSFECA66HD	SFHD 800 x 400 mm	NSYSC84HD
H 2062 x W 800 x D 430	NSYSFECA64HD	SFHD 800 x 600 mm	NSYSC86HD
Door	References	SFHD 1200 x 400 mm	NSYSC124HD
Plain door SFHD 1200 x 600 mm	NSYSFDHD126	SFHD 1200 x 600 mm	NSYSC126HD
Plain door SFHD 1200 x 800 mm	NSYSFDHD128	Handle with 1242E cylindrical barrel	References
Plain door SFHD 1200 x 1200 mm	NSYSFDHD12122D	Handle SFHD 1242E	NSYSFHS1HD
Plain door SFHD 1600 x 600 mm	NSYSFDHD166	Captive screws	References
Plain door SFHD 1600 x 800 mm	NSYSFDHD168	Captive screws for Spacial SFHD panels	NSYCSSFHD
Plain door doble SFHD 1600 x 1200 mm	NSYSFDHD16122D		
Plain door SFHD 2000 x 800 mm	NSYSFDHD208		

Air-AIR exchangers

 <p>P1030542_21_nb</p>	 <p>PB503041_nb</p>	 <p>P1030580_19_nb</p>	 <p>PB503043_nb</p>	 <p>PB503046_nb</p>
Exchanger Battery	Fan (Fan + Capacitor)	Frontal Cover RAL 7035 gray	Thermostat	Mounting Kit (instruction + full seal + screws)
References	References	References	References	References
NSYCEA22E	NSYCUSP0177	NSYCUSP0042	NSYCUSP0181	-
NSYCEA36	NSYCUSP0031	NSYCUSP0044	NSYCUSP0077	NSYCUSP0100
NSYCEA50	NSYCUSP0032	NSYCUSP0044	NSYCUSP0077	NSYCUSP0100
NSYCEA80	NSYCUSP0033	NSYCUSP0138	NSYCUSP0078	NSYCUSP0100
				NSYCUSP0184
				NSYCUSP0112
				NSYCUSP0112
				NSYCUSP0113

Air-WATER exchangers

 <p>P1030542_21_nb</p>	 <p>PB503041_nb</p>	 <p>P1030580_19_nb</p>
Exchanger Battery	Fan (Fan + Capacitor)	Frontal Cover RAL 7035 gray
References	References	References
NSYCEW1K	NSYCUSP0034	NSYCUSP0043
NSYCEW1K8	NSYCUSP0035	NSYCUSP0044
NSYCEW2K5	NSYCUSP0036	NSYCUSP0136
NSYCEW3K5	NSYCUSP0037	NSYCUSP0138
NSYCEW4K5	NSYCUSP0037	NSYCUSP0137
NSYCEW6K	NSYCUSP0038	NSYCUSP0137
NSYCEW6K2P4	NSYCUSP0038	NSYCUSP0137
NSYCEW2K5R	NSYCUSP0041	NSYCUSP0053
		NSYCUSP0079
		NSYCUSP0080
		NSYCUSP0080
		NSYCUSP0081
		NSYCUSP0081
		NSYCUSP0082
		NSYCUSP0082
		NSYCUSP0084

Air-WATER exchangers

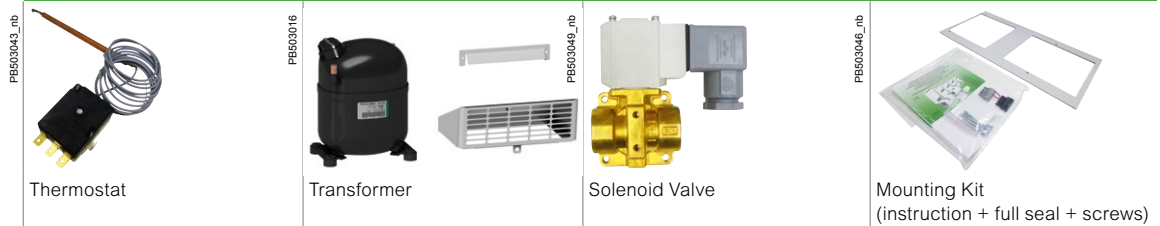

Thermostat

Transformer

Solenoid Valve

Mounting Kit
(instruction + full seal + screws)

References	References	References	References	References
NSYCEW1K	NSYCUSP0100	-	NSYCUSP0108	NSYCUSP0114
NSYCEWX1K	NSYCUSP0100	-	NSYCUSP0108	NSYCUSP0114
NSYCEW1K8	NSYCUSP0100	-	NSYCUSP0109	NSYCUSP0124
NSYCEWX1K8	NSYCUSP0100	-	NSYCUSP0109	NSYCUSP0124
NSYCEW2K5	NSYCUSP0100	-	NSYCUSP0109	NSYCUSP0124
NSYCEWX2K5	NSYCUSP0100	-	NSYCUSP0109	NSYCUSP0124
NSYCEW3K5	NSYCUSP0100	-	NSYCUSP0109	NSYCUSP0115
NSYCEW4K5	NSYCUSP0100	-	NSYCUSP0109	NSYCUSP0115
NSYCEW6K	NSYCUSP0100	-	NSYCUSP0109	NSYCUSP0125
NSYCEW6K2P4	NSYCUSP0100	NSYCUSP0107	NSYCUSP0109	NSYCUSP0125
NSYCEW2K5R	NSYCUSP0100	-	NSYCUSP0109	NSYCUSP0117

Cooling units: Side-mounted models			
References	References	References	References
NSYCU350DG	NSYCUSP001DG	NSYCUSP002DG	NSYCUSP010DG
NSYCUX350DG	NSYCUSP001DG	NSYCUSP002DG	NSYCUSP010DG
NSYCU600DG	NSYCUSP001DG	NSYCUSP002DG	NSYCUSP010DG
NSYCUX600DG	NSYCUSP001DG	NSYCUSP002DG	NSYCUSP010DG
NSYCU800DG	NSYCUSP003DG	NSYCUSP004DG	NSYCUSP010DG
NSYCU8002P4DG	NSYCUSP003DG	NSYCUSP004DG	NSYCUSP010DG
NSYCU1KDG	NSYCUSP003DG	NSYCUSP004DG	NSYCUSP010DG
NSYCUX1KDG	NSYCUSP003DG	NSYCUSP004DG	NSYCUSP010DG
NSYCU1K2P4DG	NSYCUSP003DG	NSYCUSP004DG	NSYCUSP010DG
NSYCUX1K2P4DG	NSYCUSP003DG	NSYCUSP004DG	NSYCUSP010DG
NSYCU1K2DG	NSYCUSP005DG	NSYCUSP003DG	NSYCUSP010DG
NSYCU1K22P4DG	NSYCUSP005DG	NSYCUSP003DG	NSYCUSP010DG
NSYCU1K6DG	NSYCUSP005DG	NSYCUSP003DG	NSYCUSP010DG
NSYCUX1K6DG	NSYCUSP005DG	NSYCUSP003DG	NSYCUSP010DG
NSYCU1K62P4DG	NSYCUSP005DG	NSYCUSP003DG	NSYCUSP010DG
NSYCU2KDG	NSYCUSP005DG	NSYCUSP003DG	NSYCUSP010DG
NSYCU2K3P4DG	NSYCUSP007DG	NSYCUSP006DG	NSYCUSP010DG
NSYCUX2K3P4DG	NSYCUSP007DG	NSYCUSP006DG	NSYCUSP010DG
NSYCU3K2DG	NSYCUSP008DG	NSYCUSP005DG	NSYCUSP010DG
NSYCU3K23P4DG	NSYCUSP009DG	NSYCUSP007DG	NSYCUSP010DG
NSYCU4K3P4DG	NSYCUSP009DG	NSYCUSP007DG	NSYCUSP010DG
NSYCU600RDG	NSYCUSP001DG	NSYCUSP002DG	NSYCUSP010DG
NSYCU800RDG	NSYCUSP003DG	NSYCUSP003DG	NSYCUSP010DG
NSYCU8002P4RDG	NSYCUSP003DG	NSYCUSP003DG	NSYCUSP010DG
NSYCU1K2RDG	NSYCUSP003DG	NSYCUSP003DG	NSYCUSP010DG
NSYCU1K22P4RDG	NSYCUSP003DG	NSYCUSP003DG	NSYCUSP010DG
NSYCU1K5RDG	NSYCUSP003DG	NSYCUSP003DG	NSYCUSP010DG
NSYCU1K52P4RDG	NSYCUSP003DG	NSYCUSP003DG	NSYCUSP010DG
NSYCU2KRDG	NSYCUSP003DG	NSYCUSP003DG	NSYCUSP010DG
NSYCU2K3P4RDG	NSYCUSP006DG	NSYCUSP006DG	NSYCUSP010DG
NSYCU3K3P4RDG	NSYCUSP009DG	NSYCUSP007DG	NSYCUSP010DG
NSYCU4K3P4RDG	NSYCUSP009DG	NSYCUSP007DG	NSYCUSP010DG
NSYCUHD350DG	NSYCUSP001DG	NSYCUSP002DG	NSYCUSP010DG
NSYCUHD600DG	NSYCUSP001DG	NSYCUSP002DG	NSYCUSP010DG
NSYCUHD800DG	NSYCUSP003DG	NSYCUSP004DG	NSYCUSP010DG
NSYCUHD1KDG	NSYCUSP003DG	NSYCUSP004DG	NSYCUSP010DG
NSYCUHD1K2P4DG	NSYCUSP003DG	NSYCUSP004DG	NSYCUSP010DG
NSYCUHD1K6DG	NSYCUSP005DG	NSYCUSP003DG	NSYCUSP010DG
NSYCUHD1K62P4DG	NSYCUSP005DG	NSYCUSP003DG	NSYCUSP010DG
NSYCUHD2K3P4DG	NSYCUSP007DG	NSYCUSP006DG	NSYCUSP010DG

NSYCUSP001DG



Condenser Fan Kit

NSYCUSP002DG



Evaporator Fan Kit

NSYCUSP10DG



Controller Kit



Green Premium™

More than 75% of our product sales offer superior transparency on the material content, regulatory information and environmental impact of our products:

- RoHS compliance
- REACh substance information
- Industry leading # of PEP's*
- Circularity instructions

*PEP: Product Environmental Profile (i.e. Environmental Product Declaration)

[Discover what we mean by green!](#)
[Check your products!](#)



Scan or click

The Green Premium program stands for our commitment to deliver customer-valued sustainable performance. It has been upgraded with recognized environmental claims and extended to cover all offers including products, services and solutions.

CO₂ and P&L impact through... resource performance
Green Premium brings improved resource efficiency throughout an asset's lifecycle. This includes efficient use of energy and natural resources, along with the minimization of CO₂ emissions.

Cost of ownership optimization through... circular performance
We're helping our customers optimize the total cost of ownership of their assets. To do this, we provide IoT-enabled solutions, as well as upgrade, repair, retrofit, and remanufacture services.

Peace of mind through... health performance
Green Premium products are RoHS and REACh compliant. We're going beyond regulatory compliance with step-by-step substitution of certain materials and substances from our products.

Improved sales through... differentiation
Green Premium delivers strong value propositions through third-party labels and services. By collaborating with third-party organizations we can support our customers in meeting their sustainability goals such as green-building certifications.

How to Define an Enclosure Solution?

Invariables

Switchgear and Controlgear are the cornerstone of any electrical system - in industry, infrastructure, building, energy, transport or any other segment. The correct enclosure and thermal management selection is crucial to guarantee the targeted performance. Safeguards of equipment installed inside ensure service continuity.



Correct Selection of Enclosure and Thermal Solution

Many influences must be considered when defining an enclosure system. Three groups may be distinguished:

- Protection (equipment and people)
- Thermal management
- Solution profitability

Ambient Conditions and Enclosure

The table below is only indicative and not binding. It shows, in a general concept, the optimized performance of the ranges of Universal Enclosures according to the ambient conditions, taking into account technical and commercial criteria:

- ■ ■ Highly recommended
- Recommended
- Not suitable

Ambient condition	Enclosure material						
	Steel	Steel Heavy-Duty	Stainless-steel 304L	Stainless-steel 316L	Stainless-steel 316L Paint	Polyester	Polyester Heavy-Duty
Indoor clean environment ⁽¹⁾	■ ■ ■	■	■	■	■	■	■
Difficult cleaning process ⁽²⁾	-	-	■ ■ ■	■ ■ ■	-	-	-
Outdoor (no public access)	-	■ ■ ■	■	■	■	■ ■ ■	■ ■ ■
Outdoor (public access)	-	■	■	■	■	■	■ ■ ■
Harsh chemicals	-	■	■ ■ ■	■ ■ ■	■ ■ ■	■ ■ ■	■ ■ ■
Solar radiation	-	■ ■ ■	-	■ ⁽⁴⁾	■ ⁽⁴⁾	■ ■ ■	■ ■ ■
Sand storms	-	-	■ ■ ■	■ ■ ■	-	■	■
Temperature > 40 °C ⁽³⁾	■ ■ ■	■ ■ ■	■ ■ ■	■ ■ ■	■ ■ ■	■ ■ ■	■ ■ ■
Temperature < 5 °C ⁽³⁾	■ ■ ■	■ ■ ■	■ ■ ■	■ ■ ■	■ ■ ■	■ ■ ■	■ ■ ■
Salty environment	-	-	-	■ ■ ■	■ ■ ■	■ ■ ■	■ ■ ■
Sea water splashes	-	-	-	■ ■ ■	■ ■ ■	■ ■ ■	■ ■ ■
Humidity > 70% ⁽³⁾	-	■ ■ ■	■ ■ ■	■ ■ ■	■ ■ ■	■ ■ ■	■ ■ ■
Impact	■ ■ ■	■ ■ ■	■ ■ ■	■ ■ ■	■ ■ ■	■ ■ ■	■ ■ ■
Vandalism	-	■ ■ ■	■	■	■	■	■ ■ ■
Burglary	-	■ ■ ■	■	■	■	■	■ ■ ■
Strong pollution	■	■ ■ ■	■ ■ ■	■ ■ ■	■ ■ ■	■ ■ ■	■ ■ ■
Vibration (marine application)	■ ■ ■	-	■ ■ ■	■ ■ ■	■ ■ ■	■ ■ ■	-
Seismic activity	■ ■ ■	-	-	-	-	-	-
Electro-magnetic interference	■ ■ ■	-	-	-	-	-	-

⁽¹⁾ Not considering F&B process

⁽²⁾ e.g. F&B process

⁽³⁾ Always using ClimaSys solutions

⁽⁴⁾ Marine solar plants

Thermal Management

The thermal management system must ensure the temperature and humidity controlled inside the enclosure.

The correct solution must be based on a robust process starting with the diagnosis of the ambient conditions, going to the parameters calculations and defining

the best architecture (enclosures + equipment installed + thermal solution).

ClimaSys is the definitive solution based on ClimaSys DT/EffiClima/ProClima.

Index of References

L	Page	L	Page	N	Page
LVS04192	299	LVS04742	317	NSY17990	592
LVS04197	299	LVS04743	317	NSY17991	592
LVS04229	331, 365	LVS04746	317	NSY17992	592
LVS04502	313, 316, 326, 329, 360, 361	LVS04751	317	NSY17996	592
LVS04503	313, 316, 326, 329, 360, 361	LVS04753	317	NSY17997	592
LVS04504	313, 326, 329, 360, 361	LVS04759	331, 365	NSY17998	592
LVS04505	313, 316, 326, 329, 360, 361	LVS04766	316, 331, 365	NSY1FAN230T	503, 504
LVS04506	313, 326, 329, 360, 361	LVS04767	331, 365	NSY1TH	240, 458
LVS04509	327	LVS04768	331, 365	NSY2FAN230T	504
LVS04510	327	LVS04769	331, 365	NSY2PLVDC42U10	528
LVS04512	316	LVS04772	331, 365	NSY2PLVDC42U10N	528
LVS04515	316	LVS04773	331, 365	NSY2PLVDC42U6	528
LVS04516	315, 328, 330, 363	LVS04774	331, 365	NSY2PLVDC42U8	528
LVS04518	315, 328, 330, 363	LVS04775	331, 365	NSY2PLVDC42U8N	528
LVS04525	315, 328, 330, 363	LVS04782	331, 365	NSY2SPHD124	378
LVS04526	315, 328, 330, 363	LVS04783	331, 365	NSY2SPHD126	378
LVS04528	315, 328, 330, 363	LVS04784	331, 365	NSY2SPHD164	378
LVS04550	315, 328	LVS04785	331, 365	NSY2SPHD166	378
LVS04560	311, 314, 324, 327, 362	LVS04786	331, 365	NSY2SPHD204	378
LVS04561	311, 314, 324, 327, 362	LVS04787	331, 365	NSY2SPIHD124	378
LVS04562	311, 314, 324, 327, 362	LVS04788	331, 365	NSY2SPIHD126	378
LVS04563	311, 314, 324, 327, 362	LVS04794	331, 365	NSY2SPIHD164	378
LVS04564	311, 314, 324, 327, 362	LVS04809	308	NSY2SPIHD166	378
LVS04565	311, 314, 324, 327, 362	LVS04901	334	NSY2SPIHD204	378
LVS04566	311, 314, 324, 327, 362	LVS04924	333	NSY2SPN124	83, 84, 87
LVS04567	311, 314, 324	LVS04943	334	NSY2SPN125	84, 87
LVS04568	311, 314, 324	LVS04946	335	NSY2SPN126	83, 84, 87
LVS04602	313, 316, 326, 329, 361	LVS04951	335	NSY2SPN128	84, 87
LVS04603	313, 326, 361	LVS04952	335	NSY2SPN144	83, 84, 87
LVS04604	314, 327	LVS04955	334	NSY2SPN145	84, 87
LVS04605	314, 327	LVS04956	334	NSY2SPN146	84, 87
LVS04607	314, 327	LVS06461	337	NSY2SPN148	84, 87
LVS04620	311, 324, 362	LVS06540	333, 366	NSY2SPN164	84, 87
LVS04621	311, 324, 362	LVS06541	333	NSY2SPN165	84, 87
LVS04623	311, 324	LVS06543	333	NSY2SPN166	83, 84, 87
LVS04624	324	LVS06545	333	NSY2SPN168	83, 84, 87
LVS04634	313, 326, 361	LVS06555	333	NSY2SPN184	83, 84, 87, 297
LVS04635	313, 326, 329, 330, 361	LVS06560	333	NSY2SPN185	83, 84, 87, 297
LVS04636	313, 315, 316, 326, 328-330, 361, 363	LVS06561	333, 366	NSY2SPN186	83, 84, 87, 297
LVS04637	315, 328, 363	LVS06563	333, 366	NSY2SPN188	83, 84, 87
LVS04638	313, 328	LVS06567	333	NSY2SPN204	83, 85, 87, 297
LVS04640	312, 325, 364	LVS06568	333	NSY2SPN205	83, 85, 87, 297, 336
LVS04641	312, 325, 364	LVS06570	333	NSY2SPN205ED	336
LVS04642	313, 315, 326, 328	LVS06600	335	NSY2SPN206	83, 85, 87, 297, 336, 369
LVS04643	312, 325	LVS06601	335	NSY2SPN208	83, 85, 87, 297, 336, 369
LVS04645	315, 328, 363	LVS06604	335	NSY2SPN208ED	336
LVS04646	324	LVS06605	335	NSY2SPN224	85, 87
LVS04651	313, 361	LVS06606	335	NSY2SPN225	85, 87
LVS04652	329	LVS06607	335	NSY2SPN226	83, 85, 87, 297
LVS04653	330	LVS08566	336	NSY2SPN228	83, 85, 87
LVS04656	316	LVS08881	59, 61, 261	NSY2SPX184	142
LVS04658	314, 327	LVS08892	59, 61, 261	NSY2SPX204	142
LVS04659	314, 327	LVS08895	59, 61, 261	NSY2SPX205	142
LVS04664	324, 325	LVS08897	59, 61, 261	NSY2SPX206	142
LVS04669	330	LVS08898	59, 61, 261	NSY6G2SP206	391
LVS04671	324, 327	LVS08899	59, 61, 261	NSY6G2SP208	391
LVS04672	316	LVS08911	337	NSYACC2N	550
LVS04678	305			NSYACC50N	550
				NSYACCA	550

Index of References

N	Page	N	Page	N	Page
NSYACGCS	550	NSYAEDL455K31	397	NSYAEFPF40SC	49
NSYADC16	291, 294	NSYAEDL455K33	392, 397	NSYAEFPFS3DW100	47, 49
NSYADC18	294	NSYAEDL455S3D	54	NSYAEFPFS3DW40	47, 49
NSYADG20M	656	NSYAEDL5124S3D	54	NSYAEFPFS3DW60	47, 49
NSYADG2M	656	NSYAEDL520S3D	54	NSYAEFPFS3DW80	47, 49
NSYADG3M	656	NSYAEDL601S3D	54	NSYAEFPFSB	15, 18
NSYADG5M	656	NSYAEDL610S3D	54	NSYAEFPFSBX	118, 119
NSYADR200	243	NSYAEDLB3MS3D	55	NSYAEFPFSC	49
NSYADR200D	243	NSYAEDLB3S3D	55	NSYAEFPFSC2	49
NSYAEBFZ	177, 199	NSYAEDLB5S3D	55	NSYAEFPFXSC	49, 378
NSYAEBP2F4F	537	NSYAEDLEDF13K31	397	NSYAEFTB	153
NSYAEBP2F610	523, 524, 537	NSYAEDLEDF13K33	392, 397	NSYAELYM12VD	533
NSYAEBP2F68	524, 537	NSYAEDLEDF13S3D	55	NSYAELYTCRG8	33, 53, 399, 400
NSYAEBP2F810	523, 524, 537	NSYAEDLEDF14K31	397	NSYAELYTCRXG8	134
NSYAEBP2F88	523, 524, 537	NSYAEDLEDF14K33	392, 397	NSYAE LZ	201
NSYAEBP2FS10	537	NSYAEDLEDF14S3D	55	NSYAE PX42U8	528
NSYAEBP2FS6	537	NSYAEDLEDF9K31	397	NSYAE PZM	177
NSYAEBP2FS8	537	NSYAEDLEDF9K33	392, 397	NSYAEUBU41SC	32, 52
NSYAECPFLA25	59, 60, 258	NSYAEDLEDF9S3D	55	NSYAEUBU61SC	32, 52
NSYAECPFLA33	59, 60, 258	NSYAEDLMETS3D	55	NSYAEUBUSC	32, 52
NSYAECPFLBP	59, 61, 101, 259	NSYAEDLPADS3D	55	NSYAMCSF	225, 249
NSYAECPFLT25	59, 61, 101, 259	NSYAEDLPADS3DHD	378	NSYAMFSB	15, 18, 119
NSYAECPFLT35	59, 61, 101, 259	NSYAEDLPADS3DK3	397	NSYAMFSTB	154
NSYAECPFLT7	59, 61, 101, 259	NSYAEDLS3DC	655	NSYAMPA1916TB	150, 153
NSYAEDDINS3D	55	NSYAEDLS3DKDB3	54, 654, 655, 663	NSYAMPA2419TB	150, 153
NSYAE DH120S3D	56, 654, 657	NSYAEDLS3DRLN	654	NSYAMPA2924TB	150, 153
NSYAE DH120S3HD	664	NSYAEDLS3HDRL	664	NSYAMPA3429TB	150, 153
NSYAE DH180S3D	56, 654, 657	NSYAEDLS3HFDB3	662	NSYAMP M1916TB	150, 153
NSYAE DH20TB	153	NSYAEDLS7S3D	55	NSYAMP M2419TB	150, 153
NSYAE DH40TB	153	NSYAEDLS8S3D	55	NSYAMP M2924TB	150, 153
NSYAE DHPLM	662	NSYAED LSD	34	NSYAMP M3429TB	150, 153
NSYAE DHPLM108	662	NSYAEDLT6S3D	55	NSYAMRD11357TB	154
NSYAE DHPLM3025	662	NSYAEDLT8S3D	55	NSYAMRD15357SB	15, 17, 118
NSYAE DHPLM32	662	NSYAEDN1AVD	527	NSYAMRD16357TB	154
NSYAE DHSB	15, 18	NSYAEDN1DVD	527	NSYAMRD19357TB	154
NSYAE DL1242K31	397	NSYAEDN1KVD	527	NSYAMRD20357SB	15, 17, 118
NSYAE DL1242K33	392, 397	NSYAEDN2124EVD	527	NSYAMRD24357TB	154
NSYAE DL1242S3D	54	NSYAEDN3PVD	527	NSYAMRD29357TB	154
NSYAE DL1332S3D	54	NSYAEDNH2124EVD	527	NSYAMRD30357SB	15, 17, 118
NSYAE DL2124S3D	54	NSYAE DPHD	663	NSYAMRD34357TB	154
NSYAE DL2131S3D	54	NSYAE DPLA001	661	NSYAMRD40357SB	15, 17, 118
NSYAE DL2132S3D	54	NSYAE DPLA002G	661	NSYAMRD50357SB	15, 17
NSYAE DL2133S3D	54	NSYAE DPLA003G	661	NSYAMRD60357SB	15, 17
NSYAE DL2241S3D	54	NSYAE DPLA004	661	NSYAMRD80357SB	15, 17
NSYAE DL2331S3D	54	NSYAE DPLA005	661	NSYAPU10S3	546
NSYAE DL2432S3D	54	NSYAE DPLM108	662	NSYAPU10S3S	546
NSYAE DL2433S3D	54	NSYAE DRS3DPA6	56, 275	NSYAPU19F6CB	545
NSYAE DL3113S3D	54	NSYAE DRSCST	37, 56, 133, 275	NSYAPU19F6F	545
NSYAE DL3123S3D	54	NSYAE DS20TB	152	NSYAPU19F6FT	545
NSYAE DL3131AS3D	54, 654	NSYAE DS40TB	152	NSYAPU19F7FA	545
NSYAE DL3132S3D	54	NSYAE DS60TB	152	NSYAPU19F8S	545
NSYAE DL3432S3D	54	NSYAE DSBSB	15, 18	NSYAPU19F9	545
NSYAE DL3524S3D	54	NSYAE DSTSB	15, 18	NSYAPU19S6CB	546
NSYAE DL405K31	397	NSYAE EC100C	539	NSYAPU19S6F	546
NSYAE DL405K33	392, 397	NSYAE EC1UF	539	NSYAPU19S6FT	546
NSYAE DL405S3D	54	NSYAE EC1UN	539	NSYAPU19S7FA	546
NSYAE DL421S3D	54	NSYAE ECS	539	NSYAPU19S8S	546
NSYAE DL4322S3D	54	NSYAE FAHLBSC	49	NSYAPU19S9	546
NSYAE DL4324S3D	54	NSYAE FP42S3D	48, 50	NSYAPUB	547

Index of References

N	Page	N	Page	N	Page
NSYAPUBV	547	NSYBF4B4M	368	NSYBR9F38	510, 511
NSYAPUF10S	545	NSYBF4B5M	368	NSYBR9F42	510, 511, 518, 519
NSYAPUF12CB	545	NSYBF4B6M	368	NSYBR9F47	510, 511
NSYAPUS10S	546	NSYBF4B8M	368	NSYBRF12PLAG	205
NSYAPUS12CB	546	NSYBF4B9M	368	NSYBRF17PLAG	205
NSYAS500	300, 327	NSYBHNT600	305	NSYBRF21PLAG	205
NSYAS600	300, 327	NSYBHNT800	305	NSYBRF26PLAG	205
NSYAS800	300, 327	NSYBHNW600	305	NSYBRF8PLAG	205
NSYASPLA001	661	NSYBHNW800	305	NSYBS400	298
NSYASPLA002	661	NSYBHS500	301	NSYBS500	298
NSYASPLA003	661	NSYBHS600	301, 362	NSYBS600	298
NSYASPLM	662	NSYBHS800	301, 362	NSYBS800	298
NSYASR3U	541	NSYBICRN	656, 662	NSYBSA	301, 315, 324, 325, 362
NSYATM27	164	NSYBL27	165	NSYBSA70	305
NSYATP24DTM	288	NSYBLKHN123	107	NSYBSM80	542
NSYATP72M	27, 288	NSYBN204	242, 249	NSYBST80	542
NSYATPUND	288	NSYBN206	242, 249	NSYBT2U25P	542
NSYAUPG1G	185, 197, 279	NSYBN404	242, 249	NSYBT2U25PG	542
NSYAVD1U480	595	NSYBN406	242, 249	NSYBTACRN100	656
NSYAVG2U300	595	NSYBN408	242, 249	NSYBTACRN120	656
NSYAZ3PLA	199	NSYBN606	242	NSYBTACRN140	656
NSYAZ4PLA	199	NSYBP207	658	NSYBTACRNG100	657
NSYB406	242, 249	NSYBPA7032	279	NSYBTACRNG120	657
NSYBANPLA53	211	NSYBPA7035	279	NSYBTACRNG140	657, 662
NSYBANPLA54	211	NSYBPC3	266, 549	NSYBTACRNG80	657
NSYBANPLA74	211	NSYBPC5	266, 549	NSYBTAS3D100	654, 655, 663
NSYBANPLA76	211	NSYBPHD12122D	664	NSYBTAS3D120	654, 655
NSYBBF1U40	541	NSYBPHD126	664	NSYBTAS3D140	654
NSYBBF1U40P	541	NSYBPHD128	664	NSYBTAS3D60	654, 655, 663
NSYBBF1U40PG	541	NSYBPHD1612	664	NSYBTAS3D65	654
NSYBBF1U60	541	NSYBPHD166	664	NSYBTAS3D70	654, 655, 663
NSYBBF1U60P	541	NSYBPHD168	664	NSYBTAS3D80	654, 655, 663
NSYBBF1U60PG	541	NSYBPHD208	664	NSYBTAS3D90	654
NSYBBF1U80	541	NSYBPN126	84	NSYBTSCS	544
NSYBBF1U80P	541	NSYBPN128	84	NSYBVS400	300
NSYBBF1U80PG	541	NSYBPN146	84	NSYBVS500	300, 327, 328
NSYBBT1U40	541	NSYBPN148	84	NSYBVS600	300, 327
NSYBBT1U40P	541	NSYBPN166	84	NSYBVS800	300, 327
NSYBBT1U40PG	541	NSYBPN168	84	NSYBVS800L	327
NSYBBT1U60	541	NSYBPN1810	84	NSYCAAPV	583, 586
NSYBBT1U60P	541	NSYBPN1812	84	NSYCAAPVHD	205, 381, 588
NSYBBT1U60PG	541	NSYBPN184	84	NSYCAC228RMF	599
NSYBBT1U80	541	NSYBPN186	84	NSYCAEFPF	29, 49
NSYBBT1U80P	541	NSYBPN188	84	NSYCAF104X95X	598
NSYBBT1U80PG	541	NSYBPN2010	85	NSYCAF108	594
NSYBCE10	98	NSYBPN2012	85	NSYCAF125	586
NSYBCE12	98	NSYBPN2016	85	NSYCAF125DG	576, 582
NSYBCE16	98	NSYBPN203	85, 370	NSYCAF125G3DG	576, 582
NSYBCE6	98	NSYBPN204	85, 370	NSYCAF125L55	587, 593
NSYBCE8	98	NSYBPN206	85, 369	NSYCAF125M	586
NSYBCME	35, 141, 183	NSYBPN208	85, 369	NSYCAF125O	586
NSYBCPL	35, 183	NSYBPN2210	85	NSYCAF125T	586
NSYBE27G	165, 171	NSYBPN2212	85	NSYCAF130X110X	598
NSYBF1U25P	542	NSYBPN224	85	NSYCAF170X190X	598
NSYBF2U25P	542	NSYBPN226	85	NSYCAF190	381, 588
NSYBF2U25PG	542	NSYBPN228	85	NSYCAF223	586
NSYBF2U40P	542	NSYBR9F24	510, 511, 518, 519	NSYCAF223DG	576, 582
NSYBF2U40PG	542	NSYBR9F29	510, 511	NSYCAF223G3DG	576, 582
NSYBF4B3M	368	NSYBR9F33	510, 511	NSYCAF223L55	587, 593

Index of References

N	Page	N	Page	N	Page
NSYCAF223M	586	NSYCCA500MFST	575, 580	NSYCEK	98
NSYCAF223O	586	NSYCCA50MFST	575	NSYCEP	278
NSYCAF223T	381, 586, 588	NSYCCABLK	583	NSYCEPLMAG	178
NSYCAF228R	599	NSYCCAFSDUST	583	NSYCEPLMBG	178
NSYCAF291	586	NSYCCARPM	576, 583	NSYCEPLMCG	178
NSYCAF291DG	576, 582	NSYCCASTE	635	NSYCEW1K	603, 605, 665, 666
NSYCAF291G3DG	576, 582	NSYCCO	633	NSYCEW1K8	603, 605, 665, 666
NSYCAF291L55	587, 593	NSYCCOFR55	575, 580	NSYCEW2K5	603, 605, 665, 666
NSYCAF291M	586	NSYCCOFSEM8U1	575, 580	NSYCEW2K5R	604, 605, 665, 666
NSYCAF291O	586	NSYCCOFSEM8U2	575, 580	NSYCEW3K5	603, 605, 665, 666
NSYCAF291T	586	NSYCCOFST30V	575, 580	NSYCEW4K5	603, 605, 665, 666
NSYCAF92	586	NSYCCOFST90250V	575, 580	NSYCEW6K	604, 605, 665, 666
NSYCAF92DG	576, 582	NSYCCOBY230VID	633, 635	NSYCEW6K2P4	604, 605, 665, 666
NSYCAF92M	586	NSYCCOBY120VID	633, 635	NSYCEWX1K	603, 666
NSYCAG104X95LM	598	NSYCCOBY230VID	633, 635	NSYCEWX1K8	603, 666
NSYCAG108LP	594	NSYCCOBY30VID	633, 635	NSYCEWX2K5	603, 666
NSYCAG110X46M	598	NSYCCOTH120VID	633, 635	NSYCFP100	264
NSYCAG114LPF	595	NSYCCOTH230VID	633, 635	NSYCFP60	264
NSYCAG125DG	575, 582	NSYCCOTH30VID	633, 635	NSYCFP80	264
NSYCAG125LPF	586, 587, 593	NSYCCOTH30VID	633, 635	NSYCFRS	499, 531
NSYCAG12LPH1	152, 599	NSYCCOTH30VID	633, 635	NSYCFRS	499, 531
NSYCAG12LPH2	152, 599	NSYCCOTH30VID	633, 635	NSYCFRS	499, 531
NSYCAG130X110LM	598	NSYCCOTH30VID	633, 635	NSYCFRS	499, 531
NSYCAG170X190LM	598	NSYCCOTH30VID	633, 635	NSYCFRS	499, 531
NSYCAG180X62M	598	NSYCCOTH30VID	633, 635	NSYCFRS	499, 531
NSYCAG19LP	599	NSYCCOTH30VID	633, 635	NSYCFRS	499, 531
NSYCAG216X62M	598	NSYCCOTH30VID	633, 635	NSYCFRS	499, 531
NSYCAG223DG	575, 582	NSYCCOTH30VID	633, 635	NSYCFRS	499, 531
NSYCAG223LFHD	381, 588	NSYCCOTH30VID	633, 635	NSYCFRS	499, 531
NSYCAG223LPF	586, 587, 593	NSYCCOTH30VID	633, 635	NSYCFRS	499, 531
NSYCAG291DG	575, 582	NSYCCOTH30VID	633, 635	NSYCFRS	499, 531
NSYCAG291LPF	586, 587, 593	NSYCCOTH30VID	633, 635	NSYCFRS	499, 531
NSYCAG317X120M	598	NSYCCOTH30VID	633, 635	NSYCFRS	499, 531
NSYCAG317X91M	598	NSYCCOTH30VID	633, 635	NSYCFRS	499, 531
NSYCAG33LP	599	NSYCCOTH30VID	633, 635	NSYCFRS	499, 531
NSYCAG35LP	185, 599	NSYCCOTH30VID	633, 635	NSYCFRS	499, 531
NSYCAG38LP	599	NSYCCOTH30VID	633, 635	NSYCFRS	499, 531
NSYCAG417X120M	598	NSYCCOTH30VID	633, 635	NSYCFRS	499, 531
NSYCAG45LP	599	NSYCCOTH30VID	633, 635	NSYCFRS	499, 531
NSYCAG78LPF	595	NSYCCOTH30VID	633, 635	NSYCFRS	499, 531
NSYCAG92DG	575, 582	NSYCCOTH30VID	633, 635	NSYCFRS	499, 531
NSYCAG92LPF	586	NSYCCOTH30VID	633, 635	NSYCFRS	499, 531
NSYCAP125LE	593	NSYCCOTH30VID	633, 635	NSYCFRS	499, 531
NSYCAP125LXF	587, 593	NSYCCOTH30VID	633, 635	NSYCFRS	499, 531
NSYCAP125LZF	587, 593	NSYCCOTH30VID	633, 635	NSYCFRS	499, 531
NSYCAP223LE	592, 593	NSYCCOTH30VID	633, 635	NSYCFRS	499, 531
NSYCAP223LXF	587, 593	NSYCCOTH30VID	633, 635	NSYCFRS	499, 531
NSYCAP223LZF	587, 593	NSYCCOTH30VID	633, 635	NSYCFRS	499, 531
NSYCAP291LE	592, 593	NSYCCOTH30VID	633, 635	NSYCFRS	499, 531
NSYCAP291LXF	587, 593	NSYCCOTH30VID	633, 635	NSYCFRS	499, 531
NSYCAP291LZF	587, 593	NSYCCOTH30VID	633, 635	NSYCFRS	499, 531
NSYCBCCR	34	NSYCCOTH30VID	633, 635	NSYCFRS	499, 531
NSYCBMPLAG	204	NSYCCOTH30VID	633, 635	NSYCFRS	499, 531
NSYCBXHCN	133	NSYCCOTH30VID	633, 635	NSYCFRS	499, 531
NSYCCA100MFST	575, 580	NSYCCOTH30VID	633, 635	NSYCFRS	499, 531
NSYCCA150MFST	575	NSYCCOTH30VID	633, 635	NSYCFRS	499, 531
NSYCCA200MFST	575, 580	NSYCCOTH30VID	633, 635	NSYCFRS	499, 531
NSYCCA300MFST	575, 580	NSYCCOTH30VID	633, 635	NSYCFRS	499, 531
NSYCCA400MFST	575, 580	NSYCCOTH30VID	633, 635	NSYCFRS	499, 531
		NSYCCOHC	632, 634	NSYCGHF12	426
		NSYCCOHC	632, 634	NSYCGHF16	426
		NSYCCOHC	632, 634	NSYCGHF20	426
		NSYCCOHC	632, 634	NSYCGHF25	426
		NSYCCOHC	632, 634	NSYCGHF32	426
		NSYCCOHC	632, 634	NSYCGHF40	426
		NSYCCOHC	632, 634	NSYCGSP16	64, 120, 155, 157, 263
		NSYCCOHC	632, 634	NSYCGSP20	64, 120, 155, 157, 263
		NSYCCOHC	632, 634	NSYCGSP25	64, 120, 155, 157, 263
		NSYCCOHC	632, 634	NSYCGSP32	64, 120, 155, 157, 263
		NSYCCOHC	632, 634	NSYCGSP40	64, 120, 155, 157, 263
		NSYCCOHC	632, 634	NSYCGX12	65, 121, 263
		NSYCCOHC	632, 634	NSYCGX12H	65, 121, 263
		NSYCCOHC	632, 634	NSYCGX16	65, 121, 263
		NSYCCOHC	632, 634	NSYCGX16H	65, 121, 263
		NSYCCOHC	632, 634	NSYCGX20	65, 121, 263
		NSYCCOHC	632, 634	NSYCGX20H	65, 121, 263
		NSYCCOHC	632, 634	NSYCGX25	65, 121, 263
		NSYCCOHC	632, 634	NSYCGX25H	65, 121, 263
		NSYCCOHC	632, 634	NSYCGX32	65, 121, 263
		NSYCCOHC	632, 634	NSYCGX32H	65, 121, 263
		NSYCCOHC	632, 634	NSYCGX40	65, 121, 263
		NSYCCOHC	632, 634	NSYCGX40H	65, 121, 263
		NSYCCOHC	632, 634	NSYCL1242ECSX	133
		NSYCCOHC	632, 634	NSYCL220CRN	34
		NSYCCOHC	632, 634	NSYCL27L405	165
		NSYCCOHC	632, 634	NSYCL27M	165
		NSYCCOHC	632, 634	NSYCL405CRN	34
		NSYCCOHC	632, 634	NSYCL405CSX	133
		NSYCCOHC	632, 634	NSYCL610CSX	133
		NSYCCOHC	632, 634	NSYCLL405CRN	34
		NSYCCOHC	632, 634	NSYCMACS50	444
		NSYCCOHC	632, 634	NSYCMACS80	444
		NSYCCOHC	632, 634	NSYCMBPT	442
		NSYCCOHC	632, 634	NSYCMT2560110	442

Index of References

N	Page	N	Page	N	Page
NSYCMT5005	440, 443	NSYCR20WU2C	630	NSYCRN34200	25
NSYCMT5010	440, 443	NSYCR20WU3	631	NSYCRN34200T	25
NSYCMT5015	440, 443	NSYCR250W230VV	631	NSYCRN345150	25
NSYCMT5020	440, 443	NSYCR400W230VV	631	NSYCRN43150	25
NSYCMT8005	440, 443	NSYCR50WU1C	630	NSYCRN43150P	25
NSYCMT8010	440, 443	NSYCR50WU2C	630	NSYCRN43150T	25
NSYCMT8015	440, 443	NSYCR50WU3C	630	NSYCRN43200	25
NSYCMT8020	440, 443	NSYCR55WU1	631	NSYCRN43200P	25
NSYCMUCC50	440, 444, 463	NSYCR55WU2	631	NSYCRN43200T	25
NSYCMUCC80	440, 444, 463	NSYCR55WU3	631	NSYCRN44200	25
NSYCMUCP50	440, 444, 463	NSYCRN1010300D	25	NSYCRN44200P	25
NSYCMUCP80	440, 444, 463	NSYCRN1010300T	25	NSYCRN44200T	25
NSYCMUCPAD87	444	NSYCRN1012300D	25	NSYCRN46250	25
NSYCMUCR50	440, 444, 463	NSYCRN1012400D	25	NSYCRN46250P	25
NSYCMUCR80	440, 444, 463	NSYCRN106250	25	NSYCRN46250T	25
NSYCMUIA50	440, 443, 462	NSYCRN106250P	25	NSYCRN46300	25
NSYCMUIA80	440, 443, 462	NSYCRN106250T	25	NSYCRN54150	25
NSYCMUMA50	440, 443, 462	NSYCRN106300	25	NSYCRN54150P	25
NSYCMUMA80	440, 443, 462	NSYCRN106300P	25	NSYCRN54150T	25
NSYCMUMC50	440, 443, 462	NSYCRN106300T	25	NSYCRN54200	25
NSYCMUMC80	440, 443, 462	NSYCRN106400	25	NSYCRN54200P	25
NSYCMUMR50	440, 443, 462	NSYCRN106400T	25	NSYCRN54200T	25
NSYCMUMR80	440, 443, 462	NSYCRN108250	25	NSYCRN54250	25
NSYCMUTC50	440, 444, 463	NSYCRN108250P	25	NSYCRN54250P	25
NSYCMUTC80	440, 444, 463	NSYCRN108250T	25	NSYCRN54250T	25
NSYCN20	242	NSYCRN108300	25	NSYCRN55250	25
NSYCN40	242	NSYCRN108300P	25	NSYCRN55250P	25
NSYCN9M625	90, 94, 247, 417, 540	NSYCRN108300T	25	NSYCRN55250T	25
NSYCNFM6	249	NSYCRN108400	25	NSYCRN64150	25
NSYCNFM8	249	NSYCRN108400T	25	NSYCRN64150P	25
NSYCNM6	233, 249	NSYCRN1210300D	25	NSYCRN64150T	25
NSYCNM8	233, 249	NSYCRN1210400D	25	NSYCRN64200	25
NSYCNH123	107	NSYCRN1212300D	25	NSYCRN64200P	25
NSYCNT20	242	NSYCRN1212400D	25	NSYCRN64200T	25
NSYCNT40	242	NSYCRN126300	25	NSYCRN64250	25
NSYCOCN80	28, 30, 48, 50	NSYCRN126300T	25	NSYCRN64250P	25
NSYCOCN51400	28, 30, 48, 50, 132, 179, 424	NSYCRN126400	25	NSYCRN64250T	25
NSYCOCN51800	30, 48, 50, 132, 179, 424	NSYCRN126400T	25	NSYCRN65150	25
NSYCPT37	266	NSYCRN128300	25	NSYCRN65150P	25
NSYCPTS37	266	NSYCRN128300T	25	NSYCRN65200	25
NSYCR100WU1	631	NSYCRN128400	25	NSYCRN65200P	25
NSYCR100WU1C	630	NSYCRN128400T	25	NSYCRN65200T	25
NSYCR100WU2	631	NSYCRN1410300D	25	NSYCRN65250	25
NSYCR100WU2C	630	NSYCRN22150	25	NSYCRN65250P	25
NSYCR100WU3	631	NSYCRN23150	25	NSYCRN65250T	25
NSYCR100WU3C	630	NSYCRN252150	25	NSYCRN66200	25
NSYCR10WU1	631	NSYCRN252150P	25	NSYCRN66200P	25
NSYCR10WU1C	630	NSYCRN325150	25	NSYCRN66200T	25
NSYCR10WU2	631	NSYCRN325150P	25	NSYCRN66250	25
NSYCR10WU2C	630	NSYCRN325150T	25	NSYCRN66250P	25
NSYCR150WU1	631	NSYCRN325200	25	NSYCRN66250T	25
NSYCR150WU1C	630	NSYCRN325200P	25	NSYCRN66300	25
NSYCR150WU2	631	NSYCRN325200T	25	NSYCRN66300P	25
NSYCR150WU2C	630	NSYCRN33150	25	NSYCRN66300T	25
NSYCR150WU3	631	NSYCRN33150P	25	NSYCRN68300	25
NSYCR170W230VVC	630	NSYCRN33150T	25	NSYCRN68300T	25
NSYCR20WU1	631	NSYCRN33200	25	NSYCRN75200	25
NSYCR20WU1C	630	NSYCRN33200P	25	NSYCRN75200P	25
NSYCR20WU2	631	NSYCRN33200T	25	NSYCRN75200T	25

Index of References

N	Page	N	Page	N	Page
NSYCRN75250	25	NSYCRTM1U5GCA	551	NSYCU1K6DG	613, 621, 667
NSYCRN75250P	25	NSYCRTM1UG	552	NSYCU1KDG	613, 621, 667
NSYCRN75250T	25	NSYCRTM1UVT	552	NSYCU2K3P4DG	615, 621, 667
NSYCRN810300D	25	NSYCRTM1UVTG	552	NSYCU2K3P4RDG	616, 621, 667
NSYCRN812300D	25	NSYCRTM2U	552	NSYCU2KDG	613, 621, 667
NSYCRN86200	25	NSYCRTM2U3	551	NSYCU2KRDG	616, 621, 667
NSYCRN86200P	25	NSYCRTM2UG	552	NSYCU350DG	613, 621, 667
NSYCRN86200T	25	NSYCRTM2US	551	NSYCU3K23P4DG	615, 621, 667
NSYCRN86250	25	NSYCRTM3U	552	NSYCU3K2DG	615, 621, 667
NSYCRN86250P	25	NSYCRTM3UD	548	NSYCU3K3P4RDG	616, 621, 667
NSYCRN86250T	25	NSYCRTM3UDG	548	NSYCU4K3P4DG	615, 621, 667
NSYCRN86300	25	NSYCRTM3UG	552	NSYCU4K3P4RDG	616, 621, 667
NSYCRN86300P	25	NSYCRTM4U	552	NSYCU600DG	613, 621, 667
NSYCRN86300T	25	NSYCRTM5U	552	NSYCU600RDG	616, 621, 667
NSYCRN86400	25	NSYCRTM6U	552	NSYCU8002P4DG	613, 621, 667
NSYCRN86400T	25	NSYCRTM9U	552	NSYCU8002P4RDG	616, 621, 667
NSYCRN88200	25	NSYCRTMR1U	552	NSYCU800DG	613, 621, 667
NSYCRN88200P	25	NSYCRTMR3U	552	NSYCU800RDG	616, 621, 667
NSYCRN88300	25	NSYCS200PLM	184	NSYCUACC001DG	621
NSYCRN88300P	25	NSYCS300PLM	184	NSYCUACC002DG	621
NSYCRN88300T	25	NSYCS400PLM	184	NSYCUACC003DG	621
NSYCRNCGPSTDSB	656, 657	NSYCS500PLM	184	NSYCUACC004DG	621
NSYCRNGSDR	221, 224	NSYCS600PLM	184	NSYCUACC005DG	621
NSYCRP1W120VTVC	631	NSYCS800PLM	184	NSYCUACC006DG	621
NSYCRP1W230VTVC	631	NSYCSA57	387	NSYCUACC007DG	621
NSYCRS100W240V	627	NSYCSA68	387	NSYCUACC008DG	621
NSYCRS10W240V	627	NSYCSA810	387	NSYCUACC009DG	616, 621
NSYCRS200W230V	631	NSYCSH166	290	NSYCUACC010DG	621
NSYCRS200W240V	627	NSYCSH168	290	NSYCUACC011DG	621
NSYCRS25W240V	627	NSYCSH186	290, 291	NSYCUACC013DG	621
NSYCRS50W240V	627	NSYCSH188	290	NSYCUACC014DG	621
NSYCRT4A1U	552	NSYCSH206	290	NSYCUACC015DG	621
NSYCRT4A2U	552	NSYCSH208	290	NSYCUACC017DG	621
NSYCRT4A3U	552	NSYCSHB2010	290	NSYCUACC018DG	621
NSYCRT4A4U	552	NSYCSHB2012	290	NSYCUACC019DG	621
NSYCRT4A5U	552	NSYCSPP	87	NSYCUACC020DG	621
NSYCRT4A6U	552	NSYCSPP6G	392	NSYCUACC021DG	621
NSYCRT4A9U	552	NSYCSSF	658	NSYCUACC022DG	621
NSYCRTA10U	552	NSYCSSFHD	664	NSYCUACC023DG	621
NSYCRTA12U	552	NSYCTL500DLAG	187	NSYCUACC024DG	621
NSYCRTA1U	552	NSYCTL500DLM	27, 287	NSYCUACC025DG	621
NSYCRTA2U	552	NSYCTL500DLP2	210	NSYCUACC026DG	621
NSYCRTA3U	552	NSYCTL500DLPG	210	NSYCUACC027DG	621
NSYCRTA3UD	548	NSYCTL600DLAG	187	NSYCUACC028DG	621
NSYCRTA4U	552	NSYCTL600DLM	27, 287	NSYCUACC029DG	621
NSYCRTA4UD	548	NSYCTL750DLP2	210	NSYCUACC030DG	621
NSYCRTA5U	552	NSYCTL750DLPG	210	NSYCUACC031DG	621
NSYCRTA6U	552	NSYCTL800DLAG	187	NSYCUACC032DG	621
NSYCRTA9U	552	NSYCTL800DLM	27, 287	NSYCUACC033DG	621
NSYCRTM10U	552	NSYCTOPB	500	NSYCUACC034DG	621
NSYCRTM12U	552	NSYCTVDA	539	NSYCUACC035DG	621
NSYCRTM1U	552	NSYCU1K22P4DG	613, 621, 667	NSYCUACC036DG	621
NSYCRTM1U1P	551	NSYCU1K22P4RDG	616, 621, 667	NSYCUACC037DG	621
NSYCRTM1U1PG	551	NSYCU1K2DG	613, 621, 667	NSYCUACC038DG	621
NSYCRTM1U1PS	503, 551	NSYCU1K2P4DG	613, 621, 667	NSYCUACC039DG	621
NSYCRTM1U2	551	NSYCU1K2RDG	616, 621, 667	NSYCUACC040DG	621
NSYCRTM1U32B	551	NSYCU1K52P4RDG	616, 621, 667	NSYCUH600DG	619, 621
NSYCRTM1U40B	551	NSYCU1K5RDG	616, 621, 667	NSYCUHD1K2P4DG	619, 621, 667
NSYCRTM1U40BG	551	NSYCU1K62P4DG	613, 621, 667	NSYCUHD1K62P4DG	619, 621, 667

Index of References

N	Page	N	Page	N	Page
NSYCUHD1K6DG	619, 621, 667	NSYCUX350DG	613, 621, 667	NSYDB2015M	10
NSYCUHD1KDG	619, 621, 667	NSYCUX600DG	613, 621, 667	NSYDB88M	10
NSYCUHD2K3P4DG	619, 621, 667	NSYCV114M	595	NSYDBN1010	10
NSYCUHD350DG	619, 621, 667	NSYCV178M	595	NSYDBN1510	10
NSYCUHD600DG	667	NSYCVAC100	595	NSYDBN2015	10
NSYCUHD800DG	619, 621, 667	NSYCVF156M115	594	NSYDBN2520	10
NSYCUNPL1000	529	NSYCVF156M230	594	NSYDBN3025	10
NSYCUNPL800	529	NSYCVF165M115PF	585	NSYDBN88	10
NSYCUSP001DG	667	NSYCVF165M230DG	578, 580	NSYDCD2412	59, 60, 260
NSYCUSP002DG	667	NSYCVF165M230PF	585, 587, 593	NSYDCD244	59, 60, 260
NSYCUSP0031	665	NSYCVF165M24DPF	585	NSYDCD248	59, 60, 260
NSYCUSP0032	665	NSYCVF165M48DPF	585	NSYDCD249	59, 60, 260
NSYCUSP0033	665	NSYCVF170M115	595	NSYDCM20	106, 273
NSYCUSP0034	665	NSYCVF170M230	595	NSYDCRN105L	656
NSYCUSP0035	665	NSYCVF300M115PF	585	NSYDCRN105R	656
NSYCUSP0036	665	NSYCVF300M230DG	578, 580	NSYDCRN106	656
NSYCUSP0037	665	NSYCVF300M230PF	585, 587, 593	NSYDCRN106L	656
NSYCUSP0038	665	NSYCVF300M24DPF	585	NSYDCRN106R	656
NSYCUSP003DG	667	NSYCVF300M48DPF	585	NSYDCRN108	656
NSYCUSP0041	665	NSYCVF35M115	594	NSYDCRN125L	656
NSYCUSP0042	665	NSYCVF35M230	594	NSYDCRN125R	656
NSYCUSP0043	665	NSYCVF38M115PF	585	NSYDCRN126	656
NSYCUSP0044	665	NSYCVF38M230DG	578, 580	NSYDCRN126L	656
NSYCUSP004DG	667	NSYCVF38M230PF	585	NSYDCRN126R	656
NSYCUSP0053	665	NSYCVF38M24DPF	585	NSYDCRN128	656
NSYCUSP005DG	667	NSYCVF38M48DPF	585	NSYDCRN145L	656
NSYCUSP006DG	667	NSYCVF54M230MM2	594	NSYDCRN145R	656
NSYCUSP0077	665	NSYCVF550M115FB	381, 588	NSYDCRN22	656, 662
NSYCUSP0078	665	NSYCVF550M230FB	381, 588	NSYDCRN23	656, 662
NSYCUSP0079	665	NSYCVF550M24FB	381, 588	NSYDCRN2520	656, 662
NSYCUSP007DG	667	NSYCVF560M115PF	585, 597	NSYDCRN3025	656, 662
NSYCUSP0080	665	NSYCVF560M230DG	578, 580	NSYDCRN3045	656, 662
NSYCUSP0081	665	NSYCVF560M230PF	585, 587, 593, 597	NSYDCRN33	656, 662
NSYCUSP0082	665	NSYCVF570M115MF	594	NSYDCRN34	656, 662
NSYCUSP0084	665	NSYCVF575M230MF	594	NSYDCRN43	656, 662
NSYCUSP008DG	667	NSYCVF65M115PF	594	NSYDCRN44	656, 662
NSYCUSP009DG	667	NSYCVF65M230PF	594	NSYDCRN46	656, 662
NSYCUSP0100	665, 666	NSYCVF850M115PF	585, 597	NSYDCRN54	656
NSYCUSP0107	666	NSYCVF850M230DG	578, 580	NSYDCRN55	656, 662
NSYCUSP0108	666	NSYCVF850M230PF	585, 587, 593, 597	NSYDCRN64	656
NSYCUSP0109	666	NSYCVF850M400DG	578, 580	NSYDCRN65	656
NSYCUSP010DG	667	NSYCVF850M400PF	585	NSYDCRN66	656, 662
NSYCUSP0112	665	NSYCVF85M115PF	585	NSYDCRN68	656, 662
NSYCUSP0113	665	NSYCVF85M230DG	578, 580	NSYDCRN75	656
NSYCUSP0114	666	NSYCVF85M230PF	585, 587, 593	NSYDCRN85L	656
NSYCUSP0115	666	NSYCVF85M24DPF	585	NSYDCRN85R	656
NSYCUSP0117	666	NSYCVF85M48DPF	585	NSYDCRN86	656, 662
NSYCUSP0124	666	NSYCW33	277	NSYDCRN86L	656
NSYCUSP0125	666	NSYCW44	277	NSYDCRN86R	656
NSYCUSP0136	665	NSYCW45	277	NSYDCRN88	656
NSYCUSP0137	665	NSYCW46	277	NSYDCRNG105L	657
NSYCUSP0138	665	NSYCW54	277	NSYDCRNG105R	657
NSYCUSP0177	665	NSYCW55	277	NSYDCRNG106	657
NSYCUSP0181	665	NSYCW56	277	NSYDCRNG106L	657
NSYCUSP0184	665	NSYCW65	277	NSYDCRNG106R	657
NSYCUX1K2P4DG	613, 621, 667	NSYCW66	277	NSYDCRNG108	657
NSYCUX1K6DG	613, 621, 667	NSYCW86	277	NSYDCRNG125L	657
NSYCUX1KDG	613, 621, 667	NSYDB1010M	10	NSYDCRNG125R	657
NSYCUX2K3P4DG	615, 621, 667	NSYDB1510M	10	NSYDCRNG126	657

Index of References

N	Page	N	Page	N	Page
NSYDCRNG126L	657	NSYDLS24	163	NSYDPLA155HG	661
NSYDCRNG126R	657	NSYDLS242	163	NSYDPLA157G	661
NSYDCRNG128	657	NSYDLS36	163	NSYDPLA157HG	661
NSYDCRNG145L	657	NSYDLS48	163	NSYDPLA3	210
NSYDCRNG145R	657	NSYDLS10	662	NSYDPLA4	210
NSYDCRNG85L	657	NSYDLS12	662	NSYDPLA55G	661
NSYDCRNG85R	657	NSYDLS12	662	NSYDPLA55HG	661
NSYDCRNG86	657	NSYDLS6	662	NSYDPLA57G	661
NSYDCRNG86L	657	NSYDLS8	662	NSYDPLA57HG	661
NSYDCRNG86R	657	NSYDLSDF10	662	NSYDPLA6	210
NSYDCSH2012	290, 291	NSYDLSDF12	662	NSYDPLA75G	661
NSYDHLT8080	241	NSYDLSDF16	662	NSYDPLA75HG	661
NSYDHSF	658, 659	NSYDLSDF8	662	NSYDPLA77G	661
NSYDHSM2D	659	NSYDNS3D105L	654	NSYDPLA77HG	661
NSYDLA112G	27, 45, 186	NSYDNS3D105R	654	NSYDPLM108G	662
NSYDLA234G	27, 45, 186	NSYDNS3D106L	654	NSYDPLM108TG	662
NSYDLA24G	27, 45, 186	NSYDNS3D106R	654	NSYDPLM200	184
NSYDLA48G	27, 45, 186	NSYDNS3D125L	654	NSYDPLM250	184
NSYDLA48PG	27, 45, 186	NSYDNS3D125R	654	NSYDPLM300	184
NSYDLA66G	27, 45, 186	NSYDNS3D126L	654	NSYDPLM3025G	662
NSYDLA84G	27, 45, 186	NSYDNS3D126R	654	NSYDPLM3025TG	662
NSYDLA88G	27, 186	NSYDNS3D145L	654	NSYDPLM32G	662
NSYDLCR110	27, 288	NSYDNS3D145R	654	NSYDPLM350	184
NSYDLCR135	27, 288	NSYDNS3D85L	654	NSYDPLM43G	662
NSYDLCR18	27, 288	NSYDNS3D85R	654	NSYDPLM43TG	662
NSYDLCR24	27, 288	NSYDNS3D86L	654	NSYDPLM54G	662
NSYDLCR36	27, 288	NSYDNS3D86R	654	NSYDPLM54TG	662
NSYDLCR48	27, 288	NSYDPA3	105, 273, 583	NSYDPLM64G	662
NSYDLCR64	27, 288	NSYDPA4	105, 273, 583	NSYDPLM64TG	662
NSYDLCR88	27, 288	NSYDPA44	105, 273, 583	NSYDPLM75G	662
NSYDLLSDF	662	NSYDPA5	105, 273, 583	NSYDPLM75TG	662
NSYDLM112	27, 45, 130, 287	NSYDPHD105P	663	NSYDPLM86G	662
NSYDLM168	27, 45, 287	NSYDPHD105R	663	NSYDPLM86TG	662
NSYDLM24	27, 45, 130, 287	NSYDPHD107P	663	NSYDPR200	243
NSYDLM240	27, 45, 130, 287	NSYDPHD107R	663	NSYDPR200D	243
NSYDLM48	27, 33, 45, 130, 287	NSYDPHD125LP	663	NSYDPR200T	243
NSYDLM48P	27, 33, 45, 130, 287	NSYDPHD125LR	663	NSYDS3D1010	654
NSYDLM66	27, 45, 130, 287	NSYDPHD125P	663	NSYDS3D105L	654
NSYDLM84	27, 45, 130, 287	NSYDPHD125R	663	NSYDS3D105R	654
NSYDLM84P	27, 33, 45, 130, 287	NSYDPHD127P	663	NSYDS3D106	654
NSYDLM88	27, 130, 287	NSYDPHD127R	663	NSYDS3D106L	654
NSYDLP114G	208	NSYDPHD155LP	663	NSYDS3D106R	654
NSYDLP114PG	208	NSYDPHD155LR	663	NSYDS3D108	654, 663
NSYDLP132G	208	NSYDPHD157P	663	NSYDS3D1210	654
NSYDLP133G	208	NSYDPHD157R	663	NSYDS3D125L	654
NSYDLP152G	208	NSYDPHD55P	663	NSYDS3D125R	654
NSYDLP165G	208	NSYDPHD55R	663	NSYDS3D126	654
NSYDLP171G	208	NSYDPHD75P	663	NSYDS3D126L	654
NSYDLP198G	208	NSYDPHD75R	663	NSYDS3D126R	654
NSYDLP198PG	208	NSYDPHD77P	663	NSYDS3D128	654
NSYDLP231G	208	NSYDPHD77R	663	NSYDS3D145L	654
NSYDLP264G	208	NSYDPLA105G	661	NSYDS3D145R	654
NSYDLP297G	208	NSYDPLA105HG	661	NSYDS3D32	654, 663
NSYDLP57G	208	NSYDPLA107G	661	NSYDS3D325	654
NSYDLP76G	208	NSYDPLA107HG	661	NSYDS3D33	654, 663
NSYDLP95G	208	NSYDPLA125G	661	NSYDS3D34	654
NSYDLP99G	208	NSYDPLA125HG	661	NSYDS3D43	654, 663
NSYDLPLM18G	187	NSYDPLA127G	661	NSYDS3D44	654, 663
NSYDLS12	163	NSYDPLA127HG	661	NSYDS3D46	654
		NSYDPLA155G	661		

Index of References

N	Page	N	Page	N	Page
NSYDS3D53	654	NSYDS3X75	660	NSYEC126	83, 96
NSYDS3D54	654, 663	NSYDS3X75H	660	NSYEC1261	83, 97
NSYDS3D55	654	NSYDS3X75T	660	NSYEC1262	83, 97
NSYDS3D64	654, 663	NSYDS3X86	660	NSYEC128	83, 96
NSYDS3D65	654	NSYDS3X86H	660	NSYEC1281	83, 97
NSYDS3D66	654, 663	NSYDS3X86T	660	NSYEC1282	83, 97
NSYDS3D68	654	NSYDS3X88	660	NSYEC164	83, 96
NSYDS3D75	654, 663	NSYDS3X88H	660	NSYEC1641	83, 97
NSYDS3D810	654	NSYDSFX1410L	660	NSYEC165	83, 96
NSYDS3D85L	654	NSYDSFX1410R	660	NSYEC1651	83, 97
NSYDS3D85R	654	NSYDSFX168	660	NSYEC166	83, 96
NSYDS3D86	654, 663	NSYDSFX1812L	660, 661	NSYEC1661	83, 97
NSYDS3D86L	654	NSYDSFX1812LH	660	NSYEC1662	83, 97
NSYDS3D86R	654	NSYDSFX1812R	660, 661	NSYEC300	498
NSYDS3D88	654	NSYDSFX1812RH	660	NSYEC35	83, 96
NSYDS3HD106	664	NSYDSFX1816L	660	NSYEC351	83, 97, 336
NSYDS3HD108	664	NSYDSFX1816LH	660	NSYEC36	83, 96, 371
NSYDS3HD32	664	NSYDSFX1816R	660	NSYEC361	83, 97, 336, 371
NSYDS3HD43	664	NSYDSFX1816RH	660	NSYEC381	83, 336, 371
NSYDS3HD54	664	NSYDSFX186	660, 661	NSYEC44	83, 96
NSYDS3HD64	664	NSYDSFX188	660, 661	NSYEC440	410, 532
NSYDS3HD66	664	NSYDSFX188H	660	NSYEC441	83, 97
NSYDS3HD75	664	NSYDSFX2010L	660, 661	NSYEC45	83, 96
NSYDS3HD86	664	NSYDSFX2010LH	660	NSYEC451	83, 97
NSYDS3HD88	664	NSYDSFX2010R	660, 661	NSYEC461	83, 97, 371
NSYDS3X1010L	660	NSYDSFX2010RH	660	NSYEC462	83, 97
NSYDS3X1010LH	660	NSYDSFX2012L	660, 661	NSYEC481	83, 97, 371
NSYDS3X1010R	660	NSYDSFX2012LH	660	NSYEC482	83, 97
NSYDS3X1010RH	660	NSYDSFX2012R	660, 661	NSYEC610	407
NSYDS3X108	660	NSYDSFX2012RH	660	NSYEC6101	407
NSYDS3X108H	660	NSYDSFX2016L	660, 661	NSYEC6102	408
NSYDS3X108T	660	NSYDSFX2016LH	660	NSYEC64	83, 96, 371
NSYDS3X1210L	660	NSYDSFX2016R	660, 661	NSYEC641	83, 97
NSYDS3X1210LH	660	NSYDSFX2016RH	660	NSYEC65	83, 96
NSYDS3X1210R	660	NSYDSFX206	660, 661	NSYEC651	83, 97
NSYDS3X1210RH	660	NSYDSFX208	660, 661	NSYEC66	83, 96, 371, 407
NSYDS3X128	660	NSYE1025	246	NSYEC661	83, 97, 371, 407
NSYDS3X128H	660	NSYE1525	246	NSYEC662	83, 97, 371, 408
NSYDS3X32	660	NSYE2025	246	NSYEC68	83, 96, 371, 407
NSYDS3X325	660	NSYEB1510D6	121, 278, 426	NSYEC681	83, 97, 371, 407
NSYDS3X325H	660	NSYEB1516D8	278, 371, 426	NSYEC682	83, 97, 371, 408
NSYDS3X32H	660	NSYEB156D6	121, 278, 426	NSYEC751	336
NSYDS3X33	660	NSYEB2025D8	278, 371, 426	NSYEC761	336
NSYDS3X33H	660	NSYEB2050D8	278, 371, 426	NSYEC781	336
NSYDS3X43	660	NSYEBMPLAG	204	NSYEC810	407
NSYDS3X43H	660	NSYEC104	83, 96	NSYEC8101	407
NSYDS3X43T	660	NSYEC1041	83, 97	NSYEC8102	408
NSYDS3X44	660	NSYEC105	83, 96	NSYEC84	83, 96, 371
NSYDS3X44H	660	NSYEC1051	83, 97	NSYEC841	83, 97
NSYDS3X46	660	NSYEC106	83, 96	NSYEC85	83, 96
NSYDS3X46H	660	NSYEC1061	83, 97	NSYEC851	83, 97
NSYDS3X54	660	NSYEC1062	83, 97	NSYEC86	83, 96, 371, 407
NSYDS3X54H	660	NSYEC108	83, 96	NSYEC861	83, 97, 371, 407
NSYDS3X54T	660	NSYEC1081	83, 97	NSYEC862	83, 97, 371, 408
NSYDS3X64	660	NSYEC1082	83, 97	NSYEC88	83, 96, 371, 407
NSYDS3X64H	660	NSYEC124	83, 96	NSYEC881	83, 97, 371, 407
NSYDS3X64T	660	NSYEC1241	83, 97	NSYEC882	83, 97, 371, 408
NSYDS3X66	660	NSYEC125	83, 96	NSYECAV300	498
NSYDS3X66H	660	NSYEC1251	83, 97	NSYECAV440	410, 532

Index of References

N	Page	N	Page	N	Page
NSYECB1M153	121, 278	NSYFECVT440	409, 534	NSYHPF2B3M64	366
NSYECPC300	492, 493, 498	NSYFMPHD	375	NSYHPF2B3M65	366
NSYECPC440	410, 532	NSYFNM6	233, 249	NSYHPF2B3M84	366
NSYECPC15	62, 155, 156, 262	NSYFNM8	233, 249	NSYHPF2B3M85	366
NSYECPC3	62, 155, 156, 262	NSYFPLS1827G	163	NSYHS3X	660
NSYECPC5	62, 155, 156, 262	NSYFPLS2727G	163	NSYHSD	662
NSYECPC6	62, 155, 156, 262	NSYFPLS2736G	163	NSYHSDF	662
NSYECPC9	62, 155, 156, 262	NSYFPLS2754G	163	NSYHSMX	661
NSYECPL1000	533	NSYFPLS3636G	163	NSYID166	81, 103
NSYECPL600	533	NSYFPLS3654G	163	NSYID168	81, 103
NSYECPL800	533	NSYFPLS3672G	163	NSYID1810	81, 103
NSYECPLAZ103G	197	NSYFPLS5454G	163	NSYID186	81, 103
NSYECPLAZ104G	197	NSYFPLS5472G	163	NSYID188	81, 103
NSYECPLAZ123G	197	NSYFXMNT60F	304	NSYID2010	81, 103
NSYECPLAZ124G	197	NSYFXMNT80F	304	NSYID206	81, 103
NSYECPLAZ53G	197	NSYFXMNT80W	304	NSYID208	81, 103
NSYECPLAZ54G	197	NSYFXMNT80F	304	NSYIEC13IEC14	504
NSYECPLAZ73G	197	NSYFXMNT80W	304	NSYIEC13SCH	504
NSYECPLAZ74G	197	NSYFXMNT60FW	304	NSYIN1242E1	108, 203
NSYECPT300	498	NSYFXT6040	240	NSYIN1242E2	109, 203
NSYECVT2V440	410, 534	NSYFXT6050	240	NSYIN2131A1	108, 203
NSYECVT300	492, 493, 498	NSYFXT6060	240, 458	NSYIN2132A1	108, 203
NSYECVT3V440	410, 534	NSYFXT8040	240	NSYIN2433A1	108, 203
NSYEDCOC	234	NSYFXT8050	240	NSYIN2452E1	108, 203
NSYEDCOS	278	NSYFXT8060	240	NSYIN3113A1	108, 203
NSYEDPLA	210	NSYFXT8080	240	NSYIN405E1	108, 203
NSYEL136D6	121, 278	NSYGB140	416, 543	NSYIN421E1	108, 203
NSYEL166D6	121, 278	NSYGB140H5	543	NSYIN4551	108, 203
NSYEL166D8	121, 278, 337, 371	NSYGC1010	549	NSYINASSA2	109
NSYEL2225D8	121, 278, 371	NSYGC1US19	550	NSYINDB31	108
NSYEL226D6	121, 278	NSYGC410	549	NSYINDB51	108, 203
NSYEL2510D6	121, 278	NSYGCA1010	549	NSYINDIN2	109, 203
NSYEL3525D8	121, 278, 337, 371	NSYGCA410	549	NSYINE11	108
NSYEMR	68, 221	NSYGCA46	549	NSYINF1301	108
NSYENU	535	NSYGCH213	550	NSYINICHEL8131	108
NSYETF	234	NSYGDD	654	NSYINICHEL8371	108
NSYEUVD	544	NSYGF140OPB	500	NSYINKBA2	109
NSYEVA20	245	NSYGF200OPB	500	NSYINKFAC2	109, 203
NSYEX1006	246	NSYGF356	543	NSYINKJIS2	109, 203
NSYEX1008	246	NSYGF356H5	543	NSYINKR2	109, 203
NSYEX106	246	NSYGF456	543	NSYINLCRN	37, 56, 273, 399, 400
NSYEX146	246	NSYGF556	543	NSYINPULS1	107
NSYEX158	246	NSYGF556H5	543	NSYINS61	108, 203
NSYEX166	246	NSYGF656	543	NSYINS71	108, 203
NSYEX206	246, 409, 532	NSYGF756	543	NSYINS81	108, 203
NSYEX208	246	NSYGF756H5	543	NSYINT61	108, 203
NSYEX306	246	NSYGFR12M65	247, 540	NSYINT71	108
NSYEX308	246	NSYGFR166P	247, 417	NSYINT81	108, 203
NSYEX406	246	NSYGFR95M55	247, 417, 540	NSYINT91	108
NSYEX408	246	NSYGFR95M63	247, 417, 540	NSYJPSVD	499, 533, 537
NSYEX506	246	NSYGFR95M65	247, 417, 540	NSYKDB12U6F	503
NSYEX508	246	NSYGT40	543	NSYKDB15U6F	503
NSYEX608	246	NSYGT60	543	NSYKDB6U4F	503
NSYFB45	234, 368	NSYGT80	543	NSYKDB9U4F	503
NSYFCG100	264	NSYHLCR40	238, 241, 392	NSYKPLM	34, 183
NSYFCG60	264	NSYHLCR50	238, 241	NSYLADP	109
NSYFCG80	264	NSYHLCR60	238, 241, 392	NSYLAM1M	269, 553
NSYFCMX	143	NSYHLCR80	238, 241, 392	NSYLAM1MN	269, 553
NSYFDLSD	662	NSYHPF2B3M4	366	NSYLAM1U	270, 553

Index of References

N	Page	N	Page	N	Page
NSYLAM3M	269, 553	NSYMD75	25, 45, 221, 434	NSYMM2520	25, 220
NSYLAM3MDC	269, 553	NSYMD86	25, 45, 221, 434	NSYMM2540	220
NSYLAM3MDCUL	269, 553	NSYMDCM20	106, 273	NSYMM2550	220
NSYLAM3MN	269, 553	NSYMDVVR12	225	NSYMM25SB	15, 16
NSYLAM3MUL	269, 553	NSYMDVVR3M	225	NSYMM26SB	15, 16
NSYLAMACF	270	NSYMF1010	25, 45, 130, 220	NSYMM28SB	15, 16
NSYLAMACM	270	NSYMF106	25, 45, 130, 220	NSYMM3025	25, 45, 130, 181, 220, 433
NSYLAMD CF	270	NSYMF108	25, 45, 130, 181, 220, 433	NSYMM3045	25, 220
NSYLAMD CM	270	NSYMF1210	25, 45, 130, 220	NSYMM32	25, 45, 130, 181, 220, 380, 433
NSYLAML D	269, 553	NSYMF126	25, 45, 130, 220	NSYMM33	25, 45, 130, 220, 433
NSYLAML DB	269, 553	NSYMF128	25, 45, 130, 220	NSYMM33SB	15, 16, 118
NSYLAML DD	269, 553	NSYMF2PLAZ4	374	NSYMM34SB	15, 16
NSYLAML DF	269, 553	NSYMF2PLAZ6	374	NSYMM35SB	15, 16
NSYLAML DS	269, 553	NSYMF32	25, 45, 130, 220	NSYMM36	220
NSYLAML DU	269, 553	NSYMF33	25, 45, 130, 220, 433	NSYMM36SB	15, 16
NSYLAML DVDC	269, 553	NSYMF43	25, 45, 130, 181, 220, 433	NSYMM38SB	15, 16
NSYLAMPOR TLD	271	NSYMF44	25, 45, 130, 220, 433, 448	NSYMM43	25, 45, 130, 181, 220, 380, 433
NSYLAM T5LD1	271	NSYMF53	45, 220	NSYMM44	25, 45, 130, 220, 433, 448
NSYLAM T5LD1VDC	271	NSYMF54	25, 45, 130, 181, 220, 433	NSYMM44SB	15, 16
NSYLAM T5LD2	271	NSYMF55	25, 45, 220	NSYMM45SB	15, 16
NSYLC7	34, 35, 371	NSYMF64	25, 45, 130, 181, 220, 433	NSYMM46SB	15, 16
NSYLC8	34, 35, 371	NSYMF65	25, 45, 220	NSYMM48	220
NSYLCK12SF	658, 659	NSYMF66	25, 45, 130, 220, 433	NSYMM48SB	15, 16
NSYLCK14SF	658, 659	NSYMF75	25, 45, 130, 181, 220, 433	NSYMM53	45, 220
NSYLCK16SF	658, 659	NSYMF86	25, 45, 130, 181, 220, 433	NSYMM54	25, 45, 130, 181, 220, 380, 433
NSYLCK18SF	658, 659	NSYMF88	25, 45, 130, 220	NSYMM55	25, 45, 220
NSYLCK20SF	658, 659	NSYMF B	233	NSYMM64	25, 45, 130, 181, 220, 221, 380, 433
NSYLCK22SF	658, 659	NSYMF P2M6	104, 369	NSYMM65	25, 45, 220
NSYLCK W SF	659	NSYMF P2M8	104, 369	NSYMM66	25, 45, 130, 220, 380, 433
NSYLD B5	34, 35, 371	NSYMF P5M6	104, 369	NSYMM75	25, 45, 130, 181, 220, 380, 387, 433
NSYLL333	563	NSYMF P5M8	104, 369	NSYMM76	220
NSYLSS3X10	660	NSYMF SC60	294	NSYMM86	25, 45, 130, 181, 220, 380, 387, 433
NSYLSS3X12	660	NSYMF SC60D	294	NSYMM88	25, 45, 130, 220, 380
NSYLSSDX	662	NSYMF SC80	294	NSYMP1210	81, 226
NSYLSSFX14	660, 661	NSYMF SC80D	294	NSYMP1212	81, 226, 380
NSYLSSFX16	660, 661	NSYMICN6	104, 105, 367	NSYMP126	83, 84, 226, 380
NSYLSSFX18	660, 661	NSYMICN8	104, 105, 367	NSYMP128	81, 83, 84, 226, 380
NSYLSSFX20	660, 661	NSYML23	459	NSYMP12M6	348, 349, 351, 352
NSYLT8	34, 35, 371	NSYML405SD	452	NSYMP12M8	348, 349, 351, 352
NSYMB108	25, 45, 181, 221	NSYMLCD23	459	NSYMP1410	81, 142, 226, 454
NSYMB1210	25, 45, 221	NSYMLS6	459	NSYMP1412	81, 226, 454
NSYMB3025	25, 45, 181, 221	NSYMLT6	459	NSYMP146	81, 83, 84, 226
NSYMB32	25, 45, 181, 221	NSYMM1010	25, 45, 130, 220	NSYMP148	81, 83, 84, 226, 454
NSYMB33	25	NSYMM106	25, 45, 130, 220, 380	NSYMP1610	81, 226
NSYMB43	25, 45, 181, 221	NSYMM108	25, 45, 130, 181, 220, 380, 387, 433	NSYMP1612	81, 226, 380
NSYMB54	25, 45, 181, 221	NSYMM11SB	15, 16, 118	NSYMP166	81, 83, 84, 226, 380
NSYMB64	25, 45, 181, 221	NSYMM1210	25, 45, 130, 220	NSYMP168	81, 83, 84, 142, 226, 380
NSYMB65	25, 45, 221	NSYMM1212	25, 45, 220	NSYMP16M6	348, 351, 352
NSYMB75	25, 45, 181, 221	NSYMM126	25, 45, 130, 220	NSYMP16M8	348, 351, 352
NSYMB86	25, 45, 181, 221	NSYMM128	25, 45, 130, 220	NSYMP1810	81, 83, 84, 226
NSYMBR19	413	NSYMM12SB	15, 16	NSYMP1812	81, 83, 84, 142, 226
NSYMCDFIX	295	NSYMM13SB	15, 16, 118	NSYMP1816	81, 142, 226
NSYMD108	25, 45, 221, 434	NSYMM1410	25, 45, 220	NSYMP184	83, 84, 226
NSYMD128	25, 45, 221	NSYMM14SB	15, 16	NSYMP186	81, 83, 84, 142, 226
NSYMD33	25, 45, 221, 434	NSYMM22	25, 220	NSYMP188	81, 83, 84, 142, 226
NSYMD43	25, 45, 221, 434	NSYMM22SB	15, 16, 118	NSYMP18M6	348
NSYMD54	25, 45, 221, 434	NSYMM23SB	15, 16, 118		
NSYMD64	25, 45, 221, 434	NSYMM24SB	15, 16, 118		
NSYMD66	25, 45, 221, 434				

Index of References

N	Page	N	Page	N	Page
NSYMP18M8	348	NSYMPD16M6	104, 369	NSYMR65	25, 45, 220
NSYMP2010	81, 83, 85, 142, 226	NSYMPD16M8	104, 369	NSYMR66	25, 45, 130, 220, 433
NSYMP2012	81, 83, 85, 142, 226	NSYMPD18M6	104, 369	NSYMR68	25, 45, 220
NSYMP2016	81, 83, 85, 142, 226	NSYMPD18M8	104, 369	NSYMR75	25, 45, 130, 181, 220, 433
NSYMP204	83, 85, 226	NSYMPD20M6	104, 369	NSYMR76	220
NSYMP206	81, 83, 85, 142, 226, 391	NSYMPD20M8	104, 369	NSYMR810	25, 45, 220
NSYMP208	81, 83, 85, 142, 226, 380, 391	NSYMPD24M6	104, 369	NSYMR86	25, 45, 130, 181, 220, 433
NSYMP20M6	348	NSYMPD24M8	104, 369	NSYMR88	25, 45, 130, 220
NSYMP20M8	348	NSYMPD3M6	104, 369	NSYMTRN64	367
NSYMP2210	83, 85, 226	NSYMPD3M8	104, 369	NSYMTRN65	367
NSYMP2212	83, 85, 226	NSYMPD46T	369	NSYMTRN84	367
NSYMP224	83, 85, 226	NSYMPD48T	369	NSYMTRN85	367
NSYMP226	83, 85, 226	NSYMPD4M6	104, 369	NSYMUC156	293
NSYMP228	83, 85, 226	NSYMPD4M8	104, 369	NSYMUC158	293
NSYMP24M6	348	NSYMPD5M6	104, 369	NSYMUC206	293
NSYMP24M8	348	NSYMPD5M8	104, 369	NSYMUC208	293
NSYMP3M6	348-352	NSYMPD66T	369	NSYMUC306	291, 293
NSYMP3M8	348-352	NSYMPD68T	369	NSYMUC308	291, 293
NSYMP4M6	348-350, 352, 353	NSYMPD6M6	104, 369	NSYMUC406	293
NSYMP4M8	348-350, 352, 353	NSYMPD6M8	104, 369	NSYMUC408	293
NSYMP5M6	348, 352, 353	NSYMPD86T	369	NSYMUCH156	293
NSYMP5M8	348, 352, 353	NSYMPD88T	369	NSYMUCH158	293
NSYMP6M6	348, 349, 351	NSYMPD8M6	104, 369	NSYMUCH206	293
NSYMP6M8	348, 349, 351	NSYMPD8M8	104, 369	NSYMUCH208	293
NSYMP8M6	348	NSYMPD9M6	104, 369	NSYMUCH306	293
NSYMP8M8	348	NSYMPD9M8	104, 369	NSYMUCH308	293
NSYMP9M6	348, 349, 351, 352	NSYMPFIX	348-353	NSYMUCH406	293
NSYMP9M8	348, 349, 351, 352	NSYMP108	181, 221, 387	NSYMUCH408	293
NSYMPB4SD	454	NSYMP32	181, 221	NSYMUPLA103G	196
NSYMPB6SD	454	NSYMP33	181, 221	NSYMUPLA104G	196
NSYMPBSD	454	NSYMP34	181, 221	NSYMUPLA123G	196
NSYMPC156	292	NSYMP35	181, 221	NSYMUPLA124G	196
NSYMPC158	292	NSYMP36	181, 221, 387	NSYMUPLA153G	196
NSYMPC206	292	NSYMP37	181, 221, 387	NSYMUPLA154G	196
NSYMPC208	292	NSYMP38	229	NSYMUPLA204G	196
NSYMPC306	292	NSYMP39	229	NSYMUPLA53G	196
NSYMPC308	292	NSYMP40	229	NSYMUPLA54G	196
NSYMPC406	292	NSYMP41	229	NSYMUPLA73G	196
NSYMPC408	292	NSYMP42	295	NSYMUPLA74G	196
NSYMPC456	292	NSYMP43	295	NSYMW10M	276
NSYMPC458	292	NSYMP44	25, 130, 220	NSYMW10MK	276
NSYMPC606	292	NSYMP45	25, 45, 220	NSYMW10MR	276
NSYMPC608	292	NSYMP46	25, 45, 130, 220	NSYNM4	225, 249
NSYMPCH156	292	NSYMP47	25, 45, 130, 181, 220, 433	NSYNM5	225, 249
NSYMPCH158	292	NSYMP48	25, 45, 130, 220	NSYNM6	225, 249
NSYMPCH206	292	NSYMP49	25, 45, 220	NSYOPB12U4F	493, 495
NSYMPCH208	292	NSYMP50	25, 45, 130, 220	NSYOPB12U4FR	493, 495
NSYMPCH306	292	NSYMP51	25, 45, 220	NSYOPB12U5F	493, 495
NSYMPCH308	292	NSYMP52	25, 45, 130, 181, 220, 433	NSYOPB12U5P	492, 494
NSYMPCH406	292	NSYMP53	45, 130, 181, 220, 433	NSYOPB12U6F	493, 495
NSYMPCH408	292	NSYMP54	25, 45, 130, 220, 433	NSYOPB12U6P	492, 494
NSYMPCH456	292	NSYMP55	25, 45, 220	NSYOPB12UF	497
NSYMPCH458	292	NSYMP56	25, 45, 130, 181, 220, 433	NSYOPB12UTPN	492, 493, 497
NSYMPCH606	292	NSYMP57	25, 45, 130, 220, 448	NSYOPB15U4F	493, 495
NSYMPCH608	292	NSYMP58	25, 45, 130, 220	NSYOPB15U5F	493, 495
NSYMPD106T	369	NSYMP59	45, 220	NSYOPB15U5FR	493, 495
NSYMPD108T	369	NSYMP60	25, 45, 130, 181, 220, 433	NSYOPB15U5P	492, 494
NSYMPD12M6	104, 369	NSYMP61	25, 45, 220	NSYOPB15U6F	493, 495
NSYMPD12M8	104, 369	NSYMP62	25, 45, 130, 181, 220, 433, 448	NSYOPB15U6P	492, 494

Index of References

N	Page	N	Page	N	Page
NSYOPB15UF	497	NSYPF27N	164	NSYPLA1054TG	194
NSYOPB15UTPN	492, 493, 497	NSYPF27X	164	NSYPLA1073G	194
NSYOPB18U4F	493, 495	NSYPFC2X	29, 132	NSYPLA1073TG	194
NSYOPB18U5F	493, 495	NSYPFCR	27, 29	NSYPLA1074G	194
NSYOPB18U5FR	493, 495	NSYPFCX	29, 132	NSYPLA1074TG	194
NSYOPB18U5P	492, 494	NSYFFPLM32G	178	NSYPLA12103G	194
NSYOPB18UF	497	NSYFFPLMG	178, 387	NSYPLA12103TG	194
NSYOPB18UTPN	492, 493, 497	NSYFFXPLM	178, 387	NSYPLA12104G	194
NSYOPB21U5F	493, 495	NSYPHDT553P	374, 383, 591	NSYPLA12104TG	194
NSYOPB21U6F	493, 495	NSYPHDT753P	374, 383, 591	NSYPLA12123G	194
NSYOPB21UF	497	NSYPHDZT1054	374, 383, 591	NSYPLA12123TG	194
NSYOPB21UTPN	493, 497	NSYPHDZT1054P	374, 383, 591	NSYPLA12124G	194
NSYOPB6U4F	493, 495	NSYPHDZT1074	374, 383, 591	NSYPLA12124TG	194
NSYOPB6U4P	492, 494	NSYPHDZT1074P	374, 383, 591	NSYPLA12126G	194
NSYOPB6U5F	493, 495	NSYPHDZT12124	374, 383, 591	NSYPLA12126TG	194
NSYOPB6U5P	492, 494	NSYPHDZT12124P	374, 383, 591	NSYPLA1253G	194
NSYOPB6UF	497	NSYPHDZT12126	374, 383, 591	NSYPLA1253TG	194
NSYOPB6UTPN	492, 493, 497	NSYPHDZT12126P	374, 383, 591	NSYPLA1254G	194
NSYOPB9U4F	493, 495	NSYPHDZT1254	374, 383, 591	NSYPLA1254TG	194
NSYOPB9U4FR	493, 495	NSYPHDZT1254P	374, 383, 591	NSYPLA1273G	194
NSYOPB9U4P	492, 494	NSYPHDZT1274	374, 383, 591	NSYPLA1273TG	194
NSYOPB9U5F	493, 495	NSYPHDZT1274P	374, 383, 591	NSYPLA1274G	194
NSYOPB9U5P	492, 494	NSYPHDZT1276	374, 383, 591	NSYPLA1274TG	194
NSYOPB9U6F	493, 495	NSYPHDZT1276P	374, 383, 591	NSYPLA1276G	194
NSYOPB9UF	497	NSYPHDZT15124	374, 383, 591	NSYPLA1276TG	194
NSYOPB9UTPN	492, 493, 497	NSYPHDZT15124P	374, 383, 591	NSYPLA15103G	194
NSYPA3025PLMG	179	NSYPHDZT15126	374, 383, 591	NSYPLA15103TG	194
NSYPAP108G	179	NSYPHDZT15126P	374, 383, 591	NSYPLA15104G	194
NSYPAP43G	179	NSYPHDZT1574	374, 383, 591	NSYPLA15104TG	194
NSYPAP54G	179	NSYPHDZT1574P	374, 383, 591	NSYPLA15123G	194
NSYPAP64G	179	NSYPHDZT1576	374, 383, 591	NSYPLA15123TG	194
NSYPAP75G	179	NSYPHDZT1576P	374, 383, 591	NSYPLA15124G	194
NSYPAP86G	179	NSYPHDZT2074	374, 383, 591	NSYPLA15124TG	194
NSYPAPLA105G	202	NSYPHDZT2074P	374, 383, 591	NSYPLA15126G	194
NSYPAPLA107G	202	NSYPHDZT774	374, 383, 591	NSYPLA15126TG	194
NSYPAPLA125G	202	NSYPHDZT774P	374, 383, 591	NSYPLA1553G	194
NSYPAPLA127G	202	NSYPHDZT776	374, 383, 591	NSYPLA1553TG	194
NSYPAPLA155G	202	NSYPHDZT776P	374, 383, 591	NSYPLA1554G	194
NSYPAPLA157G	202	NSYPHX200	143, 272	NSYPLA1554TG	194
NSYPAPLA55G	202	NSYPIN106	27, 37, 47, 56	NSYPLA1573G	194
NSYPAPLA57G	202	NSYPIN108	27, 37, 47, 56, 134	NSYPLA1573TG	194
NSYPAPLA75G	202	NSYPIN126	27, 37, 47, 56	NSYPLA1574G	194
NSYPAPLA77G	202	NSYPIN128	27, 37, 47, 56, 134	NSYPLA1574TG	194
NSYPC100	658, 659	NSYPIN43	27, 37, 47, 56, 134	NSYPLA1576G	194
NSYPC200	658, 659	NSYPIN54	27, 37, 47, 56, 134	NSYPLA1576TG	194
NSYPCVD126	405	NSYPIN64	27, 37, 47, 56, 134	NSYPLA2074G	194
NSYPCVD128	405	NSYPIN75	27, 37, 47, 56, 134	NSYPLA2074TG	194
NSYPCVD148	405	NSYPIN86	27, 37, 47, 56, 134	NSYPLA5103G	194
NSYPCVD168	405	NSYPLA10103G	194	NSYPLA5104G	194
NSYPCVD188	405	NSYPLA10103TG	194	NSYPLA5123G	194
NSYPCVD206	405	NSYPLA10104G	194	NSYPLA5124G	194
NSYPCVD208	405	NSYPLA10104TG	194	NSYPLA553G	194
NSYPCVD226	405	NSYPLA10123G	194	NSYPLA553TG	194
NSYPCVD228	405	NSYPLA10123TG	194	NSYPLA554G	194
NSYPCVR124HD	376, 383, 591	NSYPLA10124G	194	NSYPLA554TG	194
NSYPCVR126HD	376, 383, 591	NSYPLA10124TG	194	NSYPLA573G	194
NSYPCVR54HD	376, 383, 591	NSYPLA1053G	194	NSYPLA573TG	194
NSYPCVR74HD	376, 383, 591	NSYPLA1053TG	194	NSYPLA574G	194
NSYPCVR76HD	376, 383, 591	NSYPLA1054G	194	NSYPLA574TG	194

Index of References

N	Page	N	Page	N	Page
NSYPLA7103G	194	NSYPLAT776G	195	NSYPLAZT1274G	195
NSYPLA7103TG	194	NSYPLAZ10103G	194	NSYPLAZT1276G	195
NSYPLA7104G	194	NSYPLAZ10104G	194	NSYPLAZT15103G	195
NSYPLA7104TG	194	NSYPLAZ10123G	194	NSYPLAZT15104G	195
NSYPLA7123G	194	NSYPLAZ10124G	194	NSYPLAZT15123G	195
NSYPLA7123TG	194	NSYPLAZ1053G	194	NSYPLAZT15124G	195
NSYPLA7124G	194	NSYPLAZ1054G	194	NSYPLAZT15126G	195
NSYPLA7124TG	194	NSYPLAZ1073G	194	NSYPLAZT1553G	195
NSYPLA753G	194	NSYPLAZ1074G	194	NSYPLAZT1554G	195
NSYPLA753TG	194	NSYPLAZ12103G	194	NSYPLAZT1573G	195
NSYPLA754G	194	NSYPLAZ12104G	194	NSYPLAZT1574G	195
NSYPLA754TG	194	NSYPLAZ12123G	194	NSYPLAZT1576G	195
NSYPLA773G	194	NSYPLAZ12124G	194	NSYPLAZT2074G	195
NSYPLA773TG	194	NSYPLAZ12126G	194	NSYPLAZT553G	195
NSYPLA774G	194	NSYPLAZ1253G	194	NSYPLAZT554G	195
NSYPLA774TG	194	NSYPLAZ1254G	194	NSYPLAZT573G	195
NSYPLA776G	194	NSYPLAZ1273G	194	NSYPLAZT574G	195
NSYPLA776TG	194	NSYPLAZ1274G	194	NSYPLAZT7103G	195
NSYPLAT10103G	195	NSYPLAZ1276G	194	NSYPLAZT7104G	195
NSYPLAT10104G	195	NSYPLAZ15103G	194	NSYPLAZT7123G	195
NSYPLAT10123G	195	NSYPLAZ15104G	194	NSYPLAZT7124G	195
NSYPLAT10124G	195	NSYPLAZ15123G	194	NSYPLAZT753G	195
NSYPLAT1053G	195	NSYPLAZ15124G	194	NSYPLAZT754G	195
NSYPLAT1054G	195	NSYPLAZ15126G	194	NSYPLAZT773G	195
NSYPLAT1073G	195	NSYPLAZ1553G	194	NSYPLAZT774G	195
NSYPLAT1074G	195	NSYPLAZ1554G	194	NSYPLAZT776G	195
NSYPLAT12103G	195	NSYPLAZ1573G	194	NSYPLHD	375
NSYPLAT12104G	195	NSYPLAZ1574G	194	NSYPLM108BG	176
NSYPLAT12123G	195	NSYPLAZ1576G	194	NSYPLM108G	175-177, 189
NSYPLAT12124G	195	NSYPLAZ2074G	194	NSYPLM108TG	175, 176, 189
NSYPLAT12126G	195	NSYPLAZ553G	194	NSYPLM3025BG	176
NSYPLAT1253G	195	NSYPLAZ554G	194	NSYPLM3025G	175, 176
NSYPLAT1254G	195	NSYPLAZ573G	194	NSYPLM3025PG	176
NSYPLAT1273G	195	NSYPLAZ574G	194	NSYPLM3025TG	175, 176
NSYPLAT1274G	195	NSYPLAZ7103G	194	NSYPLM32BG	176
NSYPLAT1276G	195	NSYPLAZ7104G	194	NSYPLM32G	175, 176
NSYPLAT15103G	195	NSYPLAZ7123G	194	NSYPLM32PG	176
NSYPLAT15104G	195	NSYPLAZ7124G	194	NSYPLM32TG	175, 176
NSYPLAT15123G	195	NSYPLAZ753G	194	NSYPLM43BG	176
NSYPLAT15124G	195	NSYPLAZ754G	194	NSYPLM43G	175, 176, 189
NSYPLAT15126G	195	NSYPLAZ773G	194	NSYPLM43PG	176
NSYPLAT1553G	195	NSYPLAZ774G	194	NSYPLM43TG	175, 176, 189
NSYPLAT1554G	195	NSYPLAZ776G	194	NSYPLM43TVG	175, 176, 189
NSYPLAT1573G	195	NSYPLAZT10103G	195	NSYPLM43VG	175, 176
NSYPLAT1574G	195	NSYPLAZT10104G	195	NSYPLM54BG	176
NSYPLAT1576G	195	NSYPLAZT10123G	195	NSYPLM54G	175, 176, 189
NSYPLAT2074G	195	NSYPLAZT10124G	195	NSYPLM54PG	176
NSYPLAT553G	195	NSYPLAZT1053G	195	NSYPLM54TG	175, 176, 189
NSYPLAT554G	195	NSYPLAZT1054G	195	NSYPLM54TVG	175, 176, 189
NSYPLAT573G	195	NSYPLAZT1073G	195	NSYPLM54VG	175, 176
NSYPLAT574G	195	NSYPLAZT1074G	195	NSYPLM64BG	176
NSYPLAT7103G	195	NSYPLAZT12103G	195	NSYPLM64G	175, 176, 189
NSYPLAT7104G	195	NSYPLAZT12104G	195	NSYPLM64PG	176
NSYPLAT7123G	195	NSYPLAZT12123G	195	NSYPLM64TG	175, 176, 189
NSYPLAT7124G	195	NSYPLAZT12124G	195	NSYPLM64TVG	175, 176, 189
NSYPLAT753G	195	NSYPLAZT12126G	195	NSYPLM64VG	175, 176
NSYPLAT754G	195	NSYPLAZT1253G	195	NSYPLM75BG	176
NSYPLAT773G	195	NSYPLAZT1254G	195	NSYPLM75G	175-177, 189
NSYPLAT774G	195	NSYPLAZT1273G	195	NSYPLM75PG	176

Index of References

N	Page	N	Page	N	Page
NSYPLM75TG	175, 176, 189	NSYPMA55	207	NSYPMP500DLP	210
NSYPLM75TVG	175, 176, 189	NSYPMA75	207	NSYPMP600DLM	27
NSYPLM75VG	175, 176	NSYPMA77	207	NSYPMP7502DLP	210
NSYPLM86BG	176	NSYPMB1010	207	NSYPMP750DLP	210
NSYPLM86G	175-177, 189	NSYPMB1012	207	NSYPMP800DLM	27
NSYPLM86PG	176	NSYPMB105	207	NSYPMP85100	453
NSYPLM86TG	175, 176, 189	NSYPMB107	207	NSYPMP85120	453
NSYPLM86TVG	175, 176, 189	NSYPMB1210	207	NSYPMP85160	453
NSYPLM86VG	175, 176	NSYPMB1212	207	NSYPMP8560	453
NSYPLMRS108GA	175	NSYPMB125	207	NSYPMP8580	453
NSYPLS1827G	163	NSYPMB127	207	NSYPMR105	207
NSYPLS24	452	NSYPMB1510	207	NSYPMR107	207
NSYPLS2727AG	163	NSYPMB1512	207	NSYPMR125	207
NSYPLS2727G	163	NSYPMB155	207	NSYPMR127	207
NSYPLS2736AG	163	NSYPMB157	207	NSYPMR155	207
NSYPLS2736G	163	NSYPMB510	207	NSYPMR157	207
NSYPLS2754AG	163	NSYPMB55	207	NSYPMR1827	163
NSYPLS2754G	163	NSYPMB710	207	NSYPMR2727	163
NSYPLS30	452	NSYPMB712	207	NSYPMR2736	163
NSYPLS3636G	163	NSYPMB75	207	NSYPMR2754	163
NSYPLS3654AG	163	NSYPMB77	207	NSYPMR3654	163
NSYPLS3654G	163	NSYPMD1510	11	NSYPMR55	207
NSYPLS3672AG	163	NSYPMD2015	11	NSYPMR57	207
NSYPLS5454AG	163	NSYPMD2520	11	NSYPMR75	207
NSYPLS5454G	163	NSYPMD3025	11	NSYPMR77	207
NSYPLS5472AG	163	NSYPM1010	207	NSYPNOPB	499
NSYPLSC1827G	163	NSYPM1012	207	NSYPNVDA	536
NSYPLSC2727AG	163	NSYPM105	207, 376	NSYPPC54HD	663
NSYPLSC2727G	163	NSYPM107	207, 376	NSYPPC56HD	663
NSYPLSC2736AG	163	NSYPM1210	207	NSYPPC74HD	663
NSYPLSC2736G	163	NSYPM1212	207, 376	NSYPPC76HD	663
NSYPLSC2754AG	163	NSYPM125	207, 376	NSYPPCPHDSN	663
NSYPLSC2754G	163	NSYPM127	207, 376	NSYPPS184	87
NSYPLSC3636G	163	NSYPM1510	207	NSYPPS185	87
NSYPLSC3654AG	163	NSYPM1512	207, 376	NSYPPS186	87
NSYPLSC3654G	163	NSYPM155	207	NSYPPS204	87
NSYPLSC3672AG	163	NSYPM157	207, 376	NSYPPS205	87
NSYPLSC5454AG	163	NSYPM1827	163	NSYPPS206	87
NSYPLSC5454G	163	NSYPM207	207, 376	NSYPPS208	87
NSYPLSC5472AG	163	NSYPM2727	163	NSYPPSB	15, 18, 118, 119
NSYPLSP1827G	163	NSYPM2736	163	NSYPRVDA	536
NSYPLSP2727G	163	NSYPM2754	163	NSYPS2C27	165, 171
NSYPLSP2736G	163	NSYPM3636	163	NSYPS4C27	165
NSYPLSP2754G	163	NSYPM3654	163	NSYPTDS1	469
NSYPLSP3636G	163	NSYPM3672	163	NSYPTDS2	469
NSYPLSP3654G	163	NSYPM510	207	NSYPTDS3	469
NSYPLSP5454G	163	NSYPM5454	163	NSYPTDS4	469
NSYPMA105	207	NSYPM5472	163	NSYPTDS5	469
NSYPMA107	207	NSYPM55	207, 376	NSYPTZ3	210
NSYPMA127	207	NSYPM710	207	NSYPTZ32P	210
NSYPMA1827G	163	NSYPM712	207	NSYPTZ4	205, 210
NSYPMA2727G	163	NSYPM75	207, 376	NSYPTZ42P	210
NSYPMA2736G	163	NSYPM77	207, 376	NSYPTZ6	210
NSYPMA2754G	163	NSYPMP45100	453	NSYPTZ62P	210
NSYPMA3636G	163	NSYPMP45120	453	NSYPUNX	143
NSYPMA3654G	163	NSYPMP45160	453	NSYPV42	510, 512, 514, 516, 530
NSYPMA3672G	163	NSYPMP4580	453	NSYR19DN	548
NSYPMA5454G	163	NSYPMP5002DLP	210	NSYRBL216146M	310
NSYPMA5472G	163	NSYPMP500DLM	27	NSYRBL216296M	310

Index of References

N	Page	N	Page	N	Page
NSYRBL21656M	310	NSYRSFN85L	658	NSYS3D10825T	45, 403
NSYRBL21686M	310	NSYRSFN86L	658	NSYS3D10830	45, 69, 403
NSYRC12	412	NSYRSFN88L	658	NSYS3D10830P	45
NSYRC18	412	NSYRSW27	81, 414	NSYS3D10830T	45, 403
NSYRC1U	416	NSYRSW31	81, 414	NSYS3D10840	45, 403
NSYRC20	412	NSYRSW36	81, 414	NSYS3D10840P	45
NSYRC22	412	NSYRSW40	81, 414	NSYS3D10840T	45, 403
NSYRCDFIX	416	NSYRSW45	414	NSYS3D121030	45
NSYRCDR12	417	NSYRSW636	414	NSYS3D121030D	45
NSYRCDR18	417	NSYRSW640	414	NSYS3D121030DP	45
NSYRCINT	417	NSYRSW645	414	NSYS3D121030DT	45
NSYRCK19KIT	412	NSYRSWC36	81, 415	NSYS3D121030P	45
NSYRCK19KIT6G	392	NSYRSWC40	81, 415	NSYS3D121030T	45
NSYRCK24	411	NSYRSWC45	415	NSYS3D121040D	45
NSYRCK29	411	NSYRSWH180	415	NSYS3D121040DP	45
NSYRCK33	411	NSYRSWP12	413	NSYS3D121230D	45
NSYRCK38	411	NSYRSWP15	413	NSYS3D121230DP	45
NSYRCK42	392, 411	NSYRSWP18	413	NSYS3D121240D	45
NSYRCK47	411	NSYRSWP21	413	NSYS3D121240DP	45
NSYRCKP12	411	NSYRSWP6	413	NSYS3D12630	45
NSYRCKP17	411	NSYRSWP9	413	NSYS3D12630P	45
NSYRCKP21	411	NSYRSWSP6	413	NSYS3D12630T	45
NSYRCKP26	411	NSYRSWSP8	413	NSYS3D12640	45
NSYRCKP4	411	NSYRUFOPB	499	NSYS3D12640P	45
NSYRCKP8	411	NSYRUFPNPVA	512, 536	NSYS3D12640T	45
NSYRCKS10	412	NSYRUFPNVDA	536	NSYS3D12830	45, 403
NSYRCKS6	412	NSYRUFVDA	510, 512, 514, 516, 518, 519, 536	NSYS3D12830P	45
NSYRCKS8	412	NSYS13M5HS	131, 249	NSYS3D12830T	45, 403
NSYRCLOCK	417	NSYS16M5HS	131, 229, 249	NSYS3D12840	45, 403
NSYRCSUP15	416	NSYS16M6HS	131, 249	NSYS3D12840P	45
NSYRCSUP25	416	NSYS3CM303020	440, 442, 460	NSYS3D12840T	45, 403
NSYRE26	101, 598	NSYS3CM304020	440, 442, 460	NSYS3D141030D	45, 69
NSYRE60	101, 598	NSYS3CM404020	440, 442, 460	NSYS3D141030DP	45
NSYRETPLA	202	NSYS3CM406025	440, 442, 460	NSYS3D3215	45, 69
NSYRETPLAU	202	NSYS3CM505025	440, 442, 460	NSYS3D3215P	45
NSYRP2	448, 449	NSYS3CM606020	440, 442, 460	NSYS3D32515	45
NSYRSF104L	658	NSYS3CM608030	440, 442, 460	NSYS3D32515P	45
NSYRSF105L	658	NSYS3CM806030	440, 442, 460	NSYS3D32515T	45
NSYRSF106L	658	NSYS3D101030	45	NSYS3D3315	45
NSYRSF108L	658	NSYS3D101030D	45, 69	NSYS3D3315P	45
NSYRSF124L	658	NSYS3D101030DP	45	NSYS3D3315T	45
NSYRSF125L	658	NSYS3D101030DT	45	NSYS3D3320	45
NSYRSF126L	658	NSYS3D101030P	45	NSYS3D3320P	45
NSYRSF64L	658	NSYS3D101030T	45	NSYS3D3320T	45
NSYRSF66L	658	NSYS3D101230D	45	NSYS3D3415	45
NSYRSF84L	658	NSYS3D101230DP	45	NSYS3D3415P	45
NSYRSF85L	658	NSYS3D101240D	45	NSYS3D3415T	45
NSYRSF86L	658	NSYS3D101240DP	45	NSYS3D3420	45
NSYRSF88L	658	NSYS3D10625	45, 69, 403	NSYS3D3420P	45
NSYRSFN104L	658	NSYS3D10625P	45	NSYS3D3420T	45
NSYRSFN105L	658	NSYS3D10625T	45, 403	NSYS3D4315	45
NSYRSFN106L	658	NSYS3D10630	45, 403	NSYS3D4315P	45
NSYRSFN108L	658	NSYS3D10630P	45	NSYS3D4315T	45
NSYRSFN124L	658	NSYS3D10630T	45, 403	NSYS3D4320	45
NSYRSFN125L	658	NSYS3D10640	45, 403	NSYS3D4320P	45
NSYRSFN126L	658	NSYS3D10640P	45	NSYS3D4320T	45
NSYRSFN64L	658	NSYS3D10640T	45, 403	NSYS3D4420	45
NSYRSFN66L	658	NSYS3D10825	45, 403	NSYS3D4420P	45
NSYRSFN84L	658	NSYS3D10825P	45	NSYS3D4420T	45

Index of References

N	Page	N	Page	N	Page
NSYS3D4620	45, 403	NSYS3D8620	45, 403	NSYS3HF4320P	424
NSYS3D4620P	45	NSYS3D8620P	45	NSYS3HF6420P	424
NSYS3D4620T	45, 403	NSYS3D8620T	45, 403	NSYS3HF6625P	424
NSYS3D4625	45, 403	NSYS3D8625	45, 403	NSYS3HF8630P	424
NSYS3D4625P	45	NSYS3D8625P	45	NSYS3X101030	130
NSYS3D4625T	45, 403	NSYS3D8625T	45, 403	NSYS3X101030H	130
NSYS3D5320	45, 69	NSYS3D8630	45, 69, 403	NSYS3X10830	130
NSYS3D5320P	45	NSYS3D8630P	45	NSYS3X10830H	130
NSYS3D5320T	45	NSYS3D8630T	45, 403	NSYS3X10830T	130
NSYS3D5420	45, 69	NSYS3D8640	45, 403	NSYS3X121030	130
NSYS3D5420P	45	NSYS3D8640P	45	NSYS3X121030H	130
NSYS3D5420T	45	NSYS3D8640T	45, 403	NSYS3X12830	130
NSYS3D5425	45	NSYS3D8825	45	NSYS3X12830H	130
NSYS3D5425P	45	NSYS3D8825P	45	NSYS3X302515	130
NSYS3D5425T	45	NSYS3D8825T	45	NSYS3X302515H	130
NSYS3D5520	45	NSYS3D8830	45	NSYS3X3215	130
NSYS3D5520P	45	NSYS3D8830P	45	NSYS3X3215H	130
NSYS3D5520T	45	NSYS3D8830T	45	NSYS3X3315	130
NSYS3D5525	45	NSYS3DB25315	283	NSYS3X3315H	130
NSYS3D5525P	45	NSYS3DB25415	283	NSYS3X4315	130
NSYS3D5525T	45	NSYS3DB25515	283	NSYS3X4315H	130
NSYS3D6420	45	NSYS3DB3415	283	NSYS3X4320	130
NSYS3D6420P	45	NSYS3DB3515	283	NSYS3X4320H	130
NSYS3D6420T	45	NSYS3DB3615	283	NSYS3X4320T	130
NSYS3D6425	45, 69	NSYS3DB4815	283	NSYS3X4420	130
NSYS3D6425P	45	NSYS3DB6415	283	NSYS3X4420H	130
NSYS3D6425T	45	NSYS3DCGPSTDSB	654, 655, 657	NSYS3X4620	130
NSYS3D6525	45	NSYS3DCGSB	654, 655, 657	NSYS3X4620H	130
NSYS3D6525P	45	NSYS3DEX10830	432	NSYS3X5420	130
NSYS3D6525T	45	NSYS3DEX3215	432	NSYS3X5420H	130
NSYS3D6620	45, 69, 403	NSYS3DEX3320	432	NSYS3X5420T	130
NSYS3D6620P	45	NSYS3DEX4320	432	NSYS3X601030	130
NSYS3D6620T	45, 403	NSYS3DEX4420	432	NSYS3X601230	130
NSYS3D6625	45, 403	NSYS3DEX5420	432	NSYS3X6420	130
NSYS3D6625P	45	NSYS3DEX6425	432	NSYS3X6420H	130
NSYS3D6625T	45, 403	NSYS3DEX6625	432	NSYS3X6420T	130
NSYS3D6630	45, 403	NSYS3DEX7525	432	NSYS3X6625	130
NSYS3D6630P	45	NSYS3DEX8630	432	NSYS3X6625H	130
NSYS3D6630T	45, 403	NSYS3DLG	654, 655, 663	NSYS3X7525	130
NSYS3D6640	45, 403	NSYS3DM10615T	286	NSYS3X7525H	130
NSYS3D6640P	45	NSYS3DM10815T	286	NSYS3X7525T	130
NSYS3D6640T	45, 403	NSYS3DM4315T	286	NSYS3X801030	130
NSYS3D6830	45	NSYS3DM5415T	286	NSYS3X801230	130
NSYS3D6830P	45	NSYS3DM6415T	286	NSYS3X8625	130
NSYS3D6830T	45	NSYS3DM6615T	286	NSYS3X8625H	130
NSYS3D6G12840P	397	NSYS3DM7515T	286	NSYS3X8625T	130
NSYS3D6G32515P	397	NSYS3DM8615T	286	NSYS3X8830	130
NSYS3D6G4320P	397	NSYS3DTL	654	NSYS3X8830H	130
NSYS3D6G7525P	397	NSYS3HD10640	377, 383, 591	NSYS5GPC35	338
NSYS3D6G8630P	397	NSYS3HD10840	377, 383, 591	NSYS5GPC38	338
NSYS3D7525	45	NSYS3HD3215	377	NSYS5GPC75	338
NSYS3D7525P	45	NSYS3HD4320	377	NSYS5GPC78	338
NSYS3D7525T	45	NSYS3HD5420	377	NSYSBM151512	15, 16
NSYS3D81030	45	NSYS3HD6425	377	NSYSBM15158	15, 16
NSYS3D81030D	45	NSYS3HD6630	377	NSYSBM152012	15, 16
NSYS3D81030DP	45	NSYS3HD7525	377	NSYSBM15208	15, 16
NSYS3D81030P	45	NSYS3HD8630	377, 383, 591	NSYSBM153012	15, 16
NSYS3D81230D	45	NSYS3HD8840	377, 383, 591	NSYSBM15308	15, 16
NSYS3D81230DP	45	NSYS3HF10830P	424	NSYSBM154012	15, 16

Index of References

N	Page	N	Page	N	Page
NSYSBM15408	15, 16	NSYSC86HD	664	NSYSDR200D	243
NSYSBM202012	15, 16	NSYSCCDINLG140	265	NSYSDR30B	242
NSYSBM20208	15, 16	NSYSCCDINLG75	265	NSYSDR40B	242
NSYSBM203012	15, 16	NSYSCMX10030	141	NSYSDR50A	242
NSYSBM20308	15, 16	NSYSCMX10040	141	NSYSDR60A	242
NSYSBM204012	15, 16	NSYSCMX12040	141	NSYSDR80A	242
NSYSBM20408	15, 16	NSYSCMX16040	141	NSYSDRC	106
NSYSBM205012	15, 16	NSYSCMX16060	141	NSYSDT5	106, 274
NSYSBM20508	15, 16	NSYSCMX8040	141	NSYSDT6	106, 274
NSYSBM206012	15, 16	NSYSCMX8050	141	NSYSDT8	106, 274
NSYSBM20608	15, 16	NSYSCX10060	141	NSYSF12660E	405
NSYSBM208012	15, 16	NSYSCX12040	141	NSYSF12680E	405
NSYSBM303012	15, 16	NSYSCX12050	141	NSYSF12860E	405
NSYSBM304012	15, 16	NSYSCX12060	141	NSYSF12880E	405
NSYSBM305012	15, 16	NSYSCX16040	141	NSYSF16660PC	457
NSYSBM306012	15, 16	NSYSCX16060	141	NSYSF16680PC	457
NSYSBM308012	15, 16	NSYSCX6040	141	NSYSF18660PC	457
NSYSBM404012	15, 16	NSYSCX8040	141	NSYSF18680PC	457
NSYSBM405012	15, 16	NSYSCX8060	141	NSYSF20660E	405
NSYSBM406012	15, 16	NSYSD10	446, 451, 452	NSYSF20680E	405
NSYSBM408012	15, 16	NSYSD10R	447, 451, 452	NSYSF208100E	405
NSYSBMABS4	654	NSYSD12	446, 451, 452	NSYSF20860E	405
NSYSBMABS6	654	NSYSD12R	447, 449, 451, 452	NSYSF20880E	405
NSYSBPLA	211	NSYSD6	446, 451, 452	NSYSF226100E	405
NSYSBRF610	535	NSYSD6R	447, 449, 451, 452	NSYSF22660E	405
NSYSBRF66	511, 535	NSYSD8	446, 451, 452	NSYSF22680E	405
NSYSBRF68	535	NSYSD8R	447, 449, 451, 452	NSYSF228100E	405
NSYSBRF810	535	NSYSDC42	448, 449	NSYSF22860E	405
NSYSBRF86	535	NSYSDC43	448, 449	NSYSF22880E	405
NSYSBRF88	511, 535	NSYSDC62	448, 449	NSYSF6G20680	391
NSYSBTB	231	NSYSDC63	448, 449	NSYSF6G20860	391
NSYSBX15158	118, 123	NSYSDCR10	274	NSYSF6G20880	391
NSYSBX15308	118, 123	NSYSDCR200	27, 47, 130, 224, 434	NSYSFBK	88
NSYSBX20208	118, 123	NSYSDCR250	27, 47, 130, 224, 434	NSYSFBK19	88, 143, 337, 371
NSYSBX20308	118, 123	NSYSDCR300	27, 47, 130, 224, 434	NSYSFBKE	88
NSYSBX204012	118, 123	NSYSDCR4	274	NSYSFBKF	88
NSYSBX303012	118, 123	NSYSDCR400	27, 47, 224	NSYSFBKR	88
NSYSC1030	100	NSYSDCR5	274	NSYSFCVR124HD	380, 383, 591
NSYSC1040	100	NSYSDCR6	274	NSYSFCVR126HD	380, 383, 591
NSYSC1050	100	NSYSDCR8	274	NSYSFCVR64HD	380, 383, 591
NSYSC1060	100	NSYSDF1010	446, 451, 452	NSYSFCVR66HD	380, 383, 591
NSYSC1230	100	NSYSDF108	446, 451, 452	NSYSFCVR84HD	380, 383, 591
NSYSC1240	100	NSYSDF1210	446, 451, 452	NSYSFCVR86HD	380
NSYSC124HD	664	NSYSDF128	446, 451, 452	NSYSFDHD12122D	664
NSYSC1250	100	NSYSDF1610	446, 451, 452	NSYSFDHD126	664
NSYSC1260	100	NSYSDF168	446, 451, 452	NSYSFDHD128	664
NSYSC126HD	664	NSYSDF810	446, 451, 452	NSYSFDHD16122D	664
NSYSC1640	100	NSYSDF88	446, 451, 452	NSYSFDHD166	664
NSYSC1650	100	NSYSDFLOCKDB5	662	NSYSFDHD168	664
NSYSC630	100	NSYSDGCR5	265	NSYSFDHD208	664
NSYSC640	100	NSYSDGCR6	265	NSYSFEB	99, 337, 371
NSYSC64HD	664	NSYSDGCR8	265	NSYSFECA64HD	664
NSYSC660	100	NSYSDH	662	NSYSFECA66HD	383, 591, 664
NSYSC66HD	664	NSYSDP6M	105, 273	NSYSFELB	99, 337, 371
NSYSC830	100	NSYSDP8M	105, 273	NSYSFHD1212402D	377, 383, 591
NSYSC840	100	NSYSDR100A	242	NSYSFHD1212602D	377, 383, 591
NSYSC84HD	664	NSYSDR200	243	NSYSFHD12640	377, 383, 591
NSYSC850	100	NSYSDR200B	243	NSYSFHD12660	377, 383, 591
NSYSC860	100	NSYSDR200BD	243	NSYSFHD12840	377, 383, 591

Index of References

N	Page	N	Page	N	Page
NSYSFHD12860	377, 383, 591	NSYSFN18640P	83	NSYSFN20640	83
NSYSFHD1612402D	377, 383, 591	NSYSFN18640T	83	NSYSFN20640P	83
NSYSFHD1612602D	377, 383, 591	NSYSFN18650	83	NSYSFN20640T	83
NSYSFHD16660	377, 383, 591	NSYSFN18650P	83	NSYSFN20650	83
NSYSFHD16840	377, 383, 591	NSYSFN18650T	83	NSYSFN20650P	83
NSYSFHD16860	377, 383, 591	NSYSFN18660	83	NSYSFN20650T	83
NSYSFHD20840	377, 383, 591	NSYSFN18660P	83	NSYSFN20660	83
NSYSFHFBK184	426	NSYSFN18680T	83	NSYSFN20660P	83
NSYSFHFBK186	426	NSYSFN18840	83	NSYSFN20680	83
NSYSFHFBK2010	426	NSYSFN18840P	83	NSYSFN20680P	83
NSYSFHFBK204	426	NSYSFN18840T	83	NSYSFN20840	83
NSYSFHFBK206	426	NSYSFN18850	83	NSYSFN20840P	83
NSYSFHFBK208	426	NSYSFN18850P	83	NSYSFN20840T	83
NSYSFHFBK226	426	NSYSFN18850T	83	NSYSFN20850	83
NSYSFHFBK228	426	NSYSFN18860	83	NSYSFN20850P	83
NSYSFHNTTRIM	658, 659	NSYSFN188602D	83	NSYSFN20850T	83
NSYSFHS1	658	NSYSFN188602DP	83	NSYSFN20860	83
NSYSFHS1HD	664	NSYSFN18860P	83	NSYSFN208602D	83
NSYSFMDR	274	NSYSFN18860T	83	NSYSFN208602DP	83
NSYSFN12640	83	NSYSFN201040	83	NSYSFN20860P	83
NSYSFN12640P	83	NSYSFN2010402D	83	NSYSFN20860T	83
NSYSFN12660	83	NSYSFN2010402DP	83	NSYSFN20880	83
NSYSFN12660P	83	NSYSFN201040P	83	NSYSFN20880P	83
NSYSFN12840	83	NSYSFN201040T	83	NSYSFN20880T	83
NSYSFN12840P	83	NSYSFN201050	83	NSYSFN221060	83
NSYSFN12860	83	NSYSFN2010502D	83	NSYSFN221060P	83
NSYSFN12860P	83	NSYSFN2010502DP	83	NSYSFN2212602D	83
NSYSFN14640	83	NSYSFN201050P	83	NSYSFN2212602DP	83
NSYSFN14640P	83	NSYSFN201050T	83	NSYSFN2212802D	83
NSYSFN14840	83	NSYSFN201060	83	NSYSFN2212802DP	83
NSYSFN14840P	83	NSYSFN2010602D	83	NSYSFN22460	83, 297
NSYSFN16660	83	NSYSFN2010602DP	83	NSYSFN22660	83
NSYSFN16660P	83	NSYSFN201060P	83	NSYSFN22660P	83
NSYSFN16680	83	NSYSFN201060T	83	NSYSFN22680	83
NSYSFN16680P	83	NSYSFN201080	83	NSYSFN22680P	83
NSYSFN16860	83	NSYSFN201080P	83	NSYSFN22860	83
NSYSFN16860P	83	NSYSFN2012402D	83	NSYSFN22860P	83
NSYSFN16880	83	NSYSFN2012402DP	83	NSYSFN22880	83
NSYSFN16880P	83	NSYSFN2012502D	83	NSYSFN22880P	83
NSYSFN181040	83	NSYSFN2012502DP	83	NSYSFN22880T	83
NSYSFN1810402D	83	NSYSFN2012602D	83	NSYSFNC104	84, 85
NSYSFN1810402DP	83	NSYSFN2012602DP	83	NSYSFNC105	84, 85
NSYSFN181040P	83	NSYSFN2012802D	83	NSYSFNC106	84, 85
NSYSFN181050	83	NSYSFN2012802DP	83	NSYSFNC108	84, 85
NSYSFN181050P	83	NSYSFN2016402D	83	NSYSFNC124	84, 85
NSYSFN181060	83	NSYSFN2016402DP	83	NSYSFNC125	84, 85
NSYSFN1810602D	83	NSYSFN2016502D	83	NSYSFNC126	84, 85
NSYSFN1810602DP	83	NSYSFN2016502DP	83	NSYSFNC128	84, 85
NSYSFN181060P	83	NSYSFN2016602D	83	NSYSFNC164	85
NSYSFN1812402D	83	NSYSFN2016602DP	83	NSYSFNC165	85
NSYSFN1812402DP	83	NSYSFN20350	83, 297, 336	NSYSFNC166	85
NSYSFN1812502D	83	NSYSFN20350ED	336	NSYSFNC35	85, 336
NSYSFN1812502DP	83	NSYSFN20360	83, 297, 336, 370	NSYSFNC35ED	336
NSYSFN1812602D	83	NSYSFN20380	83, 297, 336, 370	NSYSFNC36	85, 370
NSYSFN1812602DP	83	NSYSFN20380ED	336	NSYSFNC38	85, 370
NSYSFN18440	83, 297	NSYSFN20440	83, 297	NSYSFNC44	84, 85
NSYSFN18450	83, 297	NSYSFN20450	83, 297	NSYSFNC45	84, 85
NSYSFN18460	83, 297	NSYSFN20460	83, 297, 370	NSYSFNC46	84, 85, 370
NSYSFN18640	83	NSYSFN20480	83, 297, 370	NSYSFNC48	84, 85, 370

Index of References

N	Page	N	Page	N	Page
NSYSFNC64	84, 85	NSYSFND225	86, 103	NSYSH180NC	106
NSYSFNC65	84, 85	NSYSFND226	85, 86, 103	NSYSIBTB	231
NSYSFNC66	84, 85, 369	NSYSFND226T	85	NSYSICR4040	238
NSYSFNC68	84, 85, 369	NSYSFND228	85, 86, 103	NSYSICR4050	238
NSYSFNC75	336	NSYSFND228T	85	NSYSICR4060	238
NSYSFNC75ED	336	NSYSFNDR	274	NSYSICR4080	238
NSYSFNC84	84, 85	NSYSFNHD2	109	NSYSICR65100	238
NSYSFNC85	84, 85	NSYSFNHD3	109	NSYSICR6560	238
NSYSFNC86	84, 85, 369	NSYSFNHS1	107	NSYSICR6580	238
NSYSFNC88	84, 85, 369	NSYSFNPB	230	NSYSICR90100	238
NSYSFND126	84, 86, 103	NSYSFNV12	84	NSYSICR9040	238
NSYSFND126T	84	NSYSFNV14	84	NSYSICR9060	238
NSYSFND128	84, 86, 103	NSYSFNV16	84	NSYSICR9080	238
NSYSFND128T	84	NSYSFNV18	84	NSYSIMP12	83
NSYSFND146	84, 86, 103	NSYSFNV20	85, 336, 369, 370	NSYSIMP14	83
NSYSFND146T	84	NSYSFNV20ED	336	NSYSIMP16	83
NSYSFND148	84, 86, 103	NSYSFNV22	85	NSYSIMP18	83
NSYSFND148T	84	NSYSFP300	178	NSYSIMP20	83
NSYSFND166	84, 86, 103	NSYSFP400	178	NSYSIMP22	83
NSYSFND166T	84	NSYSFP500	178	NSYSLCKP	473
NSYSFND168	84, 86, 103	NSYSFP600	178	NSYSLCKS10	473
NSYSFND168T	84	NSYSFPAED	336	NSYSLCKS6	473
NSYSFND1810	84	NSYSFPB6G	392	NSYSLCKS8	473
NSYSFND18102D	84	NSYSFPN20750ED	336	NSYSLCR40	238
NSYSFND1810T	84	NSYSFPN20750G	336	NSYSLCR50	238
NSYSFND18122D	84	NSYSFPN20750TED	336	NSYSLCR60	238
NSYSFND18122DT	84	NSYSFPN20750TG	336	NSYSLCR80	238
NSYSFND184	84, 86, 103	NSYSFPN20760G	336	NSYSM1210302D	81
NSYSFND185	86, 103	NSYSFPN20760TG	336	NSYSM1210302DP	81
NSYSFND186	84, 86, 103	NSYSFPN20780ED	336	NSYSM1212402D	81
NSYSFND186T	84	NSYSFPN20780G	336	NSYSM1212402DP	81
NSYSFND188	84, 86, 103	NSYSFPN20780TED	336	NSYSM12830	81
NSYSFND1882D	84	NSYSFPN20780TG	336	NSYSM12830P	81
NSYSFND188T	84	NSYSFPSC30	15, 17, 28, 30, 47, 50	NSYSM1410402D	81
NSYSFND2010	85	NSYSFPSC40	15, 17, 28, 30, 47, 50	NSYSM1410402DP	81
NSYSFND20102D	85	NSYSFPSC50	15, 17, 28, 30, 47, 50	NSYSM1412402D	81
NSYSFND2010T	85	NSYSFPSC60	15, 17, 28, 30, 47, 50	NSYSM1412402DP	81
NSYSFND20122D	85	NSYSFPSC80	15, 17, 28, 30, 47, 50	NSYSM14630	81
NSYSFND20122DT	85	NSYSFRSEDC1268E	419	NSYSM14630P	81
NSYSFND20162D	85	NSYSFRSEDC261E	419	NSYSM14640	81
NSYSFND203	85, 103, 370	NSYSFRSEDC268E	419	NSYSM14640P	81
NSYSFND203ED	658	NSYSFRSEDC2812E	419	NSYSM14830	81
NSYSFND204	85, 86, 103, 370	NSYSFRSEDC281E	419	NSYSM14830P	81
NSYSFND205	86, 103	NSYSFSPLMG	178	NSYSM14840	81
NSYSFND206	85, 86, 103	NSYSFTB16	99	NSYSM14840P	81
NSYSFND206T	85	NSYSFTB18	99	NSYSM14840T	81
NSYSFND207	103	NSYSFTB24	99	NSYSM1610302D	81
NSYSFND207ED	658	NSYSFTB32	99	NSYSM1610302DP	81
NSYSFND207G	658	NSYSFWFIX	102	NSYSM1610402D	81
NSYSFND207TED	658	NSYSFX181240	139	NSYSM1610402DP	81
NSYSFND207TG	658	NSYSFX18640	139	NSYSM1612302D	81
NSYSFND208	85, 86, 103	NSYSFX18840	139	NSYSM1612302DP	81
NSYSFND2082D	85	NSYSFX201060	139	NSYSM1612402D	81
NSYSFND208T	85	NSYSFX201260	139	NSYSM1612402DP	81
NSYSFND2210	85	NSYSFX20650	139	NSYSM16630	81
NSYSFND2210T	85	NSYSFX20840	139	NSYSM16630P	81
NSYSFND22122D	85	NSYSFX20860	139	NSYSM16640	81
NSYSFND22122DT	85	NSYSFXJG	143	NSYSM16640P	81
NSYSFND224	85, 86, 103	NSYSGF	93	NSYSM16640T	81

Index of References

N	Page	N	Page	N	Page
NSYSM16830	81	NSYSM20650P	81	NSYSMPS5	230
NSYSM16830P	81	NSYSM20830	81	NSYSMPS6	230
NSYSM16840	81	NSYSM20830P	81	NSYSMPS8	230
NSYSM16840P	81	NSYSM20830T	81	NSYSMPSB	226, 230
NSYSM16840T	81	NSYSM20840	81	NSYSMPSE10	232
NSYSM181040	81	NSYSM20840P	81	NSYSMPSE12	232
NSYSM1810402D	81	NSYSM20840T	81	NSYSMPSE6	232
NSYSM1810402DP	81	NSYSM20850	81	NSYSMPSE8	232
NSYSM181040P	81	NSYSM20850P	81	NSYSMVR12	239
NSYSM1810502D	81	NSYSM20850T	81	NSYSMVR14	239
NSYSM1810502DP	81	NSYSM20860	81	NSYSMVR16	239
NSYSM1812402D	81	NSYSM20860P	81	NSYSMVR18	239
NSYSM1812402DP	81	NSYSM20860T	81	NSYSMVR20	239
NSYSM1812502D	81	NSYSMBCE10	98	NSYSMWFIX	102
NSYSM1812502DP	81	NSYSMBCE6	98	NSYSMX141030	139
NSYSM1816402D	81	NSYSMBCE8	98	NSYSMX16840	139
NSYSM1816402DP	81	NSYSMBK	88	NSYSMX181240	139
NSYSM1816502D	81	NSYSMD12102D	659	NSYSMX181640	139
NSYSM1816502DP	81	NSYSMD12122D	659	NSYSMX181640H	139
NSYSM18630	81	NSYSMD14102D	659	NSYSMX18640	139
NSYSM18630P	81	NSYSMD14122D	659	NSYSMX18840	139
NSYSM18640	81	NSYSMD16102D	659	NSYSMX18840H	139
NSYSM18640P	81	NSYSMD16122D	659	NSYSMX201040	139
NSYSM18640T	81	NSYSMD18162D	659	NSYSMX201040H	139
NSYSM18650	81	NSYSMDR	274	NSYSMX201250	139
NSYSM18650P	81	NSYSMEB	99	NSYSMX201250H	139
NSYSM18830	81	NSYSMEC1031	659	NSYSMX201660	139
NSYSM18830P	81	NSYSMEC104	95	NSYSMX201660H	139
NSYSM18830T	81	NSYSMEC1041	659	NSYSMX20850	139
NSYSM18840	81	NSYSMEC1051	659	NSYSMXEB	143
NSYSM18840P	81	NSYSMEC63	95	NSYSNLPLA	202
NSYSM18840T	81	NSYSMEC631	659	NSYSNM6	233, 244, 249
NSYSM18850	81	NSYSMEC64	95	NSYSNM8	233, 244, 249
NSYSM18850P	81	NSYSMEC641	659	NSYSNSM6	233, 244, 249
NSYSM18850T	81	NSYSMEC65	95	NSYSNSM8	233, 244, 249
NSYSM18860	81	NSYSMEC661	659	NSYSODS	473
NSYSM18860P	81	NSYSMEC83	95	NSYSPB6100	92
NSYSM2010402D	81	NSYSMEC831	659	NSYSPB8100	92
NSYSM2010402DP	81	NSYSMEC84	95	NSYSPBCN35	296
NSYSM2010502D	81	NSYSMEC841	659	NSYSPBCN36	296
NSYSM2010502DP	81	NSYSMEC85	95	NSYSPBCN38	296
NSYSM2012402D	81	NSYSMEC851	659	NSYSPBOPB	497
NSYSM2012402DP	81	NSYSMEC86	95	NSYSPC	268
NSYSM2012502D	81	NSYSMEC861	659	NSYSPCP	268
NSYSM2012502DP	81	NSYSMHR10	239	NSYSPCR	93
NSYSM2012602D	81	NSYSMHR12	239	NSYSPF10100	27, 31, 47, 51, 81, 83, 91, 451
NSYSM2012602DP	81	NSYSMHR16	239	NSYSPF10200	27, 31, 47, 51, 81, 83, 91, 406, 451
NSYSM2016402D	81	NSYSMHR6	239	NSYSPF12100	27, 31, 47, 51, 81, 83, 91, 451
NSYSM2016402DP	81	NSYSMHR8	239	NSYSPF12200	27, 31, 47, 51, 81, 83, 91, 451
NSYSM2016502D	81	NSYSMNDR	274	NSYSPF16100	81, 83, 91, 451
NSYSM2016502DP	81	NSYSMP2D4	232	NSYSPF16200	81, 83, 91, 451
NSYSM2016602D	81	NSYSMP2D5	232, 291	NSYSPF3100	83, 91, 336, 371
NSYSM2016602DP	81	NSYSMP2D6	232	NSYSPF3200	83, 91, 336, 371
NSYSM20630	81	NSYSMP2D8	232	NSYSPF4100	83, 91, 371
NSYSM20630P	81	NSYSMPB	226, 230	NSYSPF4200	83, 91, 371
NSYSM20640	81	NSYSMPFA	229	NSYSPF6100	27, 31, 47, 51, 81, 83, 91, 371, 406, 451, 458
NSYSM20640P	81	NSYSMPFB	229	NSYSPF6200	27, 31, 47, 51, 81, 83, 91, 371, 406, 451, 458
NSYSM20640T	81	NSYSMPS	226		
NSYSM20650	81	NSYSMPS4	230		

Index of References

N	Page	N	Page	N	Page
NSYSPF7100	336	NSYSPS4200	81, 83, 91	NSYSRCOPB	500
NSYSPF7200	336	NSYSPS4200SD	27, 31, 47, 51, 451	NSYSSOPB	497
NSYSPF8100	27, 31, 47, 51, 81, 83, 91, 371, 406, 451	NSYSPS5100	81, 83, 91, 336	NSYST30M6	249
NSYSPF8200	27, 31, 47, 51, 81, 83, 91, 371, 406, 451	NSYSPS5100SD	451	NSYST30M6S	249
NSYSPFV6100	92	NSYSPS5200	81, 83, 91, 336	NSYST40M8	249
NSYSPFV8100	92	NSYSPS5200SD	451	NSYSTBR3	232
NSYSPFVX12200	379, 383, 591	NSYSPS6100	81, 83, 91, 336, 371, 406, 458	NSYSTBR4	232
NSYSPFVX6200	379, 383, 591	NSYSPS6100SD	451	NSYSTBR5	232
NSYSPFVX8200	379, 383, 591	NSYSPS6200	81, 83, 91, 336, 371, 406, 458	NSYSTBR6	232
NSYSPFX10100	31, 131, 140, 451	NSYSPS6200SD	451	NSYSTDCSX	133
NSYSPFX10100H	31, 131, 140	NSYSPS8100	83, 91, 336, 371, 406, 458	NSYSTDCX2H	133
NSYSPFX10200	31, 131, 140, 451	NSYSPS8200	83, 91, 336, 371, 406, 458	NSYSTDCXH	133
NSYSPFX10200H	31, 131, 140	NSYSPSJ	272	NSYSTDNCSX	133
NSYSPFX12100	140, 451	NSYSPSX3100	31, 131, 140	NSYSTMP22100	227
NSYSPFX12100H	140	NSYSPSX3100H	140	NSYSTMP22120	227
NSYSPFX12200	140, 379, 451	NSYSPSX3200	31, 131, 140, 379, 383, 591	NSYSTMP2260	227
NSYSPFX12200H	140	NSYSPSX3200H	131, 140	NSYSTMP2280	227
NSYSPFX16100	140	NSYSPSX4100	140	NSYSTMP45100	227
NSYSPFX16100H	140	NSYSPSX4100H	140	NSYSTMP45120	227
NSYSPFX16200	140	NSYSPSX4100SF	140	NSYSTMP4560	227
NSYSPFX16200H	140	NSYSPSX4200	140, 379	NSYSTMP4580	227
NSYSPFX6100	140, 451	NSYSPSX4200H	140	NSYSTMP60100	227, 454
NSYSPFX6100H	140	NSYSPSX4200SF	140, 379	NSYSTMP60120	227, 454
NSYSPFX6200	140, 379, 451	NSYSPSX5100	140, 451	NSYSTMP6060	227
NSYSPFX6200H	140	NSYSPSX5100H	140	NSYSTMP6080	227, 454
NSYSPFX8100	31, 131, 140, 451	NSYSPSX5100SF	140	NSYSTMP82100	227
NSYSPFX8100H	31, 131, 140	NSYSPSX5200	140, 451	NSYSTMP82120	227
NSYSPFX8200	31, 131, 140, 379	NSYSPSX5200H	140	NSYSTMP8260	227
NSYSPFX8200H	31, 131, 140	NSYSPSX5200SF	140	NSYSTMP8280	227
NSYSPLA100	205, 211	NSYSPSX6100	140	NSYSTVDA	527
NSYSPLA125	205, 211	NSYSPSX6100H	140	NSYSTW	272
NSYSPLA150	205, 211	NSYSPSX6100SF	140	NSYSUCR200WM	37, 53
NSYSPLA75	205, 211	NSYSPSX6200	140	NSYSUCR250WM	37, 53
NSYSPLK	94	NSYSPSX6200H	140	NSYSUCR300WM	37, 53
NSYSPLVX4200SF	379	NSYSPSX6200SF	140, 379	NSYSUCR400WM	37, 53
NSYSPLVX6200	383, 591	NSYSPV6100	92, 407	NSYSUCR40100	236
NSYSPLVX6200SF	379	NSYSPV8100	92, 407	NSYSUCR40110	94, 236
NSYSPM6	90, 94	NSYSQCR12040	237	NSYSUCR40120	236
NSYSPMP25100	207, 228	NSYSQCR12050	237	NSYSUCR40140	236
NSYSPMP25120	228	NSYSQCR12060	237	NSYSUCR40160	236
NSYSPMP2560	228	NSYSQCR12080	237	NSYSUCR40180	236
NSYSPMP2580	228	NSYSQCR40100	237	NSYSUCR40200	236, 336
NSYSPMP40100	207, 228, 454	NSYSQCR40120	237	NSYSUCR40220	236
NSYSPMP40120	228, 454	NSYSQCR4040	237, 240	NSYSUCR4030	94, 236
NSYSPMP4060	228	NSYSQCR4050	237, 240	NSYSUCR4040	94, 236, 240
NSYSPMP4080	228, 454	NSYSQCR4060	237, 240	NSYSUCR4050	94, 236, 240
NSYSPMP60120	228	NSYSQCR4080	237, 240	NSYSUCR4060	236, 240, 458
NSYSPMP6060	228	NSYSQCR65100	237	NSYSUCR4070	94, 236
NSYSPMP6080	228	NSYSQCR65120	237	NSYSUCR4080	236, 240, 458
NSYSRJ	272	NSYSQCR6540	237	NSYSUCR4090	94, 236
NSYSPS10100	406	NSYSQCR6550	237	NSYSUCR65100	236
NSYSPS3100	81, 91	NSYSQCR6560	237	NSYSUCR65120	236
NSYSPS3100SD	27, 31, 47, 51	NSYSQCR6580	237	NSYSUCR65140	236
NSYSPS3200	81, 91	NSYSQCR90100	237	NSYSUCR65160	236
NSYSPS3200SD	27, 31, 47, 51	NSYSQCR90120	237	NSYSUCR65180	236
NSYSPS4100	81, 83, 91	NSYSQCR9040	237	NSYSUCR65200	236
NSYSPS4100SD	27, 31, 47, 51, 451	NSYSQCR9050	237	NSYSUCR6530	236
		NSYSQCR9060	237	NSYSUCR6540	236
		NSYSQCR9080	237	NSYSUCR6550	236

Index of References

N	Page	N	Page	N	Page
NSYSUCR6560	236	NSYTBP241910HT	150	NSYTC12100	266
NSYSUCR6580	236	NSYTBP241910T	150	NSYTC6CRN	34, 182, 371
NSYSUCR90100	236	NSYTBP241912H	150	NSYTC6CSX	133
NSYSUCR90120	236	NSYTBP241912HT	150	NSYTC7CRN	34, 182, 371, 452
NSYSUCR90140	236	NSYTBP24198	150	NSYTC7CSX	133
NSYSUCR90160	236	NSYTBP24198T	150	NSYTC8CRN	34, 182, 371, 452
NSYSUCR90180	236	NSYTBP292412	150	NSYTC274	165
NSYSUCR90200	236	NSYTBP292412H	150	NSYTC276	165
NSYSUCR90220	236	NSYTBP292412HT	150	NSYTC278	165
NSYSUCR9030	94, 236	NSYTBP292412T	150	NSYTCL405ME	141, 182
NSYSUCR9040	94, 236	NSYTBP292416H	150	NSYTCM274	165
NSYSUCR9050	94, 236	NSYTBP292416HT	150	NSYTCRE1	656
NSYSUCR9060	236	NSYTBP29248	150	NSYTCRE1	656
NSYSUCR9070	94, 236	NSYTBP29248T	150	NSYTCRE12	656
NSYSUCR9080	236	NSYTBP342912	150	NSYTCRE12	656
NSYSUPLA3G	196	NSYTBP342912T	150	NSYTC6PLM	184
NSYSUPLA3TG	196	NSYTBP342916H	150	NSYTC6SPLM	184
NSYSUPLA4G	196	NSYTBP342916HT	150	NSYTD5ME	141, 182
NSYSUPLA4TG	196	NSYTBP775	150	NSYTD5PL	183
NSYSVR608	411	NSYTBP885	150	NSYTD5PLA	660
NSYSVR808	411	NSYTBPASBS	155	NSYTD5PLA	661
NSYSW	272	NSYTBS111113H	150	NSYTD6CRN	34
NSYSWMBP	654-656, 662	NSYTBS111116	150	NSYTD6SF2D	657-660
NSYSWMBP	654-657, 663	NSYTBS1176	150	NSYTD6SF2D	658-661
NSYSWMCH	654-656, 662	NSYTBS1179H	150	NSYTD6SFN2D	657
NSYSWMCH	654, 655, 657, 663	NSYTBS1397	150	NSYTD6SFN2D	658
NSYSWMEL	654-656, 661, 662	NSYTBS1397T	150	NSYTEDB5ML	35
NSYSWMEL	654-657, 662, 663	NSYTBS16128	150	NSYTEDB5PL	183
NSYTBCN3105	296	NSYTBS16128T	150	NSYTEL1242EPL	183
NSYTBCN3106	296	NSYTBS191210H	150	NSYTEL405ML	35
NSYTBCN3108	296	NSYTBS191210HT	150	NSYTEL405PL	183
NSYTBCN3125	296	NSYTBS19128	150	NSYTELJISPL	183
NSYTBCN3126	296	NSYTBS19128T	150	NSYTEMPL	183
NSYTBCN3128	296	NSYTBS191610H	150	NSYTERML	35
NSYTBCN345	296	NSYTBS191610HT	150	NSYTER8PL	183
NSYTBCN346	296	NSYTBS19168	150	NSYTEX5	185
NSYTBCN348	296	NSYTBS19168T	150	NSYTEX6	185
NSYTBCN365	296	NSYTBS241910	150	NSYTEX8	211
NSYTBCN366	296	NSYTBS241910H	150	NSYTEX8PLM	185
NSYTBCN368	296	NSYTBS241910HT	150	NSYTFPCR10	45, 265
NSYTBCN385	296	NSYTBS241910T	150	NSYTFPCR4	45, 265
NSYTBCN386	296	NSYTBS241912H	150	NSYTFPCR5	45, 265
NSYTBCN388	296	NSYTBS241912HT	150	NSYTFPCR6	45, 265
NSYTBP11116	150	NSYTBS24198	150	NSYTFPCR8	45, 265
NSYTBP1176	150	NSYTBS24198T	150	NSYTHL1242EPLM	182
NSYTBP1397	150	NSYTBS292412	150	NSYTHL2433APLM	182
NSYTBP1397T	150	NSYTBS292412H	150	NSYTHL3113APLM	182
NSYTBP16128	150	NSYTBS292412HT	150	NSYTHL405PLM	182
NSYTBP16128T	150	NSYTBS292412T	150	NSYTHL421PLM	182
NSYTBP191210H	150	NSYTBS292416H	150	NSYTHL455PLM	182
NSYTBP191210HT	150	NSYTBS292416HT	150	NSYTHPLM	182
NSYTBP19128	150	NSYTBS29248	150	NSYTJ10030	28, 33, 47, 53
NSYTBP19128T	150	NSYTBS29248T	150	NSYTJ10040	28, 33, 47, 53
NSYTBP191610H	150	NSYTBS342912	150	NSYTJ12030	28, 33, 47, 53
NSYTBP191610HT	150	NSYTBS342912T	150	NSYTJ12040	28, 33, 47, 53
NSYTBP19168	150	NSYTBS342916H	150	NSYTJ2015	28, 33, 47, 53
NSYTBP19168T	150	NSYTBS342916HT	150	NSYTJ2015HD	663
NSYTBP241910	150	NSYTBS775	150	NSYTJ2015HD	664
NSYTBP241910H	150	NSYTBS885	150	NSYTJ2515	47

Index of References

N	Page	N	Page	N	Page
NSY TJ3015	28, 33, 47, 53	NSY TLCRND	25, 36	NSY TSA2414SE	59, 60, 259
NSY TJ3020	28, 33, 47, 53	NSY TLCRNO	25, 36	NSY TSA2417SE	59, 60, 259
NSY TJ3020HD	663	NSY TLCU	73	NSY TSA2422SE	59, 60, 259
NSY TJ3020HD	664	NSY TLCUHD	663	NSY TSA2423SE	59, 60, 259
NSY TJ4015	28, 33, 47, 53	NSY TLCUHD	664	NSY TSA2429SE	59, 60, 259
NSY TJ4020	28, 33, 47, 53	NSY TLD	47, 57, 66, 73	NSY TSACRNB	25, 36
NSY TJ4020HD	663	NSY TLDLFL	25, 47, 57, 73, 261	NSY TSACRNC	25, 36
NSY TJ4020HD	664	NSY TLDME	25, 47, 58, 258	NSY TSACRND	25, 36
NSY TJ4025	28, 33, 47, 53	NSY TLDU	73	NSY TSAKFL	59, 62, 260
NSY TJ4025HD	663	NSY TLDUHD	663	NSY TSAM508SE	59, 60, 258
NSY TJ4025HD	664	NSY TLDUHD	664	NSY TSAM638SE	59, 60, 258
NSY TJ5020	28, 33, 47, 53	NSY TLE	47, 57, 66, 73	NSY TSML	35, 133
NSY TJ5025	28, 33, 47, 53	NSY TLEFL	25, 47, 57, 73, 261	NSY TSP450	409, 532
NSY TJ5025HD	663	NSY TLEME	25, 47, 58, 258	NSY TSPC450	409, 532
NSY TJ5025HD	664	NSY TLEU	73	NSY TSPLA	203
NSY TJ6020	28, 33, 47, 53	NSY TLEUHD	663	NSY TT6CRN	34, 182, 371
NSY TJ6025	28, 33, 47, 53	NSY TLEUHD	664	NSY TT8CRN	34, 182, 371, 452
NSY TJ6030	28, 33, 47, 53	NSY TLF	47, 57, 66, 73	NSY TT8CSX	133
NSY TJ6030HD	663	NSY TLF2FL	57, 73, 261	NSY TTG40	240
NSY TJ6030HD	664	NSY TLFFL	47, 57, 73, 261	NSY TTG50	240
NSY TJ6040	28, 33, 47, 53	NSY TLFME	47, 58, 258	NSY TTG60	240, 458
NSY TJ6040HD	663	NSY TLFU	47, 57, 73	NSY TUP7035	279
NSY TJ6040HD	664	NSY TLG	47, 57, 66, 73	NSY TVA	551
NSY TJ8025	28, 33, 47, 53	NSY TLG2FL	25, 47, 57, 73, 261	NSY TVAR	549
NSY TJ8030	28, 33, 47, 53	NSY TLG4FL	57, 73, 255	NSY TVP356	549
NSY TJ8040	28, 33, 47, 53	NSY TLGFL	57, 73, 261	NSY TVP556	549
NSY TJ8040HD	663	NSY TLGME	25, 47, 58, 258	NSY TVP756	549
NSY TJ8040HD	664	NSY TLGU	47, 57, 73	NSY TVPSL6	535
NSY TJIS	34	NSY TLGUHD	663	NSY TVPSL8	535
NSY TJPLA103G	197	NSY TLGUHD	664	NSY TVPSP10	535
NSY TJPLA104G	197	NSY TMME	141, 182	NSY TVPSP6	535
NSY TJPLA123G	197	NSY TPLS1827	163	NSY TVPSP8	535
NSY TJPLA124G	197	NSY TPLS2727	163	NSY TVR10	207, 233
NSY TJPLA126G	197	NSY TPLS2727A	163	NSY TVR12	81, 83, 233
NSY TJPLA53G	197	NSY TPLS2736	163	NSY TVR125	207, 233
NSY TJPLA54G	197	NSY TPLS2736A	163	NSY TVR14	81, 83, 143, 233, 455
NSY TJPLA73G	197	NSY TPLS2754	163	NSY TVR15	207, 233
NSY TJPLA74G	197	NSY TPLS2754A	163	NSY TVR16	81, 83, 143, 233
NSY TJPLA76G	197	NSY TPLS3636	163	NSY TVR18	81, 83, 143, 233
NSY TL1242EME	141, 182	NSY TPLS3654	163	NSY TVR20	81, 83, 143, 233
NSY TL220PLM	182	NSY TPLS3654A	163	NSY TVR22	83, 233
NSY TL27270G	164, 171	NSY TPLS3672A	163	NSY TVR7	207, 233
NSY TL27360G	164	NSY TPLS5454	163	NSY TVR8	233, 455
NSY TL405PLM	182	NSY TPLS5454A	163	NSY TX10030	132
NSY TL405SML	35	NSY TPLS5472A	163	NSY TX12030	132
NSY TLA	47, 57, 66, 73	NSY TPLSC2727AG	163	NSY TX2015	132
NSY TLAFL	57, 73	NSY TPLSC2727G	163	NSY TX2515	132
NSY TLAU	73	NSY TPLSC2736AG	163	NSY TX3015	132
NSY TLAUHD	663	NSY TPLSC2754AG	163	NSY TX3020	132
NSY TLAUHD	664	NSY TPLSC2754G	163	NSY TX4020	132
NSY TLB	47, 57, 66, 73	NSY TPLSC3654AG	163	NSY TX5025	132
NSY TLBFL	57, 73	NSY TPLSC3654G	163	NSY TX6020	132
NSY TLBU	47, 57, 73	NSY TPLSC3672AG	163	NSY TX6025	132
NSY TLC	47, 57, 66, 73, 101	NSY TPLSC5454AG	163	NSY TX8030	132
NSY TLCFL	47, 57, 73, 101, 261	NSY TPLSC5472AG	163	NSY UCC270	164
NSY TLCME	47, 58, 101, 258	NSY TPLSP2727G	163	NSY UCC360	164
NSY TLCRNB	25, 36	NSY TPLSP2754G	163	NSY UM27180	164
NSY TLCRNB	25, 36	NSY TPLSP3654G	163	NSY UM27270	164, 171
NSY TLCRNC	25, 36	NSY TPV	533	NSY UM27360	164

Index of References

N	Page	N	Page	N	Page
NSYUVPLA	196	NSYVDA47U88E	514, 515	NSYZNPLA104G	199
NSYVA2710M	276	NSYVDAC42U88B	510, 511	NSYZNPLA123G	199
NSYVA2710MA	276	NSYVDAC42U88E	514, 515	NSYZNPLA124G	199
NSYVA2712M	276	NSYVDASAVKIT	563	NSYZNPLA53G	199
NSYVA2712MA	276	NSYVDM11UP	27, 47, 247, 404	NSYZNPLA54G	199
NSYVA2716M	276	NSYVDM12UF	27, 47, 247, 404	NSYZNPLA73G	199
NSYVA2724M	276	NSYVDM16UP	27, 47, 247, 404	NSYZNPLA74G	199
NSYVA272M	276	NSYVDM17UF	27, 47, 247, 404	NSYZUN610VDA	510, 512, 514, 516, 519, 523, 524, 537
NSYVA272MA	276	NSYVDM20U8P	27, 47, 247, 404	NSYZUN650PB	499
NSYVA274M	276	NSYVDM20UP	27, 47, 247, 404	NSYZUN660PB	499
NSYVA274MA	276	NSYVDM21UF	27, 47, 247, 404	NSYZUN66VDA	510, 512, 514, 516, 518, 519, 537
NSYVA276M	276	NSYVDM25U8P	27, 47, 247, 404	NSYZUN68VDA	510, 512, 514, 516, 518, 519, 524, 537
NSYVA276MA	276	NSYVDM8UF	27, 47, 247, 404	NSYZUN810VDA	510, 512, 514, 516, 518, 519, 523, 524, 537
NSYVA278M	276	NSYVDS42U610N	523, 524	NSYZUN86VDA	510, 512, 516, 518, 519, 537
NSYVA278MA	276	NSYVDS42U810N	523, 524	NSYZUN88VDA	510, 512, 514, 516, 518, 519, 523, 524, 537
NSYVDA24U610B	510, 511	NSYVDS42U88N	523, 524	NSYZZ2103G	200
NSYVDA24U610E	514, 515	NSYVEA9	185	NSYZZ2104G	200
NSYVDA24U66B	510, 511	NSYVPFN2B4	366	NSYZZ2123G	200
NSYVDA24U66E	514, 515	NSYVPHD10	662	NSYZZ2124G	200, 375
NSYVDA24U68B	510, 511	NSYVPHD10	663	NSYZZ2124VHD	375, 383, 591
NSYVDA24U68E	514, 515	NSYVPHD15	662	NSYZZ2126G	200, 375
NSYVDA24U68L	518	NSYVPHD15	663	NSYZZ2126VHD	375, 383, 591
NSYVDA24U810B	510, 511	NSYVPLA10MG	660	NSYZZ253G	200
NSYVDA24U88B	510, 511	NSYVPLA10MG	661	NSYZZ254G	200, 375
NSYVDA29U66B	510, 511	NSYVPLA12MG	660	NSYZZ254VHD	375, 383, 591
NSYVDA33U66B	510, 511	NSYVPLA12MG	661	NSYZZ273G	200
NSYVDA33U68B	510, 511	NSYVPLA15MG	660	NSYZZ274G	200, 375
NSYVDA33U88B	510, 511	NSYVPLA15MG	661	NSYZZ274VHD	375, 383, 591
NSYVDA38U66B	510, 511	NSYVPLA5MG	660	NSYZZ276G	200, 375
NSYVDA38U68B	510, 511	NSYVPLA5MG	661	NSYZZ276VHD	375, 383, 591
NSYVDA42U610B	510, 511	NSYVPLA7MG	660	NSYZZ5103G	200
NSYVDA42U66B	510, 511	NSYVPLA7MG	661	NSYZZ5104G	200
NSYVDA42U66BK	511	NSYVPLM108	661	NSYZZ5123G	200
NSYVDA42U66E	514, 515	NSYVPLM108	662	NSYZZ5124G	200
NSYVDA42U66L	518	NSYVR18	81, 83, 143, 233	NSYZZ553G	200
NSYVDA42U66LR	518, 519	NSYVR20	81, 83, 143, 233	NSYZZ554G	200
NSYVDA42U68B	510, 511	NSYVR22	83, 233	NSYZZ573G	200
NSYVDA42U68E	514, 515	NSYZA2103G	198	NSYZZ574G	200
NSYVDA42U68L	518	NSYZA2104G	198		
NSYVDA42U6GGD	563	NSYZA2123G	198		
NSYVDA42U810B	510, 511	NSYZA2124G	198		
NSYVDA42U810BK	511	NSYZA2126G	198		
NSYVDA42U810E	514, 515	NSYZA253G	198		
NSYVDA42U810EN	514, 515	NSYZA254G	198		
NSYVDA42U810LN	518, 519	NSYZA273G	198		
NSYVDA42U86B	510, 511	NSYZA274G	198		
NSYVDA42U86L	518	NSYZA276G	198		
NSYVDA42U88B	510, 511	NSYZHPLA103G	201		
NSYVDA42U88BK	511	NSYZHPLA104G	201		
NSYVDA42U88E	514, 515	NSYZHPLA123G	201		
NSYVDA42U88EN	514, 515	NSYZHPLA124G	201		
NSYVDA42U88L	518	NSYZHPLA53G	201		
NSYVDA42U88LR	518, 519	NSYZHPLA54G	201		
NSYVDA42U8BVD	563	NSYZHPLA73G	201		
NSYVDA42U8DBVD	563	NSYZHPLA74G	201		
NSYVDA42U8GGD	563	NSYZM253G	177		
NSYVDA42ULS2P	563	NSYZM263G	177		
NSYVDA47U66B	510, 511	NSYZM283G	177		
NSYVDA47U88B	510, 511	NSYZNPLA103G	199		

V	Page
VDIM33174	526

X	Page
XALE2	151
XALE3	151
XALE3255	151
XALEK170	151

Life Is On

Schneider
Electric

Schneider Electric Industries SAS
35, rue Joseph Monier
CS 30323
92506 Rueil Malmaison Cedex
France

RCS Nanterre 954 503 439
Capital social 896 313 776
[se.com](https://www.se.com)