

GRP Cable Management Systems



Glass Reinforced Polyester (GRP/FRP) Cable Management Systems are well suited to aggressive environments where there might be extreme weather or high temperatures.

They are extremely robust, considerably lighter than aluminium or steel, and have excellent resistance against fire and corrosion resulting in a very long life span. GRP systems have a large cable capacity, and offer fast and flexible installation solutions, with the ability of on-site assembly and configuration.

Marshall-Tufflex can offer a wide range of GRP systems including trays, ladders, ground ducts, troughing*, accessories and fittings, fixings and supports.

*To special order

Contents	
About GRP Systems	page 2
Applications	page 4
Pressed Tray	page 6
Pultruded Ladder	page 10
Support Systems	page 12
Ground Ducts	page 12
Cable Troughing	page 13
Technical	page 14



How it is made

GRP standard span Cable Tray (1.5m) and fittings are pressed from glass reinforced polyester resin, using hot moulding technology and facilitating the creation of smooth intricate shapes.

GRP Cable Ladders and long span trays are manufactured by pultrusion, a process using layers of mats and rovings injected with resin and pulled through a die in a continuous operation.

GRP CABLE LADDERS PULTRUDED

RESIN TYPES (ALL ZERO HALOGEN)

Polyester (standard)	good all round performance, mechanical strength, corrosion resistance, fire behaviour, temperature rating
Acrylic (on request)	excellent resistance to fire in a corrosive environment
Vymilester (on request)	highly resistant to a specific range of chemical agents (H2S04HC1...)
Carbon loaded polyester (on request)	anitstatic properties for highly explosive atmospheres

Alternatively for specific projects we will define a solution to meet your needs.

Marshall-Tufflex manufacture and supply a broad range of Cable Management products to ensure that, whatever the design and specification, there will always be the perfect product to suit.

Proud to be known as a leading cable management manufacturer and with 65 years experience, our extensive range of cable management products are available from a network of wholesalers nationwide and from distributors across the world. Alongside this our network of sales engineers supported by advice from our technical team means immediate assistance and complete peace of mind.

As a British-based, family-owned company, our priority is to re-invest for the future and to constantly pioneer new and effective solutions.

We are holders of the ISO 14001 Environmental Management certification. However, we view this as a minimum and practice recycling throughout our operations, to minimise our impact on the environment.

Features and benefits

Easy Installation and Modification

Lightweight and robust, with interlocking and self adjusting couplings to assist assembly, GRP systems allow on-site installation and modification without the need for special tools, de-burring, painting or earth bonding.

Low Maintenance

GRP products are corrosion resistant and can withstand extreme weather conditions, salt and most chemicals without the need for painting and protective coatings.

Fire Security

Effective at temperatures between -80°C to +130°C, GRP has a low conductivity and is a self extinguishing, Zero Halogen material that is low smoke classified.

Insulating

Excellent insulating material resulting in high performance cable protection with no earthing required.

Mechanical Properties

Loading characteristics in accordance with IEC 61537. For deflection values, coefficient of safety and load calculations refer to page 14.

GRP Vs Steel

- GRP is 40% lighter
- Completely corrosion resistant. No rusting even when in contact with salt spray, H2S, acid built up from exhaust gases, or brake dust along roads and railways
- Fast installation with fewer fasteners
- Easy to cut and drill
- Slow rate of heat transfer
- Earthing not required
- Antimagnetic and therefore resistant to electromagnetic pulses
- Lower life cycle cost



APPROVALS

GRP Cable Management Systems are fully compliant to the below standards and regulations

Fire Behaviour

Inflammability to IEC 60695-2-12/ UL94
 Spread of flame to BS 476 part 7 class 2/ ASTM E84 (Up to Class 1 on request)
 Fire propagation to BS 476 Part 6
 Smoke emissions to BS 6853 App B53
 Fire standard to DIN 4102

Mechanical Behaviour

Breaking point to NEMA FG1
 Tensile strength at break point to ISO 527-5
 Modulus of elasticity to ISO 527-5
 Accelerated ageing to ISO 4892-2

Electrical behaviour

Surface resistivity to IEC 6079-0
 Breakage voltage to IEC 60243-1
 Comparative tracking index IEC 60112

Density to DIN 53479

Linear Thermal Dilatation to DIN 53752

Water Absorption to ISO 62



RECYCLING

Marshall-Tufflex is active in and financially supports various industry bodies in driving the industry forward in the use and control of PVC-based materials, with the aim of increasing awareness and use of recycled material.



Applications

Due to its non conductive and self extinguishing properties as well as its stability to UV and extreme temperature, GRP is often used in industrial applications where stability is essential and where products need to have a long life span.

Transport:

GRPs resistance to corrosion makes it the ideal solution in the construction of tunnels, bridges, railways, underground and airports. The product does not emit toxic gases and is easy to install resulting in little disturbance to transport services.



Road:

Resists corrosion: combustion gas, salt

Optimum safety:

- Self-extinguishing UL94 - V0
- Does not emit halogen or smoke (fire classification: M1, i0, F0; ASTM E84, Class 2 or Class 1; BS 476 Part 7, Class 2 or 1)
- No sharp edges or burrs, from cutting or drilling

Flexibility and easy mounting:

- Reduces installation costs
- Save time and money as no earthing is required

Ensures strong mechanical resistance with a lighter weight

No expensive protection accessories or coating necessary



Sea:

Resists corrosion: atmospheric, UV, saline

Save installation time and costs:

- Reduces use of bolts with clip-on splice plates and fixings
- No expensive protection accessories or coating
- No sharp edges or burrs, from cutting or drilling

Ensures strong mechanical resistance with a lighter weight

Excellent vibration resistance



Rail:

Optimum safety:

- Self-extinguishing UL94 - V0
- In the event of fire, no halogen toxic fumes (fire classification: M1, i0, F0; ASTM E84, Class 2 or Class 1; BS 476 Part 7, Class 2 or 1)
- No sharp edges or burrs, from cutting or drilling

Flexibility and ease of installation:

- Reduces installation costs with unique self coupling mechanism
- No earthing required

Very strong mechanical resistance, even with high temperature variation

Ultra light weight (10 times lighter than concrete)

Petrochemical and Process Plant industries: chemical and petrochemical, agriculture and food

In offshore applications GRP products are the best solution to the extreme weather and temperatures that arise. They are resistant to most chemicals, lactic agents, base acids, and are perfectly adapted for where cleanliness is essential.

Cut down corrosion and maintenance costs

Reduce installation costs

- No earthing required
- No expensive protection accessories or coating
- No sharp edges or burrs, from cutting or drilling

Ensures strong mechanical resistance and a lighter weight

Reduces weight of structure

- Saves 40% against stainless steel
- Saves 15% against aluminium



Energy Distribution: water and recycling, gas, electricity, extraction

The safety and reliability of GRP products are a dominant feature in environments where the ambient temperatures are very high. This system also benefits from excellent mechanical properties guaranteeing the perfect solution.

Very strong mechanical resistance, even with high temperature variation

No expensive protection accessories or coating necessary





Optimum safety:

- Self-extinguishing UL94 - V0
- No toxic fumes or halogen in case of fire (fire classification: M1, i0, F0; ASTM E84, Class 2 or Class 1; BS 476 Part 7, Class 2 or 1)
- No sharp edges or burrs, from cutting or drilling

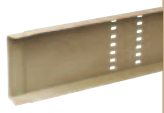

Standard Span Tray (1.5m)

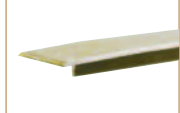
Tray/Trunking component chart

Length: 3 metres Pack: 1						
	Non-perforated pressed GRP Tray	Perforated pressed GRP Tray	Cover	Cover Clip	Divider	End cap
50 x 50mm Tray	KK5050	KKL5050	KKD50	DF50	KKT50	KKKE5050
100 x 50mm Tray	KK10050	KKL10050	KKD100	DF50	KKT50	KKKE10050
150 x 50mm Tray	KK15050	KKL15050	KKD150	DF50	KKT50	KKKE15050
200 x 50mm Tray	KK20050	KKL20050	KKD200	DF50	KKT50	KKKE20050
300 x 50mm Tray	KK30050	KKL30050	KKD300	DF50	KKT50	KKKE30050
100 x 80mm Tray	KK10080	KKL10080	KKD100	DF80	KKT80	KKKE10080
150 X 80mm Tray	KK15080	KKL15080	KKD150	DF80	KKT80	KKKE15080
200 x 80mm Tray	KK20080	KKL20080	KKD200	DF80	KKT80	KKKE20080
300 x 80mm Tray	KK30080	KKL30080	KKD300	DF80	KKT80	KKKE30080
400 x 80mm Tray	KK40080	KKL40080	KKD400	DF80	KKT80	KKKE40080

All products are supplied in pack quantities of one.

A range of Pressed GRP Trays with 110mm wall height is also available on request.



Complete range of Pultruded Trays for extended support span up to 3 metres in 50mm and 80mm wall heights are also available on request.

Internal Bend		External Bend		Flat Angle (small radius)		Flat Angle (large radius)	
Base	Cover	Base	Cover	Base	Cover	Base	Cover
KKBI5050	KKBID5050	KKBA5050	KKBAD5050	KKW5050	KKWD50	-	-
KKBI10050	KKBID10050	KKBA10050	KKBAD10050	KKW10050	KKWD100	-	-
KKBI15050	KKBID15050	KKBA15050	KKBAD15050	KKW15050	KKWD150	KKB15050	KKBD150
KKBI20050	KKBID20050	KKBA20050	KKBAD20050	KKW20050	KKWD200	KKB20050	KKBD200
KKBI30050	KKBID30050	KKBA30050	KKBAD30050	KKW30050	KKWD300	KKB30050	KKBD300
KKBI10080	KKBID10080	KKBA10080	KKBAD10080	KKW10080	KKWD100	KKB10080	KKBD100
KKBI15080	KKBID15080	KKBA15080	KKBAD15080	KKW15080	KKWD150	KKB15080	KKBD150
KKBI20080	KKBID20080	KKBA20080	KKBAD20080	KKW20080	KKWD200	KKB20080	KKBD200
KKBI30080	KKBID30080	KKBA30080	KKBAD30080	KKW30080	KKWD300	KKB30080	KKBD300
KKBI40080	KKBID40080	KKBA40080	KKBAD40080	KKW40080	KKWD400	KKB40080	KKBD400

Continued overleaf.

Pressed Tray

Tray/Trunking component chart

Length: 3 metres Pack: 1						
	Flat Angle 135°(large radius) Base	Cover	Flat Tee (small radius) Base	Cover	Flat Tee (large radius) Base	Cover
50 x 50mm Tray	-	-	KKSS5050	KKSSD50	-	-
100 x 50mm Tray	-	-	KKSS10050	KKSSD100	KKST10050	KKSTD100
150 x 50mm Tray	-	-	KKSS15050	KKSSD150	KKST15050	KKSTD150
200 x 50mm Tray	-	-	KKSS20050	KKSSD200	KKST20050	KKSTD200
300 x 50mm Tray	-	-	KKSS30050	KKSSD300	KKST30050	KKSTD300
100 x 80mm Tray	KKC10080	KKCD100	KKSS10080	KKSSD100	KKST10080	KKSTD100
150 x 80mm Tray	KKC15080	KKCD150	KKSS15080	KKSSD150	KKST15080	KKSTD150
200 x 80mm Tray	KKC20080	KKCD200	KKSS20080	KKSSD200	KKST20080	KKSTD200
300 x 80mm Tray	KKC30080	KKCD300	KKSS30080	KKSSD300	KKST30080	KKSTD300
400 x 80mm Tray	KKC40080	KKCD400	-	-	KKST40080	KKSTD400

All products are supplied in pack quantities of one.

Pultruded Tray and an additional 110mm wall height is also available on request.

Offset		Reducer Left Hand		Reducer Right Hand		Pin Rack
Base Set	Cover Set	Base	Cover	Base	Cover	
-	-	-	-	-	-	-
-	-	-	-	-	-	KR100
-	-	-	-	-	-	KR150
-	-	-	-	-	-	KR200
-	-	-	-	-	-	KR300
KKET10080	KKETD10080	-	-	-	-	KR100
KKET15080	KKETD15080	-	-	-	-	KR150
KKET20080	KKETD20080	KKRL20080 200 to 100mm	KKRLD200	KKRR20080 200 to 100mm	KKRRD200	KR200
KKET30080	KKETD30080	KKRL30080 300 to 200mm	KKRLD300	KKRR30080 300 to 200mm	KKRRD300	KR300
KKET40080	KKETD40080	KKRL40080 400 to 300mm	KKRLD400	KKRR40080 400 to 300mm	KKRRD400	KR400



Offset with Covers

Pultruded Ladder

Ladder component chart

Length: 3 metres Pack: 1						
	Cover	Cover Clip	Flat 90° Angle Base	Flat 90° Angle Cover	Int/Ext Angle Base	Int/Ext 90° Angle Cover
UL20053 200 x 53mm 	KKD200	DF50	ULB20053	ULBD200	ULBA20053	ULBAD20053
UL20080 200 x 80mm 	KKD200	DF80	ULB20080	ULBD200	ULBA20080	ULBAD20080
UL150100 150mm x 100mm 	KKD150	DF100	ULB150100	ULBD150	ULBA150100	ULBAD150100
UL300100 300 x 100mm 	KKD300	DF100	ULB300100	ULBD300	ULBA300100	ULBAD300100
UL400100 400 x 100mm 	KKD400	DF100	ULB400100	ULBD400	ULBA400100	ULBAD400100
UL600100 600 x 100mm 	KKD600	DF100	ULB600100	ULBD600	ULBA600100	ULBAD600100
UL900100 900 x 100mm 	KKD900	DF100	ULB900100	ULBD900	ULBA900100	ULBAD900100
UL150150 150 x 150mm 	KKD150	DF150	ULB150150	ULBD150	ULBA150150	ULBAD150150
UL300150 300 x 150mm 	KKD300	DF150	ULB300150	ULBD300	ULBA300150	ULBAD300150
UL400150 400 x 150mm 	KKD400	DF150	ULB400150	ULBD400	ULBA400150	ULBAD400150
UL600150 600 x 150mm 	KKD600	DF150	ULB600150	ULBD600	ULBA600150	ULBAD600150
UL900150 900 x 150mm 	KKD900	DF150	ULB900150	ULBD900	ULBA900150	ULBAD900150

All products are supplied in pack quantities of one.

Additional ladder widths in wall heights 53mm, 80mm, 100mm and 150mm are available on request.

6 metre lengths are available on request.

Flat Tee		Flat Crossover		Reducer	Horizontal Coupler (Set of 2 pieces)	Vertical Variable Angle Plate (Set of 2 pieces)	Ladder Clamp to Support
Base	Cover	Base	Cover				
ULTE20053	ULTED200	ULX20053	ULXD200	ULR15053 150mm [§]	ULIH53*	ULIV53	ULKS [†]
ULTE20080	ULTED200	ULX20080	ULXD200	ULR15080 150mm [§]	ULIH80*	ULIV80	ULKS [†]
ULTE150100	ULTED150	ULX150100	ULXD150	ULR100100 100mm [§]	ULIH100*	ULIV100	ULKS [†]
ULTE300100	ULTED300	ULX300100	ULXD300	ULR200100 200mm [§]	ULIH100*	ULIV100	ULKS [†]
ULTE400100	ULTED400	ULX400100	ULXD400	ULR300100 300mm [§]	ULIH100*	ULIV100	ULKS [†]
ULTE600100	ULTED600	ULX600100	ULXD600	ULR500100 500mm [§]	ULIH100*	ULIV100	ULKS [†]
ULTE900100	ULTED900	ULX900100	ULXD900	-	ULIH100*	ULIV100	ULKS [†]
ULTE150150	ULTED150	ULX150150	ULXD150	ULR100150 100mm [§]	ULIH150*	ULIV150	ULKS [†]
ULTE300150	ULTED300	ULX300150	ULXD300	ULR200150 200mm [§]	ULIH150*	ULIV150	ULKS [†]
ULTE400150	ULTED400	ULX400150	ULXD400	ULR300150 300mm [§]	ULIH150*	ULIV150	ULKS [†]
ULTE600150	ULTED600	ULX600150	ULXD600	ULR500150 500mm [§]	ULIH150*	ULIV150	ULKS [†]
ULTE900150	ULTED900	ULX900150	ULXD900	-	ULIH150*	ULIV150	ULKS [†]

* Foldable splice plate requires 4 x M616V4ADOM

+ ULKS requires 1 x M1040V4AHEX

§ Reduction achieved

Support Systems

Support System component chart

Pack: 1	GRP SYSTEMS				STAINLESS STEEL 316		
							
	FPAM Bracket	Bracket Type 'A' + 'B'	Adj.Rail (GRP) 45 x 45 x 2000mm	Clamp Bolt Assembly S/S M10 x 30mm	H/D Bracket Type 'A' S/S	Adj.Rail (S/S) 40 x 40 x 2000mm	Clamp Bolt Assembly S/S M10 x 30mm
100mm	FPAM100	FPAP100AC	FPAR2000AC	FPBGV10SS	AV100	ASSV2000	BGSV
150mm	-	FPAP150AC	FPAR2000AC	FPBGV10SS	AV150	ASSV2000	BGSV
200mm	FPAM200	FPAP200AC	FPAR2000AC	FPBGV10SS	AV200	ASSV2000	BGSV
250mm	FPAM250	FPAP250AC	FPAR2000AC	FPBGV10SS	AV250S	ASSV2000	BGSV
300mm	FPAM300	FPAP300AC	FPAR2000AC	FPBGV10SS	AV300S	ASSV2000	BGSV
400mm	-	FPAP400AC	FPAR2000AC	FPBGV10SS	AV400S	ASSV2000	BGSV
500mm	-	FPAP500AC	FPAR2000AC	FPBGV10SS	AV500S	ASSV2000	BGSV
600mm	-	FPAP600AC	FPAR2000AC	FPBGV10SS	AV600S	ASSV2000	BGSV

All products are supplied in pack quantities of one. Other brackets and supports available on request.

Ground Ducts

Pack: 1				
	Duct Base 2500mm	Cover 1250mm	Clip for cover mounting	Set of clips and hinge for articulate cover mounting
250 x 140mm	BK200140	BKDR200	DF94/4	DF94/C
350 x 176mm	BK300176	BKDR300	DF94/4	DF94/C
450 x 176mm	BK400176	BKDR400	DF94/4	DF94/C

- Ideal for railway applications
- Quick and easy to load and unload
- Rigid and self supporting
- 3 times lighter than GRC (Glass fibre reinforced concrete and 10 times lighter than concrete)
- Impact and frost resistant

Ground Duct Profile

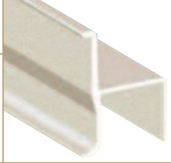
Length: 2, 3, 4 metres available	
Pack: 1	
36 x 35mm	PR3635
50 x 45mm	PR5045
55 x 55mm	PR5555

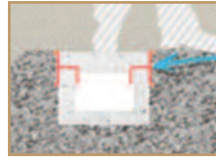

Other dimensions available on request.

- Avoids railtrack ballast falling into electrical concrete ducts when lifting lids
- Ensures perfect positioning of ground duct covers
- Installation and revamping with minimum investment and effort

Ground Duct A Profile

Length: available from 1.5 metres	
Pack: 1	
143 x 53mm	PR5080



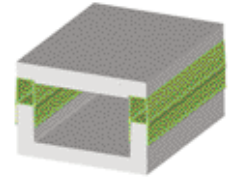



- Increases cable capacity of existing concrete ground ducts
- High mechanical and corrosion performance
- Highly effective at minimum cost





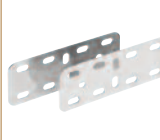

Cable Troughing

Ideally suited to railway applications where cable ducts cannot be buried.

- Self supporting base
- High mechanical loading capacity allows for one post every 6m
- Product is lightweight, so requires only a single person for installation

Length: 3 metres						
Pack: 1						
	Base and Premounted Connector	U Shaped Connector	Splice Plate	316 SS Bolts and Nuts for SPIH/KKIH	Steel Post 1500mm	Steel Post 2000mm
150 x 150mm	SP150150	SPIH150150	KKIH150	SPM1025/SS	SPP100150	SPP100200
250 x 150mm	SP250150	SPIH250150	KKIH150	SPM1025/SS	SPP100150	SPP100200

Pack: 1						
	Steel Post 3000mm	Steel Mounting Plate	HDG Steel Bolts, Nuts and U shaped washers	Cable Tray Covers	Self Tapping Screws	Internal Vertical Elbow 15°
150 x 150mm	SPP100250	SPC100150	SPM1025/HDG	KKDL150	SPAT/SS	SPBI150
250 x 150mm	SPP100250	SPC100250	SPM1025/HDG	KKDL250	SPAT/SS	SPBI250

Pack: 1						
	Cover for Internal Vertical Elbow 15°	External Vertical Elbow 15°	Cover for External Vertical Elbow 15°	Horizontal Elbow 15°	Cover for Horizontal Elbow 15°	HDG Steel cable out fitting with Bolts
150 x 150mm	SPBID150	SPBA150	SPBAD150	SPB150	SPBD150	SPKA100
250 x 150mm	SPBID250	SPBA250	SPBAD250	SPB1250	SPBD250	SPKA100

Technical

GRP (Glass Reinforced Polyester) is chosen for its mechanical strength, lightness, ease of installation and excellent resistance to fire and corrosion.

- GRP is up to 40% lighter than other materials.
- Rapid mounting and interlocking assembly.
- On-site modification without the need for special tools, no burring, no finishing.
- Developed to withstand extreme weather conditions, salt water and most chemicals.
- Very good stability to UV.
- Insulating material, non-conductive, resistant to temperatures from -80 to $+130^{\circ}\text{C}$.
- Excellent fire behaviour and self-extinguishing, GRP does not conduct heat and has zero halogen in the case of fire.
- Resistant to corrosion and contributes to low maintenance costs.

GRP MATERIAL DATA (POLYESTER)

Flammability to	UL94 94V-0
Flammability to low wire	960°C
Spread of flame	BS 476PT7 Class 2
Fire Propagation	BS 476PT6 18.3
Oxygen index	>35%
Mechanical Impact	IE10
Density	1.75-1.90g/cm ²
Water absorption	0.1%h<0.4%
Working temperature	-30°C to +80°C
Colour (standard)	RAL7032
Co-efficient of linear expansion	
Pressed	$36 \times 10^{-6}/\text{m}^{\circ}\text{C}$
Pultruded	$8.0 \times 10^{-6}/\text{m}^{\circ}\text{C}$

CUTTING/FABRICATION ON SITE

GRP can be cut and drilled with standard hand or power tools. The absence of sharp edges after fabrication makes these products safe for both cables and the installation personnel.

When cutting by hand it is recommended that a tungsten carbide tipped heavy duty type cross-cut saw be used.

Power disc cutting equipment will easily and effortlessly make this task quicker. Care and attention to compliance of Health and Safety at Work must be observed. Cutting by power tools should be done in an open air environment.

PRESSED TRUNKING/TRAY

The hot press moulded technique based on composite materials permits the forming of both 3000mm base/lids and a large range of fittings with various bend radius controls.

INSTALLATION

All bases come with built-in self-adjusting interlocking coupler, no fasteners required and they position themselves automatically in an optimal way in order to give an expansion joint for thermal movement.

The base should be supported at centres of 1500mm apart. Supports should be positioned at not more than 300mm from the start or finish of a run.

Place the projecting lip of the next base into previous base maintaining joint for expansion.

To position couplings without screwing junctions.

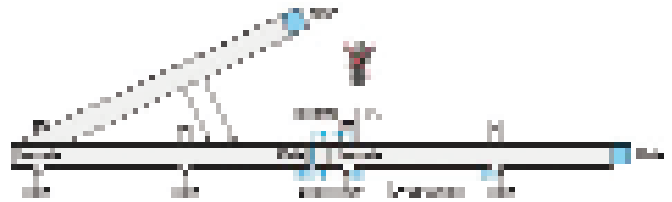

Every junction fitting should have an accompanying support within 200mm.

All bases and fittings must be fixed laterally with 4mm clearance holes on each side of the support.

COVERS

These should overlap the base joint by at least 300mm to ensure maximum strength and secured to the base by means of four clips, two required at 50 – 100mm from each end.

LOADING CHARACTERISTICS

Deflection <5mm (1/300).

Coefficient of safety > 1.7 (in accordance with IEC 61537) using the interlocking and self adjustable coupling without fasteners.

Loading diagram details in accordance with IEC 61537, at an ambient temperature of 25°C

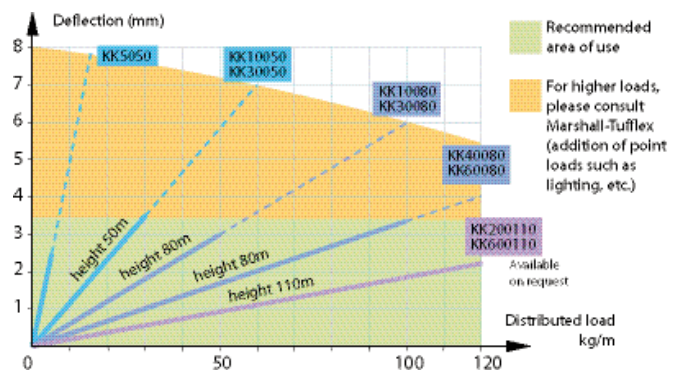
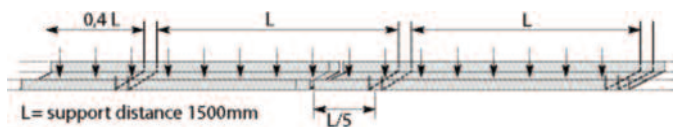

GRP CABLE LADDERS PULTRUDED

RESIN TYPES (ALL ZERO HALOGEN)

Polyester (standard)	good all round performance, mechanical strength, corrosion resistance, fire behaviour, temperature rating
Acrylic (on request)	excellent resistance to fire in a corrosive environment
Vymilester (on request)	highly resistant to a specific range of chemical agents (H2S04HC1...)
Carbon loaded polyester (on request)	anitistatic properties for highly explosive atmospheres

Alternatively for specific projects we will define a solution to meet your needs.

INSTALLATION

- 1 Place the end of the ladder about L/5 away from the supporting bracket.

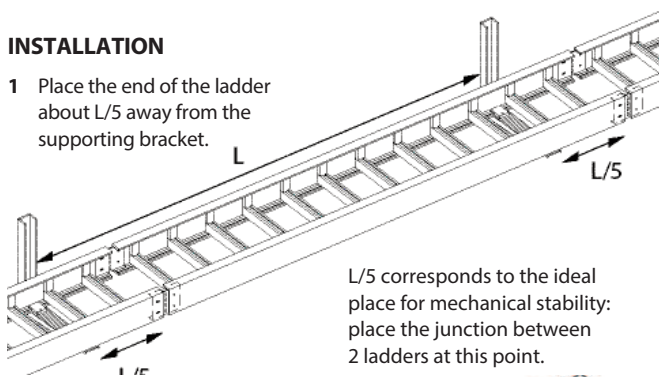

L/5 corresponds to the ideal place for mechanical stability: place the junction between 2 ladders at this point.

- 2 Connect the ladders together.

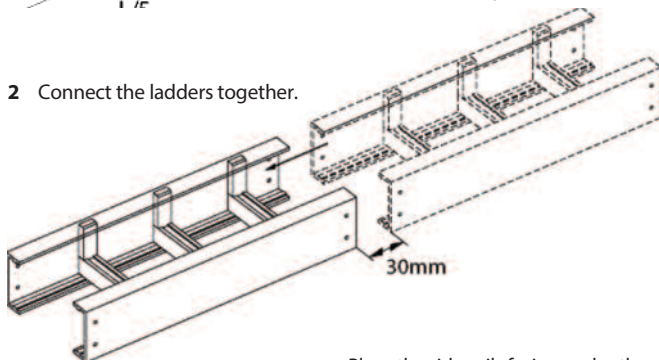

Place the side-rails facing each other.

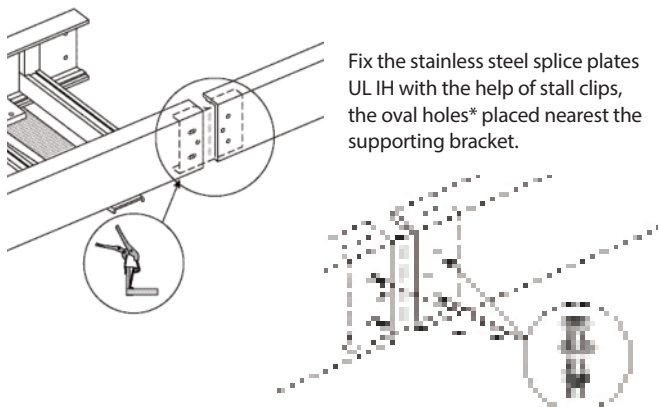

Fix the stainless steel splice plates UL IH with the help of stall clips, the oval holes* placed nearest the supporting bracket.

Lock the junction with 4 x M620/V4AS bolts.

(*) The splice plates UL IH are pre-punched with 2 holes Ø 8mm and 2 oval holes 20 x 8mm in order to assure a solid fixing and to allow the expansion of the GRP material.

- 3 Fix the ladder at each support with 2 hold-down clamps UL KS and 2 M1030/V4A bolts.

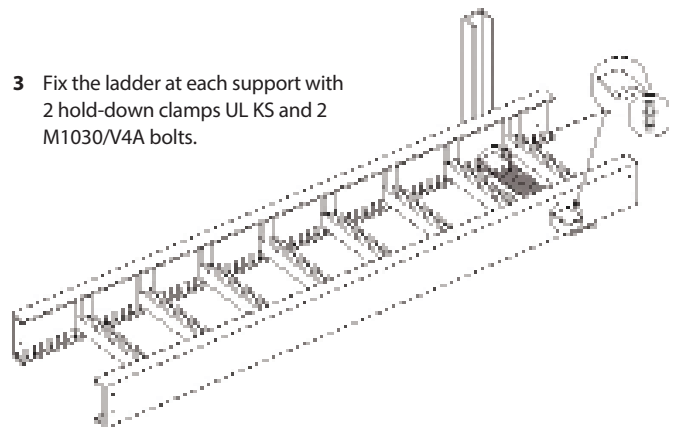

- 4 Follow the installation procedure.

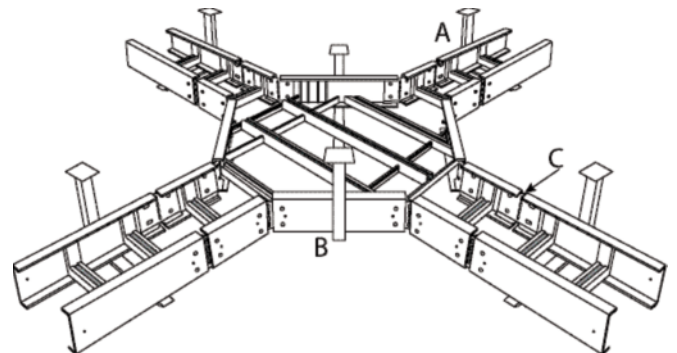

- A All fittings must be supported at every cable entry.
- B Add a central support for all fittings with radius greater than 250mm and/or with width greater than 400mm.
- C Lock systematically each splice plate UL IH with 4 M620/V4AS bolts on fittings extremities.

- 5 Fix the cover with clips made of stainless steel 316 (ref.DF50, DF80, DF100 and DF150).

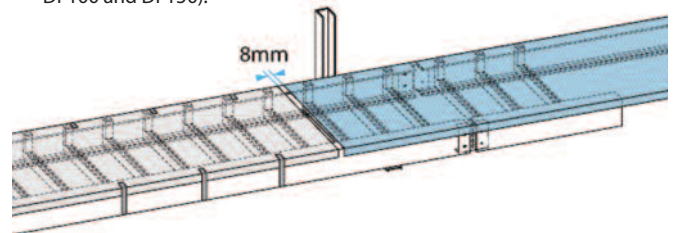

Under normal conditions use 3 clips alternatively on each side per 3 metres of ladders.

Under extreme conditions (strong winds > 60km/h) use 7 clips per 3 metres of ladders.

LOAD CHARACTERISTICS

Coefficient of safety > 1.7 (in accordance with IEC 61537) this data is given for ladders coupled with splice plates and bolts.

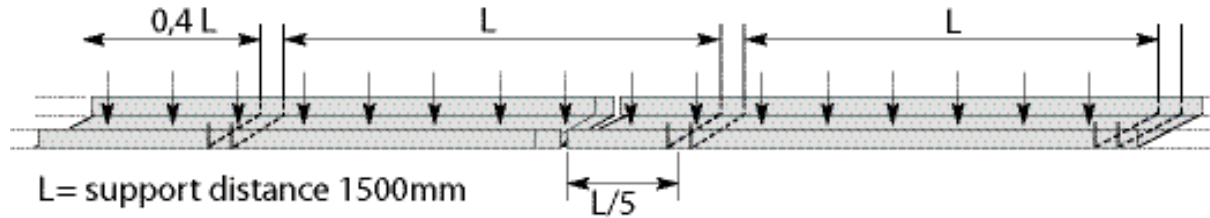

The deflection values are measured with the position of the junction between 2 ladders at a distance $L/5$ from a support. If this distance is not respected, it is necessary to raise the deflection values by about 30% when fully loaded.

	Useful area (mm ²)	Weight of cables kg/m	Maximum admissible load kg/m according to the distance between supports				
			2m	3m	4m	5m	6m
UL...53	150-300	4420-9520 = 250	160	50			
	400-600	12920-19720 = 550		50			
UL...80	150-300	7600-16800 = 450	160	160	60	30	
	400-600	22940-35140 = 1000			60	30	

Optimal conditions, for cost reduction on your installation.

Series UL load diagram: supporting distances from 2 to 5m. For 100mm and 150mm wall height refer to Marshall-Tufflex.

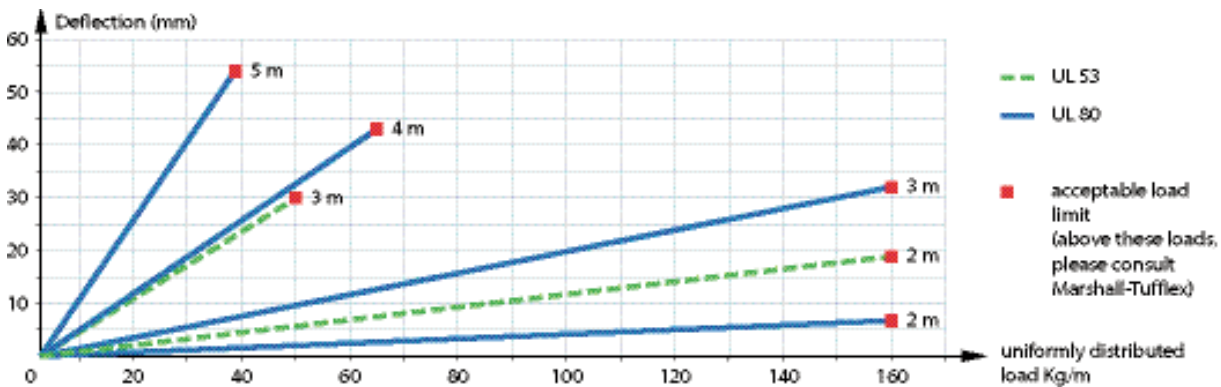

LOCALISED LOADS

To be able to compare this to a uniformly distributed load it is necessary to double the value of the localised load. Example: A 60kg local load at the centre of a ladder with 3m of support distance. Equivalent load: $60 \times 2 = 120\text{kg}$ uniformly distributed along 3m (ie 40kg/m).

GRP Ground Ducts

LOAD CHARACTERISTICS OF GROUND DUCT

BK Height 140 mm

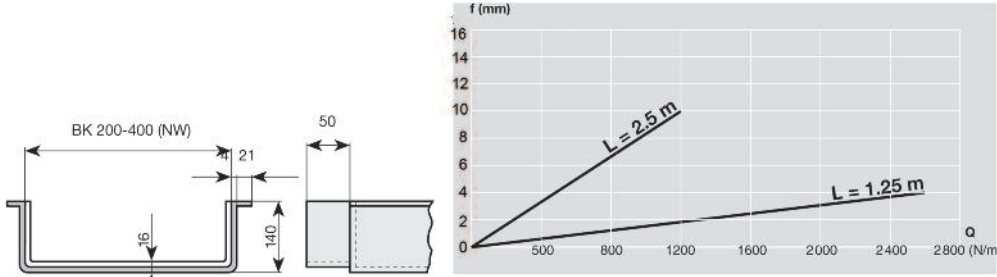

BK Height 176 mm

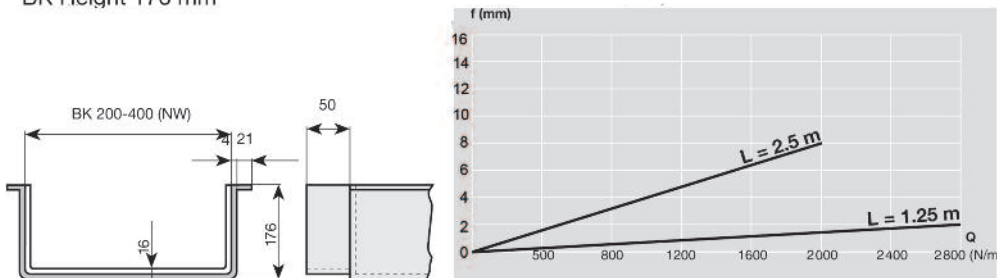

Tested in normal conditions of use

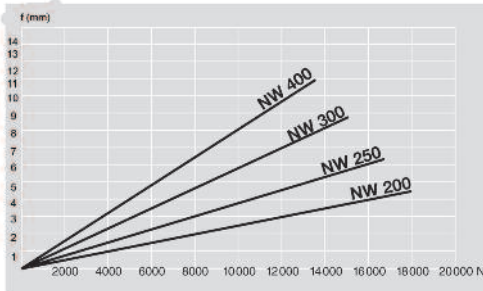
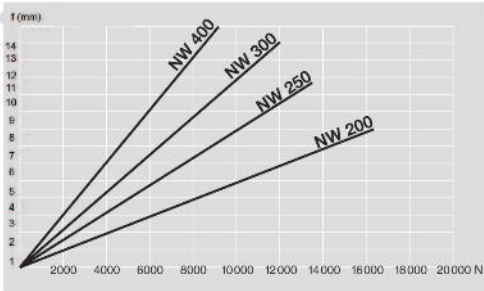
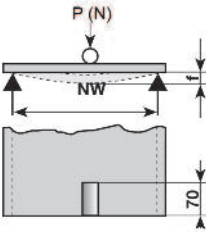
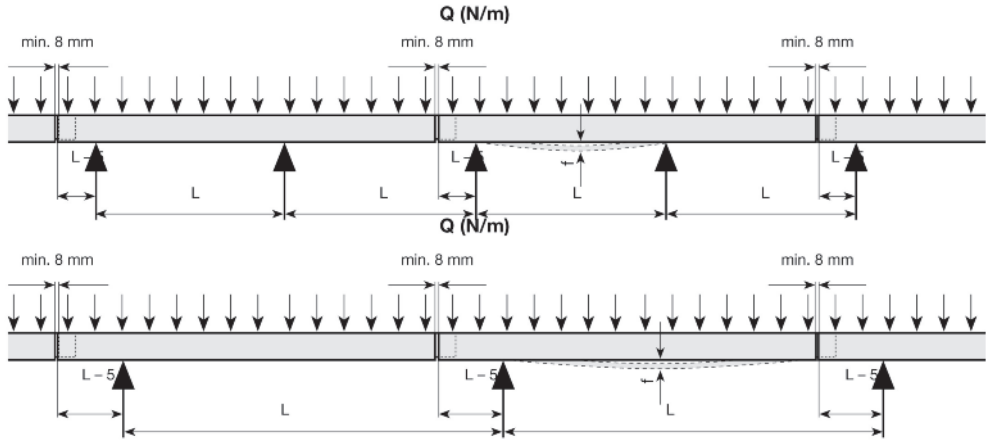

Marshall-Tufflex
Churchfields Industrial Estate
Hastings East Sussex
TN38 9PU, UK

T +44 (0)1424 856600

F +44 (0)1424 856611

E sales@marshall-tufflex.com

Technical Hotline: +44 (0)1424 856688

www.marshall-tufflex.com

**Republic of Ireland &
Northern Ireland distributor**

Core Electrical Ltd
17b Goldenbridge Industrial Estate
Tyrconnell Road, Inchicore
Dublin 8

T +353 (0)1453 7033

F +353 (0)1453 8911



In pursuance of our policy of continued improvement
Marshall-Tufflex reserves the right to change the design
or specification of its products without notification.

EL161/15014