

EZ-Path® : CM350704

Plate kit for rigid floors

Technical Data

Floor thickness	≥ 150 mm
Ø cable	OD ≤ Ø 21 mm
Cable loading	0% to 100%
Opening size	page 2/2
Performance	EI 120
Fire resistance	EN 1366-3 / EN 13501-2
Certification 	ETA - 18/0412

Max 16.6 mm Ø PVC tubes can be installed in EZ-Path® in association with cables. Please contact the local representative for more information

Not at scale. Units in millimeters

Please refer to the **CM350704** (EZP544MBE) Installation Sheet

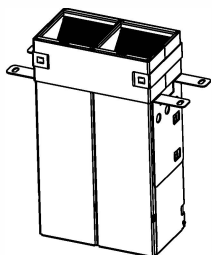
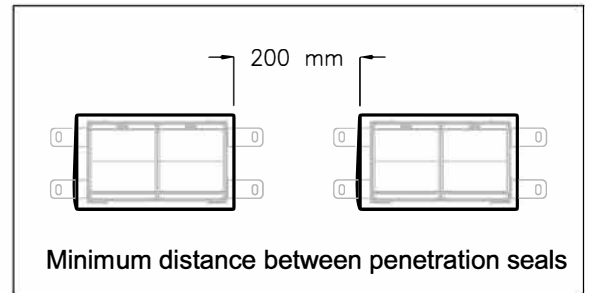
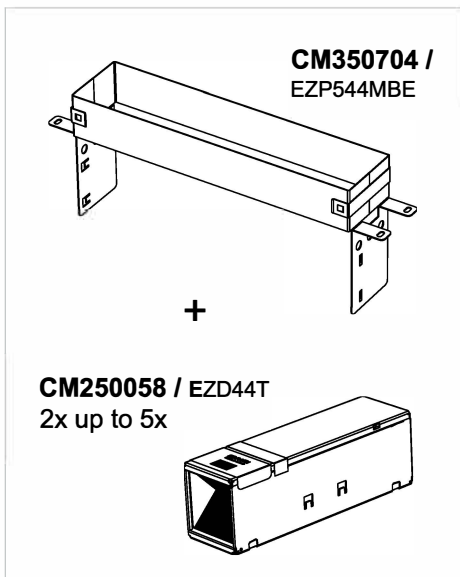
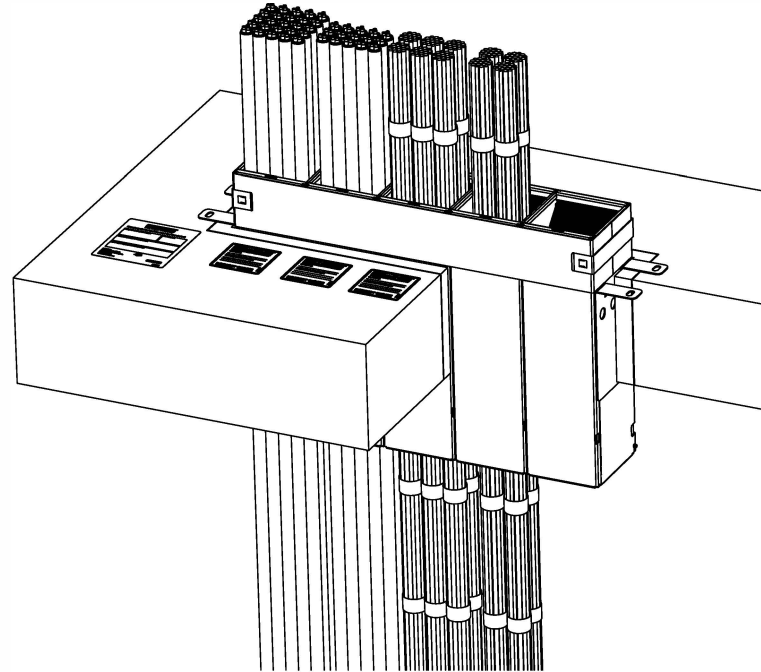

CM350704
+ 2x CM250058

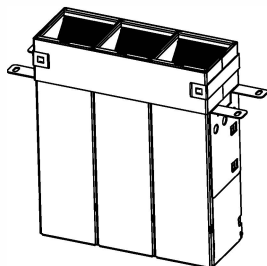

CM350704
+ 3x CM250058

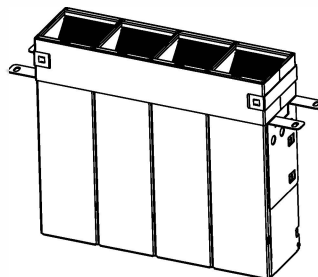

CM350704
+ 4x CM250058

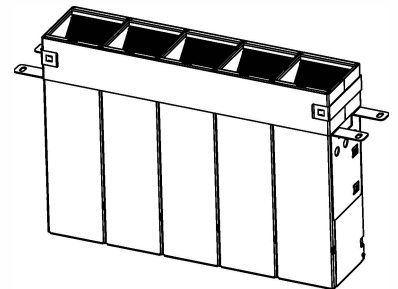

CM350704
+ 5x CM250058

