

electrium



VOLEX
ACCESSORIES



electrium

LAKESIDE
POINT

AS
1000

Electrium Sales Ltd. is a Siemens company,
Volex Accessories is part of Electrium Sales Ltd.

Contents

casa white moulded	2
volex white moulded	8
stainless steel decorative	20
polished steel decorative	24
black nickel decorative	28
stainless steel flat plate	32
polished steel flat plate	36
black nickel flat plate	40
appleby installation boxes	44
metalclad	46
residential safety alarms	50
door chimes	51
technical	52



Certificate Number 18828
ISO 9001, ISO 14001, ISO 45001



2013-RTL-L4-75
2013-RTL-L4-36



Testing Laboratory No. 1460
Testing Laboratory No. 2003

As a leading manufacturer of wiring accessory products, Volex Accessories is committed to the continual improvement of all quality assurance procedures and performance.

Volex Accessories

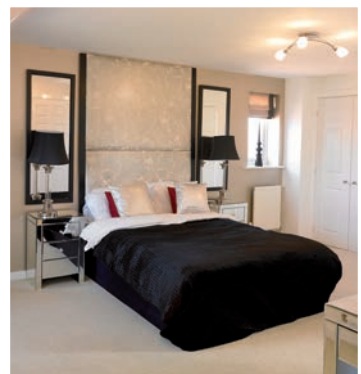
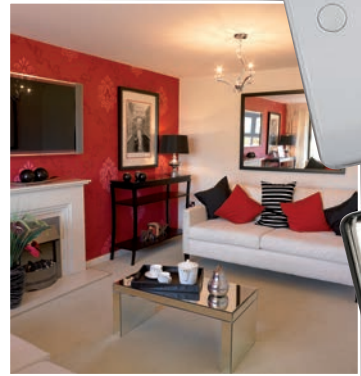



A wide range with choice of Decorative, Metal Plate, Flat Plate and White Moulded Wiring Accessories suitable for any residential application Volex Accessories offer the end user or specifier a premium finish to any property.

Volex Accessories is your complete electrical installation solution for residential new build and refurbishment.



Switch and data modules clip-in with no yoke required.



Positive switch action.



Sleek attractive profile with concealed fixing screws.

The Casa range is the ideal solution for the modern domestic installation. The range offers a contemporary sleek aesthetic, concealed fixing screws and a compact concave rocker design synonymous with the new wave of wiring accessories whilst retaining the core values of the Volex Accessories brand.

All products are manufactured and tested to the latest British Standards, are RoHS compliant and in line terminals on the sockets facilitate speed of installation.

With a clip-in grid and data range and local product marking available, this range is perfect for any residential application.



D1500NR

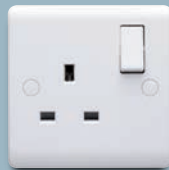

D1300NR



D1080NR



D1080FNR



D1500/DNR

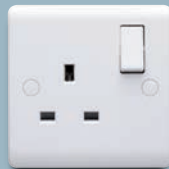

D1300/DNR



D1081NR



D1081FNR



D1500USBNR

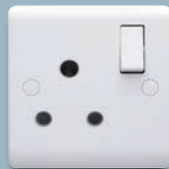

D9900NR



D1090NR



D1090FNR



D9990NR

13A Socket Outlets

LIST NO	DESCRIPTION
D1500NR	2 Gang 13A Switched Socket
D1300NR	1 Gang 13A Switched Socket
D1500/DNR	2 Gang 13A DP Switched Socket
D1500USBNR	2 Gang 13A Switched Socket complete with 2x USB ports 2A, 5V
D1300/DNR	1 Gang 13A DP Switched Socket
D9100NR	1 Gang 13A Unswitched Socket

15A Socket Outlet

LIST NO	DESCRIPTION
D9900NR	1 Gang 15A Switched Socket

3 x 2.5mm² or 2 x 4mm² terminal capacity

Product marking service available

2 Gang 145mm x 86mm
1 Gang 86mm x 86mm

Product Standard

BS 1363-2

Installation Boxes

SB655	1 Gang Flush Box 25mm	D9409NR	1 Gang 29mm Pattress
SB665	2 Gang Flush Box 25mm	D9414NR	2 Gang 29mm Pattress
SB619	1 Gang Dry Liner 35mm		
SB629	2 Gang Dry Liner 35mm		

Fused Connection Units

LIST NO	DESCRIPTION
D1080NR	13A FCU DP Switched
D1080NR—	13A FCU DP Switched Custom Printed
D1080FNR	13A FCU DP Switched Flex Outlet
D1081NR	13A FCU DP Switched Neon
D1081NR—	13A FCU DP Switched Neon Custom Printed
D1081FNR	13A FCU DP Switched Neon Flex Outlet
D1090NR	13A FCU Unswitched
D1090FNR	13A FCU Unswitched Flex Outlet
D9990NR	25A Flex Outlet Plate 3 Terminals

3 x 2.5mm² or 2 x 4mm² terminal capacity

Product marking service available

86mm x 86mm

Product Standard

FCU BS 1363-4
Flex Outlet Plate BS 5733

Installation Boxes

SB655	1 Gang Flush Box 25mm
SB619	1 Gang Dry Liner 35mm
D9409DR	1 Gang 29mm Pattress



D1070NR



D1060NR



D1060FNR



D9713NR



D9702NR



D9712NR



D9701NR



D9700NR



D9704NR

Double Pole Switch Units 20A

LIST NO	DESCRIPTION
D1070NR	20A DP Switch
D1070NR—	20A DP Switch Custom Printed
D1060NR	20A DP Switch Neon
D1060FNR	20A DP Switch Neon Flex Outlet

3 x 2.5mm², 2 x 4mm², 1 x 6mm² or 1 x 10mm² terminal capacity

Product marking service available

86mm x 86mm

Product Standard

BS EN 60669-1

Installation Boxes

SB655 1 Gang Flush Box 25mm
SB619 1 Gang Dry Liner 35mm

D9409NR 1 Gang 29mm Pattress

Double Pole Switch & Cooker Control Units 45A

LIST NO	DESCRIPTION
D9713NR	45A DP Switch
D9712NR	45A DP Switch & Neon
D9703NR	45A DP Switch 2 Gang Vertical
D9702NR	45A DP Switch Neon 2 Gang Vertical
D9701NR	45A DP Cooker Control Unit with DP 13A socket
D9700NR	45A DP Cooker Control Unit with DP 13A socket with neon
D9704NR	Cooker Outlet Plate

1 x 16mm², 1 x 10mm² or 2 x 6mm² terminal capacity
Cooker control units - 2 earth terminals

Product marking service available

1 Gang 86mm x 86mm
2 Gang 145mm x 86mm

Product Standard

45A Switches BS EN 60669-1
Cooker Control Units BS 4177, BS 1363-2
Cooker Outlet Plates BS 5733

Installation Boxes

SB618 1 Gang Flush Box 47mm
SB628 2 Gang Flush Box 47mm
SB632 1 Gang Dry Liner 47mm

SB631 2 Gang Dry Liner 47mm
VX9405 1 Gang 42mm Pattress
VX9410 2 Gang 42mm Pattress



D1010NR



D1020NR



DG3571NR



DG3572NR



D1040NR



D1050NR



D1000NR

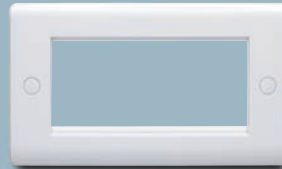

DG3574NR



DG3576NR



D1054NR



D1013NR



DG3450NR



DG3460NR



DG3460NNR



DG3436NR



DG6081NR



DG6080NR

10AX Plate Switches

LIST NO	DESCRIPTION
D1010NR	1 Gang 1 Way 10AX Switch SP
D1030NR	1 Gang 10AX Intermediate Switch
D1020NR	1 Gang 2 Way 10AX Switch SP
D1040NR	2 Gang 2 Way 10AX Switch SP
D1041NR	2 Gang 1 Way 10AX Switch SP
D1050NR	3 Gang 2 Way 10AX Switch SP
D1051NR	3 Gang 1 Way 10AX Switch SP
D1054NR	4 Gang 2 Way 10AX Switch SP
D1000NR	1 Gang Retractive 10A Switch SP
D1013NR	6A 3 Pole Fan Isolator

4 x 1mm², 3 x 1.5mm² or 2 x 2.5mm² terminal capacity

Product marking service available

1/2/3 Gang 86mm x 86mm
4 Gang 145mm x 86mm

Product Standard

BS EN 60669-1
Fan Isolator BS EN 60947-3

Installation Boxes

SB623	1 Gang Flush Box 16mm	SB629	2 Gang Dry Liner 35mm
SB655	1 Gang Flush Box 25mm	D9409NR	1 Gang 29mm Pattress
SB665	2 Gang Flush Box 25mm	D9414NR	2 Gang 29mm Pattress
SB619	1 Gang Dry Liner 35mm		

Grid Switch Assemblies

LIST NO	DESCRIPTION
DG3450NR	20AX 1 Way SP Grid Switch
DG3550NR	20AX 2 Way SP Grid Switch
DG3535NR	10AX Intermediate Grid Switch
DG3460NR	20A DP Grid Switch
DG3460NNR	20A DP Grid Switch & Neon
DG3436NR	13A Fuse Grid Unit
DG6082NR	2 Module Blank Piece
DG6081NR	1 Module Blank Piece
DG6080NR	1/2 Module Blank Piece
DG3571NR	1 Module Grid Plate
DG3572NR	2 Module Grid Plate
DG3573NR	3 Module Grid Plate
DG3574NR	4 Module Grid Plate
DG3576NR	6 Module Grid Plate
DG3578NR	8 Module Grid Plate

Product marking service available

1-3 Gang - 1 earth terminal, 4 Gang - 2 earth terminals, 6-8 Gang - 4 earth terminals
1-2 Gang 86mm x 86mm, 3-4 Gang 145mm x 86mm

Product Standard

10/20A Switches BS EN 60669-1
Blanks/Fuse Unit BS 5733

Grid Plates BS 5733

Installation Boxes

SB623	1 Gang Flush Box 16mm	SB629	2 Gang Dry Liner 35mm
SB655	1 Gang Flush Box 25mm	D9409NR	1 Gang 29mm Pattress
SB665	2 Gang Flush Box 25mm	D9414NR	2 Gang 29mm Pattress
SB619	1 Gang Dry Liner 35mm	VG3206SG	6/8 Gang



D1400PUNR



D1402PUNR



D1400LEDPUNR



D1402LEDPUNR

Dimmer Switches

LIST NO	DESCRIPTION
D1400PUNR	400W Push 1 G Dimmer
D1402PUNR	400W Push 2 G Dimmer
D1400LEDPUNR	1 G LED Dimmer 5-100W
D1402LEDPUNR	2 G LED Dimmer 5-100W

86mm x 86mm

Product Standard

BS EN 60669-2-1, BS EN 55014

Installation Boxes

SB655 | 1 Gang Flush Box 25mm
SB619 | 1 Gang Dry Liner 35mm

D9409DR | 1 Gang 29mm Pattress



D9001NR



D9706NR



D6677NR



D9215HONR



D0218HONR

Ceiling Switches & Lighting Accessories

LIST NO	DESCRIPTION
D9001NR	1 Way 6AX Ceiling Switch
D9002NR	2 Way 6AX Ceiling Switch
D9706NR	45A DP Ceiling Switch with Flag & Neon
D6677NR	6 inch Pendant Set
D6678NR	9 inch Pendant Set
D9215HONR	Straight Batten Lampholder
D0218HONR	Angle Batten Lampholder

Product Standard

Pendants/Battens BS EN 61184
Ceiling Switches BS EN 60669-1

Installation Boxes

SB639 | Circular Dry Liner 35mm

VX9405 | 1 Gang 42mm Pattress



D9800NR



D9409NR



D9414NR



D9974NR



D9984NR



D9991NR

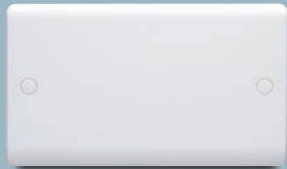

D9996NR



D9992NR



D9997NR

Shaver Socket

LIST NO	DESCRIPTION
D9800NR	20VA Dual Volt Shaver Socket

86mm x 145mm

Pattresses

LIST NO	DESCRIPTION
D9409NR	1 Gang 29mm Pattress
D9414NR	2 Gang 29mm Pattress

Blank Plates

LIST NO	DESCRIPTION
D9996NR	2 Gang Blank Plate
D9991NR	1 Gang Blank Plate

2 Gang - 145mm x 86mm
1 Gang - 86mm x 86mm

Accessories

LIST NO	DESCRIPTION
DSCCNR	Screw Cap Covers x20

Product Standard

Shaver Socket BS EN 61558-2-5
Pattress BS 5733
Blank Plate BS EN 60670-1

Telephone & TV Outlets

LIST NO	DESCRIPTION
D9974NR	BT Master Outlet
D9984NR	BT Secondary Outlet
D9992NR	Co-Axial Outlet
D9997NR	F-Type Satellite Outlet

86mm x 86mm

Product Standard

Co-Axial Outlet BS 3041-7
Others - manufacturers declaration

Installation Boxes

SB628 2 Gang Flush Box 47mm
SB631 2 Gang Dry Liner 47mm

VX9410 2 Gang 42mm Pattress

Installation Boxes

SB655 1 Gang Flush Box 25mm
SB619 1 Gang Dry Liner 35mm

D9409DR 1 Gang 29mm Pattress



D9062NR

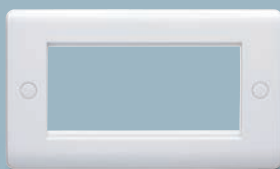

D9064NR



D9980NR



D9981NR



D9978NR



VX9983



D9989NR



DG6081NR



DG6080NR



VX9985

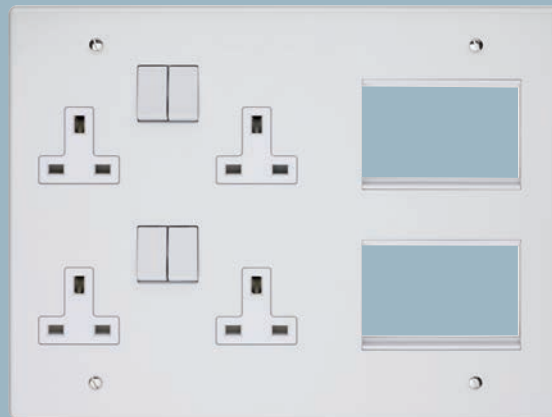

VX1590WH

Data Modules & Plates

LIST NO	DESCRIPTION
D9980NR	1 module Telephone Master Module
D9981NR	1 module Telephone Secondary Module
D9978NR	1 module Co-Axial TV Module
D9979NR	1 module Single non screened TV outlet
D9989NR	1 module Satellite Outlet Module
D9973NR	3 module Multimode (1xTV, 1xFM, 2xSky plus 1xFM Return)
D9969NR	2 module Quadplexer (1xTV, 1xFM, 2xSky)
D9976NR	1 module RJ11/12
D9975NR	1 Module RJ45 Outlet - Category 6
D9988NR	1 module RJ45 Outlet - Category 5e
D9064NR	4 Module Moulded Plate
D9062NR	2 Module Moulded Plate
DG6082NR	2 Module Blank Piece
DG6081NR	1 Module Blank Piece
DG6080NR	1/2 Module Blank Piece
VX9983	1 Module 2A 5V USB Outlet
VX9985	2 Module 2x 1A 5V USB Outlet

Product Standard

Plates/Blanks BS 5733
Co-Axial Outlet BS 3041-7
Others - manufacturers declaration

Installation Boxes

SB655	1 Gang Flush Box 25mm	SB629	2 Gang Dry Liner 35mm
SB665	2 Gang Flush Box 25mm	D9409NR	1 Gang 29mm Pattress
SB619	1 Gang Dry Liner 35mm	D9414NR	2 Gang 29mm Pattress

Lounge Plate

LIST NO	DESCRIPTION
VX1590WH	Lounge Plate White

3 x 2.5mm² or 2 x 4mm² terminal capacity

267mm x 207mm

Please refer to page 4 and page 7 of this catalogue and the main Volex Accessories catalogue for details of compatible modules

Product Standard

BS 1363-2

Installation Boxes

SB695	Lounge Plate Flush Box 35mm
SB1590	Lounge Plate Flush Box 56mm

The Volex Accessories white moulded range of wiring accessories is designed & tested in the UK by Volex R&D and test engineers to ensure that specifiers, installers and end users benefit from the quality standards that are paramount within Volex designs.

All products are designed, manufactured and tested to fully comply with the relevant product standards.

This comprehensive range includes a wide range of lighting and power controls to suit any domestic and many light commercial installations.



VX1300

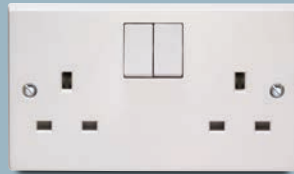

VX1500



VX1300/D



VX1500USB/D



VX9100



VX9200



VT1108



VT1208



VX9900



VX9901



VX1906

13A Socket Outlets

LIST NO	DESCRIPTION
VX1300	1 gang SP switched socket
VX1300/D	1 gang DP switched socket
VX1400	1 gang SP switched socket with neon
VX1500	2 gang SP switched socket
VX1500/D	2 gang DP switched socket
VX1500USB/D	2 gang DP switched socket with USB
VX1600	2 gang SP switched socket with neon
VX1700	2 gang DP switched socket with outboard rockers
VX1800	2 gang DP switched socket with outboard rockers & neon
VX9100	1 gang unswitched socket
VX9200	2 gang unswitched socket
VX9230	3 gang unswitched socket, fused 13A
VT1507	1-2 gang conversion socket

• 2 gang DP comes with twin earth as standard

Terminals suitable for up to 3 x 2.5mm² or 2 x 4mm² conductors

1 Gang 85mm x 85mm
2 Gang 145mm x 85mm
3 Gang 205mm x 85mm

Product Standard

Socket Outlets BS 1363

Installation Boxes

VX9409	Surface Moulded 1 gang	SB665	Flush Metal 2 gang
VX9414	Surface Moulded 2 gang	SB646	Flush Metal 3 gang
VX9403	Surface Moulded 3 gang	SB619	Flush dry lining 1 gang
SB655	Flush Metal 1 gang	SB629	Flush dry lining 2 gang

13A 30mA RCD Protected Sockets & FCU

LIST NO	DESCRIPTION
VT1108	1 gang switched RCD protected socket outlet
VT1208	2 gang switched RCD protected socket outlet
VT1092	RCD Fused Connection Unit

• Double pole switching

Round Pin Socket Outlet

LIST NO	DESCRIPTION
VX9900	15A switched socket
VX9901	2A 3 pin socket
VX1904	16A 2 pin socket (for export only)
VX1906	16A 2 pin switched socket (for export only)
VX1907	16A 2 pin twin switched socket (for export only)

Terminals suitable for up to 3 x 2.5mm² or 2 x 4mm² conductors

1 Gang 85mm x 85mm
2 Gang 145mm x 85mm
3 Gang 205mm x 85mm

Product Standard

RCD Protected Socket Outlet BS 7288

Round Pin Socket Outlet BS 546 (VX9900, VX9901), BS 5733

Installation Boxes

SB629	Flush dry lining 2 gang	VX9405	Surface Moulded 1 gang
RCD Sockets & Connection Unit		VX9417	Surface Moulded 2 gang
		SB615	Flush Metal 1 gang
		SB625	Flush Metal 2 gang



VX1080



VX1081



VX1090



VX1091



VX1070



VX1060



VX9990

Fused Connection Units with Optional Flex Outlet

LIST NO	DESCRIPTION
VX1080	13A DP switched
VX1081	13A DP switched with neon
VX1090	13A Unswitched
VX1091	13A Unswitched with neon
VX1080	3A DP switched

- Terminals suitable for up to 3 x 2.5mm² or 2 x 4mm² conductors
- Fitted with knockout position at bottom edge of plate
- Cord outlet suitable for flexible cord up to 10mm² diameter
- Marking to customer specification also available

1 Gang 85mm x 85mm

Product Standard

Fused Connection Units BS 1363

Installation Boxes

VX9409 Surface Moulded
SB655 Flush Metal
Three Pole Control Switch

VX9404 Surface Moulded
SB623 Flush Metal

20A DP Control Switches with Optional Flex Outlet

LIST NO	DESCRIPTION
VX1070	DP switch
VX1070WH	DP switch marked 'Water Heater'
VX1060	DP switch with neon
VX1060WH	DP switch with neon marked 'Water Heater'

- Terminals suitable for 3 x 2.5mm² or 2 x 4mm² conductors
- Fitted with knockout position at bottom edge of plate
- Cord outlet suitable for flexible cord up to 10mm²
- Markings to customer specification available

13A Flex Outlet Plate

LIST NO	DESCRIPTION
VX9990	Flex outlet plate with pillar type terminals

Product Standard

Control Switches BS EN 60669-1

Installation Boxes

VX9409 Surface Moulded
SB655 Flush Metal



volex white moulded



VX9712



VX9700



VX1020



VX1040



VX1050



VX9713



VX9701



VX1051



VX1054



VX9704



VX9702



VX4020



VX4000

45A Double Pole Control Switch

LIST NO	DESCRIPTION
VX9712	45A DP switch with neon
VX9713	45A DP switch
VX9702	45A DP switch with neon (large plate)
VX9703	45A DP switch (large plate)

45A Cooker Control Units

LIST NO	DESCRIPTION
VX9700	45A CCU with 13A switched socket & neon
VX9701	45A CCU with 13A switched socket

- Terminals suitable for up to 1 x 16mm² cable
- Double pole switching on both 45A & 13A circuits
- Markings to customer specification available

Cooker Outlet Plate

LIST NO	DESCRIPTION
VX9704	Cooker outlet plate with pillar terminals

- 1 gang 85mm x 85mm
- 2 gang & Cooker Control Units 85mm x 145mm

Product Standard

45A Switches BS EN 60669-1
Cooker Control Units BS 4177, BS 1363
Cooker Outlet Plates BS 5733

Installation Boxes

Cooker Outlet Plate		
SB615	1 Gang Flush 35mm	SB628 2 Gang Flush 47mm
Cooker Control Switch		VX9405 1 Gang Surface 42mm
SB618	1 Gang Flush 47mm	VX9416 2 Gang Surface 35mm

10AX Wall Switches

LIST NO	DESCRIPTION
VX1010	1 gang 1 way switch
VX1013	6A 3 Pole Fan Isolator - Marked Isolator & Fan Symbol
VX1020	1 gang 2 way switch
VX1030	1 gang intermediate switch
VX1040	2 gang 2 way switch
VX1041	2 gang 1 way switch
VX1050	3 gang 2 way switch
VX1051	3 gang 1 way switch
VX1054	4 gang 2 way switch
VX1055	4 gang 1 way switch

- Terminals suitable for 4 x 1.0mm², 3 x 1.5mm² or 1 x 2.5mm² conductors

10AX Wide Rocker Switches

LIST NO	DESCRIPTION
VX4020	1 gang 2 way switch
VX4030	1 gang Intermediate switch
VX4040	2 gang 2 way switch
VX4000	Retractive switch

- 1-3 Gang 85mm x 85mm, 4 Gang 145mm x 85mm

Product Standard

BS EN 60669-1

Installation Boxes

VX9404	Surface Moulded 1-3 gang	VX9401	Surface Moulded 1 gang
VX9412	Surface Moulded 4 gang	VX9402	Surface Moulded 2 gang
SB623	Flush Metal 1-3 gang	9257	Flush Metal 1 gang
SB665	Flush Metal 4 gang	9258	Flush Metal 2 gang



VX2060

VX2062



VX1000

VX1000/LP

VX1000/P



VX9001

VX9706

6A Architrave Switches

LIST NO	DESCRIPTION
VX2060	1 gang 1 way switch
VX2061	1 gang 2 way switch
VX2062	2 gang 2 way switch

10A Retractive Switches

LIST NO	DESCRIPTION
VX1000	1 gang bell push with bell symbol
VX1000/LP	1 gang printed Light
VX1000/P	1 gang printed Press

- Terminals suitable for 4 x 1.0mm², 3 x 1.5mm² or 1 x 2.5mm² conductors
- Can be wired for normally open (N/O) or normally closed (N/C) circuits

1 Gang 85mm x 85mm
 Architrave 1 Gang 32mm x 86mm,
 Architrave 2 Gang 32mm x 146mm

Product Standard

BS EN 60669-1

Installation Boxes

VX9404	Surface Moulded 1-3 gang	Architrave VX9401	Surface Moulded 1 gang
VX9412	Surface Moulded 4 gang	VX9402	Surface Moulded 2 gang
SB623	Flush Metal 1-3 gang	9257	Flush Metal 1 gang
SB665	Flush Metal 4 gang	9258	Flush Metal 2 gang

6AX Ceiling Switch

LIST NO	DESCRIPTION
VX9001	1 way ceiling switch
VX9002	2 way ceiling switch
VX9009	Cord & acorn for ceiling switches

- Supplied with pull cord
- 50.8mm fixing centres

50A Double Pole Ceiling Switch

LIST NO	DESCRIPTION
VX9706	50A DP ceiling switch with neon and mechanical 'off' indicator

- Double pole switching
- 60.3mm fixing centres
- Pillar terminals suitable for all cables up to 10mm²
- For ease of wiring, 2 earth terminals are fitted

Product Standard

Ceiling Switches BS EN 60669-1

Installation Boxes

50A DP Ceiling Switch
VX9405 Surface Moulded



VX0250PU



VX0402PU



VX0100PULED



VX0102PULED

250W Dimmer Switches

LIST NO	DESCRIPTION
VX0250PU	1 gang dimmer mains only
VX0250LV	1 gang dimmer mains/low voltage
VX0252LV	2 gang dimmer mains/low voltage

• Dimmers can be used 1 or 2 way

400W Dimmer Switches

LIST NO	DESCRIPTION
VX0400PU	1 gang dimmer mains only
VX0402PU	2 gang dimmer mains only
VX0400LV	1 gang dimmer mains/low voltage
VX0402LV	2 gang dimmer mains/low voltage

• Dimmers can be used 1 or 2 way

5-100W LED Dimmers

LIST NO	DESCRIPTION
VX0100PULED	1 gang LED dimmer
VX0102PULED	2 gang LED dimmer

Dimmer Switches 86mm x 86mm with 18.5mm plate depth

Product Standard

BS EN 60669-1
BS EN 55014

Installation Boxes

VX9409	Surface Moulded
SB655	Flush Metal



VX6677



VX6678



VX6681



VX6850



VX9215



VX0850

Pendant Sets

LIST NO	DESCRIPTION
VX6677	Pendant fitting (VX9074 & VX1/T2) 6" HR flex, T2 rating
VX6678	Pendant fitting (VX9074 & VX1/T2) 9" HR flex, T2 rating

• Heat resistant, 2 core, 0.75mm² PVC flexible cable

VX6681 Low energy 10-13W and 18W 6" Pendant set with compact Fluorescent Lampholder
• 42mm diameter Lamphshade • Accepts G24 4 pin lamp (not supplied)

VX6850 Safety Pendant 6" cord (VX9074 & VX0850)
• With heat resistant 0.75mm² cord to BS 6141 for service loads up to 2.5kg

Straight Batten Lampholders, with Terminal Block

LIST NO	DESCRIPTION
VX9215	Heat resistant, 3 terminals & earth, short skirt, T2 rating
VX9215HO	Heat resistant, 3 terminals & earth, home office skirt, T2 rating

Safety Lampholders

LIST NO	DESCRIPTION
VX0850	Safety pendant lampholder
VX0851	Safety batten lampholder

Product Standard

Pendant Set Ceiling Rose manufactured to BS67
Pendant Set Lampholders manufactured to BS5042
Straight Batten Lampholder BS EN 61184, T2 Rating
Safety Lampholder BS EN 61184 where applicable, T2 rating



VX0205



VX0205HO



VX1/T2



VX1/T2HO



VX4522



VX9800



VT7066

Straight Batten Lampholders

LIST NO	DESCRIPTION
VX0205	Heat resistant, 3 terminals, short skirt, T2 rating
VX0205HO	Heat resistant, 3 terminals, Home Office skirt, T2 rating

Pendant Lampholders

LIST NO	DESCRIPTION
VX1/T2	Cord grip lampholder, heat resistant, short skirt, T2
VX1/T2HO	Cord grip lampholder, heat resistant, HO skirt, T2
VX4522	1/2" screwed entry DP switched lampholder

Ceiling Roses

LIST NO	DESCRIPTION
VX9074	3 terminals & earth

Ancillary Items

LIST NO	DESCRIPTION
VX0009	Shade ring
VX0010	Short skirt
VX0011	Home Office skirt
VX0018	Break ring

Product Standard

Lampholders BS EN 61184, T2 Rating
Ceiling Rose BS67

Dual Voltage Shaver Unit

LIST NO	DESCRIPTION
VX9800	20VA dual voltage shaver unit

- Terminal suitable for 2 x 2.5mm² conductors

20A Dual Voltage Shaver Light Unit

LIST NO	DESCRIPTION
VT7066	115/230V 20VA dual voltage shaver unit

Shaver Unit 85mm x 145mm
Shaver Light Unit 438mm x 72mm

Product Standard

Flex Outlet Plate BS5733 where applicable Shaver Unit BS EN 61558
Shaver Light Unit BS EN60598 Lounge Plate BS1363

Installation Boxes

Shaver Unit
VX9410 Surface Moulded
SB628 Flush Metal



volex white moulded



VG3430



VG3490



VG3490/I



VG3460



VG3469

10AX Switches - Moulded Rocker

LIST NO	DESCRIPTION
VG3430	10AX 1 way SP
VG3530	10AX 2 way SP
VG3489	10AX Retractive
VG3490	10AX Retractive - bell symbol
VG3490/I	10AX Retractive - fan symbol

20AX Switches - Moulded Rocker

LIST NO	DESCRIPTION
VG3450	1 way SP
VG3451	1 way SP complete with key
VG3460	DP
VG3461	DP complete with key
VG3461ELT	DP complete with key marked 'Emergency light test'
VG3469	DP marked 'ON'
VG3535	Intermediate
VG3550	2 way
VG3551	2 way complete with key
VG3552	2 way and off

• Marking to customer specification also available

Grids 1-2 gang 81mm x 58mm
Grids 3-4 gang 141mm x 58mm

Product Standard
Switches BS EN 60669-1



VG3571



VG3573



VG3570WH



VG3576



VG3574



VG3578SS

Flush White Plates

LIST NO	DESCRIPTION
VG3571	1 gang white moulded
VG3572	2 gang white moulded
VG3573	3 gang white moulded
VG3574	4 gang white moulded
VG3576	6 gang white moulded
VG3578WH	8 gang white metal
VG3570WH	12 gang white metal

Flush Metal Plates

LIST NO	DESCRIPTION
VG3571 __	1 gang
VG3572 __	2 gang
VG3573 __	3 gang
VG3574 __	4 gang
VG3576 __	6 gang
VG3578 __	8 gang
VG3579 __	9 gang
VG3570 __	12 gang

add suffix PS (Polished Steel) SS (Stainless Steel)

Flush Plates
1-2 gang 86mm x 86mm 3-4 gang 146mm x 86mm
6-8 gang 147mm x 147mm 9-12 gang 147mm x 207mm

Surface Plates
1-2 gang 77mm x 77mm 3-4 gang 137mm x 77mm 6-8 gang 137mm x 137mm



VG3901

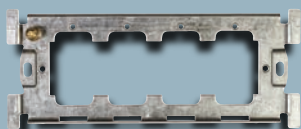

VG3904

Grid Yokes Complete with Earth Terminal

LIST NO	DESCRIPTION
VG3901	1 gang yoke
VG3902	2 gang yoke
VG3903	3 gang yoke
VG3904	4 gang yoke



VG3435



VG3436



VG3491



VG3940

Ancillary Items - Moulded

LIST NO	DESCRIPTION
VG3435	Cord outlet - 10mm diameter aperture, complete with earthing terminal and cable clamp
VG3436	Fuse unit fitted with 13A ASTA certified fuse link
VG3491	Indicator - Red
VG3492	Blanking component
VG3493	Indicator - Green
VG3494	Indicator - Amber
VG3940	Spare key



VX9062



VX9064



VX9969



VX9970



VX9972



VX9973



VX9983



VX9985



VX9976



VX9979



VX9988

Moulded Mounting Plates

LIST NO	DESCRIPTION
VX9062	2 module mounting plate
VX9064	4 module mounting plate

White Data & Communication Modules

LIST NO WHITE	LIST NO BLACK	DESCRIPTION
VX9969	VX9969BK	2 module Quadplexer (1xTV, 1xFM, 2xSky)
VX9970	-	2 module plate 4 binding posts
VX9972	-	1 module plate 2 binding posts
VX9973	-	3 module Multimode (1xTV, 1xFM, 2xSky plus 1xFM Return)
VX9976	VX9976BK	1 module RJ11/12
VX9968	VX9968BK	2 module Co-Axial Outlet Module
VX9978	VX9978BK	1 module Single screened TV outlet
VX9979	VX9979BK	1 module Single non screened TV outlet
VX9980	VX9980BK	1 module Telephone Master
VX9981	VX9981BK	1 module Telephone Secondary
VX9983	VX9983BK	1 module 2A 5V USB outlet
VX9985	VX9985BK	2 module 2 x 1A 5V USB outlet
VX9987	VX9987BK	2 module Triplexer (1xTV, 1xFM, 1xSky)
VX9988	VX9988BK	1 module RJ45 Outlet - category 5e
VX9989	VX9989BK	1 module Satellite outlet
VX6080	VX6080BK	Half module Blank
VX6081	VX6081BK	One module Blank
VX6082	-	Two module Blank

1 module - 50mm x 25mm
2 module - 50mm x 50mm
3 module - 50mm x 75mm

Installation Boxes

VX9405 Surface Moulded 1 gang

VX9416 Surface Moulded 2 gang



VX9974



VX9984



VX9986



VX9992



VX9993



VX9982



VX1590WH

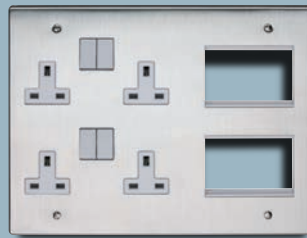

VX1590SS

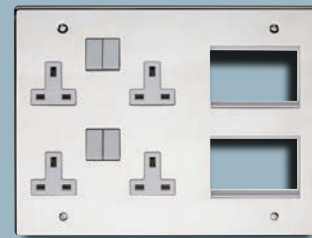

VX1590PS

Telephone Outlets

LIST NO	DESCRIPTION
VX9974	Master
VX9984	Secondary

RJ11 Telephone Outlet

LIST NO	DESCRIPTION
VX9986	RJ11 outlet

Co-Axial Outlets

LIST NO	DESCRIPTION
VX9992	1 gang, non-isolated
VX9993	2 gang, non-isolated
VX9982	1 gang, isolated

Telephone Outlets 86mm x 86mm
Co-Axial Outlets 85mm x 85mm

Product Standard

Co-Axial Outlet BS3041 where applicable

Lounge Plate

LIST NO	DESCRIPTION
VX1590WH	White Lounge Plate
VX1590SS	Stainless Steel Lounge Plate
VX1590PS	Polished Steel Lounge Plate

• Terminals suitable for up to 3 x 2.5mm² or 2 x 4mm² conductors

Lounge Plate 267mmx207mm

Installation Boxes

VX9404 Surface Moulded

SB665 Flush Metal

Installation Boxes

Lounge Plate
SB695 35mm Flush Metal
SB1590 56mm Flush Metal



VX9401

VX9402

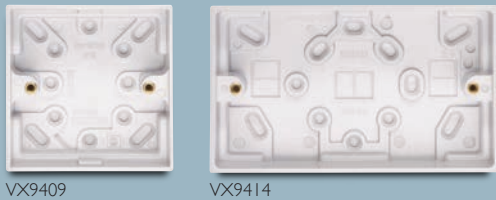

VX9409

VX9414



VX9417

VX9410



VX9991

VX9996



VX1307

VX1390



VX9023BK

VX9023

VX9029BK

Surface Mounting Boxes

LIST NO	DESCRIPTION
VX9401	1 gang architrave moulded, 19mm deep
VX9404	1 gang moulded, 20mm deep with earth terminal
VX9409	1 gang moulded, 29mm deep
VX9405	1 gang moulded, 42mm deep
VX9402	2 gang architrave moulded, 19mm deep
VX9412	2 gang moulded, 20mm deep with earth terminal
VX9414	2 gang moulded, 29mm deep
VX9415	2 gang moulded dual, 29mm deep
VX9417	2 gang moulded, 32mm deep
VX9416	2 gang moulded, 35mm deep with cable clamp
VX9410	2 gang moulded, 47mm deep with cable clamp
VX9403	3 gang moulded, 29mm deep

Conversion Pattresses

LIST NO	DESCRIPTION
VX9406	2 gang socket conversion pattress, 20mm deep
VX9143	3 gang socket conversion pattress, 20mm deep

This unique range provides the ideal method to convert a flush mounted 1 gang socket to a slim surface mounted 2 or 3 gang version

Product Standard

Surface Mounting Boxes BS5733

Blanking Plates

LIST NO	DESCRIPTION
VX9991	1 gang blanking plate
VX9996	2 gang blanking plate

Plugs

LIST NO	DESCRIPTION
VX1307	13A 3 pin White Nylon plug
VX1307BK	13A 3 pin Black Nylon plug
• Fused 13A with ASTA approved BS1362 fuse	
VX1302/W	2A round pin plug
VX0030	5A round pin plug
VX0042	15A round pin plug
• ASTA approved to BS1363/A or BS546	

Junction Boxes

LIST NO	DESCRIPTION
VX9023BK	30A, 3 terminals, black
VX9023	30A, 3 terminals, white
VX9029BK	20A, 4 terminals, black
VX9029	20A, 4 terminals, white

Adaptor

LIST NO	DESCRIPTION
VX1390	13A 3 way fused adaptor ASTA approved

Product Standard

Blanking Plates BS5733 where applicable 13A Plugs BS1363/A
Junction Boxes BS6220 Adaptor BS1363 & BS5733
Round Pin Plugs ASTA approved to BS1363/A or BS546



VX1070BO



VX31070WH



VG3460HT



VG3460HE



VG3460HD



VG3460FF



VG3460MW



VG3460TD

Product Marking Service Examples

EQUIPMENT	SUFFIX	EXAMPLE
Air Conditioning	AC	VX1070AC
Water Heater	WH	VX1070WH
Heater	HT	VG3460HT
Water Heater	WH	VG3460WH
Heating	HE	VG3460HE
Washing Machine	WM	VG3460WM
Boiler	BO	VG3460BO
Cooker Hood	HD	VG3460HD
Dishwasher	DW	VG3460DW
Extract Fan	EF	VG3460EF
Fridge	FR	VG3460FR
Freezer	FZ	VG3460FZ
Fridge Freezer	FF	VG3460FF
Hob	HOB	VG3460HOB
Microwave	MW	VG3460MW
Tumble Dryer	TD	VG3460TD
Waste Disposal	WD	VG3460WD
Washer Dryer	WM	VG3460WM

Product marking to customers requirements available
 Contact Volex Technical for quotes and availability

Available in Polished Steel, Stainless Steel and Black Nickel, the Volex Accessories Metal Plate range allows specification of a premium co-ordinated and comprehensive range of wiring accessories.

The range of products features double pole sockets and the unique labyrinth switch design which minimises visible arc flash and prevents access to live parts.

stainless steel decorative



VX1500USBSS/D



VX1500SS



VX1300SS



VX1080SS



VX1500SS/D



VX1300SS/D



VX1081SS



VX1090SS

13A Socket Outlets

LIST NO	DESCRIPTION
VX1500SS	2 Gang 13A Switched Socket
VX1300SS	1 Gang 13A Switched Socket
VX1500SS/D	2 Gang 13A DP Switched Socket
VX1500USBSS/D	2 gang 13A Switched Socket with USB
VX1300SS/D	1 Gang 13A DP Switched Socket
VX1500SSBK	2 Gang 13A Switched Socket Black Interior
VX1300SSBK	1 Gang 13A Switched Socket Black Interior
VX1500SSBK/D	2 Gang 13A DP Switched Socket Black Interior
VX1300SSBK/D	1 Gang 13A DP Switched Socket Black Interior
VX1500USBSSBK/D	2 Gang 13A DP Switched Socket 2A 2 USB Black Interior

3 x 2.5mm² or 2 x 4mm² terminal capacity
DP 2 Gang - twin earth

Product marking service available

1 Gang 84.4mm x 84.4mm
2 Gang 84.4mm x 145.6mm

Product Standard

BS 1363-2

Installation Boxes

SB655 1 Gang Flush Box 25mm
SB665 2 Gang Flush Box 25mm

SB619 1 Gang Dry Liner 35mm

SB629 2 Gang Dry Liner 35mm

Fused Connection Units

LIST NO	DESCRIPTION
VX1080SS	13A FCU DP Switched
VX1081SS	13A FCU DP Switched Neon
VX1090SS	13A FCU Unswitched
VX1080SSBK	13A FCU DP Switched Black Interior
VX1081SSBK	13A FCU DP Switched Neon Black Interior
VX1090SSBK	13A FCU Unswitched Black Interior

3 x 2.5mm² or 2 x 4mm² terminal capacity

Add 'F' suffix to part number if flex outlet is required

Product marking service available

84.4mm x 84.4mm

Product Standard

BS 1363-2

Installation Boxes

SB655 1 Gang Flush Box 25mm

SB619 1 Gang Dry Liner 35mm



VX1060SS



VX9713SS



VX9703SS



VX9700SS



VX1010SS



VX1020SS



VX1040SS



VX1050SS



VX1030SS

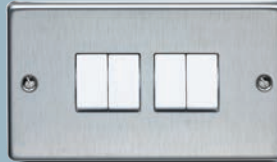

VX1054SS



VX1013SS

Double Pole Switch Units 20A & 45A

LIST NO	DESCRIPTION
VX1060SS	20A DP Switch
VX9713SS	45A DP Switch 1G Plate
VX9703SS	45A DP Switch 2 Gang Vertical
VX9700SS	Cooker Control Unit With Neon & 13A Socket
VX1060SSBK	20A DP Switch Black Interior
VX9700SSBK	Cooker Control Unit With Neon & 13A Socket Black Interior

20A Units
3 x 2.5mm² or 2 x 4mm² terminal capacity

45A Units
1 x 16mm² terminal capacity

Product marking service available

1 Gang 84.4mm x 84.4mm
2 Gang 84.4mm x 145.6mm

Product Standard

20A & 45A Switches BS EN 60669-1
Cooker Control Unit BS 4177, BS 1363-2

Installation Boxes

20A DP Switch
SB655 1 Gang Flush Box 25mm
SB619 1 Gang Dry Liner 35mm

45A DP Switch & Cooker Control Unit
SB618 1 Gang Flush Box 47mm
SB628 2 Gang Flush Box 47mm
SB632 1 Gang Dry Liner 47mm
SB631 2 Gang Dry Liner 47mm

10AX Plate Switches

LIST NO	DESCRIPTION
VX1010SS	1 Gang 1 Way 10AX Switch
VX1020SS	1 Gang 2 Way 10AX Switch
VX1040SS	2 Gang 2 Way 10AX Switch
VX1050SS	3 Gang 2 Way 10AX Switch
VX1054SS	4 Gang 2 Way 10AX Switch
VX1030SS	1 Gang Intermediate Switch
VX1013SS	Fan Isolating Switch
VX1010SSBK	1 Gang 1 Way 10AX Switch Black Rocker
VX1020SSBK	1 Gang 2 Way 10AX Switch Black Rocker
VX1040SSBK	2 Gang 2 Way 10AX Switch Black Rocker
VX1050SSBK	3 Gang 2 Way 10AX Switch Black Rocker
VX1054SSBK	4 Gang 2 Way 10AX Switch Black Rocker
VX1030SSBK	1 Gang Intermediate Switch Black Rocker
VX1013SSBK	Fan Isolating Switch Black Rocker

4 x 1mm², 3 x 1.5mm² or 1 x 2.5mm² terminal capacity

Product marking service available

1/2/3 Gang 84.4mm x 84.4mm
4 Gang 84.4mm x 145.6mm

Product Standard

Plate Switches BS EN 60669-1
Fan Isolator BS EN 60947-3

Installation Boxes

SB623 1 Gang Flush Box 16mm
SB655 1 Gang Flush Box 25mm
SB665 2 Gang Flush Box 25mm

SB619 1 Gang Dry Liner 35mm
SB629 2 Gang Dry Liner 35mm



VX0250SSPU



VX0400SSPU



VX0252SSPU



VX9974SS



VX9984SS



VX9992SS



VX9993SS



VX9062SS

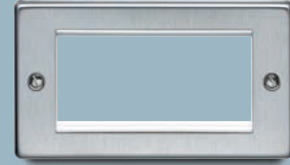

VX9064SS

Dimmer Switches

LIST NO	DESCRIPTION
VX0250SSPU	1G 2 Way Mains Dimmer 1x250W
VX0400SSPU	1G 2 Way Mains Dimmer 1x400W
VX0252SSPU	2G 2 Way Mains Dimmer 2x250W

4 x 1mm², 3 x 1.5mm² or 1 x 2.5mm² terminal capacity

84.4mm x 84.4mm

LED Dimmers 5-100W

LIST NO	DESCRIPTION
VX0100SSPULED	1 Gang LED Dimmer
VX0102SSPULED	2 Gang LED Dimmer

Product Standard

BS EN 60669-2-1
BS EN 55014-1

Installation Boxes

SB615 | 1 Gang Flush Box 35mm
SB619 | 1 Gang Dry Liner 35mm

Datacoms & Entertainment

LIST NO	DESCRIPTION
VX9974SS	Telephone Master Socket
VX9984SS	Telephone Secondary Socket
VX9974SSBK	Telephone Master Socket Black Interior
VX9984SSBK	Telephone Secondary Socket Black Interior
VX9992SS	TV Co-Axial Socket
VX9982SS	Isolated TV Co-Axial Socket
VX9993SS	Twin TV Co-Axial Socket
VX9062SS	1 Gang 2 Module Communications plate
VX9064SS	2 Gang 4 Module Communications plate

84.4mm x 84.4mm

Please refer to page 16 of this catalogue for communication plate modules

Product Standard

Co-Axial BS 3041-7
Others - manufacturers declaration

Installation Boxes

SB655 | 1 Gang Flush Box 25mm

SB619 | 1 Gang Dry Liner 35mm



VX9800SS



VX9991SS

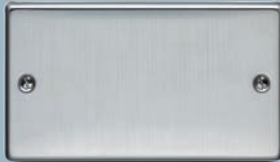

VX9996SS



VG3576SS

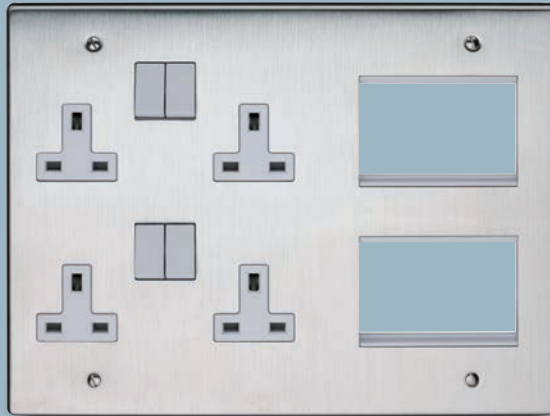

VX1590SS

Shaver Outlets

LIST NO	DESCRIPTION
VX9800SS	Dual Volt Shaver Socket
VX9800SSBK	Dual Volt Shaver Socket Black Interior

2 x 2.5mm² terminal capacity

145.6mm x 84.4mm

Blank Plates

LIST NO	DESCRIPTION
VX9991SS	1 G Blank Plate
VX9996SS	2 G Blank Plate

1 Gang 84.4mm x 84.4mm

2 Gang 84.4mm x 145.6mm

Product Standard

Shaver Socket BS EN 61558-2-5
Blank Plates BS 5733

Installation Boxes

SB618 1 Gang Flush Box 47mm
SB631 2 Gang Dry Liner 47mm

Grid Plates

LIST NO	DESCRIPTION
VG3571SS	1 gang
VG3572SS	2 gang
VG3573SS	3 gang
VG3574SS	4 gang
VG3576SS	6 gang
VG3578SS	8 gang
VG3579SS	9 gang
VG3570SS	12 gang

For grid switches and yokes see page 14 and 15

Lounge Plate

LIST NO	DESCRIPTION
VX1590SS	Lounge Plate Stainless Steel
VX1590SSBK	Lounge Plate Stainless Steel Black Interior

3 x 2.5mm² or 2 x 4mm² terminal capacity

267mm x 207mm

For communication modules see pages 4 and 7

Product Standard

Lounge Plate BS 1363-2

Installation Boxes

SB695 Lounge Plate Flush Box 35mm
SB1590 Lounge Plate Flush Box 56mm

Available in Polished Steel, Stainless Steel and Black Nickel, the Volex Accessories Metal Plate range allows specification of a premium co-ordinated and comprehensive range of wiring accessories.

The range of products features double pole sockets and the unique labyrinth switch design which minimises visible arc flash and prevents access to live parts.

polished steel decorative



VX1500USBPS/D

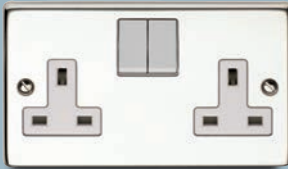

VX1500PS



VX1300PSBK



VX1080PS



VX1080PSBK



VX1500PSBK/D



VX1300PS/D



VX1081PS



VX1090PSBK

13A Socket Outlets

LIST NO	DESCRIPTION
VX1500PS	2 Gang 13A Switched Socket
VX1300PS	1 Gang 13A Switched Socket
VX1500PS/D	2 Gang 13A DP Switched Socket
VX1500USBPS/D	2 Gang 13A DP Switched Socket with USB
VX1300PS/D	1 Gang 13A DP Switched Socket
VX1500PSBK	2 Gang 13A Switched Socket Black Interior
VX1300PSBK	1 Gang 13A Switched Socket Black Interior
VX1500PSBK/D	2 Gang 13A DP Switched Socket Black Interior
VX1300PSBK/D	1 Gang 13A DP Switched Socket Black Interior
VX1500USBPSBK/D	2 Gang 13A DP Switched Socket 2A 2 USB Black Interior

3 x 2.5mm² or 2 x 4mm² terminal capacity
DP 2 Gang - twin earth

Product marking service available

1 Gang 84.4mm x 84.4mm
2 Gang 84.4mm x 145.6mm

Product Standard
BS 1363-2

Installation Boxes

SB655 1 Gang Flush Box 25mm
SB665 2 Gang Flush Box 25mm

SB619 1 Gang Dry Liner 35mm

SB629 2 Gang Dry Liner 35mm

Fused Connection Units

LIST NO	DESCRIPTION
VX1080PS	13A FCU DP Switched
VX1081PS	13A FCU DP Switched Neon
VX1090PS	13A FCU Unswitched
VX1080PSBK	13A FCU DP Switched Black Interior
VX1081PSBK	13A FCU DP Switched Neon Black Interior
VX1090PSBK	13A FCU Unswitched Black Interior

3 x 2.5mm² or 2 x 4mm² terminal capacity

Add 'F' suffix to part number if flex outlet is required

Product marking service available

84.4mm x 84.4mm

Product Standard
BS 1363-2

Installation Boxes

SB655 1 Gang Flush Box 25mm

SB619 1 Gang Dry Liner 35mm



VX1060PS



VX1060PSBK



VX9713PS

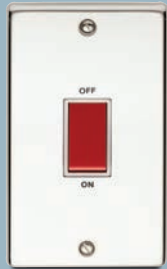

VX9703PS



VX9700PS



VX1010PS



VX1020PS



VX1040PSBK



VX1050PSBK



VX1030PSBK

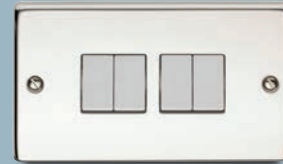

VX1054PS



VX1013PS

Double Pole Switch Units 20A & 45A

LIST NO	DESCRIPTION
VX1060PS	20A DP Switch
VX9713PS	45A DP Switch 1G Plate
VX9703PS	45A DP Switch 2 Gang Vertical
VX9700PS	Cooker Control Unit With Neon & 13A Switched Socket
VX1060PSBK	20A DP Switch Black Interior
VX9700PSBK	Cooker Control Unit with Neon & 13A Switched Socket Black Interior

20A Units
3 x 2.5mm² or 2 x 4mm² terminal capacity

45A Units
1 x 16mm² terminal capacity

Product marking service available

1 Gang 84.4mm x 84.4mm
2 Gang 84.4mm x 145.6mm

Product Standard

20A & 45A Switches BS EN 60669-1
Cooker Control Unit BS 4177, BS 1363-2

Installation Boxes

20A DP Switch	45A DP Switch & Cooker Control Unit
SB655 1 Gang Flush Box 25mm	SB618 1 Gang Flush Box 47mm
SB619 1 Gang Dry Liner 35mm	SB628 2 Gang Flush Box 47mm
	SB632 1 Gang Dry Liner 47mm
	SB631 2 Gang Dry Liner 47mm

10AX Plate Switches

LIST NO	DESCRIPTION
VX1010PS	1 Gang 1 Way 10AX Switch
VX1020PS	1 Gang 2 Way 10AX Switch
VX1040PS	2 Gang 2 Way 10AX Switch
VX1050PS	3 Gang 2 Way 10AX Switch
VX1054PS	4 Gang 2 Way 10AX Switch
VX1030PS	1 Gang Intermediate Switch
VX1013PS	Fan Isolating Switch
VX1010PSBK	1 Gang 1 Way 10AX Switch Black Rocker
VX1020PSBK	1 Gang 2 Way 10AX Switch Black Rocker
VX1040PSBK	2 Gang 2 Way 10AX Switch Black Rocker
VX1050PSBK	3 Gang 2 Way 10AX Switch Black Rocker
VX1054PSBK	4 Gang 2 Way 10AX Switch Black Rocker
VX1030PSBK	1 Gang Intermediate Switch Black Rocker
VX1013PSBK	Fan Isolating Switch Black Rocker

4 x 1mm², 3 x 1.5mm² or 1 x 2.5mm² terminal capacity

Product marking service available

1/2/3 Gang 84.4mm x 84.4mm
4 Gang 84.4mm x 145.6mm

Product Standard

Plate Switches BS EN 60669-1
Fan Isolator BS EN 60947-3

Installation Boxes

SB623 1 Gang Flush Box 16mm	SB619 1 Gang Dry Liner 35mm
SB655 1 Gang Flush Box 25mm	SB629 2 Gang Dry Liner 35mm
SB665 2 Gang Flush Box 25mm	



VX0250PSPU



VX0400PSPU



VX0252PSPU



VX9974PS



VX9984PS



VX9992PS



VX9993PS



VX9062PS

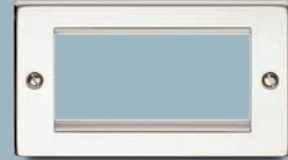

VX9064PS

Dimmer Switches

LIST NO	DESCRIPTION
VX0250PSPU	1G 2 Way Mains Dimmer 1x400W
VX0400PSPU	1G 2 Way Mains Dimmer 1x250W
VX0252PSPU	2G 2 Way Mains Dimmer 2x250W

4 x 1mm², 3 x 1.5mm² or 1 x 2.5mm² terminal capacity

84.4mm x 84.4mm

LED Dimmers 5-100W

LIST NO	DESCRIPTION
VX0100PSPULED	1 Gang LED Dimmer
VX0102PSPULED	2 Gang LED Dimmer

Product Standard

BS EN 60669-2-1
BS EN 55014-1

Installation Boxes

SB615 | 1 Gang Flush Box 35mm

SB619 | 1 Gang Dry Liner 35mm

Datacoms & Entertainment

LIST NO	DESCRIPTION
VX9974PS	Telephone Master Socket
VX9984PS	Telephone Secondary Socket
VX9974PSBK	Telephone Master Socket Black Interior
VX9984PSBK	Telephone Secondary Socket Black Interior
VX9992PS	TV Co-Axial Socket
VX9982PS	Isolated TV Co-Axial Socket
VX9993PS	Twin TV Co-Axial Socket
VX9062PS	1 Gang 2 Module Communications plate
VX9064PS	2 Gang 4 Module Communications plate

84.4mm x 84.4mm

Please refer to page 16 of this catalogue for communication plate modules

Product Standard

Co-Axial BS 3041-7
Others - manufacturers declaration

Installation Boxes

SB655 | 1 Gang Flush Box 25mm

SB619 | 1 Gang Dry Liner 35mm



VX9800PS



VX9991PS



VX9996PS



VG3576PS

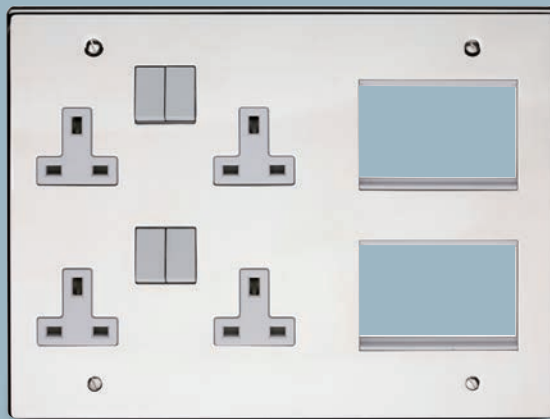

VX1590PS

Shaver Outlets

LIST NO	DESCRIPTION
VX9800PS	Dual Volt Shaver Socket
VX9800PSBK	Dual Volt Shaver Socket Black Interior

2 x 2.5mm² terminal capacity

145.6mm x 84.4mm

Blank Plates

LIST NO	DESCRIPTION
VX9991PS	1G Blank Plate
VX9996PS	2G Blank Plate

1 Gang 84.4mm x 84.4mm
2 Gang 84.4mm x 145.6mm

Product Standard

Shaver Socket BS EN 61558-2-5
Blank Plates BS 5733

Installation Boxes

SB628 2 Gang Flush Box 47mm
SB631 2 Gang Dry Liner 47mm

Flush Metal Plates

LIST NO	DESCRIPTION
VG3571PS	1 gang
VG3572PS	2 gang
VG3573PS	3 gang
VG3574PS	4 gang
VG3576PS	6 gang
VG3578PS	8 gang
VG3579PS	9 gang
VG3570PS	12 gang

For grid switches and yokes see page 14 and 15

Lounge Plate

LIST NO	DESCRIPTION
VX1590PS	Lounge Plate Polished Steel

3 x 2.5mm² or 2 x 4mm² terminal capacity

267mm x 207mm

For communication modules see pages 4 and 7

Product Standard

BS 1363-2

Installation Boxes

SB695 Lounge Plate Flush Box 35mm
SB1590 Lounge Plate Flush Box 56mm

Available in Polished Steel, Stainless Steel and Black Nickel, the Volex Accessories Metal Plate range allows specification of a premium co-ordinated and comprehensive range of wiring accessories.

The range of products features double pole sockets and the unique labyrinth switch design which minimises visible arc flash and prevents access to live parts.

black nickel decorative



VX1500USBRBN/D



VX1080RBN



VX1500RBN/D



VX1300RBN/D



VX1081RBN



VX1090RBN

13A Socket Outlets

LIST NO	DESCRIPTION
VX1500RBN/D	2 Gang 13A DP Switched Socket
VX1500USBRBN/D	2 Gang 13A DP Switched Socket with USB
VX1300RBN/D	1 Gang 13A DP Switched Socket

3 x 2.5mm² or 2 x 4mm² terminal capacity
DP 2 Gang - twin earth

15A Round Pin Switched Socket

LIST NO	DESCRIPTION
VX9900SG	Switched socket outlet

- 1 gang shuttered single pole

Product marking service available

1 gang 86.7mm x 86.7mm x 44mm
2 gang 143.9mm x 86.7mm x 44mm

Product Standard

13A Socket BS 1363-2
Round Pin Socket BS546

Installation Boxes

SB655 1 Gang Flush Box 25mm
SB665 2 Gang Flush Box 25mm

SB619 1 Gang Dry Liner 35mm

SB629 2 Gang Dry Liner 35mm

Fused Connection Units

LIST NO	DESCRIPTION
VX1080RBN	13A FCU DP Switched
VX1081RBN	13A FCU DP Switched Neon
VX1090RBN	13A FCU Unswitched

3 x 2.5mm² or 2 x 4mm² terminal capacity

Product marking service available

84.4mm x 84.4mm

Product Standard

BS 1363-4

Installation Boxes

SB655 1 Gang Flush Box 25mm

SB619 1 Gang Dry Liner 35mm



VX1060RBN



VX1020RBN



VX1040RBN



VX9712RBN



VX9703RBN



VX1050RBN



VX1054RBN



VX9700RBN



VX1030RBN



VX1013RBN

Double Pole Switch Units 20A & 45A

LIST NO	DESCRIPTION
VX1060RBN	20A DP Switch
VX9712RBN	45A DP Switch 1G Plate
VX9703RBN	45A DP Switch 2 Gang Vertical
VX9700RBN	45A Cooker Control Unit With Neon & 13A Switched Socket

20A Units
3 x 2.5mm² or 2 x 4mm² terminal capacity

45A Units
1 x 16mm² terminal capacity

Product marking service available

1 Gang 84.4mm x 84.4mm
2 Gang 84.4mm x 145.6mm

Product Standard

20A & 45A Switches BS EN 60669-1
Cooker Control Unit BS 4177, BS 1363-2

Installation Boxes

20A DP Switch	45A DP Switch & Cooker Control Unit
SB655 1 Gang Flush Box 25mm	SB618 1 Gang Flush Box 47mm
SB619 1 Gang Dry Liner 35mm	SB628 2 Gang Flush Box 47mm
	SB632 1 Gang Dry Liner 47mm
	SB631 2 Gang Dry Liner 47mm

10AX Plate Switches

LIST NO	DESCRIPTION
VX1020RBN	1 Gang 2 Way 10AX Switch
VX1040RBN	2 Gang 2 Way 10AX Switch
VX1050RBN	3 Gang 2 Way 10AX Switch
VX1054RBN	4 Gang 2 Way 10AX Switch
VX1030RBN	1 Gang Intermediate Switch
VX1013RBN	Fan Isolating Switch

4 x 1mm², 3 x 1.5mm² or 1 x 2.5mm² terminal capacity

Product marking service available

1/2/3 Gang 84.4mm x 84.4mm
4 Gang 84.4mm x 145.6mm

Product Standard

Plate Switches BS EN 60669-1
Fan Isolator BS EN 60947-3

Installation Boxes

SB623 1 Gang Flush Box 16mm	SB619 1 Gang Dry Liner 35mm
SB655 1 Gang Flush Box 25mm	SB629 2 Gang Dry Liner 35mm
SB665 2 Gang Flush Box 25mm	



VX0400LVRBN



VX0252LVRBN



VX0253LVRBN



VX9974RBN



VX9984RBN



VX9992RBN



VX9993RBN



VX9061RBN



VX9062RBN

Dimmer Switches

LIST NO	DESCRIPTION
VX0400RBNPU	1G 2 Way Mains Dimmer 1x400W
VX0252RBNPU	2G 2 Way Mains Dimmer 2x250W
VX0400LVRBN	1G 2 Way Dimmer Mains / LV 1x400VA
VX0252LVRBN	2G 2 Way Dimmer Mains / LV 2x250VA
VX0253LVRBN	3G 2 Way Dimmer Mains / LV 3x250VA

4 x 1mm², 3 x 1.5mm² or 1 x 2.5mm² terminal capacity

84.4mm x 84.4mm

LED Dimmers 5-100W

LIST NO	DESCRIPTION
VX0100RBNPULED	1 Gang LED Dimmer
VX0102RBNPULED	2 Gang LED Dimmer

Product Standard

BS EN 60669-2-1
BS EN 55014-1

Datcoms & Entertainment

LIST NO	DESCRIPTION
VX9974RBN	Telephone Master Socket
VX9984RBN	Telephone Secondary Socket
VX9992RBN	TV Co-Axial Socket
VX9993RBN	Twin TV Co-Axial Socket
VX9061RBN	1 Gang 1 Module Communication plate
VX9062RBN	1 Gang 2 Module Communication plate

84.4mm x 84.4mm

Please refer to page 16 of this catalogue for communication plate modules

Product Standard

Co-Axial BS 3041-7
Others - manufacturers declaration

Installation Boxes

SB615 | 1 Gang Flush Box 35mm

SB619 | 1 Gang Dry Liner 35mm

Installation Boxes

SB655 | 1 Gang Flush Box 25mm

SB619 | 1 Gang Dry Liner 35mm



VX9800RBN



VX9991RBN

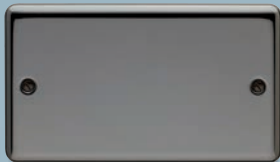

VX9996RBN

Shaver Outlets

LIST NO	DESCRIPTION
VX9800RBN	Dual Volt Shaver Socket

2 x 2.5mm² terminal capacity

145.6mm x 84.4mm

Blank Plates

LIST NO	DESCRIPTION
VX9991RBN	1G Blank Plate
VX9996RBN	2G Blank Plate

1 Gang 84.4mm x 84.4mm
2 Gang 84.4mm x 145.6mm

Product Standard

Shaver Socket BS EN 61558-2-5
Blank Plates BS 5733

Installation Boxes

SB628 2 Gang Flush Box 47mm
SB631 2 Gang Dry Liner 47mm

Available in Polished Steel, Stainless Steel and Black Nickel, the Volex Accessories Flat Plate range offers a superior clean and slim solution with a decorative finish for residential dwellings.

The range of products features double pole sockets and the unique labyrinth switch design which minimises visible arc flash and prevents access to live parts.

stainless steel flat plate



VX3300SS/D



VX3500SS/D



VX3080SS



VX3081SS



VX3090SS

13A Socket Outlets

LIST NO	DESCRIPTION
VX3300SS/D	1 Gang 13A DP Switched Socket
VX3500SS/D	2 Gang 13A DP Switched Socket

3 x 2.5mm² or 2 x 4mm² terminal capacity
DP 2 Gang - twin earth

Product marking service available

1 Gang 84.4mm x 84.4mm
2 Gang 84.4mm x 145.6mm

Product Standard

BS 1363-2

Installation Boxes

SB655 1 Gang Flush Box 25mm
SB665 2 Gang Flush Box 25mm

SB619 1 Gang Dry Liner 35mm

SB629 2 Gang Dry Liner 35mm

Fused Connection Units

LIST NO	DESCRIPTION
VX3080SS	13A FCU DP Switched
VX3081SS	13A FCU DP Switched Neon
VX3090SS	13A FCU Unswitched

3 x 2.5mm² or 2 x 4mm² terminal capacity

Product marking service available

84.4mm x 84.4mm

Product Standard

BS 1363-4

Installation Boxes

SB655 1 Gang Flush Box 25mm

SB619 1 Gang Dry Liner 35mm



VX3060SS



VX3020SS



VX3040SS



VX3712SS



VX3703SS



VX3050SS



VX3054SS



VX3700SS



VX3030SS



VX3013SS

Double Pole Switch Units 20A & 45A

LIST NO	DESCRIPTION
VX3060SS	20A DP Switch
VX3712SS	45A DP Switch 1G Plate
VX3703SS	45A DP Switch 2 Gang Vertical
VX3700SS	Cooker Control Unit With Neon & 13A Switched Socket

20A Units - 3 x 2.5mm² or 2 x 4mm² terminal capacity
 45A Units - 1 x 16mm² terminal capacity

Product marking service available

1 Gang 84.4mm x 84.4mm
 2 Gang 84.4mm x 145.6mm

Product Standard

20A & 45A Switches BS EN 60669-1
 Cooker Control Unit BS 4177, BS 1363-2

Installation Boxes

SB618	1 Gang Flush Box 47mm	SB619	1 Gang Dry Liner 35mm
SB628	2 Gang Flush Box 47mm	SB629	2 Gang Dry Liner 35mm
SB632	1 Gang Dry Liner 47mm		
SB631	2 Gang Dry Liner 47mm		

10AX Plate Switches

LIST NO	DESCRIPTION
VX3020SS	1 Gang 2 Way 10AX Switch
VX3040SS	2 Gang 2 Way 10AX Switch
VX3050SS	3 Gang 2 Way 10AX Switch
VX3054SS	4 Gang 2 Way 10AX Switch
VX3030SS	1 Gang Intermediate Switch
VX3013SS	Fan Isolating Switch

4 x 1mm², 3 x 1.5mm² or 1 x 2.5mm² terminal capacity

Product marking service available

1/2/3 Gang 84.4mm x 84.4mm
 4 Gang 84.4mm x 145.6mm

Product Standard

Plate Switches BS EN 60669-1
 Fan Isolator BS EN 60947-3

Installation Boxes

SB623	1 Gang Flush Box 16mm	SB619	1 Gang Dry Liner 35mm
SB655	1 Gang Flush Box 25mm	SB629	2 Gang Dry Liner 35mm
SB665	2 Gang Flush Box 25mm		



VX3400LVSS



VX3252LVSS



VX3253LVSS



VX3974SS



VX3992SS



VX3993SS



VX3061SS



VX3062SS

Dimmer Switches

LIST NO	DESCRIPTION
VX3400SSPU	1G 2 Way Mains Dimmer 1x400W
VX3252SSPU	2G 2 Way Mains Dimmer 2x250W
VX3400LVSS	1G 2 Way Dimmer Mains / LV 1x400VA
VX3252LVSS	2G 2 Way Dimmer Mains / LV 2x250VA
VX3253LVSS	3G 2 Way Dimmer Mains / LV 3x250VA

4 x 1mm², 3 x 1.5mm² or 1 x 2.5mm² terminal capacity

84.4mm x 84.4mm

LED Dimmers 5-100W

LIST NO	DESCRIPTION
VX3100PUSSLED	1 Gang LED Dimmer
VX3102PUSSLED	2 Gang LED Dimmer

Product Standard

BS EN 60669-2-1
BS EN 55014-1

Installation Boxes

SB615 | 1 Gang Flush Box 35mm

SB619 | 1 Gang Dry Liner 35mm

Datcoms & Entertainment

LIST NO	DESCRIPTION
VX3974SS	Telephone Master Socket
VX3984SS	Telephone Secondary Socket
VX3992SS	TV Co-Axial Socket
VX3993SS	Twin TV Co-Axial Socket
VX3061SS	1 Gang 1 Module Communication plate
VX3062SS	1 Gang 2 Module Communication plate

84.4mm x 84.4mm

Please refer to page 16 of this catalogue for communication plate modules

Product Standard

Co-Axial BS 3041-7
Others - manufacturers declaration

Installation Boxes

SB655 | 1 Gang Flush Box 25mm

SB619 | 1 Gang Dry Liner 35mm



VX3800SS



VX3991SS

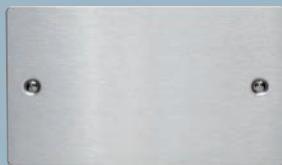

VX3996SS

Shaver Outlets

LIST NO	DESCRIPTION
VX3800SS	Dual Volt Shaver Socket

2 x 2.5mm² terminal capacity

145.6mm x 84.4mm

Blank Plates

LIST NO	DESCRIPTION
VX3991SS	1G Blank Plate
VX3996SS	2G Blank Plate

1 Gang 84.4mm x 84.4mm
2 Gang 84.4mm x 145.6mm

Product Standard

Shaver Socket BS EN 61558-2-5
Blank Plates BS 5733

Installation Boxes

SB628 2 Gang Flush Box 47mm
SB631 2 Gang Dry Liner 47mm

Available in Polished Steel, Stainless Steel and Black Nickel, the Volex Accessories Flat Plate range offers a superior clean and slim solution with a decorative finish for residential dwellings.

The range of products features double pole sockets and the unique labyrinth switch design which minimises visible arc flash and prevents access to live parts.



polished steel flat plate



VX3300PS/D



VX3500PS/D



VX3080PS



VX3081PS



VX3090PS

13A Socket Outlets

LIST NO	DESCRIPTION
VX3300PS/D	1 Gang 13A DP Switched Socket
VX3500PS/D	2 Gang 13A DP Switched Socket

3 x 2.5mm² or 2 x 4mm² terminal capacity
DP 2 Gang - twin earth

Product marking service available

1 Gang 84.4mm x 84.4mm
2 Gang 84.4mm x 145.6mm

Product Standard

BS 1363-2

Installation Boxes

SB655 1 Gang Flush Box 25mm
SB665 2 Gang Flush Box 25mm

SB619 1 Gang Dry Liner 35mm

Fused Connection Units

LIST NO	DESCRIPTION
VX3080PS	13A FCU DP Switched
VX3081PS	13A FCU DP Switched Neon
VX3090PS	13A FCU Unswitched

3 x 2.5mm² or 2 x 4mm² terminal capacity

Product marking service available

84.4mm x 84.4mm

Product Standard

BS 1363-2

Installation Boxes

SB655 1 Gang Flush Box 25mm

SB619 1 Gang Dry Liner 35mm

SB629 2 Gang Dry Liner 35mm



VX3060PS



VX3703PS



VX3712PS



VX3700PS



VX3020PS



VX3040PS



VX3050PS

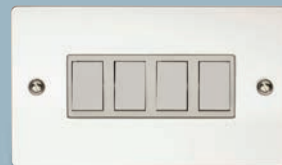

VX3054PS



VX3030PS



VX3013PS

Double Pole Switch Units 20A & 45A

LIST NO	DESCRIPTION
VX3060PS	20A DP Switch
VX3712PS	45A DP Switch 1G Plate
VX3703PS	45A DP Switch 2 Gang Vertical
VX3700PS	Cooker Control Unit With Neon & 13A Switched Socket

20A Units
3 x 2.5mm² or 2 x 4mm² terminal capacity

45A Units
1 x 16mm² terminal capacity

Product marking service available

1 Gang 84.4mm x 84.4mm
2 Gang 84.4mm x 145.6mm

Product Standard

20A & 45A Switches BS EN 60669-1
Cooker Control Unit BS 4177, BS 1363-2

Installation Boxes

20A DP Switch	45A DP Switch & Cooker Control Unit
SB655 1 Gang Flush Box 25mm	SB618 1 Gang Flush Box 47mm
SB619 1 Gang Dry Liner 35mm	SB628 2 Gang Flush Box 47mm
	SB632 1 Gang Dry Liner 47mm
	SB631 2 Gang Dry Liner 47mm

10AX Plate Switches

LIST NO	DESCRIPTION
VX3020PS	1 Gang 2 Way 10AX Switch
VX3040PS	2 Gang 2 Way 10AX Switch
VX3050PS	3 Gang 2 Way 10AX Switch
VX3054PS	4 Gang 2 Way 10AX Switch
VX3030PS	1 Gang Intermediate Switch
VX3013PS	Fan Isolating Switch

4 x 1mm², 3 x 1.5mm² or 1 x 2.5mm² terminal capacity

Product marking service available

1/2/3 Gang 84.4mm x 84.4mm
4 Gang 84.4mm x 145.6mm

Product Standard

Plate Switches BS EN 60669-1
Fan Isolator BS EN 60947-3

Installation Boxes

SB623 1 Gang Flush Box 16mm	SB619 1 Gang Dry Liner 35mm
SB655 1 Gang Flush Box 25mm	SB629 2 Gang Dry Liner 35mm
SB665 2 Gang Flush Box 25mm	



VX3400LVPS



VX3252LVPS



VX3253LVPS



VX3974PS



VX3992PS



VX3993PS



VX3061PS



VX3062PS

Dimmer Switches

LIST NO	DESCRIPTION
VX3400PSPU	1G 2 Way Mains Dimmer 1x400W
VX3250PSPU	1G 2 Way Mains Dimmer 1x250W
VX3252PSPU	2G 2 Way Mains Dimmer 2x250W
VX3400LVPS	1G 2 Way Dimmer Mains / LV 1x400VA
VX3252LVPS	2G 2 Way Dimmer Mains / LV 2x250VA
VX3253LVPS	3G 2 Way Dimmer Mains / LV 3x250VA

4 x 1mm², 3 x 1.5mm² or 1 x 2.5mm² terminal capacity

84.4mm x 84.4mm

LED Dimmers 5-100W

LIST NO	DESCRIPTION
VX3100PUPSLED	1 Gang LED Dimmer
VX3102PUPSLED	2 Gang LED Dimmer

Product Standard

BS EN 60669-2-1
BS EN 55014-1

Datcoms & Entertainment

LIST NO	DESCRIPTION
VX3974PS	Telephone Master Socket
VX3984PS	Telephone Secondary Socket
VX3992PS	TV Co-Axial Socket
VX3993PS	Twin TV Co-Axial Socket
VX3061PS	1 Gang 1 Module Communication plate
VX3062PS	1 Gang 2 Module Communication plate

84.4mm x 84.4mm

Please refer to page 16 of this catalogue for communication plate modules

Product Standard

Co-Axial BS 3041-7
Others - manufacturers declaration

Installation Boxes

SB615 | 1 Gang Flush Box 35mm

SB619 | 1 Gang Dry Liner 35mm

Installation Boxes

SB655 | 1 Gang Flush Box 25mm

SB619 | 1 Gang Dry Liner 35mm



VX3800PS



VX3991PS

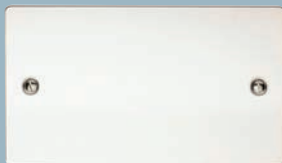

VX3996PS

Shaver Outlets

LIST NO	DESCRIPTION
VX3800PS	Dual Volt Shaver Socket

2 x 2.5mm² terminal capacity

145.6mm x 84.4mm

Blank Plates

LIST NO	DESCRIPTION
VX3991PS	1G Blank Plate
VX3996PS	2G Blank Plate

1 Gang 84.4mm x 84.4mm
2 Gang 84.4mm x 145.6mm

Product Standard

Shaver Socket BS EN 61558-2-5
Blank Plates BS 5733

Installation Boxes

SB628 2 Gang Flush Box 47mm
SB631 2 Gang Dry Liner 47mm

Available in Polished Steel, Stainless Steel and Black Nickel, the Volex Accessories Flat Plate range offers a superior clean and slim solution with a decorative finish for residential dwellings.

The range of products features double pole sockets and the unique labyrinth switch design which minimises visible arc flash and prevents access to live parts.



black nickel flat plate



VX3300BN/D



VX3500BN/D



VX3080BN



VX3081BN



VX3090BN

13A Socket Outlets

LIST NO	DESCRIPTION
VX3300BN/D	1 Gang 13A DP Switched Socket
VX3500BN/D	2 Gang 13A DP Switched Socket

3 x 2.5mm² or 2 x 4mm² terminal capacity
DP 2 Gang - twin earth

Product marking service available

1 Gang 84.4mm x 84.4mm
2 Gang 84.4mm x 145.6mm

Product Standard

BS 1363-2

Installation Boxes

SB655	1 Gang Flush Box 25mm
SB665	2 Gang Flush Box 25mm

SB619 1 Gang Dry Liner 35mm

SB629 2 Gang Dry Liner 35mm

Fused Connection Units

LIST NO	DESCRIPTION
VX3080BN	13A FCU DP Switched
VX3081BN	13A FCU DP Switched Neon
VX3090BN	13A FCU Unswitched

3 x 2.5mm² or 2 x 4mm² terminal capacity

Product marking service available

84.4mm x 84.4mm

Product Standard

BS 1363-4

Installation Boxes

SB655 1 Gang Flush Box 25mm

SB619 1 Gang Dry Liner 35mm



VX3060BN



VX3712BN



VX3703BN



VX3700BN



VX3020BN



VX3040BN



VX3050BN



VX3054BN



VX3030BN



VX3013BN

Double Pole Switch Units 20A & 45A

LIST NO	DESCRIPTION
VX3060BN	20A DP Switch
VX3712BN	45A DP Switch 1G Plate
VX3703BN	45A DP Switch 2 Gang Vertical
VX3700BN	Cooker Control Unit With Neon & 13A Switched Socket

20A Units - 3 x 2.5mm² or 2 x 4mm² terminal capacity
 45A Units - 1 x 16mm² terminal capacity

Product marking service available

1 Gang 84.4mm x 84.4mm
 2 Gang 84.4mm x 145.6mm

Product Standard

20A & 45A Switches BS EN 60669-1
 Cooker Control Unit BS 4177, BS 1363-2

Installation Boxes

20A DP Switch
 SB655 1 Gang Flush Box 25mm
 SB619 1 Gang Dry Liner 35mm

45A DP Switch &
 Cooker Control Unit
 SB618 1 Gang Flush Box 47mm
 SB628 2 Gang Flush Box 47mm
 SB632 1 Gang Dry Liner 47mm
 SB631 2 Gang Dry Liner 47mm

10AX Plate Switches

LIST NO	DESCRIPTION
VX3020BN	1 Gang 2 Way 10AX Switch
VX3040BN	2 Gang 2 Way 10AX Switch
VX3050BN	3 Gang 2 Way 10AX Switch
VX3054BN	4 Gang 2 Way 10AX Switch
VX3030BN	1 Gang Intermediate Switch
VX3013BN	Fan Isolating Switch

4 x 1mm², 3 x 1.5mm² or 1 x 2.5mm² terminal capacity

Product marking service available

1/2/3 Gang 84.4mm x 84.4mm
 4 Gang 84.4mm x 145.6mm

Product Standard

Plate Switches BS EN 60669-1
 Fan Isolator BS EN 60947-3

Installation Boxes

SB623 1 Gang Flush Box 16mm
 SB655 1 Gang Flush Box 25mm
 SB665 2 Gang Flush Box 25mm

SB619 1 Gang Dry Liner 35mm
 SB629 2 Gang Dry Liner 35mm



VX3400LVBN



VX3252LVBN



VX3253LVBN



VX3974BN



VX3984BN



VX3992BN



VX3061BN



VX3062BN

Dimmer Switches

LIST NO	DESCRIPTION
VX3400BNPU	1G 2 Way Mains Dimmer 1x400W
VX3252BNPU	2G 2 Way Mains Dimmer 2x250W
VX3400LVBN	1G 2 Way Dimmer Mains / LV 1x400VA
VX3252LVBN	2G 2 Way Dimmer Mains / LV 2x250VA
VX3253LVBN	3G 2 Way Dimmer Mains / LV 3x250VA

4 x 1mm², 3 x 1.5mm² or 1 x 2.5mm² terminal capacity

84.4mm x 84.4mm

LED Dimmers 5-100W

LIST NO	DESCRIPTION
VX3100PUBNLED	1 Gang LED Dimmer
VX3102PUBNLED	2 Gang LED Dimmer

Product Standard

BS EN 60669-2-1
BS EN 55014-1

Installation Boxes

SB615 | 1 Gang Flush Box 35mm

SB619 | 1 Gang Dry Liner 35mm

Datcoms & Entertainment

LIST NO	DESCRIPTION
VX3974BN	Telephone Master Socket
VX3984BN	Telephone Secondary Socket
VX3992BN	TV Co-Axial Socket
VX3993BN	Twin TV Co-Axial Socket
VX3061BN	1 Gang 1 Module Communication plate
VX3062BN	1 Gang 2 Module Communication plate

84.4mm x 84.4mm

Please refer to page 16 of this catalogue for communication plate modules

Product Standard

Co-Axial BS 3041-7
Others - manufacturers declaration

Installation Boxes

SB655 | 1 Gang Flush Box 25mm

SB619 | 1 Gang Dry Liner 35mm



VX3800BN

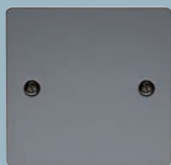

VX3991BN

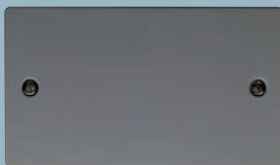

VX3996BN

Shaver Outlets

LIST NO	DESCRIPTION
VX3800BN	Dual Volt Shaver Socket

2 x 2.5mm² terminal capacity

145.6mm x 84.4mm

Blank Plates

LIST NO	DESCRIPTION
VX3991BN	1G Blank Plate
VX3996BN	2G Blank Plate

1 Gang 84.4mm x 84.4mm
2 Gang 84.4mm x 145.6mm

Product Standard

Shaver Socket BS EN 61558-2-5
Blank Plates BS 5733

Installation Boxes

SB628 2 Gang Flush Box 47mm
SB631 2 Gang Dry Liner 47mm

The market leading Appleby range offers an extensive selection of installation and mounting solutions for any domestic environment.

Appleby products are renowned for quality, value and breadth of range.

installation boxes



SB623



SB615



SB665



SB625



SB636



SB677



SB680



SB603



SB604

Switch & Socket Boxes

LIST NO	DESCRIPTION
SB623	16mm 1 Gang Adjustable Lug
SB633	16mm 2 Gang Adjustable Lug
SB655	25mm 1 Gang Adjustable Lug
SB665	25mm 2 Gang Adjustable Lug
SB676	25mm Dual Box Fixed Lugs (2 x 1 Gang)
SB615	35mm 1 Gang Adjustable Lug
SB625	35mm 2 Gang Adjustable Lug
SB636	35mm Dual Box Fixed Lug (2 x 1 Gang)
SB646	35mm 3 Gang Fixed Lug
SB717	35mm 1 Gang Adjustable Lugs*
SB727	35mm 2 Gang Adjustable Lugs*
SB618	47mm 1 Gang Adjustable Lug
SB628	47mm 2 Gang Adjustable Lug

* Mix of 20mm & 25mm knockouts

Product Standard

BS EN 4662 where applicable

1 Gang

DIMENSIONS

SB623	70mm x 70mm
SB655	68.3mm x 68.3mm
9257	36.5mm x 73mm
SB615	68.3mm x 68.3mm
SB717	68.3mm x 68.3mm
SB618	68.3mm x 68.3mm

2 Gang

DIMENSIONS

SB633	130mm x 70mm
SB665	129mm x 68.3mm
SB676	154mm x 68.3mm
SB625	129mm x 68.3mm
SB727	129mm x 68.3mm
SB636	154mm x 68.3mm
SB628	129mm x 68.3mm
9258	27.5mm 133mm
SB646	189mm x 68.3mm

Switch & Socket Boxes Accessories

LIST NO	DESCRIPTION
SB677	1 Gang 16mm deep extension
SB678	2 Gang 16mm deep extension
SB679	1 Gang 25mm deep extension
SB680	2 Gang 25mm deep extension
SB681	1 Gang 35mm deep extension
SB682	2 Gang 35mm deep extension
SB603	Flange For Dry Partition Walls
SB604	Connection Coupling 25mm & 35mm Box

Architrave Boxes

LIST NO	DESCRIPTION
9257	28mm 1 Gang Architrave Box
9258	28mm 2 Gang Architrave Box

SB677	70mm x 70mm	SB680	129mm x 68.3mm
SB678	130mm x 70mm	SB681	68.3mm x 68.3mm
SB679	68.3mm x 68.3mm	SB682	129mm x 68.3mm



SB619



SB629

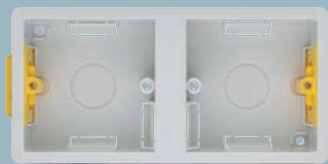

SB637



SB639



SB638



SB/BT



SB/LX

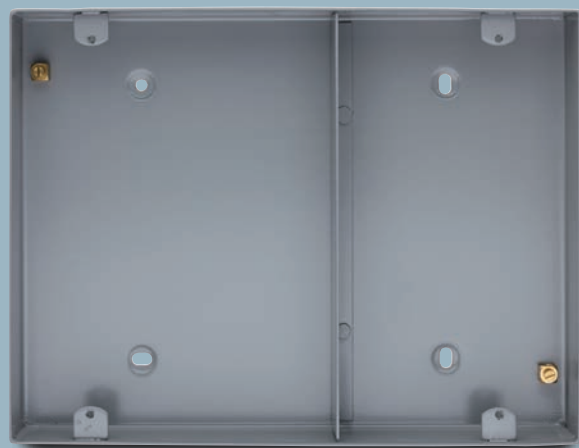

SB695

Dry Lining Boxes

LIST NO	DESCRIPTION
SB619	1 Gang 35mm
SB629	2 Gang 35mm
SB637	Dual Box (2 x 1 Gang 35mm)
SB638	Dual Box (1 + 2 Gang 35mm)
SB639	Circular Box 35mm
SB632	1 Gang 47mm
SB631	2 Gang 47mm

Ancillary Items

LIST NO	DESCRIPTION
SB/BT	Brass Earth Terminal
SB/LX	Packing Piece For Fitting Partitions Below 6.35mm

A	B	C	D	E	min F	max F	G	LIST No
73	73	36	60	6.7	6.35	15.0	83	SB619
73	73	48	60	6.7	6.35	15.0	83	SB632
133	73	36	130	6.7	6.35	15.0	143	SB629
158	73	36	130	6.7	6.35	15.0	168	SB637
133	73	48	155	6.7	6.35	15.0	143	SB631
220	73	36	-	6.7	6.35	15.0	229	SB638

A	B	C	D	min E	max E	LIST No
80	57.5	36	20	7	22	SB639

Lounge Plate Flush boxes

LIST NO	DESCRIPTION
SB695	35mm Box to Fit Volex Lounge Plate
SB1590	56mm Box to Fit Volex Lounge Plate

SB695 - 9 x 20mm knockouts
253mm x 194mm x 35mm

SB1590 - 10 x 20/25mm knockouts
253mm x 194mm x 56mm

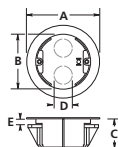
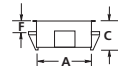
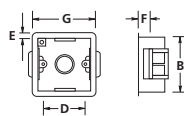



VXI300SG



VXI400SG



VTI108SG



VTI208SG



VX9900SG



VXI081SG



VXI081SG/F



VTI092SG

13A Socket Outlets

LIST NO	DESCRIPTION
VX9100SG	1 gang socket
VX9200SG	2 gang socket
VX1300SG	1 gang SP switched
VX1500SG	2 gang SP switched
VX1400SG	1 gang SP switched with neon
VX1600SG	2 gang SP switched with neon

- Terminals suitable for 3 x 2.5mm² or 2 x 4mm² conductors
- Double pole switching available. Suffix list no. -/D i.e. VX1500SG/D
- 2 gang DP sockets come with twin earth as standard

13A 30mA Metalclad RCD Protected Sockets

LIST NO	DESCRIPTION
VTI108SG	1 gang switched RCD protected socket outlet
VTI208SG	2 gang switched RCD protected socket outlet

- Double pole switching
- Terminals suitable for 3 x 2.5mm² or 2 x 4.0mm² conductors

15A Round Pin Switched Socket

LIST NO	DESCRIPTION
VX9900SG	Switched socket outlet

- 1 gang shuttered single pole

1 gang 86.7mm x 86.7mm x 44mm
2 gang 143.9mm x 86.7mm x 44mm

Product Standard

13A Socket BS1363. RCD Protected Socket BS7288. Round Pin Socket BS546

13A Fused Connection Units

LIST NO	DESCRIPTION
VX1080SG	DP switched
VX1080SG/F	DP switched with front flex outlet & cord grip
VX1081SG	DP switched with neon
VX1081SG/F	DP switched with neon, front flex outlet & cord grip
VX1090SG	13A unswitched
VX1090FSG	13A unswitched with front flex outlet & cord grip
VX1091SG	13A unswitched with neon
VX1091FSG	13A unswitched with neon, front flex outlet & cord grip

- Cord outlet suitable for flexible cord up to 10mm²

RCD Fused Connection Unit

LIST NO	DESCRIPTION
VTI092SG	RCD Fused Connection Unit

- Double pole switching

Terminals suitable for 3 x 2.5mm² or 2 x 4mm² conductors

86.7mm x 86.7mm x 44mm

Product Standard

13A Fused Connection Units BS1363
RCD Fused Connection Unit BS4293



VXI1020SG



VXI1040SG



VXI1050SG



VXI1060SG



VXI1060FSG



VXI1070SG



VXI1070FSG



VX9702SG



VX9703SG



VX9991SG

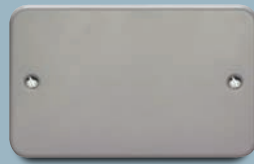

VX9996SG

10AX Switches

LIST NO	DESCRIPTION
VXI1010SG	1 gang 1 way
VXI1020SG	1 gang 2 way
VXI1030SG	1 gang intermediate
VXI1040SG	2 gang 2 way
VXI1050SG	3 gang 2 way
VXI1054SG	4 gang 2 way

• Fully rated at 10AX for fluorescent and inductive loads

20A DP Control Switches

LIST NO	DESCRIPTION
VXI1060SG	1 gang with neon indicator
VXI1060FSG	1 gang with neon, front flex outlet & cord grip
VXI1070SG	1 gang
VXI1070FSG	1 gang with front flex outlet & cord grip

• Cord outlet, suitable for flexible cord up to 10mm²

Terminals suitable for 4 x 1.0mm², 3 x 1.5mm², or 2 x 2.5mm² conductors

1 gang 86.7mm x 86.7mm x 44mm
2 gang 143.9mm x 86.7mm x 44mm

Product Standard

BS EN 60669-1

45A DP Switches

LIST NO	DESCRIPTION
VX9702SG	45A DP switch with neon
VX9703SG	45A DP switch

• Terminals suitable for conductor sizes up to 1 x 16mm²

The following markings are available; add the appropriate suffix to the list number, eg VX9702SG/CK:

COOKER – CK
SHOWER – SH
AIR CONDITIONING – AC

Blanking Plates

LIST NO	DESCRIPTION
VX9991SG	1 gang
VX9996SG	2 gang

DP Switches 86.7mm x 143.9mm x 44mm
Blanking Plates 1 gang 86.7mm x 86.7mm x 44mm
Blanking Plates 2 gang 143.9mm x 86.7mm x 44mm

Product Standard

DP Switches BS EN 60669-1



VG3430



VG3490



VG3490/1



VG3460



VG3469

10AX Switches - Moulded Rocker

LIST NO	DESCRIPTION
VG3430	10AX 1 way SP
VG3530	10AX 2 way SP
VG3489	10AX Retractive
VG3490	10AX Retractive - bell symbol
VG3490/1	10AX Retractive - fan symbol

20AX Switches - Moulded Rocker

LIST NO	DESCRIPTION
VG3450	1 way SP
VG3451	1 way SP complete with key
VG3460	DP
VG3461	DP complete with key
VG3461ELT	DP complete with key marked 'Emergency light test'
VG3469	DP marked 'ON'
VG3535	Intermediate
VG3550	2 way
VG3551	2 way complete with key
VG3552	2 way and off

• Marking to customer specification also available

Grids 1-2 gang 81mm x 58mm
Grids 3-4 gang 141mm x 58mm

Product Standard
Switches BS EN 60669-1



VG3582SG



VG3588SG

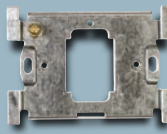

VG3901

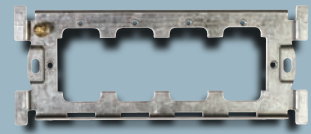

VG3904

Surface Metalclad Plates

LIST NO	DESCRIPTION
VG3581SG	1 gang
VG3582SG	2 gang
VG3583SG	3 gang
VG3584SG	4 gang
VG3586SG	6 gang
VG3588SG	8 gang

Grid Yokes Complete with Earth Terminal

LIST NO	DESCRIPTION
VG3901	1 gang yoke
VG3902	2 gang yoke
VG3903	3 gang yoke
VG3904	4 gang yoke



VG3201SG



VG3203SG



VG3209SG



VG3435



VG3436



VG3491



VG3940

Surface Boxes

LIST NO	DESCRIPTION
VG3201SG	1 and 2 gang surface or flush
VG3203SG	3 and 4 gang surface or flush
VG3206SG	6 and 8 gang surface or flush
VG3209SG	12 gang surface or flush

1-2 gang 73mm x 73 x 40mm	3-4 gang 133mm x 73mm x 40mm
6-8 gang 133mm x 133mm x 40mm	12 gang 133mm x 194mm x 40mm

20mm knock-outs in 1 and 2 gang box.
20mm and 25mm knock-outs in 3-12 gang boxes.

Ancillary Items - Moulded

LIST NO	DESCRIPTION
VG3435	Cord outlet - 10mm diameter aperture, complete with earthing terminal and cable clamp
VG3436	Fuse unit fitted with 13A ASTA certified fuse link
VG3491	Indicator - Red
VG3492	Blanking component
VG3493	Indicator - Green
VG3494	Indicator - Amber
VG3940	Spare key

Installation Boxes

SB615	1 Gang Flush 35mm	SB619	1 Gang Dry Liner 35mm
SB625	2 Gang Flush 35mm	SB629	2 Gang Dry Liner 35mm



D230OSA



D230HA



D230UP



D230COA

Optical Smoke Alarm

LIST NO	DESCRIPTION
D230OSA	230V mains powered Optical smoke alarm with 9V alkaline battery backup

Heat Alarm

LIST NO	DESCRIPTION
D230HA	230V mains powered Heat alarm with 9V alkaline battery backup

- 230V AC
- 9V alkaline battery back up included.
- 6 year warranty.
- Self test on sensor & self diagnostic feature.
- Easy installation.
- Dust cover.

Diameter 120mm

Pattress for Optcal Smoke and Heat Alarms

LIST NO	DESCRIPTION
D230UP	Pattress for installing D230OSA & D230HA

- Made from flame retardant thermoplastic
- 2 x 28mm & 2 x 20mm knockouts
- Integrated terminal block

Diameter 110mm Depth 22mmDepth 75mm

Product Standard

Optical Smoke Alarm BS EN 14604:2005
Heat Alarm BS 5446-2: 2003

Pattress BS5733

Carbon Monoxide Alarm

LIST NO	DESCRIPTION
D230COA	230V mains powered Carbon Monoxide alarm with 9V alkaline battery backup

- 230V AC
- 9V alkaline battery back up included.
- 5 year warranty.
- Self test on sensor & self diagnostic feature.
- Easy installation.

Height 46mm

Width 130mm

Depth 75mm

For CO alarm locations see installation instructions supplied with product

Product Standard

Carbon Monoxide Alarm BS EN 50291-1:2010



CA1085



CA1076



CA2001



CA2001L

Door Chimes

LIST NO	DESCRIPTION
CA1085	2 Note Chime with Integral Transformer
CA1076	2 Note Chime
CA2001	Bell Push
CA2001L	Illuminated Bell Push

Chime 169mm x 104mm x 49mm
Bell Push 65mm x 104 mm x 49mm



MC1080

VX1010

VX9706

VX1500

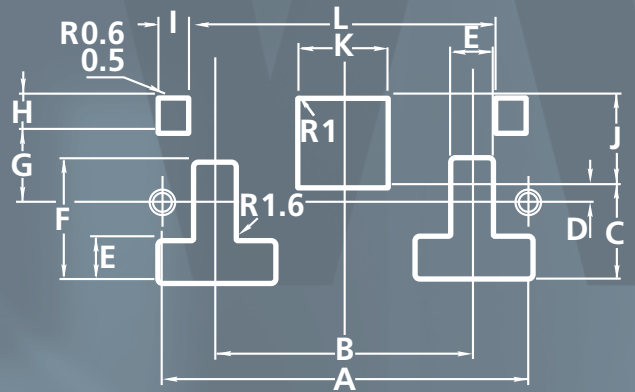

technical

technical data

TERMINAL CAPACITIES (mm²)

The following table summarises the terminal capacities of the principal wiring accessories.

Description	Conductor size
10AX switches	4x1mm ² , 3x1.5mm ² , 2x2.5mm ²
20A DP switch	3x2.5mm ² , 2x4.0mm ² , 1x6.0mm ² , 1x10mm ²
45A DP switch	2x6.0mm ² , 1x10mm ² , 1x16mm ²
13A socket outlet	3x2.5mm ² , 2x4.0mm ²
13A fused connection unit	3x2.5mm ² , 2x4.0mm ²

RECOMMENDED QUANTITY OF SOCKET OUTLETS FOR DOMESTIC INSTALLATIONS

An installation may have too few socket outlets or the existing socket outlets may be incorrectly situated. Both conditions are symptomatic of an inadequate installation which could lead to potentially dangerous improvisation.

The following is a summary of the recommendations of the Electrical Installation Industry Liaison Committee. All socket outlets should be of the twin switched type.

Room	Number of sockets
Kitchen	6
Lounge	6
Dining room	4
Double bedroom	4
Single bed-sitting room	4
Single bedroom	4
Landing/Stairs	1
Hall	2
Garage	2
Store/Workroom	2
Central heating boiler point	1

WIRING CIRCUITS FOR 10AX SWITCHES

One way circuits

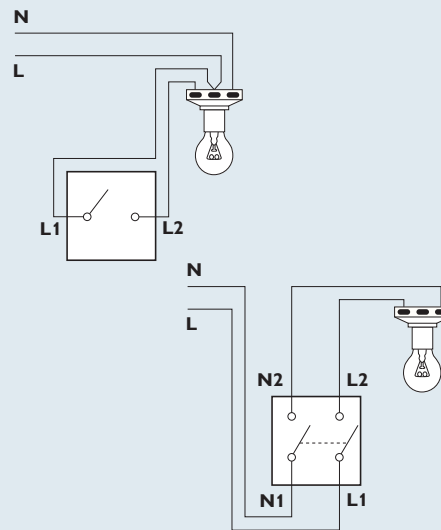

Two way circuits

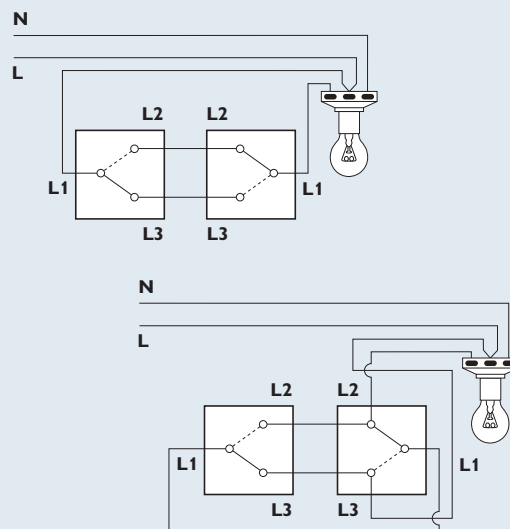

Intermediate circuits

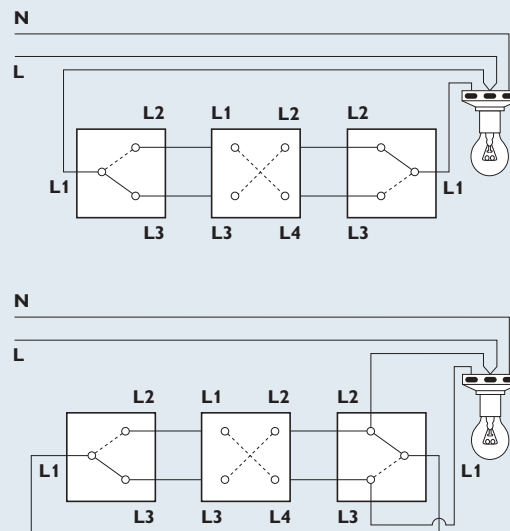

GUIDANCE ON THE USE OF LAMPHOLDERS MARKED T1 OR T2

The information in the table is a guide to the user of lampholders marked T1 or T2 with tungsten filament lamps, although it should be appreciated that the critical factor is the actual temperature of the cap of the lamp when in use. Technical information on such temperatures is contained in this specification and in BS EN 60598-1. It is also important to ensure that the wattage rating of the lamp is not higher than that for which the particular shade or luminaire is designed. This maximum rating in watts is marked on all shades and luminaires that comply with BS4533: Part 101. The recommendations in the table refer to typical conditions, in single lamp luminaires or installations, and in multi lamp luminaires having widely spaced lamps. Where lamps are in close proximity to each other, or in totally enclosed luminaires, it is recommended that T2 lampholders are used.

Maximum permitted rating of lamp

Size	Lampholder Type	Temperature	Typical conditions of use				Maximum permitted rating of lamp
			Type of shade		Lamp position		
			Closed	Open	Cap up	Cap down	
SBC	B15d	T1					40W
SBC	B15d	T2					60W
BC	B22d	T1		-		-	60W
BC	B22d	T1	-			-	100W
BC	B22d	T1		-	-		150W
BC	B22d	T1	-		-		200W
BC	B22d	T2					200W

SBC Small bayonet cap (international type B15d)

BC Standard bayonet cap (international type B22d)

T1 Lampholder suitable for conditions up to a lamp cap temperature of 165°C

T2 Lampholder suitable for conditions up to a lamp cap temperature of 210°C

Closed shade Shade open at one end only and generally mounted directly on the lampholder

Open shade Shade open at both ends, and generally mounted on the lampholder by a wire frame

Cap up Position of lamp, typically when suspended from the ceiling by a flexible cord

Cap down Position of lamp, typically when fitted on a standard or table lamp

Where two symbols are shown together, as in B15d-T1/T2 or B22d-T2, there is no restriction on the type of shade or the position of the lamp, provided the maximum working temperatures are not exceeded

If in doubt regarding the choice of any lampholder, always use one marked T2

RECOMMENDED MOUNTING BOXES FOR MOULDED VOLEX ACCESSORIES WIRING ACCESSORIES

Product	List no	Moulded (surface) box List no	Metal (flush) box List no	Drylining (flush) box List no
10A switch 1 gang	VX1010	VX9404	SB623	SB619
10A switch 1 gang	VX1020	VX9404	SB623	SB619
10A switch 1 gang	VX1030	VX9404	SB623	SB619
10A switch 2 gang	VX1040	VX9404	SB623	SB619
10A switch 3 gang	VX1050	VX9404	SB623	SB619
10A switch 4 gang	VX1054	VX9412	SB665	SB629
13A socket 1 gang	VX9100	VX9409	SB655	SB619
13A socket 1 gang	VX1300	VX9409	SB655	SB619
13A socket 1 gang	VX1400	VX9409	SB655	SB619
13A socket 2 gang	VX9200	VX9414	SB665	SB629
13A socket 2 gang	VX1500	VX9414	SB665	SB629
13A socket 2 gang	VX1600	VX9414	SB665	SB629
13A socket 2 gang	VX1700	VX9414	SB665	SB629
13A socket 2 gang	VX1800	VX9414	SB665	SB629
13A socket 3 gang	VX9230	VX9403	SB646	-
20A switch	VX1060	VX9409	SB655	SB619
20A switch	VX1070	VX9409	SB655	SB619
50A ceiling switch	VX9706	VX9405	-	-
45A switch	VX9702	VX9416	SB628	SB631
45A switch	VX9703	VX9416	SB628	SB631
45A switch	VX9712	VX9405	SB618	SB632
45A switch	VX9713	VX9405	SB618	SB632
Cooker unit	VX9700	VX9416	SB628	SB631
Cooker unit	VX9701	VX9416	SB628	SB631
Fused connection unit	VX1080	VX9409	SB655	SB619
Fused connection unit	VX1081	VX9409	SB655	SB619
Fused connection unit	VX1090	VX9409	SB655	SB619
Fused connection unit	VX1091	VX9409	SB655	SB619
Telephone socket	VX9974	VX9404	SB655	SB619
Secondary socket	VX9984	VX9404	SB655	SB619
2 module mounting plate	VX9062	VX9405	SB615	SB619
4 module mounting plate	VX9064	VX9416	SB625	SB629
Shaver unit	VX9800	VX9410	SB628	SB631
TV outlet 1 gang	VX9992	VX9409	SB655	SB619
TV outlet 2 gang	VX9993	VX9409	SB655	SB619
13A flex outlet plate	VX9990	VX9409	SB655	SB619
Cooker outlet plate	VX9704	VX9405	SB615	SB632

Flush box recommendations as shown in the adjacent table.

Industrial metalclad accessories (suffix **SG**) are supplied complete with matching surface mounting boxes.

DECORATIVE WIRING ACCESSORIES

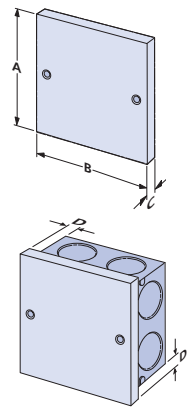

DIMENSION & CLOSE COUPLING DETAILS

Description	A	B	C	D
Flatplate 1 Gang	87.2mm	87.2mm	2mm	7.45mm
Flatplate 2 Gang	87.2mm	147.2mm	2mm	7.3mm
Round Edge 1 Gang	86.5mm	86.5mm	8.2mm	7.1mm
Round Edge 2 Gang	86.5mm	147mm	8.2mm	7.2mm
Curved Edge 1 Gang	84.4mm	84.4mm	8mm	6.05mm
Curved Edge 2 Gang	84.4mm	145.6mm	8mm	6.5mm

RECOMMENDED MOUNTING BOXES FOR DECORATIVE WIRING ACCESSORIES

Description	Raised Plate List no	Flat Plate List no	Gang Box	Minimum box Size	Metal Flush box List no	Dry Lining box List no
10AX 1 gang 2 way Switch	VX1020 __	*VX3020 __	1	16mm	SB623	SB619
10AX 2 gang 2 way Switch	VX1040 __	*VX3040 __	1	16mm	SB623	SB619
10AX 1 gang Intermediate Switch	VX1010 __	*VX3030 __	1	16mm	SB623	SB619
10AX 3 gang 2 way Switch	VX1050 __	-	1	16mm	SB623	SB619
10AX 4 gang 2 way Switch	VX1054 __	*VX3054 __	2	16mm	SB633	SB629
Fan Isolator	VX1013 __	*VX3013 __	1	25mm	SB655	SB619
1 gang 2 way Toggle Switch	VX1120 __	*VX3120 __	1	25mm	SB655	SB619
1 gang Intermediate Toggle Switch	VX1130 __	*VX3130 __	1	25mm	SB655	SB619
2 gang 2 way Toggle Switch	VX1140 __	*VX3140 __	1	25mm	SB655	SB619
3 gang 2 way Toggle Switch	VX1150 __	*VX3150 __	1	25mm	SB655	SB619
1 gang 2 way 400W Low Voltage/Mains Dimmer	VX0400LV __ PU	*VX3400LV __ PU	1	35mm	SB615	SB619
2 gang 2 way 250W Low voltage/mains Dimmer	VX0252LV __ PU	*VX33252LV __ PU	1	25mm	SB655	SB619
3 gang 2 way 250W Low voltage/mains Dimmer	VX0253LV __ PU	*VX3253LV __ PU	2	25mm	SB665	SB629
1 gang 2 way 400W Mains Dimmer	VX0400 __ PU	*VX3400 __ PU	1	35mm	SB615	SB619
2 gang 2 way 250W Mains Dimmer	VX0252 __ PU	*VX3252 __ PU	1	25mm	SB655	SB619
3 gang 2 way 250W Mains Dimmer	VX0253 __ PU	*VX3253 __ PU	2	25mm	SB655	SB629
4 gang 2 way 250W Mains Dimmer	VX0254 __ PU	*VX3254 __ PU	2	25mm	SB655	SB629
5A 3 pin socket	VX9905 __	*VX3905 __	1	25mm	SB655	SB619
13A 1 gang DP Switched Socket	VX1300 __ /D	*VX3300 __ /D	1	25mm	SB665	SB629
13A 2 gang DP Switched Socket	VX1500 __ /D	*VX3500 __ /D	2	25mm	SB665	SB629
13A Unswitched Fused Connection Unit	VX1090 __	*VX3090 __	1	25mm	SB655	SB619
13A DP Switched Fused Connection Unit	VX1080 __	*VX3080 __	1	25mm	SB655	SB619
13A DP Switched Fused Connection Unit with Neon	VX1081 __	*VX3081 __	1	25mm	SB655	SB619
20A 1 gang DP Switch with Neon	VX1060 __	*VX3060 __	1	25mm	SB655	SB619
1 gang 45A Switch	VX9713 __	*VX3713 __	1	47mm	SB618	SB632
2 gang 45A Switch	VX9703 __	-	2	47mm	SB628	SB631
Cooker control unit with Neon	VX9700 __	*VX3700 __	2	47mm	SB628	SB631
Shaver Socket	VX9800 __	*VX3800 __	2	47mm	SB628	SB631
Telephone Master Socket	VX9974 __	*VX3974 __	1	25mm	SB655	SB619
Telephone Secondary Socket	VX9984 __	*VX3984 __	1	25mm	SB655	SB619
1 gang Co-Axial TV Socket	VX9992 __	*VX3992 __	1	25mm	SB655	SB619
2 gang Co-Axial TV Socket	VX9993 __	*VX3993 __	1	25mm	SB655	SB619
1 gang Blanking off plate	VX9991 __	*VX3991 __	1	16mm	SB623	SB619
2 gang Blanking off plate	VX9996 __	*VX3996 __	2	16mm	SB633	SB629
1 gang 1 module communication plate	VX9061 __	*VX3061 __	1	16mm	SB623	SB619
1 gang 2 module communication plate	VX9062 __	*VX3062 __	1	16mm	SB623	SB619

*Note: Box size is based on boxes being mounted at least 5mm below plaster depth

BRITISH STANDARDS

Light Switches	BS EN 60669-1
Intermediate Switches	BS EN 60669-1
Pull Switches	BS EN 60669-1
Fan Isolator	BS EN 60974-3
Toggle Switch	BS EN 60669-1
Standard Dimmer	BS EN 55014, BS EN 60669-1
Low Voltage Dimmer	BS EN 55014, BS EN 60669-1

BRITISH STANDARDS

Switched Sockets	BS EN 1363
Fuse Connection Units	BS EN 1363
20A DP Switches	BS EN 60669-1
45A DP Switches	BS EN 60669-1
Shaver Socket	BS EN 61558
Co-Axial Socket	BS 3041

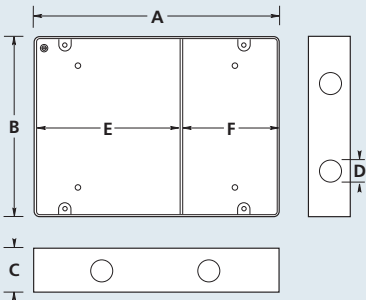
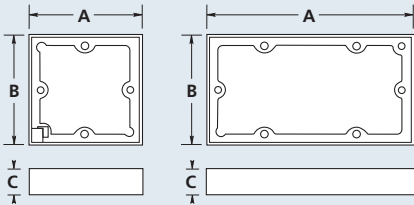
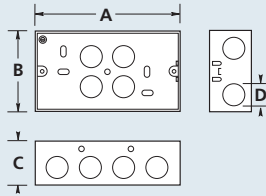
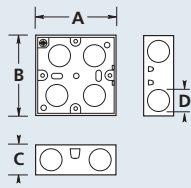

APPROXIMATE DIMENSIONS (mm)

APPLEBY FLUSH STEEL BOXES

1 GANG	A	B	C	D	LIST No
	70	70	16	20	SB623
	68.3	68.3	25	20	SB655
	26.5	73	28	16	9257
	68.3	68.3	35	20	SB615
	68.3	68.3	35	20	SB717
	68.3	68.3	47	25	SB618
2 GANG	130	70	16	20	SB633
	129	68.3	25	20	SB665
	154	68.3	25	20	SB676
	129	68.3	35	20	SB625
	129	68.3	35	20	SB727
	154	68.3	35	20	SB636
	129	68.3	47	25	SB628
	27.5	133	28	16	9258
	189	68.3	35	20	SB646

EXTENSION BOXES	A	B	C	LIST No
	70	70	16	SB677
	130	70	16	SB678
	68.3	68.3	25	SB679
	129	68.3	25	SB680
	68.3	68.3	35	SB681
	129	68.3	35	SB682

LOUNGE BOX	A	B	C	D	E	F	LIST No
	253	194	35	20	141	108	SB695
	253	194	56	20	141	108	SB1590

APPROXIMATE DIMENSIONS (mm)

APPLEBY DRY LINING BOXES

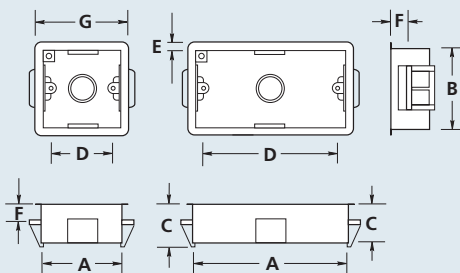

	A	B	C	D	min max		F	G	LIST No
	73	73	36	60	6.7	6.35	15.0	83	SB619
	73	73	48	60	6.7	6.35	15.0	83	SB632
	133	73	36	130	6.7	6.35	15.0	143	SB629
	158	73	36	130	6.7	6.35	15.0	168	SB637
	133	73	48	155	6.7	6.35	15.0	143	SB631
	220	73	36	-	6.7	6.35	15.0	229	SB638

For Acoustic or Fire rated solutions please contact Technical Services.

APPROXIMATE DIMENSIONS (mm)

APPLEBY CIRCULAR DRY LINING BOXES

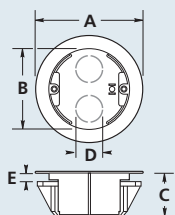

	A	B	C	D	min max		LIST No
	80	57.5	36	20	7	22	SB639

SAFETY ALARM TECHNICAL DATA

	D230OSA	D230COA	D230HA
Reliability			
Detection Principal	Optical	Carbon Monoxide	Heat
Main Unit Life	10 years	5 years	10 years
Third Party Type Test	BS EN 14604:2005	BS EN 50291-1:2010	BS 5446-2:2003
Other Compliances	RoHS, EMC, LVD	RoHS, EMC, LVD	RoHS, EMC, LVD
Self Test	Yes	Yes	Yes
Warranty	6 years	5 years	6 years
CE Mark	Yes	Yes	Yes
Operating Environment			
Operating Temperature Range	0° - 40°C	0° - 40°C	0° - 40°C
Humidity	5 - 95% RH	5 - 95% RH	5 - 95% RH
IP Rating	IP40	IP42	IP40
Electrical and Interconnection			
Voltage	230V	230V	230V
Frequency	50Hz	50Hz	50Hz
Power supply	Mains powered, with 9V alkaline battery backup	Mains powered, with 9V alkaline battery backup	Mains powered, with 9V alkaline battery backup
User Interface			
Visual Indicator	Low battery warning, LED operating indicator, alarm indicator	Low battery warning, LED operating indicator, alarm indicator	Low battery warning, LED operating indicator, alarm indicator
Button	Test / Hush Button	Test / Reset Button	Test / Hush Button
Product			
Weight	0.165kg	0.150kg	0.145kg
Dimensions	120mm diameter	130mm x 75mm x 46mm	123mm diameter

electrium

ELECTRIUM SALES LIMITED A SIEMENS COMPANY

Commercial Centre, Lakeside Plaza,
Walkmill Lane, Bridgtown,
Cannock WS11 0XE.
eMail: info@electrium.co.uk

www.electrium.co.uk

UK SALES

Telephone: 01543 455030
Facsimile: 01543 455031
eMail: volex.sales@electrium.co.uk

TECHNICAL

Telephone: 01543 438330
Facsimile: 01543 438321
eMail: volex.technical@electrium.co.uk

EXPORT SALES

Telephone: +44 1543 455049
Facsimile: +44 1543 455048
eMail: export@electrium.co.uk

DUBAI OFFICE

Telephone: +971 4 3660684
Facsimile: +971 4 3660676
eMail: export@electrium.co.uk



[@ElectriumNews](https://twitter.com/ElectriumNews) or download the APP

Although every effort has been made to ensure accuracy in the compilation of the technical detail within this publication, specifications and performance data are constantly changing. Latest details can be obtained from Volex Accessories.

Publication No. V2310d 12/21