



by Honeywell

POWERING
THE FUTURE



MK DIMENSIONS

Screwless Wiring Devices

**HASSLE FREE SPECIFICATION
AND INSTALLATION STARTS HERE.**







WEALTH OF EXPERTISE STARTS HERE

For over 100 years, MK Electric has led the market in electrical wiring devices.

Engineering excellence and manufacturing expertise ensures quality, reliability and safety come as standard.

BROAD RANGE

MK Dimensions features the latest product innovations, including integrated USB sockets, LED dimmers and multimedia plates – all designed to meet the exacting needs of any application.



* Excludes electronic devices





ENDURING DESIGN STARTS HERE

Simple, modern design with practical engineering innovation. The MK Dimensions range is perfect for every setting.

NO VISIBLE SCREWS

Thanks to its stylish screwless design and flexible range of nine modern finishes, the MK Dimensions range blends in seamlessly with every contemporary space.

MK's Design Service offers a bespoke option, perfect for when only a customised solution can meet your requirements.





THE NEW WORD IN FLEXIBILITY STARTS HERE

MK Dimensions combines style and good value, without compromising on quality. Designed and engineered to make life simple.

CHOICE

Available in nine high quality finishes including metals and synthetics.

Enabling design scalability within a building, from a typical hotel room to a larger suite, or 'back of house' offices to high footfall reception areas.

Additionally, frontplates can be interchanged to accommodate evolving interior design over time.



HASSLE-FREE INSTALL STARTS HERE

Easy to install.

Easy to use.

Hard to ignore.

MK Dimensions offers you reliable, hassle-free products that don't sacrifice form for function.

TWO-PIECE PRODUCT SOLUTION

Specifically designed to be modular, the clip-on frontplate and functional module are individual component products – so you can order the parts separately to fit in with your build schedule.

Perfect for achieving a flawless finish after interior decoration and helping eliminate damage during the fit out process.



INNOVATION AND PRACTICALITY STARTS HERE

Engineered to deliver innovative, hassle-free installation, each MK Dimensions functional module comes complete with a robust and recyclable protective cover plate.

PRACTICAL

By utilising the protective cover plate you can help safeguard the final clip-on frontplate against loss.

It also reduces the potential cost of replacing the frontplate due to damage caused by paint splatter or build up, sanding abrasions and defends against knocks and scrapes from ladders or tools whilst on site.

Although it's covered, the functional module beneath still meets British Standards and therefore is fully operational so you can continue to get the job done.

When you're ready, clip on the frontplate for a flawless finish to any contemporary interior.





FEATURED PRODUCT: 2G 13A DP DUAL EARTH SWITCH SOCKET - WHITE

PRACTICALLY ENGINEERED, INNOVATIVELY DESIGNED

MK Dimensions comes complete with a whole host of features to aid installation.

FRONTPLATE MULTI-LOCK SYSTEM

Secures to uneven walls

CAPTIVE AND BACKED OUT TERMINAL SCREWS

Pre engaged in terminal, for fast and easy installation

TOOL REMOVABLE FRONTPLATE

CLEAR TERMINAL MARKINGS

DUAL EARTH TERMINALS

Offering total user safety for high integrity earthing applications

IN LINE TERMINALS

Allow wire to be cut stripped to the same length

UPWARD FACING FUNNEL ENTRANCE TO TERMINALS

To make installation easier

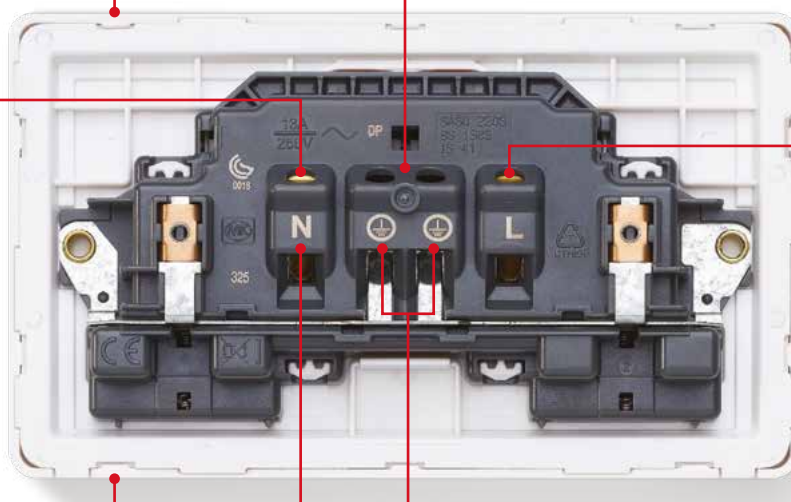

INSPIRATION STARTS HERE

We've made MK Dimensions truly flexible, so you can pick the right style to suit any contemporary space.

Choose from our range of nine metal and synthetic frontplate finishes and select a black or white functional module to complement. Metal finishes additionally come with the option of a black or white trim to harmonise with your functional module selection.

METAL FINISHES



METAL FINISHES
Brushed Stainless Steel (BSS)

METAL FINISHES
Satin Steel (SST)

METAL FINISHES
Satin Brass (SBR)

METAL FINISHES
Bronze (BRZ)

SYNTHETIC FINISHES



SYNTHETIC FINISHES
Light Silver (LTS)

SYNTHETIC FINISHES
Dark Silver (DKS)

SYNTHETIC FINISHES
Champagne (CHM)

SYNTHETIC FINISHES
White (WHI)

SYNTHETIC FINISHES
Matt Black (MBK)

FUNCTIONAL MODULES**



FUNCTIONAL
White (WHIC)

FUNCTIONAL
Black (BLKC)

** Functional modules are supplied with a protective clear cover plate.

FLEXIBLE ORDERING OPTIONS STARTS HERE

TWO-PIECE PRODUCT SOLUTION

We've made ordering just as easy as installation, thanks to our simple step-by-step product selection guide and flexible, modular two-piece product solution.

The functional module and clip on frontplate are individual components - select both to achieve your complete MK Dimensions screwless wiring device.

STEP 1: CHOOSE A FUNCTIONAL MODULE IN WHITE OR BLACK

All functional modules are supplied with a protective clear cover plate, perfect for achieving a flawless finish after interior decoration and eliminating damage during the fit out process. See our Product Selector on the following pages for part number details.

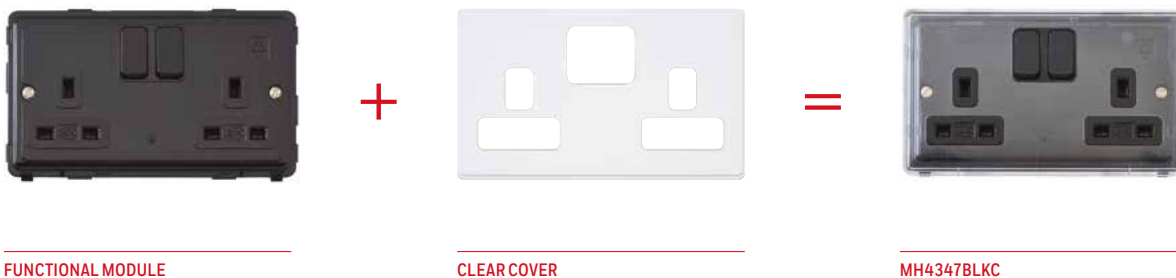

STEP 2: CHOOSE A CLIP ON FRONTPLATE FROM THE CHOICE OF NINE HIGH QUALITY FINISHES

Select the corresponding frontplate to accompany your functional module. See our Product Selector on the following pages for part number details.



Note: Metal finishes are supplied with a black or white trim to match module.

Inspiration starts here PRODUCT SELECTOR

SWITCHSOCKET OUTLETS

1 GANG 13A DP DUAL EARTH SWITCHSOCKET	1 GANG 13A DP DUAL EARTH SWITCHSOCKET W/NEON	2 GANG 13A DP DUAL EARTH SWITCHSOCKET	2 GANG 13A DP SWITCHSOCKET WITH 2 X INTEGRATED USB PORTS	2 GANG 13A DP DUAL EARTH SWITCHSOCKET WITH NEON	1 GANG 13A DP SWITCHSOCKET WITH 2X INTEGRATED USB PORTS	1 GANG 5A DP SWITCHSOCKET
---	---	---	--	--	---	------------------------------



FUNCTIONAL MODULES

White	MH4357WHIC	MH4657WHIC	MH4347WHIC	MH24344WHIC	MH4647WHIC	MH43457WHIC	MH4382WHIC
Black	MH4357BLKC	MH4657BLKC	MH4347BLKC	MH24344BLKC	MH4647BLKC	MH43457BLKC	MH4382BLKC

FRONTPLATES

METAL FINISHES

Brushed Stainless Steel (BSS)	MHFP014BSS*	MHFP014BSS*	MHFP019BSS*	MHFP040BSS*	MHFP019BSS*	MHFP044BSS*	MHFP016BSS*
Satin Steel (SST)	MHFP014SST*	MHFP014SST*	MHFP019SST*	MHFP040SST*	MHFP019SST*	MHFP044SST*	MHFP016SST*
Satin Brass (SBR)	MHFP014SBR*	MHFP014SBR*	MHFP019SBR*	MHFP040SBR*	MHFP019SBR*	MHFP044SBR*	MHFP016SBR*
Bronze (BRZ)	MHFP014BRZ*	MHFP014BRZ*	MHFP019BRZ*	MHFP040BRZ*	MHFP019BRZ*	MHFP044BRZ*	MHFP016BRZ*

SYNTHETIC FINISHES

White (WHI)	MHFP014WHI	MHFP014WHI	MHFP019WHI	MHFP040WHI	MHFP019WHI	MHFP044WHI	MHFP016WHI
Matt Black (MBK)	MHFP014MBK	MHFP014MBK	MHFP019MBK	MHFP040MBK	MHFP019MBK	MHFP044MBK	MHFP016MBK
Light Silver (LTS)	MHFP014LTS	MHFP014LTS	MHFP019LTS	MHFP040LTS	MHFP019LTS	MHFP044LTS	MHFP016LTS
Dark Silver (DKS)	MHFP014DKS	MHFP014DKS	MHFP019DKS	MHFP040DKS	MHFP019DKS	MHFP044DKS	MHFP016DKS
Champagne (CHM)	MHFP014CHM	MHFP014CHM	MHFP019CHM	MHFP040CHM	MHFP019CHM	MHFP044CHM	MHFP016CHM

MOUNTING BOX 25MM 861ZIC	MOUNTING BOX 25MM 861ZIC	MOUNTING BOX 25MM 862ZIC	MOUNTING BOXES 25MM 862ZIC	MOUNTING BOX 25MM 862ZIC	MOUNTING BOX 25MM 861ZIC	MOUNTING BOX 25MM 861ZIC
35MM 866ZIC (for extra wiring space)	35MM 866ZIC (for extra wiring space)	35MM 886ZIC (for extra wiring space)	35MM 886ZIC (for extra wiring space)	35MM 886ZIC (for extra wiring space)	35MM 866ZIC (for extra wiring space)	35MM 866ZIC (for extra wiring space)
DIMENSIONS 86 x 86mm	DIMENSIONS 86 x 86mm	DIMENSIONS 86 x 146mm	DIMENSIONS 86 x 146mm	DIMENSIONS 86 x 146mm	DIMENSIONS 86 x 86mm	DIMENSIONS 86 x 86mm
FIXING CENTRES 60.3mm	FIXING CENTRES 60.3mm	FIXING CENTRES 120.6mm	FIXING CENTRES 120.6mm	FIXING CENTRES 120.6mm	FIXING CENTRES 60.3mm	FIXING CENTRES 60.3mm
BS1363-2:2016+A1:2018	BS1363-2:2016+A1:2018	BS1363-2:2016+A1:2018 Refer to technical pages for installation guidance.	BS1363-4:2016+A1:2018	BS1363-2:2016+A1:2018	BS5733:2010+A1:2014	BS 546:1950 IEC 60884-2-3:2006

*Available with the option of either a white or black plastic trim. Add suffix 'W' or 'B' to the part number when ordering, e.g.

MHFPxxxBSSW = Brushed Stainless Steel finish with a white trim.

NB: It is recommended to match the trim colour to the functional module selected

Dual Earth: Fitted with two earth terminals to provide a double earth facility connection as specified within BS 7671 (excludes 5A socket)

Inspiration starts here

PRODUCT SELECTOR

MULTIMEDIA PLATES			SOCKET OUTLETS			
1 GANG 15A DP SWITCHSOCKET	2 GANG DP 13A SWITCHSOCKET MULTIMEDIA PLATE WITH 50X50MM EURO FRAME (RIGHT SIDE)	2 GANG DP 13A SWITCHSOCKET MULTIMEDIA PLATE WITH 50X50MM EURO FRAME (LEFT SIDE)	4 GANG DP 13A SWITCHSOCKET MULTIMEDIA PLATE WITH 100X50MM EURO FRAME X2 (RIGHT SIDE)	1 GANG 13A DUAL EARTH UNSWITCHED SOCKET	2 GANG 13A DUAL EARTH UNSWITCHED SOCKET	1 GANG 5A ROUND PIN UNSWITCHED SOCKET



FUNCTIONAL MODULES

White	MH4383WHIC	MH4206WHIC	MH4207WHIC	MH14100WHIC	MH4780WHIC	MH4781WHIC	MH4381WHIC
Black	MH4383BLKC	MH4206BLKC	MH4207BLKC	MH14100BLKC	MH4780BLKC	MH4781BLKC	MH4381BLKC

FRONTPLATES

METAL FINISHES

Brushed Stainless Steel (BSS)	MHFP017BSS*	MHFP031BSS*	MHFP032BSS*	MHFP043BSS*	MHFP013BSS*	MHFP018BSS*	MHFP015BSS*
Satin Steel (SST)	MHFP017SST*	MHFP031SST*	MHFP032SST*	MHFP043SST*	MHFP013SST*	MHFP018SST*	MHFP015SST*
Satin Brass (SBR)	MHFP017SBR*	MHFP031SBR*	MHFP032SBR*	MHFP043SBR*	MHFP013SBR*	MHFP018SBR*	MHFP015SBR*
Bronze (BRZ)	MHFP017BRZ*	MHFP031BRZ*	MHFP032BRZ*	MHFP043BRZ*	MHFP013BRZ*	MHFP018BRZ*	MHFP015BRZ*

SYNTHETIC FINISHES

White (WHI)	MHFP017WHI	MHFP031WHI	MHFP032WHI	MHFP043WHI	MHFP013WHI	MHFP018WHI	MHFP015WHI
Matt Black (MBK)	MHFP017MBK	MHFP031MBK	MHFP032MBK	MHFP043MBK	MHFP013MBK	MHFP018MBK	MHFP015MBK
Light Silver (LTS)	MHFP017LTS	MHFP031LTS	MHFP032LTS	MHFP043LTS	MHFP013LTS	MHFP018LTS	MHFP015LTS
Dark Silver (DKS)	MHFP017DKS	MHFP031DKS	MHFP032DKS	MHFP043DKS	MHFP013DKS	MHFP018DKS	MHFP015DKS
Champagne (CHM)	MHFP017CHM	MHFP031CHM	MHFP032CHM	MHFP043CHM	MHFP013CHM	MHFP018CHM	MHFP015CHM

MOUNTING BOX
25MM
861ZIC
35MM
866ZIC
(for extra wiring space)
DIMENSIONS
86 x 86mm
FIXING CENTRES
60.3mm
BS 546:1950

MOUNTING BOXES
35MM
875ZIC
47MM
870ZIC
DIMENSIONS
86 x 86mm
BS5733:2010+A1:2014

MOUNTING BOXES
35MM
875ZIC
47MM
870ZIC
DIMENSIONS
86 x 86mm
BS1363-4:2016+A1:2018

MOUNTING BOXES
35MM
K14101
47MM
K14102
DIMENSIONS
86 x 86mm
BS 1363-2-1995

MOUNTING BOX
25MM
861ZIC
35MM
866ZIC
(for extra wiring space)
DIMENSIONS
86 x 86mm
FIXING CENTRES
60.3mm
BS1363-2:2016+A1:2018

MOUNTING BOX
25MM
862ZIC
35MM
886ZIC
(for extra wiring space)
DIMENSIONS
86 x 146mm
FIXING CENTRES
120.6mm
BS1363-2:2016+A1:2018

MOUNTING BOX
25MM
861ZIC
35MM
866ZIC
(for extra wiring space)
DIMENSIONS
86 x 86mm
FIXING CENTRES
60.3mm
BS 546:1950
IEC 60884-1:2006







Mains operated products and extra low voltage modules must not be installed within the same frontplate aperture. Refer to BS 7671 for details.

*Available with the option of either a white or black plastic trim. Add suffix 'W' or 'B' to the part number when ordering, e.g. MHFPxxxBSSW = Brushed Stainless Steel finish with a white trim.

NB: It is recommended to match the trim colour to the functional module selected

Dual Earth: Fitted with two earth terminals to provide a double earth facility connection as specified within BS 7671

Inspiration starts here PRODUCT SELECTOR

SHAVER /TOOTHBRUSH SUPPLY OUTLET	COOKER CONTROLS	CONNECTION UNITS SWITCHED			CONNECTION UNITS UNSWITCHED	
SHAVER OUTLET 115/230V OUTPUT, 230V INPUT	45A DP MAIN SWITCH AND 13A SWITCH SOCKET OUTLET WITH NEONS	1 GANG 13A DP SWITCHED CONNECTION UNIT	1 GANG 13A DP SWITCHED CONNECTION UNIT WITH NEON	1 GANG 13A DP SWITCHED CONNECTION UNIT WITH NEON AND FLEX OUTLET	1 GANG 20A DP SWITCH WITH NEON & FRONT FLEX OUTLET	1 GANG 13A UNSWITCHED CONNECTION UNIT WITH NEON
						

FUNCTIONAL MODULES							
White	MH4709WHIC	MH5061WHIC	MH4941WHIC	MH4961WHIC	MH4971WHIC	MH5000WHIC	MH4958WHIC
Black	MH4709BLKC	MH5061BLKC	MH4941BLKC	MH4961BLKC	MH4971BLKC	MH5000BLKC	MH4958BLKC

FRONTPLATES							
METAL FINISHES							
Brushed Stainless Steel (BSS)	MHFP036BSS*	MHFP042BSS*	MHFP003BSS*	MHFP003BSS*	MHFP004BSS*	MHFP023BSS*	MHFP021BSS*
Satin Steel (SST)	MHFP036SST*	MHFP042SST*	MHFP003SST*	MHFP003SST*	MHFP004SST*	MHFP023SST*	MHFP021SST*
Satin Brass (SBR)	MHFP036SBR*	MHFP042SBR*	MHFP003SBR*	MHFP003SBR*	MHFP004SBR*	MHFP023SBR*	MHFP021SBR*
Bronze (BRZ)	MHFP036BRZ*	MHFP042BRZ*	MHFP003BRZ*	MHFP003BRZ*	MHFP004BRZ*	MHFP023BRZ*	MHFP021BRZ*
SYNTHETIC FINISHES							
White (WHI)	MHFP036WHI	MHFP042WHI	MHFP003WHI	MHFP003WHI	MHFP004WHI	MHFP023WHI	MHFP021WHI
Matt Black (MBK)	MHFP036MBK	MHFP042MBK	MHFP003MBK	MHFP003MBK	MHFP004MBK	MHFP023MBK	MHFP021MBK
Light Silver (LTS)	MHFP036LTS	MHFP042LTS	MHFP003LTS	MHFP003LTS	MHFP004LTS	MHFP023LTS	MHFP021LTS
Dark Silver (DKS)	MHFP036DKS	MHFP042DKS	MHFP003DKS	MHFP003DKS	MHFP004DKS	MHFP023DKS	MHFP021DKS
Champagne (CHM)	MHFP036CHM	MHFP042CHM	MHFP003CHM	MHFP003CHM	MHFP004CHM	MHFP023CHM	MHFP021CHM

MOUNTING BOXES
878ZIC
This design incorporates a double wound isolating transformer rated 20VA at 230 or 115 volts and meets BS EN 61558-2-5:2010 making it safe for use in bathrooms. Insertion of a shaver/toothbrush plug automatically switches on by energising the primary side of the isolating transformer - removal automatically switches it off. The transformer is protected against overload by an automatic solid state overload device with automatic resetting.

DIMENSIONS
146 x 86mm

FIXING CENTRES
120.6mm
BS EN 61558-2-5:1998

MOUNTING BOXES
35MM / 47MM
886ZIC / 878ZIC

DIMENSIONS
86 x 146mm

FIXING CENTRES
120.6mm
BS 4177:1992

MOUNTING BOXES
35MM
866ZIC

DIMENSIONS
86 x 86mm

FIXING CENTRES
60.3mm
BS1363-4:2016+A1:2018

MOUNTING BOXES
35MM
866ZIC

DIMENSIONS
86 x 86mm

FIXING CENTRES
60.3mm
BS1363-4:2016+A1:2018

MOUNTING BOXES
35MM
866ZIC

DIMENSIONS
86 x 86mm

FIXING CENTRES
60.3mm
BS1363-4:2016+A1:2018

MOUNTING BOXES
35MM
866ZIC

DIMENSIONS
86 x 86mm

FIXING CENTRES
60.3mm
BSEN 60669-1:2018

MOUNTING BOXES
35MM
866ZIC

DIMENSIONS
86 x 86mm

FIXING CENTRES
60.3mm
BS1363-4:2016+A1:2018

*Available with the option of either a white or black plastic trim. Add suffix 'W' or 'B' to the part number when ordering, e.g. MHFPxxxBSSW = Brushed Stainless Steel finish with a white trim. NB: It is recommended to match the trim colour to the functional module selected

Inspiration starts here

PRODUCT SELECTOR

SWITCHES

1 GANG 13A DP UNSWITCHED CONNECTION UNIT WITH NEON AND FLEX OUTLET	1 GANG 25A FRONT FLEX OUTLET	1 GANG SP 2 WAY 20A SWITCH	2 GANG SP 2 WAY 20A SWITCH	3 GANG SP 2 WAY 10A SWITCH	20A, 1 GANG, INTERMEDIATE SWITCH	20A, 1 GANG, INTERMEDIATE SWITCH, WIDE ROCKER
---	------------------------------------	----------------------------------	----------------------------------	----------------------------------	--	--



FUNCTIONAL MODULES

White	MH4978WHIC	MH5001WHIC	MH4371WHIC	MH4372WHIC	MH4373WHIC	MH4375WHIC	MH3475WHIC
Black	MH4978BLKC	MH5001BLKC	MH4371BLKC	MH4372BLKC	MH4373BLKC	MH4375BLKC	MH3475BLKC

FRONTPLATES

METAL FINISHES

Brushed Stainless Steel (BSS)	MHFP022BSS*	MHFP037BSS*	MHFP001BSS*	MHFP002BSS*	MHFP010BSS*	MHFP001BSS*	MHFP009BSS*
Satin Steel (SST)	MHFP022SST*	MHFP037SST*	MHFP001SST*	MHFP002SST*	MHFP010SST*	MHFP001SST*	MHFP009SST*
Satin Brass (SBR)	MHFP022SBR*	MHFP037SBR*	MHFP001SBR*	MHFP002SBR*	MHFP010SBR*	MHFP001SBR*	MHFP009SBR*
Bronze (BRZ)	MHFP022BRZ*	MHFP037BRZ*	MHFP001BRZ*	MHFP002BRZ*	MHFP010BRZ*	MHFP001BRZ*	MHFP009BRZ*

SYNTHETIC FINISHES

White (WHI)	MHFP022WHI	MHFP037WHI	MHFP001WHI	MHFP002WHI	MHFP010WHI	MHFP001WHI	MHFP009WHI
Matt Black (MBK)	MHFP022MBK	MHFP037MBK	MHFP001MBK	MHFP002MBK	MHFP010MBK	MHFP001MBK	MHFP009MBK
Light Silver (LTS)	MHFP022LTS	MHFP037LTS	MHFP001LTS	MHFP002LTS	MHFP010LTS	MHFP001LTS	MHFP009LTS
Dark Silver (DKS)	MHFP022DKS	MHFP037DKS	MHFP001DKS	MHFP002DKS	MHFP010DKS	MHFP001DKS	MHFP009DKS
Champagne (CHM)	MHFP022CHM	MHFP037CHM	MHFP001CHM	MHFP002CHM	MHFP010CHM	MHFP001CHM	MHFP009CHM

MOUNTING BOXES

35MM

866ZIC

DIMENSIONS

86 x 86mm

FIXING CENTRES

60.3mm

BS1363-4:2016+A1:2018

MOUNTING BOXES

35MM

866ZIC

DIMENSIONS

86 x 86mm

FIXING CENTRES

60.3mm

BS1363-4:2016+A1:2018

MOUNTING BOXES

25MM

861ZIC

DIMENSIONS

86 x 86mm

FIXING CENTRES

60.3mm

BS EN 60669-1:2018

MOUNTING BOXES

25MM

861ZIC

DIMENSIONS

86 x 86mm

FIXING CENTRES

60.3mm

BS EN 60669-1:2018

MOUNTING BOXES

25MM

861ZIC

DIMENSIONS

86 x 86mm

FIXING CENTRES

60.3mm

BS EN 60669-1:2018

MOUNTING BOXES

25MM

861ZIC

DIMENSIONS

86 x 86mm

FIXING CENTRES

60.3mm

BS EN 60669-1:2018

MOUNTING BOXES

25MM

861ZIC

DIMENSIONS

86 x 86mm

FIXING CENTRES

60.3mm





BS EN 60669-1:2018

*Available with the option of either a white or black plastic trim. Add suffix 'W' or 'B' to the part number when ordering, e.g.

MHFPxxxBSSW = Brushed Stainless Steel finish with a white trim.

NB: It is recommended to match the trim colour to the functional module selected

Inspiration starts here
PRODUCT SELECTOR

SWITCHES				
10A, 1 GANG, SINGLE POLE, ONE WAY SWITCH	10A, 1 GANG, SINGLE POLE, TWO WAY SWITCH	10A, 2 GANG, SINGLE POLE, TWO WAY SWITCH	20A, 2 GANG, TWO WAY SWITCH, WIDE ROCKER	10A, 4 GANG SP TWO WAY SWITCH
				

FUNCTIONAL MODULES					
White	MH4870WHIC	MH4871WHIC	MH4872WHIC	MH3482WHIC	MH4374WHIC
Black	MH4870BLKC	MH4871BLKC	MH4872BLKC	MH3482BLKC	MH4374BLKC

FRONTPLATES					
METAL FINISHES					
Brushed Stainless Steel (BSS)	MHFP001BSS*	MHFP001BSS*	MHFP002BSS*	MHFP009BSS*	MHFP039BSS*
Satin Steel (SST)	MHFP001SST*	MHFP001SST*	MHFP002SST*	MHFP009SST*	MHFP039SST*
Satin Brass (SBR)	MHFP001SBR*	MHFP001SBR*	MHFP002SBR*	MHFP009SBR*	MHFP039SBR*
Bronze (BRZ)	MHFP001BRZ*	MHFP001BRZ*	MHFP002BRZ*	MHFP009BRZ*	MHFP039BRZ*
SYNTHETIC FINISHES					
White (WHI)	MHFP001WHI	MHFP001WHI	MHFP002WHI	MHFP009WHI	MHFP039WHI
Matt Black (MBK)	MHFP001MBK	MHFP001MBK	MHFP002MBK	MHFP009MBK	MHFP039MBK
Light Silver (LTS)	MHFP001LTS	MHFP001LTS	MHFP002LTS	MHFP009LTS	MHFP039LTS
Dark Silver (DKS)	MHFP001DKS	MHFP001DKS	MHFP002DKS	MHFP009DKS	MHFP039DKS
Champagne (CHM)	MHFP001CHM	MHFP001CHM	MHFP002CHM	MHFP009CHM	MHFP039CHM

MOUNTING BOXES
 25MM
 861ZIC
 DIMENSIONS
 86 x 86mm
 FIXING CENTRES
 60.3mm
 BS EN 60669-1:2018

MOUNTING BOXES
 25MM
 861ZIC
 DIMENSIONS
 86 x 86mm
 FIXING CENTRES
 60.3mm
 BS EN 60669-1:2018







MOUNTING BOXES
 25MM
 861ZIC
 DIMENSIONS
 86 x 86mm
 FIXING CENTRES
 60.3mm
 BS EN 60669-1:2018

MOUNTING BOXES
 25MM
 861ZIC
 DIMENSIONS
 86 x 86mm
 FIXING CENTRES
 60.3mm
 BS EN 60669-1:2018

MOUNTING BOXES
 35MM
 866ZIC
 DIMENSIONS
 86 x 86mm
 FIXING CENTRES
 60.3mm
 BS EN 60669-1:2018

Inspiration starts here

PRODUCT SELECTOR

SWITCHES				HIGH CURRENT SWITCHES		
1 GANG SP 2 WAY 20A LARGE ROCKER SWITCH	2 GANG SP 2 WAY 20A LARGE ROCKER SWITCH	3 GANG SP 2 WAY 20A LARGE ROCKER SWITCH	1 GANG SP 2 WAY 20A WIDE ROCKER	1 GANG, 20A, DOUBLE POLE, 1 WAY SWITCH, WIDE ROCKER WITH NEON	1 GANG 32A DP SWITCH WITH NEON	1 GANG 50A DP SWITCH WITH NEON
						

FUNCTIONAL MODULES							
White	MH3471WHIC	MH3472WHIC	MH3474WHIC	MH3473WHIC	MH3499NWHIC	MH4305WHIC	MH4336WHIC
Black	MH3471BLKC	MH3472BLKC	MH3474BLKC	MH3473BLKC	MH3499NBLKC	MH4305BLKC	MH4336BLKC

FRONTPLATES							
METAL FINISHES							
Brushed Stainless Steel (BSS)	MHFP007BSS*	MHFP008BSS*	MHFP009BSS*	MHFP009BSS*	MHFP009BSS*	MHFP011BSS*	MHFP012BSS*
Satin Steel (SST)	MHFP007SST*	MHFP008SST*	MHFP009SST*	MHFP009SST*	MHFP009SST*	MHFP011SST*	MHFP012SST*
Satin Brass (SBR)	MHFP007SBR*	MHFP008SBR*	MHFP009SBR*	MHFP009SBR*	MHFP009SBR*	MHFP011SBR*	MHFP012SBR*
Bronze (BRZ)	MHFP007BRZ*	MHFP008BRZ*	MHFP009BRZ*	MHFP009BRZ*	MHFP009BRZ*	MHFP011BRZ*	MHFP012BRZ*
SYNTHETIC FINISHES							
White (WHI)	MHFP007WHI	MHFP008WHI	MHFP009WHI	MHFP009WHI	MHFP009WHI	MHFP011WHI	MHFP012WHI
Matt Black (MBK)	MHFP007MBK	MHFP008MBK	MHFP009MBK	MHFP009MBK	MHFP009MBK	MHFP011MBK	MHFP012MBK
Light Silver (LTS)	MHFP007LTS	MHFP008LTS	MHFP009LTS	MHFP009LTS	MHFP009LTS	MHFP011LTS	MHFP012LTS
Dark Silver (DKS)	MHFP007DKS	MHFP008DKS	MHFP009DKS	MHFP009DKS	MHFP009DKS	MHFP011DKS	MHFP012DKS
Champagne (CHM)	MHFP007CHM	MHFP008CHM	MHFP009CHM	MHFP009CHM	MHFP009CHM	MHFP011CHM	MHFP012CHM

MOUNTING BOXES 25MM 861ZIC	MOUNTING BOXES 25MM 861ZIC	MOUNTING BOXES 25MM 861ZIC	MOUNTING BOXES 25MM 861ZIC	MOUNTING BOXES 25MM 861ZIC	MOUNTING BOXES 25MM 861ZIC	MOUNTING BOXES 35MM 866ZIC (6mm ² conductors)	MOUNTING BOXES 35MM 866ZIC (6mm ² conductors)
DIMENSIONS 86 x 86mm	DIMENSIONS 86 x 86mm	DIMENSIONS 86 x 86mm	DIMENSIONS 86 x 86mm	DIMENSIONS 86 x 86mm	DIMENSIONS 86 x 86mm	46MM 877ZIC (10mm ² conductors)	46MM 877ZIC (10mm ² conductors)
ROCKER DIMENSIONS 22 x 40mm	ROCKER DIMENSIONS 22 x 40mm	ROCKER DIMENSIONS 22 x 40mm	ROCKER DIMENSIONS 50 x 40mm	ROCKER DIMENSIONS 50 x 40mm	ROCKER DIMENSIONS 50 x 40mm	DIMENSIONS 86 x 86mm	DIMENSIONS 86 x 86mm
FIXING CENTRES 60.3mm BS EN 60669-1:2018	FIXING CENTRES 60.3mm BS EN 60669-1:2018	FIXING CENTRES 60.3mm BS EN 60669-1:2018	FIXING CENTRES 60.3mm BS EN 60669-1:2018	FIXING CENTRES 60.3mm BS EN 60669-1:2018	FIXING CENTRES 60.3mm BS EN 60669-1:2018	FIXING CENTRES 60.3mm BS EN 60669-1:2018	FIXING CENTRES 60.3mm BS EN 60669-1:2018

*Available with the option of either a white or black plastic trim. Add suffix 'W' or 'B' to the part number when ordering, e.g.

MHFPxxxBSSW = Brushed Stainless Steel finish with a white trim.

NB: It is recommended to match the trim colour to the functional module selected

Inspiration starts here
PRODUCT SELECTOR

INTELLIGENT DIMMERS		DIMMERS		GRID PLUS FRONTPLATES	
1 GANG SINGLE 2 WAY DIMMER 40W/VA-300W/ 240VA INC. 4-70W LED, 230V~ 50HZ	1 GANG DOUBLE 2 WAY DIMMER 40W/VA-300W/ 240VA INC. 4-70W LED, 230V~ 50HZ	1 GANG SINGLE 2 WAY DIMMER 100W-1000W, 230V~ 50HZ (NON UK)	1 GANG SINGLE 2 WAY DIMMER 100W-1000W, 230V~ 60HZ (NON UK)	1 MODULE GRID FRONTPLATE	2 MODULE GRID FRONTPLATE
					

FUNCTIONAL MODULES					MOUNTING FRAMES	
White	MH1523WHICLV	MH1524WHICLV	MH1561WHI	MH1661WHI	MH4331WHIC	MH4332WHIC
Black	MH1523BLKCLV	MH1524BLKCLV	MH1561BLK	MH1661BLK	MH4331BLKC	MH4332BLKC

FRONTPLATES						
METAL FINISHES						
Brushed Stainless Steel (BSS)	MHFP033BSS*	MHFP034BSS*	MHFP033BSS*	MHFP033BSS*	MHFP001BSS*	MHFP002BSS*
Satin Steel (SST)	MHFP033SST*	MHFP034SST*	MHFP033SST*	MHFP033SST*	MHFP001SST*	MHFP002SST*
Satin Brass (SBR)	MHFP033SBR*	MHFP034SBR*	MHFP033SBR*	MHFP033SBR*	MHFP001SBR*	MHFP002SBR*
Bronze (BRZ)	MHFP033BRZ*	MHFP034BRZ*	MHFP033BRZ*	MHFP033BRZ*	MHFP001BRZ*	MHFP002BRZ*
SYNTHETIC FINISHES						
White (WHI)	MHFP033WHI	MHFP034WHI	MHFP033WHI	MHFP033WHI	MHFP001WHI	MHFP002WHI
Matt Black (MBK)	MHFP033MBK	MHFP034MBK	MHFP033MBK	MHFP033MBK	MHFP001MBK	MHFP002MBK
Light Silver (LTS)	MHFP033LTS	MHFP034LTS	MHFP033LTS	MHFP033LTS	MHFP001LTS	MHFP002LTS
Dark Silver (DKS)	MHFP033DKS	MHFP034DKS	MHFP033DKS	MHFP033DKS	MHFP001DKS	MHFP002DKS
Champagne (CHM)	MHFP033CHM	MHFP034CHM	MHFP033CHM	MHFP033CHM	MHFP001CHM	MHFP002CHM

MOUNTING BOXES
 35MM
 866ZIC
DIMENSIONS
 86 x 86mm
FIXING CENTRES
 60.3mm
 BSEN 60669-2-1:2004

MOUNTING BOXES
 35MM
 866ZIC
DIMENSIONS
 86 x 86mm
FIXING CENTRES
 60.3mm
 BSEN 60669-2-1:2004

MOUNTING BOXES
 35MM
 866ZIC
DIMENSIONS
 86 x 86mm
FIXING CENTRES
 60.3mm
 BSEN 60669-2-1:2004

MOUNTING BOXES
 35MM
 866ZIC
DIMENSIONS
 86 x 86mm
FIXING CENTRES
 60.3mm
 BSEN 60669-2-1:2004

MOUNTING BOXES
 35MM
 891ALM
DIMENSIONS
 86 x 86mm
 BS1363-4:2016+A1:2018

MOUNTING BOXES
 35MM
 891ALM
DIMENSIONS
 86 x 86mm
 BS1363-4:2016+A1:2018

These dimmers employ the latest micro-controller based circuitry to provide electronic soft-start and overload protection. They are suitable for use with good quality electronic or wire-wound transformers. Can also be used with good quality halogen lamps incorporating GU10 bases. Please check with lamp manufacturer to determine suitability.

NOTE
 See page 22 for full range of Grid Functional modules.

NOT SUITABLE FOR FLUORESCENT LOADS
 Conform to latest standards BS EN 60669-2-1. All intelligent dimmers have a combined push-on/push-off switch and rotary dimmer control, and are suitable for one or two-way switching. Only one dimmer can be used in a two way switching circuit.

*Available with the option of either a white or black plastic trim. Add suffix 'W' or 'B' to the part number when ordering, e.g. MHFPxxxBSSW = Brushed Stainless Steel finish with a white trim.
 NB: It is recommended to match the trim colour to the functional module selected

Inspiration starts here

PRODUCT SELECTOR

GRID PLUS MODULAR FRONTPLATES

3 MODULE GRID FRONTPLATE 4 MODULE GRID FRONTPLATE 6 MODULE GRID FRONTPLATE 8 MODULE GRID FRONTPLATE 12 MODULE GRID FRONTPLATE



MOUNTING FRAMES

White	MH4333WHIC	MH4334WHIC	MH4346WHIC	MH4348WHIC	MH4349WHIC
Black	MH4333BLKC	MH4334BLKC	MH4346BLKC	MH4348BLKC	MH4349BLKC

FRONTPLATES

METAL FINISHES

Brushed Stainless Steel (BSS)	MHFP024BSS*	MHFP026BSS*	MHFP027BSS*	MHFP028BSS*	MHFP038BSS*
Satin Steel (SST)	MHFP024SST*	MHFP026SST*	MHFP027SST*	MHFP028SST*	MHFP038SST*
Satin Brass (SBR)	MHFP024SBR*	MHFP026SBR*	MHFP027SBR*	MHFP028SBR*	MHFP038SBR*
Bronze (BRZ)	MHFP024BRZ*	MHFP026BRZ*	MHFP027BRZ*	MHFP028BRZ*	MHFP038BRZ*

SYNTHETIC FINISHES

White (WHI)	MHFP024WHI	MHFP026WHI	MHFP027WHI	MHFP028WHI	MHFP038WHI
Matt Black (MBK)	MHFP024MBK	MHFP026MBK	MHFP027MBK	MHFP028MBK	MHFP038MBK
Light Silver (LTS)	MHFP024LTS	MHFP026LTS	MHFP027LTS	MHFP028LTS	MHFP038LTS
Dark Silver (DKS)	MHFP024DKS	MHFP026DKS	MHFP027DKS	MHFP028DKS	MHFP038DKS
Champagne (CHM)	MHFP024CHM	MHFP026CHM	MHFP027CHM	MHFP028CHM	MHFP038CHM

MOUNTING BOXES

40MM

892ALM

DIMENSIONS

86 x 146mm

BS1363-4:2016+A1:2018

MOUNTING BOXES

40MM

892ALM

DIMENSIONS

86 x 146mm

BS1363-4:2016+A1:2018

MOUNTING BOXES

40MM

893ALM

DIMENSIONS

146mm x 146mm

BS1363-4:2016+A1:2018

MOUNTING BOXES

40MM

893ALM

DIMENSIONS

146mm x 146mm

BS1363-4:2016+A1:2018

MOUNTING BOXES

40MM

895ALM

DIMENSIONS

206 x 146mm







BS1363-4:2016+A1:2018

NOTE

See page 22 for full range of Grid Functional modules.

See Grid Plus technical pages in the MK Electric Product Catalogue for module compatibility.

Inspiration starts here PRODUCT SELECTOR

HOTEL PACK			OTHER SWITCH PRODUCTS		
1 GANG 10A BELL PUSH DO NOT DISTURB / MAKE UP ROOM SWITCH	1 GANG 10A DO NOT DISTURB / MAKE UP ROOM SWITCH	1 GANG 10A KEYCARD SWITCH 30 SEC TIME DELAY, 220- 240V~ 50/60HZ	1 GANG 1 CHANNEL ECHO TRANSMITTER'	1 GANG 2 CHANNEL ECHO TRANSMITTER'	1 GANG 10A 3 POLE FAN ISOLATOR SWITCH
					

FUNCTIONAL MODULES						
White	MH33885DNDWHIC	MH33900DNDWHIC	MH35201WHIC	MH23476WHIC	MH23477WHIC	MH4859WHIC
Black	MH33885DNDBLKC	MH33900DNDBLKC	MH35201BLKC	MH23476BLKC	MH23477BLKC	MH4859BLKC

FRONTPLATES						
METAL FINISHES						
Brushed Stainless Steel (BSS)	MHFP009BSS*	MHFP009BSS*	MHFP035BSS*	MHFP009BSS*	MHFP009BSS*	MHFP010BSS*
Satin Steel (SST)	MHFP009SST*	MHFP009SST*	MHFP035SST*	MHFP009SST*	MHFP009SST*	MHFP010SST*
Satin Brass (SBR)	MHFP009SBR*	MHFP009SBR*	MHFP035SBR*	MHFP009SBR*	MHFP009SBR*	MHFP010SBR*
Bronze (BRZ)	MHFP009BRZ*	MHFP009BRZ*	MHFP035BRZ*	MHFP009BRZ*	MHFP009BRZ*	MHFP010BRZ*
SYNTHETIC FINISHES						
White (WHI)	MHFP009WHI	MHFP009WHI	MHFP035WHI	MHFP009WHI	MHFP009WHI	MHFP010WHI
Matt Black (MBK)	MHFP009MBK	MHFP009MBK	MHFP035MBK	MHFP009MBK	MHFP009MBK	MHFP010MBK
Light Silver (LTS)	MHFP009LTS	MHFP009LTS	MHFP035LTS	MHFP009LTS	MHFP009LTS	MHFP010LTS
Dark Silver (DKS)	MHFP009DKS	MHFP009DKS	MHFP035DKS	MHFP009DKS	MHFP009DKS	MHFP010DKS
Champagne (CHM)	MHFP009CHM	MHFP009CHM	MHFP035CHM	MHFP009CHM	MHFP009CHM	MHFP010CHM

MOUNTING BOXES
35MM
866ZIC
46MM
877ZIC
DIMENSIONS
86 x 86mm
FIXING CENTRES
60.3mm
BS EN 60669-1:2018

MOUNTING BOXES
35MM
866ZIC
46MM
877ZIC
DIMENSIONS
86 x 86mm
FIXING CENTRES
60.3mm
BS EN 60669-1:2018

MOUNTING BOXES
35MM
866ZIC
46MM
877ZIC
DIMENSIONS
86 x 86mm
FIXING CENTRES
60.3mm
BS EN 60669-1:2004

DIMENSIONS
86 x 86mm
FIXING CENTRES
60.3mm
OPERATING FREQUENCY
868.3Mhz
ETSI EN 301 489-1 + -3
ETSI EN 300 220-3







DIMENSIONS
86 x 86mm
FIXING CENTRES
60.3mm
OPERATING FREQUENCY
868.3Mhz
ETSI EN 301 489-1 + -3
ETSI EN 300 220-3

DIMENSIONS
86 x 86mm
FIXING CENTRES
60.3mm
BS EN 60669-2-4:2005

NOTE
Please refer to the Echo section of the MK catalogue for information on Echo receivers

*Available with the option of either a white or black plastic trim. Add suffix 'W' or 'B' to the part number when ordering, e.g. MHFPxxxBSSW = Brushed Stainless Steel finish with a white trim.
NB: It is recommended to match the trim colour to the functional module selected

Inspiration starts here
PRODUCT SELECTOR

BLANK INSERTS	SWITCH MODULES 10 AMP				
1 MODULE	1 WAY SP 10 AMP	1 WAY DP 10 AMP	2 WAY SP 10 AMP	2 WAY RETRACTIVE SWITCH SP 10 AMP	2 WAY RED RETRACTIVE SWITCH SP 10 AMP
					

FUNCTIONAL MODULES						
White	K4880WHI	K4881WHI	K4981WHI	K4882WHI	K4885WHI	K4885RED
Black	K4880BLK	K4881BLK	K4981BLK	K4882BLK	K4885BLK	K4885REDB

BS1363-4:2016-A1:2018







These switches do NOT have to be derated when used with fluorescent or inductive loads.
 BS EN 60669-1:2018

These switches do NOT have to be derated when used with fluorescent or inductive loads.
 BS EN 60669-1:2018

These switches do NOT have to be derated when used with fluorescent or inductive loads.
 BS EN 60669-1:2018

NOTE
 Push switches are not designed for fluorescent loads.
 BS EN 60669-1:2018

NOTE
 Push switches are not designed for fluorescent loads.
 BS EN 60669-1:2018

SWITCH MODULES 20 AMP						
2 WAY RETRACTIVE SWITCH MARKED WITH BELL SYMBOL SP 10 AMP	2 WAY RETRACTIVE SWITCH MARKED 'PRESS' SP 10 AMP	2 WAY CENTRE OFF RETRACTIVE SWITCH SP 10 AMP	1 WAY SP 20 AMP	1 WAY PUSH TO MAKE DP 20 AMP	1 WAY RED ROCKER PUSH TO MAKE DP 20 AMP	
						

FUNCTIONAL MODULES						
K4885BWHI	K4885PWHI	K4900WHI	K4891WHI	K4910WHI	K4910RED	
K4885BBLK	K4885PBLK	K4900BLK	K4891BLK	K4910BLK	K4910REDB	

NOTE
 Push switches are not designed for fluorescent loads.
 BS EN 60669-1:2018

NOTE
 Push switches are not designed for fluorescent loads.
 BS EN 60669-1:2018

NOTE
 Push switches are not designed for fluorescent loads.
 BS EN 60669-1:2018

These switches do NOT have to be derated when used with fluorescent or inductive loads.
 BS EN 60669-1:2018

NOTE
 Push switches are not designed for fluorescent loads.
 BS EN 60669-1:2018

NOTE
 Push switches are not designed for fluorescent loads.
 BS EN 60669-1:2018

Inspiration starts here

PRODUCT SELECTOR

SWITCH MODULES 20 AMP

1 WAY
PUSH TO BREAK
RETRACTIVE DP
20 AMP



1 WAY
RED ROCKER
PUSH TO BREAK
RETRACTIVE DP
20 AMP



2 WAY SP
20 AMP



2 WAY
RED ROCKER SP
20 AMP



2 WAY
SWITCH WITH
INTEGRAL NEON
LOCATOR SP
20 AMP



2 WAY
AND CENTRE
OFF SP
20 AMP



FUNCTIONAL MODULES

White	K4915WHI	K4915RED	K4892WHI	K4892RED	K4892LWHI	K4899WHI
Black	K4915BLK	K4915REDB	K4892BLK	K4892REDB	K4892LBLK	K4899BLK

NOTE
Push switches are not designed for fluorescent loads.
BS EN 60669-1:2018

NOTE
Push switches are not designed for fluorescent loads.
BS EN 60669-1:2018

These switches do NOT have to be derated when used with fluorescent or inductive loads.
BS EN 60669-1:2018

These switches do NOT have to be derated when used with fluorescent or inductive loads.
BS EN 60669-1:2018

These switches do NOT have to be derated when used with fluorescent or inductive loads.
BS EN 60669-1:2018

These switches do NOT have to be derated when used with fluorescent or inductive loads.
BS EN 60669-1:2018

SWITCH MODULES 20 AMP

RED ROCKER
2 WAY AND CENTRE
OFF SP
20 AMP



INTERMEDIATE
20 AMP



INTERMEDIATE
RED ROCKER
20 AMP



1 WAY DP
20 AMP



1 WAY
NEON DP
20 AMP



1 WAY
WITH WINDOW DP
20 AMP



1 WAY
RED ROCKER DP
20 AMP



FUNCTIONAL MODULES

K4899RED	K4893WHI	K4893RED	K4896WHI	K4896NWHI	K4896WWHI	K4896RED
K4899REDB	K4893BLK	K4893REDB	K4896BLK	K4896NBLK	K4896WBK	K4896REDB

These switches do NOT have to be derated when used with fluorescent or inductive loads.
BS EN 60669-1:2018

These switches do NOT have to be derated when used with fluorescent or inductive loads.
BS EN 60669-1:2018

These switches do NOT have to be derated when used with fluorescent or inductive loads.
BS EN 60669-1:2018

These switches do NOT have to be derated when used with fluorescent or inductive loads.
BS EN 60669-1:2018

These switches do NOT have to be derated when used with fluorescent or inductive loads.
BS EN 60669-1:2018

These switches do NOT have to be derated when used with fluorescent or inductive loads.
BS EN 60669-1:2018

These switches do NOT have to be derated when used with fluorescent or inductive loads.
BS EN 60669-1:2018

Inspiration starts here
PRODUCT SELECTOR

KEY SWITCH MODULES

INTERMEDIATE SECRET KEY SWITCH 20 AMP	2 WAY SECRET KEY SWITCH SP 20 AMP	2 WAY SECRET KEY SWITCH MARKED 'EMG LTG TEST' SP 20 AMP	1 WAY SECRET KEY SWITCH DP 20 AMP	EMERGENCY LIGHTING DP 20 AMP	2 WAY SECRET KEY SWITCH (BIASED 1 WAY) SP 20 AMP
--	--	---	--	------------------------------------	--



FUNCTIONAL MODULES

White	K4894WHI	K4898WHI	K4898ELWHI	K4917WHI	K4917ELWHI	K4918WHI
Black	K4894BLK	K4898BLK	K4898ELBLK	K4917BLK		K4918BLK

These switches do NOT have to be derated when used with fluorescent or inductive loads. BS EN 60669-1:2018 Key (3405ZIC) is supplied.

These switches do NOT have to be derated when used with fluorescent or inductive loads. BS EN 60669-1:2018 Key (3405ZIC) is supplied.

These switches do NOT have to be derated when used with fluorescent or inductive loads. BS EN 60669-1:2018 Key (3405ZIC) is supplied.

These switches do NOT have to be derated when used with fluorescent or inductive loads. BS EN 60669-1:2018 Key (3405ZIC) is supplied.

These switches do NOT have to be derated when used with fluorescent or inductive loads. BS EN 60669-1:2018 Key (3405ZIC) is supplied.

This switch is not designed for fluorescent loads BS EN 60669-1:2018 Key (3405ZIC) is supplied.

INDICATOR UNIT MODULES

200-250V NEON	200-250V NEON	200-250V FLUORESCENT	21-36V FILAMENT	21-36V FILAMENT	21-36V FILAMENT
------------------	------------------	-------------------------	--------------------	--------------------	--------------------



FUNCTIONAL MODULES

White	K4889RED	K4889AMB	K4889GRN	K4836RED	K4836AMB	K4836GRN
Black	K4889REDB					

BS1363-4:2016+A1:2018

BS1363-4:2016+A1:2018

BS1363-4:2016+A1:2018

BS1363-4:2016+A1:2018

BS1363-4:2016+A1:2018

BS1363-4:2016+A1:2018

NOTE

Filament lamps wear during operation. Typical life 2000hrs @ 24V a.c.

Will Operate On Both A.C. And D.C

Inspiration starts here

PRODUCT SELECTOR

DIMMER SWITCH MODULES

TUNGSTEN FILAMENT AND LOW VOLTAGE LIGHTING

1-120W TRAILING EDGE LED DIMMER 1 MODULE	40W/VA-220W/ 180VA MAX 230V A.C., 50HZ 1 MODULE	60W/VA-400W/ 320VA MAX 230V A.C., 50HZ 2 MODULE	0-10V/1-10V FLUORESCENT CONTROLLER 1 MODULE	40-220W/180VA/ 4-70W LED INTELLIGENT DIMMER 1 MODULE
--	--	--	--	--



FUNCTIONAL MODULES					
White	K4512WHI	K4501WHILV	K4500WHILV	K4499WHI	K4511WHILV
Black	K4512BLK	K4501BLKLV	K4500BLKLV	K4499BLK	K4511BLKLV

These dimmers employ the latest microcontroller based circuitry to provide electronic soft start and overload protection. Suitable for use with good quality electronic or wire wound transformers. Can also be used with good quality mains voltage halogen lamps incorporating GU10 bases. Please check with lamp manufacturer to determine suitability.
 K4501WHI/BLK Max. No. of low voltage T/F's - 3
 K4500WHI/BLK Max. No. of low voltage T/F's - 5
Not suitable for fluorescent loads.
 All dimmers have push on - push off, 2 way switches, integral with rotary control.

MK Fluorescent Grid Dimmers are low voltage controllers for connection to 1-10V controllable ballasts.

K4511WHILV 1 Module 2 Way 40-220W/180VA/4-70W LED Intelligent Dimmer.

K4511BLKLV 1 Module 2 Way 40-220W/180VA/4-70W LED Intelligent Dimmer.

NOTE
 Refer to technical section for derating.
 Conform to BS EN 60669-2-1 and BS EN 55015

NOTE
 2 Module dimmer not compatible with 3 and 6 MODULE Grid frontplates

Inspiration starts here
PRODUCT SELECTOR

ACCESSORY MODULES

SINGLE TV CO-AXIAL OUTLET NON-ISOLATED	SINGLE TV CO-AXIAL OUTLET ISOLATED	200-250V A.C. BUZZER UNIT	21-36V A.C. BUZZER UNIT	16A CORD OUTLET	13A FUSE UNIT	13A FUSE UNIT WITH TAMPERPROOF SCREW
---	---	------------------------------	----------------------------	-----------------------	------------------	--



FUNCTIONAL MODULES

White	K4520WHI	K4521WHI	K4000WHI	K4001WHI	K4886WHI	K4890WHI	K4890KOWHI
Black	K4520BLK	K4521BLK			K4886BLK	K4890BLK	K4890KOBK

For direct connection to TV or FM aerial co-axial download. NOT to be used in same enclosure as mains exceeding 50V.
 BS 3041:1977
 IEC 169-2:1965
 BS1363-4:2016+A1:2018 where applicable.

For direct connection to TV or FM aerial co-axial download. NOT to be used in same enclosure as mains exceeding 50V.
 BS 3041:1977
 IEC 169-2:1965
 BS1363-4:2016+A1:2018 where applicable.

SOUND OUTPUT LEVEL
 Av 61 db @ 15 feet.
 BS1363-4:2016+A1:2018

SOUND OUTPUT LEVEL
 Av 61 db @ 15 feet.
 BS1363-4:2016+A1:2018

Complete with 3 pairs of terminals. The supply terminals are suitable for up to 2 x 2.5mm² or 1 x 4mm² solid conductors. The load terminals are suitable for one 1.5mm² flexible cord. A cord grip is also fitted.
 BS1363-4:2016+A1:2018

Fuse carrier fitted with 13A cartridge fuse link to BS 1362.
 BS1363-4:2016+A1:2018

Fuse carrier fitted with 13A cartridge fuse link to BS 1362.
 BS1363-4:2016+A1:2018 Key(3405ZIC) is supplied.

Inspiration starts here
PRODUCT SELECTOR

EURO MODULAR FRONTPLATES		
1 MODULE	2 MODULE	4 MODULE
25X50MM	50X50MM	100X50MM
EURO FRAME	EURO FRAME	EURO FRAME



MOUNTING FRAMES			
White	MH4181WHIC	MH4182WHIC	MH4184WHIC
Black	MH4181BLKC	MH4182BLKC	MH4184BLKC

FRONTPLATES			
METAL FINISHES			
Brushed Stainless Steel (BSS)	MHFP025BSS*	MHFP029BSS*	MHFP030BSS*
Satin Steel (SST)	MHFP025SST*	MHFP029SST*	MHFP030SST*
Satin Brass (SBR)	MHFP025SBR*	MHFP029SBR*	MHFP030SBR*
Bronze (BRZ)	MHFP025BRZ*	MHFP029BRZ*	MHFP030BRZ*
SYNTHETIC FINISHES			
White (WHI)	MHFP025WHI	MHFP029WHI	MHFP030WHI
Matt Black (MBK)	MHFP025MBK	MHFP029MBK	MHFP030MBK
Light Silver (LTS)	MHFP025LTS	MHFP029LTS	MHFP030LTS
Dark Silver (DKS)	MHFP025DKS	MHFP029DKS	MHFP030DKS
Champagne (CHM)	MHFP025CHM	MHFP029CHM	MHFP030CHM

MOUNTING BOXES
 Suitable for flush boxes to BS 4662:2006
 Refer to appropriate module for minimum box depth
DIMENSIONS
 86 x 86mm
FIXING CENTRES
 60.3mm
 BS1363-4:2016+A1:2018 where applicable

MOUNTING BOXES
 Suitable for flush boxes to BS 4662:2006
 Refer to appropriate module for minimum box depth
DIMENSIONS
 86 x 86mm
FIXING CENTRES
 60.3mm
 BS1363-4:2016+A1:2018 where applicable

MOUNTING BOXES
 Suitable for flush boxes to BS 4662:2006
 Refer to appropriate module for minimum box depth
DIMENSIONS
 86 x 146mm
FIXING CENTRES
 120.6mm
 BS1363-4:2016+A1:2018 where applicable

NOTE
 Please refer to MK Electric Product catalogue and pages 32-36 of this brochure for the full range of Euro Functional Modules

*Available with the option of either a white or black plastic trim. Add suffix 'W' or 'B' to the part number when ordering, e.g. MHFPxxxBSSW = Brushed Stainless Steel finish with a white trim.
 NB: It is recommended to match the trim colour to the functional module selected

Inspiration starts here

PRODUCT SELECTOR

EURO POWER MODULES

UK 250V 2 MODULE 50 X 50MM 13 AMP	GERMAN 2P+E 250V SHUTTERED 2 MODULE (NON UK) 16 AMP	AMERICAN 127V SHUTTERED 2 MODULE 50 X 50MM (NON UK) 15 AMP	UK 250V SHUTTERED 2 MODULE 50 X 50MM 5 AMP	FRENCH/BELGIAN 2P+E 250V SHUTTERED 2 MODULE 50 X 50MM (NON UK) 16 AMP
---	---	--	--	--



FUNCTIONAL MODULES

White	K5830WHI	K5831WHI	K5832WHI	K5833WHI	K5834WHI
Black	K5830BLK	K5831BLK	K5832BLK	K5833BLK	K5834BLK

MOUNTING BOX
35mm minimum
46mm (for extra wiring space)
DIMENSIONS
50 x 50mm
BS1363-2:2016+A1:2018

MOUNTING BOX
46mm
DIMENSIONS
50 x 50mm
IEC 60884-1:2006

MOUNTING BOX
35mm
46mm (for extra wiring space)
DIMENSIONS
50 x 50mm
SASO 2204:2003

MOUNTING BOX
35mm minimum
46mm (for extra wiring space)
DIMENSIONS
50 x 50mm
BS 546:1950





MOUNTING BOX
46mm
DIMENSIONS
50 x 50mm
NF C61-314

NOTE

Please refer to MK Electric Product catalogue for full range of Euro Functional Modules

Mains operated products and extra low voltage modules must not be installed within the same frontplate.
Refer to BS 7671:2018 for details.

Inspiration starts here
PRODUCT SELECTOR

EURO POWER MODULES	EURO DATACOM MODULES			
USB CHARGING 2 MODULE 50 X 50MM	RJ11/12 1 MODULE 25 X 50MM	RJ45 CAT 6 1 MODULE 25 X 50MM	RJ45 CAT 6 SCREENED 1 MODULE 25 X 50MM	RJ45 CAT 6 ANGLED 1 MODULE 25 X 50MM
				

FUNCTIONAL MODULES	FUNCTIONAL MODULES				
White	K5837WHI	K5887WHI	K5846WHI	K5846SWHI	K5864WHI
Black	K5837BLK	K5887BLK	K5846BLK	K5846SBLK	

USB charging sockets, each capable of supporting 2A charge (total of 2A)
K5837 MOUNTING BOX
 35mm minimum
 46mm for extra wiring space
 IEC 60950-1
 IEC 61000-6-1/3

Suitable for both RJ11 and RJ12 jacks
 RJ11: 4 wire
 RJ12: 6 wire
MOUNTING BOXES
 Minimum box depth 35mm
 FCC68
 EN 41003

Cat 6 performance.
 Suitable for both 568A and 568B wiring schemes.
MOUNTING BOXES
 Minimum Box Depth 35mm
 ISO/IEC 11801
 EN 50173
 TIA 568
 EN 41003

Cat 6 performance.
 Suitable for both 568A and 568B wiring schemes.
MOUNTING BOXES
 Minimum Box Depth 35mm
 ISO/IEC 11801
 EN 50173
 TIA 568
 EN 41003

Cat 6 performance.
 Suitable for both 568A and 568B wiring schemes.
MOUNTING BOXES
 Minimum Box Depth 35mm
 ISO/IEC 11801
 EN 50173
 TIA 568
 EN 41003

NOTE
 Please refer to MK Electric Product catalogue for full range of Euro Functional Modules

Inspiration starts here

PRODUCT SELECTOR

EURO DATACOM MODULES

RJ45 CAT 5e ANGLED 1 MODULE 25 X 50MM	RJ45 CAT 5e 1 MODULE 25 X 50MM	TELEPHONE MASTER 1 MODULE 25 X 50MM	TELEPHONE SECONDARY 1 MODULE 25 X 50MM	BNC 50Ω 1 MODULE 25 X 50MM
---	---	--	---	----------------------------------



FUNCTIONAL MODULES

White	K5844WHI	K5845WHI	K5820WHI	K5821WHI	K5801WHI
Black		K5845BLK	K5820BLK	K5821BLK	

Enhanced Cat 5 performance.
Suitable for both 568A and 568B wiring schemes.

MOUNTING BOXES
Minimum box depth
35mm standard

ISO/IEC 11801
EN 50173
TIA 568
EN 41003

Enhanced Cat 5 performance.
Suitable for both 568A and 568B wiring schemes.

MOUNTING BOXES
Minimum box depth 35mm
standard

ISO/IEC 11801
EN 50173
TIA 568
EN 41003

MOUNTING BOXES
Minimum depth 35mm
BS 6312-2EN 41003

MOUNTING BOXES
Minimum depth 35mm
BS 6312-2

50 Ohm crimp connector suitable
for use with RG58, URM43,
URM76 and Beldon 9907 type
co-axial cables.

MOUNTING BOXES
Minimum box depth 35mm

NOTE

Please refer to MK Electric Product catalogue for full range of Euro Functional Modules

Mains operated products and extra low voltage modules must not be installed within the same frontplate.

Refer to BS 7671:2018 for details.

Inspiration starts here PRODUCT SELECTOR

EURO MULTIMEDIA MODULES

SINGLE OUTLET
(IEC MALE)
1 MODULE
25 X 50MM



SINGLE OUTLET
(IEC FEMALE)
1 MODULE
25 X 50MM



SINGLE F-TYPE
SATELLITE SOCKET
1 MODULE
25 X 50MM



FEMALE HDMI OUTLET
2 MODULE
50 X 50MM



FUNCTIONAL MODULES

White	K5850WHI	K5851WHI	K5855WHI	K5807WHI
Black	K5850BLK	K5851BLK	K5855BLK	K5807BLK

Fully screened non isolated TV outlets containing a combination of single, TV/FM Diplexer, TV/FM/SAT Triplexer and BT secondary telephone outlets for use within digital TV systems and interactive TV services.

Single outlets for connection to a single TV, FM or Satellite co-axial aerial lead.

MOUNTING BOXES

Min box depth 47mm

DIMENSIONS

ONE MODULE 25 x 50mm

TWO MODULE 50 x 50mm

BS 3041:1997, IEC 169-2:1965, BS EN 50083 & BS1363-4:2016+A1:2018 where applicable.

NOTE

These products are fully compatible with Labgear TV distribution systems and are approved for use in "Sky Homes" and "Homes On" specifications. Please refer to MK Electric Product catalogue for full range of Euro Functional Modules

K5807 Female HDMI Outlet is HDMI 1.1, 1.2, 1.3 and 1.4b compatible, HDCP compliant.

DATA RATE

Up to 2.25 Gbps

SCAN

Up to 1080p/1920 x 1200

INPUT CONNECTOR

1 x HDMI Female (Type A)

OUTPUT CONNECTOR

1 x HDMI Female (Type A)

Supports high resolution input:

PC: VGA, SVGA,

SXVGA (1280 x 1024) and UXGA

(1600 x 1200, 1920 x 1200)

HDTV: 480p, 720p, 1080i and 1080p

HDMI input cable should be no larger than 20m

DIMENSIONS

50 x 50 x 20mm

Mains operated products and extra low voltage modules must not be installed within the same frontplate.

Refer to BS 7671:2018 for details.

Inspiration starts here

PRODUCT SELECTOR

EURO BLANK MODULES

2 MODULE
50 X 50MM



1 MODULE
25 X 50MM



1/2 MODULE
12.5 X 50MM



AUDIO BINDING
POST FOR SINGLE
LOUD SPEAKER
1 MODULE
25 X 50MM



RCA TO SCREW
TERMINATION SET
1 RED AND 1 BLACK
1 MODULE
25 X 50MM



FUNCTIONAL MODULES

White	K180WHI	K188WHI	K186WHI	K5805WHI	K5806WHI
Black	K180BLK	K188BLK	K186BLK	K5805BLK	K5806BLK

BS1363-4:2016+A1:2018
where applicable

BS1363-4:2016+A1:2018
where applicable

BS1363-4:2016+A1:2018
where applicable

DIMENSIONS
50 x 25 x 28mm

DIMENSIONS
50 x 25 x 28mm

NOTE

Please refer to MK Electric Product catalogue for full range of Euro Functional Modules

Inspiration starts here

PRODUCT SELECTOR

BLANK PLATES

1 GANG BLANK PLATE	2 GANG BLANK PLATE
-----------------------	-----------------------

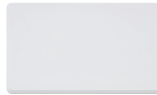

FUNCTIONAL MODULES

White	MH4330WHIC	MH4329WHIC
Black	MH4330BLKC	MH4329BLKC

FRONTPLATES

METAL FINISHES

Brushed Stainless Steel (BSS)	MHFP005BSS*	MHFP006BSS*
Satin Steel (SST)	MHFP005SST*	MHFP006SST*
Satin Brass (SBR)	MHFP005SBR*	MHFP006SBR*
Bronze (BRZ)	MHFP005BRZ*	MHFP006BRZ*

SYNTHETIC FINISHES

White (WHI)	MHFP005WHI	MHFP006WHI
Matt Black (MBK)	MHFP005MBK	MHFP006MBK
Light Silver (LTS)	MHFP005LTS	MHFP006LTS
Dark Silver (DKS)	MHFP005DKS	MHFP006DKS
Champagne (CHM)	MHFP005CHM	MHFP006CHM

DIMENSIONS

86 x 86mm

FIXING CENTRES

60.3mm

BS1363-4:2016+A1:2018

DIMENSIONS

146mm x 86mm

FIXING CENTRES

120.6mm

BS1363-4:2016+A1:2018

UK

The Arnold Centre, Paycocke Road, Basildon,
Essex, SS14 3EA, United Kingdom
Customer Service Tel +44 (0)1268 563404
Customer Service Fax +44 (0)1268 563405
E-mail mkorderenquiries@honeywell.com

Technical

Tech Helpline Tel +44 (0)1268 563720
Tech E-mail mk.technical@honeywell.com

Ireland

Sales Tel +353 1 429 6530
Sales Fax +353 1 429 6501
E-mail mkirelandorders@honeywell.com

www.mkelectric.co.uk

UKMK432-0721-EN | July 2021
©Honeywell International Inc.

